

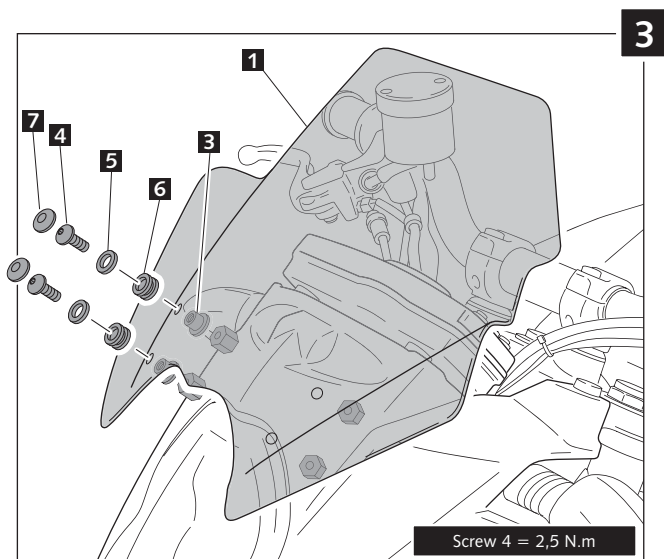

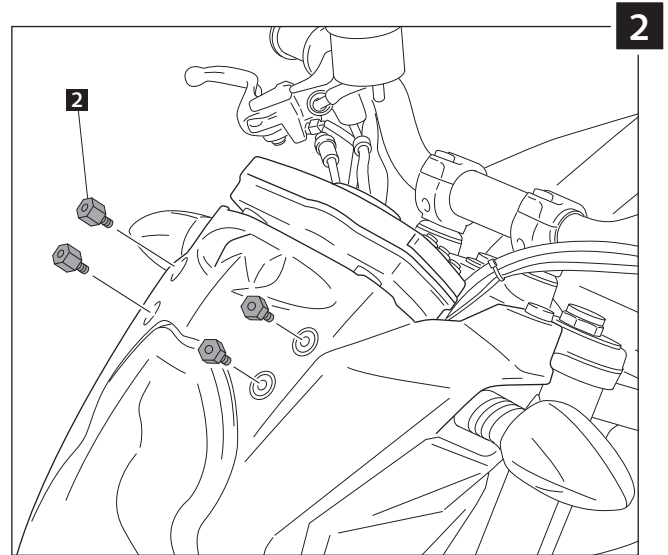

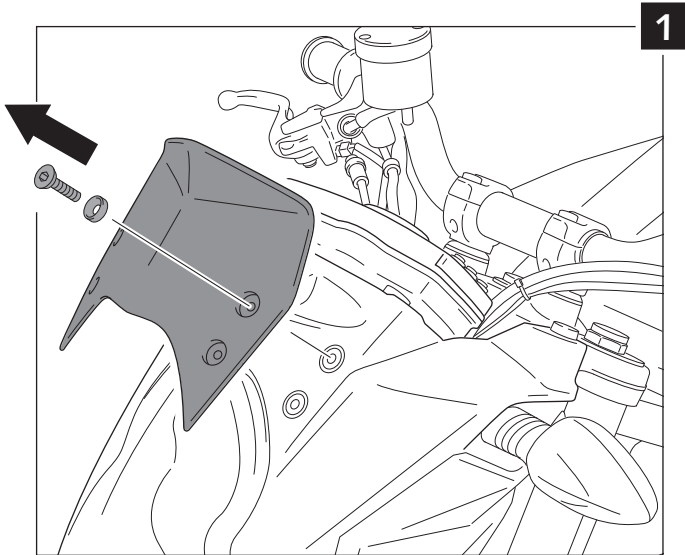
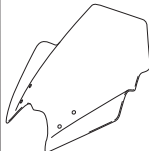

MOUNTING INSTRUCTIONS

WINDSHIELD ADAPTABLE TO
KTM 990 SUPER DUKE /R '07 - '13

Ref.: 4942



ID.		DESCRIPTION	QTY.
1		Screen	1
2		Special screw M5x13 + interior thread M5x8	4
3		Bush with flange (supplied fitted to Part No.1)	4
4		M5x16 ISO 7380 allen screw	4
5		Ø inner 5,25 x Ø outer 15x1,5 black metal washer	4
6		Well nut (supplied fitted to Part No.1)	4
7		M5 ISO 7380 screw cap	4

TIPS FOR A CORRECT WINDSCREEN ASSEMBLY

Due to storage and transport processes of the windscreens, which are subjected to positions and temperature changes out of our control, this may produce small deformations on the material causing some difficulties on the mounting process. It is recommended to:

- 1- Place the screws on one side without tighten all the way.
- 2- Stretch the windscreen to the other side (see Fig. 1). The flexibility of the material allows this stretch with no risk of breaking or cracking.
- 3- Place the screws without tightening all the way.
- 4- Tighten progressively all the screws.

