

**UNIVERSAL BASE REAR VIEW MIRROR
SUPPORT**

M O U N T I N G I N S T R U C T I O N S

REF 3532N

MOBILE COVER SUPPORT

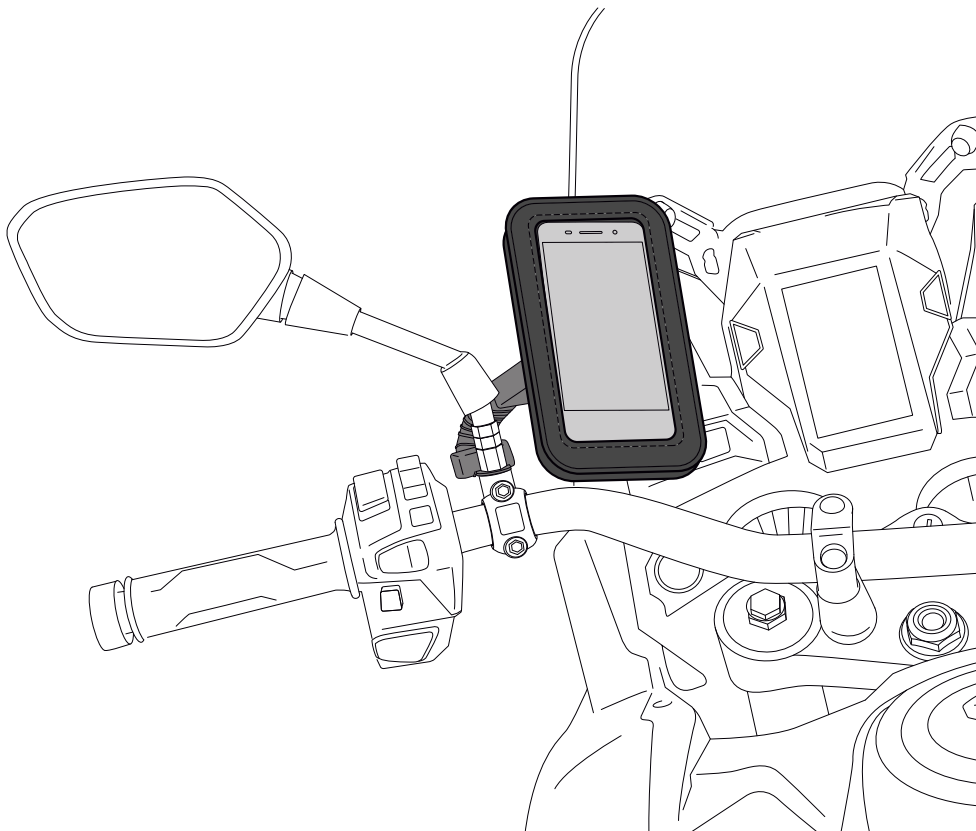

1 Person



10 min



EASY

FIX



N° 14

ID.	PART	DESCRIPTION	QTY.	REF.:
1		Support	1	3532N
2		Cover (Not supplied)	0	3530N/3531N

UNIVERSAL BASE REAR VIEW MIRROR SUPPORT

MOUNTING INSTRUCTIONS

1

ASSEMBLY

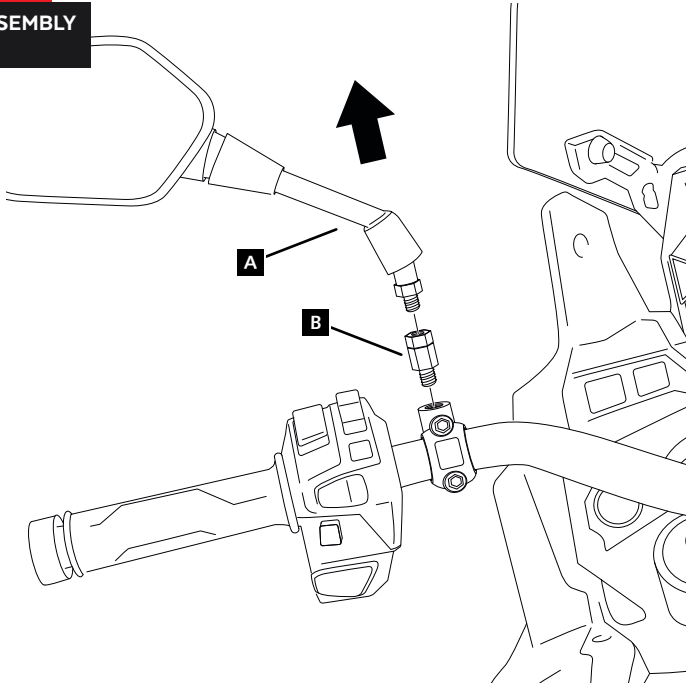

2

ASSEMBLY

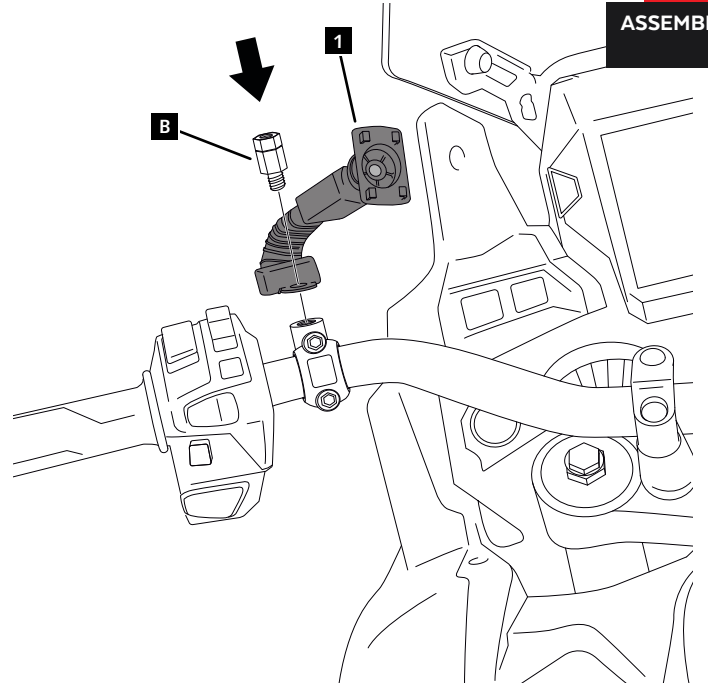

3

ASSEMBLY

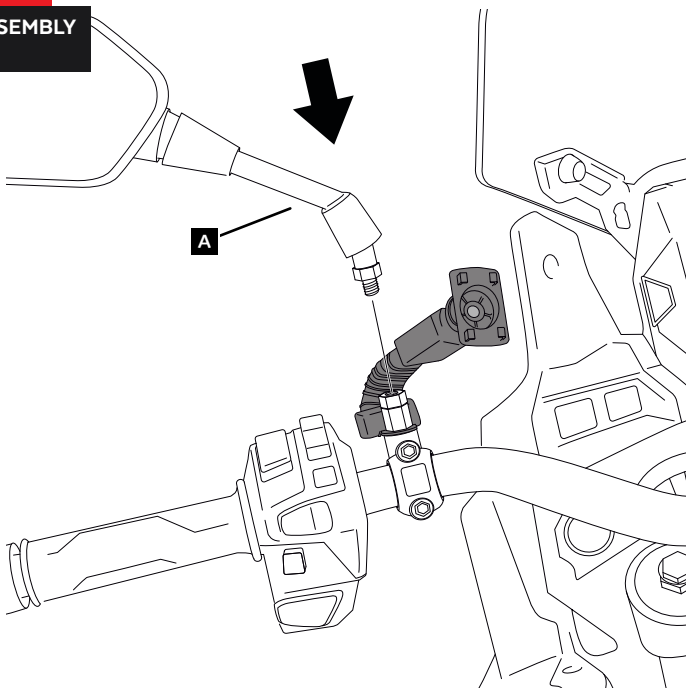

4

ASSEMBLY

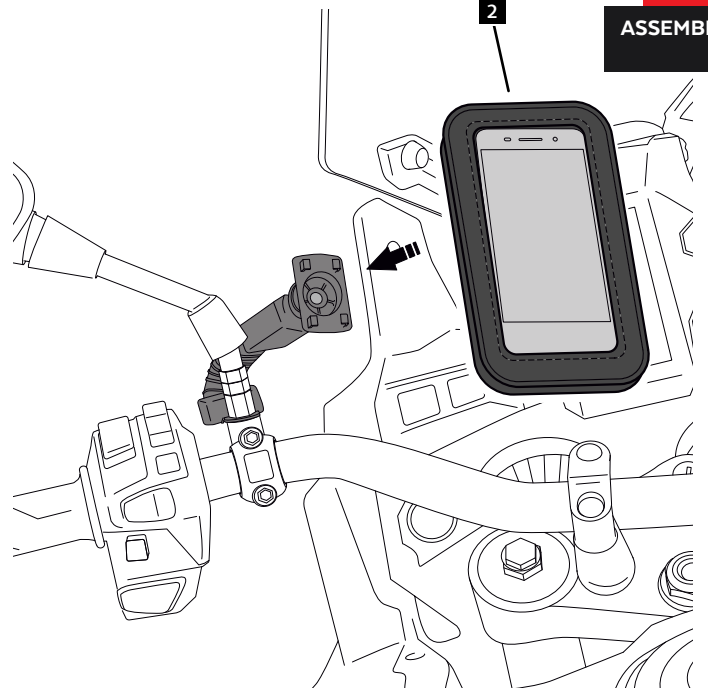

UNIVERSAL BAR REAR VIEW MIRROR
SUPPORT

M O U N T I N G I N S T R U C T I O N S

REF 3533N

MOBILE COVER SUPPORT

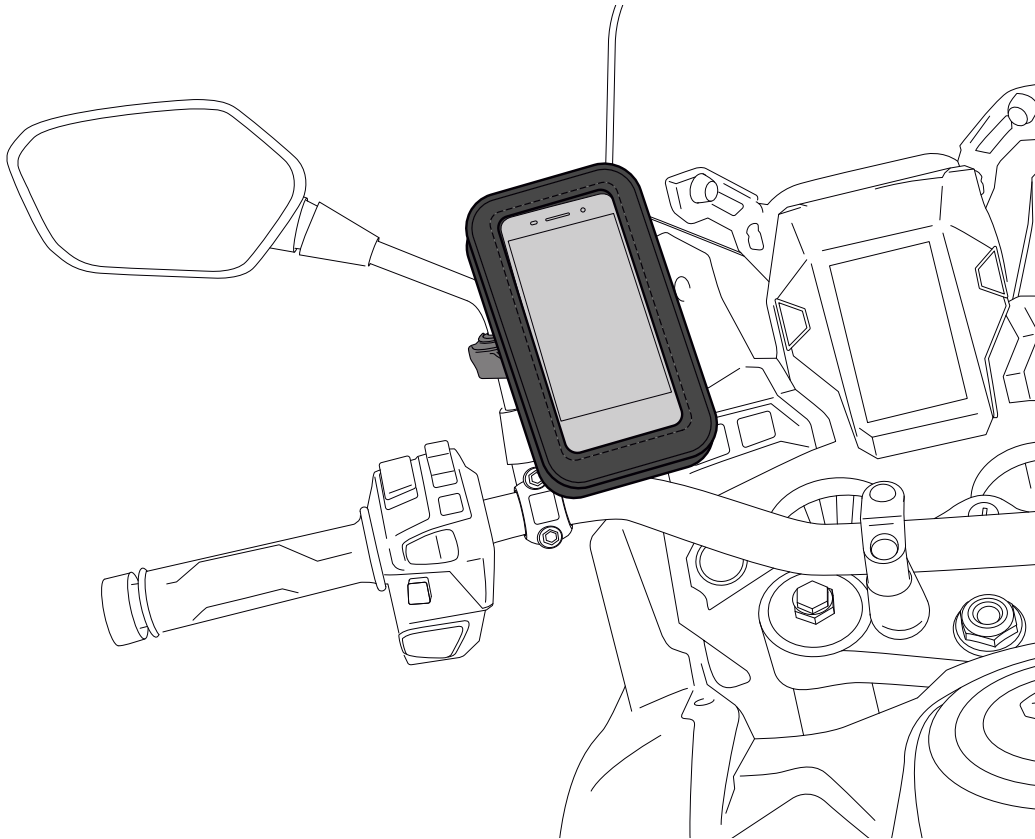

1 Person



2 min

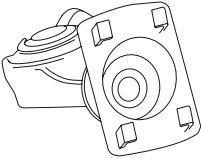
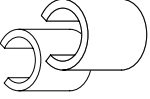
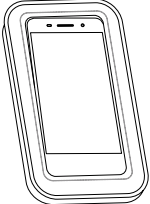

EASY

ID.	PART	DESCRIPTION	QTY.	REF.:
1		Support	1	3533N
2		Handlebar rubber band protector	2	----
3		Cover (Not supplied)	1	3530N/3531N

UNIVERSAL BAR REAR VIEW MIRROR SUPPORT

MOUNTING INSTRUCTIONS

1

ASSEMBLY

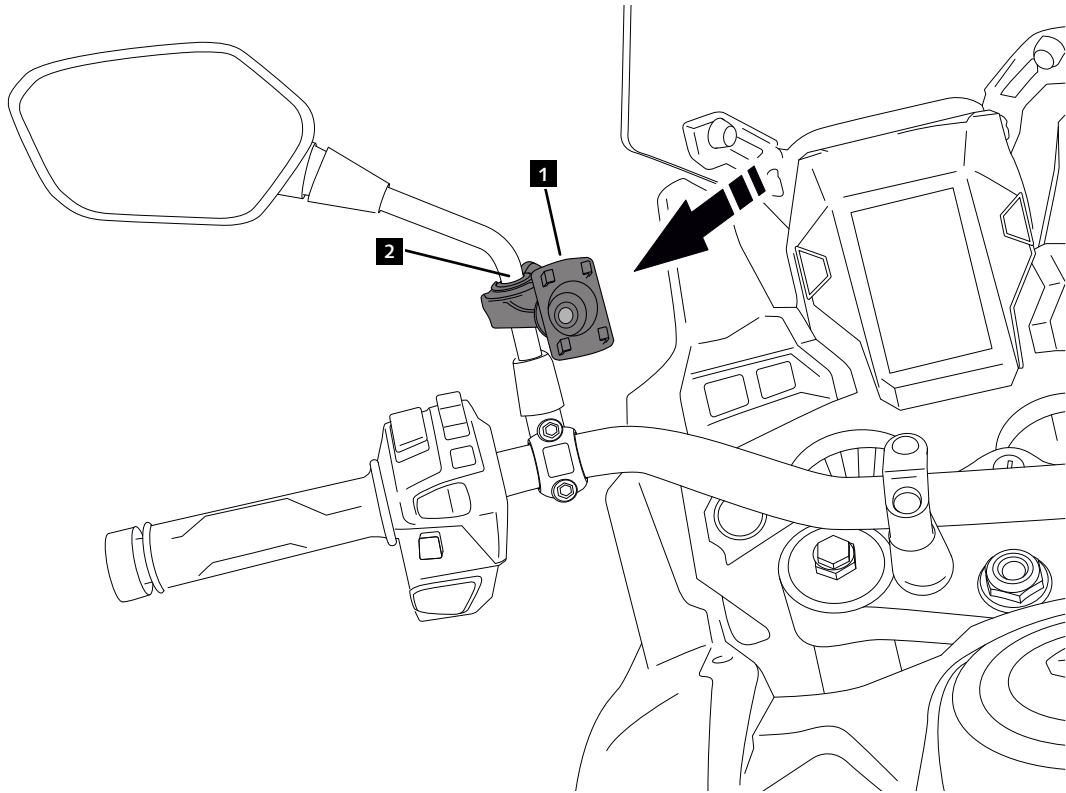

2

ASSEMBLY

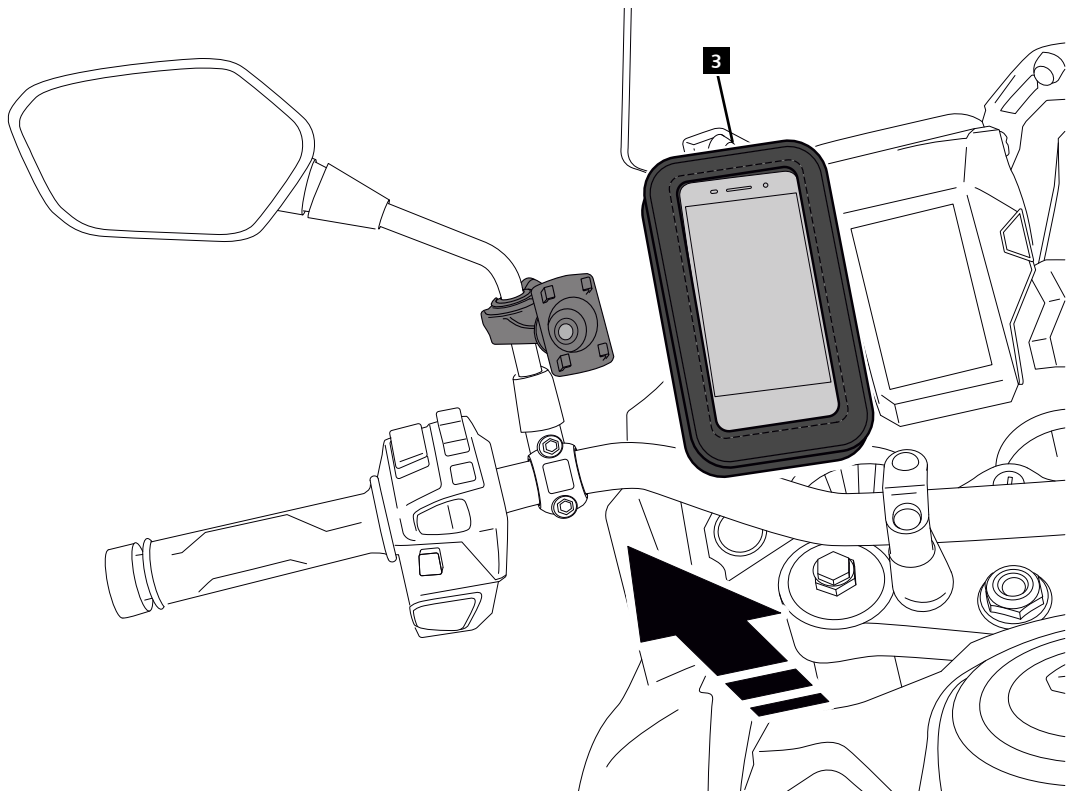

UNIVERSAL SUPPORT TO HANDLEBAR

M O U N T I N G I N S T R U C T I O N S

REF 3534N

MOBILE COVER SUPPORT

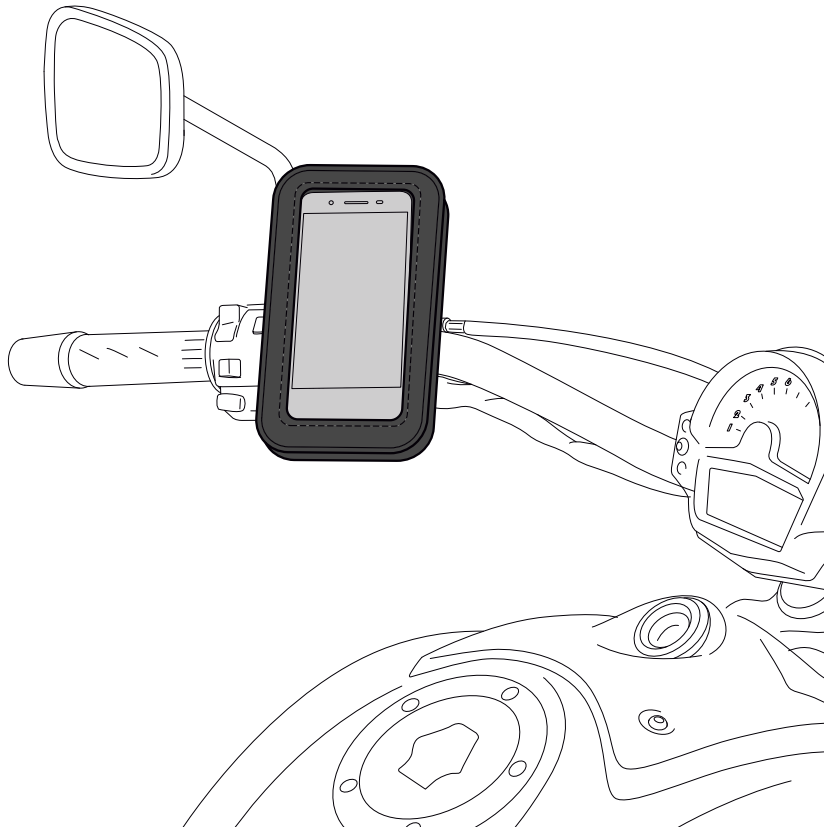

1 Person



2 min

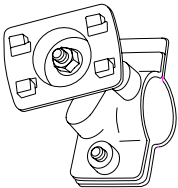
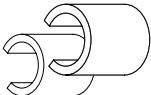
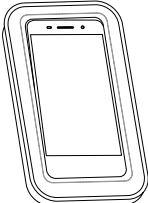

EASY

ID.	PART	DESCRIPTION	QTY.	REF.:
1		Support	1	3534N
2		Handlebar rubber band protector	2	----
3		Cover (Not supplied)	1	3530N/3531N

UNIVERSAL SUPPORT TO HANDLEBAR

MOUNTING INSTRUCTIONS

1

ASSEMBLY

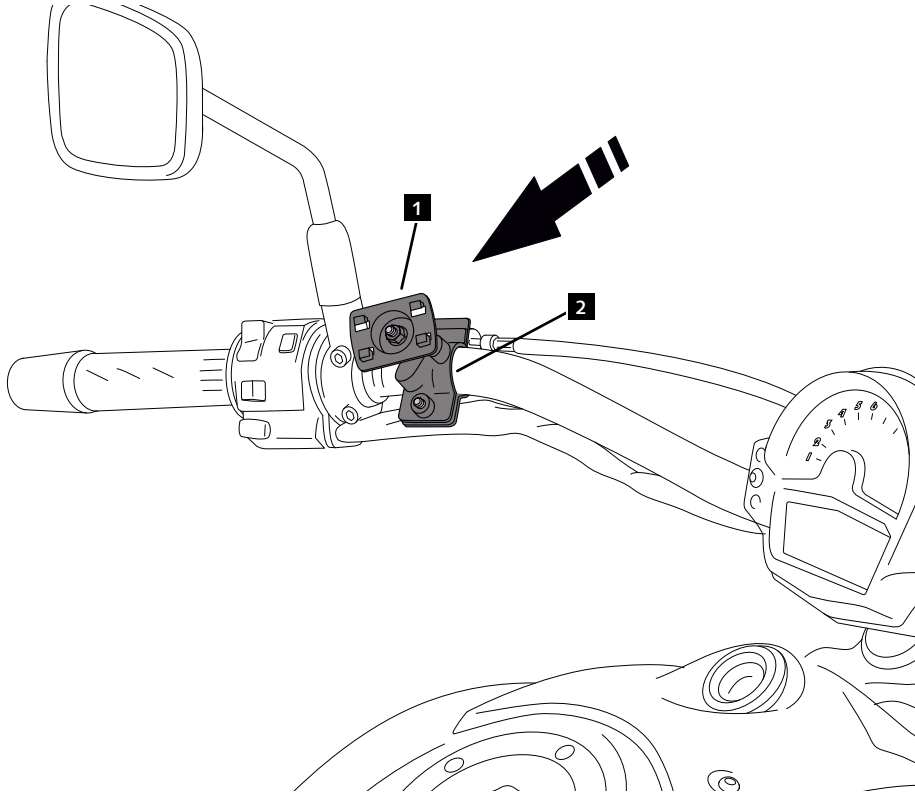

2

ASSEMBLY

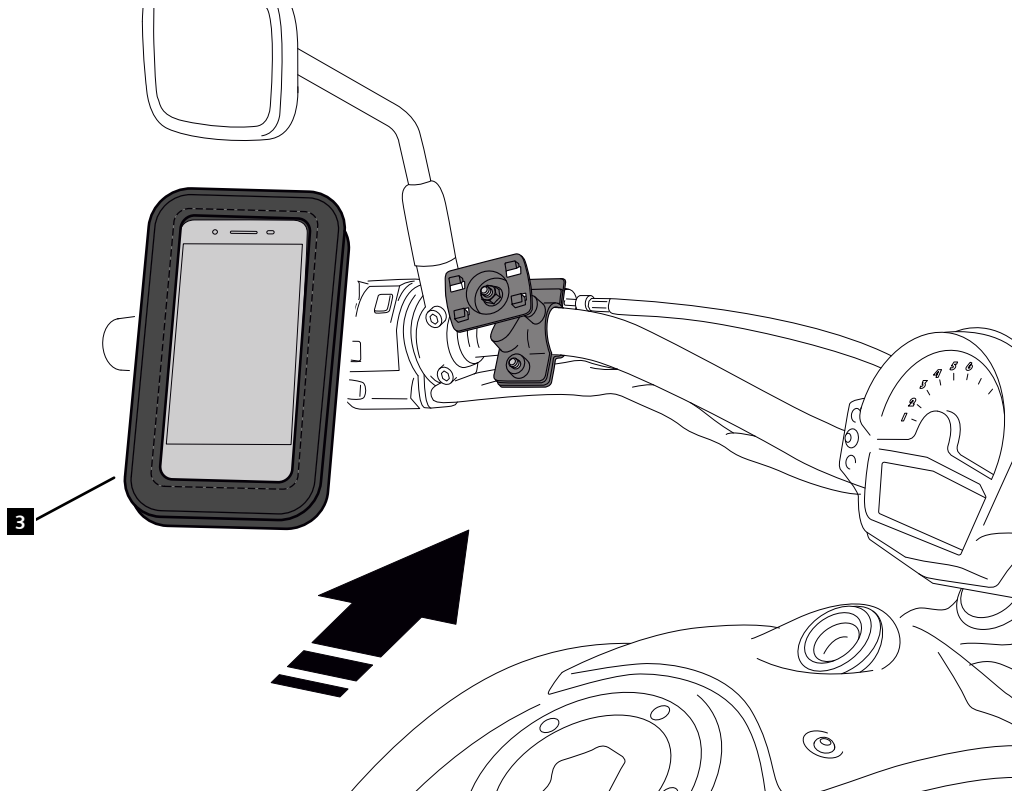

UNIVERSAL

M O U N T I N G I N S T R U C T I O N S



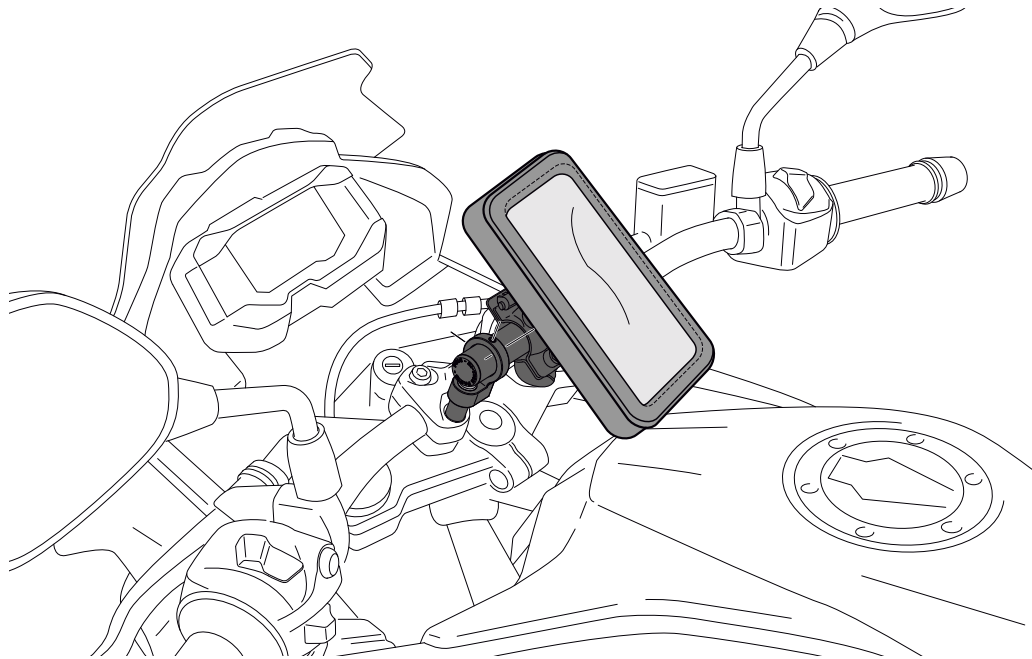

REF 3570N

MOBILE COVER SUPPORT

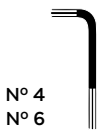

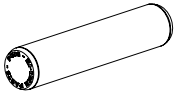
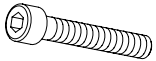
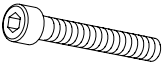
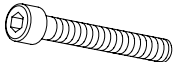
ALLEN



ID.	PART	DESCRIPTION	QTY.	REF.:
1		Support	1	3570N
2		Ø22x124 tube	1	3570N
3		M8x50 DIN912 screw	1	TORNI-D912--653
4		M8x55 DIN912 screw	1	TORNI-D912--631
5		M8x60 DIN912 screw	1	TORNI-D912--607
6		M5x5 screw	2	TORNI-D912--839
7		Spile 20mm length	1	CASQUI-----586
8		M8 DIN433 washer	1	M8 DIN433

UNIVERSAL

MOUNTING INSTRUCTIONS

1

ASSEMBLY

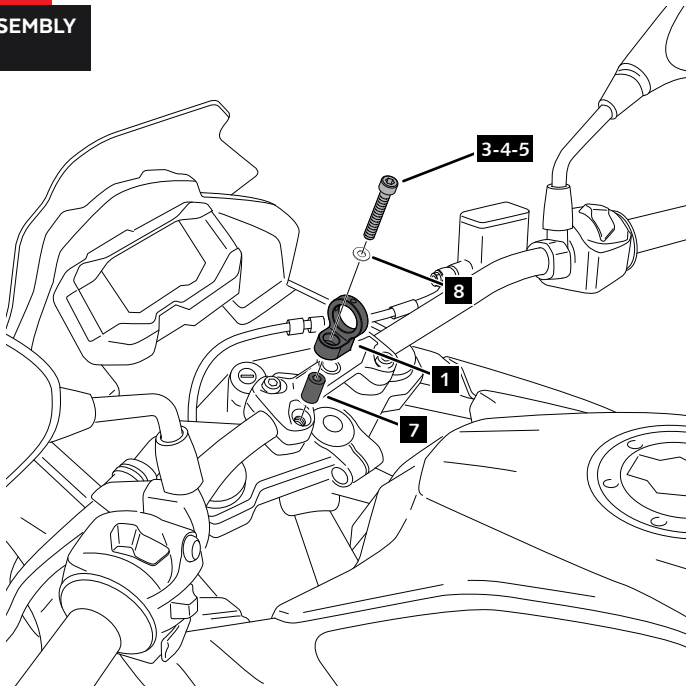

2

ASSEMBLY

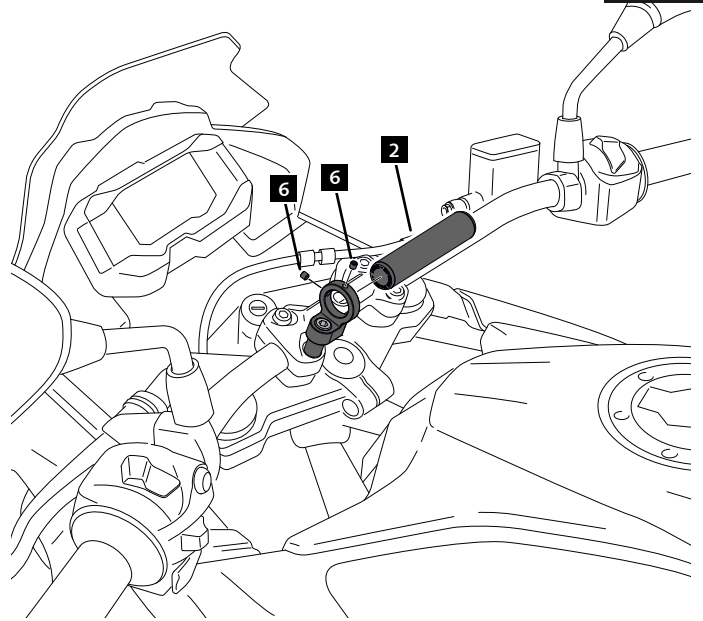

3

ASSEMBLY

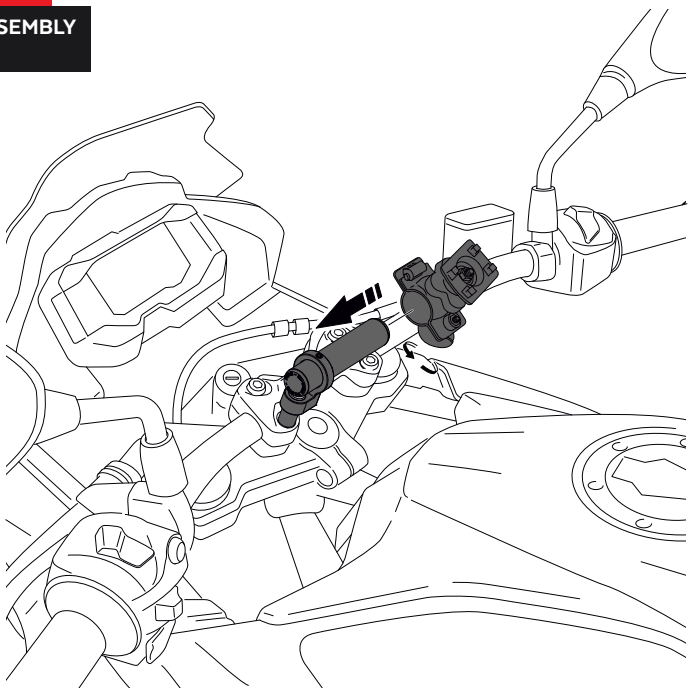

4

ASSEMBLY

