

HONDA CRF1100L AFRICA TWIN '20-

M O U N T I N G I N S T R U C T I O N S

REF 3818

TOURING SCREEN



1 Person



20 min









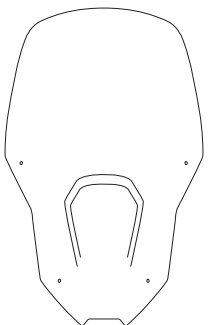
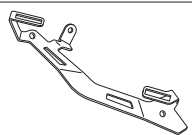
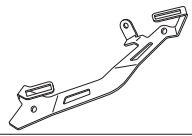

EASY



ALLEN
N° 3
N° 5



ID	PART	DESCRIPTION	QTY	REF
1		TOURING screen	1	3818W/H/N/FM3
2		Left support	1	SOPOR2P9-L-3818
3		Right support	1	SOPOR2P9-R-3818
4		M5 Lock nut (supplied munted)	4	TUERCAJFM5-408
5		Ø8,5x Ø13x 9 spacer	2	CASQUI-----777
6		M5x20 Ø11 ISO 7380 Allen screw	2	TORNI-I7380-730
7		M5x16 Ø11 ISO 7380 Allen screw	8	TORNI-I7380-493
8		M5 ISO 7380 screw cap	10	TAPON-----85
9		Ø9 xØ6 x8mm silentblock	4	AROPASACABLES-3
10		Ø12xØ6,8x7,3 Bush with flange	4	CASQUI-1A---750

HONDA CRF1100L AFRICA TWIN '20-

MOUNTING INSTRUCTIONS

1

DISASSEMBLY

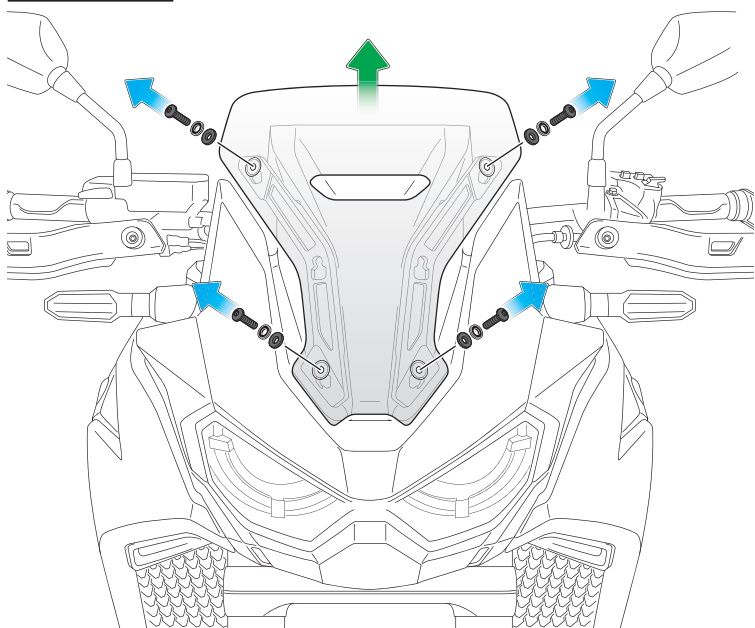

2

DISASSEMBLY

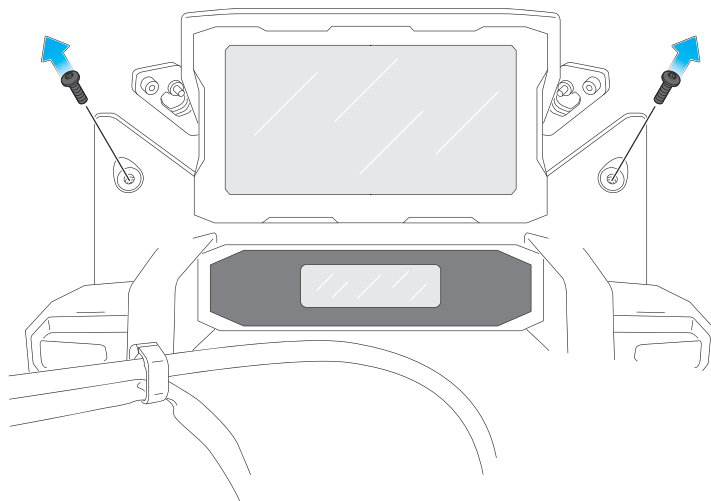

3

ASSEMBLY

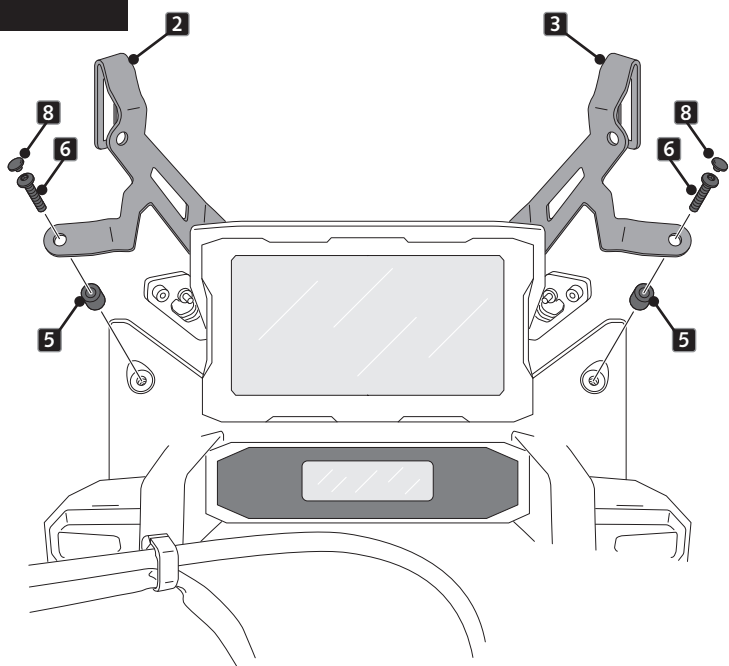

4

ASSEMBLY

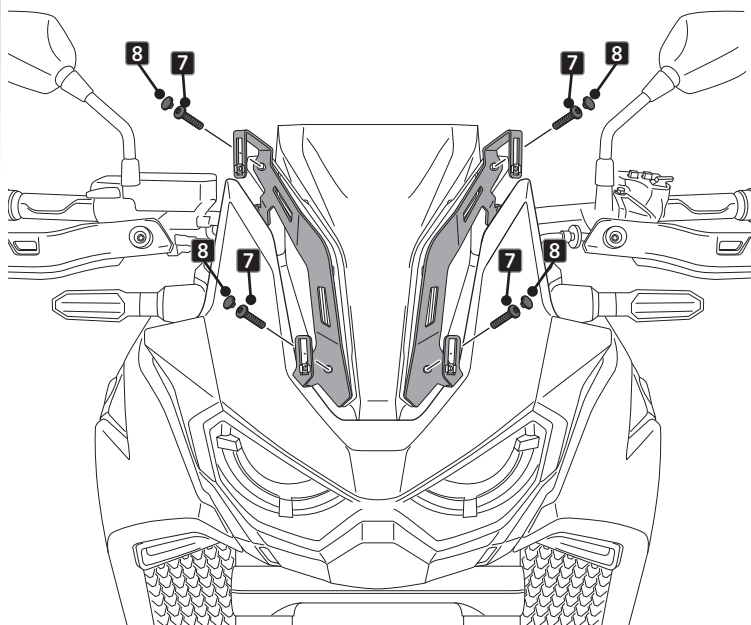

HONDA CRF1100L AFRICA TWIN '20-

MOUNTING INSTRUCTIONS

5

ASSEMBLY

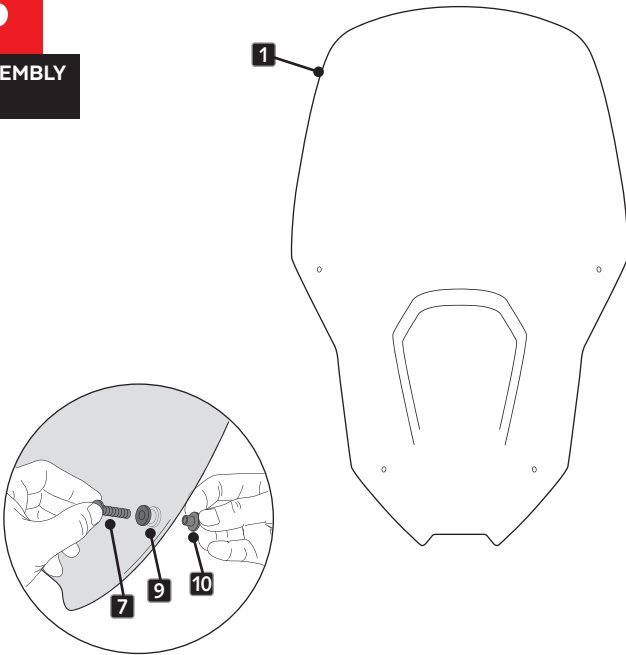

6

ASSEMBLY

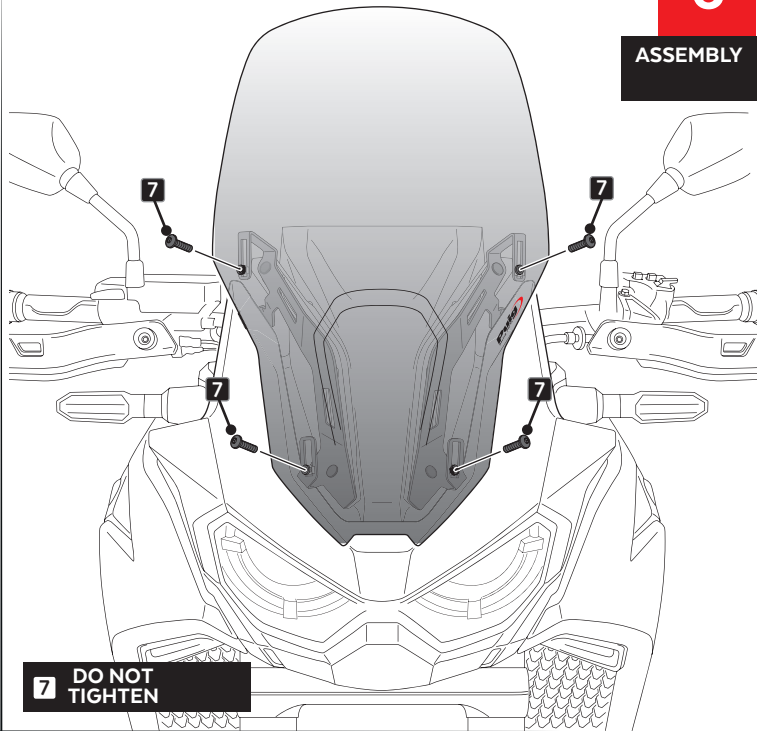

7

ASSEMBLY

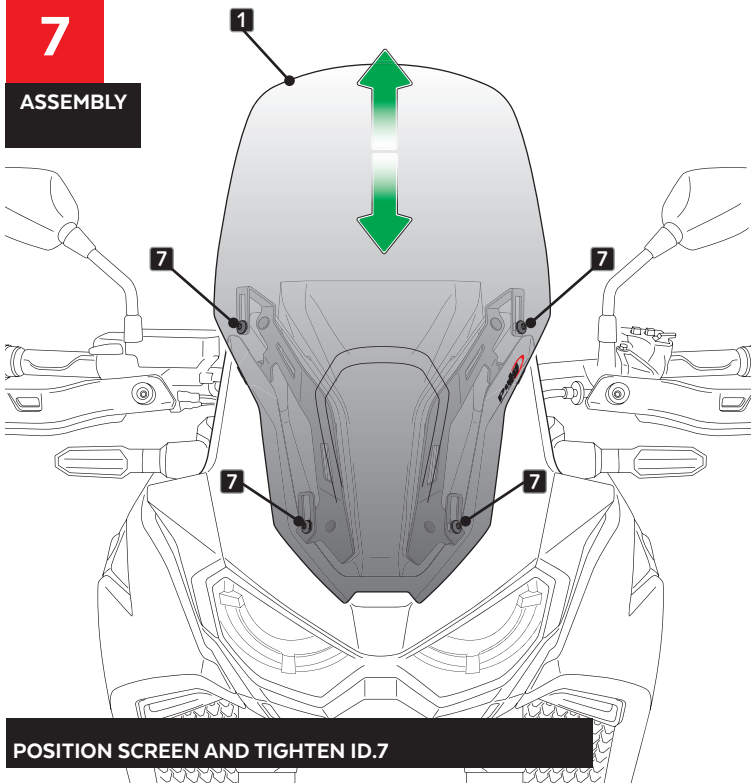

8

ASSEMBLY

