

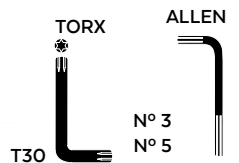





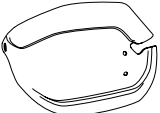

YAMAHA TENERE 700 '19-

MOUNTING INSTRUCTIONS

REF 3729

HANDGUARD EXTENSION



ID.	PART	DESCRIPTION	QTY.	REF.:
1		Right handguard extension	1	3729W/H/N/FM3
2		Left handguard extension	1	3729W/H/N/FM3
3		Right support	1	SOPOR2P3-R-3729
4		Left support	1	SOPOR2P3-L-3729
5		M5x11 Ø11 ISO 7380 allen screw	4	TORNI-IA----520
6		M5x1 nylon washer	4	ARNV0000000245
7		Ø4,5 x Ø14 x 4mm rubber washer	4	ARAND-GDI3D5X4-
8		Ø22x Ø9 x8 silentblock	2	SILENB000000036
9		Ø14 xØ8 x8 bush with flange	2	CASQUI-1A---325

YAMAHA TENERE 700 '19-

MOUNTING INSTRUCTIONS

The left side assembly is shown as an example, so the same steps can be performed for the right side assembly.

1

DISASSEMBLY

A Original screws

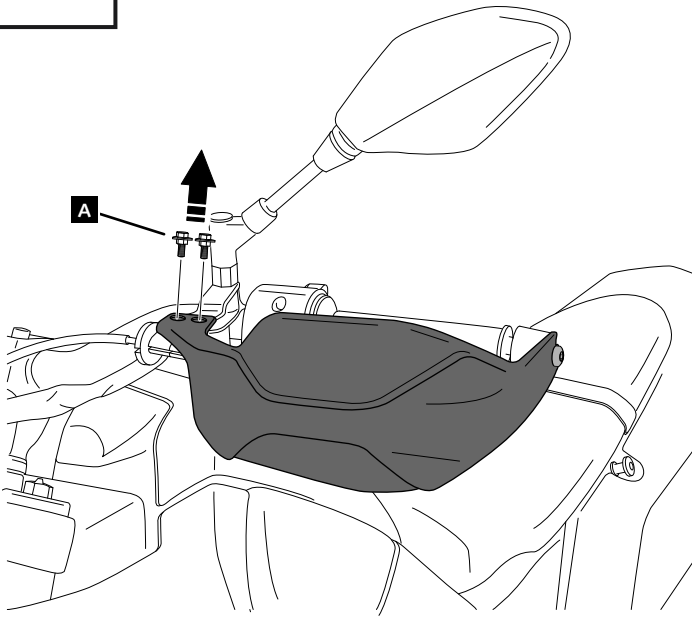

2

DISASSEMBLY

A Original screws

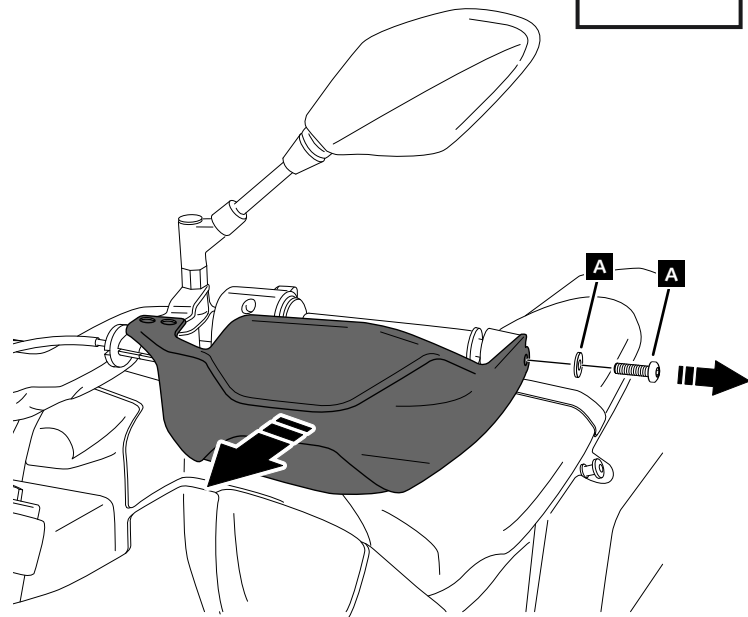

3

ASSEMBLY

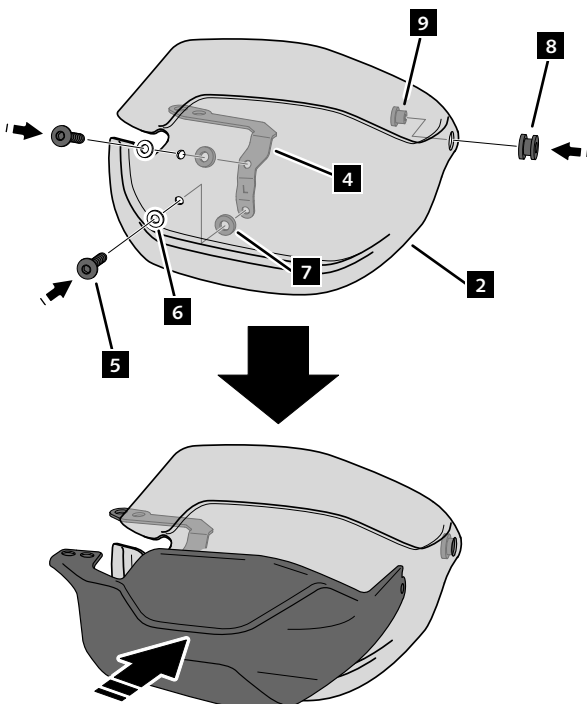

4

ASSEMBLY

A Original screws

