

# HONDA CMX 300-500 '17- / S '20-

## M O U N T I N G I N S T R U C T I O N S

REF 3701

ALUMINIUM FRONT PLATE

REF 3702

ABS FRONT PLATE



**ONLY FOR REBEL "S":**

**BEFORE INSTALLING THE PUIG PRODUCT, TAKE APART THE OEM SEMI-FAIRING**



15 min



1 Person









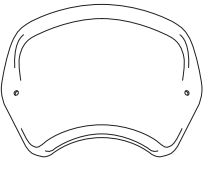
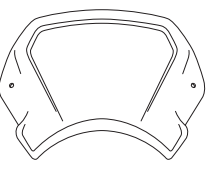
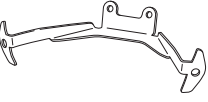

EASY



ALLEN  
N° 3  
N° 5

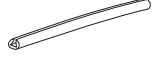

ID	PART	DESCRIPTION	QTY	REF
1		ABS front plate	1	10526J/C
		Aluminium front plate		9807P/N
2		Metal support ( R1 )	1	SOP1P5-----3701
3		M5 silentblock	2	SILENBTM5-046/1
4		M5x1 nylon washer	2	ARNV0000000245
5		M5x16 ISO7380 Allen screw (INOX)	2	TORNIAI7380-314
6		M5 screw cap	2	TAPON-----85
7		Ø8 x2 silicon spacers (supplied already mounted on items 2)	4	ADHESI-GT-D8---
8		Selft-autoadhesive trim (length 190mm ,6,2 x2,6mm) <b>*ONLY FOR ALUMINIUM FRONT PLATE (REF:9807)</b>	1	PERFIL-PVC-1048
9		Stickers set	1	10535
10		M5x16 ISO7380 Allen screw	2	TORNI-I7380-493

# HONDA CMX 300-500 '17- / S '20-

## MOUNTING INSTRUCTIONS

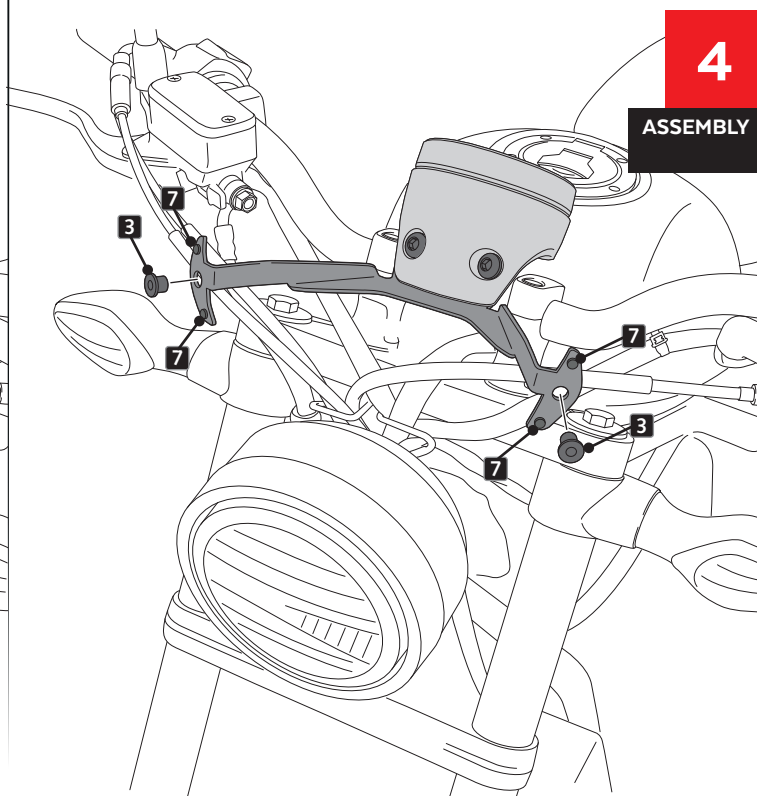
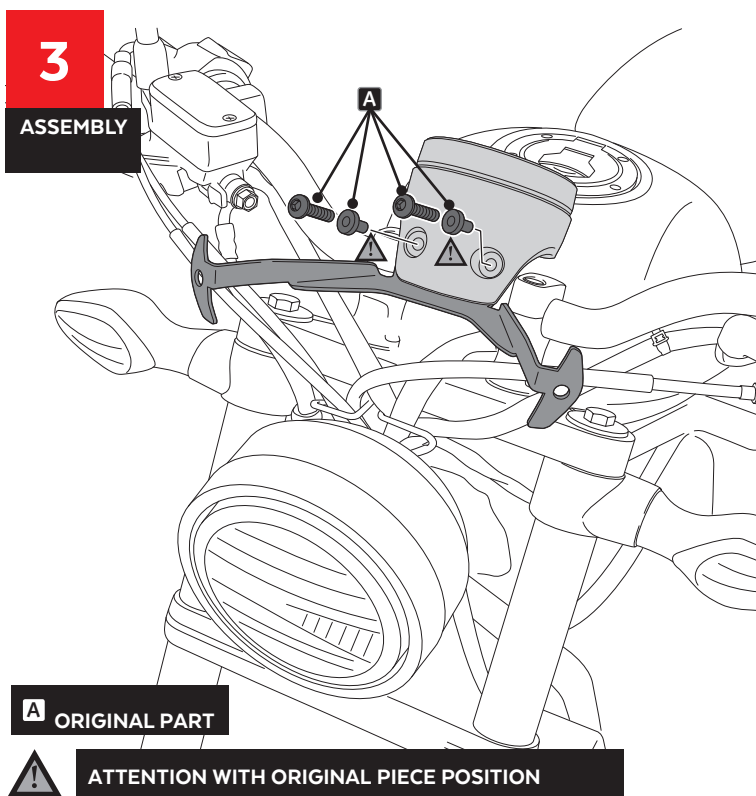
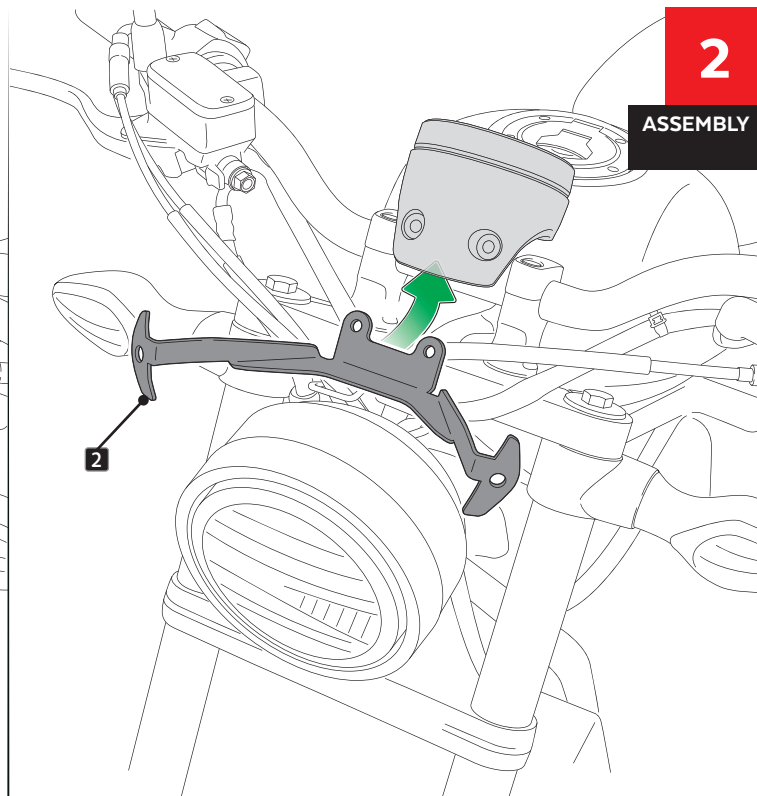
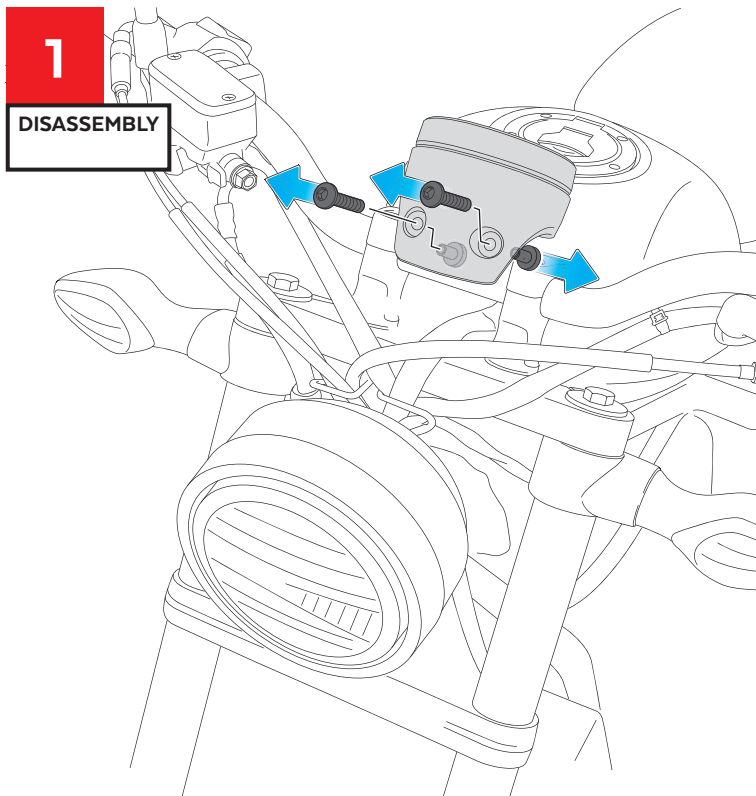

# HONDA CMX 300-500 '17- / S '20-

## MOUNTING INSTRUCTIONS

**5**

ASSEMBLY

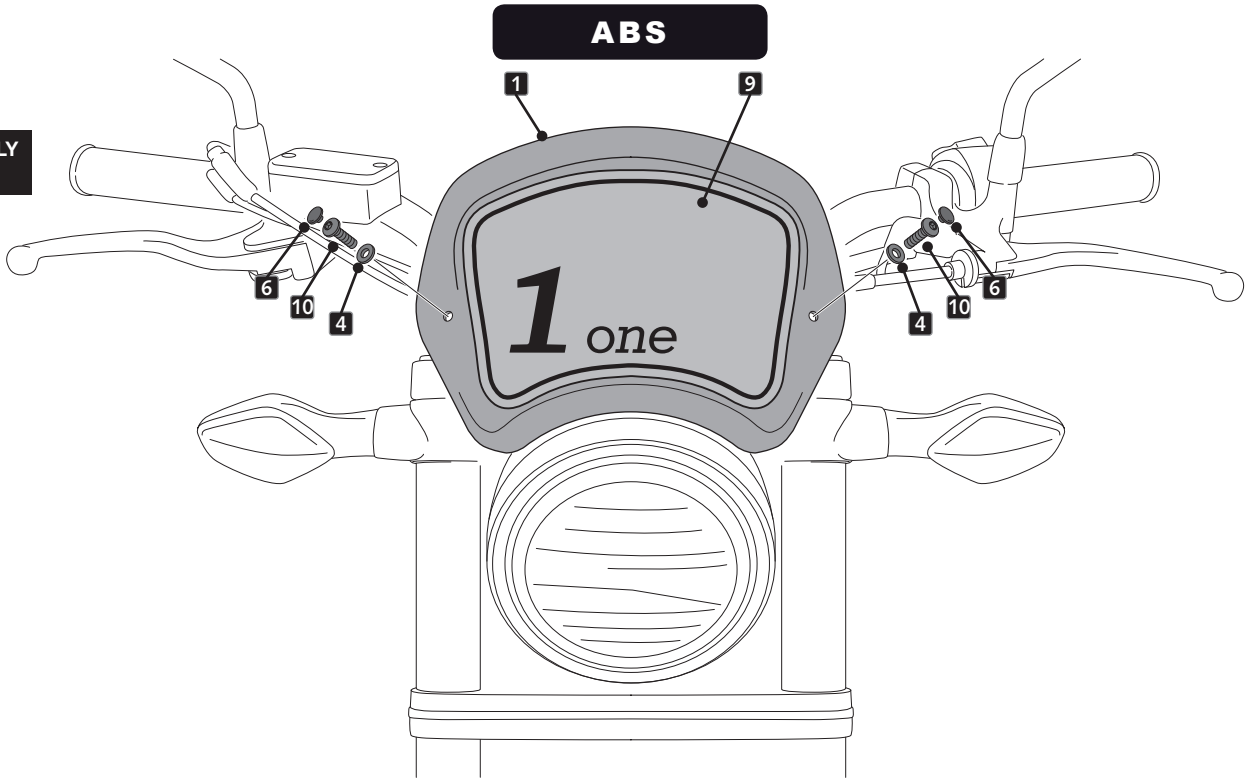

**6**

ASSEMBLY

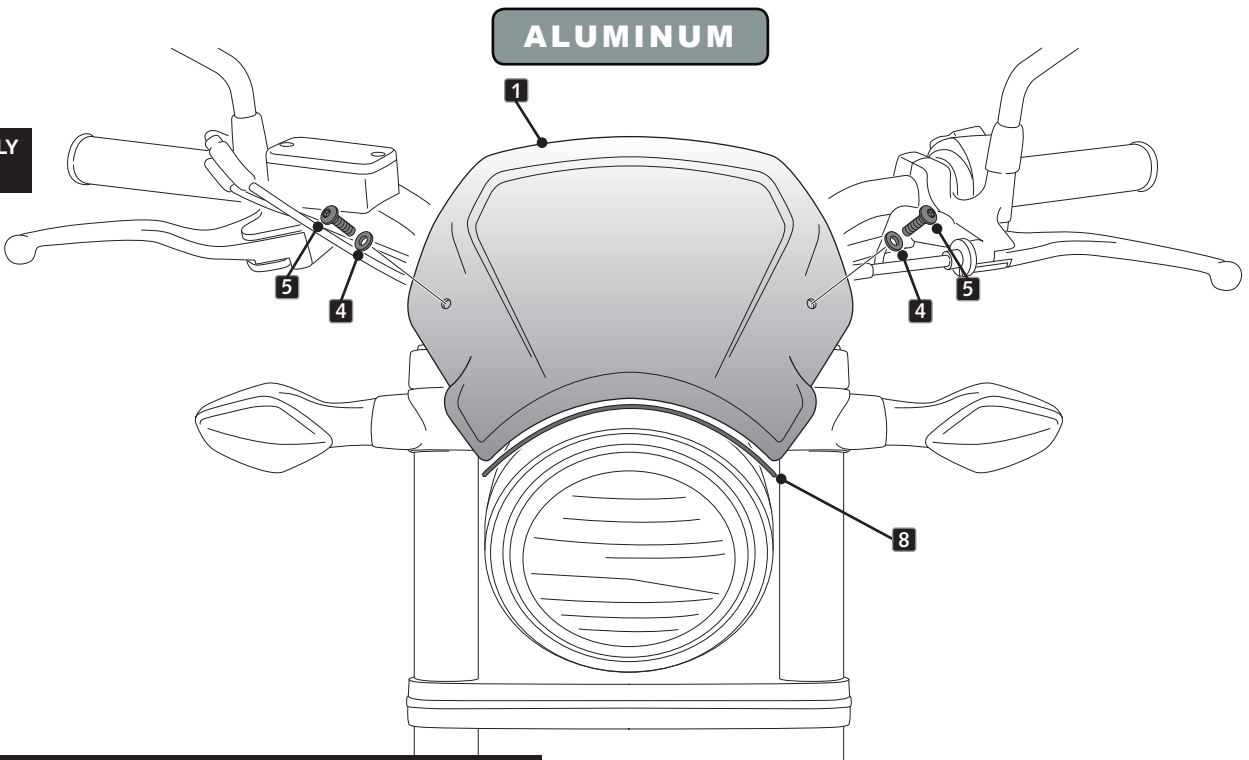

PLACE TRIM BEFORE MOUNTING THE FRONT PLATE.