

3629F +40 mm / +1,57 in

3629H +40 mm / +1,57 in

OEM

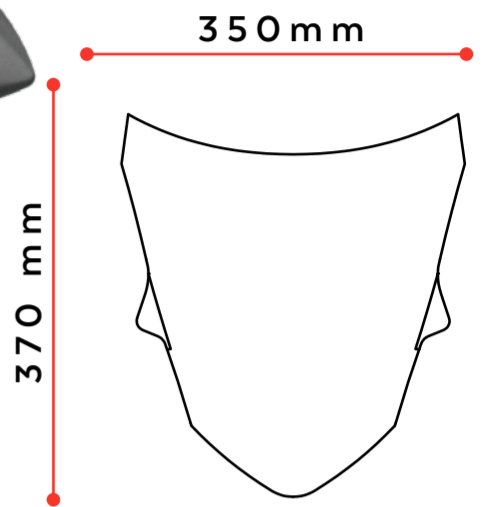

3629F +40 mm / +1,57 in

3629H +40 mm / +1,57 in

OEM

