

# UNIVERSAL

REF 3592

ALUMINUM FRONT PLATE - FORK MOUNTING



1 Person



15 min

















EASY



ALLEN N° 6  
N° 4  
N° 3



ID	PART	DESCRIPTION	QTY	REF
1		ALUMINUM front plate	1	9807P/N
2		Bracket	2	SOPORT30X30-581
3		Ø9 x200 Dispstick	2	VARILL205--0261
4		Bar cover	4	TOPEE-VPGT--8/4
5		M6x8 ISO7380 Black Allen screw	2	TORNI-I7380-825
6		M8x40 DIN 912 Allen screw	2	TORNI-D912-475
7		23 cylinder with drill through	2	CILINRTP---0217
8		M8x8 DIN 913 allen hexagonal screw	2	TORNIA88---0184
9		M6x0,5 nylon washer	2	ARANDEPNVCN0246
10		M6x35 DIN912 Allen screw	2	TORNI-D912--447
11		M6 Self-Locking nut	2	TUERCA-D982-745
12		Dispstick bridle	2	FIXVARLL-O-PR16
13		Bridle-bracket locknut	2	FIXSOPOR-O-PR16
14		Ø8,5 x Ø13 x 15 arrowhead	2	CASQUI-M----614
15		6,2x2,6mm trim length 190mm *ONLY FOR ALUMINUM FRONT PLATE (REF:9807)	1	RIBETETP---0900

# UNIVERSAL

## FORK MOUNTING

1

DISASSEMBLY

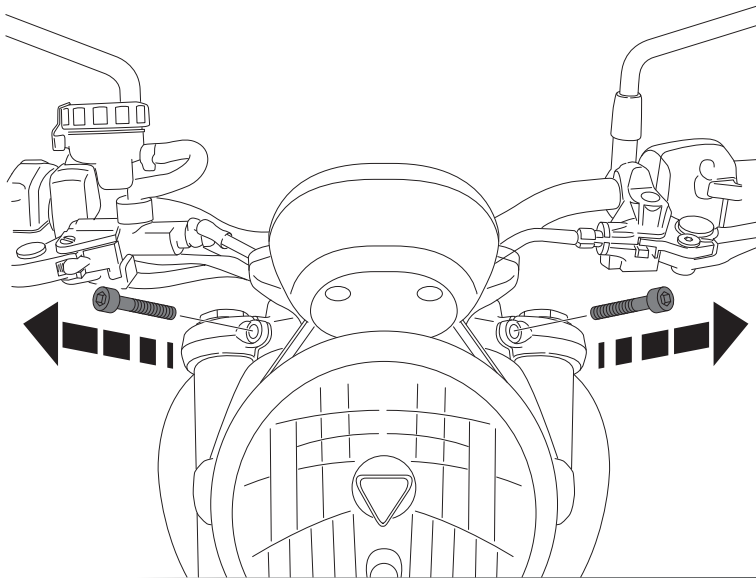

2

ASSEMBLY

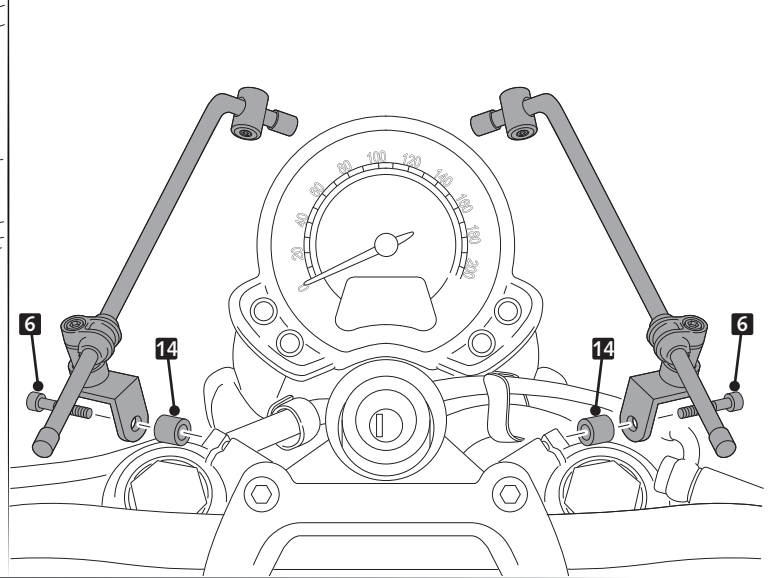

3

ASSEMBLY

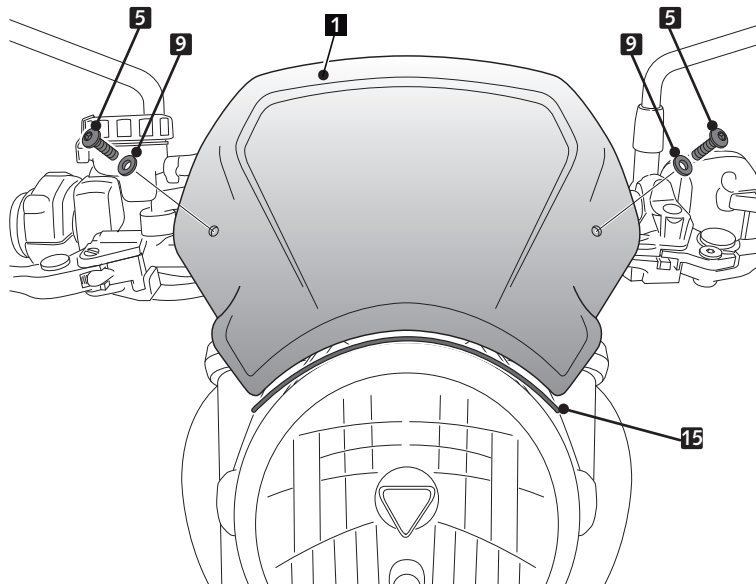

# UNIVERSAL

## FORK MOUNTING

EXPLOTING

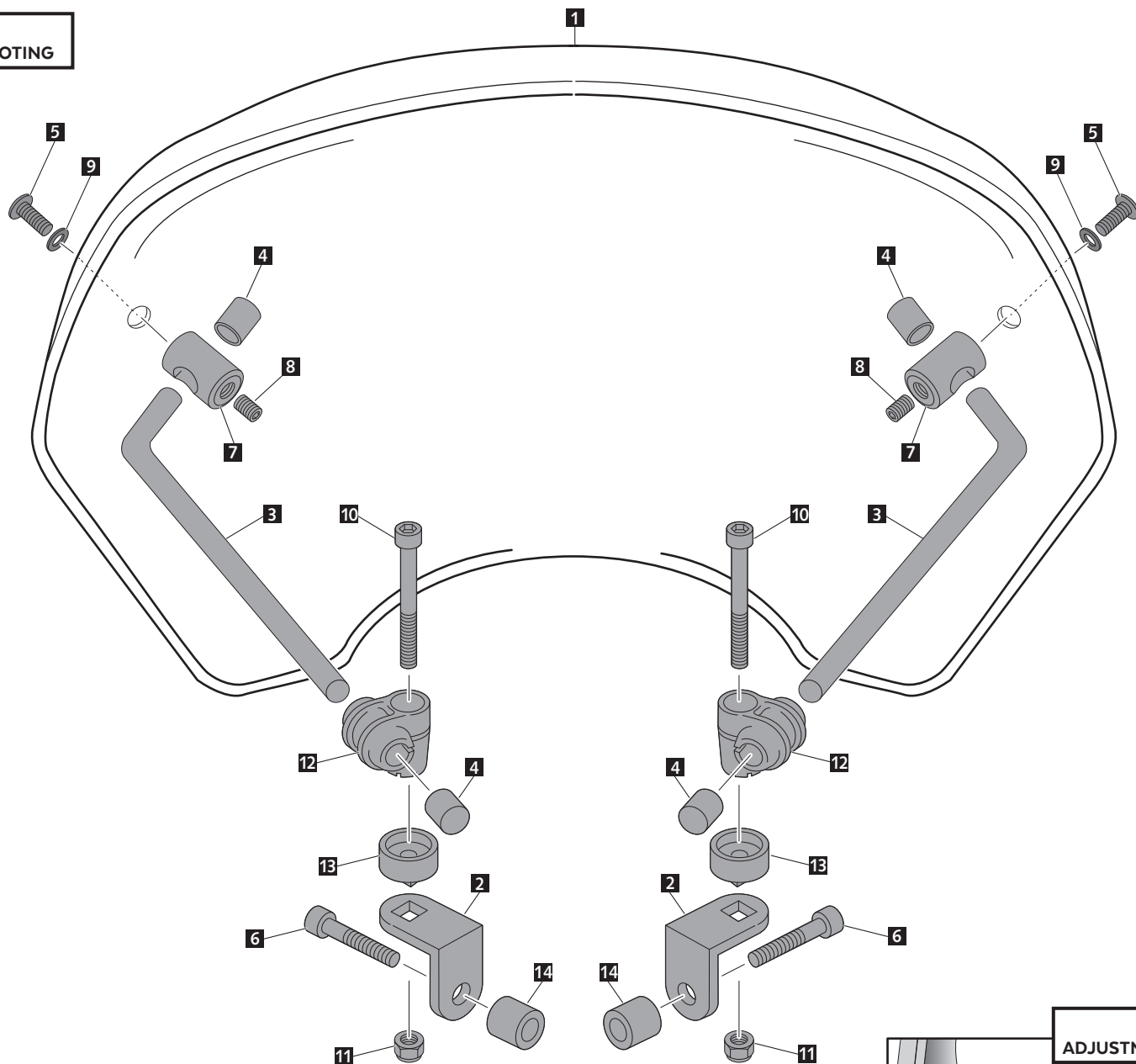

ADJUSTMENT

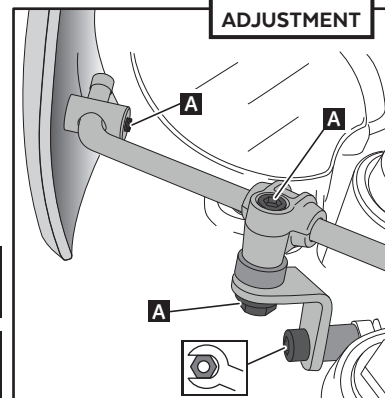

**A** Adjust position of the supports on both sides and tight the fasteners indicated.

 - Tightening torque for screws n° 6 (23Nm).