

# HONDA CB650R '19

REF 3528N

TURN SIGNAL SUPPORT



1 Person







40 min

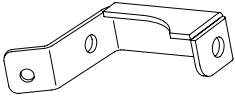

EASY



ID.	PART	DESCRIPTION	QTY.	REF.:
1		Support	2	INTDELO3-0-003
2		M6x15 DIN912	2	TORNI-AD912-430
3		M6 washer	2	ARANDEP125-054
4		M8 DIN6923 nut	2	TUERCAEM6G-0213

# HONDA CB650R '19

REF 3528N

MOUNTING INSTRUCTIONS

1

DISASSEMBLY

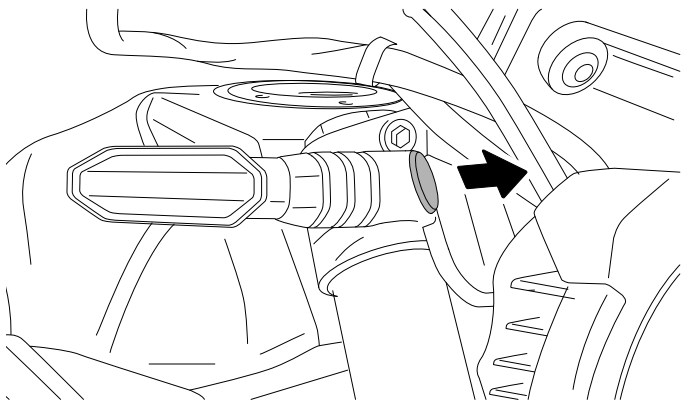

REMOVE COVER

2

DISASSEMBLY

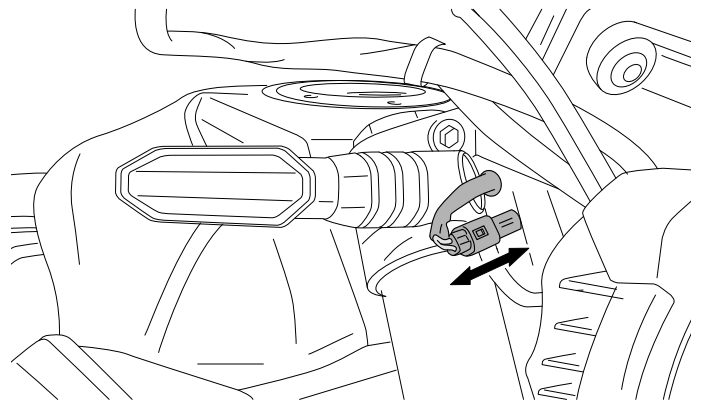

DISCONNECT

3

DISASSEMBLY

**A** Original components

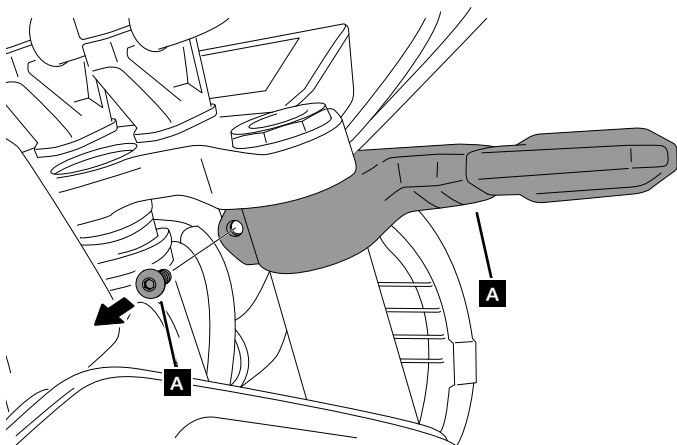

4

ASSEMBLY

