

HONDA REBEL CMX 500 / 300 '17-

M O U N T I N G I N S T R U C T I O N S

REF 3525

FRONT FENDER



1 Person









20 min

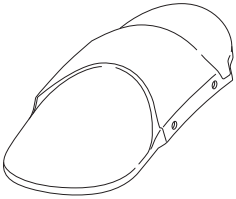

MEDIUM



ID	PART	DESCRIPTION	QTY	REF
1		Front Fender	1	SOPOREMBIP13735
2		Right metal suport	1	SOPOR2P3-R-3525
3		Left metal suport	1	SOPOR2P3-L-3525
4		M6x12 DIN912 Allen screw	4	TORNIAD912--146
5		M5 Lock nut	4	TUERCA-D985-535
6		M5x11 Ø11 ISO 7380 Allen screw	4	TORNI-AI----520
7		M5 ISO 7380 Allen screw cap	4	TAPON-----85

HONDA REBEL CMX 500 / 300 '17-

MOUNTING INSTRUCTIONS

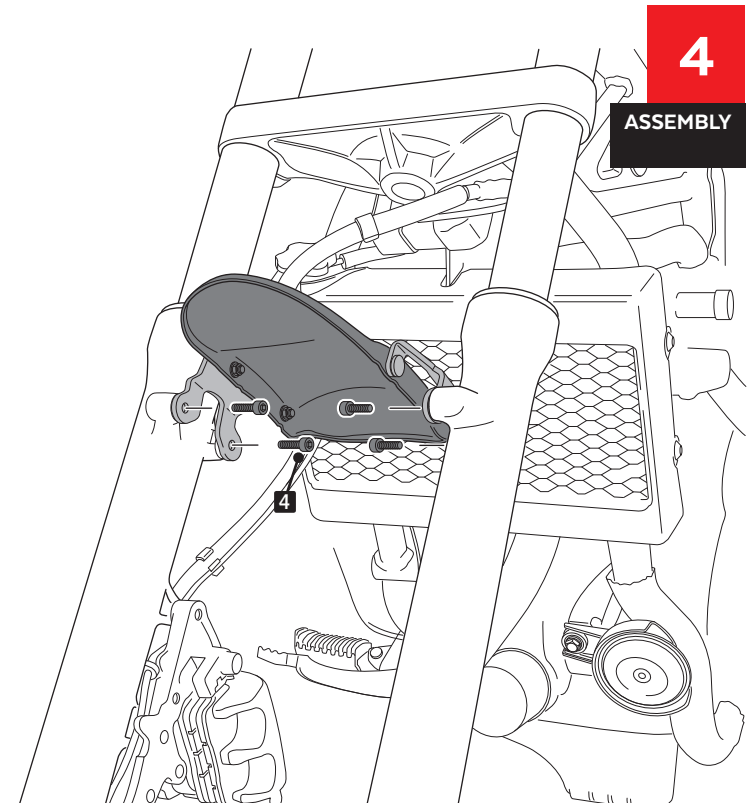
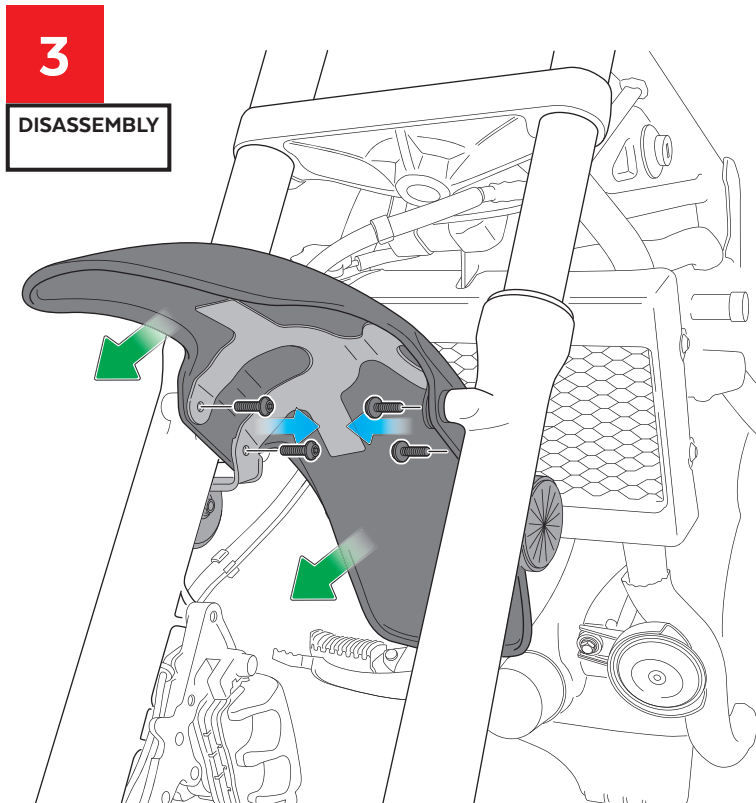
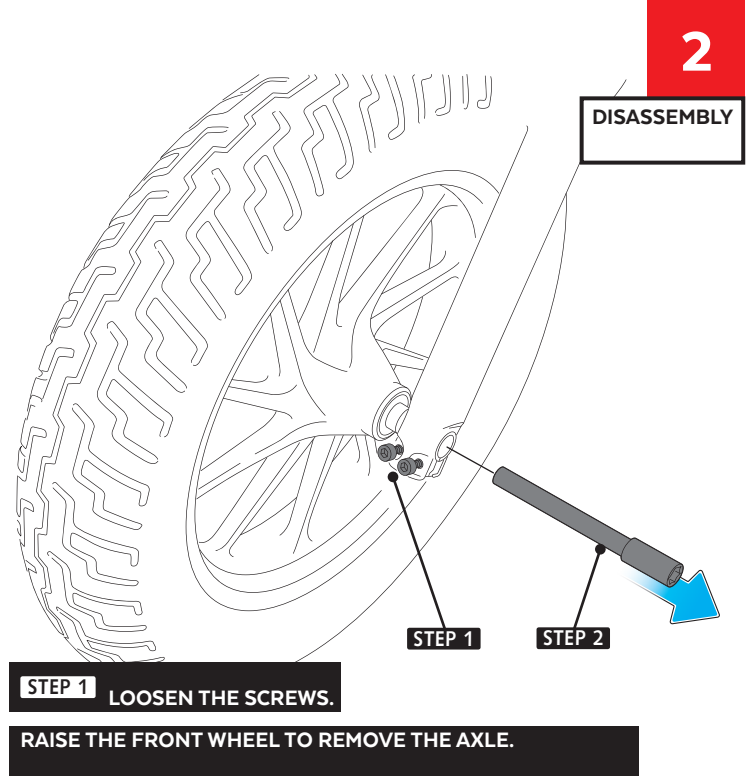
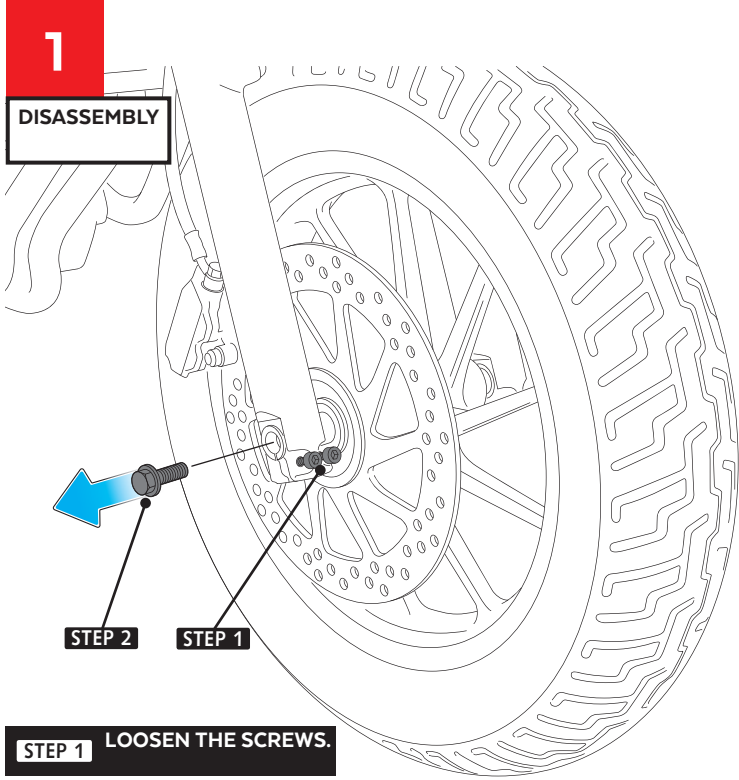

HONDA REBEL CMX 500 / 300 '17-

EXPLOTING

