

## MOUNTING INSTRUCTIONS

REAR MUDGUARD ADAPTABLE TO









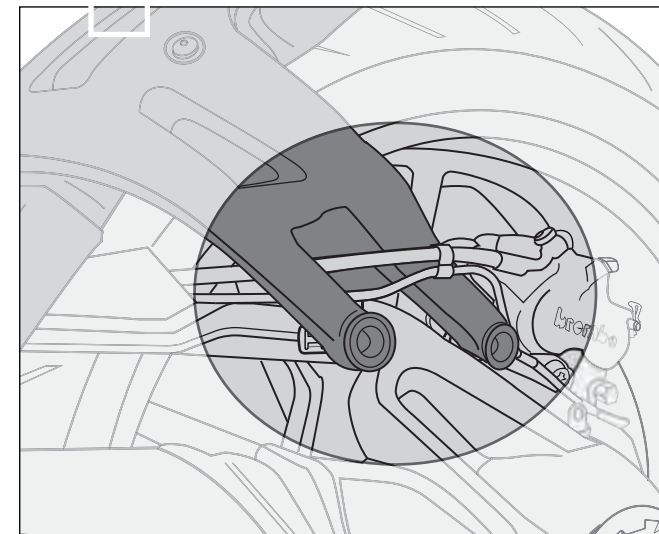
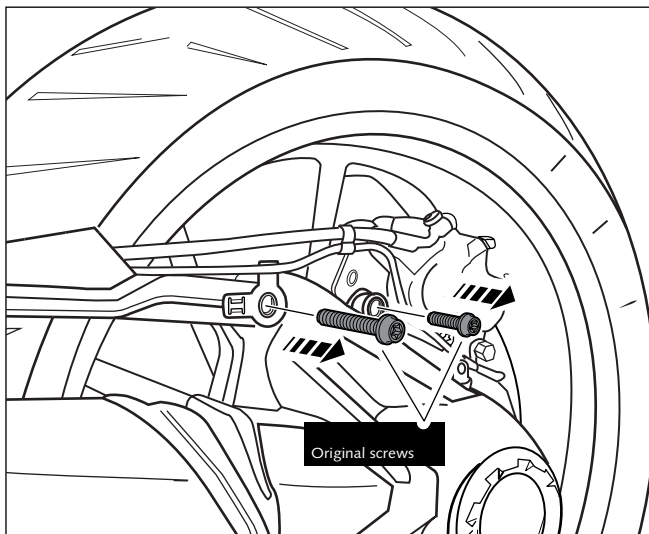

**BMW**

**R1200R '18/R1250R '19- / R1200RS '18/ R1250RS '19-**

Ref.: 3503 J  
(black colour)

Ref.: 3503 C  
(carbon look)



ID.		DESCRIPTION	QTY.	REF.
1		Mudguard	1	3503C/JM3
2		Support aluminum	1	SOPORFUN-6352-7
3		Well nut	3	SILENBGONE--064
4		M5x11 ISO 7380 Allen lock screw	3	TORNI-AI---520
5		M5 bush with flange	3	CASQUI-----517
6		DIN 127 M5 Grower washer	3	ARAND-G5----506
7		M8x35 DIN 912 12.9 Allen screw	1	TORNI-D912--837
8		M10x75 DIN 912 12.9 Allen screw	1	TORNI-D912--669
9		Arrowhead Ø inner 10,5 Øouter-(1)15 x Øouter-(2)21x19,5	1	CASQUI-M----604
10		Arrowhead IGUS Ø inner 15 x Ø outer 17x15	1	COJIN-P-WSM-517
11		M5 ISO 7380 Screw cap	3	TAPON-----85

REAR MUDGUARD ADAPTABLE TO  
**BMW R1200R '18/ R1250R '19-/ R1200RS '18/ R1250RS '19-**



IT IS RECOMMENDED TO CHECK TIGHTENING OF THE BOLTS EVERY 1000 Km.

