

# YAMAHA NIKEN '18-

## M O U N T I N G I N S T R U C T I O N S

REF 2385

TOURING SCREEN



1 Person



20 min



EASY



N° 10









ALLEN

N° 3  
N° 4

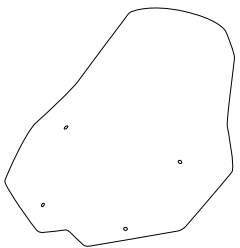
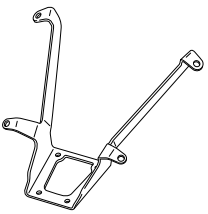

PHILLIPS  
SCREWDRIVER



| ID | PART  | DESCRIPTION                    | QTY | REF             |
|----|---|--------------------------------|-----|-----------------|
| 1  |  | Touring screen                 | 1   | 2385F/H/N/WM3   |
| 2  |  | Metal support                  | 1   | SOPORIP7---2385 |
| 3  |  | M5 silentblock                 | 4   | SILENBTM5-046/1 |
| 4  |  | M5x20 Ø11 ISO 7380 Allen screw | 4   | TORNI-I7380-730 |
| 5  |  | M5x1 Nylon washer              | 4   | ARNV00000000245 |
| 6  |  | M5 ISO 7380 Screw cap          | 4   | TAPON-----85    |
| 7  |  | Ø4,5 x Ø11 x 2mm Rubber washer | 4   | ARAND-EPDM--722 |

# YAMAHA NIKEN '18-

## MOUNTING INSTRUCTIONS

1

DISASSEMBLY

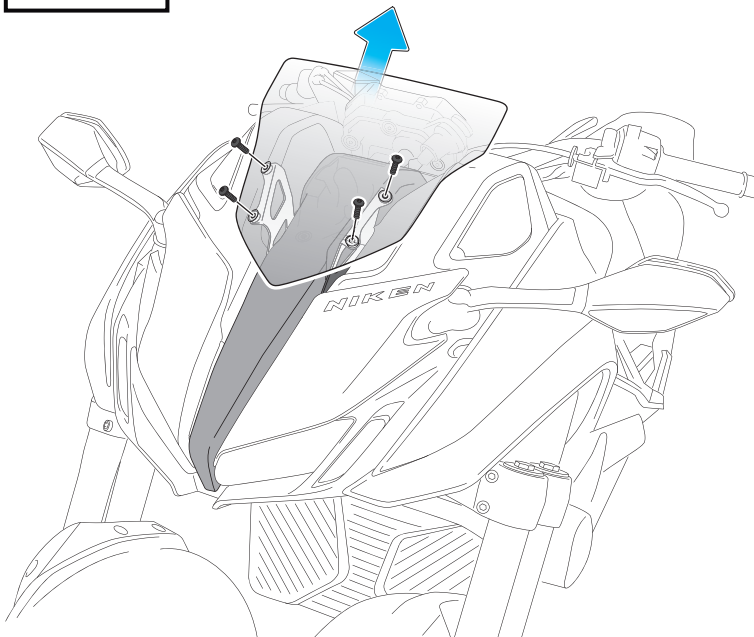

2

DISASSEMBLY

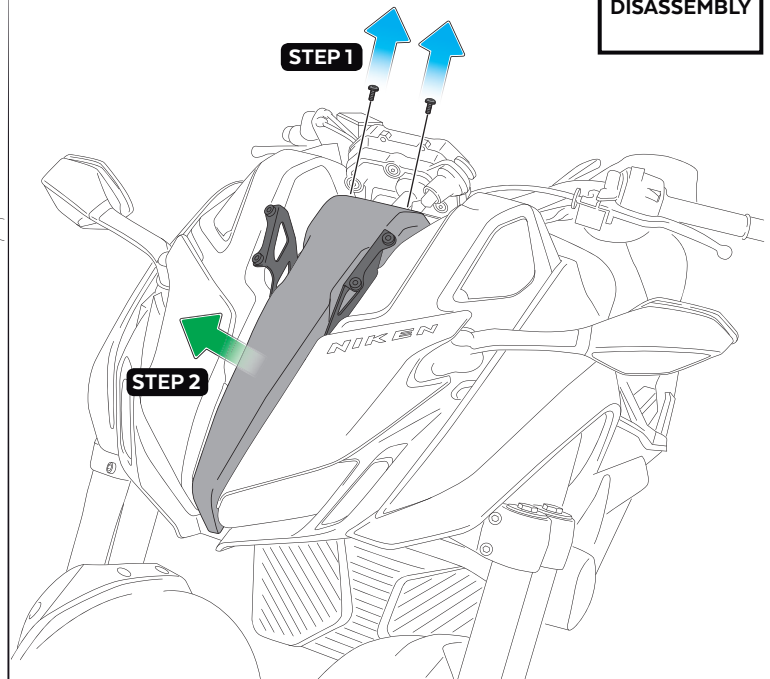

3

DISASSEMBLY

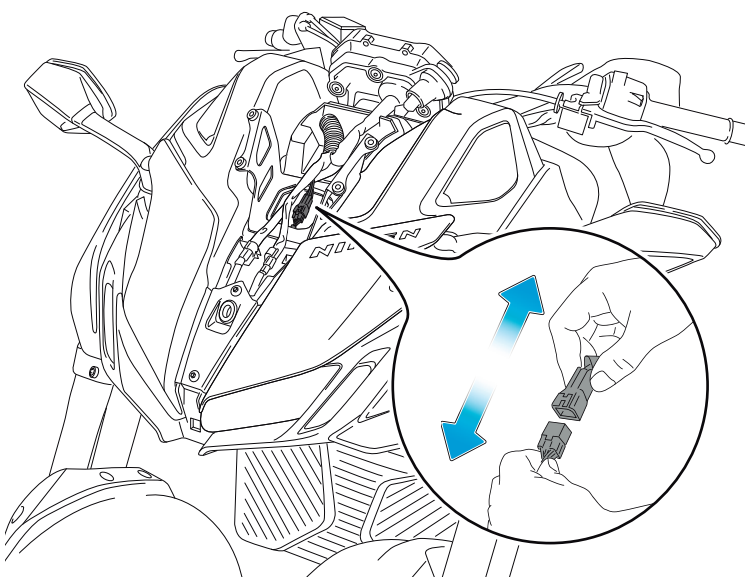

4

DISASSEMBLY

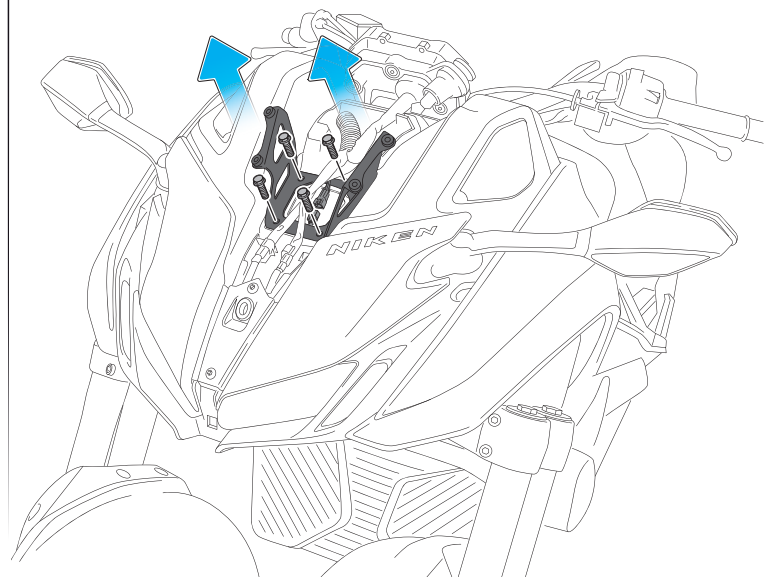

# YAMAHA NIKEN '18-

## MOUNTING INSTRUCTIONS

5

ASSEMBLY

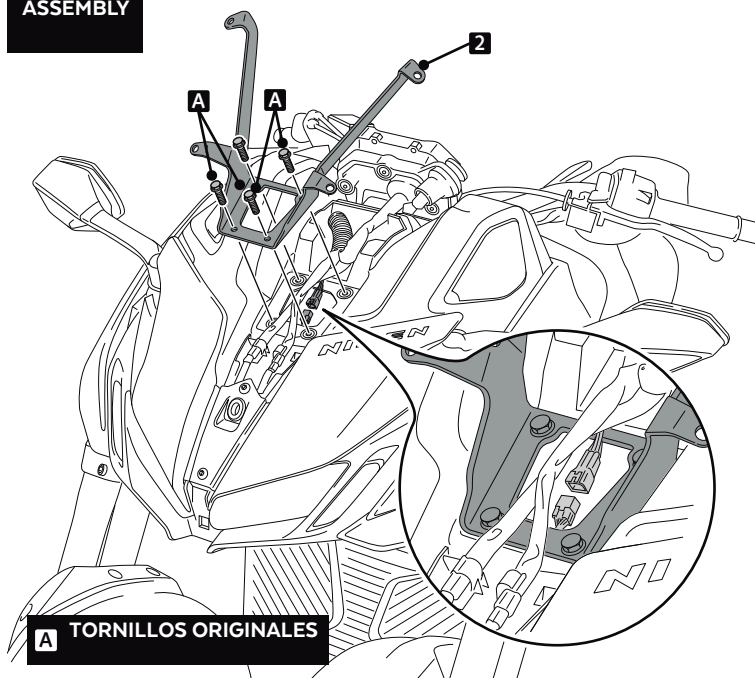

6

ASSEMBLY

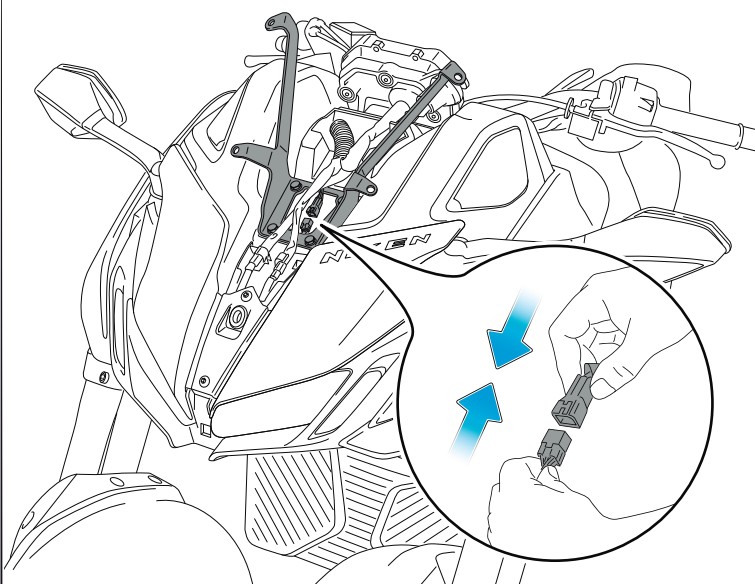

7

ASSEMBLY

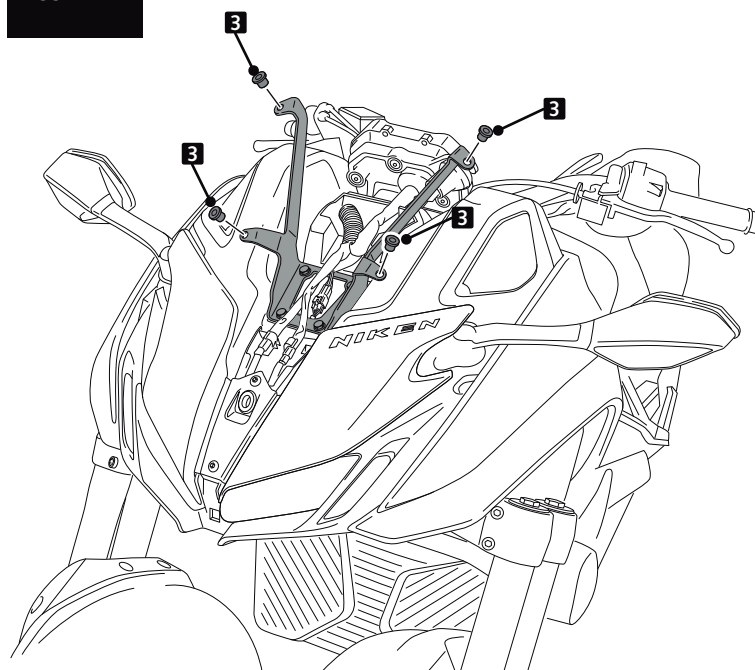

8

ASSEMBLY

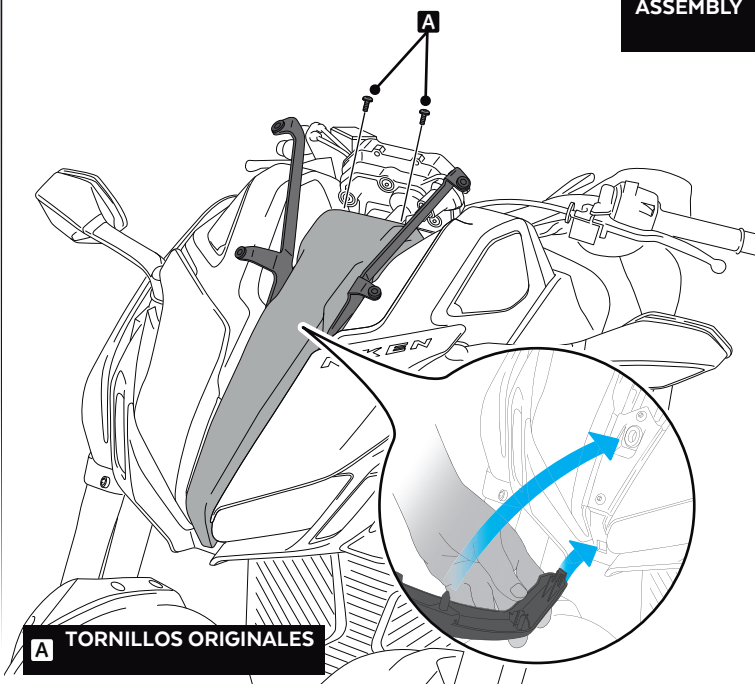

# YAMAHA NIKEN '18-

## MOUNTING INSTRUCTIONS

9

ASSEMBLY

