

YAMAHA MT-09 '21-

M O U N T I N G I N S T R U C T I O N S

REF 20671N

PHB19 PROTECTOR FRONT-AXLE



1 Person



15 min



EASY



TUBE







N° 10

RATCHET

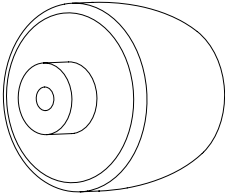
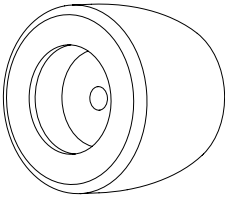

N° 10

ID.	PART	QTY.	REF.:
1		1	PROFOR11-3-0755
2		1	PROFOR56-3-0056
3		1	VARIFO21-1-0021
4		2	TUZBM6000000024
5		2	ARANDEPD125-054
6		2	FORTAPS17-18

YAMAHA MT-09 '21-

REF 20671N

MOUNTING INSTRUCTIONS

1

ASSEMBLY

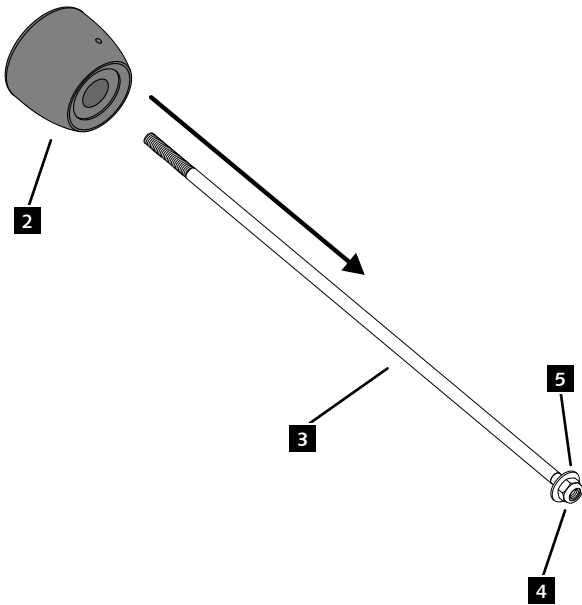

2

ASSEMBLY

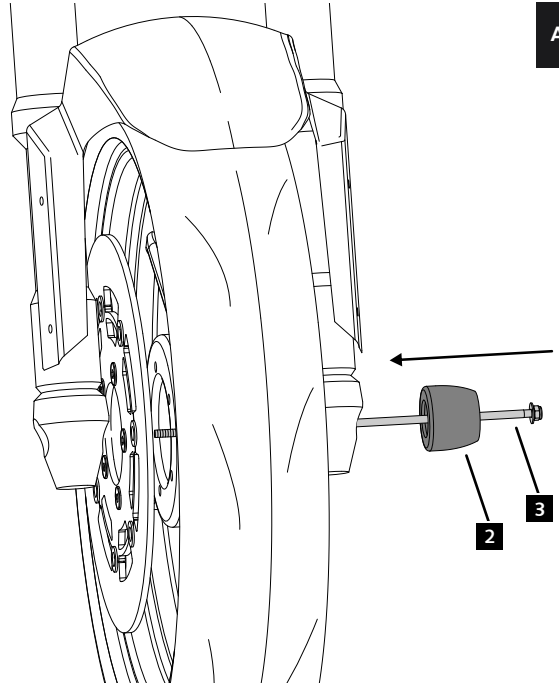

3

ASSEMBLY

