

HONDA CBR1000R '20

REF 20489N

LICENSE SUPPORT



1 Person









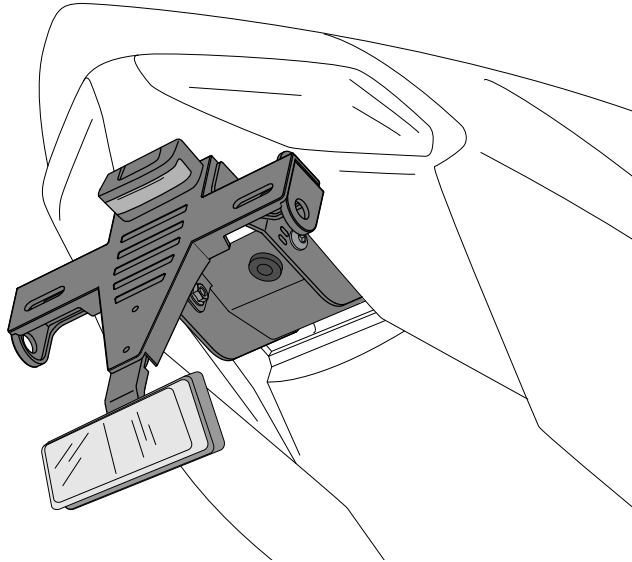

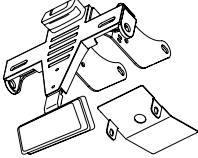

1 hour



INTERMEDIATE



Accessory verified in the basic configuration of the motorcycle. For models with extra factory settings. We cannot assure its compatibility, except for prior consultation. We decline any eventual claim.

ID.	PART	DESCRIPTION	QTY.	REF.:
1		License support	1	CONJUNTO--20489N
2		M5x11 DIN1001 screw (Black)	2	TORNI-AI----520
3		M5 DIN125/A washer (Black)	2	ARAND-----93
4		M5 DIN6923 nut (Black)	2	TUERC-D6923-255
5		Silentblock	1	SILENBGONE--064
6		Plastic bridle	5	BRIDAN100X2´5N
7		Back light	1	5577N
8		Reflector	1	4481R
9		M6 DIN1001 screw cap	4	TAPON-----85
10		M5 DIN1001 screw cap	3	TAPON-----86

HONDA CBR1000R '20

REF
20489N

MOUNTING INSTRUCTIONS

1

ASSEMBLY

A Original parts

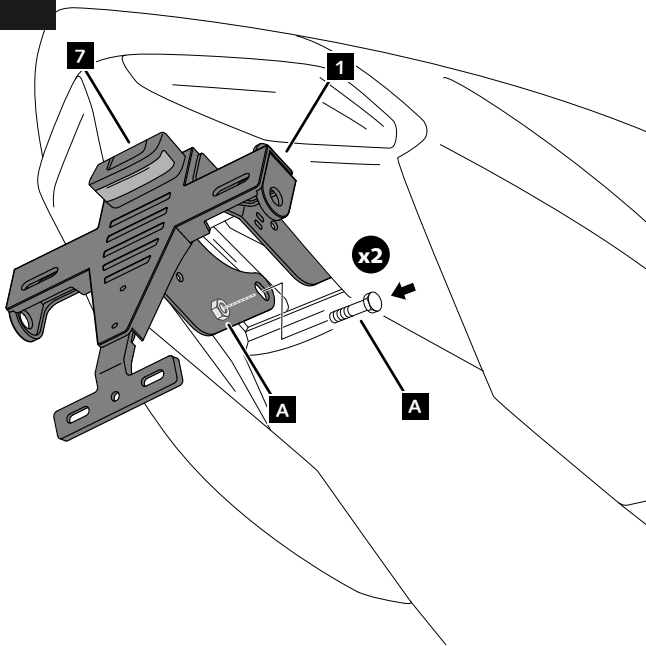

2

ASSEMBLY

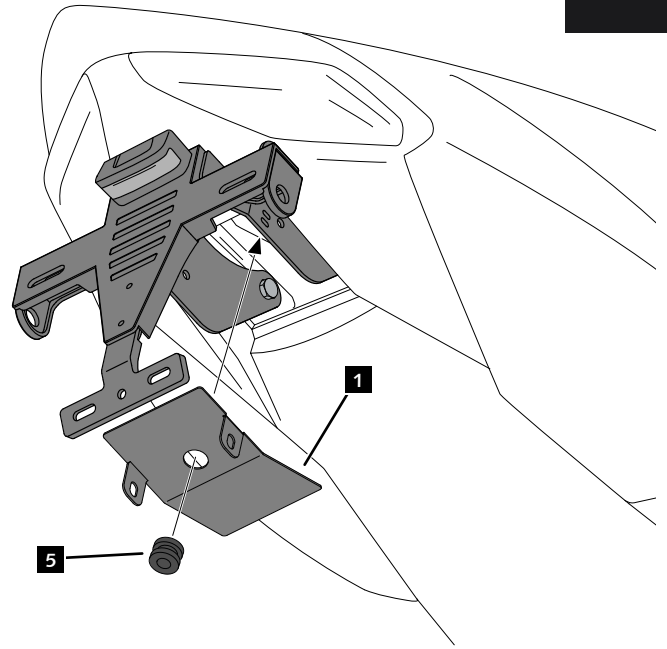

3

ASSEMBLY

INSERT THE METAL COVER INSIDE THE PLASTIC HOUSING

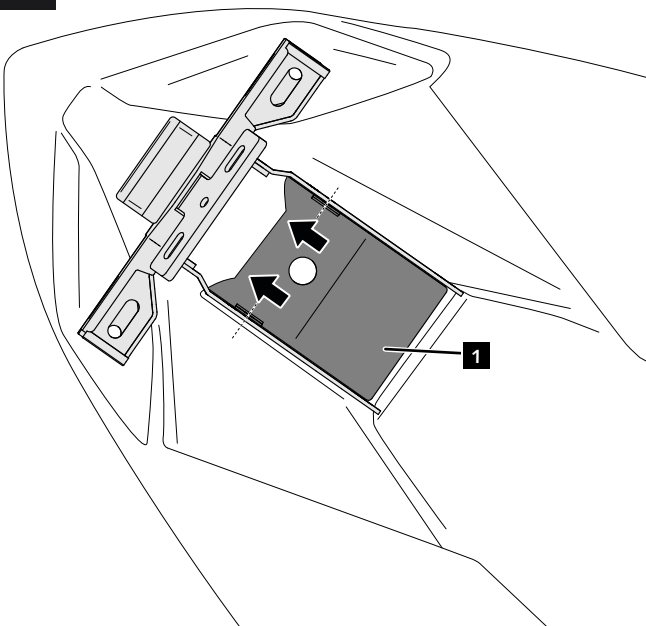

4

ASSEMBLY

