

# YAMAHA MT-07 TRACER '20-

## M O U N T I N G I N S T R U C T I O N S

REF 20433

**SPORT SCREEN**



PHILLIPS



ALLEN







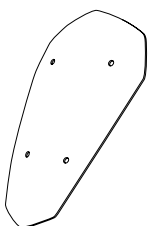

N° 3

FIX



N° 11

ID.	PART	DESCRIPTION	QTY.	REF.:
1		Sport screen	1	20433 W/H/F/NM3
2		M5x13 special screw hexagonal length 10	4	TORNI-EM5---514
3		Ø9xØ6x8mm silentblock	4	AROPASACABLES-3
4		Ø12xØ6,8x7,3 bush with blange	4	CASQUI-1A---750
5		M5x16 Ø11 ISO 7380 allen screw	4	TORNI-I7380-493
6		M5 ISO 7980 allen cap screw	4	TAPON-----85

# YAMAHA MT-07 TRACER '20-

## MOUNTING INSTRUCTIONS

**1**

DISASSEMBLY

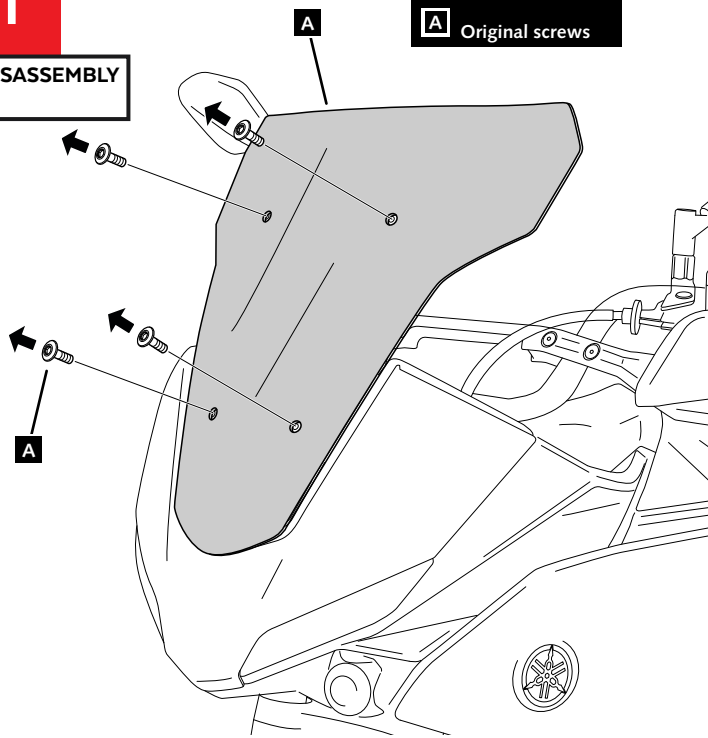

**2**

ASSEMBLY

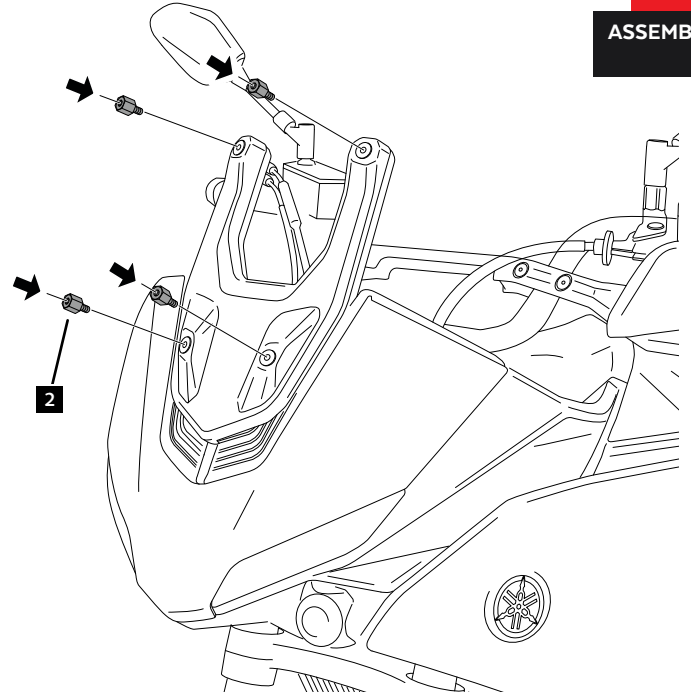

**3**

ASSEMBLY

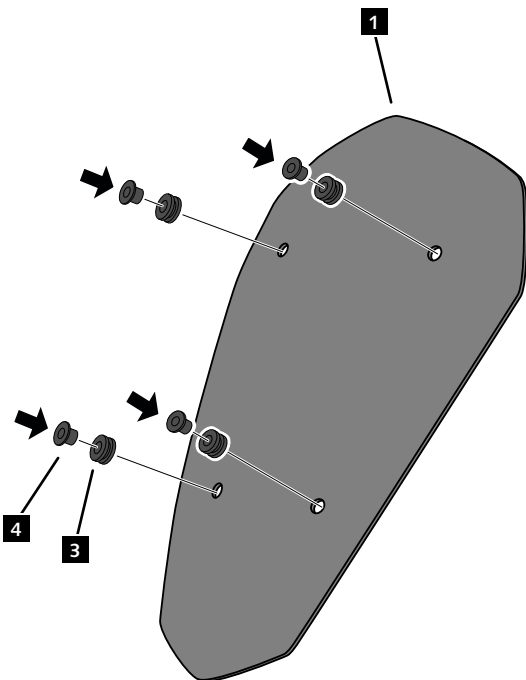

**4**

ASSEMBLY

