

BMW F900R '20-

M O U N T I N G I N S T R U C T I O N S

REF 20361

WINDSHIELD NG TOURING (PUIG SUPPORT)



NEED PUIG SUPPORT



ID	PART	DESCRIPTION	QTY	REF
1		TOURING screen	1	10776W/H/F/N
2		Metal upper support	1	SOPOR3P2-S20360
3		Right metal inferior suport	1	SOPOR3P2-IR20360
4		Left metal inferior suport	1	SOPOR3P2-IL20360
5		Reinforcement right metal support	1	SOPOR2P1-R20362
6		Reinforcement left metal support	1	SOPOR2P1-L20362
7		M8X50 DIN912 Allen screw	2	TORNI-D912--532
8		Ø8XØ14X7,5 arrowhead	2	CASQUI8147-0193
9		M5x9 special screw hexagonal lenght 10	2	TORNI-EM5---761
10		Ø9XØ6X8mm silentblock	5	AROPASACABLES-3
11		Ø12XØ6,8X7,3 bush with blange	5	CASQUI-1A---750
12		M5x11 Ø11 ISO 7380 Allen screw	6	TORNI-AI----520
13		M5x16 Ø11 ISO 7380 Allen screw	5	TORNI-I7380-493
14		M5 ISO 7380 Allen cap screw	11	TAPON-----85

BMW F900R '20-

MOUNTING INSTRUCTIONS

1

DISASSEMBLY

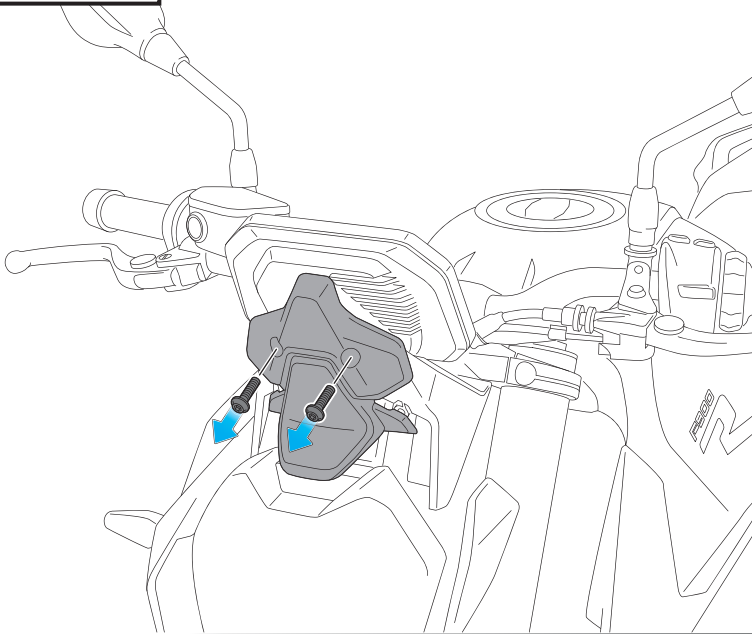

2

ASSEMBLY

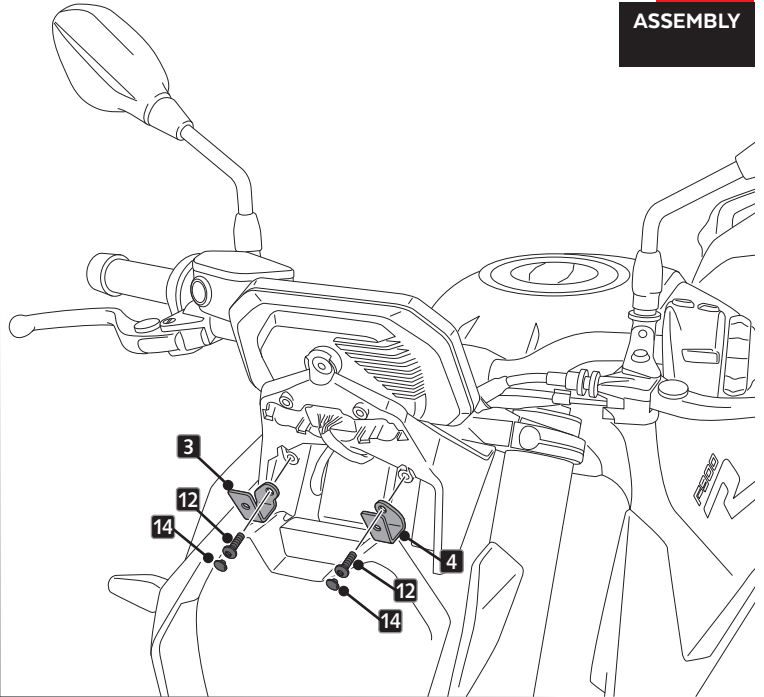

3

ASSEMBLY

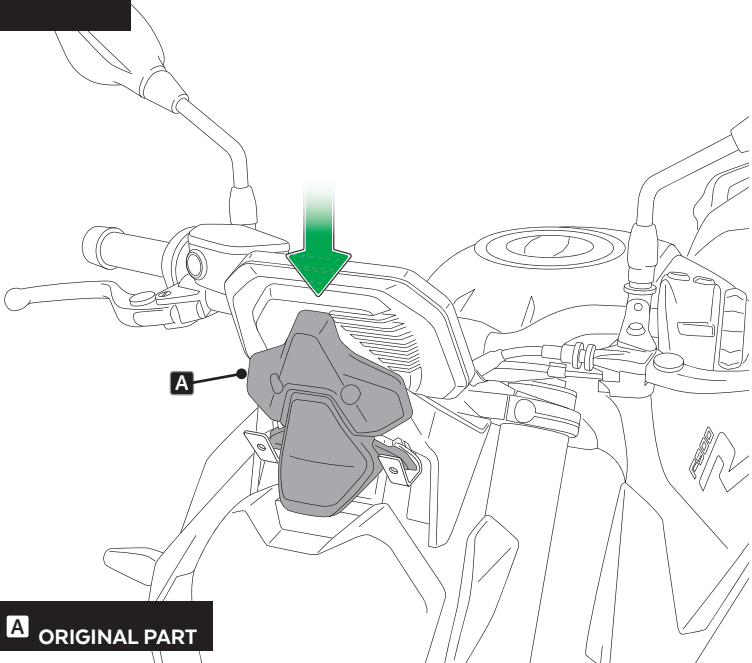

A ORIGINAL PART

4

ASSEMBLY

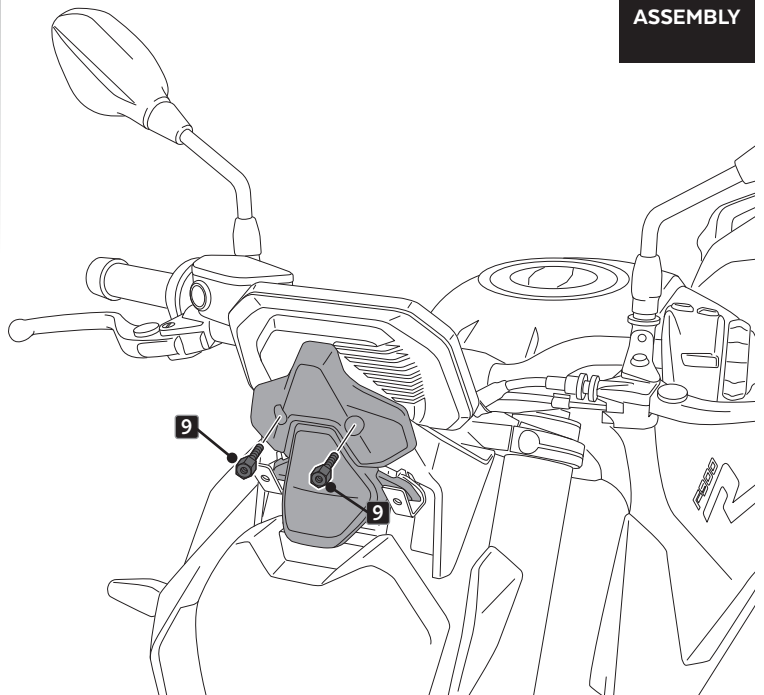

BMW F900R '20-

MOUNTING INSTRUCTIONS

5

ASSEMBLY

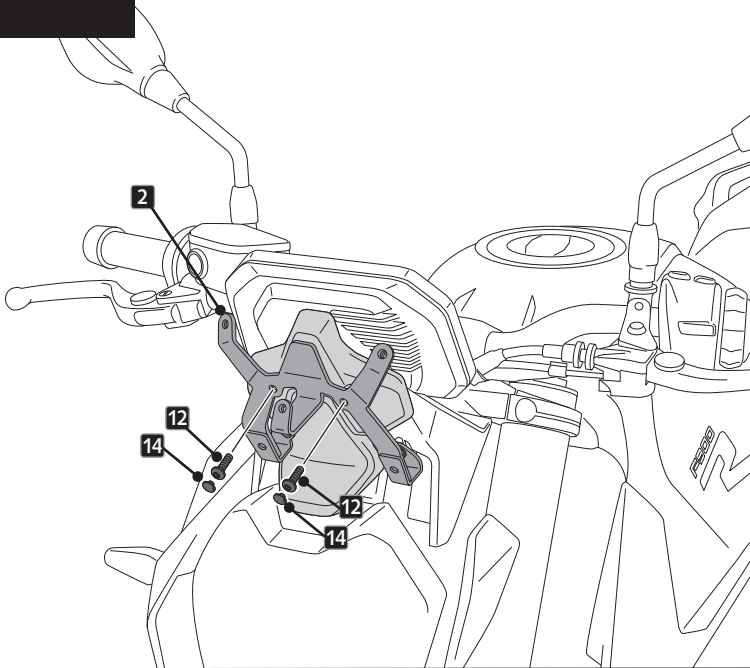

6

ASSEMBLY

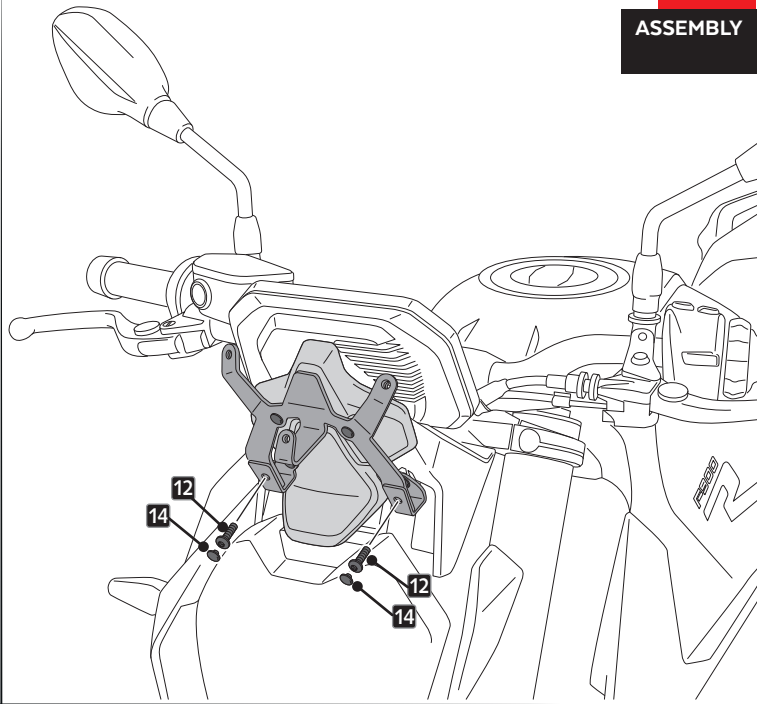

7

ASSEMBLY

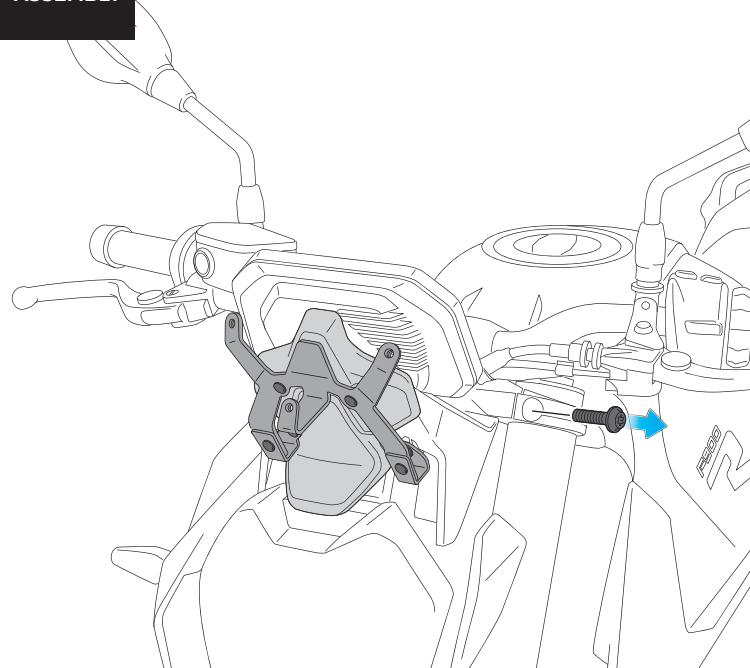

8

ASSEMBLY

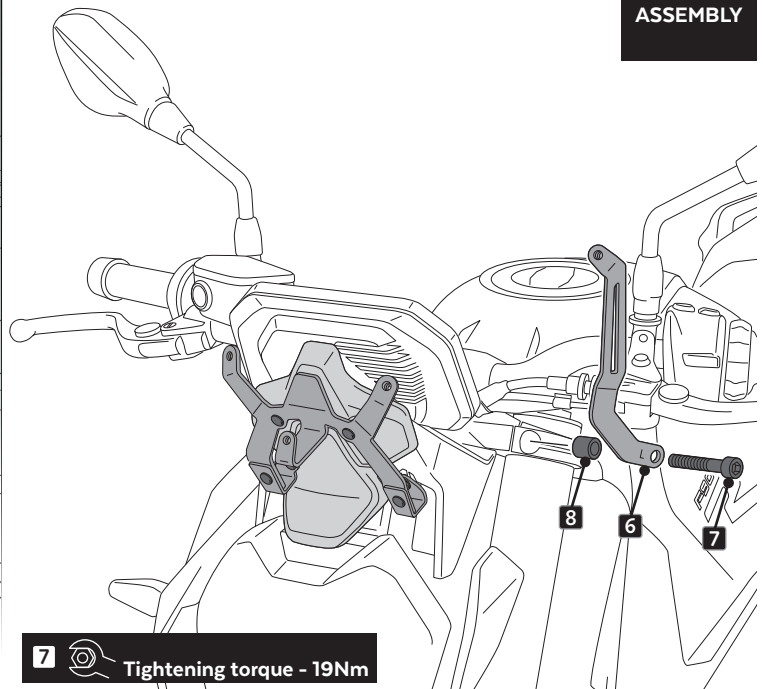

7  Tightening torque - 19Nm

BMW F900R '20-

MOUNTING INSTRUCTIONS

5

ASSEMBLY

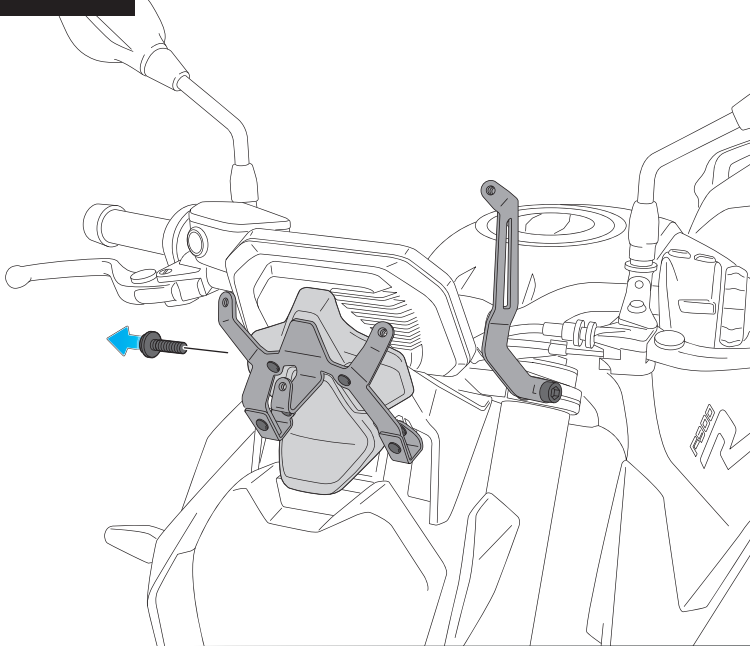

6

ASSEMBLY

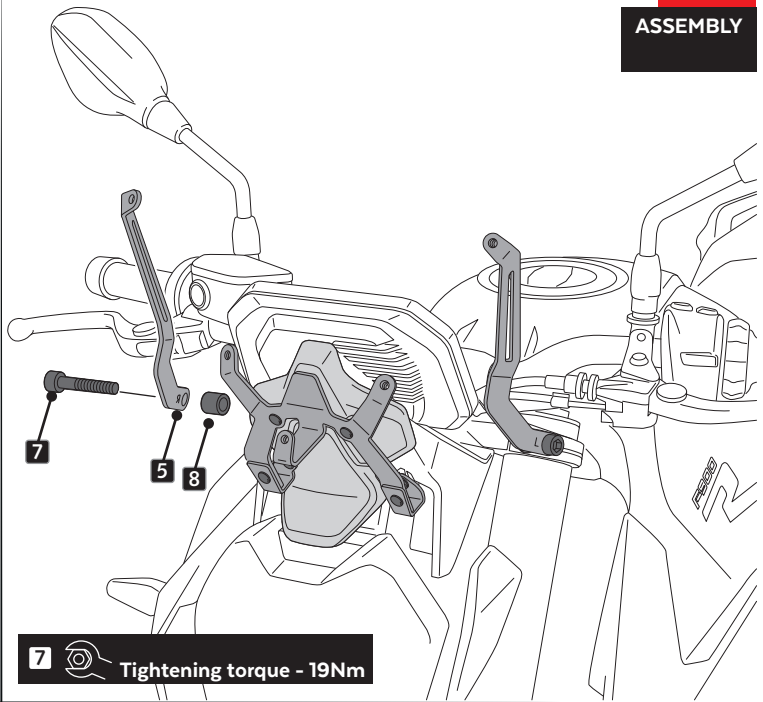

7

ASSEMBLY

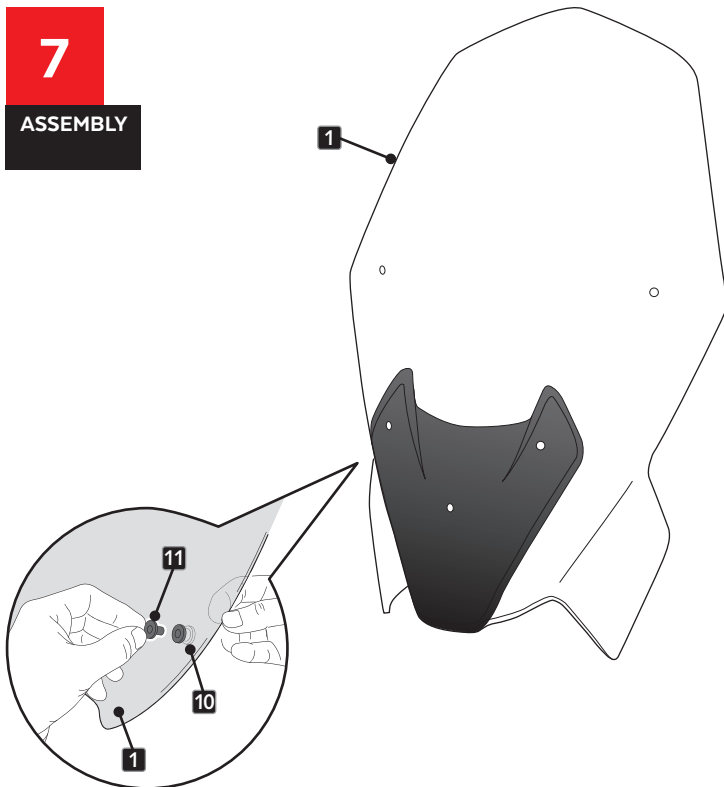

8

ASSEMBLY

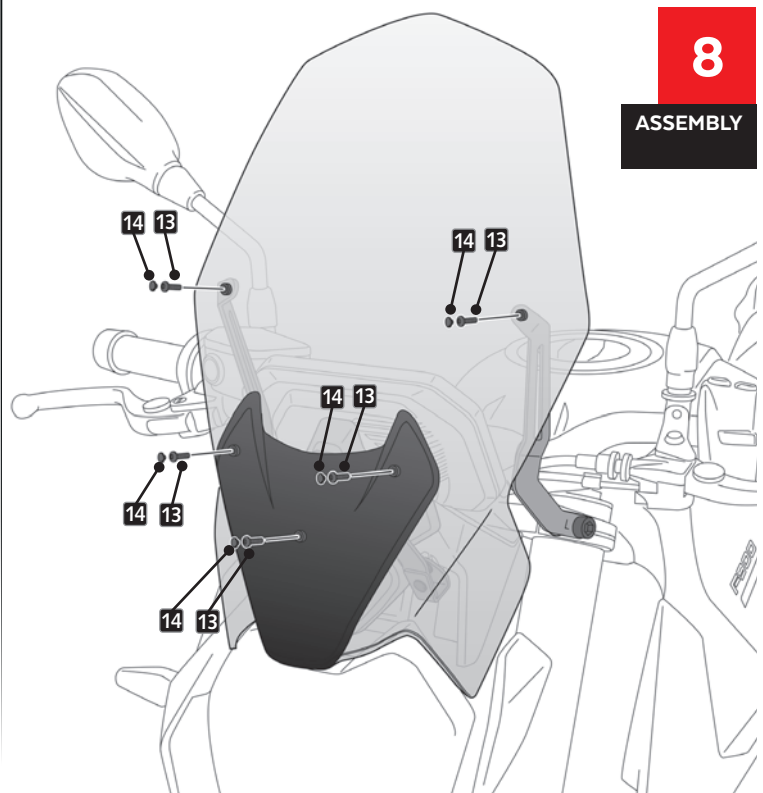

BMW F900R '20-

M O U N T I N G I N S T R U C T I O N S







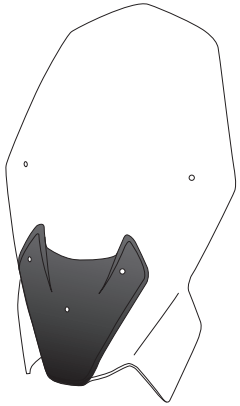
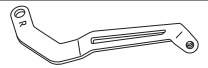
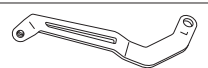

REF 20362

WINDSHIELD NG TOURING (OEM SUPPORT)



WITH ORIGINAL BMW SUPPORT



ID	PART	DESCRIPTION	QTY	REF
1		TOURING screen	1	10776W/H/F/N
2		Reinforcement right metal support	1	SOPOR2P1-R20362
3		Reinforcement left metal support	1	SOPOR2P1-L20362
4		M8X50 DIN912 Allen screw	2	TORNI-D912--532
5		Ø8XØ14X7,5 arrowhead	2	CASQUI8147-0193
6		M5x15 special screw hexagonal length 14	3	TORNI-EM5---513
7		Ø9XØ6X8mm silentblock	5	AROPASACABLES-3
8		Ø12XØ6,8X7,3 bush with blange	5	CASQUI-1A---750
9		M5x16 Ø11 ISO 7380 Allen screw	5	TORNI-I7380-493
10		M5 ISO 7380 Allen cap screw	5	TAPON-----85

BMW F900R '20-

MOUNTING INSTRUCTIONS

1

DISASSEMBLY

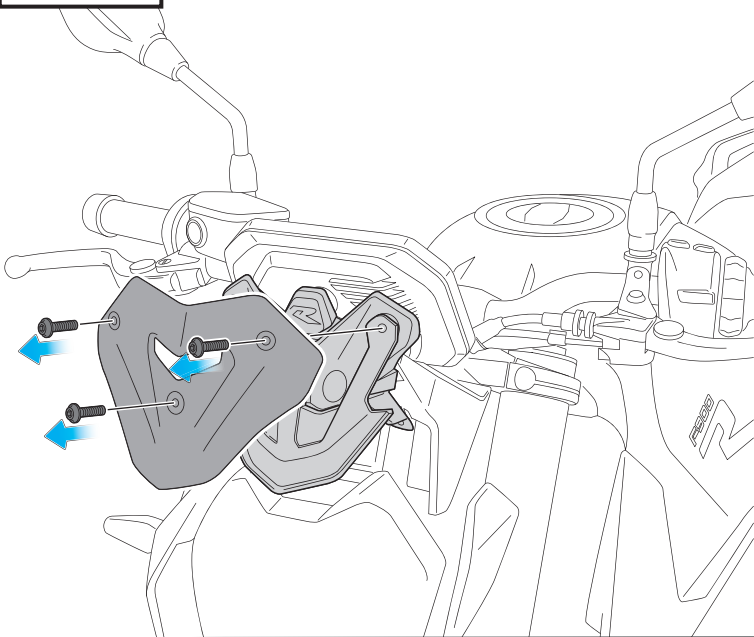

2

ASSEMBLY

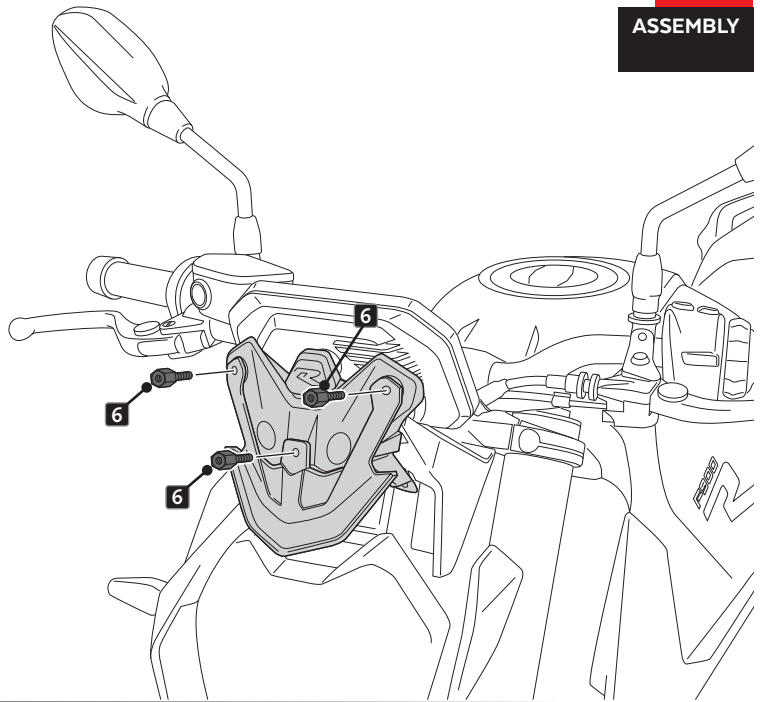

3

ASSEMBLY

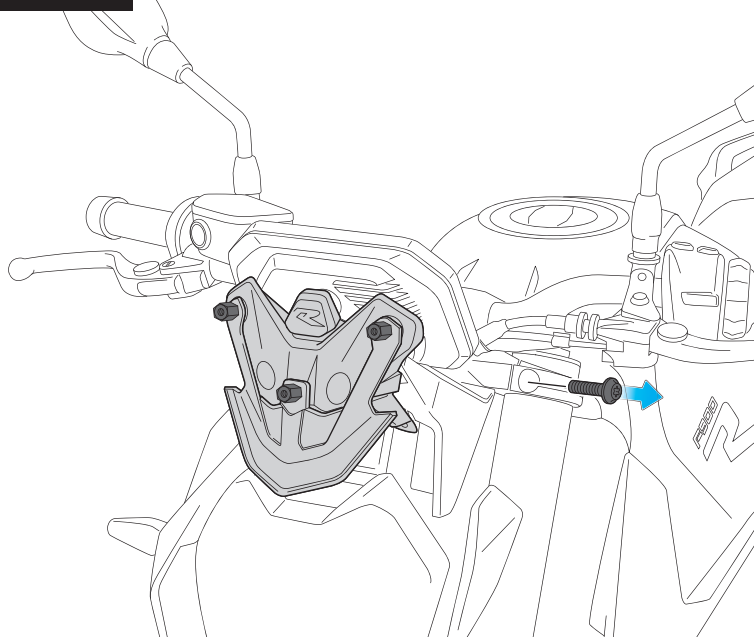

4

ASSEMBLY

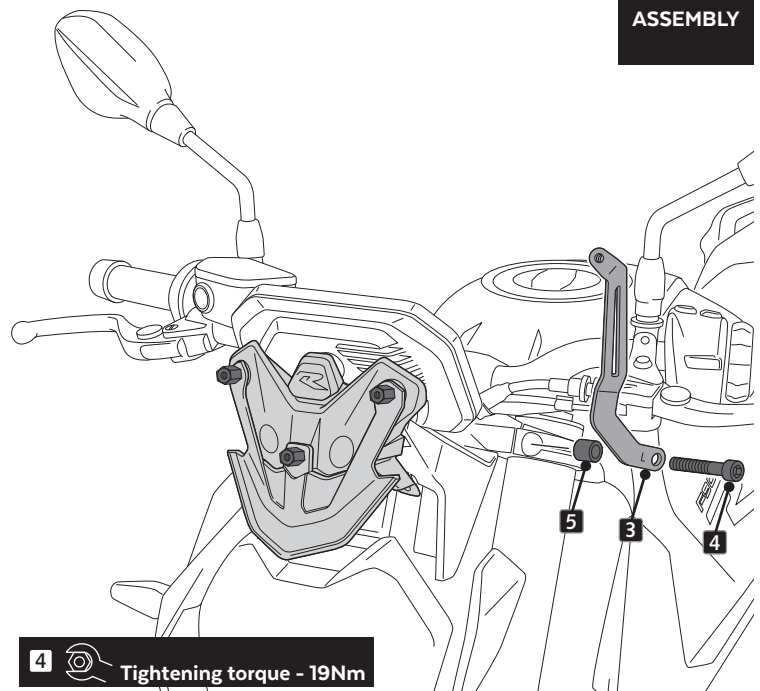

4  Tightening torque - 19Nm

BMW F900R '20-

MOUNTING INSTRUCTIONS

5

ASSEMBLY

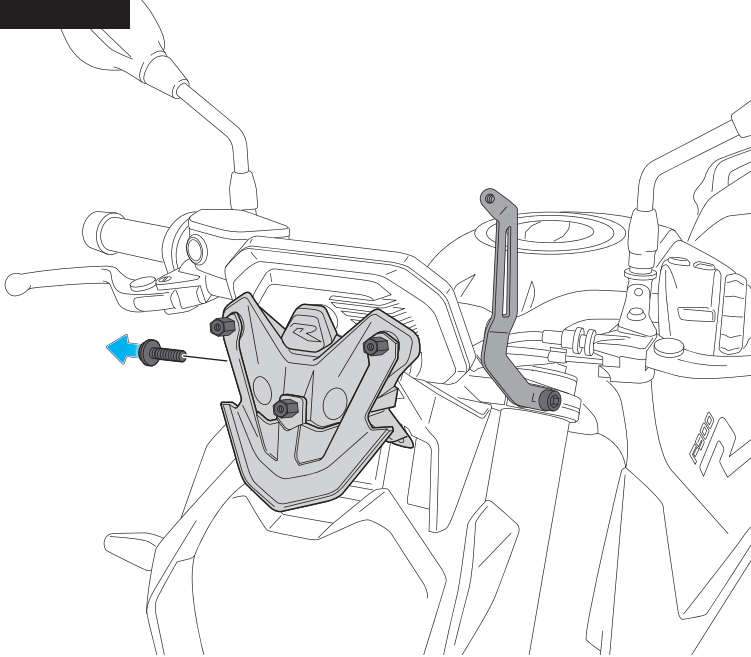

6

ASSEMBLY

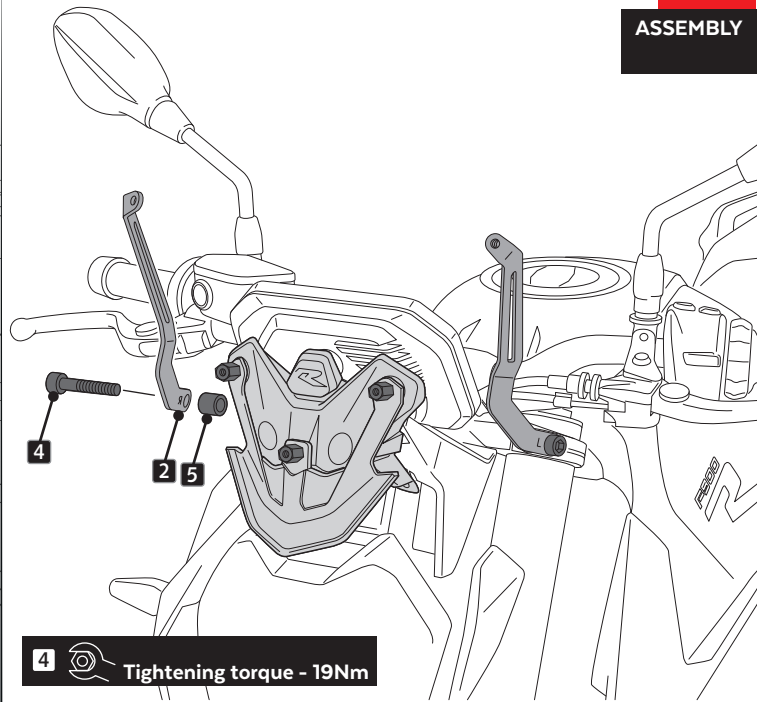

7

ASSEMBLY

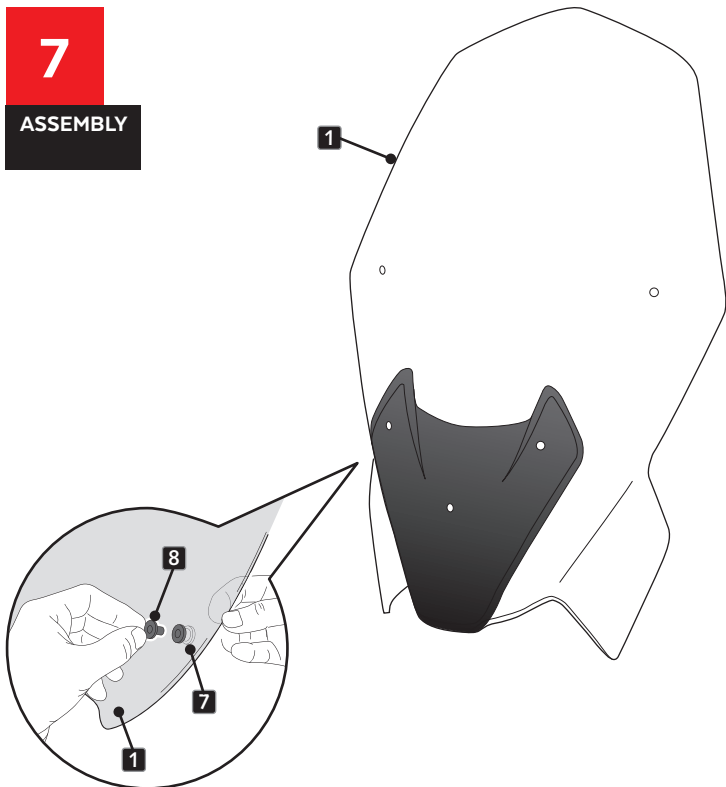

8

ASSEMBLY

