

# YAMAHA MT-03 '20-

## MOUNTING INSTRUCTIONS

REF 20285

**WINDSHIELD NAKED NEW GENERATION SPORT**



1 Person



15 min









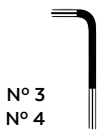

EASY

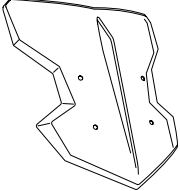
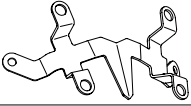

ALLEN



N° 3  
N° 4

ID.	PART	DESCRIPTION	QTY.	REF.:
1		SPORT screen	1	9376HUANHUI/W/F/H/ NM3
2		Support	1	SOP1P1----20285
3		Ø8x2 silicon adhesive spacer	1	ADHESI-GT-D8---
4		M6 ISO 7380 screw cap	2	TAPON-----86
5		M6x25 Ø14 ISO7380 Allen screw	2	TORNI-I7380-405
6		Ø8,5xØ13x3,5 Spacer	2	CASQUI-----775
7		M5 silentblock	4	SILENBTM5-046/1
8		M5x1 nylon washer	4	ARNV0000000245
9		M5x16 Ø11 ISO 7380 allen screw	4	TORNI-I7380-493
10		M5 ISO 7380 screw cap	4	TAPON-----85

# YAMAHA MT-03 '20-

## MOUNTING INSTRUCTIONS

**1**

DISASSEMBLY

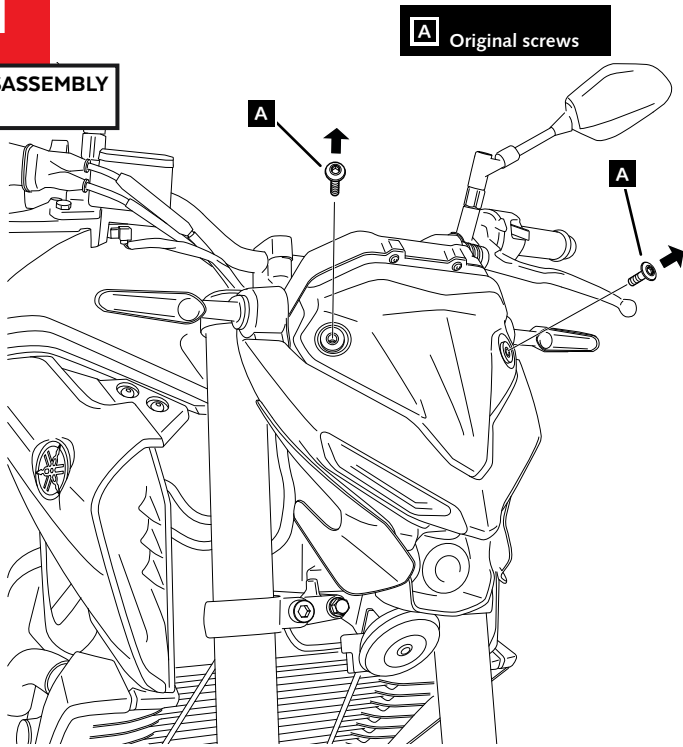

**2**

ASSEMBLY

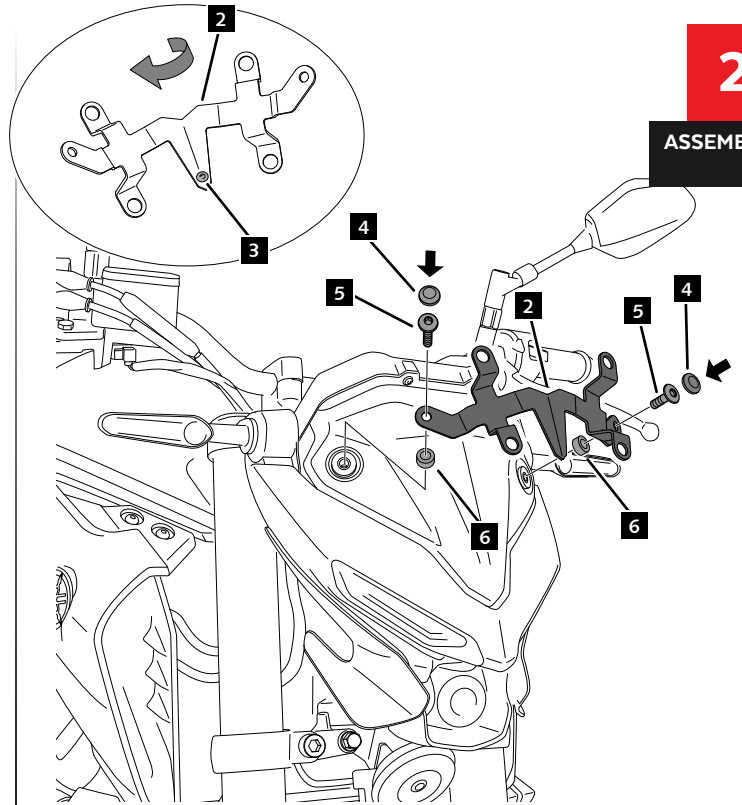

**3**

ASSEMBLY

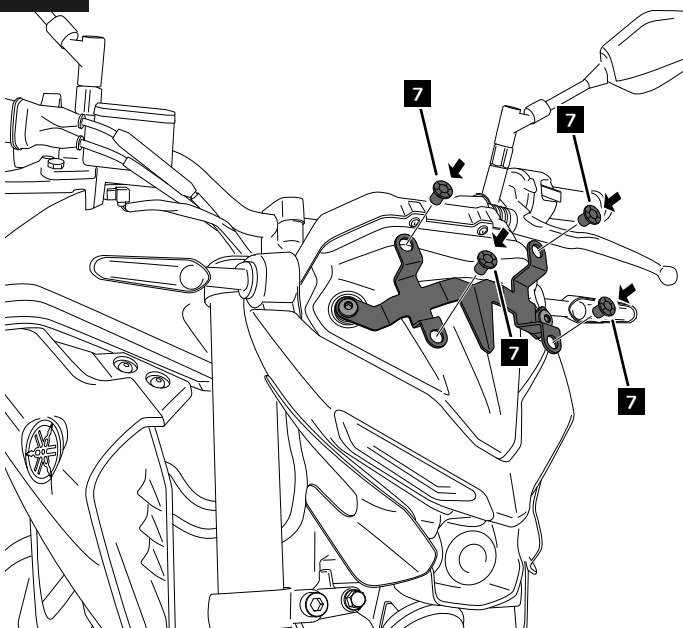

**4**

ASSEMBLY

