

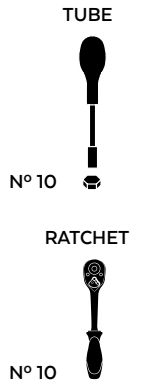

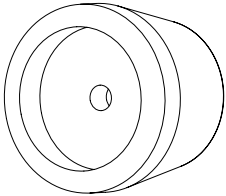
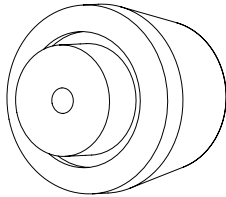

DUCATI PANIGALE V4 '18> DUCATI PANIGALE V2 '20>

REF 20058N

PHB19 PROTECTOR FRONT-AXLE



ID.	PART	QTY.	REF.:
1		1	PROFOR45-2-0789
2		1	PROFOR42-4-0786
3		1	VARIFO26-0-0026
4		2	TUZBM6000000024
5		2	ARANDEPD125-054
6		2	FORTAPS17-18

DUCATI PANIGALE V4 '18

MOUNTING INSTRUCTIONS

1

ASSEMBLY

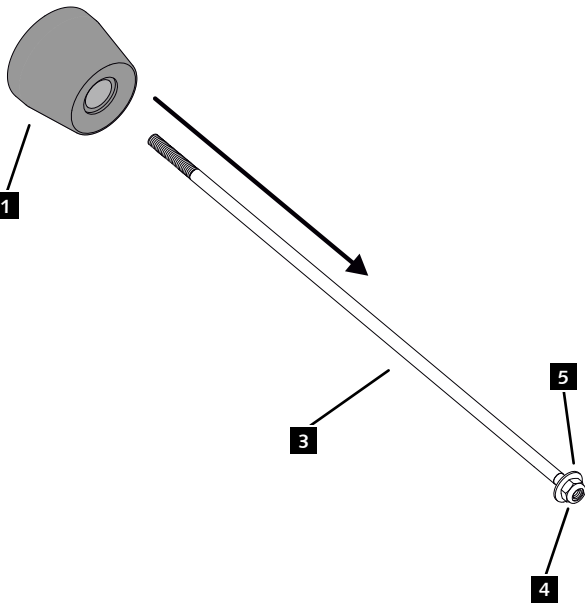

2

ASSEMBLY

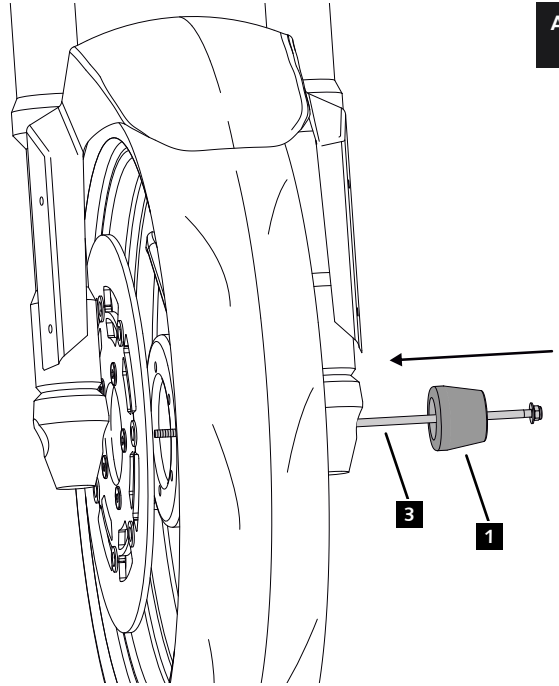

3

ASSEMBLY

