

HARLEY DAVIDSON SPORTSTER
CUSTOM (XL1200C) '04- / 883 IRON (XL883N) '09- /
883R (XL883R) '02- / NIGHTSER (XL1200N) '08- / SUPERLOW (XL883L) '11-

M O U N T I N G I N S T R U C T I O N S









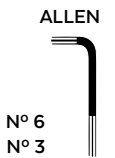





REF 1351

ABS
FRONT PLATE

REF 1352

ALUMINUM
FRONT PLATE



ID.	PART	DESCRIPTION	QTY.	REF.:
1		ABS front plate	1	10526J/C
		ALUMINUM front plate		9807P/N
2		Right metal support	1	SOPOR2P3-R-1352
3		Left metal support	1	SOPOR2P3-L-1352
4		M5 silentblock	2	SILENBTM5-046/1
5		M5x16 Ø 11 ISO7380 allen screw	2	TORNI-I7380-493
6		M5x16 Ø11 ISO 7380 allen screw (INOX)	2	TORNI-IA----423
7		M5x1 nylon washer	2	ARNV0000000245
8		M5 ISO7380 allen screw cap	2	TAPON-----85
9		M8x25 DIN912 screw	2	TORNI-D912--241
10		Ø13xØ8,5x6 arrowhead	2	CASQUI-----776
11		Ø8x2 mm silicone tear (Supplied already mounted on item ID2 & ID3)	4	ADHESI-GT-D8---
12		Self-adhesive trim length 190mm 6,2x2,6mm *ONLY FOR ALUMINUM FRONT PLATE (REF:9807)	4	PERFIL-PVC-1048
13		Stickers set	1	10535

**HARLEY DAVIDSON SPORTSTER
CUSTOM (XL1200C) '04- / 883 IRON (XL883N) '09- /
883R (XL883R) '02- / NIGHTSER (XL1200N) '08- / SUPERLOW (XL883L) '11-**

MOUNTING INSTRUCTIONS

1

DISASSEMBLY



DO NOT REMOVE THE SCREWS AT THE SAME TIME

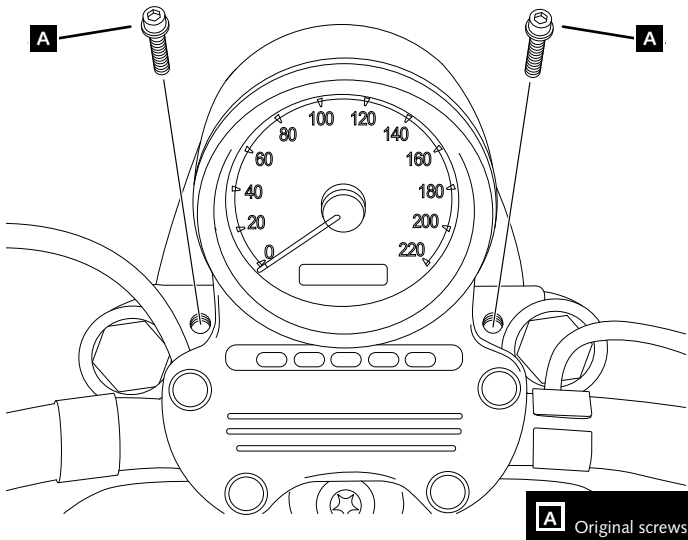

A Original screws

2

ASSEMBLY

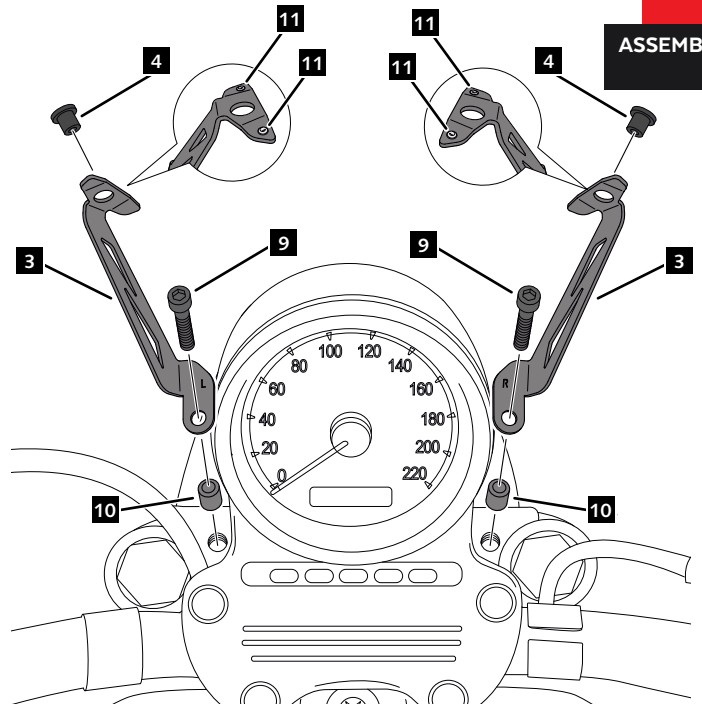

3

ASSEMBLY

ALUMINUM

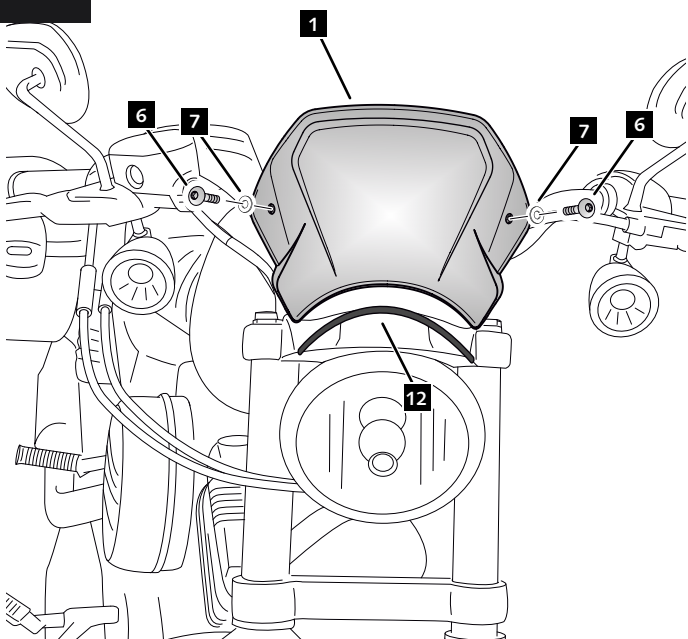

ABS

