



Planet Audio®

2018



Planet Audio®

IN-DASH



BLUETOOTH® | MP3-COMPATIBLE AM/FM RECEIVER
FEATURING 6.75" (171 mm) CAPACITIVE TOUCHSCREEN

PCP9900A

Apple CarPlay is the smarter, safer way to use iPhone® in your car. Apple CarPlay seamlessly integrates your iPhone® with the car's built-in display and controls. Now you can make phone calls, access your music, send and receive messages, get directions, and more while you stay focused on the road.

6.75"
WIDESCREEN

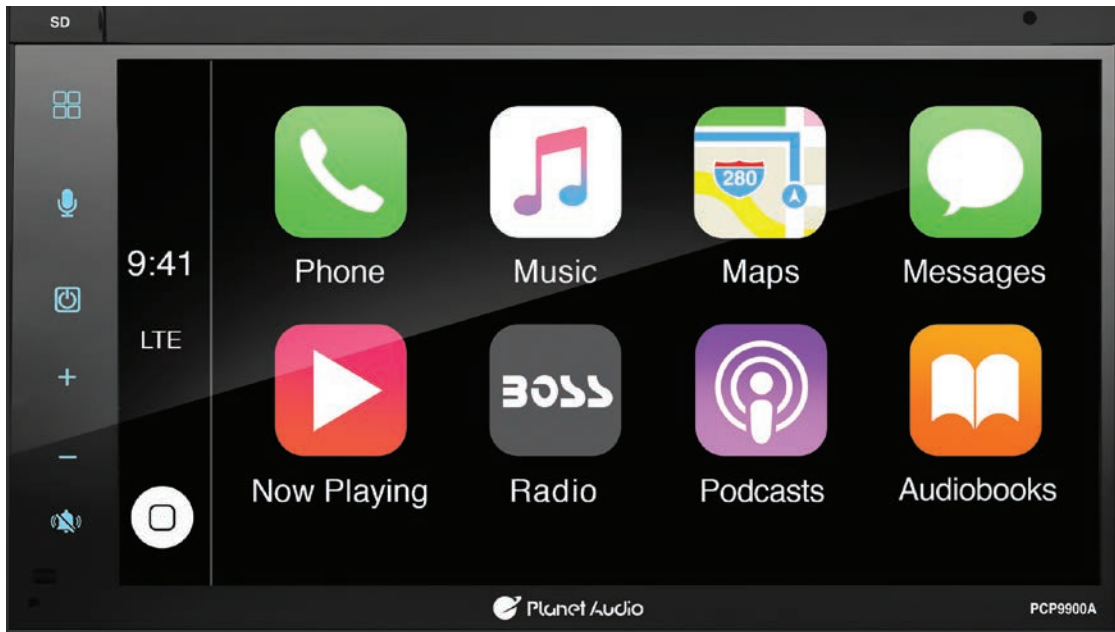

Hear The Music As The Artist Intended With Lossless Flac Playback. Capable Of 24-Bit/96 kHz Reproduction, Just Load Your Favorite FLAC Files Onto A USB/SD Drive And Enjoy! Hi-Resolution Audio Is Here And It Will Redefine How You Listen To Music!

TRUE
DOUBLE DIN
FIT



PLAYBACK

High-Resolution FLAC
MP3 / WMA / WAV
Bluetooth® Audio Streaming
(Stream and Control Your Favorite Music Apps)

INPUTS & OUTPUTS

Bluetooth® Hands-Free
USB Port
USB Charging (1A)
Aux-In
Compatible with Audio Output of iPod®/iPhone®, Smartphones, and MP3 Players
Front, Rear, Sub Pre-Amp Outputs
Rear Camera Input

GENERAL

Capacitive Touchscreen
Selectable Illumination Color
Steering Wheel Controls*
(Interface not included)
Switchable US & Europe Tuner Frequencies
RBDS Tuner
Update via USB
80 Watts x 4 Channel

*Steering wheel interface control not applicable with all vehicles.
iPod® and iPhone® are registered trademarks of Apple, Inc., in the U.S. and other countries.
The Bluetooth® word mark and logos are registered trademarks owned by Bluetooth SIG, Inc. and any use of such marks by Planet Audio is under license. Other trademarks and trade names are those of their respective owners.





Planet Audio®

IN-DASH



BLUETOOTH® | MP3-COMPATIBLE AM/FM RECEIVER
FEATURING 6.75" (171 mm) CAPACITIVE TOUCHSCREEN

PCP9800A

Apple CarPlay is the smarter, safer way to use iPhone® in your car. Apple CarPlay seamlessly integrates your iPhone® with the car's built-in display and controls. Now you can make phone calls, access your music, send and receive messages, get directions, and more while you stay focused on the road.



6.75"
WIDESCREEN

Hear The Music As The Artist Intended With Lossless Flac Playback. Capable Of 24-Bit/96 kHz Reproduction, Just Load Your Favorite FLAC Files Onto A USB/SD Drive And Enjoy! Hi-Resolution Audio Is Here And It Will Redefine How You Listen To Music!



PLAYBACK

High-Resolution FLAC
MP3 / WMA / WAV
Bluetooth® Audio Streaming
(Stream and Control Your Favorite Music Apps)

INPUTS & OUTPUTS

Bluetooth® Hands-Free
USB Port
USB Charging (1A)
Aux-In
Compatible with Audio Output of iPod®/iPhone®, Smartphones, and MP3 Players
Front, Rear, Sub Pre-Amp Outputs
Rear Camera Input

GENERAL

Capacitive Touchscreen
Selectable Illumination Color
Steering Wheel Controls*
(Interface not included)
Switchable US & Europe Tuner Frequencies
RBDS Tuner
Update via USB
80 Watts x 4 Channel

*Steering wheel interface control not applicable with all vehicles.
iPod® and iPhone® are registered trademarks of Apple, Inc., in the U.S. and other countries.
The Bluetooth® word mark and logos are registered trademarks owned by Bluetooth SIG, Inc. and any use of such marks by Planet Audio is under license. Other trademarks and trade names are those of their respective owners.





BLUETOOTH® | MP3-COMPATIBLE AM/FM RECEIVER
FEATURING 6.75" (171 mm) CAPACITIVE TOUCHSCREEN

PCP9800

Apple CarPlay is the smarter, safer way to use iPhone® in your car. Apple CarPlay seamlessly integrates your iPhone® with the car's built-in display and controls. Now you can make phone calls, access your music, send and receive messages, get directions, and more while you stay focused on the road.



6.75"
WIDESCREEN

Hear The Music As The Artist Intended With Lossless Flac Playback. Capable Of 24-Bit/96 kHz Reproduction, Just Load Your Favorite FLAC Files Onto A USB/SD Drive And Enjoy! Hi-Resolution Audio Is Here And It Will Redefine How You Listen To Music!



PLAYBACK

High-Resolution FLAC
 MP3 / WMA / WAV
Bluetooth® Audio Streaming
 (Stream and Control Your Favorite Music Apps)

INPUTS & OUTPUTS

Bluetooth® Hands-Free
 USB Port
 USB Charging (1A)
 Aux-In
 Compatible with Audio Output of iPod®/iPhone®, Smartphones, and MP3 Players
 Front, Rear, Sub Pre-Amp Outputs
 Rear Camera Input

GENERAL

Capacitive Touchscreen
 Selectable Illumination Color
 Steering Wheel Controls*
 (Interface not included)
 Switchable US & Europe Tuner Frequencies
 RBDS Tuner
 Update via USB
 80 Watts x 4 Channel

*Steering wheel interface control not applicable with all vehicles.
 iPod® and iPhone® are registered trademarks of Apple, Inc., in the U.S. and other countries.
 The Bluetooth® word mark and logos are registered trademarks owned by Bluetooth SIG, Inc. and any use of such marks by Planet Audio is under license. Other trademarks and trade names are those of their respective owners.





Planet Audio®

IN-DASH

BLUETOOTH® | IN-DASH DOUBLE-DIN DVD/MP3 CD AM/FM RECEIVER
FEATURING 6.2" (157 mm) WIDESCREEN TOUCHSCREEN DIGITAL TFT LCD MONITOR

PNV9674



6.2"
WIDESCREEN



BUILT-IN NAVIGATION WITH MAP COVERAGE OF ALL 50 STATES, AND PUERTO RICO. PLUS PRE-LOADED POINTS-OF-INTEREST • TEXT TO SPEECH AND INNOVATIVE GRAPHIC INTERFACE

Hear The Music As The Artist Intended With Lossless Flac Playback. Capable Of 24-Bit/96 kHz Reproduction, Just Load Your Favorite Flac Files Onto A USB/SD Drive And Enjoy! Hi-Resolution Audio Is Here And It Will Redefine How You Listen To Music!



PLAYBACK

DVD±R/RW Video
CD±R/RW Audio & Video
High-Resolution Audio at 24bit/96kHz FLAC
MP3 / WMA
Bluetooth® Audio Streaming
(Stream and Control Your Favorite Music Apps)

INPUTS & OUTPUTS

Bluetooth® Hands-Free
USB Port
USB Charging (1A)**
Aux-In
Compatible with Audio Output of iPod®/iPhone®, Smartphones, and MP3 Players
Video Output
Front, Rear, Sub Pre-Amp Outputs
Rear Camera Input

GENERAL

AM/FM Receiver
Touchscreen
Remote Control
Steering Wheel Control Interface*
US & Europe Switchable
Tuner Frequencies
RBDS Tuner
80 Watts x 4 Channel

*Steering wheel interface control not applicable with all vehicles.

**Charging Only. Not for mobile device playback.

iPod® and iPhone® are registered trademarks of Apple, Inc., in the U.S. and other countries.

The Bluetooth® word mark and logos are registered trademarks owned by Bluetooth SIG, Inc. and any use of such marks by Planet Audio is under license. Other trademarks and trade names are those of their respective owners.



BLUETOOTH® | IN-DASH DOUBLE-DIN DVD/MP3 CD AM/FM RECEIVER
 FEATURING 6.2" (157 mm) WIDESCREEN TOUCHSCREEN DIGITAL TFT LCD MONITOR

P9640BRC



6.2"
WIDESCREEN



REAR-VIEW FLUSH MOUNT
 High Resolution Color Camera
 On-screen Display Distance Guide



PLAYBACK

DVD±R/RW Video
 CD±R/RW Audio & Video
 MP3 / WMA
Bluetooth® Audio Streaming
 (Stream and Control Your Favorite Music Apps)

INPUTS & OUTPUTS

Bluetooth® Hands-Free
 USB Port
 SD Port
 Aux-In
Compatible with Audio Output of iPod®/iPhone®, Smartphones, and MP3 Players
 Video Output
 Front, Rear, Sub Pre-Amp Outputs
 Rear Camera Input

GENERAL

AM/FM Receiver
Touchscreen
 Remote Control
 Steering Wheel Control Interface*
 US & Europe Switchable
 Tuner Frequencies
 RDS Tuner
 80 Watts x 4 Channel
REAR-VIEW CAMERA
 High Resolution Color Camera
 Flush Mount and Hanging Mount
 On-screen Display Distance Guide
 Low Light Visibility
 Weather Proof
 Wide Angle View
 NTSC Output

*Steering wheel interface control not applicable with all vehicles.
 iPod® and iPhone® are registered trademarks of Apple, Inc., in the U.S. and other countries.
 The Bluetooth® word mark and logos are registered trademarks owned by Bluetooth SIG, Inc. and any use of such marks by Planet Audio is under license. Other trademarks and trade names are those of their respective owners.





Planet Audio®

IN-DASH

BLUETOOTH® | IN-DASH DOUBLE-DIN DVD/MP3 CD AM/FM RECEIVER
FEATURING 6.2" (157 mm) WIDESCREEN TOUCHSCREEN DIGITAL TFT LCD MONITOR

P9640B



6.2"
WIDESCREEN



PLAYBACK

DVD±R/RW Video
CD±R/RW Audio & Video
MP3 / WMA
Bluetooth® Audio Streaming
(Stream and Control Your Favorite Music Apps)

INPUTS & OUTPUTS

Bluetooth® Hands-Free
USB Port
SD Port
Aux-In
Compatible with Audio Output of iPod®/iPhone®, Smartphones, and MP3 Players
Video Output
Front, Rear, Sub Pre-Amp Outputs
Rear Camera Input

GENERAL

AM/FM Receiver
Touchscreen
Remote Control
Steering Wheel Control Interface*
US & Europe Switchable
Tuner Frequencies
RDS Tuner
80 Watts x 4 Channel

*Steering wheel interface control not applicable with all vehicles.

iPod® and iPhone® are registered trademarks of Apple, Inc., in the U.S. and other countries.
The Bluetooth® word mark and logos are registered trademarks owned by Bluetooth SIG, Inc. and any use of such marks by Planet Audio is under license. Other trademarks and trade names are those of their respective owners.





Planet Audio

IN-DASH

BLUETOOTH® | IN-DASH DOUBLE-DIN DVD/MP3 CD AM/FM RECEIVER
FEATURING 6.2" (157 mm) WIDESCREEN TOUCHSCREEN DIGITAL TFT LCD MONITOR

P9630B



6.2"
WIDESCREEN



SD . USB . AUX



PLAYBACK

DVD±R/RW Video
CD±R/RW Audio & Video
MP3 / WMA
Bluetooth® Audio Streaming
(Stream and Control Your Favorite Music Apps)

INPUTS & OUTPUTS

Bluetooth® Hands-Free
USB Port
USB Charging (1A)**
SD Port
Aux-In
Compatible with Audio Output of iPod®/iPhone®, Smartphones, and MP3 Players
Video Output
Front, Rear, Sub Pre-Amp Outputs
Rear Camera Input

GENERAL

AM/FM Receiver
Touchscreen
Remote Control
Steering Wheel Control Interface*
US & Europe Switchable
Tuner Frequencies
80 Watts x 4 Channel

*Steering wheel interface control not applicable with all vehicles.

**Charging Only. Not for mobile device playback.
iPod® and iPhone® are registered trademarks of Apple, Inc., in the U.S. and other countries.

The Bluetooth® word, mark and logos are registered trademarks owned by Bluetooth SIG, Inc. and any use of such marks by Planet Audio is under license. Other trademarks and trade names are those of their respective owners.





Planet Audio®

IN-DASH

BLUETOOTH® | IN-DASH DOUBLE-DIN DVD/MP3 CD AM/FM RECEIVER
FEATURING 6.2" (157 mm) WIDESCREEN TOUCHSCREEN DIGITAL TFT LCD MONITOR

P9628B



6.2"
WIDESCREEN



PLAYBACK

DVD±R/RW Video
CD±R/RW Audio & Video
MP3 / WMA
Bluetooth® Audio Streaming
(Stream and Control Your Favorite Music Apps)

INPUTS & OUTPUTS

Bluetooth® Hands-Free
USB Port
USB Charging (1A)**
SD Port
Aux-In
Compatible with Audio Output of iPod®/iPhone®, Smartphones, and MP3 Players
Video Output
Front, Rear, Sub Pre-Amp Outputs
Rear Camera Input

GENERAL

AM/FM Receiver
Touchscreen
Remote Control
Steering Wheel Control Interface*
US & Europe Switchable
Tuner Frequencies
80 Watts x 4 Channel

*Steering wheel interface control not applicable with all vehicles.

**Charging Only. Not for mobile device playback.
iPod® and iPhone® are registered trademarks of Apple, Inc., in the U.S. and other countries.
The Bluetooth® word mark and logos are registered trademarks owned by Bluetooth SIG, Inc. and any use of such marks by Planet Audio is under license. Other trademarks and trade names are those of their respective owners.





Planet Audio®

IN-DASH

BLUETOOTH® | IN-DASH MOTORIZED SINGLE-DIN DVD/MP3 CD AM/FM RECEIVER
FEATURING 7" (178 mm) WIDESCREEN TOUCHSCREEN DIGITAL TFT LCD MONITOR

P9759B



7"
WIDESCREEN

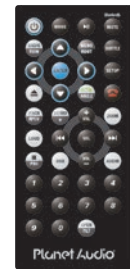

FULL DETACHABLE FRONT PANEL

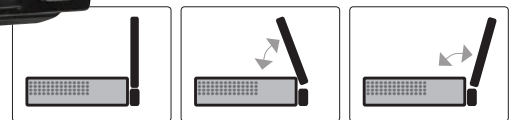

MOTORIZED, MULTIPLE VIEW ANGLES



PLAYBACK

DVD±R/RW Video
CD±R/RW Audio & Video
MP3 / WMA
Bluetooth® Audio Streaming
(Stream and Control Your Favorite Music Apps)

INPUTS & OUTPUTS

Bluetooth® Hands-Free
USB Ports
USB Charging (1A)**
SD Port
Aux-In
Compatible with Audio Output of iPod®/iPhone®, Smartphones, and MP3 Players
Video Output
Front, Rear, Sub Pre-Amp Outputs
Rear Camera Input

GENERAL

AM/FM Receiver
Touchscreen
Remote Control
Steering Wheel Control Interface*
US & Europe Switchable
Tuner Frequencies
RDS Tuner
85 Watts x 4 Channel

*Steering wheel interface control not applicable with all vehicles.

**Charging Only. Not for mobile device playback.
iPod® and iPhone® are registered trademarks of Apple, Inc., in the U.S. and other countries.
The Bluetooth® word mark and logos are registered trademarks owned by Bluetooth SIG, Inc. and any use of such marks by Planet Audio is under license. Other trademarks and trade names are those of their respective owners.





Planet Audio®

IN-DASH

BLUETOOTH® | IN-DASH DOUBLE-DIN
MP3 CD AM/FM RECEIVER

PB475RGB



PLAYBACK

CD±R/RW Audio
MP3 / WMA
Bluetooth® Audio Streaming
(Stream and Control Your Favorite Music Apps)

INPUTS & OUTPUTS

Bluetooth® Hands-Free
USB Port
USB Charging (1A)**
SD Port
Aux-In
Compatible with Audio Output of iPod®/iPhone®, Smartphones, and MP3 Players
Front, Rear, Sub Pre-Amp Outputs

GENERAL

AM/FM Receiver
Remote Control
US & Europe Switchable
Tuner Frequencies
80 Watts x 4 Channel

*Steering wheel interface control not applicable with all vehicles.
**Charging Only. Not for mobile device playback.
iPod® and iPhone® are registered trademarks of Apple, Inc., in the U.S. and other countries.
The Bluetooth® word mark and logos are registered trademarks owned by Bluetooth SIG, Inc. and any use of such marks by Planet Audio is under license. Other trademarks and trade names are those of their respective owners.





Planet Audio®

IN-DASH

**BLUETOOTH® | IN-DASH SINGLE-DIN
MP3-COMPATIBLE CD AM/FM RECEIVER**

P385UAB



PLAYBACK

CD±R/RW Audio
MP3 / WMA
Bluetooth® Audio Streaming
(Stream and Control Your Favorite Music Apps)

INPUTS & OUTPUTS

Bluetooth® Hands-Free
USB Port
USB Charging (1A)**
SD Port
Aux-In
Compatible with Audio Output of iPod®/iPhone®, Smartphones, and MP3 Players

GENERAL

AM/FM Receiver
Remote Control
US & Europe Switchable
Tuner Frequencies
50 Watts x 4 Channel

*Steering wheel interface control not applicable with all vehicles.

**Charging Only. Not for mobile device playback.
iPod® and iPhone® are registered trademarks of Apple, Inc., in the U.S. and other countries.
The Bluetooth® word mark and logos are registered trademarks owned by Bluetooth SIG, Inc. and any use of such marks by Planet Audio is under license. Other trademarks and trade names are those of their respective owners.





Planet Audio®

IN-DASH

BLUETOOTH® | IN-DASH DOUBLE-DIN MP3 COMPATIBLE DIGITAL MEDIA AM/FM RECEIVER
FEATURING 6.5" (165 mm) WIDESCREEN TOUCHSCREEN DIGITAL TFT LCD MONITOR

P650MB



6.5"
WIDESCREEN



PLAYBACK

MP3 / WMA
Bluetooth® Audio Streaming
(Stream and Control Your Favorite Music Apps)

INPUTS & OUTPUTS

Bluetooth® Hands-Free
USB Port
USB Charging (1A)**
SD Port
Aux-In
Compatible with Audio Output of iPod®/iPhone®, Smartphones, and MP3 Players
Video Output
Front, Rear, Sub Pre-Amp Outputs
Rear Camera Input

GENERAL

AM/FM Receiver
Touchscreen
Remote Control
Steering Wheel Control Interface*
US & Europe Switchable Tuner Frequencies
80 Watts x 4 Channel

*Steering wheel interface control not applicable with all vehicles.
**Charging Only. Not for mobile device playback.
iPod® and iPhone® are registered trademarks of Apple, Inc., in the U.S. and other countries.
The Bluetooth® word mark and logos are registered trademarks owned by Bluetooth SIG, Inc. and any use of such marks by Planet Audio is under license. Other trademarks and trade names are those of their respective owners.





Planet Audio®

IN-DASH

**BLUETOOTH® | IN-DASH DOUBLE-DIN
MP3-COMPATIBLE DIGITAL MEDIA AM/FM RECEIVER**

PB455RGB



PLAYBACK

MP3 / WMA
Bluetooth® Audio Streaming
(Stream and Control Your Favorite Music Apps)

INPUTS & OUTPUTS

Bluetooth® Hands-Free
USB Port
USB Charging (1A)**
SD Port
Aux-In
Compatible with Audio Output of iPod®/iPhone®, Smartphones, and MP3 Players
Front, Rear, Pre-Amp Outputs
Front and Rear only

GENERAL

AM/FM Receiver
Remote Control
US & Europe Switchable
Tuner Frequencies
60 Watts x 4 Channel

*Steering wheel interface control not applicable with all vehicles.
**Charging Only. Not for mobile device playback.
iPod® and iPhone® are registered trademarks of Apple, Inc., in the U.S. and other countries.
The Bluetooth® word mark and logos are registered trademarks owned by Bluetooth SIG, Inc. and any use of such marks by Planet Audio is under license. Other trademarks and trade names are those of their respective owners.





Planet Audio®

IN-DASH

**BLUETOOTH® | IN-DASH SINGLE-DIN
MP3-COMPATIBLE DIGITAL MEDIA AM/FM RECEIVER**

P370MB



PLAYBACK

MP3 / WMA
Bluetooth® Audio Streaming
(Stream and Control Your Favorite Music Apps)

INPUTS & OUTPUTS

Bluetooth® Hands-Free
USB Port
USB Charging (1A)**
SD Port
Aux-In
Compatible with Audio Output of iPod®/iPhone®, Smartphones, and MP3 Players
Front, Rear, Pre-Amp Outputs
Front and Rear Only

GENERAL

AM/FM Receiver
Remote Control
US & Europe Switchable
Tuner Frequencies
50 Watts x 4 Channel

*Steering wheel interface control not applicable with all vehicles.

**Charging Only. Not for mobile device playback. iPod® and iPhone® are registered trademarks of Apple, Inc., in the U.S. and other countries.

The Bluetooth® word mark and logos are registered trademarks owned by Bluetooth SIG, Inc. and any use of such marks by Planet Audio is under license. Other trademarks and trade names are those of their respective owners.





Planet Audio®

FLIP-DOWN MONITOR



INCLUDES TWO PAIRS OF
DUAL-CHANNEL WIRELESS
HEADPHONES*



12.1" WIDESCREEN FLIP-DOWN TFT MONITOR
FEATURING BUILT-IN DVD PLAYER WITH MULTI-COLOR HOUSING OPTIONS
AND TWO PAIRS OF DUAL CHANNEL HEADPHONES

P12.1ES



12.1"
TFT MONITOR

CUSTOMIZE YOUR MONITOR
HOUSING COLOR TO MATCH THE
INTERIOR OF YOUR VEHICLE
(INTERCHANGEABLE BLACK, GREY,
TAN HOUSING INCLUDED)



PLAYBACK

DVD±R/RW Video
CD±R/RW Audio & Video
MP3

INPUTS & OUTPUTS

USB Port
SD Port
A/V In/Out

*WARNING: This product contains DEHP,
a phthalate chemical known to the State of
California to cause birth defects and other
reproductive harm. (Headphones only)

GENERAL

1280 x 800 Resolution
Widescreen TFT LCD Display
Dual Channel IR Transmitter
Interchangeable Colored Housing
Wireless Remote Control
FM Transmitter



CLOSED POSITION



30° SWIVEL ROTATION





Planet Audio®

FLIP-DOWN MONITOR



INCLUDES TWO PAIRS OF DUAL-CHANNEL WIRELESS HEADPHONES*



11.2" WIDESCREEN FLIP-DOWN TFT MONITOR
FEATURING BUILT-IN DVD PLAYER WITH MULTI-COLOR HOUSING OPTIONS
AND TWO PAIRS OF DUAL CHANNEL HEADPHONES

P11.2ES



11.2"
TFT MONITOR

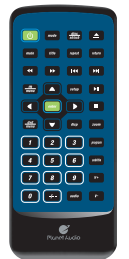

CUSTOMIZE YOUR MONITOR HOUSING COLOR TO MATCH THE INTERIOR OF YOUR VEHICLE (INTERCHANGEABLE BLACK, GREY, TAN HOUSING INCLUDED)



PLAYBACK

DVD±R/RW Video
CD±R/RW Audio & Video
MP3

INPUTS & OUTPUTS

USB Port
SD Port
A/V In/Out

*WARNING: This product contains DEHP, a phthalate chemical known to the State of California to cause birth defects and other reproductive harm. (Headphones only)

GENERAL

1024 x 600 Resolution
Widescreen TFT LCD Display
Dual Channel IR Transmitter
Interchangeable Colored Housing
Wireless Remote Control
FM Transmitter



CLOSED POSITION



30° SWIVEL ROTATION





Planet Audio®

FLIP-DOWN MONITOR



INCLUDES TWO PAIRS OF
DUAL-CHANNEL WIRELESS
HEADPHONES*



10.1" WIDESCREEN FLIP-DOWN TFT MONITOR
FEATURING BUILT-IN DVD PLAYER WITH MULTI-COLOR HOUSING OPTIONS
AND TWO PAIRS OF DUAL CHANNEL HEADPHONES

P10.1ES



10.1"
TFT MONITOR

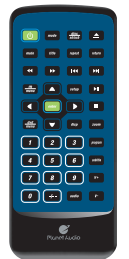

CUSTOMIZE YOUR MONITOR
HOUSING COLOR TO MATCH THE
INTERIOR OF YOUR VEHICLE
(INTERCHANGEABLE BLACK, GREY,
TAN HOUSING INCLUDED)



PLAYBACK

DVD±R/RW Video
CD±R/RW Audio & Video
MP3

INPUTS & OUTPUTS

USB Port
SD Port
A/V In/Out

*WARNING: This product contains DEHP,
a phthalate chemical known to the State of
California to cause birth defects and other
reproductive harm. (Headphones only)

GENERAL

1024 x 600 Resolution
Widescreen TFT LCD Display
Dual Channel IR Transmitter
Interchangeable Colored Housing
Wireless Remote Control
FM Transmitter



CLOSED POSITION



30° SWIVEL ROTATION





Planet Audio®

HEADREST

UNIVERSAL HEADREST WITH PRE-INSTALLED 7" (178 mm) WIDESCREEN TFT VIDEO MONITOR WITH BUILT-IN DVD PLAYER

PH7ACD



P-LINK

P-LINK Connectivity for iPhone requires an HD cable and Lightning® Digital A/V Adapter, both sold separately and not included. Android devices require an HD cable and compatible MHL® adapter. Cables and adapters are not included and sold separately. Compatibility with all Android devices is not guaranteed, please refer to our website for the latest list of devices.



PLAYBACK

DVD±R/RW Video
 CD±R/RW Audio & Video
 MP3

INPUTS & OUTPUTS

HD Digital A/V Input
 USB Port
 Compatible with Audio Output of
 iPod®/iPhone®, Smartphones
 and MP3 players
 A/V In/Out
 Headphone Output

GENERAL

1920 x 1080 Resolution
 Wireless Remote Control
 Dual Channel IR Transmitter
 Three Interchangeable
 Pillow Covers
 IR Transmitter
 FM Transmitter

iPod® and iPhone® are trademarks
 of Apple, Inc. registered in the U.S. and
 other countries.



EASY TO CHANGE PILLOW COVERS
 IN BLACK, GREY AND TAN



BUILT-IN DVD PLAYER





UNIVERSAL HEADREST WITH PRE-INSTALLED 7" (178 mm)
WIDESCREEN TFT VIDEO MONITOR

PH7MCS



7"
WIDESCREEN



REMOTE CONTROL

LED BACKLIT SCREEN FOR
BETTER PICTURE QUALITY,
LONGER LIFE AND BETTER
ENERGY EFFICIENCY



INPUTS & OUTPUTS

Compatible with Audio Output of
iPod®/iPhone®, Smartphones
and MP3 players
A/V Input
Headphone Output

GENERAL

800 x 480 Resolution
Wireless Remote Control
Dual Channel IR Transmitter
Three Interchangeable
Pillow Covers
IR Transmitter

iPod® and iPhone® are trademarks
of Apple, Inc. registered in the U.S. and
other countries.



EASY TO CHANGE PILLOW COVERS
IN BLACK, GREY AND TAN



COMPATIBLE MATCHING HEADREST
MONITOR WITH DVD [PH7ACD]
SOLD SEPARATELY





IPX6
WATERPROOF

PGR45B
BLUETOOTH® | IN-DASH MARINE GAUGE
DIGITAL MEDIA AM/FM RECEIVER
FEATURING BUILT IN 4-CH AMPLIFIER | 60W x 4 CHANNELS



INCLUDES 2 TRIM
BEZEL STYLES



ADD A PGR42R WIRED
REMOTE CONTROL
(SOLD SEPARATELY)

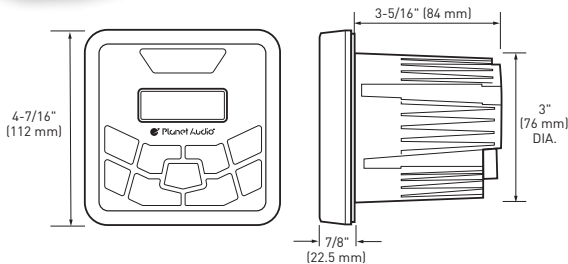

PLAYBACK

MP3 / WMA

BLUETOOTH® Audio Streaming

{Stream and Control your
Favorite Music APPs}

INPUTS & OUTPUTS

USB Port

Aux-In

USB Charging (1A)**

Compatible with Audio Output of
iPod®/iPhone®, Smartphones,
and MP3 Players

Front, Rear/Sub Pre-Amp Outputs

GENERAL

Wired Remote Ready

2 Trim Bezels Included

IPX6-Rated

NOAA Weather Band

Illuminated Soft Touch Buttons

Switchable US & Europe

Tuner Frequencies

RDS Tuner

Conformal Coated PCB

UV Protected Front Panel

Zero Current Draw Memory

*(Retains Radio Preset Memory
in case of Vehicle Battery
Disconnect)*

Cutout Diameter: 3" (76 mm)

Output Power: 60 W x 4 CH

**Charging Only. Not for mobile device playback.

iPod® and iPhone® are registered trademarks of Apple, Inc., in the U.S. and other countries.

The Bluetooth® word mark and logos are registered trademarks owned by Bluetooth SIG, Inc. and any use of such marks by Planet Audio is under license. Other trademarks and trade names are those of their respective owners.



IPX6
WATERPROOF

PGR42R

WIRED REMOTE CONTROL
COMPATIBLE WITH PGR45B BLUETOOTH® MARINE GAUGE
DIGITAL MEDIA AM/FM RECEIVER (SOLD SEPARATELY)

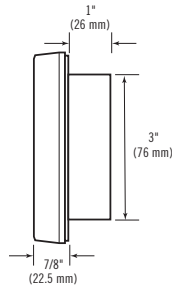
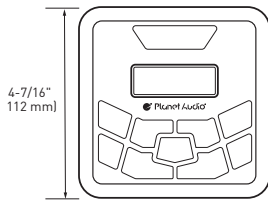

INCLUDES 2 TRIM BEZEL STYLES



COMPATIBLE WITH
PLANET AUDIO PGR45B
(SOLD SEPARATELY)

FEATURES

- Compatible with PGR45B
- 2 Trim Bezels Included
- Optional 25ft Extension Cable (PGR25C) Available-Sold Separately
- IPX6
- Illuminated Soft Touch Buttons
- Conformal Coated PCB
- Shallow Mounting Depth
- Cutout Diameter: 3" (76 mm)



PGR25C

REMOTE CONTROL CABLE
OPTIONAL 25 FT. EXTENSION CABLE FOR PGR42R

COMBINED = UP TO 100 FT.





Planet Audio®

POWERSPORTS

exceed your expectations



BLUETOOTH® | IN-DASH MARINE GAUGE
DIGITAL MEDIA AM/FM RECEIVER | BUILT-IN AMPLIFIER

PGR35B

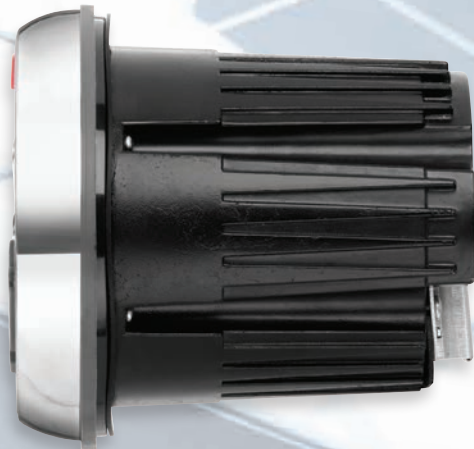

PLAYBACK

MP3 / WMA
BLUETOOTH® AUDIO STREAMING
(Stream and Control your Favorite Music APPs)

INPUTS & OUTPUTS

USB Port
USB Charging [1A]**
Aux-In
Compatible with Audio Output of iPod®/iPhone®, Smartphones, and MP3 Players
Front, Rear/Sub Pre-Amp Outputs

GENERAL

IPX6
NOAA Weather Band
Switchable US & Europe
Tuner Frequencies
RDS Tuner
Conformal Coating PCB
Front Panel UV Coating
Polished Stainless Steel Bezel
Zero Current Draw Memory
(Retains Radio Preset
Memory in case of
Vehicle Battery Disconnect)
Cutout Diameter: 3" (76 mm)
Output Power: 60 W x 4 CH

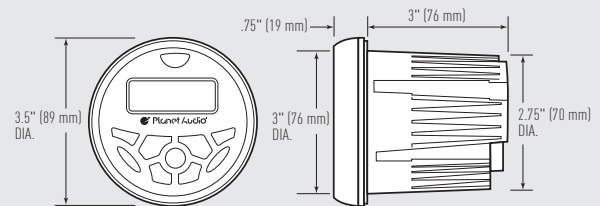

**Charging Only. Not for mobile device playback.

iPod® and iPhone® are registered trademarks of Apple, Inc., in the U.S. and other countries. The Bluetooth® word mark and logos are registered trademarks owned by Bluetooth SIG, Inc. and any use of such marks by Planet Audio is under license. Other trademarks and trade names are those of their respective owners.





Planet Audio

POWERSPORTS

exceed your expectations



BLUETOOTH® 8" WEATHERPROOF ALL-TERRAIN SOUND SYSTEM MARINE SPEAKERS / 1.5" WEATHERPROOF TWEETERS LED LIGHT BAR

PATV85



led lightbar to help guide the way.

convenient storage compartment

built-in usb charging port

marine rated and ready For all weather riding
Bluetooth® audio streaming

reinforced metal handles double as mounting point for cameras, tool bags, camping gear, etc. . .

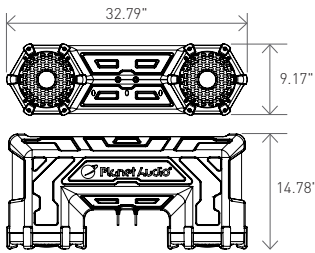

powered by internal amplifier

wired remote control

FEATURES

FULLY MARINIZED
700W MAX POWER

- BLUETOOTH®** Audio Streaming (Stream and Control your Favorite Music APPs)
- In-line Multi-function Control
- Easy Pairing with Auto Re-connect
- Weatherproof Polypropylene Cone
- Soft Dome Diaphragm High 2 Tweeters
- Aux-In
- Built-in USB Charging (1A)**
- Compatible with Audio Output of iPod®/iPhone®, Smartphones, and MP3 Players
- LED Light Bar with On/Off Control
- Speakers Powered by Internal Amplifier
- Storage Compartment
- Plug and Play for Easy Installation
- Includes (4) Heavy Duty Straps with **hook and loop fastener** for any Mounting Position Ideal for Outdoors and Recreational Use



**Charging Only. Not for mobile device playback.

iPod® and iPhone® are registered trademarks of Apple, Inc., in the U.S. and other countries. Planet Audio is not affiliated with Apple, Inc. The Bluetooth® word mark and logos are registered trademarks owned by Bluetooth SIG, Inc. and any use of such marks by Planet Audio is under license. Other trademarks and trade names are those of their respective owners.



Planet Audio

POWERSPORTS

exceed your expectations



BLUETOOTH® 6.5" WEATHERPROOF ALL-TERRAIN SOUND SYSTEM MARINE SPEAKERS / 1.5" WEATHERPROOF TWEETERS LED LIGHT BAR

PATV65



led lightbar to help guide the way.

reinforced metal handles double as mounting point for cameras, tool bags, camping gear, etc. . .

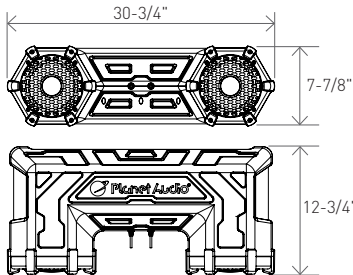

powered by internal amplifier

wired remote control



FEATURES

FULLY MARINIZED
450W MAX POWER

- BLUETOOTH®** Audio Streaming (Stream and Control your Favorite Music APPs)
- In-line Multi-function Control
- Easy Pairing with Auto Re-connect
- Weatherproof Polypropylene Cone
- Soft Dome Diaphragm High 2 Tweeters
- Aux-In
- Compatible with Audio Output of iPod®/iPhone®, Smartphones, and MP3 Players
- LED Light Bar with On/Off Control
- Speakers Powered by Internal Amplifier
- Plug and Play for Easy Installation
- Includes (4) Heavy Duty Straps with hook and loop fastener for any Mounting Position Ideal for Outdoors and Recreational Use



iPod® and iPhone® are registered trademarks of Apple, Inc., in the U.S. and other countries. Planet Audio is not affiliated with Apple, Inc. The Bluetooth® word mark and logos are registered trademarks owned by Bluetooth SIG, Inc. and any use of such marks by Planet Audio is under license. Other trademarks and trade names are those of their respective owners.



Planet Audio®

POWERSPORTS

exceed your expectations



BLUETOOTH® | 3" (76 mm) WEATHER RATED SPEAKER AND AMPLIFIER SYSTEM

PMC4B



IN-LINE VOLUME CONTROL



PMC4B
3" (76 mm) Matte Black Speakers
(2 Pair)

1000 Watts Peak Power

Bluetooth® Audio Streaming
Stream and Control your Favorite
Music APPs

Compatible with Audio Output of
iPod®/iPhone®, Smartphones, and
MP3 Players

IPX5 Rated Speakers

Weatherproof. *Not Submersible*

Compact Amplifier

Aux Input

In-line Volume Control

Adjustable Brackets



iPod® and iPhone® are registered trademarks of Apple, Inc., in the U.S. and other countries. Planet Audio is not affiliated with Apple, Inc. The Bluetooth® word mark and logos are registered trademarks owned by Bluetooth SIG, Inc. and any use of such marks by Planet Audio is under license. Other trademarks and trade names are those of their respective owners.



Planet Audio®

POWERSPORTS

exceed your expectations



BLUETOOTH® | 3" (76 mm) WEATHER RATED SPEAKER AND AMPLIFIER SYSTEM

PMC2B



IN-LINE VOLUME CONTROL



PMC2B
3" (76 mm) Matte Black Speakers
(1 Pair)

600 Watts Peak Power

Bluetooth® Audio Streaming
Stream and Control your Favorite
Music APPs

Compatible with Audio Output of
iPod®/iPhone®, Smartphones, and
MP3 Players

IPX5 Rated Speakers

Weatherproof. *Not Submersible*

Compact Amplifier

Aux Input

In-line Volume Control

Adjustable Bracketset



iPod® and iPhone® are registered trademarks of Apple, Inc., in the U.S. and other countries. Planet Audio is not affiliated with Apple, Inc. The Bluetooth® word mark and logos are registered trademarks owned by Bluetooth SIG, Inc. and any use of such marks by Planet Audio is under license. Other trademarks and trade names are those of their respective owners.



Planet Audio®

POWERSPORTS

exceed your expectations



BLUETOOTH® | 3" (76 mm) WEATHER RATED SPEAKER AND AMPLIFIER SYSTEM

PMC4C



IN-LINE VOLUME CONTROL



PMC4C
3" (76 mm) Chrome Speakers
(2 Pair)

1000 Watts Peak Power

Bluetooth® Audio Streaming
Stream and Control your Favorite
Music APPs

Compatible with Audio Output of
iPod®/iPhone®, Smartphones, and
MP3 Players

IPX5 Rated Speakers

Weatherproof. *Not Submersible*

Compact Amplifier

Aux Input

In-line Volume Control

Adjustable Brackets



iPod® and iPhone® are registered trademarks of Apple, Inc., in the U.S. and other countries. Planet Audio is not affiliated with Apple, Inc. The Bluetooth® word mark and logos are registered trademarks owned by Bluetooth SIG, Inc. and any use of such marks by Planet Audio is under license. Other trademarks and trade names are those of their respective owners.



Planet Audio®

POWERSPORTS

exceed your expectations



BLUETOOTH® | 3" (76 mm) WEATHER RATED SPEAKER AND AMPLIFIER SYSTEM

PMC2C



IN-LINE VOLUME CONTROL



PMC2C
3" (76 mm) Chrome Speakers
(1 Pair)

600 Watts Peak Power

Bluetooth® Audio Streaming
Stream and Control your Favorite
Music APPs

Compatible with Audio Output of
iPod®/iPhone®, Smartphones, and
MP3 Players

IPX5 Rated Speakers

Weatherproof. *Not Submersible*

Compact Amplifier

Aux Input

In-line Volume Control

Adjustable Bracketst



iPod® and iPhone® are registered trademarks of Apple, Inc., in the U.S. and other countries. Planet Audio is not affiliated with Apple, Inc. The Bluetooth® word mark and logos are registered trademarks owned by Bluetooth SIG, Inc. and any use of such marks by Planet Audio is under license. Other trademarks and trade names are those of their respective owners.



PM65W 200 WATTS 6.5" 2-WAY MARINE SPEAKER

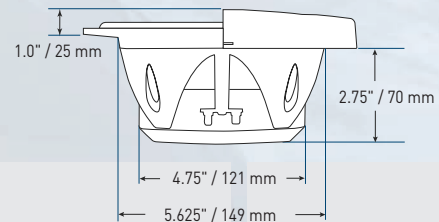
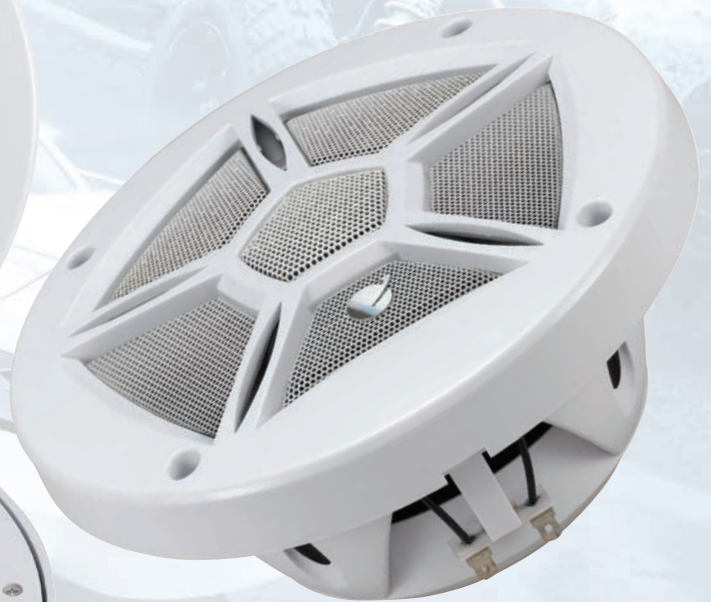

200 Watt Peak Power
Resin Treated Cloth Surround
Polypropylene Cone
Composite Basket
Dual Cone Design



SPECIFICATIONS	POWER HANDLING (MAX)	SYSTEM IMPEDANCE	FREQUENCY RESPONSE (±3 dB)	SYSTEM SENSITIVITY @ 1W / 1m	MIDRANGE	TWEETER(S)	MOUNTING DEPTH
PM65W	200w	4 Ω	80Hz-20kHz	90dB	6-1/2"	1"	2-3/4"



PM65B
200 WATTS
6.5" 2-WAY MARINE SPEAKER

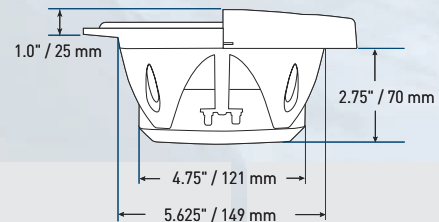

200 Watt Peak Power
Resin Treated Cloth Surround
Polypropylene Cone
Composite Basket
Dual Cone Design



SPECIFICATIONS	POWER HANDLING (MAX)	SYSTEM IMPEDANCE	FREQUENCY RESPONSE (±3 dB)	SYSTEM SENSITIVITY @ 1W / 1m	MIDRANGE	TWEETER(S)	MOUNTING DEPTH
PM65B	200w	4 Ω	80Hz-20kHz	90dB	6-1/2"	1"	2-3/4"



Planet Audio®

POWERSPORTS

exceed your expectations

PM60W 180 WATTS 6.5" MARINE DUAL CONE SPEAKER SYSTEM

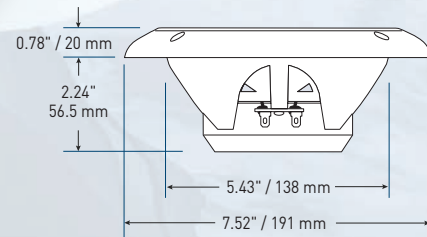

SPEAKERS

- Resin Treated Cloth Surround
- Polypropylene Cone
- Composite Basket
- Dual Cone Design



SPECIFICATIONS	POWER HANDLING (MAX)	SYSTEM IMPEDANCE	FREQUENCY RESPONSE (±3 dB)	SYSTEM SENSITIVITY @ 1W / 1m	MOUNTING DEPTH
PM60W	180w	4 Ω	80Hz-20kHz	89dB	2.24"



PM60B
180 WATTS
6.5" MARINE DUAL CONE SPEAKER SYSTEM

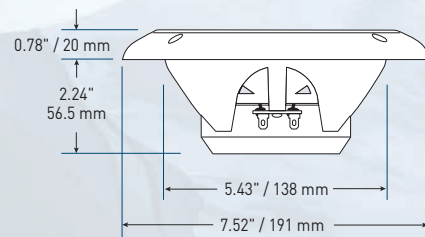

SPEAKERS

- Resin Treated Cloth Surround
- Polypropylene Cone
- Composite Basket
- Dual Cone Design



SPECIFICATIONS	POWER HANDLING (MAX)	SYSTEM IMPEDANCE	FREQUENCY RESPONSE (±3 dB)	SYSTEM SENSITIVITY @ 1W / 1m	MOUNTING DEPTH
PM60B	180w	4 Ω	80Hz-20kHz	89dB	2.24"



BLUETOOTH® | AUDIO STREAMING | MARINE GAUGE DIGITAL MEDIA AM/FM RECEIVER FEATURING BUILT-IN AMPLIFIER

PLUS: 1 PAIR - 6.5" (165 mm) MARINE DUAL CONE FULL RANGE SPEAKER SYSTEM

ALSO INCLUDED: MARINE DIPOLE ANTENNA

PMP35W.6

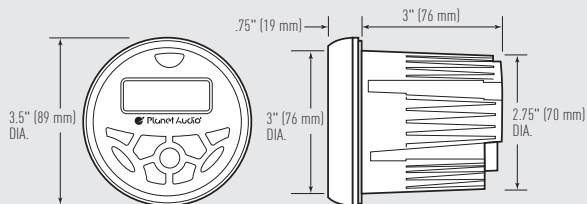

MARINE DIPOLE ANTENNA

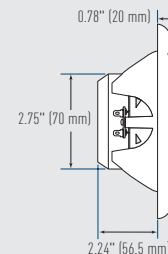
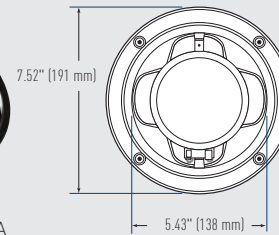

PLAYBACK

MP3/WMA
Bluetooth® Audio Streaming
and Control your Favorite Music APPs

INPUTS & OUTPUTS

USB Port
Aux-In
USB Charging (1A)**
Compatible with Audio Output of
iPod®/iPhone®, Smartphones
and MP3 players
Front, Rear/Sub Pre-Amp Outputs

GENERAL

Switchable US & EU Tuner Frequencies
RDS Tuner
IPX6
NOAA Weather Band Tuner
Conformal Coated PCB
Polished Stainless Steel Bezel
Zero Current Draw Memory (Radio
PresetMemory in case of Battery
Disconnect)
Cutout Diameter: 3" (76 mm)

SPEAKERS

Resin Treated Cloth Surround
Polypropylene Cone
Composite Basket
Dual Cone Design

SPECIFICATIONS

Max Power: 180 W
Nominal Impedance: 4 Ω
Frequency Response: 80 Hz-20 kHz, ±3 dB
System Sensitivity (1 W/1 m): 86 dB



**Charging Only. Not for mobile device playback.

iPod® and iPhone® are registered trademarks of Apple, Inc., in the U.S. and other countries. Planet Audio is not affiliated with Apple, Inc.
The Bluetooth® word mark and logos are registered trademarks owned by Bluetooth SIG, Inc. and any use of such marks by Planet Audio is under license.
Other trademarks and trade names are those of their respective owners.



Planet Audio®

POWERSPORTS

exceed your expectations



BLUETOOTH® ALL-TERRAIN AMPLIFIER SYSTEM WITH ILLUMINATED MULTI-FUNCTION CONTROLLER

PSA4CB



No head unit needed!

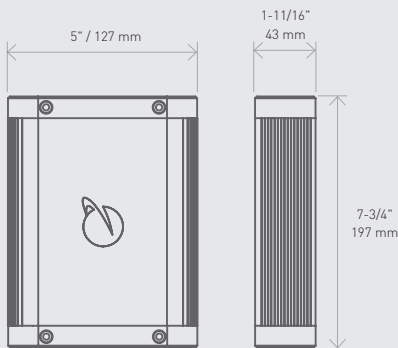

FEATURES

500 Watts Max Power

BLUETOOTH® AUDIO STREAMING
[Stream and Control your Favorite Music APPs]

Easy Pairing with Auto Re-connect
Weather Resistant

For all 12-Volt Applications

Compatible with Audio

Output of iPod®/iPhone®,
Smartphones, and MP3 Players

4 CH Full Range Amplifier

1 Pair Pre-Amp Outputs

USB Charging (1A)**

Aux-In

Slim Compact Footprint

Remote With Soft Touch Buttons

Remote With Multi-mount System:

Surface Mount, or Flush Mount



**Charging Only. Not for mobile device playback.

iPod® and iPhone® are registered trademarks of Apple, Inc., in the U.S. and other countries. Planet Audio is not affiliated with Apple, Inc. The Bluetooth® word mark and logos are registered trademarks owned by Bluetooth SIG, Inc. and any use of such marks by Planet Audio is under license. Other trademarks and trade names are those of their respective owners.



BBD4000
4000 WATTS max power
 1 ohm Stable
 Class D Monoblock



ILLUMINATED LOGO

FEATURES

- Monoblock
- Class D Topology
- 1Ω Stable
- PWM MOSFET Power Supply
- 1/0 ga. Power Terminals
- RCA In/Out
- Selectable Slope (12/24dB)
- Low Pass Filter
- Subsonic Filter
- Bass Boost
- Phase Control
- Remote Subwoofer Control
- Illuminated Logo



REMOTE SUBWOOFER CONTROL



SPECIFICATIONS	1 OHM MAX	2 OHM MAX	4 OHM MAX	@ 4 OHM (BRIDED)	CHANNEL SEPARATION (dB)	PREQ RESPONSE (Hz)	6-15/16" W x 2-7/16" H x
CLASS D MONO							
BBD4000	4000w x 1	2000w x 1	1000w x 1	—	80	10-250	17-1/8" L



BBD2500
2500 WATTS max power
 1 ohm Stable
 Class D Monoblock



ILLUMINATED LOGO

FEATURES

- Monoblock
- Class D Topology
- 1Ω Stable
- PWM MOSFET Power Supply
- RCA In/Out
- Selectable Slope (12/24dB)
- Low Pass Filter
- Subsonic Filter
- Bass Boost
- Phase Control
- Remote Subwoofer Control
- Illuminated Logo



REMOTE SUBWOOFER CONTROL



SPECIFICATIONS	1 OHM MAX	2 OHM MAX	4 OHM MAX	@ 4 OHM (BRIDED)	CHANNEL SEPARATION (dB)	PREQ REPOSE (Hz)	6-15/16" W x 2-7/16" H x
CLASS D MONO							
BBD2500	2500w x 1	1250w x 1	625w x 1	—	80	10-250	11-7/16" L



Planet Audio®

big bang



ILLUMINATED LOGO



BB4.1200

1200 WATTS max power

1 ohm Stable
Full Range Class D

FEATURES

- 4/3/2 Channel
- Full-Range, Class D
- PWM MOSFET Power Supply
- RCA In/Out
- HP & LP Filters
- Bass Boost
- Remote Subwoofer Control
- Illuminated Logo



REMOTE SUBWOOFER CONTROL



SPECIFICATIONS	1 OHM MAX	2 OHM MAX	4 OHM MAX	@ 4 OHM (BRIDGED)	CHANNEL SEPARATION (dB)	PREQ REPOSE (Hz)	6-15/16" W x 2-7/16" H x
CLASS D 4 CHANNEL							
BB4.1200	—	300w x4	150w x4	600w x 2	92	20-20	8-3/4"L



Planet Audio®

ANARCHY

CLASS D POWER AMPLIFIER



AC5000.1D
5000 WATTS max power

FEATURES

- Monoblock
- Class D Topology
- 1Ω Stable
- PWM MOSFET Power Supply
- RCA In/Out
- Low Pass Filter
- Subsonic Filter
- Bass Boost
- Phase Control
- Remote Subwoofer Control
- Illuminated Anarchy Logo
- Strapping Capable



REMOTE SUBWOOFER CONTROL



SPECIFICATIONS	1 OHM MAX	2 OHM MAX	4 OHM MAX	SIGNAL TO NOISE RATIO (dB)	FREQUENCY RESPONSE (Hz)	10" W x 2-3/8" H x 18"L
CLASS D MONO						
AC5000.1D STRAPPED - 2 AMPS	5000w x 1 N/A	2500w x 1 10000w	1250w x 1 5000w	80	15-250	18"L



Planet Audio®

ANARCHY

CLASS D POWER AMPLIFIER



AC4000.1D
4000 WATTS max power

FEATURES

- Monoblock
- Class D Topology
- 1Ω Stable
- PWM MOSFET Power Supply
- RCA In/Out
- Low Pass Filter
- Subsonic Filter
- Bass Boost
- Phase Control
- Remote Subwoofer Control
- Illuminated Anarchy Logo
- Strapping Capable



REMOTE SUBWOOFER CONTROL



SPECIFICATIONS	1 OHM MAX	2 OHM MAX	4 OHM MAX	SIGNAL TO NOISE RATIO (dB)	FREQUENCY RESPONSE (Hz)	10" W x 2-3/8" H x
CLASS D MONO						
AC4000.1D STRAPPED - 2 AMPS	4000w x1 N/A	2000w x 1 8000w	1000w x 1 4000w	79	15-250	15"L



Planet Audio®

ANARCHY

CLASS D POWER AMPLIFIER



AC3000.1D
3000 WATTS max power

FEATURES

- Monoblock
- Class D Topology
- 1Ω Stable
- PWM MOSFET Power Supply
- RCA In/Out
- Low Pass Filter
- Subsonic Filter
- Bass Boost
- Phase Control
- Remote Subwoofer Control
- Illuminated Anarchy Logo
- Strapping Capable



REMOTE SUBWOOFER CONTROL



SPECIFICATIONS	1 OHM MAX	2 OHM MAX	4 OHM MAX	SIGNAL TO NOISE RATIO (dB)	FREQUENCY RESPONSE (Hz)	10" W x 2-3/8" H x
CLASS D MONO						
AC3000.1D STRAPPED - 2 AMPS	3000w x 1 N/A	1500w x 1 6000w	750w x 1 3000w	81	15-250	13"L



Planet Audio®

ANARCHY

CLASS A/B POWER AMPLIFIER



AC2500.1M
2500 WATTS max power

FEATURES

- Monoblock
- Full-Range, Class A/B
- 2Q Stable
- PWM MOSFET Power Supply
- RCA & Speaker Level Inputs
- Low Pass Filters
- Bass Boost
- Remote Subwoofer Control
- Illuminated Anarchy Logo



REMOTE SUBWOOFER CONTROL



SPECIFICATIONS	2 OHM MAX	4 OHM MAX	SIGNAL TO NOISE RATIO (dB)	FREQUENCY RESPONSE (Hz)	10" W x 2-3/8" H x
CLASS A/B MONO					
AC2500.1M	2500W X 1	1250w x 1	85	15-20kHz	14"L



Planet Audio®

ANARCHY

CLASS A/B POWER AMPLIFIER



AC1500.1M
1500 WATTS max power

FEATURES

- Monoblock
- Full-Range, Class A/B
- 2Q Stable
- PWM MOSFET Power Supply
- RCA & Speaker Level Inputs
- Low Pass Filters
- Bass Boost
- Remote Subwoofer Control
- Illuminated Anarchy Logo



REMOTE SUBWOOFER CONTROL



SPECIFICATIONS	2 OHM MAX	4 OHM MAX	SIGNAL TO NOISE RATIO (dB)	FREQUENCY RESPONSE (Hz)	10" W x 2-3/8" H x
CLASS A/B MONO					
AC1500.1M	1500W X 1	750w x 1	85	15-20kHz	10"L



Planet Audio®

ANARCHY

5 CHANNEL POWER AMPLIFIER



AC1800.5
1800 WATTS max power

FEATURES

- 5/4/3 Channel
- Full-Range, Class A/B
- 2Ω Stable
- PWM MOSFET Power Supply
- RCA & Speaker Level Inputs
- HP & LP Filters
- Bass Boost
- Remote Subwoofer Control
- Illuminated Anarchy Logo



REMOTE SUBWOOFER CONTROL



SPECIFICATIONS	2 OHM MAX	4 OHM MAX	BRIDGED @ 4 OHM	SIGNAL TO NOISE RATIO (dB)	FREQUENCY RESPONSE (Hz)	10" W x 2-3/8" H x
5 CHANNEL			(1&2, 3&4)			
AC1800.5	300w x4 / 600w x1	150w x4 / 300w x1	600w x 2 / 300w x 1	81	20-20kHz	19-15/16"L



Planet Audio®

ANARCHY

4 CHANNEL POWER AMPLIFIER



AC2400.4
2400 WATTS max power

FEATURES

- 4 Channel
- Full-Range, Class A/B
- 2Ω Stereo Stable
- PWM MOSFET Power Supply
- RCA & Speaker Level Inputs
- HP & LP Filters
- Bass Boost
- Remote Subwoofer Control
- Illuminated Anarchy Logo



REMOTE SUBWOOFER CONTROL



SPECIFICATIONS	2 OHM MAX	4 OHM MAX	BRIDGED @ 4 OHM	SIGNAL TO NOISE RATIO (dB)	FREQUENCY RESPONSE (Hz)	10" W x 2-3/8" H x
4 CHANNEL						
AC2400.4	600w x 4	300w x 4	1200w x 2	86	20-20kHz	15-9/16"L



Planet Audio®

ANARCHY

4 CHANNEL POWER AMPLIFIER



AC1600.4
1600 WATTS max power

FEATURES

- 4 Channel
- Full-Range, Class A/B
- 2Ω Stereo Stable
- PWM MOSFET Power Supply
- RCA & Speaker Level Inputs
- HP & LP Filters
- Bass Boost
- Remote Subwoofer Control
- Illuminated Anarchy Logo



REMOTE SUBWOOFER CONTROL



SPECIFICATIONS	2 OHM MAX	4 OHM MAX	BRIDGED @ 4 OHM	SIGNAL TO NOISE RATIO (dB)	FREQUENCY RESPONSE (Hz)	10" W x 2-3/8" H x
4 CHANNEL						
AC1600.4	400w x 4	200w x 4	800w x 2	86	20-20kHz	12-3/8"L



Planet Audio®

ANARCHY

4 CHANNEL POWER AMPLIFIER



AC1200.4
1200 WATTS max power

FEATURES

- 4 Channel
- Full-Range, Class A/B
- 2Ω Stereo Stable
- PWM MOSFET Power Supply
- RCA & Speaker Level Inputs
- HP & LP Filters
- Bass Boost
- Illuminated Anarchy Logo



SPECIFICATIONS	2 OHM MAX	4 OHM MAX	BRIDGED @ 4 OHM	SIGNAL TO NOISE RATIO (dB)	FREQUENCY RESPONSE (Hz)	10" W x 2-3/8" H x
4 CHANNEL						
AC1200.4	300w x 4	150w x 4	600w x 2	88	20-20kHz	11"L



Planet Audio®

ANARCHY

4 CHANNEL POWER AMPLIFIER



AC800.4
800 WATTS max power

FEATURES

- 4 Channel
- Full-Range, Class A/B
- 2Ω Stereo Stable
- PWM MOSFET Power Supply
- RCA & Speaker Level Inputs
- HP & LP Filters
- Bass Boost
- Illuminated Anarchy Logo



SPECIFICATIONS	2 OHM MAX	4 OHM MAX	BRIDGED @ 4 OHM	SIGNAL TO NOISE RATIO (dB)	FREQUENCY RESPONSE (Hz)	10" W x 2-3/8" H x
4 CHANNEL						
AC800.4	200w x 4	100w x 4	400w x 2	88	20-20kHz	10"L



Planet Audio®

ANARCHY

2 CHANNEL POWER AMPLIFIER



AC2600.2
2600 WATTS max power

FEATURES

- 2 Channel
- Full-Range, Class A/B
- 2Ω Stereo Stable
- PWM MOSFET Power Supply
- RCA & Speaker Level Inputs
- HP & LP Filters
- Bass Boost
- Remote Subwoofer Control
- Illuminated Anarchy Logo



REMOTE SUBWOOFER CONTROL



SPECIFICATIONS	2 OHM MAX	4 OHM MAX	BRIDGED @ 4 OHM	SIGNAL TO NOISE RATIO (dB)	FREQUENCY RESPONSE (Hz)	10" W x 2-3/8" H x
2 CHANNEL						
AC2600.2	1300w x 2	650w x 2	2600w x 1	85	20-20kHz	15-9/16"L



Planet Audio®

ANARCHY

2 CHANNEL POWER AMPLIFIER



AC2000.2
2000 WATTS max power

FEATURES

- 2 Channel
- Full-Range, Class A/B
- 2Ω Stereo Stable
- PWM MOSFET Power Supply
- RCA & Speaker Level Inputs
- HP & LP Filters
- Bass Boost
- Remote Subwoofer Control
- Illuminated Anarchy Logo



REMOTE SUBWOOFER CONTROL



SPECIFICATIONS	2 OHM MAX	4 OHM MAX	BRIDGED @ 4 OHM	SIGNAL TO NOISE RATIO (dB)	FREQUENCY RESPONSE (Hz)	10" W x 2-3/8" H x
2 CHANNEL						
AC2000.2	1000w x 2	500w x 2	2000w x 1	84	20-20kHz	13-9/16"L



Planet Audio®

ANARCHY

2 CHANNEL POWER AMPLIFIER



AC1200.2
1200 WATTS max power

FEATURES

- 2 Channel
- Full-Range, Class A/B
- 2Ω Stereo Stable
- PWM MOSFET Power Supply
- RCA & Speaker Level Inputs
- HP & LP Filters
- Bass Boost
- Remote Subwoofer Control
- Illuminated Anarchy Logo



REMOTE SUBWOOFER CONTROL



SPECIFICATIONS	2 OHM MAX	4 OHM MAX	BRIDGED @ 4 OHM	SIGNAL TO NOISE RATIO (dB)	FREQUENCY RESPONSE (Hz)	10" W x 2-3/8" H x
2 CHANNEL						
AC1200.2	600w x 2	300w x 2	1200w x 1	84	20-20kHz	15-9/16"L



Planet Audio®

ANARCHY

2 CHANNEL POWER AMPLIFIER



AC1000.2
1000 WATTS max power

FEATURES

- 2 Channel
- Full-Range, Class A/B
- 2Ω Stereo Stable
- PWM MOSFET Power Supply
- RCA & Speaker Level Inputs
- HP & LP Filters
- Bass Boost
- Remote Subwoofer Control
- Illuminated Anarchy Logo



REMOTE SUBWOOFER CONTROL



SPECIFICATIONS	2 OHM MAX	4 OHM MAX	BRIDGED @ 4 OHM	SIGNAL TO NOISE RATIO (dB)	FREQUENCY RESPONSE (Hz)	10" W x 2-3/8" H x
2 CHANNEL						
AC1000.2	500w x 2	250w x 2	1000w x 1	87	20-20kHz	12-3/8"L



Planet Audio®

ANARCHY

2 CHANNEL POWER AMPLIFIER



AC600.2
600 WATTS max power

FEATURES

- 2 Channel
- Full-Range, Class A/B
- 2Ω Stereo Stable
- PWM MOSFET Power Supply
- RCA & Speaker Level Inputs
- HP & LP Filters
- Bass Boost
- Illuminated Anarchy Logo



SPECIFICATIONS	2 OHM MAX	4 OHM MAX	BRIDGED @ 4 OHM	SIGNAL TO NOISE RATIO (dB)	FREQUENCY RESPONSE (Hz)	10" W x 2-3/8" H x
2 CHANNEL						
AC600.2	300w x 2	150w x 2	600w x 1	85	20-20kHz	7-1/2"L



Planet Audio®

TORQUE

CLASS D POWER AMPLIFIER



TR5000.1D
5000 WATTS max power

FEATURES

- Monoblock
- Class D Topology
- PWM MOSFET Power Supply
- 1 Ω Stable
- RCA In/Out
- Low Pass Filter
- Subsonic Filter
- Bass Boost
- Phase Control
- Remote Subwoofer Control
- Illuminated Logo
- Strapping Capable



REMOTE SUBWOOFER CONTROL



SPECIFICATIONS	1 OHM MAX	2 OHM MAX	4 OHM MAX	SIGNAL TO NOISE RATIO (dB)	FREQUENCY RESPONSE (Hz)	10" W x 2-3/8" H x
CLASS D MONO						
TR5000.1D STRAPPED 2 AMPS	5000w x 1 N/A	2500w x 1 10000w	1250w x 1 5000w	78	15-250	18-1/2"L



Planet Audio®

TORQUE

CLASS D POWER AMPLIFIER



TR4000.1D
4000 WATTS max power

FEATURES

- Monoblock
- Class D Topology
- PWM MOSFET Power Supply
- 1 Ω Stable
- RCA In/Out
- Low Pass Filter
- Subsonic Filter
- Bass Boost
- Phase Control
- Remote Subwoofer Control
- Illuminated Logo
- Strapping Capable



REMOTE SUBWOOFER CONTROL



SPECIFICATIONS	1 OHM MAX	2 OHM MAX	4 OHM MAX	SIGNAL TO NOISE RATIO (dB)	FREQUENCY RESPONSE (Hz)	10" W x 2-3/8" H x 15" L
CLASS D MONO						
TR4000.1D STRAPPED 2 AMPS	4000w x1 N/A	2000w x 1 8000w	1000w x 1 4000w	80	15-250	15" L



Planet Audio®

TORQUE

CLASS D POWER AMPLIFIER



TR3000.1D
3000 WATTS max power

FEATURES

- Monoblock
- Class D Topology
- PWM MOSFET Power Supply
- 1 Ω Stable
- RCA In/Out
- Low Pass Filter
- Subsonic Filter
- Bass Boost
- Phase Control
- Remote Subwoofer Control
- Illuminated Logo
- Strapping Capable



REMOTE SUBWOOFER CONTROL



SPECIFICATIONS	1 OHM MAX	2 OHM MAX	4 OHM MAX	SIGNAL TO NOISE RATIO (dB)	FREQUENCY RESPONSE (Hz)	10" W x 2-3/8" H x
CLASS D MONO						
TR3000.1D STRAPPED 2 AMPS	3000w x 1 N/A	1500w x 1 6000w	750w x 1 3000w	78	15-250	13"L



Planet Audio®

TORQUE

CLASS A/B POWER AMPLIFIER



TR2500.1M
2500 WATTS max power

FEATURES

- Monoblock
- Full-Range Class A/B
- PWM MOSFET Power Supply
- 2 Ω Stable
- RCA & Speaker Level Inputs
- LP Filters
- Bass Boost
- Remote Subwoofer Control
- Illuminated Logo



REMOTE SUBWOOFER CONTROL



SPECIFICATIONS	2 OHM MAX	4 OHM MAX	SIGNAL TO NOISE RATIO (dB)	FREQUENCY RESPONSE (Hz)	10" W x 2-3/8" H x
CLASS A/B MONO					
TR2500.1M	2500w x 1	1250w x 1	86	15-20kHz	14"L



Planet Audio®

TORQUE

CLASS A/B POWER AMPLIFIER



TR1500.1M
1500 WATTS max power

FEATURES

- Monoblock
- Full-Range Class A/B
- PWM MOSFET Power Supply
- 2 Ω Stable
- RCA & Speaker Level Inputs
- LP Filters
- Bass Boost
- Remote Subwoofer Control
- Illuminated Logo



REMOTE SUBWOOFER CONTROL



SPECIFICATIONS	2 OHM MAX	4 OHM MAX	SIGNAL TO NOISE RATIO (dB)	FREQUENCY RESPONSE (Hz)	10" W x 2-3/8" H x
CLASS A/B MONO					
TR1500.1M	1500w x 1	750w x 1	84	15-20kHz	10"L



Planet Audio®

TORQUE

4 CHANNEL POWER AMPLIFIER



TR2400.4
2400 WATTS max power

FEATURES

- 4/3/2 Channel
- Full-Range, Class A/B
- PWM MOSFET Power Supply
- 2 Ω Stereo Stable
- RCA & Speaker Level Inputs
- HP & LP Filters
- Bass Boost
- Remote Subwoofer Control
- Illuminated Logo



REMOTE SUBWOOFER CONTROL



SPECIFICATIONS	2 OHM MAX	4 OHM MAX	BRIDGED @ 4 OHM	SIGNAL TO NOISE RATIO (dB)	FREQUENCY RESPONSE (Hz)	10" W x 2-3/8" H x
4 CHANNEL						
TR2400.4	600w x 4	300w x 4	x1200w x 2	87	20-20kHz	15-9/16"L



Planet Audio®

TORQUE

4 CHANNEL POWER AMPLIFIER



TR1600.4
1600 WATTS max power

FEATURES

- 4/3/2 Channel
- Full-Range, Class A/B
- PWM MOSFET Power Supply
- 2 Ω Stereo Stable
- RCA & Speaker Level Inputs
- HP & LP Filters
- Bass Boost
- Remote Subwoofer Control
- Illuminated Logo



REMOTE SUBWOOFER CONTROL



SPECIFICATIONS	2 OHM MAX	4 OHM MAX	BRIDGED @ 4 OHM	SIGNAL TO NOISE RATIO (dB)	FREQUENCY RESPONSE (Hz)	10" W x 2-3/8" H x
4 CHANNEL						
TR1600.4	400w x 4	200w x 4	800w x 2	87	20-20kHz	13-11/16"L



Planet Audio®

TORQUE

2 CHANNEL POWER AMPLIFIER



TR2600.2
2600 WATTS max power

FEATURES

- 2/1 Channel
- Full-Range, Class A/B
- PWM MOSFET Power Supply
- 2 Ω Stereo Stable
- RCA & Speaker Level Inputs
- HP & LP Filters
- Bass Boost
- Remote Subwoofer Control
- Illuminated Logo



REMOTE SUBWOOFER CONTROL



SPECIFICATIONS	2 OHM MAX	4 OHM MAX	BRIDGED @ 4 OHM	SIGNAL TO NOISE RATIO (dB)	FREQUENCY RESPONSE (Hz)	10" W x 2-3/8" H x
2 CHANNEL						
TR2600.2	1300w x 2	650w x 2	2600w x 1	84	20-20kHz	18-1/4"L



Planet Audio®

TORQUE

2 CHANNEL POWER AMPLIFIER



TR2000.2
2000 WATTS max power

FEATURES

- 2/1 Channel
- Full-Range, Class A/B
- PWM MOSFET Power Supply
- 2 Ω Stereo Stable
- RCA & Speaker Level Inputs
- HP & LP Filters
- Bass Boost
- Remote Subwoofer Control
- Illuminated Logo



REMOTE SUBWOOFER CONTROL



SPECIFICATIONS	2 OHM MAX	4 OHM MAX	BRIDGED @ 4 OHM	SIGNAL TO NOISE RATIO (dB)	FREQUENCY RESPONSE (Hz)	10" W x 2-3/8" H x
2 CHANNEL						
TR2000.2	1000w x 2	500w x 2	2000w x 1	84	20-20kHz	16-1/4"L



Planet Audio®

TORQUE

2 CHANNEL POWER AMPLIFIER



TR1000.2
1000 WATTS max power

FEATURES

- 2/1 Channel
- Full-Range, Class A/B
- PWM MOSFET Power Supply
- 2 Ω Stereo Stable
- RCA & Speaker Level Inputs
- HP & LP Filters
- Bass Boost
- Remote Subwoofer Control
- Illuminated Logo



REMOTE SUBWOOFER CONTROL



SPECIFICATIONS	2 OHM MAX	4 OHM MAX	BRIDGED @ 4 OHM	SIGNAL TO NOISE RATIO (dB)	FREQUENCY RESPONSE (Hz)	10" W x 2-3/8" H x
2 CHANNEL						
TR1000.2	500w x 2	250w x 2	1000w x 1	87	20-20kHz	9-3/4"L



PL4000.1D
4000 WATTS max power

FEATURES

- Monoblock
- Class D Topology
- 1Ω Stable
- PWM MOSFET Power Supply
- RCA In/Out
- Low Pass Filter
- Bass Boost
- Phase Control
- Remote Subwoofer Control
- Illuminated Logo
- Strapping Capable



REMOTE SUBWOOFER CONTROL



SPECIFICATIONS	1 OHM MAX	2 OHM MAX	4 OHM MAX	SIGNAL TO NOISE RATIO (dB)	FREQUENCY RESPONSE (Hz)	7" W x 2-9/32" H x
CLASS D MONO						
PL4000.1D STRAPPED 2 AMPS	4000w x 1 N/A	2000w x 1 8000w	1000w x 1 4000w	80	15-250	13-7/8"L



PL3000.1D
3000 WATTS max power

FEATURES

- Monoblock
- Class D Topology
- 1Ω Stable
- PWM MOSFET Power Supply
- RCA In/Out
- Low Pass Filter
- Bass Boost
- Phase Control
- Remote Subwoofer Control
- Illuminated Logo
- Strapping Capable



REMOTE SUBWOOFER CONTROL



SPECIFICATIONS	1 OHM MAX	2 OHM MAX	4 OHM MAX	SIGNAL TO NOISE RATIO (dB)	FREQUENCY RESPONSE (Hz)	7" W x 2-9/32" H x
CLASS D MONO						
PL3000.1D STRAPPED 2 AMPS	3000w X1 N/A	1500w x 1 6000w	750w x 1 3000w	78	15-250	11-7/8"L



PL2500.1M
2500 WATTS max power

FEATURES

- Monoblock
- Class A/B Topology
- 2Ω Stable
- PWM MOSFET Power Supply
- RCA & Speaker Level Inputs
- Low Pass Filter
- Bass Boost
- Remote Subwoofer Control
- Illuminated Logo



REMOTE SUBWOOFER CONTROL



SPECIFICATIONS	2 OHM MAX	4 OHM MAX	SIGNAL TO NOISE RATIO (dB)	FREQUENCY RESPONSE (Hz)	7" W x 2-9/32" H x
CLASS A/B MONO					
PL2500.1M	2500w x 1	1250w x 1	86	15-20kHz	15-7/8"L



PL2000.1M
2000 WATTS max power

FEATURES

- Monoblock
- Class A/B Topology
- 2Ω Stable
- PWM MOSFET Power Supply
- RCA & Speaker Level Inputs
- Low Pass Filter
- Bass Boost
- Remote Subwoofer Control
- Illuminated Logo



REMOTE SUBWOOFER CONTROL



SPECIFICATIONS	2 OHM MAX	4 OHM MAX	SIGNAL TO NOISE RATIO (dB)	FREQUENCY RESPONSE (Hz)	7" W x 2-9/32" H x
CLASS A/B MONO					
PL2000.1M	2000w x 1	1000w x	84	15-20kHz	12-3/4"L



Planet Audio

PULSE

CLASS AB MONO POWER AMPLIFIER



PL1500.1M
1500 WATTS max power

FEATURES

- Monoblock
- Class A/B Topology
- 2Ω Stable
- PWM MOSFET Power Supply
- RCA & Speaker Level Inputs
- Low Pass Filter
- Bass Boost
- Phase Control
- Remote Subwoofer Control
- Illuminated Logo



REMOTE SUBWOOFER CONTROL



SPECIFICATIONS	2 OHM MAX	4 OHM MAX	SIGNAL TO NOISE RATIO (dB)	FREQUENCY RESPONSE (Hz)	7" W x 2-9/32" H x
CLASS A/B MONO					
PL1500.1M	1500w x 1	750w x	84	15-20kHz	10"L



PL3000.2
3000 WATTS max power

FEATURES

- 2/1 Channel
- Full-Range, Class A/B
- 2Ω Stereo Stable
- PWM MOSFET Power Supply
- RCA & Speaker Level Inputs
- HP & LP Filters
- Bass Boost
- Remote Subwoofer Control
- Illuminated Logo



REMOTE SUBWOOFER CONTROL



SPECIFICATIONS	2 OHM MAX	4 OHM MAX	BRIDGED @ 4 OHM	SIGNAL TO NOISE RATIO (dB)	FREQUENCY RESPONSE (Hz)	7" W x 2-9/32" H x
2 CHANNEL						
PL3000.2	1500w x 2	750w x 2	3000w x 1	85	20-20kHz	18-7/8"L



PL1600.2
1600 WATTS max power

FEATURES

- 2/1 Channel
- Full-Range, Class A/B
- 2Ω Stereo Stable
- PWM MOSFET Power Supply
- RCA & Speaker Level Inputs
- HP & LP Filters
- Bass Boost
- Remote Subwoofer Control
- Illuminated Logo



REMOTE SUBWOOFER CONTROL



SPECIFICATIONS	2 OHM MAX	4 OHM MAX	BRIDGED @ 4 OHM	SIGNAL TO NOISE RATIO (dB)	FREQUENCY RESPONSE (Hz)	7" W x 2-9/32" H x
2 CHANNEL						
PL1600.2	800w x 2	400w x 2	1600w x 1	85	20-20kHz	12-3/4"L



PL1200.2
1200 WATTS max power

FEATURES

- 2/1 Channel
- Full-Range, Class A/B
- 2Ω Stereo Stable
- PWM MOSFET Power Supply
- RCA & Speaker Level Inputs
- HP & LP Filters
- Bass Boost
- Remote Subwoofer Control
- Illuminated Logo



REMOTE SUBWOOFER CONTROL



SPECIFICATIONS	2 OHM MAX	4 OHM MAX	BRIDGED @ 4 OHM	SIGNAL TO NOISE RATIO (dB)	FREQUENCY RESPONSE (Hz)	7" W x 2-9/32" H x
2 CHANNEL						
PL1200.2	600w x 2	300w x 2	1200w x 1	85	20-20kHz	10"L



PL2400.4
2500 WATTS max power

FEATURES

- 4/3/2 Channel
- Full-Range, Class A/B
- 2Ω Stereo Stable
- PWM Mosfet Power Supply
- RCA & Speaker Level Inputs
- HP & LP Filters
- Bass Boost (CH 3/4) Remote Subwoofer Control
- Illuminated Logo



REMOTE SUBWOOFER CONTROL



SPECIFICATIONS	2 OHM MAX	4 OHM MAX	BRIDGED @ 4 OHM	SIGNAL TO NOISE RATIO (dB)	FREQUENCY RESPONSE (Hz)	7" W x 2-9/32" H x
4 CHANNEL						
PL2400.4	600w x 4	300w x 4	1200w x 2	86	20-20kHz	15-7/8"L



PL1600.4
1600 WATTS max power

FEATURES

- 4/3/2 Channel
- Full-Range, Class A/B
- 2Ω Stereo Stable
- PWM Mosfet Power Supply
- RCA & Speaker Level Inputs
- HP & LP Filters
- Bass Boost (CH 3/4) Remote
- Subwoofer Control
- Illuminated Logo



REMOTE SUBWOOFER CONTROL



SPECIFICATIONS	2 OHM MAX	4 OHM MAX	BRIDGED @ 4 OHM	SIGNAL TO NOISE RATIO (dB)	FREQUENCY RESPONSE (Hz)	7" W x 2-9/32" H x
4 CHANNEL						
PL1600.4	400w x 4	200w x 4	800w x 2	86	20-20kHz	11-7/8"L



REMOTE SUBWOOFER CONTROL

PA300

DIGITAL BASS PROCESSOR

With Remote Subwoofer Control

FEATURES

- Maximum Bass Control
- Dash-mount Remote Controls
- Subsonic Filter and Bass Level
- Glowing Planet Lens Display
- Bass Restoration Activity
- Parametric Bass Control
- Balanced Inputs

- PWM Power Supply
- Pre-Amp Output : 10v
- Frequency Response: 10Hz - 100kHz
- THD: $\leq 0.003\%$
- S/N : $\geq 85\text{dB}$

Dimensions:
4-5/8" L x 7" W x 1-5/8" H





PEQ15

HALF-DIN SIZE
5-BAND EQUALIZER

Includes Black and Silver Face Plates

BLACK FACE PLATE



SILVER FACE PLATE



FEATURES

- Black and Silver Face Plates
- 5 Band Adjustment
- Adjustable Center Frequencies on Each Band
- CD/Aux Input
- Master Volume Control
- Fader Control
- PWM MOSFET Power Supply
- S/N : ≥ 85 dB
- Night Illumination
- Acrylic Top Cover

- Output Gain: + 18dB
- SUB: 50-250 Hz
- Low: 20-70 Hz
- Low-Mid 150-400 Hz
- MID: 1.5 KHz - 4 KHz
- High: 4 KHz - 20 KHz





PEQ10

HALF-DIN SIZE
4-BAND EQUALIZER



FEATURES

4 fixed bands (high, mid, low and sub) with 12dB of boost/cut adjustment. The adjustable subwoofer crossover and gain control add flexibility to your bottom end.

4 Band Adjustment

Subwoofer Output with Adjustable Filter

Subwoofer Level Control

Auxiliary Input

Master Volume Control

Fader Control
Input Sensitivity Adjustment
PWM Power Supply
S/N : $\geq 85\text{dB}$
Night Illumination





EQ20B

3-WAY ELECTRONIC CROSSOVER
WITH REMOTE SUBWOOFER CONTROL



REMOTE SUBWOOFER CONTROL

FEATURES

- Provides three Filter circuits for a variety of set-up options
- Variable Low Pass: 32Hz to 250Hz
- Variable High Pass: 40Hz to 400Hz
- Frequency Multiplier: x1 or x20
- Selectable Slope: 6dB or 18dB/octave
- Independent Front and Rear Level Controls
- S/N: ≥ 85 dB
- DC-to-DC Power Supply
- Outputs for 3-Way or Front, Rear and Subwoofer System Configurations
- Remote Subwoofer Control
- Bass Boost 0 to +12dB
- Dimensions: 8-1/4" L x 5-1/8" W x 1-7/8" H





EQ10B

2-WAY ELECTRONIC CROSSOVER
WITH REMOTE SUBWOOFER CONTROL



REMOTE SUBWOOFER
CONTROL

FEATURES

- Offers the same quality and performance of the EC20B in a two way (high-pass/low-pass) configuration
- Variable Low Pass: 35Hz to 400Hz
- Variable High Pass: 50Hz to 1.5kHz
- Crossover Slope: 6dB/octave
- Independent Front and Rear Level Controls
- S/N: \geq 85dB
- DC-to-DC Power Supply
- Subwoofer Phase
- Remote Subwoofer Control
- Bass Boost 0 to +12dB @ 45Hz
- Dimensions: 7-1/4" L x 4-3/8" W x 1-1/4" H





Planet Audio®

LOW-PROFILE AMPLIFIED SUBWOOFER

800 WATTS MAX POWER 8" LOW-PROFILE AMPLIFIED SUBWOOFER
FEATURING BUILT-IN AMPLIFIER AND 2 PASSIVE RADIATORS

PA8W



2 PASSIVE RADIATORS FOR MORE BASS



REMOTE CONTROL

PA8W 800 WATTS

MAX POWER

- Class A/B Topology
- PWM MOSFET Power Supply
- RCA & Speaker Level Inputs
- LP Filters
- Bass Boost
- Phase Control
- Remote Subwoofer Control
- LED-Illuminated Logo
- 2 Passive Radiators
- Max Power: 800 W

Dimensions
13.88" x 9.88" x 3" / 352 x 251 x 76 mm

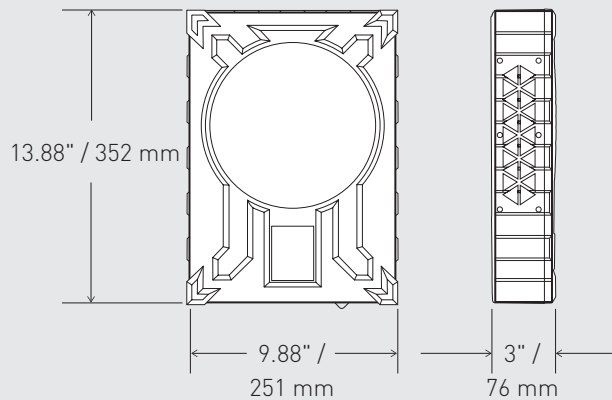

ILLUMINATED LOGO

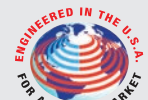



Planet Audio®

big bang

SUBWOOFERS

12"

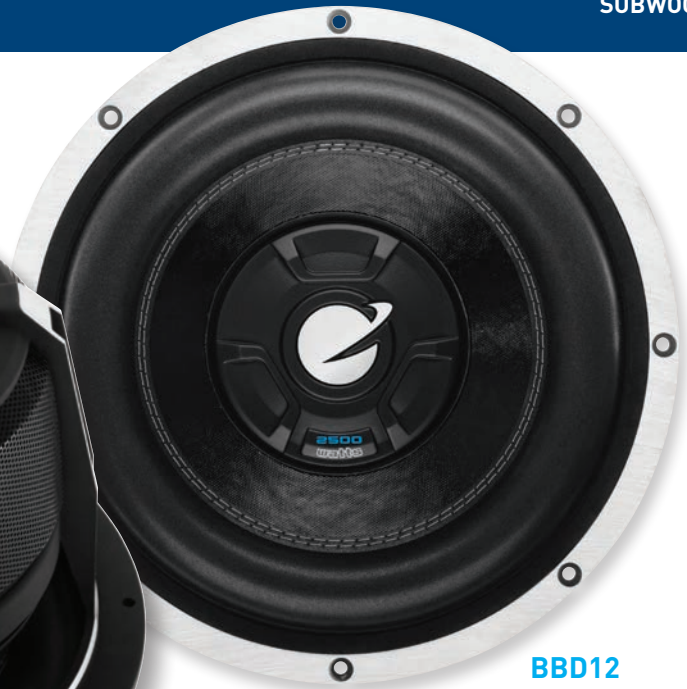

BBD12
2500 WATTS
12" Dual Voice Coil Subwoofer

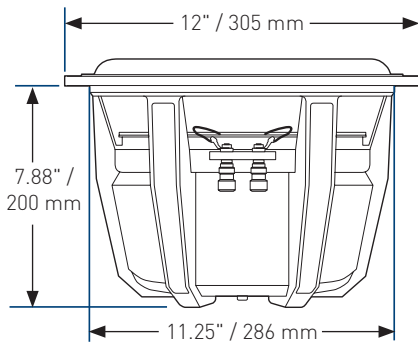

- Foam Surround
- Treated Paper Cone
- Cast Aluminum Basket
- Push Terminals

MODEL	POWER	CONE	SENSITIVITY	IMPEDANCE	DIAMETER	MOUNTING DEPTH
BB	MAX WATTS	MATERIAL	1W/1M [dB]			
BBD12	2500w	Paper Cone	95	DUAL 4 OHM	12"	7-7/8"



Planet Audio

AXIS

SUBWOOFERS

12"

PX12
1000 WATTS
12" Flat Subwoofer

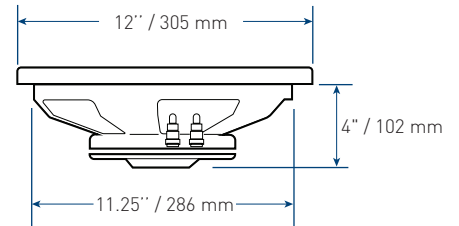

- Rubber Surround
- Stamped Steel Basket
- Polypropylene Cone
- Push Terminals
- High Temperature Voice Coil
- Slim Mounting



MODEL	POWER	CONE	SENSITIVITY	IMPEDANCE	DIAMETER	MOUNTING DEPTH
AXIS						
PX12	1000w	Polypropylene	85	4 OHM	12"	4"



Planet Audio

AXIS

SUBWOOFERS

PX10
800 WATTS
10" Flat Subwoofer



10"

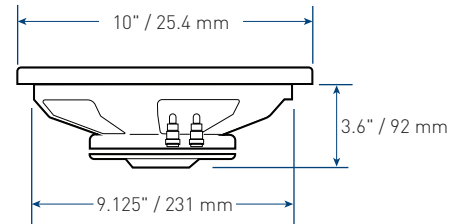

- Rubber Surround
- Stamped Steel Basket
- Polypropylene Cone
- Push Terminals
- High Temperature Voice Coil
- Slim Mounting



MODEL	POWER	CONE	SENSITIVITY	IMPEDANCE	DIAMETER	MOUNTING DEPTH
AXIS						
PX10	800w	Polypropylene	85	4 OHM	10"	3-5/8"



Planet Audio®

ANARCHY

SUBWOOFERS

15"

AC15D
2100 WATTS
15" Dual Voice Coil Subwoofer

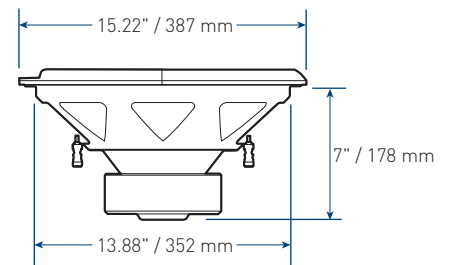

Foam Surround
Stamped Steel Basket
Polypropylene Cone
High Performance Voice Coils
Paintable Trim Ring
Push Terminals



MODEL	POWER	CONE	SENSITIVITY	IMPEDANCE	DIAMETER	MOUNTING DEPTH
ANARCHY	MAX WATTS		1W/1M [dB]			
AC15D	2100w	Polypropylene	83	DUAL 4 OHM	15-7/32"	7"



Planet Audio®

ANARCHY

SUBWOOFERS

12"

AC12D
1800 WATTS
12" Dual Voice Coil Subwoofer

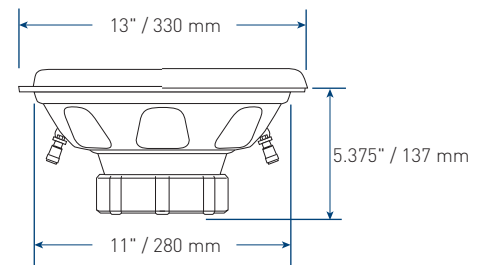

- Foam Surround
- Stamped Steel Basket
- Polypropylene Cone
- High Performance Voice Coils
- Paintable Trim Ring
- Push Terminals



MODEL	POWER	CONE	SENSITIVITY	IMPEDANCE	DIAMETER	MOUNTING DEPTH
ANARCHY	MAX WATTS		1W/1M [dB]			
AC12D	1800w	Polypropylene	85	DUAL 4 OHM	13"	5-3/8"



Planet Audio®

ANARCHY

SUBWOOFERS

10"

AC10D
1500 WATTS
10" Dual Voice Coil Subwoofer

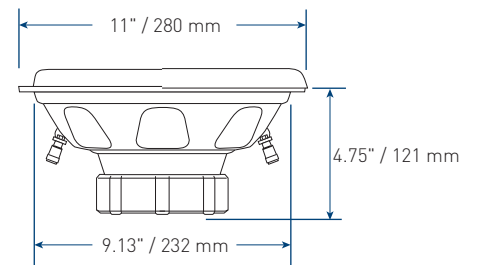

- Foam Surround
- Stamped Steel Basket
- Polypropylene Cone
- High Performance Voice Coils
- Paintable Trim Ring
- Push Terminals



MODEL	POWER	CONE	SENSITIVITY	IMPEDANCE	DIAMETER	MOUNTING DEPTH
ANARCHY	MAX WATTS		1W/1M [dB]			
AC10D	1500w	Polypropylene	85	DUAL 4 OHM	10"	4-3/4"



Planet Audio®

ANARCHY

SUBWOOFERS

8"

AC8D
1200 WATTS
8" Dual Voice Coil Subwoofer

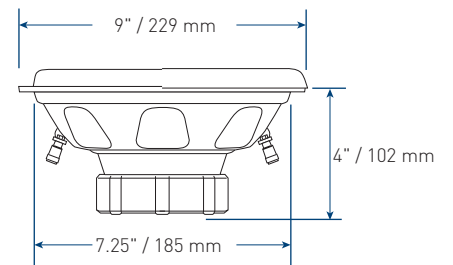

Foam Surround
Stamped Steel Basket
Polypropylene Cone
High Performance Voice Coils
Paintable Trim Ring



MODEL	POWER	CONE	SENSITIVITY	IMPEDANCE	DIAMETER	MOUNTING DEPTH
ANARCHY	MAX WATTS		1W/1M [dB]			
AC8D	1200w	Polypropylene	84	DUAL 4 OHM	9"	4"



Planet Audio®

TORQUE

SUBWOOFERS

12"

TQ12S
1500 WATTS
12" 4 OHM Subwoofer

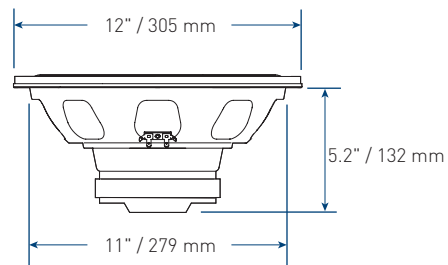

Foam Surround
Stamped Steel Basket
Treated Paper Cone
High Temperature Voice Coil



MODEL	POWER	CONE	SENSITIVITY	IMPEDANCE	DIAMETER	MOUNTING DEPTH
TORQUE	MAX WATTS	MATERIAL	1W/1M [dB]			
TQ12S	1500w	Paper	87	DUAL 4 OHM	12"	5-3/16"



Planet Audio®

TORQUE

SUBWOOFERS

10"

TQ10S
1200 WATTS
10" 4 OHM Subwoofer

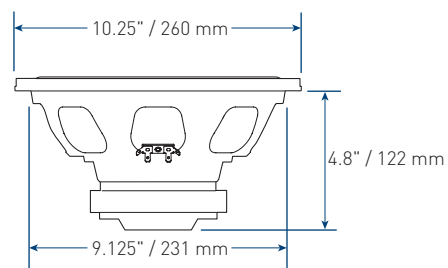

Foam Surround
Stamped Steel Basket
Treated Paper Cone
High Temperature Voice Coil



MODEL	POWER	CONE	SENSITIVITY	IMPEDANCE	DIAMETER	MOUNTING DEPTH
TORQUE	MAX WATTS	MATERIAL	1W/1M [dB]			
TQ10S	1200w	Paper	87	DUAL 4 OHM	10"	4-3/4"



Planet Audio®

ANARCHY

LED SPEAKERS

AC693

500 WATTS

6" x 9" 3-Way Speaker System

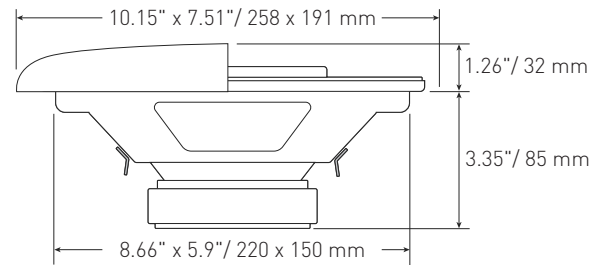

- Rubber Surround
- Stamped Steel Basket
- Polypropylene Cone
- Custom Grille
- LED Illuminated Tweeters



SPECIFICATIONS	POWER HANDLING (MAX)	SYSTEM IMPEDANCE	FREQUENCY RESPONSE (±3 dB)	SYSTEM SENSITIVITY @ 1W / 1m	MIDRANGE	TWEETER(S)	MOUNTING DEPTH
AC							
AC693	500w	4 Ω	55Hz-20kHz	88dB	2.3"	1" DOME	3.35"



Planet Audio

ANARCHY

LED SPEAKERS

AC653

300 WATTS

6.5" 3-Way Speaker System

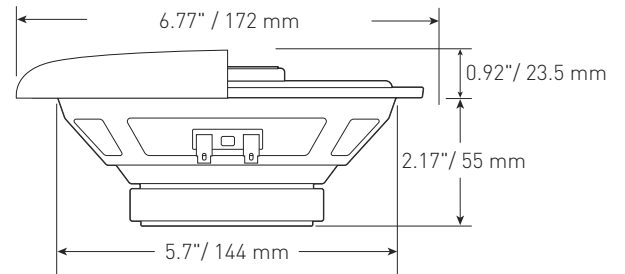

- Rubber Surround
- Stamped Steel Basket
- Polypropylene Cone
- Custom Grille
- LED Illuminated Tweeters



SPECIFICATIONS	POWER HANDLING (MAX)	SYSTEM IMPEDANCE	FREQUENCY RESPONSE (± 3 dB)	SYSTEM SENSITIVITY @ 1W / 1m	MIDRANGE	TWEETER(S)	MOUNTING DEPTH
AC							
AC653	300w	4 Ω	65Hz-20kHz	87dB	2.3"	1.3" / 1.1" DOME	2.17"



Planet Audio®

ANARCHY

LED SPEAKERS

AC573

250 WATTS

5" x 7" 3-Way Speaker System
(Also Fits 6" x 8")

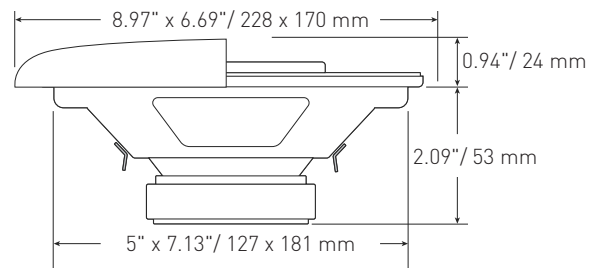

- Rubber Surround
- Stamped Steel Basket
- Polypropylene Cone
- Custom Grille
- LED Illuminated Tweeters



SPECIFICATIONS	POWER HANDLING (MAX)	SYSTEM IMPEDANCE	FREQUENCY RESPONSE (±3 dB)	SYSTEM SENSITIVITY @ 1W / 1m	MIDRANGE	TWEETER(S)	MOUNTING DEPTH
AC							
AC573	250w	4 Ω	85Hz-20kHz	87dB	2.3"	1.38" / 1.1" DOME	2.09"



Planet Audio

ANARCHY

LED SPEAKERS

AC523

300 WATTS

5.2" 3-Way Speaker System

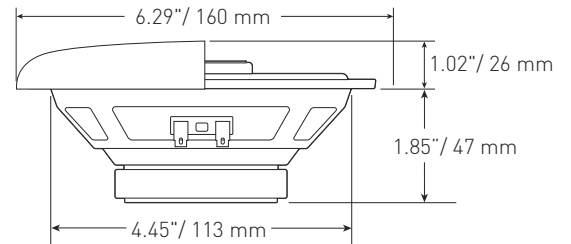

- Rubber Surround
- Stamped Steel Basket
- Polypropylene Cone
- Custom Grille
- LED Illuminated Tweeters



SPECIFICATIONS	POWER HANDLING (MAX)	SYSTEM IMPEDANCE	FREQUENCY RESPONSE (± 3 dB)	SYSTEM SENSITIVITY @ 1W / 1m	MIDRANGE	TWEETER(S)	MOUNTING DEPTH
AC							
AC523	300w	4 Ω	102Hz-20kHz	87dB	2.3"	1.3" / 1.1"	1.85"



Planet Audio®

TORQUE

SPEAKERS

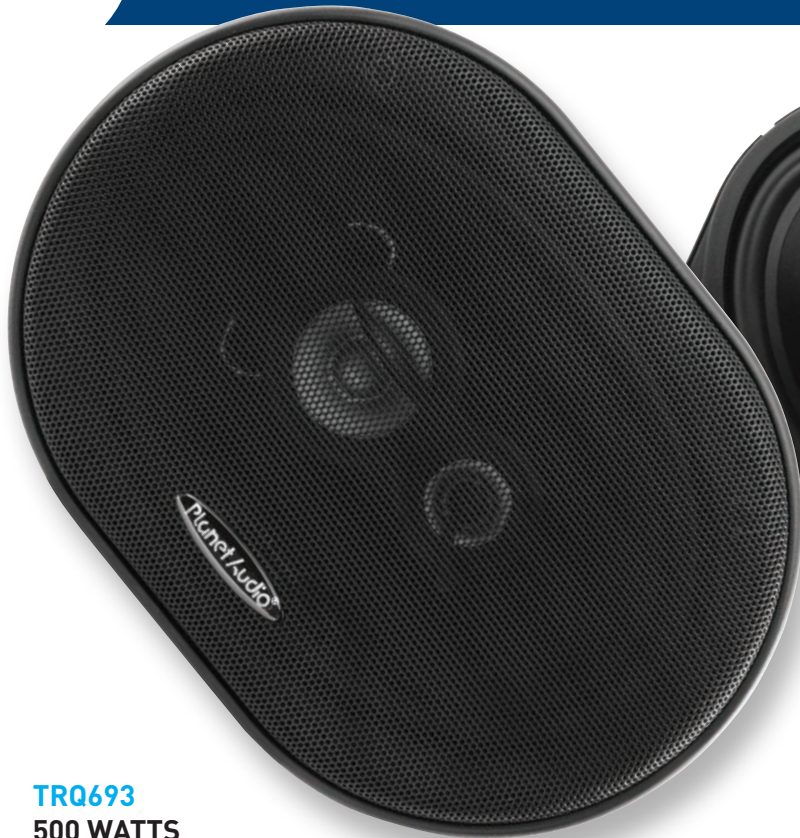

TRQ693 500 WATTS

6" x 9" 3-Way Speaker System

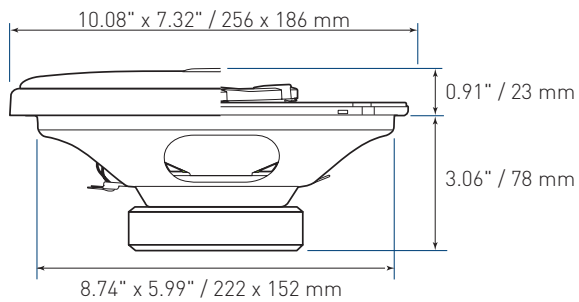

Rubber Surround
 Stamped Steel Basket
 Polypropylene Cone
 Custom Grille



SPECIFICATIONS	POWER HANDLING (MAX)	SYSTEM IMPEDANCE	FREQUENCY RESPONSE (±3 dB)	SYSTEM SENSITIVITY @ 1W / 1m	WOOFER	TWEETER(S)	MOUNTING DEPTH
TRQ							
TRQ693	500w	4 Ω	50Hz-20kHz	87dB	6X9"	2" / 1"	3-1/16"



Planet Audio®

TORQUE

SPEAKERS



TRQ623

300 WATTS

6.5" 3-Way Speaker System

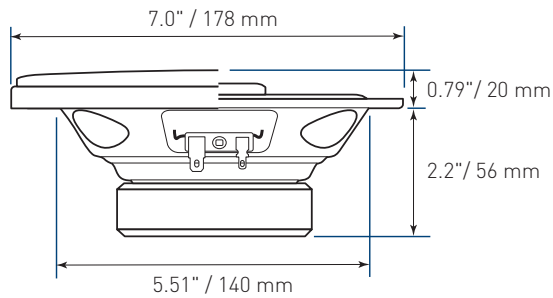

Rubber Surround
 Stamped Steel Basket
 Polypropylene Cone
 Custom Grille



SPECIFICATIONS	POWER HANDLING (MAX)	SYSTEM IMPEDANCE	FREQUENCY RESPONSE (±3 dB)	SYSTEM SENSITIVITY @ 1W / 1m	WOOFER	TWEETER(S)	MOUNTING DEPTH
TRQ							
TRQ623	300w	4 Ω	50Hz-20kHz	86dB	6-1/2"	1" / 0.5"	2-5/16"



Planet Audio®

TORQUE

SPEAKERS

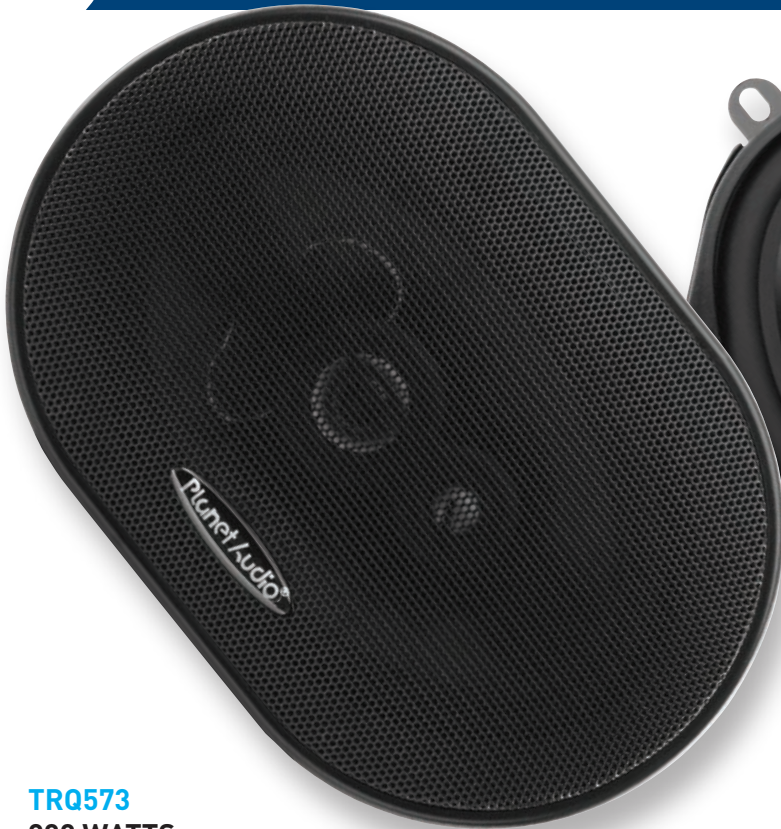

TRQ573

300 WATTS

5" X 7" 3-Way Speaker System

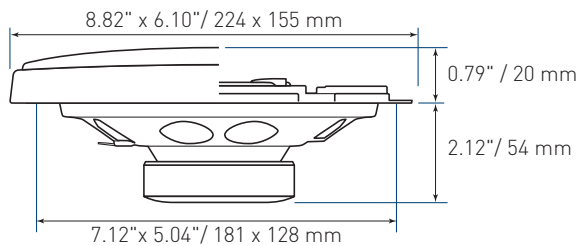

Rubber Surround
 Stamped Steel Basket
 Polypropylene Cone
 Custom Grille



SPECIFICATIONS	POWER HANDLING (MAX)	SYSTEM IMPEDANCE	FREQUENCY RESPONSE (±3 dB)	SYSTEM SENSITIVITY @ 1W / 1m	WOOFER	TWEETER(S)	MOUNTING DEPTH
TRQ							
TRQ573	300w	4 Ω	50Hz-20kHz	88dB	5" x 7"	1" / 0.5"	2-1/8"



Planet Audio®

TORQUE

SPEAKERS



TRQ622

250 WATTS

6.5" 2-Way Speaker System

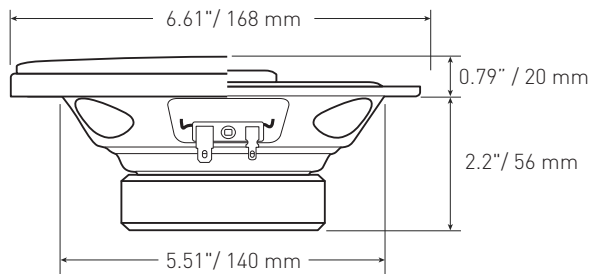

Rubber Surround
 Stamped Steel Basket
 Polypropylene Cone
 Custom Grille



SPECIFICATIONS	POWER HANDLING (MAX)	SYSTEM IMPEDANCE	FREQUENCY RESPONSE (±3 dB)	SYSTEM SENSITIVITY @ 1W / 1m	WOOFER	TWEETER(S)	MOUNTING DEPTH
TRQ							
TRQ622	250w	4 Ω	70Hz-20kHz	91dB	6-1/2"	1"	2-5/16"



Planet Audio®

TORQUE

SPEAKERS



TRQ413 400 WATTS

4" x 10" 3-Way Speaker System

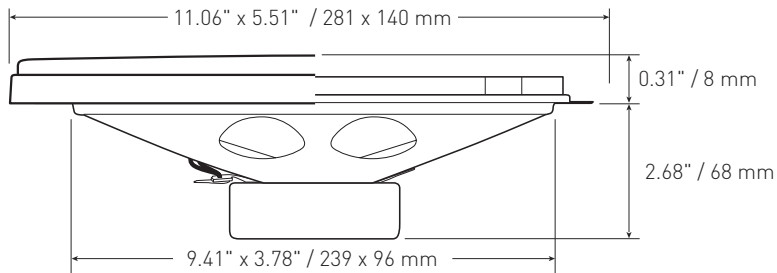

- Rubber Surround
- Stamped Steel Basket
- Polypropylene Cone
- Custom Grille



SPECIFICATIONS	POWER HANDLING (MAX)	SYSTEM IMPEDANCE	FREQUENCY RESPONSE (±3 dB)	SYSTEM SENSITIVITY @ 1W / 1m	WOOFER	TWEETER(S)	MOUNTING DEPTH
TRQ							
TRQ413	400w	4 Ω	70Hz-20kHz	86dB	4" x 10"	1" / 1/2"	2-9/16"



Planet Audio®

TORQUE

SPEAKERS



TRQ462

200 WATTS

4" x 6" 2-Way Speaker System

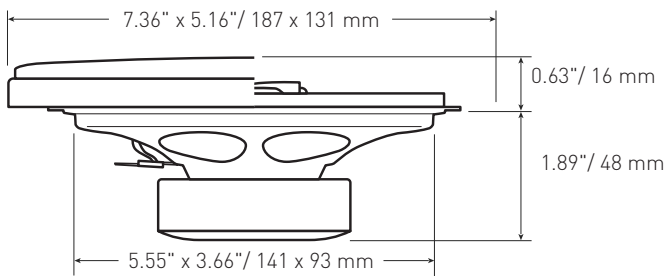

Rubber Surround
 Stamped Steel Basket
 Polypropylene Cone
 Custom Grille



SPECIFICATIONS	POWER HANDLING (MAX)	SYSTEM IMPEDANCE	FREQUENCY RESPONSE (±3 dB)	SYSTEM SENSITIVITY @ 1W / 1m	WOOFER	TWEETER(S)	MOUNTING DEPTH
TRQ							
TRQ462	200w	4 Ω	72Hz-20kHz	84dB	4" x 6"	1"	1-7/8"



Planet Audio®

TORQUE

SPEAKERS



TRQ522

225 WATTS

5.25" 2-Way Speaker System

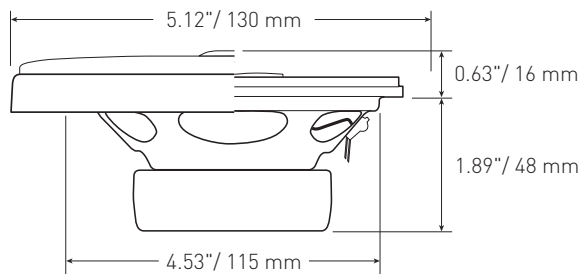

Rubber Surround
 Stamped Steel Basket
 Polypropylene Cone
 Custom Grille



SPECIFICATIONS	POWER HANDLING (MAX)	SYSTEM IMPEDANCE	FREQUENCY RESPONSE (±3 dB)	SYSTEM SENSITIVITY @ 1W / 1m	WOOFER	TWEETER(S)	MOUNTING DEPTH
TRQ							
TRQ522	225w	4 Ω	78Hz-20kHz	84dB	5-1/4"	1"	1-7/8"



Planet Audio®

TORQUE

SPEAKERS



TRQ422

225 WATTS

4" 2-Way Speaker System

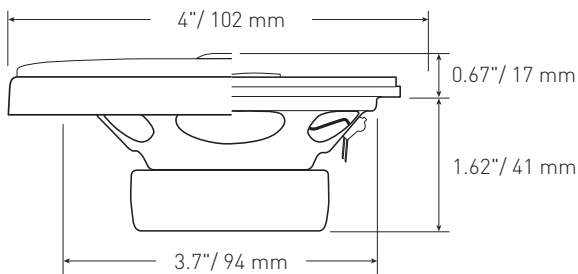

Rubber Surround
 Stamped Steel Basket
 Polypropylene Cone
 Custom Grille



SPECIFICATIONS	POWER HANDLING (MAX)	SYSTEM IMPEDANCE	FREQUENCY RESPONSE (±3 dB)	SYSTEM SENSITIVITY @ 1W / 1m	WOOFER	TWEETER(S)	MOUNTING DEPTH
TRQ							
TRQ422	225w	4 Ω	87Hz-20kHz	85dB	4"	1/2"	1-5/8"



Planet Audio®

TORQUE

SPEAKERS



TRQ322 140 WATTS

3.5" 2-Way Speaker System

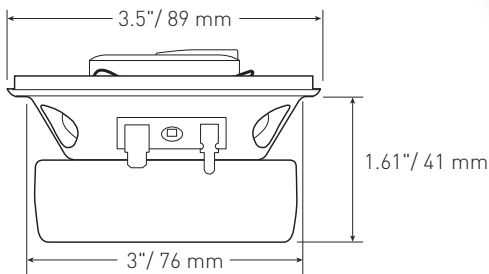

Rubber Surround
 Stamped Steel Basket
 Polypropylene Cone



SPECIFICATIONS	POWER HANDLING (MAX)	SYSTEM IMPEDANCE	FREQUENCY RESPONSE (±3 dB)	SYSTEM SENSITIVITY @ 1W / 1m	WOOFER	TWEETER(S)	MOUNTING DEPTH
TRQ							
TRQ322	140w	4 Ω	105Hz-20kHz	85dB	3-1/2"	1/2"	1-5/8"



Planet Audio®

PULSE
SPEAKERS



PL69

400 WATTS

6" x 9" 3-Way Speaker System

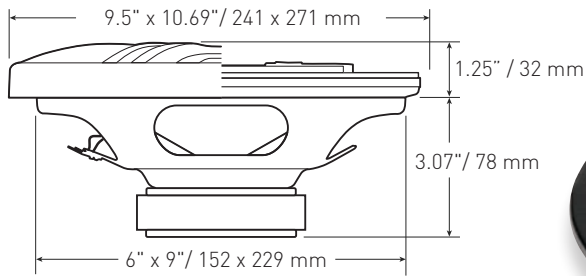

Rubber Surround
Polypropylene Cone
Stamped Steel Basket



SPECIFICATIONS	POWER HANDLING (MAX)	SYSTEM IMPEDANCE	FREQUENCY RESPONSE (±3 dB)	SYSTEM SENSITIVITY @ 1W / 1m	WOOFER	TWEETER(S)	MOUNTING DEPTH
PL							
PL69	400w	4 Ω	50Hz-20kHz	86dB	6" x 9"	2" / 1"	3-1/16"



Planet Audio®

PULSE
SPEAKERS



PL63

300 WATTS

6.5" 3-Way Speaker System

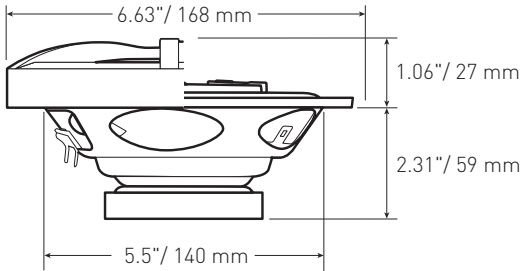

Rubber Surround
Polypropylene Cone
Stamped Steel Basket



SPECIFICATIONS	POWER HANDLING (MAX)	SYSTEM IMPEDANCE	FREQUENCY RESPONSE (±3 dB)	SYSTEM SENSITIVITY @ 1W / 1m	WOOFER	TWEETER(S)	MOUNTING DEPTH
PL							
PL63	300w	4 Ω	50Hz-20kHz	84dB	6-1/2"	1" / 1/2"	2-5/16"



Planet Audio®

PULSE

SPEAKERS



PL57
200 WATTS
5" x 7" 3-Way Speaker System

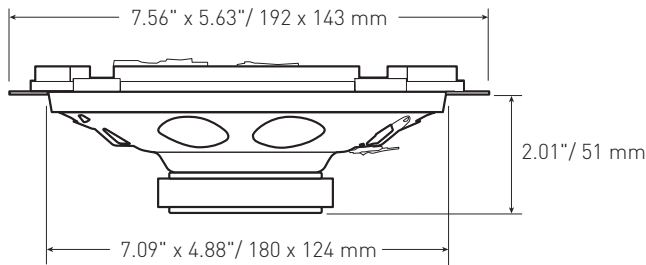

Rubber Surround
Polypropylene Cone
Stamped Steel Basket



SPECIFICATIONS	POWER HANDLING (MAX)	SYSTEM IMPEDANCE	FREQUENCY RESPONSE (±3 dB)	SYSTEM SENSITIVITY @ 1W / 1m	WOOFER	TWEETER(S)	MOUNTING DEPTH
PL							
PL57	200w	4 Ω	50Hz-20kHz	84dB	5" x 7"	1" / 1/2"	2-5/16"



PL53
200 WATTS
 5.25" 3-Way Speaker System

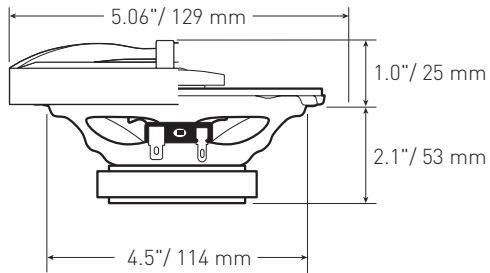

Rubber Surround Polypropylene Cone Stamped Steel Basket			
---	--	--	---

SPECIFICATIONS	POWER HANDLING (MAX)	SYSTEM IMPEDANCE	FREQUENCY RESPONSE (±3 dB)	SYSTEM SENSITIVITY @ 1W / 1m	WOOFER	TWEETER(S)	MOUNTING DEPTH
PL PL53	200w	4 Ω	50Hz-20kHz	82dB	5-1/4"	1" / 1/2"	1-5/8"



Planet Audio®

PULSE
SPEAKERS



PL43
200 WATTS
4" 3-Way Speaker System

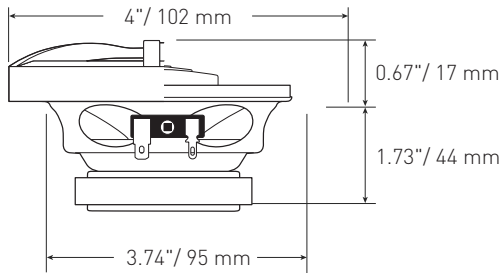

Rubber Surround
Polypropylene Cone
Stamped Steel Basket



SPECIFICATIONS	POWER HANDLING (MAX)	SYSTEM IMPEDANCE	FREQUENCY RESPONSE (±3 dB)	SYSTEM SENSITIVITY @ 1W / 1m	WOOFER	TWEETER(S)	MOUNTING DEPTH
PL							
PL43	200w	4 Ω	50Hz-20kHz	82dB	4"	1" / 1/2"	1-3/4"



Planet Audio®

CAPACITORS



PC20F
20 FARAD

PC20F

20 Farad Capacitor

Digital Voltage Display
Blue Illumination

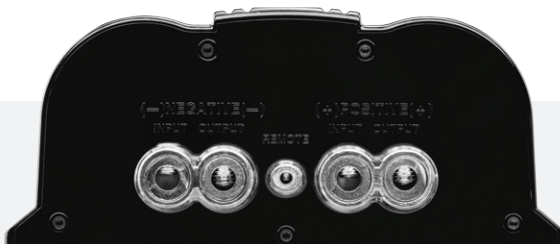



Planet Audio®

CAPACITORS



PC10F
10 FARAD

PC10F
10 Farad Capacitor

Digital Voltage Display
Blue Illumination





Planet Audio®

CAPACITORS

PCBLK3.5
3.5 FARAD



PCBLK3.5
3.5 Farad Capacitor

Digital Voltage Display
Blue Illumination
16v / 24v surge
Satin silver ring terminals
Includes mounting brackets
Digital display





PCBLK2.0
2.0 FARAD



PCBLK2.0

2.0 Farad Capacitor

- Digital Voltage Display
- Blue Illumination
- 16v / 24v surge
- Satin silver ring terminals
- Includes mounting brackets
- Digital display





8GPK 8 Gauge Amplifier Installation Kit



Kit includes:

- 20 ft. 8 GA Red Power Cable
- Competition High Quality Fuse Holder
- 3 ft. 8 GA Black Ground Cable
- 16 ft. 18 GA Blue Turn-On Wire
- 20 ft. High Performance RCA Interconnect
- 30 ft. Speaker Wire
- 6 ft. Split Loom Tubing
- [20] 4" Wire Ties
- [3] Rubber Grommets
- #10 Ring Terminal
- 5/16" Ring Terminal
- 1/4" Ring Terminal





4GPK

4 Gauge Amplifier Installation Kit



Kit includes:

- 20 ft. 8 GA Red Power Cable
- Competition High Quality Fuse Holder
- 3 ft. 8 GA Black Ground Cable
- 16 ft. 18 GA Blue Turn-On Wire
- 20 ft. High Performance RCA Interconnect
- 30 ft. Speaker Wire
- 6 ft. Split Loom Tubing
- (20) 4" Wire Ties
- (3) Rubber Grommets
- #10 Ring Terminal
- 5/16" Ring Terminal
- 1/4" Ring Terminal





PAK0

1/0 Gauge Amplifier Installation Kit

Kit includes:

- 1/0 Gauge Blue Power Wire (17 ft) w/Crimped Ring Terminal
- 1/0 Gauge Black Ground Wire (3 ft) w/Crimped Ring Terminal
- Blue Shielded RCA Cable (17 ft)
- 12 Gauge Speaker Wire (25 ft)
- ANL Fuse Holder w/ 250 A Fuse
- Grommets (3)
- 10" Zip Ties (10)
- #6 Screws (3)





HEADREST COUNTERTOP DISPLAY

Our countertop headrest display is the perfect way to demonstrate all Planet Audio Headrest Monitors. The working display comes with a power supply to power one monitor. It also includes a hook to hang a Wireless Headphone for easy customer use.

Dimensions: 16" (W) x 13" (D) x 10" (H)

Please contact your account manager for additional information regarding our FREE display program.

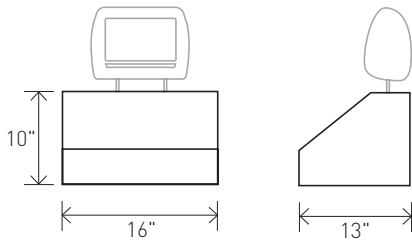

FLOOR DISPLAY

Planet Audio is proud to offer a new display program to our loyal dealers and distributors. An interactive display is proven to be the most effective way to demo product to your customer. This display allows you to showcase all product categories of the Planet Audio line. Your choice of over head video, in-dash cd and/or multimedia, a mix of full range speakers, amplifiers and sub woofers all installed, wired and ready to plug and play.

Dimensions: 36" (W) x 31-1/8" (D) x 80" (H)

Please contact your account manager for complete information and requirements for our display program.

Each display is loaded to your specific product order.

