



#### Kit Contents

Description	Part No	Pcs
Shock absorber	HD 775	2
Washer 12.8/24/6	03118-08	4
Sleeve 12.7/14/19.5	00123-17	4
Tool preload adjuster	03199-01	1
Sticker "Memo notes"	01180-01	1
Sticker set "ÖHLINS"	10207-01	1
Owners manual	07241-02	1

#### 👁 Note!

These mounting instructions are for the below versions of HD 775

Product Number	Fitted Spring
HD 775	66420-026 (B)
HD 775S2	66420-028 (B)
HD 775S3	66420-030 (B)

#### 👁 Note!

Please note that this image is a general representation of the product and may differ slightly from your product.

#### 👁 Note!

Please note that during storage and transportation, especially at high ambient temperature, some of the oil and grease used for assembling may leak and stain the packaging. This is in no way detrimental to the product, wipe off the excessive oil/grease with a cloth.

#### 👁 Note!

Before installing this product, check the contents of the kit. If anything is missing, please contact an Öhlins dealer.

#### ⚠ Warning!

Before installing this product, read the Öhlins Owner's Manual. The shock absorber/front fork/steering damper is an important part of your vehicle and will affect the stability.

## Shock absorber for Harley Davidson FLH / FLT Models

# HD 775 /S2 /S3

## Mounting Instructions

# MOUNTING INSTRUCTIONS

---

## **Warning!**

*It is advisable to have an Öhlins dealer install the shock absorber/front fork/steering damper.*

---

---

## **Warning!**

*If working on a raised vehicle, ensure it is securely supported so that it will not tip.*

---

---

## **Note!**

*Before mounting this product clean the vehicle thoroughly.*

---

---

## **Note!**

*When working on this product, always see the Vehicle Service Manual for vehicle specific procedures and important data.*

---

*1.Put the motorcycle on a lift stand so that the rear wheel barely touches the ground.*

*2.Loosen and remove the original shock absorber*

*3.Install the Öhlins shock absorber in the same way as the original shock absorbers with the Nitrogen Fill Screw pointing towards the rear.*

---

*Lower the vehicle so that the suspension is slightly compressed before tightening the screws.*

---

---

## **Caution!**

*Ensure that all screws are tightened to the correct torque and that nothing fouls or restricts movement of the shock absorber/front fork/steering damper when the suspension is fully compressed or extended.*

---

# MOUNTING INSTRUCTIONS

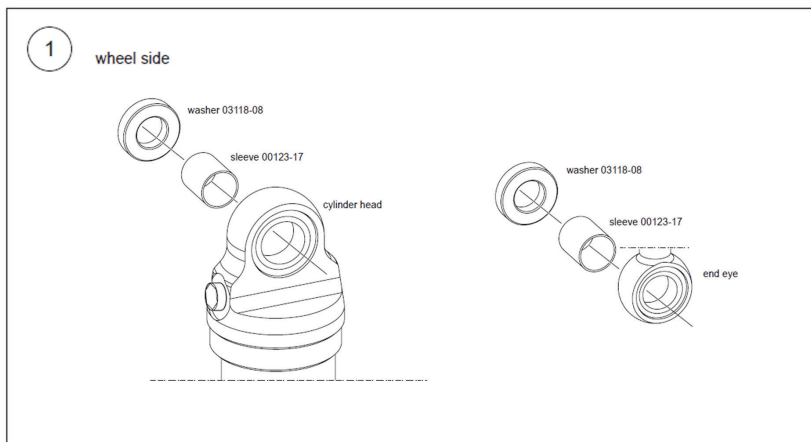

## ADJUSTMENTS

### **⚠ Warning!**

*Before riding, always make sure that the basic settings made by Öhlins are according to recommended Set-up Data. Read about adjustments and setting up in the Öhlins Owner's Manual before you make any adjustments. Contact an Öhlins dealer if you have any questions about setting up.*

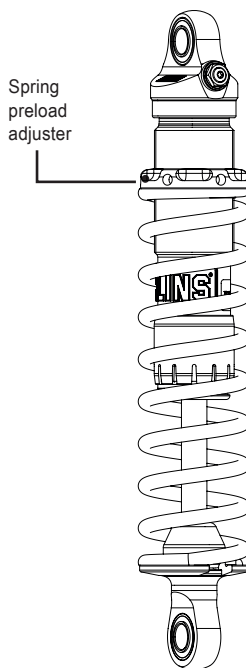

## SETUP DATA

### **Recommended set-up**

Visit [www.ohlinsusa.com](http://www.ohlinsusa.com) / search HD 775 for Spring Preload Calculator

### **Shock absorber data**

Length ..... 311 mm.

Stroke ..... 79 mm.

# SETUP SPRING CALCULATOR

Go to "www.ohlinsusa.com", under "Product Search", type HD 775 .Once on landing page, select "Setup Calculator"

## HD 775 Harley S36 Blackline Twin Shocks

OVERVIEW

IMAGES

TECH

SETUP CALCULATOR

SERVICE

*\*Once you get to the spring calculator, enter all the details about your bike and your weights.*

### Note!

- You have the option to change from lbs to kgs.

### SETUP CALCULATOR

#### About Your Bike

Model / Year

1990 - 2020 Harley-Davidson Ultra Class ▾

Tour Pack

YES

NO

Primary Use

Solo no luggage ▾

#### About The Rider

[lbs](#) | [kgs](#)

Rider Weight  
(including gear)

lbs

Passenger Weight  
(including gear)

0

lbs

Weight in Saddlebags

0

lbs

[New Setup](#) | [Returning Setup](#)

- Once you have entered the correct weights, choose "Returning Setup" so it gives you an option to select the springs installed on your shocks.

# SETUP SPRING CALCULATOR







## Note!

\*Make sure to double check the springs installed on your shocks as the distributor may have changed to accommodate your weight scenarios

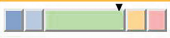
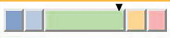
Best Fit
Best Fit
66420-026 (26 N/mm)
66420-028 (28 N/mm)
66420-030 (30 N/mm)
00280-21 (25 N/mm) Legacy
00180-97 (27 N/mm) Legacy
00180-22 (29 N/mm) Legacy
21180-01 (32 N/mm) Legacy

6. Once you click "Calculate", the setup data will be displayed. Example below:

CALCULATE

Rider Scenario	Spring Position	Comfort		
		Soft	Firm	
Solo	26 (mm)			<a href="#">SETUP DETAILS</a>
Solo With Luggage	26 (mm)			<a href="#">SETUP DETAILS</a>
Two Up	26 (mm)			<a href="#">SETUP DETAILS</a>
Two Up With Luggage	26 (mm)			<a href="#">SETUP DETAILS</a>

7. The "Spring Position" will tell you in millimeter the distance the preload collar should be from the bottom of the cylinder head for each scenario with your primary use highlighted in Gold.

You can click "Setup Details" for an image describing further. There's "Setup Details" beside all (4) rider scenarios (Solo, Solo with Luggage, Two Up and Two Up with Luggage) Make sure to click the one you plan to set the bike up for.

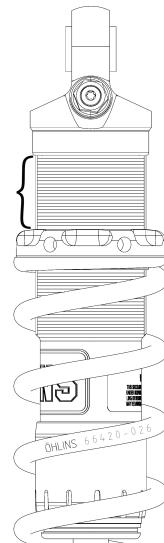

## SPRING POSITION