



NITROUS EXPRESS GUARANTEES YOUR SATISFACTION!

At NX we live and dream Nitrous Oxide. Customer service is taken very seriously and we work constantly to develop and improve our product lines. Our company is comprised of experienced and passionate people who use our products every day. A real, live human will answer the phone and provide you with accurate information based on years of experience. It is our commitment and our mission to provide the best service, performance, quality, and value.

We promise our customers complete satisfaction. If our products don't live up to your expectations, we want to hear from you. 99% of our nitrous components are made in the U.S.A and guaranteed to be of the highest quality and free of manufacturing defects.

Sincerely,
 Mike Wood
 Founder and CEO of Nitrous Express Inc.

CONTENTS

NEW PRODUCTS	PAGES 2-9
FEATURED PRODUCTS	PAGES 10-14
EFI SECTION	PAGES 14-30
Single Nozzle EFI Nitrous Systems	14
Mainline EFI System	15
Proton Systems	15
Ford Systems	16-19
GM Systems	20-23
Dodge Systems	24-25
FR-S /BRZ Systems	25
N-Tercooler System	26
NXL System	27
EFI Direct Port Systems	28-30
CARBURETED	PAGES 31-39
Carb Direct Port Nitrous Systems	31-35
Carb Plate Systems	36-42
MainLine Carb Nitrous Systems	43
DIESEL	PAGES 44-45
NITROUS CONVERSION	PAGES 46-47
NOZZLE ACCESSORIES	PAGES 42-45
Nozzle Conversions	48
Plumbing Kits	49
Custom Intake Plumbing	50-51
GEN-X ACCESSORY PACK	PAGE 52
PARTS & ACCESSORIES	PAGES 53-64
Switch Panels	53
Solenoid Brackets	53
Progressive Nitrous Controllers	54
Accessories	55-57
Nitrous Bottles	58
Bottle Accessories	59-60
Nitrous & Fuel Hoses	60
Solenoids	61
Fittings	62-64
FUEL SYSTEMS & ACCESSORIES	PAGES 65-66
WATER/METH INJECTION	PAGE 67
CHEMICAL X & R/C NITROUS SYSTEMS	PAGE 68
APPAREL & MERCHANDISE	PAGE 69

New Products



GM GEN-V NITROUS PLATE SYSTEMS

The Nitrous Express GM Gen-V plate systems feature Spraybarless technology for the ultimate in atomization and distribution. The billet plate bolts between the throttle body and intake making installation quick and easy. The solenoids are integrated into the plate for a super clean look and easy install. A direct-plug-in Fuel Line Adapter is provided to simplify installation (no need to cut your factory fuel lines). This system includes a TPS Autolearn switch so the nitrous only activates at wide open throttle and automatically turns off when you let your foot off the accelerator. The system includes jetting for 35, 50, 75, 100, 125, 150, 200 and 250 horsepower. Systems include a stainless braided N2O line, master arming switch, relay, relay harness and all necessary hardware to complete the installation. Systems ordered with a nitrous bottle include the new billet aluminum Lightning 45 bottle valve and stainless bottle brackets.

Part # Description

- 20936** 2014 GM truck plate system for 5.3L engines (35-300Whp)
- 20937** 2014 GM truck plate system for 6.2L engines (35-300Whp)
- 20938** C7 Corvette plate system (35-300Whp)

FOR BOTTLE SIZE ADD TO PART NUMBER:

- 00 System Less Bottle
- 05 System With 5Lb Bottle
- 10 System With 10Lb Bottle
- 12 System With 12Lb Composite Bottle
- 15 System With 15Lb Bottle

GM LS 3-BOLT NITROUS PLATE SYSTEMS

The Nitrous Express 78mm 3-Bolt Plate System features a billet aluminum nitrous plate that fits all car and truck intakes with a 3 bolt throttle body. The billet plate bolts between the throttle body and intake making installation quick, easy and attractive. The system includes jetting for 50, 100, 150, 200, 250, 300 and 350 horsepower, a ProPower Lightning series nitrous solenoid, 5lb, 10lb or 15lb nitrous bottle with the industry exclusive billet aluminum Lightning 45 bottle valve, 6AN feedline, braided stainless solenoid to plate lines, stainless bottle brackets, master arming switch, WOT switch as well as every nut, bolt and electrical connector needed to complete the installation. Fits 1997-2004 Corvette, 1998-02 V8 Camaro/Firebird, 2004 GTO as well as 1999-06 GM Trucks with 4.8L, 5.3L & 6.0L engines.



*Actual contents of nitrous system may vary from picture

Part # Description

- 20935** Gm Ls 78MM 3-Bolt Nitrous Plate System (35-350Whp)

New Products

NEW PRODUCTS

SHELBY GT 500 NITROUS PLATE SYSTEM

The Nitrous Express GT500 system features a billet nitrous plate that fits between the throttle body and intake making installation quick, easy and attractive. System includes billet aluminum and carbon fiber Lightning series solenoids for the ultimate in power and durability. A direct-bolt on Fuel Rail Adapter is provided to simplify installation (no need to cut your factory fuel lines), a TPS Wide Open Throttle Switch so the nitrous only activates at wide open throttle and automatically turns off when you decelerate, jetting for 35, 50, 75, 100, 125, 150, 200, 250 and 300 horsepower but you can expect larger power gains than normal due to the added power resulting from the cold air charge associated with Nitrous, 15 foot stainless braided nitrous line, master arming switch, relay, relay harness and all necessary hardware to complete the installation. Includes a 5lb, 10lb or 15lb nitrous bottle with the industry exclusive billet aluminum Lightning 45 bottle valve and stainless bottle brackets. Fits 2006 and newer GT500 Mustangs.



*Actual contents of nitrous system may vary from picture

Part #	Description
20949	Ford Shelby Gt500 Nitrous Plate System (35-300Whp) W/ 10Lb Bottle



*Actual contents of nitrous system may vary from picture

FORD 4 VALVE NITROUS PLATE SYSTEM

The Nitrous Express 4 Valve Plate System features a billet nitrous plate that fits between the throttle body and intake making installation quick, simple, and attractive. The system includes billet aluminum and carbon fiber nitrous and fuel solenoids for ultimate performance and weight savings. The system includes a Schrader valve fuel rail adapter for simple fuel system hook-ups, TPS wide open throttle switch, 15 foot nitrous feed line, master arming switch, relay, relay harness, and all necessary hardware to complete installation. System comes with jetting from 35hp-300hp. System can be purchased with 5, 10 or 15lb bottle, all of which include the Billet aluminum Lightning 45 bottle valve. Fits 1996-2004 Cobra and Mach 1 Mustangs

Part #	Description
20950	Ford 4V Nitrous Plate System

Popular Accessories



New Products



*Actual contents of nitrous system may vary from picture

GTR NITROUS PLATE SYSTEM

Nitrous Express has combined performance, quality and easy installation in this new nitrous system engineered specifically for the Nissan GTR. The system includes twin billet aluminum nitrous plates that bolt between the throttle bodies and the intake manifold for an easy install and excellent aesthetics. This system includes an Autolearn TPS module which allows the nitrous to activate only at wide open throttle. A direct-plug-in Fuel Line Adapter is provided to simplify installation (no need to cut your factory fuel lines). This system also includes billet aluminum and carbon fiber Lightning series solenoids, stainless braided N2O line, master arming switch, relay, relay harness and all necessary hardware to complete the installation. Includes jetting for 35, 70, 100, 150, 200, and 250HP. Systems with bottles include the billet aluminum lightning 45 bottle valve and stainless bottle brackets.

Part # Description

20717 Nitrous Plate System Nissan GTR (35-250Whp)

FOR BOTTLE SIZE ADD TO PART NUMBER:

- 00 System Less Bottle
- 05 System With 5Lb Bottle
- 10 System With 10Lb Bottle
- 12 System With 12Lb Composite Bottle
- 15 System With 15Lb Bottle

SCION FR-S AND SUBARU BRZ NITROUS PLATE SYSTEM

The Nitrous Express FRS / BRZ Plate Systems feature Spraybarless technology for the ultimate in atomization and distribution. The billet plate, with integrated solenoids, bolts between the throttle body and intake making installation quick and easy, a direct-plug-in Fuel Line Adapter is also provided to simplify installation (no need to cut your factory fuel lines). This system includes a TPS Wide Open Throttle Switch so the nitrous only activates at wide open throttle and automatically turns off when you lift your foot off the accelerator. System includes jetting for 35, 50, 75, and 100 horsepower, 15 foot stainless braided nitrous line, master arming switch, relay, relay harness and all necessary hardware to complete the installation. A 5lb, 10lb or 15lb nitrous bottle with the industry exclusive billet aluminum Lightning 45 bottle valve and stainless bottle brackets are also included. Fits 2013 Scion FR-S and Subaru BRZ.



*Actual contents of nitrous system may vary from picture

Part # Description

20960 Scion FRS And Subaru BRZ Nitrous Plate System (35-100Whp)

New Products



*Actual contents of nitrous system may vary from picture

BILLET CROSSBAR NITROUS PLATE SYSTEM

The new NX Billet Crossbar plate systems have just raised the bar in nitrous plate technology. The CNC machined design integrates the nitrous and fuel discharge ports into a billet divider bar. This new design provides excellent atomization and cylinder distribution while totally eliminating the possibility of rotated spray bars. Systems include billet aluminum and carbon fiber Lightning series solenoids, a custom solenoid mounting bracket, billet aluminum Y fittings, braided stainless solenoid to plate lines, nickel plated fittings, wide open throttle switch, master arming switch, 40 Amp relay, relay harness and every nut, bolt and electrical connector needed for installation. Systems ordered with bottles include the high flow Billet aluminum Lightning 45 bottle valve and stainless steel bottle brackets.

Part # Description

- 60042 Billet Crossbar Plate System (50-300HP) (4150 Flange)
- 66042 Billet Crossbar Plate System (50-300HP) (Dominator Flange)
- 60542 Billet Crossbar Plate System (100-500HP) (4150 Flange)
- 60547 Billet Crossbar Plate System (100-500HP) (Dominator Flange)
- 66042 Dual Stage Billet Crossbar Plate System (50-800HP) (4150 Flange)
- 66047 Dual Stage Billet Crossbar Plate System (50-800HP) (Dominator Flange)

FOR BOTTLE SIZE ADD TO PART NUMBER:

- 00 System Less Bottle
- 05 System With 5Lb Bottle
- 10 System With 10Lb Bottle
- 12 System With 12Lb Composite Bottle
- 15 System With 15Lb Bottle

*Optional Jetting up to 1000HP on dual stage systems

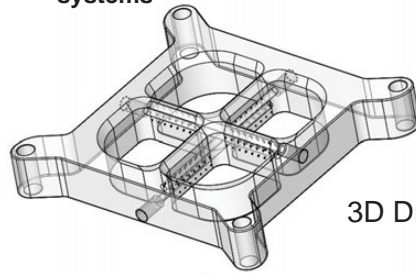

3D Drawing

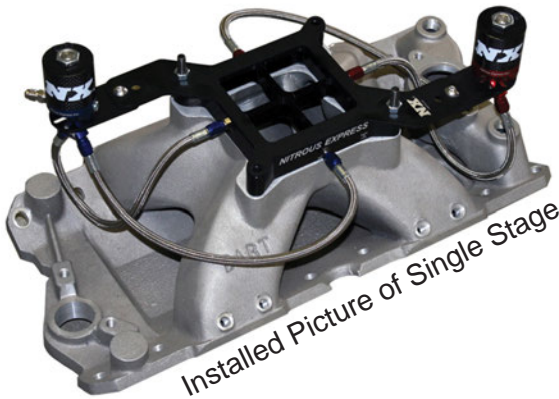

Installed Picture of Single Stage

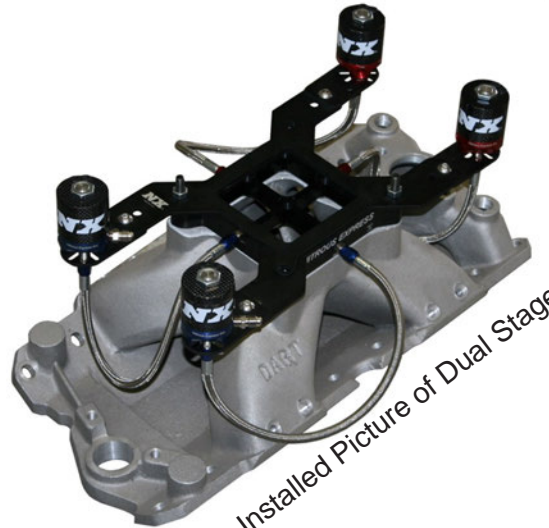

Installed Picture of Dual Stage

Popular Accessories



PN 15529 Master Flo-Check Pro Pg. 56



PN 17000 Jet Holder Pg. 62



PN 15946 Bottle Jacket Pg. 54

New Products

NEW PRODUCTS

DIRECT PORT WATER METHANOL

NX direct port water methanol systems inject the water methanol mixture directly into each intake runner providing excellent distribution to each cylinder. These systems include a high pressure electric pump, high pressure push lock hose, filtered nozzles, nickel plated fittings and a composite reservoir. Stage one systems include a wide open throttle activation switch while stage 2 and stage 3 systems include digital progressive controllers that control water methanol output. Stage 2 controllers are adjusted by setting rotary dials on the progressive box. Stage 3 controllers include a LCD display and can be finely adjusted for low, mid and high airflow levels. The LCD Screen displays boost pressure, fuel injector duty cycle, as well as water-methanol injection percent.



*Actual contents of nitrous system may vary from picture

Part # Description

15122	Direct port water methanol, 8 cylinder Stage 1
15127	Direct port water methanol, 8 cylinder Stage 2
15132	Direct port water methanol, 8 cylinder Stage 3
15121	Direct port water methanol, 6 cylinder Stage 1
15126	Direct port water methanol, 6 cylinder Stage 2
15131	Direct port water methanol, 6 cylinder Stage 3
15120	Direct port water methanol, 4 cylinder Stage 1
15125	Direct port water methanol, 4 cylinder Stage 2
15130	Direct port water methanol, 4 cylinder Stage 3



*Actual contents of nitrous system may vary from picture

PUMPLESS DIRECT PORT WATER METHANOL

NX Pumpless Direct port water methanol systems inject the water methanol mixture directly into each intake runner providing excellent distribution to each cylinder. These systems include a pressurized reservoir and pressure regulator that eliminates the need for an electric pump. These systems include braided stainless AN hoses, billet distribution blocks, filtered nozzles and nickel plated fittings.

Part # Description

15137	Pumpless direct port water methanol, 8 cylinder
15136	Pumpless direct port water methanol, 6 cylinder
15134	Pumpless direct port water methanol, 4 cylinder
15140	Pumpless 4150 carburetor plate water methanol
15141	Pumpless 4500 carburetor plate water methanol

Popular Accessories



PN GEN-X Pg. 52



PN 15946 Bottle Jacket Pg. 60



PN 15957
Maximizer 4
Progressive Nitrous Controller
Pg. 54

New Products



COMPACT 4-PORT SHOWERHEAD

These compact showerhead distribution blocks provide very consistent port to port flow in a very compact package. They feature an integrated 1/8npt male inlet so you can screw the Showerhead directly into the solenoid. They accept 5/16-24 outlet fittings which have a large ID to maximize flow.



Standard VS. Compact

Part #	Description
15010B	Compact 4 Port Showerhead
16108	AN outlet fittings
16206	Compression outlet fittings



COMPACT DISTRIBUTION BLOCKS

These compact distribution blocks are great for plumbing multiple stages or in any application that is space limited. They feature an integrated 1/8npt male inlet so you can screw the distribution block directly into the solenoid. They accept 5/16-24 outlet fittings which have a large ID to maximize flow. (Note: Does not include outlet fittings)



Standard VS. Compact

Part #	Description
16197	Compact 1 in 4 out Compact Distributon Block
16150	AN outlet fittings
16149C	Compression outlet fittings

STD NOZZLE BUNGS

NX STD (Straight Through Design) nozzle bungs feature a recessed chamber design which raises the nozzle tip out of the runner for maximum power gains.

We have seen a 40hp gain on the Dyno, compared to not using a bung!!

These are an aluminum weld in design for use with 1/16npt STD / annular nozzles.



Part # 16039 Description Aluminum annular nozzle bung



POLY PURGE LINE KIT

Here's a quick and easy solution for purge line routing that eliminates the need for bending hardlines. Includes ten feet of 1/8 poly hose and pushlock fitting.

Part #	Description
15614	Softline Purge Upgrade

CUSTOM SOLENOID MOUNTING BRACKETS AND LINE KITS

Want that high end custom install look without the hassle and expense of making custom brackets and lines? These custom solenoid mounting brackets and line kits make your nitrous install quick and easy while looking clean and attractive.

Vehicle application	Bracket Part #	Line Kit Part	Vehicle application	Bracket Part #	Line Kit Part
F150 2009-2011	15780-1	15780-1LK	C6 Corvette	15777-1	15777-1LK
F250 2008-2011	15781-1	15781-1LK	GTO 05-06	15770	15770-2LK
Mustang 87-93	15782-1	15782-1LK	G8	15770	15770-2LK
Mustang 94-04	15783-1	15783-1LK	Universal LS		
Mustang 05-09	15784-1	15784-1LK	Pass Side Head Bracket	15770	15770-3LK
Mustang 10-13	15785-1	15785-1LK	102mm LS Passenger		
Ram 09-Up	15786-1	15786-1LK	Side Throttle Body Bracket	15731	15731LK
Challenger 08-Up	15787-1	15787-1LK	Universal 4-Bolt LS Drivers		
Charger 06-Up	15788-1	15788-1LK	Side Throttle Body Bracket	15730	15730LK
GM Truck 2008-2013	15770	15770-2LK			
GM Truck, 1999- 2006	15770	15770-1LK			
Camaro 98-02	15770	15770-1LK			
Camaro 10-13	15775-1	15775-1LK			
C5 Corvette	15770	15770-1LK			



New Products

CUSTOM SWITCH PANELS

These NX switch panels offer a clean and attractive switching solution for nitrous systems as well as many other electrical devices. These switch panels include a variety of interchangeable laser engraved switch nameplates allowing you to change any switch to any location. Nameplates included are for Nitrous, Stage 2 Nitrous, Bottle Heater, Bottle Opener, Purge, Electric Fans, Water Methanol, Fuel Pump, Accessory, Go Baby Go and Ejector Seat. Need a nameplate for Machine Gun, Lights or Smoke Screen? We can also custom laser engrave any nameplate via special order.

Part # Description

- 15769 Rocker Switch name plate(Custom Laser Marking available)
- 15771 Custom Switch Panel, GM Truck 2008-2013
- 15772 Custom Switch Panel, GM Truck, 1999- 2006 - 4wd compartment
- 15773 Custom Switch Panel, GM Truck, 1999- 2006 - Radio Compartment
- 15774 Custom Switch Panel, Camaro 98-02
- 15768 Custom Switch Panel, Camaro 93-97
- 15775 Custom Switch Panel, Camaro 10-13
- 15776 Custom Switch Panel, C5 Corvette
- 15777 Custom Switch Panel, C6 Corvette
- 15778 Custom Switch Panel, CTS-V
- 15779 Custom Switch Panel, G8
- 15780 Custom Switch Panel, F150 2009-2011
- 15781 Custom Switch Panel, F250 2008-2011
- 15782 Custom Switch Panel, Mustang 87-93
- 15783 Custom Switch Panel, Mustang 94-04
- 15784 Custom Switch Panel, Mustang 05-09
- 15785 Custom Switch Panel, Mustang 10-13
- 15786 Custom Switch Panel, Ram 09-Up
- 15787 Custom Switch Panel, Challenger 08-Up
- 15788 Custom Switch Panel, Charger 08-Up



FUEL PRESSURE REGULATORS

BYPASS FUEL PRESSURE REGULATOR

The NX billet aluminum bypass fuel pressure regulator offers accurate pressure control in a compact, lightweight package. It features an optional boost/vacuum port for applications where one pound of fuel pressure increase is desired per pound of boost.

Part # Description

- 15948 NX BILLET FUEL PRESSURE REGULATOR, BYPASS 30-100 PSI
- 15949 NX BILLET FUEL PRESSURE REGULATOR, BYPASS 1.5-25 PSI



CARBURETOR PLATE SOLENOID BRACKETS

These solenoid brackets fit between the carburetor and intake manifold to provide an adjustable mounting point for your solenoids. Each solenoid mount can be swiveled on the main plate to allow the perfect solenoid position every time. As an added benefit, the Dominator version utilizes a 4 hole design with a center section that will prevent the carburetor linkage from falling into your engine in the event of a linkage malfunction.

PART # DESCRIPTION

- 15728 Carb Plate Solenoid Bracket for 4150
- 15728D Dual Stage Carb Plate Solenoid Bracket for 4150
- 15729 Carb Plate Solenoid Bracket for Dominator
- 15729D Dual Stage Carb Plate Solenoid Bracket for Dominator

Featured Products

FEATURED PRODUCTS



PART # DESCRIPTION

15957 Maximizer 4 Progressive Controller

Key Features include:

- TPS WOT switch protection (throttle activation % is adjustable)
- RPM window switch protection (user adjustable to any RPM)
- Individual timing retard outputs for both nitrous stages
- High amp solenoid drivers (will handle 60 amps per stage or 120 amps for a single stage)
- Over current and reverse polarity protection
- Air fuel ratio compensation and cut off protection

MAXIMIZER 4

The NX Maximizer 4 Progressive nitrous controller operates one or two separate stages of nitrous based on either time, RPM, MPH, throttle percentage or boost pressure. Whether your engine is naturally aspirated or forced induction, gasoline or diesel, the Maximizer 4 is the first choice. The Maximizer 4 has multiple progression options to cover a variety of racing types. These progression options are described below:

Time based progression: This option is a popular choice for drag racing applications where you always start from a dead stop. This option is very easy to fine tune so that you leave soft enough to eliminate wheel spin, and increases power as you go down track, the controller smoothly adds more nitrous as traction increases.

RPM based progression: This option works great for vehicles that have enough traction to handle full nitrous power at the top of first gear. This mode allows you to add a little nitrous in the lower engine RPMs and ramp into full nitrous as the engine rpm increases. This is a great option for vehicles with a tight torque converter. Since nitrous flow is limited to a small amount at low RPMS, you can safely activate the nitrous at lower RPMs which will help to pull the car out of the hole.

MPH (Miles Per Hour) progression: This option is great for racers who sometimes begin racing from a dead stop and other times begin racing from a rolling start. The nitrous controller will automatically limit nitrous to a smaller boost at low speeds where traction is limited while providing a larger boost at higher speeds where traction is more plentiful. Bracket racers can use this feature to set a MPH nitrous cutoff for the ultimate in consistent ETs.

Throttle percentage progression: This option allows you to “pedal” the car in the event of wheel spin. Nitrous flow smoothly increases and decreases as you “work” the throttle, allowing you to regain traction and continue racing. This is very beneficial to road race and drifting vehicles. The throttle percentage feature is also beneficial for street cars because it allows you to introduce a small amount of nitrous at mid throttle while smoothly transitioning to full nitrous power as you press the throttle to the floor. The feeling is like driving a car with twice the cubic inches.

Boost based progression: This is a useful option for turbocharged diesels and gasoline applications. Boost progression allows nitrous to come on strong to eliminate that dreaded turbo lag, then ramps out the nitrous smoothly to let the mighty turbo do its thing. The end result is monster power with zero lag, even with a HUGE turbo. On diesel applications it will not allow full nitrous delivery until the engine starts to build adequate boost, preventing a nitrous engine stall.

EGT (Exhaust Gas Temperature) progression: Injecting nitrous into a diesel application lowers EGTs. This is a useful option for diesel applications that don't want to use nitrous all the time but still want the EGT lowering properties that nitrous provides. EGT based progression allows you to create a safety ramp which will only add nitrous if EGTs rise to unsafe limits. Compatible with all EGT modules that have a 0 to 5 volt output signal.

AFR (Air Fuel Ratio) compensation and protection: The Maximizer 4 monitors the engines Air Fuel Ratio (from optional wide band O2 module), and automatically adjusts the fuel and nitrous solenoid output to achieve the desired Air Fuel Ratio (target AFR is user adjustable). As bottle pressure drops toward the end of a run, the Maximizer 4 will automatically adjust the solenoid output so you maintain a consistent and safe AFR. Air Fuel Ratio safety cut off limit (too rich and too lean) are user adjustable so the controller will completely shut off nitrous flow if the Air Fuel Ratio goes outside the user defined limits.

Popular Accessories



PN 15946 Bottle Jacket Pg. 60



PN 11108 Billet Bottle Brackets Pg. 53



PN 11107 Remote Bottle Opener Pg. 52

Featured Products

TRINITY PLATE SYSTEM

- 50-500whp depending on application
- Billet "Spraybarless" Plate
- Perfect Nitrous, Fuel Distribution
- Extra Long Stainless Braided Supply Line
- Lightning 45 Bottle Valve (See Page 52)
- Available For Alcohol
- Made in U.S.A.



The four-hole design increases air velocity at the point where nitrous and fuel is injected, resulting in superior distribution and atomization. With no spray bars to sag, split, block airflow, or damage this is truly the Next Generation in nitrous plate technology.



*Actual contents of nitrous system may vary from picture

The new Trinity plate systems have just raised the bar in nitrous plate technology. The CNC machined venturi design smoothes airflow through the carburetor which improves power and throttle response (even when you are not using nitrous). The four-hole design increases air velocity at the point where nitrous and fuel is injected, resulting in superior distribution and atomization. With no spray bars to sag, split, block airflow, or damage this is truly the Next Generation in nitrous plate technology. Trinity systems include billet aluminum and carbon fiber Lightning series solenoids, stainless solenoid to plate connectors, wide open throttle switch, heavy duty 40 amp relay, extra long supply line as well as every nut, bolt, wire and electrical connector needed to complete the installation. Systems with bottles include the industry exclusive Lightning 45 bottle valve, as well as stainless bottle brackets.

PART # DESCRIPTION

Stage 6 Plate Systems

- 60041 Holley TRINITY Stage Six (50-300whp)
- 60046 Holley TRINITY Stage Six Alcohol (50-300whp)

Pro Power Plate Systems

- 60541 Holley TRINITY Pro Power (100-500whp)
- 60546 Holley TRINITY Pro Power Alcohol (100-500whp)

FOR BOTTLE SIZE ADD TO PART NUMBER:

- 00 SYSTEM LESS BOTTLE
- 05 SYSTEM WITH 5LB BOTTLE
- 10 SYSTEM WITH 10LB BOTTLE
- 12 SYSTEM WITH 12LB COMPOSITE BOTTLE
- 15 SYSTEM WITH 15LB BOTTLE

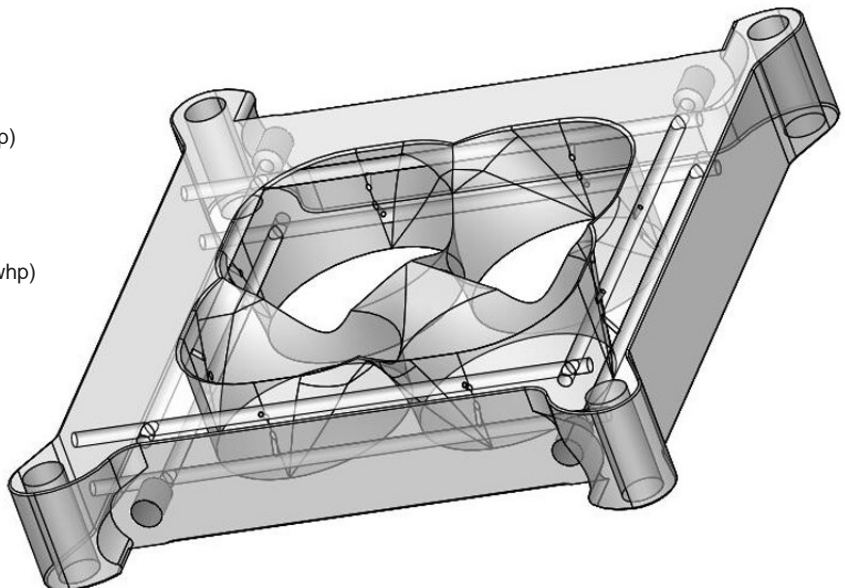

Featured Products

WATER/METHANOL

Nitrous Express introduces its new line of Water Methanol Systems.

NX Water-Methanol Injection systems provide increased performance with or without nitrous. Water Methanol Injection cools your incoming air charge and increases the total octane effect of pump gas. This allows you to run increased timing which results in increased power and torque. When used with Nitrous, the need for timing retard is greatly reduced or eliminated. Boosted applications especially benefit from reduced intake temperatures. NX Water / Methanol systems include the latest technology and the highest quality components available.

GASOLINE SYSTEMS

PART#	Description
15020	Gas Stage I Boost
15021	Gas Stg II Boost Controlled
15022	Gas Stg II MAF
15023	Gas Stg II GM MAF
15024	Gas Stg II GM MAF TL
15025	Gas Stg II Naturally Aspirated, Carbureted
15026	Gas Stg II Muscle Car, Naturally Aspirated, Carbureted V8
15027	Gas Stg 3
15028	Gas Stg 3 MPG MAX™



DIESEL SYSTEMS

PART#	Description
15030	Diesel Stage I
15031	Diesel Stg II
15032	Diesel Stg III
15033	Diesel MPG MAX



HIDDEN NITROUS SYSTEMS

Hidden systems are billed by the hour. Just call one of our nitrous experts to discuss you application and concealment options.



Top view



Front

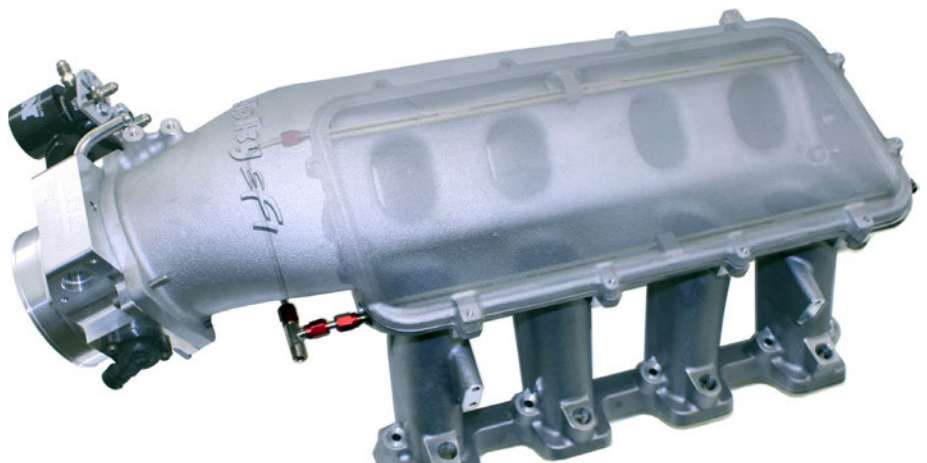

Featured Products

FEATURED PRODUCTS

S.A.F.E. STAND ALONE FUEL ENRICHMENT TANK

Nitrous Express S.A.F.E. (Stand Alone Fuel Enrichment) systems improve the performance of any nitrous system. S.A.F.E. systems include a one gallon, high strength, composite fuel cell that can be mounted in most factory battery trays without modification. When used with race gas or methanol, the need to retard timing is significantly reduced or eliminated. S.A.F.E. systems reduce the need to upgrade OEM fuel pumps, and will completely eliminate pressure drop at the fuel rail in EFI vehicles. S.A.F.E. Systems includes an integrated fuel level gauge and all mounting hardware for a no hassle installation! Tanks include a sealed cap and a safety roll over valve to prevent fuel leaks in the event of a roll over. Tank dimensions are 9Lx6Wx8H

PART # DESCRIPTION

15004 This adjustable version of the S.A.F.E. system includes a high output internally mounted fuel pump and an adjustable bypass regulator. Fuel pressure can be adjusted from 3 to 60 psi (no special jetting is required). The regulator is also boost referencing which makes it compatible with supercharged and turbocharged applications. When used with Gasoline, this system will support up to 800 nitrous horsepower. When used with Methanol, this pump will support up to 400 nitrous horsepower.

15003 This version of the SAFE system includes a 5-12psi external fuel pump and an adjustable non bypass regulator. It is designed to run with non boosted applications and will support up to 600 nitrous horsepower on gasoline and 300 Nitrous horsepower on methanol.

15083 Tank, cap and mounting hardware only. This is a great choice for those wanting to use their own external fuel pump and regulator.



Part # 15004



Part # 15003



Part # 15083

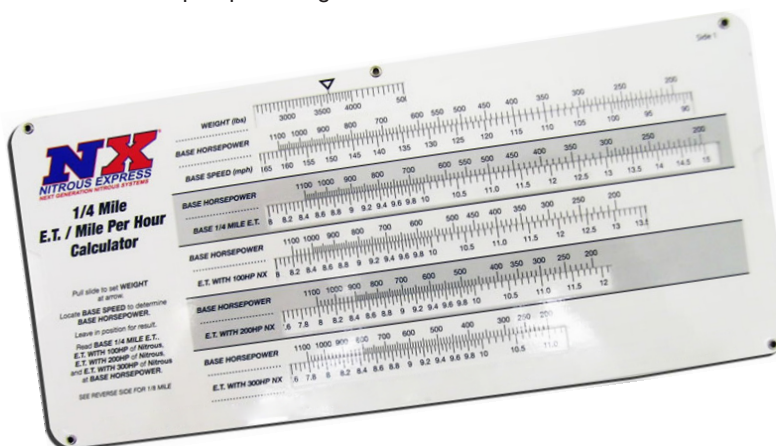

E.T. CALCULATOR

This slide calculator quickly and easily estimates the 1/8 mile and 1/4 mile times your vehicle will run with varying amounts of horsepower. The calculator also shows how quick your vehicle will run with the addition of a 100, 200 or 300HP NX Nitrous System

PART # DESCRIPTION
15976 E.T./Quarter Mile Calculator

NX EFI Single/Dual Nozzle Nitrous Systems

EFI



*Actual contents of nitrous system may vary from picture



*Actual contents of nitrous system may vary from picture
*Full Color Installation Manual Included In Every System

- 35-250whp w/optional jetting
- Patented Shark Nozzle
- Wide Open Throttle Switch
- EFI Nozzle Adapter
- Fuel Line Adaptor May Be Required (See Page 63)
- Lightning 45 Bottle Valve
- Braided S.S. Supply Line
- Made in U.S.A.

NX single nozzle systems are the most versatile EFI power boosters on the market. These systems include an NX nitrous nozzle which mounts in the air inlet before your throttle body. These systems include billet aluminum and carbon fiber Lightning series solenoids, stainless braided nozzle lines, 15 foot stainless braided nitrous feed line, wide open throttle switch, master arming switch, 40 amp relay, relay harness as well as every nut, bolt and electrical connector needed to perform the install. Systems with bottles include stainless bottle brackets and a high flow Lightning 45 bottle valve.

Single Nozzle Stage 1 systems include jetting for 35, 50, 75, 100, 125 and 150 horsepower and can be upgraded to support up to 250 horsepower by adding a SHO nozzle line (part# 10124) and a 4AN solenoid fitting (part# 16109).

Single Nozzle Race systems include jetting for 100, 150, 200 and 250 horsepower and can support up to 250HP right out of the box.

Single Nozzle SHO systems include jetting for 100, 200, 300 and 400 horsepower and can support up to 400HP right out of the box.

Dual Nozzle systems include jetting for 35, 50, 75, 100 and 150 horsepower and can support up to 300HP right out of the box.

PART # DESCRIPTION

Single Nozzle

20920	GM STAGE ONE EFI (35-150whp)
20921	DODGE STAGE ONE EFI (35-150whp)
20922	FORD STAGE ONE EFI (35-150whp)
20923	SPORT COMPACT STAGE ONE EFI (35-150whp)
20112	SHARK S.H.O. SINGLE NOZZLE SYSTEM (100-400whp)
20113	FORD EFI RACE (35-250whp)
20118	GM EFI RACE (35-250whp)
20918	DODGE HEMI STAGE ONE FLY BY WIRE (35-150whp)
20919	UNIVERSAL EFI STAGE ONE FLY BY WIRE (35-150whp)
20928	INSTABOOST DIGITAL STAGE ONE EFI (35-150whp)
20929	INSTABOOST STAGE ONE EFI (35-150whp)

FOR BOTTLE SIZE ADD TO PART NUMBER:

- 00 System Less Bottle
- 05 System With 5Lb Bottle
- 10 System With 10Lb Bottle
- 12 System With 12Lb Composite Bottle
- 15 System With 15Lb Bottle

Dual Nozzle

20115	Ford Dual Nozzle (35-150whp X 2) - Dual Nozzle, Dual Stage, includes Ford Fuel Rail Fitting
20215	GM Dual Nozzle (35-150whp X 2) - Dual Nozzle, Dual Stage
20315	Dodge Dual Nozzle (35-150whp X 2) - Dual Nozzle, Dual Stage
20325	Dodge Viper Dual Nozzle (100-300whp) - Dual Nozzle, Single Stage
20716	Nissan 350Z / Infinity G35 FLY BY WIRE (50-300Whp) - Dual Nozzle, Single Stage

Note: NX Stage 1 EFI systems can be easily upgraded to support up to 250Whp.

Mainline EFI Single Nozzle Nitrous System



If you are a serious nitrous junkie on a tight budget we have what you have been waiting for! NX introduces MainLine Nitrous Systems. MainLine Systems benefit from the years of research and development that made Nitrous Express the leader in the nitrous world, but at a price even the most budget-restricted racer can afford. Just the basics, no frills, just rock solid performance at rock bottom prices. Includes Jetting for 50, 100, and 150whp. Includes Stainless Steel Bottle Brackets, NX Piranha Nozzles, Aircraft Quality Steel Braided Hoses, 15ft Stainless Steel Braided 4AN Feedline and Nickel Plated Fittings. Made in U.S.A.



*Actual contents of nitrous system may vary from picture

PART # DESCRIPTION

ML2000 Mainline Efi Single Nozzle System With 10Lb Bottle

- 50-150whp.
- Stainless Steel Bottle Brackets
- Simple Installation
- Aircraft Quality Steel Braided Hoses
- 15ft Stainless Steel Braided 4AN Feedline
- Nickel Plated Fittings
- Made in U.S.A.
- Stainless Made in U.S.A. Solenoids

Proton Single Nozzle Nitrous Systems



*Actual contents of nitrous system may vary from picture

Proton nitrous systems combine performance, durability and value in a compact and easy to mount nitrous / fuel module. Proton systems include jetting for 35HP, 50HP, 75HP, 100HP, 125HP and 150HP but can flow up to 250HP with the optional SHO jet kit. All Proton systems include stainless braided nozzle lines, 15 foot braided stainless feed line, stainless fuel line, and stainless bottle brackets. Standard Proton systems include a brass bottle valve while Proton Plus systems include a high flow billet aluminum Lightning 45 bottle valve. Standard Proton systems include a Piranha nozzle and a push button while Proton Plus system include a Shark nozzle, nozzle adapter, master arming switch, wide open throttle switch, 40 amp relay, relay harness as well as every nut, bolt and electrical connector needed to complete the installation. (Bottle brackets and bottle valves are not included with systems that do not have a bottle). Fits all electronic fuel injected vehicles with a single throttle body.

PART # DESCRIPTION

20420 PROTON Nitrous System (35-75)whp
20421 PROTON PLUS Nitrous System (35-150)whp
20422 PROTON PLUS Fly By Wire Nitrous System (35-150)whp

- 35-150whp Upgradable to 250whp
- Billet Aluminum Solenoid Box
- Lightning Bottle Valve
- Stainless Steel Bottle Brackets
- Includes All Electrical Connectors
- NX Shark Nozzle
- Simple Installation
- Aircraft Quality Steel Braided Hoses
- 15ft Stainless Steel Braided 4AN Feedline
- Nickel Plated Fittings
- Made in U.S.A.

Ford 5.0 Coyote Nitrous Plate System

Nitrous Express 5.0 Coyote Plate System features Phase 3 Spraybarless technology for the ultimate in atomization and distribution. The billet plate bolts between the throttle body and intake making installation quick, easy and the integrated solenoids provide a super clean look. A direct-plug-in Fuel Line Adapter, to simplify installation, (no need to cut your factory fuel lines) is also included. This complete system includes a TPS Autolearn switch so the nitrous only activates at wide open throttle and automatically turns off when you lift your foot from the accelerator. The Coyote system includes jetting for 35, 50, 75, 100, 125 and 150 horsepower and can produce up to 200 horsepower with additional jets. System include extra long stainless braided N2O line, master arming switch, relay, relay harness and all necessary hardware to complete the installation. Systems with bottles include the new industry exclusive billet aluminum Lightning 45 bottle valve and stainless bottle brackets.

Fits 2011-2013 Ford GT Mustangs with the 5.0L 4 valve Coyote engine.

For your convenience an optional complete plug and play wiring harness (part # 15492-2) is available to make installation neat, easy and complete.



*Actual contents of nitrous system may vary from picture

PART # DESCRIPTION

20948 5.0 Coyote Plate System 35-200whp

FOR BOTTLE SIZE ADD TO PART NUMBER:

- 00 System Less Bottle & Brackets
- 05 System With 5Lb Bottle
- 10 System With 10Lb Bottle
- 12 System With 12Lb Composite Bottle
- 15 System With 15Lb Bottle

Mainline 5.0 Coyote Nitrous Plate System

The Nitrous Express Mainline 5.0 Coyote Plate System combines excellent performance at a budget friendly price. This system features a billet aluminum plate that bolts between the throttle body and intake, making installation quick, easy and attractive. A direct-plug-in Fuel Line Adapter, to simplify installation, (no need to cut your factory fuel lines) is also included. The Coyote system includes jetting for 50, 100 and 150 horsepower. Systems include stainless steel Made in the U.S.A. Mainline nitrous and fuel solenoids, 15ft stainless braided N2O line, master arming switch, and an activation push button. Systems with bottles include a 90 degree brass bottle valve and stainless bottle brackets. For your convenience an optional complete plug and play wiring harness (part # 15492-2) is available to make installation neat, easy and complete. Fits 2011 and newer Ford GT Mustangs with the 5.0L 4 valve Coyote engine.

PART # DESCRIPTION

ML3050 Mainline 5.0 Coyote Plate System



*Actual contents of nitrous system may vary from picture

GT 500 Nitrous Plate System

The Nitrous Express GT500 nitrous plate system features a billet nitrous plate that bolts between the throttle body and intake making installation quick, easy and attractive. System includes billet aluminum and carbon fiber Lightning series solenoids for the ultimate in power and durability. A direct-bolt on Fuel Rail Adapter is provided to simplify installation (no need to cut your factory fuel lines). System includes a TPS Wide Open Throttle Switch so the nitrous only activates at wide open throttle and automatically turns off when you decelerate. The system includes jetting for 35, 50, 75, 100, 125, 150, 200, 250 and 300 horsepower but you can expect larger power gains than normal due to the added power resulting from the cold air charge associated with Nitrous. System includes 15 foot stainless braided nitrous line, master arming switch, relay, relay harness and all necessary hardware to complete the installation. Includes a 5lb, 10lb or 15lb nitrous bottle with the industry exclusive billet aluminum Lightning 45 bottle valve and stainless bottle brackets. Fits 2006 and newer GT500 Mustangs.



*Actual contents of nitrous system may vary from picture

PART #	DESCRIPTION
20949	Ford Shelby Gt500 Nitrous Plate System (35-300Whp)

EPI

Ford 4V Cobra Nitrous Plate System



*Actual contents of nitrous system may vary from picture

The Nitrous Express 4 Valve Plate System features a billet nitrous plate that fits between the throttle body and intake making installation quick, simple, and attractive. The system includes billet aluminum and carbon fiber nitrous and fuel solenoids for ultimate performance and weight savings. The system includes a Schrader valve fuel rail adapter for simple fuel system hook-ups, TPS wide open throttle switch, 15 foot nitrous feed line, master arming switch, relay, relay harness, and all necessary hardware to complete installation. System comes with jetting from 35hp-300hp. System can be purchased with 5, 10 or 15lb bottle, all of which include the Billet aluminum Lightning 45 bottle valve. Fits 1996-2004 Cobra and Mach 1 Mustangs

PART #	DESCRIPTION
20950	Ford 4V Nitrous Plate System (35-300Whp)

FOR BOTTLE SIZE ADD TO PART NUMBER:

- 00 System Less Bottle & Brackets
- 05 System With 5Lb Bottle
- 10 System With 10Lb Bottle
- 12 System With 12Lb Composite Bottle
- 15 System With 15Lb Bottle

Popular Accessories



PN GEN-X Pg. 52



PN 15946 Bottle Jacket Pg. 60



PN 15957
Maximizer 4
Progressive Nitrous Controller
Pg. 54

Ford 4.6L 3V Nitrous Plate System



*Actual contents of nitrous system may vary from picture

PART # DESCRIPTION

20947 Ford 4.6L 3-Valve Plate System

FOR BOTTLE SIZE ADD TO PART NUMBER:

- 00 System Less Bottle And Brackets
- 05 System With 5Lb Bottle
- 10 System With 10Lb Bottle
- 12 System With 12Lb Composite Bottle
- 15 System With 15Lb Bottle

The Nitrous Express 4.6L 3 Valve Plate System features Phase 3 Spraybarless technology for the ultimate in atomization and distribution. The billet plate bolts between the throttle body and intake making installation quick and easy. The solenoids are integrated into the plate for a super clean look. This system includes a TPS Autolearn switch so nitrous only activates at wide open throttle and automatically turns off when you lift your foot off the accelerator. The system includes jetting from 35 to 200 wheel horsepower. System includes a direct plug in fuel rail adapter, braided stainless lines, stainless bottle brackets, full color installation manual, arming switch as well as every nut, bolt and electrical connector needed to complete the installation. Systems with bottles include the high flow, industry exclusive lightweight Lightning 45 Bottle valve. Fits 2005 -2010 GT Mustangs.

For your convenience an optional custom fit wiring harness (part # 15492-2) is available for 2005-2010 mustangs to make installation neat, easy and complete.

Ford 4.6L 2V System

Is your 4.6 liter 2 valve motor a little light on torque and horsepower? Nitrous Express has the solution to your problem! Designed for superior distribution and atomization this plate style nitrous system is unmatched in performance and reliability. 50 to 300 wheel horsepower, tons of mind bending torque, and no hood clearance problems! Available for all 2 valve 4.6 Fords and comes complete with billet aluminum and carbon fiber Lightning Series Solenoids, your choice of 5lb, 10lb, 15lb, or 12lb composite nitrous bottles, stainless steel bottle brackets, billet nitrous plate, and 50-300 horsepower settings. Plus all necessary hardware to complete the installation.

PART # DESCRIPTION

20946 Ford 4.6L 2-Valve Plate System

FOR BOTTLE SIZE ADD TO PART NUMBER:

- 00 System Less Bottle
- 05 System With 5Lb Bottle
- 10 System With 10Lb Bottle
- 12 System With 12Lb Composite Bottle
- 15 System With 15Lb Bottle



*Actual contents of nitrous system may vary from picture

Ford 5.0/Windsor EFI Nitrous Plate System



*Actual contents of nitrous system may vary from picture



EFI

All Ford 5.0L systems include a 3pc. Billet plate, featuring the Phase 3 Spraybarless design, and jetting from 50-300whp. Each plate can be upgraded to a Dual Stage system via PN: NX200, which can deliver a mind blowing 50-600whp through a single plate!

*Actual contents of nitrous system may vary from picture

- 50-600whp
- 6061T-6 Billet Plate
- Dual Stage Capabilities
- Phase 3 Spraybarless Design
- Extra Long Stainless Braided Supply Line
- Lightning 45 Bottle Valve
- Available For Alcohol
- Made in U.S.A.

These high tech nitrous plates bolt between the upper and lower intake manifolds on fuel injected pushrod 5.0L & 5.8L ford engines for a quick and clean install. Nitrous and fuel are injected into each cylinder from the side of the runner providing direct port like distribution without having a flow restricting nozzle or spray bar in the runner. Systems comes standard as a single stage with jetting for 50 to 300Whp. The plates include a second set of nitrous / fuel passages allowing you to quickly and easily upgrade to a second stage at any time. System comes complete with billet aluminum and carbon fiber Lightning Solenoids, industry exclusive billet aluminum Lightning 45 Bottle Valve, stainless steel braided lines, stainless steel bottle brackets, wiring, switches and every nut, bolt and connector needed to install the system.

PART #	DESCRIPTION
20100	FORD 5.0L STOCK MANIFOLD PLATE
20101	FORD 5.0L GT 40 PLATE
20102	FORD 5.0L EDELBROCK PERFORMER & RPM PLATE
20103	FORD 5.0L EDELBROCK VICTOR PLATE
20104	FORD 5.0L TRICK FLOW PLATE
20105	FORD 5.0L TRICK FLOW "R" PLATE
20106	FORD 5.0L HOLLEY SYSTEMAX PLATE
20108	FORD 5.0L EDELBROCK RPM 2 PLATE
NX 200	FORD Plate Dual Stage Conversion

FOR BOTTLE SIZE ADD TO PART NUMBER:

- 00 System Less Bottle
- 05 System With 5Lb Bottle
- 10 System With 10Lb Bottle
- 12 System With 12Lb Composite Bottle
- 15 System With 15Lb Bottle

Popular Accessories



PN GEN-X Pg. 52



PN 15946 Bottle Jacket Pg. 60



PN 15957
Maximizer 4
Progressive Nitrous Controller
Pg. 54

2014 GM Truck Nitrous Plate System



The Nitrous Express 2014 GM truck plate systems feature Spraybarless technology for the ultimate in atomization and distribution. The billet plate bolts between the throttle body and intake making installation quick and easy. The solenoids are integrated into the plate for a super clean look and easy install. A direct-plug-in Fuel Line Adapter is provided to simplify installation (no need to cut your factory fuel lines). This system includes a TPS Autolearn switch so the nitrous only activates at wide open throttle and automatically turns off when you let your foot off the accelerator. The system includes jetting for 35, 50, 75, 100, 125, 150, 200 and 250 horsepower. Systems include a stainless braided N2O line, master arming switch, relay, relay harness and all necessary hardware to complete the installation. Systems ordered with a nitrous bottle include the new billet aluminum Lightning 45 bottle valve and stainless bottle brackets.

*Actual contents of nitrous system may vary from picture

Part #	Description
20936	2014 GM truck nitrous plate system for 5.3L engines
20937	2014 GM truck nitrous plate system for 6.2L engines

C7 Corvette Nitrous Plate System

The Nitrous Express C7 plate systems feature Spraybarless technology for the ultimate in atomization and distribution. The billet plate bolts between the throttle body and intake making installation quick and easy. The solenoids are integrated into the plate for a super clean look and easy install. A direct-plug-in Fuel Line Adapter is provided to simplify installation (no need to cut your factory fuel lines). This system includes a TPS Autolearn switch so the nitrous only activates at wide open throttle and automatically turns off when you let your foot off the accelerator. The system includes jetting for 35, 50, 75, 100, 125, 150, 200 and 250 horsepower. Systems include a stainless braided N2O line, master arming switch, relay, relay harness and all necessary hardware to complete the installation. Systems ordered with a nitrous bottle include the new billet aluminum Lightning 45 bottle valve and stainless bottle brackets.



*Actual contents of nitrous system may vary from picture

Part #	Description
20938	C7 Corvette nitrous plate system

Popular Accessories



PN 15946 Bottle Jacket Pg. 60



PN 11108 Billet Bottle Brackets Pg. 59



PN 11107 Remote Bottle Opener Pg. 58

GM LS 4-Bolt Nitrous Plate System

These NX LS Plate system feature a billet plate that installs between the throttle body and intake manifold making installation quick, easy and attractive. Includes jetting for 50, 100, 150, 200, 250, 300, 350 and 400 horsepower. Systems include ProPower Lightning series solenoids, 5lb, 10lb or 15lb nitrous bottle with the industry exclusive billet aluminum Lightning 45 bottle valve, 6AN feed line, braided stainless solenoid to plate lines, stainless bottle brackets, master arming switch, WOT switch as well as every nut, bolt and electrical connector needed to complete the installation. 90mm and 102mm 4 bolt systems are pre-machined with a second set of nitrous and fuel passages so you can easily upgrade to a dual stage system by adding part # NX933D. Fits 2005 and newer Corvette, 2005 GTO, 2007-13 GM Trucks with 4.8L, 5.3L, 6.0L & 6.2L engines. Will work on 2010 and newer Camaros if you rotate the throttle body 180 degrees.



*Actual contents of nitrous system may vary from picture

PART #	DESCRIPTION
20934	LS 90mm 4-BOLT NITROUS PLATE SYSTEM W/ 10LB BOTTLE
20933	LS 102mm 4-BOLT NITROUS PLATE SYSTEM W/ 10LB BOTTLE

FOR BOTTLE SIZE ADD TO PART NUMBER:

- 00 System Less Bottle
- 05 System With 5Lb Bottle
- 10 System With 10Lb Bottle
- 12 System With 12Lb Composite Bottle
- 15 System With 15Lb Bottle

GM LS 3-Bolt Nitrous Plate System

The Nitrous Express GM LS 3-Bolt Plate System features a billet aluminum nitrous plate that fits all car and truck intakes with a 3 bolt throttle body. The billet plate bolts between the throttle body and intake making installation quick, easy and attractive. System includes jetting for 50, 100, 150, 200, 250, 300 and 350 horsepower. This system includes a ProPower Lightning series nitrous solenoid, 5lb, 10lb or 15lb nitrous bottle with the industry exclusive billet aluminum Lightning 45 bottle valve, 6AN feedline, braided stainless solenoid to plate lines, stainless bottle brackets, master arming switch, WOT switch as well as every nut, bolt and electrical connector needed to complete the installation. Fits 1997-2004 Corvette, 1998-02 V8 Camaro/Firebird, 2004 GTO as well as 1999-06 GM Trucks with 4.8L, 5.3L & 6.0L engines.



*Actual contents of nitrous system may vary from picture

PART #	DESCRIPTION
20935	GM LS 3-BOLT NITROUS PLATE SYSTEM (35-350whp)

FOR BOTTLE SIZE ADD TO PART NUMBER:

- 00 System Less Bottle
- 05 System With 5Lb Bottle
- 10 System With 10Lb Bottle
- 12 System With 12Lb Composite Bottle
- 15 System With 15Lb Bottle

5th GEN V8 Camaro Plate System

EFI



*Actual contents of nitrous system may vary from picture



Stainless Steel plate, laser welding to create the thinnest nitrous plate in history

- 35-200whp.
- Worlds Thinnest Plate
- Stainless Steel
- Laser Welded
- Simple Installation
- TPAS Switch Included
- Lightning 45 Bottle Valve
- Correct Throttle Body Orientation
- Made in U.S.A.

The Nitrous Express 5th Gen Camaro Plate System features Spraybarless technology for the ultimate in atomization and distribution. The billet plate bolts between the throttle body and intake making installation quick and easy and does not require installing the throttle body upside down. The solenoids are integrated into the plate for a super clean look. This system includes a TPS Autolearn switch so the nitrous only activates at wide open throttle and automatically turns off when you lift your foot off the accelerator. To make installation complete, a billet fuel rail adapter is included so there is no need to splice into the factory fuel lines. The system includes jetting from 35 to 200 horsepower. Comes complete with your choice of 5lb, 10lb, 15lb, or 12lb composite nitrous bottle, braided stainless lines, stainless bottle brackets, installation manual, arming switch as well as every nut, bolt and electrical connector needed to complete the installation. Fits all 5th Gen V8 Camaros as well as most other vehicles with LS2 and LS3 engines. **Does not require running the throttle body upside down.**



PART # DESCRIPTION

20931 5th Gen 8cyl Camaro System 35-200whp

FOR BOTTLE SIZE ADD TO PART NUMBER:

- 00 System Less Bottle & Brackets
- 05 System With 5Lb Bottle
- 10 System With 10Lb Bottle
- 12 System With 12Lb Composite Bottle
- 15 System With 15Lb Bottle

Popular Accessories

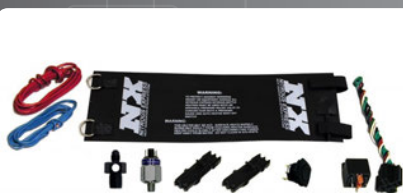

PN 15940 Bottle Heater Pg. 59



PN 15605 Purge Kit Pg. 57



PN 15957
Maximizer 4
Progressive Nitrous Controller
Pg. 54

GM MAF Systems

EFI

The NX integrated solenoid nitrous system for LS engines with a 1pc MAF housing, is the state of the art in safe horsepower production. Compact, easy to install MAF housing, machined from billet 6061 aluminum, with integrated lifetime warranty solenoids. System comes complete with bottle, stainless bottle brackets, stainless braided nitrous and fuel feed lines, TPAS module, and all necessary hardware for a complete installation. Fits 00-07 Corvette, 05-06 GTO, 01-07 GM Trucks.

- 35-200whp.
- 6061T-6 Billet MAF End
- Increased Air Flow
- Simple Installation
- TPAS Switch Included
- Available For LS-Series w/1pc MAF Housing
- Lightning 45 Bottle Valve
- Made in U.S.A.



*Actual contents of nitrous system may vary from picture



Our 1pc MAF Housing has solenoids integrated into the billet aluminium body. This allows for trouble free easy installation.

PART #	DESCRIPTION
20110	LS-Series 1pc MAF System 35-200whp



*Actual contents of nitrous system may vary from picture

The NX "MAF" replaces the factory MAF sensor housings on LT-1 and LS-1 GM cars. This 6061 billet aluminum high flow MAF housing will increase airflow and the twin discharge nitrous system will make your vehicle a giant killer! Single stage horsepower settings: 35-150whp. Dual Stage: 35-150whp X 2. Each stage is capable of 250whp with the purchase of additional jetting. This system fits 94-02 V8 Camaro/Firebird, 97-99 Corvette, 04 GTO

- 35-500whp.
- 6061T-6 Billet MAF Ends
- Increased Air Flow
- Simple Installation
- Dual Stage Compatible
- WOT Switch Included
- Lightning 45 Bottle Valve
- Available For LT1, LS1, and LS6
- Made in U.S.A.

PART #	DESCRIPTION
20109	LT-1/LS1 MAF System 35-150whp

Nitrous Plate System for the Hemi



*Actual contents of nitrous system may vary from picture

PART #	DESCRIPTION
20944	EFI Nitrous Plate For The Hemi

The Nitrous Express EFI Plate System for Hemi applications includes a billet aluminum nitrous plate that fits between the throttle body and the intake manifold making installation quick, easy and attractive. System includes Pro Power Lightning series billet aluminum and carbon fiber solenoids, 6AN feed line, braided stainless solenoid to plate lines, stainless bottle brackets, master arming switch, WOT switch as well as every nut, bolt and electrical connector needed to complete the installation. Systems with bottles include the industry exclusive billet aluminum Lightning 45 Bottle valve. Fits 2003 and newer cars & trucks with Hemi engines.

Note: This system is configured as a single stage by default and includes jetting for 50, 100, 150, 200, 250, 300, 350 and 400whp. The plate is pre-machined with a second set of nitrous and fuel passages so you can easily upgrade to a dual stage system by adding part # NX944D.

FOR BOTTLE SIZE ADD TO PART NUMBER:

- 00 System Less Bottle & Brackets
- 05 System With 5Lb Bottle
- 10 System With 10Lb Bottle
- 12 System With 12Lb Composite Bottle
- 15 System With 15Lb Bottle

Dodge Dart II Nitrous Plate System



*Actual contents of nitrous system may vary from picture

PART #	DESCRIPTION
20942	Efi Nitrous Plate System For 2.0L And 2.4L Dodge Dart (35-100whp)
20941	Efi Nitrous Plate System For 1.4L Turbo Dodge Dart (35-100whp)

The Nitrous Express EFI Nitrous Plate Systems for Dodge Dart applications transforms a cool little car into a tire smoking hot rod in the matter of a couple hours. The system includes a billet nitrous plate that bolts between the throttle body and intake making installation quick and easy. 2.0L systems have solenoids that are integrated into the nitrous plate. 1.4L systems have external solenoids. A direct-plug-in Fuel Line Adapter is provided to simplify installation (no need to cut your factory fuel lines). This system includes a TPS Wide Open Throttle Switch so the nitrous only activates at wide open throttle and automatically turns off when you lift your foot off the accelerator. Systems includes jetting for 35, 50, 75, and 100 horsepower, 15 foot stainless braided nitrous line, master arming switch, relay, relay harness and all necessary hardware to complete the installation. Includes a 5lb, 10lb or 15lb nitrous bottle with the industry exclusive billet aluminum Lightning 45 bottle valve and stainless bottle brackets. Fits 2013 Dodge Dart

Dodge Magnum Nitrous Plate System



Is your Magnum motor a little light on torque and horsepower? The Nitrous Express Dodge Plate System for Magnum engines feature Phase 3 Spraybarless technology for the ultimate in atomization and distribution. The billet plate bolts between the throttle body and the intake making installation quick and easy. This system includes Lightning series nitrous and fuel solenoids. Also includes is a wide open throttle switch so the nitrous only activates at wide open throttle and automatically turns off when you let your foot off the accelerator. The system includes jetting from 35 to 150 horsepower and can be upgraded to 250 horsepower with additional jets. Includes 10lb bottle, braided stainless lines, stainless bottle brackets, arming switch as well as every nut, bolt and electrical connector needed to complete the installation. Fits 3.9L, 5.2L and 5.9L Dodge Magnum engines.

*Actual contents of nitrous system may vary from picture

Part # Description
20945 DODGE TBI PLATE SYSTEM (MAGNUM ENGINE) (35-150hp)

FOR BOTTLE SIZE ADD TO PART NUMBER:

- 00 System Less Bottle & Brackets
- 05 System With 5Lb Bottle
- 10 System With 10Lb Bottle
- 12 System With 12Lb Composite Bottle
- 15 System With 15Lb Bottle

FR-S/BRZ Nitrous Plate System

The Nitrous Express FRS / BRZ Plate Systems feature Spraybarless technology for the ultimate in atomization and distribution. The billet plate, with integrated solenoids, bolts between the throttle body and intake making installation quick and easy, a direct-plug-in Fuel Line Adapter is also provided to simplify installation (no need to cut your factory fuel lines). This system includes a TPS Wide Open Throttle Switch so the nitrous only activates at wide open throttle and automatically turns off when you lift your foot off the accelerator. System includes jetting for 35, 50, 75, and 100 horsepower, 15 foot stainless braided nitrous line, master arming switch, relay, relay harness and all necessary hardware to complete the installation. A 5lb, 10lb or 15lb nitrous bottle with the industry exclusive billet aluminum Lightning 45 bottle valve and stainless bottle brackets are also included. Fits 2013 Scion FR-S and Subaru BRZ.



*Actual contents of nitrous system may vary from picture

Part # Description
20960 Scion FRS And Subaru BRZ Nitrous Plate System (35-100Whp)

N-Tercooler Nitrous Systems

EFI



Our N-tercooler ring is available in almost any size. They are standard 20" x 4", but we will custom make a ring for any application.



NEW Lightning Series limited lifetime warranty solenoids. Lightest, largest and highest flowing solenoids on the market. Our N-Tercooler systems come standard with a 150Whp Nitrous solenoid.



*Actual contents of nitrous system may vary from picture

From the people who INVENTED the N-Tercooler, for supercharged or turbo applications where nitrous is not an option, Nitrous Express offers another alternative, the "N-tercooler". Spraying nitrous over an air-to-air intercooler, can reduce air inlet temperatures dramatically. In a dyno test, a turbocharged Honda equipped with an NX "N-tercooler", increased its baseline by an astounding 52 wheel horsepower! If it makes horsepower, it must be Nitrous Express! Comes complete with spray ring, Lightning series solenoid, Lightning 45 bottle valve and all parts necessary for installation.

- 10-60whp.
- Limited Lifetime Warranty Solenoids
- Wide Open Throttle Switch And Bracket
- N-tercooler Ring
- Stainless Braided Supply Line
- Lightning 45 Bottle Valve
- Made in U.S.A.

PART #	DESCRIPTION
20000	Standard N-tercooler System
20000R	N-tercooler w/Remote Mount Solenoid
20000C	N-tercooler System for CO2
20000CR	N-tercooler CO2 w/Remote Mount Solenoid
22200	Dual N-tercooler w/2 6" Aluminum Rings

FOR BOTTLE SIZE ADD TO PART NUMBER:

- 00 System Less Bottle
- 05 System With 5Lb Bottle
- 10 System With 10Lb Bottle
- 12 System With 12Lb Composite Bottle
- 15 System With 15Lb Bottle



Creations n' Chrome's Supercharged Mustang using a NX N-Tercooler System!

Popular Accessories



PN 15946 Bottle Jacket Pg. 60



PN 11108 Billet Bottle Brackets Pg. 59



PN 11107 Remote Bottle Opener Pg. 58

NXL Nitrous System

EFI



The integrated rail technology is setting the standard for EFI nitrous systems. This unit replaces your factory fuel rail and has the N2O and Fuel solenoids integrated into the rail.

- 80-150whp.
- Simple Installation
- 6061T-6 Billet Fuel Rails
- Lightning 45 Bottle Valve
- High Pressure Jumper Lines
- Solenoids Integrated In Fuel Rails
- 4cyl Applications
- Made in U.S.A.
- Utilizes compact Piranha nozzles

*Actual contents of nitrous system may vary from picture

Nitrous Express introduces the NXL nozzle with Integrated Rail Technology. This plug-and-play, direct-port nozzle system is designed for B16, and GSR Honda engines. The entire nitrous system is self-contained in the high-flow fuel rail. Systems come complete with bottle, jetting, custom steel braided lines, and all installation hardware, hi-tech direct port system is equipped with the industry exclusive Lightning 45 bottle valve



PART # DESCRIPTION

20200 Honda B16a/Type R Nxl With Rail

FOR BOTTLE SIZE ADD TO PART NUMBER:

- 00 System Less Bottle & Brackets
- 05 System With 5Lb Bottle
- 10 System With 10Lb Bottle
- 12 System With 12Lb Composite Bottle
- 15 System With 15Lb Bottle

Luke Thompson's Honda with a NXL System

Popular Accessories



PN GEN-X Pg. 52



PN 15946 Bottle Jacket Pg. 60



PN 15957
Maximizer 4
Progressive Nitrous Controller
Pg. 54

EFI Direct Port Nitrous System

EFI



- 50-600whp.
- Compact Piranha Nozzle
- 4cyl, 6cyl, and 8cyl Applications
- Unmatched Nitrous Distribution
- Long D-6 Stainless Braided Supply Line
- Lightning 45 Bottle Valve
- Works With E.F.I. Fuel Pressure
- Available For Alcohol
- Multiple Rail Upgrades Available
- Made in U.S.A.

*Actual contents of nitrous system may vary from picture



NX direct port systems ensure consistent cylinder to cylinder distribution making them the preferred choice for high horsepower applications. These systems include billet aluminum and carbon fiber Lightning series solenoids, stainless hard lines, nickel plated fittings, high flow feed line and every nut, bolt and electrical connector needed for installation. Systems with bottles include stainless bottle brackets as well as a lightweight, high flow, industry exclusive, billet aluminum Lightning 45 bottle valve. These systems include standard distribution blocks but can be upgraded to showerheads, or distribution rails

PART # DESCRIPTION

PART #	DESCRIPTION
80004EFI	4 Cylinder EFI Piranha Nozzle System (100-200whp)
80006EFI	6 Cylinder EFI Piranha Nozzle System (120-250whp)
80001EFI	8 Cylinder EFI Piranha Nozzle System (150-300whp)
90006EFI	8 cylinder EFI Shark nozzle systems (200-500whp)
80016EFI	8 cylinder EFI SSV nozzle systems (200-500whp)
80018EFI	8 cylinder EFI STD (annular) nozzle systems (200-500whp)

FOR BOTTLE SIZE ADD TO PART NUMBER:

- 00 System Less Bottle & Brackets
- 05 System With 5Lb Bottle
- 10 System With 10Lb Bottle
- 12 System With 12Lb Composite Bottle
- 15 System With 15Lb Bottle

Popular Accessories



PN GEN-X Pg. 52



PN ML15601 Purge Kit Pg. 57



PN 15003
Safe Tank
Pg. 65

Mainline EFI Direct Port Nitrous System



EFI



*Actual contents of nitrous system may vary from picture

If you are a serious nitrous junkie on a tight budget we have what you have been waiting for! NX introduces MainLine Nitrous Systems. MainLine Systems benefit from the years of research and development that made Nitrous Express the leader in the nitrous world, but at a price even the most budget-restricted racer can afford. Just the basics, no frills, just rock solid performance at rock bottom prices. Includes Jetting for 100, 200, 300 and 400whp. Includes Stainless Steel Bottle Brackets, NX Piranha Nozzles, Aircraft Quality Steel Braided Hoses, 15ft Stainless Steel Braided 6AN Feedline and Nickel Plated Fittings. Made in U.S.A.

- 100-400whp.
- Stainless Steel Bottle Brackets
- NX Piranha Nozzles
- Aircraft Quality Steel Braided Hoses
- 15ft Stainless Steel Braided 6AN Feedline
- Nickel Plated Fittings
- Made in U.S.A.

PART #	DESCRIPTION
ML5000	MainLine Direct Port EFI Nitrous System 100-400whp

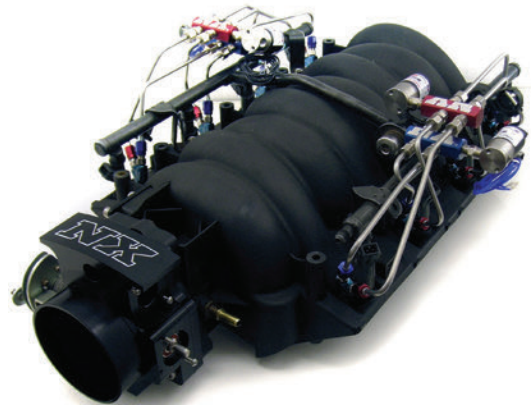

Popular Accessories



PN 15957
Maximizer 4
Progressive Nitrous Controller
Pg. 54



PN GEN-X Pg. 52



PN 15600 Purge Kit Pg. 57

Dry Direct Port Nitrous System

EFI

The NX Dry Direct port systems provide nitrous directly into each cylinder through a set of high flow NX Dry Nozzles. These systems are designed to be used with an engine management system that can add nitrous enrichment fuel through the engines injectors. Includes nitrous jets for 100-600 Whp per stage, and a tech card with pound per hour flow data for each jet setting so you can easily configure your engine management system's nitrous fuel enrichment settings. These NX Dry nitrous systems include your choice of 1/8NPT or 1/16NPT dry nozzles, two .093 Lightning solenoids per stage, 5lb, 10lb or 15lb nitrous bottle, wide open throttle switch, stainless bottle brackets, D-6 stainless braided N2O line, relay with harness and all necessary hardware to complete the installation. Dual bottles with DF5 valves and 8AN supply line should be used for jet settings over 1000whp.



*Actual contents of nitrous system may vary from picture

PART #	Description
93006	1 stage Dry Direct Port Nitrous System, 8cyl
93106	2 stage Dry Direct Port Nitrous System, 8cyl
93206	3 stage Dry Direct Port Nitrous System, 8cyl
93306	4 stage Dry Direct Port Nitrous System, 8cyl

FOR BOTTLE SIZE ADD TO PART NUMBER:

- 00 System Less Bottle
- 05 System With 5Lb Bottle
- 10 System With 10Lb Bottle
- 12 System With 12Lb Composite Bottle
- 15 System With 15Lb Bottle

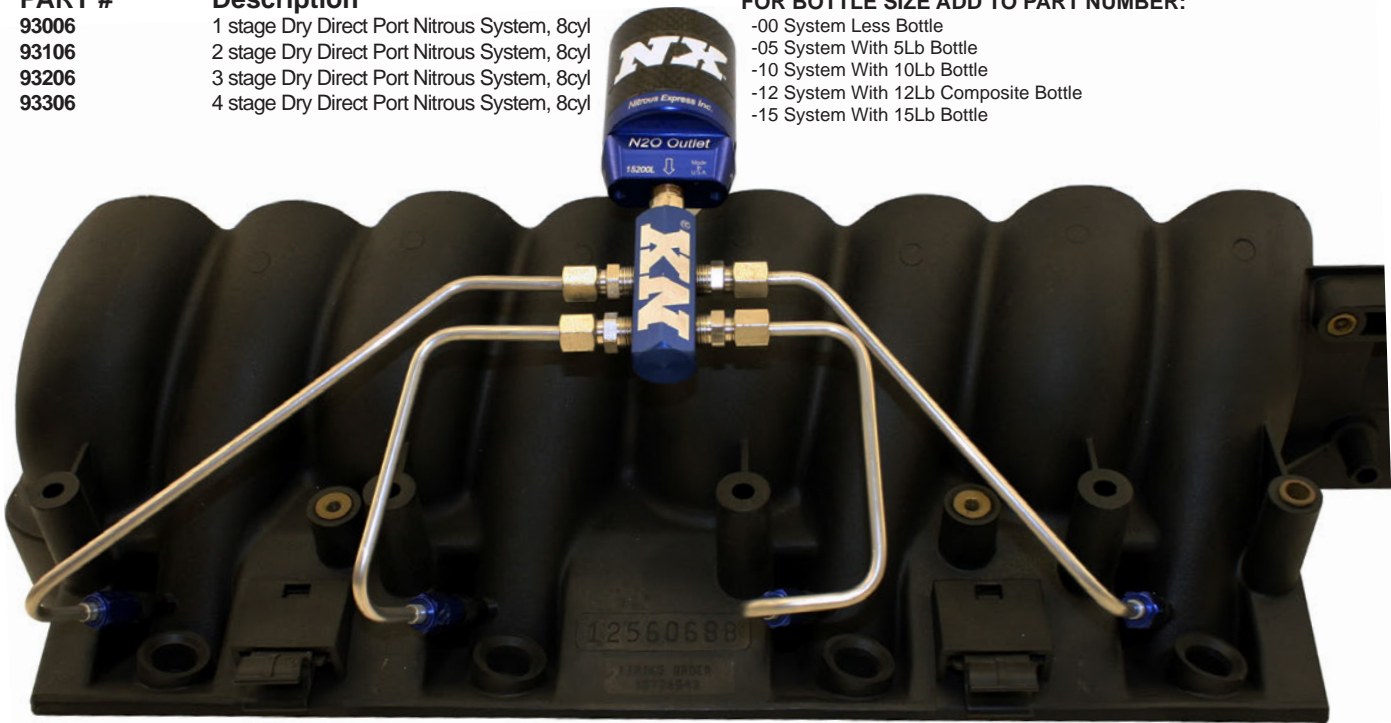

Popular Accessories

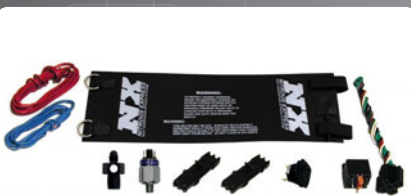

PN 15940 Bottle Heater Pg. 59



PN 15529 Master Flo-Check Pro Pg. 56



PN 15957
Maximizer 4
Progressive Nitrous Controller
Pg. 54

Piranha Direct Port Nitrous System



*Actual contents of nitrous system may vary from picture

When space is tight but performance is still a requirement, the patented "Piranha" nozzle is the answer. At just half the size of its big brother, the "Shark", the "Piranha" still packs a powerful bite. Available in settings up to 600 horsepower, the Piranha will eat the competition alive! Available with standard distribution blocks, high tech showerheads, or optional "Next Generation" rail technology. Systems come complete with optional bottle sizes, Lightning series billet aluminum and carbon fiber solenoids, industry exclusive billet Lightning 45 bottle valve, stainless steel hard lines, B-nuts, sleeves, Piranha nozzles, and all necessary components to complete the system.

PART #	DESCRIPTION
80001	8 Cylinder Gasoline (200-500whp)
80005	8 Cylinder Alcohol (200-500whp)
80006	6 Cylinder Gasoline (150-375whp)
80065	6 Cylinder Alcohol (150-375whp)
80004	4 Cylinder Gasoline (100-250whp)
80045	4 Cylinder Alcohol (125-275whp)
80044	Air Cooled VW 4 Cylinder Gas (100-250whp)
80445	Air Cooled VW 4 Cylinder Alc. (125-275whp)

FOR BOTTLE SIZE ADD TO PART NUMBER:

- 00 System Less Bottle
- 05 System With 5Lb Bottle
- 10 System With 10Lb Bottle
- 12 System With 12Lb Composite Bottle
- 15 System With 15Lb Bottle

SSV Direct Port Nitrous System

The original Vortech nozzle has returned and is better than ever. The "Stainless Steel Vortech" is the original bell cone nitrous/fuel atomizer and has been copied by many. Remember to look for the patent number laser etched on the SSV nozzle. First in Quality, first in technology, Nitrous Express, the "Next Generation" nitrous company! This Nitrous system comes complete with your choice of 5lb, 10lb, 15lb, or 12lb composite nitrous bottle, billet and carbon fiber Lightning series solenoids, the industry exclusive billet Lightning 45 bottle valve, stainless bottle brackets, stainless hard lines, nozzles, jetting, and all necessary electrical components.

PART #	DESCRIPTION
80016	SSV Direct Port System 200-500whp

FOR BOTTLE SIZE ADD TO PART NUMBER:

- 00 System Less Bottle
- 05 System With 5Lb Bottle
- 10 System With 10Lb Bottle
- 12 System With 12Lb Composite Bottle
- 15 System With 15Lb Bottle



*Actual contents of nitrous system may vary from picture

The patented NX Vortech Nozzle is back and better than ever! The original Vortech nozzle, often copied but never duplicated, is now available in stainless steel and one single SSV can produce up to 200 horsepower! The NX Vortech nozzle has set numerous ET and MPH records since the 1980's and is the most copied nozzle design ever. Get yours from the company that invented it, Nitrous Express!



U.S. Patent #5699776

STD Direct Port Nitrous System



*Actual contents of nitrous system may vary from picture

PART #	DESCRIPTION
80018	Stainless STD Direct Port System 200-500whp

S.T.D. (Straight Through Design) direct port systems are designed for applications where traditional 90 degree nozzles will not fit. The stainless steel Straight Through Design nozzle features a proprietary configuration that mixes fuel and nitrous before exiting the nozzle body. This results in the most complete atomization of any annular nozzle available. S.T.D. direct port systems include billet and carbon fiber Lightning series solenoids, the industry exclusive billet Lightning 45 bottle valve, stainless hard lines, nickel plated fittings, B-nuts, sleeves, high flow feed line and every nut, bolt and electrical connector needed for installation. Systems with bottles include stainless bottle brackets as well as the lightweight, high flow, billet aluminum Lightning 45 bottle valve.

FOR BOTTLE SIZE ADD TO PART NUMBER:

- 00 System Less Bottle
- 05 System With 5Lb Bottle
- 10 System With 10Lb Bottle
- 12 System With 12Lb Composite Bottle
- 15 System With 15Lb Bottle

Pro Mod Direct Port Nitrous System

NX Pro Mod systems feature the best of everything. Every component has been designed to minimize flow restriction for the ultimate in power production. Aluminum and carbon fiber solenoids along with aluminum bottle valves weigh half as much as old school stainless and brass components. These systems include 8 of the patented NX nozzles per stage, 2 NX Lightning 250 Nitrous solenoids per stage, 2 NX Lightning series fuel solenoids per stage, compact aluminum distribution blocks, 3/16 stainless hard lines, nickel plated fittings, Jetting for 200-2100Whp per stage, D-8 stainless braided nitrous feed line, a high flow 8AN to dual 6AN Y fitting, 6AN to 4AN showerheads, a wide open throttle switch, 40 Amp relays and relay harnesses, master arming switch, stainless bottle brackets and an NX nitrous bottle with the DF5 bottle valve. Dual bottles with DF5 valves should be used for jet settings over 1000Whp.

NX nitrous systems include the latest technology and the best components available. For you tech hungry junkies... we will provide some details explaining what makes this nitrous system so great. The key to maximizing nitrous horsepower is to keep the nitrous in a dense liquid form until it is injected into the engine. Sharp bends in the nitrous flow path cause the nitrous flow to become turbulent which causes gaseous bubbles to form in the flowing nitrous. Dense liquid nitrous makes more power than gaseous nitrous – Period! This NX nitrous system contains the key components that ensure you are getting maximum power per pound of nitrous used.

Light weight billet aluminum NX Lightning 250 solenoids feature a proprietary design that allows the solenoid to open a huge .250 inch orifice with only 8 amps of current draw. The lack of restriction provides power gains unmatched by any other nitrous solenoid on the market.

The billet aluminum DF5 bottle valve not only looks great; it weighs nearly a pound less than a brass bottle valve. It is packed



*Actual contents of nitrous system may vary from picture

with features including an integrated gauge port, a large .500 orifice and a straight through flow path. The DF5 valve includes a locking handle to prevent accidental opening.

PART #	DESCRIPTION
90506	Single Stage 8Cyl Pro Mod Direct Port
91506	Dual Stage 8Cyl Pro Mod Direct Port
92506	Three Stage 8Cyl Pro Mod Direct Port
93506	Four Stage 8Cyl Pro Mod Direct Port

SX2 Direct Port Nitrous System

CARBURETED



*Actual contents of nitrous system may vary from picture

- 50-1200whp.
- SX2 Nozzles
- Dual Stage
- 4cyl, 6cyl, and 8cyl Applications
- Extra Long 8AN Stainless Braided Supply Line
- Billet "Y" Fittings
- DF5 Bottle Valve
- Available For Alcohol
- Made in U.S.A.

U.S. Patent #5699776



Dual stage technology incorporated into one nozzle body, unmatched atomization, Next Generation rail fuel and nitrous delivery standard, ease of installation, the SX2 has it all.



NX has created the bottle valve against which all others will be judged. The "Direct Flow 500", equipped with .500 orifice and a direct flow, straight through design, is capable of flowing over 2,000 nitrous horsepower. Furnished with a .625 stainless steel siphon tube, all D-8 hardware, supply line, and fittings.



The Shark SX2 is the world's finest and only dual stage single nozzle. That's right, one nozzle with two stages. The question: How do you make a nozzle better than the Shark? The answer: Impossible!!! So we did the next best thing, we created a single nozzle with dual stages, the "Shark SX2". The design team at NX has spent extensive R&D time making the "SX2" perfect. With only one nozzle in the intake port, turbulence of the natural air flow is greatly reduced. No more drilling two sets of holes, hoping that your nozzles will clear once they are installed. The "SX2" is the most advanced nozzle on the market, period! It can deliver up to 300 horsepower per nozzle in a single or dual stage configuration. When you're ready for cutting edge technology and performance, look to NITROUS EXPRESS, the "Next Generation Nitrous Company", proven time and time again, now more than ever.....(200-1200whp) 8 nozzles.

PART # DESCRIPTION

90009	8cyl. SX2 Direct Port System 200-1200whp
90096	6cyl SX2 Direct Port System 150-750Whp
90094	4cyl. SX2 Direct Port System 100-600whp

FOR BOTTLE SIZE ADD TO PART NUMBER:

-00	System Less Bottle
-05	System With 5Lb Bottle
-10	System With 10Lb Bottle
-12	System With 12Lb Composite Bottle
-15	System With 15Lb Bottle

Popular Accessories



PN 15529 Master Flo-Check Pro Pg. 56



PN 17000 Jet Holder Pg. 62



PN 15946 Bottle Jacket Pg. 60

Mainline Direct Port Nitrous System



*Actual contents of nitrous system may vary from picture

If you are a serious nitrous junkie on a tight budget we have what you have been waiting for! NX introduces MainLine Nitrous Systems. MainLine Systems benefit from the years of research and development that made Nitrous Express the leader in the nitrous world, but at a price even the most budget-restricted racer can afford. Just the basics, no frills, just rock solid performance at rock bottom prices. Includes Jetting for 100, 200, 300 and 400whp. Includes Stainless Steel Bottle Brackets, NX Piranha Nozzles, Aircraft Quality Steel Braided Hoses, 15ft Stainless Steel Braided 6AN Feedline and Nickel Plated Fittings. Made in U.S.A.

PART #	DESCRIPTION
ML4000	MainLine Direct Port Nitrous System 50-400whp
ML15601	MainLine Purge 6AN

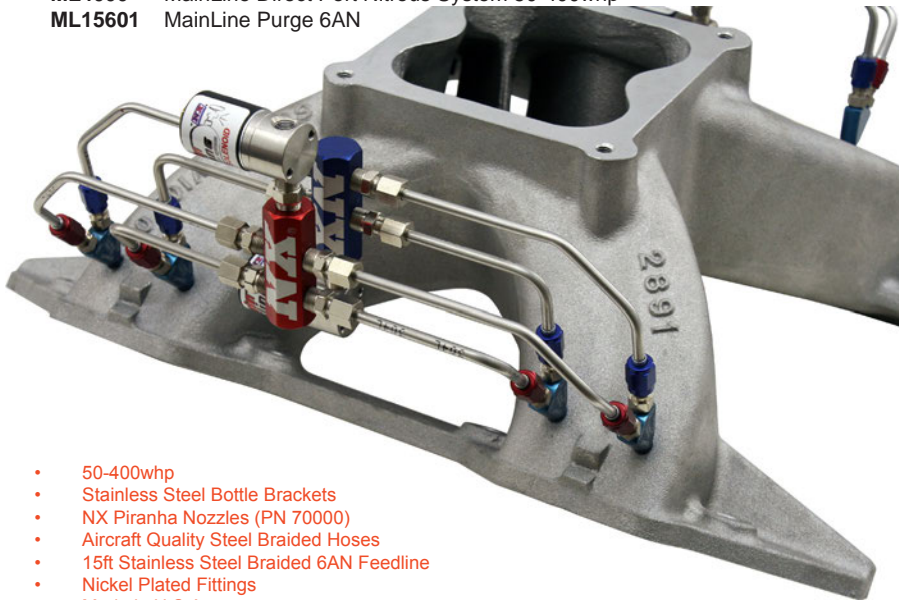

The patented Piranha nozzle is perfect for those who shoehorned that engine in their car and have limited space for a bulky nozzle system. More go, less dough. MainLine direct port systems use the same proven technology as all other NX Direct Port systems. Dollar for dollar MainLine Direct Port systems are guaranteed to be the most aggressive power maker at the lowest cost!

- 50-400whp
- Stainless Steel Bottle Brackets
- NX Piranha Nozzles (PN 70000)
- Aircraft Quality Steel Braided Hoses
- 15ft Stainless Steel Braided 6AN Feedline
- Nickel Plated Fittings
- Made in U.S.A.



U.S. Patent #5699776

Popular Accessories



PN GEN-X Pg. 52



PN ML15601 Purge Kit Pg. 57



PN 15003 Safe Tank Pg. 65

Shark Direct Port Nitrous System

CARBURETTED



*Actual contents of nitrous system may vary from picture

- 50-2000whp.
- Patented Shark Nozzles
- 800 Whp Upgrade Available
- 1/8 Nozzle Threads
- 4cyl, 6cyl, and 8cyl Applications
- Extra Long 6AN Race Hose Supply Line
- Lightning 45 Bottle Valve
- Available For Alcohol
- Made in U.S.A.



Shark direct port systems are the first choice for high horsepower direct port applications. The patented Shark nozzle features a proprietary design that mixes fuel and nitrous before exiting the nozzle body, this results in superb atomization at levels of up to 2000 horsepower on 8cyl applications. Standard distribution blocks are included but can be upgraded to high tech showerheads, or optional "Next Generation" rail technology. Shark direct port systems are available with standard Lightning solenoids, Super Shark solenoids or the new Lightning 250 solenoids. These systems include stainless lines, nickel plated fittings, B-nuts, sleeves, high flow feed line and every nut, bolt and electrical connector needed for installation. Systems with bottles include stainless bottle brackets as well as the lightweight, high flow, industry exclusive billet aluminum Lightning 45 bottle valve (systems with Lightning 250 solenoids include a DF5 bottle valve and a 8AN feed line).

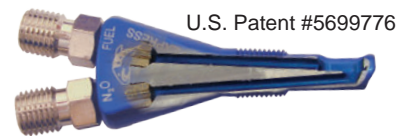

U.S. Patent #5699776

System includes eight patented "Shark" nozzles. This nozzle features a unique design for the ultimate in fuel atomization. Due to its large internal orifice size, each nozzle is capable of 250+ horsepower.

PART # DESCRIPTION

90006	8 Cyl. Gas (200-600whp) 4 Lightning Solenoid
90065	8 Cyl. Alc. (200-600whp) 4 Lightning Solenoid
90206	8 Cyl. Gas (200-600whp) w/Single Super Shark Solenoid
80007	4 Cyl. Gas (100-250whp) SOFTLINE w/pre-drilled rails
80008	6 Cyl. Gas (150-375whp) SOFTLINE w/pre-drilled rails
80009	8 Cyl. Gas (200-500whp) SOFTLINE w/pre-drilled rails
90506	8 Cyl. Gas (200-2000whp) w/Lightning 250 Solenoids

FOR BOTTLE SIZE ADD TO PART NUMBER:

- 00 System Less Bottle
- 05 System With 5Lb Bottle
- 10 System With 10Lb Bottle
- 12 System With 12Lb Composite Bottle
- 15 System With 15Lb Bottle

Popular Accessories



PN 17000 Jet Holder Pg. 62



PN GEN-X Pg. 52



PN 15946 Bottle Jacket Pg. 60

Billet Crossbar Nitrous Plate System



*Actual contents of nitrous system may vary from picture

The new NX Billet Crossbar plate systems have just raised the bar in nitrous plate technology. The CNC machined design integrates the nitrous and fuel discharge ports into a billet divider bar. This new design provides excellent atomization and cylinder distribution while totally eliminating the possibility of rotated spray bars. Systems include billet aluminum and carbon fiber Lightning series solenoids, a custom solenoid mounting bracket, billet aluminum Y fittings, braided stainless solenoid to plate lines, nickel plated fittings, wide open throttle switch, master arming switch, 40 Amp relay, relay harness and every nut, bolt and electrical connector needed for installation. Systems ordered with bottles include the high flow Billet aluminum Lightning 45 bottle valve and stainless steel bottle brackets.

***Optional Jetting up to 1000HP on dual stage systems**

Part # Description

- 60042** Billet Crossbar Plate System (50-300HP) (4150 Flange)
- 66042** Billet Crossbar Plate System (50-300HP) (Dominator Flange)
- 60542** Billet Crossbar Plate System (100-500HP) (4150 Flange)
- 60547** Billet Crossbar Plate System (100-500HP) (Dominator Flange)
- 66042** Dual Stage Billet Crossbar Plate System (50-800HP) (4150 Flange)
- 66047** Dual Stage Billet Crossbar Plate System (50-800HP) (Dominator Flange)

FOR BOTTLE SIZE ADD TO PART NUMBER:

- 00 System Less Bottle
- 05 System With 5Lb Bottle
- 10 System With 10Lb Bottle
- 12 System With 12Lb Composite Bottle
- 15 System With 15Lb Bottle

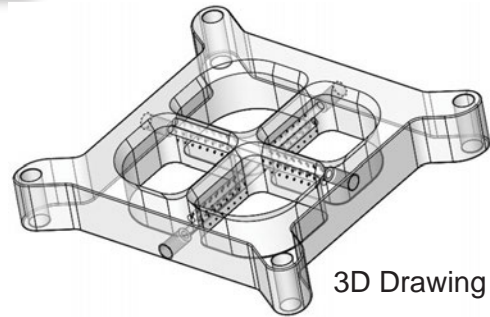

3D Drawing

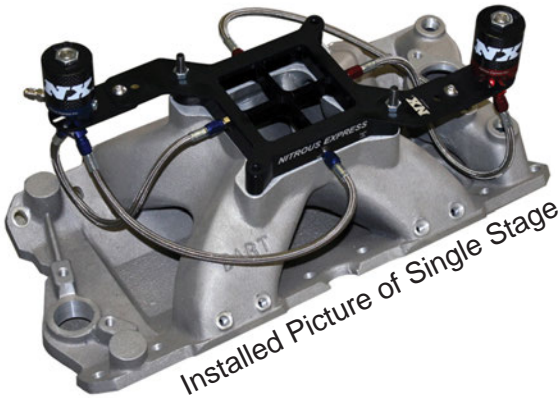

Installed Picture of Single Stage

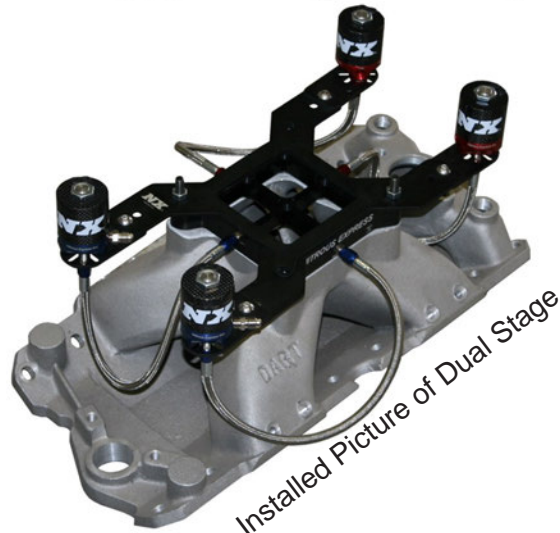

Installed Picture of Dual Stage

Popular Accessories



PN 15529 Master Flo-Check Pro Pg. 56



PN 17000 Jet Holder Pg. 62



PN 15946 Bottle Jacket Pg. 54

Titan Nitrous Plate System

If your racing class restricts you to a single nitrous plate but does not restrict the number of nitrous jets, the Titan is an excellent choice. The billet aluminum plate feeds nitrous and fuel into multiple locations in the plate for the best cylinder to cylinder distribution possible. Each Titan is hand assembled and individually performance checked. The systems include the .157 orifice Super Shark solenoid, .312 orifice Shark fuel solenoid, DF-5 bottle valve, 8AN nitrous supply line and jet settings from 100-750whp!

PART #	DESCRIPTION
60540EZ	4150 Titan Plate system (100-750whp)
60740EZ	Dominator Titan Plate system (100-750whp)

FOR BOTTLE SIZE ADD TO PART NUMBER:

- 00 System Less Bottle
- 05 System With 5Lb Bottle
- 10 System With 10Lb Bottle
- 12 System With 12Lb Composite Bottle
- 15 System With 15Lb Bottle



*Actual contents of nitrous system may vary from picture

ATTENTION RESTRICTED NITROUS CLASS RACERS:



*Actual contents of nitrous system may vary from picture

Nitrous Express restricted nitrous class systems are guaranteed to make the most power per jet size of any system on the market. If you don't make the most horsepower or are not 100% satisfied, NX will gladly take the product back and give you a 100% refund. **RNC** (Restricted Nitrous Class) systems are designed to maximize the amount of pure, liquid nitrous delivered through a limited jet size. These systems include special high flow plates, a .250 orifice Lightning 250 nitrous solenoid, .187 orifice Lightning fuel solenoid, 8AN supply line and a DF5 bottle valve. Conventional Restricted Nitrous Class systems feature a large orifice center bar nitrous plate that has only one nitrous jet and one fuel jet. Gemini Restricted Nitrous Class systems include a perimeter spray plate that has two nitrous jets and two fuel jets.

Part #	DESCRIPTION
55040	4150 Conventional RNC system (200-600whp)
55070	Dominator Conventional RNC system (200-600whp)
65540	4150 Gemini RNC system (300-800whp)
65570	Dominator Gemini RNC systems (300-800whp)

Popular Accessories



PN 17000 Jet Holder Pg. 62



PN GEN-X Pg. 52



PN 15529 Master Flo-Check Pro Pg. 56

Dual Stage Shark Nitrous Plate System



*Actual contents of nitrous system may vary from picture



U.S. Patent #5743241

NX Billet nitrous plates are the "Next Generation" in nitrous performance and reliability. This new innovation provides superior distribution and outstanding atomization. With no spray bars to sag, split, block airflow, or damage this is truly the "Next Generation" in nitrous plate technology.



NEW Lightning Series limited lifetime warranty solenoids. Lightest, largest, and highest flowing solenoids on the market. Shark systems come with multiple solenoid combinations depending on the selected systems.

Nitrous and fuel distribution and atomization are unmatched by any other design. NX now introduces the "Next Generation" Dual Stage, the Phase 3 Shark Plate. The Shark is a dual-stage system with the Phase 3 Series no spray bar design. This plate incorporates the Gemini Twin and conventional plate designs into a single unit. Systems come complete and include limited lifetime warranty billet aluminum and carbon fiber Lightning solenoids, industry exclusive billet aluminum Lightning 45 bottle valve, stainless bottle brackets, and stainless 6AN feedline.

- 50-800whp.
- Dual Stage
- Billet Spraybarless Plate
- Perfect Nitrous, Fuel Distribution
- Lightning 45 Bottle Valve
- Available For Alcohol
- Made in U.S.A.

PART # DESCRIPTION

66540	Holley Shark Plate System (Dual Stage 50-300whp &100-500whp)
66545	Holley Shark Plate System Alc. (Dual Stage 50-300whp &100-500whp)
66570	Dominator Shark Plate System (Dual Stage 50-300whp &100-500whp)
66575	Dominator Shark Plate System Alc. (Dual Stage 50-300whp &100-500whp)

FOR BOTTLE SIZE ADD TO PART NUMBER:

- 00 System Less Bottle
- 05 System With 5Lb Bottle
- 10 System With 10Lb Bottle
- 12 System With 12Lb Composite Bottle
- 15 System With 15Lb Bottle

Popular Accessories



PN 15957
Maximizer 4
Progressive Nitrous Controller
Pg. 54



PN 15508
Nitrous Gauge (0-1500)
Pg. 56



PN 17000 Jet Holder Pg. 62

Gemini Nitrous Plate System

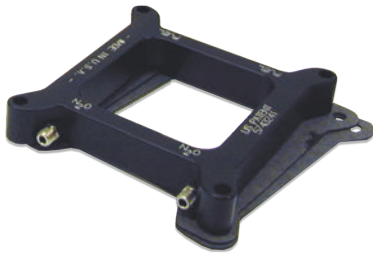

U.S. Patent #5743241



NX Billet nitrous plates are the "Next Generation" in nitrous performance and reliability. This new innovation in nitrous plates provides superior distribution and outstanding atomization. With no spray bars to sag, split, block airflow, or damage this is truly the "Next Generation" in nitrous plate technology.



*Actual contents of nitrous system may vary from picture

Nitrous Express Gemini Twin plate systems include the most technically advanced single stage plate ever designed. The perimeter spray, direct-port pattern assures perfect cylinder to cylinder distribution. It solves problems commonly found on many single plane intake manifolds, particularly small and big block Fords. Systems include billet aluminum and carbon fiber Lightning series solenoids, stainless solenoid to plate connectors, wide open throttle switch, 40 amp relay, 15 foot supply line (Race Hose) as well as every nut, bolt, wire and electrical connector needed to complete the installation. Systems with bottles include the industry exclusive billet aluminum Lightning 45 bottle valve.

- 50-500whp. depending on application
- Perfect Nitrous, Fuel Distribution
- Lightning 45 Bottle Valve
- Available For Alcohol
- Made in U.S.A.

PART # DESCRIPTION

Stage 6 Plate Systems

- 60040** Holley Gemini Twin Stage Six (50-300whp)
- 60045** Holley Gemini Twin Stage Six Alcohol (50-300whp)
- 60070** Dominator Gemini Twin Stage Six (50-300whp)
- 60075** Dominator Gemini Twin Stage Six Alcohol (50-300whp)

Pro Power Plate Systems

- 60540** Holley Gemini Twin Pro Power (100-500whp)
- 60545** Holley Gemini Twin Pro Power Alcohol (100-500whp)
- 60570** Dominator Gemini Twin Pro Power (100-500whp)
- 60575** Dominator Gemini Twin Pro Power Alcohol (100-500whp)

FOR BOTTLE SIZE ADD TO PART NUMBER:

- 00 System Less Bottle
- 05 System With 5Lb Bottle
- 10 System With 10Lb Bottle
- 12 System With 12Lb Composite Bottle
- 15 System With 15Lb Bottle

Popular Accessories



PN 15940 Bottle Heater Pg. 59



PN 15957
Maximizer 4
Progressive Nitrous Controller
Pg. 54



PN GEN-X Pg. 52

Conventional Nitrous Plate System

CARBURETED



*Actual contents of nitrous system may vary from picture



NX Billet nitrous plates are the "Next Generation" in nitrous performance and reliability. This new innovation provides superior distribution and outstanding atomization. With no spray bars to sag, split, block airflow, or damage this is truly the "Next Generation" in nitrous plate technology.

Conventional plate systems include a billet aluminum nitrous plate that discharges nitrous and fuel from a CNC machined center divider. This new innovation in nitrous plate technology provides superior distribution and outstanding atomization. Systems include billet aluminum and carbon fiber Lightning series solenoids, stainless solenoid to plate connectors, wide open throttle switch, 40 amp relay, 15 foot supply line as well as every nut, bolt, wire and electrical connector needed to complete the installation. Systems with bottles include the industry exclusive billet aluminum Lightning 45 bottle valve.

- 50-500whp depending on application
- 6061T-6 Billet Spraybarless Plate
- Stainless Braided Supply Line
- Perfect Nitrous, Fuel Distribution
- Lightning 45 Bottle Valve
- Available For Alcohol
- Made in U.S.A.

FOR BOTTLE SIZE ADD TO PART NUMBER:

- 00 System Less Bottle
- 05 System With 5Lb Bottle
- 10 System With 10Lb Bottle
- 12 System With 12Lb Composite Bottle
- 15 System With 15Lb Bottle

PART # DESCRIPTION

Stage 6 Plate Systems

30020	Holley 2bbl (Special Order Only)
30040	Holley Conventional Stg 6 50-300whp
30045	Holley Conventional Stg 6 Alcohol 50-300whp
30070	Dominator Conventional Stg 6 50-300whp
30075	Dominator Conventional Stg 6 Alcohol 50-300whp
30080	Q Jet/Spreadbore Conventional Stg 6 50-300whp
30240	Dual Holley Conventional Stg 6 50-300whp
30245	Dual Holley Conventional Stg 6 Alc. 50-300whp
30270	Dual Dom. Conventional Stg 6 50-300whp
30275	Dual Dom. Conventional Stg 6 Alc. 50-300whp

Pro Power Plate Systems

50040	Holley Conventional PP 100-500whp
50045	Holley Conventional PP Alcohol 100-500whp
50070	Dominator Conventional PP 100-500whp
50075	Dominator Conventional PP Alcohol 100-500whp
50240	Dual Holley Conventional PP 100-500whp
50245	Dual Holley Conventional PP Alc. 100-500whp
50270	Dual Dom. Conventional PP 100-500whp
50275	Dual Dom. Conventional PP Alc. 100-500whp

Popular Accessories



PN 15708
Carb Fuel
Pressure
Safety Switch
Pg. 55



PN 15940 Bottle Heater Pg. 59



PN 15508
Nitrous Gauge (0-1500)
Pg. 56

Trinity Nitrous Plate System

CARBURETED

- 50-500whp depending on application
- Billet "Spraybarless" Plate
- Perfect Nitrous, Fuel Distribution
- Stainless Braided Supply Line
- Lightning 45 Bottle Valve
- Available For Alcohol
- Made in U.S.A.

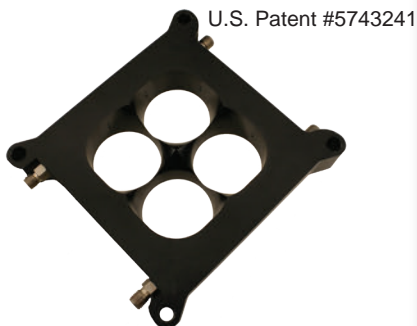

U.S. Patent #5743241

The four-hole design increases air velocity at the point where nitrous and fuel is injected, resulting in superior distribution and atomization. With no spray bars to sag, split, block airflow, or damage this is truly the Next Generation in nitrous plate technology.



*Actual contents of nitrous system may vary from picture

The new Trinity plate systems have just raised the bar in nitrous plate technology. The CNC machined venturi design smoothes airflow through the carburetor which improves power and throttle response (even when you are not using nitrous). The four-hole design increases air velocity at the point where nitrous and fuel is injected, resulting in superior distribution and atomization. With no spray bars to sag, split, block airflow, or damage this is truly the Next Generation in nitrous plate technology. Trinity systems include billet aluminum and carbon fiber Lightning series solenoids, stainless solenoid to plate connectors, wide open throttle switch, heavy duty 40 amp relay, stainless braided supply line as well as every nut, bolt, wire and electrical connector needed to complete the installation. Systems with bottles include the industry exclusive Lightning 45 bottle valve, as well as stainless bottle brackets.

FOR BOTTLE SIZE ADD TO PART NUMBER:

- 00 SYSTEM LESS BOTTLE
- 05 SYSTEM WITH 5LB BOTTLE
- 10 SYSTEM WITH 10LB BOTTLE
- 12 SYSTEM WITH 12LB COMPOSITE BOTTLE
- 15 SYSTEM WITH 15LB BOTTLE

PART # DESCRIPTION

Stage 6 Plate Systems

- 60041 Holley Trinity Stage Six (50-300whp)
- 60046 Holley Trinity Stage Six Alcohol (50-300whp)

Pro Power Plate Systems

- 60541 Holley Trinity Pro Power (100-500whp)
- 60546 Holley Trinity Pro Power Alcohol (100-500whp)

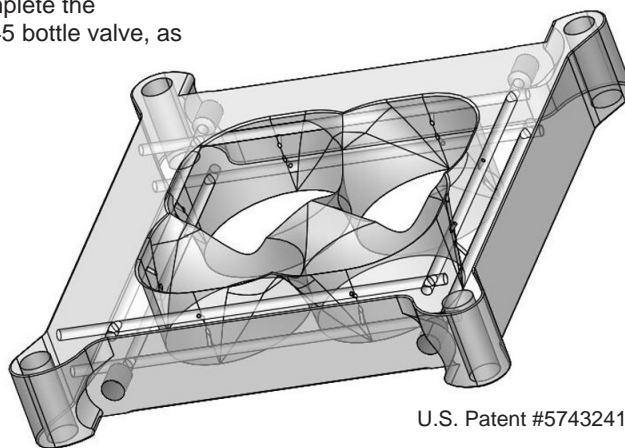

U.S. Patent #5743241

Popular Accessories



PN 15945 Bottle Jacket Pg. 60



PN 17000 Jet Holder Pg. 62



PN 15708
Carb Fuel
Pressure
Safety Switch
Pg. 55

Hitman Nitrous Plate System



*Actual contents of nitrous system may vary from picture



Even our Hitman Systems receive the NX Billet aluminum conventional nitrous plate. These plates are the "Next Generation" in nitrous performance and reliability. This new innovation in plates provides superior distribution and outstanding atomization.

- 100-200 H.P.
- Economical Nitrous System
- Limited Lifetime Warranty Solenoids
- 6061T-6 Spraybarless Billet Plate
- Extra Long Stainless Braided Supply Line
- Stainless Steel Bottle Brackets
- Made in U.S.A.

For the enthusiast who wants to use nitrous yet does not want to spend a lot of money, the "Hitman" is the way to go. Hitman systems are equipped with the latest billet aluminum and carbon fiber Lightning series solenoids, stainless bottle brackets and the adjustability of three horsepower settings: 100-150-200. The Phase 3 series nitrous plates are the "Next Generation" in nitrous performance and reliability, this new innovation provides superior distribution and outstanding atomization. With no spray bars to sag, split, block airflow, or damage this is truly the "Next Generation" in plate technology. The "Hitman" is the perfect, low cost, introductory system for the nitrous novice.

PART #	DESCRIPTION
40040	Holley Hitman Plate System (100-200whp)
40070	Dominator Hitman Plate System (100-200whp)

Popular Accessories

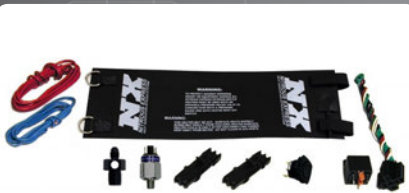

PN 15940 Bottle Heater Pg. 59



PN: 15509
Nitrous Gauge D-4
Pg. 56



PN 15600 Purge Kit Pg. 57

Mainline Nitrous Plate System

CARBURETTER

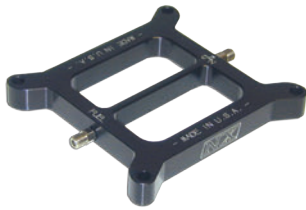

MainLine Systems include a Billet aluminum nitrous plate. These plates are the "Next Generation" in nitrous performance, reliability and this new innovation in plates provides superior distribution and outstanding atomization. With no spray bars to sag, split, block airflow, or damage this is truly the "Next Generation" in plate technology.

- 100-250Whp
- Stainless Steel Bottle Brackets
- 6061T-6 Spraybarless Billet Plate
- Simple Installation
- Aircraft Quality Steel Braided Hoses
- 15ft Stainless Steel Braided 4AN Feedline
- Nickel Plated Fittings
- Made in U.S.A.



*Actual contents of nitrous system may vary from picture

If you're a serious nitrous junkie on a tight budget we have what you've been waiting for! MainLine Systems benefit from the years of research and development that made Nitrous Express the leader in the nitrous world, but at a price even the most budget-restricted racer can afford. Just the basics, no frills, just rock solid performance at rock bottom prices, and made in the USA! 100-150-200-250 Whp jet settings included

PART # DESCRIPTION

ML1000	MainLine Holley 4150 Nitrous System 100-250whp
ML1001	MainLine Dominator Nitrous System 100-250whp
ML1002	MainLine Q-Jet/Spreadbore Nitrous System 100-250whp
ML 15600	Mainline Purge 4AN

Popular Accessories



PN 15945 Bottle Jacket Pg. 60



PN 17000 Jet Holder Pg. 62



PN 15708
Carb Fuel
Pressure
Safety Switch
Pg. 55

Nxd Diesel Nitrous System



*Actual contents of nitrous system may vary from picture

The NXD Stacker Systems let you STACK nitrous on your existing diesel chip. Guaranteed to boost horsepower & torque, erase that ugly black smoke and dramatically reduce exhaust temperatures. NXD Stacker systems are the ultimate safe, cost effective add-on for your modified diesel engine. All Stacker systems include billet & carbon fiber Lightning series solenoids, a 15lb nitrous bottle with the industry exclusive billet aluminum high flow Lightning 45 bottle valve, stainless braided feed line, nickel plated fittings and every nut, bolt and electrical connector needed to perform the installation.

- Easy To Install
- Clean Safe Power
- No Black Smoke!
- Dramatic Reduction of Exhaust Temps
- Lightning 45 Bottle Valve
- Made in U.S.A.

PART # DESCRIPTION

NXD11110 NXD STACKER

The Original "Stacker" features a .063 orifice Lightning series nitrous solenoid for up to 75 Whp gain and reduced exhaust gas temperatures. Recommended for vehicles with stock fuel systems.

NXD12000 NXD STACKER2

The "Stacker Two" features a larger capacity .093 orifice Lightning Series nitrous solenoid for up to 150 horsepower gains and dramatically lower exhaust temps. Recommended for applications with aftermarket programmers or performance modules with factory fuel systems.

NXD12001 NXD STACKER3

The "Stacker Three" goes one step further to a huge .120 orifice Lightning Series nitrous solenoid capable of 250 horsepower gains with even more exhaust temperature benefits. Recommended for applications with significant fuel upgrades including aftermarket injectors.

NXD12002 NXD STACKER4

The "Stacker Four" includes one of the largest nitrous solenoids in the industry, the .157 Super Shark monster. This beast is capable of producing 600 horsepower and can manage the most unruly exhaust temps! The Stacker Four is designed for applications with huge injectors and lots of boost.

NXD12003 NXD Stacker Ultimate

The Stacker Ultimate is for the most extreme applications. The Stacker Ultimate Includes the new NX exclusive Lightning 250 solenoid that flows 2.5 times more nitrous than the Stacker 4. This system includes one Lightning 250 nitrous solenoid, a DF5 bottle valve, a D-8 feed line, dual 1/8 Dry nozzles, SHO nozzle feed lines, and all the fittings and wiring necessary to complete the system. *Dual 15lb bottles are recommended.

Popular Accessories

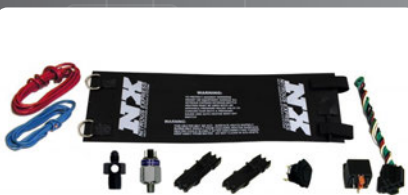

PN 15940 Bottle Heater Pg. 59



PN: 15509
Nitrous Gauge D-4
Pg. 56



PN 15600 Purge Kit Pg. 57

Progressive Diesel Nitrous System

This isn't just another plug in chip that floods your engine with raw diesel and covers the car behind you in black smoke. These systems are engineered to be the safest way to boost horsepower on any diesel engine.

NXd systems actually cool the exhaust temperatures while boosting horsepower and torque!

Digitally controlled progressive nitrous controller, 15200L Lightning solenoid, and an extra capacity 15lb nitrous bottle all working together to give you the ultimate in control and MADE IN THE U.S.A. quality!



Our NXd Systems (Excluding Stacker) include the NEW Maximizer 4 Progressive Controller. This Unit will control two stages of nitrous along with time, MAP, speed, EGT, or throttle position base ramping.



System includes NX dry nozzles. This nozzle features a unique design for the ultimate in nitrous distribution. Due to its large internal orifice size each nozzle is capable of 500+ horsepower.

- Easy To Install
- Dual Stage Progressive Nitrous Delivery Based on Boost, Time, EGT, Throttle Percent or Speed
- Clean Safe Power
- No Black Smoke!
- Dramatic Reduction of Exhaust Temps
- Dual Stage Power Levels
- Lightning 45 Bottle Valve
- Made in U.S.A.



*Actual contents of nitrous system may vary from picture

PART #	DESCRIPTION
NXD1000	Single Stage Progressive Controlled Diesel Nitrous System



*Actual contents of nitrous system may vary from picture

The "Next Generation" in diesel horsepower is here! The digitally controlled dual stage SX2d lets you use all the nitrous power your diesel can handle. Two digitally controlled progressive stages, two giant 500Whp Lightning solenoids, two giant NX dry nozzles, an extra capacity 15lb nitrous bottle all working together to give you the ultimate in control and MADE IN THE U.S.A. quality!

PART #	DESCRIPTION
NXD4000	Dual Stage Progressive Controlled Diesel Nitrous System

EFI Conversion Kits

Nitrous Express offers a complete line of conversion kits for all of our systems. Whether you're upgrading from a EFI single nozzle system to a plate system, or converting from another brand to one of our "Next Generation" nitrous systems, "Nitrous Express" has exactly what you'll need to make the conversion complete. All the conversions begin after the solenoids and include all the necessary hardware. Nitrous Express is the only nitrous company to date that has the confidence in our product to improve your performance and reliability...Guaranteed! Includes plate, connectors, jets and whp settings.

CONVERSION KITS

SINGLE NOZZLE CONVERSIONS

PART #	DESCRIPTION
NXEFI	Ford EFI Dry to Wet Conversion (50-75-100-150whp)
NXE85	Converts Single Nozzle EFI to E85 Compatible System
NXTPI	GM TPI Dry to Wet Conversion (50-75-100-150whp)
NXCUS	Custom EFI Dry to Wet Conversion (50-75-100-150whp)
NXEFI-DS	Single Stage wet to Dual Stage Wet (50-75-100-150whp x 2)
NX400	Single Nozzle to 4cyl. Piranha Nozzle Direct Port (100-250whp)

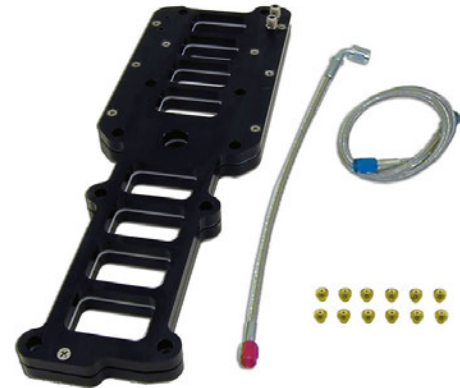

Part # NX102

FORD EFI PLATE CONVERSIONS

PART #	DESCRIPTION
NX100	Ford 5 Liter EFI Stock Intake Manifold (50-300whp)
NX101	Ford 5 Liter EFI GT 40/Cobra Intake Manifold (50-300whp)
NX102	Ford 5 Liter EFI Edelbrock Performer/RPM Intake Manifold (50-300whp)
NX103	Ford 5 Liter EFI Edelbrock Victor Intake Manifold (50-300whp)
NX104	Ford 5 Liter EFI Trick Flow Intake Manifold (50-300whp)
NX105	Ford 5 Liter EFI Trick Flow "R" Intake Manifold (50-300whp)
NX106	Ford 5 Liter EFI Holley Systemax Intake Manifold (50-300whp)
NX108	Ford 5 Liter EFI Edelbrock RPM 2 Intake Manifold (50-300whp)
NX200	Dual Stage Conversion For Ford 5 Liter Plate Systems (50-300whp)
NX346	Ford 4.6 Liter 2V Plate Conversion (50-150whp)
NX347	Ford 4.6 Liter 3V Plate Conversion W/o Integrated Solenoids (50-150whp)
NX347S	Ford 4.6 Liter 3V Plate Conversion With Integrated Solenoids (50-150whp)
NX948	Ford 5.0 Liter Coyote Plate Conversion With Integrated Solenoids (50-150whp)



Part # NX346



Part # NX347S

GM EFI PLATE CONVERSIONS

PART #	DESCRIPTION
NX109	LS1/LT1 3 Piece MAF Conversion (50-250whp)
NXMAF-DS	Single Stage MAF to Dual Stage MAF (50-250whp x 2)
NX110	1pc GM MAF Conversion W/o Integrated Solenoids (50-250whp)
NX110S	1pc GM MAF Conversion With Integrated Solenoids (50-250whp)
NX9333	GM LS 4 bolt 102 MM EFI Nitrous Throttle Body Plate (50-400whp)
NX9334	GM LS 4 Bolt 90 MM EFI Nitrous Throttle Body Plate (50-400whp)
NX9335	GM LS 3 Bolt 78 MM EFI Nitrous Throttle Body Plate (50-350whp)



Part # NX109

Plate Conversion Kits

CONVERSION KITS

BILLET CROSSBAR PLATE CONVERSION KITS

PART #	DESCRIPTION
NX606	Holley 4150 (50-300HP)
NX608	Dominator (50-300HP)
NX616	Holley 4150 (100-500HP)
NX618	Dominator (100-500HP)

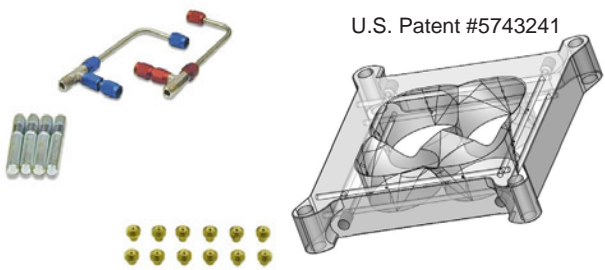
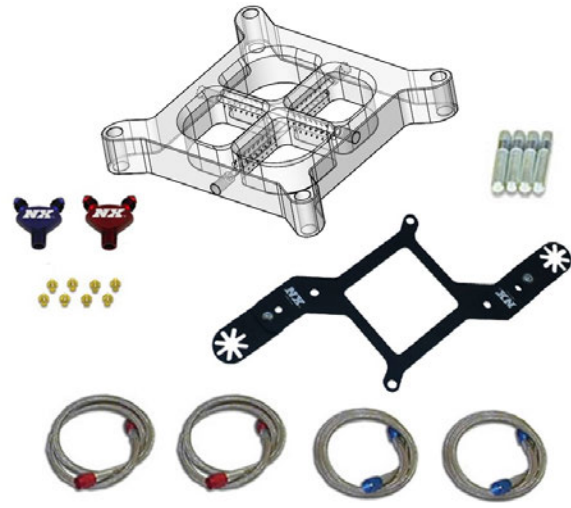

U.S. Patent #5743241

TRINITY PLATE CONVERSIONS

PART #	DESCRIPTION
NX605	Holley 4150 (50-300HP)
NX615	Holley 4150 (100-500HP)

CONVENTIONAL PLATE CONVERSION KITS

PART #	DESCRIPTION
NX302	Holley 2bbl (50-300HP)
NX304	Holley 4bbl (50-300HP)
NX307	Dominator (50-300HP)
NX308	Q-Jet/Spreadbore (Special Order)
NX3024	Dual Holley (50-300HP)
NX3027	Dual Dominator (50-300HP)
NX504	Holley 4bbl (50-300HP)
NX507	Dominator (100-500HP)
NX5024	Dual Holley (100-500HP)
NX5027	Dual Dominator (100-500HP)



GEMINI PLATE CONVERSION KITS

PART #	DESCRIPTION
NX604	Holley 4bbl (50-300whp)
NX607	Dominator (50-300whp)
NX614	Holley 4bbl (100-500HP)
NX617	Dominator (100-500HP)

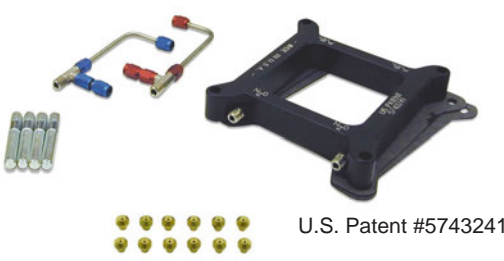

U.S. Patent #5743241

SHARK DUAL STAGE CONVERSION KITS

(50-100-150-200-250-300-350-400-450-500-550-600-650-700-750-800-900-1000whp)

PART #	DESCRIPTION
NX624	Holley 4bbl (50-300whp x 2)
NX627	Dominator (50-300whp x 2)
NX634	Holley 4bbl (50-300whp / 100-500whp)
NX637	Dominator (50-300whp / 100-500whp)
NX654	Holley 4bbl (100-500whp x 2)
NX657	Dominator (100-500whp x 2)

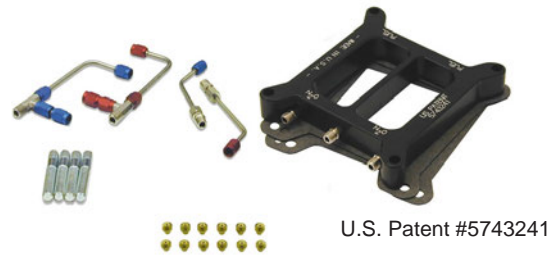

U.S. Patent #5743241

Nozzles

NOZZLE CONVERSIONS

Convert Any Brand Nozzle System to NX

PART #	DESCRIPTION
NX700	Piranha Nozzles 8-Cyl (8 nozzles, jet pack)
NX704	Piranha Nozzles 4-Cyl (4 nozzles, jet pack)
NX800	STD Nozzles 8-Cyl (8 nozzles, jet pack)
NX900	Shark Nozzles 8-Cyl (8 nozzles, jet pack)
NX906	Shark Nozzles 6-Cyl (6 nozzles, jet pack)
NX904	Shark Nozzles 4-Cyl (4 nozzles, jet pack)

NOZZLES & NOZZLE ACCESSORIES

PART #	DESCRIPTION
70000	Single Piranha Nozzle
80016	Single Stainless Steel Vortech (SSV) Nozzle
80018	Single Straight Thru Design (STD) Nozzle
90016	Single Shark/Pro-Shark/Super Shark Nozzle
90017	Single SX2 Nozzle
90019	Single High Output Nozzle 400Whp
DryNozzle	Single 1/8 NPT Dry Nozzle
DryNozzle1/16	Single 1/16 NPT Dry Nozzle
91018	1/8 NPT Tap For Shark Nozzle & SX2
80017	1/16 NPT Tap For Piranha Nozzle
91017	Piranha, Shark Nozzle Fitting
92017	STD, SSV & SX2 Nozzle Fitting
15719	1/8" Nozzle Adapter
80040	4-Cylinder Stainless Tubing Plumbing Kit (Tubing Only)
80060	6-Cylinder Stainless Tubing Plumbing Kit (Tubing Only)
80080	8-Cylinder Stainless Tubing Plumbing Kit (Tubing Only)
80081	3/16 Stainless Tubing (per foot)
80090	D-3 B-Nut & Sleeve blue
80091	D-3 B-Nut & Sleeve red

U.S. Patent #5699776



Part # 90016
Shark Nozzle



Part # 80018
STD Nozzle

U.S. Patent #5699776

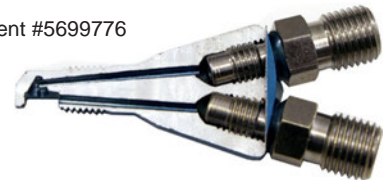

Part #70000
Piranha Nozzle

U.S. Patent #5699776



Part #80016
SSV Nozzle

U.S. Patent #5699776



Part # 90017
SX2 Nozzle



Part # DryNozzle
1/8 NPT Dry Nozzle

Plumbing Kits

PLUMBING KITS WITH SOLENOIDS

PART#	DESCRIPTION
13385	8 cylinder four solenoid direct port system, includes 8 Shark Nozzles, 2 15200L nitrous solenoids, 2 15201L fuel solenoids, all stainless tubing, B-nuts, sleeves, distribution blocks, all fittings and lines to complete intake manifold, includes jetting for 200-600whp.
13386	8 cylinder four solenoid direct port system, includes 8 Piranha Nozzles, 2 15200L nitrous solenoids, 2 15201L fuel solenoids, all stainless tubing, B-nuts, sleeves, distribution blocks, all fittings and lines to complete intake manifold, includes jetting for 200-500Whp.
13383-STNX	8 cylinder direct port system, includes 8 SSV Nozzles, 2 15200L nitrous solenoids, 2 15201L fuel solenoids, all stainless tubing, B-nuts, sleeves, distribution blocks, all fittings and lines to complete intake manifold, includes jetting for 200-500whp
13384	8 cylinder direct port system, includes 8 STD Nozzles, 2 15200L nitrous solenoids, 2 15201L fuel solenoids, all stainless tubing, B-nuts, sleeves, distribution blocks, all fittings and lines to complete intake manifold, includes jetting for 200-500whp
13387	8 cylinder direct port system, includes 8 SX2 nozzles, 4 15200L nitrous solenoids, 4 15301L fuel solenoids, all stainless tubing, B-nuts, sleeves, Hex Rails, all fittings and lines to complete intake manifold, includes jetting for 200-600whp per stage.
13381	8 cylinder DRY direct port system, includes 8 Dry 1/16 nozzles, 2 15200L nitrous solenoids, all stainless tubing, B-nuts, sleeves, distribution blocks, all fittings and lines to complete intake manifold, includes jetting for 200-600whp.
13382	8 cylinder DRY direct port system, includes Dry 1/8 nozzles, 2 15200L nitrous solenoids, all stainless tubing, B-nuts, sleeves, distribution blocks, all fittings and lines to complete intake manifold, includes jetting for 200-600whp.

PLUMBING KITS WITHOUT SOLENOIDS

PART#	DESCRIPTION
13389	8 cylinder direct port system, includes 8 Shark nozzles, no solenoids, all stainless tubing, B-nuts, sleeves, distribution blocks, all fittings and lines to complete intake manifold, includes 300whp jets
13390	8 cylinder direct port system, includes 8 SSV nozzles, no solenoids, all stainless tubing, B-nuts, sleeves, distribution blocks, all fittings and lines to complete intake manifold, includes 300whp jets

STAINLESS STEEL TUBING KITS

PART #	DESCRIPTION
80080	3/16 Stainless steel tubing kit to install an 8 cylinder direct port nitrous system
80085	3/16 Stainless steel tubing kit to install an 8 cylinder direct port nitrous system, includes red and blue B-nuts and sleeves
80060	3/16 Stainless steel tubing kit to install a 6 cylinder direct port nitrous system
80065	3/16 Stainless steel tubing kit to install a 6 cylinder direct port nitrous system, includes red and blue B-nuts and sleeves
80040	3/16 Stainless steel tubing kit to install a 4 cylinder direct port nitrous system
80045	3/16 Stainless steel tubing kit to install a 4 cylinder direct port nitrous system, includes red and blue B-nuts and sleeves

Intake Plumbing

DIRECT PORT NITROUS SYSTEM INSTALLATION

Direct Port installation includes drilling and tapping the intake runners, installing nozzles, bending hard lines, installing solenoids and dry flowing the system. TIG welding services are available if needed at added cost.

INTAKE PLUMBING



CUSTOM NITROUS SYSTEMS

NX offers custom Intake plumbing, hidden systems, custom colors and more. One stage or multiple stages - Gasoline, e85 or methanol - You name it... we have it. If you have something special in mind, just call one of our nitrous experts for a custom quote.



Intake Plumbing

INSTALLING CUSTOM SPRAY BARS IN YOUR INTAKE MANIFOLD

Installing custom spray bars in your intake manifold is a good option for applications that do not have enough hood clearance to run a nitrous plate below the carburetor. For tunnel ram intakes, custom spray bars are preferred over nitrous plates because they inject nitrous directly in to each port for perfect cylinder to cylinder distribution.

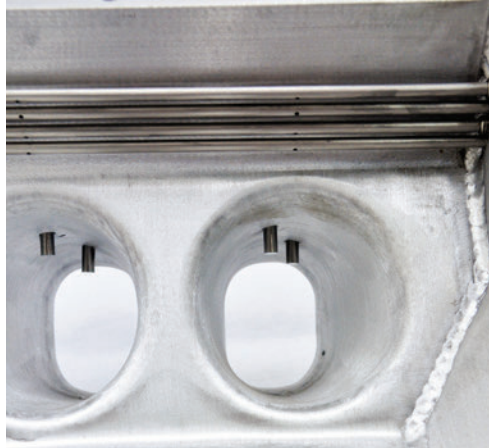

HIDDEN NITROUS SYSTEMS

Hidden systems are billed by the hour. Just call one of our nitrous experts to discuss your application and concealment options.



LS3 Hidden NX System

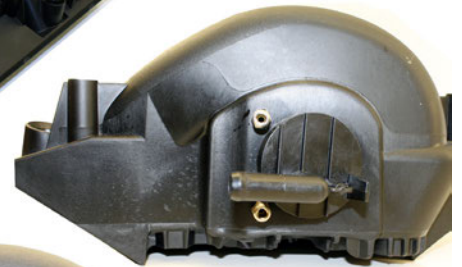

Rear



Front



Gen-X Accessory Pack

Gen-X accessory packs include all the components you need to make your nitrous system dependable and worry free. Gen-X kit includes: fully automatic bottle heater with pressure transducer, fuel pressure safety switch, liquid filled N2O pressure gauge, NHRA approved pressure release fitting, NHRA approved blowdown tube, all the electrical connectors and wire needed to complete the installation. Gen X-2 kit includes all of the above plus a purge valve for the NX Lightning Series or NX Ice-Man solenoids.



PN GENX



PN GENX-2

EFI (HIGH PRESSURE)

PN: GEN-X

Accessory pack includes: fully automatic bottle heater, EFI fuel pressure safety switch, N2O pressure gauge, NHRA pressure relief fitting, NHRA blow down tube

PN: GENX-2

Accessory pack includes: fully automatic bottle heater, EFI fuel pressure safety switch, N2O pressure gauge, NHRA pressure relief fitting, NHRA blow down tube, purge valve

PN: GENX-2

Accessory pack includes: fully automatic bottle heater, EFI fuel pressure safety switch, N2O pressure gauge, NHRA pressure relief fitting, NHRA blow down tube, purge valve for plates with integrated solenoids, such as the Coyote Plate System and the C7 Corvette Plate System

CARBURETED (5-10PSI)

PN: GEN-X-4

GEN-X package with carb fuel press. safety switch. For D-4 supply lines.

PN: GEN-X-6

GEN-X package with carb fuel press. safety switch. For D-6 supply lines.

PN: GENX-8

GEN-X package with carb fuel press. safety switch. For D-8 supply lines.

PN: GENX-2-4

CARB GENX-2 package with carb fuel press. safety switch & purge valve. For D-4 supply lines.

PN: GENX-2-6

CARB GENX-2 package with carb fuel press. safety switch & purge valve. For D-6 supply lines.

PN: GENX2-8

GENX-2 package with carb fuel press. safety switch & purge valve. For D-8 supply lines.



To keep an eye on that ever so vital pressure, we've also included a N2O pressure gauge and blue anodized adapter manifold.



The NX nitrous pressure transducer monitors bottle pressure and activates the heater element. Switches on when bottle pressure falls below 1000psi, and cycles off at 1050psi. thus keeping proper bottle pressure at all times.



Taking things a step up in the GenX-2, a NEW Lightning Solenoid purge valve is incorporated to add to the performance of your existing system. A purge valve allows quicker 60ft times, which in turn, can shave up to 2 tenths off of your quarter mile ETs.



The first NHRA pressure relief fitting with a built in diffuser. This device is used to relieve bottle pressure over 3000psi and vent nitrous to the outside of the vehicle. Fitting comes with replaceable pressure disc.



Both kits include our fuel pressure safety switch. This is an important feature with any nitrous system. The switch disarms the N2O system if fuel pressure drops below safe levels.



Heater element has surface temperatures above 300 degrees. This element can take a bottle from ice cold to operating pressure in minutes.

Parts & Accessories

CUSTOM SWITCH PANELS

These NX switch panels offer a clean and attractive switching solution for nitrous systems as well as many other electrical devices. These switch panels include a variety of interchangeable laser engraved switch nameplates allowing you to change any switch to any location. Nameplates included are for Nitrous, Stage 2 Nitrous, Bottle Heater, Bottle Opener, Purge, Electric Fans, Water Methanol, Fuel Pump, Accessory, Go Baby Go and Ejector Seat. Need a nameplate for Machine Gun, Lights or Smoke Screen? We can also custom laser engrave any nameplate via special order.

Part # Description

- 15769 Rocker Switch name plate(Custom Laser Marking available)
- 15771 Custom Switch Panel, GM Truck 2008-2013
- 15772 Custom Switch Panel, GM Truck, 1999- 2006 - 4wd compartment
- 15773 Custom Switch Panel, GM Truck, 1999- 2006 - Radio Compartment
- 15774 Custom Switch Panel, Camaro 98-02
- 15768 Custom Switch Panel, Camaro 93-97
- 15775 Custom Switch Panel, Camaro 10-13
- 15776 Custom Switch Panel, C5 Corvette
- 15777 Custom Switch Panel, C6 Corvette
- 15778 Custom Switch Panel, CTS-V
- 15779 Custom Switch Panel, G8
- 15780 Custom Switch Panel, F150 2009-2011
- 15781 Custom Switch Panel, F250 2008-2011
- 15782 Custom Switch Panel, Mustang 87-93
- 15783 Custom Switch Panel, Mustang 94-04
- 15784 Custom Switch Panel, Mustang 05-09
- 15785 Custom Switch Panel, Mustang 10-13
- 15786 Custom Switch Panel, Ram 09-Up
- 15787 Custom Switch Panel, Challenger 08-Up
- 15788 Custom Switch Panel, Charger 08-Up



CUSTOM SOLENOID MOUNTING BRACKETS AND LINE KITS

Want that high end custom install look without the hassle and expense of making custom brackets and lines? These custom solenoid mounting brackets and line kits make your nitrous install quick and easy while looking clean and attractive.

Vehicle Application	Bracket Part #	Line Kit Part #	Vehicle application	Bracket Part #	Line Kit Part
F150 2009-2011	15780-1	15780-1LK	C6 Corvette	15777-1	15777-1LK
F250 2008-2011	15781-1	15781-1LK	GTO 05-06	15770	15770-2LK
Mustang 87-93	15782-1	15782-1LK	G8	15770	15770-2LK
Mustang 94-04	15783-1	15783-1LK	Universal LS		
Mustang 05-09	15784-1	15784-1LK	Pass Side Head Bracket	15770	15770-3LK
Mustang 10-13	15785-1	15785-1LK	102mm LS Passenger		
Ram 09-Up	15786-1	15786-1LK	Side Throttle Body Bracket	15731	15731LK
Challenger 08-Up	15787-1	15787-1LK	Universal 4-Bolt LS Drivers		
Charger 06-Up	15788-1	15788-1LK	Side Throttle Body Bracket	15730	15730LK
GM Truck 2008-2013	15770	15770-2LK			
GM Truck, 1999- 2006	15770	15770-1LK			
Camaro 98-02	15770	15770-1LK			
Camaro 10-13	15775-1	15775-1LK			
C5 Corvette	15770	15770-1LK			



CARBURETOR PLATE SOLENOID BRACKETS

These solenoid brackets fit between the carburetor and intake manifold to provide an adjustable mounting point for your solenoids. Each solenoid mount can be swiveled on the main plate to allow the perfect solenoid position every time. As an added benefit, the Dominator version utilizes a 4 hole design with a center section that will prevent the carburetor linkage from falling into your engine in the event of a linkage malfunction.

PART # DESCRIPTION

- 15728 Carb Plate Solenoid Bracket for 4150
- 15729 Carb Plate Solenoid Bracket for Dominator
- 15728D Carb Plate Solenoid Bracket for 4150 (dual stage)
- 15729D Carb Plate Solenoid Bracket for Dominator (dual stage)



Progressive Controllers



Key Features include:

- TPS WOT switch protection (throttle activation % is adjustable)
- RPM window switch protection (user adjustable to any RPM)
- Individual timing retard outputs for both nitrous stages
- High amp solenoid drivers (will handle 60 amps per stage or 120 amps for a single stage)
- Over current and reverse polarity protection
- Air fuel ratio compensation and cut off protection

MAXIMIZER 4

The NX Maximizer 4 progressive nitrous controller operates one or two separate stages of nitrous based on either time, RPM, MPH, throttle percentage or boost pressure. Whether your engine is naturally aspirated or forced induction, gasoline or diesel, the Maximizer 4 is the first choice. The Maximizer 4 has multiple progression options to cover a variety of racing types. These progression options are described below:

Time based progression: This option is a popular choice for drag racing applications where you always start from a dead stop. This option is very easy to fine tune so that you leave soft enough to eliminate wheel spin, and increases power as you go down track, the controller smoothly adds more nitrous as traction increases.

RPM based progression: This option works great for vehicles that have enough traction to handle full nitrous power at the top of first gear. This mode allows you to add a little nitrous in the lower engine RPMs and ramp into full nitrous as the engine rpm increases. This is a great option for vehicles with a tight torque converter. Since nitrous flow is limited to a small amount at low RPMs, you can safely activate the nitrous at lower RPMs which will help to pull the car out of the hole.

MPH (Miles Per Hour) progression: This option is great for racers who sometimes begin racing from a dead stop and other times begin racing from a rolling start. The nitrous controller will automatically limit nitrous to a smaller boost at low speeds where traction is limited while providing a larger boost at higher speeds where traction is more plentiful. Bracket racers can use this feature to set a MPH nitrous cutoff for the ultimate in consistent ETs.

Throttle percentage progression: This option allows you to “pedal” the car in the event of wheel spin. Nitrous flow smoothly increases and decreases as you “work” the throttle, allowing you to regain traction and continue racing. This is very beneficial to road race and drifting vehicles. The throttle percentage feature is also beneficial for street cars because it allows you to introduce a small amount of nitrous at mid throttle while smoothly transitioning to full nitrous power as you press the throttle to the floor. The feeling is like driving a car with twice the cubic inches.

Boost based progression: This is a useful option for turbocharged diesels and gasoline applications. Boost progression allows nitrous to come on strong to eliminate that dreaded turbo lag, then ramps out the nitrous smoothly to let the mighty turbo do its thing. The end result is monster power with zero lag, even with a HUGE turbo. On diesel applications it will not allow full nitrous delivery until the engine starts to build adequate boost, preventing a nitrous engine stall.

EGT (Exhaust Gas Temperature) progression: Injecting nitrous into a diesel application lowers EGTs. This is a useful option for diesel applications that don't want to use nitrous all the time but still want the EGT lowering properties that nitrous provides. EGT based progression allows you to create a safety ramp which will only add nitrous if EGTs rise to unsafe limits. Compatible with all EGT modules that have a 0 to 5 volt output signal.

AFR (Air Fuel Ratio) compensation and protection: The Maximizer 4 monitors the engines Air Fuel Ratio (from optional wide band O2 module), and automatically adjusts the fuel and nitrous solenoid output to achieve the desired Air Fuel Ratio (target AFR is user adjustable). As bottle pressure drops toward the end of a run, the Maximizer 4 will automatically adjust the solenoid output so you maintain a consistent and safe AFR. Air Fuel Ratio safety cut off limit (too rich and too lean) are user adjustable so the controller will completely shut off nitrous flow if the Air Fuel Ratio goes outside the user defined limits.

Part #	Description
15957	MAXIMIZER 4 PROGRESSIVE NITROUS CONTROLLER

Parts & Accessories

SWITCHES & ELECTRONICS

15504 Wide open throttle nitrous control switch w/H.D. 60 Amp relay

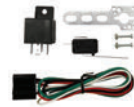

15504

15505 Dominator throttle switch w/H.D. 60 Amp relay



15505

15515 60 Amp anti-fly back HD relay (w/ wire harness) Double Pole Double Throw For Use with Trans-Brake



15515

15526 60 Amp heavy duty relay (only)



15526

15516 Wide open throttle switch only (no relay, bracket or hdwr)



15516

15517 Universal wot switch bracket (only)



15517

15518 Dominator wot switch bracket (only)



15518

15533 Bottle heater pressure transducer (0-1500PSI)



15533

15704 Toggle W/Safety Guard



15704

15705 Power Sports Toggle Switch



15705

15706 Nitrous system activation push button



15706

15707 Lighted (red) nitrous system arm switch



15707

15708 Heavy duty fuel pressure safety switch (carb. Fuel pressure)



15708

15718 Heavy duty fuel pressure safety switch w/manifold (EFI fuel pressure)



15718

15961 TPS Voltage Sensing Full Throttle Activation Switch



15961

15964 NX "Digi-Set" compact, solid state delay timer



15964

15957 Maximizer 4 Progressive Nitrous Controller



15957

Parts & Accessories

GAUGES & GAUGE ADAPTERS

- 15501 Nitrous flo-thru manifold (D-4) Dual Outlet Swivel
- 15502 Nitrous flo-thru manifold (D-6) Dual Outlet Swivel
- 15508 Nitrous pressure gauge only (0-1500 psi)
- 15509 Nitrous flo-thru pressure gauge (d-4 w/manifold)
- 15510 Nitrous flo-thru pressure gauge (d-6 w/manifold)
- 15511 Gasoline pressure gauge (0-15 psi w/adaptor)
- 15512 Gasoline pressure gauge (0-100 psi w/adaptor)
- 15519 Master flo-check (checks flowing fuel pressures, gauge incl.)
- 15529 Master flo-check Pro (6" certified gauge & molded case)
- 15530 6" Certified Fuel Pressure Gauge Only
- 15531 Remote Electronic Nitrous Pressure Gauge



PLUG AND PLAY WIRING HARNESS

- 15492-1 Custom wire harness, 1979-2004 Mustang
- 15492-2 Custom wire harness, 05 & up Mustang
- 15492-3 Custom wire harness, 93-02 F-body
- 15492-4 Custom wire harness, 5th gen Camaro
- 15492-5 Custom wire harness, C5 Corvette
- 15492-6 Custom wire harness, C6 Corvette
- 15492-7 Custom wire harness, G8 04-06



NITROUS FILTERS AND FILTER FITTINGS

- 15607 D-4 "Pure-Flo" N2O filter & 7" stainless hose (life time cleanable)
- 15608 1/4XD-4 nitrous filter fitting
- 15609 1/4 X D-6 nitrous filter fitting
- 15610 D-6 "Pure-Flo" N2O filter & 7" stainless hose (lifetime cleanable)
- 15611m/c -4 x 1/8 NPT Filter Fitting
- 16112m/c -6 x 1/8 NPT Filter Fitting



Parts & Accessories

NITROUS PUMPING STATIONS AND ACCESSORIES

- 15850 1/4 NPT nitrous control valve (brass body w/stainless ball)
- 15904 Next generation nitrous pump only (6lbs. Per min)
- 15905 Nitrous refill pump station, lines and pump
- 15906 Next generation pump station (with digital scale, & 3 way valve)
- 15907 Digital nitrous scale
- 15908 Kit to convert pump station to use CO2 instead of compressed air
- 15910 Bottle transfer kit (complete w/stand, control valve,& lines)
- 15930 Bottle stand



PURGE VALVES AND ACCESSORIES

- 15600 Nitrous purge valve (w/D-4 manifold, push button, and vent tube)
- ML15600 Mainline Nitrous purge valve (w/D-4 manifold, push button, and vent tube)
- 15601 Nitrous purge valve (w/D-6 manifold, push button, and vent tube)
- ML15601 Mainline Nitrous purge valve (w/D-6 manifold, push button, and vent tube)
- 15602 Plumbing kit for dual vent purge system
- 15603 Purge valve for the Lightning solenoids (solenoid, push button, and vent tube)
- 15604 Dual vent soft line for purge kit
- 15605 Purge kit for integrated solenoid nitrous systems



EFI FUEL ADAPTERS

- 15235 1/4" fuel "T"
- 16179 Ford EFI fuel rail fitting (for schrader valve)
- 16183 Ford 4.6L fuel rail adapter ('99-'04)
- 16184 Ford 4.6L fuel rail adapter ('05 & up)
- 16185 3/8-10mm fuel line adapter
- 16185D 3/8-10mm fuel line adapter 90 Degree
- 16190 5/16-8mm fuel line adapter



Part # 16183



Part # 16185



Part # 16184



Part # 16185D

SOLENOID CONNECTORS & BRACKETS

- 15709 Universal solenoid mount (incl.. screws, specify solenoid)
- 15710 Hitman, Stage 6, & ProPower S.S. solenoid to plate connector (blue)
- 15711 Hitman, Stage 6, & ProPower S.S. solenoid to plate connector (red)
- 15722 Holley. "Gemini twin." Phase 3 S.S. solenoid to plate connectors (blue)
- 15723 Holley. "Gemini twin." Phase 3 S.S. solenoid to plate connectors (red)
- 15726 Dom. "Gemini twin" Phase 3 S.S. solenoid to plate connectors (blue)
- 15727 Dom. "Gemini twin" Phase 3 S.S. solenoid to plate connectors (red)
- 15728 Carb Plate Solenoid Bracket for 4150
- 15728D Dual Stage Carb Plate Solenoid Bracket for 4150
- 15729 Carb Plate Solenoid Bracket for Dominator
- 15729D Dual Stage Carb Plate Solenoid Bracket for Dominator

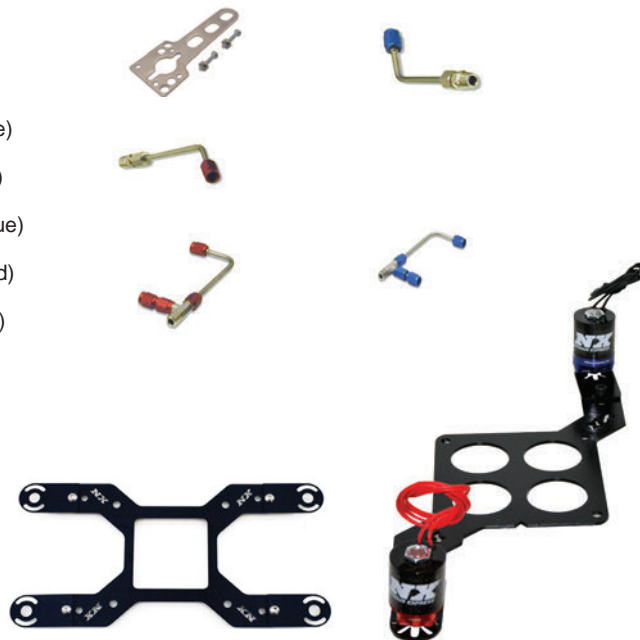

Nitrous Bottles

Even with the use of a high flowing solenoid, you still have to have precise flow to the solenoid. So when we set out to create the highest flowing nitrous solenoid, we had to spend equal time addressing the nitrous bottle valve flow. Steps were taken to match the flow characteristics of the bottle valve with that of the solenoid. Our final results led to the highest flowing bottle valves on the market.

PART #	DESCRIPTION
11010	16oz bottle (w/ motorcycle valve)
11025	2.5lb bottle (w/ motorcycle valve)
11055	5.0lb bottle (w/ motorcycle valve)
11050	5.0lb bottle (w/ Lightning 45 valve)
11100	10lb bottle (w/ Lightning 45 valve)
11152	12lb composite bottle (w/ Lightning 45 valve)
11150	15lb bottle (w/ Lightning 45 valve)

Bottle Accessories

BOTTLE VALVES & ADAPTERS

PART #	DESCRIPTION
11500-10	DF5 system for 10lb bottle 14 ft. -8 line, solenoid & -4 refill fittings, n2o gauge, & NHRA safety valve (bottle not included)
11500-15	DF-5 system for 15lb bottle 14 ft. -8 line, solenoid & -4 refill fittings, n2o gauge, & NHRA safety valve (bottle not included)
11501-10	DF5 valve only w/siphon tube for 10lb bottle (-4 bottle refill fitting)
11501-15	DF5 valve only w/siphon tube for 15lb bottle (-4 bottle refill fitting)
11660	-4 Bottle fitting for 660 valve (pump station master bottle)
11698	Pure-Flo 45 Motorcycle bottle valve
11700	Standard Pure-Flo bottle valve (fits 5, 10, 12 & 15lb bottles chrome)
11699L	Standard Lightning 45 Bottle Valve for 10lb Bottle w/ Gauge
11699L-15	Standard Lightning 45 Bottle Valve for 15lb Bottle w/ Gauge
11700L	Standard Lightning 45 Bottle Valve for 10lb Bottle
11700L-15	Standard Lightning 45 Bottle Valve for 10lb Bottle
11715	CO2 Valve for 10lb Bottle
11715-15	CO2 Valve for 15lb Bottle



Part # 11500

The DF5 bottle valve features a .500 orifice and a direct flow, straight through design that is capable of flowing over 2,000 nitrous horsepower. The valve features an integrated gauge port, push port and a locking handle to prevent accidental opening.

LIGHTNING 45 BOTTLE VALVE

The "Lightning 45" is the first nitrous specific valve ever produced in light weight aluminum. Manufactured from 6061T6 billet aluminum and pressure tested to over 10,000PSI to assure your safety. Restrictive bottle valves will no longer be a problem in the nitrous world; this valve will retrofit to any brand nitrous system.

PART #	DESCRIPTION
11699L	Lightning 45 Bottle Valve for 10lb Bottle w/ Gauge
11699L-15	Lightning 45 Bottle Valve for 15lb Bottle w/ Gauge
11700L	Lightning 45 Bottle Valve for 10lb Bottle
11700L-15	Lightning 45 Bottle Valve for 10lb Bottle



Part # 11700L

REMOTE BOTTLE VALVE OPENER AND COMPONENTS

PART #	DESCRIPTION
11107	NX automatic remote bottle opener (will operate any brand nitrous valve)
15966	Remote bottle opener only (black opener)
15967	Switch for the remote bottle opener (black opener)
15968	Body for remote bottle opener (black opener)
15969	Gear for remote bottle opener (black opener)
15970	Collar for remote bottle opener (black opener)



Part # 11107

Bottle Accessories

BOTTLE BRACKETS

PART #	DESCRIPTION
11026	2.5lb stainless motorcycle bottle bracket
11106	10lb & 15lb stainless steel bottle brackets
11106C	12lb Composite stainless steel bottle brackets
11109	5 lb. Stainless steel bottle brackets



Part # 11008D



Part # 11008

BILLET BOTTLE BRACKETS

PART #	DESCRIPTION
11108	Polished floor mount billet brackets for 10-12-15lb N2O bottle
11108B	Polished bar mount billet brackets for 10-12-15lb N2O bottle
11108D	DUAL Polished floor mount billet brackets for 10-12-15lb N2O bottle
SPEED00003	Billet Race Bracket (Fits 10lb, 12lb, 15lb N2O bottle)
11009	2" Billet Flat Mount (Mounts 2" dia. Bottle to Flat Surface)
11011	1 & 1.25Lb motorcycle bottle bracket polished billet (each)
11013	2" Bottle Mount Billet (Bar mount required for this PN)



Part # Speed00003

BILLET BAR MOUNTS FOR BILLET BOTTLE BRACKETS

PART #	DESCRIPTION
11007	1 1/2" Billet Bar Mount For Billet Bottle Brackets
11008	1 1/4" Billet Bar Mount For Billet Bottle Brackets
11012	1 1/8" Billet Bar Mount For Billet Bottle Brackets
11014	1 3/8" Billet Bar Mount For Billet Bottle Brackets
11015	1 3/4" Billet Bar Mount For Billet Bottle Brackets
11016	1 5/8" Billet Bar Mount For Billet Bottle Brackets
11017	2" Billet Bar Mount For Billet Bottle Brackets
11018	2.5lb Bar Mount Billet Bottle Bracket
11019	1" Billet Bar Mount For Billet Bottle Brackets



Part # 11007

BOTTLE VALVE FITTINGS & ACCESSORIES

PART #	DESCRIPTION
11027	2.5lb bottle valve O-ring
11028	5-10-12-15lb bottle valve O-ring
11701	4AN bottle nipple (326nx valve)
11717	4AN bottle nipple (Original Lightning 45 valve)
11721	4AN bottle nipple (New Lightning 45 valve)
11702	6AN bottle nipple (326nx valve)
11716	6AN bottle nipple (Original Lightning 45 valve)
11722	6AN bottle nipple (New Lightning 45 valve)
11723	8AN bottle nipple (New Lightning 45 valve)
11703	Bottle nut (326nx valve)
11705	Safety blow-off cap (3000 psi) fits standard valves
11706	N.H.R.A. Safety blow-off cap(3000 psi) D-8 thread-standard valve
11707	Safety blow-off for Pure-Flo & Lightning 45 valve
11708	Blow down tube plumbing kit (nut, sleeve, alum tubing)
11709	NHRA safety blow-off fitting (3000 psi) D-8 thread Pure-Flo and Lightning 45 valve
11710	Safety blow-off cap (3000) for motorcycle valve
11712	Safety blow-off cap (3000) for 312 valve
11712L	Safety blow-off cap (3000) for Lightning 45 valve



Part # 11709

BOTTLE HEATERS FOR 10, 12, & 15LB BOTTLES

PART #	DESCRIPTION
15939	Fully automatic bottle heater (4AN) w/ gauge
15940	Fully automatic bottle heater (4AN)
15941	Fully automatic bottle heater (6AN)
15942	Bottle heater element only
15943	Bottle heater pressure transducer only
15942-110	110 Volt Bottle Heater



Part # 15939

Bottle Accessories

BOTTLE JACKETS

PART #	DESCRIPTION
15947P	Bottle insulated Jacket (2.5Lb)
15945	Bottle insulated jacket (10lb)
15946	Bottle insulated jacket (15lb)



Nitrous & Fuel Lines

10008	3AN (8in) stainless steel braided hose (blue)	12012	6AN (12in) stainless steel braided hose (blue)
10009	3AN (8in) stainless steel braided hose (red)	12013	6AN (12in) stainless steel braided hose (red)
10012	3AN (12in) stainless steel braided hose (blue)	12018	6AN (18in) stainless steel braided hose (blue)
10013	3AN (12in) stainless steel braided hose (red)	12019	6AN (18in) stainless steel braided hose (red)
10018	3AN (18in) stainless steel braided hose (blue)	12024	6AN (2ft) stainless steel braided hose (blue)
10019	3AN (18in) stainless steel braided hose (red)	12025	6AN (2ft) stainless steel braided hose (red)
10024	3AN (2ft) stainless steel braided hose (blue)	12036	6AN (3ft) stainless steel braided hose (blue)
10025	3AN (2ft) stainless steel braided hose (red)	12037	6AN (3ft) stainless steel braided hose (red)
10030	3AN (30 in) stainless steel braided hose (blue)	12048	6AN (4ft) stainless steel braided hose (blue)
10031	3AN (30 in) stainless steel braided hose (red)	12072	6AN (6ft) stainless steel braided hose (blue)
10036	3AN (3ft) stainless steel braided hose (blue)	12096	6AN (8ft) stainless steel braided hose (blue)
10037	3AN (3ft) stainless steel braided hose (red)	12120	6AN (10ft) stainless steel braided hose (blue)
10040	3AN (42 in) stainless steel braided hose (blue)	12144	6AN (12ft) stainless steel braided hose (blue)
10041	3AN (42 in) stainless steel braided hose (red)	12168	6AN (14ft) stainless steel braided hose (blue)
10124	SHO Hose (24in) 4AN w/1 3AN End	12192	6AN (16ft) stainless steel braided hose (blue)
11112	4AN (12in) stainless steel braided hose (blue)	12240	6AN (20ft) stainless steel braided hose (blue)
11113	4AN (12in) stainless steel braided hose (red)		
11118	4AN (18in) stainless steel braided hose (blue)		
11119	4AN (18in) stainless steel braided hose (red)		
11124	4AN (2ft) stainless steel braided hose (blue)		
11125	4AN (2ft) stainless steel braided hose (red)		
11136	4AN (3ft) stainless steel braided hose (blue)		
11137	4AN (3ft) stainless steel braided hose (red)		
11148	4AN (4ft) stainless steel braided hose (blue)		
11172	4AN (6ft) stainless steel braided hose (blue)		
11196	4AN (8ft) stainless steel braided hose (blue)		
11120	4AN (10ft) stainless steel braided hose (blue)		
11144	4AN (12ft) stainless steel braided hose (blue)		
11168	4AN (14ft) stainless steel braided hose (blue)		
11192	4AN (16ft) stainless steel braided hose (blue)		
11240	4AN (20ft) stainless steel braided hose (blue)		

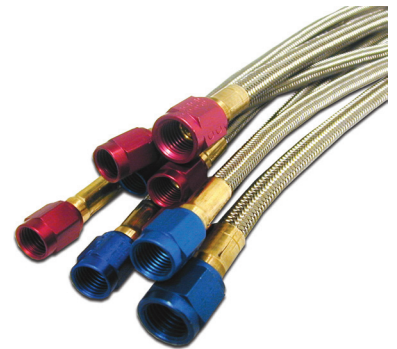

Race Hose

Nitrous Express RACE HOSE has a larger inner diameter than standard AN hose which results in increased flow potential while keeping a stock like appearance.

14012	6AN (1ft) High flow race hose	13012	4AN (1ft) High flow race hose
14024	6AN (2ft) High flow race hose	13024	4AN (2ft) High flow race hose
14036	6AN (3ft) High flow race hose	13036	4AN (3ft) High flow race hose
14048	6AN (4ft) High flow race hose	13048	4AN (4ft) High flow race hose
14072	6AN (6ft) High flow race hose	13072	4AN (6ft) High flow race hose
14096	6AN (8ft) High flow race hose	13096	4AN (8ft) High flow race hose
14120	6AN (10ft) High flow race hose	13120	4AN (10ft) High flow race hose
14144	6AN (12ft) High flow race hose	13144	4AN (12ft) High flow race hose
14168	6AN (14ft) High flow race hose	13168	4AN (14ft) High flow race hose
14192	6AN (16ft) High flow race hose	13192	4AN (16ft) High flow race hose
14240	6AN (20ft) High flow race hose	13240	4AN (20ft) High flow race hose

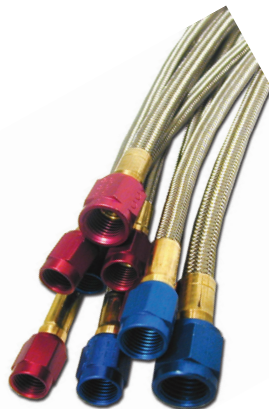

Solenoids

NX Lightning solenoids feature a raised inlet and bottom exit which eliminate up to three 90 degree turns and one expansion area in the body of the solenoid. The result is more horsepower! Lightning solenoids are CNC machined from lightweight billet 6061T6 aluminum and topped with true carbon fiber cans for the ultimate in weight savings and beauty. Lightning series nitrous solenoids feature a bypass (purge) port which allow you to connect a purge valve directly to the body of the nitrous solenoid. Lightning series fuel solenoids feature a bypass port which allows you to connect a small bypass/return line to your fuel tank. This feature eliminates lean spikes caused by air trapped between the fuel pressure regulator and the fuel solenoid. Nitrous Express only uses the highest quality, made in the USA solenoid components. Lightning series solenoids come standard in many NX nitrous systems and are also available separately as an upgrade to your existing nitrous system.

SOLENOIDS

PART #	DESCRIPTION
15098L	Lightning Nitrous .031 Orifice Solenoid
15100L	Lightning Nitrous Solenoid, Hitman (200Whp)
15101L	Lightning Gasoline Solenoid, Hitman (.150 Orifice)
15200L	Lightning Nitrous Solenoid, Stage Six (300Whp)
15201L	Lightning Gasoline Solenoid, Stage Six (.187 Orifice)
15300L	Lightning Nitrous Solenoid, Pro-power (500Whp)
15301L	Lightning Gasoline Solenoid, Pro-power (.310 Orifice)
15302L	Lightning Alcohol Solenoid, Pro-power (.310 Orifice)
15503	Nitrous Solenoid , Super Shark (1200Whp)
15400L	Lightning 250 Nitrous Solenoid (.250 Orifice)
MAINLINE FUEL-	MainLine Fuel Solenoid
MAINLINE N20-	MainLine Nitrous Solenoid

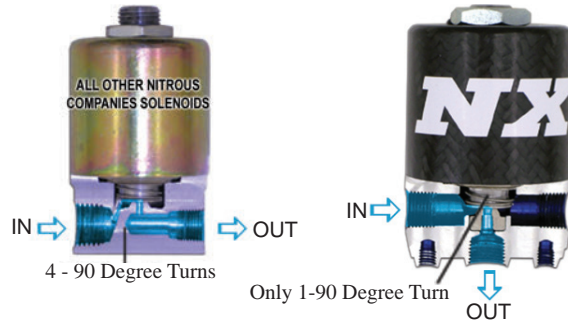

SOLENOID COMPONENTS

PART #	DESCRIPTION
15733	Solenoid maintenance wrench
15738	Piston only, (fuel .150)
15739	Piston only, (fuel .187 Stainless Base)
15740	Piston only, (fuel .312 All and Lightning .187)
15741	Piston only, (nitrous small 200Whp)
15742	Piston only, (nitrous 300Whp & 500Whp)
15761	Piston only, (nitrous Super Shark 1200Whp)
15743	Electro-magnet only (nitrous 300Whp & 500Whp)
15746	Electro-magnet only (nitrous small 200Whp)
15747	Electro-magnet only (nitrous super shark 1200Whp)
15748	Electro-magnet only (fuel .125)
15749	Electro-magnet only (fuel .187)
15750	Electro-magnet only (fuel .312)
15744	Tower only, (nitrous 300Whp & 500Whp)
15751	Solenoid tower only, (nitrous small 200Whp)
15752	Tower only, (nitrous Super Shark 1200Whp)
15753	Tower only, (fuel small .125)
15754	Tower only, (fuel .187 Stainless Base)
15755	Tower only, (fuel .312 All and Lightning .187)
15745	Tower gasket (nitrous 300Whp & 500Whp)
15756	Tower gasket (nitrous small 200Whp)
15757	Tower gasket (nitrous Super Shark 1200Whp)
15758	Tower gasket (fuel small .125)
15759	Tower gasket (fuel .187)
15760	Tower gasket (fuel .312)



Jets & Jet Packs

There has been a lot of bragging about who makes the best, most accurate jets. Some claim brass jets are eroded by flowing gasoline and nitrous, thus making them inaccurate. While it is true that the flow of gasoline and nitrous will eventually wear away the brass surface, that process would take about 1 million years, not a concern for most of us. The NX Whp Jets are manufactured on CNC equipment, and are guaranteed to be within .0005 of specified jet size. In recent testing, using the same jet size, NX jets out flowed the competition by 35%! That's right 35% more flow through the same orifice, how you ask? The Whp jet was designed to be more than just a hole in a piece of brass; its contoured inlet and multi-stepped outlet allow turbulence free flow with no restrictions.



Individual jets are ordered using the prefix 17, just add the jet size to the end as follows:
 Example 1: A size 41 jet would be part number 17041
 Example 2: A size 136 jet would be part number 17136

PART #	DESCRIPTION
40001MP	Jet Master Pack (includes 10 jets of every size - 250 jets)
40001BP	Jet Bulk Pack (includes 100 of any one jet size - specify size)

Tired of chasing your nitrous jets around? Never can find the one you need when you need it? The NX Jet Box is a convenient, safe way to store your Nitrous Express jets. Protecting them from damage and with enough capacity to store a nozzle systems complete jet inventory, this is a must for the serious nitrous user. A custom, anodized, aluminum, billet, jet-changing wrench is included.



Part# 17000
 Jet Box w/ Aluminum
 -AN Wrench

PART #	DESCRIPTION
17000	Jet Box w/ Aluminum -AN Wrench
17001	Aluminum -AN Wrench Only
17003	Jet Box Only

Fittings

"Y" FITTINGS

PART #	DESCRIPTION
16075	-3 x 3 x 3 (RED)
16076	-3 x 3 x 3 (BLUE)
16077	-3 x 3 x 1/8 (RED)
16078	-3 x 3 x 1/8 (BLUE)
16079	-6 x 4 x 4 (PURPLE)
16080	-6 x 6 x 6 (PURPLE)
16081	-4 x 4 x 4 (RED)
16082	-4 x 4 x 4 (BLUE)
16083	-6 x 4 x 4 (RED)
16084	-6 x 4 x 4 (BLUE)
16085	-6 x 6 x 6 (RED)
16086	-6 x 6 x 6 (BLUE)
16087	-8 x 6 x 6 (RED)
16088	-8 x 6 x 6 (BLUE)



Part # 16084



Part # 16083



Part # 16078

-AN & NPT MALE UNIONS

PART #	DESCRIPTION
16099	-3 x -3
16121	-4 x -4
16122	-6 x -6
16123	1/8 NPT x 1/8 npt
16124	1/4 NPT x 1/4 npt
16125	3/8 NPT x 1/4 npt
16126	1/4 NPT x 1/8 npt
16127	3/8 NPT x 1/8 npt
16128	1/8 NPT x 1/8 npt 90'
16129	1/4 NPT x 1/8 npt 90'
16130	1/4 NPT x 1/4 npt 90'



Part # 16128

-AN TO NPT CONNECTORS

PART #	DESCRIPTION
15611m/c	-4 Male x 1/8 NPT filter fitting
16112m/c	-6 Male x 1/8 NPT filter fitting
15609	-6 Male x 1/4 NPT filter fitting
15612	-4 Male x 1/4 NPT filter fitting
16091	-4 Male x 1/8 NPT 45'
16092	-4 Male x 1/4 NPT 45'
16108	-3 x 1/8 NPT straight
15236	-4 x 1/8 FPT straight
16109	-4 x 1/8 NPT straight
16110	-3 x 1/4 NPT straight
16111	-4 x 1/4 NPT straight
16112	-6 x 1/8 NPT straight
16113	-6 x 1/4 NPT straight
16114	-6 x 3/8 NPT straight
16115	-3 x 1/8 NPT 90'
16116	-4 x 1/8 NPT 90'
16117	-4 x 1/4 NPT 90'
16118	-6 x 1/8 NPT 90'
16119	-6 x 1/4 NPT 90'
16119	-6 x 1/4 NPT 90'
16120	-6 x 3/8 NPT 90'
16149	-3 x 5/16 plate fitting (machined for jet)
16150	-3 x 5/16 nozzle systems rail fitting
16179	-4 Male x 1/16 npt male (ford fuel rail fitting)



Part # 16121



Part # 16123

Fittings

EFI FUEL ADAPTERS

PART #	DESCRIPTION
15235	Sport Compact Fuel "t"
16179	Ford EFI Fuel Rail Fitting (For Schrader Valve)
16183	Ford 4.6L Fuel Rail Adapter ('99-'04)
16184	Ford 4.6L Fuel Rail Adapter ('05 & Up)
16185	3/8-10mm Fuel Line Adapter
16190	5/16-8mm Fuel Line Adapter



Part # 16185
3/8 - 10mm Fuel Line Adapt



Part # 16183
Ford 4.6L Adapter

HOSE BARB FITTINGS

PART #	DESCRIPTION
16100	1/8 NPT x 3/8 straight barb
16101	1/4 NPT x 3/8 straight barb
16102	3/8 NPT x 3/8 straight barb
16103	1/8 NPT x 1/4 straight barb
16104	1/8 NPT x 3/8 90° barb
16105	1/4 NPT x 3/8 90° barb
16106	3/8 NPT x 3/8 90° barb



Part # 16100
1/8 npt x 3/8 Barb Str.



Part # 16104
1/8 npt x 3/8 Barb 90°

"T" FITTINGS

PART #	DESCRIPTION
15234	1/4 x 1/8 NPT Male Barb "t"
16131	-3 Male x 1/8 NPT straight "t"
16132	-3 Male x 1/8 NPT run "t"
16134	-4 Male x 1/8 NPT straight "t"
16133	-3 Tee
16135	-4 Male 3 way "t"
16136	-6 Male 3 way "t"
16107	1/4 Hose barb "t"
16137	3/8 Hose barb "t"



Part # 16133
-3 Male Tee



Part # 16138
1/8npt x 3/16 Compression

COMPRESSION FITTINGS

PART #	DESCRIPTION
16096	3/8 Compression x 1/8 male NPT branch "t"
16138	1/8 NPT male x 3/8 compression straight
16139	1/4 NPT male x 3/8 compression straight
16206	1/8 NPT x 3/16 compression fitting
16230	5/16 x 24 3/16 compression fitting

-AN CAPS

PART #	DESCRIPTION
16090	-3 Cap
16144	-4 Cap
16145	-6 Cap
16051	-8 Cap

PLUGS

PART #	DESCRIPTION
16098	-3 Plug
16089	-4 Plug
16067	-6 Plug
16068	-8 Plug
16140	1/16 NPT plug
16141	1/8 NPT plug
16142	1/4 NPT plug
16143	3/8 NPT plug
16093	-8 Female x -4 male (DF5 fill fitting)



Part # 16141
1/8 Npt Plug



Part # 16098
-3 Male Plug

Fittings

DISTRIBUTION BLOCKS

PART #	DESCRIPTION
15011	Red 1 in 4 out Showerhead
15012	Blue 1 in 4 out Showerhead
15017	1 in 6 out Distribution Block
15018	Black 3 Port Showerhead
15019B	Blue 4 Port Showerhead w/-6 Male Out
15019R	Red 4 Port Showerhead w/-6 Male Out
16173B	Blue 1 in 4 Out Distribution Block
16173R	Red 1 in 4 Out Distribution Block
16174	2 in 16 out Distribution Block
16197	Black 1 in 4 out Compact Distributon Block



Part # 16173
1 in 4 Out Distribution Block
(Shown with optional fittings)
For AN outlet fittings use NX Part 16108
For compression outlet fittings use NX Part 16206



Part #16197
Black 1 in 4 out Compact
Distributon Block
(Shown with optional fittings)
For AN outlet fittings use NX Part 16150
For compression outlet fittings use NX Part 16149

REDUCERS

PART #	DESCRIPTION
16095	-4 Male x -6 male reducer
16097	-3 Male x -4 male reducer
16146	1/4 Male NPT x 1/8 female npt reducer
16147	3/8 Male NPT x 1/8 female npt reducer
16148	3/8 Male NPT x 1/4 female npt reducer



Part # 15017
1 in 6 out Dist Block



Part # 16174
2 in 16 out Dist Block



Part # 15010B
MINI 4 PORT SHOWERHEAD
(Shown with optional fittings)
For AN outlet fittings use NX Part 16150
For compression outlet fittings use NX Part 16149



Part # 15011
STANDARD 4
PORT SHOWERHEAD
(shown with optional fittings)
For AN outlet fittings use NX Part 16108
For compression outlet fittings use NX Part 16206

B-NUTS & SLEEVES

PART #	DESCRIPTION
16161	-3 Red B-nut
16162	-3 Blue B-nut
16163	-4 Red B-nut
16164	-4 Blue B-nut
16165	-6 Blue B-nut
16169	-6 Red B-nut
16200	-8 Blue B-nut
16166	-3 Steel Sleeve for 3/16 Tubing
16167	-4 Steel Sleeve for 1/4 Tubing
16168	-6 Steel Sleeve for 3/8 Tubing
16267	1/2" Tubing Sleeves Blue Aluminum



Part # 15019B
4 PORT SHOWERHEAD



Part # 16095
-4 x -6 Male Reducer



Part # 16267
1/2" Tubing Sleeve

MISCELLANEOUS

PART #	DESCRIPTION
16204	1/4 NPT x -6 W/ 1/8 Gauge hole (fuel bypass fitting)
16207	Red 90' Jet Fitting for MAF Housing
16208	Blue 90' Jet Fitting for MAF Housing
16267	1/2" (D-8) Tubing Sleeves Blue Aluminum
91017	Vortech/Shark/Piranha nozzle fitting
92017	SSV, STD, SX2 nozzle fitting



Part # 16204
1/4 x -6 Fuel Bypass
Fitting



Part # 16208
Blue 90' Jet Fitting for
MAF



Nitrous Express carries a complete line of Aeroquip hoses and fittings to fill all of our customers needs!

Fuel Systems & Accessories

S.A.F.E. STAND ALONE FUEL ENRICHMENT TANK

Nitrous Express S.A.F.E. (Stand Alone Fuel Enrichment) systems improve the performance of any nitrous system. S.A.F.E. systems include a one gallon, high strength, composite fuel cell that can be mounted in most factory battery trays without modification. When used with race gas or methanol, the need to retard timing is significantly reduced or eliminated. S.A.F.E. systems reduce the need to upgrade OEM fuel pumps, and will completely eliminate pressure drop at the fuel rail in EFI vehicles. S.A.F.E. Systems includes an integrated fuel level gauge and all mounting hardware for a no hassle installation! Tanks include a sealed cap and a safety roll over valve to prevent fuel leaks in the event of a roll over. Tank dimensions are 9Lx6Wx8H



PART # DESCRIPTION

15004 This adjustable version of the S.A.F.E. system includes a high output internally mounted fuel pump and an adjustable bypass regulator. Fuel pressure can be adjusted from 3 to 60 psi (no special jetting is required). The regulator is also boost referencing which makes it compatible with supercharged and turbocharged applications. When used with Gasoline, this system will support up to 800 nitrous horsepower. When used with Methanol, this pump will support up to 400 nitrous horsepower.



15003 This version of the SAFE system includes a 5-12psi external fuel pump and an adjustable non bypass regulator. It is designed to run with non boosted applications and will support up to 600 nitrous horsepower on gasoline and 300 Nitrous horsepower on methanol.



15083 Tank, cap and mounting hardware only. This is a great choice for those wanting to use their own external fuel pump and regulator.



Fuel System & Accessories

Every NX nitrous system requires a solid fuel system to support it. These components are the best values for your dollar and are engineered to perform under the most demanding conditions! Whether it's a ProMod or a Street Rod, NX has a fuel system for you.



PN: 15078 FUEL PUMP IN-LINE 500Whp, HIGH PRESSURE

This high output in-line fuel pump can be used as a standalone pump or as an in-line helper pump. High quality internal components ensure long life and low amp draw. Includes rubber coated mounting brackets. This pump will support up to 700 whp at 5 psi and up to 500 whp at 45 psi. Must be used with a bypass style regulator.



PN: 15077 FUEL PUMP IN-LINE, 700Whp, HIGH PRESSURE

This high output in-line fuel pump flows like a race pump but is durable enough to run for extended periods on the street. High quality internal components ensure long life, low vibration, quiet operation and low amp draw. Includes stainless mounting brackets. This pump will support up to 900 whp at 5 psi and up to 700 whp at 45 psi. Must be used with a bypass style regulator.



PN: 15953 NX BLACK PUMP WITH NX BILLET REGULATOR

This package includes a NX "Black style" fuel pump and a NX billet fuel pressure regulator. The fuel pump will support up to 600 Whp on Gasoline. The regulator is a non return style and includes a 1/8 NPT port that can be used for a fuel pressure gauge or for an air bleed port. This is a great choice for carbureted applications as well as dedicated nitrous fuel systems.



PN: 15951 NX Billet Fuel Pressure Regulator, Non Bypass

PN: 15952 NX Billet Fuel Pressure Regulator, Non Bypass, With Fuel Pressure Gauge

Part # 15952



PN: 15948 NX Billet Fuel Pressure Regulator, Bypass 30-100 Psi

PN: 15949 NX Billet Fuel Pressure Regulator, Bypass 1.5 -25 Psi

Part # 15949

Water Methanol Injection

WATER/METHANOL

Nitrous Express introduces its new line of Water Methanol Systems.

NX Water-Methanol Injection systems provide increased performance with or without nitrous. Water Methanol Injection cools your incoming air charge and increases the total octane effect of pump gas. This allows you to run increased timing which results in increased power and torque. When used with Nitrous, the need for timing retard is greatly reduced or eliminated. Boosted applications especially benefit from reduced intake temperatures. NX Water / Methanol systems include the latest technology and the highest quality components available.

GASOLINE SYSTEMS

PART#	Description
15020	Gas Stage I Boost
15021	Gas Stg II Boost Controlled
15022	Gas Stg II MAF
15023	Gas Stg II GM MAF
15024	Gas Stg II GM MAF TL
15025	Gas Stg II Naturally Aspirated, Carbureted
15026	Gas Stg II Muscle Car, Naturally Aspirated, Carbureted V8
15027	Gas Stg 3
15028	Gas Stg 3 MPG MAX™



DIESEL SYSTEMS

PART#	Description
15030	Diesel Stage I
15031	Diesel Stg II
15032	Diesel Stg III
15033	Diesel MPG MAX



SAFE INJECTION

PART#	Description
15040	Safe Injection



ACCESSORIES / UPGRADES

PART#	Description
15050	2.5 Gal (9.3L) Reservoir w/ fittings & brackets (13Lx9.5Hx7.5w)
15051	7 Gallon Reservoir (w/ bracket, solenoid & hose) (15Lx17Hx9W)
15052	Level Switch Upgrade w/red LED
15053	Dual Nozzle Upgrade
15054	Carb Plate
15055	Solenoid Upgrade(fluid flow)w/fittings
15056	Nozzle Mounting adapter for hose
15057	Nozzle Mounting Bung for Aluminum
15058	Nozzle Mounting Bung for Steel



Chemical X & R/C Nitrous Systems

CHEMICAL X

Increased fuel mileage, decreased engine wear, and higher octane, the best of all worlds in one small package. Chemical X, a product of the NASA laboratories, not only increases the octane of the fuel it will also increase your gas mileage up to 10%! It's high tech ingredients will allow you to run a more aggressive tune-up without the fear of detonation and the lubricating properties of Chemical X will decrease wear on cylinder walls, and exhaust valve seats by 500%! Safe for all fuel systems and is legal in all states and Canada.



PART #	DESCRIPTION
16003	Nitrous Street Formula
16004	Full Race Formula
16005	Forced induction Formula

RC NITROUS SYSTEM

You are probably asking yourself, why in the world would you put nitrous on an r/c vehicle? Let's see, monster wheelies, tire shredding acceleration, blistering top speeds, not to mention the looks on your friends face when you take the body off. So how does the NX r/c nitrous system work? Simple, just arm the mini-toggle switch, and at full throttle the system is activated. You won't believe the difference.

PN:SPEED2000 comes complete with nitrous solenoid, 8-gram nitrous cartridge crusher, three 8-gram nitrous bottles, mini-toggle, mini-wot switch, and 9-volt battery terminal. Available for most nitro powered, boats, cars, trucks, and airplanes.

PART #	DESCRIPTION
SPEED2000	R/C Nitrous System w/3 8 Gram N2O Bottles
SPEED2001	Replacement 8 Gram Bottle For SPEED2000
SPEED2001-5	Replacement 8 Gram Bottles Qty.5
SPEED2001-10	Replacement 8 Gram Bottles Qty.10
SPEED2002	Adjustable Light Weight RC Nitrous System
SPEED3000	1/5 Scale R/C Nitrous System Refillable w/4 oz Nitrous Bottle



Apparel & Merchandise

APPAREL & MERCHANDISE



Black w/White NX
 *16506 Small
 *16507 Medium
 *16508 Large
 *16509 X-Large
 *16510 XX-Large
 *16511 XXX-Large



Red w/White NX
 *16565 Small
 *16566 Medium
 *16567 Large
 *16568 X-Large
 *16569 XX-Large



White w/Black NX
 *16512 Small
 *16513 Medium
 *16514 Large
 *16515 X-Large
 *16516 XX-Large



Black Flag NX
 *16544 Small
 *16545 Medium
 *16546 Large
 *16547 X-Large
 *16548 XX-Large



PART#
 16581
 16580

Description
 Black/Flag NX Hat (pictured)
 Black/White NX Hat



Black w/White NX
 *16526 Small
 *16527 Medium
 *16528 Large
 *16529 X-Large
 *16530 XX-Large
 *16531 XXX-Large

BANNERS



PART#
 15985
 15985small

DESCRIPTION
 2' x 4' Vinyl Banner
 30" x 18" Refill Banner



NX TIRE SHADES



PART#
 16499

DESCRIPTION
 Tire Cover w/Suction Cups

NEON SIGN

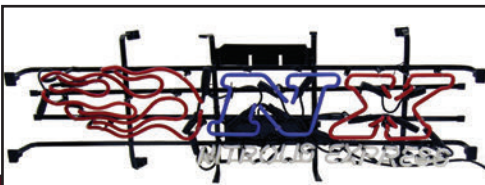

PART#
 19050

DESCRIPTION
 NX Neon Sign (6wk Delivery Time)

DECALS

Whether it is for your car, truck, trailer, or speed shop, Nitrous Express has a decal to fit your needs.



PART#
 15995
 15995-2
 15998
 15999
 15999-trailer

DESCRIPTION
 7" Bumper Decal
 12" Bumper Decal
 4" Flame Decal
 8" Flame Decal
 36" Flame Decal
 (Specify Color on Flame Decal: Red, White, Silver, and Black)