

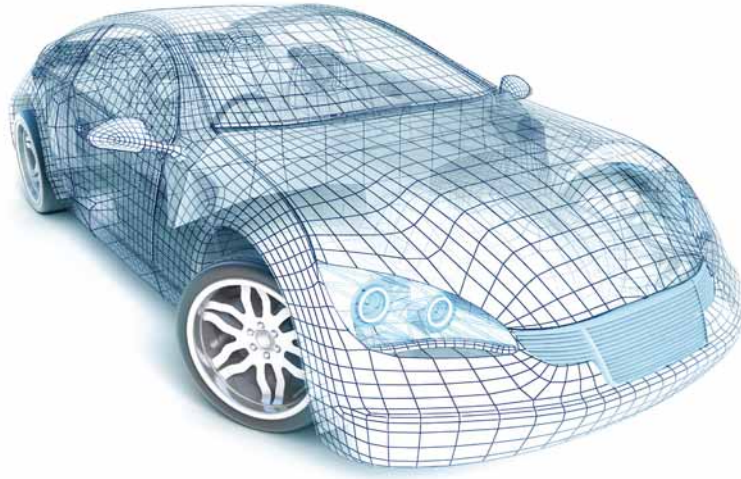

2017 - 2018





IGNITION  
PARTS

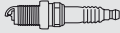

















## NGK SPARK AND GLOW PLUGS – OEM WORLDWIDE

Manufacturer		
Alfa Romeo	●	●
AMG	●	
Aston Martin	●	
Audi	●	●
Bentley	●	
BMW	●	
Bugatti	●	
Chrysler	●	
Citroën	●	●
Daewoo	●	●
Daihatsu	●	
Ferrari	●	
Fiat	●	●
Ford	●	●
General Motors	●	
Honda	●	
Hyundai	●	●
Isuzu	●	●
Jaguar	●	●
Kia	●	●
Lancia	●	●

Manufacturer		
Land Rover	●	●
Lamborghini	●	
Lotus	●	
Maserati	●	
Mazda	●	●
Mercedes	●	●
Mitsubishi	●	●
Nissan	●	●
Opel	●	
Porsche	●	●
Peugeot	●	●
Renault	●	●
Saab	●	
Seat	●	●
Škoda	●	●
Smart	●	●
Subaru	●	
Suzuki	●	●
Toyota	●	
Volkswagen	●	●
Volvo	●	●



IGNITION  
PARTS

 	_____	i 2 - 27
 	_____	i 28 - 53
  	_____	i 54 - 79
<b>Ranges overview</b>	_____	i 80 - 105
<b>D-POWER</b> <sup>NGK</sup>	_____	i 106 - 107
<b>V-LINE</b>	_____	i 108 - 109
<b>LPG LaserLine</b>	_____	i 110
<b>IRIDIUM</b> <b>IX</b>	_____	i 111 - 112
<b>Racing</b> 	_____	1 - 11
<b>Location of the Engine Code</b>	_____	12
<b>Series</b> 	_____	13 - 24
<b>Series</b> 	_____	25 - 46
<b>Info</b> 	_____	47 - 50
 	_____	51 - 238
 	_____	239 - 332
<b>Cross</b>   <b>NGK</b>	_____	333 - 453
<b>PS (HP) ↔ KW</b>	_____	454

# How to read our part number: Spark Plugs

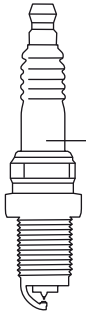

**B P R 5 E S - 11**

Unit : mm

B		P		R		5		E		S		-11													
Thread size	Hex size	Structure		Resistor		Heat rating		Thread length		Design features		Spark gap													
A	∅ 18.0	Hex 25.4	P	Projected insulator type	R	Resistor	2		E	19.0	B	Integral terminal (CR8EB)	None	Motorcycle : 0.7~0.8											
B	∅ 14.0	Hex 20.8			Z	Inductive resistor type	4		Car : 0.8~0.9																
BC	∅ 14.0	Hex 16.0	M	Small spark plug	5	None	EH		19.0 half-thread	CM	Slant ground electrode Compact type (Exposed insulator length: 18.5)	-8	0.8												
BK	∅ 14.0	Hex 16.0			6		H		12.7																
C	∅ 10.0	Hex 16.0	U	Surface gap, Semi-surface discharge gap or Supplementary gap	7	None	L		11.2	G, GV	Racing spark plug	-9	0.9												
D	∅ 12.0	Hex 18.0			8		Tapered seat type A(P)-F : 10.9 B(P)-F : 11.2 BM(P)-F : 7.8		Small type plug B(P)M- : 9.5 B-LM : 9.5 CM- : 9.5 CM-6 : 8.6 C-50 : 8.5					I	Iridium central electrode	-10	1.0								
DC	∅ 12.0	Hex 16.0			9													IX	Iridium IX spark plug	-11	1.1				
E	∅ 8.0	Hex 13.0			10																	J	2-projecting-ground electrodes	-13	1.3
*Exception B(P)M-A, Y : ∅ 14.0, Hex 19.0 P(P)-(E)F : ∅ 14.0, Hex 16.0 CM-6 : ∅ 10.0, Hex 14.0		N			Special ground electrode																				
BC : Old JIS standard size The length from gasket circuit to terminal contact is 53.0mm.			IX-P	Iridium MAX plug																					
BK : ISO / JIS standard size The length from gasket circuit to terminal contact is 50.5mm.						LPG 1-8	LaserLine spark plug range for gas engine use																		
								Q	4-ground-electrodes																
										S	Standard type														
		T			3-ground-electrodes																				
			U	Semi-surface discharge gap																					
						Y	V-grooved center electrode																		
								Z	Special design																



# How to read our part number: Spark Plugs

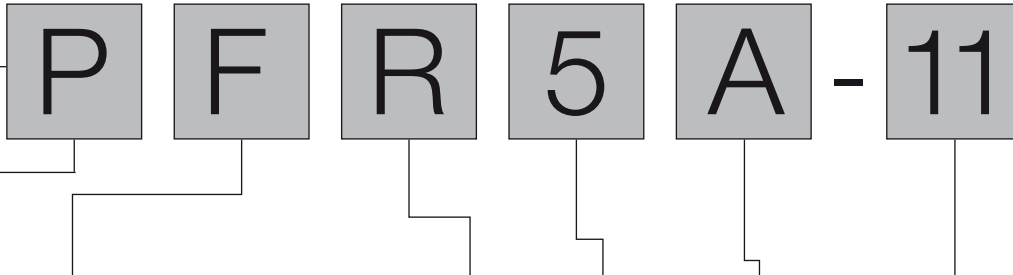
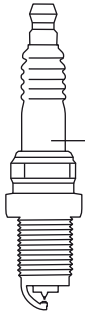

Unit : mm

P		F				R		5		A		-11					
Plug type		Thread diameter	Thread length	Seat configuration	Hex size	Resistor		Heat rating		Design		Spark gap					
DI	High ignitability plug: Double fine electrodes	F	φ 14.0	19.0	Gasket	Hex 16.0	R	Resistor	2	Hot type 	A,B,C... Suffix code		None	Motorcycle : 0.7~0.8			
		FE	φ 14.0	19.0	Gasket	Hex 16.0			4		Car : 0.8~0.9						
I	Double iridium spark plug	G	φ 14.0	19.0	Gasket	Hex 20.8			5					-7	0.7		
L	Long thread reach plug	J	φ 12.0	19.0	Gasket	Hex 18.0			6						-9	0.9	
P	Double platinum spark plug	K	φ 12.0	19.0	Gasket	Hex 16.0			7				I	Iridium central electrode	-10	1.0	
S	High ignitability plug : thin square tip type	KA	φ 12.0	19.0	Gasket	Hex 14.0			8				IX	Iridium IX spark plug	-11	1.1	
		KB	φ 12.0	19.0	Gasket	Bi-Hex 14.0 (Bi-hexagonal *)			9						P	Platinum central electrode	-13
Z	Projected firing end								10						-15	1.5	
Above alphabets are occasionally used in combination <Example>ILFR..., PLZFR..., When „L“ is included, priority is given to „L“ (long reach)* in thread length. <Example> * Gasket type FR5AP : Thread length 19.0mm ↓ LFR5AP-11 : Thread length 26.5mm  * Tapered seat type PTR5C-13 : Thread length 17.5mm ↓ PLTR6A-10G : Thread length 25.0mm		KE	φ 12.0	19.0	Gasket	Hex 16.0									-A	Non gasket	
		KF	φ 12.0	19.0	Gasket	Hex 14.0									-D	Metal shell : nickel plating	
		KG	φ 12.0	19.0	Gasket	Bi-Hex 14.0 (Bi-hexagonal *)							-E	Special resistance			
		L	φ 10.0	12.7	Gasket	Hex 16.0							-G	Copper cored ground electrode			
		M	φ 10.0	19.0	Gasket	Hex 16.0							-H	Special thread shape			
		MA	φ 10.0	19.0	Gasket	Hex 14.0							-J	2 ground-electrode			
		MF	φ 10.0	19.0	Gasket	Hex 14.0							-K	Vibration-resistance ground electrode			
		NA	φ 12.0	17.5	Tapered seat	Hex 14.0							-N	Special ground electrode			
		T	φ 14.0	17.5	Tapered seat	Hex 16.0							-Q	4-ground-electrode			
		U	φ 14.0	11.2	Tapered seat	Hex 16.0							-S	Special gasket			
		W	φ 18.0	10.9	Tapered seat	Hex 20.8							-T	3-ground-electrode			
		X	φ 14.0	9.5	Gasket	Hex 20.8							-U	Semi-surface discharge type			
		Y	φ 14.0	11.2	Tapered seat	Hex 16.0							IX-P	Iridium MAX plug			
		*Exception TR5A-10, TR5A-13, TR5B-13, TR6B-10, TR6B-13, PTR5A-10, PTR5A-13 : Thread length 25.0mm				Bi-hexagonal 							LPG 1-8	LaserLine spark plugs range for gas engines			
		*Bi-hexagonal socket is necessary.				Hexagonal 											
		*FE, KE, KF, KG, MF : Longer exposed insulator length type															

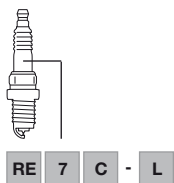

RE 7 C - L

RE		7		C		-L				
Plug type		Heat rating		Design		Spark gap				
RE	Plug for rotary engines	5	Hot type 	A,B,C...-Suffix code		-L		Leading side		
SD	Plug for rotary engines (Semi-surface discharge gap)	6		7			-T		Trading side	
		8		9						
		10		11						

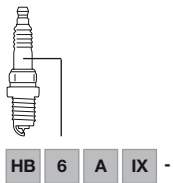

HB 6 A IX - 11 P

HB		6		A				IX		-11		P	
Plug type		Heat rating		Thread diameter	Thread length	Seat configuration	Hex size			Spark gap			
HB	HYBD (3-ground-electrode hybrid type)	4	Hot type 	A	φ 14.0	20.5	Gasket	Hex 16.0	IX	-8	0.8		
		5		B	φ 14.0	19.0	Gasket	Hex 16.0		-9	0.9		
		6						-10		1.0			
		7						-11		1.1			
		8	Cold type							-13	1.3		

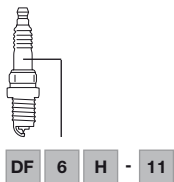

DF 6 H - 11 A

DF		6		H				-11		A			
Plug type		Heat rating		Thread diameter	Thread length	Seat configuration	Hex size			Spark gap			
DF	High ignitability plug (Double fine electrodes)	4	Hot type 	A	φ 14.0	19.0	Gasket	Hex 16.0		-8	0.8	A,B,C... Suffix code	
		5		B	φ 14.0	26.5	Gasket	Hex 16.0		-9	0.9		
DFH	High ignitability plug (DF + Hybrid type)	6		C	φ 12.0	26.5	Gasket	Hex 14.0		-10	1.0		
		7		*DF6H-11A : Thread length 28.0mm				-11		1.1			
		8						-13		1.3			
		9	Cold type							-15	1.5		

# How to read our part number: Metal Glow Plugs



Y - 2 0 4 T S 1

Unit : mm

Y		- 2		0		4		T		S		1	
Model / Type		Thread size		Battery Voltage		Serial Number		Heating Characteristics		Glow tube material		Modification no.	
Y/YS	Sheathed type	1	10 mm	0-4	12 V	this figure is the serial number		A	AQGS type	S	Special		
YD	Sheathed, with double insulators	2	12 mm	5-9	24 V			J	SRM type	None	Standard		
		3	10 mm					K or no letter	Standard type				
		4	14 mm					R, M, U	QGS type				
		5	10 mm					T, V	Fast heating type				
		6	10 mm					Note: Y-7XXR, Y-9XXR are SRM Types					
		7	10 mm					<b>Declaration</b>					
		8	18 mm					<b>AQGS</b> Advanced Quick Glow System					
		9	12 mm					<b>SRM</b> Self Regulating Metal Glow Plug					
		*Y-109, Y-159 and Y-171 for Caterpillar Mitsubishi have a thread size of 3/8" (~9.5mm).						<b>QGS</b> Quick Glow System					



Y 1 001 A S 1

Unit : mm

Y		1		001		A		S		1	
Model / Type		Thread size		Serial Number / Battery Voltage		Heating Characteristics		Glow tube material		Modification no.	
Y	Sheathed type	1	10 mm	001-899	12 V	A	AQGS type	S	Special		
		2	12 mm	900-999	24 V	J	SRM type	None	Standard		
		4	14 mm			K or no letter	Standard type				
		8	8 mm			R, M, U	QGS type				
		9	9 mm			T, V	Fast heating type				
						<b>Declaration</b>					
						<b>AQGS</b> Advanced Quick Glow System					
						<b>SRM</b> Self Regulating Metal Glow Plug					
						<b>QGS</b> Quick Glow System					

## How to read our part number: Metal Glow Plugs

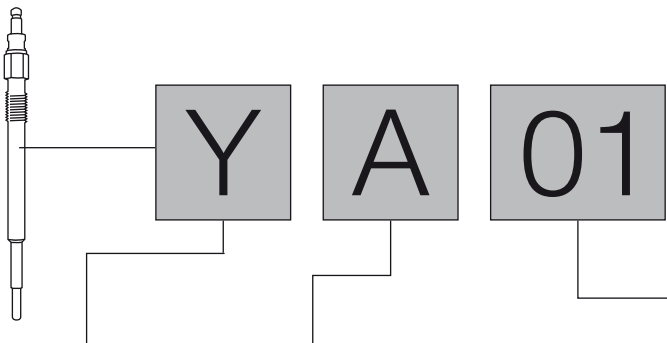

Unit : mm

Y	A	01
<b>Model / Type</b>	<b>Heating Characteristics</b>	<b>Serial Number</b>
<b>Sheathed type</b> Thread size: 8mm or 9mm	<b>A Standard type</b>	
	<b>E QGS type or SRM type</b>	

## How to read our part number: Ceramic Glow Plugs

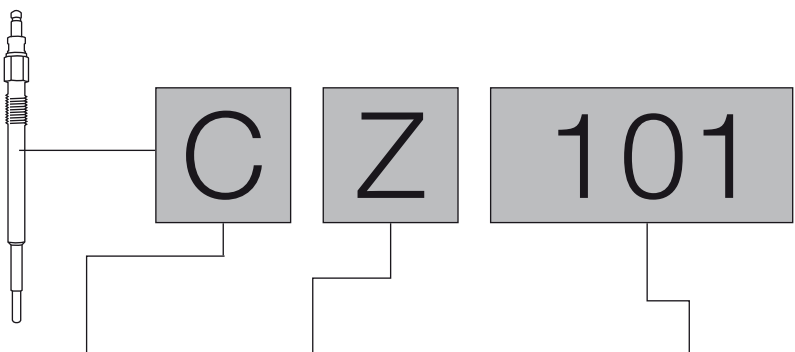

Unit : mm

C	Z	101
<b>Model / Type</b>	<b>Heating Characteristics</b>	<b>Serial Number</b>
<b>Ceramic Glow Plug</b>	<b>X QGS Type</b> Quick Glow System	
	<b>Y SRC Type / HTC</b> Self Regulating Ceramic Glow Plug	
	<b>Z NHTC Type</b> Quick Glow System	

### Notes about the table

- △ = only for automobiles with immobilizer
- ◆ = only for automobiles without immobilizer

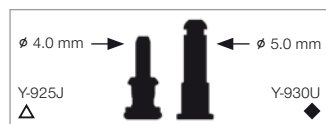

# IMPORTANT TIPS FOR THE INSTALLATION OF SPARK PLUGS

A torque wrench is required for the professional installation of a spark plug. Even for professionals the estimation of the tightening torque is nearly impossible. That is because a torque can be calculated from two sizes which are multiplied by one another: the force which is applied to the respective centre of rotation and the length of the

handle. Most spark plug failures can be traced back to an incorrect tightening torque. If it is set too low, there is a risk of compression losses and overheating. A break of the insulator or middle electrode as a result of vibrations is also feasible. If the tightening torque is set too high, the spark plug can snap off. The casing can also expand

or warp. Heat dissipation zones are disrupted, overheating and melting of the electrodes or even engine damage can occur.

## Spark plug tightening torques

The required tightening torque depends on seat type, thread diameter and cylinder head material. Please take care of the tightening torques or angles, whenever these are printed on the packaging material!

### 1 Seat type

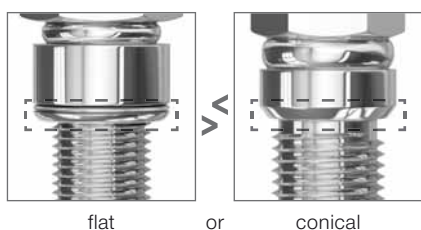

flat or conical

### 2 Thread diameter

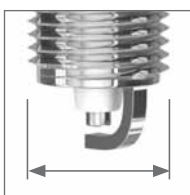

### 3 Cylinder head material

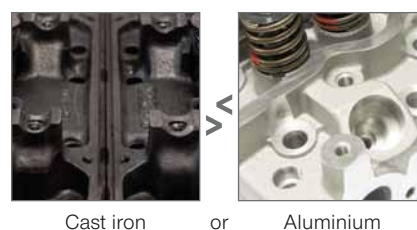

Cast iron or Aluminium

1	Seat type	Spark plug with a flat seat (with seal)				Spark plug with a conical seat	
		10 mm	12 mm	14 mm	18 mm	14 mm	18 mm
3	Cast iron head	10-15 Nm	15-25 Nm	25-35 Nm	35-45 Nm	15-25 Nm	20-30 Nm
	Aluminium head	10-12 Nm	15-20 Nm	25-30 Nm	35-40 Nm	10-20 Nm	20-30 Nm

## Alternative: Angle of rotation details

1	Seat type	Spark plug with a flat seat (with seal)				Spark plug with a conical seat	
		10 mm	12 mm	14 mm	18 mm	14 mm	18 mm
3	Angle of rotation, regardless of the cylinder head material	1/2 turn: 180°		1/2 - 2/3 turn: 180°-240°		1/16 turn: 22.5°	



# IMPORTANT TIPS FOR THE REMOVAL AND INSTALLATION OF GLOW PLUGS

## 1 Removal / Breakaway torque

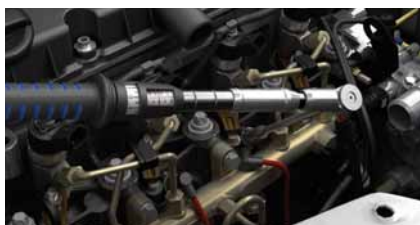

When changing glow plugs you must always use the correct torque, so that the breakaway torque is not exceeded, if not there is danger of tear-off.

Glow plug breakaway torque				
Ø Thread	M8	M9	M10	M12
<b>Breakaway torque</b>	20 Nm	30 Nm	40 Nm	50 Nm

**Note:** Other manufacturers often have, due to the varying thread materials, lower breakaway torque values. For this reason, you should reduce of a further 5 Nm the value, whenever the glow plug manufacturer is unknown.

## 2 Tips on removal issues

If an immediate removal is not urgent, we suggest proceeding as follows:

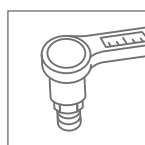
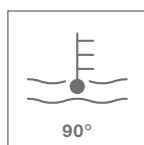

- > Sprinkle the glow plug seat on the transition to the cylinder head with synthetic motor oil.
- > Let absorb for a couple of days and move the vehicle.
- > Remove the glow plugs with the engine at operating temperature paying attention to the breakaway torques using a suitable torque wrench.

## 3 Cleaning



Before installing new glow plugs oil and soot residue should be removed from the glow plug hole with a greased reamer.

## 4 Glow plug installation / tightening torques

Metal rod glow plugs						Ceramic glow plugs	
Ø Thread	M8	M9	M10	M12	M14	M8	M10
<b>Tightening torque</b>	8,5Nm	11Nm	15Nm	23Nm	23Nm	10Nm	18Nm
<b>Tolerance in %</b>	+/- 10	+/- 10	+/- 10	+/- 10	+/- 10	+/- 10	+/- 10

Connecting nut		
Ø Thread	M4	M5
<b>Tightening torque</b>	0,8–1,5 Nm	3,0–4,0 Nm
<b>Tolerance in %</b>	+/- 10	+/- 10

 Please take care of the tightening torques, whenever these are printed on the packaging material! Glow plugs will function properly only when tightened with the correct tightening torque!

# QUALITY FROM THE WORLD LEADER. GLOW PLUGS. THE BASIC PRODUCT RANGE.



## The complete product range of leading manufacturers

NGK supplies the serial production from, among others, BMW, VW, Citroen, Fiat, Ford, Mazda, Mercedes, Audi, Skoda, Renault, Nissan, Kia, Hyundai, Opel, Peugeot. The complete product range includes glow plugs for practically any diesel vehicle.



## D-Power: fast moving items under the same roof

The D-Power fast moving product range covers approximately 90% of the European car fleet. The product range includes many items in the OE proven technology. Including NHTC and AQGS glow plugs.

# SPARK PLUGS. THE BASIC PRODUCT RANGE.



## Yellow Line: simply complete

The complete product range with many spark plugs directly from the original equipment and a market coverage of approx. 95%.



## V-Line: the fast mover

The product range thanks to the high turnover rate and equally high returns achieves already with 45 spark plugs a very high market coverage. 80% of the V-Line types come directly from the original equipment, among these many precious metal spark plugs.

# HIGHER PERFORMANCE. MORE HIGH-TECH. SPARK PLUGS. THE SPECIAL SOLUTIONS.



## **Iridium IX: combined expertise**

The solution for Old-timers, with an extremely thin, laser welded central electrode and special technology against soot provoked ignition problems. To guarantee every time optimal ignition, a noticeably better acceleration and lower fuel consumption.



## **Laser Platinum / Laser Iridium: the Premium spark plugs**

The NGK precious metal Joker, offers absolute performance with low consumption. The ideal technology for modern engines, in series with the most important European vehicle manufacturers.



## **LPG LaserLine: the product range for CNG / LPG**

Eight double precious metal spark plugs specially developed for natural gas and LPG engines. The perfect choice for 95% of all conversion capable vehicles in Europe, with the proven NGK short numbering system for an efficient allocation and re-ordering.



## **NGK Racing: Performance without compromise**

Special spark plugs for high rev engines and extreme operating conditions. Many years of development of a world champion and official supplier of Formula 1 leading teams and MotoGP included.

# D-Power Range

**D-POWER** <sup>NGK</sup>

D-Power	Type	Car Manufacturer
1	Y-924J	ALFA ROMEO, BMW, CHRYSLER, CITROEN, DAF, FIAT, FORD, FSO, HONDA, HYUNDAI, INNOCENTI, JEEP, LADA (AVTOVAZ), LANCIA, LAND ROVER, MERCEDES, OPEL, PEUGEOT, RENAULT, ROVER, SEAT, SUZUKI
2	Y-918J	AUDI, MERCEDES, SEAT, SKODA, VOLVO, VW
3	Y-910J	CITROEN, FIAT, FORD, LADA (AVTOVAZ), LANCIA, MAZDA, OPEL, PEUGEOT, RENAULT, ROVER
4	Y-732J	AUDI, DACIA, FORD, MITSUBISHI, NISSAN, OPEL, RENAULT, SEAT, SKODA, SUZUKI, VOLVO, VW
5	Y-937J	FORD
6	Y-916J	DAEWOO, MERCEDES, SSANGYONG, STEYR
7	Y-506J	OPEL, RENAULT
10	Y-503J	CITROEN, FIAT, LADA (AVTOVAZ), NISSAN, PEUGEOT, RENAULT, ROVER
11	Y-745U	CHRYSLER, MERCEDES
12	Y-516J	DACIA, RENAULT
13	Y-733J	MITSUBISHI
14	Y-748U	OPEL, SAAB
15	Y-913J	JEEP, RENAULT
16	Y-925J	MERCEDES
17	Y-730U	HONDA, LAND ROVER, MG, RENAULT, ROVER
19	Y-927J	RENAULT
20	Y-741U	ALFA ROMEO, AUDI, CHRYSLER, FORD, JEEP, OPEL, PORSCHE, ROVER, SEAT, SKODA, VW
22	Y-740U	RENAULT, VOLVO
24	Y-504J	CITROEN, FIAT, LANCIA, PEUGEOT, SUZUKI
25	Y-933J	MITSUBISHI, RENAULT, VOLVO
26	Y-747U	ALFA ROMEO, FIAT, LANCIA
27	Y-524J	FORD
28	Y-711J	ISUZU, OPEL
29	Y-928U	FIAT, LANCIA
30	Y-930U	MERCEDES
31	Y-501U	AUDI, SKODA, VW
32	Y-507J	BMW, LAND ROVER, MG, ROVER
34	Y-729U	LAND ROVER
36	Y-534J	ALFA ROMEO, FIAT, LANCIA, OPEL, SAAB
37	Y-523J	OPEL, SAAB
38	Y-746J	MERCEDES
39	Y-701J	KIA, MAZDA, SUZUKI
40	YE04	CITROEN, FORD, MAZDA, PEUGEOT, SUZUKI, VOLVO
41	Y-929U	MERCEDES
42	Y-541J	HONDA, OPEL

D-Power	Type	Car Manufacturer
43	Y-939J	FIAT
44	Y-531J	TOYOTA
45	Y-542J	MINI, TOYOTA
46	Y-543J	SMART
47	Y-547AS	ALPINA, BMW
48	YE14	AUDI, MITSUBISHI, SEAT, SKODA, VW
49	Y-609AS	AUDI, SEAT, VW
50	Y-607AS	AUDI, CHRYSLER, SEAT, SKODA, VW
51	Y8002AS	CHRYSLER, JEEP, MERCEDES
52	CZ104	AUDI, SEAT, SKODA, VW
53	CZ106	MERCEDES
54	CZ303	MERCEDES
55	CZ304	AUDI, JEEP, MITSUBISHI, SEAT, SKODA, VW
56	Y1005J	CITROEN, FIAT, FORD, PEUGEOT, VOLVO
57	Y1002AS	AUDI, PORSCHE, SEAT, SKODA, VW
58	Y8001AS	CITROEN, FORD, PEUGEOT
59	Y1007J	MITSUBISHI
60	Y-603J	MAZDA, OPEL
61	Y-519J	NISSAN
62	Y8003J	ALFA ROMEO, FIAT, FORD, LANCIA, OPEL, SUZUKI
63	Y1013J	TOYOTA
64	Y8005J	CITROEN, FIAT, PEUGEOT
65	Y1012J	TOYOTA
66	Y-517J	NISSAN, OPEL, RENAULT
67	Y-527J	HYUNDAI, KIA
68	CZ203	HYUNDAI, KIA
69	Y-526J1	MAZDA
70	Y1030J	ALFA ROMEO, FIAT, OPEL, SUZUKI
71	Y1031J	CHRYSLER, JEEP
72	Y9001AS	ALFA ROMEO, CITROEN, FIAT, LANCIA, PEUGEOT
73	YE05	CITROEN, FORD, MINI, PEUGEOT, TOYOTA, VOLVO
74	Y8008AS	VOLVO
75	Y-548J	CITROEN, FIAT, FORD, JAGUAR, PEUGEOT
76	CZ251	MITSUBISHI
77	Y1035AS	DACIA, MERCEDES, NISSAN, RENAULT
78	Y9003AS	ALFA ROMEO, FIAT, LANCIA, SAAB, SUZUKI
80	Y1039AS	MINI
81	Y-536J	SSANGYONG
82	CZ163	MAZDA
83	CZ257	HYUNDAI, KIA, MITSUBISHI
84	CZ159	MERCEDES
85	CZ551	MERCEDES
87	CZ165	MAZDA

# D-Power Cross List

**D-POWER** <sup>NGK</sup>

D-Power	NGK	BERU	BOSCH
<b>1</b>	<b>Y-924J</b>	603 MJ 609 MJ 613 MJ 624 MJ 633 MJ 636 MJ 642 MJ 663 MJ 719 MJ 908 MJ 909 MJ 917 MJ 954 MJ GN 013 GN 908 GN 909 GN 917 GN 954 GV 603 GV 636 GV 642 GV 663 GV 719	GLP 001 GLP 005 GLP 015
<b>2</b>	<b>Y-918J</b>	601 MJ 857 MJ GN 857	GLP 002
<b>3</b>	<b>Y-910J</b>	661 MJ 666 MJ 927 MJ GN 927 GV 661 GV 666	GLP 010 GLP 121
<b>4</b>	<b>Y-732J</b>	855 MJ 950 MJ GN 018 GN 855	GLP 003 GLP 224
<b>5</b>	<b>Y-937J</b>	GN 022	GLP 012
<b>6</b>	<b>Y-916J</b>	858 MJ GN 858	GLP 006
<b>7</b>	<b>Y-506J</b>	963 MJ GN 963	GLP 009
<b>10</b>	<b>Y-503J</b>	912 MJ GN 016 GN 912	GLP 004
<b>11</b>	<b>Y-745U</b>	GN 003	GLP 008 GLP 022
<b>12</b>	<b>Y-516J</b>	GN 019	GLP 011
<b>13</b>	<b>Y-733J</b>	GN 107	GLP 054
<b>14</b>	<b>Y-748U</b>	GN 992	GLP 019
<b>15</b>	<b>Y-913J</b>	852 MJ GV 852	GLP 037
<b>16</b>	<b>Y-925J</b>	948 MJ GN 948	GLP 017
<b>17</b>	<b>Y-730U</b>	905 MJ GN 905	GLP 014
<b>19</b>	<b>Y-927J</b>	991 MJ GN 991	GLP 020
<b>20</b>	<b>Y-741U</b>	GN 007 GN 046	GLP 023 GLP 033

D-Power	NGK	BERU	BOSCH
<b>22</b>	<b>Y-740U</b>	999 MJ GN 999	-
<b>24</b>	<b>Y-504J</b>	GN 027	GLP 013
<b>25</b>	<b>Y-933J</b>	844 MJ 959 MJ GN 959 GV 844	GLP 036
<b>26</b>	<b>Y-747U</b>	GN 017	GLP 032
<b>27</b>	<b>Y-524J</b>	GN 993	GLP 024
<b>28</b>	<b>Y-711J</b>	947 MJ GV 947	GLP 046
<b>29</b>	<b>Y-928U</b>	970 MJ GN 970	GLP 026
<b>30</b>	<b>Y-930U</b>	860 MJ GN 860	GLP 025
<b>31</b>	<b>Y-501U</b>	GN 008	GLP 031
<b>32</b>	<b>Y-507J</b>	GN 024	GLP 040
<b>34</b>	<b>Y-729U</b>	783 MJ GV 783	GLP 048
<b>36</b>	<b>Y-534J</b>	GN 041	GLP 007
<b>37</b>	<b>Y-523J</b>	GN 033	GLP 030
<b>38</b>	<b>Y-746J</b>	GN 010	GLP 102
<b>39</b>	<b>Y-701J</b>	GN 005	GLP 038
<b>40</b>	<b>YE04</b>	GN 047	GLP 059
<b>41</b>	<b>Y-929U</b>	961 MJ GN 961	GLP 021
<b>42</b>	<b>Y-541J</b>	GN 104	GLP 092
<b>43</b>	<b>Y-939J</b>	GN 030	GLP 045
<b>44</b>	<b>Y-531J</b>	GN 065	GLP 101
<b>45</b>	<b>Y-542J</b>	GN 042	-
<b>46</b>	<b>Y-543J</b>	GN 015	-
<b>47</b>	<b>Y-547AS</b>	GE 102	GLP 070
<b>48</b>	<b>YE14</b>	GE 101	GLP 093
<b>49</b>	<b>Y-609AS</b>	GE 108 GE 115	-
<b>50</b>	<b>Y-607AS</b>	GE 100	GLP 050
<b>51</b>	<b>Y8002AS</b>	GE 105	GLP 202
<b>52</b>	<b>CZ104</b>	CGP 002	-
<b>53</b>	<b>CZ106</b>	-	-
<b>54</b>	<b>CZ303</b>	-	-
<b>55</b>	<b>CZ304</b>	-	-
<b>56</b>	<b>Y1005J</b>	GN 054	GLP 055 GLP 111
<b>57</b>	<b>Y1002AS</b>	-	GLP 194
<b>58</b>	<b>Y8001AS</b>	GE 121 GE 121 A	-
<b>59</b>	<b>Y1007J</b>	-	GLP 137
<b>60</b>	<b>Y-603J</b>	GN 103	GLP 035
<b>61</b>	<b>Y-519J</b>	GN 109	-
<b>62</b>	<b>Y8003J</b>	GN 053	GLP 016

D-Power	NGK	BERU	BOSCH
<b>63</b>	<b>Y1013J</b>	GN 110	-
<b>64</b>	<b>Y8005J</b>	GN 037	GLP 205
<b>65</b>	<b>Y1012J</b>	GN 108	GLP 212
<b>66</b>	<b>Y-517J</b>	GN 026	GLP 057
<b>67</b>	<b>Y-527J</b>	GN 062	-
<b>68</b>	<b>CZ203</b>	-	-
<b>69</b>	<b>Y-526J1</b>	-	-
<b>70</b>	<b>Y1030J</b>	GN 097	GLP 066
<b>71</b>	<b>Y1031J</b>	GN 055	GLP 109
<b>72</b>	<b>Y9001AS</b>	GE112	GLP226
<b>73</b>	<b>YE05</b>	GN 056	GLP 094
<b>74</b>	<b>Y8008AS</b>	-	GLP 144
<b>75</b>	<b>Y-548J</b>	GN 939	GLP 051
<b>76</b>	<b>CZ251</b>	-	GLP252
<b>77</b>	<b>Y1035AS</b>	GE 110	GLP 221
<b>78</b>	<b>Y9003AS</b>	GE 114	GLP 196
<b>80</b>	<b>Y1039AS</b>	GE 118	-
<b>81</b>	<b>Y-536J</b>	GN 060	-
<b>82</b>	<b>CZ163</b>	-	-
<b>83</b>	<b>CZ257</b>	-	GLP 039
<b>84</b>	<b>CZ159</b>	-	-
<b>85</b>	<b>CZ551</b>	-	-
<b>87</b>	<b>CZ165</b>	-	-





# LPG Range

# LPG

<b>LPG No.</b> <b>1</b>	BKR5E	BKR6EIX-11	BKUR5ET	IFR5J11	PFR4G-11	PFR6G	PFR7B	
	BKR5E-11	BKR6EK	BKUR5ET-10	IFR5N10	PFR5B-9	PFR6G-11	PFR7B-11	
	BKR5EIX	BKR6EKC	BKUR6ET	IFR6B	PFR5C-11	PFR6G-9	PFR7B-9	
	BKR5EIX-11	BKR6EKUB	BKUR6ET-10	IFR6B11	PFR5G-11	PFR6J	PFR7G	
	BKR5EK	BKR6EQUA	FR5AP-10	IFR6B-K	PFR5G-11E	PFR6J-11	PFR7G-11	
	BKR5ES	BKR6EQUP	FR5AP-11	IFR6C	PFR5J-11	PFR6M	PFR7G-11S	
	BKR5ES-11	BKR6ES	FR5CP	IFR6D10	PFR5N-11	PFR6N-11	PFR7G-9	
	BKR5EY	BKR6ES-11	FR5EI	IFR6E11	PFR5P-11	PFR6Q	PFR7M	
	BKR5EY-11	BKR6EY	FR6EI	IFR6G-11K	PFR5R-11	PFR6T-10G	PFR7N-D	
	BKR5EZ	BKR6EYA	IFR5D10	IFR6J11	PFR6B-11	PFR6T-G	PFR7Q	
	BKR6E	BKR6EYA-11	IFR5E11	IFR6S	PFR6B-9	PFR6U-11G	PFR7S8EG	
	BKR6E-11	BKR6EZ	IFR5G11	IFR7G-11KS	PFR6D10G	PFR6X-11	PFR8S8EG	
	BKR6EIX	BKR7EIX	IFR5G-11K	IFR7X8G	PFR6E-10	PFR7AB		

<b>LPG No.</b> <b>2</b>	BP5E	BP6E	BPR5EIX	BPR5EY-11	BPR6ES-11	BUR5ET		
	BP5ES	BP6ES	BPR5ES	BPR6E	BPR6EY	BUR6ET		
	BP5ESZ	BP6ET	BPR5ES-11	BPR6EIX	BPR6EY-11	PGR5A		
	BP5EY	BPR5E	BPR5EY	BPR6ES	BPR7EIX	PGR6A		

<b>LPG No.</b> <b>3</b>	BCP5E	BCP6ES-11	BCPR5ES	BCPR6E-11	BCPR6ES	BCPR7EIX	PFR5K-11	PFR6H-10
	BCP5ES	BCPR5EIX	BCPR5ES-11	BCPR6EIX	BCPR6ES-11	BCPR7EIX-11	PFR6A-11	PFR7A-11
	BCP6E	BCPR5EIX-11	BCPR5EY	BCPR6EIX-11	BCPR6EY	PFR5A-11	PFR6A-11A	PFR7H-10
	BCP6ES	BCPR5EIX-11P	BCPR6E	BCPR6EIX-11P	BCPR6EY-11	PFR5F-11A	PFR6F-11A	

<b>LPG No.</b> <b>4</b>	ILTR5D	LTR6IX-11						
	ILTR6A-8G	PTR5A-10						
	ILTR6G8G	PTR5A-13						
	ILTR6H8G	TR5A-10						

<b>LPG No.</b> <b>5</b>	BP6EFS	PTR5F-11	TR55					
	BPR6EF	PTR6D-13	TR5IX					
	BPR6EFIX-10	PTR6F-13						
	BPR6EFS	TR5						

<b>LPG No.</b> <b>6</b>	IZFR5B	IZFR6H11	PZFR5F-11	ZFR4F-11	ZFR5FIX-11P	ZFR6BP-G	ZFR6FIX-11P	ZFR7J-11
	IZFR5G	PZFR5B	PZFR6F	ZFR5F	ZFR5FVX-11	ZFR6F-11	ZFR6J-11	
	IZFR6B	PZFR5D-11	PZFR6F-11	ZFR5F-11	ZFR5J-11	ZFR6F-11G	ZFR7F	
	IZFR6F11	PZFR5F	PZFR6J-11	ZFR5FIX-11	ZFR5P-G	ZFR6FIX-11	ZFR7F-11	

<b>LPG No.</b> <b>7</b>	DILFR6J11	ILFR6B	ILFR6K8	LFR5AIX-11P	LFR6AIX-11	LFR7AIX	PLFR6A	SILFR6A
	DILFR7B10G	ILFR6G	LFR4AP-11	LFR5AP-11	LFR6AIX-11P	LFR7AIX-P	PLFR6A-11	SILFR6A11
	ILFR5B11	ILFR6G-E	LFR5A-11	LFR5B	LFR6AIX-P	PLFER7A8EG	PLFR6A-9	
	ILFR6A	ILFR6J-11K	LFR5AIX-11	LFR5BP-11	LFR6B	PLFR5A-11	PLFR6C-10G	

<b>LPG No.</b> <b>8</b>	DCPR7E	ZKR7A-10						
	DCPR8E							
	DCPR8EKC							
	DCPR8E-N							



# Iridium IX Range



Standard	Iridium	Order No.
B10ES	BR10EIX	6801
B6HS	BR6HIX	3419
B7ES	BR7EIX	6664
B7HS	BR7HIX	7067
B8ES	BR8EIX	5044
B8HS	BR8HIX	7001
B9ES	BR9EIX	3981
B9HS	BR9HIX	5687
BCP7ET	BCPR7EIX	5690
BCPR6E	BCPR6EIX	5689
BCPR6ES	BCPR6EIX-11	4919
BCPR6ET	BKR6EIX	6418
BKR5E	BKR5EIX	6341
BKR5E-11	BKR5EIX-11	5464
BKR6E	BKR6EIX	6418
BKR6E-11	BKR6EIX-11	3764
BKR6EKC	BKR6EIX	6418
BKR6ES	BKR6EIX	6418
BKR7E	BKR7EIX	2667
BP5ES	BPR5EIX	6597
BP6ES	BPR6EIX	6637
BP6HS	BPR6HIX	4085
BP6HSA	BPR6HIX	4085
BP7ES	BPR7EIX	4055
BP7HS	BPR7HIX	5944
BP8ES	BPR8EIX	6684
BP8HS	BPR8HIX	6742
BPR5ES	BPR5EIX	6597
BPR5ES-11	BPR5EIX-11	2115
BPR6ES	BPR6EIX	6637
BPR6ES-11	BPR6EIX-11	3903
BPR6HS	BPR6HIX	4085
BPR6HSA	BPR6HIX	4085
BPR7ES	BPR7EIX	4055
BPR7HS	BPR7HIX	5944
BPR8ES	BPR8EIX	6684
BPR8HS	BPR8HIX	6742
BPR8HSA	BPR8HIX	6742
BPR9ES	BPR9EIX	6853
BR10ES	BR10EIX	6801
BR6HS	BR6HIX	3419
BR6HSA	BR6HIX	3419
BR7ES	BR7EIX	6664
BR7HS	BR7HIX	7067
BR8ECM	BR8ECMIX	3520
BR8ES	BR8EIX	5044
BR8HS	BR8HIX	7001

Standard	Iridium	Order No.
BR8HSA	BR8HIX	7001
BR9ECM	BR9ECMIX	2707
BR9ES	BR9EIX	3981
BR9EYA	BR9EIX	3981
BR9HS	BR9HIX	5687
C5HSA	CR5HIX	7120
C5HSB	CR5HIX	7120
C6HSA	CR6HIX	7274
C7E	CR7EIX	7385
C7HSA	CR7HIX	7544
C8E	CR8EIX	4218
C8EH-9	CR8EHIX-9	3797
C8HSA	CR8HIX	7669
C9E	CR9EIX	3521
CPR7EA-9	CPR7EAIX-9	9198
CR5HSA	CR5HIX	7120
CR5HSB	CR5HIX	7120
CR6HS	CR6HIX	7274
CR6HSA	CR6HIX	7274
CR7E	CR7EIX	7385
CR7EK	CR7EIX	7385
CR7HS	CR7HIX	7544
CR7HSA	CR7HIX	7544
CR7HSA-9	CR7HIX	7544
CR8E	CR8EIX	4218
CR8EB	CR8EIX	4218
CR8EH-9	CR8EHIX-9	3797
CR8EK	CR8EIX	4218
CR8HS	CR8HIX	7669
CR8HSA	CR8HIX	7669
CR9E	CR9EIX	3521
CR9EB	CR9EIX	3521
CR9EH-9	CR9EHIX-9	6216
CR9EK	CR9EIX	3521
CR9EKB	CR9EIX	3521
CR10E	CR10EIX	6482
CR10EK	CR10EIX	6482
D7EA	DR7EIX	5686
D8EA	DR8EIX	6681
D9EA	DR9EIX	4772
DCPR6E	DCPR6EIX	8196
DCPR7E	DCPR7EIX	6046
DCPR8E	DCPR8EIX	6546
DCPR9E	DCPR9EIX	2316
DP7EA-9	DPR7EIX-9	7803
DP8EA-9	DPR8EIX-9	2202
DP9EA-9	DPR9EIX-9	5545





**2015-2016**  
**NGK**  
**RACING SPARK PLUGS**



Choosing a racing plug

**1 Choose the right spark plug for your engine based on heat range and electrode design, engine tuning, and racing conditions.**

**▶ Heat range**

**Normal** Spark plugs with a higher heat-range number have superior cooling characteristics. **High performance**

**▶ Electrode design**

- Engine tuning
- Torturous racing conditions
- Avoid problems due to extremes of temperature

**High response** **High performance**

- Low-speed performance

Racing plugs for both two- and four-wheel vehicles have been developed and designed for use in engines that have been fine-tuned to achieve maximum power under specific racing conditions. Racing plugs differ from standard plugs, both in appearance and performance, and often sacrifice plug life, and efficiency at low-speeds for optimum performance and durability under torturous racing conditions. Racing plugs do not improve output.

**2 What to look for when choosing a racing plug**

**CAUTION 1** Shell design – To determine what kind of shell design fits in your engine, check the serial number of regulation plugs or the plugs you are currently using to verify the thread diameter, pitch, thread length and shell seat.

**CAUTION 2** Firing End design – Refer to the section below on electrode design to determine which type is best for your needs.

**CAUTION 3** Heat range – It's important to choose a racing plug with a heat range that keeps the electrode at an optimum temperature under even the most torturous racing conditions. And remember: A higher heat-range number does not improve engine performance, it increases the plug's ability to dissipate heat.

**CAUTION 4** Resistors – Due to advances in ignition-system technology, there is little if any difference in performance between plugs with resistors and those without. However there are still some variations of some models that require plugs with resistors to avoid engine trouble.

**3 Choosing a firing end design**

Although a good rule of thumb is that the more an electrode projects into the cylinder, the better ignition it provides, it's also true that longer projections are more susceptible to the wear and tear of extreme temperatures. High-power, high-performance engines, of course, not only run hotter, they also vibrate more, which is why we recommend choosing a firing end design that reduces exposure of the electrode and insulator as much as possible.

Projected type	Angled ground strap type	Semi-surface discharge
		
<p>Quite similar to a standard spark plug electrode, these plugs give good overall performance in lightly tuned and naturally aspirated engines, as well as good performance in the low to medium torque range in turbo engines.</p>	<p>These provide superior performance in turbocharged engines with power boosts of 50% or more. The short ground electrode is also highly durable against mechanical shock.</p>	<p>In a sense, this is the ultimate plug configuration. Nearly all insulator cracking and electrode melting can be prevented with this type. Nevertheless, service life and low-speed performance may suffer slightly.</p>



Please choose racing plugs with the appropriate heat range and electrode design according to the tune-up level of the engine and the running conditions of the vehicle. NGK is not responsible for an engine or spark plugs troubles caused by a failure to choose the appropriate spark plug for your engine.

Spark Plug Maintenance

## ▶ How to correctly install spark plugs

You must take great care when installing spark plugs. In particular, you have to watch the torque. If you use too much or too little torque when installing spark plugs you can cause damage to the spark plugs and the engine, so be sure you abide by the following.

### ▶ Be sure to use the correct spark plug wrench.

Some engines have narrow spark plug holes thereby preventing the spark plugs from being tightened correctly with a plug wrench that does not perfectly fit the hexagonal portion of the plug. So, please use the appropriate spark plug wrench for your engine.

### ▶ Be sure to tighten the spark plug to the correct torque.

Screw in the spark plug and then use a torque wrench to tighten the spark plug to the standard torque noted in the chart on the right. If you do not have access to a torque wrench screw in the plug with your fingertips and then tighten to the rotation angle noted below (corresponds to the tightening torque in the chart on the right) using a spark plug wrench once the spark plug comes in contact with the spark plug tube gasket mount.

#### ⚠ CAUTION

If any lubricants, such as grease, or seizure prevention agents are used on the threads there is a danger of over tightening the spark plug past the standard torque. Therefore, do not use lubricants or seizure prevention agents on these parts.

### Standard Torque

Plug thread size	Tightening torque
φ18mm	35~40N·m (3.5~4.0kgm)
φ14mm	25~30N·m (2.5~3.0kgm)
φ12mm	15~20N·m (1.5~2.0kgm)
φ10mm	10~12N·m (1.0~1.2kgm)
φ8mm	8~10N·m (0.8~1.0kgm)

### Conical seat type (without gasket)

Tightening torque	
	10~20N·m (1.0~2.0kgm)

## ▶ Tightening angles

Thread size	New gasket	Used gasket
φ14mm	$\frac{1}{2} \sim \frac{2}{3}$ of a turn (180°~240°)	$\frac{1}{12}$ of a turn (30°)
φ12mm (except ▼)	$\frac{1}{2}$ of a turn (180°)	$\frac{1}{12}$ of a turn (30°)
▼ R2556B-○ R2558A-○	$\frac{1}{4}$ of a turn (90°)	$\frac{1}{8}$ of a turn (45°)

Thread size	New gasket	Used gasket
φ10mm (except ▼)	$\frac{1}{2}$ of a turn (180°)	$\frac{1}{12}$ of a turn (30°)
R0409B-○ ▼ R0451B-○ R0465B-○	$\frac{1}{6}$ of a turn (60°)	$\frac{1}{12}$ of a turn (30°)
φ8mm	$\frac{1}{3}$ of a turn (120°)	$\frac{1}{12}$ of a turn (30°)
Copper gasket type	$\frac{1}{12}$ of a turn (30°)	$\frac{1}{24}$ of a turn (15°)

▶ Plugs with gaskets that had a thread diameter of φ18mm or φ14mm

New gasket  $\frac{1}{2} \sim \frac{2}{3}$  (180°~240°)

Used gasket  $\frac{1}{12}$  (30°)

▶ Plugs with gaskets that had a thread diameter of φ12mm

New gasket (except ▼)  $\frac{1}{2}$  (180°)

Used gasket (except ▼)  $\frac{1}{12}$  (30°)

▼ in the case of a part number

New gasket	Used gasket
$\frac{1}{4}$ (90°)	$\frac{1}{8}$ (45°)

▶ Plugs with gaskets that had a thread diameter of φ10mm

New gasket (except ▼)  $\frac{1}{2}$  (180°)

Used gasket (except ▼)  $\frac{1}{12}$  (30°)

▼ in the case of a part number

New gasket	Used gasket
$\frac{1}{6}$ (60°)	$\frac{1}{12}$ (30°)

▶ Plugs with gaskets that had a thread diameter of φ8mm

New gasket  $\frac{1}{3}$  (120°)

Used gasket  $\frac{1}{12}$  (30°)

▶ Conical seat type without gaskets

New and Used gasket  $\frac{1}{16}$  (22.5°)

▶ Plugs with copper gaskets

New gasket  $\frac{1}{12}$  (30°)

Used gasket  $\frac{1}{24}$  (15°)

Red color indicates non resistor plugs.

▶  $\phi 14 \times 19 \text{mm} (20.8 \text{Hex})$



**R4304A-** ○

Heat range	8	9	10
Spark plug type	BP-E		
Terminal type	⌚		
Electrode material	Center	Gold Palladium	
	Ground	Nickel	



**R6918B-** ○

Heat range	7	8	9
Spark plug type	B-E		
Terminal type	⌚		
Electrode material	Center	Platinum	
	Ground	Nickel	



**R7376-** ○

Heat range	7	8	9	10
Spark plug type	B-E			
Terminal type	⌚			
Electrode material	Center	Iridium		
	Ground	Platinum		



**R6712-** ○

Heat range	9	10
Spark plug type	B-E	
Terminal type	⌚	
Electrode material	Center	Nickel
	Ground	—

▶  $\phi 14 \times 22 \text{mm} (20.8 \text{Hex})$



Short  
**R6179C-PA** ○

Heat range	105
Spark plug type	—
Terminal type	⌚
Electrode material	Center Platinum
	Ground Platinum



**R7376B-** ○

Heat range	9	10
Spark plug type	—	
Terminal type	⌚	
Electrode material	Center	Iridium
	Ground	Platinum

▶  $\phi 14 \times 22 \text{mm} (16.0 \text{Hex})$



Short  
**R7282A-** ○<sup>※1</sup>



Heat range	10	105	11
Spark plug type	—		
Terminal type	⌚		
Electrode material	Center	Iridium	
	Ground	Platinum	

- ※ 1 ) It's necessary to use special plug caps(Please refer to page 8)
- ※ 2 ) The length from gasket to terminal of ISO/JIS type spark plugs is 50.5mm which is 2.5mm shorter than old JIS type spark plugs
- ※ 3 ) Resistor spark plugs are recommended for cars originally equipped with resistor spark plugs. When non resistor spark plugs are installed in such cars, there is some possibility that the electric devices in the car, such as the audio system or the engine management system, would be affected by noise
- ※ 4 ) Heat range number enters

NOTICE) ⌚ = Solid post terminal   ⌚ = Thread terminal with nut   ⌚ = Thread terminal



φ14×19mm(16.0Hex)

Please be aware that some plugs cannot be replaced despite having the same thread size and length

Short  
**R7282-**  \*1 



Heat range	9	10	105	11
Spark plug type	—			
Terminal type				
Electrode material	Center	Iridium	Platinum	
	Ground			



Short  
**R7282M-**  \*1 

Heat range	11	115	—	
Spark plug type	—			
Terminal type				
Electrode material	Center	Iridium	Platinum	
	Ground			





**R7433-**  

50.5mm

Heat range	8	9	10	—	
Spark plug type	BK-E (ISO/JIS) *2		—		
Terminal type					
Electrode material	Center	Iridium	Nickel		
	Ground				





**R7434-**  

50.5mm

Heat range	8	9	10	—	
Spark plug type	BK-E (ISO/JIS) *2		—		
Terminal type					
Electrode material	Center	Iridium	Platinum		
	Ground				





**R6601-**  

50.5mm

Heat range	8	9	10	11	—	
Spark plug type	BK-E (ISO/JIS) *2		—			
Terminal type						
Electrode material	Center	Nickel	—			
	Ground					





**R7435-**  

53.0mm

Heat range	8	9	10	—		
Spark plug type	BCP-E (old JIS)			—		
Terminal type						
Electrode material	Center	Iridium	Nickel			
	Ground					





**R7436-**  

53.0mm

Heat range	8	9	10	—		
Spark plug type	BC-E (old JIS)			—		
Terminal type						
Electrode material	Center	Iridium	Platinum			
	Ground					



**R6690-**  

53.0mm

Heat range	9	10	11	—		
Spark plug type	BC-E (old JIS)			—		
Terminal type						
Electrode material	Center	Nickel	—			
	Ground					



Red color indicates non resistor plugs.

▶  $\phi 14 \times 26.5\text{mm}$  (16.0Hex)



long reach  
**R7437-**

Heat range	8	9	10
Spark plug type	LFR		
Terminal type			
Electrode material	Center	Iridium	
	Ground	Nickel	



long reach  
**R7438-**

Heat range	8	9	10
Spark plug type	LFR		
Terminal type			
Electrode material	Center	Iridium	
	Ground	Platinum	



▶  $\phi 14 \times 12.7\text{mm}$  (20.8Hex)



**R5525-**

Heat range	8	9	10	11
Spark plug type	B-H			
Terminal type				
Electrode material	Center	Gold Palladium		
	Ground	Nickel		



▶  $\phi 14 \times 21.5\text{mm}$  (20.8Hex)



**R6725-**

Heat range	9	10	105	11	115
Spark plug type	Rotary Engine RX-7				
Terminal type					
Electrode material	Center	Platinum			
	Ground	Platinum			



**R7420-**

Heat range	9	10	105	11
Spark plug type	Rotary Engine RX-7			
Terminal type				
Electrode material	Center	Iridium		
	Ground	Platinum		



▶  $\phi 14 \times 21\text{mm}$  (20.8Hex)



**R7440A-L**

Heat range	9	10
Spark plug type	Rotary Engine RX-8 Lside	
Terminal type		
Electrode material	Center	Iridium
	Ground	Platinum



▶  $\phi 14 \times 19\text{mm}$  (20.8Hex)



**R7440B-T**

Heat range	10	11
Spark plug type	Rotary Engine RX-8 Tside	
Terminal type		
Electrode material	Center	Iridium
	Ground	Platinum



▶  $\phi 12 \times 26.5\text{mm}$  (16.0Hex)



long reach  
**R2556B-**

Heat range	8	9	10
Spark plug type	LKR		
Terminal type			
Electrode material	Center	Iridium	
	Ground	Platinum	



▶  $\phi 12 \times 26.5\text{mm}$  (14.0Hex)



long reach  
**R2558A-**

Heat range	8	9	10
Spark plug type	LKAR		
Terminal type			
Electrode material	Center	Iridium	
	Ground	Platinum	





▶  $\phi 12 \times 19 \text{mm} (16.0 \text{Hex})$



**R2349-** ○

Heat range	9	10	11
Spark plug type	DC-E		
Terminal type			
Electrode material	Center	Nickel	
	Ground	-	



**R2525-** ○

Heat range	9	10
Spark plug type	DC-E	
Terminal type		
Electrode material	Center	Platinum
	Ground	Nickel



▶  $\phi 10 \times 26.5 \text{mm} (16.0 \text{Hex})$



long reach  
**R0452A-** ○

Heat range	10
Spark plug type	LMR
Terminal type	
Electrode material	Center
	Ground



▶  $\phi 10 \times 26.5 \text{mm} (14.0 \text{Hex})$



long reach  
**R0465B-** ○

Heat range	10
Spark plug type	LMAR
Terminal type	
Electrode material	Center
	Ground



long reach  
**R0451B-** ○

Heat range	8
Spark plug type	LMAR
Terminal type	
Electrode material	Center
	Ground



long reach  
**R0451C-** ○

Heat range	10
Spark plug type	LMAR
Terminal type	
Electrode material	Center
	Ground



※ 3) Resistor spark plugs are recommended for cars originally equipped with resistor spark plugs. When non resistor spark plugs are installed in such cars, there is some possibility that the electric devices in the car, such as the audio system or the engine management system, would be affected by noise

※ 4) Heat range number enters

NOTICE) = Solid post terminal = Thread terminal with nut = Thread terminal

Red color indicates non resistor plugs.

▶  $\phi 10 \times 19 \text{mm} (16.0 \text{Hex})$



**R0373A-** 

Heat range	8	9	10	11
Spark plug type	C-E			
Terminal type				
Electrode material	Center	Iridium		
	Ground	Platinum		





GAP1 4  
**R0045G-** 

Heat range	10	11
Spark plug type	C-E	
Terminal type		
Electrode material	Center	Nickel
	Ground	—



GAP1 1  
**R0045J-** 

Heat range	9	10	11
Spark plug type	C-E		
Terminal type			
Electrode material	Center	Nickel	
	Ground	—	





GAP1 1  
**R0045Q-** 

Heat range	10	11
Spark plug type	C-E	
Terminal type		
Electrode material	Center	Nickel
	Ground	—

▶  $\phi 10 \times 19 \text{mm} (16.0 \text{Hex})$  Half thread



**R0409B-** 

Heat range	8	9	10
Spark plug type	C-EH		
Terminal type			
Electrode material	Center	Iridium	
	Ground	Nickel	





**R0459A-** 

Heat range	10
Spark plug type	C-EH
Terminal type	
Electrode material	Center Nickel
	Ground —

▶  $\phi 10 \times 12.7 \text{mm} (16.0 \text{Hex})$

▶  $\phi 8 \times 19 \text{mm} (13.0 \text{Hex})$  Half thread



**R0161-** 

Heat range	9	10	11
Spark plug type	C-H		
Terminal type			
Electrode material	Center	Nickel	
	Ground	Nickel	



**R847-** 

Heat range	10	11
Spark plug type	E-EH	
Terminal type		
Electrode material	Center	Nickel
	Ground	—

※ 3) Resistor spark plugs are recommended for cars originally equipped with resistor spark plugs. When non resistor spark plugs are installed in such cars, there is some possibility that the electric devices in the car, such as the audio system or the engine management system, would be affected by noise

※ 4) Heat range number enters

NOTICE)  = Solid post terminal  = Thread terminal with nut  = Thread terminal



## ▶ Discontinued plug types

Red color indicates non resistor plugs Heat range number enters

Old part number	New part number	Old part number	New part number
R016- , R017-	→ R0373A-	R6205- , R6241-	→ R7433- or R7434-
R216- , R217-	→ R2525-	R6206- , R6242-	→ R7434-
R2270- , R2430-	→ R2349-	R5400- , R5400F- , R6337-	→ R7435-
R5530-	→ R5525-	R5686-	→ R7435- or R7436-
R5649-	→ R6712-	R5830- , R5687-	→ R7436-
R6711-	→ R6601-	R7112- , R7113-	→ R7433-
R5883-	→ R6690-	R7114- , R7115-	→ R7433- or R7434-
R4630A- , R6385- P	→ R7376-	R7116- , R7117-	→ R7434-
R6120-	→ R7282-	R7118- , R7119-	→ R7434-
R6120A-	→ R7282A-	R7232- , R7233-	→ R7435-
R6120M-	→ R7282M-	R7234- , R7235-	→ R7435- or R7436-
R6179A-	→ R7282-	R7236- , R7237-	→ R7436-
R6255- , R6255F- , R6326-	→ R7433-	R7238- , R7239-	→ R7436-

## ▶ Racing plug caps

Heat range number enters

Plug cap number(color)	Plugs and cables
 <b>TRS1225-B (Blue)</b> ※for HONDA RACE	R7282- , R7282A- , R7282M- φ8mm Cable
 <b>TRS1233A-R (Red)</b> <b>TRS1233B-Y (Yellow)</b> <b>TRS1233C-G (Green)</b>	R7282- , R7282A- , R7282M- φ7mm Cable

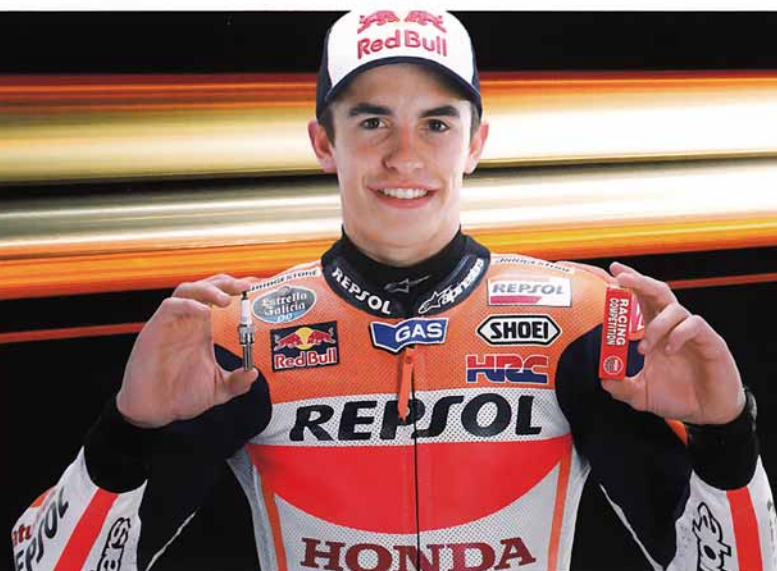

**NOTICE**

Choose appropriate heat range and firing end of racing spark plugs according to engine modification or driving condition. (Please refer to the first page.)

**Motorcycles**

Heat range number enters

Manufacturer	Model	Spark plug Number	Racing spark plug IX spark plug	other applicable plug number
<b>HONDA</b>				
Road	CBR1000RR	IMR9E-9HES	R0409B-⊙,R0459A-⊙	p7
	CBR600RR	IMR9E-9HES	R0409B-	
	CBR400RR	CR8EH-9	CR⊙EHIX-9,R0409B-⊙	
	CBR250R	SIMR8A9	CR EIX,R0373A-	p7
	NSR250R-SP/SE	BR9ECM	BR⊙ECMIX	p3
	NSR50	BR8ES	BR EIX,R7376-	
Race	NSF250R	R0452A-10	R0452A-⊙,R0451C-⊙	p6
Motocross	CRF450R('09~)	SILMAR9A9S	-	p6
	CRF250R('10~)	R0451B-8	R0451B-⊙	
	CRF250R('04~'09)	R0409B-8	R0409B-	p7
	CRF150R/R II	CR8EH-9	CR⊙EHIX-9,R0409B-⊙	
	CRF125F	CPR6EA-9	CPR6EAIX-9S	
	CRF50F	CR6HSA	CR⊙HIX	p7
	CR125R	BR9EG	BR EIX,R7376-	p3
	CR85R/R II	BR10EG	BR⊙EIX,R7376-⊙	
	CR80R/R II	BR10EG	BR EIX,R7376-	
<b>KAWASAKI</b>				
Road	Ninja ZX-10R	CR9EIA-9	R0373A-⊙,R0045Q-⊙	p7
	Ninja ZX-6R/RR	CR9E	R0373A- ,R0045Q-	
	Ninja 400	CR9EIA-9	R0373A-⊙,R0045Q-⊙	
	Ninja 250	CR8E	CR EIX,R0373A-	
	Ninja 250SL	MR8CI-8	CR⊙EIX,R0373A-⊙	
Motocross	KX450F	CPR8EB-9	-	p3
	KX250F('11~)	CPR8EB-9	-	
	KX250F('06~'11)	CR8E	CR EIX,R0373A-	
	KX250('05~)	BR8ECMVX	BR⊙ECMIX	
	KX125('06~)	BR9ECMVX	BR ECMIX	
	KX85/ II	R6252K-105	R7376-⊙	
	KX65	BR10EG	BR EIX,R7376-	
	KLX450R	CPR8EB-9	-	
	KLX250	CR8E	CR EIX,R0373A-	
	KLX125	CR7HSA	CR⊙HIX	
	KLX110L	CR6HSA	CR HIX	
<b>SUZUKI</b>				
Road	GSX-R1000('07~)	CR9EIA-9	R0373A-⊙,R0045Q-⊙	p7
	GSX-R600('08~)	CR9EIA-9	R0373A- ,R0045Q-	
Motocross	RM-Z450('07~)	DIMR8A10	-	p3
	RM-Z250('13~)	CR8EIB-10	-	
	RM-Z250('07~'13)	CR8EIA-10	-	
	RM250('02~)	BR8EG	BR EIX,R7376-	
	RM125('97~)	R6918B-8	R6918B-⊙	
	RM85/85L	BR10ES	BR EIX,R7376-	



Heat range number enters

Manufacturer	Model	Spark plug Number	Racing spark plug IX spark plug	other applicable plug number
<b>▶ YAMAHA</b>				
Road	YZF-R1/R1M('09~)	LMAR9E-J	R0465B-	p6
	YZF-R1('04~'08)	CR9EK	R0373A-,R0045Q-	p7
	YZF-R6('98~)	CR10EK	R0373A-,R0045Q-	
	YZF-R3/R25	CR9E	CR-EIX,R0373A-	
Motocross	YZ450F	CR8E	CR-EIX,R0373A-	p7
	YZ250F('14~)	LMAR8G	-	p7
	YZ250F(~'13)	CR8E	CR-EIX,R0373A-	
	YZ250	BR8EG	BR-EIX,R7376-	p3
	YZ125	BR9EVX	BR-EIX,R7376-	
	YZ85/LW	BR10EG	BR-EIX,R7376-	
	WR250R/X	CR9EK	CR-EIX,R0373A-	p7
<b>▶ APRILIA</b>				
Road	RSV4	CR9EKB	R0373A-※2,R0045Q-※2	p7
	RS4 125	CR9EB	CR-EIX※2,R0373A-※2	
<b>▶ BMW</b>				
Road	S1000RR	LMAR9D-J	R0465B-※2	p6
<b>▶ DUCATI</b>				
Road	1199 Panigale S/R	MAR9A-J	-	
	1198/S/R	MAR10A-J	-	
	1098/S/R	MAR10A-J	-	
	899 Panigale	MAR9A-J	-	
<b>▶ KTM</b>				
Road	1190 RC8/R	LKAR9BI9,LMAR7A-9※3	-	
Motocross	450SX-F('13~)	LKAR8AI-9	-	
	450SX-F('07~'12)	CR9EKB	R0373A-※2	p7
	350SX-F('11~)	LMAR9AI-8	-	p6
	250SX-F('13~)	LMAR9AI-8	-	
	250SX-F('06~'12)	CR9EKB	R0373A-※2	p7
	125SX('02~'08)	BR9EVX	BR-EIX,R7376-	p3
	65SX('09~)	LR8B	-	
50SX('09~)	CR8HSA	CR-HIX	p7	

※ 1 : The thread length is longer than the normal type due to setting the detonation counter.  
 ※ 2 : You need terminal nut.

※ 3 : There are two product numbers for twin spark engines.

# Placing of motor identification numbers:

This information applies only to OE installations of the automobile manufacturer

<b>Alfa</b>	<b>identification plate, engine block</b>
<b>Audi</b>	service manual, engine block and <b>A2, A3, A4, A5, A6, A8</b> spare wheel pan, right <b>100/200</b> plate back side, inside left <b>Avant</b> bottom back in the middle <b>80/90, Audi V8</b> inside luggage space flap <b>Audi Coupé</b> luggage space right under insert of tray
<b>BMW</b>	engine block
<b>Citroën</b>	on the engine block
<b>Daihatsu</b>	operating instructions, engine block
<b>Fiat</b>	identification plate, engine block
<b>Ford</b>	engine block, identification plate
<b>Honda</b>	engine block at passing to transmission
<b>Hyundai</b>	engine block
<b>Jaguar</b>	engine block, identification plate
<b>Kia</b>	engine block, transmission side
<b>Lada</b>	engine block, left side
<b>Lancia</b>	engine block, identification plate
<b>Mazda</b>	engine block (place see operating instructions)
<b>Mercedes</b>	engine block
<b>Mitsubishi</b>	engine block, identification plate at the engine hood and service manual
<b>Nissan</b>	engine block
<b>Opel</b>	engine block in high of transmission
<b>Peugeot</b>	engine block (aluminium plate)
<b>Renault</b>	engine block (middle), resp. aluminium plate
<b>Rover</b>	engine block in front of right, high of cylinder head
<b>Saab</b>	engine block, below
<b>Seat</b>	engine block, from model 93 like VW
<b>Skoda</b>	engine block near ignition distributor
<b>Subaru</b>	engine block near toothed-belt plate
<b>Suzuki</b>	engine block at passing to transmission F = iron block G = aluminium block
<b>Toyota</b>	label at the toothed belt plate
<b>VW</b>	in service manual, engine block and <b>Käfer:</b> front plate, left <b>Lupo, Polo, Derby,</b> <b>Golf, Scirocco, Jetta</b> <b>Passat Limousine,</b> <b>Corrado, Vento, Bora:</b> back plate, inside left <b>Golf Cabrio:</b> cross-tie behind rear seat bench, left <b>Passat Variant:</b> spare wheel pan, back-side left <b>Transporter:</b> cross member gear shift pattern <b>LT:</b> B-column, left down <b>Ilitis:</b> bottom plate left beside first-aid box <b>Taro:</b> cabin wall, inside left
<b>Volvo</b>	300, 700, 900, C, S and V serie: label on the front face cover all other models: label on valve cover

# SERIES OF NGK SPARK PLUGS

## STANDARD TYPES

	NON-RESISTOR	RESISTOR
14mm x 9.5mm Hex 20.8mm Fig. ①②	B-2 B-4 B6S B7S B8S	BR6S
	Fig. ①③ BP-4 BP5S BP6S	
14mm x 19.0mm Hex 20.8mm Fig. ②④	B4ES B5ES B6ES,-11 B7ES,-11 B8ES B9ES B10ES	BR4ES BR5ES BR6ES,-11 BR7ES BR8ES,-11 BR9ES BR10ES
	Fig. ②⑤	BR6EB-L-11
	Fig. ②⑥	BR8EYA BR9EYA BR10EYA
	Fig. ②⑦ BP2ES, BP-2E BP4ES,-11 BP5ES,-11,-13 BP6ES,-11 BP7ES,-11 BP8ES BP9ES	BP5ESZ BP6ESZ BPR2ES, BPR-2E BPR4ES,-11,-13 BPR5ES,-11,-13 BPR6ES,-5,-11 BPR7ES,-11 BPR8ES,-6 BPR9ES
	Fig. ③⑧	BPR6EKN BPR7EKN
	Fig. ②⑨ BP4EY,-11 BP5EY,-11 BP6EY,-11 BP7EY	BPR4EY,-11 BPR5EY,-11 BPR6EY,-11 BPR7EY-11
	Fig. ②⑩ BP5E BP6E	BPR4E,-11 BPR5E,-11 BPR6E,-11 BPR7E
	Fig. ④⑪ BP5ET,-10 BP6ET BP7ET	
	Fig. ⑤⑫	BPR5EJ
	14mm x 19.0mm Hex 16.0mm Fig. ⑥⑬	BCP4ES,-11 BCP5ES,-11 BCP6ES,-11 BCP7ES,-11
Fig. ⑧⑭ ISO BCP5ET BCP6ET BCP7ET		BCPR5ET BCPR6ET BCPR7ET
Fig. ⑥⑮ BC6ES		BCR8ES
Fig. ⑦⑯ ISO BK5ES		BK5ESZ BKR4ES-11 BKR5ES,-11 BKR6ES,-11 BKR7ES-11

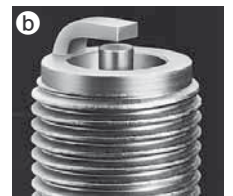
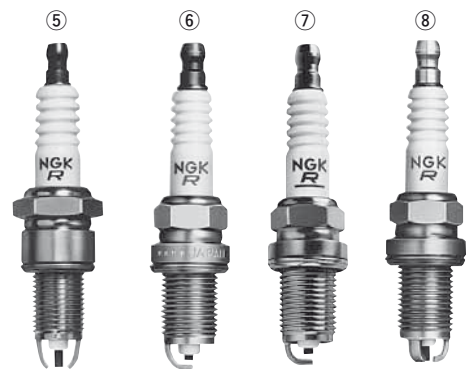
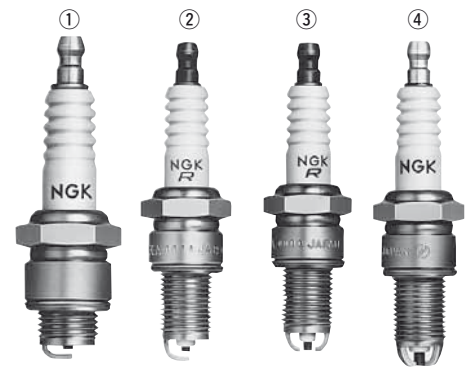

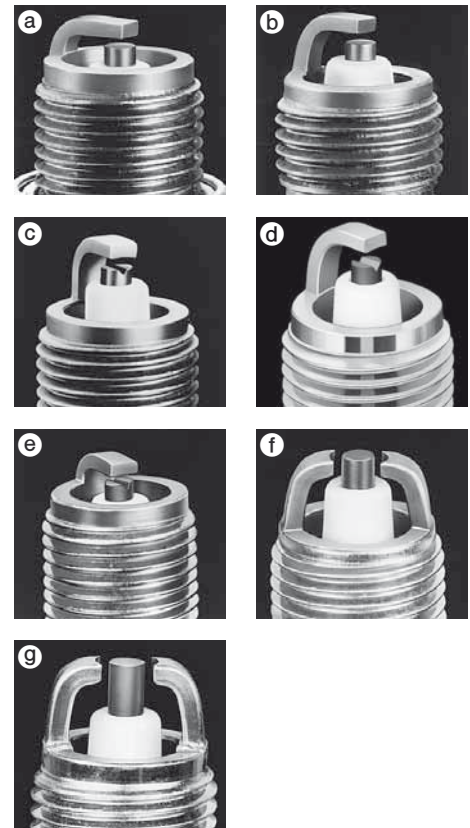

	NON-RESISTOR	RESISTOR
14mm x 19.0mm Hex 16.0mm Fig. ①③		BCPR4EY,-11 BCPR5EY,-11 BCPR6EY,-11,-N-11 BCPR7EY,-11,-N-11
Fig. ②④ ISO		BKR4EY,-11 BKR5EY,-11 BKR5EYA,-11 BKR6EY,-11 BKR6EYA,-11 BKR7EY
Fig. ①⑤	BCP5E BCP6E,-11 BCP7E,-11	BCPR5E,-11 BCPR6E,-11 BCPR7E,-11
Fig. ②⑥ ISO	BK5E,-11 BK6E,-11	BKR4E,-11 BKR5E,-11,-N,-N-11 BKR5EZ BKR6E,-11-E,-N,-N-11 BKR6EZ BKR7E,-11,-N-11 BKR8E-11 FR6F-11DK FR6F-11K
Fig. ⑥⑦ ISO		BKR5EK BKR6EK
Fig. ⑥⑧ ISO		BKR5EKB-11 BKR6EKB-11
		BKR5EKC BKR6EKC,-N-11 BKR6EKE BKR7EKC,-N,-N-11
14mm x 26.5mm Hex 16.0mm Fig. ⑧④		LFR4A,-11 LFR4A-E LFR5A,-11 LFR6A,-11 LFR7A
14mm x 11.2mm Conical seat Hex 16.0mm Fig. ③①	B7FS	BR5FS BR6FS,-15
Fig. ③②	BP4FS BP5FS BP6FS BP7FS	BPR4FS,-11,-15 BPR5FS,-11,-15 BPR6FS
Fig. ③③	BP5F BP6F	
14mm x 17.5mm Conical seat Hex 16.0mm Fig. ④①	B8EFS B9EFS	BR7EFS
Fig. ④②		BR6EF BR7EF
Fig. ④③	BP5EFS,-13 BP6EFS,-13 BP7EFS	BPR5EFS,-13 BPR6EFS,-13,-15 BPR7EFS-15
Fig. ④④	BP6EF	BPR6EF,-11,-13
14mm x 25.0mm Conical seat Hex 16.0mm Fig. ⑦②		TR5A-13 TR5B-13 TR6B-10
14mm x 11.2mm Hex 20.8mm Fig. ⑤①	B-4L B-6L B6LY(Fig. ⑤②)	





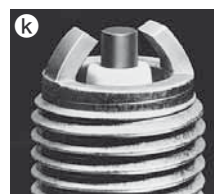
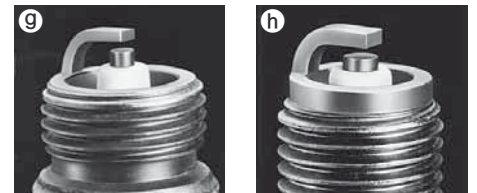
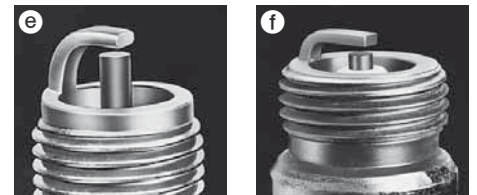
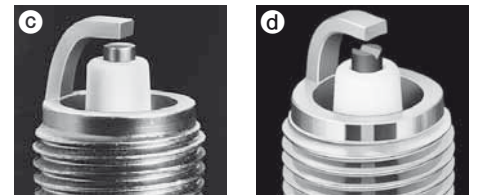
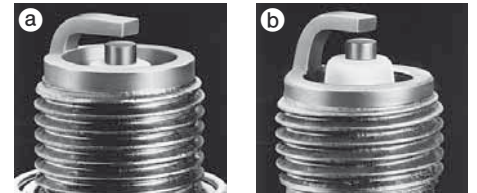

	NON-RESISTOR	RESISTOR
14mm x 12.7mm Hex 20.8mm Fig. ①a	<b>B-2H</b> <b>B-4H,-10</b> <b>B5HS</b> <b>B6HS,-10</b> <b>B7HS,-10</b> <b>B8HS,-10</b> <b>B9HS</b> <b>B10HS</b>	<b>BR4HS</b> <b>BR5HS</b> <b>BR6HS,-10</b> <b>BR7HS,-10</b> <b>BZ7HS-10</b> <b>BR8HS,-10</b> <b>BR9HS,-10</b>
Fig. ①b	<b>BP2HS</b> <b>BP4HS,-10</b> <b>BP5HS,-10</b> <b>BP6HS,-10</b> <b>BP6HSA</b> <b>BP7HS,-10</b> <b>BP8HS,-10,-15</b>	<b>BP-2H</b> <b>BP-4H</b>  <b>BP6H</b> <b>BP7H</b>  <b>BPR2HS</b> <b>BPR4HS,-10</b> <b>BPR4HSA</b> <b>BPR-4H</b> <b>BPR5HS</b> <b>BPR6HS,-10</b> <b>BPR6HSA</b> <b>BPR7HS,-10</b> <b>BPZ8H-N-10</b> <b>BPR8HS,-10</b> <b>BPR8HSA</b> <b>BPZ8HS-10,-15</b>
Fig. ①c	<b>BP4HA</b>	
Fig. ①e	<b>B6HSA</b> <b>B8HSA</b>	<b>BR4HSA</b> <b>BR6HSA,-9</b> <b>BR8HSA,-9</b>
18mm x 12.0mm Hex 20.8mm Fig. ⑤f	<b>AB-2</b> <b>AB-6</b> <b>AB-7</b> <b>AB-8</b>	
18mm x 16.0mm Hex 25.4mm		<b>R8102B-10</b>
12mm x 19.0mm Hex 18.0mm Fig. ⑥h	<b>D6EA</b> <b>D7EA</b> <b>D8EA</b> <b>D9EA</b> <b>D10EA</b>	<b>DR7EA</b> <b>DR7EB</b> <b>DR8EA</b> <b>DR8EB</b> <b>DR9EA</b>
Fig. ⑥i	<b>DP6EA-9</b> <b>DP7EA-9</b> <b>DP8EA-9</b> <b>DP9EA-9</b>	<b>DPR5EA-9</b> <b>DPR6EA-9</b> <b>DPR6EB-9</b> <b>DPR7EA-9</b> <b>DPR8EA-9</b> <b>DPR9EA-9</b>
Fig. ⑥h	<b>J9A</b>	<b>JR8B</b> <b>JR9B</b> <b>JR10B</b>
Fig. ⑥k		<b>JR8C</b> <b>JR9C</b>
12mm x 21.0mm Hex 18.0mm Fig. ⑦j	<b>DP8Z</b>	<b>DPR7Z</b> <b>DPR8Z</b> <b>DPR9Z</b>
12mm x 19.0mm Hex 16.0mm Fig. ⑧i	<b>DCP6E</b> <b>DCP7E</b>	<b>DCPR6E</b> <b>KR6A-10</b> <b>DCPR7E,-N</b> <b>DCPR8E,-N</b> <b>KR8C-G</b> <b>DCPR9E</b> <b>KR9C-G</b>
Fig. ⑧m		<b>DCPR8EKC</b>
12mm x 20.5mm Hex 16.0mm		<b>KER7A-8DEG</b>
12mm x 26.5mm Hex 16.0mm Fig. ⑨b		<b>LKR6C</b> <b>LKR6E</b> <b>LKR6F-10</b> <b>LKR7E</b>
12mm x 25.0mm Hex 14.0mm		<b>LNAR7A-9G</b>
12mm x 26.5mm Hex 14.0mm Fig. ⑨b		<b>LZKAR6C-9</b> <b>LZKAR7D-9,-9D</b> <b>LKAR8A-9,-9S</b>



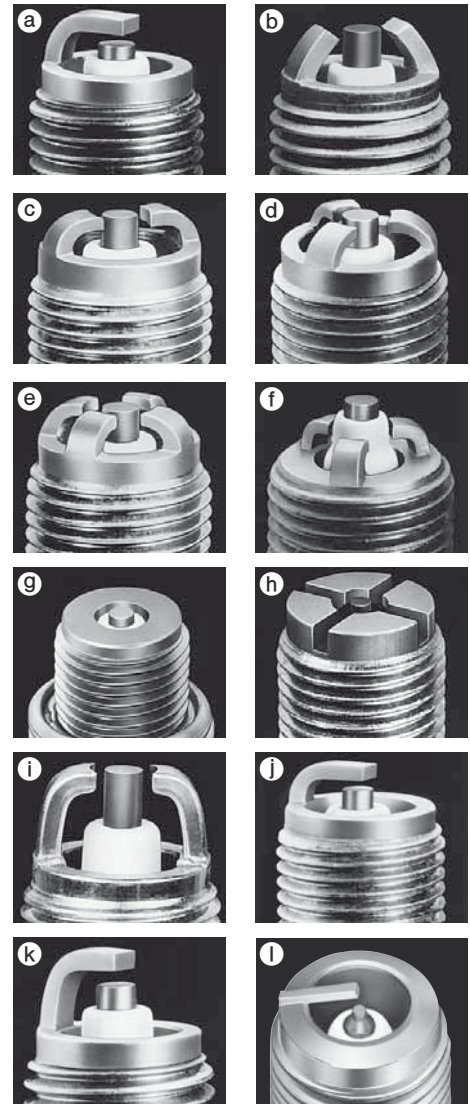
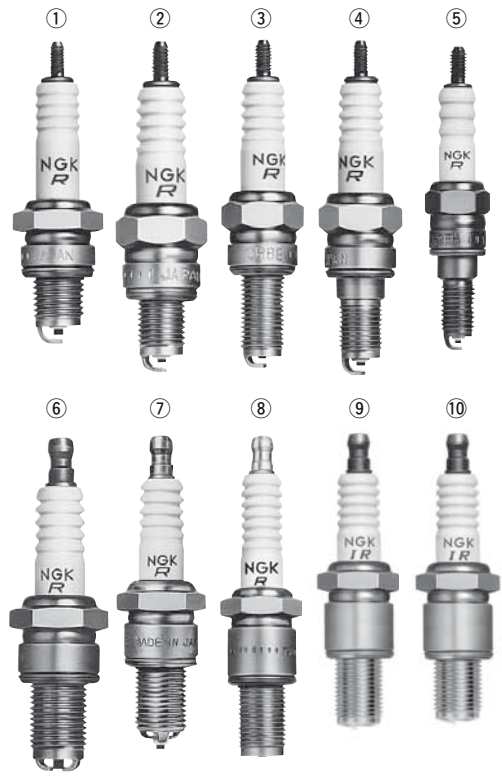





	NON-RESISTOR	RESISTOR
12mm x 12.7mm Hex 18.0mm Fig. ①②	<b>D6HA</b> <b>D8HA</b>	<b>DR4HS</b> <b>DR5HS</b> <b>DR6HS</b> <b>DR8HS</b>
10mm x 12.7mm Hex 16.0mm Fig. ②③	<b>C2H</b> <b>C5HSA</b> <b>C6HSA</b> <b>C7HSA</b> <b>C8HSA</b>	<b>C4HSB</b> <b>C5HSB</b> <b>CR4HSA CR4HSB LR4C-E</b> <b>CR5HSA CR5HSB</b> <b>CR6HSA LR6E</b> <b>CR7HSA LR7D</b> <b>CR8HSA CMR8H LR8A LR8B</b>
10mm x 19.0mm Hex 16.0mm Fig. ③④	<b>C7E</b> <b>C8E</b> <b>C9E</b>	<b>CR6E</b> <b>CR7E</b> <b>CR8E</b> <b>CR9E</b> <b>CR10E</b>
Fig. ③⑤		<b>CPR6EA-9S</b> <b>CPR7EA-9</b> <b>CPR8E</b>
10mm x 19.0mm Hex 16.0mm Fig. ④⑥	<b>C8EH-9</b> <b>C9EH-9</b>	<b>CR5EH-9</b> <b>CR7EH-9 MR7C-9N MR7E-9</b> <b>CR8EH-9 MR8C-9N MR8D-9 MR8E-9 MR8F</b> <b>CR9EH-9 MR9C-9N</b>
10mm x 19.0mm Hex 16.0mm Fig. ③⑦		<b>CR7EK</b> <b>CR8EK</b> <b>CR9EK</b> <b>CR10EK</b>
Fig. ③⑧		<b>CR7EKB</b> <b>CR8EKB</b> <b>CR9EKB</b>
10mm x 19.0mm Hex 14.0mm Fig. ⑥		<b>MAR8B-JDS</b> <b>MAR9A-J</b> <b>MAR9B-JDS</b> <b>MAR10A-J</b>
10mm x 26.5mm Hex 14.0mm Fig. ⑥		<b>LMAR6A-9</b> <b>LMAR7A-9</b> <b>LMAR8A-7,9,9S</b>
Fig. ⑥		<b>LMAR6C-9</b> <b>LMAR7H-9DS</b> <b>LMAR8F-9</b> <b>LMAR8G</b> <b>LMAR9D-J</b>
8mm x 19.0mm Hex 13.0mm Fig. ⑤⑨		<b>ER8EH, -N</b> <b>ER9EH, -N, -6N</b> <b>ER10EH</b>



**FOR ROTARY ENGINE**  
**FÜR WANKELMOTOR**    **POUR MOTEUR ROTATIF**  
**PARA MOTOR ROTATIVO**    **TÄNDSTIFT FÜR WANKELMOTOREN**

	NON-RESISTOR	RESISTOR
14mm x 19.5mm Hex 20.8mm Fig. ⑥⑩	<b>B7EM</b>	<b>BR8EM</b>
Fig. ⑥⑪		<b>BR7ET</b> <b>BR8ET</b> <b>BR9ET</b> <b>BR10ET</b>
Fig. ⑥⑫		<b>BR8EQ,-14</b> <b>BR9EQ,-14</b>
14mm x 21.5mm Hex 20.8mm Fig. ⑧⑬		<b>SD10A</b> <b>SD11A</b>
Fig. ⑧⑭		<b>BUR6EQ</b> <b>BUR7EQ</b> <b>BUR8EQ</b> <b>BUR9EQ</b>
		<b>BUR7EQP</b> <b>BUR9EQP</b>
14mm x 21.0mm Hex 20.8mm Fig. ⑨		<b>RE6C-L</b> <b>RE7C-L</b> <b>RE8C-L</b>
14mm x 19.0mm Hex 20.8mm Fig. ⑩⑮		<b>RE9B-T</b>

# SEMI SURFACE DISCHARGE TYPES AND SUPPLEMENTARY GAP TYPE

	NON-RESISTOR	RESISTOR
14mm x 12.7mm Hex 20.8mm Fig.①①	<b>BU8H</b>	<b>BUZ8H</b>
14mm x 19.0mm Hex 20.8mm Fig.②②		<b>BUR5EA-11</b> <b>BUR6EA-11</b> <b>BUR7EA-11</b>
14mm x 19.0mm Hex 20.8mm Fig.②③		<b>BUR4EB-11</b> <b>BUR5EB-11</b> <b>BUR6EB-11</b> <b>BUR7EB-11</b>
		<b>BUR5ET,-10</b> <b>BUR6ET</b>
14mm x 19.0mm Hex 20.8mm Fig.③④		<b>BPR6EK-A</b>
		<b>BPR5EKU</b>
14mm x 17.5mm Conical seat Hex 16.0mm Fig.④⑤	<b>BU6EFSZ</b>	<b>BUR6EFSZ</b>
14mm x 19.0mm Hex 16.0mm Fig.⑥⑥ ISO		<b>BKUR6EK,-9</b> <b>BKUR7EK</b>
		<b>BKUR5ET,-10</b> <b>BKUR5ETZ-10</b> <b>BKUR6ET,-10</b> <b>BKUR6ETB</b> <b>BKUR7ET</b>
	<b>BK7EKU</b>	<b>BKR5EKU</b> <b>BKR6EKU</b> <b>BKR7EKU</b>
		<b>BKR6EKUE</b>
		<b>BKR6EKUB</b>
14mm x 22.0mm Hex 16.0mm Fig.⑦⑦		<b>BKR5EKUC</b> <b>BKR6EKUC</b>
14mm x 19.0mm Hex 16.0mm Fig.⑥⑧		<b>BKR6EQUA</b>

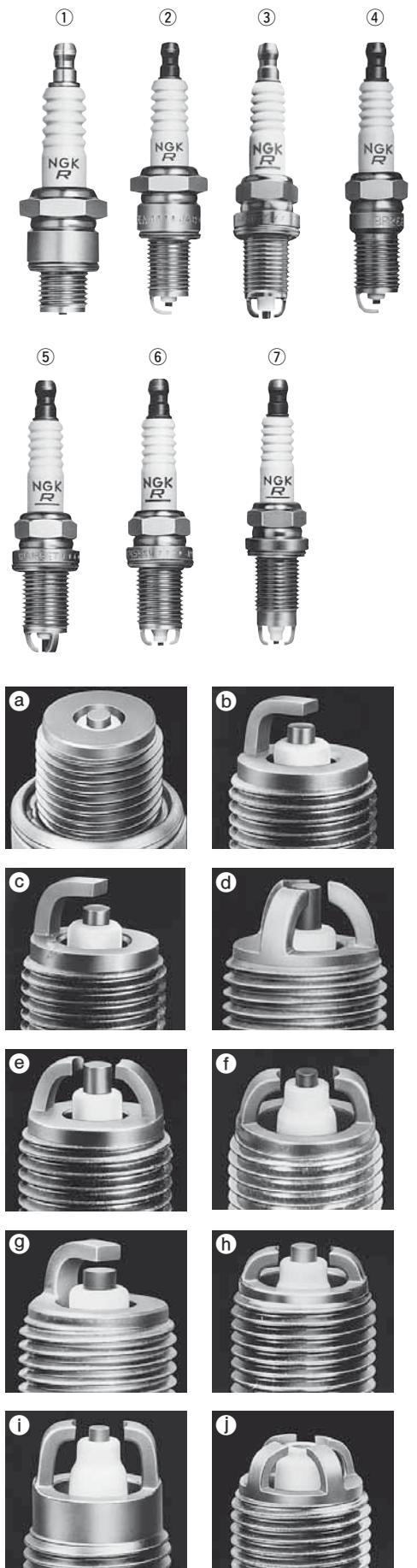

# PROJECTED GAP TYPES

	NON-RESISTOR	RESISTOR
14mm x 19.0mm Hex 20.8mm Fig. ①(a)	<b>BE529Y-11</b>	<b>BRE527Y-11</b> <b>BRE529Y,-11</b>
Fig. ②(b)		<b>ZGR4A</b> <b>ZGR5A</b>
14mm x 20.5mm Hex 20.8mm Fig. ②(b)		<b>ZGR5B,-11</b> <b>ZGR6B-11</b>
14mm x 22.0mm Hex 20.8mm Fig. ②(c)		<b>ZGR5C</b>
14mm x 19.0mm Hex 16.0mm Fig. ③(b)	<b>ZF6A-11</b>	<b>ZFR5A-11</b> <b>ZFR6A-11</b>
Fig. ④(b) ISO		<b>ZFR4F-11</b> <b>ZFR5F,-11</b> <b>ZFR5J-11</b> <b>ZFR6F-11,G</b> <b>ZFR6J-11</b> <b>ZFR7F-11</b> <b>ZFR7J-11</b>
Fig. ③(a)		<b>BCRE527Y</b>
14mm x 20.5mm Hex 16.0mm		<b>ZFR6K-9E,-11S</b>
Fig. ③(e)		<b>ZFR5G</b> <b>ZFR6G</b>
14mm x 22.5mm Hex 16.0mm Fig. ③(c)		<b>ZFR4E-11</b> <b>ZFR5E-11</b> <b>ZFR6E-11</b>
Fig. ③(d)		<b>ZFR5D-11</b>
14mm x 25.0mm Conical seat Hex 16.0mm Fig. ⑤(b)		<b>LZTR4A-11</b> <b>LZTR5A-13</b>
12mm x 19.0mm Hex 16.0mm		<b>ZKR7A-10</b>
12mm x 21.5mm Hex 16.0mm		<b>ZKER6A-10DEG,-10EG</b>
12mm x 26.5mm Hex 16.0mm		<b>LZKR6B-10E</b>
12mm x 26.5mm Hex 14.0mm		<b>LZKAR6C-11</b>
12mm x 26.3mm Bi-Hex 14.0mm		<b>ZKBR7A-HTU</b>

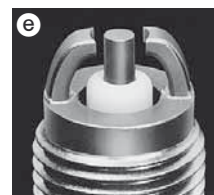
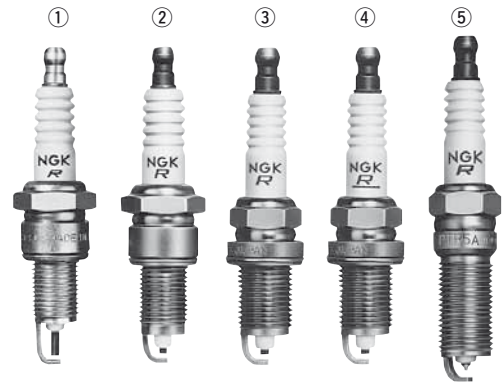



# SLANT GROUND ELECTRODE TYPES

14mm x 12.7mm Hex 20.8mm Fig. ⑥(f)	<b>B7HCS</b> <b>B8HCS</b> <b>B9HCS</b>	<b>BR8HCS-10</b>
14mm x 19.0mm Hex 20.8mm Fig. ⑦(f)	<b>B7ECS</b> <b>B8ECS</b> <b>B9ECS</b>	<b>BR8ECS</b> <b>BR9ECS</b> <b>BR10ECS</b>
Fig. ⑧(f)		<b>BR8ECM</b> <b>BR9ECM</b> <b>BR10ECM</b>

# PLATINUM, IRIIDIUM TIPPED TYPES

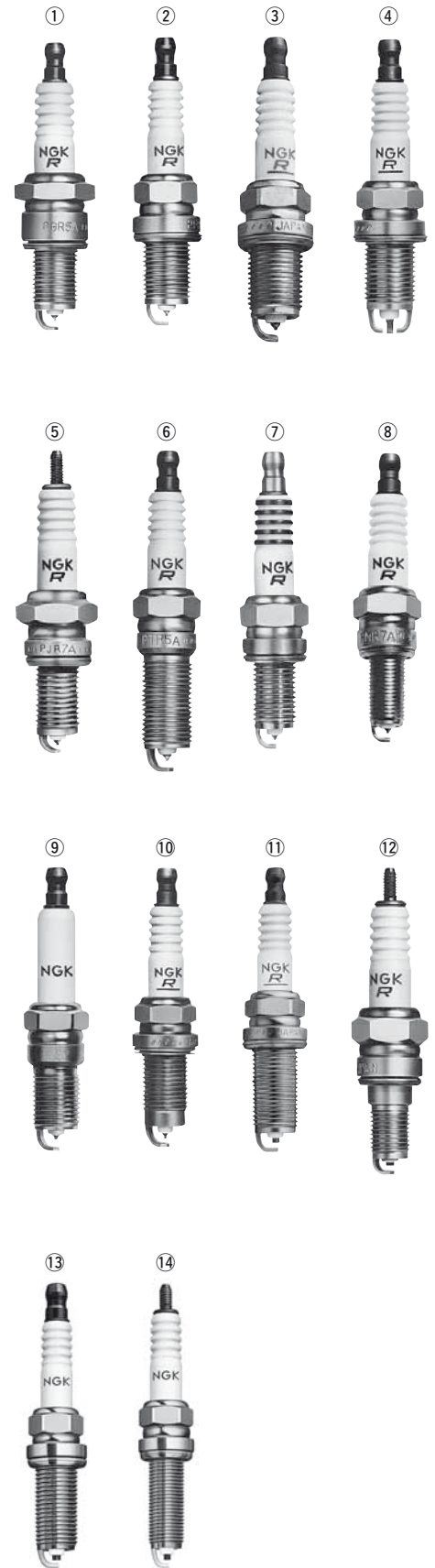
	RESISTOR
14mm x 19.0mm Hex 20.8mm Fig.①①	PGR5A,-11 PGR5C-11 BPR5EP-11,-13 PGR6A,-11 PGR6C-11 BPR6EP-8 PGR7A 125CX 126CX IGR7A
14mm x 19.0mm Hex 20.8mm Fig.①②	IGR5C13 GR7CI-8
14mm x 19.0mm Hex 16.0mm Fig.②②	PFR5A-11 PFR5K-11 BCPR5EP-8,-11,-13 PFR6A-11 PFR6H-10 PFR6K-11 BCPR6EP-8,N-8,-11,-N-11,-13 PFR7A-11 PFR7H-10
Fig.③③ ISO	FR4AP-10,-11 FR4BP-11 FR5AP-10,-11 FR5BP-11 FR5AP-11E FR6AP-10,-11 FR6BP-11 FR7AP-11 115CX 116CX 136CX FR5EI-13 PFR5B-9,-11,-11B PFR5C-11 PFR6B,-9,-11,-11B,-11C PFR6E-10 PFR7B,-9,-11 PFR8B,-9 PFR4G-11 PFR5G-11,-13E PFR5J-11 PFR6G,-9,-11,-13,-13E PFR6H-10 PFR6J,-11 PFR7G,-9,-11 PFR7S11EG PFR5L-11 PFR5N-11,8DS PFR5P-11 PFR6L-11,-13 PFR6N-11 PFR6P-11 PFR6Q PFR7N-D PFR7Q PFR5R-11 BKR5EP-11 BKR6EP-8,-11,-13,-N-8
Fig.④④ ISO	BKR6EKPA
Fig.④④ ISO	BKR5EKUP
Fig.④④ ISO	BKR5EKPB-11,-13 BKR6EKPB-11
Fig.④④ ISO	BKR5EQUPA BKR6EQUP BKR6EQUPA
Fig.③③ ISO	PFR6M PFR6X-11 PFR7M PFR7S8EG
Fig.③③ ISO	PZFR5B PZFR5F,-11 IZFR5B IZFR5F11 IZFR5G IZFR5L11 PZFR6B PZFR6F,-11 IZFR6B IZFR6F11 SIFR6B7G T6728R T6728U-G035
Fig.③③ ISO	IFR5A11,-8N IFR5D10 IFR5E11 IFR6A11 IFR6C IFR6D10 IFR6E11 IFR6AD7DG IFR6AE11S IFR7F-D IFR7B4D IFR8AF4D IFR8AG8 IFR5G11 IFR5J11 IFR5N10 IFR5T-8N,11 IFR6J11 IFR6S IFR6T11 IFR7X7G
Fig.③	PZFR6H IZFR6J IZFR6N-E IZFR6Q
Fig.③③ m	PFR6W-TG
Fig.③③ n	DIFR5E11 DF6A-13B DIFR6D11D DIFR6D13 ZFR5LP-13G IZFER7A4D 11G-55
14mm x 21.5mm Hex 16.0mm	PZFR6R,8EG
14mm x 22.0mm Hex 16.0mm Fig.⑩⑩ ISO	PZFR5C PZFR5D-11 IZFR5C IZFR7E-D
14mm x 22.5mm Hex 16.0mm	135CX
14mm x 25.0mm conical seat Hex 16.0mm Fig.⑥⑥ h	PTR5A-13 ILTR5D



	RESISTOR
14mm x 17.5mm conical seat Hex 16.0mm Fig. ⑨①	<b>PTR4B-15 PTR5C-13</b> <b>ITR4A15</b> <b>ITR6F13</b>
14mm x 17.5mm conical seat Hex 16.0mm Fig. ③⑧ Fig. ⑨⑨	<b>ITR5H13 PTR5D-10,-13 TR5AI-13 TR5AP-13</b> <b>ITR6G9 PTR6D-13,-13G</b> <b>ITR7J9D</b> <b>PZTR5A-15</b>
14mm x 20.5mm Hex 16.0mm Fig. ③⑫	<b>IZFR6K11,11E,13</b> <b>IZFR6K-11S,IZFR6K11NS PZFR7G-G</b>
14mm x 21.5mm Hex 16.0mm Fig. ⑭	<b>PZFR5N-11T</b>
14mm x 22.0mm Hex 16.0mm Fig.	<b>PZFR6J-11</b>
14mm x 26.5mm Hex 16.0mm Fig. ⑪	PLFR4A-11 PLFR5A-9,-11 ILFR5T11 ILFR5B11 DILFR5A11 DILFR5C11 DILFR5E11 DF5B-8A DILFR5L11 ILZFR5E8D LZFR5C1-11 PLFR6A-9,-11 ILFR6T11 ILFR6K8 ILFR6G,-E SILFR6A11 DILFR6D11D DILFR6L11 PLFR7A-9 DILFR7K9G ILFR7A8EG SILZFR7A9G PLZFR6A-11S ILZFR6A11 DILFR7B10G 155CX 156CX
14mm x 28.0mm Hex 16.0mm Fig. ⑪	<b>LZFR5BI-11 LZFR5DI-11</b> <b>LZFR6AI</b>
14mm x 29.5mm Hex 16.0mm Fig. ⑪①	<b>LZFR5AQP</b>
14mm x 25.0mm conical seat Hex 16.0mm	PLZTR4A-13 PLZTR5A-13 ILTR5A-13G ILTR5P11D LTR5BI-13 LTR6AP-11 ILTR6A-8G,-13G ILTR6J13 ILTR6M9G LTR6AI-8 LTR6BI-13 LTR6BI-9 LTR6DI-8 LTR6DP13 ILTR7E9D ILTR7J8 ILTR7N8 ILTR7Q9 LTR7CP13
12mm x 19.0mm Hex 18.0mm Fig. ⑤⑧	<b>PJR6A</b> <b>PJR7A IJR7A9</b> <b>PJR8A</b>
12mm x 19.0mm Hex 16.0mm	<b>IKR6G8</b> <b>IKR7H8</b> <b>IZKR8C10D SIKR8B7G</b> <b>IKR9H8 IKR9J8</b> <b>147CX</b>
12mm x 19.0mm Hex 16.0mm Fig. ⑦①	<b>PKR7A</b> <b>PKR9B</b> <b>KR7AI</b> <b>KR8AI</b> <b>KR9CI</b> <b>IKR6G11</b> <b>IKR9F8</b>
12mm x 19.0mm Hex 16.0mm Fig. ⑦③	<b>DCPR8EKP</b>
12mm x 20.5mm Hex 16.0mm	<b>IKER7A8EGS ZKR7BI-10 PKER7A8EGS PKER7A8DES</b>
12mm x 21.5mm Hex 16.0mm	<b>PZKER7B8EGS</b>
12mm x 22.0mm Hex 16.0mm	<b>IZKR7A</b>
12mm x 26.5mm Hex 16.0mm	ILKR6F11 ILZKR6F11 SILKR6C10E SILKR6D10G ILKR7D8 ILKR7J8 ILKR7K8 ILKR7L8G ILZKR7D8 ILZKR7E10DG LKR7F1-8 SILKR7C8DE SILZKR7E11 SILZKR7E8EG SILZKR7E9 SILZKR7E9G SILZKR7G8DE ILKR8M5D ILKR8P8 SILZKR8E8D SILZKR8E8G ILKR9G8 ILKR9H8 HKS-G40XL
Fig. ⑩	<b>DILKR7E11</b>
Fig.	
12mm x 28.0mm Hex 16.0mm	<b>DILZKR7B11G ILZKR7G7G</b>
12mm x 29.0mm Hex 16.0mm	<b>SILZKKER8A8E</b>
12mm x 25.0mm Hex 14.0mm	<b>SILZNR6D9</b> <b>SILNAR7B7 SILNAR7C7DG</b> <b>ILNAR8B7G ILZNR8B7G SILNAR8A7</b>
12mm x 26.5mm Hex 14.0mm	ILKAR7L11 ILKAR7L11D ILKAR7M10 ILZKAR7D11 LKAR7CI-8 SILKAR8H6 LKAR8CI-8 SILKAR8C6DG SILKAR8C6DS SILKAR8D6 SILKAR8E4DG SILKAR8F8 SILZKAR8D4D SILZKFR8B7S SILZNR8C7H HKS-M50HL
Fig. ⑬④	<b>LKAR8AP7JD LKAR8AP7JDS</b>
Fig. ⑬⑧	<b>DILKAR7B8 DILKAR7G11DS DILKAR7H11GS DILKAR7M8 DILZKAR7B11</b> <b>DILKAR8J9G DILKAR8K8D DILKAR8L8D</b>
Fig. ⑬	

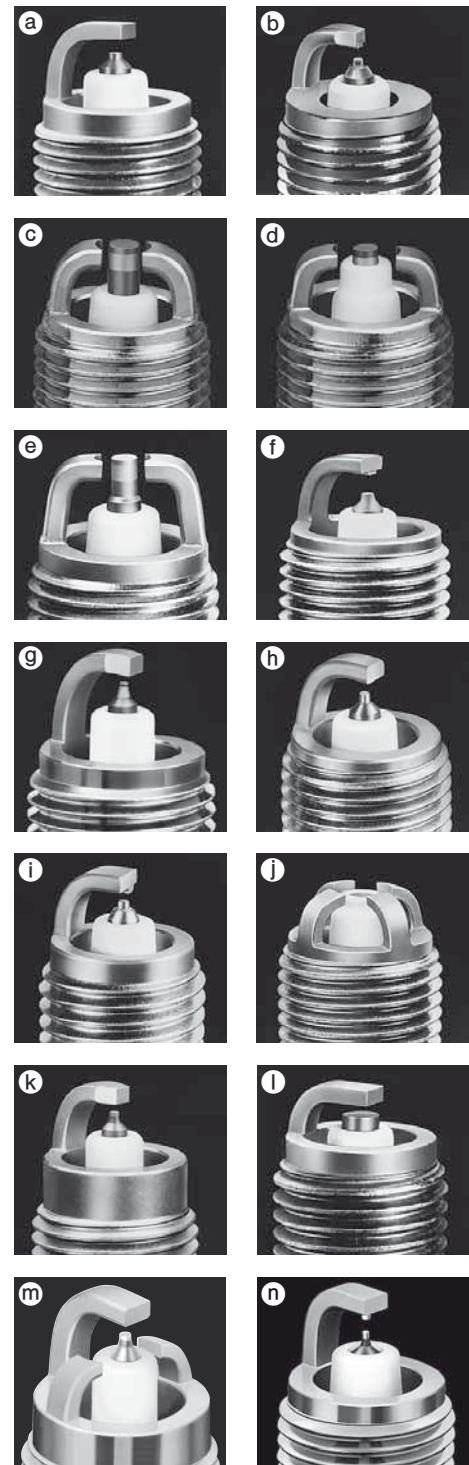

	RESISTOR
12mm x 27.0mm Hex 14.0mm	<b>SILZKFR8C7S SILZKFR8D7S</b>
12mm x 27.5mm Hex 14.0mm	<b>SILZKFR8E7S</b>
12mm x 28.0mm Hex 14.0mm Fig. (k)	<b>DILZKAR7C11S ILZKAR7E11S ILZKAR8F8S ILZKAR8G8 ILZKAR8H8S ILZKAR8J8SY ILZNR8A7G SILZKAR8F7S</b>
12mm x 28.5mm Hex 14.0mm Fig. (n)	<b>DILKA7E9HS</b>
10mm x 19.0mm Hex 16.0mm Fig. (8) (i)	<b>CR9EBI-9</b>
Fig. (8)	<b>MR8CI-8 SIMR7B9DS</b>
Fig. (8) (c)	<b>MR8BI-8</b>
10mm x 19.0mm Hex 16.0mm Fig. (12)	
10mm x 22.0mm Hex 16.0mm	<b>MR8BP8HJS</b>
10mm x 26.5mm Hex 14.0mm Fig. (14)	<b>ILMAR7B8 LMAR7CI-8 SILMAR7D9DS ILMAR8C9D LMAR8AI-8E LMAR8BI-9 SILMAR8C9 SILMFR8A8G SILMAR9B9</b>
10mm x 26.5mm Hex 14.0mm Fig. (d)	<b>LMAR9AP8JS</b>
12mm x 26.5mm Bi-Hex 14.0mm	<b>ILZKBR7B8DG PLZKBR7B8DG SILZKBR8B8HG SILKGR9A7EG</b>
12mm x 27.5mm Bi-Hex 14.0mm	<b>SILZKBR8D8S SILZKBR8E8S SILZKGR8A8S SILZKGR8B8S</b>
12mm x 28.0mm Bi-Hex 14.0mm	<b>SILZKG8D7E</b>
12mm x 28.5mm Bi-Hex 14.0mm	<b>SILZKBR8F8S SILZKGR8C8S</b>

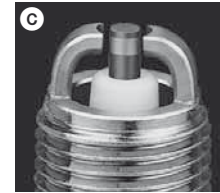

# COMPACT TYPES

	NON-RESISTOR	RESISTOR
18mm x 16mm Hex 25.4mm	<b>R8160B-10</b>	
14mm x 9.5mm Hex 19.0mm Fig. ①(a)	<b>BM4A</b> <b>BM6A</b> <b>BM6*</b> <b>BM7A</b> <b>BM7*</b> * Hex.20.8mm	<b>B2-LM*</b> <b>B4-LM*</b> <b>BMR2A,-10</b> <b>BMR4A</b> <b>BMR6A</b> <b>BMR7A</b> * Hex.20.8mm
Fig. ①(b)	<b>BPM4A</b> <b>BPM6A,-10</b> <b>BPM7A</b>	<b>BPMR4A,-10</b> <b>BPMR6A,-10</b> <b>BPMR7A,-9</b>
14mm x 12.7mm Hex 20.8mm Fig. ②(a)	<b>BL-6H</b>	
14mm x 7.8mm Conical seat Hex 16.0mm Fig. ③(a)	<b>BM6F</b> <b>BM6FY</b> <b>BM7F</b>	<b>BMR6F</b>
Fig. ③(b)	<b>BPM6F</b> <b>BPM7F</b>	<b>BPMR6F</b>
10mm x 8.6mm Hex 14.0mm Fig. ④(a)	<b>CM-6</b>	
10mm x 9.5mm Hex 16.0mm Fig. ⑧(a)		<b>CMR6A</b> <b>CMR7A</b>
10mm x 12.7mm Hex 16.0mm Fig. ⑧(e)		<b>CMR5H</b> <b>CMR6H</b> <b>CMR7H</b>
14mm x 9.5mm Hex 19.0mm Fig. ①(c)	<b>BPM6Y</b> <b>BPM7Y</b> <b>BPM8Y</b>	<b>BPMR6Y</b> <b>BPMR7Y</b> <b>BPMR8Y</b>

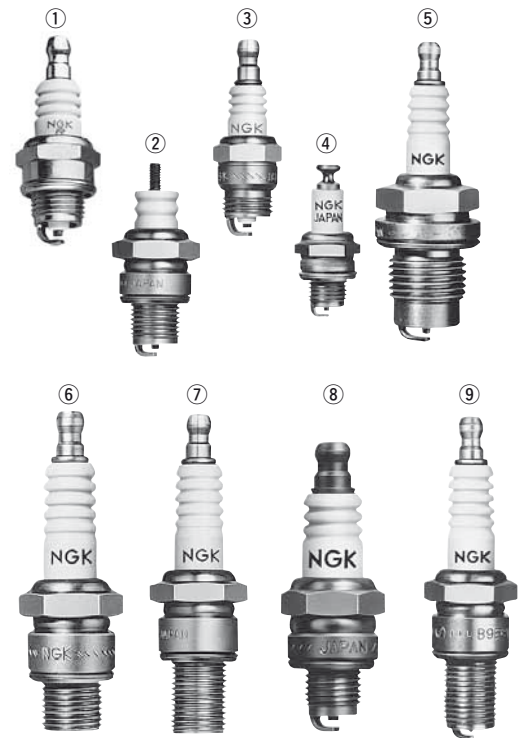

# FARM EQUIPMENT TYPES

PF1/2" x 22.5mm Hex 23.8mm Fig. ⑤(d)	<b>G-27</b> <b>G-2Z</b>
--	----------------------------

# SURFACE DISCHARGE TYPES

14mm x 12.7mm Hex 20.8mm Fig. ⑥(f)	<b>BUHX(Series gap)</b> <b>BUHXW-1(Series gap)</b>	
	<b>BUH</b>	
	<b>BUHW</b> <b>BUHW-2</b>	<b>BUZHW</b> <b>BUZHW-2</b>
14mm x 19.0mm Hex 20.8mm Fig. ⑦(f)	<b>BUE</b>	

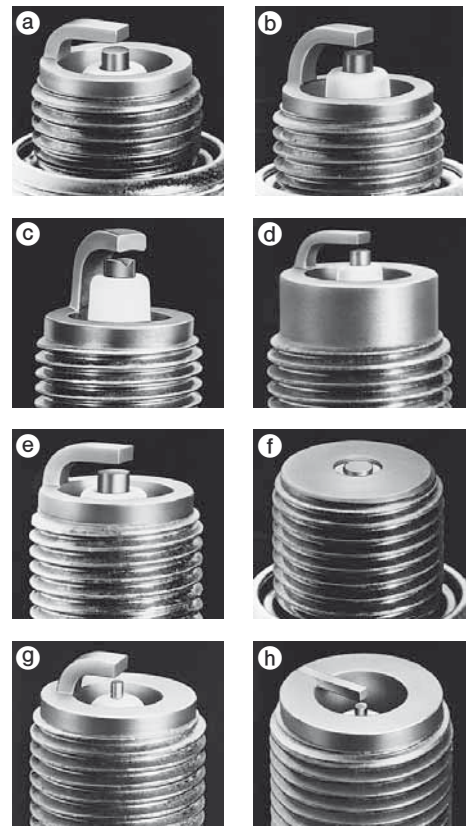

# RACING TYPES

	Nickel electrode	Precious metal electrode	Platinum electrode
14mm x 19.0mm Hex 20.8mm	<b>B8EG</b> Fig. ⑨(g) <b>BR8EG*</b> <b>B9EG</b> <b>BR9EG*</b> <b>B10EG</b> <b>BR10EG*</b> <b>B11EG</b>	Fig. ⑨(g) <b>B8EGV</b> <b>B85EGV</b> <b>B9EGV</b> <b>B95EGV</b> <b>B10EGV</b> <b>B105EGV</b> <b>B11EGV</b>	Fig. ⑨(h) <b>B10EGP</b>
*Resistor Type			



# IX TYPES

	RESISTOR
18mm x 10.9mm Hex 20.8mm Fig. ①①	WR5IX
14mm x 19.0mm Hex 20.8mm Fig. ②②	GR4IX GR5IX BPR5EIX,-11 BPR6EIX,-11 BPR7EIX BPR8EIX BPR9EIX BPR10EIX
Fig. ②③	BR7EIX BR8EIX BR9EIX BR10EIX
Fig. ②④	BR8ECSIX BR9ECSIX,-5
Fig. ③④	BR8ECMIX BR9ECMIX BR10ECMIX
14mm x 12.7mm Hex 20.8mm Fig. ④②	BPR6HIX BPR7HIX BPR8HIX
Fig. ④③	BR6HIX BR7HIX BR8HIX BR9HIX BR10HIX
14mm x 9.5mm Hex 20.8mm Fig. ⑤①	XR4IX XR5IX XR45IX
14mm x 19.0mm Hex 16.0mm Fig. ⑥②	BCPR7EDIX BCPR5EIX,-11 BCPR6EIX,-11 BCPR7EIX,-11
Fig. ⑧②	BKR4EIX BKR5EIX,-11 BKR6EIX,-11 BKR7EIX,-11 BKR8EIX BKR9EIX
Fig. ⑧③	ZFR5FIX-11 ZFR6FIX-11
14mm x 26.5mm Hex 16.0mm Fig. ⑨②	LFR5AIX-11 LFR6AIX-11 LFR7AIX LKR6AIX LKR6AIX-P LKR6CIX LKR7AIX
14mm x 17.5mm Conical seat Hex 16.0mm Fig. ⑩②	BPR6EFIX-10,-15
Fig. ⑩①	TR4IX TR5IX TR6IX TR7IX TR8IX TR55IX TR65IX TR75IX TR85IX
14mm x 20.5mm Conical seat Hex 16.0mm Fig. ⑪③	TR5-1IX TR45-1IX TR55-1IX
14mm x 11.2mm Conical seat Hex 16.0mm Fig. ⑫③	YR5IX YR55IX
Fig. ⑫③	BR6FIX
Fig. ⑫①	UR4IX UR5IX UR6IX UR45IX UR55IX
14mm x 25.0mm Conical seat Hex 16.0mm Fig. ⑬②	LTR5IX-11 LTR6IX-11 LTR7IX-11
Fig. ⑬③	LZTR4AIX-11 LZTR5AIX-13 LZTR6AIX-13 LZTR7AIX-13

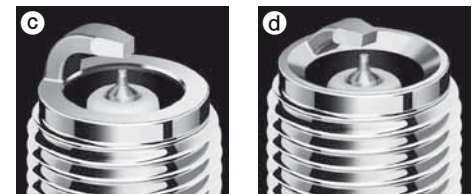
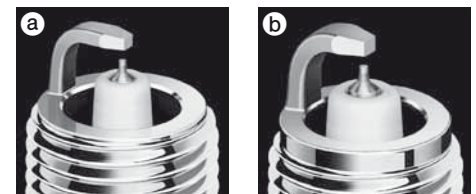
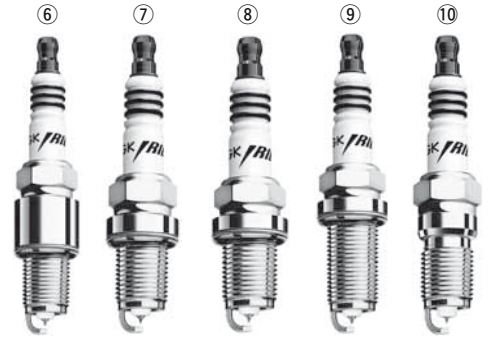

## IX TYPES

	RESISTOR
12mm x 19.0mm Hex 16.0mm Fig. ①(a)	<b>DCPR6EIX</b> <b>DCPR7EIX</b> <b>DCPR8EIX</b> <b>DCPR9EIX</b>
Fig. ①(b)	<b>DCR7EIX</b> <b>DCR8EIX</b> <b>DCR9EIX</b>
12mm x 19.0mm Hex 18.0mm Fig. ②(a)	<b>DPR7EIX-9</b> <b>DPR8EIX-9</b> <b>DPR9EIX-9</b>
Fig. ②(b)	<b>DR7EIX</b> <b>DR8EIX</b> <b>DR9EIX</b>
12mm x 21.0mm Hex 18.0mm Fig. ③(a)	<b>DPR8ZIX</b>
12mm x 26.5mm Conical seat Hex 14.0mm Fig. ④(d)	<b>ZNAR7AIX</b> <b>ZNAR6AIX-11</b>
12mm x 26.5mm Hex 14.0mm	<b>LZKR6AIX</b>
10mm x 19.0mm Hex 16.0mm Fig. ⑤(a)	<b>CPR6EAIX-9S</b> <b>CPR7EAIX-9</b> <b>CPR9EAIX-9</b>
Fig. ⑤(c)	<b>CR7EIX</b> <b>CR8EIX</b> <b>CR9EIX</b> <b>CR10EIX</b>
Fig. ⑥(b)	<b>CR8EHIX-9</b> <b>CR9EHIX-9</b>
10mm x 12.7mm Hex 16.0mm Fig. ⑦(b)	<b>CR5HIX</b> <b>CR6HIX</b> <b>CR7HIX</b> <b>CR8HIX</b> <b>CR9HIX</b>
8mm x 19.0mm Hex 13.0mm Fig. ⑧(e)	<b>ER8EHIX</b> <b>ER9EHIX</b>

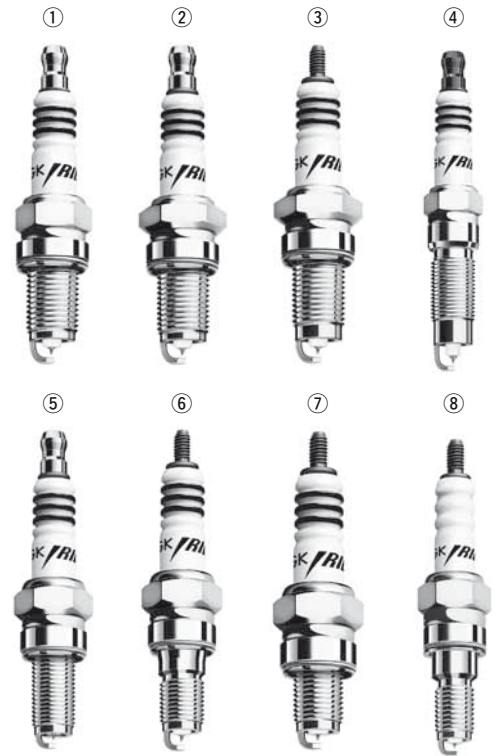

# SERIES OF NGK GLOW PLUGS

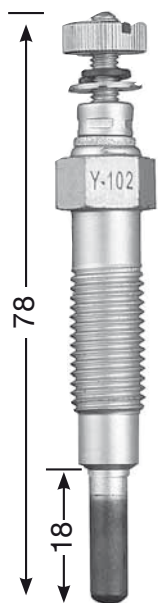

**Y-102**  
M 10 x 1.25  
12 Hex  
10,5 V

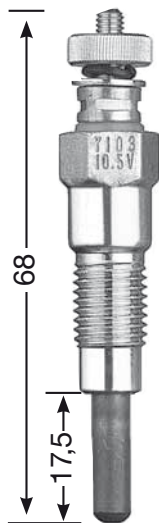

**Y-103**  
M 10 x 1.25  
12 Hex  
10,5 V

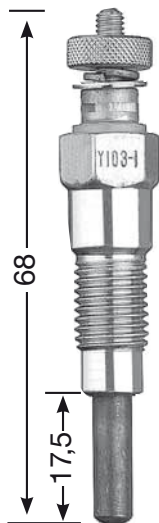

**Y103-1**  
M 10 x 1.25  
12 Hex



**Y103-2**  
M 10 x 1.25  
12 Hex



**Y103 K**  
M 10 x 1.25  
12 Hex  
10,5 V

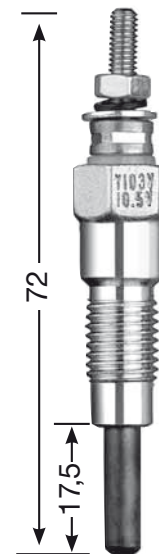

**Y103 V**  
M 10 x 1.25  
12 Hex  
10,5 V

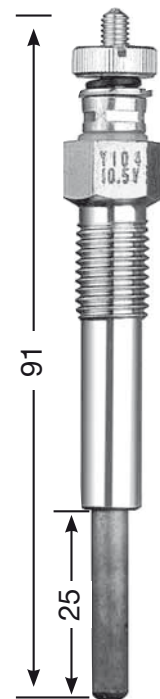

**Y-104**  
M 10 x 1.25  
12 Hex  
10,5 V

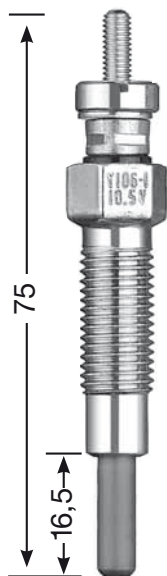

**Y106-1**  
M 10 x 1.25  
12 Hex  
10,5 V

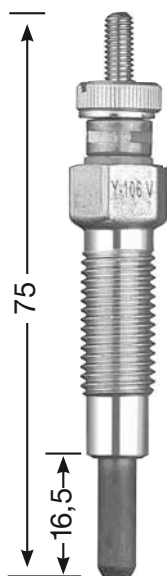

**Y106 V**  
M 10 x 1.25  
12 Hex  
10,5 V

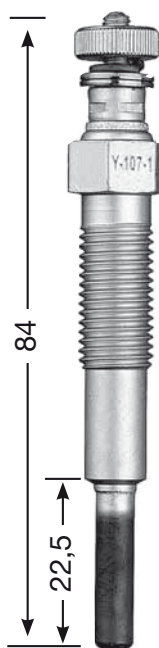

**Y-107-1**  
M 10 x 1.25  
12 Hex  
10,5 V

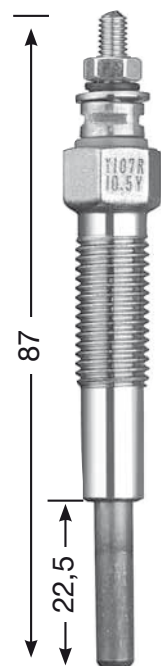

**Y107 R**  
M 10 x 1.25  
12 Hex  
10,5 V

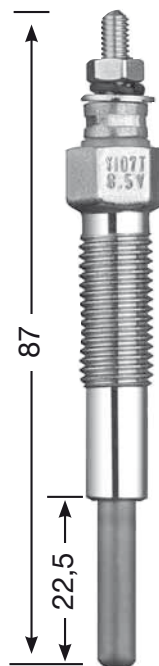

**Y107 T**  
M 10 x 1.25  
12 Hex  
8,5 V

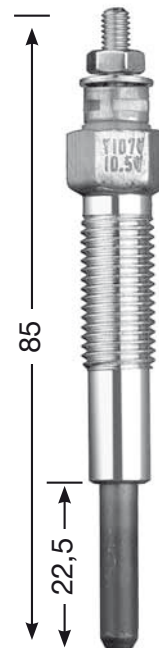

**Y107 V**  
M 10 x 1.25  
12 Hex  
10,5 V

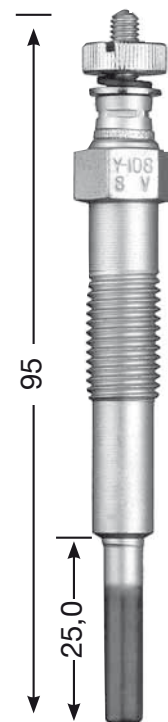

**Y-108**  
M 10 x 1.25  
12 Hex  
8 V

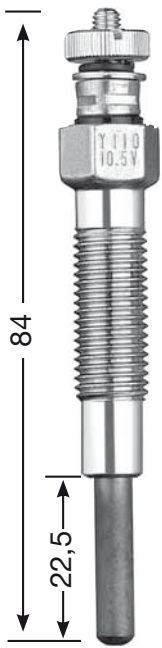

**Y-110**  
M 10 x 1.25  
12 Hex  
10,5 V

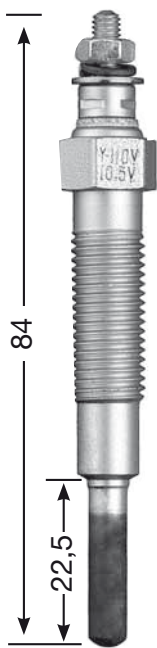

**Y-110 V**  
M 10 x 1.25  
12 Hex  
10,5 V

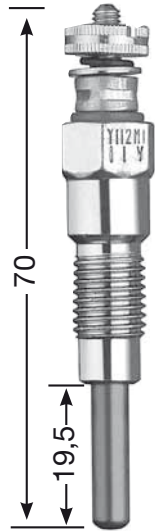

**Y-112 M1**  
M 10 x 1.25  
12 Hex  
11 V

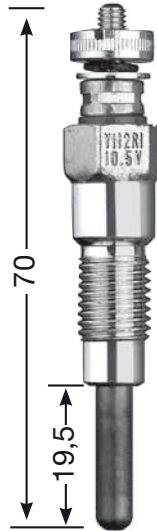

**Y-112 R1**  
M 10 x 1.25  
12 Hex  
10,5 V



**Y-112 T**  
M 10 x 1.25  
12 Hex  
11 V

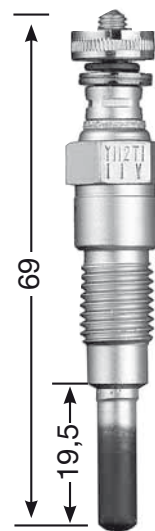

**Y-112 T1**  
M 10 x 1.25  
12 Hex  
11 V



**Y-112 TS**  
M 10 x 1.25  
12 Hex  
11 V

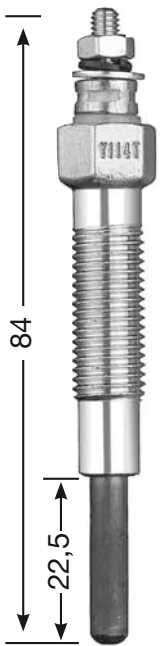

**Y-114 T**  
M 10 x 1.25  
12 Hex  
10,5 V

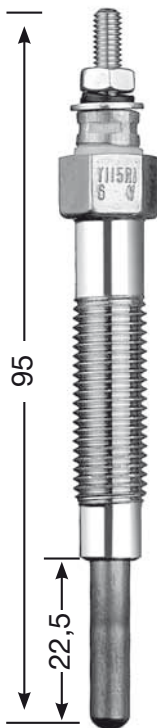

**Y-115 R1**  
M 10 x 1.25  
12 Hex  
6 V

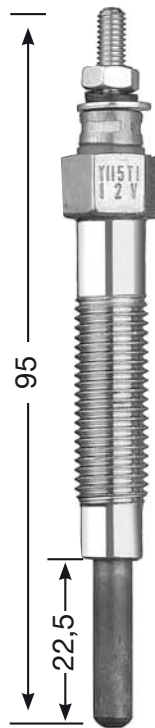

**Y-115 T1**  
M 10 x 1.25  
12 Hex  
12 V

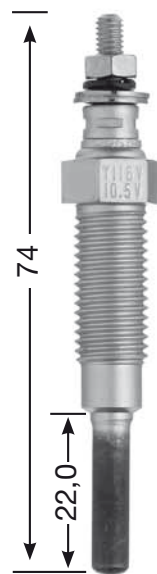

**Y-116 V**  
M 10 x 1.25  
12 Hex  
10,5 V

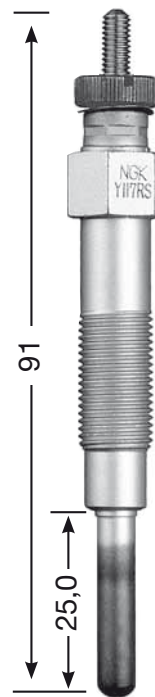

**Y-117 RS**  
M 10 x 1  
12 Hex  
6,5 V

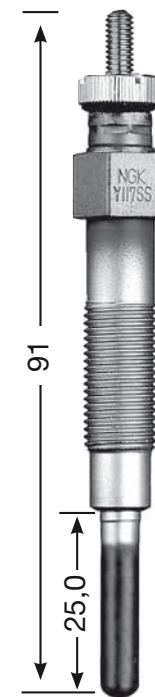

**Y-117 SS**  
M 10 x 1  
12 Hex  
8,5 V

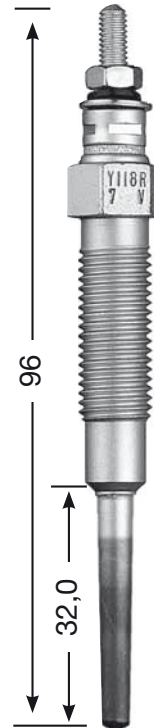

**Y-118 R**  
M 10 x 1.25  
12 Hex  
7 V

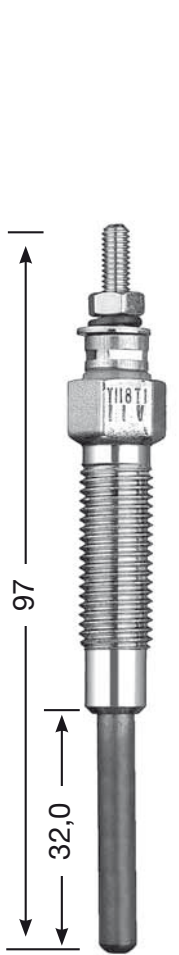

**Y-118 T1**  
M 10 x 1.25  
12 Hex  
11 V

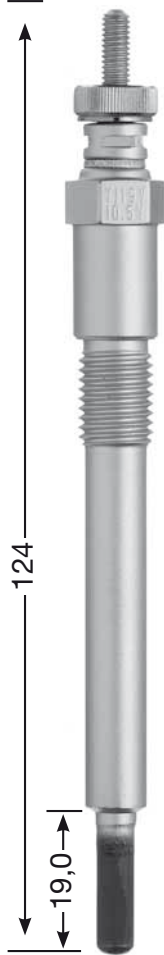

**Y-119 V**  
M 10 x 1.25  
12 Hex  
10,5 V

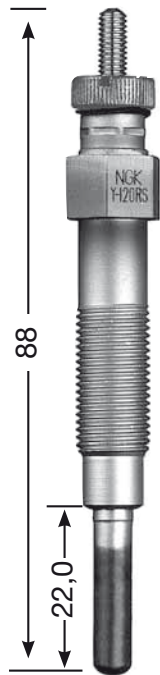

**Y-120 RS**  
M 10 x 1.0  
12 Hex  
6,5 V

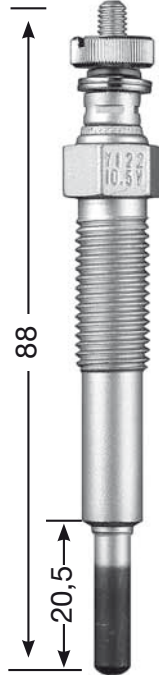

**Y-122**  
M 10 x 1.25  
12 Hex  
10,5 V

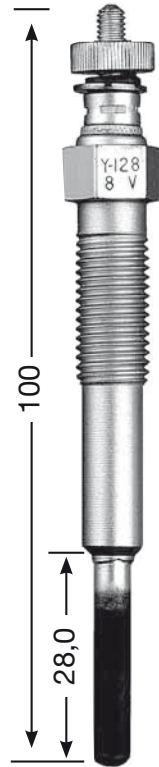

**Y-128**  
M 10 x 1.25  
12 Hex  
8 V

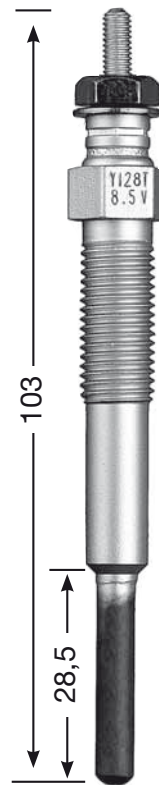

**Y-128 T**  
M 10 x 1.25  
12 Hex  
8,5 V

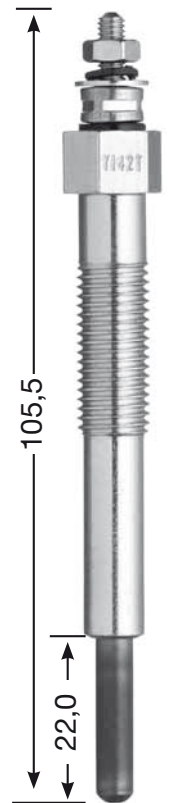

**Y-142 T**  
M 10 x 1.25  
12 Hex

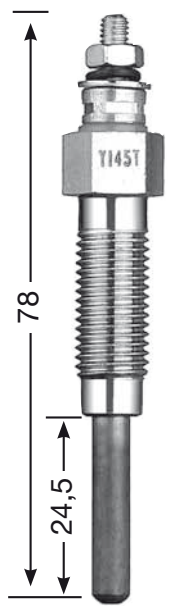

**Y-145 T**  
M 10 x 1.25  
12 Hex  
10,5 V

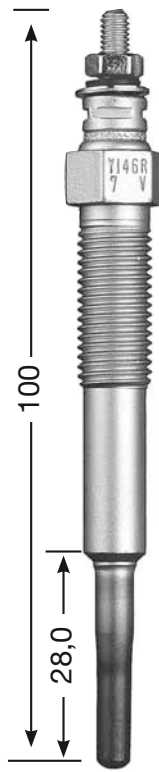

**Y-146 R**  
M 10 x 1.25  
12 Hex  
7 V

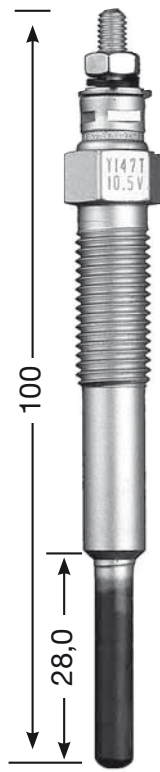

**Y-147 T**  
M 10 x 1.25  
12 Hex  
10,5 V

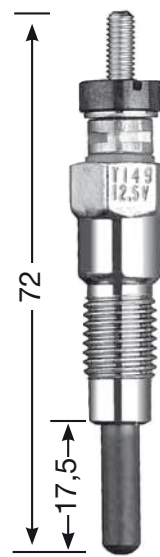

**Y-149**  
M 10 x 1.25  
12 Hex  
12,5 V

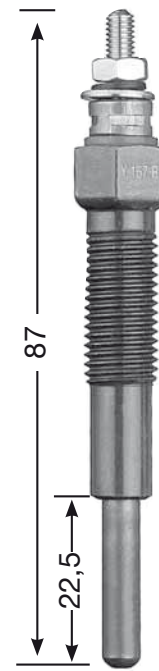

**Y-157 R**  
M 10 x 1.25  
12 Hex  
23 V

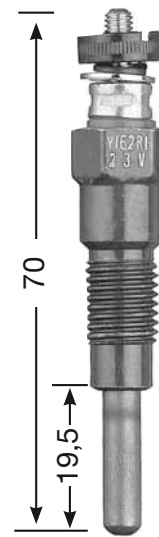

**Y-162 R1**  
M 10 x 1.25  
12 Hex  
23 V



**Y-168 R**  
M 10 x 1.25  
12 Hex  
16 V

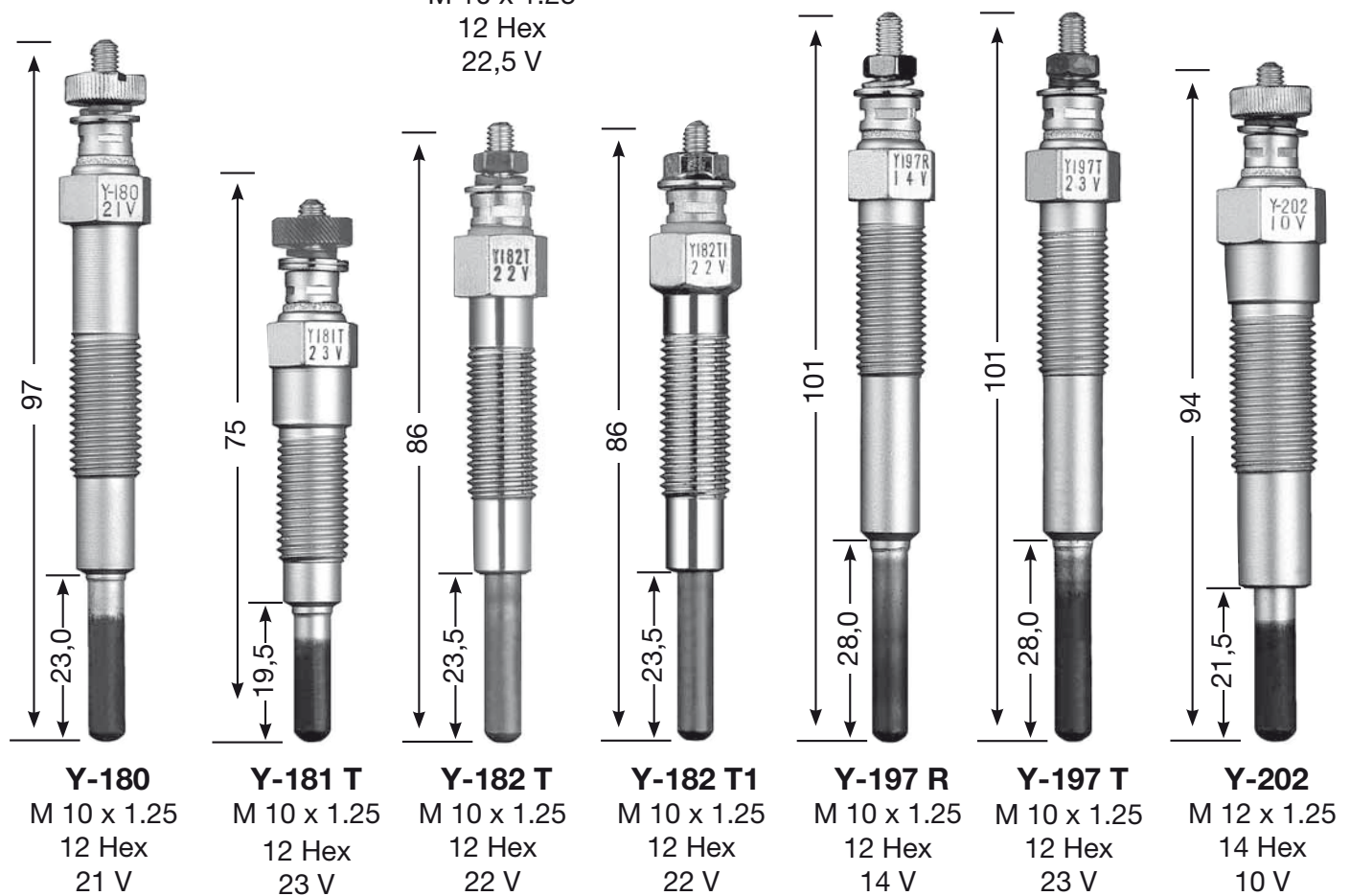
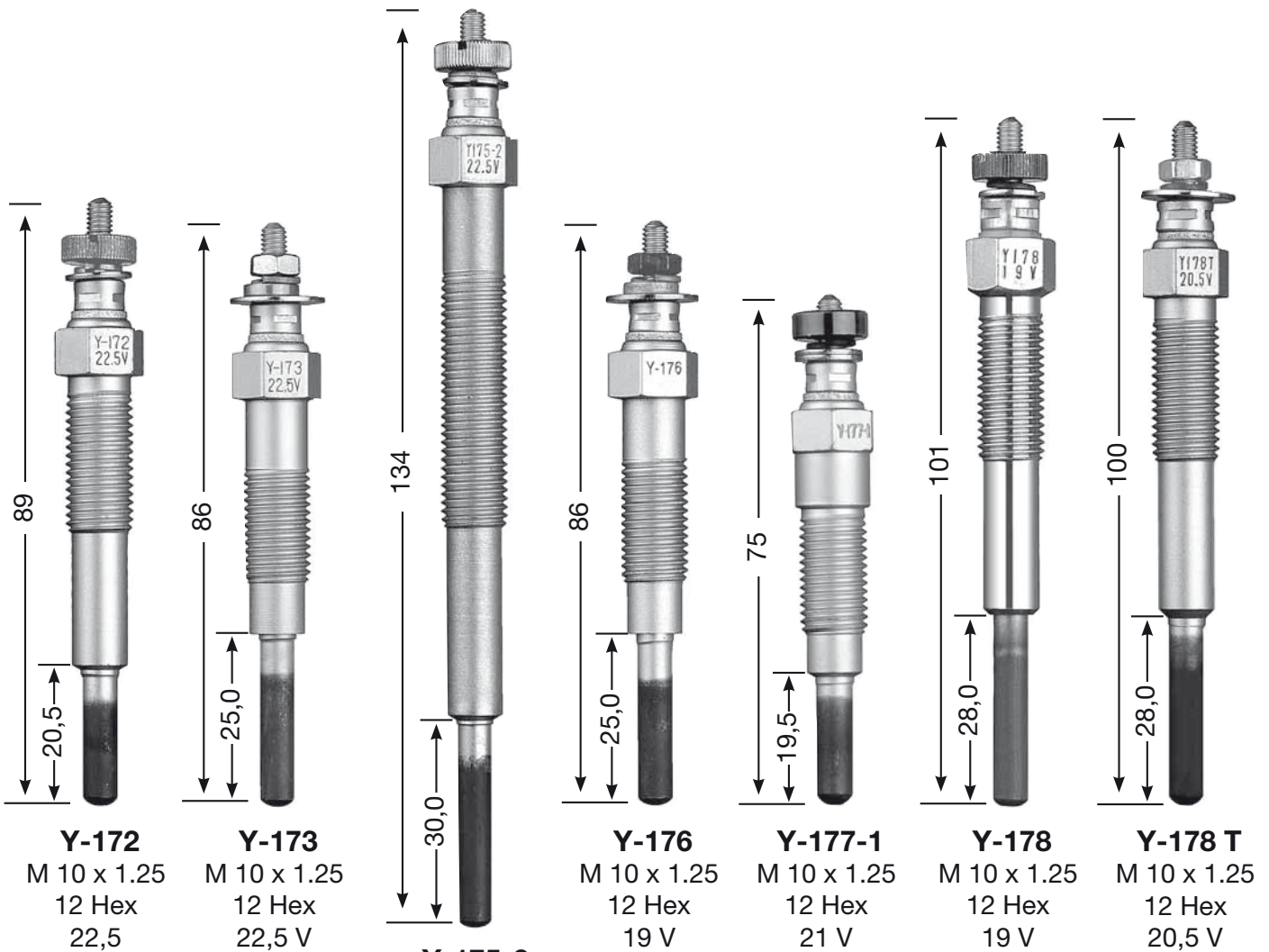

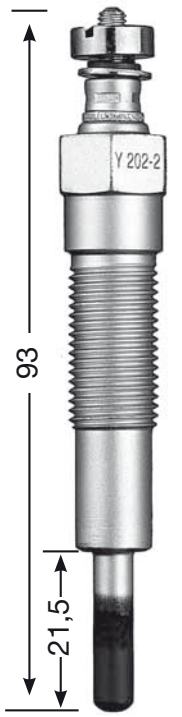

**Y-202-2**  
M 12 x 1.25  
14 Hex

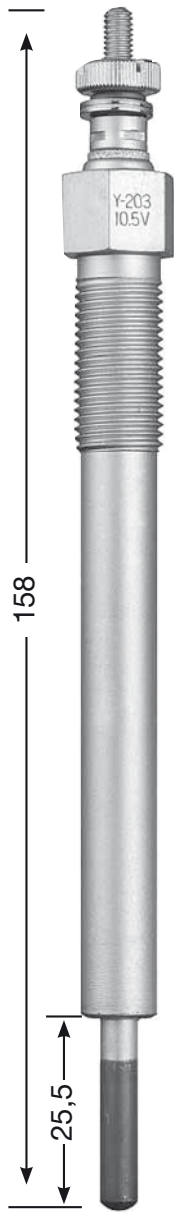

**Y-203**  
M 12 x 1.25  
14 Hex  
10,5 V

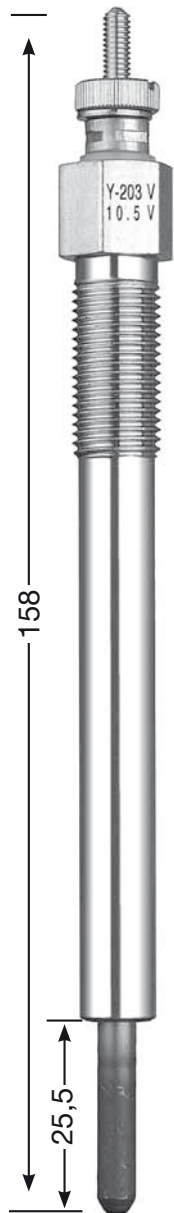

**Y-203 V**  
M 12 x 1.25  
14 Hex  
10,5 V

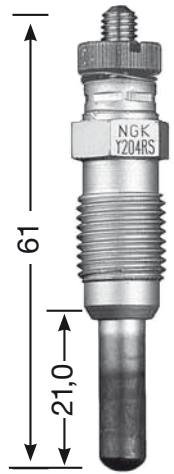

**Y-204 RS**  
M 12 x 1.25  
12 Hex  
6,5 V

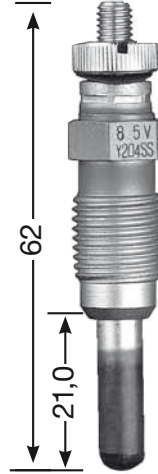

**Y-204 SS**  
M 12 x 1.25  
12 Hex  
8,5 V

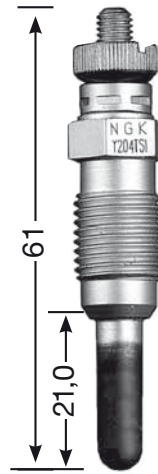

**Y-204 TS1**  
M 12 x 1.25  
12 Hex  
11 V

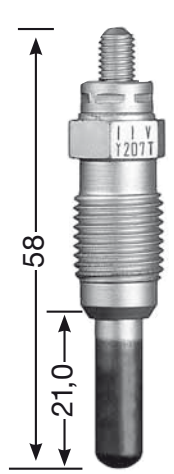

**Y-207 T**  
M 12 x 1.25  
12 Hex  
11 V

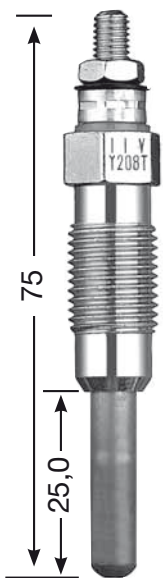

**Y-208 T**  
M 12 x 1.25  
12 Hex  
11 V

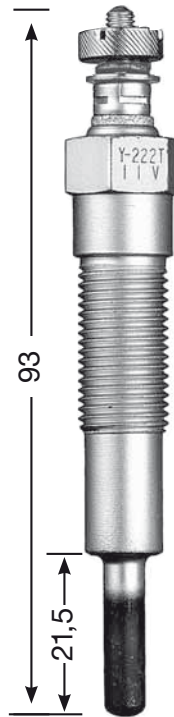

**Y-222 T**  
M 12 x 1.25  
14 Hex  
11 V

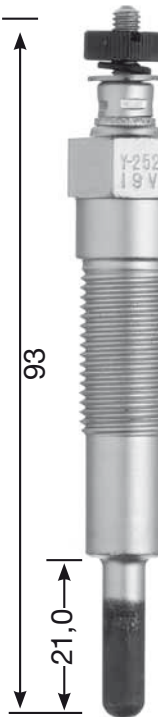

**Y-252**  
M 12 x 1.25  
14 Hex  
19 V

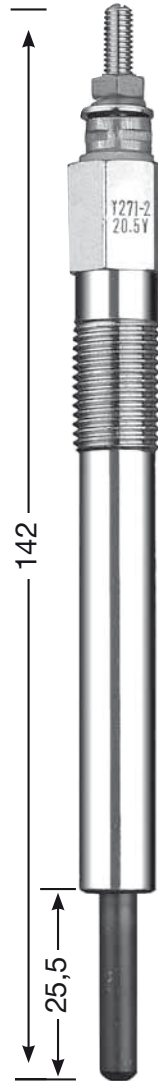

**Y-271-2**  
M 12 x 1.25  
12 Hex  
20,5 V

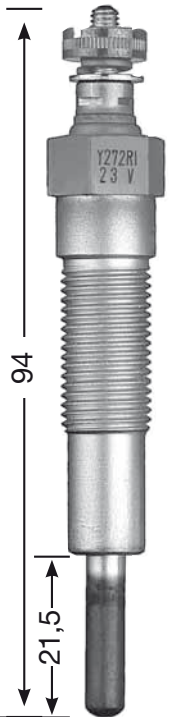

**Y-272 R1**  
M 12 x 1.25  
14 Hex  
23 V

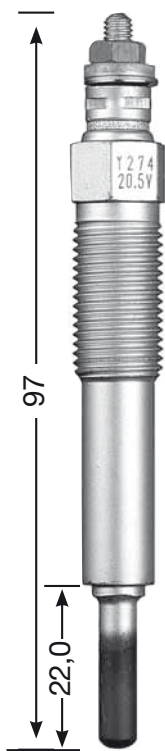

**Y-274**  
M 12 x 1.25  
12 Hex  
20,5 V

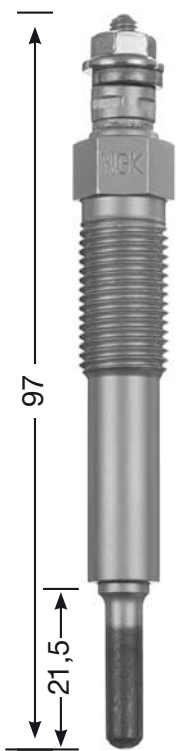

**Y-274 R**  
M 12 x 1.25  
12 Hex  
24 V

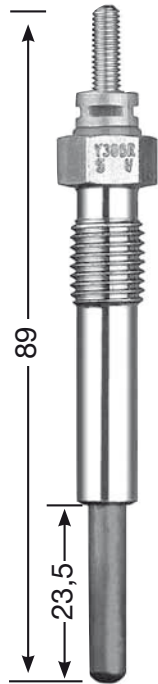

**Y-306 R**  
M 10 x 1.25  
12 Hex  
5 V

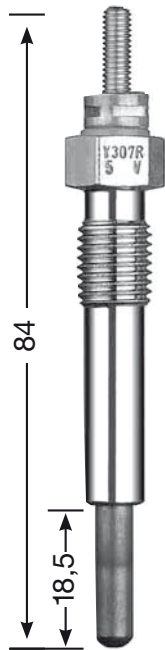

**Y-307 R**  
M 10 x 1.25  
12 Hex  
5 V



**Y-401-3**  
M 12 x 1.25  
14 Hex  
10,5 V

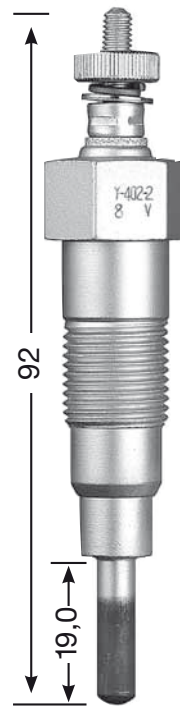

**Y-402-2**  
M 14 x 1.25  
17 Hex  
8 V

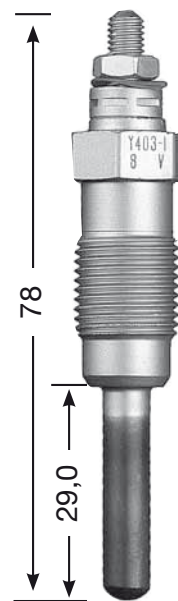

**Y-403-1**  
M 14 x 1.25  
14 Hex  
8 V

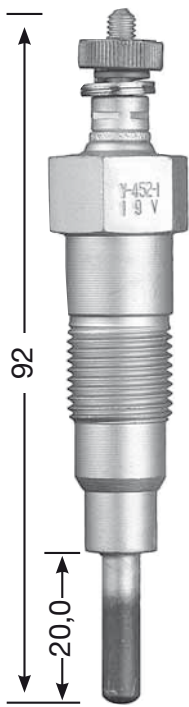

**Y-452-1**  
M 14 x 1.25  
17 Hex  
19 V

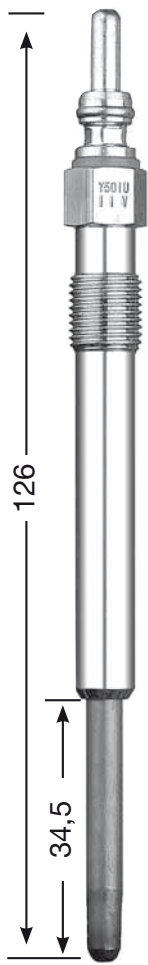

**Y-501-U**  
M 10 x 1.0  
10 Hex  
11 V  
**DP 31**

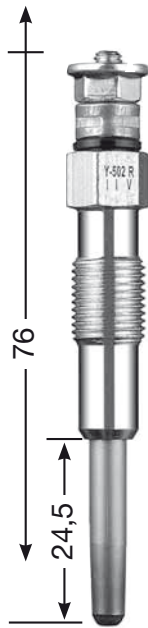

**Y-502 R**  
M 10 x 1.0  
10 Hex  
11 V

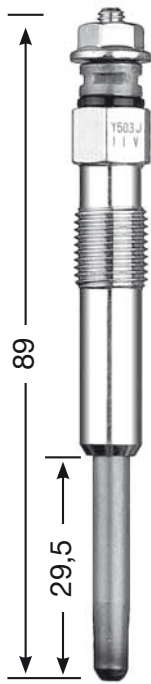

**Y-503 J**  
M 10 x 1.0  
10 Hex  
11 V  
**DP 10**  
30

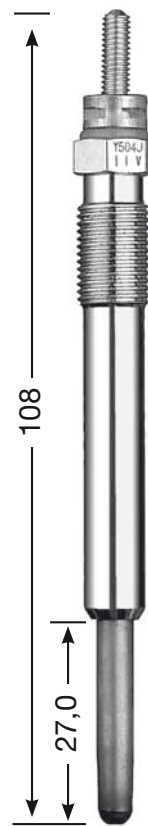

**Y-504 J**  
M 10 x 1.0  
10 Hex  
11 V  
**DP 24**

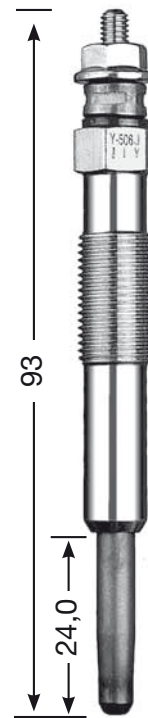

**Y-506 J**  
M 10 x 1.0  
10 Hex  
11 V  
**DP 7**



**Y-507 J**  
M 10 x 1.0  
10 Hex  
11 V  
**DP 32**



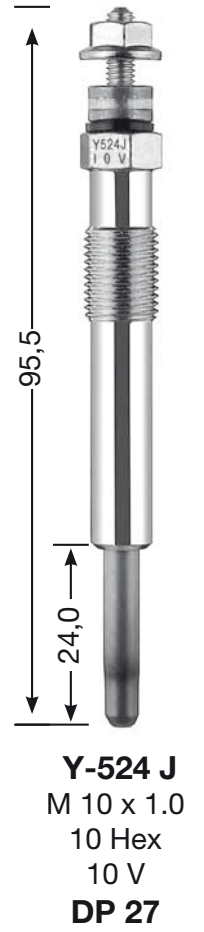
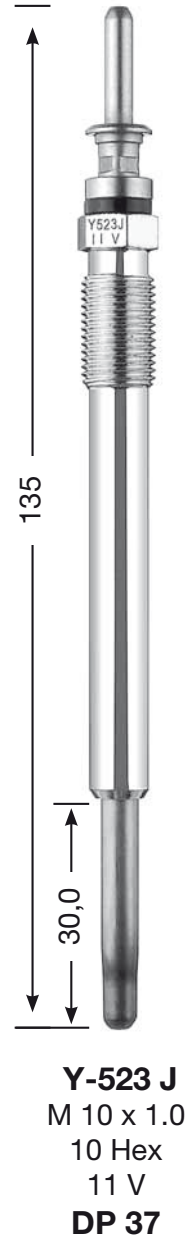
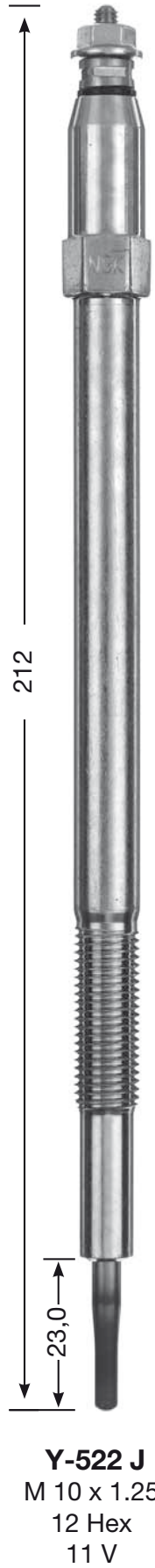
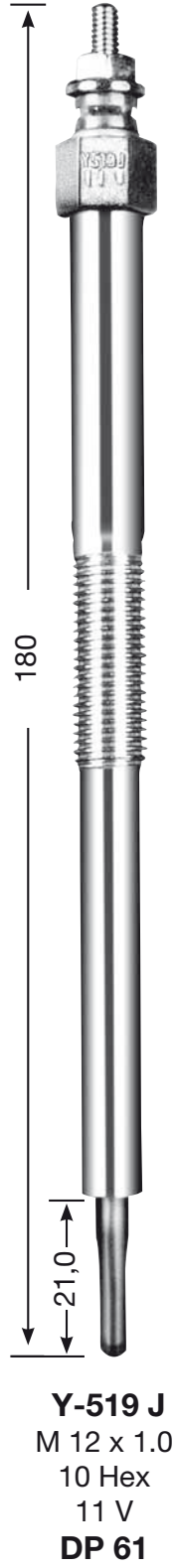
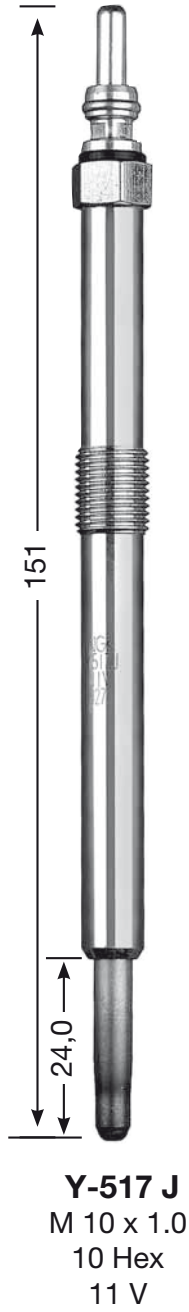
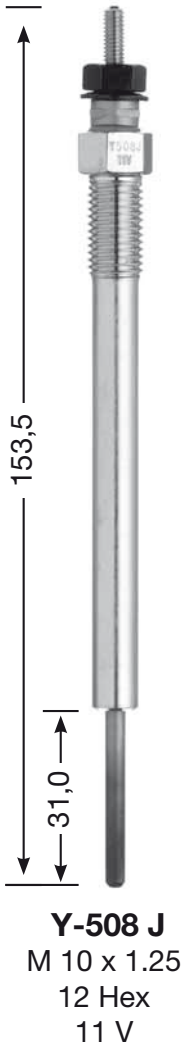

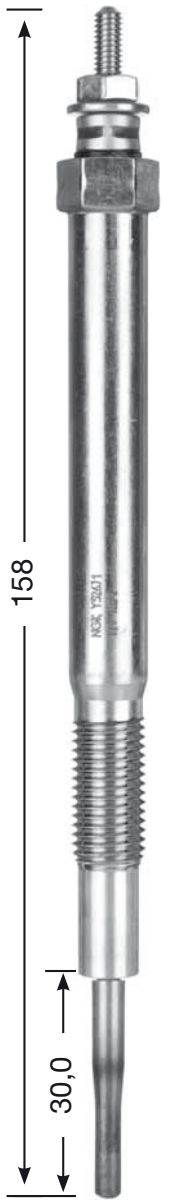

**Y-526 J1**  
 M 10 x 1.25  
 12 Hex  
 11 V  
**DP 69**

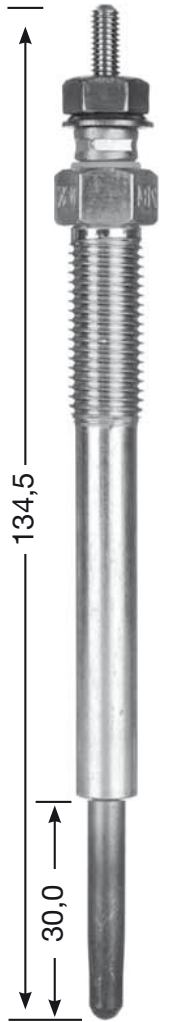

**Y-527 J**  
 M 10 x 1.25  
 12 Hex  
 11 V  
**DP 67**

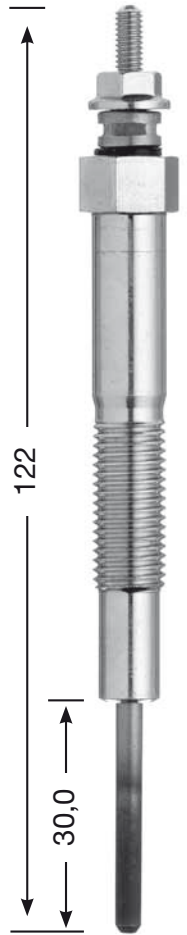

**Y-529 J**  
 M 10 x 1.25  
 12 Hex  
 11 V

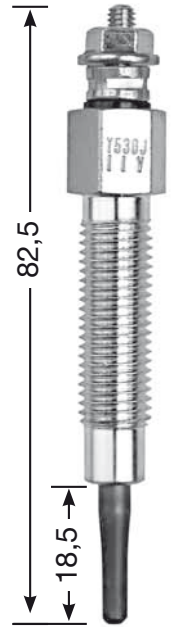

**Y-530 J**  
 M 10 x 1.25  
 12 Hex  
 11 V



**Y-531 J**  
 M 10 x 1.25  
 12 Hex  
 11 V  
**DP 44**



**Y-532 J**  
 M 10 x 1.25  
 12 Hex  
 11 V

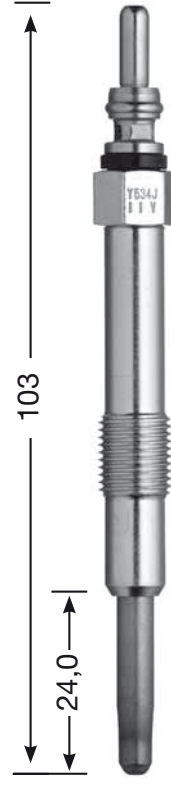

**Y-534 J**  
 M 10 x 1.0  
 10 Hex  
 11 V  
**DP 36**

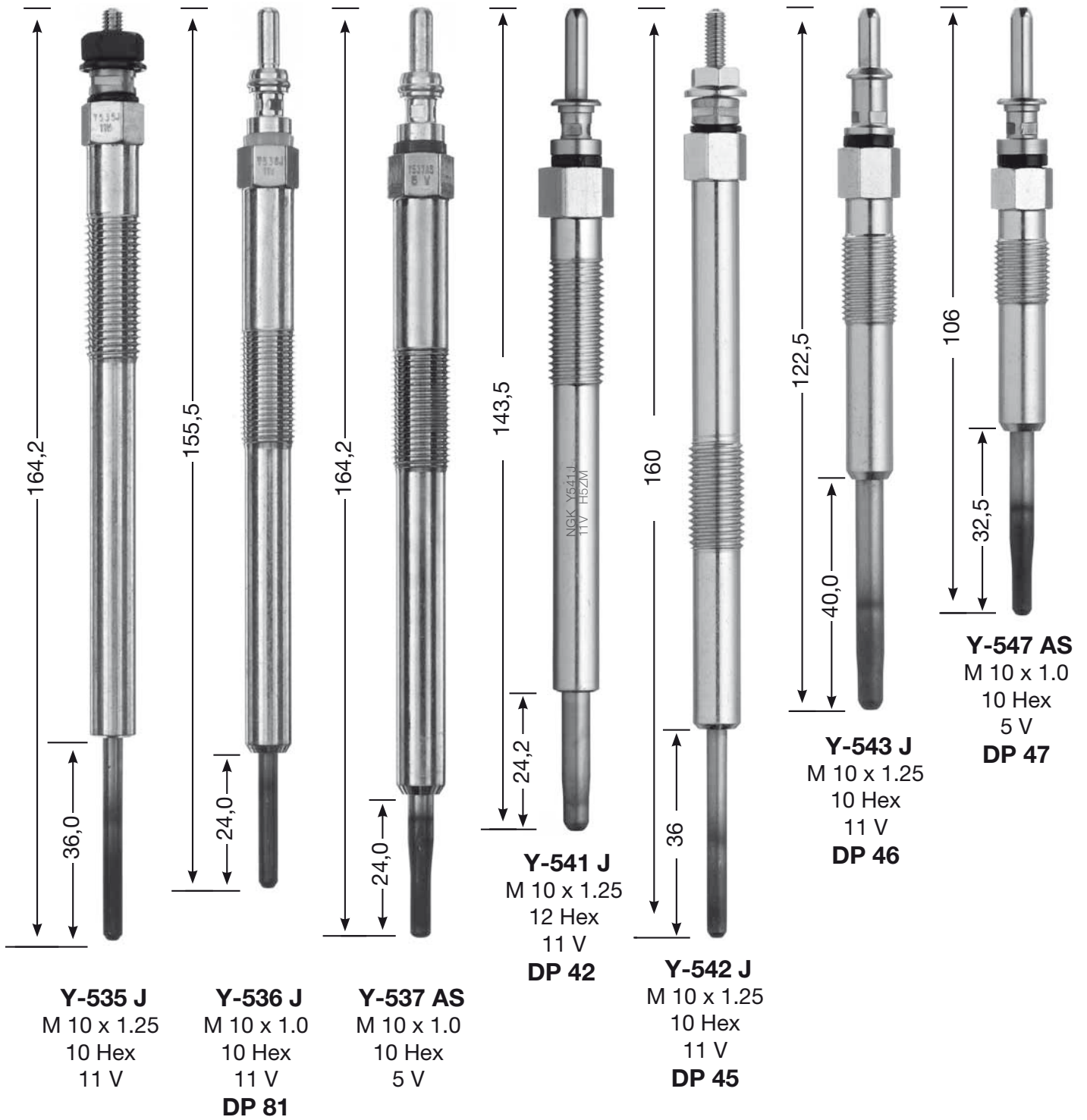



**Y-548 J**  
M 10 x 1.0  
10 Hex  
11,5 V  
DP 75



**Y-603 J**  
M 12 x 1.25  
12 Hex  
11 V  
DP 60

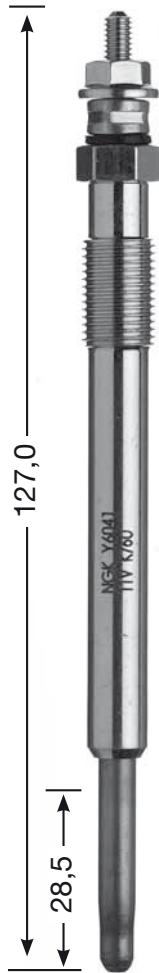

**Y-604 J**  
M 10 x 1.0  
10 Hex  
11 V



**Y-605 J**  
M 10 x 1.0  
10 Hex  
11 V



**Y-607 AS**  
M 10 x 1.0  
10 Hex  
5 V  
DP 50

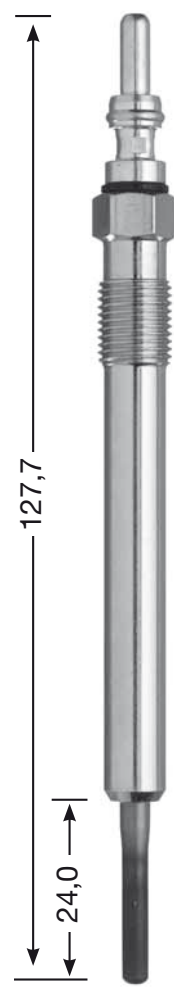

**Y-609 AS**  
M 10 x 1.0  
10 Hex  
4,4 V  
DP 49

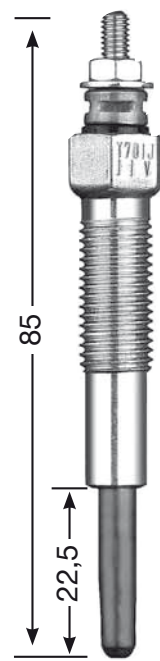

**Y-701 J**  
M 10 x 1.25  
12 Hex  
11 V  
DP 39

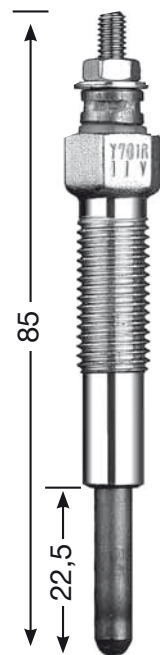

**Y-701 R**  
M 10 x 1.25  
12 Hex  
11 V

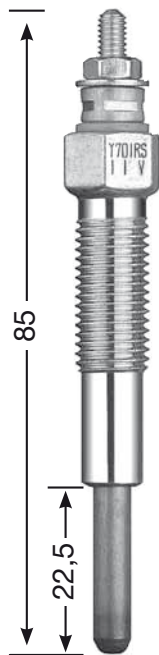

**Y-701 RS**  
M 10 x 1.25  
12 Hex  
11 V



**Y-701 U**  
M 10 x 1.25  
12 Hex  
10 V

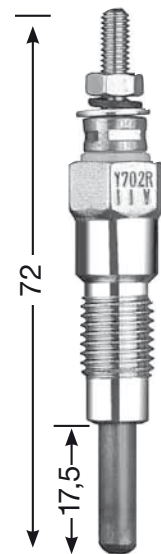

**Y-702 R**  
M 10 x 1.25  
12 Hex  
11 V

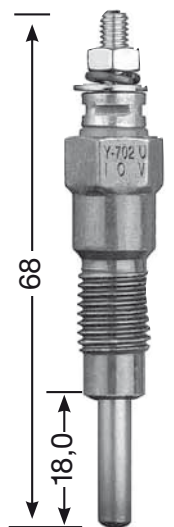

**Y-702 U**  
M 10 x 1.25  
12 Hex  
10 V



**Y-703 M1**  
M 10 x 1.25  
12 Hex  
11 V

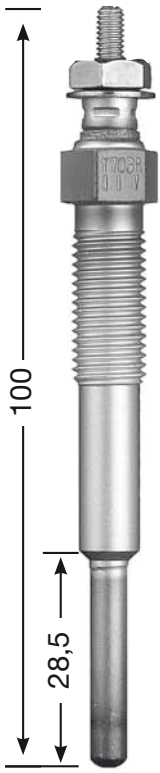

**Y-703 R**  
M 10 x 1.25  
12 Hex  
11 V

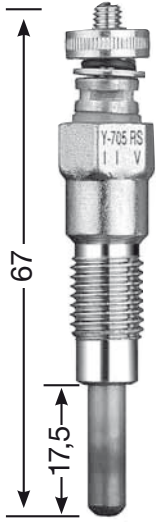

**Y-705 RS**  
M 10 x 1.25  
12 Hex  
11 V

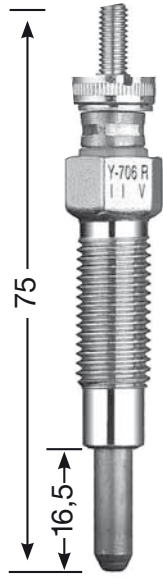

**Y-706 R**  
M 10 x 1.25  
12 Hex  
11 V

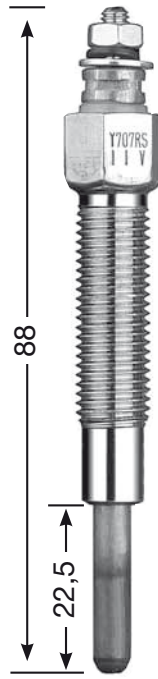

**Y-707 RS**  
M 10 x 1.25  
12 Hex  
11 V

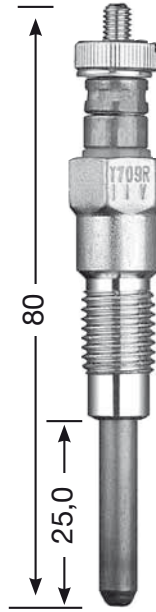

**Y-709 R**  
M 10 x 1.25  
12 Hex  
11 V

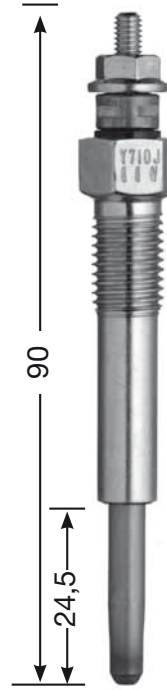

**Y-710 J**  
M 10 x 1.25  
12 Hex  
11 V



**Y-711 J**  
M 10 x 1.25  
12 Hex  
11 V  
**DP 28**

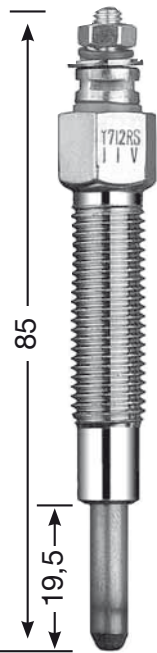

**Y-712 RS**  
M 10 x 1.25  
12 Hex  
11 V

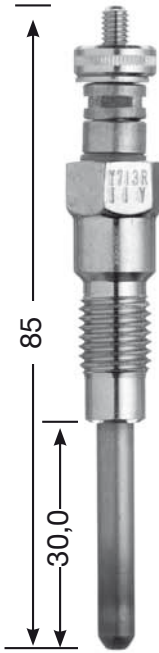

**Y-713 R**  
M 10 x 1.25  
12 Hex  
11 V

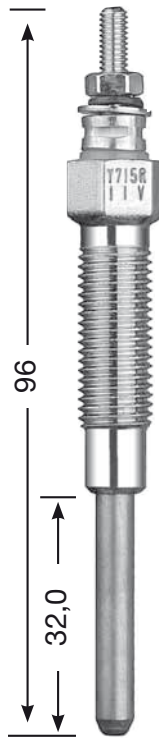

**Y-715 R**  
M 10 x 1.25  
12 Hex  
11 V

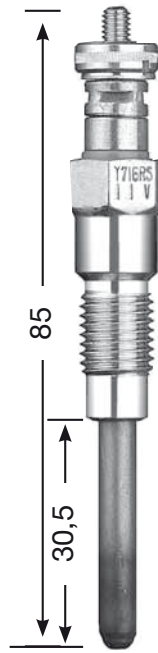

**Y-716 RS**  
M 10 x 1.25  
12 Hex  
11 V

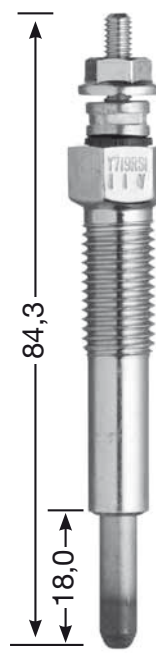

**Y-719 RS 1**  
M 10 x 1.25  
12 Hex  
11 V

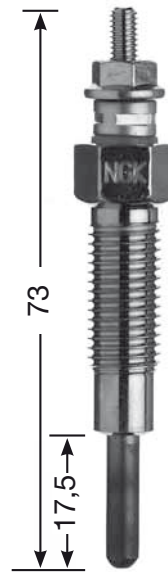

**Y-720 U1**  
M 12 x 1.25  
12 Hex  
10 V

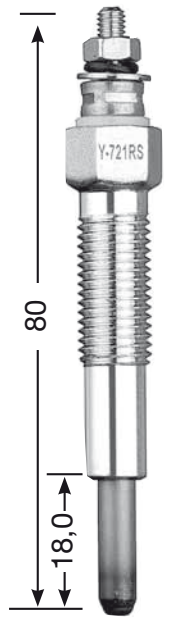

**Y-721 RS**  
M 10 x 1.25  
12 Hex  
11 V

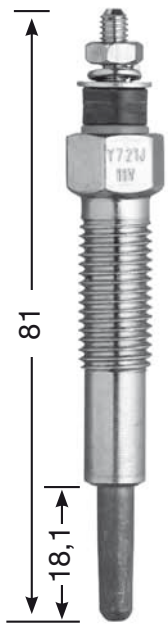

**Y-721 J**  
M 10 x 1.25  
12 Hex  
11 V

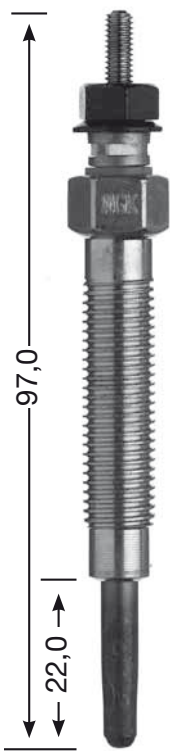

**Y-722 JS**  
M 12 x 1.25  
12 Hex  
11 V

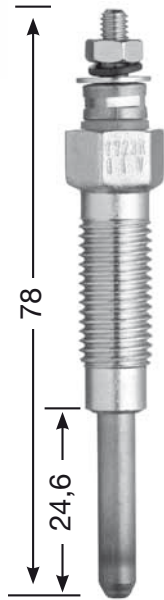

**Y-723 R**  
M 10 x 1.25  
12 Hex  
11 V



**Y-723 U**  
M 10 x 1.25  
12 Hex  
8 V

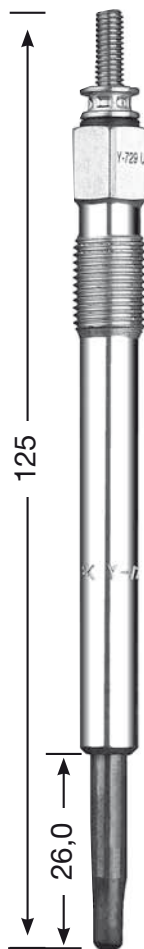

**Y-729 U**  
M 10 x 1.0  
10 Hex  
11,5 V  
DP 34

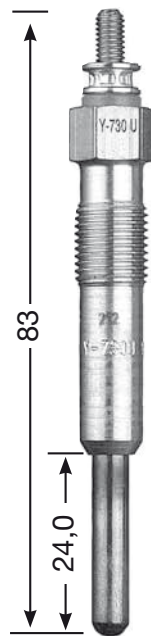

**Y-730 U**  
M 10 x 1.0  
10 Hex  
11 V  
DP 17



**Y-732 J**  
M 10 x 1.0  
10 Hex  
12 V  
DP 4

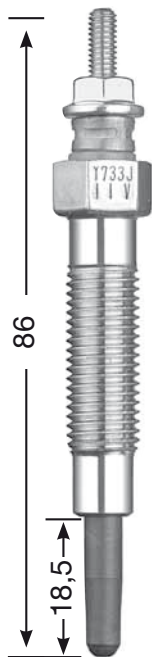

**Y-733 J**  
M 10 x 1.25  
12 Hex  
11 V  
DP 13

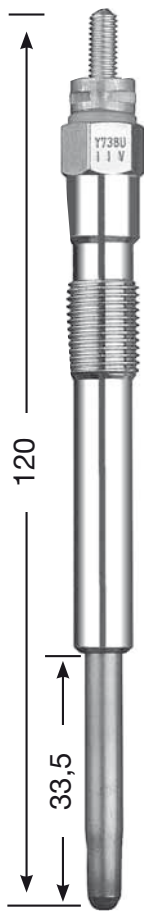

**Y-738 U**  
M 10 x 1.0  
10 Hex  
11 V

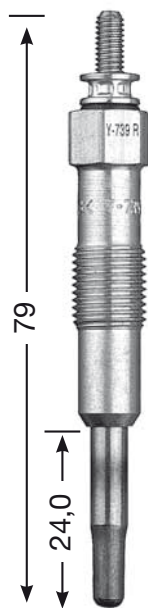

**Y-739 R**  
M 10 x 1.0  
10 Hex  
11 V

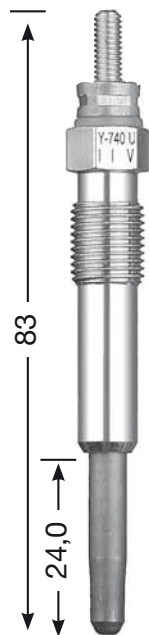

**Y-740 U**  
M 10 x 1.0  
10 Hex  
11 V  
DP 22

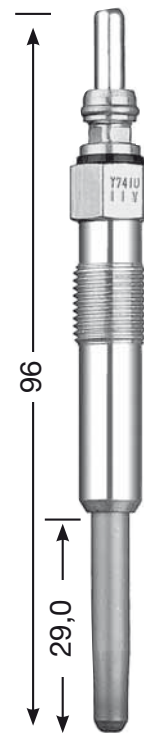

**Y-741 U**  
M 10 x 1  
10 Hex  
11 V  
DP 20

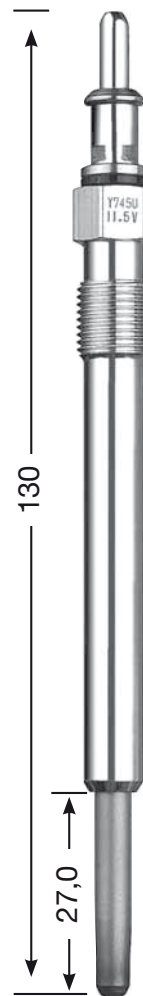

**Y-745 U**  
M 10 x 1.0  
10 Hex  
11,5 V  
DP 11

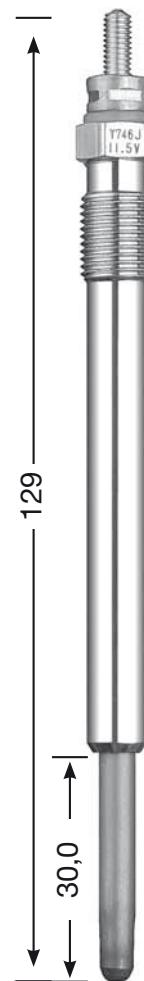

**Y-746 J**  
M 10 x 1.0  
10 Hex  
11,5 V  
DP 38

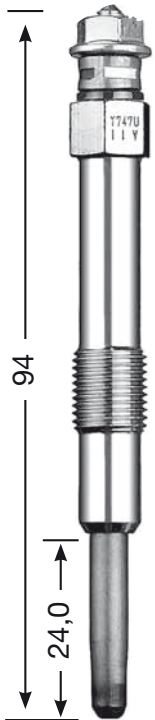

**Y-747 U**  
M 10 x 1  
10 Hex  
11 V  
DP 26

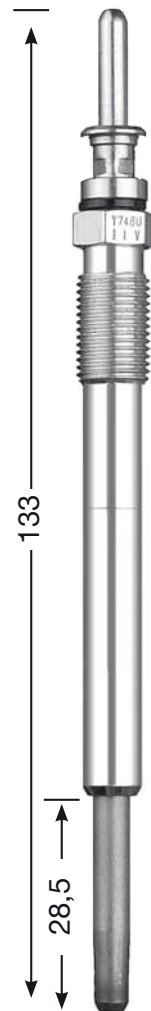

**Y-748 U**  
M 10 x 1  
10 Hex  
11 V  
DP 14

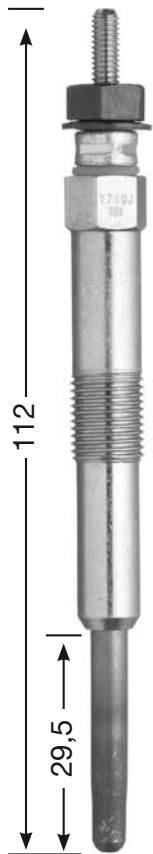

**Y-749 J**  
M 10 x 1.0  
10 Hex  
11 V



**Y-752 M**  
M 12 x 1.25  
12 Hex  
23 V



**Y-755 RS**  
M 10 x 1.25  
12 Hex  
24 V

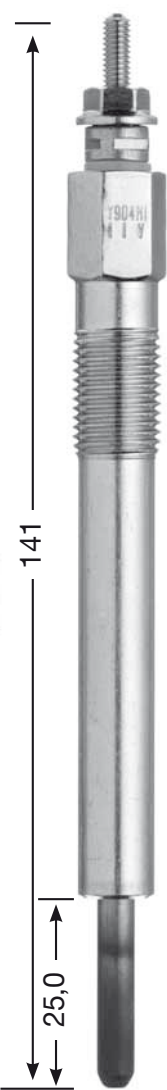

**Y-904 M1**  
M 12 x 1.25  
12 Hex  
11 V

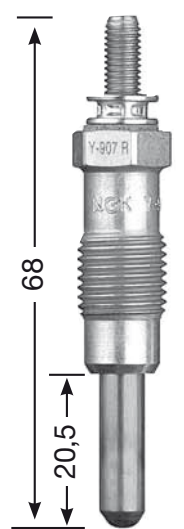

**Y-907 R**  
M 12 x 1.25  
12 Hex  
11,5 V

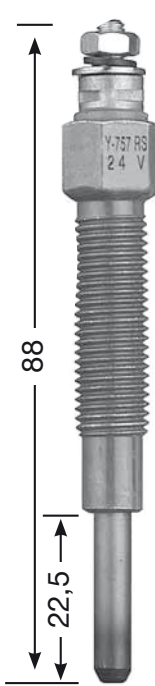

**Y-757 RS**  
M 10 x 1.25  
12 Hex  
24 V

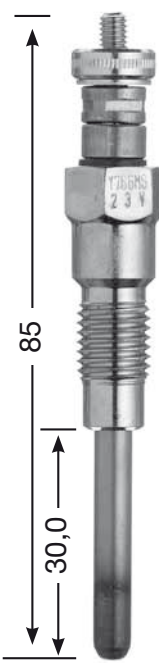

**Y-766 MS**  
M 10 x 1.25  
12 Hex  
23 V

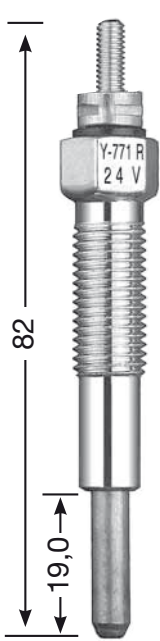

**Y-771 R**  
M 10 x 1.25  
12 Hex  
24 V

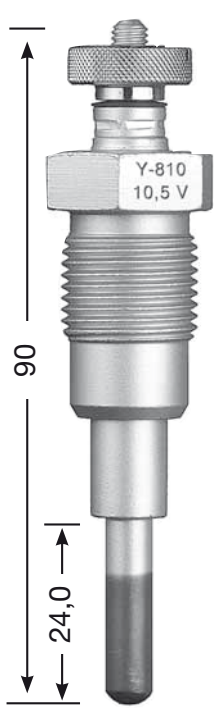

**Y-810**  
M 18 x 1.5  
20.6 Hex  
10,5 V

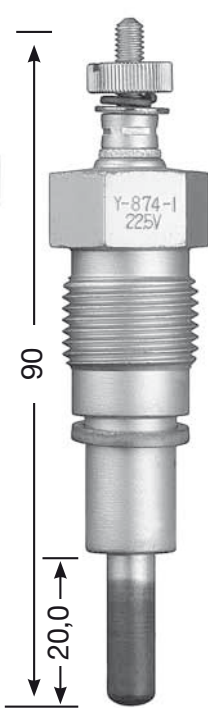

**Y-874-1**  
M 18 x 1.5  
19 Hex  
22,5 V

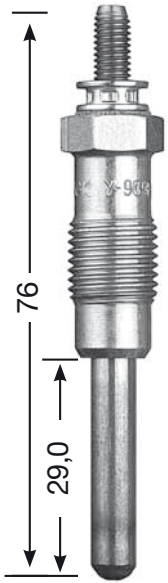

**Y-909 R**  
M 12 x 1.25  
12 Hex  
11 V

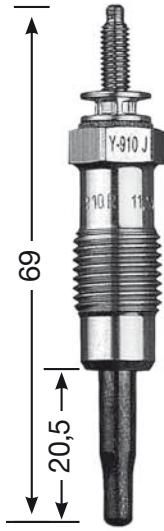

**Y-910 J**  
M 12 x 1.25  
12 Hex  
11,5 V  
**DP 3**



**Y-913 J**  
M 12 x 1.25  
12 Hex  
11 V  
**DP 15**

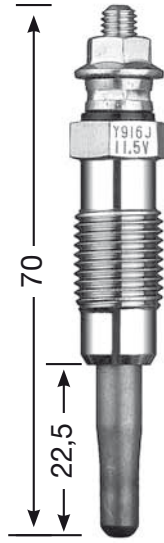

**Y-916 J**  
M 12 x 1.25  
12 Hex  
11,5 V  
**DP 6**

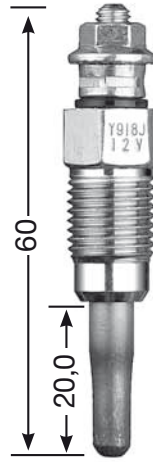

**Y-918 J**  
M 12 x 1.25  
12 Hex  
12 V  
**DP 2**

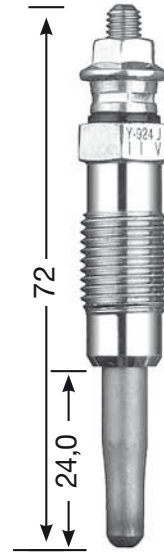

**Y-924 J**  
M 12 x 1.25  
12 Hex  
11 V  
**DP 1**

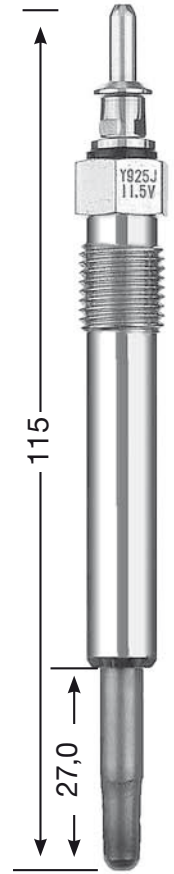

**Y-925 J**  
M 12 x 1.25  
12 Hex  
11,5 V  
**DP 16**

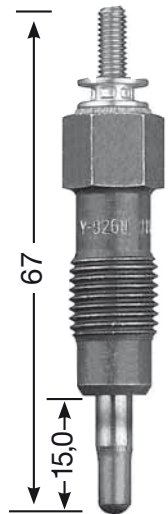

**Y-926 U**  
M 12 x 1.25  
12 Hex  
11 V

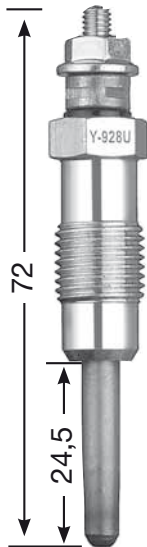

**Y-928 U**  
M 12 x 1.25  
12 Hex  
11 V  
**DP 29**

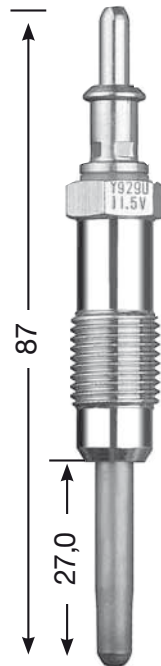

**Y-929 U**  
M 12 x 1.25  
12 Hex  
11,5 V  
**DP 41**

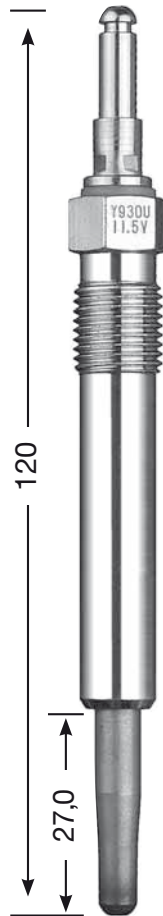

**Y-930 U**  
M 12 x 1.25  
12 Hex  
11,5 V  
**DP 30**

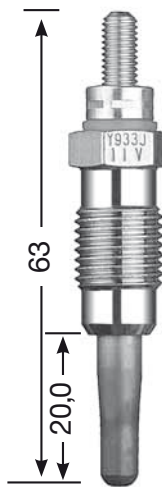

**Y-933 J**  
M 12 x 1.25  
12 Hex  
11 V  
**DP 25**

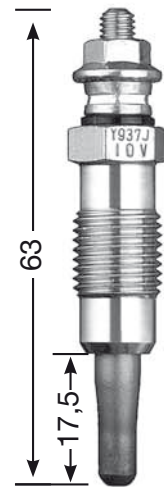

**Y-937 J**  
M 12 x 1.25  
12 Hex  
10 V  
**DP 5**

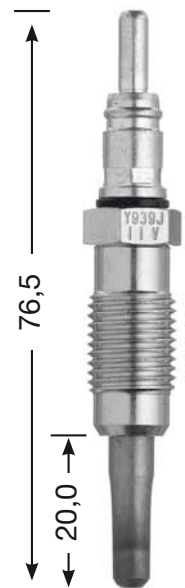

**Y-939 J**  
M 12 x 1.25  
12 Hex  
11 V  
**DP 43**



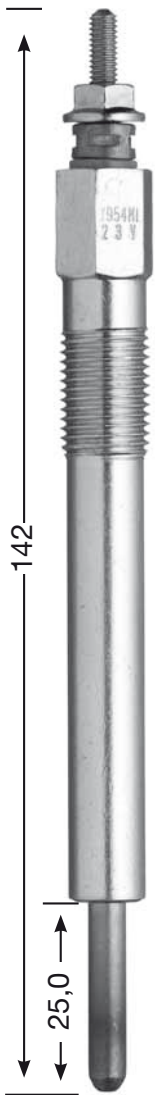

**Y-954 M1**  
M 12 x 1.25  
12 Hex  
23 V



**Y-955 RS**  
M 12 x 1.25  
14 Hex  
24 V

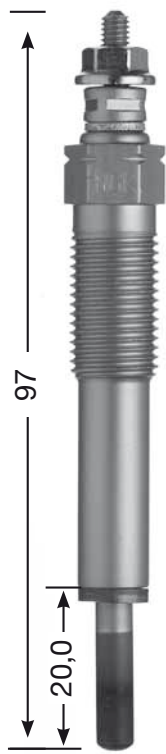

**Y-971 M**  
M 12 x 1.25  
12 Hex  
23 V



**Y1001 J1**  
M 10 x 1.25  
12 Hex  
11 V

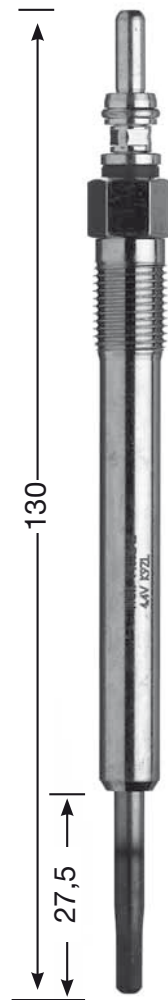

**Y1002 AS**  
M 10 x 1.0  
10 Hex  
4,4 V  
**DP 57**



**Y1003 AS**  
M 10 x 1.25  
10 Hex  
5 V



**Y1005 J**  
M 10 x 1.0  
10 Hex  
11 V  
**DP 56**

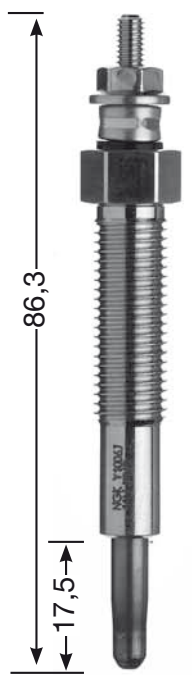

**Y1006 J**  
M 12 x 1.25  
12 Hex  
11 V



**Y1007 J**  
M 12 x 1.25  
12 Hex  
11 V  
**DP 59**



**Y1010 AS**  
M 10 x 1.0  
10 Hex  
4,5 V

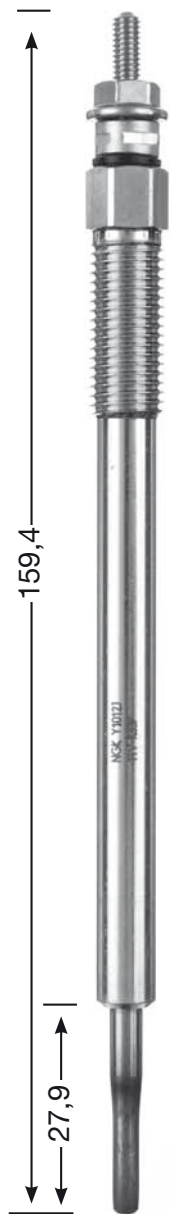

**Y1012 J**  
M 10 x 1.25  
10 Hex  
11 V  
**DP 65**



**Y1013 J**  
M 10 x 1.25  
10 Hex  
11 V  
**DP 63**

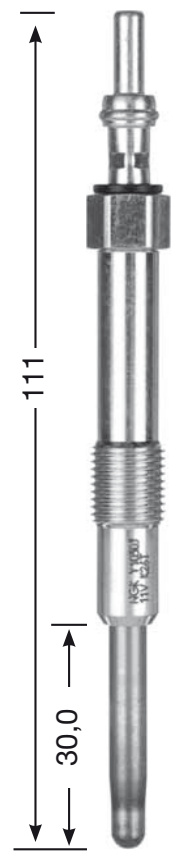

**Y1030 J**  
M 10 x 1.0  
10 Hex  
11 V  
**DP 70**

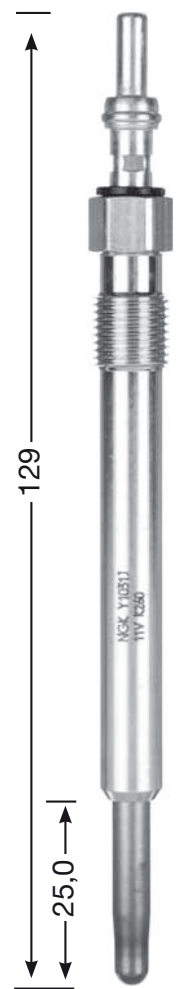

**Y1031 J**  
M 10 x 1.0  
10 Hex  
11 V  
**DP 71**



**Y1036 AS**  
M 10 x 1.0  
10 Hex  
4,4 V

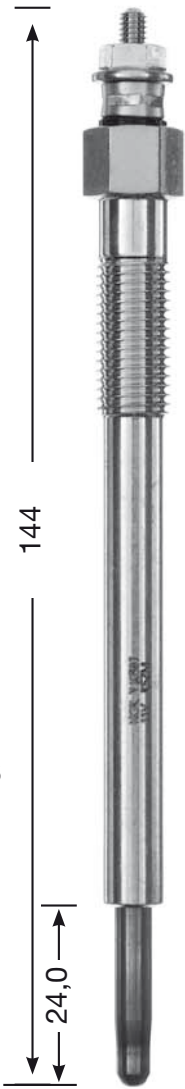

**Y1038 J**  
M 10 x 1.0  
12 Hex  
11 V



**Y8001 AS**  
M 8 x 1.0  
8 Hex  
5 V  
DP 58

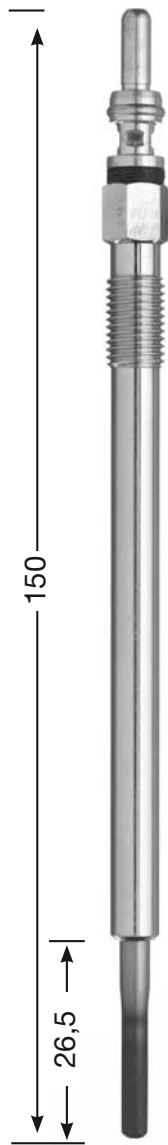

**Y-8002 AS**  
M 8 x 1.0  
8 Hex  
4,4 V  
DP 51

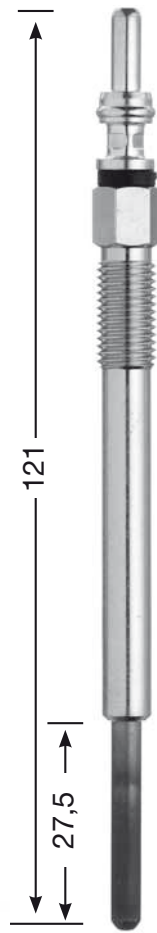

**Y8003 J**  
M 8 x 1.0  
8 Hex  
11 V  
DP 62



**Y8005 J**  
M 8 x 1.0  
8 Hex  
11 V  
DP 51



**Y8008 AS**  
M 8 x 1.0  
8 Hex  
11 V  
DP 74

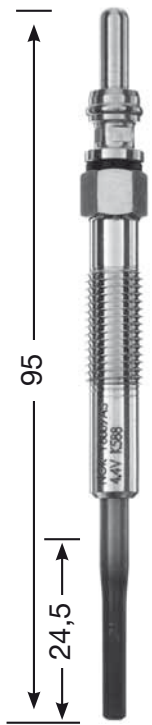

**Y8009 AS**  
M 8 x 1.0  
8 Hex  
4,4 V



**Y9001 AS**  
M 9 x 1.0  
9 Hex  
4,3 V  
DP 72

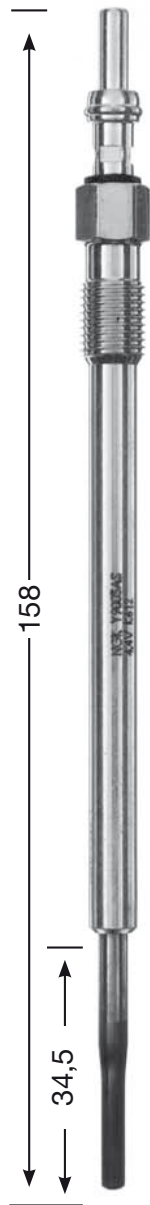

**Y9003 AS**  
M 9 x 1.0  
9 Hex  
4,4 V  
DP 72



**Y9004 AS**  
M 9 x 1.0  
9 Hex  
4,4 V  
DP 72

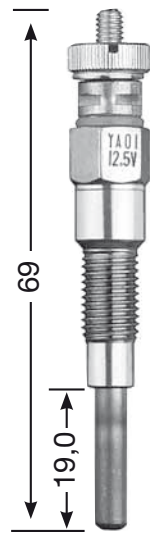

**YA 01**  
M 8 x 1.0  
10 Hex  
12,5 V

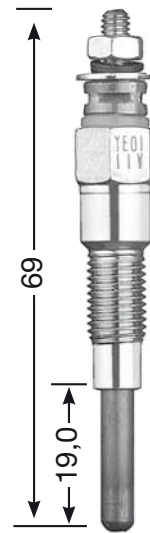

**YE 01**  
M 8 x 1.0  
10 Hex  
11 V



**YE 04**  
M 8 x 1.0  
8 Hex  
11 V  
DP 40

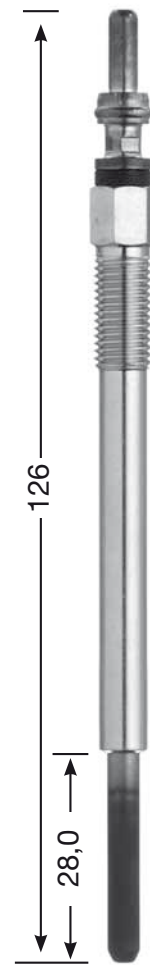

**YE 05**  
M 8 x 1.0  
8 Hex  
11 V

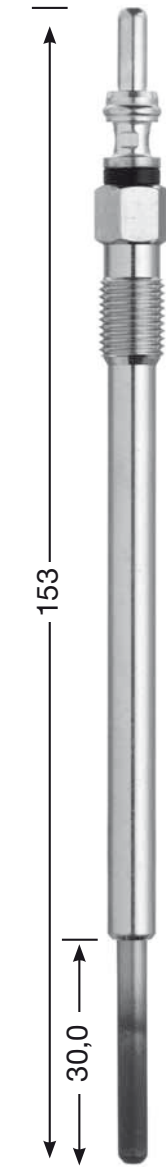

**YE 07**  
M 9 x 1.0  
9 Hex  
11 V

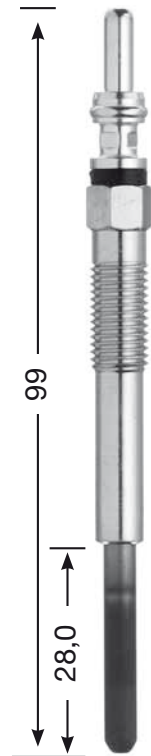

**YE 08**  
M 8 x 1.0  
8 Hex  
11 V

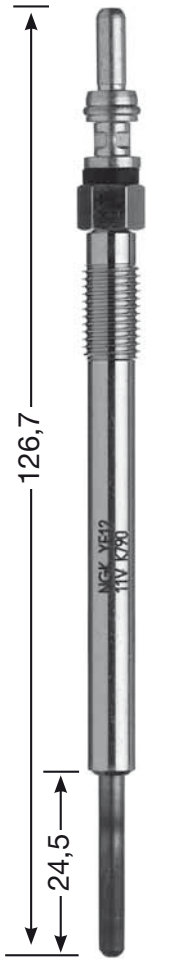

**YE 12**  
M 8 x 1.0  
8 Hex  
11 V

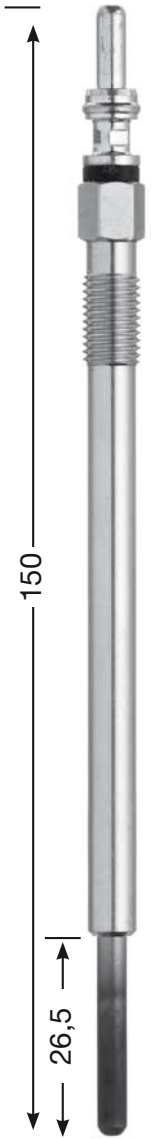

**YE 13**  
M 8 x 1.0  
8 Hex  
11,5 V

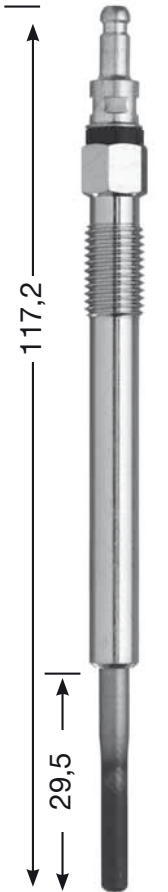

**YE 14**  
M 8 x 1.0  
8 Hex  
4,4 V  
**DP 48**

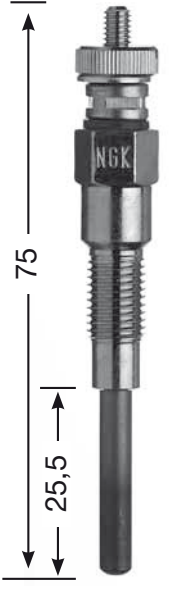

**YE 52**  
M 10 x 1.0  
10 Hex  
23 V

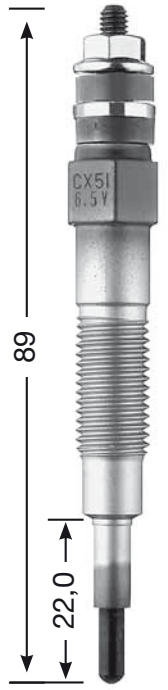

**CX 51**  
M 10 x 1.25  
10 Hex  
6,5 V

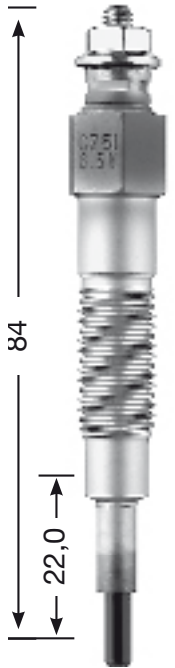

**CZ 51**  
M 10 x 1.25  
12 Hex  
6,5 V



**CZ 104**  
M 10 x 1.0  
10 Hex  
7 V  
**DP 52**



**CZ 105**  
M 10 x 1.0  
10 Hex  
7 V

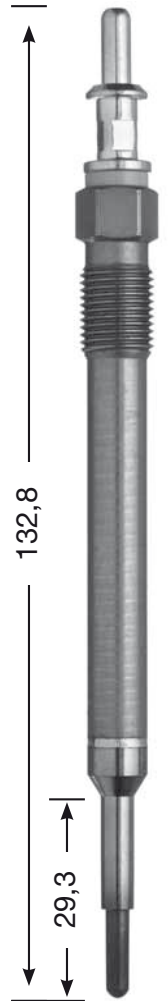

**CZ 106**  
M 10 x 1.0  
10 Hex  
7 V  
**DP 53**



**CZ 158**  
M 10 x 1.0  
10 Hex  
7 V

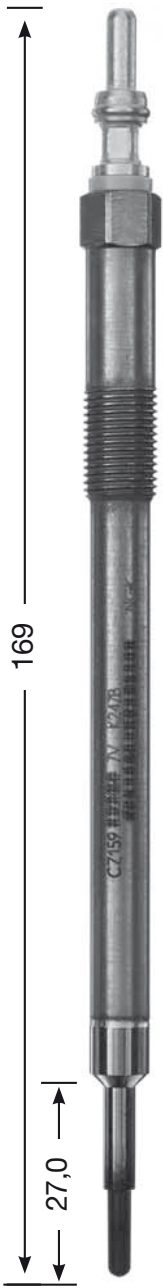

**CZ 159**  
M 10 x 1.0  
10 Hex  
7 V  
DP 84

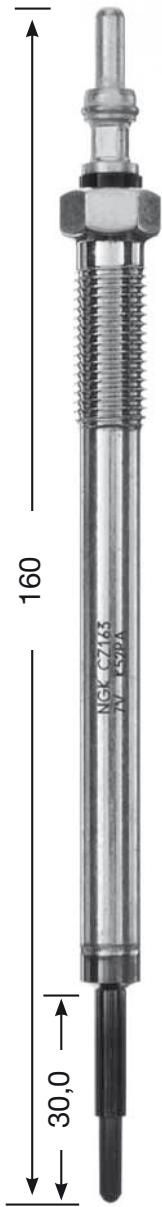

**CZ 163**  
M 10 x 1.25  
12 Hex  
7 V  
DP 82



**CZ 165**  
M 10 x 1.25  
10 Hex  
7 V  
DP 87



**CZ 203**  
M 10 x 1.25  
12 Hex  
11 V  
DP 68

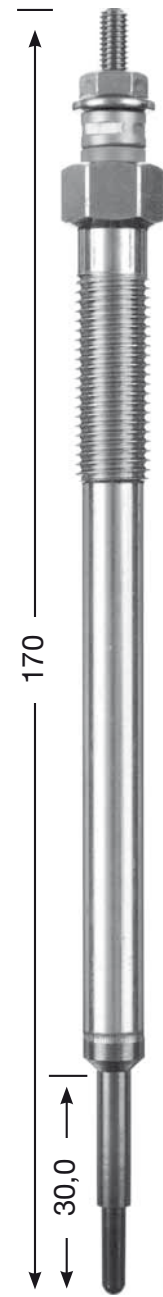

**CZ 251**  
M 10 x 1.25  
12 Hex  
11 V  
DP 76



**CZ 256**  
M 10 x 1.25  
12 Hex  
11 V

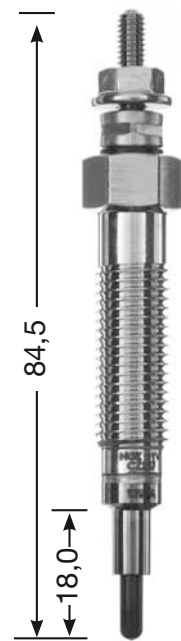

**CZ 257**  
M 10 x 1.25  
12 Hex  
11 V  
DP 83



**CZ 258**  
M 10 x 1.25  
12 Hex  
11 V

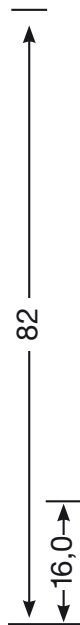

**CZ 261**  
M 10 x 1.25  
12 Hex  
11 V



**CZ 262**  
M 10 x 1.25  
12 Hex  
11 V  
DP 13

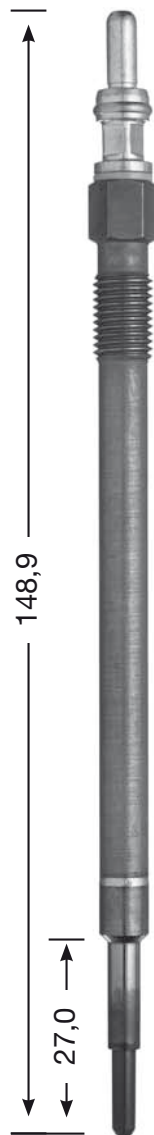

**CZ 303**  
M 8 x 1.0  
8 Hex  
7 V  
DP 54

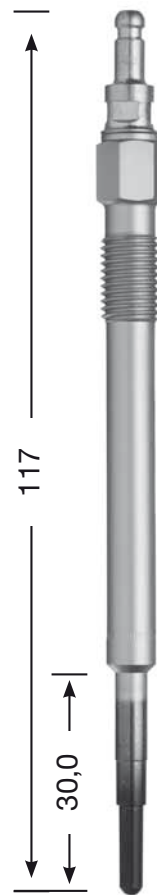

**CZ 304**  
M 8 x 1.0  
8 Hex  
7 V  
DP 55



**CZ 551**  
M 10 x 1.0  
8 Hex  
12 V  
DP 85

This catalogue supersedes all previous catalogs.

NGK Spark Plug Europe GmbH has made its best effort

to ensure an accurate information, based on information available at the time of the compilation of the catalog.

This catalog is made for information only. NGK Spark Plug Europe GmbH will not accept liability for any inaccuracy.

Product linkage to vehicles or tools applications from this publication are considered under normal condition of use,

fitted by a professional and for vehicles registered in Europe. For all different usage or post equipment, the

responsibility of NGK cannot be engaged. All ordered products are subject to valid terms and conditions supplied by

NGK Spark Plug Europe GmbH. Pictures, diagrams and drawings in this publication are not contractual. The property

of the pictures, diagrams, drawings and other graphic elements and data belong to NGK Spark Plug Europe GmbH

exclusively. Reproduction of this publication, partial or total, is strictly prohibited without a prior written authorization of

NGK Spark Plug Europe GmbH.





l kW  
C  
y  
i

0201



Stock-No

VALVE

LPG / CNG

## ABARTH

500 1.4 T-Jet 16V	1.4	99	4	08.08-		0,8	IKR9J8	93311		
500 Abarth	1.4	103	4	06.10-		0,8	IKR9J8	93311		
Grande Punto 1.4 T-Jet 16V	1.4	114	4	12.07-	199A8000	0,8	IKR9J8	93311		
Grande Punto 1.4 T-Jet 16V	1.4	132	4	09.09-		0,8	IKR9J8	93311		
Punto EVO Abarth	1.4	120	4	06.10-		0,8	IKR9J8	93311		

## ACURA

Legend LX	2.5	122	6	01.86-12.87	C25A1	1,1	BCPR6E-11	3132	11	LPG 3
RSX	2.0	147	4	.02- .03	K20A2	1,1	IFR7G-11KS	7746		
RSX	2.0		4	.02- .02	K20A3	1,1	IZFR6K11	6994		
SLX	3.2		6	.96- .97	6VD1	1,1	PFR5G-11	2647		PFR6G-11
SLX	3.5		6	.98-	6VE1	1,1	PFR5G-11	2647		PFR6G-11

## ALFA ROMEO

### 4C

4C 1.8 Tbi	1.8	177	4	03.13-	960A1000	0,6	ILKAR7D6G	93607		
------------	-----	-----	---	--------	----------	-----	-----------	-------	--	--

### 8C

8C 4.7	4.7	331	8	01.07-10.10	F136YC	0,7	PMR8C-H	96361		
--------	-----	-----	---	-------------	--------	-----	---------	-------	--	--

### 33

33 i.e	1.3	65	4	02.94-10.94	AR307.32	0,7	BP6ES	7811	4	LPG 2
33 i.e Sport Wagon	1.3	65	4	02.94-10.94	AR307.32-301.68	0,7	BP6ES	7811	4	LPG 2
33 -1.3 L	1.3		4	.87-01.94	AR305.02-86-87	0,7	BP6ES	7811	4	LPG 2
33 i.e.	1.4	66	4	01.92-12.93	AR307.53	0,7	BP6ES	7811	4	LPG 2
33 i.e.; Cat.	1.5	74	4	12.90- .93	AR307.51	0,7	BP6ES	7811	4	LPG 2
33 -1.5 L	1.5	77	4	.84- .93	AR307.34-305.88	0,7	BP6ES	7811	4	LPG 2
33 i.e. all 1.7 Ltr. cat.	1.7	77	4	.90- .93	AR307.46-47	0,9	PFR6B	3500		PFR7B
33 i.e.-1.7 L	1.7	85	4	.88- .93	AR305.50	0,7	BP6ES	7811	4	LPG 2
33 i.e.- 1.7 Ltr.16V	1.7	95	4	01.88-12.93	AR307.36-37	0,9	PFR6B	3500		PFR7B

### 75

75	1.6	81	4	05.85-09.89	AR061.00	0,7	BP6ES	7811	4	LPG 2
75	1.8	89	4	05.85-09.89	AR062.02	0,7	BP6ES	7811	4	LPG 2
75 i. Turbo	1.8	121	4	12.86-12.87	AR061.58	0,7	BP6ES	7811	4	LPG 2
75	2.0	94	4	05.85-10.88	AR062.12	0,7	BP6ES	7811	4	LPG 2
75 i.T.S.	2.0	106	4	01.87-02.92	AR061.66 Cat.-062.24	0,7	BCP6ES	4930	17	LPG 3
75 i. V6	2.5	110	6	09.85-02.92	AR016.46-019.11 Cat.	0,8	BP7ES	2412		BPR8EIX
75 i. V6	3.0	133	6	01.87-02.92	AR061.20-061.24 Cat.	0,7	BP6ES	7811	4	LPG 2
75 i. V6	3.0	139	6	02.90-02.92	AR061.503	0,7	PGR6A	4984		PGR7A

### 145

145 i.e L	1.4	66	4	08.94-11.96	AR33.501	0,7	BP6ES	7811	4	LPG 2
145 i. 16V T.S.	1.4	76	4	12.96-12.01	AR33.503		BKR6EKPA + PMR7A	2513+ 4259		
145 i.e L	1.6	76	4	08.94-11.96	AR33.201	0,7	BP6ES	7811	4	LPG 2
145 i. 16V T.S. L	1.6	88	4	09.97-12.00	AR67.601		BKR6EKPA + PMR7A	2513+ 4259		
145 i.e 16V	1.7	95	4	08.94-11.96	AR33.401	0,9	PFR6B	3500		PFR7B
145 i. T.S. 16V- L	1.8	103	4	12.96-03.98	AR67.106		BKR6EKPA + PMR7A	2513+ 4259		
145 i. 16V T.S.	1.8	106	4	03.98-12.01	AR32.201		BKR6EKPA + PMR7A	2513+ 4259		



e kW

C  
Y  
I

0201



Stock-No

VELINE

LPG / CNG

**ALFA ROMEO****145**

145 i. 16V T.S. Quadrifoglio (Brazil)	2.0	110	4	10.95-04.01	AR67.204		BKR6EKPA + PMR7A	2513+ 4259		
145 i 2.0 16V T.S.	2.0	114	4	03.98-04.01	AR32.301		BKR6EKPA + PMR7A	2513+ 4259		

**146**

146 i.e- L	1.4	66	4	08.94-02.97	AR33.501	0,7	BP6ES	7811	4	LPG 2
146 T.S.	1.4	76	4	11.96-12.01	AR33.503		BKR6EKPA + PMR7A	2513+ 4259		
146 i T.S. 16V	1.4	76	4	02.97-12.01	AR33.503		BKR6EKPA + PMR7A	2513+ 4259		
146 i.e.	1.6	66	4	07.95-11.97	AR33.201	0,7	BP6ES	7811	4	LPG 2
146 i.e L	1.6	76	4	07.94-12.97	AR33.201	0,7	BP6ES	7811	4	LPG 2
146 i 16V T.S. L	1.6	88	4	04.96-12.01	AR67.601		BKR6EKPA + PMR7A	2513+ 4259		
146	1.7	78	4	08.98-04.99	AR32.201		BKR6EKPA + PMR7A	2513+ 4259		
146 i.e 16V	1.7	95	4	08.94-02.97	AR33.401	0,9	PFR6B	3500		PFR7B
146 i. 16V T.S. L	1.8	103	4	02.97-12.01	AR67.106		BKR6EKPA + PMR7A	2513+ 4259		
146 i. 16V T.S.	1.8	106	4	12.96-04.01	AR32.201		BKR6EKPA + PMR7A	2513+ 4259		
146 i. T.S. 16V- ti	2.0	110	4	02.96-04.01	AR67.204		BKR6EKPA + PMR7A	2513+ 4259		
146 i 2.0 16V T.S.	2.0	114	4	03.98-12.01	AR32.301		BKR6EKPA + PMR7A	2513+ 4259		

**147**

147 1.6 T.S. 16V	1.6	76	4	10.00-	AR37.203		BKUR6ETB + CR7EKC	6992+ 7004		
147 1.6 T.S. 16V	1.6	88	4	10.00-	AR32.104		BKR6EKPA + PMR7A	2513+ 4259		
147 2.0 T.S. 16V	2.0	110	4	10.00-	AR 32310		BKR6EKPA + PMR7A	2513+ 4259		
147 2.0 JTS	937	2.0	125	4	10.00-	937A1000	0,9	BKR6EKPA	2513	
147 GTA	3.2	184	6	11.02-05.06	932A.000	0,9	PFR6B	3500		PFR7B

**155**

155 i.16 V T.S.	1.6	88	4	07.96-01.98	AR67.601		BKR6EKPA + PMR7A	2513+ 4259		
155 i T.S.	1.7	86	4	02.92-04.93	AR67.103	0,7	BKP6ES	4930	17	LPG 3
155 i T.S.	1.7	95	4	05.93-07.96	AR67.105	0,7	BKP6ES	4930	17	LPG 3
155 i T.S.	1.8	93	4	02.92-07.96	AR67.102	0,7	BKP6ES	4930	17	LPG 3
155 i T.S.	1.8	93	4	04.94-07.96	AR67.101-67.102	0,7	BKP6ES	4930	17	LPG 3
155 i.16 V T.S.	1.8	103	4	05.96-01.98	AR67.106		BKR6EKPA + PMR7A	2513+ 4259		
155 i T.S.L	2.0	104	4	02.92-02.95	AR67.201-67.202	0,7	BKP6ES	4930	17	LPG 3
155 i T.S.	2.0	106	4	02.92-02.95	AR67.202	0,7	BKP6ES	4930	17	LPG 3
155 i.16V T.S.	2.0	110	4	06.94-01.98	AR67.204		BKR6EKPA + PMR7A	2513+ 4259		



l kW  
C  
y  
i

0201



Stock-No

VALVE

LPG/CNG

## ALFA ROMEO

### 155

155 i Turbo 4x4	2.0	137	4	08.92-04.98	AR67.203	0,8	BP6ET	1263		LPG 2
155 i.	2.5	120	6	02.92-	AR67.301	0,8	BPR7ES	2023	19	BPR8EIX
155 i. V6	2.5	120	6	02.92-04.95	AR67.301	0,8	BPR7ES	2023	19	BPR8EIX
155 i. V6	2.5	120	6	05.95-02.97	AR67.301	0,7	BP6ES	7811	4	LPG 2

### 156

156 16V T.S.	1.6	88	4	12.97-05.06	AR32.101		BKR6EKPA + PMR7A	2513+ 4259		
156 16V T.S.	1.8	106	4	12.97-05.06	AR32.201		BKR6EKPA + PMR7A	2513+ 4259		
156 16V T.S	2.0	114	4	12.97-12.02	AR32.301		BKR6EKPA + PMR7A	2513+ 4259		
156 16V T.S. Selespeed	2.0	114	4	05.99-12.02	AR32.301		BKR6EKPA + PMR7A	2513+ 4259		
156 JTS	2.0	121	4	11.01-05.06	937A1000	0,9	BKR6EKPA	2513		
156 24V	2.5	140	6	10.97-05.06	AR32.401	0,9	PFR6B	3500		PFR7B
156 GTA	3.2	184	6	11.02-05.06	932A.000	0,9	PFR6B	3500		PFR7B

### 159

159 1.8 16V	939	1.8	103	4	07.05-11.11	939A4000	1,1	ZFR5F-11	2262	40	LPG 6
159 1750 TBi		1.8	147	4	05.09-11.11	939B1000	0,6	ILKAR7D6G	93607		
159 1.9 JTS 16V		1.9	118	4	07.05-11.11	939A6000	0,8	FR5CP	6368		
159 2.2 JTS 16V		2.2	136	4	07.05-	939A5000	0,8	FR5CP	6368		

### 164

164 i.T.S.	2.0	102	4	06.87-09.92	AR064.16Cat-064.20	0,7	BCP6ES	4930	17	LPG 3
164 i.T.S Super / Super L	2.0	106	4	07.94-10.98	AR67.201-67202	0,7	BCP6ES	4930	17	LPG 3
164 i.e. Turbo	2.0	126	4	01.88-09.92	AR064.76	0,8	BPR7ES	2023	19	BPR8EIX
164 i. V6 Turbo Super	2.0	148	6	03.91-10.98	AR64.102	0,8	BP7ES	2412		BPR8EIX
164 i.	2.0			03.91-		0,8	BP7ES	2412		BPR8EIX
164 i. V6 Super	3.0	132	6	01.96-		0,7	PGR6A	4984		PGR7A
164 i. V6 12V	3.0	138	6	01.90-10.98	AR64.305	0,7	BP6ES	7811	4	LPG 2
164 i. V6 24V CF2	3.0	155	6	01.87- .92	AR64.301	0,7	PGR6A	4984		PGR7A
164 i. V6 12V	3.0	155	6	.92-10.98	AR66.301	0,9	PFR6B	3500		PFR7B
164 i. V6 24V Super	3.0	155	6	07.94-10.98	AR64.304-64.308	0,9	PFR6B	3500		PFR7B
164 i. V6 QV	3.0	169	6	-10.98	AR16.102	0,7	PGR6A	4984		PGR7A
164 i. Q.4	3.0	171	6	01.90-10.98	AR64.304	0,9	PFR6B	3500		PFR7B
164 12V	3.0		6	06.87-09.93	06410, 06412	0,7	B7ES	1111		BR8EIX

### 166

166 2.0 T.S. 16V	2.0	114	4	11.98-06.06	AR34.103		BKR6EKPA + PMR7A	2513+ 4259		
166 2.0 TS	2.0	125	4	11.03-06.06	AR36301		BKR6EKPA + PMR7A	2513+ 4259		
166 2.0 V6 Turbo Super	2.0	151	6	11.98-06.06	AR34.102	0,8	BP6E	5637	4	LPG 2
166 24V V6 (Brazil)	2.0	151		10.98-06.06		0,9	PFR6B	3500		PFR7B
166 2.5 I V6 24V	2.5	140	6	11.98-06.06	AR34.201	0,9	PFR6B	3500		PFR7B
166 3.0 I V6 24V	3.0	162	6	11.98-06.06	AR34.301	0,9	PFR6B	3500		PFR7B
166 3.2 V6 24V	3.2	176	6	11.03-06.06	936A6000	0,9	PFR6B	3500		PFR7B

### ALFA 90

Alfa 90 i. Super	162	2.5	110	6	10.84-12.90	AR016.46-019.11 cat	0,7	B7ES	1111		BR8EIX
Alfa 90 i. V6 Super	162	2.0	97	6	05.85-01.87	AR062.10/12	0,8	BP7ES	2412		BPR8EIX
Alfa 90 Super	162	1.8	89	4	10.84-01.87	AR062.02	0,7	BP6ES	7811	4	LPG 2

e kW  
C  
Y  
I

0201



Stock-No

V-ELINE

LPG / CNG

**ALFA ROMEO****BRERA**

Brera 1750 Tbi	1.8	147	4	03.09-03.11	939B1000	0,6	ILKAR7D6G	93607		ILKAR7D6G
Brera 2.2 JTS	2.2	136	4	09.05-03.11	939A5000	0,8	FR5CP	6368		

**GIULIETTA**

Giulietta 1.4 TB	940	1.4	85	4	04.10-	940A6000 / 198A6000	0,8	IKR9J8	93311		
Giulietta 1.4 TB	940	1.4	88	4	03.10-	198A4000	0,8	IKR9J8	93311		
Giulietta 1.4 TB	940	1.4	77	4	04.11-	940B1000	0,8	IKR9J8	93311		
Giulietta 1.4 TB BiFuel	940	1.4	88	4	12.11-	198A4000	0,8	IKR9J8	93311		
Giulietta 1.4 TB	940	1.4	120	4	04.10-	955A8000	0,8	IKR9J8	93311		
Giulietta 1.4 TB	940	1.4	125	4	03.10-	940A2000	0,8	IKR9J8	93311		
Giulietta 1750 Tbi Quadrifoglio Verde	940	1.8	173	4	03.10-	940A1000	0,6	ILKAR7D6G	93607		
Giulietta 1750 Tbi Quadrifoglio Verde	940	1.8	177	4	09.13-	960A1000	0,6	ILKAR7D6G	93607		

**GT**

GT 1.8 16V T.S.	1.8	103	4	12.03-	AR32205		BKR6EKPA + PMR7A	2513+ 4259		
GT 2.0 J.T.S.	2.0	121	4	12.03-	937A1000	0,9	BKR6EKPA	2513		
GT	3.2	176	6	12.03-12.04	936A6000	0,9	PFR6B	3500		PFR7B

**GTV**

GTV i T.S. 16V	1.8	106	4	06.98-06.02	AR32.201		BKR6EKPA + PMR7A	2513+ 4259		
GTV T.S. 16V	2.0	110	4	04.95-05.98	AR16.201		BKR6EKPA + PMR7A	2513+ 4259		
GTV 2.0 L T.S. -16V	2.0	110	4	06.98-	AR32.301		BKR6EKPA + PMR7A	2513+ 4259		
GTV 2.0 JTS 16V	2.0	121	4	06.03-	937A1000	0,9	BKR6EKPA	2513		
GTV V6 Turbo	2.0	147	6	04.95-05.98	AR16.202	0,8	BP7ES	2412		BPR8EIX
GTV 2.0 L turbo V6	2.0	148	6	06.98-12.99	AR16.202	0,9	BPR6E	6464	2	LPG 2
GTV V6 12V	2.0	151	6	09.97-12.00		0,8	BPR7ES	2023	19	BPR8EIX
GTV V6 24V	3.0	160	6	11.96-12.00	AR16.102	0,9	PFR6B	3500		PFR7B
GTV V6 24V	3.0	162	6	02.97-05.98	AR67.601	0,9	PFR6B	3500		PFR7B
GTV V6 24V	3.2	176	6	06.03-	936A6000	0,9	PFR6B	3500		PFR7B

**MITO**

MITO 0.9 Twin Air	955	0.9	63	2	07.11-	312A2000	0,8	ILKR9G8	97168		
MITO 0.9 Twin Air	955	0.9	77	2	04.13-	199B6000	0,8	ILKR9G8	97168		
MITO 1.4	955	1.4	51	4	05.11-	955A9000	1,0	ZKR7A-10	1691	42	
MITO 1.4	955	1.4	57	4	03.11-	350A1000	1,0	ZKR7A-10	1691	42	
MITO 1.4	955	1.4	58	4	09.08-	955A1000	1,0	ZKR7A-10	1691	42	
MITO 1.4	955	1.4	70	4	09.08-	199A6000	1,0	ZKR7A-10	1691	42	
MITO 1.4 16V Multi-Air	955	1.4	77	4	10.09-	955A6000	1,0	DCPR7E-N-10	4983	43	
MITO 1.4 T-Jet	955	1.4	88	4	09.08-	198A4000	0,8	IKR9J8	93311		
MITO 1.4 T-Jet Bifuel LPG	955	1.4	88	4	10.09-	198A4000	0,8	IKR9J8	93311		
MITO 1.4 TB 16V Multi-Air	955	1.4	99	4	08.09-	955A2000 / 955A7000	0,8	IKR9J8	93311		
MITO 1.4 T-Jet	955	1.4	110	4	09.08-06.11	198A1000	0,8	IKR9J8	93311		
MITO 1.4 TB	955	1.4	114	4	09.08-	199A8000	0,8	IKR9J8	93311		
MITO 1.4 TB	955	1.4	120	4	10.09-	955A8000	0,8	IKR9J8	93311		
MITO 1.4 TB	955	1.4	125	4	12.09-	940A2000	0,8	IKR9J8	93311		

e kW  
C  
y  
i

0201



Stock-No

VLINE

LPG / CNG

**ALFA ROMEO****SPIDER**

Spider T.S. 16V	1.8	106	4	05.98-03.01	AR32.201		BKR6EKPA + PMR7A	2513+ 4259		
Spider 1750 TBi	1.8	147	4	03.09-	939B1000	0,6	ILKAR7D6G	93607		
Spider i.	2.0	86	4	01.90-12.94	AR015.44-88-90 Cat.	0,7	BP6ES	7811	4	LPG 2
Spider T.S. 16V	2.0	110	4	04.95-05.98	AR16.201		BKR6EKPA + PMR7A	2513+ 4259		
Spider T.S. 16V	2.0	114	4	06.98-	AR32.301		BKR6EKPA + PMR7A	2513+ 4259		
Spider 2.0 J.T.S. 16V	2.0	121	4	06.03-	937A1000	0,9	BKR6EKPA	2513		
Spider i V6 turbo	2.0	147	6	06.98-12.99	AR16.202	0,9	BPR6E	6464	2	LPG 2
Spider 2.2 J.T.S.	2.2	136	4	01.06-	939A5000	0,8	FR5CP	6368		
Spider i V6 12V	3.0	140	6	04.95-05.98	AR16.101-16.199	0,8	BPR6ES	7822	2	LPG 2
Spider 3.0 V6 24V	3.0	165	6	06.98- .04	AR16.102	0,9	PFR6B	3500		PFR7B
Spider 3.2 V6 24V	3.2	176	6	06.03-	936A6000	0,9	PFR6B	3500		PFR7B

**SPRINT**

Sprint Q.V.	1.5	70	4	01.83-12.89	AR301.28-46-98	0,7	BP6ES	7811	4	LPG 2
Sprint Q.V.	1.7	87	4	10.87-12.89	AR305.50	0,7	BP6ES	7811	4	LPG 2
Sprint Veloce	1.3	64	4	01.90-	AR301.68	0,7	BP6ES	7811	4	LPG 2

**SZ**

SZ V6 / RZ V6	3.0	152	6	03.90-05.96	AR64.304	0,7	PGR6A	4984		PGR7A
---------------	-----	-----	---	-------------	----------	-----	-------	------	--	-------

**ALPINA****B 3**

B 3	E36	3.0	184	6	04.93-03.96	M50B30	0,9	BKR6EK	2288	20	LPG 1
B 3	E36	3.2	195	6	04.96-03.99	S52B32	0,9	BKR6EK	2288	20	LPG 1
B 3 3.2	E36	3.2	195	6	04.96-03.99	S52B32	0,9	BKR6EK	2288	20	LPG 1
B 3 3.3	E46	3.3	206	6	03.99-01.05	S52B33	1,5	BKR6EQUIP	3199	30	LPG 1
B 3 S	E46	3.3	224	6	08.02-01.06	S52B33	1,5	BKR6EQUIP	3199	30	LPG 1

**B 5**

B 5	E60	4.4	368	8	03.05-	S62B44 H1/2	0,6	PFR7B	4853		PFR8B
B 5 Biturbo	F10	4.4	373	8	.10-	M1	0,8	SIZKBR8A8HS	1555		
B 5 S	E60	4.4	390	8	.07-	S62B44 H1/2	0,6	PFR7B	4853		PFR8B

**B 6**

B 6	E64	4.4	368	8	10.05-	S62B44 H1/2	0,6	PFR7B	4853		PFR8B
B 6 S	E64	4.4	390	8	.07-	S62B44 H1/2	0,6	PFR7B	4853		PFR8B

**B 7**

B 7	E65	4.4	368	8	03.05-	S62B44 H1/2	0,6	PFR7B	4853		PFR8B
B 7 Biturbo	F01	4.4	373	8	05.09-	M1	0,8	SIZKBR8A8HS	1555		

**B 8**

B 8	E36	4.6	245	8	01.95-11.98	M62B46	0,9	BKR6EK	2288	20	LPG 1
-----	-----	-----	-----	---	-------------	--------	-----	--------	------	----	-------

**B 10**

B 10 3.2	E39	3.2	191	6	08.97-12.98	S52B32	0,9	BKR6EK	2288	20	LPG 1
B 10 3.3	E39	3.3	206	6	02.99-10.03	S52B33	1,5	BKR6EQUIP	3199	30	LPG 1
B 10 3.5	E34	3.5	187	6	04.88-12.92	B11/3	0,8	BPR6ES	7822	2	LPG 2
B 10 3.5 Biturbo	E34	3.5	265	6	08.89-03.94	B7/5	0,8	BPR6ES	7822	2	LPG 2
B 10 4.0	E34	4.0	232	8	04.93-08.95	F1	1,5	BKR6EQUIP	3199	30	LPG 1
B 10 4.6	E34	4.6	250	8	03.94-04.96	F2	1,5	BKR6EQUIP	3199	30	LPG 1
B 10 V8	E39	4.6	250	8	12.96-10.98	M62B46	0,9	BKR6EK	2288	20	LPG 1
B 10 V8	E39	4.6	255	8	10.98-08.00	M62B46	1,5	BKR6EQUIP	3199	30	LPG 1



l kW  
C  
y  
i

0201



Stock-No  
VELINE

LPG / CNG

## ALPINA

### B 10

B 10 V8S	E39	4.8	276	8	01.02-12.03	M62B48	1,5	BKR6EQUIP	3199	30	LPG 1
----------	-----	-----	-----	---	-------------	--------	-----	-----------	------	----	-------

### B 12

B 12 5.7 E-Kat	E38	5.7	285	12	12.95-09.98	M73B57	0,9	BKR6EK	2288	26	LPG 1
B 12 6.0 E-Kat	E38	6.0	316	12	06.99-07.01	M73B60	1,5	BKR6EQUIP	3199	30	LPG 1

## ROADSTER

Roadster S	E85	3.4	221	6	07.03-12.05	E5/2	1,5	BKR6EQUIP	3199	30	LPG 1
Roadster V8	E52	4.8	280	8	06.02-10.03	S62 B48	1,5	BKR6EQUIP	3199	30	LPG 1

## ARO

Spartana		1.2	40	4	.97-	C3GD7	0,9	BP5ESZ	4691		LPG 2
----------	--	-----	----	---	------	-------	-----	--------	------	--	-------

## ASIA MOTORS

Rocsta		1.8	57	4	02.94-12.97	F8	0,9	BPR5ES	7422	6	LPG 2
--------	--	-----	----	---	-------------	----	-----	--------	------	---	-------

## ASTON MARTIN

DB7		3.2	250	6	09.94-06.99	DOHC	0,8	BCPR7ES	3330		BCPR7EIX
DB7		5.9		12	07.99-11.00	DOHC	1,3	PTR6D-13	5598		LPG 5
DB7		5.9		12	11.00-	DOHC	1,3	PTR5D-13	6644		
Turbo 24V Coupé, Cabriolet		3.2	246	6	.95-		0,7	BCPR7ES	3330		BCPR7EIX
48V V12		6.0	420	12	04.00-		1,0	PTR5D-10	3784		LPG 5
Vanquish		5.9		12	06.01-	AM 702	1,3	PTR6D-13	5598		LPG 5
Vantage		5.3	410	8	08.93-	10.2:1 Comp(Zagato)	0,8	BCR8ES	5430		
Vantage		5.3		8	03.86-12.89	9.3:1 Comp	0,9	BPR7EIX	4055		BPR8EIX
Virage / Volante		5.3		8	02.90-01.98	V8 32V	0,8	BCPR6E	1269	12	LPG 3

## AUDI

### 80 4 (B4)

80 1.6	B4	1.6	52	4	08.91-06.94	ABM	0,8	BUR5ET	3377	22	LPG 2
80 1.6	B4	1.6	74	4	06.93-07.95	ADA	0,8	BUR6ET	3172	1	LPG 2
80 2.0	B4	2.0	66	4	09.91-06.95	ABT	0,8	BUR6ET	3172	1	LPG 2
80 2.0 E	B4	2.0	85	4	09.91-07.95	ABK	0,8	BUR6ET	3172	1	LPG 2
80 2.0 E 16V	B4	2.0	103	4	08.92-07.95	ACE	0,8	BKUR7ET	7873		
80 2.3 E	B4	2.3	98	5	09.91-12.94	NG	0,7	BPR5EKU	5685		LPG 2
80 2.6 E	B4	2.6	110	6	07.92-07.95	ABC	1,0	BKUR6ET-10	2397	24	LPG 1
80 2.8 E	B4	2.8	128	6	09.91-07.95	AAH	1,0	BKUR6ET-10	2397	24	LPG 1
80 S2 quattro	B4	2.2	169	5	02.93-07.95	ABY	0,6	PFR7B	4853		PFR8B
80 avant RS2 quattro	B4	2.2	232	5	03.94-07.95	ADU	0,6	PFR7B	4853		PFR8B

### 100 4 (C4)

100 2.0	4A/C4	2.0	74	4	12.90-07.94	AAE	0,8	BUR6ET	3172	1	LPG 2
100 2.0 E	4A/C4	2.0	85	4	12.90-12.92	AAD	0,8	BUR6ET	3172	1	LPG 2
100 2.0 E	4A/C4	2.0	85	4	01.93-07.94	ABK	0,8	BUR6ET	3172	1	LPG 2
100 2.0 E 16V	4A/C4	2.0	103	4	01.92-07.94	ACE	0,8	BKUR7ET	7873		
100 2.2 S4 quattro	4A/C4	2.2	169	5	08.91-07.94	AAN	0,6	PFR7B	4853		PFR8B
100 2.3 E	4A/C4	2.3	98	5	12.90-06.94	AAR	0,7	BPR5EKU	5685		LPG 2
100 2.6 E	4A/C4	2.6	110	6	03.92-07.94	ABC	1,0	BKUR6ET-10	2397	24	LPG 1

e kW  
C  
y  
i

0201



Stock-No

VLINE

LPG/CNG

AUDI

**100 4 (C4)**

100 2.8 E	4A/C4	2.8	128	6	12.90-07.94	AAH	1,0	BKUR6ET-10	2397	24	LPG 1
100 4.2 V8 S4 quattro	4A/C4	4.2	206	8	10.92-07.94	ABH	0,8	BUR6EFSZ	6837		
100 4.2 V8 S4 quattro	4A/C4	4.2	213	8	03.94-06.94	AEC	0,8	BUR6EFSZ	6837		

**A 1 (8X)**

A 1 1.2 TFSI	8X1 / 8XA	1.2	63	4	05.10-	CBZA	0,7	IZFR6P7	97153		IZFR6P7
A 1 1.4 TFSI	8X1 / 8XA	1.4	90	4	05.10-	CAXA	0,9	PZFR6R	5758		PZFR6R
A 1 1.4 TFSI	8X1 / 8XA	1.4	136	4	11.10-	CAVG	0,8	SIZFR6B8EG	96209		
A 1 1.4 TFSI COD	8X1/8XA	1.4	103	4	04.12-	CPTA	0,8	PZKER7A8EGS	94968		
A 1 quattro 2.0 TFSI	8X1	2.0	188	4	03.12-	CDLH	0,8	PFR7S8EG	1675		PFR8S8EG
A 1 1.4 TFSI	8XK/8XF	1.4	92	4	11.14-	CZCA	0,8	PZKER7A8EGS	94968		
A 1 1.4 TFSI COD	8XK/8XF	1.4	110	4	11.14-	CZEA	0,8	PZKER7A8EGS	94968		

**A 2**

A 2 1.4	8Z0	1.4	55	4	06.00-04.02	AUA	1,0	BKUR6ET-10	2397	24	LPG 1
A 2 1.4	8Z0	1.4	55	4	05.02-08.05	BBY	1,0	BKUR6ET-10	2397	24	LPG 1
A 2 1.6 FSI	8Z0	1.6	81	4	05.02-08.05	BAD	0,5	ZFR6S-Q	6449		ZFR6S-Q

**A 3 1 (8L)**

A 3 1.6	8L1	1.6	74	4	09.96-06.01	AEH	1,0	BKUR6ET-10	2397	24	LPG 1
A 3 1.6	8L1	1.6	74	4	08.97-06.03	AKL	1,0	BKUR6ET-10	2397	24	LPG 1
A 3 1.6	8L1	1.6	74	4	06.99-08.00	APF	1,0	BKUR6ET-10	2397	24	LPG 1
A 3 1.6	8L1	1.6	75	4	05.00-04.02	AVU	1,0	BKUR6ET-10	2397	24	LPG 1
A 3 1.6	8L1	1.6	75	4	05.02-06.03	BFQ	1,0	BKUR6ET-10	2397	24	LPG 1
A 3 1.8	8L1	1.8	92	4	09.96-08.00	AGN	1,0	BKUR6ET-10	2397	24	LPG 1
A 3 1.8	8L1	1.8	92	4	11.99-06.03	APG	1,0	BKUR6ET-10	2397	24	LPG 1
A 3 1.8 T	8L1	1.8	110	4	12.96-06.03	AGU	0,8	PFR6Q	6458	37	LPG 1
A 3 1.8 T	8L1	1.8	110	4	08.98-04.01	AQA	0,8	PFR6Q	6458	37	LPG 1
A 3 1.8 T	8L1	1.8	110	4	07.99-04.00	ARZ	0,8	PFR6Q	6458	37	LPG 1
A 3 1.8 T	8L1	1.8	110	4	09.00-06.03	ARX	0,8	PFR6Q	6458	37	LPG 1
A 3 1.8 T	8L1	1.8	110	4	05.00-06.03	AUM	0,8	PFR6Q	6458	37	LPG 1
A 3 1.8 T	8L1	1.8	132	4	11.98-08.00	AJQ	0,8	PFR6Q	6458	37	LPG 1
A 3 1.8 T	8L1	1.8	132	4	07.99-05.00	APP	0,8	PFR6Q	6458	37	LPG 1
A 3 1.8 T	8L1	1.8	132	4	09.00-06.03	ARY	0,8	PFR6Q	6458	37	LPG 1
A 3 1.8 T	8L1	1.8	132	4	05.00-06.03	AUQ	0,8	PFR6Q	6458	37	LPG 1
A 3 S 3	8L1	1.8	154	4	11.98-08.00	APY	0,8	PFR6Q	6458	37	LPG 1
A 3 S 3	8L1	1.8	154	4	09.99-04.01	AUL	0,8	PFR6Q	6458	37	LPG 1
A 3 S 3	8L1	1.8	154	4	09.00-04.02	AMK	0,8	PFR6Q	6458	37	LPG 1
A 3 S 3	8L1	1.8	165	4	08.01-06.03	BAM	0,8	PFR6Q	6458	37	LPG 1

**A 3 2 (8P)**

A 3 1.2 TFSI	8P1	1.2	77	4	03.10-	CBZB	0,7	IZFR6P7	97153		
A 3 1.4 TFSI	8P1	1.4	92	4	09.07-	CAXC	0,9	PZFR6R	5758		
A 3 1.4 TFSI	8P1	1.4	92	4	05.10-	CMSA	0,9	PZFR6R	5758		
A 3 1.6	8P1	1.6	75	4	05.03-05.05	BGU	1,0	BKUR6ET-10	2397	24	LPG 1
A 3 1.6	8P1	1.6	75	4	06.05-	BSE	1,0	BKUR6ET-10	2397	24	LPG 1
A 3 1.6	8P1	1.6	75	4	06.05-	BSF	1,0	BKUR6ET-10	2397	24	LPG 1
A 3 1.6	8P1	1.6	75	4	07.08-	CCSA	1,0	BKUR6ET-10	2397	24	LPG 1
A 3 1.6	8P1	1.6	75	4	05.10-	CMXA	1,0	BKUR6ET-10	2397	24	LPG 1
A 3 1.6 FSI	8P1	1.6	85	4	08.03-05.04	BAG	0,5	ZFR6S-Q	6449		
A 3 1.6 FSI	8P1	1.6	85	4	06.04-12.04	BLP	0,5	ZFR6S-Q	6449		
A 3 1.6 FSI	8P1	1.6	85	4	01.05-05.07	BLF	0,5	ZFR6S-Q	6449		
A 3 1.8 TFSI	8P1	1.8	118	4	01.07-05.07	BYT	0,8	PFR7S8EG	1675		PFR8S8EG
A 3 1.8 TFSI	8P1	1.8	118	4	06.07-05.08	BZB	0,8	PFR7S8EG	1675		PFR8S8EG

e kW  
C  
y  
i

0201



Stock-No

VLINE

LPG / CNG

**AUDI****A 3 2 (8P)**

A 3 1.8 TFSI	8P1	1.8	118	4	07.08-	CDA	0,8	PFR7S8EG	1675		PFR8S8EG
A 3 2.0 FSI	8P1	2.0	110	4	05.03-05.04	AXW	1,1	PZFR5N-11T	7742		
A 3 2.0 FSI	8P1	2.0	110	4	06.04-01.05	BLX	1,1	PZFR5N-11T	7742		
A 3 2.0 FSI	8P1	2.0	110	4	06.04-11.05	BLY	0,9	BKR6E	6962	28	LPG 1
A 3 2.0 FSI	8P1	2.0	110	4	01.04-01.05	BMB	0,9	BKR6E	6962	28	LPG 1
A 3 2.0 FSI	8P1	2.0	110	4	01.05-11.05	BLR	1,1	PZFR5N-11T	7742		
A 3 2.0 FSI	8P1	2.0	110	4	11.05-01.07	BVY	1,1	PZFR5N-11T	7742		
A 3 2.0 FSI	8P1	2.0	110	4	11.05-	BVZ	0,9	BKR6E	6962	28	LPG 1
A 3 2.0 TFSI	8P1	2.0	147	4	09.04-10.05	AXX	0,8	PFR7S8EG	1675		PFR8S8EG
A 3 2.0 TFSI	8P1	2.0	147	4	09.05-	BWA	0,8	PFR7S8EG	1675		PFR8S8EG
A 3 2.0 TFSI	8P1	2.0	147	4	07.08-	CBFA	0,8	PFR7S8EG	1675		PFR8S8EG
A 3 2.0 TFSI	8P1	2.0	147	4	07.08-	CCZA	0,8	PFR7S8EG	1675		PFR8S8EG
A 3 2.0 TFSI	8P1	2.0	147	4	02.08-01.09	CAWB	0,8	PFR7S8EG	1675		PFR8S8EG
A 3 S 3	8P1	2.0	188	4	02.07-	BZC	0,8	PFR7S8EG	1675		PFR8S8EG
A 3 S 3	8P1	2.0	188	4	07.08-	CDLC	0,8	PFR7S8EG	1675		PFR8S8EG
A 3 S 3	8P1	2.0	195	4	11.06-05.07	BHZ	0,8	PFR7S8EG	1675		PFR8S8EG
A 3 S 3	8P1	2.0	195	4	07.08-	CDLA	0,8	PFR7S8EG	1675		PFR8S8EG
A 3 3.2 quattro	8P1	3.2	184	6	07.03-08.04	BDB	0,9	IZKR7B	7563		
A 3 3.2 quattro	8P1	3.2	184	6	09.04-10.05	BMJ	0,9	IZKR7B	7563		
A 3 3.2 quattro	8P1	3.2	184	6	11.05-	BUB	0,9	IZKR7B	7563		

**A 3 3 (8V)**

A 3 1.2 TFSI	8V1/8VA	1.2	77	4	09.12-	CJZA	0,8	PZKER7A8EGS	94968		
A 3 1.2 TFSI	8V1/8VA	1.2	81	4	05.14-	CYVB	0,8	PZKER7A8EGS	94968		
A 3 1.4 TFSI	8V1/8VA/8VS	1.4	90	4	04.12-	CXSA	0,8	PZKER7A8EGS	94968		
A 3 1.4 TFSI e-tron Hybrid	8VA	1.4	110	4	05.14-	CUKB	0,8	PZKER7A8EGS	94968		
A 3 1.4 TFSI g-tron	8VA	1.4	81	4	11.13-	CPWA	0,8	PZKER7A8EGS	94968		
A 3 1.4 TFSI	8V1/8VA	1.4	90	4	04.12-	CMBA	0,8	PZKER7A8EGS	94968		
A 3 1.4 TFSI	8V1/8VA/8VS/8V7	1.4	92	4	09.13-	CXSB	0,8	PZKER7A8EGS	94968		
A 3 1.4 TFSI	8V1/8VA/8VS/8V7	1.4	92	4	09.13-	CZCA	0,8	PZKER7A8EGS	94968		
A 3 1.4 TFSI COD	8V1/8VA/8VS/8V7	1.4	103	4	10.12-	CPTA	0,8	PZKER7A8EGS	94968		
A 3 1.4 TFSI COD	8V1/8VA/8VS/8V7	1.4	110	4	05.14-	CZEA	0,8	PZKER7A8EGS	94968		

**A 4 1 (B5)**

A 4 1.6	8D2/8D5 B5	1.6	74	4	11.94-10.96	ADP	1,0	BKUR6ET-10	2397	24	LPG 1
A 4 1.6	8D2/8D5 B5	1.6	74	4	10.96-07.99	AHL	1,0	BKUR6ET-10	2397	24	LPG 1
A 4 1.6	8D2/8D5 B5	1.6	74	4	08.98-06.00	ANA	1,0	BKUR6ET-10	2397	24	LPG 1
A 4 1.6	8D2/8D5 B5	1.6	74	4	08.98-09.01	ARM	1,0	BKUR6ET-10	2397	24	LPG 1
A 4 1.6	8D2/8D5 B5	1.6	75	4	07.00-11.00	ALZ	1,0	BKUR6ET-10	2397	24	LPG 1
A 4 1.8	8D2/8D5 B5	1.8	85	4	07.95-12.98	AFY	1,0	BKUR6ET-10	2397	24	LPG 1
A 4 1.8	8D2/8D5 B5	1.8	92	4	11.94-04.99	ADR	1,0	BKUR6ET-10	2397	24	LPG 1
A 4 1.8	8D2/8D5 B5	1.8	92	4	07.98-09.01	ARG	1,0	BKUR6ET-10	2397	24	LPG 1
A 4 1.8	8D2/8D5 B5	1.8	92	4	02.99-09.01	APT	1,0	BKUR6ET-10	2397	24	LPG 1
A 4 1.8	8D2/8D5 B5	1.8	92	4	06.00-09.01	AVV	1,0	BKUR6ET-10	2397	24	LPG 1
A 4 1.8 T	8D2/8D5 B5	1.8	110	4	01.96-12.98	AEB	0,8	PFR6Q	6458	37	LPG 1
A 4 1.8 T	8D2/8D5 B5	1.8	110	4	08.98-09.01	APU	0,8	PFR6Q	6458	37	LPG 1
A 4 1.8 T	8D2/8D5 B5	1.8	110	4	07.98-07.99	ARK	0,8	PFR6Q	6458	37	LPG 1
A 4 1.8 T	8D2/8D5 B5	1.8	110	4	05.99-06.00	ANB	0,8	PFR6Q	6458	37	LPG 1
A 4 1.8 T	8D2/8D5 B5	1.8	110	4	06.00-09.01	AWT	0,8	PFR6Q	6458	37	LPG 1
A 4 1.8 T	8D2/8D5 B5	1.8	132	4	08.97-09.01	AJL	0,8	PFR6Q	6458	37	LPG 1
A 4 1.8 T USA	8D2/8D5 B5	1.8	110	4	08.99-05.00	ATW	0,8	PFR6Q	6458	37	LPG 1



e kW  
C  
y  
l

0201



Stock-No

VLINE

LPG/CNG

**AUDI****A 4 1 (B5)**

A 4 2.4 V6	8D2/8D5 B5	2.4	120	6	08.97-07.98	AJG	0,5	BKR6EKUB	3584		LPG 1
A 4 2.4 V6	8D2/8D5 B5	2.4	120	6	08.97-11.00	AMM	0,5	BKR6EKUB	3584		LPG 1
A 4 2.4 V6	8D2/8D5 B5	2.4	120	6	08.98-06.00	APZ	0,5	BKR6EKUB	3584		LPG 1
A 4 2.4 V6	8D2/8D5 B5	2.4	121	6	08.97-07.98	AGA	0,5	BKR6EKUB	3584		LPG 1
A 4 2.4 V6	8D2/8D5 B5	2.4	121	6	08.97-07.98	ALF	0,5	BKR6EKUB	3584		LPG 1
A 4 2.4 V6	8D2/8D5 B5	2.4	121	6	08.98-09.01	AML	0,5	BKR6EKUB	3584		LPG 1
A 4 2.4 V6	8D2/8D5 B5	2.4	121	6	08.98-06.00	ARJ	0,5	BKR6EKUB	3584		LPG 1
A 4 2.4 V6 China	8D2/8D5 B5	2.4	110	6	07.95-07.97	AFM	1,0	BKUR6ET-10	2397	24	LPG 1
A 4 2.4 V6 China	8D2/8D5 B5	2.4	121	6	08.98-09.01	APS	0,5	BKR6EKUB	3584		LPG 1
A 4 2.6 V6	8D2/8D5 B5	2.6	110	6	11.94-07.97	ABC	1,0	BKUR6ET-10	2397	24	LPG 1
A 4 2.6 V6 China / GUS	8D2/8D5 B5	2.6	102	6	06.94-10.97	ACZ	1,0	BKUR6ET-10	2397	24	LPG 1
A 4 2.7 avant RS 4 quattro	8D2/8D5 B5	2.7	280	6	06.00-10.00	ASJ	0,8	PFR7Q	7963		
A 4 2.7 avant RS 4 quattro	8D2/8D5 B5	2.7	280	6	11.00-09.01	AZR	0,8	PFR7Q	7963		
A 4 2.7 S 4 quattro	8D2/8D5 B5	2.7	169	6	07.98-08.00	AJK	0,8	PFR6Q	6458	37	LPG 1
A 4 2.7 S 4 quattro	8D2/8D5 B5	2.7	184	6	07.98-12.98	APB	0,8	PFR6Q	6458	37	LPG 1
A 4 2.7 S 4 quattro	8D2/8D5 B5	2.7	195	6	10.97-09.01	AGB	0,8	PFR6Q	6458	37	LPG 1
A 4 2.7 S 4 quattro	8D2/8D5 B5	2.7	195	6	11.00-09.01	AZB	0,8	PFR6Q	6458	37	LPG 1
A 4 2.8 V6	8D2/8D5 B5	2.8	128	6	11.94-07.97	AAH	1,0	BKUR6ET-10	2397	24	LPG 1
A 4 2.8 V6	8D2/8D5 B5	2.8	142	6	03.96-07.98	ACK	0,5	BKR6EKUB	3584		LPG 1
A 4 2.8 V6	8D2/8D5 B5	2.8	142	6	05.97-07.98	ALG	0,5	BKR6EKUB	3584		LPG 1
A 4 2.8 V6	8D2/8D5 B5	2.8	142	6	07.98-09.01	AMX	0,5	BKR6EKUB	3584		LPG 1
A 4 2.8 V6	8D2/8D5 B5	2.8	142	6	08.98-06.00	APR	0,5	BKR6EKUB	3584		LPG 1
A 4 2.8 V6	8D2/8D5 B5	2.8	142	6	08.98-06.00	AQD	0,5	BKR6EKUB	3584		LPG 1
A 4 2.8 V6 China / USA	8D2/8D5 B5	2.8	140	6	03.99-09.01	ATX	0,5	BKR6EKUB	3584		LPG 1
A 4 2.8 V6 USA	8D2/8D5 B5	2.8	128	6	08.94-07.98	AFC	1,0	BKUR6ET-10	2397	24	LPG 1

**A 4 2 (B6)**

A 4 1.6	8E2/8E5 B6	1.6	75	4	11.00-11.04	ALZ	1,0	BKUR6ET-10	2397	24	LPG 1
A 4 1.8 T	8E2/8E5 B6	1.8	110	4	12.00-06.02	AVJ	0,8	PFR6Q	6458	37	LPG 1
A 4 1.8 T	8E2/8E5 B6	1.8	120	4	07.02-11.04	BFB	0,8	PFR6Q	6458	37	LPG 1
A 4 1.8 T	8E2/8E5 B6	1.8	120	4	07.02-12.04	BKB	0,8	PFR6Q	6458	37	LPG 1
A 4 1.8 T	8E2/8E5 B6	1.8	140	4	11.02-12.04	BEX	0,8	PFR6Q	6458	37	LPG 1
A 4 2.0	8E2/8E5 B6	2.0	96	4	12.00-11.04	ALT	1,0	BKUR5ET-10	7553		LPG 1
A 4 2.0 FSI	8E2/8E5 B6	2.0	110	4	07.02-12.04	AWA	1,1	PZFR5N-11T	7742		
A 4 2.4 V6	8E2/8E5 B6	2.4	120	6	09.01-12.04	AMM	0,5	BKR6EKUB	3584		LPG 1
A 4 2.4 V6	8E2/8E5 B6	2.4	125	6	09.01-12.04	BDV	0,5	BKR6EKUB	3584		LPG 1
A 4 3.0 V6	8E2/8E5 B6	3.0	160	6	04.01-10.04	BBJ	0,5	BKR6EKUB	3584		LPG 1
A 4 3.0 V6	8E2/8E5 B6	3.0	162	6	12.00-12.05	ASN	0,5	BKR6EKUB	3584		LPG 1
A 4 3.0 V6	8E2/8E5 B6	3.0	162	6	09.01-06.02	AVK	1,1	PFR6U-11G	5874		
A 4 S 4 quattro	8E2/8E5 B6	4.2	253	8	03.03-10.04	BBK	0,5	BKR6EQUA	6872		LPG 1

**A 4 3 (B7)**

A 4 1.6	8EC/8ED	1.6	75	4	11.04-	ALZ	1,0	BKUR6ET-10	2397	24	LPG 1
A 4 1.8 T	8EC/8ED	1.8	120	4	11.04-	BFB	0,8	PFR6Q	6458	37	LPG 1
A 4 2.0	8EC/8ED	2.0	96	4	11.04-	ALT	1,0	BKUR5ET-10	7553		LPG 1
A 4 2.0 TFSI	8EC/8ED	2.0	125	4	10.06-	BYK	0,8	PFR7S8EG	1675		PFR8S8EG
A 4 2.0 TFSI	8EC/8ED	2.0	125	4	03.07-	BPJ	0,8	PFR7S8EG	1675		PFR8S8EG
A 4 2.0 TFSI	8EC/8ED	2.0	147	4	11.04-03.08	BGB	0,8	PFR7S8EG	1675		PFR8S8EG
A 4 2.0 TFSI	8EC/8ED	2.0	147	4	09.05-03.09	BWE	0,8	PFR7S8EG	1675		PFR8S8EG
A 4 2.0 TFSI	8EC/8ED	2.0	147	4	09.05-03.09	BWT	0,8	PFR7S8EG	1675		PFR8S8EG
A 4 2.0 TFSI	8EC/8ED	2.0	162	4	06.05-	BUL	0,8	PFR7S8EG	1675		PFR8S8EG
A 4 3.0 V6	8EC/8ED	3.0	160	6	11.04-07.06	BBJ	0,5	BKR6EKUB	3584		LPG 1
A 4 3.2 FSI	8EC/8ED	3.2	188	6	01.05-	AUK	0,9	PFR7W-T	6840		

e kW  
C  
Y  
I

0201



Stock-No

VLINE

LPG / CNG

**AUDI****A 4 3 (B7)**

A 4 RS 4 quattro	8EC/8ED	4.2	309	8	11.05-	BNS	0,9	PFR7W-TG	5592		
A 4 S 4 quattro	8EC/8ED	4.2	253	8	11.04-	BBK	0,5	BKR6EQUA	6872		LPG 1
A 4 S 4 quattro	8EC/8ED	4.2	253	8	03.06-	BHF	0,5	BKR6EQUA	6872		LPG 1

**A 4 4 (8K)**

A 4 1.8 TFSI	8K2/8K5	1.8	88	4	01.08-05.08	CABA	0,8	PFR7S8EG	1675		PFR8S8EG
A 4 1.8 TFSI	8K2/8K5	1.8	88	4	06.08-	CDHA	0,8	PFR7S8EG	1675		PFR8S8EG
A 4 1.8 TFSI	8K2/8K5	1.8	118	4	11.07-05.08	CABB	0,8	PFR7S8EG	1675		PFR8S8EG
A 4 1.8 TFSI	8K2/8K5	1.8	118	4	06.08-	CDHB	0,8	PFR7S8EG	1675		PFR8S8EG
A 4 2.0 TFSI	8K2/8K5	2.0	132	4	06.08-	CAEA	0,8	PFR7S8EG	1675		PFR8S8EG
A 4 2.0 TFSI	8K2/8K5	2.0	132	4	06.08-	CDNB	0,8	PFR7S8EG	1675		PFR8S8EG
A 4 2.0 TFSI	8K2/8K5	2.0	155	4	06.08-	CDNC	0,8	PFR7S8EG	1675		PFR8S8EG
A 4 2.0 TFSI flexible fuel	8K2/8K5	2.0	132	4	11.09-	CFKA	0,8	PFR7S8EG	1675		PFR8S8EG
A 4 3.2 FSI	8K2/8K5	3.2	195	6	11.07-	CALA	1,1	PFR6X-11	5757		
A 4 S 4 quattro	8K2/8K5	3.0	245	6	03.09-	CAKA	0,8	PFR8S8EG	94460		
A 4 S 4 quattro	8K2/8K5	3.0	245	6	03.09-	CCBA	0,8	PFR8S8EG	94460		

**A 5**

A 5 1.8 TFSI	8T3/8F7/8TA	1.8	118	4	05.09-	CDHB	0,8	PFR7S8EG	1675		PFR8S8EG
A 5 1.8 TFSI	8T3/8F7/8TA	1.8	125	4	10.07-11.08	CABD	0,8	PFR7S8EG	1675		PFR8S8EG
A 5 2.0 TFSI	8T3/8F7/8TA	2.0	132	4	09.08-	CDNB	0,8	PFR7S8EG	1675		PFR8S8EG
A 5 2.0 TFSI	8T3/8F7/8TA	2.0	132	4	03.09-	CAEA	0,8	PFR7S8EG	1675		PFR8S8EG
A 5 2.0 TFSI	8T3/8F7/8TA	2.0	155	4	06.08-	CAEB	0,8	PFR7S8EG	1675		PFR8S8EG
A 5 2.0 TFSI	8T3/8F7/8TA	2.0	155	4	06.08-	CDNC	0,8	PFR7S8EG	1675		PFR8S8EG
A 5 S 5 Coupé/Sportback 3.0 FSI quattro	8T3/8TA	3.0	245	6	06.09-	CAKA	0,8	PFR8S8EG	94460		
A 5 3.0 V6 TFSI quattro	8T3/8F7/8TA	3.0	200	6	11.11-	CMUA	0,8	PFR8S8EG	94460		
A 5 S 5 3.0 FSI quattro	8T3	3.0	245	6	10.11-	CGXC	0,8	PFR8S8EG	94460		
A 5 S 5 3.0 FSI quattro	8T3/8F7/8TA	3.0	245	6	05.09-	CCBA	1,1	PFR6X-11	5757		
A 5 S 5 Cabriolet 3.0 FSI quattro	8F7	3.0	245	6	06.09-	CAKA	1,1	PFR6X-11	5757		
A 5 3.2 FSI	8T3/8F7/8TA	3.2	195	6	06.07-	CALA	1,1	PFR6X-11	5757		
A 5 S 5 4.2 FSI quattro	8T3	4.2	260	8	06.07-	CAUA	0,9	PFR6W-TG	5547		
A 5 RS 5 4.2 FSI quattro	8T3	4.2	331	8	03.10-	CFSA	0,8	PFR7S8EG	1675		PFR8S8EG

**A 6 1 (C4)**

A 6 1.8	4A/C4	1.8	92	4	10.95-10.97	ADR	1,0	BKUR6ET-10	2397	24	LPG 1
A 6 2.0	4A/C4	2.0	74	4	06.94-06.96	AAE	0,8	BUR6ET	3172	1	LPG 2
A 6 2.0 16V	4A/C4	2.0	103	4	06.94-10.97	ACE	0,8	BKUR7ET	7873		PFR7Q
A 6 2.0 E	4A/C4	2.0	85	4	06.94-06.96	ABK	0,8	BUR6ET	3172	1	LPG 2
A 6 2.3 E	4A/C4	2.3	98	5	06.94-06.96	AAR	0,7	BPR5EKU	5685		LPG 2
A 6 2.6 E	4A/C4	2.6	110	6	06.94-10.97	ABC	1,0	BKUR6ET-10	2397	24	LPG 1
A 6 2.8 E	4A/C4	2.8	128	6	06.94-10.97	AAH	1,0	BKUR6ET-10	2397	24	LPG 1
A 6 2.8 E	4A/C4	2.8	128	6	08.94-06.95	AFC	1,0	BKUR6ET-10	2397	24	LPG 1
A 6 2.8 E	4A/C4	2.8	142	6	10.95-07.98	ACK	0,5	BKR6EKUB	3584		LPG 1
A 6 S 6	4A/C4	2.2	169	5	06.94-07.97	AAN	0,6	PFR7B	4853		PFR8B
A 6 S 6 4.2	4A/C4	4.2	213	8	09.94-10.97	AEC	0,8	BUR6EFSZ	6837		
A 6 S 6 Plus	4A/C4	4.2	240	8	06.96-10.97	AHK	0,8	BUR6EFSZ	6837		

**A 6 2 (C5)**

A 6 1.8	4B/C5	1.8	92	4	12.97-07.99	AJP	1,0	BKUR6ET-10	2397	24	LPG 1
A 6 1.8	4B/C5	1.8	92	4	01.99-04.01	AQE	1,0	BKUR6ET-10	2397	24	LPG 1
A 6 1.8	4B/C5	1.8	92	4	01.99-04.01	ARH	1,0	BKUR6ET-10	2397	24	LPG 1
A 6 1.8 GUS	4B/C5	1.8	85	4	05.97-05.00	AFY	1,0	BKUR6ET-10	2397	24	LPG 1
A 6 1.8 T	4B/C5	1.8	110	4	04.97-01.99	AEB	0,8	PFR6Q	6458	37	LPG 1



l kW  
C  
Y  
I

0201



Stock-No

VALINE

LPG / CNG

**AUDI**

**A 6 2 (C5)**

A 6 1.8 T	4B/C5	1.8	110	4	11.98-05.01	APU	0,8	PFR6Q	6458	37	LPG 1
A 6 1.8 T	4B/C5	1.8	110	4	01.99-05.01	ANB	0,8	PFR6Q	6458	37	LPG 1
A 6 1.8 T	4B/C5	1.8	110	4	01.99-05.99	ARK	0,8	PFR6Q	6458	37	LPG 1
A 6 1.8 T	4B/C5	1.8	110	4	05.00-01.05	AWT	0,8	PFR6Q	6458	37	LPG 1
A 6 1.8 T	4B/C5	1.8	132	4	11.97-10.00	AJL	0,8	PFR6Q	6458	37	LPG 1
A 6 2.0	4B/C5	2.0	96	4	06.01-01.05	ALT	1,0	BKUR5ET-10	7553		LPG 1
A 6 2.4	4B/C5	2.4	99	6	08.97-01.99	ALW	0,5	BKR6EKUB	3584		LPG 1
A 6 2.4	4B/C5	2.4	100	6	02.99-05.00	ARN	0,5	BKR6EKUB	3584		LPG 1
A 6 2.4	4B/C5	2.4	100	6	06.00-01.05	ASM	0,5	BKR6EKUB	3584		LPG 1
A 6 2.4	4B/C5	2.4	120	6	04.97-01.99	AJG	0,5	BKR6EKUB	3584		LPG 1
A 6 2.4	4B/C5	2.4	120	6	11.98-05.01	APZ	0,5	BKR6EKUB	3584		LPG 1
A 6 2.4	4B/C5	2.4	120	6	06.00-04.01	AMM	0,5	BKR6EKUB	3584		LPG 1
A 6 2.4	4B/C5	2.4	121	6	04.97-01.99	AGA	0,5	BKR6EKUB	3584		LPG 1
A 6 2.4	4B/C5	2.4	121	6	06.97-01.99	ALF	0,5	BKR6EKUB	3584		LPG 1
A 6 2.4	4B/C5	2.4	121	6	04.98-05.01	APC	0,5	BKR6EKUB	3584		LPG 1
A 6 2.4	4B/C5	2.4	121	6	11.98-05.01	ARJ	0,5	BKR6EKUB	3584		LPG 1
A 6 2.4	4B/C5	2.4	121	6	06.00-05.01	AML	0,5	BKR6EKUB	3584		LPG 1
A 6 2.4	4B/C5	2.4	125	6	06.01-01.05	BDV	0,5	BKR6EKUB	3584		LPG 1
A 6 2.4 (China)	4B/C5	2.4	121	6	11.98-05.01	APS	0,5	BKR6EKUB	3584		LPG 1
A 6 2.7 T	4B/C5	2.7	169	6	02.99-08.00	AJK	0,8	PFR6Q	6458	37	LPG 1
A 6 2.7 T	4B/C5	2.7	169	6	09.00-05.01	AZA	0,8	PFR6Q	6458	37	LPG 1
A 6 2.7 T	4B/C5	2.7	184	6	05.00-06.02	ARE	0,8	PFR6Q	6458	37	LPG 1
A 6 2.7 T	4B/C5	2.7	184	6	07.02-08.05	BES	0,8	PFR6Q	6458	37	LPG 1
A 6 2.8	4B/C5	2.8	132	6	02.98-05.01	AGE	0,5	BKR6EKUB	3584		LPG 1
A 6 2.8	4B/C5	2.8	140	6	07.99-05.01	ATX	0,5	BKR6EKUB	3584		LPG 1
A 6 2.8	4B/C5	2.8	142	6	06.97-01.99	ALG	0,5	BKR6EKUB	3584		LPG 1
A 6 2.8	4B/C5	2.8	142	6	11.98-05.01	APR	0,5	BKR6EKUB	3584		LPG 1
A 6 2.8	4B/C5	2.8	142	6	11.98-05.01	AQD	0,5	BKR6EKUB	3584		LPG 1
A 6 2.8	4B/C5	2.8	142	6	06.00-05.01	AMX	0,5	BKR6EKUB	3584		LPG 1
A 6 2.8 (USA)	4B/C5	2.8	142	6	08.97-07.99	AHA	0,5	BKR6EKUB	3584		LPG 1
A 6 3.0	4B/C5	3.0	162	6	06.01-01.05	ASN	0,5	BKR6EKUB	3584		LPG 1
A 6 4.2 quattro	4B/C5	4.2	220	8	11.98-01.05	ARS	0,5	BKR6EQUA	6872		LPG 1
A 6 4.2 quattro	4B/C5	4.2	220	8	11.98-01.05	ASG	0,5	BKR6EQUA	6872		LPG 1
A 6 4.2 allroad	4B/C5	4.2	220	8	04.03-08.05	BAS	0,5	BKR6EQUA	6872		LPG 1
A 6 RS 6 quattro	4B/C5	4.2	331	8	07.02-09.04	BCY	0,8	PFR7Q	7963		PFR7Q
A 6 RS 6 plus quattro	4B/C5	4.2	353	8	04.04-01.05	BRV	0,8	PFR7Q	7963		PFR7Q

**A 6 3 (4F)**

A 6 2.0 TFSI	4F2/4F5	2.0	125	4	06.05-	BPJ	0,8	PFR7S8EG	1675		PFR8S8EG
A 6 2.4	4F2/4F5	2.4	130	6	04.04-10.08	BDW	1,1	PFR6X-11	5757		
A 6 2.8 FSI	4F2/4F5	2.8	140	6	10.08-	CCDA	1,1	PFR6X-11	5757		
A 6 2.8 FSI	4F2/4F5	2.8	154	6	11.06-	BDX	1,1	PFR6X-11	5757		
A 6 2.8 FSI	4F2/4F5	2.8	162	6	10.08-	CCEA	1,1	PFR6X-11	5757		
A 6 3.0 quattro	4F2/4F5	3.0	160	6	06.01-05.06	BBJ	0,5	BKR6EKUB	3584		LPG 1
A 6 3.0 TFSI	4F2/4F5	3.0	213	6	10.08-	CAJA	0,8	PFR8S8EG	94460		
A 6 3.0 TFSI quattro	4F2/4F5	3.0	220	6	10.08-	CCAA	0,8	PFR8S8EG	94460		
A 6 3.2 FSI	4F2/4F5	3.2	188	6	04.04-	AUK	0,9	PFR7W-T	6840		
A 6 3.2 FSI	4F2/4F5	3.2	188	6	10.08-	BKH	1,1	PFR6X-11	5757		
A 6 4.2 FSI quattro	4F2/4F5	4.2	257	8	05.06-	BVJ	0,9	PFR6W-TG	5547		
A 6 4.2 quattro	4F2/4F5	4.2	246	8	04.04-05.06	BAT	0,5	BKR6EQUA	6872		LPG 1
A 6 S 6 quattro	4F2/4F5	5.2	320	10	06.06-	BXA	0,9	PFR6W-TG	5547		

e kW  
C  
Y  
I

0201



Stock-No

VLINE

LPG / CNG

**AUDI****A 6 4 (4G)**

A 6 2.0 TFSI	4G2/4G5	2.0	132	4	05.11-	CDNB	0,8	PFR7S8EG	1675		PFR8S8EG
A 6 2.0 TFSI	4G2/4G5	2.0	155	4	03.11-	CAEB	0,8	PFR7S8EG	1675		PFR8S8EG
A 6 2.0 TFSI Hybrid	4G2/4G5	2.0	155	4	11.11-	CHJA	0,8	PFR7S8EG	1675		PFR8S8EG
A 6 3.0 TFSI quattro	4G2/4G5	3.0	220	6	04.11-	CGWB	0,8	PFR8S8EG	94460		
A 6 3.0 TFSI quattro	4G2/4G5	3.0	228	6	03.11-	CGWD	0,8	PFR8S8EG	94460		
A 6 3.0 TFSI quattro	4G2/4G5	3.0	228	6	03.11-	CGXB	0,8	PFR8S8EG	94460		
A 6 3.0 TFSI quattro	4G2/4G5	3.0	228	6	03.11-	CTUA	0,8	PFR8S8EG	94460		

**A 7**

A 7 Sportback 3.0 TFSI	4GA	3.0	220	6	07.10-	CGWB	0,8	PFR8S8EG	94460		
A 7 Sportback 3.0 TFSI	4GA	3.0	228	6	05.11-	CGXB	0,8	PFR8S8EG	94460		
A 7 Sportback 3.0 TFSI quattro	4GA	3.0	245	6	05.14-	CREC	0,8	PFR8S8EG	94460		

**A 8 1 (4D)**

A 8 2.8	4D2	2.8	128	6	06.94-03.96	AAH	1,0	BKUR6ET-10	2397	24	LPG 1
A 8 2.8	4D2	2.8	142	6	04.96-09.98	ACK	0,5	BKR6EKUB	3584		LPG 1
A 8 2.8	4D2	2.8	142	6	01.99-02.01	APR	0,5	BKR6EKUB	3584		LPG 1
A 8 2.8	4D2	2.8	142	6	01.99-02.01	AQD	0,5	BKR6EKUB	3584		LPG 1
A 8 2.8	4D2	2.8	142	6	05.00-09.02	AMX	0,5	BKR6EKUB	3584		LPG 1
A 8 2.8	4D2	2.8	142	6	10.97-12.98	ALG	0,5	BKR6EKUB	3584		LPG 1
A 8 3.7	4D2	3.7	169	8	07.95-12.98	AEW	0,8	BUR6EFSZ	6837		
A 8 3.7	4D2	3.7	169	8	05.97-12.98	AKJ	0,8	BUR6EFSZ	6837		
A 8 4.2 quattro	4D2	4.2	180	8	06.94-07.96	AEM	0,8	BUR6EFSZ	6837		
A 8 4.2 quattro	4D2	4.2	220	8	06.97-12.98	AKG	0,8	BUR6EFSZ	6837		
A 8 4.2 quattro	4D2	4.2	220	8	06.94-05.99	ABZ	0,8	BUR6EFSZ	6837		
A 8 6.0 W12 quattro	4D2	6.0	309	12	03.01-09.02	AZC	1,1	PZFR6J-11	3586		LPG 6
A 8 S 8 4.2 quattro	4D2	4.2	250	8	09.96-12.98	AHC	0,8	BUR6EFSZ	6837		
A 8 S 8 4.2 quattro	4D2	4.2	250	8	08.97-12.98	AKH	0,8	BUR6EFSZ	6837		

**A 8 2 (4E)**

A 8 2.8 FSI	4E	2.8	154	6	09.07-07.10	BDX	1,1	PFR6X-11	5757		
A 8 3.0	4E	3.0	160	6	07.03-05.06	BBJ	0,5	BKR6EKUB	3584		LPG 1
A 8 3.0	4E	3.0	162	6	07.03-05.05	ASN	0,5	BKR6EKUB	3584		LPG 1
A 8 3.2 FSI	4E	3.2	191	6	06.05-07.10	BPK	0,9	PFR7W-T	6840		
A 8 3.7 quattro	4E	3.7	206	8	11.02-05.06	BFL	0,5	BKR6EQUA	6872		LPG 1
A 8 4.2 FSI quattro	4E	4.2	257	8	06.06-07.10	BVJ	0,9	PFR6W-TG	5547		
A 8 4.2 quattro	4E	4.2	246	8	11.02-05.06	BFM	0,5	BKR6EQUA	6872		LPG 1
A 8 6.0 W12 quattro	4E	6.0	331	12	02.04-07.10	BHT	1,1	PZFR6J-11	3586		LPG 6
A 8 S 8 5.2 quattro	4E	5.2	331	10	06.06-07.10	BSM	0,9	PFR6W-TG	5547		

**A 8 3 (4H)**

A 8 2.0 TFSI Hybrid	4H	2.0	155	4	02.12-	CHJA	0,8	PFR7S8EG	1675		PFR8S8EG
A 8 3.0 TFSI quattro	4H	3.0	245	6	06.10-	CMDA	0,8	PFR8S8EG	94460		
A 8 3.0 TFSI quattro	4H	3.0	213	6	07.10-	CGWA	0,8	PFR8S8EG	94460		
A 8 3.0 TFSI quattro	4H	3.0	213	6	07.10-	CGXA	0,8	PFR8S8EG	94460		
A 8 3.0 TFSI quattro	4H	3.0	245	6	05.11-	CGXC	0,8	PFR8S8EG	94460		
A 8 3.0 TFSI quattro	4H	3.0	228	6	11.11-	CGWD	0,8	PFR8S8EG	94460		
A 8 4.2 FSI quattro	4H	4.2	273	8	11.09-	CDRA	0,9	PFR6W-TG	5547		
A 8 6.3 W12 quattro	4H	6.3	368	12	01.11-	CEJA	0,8	ILZKR8A	94290		

**CABRIO**

Cabrio 1.8		1.8	92	4	04.97-08.00	ADR	1,0	BKUR6ET-10	2397	24	LPG 1
Cabrio 2.0 E		2.0	85	4	01.93-09.98	ABK	0,8	BUR6ET	3172	1	LPG 2
Cabrio 2.0 E 16V		2.0	103	4	05.95-07.96	ACE	0,8	BKUR7ET	7873		PFR7Q



l kW  
C  
Y  
I

0201



Stock-No

VALE

LPG / CNG

**AUDI**

**CABRIO**

Cabrio 2.3 E	2.3	98	5	06.91-07.94	NG	0,7	BPR5EKU	5685		LPG 2
Cabrio 2.6 E	2.6	110	6	01.94-08.00	ABC	1,0	BKUR6ET-10	2397	24	LPG 1
Cabrio 2.6 E China / GUS	2.6	102	6	05.95-12.99	ACZ	1,0	BKUR6ET-10	2397	24	LPG 1
Cabrio 2.8 E	2.8	128	6	11.92-08.00	AAH	1,0	BKUR6ET-10	2397	24	LPG 1

**COUPÉ**

Coupé 2.0 E	2.0	85	4	08.90-07.91	AAD	0,8	BUR6ET	3172	1	LPG 2
Coupé 2.0 E	2.0	85	4	08.91-12.95	ABK	0,8	BUR6ET	3172	1	LPG 2
Coupé 2.0 E 16V	2.0	101	4	03.90-07.92	6A	0,8	BKUR7ET	7873		
Coupé 2.0 E 16V	2.0	103	4	08.92-12.95	ACE	0,8	BKUR7ET	7873		
Coupé 2.2 S2	2.2	162	5	09.90-09.92	3B	0,6	PFR7B	4853		PFR8B
Coupé 2.2 S2	2.2	169	5	10.92-12.95	ABY	0,6	PFR7B	4853		PFR8B
Coupé 2.6 E	2.6	110	6	08.92-12.95	ABC	1,0	BKUR6ET-10	2397	24	LPG 1
Coupé 2.8 E	2.8	128	6	08.91-12.95	AAH	1,0	BKUR6ET-10	2397	24	LPG 1

**Q 3**

Q 3 1.4 TFSI	8UB	1.4	110	4	10.13-	CHPB	0,8	PZKER7A8EGS	94968		
Q 3 1.4 TFSI	8UB	1.4	110	4	10.13-	CZDA	0,8	PZKER7A8EGS	94968		
Q 3 1.4 TFSI	8UB	1.4	110	4	10.13-	CZEA	0,8	PZKER7A8EGS	94968		
Q 3 2.0 TFSI	8UB	2.0	125	4	06.11-	CCZC	0,8	PFR7S8EG	1675		PFR8S8EG
Q 3 2.0 TFSI	8UB	2.0	155	4	06.11-	CPSA	0,8	PFR7S8EG	1675		PFR8S8EG

**Q 5**

Q 5 2.0 TFSI	8R	2.0	130	4	09.09-	CDNA	0,8	PFR7S8EG	1675		PFR8S8EG
Q 5 2.0 TFSI	8R	2.0	132	4	08.09-	CDNB	0,8	PFR7S8EG	1675		PFR8S8EG
Q 5 2.0 TFSI	8R	2.0	155	4	11.08-	CDNC	0,8	PFR7S8EG	1675		PFR8S8EG
Q 5 2.0 TFSI	8R	2.0	155	4	05.10-	CAEB	0,8	PFR7S8EG	1675		PFR8S8EG
Q 5 2.0 TFSI Hybrid	8R	2.0	155	4	06.11-	CHJA	0,8	PFR7S8EG	1675		PFR8S8EG
Q 5 3.2 V6 FSI	8R	3.2	199	6	11.08-	CALB	1,1	PFR6X-11	5757		

**Q 7**

Q 7 3.0 TFSI	4L	3.0	200	6	05.10-	CJTC	0,8	PFR8S8EG	94460		
Q 7 3.0 TFSI	4L	3.0	200	6	07.10-	CJWC	0,8	PFR8S8EG	94460		
Q 7 3.0 TFSI	4L	3.0	245	6	05.10-	CJTB	0,8	PFR8S8EG	94460		
Q 7 3.0 TFSI	4L	3.0	245	6	07.10-	CJWB	0,8	PFR8S8EG	94460		
Q 7 3.0 TFSI	4L	3.0	245	6	07.10-	CNAA	0,8	PFR8S8EG	94460		
Q 7 3.6 FSI	4L	3.6	206	6	08.06-	BHK	0,9	ILZKR7A	1961		
Q 7 4.2 FSI	4L	4.2	257	8	03.06-	BAR	0,9	PFR6W-TG	5547		

**R 8**

R 8 4.2		4.2	309	8	04.07-	BYH	0,9	PFR7W-TG	5592		
R 8 5.2		5.2	386	10	04.09-09.10	BUJ	0,9	PFR7W-TG	5592		
R 8 5.2		5.2	386	10	09.10-	BUJ	0,8	PFR7S8EG	1675		PFR8S8EG
R 8 5.2 GT		5.2	412	10	11.10-	CMPA	0,8	PFR7S8EG	1675		PFR8S8EG

**TT 1 (8N)**

TT 1.8T	8N3/8N9	1.8	110	4	01.01-06.06	AUM	0,8	PFR6Q	6458	37	LPG 1
TT 1.8T	8N3/8N9	1.8	120	4	09.05-06.06	BVP	0,8	PFR6Q	6458	37	LPG 1
TT 1.8T	8N3/8N9	1.8	132	4	10.98-08.00	AJQ	0,8	PFR6Q	6458	37	LPG 1
TT 1.8T	8N3/8N9	1.8	132	4	09.99-09.00	APP	0,8	PFR6Q	6458	37	LPG 1
TT 1.8T	8N3/8N9	1.8	132	4	09.00-05.05	ARY	0,8	PFR6Q	6458	37	LPG 1
TT 1.8T	8N3/8N9	1.8	132	4	09.00-06.06	AUQ	0,8	PFR6Q	6458	37	LPG 1
TT 1.8T (USA)	8N3/8N9	1.8	132	4	09.00-06.06	AWP	0,8	PFR6Q	6458	37	LPG 1

e kW  
C  
y  
i

0201



Stock-No

VLINE

LPG / CNG

**AUDI****TT 1 (8N)**

TT 1.8T (USA)	8N3/8N9	1.8	165	4	03.00-08.02	AMU	0,8	PFR6Q	6458	37	LPG 1
TT 1.8T quattro	8N3/8N9	1.8	140	4	09.05-06.06	BVR	0,8	PFR6Q	6458	37	LPG 1
TT 1.8T quattro	8N3/8N9	1.8	165	4	10.98-08.01	APX	0,8	PFR6Q	6458	37	LPG 1
TT 1.8T quattro	8N3/8N9	1.8	165	4	09.00-05.05	BAM	0,8	PFR6Q	6458	37	LPG 1
TT 1.8T quattro	8N3/8N9	1.8	180	4	03.05-05.05	BFV	0,8	PFR6Q	6458	37	LPG 1
TT 3.2 V6 quattro	8N3/8N9	3.2	184	6	07.03-06.06	BHE	0,9	IZKR7B	7563		

**TT 2 (8J)**

TT 1.8TFSI	8J3/8J9	1.8	118	4	06.08-	CDA	0,8	PFR7S8EG	1675		PFR8S8EG
TT 2.0 TFSI	8J3/8J9	2.0	147	4	08.06-	BWA	0,8	PFR7S8EG	1675		PFR8S8EG
TT 2.0 TFSI	8J3/8J9	2.0	147	4	06.08-06.10	CCZA	0,8	PFR7S8EG	1675		PFR8S8EG
TT 2.0 TFSI	8J3/8J9	2.0	155	4	05.10-	CESA	0,8	PFR7S8EG	1675		PFR8S8EG
TT 2.0 TFSI quattro	8J3/8J9	2.0	155	4	05.10-	CETA	0,8	PFR7S8EG	1675		PFR8S8EG
TT 2.0 TFSI quattro	8J3/8J9	2.0	195	4	05.08-	CDLA	0,8	PFR7S8EG	1675		PFR8S8EG
TT 2.0 TFSI quattro	8J3/8J9	2.0	195	4	05.10-	CDMA	0,8	PFR7S8EG	1675		PFR8S8EG
TT 2.0 TFSI quattro	8J3/8J9	2.0	200	4	05.08-	CDLB	0,8	PFR7S8EG	1675		PFR8S8EG
TT 3.2 V6 quattro	8J3/8J9	3.2	184	6	08.06-	BUB	0,9	IZKR7B	7563		

**V8**

V 8 3.6		3.6	184	8	10.88-11.93	PT	0,8	BUR6EFSZ	6837		
V 8 4.2		4.2	206	8	08.91-11.93	ABH	0,8	BUR6EFSZ	6837		

**AUSTIN**

Metro 310		1.0		4	09.89-04.92		0,7	BP6ES	7811	4	LPG 2
Metro 310		1.3		4	09.89-04.92		0,8	BPR6ES	7822	2	LPG 2

**AUTOBIANCHI**

Y10 Fire		1.0	32	4	10.87-09.92	156A2.100 Cat.	0,8	BCPR6ES	2330	12	LPG 3
Y10 i.e Igloo		1.1	37	4	03.94-10.96	156C046	0,8	BCPR6ES	2330	12	LPG 3
Y10 i.e Junior		1.1	37	4	03.94-10.96	156C046	0,8	BCPR6ES	2330	12	LPG 3
Y10 i.e Mia		1.1	37	4	01.94-10.96	156C046	0,8	BCPR6ES	2330	12	LPG 3
Y10 i.e 4WD		1.1	37	4	03.94-10.96	156C046	0,8	BCPR6ES	2330	12	LPG 3
Y10 i.e Seleccion		1.1	37	4	03.94-01.95	156C046	0,8	BCPR6ES	2330	12	LPG 3
Y10 i.e.		1.1	40	4	03.95-		0,8	BCPR6ES	2330	12	LPG 3
Y10 Fire IE all Models		1.1	41	4	01.89-10.96	156C000	0,8	BCPR6ES	2330	12	LPG 3
Y10 i.e GT/i.e GT Kat./Elite		1.3	53	4	11.87-09.92	156C5.046	0,8	BPR6ES	7822	2	LPG 2

**AZLK (MOSKWITCZ)**

Aleko		1.8	70	4	12.86-12.00		0,8	BPR6ES	7822	2	LPG 2
Aleko		2.0	83	4	01.86-12.00	REN-F3R	0,9	BPR5ES	7422	6	LPG 2
Ish 2126		1.5		4	09.87-		0,7	BP6ES	7811	4	LPG 2

**BENTLEY**

Arnage		4.4	210	8	04.98-08.98	BMW M62B44	0,9	BKR6EK	2288	20	LPG 1
Arnage		4.4	210	8	08.98-	BMW M62B44	1,5	BKR6EQUP	3199	30	LPG 1
Arnage Green Label V8 Biturbo		4.4	260	8	08.99-12.01		1,5	BKR6EQUP	3199	30	LPG 1
Arnage		4.4		8	09.99- .01	BMW	1,5	BKR6EQUP	3199	30	LPG 1
Arnage Red Label V8 6.8 turbo		6.8		8	09.99-	RR	1,3	PFR5G-13E	2761		LPG 1
Arnage Le Mans		6.8		8	03.01-	RR	0,9	BKR4EVX	4870		



ℓ kW C y i

0201



Stock-No

VALVE

LPG / CNG

**BENTLEY**

Azure	6.8		8	03.95-		1,3	PFR5G-13E	2761		LPG 1
Azure Mulliner	6.8		8	03.99-		1,3	PFR5G-13E	2761		LPG 1
Brooklands	6.8		8	09.92-09.99		1,3	PFR5G-13E	2761		LPG 1
Continental Flying Spur	6.0		12	.05-		0,8	PFR6Q	6458	37	LPG 1
Continental GT	6.0		12	.03- .07		0,8	PFR6Q	6458	37	LPG 1
Continental R	6.8		8	12.91-		1,3	PFR5G-13E	2761		LPG 1
Continental / Mulliner	6.8		8	02.97-		1,3	PFR5G-13E	2761		LPG 1
Continental R Mulliner	6.8		8	03.99-		1,3	PFR5G-13E	2761		LPG 1
Continental SC / Mulliner	6.8		8	03.99-09.00		1,3	PFR5G-13E	2761		LPG 1
Continental R Le Mans	6.8		8	03.01-		1,3	PFR5G-13E	2761		LPG 1
Corniche 71-->02	6.8		8	07.93-08.95		0,9	BKR4EVX	4870		
Corniche 71-->02	6.8		8	09.95-		1,3	PFR5G-13E	2761		LPG 1
Mulsanne / S / Eight	6.8		8	07.93-		0,9	BKR4EVX	4870		
Turbo R 85-->96	6.8		8	01.89-09.96		1,3	PFR5G-13E	2761		LPG 1

**BERTONE**

Freeclimber 1.6i	1.6	74	4	02.92-	M40 B16	0,9	BKR6EK	2288	20	LPG 1
Freeclimber 2.0i 4x4	2.0	95	6	01.91-	M20 B20	0,8	ZGR5A	5839	15	
Freeclimber 2.7i 4x4	2.7	95	6	01.91-	M20 B27	0,8	ZGR5A	5839	15	

**BMW**

**1 (SERIES) E**

116i	E87	1.6	85	4	08.07-	N45 B16	0,5	BKR6EQU	6002		LPG 1
116i	E81	1.6	90	4	08.07-	N43 B16	0,5	ZKBR7A-HTU	91785		
116i	E87	1.6	85	4	09.04-	N45 B16	0,5	BKR6EQU	6002		LPG 1
116i	E87	1.6	90	4	08.07-	N43 B16	0,5	ZKBR7A-HTU	91785		
116i	E87	2.0	90	4	10.07-09.12	N43 B20A	0,5	ZKBR7AP-HTU	7716		
118 i	E81	2.0	95	4	04.07-	N46 B20	1,1	IZFR6H11	4294		
118 i	E81	2.0	105	4	05.07-	N43 B20	0,5	ZKBR7A-HTU	91785		
118 i	E87	2.0	95	4	09.04-	N46 B20	1,1	IZFR6H11	4294		
118 i	E87	2.0	105	4	05.07-	N43 B20	0,5	ZKBR7A-HTU	91785		
118 i Cabrio	E88	2.0	105	4	04.08-	N43 B20	0,5	ZKBR7A-HTU	91785		
120 i	E87	2.0	110	4	09.04-	N46 B20	1,1	IZFR6H11	4294		
120 i	E81	2.0	125	4	03.07-	N43 B20	0,5	ZKBR7A-HTU	91785		
120 i	E87	2.0	125	4	12.06-	N43 B20	0,5	ZKBR7A-HTU	91785		
120i Coupé	E82	2.0	115	4	06.09-	N46 B20B	0,5	ZKBR7AP-HTU	7716		
120 i Cabrio	E88	2.0	125	4	04.08-	N43 B20	0,5	ZKBR7A-HTU	91785		
125 i Cabrio	E88	3.0	160	4	04.08-	N52 B30	1,1	PLZFR6A11S	5987		
125 i Coupé	E82	3.0	160	6	09.07-	N52 B30	1,1	PLZFR6A11S	5987		
130 i	E81	3.0	195	6	09.06-	N52 B30	1,1	ILZFR6D11	1208		
130 i	E87	3.0	195	6	09.05-	N52 B30	1,1	ILZFR6D11	1208		
130i	E87	3.0	195	6	01.10-09.12	N52B30A	1,1	LZFR6AP11GS	95712		
130i	E87	3.0	195	6	01.10-09.12	N52B30B	1,1	LZFR6AP11GS	95712		
130i	E87	3.0	195	6	01.10-09.12	N52B30BF	1,1	LZFR6AP11GS	95712		

**1 (SERIES) F**

114i	F20	1.6	75	4	11.11-	N13B16A	0,8	PLZKBR7B8DG	90223		
116i	F20	1.6	100	4	06.11-	N13B16A	0,8	PLZKBR7B8DG	90223		
118i	F20	1.6	125	4	06.11-	N13B16A	0,8	PLZKBR7B8DG	90223		
125i	F20	2.0	160	4	12.11-	N20B20A	0,75	SILZKBR8D8S	97506		
125i	F21	2.0	160	4	03.12-	N20B20A	0,75	SILZKBR8D8S	97506		

e kW  
C  
y  
i

0201



Stock-No

VLINE

LPG / CNG

**BMW****1 (SERIES) F**

125i M Performance Power Kit	F21	2.0	175	4	07.12-	N20B20A	0,75	SILZKBR8D8S	97506		
125i M Performance Power Kit	F20	2.0	175	4	07.12-	N20B20A	0,75	SILZKBR8D8S	97506		
125i	F20	2.0	160	4	08.14-	N20B20A	0,75	SILZKBR8D8S	97506		

**2 (SERIES) F**

220i Cabrio	F23	2.0	160	4	08.14-	N20B20A	0,75	SILZKBR8D8S	97506		
220i Cabrio	F23	2.0	135	4	10.14-	N20B20A	0,75	SILZKBR8D8S	97506		
220i Coupe	F22	2.0	135	4	10.14-	N20B20A	0,75	SILZKBR8D8S	97506		
220i Coupe	F22	2.0	135	4	10.14-	N20B20B	0,75	SILZKBR8D8S	97506		
220i Coupe	F22	2.0	135	4	10.13-	N20B20A	0,75	SILZKBR8D8S	97506		
228i Cabrio	F23	2.0	135	4	10.13-	N20B20A	0,75	SILZKBR8D8S	97506		
228i Cabrio	F23	2.0	135	4	10.13-	N20B20B	0,75	SILZKBR8D8S	97506		
228i Coupe	F22	2.0	135	4	10.13-	N20B20B	0,75	SILZKBR8D8S	97506		
228i Coupe	F22	2.0	180	4	10.14-	N20B20A	0,75	SILZKBR8D8S	97506		

**3 (SERIES) E30**

316 i	E30	1.6	73	4	09.88-09.94	M40 B16	0,9	BKR6EK	2288	20	LPG 1
316 i	E30	1.8	75	4	09.87-08.88	M10 B18	0,8	BP5ES	6511	8	LPG 2
318 i	E30	1.8	83	4	09.87-04.91	M40 B18	0,9	BKR6EK	2288	20	LPG 1
318 i Touring	E30	1.8	82	4	04.89-09.94	M40 B18	0,9	BKR6EK	2288	20	LPG 1
318 iS	E30	1.8	103	4	09.89-10.90	M42 B18	0,9	BKR6EK	2288	20	LPG 1
320 i	E30	2.0	90	6	12.86-12.90	M20 B20 Cat.	0,8	ZGR5A	5839	15	
320 i	E30	2.0	92	6	01.88-08.88	M20 B20	0,8	ZGR5A	5839	15	
320 i Touring	E30	2.0	90	6	01.88-08.91	M20 B20	0,8	ZGR5A	5839	15	
325 i	E30	2.5	125	6	12.86-12.90	M20 B25	0,8	ZGR5A	5839	15	
325 i Touring	E30	2.5	125	6	07.87- .91	M20 B25	0,8	ZGR5A	5839	15	
325 iX	E30	2.5	125	6	12.86-01.91	M20 B25	0,8	ZGR5A	5839	15	
325 iX Touring	E30	2.5	125	6	06.88- .91	M20 B25	0,8	ZGR5A	5839	15	

**3 (SERIES) E36**

316 g Compact	E36	1.6	65	4	02.96-07.00	M43 B16	0,9	BKR6EK	2288	20	LPG 1
316 i	E36	1.6	73	4	05.91-08.93	M40 B16	0,9	BKR6EK	2288	20	LPG 1
316 i	E36	1.6	75	4	08.93-05.99	M43 B16	0,9	BKR6EK	2288	20	LPG 1
316 i Compact	E36	1.6	75	4	04.94-12.98	M43 B16	0,9	BKR6EK	2288	20	LPG 1
316 i Compact	E36	1.9	77	4	04.98-08.00	M43 B19	0,9	BKR6EK	2288	20	LPG 1
318 i	E36	1.8	83	4	10.90-09.93	M40 B18	0,9	BKR6EK	2288	20	LPG 1
318 i	E36	1.8	85	4	08.93-09.99	M43 B18	0,9	BKR6EK	2288	20	LPG 1
318 i Touring	E36	1.8	85	4	09.94-09.99	M43 B18	0,9	BKR6EK	2288	20	LPG 1
318 iS	E36	1.8	103	4	10.91-03.96	M42 B18	0,9	BKR6EK	2288	20	LPG 1
318 ti Compact	E36	1.8	103	4	11.94-02.96	M42 B18	0,9	BKR6EK	2288	20	LPG 1
318 iS Coupe	E36	1.9	103	4	01.96-09.99	M44 B19	0,9	BKR6EK	2288	20	LPG 1
318 ti Compact	E36	1.9	103	4	02.95-12.98	M44 B19	0,9	BKR6EK	2288	20	LPG 1
320 i	E36	2.0	110	6	01.90-07.95	M50 B20	0,9	BKR6EK	2288	20	LPG 1
320 i	E36	2.0	110	6	09.94-09.99	M52 B20	0,9	BKR6EK	2288	20	LPG 1
320 i Touring	E36	2.0	110	6	04.94-05.99	M52 B20	0,9	BKR6EK	2288	20	LPG 1
323 i	E36	2.5	125	6	06.95-04.99	M52 B25	0,9	BKR6EK	2288	20	LPG 1
323 i Touring	E36	2.5	125	6	12.95-05.99	M52 B25	0,9	BKR6EK	2288	20	LPG 1
323 ti Compact	E36	2.5	125	6	10.97-12.98	M52 B25	0,9	BKR6EK	2288	20	LPG 1
325 i	E36	2.5	141	6	12.89-12.94	M50 B25	0,9	BKR6EK	2288	20	LPG 1
328 i	E36	2.8	142	6	01.95-09.99	M52 B28	0,9	BKR6EK	2288	20	LPG 1
328 i Touring	E36	2.8	142	6	05.95-05.99	M52 B28	0,9	BKR6EK	2288	20	LPG 1
M3	E36	3.2	236	6	11.95-10.99	S50 B32	0,7	PKR7A	3641		PKR7A





ℓ kW  
C  
Y  
I

0201



Stock-No

VALVE

LPG / CNG

**BMW**

**3 (SERIES) E46**

316 Ci Coupé	E46	1.6	75	4	04.99-02.02	M43 B16	1,5	BKR6EQU	3199	30	LPG 1
316 i	E46	1.6	85	4	09.03-01.05	N45 B16	1,1	IZFR6H11	4294		
316 Ci Coupé	E46	1.8	85	4	03.02-02.04	N40 B18	1,5	BKR6EQU	3199	30	LPG 1
316 Ci Coupé	E46	1.8	85	4	03.04-05.06	N45 B18	1,1	IZFR6H11	4294		
316 i	E46	1.8	85	4	10.01-02.04	N42 B18	1,5	BKR6EQU	3199	30	LPG 1
316 i	E46	1.8	85	4	09.03-01.05	N46 B18	1,1	IZFR6H11	4294		
316 i Touring	E46	1.8	85	4	10.01-02.04	N42 B18	1,5	BKR6EQU	3199	30	LPG 1
316 i Touring	E46	1.8	85	4	10.03-07.05	N46 B18	1,1	IZFR6H11	4294		
316 ti Compact	E46	1.8	85	4	05.01-02.04	N42 B18	1,5	BKR6EQU	3199	30	LPG 1
316 ti Compact	E46	1.8	85	4	09.03-12.04	N46 B18	1,1	IZFR6H11	4294		
316 i	E46	1.9	77	4	01.99-09.01	M43 B19	1,5	BKR6EQU	3199	30	LPG 1
318 Ci Coupé	E46	1.9	87	4	09.99-08.01	M43 B19	1,5	BKR6EQU	3199	30	LPG 1
318 i	E46	1.9	87	4	04.98-08.01	M43 B19	1,5	BKR6EQU	3199	30	LPG 1
318 i Touring	E46	1.9	87	4	09.00-08.01	M43 B19	1,5	BKR6EQU	3199	30	LPG 1
318 Ci Cabrio	E46	2.0	105	4	12.00-03.05	N42 B20	1,5	BKR6EQU	3199	30	LPG 1
318 Ci Coupé	E46	2.0	105	4	09.01-02.04	N42 B20	1,5	BKR6EQU	3199	30	LPG 1
318 i	E46	2.0	105	4	09.01-02.04	N42 B20	1,5	BKR6EQU	3199	30	LPG 1
318 i	E46	2.0	105	4	10.03-02.05	N46 B20	1,1	IZFR6H11	4294		IZFR6H11
318 i Touring	E46	2.0	105	4	12.00-02.04	N42 B20	1,5	BKR6EQU	3199	30	LPG 1
318 ti Compact	E46	2.0	105	4	03.01-02.04	N42 B20	1,5	BKR6EQU	3199	30	LPG 1
318 ti Compact	E46	2.0	105	4	09.03-12.04	N46 B20	1,1	IZFR6H11	4294		
318 Ci Cabrio	E46	2.0	110	4	04.05-08.06	N46 B20	1,1	IZFR6H11	4294		
318 Ci Coupé	E46	2.0	110	4	10.03-05.06	N46 B20	1,1	IZFR6H11	4294		
320 Ci Coupé	E46	2.0	110	6	11.98-08.01	M52 B20	1,5	BKR6EQU	3199	30	LPG 1
320 i	E46	2.0	110	6	07.97-07.01	M52 B20	1,5	BKR6EQU	3199	30	LPG 1
320 i Touring	E46	2.0	110	6	05.98-08.01	M52 B20	1,5	BKR6EQU	3199	30	LPG 1
320 Ci Cabrio	E46	2.2	125	6	02.00-08.06	M54 B22	1,5	BKR6EQU	3199	30	LPG 1
320 Ci Coupé	E46	2.2	125	6	01.00-03.03	M54 B22	1,5	BKR6EQU	3199	30	LPG 1
320 i	E46	2.2	125	6	06.00-01.05	M54 B22	1,5	BKR6EQU	3199	30	LPG 1
320 i Touring	E46	2.2	125	6	05.01-07.05	M54 B22	1,5	BKR6EQU	3199	30	LPG 1
323 Ci Cabrio	E46	2.5	125	6	11.98-09.00	M52 B25	1,5	BKR6EQU	3199	30	LPG 1
323 Ci Coupé	E46	2.5	125	6	03.98-08.00	M52 B25	1,5	BKR6EQU	3199	30	LPG 1
323 i	E46	2.5	125	6	07.97-10.00	M52 B25	1,5	BKR6EQU	3199	30	LPG 1
325 Ci Cabrio	E46	2.5	141	6	02.00-08.06	M54 B25	1,5	BKR6EQU	3199	30	LPG 1
325 Ci Coupé	E46	2.5	141	6	01.00-05.06	M54 B25	1,5	BKR6EQU	3199	30	LPG 1
325 i	E46	2.5	141	6	01.00-01.05	M54 B25	1,5	BKR6EQU	3199	30	LPG 1
325 i Touring	E46	2.5	141	6	02.00-07.05	M54 B25	1,5	BKR6EQU	3199	30	LPG 1
325 ti Compact	E46	2.5	141	6	03.00-12.04	M54 B25	1,5	BKR6EQU	3199	30	LPG 1
325 Xi	E46	2.5	141	6	01.00-12.04	M54 B25	1,5	BKR6EQU	3199	30	LPG 1
325 Xi Touring	E46	2.5	141	6	02.00-05.05	M54 B25	1,5	BKR6EQU	3199	30	LPG 1
328 Ci Coupé	E46	2.8	142	6	03.98-06.00	M52 B28	1,5	BKR6EQU	3199	30	LPG 1
328 i	E46	2.8	142	6	04.97-05.00	M52 B28	1,5	BKR6EQU	3199	30	LPG 1
328 i Touring	E46	2.8	142	6	05.98-06.00	M52 B28	1,5	BKR6EQU	3199	30	LPG 1
330 Ci Cabrio	E46	3.0	170	6	12.99-08.06	M54 B30	1,5	BKR6EQU	3199	30	LPG 1
330 Ci Coupé	E46	3.0	170	6	09.99-05.06	M54 B30	1,5	BKR6EQU	3199	30	LPG 1
330 i	E46	3.0	170	6	09.99-01.05	M54 B30	1,5	BKR6EQU	3199	30	LPG 1
330 i Touring	E46	3.0	170	6	09.99-07.05	M54 B30	1,5	BKR6EQU	3199	30	LPG 1
330 Xi	E46	3.0	170	6	09.99-12.04	M54 B30	1,5	BKR6EQU	3199	30	LPG 1
330 Xi Touring	E46	3.0	170	6	09.99-05.05	M54 B30	1,5	BKR6EQU	3199	30	LPG 1
M3	E46	3.2	252	6	07.99-08.06	S54 B32	0,9	DCPR8EK	7415		
M3 CSL	E46	3.2	265	6	09.02-12.03	S54 B32	0,9	DCPR8EK	7415		

e kW  
C  
y  
i

0201



Stock-No

VLINE

LPG / CNG

**BMW****3 (SERIES) E90**

316 i	E90	1.6	85	4	02.06-12.11	N45 B16	0,5	BKR6EQU	6002		LPG 1
316 i	E90	1.6	90	4	09.07-12.11	N43 B16A	0,5	ZKBR7AP-HTU	7716		
318 i	E90	2.0	100	4	06.07-12.11	N43 B20A	0,5	ZKBR7AP-HTU	7716		
318 i	E90	2.0	95	4	09.04-	N46 B20	1,1	IZFR6H11	4294		
318 i	E90	2.0	105	4	07.07-	N43 B20	0,5	ZKBR7A-HTU	91785		
320 i	E90	2.0	110	4	03.05-	N46 B20	1,1	IZFR6H11	4294		
320 i	E90	2.0	125	4	05.07-	N43 B20	0,5	ZKBR7A-HTU	91785		
323i	E90	2.5	140	6	03.08-12.11	N52B25A	1,1	LZFR6AP11GS	95712		
325 i	E90	2.5	160	6	03.05-	N52 B25	1,1	ILZFR6D11	1208		
325 i	E90	3.0	160	6	09.07-	N53 B30	0,5	ZKBR7A-HTU	91785		
325i xDrive	E90	2.5	160	6	01.10-12.11	N52NB25A	1,1	LZFR6AP11GS	95712		
330 i	E90	3.0	190	6	03.05-	N52 B30	1,1	ILZFR6D11	1208		
330 i	E90	3.0	200	6	07.07-	N53 B30	0,5	ZKBR7A-HTU	91785		
M3	E90	4.0	309	8	09.07-	S65 B40	0,9	LKR8AP	4471		

**3 (SERIES) E91**

318 i Touring	E91	2.0	100	4	09.07-12.11	N43 B20A	0,5	ZKBR7AP-HTU	7716		
318 i Touring	E91	2.0	105	4	09.07-	N43 B20	0,5	ZKBR7A-HTU	91785		
318 i Touring	E91	2.0	95	4	03.06-	N46 B20	1,1	IZFR6H11	4294		
320 i Touring	E91	2.0	110	4	10.05-	N46 B20	1,1	IZFR6H11	4294		
320 i Touring	E91	2.0	125	4	09.07-	N43 B20	0,5	ZKBR7A-HTU	91785		
325 i Touring	E91	2.5	160	6	09.05-	N52 B25	1,1	ILZFR6D11	1208		
325 i Touring	E91	3.0	160	6	09.07-	N53 B30	0,5	ZKBR7A-HTU	91785		
330 i Touring	E91	3.0	190	6	09.05-	N52 B30	1,1	ILZFR6D11	1208		
330 i Touring	E91	3.0	200	6	09.07-	N53 B30	0,5	ZKBR7A-HTU	91785		

**3 (SERIES) E92**

316 i Coupe	E92	1.6	90	4	08.07-	N43 B16A	0,5	ZKBR7A-HTU	91785		
316 i Coupé	E92	2.0	90	4	08.07-	N43 B16	0,5	ZKBR7A-HTU	91785		
320 i Coupé	E92	2.0	115	4	10.06-	N46 B20	1,1	IZFR6H11	4294		
320 i Coupé	E92	2.0	125	4	03.07-	N43 B20	0,5	ZKBR7A-HTU	91785		
320 i Coupe	E92	2.0	120	4	01.07-	N43 B20A	0,5	ZKBR7AP-HTU	7716		
325 i Coupé	E92	2.5	160	6	09.06-	N52 B25	1,1	LZFR6AP11GS	95712		
325i Coupe	E92	2.5	160	6	08.06-	N52NB25BF	1,1	LZFR6AP11GS	95712		
325i Coupe	E92	2.5	150	6	03.13-	N52NB25A	1,1	LZFR6AP11GS	95712		
325i xDrive Coupe	E92	2.5	160	6	03.10-03.12	N52NB25A	1,1	LZFR6AP11GS	95712		
325i xDrive Coupe	E92	2.5	150	6	03.12-	N52NB25A	1,1	LZFR6AP11GS	95712		
325 i Coupé	E92	3.0	160	6	09.07-	N53 B30	0,5	ZKBR7A-HTU	91785		
330 i Coupé	E92	3.0	200	6	09.06-	N52 B30	1,1	LZFR6AP11GS	95712		
330 i Coupé	E92	3.0	200	6	09.07-	N53 B30	0,5	ZKBR7A-HTU	91785		
M3	E92	4.0	309	8	03.07-	S65 B40	0,9	LKR8AP	4471		

**3 (SERIES) E93**

320 i Cabrio	E93	2.0	120	4	01.07-	N43 B20A	0,5	ZKBR7AP-HTU	7716		
320 i Cabrio	E93	2.0	125	4	04.07-	N46 B20	1,1	IZFR6H11	4294		
325i Cabrio	E93	2.5	160	6	01.10-	N52NB25A	1,1	LZFR6AP11GS	95712		
325 i Cabrio	E93	2.5	160	6	04.07-	N52 B25	1,1	LZFR6AP11GS	95712		
325 i Cabrio	E93	3.0	160	6	09.07-	N53 B30	0,5	ZKBR7A-HTU	91785		
330 i Cabrio	E93	3.0	200	6	04.07-	N52 B30	1,1	ILZFR6D11	1208		
330 i Cabrio	E93	3.0	200	6	09.07-	N53 B30	0,5	ZKBR7A-HTU	91785		
330i Cabrio	E93	3.0	200	6	01.10-	N52NB30A	1,1	LZFR6AP11GS	95712		
330i Cabrio	E93	3.0	200	6	01.10-	N52NB30B	1,1	LZFR6AP11GS	95712		



l kW  
C  
y  
i

0201



Stock-No

VALVE

LPG/CNG

**BMW**

**3 (SERIES) E93**

330i Cabrio	E93	3.0	200	6	01.10-	N52NB30BF	1,1	LZFR6AP11GS	95712		
M3	E93	4.0	309	8	09.07-	S65 B40	0,9	LKR8AP	4471		

**3 (SERIES) F**

316i	F30	1.6	100	4	08.12-	N13B16A	0,8	PLZKBR7B8DG	90223		
316i Touring	F31	1.6	100	4	11.12-	N13B16A	0,8	PLZKBR7B8DG	90223		
320i	F30	1.6	125	4	10.12-	N13B16A	0,8	PLZKBR7B8DG	90223		
320i	F30	2.0	180	4	10.14-	N20B20A	0,75	SILZKBR8D8S	97506		
320i	F30	2.0	180	4	07.14-	N20B20A	0,75	SILZKBR8D8S	97506		
320i	F30	2.0	135	4	01.12-	N20B20A	0,75	SILZKBR8D8S	97506		
320i Gran Turismo	F34	2.0	135	4	01.12-	N20B20A	0,75	SILZKBR8D8S	97506		
320i Gran Turismo	F34	2.0	135	4	01.12-	N20B20B	0,75	SILZKBR8D8S	97506		
320i Gran Turismo	F34	2.0	135	4	03.13-	N20B20A	0,75	SILZKBR8D8S	97506		
320i Gran Turismo	F34	2.0	135	4	03.13-	N20B20B	0,75	SILZKBR8D8S	97506		
320i Touring	F31	2.0	135	4	03.13-	N20B20B	0,75	SILZKBR8D8S	97506		
320i Touring	F31	2.0	120	4	07.13-	N20B20A	0,75	SILZKBR8D8S	97506		
320i xDrive	F30	2.0	120	4	07.13-	N20B20A	0,75	SILZKBR8D8S	97506		
320i xDrive	F30	2.0	135	4	06.12-	N20B20B	0,75	SILZKBR8D8S	97506		
320i xDrive Gran Turismo	F34	2.0	135	4	06.12-	N20B20B	0,75	SILZKBR8D8S	97506		
320i xDrive Gran Turismo	F34	2.0	135	4	11.11-	N20B20A	0,75	SILZKBR8D8S	97506		
320i xDrive Gran Turismo	F34	2.0	135	4	07.13-	N20B20A	0,75	SILZKBR8D8S	97506		
320i xDrive Touring	F31	2.0	135	4	07.13-	N20B20A	0,75	SILZKBR8D8S	97506		
320i xDrive Touring	F31	2.0	120	4	07.13-	N20B20A	0,75	SILZKBR8D8S	97506		
328i	F30	2.0	120	4	07.13-	N20B20A	0,75	SILZKBR8D8S	97506		
328i	F30	2.0	135	4	03.13-	N20B20A	0,75	SILZKBR8D8S	97506		
328i	F30	2.0	180	4	10.11-	N20B20A	0,75	SILZKBR8D8S	97506		
328i Gran Turismo	F34	2.0	180	4	10.11-	N20B20A	0,75	SILZKBR8D8S	97506		
328i Gran Turismo	F34	2.0	180	4	10.11-	N26B20A	0,75	SILZKBR8D8S	97506		
328i Touring	F31	2.0	180	4	10.11-	N26B20A	0,75	SILZKBR8D8S	97506		
328i Touring	F31	2.0	180	4	03.13-	N20B20A	0,75	SILZKBR8D8S	97506		
328i xDrive	F30	2.0	180	4	03.13-	N20B20A	0,75	SILZKBR8D8S	97506		
328i xDrive	F30	2.0	180	4	06.12-	N20B20A	0,75	SILZKBR8D8S	97506		
328i xDrive Gran Turismo	F34	2.0	180	4	06.12-	N20B20A	0,75	SILZKBR8D8S	97506		
328i xDrive Gran Turismo	F34	2.0	180	4	10.11-	N20B20A	0,75	SILZKBR8D8S	97506		
328i xDrive Touring	F31	2.0	180	4	10.11-	N20B20A	0,75	SILZKBR8D8S	97506		
328i xDrive Touring	F31	2.0	180	4	07.13-	N20B20A	0,75	SILZKBR8D8S	97506		

**4 (SERIES) F**

420i Cabrio	F33	2.0	135	4	07.14-	N20B20B	0,75	SILZKBR8D8S	97506		
420i Cabrio	F33	2.0	180	4	07.13-	N20B20A	0,75	SILZKBR8D8S	97506		
420i Cabrio	F33	2.0	180	4	02.13-	N20B20A	0,75	SILZKBR8D8S	97506		
420i Coupe	F32	2.0	120	4	07.14-	N20B20B	0,75	SILZKBR8D8S	97506		
420i Coupe	F32	2.0	120	4	11.13-	N20B20A	0,75	SILZKBR8D8S	97506		
420i Coupe	F32	2.0	120	4	11.13-	N20B20B	0,75	SILZKBR8D8S	97506		
420i Coupe	F32	2.0	135	4	07.14-	N20B20B	0,75	SILZKBR8D8S	97506		
420i Coupe	F32	2.0	135	4	11.13-	N20B20A	0,75	SILZKBR8D8S	97506		
420i Gran Coupe	F36	2.0	135	4	11.13-	N20B20A	0,75	SILZKBR8D8S	97506		
420i Gran Coupe	F36	2.0	135	4	11.13-	N20B20B	0,75	SILZKBR8D8S	97506		
420i Gran Coupe	F36	2.0	135	4	03.14-	N20B20B	0,75	SILZKBR8D8S	97506		
420i xDrive Coupe	F32	2.0	120	4	03.14-	N20B20B	0,75	SILZKBR8D8S	97506		
420i xDrive Coupe	F32	2.0	135	4	03.14-	N20B20B	0,75	SILZKBR8D8S	97506		



e kW

C  
y  
l

0201



Stock-No

VLINE

LPG / CNG

**BMW****4 (SERIES) F**

420i xDrive Coupe	F32	2.0	135	4	11.13-	N20B20B	0,75	SILZKBR8D8S	97506		
420i xDrive Gran Coupe	F36	2.0	135	4	11.13-	N20B20B	0,75	SILZKBR8D8S	97506		
420i xDrive Gran Coupe	F36	2.0	120	4	05.14-	N20B20B	0,75	SILZKBR8D8S	97506		
420i xDrive Gran Coupe	F36	2.0	120	4	07.14-	N20B20A	0,75	SILZKBR8D8S	97506		
428i Cabrio	F33	2.0	120	4	07.14-	N20B20A	0,75	SILZKBR8D8S	97506		
428i Cabrio	F33	2.0	135	4	07.14-	N20B20A	0,75	SILZKBR8D8S	97506		
428i Cabrio	F33	2.0	180	4	10.13-	N20B20A	0,75	SILZKBR8D8S	97506		
428i Coupe	F32	2.0	180	4	10.13-	N20B20A	0,75	SILZKBR8D8S	97506		
428i Coupe	F32	2.0	180	4	10.13-	N26B20A	0,75	SILZKBR8D8S	97506		
428i Coupe	F32	2.0	180	4	07.13-	N20B20A	0,75	SILZKBR8D8S	97506		
428i Gran Coupe	F36	2.0	180	4	07.13-	N20B20A	0,75	SILZKBR8D8S	97506		
428i Gran Coupe	F36	2.0	180	4	07.13-	N26B20A	0,75	SILZKBR8D8S	97506		
428i xDrive Cabrio	F33	2.0	180	4	07.13-	N26B20A	0,75	SILZKBR8D8S	97506		
428i xDrive Cabrio	F33	2.0	180	4	03.14-	N20B20A	0,75	SILZKBR8D8S	97506		
428i xDrive Coupe	F32	2.0	180	4	03.14-	N20B20A	0,75	SILZKBR8D8S	97506		
428i xDrive Coupe	F32	2.0	180	4	01.14-	N20B20A	0,75	SILZKBR8D8S	97506		
428i xDrive Gran Coupe	F36	2.0	180	4	01.14-	N20B20A	0,75	SILZKBR8D8S	97506		
428i xDrive Gran Coupe	F36	2.0	180	4	07.13-	N20B20A	0,75	SILZKBR8D8S	97506		

**5 (SERIES) E34**

518 g Touring	E34	1.8	75	4	11.95-06.96	M43 B18	0,9	BKR6EK	2288	20	LPG 1
518 i	E34	1.8	83	4	09.89-04.94	M40 B18	0,9	BKR6EK	2288	20	LPG 1
518 i	E34	1.8	85	4	05.94-06.96	M43 B18	0,9	BKR6EK	2288	20	LPG 1
520 i	E34	2.0	95	6	01.88-08.91	M20 B20	0,8	ZGR5A	5839	15	
520 i	E34	2.0	110	6	03.89-06.96	M50 B20	0,9	BKR6EK	2288	20	LPG 1
525 i	E34	2.5	125	6	01.88-08.91	M20 B25	0,8	ZGR5A	5839	15	
525 i	E34	2.5	141	6	01.89-06.96	M50 B25	0,9	BKR6EK	2288	20	LPG 1
525 iX	E34	2.5	141	6	01.92-09.95	M50 B25	0,9	BKR6EK	2288	20	LPG 1
530 i	E34	3.0	138	6	01.88-08.91	M30 B30	0,8	ZGR5A	5839	15	
530 i	E34	3.0	155	8	04.92-06.96	M60 B30	0,9	BKR6EK	2288	20	LPG 1
535 i	E34	3.5	155	6	01.88-08.92	M30 B35	0,8	ZGR5A	5839	15	
540 i	E34	4.0	210	8	03.92-06.96	M60 B40	0,9	BKR6EK	2288	20	LPG 1

**5 (SERIES) E39**

520 i	E39	2.0	110	6	01.96-08.98	M52 B20	0,9	BKR6EK	2288	20	LPG 1
520 i	E39	2.0	110	6	09.98-06.03	M52 B20	1,5	BKR6EQUP	3199	30	LPG 1
520 i Touring	E39	2.0	110	6	03.97-08.98	M52 B20	0,9	BKR6EK	2288	20	LPG 1
520 i Touring	E39	2.0	110	6	09.98-07.01	M52 B20	1,5	BKR6EQUP	3199	30	LPG 1
520 i	E39	2.2	125	6	08.00-09.03	M54 B22	1,5	BKR6EQUP	3199	30	LPG 1
520 i	E39	2.2	125	6	08.00-06.03	M54 B22	1,5	BKR6EQUP	3199	30	LPG 1
520 i Touring	E39	2.2	125	6	04.00-12.03	M54 B22	1,5	BKR6EQUP	3199	30	LPG 1
520 i Touring	E39	2.2	125	6	08.00-05.04	M54 B22	1,5	BKR6EQUP	3199	30	LPG 1
523 i	E39	2.5	125	6	12.95-08.98	M52 B25	0,9	BKR6EK	2288	20	LPG 1
523 i	E39	2.5	125	6	09.98-12.00	M52 B25	1,5	BKR6EQUP	3199	30	LPG 1
523 i Touring	E39	2.5	125	6	03.97-08.98	M52 B25	0,9	BKR6EK	2288	20	LPG 1
523 i Touring	E39	2.5	125	6	09.98-12.00	M52 B25	1,5	BKR6EQUP	3199	30	LPG 1
525 i	E39	2.5	141	6	11.99-11.03	M54 B25	1,5	BKR6EQUP	3199	30	LPG 1
525 i Touring	E39	2.5	141	6	04.00-12.03	M54 B25	1,5	BKR6EQUP	3199	30	LPG 1
528 i	E39	2.8	142	6	12.95-08.98	M52 B28	0,9	BKR6EK	2288	20	LPG 1
528 i	E39	2.8	142	6	09.98-11.00	M52 B28	1,5	BKR6EQUP	3199	30	LPG 1
528 i Touring	E39	2.8	142	6	03.97-08.98	M52 B28	0,9	BKR6EK	2288	20	LPG 1



ℓ kW  
C  
y  
i

0201



Stock-No

U-TIME

LPG / CNG

**BMW**

**5 (SERIES) E39**

528 i Touring	E39	2.8	142	6	09.98-12.00	M52 B28	1,5	BKR6EQUIP	3199	30	LPG 1
530 i	E39	3.0	170	6	04.00-06.03	M54 B30	1,5	BKR6EQUIP	3199	30	LPG 1
530 i Touring	E39	3.0	170	6	11.99-12.03	M54 B30	1,5	BKR6EQUIP	3199	30	LPG 1
535 i	E39	3.5	180	8	06.96-08.98	M62 B35	0,9	BKR6EK	2288	20	LPG 1
535 i	E39	3.5	180	8	09.98-09.03	M62 B35	1,5	BKR6EQUIP	3199	30	LPG 1
540 i	E39	4.4	210	8	04.96-08.98	M62 B44	0,9	BKR6EK	2288	20	LPG 1
540 i	E39	4.4	210	8	09.98-11.03	M62 B44	1,5	BKR6EQUIP	3199	30	LPG 1
540 i Touring	E39	4.4	210	8	03.97-08.98	M62 B44	0,9	BKR6EK	2288	20	LPG 1
540 i Touring	E39	4.4	210	8	09.98-12.03	M62 B44	1,5	BKR6EQUIP	3199	30	LPG 1
M5	E39	5.0	294	8	09.98-07.03	S62 B50	1,5	BKR6EQUIP	3199	30	LPG 1

**5 (SERIES) E60**

520 i	E60	2.0	125	4	05.07-	N43 B20	0,5	ZKBR7A-HTU	91785		
520 i	E60	2.2	125	6	02.02-02.05	M54 B22	1,5	BKR6EQUIP	3199	30	LPG 1
523 i	E60	2.5	130	6	07.04-11.06	N52 B25	1,1	ILZFR6D11	1208		
523 i	E60	2.5	140	6	02.07-	N53 B25	0,5	ZKBR7A-HTU	91785		
525 i	E60	2.5	141	6	09.03-12.04	M54 B25	1,5	BKR6EQUIP	3199	30	LPG 1
523 i	E60	2.5	140	6	02.07-03.10	N52 B25A / N53 B25A	0,5	ZKBR7A-HTU	91785		
525 i	E60	2.5	160	6	03.07-	N53 B25	0,5	ZKBR7A-HTU	91785		
525i	E60	2.5	160	6	03.05-03.10	N52B25A	1,1	LZFR6AP11GS	95712		
525i	E60	2.5	160	6	03.05-03.10	N52B25B	1,1	LZFR6AP11GS	95712		
525i	E60	2.5	160	6	03.05-03.10	N52B25BF	1,1	LZFR6AP11GS	95712		
525i	E60	2.5	160	6	03.05-03.10	N52NB25A	1,1	LZFR6AP11GS	95712		
530 i	E60	3.0	170	6	07.03-12.04	M54 B30	1,5	BKR6EQUIP	3199	30	LPG 1
530 i	E60	3.0	190	6	10.04-	N52 B30	1,1	ILZFR6D11	1208		
530 i	E60	3.0	200	6	01.07-	N53 B30	0,5	ZKBR7A-HTU	91785		
540 i	E60	4.0	225	8	10.05-	N62 B40	1,1	IZFR6H11	4294		
545 i	E60	4.4	245	8	09.03-10.05	N62 B44	1,5	BKR6EQUIP	3199	30	LPG 1
550 i	E60	4.8	270	8	02.05-	N62 B48	1,1	IZFR6H11	4294		
M5	E60	5.0	373	10	11.04-	S85 B50	0,9	LKR8AP	4471		

**5 (SERIES) E61**

520 i Touring	E61	2.0	125	4	09.07-05.10	N43 B20A	0,5	ZKBR7AP-HTU	7716		
523 i Touring	E61	2.5	130	6	03.05-	N52 B25	1,1	ILZFR6D11	1208		
523 i Touring	E61	2.5	140	6	03.07-	N53 B25	0,5	ZKBR7A-HTU	91785		
525 i Touring	E61	2.5	141	6	05.04-12.04	M54 B25	1,5	BKR6EQUIP	3199	30	LPG 1
525 i Touring	E61	2.5	160	6	09.04-	N52 B25	1,1	ILZFR6D11	1208		
525 i Touring	E61	2.5	160	6	03.07-	N53 B25	0,5	ZKBR7A-HTU	91785		
523i Touring	E61	2.5	130	6	03.05-12.10	N52B25A	1,1	LZFR6AP11GS	95712		
523i Touring	E61	2.5	130	6	03.05-12.10	N52B25B	1,1	LZFR6AP11GS	95712		
523i Touring	E61	2.5	130	6	03.05-12.10	N52B25BE	1,1	LZFR6AP11GS	95712		
523i Touring	E61	2.5	130	6	03.05-12.10	N52NB25A	1,1	LZFR6AP11GS	95712		
530 i Touring	E61	3.0	190	6	10.05-	N52 B30	1,1	ILZFR6D11	1208		
530 i Touring	E61	3.0	200	6	01.07-	N53 B30	0,5	ZKBR7A-HTU	91785		
545 i Touring	E61	4.4	245	8	05.04-08.05	N62 B44	1,5	BKR6EQUIP	3199	30	LPG 1
550 i Touring	E61	4.8	270	8	02.05-	N62 B48	1,1	IZFR6H11	4294		

**5 (SERIES) F10**

520i	F10	1.6	180	4	07.13-	N20B20A	0,75	SILZKBR8D8S	97506		
520i	F10	1.6	180	4	03.14-	N20B20A	0,75	SILZKBR8D8S	97506		
520i	F10	2.0	180	4	03.14-	N20B20A	0,75	SILZKBR8D8S	97506		

e kW  
C  
y  
i

0201



Stock-No

VLINE

LPG / CNG

**BMW****5 (SERIES) F10**

520i	F10	1.6	125	4	08.13-	N20B16A	0,75	SILZKBR8D8S	97506		
520i	F10	2.0	135	4	09.11-	N20B20A	0,75	SILZKBR8D8S	97506		
520i	F10	2.0	135	4	09.11-	N20B20B	0,75	SILZKBR8D8S	97506		
520i	F10	2.0	120	4	09.11-	N20B20A	0,75	SILZKBR8D8S	97506		
520i	F10	2.0	120	4	09.11-	N20B20B	0,75	SILZKBR8D8S	97506		
523i	F10	2.5	150	6	03.10-	N52NB25A	1,1	LZFR6AP11GS	95712		
523 i	F10	3.0	150	6	03.10-	N53 B30	0,5	ZKBR7A-HTU	91785		
528 i	F10	3.0	190	6	03.10-	N53 B30	0,5	ZKBR7A-HTU	91785		
528i	F10	2.0	120	4	09.11-	N20B20B	0,75	SILZKBR8D8S	97506		
528i	F10	2.0	180	4	09.11-	N20B20A	0,75	SILZKBR8D8S	97506		
528i xDrive	F10	2.0	180	4	09.11-	N20B20A	0,75	SILZKBR8D8S	97506		
528i	F10	3.0	190	6	03.10-	N52NB30A	1,1	LZFR6AP11GS	95712		
530i	F10	3.0	200	6	09.11-07.13	N52NB30A	1,1	LZFR6AP11GS	95712		
530i	F10	3.0	200	6	09.11-07.13	N52NB30BF	1,1	LZFR6AP11GS	95712		
550i	F10	4.4	180	4	09.11-	N20B20A	0,75	SILZKBR8D8S	97506		
550i xDrive	F10	4.4	330	8	07.13-	N63B44B	0,75	SILZKBR8D8S	97506		

**5 (SERIES) F11**

520i Touring	F11	2.0	120	4	09.11-	N20B20B	0,75	SILZKBR8D8S	97506		
520i Touring	F11	2.0	135	4	09.11-	N20B20A	0,75	SILZKBR8D8S	97506		
520i Touring	F11	2.0	135	4	09.11-	N20B20B	0,75	SILZKBR8D8S	97506		
520i Touring	F11	2.0	120	4	09.11-	N20B20A	0,75	SILZKBR8D8S	97506		
523i Touring	F11	2.5	150	6	04.10-12.11	N52NB25A	1,1	LZFR6AP11GS	95712		
528i Touring	F11	2.0	180	4	09.11-	N20B20A	0,75	SILZKBR8D8S	97506		
528i xDrive Touring	F11	2.0	180	4	09.11-	N20B20A	0,75	SILZKBR8D8S	97506		
530i Touring	F11	3.0	200	6	09.11-07.13	N52NB30A	1,1	LZFR6AP11GS	95712		
530i Touring	F11	3.0	200	6	09.11-07.13	N52NB30AF	1,1	LZFR6AP11GS	95712		
550i Touring	F11	4.4	180	4	09.11-	N20B20A	0,75	SILZKBR8D8S	97506		
550i Touring	F11	4.4	330	8	07.13-	N63B44B	0,75	SILZKBR8D8S	97506		

**6 (SERIES) E63**

630 Ci	E63	3.0	190	6	02.04-	N52 B30	1,1	ILZFR6D11	1208		
630 Ci	E63	3.0	200	6	04.06-	N53 B30	0,5	ZKBR7A-HTU	91785		
630i Coupe	E63	3.0	190	6	12.09-12.11	N52B30A	1,1	LZFR6AP11GS	95712		
630i Coupe	E63	3.0	190	6	12.09-12.11	N52B30BF	1,1	LZFR6AP11GS	95712		
635 Ci	E63	3.6	200	8	09.04-	N62 B36	1,5	BKR6EQUIP	3199	30	LPG 1
645 Ci	E63	4.4	245	8	09.02-08.05	N62 B44	1,5	BKR6EQUIP	3199	30	LPG 1
650 Ci	E63	4.8	270	8	10.05-	N62 B48	1,1	IZFR6H11	4294		
M6	E63	5.0	373	10	09.04-	S85 B50	0,9	LKR8AP	4471		

**6 (SERIES) E64**

630 Ci Cabrio	E64	3.0	190	6	09.04-	N52 B30	1,1	ILZFR6D11	1208		
630i Cabrio	E64	3.0	190	6	12.09-12.11	N52B30A	1,1	LZFR6AP11GS	95712		
630i Cabrio	E64	3.0	190	6	12.09-12.11	N52B30B	1,1	LZFR6AP11GS	95712		
630i Cabrio	E64	3.0	190	6	12.09-12.11	N52B30BF	1,1	LZFR6AP11GS	95712		
645 Ci Cabrio	E64	4.4	245	8	02.04-09.05	N62 B44	1,5	BKR6EQUIP	3199	30	LPG 1
650 Ci Cabrio	E64	4.8	270	8	03.05-	N62 B48	1,1	IZFR6H11	4294		
M6 Cabrio	E64	5.0	373	10	07.05-	S85 B50	0,9	LKR8AP	4471		

**7 (SERIES) E32**

730 i	E32	3.0	136	6	09.86-08.92	M30 B30	0,8	ZGR5A	5839	15	
730 i	E32	3.0	160	8	04.92-09.94	M60 B30	0,9	BKR6EK	2288	30	LPG 1
735 i	E32	3.4	155	6	09.86-07.92	M30 B35	0,8	ZGR5A	5839	15	



ℓ kW  
C  
y  
i

0201



Stock-No

VALVE

LPG / CNG

**BMW**

**7 (SERIES) E32**

740 i	E32	4.0	210	8	04.92-09.94	M60 B40	0,9	BKR6EK	2288	30	LPG 1
750 i	E32	5.0	220	12	09.87-09.94	M70 B50	0,7	ZFR5F	5165		LPG 6

**7 (SERIES) E38**

728 i	E38	2.8	142	6	09.95-08.98	M52 B28	0,9	BKR6EK	2288	20	LPG 1
728 i	E38	2.8	142	6	09.98-11.01	M52 B28	1,5	BKR6EQU	3199	30	LPG 1
730 i	E38	3.0	160	8	09.94-09.95	M60 B30	0,9	BKR6EK	2288	20	LPG 1
735 i	E38	3.5	175	8	03.96-08.98	M62 B35	0,9	BKR6EK	2288	20	LPG 1
735 i	E38	3.5	175	8	09.98-	M62 B35	1,5	BKR6EQU	3199	30	LPG 1
740 i	E38	4.0	210	8	09.94-05.95	M60 B40	0,9	BKR6EK	2288	20	LPG 1
740 i	E38	4.4	210	8	05.95-08.98	M62 B44	0,9	BKR6EK	2288	20	LPG 1
740 i	E38	4.4	210	8	09.99-11.01	M62 B44	1,5	BKR6EQU	3199	30	LPG 1
750 i	E38	5.4	240	12	11.94-	M73 B54	1,5	BKR6EQU	3199	30	LPG 1

**7 (SERIES) E65**

730 i	E65	3.0	170	6	10.02-02.05	M54 B30	1,5	BKR6EQU	3199	30	LPG 1
730 i	E65	3.0	190	6	03.05-	N52 B30	1,1	ILZFR6D11	1208		
735 i	E65	3.6	200	8	07.01-02.05	N62 B36	1,5	BKR6EQU	3199	30	LPG 1
740 i	E65	4.0	225	8	01.05-	N62 B40	1,1	IZFR6H11	4294		
745 i	E65	4.4	245	8	07.01-02.05	N62 B44	1,5	BKR6EQU	3199	30	LPG 1
750 i	E65	4.8	270	8	01.05-	N62 B48	1,1	IZFR6H11	4294		
760 i	E65	6.0	327	12	01.03-	N73 B60	1,5	BKR6EQU	3199	30	LPG 1

**7 (SERIES) F01/F02**

730i	F01	3.0	190	6	01.10-08.15	N52B30A	1,1	LZFR6AP11GS	95712		
730i	F01	3.0	190	6	01.10-08.15	N52B30AF	1,1	LZFR6AP11GS	95712		
730i	F01	3.0	190	6	01.10-08.15	N52B30BF	1,1	LZFR6AP11GS	95712		
730i Li	F02	3.0	190	6	01.10-08.15	N52B30A	1,1	LZFR6AP11GS	95712		
730i Li	F02	3.0	190	6	01.10-08.15	N52B30AF	1,1	LZFR6AP11GS	95712		
730i Li	F02	3.0	190	6	01.10-08.15	N52B30BF	1,1	LZFR6AP11GS	95712		

**8 (SERIES) E31**

840 Ci	E31	4.0	210	8	12.93-02.96	M60 B40	0,9	BKR6EK	2288	20	LPG 1
840 Ci	E31	4.4	210	8	03.96-05.99	M62 B44	0,9	BKR6EK	2288	20	LPG 1
850 Ci	E31	5.0	220	12	05.89-10.94	M70 B50	0,7	ZFR5F	5165		LPG 6
850 Ci	E31	5.4	240	12	10.94-05.99	M73 B54	1,5	BKR6EQU	3199	20	LPG 1
850 CSI	E31	5.6	280	12	02.93-11.96	S70 B56	0,7	ZFR5F	5165		LPG 6

**X1 E84**

X1 sDrive 16i	E84	2.0	105	4	03.13-	N20B16A	0,75	SILZKBR8D8S	97506		
X1 xDrive 20i	E84	2.0	105	4	03.13-	N20B16A	0,75	SILZKBR8D8S	97506		
X1 xDrive 20i	E84	2.0	135	4	09.11-	N20B20A	0,75	SILZKBR8D8S	97506		
X1 xDrive 28i	E84	2.0	135	4	09.11-	N20B20A	0,75	SILZKBR8D8S	97506		
X 1 Xdrive18i	E84	2.0	110	4	09.08-	N46 B20	1,1	IZFR6H11	4294		
X1 xDrive 25i	E84	3.0	160	6	01.10-12.12	N52B30A	1,1	LZFR6AP11GS	95712		
X1 xDrive 28i	E84	3.0	190	6	01.10-06.15	N52NB30A	1,1	LZFR6AP11GS	95712		

**X3 E83**

X 3 xDrive20i 4X4	E83	2.0	110	4	09.05-	N46 B20	1,1	IZFR6H11	4294		
X 3 xDrive25i 4x4	E83	2.5	141	6	01.04-	M54 B25	1,5	BKR6EQU	3199	30	LPG 1
X3 xDrive 25i Si	E83	2.5	160	6	01.10-12.11	N52B25A	1,1	LZFR6AP11GS	95712		
X3 xDrive 25i Si	E83	2.5	160	6	01.10-12.11	N52B25B	1,1	LZFR6AP11GS	95712		
X3 xDrive 25i Si	E83	2.5	160	6	01.10-12.11	N52B25BF	1,1	LZFR6AP11GS	95712		
X 3 xDrive30i 4x4	E83	3.0	170	6	01.04-	M54 B30	1,5	BKR6EQU	3199	30	LPG 1
X3 xDrive 30i Si	E83	3.0	200	6	10.09-12.11	N52B30A	1,1	LZFR6AP11GS	95712		

e kW  
C  
y  
i

0201



Stock-No

VLINE

LPG / CNG

**BMW****X3 E83**

X3 xDrive 30i Si	E83	3.0	200	6	10.09-12.11	N52B30B	1,1	LZFR6AP11GS	95712		
X3 xDrive 30i Si	E83	3.0	200	6	10.09-12.11	N52B30BF	1,1	LZFR6AP11GS	95712		

**X3 F25**

X3 sDrive 20i	F25	1.6	125	4	09.11-	N20B16A	0,75	SILZKBR8D8S	97506		
X3 sDrive 20i	F25	1.6	125	4	04.11-	N20B16A	0,75	SILZKBR8D8S	97506		
X3 sDrive 20i	F25	2.0	135	4	04.14-	N20B20A	0,75	SILZKBR8D8S	97506		
X3 xDrive 20i	F25	2.0	135	4	04.14-	N20B20A	0,75	SILZKBR8D8S	97506		
X3 xDrive 28i	F25	2.0	135	4	02.14-	N20B20A	0,75	SILZKBR8D8S	97506		
X3 xDrive 28i	F25	2.0	135	4	09.11-	N20B20A	0,75	SILZKBR8D8S	97506		
X3 sDrive 20i	F25	2.0	180	4	04.11-	N20B20A	0,75	SILZKBR8D8S	97506		
X3 xDrive 28i	F25	3.0	190	6	01.11-	N52NB30A	1,1	LZFR6AP11GS	95712		
X3 xDrive 28i	F25	3.0	190	6	01.11-	N52NB30AF	1,1	LZFR6AP11GS	95712		
X3 xDrive 28i	F25	3.0	190	6	01.11-	N52NB30BF	1,1	LZFR6AP11GS	95712		

**X4 F26**

X4 xDrive 20i	F26	2.0	135	4	09.11-	N20B20A	0,75	SILZKBR8D8S	97506		
X4 xDrive 20i	F26	2.0	180	4	12.10-	N20B20A	0,75	SILZKBR8D8S	97506		
X4 xDrive 28i	F26	2.0	180	4	12.10-	N20B20A	0,75	SILZKBR8D8S	97506		
X4 xDrive 28i	F26	2.0	135	4	04.14-	N20B20A	0,75	SILZKBR8D8S	97506		

**X5 E53**

X 5i 4x4	E53	3.0	170	6	08.99-09.06	M54 B30	1,5	BKR6EQUIP	3199	30	LPG 1
X 5i 4x4	E53	4.4	210	8	10.98-09.03	M62 B44	1,5	BKR6EQUIP	3199	30	LPG 1
X 5i 4x4	E53	4.4	235	8	01.03-09.06	N62 B44	1,5	BKR6EQUIP	3199	30	LPG 1
X 5 4.6 iS 4x4	E53	4.6	255	8	01.01-09.03	M62 B46	1,5	BKR6EQUIP	3199	30	LPG 1
X 5 4.8 iS 4x4	E53	4.8	265	8	11.03-09.06	N62 B48	1,1	IZFR6H11	4294		

**X5 E70**

X 5i 3.0 si 4x4	E70	3.0	200	6	02.07-	N52 B30	1,1	ILZFR6D11	1208		
X 5 4.8 iS 4x4	E70	4.8	261	8	02.07-	N62 B48	1,1	IZFR6H11	4294		
X 5 M	E70	4.4	408	8	06.09-10.13	S63B44A	0,8	SILKBR8D8S	97506		

**X5 F15**

X5 xDrive 40e	F15	2.0	135	4	04.14-	N20B20A	0,75	SILZKBR8D8S	97506		
X5 xDrive 40e	F15	2.0	180	4	04.14-	N20B20A	0,75	SILZKBR8D8S	97506		

**X6 E71**

X 6 M	E70	4.4	408	8	06.09-10.13	S63B44A	0,8	SILKBR8D8S	97506		
-------	-----	-----	-----	---	-------------	---------	-----	------------	-------	--	--

**Z3 E36/7**

Z 3	E36/7	1.8	85	4	02.96-09.98	M43 B18	0,9	BKR6EK	2288	20	LPG 1
Z 3	E36/7	1.8	85	4	01.98-02.99	M43 B18	1,5	BKR6EQUIP	3199	30	LPG 1
Z 3	E36/7	1.9	87	4	03.99-06.02	M43 B19	1,5	BKR6EQUIP	3199	30	LPG 1
Z 3	E36/7	1.9	103	4	11.95-03.99	M44 B19	0,9	BKR6EK	2288	20	LPG 1
Z 3	E36/7	2.0	110	6	09.98-12.00	M52 B20	1,5	BKR6EQUIP	3199	30	LPG 1
Z 3	E36/7	2.2	125	6	12.99-06.02	M54 B22	1,5	BKR6EQUIP	3199	30	LPG 1
Z 3	E36/7	2.8	142	6	06.96-09.98	M52 B28	0,9	BKR6EK	2288	20	LPG 1
Z 3	E36/7	2.8	142	6	01.98-05.00	M52 B28	1,5	BKR6EQUIP	3199	30	LPG 1
Z 3 Coupé	E36/7	2.8	142	6	01.98-12.00	M52 B28	1,5	BKR6EQUIP	3199	30	LPG 1
Z 3	E36/7	3.0	170	6	09.99-06.02	M54 B30	1,5	BKR6EQUIP	3199	30	LPG 1
Z 3 Coupé	E36/7	3.0	170	6	09.99-06.02	M54 B30	1,5	BKR6EQUIP	3199	30	LPG 1
Z 3 M	E36/7	3.2	236	6	04.96-06.00	S50 B32	0,7	PKR7A	3641		
Z 3 M	E36/7	3.2	239	6	03.00-05.02	S54 B32	0,9	DCPR8EKP	7415		





ℓ kW  
C y  
i

0201



Stock-No

VALVE

LPG / CNG

**BMW**

**Z3 E36/7**

Z 3 M Coupé	E36/7	3.2	236	6	09.97-07.00	S50 B32	0,7	PKR7A	3641		
Z 3 M Coupé	E36/7	3.2	239	6	03.00-05.02	S54 B32	0,9	DCPR8EKP	7415		

**Z4 E85**

Z 4	E85	2.0	110	4	09.04-	N46 B20	1,1	ILZFR6H11	4294		
Z 4	E85	2.2	125	6	09.03-	M54 B22	1,5	BKR6EQU	3199	30	LPG 1
Z 4	E85	2.5	130	6	.07-	N52 B25	1,1	ILZFR6D11	1208		
Z 4	E85	2.5	141	6	04.03-	M54 B25	1,5	BKR6EQU	3199	30	LPG 1
Z 4si	E85	2.5	160	6	10.04-	N52 B25	1,1	ILZFR6D11	1208		
Z 4	E85	3.0	170	6	04.03-	M54 B30	1,5	BKR6EQU	3199	30	LPG 1
Z 4 si	E85	3.0	195	6	10.05-	N52 B30	1,1	ILZFR6D11	1208		
Z 4 M	E85	3.2	252	6	03.06-	S54 B32	0,9	DCPR8EKP	7415		

**Z4 E86**

Z 4 si Coupé	E86	3.0	195	6	10.05-	N52 B30	1,1	ILZFR6D11	1208		ILZFR6D11
Z 4 M Coupé	E86	3.2	252	6	10.05-	S54 B32	0,9	DCPR8EKP	7415		

**Z4 E89**

Z4 sDrive 18i Cabrio	E89	2.0	180	4	04.14-	N20B20A	0,75	SILZKBR8D8S	97506		
Z4 sDrive 20i Cabrio	E89	2.0	115	4	03.13-	N20B20A	0,75	SILZKBR8D8S	97506		
Z4 sDrive 20i Cabrio	E89	2.0	135	4	09.11-	N20B20A	0,75	SILZKBR8D8S	97506		
Z4 sDrive 28i Cabrio	E89	2.0	135	4	09.11-	N20B20A	0,75	SILZKBR8D8S	97506		
Z4 sDrive 28i Cabrio	E89	2.0	120	4	09.11-	N20B20A	0,75	SILZKBR8D8S	97506		
Z4 sDrive 23i Cabrio	E89	2.5	150	6	01.10-	N52B25A	1,1	LZFR6AP11GS	95712		
Z4 sDrive 23i Cabrio	E89	2.5	150	6	01.10-	N52B25BF	1,1	LZFR6AP11GS	95712		
Z4 sDrive 30i Cabrio	E89	3.0	190	6	01.10-	N52B30A	1,1	LZFR6AP11GS	95712		
Z4 sDrive 30i Cabrio	E89	3.0	190	6	01.10-	N52B30B	1,1	LZFR6AP11GS	95712		
Z4 sDrive 30i Cabrio	E89	3.0	190	6	01.10-	N52B30BF	1,1	LZFR6AP11GS	95712		

**Z8 E52**

Z 8	E52	5.0	294	8	06.00-07.03	S62 B50	1,5	BKR6EQU	3199	30	LPG 1
-----	-----	-----	-----	---	-------------	---------	-----	---------	------	----	-------

**BUICK**

Century		2.2		4	.93- .94	4	1,0	TR4	3754		LPG 5
Century		2.2		4	.95- .96	4	1,5	TR55-1	2683		
Century		3.1		6	.94- .99	M OHV V6	1,3	TR55IX	7164		LPG 5
Century		3.1		6	.00-	J OHV V6	1,3	TR55IX	7164		LPG 5
LeSabre		3.0		6	.86-	L V6	1,0	TR5	2238		LPG 5
Lacrosse		3.6		6	.05-	V6 2 FI	1,5	TR55	3951		LPG 5
Lacrosse		3.6		6	.05-	V6 7 FI 217	1,0	PLTR6A-10G	3587		
LeSabre		3.8		6	.92- .95	L V6	1,5	PTR4B-15	5146		LPG 5
LeSabre		3.8		6	.96- .01	K V6	1,5	PTR4B-15	5146		LPG 5
LeSabre		3.8		6	.02-	K V6	1,5	PTR4B-15	5146		LPG 5
Park Avenue		3.8		6	.91-	K V6	1,5	PTR4B-15	5146		LPG 5
Park Avenue		3.8		6	.92- .97	1 V6 Super Charged	1,5	PTR4B-15	5146		LPG 5
Park Avenue		3.8		6	.02-	V6 1 FI Supercharged	1,5	TR55	3951		LPG 5
Park Avenue		3.8		6	.02-	V6 K FI	1,5	TR55	3951		LPG 5
Regal		3.8		6	.96-	K V6 MFI	1,5	PTR4B-15	5146		LPG 5
Regal		3.8		6	.96-	SC V6 MFI 1	1,5	PTR4B-15	5146		LPG 5
Rivera		3.8		6	.96- .97	K V6 MFI	1,5	PTR4B-15	5146		LPG 5
Rivera		3.8		6	.96-	SC V6 MFI 1	1,5	PTR4B-15	5146		LPG 5

e kW  
C  
Y  
I

0201



Stock-No

VLINE

LPG / CNG

**CADILLAC**

Allante	4.6		8	.87- .90	7 DFI / 8 MFI	1,5	TR55	3951		LPG 5
Allante	4.6		8	.91- .94	8 / 9 MFI	1,5	TR55	3951		LPG 5
BLS 2.0 T	2.0	129	4	04.06-	B207L	1,0	PFR6T-10G	5542		
BLS 2.0 T	2.0	154	4	04.06-	B207R	1,0	PFR6T-10G	5542		
BLS 2.0 T Flexpower	2.0	147	4	12.07-	Z20LER	1,0	PFR6T-10G	5542		
Brougham	5.0		8	.91- .92	E TBI	1,1	UR4	6630		UR5IX
Brougham	5.7		8	.91- .92	7 TBI	1,3	UR5	2771		UR6IX
Brougham	5.7		8	.93-	7 TBI	1,1	UR4	6630		UR5IX
Catera	3.0		6	.97- .01	R DOHC MFI	0,8	BKR5EK	7956	23	LPG 1
Concours	4.6		8	.94- .94	Y SFI	1,5	TR55	3951		LPG 5
Concours	4.6		8	.95- .95	Y MFI	1,5	TR55	3951		LPG 5
Concours	4.6		8	.96- .98	9 MFI	1,5	TR55	3951		LPG 5
CTS-V	5.7	298	8	.05-		1,5	TR55	3951		LPG 5
De Ville	4.6		8	.96- .98	Y MFI	1,5	TR55	3951		LPG 5
De Ville	4.6		8	.99-	Y MFI	1,5	TR55	3951		LPG 5
De Ville	4.6		8	.01-	9 MFI	1,5	TR55	3951		LPG 5
De Ville	4.9		8	.91- .91	B MFI	1,5	TR55	3951		LPG 5
De Ville	4.9		8	.92- .95	B MFI	1,5	TR55	3951		LPG 5
DeVille	6.0		8	.81-	9 EFI CID368	1,2	GR45	4268		GR5IX
Eldorado	4.6		8	.93- .93	9 / Y MFI	1,5	TR55	3951		LPG 5
Eldorado	4.6		8	.94- .98	9 MFI / SFI	1,5	TR55	3951		LPG 5
Eldorado	4.6		8	.94- .98	Y MFI / SFI	1,5	TR55	3951		LPG 5
Eldorado	4.6		8	.99-	V8 MFI 9	1,5	TR55	3951		LPG 5
Eldorado	4.6		8	.99-	V8 MFI Y	1,5	TR55	3951		LPG 5
Eldorado	4.9		8	.92- .93	B MFI	1,5	TR55	3951		LPG 5
Seville	4.6		8	.99-	V8 MFI 9	1,5	TR55	3951		LPG 5
Seville	4.6		8	.99-	V8 MFI Y	1,5	TR55	3951		LPG 5
SRX Sport Luxury	4.6	239	8	10.04-	A V8 FI	1,5	TR55	3951		LPG 5
XLR	4.6	239	8	.05-	A V8 FI	1,5	TR55	3951		LPG 5

**CATERHAM**

Super Seven			4	.85-		0,6	B8ECS	2841		
Super Seven HPC	2.0	110	4	07.91-	Opel 16V	0,8	BCPR7ES	3330		BCPR7EIX

**CHEVROLET****ALERO**

Alero	3.4		6	03.99-	LA1	1,5	TR55	3951		LPG 5
-------	-----	--	---	--------	-----	-----	------	------	--	-------

**AVEO**

Aveo 1.2	1.2	62	4	.08-	B12D1	0,9	DCPR8E	4339		LPG 8
Aveo 1.4	1.4	69	4	02.05- .08	F14D3	1,1	BKR6E-11	2756	14	LPG 1
Aveo 1.4	1.4	74	4	.08-	F14D4	1,1	ZFR6F-11	4291		LPG 6
Aveo 1.4 16V SX	1.4	69	4	12.05- .08	F14D3 DOHC	1,1	BKR6E-11	2756	14	LPG 1

**BLAZER**

Blazer	4.3		6	.95- .05	V6 W EFI	1,3	UR5	2771		UR6IX
Blazer	4.3		6	.96- .02	V6 W EFI	1,0	TR5	2238		LPG 5
Blazer	4.3		6	.03- .03	V6 X EFI	1,0	TR5	2238		LPG 5
Blazer	5.7		8	.87- .93	V8 K EFI	1,3	UR5	2771		UR6IX
Blazer	5.7		8	.87- .93	V8 K TBI	1,3	UR5	2771		UR6IX
Blazer	5.7		8	.94- .94	V8 K EFI	1,3	UR6	7773		UR6IX
Blazer	5.7		8	.94-	V8 K TBI	1,3	UR6	7773		UR6IX



l kW  
C  
y  
i

0201



Stock-No

VALVE

LPG / CNG

## CHEVROLET

### CAMARO

Camaro	2.8		6	.82-	1 2 bbl CID173	1,3	UR5	2771		UR6IX
Camaro	2.8		6	.85- .89	S V6 EFI	1,3	UR5	2771		UR6IX
Camaro	3.1		6	.90- .92	T V6 EFI	1,3	UR5	2771		UR6IX
Camaro	3.4		6	.93- .95	S V6 EFI	1,3	UR5	2771		UR6IX
Camaro	3.8		6	.96-	V6 MFI K	1,5	TR55	3951		LPG 5
Camaro	3.8		6	.01-		1,5	PTR4B-15	5146		LPG 5
Camaro	5.0		8	.82-	7 EFI CID305	1,1	UR4	6630		UR5IX
Camaro	5.0		8	.83-	S EFI CID305	1,1	UR4	6630		UR5IX
Camaro	5.0		8	.85- .92	F V8 EFI	1,1	UR4	6630		UR5IX
Camaro	5.0		8	.88- .92	E V8 EFI	1,1	UR4	6630		UR5IX
Camaro	5.7		8	.87- .92	V8 EFI Alu Heads	0,9	FR4	5155		
Camaro	5.7		8	.87- .92	V8 EFI Cast Iron Heads	1,1	UR4	6630		UR5IX
Camaro	5.7		8	.93- .97	P V8 EFI	1,5	TR55	3951		LPG 5
Camaro	5.7		8	.98- .02	G V8 EFI	1,5	TR55	3951		LPG 5

### CAPTIVA

Captiva 2.4	2.4	100	4	09.06-	Z24SED	0,8	BKR5EK	7956	23	LPG 1
Captiva 3.2	3.2	169	6	09.06-	Z32SED	1,3	PTR5A-13	2467	25	LPG 4

### CORVETTE

Corvette	5.7	294	8	.97- .00	G V8 EFI	1,5	TR55	3951		LPG 5
Corvette	5.7		8	.86- .91	8 V8 EFI Alu Heads	0,9	FR4	5155		
Corvette	5.7		8	.88- .91	8 V8 EFI Cast Iron Heads	1,1	UR4	6630		UR5IX
Corvette	5.7		8	.90- .92	J V8 EFI ZR1	1,5	TR55	3951		LPG 5
Corvette	5.7		8	.92- .96	P V8 EFI	1,5	TR55	3951		LPG 5
Corvette	5.7		8	.93- .95	J V8 EFI	1,5	TR55	3951		LPG 5
Corvette	5.7		8	.96- .96	5 V8 EFI	1,5	TR55	3951		LPG 5
Corvette	5.7		8	.01- .03	G V8 EFI	1,5	TR55	3951		LPG 5
Corvette	5.7		8	.01- .01	S V8 EFI	1,5	TR55	3951		LPG 5
Corvette	5.7		8	.03- .04	V8	1,5	PZTR5A-15	7862		
Corvette	6.0		8	.05-	V8	1,5	PZTR5A-15	7862		

### CRUZE

Cruze 1.6	J300 / J305	1.6	83	4	05.09-	F16D4	1,1	ZFR6F-11	4291		LPG 6
Cruze 1.6	J300 / J305	1.6	91	4	05.09-	F16D4	1,1	ZFR6F-11	4291		LPG 6
Cruze 1.8	J300 / J305	1.8	104	4	05.09-	F18D4	1,1	ZFR6F-11	4291		LPG 6

### EPICA

Epica	KL1	2.0	106	6	06.06-	XK	0,8	BKUR6ETB	6992		
Epica	KL1	2.5	115	6	06.06-		1,1	IFR6E11	6741		

### EVANDA

Evanda		2.0	96	4	02.05-	T20SED DOHC 16v	0,8	BKR5EK	7956	23	LPG 1
--------	--	-----	----	---	--------	-----------------	-----	--------	------	----	-------

### KALOS

Kalos 1.4		1.4	61	4	02.05-	F14S3 SOHC	0,8	BPR6ES	7822	2	LPG 2
Kalos 1.4 16V SX		1.4	69	4	02.05-	F14D3 DOHC	1,1	BKR6E-11	2756	14	LPG 1

### LACETTI

Lacetti		1.4	70	4	02.05-	F14D3	1,1	BKR6E-11	2756		LPG 1
Lacetti		1.6	80	4	02.05-	F16D3	1,1	BKR6E-11	2756		LPG 1
Lacetti		1.8	89	4	02.05-	T18SED	0,8	BKR5EK	7956		LPG 1
Lacetti 1.8		1.8	89	4	08.05-	F18D3	0,8	BKUR6ETB	6992		

e kW  
C  
Y  
I

0201



Stock-No

VELINE

LPG / CNG

**CHEVROLET****LUMINA**

Lumina	3.8		6	.98-	V6 MFI K	1,5	PTR4B-15	5146		LPG 5
--------	-----	--	---	------	----------	-----	----------	------	--	-------

**MALIBU**

Malibu	2.4		4	.97- .99	T MFI DOHC	1,5	TR55	3951		LPG 5
Malibu	3.1		6	.97- .99	M V6 MFI	1,5	TR55	3951		LPG 5
Malibu	3.1		6	.00-	J V6 SFI	1,5	TR55	3951		LPG 5

**MATIZ**

Matiz	0.8	38	3	02.05-	F8CV	1,1	BCPR5EY-11	4120		LPG 3
Matiz	1.0	47	4	02.05-	B10S	1,1	BCPR5EY-11	4120		LPG 3

**METRO**

Metro	1.0		3	.98-	L3 TBI 6	1,1	BPR6E-11	4824	13	LPG 2
Metro	1.3		4	.98-	L4 TBI 9	1,1	BKR6E-11	2756	14	LPG 1

**NUBIRA**

Nubira 1.6	1.6	80	4	02.05-	A16DMS DOHC	1,1	BKR6E-11	2756	14	LPG 1
Nubira 1.8 CDX	1.8	89	4	02.05-	T18SED	0,8	BKR5EK	7956	23	LPG 1
Nubira 1.8	1.8	89	4	08.05-	F18D3	0,8	BKUR6ETB	6992		

**PRIZM**

Prizum	1.8		4	.98- .99	L4 MPI 8 DOHC	1,1	BKR5EKB-11	3967		
Prizum	1.8		4	.00-	L4 MPI 8 DOHC	1,1	IFR5T11	4996		IFR5T11

**REZZO / TACUMA**

Rezzo / Tacuma U100	1.6	77	4	02.05-	A16DMS	1,1	BKR5E-11	6953	33	LPG 1
Rezzo / Tacuma	1.8	72	4	.00-	F18S2 SOHC	0,9	BPR5ES	7422	6	LPG 2
Rezzo / Tacuma U100	2.0	89	4	02.05-	T20SED	0,8	BKR5EK	7956	23	LPG 1

**SPARK**

Spark 1.0 / 1.0 LPG	M300	1.0	50	4	03.10-	B10D1	0,9	DCPR8E	4339		LPG 8
Spark 1.2 / 1.2 LPG	M300	1.2	60	4	03.10-	B12D1	0,9	DCPR8E	4339		LPG 8

**TAHOE**

Tahoe	4.8		8	.00- .00	V FI V8	1,5	TR55	3951		LPG 5
Tahoe	4.8		8	.01-	V FI V8	1,5	TR55	3951		LPG 5
Tahoe	5.3	201	8	.00-	T FI V8	1,5	TR55	3951		LPG 5
Tahoe	5.3		8	.02- .03	Z FLEX V8	1,5	TR55	3951		LPG 5
Tahoe	5.3		8	.04-	Z FI V8	1,5	TR55	3951		LPG 5
Tahoe	5.3		8	.05-	Z FLEX V8 323	1,5	TR55	3951		LPG 5
Tahoe	5.7	147	8	04.96- .00	R V8	1,5	TR55	3951		LPG 5

**TRAIL BLAZER**

Trail Blazer 4.2 LTZ	4.2	201	6	.02- .03	S EFI	1,3	PTR5A-13	2467	25	LPG 4
Trail Blazer 5.3	5.3		8	.03-	V8 P EFI	1,5	TR55	3951		LPG 5



e kW C y i

0201



Stock-No

VLINE

LPG/CNG

**CHRYSLER****300**

300	2.7		6	.05-	V6 R FI Dir. Ign.	1,3	LZTR5A-13	4612		
-----	-----	--	---	------	-------------------	-----	-----------	------	--	--

**300C**

300 C	2.7	142	6	01.05-	V6	1,3	LZTR5A-13	4612		
300 C	3.5	183	6	07.04-	V6 G FI	1,3	ZFR5LP-13G	7781		ZFR5LP-13G
300 C (T.S.)	5.7	250	8	07.04-.08	V8 HEMI	1,1	LZTR4A-11	5444		
300 C SRT8 (T.S.)	6.1	316	8	.06-	W V	1,3	LZTR5A-13	4612		

**300M**

300 M	2.7	150	6	08.00-09.04	V6 EER	1,3	LZTR5A-13	4612		
300 M	3.5	189	6	09.99-	V6 G FI	1,3	ZFR5LP-13G	7781		ZFR5LP-13G
300 M	3.5		6	.03-	V6 K FI Dir.Ign.	1,3	ZFR5LP-13G	7781		ZFR5LP-13G

**CIRRUS**

Cirrus	2.4		4	.99-	X DOHC	1,3	FR45	3686		
Cirrus	2.5		6	.95-	V6 MPI H DOHC	1,1	PFR5G-11	2647		PFR6G-11

**CONCORDE**

Concorde	2.7		6	.98-	V6 MPI R DOHC	1,3	PTR5A-13	2467	25	LPG 4
Concorde	3.3		6	.93-.96	V6 MPI T	1,2	GR45	4268		GR5IX
Concorde	3.3		6	.94-.94	V6 FF U	1,2	GR45	4268		GR5IX
Concorde	3.5		6	.93-.97	V6 MPI F	0,9	FR5-1	7252		

**CROSSFIRE**

Crossfire	3.2	160	6	.03-	engine Mercedes SLK	1,0	IFR6D10	5344		LPG 1
-----------	-----	-----	---	------	---------------------	-----	---------	------	--	-------

**DODGE VIPER**

Dodge Viper	8.0		10	.96-	E MPI V10	0,9	FR5-1	7252		
-------------	-----	--	----	------	-----------	-----	-------	------	--	--

**IMPERIAL**

Imperial	3.3		6	.90-.91	V6 MPI 3	1,2	GR45	4268		GR5IX
Imperial	3.8		6	.91-.93	V6 MPI L	1,2	GR45	4268		GR5IX

**NEON**

Neon	1.8		4	03.98-10.99		0,9	BKR6E	6962	28	LPG 1
Neon LE	2.0	98	4	01.95-	ECB 16V	0,8	BCPR6ES	2330	12	LPG 3

**PT CRUISER**

PT Cruiser 2.0	2.0	104	4	06.00-		1,1	LZTR4A-11	5444		
PT Cruiser 2.4	2.4	105	4	08.05-	EDZ	1,1	LZTR4A-11	5444		
PT Cruiser 2.4	2.4	110	4	06.00-	EDZ	1,1	LZTR4A-11	5444		
PT Cruiser GT 2.4	2.4	164	4	08.03-	EDV	1,1	LZTR4A-11	5444		

**SEBRING**

Sebring 2.0	2.0	104	4	06.01-	EC4	1,1	LZTR4A-11	5444		
Sebring 2.0	2.0		4	.95-.99	L4 MPI Y DOHC	1,3	PFR6G-13E	2341		LPG 1
Sebring 2.4	2.4		4	.96-.98	L4 MPI X DOHC	1,1	FR45	3686		
Sebring 2.4	2.4		4	.01-	4G64 SOHC	1,1	BKR5E-11	6953	33	LPG 1
Sebring 2.5	2.5		6	.95-.99	V6 MPI N DOHC	1,1	PFR5G-11	2647		PFR6G-11

**STRATUS**

Stratus 2.0	2.0	96	4	.00-		0,9	BKR6E	6962	28	LPG 1
Stratus 2.0	2.0	98	4	.95-.00	ECB 16V	0,8	BCPR6ES	2330	12	LPG 3
Stratus 2.5	2.5	120	6	04.95-	EEB V6 MPI	1,1	PFR6B-11	4014		PFR7B

e kW  
C  
Y  
I

0201



Stock-No

VLINE

LPG / CNG

**CHRYSLER****VOYAGER 1**

Voyager 1	2.5	72	4	.88- .90	EDM	0,8	BPR6ES	7822	2	LPG 2
Voyager 1 3.0	3.0	100	6	.88- .91	EFA	1,1	BPR5ES-11	4424		LPG 2

**VOYAGER 2**

Voyager 2 2.0	2.0	98	4	.97-01.01	ECB C00	0,9	BKR6E	6962	28	LPG 1
Voyager 2 2.4	2.4	110	4	.96-01.01	EDZ B00	1,1	ZFR5A-11	5084		LPG 6
Voyager 2 2.5	2.5	72	4	.91- .95	EDM	0,8	BPR6ES	7822		LPG 2
Voyager 2 3.3	3.3	116	6	.96-01.01	EGA V6 MPI R	0,9	GR4IX	7149		GR5IX
Voyager 2 3.3	3.3	120	6	.91- .95	EGA V6 MPI R	1,3	GR4	2635		GR5IX
Voyager 2 3.8	3.8	122	6	.96-01.01	EGH V6 MPI	0,9	GR4	2635		GR5IX

**VOYAGER 3**

Voyager 3 2.4	2.4	108	4	03.01-	EDZ	1,3	LZTR5A-13	4612		
Voyager 3 2.4	2.4	112	4	.00-		1,3	FR45	3686		

**VOYAGER 4**

Voyager 4 3.3	3.3	128	6	03.01-	EGA	1,3	LZTR5A-13	4612		
---------------	-----	-----	---	--------	-----	-----	-----------	------	--	--

**CITROEN****AX**

AX 1.0i	1.0	30	4	10.86-	TU9	0,7	BCP6ES	4930	17	LPG 3
AX 1.0i	1.0	37	4	07.92-	TU9.M Cat.	0,8	BKR5EK	7956	23	LPG 1
AX 1.0i	1.0	37	4	03.95-	TU9M CDZ	0,8	BKR5EK	7956	23	LPG 1
AX 1.0i	1.0		4	09.86-06.92	TU9 C1A	0,8	BCP5ES	7496	16	LPG 3
AX 1.0i	1.0		4	07.92-02.95	TU9M CDZ	0,8	BCPR5ES	6130	32	LPG 3
AX 1.1	1.1	44	4	07.92-06.95	TU1M HDZ Cat.	0,8	BCPR5ES	6130	32	LPG 3
AX 1.1i	1.1		4	09.86-06.92	TU1 H1A	0,8	BCP5ES	7496	16	LPG 3
AX 1.1i	1.1		4	07.92-06.95	TU1M HDZ	0,8	BCPR5ES	6130	32	LPG 3
AX 1.1i	1.1		4	07.95-	TU1M HDZ	0,8	BKR5EK	7956	23	LPG 1
AX 1.3i Sport	1.3	69	4	02.87-12.92	TU24 M4A	0,8	BKUR7ET	7873		PFR7Q
AX 1.4i	1.4	55	4	07.92-	TU3MC Cat.	0,9	BKR6EK	2288	20	LPG 1
AX 1.4i GT	1.4	55	4	07.92-	TU3FM Cat.	0,9	BKR6EK	2288	20	LPG 1
AX 1.4i	1.4	55	4	07.94-	TU3FM	0,9	BKR6EK	2288	20	LPG 1
AX 1.4	1.4		4	09.86-12.92	TU3 K1A, TU3A K1G	0,8	BCP5ES	7496	16	LPG 3
AX 1.4 GT	1.4		4	10.87-12.92	TU3S K2A	0,7	BCP6ES	4930	17	LPG 3
AX 1.4 Gti	1.4		4	09.91-12.92	TU3J2 K6B	0,9	BKR6EK	2288	20	LPG 1
AX 1.4i Gti	1.4		4	09.91-12.92	TU3FJ2Z	0,9	BKR6EK	2288	20	LPG 1
AX 1.4	1.4		4	07.92-	TU3M Cat.	0,8	BCPR5ES	6130	32	LPG 3
AX 1.4 Gti	1.4		4	07.92-	TU3J2 KFZ	0,9	BKR6EK	2288	20	LPG 1
AX 1.4i	1.4		4	07.92-06.95	TU3MC KDX	0,8	BCPR5ES	6130	32	LPG 3
AX 1.4i GT	1.4		4	07.92-06.95	TU3MC KDX	0,8	BCPR5ES	6130	32	LPG 3
AX 1.4i	1.4		4	07.95-	TU3MC KDX	0,9	BKR6EK	2288	20	LPG 1

**BERLINGO**

Berlingo 1.1i	1.1	44	4	07.96-03.08	TU1JP	0,9	BKR6EZ	4619	38	LPG 1
Berlingo 1.1i	1.1	44	4	07.96-03.08	TU1M+	0,9	BCPR5ES	6130	32	LPG 3
Berlingo 1.1i	1.1	44	4	07.96-	TU1M HDZ	0,9	BKR6EK	2288	20	LPG 1
Berlingo 1.4i	1.4	55	4	07.96-12.99	TU3JP-KFX,KFW	0,9	BKR6EK	2288	20	LPG 1
Berlingo 1.4i	1.4	55	4	01.00-	TU3JP KFX	0,9	BKR6EZ	4619	38	LPG 1
Berlingo 1.6 95 Vti	1.6	72	4	07.10-	EP6CDTR	0,8	PLZKBR7B8DG	90223		
Berlingo 1.6i 16V	1.6	81	4	02.01-	TU5JP4 NFU	0,9	LFR6B	6677		LPG 7

e kW C  
y  
i

0201



Stock-No

VLINE

LPG/CNG

**CITROËN****BERLINGO**

Berlingo 1.6 120 Vti	1.6	88	4	11.09-	EP6C	0,8	PLZKBR7B8DG	90223		
Berlingo 1.8i	1.8	66	4	07.96-	XU7JB LFX	0,9	BKR6EK	2288	20	LPG 1
Berlingo Multispace 1.4i	1.4	55	4	01.97-12.99	TU3JP KFX, KFW	0,9	BKR6EK	2288	20	LPG 1
Berlingo Multispace 1.4i	1.4	55	4	01.00-	TU3JP KFX, KFW	0,9	BKR6EZ	4619	38	LPG 1
Berlingo Multispace 1.6i	1.6	81	4	02.01-	TU5JP4 NFU	0,9	LFR6B	6677		LPG 7
Berlingo Multispace 1.8i	1.8	66	4	07.97-	XU7JB LFX	0,9	BKR6EK	2288	20	LPG 1

**BX**

BX 14	1.4	47	4	07.88-	TU3.A	0,8	BCP5ES	7496	16	LPG 3
BX 15	1.5	59	4	07.87-06.92	XU5.1C	0,8	BCP5ES	7496	16	LPG 3
BX 16i Image, Millésime	1.6		4	07.92-	XU5M BDY cat.	0,8	BCPR5ES	6130	32	LPG 3
BX 16	1.6	68	4	04.88-06.92	XU5.2C	0,7	BCP6ES	4930	17	LPG 3
BX 16 16V	1.6		4	07.87-06.92	XU9.J4	0,9	BCP6ET	4563		LPG 3
BX 16	1.6		4	07.92-	XU5MZ BDZ Cat.	0,8	BCPR5ES	6130	32	LPG 3
BX 16 16V	1.6		4	07.92-	XU9.J4 Cat.	0,9	BCPR6ET	2197		LPG 3
BX 19	1.9	105	4	07.87-06.89	XU92C D2A	0,9	BCP5ES	7496	16	LPG 3
BX 19i Gti, Tri, Tzi / 4x4	1.9		4	07.86-06.92	XU9J2 D6A	0,7	BCP6ES	4930	17	LPG 3
BX 19i Gti 16S	1.9		4	07.87-06.92	XU9J4 D6C	0,9	BCP6ET	4563		LPG 3
BX 19i Gti 16S	1.9		4	07.92-	XU9J4 DFW cat.	0,9	BCPR6ET	2197		LPG 3
BX 19	1.9	77	4	07.89-06.92	XU92C	0,7	BCP6ES	4930	17	LPG 3
BX 19	1.9	77	4	07.89-06.92	XU92C D2E	0,7	BCP6ES	4930	17	LPG 3
BX 19i Gti	1.9		4	07.88-06.92	XU9.J2	0,7	BCP6ES	4930	17	LPG 3
BX 19i	1.9		4	07.92-	XU9.JA DKZ Cat.	0,8	BCPR5ES	6130	32	LPG 3

**C1**

C1	1.0	50	3	06.05-12.12	384F	1,1	LFR6C-11	5788		
C1	1.0	50	3	06.05-	1KR-FE	1,1	LFR6C-11	5788		
C1	1.2	60	3	04.14-	EB2D	1,0	LZKR6AI-10G	97999		

**C15**

C15 E	1.0	33	4	09.88-	TU9 C1A	0,8	BCP5ES	7496	16	LPG 3
C15 E	1.1	44	4	09.92-06.95	TU1.M HDZ Cat.	0,8	BCPR5ES	6130	32	LPG 3
C15 E	1.1		4	10.88-	TU1 H1A	0,8	BCP5ES	7496	16	LPG 3
C15 E	1.4		4	10.87-	TU3A K1G	0,8	BCP5ES	7496	16	LPG 3
C15E	1.1		4	07.95-	TU1M HDZ	0,8	BKR5EK	7956	23	LPG 1

**C2**

C2 1.1	1.1	45	4	08.03-	TU1JP	0,9	BKR6EZ	4619	38	LPG 1
C2	1.1	44	4	11.03-12.09	TU1A	0,9	BKR6EZ	4619	38	LPG 1
C2	1.4	54	4	09.03-12.09	TU3A	0,9	BKR6EZ	4619	38	LPG 1
C2	1.4	65	4	04.05-12.09	ET3J4	0,9	LZKAR7A	6799		
C2 1.4	1.4	55	4	08.03-	TU3JP	0,9	BKR6EZ	4619	38	LPG 1
C2 1.6 16V	1.6	81	4	08.03-	TU5JP4	0,9	LFR6B	6677		LPG 7
C2 1.6 16V	1.6	92	4	01.05-	TU5JP4	0,9	LFR6B	6677		LPG 7

**C25**

C25	2.0	79	4	09.81-03.94	XM7T/XN1T/XN1TA	0,9	BP6ES	7811	4	LPG 2
-----	-----	----	---	-------------	-----------------	-----	-------	------	---	-------

**C3 1**

C3 1.1	1.1	44	4	04.02-12.09	TU1A-HFX	0,9	BKR6EZ	4619	38	LPG 1
C3 1.1	1.1	44	4	04.02-12.09	TU1JP-HFZ, HFY	0,9	BKR6EZ	4619	38	LPG 1
C3 1.4	1.4	55	4	04.02-	TU3A-KFV	0,9	BKR6EZ	4619	38	LPG 1
C3 /Pluriel 1.4	1.4	55	4	04.02-12.09	TU3JP-KFX, KFV	0,9	BKR6EZ	4619	38	LPG 1
C3 / Pluriel 1.4	1.4	55	4	.03-12.11	TU3JP	0,9	BKR6EZ	4619	38	LPG 1
C3 1.4	1.4	66	4	10.03-08.10	ET3J4~KFU	0,8	LZKAR7A	6799		
C3 /Pluriel 1.6	1.6	81	4	04.02-	TU5JP4-NFU	0,9	LFR6B	6677		LPG 7



e kW  
C  
Y  
I



Stock-No



LPG / CNG

## CITROEN

### C3 1

C3 / Pluriel 1.6 16V	1.6	81	4	.03-12.11	TU5JP4	0,9	LFR6B	6677		LPG 7
----------------------	-----	----	---	-----------	--------	-----	-------	------	--	-------

### C3 2

C3 II 1.0 PureTech VTi 68	1.0	50	3	03.12-	EB0	1,0	LZKR6AI-10G	97999		
C3 II 1.1	1.1	44	4	11.09-	TU1A	0,9	BKR6EZ	4619	38	LPG 1
C3 II 1.2 PureTech VTi 82	1.2	60	3	03.12-	EB2	1,0	LZKR6AI-10G	97999		
C3 II 1.4	1.4	54	4	11.09-	TU3A	0,9	BKR6EZ	4619	38	LPG 1
C3 II 1.4 VTi 95	1.4	72	4	11.09-	EP3C	0,8	PLZKBR7B8DG	90223		
C3 II 1.6 VTi 120	1.6	88	4	11.09-	EP6C	0,8	PLZKBR7B8DG	90223		
C3	1.6	85	4	07.09-	EP6	0,8	PLZKBR7B8DG	90223		

### C3 PICASSO

C3 Picasso 1.4 Vti 95	1.4	70	4	12.08-	EP3	0,8	PLZKBR7B8DG	90223		
C3 Picasso 1.6 Vti 120	1.6	88	4	02.09-	EP6	0,8	PLZKBR7B8DG	90223		

### C4

C4 1.4 16V	1.4	65	4	11.04-	ET3J4~KFU	0,8	LZKAR7A	6799		
C4 1.6 16V	1.6	81	4	11.04-	TU5JP4~NFU	0,9	LFR6B	6677		LPG 7
C4 1.6 Vti 120	1.6	88	4	06.08-	EP6	0,8	PLZKBR7B8DG	90223		
C4 1.6 16V	1.6	103	4	06.08-	EP6DT	0,8	PLZKBR7B8DG	90223		
C4 1.6 16V	1.6	110	4	06.08-	EP6DT	0,8	PLZKBR7B8DG	90223		
C4 2.0 16V	2.0	100	4	11.04-	EW10J4~RFN	0,9	LFR6B	6677		LPG 7
C4 2.0 16V	2.0	103	4	11.04-	EW10A	0,9	LFR5B	7113		LPG 7
C4 2.0 16V	2.0		4	11.04-	EW10A	0,9	LFR5B	7113		LPG 7

### C4 2

C4 II 1.4 Vti 95	1.4	70	4	11.09-	EP3C	0,8	PLZKBR7B8DG	90223		
C4 II 1.6 Vti 120	1.6	88	4	11.09-	EP6C	0,8	PLZKBR7B8DG	90223		
C4 II 1.6 THP 155	1.6	115	4	11.09-	EP6CDT	0,8	PLZKBR7B8DG	90223		

### C4 3

C4 III 1.2	1.2	55	3	03.14-	EB2D	1,0	LZKR6AI-10G	97999		
C4 III 1.2	1.2	60	3	09.14-	EB2	1,0	LZKR6AI-10G	97999		
C4 III 2.0	2.0	110	4	04.12-	4B11	0,8	FR6EI	2687		

### C4 AIRCROSS

C4 Aircross 1.6	1.6	86	4	04.12-	4A92	1,1	DILFR5A11	93759		
-----------------	-----	----	---	--------	------	-----	-----------	-------	--	--

### C4 GRAND PICASSO

C4 Grand Picasso 1.6 Vti 120	1.6	88	4	06.08-	EP6	0,8	PLZKBR7B8DG	90223		
C4 Grand Picasso 1.6 16V	1.6	103	4	06.08-	EP6DT	0,8	PLZKBR7B8DG	90223		
C4 Grand Picasso 1.6 16V	1.6	110	4	06.08-	EP6DT	0,8	PLZKBR7B8DG	90223		
C4 Grand Picasso 1.6 THP 155	1.6	115	4	08.10-	EP6CDT	0,8	PLZKBR7B8DG	90223		
C4 Grand Picasso 1.8i 16V	1.8		4	09.06-	EW7A	0,9	LFR5B	7113		LPG 7
C4 Grand Picasso 2.0	2.0	105	4	09.06-	EW10A	0,9	LFR5B	7113		LPG 7

### C4 PICASSO I

C4 Picasso I 1.6 Vti 120	1.6	88	4	06.08-	EP6	0,8	PLZKBR7B8DG	90223		
C4 Picasso I 1.6 16V	1.6	103	4	06.08-	EP6DT	0,8	PLZKBR7B8DG	90223		
C4 Picasso I 1.6 16V	1.6	110	4	06.08-	EP6DT	0,8	PLZKBR7B8DG	90223		
C4 Picasso I 1.6 THP 155	1.6	115	4	08.10-	EP6CDT	0,8	PLZKBR7B8DG	90223		
C4 Picasso I 1.8i 16V	1.8		4	02.07-	EW7A	0,9	LFR5B	7113		LPG 7
C4 Picasso I 2.0	2.0	105	4	02.07-	EW10A	0,9	LFR5B	7113		LPG 7
C4 Picasso I 2.0 16V	2.0		4	02.07-	EW10A	0,9	LFR5B	7113		LPG 7





l kW  
C  
y  
i

0201



Stock-No

VALVE

LPG/CNG

**CITROËN**

**C4 PICASSO II**

C4 Picasso II 1.6 THP 155	1.6	156	4	02.13-	EP6CDT	0,8	PLZKBR7B8DG	90223		
C4 Picasso II 1.6 VTi 120	1.6	120	4	02.13-	EP6C	0,8	PLZKBR7B8DG	90223		

**C5**

C5 1.8	1.8	86	4	06.02-	EW7J4 6FZ	0,9	LFR5B	7113		LPG 7
C5 2.0	2.0	100	4	10.00-	EW10J4-RFN	0,9	LFR5B	7113		LPG 7
C5 2.0 16V	2.0	105	4	09.04-	EW10A	0,9	LFR5B	7113		LPG 7
C5 3.0 V6	3.0	154	6	10.00-	ES9J4S XFX	1,1	PLFR5A-11	6240		LPG 7

**C5 3**

C5 III 1.6 120 Vti	1.6	88	4	07.10-	EP6C	0,8	PLZKBR7B8DG	90223		
C5 III 1.6 155 THP	1.6	115	4	06.09-	EP6CDT	0,8	PLZKBR7B8DG	90223		
C5 III 1.8	1.8	92	4	02.08-	EW7A	0,9	LFR5B	7113		LPG 7
C5 III 1.8	1.8	85	4	09.04-08.05	EW7J4	0,9	LFR5B	7113		LPG 7
C5 III 2.0	2.0	103	4	02.08-	EW10A	0,9	LFR5B	7113		LPG 7
C5 III 3.0 V6	3.0	155	6	02.08-	ES9A	1,1	PLFR5A-11	6240		LPG 7

**C6**

C6 3.0 V6	3.0	155	6	08.05-	ES9A / ES9J4S	1,1	PLFR5A-11	6240		LPG 7
-----------	-----	-----	---	--------	---------------	-----	-----------	------	--	-------

**C8**

C8 2.0	2.0	102	4	06.02-	EW10J4-RFN	0,9	LFR5B	7113		LPG 7
C8 2.0	2.0	104	4	09.05-	EW10A	0,9	LFR5B	7113		LPG 7
C8 2.0 16V	2.0	104	4	09.05-	EW10A	0,9	LFR5B	7113		LPG 7
C8 2.2	2.2	118	4	06.02-	EW12J4-3FZ	0,9	LFR5B	7113		LPG 7
C8 3.0 V6	3.0	150	6	10.02-	ES9J4S	1,1	PLFR5A-11	6240		LPG 7

**C-CROSSER**

C-Crosser	2.4	125	4	09.07-	VUSFZC/VUSFZF/ VWSFZC/VWSFZF	0,8	FR5EI	1313		FR6EI
C-Crosser	2.0	108	4	11.10-12.12	4B11	0,8	FR6EI	2687		FR6EI

**C-ELYSÉE**

C-Elysée 1.2 VTi 72	1.2	52	3	.12-	EB2M	1,0	LZKR6AI-10G	97999		
C-Elysée 1.6 115 VTi	1.6	114	4	.12-	EC5	0,8	PLZKBR7B8DG	90223		

**DISPATCH**

Dispatch	2.0	102	4	03.00-10.06	EW10J4	0,9	LFR5B	7113		LPG 7
Dispatch	2.0	103	4	03.09-03.11	EW10A	0,9	LFR5B	7113		LPG 7

**DS3**

DS3 1.2 PureTech VTi 82	1.2	60	3	.11-	EB2	1,0	LZKR6AI-10G	97999		LZKR6AI-10G
DS3 1.4 Vti 95	1.4	70	4	04.10-	EP3C	0,8	PLZKBR7B8DG	90223		
DS3 1.6 Vti 120	1.6	88	4	04.10-	EP6C	0,8	PLZKBR7B8DG	90223		
DS3 1.6 THP 155	1.6	115	4	04.10-	EP6DT / EP6CDT	0,8	PLZKBR7B8DG	90223		

**DS4**

DS4 1.6 Vti 120	1.6	88	4	04.11-	EP6C	0,8	PLZKBR7B8DG	90223		
DS4 1.6 THP 155	1.6	115	4	04.11-	EP6DT / EP6CDT	0,8	PLZKBR7B8DG	90223		
DS4 1.6 THP 200	1.6	147	4	04.11-	EP6CDTX	0,8	ILZKBR7B8DG	95770		

**EVASION**

Evasion 1.8	1.8	72	4	09.96-06.00	XU7JP LFW	0,8	BKR5EK	7956	23	LPG 1
Evasion 2.0	2.0	89	4	07.94-03.95	XU10J2 RFU	0,8	BCPR5ES	6130	32	LPG 3

e kW  
C  
Y  
I

0201



Stock-No

VLINE

LPG / CNG

**CITROEN****EVASION**

Evasion 2.0	2.0	90	4	04.95-05.00	XU10J2 RFU	0,8	BKR5EK	7956	23	LPG 1
Evasion 2.0	2.0	101	4	06.00-	EW10J4-RFR	0,9	LFR5B	7113		LPG 7
Evasion 2.0 Turbo	2.0	110	4	09.94-05.00	XU10J2TE RGX	0,9	BKR6EK	2288	20	LPG 1

**JUMPER**

Jumper 2.0	2.0	81	4	04.95-	XU10.J2U RFW	0,9	BKR6EK	2288	20	LPG 1
------------	-----	----	---	--------	--------------	-----	--------	------	----	-------

**JUMPY**

Jumpy 1.6	1.6	59	4	10.95-	1580 SPI 220.A2.000	0,8	BCPR7ES	3330		BCPR7EIX
Jumpy 2.0	2.0	102	4	06.01-	EW10J4-RFN	0,9	LFR5B	7113		LPG 7
Jumpy 2.0 16V	2.0	105	4	12.06-	EW10A	0,9	LFR5B	7113		LPG 7

**NEMO**

Nemo 1.4	1.4	54	4	11.07-	TU3AE5	0,9	BKR6EZ	4619	38	LPG 1
Nemo 1.4	1.4	54	4	04.09-	TU3A	0,9	BKR6EZ	4619	38	LPG 1
Nemo 1.4	1.4	54	4	02.08-	KFV (TU3A)	0,9	BKR6EZ	4619	38	LPG 1

**SAXO 1**

Saxo 1 1.0	1.0	37	4	02.96-09.99	TU9M CDZ	0,8	BKR5EK	7956	23	LPG 1
Saxo 1 1.1	1.1	44	4	02.96-08.99	TU1M+ HDZ	0,9	BKR6EK	2288	20	LPG 1
Saxo 1 1.4	1.4	55	4	02.96-08.99	TU3JP KFW	0,9	BKR6EK	2288	20	LPG 1
Saxo 1 1.4	1.4	55	4	02.96-08.99	TU3JP+ KFX	0,9	BKR6EK	2288	20	LPG 1
Saxo 1 1.6	1.6	66	4	07.98-08.99	TU5JP+ NFZ	0,9	BKR6EK	2288	20	LPG 1

**SAXO 2**

Saxo 2 1.0	1.0	37	4	09.99-12.00	TU9M CDZ	0,8	BKR5EK	7956	23	LPG 1
Saxo 2 1.1	1.1	44	4	09.99-	TU1M+ HDZ	0,9	BKR6EK	2288	20	LPG 1
Saxo 2 1.1	1.1	44	4	06.00-	TU1JP HFX	0,9	BKR6EZ	4619	38	LPG 1
Saxo 2 1.1	1.1	44	4	06.00-	TU1JP HFX	0,9	BKR6EZ	4619	38	LPG 1
Saxo 2 1.4	1.4	55	4	09.99-	TU3JP KFW	0,9	BKR6EZ	4619	38	LPG 1
Saxo 2 1.4	1.4	55	4	09.99-	TU3JP+ KFX	0,9	BKR6EZ	4619	38	LPG 1
Saxo 2 1.6	1.6	66	4	09.99-12.00	TU5JP+ NFZ	0,9	BKR6EZ	4619	38	LPG 1
Saxo 2 1.6	1.6	66	4	01.01-	TU5JP NFT	0,9	BKR6EZ	4619	38	LPG 1
Saxo 2 1.6	1.6	88	4	03.01-04.02	TU5JP NFX	0,9	BKR6EK	2288	20	LPG 1

**SYNERGIE**

Synergie	2.0	100	4	09.00-02.03	EW10J4	0,9	LFR5B	7113		LPG 7
----------	-----	-----	---	-------------	--------	-----	-------	------	--	-------

**XANTIA**

Xantia 1.6	1.6	66	4	06.93-05.95	XU5JP BFZ	0,8	BCPR5ES	6130	32	LPG 3
Xantia 1.6	1.6	66	4	06.95-	XU5JP BFZ	0,8	BKR5EK	7956	23	LPG 1
Xantia 1.8	1.8	66	4	01.98-	XU7JB LFX	0,9	BKR6EK	2288	20	LPG 1
Xantia 1.8	1.8	76	4	07.93-03.95	XU7JP LFZ	0,8	BCPR5ES	6130	32	LPG 3
Xantia 1.8	1.8	76	4	04.95-	XU7JP LFZ	0,8	BKR5EK	7956	23	LPG 1
Xantia 1.8 16V	1.8	82	4	07.95-	XU7JP4 LFY	0,8	BKR5EK	7956	23	LPG 1
Xantia 2.0	2.0	90	4	03.93-05.95	XU10J2 RFX	0,8	BCPR5ES	6130	32	LPG 3
Xantia 2.0	2.0	90	4	06.95-	XU10J2 RFX	0,8	BKR5EK	7956	23	LPG 1
Xantia 2.0 16V	2.0	99	4	06.95-	XU10J4R RFV	0,8	BKR5EK	7956	23	LPG 1
Xantia 2.0 CT Turbo	2.0	110	4	07.96-	XU10J2TE RGX	0,9	BKR6EK	2288	20	LPG 1
Xantia 2.0 16V	2.0	112	4	.93-	XU10J4D	0,8	BKR6ES	3783	35	LPG 1
Xantia 3.0 V6	3.0	142	6	03.97-	ES9J4 XFZ	0,9	BKR6EK	2288	20	LPG 1

**XM**

XM 2.0	2.0	99	4	07.94-12.00	XU10J4R RFV	0,8	BKR5EK	7956	23	LPG 1
XM 2.0 CT Turbo	2.0	110	4	11.92-12.00	XU10J2TE RGX	0,9	BKR6EK	2288	20	LPG 1
XM 2.0 CT Turbo	2.0	110	4	.96-	XU10J2CTE	0,9	BKR6EK	2288	20	LPG 1
XM 2.0	2.0		4	05.89-12.92	XU102C-R2A	0,7	BCP6ES	4930	17	LPG 3
XM 2.0	2.0		4	05.89-12.92	XU10J2 R6A	0,8	BCPR6ES	2330	12	LPG 3



l kW  
C  
y  
i

0201



Stock-No

VALVE

LPG / CNG

**CITROEN**

**XM**

XM 2.0	2.0		4	05.92-12.00	XU10J2 RFZ Cat.	0,8	BCPR5ES	6130	32	LPG 3
XM 2.0 16V	2.0		4	07.94-		0,8	BCPR6ES	2330	12	LPG 3
XM 3.0 V6 24V	3.0	140	6	01.97-12.00	ES9J4-XFZ	0,9	BKR6EK	2288	20	LPG 1
XM 3.0 V6	3.0		6	05.89-06.94	ZPJ-SFZ	0,9	BCPR6ET	2197		LPG 3
XM 3.0 V6	3.0		6	07.94-06.97	ZPJ-UFZ	0,9	BCPR6ET	2197		LPG 3
XM 3.0 V6 24V	3.0		6	07.94-07.97	ZPJ4-UKZ	0,9	BCPR7ET	2164		BCPR7EIX

**XSARA**

Xsara 1.4	1.4	55	4	09.97-08.00	TU3JP KFX	0,9	BKR6EK	2288	20	LPG 1
Xsara 1.6	1.6	66	4	09.97-08.00	TU5JP NFZ	0,9	BKR6EK	2288	20	LPG 1
Xsara 1.8	1.8	66	4	09.97-08.00	XU7JB LFX	0,9	BKR6EK	2288	20	LPG 1
Xsara 1.8 16V	1.8	75	4	09.97-08.00	XU7JP LFZ	0,8	BKR5EK	7956	23	LPG 1
Xsara 1.8 16V	1.8	82	4	09.97-08.00	XU7JP4 LFY	0,8	BKR5EK	7956	23	LPG 1
Xsara 2.0 16V	2.0	120	4	09.97-08.00	XU10J4RS RFS	0,9	BKR6EK	2288	20	LPG 1
Xsara 2 1.4	1.4	55	4	09.00-	TU3JP KFW	0,9	BKR6EZ	4619	38	LPG 1
Xsara 2 1.6 16V	1.6	81	4	09.00-	TU5JP4-NFU	0,9	LFR6B	6677		LPG 7
Xsara 2 1.8 16V	1.8	86	4	09.00-	EW7J4 6FZ	0,9	LFR5B	7113		LPG 7
Xsara 2 2.0 16V	2.0	101	4	09.00-	EW10J4-RFN	0,9	LFR5B	7113		LPG 7
Xsara 2 2.0i 16V VTS	2.0	123	4	09.00-	XU10J4RS RFS	0,9	BKR5EZ	7642	36	LPG 1
Xsara Picasso 1.6	1.6	66	4	12.99-	TU5JP NFZ, NFV	0,9	BKR6EZ	4619	38	LPG 1
Xsara Picasso 1.8i 16V	1.8	86	4	12.99-	EW7J4-6FZ	0,9	LFR5B	7113		LPG 7
Xsara Picasso 2.0	2.0	101	4	09.00-	EW10J4-RFM	0,9	LFR5B	7113		LPG 7

**ZX**

ZX 1.1	1.1	40	4	03.91-06.92	TU1	0,8	BCP5ES	7496	16	LPG 3
ZX 1.1	1.1	44	4	07.92-03.96	TU1M HDZ	0,8	BCPR5ES	6130	32	LPG 3
ZX 1.1	1.1	44	4	04.96-	TU1M	0,8	BKR5EK	7956	23	LPG 1
ZX 1.1i	1.1	44	4	04.96-	TU1M HDZ	0,8	BKR5EK	7956	23	LPG 1
ZX 1.4	1.4	55	4	03.91-12.92	TU32 K2C	0,8	BCP5ES	7496	16	LPG 3
ZX 1.4	1.4	55	4	03.91-06.97	TU3MC KDX	0,8	BCPR6ES	2330	12	LPG 3
ZX 1.4	1.4	55	4	07.92-06.97	TU3MC KDY Cat.	0,9	BKR6EK	2288	20	LPG 1
ZX 1.4	1.4	55	4	07.97-	TU3JP KFX	0,9	BKR6EK	2288	20	LPG 1
ZX 1.4	1.4	55	4	07.97-	TU3JP-KFX	0,9	BKR6EK	2288	20	LPG 1
ZX 1.6	1.6	65	4	03.91-06.93	XU5M BDY Cat.	0,8	BCPR5ES	6130	32	LPG 3
ZX 1.6	1.6	66	4	07.93-06.95	XU5JP Cat.	0,8	BCPR5ES	6130	32	LPG 3
ZX 1.6i	1.6	66	4	07.93-06.95	XU5JP BFZ	0,8	BCPR5ES	6130	32	LPG 3
ZX 1.6	1.6	66	4	07.95-07.98	TU5JP	0,8	BKR5EK	7956	23	LPG 1
ZX 1.6i	1.6	66	4	07.95-07.98	XU5JP BFZ	0,8	BKR5EK	7956	23	LPG 1
ZX 1.8	1.8	76	4	07.92-06.95	XU7JP LFZ	0,8	BCPR5ES	6130	32	LPG 3
ZX 1.8	1.8	76	4	07.95-	XU7JP Cat.	0,8	BKR5EK	7956	23	LPG 1
ZX 1.8i	1.8	76	4	07.95-	XU7JP LFZ	0,8	BKR5EK	7956	23	LPG 1
ZX 1.8	1.8	82	4	07.97-	XU7JP4 LFY	0,8	BKR5EK	7956	23	LPG 1
ZX 1.9	1.9	88	4	07.92-	XU9JA DKZ Cat.	0,8	BCPR5ES	6130	32	LPG 3
ZX 1.9	1.9	96	4	03.91-06.92	XU9JA D6A	0,7	BCP6ES	4930	17	LPG 3
ZX 2.0	2.0	90	4	07.92-03.96	XU10J2C	0,8	BCPR5ES	6130	32	LPG 3
ZX 2.0i	2.0	90	4	07.92-03.96	XU10J2 RFX	0,8	BCPR5ES	6130	32	LPG 3
ZX 2.0	2.0	90	4	04.96-	XU10J2C Cat.	0,8	BKR5EK	7956	23	LPG 1
ZX 2.0i	2.0	90	4	04.96-	XU10J2 RFX	0,8	BKR5EK	7956	23	LPG 1
ZX 2.0	2.0	110	4	11.92-06.96	XU10J4D RFT Cat.	0,9	BKR6EK	2288	20	LPG 1
ZX 2.0	2.0	110	4	07.94-06.96	XU10J4D	0,8	BCPR6ES	2330	12	LPG 3
ZX 2.0	2.0	110	4	07.96-	XU10J4RS-RFS	0,9	BKR5EZ	7642	36	LPG 1

e kW  
C  
Y  
I

0201



Stock-No

VLINE

LPG / CNG

**DACIA****DOKKER**

Dokker 1.2 TCe	1.2	85	4	11.12-	H5F 402	0,7	ILKAR7F7G	90061		
Dokker 1.6 16V	1.6	61	4	11.12-	K7M 812	0,9	BKR6EK	2288	20	LPG 1

**DUSTER 2**

Duster 1.6	1.6	77	4	03.10-	K4M 616 / 642	0,9	BKR6EK	2288	20	LPG 1
Duster 1.6	1.6	77	4	03.10-	K4M 690 / 696	0,9	BKR6EK	2288	20	LPG 1

**LODGY**

Lodgy 1.2 TCe	1.2	85	4	03.12-	H5F 402	0,7	ILKAR7F7G	90061		
Lodgy 1.6	1.6	61	4	03.12-	K7M 812	0,9	BKR6EK	2288	20	LPG 1

**LOGAN I**

Logan I 1.2 16V LPG	1.2	55	4	02.06-	D4F 732/734	0,9	LZKAR7B	5942		
Logan I 1.4 MPI	1.4	55	4	09.04-	K7J 710 / 714	0,9	BKR6EK	2288	20	LPG 1
Logan I 1.6 16V	1.6	77	4	02.06-	K4M 690 / 696	0,9	BKR6EK	2288	20	LPG 1
Logan I 1.6 MPI	1.6	62	4	05.10-12.12	K7M 800	0,9	BKR6EK	2288	20	LPG 1
Logan I 1.6 MPI	1.6	64	4	09.04-	K7M 710	0,9	BKR6E	6962	28	LPG 1
Logan I 1.6 16V	1.6	77	4	02.06-	K4MA6	0,9	BKR6EZ	4619	36	LPG 1

**LOGAN II**

Logan II 0.9 TCe 90	L8	0,9	66	3	11.12-	H4B 400	0,7	ILKAR7J7G	91121	
Logan II 1.2 16V	L8	1.2	55	4	11.12-	D4F 732/734	0,9	LZKAR7B	5942	
Logan II 1.2 16V LPG	L8	1.2	55	4	02.13-	D4F 732/734	0,9	LZKAR7B	5942	

**LOGAN MCV I**

Logan MCV I 1.4 MPI	KS	1.4	55	4	08.06-12.12	K7J 710	0,9	BKR6E	6962	28	LPG 1
Logan MCV I 1.6	KS	1.6	64	4	08.06-06.13	K7M 710	0,9	BKR6EK	2288	20	LPG 1
Logan MCV I 1.6 16V	KS	1.6	77	4	08.06-06.13	K4M 690 / 696 / 697	0,9	BKR6EK	2288	20	LPG 1
Logan MCV I 1.6 16V HiFlex	KS	1.6	77	4	11.09-06.13	K4M 694 / 696	0,9	BKR6EK	2288	20	LPG 1
Logan MCV I 1.6	KS	1.6	64	4	08.06-06.13	K7M 710 / 718	0,9	BKR6EK	2288	20	LPG 1
Logan MCV I 1.6 MPI	KS	1.6	62	4	05.10-06.13	K7M 800	0,9	BKR6EK	2288	20	LPG 1

**LOGAN MCV II**

Logan MCV II 0.9 TCe 90	K8	0,9	66	3	02.13-	H4B 400	0,7	ILKAR7J7G	91121	
Logan MCV II 1.2 16V	K8	1.2	55	4	02.13-	D4F 732/734	0,9	LZKAR7B	5942	
Logan MCV II 1.2 16V LPG	K8	1.2	55	4	02.13-	D4F 732/734	0,9	LZKAR7B	5942	

**LOGAN PICK-UP**

Logan Pick-up 1.4 MPI	US	1.4	55	4	01.09-	K7J 710	0,9	BKR6E	6962	28	LPG 1
Logan Pick-up 1.6	US	1.6	64	4	03.08-	K7M 710 / 718	0,9	BKR6EK	2288	20	LPG 1
Logan Pick-up 1.6 MPI	US	1.6	62	4	05.10-	K7M 800	0,9	BKR6EK	2288	20	LPG 1

**NOVA**

Nova 1.4	1.4	48	4	04.96-03.01	C2J	0,7	BPR6HS	7022	3	BPR7HIX
Nova 1.6	1.6	53	4	04.96-03.03		0,9	BPR5ES	7422	6	LPG 2

**SANDERO I**

Sandero I 1.2 16V	1.2	55	4	11.08-	D4F 732	0,9	LZKAR7B	5942		
Sandero I 1.2 16V Bifuel	1.2	55	4	11.08-	D4F 732	0,9	LZKAR7B	5942		
Sandero I 1.4 Mpi	1.4	55	4	06.08-	K7J 710	0,9	BKR6E	6962	28	LPG 1
Sandero I 1.6 Mpi 85	1.6	62	4	05.10-	K7M 800	0,9	BKR6EK	2288	20	LPG 1
Sandero I 1.6 Mpi	1.6	64	4	06.08-	K7M 710	0,9	BKR6E	6962	28	LPG 1
Sandero I 1.6 16V Bifuel	1.6	77	4	01.11-	K4M 696	0,9	BKR6EK	2288	20	LPG 1



e kW C y l

0201



Stock-No

VLINE

LPG/CNG

**DACIA****SANDERO II**

Sandero II 0.9 TCe 90	B8	0.9	66	3	01.13-	H4B 400	0,7	ILKAR7J7G	91121		
Sandero II 1.2 16V	B8	1.2	55	4	01.13-	D4F 732	0,9	LZKAR7B	5942		
Sandero II 1.2 16V LPG	B8	1.2	53	4	01.13-	D4F 734	0,9	LZKAR7B	5942		

**SOLENZA**

Solenza 1.4		1.4	55	4	02.03-	K7J 710	0,9	BKR6E	6962	28	LPG 1
-------------	--	-----	----	---	--------	---------	-----	-------	------	----	-------

**DAEWOO****ARANOS**

Aranos		1.8	70	4	11.94-12.99	SOHC	0,9	BPR5ES	7422	6	LPG 2
Aranos		2.0	81	4	11.94-12.99	SOHC	1,1	BPR5ES-11	4424		LPG 2

**CIELO**

Cielo		1.5	57	4	08.94-08.97	G15MF SOHC	0,8	BPR6ES	7822	2	LPG 2
Cielo		1.5	74	4	08.94-08.97	A15MF DOHC	1,1	BKR6E-11	2756	14	LPG 1

**ESPERO**

Espero		1.5	66	4	.95-10.99	A15MF DOHC 16V	1,1	BKR6E-11	2756	14	LPG 1
Espero		1.8	66	4	02.95-10.99	C18LE	0,8	BPR6ES	7822	2	LPG 2
Espero		2.0	77	4	02.95-10.99	C20LE	0,8	BPR6ES	7822	2	LPG 2

**EVANDA**

Evanda		2.0	96	4	.03-02.05	T20SED	0,8	BKR5EK	7956	23	LPG 1
--------	--	-----	----	---	-----------	--------	-----	--------	------	----	-------

**KALOS**

Kalos 1.4 SE S100		1.4	61	4	09.02-02.05	F14S3	0,8	BPR6ES	7822	2	LPG 2
Kalos 1.4 SE		1.4	61	4	04.03-02.05	F14S3 SOHC	0,8	BPR6ES	7822	2	LPG 2
Kalos 1.4 SX		1.4	69	4	04.03-02.05	F14D3 DOHC	1,1	BKR6E-11	2756	14	LPG 1

**LACETTI**

Lacetti 1.4		1.4	68	4	09.03-02.05	F14D3	1,1	BKR6E-11	2756	14	LPG 1
Lacetti 1.6		1.6	80	4	09.03-02.05	F16D3	1,1	BKR6E-11	2756	14	LPG 1
Lacetti 1.8		1.8	90	4	09.03-02.05	T18SED	0,8	BKR5EK	7956	23	LPG 1

**LANOS**

Lanos 1.4		1.4	55	4	05.97-02.05	A14SMS SOHC	0,8	BPR6ES	7822	2	LPG 2
Lanos 1.5		1.5	63	4	05.97-02.05	A15SMS SOHC	0,8	BPR6ES	7822	2	LPG 2
Lanos 1.6		1.6	78	4	05.97-02.05	A16DMS DOHC	1,1	BKR6E-11	2756	14	LPG 1

**LEGANZA**

Leganza 2.0		2.0	100	4	07.97-12.02	X20SED DOHC	0,8	BKR5EK	7956	23	LPG 1
Leganza 2.2		2.2		4	07.97-12.02	T22SED DOHC	0,9	BKR6EK	2288	20	LPG 1

**MATIZ**

Matiz 0.8		0.8	38	3	06.98-02.05	F8CV	1,1	BCPR5EY-11	4120		LPG 3
Matiz 1.0		1.0	47	4	03.03-02.05	B10S	1,1	BCPR5EY-11	4120		LPG 3

**MUSSO**

Musso 2.0		2.0	100	4	09.96-	M 161.940	0,8	BCP5ES	7496	16	LPG 3
Musso 2.3 16V		2.3	110	4	11.96-	M 161.970	0,8	BCP5ES	7496	16	LPG 3
Musso 3.2 E32		3.2	162	6	05.96-	Mercedes M162990	0,8	BCP5ES	7496	16	LPG 3

**NEW BROUGHAM**

New Brougham		2.0	85	4	01.96-02.97	SOHC	1,1	BPR5ES-11	4424		LPG 2
New Brougham		2.0	106	4	01.96-02.97	DOHC 16V	0,8	BKR5EK	7956	23	LPG 1
New Brougham		2.2	110	4	01.96-02.97	DOHC 16V	0,8	BKR5EK	7956	23	LPG 1

e kW  
C  
Y  
I

0201



Stock-No

VLINE

LPG / CNG

**DAEWOO****NEW PRINCE**

New Prince	1.8	81	4	04.96-02.97	SOHC	1,1	BPR5E-11	4424		LPG 2
New Prince	1.8	101	4	04.96-02.97	DOHC 16V	0,8	BKR5EK	7956	23	LPG 1
New Prince	2.0	85	4	04.96-02.97	SOHC	1,1	BPR5E-11	4424		LPG 2
New Prince	2.0	106	4	04.96-02.97	DOHC 16V	0,8	BKR5EK	7956	23	LPG 1

**NEXIA**

Nexia 1.5	1.5	55	4	02.95-	OHC	0,8	BPR6ES	7822	2	LPG 2
Nexia 1.5	1.5	66	4	02.95-	DOHC 16V	1,1	BKR6E-11	2756	14	LPG 1
Nexia 1.8	1.8	74	4	12.95-10.96	C18LE SOHC	0,8	BPR6ES	7822	2	LPG 2

**NUBIRA**

Nubira 1.6	1.6	80	4	07.97-02.05	A16DMS DOHC	1,1	BKR6E-11	2756	14	LPG 1
Nubira 1.8 CDX	1.8	90	4	.03-02.05	T18SED	0,8	BKR5EK	7956	23	LPG 1
Nubira 2.0	2.0	99	4	07.97-02.05	X20SED DOHC	0,8	BKR5EK	7956	23	LPG 1

**REZZO / TACUMA U100**

Rezzo / Tacuma U100	1.6	77	4	.01-02.05	A16DMS	1,1	BKR5E-11	6953	23	LPG 1
Rezzo / Tacuma U100	2.0	89	4	.01-02.05	T20SED	0,8	BKR5EK	7956	23	LPG 1

**TACUMA**

Tacuma 1.6	1.6		4	.01-	L4 DOHC	1,1	BKR6E-11	2756	14	LPG 1
Tacuma 1.8	1.8		4	.01-	L4 SOHC	0,9	BPR5ES	7422	6	LPG 2
Tacuma 2.0	2.0		4	.01-	L4 DOHC	0,8	BKR5EK	7956	23	LPG 1

**DAIHATSU****CHARADE CL10,60**

Charade GTi G100	1.0	74	3	03.87-	CB80	0,8	BPR6EKN	1128		
Charade G102	1.3	66	4	07.91-	HC-E	1,1	BKR6E-11	2756	14	LPG 1
Charade G112 4WD	1.3	66	4	02.97-	HC-E	1,1	BKR6E-11	2756	14	LPG 1

**COPEN L880K**

Copen L880K	0.66	50	4	09.03-	JB-DET	1,1	IFR6J11	7658		
Copen L881	1.3	64	4	10.05-	K3-VE	1,1	BKR6EY-11	4368		LPG 1

**CUORE**

Cuore L55	0.54	21	3		AB30	0,8	BPR6ES	7822	2	LPG 2
Cuore L60	0.61	22	3		AD10	0,8	BPR6ES	7822	2	LPG 2
Cuore L201	0.85	30	3		ED10	0,8	BPR6EY	6427		LPG 2
Cuore L80	0.85	32	3		ED10	0,8	BPR6EY	6427		LPG 2
Cuore L501	0.85	32	3	05.95-04.96	ED20	0,8	BPR6EY	6427		LPG 2
Cuore L701	1.0	40	3	06.98-.01	EJ-DE	1,1	BKR5E-11	6953	33	LPG 1
Cuore L701	1.0	43	3	07.01-	EJ-VE	0,9	BKR5EKC	5216		LPG 1
Cuore L251	1.0	43	3	05.03-	EJ-VE	0,9	BKR5EKC	5216		LPG 1
Cuore 1.0 Top L276	1.0	52	3	09.07-	1KR-FE	1,1	ILFR6T11	4904		

**FOURTRAK**

Fourtrak	2.2		4	.86-	DL52	0,8	BPR5EY	2828	9	LPG 2
----------	-----	--	---	------	------	-----	--------	------	---	-------

**GRAN MOVE**

Gran Move L901	1.0	40	3	10.99-	EJ-DE	1,0	BKUR6EK	2213		
Gran Move G303	1.5	66	4	04.97-	HE-EG	1,1	BKR6E-11	2756		LPG 1
Gran Move G301	1.6	67	4	07.99-	HD-EP	1,1	BKR6E-11	2756		LPG 1

**HIJET**

Hijet	1.0		3	.86-	CB42	0,8	BPR5EY	2828	9	LPG 2
Hijet	1.3	48	4	08.98-	HC-ES	1,0	BKUR6EK	2213		



l kW C y I

0201



Stock-No

VALE

LPG/CNG

**DAIHATSU**

**MATERIA**

Materia 1.3	1.3	67	4	12.06-	K3-VE	0,9	IKR7D	4759		IKR7D
Materia 1.5	1.5	76	4	12.06-	3SZ-VE	0,9	IKR7D	4759		IKR7D

**MIRA**

Mira	0.85		3	01.93-	.97 ED10 (K)	0,9	BPR6EY	6427		LPG 2
------	------	--	---	--------	--------------	-----	--------	------	--	-------

**MOVE**

Move L901	1.0	40	3	10.99-09.02	EJ-DE	1,0	BKUR6EK	2213		
-----------	-----	----	---	-------------	-------	-----	---------	------	--	--

**ROCKY**

Rocky F80	2.0	65	4	04.84-04.93	3Y	0,8	BP5EY	7327		LPG 2
Rocky F85	2.0	65	4	04.84-04.93	3Y	0,8	BP5EY	7327		LPG 2

**SIRION 1**

Sirion 1 1.0	M100 / M110	1.0	40	3	06.98-	.00 EJ-DE	1,0	BKUR6EK	2213		
Sirion 1 1.0	M100 / M110	1.0	43	3	05.00-	.04 EJ-VE	0,9	BKR5EKC	5216		LPG 1
Sirion 1 1.3	M101 / M111	1.3	75	4	09.01-	.04 K3-VE2	1,0	BKUR6ETB-10	5742		

**SIRION 2**

Sirion 2 1.0	M300	1.0	51	3	01.05-	1KR-FE	1,1	ILFR6T11	4904		ILFR6T11
Sirion 2 1.3	M301 / M311	1.3	64	4	07.07-	K3-VE	0,9	DCPR7EA-9	6651		
Sirion 2 1.3	M301 / M311	1.3	64	4	01.05-06.07	K3-VE	1,1	BKR6EY-11	4368	10	LPG 1
Sirion 2 1.3	M301 / M311	1.3	67	4	03.08-	K3-VE	0,9	DCPR7EA-9	6651		
Sirion 2 1.5	M303	1.5	76		03.08-	3SZ-VE	0,9	DCPR7EA-9	6651		

**TERIOS 1**

Terios 1 1.3	J100	1.3	61	4	09.97-	.00 HC-EJ Aluengien	1,0	BKUR6EK	2213		
Terios 1 1.3	J102	1.3	63	4	05.00-12.05	K3-VE	1,0	BKUR6ETB-10	5742		

**TERIOS 2**

Terios 2 1.3	J211	1.3	63	4	11.05-	K3-VE	1,1	BKR6EY-11	4368	10	LPG 1
Terios 2 1.5	J200 / J210	1.5	77	4	01.06-12.07	3SZ-VE	0,9	IKR7D	4759		IKR7D
Terios 2 1.5	J200 / J210	1.5	77	4	01.08-	3SZ-VE	0,9	DCPR7EA-9	6651		

**TREVIS**

Trevis automatic		1.0	43	4	09.06-	EJ-VE	0,9	BKR6EKC	2848	26	LPG 1
Trevis Schaltgetriebe / gearbox		1.0	43	4	09.06-	EJ-VE	1,0	BKUR6EK	2213		

**YRV**

YRV 1.0	M200	1.0	43	4	08.00-07.05	EJ-VE	0,9	BKR5EKC	5216		LPG 1
YRV 1.3	M201 / M211	1.3	64	4	01.01-07.05	K3-VE	1,0	BKUR6ETB-10	5742		
YRV 1.3 GTi	M201	1.3	95	4	07.02-07.05	K3-VT	0,8	BKR6EP-8	2215		LPG 1

**DAIMLER**

4.0 Litre		4.0	164	6	09.89-09.94	AJ6	0,8	BCPR6ES	2330	12	LPG 3
4.0 Super V8		4.0		8	09.97-03.00		1,3	PFR6G-13E	2341		LPG 1
4.0 Super V8		4.0		8	03.00-03.02		1,1	PFR5G-11E	3000		
4.0 Super V8		4.0		8	03.02-		1,0	IFR5N10	7866		
4.0 V8		4.0		8	09.97-09.98		1,3	PFR5G-13E	2761		LPG 1
4.0 V8		4.0		8	09.98-03.00		1,3	PFR5G-13E	2761		LPG 1
4.0 V8		4.0		8	03.00-03.02		1,1	PFR5G-11E	3000		
4.0 V8		4.0		8	03.02-		1,0	IFR5N10	7866		
Century 4.0		4.0	180	6	10.95-09.96	AJ6	0,8	BCPR6ES	2330	12	LPG 3
Century 6.0		6.0		12	10.95-09.96	HE	0,6	BR6EF	3177		
Double Six				12	.86-09.91	HE	0,6	BR7EFS	1094		
Double Six				12	10.91-	.93 HE	0,6	BR7EF	3346		

e kW C  
y  
i

0201



Stock-No

VLINE

LPG / CNG

**DAIMLER**

Double Six	5.3		12	.90-	V12 HE	0,6	BR7EFS	1094		
Double Six	6.0		12	02.93-09.94	HE	0,6	BR7EFS	1094		
Double Six 6.0	6.0		12	.93-	HE	0,6	BR7EF	3346		
Double six	6.0		12	09.94-09.97	HE	0,6	BR6EF	3177		
Six 4.0	4.0		6	09.94-09.97	AJ6	0,8	BCPR6ES	2330	12	LPG 3
Sovereign 4.0	4.0			.89-		0,8	BCPR6ES	2330	12	LPG 3
4.0 Super V8	4.0	267	8	09.97-03.00	V8	1,3	PFR6G-13E	2341		LPG 1
4.0 V8	4.0		8	09.97-09.98	AJ26	1,3	PFR5G-13E	2761		LPG 1
4.0 V8	4.0		8	09.98-03.00	AJ26	1,3	PFR5G-13E	2761		LPG 1
4.0 Super V8	4.0		8	03.00-03.02	AJ26	1,1	PFR5G-11E	3000		
4.0 V8	4.0		8	03.00-03.02	AJ26	1,1	PFR5G-11E	3000		
4.2 Super V8	4.2		8	03.02-	AJ26	1,0	IFR5N10	7866		
4.2 V8	4.2		8	03.02-	AJ26	1,0	IFR5N10	7866		

**DODGE****AVENGER**

Avenger 2.0	2.0	115	6	06.07-		1,1	PZFR5F-11	4363		LPG 6
Avenger 2.0	2.0		4	.95- .99	L4 MPI Y DOHC	1,3	PFR6G-13E	2341		LPG 1
Avenger 2.5	2.5		6	.95-	V6 MPI N DOHC	1,1	PFR5G-11	2647		PFR6G-11
Avenger 2.7	2.7	138	6	06.07-	V6	1,3	LZTR5A-13	4612		

**CALIBER**

Caliber 1.8	1.8	110	4	.06-		1,1	ZFR5F-11	2262	40	LPG 6
Caliber 2.0	2.0	115	4	.06-		1,1	ZFR5F-11	2262	40	LPG 6
Caliber 2.4	2.4	125	4	.06-		1,1	ZFR5F-11	2262	40	LPG 6

**CHARGER**

Charger SRT8 Twinspark	6.1		8	.06-	W V8 FI	1,3	LZTR5A-13	4612		
------------------------	-----	--	---	------	---------	-----	-----------	------	--	--

**COLT**

Colt 1.5	1.5		4	.93- .94	L4 MPI A	1,1	BPR5EIX-11	2115		LPG 2
Colt 1.8	1.8		4	.92- .94	L4 MPI C	1,3	PFR5G-13E	2761		LPG 1
Colt 2.4	2.4		4	.92- .92	L4 MPI W	1,1	BPR5EIX-11	2115		LPG 2
Colt 2.4	2.4		4	.93- .94	L4 MPI G	1,3	PFR6G-13E	2341		LPG 1

**INTREPID**

Intrepid 2.7	2.7		6	.98-	V6 MPI R DOHC	1,3	LZTR5A-13	4612		
Intrepid 3.3	3.3		6	.93- .97	V6 MPI T	1,2	GR45	4268		
Intrepid 3.3	3.3		6	.94- .95	V6 FF U	1,2	GR45	4268		
Intrepid 3.5	3.5		6	.93- .97	V6 MPI F	0,9	FR5-1	7252		

**MAGNUM**

Magnum SRT8	6.1		8	.06-	W V8 FI	1,3	LZTR5A-13	4612		
-------------	-----	--	---	------	---------	-----	-----------	------	--	--

**NEON**

Neon 2.0	2.0		4	.95- .99	L4 MPI Y DOHC	0,8	BKR6ES	3783	28	LPG 1
Neon 2.0	2.0		4	.02-	L4 MPI C SOHC	0,8	BKR6ES	3783	28	LPG 1

**NITRO**

Nitro 4.0 V6	KJ (UE86)	4.0	191	6	.06-	V 6	1,3	ZFR5LP-13G	7781		
--------------	-----------	-----	-----	---	------	-----	-----	------------	------	--	--

**R1500-3500**

R1500-3500		3.9		6	.94- .96	MPI X	0,9	FR4	5155		
R1500-3500		3.9		6	.97- .99	MPI X	1,1	FR5-1	7252		
R1500-3500		5.2		8	.94- .96	MPI Y	0,9	FR4	5155		





l kW  
C  
Y  
I

0201



Stock-No

VALVE

LPG/CNG

**DODGE**

**R1500-3500**

R1500-3500	5.2	8	.95- .96	CNG T	0,9	FR4	5155		
R1500-3500	5.2	8	.97- .99	CNG T	1,1	FR5-1	7252		
R1500-3500	5.2	8	.97- .99	MPI Y	1,1	FR5-1	7252		
R1500-3500	5.9	8	.94- .97	MPI Z	0,9	FR4	5155		
R1500-3500	5.9	8	.94- .95	TBI 5	1,1	WR5	2438		
R1500-3500	5.9	8	.97- .97	MPI 5	0,9	FR4	5155		
R1500-3500	5.9	8	.98- .99	MPI 5	1,1	FR5-1	7252		
R1500-3500	5.9	8	.98- .99	MPI Z	1,1	FR5-1	7252		
R1500-3500	8.0	10	.94- .96	MPI W	1,1	PZFR5F-11	4363		LPG 6
R1500-3500	8.0	10	.97- .99	MPI W	1,1	PZFR5F-11	4363		LPG 6

**STEALTH**

Stealth	3.0	6	.91- .92	V6 MPI B DOHC	1,1	PFR6J-11	2743		PFR6J
Stealth Turbo	3.0	6	.91- .92	V6 MPI C DOHC	1,1	PFR6J-11	2743		PFR6J
Stealth	3.0	6	.93- .96	V6 MPI H SOHC	1,1	BPR5EIX-11	2115		LPG 2
Stealth	3.0	6	.93- .96	V6 MPI J DOHC	1,1	PFR6J-11	2743		PFR6J
Stealth Turbo	3.0	6	.93- .96	V6 MPI K DOHC	1,1	PFR6J-11	2743		PFR6J

**STRATUS**

Stratus 2.0	2.0	4	.95-	L4 MPI C SOHC	0,9	FR5	7373		
Stratus 2.4	2.4	4	.95- .00	L4 MPI X DOHC	1,1	FR45	3686		
Stratus 2.4	2.4	4	.01- .03	L4 FI X,G DOHC/TURBO	1,3	LZTR5A-13	4612		
Stratus 2.4	2.4	4	.04-	L4 FI X,G	1,1	LZTR4A-11	5444		
Stratus 2.5	2.5	6	.95-	V6 MPI H DOHC	1,1	PFR5G-11	2647		PFR6G-11

**VIPER**

Viper 8.0	8.0	10	.92- .02	E V10 MPI	0,9	FR5-1	7252		
Viper 8.3	8.3	10	.03- .03	Z V10	0,8	ZFR5N	3459		
Viper 8.3	8.3	10	.04- .06	Z V10	1,1	PZFR6F-11	3271		LPG 6

**FERRARI**

F208 GTB; GTS	2.0	187	8	04.86-10.90	F106N..	0,5	B95EGV	2145		
F328 GTB; GTS	3.2	199	8	01.88-09.89	F105CB..	0,6	DR8EIX	6681		
California	4.3	338	8	07.08-	F131B48	0,6	SPMR8A6HDG	92264		
California	4.3	360	8	09.08-	F131B48	0,6	SPMR8A6HDG	92264		
575 M Maranello / F1	5.7	379	12	02.02-06.06	F133E	0,8	DCPR9EIX	2316		
599 GTB FIORANO	6.0	456	12	05.06-	F140C	0,7	PMR8B	6378		PMR9B
612 Scaglietti	5.7	397	12	09.04-	F133F	0,8	DCPR9EIX	2316		
Challenge Stradale	3.6	313	8	01.04-	F131B	0,7	PMR8B	6378		PMR9B
Enzo	6.0	485	12	.02-	F140B	0,7	PMR8B	6378		PMR9B
F348 TB; TS	3.4	221	8	09.89-04.94	F119D040 Cat.	0,8	DR8EIX	6681		
348 GTB; GTS	3.4	221	8	04.90-03.93	F119F	0,8	DCPR9EIX	2316		
348 GTB; GTS	3.4	236	8	03.93-06.94	F119H	0,8	DCPR9EIX	2316		
F348 GTB; GTS / Spider	3.9	221	8	07.94-07.95	F119	0,8	DCPR9EIX	2316		
F355	3.5	280	8	05.94-01.96	F129C	0,7	PMR8A	5851		
F355 Berlinetta	3.5	280	8	07.94-		0,8	CR8EIX	4218		
F355GTS	3.5	280	8	05.94-01.96	F129B	0,7	PMR8A	5851		PMR8A
F355 Spider	3.5	280	8	07.95-		0,7	PMR7A	4259		PMR8A
F355GTS	3.5	280	8	02.96-	F129C	0,7	PMR7A	4259		PMR8A
F355 F1 berlinetta; GTS; Spider	3.5	280	8	11.97-	F129C	0,7	PMR7A	4259		PMR8A
Modena 360-360 F1	3.6	294	8	05.99-11.03	F131B	0,7	PMR8A	5851		
360 Spider / F1	3.6	294	8	09.00-11.03	F131B	0,7	PMR8A	5851		
360 Spider / F1	3.6	294	8	12.03-	F131B	0,7	PMR8B	6378		PMR9B

e kW  
C  
Y  
I

0201



Stock-No

VLINE

LPG / CNG

**FERRARI**

Coupè 360 Modena/F1	3.6	294	8	12.03-	F131B	0,7	PMR8B	6378		PMR9B
F40	2.9	353	8	01.88-05.92	F120A	0,5	C8E	7471		
F430 Coupé / F430 Spider / F430 Challenge	4.3	360	8	01.05-	F136E	0,7	PMR8B	6378		PMR9B
430 Scuderia	4.3	375	8	.08-	F136ED	0,7	PMR8B	6378		PMR9B
F456 GT	5.5	324	12	02.96-04.98	F116C	0,8	DCPR9EIX	2316		
F456 GTA	5.5	324	12	07.96-04.98	F116C.010	0,8	DCPR9EIX	2316		
456 M GTA	5.5	325	12	05.98-	F116C.010	0,8	DCPR9EIX	2316		
465 M GT	5.5	325	12	05.98-	F116C	0,8	DCPR9EIX	2316		
F50	4.7	361	12	05.95-	F130B	0,7	PMR7A	4259		PMR8A
512 TR	5.0	316	12	02.91-10.96	F113D	0,8	DCPR9EIX	2316		
Mondial T/ T Cabriolet	3.4	221	8	11.88-02.94	F119DL Cat	0,8	DR8EIX	6681		
Testarossa	4.9	272	12	10.84-10.91	F113B000 Cat.	0,8	DR8EIX	6681		
F456 GT	5.5	324	12	04.93-01.96	F116B	0,8	DCPR9EIX	2316		
F550 Maranello	5.5	357	12	08.96-	F133A	0,8	DCPR9EIX	2316		

**FIAT****126**

126 (650cc)	0.65	22	2	01.83-06.96	141A000	0,8	BPR6ES	7822	2	LPG 2
126 BIS	0.7	19	2	09.87-06.91	126A2000	0,8	BPR6ES	7822	2	LPG 2

**500**

500 0.9 Natural Power TwinAir	312	0.9	63	2	07.10-	312A2000CNG	0,8	ILKR9G8	97168		
500 0.9 Twin Air	312	0.9	59	2	12.13-	312A5000	0,8	ILKR9G8	97168		
500 0.9 Twin Air	312	0.9	77	2	10.13-	199B6000	0,8	ILKR9G8	97168		
500 1.0	312	1.0	48	2	09.12-	312A4000	1,2	LKR7DI-12	90779		
500 1.0 Twin Air	312	1.0	44	2	12.13-	312A6000	1,2	LKR7DI-12	90779		
500 1.2	312	1.2	51	4	07.07-	169A4000	1,0	ZKR7A-10	1691	42	LPG 8
500 1.2 LPG Euro V (Italy)	312	1.2	51	4	01.09-	169A4000	0,8	ZKR7AI-8	92402		
500 1.4	312	1.4	103	4	09.09-	312A3000	0,75	IKR9J8	93311		
500 1.4	312	1.4	140	4	08.08-	312A9000	0,75	IKR9J8	93311		
500 1.4 16V	312	1.4	74	4	07.07-	169A3000	1,0	DCPR7E-N-10	4983	43	
500 1.4 Abarth	312	1.4	99	4	08.08-	312A1000	0,75	IKR9J8	93311		
500 1.4 Abarth	312	1.4	132	4	08.08-	312A3000	0,75	IKR9J8	93311		
500 1.4 Abarth	312	1.4	140	4	08.08-	312A1000	0,75	IKR9J8	93311		
500 1.4 T-Jet (Abarth)	312	1.4	102	4	05.08-	198A1000	0,75	IKR9J8	93311		

**500C**

500C 0.9	312	0.9	63	2	09.10-	312A2000	0,8	ILKR9G8	97168		
500C 0.9 TwinAir	312	0.9	59	2	12.13-	312A5000	0,8	ILKR9G8	97168		
500C 0.9 TwinAir	312	0.9	77	2	12.13-	199B6000	0,8	ILKR9G8	97168		
500C 1.0	312	1.0	48	2	09.12-	312A4000	1,2	LKR7DI-12	90779		
500C 1.0 TwinAir	312	1.0	44	2	01.14-	312A6000	1,2	LKR7DI-12	90779		
500C 1.2	312	1.2	51	4	06.09-	169A4000	1,0	ZKR7A-10	1691	42	LPG 8
500C 1.4	312	1.4	103	4	09.09-	312A3000	0,75	IKR9J8	93311		
500C 1.4	312	1.4	118	4	05.11-	312A1000	0,75	IKR9J8	93311		
500C 1.4	312	1.4	118	4	05.11-	312A3000	0,75	IKR9J8	93311		
500C 1.4	312	1.4	132	4	02.13-	312A3000	0,75	IKR9J8	93311		
500C 1.4	312	1.4	74	4	06.09-	169A3000	1,0	DCPR7E-N-10	4983	43	
500C 1.4	312	1.4	99	4	01.11-	312A1000	0,75	IKR9J8	93311		
500C 1.4 ABARTH 695	312	1.4	132	4	09.09-01.13	312A3000	0,75	IKR9J8	93311		

**500L**

500L 0.9 Natural Power TwinAir	199	0.9	63	2	03.13-	312A2000CNG	0,8	ILKR9G8	97168		
--------------------------------	-----	-----	----	---	--------	-------------	-----	---------	-------	--	--



l kW  
C  
y  
i

0201



Stock-No

VALVE

LPG / CNG

**FIAT**

**500L**

500L 0.9 TwinAir	199	0.9	77	2	09.12-	199B6000	0,8	ILKR9G8	97168		
500L 1.4	199	1.4	70	4	09.12-	843A1000	1,0	DCPR7E-N-10	4983	43	
500L 1.4 T-Jet	199	1.4	88	4	10.13-	940B7000	0,75	IKR9J8	93311		

**500X**

500X 1.4 MultiAir	334	1.4	100	4	09.14-	55263624	0,75	IKR9J8	93311		
500X 1.4 MultiAir	334	1.4	125	4	02.15-	55263623	0,75	IKR9J8	93311		

**600**

600 Chassis--->2543171	187	1.1	40	4	06.05-01.10	187A1000	0,9	BKR6EKC	2848	26	LPG 1
600 2543171--->Chassis	187	1.1	40	4	06.05-01.10	187A1000	1,0	DCPR7E-N-10	4983	43	

**ALBEA / SIENA**

Albea / Siena 1.2	178	1.2	44	4	09.01-12.12	178C4066	0,9	BKR5EZ	7642	36	LPG 1
Albea / Siena 1.2	178	1.2	54	4	09.98-12.02	178B5000	0,9	BKR6EKC	2848	26	LPG 1
Albea / Siena 1.2	178	1.2	59	4	09.01-12.11	188A5000	1,0	DCPR7E-N-10	4983	43	
Albea / Siena 1.2 to engine no. 2533528	178	1.2	44	4	09.01-12.12	188A4000	0,9	BKR6EKC	2848	26	LPG 1
Albea / Siena 1.2 from engine no. 2533529	178	1.2	44	4	09.01-12.12	188A4000	1,0	DCPR7E-N-10	4983	43	
Albea / Siena 1.4	178	1.4	51	4	04.96-12.02	178B2000	0,9	BKR5EZ	7642	36	LPG 1
Albea / Siena 1.4	178	1.4	51	4	04.96-12.02	178B2016	0,9	BKR5EZ	7642	36	LPG 1
Albea / Siena 1.4	178	1.4	57	4	10.05-12.12	199A1000	0,9	BKR5EZ	7642	36	LPG 1
Albea / Siena 1.4	178	1.4	57	4	10.05-12.12	834A1000	0,9	BKR5EZ	7642	36	LPG 1
Albea / Siena 1.6	178	1.6	76	4	11.00-12.12	182B6000	0,9	BKR5EZ	7642	36	LPG 1
Albea / Siena 1.6	178	1.6	78	4	07.97-06.99	178B3000	0,9	BKR6EKC	2848	26	LPG 1
Albea / Siena 1.6	178	1.6	78	4	07.99-12.04	178B3000	0,9	BKR5EZ	7642	36	LPG 1

**BARCETTA**

Barchetta 1.8	183	1.8	96	4	04.95-07.00	183A1000	0,9	BKR6EKC	2848	26	LPG 1
Barchetta 1.8	183	1.8	96	4	08.00-05.05	183A1000	0,9	BKR6EZ	4619	38	LPG 1
Barchetta 1.8 Chassis --> 1945438	183	1.8	96	4	01.95-06.05	188A6000	0,9	BKR6EKC	2848	26	LPG 1
Barchetta 1.8 1945438 --> Chassis	183	1.8	96	4	01.95-06.05	188A6000	0,9	BKR6EZ	4619	38	LPG 1

**BRAVA**

Brava 1.2	182	1.2	59	4	09.00-05.02	188A5000	0,9	DCPR8E-N	5692		LPG 8
Brava 80 16V; Trofeo,Steel Sx,Hsx	182	1.2	59	4	06.99-05.01	182B2000	0,9	DCPR8E-N	5692		LPG 8
Brava i.,80 16V Sx,Hsx	182	1.2	59	4	03.98-05.99	182B2000	0,9	DCPR8EKC	7168		LPG 8
Brava S,SX	182	1.4	59	4	10.95-05.01	182A3000	0,9	BKR6EKC	2848	26	LPG 1
Brava i.	182	1.4	55	4	10.95-02.98	182A5000	0,9	BKR6EKC	2848	26	LPG 1
Brava 1.6	182	1.6	76	4	09.00-05.02	182B6000	0,9	BKR6EKC	2848	26	LPG 1
Brava (Northern Europe)	182	1.6	76	4	09.00-05.02	182B6000	0,9	BKR5EZ	7642	36	LPG 1
Brava 16V	182	1.6	66	4	10.95-05.01	182A6000	0,9	BKR6EKC	2848	26	LPG 1
Brava 100 16V Sx,Hsx,Elx;Aut. (Northern Europe)	182	1.6	76	4	07.99-05.01	182A4000	0,9	BKR5EZ	764	36	LPG 1
Brava i. 16V EL; aut. EL; ELX	182	1.6	76	4	10.95-06.96	182A4000	0,9	BKR6EKC	2848	26	LPG 1
Brava i.,100 16V;Aut. Sx,Hsx,Elx	182	1.6	76	4	05.98-06.99	182A4000	0,9	BKR6EKC	2848	26	LPG 1
Brava 16V Aut.	182	1.8	83	4	10.95-05.01	182A2000	0,9	BKR6EKC	2848	26	LPG 1

**BRAVO 182**

Bravo 80 16V Sx Trofeo; Steel	182	1.2	59	4	08.99-08.00	182B2000	0,9	DCPR8EKC	7168		LPG 8
Bravo i.,80 16V Sx;Trofeo;Steel	182	1.2	59	4	09.98-07.99	182B2000	0,9	DCPR8E-N	5692		LPG 8
Bravo 1.4i S	182	1.4	59	4	03.98-05.01	182A3000	0,9	BKR6EKC	2848	26	LPG 1
Bravo i.	182	1.4	55	4	10.95-02.97	182A5000	0,9	BKR6EKC	2848	26	LPG 1
Bravo i., 100 16V EL;Aut.	182	1.6	76	4	10.95-06.01	182A4000	0,9	BKR6EKC	2848	26	LPG 1

e kW  
C  
Y  
I

0201



Stock-No

VELINE

LPG / CNG

**FIAT****BRAVO 182**

Bravo i. 16V	182	1.6	66	4	10.95-05.01	182A6000	0,9	BKR6EKC	2848	26	LPG 1
Bravo i.100 16V EI,Sx,GT,Steel; Aut. (Northern Europe)	182	1.6	76	4	07.99-05.01	182A4000	0,9	BKR5EZ	7642	36	LPG 1
Bravo 1.8L - 16V GT	182	1.8	83	4	03.95-05.01	182A2000	0,9	BKR6EKC	2848	26	LPG 1
Bravo 2.0	182	2.0	113	5	09.98-08.00	182B7000	0,9	BKR6EKC	2848	26	LPG 1
Bravo i. 20V, 155 HGT	182	2.0	108	5	10.95-05.01	182A1000	0,9	BKR6EKC	2848	26	LPG 1
Bravo 155 20V	182	2.0	113	4	12.99-05.01	182A1000	0,9	BKR6EKC	2848	26	LPG 1

**BRAVO 198**

Bravo 1.4 16V	198	1.4	66	4	04.07-12.14	192B2000	1,0	DCPR7E-N-10	4983	43	
Bravo 1.4 MultiAir	198	1.4	103	4	05.10-12.14	198A7000	0,75	IKR9J8	93311		
Bravo 1.4 T-Jet	198	1.4	88	4	09.07-12.14	198A4000	0,75	IKR9J8	93311		
Bravo 1.4 T-Jet	198	1.4	110	4	04.07-12.14	198A1000	0,75	IKR9J8	93311		

**CINQUECENTO**

Cinquecento (700cc)	170	0.7	23	2	07.91-02.97	170A000	0,8	BPR6ES	7822	2	LPG 2
Cinquecento (700cc)	170	0.7	23	2	12.91-01.96	171A000	0,8	BPR6ES	7822	2	LPG 2
Cinquecento iE (700cc)	170	0.7	22	2	07.91-01.98	170A046	0,8	BPR6ES	7822	2	LPG 2
Cinquecento (900cc)	170	0.9	29	4	04.96-05.98	11701046	0,8	BPR6ES	7822	2	LPG 2
Cinquecento (900cc)	170	0.9	30	4	.92-05.98	170A1046Cat	0,8	BPR6ES	7822	2	LPG 2
Cinquecento iE (900cc)	170	0.9	29	4	02.95-05.98	1170A1046	0,8	BPR6ES	7822	2	LPG 2
Cinquecento iE (900cc)	170	0.9	30	4	.92-05.98	170A1000	0,8	BPR6ES	7822	2	LPG 2
Cinquecento iE	170	1.1	40	4	10.94-05.98	176B2000	0,9	BCPR6ES	2330	12	LPG 3
Cinquecento Sporting Fire	170	1.1	40	4	.94-05.98	176A6000	0,9	BCPR6ES	2330	12	LPG 3

**COUPE**

Coupé 1.8L 16V Eng. Number --> 1070427 FA/175	175	1.8	96	4	02.96-02.01	183A1000	0,9	BKR6EKC	2848	26	LPG 1
Coupé 1.8L 16V 1070427--> Eng. Number FA/175	175	1.8	96	4	06.98-08.00	183A1000	0,9	BKR6EZ	4619	38	LPG 1
Coupé 2.0 FA/175	175	2.0	96	5	03.96-08.00	182B3000	0,9	BKR6EKC	2848	26	LPG 1
Coupé 2.0 iE FA/175	175	2.0	102	4	02.94-08.96	836A3011	0,8	B7ES	1111		BR8EIX
Coupé 2.0L 16V FA/175	175	2.0	103	4	02.94-09.96	836A3000	0,8	BPR7ES	2023	19	BPR8EIX
Coupé 2.0L 16V Turbo FA/175	175	2.0	140	4	02.94-09.96	175A1000	0,8	BUR6ET	3172	1	LPG 2
Coupé 2.0L 20 V FA/175	175	2.0	108	5	10.96-02.01	182A1000	0,9	BKR6EKC	2848	26	LPG 1
Coupé 2.0L 20V Turbo FA/175	175	2.0	162	5	-12.96	175A3000	0,9	BKR6EKC	2848	26	LPG 1
Coupé 2.0L 20V Turbo FA/175	175	2.0	162	5	12.96-02.01	175A3000	0,8	BKUR6ET	6437	27	LPG 1

**CROMA 154**

Croma 1.6L CHT	154	1.6	61	4	12.85-06.90	154A048	0,8	BPR7ES	2023	19	BPR8EIX
Croma 2.0L 16V	154	2.0	101	4	.91-02.97	154E1000	0,8	BPR7ES	2023	19	BPR8EIX
Croma 2.0 Ti Turbo	154	2.0	110	4	.86-02.97	834C146	0,8	BP6ET	1263		LPG 2
Croma 2.0 Turbo	154	2.0	114	4	.86-02.97	154A2000	0,8	BP6ET	1263		LPG 2
Croma 2.0L	154	2.0	66	4	.86-.91	154C2000	0,8	BPR7ES	2023	19	BPR8EIX
Croma 2.0L	154	2.0	84	4	.86-02.97	834B146	0,8	BPR7ES	2023	19	BPR8EIX
Croma 2.0L	154	2.0	85	4	07.91-02.97	154C3046Cat	0,8	BPR7ES	2023	19	BPR8EIX
Croma 2.0L	154	2.0	89	4	.86-.91	154C000	0,8	BPR7ES	2023	19	BPR8EIX
Croma 2.0L CHT	154	2.0	72	4	.91-02.97	154C5000	0,8	BPR7ES	2023	19	BPR8EIX
Croma 2.0L	154	2.0	86	4	.91-02.97	154C3000	0,8	BPR7ES	2023	19	BPR8EIX
Croma Ti Turbo	154	2.0	110	4	.86-02.97	154C4000	0,8	BP6ET	1263		LPG 2
Croma Turbo	154	2.0	110	4	.91-02.97	154C4046/Cat	0,8	BP6ET	1263		LPG 2
Croma 2.5L V6	154	2.5	117	6	.93-02.97	834G000	0,8	BPR7ES	2023	19	BPR8EIX

e kW  
C  
Y  
I

0201



Stock-No

VLINE

LPG/CNG

**FIAT****CROMA 194**

Croma 1.8 16V	194	1.8	103	4	06.05-12.11	939A4000	0,8	ZFR5F	5165		LPG 6
Croma 2.2 16V	194	2.2	108	4	06.05-12.13	194A1000	1,0	LTR6B-10T	5948		

**DOBLO 119**

Doblò 1.2	119	1.2	48	4	11.00-12.04	223A5000	0,9	BKR5EZ	7642	36	LPG 1
Doblò 1.2	119	1.2	48	4	12.04-02.05	223A5000	1,0	DCPR7E-N-10	4983	43	
Doblò 1.4	119	1.4	56	4	09.05-08.13	350A1000	1,0	ZKR7A-10	1691	42	LPG 8
Doblò 1.6	119	1.6	76	4	11.00-06.05	182B6000	0,9	BKR5EZ	7642	36	LPG 1
Doblò 1.6 Natural Power Active	119	1.6	76	4	11.00-07.09	182B6000CNG	0,9	BKR6EKC	2848	26	

**DOBLO 152**

Doblò 1.4	152	1.4	70	4	02.10-	843A1000	1,0	DCPR7E-N-10	4983	43	
Doblò 1.4 T-Jet	152	1.4	88	4	10.11-	198A4000	0,75	IKR9J8	93311		
Doblò 1.4 T-Jet Natural Power	152	1.4	88	4	02.10-	198A4000CNG	0,75	IKR9J8	93311		

**DUCATO**

Ducato 2.0		2.0	62	4	06.90-05.94	170D	0,9	BP6ES	7811	4	LPG 2
Ducato 2.0		2.0	74	4	06.94-12.95	R5B	0,9	BKR6EKC	2848	26	LPG 1
Ducato 2.0		2.0	81	4	12.01-07.06	RFL	0,9	BKR6EKC	2848	26	LPG 1
Ducato 2.0		2.0	55	4	01.86-01.94	170BXN1T/170DXN1TA	0,9	BP6ES	7811	4	LPG 2
Ducato 2.0		2.0	80	4	06.94-09.01	RFW	0,9	BKR6EKC	2848	26	LPG 1

**EGEA**

Egea 1.4	356	1.4	70	4	10.15-	843A1000	1,0	DCPR7E-N-10	4983	43	
----------	-----	-----	----	---	--------	----------	-----	-------------	------	----	--

**FIORINO**

Fiorino 1.3 Pick Up		1.3	49	4	10.93-12.94	146A5000	0,8	BPR6ES	7822	2	LPG 2
Fiorino 1.4		1.4	51	4	01.93-07.96	160A1046	0,8	BPR5ES	7422	6	LPG 2
Fiorino 1.4		1.4	54	4	02.08-	KFT	0,9	BKR6EZ	4619	38	LPG 1
Fiorino 1.4 iE		1.4	52	4	10.93-10.96	146C5000	0,8	BPR6ES	7822	2	LPG 2
Fiorino 1.4 Natural Power		1.4	57	4	10.09-	350A1000CNG	1,0	ZKR7A-10	1691	42	
Fiorino 1.4 Pick Up		1.4	49	4	05.94-05.01	146D5000	0,9	BKR6E	6962	28	LPG 1
Fiorino 1.4 Pick Up		1.4	52	4	10.93-10.96	146C5000	0,8	BPR6ES	7822	2	LPG 2
Fiorino 1.5		1.5	55	4	01.90-08.93	149C1000Cat	0,8	BPR6ES	7822	2	LPG 2
Fiorino 1.6 iE		1.6	55	4	10.93-05.01	146D6000	0,9	BCPR7ES	3330		BCPR7EIX
Fiorino 1.6 Pick Up		1.6	55	4	01.94-05.01	146C6000	0,8	BPR7ES	2023	19	BPR8EIX

**GRANDE PUNTO**

Grande Punto 1.2	199	1.2	48	4	09.05-06.13	199A4000	1,0	ZKR7A-10	1691	42	LPG 8
Grande Punto 1.2	199	1.2	51	4	09.10-05.12	169A4000	1,0	ZKR7A-10	1691	42	LPG 8
Grande Punto 1.4	199	1.4	55	4	06.06-07.07	199A7000	1,0	ZKR7A-10	1691	42	LPG 8
Grande Punto 1.4	199	1.4	57	4	09.05-06.13	350A1000	1,0	ZKR7A-10	1691	42	LPG 8
Grande Punto 1.4 16V	199	1.4	70	4	09.05-08.11	199A6000	1,0	ZKR7A-10	1691	42	LPG 8
Grande Punto 1.4 Abarth	199	1.4	114	4	12.07-12.12	199A8000	0,75	IKR9J8	93311		
Grande Punto 1.4 Abarth	199	1.4	132	4	04.09-12.12	199A8000	0,75	IKR9J8	93311		
Grande Punto 1.4 Natural Power	199	1.4	57	4	09.08-12.12	350A1000CNG	1,0	ZKR7A-10	1691	42	
Grande Punto 1.4 T-Jet	199	1.4	88	4	06.07-08.10	198A4000	0,75	IKR9J8	93311		

**IDEA**

Idea 1.2 16V	350	1.2	59	4	12.03-12.10	188A5000	1,0	DCPR7E-N-10	4983	43	
Idea 1.4	350	1.4	57	4	09.05-12.12	350A1000	1,0	ZKR7A-10	1691	42	LPG 8
Idea 1.4	350	1.4	66	4	12.03-12.10	192B2000	1,0	DCPR7E-N-10	4983	43	
Idea 1.4	350	1.4	70	4	10.03-12.12	843A1000	1,0	DCPR7E-N-10	4983	43	

e kW  
C  
y  
i

0201



Stock-No

VLINE

LPG/CNG

**FIAT LINEA**

Linea 1.4	323	1.4	57	4	06.07-	350A1000	1,0	ZKR7A-10	1691	42	LPG 8
Linea 1.4 T-Jet	323	1.4	88	4	09.07-	198A4000	0,75	IKR9J8	93311		

**MAREA**

Marea 1.2 80 16V Sx Hsx Weekend	185	1.2	60	4	12.98-12.00	182B2000	0,9	DCPR8E-N	5692		LPG 8
Marea 1.2 i. 80 16V Weekend	185	1.2	59	4	03.98-05.99	182B2000	0,9	DCPR8EKC	7168		LPG 8
Marea 1.4 i. 12 V Weekend	185	1.4	55	4	10.96-02.98	182A3000	0,9	BKR6EKC	2848	26	LPG 1
Marea 1.6	185	1.6	72	4	09.00-08.02	182B5098	0,9	BKR6EKC	2848	26	LPG 1
Marea 1.6	185	1.6	75	4	04.97-02.99	185A3000	0,9	BKR6EKC	2848	26	LPG 1
Marea 1.6 16V Sx Elx Aut. Weekend	185	1.6	76	4	05.98-12.03	182A4000	0,9	BKR5EZ	7642	36	LPG 1
Marea 1.6 i. 16V Sx Bipower	185	1.6	76	4	11.97-12.03	182A4000	0,9	BKR6EKC	2848	26	
Marea 1.6 i. 16V Weekend	185	1.6	76	4	09.96-04.98	182A4000	0,9	BKR6EKC	2848	26	LPG 1
Marea 1.6 S.W. Weekend	185	1.6	76	4	09.00-08.02	182B6000	0,9	BKR6EKC	2848	26	LPG 1
Marea 1.8 16V Weekend	185	1.8	83	4	12.99-08.00	182A2000	0,9	BKR6EKC	2848	26	LPG 1
Marea 1.8 i. 16V Weekend	185	1.8	83	4	09.96-11.98	182A2000	0,9	BKR6EKC	2848	26	LPG 1
Marea 2.0	185	2.0	110	5	09.00-06.06	185A8000	0,9	BKR6EKC	2848	26	LPG 1
Marea 2.0	185	2.0	113	5	03.99-08.00	182B7000	0,9	BKR6EKC	2848	26	LPG 1
Marea 2.0 20V	185	2.0	108	5	09.96-02.99	182A1000	0,9	BKR6EKC	2848	26	LPG 1
Marea 2.0 i. 155 20 V Weekend	185	2.0	108	5	10.96-12.03	182A1000	0,9	BKR6EKC	2848	26	LPG 1

**MULTIPLA**

Multipla 1.6	186	1.6	76	4	04.99-08.00	182A4000	0,9	BKR6EKC	2848	26	LPG 1
Multipla 1.6 16V	186	1.6	76	4	09.04-06.10	182B6000	0,9	BKR5EZ	7642	36	LPG 1
Multipla 1.6 16V Bipower	186	1.6	76	4	01.99-06.99	186A4000	0,9	BKR6EKC	2848	26	LPG 1
Multipla 1.6 16V Natural Power	186	1.6	70	4	01.99-12.04	186A3000CNG	0,9	BKR6EKC	2848	26	
Multipla 1.6 16V Sx	186	1.6	76	4	07.99-12.04	186A4000	0,9	BKR5EZ	7642	36	LPG 1

**PALIO**

Palio 1.0	178	1.0	45	4	06.96-10.03	178A1000	0,9	BKR6E	6962	28	LPG 1
Palio 1.1	178	1.1	40	4	06.96-10.03	178B9033	0,9	BKR6EKC	2848	26	LPG 1
Palio 1.2	178	1.2	44	4	07.97-08.02	178B7045	0,9	BKR6EKC	2848	26	LPG 1
Palio 1.2 16V	178	1.2	59	4	09.01-11.02	188A5000	0,9	DCPR8E-N	5692		LPG 8
Palio 1.2 16V	178	1.2	59	4	12.02-01.12	188A5000	1,0	DCPR7E-N-10	4983	43	
Palio 1.2 65	178	1.2	50	4	01.00-12.00	178E2000	0,9	BKR6EKC	2848	26	LPG 1
Palio 1.2 75 Weekend	178	1.2	54	4	11.97-02.01	178B5000	0,9	BKR6EKC	2848	26	LPG 1
Palio 1.2 8V	178	1.2	44	4	07.97-10.04	188A4000	0,9	BKR5EZ	7642	36	LPG 1
Palio 1.2 Weekend	178	1.2	44	4	07.97-10.04	178C4066	0,9	BKR6EKC	2848	26	LPG 1
Palio 1.2 Weekend	178	1.2	44	4	07.97-10.04	188A4000	0,9	BKR6EKC	2848	26	LPG 1
Palio 1.4	178	1.4	51	4	09.97-08.01	178B2000	0,9	BKR5EZ	7642	36	LPG 1
Palio 1.4	178	1.4	57	4	04.05-01.12	199A1000	0,9	BKR6EKC	2848	26	LPG 1
Palio 1.4	178	1.4	63	4	10.02-10.04	350A1000	1,0	ZKR7A-10	1691	42	LPG 8
Palio 1.5	178	1.5	62	4	02.02-01.12	178E5022	0,9	BKR6ES	3783	28	LPG 1
Palio 1.6 16V	178	1.6	74	4	.96-06.99	182B6000	0,9	BKR6EKC	2848	26	LPG 1
Palio 1.6 16V Weekend	178	1.6	76	4	11.97-06.99	178B3000	0,9	BKR6EKC	2848	26	LPG 1
Palio 1.6 16V Weekend	178	1.6	76	4	07.99-10.02	178B3000	0,9	BKR5EZ	7642	36	LPG 1

**PANDA 141**

Panda 0.75 Young	141	0.75	25	4	01.86-12.96	141B000	0,8	BPR6ES	7822	2	LPG 2
Panda 750 CLX -CL-L- Fire	141	0.75	24	4	01.86-12.96	156A	0,9	BCPR6ES	2330	12	LPG 3
Panda 850	141	0.85	25	4	02.81-12.85	M020BS	0,8	BPR6ES	7822	2	LPG 2
Panda 900	141	0.9	29	4	-12.96	1170A1046	0,8	BPR6ES	7822	2	LPG 2
Panda 900 4x4	141	0.9	33	4	-12.96	146A	0,8	BPR6ES	7822	2	LPG 2



l kW  
C  
y  
i

0201



Stock-No

VALVE

LPG/CNG

**FIAT**

**PANDA 141**

Panda 900- Jolly-Van	141	0.9	29	4	01.97-01.01	1170A1046	0,9	BKR5EZ	7642	36	LPG 1
Panda 1.0	141	1.0	32	4	01.86-04.96	156A2048 -156A2146/246	0,9	BCPR6ES	2330	12	LPG 3
Panda 1.0	141	1.0	33	4	01.86-07.89	156A2146/246	0,9	BCPR6ES	2330	12	LPG 3
Panda 1.0	141	1.0	33	4	01.86-12.96	156A2246	0,9	BCPR6ES	2330	12	LPG 3
Panda 1.0 young-L- CLX	141	1.0	33	4	06.94-12.96	141C2000	0,8	BPR6ES	7822	2	LPG 2
Panda Van 1.0	141	1.0	33	4	01.97-	141C2000	0,9	BKR6EKC	2848	26	LPG 1
Panda 1.1	141	1.1	40	4	02.95-12.96	176B2000	0,9	BCPR6ES	2330	12	LPG 3
Panda 1.1	141	1.1	40	4	09.00-12.04	187A1000	0,9	BKR5EZ	7642	36	LPG 1
Panda 1.1 4X4	141	1.1	40	4	01.96-08.00	156C046	0,9	BCPR6ES	2330	12	LPG 3
Panda 1.1 4x4	141	1.1	40	4	02.95-12.96	176B2000	0,9	BCPR6ES	2330	12	LPG 3
Panda 1.1 Selecta	141	1.1	37	4	07.90-12.96	156C046Cat	0,9	BCPR6ES	2330	12	LPG 3
Panda Van 1.1 Selecta	141	1.1	40	4	01.97-08.00	176B2000	0,9	BKR6EKC	2848	26	LPG 1

**PANDA 169**

Panda 1.1	169	1.1	40	4	09.03-12.04	187A1000	0,9	BKR5EZ	7642	36	LPG 1
Panda 1.1	169	1.1	40	4	12.04-12.12	187A1000	1,0	DCPR7E-N-10	4983	43	
Panda 1.2 Easypower LPG Euro V	169	1.2	51	4	11.10-	169A4000CNG	0,8	ZKR7AI-8	92402		
Panda 1.2	169	1.2	51	4	03.10-12.12	169A4000	1,0	ZKR7A-10	1691	42	LPG 8
Panda 1.2 to engine no. 2533528	169	1.2	44	4	10.04-12.12	188A4000	0,9	BKR5EZ	7642	36	LPG 1
Panda 1.2 from engine no. 2533529	169	1.2	44	4	10.04-12.12	188A4000	1,0	DCPR7E-N-10	4983	43	
Panda 1.4 16V ABARTH	169	1.4	74	4	06.07-12.11	169A3000	1,0	DCPR7E-N-10	4983	43	
Panda 1.4 Natural Power	169	1.4	57	4	01.10-12.12	350A1000CNG	1,0	ZKR7A-10	1691	42	

**PANDA 312**

Panda 0.9	312	0.9	63	2	01.12-	312A2000	0,8	ILKR9G8	97168		
Panda 0.9 Natural Power	312	0.9	63	2	07.12-	312A2000CNG	0,8	ILKR9G8	97168		
Panda 0.9 Natural Power TwinAir	312	0.9	59	2	01.15-	312A5000CNG	0,8	ILKR9G8	97168		
Panda 0.9 TwinAir	312	0.9	59	2	12.13-	312A5000	0,8	ILKR9G8	97168		
Panda 0.9 TwinAir	312	0.9	66	2	06.14-	312A7000	0,8	ILKR9G8	97168		
Panda 1.0	312	1.0	48	2	01.12-	312A4000	1,2	LKR7DI-12	90779		
Panda 1.0 TwinAir	312	1.0	44	2	12.13-	312A6000	1,2	LKR7DI-12	90779		
Panda 1.2	312	1.2	51	4	01.12-	169A4000	1,0	ZKR7A-10	1691	42	LPG 8

**PUNTO (1) 176**

Punto 1 1.1	176	1.1	40	4	11.93-05.97	176A6000	0,9	BCPR6ES	2330	12	LPG 3
Punto 1 1.1 60 Cabrio S	176	1.1	40	4	06.97-06.98	176B2000	0,9	BCPR6ES	2330	12	LPG 3
Punto 1 1.1 S	176	1.1	40	4	06.94-05.97	176A6000	0,9	BCPR6ES	2330	12	LPG 3
Punto 1 1.1 S; Sx; 6 Speed	176	1.1	40	4	06.97-09.99	176B2000	0,9	BCPR6ES	2330	12	LPG 3
Punto 1 Van 1.1	176	1.1	40	4	06.97-06.00	176B2000	0,9	BCPR6ES	2330	12	LPG 3
Punto 1 1.2	176	1.2	43	4	06.94-05.98	176A7000	0,9	BCPR6ES	2330	12	LPG 3
Punto 1 1.2	176	1.2	44	4	11.93-05.97	176B1000	0,9	BCPR6ES	2330	12	LPG 3
Punto 1 1.2	176	1.2	44	4	06.97-09.99	176B4000	0,9	BCPR6ES	2330	12	LPG 3
Punto 1 1.2	176	1.2	54	4	11.93-05.98	176A8000	0,9	BCPR6ES	2330	12	LPG 3
Punto 1 1.2 16V	176	1.2	63	4	05.97-09.01	176B9000	0,9	DCPR8E	4339		LPG 8
Punto 1 1.2 Cabrio	176	1.2	44	4	06.98-02.01	176B4000	0,9	BCPR6ES	2330	12	LPG 3
Punto 1.2 16V Cabrio	176	1.2	63	4	06.97-06.01	176B9000	0,9	DCPR8E	4339		LPG 8
Punto 1 1.4 GT Turbo	176	1.4	96	4	06.93-09.99	176B000/176A4000	0,9	BCPR6ET	2197		LPG 3
Punto 1 1.6	176	1.6	65	4	01.94-05.97	176A9000	0,9	BCPR7ES	3330		BCPR7EIX
Punto 1 1.6 Cabrio ELX	176	1.6	65	4	06.94-05.98	176A9000	0,9	BCPR7ES	3330		BCPR7EIX

e kW  
C  
Y  
I

Stock-No



LPG / CNG

**FIAT****PUNTO (1) 176**

Punto 1 1.6 Sporting	176	1.6	65	4	07.95-05.97	176A9000	0,9	BCPR7ES	3330		BCPR7EIX
----------------------	-----	-----	----	---	-------------	----------	-----	---------	------	--	----------

**PUNTO (2) 188**

Punto 2 1.2 16V	188	1.2	59	4	09.00-11.02	188A5000	0,9	DCPR8E-N	5692		LPG 8
Punto 2 1.2 16V	188	1.2	59	4	12.02-04.06	188A5000	1,0	DCPR7E-N-10	4983	43	
Punto 2 1.2	188	1.2	44	4	09.00-10.04	188A4000	0,9	BKR5EZ	7642	36	LPG 1
Punto 2 1.2 Classic	188	1.2	44	4	10.04-03.12	188A4000	1,0	DCPR7E-N-10	4983	43	
Punto 2 1.2 Natural Power	188	1.2	44	4	01.04-10.04	188A4000	0,9	BKR5EZ	7642	36	LPG 1
Punto 2 1.2 Natural Power	188	1.2	44	4	11.04-10.11	188A4000	1,0	DCPR7E-N-10	4983	43	
Punto 2 1.4 16V	188	1.4	70	4	06.03-10.05	843A1000	1,0	DCPR7E-N-10	4983	43	
Punto 2 1.8	188	1.8	96	4	09.00-08.02	183A1000	0,9	BKR6EKC	2848	26	LPG 1
Punto 2 1.8	188	1.8	96	4	09.02-10.05	183A1000	0,9	BKR6EZ	4619	38	LPG 1
Punto 2 1.8	188	1.8	96	4	09.00-08.02	188A6000	0,9	BKR6EKC	2848	26	LPG 1
Punto 2 1.8	188	1.8	96	4	09.02-10.05	188A6000	0,9	BKR6EZ	4619	38	LPG 1

**PUNTO (3) 199**

Punto 3 0.9	199	0.9	63	2	03.12-	312A2000	0,8	ILKR9G8	97168		
Punto 3 0.9	199	0.9	63	2	03.12-	312A2000CNG	0,8	ILKR9G8	97168		
Punto 3 0.9 TwinAir	199	0.9	77	2	07.13-	199B6000	0,8	ILKR9G8	97168		
Punto 3 0.9 TwinAir	199	0.9	74	2	12.13-	199B7000	0,8	ILKR9G8	97168		
Punto 3 1.2	199	1.2	51	4	03.12-	169A4000	1,0	ZKR7A-10	1691	42	LPG 8
Punto 3 1.2 TwinAir	199	1.2	49	4	02.14-	199B9000	0,8	ZKR7AI-8	92402		
Punto 3 1.4 Euro IV	199	1.4	55	4	03.12-	199A7000	1,0	ZKR7A-10	1691	42	LPG 8
Punto 3 1.4 Euro IV	199	1.4	57	4	03.12-	350A1000	1,0	ZKR7A-10	1691	42	LPG 8
Punto 3 1.4 Euro V	199	1.4	55	4	03.12-	199A7000	0,8	ZKR7AI-8	92402		
Punto 3 1.4 Euro V	199	1.4	57	4	03.12-	350A1000	0,8	ZKR7AI-8	92402		
Punto 3 1.4 MultiAir	199	1.4	77	4	03.12-	955A6000	1,0	DCPR7E-N-10	4983	43	
Punto 3 1.4 Natural Power	199	1.4	57	4	03.12-	350A1000CNG	1,0	ZKR7A-10	1691	42	
Punto 3 1.4 Turbo MultiAir	199	1.4	99	4	03.12-	955A2000	0,75	IKR9J8	93311		

**PUNTO EVO**

Punto EVO 1.2	199	1.2	48	4	09.09-02.12	199A4000	1,0	ZKR7A-10	1691	42	LPG 8
Punto EVO 1.2	199	1.2	51	4	10.09-02.12	169A4000	1,0	ZKR7A-10	1691	42	LPG 8
Punto EVO 1.4	199	1.4	55	4	07.09-02.12	199A7000	1,0	ZKR7A-10	1691	42	LPG 8
Punto EVO 1.4	199	1.4	57	4	09.09-02.12	350A1000	1,0	ZKR7A-10	1691	42	LPG 8
Punto EVO 1.4 Abarth	199	1.4	120	4	10.09-02.12	955A8000	0,75	IKR9J8	93311		
Punto EVO 1.4 Abarth	199	1.4	132	4	07.08-02.12	955A8000	0,75	IKR9J8	93311		
Punto EVO 1.4 MultiAir	199	1.4	77	4	09.09-02.12	955A6000	1,0	DCPR7E-N-10	4983	43	
Punto EVO 1.4 Natural Power	199	1.4	57	4	09.09-02.12	350A1000CNG	1,0	ZKR7A-10	1691	42	
Punto EVO 1.4 Turbo MultiAir	199	1.4	99	4	09.09-02.12	955A2000	0,75	IKR9J8	93311		

**QUBO**

Qubo 1.4	225	1.4	54	4	09.08-	KFT	0,9	BKR6EZ	4619	38	LPG 1
Qubo 1.4	225	1.4	54	4	09.08-	KFV	0,9	BKR6EZ	4619	38	LPG 1
Qubo 1.4 Natural Power	225	1.4	57	4	10.09-	350A1000CNG	1,0	ZKR7A-10	1691	42	

**REGATA**

Regata 1.3	138	1.3	48	4	09.83-07.89	149A7000	0,8	BPR6ES	7822	2	LPG 2
Regata 1.5 IE	138	1.5	55	4	02.87-06.90	149C1000	0,8	BPR7ES	2023	19	BPR8EIX
Regata 1.6 IE	138	1.6	66	4	01.87-03.89	149C2000Cat	0,8	BPR6ES	7822	2	LPG 2
Regata 1.6 IE S / IE Riv.	138	1.6	74	4	06.86-07.89	149C3000	0,8	BPR6ES	7822	2	LPG 2
Regata 1.6 IE Week./Riv./S	138	1.6	74	4	06.86-06.90	149A4	0,8	BPR6ES	7822	2	LPG 2
Regata 1.6 S / Weekend	138	1.6	74	4	06.86-06.90	149A4	0,8	BPR7ES	2023	19	BPR8EIX





l kW  
C  
y  
i

0201



Stock-No

VALE

LPG/CNG

**FIAT**

**SCUDO**

Scudo 1.6	220	1.6	59	4	02.96-	220A2000	0,9	BCPR7ES	3330		BCPR7EIX
Scudo 2.0	220	2.0	100	4	09.99-10.06	RFN	0,9	LF5B	7113		LPG 7

**SEDICI**

Sedici 1.6 VVT (ex. Russia)	189	1.6	79	4	09.05-11.11	M16A	1,1	IFR6J11	7658		
Sedici 1.6 VVT (ex. Russia)	189	1.6	88	4	12.12-	M16A	1,1	SILFR6A11	5468		

**SEICENTO**

Seicento 900 iE	187	0.9	29	4	03.98-12.08	1170A1046	0,8	BPR6ES	7822	2	LPG 2
Seicento 1.1 iE	187	1.1	40	4	03.98-01.10	176B2000	0,9	BCPR6ES	2330	12	LPG 3
Seicento 1.1 iE	187	1.1	40	4	10.00-10.04	187A1000	0,9	BKR5EZ	7642	36	LPG 1
Seicento 1.1 iE	187	1.1	40	4	10.04-01.10	187A1000	1,0	DCPR7E-N-10	4983	43	

**STILO**

Stilo 1.2 16V	192	1.2	59	4	09.01-10.03	188A5000	0,9	DCPR8E-N	5692		LPG 8
Stilo 1.2 16V	192	1.2	59	4	12.02-06.04	188A5000	1,0	DCPR7E-N-10	4983	43	
Stilo 1.4	192	1.4	66	4	09.03-11.06	192B2000	1,0	DCPR7E-N-10	4983	43	
Stilo 1.4 16V / SW	192	1.4	70	4	01.04-02.05	843A1000	1,0	DCPR7E-N-10	4983	43	
Stilo 1.4 16V /SW	192	1.4	70	4	02.05-08.08	843A1000	1,0	DCPR7E-N-10	4983	43	
Stilo 1.6	192	1.6	76	4	09.01-05.06	182B6000	0,9	BKR5EZ	7642	36	LPG 1
Stilo 1.6	192	1.6	77	4	05.05-11.06	192B3000	1,1	ZFR5F-11	2262	40	LPG 6
Stilo 1.8 16V	192	1.8	96	4	09.01-08.08	192A4000	0,9	BKR6EZ	4619	38	LPG 1
Stilo 1.8 SW	192	1.8	98	4	09.02-08.08	192A4000	0,9	BKR6EZ	4619	38	LPG 1
Stilo 2.4 20V Abarth	192	2.4	125	5	09.01-04.07	192A2000	0,9	BKR6EZ	4619	38	LPG 1

**STRADA**

Strada 1.2	178	1.2	44	4	01.99-10.05	188A4000	0,9	BKR5EZ	7642	36	LPG 1
Strada 1.2	178	1.2	48	4	10.04-	178B7045	1,0	DCPR7E-N-10	4983	43	
Strada 1.2	178	1.2	54	4	05.99-05.01	178B5000	0,9	BKR5EZ	7642	36	LPG 1
Strada 1.6	178E	1.6		4	10.99-10.04	178D2011	0,9	BKR5EZ	7642	36	LPG 1

**TALENTO**

Talento 2.0		2.0	55	4	09.89-04.94	170B	0,9	BP6ES	7811	4	LPG 2
-------------	--	-----	----	---	-------------	------	-----	-------	------	---	-------

**TEMPRA**

Tempra 1.4	159	1.4	56	4	03.90-10.96	159A2000	0,8	BPR6ES	7822	2	LPG 2
Tempra 1.4 S.W	159	1.4	51	4	10.94-10.96	836A4000	0,8	BPR6ES	7822	2	LPG 2
Tempra 1.4	159	1.4	62	4	04.91-06.93	160A1046	0,8	BPR6ES	7822	2	LPG 2
Tempra 1.6	159	1.6	55	4	02.90-12.94	159A3048	0,8	BPR7ES	2023	19	BPR8EIX
Tempra 1.6	159	1.6	55	4	09.94-10.96	835C1000	0,9	BCPR7ES	3330		BCPR7EIX
Tempra 1.6	159	1.6	57	4	06.90-07.92	159A3046	0,8	BPR7ES	2023	19	BPR8EIX
Tempra 1.6	159	1.6	63	4	03.90-08.96	159A3000	0,8	B7ES	1111		BR8EIX
Tempra 1.6	159	1.6	63	4	03.90-08.96	159B9000	0,9	BCPR7ES	3330		BCPR7EIX
Tempra 1.8	159	1.8	66	4	07.93-07.96	835C4000	0,8	BPR7ES	2023	19	BPR8EIX
Tempra 1.8	159	1.8	71	4	11.92-10.96	836A5000	0,8	BPR7ES	2023	19	BPR8EIX
Tempra 1.8	159	1.8	77	4	03.92-08.96	835C2000	0,8	BPR7ES	2023	19	BPR8EIX
Tempra 1.8	159	1.8	81	4	03.90-08.96	159A4000	0,8	BPR7ES	2023	19	BPR8EIX
Tempra 1.8 i.e	159	1.8	77	4	02.90-10.96	159A4046	0,8	BPR7ES	2023	19	BPR8EIX
Tempra 2.0	159	2.0	83	4	02.90-10.96	159A6046	0,8	BPR7ES	2023	19	BPR8EIX



e kW

C  
y  
l

0201



Stock-No

VLINE

LPG / CNG

**FIAT****TIPO 160**

Tipo 1.1	160	1.1	41	4	07.87-03.93	160A3000	0,9	BCPR6ES	2330	12	LPG 3
Tipo 1.4	160	1.4	51	4	02.88-11.90	160A1000	0,8	BPR7ES	2023	19	BPR8EIX
Tipo 1.4	160	1.4	51	4	07.87-11.90	160A1046	0,8	BPR6ES	7822	2	LPG 2
Tipo 1.4	160	1.4	57	4	01.90-05.95	159A2000	0,8	BPR6ES	7822	2	LPG 2
Tipo 1.6	160	1.6	55	4	03.93-10.94	835C1000	0,9	BCPR7ES	3330		BCPR7EIX
Tipo 1.6	160	1.6	57	4	01.92-03.93	159A3046	0,8	BPR7ES	2023	19	BPR8EIX
Tipo 1.6	160	1.6	63	4	04.90-12.92	159A3000DOHC	0,8	BPR7ES	2023	19	BPR8EIX
Tipo 1.6 iE	160	1.6	55	4	03.93-10.95	835C1000	0,8	BPR7ES	2023	19	BPR8EIX
Tipo 1.6 iE	160	1.6	66	4	03.93-10.95	159A3048	0,8	BPR7ES	2023	19	BPR8EIX
Tipo 1.6 iE	160	1.6	66	4	02.88-06.90	160A1000	0,8	BPR7ES	2023	19	BPR8EIX
Tipo 1.8 i.E	160	1.8	76	4	11.91-10.95	835C2000	0,8	BPR7ES	2023	19	BPR8EIX
Tipo 1.8 i.E 16V	160	1.8	80	4	06.89-05.90	159A4000	0,8	BPR7ES	2023	19	BPR8EIX
Tipo 1.8 i.E 16V	160	1.8	102	4	06.89-09.91	160A5000	0,8	BP6ET	1263		LPG 2
Tipo 1.8 i.E GT	160	1.8	80	4	03.92-03.93	139A4000	0,8	BPR7ES	2023	19	BPR8EIX
Tipo 2.0	160	2.0	83	4	03.90-03.92	159A6046	0,8	BPR7ES	2023	19	BPR8EIX
Tipo 2.0 GT	160	2.0	83	4	11.91-10.95	159A6046Cat	0,8	BPR7ES	2023	19	BPR8EIX
Tipo 2.0 i.E 16V	160	2.0	109	4	05.91-10.95	160A8046	0,8	BPR7ES	2023	19	BPR8EIX
Tipo 2.0 i.E 16V	160	2.0	102	4	05.91-10.95	836A3000Cat	0,8	BPR7ES	2023	19	BPR8EIX

**TIPO 356**

Tipo 1.4	356	1.4	70	4	01.16-	843A1000	1,0	DCPR7E-N-10	4983	43	
----------	-----	-----	----	---	--------	----------	-----	-------------	------	----	--

**ULYSSE**

Ulysse 1.8 iE		1.8	73	4	04.96-08.00	LFW	0,9	BKR6EKC	2848	26	LPG 1
Ulysse 2.0		2.0	100	4	09.00-08.02	EW10J4RFN	0,9	LFR5B	7113		LPG 7
Ulysse 2.0		2.0	108	4	07.94-12.98	RGX	0,9	BKR6EK	2288	20	LPG 1
Ulysse 2.0		2.0	100	4	09.00-08.02	RFN	0,9	LFR5B	7113		LPG 7
Ulysse 2.0 iE		2.0	89	4	07.94-08.00	RFU	0,8	BKR5EK	7956	23	LPG 1
Ulysse 3.0 V6		3.0	150	6	06.02-06.11	XFW	1,1	PLFR5A-11	6240		LPG 7

**UNO**

Uno 45 ES/S/Sting/Trend		0.9	33	4	01.83-10.95	146A	0,8	BPR6ES	7822	2	LPG 2
Uno 1.0L- Start		1.0	33	4	08.94-10.95	156A2000-2048	0,8	BPR5ES	7422	6	LPG 2
Uno 45		1.0	32	4	06.85-10.95	156A2	0,9	BCPR6ES	2330	12	LPG 3
Uno 60 /60 CS / 60 S		1.1	43	4	05.85-08.89	146A4	0,8	BPR6ES	7822	2	LPG 2
Uno 60 IE / S		1.1	37	4	07.91-10.95	156C046Cat	0,9	BCPR6ES	2330	12	LPG 3
Uno 60 SL / Trend		1.1	41	4	09.89-09.92	146A6000	0,8	BPR6ES	7822	2	LPG 2
Uno Selecta / Selecta S		1.1	43	4	04.87-08.89	146A4048	0,8	BPR6ES	7822	2	LPG 2
Uno 70 S / SL / SX		1.3	48	4	05.85-09.89	149A7	0,8	BPR6ES	7822	2	LPG 2
Uno Turbo i.e.		1.3	73	4	04.85-08.89	146A2Cat	0,9	BCPR7ET	2164		BCPR7EIX
Uno 70 all models		1.4	51	4	.83-10.95	160A1046	0,8	BPR6ES	7822	2	LPG 2
Uno Turbo IE/ Racing		1.4	82	4	09.89-12.93	146A8046Cat	0,9	BCPR7ET	2164		BCPR7EIX
Uno 75 I.E. SPi		1.5	55	4	12.87-10.95	149C1000	0,8	BPR6ES	7822	2	LPG 2

**FORD****B-MAX**

B-Max 1.0 EcoBoost	JK	1.0	74	3	10.12-	SFJA / SFJB	0,7	SILZNAR8C7H	93593		LPG 4
B-Max 1.0 EcoBoost	JK	1.0	88	3	10.12-	M1JA	0,7	SILZNAR8C7H	93593		LPG 4
B-Max 1.0 EcoBoost	JK	1.0	92	3	10.12-	M1JE	0,7	SILZNAR8C7H	93593		LPG 4
B-Max 1.4	JK	1.4	66	4	10.12-	SPJD	1,3	TR5B-13	4559	45	LPG 4
B-Max 1.6 Ti	JK	1.6	77	4	10.12-	IQJA	1,3	TR5B-13	4559	45	LPG 4



l kW  
C  
y  
i

0201



Stock-No

VALVE

LPG / CNG

**FORD**

**C-MAX**

C-Max ,11 1.0 EcoBoost	BJ	1.0	74	3	10.12-	M2DA	0,7	SILZNR8C7H	93593		LPG 4
C-Max ,11 1.0 EcoBoost	BJ	1.0	92	3	10.12-	M1DA	0,7	SILZNR8C7H	93593		LPG 4
C-Max ,11 1.6 EcoBoost	BJ	1.6	110	4	12.10-	JQDA / JQDB	0,8	ILZTR6A8G	94769		
C-Max ,11 1.6 EcoBoost	BJ	1.6	134	4	12.10-	JTDA / JTDB	0,8	ILZTR6A8G	94769		
C-Max ,11 1.6 Ti-VCT	BJ	1.6	77	4	12.10-	IQDA / IQDB	1,3	TR5B-13	4559	45	LPG 4
C-Max ,11 1.6 Ti-VCT	BJ	1.6	92	4	12.10-	PNDA	1,3	TR5B-13	4559	45	LPG 4
C-Max ,11 1.6 Ti-VCT	BJ	1.6	63	4	09.11-	XTDA	1,3	TR5B-13	4559	45	LPG 4
C-Max ,11 2.0 Hybrid	BV	2.0	101	4	01.15-	20EDEF	1,3	ILTR5K13	90607		

**COUGAR**

Cougar 2.0		2.0	96	4	08.98-01.01	EDBA ZETEC-E SEFI	1,3	PTR5A-13	2467	25	LPG 4
Cougar 2.0		2.0	96	4	08.98-01.01	EDBB ZETEC-E SEFI	1,3	PTR5A-13	2467	25	LPG 4
Cougar 2.0		2.0	96	4	08.98-01.01	EDBC ZETEC-E SEFI	1,3	PTR5A-13	2467	25	LPG 4
Cougar 2.0		2.0	96	4	08.98-01.01	EDBD ZETEC-E SEFI	1,3	PTR5A-13	2467		LPG 4
Cougar 2.5 V6		2.5	125	6	08.98-01.01	LCBA Duratec VE SEFI	1,0	PTR5D-10	3784	31	LPG 5
Cougar 2.5 V6		2.5	125	6	08.98-01.01	LCBB Duratec-VE SEFI	1,0	PTR5D-10	3784	31	LPG 5
Cougar 2.5 V6		2.5	125	6	08.98-01.01	LCBC Duratec VE SEFI	1,0	PTR5D-10	3784	31	LPG 5
Cougar 2.5 V6		2.5	125	6	08.98-01.01	LCBE Duratec-VE SEFI	1,0	PTR5D-10	3784	31	LPG 5
Cougar 2.5 V6		2.5	151	6	08.98-01.01	MABB Duratec VE SEFI	1,0	PTR5D-10	3784	31	LPG 5

**ECOSPORT**

EcoSport 1.0 EcoBoost	KB	1.0	92	3	10.13-	M1JC	0,7	SILZNR8C7H	93593		LPG 4
-----------------------	----	-----	----	---	--------	------	-----	------------	-------	--	-------

**ESCORT '86**

Escort '86		1.1	37	4	01.86-07.90	GSG VAL VV	1,0	BPR6EFS	3623	7	LPG 5
Escort '86		1.1	40	4	01.86-07.90	GUC HCS 2V	1,0	BPR6EFS	3623	7	LPG 5
Escort '86		1.3	44	4	01.86-07.90	JBB HCS 2V	1,0	BPR6EFS	3623	7	LPG 5
Escort '86		1.3	44	4	01.86-07.90	JLA VAL VV	1,0	BPR6EFS	3623	7	LPG 5
Escort '86		1.3	44	4	01.86-07.90	JLA VAL VV Cat.	1,0	BPR6EFS	3623	7	LPG 5
Escort '86		1.3	44	4	01.86-07.90	JLB VAL VV	1,0	BPR6EFS	3623	7	LPG 5
Escort '86		1.3	46	4	01.86-07.90	JBA HCS 2V	1,0	BPR6EFS	3623	7	LPG 5
Escort '86		1.4	51	4	01.86-07.90	FUAA CVH 2V	0,8	BCPR6ES	2330	12	LPG 3
Escort '86		1.4	54	4	01.86-07.90	F6B CVH CFI	1,1	BCPR6ES-11	7121	11	LPG 3
Escort '86		1.4	54	4	01.86-07.90	F6D CVH CFI	1,1	BCPR6ES-11	7121	11	LPG 3
Escort '86		1.4	54	4	01.86-07.90	FUC CVH 2V	1,1	BCPR7ES-11	1095	11	BCPR7EIX
Escort '86		1.4	55	4	01.86-07.90	FUA CVH 2V	0,8	BCPR6ES	2330	12	LPG 3
Escort '86		1.4	55	4	01.86-07.90	FUA CVH 2V Cat.	0,8	BCPR6ES	2330	12	LPG 3
Escort '86		1.6	58	4	01.86-07.90	LP2 CVH W	0,8	BCPR6ES	2330	12	LPG 3
Escort '86		1.6	65	4	01.86-07.90	LUG CVH 2V	0,8	BCPR6ES	2330	12	LPG 3
Escort '86		1.6	66	4	01.86-07.90	L4B CVH FI	0,8	BCPR6ES	2330	12	LPG 3
Escort '86		1.6	66	4	01.86-07.90	LUC CVH 2V	0,8	BCPR6ES	2330	12	LPG 3
Escort '86		1.6	66	4	01.86-07.90	LUC CVH 2V Cat.	0,8	BCPR6ES	2330	12	LPG 3
Escort '86		1.6	75	4	01.86-07.90	LJB CVH EFI	1,1	BCPR6ES-11	7121	11	LPG 3
Escort '86		1.6	77	4	01.86-07.90	LR2 CVH FI	0,8	BCPR7ES	3330		BCPR7EIX
Escort '86		1.6	77	4	01.86-07.90	LRB CVH FI	0,8	BCPR7ES	3330		BCPR7EIX
Escort '86		1.6	77	4	01.86-07.90	LRB CVH FI Cat.	0,8	BCPR7ES	3330		BCPR7EIX
Escort '86		1.6	79	4	01.86-07.90	LJA CVH EFI	1,1	BCPR6ES-11	7121	11	LPG 3
Escort '86		1.6	97	4	01.86-07.90	LNB CVH FI	0,8	BCR8ES	5430		

e kW  
C  
y  
i

0201



Stock-No

VLINE

LPG / CNG

**FORD****ESCORT '91**

Escort '91 1.1	1.1	40	4	08.90-09.01	GUF HCS 2V	1,0	PTR5D-10	3784	31	LPG 5
Escort '91 1.3	1.3	44	4	08.90-09.01	J4B Endura-E SEFI	1,0	PTR5D-10	3784	31	LPG 5
Escort '91 1.3	1.3	44	4	08.90-09.01	J6A HCS CFI	1,0	PTR5D-10	3784	31	LPG 5
Escort '91 1.3	1.3	44	4	08.90-09.01	JBE HCS 2V	1,0	PTR5D-10	3784	31	LPG 5
Escort '91 1.3	1.3	46	4	08.90-09.01	JBD HCS 2V	1,0	PTR5D-10	3784	31	LPG 5
Escort '91 1.4	1.4	52	4	08.90-09.01	F6F CVH CFI	1,1	BCPR6ES-11	7121	11	LPG 3
Escort '91 1.4	1.4	52	4	08.90-09.01	F6G CVH CFI	1,1	BCPR6ES-11	7121	11	LPG 3
Escort '91 1.4	1.4	54	4	08.90-09.01	F4B PTE SEFI	1,1	BCPR6ES-11	7121	11	LPG 3
Escort '91 1.4	1.4	54	4	08.90-09.01	FUH CVH 2V	0,8	BCPR6ES	2330	12	LPG 3
Escort '91 1.6	1.6	65	4	08.90-09.01	L1H ZETEC-E SEFI	1,3	PTR5A-13	2467	25	LPG 4
Escort '91 1.6	1.6	66	4	08.90-09.01	L1E ZETEC-E SEFI	1,3	PTR5A-13	2467	25	LPG 4
Escort '91 1.6	1.6	66	4	08.90-09.01	L1K ZETEC-E SEFI	1,3	PTR5A-13	2467	25	LPG 4
Escort '91 1.6	1.6	66	4	08.90-09.01	LUJ CVH 2V	0,8	BCPR6ES	2330	12	LPG 3
Escort '91 1.6	1.6	66	4	08.90-09.01	LUK CVH 2V	0,8	BCPR6ES	2330	12	LPG 3
Escort '91 1.6	1.6	77	4	08.90-09.01	LJF CVH EFI	1,1	BCPR6ES-11	7121	11	LPG 3
Escort '91 1.6	1.6	79	4	08.90-09.01	LJE CVH EFI	1,1	BCPR6ES-11	7121	11	LPG 3
Escort '91 1.8	1.8	77	4	08.90-09.01	RDA ZETEC SEFI	1,3	PTR5A-13	2467	25	LPG 4
Escort '91 1.8	1.8	85	4	08.90-09.01	RKC ZETEC-E SEFI	1,3	PTR5A-13	2467	25	LPG 4
Escort '91 1.8	1.8	96	4	08.90-09.01	RQB ZETEC SEFI	1,3	PTR5A-13	2467	25	LPG 4
Escort '91 2.0 RS 2000	2.0	110	4	08.90-09.01	N7A DOHC 16V EFI	1,1	BCPR6ES-11	7121	11	LPG 3
Escort '91 Cosworth	2.0	162	4	08.90-09.01	N5F DOHC COSWORTH	0,6	PFR7B	4853		PFR8B
Escort '91 Cosworth	2.0	162	4	08.90-09.01	N5E DOHC COSWORTH	1,1	PFR7B-11	5667		

**EXPLORER**

Explorer 4.0	4.0	115	6	01.93- .03	V6 SEFI	1,5	TR55	3951		LPG 5
Explorer 4.0	4.0	121	6	01.93- .03	V6 EFI	1,5	TR55	3951		LPG 5
Explorer 4.0	4.0	152	6	01.93- .03	V6 SOHC SEFI	1,5	TR55	3951		LPG 5
Explorer 5.0	5.0		8	01.97- .01	V8	1,5	TR55	3951		LPG 5

**FIESTA '89**

Fiesta '89 1.0	GFJ	1.0	33	4	03.89-06.96	TLB HCS 1V	1,0	BPR6EFS	3623	7	LPG 5
Fiesta '89 1.1	GFJ	1.1	37	4	03.89-06.96	G6A HCS CFI	1,0	BPR6EFS	3623	7	LPG 5
Fiesta '89 1.1	GFJ	1.1	40	4	03.89-06.96	GUD HCS 2V	1,0	BPR6EFS	3623	7	LPG 5
Fiesta '89 1.1	GFJ	1.1	40	4	03.89-06.96	GUE HCS 2V	1,0	BPR6EFS	3623	7	LPG 5
Fiesta '89 1.3	GFJ	1.3	44	4	03.89-06.96	J6B HCS CFI	1,0	BPR6EFS	3623	7	LPG 5
Fiesta '89 1.3	GFJ	1.3	44	4	03.89-06.96	JBC HCS 2V	1,0	BPR6EFS	3623	7	LPG 5
Fiesta '89 1.4	GFJ	1.4	52	4	03.89-06.96	F6E CVH CFI	1,1	BCPR6ES-11	7121	11	LPG 3
Fiesta '89 1.4	GFJ	1.4	54	4	03.89-06.96	F4A PTE SEFI	1,1	BCPR6ES-11	7121	11	LPG 3
Fiesta '89 1.4	GFJ	1.4	54	4	03.89-06.96	FUG CVH 2V	1,1	BCPR6ES-11	7121	11	LPG 3
Fiesta '89 1.4	GFJ	1.4	54	4	03.89-06.96	FUJ CVH 2V	0,8	BCPR6ES	2330	12	LPG 3
Fiesta '89 1.4	GFJ	1.4	55	4	03.89-06.96	FUF CVH 2V	0,8	BCPR6ES	2330	12	LPG 3
Fiesta '89 1.6	GFJ	1.6	66	4	03.89-06.96	L1G ZETEC SEFI	1,3	PTR5A-13	2467	25	LPG 4
Fiesta '89 1.6	GFJ	1.6	66	4	03.89-06.96	LUH CVH 2V	0,8	BCPR6ES	2330	12	LPG 3
Fiesta '89 1.6 XR2i	GFJ	1.6	76	4	03.89-06.96	LJD CVH EFI	1,1	BCPR6ES-11	7121	11	LPG 3
Fiesta '89 1.6 XR2i	GFJ	1.6	81	4	03.89-06.96	LJC CVH EFI	1,1	BCPR6ES-11	7121	11	LPG 3
Fiesta '89 1.6 Turbo	GFJ	1.6	96	4	03.89-06.96	LHA CVH Turbo	0,8	BCR8ES	5430		
Fiesta '89 1.8 16V	GFJ	1.8	77	4	03.89-06.96	RDB ZETEC SEFI	1,3	PTR5A-13	2467	25	LPG 4
Fiesta '89 1.8 XR2i	GFJ	1.8	96	4	03.89-06.96	RQC ZETEC SEFI	1,3	PTR5A-13	2467	25	LPG 4

**FIESTA '96**

Fiesta '96 1.25	JA / JB	1.25	55	4	11.95-02.02	DHA ZETEC-SE SEFI	1,3	PTR5A-13	2467	25	LPG 4
-----------------	---------	------	----	---	-------------	-------------------	-----	----------	------	----	-------

e kW  
C  
Y  
I

0201



Stock-No

VLINE

LPG/CNG

**FORD****FIESTA '96**

Fiesta '96 1.25	JA / JB	1.25	55	4	11.95-02.02	DHB ZETEC-SE SEFI	1,3	PTR5A-13	2467	25	LPG 4
Fiesta '96 1.25	JA / JB	1.25	55	4	11.95-02.02	DHC ZETEC-SE SEFI	1,3	PTR5A-13	2467	25	LPG 4
Fiesta '96 1.25	JA / JB	1.25	55	4	11.95-02.02	DHD ZETEC-SE SEFI	1,3	PTR5A-13	2467	25	LPG 4
Fiesta '96 1.25	JA / JB	1.25	55	4	11.95-02.02	DHE ZETEC-SE SEFI	1,3	PTR5A-13	2467	25	LPG 4
Fiesta '96 1.25	JA / JB	1.25	55	4	11.95-02.02	DHF ZETEC-SE SEFI	1,3	PTR5A-13	2467	25	LPG 4
Fiesta '96 1.25	JA / JB	1.25	55	4	11.95-02.02	DHG ZETEC-SE SEFI	1,3	PTR5A-13	2467	25	LPG 4
Fiesta '96 1.3	JA / JB	1.3	37	4	11.95-02.02	JJA Endura-E SEFI	1,0	PTR5D-10	3784	31	LPG 5
Fiesta '96 1.3	JA / JB	1.3	37	4	11.95-02.02	JJC Endura-E SEFI	1,0	PTR5D-10	3784	31	LPG 5
Fiesta '96 1.3	JA / JB	1.3	37	4	11.95-02.02	JJE Endura-E SEFI	1,0	PTR5D-10	3784	31	LPG 5
Fiesta '96 1.3	JA / JB	1.3	37	4	11.95-02.02	JJJ Endura-E SEFI	1,0	PTR5D-10	3784	31	LPG 5
Fiesta '96 1.3	JA / JB	1.3	37	4	11.95-02.02	JJK Endura-E SEFI	1,0	PTR5D-10	3784	31	LPG 5
Fiesta '96 1.3	JA / JB	1.3	37	4	11.95-02.02	JJM Endura-E SEFI	1,0	PTR5D-10	3784	31	LPG 5
Fiesta '96 1.3	JA / JB	1.3	44	4	11.95-02.02	J4C Endura-E SEFI	1,0	PTR5D-10	3784	31	LPG 5
Fiesta '96 1.3	JA / JB	1.3	44	4	11.95-02.02	J4J Endura-E SEFI	1,0	PTR5D-10	3784	31	LPG 5
Fiesta '96 1.3	JA / JB	1.3	44	4	11.95-02.02	J4L Endura-E SEFI	1,0	PTR5D-10	3784	31	LPG 5
Fiesta '96 1.3	JA / JB	1.3	44	4	11.95-02.02	J4Q Endura-E SEFI	1,0	PTR5D-10	3784	31	LPG 5
Fiesta '96 1.3	JA / JB	1.3	44	4	11.95-02.02	J4R Endura-E SEFI	1,0	PTR5D-10	3784	31	LPG 5
Fiesta '96 1.3	JA / JB	1.3	44	4	11.95-02.02	J4T Endura-E SEFI	1,0	PTR5D-10	3784	31	LPG 5
Fiesta '96 1.4 16V	JA / JB	1.4	66	4	11.95-02.02	FHA ZETEC-SE SEFI	1,3	PTR5A-13	2467	25	LPG 4
Fiesta '96 1.4 16V	JA / JB	1.4	66	4	11.95-02.02	FHE ZETEC-SE SEFI	1,3	PTR5A-13	2467	25	LPG 4
Fiesta '96 1.6 16V Sport	JA / JB	1.6	76	4	11.95-02.02	L1T ZETEC-SE SEFI	1,3	PTR5A-13	2467	25	LPG 4
Fiesta '96 1.6 16V Sport	JA / JB	1.6	76	4	11.95-02.02	L1V ZETEC-SE SEFI	1,3	PTR5A-13	2467	25	LPG 4

**FIESTA '01**

Fiesta '01 1.25	JH / JD	1.25	51	4	11.01-	M7JA Duratec 16V SFI	1,3	PTR5A-13	2467	25	LPG 4
Fiesta '01 1.25	JH / JD	1.25	51	4	11.01-	M7JB Duratec 16V SFI	1,3	PTR5A-13	2467	25	LPG 4
Fiesta '01 1.25	JH / JD	1.25	55	4	11.01-	FUJA Duratec 16V SFI	1,3	PTR5A-13	2467	25	LPG 4
Fiesta '01 1.25	JH / JD	1.25	55	4	11.01-	FUJB Duratec 16V SFI	1,3	PTR5A-13	2467	25	LPG 4
Fiesta '01 1.3	JH / JD	1.3	44	4	11.01-	BAJA Duratec 8V SFI	1,3	TR5B-13	4559	45	LPG 4
Fiesta '01 1.3	JH / JD	1.3	51	4	11.01-	A9JA Duratec 8V SFI	1,3	TR5B-13	4559	45	LPG 4
Fiesta '01 1.3	JH / JD	1.3	51	4	11.01-	A9JB Duratec 8V SFI	1,3	TR5B-13	4559	45	LPG 4
Fiesta '01 1.4 16V	JH / JD	1.4	59	4	11.01-	FXJA Duratec 16V SFI	1,3	PTR5A-13	2467	25	LPG 4
Fiesta '01 1.4 16V	JH / JD	1.4	59	4	11.01-	FXJB Duratec 16V SFI	1,3	PTR5A-13	2467	25	LPG 4
Fiesta '01 1.6 16V	JH / JD	1.6	74	4	11.01-	FYJB Duratec 16V SFI	1,3	PTR5A-13	2467	25	LPG 4
Fiesta '01 1.6 16V	JH / JD	1.6	74	4	11.01-	FYJA Duratec 16V SFI	1,3	PTR5A-13	2467	25	LPG 4
Fiesta '01 2.0 ST 150	JH / JD	2.0	110	4	03.05-	N4JB Duratec-ST (MI4) SFI	1,3	ITR6F13	4477		LPG 5

**FIESTA '08**

Fiesta '08 1.0 EcoBoost	JC / JD	1.0	92	3	09.12-	M1JE	0,7	SILZNR8C7H	93593		LPG 4
Fiesta '08 1.0 EcoBoost	JC / JD	1.0	74	3	01.13-	SFJA / SFJB	0,7	SILZNR8C7H	93593		LPG 4
Fiesta '08 1.25	JDG / JDJ	1.25	44	4	08.08-	STJA / STJB	1,3	TR5B-13	4559	45	LPG 4
Fiesta '08 1.25	JDG / JDJ	1.25	60	4	08.08-	SNJA / SNJB	1,3	TR5B-13	4559	45	LPG 4
Fiesta '08 1.4 LPG	JDG / JDJ	1.4	68	4	01.09-	RTJA / RTJB	0,8	ILTR6H8G	96870		
Fiesta '08 1.4	JDG / JDJ	1.4	71	4	10.08-	SPJA / SPJC	1,3	TR5B-13	4559	45	LPG 4
Fiesta '08 1.6 Ti	JDG / JDJ	1.6	88	4	10.08-	HXJA / HXJB	1,3	TR5B-13	4559	45	LPG 4
Fiesta '08 1.6 Ti	JDG / JDJ	1.6	99	4	12.10-	U5JA	1,3	TR5B-13	4559	45	LPG 4

**FOCUS '98**

Focus '98 1.4 16V	DAW / DBW	1.4	55	4	08.98-12.04	FXDA ZETEC-SE SFI	1,3	PTR5A-13	2467	25	LPG 4
Focus '98 1.4 16V	DAW / DBW	1.4	55	4	08.98-12.04	FXDB ZETEC-SE SFI	1,3	PTR5A-13	2467	25	LPG 4
Focus '98 1.4 16V	DAW / DBW	1.4	55	4	08.98-12.04	FXDC ZETEC-SE SEFI	1,3	PTR5A-13	2467	25	LPG 4
Focus '98 1.4 16V	DAW / DBW	1.4	55	4	08.98-12.04	FXDD ZETEC-SE SFI	1,3	PTR5A-13	2467	25	LPG 4

e kW  
C  
y  
i

0201



Stock-No

VELINE

LPG / CNG

**FORD****FOCUS '98**

Focus '98 1.6 16V	DAW / DBW	1.6	72	4	08.98-12.04	CDDA Duratec SFI	1,3	TR5B-13	4559	45	LPG 4
Focus '98 1.6 16V	DAW / DBW	1.6	74	4	08.98-12.04	FYDA ZETEC-SE SFI	1,3	PTR5A-13	2467	25	LPG 4
Focus '98 1.6 16V	DAW / DBW	1.6	74	4	08.98-12.04	FYDB ZETEC-SE SFI	1,3	PTR5A-13	2467	25	LPG 4
Focus '98 1.6 16V	DAW / DBW	1.6	74	4	08.98-12.04	FYDC ZETEC-SE SFI	1,3	PTR5A-13	2467	25	LPG 4
Focus '98 1.6 16V	DAW / DBW	1.6	74	4	08.98-12.04	FYDD ZETEC-SE SFI	1,3	PTR5A-13	2467	25	LPG 4
Focus '98 1.6 16V	DAW / DBW	1.6	74	4	08.98-12.04	FYDH ZETEC-SE SFI	1,3	PTR5A-13	2467	25	LPG 4
Focus '98 1.8 16V	DAW / DBW	1.8	85	4	08.98-12.04	EYDB ZETEC-E SFI	1,3	PTR5A-13	2467	25	LPG 4
Focus '98 1.8 16V	DAW / DBW	1.8	85	4	08.98-12.04	EYDC ZETEC-E SFI	1,3	PTR5A-13	2467	25	LPG 4
Focus '98 1.8 16V	DAW / DBW	1.8	85	4	08.98-12.04	EYDD ZETEC-E SFI	1,3	PTR5A-13	2467	25	LPG 4
Focus '98 1.8 16V	DAW / DBW	1.8	85	4	08.98-12.04	EYDE ZETEC-E SFI	1,3	PTR5A-13	2467	25	LPG 4
Focus '98 1.8 16V	DAW / DBW	1.8	85	4	08.98-12.04	EYDF ZETEC-E SFI	1,3	PTR5A-13	2467	25	LPG 4
Focus '98 1.8 16V	DAW / DBW	1.8	85	4	08.98-12.04	EYDG ZETEC-E SFI	1,0	TR5A-10	0005		
Focus '98 1.8 16V	DAW / DBW	1.8	85	4	08.98-12.04	EYDI ZETEC-E SFI	1,0	TR5A-10	0005		
Focus '98 1.8 16V	DAW / DBW	1.8	85	4	08.98-12.04	EYDJ ZETEC-E SFI	1,0	TR5A-10	0005		
Focus '98 1.8 16V	DAW / DBW	1.8	85	4	08.98-12.04	EYDL ZETEC-E SFI	1,0	TR5A-10	0005		
Focus '98 1.8 16V RUS	DAW / DBW	1.8	85	4	08.98-12.04	EYDK ZETEC-E EFI	1,3	PTR5A-13	2467	25	LPG 4
Focus '98 2.0 16V	DAW / DBW	2.0	96	4	08.98-12.04	EDDB ZETEC-E SFI	1,3	PTR5A-13	2467	25	LPG 4
Focus '98 2.0 16V	DAW / DBW	2.0	96	4	08.98-12.04	EDDC ZETEC-E SFI	1,3	PTR5A-13	2467	25	LPG 4
Focus '98 2.0 16V	DAW / DBW	2.0	96	4	08.98-12.04	EDDD ZETEC-E SFI	1,3	PTR5A-13	2467	25	LPG 4
Focus '98 2.0 16V	DAW / DBW	2.0	96	4	08.98-12.04	EDDF ZETEC-E SFI	1,3	PTR5A-13	2467	25	LPG 4
Focus '98 2.0 RS Turbo	DAW / DBW	2.0	158	4	10.02-12.04	HMDA Duratec RS SFI	1,0	PLTR6A-10G	3587		

**FOCUS '02**

Focus / C-Max 1.6	DAW / DBW	1.6	74	4	06.03-	HWDA Duratec-16V SFI	1,3	TR5B-13	4559	45	LPG 4
Focus / C-Max 1.6	DAW / DBW	1.6	74	4	06.03-	HWDB Duratec-16V SFI	1,3	TR5B-13	4559	45	LPG 4
Focus / C-Max 1.6	DAW / DBW	1.6	74	4	06.03-	SHDA Duratec-HE SFI	1,3	TR5B-13	4559	45	LPG 4
Focus / C-Max 1.6	DAW / DBW	1.6	74	4	06.03-	SHDB Duratec-HE SFI	1,3	TR5B-13	4559	45	LPG 4
Focus / C-Max 1.6 Ti	DAW / DBW	1.6	85	4	06.03-	HXDA Duratec-16V Ti-VCT	1,3	TR5B-13	4559	45	LPG 4
Focus / C-Max 1.6 Ti	DAW / DBW	1.6	85	4	06.03-	HXDB Duratec-HE SFI	1,3	TR5B-13	4559	45	LPG 4
Focus / C-Max 1.8	DAW / DBW	1.8	88	4	06.03-	CSDA Duratec-HE SFI	1,3	ITR6F13	4477		LPG 5
Focus / C-Max 1.8	DAW / DBW	1.8	88	4	06.03-	CSDB Duratec-HE SFI	1,3	ITR6F13	4477		LPG 5
Focus / C-Max 1.8	DAW / DBW	1.8	92	4	06.03-	QQDA Duratec-HE SFI	1,3	TR6AP-13	5809		LPG 5
Focus / C-Max 1.8	DAW / DBW	1.8	92	4	06.03-	QQDB Duratec-HE SFI	1,3	TR6AP-13	5809		LPG 5
Focus / C-Max 1.8	DAW / DBW	1.8	92	4	06.03-	QQDC Duratec-HE SFI	1,3	TR6AP-13	5809		LPG 5
Focus / C-Max 1.8 Flexifuel	DAW / DBW	1.8	92	4	06.03-	Q7DA Duratec-HE SFI	1,3	TR6AP-13	5809		LPG 5
Focus / C-Max 2.0	DAW / DBW	2.0	107	4	04.04-03.07	AODA Duratec-HE SFI	1,3	TR6AP-13	5809		LPG 5
Focus / C-Max 2.0	DAW / DBW	2.0	107	4	04.04-03.07	AODB Duratec-HE SFI	1,3	TR6AP-13	5809		LPG 5
Focus / C-Max 2.0 LPG / CNG	DAW / DBW	2.0	107	4	04.04-03.07	SYDA Duratec-HE SFI	1,3	TR6AP-13	5809		LPG 5
Focus ST 170	DAW / DBW	2.0	127	4	03.02-11.04	ALDA Duratec-ST	1,0	PLTR6A-10G	3587		

**FOCUS '04**

Focus '04 1.4	DA / DAW	1.4	59	4	07.04-	ASDA Duratec-16V SFI	1,3	TR5B-13	4559	45	LPG 4
Focus '04 1.4	DA / DAW	1.4	59	4	07.04-	ASDB Duratec-16V SFI	1,3	TR5B-13	4559	45	LPG 4
Focus '04 1.6	DA / DAW	1.6	74	4	07.04-	HWDA Duratec-16V SFI	1,3	TR5B-13	4559	45	LPG 4
Focus '04 1.6	DA / DAW	1.6	74	4	07.04-	HWDB Duratec-16V SFI	1,3	TR5B-13	4559	45	LPG 4
Focus '04 1.6	DA / DAW	1.6	74	4	07.04-	SHDA Duratec-16V SFI	1,3	TR5B-13	4559	45	LPG 4
Focus '04 1.6	DA / DAW	1.6	74	4	07.04-	SHDB Duratec-16V SFI	1,3	TR5B-13	4559	45	LPG 4
Focus '04 1.6 Ti	DA / DAW	1.6	85	4	07.04-	HXDA Duratec-16V Ti-VCT	1,3	TR5B-13	4559	45	LPG 4
Focus '04 1.6 Ti	DA / DAW	1.6	85	4	07.04-	HXDB Duratec-16V Ti-VCT	1,3	TR5B-13	4559	45	LPG 4
Focus '04 1.8	DA / DAW	1.8	92	4	07.04-	Q7DA Duratec-HE SFI	1,3	TR6AP-13	5809		LPG 5
Focus '04 1.8	DA / DAW	1.8	92	4	07.04-	QQDB Duratec-HE SFI	1,3	TR6AP-13	5809		LPG 5
Focus '04 1.8	DA / DAW	1.8	92	4	.06-	QQDA Duratec-HE SFI	1,3	TR6AP-13	5809		LPG 5

e kW  
C  
Y  
I

0201



Stock-No

VLINE

LPG/CNG

**FORD****FOCUS '04**

Focus '04 1.8	DA / DAW	1.8	96	4	.06-	QQDD Duratec-HE SFI	1,3	TR6AP-13	5809		LPG 5
Focus '04 2.0 CNG	DA / DAW	2.0	93	4	03.09-	Duratec-HE SFI	1,3	TR6AP-13	5809		LPG 5
Focus '04 2.0 CNG	DA / DAW	2.0	107	4	03.09-	Duratec-HE SFI	1,3	TR6AP-13	5809		LPG 5
Focus '04 2.0 LPG	DA / DAW	2.0	107	4	03.09-	Duratec-HE SFI	1,3	TR6AP-13	5809		LPG 5
Focus '04 2.0	DA / DAW	2.0	107	4	07.04-	AODA Duratec-HE SFI	1,3	TR6AP-13	5809		LPG 5
Focus '04 2.0	DA / DAW	2.0	107	4	07.04-	AODB Duratec-HE SFI	1,3	TR6AP-13	5809		LPG 5
Focus '04 2.0	DA / DAW	2.0	107	4	.06-	SYDA Duratec-HE SFI	1,3	TR6AP-13	5809		LPG 5
Focus '04 2.5 ST	DA / DAW	2.5	166	5	12.05-	HYDA	0,8	PLFR6A	5472		

**FOCUS '11**

Focus '11 1.6 TI-VCT	DYM	1.6	63	4	08.11-	XTDA	1,3	TR5B-13	4559	45	LPG 4
Focus '11 1.6 TI-VCT	DYM	1.6	77	4	04.11-	IQDA / IQDB	1,3	TR5B-13	4559	45	LPG 4
Focus '11 1.6 Flexifuel	DYM	1.6	88	4	04.11-	MUDA	1,3	TR5B-13	4559	45	LPG 4
Focus '11 1.6 TI-VCT	DYM	1.6	92	4	04.11-	PNDA	1,3	TR5B-13	4559	45	LPG 4
Focus '11 1.6 EcoBoost	DYM	1.6	110	4	04.11-	JQDA / JQDB	0,8	ILZTR6A8G	94769		
Focus '11 1.6 EcoBoost	DYM	1.6	134	4	04.11-	JTDA / JTDB	0,8	ILZTR6A8G	94769		
Focus '11 2.0	DYK	2.0	125	4	10.11-	XQDA	0,9	LTR6BI-9	92182		
Focus '11 2.0	DYL	2.0	110	4	10.11-	XQDA	0,9	LTR6BI-9	92182		
Focus '11 2.0	DYM	2.0	110	4	10.11-	XQDA	0,9	LTR6BI-9	92182		
Focus '11 2.0 ST Eco Boost MK II	DYL	2.0	184	4	07.12-	R9DA	0,8	LTR6DI-8	96588		
Focus '11 2.0 ST Eco Boost MKIII	DYK	2.0	184	4	07.12-	R9DA	0,8	LTR6DI-8	96588		
Focus '11 2.3 RS MKIII	DYK	2.3	257	4	12.15-	C23HD0D	0,8	LTR6DI-8	96588		
Focus '11 2.5 RS		2.5	224	5		JZDA	0,8	ILFR6B	6481		

**FOCUS C-MAX '11**

Focus C-Max '11 1.6 Ti-VCT	BJ	1.6	63	4	09.11-	XTDA	1,3	TR5B-13	4559	45	LPG 4
Focus C-Max '11 1.6	BJ	1.6	77	4	12.10-	IQDA / IQDB	1,3	TR5B-13	4559	45	LPG 4
Focus C-Max '11 1.6	BJ	1.6	92	4	12.10-	PNDA	1,3	TR5B-13	4559	45	LPG 4
Focus C-Max '11 1.6 EcoBoost	BJ	1.6	110	4	12.10-	JQDA / JQDB	0,8	ILZTR6A8G	94769		
Focus C-Max '11 1.6 EcoBoost	BJ	1.6	134	4	12.10-	JTDA / JTDB	0,8	ILZTR6A8G	94769		

**FUSION**

Fusion 1.25	JU	1.25	55	4	06.02-	FUJA Duratec 16V SFI	1,3	PTR5A-13	2467	25	LPG 4
Fusion 1.25	JU	1.25	55	4	06.02-	FUJB Duratec 16V SFI	1,3	PTR5A-13	2467	25	LPG 4
Fusion 1.4	JU	1.4	59	4	06.02-	FXJA Duratec 16V SFI	1,3	PTR5A-13	2467	25	LPG 4
Fusion 1.4	JU	1.4	59	4	06.02-	FXJB Duratec 16V SFI	1,3	PTR5A-13	2467	25	LPG 4
Fusion 1.6	JU	1.6	74	4	06.02-	FYJA Duratec 16V SFI	1,3	PTR5A-13	2467	25	LPG 4
Fusion 1.6	JU	1.6	74	4	06.02-	FYJB Duratec 16V SFI	1,3	PTR5A-13	2467	25	LPG 4

**GALAXY '95**

Galaxy 2.0	WGR	2.0	85	4	02.95-03.00	NSE DOHC SEFI	1,1	BKR7EIX-11	6988		
Galaxy 2.3 16V	WGR	2.3	107	4	02.95-03.00	Y5B DOHC 16V SEFI	1,3	PFR6G-13E	2341		LPG 1
Galaxy 2.8 VR6 4x4	WGR	2.8	128	6	02.95-03.98	AAA CD V6 SEFI	0,6	BKR5EKUP	2890		
Galaxy 2.8 VR6 4x4	WGR	2.8	128	6	04.98-03.00	AMY CD V6 SEFI	0,6	BKR5EKUP	2890		

**GALAXY 2000**

Galaxy 2.0	WGR	2.0	85	4	04.00-02.06	ZVSA DOHC SEFI	1,1	BKR7EIX-11	6988		
Galaxy 2.3 16V	WGR	2.3	103	4	04.00-02.06	E5SB DOHC 16V SEFI	1,3	PFR6G-13E	2341		LPG 1
Galaxy 2.3 16V	WGR	2.3	107	4	04.00-02.06	E5SA DOHC 16V SEFI	1,3	PFR6G-13E	2341		LPG 1
Galaxy 2.8 24V	WGR	2.8	150	6	04.00-02.06	AYL CD V6 24V SEFI	1,1	PZFR5D-11	1664	34	LPG 6

**GALAXY '06**

Galaxy '06 1.6 EcoBoost	WM	1.6	118	4	02.11-	JTWA / JTWB	0,8	ILZTR6A8G	94769		
-------------------------	----	-----	-----	---	--------	-------------	-----	-----------	-------	--	--

e kW  
C  
y  
i

0201



Stock-No

VLINE

LPG / CNG

**FORD****GALAXY '06**

Galaxy '06 2.0	WM	2.0	107	4	05.06-	AOWA / AOWB	1,3	TR6AP-13	5809		LPG 5
Galaxy '06 2.0 Flexifuel	WM	2.0	107	4	05.06-	TBWA / TBWB	1,3	TR6AP-13	5809		LPG 5
Galaxy '06 2.0 Ecoboost	WM	2.0	149	4	05.11-06.15	TNWA	0,8	LTR6DI-8	96588		
Galaxy '06 2.0 Ecoboost	WM	2.0	176	4	04.15-	C20HDTX	0,8	LTR6DI-8	96588		
Galaxy '06 2.3	WM	2.3	118	4	07.07-06.15	SEWA	1,3	ILTR5K13	90607		

**GRANADA '85**

Granada '85		1.8	66	4	05.85-10.94	REC OHC 2V	0,8	APR6FS	2922		
Granada '85		2.0	74	4	05.85-10.94	NE4 OHC 2V	0,8	APR6FS	2922		
Granada '85		2.0	74	4	05.85-10.94	NER OHC 2V	0,8	APR6FS	2922		
Granada '85		2.0	74	4	05.85-10.94	NRC OHC EFI	0,8	APR6FS	2922		
Granada '85		2.0	77	4	05.85-10.94	N8D DOHC 2V	0,8	BCPR6ES	2330	12	LPG 3
Granada '85		2.0	77	4	05.85-10.94	NEL OHC 2V	0,8	APR6FS	2922		
Granada '85		2.0	77	4	05.85-10.94	NEL OHC 2V Cat.	0,8	APR6FS	2922		
Granada '85		2.0	80	4	05.85-10.94	N8B DOHC 2V	0,8	BCPR6ES	2330	12	LPG 3
Granada '85		2.0	85	4	05.85-10.94	N9F DOHC EFI	0,8	BCPR6ES	2330	12	LPG 3
Granada '85		2.0	85	4	05.85-10.94	NRA OHC EFI	0,8	APR6FS	2922		
Granada '85		2.0	85	4	05.85-10.94	NRA OHC EFI Cat.	0,8	APR6FS	2922		
Granada '85		2.0	85	4	05.85-10.94	NRI OHC EFI	0,8	APR6FS	2922		
Granada '85		2.0	88	4	05.85-10.94	N9D DOHC EFI	0,8	BCPR6ES	2330	12	LPG 3
Granada '85		2.0	90	4	05.85-10.94	N9B DOHC EFI	0,8	BCPR6ES	2330	12	LPG 3
Granada '85		2.4	92	6	05.85-10.94	ARD V6 EFI	1,0	BPR6EFS	3623	7	LPG 5
Granada '85		2.4	96	6	05.85-10.94	ARC V6 EFI	0,8	BCPR6ES	2330	12	LPG 3
Granada '85		2.8	105	6	05.85-10.94	PR4 V6 EFI	0,8	BPR6ES	4008	2	LPG 2
Granada '85		2.8	107	6	05.85-10.94	PR3 V6 EFI	0,8	BPR6ES	4008	2	LPG 2
Granada '85		2.8	110	6	05.85-10.94	PRE V6 EFI	0,8	BPR6ES	4008	2	LPG 2
Granada '85		2.9	107	6	05.85-10.94	BRD V6 EFI	1,0	BPR6EFS	3623	7	LPG 5
Granada '85		2.9	107	6	05.85-10.94	BRE V6 EFI	1,0	BPR6EFS	3623	7	LPG 5
Granada '85		2.9	107	6	05.85-10.94	BRF V6 EFI	1,0	BPR6EFS	3623	7	LPG 5
Granada '85		2.9	110	6	05.85-10.94	BRC V6 EFI	0,8	BCPR6ES	2330	12	LPG 3
Granada '85		2.9	143	6	05.85-10.94	BOA V6 24V EFI	1,1	BKR6EIX-11	3764		

**GRAND C-MAX '11**

Grand C-Max '11 1.0 EcoBoost	BH	1.0	74	3	10.12-	M2DA	0,7	SILZNR8C7H	93593		LPG 4
Grand C-Max '11 1.0 EcoBoost	BH	1.0	92	3	10.12-	M1DA	0,7	SILZNR8C7H	93593		LPG 4
Grand C-Max '11 1.6 EcoBoost	BH	1.6	110	4	12.10-	JQDA / JQDB	0,8	ILZTR6A8G	94769		
Grand C-Max '11 1.6 EcoBoost	BH	1.6	134	4	12.10-	JTDA / JTDB	0,8	ILZTR6A8G	94769		
Grand C-Max '11 1.6 Ti-VCT	BH	1.6	77	4	12.10-	IQDA / IQDB	1,3	TR5B-13	4559	45	LPG 4
Grand C-Max '11 1.6 Ti-VCT	BH	1.6	92	4	12.10-	PNDA	1,3	TR5B-13	4559	45	LPG 4

**KA '96**

Ka '96 1.3	RB	1.3	36	4	09.96-	JJD Endura-E SEFI	1,0	PTR5D-10	3784	31	LPG 5
Ka '96 1.3	RB	1.3	36	4	09.96-	JJF Endura-E SEFI	1,0	PTR5D-10	3784	31	LPG 5
Ka '96 1.3	RB	1.3	36	4	09.96-	JJG Endura-E SEFI	1,0	PTR5D-10	3784	31	LPG 5
Ka '96 1.3	RB	1.3	36	4	09.96-	JJH Endura-E SEFI	1,0	PTR5D-10	3784	31	LPG 5
Ka '96 1.3	RB	1.3	36	4	09.96-	JJL Endura-E SEFI	1,0	PTR5D-10	3784	31	LPG 5
Ka '96 1.3	RB	1.3	37	4	09.96-	JJB Endura-E SEFI	1,0	PTR5D-10	3784	31	LPG 5
Ka '96 1.3	RB	1.3	44	4	09.96-	BAA Duratec 8V SFI	1,3	TR5B-13	4559	45	LPG 4
Ka '96 1.3	RB	1.3	44	4	09.96-	J4D Endura-E SEFI	1,0	PTR5D-10	3784	31	LPG 5
Ka '96 1.3	RB	1.3	44	4	09.96-	J4K Endura-E SEFI	1,0	PTR5D-10	3784	31	LPG 5
Ka '96 1.3	RB	1.3	44	4	09.96-	J4M Endura-E SEFI	1,0	PTR5D-10	3784	31	LPG 5
Ka '96 1.3	RB	1.3	44	4	09.96-	J4N Endura-E SEFI	1,0	PTR5D-10	3784	31	LPG 5





l kW  
C y  
I

0201



Stock-No

VALUE

LPG/CNG

**FORD**

**KA '96**

Ka '96 1.3	RB	1.3	44	4	09.96-	J4P Endura-E SEFI	1,0	PTR5D-10	3784	31	LPG 5
Ka '96 1.3	RB	1.3	44	4	09.96-	J4S Endura-E SEFI	1,0	PTR5D-10	3784	31	LPG 5
Ka '96 1.3	RB	1.3	51	4	09.96-	A9A Duratec 8V SFI	1,3	TR5B-13	4559	45	LPG 4
Ka '96 1.3	RB	1.3	51	4	09.96-	A9B Duratec 8V SFI	1,3	TR5B-13	4559	45	LPG 4
Ka '96 1.6	RB	1.6	70	4	09.96-	CDB Duratec 8V SFI	1,3	PTR5A-13	2467	25	LPG 4
Ka '96 1.6	RB	1.6	70	4	09.96-	CDC Duratec 8V SFI	1,3	PTR5A-13	2467	25	LPG 4

**KA '08**

Ka '08 1.2	JDU	1.2	51	4	02.09-	FP4	1,0	ZKR7A-10	1691	42	LPG 8
------------	-----	-----	----	---	--------	-----	-----	----------	------	----	-------

**KUGA 2**

Kuga 2 1.6 EcoBoost	MA	1.6	110	4	11.12-	JQMA / JQMB	0,8	ILZTR6A8G	94769		
Kuga 2 1.6 EcoBoost	MA	1.6	134	4	11.12-	JTMA	0,8	ILZTR6A8G	94769		

**MAVERICK '93**

Maverick '93 2.4	UDS / UNS	2.4	85	4	06.93-04.98	KA24 OHC 12V SEFI	1,1	ZFR5E-11	4435		
Maverick '93 2.4	UDS / UNS	2.4	87	4	06.93-04.98	KA24 OHC 12V SEFI	1,1	ZFR5E-11	4435		
Maverick '93 2.4	UDS / UNS	2.4	91	4	06.93-04.98	KA24 OHC 12V SEFI	1,1	ZFR5E-11	4435		

**MAVERICK '01**

Maverick '01 2.0 16V		2.0	91	4	12.00-11.03	YF ZETEC-E SFI	1,3	PTR5A-13	2467	25	LPG 4
Maverick '01 2.3 16V		2.3	110	4	12.03-	GZ Duratec-HE SFI	1,3	ITR6F13	4477		LPG 5
Maverick '01 3.0		3.0	145	6	12.00-11.03	AJ Duratec-VE SFI	1,0	TR5IX	7397		LPG 5
Maverick '01 3.0		3.0	149	6	12.03-	AJ Duratec-VE SFI	1,0	TR5IX	7397		LPG 5

**MONDEO '93**

Mondeo '93 1.6		1.6	65	4	01.93-07.96	L1J ZETEC-E SEFI	1,3	PTR5A-13	2467	25	LPG 4
Mondeo '93 1.6		1.6	66	4	01.93-07.96	L1F ZETEC SEFI	1,3	PTR5A-13	2467	25	LPG 4
Mondeo '93 1.8		1.8	82	4	01.93-07.96	RKB ZETEC-E SEFI	1,3	PTR5A-13	2467	25	LPG 4
Mondeo '93 1.8		1.8	85	4	01.93-07.96	RKA ZETEC SEFI	1,3	PTR5A-13	2467	25	LPG 4
Mondeo '93 2.0		2.0	100	4	01.93-07.96	NGA ZETEC SEFI	1,3	PTR5A-13	2467	25	LPG 4
Mondeo '93 2.5 i 24V		2.5	125	6	01.93-07.96	SEA Duratec-VE SEFI	1,0	PTR5D-10	3784	31	LPG 5

**MONDEO '97**

Mondeo '97 1.6		1.6	65	4	08.96-09.00	L1J ZETEC-E SEFI	1,3	PTR5A-13	2467	25	LPG 4
Mondeo '97 1.6 16V		1.6	70	4	08.96-09.00	L1L ZETEC-E SEFI	1,3	PTR5A-13	2467	25	LPG 4
Mondeo '97 1.6 16V		1.6	70	4	08.96-09.00	L1N ZETEC-E SEFI	1,3	PTR5A-13	2467	25	LPG 4
Mondeo '97 1.6 16V		1.6	70	4	08.96-09.00	L1Q ZETEC-E SEFI	1,3	PTR5A-13	2467	25	LPG 4
Mondeo '97 1.8		1.8	85	4	08.96-09.00	RKB ZETEC-E SEFI	1,3	PTR5A-13	2467	25	LPG 4
Mondeo '97 1.8		1.8	85	4	08.96-09.00	RKF ZETEC-E SEFI	1,3	PTR5A-13	2467	25	LPG 4
Mondeo '97 1.8		1.8	85	4	08.96-09.00	RKH ZETEC-E SEFI	1,3	PTR5A-13	2467	25	LPG 4
Mondeo '97 1.8		1.8	85	4	08.96-09.00	RKJ ZETEC-E SEFI	1,3	PTR5A-13	2467	25	LPG 4
Mondeo '97 1.8		1.8	85	4	08.96-09.00	RKK ZETEC-E SEFI	1,3	PTR5A-13	2467	25	LPG 4
Mondeo '97 2.0		2.0	96	4	08.96-09.00	NGA ZETEC-E SEFI	1,3	PTR5A-13	2467	25	LPG 4
Mondeo '97 2.0		2.0	96	4	08.96-09.00	NGB ZETEC-E SEFI	1,3	PTR5A-13	2467	25	LPG 4
Mondeo '97 2.0		2.0	96	4	08.96-09.00	NGC ZETEC-E SEFI	1,3	PTR5A-13	2467	25	LPG 4
Mondeo '97 2.0		2.0	96	4	08.96-09.00	NGD ZETEC-E SEFI	1,3	PTR5A-13	2467	25	LPG 4
Mondeo '97 2.5 24V		2.5	125	6	08.96-09.00	SEA Duratec-VE SEFI	1,0	PTR5D-10	3784	31	LPG 5
Mondeo '97 2.5 24V		2.5	125	6	08.96-09.00	SEB Duratec-VE SEFI	1,0	PTR5D-10	3784	31	LPG 5
Mondeo '97 2.5 24V		2.5	125	6	08.96-09.00	SEC Duratec-VE SEFI	1,0	PTR5D-10	3784	31	LPG 5
Mondeo '97 2.5 ST 200		2.5	151	6	08.96-09.00	SGA Duratec-VE SEFI	1,3	PTR6D-13G	6989		

**MONDEO '01**

Mondeo '01 1.8 16V		1.8	81	4	10.00-08.07	CGBA Duratec-HE SFI	1,3	PTR6F-13	7569		
--------------------	--	-----	----	---	-------------	---------------------	-----	----------	------	--	--

e kW C  
Y  
I

0201

Stock-No  
VLINE

LPG / CNG

**FORD****MONDEO '01**

Mondeo '01 1.8 16V	1.8	81	4	10.00-08.07	CGBB Duratec-HE SFI	1,3	PTR6F-13	7569		
Mondeo '01 1.8 16V	1.8	92	4	10.00-08.07	CHBA Duratec-HE SFI	1,3	PTR6F-13	7569		
Mondeo '01 1.8 16V	1.8	92	4	10.00-08.07	CHBB Duratec-HE SFI	1,3	PTR6F-13	7569		
Mondeo '01 2.0 16V	2.0	107	4	10.00-08.07	CJBA Duratec-HE SFI	1,3	PTR6F-13	7569		
Mondeo '01 2.0 16V	2.0	107	4	10.00-08.07	CJBB Duratec-HE SFI	1,3	PTR6F-13	7569		
Mondeo '01 2.5 V6 24V	2.5	125	6	10.00-08.07	LCBD Duratec-VE SFI	1,3	PTR5D-13	6644	31	
Mondeo '01 3.0 V6 24V	3.0	150	6	10.00-08.07	REBA Duratec-ST SFI	1,3	PTR6D-13G	6989		
Mondeo '01 2.5 ST 220	3.0	166	6	10.00-08.07	MEBA Duratec-ST SFI	1,3	PTR6D-13G	6989		

**MONDEO '07**

Mondeo '07 1.6 Ti	1.6	81	4	02.07-	RHBA Duratec-16V Ti-VCT	1,3	TR5B-13	4559	45	LPG 4
Mondeo '07 1.6 Ti	1.6	88	4	07.10-		1,3	TR5B-13	4559	45	LPG 4
Mondeo '07 1.6 Ti	1.6	92	4	02.07-	PNBA Duratec-16V Ti-VCT	1,3	TR5B-13	4559	45	LPG 4
Mondeo '07 1.6 EcoBoost	1.6	118	4	02.11-	JTBA / JTBB	0,8	ILZTR6A8G	94769		
Mondeo '07 2.0	2.0	107	4	02.07-	AOBA / AOBC	1,3	TR6AP-13	5809		LPG 5
Mondeo '07 2.0 Flexifuel	2.0	107	4	03.07-	TBBA / TBBB	1,3	TR6AP-13	5809		LPG 5
Mondeo '07 2.0 LPG	2.0	107	4	03.09-	TBBA	1,3	TR6AP-13	5809		LPG 5
Mondeo '07 2.3	2.3	118	4	02.07-09.14	SEBA	1,3	ILTR5K13	90607		
Mondeo '07 2.5	2.5	162	5	02.07-	HUBA	0,8	PLFR6A	5472		

**MONDEO '11**

Mondeo '11 2.0 EcoBoost	2.0	149	4	03.11-09.14	TNBA	0,8	LTR6DI-8	96588		
Mondeo '11 2.0 EcoBoost	2.0	176	4	03.11-09.14	TPBA	0,8	LTR6DI-8	96588		
Mondeo '11 2.0 EcoBoost	2.0	176	4	09.14-	R9CB	0,8	LTR6DI-8	96588		
Mondeo '11 2.0 EcoBoost	2.0	176	4	09.14-	R9CF	0,8	LTR6DI-8	96588		
Mondeo '11 2.0 EcoBoost	2.0	176	4	09.14-	R9CH	0,8	LTR6DI-8	96588		
Mondeo '11 2.0 EcoBoost	2.0	149	4	10.14-	TNCD	0,8	LTR6DI-8	96588		
Mondeo '11 2.0 EcoBoost	2.0	146	4	05.15-	TNCC	0,8	LTR6DI-8	96588		
Mondeo Hybrid	CD	2.0	130	4	09.14-	C20EDEF	1,3	ILTR5K13	90607	

**ORION '86**

Orion '86 1.3	1.3	44	4	01.86-07.90	JBB HCS 2V	1,0	BPR6EFS	3623	7	LPG 5
Orion '86 1.3	1.3	44	4	01.86-07.90	JLA VAL VV	1,0	BPR6EFS	3623	7	LPG 5
Orion '86 1.3	1.3	44	4	01.86-07.90	JLA VAL VV Cat.	1,0	BPR6EFS	3623	7	LPG 5
Orion '86 1.3	1.3	44	4	01.86-07.90	JLB VAL VV	1,0	BPR6EFS	3623	7	LPG 5
Orion '86 1.4	1.4	54	4	01.86-07.90	F6B CVH CFI	1,1	BCPR6ES-11	7121	11	LPG 3
Orion '86 1.4	1.4	54	4	01.86-07.90	F6D CVH CFI	1,1	BCPR6ES-11	7121	11	LPG 3
Orion '86 1.4	1.4	54	4	01.86-07.90	FUC CVH 2V	1,1	BCPR7ES-11	1095		BCPR7EIX
Orion '86 1.4	1.4	55	4	01.86-07.90	FUA CVH 2V	0,8	BCPR6ES	2330	12	LPG 3
Orion '86 1.4	1.4	55	4	01.86-07.90	FUA CVH 2V Cat.	0,8	BCPR6ES	2330	12	LPG 3
Orion '86 1.6	1.6	65	4	01.86-07.90	LUG CVH 2V	0,8	BCPR6ES	2330	12	LPG 3
Orion '86 1.6	1.6	66	4	01.86-07.90	L4B CVH FI	0,8	BCPR6ES	2330	12	LPG 3
Orion '86 1.6	1.6	66	4	01.86-07.90	LUC CVH 2V	0,8	BCPR6ES	2330	12	LPG 3
Orion '86 1.6	1.6	66	4	01.86-07.90	LUC CVH 2V Cat.	0,8	BCPR6ES	2330	12	LPG 3
Orion '86 1.6	1.6	75	4	01.86-07.90	LJB CVH EFI	1,1	BCPR6ES-11	7121	11	LPG 3
Orion '86 1.6	1.6	77	4	01.86-07.90	LRB CVH FI	0,8	BCPR7ES	3330		BCPR7EIX
Orion '86 1.6	1.6	77	4	01.86-07.90	LRB CVH FI Cat.	0,8	BCPR7ES	3330		BCPR7EIX
Orion '86 1.6	1.6	79	4	01.86-07.90	LJA CVH EFI	1,1	BCPR6ES-11	7121	11	LPG 3

**ORION '91**

Orion '91 1.3	1.3	44	4	08.90-07.93	J6A HCS CFI	1,0	PTR5D-10	3784	31	LPG 5
---------------	-----	----	---	-------------	-------------	-----	----------	------	----	-------



l kW  
C  
Y  
I

0201



Stock-No

VLINE

LPG/CNG

**FORD**

**ORION '91**

Orion '91 1.3	1.3	44	4	08.90-07.93	JBE HCS 2V	1,0	PTR5D-10	3784	31	LPG 5
Orion '91 1.3	1.3	46	4	08.90-07.93	JBD HCS 2V	1,0	PTR5D-10	3784	31	LPG 5
Orion '91 1.4	1.4	52	4	08.90-07.93	F6F CVH CFI	1,1	BCPR6ES-11	7121	11	LPG 3
Orion '91 1.4	1.4	52	4	08.90-07.93	F6G CVH CFI	1,1	BCPR6ES-11	7121	11	LPG 3
Orion '91 1.4	1.4	54	4	08.90-07.93	FUH CVH 2V	0,8	BCPR6ES	2330	12	LPG 3
Orion '91 1.6 16V	1.6	66	4	08.90-07.93	L1E ZETEC SEFI	1,3	PTR5A-13	2467	25	LPG 4
Orion '91 1.6 16V	1.6	66	4	08.90-07.93	LUJ CVH 2V	0,8	BCPR6ES	2330	12	LPG 3
Orion '91 1.6 16V	1.6	66	4	08.90-07.93	LUK CVH 2V	0,8	BCPR6ES	2330	12	LPG 3
Orion '91 1.6	1.6	77	4	08.90-07.93	LJF CVH EFI	1,1	BCPR6ES-11	7121	11	LPG 3
Orion '91 1.6	1.6	79	4	08.90-07.93	LJE CVH EFI	1,1	BCPR6ES-11	7121	11	LPG 3
Orion '91 1.8 16V	1.8	77	4	08.90-07.93	RDA ZETEC SEFI	1,3	PTR5A-13	2467	25	LPG 4
Orion '91 1.8 16V	1.8	96	4	08.90-07.93	RQB ZETEC SEFI	1,3	PTR5A-13	2467	25	LPG 4

**PROBE**

Probe 2.0	2.0	85	4	01.93-07.97	FS DOHC 16V SEFI	1,1	BCPR6ES-11	7121	11	LPG 3
Probe 2.2 GT	2.2	108	4	03.91-12.92	OHC EFI	1,1	ZFR6F-11	4291		LPG 6
Probe 2.5 V6 24V	2.5	120	6	01.93-07.97	KL V6 24V EFI	1,1	ZFR6F-11	4291		LPG 6

**PUMA '97**

Puma '97 1.4 16V	EC	1.4	66	4	06.97-12.01	FHD ZETEC-SE SEFI	1,3	PTR5A-13	2467	25	LPG 4
Puma '97 1.4 16V	EC	1.4	66	4	06.97-12.01	FHF ZETEC-SE SEFI	1,3	PTR5A-13	2467	25	LPG 4
Puma '97 1.6 16V	EC	1.6	76	4	06.97-12.01	L1W ZETEC-SE SFI	1,3	PTR5A-13	2467	25	LPG 4
Puma '97 1.7 16V	EC	1.7	92	4	06.97-12.01	MHA ZETEC-S VCT SFI	1,3	PTR5A-13	2467	25	LPG 4
Puma '97 1.7 16V	EC	1.7	92	4	06.97-12.01	MHB ZETEC-S VCT SFI	1,3	PTR5A-13	2467	25	LPG 4

**SCORPIO '85**

Scorpio '85 1.8		1.8	66	4	05.85-10.94	REC OHC 2V	0,8	APR6FS	2922		
Scorpio '85 2.0		2.0	74	4	05.85-10.94	NE4 OHC 2V	0,8	APR6FS	2922		
Scorpio '85 2.0		2.0	74	4	05.85-10.94	NER OHC 2V	0,8	APR6FS	2922		
Scorpio '85 2.0 i		2.0	74	4	05.85-10.94	NRC OHC EFI	0,8	APR6FS	2922		
Scorpio '85 2.0		2.0	77	4	05.85-10.94	N8D DOHC 2V	0,8	BCPR6ES	2330	12	LPG 3
Scorpio '85 2.0		2.0	77	4	05.85-10.94	NEL OHC 2V	0,8	APR6FS	2922		
Scorpio '85 2.0		2.0	77	4	05.85-10.94	NEL OHC 2V Cat.	0,8	APR6FS	2922		
Scorpio '85 2.0		2.0	80	4	05.85-10.94	N8B DOHC 2V	0,8	BCPR6ES	2330	12	LPG 3
Scorpio '85 2.0 i		2.0	85	4	05.85-10.94	N9F DOHC EFI	0,8	BCPR6ES	2330	12	LPG 3
Scorpio '85 2.0 i		2.0	85	4	05.85-10.94	NRA OHC EFI	0,8	APR6FS	2922		
Scorpio '85 2.0 i		2.0	85	4	05.85-10.94	NRA OHC EFI Cat.	0,8	APR6FS	2922		
Scorpio '85 2.0 i		2.0	85	4	05.85-10.94	NRI OHC EFI	0,8	APR6FS	2922		
Scorpio '85 2.0 i		2.0	88	4	05.85-10.94	N9D DOHC EFI	0,8	BCPR6ES	2330	12	LPG 3
Scorpio '85 2.0 i		2.0	90	4	05.85-10.94	N9B DOHC EFI	0,8	BCPR6ES	2330	12	LPG 3
Scorpio '85 2.4 i		2.4	92	6	05.85-10.94	ARD V6 EFI	1,0	BPR6EFS	3623	7	LPG 5
Scorpio '85 2.4 i		2.4	96	6	05.85-10.94	ARC V6 EFI	0,8	BCPR6ES	2330	12	LPG 3
Scorpio '85 2.8 i		2.8	105	6	05.85-10.94	PR4 V6 EFI	0,8	BPR6ES	4008	2	LPG 2
Scorpio '85 2.8 i		2.8	107	6	05.85-10.94	PR3 V6 EFI	0,8	BPR6ES	4008	2	LPG 2
Scorpio '85 2.8 i		2.8	110	6	05.85-10.94	PRE V6 EFI	0,8	BPR6ES	4008	2	LPG 2
Scorpio '85 2.9 i		2.9	107	6	05.85-10.94	BRD V6 EFI	1,0	BPR6EFS	3623	7	LPG 5
Scorpio '85 2.9 i		2.9	107	6	05.85-10.94	BRE V6 EFI	1,0	BPR6EFS	3623	7	LPG 5
Scorpio '85 2.9 i		2.9	107	6	05.85-10.94	BRF V6 EFI	1,0	BPR6EFS	3623	7	LPG 5
Scorpio '85 2.9 i		2.9	110	6	05.85-10.94	BRC V6 EFI	0,8	BCPR6ES	2330	12	LPG 3
Scorpio '85 2.9 i Cosworth		2.9	143	6	05.85-10.94	BOA V6 24V EFI	1,3	PFR6G-13E	2341		LPG 1

**SCORPIO '95**

Scorpio '95 2.0 i		2.0	85	4	10.94-06.98	NSD DOHC 8V SEFI	1,1	PFR6B-11	4014		PFR7B
-------------------	--	-----	----	---	-------------	------------------	-----	----------	------	--	-------

e kW C  
y  
i

0201



Stock-No

VELINE

LPG / CNG

**FORD****SCORPIO '95**

Scorpio '95 2.0 i	2.0	100	4	10.94-06.98	N3A DOHC 16V SEFI	1,1	PFR6B-11	4014		PFR7B
Scorpio '95 2.3	2.3	108	4	10.94-06.98	Y5A 16V SEFI	1,3	PFR6G-13E	2341		LPG 1
Scorpio '95 2.9 i	2.9	110	6	10.94-06.98	BRG V6 12V SEFI	1,0	BPR6EFS	3623	7	LPG 5
Scorpio '95 2.9 i Cosworth	2.9	152	6	10.94-06.98	BOB V6 24V SEFI	1,1	PFR6B-11	4014		PFR7B

**SIERRA '87**

Sierra '87 1.6	1.6	53	4	01.87-12.92	LSF OHC 2V	0,8	APR6FS	2922		
Sierra '87 1.6	1.6	55	4	01.87-12.92	LSE OHC 2V	0,8	APR6FS	2922		
Sierra '87 1.6	1.6	55	4	01.87-12.92	LSE OHC 2V Cat.	0,8	APR6FS	2922		
Sierra '87 1.6	1.6	59	4	01.87-12.92	L6B CVH CFI	1,1	BCPR6ES-11	7121	11	LPG 3
Sierra '87 1.8	1.8	59	4	01.87-12.92	RED OHC 2V Cat.	0,8	APR6FS	2922		
Sierra '87 1.8	1.8	59	4	01.87-12.92	REF OHC 2V	0,8	APR6FS	2922		
Sierra '87 1.8	1.8	63	4	01.87-12.92	R6A CVH CFI	1,1	BCPR6ES-11	7121	11	LPG 3
Sierra '87 1.8	1.8	64	4	01.87-12.92	R2C CVH 2V	1,1	BCPR6ES-11	7121	11	LPG 3
Sierra '87 1.8	1.8	66	4	01.87-12.92	R2A CVH 2V	1,1	BCPR6ES-11	7121	11	LPG 3
Sierra '87 1.8	1.8	66	4	01.87-12.92	RED OHC 2V	0,8	APR6FS	2922		
Sierra '87 2.0 i	2.0	74	4	01.87-12.92	N4B OHC EFI	0,8	APR6FS	2922		
Sierra '87 2.0 i	2.0	74	4	01.87-12.92	NE5 OHC 2V	0,8	APR6FS	2922		
Sierra '87 2.0 i	2.0	74	4	01.87-12.92	NEJ OHC 2V	0,8	APR6FS	2922		
Sierra '87 2.0	2.0	77	4	01.87-12.92	N8C DOHC 2V	0,8	BCPR6ES	2330	12	LPG 3
Sierra '87 2.0	2.0	77	4	01.87-12.92	NES OHC 2V	0,8	APR6FS	2922		
Sierra '87 2.0	2.0	77	4	01.87-12.92	NES OHC 2V Cat.	0,8	APR6FS	2922		
Sierra '87 2.0 i	2.0	80	4	01.87-12.92	N8A DOHC 2V	0,8	BCPR6ES	2330	12	LPG 3
Sierra '87 2.0 i	2.0	85	4	01.87-12.92	N4A OHC EFI	0,8	APR6FS	2922		
Sierra '87 2.0 i	2.0	85	4	01.87-12.92	N4A OHC EFI Cat.	0,8	APR6FS	2922		
Sierra '87 2.0 i	2.0	85	4	01.87-12.92	N4I OHC EFI	0,8	APR6FS	2922		
Sierra '87 2.0 i	2.0	85	4	01.87-12.92	N9E DOHC EFI	0,8	BCPR6ES	2330	12	LPG 3
Sierra '87 2.0 i	2.0	88	4	01.87-12.92	N9C DOHC EFI	0,8	BCPR6ES	2330	12	LPG 3
Sierra '87 2.0 i	2.0	90	4	01.87-12.92	N9A DOHC EFI	0,8	BCPR6ES	2330	12	LPG 3
Sierra '87 2.0 16V Cosworth 4x4	2.0	162	4	01.87-12.92	N5C DOHC COSWORTH	1,1	PFR7B-11	5667		
Sierra '87 2.0 16V Cosworth 4x4	2.0	162	4	01.87-12.92	N5D DOHC COSWORTH	1,1	PFR7B-11	5667		
Sierra '87 2.8 i	2.8	105	6	01.87-12.92	PR8 V6 EFI	0,8	BPR6ES	4008	2	LPG 2
Sierra '87 2.8 i	2.8	107	6	01.87-12.92	PR7 V6 EFI	0,8	BPR6ES	4008	2	LPG 2
Sierra '87 2.8 i	2.8	110	6	01.87-12.92	PRG V6 FI	0,8	BPR6ES	4008	2	LPG 2
Sierra '87 2.9 i	2.9	107	6	01.87-12.92	B4B V6 EFI	1,0	BPR6EFS	3623	7	LPG 5
Sierra '87 2.9 i	2.9	107	6	01.87-12.92	B4C V6 EFI	1,0	BPR6EFS	3623	7	LPG 5
Sierra '87 2.9 i	2.9	110	6	01.87-12.92	B4A V6 EFI	0,8	BCPR6ES	2330	12	LPG 3

**S-MAX**

S-MAX 1.6 EcoBoost	WS	1.6	118	4	02.11-	JTWA	0,8	ILZTR6A8G	94769	
S-Max Ecoboost	FS	2.0	176	4	02.15-	C20HDTX	0,8	LTR6DI-8	96588	
S-Max Ecoboost	WS	2.0	146	4	02.11-12.14	TNWB	0,8	LTR6DI-8	96588	
S-Max Ecoboost	WS	2.0	149	4	05.11-12.14	TNWA	0,8	LTR6DI-8	96588	
S-Max Ecoboost	WS	2.0	176	4	05.11-12.14	TPWA	0,8	LTR6DI-8	96588	
S-MAX 2.0	WS	2.0	107	4	03.06-	AOWA / AOWB	1,3	TR6AP-13	5809	LPG 5
S-MAX 2.0 Flexifuel	WS	2.0	107	4	05.06-	TBWA / TBWB	1,3	TR6AP-13	5809	LPG 5
S-MAX 2.3	WS	2.3	118	4	08.07-12.14	SEWA	1,3	ILTR5K13	90607	
S-MAX 2.5 ST	WS	2.5	162	5	03.06-	HUWA	0,8	PLFR6A	5472	

**SPORT-KA**

Sportka		1.6		4	05.03-	Duratec Rocam	1,3	TR5B-13	4559	45	LPG 4
---------	--	-----	--	---	--------	---------------	-----	---------	------	----	-------

e kW  
C  
Y  
I

0201



Stock-No

VALVE

LPG / CNG

**FORD****STREET-KA**

Streetka	1.6	70	4	01.03-07.05	CDRA Duratec 8V	1,3	TR5B-13	4559	45	LPG 4
Streetka	1.6	70	4	01.03-07.05	CDRB Duratec 8V	1,3	PTR5A-13	2467	25	LPG 4

**TOURNEO CONNECT I**

Tourneo Connect I 1.8	1.8	85	4	06.02-	EYPA ZETEC-E SFI	1,3	PTR5A-13	2467	25	LPG 4
Tourneo Connect I 1.8	1.8	85	4	06.02-	EYPC ZETEC-E SFI	1,0	TR5A-10	0005		

**TOURNEO CONNECT II**

Tourneo Connect II 1.0 EcoBoost	GAD	1.0	74	3	11.13-	M2GA	0,7	SILZNR8C7H	93593		LPG 4
Tourneo Connect II 1.6 EcoBoost	GAD	1.6	110	4	11.13-	JQGA	0,8	ILZTR6A8G	94769		

**TRANSIT CONNECT I**

Transit Connect	1.8	85	4	06.02-	EYPA ZETEC-E SFI	1,3	PTR5A-13	2467	25	LPG 4
Transit Connect	1.8	85	4	06.02-	EYPC ZETEC-E SFI	1,0	TR5A-10	0005		

**TRANSIT CONNECT II**

Transit Connect II 1.0 EcoBoost	GCD	1.0	74	3	11.13-	M2GA	0,7	SILZNR8C7H	93593		LPG 4
Transit Connect II 1.6 EcoBoost	GCD	1.6	110	4	11.13-	JQGA	0,8	ILZTR6A8G	94769		

**TRANSIT '86**

Transit '86	1.6	46	4	01.86-07.91	LAC OHC VV	0,8	APR6FS	2922		
Transit '86	1.6	46	4	01.86-07.91	LAT OHC VV	0,8	APR6FS	2922		
Transit '86	2.0	55	4	01.86-07.91	NAV OHC VV	0,8	APR6FS	2922		
Transit '86	2.0	56	4	01.86-07.91	NAW OHC	0,8	APR6FS	2922		
Transit '86	2.0	56	4	01.86-07.91	NAX OHC	0,8	APR6FS	2922		
Transit '86	2.0	57	4	01.86-07.91	N6T OHC CFI	0,8	APR6FS	2922		
Transit '86	2.0	57	4	01.86-07.91	NAT OHC VV	0,8	APR6FS	2922		
Transit '86	2.0	60	4	01.86-07.91	N6TS OHC CFI	0,8	APR6FS	2922		
Transit '86	2.9	110	6	01.86-07.91	B4T V6 EFI	0,8	BCPR6ES	2330	12	LPG 3
Transit '86	3.0	78	6	01.86-07.91	HXC V6 ESX 1V	0,8	BPR6ES	4008	2	LPG 2

**TRANSIT '92**

Transit '92	2.0	66	4	08.91-07.94	NBA OHC 2V	0,8	APR6FS	2922		
Transit '92	2.0	72	4	08.91-07.94	NCA OHC EFI	0,8	APR6FS	2922		
Transit '92	2.9	107	6	08.91-07.94	BRT V6 EFI	1,1	BCPR6ES-11	7121	11	LPG 3
Transit '95	2.0	84	4	08.94-07.00	NSF DOHC 8V SEFI	1,1	BKR7EIX-11	6988		
Transit '95	2.0	84	4	08.94-07.00	NSG DOHC 8V SEFI	1,1	BKR7EIX-11	6988		
Transit '95	2.0	84	4	08.94-07.00	NSH DOHC-8V SEFI	1,1	BKR7EIX-11	6988		

**TRANSIT '2000**

Transit 2000.5 (RW)	2.3	107	4	01.00-05.06	E5FA	1,1	PFR6B-11	4014		PFR7B
Transit 2000.5 (RW)	2.3	107	4	01.00-05.06	E5FC	1,1	PFR6B-11	4014		PFR7B

**WINDSTAR**

Windstar	3.0	109	6	10.94-	V6 SEFI	1,0	TR5	2238		LPG 5
----------	-----	-----	---	--------	---------	-----	-----	------	--	-------

**FORD (USA)****BRONCO**

Bronco	4.9		6	.87- .95	Y EFI	1,1	WR4-1	4652		
Bronco	5.0		8	.85- .96	N EFI	1,1	UR4	6630		UR51X
Bronco	5.8		8	.88- .95	H EFI	1,3	UR5	2771		UR61X

e kW  
C  
y  
i

0201



Stock-No

VLINE

LPG / CNG

**FORD (USA)****BRONCO**

Bronco II	4.0		6	.90-	X EFI	1,5	TR55	3951		LPG 5
-----------	-----	--	---	------	-------	-----	------	------	--	-------

**GT**

GT	5.4	368	8	09.06-		1,0	TR6	4177		
----	-----	-----	---	--------	--	-----	-----	------	--	--

**MUSTANG**

Mustang (Mexico)	3.0		6	.06-	V6 24V DOHC	1,5	TR55	3951		LPG 5
------------------	-----	--	---	------	-------------	-----	------	------	--	-------

Mustang	3.8		6	.03-	V6	1,5	TR55	3951		LPG 5
---------	-----	--	---	------	----	-----	------	------	--	-------

Mustang	4.0		6	.05-	V6	1,1	TR55	3951		LPG 5
---------	-----	--	---	------	----	-----	------	------	--	-------

Mustang	4.6		8	.03-	V8	1,5	TR55	3951		LPG 5
---------	-----	--	---	------	----	-----	------	------	--	-------

Mustang GTDI Ecoboost	P8T	2.3	231	4	12.14-	C23HD0D	0,8	LTR6DI-8	96588	
-----------------------	-----	-----	-----	---	--------	---------	-----	----------	-------	--

**TAURUS**

Taurus	3.0		6	.89- .95	Y DOHC V6 SFI	1,1	PFR5G-11	2647		PFR6G-11
--------	-----	--	---	----------	---------------	-----	----------	------	--	----------

Taurus	3.0		6	.92- .99	U OHV V6 SFI	1,0	TR5	2238		LPG 5
--------	-----	--	---	----------	--------------	-----	-----	------	--	-------

Taurus	3.0		8	.96- .99	N SHO V8 SFI	1,0	TR5	2238		LPG 5
--------	-----	--	---	----------	--------------	-----	-----	------	--	-------

Taurus	3.0		6	.96- .99	S DOHC V6 SFI	1,5	TR55	3951		LPG 5
--------	-----	--	---	----------	---------------	-----	------	------	--	-------

Taurus	3.2		6	.93- .95	P SHO V6 SFI	1,1	PFR5G-11	2647		PFR6G-11
--------	-----	--	---	----------	--------------	-----	----------	------	--	----------

**THUNDERBIRD**

Thunderbird	3.8		6	.88- .97	4 EFI V6 EFI	1,5	TR55-1	2683		TR55-11X
-------------	-----	--	---	----------	--------------	-----	--------	------	--	----------

Thunderbird	3.8		6	.89- .95	R EFI V6 EFISupercharged	1,5	TR55-1	2683		TR55-11X
-------------	-----	--	---	----------	--------------------------	-----	--------	------	--	----------

Thunderbird	3.9		8	- .02	A EFI V8 DOHC	1,1	BKR5ES-11	2382	33	LPG 1
-------------	-----	--	---	-------	---------------	-----	-----------	------	----	-------

Thunderbird	3.9		8	.03-	A EFI V8 DOHC	1,0	BKR5ES-11	2382	33	LPG 1
-------------	-----	--	---	------	---------------	-----	-----------	------	----	-------

Thunderbird	4.6		8	.94- .97	W EFI V8 SOHC	1,5	TR55	3951		LPG 5
-------------	-----	--	---	----------	---------------	-----	------	------	--	-------

Thunderbird	5.0		8	.91- .93	T EFI V8 H O	1,5	UR45	6945		
-------------	-----	--	---	----------	--------------	-----	------	------	--	--

**FSO**

Polonez	1.4	75	4	09.93-	16DOHC Rover	0,8	BKR6ES	3783	28	LPG 1
---------	-----	----	---	--------	--------------	-----	--------	------	----	-------

Polonez	1.5	60	4	07.95-	Cat.	0,8	BP6ET	1263		LPG 2
---------	-----	----	---	--------	------	-----	-------	------	--	-------

Polonez	1.6	64	4	07.95-	Cat.	0,8	BP6ET	1263		LPG 2
---------	-----	----	---	--------	------	-----	-------	------	--	-------

**GAZ (VOLGA)**

Gazel	2.5	119	4	.07-	3M3-4052	0,9	BPR5ES	4006	6	LPG 2
-------	-----	-----	---	------	----------	-----	--------	------	---	-------

Gazel Euro3	2.5	119	4	.07-	3M3-405.24	0,8	BKR5ES	2460	35	
-------------	-----	-----	---	------	------------	-----	--------	------	----	--

Gazel	2.7	105	4	.07-	3M3-409	0,9	BPR5ES	4006	6	LPG 2
-------	-----	-----	---	------	---------	-----	--------	------	---	-------

Gazel Euro3	2.7	105	4	.07-	3M3-409.10	0,8	BKR5ES	2460	35	
-------------	-----	-----	---	------	------------	-----	--------	------	----	--

Sobol	2.5	119	4	.07-	3M3-4052	0,9	BPR5ES	4006	6	LPG 2
-------	-----	-----	---	------	----------	-----	--------	------	---	-------

Sobol Euro3	2.5	119	4	.07-	3M3-405.24	0,8	BKR5ES	2460	35	
-------------	-----	-----	---	------	------------	-----	--------	------	----	--

Sobol	2.7	105	4	.07-	3M3-409	0,9	BPR5ES	4006	6	LPG 2
-------	-----	-----	---	------	---------	-----	--------	------	---	-------

Sobol Euro3	2.7	105	4	.07-	3M3-409.10	0,8	BKR5ES	2460	35	
-------------	-----	-----	---	------	------------	-----	--------	------	----	--

Volga	2.7	105	4	.07-	3M3-409	0,9	BPR5ES	4006	6	LPG 2
-------	-----	-----	---	------	---------	-----	--------	------	---	-------

Volga Euro3	2.7	105	4	.07-	3M3-409.10	0,8	BKR5ES	2460	35	
-------------	-----	-----	---	------	------------	-----	--------	------	----	--

Volga 31105-501	2.4	110		.06-	DCC	1,1	LZTR4A-11	5444		
-----------------	-----	-----	--	------	-----	-----	-----------	------	--	--

Volga 3111	2.3	107	4	.00-	3M3-4062.10	0,9	BPR5ES	4006	6	LPG 2
------------	-----	-----	---	------	-------------	-----	--------	------	---	-------

Volga 3111	2.5	112	4	.00-	3M3-4052.10	0,9	BPR5ES	4006	6	LPG 2
------------	-----	-----	---	------	-------------	-----	--------	------	---	-------

**HOMMELL**

Berlinette RS 16V	2.0	123	4	.98-	XU10.J4RS	0,9	BKR6EK	2288	20	LPG 1
-------------------	-----	-----	---	------	-----------	-----	--------	------	----	-------



l kW  
C  
y  
i

0201



Stock-No

ULINE

LPG/CNG

**HONDA**

**ACCORD**

Accord 1.8 i /iLS	CE7	1.8	85	4	.96-10.98	F18A3	1,1	ZFR6F-11	4291		LPG 6
Accord 1.8 iS	CG8	1.8	100	4	.99-02.03	F18B2	1,1	ZFR6F-11	4291		LPG 6
Accord 2.0	CB3	2.0	66	4	.90-05.93	F20A2 Cat.	1,1	ZFR6F-11	4291		LPG 6
Accord 2.0	CB3	2.0	66	4	.90-05.93	F20A6	1,1	ZFR6F-11	4291		LPG 6
Accord 2.0i	CC7	2.0	85	4	.93-	F30Z2	1,1	ZFR6F-11	4291		LPG 6
Accord 2.0 S,LS,ES	CC7	2.0	96	4	.93-	F20Z1	1,1	ZFR6F-11	4291		LPG 6
Accord 2.0i LS	CE8	2.0	96	4	.95-		1,1	ZFR6F-11	4291		LPG 6
Accord 2.0i LS/ES	CE8	2.0	96	4	.96-	F20Z1	1,1	ZFR6F-11	4291		LPG 6
Accord 2.0i 16V	CA5	2.0	98	4	.88-	B20A8 Cat.	1,1	BCPR6E-11	3132	11	LPG 3
Accord 2.0i	CB3	2.0	98	4	01.90-10.98	F20A4	1,1	ZFR6F-11	4291		LPG 6
Accord 2.0i	CB3	2.0	98	4	.90-	F20A8	1,1	ZFR6F-11	4291		LPG 6
Accord 2.0i 16V EX	CA	2.0	101	4	.87-	B20A2	1,1	BCPR6EY-N-11	6262		
Accord 2.0iLS / iES	CG9	2.0	108	4	.99-02.03	F20B6	1,1	ZFR6F-11	4291		LPG 6
Accord 2.0i	CL7	2.0	114	4	10.02-	K20A6	1,1	ZFR6K-11	6711		
Accord 2.0 Sport	CL7	2.0	114	4	10.02-	K20A6	1,1	ZFR6K-11	6711		
Accord 2.0 iVtec	CU1	2.0	115	4	06.08-06.15	R20A3	1,1	SILZKR7C11S	92932		
Accord 2.0 iVtec	CW1	2.0	115	4	07.08-06.15	R20A3	1,1	SILZKR7C11S	92932		
Accord 2.2i (4WS)	CB7	2.2	110	4	.90-05.03	F22A3	1,1	ZFR6F-11	4291		LPG 6
Accord 2.2i 16V	CE9	2.2	110	4	.95-10.98		1,1	ZFR6F-11	4291		LPG 6
Accord 2.2i VTEC	CE9	2.2	110	4	.95-10.98	F22Z2	1,1	ZFR6F-11	4291		LPG 6
Accord 2.2iR	CH1	2.2	156	4	.99-02.03	H22A7	1,1	PZFR6F-11	3271		LPG 6
Accord 2.3 ES	CL3	2.3	113	4	.01-05.03	F23Z5	1,1	ZFR6F-11	4291		LPG 6
Accord 2.3 SR	CC7	2.3	116	4	.93-05.03	H23A3	1,1	ZFR6F-11	4291		LPG 6
Accord 2.4i	CL9	2.4	140	4	02.03-	K24A3	1,1	IZFR6K11	6994		IZFR6K11
Accord 2.4 Sport	CL9	2.4	140	4	02.03-	K24A3	1,1	IZFR6K11	6994		IZFR6K11
Accord 2.4	CU2	2.4	148	4	.09-	K24Z3	1,1	ILZKR7B11GS	7960		

**ACCORD AERO**

Accord Aero 2.0 EX	CA-53700C	2.0	75	4	.87-	A20A1 Cat. 5MT	1,1	BPR6EY-11	3577	10	LPG 2
Accord Aero 2.0 EX	CA-54700C	2.0	76	4	.87-	A20A1 Cat. 4AT	1,1	BPR6EY-11	3577	10	LPG 2
Accord Aero 2.0 EX	CA-53300C	2.0	78	4	.86-	A20A2	1,1	BPR6EY-11	3577	10	LPG 2
Accord Aero 2.0 EX	CA-54300C	2.0	78	4	.86-	A20A2	1,1	BPR6EY-11	3577	10	LPG 2
Accord Aero 2.0i EX	CA-53800C	2.0	85	4	.87-	A20A3 Cat.	1,1	BPR6EY-11	3577	10	LPG 2
Accord Aero 2.0i EX	CA-54800C	2.0	85	4	.87-	A20A3 Cat.	1,1	BPR6EY-11	3577	10	LPG 2
Accord Aero 2.0 Exi	CA-53400C	2.0	90	4	.86-	A20A4	1,1	BPR6EY-11	3577	10	LPG 2
Accord Aero 2.0 Exi	CA-54400C	2.0	90	4	.86-	A20A4	1,1	BPR6EY-11	3577	10	LPG 2
Accord Aero 2.0i	CC9	2.0	98	4	.93-	F20Z3	1,1	ZFR6F-11	4291		LPG 6
Accord Aero 2.0i LS, ES	CE2	2.0	100	4	.94-	F20B3	1,1	ZFR6F-11	4291		LPG 6
Accord Aero 2.2i	CB8	2.2	110	4	.91- .91	F22A7-F22A8	1,1	ZFR6F-11	4291		LPG 6
Accord Aero 2.2i LS, ES	CE1	2.2	110	4	.94-10.98	F22B5	1,1	ZFR6F-11	4291		LPG 6

**ACCORD COUPE**

Accord Coupe 2.0	CC1	2.0	98	4	.92-	F20A7	1,1	ZFR6F-11	4291		LPG 6
Accord Coupe 2.0i ES / iLS	CG4	2.0	108	4	01.98-	F20B5	1,1	ZFR6F-11	4291		LPG 6
Accord Coupe 2.2i	CD7	2.2	110	4	.94-10.98	F22B5	1,1	ZFR6F-11	4291		LPG 6
Accord Coupe 3.0i V6	CG2	3.0	147	6	.98-	J30A1	1,1	ZFR5F-11	2262	40	LPG 6
Accord Tourer	CM1	2.0	114	4	04.03-	K20A6	1,1	ZFR6K-11	6711		
Accord Tourer	CM2	2.4	140	4	04.03-	K24A3	1,1	IZFR6K11	6994		IZFR6K11
Accord Tourer 2.4	CW2	2.4	148	4	.09-	K24Z3	1,1	ILZKR7B11GS	7960		

**CIVIC**

Civic 1.3	EC8	1.3	55	4	.88-09.91	D13B1	1,1	BCPR6E-11	3132	11	LPG 3
-----------	-----	-----	----	---	-----------	-------	-----	-----------	------	----	-------

e kW  
C  
y  
i

0201



Stock-No

VELINE

LPG / CNG

**HONDA  
CIVIC**

Civic 1.3	EC8	1.3	55	4	.90-	.95	D13B2 Cat.	1,1	BCPR6E-11	3132	11	LPG 3
Civic 1.3	EG3	1.3	55	4	.92-	.95	D13B2	1,1	BKR6E-11	2756	14	LPG 1
Civic 1.3 IMA Hybrid	ES9	1.3	61	4	.04-		LDA1 Twinspark	1,1	IFR5G-11K	3107		
Civic 1.3i IMA Hybrid	ES9	1.3	66	4	.03-			1,1	IFR5G-11K	3107		
Civic 1.3 Hybrid	FD3	1.3	85	4	11.05-		LDA	1,1	ILFR6J-11K	4458		
Civic 1.4i	EJ9	1.4	55	4	.96-02.01		D14A3	1,1	BKR6E-11	2756	14	LPG 1
Civic 1.4i	EJ9	1.4	55	4	.99-02.01		D14Z1	1,1	ZFR5J-11	5584		
Civic 1.4	FN / FK	1.4	61	4	.06-		L13A7 Twinspark	1,1	IFR6G-11K	1314		
Civic 1.4	EC9 / ED2	1.4	66	4	.88-		D14A1	1,1	BCPR6E-11	3132	11	LPG 3
Civic 1.4iS	EJ9	1.4	66	4	.96-02.01		D14A4	1,1	BKR6E-11	2756	14	LPG 1
Civic 1.4iS	EJ9	1.4	66	4	.99-12.05		D14Z2	1,1	ZFR5J-11	5584		
Civic 1.4	EU7	1.4	66	4	03.01-09.05		D14Z6	1,1	ZFR5J-11	5584		
Civic 1.4	FN4	1.4	74	4	.09-		L13Z1	1,3	IZFR6K13	6774		
Civic 1.4		1.4		4	01.97-		PIJ (SOHC)	1,1	ZFR5F-11	2262	40	LPG 6
Civic 1.4 i-VTEC	FB	1.4	73	4	02.12-		L13Z4	1,3	IZFR6K13	6774		
Civic 1.4i 5Door	MB2	1.4	55	4	.97-		D14A7	1,1	ZFR5F-11	2262	40	LPG 6
Civic 1.4i 5Door	MB2	1.4	55	4	.99-		D14Z3	1,1	ZFR5F-11	2262	40	LPG 6
Civic 1.4i 5Door	MA8	1.4	66	4	.95-		D14A2	1,1	BKR6E-11	2756	14	LPG 1
Civic 1.4 iS 5Door	MB2	1.4	66	4	.97-		D14A8	1,1	ZFR5F-11	2262	40	LPG 6
Civic 1.4iS 5Door	MB2	1.4	66	4	.99-		D14Z4	1,1	ZFR5F-11	2262	40	LPG 6
Civic 1.4 5Door	EU7	1.4	66	4	.01-09.05		D14Z6 SOHC	1,1	ZFR5J-11	5584		
Civic 1.4 5 Door	FK1	1.4	74	4	.09-		L13Z1	1,3	IZFR6K13	6774		
Civic 1.4 5 Door		1.4		4			PIH	1,1	BKR6E-11	2756	14	LPG 1
Civic IX 1.4 i-VTEC	FK	1.4	73	4	02.12-		L13Z4	1,3	IZFR6K13	6774		
Civic 1.4i 5Door	MA8	1.4	55	4	.96-		D14A5	1,1	BKR6E-11	2756	14	LPG 1
Civic 1.4i Aerodeck	MB8	1.4	55	4	.98-		D14A7	1,1	ZFR6F-11	4291		LPG 6
Civic 1.4iS Aerodeck	MB8	1.4	66	4	.98-		D14A8	1,1	ZFR6F-11	4291		LPG 6
Civic 1.5i VTEC Aerodeck	MB9	1.5	85	4	.98-		D15Z8	1,1	ZFR6F-11	4291		LPG 6
Civic 1.5 VTEC-E 5Door	MA9	1.5	66	4	.95-		D15Z3	1,1	ZFR6F-11	4291		LPG 6
Civic 1.5 Vtec 5Door	MB3	1.5	85	4	.97-		D15Z8	1,1	ZFR5F-11	2262	40	LPG 6
Civic 1.5i	ED6 / ED3	1.5	66	4	.89-09.91		D15B2 Cat.	1,1	BCPR6E-11	3132	11	LPG 3
Civic 1.5 DXI/Lsi	EG4 / EG8	1.5	66	4	.92-		D15B2	1,1	BKR6E-11	2756	14	LPG 1
Civic 1.5 VEI	EG4	1.5	66	4	.92-		D15Z1	1,1	ZFR6F-11	4291		LPG 6
Civic 1.5i GT	AH-5330S	1.5	74	4	.85-		EW3	1,1	BPR6EY-11	3577	10	LPG 2
Civic 1.5i LS	EK3	1.5	84	4	.96-		D15Z6	1,1	ZFR6J-11	5585		
Civic 1.5 VTEC	P9L	1.5		4	01.97-02.01		D15Z8	1,1	ZFR5F-11	2262	40	LPG 6
Civic 1.6	ED4 / ED7	1.6	80	4	.88-		D16A6 Cat.	1,1	BCPR6E-11	3132	11	LPG 3
Civic 1.6	ED4 / ED7	1.6	81	4	.90-	.01	D16Z2 Cat.	1,1	BCPR6E-11	3132	11	LPG 3
Civic 1.6	EU8	1.6	81	4	03.01-		D16V1	1,1	ZFR6J-11	5585		
Civic 1.6i ES	EK1	1.6	84	4	.96-		D16Y5	1,1	ZFR6J-11	5585		
Civic 1.6 ESI	EG5 / EG9	1.6	92	4	.92-		D16Z6	1,1	BKR6E-11	2756	14	LPG 1
Civic 1.6 iVtec		1.6	92	4	01.12-		R16B1	1,1	SILZKR7C11DS	94742		
Civic 1.6 VTEC	EE9	1.6	110	4	.90-		B16A1	1,1	BKR6EN-11	5724		
Civic 1.6 VTI	EG6 / EG9	1.6	118	4	.92-	.95	B16A2	1,1	BKR6E-11	2756	14	LPG 1
Civic 1.6 VTi	EK4	1.6	118	4	.96-		B16A2	1,1	BKR7EN-11	6256		
Civic Type R	EK9	1.6	148	4	-12.01		B16B	1,1	PFR7G-11S	7772		
Civic 1.6		1.6		4	01.97-		PIK(SOHC)	1,1	ZFR5F-11	2262	40	LPG 6
Civic 1.6 Vtec 5Door	EU8	1.6	81	4	.01-		D16V1 SOHC	1,1	ZFR6J-11	5585		
Civic 1.6LS 5Door	MB1	1.6	83	4	.95-		D16Y3	1,1	BKR6E-11	2756	14	LPG 1
Civic 1.6 LS 5Door	MB4	1.6	85	4	.97-		D16B2	1,1	ZFR5F-11	2262	40	LPG 6
Civic 1.6i/LS 5Door	MB4	1.6	85	4	.99-		D16W3	1,1	ZFR5F-11	2262	40	LPG 6



e kW  
C  
y  
l

0201



Stock-No

VTEC

LPG/CNG

**HONDA****CIVIC**

Civic 1.6SR VTEC 5Door	MB1	1.6	93	4	.95-	D16Y2	1,1	BKR6E-11	2756	14	LPG 1
Civic 1.6 5 Door		1.6		4		PIJ DOHC	1,1	BKR6E-11	2756	14	LPG 1
Civic 1.6 5 Door		1.6		4		PIK DOHC	1,1	BKR6E-11	2756	14	LPG 1
Civic 1.6i SR Aerodeck	MC1	1.6	85	4	.98-	D16B2	1,1	ZFR6F-11	4291		LPG 6
Civic 1.8 VTI 5Door	MB6	1.8	124	4	.97-	B18C4	1,1	BKR6EN-11	5724		
Civic 1.8 i-VTEC	FD1	1.8	103	4	09.05-	R18A	1,1	IZFR6K-11S	5266		
Civic 1.8 iVtec	FB	1.8	104	4	01.12-	R18Z1	1,1	SILZKR7C11DS	94742		
Civic 1.8 iVtec	FK	1.8	104	4	02.12-	R18Z4	1,1	SILZKR7C11DS	94742		
Civic 1.8 iVtec	FK	1.8	104	4	01.14-	R18Z4	1,1	SILZKR7C11DS	94742		
Civic 1.8	FK2	1.8	103	4	.06-	R18A2	1,1	IZFR6K-11S	5266		
Civic 1.8i VTI Aerodeck	M18C4	1.8	124	4	.98-	B18C4	1,1	BKR7EN-11	6256		
Civic Type-R	EP3	2.0	147	4	08.01- .06	K20A2	1,1	IFR7G-11KS	7746		
Civic Type R	FN2	2.0	148	4	.07-	K20ZA	1,1	IFR7G-11KS	7746		
Civic 2.0i Sport	EV1	2.0	118	4	.04-	K20A3	1,1	ZFR6K-11	6711		

**CIVIC COUPÉ**

Civic Coupé 1.5i/Lsi	EJ2	1.5	74	4	.94-	D15B7	1,1	ZFR6F-11	4291		LPG 6
Civic Coupé 1.6 LS	EJ6	1.6	77	4	.96- .98	D16Y7	1,1	BKR6E-11	2756	14	LPG 1
Civic Coupé 1.6 LS	EJ6	1.6	77	4	.96- .98	D16Y7	1,1	BKR6E-11	2756	14	LPG 1
Civic Coupé 1.6iLS	EJ6	1.6	77	4	.99-	D16Y7	1,1	ZFR5F-11	2262	40	LPG 6
Civic Coupé 1.6 Esi	EJ1	1.6	92	4	.94-	D16Z9	1,1	BKR6E-11	2756	14	LPG 1
Civic Coupé 1.6i SR	EJ8	1.6	92	4	.96- .98	D16Y8	1,1	BKR6E-11	2756	14	LPG 1
Civic Coupé 1.6i SR	EJ8	1.6	92	4	.96-	D16Y8	1,1	BKR6E-11	2756	14	LPG 1
Civic Coupé 1.6 SR	EJ8	1.6	92	4	.99-	D16Y8	1,1	ZFR5F-11	2262	40	LPG 6
Civic Coupé 1.7 LS	EM2	1.7	88	4	.01-	D17A8	1,1	ZFR6J-11	5585		
Civic Coupé 1.7 ES	EM2	1.7	92	4	.01-	D17A9	1,1	ZFR6J-11	5585		

**CIVIC SHUTTLE**

Civic Shuttle 1.6i	EE	1.6	80	4	.88-	D16A6 Cat.	1,1	BCPR6E-11	3132	11	LPG 3
Civic Shuttle 1.6i	EE	1.6	81	4	.88-	D16Z2 Cat.	1,1	BCPR6E-11	3132	11	LPG 3

**CONCERTO**

Concerto 1.5i	HW	1.5	66	4	.90- .95	D15B2 Cat.	1,1	BCPR6E-11	3132	11	LPG 3
Concerto 1.6i	HW	1.6	82	4	.90- .95	D16Z2 SOHC Cat.	1,1	BCPR6E-11	3132	11	LPG 3
Concerto 1.6-16V	HW	1.6	90	4	.90- .95	D16A8 DOHC	1,1	BCPR6E-11	3132	11	LPG 3

**CR-V**

CR-V 2.0	RD1	2.0	94	4	05.97-12.00	B20B3	1,1	ZFR5F-11	2262	40	LPG 6
CR-V 2.0	RD1	2.0	108	4	03.99-02.02	B20Z1	1,1	ZFR6F-11	4291		LPG 6
CR-V 2.0	RD8	2.0	110	4	.02-09.06	K20A4	1,1	ZFR6K-11	6711		
CR-V 2.0	RE5	2.0	110	4	.07-02.13	R20A2	1,1	IZFR6K-11S	5266		
CR-V 2.0 iVtec	RE5	2.0	110	4	10.12-	R20A9	1,1	SILZKR7C11S	92932		
CR-V 2.4 Vtec	RD7	2.4	118	4	09.01-09.06	K24A1	1,1	ZFR6K-11	6711		
CR-V 2.4	RE4	2.4	124	4	06.06-06.12	K24Z1	1,1	IZFR6K-11	6994		

**CRX**

CRX 1.6i-16	ED9	1.6	91	4	.89-	D16Z5 Cat.	1,1	BCPR6E-11	3132	11	LPG 3
CRX 1.6	EH6	1.6	92	4	.92-	D16Z6	1,1	BKR6E-11	2756	14	LPG 1
CRX 1.6i-16	ED9	1.6	96	4	.88-	D16A9	1,1	BCPR6E-11	3132	11	LPG 3
CRX 1.6 VTEC	EE8	1.6	110	4	.90-	B16A1	1,1	BKR6EN-11	5724		
CRX 1.6	EG2	1.6	118	4	.92-	B16A2	1,1	BKR6EN-11	5724		

**CR-Z**

CR-Z 1.5 Hybrid		1.5	84	4	02.10-	LEA1	1,3	DIFR6D13	94167		
-----------------	--	-----	----	---	--------	------	-----	----------	-------	--	--

e kW  
C  
Y  
I

0201

Stock-No  
V-ELINE

LPG / CNG

**HONDA****FR-V**

FR-V 1.7	BE1	1.7	92	4	01.05-	D17A2 SOHC VTEC	1,1	ZFR6J-11	5585		
FR-V 1.8	BE1	1.8	103	4	01.07-	R18A1	1,1	IZFR6K-11S	5266		
FR-V 2.0	BE3	2.0	110	4	01.05-	K20A9 DOHC i-VTEC	1,1	ZFR6K-11	6711		

**HR-V**

HR-V 1.6	GH2	1.6	77	4	02.99-	D16W1	1,1	ZFR5J-11	5584		
HR-V 1.6 VTEC	GH2	1.6	91	4	10.99-	VTEC	1,1	ZFR5J-11	5584		

**INSIGHT**

Insight	ZE2	1.3	65	4	04.09-	LDA3 L4	1,1	DILFR6J11	92491		
---------	-----	-----	----	---	--------	---------	-----	-----------	-------	--	--

**INTEGRA**

Integra Type-R 16V		2.0	162	4	02.02-	K20A	1,1	IFR7G-11KS	7746		
Integra R	DC2	1.8	140	4	10.97-.99	B18C6	1,1	PFR7G-11	2380		
Integra R	DC2	1.8	140	4	.99-.01	B18C6	1,1	PFR7G-11	2380		

**JAZZ**

Jazz 1.2 i-DSI		1.2	57	4	.02-	TwinSpark	1,1	BKR6E-11	2756	14	LPG 1
Jazz 1.2	GD5	1.2	57	4	.03-	L12A1 TwinSpark	1,1	BKR6E-11	2756	14	LPG 1
Jazz 1.2 CHAC	GE2	1.2	57	4	.06-	L12A4	1,1	BKR6E-11	2756	14	LPG 1
Jazz 1.2	GG1	1.2	66	4	07.08-	L12B1	1,3	DIFR6D13	94167		
Jazz 1.3 CHAC	GE3	1.3	61	4	.06-	L13A6	1,1	BKR6E-11	2756	14	LPG 1
Jazz 1.4	GD1	1.4	61	4	.02-	L13A1 TwinSpark	1,1	BKR6E-11	2756	14	LPG 1
Jazz 1.4 CHAC	GE3	1.4	61	4	.06-	L13A6	1,1	BKR6E-11	2756	14	LPG 1
Jazz 1.4 Hybrid	GP1	1.4	65	4	04.11-	LDA3	1,1	DILFR6J11	92491		
Jazz 1.4	GE6	1.4	74	4	.09-	L13Z1	1,3	IZFR6K13	6774		

**LEGEND**

Legend V6 2.5i	HS..N	2.5	110	6	.87-	C25A1 Cat.	1,1	BCPR6E-11	3132	11	LPG 3
Legend V6 2.5i	HS..Y	2.5	110	6	.87-	C25A1 Cat.	1,1	BCPR6E-11	3132	11	LPG 3
Legend V6 2.5i	HS..N	2.5	127	6	.87-	C25A1	1,1	BCPR6E-11	3132	11	LPG 3
Legend V6 2.5i	HS..Y	2.5	127	6	.87-	C25A1	1,1	BCPR6E-11	3132	11	LPG 3
Legend 2.7i	HS / KA4	2.7	124	6	.88-02.91	C27A1 Cat.	1,1	BCPR6E-11	3132	11	LPG 3
Legend 3.2	KA7 / KA8	3.2	151	6	.91-.96	C32A2	1,1	PFR6G-11	5555		PFR7G
Legend 3.2	KA7 / KA8	3.2	151	6	.93-.96	C32A2	1,1	PFR6G-11	5555		PFR7G
Legend 3.5 V6		3.5	151	6	.95-.04	C35A2	1,1	PFR6G-11	5555		PFR7G
Legend 3.5 V6	KA9	3.5	151	6	.96-.04	C35A5	1,1	PFR6G-11	5555		PFR7G
Legend 3.5 SH-AWD	KB1	3.5	217	6	.06-	J35A8	1,1	IZFR6K11	6994		
Legend 3.5 V6	KB1	3.5	217	6	.07-	J35A8	1,1	IZFR6K11	6994		
Legend Coupe 2.7i	KA3	2.7	124	6	.88-	C27A1 Cat.	1,1	BCPR6EY-N-11	6262		

**LOGO**

Logo 1.3 i		1.3	48	4	.99-.01	D13B7	1,1	ZFR5J-11	5584		
------------	--	-----	----	---	---------	-------	-----	----------	------	--	--

**NSX**

NSX	NA1	3.0	188	6	.91-01.05	C30A3/C30A4	1,1	PFR6G-11	5555		PFR7G
NSX	NA2	3.2	206	6	01.97-09.05	C32B2	1,1	PFR6G-11	5555		PFR7G

**PRELUDE**

Prelude 1.8	AB-7230C	1.8	74	4	.83-.92	ET	0,8	BPR6EY	6427		LPG 2
Prelude 1.8	AB-5240C	1.8	74	4	.85-.92	ET2	1,1	BPR6EY-11	3577	10	LPG 2
Prelude 1.8	AB-5220C	1.8	77	4	.83-.92	ET	0,8	BPR6EY	6427		LPG 2
Prelude 1.8	AB-5230C	1.8	77	4	.83-.92	ET	0,8	BPR6EY	6427		LPG 2
Prelude 2.0	BA4	2.0	80	4	.88-01.92	B20A3 Cat.	1,1	BCPR6EY-N-11	6262		
Prelude 2.0	BA4	2.0	80	4	.90-01.92	B20A3 Cat.	1,1	BCPR6EY-N-11	6262		
Prelude 2.0	BA4	2.0	84	4	.88-01.92	B20A4	1,1	BCPR6EY-N-11	6262		

e kW  
C  
y  
l

0201



Stock-No

V-TRADE

LPG / CNG

**HONDA****PRELUDE**

Prelude 2.0	BB3	2.0	98	4	.92-12.99	F20A4	1,1	ZFR6F-11	4291		LPG 6
Prelude 2.0		2.0	98	4	.97-12.99		1,1	ZFR6F-11	4291		LPG 6
Prelude 2.0 i	BB9	2.0	98	4	.99-12.99	F20A4	1,1	ZFR6F-11	4291		LPG 6
Prelude 2.0i 16V	BA2-1300C	2.0	101	4	.86- .92	BA20A1 DOHC	1,1	BCPR6E-11	3132	11	LPG 3
Prelude 2.0 16V 4WS	BA4	2.0	101	4	.88-01.92	B20A5 Cat.	1,1	BCPR6EY-N-11	6262		
Prelude 2.0 16V 4WS	BA4	2.0	103	4	.90-01.92	B20A9 Cat.	1,1	BCPR6EY-N-11	6262		
Prelude 2.2 VTEC	BB1	2.2	136	4	.93-09.96	H22A2	1,1	PZFR6F-11	3271		LPG 6
Prelude 2.2i		2.2	136	4	.97-12.01	H22A5	1,1	PZFR6F-11	3271		LPG 6
Prelude 2.2 Vti	BB6 / BB8	2.2	136	4	.99-12.01	H22A5	1,1	PZFR6F-11	3271		LPG 6
Prelude 2.3	BB2	2.3	118	4	.92-09.96	H23A2	1,1	ZFR6F-11	4291		LPG 6

**S 2000**

S 2000	AP1	2.0	177	4	06.00-	F20C2	1,1	PFR7G-11S	7772		
--------	-----	-----	-----	---	--------	-------	-----	-----------	------	--	--

**SHUTTLE**

Shuttle	AN-3520S	1.5	63	4	.84-	EW2	1,1	BPR6EY-11	3577	10	LPG 2
Shuttle	AN-5520S	1.5	63	4	.84-	EW2	1,1	BPR6EY-11	3577	10	LPG 2
Shuttle 4WD	AR-6520C	1.5	63	4	.85-	EW2	1,1	BPR6EY-11	3577	10	LPG 2
Shuttle 2.2i ES		2.2	110	4	.95-12.97	F22 RA1 (AT)	1,1	ZFR6F-11	4291		LPG 6
Shuttle 2.3	RA3	2.3	110	4	.98-05.01	F23A7	1,1	ZFR6F-11	4291		LPG 6

**STREAM**

Stream	RN1	1.7	92	4	04.01-	D17A2	1,1	ZFR6J-11	5585		
Stream	RN3	2.0	115	4	04.01-	K20A1	1,1	ZFR6K-11	6711		

**HUMMER-AM GENERAL**

Hummer H 3		3.4	162	5	.05-		1,3	PTR5A-13	2467	25	LPG 4
Hummer		5.7		8	.94- .96	D EFI V8	1,3	UR5	2771		UR6IX
Hummer H 2		6.0		8	.03- .06	N EFI V8	1,0	TR5	2238		LPG 5
Hummer		8.1		8	.03-	G EFI V8	1,5	PZTR5A-15	7862		

**HYUNDAI****ACCENT**

Accent		1.3	44	4	10.94- .99	G4EH	1,1	BKR5ES-11	2382	33	LPG 1
Accent		1.3	55	4	10.94- .99	G4EH	1,1	BKR5ES-11	2382	33	LPG 1
Accent	LC	1.3	55	4	.99-03.06	G4EA	1,1	BKR5ES-11	2382	33	LPG 1
Accent	LC	1.3	64	4	.99-03.06	G4EA	1,1	BKR5ES-11	2382	33	LPG 1
Accent 1.4		1.4	71	4	06.06-	G4EE	1,1	BKR5ES-11	2382	33	LPG 1
Accent		1.5	65	4	10.94-07.99	G4EK	1,1	BKR5ES-11	2382	33	LPG 1
Accent	LC	1.5	66	4	01.00- .06	G4EB	1,1	BKR5ES-11	2382	33	LPG 1
Accent 16V	LC	1.5	75	4	.99- .06	G4EA	1,1	BKR5ES-11	2382	33	LPG 1
Accent GT 16V		1.5		4	.95-07.99	G4EK	1,1	BKR5ES-11	2382	33	LPG 1
Accent 1.6	MC	1.6	82	4	06.06-	G4ED	1,1	BKR5ES-11	2382	33	LPG 1

**ATOS**

Atos	MX	0.8		4	- .02	LPG	0,8	BKR6ES	3783	28	LPG 1
Atos	MX	1.0	40	4	.99- .02	G4HC	1,1	BKR5ES-11	2382	33	LPG 1
Atos Prime	MX	1.0	40	4	.99- .02	G4HC	1,1	BKR5ES-11	2382	33	LPG 1
Atos	MX	1.1	46	4	03.04-		1,1	BKR5ES-11	2382	33	LPG 1

**COUPÉ**

Coupé	RD	1.6	84	4	12.96-04.02	4G61	1,1	BKR5ES-11	2382	33	LPG 1
-------	----	-----	----	---	-------------	------	-----	-----------	------	----	-------

e kW  
C  
y  
i

0201



Stock-No

VLINE

LPG / CNG

**HYUNDAI  
COUPÉ**

Coupé 2.0	RD	2.0	99	4	.01-	G4GF-EG	1,1	BKR5ES-11	2382	33	LPG 1
Coupé	RD	2.0	102	4	03.96-09.01	G4GF DOHC	1,1	BKR5ES-11	2382	33	LPG 1
Coupé 2.0	RD	2.0	102	4	.99-	G4GC	1,1	BPR5ES-11	4424		LPG 2
Coupé	GK	2.0	105	4	03.02-	G4GC-G	1,1	BKR5ES-11	2382	33	LPG 1
Coupé	GK	2.7	121	6	03.02-	G6BA-G V6	1,1	PFR5J-11	4642		

**ELANTRA**

Elantra	XD	1.5		4	-02.95	DOHC	1,1	BPR6ES-11	4824	13	LPG 2
Elantra	XD	1.5		4	03.95-06.05		1,1	BKR5E-11	1662	33	LPG 1
Elantra	XD	1.6	79	4	.00-	G4ED-G DOHC	1,1	BKR5ES-11	2382	33	LPG 1
Elantra	XD	1.6		4	- .99	DOHC	1,1	BPR6ES-11	4824	13	LPG 2
Elantra	XD	2.0	102	4	.00-	G4GC-G DOHC	1,1	BKR5ES-11	2382	33	LPG 1
Elantra	XD	2.0	105	4	.03-		1,1	BKR5E-11	1662	33	LPG 1

**GALLOPER**

Galopper		3.0	104	6	08.98-08.01	G6AT Unleaded	1,1	BPR5ES-11	4424		LPG 2
Galopper		3.0	104	6	08.98-	Leaded+LPG	0,9	BPR5ES	4006	6	LPG 2
Galopper		3.0		6	.98-08.01	G6AT SOHC V6	1,1	BKR5ES-11	2382	33	LPG 1

**GETZ**

Getz	TB	1.1	46	4	09.02- .08	G4HD	1,1	BKR5ES-11	2382	33	LPG 1
Getz	TB	1.3	60	4	09.02- .08	G4EA	1,1	BKR5ES-11	2382	33	LPG 1
Getz	TB	1.4	71	4	.05- .08	G4EE	1,1	BKR5ES-11	2382	33	LPG 1
Getz	TB	1.6	78	4	09.02-	G4ED	1,1	BKR5ES-11	2382	33	LPG 1

**GENESIS**

Genesis 3.8 V6	GC38	3.8	223	6	01.08-	G6DA	1,1	SILZKR7B11	9723		
Genesis 3.8 V6	GC38	3.8	255	6	11.11-	G6DA	1,1	SILZKR7B11	9723		

**H 1**

H 1		2.4	85	4	09.97-	H100	1,1	BPR6ES-11	4824	13	LPG 2
H 1 Starex		2.4	82	4	.98-	G4CS	1,1	BPR6ES-11	4824	13	LPG 2

**H 100**

H 100 i		2.4	84	4	01.97-		1,1	BP6EY-11	4128		
---------	--	-----	----	---	--------	--	-----	----------	------	--	--

**i10**

i10 1.1	PA	1.1	49	4	01.08-	G4HG	1,1	BKR5ES-11	2382	33	LPG 1
i10 1.1	PA	1.1	51	4	04.11-	G4HG	1,1	BKR5ES-11	2382	33	LPG 1
i10 1.2	PA	1.2	57	4	11.08-	G4LA	0,8	PLKR7A	4288		
i10 1.2	PA	1.2	63	4	04.11-	G4LA	0,8	PLKR7A	4288		

**i20**

i20 1.2	PB	1.2	57	4	09.08-	G4LA	0,8	PLKR7A	4288		
i20 1.4 (PB)	PB	1.4	74	4	09.08-01.09	G4FA	1,1	ZFR5F-11	2262	40	LPG 6
i20 1.4 (PB)	PB	1.4	74	4	02.09-	G4FA	1,0	ZFR5F-11	2262	40	LPG 6
i20 1.6	PB	1.6	93	4	09.08-	G4FC	1,1	ZFR5F-11	2262	40	LPG 6

**i30 1**

i30 1 1.4	FD	1.4	77	4	10.07-01.09	G4FA	1,1	ZFR5F-11	2262	40	LPG 6
i30 1 1.4	FD	1.4	77	4	02.09-	G4FA	1,0	ZFR5F-11	2262	40	LPG 6
i30 1 1.4	FD	1.4	80	4	06.07-01.09	G4FA	1,1	ZFR5F-11	2262	40	LPG 6
i30 1 1.4	FD	1.4	80	4	02.09-	G4FA	1,0	ZFR5F-11	2262	40	LPG 6
i30 1 1.6	FD	1.6	85	4	10.07-01.09	G4FC	1,1	ZFR5F-11	2262	40	LPG 6

e kW  
C  
y  
l

0201



Stock-No

VALVE

LPG / CNG

**HYUNDAI****i30 1**

i30 1 1.6	FD	1.6	85	4	02.09-	G4FC	1,0	ZFR5F-11	2262	40	LPG 6
i30 1 1.6	FD	1.6	90	4	06.07-01.09	G4FC	1,1	ZFR5F-11	2262	40	LPG 6
i30 1 1.6	FD	1.6	90	4	02.09-	G4FC	1,0	ZFR5F-11	2262	40	LPG 6
i30 1 1.6	FD	1.6	93	4	02.08-01.09	G4FC	1,1	ZFR5F-11	2262	40	LPG 6
i30 1 1.6	FD	1.6	93	4	02.09-	G4FC	1,0	ZFR5F-11	2262	40	LPG 6
i30 1 2.0	FD	2.0	105	4	07.07-	G4GC	1,1	BKR5ES-11	2382	33	LPG 1

**i30 2**

i30 2 1.4	GD	1.4	73	4	11.11-	G4FA	1,0	LZKR6B-10E	1578		
i30 II 1.6 GDI (GD)	GD	1.6	95	4	11.11-	G4FD	1,0	SILZKR6B10E	93815		

**i30 CW 1**

i30 CW 1 1.4		1.4	80	4	06.09-	G4FA	1,0	LZKR6B-10E	1578		
i30 CW 1 1.6		1.6	85	4	02.08-01.09	G4FC	1,1	ZFR5F-11	2262	40	LPG 6
i30 CW 1 1.6		1.6	85	4	02.09-	G4FC	1,0	ZFR5F-11	2262	40	LPG 6
i30 CW 1 1.6		1.6	90	4	02.08-01.09	G4FC	1,1	ZFR5F-11	2262	40	LPG 6
i30 CW 1 1.6		1.6	90	4	02.09-	G4FC	1,0	ZFR5F-11	2262	40	LPG 6
i30 CW 1 1.6		1.6	93	4	02.08-01.09	G4FC	1,1	ZFR5F-11	2262	40	LPG 6
i30 CW 1 1.6		1.6	93	4	02.09-	G4FC	1,0	ZFR5F-11	2262	40	LPG 6
i30 CW I 1.6 GDI		1.6	99	4	11.11-	G4FD	1,0	SILZKR6B10E	93815		
i30 CW 1 2.0		2.0	105	4	02.08-	G4GC	1,1	BKR5ES-11	2382	33	LPG 1

**i40**

i40 2.0 GDI		2.0	130	4	07.11-	G4NC	1,1	SILZKR7B11	9723		
i40 1.6		1.6	99	4	07.11-	G4FD	1,0	SILZKR6B10E	93815		

**ix20**

ix20 1.4	JC	1.4	66	4	11.10-	G4FA	1,0	LZKR6B-10E	1578		
ix20 1.6	JC	1.6	92	4	11.10-	G4FC	1,0	LZKR6B-10E	1578		

**ix35 (LM)**

ix35 2.0	LM	2.0	120	4	08.09-	G4KD	1,1	LFK5A-11	6376		LPG 7
----------	----	-----	-----	---	--------	------	-----	----------	------	--	-------

**LANTRA**

Lantra 1	J-1	1.5	63	4	.92-04.95	G4DJ	1,1	BPR6ES-11	4824	13	LPG 2
Lantra 2	J-2	1.6	66	4	09.95-09.00	G4GR	1,1	BKR5ES-11	2382	33	LPG 1
Lantra 1	J-1	1.6	78	4	.92-04.95	G4CR	1,1	BPR6ES-11	4824	13	LPG 2
Lantra 3		1.6	79	4	09.00-	G4ED-G DOHC	1,1	BKR5ES-11	2382	33	LPG 1
Lantra 2	J-2	1.6	84	4	09.95-09.00	G4GR	1,1	BKR5ES-11	2382	33	LPG 1
Lantra 1	J-1	1.8	93	4	.92-04.95	G4CN	1,1	BPR6ES-11	4824	13	LPG 2
Lantra 2	J-2	1.8	94	4	09.95-09.00	G4GM	1,1	BKR5ES-11	2382	33	LPG 1
Lantra 3		2.0	101	4	09.00-	G4GC-G DOHC	1,1	BKR5ES-11	2382	33	LPG 1
Lantra 2	J-2	2.0	102	4	02.97- .00		1,1	BKR5ES-11	2382	33	LPG 1

**MATRIX**

Matrix	FC	1.6	76	4	08.01-	G4ED	1,1	BKR5ES-11	2382	33	LPG 1
Matrix	FC	1.8	90	4	08.01-	G4GB	1,1	BKR5ES-11	2382	33	LPG 1
Matrix	FC	1.8	98	4	07.01-	G4GB	1,1	BKR5ES-11	2382	33	LPG 1

**PONY/EXEL**

Pony/Exel		1.3		4	.85- .94	G13B/G4DG	1,1	BPR6ES-11	4824	11	LPG 2
Pony/Exel		1.5		4	.85- .94	G15B/G4DJ	1,1	BPR6ES-11	4824	11	LPG 2
Pony/Exel		1.5		4	.85- .94	G15B/G4DJ Cat.	1,1	BPR6ES-11	4824	11	LPG 2

**S COUPÉ**

S Coupé N/A	SLC	1.5	65	4	04.92-05.96	G4EK	1,1	BKR5ES-11	2382	33	LPG 1
-------------	-----	-----	----	---	-------------	------	-----	-----------	------	----	-------

e kw  
C  
Y  
I

0201



Stock-No

VLINE

LPG / CNG

**HYUNDAI  
S COUPÉ**

S Coupé Turbo Charge	SLC	1.5	85	4	04.91-05.98	G4EK-TC	0,8	BKR6ES	3783	28	LPG 1
S Coupé	SLC	1.5		4	.92-	G15B	1,1	BKR5ES-11	2382	33	LPG 1
S Coupe Turbo	SLC	1.5		4	.92-		0,8	BKR6ES	3783	28	LPG 1

**SANTA FE 1**

Santa Fe / SM	SM	2.4	107	4	02.01-.05	G4JS-G	1,1	PGR5C-11	5760		
Santa Fe / SM	SM	2.7	127	6	08.00-12.05	G6BA-G	1,1	PFR5N-11	5838		
Santa Fe I 2.0	SM	2.0	99	4	08.01-03.06	G4BP	1,1	BPR6ES-11	4824	13	LPG 2
Santa Fe I 2.4	SM	2.4	100	4	08.00-12.05	G4JS	1,1	PGR5C-11	5760		

**SANTA FE 2**

Santa Fe II 2.4	CM	2.4	128	4	11.10-	G4KC / G4KE	1,1	LFR5A-11	6376		LPG 7
Santa Fe II 2.7	CM	2.7	125	6	03.06-09.09	G6BA / G6EA	1,1	ILFR5B11	1637		
Santa Fe II 2.7	CM	2.7	139	6	11.05-09.09	G6BA / G6EA	1,1	ILFR5B11	1637		

**SANTAMO**

Santamo		2.0	101	4	.99-12.02	G4CP DOHC / SOHC	1,1	BP6ES-11	1212		LPG 2
---------	--	-----	-----	---	-----------	------------------	-----	----------	------	--	-------

**SONATA**

Sonata 1.8i		1.8	70	4	.89-	G62B	1,1	BPR6ES-11	4824	13	LPG 2
Sonata 2.0i		2.0	74	4	.89-.93	4G63 DOHC	1,1	BPR6ES-11	4824	13	LPG 2
Sonata 2.0i		2.0	77	4	06.94-.96	G4CP-D SOHC	1,1	BUR6EA-11	5428		
Sonata 2.0	EF	2.0	100	4	09.98-.01	G4JP-G DOHC	1,1	BPR6ES-11	4824	13	LPG 2
Sonata 2.0i		2.0		4	.93-.98	G4CP-D DOHC	1,1	BPR6ES-11	4824	13	LPG 2
Sonata 2.4i	NF	2.4	118	4	.89-.01	G4KC	1,1	BKR5ES-11	2382	33	LPG 1
Sonata 2.4i		2.4	120	4	.89-	4G64	1,1	BPR6ES-11	4824	13	LPG 2
Sonata 2.4i		2.4	121	4	.08-		1,1	BKR5ES-11	2382	33	LPG 1
Sonata VI 2.4	YF	2.4	131	4	01.09-	G4KC	1,1	LFR5A-11	6376		LPG 7
Sonata 2.5 V6		2.5	118	6	09.98-.01	G6BV-EG DOHC	1,1	PFR5J-11	4642		
Sonata 2.7 V6		2.7	127	6	10.01-11.04	G6BA-G	1,1	PFR5B-11	2300		PFR6B
Sonata 3.0 V6		3.0		6	.91-.98	G6AT	1,1	PGR5A-11	3573		
Sonata 3.3 V6	NF	3.3	173	6	01.05-.08	G6DB	1,1	IFR5G11	7854		
Sonata 3.3		3.3	184	6			1,1	IFR5G11	7854		

**STAREX**

Starex	H1	2.4	82	4	02.98-	SOHC	1,1	BP6ES-11	1212		LPG 2
--------	----	-----	----	---	--------	------	-----	----------	------	--	-------

**TIBURON**

Tiburon 1.6		1.6		4	.00-	DOHC	1,1	BKR5ES-11	2382	33	LPG 1
Tiburon 1.8		1.8		4	.00-	DOHC	1,1	BKR5ES-11	2382	33	LPG 1
Tiburon 2.0		2.0		4	.00-	DOHC	1,1	BKR5ES-11	2382	33	LPG 1

**TRAJET**

Trajet 2.0	FO	2.0	100	4	05.00-	G4JP-G DOHC	1,1	BPR6ES-11	4824	13	LPG 2
Trajet 2.0	FO	2.0	103	4	01.04-		1,1	BKR5ES-11	2382	33	LPG 1
Trajet 2.7	FO	2.7	127	6	07.00-	G6BA DOHC	1,1	PFR5N-11	5838		

**TUCSON**

Tucson 2.0	JM	2.0	104	4	09.04-	G4GC	1,1	BKR5ES-11	2382	33	LPG 1
Tucson 2.7 V6	JM	2.7	129	6	09.04-	G6BA	1,1	PFR5N-11	5838		

**XG**

XG 250 V6	XG	2.5	120	6	06.99-09.03	G6AV	1,1	PFR5N-11	5838		
XG 300 V6	XG	3.0	138	6	12.98-	G6CT	1,1	PFR5N-11	5838		
XG 350 V6	XG	3.5	145	6	10.02-09.05	G6CU	1,1	PFR5N-11	5838		



l kW  
C  
y  
i

0201



Stock-No

VALVE

LPG / CNG

## INFINITI

EX 35	J50	3.5	221	6	10.08-12.10	VQ35HR	1,1	DF7H-11B	1317		
EX 37	J50	3.7	235	6	09.10-	VQ37VHR	1,1	DF8H-11B	1305		
FX 35	S50	3.5	206	6	.05-	VQ35DE V6	1,1	PLFR5A-11	6240		LPG 7
FX 37	S51	3.7	235	6	10.08-	VQ37VHR	1,1	DF8H-11B	1305		
FX 45	S50	4.5	233	8	.04-	VK45DE V8	1,1	PLFR5A-11	6240		LPG 7
FX 50	S51	5.0	287	8	10.08-	VK50VE	1,1	DF7H-11B	1317		
G 20		2.0		4	.91- .94	SR20DE	1,1	PFR5B-11	2300		PFR6B
G 20		2.0		4	.95- .96	SR20DE	1,1	PFR5B-11	2300		PFR6B
G 20		2.0		4	.99-	SR20DE	1,1	PFR5B-11	2300		PFR6B
G 25	V36	2.5	163	6	01.11-	VQ25HR	1,1	DF7H-11B	1317		
G 37	V36	3.7	235	6	10.08-	VQ37VHR	1,1	DF8H-11B	1305		
G 37	V36	3.7	243	6	10.08-	VQ37VHR	1,1	DF8H-11B	1305		
I 30		3.0		6	.96- .99	VQ30DE V6	1,1	PFR5G-11	2647		PFR6G-11
J 30		3.0		6	.93- .97	VG30DE V6	1,1	PFR5G-11	2647		PFR6G-11
M 30		3.0		6	.90- .92	VG30E	1,1	PFR6B-11	4014		PFR7B
M 35 Hybrid	Y51HV	3.5	225	6	04.11-	VQ35HR	1,1	DF7H-11B	1317		
M 35 Hybrid	Y51HV	3.5	268	6	01.10-	VQ35HR	1,1	DF7H-11B	1317		
M 37	Y51	3.7	235	6	03.10-	VQ37VHR	1,1	DF8H-11B	1305		
M 45	Y50	4.5	250	8	01.05-05.10	VK45DE	1,1	PLFR5A-11	6240		LPG 7
M 56	Y51	5.6	300	8	07.10-	VK56VD	1,1	DILKAR7B11	1406		
Q 45		4.1		8	.97- .98	VH41DE	1,1	PFR5G-11	2647		PFR6G-11
Q 45		4.5		8	.90- .93	VH45D	1,1	PFR5B-11	2300		PFR6B
Q 45		4.5		8	.94- .96	VH45DE	1,1	PFR5G-11	2647		PFR6G-11
QX 56		5.6		8	.08-	VK56DE FI	1,1	LFR5A-11	6376		LPG 7
QX 4		3.3		6	.97- .98	VG33E	1,1	BKR5ES-11	2382		LPG 1
QX 4		3.3		6	.99-	VD33DE	1,0	FR5AP-10	6371		
QX 4		3.5		6	.01-	VQ35DE	1,1	PLFR5A-11	6240		LPG 7
QX 56	Z62	5.6	298	8	03.10-	VK56VD	1,1	DILKAR7B11	1406		
QX 56		5.6		8	.08-	VK56DE FI	1,1	LFR5A-11	6376		LPG 7
QX 70 37	S51	3.7	235	6	08.13-	VQ37VHR	1,1	DF8H-11B	1305		
QX 70 50	S51	5.0	287	8	08.13-	VK50VE	1,1	DF7H-11B	1317		

## INNOCENTI

Clip ie		1.0	35	4	09.95-06.97	146C7.000	0,9	BPR5ES	4006	6	LPG 2
Clip ie Super		1.4	51	4	09.95-06.97	160A1.046	0,8	BPR6ES	4008	2	LPG 2
Elba		1.3	49	4	07.91-08.93	146A5.000	0,8	BPR6ES	4008	2	LPG 2
Elba ie		1.4	49	4	11.95-06.97	146C5.000	0,8	BPR6ES	4008	2	LPG 2
Elba ie		1.6	55	4	11.95-06.97	146C6.000	0,8	BPR6ES	4008	2	LPG 2
Elba ie Happy		1.6	55	4	06.95-06.96	146C6.000	0,8	BPR6ES	4008	2	LPG 2
Koral 45		0.9	33	4	10.90-06.97	100GL 064	0,8	BPR6ES	4008	2	LPG 2
Koral 55		1.1	41	4	10.90-06.97	128A 064	0,8	BPR6ES	4008	2	LPG 2
Mille		1.0	35	4	07.94-06.97	146C7.000	0,7	BP6ES	7811	4	LPG 2
Mille i.		1.0	35	4	07.94-06.97	146C7.000	0,9	BPR5ES	4006	6	LPG 2
Small 500 L / LS		0.6	23	3	01.91-06.97	Daihatsu E	0,9	BPR6EY	6427		LPG 2
Small 990 SE		1.0	38	3	01.91-06.97	Daihatsu CB	0,8	BPR5EY	2828	9	LPG 2

## ISUZU

Rodeo		3.2	151	6	.98-	V DOHC	1,1	PFR5G-11	2647		PFR6G-11
Trooper		2.3	66	4	01.87-	4ZD1 Cat.	1,1	BPR6ES-11	4824	13	LPG 2
Trooper		2.3		4	.87-		0,8	BPR6ES	4008	2	LPG 2
Trooper		2.3		4	.88-	4ZD1	0,8	BPR6ES	4008	2	LPG 2

e kW C  
Y I

0201



Stock-No

VLINE

LPG / CNG

**ISUZU**

Trooper	2.6	85	4	10.87-	4ZE1 Cat.	1,1	BPR6ES-11	4824	13	LPG 2
Trooper	3.5	158	6	04.00-	6VE1 V6	1,1	PFR6B-11	4014		PFR7B
Vehicross 3.2 24V	3.2	158	6	03.97-	6VDI	1,1	BKR6E-11	2756	14	LPG 1

**JAGUAR**

Double Six	5.3		12	.90-	V 12 HE	0,6	BR7EF	3346		
Sovereign 2.9	2.9		6	08.86-08.90	AJ6 SOHC	0,8	B8ES	1015		
Sovereign 3.2	3.2		6	07.90-07.97	AJ6	0,8	BCPR6ES	2330	12	LPG 3
Sovereign 4.0	4.0		6	09.89-09.97	AJ6	0,8	BCPR6ES	2330	12	LPG 3

**F-TYPE**

F-Type 3.0 Supercharged	X152	3.0	280	6	10.12-	AJ126	0,8	SILZKAR7E8S	93476	
F-Type 3.0 Supercharged	X152	3.0	250	6	10.13-	AJ126	0,8	SILZKAR7E8S	93476	
F-Type 5.0		5.0	364	8	10.12-	AJ-V8	1,0	ILKAR7C10	94940	

**S-TYPE**

S-Type 2.5	2.5	143	6	02.01-	AJV6	1,3	TR6AP-13E	4968		
S-Type 3.0	3.0	175	6	10.98-	FC AJ-V6	1,3	TR6AP-13E	4968		
S-Type 4.2 V8	4.2		8	03.02-	AJ-V8	1,0	IFR5N10	7866		
S-Type R	4.2		8	03.02-	AJ28	1,0	IFR5N10	7866		
S-Type R	4.2		8	03.02-	AJ-V8	1,0	IFR5N10	7866		
S-Type V8	4.0	203	8	10.98-03.00	GC AJ-V8	1,3	PFR5G-13E	2761		LPG 1
S-Type V8	4.0	203	8	03.00-03.02	GC AJ-V8	1,1	PFR5G-13E	2761		LPG 1

**XF**

XF 3.0		3.0	175	6	03.08-	AJV6	1,3	TR6AP-13E	4968	
XF Supercharged	X250	3.0	250	6	10.12-04.15	AJ126	0,8	SILZKAR7E8S	93476	
XF 4.2		4.2	219	8	03.08-	AJ33	1,0	IFR5N10	7866	
XF 4.2 Supercharged		4.2	306	8	03.08-	AJ33	1,0	IFR5N10	7866	
XF 5.0		5.0	283	8	03.09-	AJ133	1,0	ILKAR7C10	94940	
XFR 5.0 Supercharged		5.0	375	8	03.09-	AJ133	1,0	ILKAR7C10	94940	

**XJ**

XJ 3.0 Supercharged	X351	3.0	250	6	03.12-	AJ126	0,8	SILZKAR7E8S	93476	
XJ 5.0		5.0	283	8	01.10-	AJ133	1,0	ILKAR7C10	94940	
XJ 5.0 Supercharged		5.0	346	8	01.10-	AJ133	1,0	ILKAR7C10	94940	
XJ 5.0 Supercharged		5.0	375	8	01.10-	AJ133	1,0	ILKAR7C10	94940	

**XJ12**

XJ12		5.3		12	.91- .93	HE(V12)	0,6	BR7EF	3346	
XJ12		6.0		12	.92-11.94	V12	0,6	BR7EF	3346	
XJ12		6.0		12	.93-11.94	HE(V12)	0,6	BR7EF	3346	
XJ12		6.0		12	11.94-09.96	HE(V12)	0,6	BR7EF	3346	

**XJ6**

XJ6 3.0		3.0		6	03.03-	AJ-V6	1,3	PTR6D-13	5598	LPG 5
XJ6		3.2		6	07.90-07.97	AJ6 Cat./ 9BPMNA	0,8	BCPR6ES	2330	12 LPG 3
XJ6		3.6	136	6	08.86-05.92	AJ6 / 9DPANA	0,8	BCPR6ES	2330	12 LPG 3
XJ6		4.0		6	09.89-09.97	AJ6 Cat.	0,8	BCPR6ES	2330	12 LPG 3
XJ6 V12		5.3		12	01.91-	V12	0,6	BR7EFS	1094	

**XJ8**

XJ8		3.2	174	8	09.97-09.98	V8	1,3	PFR6G-13E	2341	LPG 1
XJ8		3.2	176	8	09.97-		1,3	PFR6G-13E	2341	LPG 1
XJ8		3.2		8	09.97-09.98	AJ26	1,3	PFR5G-13E	2761	LPG 1





l kW C y i

0201



Stock-No

VALVE

LPG / CNG

**JAGUAR**

**XJ8**

XJ8	3.2		8	09.98-03.00	AJ26	1,3	PFR5G-13E	2761		LPG 1
XJ8	3.2		8	03.00-03.02	AJ26	1,1	PFR5G-13E	2761		LPG 1
XJ8	3.2		8	03.02-	AJ26	1,0	PFR5G-13E	2761		LPG 1
XJ8	3.5	190	8	03.03-06.06	AJ33	1,0	IFR5N10	7866		
XJ8	3.5		8	03.02-	AJ26	1,0	PFR5G-13E	2761		LPG 1
XJ8	4.0	209	8	09.97-	V8	1,3	PFR6G-13E	2341		LPG 1
XJ8	4.0		8	09.97-09.98	AJ26	1,3	PFR5G-13E	2761		LPG 1
XJ8	4.0		8	09.98-03.00	AJ26	1,3	PFR5G-13E	2761		LPG 1
XJ8	4.0		8	03.00-03.02	AJ26	1,1	PFR5G-13E	2761		LPG 1
XJ8	4.0		8	03.02-	AJ26	1,0	PFR5G-13E	2761		LPG 1
XJ8	4.2	219	8	03.03-06.06	AJ33	1,0	IFR5N10	7866		
XJ8 Supercharged	4.2	291	8	03.03-09.09	AJ33	1,0	IFR5N10	7866		
XJ8	4.2		8	03.02-	AJ26	1,0	PFR5G-13E	2761		LPG 1

**XJ8R**

XJ8R	4.0	272	8	09.97-03.00		1,3	PFR6G-13E	2341		LPG 1
XJ8R Supercharged	4.0		8	09.97-02.00	AJ26	1,3	PFR6G-13E	2341		LPG 1
XJ8R 4.0	4.0		8	03.00-03.02	AJ26	1,1	PFR5G-11E	3000		
XJ8R	4.0		8	03.02-	AJ26	1,0	IFR5N10	7866		
XJR Supercharged X300	4.0	235	6	08.94-08.97	AJ16 Kompressor	0,9	BKR7E	6097		BKR8EIX
XJR 4.0	4.0		6	09.89-09.94	AJ6	0,8	BCPR6ES	2330	12	LPG 3
XJR V8 (X300)	4.0	267	8	09.97-02.00	AJ26	1,3	PFR6G-13E	2341		LPG 1
XJ8R 4.2	4.2		8	03.02-		1,0	IFR5N10	7866		

**XJS**

XJS 3.6	3.6		6	08.86-05.91	AJ6	0,8	BCPR6ES	2330	12	LPG 3
XJS Coupe	4.0		6	04.91-09.96	AJ6	0,8	BCPR6ES	2330	12	LPG 3
XJS	5.3		12	.91- .93	V12 HE	0,6	BR7EF	3346		
XJS V12	6.0		12	05.93-11.94	V12	0,6	BR7EF	3346		
XJS V12	6.0		12	11.94-05.95	V12	0,6	BR7EF	3346		

**XK8**

XK8	4.0	213	8	10.96-09.97	AJ / V8	1,3	PFR6G-13E	2341		LPG 1
XK8	4.0	213	8	09.97-09.98	AJ26	1,3	PFR5G-13E	2761		LPG 1
XK8	4.0	389	8	10.96-09.97	AJ26	1,3	PFR5G-13E	2761		LPG 1
XK8	4.0		8	09.97-09.98	AJ27	1,3	PFR5G-13E	2761		LPG 1
XK8	4.0		8	09.98-03.00	AJ26	1,3	PFR5G-13E	2761		LPG 1
XK8	4.0		8	09.98-03.00	AJ27	1,3	PFR5G-13E	2761		LPG 1
XK8	4.0		8	03.00-	AJ26	1,1	PFR5G-13E	2761		LPG 1
XK8	4.0		8	03.00-02.02	AJ27	1,1	PFR5G-13E	2761		LPG 1
XK8	4.0		8	03.02-	AJ27	1,0	PFR5G-13E	2761		LPG 1
XK8	4.2		8	09.02-	AJ34	1,0	IFR5N10	7866		
XK8 5.0	5.0	283	8	01.09-	AJ133	1,0	ILKAR7C10	94940		

**XKR**

XKR	4.0	267	8	05.98-03.00	AJ27	1,3	PFR6G-13E	2341		LPG 1
XKR	4.0	267	8	03.00-02.02	AJ27	1,1	PFR6G-13E	2341		LPG 1
XKR	4.0		8	03.02-	AJ27	1,0	PFR6G-13E	2341		LPG 1
XKR	4.2		8	09.02-	AJ34	1,0	IFR5N10	7866		
XKR 5.0 Supercharged	5.0	375	8	01.09-	AJ133	1,0	ILKAR7C10	94940		
XKR 5.0 Supercharged	5.0	390	8	09.10-	AJ133	1,0	ILKAR7C10	94940		
XKR-S 5.0 Supercharged	5.0	405	8	01.11-	AJ133	1,0	ILKAR7C10	94940		

**X-TYPE**

X-Type 2.0	2.0	117	6	12.01-	AJ-V6	1,3	TR6AP-13E	4968		
------------	-----	-----	---	--------	-------	-----	-----------	------	--	--

e kW  
C  
y  
I

0201



Stock-No

VLINE

LPG / CNG

**JAGUAR****X-TYPE**

X-Type 2.5	2.5	140	6	02.01-	AJ-V6	1,3	TR6AP-13E	4968		
X-Type 3.0	3.0	173	6	02.01-	AJ-V6	1,3	TR6AP-13E	4968		

**JEEP****CHEROKEE**

Cherokee 2.4	KJ	2.4	108	4	08.01-	ED1	1,1	LZTR4A-11	5444		
Cherokee		2.5		4	.89- .90	L4 TBI E	0,9	FR5-1	7252		
Cherokee		2.5		4	.90- .98	L4 MPI P	0,9	FR5-1	7252		
Cherokee 3.7 V6	KJ	3.7	155	6	10.01-	EKG	1,1	ZFR5F-11	2262	40	LPG 6
Cherokee		4.0		6	.89- .90	L6 MPI L	0,9	FR5	7373		

**COMMANCHE**

Commanche		2.5		4	.91- .92	L4 MPI P	0,9	FR5-1	7252		
Commanche		4.0		6	.91- .92	L6 MPI S	0,9	FR5-1	7252		

**COMPASS**

Compass 2.0		2.0	115	4	05.11-	ECN	1,1	ZFR5F-11	2262	40	LPG 6
Compass 2.4		2.4	125	4	08.06-	ED3 / EDG	1,1	ZFR5F-11	2262	40	LPG 6

**GRAND CHEROKEE**

Grand Cherokee		3.7		6	.05-	V6 K FI	1,1	PZFR6F-11	3271		LPG 6
Grand Cherokee		4.0		6	.91- .98	L6 S MPI	0,9	FR5-1	7252		
Grand Cherokee		4.0		6	.03- .04	L6 S FI	0,8	ZFR5N	7917		
Grand Cherokee		4.7	173	8	02.99- .99	V8 N MPI	1,1	PZFR6F-11	3271		LPG 6
Grand Cherokee		4.7		8	.00- .04	V8 N FI SOHC	1,1	PZFR6F-11	3271		LPG 6
Grand Cherokee		4.7		8	.02- .04	V8 J FI SOHC&H.O.	1,1	PZFR6F-11	3271		LPG 6
Grand Cherokee		4.7		8	.05-	V8 N FI	1,1	PZFR6F-11	3271		LPG 6
Grand Cherokee		5.2		8	.93- .96	V8 Y MPI	0,9	FR4	5155		
Grand Cherokee		5.2		8	.97- .98	V8 Y MPI	0,9	FR4	5155		
Grand Cherokee		5.7	240	8	.05-	V8 2 FI	1,1	LZTR4A-11	5444		
Grand Cherokee		5.9		8	.98-	V8 MPI Z	1,0	FR5-1	7252		
Grand Cherokee SRT-8		6.1	313	8	08.06-		1,3	PLZTR5A-13	4998		
Grand Wagoneer		5.2		8	.93- .93	V8 MPI Y	0,9	FR4	5155		
Grand Wagoneer		5.9		8	.89- .91	V8 2Bbl 7	0,9	GR4	2635		GR5IX
Grand Wagoneer		5.9		8	.97-	V8 MPI Z	0,9	FR4	5155		

**LIBERTY**

Liberty		2.4		4	.02-	L4 1 FI	1,1	LZTR4A-11	5444		
Liberty		3.7		6	.02-	V6 K FI	1,1	PZFR6F-11	3271		LPG 6

**WAGONEER**

Wagoneer		2.5		4	.91- .92	L4 MPI P	0,9	FR5-1	7252		
Wagoneer		4.0		6	.91- .92	L6 MPI S	0,9	FR5-1	7252		

**WRANGLER**

Wrangler		2.5		4	.91-01.01	L4 MPI P	0,9	FR5-1	7252		
Wrangler Rubicon 3.8		3.8	146	6	.07-	V6 FI	1,3	LZTR5A-13	4612		
Wrangler Unlimited		3.8	151	6	.07-		1,3	LZTR5A-13	4612		
Wrangler		4.0	135	6	.91-	L6 MPI	1,1	ZFR5A-11	5084		LPG 6
Wrangler		4.0		6	.91- .95	L6 MPI S	0,9	FR5-1	7252		
Wrangler		4.0		6	.96- .97	L6 MPI V	0,9	FR5-1	7252		
Wrangler		4.0		6	.98- .02	L6 MPI S	0,9	FR5-1	7252		



l kW  
C  
y  
i

0201



Stock-No

U-TIME

LPG / CNG

**KIA**

**CARENS 1**

Carens 1.6	FC	1.6	77	4	06.02-	S6D	1,1	BKR6ES-11	5553	14	LPG 1
Carens 1.8	FC	1.8	81	4	.01-		0,9	BKR6E	4856	28	LPG 1
Carens 1.8	FC	1.8	93	4	06.02-	TB	0,8	BKR6ES	3783	28	LPG 1

**CARENS 2**

Carens II 2.0	FJ	2.0	102	4	08.04-	G4GC	1,1	BKR5ES-11	2382	33	LPG 1
---------------	----	-----	-----	---	--------	------	-----	-----------	------	----	-------

**CARENS 3**

Carens III 1.6 CVT	UN	1.6	93	4	06.09-	G4FC	1,0	LZKR6B-10E	1578		
Carens III 1.6 CVT	UN	1.6	97	4	08.09-	G4FC	1,0	LZKR6B-10E	1578		
Carens III 2.0	UN	2.0	106	4	09.06-	G4KA	1,1	BKR5ES-11	2382	33	LPG 1

**CARENS 4**

Carens IV 1.6		1.6	99	4	03.13-	G4FD	1,0	SILZKR6B10E	93815		
Carens IV 2.0 GDI		2.0	122	4	03.13-	G4NC	1,1	SILZKR7B11	9723		

**CARNIVAL 1**

Carnival 2.5	UP	2.5	121	6	12.98-	.01 K5	1,1	PFR6N-11	3546		LPG 1
Carnival 2.5	UP	2.5	129	6	12.98-	.01 KV5 DOHC	1,1	PFR6N-11	3546		LPG 1

**CARNIVAL 2**

Carnival II 2.5	GQ	2.5	110	6	10.01-		1,1	PFR6N-11	3546		LPG 1
Carnival II 2.7	GQ	2.7	139	6	06.06-	G6EA V6	1,1	ILFR5B11	1637		

**CEE'D (ED)**

Cee'd 1.4	ED	1.4	66	4	07.09-	G4FA	1,0	LZKR6B-10E	1578		
Cee'd 1.4	ED	1.4	80	4	01.07-12.08	G4FA	1,1	LZKR6B-10E	1578		
Cee'd 1.4	ED	1.4	80	4	01.09-	G4FA	1,0	LZKR6B-10E	1578		
Cee'd 1.6	ED	1.6	85	4	09.07-	G4FC	1,0	LZKR6B-10E	1578		
Cee'd 1.6	ED	1.6	90	4	12.06-12.08	G4FC	1,1	LZKR6B-10E	1578		
Cee'd 1.6	ED	1.6	90	4	01.09-	G4FC	1,0	LZKR6B-10E	1578		
Cee'd 1.6 CVT	ED	1.6	92	4	10.10-	G4FC	1,0	LZKR6B-10E	1578		
Cee'd 1.6	ED	1.6	93	4	09.07-12.08	G4FC	1,1	LZKR6B-10E	1578		
Cee'd 1.6	ED	1.6	93	4	01.09-	G4FC	1,0	LZKR6B-10E	1578		
Cee'd 2.0	ED	2.0	105	4	01.07-	G4GC	0,8	BKR5ES-11	2382	33	LPG 1

**CERATO**

Cerato 1.6	LD	1.6	77	4	05.04-	G4ED	1,1	BKR5ES-11	2382	33	LPG 1
Cerato 1.6	LD	1.6	90	4	05.06-	G4FC	1,1	ZFR5F-11	2262	40	LPG 6
Cerato 2.0	LD	2.0	106	4	05.04-	G4GC	1,1	BKR5ES-11	2382	33	LPG 1

**CLARUS**

Clarus 1.8	K9A / GC	1.8	85	4	06.96-	.01 T8 DOHC	0,8	BKR5E	1667	35	LPG 1
Clarus 2.0	K9A / GC	2.0	98	4	09.96-	.01 FE DOHC	1,1	BK6E-11	7340		LPG 1

**JOICE**

Joice		2.0	103	4	09.01-	.03 G4CP	1,1	BPR6ES-11	4824	13	LPG 2
-------	--	-----	-----	---	--------	----------	-----	-----------	------	----	-------

**MAGENTIS**

Magentis V6	GD	2.5	118	6	.01-	G6BV	0,8	BKR5ES	2460	35	
Magentis V6	GD	2.5	124	6	.03-	G6BV	0,8	BKR5ES	2460	35	
Magentis V6	MG	2.7	138	6	.06-.09	G6EA	1,1	ILFR5B11	1637		
Magentis	GD	2.0	100	4	.01-.05		0,8	BPR6ES	4008	2	LPG 2
Magentis	MG	2.0	106	4	.06-.09	G4KA	1,1	BKR5ES-11	2382	33	LPG 1
Magentis 2.0	MG	2.0	121	4	07.09-	G4KD	1,1	LF5A-11	6376		LPG 7

e kW  
C  
Y  
I

0201



Stock-No

VLINE

LPG / CNG

**KIA****OPIRUS**

Opirus	GH	3.8		6	.07-	G6DA	1,1	IFR5G11	7854		
Opirus	GH	3.5	149	6	.03- .06		1,1	PFR5N-11	5838		

**OPTIMA**

Optima 2.0	TF	2.0	120	4	03.12-	G4KD	1,1	SILZKR7B11	9723		
Optima 2.0	TF	2.0	125	4	03.12-	G4KD	1,1	SILZKR7B11	9723		
Optima 2.0 Hybrid	TF	2.0	110	4	03.12-	G4KD	1,1	SILZKR7B11	9723		

**PICANTO (BA)**

Picanto 1.0	BA	1.0	45	4	05.04-	G4HE	1,1	BKR5ES-11	2382	33	LPG 1
Picanto 1.0	BA	1.0	46	4	11.09-	G4HE	1,1	BKR5ES-11	2382	33	LPG 1
Picanto 1.1	BA	1.1	48	4	10.03-	G4HG	1,1	BKR5ES-11	2382	33	LPG 1

**PICANTO (TA)**

Picanto 1.0	TA	1.0	51	3	05.11-	G3LA	1,0	LKR6D-10E	96569		
Picanto 1.2	TA	1.2	60	4	09.11-	G4LA	1,0	LKR6D-10E	96569		

**PRIDE**

Pride		1.3	44	4	05.95- .01		1,1	BPR5ES-11	4424		LPG 2
Pride		1.3	53	4	05.95- .01		1,1	BPR5ES-11	4424		LPG 2

**RETONA**

Retona 16V	CE	2.0	94	4	.00-	FED	1,1	BKR6E-11	2756	14	LPG 1
------------	----	-----	----	---	------	-----	-----	----------	------	----	-------

**RIO 1**

Rio 1.3	DC	1.3	60	4	.03-		1,1	BPR5EY-11	3028		
Rio 1.5	DC	1.5	71	4	.03-		1,1	BKR6ES-11	5553	14	LPG 1
Rio 1.5	DC	1.5	72	4	.00- .02		0,9	BKR6ES-11	5553	14	LPG 1

**RIO 2**

Rio II 1.4 16V	JB	1.4	71	4	06.05-	G4EE	1,1	BKR5ES-11	2382	33	LPG 1
Rio II 1.6 CVT	JB	1.6	82	4	06.05-	G4ED	1,1	BKR5ES-11	2382	33	LPG 1

**RIO 3**

Rio III 1.25 CVT	UB	1.3	63	4	06.11-	G4LA	1,0	LKR6D-10E	96569		
Rio III 1.4 CVT	UB	1.4	80	4	06.11-	G4FA	1,0	LZKR6B-10E	1578		

**SEDONA 1**

Sedona 2.5		2.5		6	09.99-	KV6	1,1	PFR6N-11	3546		LPG 1
------------	--	-----	--	---	--------	-----	-----	----------	------	--	-------

**SEPHIA**

Sephia	FA	1.5	59	4	.96-	B5E MMO	1,1	BPR5ES-11	4424		LPG 2
Sephia	FA	1.8		4	06.96-		0,8	BKR5E	1667	35	LPG 1
Sephia 2 FB522	FB	1.6	75	4	04.01-	OKAB5	0,9	BKR6E	4856	28	LPG 1
Sephia GTX	FA	1.6	59	4	09.93-	B6 SOHC	1,1	BPR6ES-11	4824	13	LPG 2

**SHUMA 1**

Shuma 1 1.5	FB	1.5	65	4	05.98-	BFD	1,1	BKR6E-11	2756	14	LPG 1
Shuma 1 1.8	FB	1.8	82	4	05.98-	TED	0,9	BKR6E	4856	28	LPG 1

**SHUMA 2**

Shuma 2 1.6 FB522,FB624	FB	1.6	75	4	04.01-	OKAB5	0,9	BKR6E	4856	28	LPG 1
Shuma 2 1.8	FB	1.8	82	4	.01-	TED	0,9	BKR6E	4856	28	LPG 1

**SORENTO 1**

Sorento 2.4	JC	2.4	75	4	.02-	G4JF	1,1	PGR5C-11	5760		
-------------	----	-----	----	---	------	------	-----	----------	------	--	--



e kW C y i

0201



Stock-No

VLINE

LPG/CNG

KIA

**SORENTO 1**

Sorento 3.3	JC	3.3	177	6	.06-	G6DB	1,1	IFR5G11	7854		
Sorento 3.5	JC	3.5	143	6	.02-	G6CU	1,1	PFR5N-11	5838		
Sorento 3.8	JC	3.8		6	.06-	G6DA	1,1	IFR5G11	7854		

**SORENTO 2**

Sorento 2.4 CVT	XM	2.4	128	4	11.09-	G4KE	1,1	LF5A-11	6376		LPG 7
-----------------	----	-----	-----	---	--------	------	-----	---------	------	--	-------

**SOUL**

Soul 1.6 CVT	AM	1.6	77	4	02.09-	G4FC	1,0	LZKR6B-10E	1578		
Soul 1.6	AM	1.6	93	4	02.09-	G4FC	1,0	LZKR6B-10E	1578		

**SPORTAGE 1**

Sportage	K00	2.0	70	4	.94-12.02	SOHC	0,8	BKR5E	1667	35	LPG 1
Sportage 16V	K00	2.0	94	4	.94-08.04	DOHC 16V	1,1	BKR6E-11	2756	14	LPG 1

**SPORTAGE 2**

Sportage 2.0	JE	2.0	104	4	.06-	G4GC	1,1	BKR5ES-11	2382	33	LPG 1
Sportage 2.5	JE	2.5	129	6	09.04-		1,1	BKR5ES-11	2382	33	LPG 1
Sportage 2.7	JE	2.7	129	6	.06-	G6BA V6	1,1	PFR5N-11	5838		

**SPORTAGE 3**

Sportage 2.0 CVT	SL	2.0	120	4	07.10-	G4KD	1,1	LF5A-11	6376		LPG 7
------------------	----	-----	-----	---	--------	------	-----	---------	------	--	-------

**VENGA**

Venga 1.4	YN	1.4	66	4	10.09-	G4FA	1,0	LZKR6B-10E	1578		
Venga 1.6	YN	1.6	92	4	10.09-	G4FC	1,0	LZKR6B-10E	1578		

**LADA (AVTOVAZ)**

112 2112 16V		1.5	54	4	01.96-	VAZ-2111	0,8	BPR6ES	4008	2	LPG 2
112 Gli		1.5	67	4	.03-	16V	1,1	BCPR6ES-11	7121	11	LPG 3
1200		1.2		4			0,8	BP5ES	6511	8	LPG 2
2101, 21011, 21012, 21013, 21014 1.2-1.5 ltr			44	4			0,7	BP6ES	7811	4	LPG 2
2107 Lada 1300 L		1.3		4			0,7	BP6ES	7811	4	LPG 2
2107 Lada 1500 L		1.5		4			0,7	BP6ES	7811	4	LPG 2
2108 Samara / Fun 1100		1.1		4			0,7	BP6ES	7811	4	LPG 2
2108 Samara / Fun 1300		1.3		4			0,7	BP6ES	7811	4	LPG 2
2108 Samara / Fun 1500		1.5		4			0,7	BP6ES	7811	4	LPG 2
210993 Samara 1.5		1.5	53	4	01.90-		0,8	BPR6ES	4008	2	LPG 2
210993 Samara 1.5i		1.5	57	4		VAZ-2111	1,1	BPR6ES-11	4824	13	LPG 2
2110 1.5		1.5	53	4	06.96-		0,8	BPR6ES	4008	2	LPG 2
2110		1.5	56	4	.96-		0,8	BPR6ES	4008	2	LPG 2
2110		1.5	58	4	.97-		0,8	BPR6ES	4008	2	LPG 2
2111		1.5	58	4	.97-		0,8	BPR6ES	4008	2	LPG 2
2115 1.5		1.5	53	4	.00-		0,8	BPR6ES	4008	2	LPG 2
2115 1.5i		1.5	57	4	01.00-	VAZ-2111	1,1	BPR6ES-11	4824	13	LPG 2
2120 Nadeschda 1.7i		1.7	60	4	01.98-	BA3-21214	1,1	BPR6ES-11	4824	13	LPG 2
2120 Nadeschda 1.8		1.8	59	4	01.98-	BA3-2130	0,8	BPR6ES	4008	2	LPG 2
Forma		1.3		4	09.91-		0,8	BPR6ES	4008	2	LPG 2
Forma		1.5	50	4	09.91-		0,8	BPR6ES	4008	2	LPG 2
Forma 21099		1.5	56	4			0,8	BPR6ES	4008	2	LPG 2
Lada 2101/ 21011/ 21012/ 21013/ 21014				4			0,7	BP6ES	7811	4	LPG 2
Lada 2102/ 21021/ 21022/ 21023/ 21024/ 21026				4			0,7	BP6ES	7811	4	LPG 2
Lada 2103/ 21033/ 21035				4			0,7	BP6ES	7811	4	LPG 2
Lada 2104/ 21043/ 21046/ 21047				4			0,7	BP6ES	7811	4	LPG 2

e kW  
C  
y  
i

Stock-No



LPG / CNG

**LADA (AVTOVAZ)**

Lada 2105/ 21051/ 21053/ 21056/ 21057			4			0,7	BP6ES	7811	4	LPG 2
Lada 2106/ 21061/ 21064/ 21065-01/ 21066			4			0,7	BP6ES	7811	4	LPG 2
Lada 2107/ 21072/ 21073/ 21074/ 21076/ 21077/ 21078/ 210736-40			4			0,7	BP6ES	7811	4	LPG 2
Lada 2108/ 21081/ 21083/ 21087/ 21088			4			0,8	BPR6ES	4008	2	LPG 2
Lada 21083i/ 21093i/ 21099i/ 21102/ 211026/ 21110/ 2131i			4			1,1	BPR6ES-11	4824	13	LPG 2
Lada 2109/ 21091/ 21093			4			0,8	BPR6ES	4008	2	LPG 2
Lada 21099			4			0,8	BPR6ES	4008	2	LPG 2
Lada 2110/ 2111			4			0,8	BPR6ES	4008	2	LPG 2
Lada 21103/ 211036/ 21113/ 21109/ 21108/ 21083-37/ 2112/ 2113/ 21103			4			1,1	BCPR6ES-11	7121	11	LPG 3
Lada 2115-01/ 2115-03/ 21153-01			4			0,8	BPR6ES	4008	2	LPG 2
Lada 2115-20/ 2115-21/ 2115-23/ 21153-21			4			1,1	BPR6ES-11	4824	13	LPG 2
Lada NIVA 4x4 2121			4			0,7	BP6ES	7811	4	LPG 2
Lada NIVA 4x4 21211/ 21212			4			0,8	BPR6ES	4008	2	LPG 2
Lada NIVA 4x4 2131/ 2130/ 2129/ 21217/ 21214/ 21213			4			0,8	BPR6ES	4008	2	LPG 2
Lada OKA 1111/ 1113			4			0,7	BCP6ES	4930	17	LPG 3
21102 i	1.5	57	4	01.96-	BA3 2111	1,1	BPR6ES-11	4824	13	LPG 2
21103 16V	1.5	67	4	01.96-	BA3 2112	1,1	BCPR6ES-11	7121	11	LPG 3
Lada 110 21101 8V	1.6	59	4	.04-	XXX 21114	1,1	BPR6ES-11	4824	12	LPG 2
Lada 110 21104	1.6	66	4	.04-	XXX 21124	1,1	BCPR6ES-11	7121	11	LPG 3
2110 GTi 16V	2.0	110	4	01.96-	C20XE Opel	0,9	BKR6E	4856	28	LPG 1
110 2.0 GTI	2.0	110	4	01.00-	C20XE	0,9	BKR6EK	2288	20	LPG 1
21111	1.5	53	4	01.98-	BA3 2120	0,8	BPR6ES	4008	2	LPG 2
21110 i	1.5	57	4	01.98-	BA3 2111	1,1	BPR6ES-11	4824	13	LPG 2
21113 16V	1.5	67	4	01.98-	BA3 2112	1,1	BCPR6ES-11	7121	11	LPG 3
Lada 111 21112 8V	1.6	59	4	.04-	XXX 21114	1,1	BPR6ES-11	4824	13	LPG 2
Lada 111 21114 16V	1.6	66	4	.04-	XXX 21124	1,1	BCPR6ES-11	7121	11	LPG 3
21122 i	1.5	57	4	01.00-	VAZ-2111	1,1	BPR6ES-11	4824	13	LPG 2
21120 16V	1.5	67	4	01.00-	VAZ-2112	1,1	BCPR6ES-11	7121	11	LPG 3
Lada 112 21121 8V	1.6	59	4	.04-	XXX 21114	1,1	BPR6ES-11	4824	13	LPG 2
Lada 112 21124 16V	1.6	66	4	.04-	XXX 21124	1,1	BCPR6ES-11	7121	11	LPG 3
2102, 21021, 21022, 21023, 21024, 21026 Lada Kombi	1.2	43	4		BA3 2101	0,7	BP6ES	7811	4	LPG 2
2102, 21021, 21022, 21023, 21024, 21026 Lada Kombi	1.3	47	4		BA3 21011	0,7	BP6ES	7811	4	LPG 2
21043 / Nova Kombi	1.5	53	4	01.88-	BA3-2103	0,7	BP6ES	7811	4	LPG 2
21050	1.5	53	4	01.88-	BA3 21011	0,7	BP6ES	7811	4	LPG 2
21060	1.3	47	4		BA3 21011	0,7	BP6ES	7811	4	LPG 2
21063	1.5	52	4		BA3 2103	0,7	BP6ES	7811	4	LPG 2
21073	1.5	53	4	01.88-	BA3 2103	0,7	BP6ES	7811	4	LPG 2
Lada Kalina 1117	1.6	58	4	10.04-	BA3 11183	1,1	BCPR6ES-11	7121	11	LPG 3
Lada Kalina 1118	1.6	58	4	10.04-	BA3 11183	1,1	BCPR6ES-11	7121	11	LPG 3
Lada Kalina 1119	1.6	58	4	10.04-	BA3 11183	1,1	BCPR6ES-11	7121	11	LPG 3
Lada Kalina 1117 8V	1.6	59	4	.05-	XXX 21114	1,1	BPR6ES-11	4824	13	LPG 2
Lada Kalina 1118 8V	1.6	59	4	.05-	XXX 21114	1,1	BPR6ES-11	4824	13	LPG 2
Lada Kalina 1119 8V	1.6	59	4	.05-	XXX 21114	1,1	BPR6ES-11	4824	13	LPG 2
Lada Kalina 1117 16V	1.6	65	4	10.04-	BA3 21124	1,1	BCPR6ES-11	7121	11	LPG 3
Lada Kalina 1118 16V	1.6	65	4	10.04-	BA3 21124	1,1	BCPR6ES-11	7121	11	LPG 3
Lada Kalina 1119 16V	1.6	65	4	10.04-	BA3 21124	1,1	BCPR6ES-11	7121	11	LPG 3

e kW  
C  
y  
i

0201



Stock-No

VALVE

LPG/CNG

**LADA (AVTOVAZ)**

Lada Niva 2129 1.7 Niva	1.7	59	4	.93-	XXX 21213	0,8	BPR6ES	4008	2	LPG 2
2105 Nova Junior	1.2		4			0,7	BP6ES	7811	4	LPG 2
2105 Nova 1300	1.3		4			0,7	BP6ES	7811	4	LPG 2
2105 Nova Spezial	1.5		4			0,7	BP6ES	7811	4	LPG 2
21091	1.1	39	4	01.87-		0,8	BPR6ES	4008	2	LPG 2
21090	1.3	48	4	01.87-	BA3 2108	0,8	BPR6ES	4008	2	LPG 2
21099	1.3	48	4	01.90-	BA3 2108	0,8	BPR6ES	4008	2	LPG 2
21093	1.5	53	4	01.87-	BA3 2103	0,8	BPR6ES	4008	2	LPG 2
Lada Samara 2113 8V	1.5	56	4	.04-	XXX 2111	1,1	BPR6ES-11	4824	13	LPG 2
21083 i	1.5	57	4		BA3 2111	1,1	BPR6ES-11	4824	13	LPG 2
21093 i	1.5	57	4		BA3 2111	1,1	BPR6ES-11	4824	13	LPG 2
2114 i	1.5	57	4	01.01-	BA3 2111	1,1	BPR6ES-11	4824	13	LPG 2
2107 Toscana	1.5	55	4	07.88-		0,7	BP6ES	7811	4	LPG 2
21213 Niva 1.7	1.7	55	4	01.93-		0,8	BPR6ES	4008	2	LPG 2
21214 Niva 1.7i	1.7	60	4	01.01-	BA3-21214	1,1	BPR6ES-11	4824	13	LPG 2
Niva	1.7	59	4	.95-		0,8	BPR6ES	4008	2	LPG 2
21310 Niva 1.7i	1.7	60	4	01.95-	BA3-21214	1,1	BPR6ES-11	4824	13	LPG 2
21312 Niva 1.8	1.8	59	4	01.95-	BA3-2130	0,8	BPR6ES	4008	2	LPG 2
Nova / Vaz 2104, 2105		55	4	07.88-		0,8	BPR6ES	4008	2	LPG 2
Nova / Vaz 2107		57	4	07.88-		0,8	BPR6ES	4008	2	LPG 2
Nova / Vaz 21051	1.2	44	4	07.88-		0,8	BPR6ES	4008	2	LPG 2
Nova / Vaz 2102, 2105	1.3	48	4	07.88-		0,8	BPR6ES	4008	2	LPG 2
Nova / Vaz 21043	1.5	55	4	07.88-		0,8	BPR6ES	4008	2	LPG 2
Nova i	1.7	59	4	11.94-		0,8	BPR6ES	4008	2	LPG 2
Nova i	1.7	62	4	11.94-		0,8	BPR6ES	4008	2	LPG 2
1111 Oka / 640	0.65	22	2	09.89-	BA3 1111	0,7	BCP6ES	4930	17	LPG 3
Oka /640	0.65	22	2	09.89-	Vaz 1111	0,7	BCP6ES	4930	17	LPG 3
1111 Oka 1.3	1.3	46	4	01.98-	A-Plus ROV	0,8	BPR6ES	4008	2	LPG 2
Oka 1.3 VAZ-1111	1.3	46	4	01.98-	A-Plus ROV	0,8	BPR6ES	4008	2	LPG 2
Sagona i	1.5		4	07.94-		0,9	BPR5ES	4006	6	LPG 2
Sagona GLX	1.5		4	07.95-		0,8	BPR6ES	4008	2	LPG 2
Samara Fun	1.1	39	4	09.91-		0,8	BPR6ES	4008	2	LPG 2
Samara / Vaz 2108	1.1	41	4	07.88-		0,8	BPR6ES	4008	2	LPG 2
Samara / Vaz 2108	1.3	46	4	07.88-		0,8	BPR6ES	4008	2	LPG 2
Samara 21093	1.5	56	4			0,8	BPR6ES	4008	2	LPG 2
Samara Sport	1.5	65	4	.96-		0,8	BPR6ES	4008	2	LPG 2

**LAMBORGHINI**

Gallardo Coupé	5.0	382	10	05.05-	L140	0,8	PFR7G	4364		
Gallardo Spider	5.0	382	10	05.05-	L140	0,8	PFR7G	4364		
Gallardo Coupé Superleggera	5.0	390	10	06.07-	L140	0,8	PFR7G	4364		
Murciélago Coupé	6.5	471	12	04.06-	L537	0,8	KR8BI	4347		KR8BI
Murciélago LP640 Coupe / Roadster	6.5	471	12	.07-	L537	0,8	KR8BI	4347		KR8BI

**LANCIA****DEDRA**

Dedra 1.6L i.e.	1.6	57	4	08.89-09.94	835A1046 Cat.	0,8	BPR6ES	4008	2	LPG 2
Dedra 1.6L-LE/S.W. LE	1.6	66	4	10.94-02.98	159B9000	0,9	BCPR7ES	3330		BCPR7EIX
Dedra 1.6	1.6	66	4	03.97-02.98	159B9000	0,9	BCPR7ES	3330		BCPR7EIX
Dedra 1.6i.e. S.W. 16V	1.6	76	4	03.98-01.00	182A4000	0,9	BKR5EZ	6714	36	LPG 1
Dedra 1.6i.e. 16V	1.6	76	4	03.98-01.00	182A4000	0,9	BKR5EZ	6714	36	LPG 1

e kW  
C  
Y  
I

Stock-No



LPG / CNG

**LANCIA****DEDRA**

Dedra 1.8L-LE-LS-SW	1.8	74	4	10.94-02.98	835A2046	0,9	BCPR7ES	3330		BCPR7EIX
Dedra i.e./ LE	1.8	77	4	01.89-09.94	835A2046 Cat.	0,8	BPR7ES	2023	19	BPR8EIX
Dedra 1.8- 16V	1.8	83	4	07.97-01.00	182A2000	0,9	BKR6EKC	2848	26	LPG 1
Dedra i.e. / LS	2.0	83	4	01.89-09.94	835A5046 Cat.	0,8	BPR7ES	2023	19	BPR8EIX
Dedra i.e. automatica LS	2.0	83	4	10.94-04.97	835A5046	0,8	BPR7ES	2023	19	BPR8EIX
Dedra 2.0L-16V- S.W.LX / integrale	2.0	102	4	10.94-02.98	836A3000	0,8	BPR7ES	2023	19	BPR8EIX
Dedra 2000 Turbo	2.0	119	4	08.91-02.98	835A8046	0,8	BP6ET	1263		LPG 2
Dedra i.e. Turbo/Integr.	2.0	124	4	01.91-09.94	835A7046 Cat.	0,8	BP6ET	1263		LPG 2

**DELTA**

Delta / LX	1.3	57	4	- .93	831A...- 831B.000	0,8	BPR7ES	2023	19	BPR8EIX
Delta 1.4 T-JET 120CV	1.4	88	4	.08-	198A4000	0,8	IKR9J8	93311		
Delta 1.4 T-JET 150CV	1.4	110	4	.08-	198A1000	0,8	IKR9J8	93311		
Delta / LX / Automatic	1.5	59	4	- .93	831A...- 831B.000	0,8	BPR7ES	2023	19	BPR8EIX
Delta	1.6	55	4	09.93-11.97	851C1000	0,9	BCPR7ES	3330		BCPR7EIX
Delta (836)	1.6	66	4	03.96-02.98	182A6000	0,9	BCPR7ES	3330		BCPR7EIX
Delta 16V-HPE	1.6	76	4	06.96-11.97	182A4000	0,9	BKR6EKC	2848	26	LPG 1
Delta 1.6i.e. 16V HPE; LS	1.6	76	4	12.97-02.98	182A4000	0,9	BKR6EKC	2848	26	LPG 1
Delta	1.6	76	4	03.98-01.00	182A4000	0,9	BKR5EZ	6714	36	LPG 1
Delta GT	1.6	77	4	- .93	831A4000	0,8	BPR7ES	2023	19	BPR8EIX
Delta i.e. GT	1.6	77	4	- .93	182A4000 Cat.	0,8	BPR6ES	4008	2	LPG 2
Delta i.e. / Turbo HF	1.6	95	4	- .93	831A7000 Cat.	0,8	BPR7ES	2023	19	BPR8EIX
Delta i.e. / LE	1.8	66	4	09.93-11.97	835C4000	0,8	BPR7ES	2023	19	BPR8EIX
Delta 16V/ HPE	1.8	96	4	06.96-11.97	183A1000	0,9	BKR6EKC	2848	26	LPG 1
Delta 1.8- 16V- HPE/LS	1.8	96	4	12.97-01.00	183A1000	0,9	BKR6EKC	2848	26	LPG 1
Delta i.e. 16V / LS	2.0	102	4	09.93-11.97	836A3000	0,8	BPR7ES	2023	19	BPR8EIX
Delta i.e. 16V GT	2.0	102	4	10.94-11.97	836A3000	0,8	BPR7ES	2023	19	BPR8EIX
Delta HPE ie	2.0	102	4	06.95-		0,8	BPR7ES	2023	19	BPR8EIX
Delta i.e. HPE Turbo 16V	2.0	137	4	01.93-09.96	836A2000	0,8	BPR7ES	2023	19	BPR8EIX
Delta Turbo	2.0	137	4	09.93-11.97	836A2000	0,8	BP6ET	1263		LPG 2
Delta HPE Turbo 16V HF	2.0	137	4	06.95-		0,8	BUR6ET	2876	1	LPG 2
Delta i.e. HPE Turbo 16V HF	2.0	142	4	12.97-01.00	175A4000	0,9	BCPR6ET	2197		LPG 3
Delta i.e. Turbo HF 16V Integr.	2.0	144	4	10.87-11.97	831C5000	0,8	BPR7ES	2023	19	BPR8EIX
Delta HF Integrale Evo 3	2.0	144	4	07.92-11.97	831C5046	0,8	BP6ET	1263		LPG 2
Delta i.e. Turbo HF Integr.	2.0	144	4	07.92-11.97	831C5046	0,8	BPR7ES	2023	19	BPR8EIX
Delta HF integrale Spec. ed.	2.0	155	4	02.94-11.97	831E5046	0,8	BUR6ET	2876	1	LPG 2

**DELTA III**

Delta 3 1.4 T-Jet	844	1.4	88	4	09.08-	198A4000	0,8	IKR9J8	93311	
Delta 3 1.4 T-Jet LPG	844	1.4	88	4	10.09-	198A4000	0,8	IKR9J8	93311	
Delta 3 1.4 T-Jet	844	1.4	103	4	07.10-	198A7000	0,8	IKR9J8	93311	
Delta 3 1.4 T-Jet	844	1.4	110	4	09.08-	198A1000	0,8	IKR9J8	93311	
Delta 3 1.8 Di TURBO-JET	844	1.8	147	4	05.09-	939B1000	0,6	ILKAR7D6G	93607	

**KAPPA (K)**

K	2.0	114	4	11.94-02.01	838A6000	0,9	BKR6EKC	2848	26	LPG 1
K	2.0	114	4	07.98-02.01	838A6000	0,9	BKR6EKC	2848	26	LPG 1
K 20V LS; S.W.	2.0	114	5	07.98-02.01	838A6000	0,9	BKR6EKC	2848	26	LPG 1
K turbo	2.0	151	4	02.95-06.98	838A4000	0,8	BP6ET	1263		LPG 2
K Turbo 16V Coupé	2.0	151	4	07.97-06.98	838A4000	0,8	BP6ET	1263		LPG 2
K i. 20V LS/LE/LX/SW	2.4	129	5	01.95-02.01	838A2000	0,9	BKR6EKC	2848	26	LPG 1
K i 20V Coupé	2.5	129	5	07.97-02.01	838A2000	0,9	BKR6EKC	2848	26	LPG 1





l kW  
C  
y  
i

0201



Stock-No

VALVE

LPG/CNG

**LANCIA**

**KAPPA (K)**

K V6-24V-LX/LS/SW/coupè	3.0	150	6	01.95-02.01	838B000	0,9	PFR6B	3500		PFR7B
K i V6 24V aut. Coupé	3.0	150	6	07.97-02.01	838B000	0,9	PFR6B	3500		PFR7B
KAPPA 2000 20V 150CV	2.0	110	5	01.95-	838A1000	0,9	BKR6EKC	2848	26	LPG 1
KAPPA 2000 16V TURBO	2.0	151	4	02.95-02.01	838A4000	0,8	BP6ET	1263		LPG 2
KAPPA 2000 TURBO 20V	2.0	162	5	07.98-02.01	175A3000	0,8	BKUR6ET	5461	27	LPG 1
KAPPA 2400 20V 175CV	2.4	129	5	01.95-02.01	838A2000	0,9	BKR6EKC	2848	26	LPG 1
KAPPA 3000 V6 24V	3.0	150	6	01.95-02.01	838B000	0,9	PFR6B	3500		PFR7B

**LYBRA**

Lybra 16V;Lx;S.W.	1.6	76	4	09.99-	182A4000	0,9	BKR5EZ	6714	36	LPG 1
Lybra 16V;Lx;S.W.	1.8	96	4	09.99-08.02	839A4000	0,9	BKR6EKC	2848	26	LPG 1
Lybra 16V;Lx;S.W.	1.8	96	4	09.02-	839A4000	0,9	BKR6EKC	2848	26	LPG 1
Lybra 20V;Lx;S.W.;Aut.	2.0	110	5	09.99-08.02	182B7000	0,9	BKR6EKC	2848	26	LPG 1
Lybra 20V;Lx;S.W.;Aut.	2.0	110	5	09.02-	182B7000	0,9	BKR6EKC	2848	26	LPG 1

**MUSA**

Musa 1.4	1.4	57	4	09.05-	350A1000	1,0	ZKR7A-10	1691	42	LPG 8
Musa 1.4 LPG EURO IV	1.4	57	4	04.09-	350A1000	1,0	ZKR7A-10	1691	42	LPG 8
Musa 1.4 LPG EURO V	1.4	57	4	11.10-	350A1000	0,8	ZKR7AI-8	92402		
Musa 1.4 16V	1.4	66	4	10.04-12.12	192B2000	1,0	DCPR7E-N-10	4983	43	
Musa 1.4 16V	1.4	70	4	09.04-02.05	843A1000	1,0	DCPR7E-N-10	4983	43	
Musa 1.4 16V	1.4	70	4	03.05-	843A1000	1,0	DCPR7E-N-10	4983	43	

**PHEDRA**

Phedra 2.0	2.0	100	4	10.02-	RFN	0,9	LFR5B	7113		LPG 7
Phedra 3.0 V6	3.0	150	6	10.02-	XFW	1,1	PLFR5A-11	6240		LPG 7

**THEMA**

Thema i.e. / Wagon	2.0	85	4	-01.95	834B.146 Cat.	0,8	BPR7ES	2023	19	BPR8EIX
Thema i.e. 16V Tur. SW/LS/LX	2.0	108	4	-01.95	834B2000	0,8	BP6ET	1263		LPG 2
Thema i.e. Turbo SW	2.0	110	4	-01.95	834C146 Cat.	0,8	BPR7ES	2023	19	BPR8EIX
Thema 16V / LE / LS	2.0	112	4	-01.95	834F1000 Cat.	0,8	BPR7ES	2023	19	BPR8EIX
Thema i.e.16V S.W. Fairway	2.0	112	4	04.94-01.95	834F1000	0,8	BPR7ES	2023	19	BPR8EIX
Thema i.e. Turbo	2.0	122	4	-01.95	834C146	0,8	BPR7ES	2023	19	BPR8EIX
Thema Turbo 16V LS/LX	2.0	132	4	-01.95	834C1000	0,8	BP6ET	1263		LPG 2
Thema i.e. Turbo 16V LX	2.0	148	4	10.91-01.95	834F2000 Cat.	0,8	BP6ET	1263		LPG 2
Thema i.e. Turbo 16V	2.0	148	4	04.94-		0,8	BP6ET	1263		LPG 2
Thema i.e. Turbo 16V S.W.Fairway	2.0	148	4	04.94-01.95	834C1246	0,8	BUR6ET	2876	1	LPG 2
Thema i.e. V6	2.8	110	6	-01.95	PRV834AB Cat.	1,0	BPR6EFS	3623	5	LPG 5
Thema i.e. V6 LS / LX / SW	3.0	126	6	.92-01.95	834F.000	0,8	BPR7ES	2023	19	BPR8EIX
Thema 8.32	3.0	150	8	.90- .92	F105L Cat.	0,7	DCPR9E	2641		

**THESIS**

Thesis 2.0 20 V TB	2.0	136	5	11.02-	841E000	0,8	BKUR6ETB	6992		
Thesis 2.0 TB cambio 6 marce	2.0	136	5	11.02-	841E000	0,8	BKUR6ETB	6992		
Thesis 2.4 20V	2.4	125	5	11.02-	841D000	0,9	BKR6EZ	4619	38	LPG 1
Thesis 3.0 24V V6	3.0	158	6	11.02-	841A000	0,9	PFR6B	3500		PFR7B
Thesis 3.2 24V V6	3.2	169	6	11.03-	841A000	0,9	PFR6B	3500		PFR7B

**Y**

Y 1.2 8V: Vanity- LS-Unica	1.2	44	4	10.00-12.03	188A4000	0,9	BKR5EZ	6714	36	LPG 1
Y 1.2 16V- LS-LX-Unica	1.2	59	4	10.00-11.02	188A5000	0,9	DCPR8E-N	5692		LPG 8
Y 1.2 16V- LS-LX-Unica	1.2	59	4	12.02-12.03	188A5000	0,9	DCPR8E-N	5692		LPG 8
Y 10 4WD	1.0	33	4	.85-10.96	156A2246	0,8	BCPR6ES	2330	12	LPG 3
Y 10 Fire	1.0	33	4	.85-10.96	156A2000	0,8	BCPR6ES	2330	12	LPG 3

e kW  
C  
y  
i

0201



Stock-No

VE LINE

LPG / CNG

**LANCIA****Y**

Y 10 Selectronic i.e.	1.1	37	4	-10.96	156C046 Cat.	0,8	BCPR6ES	2330	12	LPG 3
Y 10 /4x4	1.1	37	4	09.86-10.96	156C046	0,6	BCPR7ES	3330	12	BCPR7EIX
Y Elefantino Blu	1.1	40	4	05.97-04.00	176B2000	0,9	BKR6E	4856	28	LPG 1
Y Elefantino Blu	1.1	40	4	05.97-09.00	176B2000	0,8	BKR6E	4856	28	LPG 1
Y 8 V	1.2	44	4	01.96-03.97	840A3000	0,8	BCPR6ES	2330	12	LPG 3
Y 8 V LS,LE;ECVT	1.2	44	4	01.96-10.99	840A3000	0,8	BCPR6ES	2330	12	LPG 3
Y 8 V Elefantino Blu -unica	1.2	44	4	10.99-09.03	188A4000	0,9	BKR5EZ	6714	36	LPG 1
Y 16V elefantino Blu /Rosso	1.2	59	4	10.00-11.02	188A5000	0,9	DCPR8E-N	5692		LPG 8
Y 16V	1.2	63	4	04.97-03.00	176B9000	0,9	DCPR8E	4179		LPG 8
Y 16V,LE,LS,LX, Elefantino Rosso	1.2	63	4	04.97-04.00	176B9000	0,9	DCPR8E	4179		LPG 8
Y 16V LE	1.2	63	4	02.98-09.00	176B9000	0,9	DCPR8E	4179		LPG 8
Y 10 1300; G.T.	1.3	53	4	11.87-10.96	146A5046	0,8	BPR6ES	4008	2	LPG 2
Y	1.4	55	4	01.96-12.97		0,9	BCPR6ET	2197		LPG 3
Y i. 12V	1.4	55	4	01.96-01.98	840A2000-4000	0,9	BKR6EKC	2848	26	LPG 1
Y i.e. 12V	1.4	59	4	01.96-01.98	840A4000	0,9	BKR6EKC	2848	26	LPG 1

**YPSILON (843)**

Ypsilon 1.2 8V	843	1.2	44	4	09.03-10.04	188A4000	0,9	BKR5EZ	6714	36	LPG 1
Ypsilon 1.2	843	1.2	44	4	10.04-	188A4000	1,0	DCPR7E-N-10	4983	43	
Ypsilon 1.2	843	1.2	51	4	09.10-	169A5000	1,0	ZKR7A-10	1691	42	LPG 8
Ypsilon 16V	843	1.2	57	4	09.03-02.05	188A5000	1,0	DCPR7E-N-10	4983	43	
Ypsilon 16V	843	1.2	57	4	02.05-	188A5000	1,0	DCPR7E-N-10	4983	43	
Ypsilon 1,4	843	1.4	57	4	09.06-	350A1000	1,0	ZKR7A-10	1691	42	LPG 8
Ypsilon 1.4 LPG	843	1.4	57	4	04.09-	350A1000	1,0	ZKR7A-10	1691	42	LPG 8
Ypsilon 1.4 16V	843	1.4	70	4	09.03-02.05	843A1000	1,0	DCPR7E-N-10	4983	43	
Ypsilon 1.4 16V	843	1.4	70	4	02.05-	843A1000	1,0	DCPR7E-N-10	4983	43	

**YPSILON (846)**

Ypsilon 0.9 Twinair	846	0.9	63	2	05.11-	312A2000	0,8	ILKR9G8	97168		
Ypsilon 1.2 LPG	846	1.2	49	4	05.11-	169A4000	0,8	ZKR7AI-8	92402		
Ypsilon 1.2	846	1.2	51	4	05.11-	169A4000	1,0	ZKR7A-10	1691	42	LPG 8

**ZETA**

Zeta i.e.	2.0	89	4	04.99-12.01	RFV	0,8	BKR5EK	4483	23	LPG 1
Zeta 2.0 16V	2.0	100	4	07.00-09.02	RFN	0,9	LFR5B	7113		LPG 7
Zeta i.e. Turbo,LS	2.0	108	4	10.94-03.99	RGX	0,9	BKR6EK	2288	20	ILKAR7D6G

**LAND ROVER****DEFENDER**

Defender 2.5	2.5		6	.90-		0,8	BP6ES	7811	4	LPG 2
Defender 3.5 V8	3.5		8	.90-		0,9	BPR5ES	4006	6	LPG 2

**DISCOVERY**

Discovery 2.0	2.0	99	4	06.93-01.99	Mpi	0,9	BKR6E	4856	28	LPG 1
Discovery V8	3.5	107	8	09.89-01.99	V8 3.5	0,8	BPR6ES	4008	2	LPG 2
Discovery V8	3.9	136	8	02.99-	V8	0,8	BPR6ES	4008	2	LPG 2
Discovery 4.0	4.0		8	.94- .99		0,8	BPR6ES	4008	2	LPG 2
Discovery 4.0	4.0		8	10.98-		1,1	BPR6ES	4008	2	LPG 2
Discovery 3 4.4	4.4	220	8	07.04-10.08		1,0	IFR5N10	7866		

**FREELANDER 1**

Freelander 1.8	1.8	87	4	.97-	K SERIES	1,1	PFR6N-11	3546		LPG 1
Freelander 2.0	2.0		6	.01-	KV6	1,1	PFR6N-11	3546		LPG 1
Freelander 2.5 V6	2.5	130	6	09.00-	KV6	1,1	PFR6N-11	3546		LPG 1



l kW C y i

0201



Stock-No

VALENTINE

LPG / CNG

## LAND ROVER

### RANGE ROVER

Range Rover	182	3.9	127	8	11.88-10.95	V8	0,8	BPR6ES	4008	2	LPG 2
Range Rover	182	4.0	131	8	01.99- .02		1,1	PFR6N-11	3546		LPG 1
Range Rover	182	4.0		8	09.94-12.98		0,8	PFR6N-11	3546		LPG 1
Range Rover	182	4.2		8	10.92-12.94	V8	0,8	BPR6ES	4008	2	LPG 2
Range Rover	182	4.4	210	8	09.99-	BMW M62 B44	1,5	BKR6EQUP	3199	30	LPG 1
Range Rover	182	4.6	160	8	01.99-		1,1	PFR6N-11	3546		LPG 1
Range Rover	182	4.6	165	8	09.94-10.98	V8	0,8	BPR6ES	4008	2	LPG 2

### RANGE ROVER 4

Range Rover 4 4.2 Supercharged		4.2	291	8	05.05-	AJ41	1,0	IFR5N10	7866		
Range Rover 4 4.4		4.4	225	8	05.05-	AJ41	1,0	IFR5N10	7866		
Range Rover 4 5.0		5.0	276	8	09.09-	AJ133	1,0	ILKAR7C10	94940		
Range Rover 4 5.0 Supercharged		5.0	375	8	09.09-	AJ133	1,0	ILKAR7C10	94940		

### RANGE ROVER SPORT

Range Rover Sport 4.2 Supercharged		4.2	287	8	02.05-	AJ41	1,0	IFR5N10	7866		
Range Rover Sport 4.4		4.4	220	8	02.05-	AJ41	1,0	IFR5N10	7866		
Range Rover Sport 5.0		5.0	276	8	07.09-	AJ133	1,0	ILKAR7C10	94940		
Range Rover Sport 5.0 Supercharged		5.0	372	8	01.10-	AJ133	1,0	ILKAR7C10	94940		
Range Rover Sport 5.0 Supercharged		5.0	375	8	09.09-	AJ133	1,0	ILKAR7C10	94940		

## LEXUS

### CT

CT 200h Hybrid	ZWA10	1.8	73	4	12.10-	2ZR-FXE	1,1	ILKAR7B11	4912		
----------------	-------	-----	----	---	--------	---------	-----	-----------	------	--	--

### ES

ES 300	MCV20	3.0		6	01.00- .03	2JZ-GE	1,1	BKR6EKP-11	3452		
ES 300	MCV30	3.0		6	01.04-	1MZ-FE	1,1	IFR6T11	4589		

### GS

GS 250	GRL11	2.5	154	6	03.12-	4GR-FSE	1,1	DFH6B-11A	1501		
GS 300	JZS147	3.0	156	6	.93- .99	2JZ-GE	1,1	BKR5EP-11	3440		LPG 1
GS 300	JZS160 / UZS161	3.0	161	6	01.02-	2JZ-GE	1,1	BKR6EP-11	2978		LPG 1
GS 300		3.0	163	6	.97-	2TZ-GE	1,1	BKR6EKP-11	3452		
GS 300	UZS190 / GRS190	3.0	170	6	04.05-	3GR-FE	1,1	DFH6B-11A	1501		
GS 300	UZS190 / GRS190	3.0	183	6	04.05-08.07	3GR-FSE	1,1	DFH6B-11A	1501		
GS 300	UZS190 / GRS190	3.0	183	6	09.07-	3GR-FSE	1,1	DFH6B-11A	1501		
GS 300	JZS160	3.0		6	01.00-	1MZ-FE	1,1	BKR6EKP-11	3452		
GS 300	UZS190 / GRS190	3.0		6	05.05-	3GR-FSE	1,1	DFH6B-11A	1501		
GS 430	JZS160 / UZS161	4.3	208	6	01.02-	3UZ-FE	1,1	IFR6T11	4589		
GS 430	GRS190	4.3	208	8	08.05-	3UZ-FE	1,1	IFR6T11	4589		
GS 430	UZS190	4.3	208	8	08.05-	3UZ-FE	1,1	IFR6T11	4589		
GS 450h Hybrid	GWS191	3.5	218	6	02.06-11.11	2GR-FSE	1,1	DFH6B-11A	1501		
GS 450h Hybrid	GWS191	3.5	254	6	02.06-11.11	2GR-FSE	1,1	DFH6B-11A	1501		
GS 460	URS190	4.6	255	8	09.07-	1UR-FSE	1,1	DFH6B-11A	1501		

### IS

IS 200	GXE10	2.0	114	6	01.00-	1G-FE	1,1	IFR6T11	4589		
IS 250	GSE20	2.5	153	6	08.05-	4GR-FSE	1,1	DFH6B-11A	1501		
IS 300	GXE10/JCE10/15	2.0	114	6	09.01-	1G-FE	1,1	IFR6T11	4589		
IS 300	GXE10/JCE10/15	3.0		6	01.02-	2JZ-GE	1,1	BKR6EP-11	2978		LPG 1

### IS C

IS C	GSE20	2.5	153	6	04.09-	4GR-FSE	1,1	DFH6B-11A	1501		
------	-------	-----	-----	---	--------	---------	-----	-----------	------	--	--

e kW  
C  
y  
i

0201



Stock-No

VLINE

LPG / CNG

**LEXUS****ISF**

IS-F	USE20	5.0	311	8	11.07-	2UR-GSE	1,1	DFH6B-11A	1501		
------	-------	-----	-----	---	--------	---------	-----	-----------	------	--	--

**LS**

LS 400		4.0	180	8	.90- .94	1UZ-FE Cat.	1,1	BKR6EP-11	2978		LPG 1
LS 400		4.0	194	8	10.94-12.99	1UZ-FE	0,8	BKR6EP-8	2215		LPG 1
LS 400		4.0		8	06.90-06.97	1UAZ-FE	1,1	BKR5EP-11	3440		LPG 1
LS 400	UCF20	4.0		8	01.00-	1UZ-FE	1,1	IFR6T11	4589		
LS 430	UCF30	4.3	207	8	08.00-	3UZ-FE with TWC	1,1	IFR6T11	4589		
LS 430	UCF30	4.3		8	08.00-	3UZ-FE without TWC	0,8	BKR6EYA	2249		LPG 1
LS 460	USF40 / 41	4.6		8	09.06-	1UR-FE	1,1	ILFR6T11	4904		

**LX**

LX 470	UZJ100	4.7		8	01.00-	2UZ-FE with TWC	1,1	IFR6T11	4589		
LX 470	UZJ100	4.7		8	01.00-	2UZ-FE without TWC	0,8	BKR6EYA	2249		LPG 1

**RX**

RX 300	MCU10	3.0	148	6	01.98-02.03	1MZ-FE	1,1	IFR6T11	4589		
RX 300	MCU15	3.0	150	6	07.00- .06	1MZ-FE	1,1	IFR6T11	4589		
RX 300	MCU35 / 38	3.0		6	01.04- .06	1MZ-FE	1,1	IFR6T11	4589		
RX 300	MCU35 / 38	3.0		6	01.04-	1MZ-FE	1,1	IFR6T11	4589		
RX 300	MCU35 / 38	3.3		6	01.04- .06	3MZ-FE	1,1	IFR6T11	4589		
RX 330	MCU35 / 38	3.3	171	6	04.03-01.06	3MZ-FE	1,1	IFR6T11	4589		
RX 400 h	MHU38	3.3	155	6	03.05-	3MZ-FE	1,1	IFR6T11	4589		

**SC 430**

SC 430	UZZ40	4.3	210	8	05.01-	3UZ-FE	1,1	IFR6T11	4589		
--------	-------	-----	-----	---	--------	--------	-----	---------	------	--	--

**LOTUS**

Elan SE 16V Turbo		1.6		4	10.89-		0,8	BKR6E	4856	28	LPG 1
Elan 1.6 16V		1.6		4	10.89-		1,1	BKR6E-11	2756	14	LPG 1
Elise		1.8	88	4	.96-	K- SERIES (Including) WC	1,1	PFR6N-11	3546		LPG 1
Elise 111S		1.8	107	4	.99-		1,1	PFR6N-11	3546		LPG 1
Esprit 2.0 Turbo 16V GT3		2.0		4	10.96-		0,8	BPR6EKN	1128		
Esprit Turbo SE		2.2	197	4	.89-	910S	0,6	BPR6EKN	1128		
Esprit Turbo		2.2		4	.87-		0,8	BPR6ES	4008	2	LPG 2
Esprit S4		2.2		4	.93-07.96		0,6	BPR6EKN	1128		
Esprit Sport 300		2.2		4	.93-		0,6	BPR6EKN	1128		
Esprit SE 2.2		2.2		4	11.94-07.96	Cat.	0,8	BPR6EKN	1128		
Esprit		3.5	260	8	.96-	918	0,9	BKR6EKC	2848	26	LPG 1
Excel SA / SE		2.2	135	4	.85- .91	912S	0,8	BPR7ES	2023	19	BPR8EIX
Exige 1.8 16V		1.8	132	4	07.00-		0,8	BKR7E	6097		BKR8EIX

**MASERATI**

2.24 V		2.0	180	4	.88-	AM 475	0,9	DCPR8E	4179		LPG 8
228 I		2.8	184	6	12.87-	Bi Turbo Cat.	0,8	BP8ES	2912		
3200 GT		3.2	271	8	12.98-09.01	585	0,7	PMR8A	5851		
4.18 V		2.0		6	02.91-		0,8	BP8ES	2912		
4.24 V / Spider 24V		2.0	180	6	.90-	475	0,9	DCPR8E	4179		LPG 8
420 / I / S / SI /		2.0	138	6	01.87-	470	0,8	BP8ES	2912		
422		2.0	164	6	.88-	AM 471	0,8	BP8ES	2912		
430		2.8	182	6	02.88-	473 Cat.	0,8	BP8ES	2912		

e kW  
C  
y  
i

0201



Stock-No

VLINE

LPG / CNG

**MASERATI**

Coupè GT / Cambiocorsa	4.2	287	8	06.02-11.03	F136R	0,7	PMR8A	5851		
Coupè GT / Cambiocorsa	4.2	287	8	12.03-	F136R	0,7	PMR8A	5851		
Ghibli	2.0	209	6	09.96-	496	0,7	DCPR9E	2641		
Ghibli V6	2.8	209	6	11.95-		0,8	DCPR9E	2641		
GranSport	4.2	294	8	09.04-	F136S	0,7	PMR8B	6378		PMR9B
Karif	2.8	165	6	04.88-	437 Cat.	0,8	BP8ES	2912		
Quattroporte II 2.0 V6 Biturbo	2.0	211	6	03.94- .99	475	0,6	DCPR9E	2641		
Quattroporte II 2.8 V6 Biturbo	2.8	209	6	11.95-01.99		0,8	DCPR9E	2641		
Quattroporte II 2.8 V6 Evoluzione	2.8	260	6	02.99-12.01	588	0,9	DCPR8E	4179		LPG 8
Quattroporte II 3.2 V8 Evoluzione	3.2	270	8	02.99- .02	578	0,7	PMR8A	5851		
Quattroporte III 4.7 GT S	4.7	323	8	06.08-12.12	M139S	0,7	PMR8C-H	96361		
Quattroporte III 4.7 GT S	4.7	331	8	01.10-12.12	M145T	0,7	PMR8C-H	96361		
Quattroporte III 4.2 V8	4.2	295	8	09.03-12.12	M139A	0,7	PMR8C-H	96361		
Quattroporte III 4.7 S	4.7	317	8	06.08-12.12	M139R / F136YG	0,7	PMR8C-H	96361		
Quattroporte 4.2	4.2	294	8	11.02-11.03		0,7	PMR8A	5851		
Quattroporte 4.2	4.2	294	8	12.03-	F136S	0,7	PMR8B	6378		PMR9B
Racing	2.0	194	6	02.91-	475	0,7	DCPR9E	2641		
Shamal I Turbo 32V	3.2	240	8	02.91-02.96	AM 479 Cat.	0,9	DCPR8E	4179		LPG 8
Spyder	2.8	165	6	01.90-	473 Cat.	0,8	BP8ES	2912		
Spyder GT/Cambiocorsa	4.2	287	8	10.01-11.03	F136R	0,7	PMR8A	5851		
Spyder GT/Cambiocorsa	4.2	287	8	12.03-	F136R	0,7	PMR8A	5851		
Gran Turismo 4.2 V8	4.2	298	8	08.08-	M139P / F136UD	0,7	PMR8C-H	96361		
Gran Turismo 4.2 V8	4.7	331	8	01.11-	M145T	0,7	PMR8C-H	96361		
Gran Turismo 4.7 V8 S	4.7	323	8	08.08-12.12	M139S / F136YE	0,7	PMR8C-H	96361		
GranCabrio 4.7 V8	4.7	323	8	06.10-01.13	M139S	0,7	PMR8C-H	96361		
GranCabrio 4.7 V8	4.7	331	8	01.11-	M145T	0,7	PMR8C-H	96361		

**MAYBACH**

Maybach 57/ 62	240	5.5	404	12	09.02-	M 285.950	0,8	IFR6Q-G	5648		
Maybach 62S	240	6.0	450	12	09.05-	M 285.980	0,8	IFR6Q-G	5648		

**MAZDA****121**

121 DA VIN--> 200000	1.1	40	4	-03.91	B1 u.Cat.	0,9	BPR5ES	4006	6	LPG 2
121 16V	1.25	55	4	.00- .02	DHB / DHC / DHD / DHF	1,3	PTR5A-13	2467	25	LPG 4
121 ZQ	1.3	37	4	03.96-	JJA / JJC / JJE / J4C	1,0	PTR5D-10	3784	31	LPG 5
121 DA VIN 200001-->	1.3	40	4	- .96	B3 Cat.	1,1	BPR6ES-11	4824	13	LPG 2
121 DA --> VIN 200000	1.3	44	4	03.96-	B3	0,9	BPR5ES	4006	6	LPG 2
121 DB --> VIN 400000	1.3	39	4	- .96	B3 16V Cat.	1,1	BKR6E-11	2756	14	LPG 1
121 DB VIN 400000-->	1.3	53	4	- .96	B3 16V Cat.	1,1	BKR6E-11	2756	14	LPG 1
121 ZQ	1.3	55	4	03.96-	DHA Zetec (FORD)	1,3	PTR5A-13	2467	25	LPG 4

**2**

2 DY VIN 3*00001-->	1.25	55	4	.03- .07	MZI FUJA / F8JB	1,3	PTR5A-13	2467	25	LPG 4
2 DY VIN 3*00001-->	1.25	55	4	.03- .07	MZI FUJB / F8JA	1,3	PTR5A-13	2467	25	LPG 4
2 1.3 (DE)	1.3	55	4	10.07-	ZJ-VE / FUJA	1,3	IFR5E13	6903		IFR6E11
2 DY VIN 3*00001-->	1.3	59	4	.03- .07	MZI DOHC FXJA / FXJB	1,3	PTR5A-13	2467	25	LPG 4
2 1.3 (DE)	1.3	63	4	10.07-	ZJ-VEM / FXJA	1,3	IFR5E13	6903		IFR6E11
2 1.5 (DE)	1.5	76	4	10.07-	ZY-VE / FYJA	1,3	IFR5E13	6903		IFR6E11
2 DY VIN 3*00001-->	1.6	74	4	.03- .07	MZI DOHC FYJA	1,3	PTR5A-13	2467	25	LPG 4

**3**

3 1.4	BK	1.4	59	4	.04- .09	ZJ	1,1	BKR5E-11	6953	33	LPG 1
-------	----	-----	----	---	----------	----	-----	----------	------	----	-------

e kW  
C  
Y  
I

0201



Stock-No

VLINE

LPG / CNG

**MAZDA****3**

3 1.4	BK	1.4	62	4	10.03-03.06	ZJ07	1,1	BKR5E-11	6953	33	LPG 1
3 1.5 Skyactiv-G 100	BM	1.5	74	4	07.13-	P5Y1	1,1	ILKAR7L11	94124		
3 1.6	BK	1.6	77	4	10.03-	CE	1,1	BKR5E-11	6953	33	LPG 1
3 1.6	BK	1.6	77	4	10.03-.09	Z601 / Z627	1,1	BKR5E-11	6953	33	LPG 1
3 1.6 MZR	BL	1.6	77	4	06.09-	Z668	1,3	IFR5E13	6903		IFR6E11
3 2.0 Spark Plug to be determined on Veh.	BK	2.0	110	4	10.03-01.04	LF17 / 50 / 72 / LFN7 / LFN8	1,3	ILTR5A-13G	3811		ILTR6A-13G
3 2.0 Spark Plug to be determined on Veh.	BK	2.0	110	4	02.04-12.09	LF17 / 50 / 72 / LFN7 / LFN8	1,3	TR5AI-13	90813		LPG 5
3 2.0 MZR	BL	2.0	110	4	02.09-	LF5H / LF5W / LFZ2	1,3	ILTR5A-13G	3811		ILTR6A-13G
3 2.0 MZR DISI	BL	2.0	111	4	02.09-	LF5H / LF5W / LFZ2	1,3	ILTR5A-13G	3811		ILTR6A-13G
3 2.0 Skyactiv-G 120	BM	2.0	88	4	07.13-	PEY7	1,1	ILKAR7L11	94124		
3 2.0 Skyactiv-G 165 i-ELOOP	BM	2.0	121	4	07.13-	PEY7	1,1	ILKAR7L11	94124		
3 2.3 MPS Turbo	BL	2.3	191	4	05.09-	L3Y7	0,7	SILTR6A7G	95369		
3 2.3 MPS	BK	2.3	191	4	06.06-01.09	L3M6	0,8	ILTR6A-8G	3787		

**323**

323 (BD1) VIN 800000 -->	1.1	40	4			E1	0,8	BPR6ES	7822	2	LPG 2
323 (BF) VIN--> 400000	1.1	40	4			E1	0,8	BPR6ES	7822	2	LPG 2
323 (BD1) VIN 800000 -->	1.3	44	4			E3	0,8	BPR6ES	7822	2	LPG 2
323 (BG)	1.3		4	.90-		B3 carbu.	0,8	BKR5E	7938	35	LPG 1
323 (BF) VIN 400001 -->	1.4	44	4			B3 u.Cat.	0,8	BPR6ES	7822	2	LPG 2
323 (BG) VIN--> 500000	1.4	49	4			B3E Cat.	1,1	BPR6ES-11	4824	13	LPG 2
323 (BJ) VIN 400001-->	1.4	53	4	.02-		B3 SOHC	1,1	BKR5E-11	6953	33	LPG 1
323 (BA) VIN 500001 -->	1.4	54	4			B3 16V Cat.	1,1	BKR6E-11	2756	14	LPG 1
323 (BG) VIN 500001 -->	1.4	54	4			B3 16V Cat.	1,1	BKR6E-11	2756	14	LPG 1
323 (BA) VIN 300001 -->	1.4	54	4	09.94-		B3	1,1	BKR6E-11	2756	14	LPG 1
323 (BJ) VIN 100001-->	1.4	54	4	09.98-		B3	1,1	BKR5E-11	6953	33	LPG 1
323 (BF) VIN 400001 -->	1.5	54	4			B5 u.Cat.	0,8	BPR6ES	7822	2	LPG 2
323 (BF) VIN--> 400000	1.5	55	4			E5	0,8	BPR6ES	7822	2	LPG 2
323 (BW) VIN--> 400000	1.5	55	4			E5	0,8	BPR6ES	7822	2	LPG 2
323 (BW) VIN400001--500000	1.5	54	4			B5 u.Cat.	0,8	BPR6ES	7822	2	LPG 2
323 (BD1) VIN 800000 -->	1.5	55	4			E5	0,8	BPR6ES	7822	2	LPG 2
323 (BA) VIN 500001 -->	1.5	65	4			Z5 16V Cat.	1,1	BKR6E-11	2756	14	LPG 1
323 (BA) VIN 100001-->	1.5	65	4	09.94-		Z5 Cat.	1,1	BKR5E-11	6953	33	LPG 1
323 (BJ) VIN 100001 -->	1.5	65	4	09.98-		ZL	1,1	BKR5E-11	6953	33	LPG 1
323 (BG) VIN--> 500000	1.6	62	4			B6E Cat.	1,1	BPR6ES-11	4824	13	LPG 2
323 (BF1) VIN 400001 -->	1.6	63	4			B6 Cat.	0,8	BPR6ES	7822	2	LPG 2
323 (BF1) VIN--> 400000	1.6	63	4			B6 Cat.	1,1	BPR5ES-11	4424		LPG 2
323 (BW) VIN 500001 -->	1.6	63	4			B6 Cat.	1,1	BPR6ES-11	4824	13	LPG 2
323 (BW) VIN 400001-500000	1.6	63	4			B6 Cat.	1,1	BPR5ES-11	4424		LPG 2
323 (BG) VIN 500001 -->	1.6	65	4			B6 16V Cat.	1,1	BKR6E-11	2756	14	LPG 1
323 (BF1) VIN--> 400000	1.6	77	4			B6	0,8	BPR6ES	7822	2	LPG 2
323 Turbo BF2 400001 -->	1.6	103	4			B6 DOHC Cat.	1,1	BCPR6E-11	3132	11	LPG 3
323 (BF1) VIN 400001 -->	1.6	103	4	.85-.91		B6 DOHC Cat.	1,1	BCPR6E-11	3132	11	LPG 3
323 (BF2) VIN--> 400000	1.6	110	4			B6 DOHC	0,8	BCPR6E	1269	12	LPG 3
323	1.8	84	4	02.97-		B6D	1,1	BKR5E-11	6953	33	LPG 1
323 GTR Turbo	1.8	136	4	.95-			1,1	PFR6G-13E	2341		LPG 1
323	1.8		4	.89-		BP DOHC Cat.	1,1	BKR6E-11	2756	14	LPG 1
323	1.8		4	.89-		BP EGI Cat.	0,8	BKR5E	7938	35	LPG 1
323 Turbo	1.8		4	.89-		BP	1,1	BKR6E-11	2756	14	LPG 1
323 (BG) VIN 500001 -->	1.9	76	4			BP SOHC 16V Cat.	1,1	BKR6E-11	2756	14	LPG 1



l kW  
C  
y  
i

0201



Stock-No

VALE

LPG / CNG

**MAZDA**

**323**

323 (BG) VIN--> 500000	1.9	76	4			BP SOHC 16V Cat.	1,1	BKR6E-11	2756	14	LPG 1
323 (BA) VIN 500001 -->	1.9	84	4			BP 16V Cat.	1,1	BKR6E-11	2756	14	LPG 1
323 (BA) VIN 300001 -->	1.9	84	4	09.94-		BP 16V Cat.	1,1	BKR5E-11	6953	33	LPG 1
323 (BJ) VIN 100001 -->	1.9	84	4	09.98-		FP	1,1	BKR5E-11	6953	33	LPG 1
323 (BG) VIN 500001 -->	1.9	94	4			BP DOHC 16V Cat.	1,1	BKR6E-11	2756	14	LPG 1
323 (BG) VIN--> 500000	1.9	94	4			BP DOHC 16V Cat.	1,1	BKR6E-11	2756	14	LPG 1
323 (BG) Turbo 16V	1.9	120	4			BP DOHC 16V Cat.	1,1	BKR6E-11	2756	14	LPG 1
323 (BJ) VIN 400001-->	2.0	96	4	.02- .04		FS7G / FS7E DOHC (High Power)	1,1	ZFR5F-11	2262	40	LPG 6
323 (BA) VIN 100001 -->	2.0	106	6	09.94-10.98		KF DOHC V6	1,1	BKR6E-11	2756	14	LPG 1
323 (BA) VIN 500001 -->	2.0	106	6	08.94-10.98		KF DOHC V6	1,1	BKR6E-11	2756	14	LPG 1

**5**

5 1.8 Spark Plug to be determined on Veh. ! CW19	1.8	85	4	06.10-		L850	1,3	TR5AI-13	90813		LPG 5
5 1.8 Spark Plug to be determined on Veh. ! CW19	1.8	85	4	06.10-		L850	1,3	ILTR6A-13G	3789		ILTR6A-13G
5 1.8 CR19	1.8	85	4	06.05-		L8	1,3	TR5AI-13	90813		LPG 5
5 2.0 CR19	2.0	107	4	06.05-		LFF7	1,3	TR5AI-13	90813		LPG 5
5 2.3 CR19	2.3		4	.05-		L3-VE	1,3	TR5AI-13	90813		LPG 5
5 2.0 Spark Plug to be determined on Veh. ! CW19	2.0	106	4	06.10-		LFZB	1,3	TR5AI-13	90813		LPG 5
5 2.0 Spark Plug to be determined on Veh. ! CW19	2.0	106	4	06.10-		LFZB	1,3	ILTR6A-13G	3789		ILTR6A-13G
5 2.0 Spark Plug to be determined on Veh. ! CW19	2.0	110	4	06.10-		LF5H	1,3	TR5AI-13	90813		LPG 5
5 2.0 Spark Plug to be determined on Veh. ! CW19	2.0	110	4	06.10-		LF5H	1,3	ILTR6A-13G	3789		ILTR6A-13G

**6**

6 1.8 VIN 100001-->	GG	1.8	88	4	06.02- .07	MZR-L8 DOHC	1,3	ITR6F13	4477		LPG 5
6 1.8 Sport-Kombi VIN 100001-->	GY	1.8	88	4	06.02- .07	MZR-L8 DOHC	1,3	ITR6F13	4477		LPG 5
6 1.8		1.8	88	4	09.07-	L823	1,3	TR5AI-13	90813		LPG 5
6 2.0 Spark Plug to be determined on Veh. ! GG	GG	2.0	104	4	06.02-09.07	LF17 / LF18	1,3	ITR6F13	4477		LPG 5
6 2.0 Spark Plug to be determined on Veh. ! GG	GG	2.0	104	4	06.02-09.07	LF17 / LF18	1,3	ILTR5A-13G	3811		ILTR6A-13G
6 2.0 Sport-Kombi VIN 100001-->	GY	2.0	104	4	06.02-02.05	LF17 / LF18	1,3	ILTR5A-13G	3811		ILTR6A-13G
6 2.0 Spark Plug to be determined on Veh. ! GG	GG	2.0	108	4	03.05-09.07	LFH1 / LFF7	1,3	ITR6F13	4477		LPG 5
6 2.0 Spark Plug to be determined on Veh. ! GG	GG	2.0	108	4	03.05-09.07	LFH1 / LFF7	1,3	ILTR5A-13G	3811		ILTR6A-13G
6 2.0 GY	GY	2.0	108	4	03.05-01.08	LFH1 / LFF7	1,3	ILTR5A-13G	3811		ILTR6A-13G
6 2.0 GH	GH	2.0	108	4	08.07-	L17 / LF95	1,3	ILTR5A-13G	3811		ILTR6A-13G
6 2.0		2.0		4	06.05-	LF-VE	1,3	ILTR5A-13G	3811		ILTR6A-13G
6 2.0 Skyactiv-G 145 GJ2/GJ9	GJ2/GJ9	2.0	107	4	10.12-	PEY7	1,1	ILKAR7L11	94124		
6 2.0 Skyactiv-G 165 GJ2/GJ9	GJ2/GJ9	2.0	121	4	10.12-	PEY7	1,1	ILKAR7L11	94124		
6 2.3 4WD VIN 100001-->	GY	2.3	119	4	06.02- .07	MZR-L3 DOHC	1,3	ITR6F13	4477		LPG 5
6 2.3 VIN 100001-->	GG	2.3	122	4	06.02- .07	MZR-L3 DOHC	1,3	ITR6F13	4477		LPG 5
6 2.3 VIN 100001-->	GY	2.3	122	4	06.02- .07	MZR-L3 DOHC	1,3	ITR6F13	4477		LPG 5
6 2.3		2.3	122	4	06.05-	L3C1	1,3	ILTR5A-13G	3811		ILTR6A-13G
6 2.5 Skyactiv-G 192 i-ELOOP GJ2/GJ9	GJ2/GJ9	2.5	141	4	10.12-	PYY1	1,1	ILKAR7L11	94124		

**626**

626 (GF) VIN 100001-->		1.8	66	4	07.97-	FP DOHC	0,8	PZFR6F	7550		LPG 6
626 (GF) VIN.100001 -->		1.9	66	4		FP DOHC	0,8	PZFR6F	7550		LPG 6
626 (GW) VIN 100001 -->		1.9	66	4		FP DOHC 16V	0,8	PZFR6F	7550		LPG 6
626 (GE) VIN 434202 -->		1.9	66	4	09.94-	FP DOHC	1,1	BKR6E-11	2756	14	LPG 1
626 (GF)		1.9	66	4	07.97-	FP	0,8	PZFR6F	7550		LPG 6
626 (GF) VIN 400001-->		1.9	74	4	.00-	FP DOHC	0,8	PZFR6F	7550		LPG 6
626 (GW) VIN 208843-->		1.9	74	4	.00-	FP DOHC	0,8	PZFR6F	7550		LPG 6
626 (GE) VIN 100001 -->		1.9	77	4	.92-	FP DOHC Cat.	1,1	BKR6E-11	2756	14	LPG 1



Stock-No



LPG / CNG

**MAZDA****626**

626 (GD) VIN 500001-->	2.0	66	4		FE Cat.	0,8	BPR6ES	7822	2	LPG 2
626 (GD) VIN--> 500000	2.0	66	4		FE Cat.	1,1	BPR6ES-11	4824	13	LPG 2
626 (GV) VIN 200001 -->	2.0	66	4		FE Cat.	0,8	BPR6ES	7822	2	LPG 2
626 (GV) VIN--> 200000	2.0	66	4		FE Cat.	0,8	BPR6ES	7822	2	LPG 2
626 (GC) VIN 700001-->	2.0	68	4		FE Cat.	0,8	BPR6ES	7822	2	LPG 2
626 (GC) VIN--> 700000	2.0	74	4		FE	0,8	BPR6ES	7822	2	LPG 2
626 (GD) VIN--> 500000	2.0	79	4		FE 12 Valve	0,8	BCPR6E	1269	12	LPG 3
626 (GF) VIN 100001-->	2.0	85	4		FS DOHC	0,8	PZFR6F	7550		LPG 6
626 (GW) VIN 100001 -->	2.0	85	4		FS DOHC 16V	0,8	PZFR6F	7550		LPG 6
626(USA)GE VIN 803719-->	2.0	85	4		FS DOHC	1,1	BKR5E-11	6953	33	LPG 1
626(USA)GE VIN 802219-->	2.0	85	4	.92- .98	FS DOHC	1,1	BKR5E-11	6953	33	LPG 1
626 (GE) VIN 4343202-->	2.0	85	4	.94-	FS DOHC Cat.	1,1	BKR6E-11	2756	14	LPG 1
626 (GF) VIN 400001-->	2.0	85	4	.00-	FS DOHC	0,8	PZFR6F	7550		LPG 6
626 (GW) VIN 200001-->	2.0	85	4	.00-	FS DOHC	0,8	PZFR6F	7550		LPG 6
626 (GC) VIN 700001-->	2.0	88	4		FE	0,8	BPR6ES	7822		LPG 2
626 (GF) VIN.100001 -->	2.0	100	4		FS DOHC	0,8	PZFR6F	7550		LPG 6
626 (GW) VIN 100001 -->	2.0	100	4		FS DOHC 16V	0,8	PZFR6F	7550		LPG 6
626 (GF)	2.0	100	4	07.97-	FS	0,8	PZFR6F	7550		LPG 6
626 (GF) VIN 400001-->	2.0	100	4	.00-	FS DOHC High Power	0,8	PZFR6F	7550		LPG 6
626 (GW) VIN 208843-->	2.0	100	4	.00-	FS DOHC High Power	0,8	PZFR6F	7550		LPG 6
626 (GD) VIN 500001-->	2.0	103	4		FE 16V Cat.	1,1	BKR6E-11	2756	14	LPG 1
626 (GD) VIN--> 500000	2.0	103	4		FE 16V Cat.	1,1	BCPR6E-11	3132	11	LPG 3
626 (GD) VIN 500001-->	2.2	85	4		F2 12 Valve Cat.	1,1	ZFR6F-11	4291		LPG 6
626 (GD) VIN--> 500000	2.2	85	4		F2 12 Valve Cat.	1,1	ZFR6A-11	1041		
626 (GV) VIN 200001-->	2.2	85	4		F2 12 Valve Cat.	1,1	ZFR6F-11	4291		LPG 6
626 (GV) VIN--> 200000	2.2	85	4		F2	1,1	ZFR6A-11	1041		
626 (GE) VIN 434202 -->	2.5	120	6	09.94-	KL DOHC V6	1,1	ZFR5F-11	2262	40	LPG 6
626 (GE) VIN 100001-->	2.5	121	6	.92- .94	KL DOHC V6 Cat.	1,1	ZFR6F-11	4291		LPG 6

**B SERIE**

B 1600	1.6		4			0,9	BPR5ES	7422	6	LPG 2
B 1800	1.8		4			0,9	BPR5ES	7422	6	LPG 2
B 2000	2.0		4			0,9	BPR5ES	7422	6	LPG 2
B 2200	2.2		4	.90-	F2	0,9	BPR5ES	7422	6	LPG 2
B 2200	2.2		4	.90-	F2 EGI	1,1	BPR5ES-11	4424		LPG 2
B 2600	2.6		6	.90-	G6	1,1	ZFR5F-11	2262	40	LPG 6

**CX-5**

CX-5 2.0	KE	2.0	113	4	11.11-	PEY5	1,1	ILKAR7L11	94124		
CX-5 2.0	KE	2.0	114	4	11.11-	PEY5	1,1	ILKAR7L11	94124		
CX-5 2.0 Skyactiv-G 160	KE	2.0	118	4	11.11-	PEY6	1,1	ILKAR7L11	94124		
CX-5 2.0 Skyactiv-G 165	KE	2.0	121	4	11.11-	PEY6	1,1	ILKAR7L11	94124		

**CX-7**

CX-7 2.3 MZR DISI Turbo	ER8	2.3	190	4	10.07-05.09	L3K4 / L3-VDT	0,8	ILTR6A-8G	3787		
CX-7 2.3 MZR DISI Turbo	ER8	2.3	190	4	06.09-08.09	L3K4 / L3-VDT	0,7	SILTR6A7G	95369		
CX-7 2.3 MZR DISI Turbo	ER9	2.3	191	4	09.09-	L3ZA	0,7	SILTR6A7G	95369		

**DEMIO**

Demio DW VIN 100.001 -->	1.4	46	4	.98- .03	B3 SOHC	1,1	BKR6E-11	2756	14	LPG 1
Demio DW VIN 300001-->	1.4	46	4	.00- .03	B3 SOHC	1,1	BKR5E-11	6953	33	LPG 1
Demio DW VIN 300001-->	1.5	55	4	05.00- .03	B5 SOHC	1,1	BKR6E-11	2756	14	LPG 1





l kW  
C  
y  
i

0201



Stock-No

U-LINE

LPG / CNG

**MAZDA**

**E SERIE**

E 2000 SR VIN 600001-->	2.0	60	4		FE	0,9	BPR5ES	7422	6	LPG 2
E 2000 SR VIN--> 600000	2.0	63	4	.84- .95	FE	0,8	BPR6ES	7822	2	LPG 2
E 2000 SR VIN 800001-->	2.0	70	4		FE 8V	1,1	BKR5E-11	6953	33	LPG 1
E 2000 SR VIN 700001-->	2.0	70	4	.95-	FE	1,1	BKR6E-11	2756	14	LPG 1
E 2000 SR VIN X100001-->	2.0	70	4	.99-	FE	1,1	BKR5E-11	6953	33	LPG 1

**MPV**

MPV LW VIN Y100001-->	2.0	90	4	06.99-04.02	FS DOHC	1,1	ZFR5F-11	2262	40	LPG 6
MPV LW VIN 200001-->	2.3	104	4	05.02-	MZR-L3 DOHC	1,3	ITR6F13	4477		LPG 5
MPV	2.5		6	.02-	AJ	1,0	TR5IX	7397		LPG 5
MPV LV VIN 100001-->	3.0	109	6	05.96-	JE 12V	1,1	BKR6E-11	2756	14	LPG 1
MPV LV 52 VIN 631983-->	3.0	113	6	09.94-	JEE	1,1	ZFR6F-11	4291		LPG 6

**MX-3**

MX-3 EC	1.6	65	4	08.91-	B6 SOHC Cat.	1,1	BKR5E-11	6953	33	LPG 1
MX-3 EC VIN 208015-->	1.6	79	4	.94-	B6 DOHC	1,1	BKR6E-11	2756	14	LPG 1
MX-3 EC VIN 208015-->	1.8	95	6	.95-	K8 DOHC	1,1	BKR5E-11	6953	33	LPG 1
MX-3 EC	1.8	98	6	08.91-	K8 DOHC Cat.	1,1	BKR5E-11	6953	33	LPG 1

**MX-5**

MX-5 NA VIN 308212-->	1.6	66	4		B6 DOHC	1,1	BKR6E-11	2756	14	LPG 1
MX-5 NA VIN 200001-->	1.6	66	4	.95-	B6 DOHC	1,1	BKR6E-11	2756	14	LPG 1
MX-5 NB VIN 100001 -->	1.6	81	4	.98-	B6 DOHC	1,1	BKR5E-11	6953	33	LPG 1
MX-5 NA VIN 100001-->	1.6	85	4	.90-	B6 DOHC Cat.	1,1	BKR6E-11	2756	14	LPG 1
MX-5	1.8	93	4	.06-		1,3	TR5AI-13	90813		LPG 5
MX-5 NA VIN 308212-->	1.9	96	4		BP DOHC	1,1	BKR6E-11	2756	14	LPG 1
MX-5 NA VIN 100000-->	1.9	96	4	.94-	BP DOHC Cat.	1,1	BKR6E-11	2756	14	LPG 1
MX-5 NB VIN 300001--> Automatic	1.9	102	4	.01-	BP DOHC	1,1	BKR5E-11	6953	33	LPG 1
MX-5 NB VIN 100001-->	1.9	103	4	.98-	BP DOHC	1,1	BKR5E-11	6953	33	LPG 1
MX-5 NB VIN 121912--> (Anniversary)	1.9	103	4	.00-	BP DOHC	1,1	BKR5E-11	6953	33	LPG 1
MX-5 NB VIN 200001-->	1.9	107	4	.01-	BP DOHC	1,1	BKR5E-11	6953	33	LPG 1
MX-5	2.0	118	4	01.06-	LF-VE	1,3	ILTR6A-13G	3789		

**MX-6**

MX-6 GE VIN 100001-->	2.0	85	4	.92-	FS DOHC Cat.	1,1	BKR6E-11	2756	14	LPG 1
MX-6 GE VIN 400001-->	2.0	85	4	09.94-	FS DOHC	1,1	BKR5E-11	6953	33	LPG 1
MX-6	2.2		4	.92-	F2	1,1	ZFR6F-11	4291		LPG 6
MX-6 GE VIN 400001-->	2.5	120	6	09.94-	KL DOHC V6	1,1	ZFR5F-11	2262	40	LPG 6
MX-6 GE VIN 100001-->	2.5	121	6	.92-	KL DOHC V6 Cat.	1,1	ZFR5F-11	2262	40	LPG 6

**PREMACY**

Premacy 1.9 VIN 100001-->151176	CP	1.9	74	4		FP DOHC	1,1	BKR5E-11	6953	33	LPG 1
Premacy 1.9 VIN 151177-->	CP	1.9	74	4	06.99-	FP DOHC	1,1	ZFR5F-11	2262	40	LPG 6
Premacy 1.9 VIN 151177-->	CP	1.9	85	4	06.99-	FP DOHC with VICS	1,1	ZFR5F-11	2262	40	LPG 6
Premacy 2.0 VIN 300001-->	CP	2.0	96	4		FS DOHC	1,1	BKR5E-11	6953	33	LPG 1
Premacy	CP19	2.0	96	4	08.01-06.05	FS7E	1,1	ZFR6F-11	4291		LPG 6
Premacy	CP19	2.0	96	4	08.01-06.05	FS7G	1,1	ZFR6F-11	4291		LPG 6
Premacy	CR19	2.0	107	4	02.05-05.10	LFD7	1,1	ZFR6F-11	4291		LPG 6
Premacy	CR19	2.0	107	4	02.05-05.10	LFF7	1,1	ZFR6F-11	4291		LPG 6

**RX-7**

RX-7 FB VIN 700001-->		83			12 A	1,05	BR8ET	4221		BR9EIX
RX-7 FC VIN--> 200000		110			13 B	1,05	BR10ET	7480		BR10EIX
RX-7 Turbo FC VIN-->200000		133			RE 13 B	1,0	SD11A	1199		

e kW  
C  
Y  
I

0201



Stock-No

VELINE

LPG / CNG

**MAZDA****RX-7**

RX-7 Turbo FC VIN 200001-->		147		.90-	RE 13 B	1,4	BUR9EQ	5483		
RX-7 Turbo FD VIN-->100000		176			13B-REV	1,4	BUR9EQP	5255		

**RX-8**

RX-8	2.6	141		09.03-12.10	13B-MSP 2+ 2sparkplug		RE8C-L + RE9B-T	5745+ 2809		
RX-8 Sport	2.6	170		09.03-12.10	13B-MSP(high power) 2+2sparkplug		RE8C-L + RE9B-T	5745+ 2809		

**TRIBUTE**

Tribute EP VIN M00001-->	2.0	91	4	04.00-	Zetec 16V	1,3	PTR5A-13	2467	25	LPG 4
Tribute EP2 VIN M00001-->	2.0	91	4	04.00-	Zetec 16V	1,3	PTR5A-13	2467	25	LPG 4
Tribute	2.0		4	.03-	Ford	1,3	PTR5A-13	2467	25	LPG 4
Tribute	2.3	110	4	.03-	MZR-L3 DOHC	1,3	ITR6F13	4477		LPG 5
Tribute V6 EP VIN M00001-->	3.0	145	6	04.00-	Duratec 24V	1,0	TR5IX	7397		LPG 5
Tribute V6 EP2 VIN M00001-->	3.0	145	6	04.00-	Duratec 24V	1,0	TR5IX	7397		LPG 5

**XEDOS 6**

Xedos 6 CA VIN 210758-->	1.6	79	4	09.94-	B6 DOHC	1,1	BKR5E-11	6953	33	LPG 1
Xedos 6 CA VIN 210758-->	2.0	103	6	09.94-	KF DOHC V6	1,1	BKR6E-11	2756	14	LPG 1
Xedos 6 CA VIN 100001-->	2.0	106	4	06.92-		1,1	BKR6E-11	2756	14	LPG 1

**XEDOS 9**

Xedos 9 TA VIN 200001-->	2.0	105	6	10.93-	KF V6 DOHC	1,1	BKR6E-11	2756	14	LPG 1
Xedos 9 TA VIN 200001-->	2.3	155	6	02.95-	KJ V6 DOHC Miller Mot	0,8	PZFR5F	3741		LPG 6
Xedos 9 TA VIN 400001-->	2.5	120	6		KL-V6 DOHC	1,1	ZFR5F-11	2262	40	LPG 6
Xedos 9 TA V6	2.5	120	6	.01-	KJD	1,1	BKR5E-11	6953	33	LPG 1
Xedos 9 TA VIN 200001-->	2.5	128	6	10.93-	KL-ZE V6	1,1	ZFR5F-11	2262	40	LPG 6

**MERCEDES****190 W201**

190 E 1.8	201	1.8	80	4	05.90-05.93	M 102.910	0,8	BP6EFS	3812	5	LPG 5
190 E	201	2.0	87	4	09.85-08.93	M 102.962	0,8	BP6EFS	3812	5	LPG 5
190 E 2.3	201	2.3	97	4	09.86-05.93	M 102.985	0,8	BP6EFS	3812	5	LPG 5
190 E 2.5 16V	201	2.5	143	4	09.88-05.93	M 102.990	0,8	BP6EFS	3812	5	LPG 5
190 E Evolution II 2.5 16V	201	2.5	173	4	05.90-05.93	M 102.992	0,8	BP6EFS	3812	5	LPG 5
190 E 2.6	201	2.6	118	6	09.86-05.93	M 103.942	0,8	BP6EFS	3812	5	LPG 5

**A W168**

A 140	168	1.4	60	4	10.97-08.04	M 166.940	0,8	BKUR5ET	2789	29	LPG 1
A 140	168	1.6	60	4	01.01-08.04	M 166.960	0,8	BKUR5ET	2789	29	LPG 1
A 160	168	1.6	75	4	10.97-08.04	M 166.960	0,8	BKUR5ET	2789	29	LPG 1
A 190	168	1.9	92	4	03.99-08.04	M 166.990	0,8	BKUR5ET	2789	29	LPG 1
A 210 Evolution	168	2.0	103	4	03.02-08.04	M 166.995	0,8	BKUR5ET	2789	29	LPG 1

**A W169**

A 150	169	1.5	70	4	09.04-	M 266.920	0,9	BKR6EZB	4293		
A 170	169	1.7	85	4	09.04-	M 266.940	0,9	BKR6EZB	4293		
A 200	169	2.0	100	4	09.04-	M 266.960	0,9	BKR6EZB	4293		
A 200 Turbo	169	2.0	142	4	09.05-	M 266.980	1,0	IFR6D10	5344		LPG 1

**A W176**

A 180	176	1.6	90	4	06.12-	M 270.910	0,7	SILZKFR8D7S	95875		
-------	-----	-----	----	---	--------	-----------	-----	-------------	-------	--	--



ℓ kW  
C y  
i

0201



Stock-No

U-TIME

LPG / CNG

## MERCEDES

### A W176

A 200	176	1.6	115	4	06.12-	M 270.910	0,7	SILZKFR8D7S	95875		
A 220 4-matic	176	2.0	135	4	05.14-	M 270.920	0,7	SILZKFR8E7S	90654		
A 250	176	2.0	155	4	06.12-	M 270.920	0,7	SILZKFR8E7S	90654		
A 45 AMG	176	2.0	265	4	04.13-	M 133.980	0,7	SILZKFR8D7S	95875		

### B W245

B 150	245	1.5	70	4	04.05- .11	M 266.920	0,9	BKR6EZB	4293		
B 170	245	1.7	85	4	04.05- .11	M 266.940	0,9	BKR6EZB	4293		
B 180 NGT	245	2.0	85	4	04.08-	M 266.960	0,9	BKR6EZB	4293		
B 200	245	2.0	100	4	04.05- .11	M 266.960	0,9	BKR6EZB	4293		
B 200 Turbo	245	2.0	142	4	04.05- .11	M 266.980	1,0	IFR6D10	5344		LPG 1

### B W246

B 180	246	1.6	90	4	11.11-	M 270.910	0,7	SILZKFR8D7S	95875		
B 200	246	1.6	115	4	11.11-	M 270.910	0,7	SILZKFR8D7S	95875		
B 200 NGT	246	2.0	115	4	11.12-	M 270.920	0,7	SILZKFR8E7S	90654		
B 220 4-matic	246	2.0	135	4	05.13-	M 270.920	0,7	SILZKFR8E7S	90654		
B 250	246	2.0	155	4	05.12-	M 270.920	0,7	SILZKFR8E7S	90654		

### C W/S 202

C 180	202	1.8	90	4	06.93-06.97	M 111.920	0,7	BCP6ES	4930	17	LPG 3
C 180	202	1.8	90	4	07.97-05.00	M 111.921	0,8	BKUR5ET	2789	29	LPG 1
C 180	202	1.8	95	4	09.00-03.01	M 111.952	1,0	IFR6D10	5344		LPG 1
C 200	202	2.0	100	4	03.94-06.97	M 111.941	0,7	BCP6ES	4930	17	LPG 3
C 200	202	2.0	100	4	07.97-05.00	M 111.945	0,8	BKUR5ET	2789	29	LPG 1
C 200	202	2.0	120	4	09.00-03.01	M 111.956	1,0	IFR6D10	5344		LPG 1
C 200 Kompressor	202	2.0	132	4	09.95-10.96	M 111.944	1,0	BKUR6ET-10	2397	24	LPG 1
C 200 Kompressor	202	2.0	141	4	11.96-05.00	M 111.944	1,0	BKUR6ET-10	2397	24	LPG 1
C 220	202	2.2	110	4	06.93-09.96	M 111.961	0,7	BCP6ES	4930	17	LPG 3
C 230	202	2.3	110	4	09.96-05.97	M 111.974	0,7	BCP6ES	4930	17	LPG 3
C 230 Kompressor	202	2.3	142	4	10.95-05.00	M 111.975	1,0	BKUR6ET-10	2397	24	LPG 1
C 240 V6	202	2.4	125	6	04.97-05.00	M 112.910 T.S.	1,1	PFR5R-11	4292		LPG 1
C 240 V6	202	2.6	125	6	09.00-03.01	M 112.915 T.S.	1,1	PFR5R-11	4292		LPG 1
C 280	202	2.8	141	6	06.93-05.97	M 104.941	0,7	BCP6ES	4930	17	LPG 3
C 280 V6	202	2.8	145	6	06.97-05.00	M 112.920 T.S.	1,1	PFR5R-11	4292		LPG 1
C 36 AMG	202	3.6	206	6	01.94-05.97	M 104.941	0,7	BKR5EKU	3964		
C 43 AMG	202	4.3	225	8	09.97-05.00	M 113.944 T.S.	1,1	PFR5R-11	4292		LPG 1

### C W/S 203

C 180	203	2.0	95	4	05.00-05.02	M 111.951	1,0	IFR6D10	5344		LPG 1
C 180 Kompressor	203	1.8	105	4	05.02-11.06	M 271.940 -> 30853899	0,8	ILFR6A	3588		
C 180 Kompressor	203	1.8	105	4	12.06-	M 271.940 30853900 ->	0,8	PLKR7B8E	94716		
C 180 Kompressor	203	1.8	105	4	05.02-11.06	M 271.946 -> 30853899	0,8	ILFR6A	3588		
C 180 Kompressor	203	1.8	105	4	12.06-	M 271.946 30853900 ->	0,8	PLKR7B8E	94716		
C 200 CGI Kompressor	203	1.8	125	4	02.03-11.06	M 271.942 -> 30853899	0,8	ILFR6A	3588		
C 200 CGI Kompressor	203	1.8	125	4	12.06-	M 271.942 30853900 ->	0,8	PLKR7B8E	94716		
C 200 Kompressor	203	1.8	105	4	02.03-11.06	M 271.942 -> 30853899	0,8	ILFR6A	3588		

e kW  
C  
y  
i

0201



Stock-No

VELINE

LPG / CNG

**MERCEDES****C W/S 203**

C 200 Kompressor	203	1.8	105	4	12.06-	M 271.942 30853900 ->	0,8	PLKR7B8E	94716		
C 200 Kompressor	203	1.8	120	4	02.03-11.06	M 271.940 -> 30853899	0,8	ILFR6A	3588		
C 200 Kompressor	203	1.8	120	4	12.06-	M 271.940 30853900 ->	0,8	PLKR7B8E	94716		
C 200 Kompressor	203	1.8	135	4	12.06-	M 271.957 30853900 ->	0,8	PLKR7B8E	94716		
C 200 Kompressor	203	2.0	120	4	05.00-	M 111.955	1,0	IFR6D10	5344		LPG 1
C 230	203	2.5	150	6	12.04-	M 272.920	0,8	PLKR7A	4288		
C 230 Kompressor	203	2.3	145	4	03.01-05.02	M 111.981	1,0	IFR6D10	5344		LPG 1
C 230 Kompressor	203	1.8	141	4	02.04-11.06	M 271.948 -> 30853899	0,8	ILFR6A	3588		
C 230 Kompressor	203	1.8	141	4	12.06-	M 271.948 30853900 ->	0,8	PLKR7B8E	94716		
C 240	203	2.6	125	6	05.00-	M 112.912 T.S.	1,1	PFR5R-11	4292		LPG 1
C 240 4-Matic	203	2.6	125	6	07.02-	M 112.916 T.S.	1,1	PFR5R-11	4292		LPG 1
C 280	203	3.0	170	6	11.04-	M 272.940	0,8	PLKR7A	4288		
C 280 4-Matic	203	3.0	170	6	02.05-	M 272.941	0,8	PLKR7A	4288		
C 32 AMG Kompressor	203	3.2	260	6	.00-	M 112.961 T.S.	1,0	IFR6D10	5344		LPG 1
C 320	203	3.2	160	6	05.00-	M 112.946 T.S.	1,1	PFR5R-11	4292		LPG 1
C 320 4-Matic	203	3.2	160	6	07.02-	M 112.953 T.S.	1,1	PFR5R-11	4292		LPG 1
C 350	203	3.5	200	6	12.04-	M 272.960	0,8	PLKR7A	4288		
C 350 4-Matic	203	3.5	200	6	12.04-	M 272.970	0,8	PLKR7A	4288		
C 55 AMG	203	5.4	270	8	02.04-	M 113.988 T.S.	1,0	IFR6D10	5344		LPG 1

**C COUPÉ C203**

CLC 160	203	1.6	95	4	02.09-	M 271.911	0,8	PLKR7B8E	94716		
CLC 180 Kompressor	203	1.8	105	4	05.08-	M 271.940 -> 30853899	0,8	ILFR6A	3588		
CLC 180 Kompressor	203	1.8	105	4	05.08-	M 271.940 30853900 ->	0,8	PLKR7B8E	94716		
CLC 180 Kompressor	203	1.8	105	4	05.08-	M 271.946 -> 30853899	0,8	ILFR6A	3588		
CLC 180 Kompressor	203	1.8	105	4	05.08-	M 271.946 30853900 ->	0,8	PLKR7B8E	94716		
CLC 200 Kompressor	203	1.8	135	4	05.08-	M 271.957 30853900 ->	0,8	PLKR7B8E	94716		
CLC 230	203	2.5	150	6	05.08-	M 272.920	0,8	PLKR7A	4288		
CLC 350	203	3.5	200	6	05.08-	M 272.960	0,8	PLKR7A	4288		

**C W/S 204**

C 180 Kompressor	204	1.8	115	4	01.07-	M 271.952 30853900 ->	0,8	PLKR7B8E	94716		
C 180 Kompressor	204	1.6	115	4	01.08-	M 271.910	0,8	PLKR7A	4288		
C 180	204	1.6	115	4	07.12-	M 274.910	0,7	SILZKFR8D7S	95875		
C 180 CGI	204	1.8	115	4	01.07-	M 271.820	0,8	PLKR7B8E	94716		
C 200 CGI Kompressor	204	1.8	135	4	05.07-	M 271.950 30853900 ->	0,8	PLKR7B8E	94716		
C 200 CGI	204	1.8	135	4	01.07-	M 271.820	0,8	PLKR7B8E	94716		
C 230	204	2.5	150	6	08.07-	M 272.921	0,8	PLKR7A	4288		
C 230 4-matic	204	2.5	150	6	01.07-	M 272.911	0,8	PLKR7A	4288		

e kW  
C  
y  
i

0201



Stock-No

VLINE

LPG/CNG

**MERCEDES****C W/S 204**

C 250 CGI	204	1.8	150	4	07.09-	M 271.860	0,8	PLKR7B8E	94716		
C 280	204	3.0	170	6	05.07-	M 272.947	0,8	PLKR7A	4288		
C 280 4-Matic	204	3.0	170	6	05.07-	M 272.948	0,8	PLKR7A	4288		
C 300	204	3.0	170	6	07.09-	M 272.947	0,8	PLKR7A	4288		
C 300 4-Matic	204	3.0	170	6	07.07-	M 272.948	0,8	PLKR7A	4288		
C 350	204	3.5	200	6	05.07-	M 272.961	0,8	PLKR7A	4288		
C 350 4-Matic	204	3.5	200	6	05.07-	M 272.971	0,8	PLKR7A	4288		
C 350 CGI	204	3.5		6	.08-	M 272.982	0,7	SILZKR7A-S	7718		
C 63 AMG	204	6.3	336	8	08.07-	M 156.985	1,0	ILZKAR7A10	6043		
C 63 AMG	204	6.3	358	8	01.11-	M 156.985	1,0	ILZKAR7A10	6043		ILZKAR7A10
C 63 AMG Coupé Black Series	204	6.3	380	8	01.12-	M 156.985	1,0	ILZKAR7A10	6043		ILZKAR7A10

**C W/S 205**

C 180	205	1.6	115	4	03.14-	M 274.910	0,7	SILZKFR8D7S	95875		
C 200	205	2.0	135	4	12.13-	M 274.920	0,7	SILZKFR8E7S	90654		
C 250	205	2.0	155	4	03.14-	M 274.920	0,7	SILZKFR8E7S	90654		
C 300 e Hybrid	205	2.0	155	4	02.15-	M 274.920	0,7	SILZKFR8E7S	90654		
C 400 4-Matic	205	3.0	245	6	10.14-	M 276.823	0,7	SILZKFR8E7S	90654		

**CLA W/S 117**

CLA 180	117	1.6	90	4	01.13-	M 270.910	0,7	SILZKFR8D7S	95875		
CLA 200	117	1.6	115	4	01.13-	M 270.910	0,7	SILZKFR8D7S	95875		
CLA 250	117	2.0	155	4	01.13-	M 270.920	0,7	SILZKFR8E7S	90654		
CLA 45 AMG	117	2.0	265	4	06.13-	M 133.980	0,7	SILZKFR8D7S	95875		

**CLK C208**

CLK 200	208	2.0	100	4	06.97- .02	M 111.945	0,8	BKUR5ET	2789	29	LPG 1
CLK 200 Kompressor	208	2.0	120	4	06.00-06.02	M 111.956	1,0	IFR6D10	5344		LPG 1
CLK 200 Kompressor	208	2.0	135	4	07.97- .02	M 111.944	1,0	BKUR6ET-10	2397	24	LPG 1
CLK 230 Kompressor	208	2.3	142	4	06.97-02.00	M 111.975	1,0	BKUR6ET-10	2397	24	LPG 1
CLK 230 Kompressor	208	2.3	145	4	03.00-06.02	M 111.982	1,0	IFR6D10	5344		LPG 1
CLK 320 V6	208	3.2	160	6	06.97- .02	M 112.940 T.S.	1,1	PFR5R-11	4292		LPG 1
CLK 430	208	4.3	205	8	06.98- .02	M 113.943 T.S.	1,1	PFR5R-11	4292		LPG 1
CLK 55	208	5.5	255	8	08.99- .03	M 113.984 T.S.	1,1	PFR5R-11	4292		LPG 1

**CLK C209**

CLK 200 CGI	209	1.8	125	4	02.03-11.06	M 271.942 -> 30853899	0,8	ILFR6A	3588		
CLK 200 CGI	209	1.8	125	4	12.06-	M 271.942 30853900 ->	0,8	PLKR7B8E	94716		
CLK 200 Kompressor	209	1.8	120	4	09.02-11.06	M 271.940 -> 30853899	0,8	ILFR6A	3588		
CLK 200 Kompressor	209	1.8	120	4	12.06-	M 271.940 30853900 ->	0,8	PLKR7B8E	94716		
CLK 200 Kompressor	209	1.8	120	4	10.06-	M 271.955 30853900 ->	0,8	PLKR7B8E	94716		
CLK 240	209	2.6	125	6	02.03-	M 112.912 T.S.	1,1	PFR5R-11	4292		LPG 1
CLK 280	209	3.0	170	6	01.05-	M 272.940	0,8	PLKR7A	4288		
CLK 320	209	3.2	160	6	03.03-	M 112.955 T.S.	1,1	PFR5R-11	4292		LPG 1
CLK 350	209	3.5	200	6	01.05-	M 272.960	0,8	PLKR7A	4288		
CLK 500	209	5.5	286	8	.06-	M 273.967	0,8	PLKR7A	4288		
CLK 500	209	5.0	225	8	06.02-	M 113.968 T.S.	1,1	PFR5R-11	4292		LPG 1
CLK 55 AMG	209	5.4	270	8	09.02-	M 113.987 T.S.	1,0	IFR6D10	5344		LPG 1

e kW  
C  
y  
I

0201



Stock-No

V-ELINE

LPG / CNG

**MERCEDES****CLK C209**

CLK 63 AMG	209	6.3	354	8	04.06-	M 156.982	1,0	ILZKAR7A10	6043		
CLK 63 AMG	209	6.3	373	8	05.07-	M 156.982	1,0	ILZKAR7A10	6043		

**CLS C219**

CLS 280	219	3.0	170	6	.07-	M 272.943	0,8	PLKR7A	4288		
CLS 300	219	3.0	170	6	04.09-	M 272.943	0,8	PLKR7A	4288		
CLS 350	219	3.5	200	6	10.04-	M 272.964	0,8	PLKR7A	4288		
CLS 350 CGI	219	3.5	215	6	04.06-	M 272.985	0,7	SILZKR7A-S	7718		
CLS 500	219	5.5	286	8	04.06-	M 273.960	0,8	PLKR7A	4288		
CLS 500	219	5.0	225	8	10.04-	M 113.967 T.S.	1,1	PFR5R-11	4292		LPG 1
CLS 55 AMG	219	5.5	350	8	01.05-	M 113.990 T.S.	0,8	ILFR6A	3588		
CLS 63 AMG	219	6.3	378	8	05.06-	M 156.983	1,0	ILZKAR7A10	6043		

**E W/S 124**

200 E	124	2.0	87	4	12.88-09.92	M 102.963	0,8	BP6EFS	3812	5	LPG 5
200 E	124	2.0	100	4	10.92-06.93	M 111.940	0,7	BCP6ES	4930	4	LPG 3
220 E	124	2.2	110	4	10.92-06.93	M 111.960	0,7	BCP6ES	4930	4	LPG 3
230 E	124	2.3	90	4	12.84-09.92	M 102.982	0,8	BP6EFS	3812	5	LPG 5
260 E	124	2.6	118	6	09.85-09.92	M 103.940/943	0,8	BP6EFS	3812	5	LPG 5
280 E	124	2.8	142	6	-06.95	M 104.942	0,7	BCP6ES	4930	4	LPG 3
300 E	124	3.0	132	6	09.85-09.92	M 103.983	0,8	BP6EFS	3812	5	LPG 5
300 E 4-Matic	124	3.0	132	6	09.86-06.93	M 103.985	0,8	BP6EFS	3812	5	LPG 5
300 E-24V	124	3.0	162	6	09.89-06.93	M 104.980	0,7	BCP6ES	4930	4	LPG 3
320 E	124	3.2	162	6	10.92-06.93	M 104.992	0,7	BCP6ES	4930	4	LPG 3
400 E	124	4.2	205	8	10.92-06.93	M 119.975	0,7	BCP6ES	4930	4	LPG 3
500 E	124	5.0	235	8	06.91-06.93	M 119.974	0,7	BCP6ES	4930	4	LPG 3
E 200	124	2.0	100	4	06.93-06.97	M 111.942	0,7	BCP6ES	4930	4	LPG 3
E 220	124	2.2	110	4	06.93-06.95	M 111.960	0,7	BCP6ES	4930	4	LPG 3
E 280	124	2.8	142	6	07.93-02.97	M 104.942	0,7	BCP6ES	4930	4	LPG 3
E 280	124	2.8	142	6	06.93-06.95	M 104.945	0,7	BCP6ES	4930	4	LPG 3
E 300 24V	124	3.0	162	6	06.93-06.97	M 104.980	0,7	BCP6ES	4930	4	LPG 3
E 300 4-Matic	124	3.0	132	6	09.86-06.93	M 103.985	0,8	BP6EFS	3812	5	LPG 5
E 320	124	3.2	162	6	06.93-06.95	M 104.992	0,7	BCP6ES	4930	4	LPG 3
E 420	124	4.2	205	8	06.93-06.95	M 119.975	0,7	BCP6ES	4930	4	LPG 3
E 500	124	5.0	235	8	06.93-06.95	M 119.974	0,7	BCP6ES	4930	4	LPG 3

**E W/S 210**

E 200	210	2.0	100	4	06.95-06.97	M 111.942	0,8	BCP5ES	7496	16	LPG 3
E 200	210	2.0	100	4	07.97-08.00	M 111.942	0,8	BKUR5ET	2789	29	LPG 1
E 200 Kompressor	210	2.0	120	4	06.00-03.03	M 111.957	1,0	IFR6D10	5344		LPG 1
E 200 Kompressor	210	2.0	137	4	09.96-03.03	M 111.947	1,0	BKUR6ET-10	2397	24	LPG 1
E 230	210	2.3	110	4	06.95-06.97	M 111.970	0,8	BCP5ES	7496	16	LPG 3
E 240	210	2.6	125	6	06.00-03.03	M 112.914 T.S.	1,1	PFR5R-11	4292		LPG 1
E 240 V6	210	2.4	125	6	04.97-06.99	M 112.911 T.S.	1,1	PFR5R-11	4292		LPG 1
E 280	210	2.8	142	6	01.96-06.99	M 104.945	0,8	BCP5ES	7496	16	LPG 3
E 280 V6	210	2.8	150	6	03.97-03.03	M 112.921 T.S.	1,1	PFR5R-11	4292		LPG 1
E 320	210	3.2	170	6	06.95-05.99	M 104.995	0,8	BCP5ES	7496	16	LPG 3
E 320 V6	210	3.2	165	6	06.99-03.03	M 112.941 T.S.	1,1	PFR5R-11	4292		LPG 1
E 420 V8	210	4.2	205	8	07.97-05.98	M 119.985	0,8	BKUR5ET	2789	29	LPG 1
E 430 V8	210	4.3	205	8	04.97-03.03	M 113.940 T.S.	1,1	PFR5R-11	4292		LPG 1
E 50 AMG	210	5.0	255	8	02.96-08.97	M 119.985	0,7	BKR5EKU	3964		
E 50 AMG USA	210	5.0	235	8	02.96-05.99	M 119.980	0,7	BCP6ES	4930	17	LPG 3



l kW  
C  
y  
l

0201



Stock-No

VALVE

LPG/CNG

**MERCEDES**

**E W/S 210**

E 55 AMG	210	5.5	260	8	09.97-03.03	M 113.980 T.S.	1,1	PFR5R-11	4292		LPG 1
----------	-----	-----	-----	---	-------------	----------------	-----	----------	------	--	-------

**E W/S 211**

E 200 Kompressor	211	1.8	120	4	11.02-11.06	M 271.941 -> 30853899	0,8	ILFR6A	3588		
E 200 Kompressor	211	1.8	120	4	12.06-07.09	M 271.941 30853900 ->	0,8	PLKR7B8E	94716		
E 200 Kompressor	211	1.8	135	4	04.06-11.06	M 271.956 -> 30853899	0,8	ILFR6A	3588		
E 200 Kompressor	211	1.8	135	4	12.06-07.09	M 271.956 30853900 ->	0,8	PLKR7B8E	94716		
E 200 NGT	211	1.8	120	4	03.04-11.06	M 271.941 -> 30853899	0,8	ILFR6A	3588		
E 200 NGT	211	1.8	120	4	12.06-07.09	M 271.941 30853900 ->	0,8	PLKR7B8E	94716		
E 230	211	2.5	150	6	09.07-07.09	M 272.922	0,8	PLKR7A	4288		
E 240	211	2.6	130	6	03.02-07.09	M 112.913 T.S.	1,1	PFR5R-11	4292		LPG 1
E 240 4-matic	211	2.6	130	6	03.03-07.09	M 112.917 T.S.	1,1	PFR5R-11	4292		LPG 1
E 280	211	3.0	170	6	01.06-07.09	M 272.943	0,8	PLKR7A	4288		
E 280 4-Matic	211	3.0	170	6	01.06-07.09	M 272.944	0,8	PLKR7A	4288		
E 320	211	3.2	165	6	03.02-07.09	M 112.949 T.S.	1,1	PFR5R-11	4292		LPG 1
E 320 4-matic	211	3.2	165	6	03.03-07.09	M 112.954 T.S.	1,1	PFR5R-11	4292		LPG 1
E 350	211	3.5	200	6	10.04-07.09	M 272.964	0,8	PLKR7A	4288		
E 350 4-matic	211	3.5	200	6	11.04-07.09	M 272.972	0,8	PLKR7A	4288		
E 350 CGI	211	3.5	215	6	.08-07.09	M 272.985	0,7	SILZKR7A-S	7718		
E 500	211	5.5	285	8	04.06-07.09	M 273.960	0,8	PLKR7A	4288		
E 500	211	5.5	300	8	04.06-07.09	M 273.962	0,8	PLKR7A	4288		
E 500	211	5.0	225	8	03.02-07.09	M 113.967 T.S.	1,1	PFR5R-11	4292		LPG 1
E 500 4-matic	211	5.0	225	8	03.03-07.09	M 113.969 T.S.	1,1	PFR5R-11	4292		LPG 1
E 55 AMG	211	5.5	350	8	10.02-07.09	M 113.990 T.S.	0,8	ILFR6A	3588		
E 63 AMG	211	6.3	378	8	05.06-07.09	M 156.983	1,0	ILZKAR7A10	6043		

**E W/S 212**

E200	212	2.0	135	4	01.13-	M 274.920	0,7	SILZKFR8E7S	90654		
E 200 CGI	212	1.8	135	4	08.09-	M 271.820	0,8	PLKR7B8E	94716		
E 200 CGI	212	1.8	135	4	08.09-	M 271.860	0,8	PLKR7B8E	94716		
E 250 Coupé / Cabriolet	207	2.0	155	4	03.13-	M 274.920	0,7	SILZKFR8E7S	90654		
E 250 CGI	212	1.8	150	4	01.09-	M 271.860	0,8	PLKR7B8E	94716		
E 350 4-matic	212	3.5	200	6	01.09-	M 272.977	0,8	PLKR7A	4288		
E 350 CGI BlueEfficiency	212	3.5	215	6	03.09-	M 272.983	0,7	SILZKR7A-S	7718		
E 500	212	5.0	286	8	03.09-	M 273.971	0,8	PLKR7A	4288		
E 63 AMG	212	6.3	386	8	12.09-	M 156.985	1,0	ILZKAR7A10	6043		

**E COUPÉ/CABRIOLET C/A 207**

E200 Coupé / Cabriolet	207	2.0	135	4	03.13-	M 274.920	0,7	SILZKFR8E7S	90654		
E 200 CGI Coupé / Cabriolet	207	1.8	135	4	01.10-	M 271.860	0,8	PLKR7B8E	94716		
E 250 Coupé / Cabriolet	207	2.0	155	4	03.13-	M 274.920	0,7	SILZKFR8E7S	90654		
E 250 CGI Coupé / Cabriolet	207	1.8	150	4	01.09-	M 271.860	0,8	PLKR7B8E	94716		
E 350 CGI Coupé / Cabriolet	207	3.5	215	6	01.09-	M 272.982	0,7	SILZKR7A-S	7718		
E 500 Coupé / Cabriolet	207	5.5	286	8	01.09-	M 273.966	0,8	PLKR7A	4288		
E 250 Coupé / Cabriolet	207	2.0	155	4	03.13-	M 274.920	0,7	SILZKFR8E7S	90654		

**230 W460/W461**

230 G	461	2.3	66	4	04.92-09.93	M 115.974	0,6	BP5EFS	3712	5	
-------	-----	-----	----	---	-------------	-----------	-----	--------	------	---	--

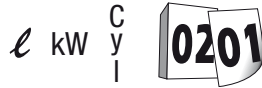

## MERCEDES

### 230 W460/W461

230 G	461	2.3	79	4	04.92-09.95	M 102.958	0,6	BP5EFS	3712	5	
230 GE	460	2.3	90	4	05.87-08.92	M 102.987 Cat.	0,8	BP6EFS	3812	5	LPG 5
230 GE	461	2.3	90	4	02.93-09.95	M 102.979	0,8	BP6EFS	3812	5	LPG 5
230 GE	461	2.3	90	4	02.93-09.95	M 102.979	0,8	BP6EFS	3812	5	LPG 5
230 GE	460	2.3	92	4	04.82-08.92	M 102.981	0,8	BP6EFS	3812	5	LPG 5
230 GE	461	2.3	92	4	04.92-09.95	M 102.981	0,8	BP6EFS	3812	5	LPG 5
230 GE	461	2.3	92	4	04.92-09.95	M 102.998	0,8	BP6EFS	3812	5	LPG 5
230 GE	461	2.3	92	4	06.93-09.95	M 102.996	0,8	BP6EFS	3812	5	LPG 5
230 GE	461	2.3	92	4	04.92-09.95	M 102.981	0,8	BP6EFS	3812	5	LPG 5
230 GE	461	2.3	92	4	06.93-09.95	M 102.996	0,8	BP6EFS	3812	5	LPG 5
230 GE	461	2.3	92	4	04.92-09.95	M 102.998	0,8	BP6EFS	3812	5	LPG 5
280 GE	461	2.8	110	6	04.92-07.97	M 110.994	0,7	BP6ES	7811	4	LPG 2

### G W463

200 GE	463	2.0	79	4	06.92-06.95	M 102.965	0,8	BP6EFS	3812	5	LPG 5
230 GE	463	2.3	93	4	09.89-07.93	M 102.989	0,8	BP6EFS	3812	5	LPG 5
300 GE	463	3.0	128	6	09.89-07.93	M 103.987	0,8	BP6EFS	3812	5	LPG 5
G 200	463	2.0	80	4	09.93-	M 102.965	0,8	BP6EFS	3812	5	LPG 5
G 230	463	2.3	93	4	08.93-10.94	M 102.989	0,8	BP6EFS	3812	5	LPG 5
G 300	463	3.0	126	6	08.93-10.94	M 103.987	0,8	BP6EFS	3812	5	LPG 5
G 320	463	3.2	155	6	09.93-12.97	M 104.996	0,8	BCP5ES	7496	16	LPG 3
G 320	463	3.2	158	6	07.97-	M 112.945 T.S.	1,1	PFR5R-11	4292		LPG 1
G 36 AMG	463	3.2	155	6	01.95-	M 104.996	0,8	BCP5ES	7496	16	LPG 3
G 500	463	5.0	195	8	08.93-10.94	M 117.965	0,7	BP6ES	7811	4	LPG 2
G 500	463	5.0	218	8	.00-	M 113.962 T.S.	1,1	PFR5R-11	4292		LPG 1
G 55 AMG	463	5.5	260	8	04.99-	M 113.982 T.S.	1,1	PFR5R-11	4292		LPG 1
G 55 AMG	463	5.5	350	8	06.04-	M 113.993 T.S.	0,8	ILFR6A	3588		
G 55 AMG	463	5.0	218	8	04.99-	M 113.962 T.S.	1,1	PFR5R-11	4292		LPG 1

### GLA X156

GLA 180	X156	1.6	90	4	02.15-	M 270.910	0,7	SILZKFR8D7S	95875		
GLA 200	X156	1.6	115	4	12.13-	M 270.910	0,7	SILZKFR8D7S	95875		
GLA 250	X156	2.0	155	4	12.13-	M 270.920	0,7	SILZKFR8E7S	90654		
GLA 45 AMG	X156	2.0	265	4	05.14-	M 133.980	0,7	SILZKFR8D7S	95875		

### GL X164

GL 450	X164	4.6	250	8	01.06-	M 273.923	0,8	PLKR7A	4288		
GL 500	X164	5.5	286	8	01.06-	M 273.963	0,8	PLKR7A	4288		

### GLK X204

GLK 200	X204	2.0	135	4	08.13-	M 274.920	0,7	SILZKFR8E7S	90654		
GLK 250	X204	2.0	155	4	04.13-	M 274.920	0,7	SILZKFR8E7S	90654		
GLK 280	X204	3.0	170	6	06.08-06.09	M 272.948	0,8	PLKR7A	4288		
GLK 300	X204	3.0	170	6	07.09-	M 272.948	0,8	PLKR7A	4288		
GLK 350	X204	3.5	200	6	06.08-	M 272.961	0,8	PLKR7A	4288		
GLK 350	X204	3.5	200	6	.08-	M 272.971	0,8	PLKR7A	4288		

### M W163

ML 230	163	2.3	110	4	02.98-06.05	M 111.977	0,8	BKUR5ET	2789	29	LPG 1
ML 320	163	3.2	160	6	02.98-08.02	M 112.942 T.S.	1,1	PFR5R-11	4292		LPG 1
ML 350	163	3.7	173	6	08.00-06.05	M 112.970 T.S.	1,1	PFR5R-11	4292		LPG 1





l kW  
C  
y  
I

0201



Stock-No

VALVE

LPG / CNG

MERCEDES

**M W163**

ML 430	163	4.3	200	8	11.98-06.05	M 113.942 T.S.	1,1	PFR5R-11	4292		LPG 1
ML 500	163	5.0	215	8	09.00-06.04	M 113.965 T.S.	1,1	PFR5R-11	4292		LPG 1
ML 55 AMG	163	5.5	255	8	11.99-06.05	M 113.981 T.S.	1,1	PFR5R-11	4292		LPG 1

**M W164**

ML 350	164	3.5	200	6	07.05-	M 272.967	0,8	PLKR7A	4288		
ML 500	164	5.0	225	8	12.04-	M 113.964 T.S.	1,1	PFR5R-11	4292		LPG 1
ML 500	164	5.5	286	8	12.07-	M 273.963	0,8	PLKR7A	4288		
ML 63 AMG	164	6.3	375	8	01.06-	M 156.980	1,0	ILZKAR7A10	6043		

**R W251**

R 280	251	3.0	170	6	02.06-	M 272.945	0,8	PLKR7A	4288		
R 300	251	3.0	170	6	07.09-	M 272.945	0,8	PLKR7A	4288		
R 350	251	3.5	200	6	02.06-	M 272.967	0,8	PLKR7A	4288		
R 500	251	5.0	225	8	02.06-	M 113.971 T.S.	1,1	PFR5R-11	4292		LPG 1
R 500	251	5.5	286	8	01.07-	M 273.963	0,8	PLKR7A	4288		
R 63 AMG	251	6.3	375	8	11.05-	M 156.980	1,0	ILZKAR7A10	6043		

**S W140**

300 SE 2.8	140	2.8	142	6	02.93-10.98	M 104.944	0,7	BCP6ES	4930	17	LPG 3
300 SE/SEL 3.2	140	3.2	170	6	03.91-06.93	M 104.990	0,7	BCP6ES	4930	17	LPG 3
400 SE/SEL	140	4.2	210	8	02.91-06.93	M 119.971	0,7	BCP6ES	4930	17	LPG 3
500 SE/SEL	140	5.0	240	8	02.91-06.93	M 119.970	0,7	BCP6ES	4930	17	LPG 3
500 SEC	140	5.0	240	8	10.92-06.93	M 119.970	0,7	BCP6ES	4930	17	LPG 3
600 SE/SEL	140	6.0	290	12	04.91-06.93	M 120.980	0,7	BCP6ES	4930	17	LPG 3
600 SEC	140	6.0	290	12	10.92-06.93	M 120.980	0,7	BCP6ES	4930	17	LPG 3
S 280	140	2.8	142	6	07.93-06.97	M 104.944	0,7	BCP6ES	4930	17	LPG 3
S 320	140	3.2	170	6	07.93-06.97	M 104.994	0,7	BCP6ES	4930	17	LPG 3
S 420	140	4.2	205	8	07.93-06.97	M 119.971	0,7	BCP6ES	4930	17	LPG 3
S 420	140	4.2	205	8	06.93-06.97	M 119.981	0,7	BCP6ES	4930	17	LPG 3
S 500	140	5.0	235	8	07.93-06.97	M 119.970	0,7	BCP6ES	4930	17	LPG 3
S 600	140	6.0	290	12	07.93-06.97	M 120.980	0,7	BCP6ES	4930	17	LPG 3
S 600	140	6.0	290	12	06.93-06.97	M 120.982	0,7	BCP6ES	4930	17	LPG 3

**S W220**

S 280	220	2.8	142	6	10.99-08.05	M 112.922 T.S.	1,1	PFR5R-11	4292		LPG 1
S 320	220	3.2	165	6	10.98-08.05	M 112.944 T.S.	1,1	PFR5R-11	4292		LPG 1
S 350	220	3.7	180	6	09.02-08.05	M 112.972 T.S.	1,1	PFR5R-11	4292		LPG 1
S 350 4-matic	220	3.7	180	6	06.03-08.05	M 112.975 T.S.	1,1	PFR5R-11	4292		LPG 1
S 430	220	4.3	205	8	10.98-08.05	M 113.941 T.S.	1,1	PFR5R-11	4292		LPG 1
S 430 4-matic	220	4.3	205	8	09.02-08.05	M 113.948 T.S.	1,1	PFR5R-11	4292		LPG 1
S 500	220	5.0	225	8	10.98-08.05	M 113.960 T.S.	1,1	PFR5R-11	4292		LPG 1
S 500 4-matic	220	5.0	225	8	09.02-08.05	M 113.966 T.S.	1,1	PFR5R-11	4292		LPG 1
S 55 AMG	220	5.5	265	8	.99-08.05	M 113.980 T.S.	1,1	PFR5R-11	4292		LPG 1
S 55 AMG	220	5.5	265	8	04.99-08.05	M 113.986 T.S.	1,1	PFR5R-11	4292		LPG 1
S 55 AMG Kompressor	220	5.5	368	8	.02-08.05	M 113.991 T.S.	0,8	ILFR6A	3588		
S 600	220	6.0	270	12	01.00-08.05	M 137.970 T.S.	0,8	IFR6Q-G	5648		
S 600	220	6.0	368	12	.01-08.05	M 275.950 T.S.	0,8	IFR6Q-G	5648		
S 65 AMG	220	6.0	450	12	.03-08.05	M 275.980 T.S.	0,8	IFR6Q-G	5648		

**S W221/W222**

S 280	221	3.0	170	6	.05-	M 272.946	0,8	PLKR7A	4288		
-------	-----	-----	-----	---	------	-----------	-----	--------	------	--	--

e kW  
C  
y  
i

0201



Stock-No

VLINE

LPG / CNG

**MERCEDES****S W221/W222**

S 350	221	3.5	200	6	10.05-	M 272.965	0,8	PLKR7A	4288		
S 350 4Matic	221	3.5	200	6	06.07-	M 272.965	0,8	PLKR7A	4288		
S 400 BlueHybrid	221	3.5	205	6	01.09-	M 272.974	0,8	PLKR7A	4288		
S 450	221	4.6	250	8	07.05-	M 273.922	0,8	PLKR7A	4288		
S 450 4-Matic	221	4.6	250	8	12.05-	M 273.924	0,8	PLKR7A	4288		
S 500	221	5.5	285	8	07.05-	M 273.961	0,8	PLKR7A	4288		
S 500 4-Matic	221	5.5	285	8	10.05-	M 273.968	0,8	PLKR7A	4288		
S 600	221	6.0	380	12	03.06-	M 275.953 T.S.	0,8	IFR6Q-G	5648		
S 63 AMG	221	6.3	386	8	10.06-	M 156.984	1,0	ILZKAR7A10	6043		
S 65 AMG	221	6.0	450	12	12.05-	M 275.982 T.S.	0,8	IFR6Q-G	5648		

**S COUPÉ C140**

CL 420	140	4.2	205	8	06.96-06.97	M 119.981	0,7	BCP6ES	4930	17	LPG 3
CL 420	140	4.2	205	8	07.97-10.98	M 119.981	1,1	PFR5R-11	4292		LPG 1
CL 500	140	5.0	235	8	09.96-06.97	M 119.980	1,1	PFR5R-11	4292		LPG 1
CL 500	140	5.0	235	8	07.97-10.98	M 119.980	1,1	PFR5R-11	4292		LPG 1
CL 600	140	6.0	290	12	06.96-05.97	M 120.982	0,7	BCP6ES	4930	17	LPG 3
CL 600	140	6.0	290	12	06.97-10.98	M 120.982	1,1	PFR5R-11	4292		LPG 1

**S COUPÉ C215**

CL 500	215	5.0	225	8	09.00-03.06	M 113.960 T.S.	1,1	PFR5R-11	4292		LPG 1
CL 55 AMG	215	5.5	265	8	10.99-03.06	M 113.986 T.S.	1,1	PFR5R-11	4292		LPG 1
CL 55 AMG Kompressor	215	5.5	386	8	.00-03.06	M 113.991 T.S.	0,8	ILFR6A	3588		
CL 600	215	6.0	270	12	03.99-03.06	M 137.970 T.S.	0,8	IFR6Q-G	5648		
CL 65 AMG	215	6.0	450	12	09.03-03.06	M 275.980 T.S.	0,8	IFR6Q-G	5648		

**S COUPÉ C216**

CL 500	216	5.5	286	8	10.06-	M 273.961	0,8	PLKR7A	4288		
CL 500 4matic	216	5.5	286	8	02.08-	M 273.968	0,8	PLKR7A	4288		
CL 600	216	6.0	368	12	.02-03.06	M 275.950 T.S.	0,8	IFR6Q-G	5648		
CL 600	216	6.0	381	12	09.06-	M 275.953 T.S.	0,8	IFR6Q-G	5648		
CL 63 AMG	216	6.3	386	8	09.06-	M 156.984	1,0	ILZKAR7A10	6043		
CL 65 AMG	216	6.0	450	12	10.06-	M 275.982 T.S.	0,8	IFR6Q-G	5648		

**SL R129**

300 SL	129	3.0	140	6	03.89-06.93	M 103.984	0,8	BP6EFS	3812	5	LPG 5
300 SL-24V	129	3.0	170	6	07.89-06.93	M 104.981	0,7	BCP6ES	4930	17	LPG 3
500 SL	129	5.0	235	8	09.92-06.93	M 119.972	0,7	BCP6ES	4930	17	LPG 3
500 SL	129	5.0	240	8	03.89-06.93	M 119.960	0,7	BCP6ES	4930	17	LPG 3
600 SL	129	6.0	290	12	07.92-06.93	M 120.981	0,7	BCP6ES	4930	17	LPG 3
SL 280	129	2.8	141	6	07.93-06.97	M 104.943	0,7	BCP6ES	4930	17	LPG 3
SL 280	129	2.8	142	6	07.97-05.98	M 104.943	0,8	BKUR5ET	2789	29	LPG 1
SL 280	129	2.8	150	6	06.98-	M 112.923 T.S.	1,1	PFR5R-11	4292		LPG 1
SL 320	129	3.2	165	6	06.98-	M 112.943 T.S.	1,1	PFR5R-11	4292		LPG 1
SL 320	129	3.2	170	6	07.93-06.97	M 104.991	0,7	BCP6ES	4930	17	LPG 3
SL 320	129	3.2	170	6	07.97-05.98	M 104.991	0,8	BKUR5ET	2789		LPG 1
SL 500	129	5.0	225	8	.98-	M 113.961 T.S.	1,1	PFR5R-11	4292	29	LPG 1
SL 500	129	5.0	235	8	07.93-06.97	M 119.972	0,7	BCP6ES	4930	17	LPG 3
SL 500	129	5.0	235	8	07.93-06.97	M 119.982	0,7	BCP6ES	4930	17	LPG 3
SL 60	129	6.0	280	12	.95-	M 119.E60	0,7	BKR5EKU	3964		
SL 60 AMG	129	6.0	280	12	.95-	M 119.E60	0,7	BKR5EKU	3964		
SL 600	129	6.0	290	12	07.93-06.97	M 120.981	0,7	BCP6ES	4930	17	LPG 3

e kW  
C  
y  
i

0201

Stock-No  
VLINE  
LPG/CNG**MERCEDES****SL R129**

SL 600	129	6.0	290	12	07.93-06.97	M 120.983	0,8	BCP5ES	7496	16	LPG 3
SL 600	129	6.0	290	12	.98-	M 120.983	1,1	PFR5R-11	4292		LPG 1
SL 73 AMG	129	7.3	386	12	.99-	M 120.E73	1,1	PFR5R-11	4292		LPG 1

**SL R230**

SL 280	230	3.0	170	6	03.08-	M 272.949	0,8	PLKR7A	4288		
SL 300	230	3.0	170	6	04.09-	M 272.949	0,8	PLKR7A	4288		
SL 350	230	3.5	200	6	05.05-	M 272.966	0,8	PLKR7A	4288		
SL 350	230	3.5	233	6	04.08-	M 272.968	0,8	PLKR7A	4288		
SL 350	230	3.7	180	6	03.03-	M 112.973 T.S.	1,1	PFR5R-11	4292		LPG 1
SL 500	230	5.5	286	8	03.06-	M 273.965	0,8	PLKR7A	4288		
SL 500	230	5.0	225	8	10.01-	M 113.963 T.S.	1,1	PFR5R-11	4292		LPG 1
SL 55 AMG	230	5.5	350	8	10.01-06.02	M 113.992 T.S.	0,8	ILFR6A	3588		
SL 55 AMG	230	5.5	368	8	06.02-	M 113.992 T.S.	0,8	ILFR6A	3588		
SL 55 AMG	230	5.5	380	8	03.06-	M 113.995 T.S.	0,8	ILFR6A	3588		
SL 600	230	5.5	368	12	04.03-	M 275.951 T.S.	0,8	IFR6Q-G	5648		
SL 600	230	5.5	381	12	03.06-	M 275.954 T.S.	0,8	IFR6Q-G	5648		
SL 63 AMG	230	6.3	386	8	03.08-	M 156.981	1,0	ILZKAR7A10	6043		
SL 65 AMG	230	6.0	450	12	03.04-	M 275.981 T.S.	0,8	IFR6Q-G	5648		

**SLK R170**

SLK 200	170	2.0	100	4	09.96-	M 111.946	0,8	BKUR5ET	2789	29	LPG 1
SLK 200 Kompressor	170	2.0	120	4	03.00-	M 111.958	1,0	IFR6D10	5344		LPG 1
SLK 200 Kompressor	170	2.0	141	4	09.96-02.00	M 111.943	1,0	BKUR6ET-10	2397	24	LPG 1
SLK 230 Kompressor	170	2.3	142	4	09.96-02.00	M 111.973	1,0	BKUR6ET-10	2397	24	LPG 1
SLK 230 Kompressor	170	2.3	145	4	03.00-	M 111.983	1,0	IFR6D10	5344		LPG 1
SLK 32 AMG	170	3.2	260	6	.01-	M 112.960 T.S.	1,0	IFR6D10	5344		LPG 1
SLK 32 AMG Kompressor	170	3.2	260	6	11.00-	M 112.960 T.S.	1,0	IFR6D10	5344		LPG 1
SLK 320	170	3.2	160	6	03.00-	M 112.947 T.S.	1,1	PFR5R-11	4292		LPG 1

**SLK R171**

SLK 200 Kompressor	171	1.8	120	4	04.04-11.06	M 271.944 -> 30853899	0,8	ILFR6A	3588		
SLK 200 Kompressor	171	1.8	120	4	12.06-12.10	M 271.944 30853900 ->	0,8	PLKR7B8E	94716		
SLK 200 Kompressor	171	1.8	135	4	01.08-12.10	M 271.954 30853900 ->	0,8	PLKR7B8E	94716		
SLK 250	171	1.8	150	4	02.11-	M 271.861	0,8	PLKR7B8E	94716		
SLK 280	171	3.0	170	6	01.05-	M 272.942	0,8	PLKR7A	4288		
SLK 300	171	3.0	170	6	04.09-	M 272.942	0,8	PLKR7A	4288		
SLK 350	171	3.5	200	6	06.04-	M 272.963	0,8	PLKR7A	4288		
SLK 350	171	3.5	224	6	01.08-	M 272.969	0,8	PLKR7A	4288		
SLK 55 AMG	171	5.5	265	8	04.04-	M 113.989 T.S.	1,0	IFR6D10	5344		LPG 1

**SLK R172**

SLK 200	172	1.8	135	4	02.11-	M 271.861	0,8	PLKR7B8E	94716		
SLK 250	172	1.8	150	4	02.11-	M 271.861	0,8	PLKR7B8E	94716		

**SLR**

SLR Mc Laren	199	5.4	460	8	04.04-01.10	M 155.980 T.S.	0,8	ILFR6A	3588		
--------------	-----	-----	-----	---	-------------	----------------	-----	--------	------	--	--

**SPRINTER 901 / 902**

Sprinter 214	901/902	2.3	105	4	04.95-	M 111.979	0,8	BKUR5ET	2789	29	LPG 1
--------------	---------	-----	-----	---	--------	-----------	-----	---------	------	----	-------

e kW  
C  
y  
i

0201



Stock-No

VLINE

LPG/CNG

**MERCEDES  
SPRINTER 903**

Sprinter 314	903	2.3	105	4	04.95-	M 111.979	0,8	BKUR5ET	2789	29	LPG 1
--------------	-----	-----	-----	---	--------	-----------	-----	---------	------	----	-------

**SPRINTER 906**

Sprinter 216	906	1.8	115	4	09.08-	M 271.951	0,8	PLKR7B8E	94716		
Sprinter 224	906	3.5	190	6	06.06-	M 272.979	0,8	PLKR7A	4288		
Sprinter 316	906	1.8	115	4	09.08-	M 271.951	0,8	PLKR7B8E	94716		
Sprinter 316 NGT	906	1.8	115	4	09.08-	M 271.951	0,8	PLKR7B8E	94716		
Sprinter 324	906	3.5	190	6	06.06-	M 272.979	0,8	PLKR7A	4288		
Sprinter 424	906	3.5	190	6	06.06-	M 272.979	0,8	PLKR7A	4288		
Sprinter 516	906	1.8	115	4	09.08-	M 271.951	0,8	PLKR7B8E	94716		
Sprinter 516 NGT	906	1.8	115	4	09.08-	M 271.951	0,8	PLKR7B8E	94716		
Sprinter 524	906	3.5	190	6	06.06-	M 272.979	0,8	PLKR7A	4288		

**VANEO 414**

Vaneo	414	1.6	60	4	01.02-	M 166.961	0,8	BKUR5ET	2789	29	LPG 1
Vaneo	414	1.6	75	4	01.02-	M 166.961	0,8	BKUR5ET	2789	29	LPG 1
Vaneo	414	1.9	92	4	01.02-	M 166.991	0,8	BKUR5ET	2789	29	LPG 1

**VIANO 639**

Viano 3.0I	639	3.2	140	6	09.03-	M 112.951 T.S.	1,1	PFR5R-11	4292		LPG 1
Viano 3.2I	639	3.2	190	6	09.05-	M 272.978	0,8	PLKR7A	4288		
Viano 3.5I	639	3.5	190	6	09.07-	M 272.979	0,8	PLKR7A	4288		
Viano 3.5I	639	3.7	170	6	01.05-	M 112.976 T.S.	1,1	PFR5R-11	4292		LPG 1

**VITO 638**

Vito 113	638	2.0	95	4	03.96-	M 111.948/950	1,0	BKUR5ET-10	7553		LPG 1
Vito 114	638	2.3	105	4	03.96-07.03	M 111.978	1,0	BKUR5ET-10	7553		LPG 1

**VITO 639**

Vito 3.5I	639	3.5	190	6	09.07-	M 272.978	0,8	PLKR7A	4288		
-----------	-----	-----	-----	---	--------	-----------	-----	--------	------	--	--

**V 638**

V 230	638	2.3	105	4	09.96-	M 111.978	0,9	BKR6EK	2288	20	LPG 1
V 280 VR6	638	2.8	125	6	.98-	M 104.900(AFS)	0,6	BKR5EKUP	2890		

**MG**

MGF 1.6		1.6	81	4	02.00-	K Series	1,1	PFR6N-11	3546		LPG 1
MGF Roadster		1.8	88	4	11.95-	NPI	1,1	PFR6N-11	3546		LPG 1
MGF Roadster		1.8	106	4	11.95-	VV10	1,1	PFR6N-11	3546		LPG 1
MGF Trophy 160 SE		1.8	116	4	02.95-	K Series VVC	1,0	PFR6N-11	3546		LPG 1
MGTF 1.6		1.6	85	4	03.02-	K Series	1,0	PFR6N-11	3546		LPG 1
MGTF 1.8		1.8	88	4	03.02-	K Series	1,0	PRF6N-11	3546		
MGTF 1.8		1.8	99	4	03.02-	K Series	1,0	PFR6N-11	3546		LPG 1
MGTF 1.8		1.8	118	4	03.02-	K Series	1,0	PFR6N-11	3546		LPG 1
RV 8		3.9	140	8	10.92-10.95	Rover V8 Efi	0,8	BPR6ES	7822	2	LPG 2
ZR 105		1.4	74	4	06.01-	K	1,1	PFR6N-11	3546		LPG 1
ZR 105		1.4	74	4	06.01-	K	1,1	PFR6N-11	3546		LPG 1
ZR 120		1.8	85	4	06.01-	K	1,1	PFR6N-11	3546		LPG 1
ZR 120		1.8	85	4	06.01-	K	1,1	PFR6N-11	3546		LPG 1
ZR 160		1.8	116	4	06.01-	K VVC	1,1	PFR6N-11	3546		LPG 1
ZS 110		1.6		4	07.03-	K Series	1,1	PFR6N-11	3546		LPG 1
ZS 120		1.8	85	4	06.01-	K	1,1	PFR6N-11	3546		LPG 1
ZS 120		1.8	88	4	06.01-	K	1,1	PFR6N-11	3546		LPG 1
ZS 180		2.5	132	6	06.01-	KV6	1,1	PFR6N-11	3546		LPG 1

e kW  
C  
Y  
I

0201



Stock-No

VLINE

LPG/CNG

**MG**

ZT 160 Turbo	1.8		4	10.02-	K Series	1,1	PFR6N-11	3546		LPG 1
ZT-T 160 Turbo	1.8		4	10.02-	K series	1,1	PFR6N-11	3546		LPG 1
ZT 120	1.8		4	07.03-	K Series	1,1	PFR6N-11	3546		LPG 1
ZT 160	2.5	116	6	06.01-	KV6	1,1	PFR6N-11	3546		LPG 1
ZT 160	2.5	116	6	06.01-	KV6	1,1	PFR6N-11	3546		LPG 1
ZT-T 160	2.5	116	6	06.01-	KV6	1,1	PFR6N-11	3546		LPG 1
ZT-T 160	2.5	116	6	06.01-	KV6	1,1	PFR6N-11	3546		LPG 1
ZT 190	2.5	138	6	06.01-	KV6	1,1	PFR6N-11	3546		LPG 1
ZT 190	2.5	138	6	06.01-	KV6	1,1	PFR6N-11	3546		LPG 1
ZT-T 190	2.5	138	6	06.01-	KV6	1,1	PFR6N-11	3546		LPG 1

**MINI**

Mini One	R50	1.4	55	4	09.02-12.04	W10 B14	1,5	BKR6EQU	3199	30	LPG 1
Mini One	R50	1.6	66	4	04.01-	W10 B16	1,5	BKR6EQU	3199	30	LPG 1
Mini Clubman Cooper S	R55	1.6	120	4	09.07-02.10	N14 B16	0,8	PLZKBR7B8DG	90223	30	
Mini One	R56	1.4	55	4	03.09-03.10	N12 B14A	0,8	PLZKBR7B8DG	90223	30	
Mini One	R56	1.4	70	4	03.07-	N12 B14	0,8	PLZKBR7B8DG	90223		
Mini One	R56	1.6	55	4	03.10-	N16 B16A	0,8	PLZKBR7B8DG	90223		
Mini One	R56	1.6	72	4	03.10-	N16 B16	0,8	PLZKBR7B8DG	90223		
Mini Cooper	R56	1.6	88	4	09.06-	N12 B16	0,8	PLZKBR7B8DG	90223		
Mini Cooper	R56	1.6	90	4	03.10-	N16 B16A	0,8	PLZKBR7B8DG	90223		
Mini Cooper	R50	1.6	85	4	04.01-	W10 B16	1,5	BKR6EQU	3199	30	LPG 1
Mini Cooper S 16V	R53	1.6	125	4	12.01-	W11 B16	1,5	BKR6EQU	3199	30	LPG 1
Mini Cooper S 16V JCW	R53	1.6	147	4	01.03-	W11 B16	1,5	BKR7EQU	4285		
Mini Cooper S	R56	1.6	128	4	09.06-	N14 B16A	0,8	PLZKBR7B8DG	90223		
Mini Coupe Cooper	R58	1.6	85	4	09.11-	N16 B16A	0,8	PLZKBR7B8DG	90223		
Mini Coupe Cooper	R58	1.6	90	4	09.11-	N16 B16A	0,8	PLZKBR7B8DG	90223		
Mini Coupe Cooper S	R58	1.6	120	4	09.11-	N18 B16A	0,8	PLZKBR7B8DG	90223		
Mini Coupe Cooper S	R58	1.6	135	4	09.11-	N18 B16A	0,8	PLZKBR7B8DG	90223		
Mini Coupe Cooper S	R58	1.6	147	4	09.11-	N18 B16A	0,8	PLZKBR7B8DG	90223		
Mini John Cooper Works	R56	1.6	155	4	05.08-	N14 B16	0,8	ILZKBR7B8DG	95770		
Mini John Cooper Works	R56	1.6	160	4	07.07-	N14 B16	0,8	ILZKBR7B8DG	95770		
Mini Coupe John Cooper Works	R58	1.6	155	4	09.11-	N14 B16C	0,8	ILZKBR7B8DG	95770		
Mini Roadster Cooper	R59	1.6	85	4	02.12-	N16 B16A	0,8	PLZKBR7B8DG	90223		
Mini Roadster Cooper	R59	1.6	90	4	02.12-	N16 B16A	0,8	PLZKBR7B8DG	90223		
Mini Roadster John Cooper Works	R59	1.6	155	4	02.12-	N14 B16C	0,8	ILZKBR7B8DG	95770		
Mini Countryman One	R60	1.6	72	4	06.10-	N16 B16A	0,8	PLZKBR7B8DG	90223		
Mini Countryman Cooper	R60	1.6	85	4	06.10-	N16 B16A	0,8	PLZKBR7B8DG	90223		
Mini Countryman Cooper	R60	1.6	90	4	06.10-	N16 B16A	0,8	PLZKBR7B8DG	90223		
Mini Countryman Cooper S	R60	1.6	135	4	06.10-	N18 B16A	0,8	PLZKBR7B8DG	90223		
Mini Countryman Cooper S	R60	1.6	147	4	02.12-	N18 B16A	0,8	PLZKBR7B8DG	90223		
Mini Countryman Cooper S ALL4	R60	1.6	120	4	06.10-	N18 B16A	0,8	PLZKBR7B8DG	90223		

**MITSUBISHI**

2000 GTX	2.0		4	.94-	4G63	1,1	BKR5E-11	6953	33	LPG 1
3000 GT	3.0	210	6	09.92-.00	6G72/T DOHC	1,1	PFR6J-11	2743		
3000 GT	3.0		6	.95-.00	6G72 MPI TC	1,1	PFR6J-11	2743		
3000 GT	3.0		6	.97-	6G7	1,1	PFR6J-11	2743		

**AIRTRAK**

Airtrek	2.0	93	4	.02-	4G63 MPI	1,1	BKR6E-11	2756	14	LPG 1
Airtrek	2.0		4	06.02-	4G63	0,7	PGR6A	4984		
Airtrek	2.4		4	01.03-	4G64	1,1	BKR5E-11	6953	33	LPG 1

e kW  
C  
Y  
I

0201



Stock-No

VLINE

LPG / CNG

**MITSUBISHI****ASX**

ASX 1.6 GA1W	1.6	86	4	06.10-	4A92	1,1	DILFR5A11	93759		
ASX 1.8	1.8	102	4	02.10-	4B10	0,8	FR6EI	2687		
ASX 2.0 GA2W	2.0	110	4	06.10-	4B11	0,8	FR6EI	2687		

**CARISMA**

Carisma 1.3	1.3	55	4	09.00-10.04	4G13	1,1	BKR6E-11	2756	14	LPG 1
Carisma 1600 DAO	1.6	66	4	07.95- .99	4G92	1,1	BKR6E-11	2756	14	LPG 1
Carisma	1.6		4	.97- .99	4G92 SOHC	1,1	BKR6E-11	2756	14	LPG 1
Carisma 1800 DAO	1.8	85	4	09.95-	4G93	1,1	BKR6E-11	2756	14	LPG 1
Carisma GDI	1.8	92	4	09.97-	4G93 GDI	0,6	IZFR6B	3116		
Carisma Elegance GDI	1.8	92	4	.99-	4G93 GDI	0,6	IZFR6B	3116		
Carisma 1800 DAO	1.8	103	4	09.95-	4G93	1,1	BKR6E-11	2756	14	LPG 1
Carisma	1.8		4	.97- .00	4G93 SOHC	1,1	BKR6E-11	2756	14	LPG 1

**COLT**

Colt 1600 (2)	1.6		4	- .92		0,8	BPR6ES	7822	2	LPG 2
Colt 1300 (3)	1.3		4	.89- .92	4G13	1,1	BPR6ES-11	4824	13	LPG 2
Colt 1500 (3)	1.5		4	-12.93	4G15	0,8	BPR6ES	7822	2	LPG 2
Colt 1500 (3)	1.5		4	.91-	4G15 Cat.	1,1	BPR6ES-11	4824	13	LPG 2
Colt 1800 (3)	1.8		4		4G67 Cat.	0,8	BPR7ES	2023	19	BPR8EIX
Colt 1300 (4)	1.3	55	4	.93- .94	4G13 / MPI Cat.	1,1	BPR6ES-11	4824	13	LPG 2
Colt 1300 (4)	1.3		4	.92-	4G13 / MPI	1,1	BPR5ES-11	4424		LPG 2
Colt 1300 (4)	1.3		4	.95-	4G13	1,1	BPR5ES-11	4424		LPG 2
Colt 1500 (4)	1.5	69	4	.94-	4G15	0,8	BP5ES	6511	8	LPG 2
Colt 1600 16V (4)	1.6	83	4	12.91-	4G92	0,8	BPR6ES	7822	2	LPG 2
Colt 1600 (4)	1.6	83	4	.94- .95	4G92 MPI	1,1	BKR6E-11	2756	14	LPG 1
Colt 1600 (4)	1.6		4	.92- .93	4G92	1,1	BKR6E-11	2756	14	LPG 1
Colt 1600 (4)	1.6		4	.95- .96	4G92 MPI MVV	1,1	BKR6E-11	2756	4	LPG 1
Colt 1800 GTI 16V (4)	1.8	103	4	.94-	4G93 MPI	1,1	BKR6E-11	2756	4	LPG 1
Colt 1300 (5)	1.3	55	4	03.96-	4G13	1,1	BPR5ES-11	4424		LPG 2
Colt 1300 (5)	1.3	60	4	09.00-		1,1	BKR6E-11	2756	14	LPG 1
Colt 1300 (5)	1.3		4	.97-	4G13	1,1	BPR5ES-11	4424		LPG 2
Colt (5)	1.6	66	4	03.96- .03	4G92	1,1	BKR6E-11	2756	14	LPG 1
Colt 1600 (5)	1.6	66	4	03.96-	4G92	1,1	BKR6E-11	2756	14	LPG 1
Colt 1600 (5)	1.6		4	.97-	4G9 MVV	1,1	BKR6E-11	2756	14	LPG 1
Colt 1600 (5)	1.6		4	.97-	4G9 (not MVV Lean Mix)	1,1	BKR6E-11	2756	14	LPG 1
Colt (6) Z31A / Z32A	1.1	55	3	04.05-	3A91 12V	1,1	LFR6C-11	5788		
Colt (6) 1.1	1.1	55	3	10.04-06.10	3A91	1,1	LFR6C-11	5788		
Colt (6) 1.1	1.1	55	3	07.10-06.12	3A91	1,1	LZFR5BI-11	93298		
Colt (6) 1.3	1.3	70	4	06.04-06.10	4A90 16V	1,1	LFR6C-11	5788		
Colt (6) 1.3	1.3	70	4	07.10-06.12	4A90 16V	1,1	LZFR6BI-11	95181		
Colt (6) 1.3 Bifuel LPG	1.3	70	4	06.04-06.12	4A90 16V	1,1	LZFR6BI-11	95181		
Colt (6) Z33A / Z34A	1.3	70	4	04.05-06.10	4A90 16V	1,1	LFR6C-11	5788		
Colt (6) Z36A	1.5	80	4	04.05-	4A91 16V	0,8	ILZFR6C-K	6645		
Colt CZC (6) Z36A	1.5	80	4	04.05-07.08	4A91 16V	0,8	ILZFR6C-K	6645		
Colt CZC (6) Z37A	1.5	110	4	03.05-07.08	4G15T DOHC	0,8	ILZFR6C-K	6645		
Colt CZT (6) Z37A	1.5	110	4	03.05-	4G15T DOHC	0,8	ILZFR6C-K	6645		

**DIAMANTE**

Diamante (F31A, F41A) 2500 GDI	2.5			09.99-09.01	6G73	0,8	IZFR5C	7748		
Diamante 3000	3.0		6	.94-	6G72 MPI DOHC	0,8	BK6E	3536		LPG 1
Diamante 3000	3.0		6	.94-	6G72 MPI SOHC	1,1	BPR6ES-11	4824	13	LPG 2



e kW C y i

0201



Stock-No

VLINE

LPG/CNG

**MITSUBISHI****DIAMANTE**

Diamante (F36A, F46A) 3000 GDI	3.0		6	09.99-09.01	6G72	0,8	IZFR5C	7748		
--------------------------------	-----	--	---	-------------	------	-----	--------	------	--	--

**ECLIPSE**

Eclipse 2000 D30	2.0	107	4	11.95-04.99	4G63	1,1	BPR6ES-11	4824	13	LPG 2
Eclipse 2000	2.0	110	4	.91-10.95	4G63 MPI DOHC	0,8	BPR7ES	2023	19	BPR8EIX
Eclipse	2.0		4	.97-	4G6	1,1	BPR6ES-11	4824	13	LPG 2
Eclipse 2400	2.4	105	4	09.98-04.99	4G64	1,1	BKR5E-11	6953	33	LPG 1
Eclipse V6 24V	3.0	147	6	07.03-	4G72 SOHC MPI	0,8	FR6EI	2687		FR6EI

**ETERNA**

Eterna 2000 (E74A,E84A)	2.0		4	05.92-10.94	6A12	0,8	PFR6J	2645		
Eterna 2500 (EC5A)	2.5		4	08.96-	6A13	0,8	PFR6J	2645		

**EVOLUTION**

Evolution-V	CP9A	2.0	206	4		4G63 Turbo	0,8	PGR7A	3200	
Evolution-VI	CP9A	2.0	206	4	02.98-05.99	4G63 Turbo	0,8	PGR7A	3200	
Evolution-VI Tommi Makinen Edit.	CP9A	2.0	250	4	01.99-	4G63 Turbo	0,8	IGR7A	6687	
Evolution-VII	CT9A	2.0	206	4	.01-	4G63 Turbo	0,8	IGR7A-G	3106	
Evolution-VIII	CT9A	2.0	195	4	.04-	4G63 Turbo	0,8	IGR7A-G	3106	
Evolution-IX	CT9A	2.0	195	4	03.05-	4G63 Turbo D4(VVT)DOHC	0,6	ILFR7H	5245	
Evolution-X		2.0	217	4	04.08-09.10	4B11 FQ30	0,6	ILKR8E6	1422	
Evolution-X		2.0	217	4	10.10-	4B11 FQ30	0,6	DILKR8B6	91448	

**GALANT**

Galant 1800		1.8	85	4	.93- .94	4G93 MPI	1,1	BKR6E-11	2756	14	LPG 1
Galant 1800		1.8		4	.90- .91	4G37 Cat.	1,1	BPR6ES-11	4824	13	LPG 2
Galant 1800		1.8		4	.92- .96	4G37 Cat.	1,1	BPR7ES-11	7226		BPR8EIX
Galant 1800		1.8		4	.94- .96	4G93	0,8	BK6E	3536		LPG 1
Galant 2000		2.0	100	4	.96- .03	4G63	1,1	BKR6E-11	2756	14	LPG 1
Galant 2000		2.0	101	4	.94- .03	4G63 MPI	1,1	BKR6E-11	2756	14	LPG 1
Galant 2000 V6 (E74A,E84A)		2.0	110	6	05.92-10.94	6A12 MPI 24V	1,1	PFR6J-11	2743		
Galant		2.0		4	.88- .93	4G63 GTi16	0,8	BPR7ES	2023	19	BPR8EIX
Galant		2.0		4	.91- .91	4G63	0,8	BPR6ES	7822	2	LPG 2
Galant 2000		2.0		4	.92-	Cat.	1,1	BPR7ES-11	7226		BPR8EIX
Galant 2000		2.0		4	.92- .92	4G63	1,1	BPR7ES-11	7226		BPR8EIX
Galant 2000		2.0		4	.92- .92	4G63D	0,8	BPR6ES	7822	2	LPG 2
Galant 2000		2.0		4	.93- .96	4G63	0,8	BK6E	3536		LPG 1
Galant		2.0		4	.97- .03	4G63	1,1	BKR6E-11	2756	14	LPG 1
Galant GDI		2.4	110	6	10.98-	4G64 GDI	0,6	IZFR5B	4080		
Galant 2400		2.4		6	.94-	4G64 MPI DOHC	1,1	BPR6ES-11	4824	13	LPG 2
Galant 2400		2.4		6	.94-	4G64 MPI SOHC	1,1	BKR6E-11	2756	14	LPG 1
Galant 2500 V6		2.5	125	6	.93-03.97	6G12 24V	1,1	PFR6J-11	2743		
Galant V6 24V		2.5		6	.95- .00	6G73 MPI	1,1	PFR6J-11	2743		
Galant 2500 (EC5A)		2.5		4	08.96- .03	6A13	0,8	PFR6J	2645		
Galant V6		2.5		6	03.97- .03	6A13	1,1	PFR6G-11	5555		

**GALLOPER**

Galopper		3.0	104	6	.98-12.01	G6AT	1,1	BPR5ES-11	4424		LPG 2
----------	--	-----	-----	---	-----------	------	-----	-----------	------	--	-------

**GRANDIS**

Grandis 2.4		2.4	121	4	04.04-	4G69	0,8	LZFR6AI	3656		
-------------	--	-----	-----	---	--------	------	-----	---------	------	--	--

**i**

i 0.7		0.66	38	3	02.07-	3B20	0,8	ILKR7B8	1989		
-------	--	------	----	---	--------	------	-----	---------	------	--	--



e kW  
C  
Y  
I



Stock-No  
VLINE

LPG / CNG

## MITSUBISHI

L200										
L200	1.6		4		4G32 Cat.	0,8	BPR6ES	7822	2	LPG 2
L200	1.6		4	.92-	4G32	0,9	BPR5ES	7422	6	LPG 2
L200	2.0		4	- .92	4G63	0,8	BPR7ES	2023	19	BPR8EIX
L200	2.0		4	.92-	4G63	0,8	BPR6ES	7822	2	LPG 2
L200	2.4	82	4	.94-	4G64 MPI	1,1	BCPR6ES-11	7121	11	LPG 3
L200	2.4	97	4	.99-		1,1	BPR6ES-11	4824	13	LPG 2
L200	2.6	76	4	.93-	4G54/B	1,1	BPR6ES-11	4824	13	LPG 2
L200	2.6		4	- .92	4G54	1,1	BPR6ES-11	4824	13	LPG 2
L200	2.6		4	.95-	G54B	1,1	BUR6EA-11	5428		
L300										
L300	1.4		4	.94-	4G33	0,7	BP6ES	7811	4	LPG 2
L300	2.0	66	4	.92-	4G63 Cat.	0,8	BPR6ES	7822	2	LPG 2
L300	2.0	85	4	07.94-	4G63	0,9	BPR5ES	7422	6	LPG 2
L300	2.0		4	- .92	4G63	0,8	BPR6ES	7822	2	LPG 2
L300	2.0		4	10.94-	4G63 MPI	1,1	BKR5E-11	6953	33	LPG 1
L300	2.0		4	.95-	4G63 FBC	1,1	BKR5E-11	6953	33	LPG 1
L300	2.4	82	4	.92-	4G64 Cat.	1,1	PGR6A-11	3738		PGR7A
L400										
L400	2.0		4	.95-	4G63 MPI	1,1	BKR5E-11	6953	33	LPG 1
L400	2.4		4	.95-	4G64 MPI	1,1	BKR5E-11	6953	33	LPG 1
LANCER										
Lancer 1300	1.3	55	4	10.92-	.01 4G13 MPI	1,1	BPR5ES-11	4424		LPG 2
Lancer	1.3	55	4	03.96-	.01 4G13	1,1	BUR6EA-11	5428		
Lancer 1.3	1.3	60	4	09.03-06.06	4G13S	1,1	BKR6E-11	2756	14	LPG 1
Lancer 1.3	1.3	60	4	07.06-	4G13S	0,8	IFR6S	99404		
Lancer 1300	1.3		4	-09.92	4G13 Cat.	0,8	BPR6ES	7822	2	LPG 2
Lancer 1300	1.3		4	.89-	.92 4G13	0,8	BPR6ES	7822	2	LPG 2
Lancer 1300	1.3		4	10.92-	.01 4G13	0,8	BP5ES	6511	8	LPG 2
Lancer 1300	1.3		4	.97-	4G1	1,1	BPR5ES-11	4424		LPG 2
Lancer 1500	1.5	69	4	.93-	.00 4G15	0,8	BP5ES	6511	8	LPG 2
Lancer Sportback 1.5	1.5	80	4	06.08-	4A91 MIVEC	1,1	ILZFR6C-11K	4673		
Lancer Saloon 1.5	1.5	80	4	06.08-	4A91 MIVEC	1,1	ILZFR6C-11K	4673		
Lancer 1500	1.5		4	08.84-	.92 4G15	0,8	BPR6ES	7822	2	LPG 2
Lancer 1500	1.5		4	.86-	.92 4G15 Cat.	1,1	BPR6ES-11	4824	13	LPG 2
Lancer 1500	1.5		4	.94-	.96 4G91 MPI	1,1	BK6E-11	7340		LPG 1
Lancer 1.6	1.6	72	4	09.03-06.06	4G18	1,1	BKR6E-11	2756	14	LPG 1
Lancer 1.6	1.6	72	4	07.06-	4G18	0,8	IFR6S	99404		
Lancer 1600	1.6	83	4	10.92-	.00 4G92 MPI	1,1	BKR6E-11	2756	14	LPG 1
Lancer 1.6	1.6	86	4	05.10-	4A92	1,1	DILFR5A11	93759		
Lancer 1600 Twin Carb.	1.6		4			0,8	BPR6ES	7822	2	LPG 2
Lancer 1600	1.6		4	.90-09.92	4G61 DOHC	0,8	BPR6ES	7822	2	LPG 2
Lancer 1600	1.6		4	.94-12.96	4G92 MVV	1,1	BKR5E-11	6953	33	LPG 1
Lancer 1600	1.6		4	.97-	4G9 MVV	1,1	BKR5E-11	6953	33	LPG 1
Lancer 1600	1.6		4	.97-	.00 4G9 (not MVV Magermix)	1,1	BKR6E-11	2756	14	LPG 1
Lancer Sportback 1.8	1.8	105	4	06.08-	4B10 MIVEC	0,8	FR6EI	2687		
Lancer Saloon 1.8	1.8	105	4	02.08-03.09	4B10 MIVEC	0,8	FR6EI	2687		
Lancer Saloon 1.8	1.8	105	4	04.09-	4B10 MIVEC	1,1	DIFR5C11	1311		
Lancer 1800	1.8		4	.86-	.92 4G37 Cat.	1,1	BPR6ES-11	4824	13	LPG 2
Lancer 1800	1.8		4	.86-	.92 4G67	0,8	BPR7ES	2023	19	
Lancer	1.8		4	.90-	.92 4G37 GLXi	1,1	BPR6ES-11	4824	13	LPG 2





l kW  
C  
y  
I

0201



Stock-No

VALVE

LPG / CNG

**MITSUBISHI**

**LANCER**

Lancer	1.8		4	.90- .92	4G37 GTi16	0,8	BPR6ES	7822	2	LPG 2
Lancer	1.8		4	.93-	4G93 GTi16	1,1	BKR6E-11	2756	14	LPG 1
Lancer 1800 16V	1.8		4	.93-	4G93 MPI	0,8	BK6E	3536		LPG 1
Lancer	2.0	99	4	09.03-	4G63	1,1	IGR6A11	5743		IGR6A11
Lancer 2000	2.0		4	01.05-	4G94	1,1	BKR5E-11	6953	33	LPG 1
Lancer Sportback 2.0 Ralliart (CX4A)	2.0	177	4	06.08-	4B11 T/C	0,6	ILKR8E6	1422		

**MIRAGE**

Mirage	1.5		4	.94-	4G15 MPI	1,1	BPR5ES-11	4424		LPG 2
Mirage	1.6		4	.96-	4G92	1,1	BKR6E-11	2756	14	LPG 1
Mirage	1.8		4	.94-	4G93 MPI	1,1	BKR5E-11	6953	33	LPG 1

**MONTERO**

Montero V6 3000	3.0		6	.91-	6G72	1,1	BPR5ES-11	4424		LPG 2
-----------------	-----	--	---	------	------	-----	-----------	------	--	-------

**OUTLANDER**

Outlander 2.0	2.0	93	4	05.03-		1,1	IGR6A11	5743		
Outlander 2.0	2.0	100	4	05.03-	4G63	1,1	IGR6A11	5743		
Outlander 2.0 (CW4W)	2.0	108	4	06.09-	4B11	1,1	DIFR6C11	1312		
Outlander 2.0 Turbo	2.0	148	4	.05-	4G63 Turbo Mpi	1,1	IGR6A11	5743		
Outlander 2.0	2.0	177	4	05.03-		1,1	IGR6A11	5743		
Outlander2.0	2.0	110	4	08.12-	4J11	1,1	DILKR6D11G	95264		
Outlander 2.0	2.0	107	4	10.12-	4J11	1,1	DILKR6D11G	95264		
Outlander 2.0 Hybrid	2.0	89	4	12.12-	4B11	0,8	FR6EI	2687		
Outlander 2.4	2.4	102	4	05.03-		0,8	LZFR6AI	3656		
Outlander 2.4	2.4	118	4	05.03-	4G69	0,8	LZFR6AI	3656		
Outlander 2.4	2.4	125	4	06.07-	4B12	0,8	FR5EI	1313		
Outlander 3.0	3.0	162	6	11.06-	6B31	0,8	ILKR7B8	1989		

**PAJERO**

Pajero 2400	2.4		4	03.91-	4G64	1,1	BPR6ES-11	4824	13	LPG 2
Pajero	2.4		4	.97-	4G64	1,1	BPR6ES-11	4824	13	LPG 2
Pajero 2600	2.6		4		4G54	0,9	BPR5ES	7422	6	LPG 2
Pajero 2600	2.6		4		4G54 Cat.	1,1	BPR5ES-11	4424		LPG 2
Pajero 2600	2.6		4	.92-		1,1	BP6ES-11	1212		LPG 2
Pajero	3.0	130	6	.97-	6G72 24 Ventiler	1,1	PFR6J-11	2743		
Pajero 3000 V6	3.0		6	.89-	6G72	1,1	BPR5ES-11	4424		LPG 2
Pajero	3.0		6	.97-	6G72 12 Ventiler	1,1	BPR5ES-11	4424		LPG 2
Pajero Sport	3.0		6	.99-	6G72 24 Ventiler	1,1	PFR6J-11	2743		
Pajero	3.5	143	6	.97-	6G74	1,1	PFR5J-11	4642		
Pajero GDI V60	3.5	149	6	04.00-	V6	0,6	IZFR5B	4080		IZFR6B
Pajero 3500 V6	3.5	153	6	04.94- .97	6G74 DOHC	1,1	PFR6J-11	2743		
Pajero 3.8 V6 GDI	3.8	182	6	02.10-	6G75	0,8	IFR6B-K	4867		
Pajero 3.8 V6 GDI	3.8	184	6	11.06-	6G75	0,8	IFR6B-K	4867		

**PAJERO PININ**

Pajero Pinin 1.8	1.8	88	4	.00-	4G93 GDI	0,6	IZFR6B	3116		IZFR6B
Pajero Pinin 2.0	2.0	95	4	09.00-	4G94 GDI	0,6	IZFR5B	4080		IZFR6B

**SANTAMO**

Santamo	2.0	102	4	.99-	DOHC / SOHC	1,1	BP6ES-11	1212		LPG 2
---------	-----	-----	---	------	-------------	-----	----------	------	--	-------

e kW  
C  
Y  
I

0201

Stock-No  
VLINE

LPG / CNG

**MITSUBISHI  
SHOGUN**

Shogun	1.8		4	.00-	4G93 GDI	0,8	IZFR6B	3116		
Shogun	2.0		4	.00-	4G94 GDI	0,8	IZFR5B	4080		IZFR6B
Shogun	3.0		6	.91- .94	6G72	1,1	BPR5ES-11	4424		LPG 2
Shogun	3.0		6	.91- .94	6G72	1,1	BPR5ES-11	4424		LPG 2
Shogun	3.0		6	.94-	6G72	1,1	PFR6J-11	2743		
Shogun	3.5		6	.91-	6G74	1,1	PFR5J-11	4642		
Shogun	3.5		6	.00-		0,8	IZFR5B	4080		IZFR6B

**SIGMA**

Sigma V6	3.0		6	.91- .93	6G72 DOHC 24V	1,1	PFR6J-11	2743		
Sigma V6	3.0		6	.91- .93	6G72 SOHC	1,1	BPR6ES-11	4824	13	LPG 2
Sigma 3000	3.0		6	.93- .96	6G72 MPI V6	1,1	BPR6ES-11	4824	13	LPG 2
Sigma 3000	3.0		6	.94- .96	6G72 MPI V6-24V	1,1	PFR6J-11	2743		

**SPACE GEAR**

Space Gear	2.0	83	4	04.95- .01	4G63 MPI	1,1	BKR5E-11	6953	33	LPG 1
Space Gear	2.0		4	.97- .01	4G69	1,1	BKR5E-11	6953	33	LPG 1
Space Gear	2.4	97	4	04.95- .01	4G64 MPI	1,1	BKR5E-11	6953	33	LPG 1

**SPACE RUNNER**

Space Runner 1800	1.8	90	4	09.91- .92	4G93	1,1	BKR6E-11	2756	14	LPG 1
Space Runner 1800	1.8	90	4	.91- .99	4G93 MPI	1,1	BKR6E-11	2756	14	LPG 1
Space Runner 1800	1.8		4	.94- .99	4G93	0,8	BK6E	3536		LPG 1
Space Runner	1.8		4	.97- .99	4G93	1,1	BKR6E-11	2756	14	LPG 1
Space Runner	2.0	100	4	.99-08.02	4G63 MPI	1,1	BKR6E-11	2756	14	LPG 1
Space Runner GDI	2.4	110	4	.99-	4G64 GDI	0,6	IZFR5B	4080		IZFR6B

**SPACE STAR**

Space Star 1.3	1.3	63	4	12.98-05.00	4G13	1,1	BKR5E-11	6953	33	LPG 1
Space Star 1.3	1.3	63	4	06.00-12.04	4G13	1,1	BKR6E-11	2756	14	LPG 1
Space Star 1.6	1.6	72	4	04.01-12.04	4G18	1,1	BKR6E-11	2756	14	LPG 1
Space Star 1.8 MPI	1.8	82	4	08.02-12.04	4G93	0,6	IZFR6B	3116		
Space Star 1.8 GDI	1.8	87	4	06.98-12.04	4G93 GDI	0,6	IZFR6B	3116		
Space Star 1.8 GDI	1.8	90	4	06.98-12.04	4G93 GDI	0,6	IZFR6B	3116		

**SPACE WAGON**

Space Wagon 1800	1.8		4	09.91- .93	4G93	1,1	BKR6E-11	2756	14	LPG 1
Space Wagon 1800	1.8		4	.94-	4G93	0,8	BK6E	3536		LPG 1
Space Wagon 1800	1.8		4	.94-	4G93 MPI	1,1	BKR6E-11	2756	14	LPG 1
Space Wagon 2000	2.0	98	4	.92- .00	4G63 MPI Cat.	1,1	BKR6E-11	2756	14	LPG 1
Space Wagon Gdi (N5.)	2.0	98	4	02.02-	4G94	1,1	HB6BIX-11P	5705		
Space Wagon	2.0		4	.97-	4G63	1,1	BKR5E-11	6953	33	LPG 1
Space Wagon GDI	N84W/N94W	2.4	110	4	10.98-01.04	4G64 GDI	0,6	IZFR5B	4080	IZFR6B
Space Wagon 2400	2.4		4	.93- .95	4G64 Cat.	1,1	BKR6E-11	2756	14	LPG 1

**MORGAN**

4/4	1.6	71	4	01.82- .93	CVH Ford	0,8	BCPR6ES	2330	12	LPG 3
4/4	1.6	72	4	01.82-	132D.000	0,7	BP6ES	7811	4	LPG 2
4/4	1.8	89	4	02.93-	Zetec 16V	1,3	PTR5A-13	2467	25	LPG 4
4/4	1.8		4	.94- .98	FORD ZETEC	1,0	PTR5A-10	5055		
Aero 8	4.4	210	8	.00-	BMW M62B44	1,5	BKR6EQUP	3199	30	LPG 1
Plus 4	2.0	98	4	09.87- .92	M16i	0,8	BCPR6ES	2330	12	LPG 3



l kW  
C  
y  
i

0201



Stock-No

VALE

LPG/CNG

## MORGAN

Plus 4	2.0	99	4	09.92-	.96	T16	0,8	BCPR6ES	2330	12	LPG 3
Plus 8	3.5	136	8	01.90-	.01	V8 Rover Cat.	0,7	BP6ES	7811	4	LPG 2
Plus 8	3.5	142	8	01.90-	.01	V8 Rover	0,7	BP6ES	7811	4	LPG 2
Plus 8	3.9	140	8	01.90-09.03		V8 Kat Rover	0,8	BPR6ES	7822	2	LPG 2
Plus 8	4.0		8	.01-		ROVER V8	1,1	PFR6N-11	3546		LPG 1
Plus 8	4.6		8	.97-	.99	ROVER V8	1,1	PFR6N-11	3546		LPG 1

## NISSAN

### 100 NX

100 NX 1.6	B13	1.6	66	4	10.90-	.95	GA16DE Cat.	0,9	BKR6E	6962	28	LPG 1
100 NX 1.6	B13	1.6	66	4	10.90-	.93	GA16DS Cat.	0,9	BKR6E	6962	28	LPG 1
100 NX 1.6 SR	B13	1.6	75	4	09.93-	.94	GA16DE	0,8	BKR5E	7938	35	LPG 1
100 NX 2.0 GTI	B13	2.0	105	4	10.90-	.95	SR20DE Cat.	0,9	BKR6EY	3696		LPG 1

### 200 SX

200 SX Turbo	S13	1.8	124	4	.89-	.93	CA18DET	1,1	PFR6A-11	4045		
200 SX Turbo	S13	1.8	124	4	09.88-	.93	CA18DET Cat.	1,1	PFR6A-11	4045		
200 SX Turbo	S13	1.8	129	4	09.88-	.93	CA18DET	1,1	BCPR6ES-11	7121	11	LPG 3
200 SX Turbo	S14	2.0	147	4	08.94-12.99		SR20DET	0,9	PFR6B-9	3100		PFR7B

### 300 ZX

300 ZX	Z32	3.0		6	.90-	.96	VG30DE	1,1	PFR6B-11	4014		PFR7B
300 ZXTT Biturbo	Z32	3.0	197	6	.90-	.95	VG30DETT	1,1	PFR6B-11C	2684		
300 ZX Biturbo	Z32	3.0	206	6	01.90-	.95	VG30DETT Cat.	1,1	PFR6B-11C	2684		

### 350 Z

350 Z	Z33	3.5	206	6	10.03-06.06		VQ35DE	1,1	PLFR5A-11	6240		LPG 7
350 Z	Z33	3.5	230	6	09.05-		VQ35HR	1,1	DF7H-11B	1317		
350 Z	Z33	3.5	221	6	04.06-01.07		VQ35DE	1,1	PLFR5A-11	6240		LPG 7
350 Z Roadster	Z33	3.5	206	6	11.04-08.05		VQ35DE	1,1	PLFR5A-11	6240		LPG 7
350 Z Roadster	Z33	3.5	221	6	.06-01.07		VQ35DE	1,1	PLFR5A-11	6240		LPG 7

### 370 Z

370 Z	Z34	3.7	241	6	06.09-		VQ37VHR	1,1	DF8H-11B	1305		
370 Z	Z34	3.7	243	6	06.09-		VQ37VHR	1,1	DF8H-11B	1305		

### ALMERA 1

Almera 1.4	N15	1.4	55	4	09.95-04.00		GA14DE	0,8	BKR5E	7938	35	LPG 1
Almera 1.6	N15	1.6	66	4	09.95-		GA16DE	0,8	BKR5E	7938	35	LPG 1
Almera 1.6	N15	1.6	66	4	.95-	.00	QG15DE	1,1	BKR5E-11	6953	33	LPG 1
Almera 2.0 Gti	N15	2.0	105	4	.95-04.00		SR20DE	1,1	BKR5EY-11	2355		LPG 1

### ALMERA 2

Almera 1.5	N16	1.5	66	4	02.00-09.02		QG15DE	1,1	BKR5E-11	6953	33	LPG 1
Almera 1.5	N16	1.5	72	4	10.02-		QG15DE	1,1	LFR5A-11	6376		LPG 7
Almera 1.8	N16	1.8	84	4	02.00-09.02		QG18DE	1,1	BKR5E-11	6953	33	LPG 1
Almera 1.8	N16	1.8	85	4	10.02-		QG18DE	1,1	LFR5A-11	6376		LPG 7

### ALMERA TINO

Almera Tino 1.8	V10	1.8	84	4	.00-	.02	QG18DE	1,1	BKR5E-11	6953	33	LPG 1
Almera Tino 1.8	V10	1.8	85	4	.03-		QG18DE	1,1	LFR5A-11	6376		LPG 7
Almera Tino 2.0	V10	2.0	100	4	.00-	.02	SR20DE	1,1	PFR6G-11	5555		PFR7G

e kW  
C  
Y  
I

0201



Stock-No

VLINE

LPG / CNG

**NISSAN****BLUEBIRD**

Bluebird 1.8		1.8		4	.90-	CA18NS	0,8	BCP5ES	7496	16	LPG 3
Bluebird 1.8		1.8		4	.90-	CA18S	0,8	BCP5ES	7496	16	LPG 3
Bluebird 1.6	U13	1.6		4	.94-	CA16NS	0,8	BCP5ES	7496	16	LPG 3
Bluebird 2.0	U13	2.0		4	.93-	CA20E	1,1	BCPR6ES-11	7121	11	LPG 3
Bluebird 2.0	U13	2.0		4	.93-	CA20S	0,7	BCP6ES	4930	12	LPG 3

**CABSTER**

Cabster 1.6	F23 / H41	1.6		4	.93-	Z16	0,8	BP5ES	6511	8	LPG 2
Cabster 2.0	F23 / H41	2.0		4	.93-	Z20	0,8	BP5ES	6511	8	LPG 2
Cabster 2.4	F23 / H41	2.4		6	.93-	Z24	0,7	BP6ES	7811	4	LPG 2

**CARAVAN**

Caravan 2.0		2.0	120	4	01.01-	KA20DE (DOHC)	1,1	BKR5E-11	6953	33	LPG 1
Caravan 2.4		2.4		4	01.01-	KA24DE (DOHC)	1,1	BKR5E-11	6953	33	LPG 1

**CUBE**

Cube 1.6 16V	Z12	1.6	81	4	03.10-	HR16DE	1,1	LZKAR6AP-11	6643		
--------------	-----	-----	----	---	--------	--------	-----	-------------	------	--	--

**EVALIA**

Evalia 1.6 16V	M20M	1.6	81	4	07.10-	HR16DE	1,1	PLZKAR6A-11	5118		
----------------	------	-----	----	---	--------	--------	-----	-------------	------	--	--

**GLORIA**

Gloria	MY34	2.5		4	06.99-06.00	VQ25DD Ne-Di	1,1	PFR5P-11	4341		
--------	------	-----	--	---	-------------	--------------	-----	----------	------	--	--

**JUKE**

Juke 1.6	F15E	1.6	86	4	06.10-	HR16DE	1,1	DILZKAR6A11	91691		
Juke 1.6	F15E	1.6	140	4	06.10-	MR16DDT	0,9	DILKAR7C9H	91215		
Juke 1.6	F15E	1.6	69	4	01.13-	HR16DE	1,1	DILZKAR6A11	91691		
Juke 1.6 4x4	F15E	1.6	140	4	06.10-	MR16DDT	0,9	DILKAR7C9H	91215		
Juke 1.6 DIG-T	F15E	1.6	147	4	11.12-	MR16DDT	0,9	DILKAR7C9H	91215		

**KUBISTAR**

Kubistar 1.2	X76	1.1	43	4	.03-	D7F	0,8	BKR5EK	7956	23	LPG 1
Kubistar 1.2 16V	X76	1.2	55	4	04.06-	D4F-712	0,8	LZKAR7A	6799		LZKAR7A
Kubistar 1.6 16V	X76	1.6	70	4	09.03-	K4M-720 / 744 / 745 / 748	0,9	BKR6E	6962	28	LPG 1

**MAXIMA**

Maxima	J30	3.0	125	6	10.88- .95	VG30E	1,1	BKR6ES-11	5553	14	LPG 1
Maxima	J30	3.0		6		VG30DE	1,1	PFR5C-11	2271		PFR5C-11

**MAXIMA QX**

Maxima QX	A32	2.0	103	6	.95- .00	VQ20DE	1,1	PFR6G-11	5555		PFR7G
Maxima QX	A32	3.0	141	6	.95- .00	VQ30DE	1,1	PFR6G-11	5555		PFR7G
Maxima QX	A33	2.0	103	6	.00-	VQ20DE	1,1	PFR6G-11	5555		PFR7G
Maxima QX	A33	3.0	147	6	.00-	VQ30DE	1,1	PFR6G-11	5555		PFR7G

**MICRA 1**

Micra 1.0	K10	1.0	37	4	12.82- .92	MA10S	0,9	BPR5ES	7422	6	LPG 2
Micra 1.0	K10	1.0	40	4	.93-	MA10	0,9	BPR5ES	7422	6	LPG 2
Micra 1.2	K10	1.2	40	4	01.86- .93	MA12	1,1	BPR5ES-11	4424		LPG 2
Micra 1.3 Super S	K10	1.3	55	4	.93-	CG13DE	1,1	BKR5E-11	6953	33	LPG 1

**MICRA 2**

Micra 1.0 16V	K11	1.0	40	4	.93- .00	CG10DE Cat.	1,1	BKR5E-11	6953	33	LPG 1
Micra 1.0	K11	1.0	44	4	.00- .02	CG10DE	1,1	BKR5E-11	6953	33	LPG 1
Micra 1.3 16V	K11	1.3	55	4	.93- .00	CG13DE Cat.	1,1	BKR5E-11	6953	33	LPG 1
Micra 1.3 16 V Sport	K11	1.3	60	4	.00- .02	CGA3DE	1,1	BKR5E-11	6953	33	LPG 1



l kW  
C  
y  
i

0201



Stock-No

ULINE

LPG/CNG

**NISSAN**

**MICRA 3**

Micra 1.6	K12	1.6	81	4	07.05-	HR16DE	1,1	PLZKAR6A-11	5118		
Micra C+C	K12	1.6	81	4	.06-	HR16DE	1,1	PLZKAR6A-11	5118		
Micra SR160	K12	1.6	85	4	.07-	HR16DE	1,1	PLZKAR6A-11	5118		

**MICRA 4**

Micra 1.2	K13	1.2	59	3	05.10-	HR12DE	1,1	LZKAR6AP-11	6643		
Micra 1.2 DIG	K13	1.2	72	3	04.11-	HR12DDR	1,1	LZKAR6AP-11	6643		

**MURANO 1**

Murano 2.5	Z50	2.5		4	09.04-	QR25DE	1,1	LFR5A-11	6376		LPG 7
Murano 3.5	Z50	3.5	172	6	12.02-	VQ35DE	1,1	PLFR5A-11	6240		LPG 7

**MURANO 2**

Murano II 3.5	Z51	3.5	188	6	10.08-	VQ35DE	1,1	DF7H-11B	1317		
Murano II 3.5	Z51	3.5	191	6	01.10-	VQ35DE	1,1	DF7H-11B	1317		
Murano II 3.5	Z51	3.5	195	6	11.07-	VQ35DE	1,1	DF7H-11B	1317		

**NOTE**

Note I 1.6	E11	1.6	81	4	03.06-08.13	HR16DE	1,1	PLZKAR6A-11	5118		
Note I 1.6	E11	1.6	85	4	03.06-08.13	HR16DE	1,1	PLZKAR6A-11	5118		
Note II 1.2	E12	1.2	59	3	06.13-	HR12DE	1,1	LZKAR6AP-11	6643		
Note II 1.2 DIG-S (OE 22401-1HC1B)	E12	1.2	72	3	06.13-	HR12DDR	1,1	LZKAR6AP-11	6643		

**NV 200**

NV200 1.6 16V	M20M	1.6	81	4	02.10-	HR16DE	1,1	PLZKAR6A-11	5118		
---------------	------	-----	----	---	--------	--------	-----	-------------	------	--	--

**PATHFINDER**

Pathfinder	D21	2.0		4		Z20S	0,8	BPR6ES	7822	2	LPG 2
Pathfinder	D21	2.4		6		KA24	1,1	ZFR5E-11	4435		
Pathfinder	D21	2.4		6		Z24i	0,9	BPR5ES	7422	6	LPG 2
Pathfinder	D21	2.4		6		Z24S	0,8	BPR6ES	7822	2	LPG 2
Pathfinder	D21	3.0		6		VG30i	1,1	BCPR5ES-11	3524		LPG 3
Pathfinder	D21	3.0		6	.92-	VG30E	0,9	BKR6EY	3696		LPG 1
Pathfinder	R50	3.3	110	6	.92-12.00	VG33E V6	1,1	BKR5E-11	6953	33	LPG 1
Pathfinder	R50	3.3	110	6	.97- .00	VG33E V6	1,1	BKR5ES-11	2382	33	LPG 1
Pathfinder	R50	3.5	162	6	01.00-	VQ35E V6	1,1	PLFR5A-11	6240		LPG 7
Pathfinder	R51M	4.0	198	6	09.05-	VQ40DE	1,1	LFR5AIX-11	4469		LPG 7

**PATROL**

Patrol	Y60 / 260	2.0		4	04.89-	RB30S	0,9	BKR6E	6962	28	LPG 1
Patrol		4.2		6	- .92	TB42S	0,8	BP5ES	6511	8	LPG 2
Patrol	Y60	4.2		6	.88-12.95	TB42S	0,7	BP6ES	7811	4	LPG 2
Patrol	Y60	4.2		6	.93- .94	RB42S	0,9	BPR5E	7281	6	LPG 2
Patrol	Y60	4.2		6	.93-	TB42E	0,9	BPR5E	7281	6	LPG 2
Patrol		4.5		6	.98-	TB45E	1,1	BPR5E-11	5638		LPG 2
Patrol	Y62	5.6	298	8	04.10-	VK56VD	1,1	DILKAR7B11	1406		

**PICK UP**

Pick-Up	B120	1.2		4	.93-	A12	0,8	BP5ES	6511	8	LPG 2
Pick-Up	D21	1.6		4	09.85-	Z16	0,8	BPR6ES	7822	2	LPG 2
Pick-Up	D21	2.0		4	09.85-04.92	Z20	0,8	BPR6ES	7822	2	LPG 2
Pick-Up	D21	2.0		4	04.92-	Z20S	0,8	BPR6ES	7822	2	LPG 2
Pick-Up	720	2.2	71	4	03.86-04.93	Z22	0,7	BP6ES	7811	4	LPG 2
Pick-Up	D21	2.4	74	4	09.85-04.92	Z24	0,8	BPR6ES	7822	2	LPG 2
Pick-Up	D21	2.4	76	4	10.88-04.92	Z24i	0,8	BPR6ES	7822	2	LPG 2

e kW  
C  
y  
I

0201



Stock-No

VLINE

LPG / CNG

**NISSAN****PICK UP**

Pick-Up	D21	2.4	88	4	.98-	.01	KA24E	1,1	ZFR5E-11	4435		
Pick-Up	MD21	2.4	93	4	.94-	.98	KA24E	1,1	ZFR5E-11	4435		
Pick-Up	D22	2.4	98	4	.02-		KA24E	1,1	BKR6E-11	2756	14	LPG 1
Pick Up		3.0		6	.90-		VG30I	1,1	BCPR5ES-11	3524		LPG 3
Pick Up		3.0		6	.93-		VG30E	0,9	BKR6EY	3696		LPG 1

**PIXO**

Pixo	UA0	1.0	50	3	06.09-		K10B	1,1	IKR6G11	7980		
------	-----	-----	----	---	--------	--	------	-----	---------	------	--	--

**PRAIRIE**

Prairie	M11	2.0	98	4	.93-	.95	CA20S	0,7	BCP6ES	4930	17	LPG 3
Prairie	M11	2.0		4	.90-	.92	CA20S	0,8	BCPR6ES	2330	12	LPG 3
Prairie	M11	2.4	98		.94-	.95	KA24E	1,1	ZFR5E-11	4435		
Prairie	M11	3.0	98	4	.92-	.95	KA24E	1,1	ZFR5E-11	4435		
Prairie 4 x EX + 4 x IN	M11	2.0	72	4	10.88-	.92	CA20E T.S. Cat.	1,1	BCPR5ES-11 + BCPR6ES-11	3524 + 7121		LPG 3 * 8 pcs
Prairie 4 x EX + 4 x IN	M11	2.0	73	4	10.88-	.92	CA20E T.S.	1,1	BCPR5ES-11 + BCPR6ES-11	3524 + 7121		LPG 3 * 8 pcs
Prairie 4 x EX + 4 x IN	M11	2.0	98	4	.93-	.95	CA20E T.S.	1,1	BCPR5ES-11 + BCPR6ES-11	3524 + 7121		LPG 3 * 8 pcs

**PRIMASTAR**

Primastar J4	X83	2.0	88	4	.03-		F4R	0,9	BKR6EZ	4619	38	LPG 1
--------------	-----	-----	----	---	------	--	-----	-----	--------	------	----	-------

**PRIMERA 1**

Primera 1.6	P10	1.6	66	4	07.90-	.93	GA16DS Cat.	0,9	BKR6E	6962	28	LPG 1
Primera 1.6	P10	1.6	66	4	.93-	.97	GA16DE	0,9	BKR5EY	7390		LPG 1
Primera 1.6	P10	1.6	66	4	.93-		GA16DS	0,9	BKR6E	6962	28	LPG 1
Primera 1.6	P10	1.6	66	4	.93-	.96	GA16DE	0,8	BKR5E	7938	35	LPG 1
Primera 1.6	P10	1.6	66	4	.93-		GA16DS	0,9	BKR6EY	3696		LPG 1
Primera 1.6	P10E	1.6	66	4	06.90-	.93	GA16DS Cat.	0,9	BKR6E	6962	28	LPG 1
Primera 1.6	P10	1.6	70	4	07.90-	.93	GA16DS	0,9	BKR6E	6962	28	LPG 1
Primera 1.6	P10E	1.6	70	4	06.90-	.92	GA16DS	0,9	BKR6E	6962	28	LPG 1
Primera 2.0	P10	2.0	85	4	07.90-	.96	SR20Di	0,9	BKR5EY	7390		LPG 1
Primera 2.0	P10	2.0	85	4	.93-	.96	SR20DE	0,9	BKR5EY	7390		LPG 1
Primera 2.0	P10E	2.0	85	4	06.90-	.96	SR20Di	0,9	BKR5EY	7390		LPG 1
Primera 2.0	P10	2.0	89	4	07.90-	.96	SR20Di SPI	0,9	BKR5EY	7390		LPG 1
Primera 2.0	P10E	2.0	89	4	06.90-	.96	SR20Di SPI	0,9	BKR5EY	7390		LPG 1
Primera 2.0	P10E	2.0	110	4	06.90-	.96	SR20DE EGI Cat.	0,9	BKR6EY	3696		LPG 1

**PRIMERA 2**

Primera 1.6	P11	1.6	66	4	.96-		GA16DE	0,9	BKR6E	6962	28	LPG 1
Primera 1.6 16V	P11	1.6	74	4	09.96-	.00	GA16DE	0,8	BKR5E	7938	35	LPG 1
Primera 1.6	P11	1.6	78	4	02.00-	07.02	QG16DE	1,1	BKR5E-11	6953	33	LPG 1
Primera 1.8	P11	1.8	83	4	02.00-	.02	QG18DE	1,1	BKR5E-11	6953	33	LPG 1
Primera 2.0 16V	P11	2.0	85	4	09.96-	.99	SR20DE	1,1	BKR5EY-11	2355		LPG 1
Primera 2.0	P11	2.0	91	4	.96-	.99	SR20DE	0,9	BKR5EY	7390		LPG 1
Primera 2.0 16V	P11	2.0	96	4	09.96-	.99	SR20DE	1,1	BKR5EY-11	2355		LPG 1
Primera 2.0	P11	2.0	103	4	.00-	.02	SR20DE	1,1	PFR6G-11	5555		PFR7G
Primera 2.0	P11	2.0	109	4	.96-	.99	SR20DE	0,9	BKR5EY	7390		LPG 1
Primera 2.0	P11	2.0	110	4	06.97-	.99	SR20DE	0,9	BKR6EY	3696		LPG 1
Primera 2.0 GT UK	P11	2.0	110	4	04.97-		SR20DE	1,1	BKR5EY-11	2355		LPG 1

**PRIMERA 3**

Primera 1.6	P12	1.6	78	4	01.02-		QG16DE	1,1	LFR5A-11	6376		LPG 7
Primera 1.8	P12	1.8	85	4	03.02-		QG18DE	1,1	LFR5A-11	6376		LPG 7



e kW C y i

0201



Stock-No

VLINE

LPG/CNG

**NISSAN****PRIMERA 3**

Primera 1.8 Traveller	P12	1.8	85	4	03.02-	QG18DE	1,1	LFR5A-11	6376		LPG 7
Primera 2.0	P12	2.0	103	4	03.02-	QR20DE	1,1	LFR5A-11	6376		LPG 7
Primera 2.0	P12	2.0		4	08.01-06.03	SR20VE	0,9	PLFR6A-9	4342		LPG 7
Primera 2.0 Wagon	P12	2.0		4	08.01-06.03	SR20VE	0,9	PLFR6A-9	4342		LPG 7

**PULSAR**

Pulsar 1.2 DIG-T	C13M	1.2	85	4	07.14-	HRA2DDT	0,7	ILKAR7F7G	90061		
------------------	------	-----	----	---	--------	---------	-----	-----------	-------	--	--

**QASHQAI**

Qashqai 1.6	J10	1.6	84	4	02.07-	HR16DE	1,1	PLZKAR6A-11	5118		
Qashqai 2.0	J10	2.0	104	4	02.07-	MR20DE	1,1	PLZKAR6A-11	5118		

**SERENA**

Serena 1.6	C23M	1.6	71	4	07.93-	GA16DE Cat.	0,8	BKR5E	7938	35	LPG 1
Serena 2.0	C23M	2.0	93	4	01.92-	SR20DE Cat.	0,9	BKR5EY	7390		LPG 1
Serena 2.0	C25	2.0		4	05.05-	MR20DE	1,1	LZKAR6AP-11	6643		

**SILVIA**

Silvia RS12 4x EX + 4 x IN		1.8	90	4	.89- .95	CA18E	1,1	BCPR5ES-11 + BCPR6ES-11	3524 + 7121		LPG 3 * 8 pcs
Silvia Turbo 4x EX + 4 x IN S12(CH)		1.8	90	4	10.83- .95	CA18ET Cat.	1,1	BCPR5ES-11 + BCPR6ES-11	3524 + 7121		LPG 3 * 8 pcs

**SKYLINE**

Skyline V6 24V	V35	2.5	158	6	.02-	VQ25DD	1,1	LFR5AIX-11	4469		LPG 7
Skyline	V35	2.6		6	.98-	RB26DETT	1,1	PFR7A-11	4579		
Skyline V6 24V	V35	3.0	191	6	.02-	VQ30DD	1,1	LFR5AIX-11	4469		LPG 7
Skyline V6 24V	V35	3.5	200	6	.02-	VQ35DE	1,1	LFR5AIX-11	4469		LPG 7

**SUNNY**

Sunny 1.0	B13	1.0		4	.93- .95	E10S Cat.	0,8	BP5ES	6511	8	LPG 2
Sunny 1.3	B13	1.3		4	.93- .95	GA13DS	0,9	BKR6E	6962	28	LPG 1
Sunny 1.4	B13	1.4	55	4	.93- .95	GA14DS	0,9	BKR6E	6962	28	LPG 1
Sunny 1.6	B13	1.6		4	- .96	GA16DE	0,9	BKR6E	6962	28	LPG 1
Sunny 1.6	B13	1.6		4	- .95	GA16DS	0,9	BKR6E	6962	28	LPG 1
Sunny 2.0	B13	2.0		4	.91- .96	SR20DE	0,9	BKR6EY	3696		LPG 1
Sunny 1.3	B14	1.3		4	.95-	GA13DE	1,1	BKR6E-11	2756	14	LPG 1
Sunny 1.3	B14	1.3		4	.95-	GA13DS	0,9	BKR6E	6962	28	LPG 1
Sunny 1.4	B14	1.4		4	.95-	GA14DE	0,9	BKR6E	6962	28	LPG 1
Sunny 1.6	B14	1.6		4	.95-	GA16DE	1,1	BKR6E-11	2756	14	LPG 1
Sunny 1.8	B14	1.8		4	.95-	GA18DE(A)	1,1	BKR6E-11	2756	14	LPG 1
Sunny 1.8	B14	1.8		4	.95-	GA18DE(B)	0,9	BKR6E	6962	28	LPG 1
Sunny 2.0	B14	2.0		4	.95-	SR20DE	0,9	BKR6EY	3696		LPG 1
Sunny 1.4	N14	1.4	55	4	10.90- .93	GA14DS	0,8	BKR5E	7938	35	LPG 1
Sunny 1.4	N14	1.4	55	4	10.92- .95	GA14DE	0,8	BKR5E	7938	35	LPG 1
Sunny 1.6	N14	1.6	66	4	10.90- .93	GA16DS	0,9	BKR6E	6962	28	LPG 1
Sunny 1.6	N14	1.6	66	4	10.92- .95	GA16DE	0,8	BKR5E	7938	35	LPG 1
Sunny 1.6	N14	1.6	75	4	10.92- .95	GA16DE	0,8	BKR5E	7938	35	LPG 1
Sunny 2.0	N14	2.0		4	.95-	SR20DET	0,6	PFR7B	4853		PFR8B
Sunny 1.6	Y10	1.6	66	4	.94- .00	GA16DS	0,9	BKR6E	6962	28	LPG 1
Sunny 1.6	Y10	1.6	67	4	.94- .00	SR16DE	0,8	BKR5E	7938	35	LPG 1
Sunny 2.0	Y10	2.0	105	4	.93- .00	GA20DE	0,9	BKR6EY	3696		LPG 1
Sunny 1.6	Y10L	1.6	66	4	10.90- .93	GA16DS	0,9	BKR6E	6962	28	LPG 1

e kW  
C  
Y  
I

0201



Stock-No

VLINE

LPG / CNG

**NISSAN****SUNNY**

Sunny 1.6	Y10L	1.6	66	4	10.92-	.00	GA16DE	0,8	BKR5E	7938	35	LPG 1
Sunny GTI	N14	2.0	105	4	10.90-05.95		SR20DE Cat.	0,9	BKR6EY	3696		LPG 1
Sunny GTI-R	N14	2.0	162	4	10.93-	.95	SR20DET Cat.	0,9	PFR7B-9	4180		PFR8B

**TEANA**

Teana 3.5	J32	3.5	185	6	07.08-		VQ35DE	1,1	DF7H-11B	1317		
-----------	-----	-----	-----	---	--------	--	--------	-----	----------	------	--	--

**TERRANO 1**

Terrano 1	WD21	2.0		4			Z20S	0,8	BPR6ES	7822	2	LPG 2
Terrano 1 4 x EX + 4 x IN	WD21	2.4	76	4	08.86-	.92	Z24i T.S.	0,9	BPR5ES	7422	6	LPG 2
Terrano 1	WD21	2.4	76	6	08.87-07.92		Z24i Cat.	0,9	BPR5ES	7422	6	LPG 2
Terrano 1	WD21	3.0	109	6	01.90-07.96		VG30E Cat.	0,9	BKR6EY	3696	9	LPG 1

**TERRANO 2**

Terrano 2	R20	2.4	86	6	05.96-	.01	KA24E	1,1	ZFR5E-11	4435		
Terrano 2	R20	2.4	87	6	05.96-	.01	KA24E	1,1	ZFR5E-11	4435		
Terrano 2	R20	2.4	91	6	07.93-	.96	KA24E	1,1	ZFR5E-11	4435		

**TIIDA**

Tiida 1.6	C11X	1.6	81	4	01.08-		HR16DE	1,1	PLZKAR6A-11	5118		
Tiida 1.8	C11X	1.8	93	4	01.08-		MR18DE	1,1	PLZKAR6A-11	5118		

**TINO**

Tino 1.8 16V V10		1.8	88	4	.99-		NEOQG18DE	1,1	BKR5E-11	6953	33	LPG 1
Tino 2.0 16V V10		2.0	99	4	.99-		SR20DE	1,1	PFR6G-11	5555		PFR7G

**URVAN**

Urvan	E23 / E24	2.0	64	4	11.86-	.97	Z20 OHC	0,9	BPR5ES	7422	6	LPG 2
Urvan	E23 / E24	2.0		4	.95-	.97	NA20S	1,1	BPR6ES-11	4824	13	LPG 2
Urvan	E23 / E24	2.4	74	6	02.87-	.97	Z24S OHC	0,9	BPR5ES	7422	6	LPG 2
Urvan	E23 / E24	2.4	74	6	05.89-	.96	Z24i	0,9	BPR5ES	7422	6	LPG 2
Urvan	E23 / E24	2.4		6	.95-	.97	Z24	0,7	BP6ES	7811	4	LPG 2

**VANETTE**

Vanette	M20	1.6		4	.09-		HR16DE	1,1	LZKAR6AP-11	6643		
Vanette		2.0		4	.93-		SR20E	0,9	BKR5EY	7390		LPG 1
Vanette	C22	2.4	74	4	09.86-	.93	Z24i .	0,9	BPR5ES	7422	6	LPG 2
Vanette	C22	1.5	51	4	09.86-	.95	A15S	0,9	BPR5ES	7422	6	LPG 2
Vanette	C22	2.0	64	4	09.86-	.95	Z20S	0,8	BPR6ES	7822	2	LPG 2
Vanette Cargo (NL)		1.6	71	4	03.95-			0,8	BKR5E	7938	35	LPG 1
Vanette E (NL)		1.6	71	4	03.95-			0,8	BKR5E	7938	35	LPG 1

**X-TRAIL**

X-Trail 2.0	T30	2.0	103	4	06.01-		QR20DE	1,1	LFR5A-11	6376		LPG 7
X-Trail 2.0	T30	2.0		4	02.01-		SR20VET	0,9	PLFR6A-9	4342		LPG 7
X-Trail 2.5	T30	2.5	121	4	09.01-02.07		QR25DE	1,1	LFR5A-11	6376		LPG 7
X-Trail 2.5	T30	2.5	132	4	11.02-02.07		QR25DE	1,1	LFR5A-11	6376		LPG 7
X-Trail 2.0	T31	2.0	104	4	06.07-		MR20DE	1,1	PLZKAR6A-11	5118		
X-Trail 2.5	T31	2.5	124	4	06.07-		QR25DE	1,1	DILKAR6A11	9029		

**OPEL****ADAM**

Adam 1.2		1.2	51	4	10.12-		A12XEL	0,9	ZFR6V-G	8894		LPG 6
Adam 1.4		1.4	64	4	10.12-		A14XEL	0,9	ZFR6V-G	8894		LPG 6
Adam 1.4		1.4	74	4	10.12-		A14XER	0,9	ZFR6V-G	8894		LPG 6



e kW  
C  
y  
i

0201



Stock-No

VALVE

LPG / CNG

**OPEL****AGILA A**

Agila 1.0 12V	1.0	43	3	07.00-07.04	Z10XE	0,8	BKR5EK	7956	23	LPG 1
Agila 1.0 12V	1.0	44	3	08.03-03.08	Z10XEP	0,8	ZFR5F	5165		LPG 6
Agila 1.2 16V	1.2	55	4	07.00-07.04	Z12XE	0,8	BKR5EK	7956	23	LPG 1
Agila 1.2 16V	1.2	59	4	07.04-04.08	Z12XEP	0,8	ZFR5F	5165		LPG 6

**AGILA B**

Agila 1.0	1.0	48	3	05.08-	K10B	1,1	IKR6G11	7980		
Agila 1.2	1.2	63	4	05.08-	K12B	1,1	IKR6G11	7980		
Agila 1.2	1.2	69	4	06.10-	K12B	1,1	IKR6G11	7980		

**ANTARA**

Antara 2.4 ECOTEC	2.4	103	4	09.06-12.11	Z24XE	0,8	BKR5EK	7956	23	LPG 1
Antara 3.2	3.2	167	6	03.07-12.11	Z32SEE	1,3	PTR5A-13	2467	25	LPG 4

**ASTRA F**

Astra F 1.4	1.4	44	4	09.91-07.95	C14NZ	0,8	BPR5ES	7422	6	LPG 2
Astra F 1.4	1.4	44	4	08.95-02.98	C14NZ	0,8	BKR5EK	7956	23	LPG 1
Astra F 1.4	1.4	44	4	09.91-02.98	X14NZ	0,8	BKR5EK	7956	23	LPG 1
Astra F 1.4	1.4	55	4	09.91-03.93	14NV	0,8	BKR5EK	7956	23	LPG 1
Astra F 1.4	1.4	66	4	02.96-02.98	X14XE	0,8	BKR5EK	7956	23	LPG 1
Astra F 1.4 Si	1.4	60	4	03.93-07.95	14SE	0,8	BPR5ES	7422	6	LPG 2
Astra F 1.4 Si	1.4	60	4	08.95-02.98	14SE	0,8	BKR5EK	7956	23	LPG 1
Astra F 1.4 Si	1.4	60	4	09.91-07.95	C14SE	0,8	BPR5ES	7422	6	LPG 2
Astra F 1.4 Si	1.4	60	4	08.95-02.98	C14SE	0,8	BKR5EK	7956	23	LPG 1
Astra F 1.6	1.6	52	4	03.93-12.94	X16SZ	0,8	BPR5ES	7422	6	LPG 2
Astra F 1.6	1.6	52	4	01.95-02.96	X16SZ	0,8	BKR5EK	7956	23	LPG 1
Astra F 1.6	1.6	55	4	08.94-02.98	16LZ2	0,8	BKR5EK	7956	23	LPG 1
Astra F 1.6	1.6	55	4	09.97-	16NZR	0,8	BKR5EK	7956	23	LPG 1
Astra F 1.6	1.6	55	4	09.91-07.95	C16NZ	0,8	BPR5ES	7422	6	LPG 2
Astra F 1.6	1.6	55	4	08.95-02.96	C16NZ	0,8	BKR5EK	7956	23	LPG 1
Astra F 1.6	1.6	55	4	02.96-08.00	X16SZR	0,8	BKR5EK	7956	23	LPG 1
Astra F 1.6 16V	1.6	74	4	08.95-02.98	C16SE	0,8	BKR5EK	7956	23	LPG 1
Astra F 1.6 16V	1.6	74	4	08.94-02.98	X16XEL	0,8	BKR5EK	7956	23	LPG 1
Astra F 1.6 Si	1.6	74	4	02.92-07.95	C16SE	0,8	BPR5ES	7422	6	LPG 2
Astra F 1.8	1.8	66	4	09.91-07.95	C18NZ	0,8	BPR5ES	7422	6	LPG 2
Astra F 1.8	1.8	66	4	08.95-02.98	C18NZ	0,8	BKR5EK	7956	23	LPG 1
Astra F 1.8 16V	1.8	85	4	02.94-03.96	C18XEL	0,8	BKR5EK	7956	23	LPG 1
Astra F 1.8 16V	1.8	85	4	02.96-02.98	X18XE	0,8	BKR5EK	7956	23	LPG 1
Astra F 1.8 16V	1.8	92	4	05.93-04.94	C18XE	0,8	BKR5EK	7956	23	LPG 1
Astra F 2.0	2.0	85	4	09.91-07.95	C20NE	0,8	BPR5ES	7422	6	LPG 2
Astra F 2.0	2.0	85	4	08.95-02.98	C20NE	0,8	BKR5EK	7956	23	LPG 1
Astra F 2.0 16V	2.0	100	4	02.95-02.98	X20XEV	0,8	BKR5EK	7956	23	LPG 1
Astra F 2.0 GSI 16V	2.0	110	4	09.91-08.92	C20XE	0,9	BKR6EK	2288	20	LPG 1
Astra F 2.0 GSI 16V	2.0	110	4	09.92-02.98	C20XE	0,8	BKR5EK	7956	23	LPG 1
Astra F 2.0 GSI 16V	2.0	110	4	09.91-08.92	C20XE-LN	0,9	BKR6EK	2288	20	LPG 1
Astra F 2.0 GSI 16V	2.0	110	4	09.92-02.98	C20XE-LN	0,8	BKR5EK	7956	23	LPG 1

**ASTRA G**

Astra G 1.2 16V	1.2	48	4	03.98-09.00	X12XE	0,8	BKR5EK	7956	23	LPG 1
Astra G 1.2 16V	1.2	55	4	08.00-01.05	Z12XE	0,8	BKR5EK	7956	23	LPG 1
Astra G 1.4 16V	1.4	66	4	03.98-01.05	X14XE	0,8	BKR5EK	7956	23	LPG 1
Astra G 1.4	1.4	66	4	08.03-01.05	Z14XE	0,8	ZFR5F	5165		LPG 6
Astra G 1.4	1.4	66	4	08.00-08.03	Z14XE	0,8	BKR5EK	7956	23	LPG 1

e kW  
C  
y  
I

0201



Stock-No

VLINE

LPG / CNG

**OPEL****ASTRA G**

Astra G 1.6 16V	1.6	55	4	03.98-09.00	X16SZR	0,8	BKR5EK	7956	23	LPG 1
Astra G 1.6	1.6	62	4	08.00-01.05	Z16SE	0,8	BKR5EK	7956	23	LPG 1
Astra G 1.6 16V	1.6	74	4	03.98-01.05	X16XEL	0,8	BKR5EK	7956	23	LPG 1
Astra G 1.6 16V	1.6	74	4	08.00-01.05	Z16XE	0,8	BKR5EK	7956	23	LPG 1
Astra G 1.6 16V	1.6	74	4	03.03-01.05	Z16XEP	0,8	ZFR5F	5165		LPG 6
Astra G 1.8 16V	1.8	85	4	03.98-09.00	X18XE1	0,8	BKR5EK	7956	23	LPG 1
Astra G 1.8 16V	1.8	85	4	08.00-	Z18XEL	0,6	BKR5EQUA	3566		
Astra G 1.8 16V	1.8	92	4	05.04-05.05	Z18XE	0,8	ZFR5F	5165		LPG 6
Astra G 1.8 16V	1.8	92	4	08.00-04.04	Z18XE	0,8	BKR5EK	7956	23	LPG 1
Astra G 2.0 16V	2.0	100	4	03.98-01.05	X20XEV	0,8	BKR5EK	7956	23	LPG 1
Astra G 2.0 16V Turbo	2.0	140	4	09.00-01.05	Z20LET	0,8	BKR5EK	7956	23	LPG 1
Astra G 2.0 GTC Turbo	2.0	147	4	11.02-05.05	Z20LER	0,8	ZFR5F	5165		LPG 6
Astra G 2.0 16V	2.0	118	4	10.99-09.02	X20XER	0,8	BKR5EK	7956	23	LPG 1
Astra G 2.2 16V	2.2	108	4	01.99-	X22XE	0,8	BKR5EK	7956	23	LPG 1
Astra G 2.2 16V	2.2	108	4	09.00-01.05	Z22SE	1,0	LTR6B-10T	5948		

**ASTRA H**

Astra H 1.4	1.4	55	4	03.04-12.11	Z14XEL	0,8	ZFR5F	5165		LPG 6
Astra H 1.4 ECOTEC	1.4	66	4	03.04-	Z14XEP	0,8	ZFR5F	5165		LPG 6
Astra H 1.6	1.6	74	4	03.04-12.12	Z16XEP	0,8	ZFR5F	5165		LPG 6
Astra H 1.6 ECOTEC	1.6	132	4	10.06-12.11	Z16LET	0,9	ZFR6BP-G	1748		LPG 6
Astra H 1.6 ECOTEC/VVT/VVT ECOTEC	1.6	85	4	01.07-	Z16XER	0,8	ZFR5F	5165		LPG 6
Astra H 1.8	1.8	92	4	03.04-06.10	Z18XE	0,8	ZFR5F	5165		LPG 6
Astra H 1.8 VVT ECOTEC	1.8	103	4	05.06-	Z18XER	0,8	ZFR5F	5165		LPG 6
Astra H 2.0 GTC Turbo	2.0	147	4	03.05-12.12	Z20LER	0,8	ZFR5F	5165		LPG 6
Astra H 2.0 OPC/VXR	2.0	125	4	03.04-12.09	Z20LEL	0,8	ZFR5F	5165		LPG 6
Astra H 2.0 OPC/VXR	2.0	177	4	09.05-09.11	Z20LEH	0,8	PFR6T-G	6314		

**ASTRA J**

Astra J 1.4 ECOTEC	1.4	64	4	10.09-10.15	A14XEL	0,9	ZFR6V-G	8894		LPG 6
Astra J 1.4 ECOTEC	1.4	74	4	10.09-10.15	A14XER	0,9	ZFR6V-G	8894		LPG 6
Astra J 1.4 ECOTEC	1.4	88	4	07.10-10.15	A14NEL	0,7	IFR7X7G	91039		
Astra J 1.4 ECOTEC	1.4	103	4	10.09-10.15	A14NET	0,7	IFR7X7G	91039		
Astra J 1.6 ECOTEC	1.6	132	4	10.09-10.15	A16LET	0,9	ZFR6BP-G	1748		LPG 6
Astra J 1.6 ECOTEC / VVT ECOTEC	1.6	85	4	10.09-10.15	A16XER	0,9	ZFR6V-G	8894		LPG 6
Astra J 1.8 ECOTEC / VVT ECOTEC	1.8	103	4	10.11-	A18XER	0,9	ZFR6V-G	8894		LPG 6

**CALIBRA**

Calibra 2.0	2.0	85	4	06.90-07.95	C20NE	0,8	BPR5ES	7422	6	LPG 2
Calibra 2.0	2.0	85	4	08.95-08.97	C20NE	0,8	BKR5EK	7956	23	LPG 1
Calibra 2.0 16V	2.0	100	4	11.93-08.97	X20XEV	0,8	BKR5EK	7956	23	LPG 1
Calibra 2.0 16V	2.0	110	4	02.90-08.92	C20XE	0,9	BKR6EK	2288	20	LPG 1
Calibra 2.0 16V	2.0	110	4	09.92-02.94	C20XE	0,8	BKR5EK	7956	23	LPG 1
Calibra 2.0 16V	2.0	110	4	06.90-04.97	C20XE-LN	0,9	BKR6EK	2288	20	LPG 1
Calibra 2.0 Turbo 4x4	2.0	150	4	03.92-08.97	C20LET	1,1	ZFR6F-11	4291		LPG 6
Calibra 2.5 V6	2.5	125	6	09.93-08.97	C25XE	0,8	BKR5EK	7956	23	LPG 1
Calibra 2.5 V6	2.5	125	6	09.93-08.97	X25XE	0,8	BKR5EK	7956	23	LPG 1

**CAMPO**

Campo 2.3	2.3	66	4	11.88-09.91	4ZD1	0,8	BPR6ES	7822	2	LPG 2
Campo 2.3	2.3	72	4	10.91-09.96	4ZD1	0,8	BPR6ES	7822	2	LPG 2

e kW  
C  
y  
l

0201



Stock-No

VALVE

LPG / CNG

**OPEL****CASCADA**

Cascada 1.4 ECOTEC	1.4	88	4	03.13-	A14NEL	0,7	IFR7X7G	91039		
Cascada 1.4 ECOTEC	1.4	103	4	03.13-	A14NET	0,7	IFR7X7G	91039		

**COMBO**

Combo 1.4	1.4	44	4	03.93-10.01	C14NZ	0,8	BKR5EK	7956	23	LPG 1
Combo 1.4	1.4	44	4	02.96-10.01	X14SZ	0,8	BKR5EK	7956	23	LPG 1
Combo 1.4	1.4	60	4	03.93-10.01	C14SE	0,8	BKR5EK	7956	23	LPG 1
Combo 1.4	1.4	66	4	10.04-	Z14XEP	0,8	ZFR5F	5165		LPG 6
Combo 1.6	1.6	64	4	10.01-	Z16SE	0,8	BKR5EK	7956	23	LPG 1

**CORSA A**

Corsa A 1.0	1.0	33	4	09.82-09.92	10S	0,7	BPR6HS	7022	3	BPR7HIX
Corsa A 1.2	1.2	33	4	02.90-03.93	12NV	0,8	BPR6ES	7822	2	LPG 2
Corsa A 1.2	1.2	33	4	09.90-03.93	C12NZ	0,8	BPR5ES	7422	6	LPG 2
Corsa A 1.2	1.2	33	4	03.87-06.90	E12GV	0,7	BPR6HS	7022	3	BPR7HIX
Corsa A 1.2	1.2	37	4	09.86-03.93	A12ST	0,8	BPR6ES	7822	2	LPG 2
Corsa A 1.3 Irmscher	1.3	61	4	04.85-03.93	13E	0,8	BPR6ES	7822	2	LPG 2
Corsa A 1.4	1.4	44	4	10.89-03.93	C14NZ	0,8	BPR5ES	7422	6	LPG 2
Corsa A 1.4	1.4	53	4	10.89-09.92	14NV	0,8	BPR6ES	7822	2	LPG 2
Corsa A 1.4	1.4	60	4	09.91-03.93	C14SE	0,8	BPR5ES	7422	6	LPG 2
Corsa A 1.6	1.6	55	4	03.88-09.91	C16NZ	0,8	BPR5ES	7422	6	LPG 2
Corsa A 1.6	1.6	74	4	02.92-03.93	C16SE	0,8	BPR5ES	7422	6	LPG 2
Corsa A 1.6	1.6	74	4	03.88-03.92	E16SE	0,8	BPR6ES	7822	2	LPG 2
Corsa A 1.6 Irmscher	1.6	72	4	06.90-03.92	C16SEI	0,8	BPR6ES	7822	2	LPG 2

**CORSA B**

Corsa B 1.0 12V	1.0	40	3	03.97-08.00	X10XE	0,8	BKR5EK	7956	23	LPG 1
Corsa B 1.2	1.2	33	4	03.93-07.95	12NZ	0,8	BPR5ES	7422	6	LPG 2
Corsa B 1.2	1.2	33	4	08.95-12.97	12NZ	0,8	BKR5EK	7956	23	LPG 1
Corsa B 1.2	1.2	33	4	03.93-07.95	C12NZ	0,8	BPR5ES	7422	6	LPG 2
Corsa B 1.2	1.2	33	4	08.95-09.00	C12NZ	0,8	BKR5EK	7956	23	LPG 1
Corsa B 1.2	1.2	33	4	03.93-07.95	X12SZ	0,8	BPR5ES	7422	6	LPG 2
Corsa B 1.2	1.2	33	4	08.95-09.00	X12SZ	0,8	BKR5EK	7956	23	LPG 1
Corsa B 1.2 16V	1.2	48	4	09.97-08.01	X12XE	0,8	BKR5EK	7956	23	LPG 1
Corsa B 1.4	1.4	44	4	03.93-07.95	C14NZ	0,8	BPR5ES	7422	6	LPG 2
Corsa B 1.4	1.4	44	4	08.95-08.98	C14NZ	0,8	BKR5EK	7956	23	LPG 1
Corsa B 1.4	1.4	44	4	03.96-07.00	X14SZ	0,8	BKR5EK	7956	23	LPG 1
Corsa B 1.4	1.4	60	4	03.93-07.95	C14SE	0,8	BPR5ES	7422	6	LPG 2
Corsa B 1.4	1.4	60	4	08.95-07.97	C14SE	0,8	BKR5EK	7956	23	LPG 1
Corsa B 1.4	1.4	63	4	06.98-10.00	C14SEL	0,8	BKR5EK	7956	23	LPG 1
Corsa B 1.4 16V	1.4	66	4	11.94-08.00	X14XE	0,8	BKR5EK	7956	23	LPG 1
Corsa B 1.4 16V	1.6	78	4	08.94-08.01	X16XE	0,8	BKR5EK	7956	23	LPG 1
Corsa B 1.6	1.6	74	4	06.98-10.00	C16SEL	0,8	BKR5EK	7956	23	LPG 1
Corsa B 1.6	1.6	80	4	03.93-08.94	C16XE	0,8	BKR5EK	7956	23	LPG 1

**CORSA C**

Corsa C 1.0 12V	1.0	43	3	08.00-06.03	Z10XE	0,8	BKR5EK	7956	23	LPG 1
Corsa C 1.0 ECOTEC	1.0	44	3	06.03-12.09	Z10XEP	0,8	ZFR5F	5165		LPG 6
Corsa C 1.2	1.2	55	4	08.00-06.04	Z12XE	0,8	BKR5EK	7956	23	LPG 1
Corsa C 1.2	1.2	59	4	07.04-06.06	Z12XEP	0,8	ZFR5F	5165		LPG 6
Corsa C 1.4	1.4	66	4	08.00-10.06	Z14XE	0,8	BKR5EK	7956	23	LPG 1
Corsa C 1.4	1.4	66	4	06.03-06.06	Z14XEP	0,8	ZFR5F	5165		LPG 6
Corsa C 1.6	1.6	62	4	08.00-04.05	Z16SE	0,8	BKR5EK	7956	23	LPG 1

e kW  
C  
y  
i

0201



Stock-No

VELINE

LPG / CNG

**OPEL****CORSA C**

Corso C 1.8	1.8	92	4	08.00-07.06	Z18XE	0,8	BKR5EK	7956	23	LPG 1
-------------	-----	----	---	-------------	-------	-----	--------	------	----	-------

**CORSA D**

Corso D 1.0 ECOTEC	1.0	44	3	07.06-08.14	Z10XEP	0,8	ZFR5F	5165		LPG 6
Corso D 1.0 ECOTEC	1.0	48	3	01.10-08.14	A10XEP	0,9	ZFR6V-G	8894		LPG 6
Corso D 1.2 ECOTEC	1.2	59	4	07.06-08.14	Z12XEP	0,8	ZFR5F	5165		LPG 6
Corso D 1.2 ECOTEC	1.3	51	4	06.10-08.14	A12XEL	0,9	ZFR6V-G	8894		LPG 6
Corso D 1.2 ECOTEC	1.3	63	4	06.10-08.14	A12XER	0,9	ZFR6V-G	8894		LPG 6
Corso D 1.4 ECOTEC	1.4	64	4	01.10-08.14	A14XEL	0,9	ZFR6V-G	8894		LPG 6
Corso D 1.4 ECOTEC	1.4	66	4	07.06-08.14	Z14XEP	0,8	ZFR5F	5165		LPG 6
Corso D 1.4 ECOTEC	1.4	74	4	01.10-08.14	A14XER	0,9	ZFR6V-G	8894		LPG 6
Corso D 1.4 ECOTEC	1.4	88	4	08.12-08.14	A14NEL	0,7	IFR7X7G	91039		
Corso D 1.6	1.6	132	4	04.07-	Z16LET	1,0	PFR6T-10G	5542		
Corso D 1.6 ECOTEC	1.6	110	4	02.07-08.14	Z16LEL	0,9	ZFR6BP-G	1748		LPG 6
Corso D 1.6 OPC ECOTEC/VXR	1.6	141	4	11.06-08.14	A16LER	0,9	ZFR6BP-G	1748		LPG 6
Corso D 1.6 OPC ECOTEC/VXR	1.6	141	4	11.06-08.14	Z16LER	0,9	ZFR6BP-G	1748		LPG 6
Corso D 1.6 OPC ECOTEC/VXR	1.6	155	4	06.11-08.14	A16LES	0,9	ZFR6BP-G	1748		LPG 6

**CORSA E**

Corso E 1.2 ECOTEC	1.2	51	4	09.14-	B12XEL	0,9	ZFR6V-G	8894		LPG 6
Corso E 1.4 ECOTEC	1.4	66	4	09.14-	B14XEL	0,9	ZFR6V-G	8894		LPG 6
Corso E 1.4 Turbo	1.4	74	4	09.14-	B14NEJ	0,7	IFR7X7G	91039		

**FRONTERA**

Frontera 2.0	2.0	85	4	09.91-08.95	C20NE	0,8	BKR5EK	7956	23	LPG 1
Frontera 2.0	2.0	85	4	02.95-06.98	X20SE	0,8	BKR5EK	7956	23	LPG 1
Frontera 2.2 16V	2.2	100	4	02.95-06.98	X22XE	0,8	BKR5EK	7956	23	LPG 1
Frontera 2.2	2.2	100	4	10.98-07.04	Y22SE	0,7	BPR6HS	7022	3	BPR7HIX
Frontera 2.2	2.2	100	4	10.98-12.04	X22SE	0,8	BKR5EK	7956	23	LPG 1
Frontera 2.4	2.4	92	4	09.91-02.95	C24NE	0,7	BPR6HS	7022	3	BPR7HIX
Frontera 3.2 V6	3.2	151	6	08.98-07.04	Y32NE 6VD1	1,1	PFR5G-11	2647		

**GT**

GT Turbo 2.0	2.0	194	4	11.07-01.10	Z20LNF / Z20NHH	0,9	ILTR5D	5476		
--------------	-----	-----	---	-------------	-----------------	-----	--------	------	--	--

**INSIGNIA A**

Insignia 1.4 ECOTEC	1.4	103	4	08.11-	A14NET	0,7	IFR7X7G	91039		
Insignia 1.6 ECOTEC	1.6	85	4	07.08-	A16XER	0,9	ZFR6V-G	8894		LPG 6
Insignia 1.6 ECOTEC	1.6	132	4	07.08-	A16LET	0,9	ZFR6BP-G	1748		LPG 6
Insignia 1.8 VVT ECOTEC	1.8	103	4	07.08-	A18XER	0,9	ZFR6V-G	8894		LPG 6
Insignia 2.0 ECOTEC	2.0	162	4	07.08-12.12	A20NHT	0,9	ILTR5D	5476		
Insignia 2.0 FlexFuel	2.0	184	4	07.11-	A20NFT	0,9	ILTR5D	5476		
Insignia 2.8 V6 ECOTEC	2.8	191	6	07.08-	A28NET	1,0	DILFR7B10G	97218		
Insignia 2.8 V6 OPC ECOTEC/VXR	2.8	239	6	07.09-	A28NER	1,0	DILFR7B10G	97218		

**KADETT E**

Kadett E 1.4	1.4	44	4	10.89-09.91	C14NZ	0,8	BPR5ES	7422	6	LPG 2
Kadett E 1.4	1.4	44	4	01.90-08.91	E14LV	0,8	BPR6ES	7822	2	LPG 2
Kadett E 1.4	1.4	44	4	10.89-09.93	14NV	0,8	BPR6ES	7822	2	LPG 2
Kadett E 1.6	1.6	55	4	09.87-08.91	E16SE	0,8	BPR6ES	7822	2	LPG 2
Kadett E 1.6	1.6	55	4	09.87-09.91	E16NZ	0,8	BPR6ES	7822	2	LPG 2
Kadett E 1.6	1.6	55	4	09.87-09.93	C16NZ	0,8	BPR5ES	7422	6	LPG 2
Kadett E 1.8	1.8	62	4	03.87-07.89	E18NV	0,8	BPR6ES	7822	2	LPG 2



l kW C y i

0201



Stock-No

VALVE

LPG / CNG

**OPEL**

**KADETT E**

Kadett E 1.8	1.8	62	4	09.86-08.91	S18NV	0,8	BPR6ES	7822	2	LPG 2
Kadett E 1.8	1.8	66	4	09.90-09.91	C18NZ	0,8	BPR5ES	7422	6	LPG 2
Kadett E 2.0	2.0	85	4	09.86-09.91	20NE	0,8	BPR5ES	7422	6	LPG 2
Kadett E 2.0	2.0	85	4	09.86-03.93	C20NE	0,8	BPR5ES	7422	6	LPG 2
Kadett E 2.0	2.0	91	4	03.87-09.91	20SER	0,8	BPR6ES	7822	2	LPG 2
Kadett E 2.0	2.0	95	4	09.86-09.91	20SEH	0,8	BPR6ES	7822	2	LPG 2
Kadett E 2.0	2.0	110	4	04.89-09.91	20XEJ	0,9	BKR6EK	2288	20	LPG 1
Kadett E 2.0	2.0	110	4	03.88-09.91	C20XE	0,9	BKR6EK	2288	20	LPG 1

**MERIVA A**

Meriva A 1.4 ECOTEC	1.4	66	4	06.05-05.10	Z14XEP	0,8	ZFR5F	5165		LPG 6
Meriva A 1.6	1.6	64	4	05.03-05.10	Z16SE	0,8	BKR5EK	7956	23	LPG 1
Meriva A 1.6	1.6	74	4	05.03-05.10	Z16XE	0,8	BKR5EK	7956	23	LPG 1
Meriva A 1.6	1.6	77	4	01.06-05.10	Z16XEP	0,8	ZFR5F	5165		LPG 6
Meriva A 1.6 OPC/VXR	1.6	132	4	08.05-05.10	Z16LET	0,9	ZFR6BP-G	1748		LPG 6
Meriva A 1.8 ECOTEC	1.8	92	4	05.03-05.10	Z18XE	0,8	BKR5EK	7956	23	LPG 1

**MERIVA B**

Meriva B 1.4 ECOTEC	1.4	74	4	03.10-	A14XER	0,9	ZFR6V-G	8894		LPG 6
Meriva B 1.4 ECOTEC	1.4	88	4	03.10-	A14NEL	0,7	IFR7X7G	91039		
Meriva B 1.4 ECOTEC	1.4	88	4	03.10-	B14NEL	0,7	IFR7X7G	91039		
Meriva B 1.4 ECOTEC	1.4	103	4	03.10-	A14NET	0,7	IFR7X7G	91039		

**MOKKA**

Mokka 1.4 ECOTEC	1.4	103	4	06.12-	A14NET	0,7	IFR7X7G	91039		
Mokka 1.6 ECOTEC	1.6	85	4	06.12-	A16XER	0,9	ZFR6V-G	8894		LPG 6
Mokka 1.8 ECOTEC	1.8	103	4	01.13-	A18XER	0,9	ZFR6V-G	8894		LPG 6

**MONTEREY**

Monterey A 3.2 V6 24V	3.2	130	6	04.92-12.98	6VDI	0,9	BKR6E	6962	28	LPG 1
Monterey B 3.5 V6 24V	3.5	158	6	02.98-07.99	6VE1	1,1	BKR5EIX-11	5464		LPG 1

**OMEGA A**

Omega A 1.8	1.8	60	4	09.86-03.94	18NV	0,8	BPR6ES	7822	2	LPG 2
Omega A 1.8	1.8	60	4	09.87-03.90	E18NVR	0,8	BPR6ES	7822	2	LPG 2
Omega A 1.8	1.8	62	4	09.86-03.94	S18NV	0,8	BPR6ES	7822	2	LPG 2
Omega A 1.8	1.8	66	4	09.86-09.90	18SV	0,8	BPR6ES	7822	2	LPG 2
Omega A 1.8	1.8	85	4	09.86-09.92	18SEH	0,8	BPR6ES	7822	2	LPG 2
Omega A 2.0	2.0	74	4	09.86-03.94	20NE	0,8	BPR5ES	7422	6	LPG 2
Omega A 2.0	2.0	74	4	09.86-03.94	20NEJ	0,9	BKR6EK	2288	20	LPG 1
Omega A 2.0	2.0	74	4	04.90-02.92	C20NEJ	0,9	BKR6EK	2288	20	LPG 1
Omega A 2.0	2.0	85	4	09.86-03.94	C20NE	0,8	BPR5ES	7422	6	LPG 2
Omega A 2.0	2.0	90	4	09.89-03.94	20SE	0,9	BKR6EK	2288	20	LPG 1
Omega A 2.4	2.4	92	6	09.88-03.94	C24NE	0,7	BPR6HS	7022	3	BPR7HIX
Omega A 2.6	2.6	110	6	09.90-03.94	C26NE	0,7	BPR6HS	7022	3	BPR7HIX
Omega A 3.0	3.0	115	6	03.87-09.90	30NE	0,7	BPR6HS	7022	3	BPR7HIX
Omega A 3.0	3.0	115	6	03.87-03.94	C30NE	0,7	BPR6HS	7022	3	BPR7HIX
Omega A 3.0	3.0	147	6	09.89-03.94	C30SE	0,9	BKR6EK	2288	20	LPG 1
Omega A 3.0	3.0	147	6	09.90-03.94	C30SEJ	0,9	BKR6EK	2288	20	LPG 1
Omega A 3.0 EVO	3.0	170	6	03.91-09.92	C30XEI	0,9	BKR6EK	2288	20	LPG 1

e kW C  
Y  
I

0201



Stock-No

VELINE

LPG / CNG

**OPEL****OMEGA B**

Omega B 2.0	2.0	85	4	01.94-09.99	20SE	0,8	BKR5EK	7956	23	LPG 1
Omega B 2.0	2.0	85	4	01.94-09.00	X20SE	0,8	BKR5EK	7956	23	LPG 1
Omega B 2.0	2.0	100	4	01.94-09.00	X20XEV	0,8	BKR5EK	7956	23	LPG 1
Omega B 2.2	2.2	106	4	09.99-09.00	Y22XE	0,8	BKR5EK	7956	23	LPG 1
Omega B 2.2	2.2	108	4	08.00-08.03	Z22XE	0,8	BKR5EK	7956	23	LPG 1
Omega B 2.5	2.5	125	6	01.94-09.00	X25XE	0,8	BKR5EK	7956	23	LPG 1
Omega B 2.6	2.6	132	6	08.00-07.03	Y26SE	0,6	BKR5EQUA	3566		
Omega B 3.0	3.0	155	6	09.94-10.01	X30XE	0,8	BKR5EK	7956	23	LPG 1
Omega B 3.2	3.2	160	6	05.01-07.03	Y32SE	0,6	BKR5EQUA	3566		

**SENATOR B**

Senator B 2.5 i	2.5	103	6	03.88-09.90	25NE	0,7	BPR6HS	7022	3	BPR7HIX
Senator B 2.6 i	2.6	110	6	09.90-09.93	C26NE	0,7	BPR6HS	7022	3	BPR7HIX
Senator B 3.0	3.0	115	6	08.87-09.90	C30LE	0,7	BPR6HS	7022	3	BPR7HIX
Senator B 3.0	3.0	130	6	08.87-09.90	30NE	0,7	BPR6HS	7022	3	BPR7HIX
Senator B 3.0	3.0	150	6	09.89-06.93	C30SE	0,9	BKR6EK	2288	20	LPG 1
Senator B 3.6	3.6	145	6	08.89-09.93	C3,6NE irmscher	0,7	BPR6HS	7022	3	BPR7HIX
Senator B 3.6	3.6	145	6	08.89-09.93	C3,6NEI irmscher	0,7	BPR6HS	7022	3	BPR7HIX
Senator B 4.0	4.0	200	6	01.91-09.93	C40SE irmscher	0,7	BPR6HS	7022	3	BPR7HIX

**SIGNUM**

Signum 1.8	1.8	85	4	05.03-12.06	Z18XEL	0,6	BKR5EQUA	3566		
Signum 1.8	1.8	103	4	09.05-03.07	Z18XER	0,8	ZFR5F	5165		LPG 6
Signum 1.8	1.8	90	4	05.03-07.05	Z18XE	0,6	BKR5EQUA	3566		
Signum 2.0	2.0	129	4	05.03-12.08	Z20NET	1,0	PFR6T-10G	5542		
Signum 2.2	2.2	108	4	05.03-05.05	Z22SE	1,0	LTR6B-10T	5948		
Signum 2.2 DGI	2.2	114	4	05.03-09.08	Z22YH	0,6	BKR5EQUA	3566		
Signum 2.8	2.8	169	6	09.05-12.08	Z28NEL	1,0	PLFR6C-10G	1959		
Signum 2.8	2.8	184	6	01.06-12.08	Z28NET	1,0	DILFR7B10G	97218		
Signum 3.2	3.2	155	6	05.03-07.05	Z32SE	0,6	BKR5EQUA	3566		

**SINTRA**

Sintra 2.2	2.2	104	4	09.96-09.99	X22XE	0,8	BKR5EK	7956	23	LPG 1
Sintra 3.0	3.0	155	6	09.96-09.99	X30XE	0,8	BKR5EK	7956	23	LPG 1

**SPEEDSTER**

Speedster 2.0	2.0	147	4	08.03-08.06	Z20LET	0,8	BKR5EK	7956	23	LPG 1
Speedster 2.2	2.2	108	4	04.00-09.05	Z22SE	1,0	LTR6B-10T	5948		

**TIGRA A**

Tigra A 1.4	1.4	63	4	08.97-12.00	C14SEL	0,8	BKR5EK	7956	23	LPG 1
Tigra A 1.4	1.4	66	4	08.94-12.00	X14XE	0,8	BKR5EK	7956	23	LPG 1
Tigra A 1.6	1.6	74	4	06.97-08.98	C16SEL	0,8	BKR5EK	7956	23	LPG 1
Tigra A 1.6	1.6	78	4	08.94-08.98	X16XE	0,8	BKR5EK	7956	23	LPG 1

**TIGRA B**

Tigra B 1.4	1.4	66	4	06.04-12.10	Z14XEP	0,8	ZFR5F	5165		LPG 6
Tigra B 1.8	1.8	92	4	06.04-12.10	Z18XE	0,8	ZFR5F	5165		LPG 6

**VECTRA A**

Vectra A 1.4	1.4	55	4	09.88-09.92	14NV	0,8	BPR6ES	7822	2	LPG 2
Vectra A 1.6	1.6	52	4	09.93-08.95	X16SZ	0,8	BKR5EK	7956	23	LPG 1
Vectra A 1.6	1.6	55	4	09.88-08.94	C16NZ	0,8	BPR5ES	7422	6	LPG 2



l kW  
C  
y  
i

0201



Stock-No

VECTRA

LPG / CNG

**OPEL**

**VECTRA A**

Vectra A 1.6	1.6	60	4	09.88-09.92	16SV	0,8	BPR6ES	7822	2	LPG 2
Vectra A 1.8	1.8	65	4	09.88-08.95	E18NVR	0,8	BPR6ES	7822	2	LPG 2
Vectra A 1.8	1.8	66	4	09.89-08.95	18SV	0,8	BPR6ES	7822	2	LPG 2
Vectra A 1.8	1.8	66	4	03.90-08.95	C18NZ	0,8	BKR5EK	7956	23	LPG 1
Vectra A 1.8	1.8	66	4	09.89-08.95	C18SV	0,8	BPR6ES	7822	2	LPG 2
Vectra A 2.0	2.0	85	4	01.89-08.95	20NE	0,8	BKR5EK	7956	23	LPG 1
Vectra A 2.0	2.0	85	4	09.89-08.95	C20NE	0,8	BKR5EK	7956	23	LPG 1
Vectra A 2.0	2.0	95	4	01.89-09.92	20SEH	0,8	BPR6ES	7822	2	LPG 2
Vectra A 2.0	2.0	100	4	08.92-08.95	20XE	0,8	BKR5EK	7956	23	LPG 1
Vectra A 2.0	2.0	100	4	08.92-08.95	C20XE	0,8	BKR5EK	7956	23	LPG 1
Vectra A 2.0	2.0	150	4	09.92-08.95	C20LET	1,1	ZFR6F-11	4291		LPG 6
Vectra A 2.0	2.0	100	4	08.92-08.95	C20XE-LN	0,8	BKR5EK	7956	23	LPG 1
Vectra A 2.0	2.0	100	4	12.94-08.95	X20XEV	0,8	BKR5EK	7956	23	LPG 1
Vectra A 2.0	2.0	110	4	09.89-08.92	20XE	0,9	BKR6EK	2288	20	LPG 1
Vectra A 2.0	2.0	110	4	09.89-08.92	C20XE	0,9	BKR6EK	2288	20	LPG 1
Vectra A 2.5	2.5	125	6	02.93-08.95	25XE	0,8	BKR5EK	7956	23	LPG 1
Vectra A 2.5	2.5	125	6	03.93-08.95	C25XE	0,8	BKR5EK	7956	23	LPG 1

**VECTRA B**

Vectra B 1.6	1.6	55	4	08.95-	16LZ2	0,8	BKR5EK	7956	23	LPG 1
Vectra B 1.6	1.6	55	4	08.95-09.00	X16SZR	0,8	BKR5EK	7956	23	LPG 1
Vectra B 1.6	1.6	74	4	08.95-09.00	X16XEL	0,8	BKR5EK	7956	23	LPG 1
Vectra B 1.6	1.6	74	4	08.00-04.02	Z16XE	0,8	BKR5EK	7956	23	LPG 1
Vectra B 1.8	1.8	85	4	08.95-09.00	X18XE	0,8	BKR5EK	7956	23	LPG 1
Vectra B 1.8	1.8	85	4	03.99-09.00	X18XE1	0,8	BKR5EK	7956	23	LPG 1
Vectra B 1.8	1.8	85	4	08.00-04.02	Z18XEL	0,8	BKR5EK	7956	23	LPG 1
Vectra B 1.8	1.8	92	4	08.00-04.02	Z18XE	0,8	BKR5EK	7956	23	LPG 1
Vectra B 2.0	2.0	80	4	08.95-	20NEJ	0,8	BKR5EK	7956	23	LPG 1
Vectra B 2.0	2.0	100	4	02.97-	C20SEL	0,8	BKR5EK	7956	23	LPG 1
Vectra B 2.0	2.0	100	4	08.95-09.00	X20XEV	0,8	BKR5EK	7956	23	LPG 1
Vectra B 2.2	2.2	106	4	10.99-	C22SEL	0,8	BKR5EK	7956	23	LPG 1
Vectra B 2.2	2.2	108	4	08.00-04.02	Z22SE	1,0	LTR6B-10T	5948		
Vectra B 2.5	2.5	143	6	01.98-09.00	X25XE	0,8	BKR5EK	7956	23	LPG 1
Vectra B 2.5	2.5	125	6	08.95-09.00	X25XE	0,8	BKR5EK	7956	23	LPG 1
Vectra B 2.6	2.6	125	6	08.00-07.03	Y26SE	0,6	BKR5EQUA	3566		

**VECTRA C**

Vectra C 1.6	1.6	74	4	06.04-08.08	Z16XE	0,6	BKR5EQUA	3566		
Vectra C 1.6	1.6	77	4	01.06-08.08	Z16XEP	0,8	ZFR5F	5165		LPG 6
Vectra C 1.8	1.8	81	4	04.02-07.03	Z18XEL	0,6	BKR5EQUA	3566		
Vectra C 1.8	1.8	92	4	08.02-09.05	Z18XE	0,6	BKR5EQUA	3566		
Vectra C 1.8	1.8	103	4	01.06-08.08	Z18XER	0,8	ZFR5F	5165		LPG 6
Vectra C 2.0 GTS	2.0	129	4	03.03-08.08	Z20NET	1,0	PFR6T-10G	5542		
Vectra C 2.2	2.2	108	4	08.02-04.04	Z22SE	1,0	LTR6B-10T	5948		
Vectra C 2.2 DGI	2.2	114	4	10.03-08.08	Z22YH	0,6	BKR5EQUA	3566		
Vectra C 2.8	2.8	169	6	09.05-08.08	Z28NEL	1,0	PLFR6C-10G	1959		
Vectra C 2.8	2.8	184	6	08.06-08.08	Z28NET	1,0	PLFR6C-10G	1959		
Vectra C 2.8	2.8	188	6	08.05-08.06	Z28NET	1,0	PLFR6C-10G	1959		

e kW C  
y  
i

0201



Stock-No

VELINE

LPG / CNG

**OPEL  
VECTRA C**

Vectra C 3.2 GTS	3.2	155	6	08.02-07.05	Z32SE	0,6	BKR5EQUPA	3566		
------------------	-----	-----	---	-------------	-------	-----	-----------	------	--	--

**VIVARO**

Vivaro 2.0	2.0	86	4	08.06-07.14	F4R 820	0,9	PFR6G-9	4377		PFR7G
Vivaro 2.0	2.0	88	4	09.01-07.06	F4R 720	0,9	PFR6G-9	4377		PFR7G

**ZAFIRA A**

Zafira A 1.6	1.6	74	4	03.99-06.05	X16XE DOHC	0,8	BKR5EK	7956	23	LPG 1
Zafira A 1.6 ECOTEC	1.6	74	4	08.00-	Z16XE	0,8	BKR5EK	7956	23	LPG 1
Zafira A 1.8	1.8	85	4	03.99-09.00	X18XE DOHC	0,8	BKR5EK	7956	23	LPG 1
Zafira A 1.8	1.8	85	4	04.99-09.00	X18XE1	0,8	BKR5EK	7956	23	LPG 1
Zafira A 1.8	1.8	92	4	09.00-	Z18XE	0,8	BKR5EK	7956	23	LPG 1
Zafira A 2.0 Turbo OPC	2.0	141	4	06.02-06.05	Z20LET	0,8	BKR5EK	7956	23	LPG 1
Zafira A 2.2	2.2	108	4	08.00-	Z22SE	1,0	LTR6B-10T	5948		

**ZAFIRA B**

Zafira B 1.6	1.6	77	4	07.05-	Z16XEP	0,8	ZFR5F	5165		LPG 6
Zafira B 1.6	1.6	85	4	01.08-07.10	A16XER	0,9	ZFR6V-G	8894		LPG 6
Zafira B 1.6	1.6	85	4	01.08-	Z16XER	0,8	ZFR5F	5165		LPG 6
Zafira B 1.6 ECOTEC	1.6	74	4	07.05-	Z16XE	0,8	BKR5EK	7956	23	LPG 1
Zafira B 1.8 ECOTEC	1.8	103	4	07.05-	Z18XER	0,8	ZFR5F	5165		LPG 6
Zafira B 2.0	2.0	147	4	07.05-	Z20LER	0,8	ZFR5F	5165		LPG 6
Zafira B 2.0 OPC	2.0	177	4	09.05-	Z20LEH	0,8	PFR6T-G	6314		
Zafira B 2.2 DGI	2.2	110	4	07.05-	Z22YH	0,6	BKR5EQUPA	3566		

**ZAFIRA TOURER**

Zafira Tourer 1.4 ECOTEC	P12	1.4	88	4	10.11-	A14NEL	0,7	IFR7X7G	91039		
Zafira Tourer 1.4 ECOTEC	P12	1.4	103	4	10.11-	A14NET	0,7	IFR7X7G	91039		
Zafira Tourer 1.6 ECOTEC	P12	1.6	110	4	10.11-	A16XNT	0,7	IFR7X7G	91039		
Zafira Tourer 1.8 ECOTEC	P12	1.8	103	4	12.11-	A18XER	0,9	ZFR6V-G	8894		LPG 6





e kW C y i

0201



Stock-No

VLINE

LPG/CNG

**PEUGEOT****106 1.VERSION**

106 XN	0.9	37	4	08.91-12.92	TU9-C1A	0,8	BCP5ES	7496	16	LPG 3
106i XN, XA, Kid	0.9	37	4	07.92-06.95	TU9M-CDZ	0,8	BCPR5ES	6130	32	LPG 3
106i XN, XA, Kid	0.9	37	4	07.95-03.96	TU9M-CDZ	0,8	BKR5EK	7956	23	LPG 1
106 XN, XR	1.1	38	4	08.91-12.92	TU1-H1A	0,8	BCP5ES	7496	16	LPG 3
106i XN, XR, XT, Green	1.1	44	4	07.92-06.95	TU1M-HDZ	0,8	BCPR5ES	6130	32	LPG 3
106i XN, XR, XT, Green	1.1	44	4	07.95-03.96	TU1M-HDZ	0,9	BKR6EK	2288	20	LPG 1
106 Rallye	1.3	74	4	11.93-03.96	TU2J2-MFZ	0,9	BKR6EK	2288	20	LPG 1
106	1.4	69	4	08.91-03.96	TU3J2	0,9	BKR6EK	2288	20	LPG 1
106 XR, XT	1.4	51	4	08.91-12.92	TU3.2-K2D	0,7	BCP6ES	4930	17	LPG 3
106 Xsi	1.4	55	4	08.91-12.92	TU3JP~KFX	0,9	BKR6EK	2288	20	LPG 1
106 Xsi	1.4	55	4	07.92-03.96	TU3JP cat.~KFX	0,9	BKR6EK	2288	20	LPG 1
106i XR, XS, XT	1.4	55	4	07.92-06.95	TU3MC~KDX	0,8	BCPR5ES	6130	32	LPG 3
106i XR, XS, XT	1.4	55	4	07.95-03.96	TU3MC~KDX	0,9	BKR6EK	2288	20	LPG 1
106i XS, XT, Griffé	1.6	66	4	07.94-03.96	TU5JP~NFZ	0,9	BKR6EK	2288	20	LPG 1
106 Xsi	1.6	74	4	12.93-06.95	TU5J2~NFW	0,8	BKR6ES	3783	28	LPG 1
106 Xsi	1.6	74	4	07.95-05.96	TU5J2~NFW	0,9	BKR6EK	2288	20	LPG 1

**106 2.VERSION**

106i	1.0	37	4	04.96-	TU9M~CDZ /Y	0,8	BKR5EK	7956	23	LPG 1
106i	1.1	44	4	04.96-	TU1M+ ~HDZ	0,9	BKR6EK	2288	20	LPG 1
106	1.1	44	4	05.00-	TU1JP	0,9	BKR6EZ	4619	38	LPG 1
106i	1.4	55	4	04.96-12.99	TU3JP~KFX	0,9	BKR6EK	2288	20	LPG 1
106i	1.4	55	4	01.00-	TU3JP~KFX	0,9	BKR6EZ	4619	38	LPG 1
106i	1.6	66	4	04.96-12.99	TU5JP~NFZ	0,9	BKR6EK	2288	20	LPG 1
106i	1.6	66	4	01.00-	TU5JP~NFZ	0,9	BKR6EZ	4619	38	LPG 1
106 Rallye	1.6	74	4	06.96-	TU5J2~NFW	0,9	BKR6EK	2288	20	LPG 1
106 S16, Gti	1.6	88	4	06.96-12.99	TU5J4~NFX	0,9	BKR6EK	2288	20	LPG 1
106 S16, Gti	1.6	88	4	01.00-	TU5J4~NFX	0,9	BKR6EZ	4619	38	LPG 1

**107**

107 12V	1.0	50	3	06.05-	384F	1,1	LFR6C-11	5788		
107	1.1		4	09.04-	TU1A	0,9	BKR6EZ	4619	38	LPG 1
107	1.4		4	09.04-	TU3A	0,9	BKR6EZ	4619	38	LPG 1

**108**

108 1.0 VTi 68	1.0	50	3	.14-	1KR	1,0	LZKR6AI-10G	97999		
108 1.2 VTi 82	1.2	60	3	.14-	EB2D	1,0	LZKR6AI-10G	97999		

**205**

205 XE, GL, Junior	0.9	33	4	07.87-12.92	TU9	0,8	BCP5ES	7496	16	LPG 3
205 XE, GL, Junior	0.9	33	4	07.92-	TU9M Cat.	0,8	BCPR5ES	6130	32	LPG 3
205 XR, XL, GL, GR	1.1	34	4	07.87-12.92	TU1	0,8	BCP5ES	7496	16	LPG 3
205	1.1	44	4	-06.92		0,8	BCPR6ES	2330	12	LPG 3
205 GR, Color Line	1.1	44	4	07.92-06.95	TU1M Cat.	0,8	BCPR5ES	6130	32	LPG 3
205 GR, Color, Sacre Num	1.1	44	4	03.95-	TU1.M Cat.	0,9	BKR6EK	2288	20	LPG 1
205 Rallye	1.3	75	4	03.88-06.92	TU2.4	0,8	BKUR7ET	7873		
205 XR, GR, SR, CJ	1.4	43	4	07.87-12.92	TU3 , TU3A	0,8	BCP5ES	7496	16	LPG 3
205 XR, GR, SR, CJ	1.4	55	4	07.92-	TU3FM Cat.	0,8	BCPR5ES	6130	32	LPG 3
205 XR, XS	1.4	55	4	07.92-06.95	TU3MC Cat.	0,8	BCPR6ES	2330	12	LPG 3
205 XR, GR, SR, SJ, Sacre N°	1.4	55	4	07.95-	TU3.MC Cat.	0,9	BKR6EK	2288	20	LPG 1
205 XT, XS, GT, CT	1.4	62	4	07.87-12.92	TU3S	0,7	BCP6ES	4930	17	LPG 3
205 Rallye	1.4		4	03.88-06.92	TU2.4	0,8	BKUR7ET	7873		PFR7Q



e kW C y i

0201



Stock-No

VLINE

LPG / CNG

**PEUGEOT****205**

205 XS,GT,Auto	1.6	65	4	07.92-	XU5.M Cat.	0,8	BCPR5ES	6130	32	LPG 3
205 GTi / CTi	1.6	83	4	07.87-06.92	XU5JA	0,7	BCP6ES	4930	17	LPG 3
205 GR,XS,XT,Auto	1.6		4	07.90-12.92	XU5.1C	0,7	BCP6ES	4930	17	LPG 3
205 Gentry	1.9	75	4	07.92-	XU9.J1 Cat.	0,8	BCPR5ES	6130	32	LPG 3
205 GTi	1.9	88	4	07.92-	XU9.JA Cat.	0,8	BCPR5ES	6130	32	LPG 3
205 GTi / Gentry	1.9	94	4	-12.92	XU9.JA	0,7	BCP6ES	4930	17	LPG 3

**206**

206	1.1	44	4	09.98-12.99	TU1JP-HFZ,HFY	0,9	BKR6EK	2288	20	LPG 1
206	1.1	44	4	01.00-	„TU1JP-HFZ;HFY“	0,9	BKR6EZ	4619	38	LPG 1
206	1.4	55	4	08.98-12.12	TU3A	0,9	BKR6EZ	4619	38	LPG 1
206	1.4	54	4	09.10-06.13	TU3AE5	0,9	BKR6EZ	4619	38	LPG 1
206	1.4	55	4	09.98-12.99	TU3JP-KFX	0,9	BKR6EK	2288	20	LPG 1
206	1.4	55	4	01.00-	TU3JP-KFX	0,9	BKR6EZ	4619	38	LPG 1
206	1.6	66	4	09.98-08.00	TU5JP-NFZ	0,9	BKR6EK	2288	20	LPG 1
206	1.6	66	4	01.00-	TU5JP-NFZ	0,9	BKR6EZ	4619	38	LPG 1
206 16V CC	1.6	81	4	03.01-	TU5JP4-NFU	0,9	LFR6B	6677		LPG 7
206 Coupé 16V XS, XT	1.6	81	4	03.01-	TU5JP4	0,9	LFR6B	6677		LPG 7
206 S16,GT,CC	2.0	101	4	04.99-	EW10J4	0,9	LFR5B	7113		LPG 7
206 Coupé 16V	2.0	102	4	04.99-	EW10J4	0,9	LFR5B	7113		LPG 7
206 2.0 S16 RC	2.0	132	4	10.02-	EW10J4S- RFK	0,9	LFR6B	6677		LPG 7
206 S16	2.0	132	4	10.02-	EW10J4S~RFK	0,9	LFR6B	6677		LPG 7

**206 SW**

206 SW	1.1	44	4	09.98-12.99	TU1JP~HFZ, HFY	0,9	BKR6EK	2288	20	LPG 1
206 SW	1.1	44	4	01.00-	TU1JP~HFZ, HFY	0,9	BKR6EZ	4619	38	LPG 1
206 SW	1.4	55	4	09.98-12.99	TU3JP~KFX	0,9	BKR6EK	2288	20	LPG 1
206 SW	1.4	55	4	01.00-	TU3JP~KFX	0,9	BKR6EZ	4619	38	LPG 1
206 SW	1.4	66	4	.04-	ET3J4~KFU	0,8	LZKAR7A	6799		
206 SW	1.6	66	4	09.98-12.99	TU5JP~NFZ	0,9	BKR6EK	2288	20	LPG 1
206 SW	1.6	66	4	01.00-	TU5JP~NFZ	0,9	BKR6EZ	4619	38	LPG 1
206 SW 16V	1.6	81	4	03.01-	TU5JP4~NFU	0,9	LFR6B	6677		LPG 7
206 SW S16	2.0	101	4	04.99-	EW10J4-RFR, RFN	0,9	LFR5B	7113		LPG 7

**207**

207	1.4	55	4	05.06-	TU3A-KFV	0,9	BKR6EZ	4619	38	LPG 1
207	1.4	55	4	01.12-10.13	TU3A	0,9	BKR6EZ	4619	38	LPG 1
207	1.4	72	4	11.09-12.12	EP3C	0,8	PLZKBR7B8DG	90223		
207 16V	1.4	55	4	.07-10.13	EP3	0,8	PLZKBR7B8DG	90223		
207 16V	1.4	66	4	04.06-12.12	ET3J4-KFU	0,8	LZKAR7A	6799		
207 1.4 Vti 95	1.4	70	4	10.07-12.12	EP3 / EP3C	0,8	PLZKBR7B8DG	90223		
207	1.4	54	4	08.07-12.12	TU3AE5	0,9	BKR6EZ	4619	38	LPG 1
207	1.6	88	4	11.06-10.13	EP6C	0,8	PLZKBR7B8DG	90223		
207 16V	1.6	75	4	04.06-10.13	EP6	0,8	PLZKBR7B8DG	90223		
207 1.6 Vti 120	1.6	88	4	02.07-	EP6 / EP6C	0,8	PLZKBR7B8DG	90223		
207 1.6 16V	1.6	110	4	06.06-12.12	EP6DT	0,8	PLZKBR7B8DG	90223		
207	1.6	110	4	.07-12.12	EP6DT	0,8	PLZKBR7B8DG	90223		
207 1.6 THP 155	1.6	115	4	10.09-	EP6DT / EP6CDT	0,8	PLZKBR7B8DG	90223		
207	1.6	129	4	11.06-12.12	EP6DTS	0,8	PLZKBR7B8DG	90223		
207 RC	1.6	129	4	04.07-12.12	EP6DTS	0,8	PLZKBR7B8DG	90223		

**208**

208 1.0 68 VTi	1.0	50	3	03.12-	EB0	1,0	LZKR6AI-10G	97999		
----------------	-----	----	---	--------	-----	-----	-------------	-------	--	--



l kW  
C  
y  
l

0201



Stock-No

LINE

LPG/CNG

**PEUGEOT**

**208**

208 1.2 82 VTi	1.2	60	3	03.12-	EB2	1,0	LZKR6AI-10G	97999		
208 1.4 95 VTi	1.4	70	4	03.12-	EP3C	0,8	PLZKBR7B8DG	90223		
208 1.6 120 VTi	1.6	88	4	03.12-	EP6C	0,8	PLZKBR7B8DG	90223		
208 1.6 155 THP	1.6	115	4	03.12-	EP6CDT	0,8	PLZKBR7B8DG	90223		
208 1.6 Gti	1.6	147	4	08.12-	EP6CDTXM	0,8	ILZKBR7B8DG	95770		

**301**

301 1.2 72 VTi	1.2	52	3	.12-	EB2M	1,0	LZKR6AI-10G	97999		
301 1.6 115 VTi	1.6	84	4	.12-	EC5	0,8	PLZKBR7B8DG	90223		

**306**

306	1.1	44	4	02.93-06.95	TU1M-HDZ	0,8	BCPR5ES	6130	32	LPG 3
306	1.1	44	4	07.95-04.97	TU1M-HDZ	0,8	BKR5EK	7956	23	LPG 1
306	1.1		4	.96-	TU1.M+	0,9	BKR6EK	2288	20	LPG 1
306	1.4	55	4	02.93-06.95	TU3.MC-KDX	0,8	BCPR5ES	6130	32	LPG 3
306	1.4	55	4	07.95-12.03	TU3JP-KFX	0,9	BKR6EK	2288	20	LPG 1
306	1.4	55	4	01.00-10.03	TU3JP-KFX	0,9	BKR6EZ	4619	38	LPG 1
306	1.6	66	4	02.93-12.99	TU5JP-NFZ	0,9	BKR6EK	2288	20	LPG 1
306	1.6	66	4	01.00-10.03	TU5JP-NFZ	0,9	BKR6EZ	4619	38	LPG 1
306	1.8	74	4	02.93-03.95	XU7JP-LFZ	0,8	BCPR5ES	6130	32	LPG 3
306	1.8	74	4	04.95-10.03	XU7JP-LFZ	0,8	BKR5EK	7956	23	LPG 1
306 16V	1.8	81	4	04.97-10.03	XU7JP4-LFY	0,8	BKR5EK	7956	23	LPG 1
306	2.0	89	4	-03.97	XU10.J4-RFY	0,8	BKR6ES	3783	28	LPG 1
306	2.0	89	4	02.93-03.95	XU10.J2-RFX	0,8	BCPR5ES	6130	32	LPG 3
306	2.0	89	4	04.95-04.97	XU10.J2-RFX	0,8	BKR5EK	7956	23	LPG 1
306	2.0	98	4	04.97-	XU10J4R-RFV	0,8	BKR5EK	7956	23	LPG 1
306 Le Mans	2.0	110	4	11.93-.96	XU10J4	0,8	BKR6ES	3783	28	LPG 1
306	2.0	120	4	07.96-10.03	XU10J4RS-RFS	0,9	BKR5EZ	7642	36	LPG 1
306 2.0 16V	2.0		4	11.93-.96	XU10J4	0,8	BKR6ES	3783	28	LPG 1

**307**

307	1.4	55	4	04.01-05.05	TU3JP-KFX	0,9	BKR6EZ	4619	38	LPG 1
307 XR	1.4	55	4	04.01-.99	TU3JP~KFX	0,9	BKR6EZ	4619	38	LPG 1
307 16V	1.4	66	4	03.04-	ET3J4 KFU	0,8	LZKAR7A	6799		
307	1.6	81	4	04.01-	TU5JP4-NFU	0,9	LFR6B	6677		LPG 7
307 16V	1.6	81	4	04.01-	TU5JP4~NFU	0,9	LFR6B	6677		LPG 7
307	2.0	130	4	10.03-04.09	EW10J4S	0,9	LFR5B	7113		LPG 7
307	2.0	101	4	04.01-	EW10J4-RFN	0,9	LFR5B	7113		LPG 7
307 16V	2.0	101	4	04.01-	EW10J4-RFN	0,9	LFR5B	7113		LPG 7
307 16V	2.0	102	4	.03-	EW10J4	0,9	LFR5B	7113		LPG 7
307	2.0	104	4	09.06-	EW10A	0,9	LFR5B	7113		LPG 7
307 2.0 16V	2.0	104	4	09.06-	EW10A	0,9	LFR5B	7113		LPG 7

**308**

308 1.2 82 Vti	1.2	60	3	09.13-	EB2	1,0	LZKR6AI-10G	97999		
308 1.4 16V	1.4	55	4	09.07-	EP3	0,8	PLZKBR7B8DG	90223		
308 1.4 Vti 95	1.4	70	4	09.07-	EP3 / EP3C	0,8	PLZKBR7B8DG	90223		
308 1.4 Vti 95	1.4	72	4	12.09-	EP3C	0,8	PLZKBR7B8DG	90223		
308 1.6 16V	1.6	80	4	09.07-	EP6	0,8	PLZKBR7B8DG	90223		
308 1.6 16V	1.6	88	4	09.07-	EP6 / EP6C	0,8	PLZKBR7B8DG	90223		
308 1.6 16V	1.6	103	4	09.07-	EP6DT	0,8	PLZKBR7B8DG	90223		
308 1.6 THP 150	1.6	110	4	09.07-	EP6DT	0,8	PLZKBR7B8DG	90223		
308 1.6 THP 155	1.6	115	4	07.09-	EP6CDT	0,8	PLZKBR7B8DG	90223		

e kW  
C  
Y  
I

0201



Stock-No

VLINE

LPG / CNG

**PEUGEOT****308**

308 1.6 THP 175	1.6	130	4	09.07-	EP6DTS	0,8	PLZKBR7B8DG	90223		
308 1.6 GTi	1.6	147	4	07.10-	EP6CDTX	0,8	ILZKBR7B8DG	95770		
308	2.0	103	4	07.09-12.14	EW10A	0,9	LFR5B	7113		LPG 7

**308CC**

308 CC 1.6 THP 16V	1.6	105	4	03.09-	EP6DT	0,8	PLZKBR7B8DG	90223		
308 CC 1.6 THP 16V	1.6	110	4	03.09-	EP6DT	0,8	PLZKBR7B8DG	90223		
308 CC 1.6 THP 200	1.6	147	4	10.10-	EP6CDTX	0,8	ILZKBR7B8DG	95770		

**309**

309 GE, GL, GR	1.1	40	4	-12.92	E1A	0,8	BCP5ES	7496	16	LPG 3
309 XA, XR, XL	1.1	40	4	-12.92	E1A	0,8	BCP5ES	7496	16	LPG 3
309 XE, GE	1.1	40	4	-12.92	TU1	0,8	BCP5ES	7496	16	LPG 3
309 Vital	1.1	40	4	07.92-	TU1M Cat.	0,8	BCPR5ES	6130	32	LPG 3
309 GE, GL, GR, XE, XL, XR, XA	1.3	47	4	10.86-12.93	G1A	0,8	BCP5ES	7496	16	LPG 3
309 XL, GL	1.4	44	4	10.86-12.93	TU3	0,8	BCP5ES	7496	16	LPG 3
309 GRX	1.4	55	4	10.86-12.93	TU3M Cat.	0,8	BCPR5ES	6130	32	LPG 3
309 SR, GRX	1.6	65	4	07.92-	XU5M Cat.	0,8	BCPR5ES	6130	32	LPG 3
309 GR, GRX, SR, SX, XS, XR	1.6	68	4	07.89-12.92	XU5.2C	0,7	BCP6ES	4930	17	LPG 3
309 XS, SX	1.9	80	4	07.89-06.92	XU9.2C	0,7	BCP6ES	4930	17	LPG 3
309 XS, SX	1.9	80	4	07.92-	XU9M Cat.	0,8	BCPR5ES	6130	32	LPG 3
309 GTi	1.9	88	4	07.92-	XU9.JA Cat.	0,8	BCPR5ES	6130	32	LPG 3
309 GTi	1.9	94	4	-12.92	XU9.JA	0,7	BCP6ES	4930	17	LPG 3
309 GTi 16V	1.9	110	4	07.92-	XU9.J4 Cat.	0,9	BCPR6ET	2197		LPG 3
309 GTi 16V	1.9	118	4	-06.92	XU9.J4	0,9	BCP6ET	4563		LPG 3

**405**

405 GL	1.4	47	4	07.87-06.92	TU3	0,8	BCP5ES	7496	16	LPG 3
405 GL	1.4	55	4	07.92-06.95	TU3M-KDX Cat.	0,8	BCPR5ES	6130	32	LPG 3
405	1.4	55	4	07.95-04.97	TU3M-KDX Cat.	0,9	BKR6EK	2288	20	LPG 1
405	1.4	55	4	08.92-08.94	TU3MC	0,9	BKR6EK	2288	20	LPG 1
405	1.4	55	4	08.92-08.94	TU32	0,9	BCP5ES	7496	16	LPG 3
405	1.6	80	4	08.92-05.97	TU5JP4	0,9	LFR6B	6677		LPG 7
405 GL, GR, SR	1.6	55	4	07.87-06.92	XU51C	0,8	BCP5ES	7496	16	LPG 3
405 GL, GR, SR	1.6	65	4	07.92-06.94	XU5M-BDY Cat.	0,8	BCPR5ES	6130	32	LPG 3
405	1.6	66	4	04.95-	XU5JP-BFZ	0,8	BKR5EK	7956	23	LPG 1
405 Sillage, Style	1.6		4	07.94-03.95	XU5JP-BFZ Cat.	0,8	BCPR5ES	6130	32	LPG 3
405 Signa, Style	1.8	74	4	07.92-03.95	XU7JP-LFZ Cat.	0,8	BCPR5ES	6130	32	LPG 3
405	1.8		4	04.95-	XU7JP-LFZ	0,8	BKR5EK	7956	23	LPG 1
405 GR, SR	1.9		4	07.87-06.92	XU92C	0,7	BCP6ES	4930	17	LPG 3
405 GRi, SRi, Si, X4	1.9		4	07.87-06.92	XU9J2-D6A	0,7	BCP6ES	4930	17	LPG 3
405 MI16, X4	1.9		4	07.90-06.92	XU9J4-D6C	0,9	BCPR6ET	2197		LPG 3
405 Signature, STI	2.0	90	4	07.92-03.95	XU10J2-RFX Cat.	0,8	BKR5EK	7956	23	LPG 1
405 Mi16	2.0	110	4	07.92-	XU10J4-RFY Cat.	0,8	BKR6ES	3783	28	LPG 1
405 T16	2.0	147	4	09.92-04.97	XU10J4TE-RGZ Cat.	0,9	BKR6EK	2288	20	LPG 1
405 Signature, STI	2.0		4	07.92-03.95	XU10J2-RFX Cat.	0,8	BCPR5ES	6130	32	LPG 3

**406**

406	1.6	66	4	10.95-06.04	XU5JP-BFZ	0,8	BKR5EK	7956	23	LPG 1
406	1.8	66	4	10.95-06.04	XU7JP-L6A	0,8	BKR5EK	7956	23	LPG 1
406	1.8	81	4	10.95-06.04	XU7JP4-LFY	0,8	BKR5EK	7956	23	LPG 1
406	2.0	97	4	10.95-06.04	XU10J4R-RFV	0,8	BKR5EK	7956	23	LPG 1
406 Coupé 16V	2.0	97	4	06.97-03.99	XU10J4R-RFV	0,8	BKR5EK	7956	23	LPG 1
406 Coupé 16V	2.0	101	4	04.99-02.05	EW10J4-RFR	0,9	LFR5B	7113		LPG 7
406	2.0	107	4	07.96-03.99	XU10J2TE-RGX	0,9	BKR6EK	2288	20	LPG 1



l kW  
C  
y  
i

0201



Stock-No

VALVE

LPG/CNG

**PEUGEOT**

**406**

406 Coupé 16V	2.2	118	4	05.00-02.05	EW12J4-3FZ	0,9	LF5R5B	7113		LPG 7
406 24V V6	3.0	140	6	10.96-02.05	ES9J4-XFZ	0,9	BKR6EK	2288	20	LPG 1
406 Coupé V6	3.0	143	6	06.97-02.05	ES9J4-XFZ	0,9	BKR6EK	2288	20	LPG 1
406 Coupé V6	3.0	154	6	06.00-11.04	ES9J4S-XFX	1,1	PLFR5A-11	6240		LPG 7

**406 PHASE 2**

406 Phase 2	1.8	66	4	04.99-02.05	XU7JB-LFX	0,9	BKR6EK	2288	20	LPG 1
406 Phase 2	1.8	81	4	04.99-06.04	XU7JP4-LFY	0,8	BKR5EK	7956	23	LPG 1
406 Phase 2	1.8	86	4	09.00-06.04	EW7J4-6FZ	0,9	LF5R5B	7113		LPG 7
406 Phase 2	2.0	101	4	04.99-02.05	EW10J4-RFR, RFN	0,9	LF5R5B	7113		LPG 7
406 Phase 2	2.2	117	4	04.99-02.05	EW12J4-3FZ	0,9	LF5R5B	7113		LPG 7
406 Phase 2	3.0	140	6	04.99-02.05	ES9J4-XFZ	0,9	BKR6EK	2288	20	LPG 1
406 Phase 2	3.0	154	6	10.00-02.05	ES9J4S-XFX	1,1	PLFR5A-11	6240		LPG 7

**407**

407	1.8	92	4	08.05-12.10	EW7A	0,9	LF5R5B	7113		LPG 7
407 1.8	1.8	85	4	04.04-07.05	EW7J4-6FZ	0,9	LF5R5B	7113		LPG 7
407 2.0	2.0	100	4	05.04-07.05	EW10J4 RFN	0,9	LF5R5B	7113		LPG 7
407 16V	2.0	104	4	09.06-	EW10A	0,9	LF5R5B	7113		LPG 7
407 2.0 16V	2.0		4	09.06-	EW10A	0,9	LF5R5B	7113		LPG 7
407 2.2	2.2	116	4	04.04-	EW12J4-3FZ	0,9	LF5R5B	7113		LPG 7
407 2.2 16V	2.2	120	4	08.05-	EW12J4-3FZ	0,9	LF5R5B	7113		LPG 7
407 V6	3.0	155	6	04.04-	ES9A~XFV	1,1	PLFR5A-11	6240		LPG 7
407 3.0 V6 24V	3.0		6	04.04-	ES9A~XFV	1,1	PLFR5A-11	6240		LPG 7

**508**

508 1.6 Vti 120	1.6	88	4	11.10-	EP6C	0,8	PLZKBR7B8DG	90223		
508 1.6 THP 155	1.6	115	4	11.10-	EP6CDT	0,8	PLZKBR7B8DG	90223		

**605**

605 SL	2.0	79	4	07.89-06.92	XU102C-R2A	0,7	BCP6ES	4930	17	LPG 3
605 SRi	2.0	89	4	09.89-12.92	XU10J2-R6A	0,8	BCPR6ES	2330	12	LPG 3
605 SLI	2.0	89	4	07.92-07.94	XU10J2-RFZ Cat.	0,8	BCPR5ES	6130	32	LPG 3
605	2.0	99	4	08.94-05.99	XU10J4R-RFV	0,8	BKR5EK	7956	23	LPG 1
605 SRTi Turbo	2.0	104	4	12.92-05.99	XU10J2TE-RGX	0,9	BKR6EK	2288	20	LPG 1
605 SR, SV	3.0	125	6	07.89-06.97	ZPJ-SFZ Cat.	0,9	BCPR6ET	2197		LPG 3
605 3.0	3.0	140	6	07.97-05.99	ES9J4-XFZ	0,9	BKR6EK	2288	20	LPG 1
605 SV 24V	3.0	147	6	07.89-06.97	ZPJ4-SKZ Cat.	0,9	BCPR6ET	2197		LPG 3

**607**

607	2.0	101	4	05.00-11.04	EW10J4-RFN	0,9	LF5R5B	7113		LPG 7
607	2.2	118	4	05.00-	EW12J4-3FZ	0,9	LF5R5B	7113		LPG 7
607 3.0 V6	3.0	152	6	05.00-	ES9J4S-XFX	1,1	PLFR5A-11	6240		LPG 7

**806**

806	1.8	74	4	10.96-06.00	XU7JP-LFW	0,8	BKR5EK	7956	23	LPG 1
806	2.0	97	4	05.98-09.00	XU10J4R	0,8	BKR5EK	7956	23	LPG 1
806 16V	2.0	89	4	06.94-03.95	XU10J2-RFU	0,8	BCPR5ES	6130	32	LPG 3
806	2.0	90	4	04.95-05.00	XU10J2-RFU	0,8	BKR5EK	7956	23	LPG 1
806	2.0	101	4	06.00-	EW10J4-RFR	0,9	LF5R5B	7113		LPG 7
806 Turbo	2.0	110	4	06.94-05.00	XU10J2TE-RGX	0,9	BKR6EK	2288	20	LPG 1

e kW  
C  
y  
I

0201



Stock-No

VLINE

LPG / CNG

**PEUGEOT****807**

807 2.0	2.0	102	4	06.02-09.05	EW10J4-RFR	0,9	LFR5B	7113		LPG 7
807 2.0 16V	2.0	104	4	10.05-	EW10A	0,9	LFR5B	7113		LPG 7
807 2.2 16V	2.2	118	4	06.02-	EW12J4-3FZ	0,9	LFR5B	7113		LPG 7
807 3.0 V6	3.0	154	6	06.02-	ES9J4S-XFX	1,1	PLFR5A-11	6240		LPG 7

**1007**

1007 1.4	1.4	55	4	04.05-	TU3A / TU3JP	1,1	BKR6E-11	2756	14	LPG 1
1007 1.4 16V	1.4	65	4	10.05-	ET3J4	0,8	LZKAR7A	6799		
1007 1.6	1.6	81	4	04.05-	TU5JP4-NFU	0,9	LFR6B	6677		LPG 7

**2008**

2008 1.2 82 Vti	1.2	60	3	03.13-	EB2	1,0	LZKR6AI-10G	97999		
2008 1.6 120 Vti	1.6	88	4	03.13-	EP6C	0,8	PLZKBR7B8DG	90223		

**3008**

3008 1.6 Vti 120	1.6	88	4	05.09-	EP6	0,8	PLZKBR7B8DG	90223		
3008 THP	1.6	110	4	05.09-	EP6DT	0,8	PLZKBR7B8DG	90223		
3008 Vti	1.6	88	4	06.09-	EP6C	0,8	PLZKBR7B8DG	90223		
3008 1.6 THP 155	1.6	115	4	05.09-	EP6CDT	0,8	PLZKBR7B8DG	90223		

**4007**

4007	2.0	108	4	11.10-03.13	4B11	0,8	FR6EI	2687		
4007 2.4	2.4	125	4	02.07-	VUSFZC/VUSFZF/ VVSFZC/VVSFZF	0,8	FR5EI	1313		FR6EI

**4008**

4008 2.0	2.0	110	4	04.12-	4B11	0,8	FR6EI	2687		
----------	-----	-----	---	--------	------	-----	-------	------	--	--

**5008**

5008	1.6	88	4	09.09-	EP6C	0,8	PLZKBR7B8DG	90223		
5008 1.6 Hdi	1.6	110	4	02.12-	EP6DT	0,8	PLZKBR7B8DG	90223		
5008 1.6 Vti 120	1.6	88	4	09.09-	EP6	0,8	PLZKBR7B8DG	90223		
5008 1.6 THP 155	1.6	115	4	09.09-	EP6CDT	0,8	PLZKBR7B8DG	90223		

**BIPPER**

Bipper	1.4	54	4	04.08-	TU3A	0,9	BKR6EZ	4619	38	LPG 1
Bipper	1.4	54	4	04.08-	TU3AE5	0,9	BKR6EZ	4619	38	LPG 1
Bipper 1.4	1.4	54	4	02.08-	KFV (TU3A)	0,9	BKR6EZ	4619	38	LPG 1
Bipper Tepee 1.4	1.4	54	4	05.08-	KFV (TU3A)	0,9	BKR6EZ	4619	38	LPG 1

**BOXER**

Boxer	2.0	81	4	-03.95	XU10J2U-RFW	0,8	BCPR6ES	2330	12	LPG 3
Boxer	2.0	81	4	04.95-	XU10J2U-RFW	0,9	BKR6EK	2288	20	LPG 1

**EXPERT**

Expert	1.6	59	4	.95-	1580 SPI 222A2.000	0,8	BCPR7ES	3330		BCPR7EIX
Expert	1.8	74	4	.96-	XU7JP	0,8	BKR5EK	7956	23	LPG 1
Expert	2.0	101	4	06.00-	EW10J4-RFN	0,9	LFR5B	7113		LPG 7
Expert	2.0	104	4	01.07-	EW10A	0,9	LFR5B	7113		LPG 7
Expert 2.0 16V	2.0	105	4	01.07-	EW10A	0,9	LFR5B	7113		LPG 7

**PARTNER**

Partner	1.1	44	4	07.96-	TU1M+HDZ	0,9	BKR6EK	2288	20	LPG 1
Partner	1.1	44	4	06.96-09.05	TU1JP	0,9	BKR6EZ	4619	38	LPG 1



l kW C y i

0201



Stock-No

LINE

LPG/CNG

## PEUGEOT

### PARTNER

Partner	1.4	55	4	06.96-12.15	TU32	0,9	BCP5ES	7496	16	LPG 3
Partner	1.4	55	4	06.96-12.15	TU3A	0,9	BKR6EZ	4619	38	LPG 1
Partner	1.4	55	4	07.96-	TU3JP-KFX/KFW	0,9	BKR6EK	2288	20	LPG 1
Partner	1.6	66	4	06.08-	TU5JP4	0,9	LF6B	6677		LPG 7
Partner	1.8	66	4	07.97-	XU7JB-LFX	0,9	BKR6EK	2288	20	LPG 1
Partner Multispace	1.4	55	4	01.97-12.99	TU3JP-KFX/KFW	0,9	BKR6EK	2288	20	LPG 1
Partner Multispace	1.4	55	4	01.00-	TU3JP-KFX/KFW	0,9	BKR6EZ	4619	38	LPG 1
Partner Multispace	1.6	81	4	02.01-	TU5JP4-NFU	0,9	LF6B	6677		LPG 7
Partner Multispace	1.8	66	4	07.97-	XU7JB-LFX	0,9	BKR6EK	2288	20	LPG 1

### RCZ

RCZ 1.6 155 THP	1.6	115	4	03.10-	EP6CDT	0,8	PLZKBR7B8DG	90223		
RCZ 1.6 200 THP	1.6	147	4	06.10-	EP6CDTX	0,8	ILZKBR7B8DG	95770		

## PIAGGIO

Porter 1.3i 16V	1.3	48	4	05.98-	HC-ES	1,0	BKUR6EK	2213		
-----------------	-----	----	---	--------	-------	-----	---------	------	--	--

## PORSCHE

### 911 SERIE 964

911 Turbo	964	3.3	236	6	.91- .92	M30.69	0,8	BPR8EIX	6684		BPR9EIX
911 Turbo S	964	3.3	280	6	.92- .92	M30.69SL	0,8	BPR8EIX	6684		BPR9EIX
911 Carrera 2	964	3.6	184	6	.90- .93	M64.01	0,9	BCPR7ET	2164		BCPR7EIX
911 Carrera 2	964	3.6	184	6	.90- .93	M64.02	0,9	BCPR7ET	2164		BCPR7EIX
911 Carrera 4	964	3.6	184	6	.90- .93	M64.01	0,9	BCPR7ET	2164		BCPR7EIX
911 Carrera RS America	964	3.6	184	6	.92- .92	M64.01	0,9	BCPR7ET	2164		BCPR7EIX
911 Turbo Look	964	3.6	184	6	.92- .92	M64.01	0,9	BCPR7ET	2164		BCPR7EIX
911 Turbo Look	964	3.6	184	6	.92- .92	M64.02	0,9	BCPR7ET	2164		BCPR7EIX
911 Carrera RS	964	3.6	191	6	.92- .92	M64.03	0,9	BCPR7ET	2164		BCPR7EIX
911 Turbo 3.6	964	3.6	265	6	.93- .93	M64.50	0,9	BKR6EK	2288	20	LPG 1

### 911 SERIE 993

911 Carrera 2	993	3.6	184	6	.94- .95	M64.01	0,9	BCPR7ET	2164		BCPR7EIX
911 Carrera 2	993	3.6	184	6	.94- .95	M64.02	0,9	BCPR7ET	2164		BCPR7EIX
911 Carrera 2 Speedster	993	3.6	184	6	.94- .94	M64.01	0,9	BCPR7ET	2164		BCPR7EIX
911 Carrera 2 Speedster	993	3.6	184	6	.94- .94	M64.02	0,9	BCPR7ET	2164		BCPR7EIX
911 Carrera 4 Turbo Look	993	3.6	184	6	.94- .94	M64.01	0,9	BCPR7ET	2164		BCPR7EIX
911 Carrera	993	3.6	200	6	.93- .97	M64.07	0,9	BCPR7ET	2164		BCPR7EIX
911 Carrera	993	3.6	200	6	.93- .97	M64.08	0,9	BCPR7ET	2164		BCPR7EIX
911 Carrera	993	3.6	200	6	.93- .97	M64.23	0,9	BCPR7ET	2164		BCPR7EIX
911 Carrera	993	3.6	200	6	.93- .97	M64.24	0,9	BCPR7ET	2164		BCPR7EIX
911 Carrera	993	3.6	200	6	.94- .95	M64.05	0,9	BCPR7ET	2164		BCPR7EIX
911 Carrera	993	3.6	200	6	.94- .95	M64.06	0,9	BCPR7ET	2164		BCPR7EIX
911 Carrera 4	993	3.6	200	6	.95- .95	M64.05	0,9	BCPR7ET	2164		BCPR7EIX
911 Carrera	993	3.6	210	6	.97- .97	M64.21	0,9	BCPR7ET	2164		BCPR7EIX
911 Carrera	993	3.6	210	6	.97- .97	M64.22	0,9	BCPR7ET	2164		BCPR7EIX
911 Carrera 4	993	3.6	210	6	.97- .98	M64.21	0,9	BCPR7ET	2164		BCPR7EIX
911 Carrera 4 S	993	3.6	210	6	.97- .98	M64.21	0,9	BCPR7ET	2164		BCPR7EIX
911 Carrera S	993	3.6	210	6	.97- .98	M64.21	0,9	BCPR7ET	2164		BCPR7EIX
911 Carrera S	993	3.6	210	6	.97- .98	M64.22	0,9	BCPR7ET	2164		BCPR7EIX
911 Carrera 4s	993	3.6	221	6	.96- .96	M64.21	0,9	BCPR7ET	2164		BCPR7EIX

e kW  
C  
y  
I

0201



Stock-No

VLINE

LPG / CNG

**PORSCHE****911 SERIE 993**

911 Turbo 3.6	993	3.6	265	6	.94- .94	M64.50	0,9	BKR6EK	2288	20	LPG 1
911 Turbo Biturbo	993	3.6	300	6	.95- .97	M64.60	0,9	BKR6EK	2288	20	LPG 1
911 Turbo 3.6 Biturbo	993	3.6	300	6	.98- .98	M64.60	0,9	BKR6EK	2288	20	LPG 1
911 GT2	993	3.6	316	6	.96- .98	M64.60R	0,9	BKR6EK	2288	20	LPG 1
911 Carrera	993	3.8	210	6	.96- .96	M64.05	0,9	BCPR7ET	2164		BCPR7EIX
911 Carrera	993	3.8	210	6	.96- .96	M64.06	0,9	BCPR7ET	2164		BCPR7EIX
911 Carrera 4	993	3.8	210	6	.96- .96	M64.05	0,9	BCPR7ET	2164		BCPR7EIX
911 Carrera RS America	993	3.8	221	6	.95- .96	M64.20	0,9	BCPR7ET	2164		BCPR7EIX

**911 SERIE 996**

911 Carrera	996	3.4	221	6	.98- .98	M96.01	1,5	BKR6EQUIP	3199	30	LPG 1
911 Carrera 2	996	3.4	221	6	.99- .00	M96.01	1,5	BKR6EQUIP	3199	30	LPG 1
911 Carrera 4	996	3.4	221	6	.99- .00	M96.02	1,5	BKR6EQUIP	3199	30	LPG 1
911 Carrera 2	996	3.4	221	6	.01- .04	M96.04	1,5	BKR6EQUIP	3199	30	LPG 1
911 Carrera 4	996	3.4	221	6	.01- .00	M96.04	1,5	BKR6EQUIP	3199	30	LPG 1
911 Carrera	996	3.6	235	6	.01- .03	M96.03	1,5	BKR7EQUIP	4285		
911 GT3	996	3.6	265	6	.00- .00	M96.76	0,9	BKR6EK	2288	20	LPG 1
911 GT3	996	3.6	280	6	.01- .04	M96.76/ M 96.79	0,7	BKR7EIX	2667		BKR8EIX
911 Turbo	996	3.6	309	6	.01- .06	M96.70	0,9	BCPR7ET	2164		BCPR7EIX
911 GT2	996	3.6	340	6	.01- .04	M96.70S	0,9	BKR7EKC	7354		

**911 SERIE 997**

911 Carrera	997	3.6	239	6	.04-	M96.05	1,5	BKR7EQUIP	4285		
911 Carrera S (997)	997	3.8	261	6	.04-	M97.01	1,5	BKR7EQUIP	4285		

**928**

928 GT		5.0	243	8	01.89-07.91	M 28.47	0,8	BPR6ES	7822	2	LPG 2
928 GTS		5.4	250	8	08.91-11.95	M 28.49/50	0,8	BPR6ES	7822	2	LPG 2
928 S4/CS		5.0	235	8	08.86-07.91	M 28.41/42	0,8	BPR6ES	7822	2	LPG 2

**968**

968		3.0	176	4	08.91-11.95	M 44.43/44	0,8	BPR6ES	7822	2	LPG 2
968 Turbo S		3.0	224	4	01.93-11.95		0,8	BKR6ES	3783	28	LPG 1

**BOXSTER SERIE 986**

Boxster 2.5	986	2.5	150	6	09.96-08.99	M 96.20	0,9	BKR6EK	2288	20	LPG 1
Boxster 2.7	986	2.7	162	6	09.99-07.02	M 96.22	1,5	BKR6EQUIP	3199	30	LPG 1
Boxster 2.7	986	2.7	168	6	07.02-	M 96.23	1,5	BKR6EQUIP	3199	30	LPG 1
Boxster S 3.2	986	3.2	185	6	09.99-07.02	M 96.21	1,5	BKR6EQUIP	3199	30	LPG 1
Boxster S 3.2	986	3.2	191	6	07.02-	M 96.24	1,5	BKR6EQUIP	3199	30	LPG 1

**BOXSTER SERIE 987**

Boxster 2.7	987	2.7	176	6	12.04-	M 96.25	1,5	BKR7EQUIP	4285		
Boxster 2.7	987	2.7	180	6	07.06-	M 97.20	1,5	BKR7EQUIP	4285		
Boxster 2.9	987	2.9	188	6	.08-	M 96.25 / 20	1,5	BKR7EQUIP	4285		
Boxster S 3.2	987	3.2	206	6	09.04-08.06	M 96.26	1,5	BKR7EQUIP	4285		
Boxster S 3.4	987	3.4	217	6	09.06-	M 97.21	1,5	BKR7EQUIP	4285		
Boxster S 3.4	987	3.4	228	6	.08-	M 97.26 / 21	1,5	BKR7EQUIP	4285		
Boxster Spyder 3.4	987	3.4	236	6	.08-	M 97.21	1,5	BKR7EQUIP	4285		

**CARRERA GT**

Carrera GT		5.7	450	10	07.03-	M 80.01	0,9	PFR8B-9	3169		
------------	--	-----	-----	----	--------	---------	-----	---------	------	--	--

**CAYENNE SERIE 955**

Cayenne 3.2	955	3.2	184	6	10.03-	M 02.2Y BFD	0,9	IZKR7B	7563		
-------------	-----	-----	-----	---	--------	-------------	-----	--------	------	--	--





e kW C y i

0201



Stock-No

VLINE

LPG / CNG

**PORSCHE****CAYENNE SERIE 955**

Cayenne I 3.6	955	3.6	213	6	02.07-05.10	M55.01	0,9	ILZKR7A	1961		
Cayenne S 4.5	955	4.5	250	8	10.02-	M 48.00	1,5	BKR6EQUIP	3199	30	LPG 1
Cayenne Turbo 4.5	955	4.5	331	8	10.02-	M 48.50	0,8	PFR7Q	7963		

**CAYENNE SERIE 958**

Cayenne 3.6		3.6	220	6	06.10-	M55.02	0,8	ILZKR8A	94290		
-------------	--	-----	-----	---	--------	--------	-----	---------	-------	--	--

**CAYMAN SERIE 987**

Cayman 2.7	987	2.7	180	6	09.06-	M 97.20	1,5	BKR7EQUIP	4285		
Cayman 2.9	987	2.9	195	6	.08-	M 97.20	1,5	BKR7EQUIP	4285		
Cayman S 3.4	987	3.4	217	6	11.05-	M 97.21	1,5	BKR7EQUIP	4285		
Cayman S 3.4	987	3.4	236	6	.08-	M 97.21	1,5	BKR7EQUIP	4285		

**PROTON**

1300		1.3		4	-10.92		0,8	BPR6ES	7822	2	LPG 2
1300		1.3		4	10.92-	Multipoint	0,9	BPR5ES	7422	6	LPG 2
1500		1.5		4	-10.92		0,8	BPR6ES	7822	2	LPG 2
1500		1.5		4	10.92-	Multipoint	0,9	BPR5ES	7422	6	LPG 2
313		1.3	55	4	.96-	(Mitsubishi)	1,1	BPR5ES-11	4424		LPG 2
315		1.5	64	4	.96-	(Mitsubishi)	1,1	BKR6E-11	2756	14	LPG 1
318 GTI		1.9	100	4	09.99-		1,1	BKR6E-11	2756	14	LPG 1
413		1.3	55	4	05.96-	C96	1,1	BPR5ES-11	4424		LPG 2
415		1.5	66	4	03.95-	C97	1,1	BPR5ES-11	4424		LPG 2
416		1.6	85	4	03.95-	C98	1,1	BKR6E-11	2756	14	LPG 1
418		1.8	85	4	05.96-	C99	1,1	BKR6E-11	2756	14	LPG 1
418 LRS		1.8	99	4	.98-		1,1	BKR6E-11	2756	14	LPG 1
Persona		1.3		4		4G13	0,8	BPR6ES	7822	2	LPG 2
Persona		1.5		4	11.93-	4G15	0,9	BPR5ES	7422	6	LPG 2
Persona		1.6		4	11.93-	4G92	1,1	BKR6E-11	2756	14	LPG 1
Persona		1.8		4	09.96-	4G92	1,1	BKR6E-11	2756	14	LPG 1
Satria		1.3		4	03.00-		0,9	BPR5ES	7422	6	LPG 2
Wira		1.5		4	03.00-	4G15	1,1	BPR5ES-11	4424		LPG 2
Wira		1.6		4	05.00-	4G92	1,1	BKR6E-11	2756	14	LPG 1
Wira		1.8		4	05.00-		1,1	BKR6E-11	2756	14	LPG 1

**RELIANT**

Robin				4	09.96-		0,8	BCPR5ES	6130	32	LPG 3
-------	--	--	--	---	--------	--	-----	---------	------	----	-------

**RENAULT****AVANTIME**

Avantime 2.0i 16V Turbo		2.0	121	4	04.02-05.03	F4RT 760/762	0,9	PFR6G-9	4377		PFR7G
Avantime 16V Turbo		2.0	121	4	04.02-05.03	F4R 760/761	0,8	BKR6EIX	6418		LPG 1
Avantime 3.0 V6		3.0	154	6	02.02-05.03	L7X 720/721	1,1	PLFR5A-11	6240		LPG 7

**CAPTUR**

Captur 0.9 TCe 90		0.9	66	3	06.13-	H4B 400	0,7	ILKAR7J7G	91121		
Captur 0.9 TCe 90		0.9	66	3	06.13-	H4B408	0,7	ILKAR7J7G	91121		
Captur 1.2 TCe 120		1.2	88	4	06.13-	H5F 403	0,7	ILKAR7F7G	90061		

**CLIO 1**

Clio		1.1	35	4	06.90-03.96	C1E 700	0,8	BP5ES	6511	8	LPG 2
Clio		1.2	40	4	06.90-02.98	E5F 710/716	0,8	BCP5ES	7496	16	LPG 3
Clio		1.2	40	4	06.90-02.98	E5F 710/716	0,8	BCP5ES	7496	16	LPG 3

e kW  
C  
y  
i

0201



Stock-No

VLINE

LPG / CNG

**RENAULT****CLIO 1**

Clio	1.2	40	4	06.90-02.98	E7F 706/700	0,8	BCP5ES	7496	16	LPG 3
Clio	1.2	40	4	11.94-03.96	C3G 720	0,8	BP5ESZ	4691		LPG 2
Clio	1.2	44	4	01.96-06.97	D7F 730	0,9	BK5ESZ	5675		
Clio	1.2	44	4	07.97-02.98	D7F 730	0,8	BKR5EK	7956	23	LPG 1
Clio	1.4	55	4	06.90-02.98	E6J 712 / 713	0,8	BCP5ES	7496	16	LPG 3
Clio	1.4	55	4	06.90-	E7J 718 / 719	0,8	BCP5ES	7496	16	LPG 3
Clio	1.4	55	4	04.96-	E7J 754	0,8	BCP5ES	7496	16	LPG 3
Clio	1.4	58	4	06.90-02.98	E7J 710 / 711	0,8	BCP5ES	7496	16	LPG 3
Clio	1.7	66	4	06.90-03.96	F2N 770	0,8	BP7ES	2412		BPR8EIX
Clio	1.8	65	4	06.90-04.96	F3P 710/714	0,9	BP6ESZ	7639		LPG 2
Clio	1.8	65	4	06.96-02.98	F3P 755	0,9	BP6ESZ	7639		LPG 2
Clio	1.8	66	4	06.90-02.98	F3P	0,7	BP6ESZ	7639		LPG 2
Clio RSi	1.8	79	4	08.94-	F3P 758 Cat.	0,8	BP7ES	2412		BPR8EIX
Clio	1.8	79	4	08.95-	F3P R758	0,7	BP6ES	7811	4	LPG 2
Clio	1.8	81	4	02.91-04.96	F3P 712	0,7	BP6ESZ	7639		LPG 2
Clio 16V	1.8	100	4	03.91-03.96	F7P 720/722	0,5	BKR6EKUB	3584		LPG 1
Clio Williams 2.0 16S	2.0	110	4	12.93-01.96	F7R 700	0,5	BKR6EKUB	3584		LPG 1

**CLIO 2**

Clio 2	1.2	44	4	03.98-	D7F 720/722	0,8	BKR5EK	7956	23	LPG 1
Clio 2	1.2	44	4	10.99-	D7F 726	0,9	BKR6EZ	4619	38	LPG 1
Clio 2	1.2	44	4	10.99-	D7F 726	0,9	BKR6EZ	4619	38	LPG 1
Clio 2 16V	1.2	55	4	03.00-	D4F 712 / 714	0,8	LZKAR7A	6799		
Clio 2	1.4	55	4	03.98-03.01	E7J 780	0,9	BKR5EZ	7642	36	LPG 1
Clio 2	1.4	55	4	07.00- .03	K7J 700/701	0,9	BKR5EZ	7642	36	LPG 1
Clio 2	1.4	55	4	07.00- .03	K7J 710	0,9	BKR5EZ	7642	36	LPG 1
Clio 2 16V	1.4	73	4	03.98-06.00	K4J 712/713	0,9	BKR6EZ	4619	38	LPG 1
Clio 2	1.6	66	4	03.98-09.99	K7M 745	0,8	BKR5EK	7956	23	LPG 1
Clio 2 16V	1.6	66	4	03.98-09.99	K7M 744	0,8	BKR5EK	7956	23	LPG 1
Clio 2	1.6	81	4	02.99-	K4M 748	0,9	BKR6EZ	4619	38	LPG 1
Clio 2 16V RS	2.0	126	4	01.00-	F4R 730	1,0	PFR6E-10	3688		

**CLIO 2 PHASE 2**

Clio 2 Phase 2	1.2	44	4	06.01-	D7FGPL	1,3	PFR5G-13E	2761		LPG 1
Clio 2 Phase 2 8S	1.2	44	4	06.01-	D7F 726	0,9	BKR5EZ	7642	36	LPG 1
Clio 2 Phase 2 16S	1.2	55	4	01.02-	D4F-712	0,8	LZKAR7A	6799		
Clio 2 Phase 2 16S	1.4	72	4	06.01-	K4J 710/711	0,9	BKR6EZ	4619	38	LPG 1
Clio 2 Phase 2 16S	1.6	81	4	06.01-	K4M 744/745	0,9	BKR6EZ	4619	38	LPG 1
Clio 2 Phase 2 16V RS	2.0	126	4	06.01-	F4R 730	1,0	PFR6E-10	3688		
Clio 3 1.2 16V	1.2	55	4	06.05-05.07	D4F 740/764	0,8	LZKAR7A	6799		

**CLIO 3**

Clio 3 1.2 16V	1.2	55	4	05.07-	D4F 722/740/772	0,9	LZKAR7B	5942		
Clio 3 1.2 16V Hi-Flex	1.2	55	4	07.08-	D4F 740/742	0,9	LZKAR7B	5942		
Clio 3 TCe 100	1.2	74	4	05.07-	D4F 780 / 784	0,7	ILKAR7A7	91432		
Clio 3 16V	1.4	70	4	06.05-	K4J 780	0,9	BKR6EZ	4619	38	LPG 1
Clio 3 16V	1.6	81	4	06.05-	K4M 800/801/804	0,9	BKR6EZ	4619	38	LPG 1
Clio 3 1.6 16V	1.6	94	4	11.07-	K4M 862	0,9	PFR7Z-TG	5768		
Clio 3 2.0 16V	2.0	103	4	04.06-	M4R Nissan	1,1	PLZKAR6A-11	5118		
Clio 3 2.0 16V RS	2.0	145	4	02.06-	F4R 830 / 832	0,9	PFR7Z-TG	5768		
Clio 3 2.0 16V RS	2.0	148	4	09.08-	F4R 830	0,9	PFR7Z-TG	5768		

**CLIO 4**

Clio 4 0.9 TCe 90	0.9	66	3	10.12-	H4B 400	0,7	ILKAR7J7G	91121		
-------------------	-----	----	---	--------	---------	-----	-----------	-------	--	--



l kW  
C  
Y  
I

0201



Stock-No

VALVE

LPG / CNG

**RENAULT**

**CLIO 4**

Clio 4 1.2 TCE 120	1.2	88	4	03.13-	H5F 403	0,7	ILKAR7F7G	90061		
Clio 4 1.2	1.2	54	4	10.12-	D4F 740	0,7	ILKAR7A7	91432		ILKAR7A7
Clio 4 1.6 RS	1.6	147	4	03.13-	M5M 400	0,9	DILKAR7C9H	91215		

**ESPACE 2**

Espace 2	2.0		4	04.91-10.96	J7R 768 Cat	0,8	BP6EFS	3812	5	LPG 5
Espace 2	2.2	81	4	04.91-10.96	J7T 772 CAT	0,7	BP7EFS	3526		
Espace 2	2.8	113	6	04.91-10.96	Z7W 712/ 717 Cat	0,7	BP7EFS	3526		

**ESPACE 3**

Espace 3	2.0	103	4	09.00-	F5R	1,1	LFR4AP-11	5613		
Espace 3	2.0	85	4	11.96-09.00	F3R 728 /729 /768 /769	0,9	BPR5ES	7422	6	LPG 2
Espace 3	2.0	103	4	10.98-10.02	F4R 700 /701	0,9	BKR6EZ	4619	38	LPG 1
Espace 3 V6	3.0	121	6	11.96-09.98	Z7X 775	0,5	BKR6EKUB	3584		LPG 1
Espace 3 V6 24 V	3.0	140	6	10.98-	L7X 727	1,0	PFR6E-10	3688		

**ESPACE 4**

Espace 4	2.0	103	4	10.02-	F4Rt	0,9	BKR6EK	2288	20	LPG 1
Espace 4 Turbo	2.0	121	4	10.02-	F4R 760	0,9	PFR6G-9	4377		PFR7G
Grand Espace Turbo	2.0	121	4	.03-	F4R 760/762	0,9	PFR6G-9	4377		PFR7G
Espace 4 Turbo	2.0	125	4	03.05-	F4R 794/795/796/ 797/896/897	0,9	PFR6G-9	4377		PFR7G
Espace 4	3.5	180	6	10.02-	V4Y 711	1,1	PLFR5A-11	6240		LPG 7
Grand Espace 4	3.5	180	6	10.02-	V4Y 711	1,1	PLFR5A-11	6240		LPG 7

**EXPRESS 1**

Express	1.0		4	03.86-08.91	C1C 706/700	0,8	BP5ES	6511	8	LPG 2
Express	1.1	35	4	06.87-10.97	C1E	0,8	BP5ES	6511	8	LPG 2
Express	1.4	44	4	03.86-09.91	C1J / C2J	0,8	BP5ES	6511	8	LPG 2

**EXPRESS 2**

Express	1.0		4	10.91-	C1C	0,8	BP5ES	6511	8	LPG 2
Express	1.2	40	4	10.91-	C3G 710 Cat.	0,9	BP5ESZ	4691		LPG 2
Express	1.2		4	10.91-10.97	C1G	0,8	BP5ES	6511	8	LPG 2
Express	1.4	59	4	10.91-	E7J Cat.	0,8	BCP5ES	7496	16	LPG 3
Express	1.4		4	10.91-	E6J	0,8	BCP5ES	7496	16	LPG 3
Express	1.4		4	08.92-	C3J 760 Cat.	0,9	BPR5ES	7422	6	LPG 2

**FLUENCE**

Fluence 1.6 16V	1.6	81	4	02.10-	K4M 838/839	0,9	BKR6EZ	4619	38	LPG 1
Fluence 2.0 16V	2.0	103	4	02.10-	M4R 714/751	1,1	PLZKAR6A-11	5118		

**GRAND ESPACE**

Grand Espace 4	2.0	121	4	11.02-02.06	F4R794	0,9	PFR6G-9	4377		PFR7G
Grand Espace Turbo	2.0	121	4	.03-	F4R 760/762	0,9	PFR6G-9	4377		PFR7G
Grand Espace 4	3.5	180	6	10.02-	V4Y 715	1,1	PLFR5A-11	6240		LPG 7
Grand Espace 4	3.5	180	6	10.02-	V4Y 711	1,1	PLFR5A-11	6240		LPG 7

**GRAND SCENIC**

Grand Scenic 16 V	2.0	100	4	03.04-06.09	F4R770	0,9	BKR6EZ	4619	38	LPG 1
Grand Scenic 16 V	2.0	100	4	03.04-06.09	F4R771	0,9	BKR6EZ	4619	38	LPG 1
Grand Scenic 16 V	2.0	120	4	03.04-06.09	F4R776	0,9	BKR6EZ	4619	38	LPG 1
Grand Scenic Turbo	2.0	121	4	03.04-	F4RT 760 / 762	0,9	PFR6G-9	4377		PFR7G



e kW C y I



Stock-No



LPG / CNG

**RENAULT****KANGOO**

Kangoo (XCOA)	1.2	44	4	08.97-05.00	D7F 710/720/722/ 726/744/746	0,8	BKR5EK	7956	23	LPG 1
Kangoo	1.2	44	4	05.00-	D7F 710/720/722/ 726 / 744 Euro2000	0,9	BKR6EZ	4619	38	LPG 1
Kangoo	1.2	44	4	05.00-	D7F 726	0,9	BKR6EZ	4619	38	LPG 1
Kangoo	1.2	44	4	05.00-	D7FGPL	1,3	PFR5G-13E	2761		LPG 1
Kangoo 16V	1.2	55	4	07.00-	D4F 712/714	0,8	LZKAR7A	6799		LZKAR7A
Kangoo 16V	1.2	55	4	.07-	D4F 722/740/772	0,9	LZKAR7B	5942		
Kangoo (XCOC)	1.4	55	4	10.97-03.99	E7J 634/635/780	0,9	BKR6EZ	4619	38	LPG 1
Kangoo	1.4	55	4	07.00-	K7J 700/701	0,9	BKR5EZ	7642	36	LPG 1
Kangoo	1.6	70	4	07.01-	K7M 746	0,8	BKR5EK	7956	23	LPG 1
Kangoo 16V	1.6	70	4	07.01-	K4M 708/750/752	0,9	BKR6EZ	4619	38	LPG 1
Kangoo 2 4X4	1.6	70	4	.03-	K4M	0,9	BKR6EZ	4619	38	LPG 1

**KOLEOS**

Koleos 2.5	2.5	125	4	06.08-	2TR700/702/703	1,1	DILKAR6A11	9029		DILKAR6A11
------------	-----	-----	---	--------	----------------	-----	------------	------	--	------------

**LAGUNA 1**

Laguna / Nevada	1.8	66	4	01.94-12.00	F3P 670/674/676/678	0,9	BP6ESZ	7639		LPG 2
Laguna / Nevada	1.8	70	4	01.94-12.00	F3P 720/724	0,9	BP6ESZ	7639		LPG 2
Laguna / Nevada	1.9	103	4	03.94-12.00	N7Q 700	0,8	BKR5EK	7956	23	LPG 1
Laguna / Nevada	2.0	83	4	01.94-03.01	F3R 722/723	0,9	BP6ESZ	7639		LPG 2
Laguna / Nevada	3.0	123	6	04.94-05.96	Z7X 760/765/767	0,5	BKR6EKUB	3584		LPG 1
Laguna / Nevada	3.0	143	6	06.96-04.98	L7X 700/701 (980511-->)	1,0	PFR6E-10	3688		
Laguna / Nevada	3.0		6	09.96-04.98	L7X 700/701 (-->980511)	0,9	BKR6EKC	2848	26	LPG 1

**LAGUNA 1 PHASE 2**

Laguna / Nevada Phase 2	1.6	81	4	04.98-12.00	K4M 720/724	0,8	BKR5EK	7956	23	LPG 1
Laguna / Nevada Phase 2	1.8	88	4	09.98-12.00	F4P 760	0,8	BKR6ES	3783	28	LPG 1
Laguna / Nevada Phase 2	2.0	85	4	04.98-08.98	F3R	0,8	BPR6ES	7822	2	LPG 2
Laguna / Nevada Phase 2	2.0	103	4	02.99-12.00	F4R 780	0,8	BKR6ES	3783	28	LPG 1
Laguna / Nevada Phase 2	3.0	143	6	05.98-12.00	L7X 700/701	1,0	PFR6E-10	3688		

**LAGUNA 2**

Laguna 2 1.6 16V	1.6	81	4	01.01-	K4M 720	0,9	BKR6EZ	4619	38	LPG 1
Laguna 2 1.8 16V	1.8	87	4	01.01-	K4M 720	0,8	BKR6ES	3783	28	LPG 1
Laguna 2 1.8 16V	1.8	87	4	01.01-	F4P 760	0,8	BKR6ES	3783	28	LPG 1
Laguna 2 2.0 16V	2.0	100	4	.04-	F4R atmo	0,9	BKR6EZ	4619	38	LPG 1
Laguna 2 2.0 16V IDE	2.0	103	4	09.01-	F5R 700	1,1	LFR4AP-11	5613		
Laguna 2 2.0 Turbo	2.0	120	4	01.03-03.05	F4R 764 / 765	0,9	PFR6G-9	4377		PFR7G
Laguna 2 2.0 Turbo	2.0	121	4	.03-	F4RT 762	0,9	PFR6G-9	4377		PFR7G
Laguna 2 2.0 Turbo	2.0	125	4	03.05-12.07	F4R 784	0,9	PFR7Z-TG	5768		
Laguna 2 2.0 Turbo	2.0	125	4	03.05-12.07	F4R 786 / 787	0,9	PFR6G-9	4377		PFR7G
Laguna 2 2.0 Turbo	2.0	150	4	03.05-08.07	F4R 886	0,9	PFR6G-9	4377		PFR7G
Laguna 2 2.0 Turbo	2.0	150	4	03.05-08.07	F4R 887	0,9	PFR7Z-TG	5768		
Laguna 2 3.0 V6 24V	3.0	152	6	01.01-12.07	L7X 731	1,1	PLFR5A-11	6240		LPG 7
Laguna 2 3.0 V6 24V	3.0	155	6	01.01-12.07	L7X	1,1	PLFR5A-11	6240		LPG 7

**LAGUNA 3**

Laguna 3 1.6 16V	1.6	85	4	02.07-	K4M	0,9	BKR6EZ	4619	38	LPG 1
Laguna 3 2.0 16V	2.0	100	4	02.07-	F4R	0,9	BKR6EZ	4619	38	LPG 1
Laguna 3 2.0 16V	2.0	103	4	02.07-	M4R 704 / 726	1,1	PLZKAR6A-11	5118		PLZKAR6A-11
Laguna 3 2.0 Turbo	2.0	121	4	02.07-	F4R 762	0,9	PFR6G-9	4377		PFR7G
Laguna 3 2.0 Turbo	2.0	125	4	09.07-	F4R 811 / 813	0,9	PFR6G-9	4377		PFR7G



l kW  
C  
y  
i

0201



Stock-No

ULINE

LPG/CNG

**RENAULT**

**LAGUNA 3**

Laguna 3 2.0 GT Turbo	2.0	150	4	03.08-	F4R 800	0,9	PFR7Z-TG	5768		
-----------------------	-----	-----	---	--------	---------	-----	----------	------	--	--

**LOGAN**

Logan (X90)	1.4	55	4	.05-	K7J710	0,9	BKR6E	6962	28	LPG 1
Logan (X90)	1.6	66	4	.05-	K7M710	0,9	BKR6E	6962	28	LPG 1
Logan (X90)	1.6	66	4	.05-	K7M812	0,9	BKR6E	6962	28	LPG 1

**MEGANE 1**

Mégane	1.8	88	4	10.00-09.03	F4P-720 / 722	1,1	BKR6E-11	2756	14	LPG 1
Mégane / Classic	1.4	51	4	10.95-03.99	E7J 624	0,8	BCP5ES	7496	16	LPG 3
Mégane / Classic	1.4	55	4	10.95-03.99	E7J 764	0,8	BCP5ES	7496	16	LPG 3
Mégane / Classic	1.6	66	4	10.95-10.98	K7M 702/703/720	0,8	BCPR5ES	6130	32	LPG 3
Mégane Coupé / cabrio	1.6	66	4	10.95-10.98	K7M 702/703	0,8	BCPR5ES	6130	32	LPG 3
Mégane / Classic GPL	1.6	66	4	07.97-04.99	K7M 702	0,6	BKR5EIX	6341		LPG 1
Mégane / Classic	1.6	66	4	10.98-04.99	K7M 702/703/720	0,9	BKR5EZ	7642	36	LPG 1
Mégane Coupé / cabrio	1.6	66	4	10.98-03.99	K7M 702/703	0,9	BKR5EZ	7642	36	LPG 1
Mégane / Classic	2.0	85	4	10.95-03.99	F3R 750/751/791, 796, 797, 798	0,9	BPR5ES	7422	6	LPG 2
Mégane Coupé / cabrio	2.0	85	4	10.95-03.99	F3R 750/751/791, 796, 797, 798	0,9	BPR5ES	7422	6	LPG 2
Mégane IDE Coupé Cab. Phase 2 2.0 16V Ide	2.0	103	4	11.99-	F5R 740	1,1	LF4AP-11	5412		
Mégane / Classic	2.0	110	4	10.95-03.99	F7R 710/714	0,5	BKR6EKUB	3584		LPG 1
Mégane Coupé / cabrio	2.0	110	4	10.95-03.99	F7R 710/714	0,5	BKR6EKUB	3584		LPG 1

**MEGANE 1 PHASE 2**

Mégane / Classic Phase 2	1.4	55	4	04.99-	E7J 626	0,8	BKR6ES	3783	28	LPG 1
Mégane / Classic Phase 2	1.4	70	4	09.99-	K4J 750	0,9	BKR6EZ	4619	38	LPG 1
Mégane Coupé / cab. phase 2	1.4	70	4	09.99-	K4J 750	0,9	BKR6EZ	4619	38	LPG 1
Mégane / Classic Phase 2	1.6	66	4	04.99-	K7M 704	0,8	BKR5EK	7956	23	LPG 1
Mégane / Classic Phase 2	1.6	81	4	04.99-	K4M 700/701/704, 706	0,9	BKR6EZ	4619	38	LPG 1
Mégane Coupé / cab. phase 2	1.6	81	4	04.99-	K4M 700/701	0,9	BKR6EZ	4619	38	LPG 1
Mégane Coupé / cab. phase 2	1.8	87	4	05.01-	F4P 760	0,8	BKR6ES	3783	28	LPG 1
Mégane IDE Coupé Cab. Phase 2 2.0 16V Ide	2.0	103	4	11.99-	F5R 740	1,1	LF4AP-11	5412		

**MEGANE 2**

Mégane 2	1.4	70	4	.03-	K4J 730	0,9	BKR6EZ	4619	38	LPG 1
Mégane 2 Coupé / Cab. 16V	1.4	72	4	.03-	K4J	0,9	BKR6EZ	4619	38	LPG 1
Mégane 2 1.6 Flex Fuel	1.6	77	4	02.08-07.09	K4M	1,0	BKR6EZ	4619	38	LPG 1
Mégane 2	1.6	85	4	.03-	K4M 760	0,9	BKR6EZ	4619	38	LPG 1
Mégane 2 Coupé / Cab. 16V	1.6	85	4	.03-	K4M	0,9	BKR6EZ	4619	38	LPG 1
Mégane 2	2.0	100	4	.03-	F4R	0,9	BKR6EZ	4619	38	LPG 1
Mégane 2 Coupé / Cab.	2.0	100	4	.03-	F4R	0,9	BKR6EZ	4619	38	LPG 1
Mégane 2	2.0	121	4	.05-	F4R 762/776	0,9	PFR6G-9	4377		PFR7G
Mégane 2 2.0 Renault Sport	2.0	165	4	05.04-10.09	F4R 774	0,9	PFR7Z-TG	5768		
Mégane 2 2.0 Renault Sport	2.0	169	4	08.06-02.08	F4R 774	0,9	PFR7Z-TG	5768		
Mégane 2 RS	2.0	147	4	.06-	F4R 830	0,9	PFR7Z-TG	5768		
Mégane 2 RS	2.0	165	4	03.04- .07	F4RT 774	0,9	PFR7G-9	4371		
Mégane 2 RS	2.0	169	4	.07-	F4RT 774	0,9	PFR7Z-TG	5768		

**MEGANE 3**

Mégane 3 1.2 TCe 115	1.2	85	4	03.12-	H5F 400	0,7	ILKAR7F7G	90061		
Mégane 3 1.4 TCe 130	1.4	96	4	06.09-	H4J 700	0,7	ILKAR7A7	91432		
Mégane 3 1.6 16V	1.6	74	4	11.08-	K4M 812 / 848	0,9	BKR6EZ	4619	38	LPG 1
Mégane 3 1.6 16V	1.6	81	4	11.08-	K4M 858	0,9	BKR6EZ	4619	38	LPG 1
Mégane 3 2.0 CVT	2.0	103	4	02.09-	M4R 711 / 713	1,1	PLZKAR6A-11	5118		

e kW C  
y  
i

0201



Stock-No

VLINE

LPG / CNG

**RENAULT****MEGANE 3**

Mégane 3 2.0 Tce 180	2.0	132	4	11.08-	F4R 870 / 872	0,9	PFR6G-9	4377		PFR7G
----------------------	-----	-----	---	--------	---------------	-----	---------	------	--	-------

**MODUS**

Modus 16 V	1.2	55	4	09.04-05.07	D4F	0,8	LZKAR7A	6799		LZKAR7A
Modus	1.2	55	4	06.07-	D4F 722/740/772	0,9	LZKAR7B	5942		
Modus Tce 100	1.2	74	4	05.07-	D4F 780/784	0,7	ILKAR7A7	91432		ILKAR7A7
Modus 16 V	1.4	72	4	09.04-	K4M	0,9	BKR6EZ	4619	38	LPG 1
Modus 1.6	1.6	65	4	12.04-	K4M 792/794	0,9	BKR6EZ	4619	38	LPG 1
Modus 1.6	1.6	82	4	09.04-	K4J	0,9	BKR6EZ	4619	38	LPG 1

**R 5**

R 5	1.0	30	4	10.84-12.96	C1C-700	0,7	BP6ES	7811	4	LPG 2
R 5	1.2	40	4	10.86-12.96	C1G 720/722	0,7	BP6ES	7811	4	LPG 2
R 5	1.4	43	4	10.84-12.96	C1J 768	0,7	BP6ES	7811	4	LPG 2
R 5	1.4	44	4	10.84-12.96	C3J 700/702/760	0,9	BPR5ES	7422	6	LPG 2
R 5	1.4	44	4	06.87-12.96	C2J 784	0,7	BP6ES	7811	4	LPG 2
R 5	1.4	49	4	10.84-12.96	C2J 780/781/782	0,7	BP6ES	7811	4	LPG 2
R 5	1.4	49	4	10.84-12.96	C2J 788/789/798	0,7	BP6ES	7811	4	LPG 2
R 5	1.4	50	4	06.87-12.96	C2J 700	0,7	BP6ES	7811	4	LPG 2
R 5 Turbo	1.4	77	4	10.84-12.96	C1J 782/784	0,7	BR8EIX	5044		BR9EIX
R 5	1.7	55	4	10.86-12.96	F3N 716/717	0,8	BPR6ES	7822	2	LPG 2
R 5	1.7	66	4	06.87-12.96	F2N 740/742	0,7	BP6ES	7811	4	LPG 2
R 5	1.7	69	4	10.86-12.96	F3N 702	0,8	BP7ES	2412		BPR8EIX

**R 19**

R 19	1.2	40	4	09.88-30.92	C1G 730	0,9	BP5ESZ	4691		LPG 2
R 19	1.4	43	4	09.88-03.92	C1J 742, C2J 772	0,9	BP5ESZ	4691		LPG 2
R 19	1.4	50	4	09.88-03.96	C2J 776	0,8	BP5ES	6511	8	LPG 2
R 19	1.4	59	4	09.88-03.92	E6J...,E7J.... Cat.	0,8	BCP5ES	7496	16	LPG 3
R 19	1.7	54	4	03.86-	F3N-740/741	0,8	BPR6ES	7822	2	LPG 2
R 19	1.7	55	4	09.88-03.96	F2N-724	0,8	BP7ES	2412		BPR8EIX
R 19	1.7	66	4	09.88-03.92	F3N 746	0,8	BPR6ES	7822	2	LPG 2
R 19	1.7	66	4	09.88-03.92	F3N-742/743 Cat	0,8	BP7ES	2412		BPR8EIX
R 19	1.7	68	4	09.88-03.96	F2N 720/721	0,8	BP7ES	2412		BPR8EIX
R 19	1.8	54	4	.94-	F3N 740 / 741	0,8	BPR6ES	7822	2	LPG 2
R 19	1.8	81	4	06.89-03.92	F7P 700 Cat.	0,5	BKR6EKUB	3584		LPG 1
R 19 16V	1.8		4	06.89-03.96	F7P 704 Cat.	0,7	BCP6ES	4930	17	LPG 3

**R 19 PHASE 2**

R 19 Phase 2	1.2	40	4	04.92-12.95	C1G 730	0,8	BP5ESZ	4691		LPG 2
R 19 Phase 2	1.2	45	4	04.92-12.95	E7F 730 Cat	0,8	BCP5ES	7496	16	LPG 3
R 19 Phase 2	1.4	44	4	04.92-12.95	C3J 710 Cat.	0,9	BPR5ES	7422	6	LPG 2
R 19 Phase 2	1.4	55	4	04.92-12.95	E7J 706	0,8	BCP5ES	7496	16	LPG 3
R 19 Phase 2	1.4	55	4	04.92-12.95	E7J 745	0,8	BCP5ES	7496	16	LPG 3
R 19 Phase 2	1.4		4	04.92-12.95	C1J	0,8	BP5ESZ	4691		LPG 2
R 19 Phase 2	1.4		4	04.92-12.95	E6J...,E7J.... Cat.	0,8	BCP5ES	7496	16	LPG 3
R 19 Phase 2	1.8	70	4	04.92-12.95	F3P 704/706 Cat.	0,7	BP6ES	7811	4	LPG 2
R 19 Phase 2	1.8	99	4	04.92-12.95	F7P 704 Cat.	0,5	BKR6EKUB	3584		LPG 1
R 19 Phase 2	1.8		4	04.92-12.95	F3P 705	0,7	BP6ES	7811	4	LPG 2
R 19 Phase 2	1.8		4	04.92-12.95	F3P 707	0,7	BP6ES	7811	4	LPG 2
R 19 Phase 2	1.8		4	04.92-12.95	F7P 700 Cat.	0,9	BP6ESZ	7639		LPG 2



l kW  
C  
y  
i

0201



Stock-No

VALVE

LPG / CNG

**RENAULT**

**R 21**

R 21	1.4	51	4	09.89-10.93	C2J	0,7	BP6ES	7811	4	LPG 2
R 21 Nevada	1.7	65	4	03.86-12.95	F2N 711	0,8	BP7ES	2412		BPR8EIX
R 21 Nevada	1.7	65	4	02.88-12.95	F2N 754	0,8	BP7ES	2412		BPR8EIX
R 21	1.7		4	09.89-12.95	F3N 726	0,8	BPR6ES	7822	2	LPG 2
R 21 Nevada	1.7		4	09.89-12.95	F3N 722/723	0,8	BP7ES	2412		BPR8EIX
R 21	2.0	66	4	08.86-12.95	F2R 702	0,8	BP7ES	2412		BPR8EIX
R 21	2.0	76	4	03.86-12.95	J6R	0,8	BP6EFS	3812	5	LPG 5
R 21 Nevada	2.0	98	4	05.89-12.95	J7R 754	0,9	BCP6ET	4563		LPG 3
R 21	2.0	99	4	06.90-12.93	J7R 746/747	0,8	BP6EFS	3812	5	LPG 5
R 21 Nevada	2.0	110	4	09.89-12.95	J7R 740	0,9	BCP6ET	4563		LPG 3
R 21 Nevada Turbo	2.0	119	4	08.89-10.93	J7R 752	0,8	TR7IX	3690		
R 21 Nevada Turbo	2.0	119	4	01.93-	J7R 756	0,8	TR7IX	3690		
R 21 Nevada	2.2	79	4	01.93-	J7T 754/755	0,9	BP7EFS	3526		

**R 25**

R 25	2.0	74	4	01.84-12.92	J6R 706/707	0,8	BP6EFS	3812	5	LPG 5
R 25	2.0	74	4	01.84-12.92	J6R 762/763	0,8	BP6EFS	3812	5	LPG 5
R 25	2.0	88	4	06.87-12.92	J7R 722/723	0,9	BP7EFS	3526		
R 25	2.0	103	4	10.88-12.92	J7R 720/721/726	0,9	BCP6ET	4563		LPG 3
R 25	2.2	79	4	10.86-12.92	J7T706/707/730/ 731/732/733	0,9	BP7EFS	3526		
R 25 V6 Turbo	2.5	147	6	05.89-12.92	Z7U700 Cat.	0,8	TR7IX	3690		
R 25 V6	2.8	110	6	06.87-12.92	Z7W 700/701	0,9	BP7EFS	3526		
R 25 V6	2.8	110	6	06.87-12.92	Z7W 706/707 Cat.	0,9	BP7EFS	3526		

**RAPID**

Rapid 1.4	1.4		4	.91-		0,8	BCP5ES	7496	16	LPG 3
Rapid	1.9	47	4	07.95-03.98	F8Q776	0,9	BCP5ES	7496	16	LPG 3
Rapid	1.4	54	4	09.91-08.93	E7J724	0,9	BCP5ES	7496	16	LPG 3
Rapid	1.4	58	4	01.94-03.98	E7J724	0,9	BCP5ES	7496	16	LPG 3
Rapid	1.4	58	4	01.94-03.98	E7J772	0,9	BCP5ES	7496	16	LPG 3
Rapid	1.4	58	4	01.94-03.98	E7J773	0,9	BCP5ES	7496	16	LPG 3
Rapid	1.4	59	4	07.95-08.97	E7J726	0,9	BCP5ES	7496	16	LPG 3
Rapid	1.4	59	4	07.95-08.97	E7J773	0,9	BCP5ES	7496	16	LPG 3

**SAFRANE**

Safrane	1.9		4		N7Q 716	0,5	BKR6EKUB	3584		LPG 1
Safrane	1.9		4	06.92-09.96	N7Q 710/ 711	0,5	BKR6EKUB	3584		LPG 1
Safrane	2.0	77	4	06.92-09.96	J7R 723/733	0,8	BP6EFS	3812	5	LPG 5
Safrane	2.0	97	4	04.92-09.96	J7R 734/735/738/739	0,9	BCP6ET	4563		LPG 3
Safrane	2.2	103	4	06.92-09.96	J7T 760/761	0,9	BCP6ET	4563		LPG 3
Safrane	2.2		4	06.92-09.96	J7T 762	0,8	BP6EFS	3812	5	LPG 5
Safrane V6	3.0	123	6	10.96-	Z7X W755	0,9	BKR6EK	2288	20	LPG 1
Safrane V6	3.0	125	6	06.92-09.96	Z7X 721/722/723/ 753/755	0,5	BKR6EKUB	3584		LPG 1
Safrane Biturbo	3.0	194	6	.94-09.96	Z7X 726	0,8	BKUR7ET	7873		

**SAFRANE PHASE 2**

Safrane Phase 2	1.9	100	4	10.96-12.00	N7Q 710/711	0,8	BKR5EK	7956	23	LPG 1
Safrane Phase 2	2.5	121	6	10.96-12.00	N7U 700/701	0,8	BCPR6ES	2330	12	LPG 3
Safrane Phase 2 V6	3.0	125	6	10.96-03.99	Z7X 721/722/723/ 753/755	0,5	BKR6EKUB	3584		LPG 1
Safrane Phase 2 V6	3.0	143	6	04.99-12.00	L7X 713	1,0	PFR6E-10	3688		

e kW  
C  
y  
i

0201



Stock-No

VLINE

LPG / CNG

**RENAULT****SCENIC 1**

Scenic	1.4	55	4	10.95-03.99	E7J 764	0,8	BCP5ES	7496	16	LPG 3
Scenic	1.6	66	4	10.95-09.98	K7M 702,703,720	0,8	BCPR5ES	6130	32	LPG 3
Scenic GPL	1.6	66	4	07.97-03.99	K7M 702	0,8	BKR5EK	7956	23	LPG 1
Scenic	1.6	66	4	10.98-03.99	K7M 702,703,720	0,9	BKR5EZ	7642	36	LPG 1
Scenic	2.0	85	4	10.95-03.99	F3R 750/751/791 ,796,797,798	0,9	BPR5ES	7422	6	LPG 2

**SCENIC 1 PHASE 2**

Scenic Phase 2	1.4	70	4	09.99-	K4J 750	0,9	BKR6EZ	4619	38	LPG 1
Scenic Phase 2	1.6	81	4	09.99-	K4M 708/709	0,9	BKR6EZ	4619	38	LPG 1
Scenic Phase 2	1.8	87	4	07.00-	F4P 760	0,8	BKR6ES	3783	28	LPG 1
Scenic Phase 2	2.0	103	4	08.99-	F4R 740/741	0,8	BKR6ES	3783	28	LPG 1
Scenic Phase 2	2.0	103	4	03.00-	F4R 744	0,8	BKR6ES	3783	28	LPG 1
Scenic Phase 2	2.0	120	4	03.04-11.08	F4R 776	0,9	PFR6G-9	4377		PFR7G

**SCENIC 2**

Scenic 2 1.4	1.4	72	4	.03-	K4J	0,9	BKR6EZ	4619	38	LPG 1
Scenic 2 1.6	1.6	85	4	.03-	K4M	0,9	BKR6EZ	4619	38	LPG 1
Scenic 2 2.0	2.0	100	4	.03-	F4R	0,9	BKR6EZ	4619	38	LPG 1

**SCENIC 3**

Scenic 3 TCe 130	1.4	96	4	02.09-	H4J 700	0,7	ILKAR7A7	91432		
Scenic 3 2.0 16V	2.0	103	4	02.09-	M4R 710 / 711	1,1	PLZKAR6A-11	5118		

**SPORT SPIDER**

Spider			4		F7R 710/712/720	0,5	BKR6EKUB	3584		LPG 1
Sport Spider	2.0	110	4	03.95-	F7R 710/712/720	0,5	BKR6EKUB	3584		LPG 1

**THALIA / SYMBOL**

Thalia / Symbol 1.2 16V (LB0/1/2)	1.2	55	4	04.02-	D4F 712	0,8	LZKAR7A	6799		
Thalia / Symbol 1.4 (LB0/1/2)	1.4	55	4	08.00-10.05	K7J 700	0,9	BKR5EZ	7642	36	LPG 1
Thalia / Symbol 1.4 16V (LB0/1/2)	1.4	72	4	08.00-	K4J 712	0,9	BKR6EZ	4619	38	LPG 1
Thalia / Symbol 1.6 16V (LB0/1/2)	1.6	79	4	04.02-10.05	K4M 734/740/745	0,9	BKR6EZ	4619	38	LPG 1
Thalia / Symbol II 1.2 16V	1.2	55	4	09.08-	D4F 712	0,8	LZKAR7A	6799		
Thalia / Symbol II 1.6 16V	1.6	77	4	09.08-	K4M 745	0,9	BKR6EZ	4619	38	LPG 1

**TRAFIC**

Trafic T1100 / P1400 / T1400 / V1000	2.0	59	4	09.89-12.97	J5R- 829	0,7	BP6ES	7811	4	LPG 2
Trafic 2.0 16V	2.0	86	4	08.06-	F4R 820	0,9	PFR6G-9	4377		PFR7G
Trafic 2.0	2.0	88	4	03.01-	F4R 720 / 722	0,9	PFR6G-9	4377		PFR7G

**TWINGO 1**

Twingo	1.2	40	4	03.93-06.97	C3G 700	0,9	BP5ESZ	4691		LPG 2
Twingo easy	1.2	40	4	09.94- .96	C3G 702	0,9	BP5ESZ	4691		LPG 2
Twingo	1.2	44	4	04.94-06.97	D7F 730	0,8	BK5ESZ	5675		
Twingo	1.2	44	4	07.97-07.98	D7F 700/701/702 / 703 / 704 / 706	0,8	BKR5EK	7956	23	LPG 1
Twingo	1.2	44	4	04.00-	D7F GPL	1,3	PFR5G-13E	2761		LPG 1

**TWINGO 2**

Twingo 2	1.2	44	4	08.98-	D7F 702/703	0,8	BKR5EK	7956	23	LPG 1
Twingo 2 Euro2000	1.2	44	4	04.00-	D7F 726	0,9	BKR6EZ	4619	38	LPG 1
Twingo 2	1.2	44	4	06.07-	D4F 764	0,9	LZKAR7B	5942		
Twingo 2	1.2	44	4	.08-	D7F 800	0,9	BKR6EZ	4619	38	LPG 1
Twingo 2 16V	1.2	55	4	11.00-	D4F 702/703/704/740	0,8	LZKAR7A	6799		





l kW  
C  
y  
i

0201



Stock-No

VALVE

LPG/CNG

## RENAULT

### TWINGO 2

Twingo 2	1.2	55	4	06.07-	D4F 722/740/772	0,9	LZKAR7B	5942		
Twingo 2 Tce 100	1.2	74	4	06.07-	D4F 780 / 782	0,7	ILKAR7A7	91432		
Twingo 2 1.6 RS	1.6	98	4	05.08-	K4M 854/862	0,9	PFR7Z-TG	5768		

### TWINGO 3

Twingo 3	0.9	66	3	09.14-	H4B401	0,7	ILKAR7J7G	91121		
----------	-----	----	---	--------	--------	-----	-----------	-------	--	--

### VEL SATIS

Vel Satis 16V Turbo	2.0	108	4	04.05-08.09	F4R 867	0,9	PFR6G-9	4377		PFR7G
Vel Satis 16V Turbo	2.0	120	4	03.02-08.09	F4R 760/762/763	0,9	PFR6G-9	4377		PFR7G
Vel Satis 16V Turbo	2.0	125	4	04.04-08.09	F4R 766 / 767	0,9	PFR6G-9	4377		PFR7G
Vel Satis	2.0	147	4	.06-	F4R 830	0,9	PFR7Z-TG	5768		
Vel Satis 3.0 V6 24V	3.5	180	6	02.02-	V4Y 701	1,1	PLFR5A-11	6240		LPG 7

### WIND

Wind 1.2 TCe 100	1.2	74	4	07.10-	D4F 782	0,7	ILKAR7A7	91432		
Wind 1.2 TCe 100	1.2	75	4	02.11-	D4F 780	0,7	ILKAR7A7	91432		
Wind 1.6 16V 130	1.6	98	4	07.10-	K4M 854	0,9	PFR7Z-TG	5768		

## ROLLS ROYCE

Corniche 71-->02	6.75		8	07.93-08.95		0,9	BKR4EVX	4870		
Corniche 71-->02	6.75		8	09.95-		1,3	PFR5G-13E	2761		LPG 1
Flying Spur	6.75		8	08.94-07.95		1,3	PFR5G-13E	2761		LPG 1
Park Ward	5.4		12	10.00-	V12 BMW	1,5	BKR6EQUP	3199	30	LPG 1
Park Ward	6.8		8	02.97-09.00		0,9	BKR4EVX	4870		
Silver Dawn	6.75		8	.94- .98		1,3	PFR5G-13E	2761		LPG 1
Silver Seraph	5.4	240	12	.98-07.99	BMW M73B54	0,9	BKR6EK	2288	20	LPG 1
Silver Seraph	5.4	240	12	08.99-	BMW M73B54	1,5	BKR6EQUP	3199	30	LPG 1
Silver Spirit/ Spur	6.75		8	07.93-		0,9	BKR4EVX	4870		

## ROVER

### 25

25 1.1	1.1	44	4	11.99-	K Series	1,1	PFR6N-11	3546		LPG 1
25 1.1 16V	1.1	55	4	01.04-	K Series	1,1	PFR6N-11	3546		LPG 1
25 1.4 16V	1.4	62	4	11.99-	K Series	1,1	PFR6N-11	3546		LPG 1
25 1.6 16V	1.6	80	4	11.99-	K Series	1,1	PFR6N-11	3546		LPG 1
25 1.8 16V	1.8	85	4	.99-	K Series with VVC	1,1	PFR6N-11	3546		LPG 1
25 Steptronic	1.8	86	4	05.01-		1,1	PFR6N-11	3546		LPG 1
25 1.8 16V	1.8	107	4	02.00-	K Series	1,1	PFR6N-11	3546		LPG 1

### 45

45 1.4	1.4	76	4	11.99-	K Series	1,1	PFR6N-11	3546		LPG 1
45 1.6	1.6	80	4	11.99-	K Series	1,1	PFR6N-11	3546		LPG 1
45 1.8	1.8	86	4	.99-	K Series	1,1	PFR6N-11	3546		LPG 1
45 2.0 V6	2.0	110	6	.99-	KV6	1,1	PFR6N-11	3546		LPG 1

### 75

75 1.8	1.8	87	4	02.99-	K Series	1,1	PFR6N-11	3546		LPG 1
75 1.8 Turbo	1.8		4	07.02-	K Series	1,1	PFR6N-11	3546		LPG 1
75 2.0 V6	2.0	109	6	02.99-	K V6	1,1	PFR6N-11	3546		LPG 1
75 2.5 V6	2.5	128	6	02.99-	K V6	1,1	PFR6N-11	3546		LPG 1

### SERIE 100

111	1.1	44	4	.91-	K8 8 VALVE	0,9	BKR6E	6962	28	LPG 1
-----	-----	----	---	------	------------	-----	-------	------	----	-------

e kW  
C  
y  
i

0201



Stock-No

VLINE

LPG / CNG

**ROVER****SERIE 100**

114	1.4	55	4	.91-	K8	0,9	BKR6E	6962	28	LPG 1
114	1.4		4	.91-	K16	0,9	BKR6E	6962	28	LPG 1

**SERIE 200**

211	1.1	43	4	01.98-04.99	K Series 8 V	0,8	BKR6ES	3783	28	LPG 1
214 Mk.2	1.4		4	10.89-	K Series	0,9	BKR6E	6962	28	LPG 1
214 Mk.3	1.4		4	11.95-		0,9	BKR6E	6962	28	LPG 1
216 Mk.2	1.6		4	10.89-	SOHC	1,1	BCPR6E-11	3132	11	LPG 3
216 Mk.2	1.6		4	09.90-	DOHC	1,1	BCPR6E-11	3132	11	LPG 3
216 Mk.3	1.6		4	11.95-		0,9	BKR6E	6962	28	LPG 1
218 Mk.3	1.8	107	4	01.96-	K Series with WC	1,1	PFR6N-11	3546		LPG 1
220 Mk.2	2.0		4	06.91-	T16 TURBO	0,9	BKR6E	6962	28	LPG 1

**SERIE 400**

414 Mk.1	1.4		4	03.90-07.95		0,9	BKR6E	6962	28	LPG 1
414 Mk.2	1.4		4	05.95-		0,9	BKR6E	6962	28	LPG 1
Tourer 1.6	1.6	80	4	03.96-04.99	K Series	0,8	BKR6ES	3783	28	LPG 1
416 Mk.1	1.6		4	03.90-12.91	DOHC	1,1	BCPR6E-11	3132	11	LPG 3
416 Mk.1	1.6		4	03.90-	SOHC	1,1	BCPR6E-11	3132	11	LPG 3
416 Mk.2	1.6		4	05.95-	Automatik	1,1	BKR6E-11	2756	14	LPG 1
416 Mk.2	1.6		4	05.95-	Schaltgetriebe	0,9	BKR6E	6962	28	LPG 1
418	1.8	105	4	03.96-10.97	K Series	1,1	PFR6N-11	3546		LPG 1
420 Mk.1	2.0		4	10.91-11.94		0,9	BKR6E	6962	28	LPG 1
420 Turbo	2.0		4	.92-	T16 TURBO	0,9	BKR6E	6962	28	LPG 1
420 Mk.2	2.0		4	12.95-		0,7	BCP6ES	4930		LPG 3

**SERIE 600**

618	1.8		4	02.96-	Honda	1,1	ZFR6F-11	4291		LPG 6
620	2.0	85	4	04.93-	HONDA	1,1	ZFR6F-11	4291		LPG 6
620 Turbo	2.0		4	.94-	T Series	0,9	BKR6E	6962	28	LPG 1
623	2.3	116	4	04.94-	HONDA	1,1	ZFR6F-11	4291		LPG 6

**SERIE 800**

820 Turbo	2.0	132	4	10.92-	20T4 TURBO MPI	0,9	BKR6E	6962	28	LPG 1
820	2.0		4	07.86-10.91	M16 Inj.	0,9	BKR6E	6962	28	LPG 1
820	2.0		4	03.91-10.91	M16 Turbo Inj.	0,9	BKR6E	6962	28	LPG 1
820	2.0		4	11.91-	T16 / Turbo/ Inj.	0,9	BKR6E	6962	28	LPG 1
820 i	2.0		4	.91-	20T4 MPI	0,9	BKR6E	6962	28	LPG 1
825 i	2.5		6	01.96-	KV6	0,9	BKR6E	6962	28	LPG 1
827	2.7		6	02.88-01.96	G27A V6	1,1	BCPR6E-11	3132	11	LPG 3

**CITY ROVER**

City Rover 1.4	1.4		4	10.03-	K Series	0,8	BK6E	3536		LPG 1
----------------	-----	--	---	--------	----------	-----	------	------	--	-------

**MAESTRO**

Maestro	1.3	51	4	03.89-12.94		0,8	BPR6ES	7822	2	LPG 2
Maestro	1.6	63	4	07.89-04.92	S Series	0,8	BCPR6ES	2330	12	LPG 3

**METRO**

Metro	1.1		4	05.90-12.94	K8	0,9	BKR6E	6962	28	LPG 1
Metro /16V/16V GTI	1.4		4	05.90-01.95	K8/K16/K16	0,9	BKR6E	6962	28	LPG 1

**RV 8**

MG RV8	3.9	140	8	.94-	V8i	0,8	BPR6ES	7822	2	LPG 2
--------	-----	-----	---	------	-----	-----	--------	------	---	-------



l kW  
C  
y  
i

0201



Stock-No

VALVE

LPG / CNG

## ROVER

### MINI

Mini	1.0		4	10.89-04.92		0,8	BPR6ES	7822	2	LPG 2
Mini Cooper i	1.3	46	4	.91-	12A2EF77/SPI	0,8	BPR6ES	7822	2	LPG 2
Mini	1.3		4	10.89-	not Turbo	0,8	BPR6ES	7822	2	LPG 2

### MONTEGO

Montego 1.4	1.4		4	12.94-		0,7	BCP6ES	4930	17	LPG 3
Montego 1.6	1.6		4	04.89-01.93		0,8	BCPR6ES	2330	12	LPG 3
Montego 2.0	2.0		4	04.89-12.94		0,8	BPR6ES	7822	2	LPG 2

### STREETWISE

Streetwise 1.4	1.4		4	07.03-	K Series	1,1	PFR6N-11	3546		LPG 1
Streetwise 1.4	1.4		4	07.03-	K Series	1,1	PFR6N-11	3546		LPG 1
Streetwise 1.6	1.6		4	07.03-	K Series	1,1	PFR6N-11	3546		LPG 1
Streetwise 1.8	1.8		4	07.03-	K Series	1,1	PFR6N-11	3546		LPG 1

## SAAB

### 900

900	2.0	74	4	- .93	B201C	0,7	BP6ES	7811	4	LPG 2
900	2.0	136	4	10.93-	B204L	1,1	BCPR7ES-11	1095		BCPR7EIX
900	2.0		4	- .93	B202	0,7	PFR5A-11	4588		
900	2.0		4	- .93	B212	0,7	PFR5A-11	4588		
900 Turbo	2.0		4	.83- .93	B201 with APC	0,8	BPR7EIX	4055		BPR8EIX
900	2.5	125	6	.94-	B258 Motronic	0,8	BKR5EK	7956	23	LPG 1
900	2.5		6	10.93-	B258i, B308i	0,9	BKR6EK	2288	20	LPG 1

### 9000

9000	2.0	87	4	09.84-12.98	B202L	1,1	BCPR7ES-11	1095		BCPR7EIX
900	2.0	96	4	08.94-02.98	B204i	0,7	PFR5A-11	4588		
9000	2.0	110	4	.94- .98	B204 E	1,1	BCPR7ES-11	1095		BCPR7EIX
9000	2.0		4	.94- .96	B202 with Di	0,8	BCPR7ES	3330		BCPR7EIX
9000	2.0		4	.94- .96	B202S with Di	0,8	BCPR7ES	3330		BCPR7EIX
9000	2.0		4	- .93	B202i without Di	0,7	PFR5A-11	4588		
9000 CS 2.3-16	2.3	107	4	09.91-12.98	B234i Cat.	1,1	BCPR6ES-11	7121		LPG 3
9000	2.3	125	4	.94- .98	B234 E	1,1	BCPR7ES-11	1095		BCPR7EIX
9000	2.3	147	4	.92- .98	B234L	1,1	BCPR7ES-11	1095		BCPR7EIX
9000 Aero	2.3	165	4	.93- .98	B234R	1,1	BCPR7ES-11	1095		BCPR7EIX
9000 V6	3.0	155	6	11.94-12.98	B308 V6	0,8	BKR5EK	7956	23	LPG 1

### 9-3 1

9-3 2.0 Turbo	YS3D	2.0	113	4	10.98-08.03	B204E	1,1	BCPR7ES-11	1095		BCPR7EIX
9-3 16V Pack	YS3D	2.0	96	4	04.98-08.03	B204i	0,7	PFR5A-11	4588		
9-3 2.0 Turbo	YS3D	2.0	110	4	03.99-08.03	B205E	0,7	PFR5A-11	4588		
9-3 2.0 Turbo	YS3D	2.0	136	4	02.98-07.03	B204L	1,1	BCPR7ES-11	1095		BCPR7EIX
9-3 2.0 Turbo	YS3D	2.0	136	4	02.98-07.03	B205L	1,0	PFR6H-10	6290		PFR7H-10
9-3 2.0 SE Turbo	YS3D	2.0	147	4	02.98-08.03	B204R	1,1	BCPR7ES-11	1095		BCPR7EIX
9-3 2.0 Turbo	YS3D	2.0	151	4	09.99-08.03	B205R	1,0	PFR6H-10	6290		PFR7H-10
9-3 2.3i	YS3D	2.3	110	4	02.98-08.03	B234i	1,0	PFR6H-10	6290		PFR7H-10
9-3 2.3 Turbo	YS3D	2.3	165	4	10.98-03.03	B235R	1,0	PFR6H-10	6290		PFR7H-10
9-3 2.3	YS3D	2.3	169	4	09.99-12.02	B235R	1,0	PFR6H-10	6290		PFR7H-10

### 9-3 2

9-3 1.8i	YS3F	1.8	90	4	11.03-03.09	Z18XE	0,6	BKR5EUPA	3566		
9-3 1.8t	YS3F	2.0	110	4	09.02-12.07	B207E	1,0	PFR6T-10G	5542		
9-3 1.8t	YS3F	2.0	110	4	01.08-07.12	B207E	1,0	PFR6D10G	1632		

e kW  
C  
y  
i

0201



Stock-No

VLINE

LPG/CNG

**SAAB**

<b>9-3 2</b>										
9-3 1.8t BioPower	YS3F	2.0	110	4	01.07-12.07	B207E	1,1	BKR7ESC-11	6313	
9-3 1.8t BioPower	YS3F	2.0	110	4	01.08-07.12	B207E	1,0	PFR6D10G	1632	
9-3 1.8t BioPower from engine-no. 11765306	YS3F	2.0	129	4	01.10-07.12	B207L	1,0	PFR6D10G	1632	
9-3 1.8t BioPower to engine-no. 11765305	YS3F	2.0	129	4	01.07-12.09	B207L	1,1	BKR7ESC-11	6313	
9-3 2.0t	YS3F	2.0	110	4	03.05-12.07	B207E	1,0	PFR6T-10G	5542	
9-3 2.0t	YS3F	2.0	110	4	01.08-07.12	B207E	1,0	PFR6D10G	1632	
9-3 2.0t	YS3F	2.0	120	4	01.07-12.07	B207R	1,0	PFR6T-10G	5542	
9-3 2.0t	YS3F	2.0	120	4	01.08-07.12	B207R	1,0	PFR6D10G	1632	
9-3 2.0t BioPower	YS3F	2.0	120	4	01.07-12.07	B207R	1,1	BKR7ESC-11	6313	
9-3 2.0t BioPower	YS3F	2.0	120	4	01.08-07.12	B207R	1,0	PFR6D10G	1632	
9-3 2.0t	YS3F	2.0	129	4	09.02-12.07	B207L	1,0	PFR6T-10G	5542	
9-3 2.0t	YS3F	2.0	129	4	01.08-07.12	B207L	1,0	PFR6D10G	1632	PFR6D10G
9-3 2.0t BioPower	YS3F	2.0	129	4	01.07-12.07	B207L	1,1	BKR7ESC-11	6313	
9-3 2.0t BioPower	YS3F	2.0	129	4	01.08-07.12	B207L	1,0	PFR6D10G	1632	
9-3 2.0t BioPower to engine-no. 11765305	YS3F	2.0	145	4	06.07-12.07	B207R	1,1	BKR7ESC-11	6313	
9-3 2.0t BioPower from engine-no. 11765306	YS3F	2.0	145	4	01.08-07.12	B207R	1,0	PFR6D10G	1632	
9-3 2.0t	YS3F	2.0	147	4	06.07-12.07	B207R	1,0	PFR6T-10G	5542	
9-3 2.0t	YS3F	2.0	147	4	01.08-07.12	B207R	1,0	PFR6D10G	1632	
9-3 2.0t BioPower to engine-no. 11765305	YS3F	2.0	147	4	06.07-12.07	B207R	1,1	BKR7ESC-11	6313	
9-3 2.0t BioPower from engine-no. 11765306	YS3F	2.0	147	4	01.08-07.12	B207R	1,0	PFR6D10G	1632	
9-3 2.0 T	YS3F	2.0	154	4	09.02-12.07	B207R	1,0	PFR6T-10G	5542	
9-3 2.0 T	YS3F	2.0	154	4	01.08-07.12	B207R	1,0	PFR6D10G	1632	
9-3 2.0 T BioPower	YS3F	2.0	154	4	09.02-12.07	B207R	1,1	BKR7ESC-11	6313	
9-3 2.0 T BioPower	YS3F	2.0	154	4	01.08-07.12	B207R	1,0	PFR6D10G	1632	
9-3 2.0 T	YS3F	2.0	162	4	01.11-07.12	B207R / A20NFT	1,0	PFR6D10G	1632	
9-3 2.0 T BioPower	YS3F	2.0	162	4	01.11-07.12	B207R / A20NFT	1,0	PFR6D10G	1632	
9-3 2.0 T Aero	YS3F	2.0	177	4	05.09-07.12	B207R	1,0	PFR6D10G	1632	
9-3 2.8 Turbo Aero	YS3F	2.8	169	6	04.05-07.12	B284E HFV6	1,0	PLFR6C-10G	1959	
9-3 2.8 Turbo V6	YS3F	2.8	184	6	03.05-12.07	B284E / B284L	1,0	PLFR6C-10G	1959	
9-3 2.8 Turbo V6	YS3F	2.8	184	6	01.08-07.12	B284E / B284L	1,0	DILFR7B10G	97218	
9-3 2.8 Turbo V6	YS3F	2.8	188	6	09.07-12.07	B284L	1,0	PLFR6C-10G	1959	
9-3 2.8 Turbo V6	YS3F	2.8	188	6	01.08-07.12	B284L	1,0	DILFR7B10G	97218	
9-3 2.8 Turbo V6	YS3F	2.8	203	6	02.09-07.12	B284R	1,0	DILFR7B10G	97218	
9-3 2.8 Turbo V6	YS3F	2.8	206	6	09.07-12.07	B284R	1,0	PLFR6C-10G	1959	
9-3 2.8 Turbo V6	YS3F	2.8	206	6	01.08-07.12	B284R	1,0	DILFR7B10G	97218	
<b>9-3 X</b>										
9-3X 2.0 T XWD	YS3F	2.0	154	4	02.09-07.12	B207R	1,0	PFR6T-10G	5542	
9-3X 2.0 T BioPower XWD	YS3F	2.0	154	4	02.09-07.12	B207R	1,1	BKR7ESC-11	6313	
9-3X 2.0 T BioPower XWD	YS3F	2.0	162	4	01.11-07.12	B207R	1,0	PFR6D10G	1632	
<b>9-5 1</b>										
9-5 2.0t	YS3E	2.0	110	4	09.97-05.10	B205E	1,1	BCPR7ES-11	1095	BCPR7EIX
9-5 2.0t Bio Power	YS3E	2.0	132	4	07.07-05.10	A20NHL	1,1	BKR7ESC-11	6313	
9-5 2.0t SE	YS3E	2.0	136	4	07.00-07.01	B205L	1,0	PFR6H-10	6290	PFR7H-10
9-5 2.0t	YS3E	2.0	140	4	09.97-07.00	B205E Trim Kit	1,0	PFR6H-10	6290	PFR7H-10
9-5 2.3t	YS3E	2.3	125	4	09.97-07.01	B235E	1,1	BCPR6ES-11	7121	11 LPG 3
9-5 2.3t	YS3E	2.3	136	4	09.99-05.10	B235E	1,1	BCPR6ES-11	7121	11 LPG 3
9-5 2.3t Bio Power	YS3E	2.3	155	4	09.06-05.10		1,1	BCPR7ES-11	1095	BCPR7EIX
9-5 2.3 Turbo	YS3E	2.3	162	4	07.03-05.10	B235L	1,0	PFR6H-10	6290	PFR7H-10
9-5 2.3 Turbo	YS3E	2.3	165	4	07.98-05.10	B235R	1,0	PFR6H-10	6290	PFR7H-10
9-5 2.3 Turbo	YS3E	2.3	169	4	10.99-09.01	B235R	1,0	PFR6H-10	6290	PFR7H-10
9-5 2.3 Turbo	YS3E	2.3	184	4	10.99-05.10	B235R	1,0	PFR6H-10	6290	PFR7H-10



l kW  
C  
y  
i

0201



Stock-No

VALE

LPG/CNG

## SAAB

### 9-5 1

9-5 2.3 Turbo	YS3E	2.3	191	4	11.05-05.10	B235R	1,0	PFR6H-10	6290		PFR7H-10
9-5 3.0 V6	YS3E	3.0	147	6	09.97-08.05	B308E	1,1	BKR7ES-11	2387		BKR8EIX

### 9-5 2

9-5 1.6T	YS3G	1.6	132	4	05.10-07.12	A16LET	0,9	ZFR6BP-G	1748		
9-5 2.0T Bio Power	YS3G	2.0	162	4	05.10-07.12	A20NFT	0,9	ILTR5D	5476		
9-5 2.0T	YS3G	2.0	162	4	05.10-07.12	A20NHT	0,9	ILTR5D	5476		
9-5 2.8 T V6 XWD	YS3G	2.8	221	6	05.10-07.12	A28NER	1,0	DILFR7B10G	97218		

## SEAT

### ALHAMBRA 1

Alhambra 1.8 T	7V8 / 7V9	1.8	110	4	05.98-02.00	AJH	1,0	BKR6ETA-10	7998		
Alhambra 2.0	7V8 / 7V9	2.0	85	4	03.96-02.00	ADY	0,8	BKUR6ET	6437	27	LPG 1
Alhambra 2.8 V6	7V8 / 7V9	2.8	128	6	06.96-	AAA	0,6	BKR5EKUP	2890		
Alhambra 1.8 T	7V8 / 7V9	1.8	110	4	06.00-03.10	AWC	0,8	PFR6Q	6458	37	LPG 1
Alhambra 2.0	7V8 / 7V9	2.0	85	4	06.00-03.10	ATM	1,0	BKUR6ET-10	2397	24	LPG 1
Alhambra 2.8 V6	7V8 / 7V9	2.8	150	6	06.00-04.02	AUE	1,1	PZFR5D-11	7968	34	LPG 6
Alhambra 2.8 V6	7V8 / 7V9	2.8	150	6	06.00-03.10	AYL	1,1	PZFR5D-11	7968	34	LPG 6

### ALHAMBRA 2

Alhambra 1.4 TSI	710	1.4	110	4	06.10-	CAVA	0,8	SIZFR6B8EG	96209		
Alhambra 1.4 TSI	710	1.4	110	4	06.10-	CNWB	0,8	SIZFR6B8EG	96209		
Alhambra 1.4 TSI	710	1.4	110	4	06.10-	CTHA	0,8	SIZFR6B8EG	96209		
Alhambra 2.0 TSI	710	2.0	147	4	11.10-	CCZA	0,8	PFR7S8EG	1675		PFR8S8EG

### ALTEA

Altea 1.2 TSI	5P1	1.2	77	4	04.10-	CBZB	0,7	IZFR6P7	97153		
Altea 1.4	5P1	1.4	63	4	05.06-	BXW	1,1	ZFR6T-11G	5960	44	
Altea 1.4	5P1	1.4	63	4	05.10-	CGGB	1,1	ZFR6T-11G	5960	44	
Altea 1.4 FSI	5P1	1.4	92	4	11.07-	CAXC	0,9	PZFR6R	5758		
Altea 1.6	5P1	1.6	75	4	03.04-05.05	BGU	1,0	BKUR6ET-10	2397	24	LPG 1
Altea 1.6	5P1	1.6	75	4	05.05-	BSE	1,0	BKUR6ET-10	2397	24	LPG 1
Altea 1.6	5P1	1.6	75	4	05.05- .09	BSF	1,0	BKUR6ET-10	2397	24	LPG 1
Altea 1.6	5P1	1.6	75	4	12.07-	CCSA	1,0	BKUR6ET-10	2397	24	LPG 1
Altea 1.6 LPG	5P1	1.6	75	4	09.09-	CHGA	1,0	BKUR6ET-10	2397	24	LPG 1
Altea 1.8 TFSI	5P1	1.8	118	4	01.07-06.07	BYT	0,8	PFR7S8EG	1675		PFR8S8EG
Altea 1.8 TFSI	5P1	1.8	118	4	06.07-03.09	BZB	0,8	PFR7S8EG	1675		PFR8S8EG
Altea 1.8 TFSI	5P1	1.8	118	4	03.09-	CDA	0,8	PFR7S8EG	1675		PFR8S8EG
Altea 2.0 FSI	5P1	2.0	110	4	05.04-11.05	BLR	1,1	PZFR5N-11T	7742		
Altea 2.0 FSI	5P1	2.0	110	4	11.04-11.05	BLY	0,9	BKR6E	6962	28	LPG 1
Altea 2.0 FSI	5P1	2.0	110	4	11.05-	BVY	1,1	PZFR5N-11T	7742		
Altea 2.0 FSI	5P1	2.0	110	4	11.05-	BVZ	0,9	BKR6E	6962	28	LPG 1
Altea 2.0 TFSI	5P1	2.0	147	4	02.06-05.09	BWA	0,8	PFR7S8EG	1675		PFR8S8EG
Altea XL 1.6 LPG	5P5	1.6	75	4	09.09-	CHGA	1,0	BKUR6ET-10	2397	24	LPG 1
Altea XL 2.0 TFSI 4x4	5P5	2.0	155	4	05.09-	CCZB	0,8	PFR7S8EG	1675		PFR8S8EG

### AROSA

Arosa 1.0	6H	1.0	37	4	02.97-09.99	AER	0,8	BUR6ET	3172	1	LPG 2
Arosa 1.0	6H	1.0	37	4	08.97-06.99	ALL	0,8	BUR6ET	3172	1	LPG 2
Arosa 1.0	6H	1.0	37	4	11.98-02.00	AHT	1,0	BKR6ETA-10	7998		
Arosa 1.0	6H	1.0	37	4	07.99-07.00	ALD	1,1	PZFR5D-11	7968	34	LPG 6
Arosa 1.0	6H	1.0	37	4	07.99-07.00	ANV	1,1	PZFR5D-11	7968	34	LPG 6



e kW C y I



Stock-No



LPG / CNG

**SEAT****AROSA**

Arosa 1.0	6H	1.0	37	4	07.00-06.04	AUC	1,1	PZFR5D-11	7968	34	LPG 6
Arosa 1.4	6H	1.4	44	4	02.97-11.97	AEX	0,8	BUR6ET	3172	1	LPG 2
Arosa 1.4	6H	1.4	44	4	05.97-09.99	AKV	0,8	BUR6ET	3172	1	LPG 2
Arosa 1.4	6H	1.4	44	4	12.97-08.99	APQ	0,8	BUR6ET	3172	1	LPG 2
Arosa 1.4	6H	1.4	44	4	07.99-10.00	AKK	1,1	PZFR5D-11	7968	34	LPG 6
Arosa 1.4	6H	1.4	44	4	07.99-10.00	ANW	1,1	PZFR5D-11	7968	34	LPG 6
Arosa 1.4	6H	1.4	44	4	09.00-06.04	AUD	1,1	PZFR5D-11	7968	34	LPG 6
Arosa 1.4	6H	1.4	55	4	01.98-	AHW	1,0	BKUR6ET-10	2397	24	LPG 1
Arosa 1.4 16V	6H	1.4	74	4	01.99-09.00	AFK	1,0	BKUR6ET-10	2397	24	LPG 1
Arosa 1.4 16V	6H	1.4	74	4	01.99-	ANM	1,0	BKUR6ET-10	2397	24	LPG 1
Arosa 1.4 16V	6H	1.4	74	4	10.99-09.00	AQQ	1,0	BKUR6ET-10	2397	24	LPG 1
Arosa 1.4 16V	6H	1.4	74	4	09.00-06.04	AUB	1,0	BKUR6ET-10	2397	24	LPG 1

**CORDOBA**

Cordoba / Vario		1.0	37	4	09.96-	AER	0,8	BUR6ET	3172	1	LPG 2
Cordoba / Vario		1.0	37	4	08.99-08.02	ALD	1,1	PZFR5D-11	7968	34	LPG 6
Cordoba / Vario		1.0	37	4	08.99-07.00	ANV	1,1	PZFR5D-11	7968	34	LPG 6
Cordoba		1.0	37	4	07.00-	AUC	1,1	PZFR5D-11	7968	34	LPG 6
Cordoba		1.0	51	4	05.00-	AVZ	1,0	BKUR6ETB-10	5742		
Cordoba 12V		1.2	47	3	05.05-06.06	BME	0,9	ZFR5P-G	6893	41	LPG 6
Cordoba		1.3	40	4	02.93-08.94	2G	0,8	BUR6ET	3172	1	LPG 2
Cordoba		1.3	40	4	02.93-08.94	AAV	0,8	BP5ET	2287		LPG 2
Cordoba		1.4	40	4	01.98-	ANX	0,8	BUR6ET	3172	1	LPG 2
Cordoba		1.4	44	4	09.93-12.95	ABD	0,8	BP5ET	2287		LPG 2
Cordoba / Vario		1.4	44	4	09.95-12.97	AEX	0,8	BUR6ET	3172	1	LPG 2
Cordoba / Vario		1.4	44	4	09.97-	AKV	0,8	BUR6ET	3172	1	LPG 2
Cordoba / Vario		1.4	44	4	12.97-05.98	APQ	0,8	BUR6ET	3172	1	LPG 2
Cordoba / Vario		1.4	44	4	08.99-08.02	AKK	1,1	PZFR5D-11	7968	34	LPG 6
Cordoba / Vario		1.4	44	4	05.99-08.00	ANW	1,1	PZFR5D-11	7968	34	LPG 6
Cordoba / Vario		1.4	44	4	06.00-07.05	AUD	1,1	PZFR5D-11	7968	34	LPG 6
Cordoba 16V		1.4	55	4	05.99-06.00	APE	1,0	BKUR6ET-10	2397	24	LPG 1
Cordoba 16V		1.4	55	4	06.00-	AUA	1,0	BKUR6ET-10	2397	24	LPG 1
Cordoba 16 V Automatic		1.4	55	4	09.02-04.04	BBY	1,1	PZFR5D-11	7968	34	LPG 6
Cordoba 16 V		1.4	55	4	05.04-	BKY	1,0	BKUR6ET-10	2397	24	LPG 1
Cordoba 16 V Automatic		1.4	55	4	05.04-	BKY	1,1	PZFR5D-11	7968	34	LPG 6
Cordoba		1.4	63	4	05.06-	BXW	1,1	ZFR6T-11G	5960	44	
Cordoba / Vario 16V		1.4	74	4	06.97-	AFH	0,8	BKUR6ET	6437	27	LPG 1
Cordoba / Vario 16V		1.4	74	4	09.99-07.00	AQQ	1,0	BKUR6ET-10	2397	24	LPG 1
Cordoba / Vario 16V		1.4	74	4	07.00-	AUB	1,0	BKUR6ET-10	2397	24	LPG 1
Cordoba 16 V		1.4	74	4	05.05-	BBZ	1,0	BKUR6ET-10	2397	24	LPG 1
Cordoba		1.6	52	4	11.93-	ABM	0,8	BUR5ET	3377	22	LPG 2
Cordoba		1.6	55	4	02.93-07.94	ABU	0,8	BUR6ET	3172	1	LPG 2
Cordoba / Vario		1.6	55	4	09.94-09.97	1F	0,8	BUR5ET	3377	22	LPG 2
Cordoba / Vario		1.6	55	4	05.97-12.98	AEE	0,8	BUR6ET	3172	1	LPG 2
Cordoba / Vario		1.6	55	4	09.97-08.02	ALM	0,8	BUR6ET	3172	1	LPG 2
Cordoba		1.6	74	4			0,8	BUR5ET	3377	22	LPG 2
Cordoba / Vario		1.6	74	4	09.95-05.98	AFT	1,0	BKUR6ET-10	2397	24	LPG 1
Cordoba		1.6	74	4	01.96-	AEK	0,8	BKUR5ET	2789	29	LPG 1
Cordoba		1.6	74	4	05.99-08.02	AKL	1,0	BKUR6ET-10	2397	24	LPG 1
Cordoba / Vario		1.6	74	4	05.99-08.02	AEH	1,0	BKUR6ET-10	2397	24	LPG 1
Cordoba / Vario		1.6	74	4	03.00-10.00	APF	1,0	BKUR6ET-10	2397	24	LPG 1



l kW  
C  
y  
i

0201



Stock-No

VALUE

LPG/CNG

**SEAT**

**CORDOBA**

Cordoba / Vario	1.6	74	4	05.00-	AUR	1,0	BKUR6ET-10	2397	24	LPG 1
Cordoba	1.6	77	4	11.06-	BTS	1,1	ZFR6T-11G	5960	44	
Cordoba	1.8	55	4	08.91-	AAM	0,8	BUR5ET	3377	22	LPG 2
Cordoba	1.8	66	4	02.93-08.94	ABS	0,8	BUR6ET	3172	1	LPG 2
Cordoba / Vario	1.8	66	4	07.94-	ADZ	0,8	BUR6ET	3172	1	LPG 2
Cordoba	1.8	66	4	07.96-	ACC	0,8	BUR6ET	3172	1	LPG 2
Cordoba	1.8	95	4	02.94-06.96	ADL	0,8	BKUR7ET	7873		
Cordoba 16 V	1.8	100	4			0,8	BUR6ET	3172	1	LPG 2
Cordoba 20V	1.8	115	4	12.99-	AQX	1,0	BKUR6ET-10	2397	24	LPG 1
Cordoba	1.8	115	4	09.00-	AYP	1,0	BKUR6ET-10	2397	24	LPG 1
Cordoba	2.0	85	4	02.93-06.96	2E	0,8	BUR6ET	3172	1	LPG 2
Cordoba / Vario	2.0	85	4	04.96-	AGG	0,8	BUR6ET	3172	1	LPG 2
Cordoba	2.0	85	4	09.02-	AZL	1,0	BKUR6ET-10	2397	24	LPG 1
Cordoba	2.0	85	4	04.03-	BBX	1,0	BKUR6ET-10	2397	24	LPG 1
Cordoba 16V	2.0	110	4	07.96-	ABF	1,0	BKUR6ET-10	2397	24	LPG 1

**EXEO**

Exeo 1.6	3R2 / 3R5	1.6	75	4	03.09-09.10	ALZ	1,0	BKUR6ET-10	2397	24	LPG 1
Exeo 1.8 TSI	3R2 / 3R5	1.8	88	4	09.10-05.13	CDHA	0,8	PFR7S8EG	1675		PFR8S8EG
Exeo 1.8 T	3R2 / 3R5	1.8	110	4	12.08-05.10	CFMA	1,0	BKUR6ET-10	2397	24	LPG 1
Exeo 1.8 TSI	3R2 / 3R5	1.8	118	4	05.10-05.13	CDHB	0,8	PFR7S8EG	1675		PFR8S8EG
Exeo 2.0 TFSI	3R2 / 3R5	2.0	147	4	03.09-05.13	BWE	0,8	PFR7S8EG	1675		PFR8S8EG
Exeo 2.0 TFSI	3R2 / 3R5	2.0	155	4	05.10-05.13	CDND	0,8	PFR7S8EG	1675		PFR8S8EG

**IBIZA 1**

Ibiza 1 0.9	021A	0.9	29	4	06.84-09.93	NCA	0,8	BPR6ES	7822		LPG 2
Ibiza 1 1.2i	021A	1.2	52	4	08.89-03.93	021-C-1000 Cat.	0,9	BCP7ES	5030		BCPR7EIX
Ibiza 1 1.5	021A	1.5	65	4	04.89-08.91	021-D-2000	0,9	BCP7ES	5030		BCPR7EIX
Ibiza 1 1.5i	021A	1.5	66	4	09.87-09.93	021-C-2000 Cat.	0,9	BCP7ES	5030		BCPR7EIX
Ibiza 1 1.5i SXi	021A	1.5	74	4	06.88-08.91	021-B-2000	0,9	BCP7ES	5030		BCPR7EIX
Ibiza 1 1.7	021A	1.7	72	4	02.92-05.93	021A3000	0,9	BCP7ES	5030		BCPR7EIX

**IBIZA 2**

Ibiza 2 1.0	6K1	1.0	33	4	03.93-09.96	AAU	0,8	BP5ET	2287		LPG 2
Ibiza 2 1.0	6K1	1.0	37	4	09.96-08.99	AER	0,8	BUR6ET	3172	1	LPG 2
Ibiza 2 1.3	6K1	1.3	40	4	02.93-08.94	2G	0,8	BP6ET	1263		LPG 2
Ibiza 2 1.3	6K1	1.3	40	4	02.93-08.99	AAV	0,8	BP5ET	2287		LPG 2
Ibiza 2 1.4	6K1	1.4	44	4	09.93-12.95	ABD	0,8	BP5ET	2287		LPG 2
Ibiza 2 1.4	6K1	1.4	44	4	09.95-12.97	AEX	0,8	BUR6ET	3172	1	LPG 2
Ibiza 2 1.4	6K1	1.4	44	4	09.97-08.99	AKV	0,8	BUR6ET	3172	1	LPG 2
Ibiza 2 1.4	6K1	1.4	44	4	12.97-05.98	APQ	0,8	BUR6ET	3172	1	LPG 2
Ibiza 2 1.4 16V	6K1	1.4	74	4	06.97-08.99	AFH	0,8	BKUR6ET	6437	27	LPG 1
Ibiza 2 1.6	6K1	1.6	55	4	02.93-07.94	ABU	0,8	BUR6ET	3172	1	LPG 2
Ibiza 2 1.6	6K1	1.6	55	4	09.94-09.97	1F	0,8	BUR5ET	3377	22	LPG 2
Ibiza 2 1.6	6K1	1.6	55	4	05.97-12.98	AEE	0,8	BUR6ET	3172	1	LPG 2
Ibiza 2 1.6	6K1	1.6	55	4	09.97-05.02	ALM	0,8	BUR6ET	3172	1	LPG 2
Ibiza 2 1.6	6K1	1.6	74	4	09.95-05.98	AFT	1,0	BKUR6ET-10	2397	24	LPG 1
Ibiza 2 1.8	6K1	1.8	66	4	02.93-08.94	ABS	0,8	BUR6ET	3172	1	LPG 2
Ibiza 2 1.8	6K1	1.8	66	4	07.94-08.99	ADZ	0,8	BUR6ET	3172	1	LPG 2
Ibiza 2 1.8 16V	6K1	1.8	95	4	02.94-06.96	ADL	0,8	BKUR7ET	7873		
Ibiza 2 2.0	6K1	2.0	85	4	02.93-06.96	2E	0,8	BUR6ET	3172	1	LPG 2
Ibiza 2 2.0	6K1	2.0	85	4	04.96-08.99	AGG	0,8	BUR6ET	3172	1	LPG 2

e kW  
C  
y  
i

0201



Stock-No

VELENE

LPG / CNG

**SEAT****IBIZA 2**

Ibiza 2 2.0 16V	6K1	2.0	110	4	07.96-08.99	ABF	1,0	BKUR6ET-10	2397	24	LPG 1
-----------------	-----	-----	-----	---	-------------	-----	-----	------------	------	----	-------

**IBIZA 3**

Ibiza 3 1.0	6K1	1.0	37	4	08.99-05.02	ALD	1,1	PZFR5D-11	7968	34	LPG 6
Ibiza 3 1.0	6K1	1.0	37	4	08.99-07.00	ANV	1,1	PZFR5D-11	7968	34	LPG 6
Ibiza 3 1.0	6K1	1.0	37	4	07.00-05.02	AUC	1,1	PZFR5D-11	7968	34	LPG 6
Ibiza 3 1.4	6K1	1.4	44	4	08.99-05.02	AKK	1,1	PZFR5D-11	7968	34	LPG 6
Ibiza 3 1.4	6K1	1.4	44	4	05.99-08.00	ANW	1,1	PZFR5D-11	7968	34	LPG 6
Ibiza 3 1.4	6K1	1.4	44	4	06.00-05.02	AUD	1,1	PZFR5D-11	7968	34	LPG 6
Ibiza 3 1.4 16V	6K1	1.4	55	4	09.99-06.00	APE	1,0	BKUR6ET-10	2397	24	LPG 1
Ibiza 3 1.4 16V	6K1	1.4	55	4	06.00-05.02	AUA	1,0	BKUR6ET-10	2397	24	LPG 1
Ibiza 3 1.4 16V	6K1	1.4	74	4	09.99-07.00	AQQ	1,0	BKUR6ET-10	2397	24	LPG 1
Ibiza 3 1.4 16V	6K1	1.4	74	4	07.00-05.02	AUB	1,0	BKUR6ET-10	2397	24	LPG 1
Ibiza 3 1.6	6K1	1.6	74	4	05.99-05.02	AEH	1,0	BKUR6ET-10	2397	24	LPG 1
Ibiza 3 1.6	6K1	1.6	74	4	06.99-05.02	AKL	1,0	BKUR6ET-10	2397	24	LPG 1
Ibiza 3 1.6	6K1	1.6	74	4	03.00-02.02	APF	1,0	BKUR6ET-10	2397	24	LPG 1
Ibiza 3 1.6	6K1	1.6	74	4	05.00-05.02	AUR	1,0	BKUR6ET-10	2397	24	LPG 1
Ibiza 3 1.8T 20V Cupra	6K1	1.8	115	5	12.99-02.02	AQX	1,0	BKUR6ET-10	2397	24	LPG 1
Ibiza 3 1.8T 20V Cupra	6K1	1.8	115	5	05.00-05.02	AYP	1,0	BKUR6ET-10	2397	24	LPG 1

**IBIZA 4**

Ibiza 4 1.2	6L1	1.2	44	3	06.07-05.08	BBM	0,9	ZFR5P-G	6893	41	LPG 6
Ibiza 4 1.2	6L1	1.2	47	3	01.02-06.06	AZQ	0,9	ZFR5P-G	6893	41	LPG 6
Ibiza 4 1.2 (0E 101000060AA)	6L1	1.2	47	3	01.02-06.06	AZQ	0,9	BKUR5ET-10	7553		LPG 1
Ibiza 4 1.2	6L1	1.2	47	3	05.05-06.06	BME	0,9	ZFR5P-G	6893	41	LPG 6
Ibiza 4 1.2 12V	6L1	1.2	51	3	05.06-11.09	BXV	0,9	ZFR5P-G	6893	41	LPG 6
Ibiza 4 1.4 12V	6L1	1.4	55	4	01.02-04.04	BBY	1,0	BKUR6ET-10	2397	24	LPG 1
Ibiza 4 1.4 12V	6L1	1.4	55	4	05.04-06.06	BKY	1,0	BKUR6ET-10	2397	24	LPG 1
Ibiza 4 1.4 12V Automatic	6L1	1.4	55	4	01.02-04.04	BBY	1,1	PZFR5D-11	7968	34	LPG 6
Ibiza 4 1.4 12V Automatic	6L1	1.4	55	4	05.04-06.06	BKY	1,1	PZFR5D-11	7968	34	LPG 6
Ibiza 4 1.4 16V	6L1	1.4	74	4	04.02-11.09	BBZ	1,0	BKUR6ET-10	2397	24	LPG 1
Ibiza 4 1.6	6L1	1.6	74	4	01.07-11.09	BAH	1,1	PZFR5D-11	7968	34	LPG 6
Ibiza 4 1.8T FR	6L1	1.8	110	4	12.03-05.08	BJX	0,8	PFR6Q	6458	37	LPG 1
Ibiza 4 1.8T FR	6L1	1.8	110	4	12.03-05.08	BKV	0,8	PFR6Q	6458	37	LPG 1
Ibiza 4 1.8T Cupra R	6L1	1.8	132	4	05.04-02.08	BBU	0,8	PFR6Q	6458	37	LPG 1
Ibiza 4 2.0	6L1	2.0	85	4	07.02-04.04	AZL	1,0	BKUR6ET-10	2397	24	LPG 1
Ibiza 4 2.0	6L1	2.0	85	4	04.03-11.09	BBX	1,0	BKUR6ET-10	2397	24	LPG 1

**IBIZA 5**

Ibiza 5 1.2	6J5	1.2	44	3	07.09-	CGPB	1,1	ZFR6T-11G	5960	44	
Ibiza 5 1.2 TSI	6J5	1.2	63	4	08.12-	CBZA	0,7	IZFR6P7	97153		
Ibiza 5 1.2	6J5	1.2	51	3	03.08-	BZG	0,9	ZFR5P-G	6893	41	LPG 6
Ibiza 5 1.2	6J5	1.2	51	3	05.09-	CGPA	0,9	ZFR6T-11G	5960	44	
Ibiza 5 1.2 TSI	6J5	1.2	77	4	09.10-	CBZB	0,7	IZFR6P7	97153		
Ibiza 5 1.4 TSI ACT	6J5	1.4	103	4	10.13-	CPTA	0,8	PZKER7A8EGS	94968		
Ibiza 5 1.4 TSI	6J5	1.4	110	4	02.12-	CNUB	0,8	SIZFR6B8EG	96209		
Ibiza 5 1.4	6J5	1.4	63	4	05.06-	BXW	1,1	ZFR6T-11G	5960	44	
Ibiza 5 1.4	6J5	1.4	63	4	07.08-	CGGB	1,1	ZFR6T-11G	5960	44	
Ibiza 5 1.4 TSI	6J5	1.4	110	4	06.09-	CAVF	0,8	SIZFR6B8EG	96209		
Ibiza 5 1.4 TSI	6J5	1.4	132	4	05.09-	CAVE	0,8	SIZFR6B8EG	96209		
Ibiza 5 1.6 BiFuel	6J5	1.6	60	4	05.11-	CNKA	1,1	ZFR6T-11G	5960	44	
Ibiza 5 1.6	6J5	1.6	77	4	11.06-	BTS	1,1	ZFR6T-11G	5960	44	





l kW C y l

0201



Stock-No

VLINE

LPG/CNG

**SEAT****IBIZA 5**

Inca	6K9	1.4	44	4	11.95-12.97	AEX	0,8	BUR6ET	3172	1	LPG 2
Inca	6K9	1.4	44	4	12.97-09.00	AKV	0,8	BUR6ET	3172	1	LPG 2
Inca	6K9	1.4	44	4	12.97-06.03	APQ	0,8	BUR6ET	3172	1	LPG 2
Inca	6K9	1.4	44	4	09.00-06.03	AUD	1,1	PZFR5D-11	7968	34	LPG 6
Inca 16V	6K9	1.4	55	4	09.00-06.03	AUA	1,0	BKUR6ET-10	2397	24	LPG 1
Inca	6K9	1.6	55	4	11.95-05.97	1F	0,8	BUR5ET	3377	22	LPG 2
Inca	6K9	1.6	55	4	06.97-09.00	AEE	0,8	BUR6ET	3172	1	LPG 2

**LEÓN 1**

León 1 1.4 16V	1M1	1.4	55	4	11.99-05.00	APE	1,0	BKUR6ET-10	2397	24	LPG 1
León 1 1.4 16V	1M1	1.4	55	4	01.00-05.02	AHW	1,0	BKUR6ET-10	2397	24	LPG 1
León 1 1.4 16V	1M1	1.4	55	4	.00-	AKQ	1,0	BKUR6ET-10	2397	24	LPG 1
León 1 1.4 16V	1M1	1.4	55	4	06.00-02.02	AXP	1,0	BKUR6ET-10	2397	24	LPG 1
León 1 1.4 16V	1M1	1.4	55	4	02.02-10.05	BCA	1,0	BKUR6ET-10	2397	24	LPG 1
León 1 1.6	1M1	1.6	74	4	11.98-10.05	AEH	1,0	BKUR6ET-10	2397	24	LPG 1
León 1 1.6	1M1	1.6	74	4	10.98-10.05	AKL	1,0	BKUR6ET-10	2397	24	LPG 1
León 1 1.6	1M1	1.6	75	4	10.05-	BFQ	1,0	BKUR6ET-10	2397	24	LPG 1
León 1 1.6 16V	1M1	1.6	77	4	11.99-	ATN	1,0	BKUR6ET-10	2397	24	LPG 1
León 1 1.6 16V	1M1	1.6	77	4	06.00-04.01	AUS	1,0	BKUR6ET-10	2397	24	LPG 1
León 1 1.6 16V	1M1	1.6	77	4	05.01-04.02	AZD	1,1	PZFR5D-11	1664	34	LPG 6
León 1 1.6 16V	1M1	1.6	77	4	04.02-06.06	BCB	1,1	PZFR5D-11	1664	34	LPG 6
León 1 1.8 20V	1M1	1.8	92	4	10.98-12.03	AGN	1,0	BKUR6ET-10	2397	24	LPG 1
León 1 1.8 20V	1M1	1.8	92	4	06.00-10.05	APG	1,0	BKUR6ET-10	2397	24	LPG 1
León 1 1.8 20V T	1M1	1.8	132	4	11.99-	APP	0,8	PFR6Q	6458	37	LPG 1
León 1 1.8 20V T	1M1	1.8	132	4	09.00-10.05	AUQ	0,8	PFR6Q	6458	37	LPG 1
León 1 1.8 20V T	1M1	1.8	132	4	05.01-10.05	AUQ	0,8	PFR6Q	6458	37	LPG 1
León 1 1.8 20V T4	1M1	1.8	132	4	04.00-	AJQ	0,8	PFR6Q	6458	37	LPG 1
León 1 1.8 20V T4	1M1	1.8	132	4	09.00-04.04	ARY	0,8	PFR6Q	6458	37	LPG 1
León 1 1.8T Cupra R	1M1	1.8	154	4	05.02-05.03	AMK	0,8	PFR6Q	6458	37	LPG 1
León 1 1.8T Cupra R	1M1	1.8	165	4	05.03-	BAM	0,8	PFR6Q	6458	37	LPG 1
León 1 2.3 V5 20V	1M1	2.3	125	5	05.01-11.03	AQN	1,1	PZFR5D-11	7968	34	LPG 6
León 1 2.8 Cupra 4	1M1	2.8	150	6	06.01-04.04	BDE	1,1	PZFR5D-11	7968	34	LPG 6
León 1 2.8 Cupra 4	1M1	2.8	150	6	05.01-07.01	AUE	1,1	PZFR5D-11	7968	34	LPG 6

**LEÓN 2**

León 2 1.2 TSI	1P1	1.2	77	4	02.10-	CBZB	0,7	IZFR6P7	97153		
León 2 1.4 16V	1P1	1.4	63	4	06.06-	BXW	1,1	ZFR6T-11G	5960	44	
León 2 1.4 16V	1P1	1.4	63	4	05.10-	CGGB	0,8	SIZFR6B8EG	96209		
León 2 1.4 TFSI	1P1	1.4	92	4	11.07-	CAXC	0,9	PZFR6R	5758		
León 2 1.6	1P1	1.6	75	4	07.05-	BSE	1,0	BKUR6ET-10	2397	24	LPG 1
León 2 1.6	1P1	1.6	75	4	07.05-	BSF	1,0	BKUR6ET-10	2397	24	LPG 1
León 2 1.6	1P1	1.6	75	4	10.09-	CCSA	1,0	BKUR6ET-10	2397	24	LPG 1
León 2 1.6 LPG	1P1	1.6	75	4	12.09-	CHGA	1,0	BKUR6ET-10	2397	24	LPG 1
León 2 1.8 TFSI	1P1	1.8	118	4	05.07-03.09	BZB	0,8	PFR7S8EG	1675		PFR8S8EG
León 2 1.8 TFSI	1P1	1.8	118	4	03.09-	CDAA	0,8	PFR7S8EG	1675		PFR8S8EG
León 2 2.0 FSI	1P1	2.0	110	4	07.05-11.05	BLR	1,1	PZFR5N-11T	7742		
León 2 2.0 FSI	1P1	2.0	110	4	07.05-11.05	BLY	1,1	PZFR5N-11T	7742		
León 2 2.0 FSI	1P1	2.0	110	4	11.05-03.09	BVY	1,1	PZFR5N-11T	7742		
León 2 2.0 FSI	1P1	2.0	110	4	11.05-	BVZ	1,1	PZFR5N-11T	7742		
León 2 2.0 TFSI	1P1	2.0	136	4	10.05-05.06	BWA1	0,8	PFR7S8EG	1675		PFR8S8EG
León 2 2.0 TFSI	1P1	2.0	147	4	05.05-03.09	BWA	0,8	PFR7S8EG	1675		PFR8S8EG
León 2 2.0 TFSI	1P1	2.0	155	4	06.09-	CCZB	0,8	PFR7S8EG	1675		PFR8S8EG

e kW  
C  
Y  
I

0201



Stock-No

VLINE

LPG / CNG

**SEAT****LEÓN 2**

León 2 2.0 TFSI	1P1	2.0	177	4	11.06-05.09	BWJ	0,8	PFR7S8EG	1675		PFR8S8EG
León 2 2.0 TFSI	1P1	2.0	177	4	06.09-	CDLD	0,8	PFR7S8EG	1675		PFR8S8EG
León 2 2.0 TFSI Cupra R	1P1	2.0	195	4	09.09-	CDLA	0,8	PFR7S8EG	1675		PFR8S8EG

**LEÓN 3**

León 3 1.2 TSI	5F1	1.2	63	4	01.13-	CJZB	0,8	PZKER7A8EGS	94968		
León 3 1.2 TSI	5F1	1.2	77	4	01.13-	CJZA	0,8	PZKER7A8EGS	94968		
León 3 1.2 TSI	5F1	1.2	81	4	04.14-	CYVB	0,8	PZKER7A8EGS	94968		
León 3 1.4 TSI	5F1	1.4	103	4	09.12-	CHPA	0,8	PZKER7A8EGS	94968		
León 3 1.4 TSI ACT	5F1	1.4	110	4	05.14-	CZEA	0,8	PZKER7A8EGS	94968		
León 3 1.4 TSI	5F1	1.4	103	4	09.12-	CPTA	0,8	PZKER7A8EGS	94968		
León 3 1.4 TSI	5F1	1.4	90	4	10.12-	CMBA	0,8	PZKER7A8EGS	94968		
León 3 1.4 TSI	5F1	1.4	92	4	05.14-	CZCA	0,8	PZKER7A8EGS	94968		
León 3 1.8 TSI	5F1	1.8	132	4	02.13-	CJSA	0,8	PLFER7A8EG	94833		
León 3 2.0 TSI Cupra	5F1	2.0	195	4	10.13-	CJXE	0,8	PLFER7A8EG	94833		
León 3 2.0 TSI Cupra	5F1	2.0	206	4	10.13-	CJXA	0,8	PLFER7A8EG	94833		

**MARBELLA**

Marbella 0.9		0.9	30	4	.92-05.98	09NCB Cat.	0,9	BPR5ES	7422	6	LPG 2
--------------	--	-----	----	---	-----------	------------	-----	--------	------	---	-------

**TERRA**

Terra 0.9		0.9	29	4	09.87-08.91	09NCA	0,8	BPR6ES	7822	2	LPG 2
Terra 0.9		0.9	29	4	08.91-05.98	09NCB Cat.	0,9	BPR5ES	7422	2	LPG 2

**TOLEDO 1**

Toledo 1 1.6	1L	1.6	52	4	11.93-10.99	ABN	0,8	BUR5ET	3377	22	LPG 2
Toledo 1 1.6	1L	1.6	54	4	08.91-10.99	EZ	1,0	BUR5ET-10	7264	21	LPG 2
Toledo 1 1.6	1L	1.6	55	4	11.93-03.99	1F	0,8	BUR5ET	3377	22	LPG 2
Toledo 1 1.6	1L	1.6	55	4	03.93-	ABU	0,8	BUR6ET	3172	1	LPG 2
Toledo 1 1.6	1L	1.6	74	4	04.96-03.99	AFT	1,0	BKUR6ET-10	2397	24	LPG 1
Toledo 1 1.8	1L	1.8	66	4	05.91-07.94	ABS	0,8	BUR6ET	3172	1	LPG 2
Toledo 1 1.8	1L	1.8	66	4	08.91-12.92	RP	0,8	BUR6ET	3172	1	LPG 2
Toledo 1 1.8	1L	1.8	66	4	11.94-05.99	ADZ	0,8	BUR6ET	3172	1	LPG 2
Toledo 1 1.8	1L	1.8	66	4	01.95-	ACC	0,8	BUR6ET	3172	1	LPG 2
Toledo 1 1.8 16V	1L	1.8	92	4	08.91-05.94	PL	0,8	BKUR7ET	7873		PFR7Q
Toledo 1 1.8 16V	1L	1.8	98	4	08.91-	KR	0,9	BCPR7ET	2164		BCPR7EIX
Toledo 1 2.0	1L	2.0	85	4	05.91-	2E	0,8	BUR6ET	3172	1	LPG 2
Toledo 1 2.0	1L	2.0	85	4	07.95-03.99	AGG	0,8	BUR6ET	3172	1	LPG 2
Toledo 1 2.0 16V	1L	2.0	100	4		9A	0,8	BKUR7ET	7873		
Toledo 1 2.0 16V	1L	2.0	110	4	05.94-03.99	ABF	1,0	BKUR6ET-10	2397	24	LPG 1

**TOLEDO 2**

Toledo 2 1.4 16V	1M2	1.4	55	4	11.99-	APE	1,0	BKUR6ET-10	2397	24	LPG 1
Toledo 2 1.4 16V	1M2	1.4	55	4	01.00-05.02	AHW	1,0	BKUR6ET-10	2397	24	LPG 1
Toledo 2 1.4 16V	1M2	1.4	55	4	06.00-	AXP	1,0	BKUR6ET-10	2397	24	LPG 1
Toledo 2 1.4 16V	1M2	1.4	55	4	02.02-10.05	BCA	1,0	BKUR6ET-10	2397	24	LPG 1
Toledo 2 1.6	1M2	1.6	74	4	01.96-.03	AEK	0,8	BKUR5ET	2789	29	LPG 1
Toledo 2 1.6	1M2	1.6	74	4	11.98-10.05	AEH	1,0	BKUR6ET-10	2397	24	LPG 1
Toledo 2 1.6	1M2	1.6	74	4	02.99-10.05	AKL	1,0	BKUR6ET-10	2397	24	LPG 1
Toledo 2 1.6	1M2	1.6	74	4	09.99-	APF	1,0	BKUR6ET-10	2397	24	LPG 1
Toledo 2 1.6	1M2	1.6	75	4	10.05-	BFQ	1,0	BKUR6ET-10	2397	24	LPG 1
Toledo 2 1.6	1M2	1.6	77	4	11.99-	ATN	1,0	BKUR6ET-10	2397	24	LPG 1
Toledo 2 1.6 16V	1M2	1.6	77	4	06.00-	AUS	1,0	BKUR6ET-10	2397	24	LPG 1
Toledo 2 1.6 16V	1M2	1.6	77	4	09.00-04.02	AZD	1,0	BKUR6ET-10	2397	24	LPG 1
Toledo 2 1.6 16V	1M2	1.6	77	4	04.02-05.06	BCB	1,1	PZFR5D-11	1664	34	LPG 6



l kW  
C  
y  
i

0201



Stock-No

VALVE

LPG/CNG

**SEAT**

**TOLEDO 2**

Toledo 2 1.8 20V	1M2	1.8	92	4	10.98-12.03	AGN	1,0	BKUR6ET-10	2397	24	LPG 1
Toledo 2 1.8 20V	1M2	1.8	92	4	09.00-10.05	APG	1,0	BKUR6ET-10	2397	24	LPG 1
Toledo 2 1.8 20V Cupra R	1M2	1.8	154	4	05.02-05.03	AMK	0,8	PFR6Q	6458	37	LPG 1
Toledo 2 1.8 20V Cupra R	1M2	1.8	165	4	05.03-	BAM	0,8	PFR6Q	6458	37	LPG 1
Toledo 2 1.8 20V T	1M2	1.8	132	4	11.99-	APP	0,8	PFR6Q	6458	37	LPG 1
Toledo 2 1.8 20V T	1M2	1.8	132	4	03.00-01.01	AJQ	0,8	PFR6Q	6458	37	LPG 1
Toledo 2 1.8 20V T	1M2	1.8	132	4	05.01-04.04	ARY	0,8	PFR6Q	6458	37	LPG 1
Toledo 2 1.8 20V T	1M2	1.8	132	4	05.01-10.05	AUQ	0,8	PFR6Q	6458	37	LPG 1
Toledo 2 2.0	1M2	2.0	85	4	06.99-	AQY	1,0	BKUR6ET-10	2397	24	LPG 1
Toledo 2 2.3 V5	1M2	2.3	110	5	10.98-11.00	AGZ	0,6	BKR5EKUP	2890		
Toledo 2 2.3 V5 20V	1M2	2.3	125	5	09.00-11.03	AQN	1,1	PZFR5D-11	7968	34	LPG 6
Toledo 2 2.8 V6	1M2	2.8	150	6	05.01-	AUE	1,1	PZFR5D-11	7968	34	LPG 6
Toledo 2 2.8 V6	1M2	2.8	150	6	05.02-04.04	BDE	1,1	PZFR5D-11	7968	34	LPG 6

**TOLEDO 3**

Toledo 3 1.4 TFSI	5P2	1.4	92	4	11.07-05.09	CAXC	0,9	PZFR6R	5758		
Toledo 3 1.6	5P2	1.6	75	4	09.04-05.05	BGU	1,0	BKUR6ET-10	2397	24	LPG 1
Toledo 3 1.6	5P2	1.6	75	4	05.05-	BSE	1,0	BKUR6ET-10	2397	24	LPG 1
Toledo 3 1.6	5P2	1.6	75	4	05.05-05.07	BSF	1,0	BKUR6ET-10	2397	24	LPG 1
Toledo 3 1.6	5P2	1.6	75	4	12.07-	CCSA	1,0	BKUR6ET-10	2397	24	LPG 1
Toledo 3 1.8 TFSI	5P2	1.8	118	4	01.07-06.07	BYT	0,8	PFR7S8EG	1675		PFR8S8EG
Toledo 3 1.8 TFSI	5P2	1.8	118	4	06.07-03.09	BZB	0,8	PFR7S8EG	1675		PFR8S8EG
Toledo 3 1.8 TFSI	5P2	1.8	118	4	03.09-05.09	CDAA	0,8	PFR7S8EG	1675		PFR8S8EG
Toledo 3 2.0 FSI	5P2	2.0	110	4	09.04-11.05	BLR	1,1	PZFR5N-11T	7742		
Toledo 3 2.0 FSI	5P2	2.0	110	4	11.04-11.05	BLY	0,9	BKR6E	6962	28	LPG 1
Toledo 3 2.0 FSI	5P2	2.0	110	4	11.05-03.09	BVY	1,1	PZFR5N-11T	7742		
Toledo 3 2.0 FSI	5P2	2.0	110	4	11.05-03.09	BVZ	0,9	BKR6E	6962	28	LPG 1
Toledo 3 2.0 TFSI	5P2	2.0	147	4	11.05-05.09	BWA	0,8	PFR7S8EG	1675		PFR8S8EG

**TOLEDO 4**

Toledo 4 1.2	KG3	1.2	55	3	10.12-	CGPC	0,9	ZFR6T-11G	5960	44	
Toledo 4 1.2 TSI	KG3	1.2	63	4	10.12-	CBZA	0,7	IZFR6P7	97153		
Toledo 4 1.2 TSI	KG3	1.2	77	4	10.12-	CBZB	0,7	IZFR6P7	97153		
Toledo 4 1.4 TSI	KG3	1.4	90	4	10.12-	CAXA	0,9	PZFR6R	5758		

**SKODA**

**CITIGO 1.0**

Citigo 1.0	NF1/NF2	1.0	44	3	10.11-	CHYA	1,0	ZKER6A-10EG	96596		
Citigo 1.0	NF1/NF2	1.0	55	3	10.11-	CHYB	1,0	ZKER6A-10EG	96596		
Citigo 1.0 G-TEC CNG	NF1/NF2	1.0	50	3	11.12-	CPGA	0,8	PZKER7A8EGS	94968		

**FAVORIT / FORMAN**

135 LE / LSE		1.3		4	08.89-08.92		0,8	BKR6ES	3783	28	LPG 1
135 LX / GLX		1.3		4	01.93- .96		0,8	BKR6ES	3783	28	LPG 1
135 Favorit L / LS		1.3		4	04.88- .95		0,8	BCPR5ES	6130	32	LPG 3
135 Favorit LE / LSE		1.3		4	08.89- .95		0,8	BKR6ES	3783	28	LPG 1
135 Favorit LX / GLX		1.3		4	01.93- .95		0,8	BKR6ES	3783	28	LPG 1
135 Forman L / LS		1.3		4	08.90- .95		0,8	BCPR5ES	6130	32	LPG 3
135 Forman LE / LSE		1.3		4	02.91- .95		0,8	BKR6ES	3783	28	LPG 1
135 Forman LX / GLX		1.3		4	01.93- .95		0,8	BKR6ES	3783	28	LPG 1
136 Favorit				4	.90- .92		0,8	BCPR6E	1269	12	LPG 3
136 Favorit				4	.93- .95	mit Catalysator	0,9	BCPR6ET	2197		LPG 3
136 Favorit				4	.93- .95		0,9	BKR6E	6962	28	LPG 1

e kW  
C  
y  
i

0201



Stock-No

VELINE

LPG / CNG

**SKODA****FABIA 1**

Fabia 1 1.0	6Y2	1.0	37	4	10.00-08.02	AQV	1,0	BKR6ETA-10	7998		
Fabia 1 1.0	6Y2	1.0	37	4	10.00-08.02	ARV	1,0	BKR6ETA-10	7998		
Fabia 1 1.2	6Y2 / 6Y5	1.2	40	3	07.01-05.04	AWY	0,9	ZFR5P-G	6893	41	LPG 6
Fabia 1 1.2 VIN	6Y2 / 6Y5	1.2	40	3	05.04-12.07	BMD	0,9	ZFR5P-G	6893	41	LPG 6
--> 6Y-8B451106* VIN --> 6Y-84035536*											
Fabia 1 1.2 VIN	6Y2 / 6Y5	1.2	40	3	05.04-12.07	BMD	1,1	ZFR6T-11G	5960	44	
6Y-8B451107--> * VIN 6Y-84035537-->*											
Fabia 1 1.2 VIN	6Y2 / 6Y5	1.2	47	3	11.04-12.07	BME	0,9	ZFR5P-G	6893	41	LPG 6
--> 6Y-8B451106* VIN --> 6Y-84035536*											
Fabia 1 1.2	6Y2 / 6Y5	1.2	47	3	11.04-12.07	BME	1,1	ZFR6T-11G	5960	44	
VIN 6Y-8B451107--> * VIN 6Y-84035537-->*											
Fabia 1 1.2 (OE 101000060AA)	6Y2 / 6Y5	1.2	47	3	01.03-12.04	AZQ	0,9	BKUR5ET-10	7553		LPG 1
Fabia 1 1.2	6Y2 / 6Y5	1.2	47	3	01.03-12.04	AZQ	0,9	ZFR5P-G	6893	41	LPG 6
(all OE ref. except 101000060AA)											
Fabia 1 1.4 (OE 101000060AA)	6Y2/6Y5	1.4	44	4	04.00-03.03	AZE	0,8	BKUR5ET-10	7553		LPG 1
Fabia 1 1.4	6Y2/6Y5	1.4	44	4	04.00-03.03	AZE	0,8	PFR6Q	6458	37	LPG 1
(all OE ref. except 101000060AA)											
Fabia 1 1.4	6Y2 / 6Y5	1.4	44	4	04.00-03.03	AZF	0,8	PFR6Q	6458	37	LPG 1
Fabia 1 1.4	6Y2 / 6Y5	1.4	50	4	08.99-05.03	AME	1,0	BKUR5ET-10	7553		LPG 1
Fabia 1 1.4	6Y2 / 6Y5	1.4	50	4	08.99-01.01	ATZ	1,0	BKUR5ET-10	7553		LPG 1
Fabia 1 1.4	6Y2 / 6Y5	1.4	50	4	08.00-05.03	AQW	1,0	BKUR5ET-10	7553		LPG 1
Fabia 1 1.4 16V	6Y2 / 6Y5	1.4	55	4	10.99-08.03	AUA	1,0	BKUR6ET-10	2397	24	LPG 1
Fabia 1 1.4 16V Automatic	6Y2 / 6Y5	1.4	55	4	10.99-08.03	AUA	1,1	PZFR5D-11	7968	34	LPG 6
Fabia 1 1.4 16V Automatic	6Y2 / 6Y5	1.4	55	4	04.02-05.04	BBY	1,1	PZFR5D-11	7968	34	LPG 6
Fabia 1 1.4 16V Schaltgetriebe	6Y2 / 6Y5	1.4	55	4	04.02-05.04	BBY	1,0	BKUR6ET-10	2397	24	LPG 1
Fabia 1 1.4 16V	6Y2 / 6Y5	1.4	55	4	05.04-12.07	BKY	0,9	ZFR5P-G	6893	41	LPG 6
Fabia 1 1.4	6Y2 / 6Y5	1.4	59	4	05.06-12.07	BUD	1,1	ZFR6T-11G	5960	44	
Fabia 1 1.4 16V	6Y2 / 6Y5	1.4	74	4	10.99-08.03	AUB	1,0	BKUR6ET-10	2397	24	LPG 1
Fabia 1 1.4 16V	6Y2 / 6Y5	1.4	74	4	05.02-12.07	BBZ	1,0	BKUR6ET-10	2397	24	LPG 1
Fabia 1 2.0	6Y2 / 6Y5	2.0	85	4	12.99-12.07	AZL	1,0	BKUR6ET-10	2397	24	LPG 1

**FABIA 2**

Fabia 2 1.2	542 / 545	1.2	44	3	12.06-03.09	BBM	0,9	ZFR5P-G	6893	41	LPG 6
Fabia 2 1.2	542 / 545	1.2	44	3	03.09-11.11	CHFA	1,1	ZFR6T-11G	5960	44	
Fabia 2 1.2	542 / 545	1.2	44	3	11.11-	CGPB	1,1	ZFR6T-11G	5960	44	
Fabia 2 1.2	542 / 545	1.2	51	3	03.09-03.10	CGPA	1,1	ZFR6T-11G	5960	44	
Fabia 2 1.2 VIN	542 / 545	1.2	52	3	01.07-05.09	BZG	0,9	ZFR5P-G	6893	41	LPG 6
--> 5J-8B501225* VIN --> 5J-83074394*											
Fabia 2 1.2	542 / 545	1.2	52	3	01.07-05.09	BZG	1,1	ZFR6T-11G	5960	44	
VIN 5J-8B501226 --> * VIN 5J-83074395 -->*											
Fabia 2 1.2	542 / 545	1.2	52	3	01.08-09.10	CEVA	1,1	ZFR6T-11G	5960	44	
VIN 5J-8B501226 --> * VIN 5J-83074395 -->*											
Fabia 2 1.2 TSI	542 / 545	1.2	63	4	03.10-	CBZA	0,7	IZFR6P7	97153		
Fabia 2 1.2 TSI	542 / 545	1.2	77	4	03.10-	CBZB	0,7	IZFR6P7	97153		
Fabia 2 1.4	542 / 545	1.4	63	4	03.10-	CGGB	1,1	ZFR6T-11G	5960	44	
Fabia 2 1.4	542 / 545	1.4	63	4	01.07-03.10	BXW	1,1	ZFR6T-11G	5960	44	
Fabia 2 1.4 TSI RS	542 / 545	1.4	132	4	05.10-02.11	CAVE	0,8	SIZFR6B8EG	96209		
Fabia 2 1.4 TSI RS	542 / 545	1.4	132	4	05.10-	CTHE	0,8	SIZFR6B8EG	96209		
Fabia 2 1.6	542 / 545	1.6	77	4	04.07-	BTS	1,1	ZFR6T-11G	5960	44	
Fabia 2 1.6	542 / 545	1.6	77	4	06.10-	CFNA	1,1	ZFR6T-11G	5960	44	
Fabia 3 1.0	NJ3/NJ5	1.0	44	3	10.14-	CHYA	1,0	ZKER6A-10EG	96596		

e kW  
C  
Y  
I

0201



Stock-No

VLINE

LPG/CNG

SKODA

**FABIA 2**

Fabia 3 1.0	NJ3/NJ5	1.0	55	3	10.14-	CHYB	1,0	ZKER6A-10EG	96596		
Fabia 3 1.2 TSI	NJ3/NJ5	1.2	66	4	10.14-	CJZC	0,8	PZKER7A8EGS	94968		
Fabia 3 1.2 TSI	NJ3/NJ5	1.2	81	4	10.14-	CJZD	0,8	PZKER7A8EGS	94968		

**FELICIA**

Felicia		1.0	37	4	08.99-	AHT	1,0	BKR6ETA-10	7998		
Felicia 135i		1.3	40	4	10.94-07.96	MPI	1,0	BKUR5ET-10	7553		LPG 1
Felicia		1.3	40	4	08.96-08.01	AMG	1,0	BKUR5ET-10	7553		LPG 1
Felicia		1.3	43	4	10.94-07.96		0,8	BCPR5ES	6130	32	LPG 3
Felicia 135i		1.3	43	4	08.96-	AMJ	0,8	BCPR5ES	6130	32	LPG 3
Felicia 136i		1.3	50	4	10.94-07.96	136B	0,8	BCPR6ES	2330	12	LPG 3
Felicia 136i		1.3	50	4	10.94-07.96	136M	0,8	BKR6ES	3783	28	LPG 1
Felicia		1.3	50	4	08.96-08.01	AMH	1,0	BKUR5ET-10	7553		LPG 1
Felicia		1.4	74	4	.99-		1,0	BKUR6ET-10	2397	24	LPG 1
Felicia		1.6	55	4	05.95-08.01	AEE	0,8	BUR6ET	3172	1	LPG 2

**OCTAVIA 1**

Octavia 1 1.4	1U2 / 1U5	1.4	44	4	02.99-03.01	AMD	1,0	BKUR6ET-10	2397	24	LPG 1
Octavia 1 1.4 16V	1U2 / 1U5	1.4	55	4	01.02-12.10	BCA	1,0	BKUR6ET-10	2397	24	LPG 1
Octavia 1 1.4 16V Automatic	1U2 / 1U5	1.4	55	4	08.00-01.02	AXP	1,1	PZFR5D-11	7968	34	LPG 6
Octavia 1 1.4 16V Manual	1U2 / 1U5	1.4	55	4	08.00-01.02	AXP	1,0	BKUR6ET-10	2397	24	LPG 1
Octavia 1 1.4	1U2/1U5	1.4	55	4	05.99-	AHW	1,0	BKUR6ET-10	2397	24	LPG 1
Octavia 1 1.4	1U2/1U5	1.4	55	4	.00-	AKQ	1,0	BKUR6ET-10	2397	24	LPG 1
Octavia 1 1.4	1U2/1U5	1.4	55	4	.00-	APE	1,0	BKUR6ET-10	2397	24	LPG 1
Octavia 1 1.6	1U2 / 1U5	1.6	55	4	10.96-09.04	AEE	0,8	BUR6ET	3172	1	LPG 2
Octavia 1 1.6	1U2 / 1U5	1.6	74	4	02.97-12.07	AEH	1,0	BKUR6ET-10	2397	24	LPG 1
Octavia 1 1.6	1U2 / 1U5	1.6	74	4	08.98-12.07	AKL	1,0	BKUR6ET-10	2397	24	LPG 1
Octavia 1 1.6	1U2 / 1U5	1.6	75	4	08.00-04.02	AVU	1,0	BKUR6ET-10	2397	24	LPG 1
Octavia 1 1.6	1U2 / 1U5	1.6	75	4	04.02-12.10	BFQ	1,0	BKUR6ET-10	2397	24	LPG 1
Octavia 1 1.8 20V	1U2 / 1U5	1.8	92	4	10.96-07.00	AGN	1,0	BKUR6ET-10	2397	24	LPG 1
Octavia 1 1.8 T	1U2 / 1U5	1.8	110	4	05.98-12.10	AGU	0,8	PFR6Q	6458	37	LPG 1
Octavia 1 1.8 T	1U2/1U5	1.8	110	4	.98-	AEB	0,8	PFR6Q	6458	37	LPG 1
Octavia 1 1.8 T	1U2 / 1U5	1.8	110	4	08.00-05.06	ARX	0,8	PFR6Q	6458	37	LPG 1
Octavia 1 1.8 T	1U2 / 1U5	1.8	110	4	01.00-07.00	ARZ	0,8	PFR6Q	6458	37	LPG 1
Octavia 1 1.8 T	1U2 / 1U5	1.8	110	4	08.00-12.10	AUM	0,8	PFR6Q	6458	37	LPG 1
Octavia 1 1.8 T RS	1U2 / 1U5	1.8	132	4	12.00-01.06	AUQ	0,8	PFR6Q	6458	37	LPG 1
Octavia 1 2.0	1U2 / 1U5	2.0	85	4	05.99-05.07	APK	1,0	BKUR6ET-10	2397	24	LPG 1
Octavia 1 2.0	1U2 / 1U5	2.0	85	4	05.99-03.02	AQY	1,0	BKUR6ET-10	2397	24	LPG 1
Octavia 1 2.0	1U2 / 1U5	2.0	85	4	11.99-09.04	AZH	1,0	BKUR6ET-10	2397	24	LPG 1
Octavia 1 2.0	1U2 / 1U5	2.0	85	4	09.00-01.05	AEG	1,0	BKUR6ET-10	2397	24	LPG 1
Octavia 1 2.0 4x4	1U5	2.0	85	4	03.02-01.06	AZJ	1,1	PZFR5D-11	7968	34	LPG 6
Octavia 1 2.0 4x4	1U5	2.0	88	4	11.99-04.01	ATF	1,1	PZFR5D-11	7968	34	LPG 6

**OCTAVIA 2**

Octavia 2 1.2 TSI	1Z3 / 1Z5	1.2	77	4	02.10-	CBZB	0,7	IZFR6P7	97153		
Octavia 2 1.4	1Z3 / 1Z5	1.4	55	4	05.04-05.06	BCA	1,0	BKUR6ET-10	2397	24	LPG 1
Octavia 2 1.4	1Z3 / 1Z5	1.4	59	4	05.06-	BUD	1,1	ZFR6T-11G	5960	44	
Octavia 2 1.4 TSI	1Z3 / 1Z5	1.4	90	4	11.08-	CAXA	0,9	PZFR6R	5758		
Octavia 2 1.6	1Z3 / 1Z5	1.6	75	4	05.04-05.05	BGU	1,0	BKUR6ET-10	2397	24	LPG 1
Octavia 2 1.6	1Z3 / 1Z5	1.6	75	4	05.05-	BSE	1,0	BKUR6ET-10	2397	24	LPG 1
Octavia 2 1.6	1Z3 / 1Z5	1.6	75	4	05.05-	BSF	1,0	BKUR6ET-10	2397	24	LPG 1
Octavia 2 1.6	1Z3 / 1Z5	1.6	75	4	11.07-05.10	CCSA	1,0	BKUR6ET-10	2397	24	LPG 1
Octavia 2 1.6	1Z3 / 1Z5	1.6	75	4	05.10-	CMXA	1,0	BKUR6ET-10	2397	24	LPG 1

e kW  
C  
y  
i

0201



Stock-No

VLINE

LPG / CNG

**SKODA****OCTAVIA 2**

Octavia 2 1.6 FSI	1Z3 / 1Z5	1.6	85	4	02.04-10.08	BLF	0,5	ZFR6S-Q	6449		
Octavia 2 1.6 LPG	1Z3 / 1Z5	1.6	75	4	08.09-	CHGA	1,0	BKUR6ET-10	2397	24	LPG 1
Octavia 2 1.8 TSI	1Z3 / 1Z5	1.8	118	4	06.07-10.08	BZB	0,8	PFR7S8EG	1675		PFR8S8EG
Octavia 2 1.8 TSI	1Z3 / 1Z5	1.8	118	4	11.08-	CDA	0,8	PFR7S8EG	1675		PFR8S8EG
Octavia 2 1.8 TSI 4x4	1Z5	1.8	112	4	03.09-	CDAB	0,8	PFR7S8EG	1675		PFR8S8EG
Octavia 2 2.0 FSI	1Z3 / 1Z5	2.0	110	4	11.04-11.05	BLR	1,1	PZFR5N-11T	7742		
Octavia 2 2.0 FSI	1Z3 / 1Z5	2.0	110	4	11.04-11.05	BLY	0,9	BKR6E	6962	28	LPG 1
Octavia 2 2.0 FSI	1Z3 / 1Z5	2.0	110	4	11.05-10.08	BVY	1,1	PZFR5N-11T	7742		
Octavia 2 2.0 FSI	1Z3 / 1Z5	2.0	110	4	11.05-10.08	BVZ	0,9	BKR6E	6962	28	LPG 1
Octavia 2 2.0 FSI 4x4	1Z5	2.0	110	4	11.04-11.05	BLX	1,1	PZFR5N-11T	7742		
Octavia 2 2.0 FSI 4x4	1Z5	2.0	110	4	11.05-10.08	BVX	1,1	PZFR5N-11T	7742		
Octavia 2 2.0 TSI RS	1Z3 / 1Z5	2.0	147	4	10.05-10.08	BWA	0,8	PFR7S8EG	1675		PFR8S8EG
Octavia 2 2.0 TSI RS	1Z3 / 1Z5	2.0	147	4	11.08-	CCZA	0,8	PFR7S8EG	1675		PFR8S8EG

**OCTAVIA 3**

Octavia 3 1.2 TSI	5E3/5E5	1.2	63	4	11.12-	CJZB	0,8	PZKER7A8EGS	94968		
Octavia 3 1.2 TSI	5E3/5E5	1.2	77	4	11.12-	CJZA	0,8	PZKER7A8EGS	94968		
Octavia 3 1.4 TSI	5E3/5E5	1.4	103	4	11.12-	CHPA	0,8	PZKER7A8EGS	94968		
Octavia 3 1.4 TSI G-TEC	5E3/5E5	1.4	81	4	11.13-	CPWA	0,8	PZKER7A8EGS	94968		
Octavia 3 1.8 TSI	5E3/5E5	1.8	132	4	11.12-	CJSA	0,8	PLFER7A8EG	94833		
Octavia 3 1.8 TSI	5E3/5E5	1.8	132	4	11.12-	CJSB	0,8	PLFER7A8EG	94833		
Octavia 3 2.0 TSI RS	5E3/5E5	2.0	162	4	06.13-	CHHB	0,8	PLFER7A8EG	94833		

**PICKUP**

Pickup 135 L		1.3		4	06.90- .96	u.Cat.	0,8	BCPR5ES	6130	32	LPG 3
Pickup 135 LE		1.3		4	10.91- .96		0,8	BKR6ES	3783	28	LPG 1
Pickup 135 LX		1.3		4	01.93- .96		0,8	BKR6ES	3783	28	LPG 1
Pick-up 135i		1.3	40	4	.96-	135M	1,0	BKUR5ET-10	7553		LPG 1
Pick-up 136i		1.3	50	4	.96-	136M	1,0	BKUR5ET-10	7553		LPG 1

**RAPID**

Rapid 1.2	NH3	1.2	55	3	07.12-	CGPC	1,1	ZFR6T-11G	5960	44	
Rapid 1.2 TSI	NH3	1.2	63	4	07.12-	CBZA	0,7	IZFR6P7	97153		
Rapid 1.2 TSI	NH3	1.2	77	4	07.12-	CBZB	0,7	IZFR6P7	97153		
Rapid 1.4 TSI	NH3	1.4	90	4	07.12-	CAXA	0,9	PZFR6R	5758		

**ROOMSTER**

Roomster 1.2 VIN --> 5J-8B600480* VIN --> 5J-85036340*	5J	1.2	47	3	05.06-01.07	BME	0,9	ZFR5P-G	6893	41	LPG 6
Roomster 1.2 VIN 5J-8B600481 -->* VIN 5J-85036341 -->*	5J	1.2	47	3	05.06-01.07	BME	1,1	ZFR6T-11G	5960	44	
Roomster 1.2	5J	1.2	51	3	03.09-	CGPA	1,1	ZFR6T-11G	5960	44	
Roomster 1.2 VIN --> 5J-8B600480* VIN --> 5J-85036340*	5J	1.2	52	3	01.07-03.09	BZG	0,9	ZFR5P-G	6893	41	LPG 6
Roomster 1.2 VIN 5J-8B600481 -->* VIN 5J-85036341 -->*	5J	1.2	52	3	01.07-03.09	BZG	1,1	ZFR6T-11G	5960	44	
Roomster 1.2 TSI	5J	1.2	63	4	03.10-	CBZA	0,7	IZFR6P7	97153		
Roomster 1.2 TSI	5J	1.2	77	4	03.10-	CBZB	0,7	IZFR6P7	97153		
Roomster 1.4	5J	1.4	63	4	05.06-	BXW	1,1	ZFR6T-11G	5960	44	
Roomster 1.4	5J	1.4	63	4	03.10-	CGGB	1,1	ZFR6T-11G	5960	44	
Roomster 1.6	5J	1.6	77	4	05.06-	BTS	1,1	ZFR6T-11G	5960	44	
Roomster 1.6	5J	1.6	77	4	06.10-	CFNA	1,1	ZFR6T-11G	5960	44	



e kW C y i

0201



Stock-No

VLINE

LPG / CNG

**SKODA****SUPERB 1**

Superb 1 1.8 Turbo	3U4	1.8	110	4	10.01-03.08	AWT	0,8	PFR6Q	6458	37	LPG 1
Superb 1 2.0	3U4	2.0	85	4	12.01-03.08	AZM	1,0	BKUR6ET-10	2397	24	LPG 1
Superb 1 2.8 V6	3U4	2.8	140	6	05.02-03.08	BBG	0,5	BKR6EKUB	3584		LPG 1
Superb 1 2.8 V6	3U4	2.8	142	6	12.01-03.08	AMX	0,5	BKR6EKUB	3584		LPG 1

**SUPERB 2**

Superb 2 1.4 TSI	3T4 / 3T5	1.4	92	4	08.08-	CAXC	0,9	PZFR6R	5758		
Superb 2 1.8 TSI	3T4 / 3T5	1.8	118	4	03.08-05.09	BZB	0,8	PFR7S8EG	1675		PFR8S8EG
Superb 2 1.8 TSI	3T4 / 3T5	1.8	118	4	09.08-	CDAA	0,8	PFR7S8EG	1675		PFR8S8EG
Superb 2 1.8 TSI	3T4 / 3T5	1.8	112	4	03.09-	CDAB	0,8	PFR7S8EG	1675		PFR8S8EG
Superb 2 2.0 TSI	3T4 / 3T5	2.0	147	4	05.10-	CCZA	0,8	PFR7S8EG	1675		PFR8S8EG
Superb 2 3.6 V6 4x4	3T4 / 3T5	3.6	191	6	09.08-	CDVA	0,8	ILZKR8A	94290		

**YETI**

Yeti 1.2 TSI	5L	1.2	77	4	09.09-	CBZB	0,7	IZFR6P7	97153		
Yeti 1.4 TSI	5L	1.4	90	4	06.10-	CAXA	0,9	PZFR6R	5758		
Yeti 1.8 TSI 4x4	5L	1.8	112	4	11.09-	CDAB	0,8	PFR7S8EG	1675		PFR8S8EG
Yeti 1.8 TSI 4x4	5L	1.8	118	4	05.09-	CDAA	0,8	PFR7S8EG	1675		PFR8S8EG

**SMART****CITY-COUPÉ**

Smart	MC01	0.6	33	3	10.98-01.04	M 160 ... T.S.	0,65	BKR6EKE	5649		
Smart	MC01	0.6	40	3	10.98-01.04	M 160 ... T.S.	0,65	BKR6EKE	5649		
Smart	MC01	0.7	37	3	10.02-01.04	M 160/1 T.S.	0,6	LKR8A	5214		
Smart	MC01	0.7	60	3	10.02-01.04	M 160/1 T.S.	0,6	LKR8A	5214		

**CROSSBLADE**

Smart Crossblade		0.6	52	3	10.02-01.04	M 160 ... T.S.	0,65	BKR6EKE	5649		
------------------	--	-----	----	---	-------------	----------------	------	---------	------	--	--

**FORTWO 1**

Smart fortwo	450	0.7	37	3	01.04-	M 160/1 T.S.	0,6	LKR8A	5214		
Smart fortwo	450	0.7	45	3	01.04-	M 160/1 T.S.	0,6	LKR8A	5214		

**FORTWO 2**

Smart fortwo 2	451	1.0	45	3	03.07-	M 132.910	0,9	LKR7B-9	5847		
Smart fortwo 2	451	1.0	52	3	03.07-	M 132.910	0,9	LKR7B-9	5847		
Smart fortwo 2 Turbo	451	1.0	62	3	03.07-	M 132.930	0,9	LKR7B-9	5847		
Smart fortwo Brabus	451	1.0	72	3	01.08-	M 132.930	0,9	LKR7B-9	5847		

**ROADSTER / COUPÉ**

Smart Roadster	452	0.7	45	3	10.02-11.05	M 160/1 T.S.	0,6	LKR8A	5214		
Smart Roadster	452	0.7	60	3	06.03-11.05	M 160/1 T.S.	0,6	LKR8A	5214		
Smart Roadster Brabus	452	0.7	74	3	12.03-	M 160/1 T.S.	0,6	LKR8A	5214		

**FORFOUR**

Smart forfour	454	1.1	55	3	01.04- .06	M 134.910	1,1	LFR6C-11	5788		
Smart forfour	454	1.3	70	4	01.04- .06	M 135.930	1,1	LFR6C-11	5788		
Smart forfour	454	1.5	80	4	01.04- .06	M 135.950	1,1	LFR6C-11	5788		
Smart forfour Brabus	454	1.5	130	4	05.05-	M 122.950	0,8	ILZFR6C-K	6645		



e kW C y I

0201



Stock-No

VLINE

LPG / CNG

**SSANGYONG****CHAIRMAN**

Chairman	P19	3.2	165	6	06.07-	M162E32	1,0	BKUR5ETZ-10	91926		
----------	-----	-----	-----	---	--------	---------	-----	-------------	-------	--	--

**KORANDO**

Korando		2.0	100	4	07.96-	M161E20 M111.940	0,8	BCP5ES	7496	16	LPG 3
Korando		2.3	110	4	09.96-02.99	M161E23 M111.970	0,8	BCP5ES	7496	16	LPG 3
Korando		3.2	162	6	09.96-03.00	M162E32 M104...	0,8	BCP5ES	7496	16	LPG 3
Korando LPG		3.2	162	6	07.97-03.00		0,8	BKR5EIX	6341		LPG 1

**KYRON**

Kyron 3.2		3.2	162	6	03.08-	G32D	0,8	BCP5ES	7496	16	LPG 3
-----------	--	-----	-----	---	--------	------	-----	--------	------	----	-------

**MUSSO**

Musso		2.0	100	4	05.96-	M161E20 M111.940	0,8	BCP5ES	7496	16	LPG 3
Musso		2.3	110	4	05.96-02.99	M161E23 M111.970	0,8	BCP5ES	7496	16	LPG 3
Musso E32		3.2	162	6	01.96-	M162E32 M104...	0,8	BCP5ES	7496	16	LPG 3

**REXTON**

Rexton RX 230 4x4		2.3	110	4	05.02-08.06	G23D	0,8	BCP5ES	7496	16	LPG 3
Rexton RX 320s		3.2	162	6	04.02-08.06	G32D	0,8	BCP5ES	7496	16	LPG 3

**RODIUS**

Rodius 3.2		3.2	162	6	07.07-	G32D	0,8	BCP5ES	7496	16	LPG 3
Rodius 3.2		3.2	162	6	05.05-12.12	M162E32	1,0	BKUR5ETZ-10	91926		
Rodius 3.2		3.2	162	6	07.07-12.12	M162E32	1,0	BKUR5ETZ-10	91926		

**SUBARU****FORESTER**

Forester		2.0	90	4	09.97- .02	EJ20J	1,1	BCPR6ES-11	7121	11	LPG 3
Forester		2.0	92	4	09.97-	EJ20	1,1	BKR6E-11	2756	14	LPG 1
Forester		2.0	110	4	01.08-	EJ204	1,1	SILFR6A11	5468		
Forester		2.0	116	4	09.05-02.08	EJ20	0,8	ILFR6B	6481		
Forester		2.0	116	4	03.08-	EJ20	0,8	ILFR6B	6481		
Forester 2.0 X	SJ13	2.0	110	4	08.12-	FB20A / FB20B	1,1	SILZKAR7B11	93482		
Forester 2.0 Turbo		2.0	130	4	03.99- .02	EJ20	0,9	PFR6B	3500		PFR7B
Forester 2.5 Turbo		2.5	155	4	.05-	EJ25	0,8	PFR6G	4793		PFR7G
Forester		2.5	169	4	.06-02.08	EJ25	0,8	ILFR6B	6481		
Forester		2.5	169	4	06.08-	EJ255	0,8	ILFR6B	6481		

**IMPREZA**

Impreza 1.5R		1.5	79	4	09.07-	EJ15	0,8	ILFR6B	6481		
Impreza 1.6		1.6	66	4	.93- .00	EJ16	1,1	BKR6E-11	2756	14	LPG 1
Impreza 1.6		1.6	70	4	12.00- .03	EJ16	1,1	BKR6E-11	2756	14	LPG 1
Impreza 1.6		1.6	70	4	.03- .06	EJ16	0,8	PFR6G	4793		PFR7G
Impreza 1.8		1.8	76	4	.93- .00	EJ18	1,1	BKR6E-11	2756	14	LPG 1
Impreza 2.0		2.0	92	4	12.00-	EJ20	1,1	BKR6E-11	2756	14	LPG 1
Impreza 2.0		2.0	110	4	01.08-02.10	EJ204	1,1	SILFR6A11	5468		
Impreza 2.0		2.0	110	4	03.10-	EJ204	1,1	SILFR6C11	7505		
Impreza 2.0R		2.0	110	4	09.07-	EK20	0,8	ILFR6B	6481		
Impreza R		2.0	118	4	.06-	EJ20	0,8	ILFR6B	6481		
Impreza 2.0 RS		2.0	92	4	11.04-	EJ20	1,1	BKR6E-11	2756	14	LPG 1
Impreza Turbo		2.0	155	4	05.94-07.96	EJ20	0,8	PFR6G	4793		PFR7G
Impreza Turbo		2.0	160	4	03.94- .00	EJ20	0,9	PFR6B	3500		PFR7B
Impreza WRX Turbo		2.0	160	4	12.00-	EJ20	0,9	PFR6B	3500		PFR7B
Impreza WRX Turbo		2.0	165	4	11.02-	EJ20	0,9	PFR6B	3500		PFR7B





l kW  
C  
y  
i

0201



Stock-No

LINE

LPG/CNG

## SUBARU

### IMPREZA

Impreza WRX Turbo	2.0	169	4	.06-	EJ25	0,8	ILFR6B	6481		
Impreza WRX Sti	2.0	195	4	.03-	EJ20	0,8	PFR6G	4793		PFR7G
Impreza WRX Sti	2.0	236	4	02.04-		0,8	PFR6G	4793		PFR7G
Impreza 2.5	2.5	169	4	.08-	N/A	0,8	ILFR6B	6481		
Impreza WRX	2.5	169	4	09.05-	EJ25	0,8	ILFR6B	6481		
Impreza WRX Sti St1	2.5	206	4	09.05-	EJ25	0,8	ILFR6B	6481		
Impreza WRX Sti	2.5	206	4	.06-	EJ25	0,8	ILFR6B	6481		
Impreza WRX Sti (GRF)	2.5	221	4	01.08-	EJ25	0,8	SILFR6A	7913		

### JUSTY

Justy 1.0	1.0	52	3	.07-	1KR-FE Daihatsu engine	1,1	ILFR6T11	4904		
Justy 1000	1.0		4	.85- .03	EF10 Cat.	1,1	BPR6ES-11	4824	13	LPG 2
Justy 1200	1.2	55	4	.87- .03	EF12/EF12 Cat.	1,1	BPR6ES-11	4824	13	LPG 2
Justy 1300	1.3	50	4	10.95- .03	G13BA	0,8	BPR6ES	7822		LPG 2
Justy	1.3	63	4	- .03	G13BB	1,1	BKR6E-11	2756	14	LPG 1
Justy G3X	1.3	69	4	09.03-	M13A DOHC	1,1	BKR6E-11	2756	14	LPG 1
Justy G3X	1.5	73	4	09.03-	M15A DOHC	1,1	IFR6J11	7658		

### LEGACY

Legacy 1.8 Sedan	1.8	76	4	.90- .91	EJ18/4	1,1	BKR6E-11	2756	14	LPG 1	
Legacy 1.8 Station	1.8	76	4	.90- .91	EJ18/4	1,1	BKR6E-11	2756	14	LPG 1	
Legacy 1.8 Super Station	1.8	76	4	.90- .91	EJ18/4	1,1	BKR6E-11	2756	14	LPG 1	
Legacy 2.0 Sedan	2.0	84	4	.92- .95	EJ20/4	1,1	BKR6E-11	2756	14	LPG 1	
Legacy 2.0 Super Station	2.0	84	4	.92- .95	EJ20	1,1	BKR6E-11	2756	14	LPG 1	
Legacy 2.0	2.0	85	4	05.94-	EJ20	1,1	BKR6E-11	2756	14	LPG 1	
Legacy 2.0	2.0	92	4	12.98- .03	EJ20	1,1	BKR6E-11	2756	14	LPG 1	
Legacy 2.0	B13BL	2.0	101	4	09.03-10.05	EJ20	1,1	BKR6E-11	2756	14	LPG 1
Legacy 2.0	B13BL	2.0	110	4	06.03-04.09	EJ204	0,8	ILFR6B	6481		
Legacy 2.0	B14BM	2.0	110	4	04.09-	EJ204	1,1	SILFR6C11	7505		
Legacy 2.0	B13BL	2.0	121	4	06.05-04.09	EJ20X	0,8	ILFR6B	6481		
Legacy 2.0 Turbo Sedan	2.0	147	4	.92- .93	EJ20	0,8	PFR6B	3500		PFR7B	
Legacy 2.0 Turbo Sup.Stat.	2.0	147	4	.92- .93	EJ20	0,8	PFR6B	3500		PFR7B	
Legacy 2.0 Turbo	2.0	147	4	.93- .96	EJ20	0,8	PFR6G	4793		PFR7G	
Legacy	2.2	94	4	05.94- .02	EJ22	1,1	BKR6E-11	2756	14	LPG 1	
Legacy 2.2 Station	2.2	96	4	.94- .02	EJ22	1,1	BKR6E-11	2756	14	LPG 1	
Legacy 2.2 Sedan	2.2	100	4	.90- .93	EJ22	1,1	BKR6E-11	2756	14	LPG 1	
Legacy 2.2 Super Station	2.2	100	4	.90- .94	EJ22/4	1,1	BKR6E-11	2756	14	LPG 1	
Legacy Outback	2.5	110	4	.96- .02	EJ25	1,1	PFR6B-11	4014		PFR7B	
Legacy 2.5 Outback	2.5	115	4	12.98- .03	EJ25	1,1	BKR6E-11	2756	14	LPG 1	
Legacy 2.5	B13BL	2.5	121	4	09.03-04.09	EJ25	1,1	PFR5B-11	2300		PFR6B
Legacy V 2.5	B14BM	2.5	123	4	09.09-	EJ253	1,1	SIFR6A11	0127		
Legacy H6-3.0	3.0	154	6	.01- .03		1,1	PLFR6A-11	7654		LPG 7	
Legacy Outback H6-3.0	3.0	154	6	.01- .03		1,1	PLFR6A-11	7654		LPG 7	
Legacy 3.0 R	B13BL	3.0	180	6	09.03-06.09	EZ30	0,8	ILFR6B	6481		
Legacy 3.6	3.6	188	6	04.09-	EZ5 H6	1,1	SILFR6C11	7505			

### LIBERO

Libero 1200	1.2	38	4	.87- .00	EF12	1,1	BPR6ES-11	4824	13	LPG 2

e kW  
C  
Y  
I

0201



Stock-No

VALVE

LPG / CNG

**SUBARU****M80**

M80 Mini Jumbo	0.8		4		M80	0,9	BKR6E	6962	28	LPG 1
----------------	-----	--	---	--	-----	-----	-------	------	----	-------

**OUTBACK**

Outback 2.5	BR	2.5	123	4	09.09-	EJ253	1,1	SIFR6A11	0127		
Outback 2.5	BL / BP	2.5	121	4	09.03-	EJ25	1,1	PFR5B-11	2300		PFR6B
Outback 3.0 R	BL / BP	3.0	180	6	11.03-	EZ30	0,8	ILFR6B	6481		
Outback 3.6 R	BM / BR	3.6	191	6	09.09-	EZ36D	1,1	SILFR6C11	7505		

**PLEO**

Pleo	RA1 / RA2	0.66		4	10.01-01.04	EN07	0,8	KR8BI	4347		
------	-----------	------	--	---	-------------	------	-----	-------	------	--	--

**R1**

R1	RJ1 / RJ2	0.66		4	.06-	EN07	0,8	KR8BI	4347		
----	-----------	------	--	---	------	------	-----	-------	------	--	--

**R2**

R2	RC1 / RC2	0.66		4	12.03-	EN07	0,8	KR8BI	4347		
----	-----------	------	--	---	--------	------	-----	-------	------	--	--

**SVX**

SVX	CX	3.3	162	6	.92-12.97	EG33	1,1	PFR6G-11	5555		PFR7G
-----	----	-----	-----	---	-----------	------	-----	----------	------	--	-------

**TRIBECA**

Tribeca 3.0	B9	3.0	184	6	.06-	EZ30	0,8	ILFR6B	6481		
Tribeca 3.6	B9	3.6	190	6	09.07-	EZ36D	0,8	SILFR6A	7913		

**VIVIO**

Vivio		0.7		4	03.92-	MFI	1,1	BKR6E-11	2756	14	LPG 1
Vivio		0.7		4	03.92-	Vergaser/Carb	1,1	BKR5E-11	6953	33	LPG 1

**XV**

XV 1.6i	G33	1.6	84	4	03.12-	FB16A / FB16B	1,1	SILZKAR7B11	93482		
XV 2.0i	G33	2.0	110	4	03.12-	FB20A / FB20B	1,1	SILZKAR7B11	93482		

**SUZUKI****ALTO**

Alto (HA24V)		0.6		3	01.05-	K6A	0,8	KR7AI	7789		
Alto (SB308)		0.8	29	3	.86- .92	F8B	0,9	BPR5ES	7422	6	LPG 2
Alto (SH410)		1.0	39	4	.94- .00	G10B	0,8	BPR5EY	2828	9	LPG 2
Alto (AMF310)		1.0	50	3	04.09-	K10B	1,1	IKR6G11	7980		
Alto (SH410)		1.0	53	4	.94-12.00	G10B	0,8	BPR5EY	2828	9	LPG 2
Alto		1.0		4	01.01-	G10B	0,9	BKR6E	6962	28	LPG 1
Alto (FF)		1.1	46	4	06.02-	K10A / F10D DOHC 16V	0,8	DCPR7E	3932		LPG 8
Alto Lapin HE21S		1.6		4	01.02-	K6A...	0,8	DCPR7E	3932		LPG 8

**BALENO**

Baleno (SY413)		1.3	63	4	04.95-	G13BB	0,9	BKR6E	6962	28	LPG 1
Baleno (SY416)		1.6	72	4	04.95-	G16B	0,9	BKR6E	6962	28	LPG 1
Baleno		1.6		4	.95-	G16A (16V)	0,9	BKR6E	6962	28	LPG 1
Baleno (SY418)		1.8	89	4	03.96-12.00	J18A	1,1	BKR6E-11	2756	14	LPG 1
Baleno (SY418)		1.8	89	4	11.00-	16V	1,1	IFR6J11	7658		

**CARRY**

Carry (DA51T/B,DB51T)		0.66		3	03.90-09.91	F6A 4Valve	0,8	DCPR7E	3932		LPG 8
Carry (DC51T/B,DD51T)		0.66		3	09.91-01.99	F6A 4Valve	0,8	DCPR7E	3932		LPG 8
Carry (DE51V,DF51V)		0.66		3	09.91-01.99	F6A 2Valve Turbo	0,9	BPR5E	7281	6	LPG 2
Carry (DE51V,DF51V)		0.66		3	09.91-01.99	F6A 4Valve	0,8	DCPR7E	3932		LPG 8
Carry (DC51T,DD51T)		0.66		3	04.97-01.99	F6A 2Valve Turbo	0,7	PGR5A	3987		PGR6A



l kW  
C  
y  
I

0201



Stock-No

VALVE

LPG/CNG

**SUZUKI**

**CARRY**

Carry (DA52T,DB52T)	0.66		3	01.99-05.00	F6A 2Valve Turbo	0,9	BPR5E	7281	6	LPG 2
Carry (DA52T,DB52T)	0.66		3	01.99-09.01	F6A 4Valve	0,8	DCPR7E	3932		LPG 8
Carry (DA62T)	0.66		3	09.01-05.02	K6A 4Valve DOHC	0,8	DCPR7E	3932		LPG 8
Carry (DA63T)	0.66		3	05.02-	K6A 4Valve DOHC	0,8	DCPR7E	3932		LPG 8
Carry	1.3		4	06.99-	G13BB	0,9	BKR6E	6962	28	LPG 1
Carry Super (SK410)	1.0	31	4	.92- .99	F10A Cat.	0,9	BPR5ES	7422	6	LPG 2
Carry Super (SK410)	1.0	33	4	.87- .99	F10A u.Cat.	0,9	BPR5ES	7422	6	LPG 2
Carry Van	1.3		4	.99-	G13BB	0,9	BKR6E	6962	28	LPG 1

**ESCUDO**

Escudo	1.6	71	4	08.90-11.97	G16A	0,9	BKR6E	6962	28	LPG 1
Escudo	1.6	71	4	12.97-04.00	G16A	1,1	BKR6E-11	2756	14	LPG 1
Escudo	1.6	71	4	05.00-	G16A	1,1	IFR6E11	6741		
Escudo	2.0		4	12.94-10.96	H20A	0,9	BKR6E	6962	28	LPG 1
Escudo	2.0		4	10.96-11.97	J20A	0,9	BKR6E	6962	28	LPG 1
Escudo	2.0		4	11.97-04.00	J20A	1,1	BKR6E-11	2756	14	LPG 1
Escudo	2.0		6	04.00-	H25A	1,1	IFR5J11	7418		
Escudo	2.0		4	04.00-04.05	J20A	1,1	IFR5J11	7418		
Escudo (TD54W)	2.0		4	05.05-	J20A	1,1	IFR6J11	7658		
Escudo	2.5		6	10.96-11.97	H25A	0,9	BKR6E	6962	28	LPG 1
Escudo	2.5		6	03.98-04.00	H25A	1,1	BKR6E-11	2756	14	LPG 1
Escudo (TD94W)	2.7		4	06.05-	H27A	1,1	IFR6J11	7658		

**GRAND VITARA**

Grand Vitara	FT / GT	1.6	69	4	03.98-	G16A / G16B	1,1	BKR6E-11	2756	14	LPG 1
Grand Vitara (only D)	FT / GT	1.6	69	4	.01-	G16A / G16B	1,1	IFR6J11	7658		
Grand Vitara	FT / GT	2.0	94	4	01.98-09.00	J20A	1,1	IFR6J11	7658		
Grand Vitara	FT / GT	2.0		4	10.00-	J20	1,1	IFR5J11	7418		
Grand Vitara V6 ( SV620)	FT / GT	2.5	106	6	04.98-09.00	H25	1,1	BKR6E-11	2756	14	LPG 1
Grand Vitara V6 (SV620)	FT / GT	2.5	125	6	01.98-	H25A	1,1	BKR6E-11	2756	14	LPG 1
Grand Vitara	FT / GT	2.5		6	10.00-	H25	1,1	IFR5J11	7418		IFR6J11
Grand Vitara V6	FT / GT	2.7	127	6	09.01-	H27A	1,1	IFR5J11	7418		IFR6J11
Grand Vitara XL7 (UBD) JB627W	FT / GT	2.7	135	6	04.03-08.08	H27A	1,1	IFR6J11	7658		
Grand Vitara (JB416)	JT	1.6	78	4	04.05-	M16A VVT	1,1	IFR6J11	7658		
Grand Vitara (JB420)	JT	2.0	103	4	09.05-	J20A	1,1	IFR5J11	7418		IFR6J11
Grand Vitara (JB420)	JT	2.0	103	4	09.05-	M20A	1,1	IFR5E11	7994		IFR6E11
Grand Vitara 2.4 (JB424)	JT	2.4	124	4	06.08-	J24B	1,1	SILFR6A11	5468		

**IGNIS**

Ignis 1.3	RG413	1.3	61	4	10.00-	M13A	1,1	IFR6J11	7658		
Ignis II 1.3	RM413	1.3	69	4	10.03-	M13A mit V V T	1,1	IFR6J11	7658		
Ignis II 1.5	RM415	1.5	73	4	08.03-	M15A mit V V T	1,1	IFR6J11	7658		
Ignis II 1.5I Sport	RG415	1.5	80	4	08.03-	M15A	1,1	IFR6J11	7658		

**JIMNY**

Jimny Cabrio	FJ	1.3	59	4	10.98-	G13BB	0,9	BKR6E	6962	28	LPG 1
Jimny	FJ	1.3	60	4	05.01-07.04	M13A	1,1	IFR6J11	7658		
Jimny	FJ	1.3	63	4	08.05-	M13A	1,1	IFR6J11	7658		

**KIZASHI**

Kizashi 2.4	FR	2.4	131	4	10.10-	J24B	1,1	SILFR6A11	5468		
-------------	----	-----	-----	---	--------	------	-----	-----------	------	--	--

**LIANA**

Liana	ER	1.3	66	4	03.01-01.04	M13A	1,1	BKR6E-11	2756	14	LPG 1
-------	----	-----	----	---	-------------	------	-----	----------	------	----	-------

e kW  
C  
Y  
I

0201



Stock-No

VLINE

LPG / CNG

**SUZUKI****LIANA**

Liana	ER	1.3	66	4	02.04-	M13A	1,1	IFR6J11	7658		
Liana	ER	1.6	78	4	03.01-01.04		1,1	BKR6E-11	2756	14	LPG 1
Liana	ER	1.6	78	4	02.04-	M16A	1,1	IFR6J11	7658		

**SAMURAI**

Samurai		1.0	33	4	.90-	F10A	0,9	BPR5ES	7422	6	LPG 2
Samurai (SJ413)		1.3	51	4	.90-	G13BA Cat.	0,9	BPR5ES	7422	6	LPG 2
Samurai		1.3	51	4	.92-	G13BA	0,9	BPR5ES	7422	6	LPG 2
Samurai Pick-up		1.3	51	4	10.99-10.00	G13BA	0,9	BPR5ES	7422	6	LPG 2

**SUPER CARRY**

SK 410 Super Carry		1.0	31	4	.85-	F10A	0,9	BPR5ES	7422	6	LPG 2
--------------------	--	-----	----	---	------	------	-----	--------	------	---	-------

**SPLASH**

Splash 1.0 (A5B310)		1.0	48	3	01.08-07.11	K10B	1,1	IKR6G11	7980		
Splash 1.2 (A5B412)		1.2	63	4	01.08-	K12B	1,1	IKR6G11	7980		
Splash 1.2 VWT (A5B412)		1.2	69	4	09.10-	K12B	1,1	IKR6G11	7980		

**SWIFT**

Swift II 1.0	SF310	1.0	37	3	03.89-05.01	G10A	0,8	BPR6ES	7822	2	LPG 2
Swift II 1.0	SF310	1.0	39	3	09.91-05.01	G10A	0,8	BPR6ES	7822	2	LPG 2
Swift II 1.0	SF310	1.0	40	3	03.89-12.91	G10A	0,8	BPR6ES	7822	2	LPG 2
Swift II 1.3	SF413	1.3	50	4	03.89-05.01	G13A	0,8	BPR6ES	7822	2	LPG 2
Swift II 1.3 4WD	SF413	1.3	50	4	03.89-05.01	G13A	0,8	BPR6ES	7822	2	LPG 2
Swift II 1.3	SF413	1.3	52	4	03.89-12.91	G13A	0,8	BPR6ES	7822	2	LPG 2
Swift II 1.3 Gti	SF413	1.3	74	4	03.89-05.01	G13B	0,8	BPR6ES	7822	2	LPG 2
Swift II 1.6	SF416	1.6	68	4	01.90-05.01	G16B	0,9	BKR6E	6962	28	LPG 1
Swift II 1.6	SF416	1.6	70	4	11.89-12.91	G16B	0,9	BKR6E	6962	28	LPG 1
Swift III 1.3 4X4	RS413	1.3	66	4	01.06-	M13A	1,1	IFR6J11	7658		
Swift III 1.3	RS413	1.3	68	4	02.05-	M13A	1,1	IFR6J11	7658		
Swift III 1.5	RS415	1.5	75	4	02.05-	M15A	1,1	IFR6J11	7658		
Swift III 1.6 Sport	RS416	1.6	92	4	05.06-	M16A	1,1	IFR6J11	7658		
Swift IV 1.2	AZG41	1.2	66	4	10.10-	K12B	1,1	IKR6G11	7980		
Swift IV 1.2	AZG41	1.2	69	4	10.10-	K12B	1,1	IKR6G11	7980		
Swift IV 1.6	AZG41	1.6	100	4	01.12-	M16A	1,1	SILFR6A11	5468		

**SX4**

SX4 1.5	RW415	1.5	73	4	06.06-	M15A	1,1	IFR6J11	7658		
SX4 1.5 VWT	RW415	1.5	82	4	07.09-	M15A VWT	1,1	IFR6J11	7658		
SX4 1.6 VWT	RW416	1.6	79	4	06.06-	M16A VWT	1,1	IFR6J11	7658		
SX4 1.6 VWT	RW416	1.6	88	4	07.09-	M16A VWT	1,1	IFR6J11	7658		
SX4 II 1.6 VWT S-Cross	AKK416	1.6	88	4	08.13-	M16A	1,1	SILFR6A11	5468		

**VITARA**

Vitara (SE416) Typ 2		1.6	59	4	- .98	G16A SOHC	0,9	BPR5ES	7422	6	LPG 2
Vitara		1.6	59	4	.91- .98	G16B Cat.	0,8	BPR6ES	7822	2	LPG 2
Vitara (SE416) Typ 1		1.6	60	4	.88- .98	G16A SOHC Cat.	0,9	BPR5ES	7422	6	LPG 2
Vitara		1.6	60	4	.91- .98	G16A	0,9	BPR5ES	7422	6	LPG 2
Vitara Long		1.6	71	4	.91- .98	G16B SOHC Cat.	0,9	BKR6E	6962	28	LPG 1
Vitara 16V		1.6	71	4	04.95- .98	G16A	0,9	BKR6E	6962	28	LPG 1
Vitara		1.6		4	10.00-	G16A	1,1	IFR6E11	6741		
Vitara (SV620)		2.0	100	6	06.95-	H20A	0,9	BKR6E	6962	28	LPG 1
Vitara		2.0		6		J20A	0,9	BKR6E	6962	28	LPG 1
Vitara V6 (SV620)		2.5	125	6	05.98-	H25A	1,1	BKR6E-11	2756	14	LPG 1
Vitara		1.6	70	4	09.93- .98	G16B	0,9	BKR6E	6962	28	LPG 1



l kW  
C  
y  
i

0201



Stock-No

VALVE

LPG / CNG

## SUZUKI

### WAGON R+

Wagon R+ 12V	1.0	44	3	03.05-	Z10XEP	1,1	ZFR5F	5165		LPG 6
Wagon R+ (SR410)	1.0	48	4	.97-	K10A	0,8	DCPR7E	3932		LPG 8
Wagon R+	1.0	55	4	02.04-	G10	1,1	BPR6ES-11	4824	13	LPG 2
Wagon R+	1.2	51	4	.98-	K12A	0,8	DCPR7E	3932		LPG 8
Wagon R+ 16V	1.2	59	4	03.05-	Z12XEP	0,8	ZFR5F	5165		LPG 6
Wagon R GL	1.3	56	4	04.00-	G13BB	1,1	BKR6E-11	2756	14	LPG 1
Wagon R+	1.3	68	4	02.04-	M13A mit VVT	1,1	IFR6J11	7658		IFR6J11
Wagon R+	1.3	69	4		G13BB	1,1	BKR6E-11	2756	14	LPG 1

### X-90

X-90	EL	1.6	71	4	10.95-	G16A	0,9	BKR6E	6962	28	LPG 1
X-90	EL	1.6	71	4	03.96-	G16B/G16W	0,9	BKR6E	6962	28	LPG 1

## TOFAS

124 Serce	1.3	48	4	09.83-		0,7	BP6ES	7811	4	LPG 2
131 Dogan	1.6	55	4	03.81-		0,7	BP6ES	7811	4	LPG 2
131 Dogan S/SX/SLX	1.6	55	4	06.92-		0,8	BPR6ES	7822	2	LPG 2
131 Kartal L	1.6	55	4	03.81-06.92		0,7	BP6ES	7811	4	LPG 2
131 Kartal SL / SLX	1.6	55	4	06.92-		0,8	BPR6ES	7822	2	LPG 2
Sahin	1.6	55	4	02.82-		0,7	BP6ES	7811	4	LPG 2
Tempra	1.6	63	4	11.90-		0,8	BPR6ES	7822	2	LPG 2
Tempra i.e.	2.0	88	4	07.92-		0,8	BPR6ES	7822	2	LPG 2

## TOFAS / FIAT

Brava 16V	1.2		4	11.98-09.01	16V	0,9	DCPR8E-N	5692		LPG 8
Brava 1.4 12V	1.4		4	10.95-10.98	12V	0,9	BKR6EKC	2848	26	LPG 1
Bravo 16V	1.2		4	11.98-09.01	16V	0,9	DCPR8E-N	5692		LPG 8
Bravo 1.4 12V	1.4		4	10.95-10.98	12V	0,9	BKR6EKC	2848	26	LPG 1
Doblo 16V	1.3		4	11.01-	MPI 16V	0,9	DCPR8E-N	5692		LPG 8
Marea 1.4 12V	1.4		4	10.96-02.99	12V	0,9	BKR6EKC	2848	26	LPG 1
Marea 2.0 20V	2.0		4	10.96-02.99	20V	0,9	BKR6EKC	2848	26	LPG 1
Palio 1.2 i.e.	1.2		4	10.01-	16V	0,9	DCPR8E-N	5692		LPG 8
Palio Weekend 1.2 i.e.	1.2		4	10.01-	16V	0,9	DCPR8E-N	5692		LPG 8
Palio 16V	1.3		4	03.00-	MPI 16V	0,9	DCPR8E-N	5692		LPG 8
Palio Weekend 16V	1.3		4	03.00-	MPI 16V	0,9	DCPR8E-N	5692		LPG 8
Palio 1.4 i.e.	1.4		4	03.98-09.01		0,8	BKR5EK	7956	23	LPG 1
Palio Weekend 1.4 i.e.	1.4		4	09.98-06.01		0,8	BKR5EK	7956	23	LPG 1
Siena 16V	1.3		4	03.00-	MPI 16V	0,9	DCPR8E-N	5692		LPG 8
Siena 1.4 i.e.	1.4		4	05.98-06.01		0,8	BKR5EK	7956	23	LPG 1
Stilo 16V	1.2		4	10.01-	16V	0,9	DCPR8E-N	5692		LPG 8
Stilo 1.6 16V	1.6		4	10.01-	16V	0,9	BKR5EZ	7642	36	LPG 1
Stilo S.W. 1.6 16V	1.6		4	01.03-	16V	0,9	BKR5EZ	7642	36	LPG 1
Stilo 1.8 16V	1.8		4	10.01-	16V	0,9	BKR6EZ	4619	38	LPG 1
Stilo S.W. 1.8 16V	1.8		4	01.03-	16V	0,9	BKR6EZ	4619	38	LPG 1

## TOYOTA

### 4 RUNNER

4 Runner	2.4	82	4	.89- .95	22R/22RE Cat.	0,8	BPR5EY	2828	9	LPG 2
4 Runner (RZN185)	2.7	112	6	.98-12.99	3RZ-FE	0,8	BKR5EYA	2087		LPG 1
4 Runner (VZN185)	2.7	112	6	.98-12.99	3RZ-FE	0,8	BKR5EYA	2087		LPG 1

e kW  
C  
Y  
I

0201

Stock-No  
VZLINE

LPG / CNG

**TOYOTA****4 RUNNER**

4 Runner (RZN180,185,VZN180 185)	2.7		6	01.00-	3RZ-FE	0,8	BKR5EYA	2087		LPG 1
4 Runner	3.0	105	6	.89- .96	3VZ-E Cat.	0,8	BKR5EYA	2087		LPG 1
4 Runner (RZN185)	3.4	136	6	.98-12.99	5VZ-FE	1,1	BKR5EKB-11	3967		
4 Runner (VZN185)	3.4	136	6	.98-12.99	5VZ-FE	1,1	BKR5EKB-11	3967		
4 Runner (RZN180,185,VZN180,185)	3.4		6	01.00-	5VZ-FE	1,1	BKR5EKB-11	3967		
4 Runner (GRN210,215)	4.0		6	01.04-	1GR-FE	1,1	LFR6C-11	5788		

**AURIS**

Auris 1.33 VVT-i (NRE150)	1.33	73	4	01.10-	1NR-FE	1,1	ILKAR7B11	4912		
Auris 1.33 VVT-i (NRE150)	1.33	74	4	11.08-01.10	1NR-FE	1,1	ILKAR7B11	4912		
Auris 1.4 WT-i (ZRE151)	1.4	71	4	10.06-	4ZZ-FE	1,1	BKR5EYA-11	2526	39	LPG 1
Auris II 1.5	1.5	80	4	10.12-	1NZ-FE	1,1	ILKAR7B11	4912		
Auris 1.6 VVT-i (ZRE151)	1.6	91	4	10.06-	1ZR-FE	1,1	ILKAR7B11	4912		
Auris 1.6 (ZRE151)	1.6	97	4	12.08-	1ZR-FAE	1,1	ILKAR7B11	4912		
Auris 1.8 Hybrid (ZWE 150)	1.8	73	4	09.10-	2ZR-FXE	1,1	ILKAR7B11	4912		
Auris 1.8 (ZZE150)(ZRE151,152 )	1.8	100	4	10.06-	2ZR-FE	1,1	ILKAR7B11	4912		
Auris 1.8 (ZRE152H)	1.8	108	4	10.09-	2ZR-FAE	1,1	ILKAR7B11	4912		

**AVALON**

Avalon (MCX20)	3.0		6	01.01-12.01	1MZ-FE	1,1	BKR6EKB-11	3583		
Avalon (MCX20)	3.0		6	01.02-	1MZ-FE	1,1	BKR6EKP-11	3452		

**AVENSIS**

Avensis (AT220,221,ST220)	1.6	81	4	04.98-	4A-FE	1,1	BKR6EYA-11	4073		LPG 1
Avensis (AZT220)	1.6		4	01.02-	3ZZ-FE	1,1	BKR5EYA-11	2526	39	LPG 1
Avensis (ST220)	1.6		4	01.02-	3ZZ-FE	1,1	BKR5EYA-11	2526	39	LPG 1
Avensis (ZZT220, 221)	1.6		4	01.02-	3ZZ-FE	1,1	BKR5EYA-11	2526	39	LPG 1
Avensis (ZZT250,251)(AZT250)	1.6		4	09.03-	3ZZ-FE	1,1	BKR5EYA-11	2526	39	LPG 1
Avensis (AT220,221,ST220)	1.8	81	4	01.98-	7A-FE	1,3	BKR6EP-13	2550		
Avensis (ST220)	1.8	95	4	01.02-	1ZZ-FE	1,1	BKR5EYA-11	2526	39	LPG 1
Avensis (ZZT220, 221)	1.8	95	4	01.02-	1ZZ-FE	1,1	BKR5EYA-11	2526	39	LPG 1
Avensis (AZT220)	1.8		4	01.02-	1ZZ-FE	1,1	BKR5EYA-11	2526	39	LPG 1
Avensis (ZZT250,251)(AZT250)	1.8		4	09.03-	1ZZ-FE	1,1	BKR5EYA-11	2526	39	LPG 1
Avensis (AT220,221,ST220)	2.0	94	4	01.98-	3S-FE	1,1	BKR6EKP-11	3452		
Avensis (AZT220)	2.0	110	4	07.00-02.03	1AZ-FSE	1,1	HB6BIX-11P	5705		HB6BIX-11P
Avensis (AZT220)	2.0		4	01.02-	3S-FE	1,1	BKR6EKB-11	3583		
Avensis (ST220)	2.0		4	01.02-	3S-FE	1,1	BKR6EKB-11	3583		
Avensis (ZZT220, 221)	2.0		4	01.02-	3S-FE	1,1	BKR6EKB-11	3583		
Avensis (1AZ-FE)	2.0		4	01.03-	1AZ-FE with 3way cat	1,1	IFR6T11	4589		
Avensis (1AZ-FE)	2.0		4	01.03-	1AZ-FE without cat	1,1	BKR6EYA-11	4073		LPG 1
Avensis (AZT250 / W)	2.0	108	4	03.03-10.08	1AZ-FSE	1,1	HB6BIX-11P	5705		
Avensis (AZT251/ W)	2.4	120	4	09.05-	2AZ-FSE	1,1	HB6BIX-11P	5705		
Avensis 2 (ZZT250;251)(AZT250)	1.6	81	4	03.03- .09	3ZZ-FE	1,1	BKR5EYA-11	2526	39	LPG 1
Avensis 2 (ZZT250;251)(AZT250)	1.8	95	4	03.03- .09	1ZZ-FE	1,1	BKR5EYA-11	2526	39	LPG 1
Avensis 2 (ATZ250)	2.0	110	4	01.03- .09	1AZ-FE V V T-i	1,1	IFR6T11	4589		
Avensis 3 (ZRT270)	1.6	81	4	04.08-	1ZRFAE	1,1	ILKAR7B11	4912		
Avensis 3 (ZRT270)	1.6	97	4	11.08-	1ZRFAE	1,1	ILKAR7B11	4912		
Avensis 3 (ZRT271)	1.8	108	4	11.08-	2ZRFAE	1,1	ILKAR7B11	4912		
Avensis 3 (ZRT272)	2.0	112	4	11.08-	3ZRFAE	1,1	ILKAR7B11	4912		



l kW  
C  
Y  
I

0201



Stock-No

VALVE

LPG / CNG

**TOYOTA**

**AVENSIS VERSO**

Avensis Verso (ACM20)	2.0	110	4	05.01-	1AZ-FE	1,1	IFR6T11	4589		
Avensis Verso (ACM20)	2.4		4	01.04-	2AZ-FE	1,1	BKR6EYA-11	4073		LPG 1

**AYGO**

Aygo	B10	1.0	50	3	05.05-	1KR-FE	1,1	LF6C-11	5788	
------	-----	-----	----	---	--------	--------	-----	---------	------	--

**CAMRY**

Camry (SV20,21,25,VZV21)	2.0	89	4	.86-	3S-FE Cat.	1,1	BCPR6EY-11	3720		LPG 3
Camry (SV20,21,25,VZV21)	2.0	94	4	.87-	3S-FE	1,1	BCPR6EY-11	3720		LPG 3
Camry (ACV30,31)	2.0		4	08.01-	1AZ-FE	1,1	IFR6T11	4589		
Camry (MCV30)	2.0		4	08.01-	1AZ-FE	1,1	IFR6T11	4589		
Camry (SXV10,VCV10)	2.2	100	4	.92-	5S-FE	1,1	BKR6EYA-11	4073		LPG 1
Camry MCV20	2.2	100	4	08.96-12.99	5S-FE with 3way cat	1,1	BKR6EKP-11	3452		
Camry MCV20	2.2	100	4	08.96-12.99	5S-FE without 3way cat	1,1	BKR6EKB-11	3583		
Camry SXV20	2.2	100	4	08.96-12.99	5S-FE with 3way cat	1,1	BKR6EKP-11	3452		
Camry SXV20	2.2	100	4	08.96-12.99	5S-FE without 3way cat	1,1	BKR6EKB-11	3583		
Camry (MCV20)	2.2		4	.98-12.99	5S-FE	1,1	BKR6EKP-11	3452		
Camry (SVX20)	2.2		4	.98-12.99	5S-FE	1,1	BKR6EKP-11	3452		
Camry (SVX20, MCV20)	2.2		4	01.00-	5S-FE	1,1	BKR6EKB-11	3583		
Camry (ACV30,31)	2.4	112	4	08.01-	2AZ-FE	1,1	IFR6T11	4589		IFR6T11
Camry (MCV30)	2.4	112	4	08.01-	2AZ-FE	1,1	IFR6T11	4589		IFR6T11
Camry (ACV 40)	2.4	116	4	01.06-	2AZ-FE	1,1	IFR6T11	4589		IFR6T11
Camry (SV21,25,VZV21)	2.5	118	6	.88- .92	2VZ-FE Cat.	1,1	BCPR6EP-11	3350		LPG 3
Camry (SVX20, MCV20)	3.0	137	6	01.00-	1MZ-FE V6	1,1	BKR6EKP-11	3452		
Camry (SXV10,VCV10)	3.0	138	6	.92-	3VZ-FE	1,1	BCPR6EP-11	3350		LPG 3
Camry MCV20	3.0	138	6	08.96-12.99	1MZ-FE with 3way cat	1,1	BKR6EKP-11	3452		
Camry MCV20	3.0	138	6	08.96-12.99	1MZ-FE without 3way cat	1,1	BKR6EKB-11	3583		
Camry SXV20	3.0	138	6	08.96-12.99	1MZ-FE with 3way cat	1,1	BKR6EKP-11	3452		
Camry SXV20	3.0	138	6	08.96-12.99	1MZ-FE without 3way cat	1,1	BKR6EKB-11	3583		
Camry (ACV30,31)	3.0		6	08.01-	1MZ-FE	1,1	IFR6T11	4589		
Camry (MCV30)	3.0		6	08.01-	1MZ-FE	1,1	IFR6T11	4589		

**CARINA E**

Carina E (AT190,191,ST191)	1.6	77	4	.93- .97	4A-FE Lean Burn engine	1,3	BKR6EP-13	2550		
Carina E (AT190,191,ST191)	1.6		4	.93- .97	4A-FE Standard engine	0,8	BKR6EYA	2249		LPG 1
Carina E (AT190,191,ST191)	1.8	79	4	.95-	7A-FE	1,3	BKR6EP-13	2550		
Carina E (AT190,191,ST191)	2.0	98	4	.93- .97	3S-FE Cat.	1,1	BKR6EYA-11	4073		LPG 1
Carina E (AT190,191,ST191)	2.0	116	4	.93-	3S-GE Cat.	0,8	BKR6EP-8	2215		LPG 1
Carina E (DK)	1.6		4	.92-	4A-FE Cat.	0,8	BKR6EYA	2249		LPG 1
Carina E (DK)	1.6		4	.92-	4A-FE Cat. Lean Burn	1,3	BKR6EP-13	2550		
Carina E (DK)	1.8		4	.92-	7A-FE Cat. Lean Burn	1,3	BKR6EP-13	2550		
Carina E (DK)	2.0		4	.92-	3S-FE Cat.	1,1	BKR6EYA-11	4073		LPG 1
Carina E (DK)	2.0		4	.92-	3S-FE Cat. Lean Burn	1,1	BKR6EP-11	2978		LPG 1

**CARINA II**

Carina II (AT171,177,ST171)	1.6	66	4	.87- .92	4A-F Cat.	0,8	BCRE527Y	2074		
Carina II (AT171,177,ST171)	1.6	72	4	.90- .92	4A-FE	0,8	BCPR5EY	1266		LPG 3
Carina II (AT171,177,ST171)	1.6	72	4	.90- .92	4A-FE Cat.	1,1	BCPR6EIX-11	4919		LPG 3
Carina II (AT171,177,ST171)	1.6	72	4	.90- .92	4A-FE with EGR	0,8	BCPR5EY	1266		LPG 3
Carina II (AT171,177,ST171)	1.6	72	4	.90- .92	4A-FE without EGR	1,1	BCPR6EIX-11	4919		LPG 3
Carina II (AT171,177,ST171)	2.0	89	4	.88- .92	3S-F	1,1	BCPR6EY-11	3720		LPG 3
Carina II (AT171,177,ST171)	2.0	98	4	.88- .92	3S-FE Cat.	1,1	BCPR6EY-11	3720		LPG 3

e kW  
C  
y  
i

Stock-No



LPG / CNG

**TOYOTA  
CELICA**

Celica (AT180,ST182,184,185)	1.6	77	4	.90-	.94	4A-FE	0,8	BCPR5EY	1266		LPG 3
Celica (AT200,ST202,204,205)	1.8	85	4	03.94-		7A-FE	0,8	BKR6EYA	2249		LPG 1
Celica S (ZZT230)	1.8	105	4	08.99-		1ZZ-FE	1,1	BKR5EYA-11	2526	39	LPG 1
Celica (ZZT230,231)	1.8		4	08.99-		1ZZ-FE	1,1	BKR5EYA-11	2526	39	LPG 1
Celica (ZZT230,231)	1.8		4	08.99-		2ZZ-GE	1,1	IFR6T11	4589		
Celica (AT200,ST202,204,205)	2.0	95	4	.94-		3S-FE	1,1	BKR6EYA-11	4073		LPG 1
Celica (AT180,200,ST182,184,185,202,204,205)	2.0	115	4	.90-		3S-GE Cat.	0,8	BKR6EP-8	2215		LPG 1
Celica (AT180,200,ST182,184,185,202,204,205)	2.0	129	4	03.94-		3S-GE	0,8	BKR6EP-8	2215		LPG 1
Celica (AT200)	2.0		4	.98-		3S-GE	0,8	BKR6EP-8	2215		LPG 1
Celica (ST202,204,205)	2.0		4	.98-		3S-GE	0,8	BKR6EP-8	2215		LPG 1
Celica (AT180,ST182,184,185)	2.2	100	4	.91-		5S-FE Cat.	1,1	BKR6EP-11	2978		LPG 1
Celica (AT200)	2.2		4	.98-		5S-FE	1,1	BKR6EP-11	2978		LPG 1
Celica (ST202,204,205)	2.2		4	.98-		5S-FE	1,1	BKR6EP-11	2978		LPG 1
Celica Supra	3.0		6			7M-GE	0,9	BCPR6EY	1146		LPG 3
Celica Turbo (AT200,ST202,204,205)	2.0	150	4	.90-		3S-GTE	0,8	BKR6EP-8	2215		LPG 1

**COROLLA**

Corolla	1.2		4			3K	0,9	BPR5ES	7422	6	LPG 2
Corolla (EE80,90,97,100,105,AE82,92,95,101)	1.3	55	4	.86-	.92	2E	1,1	BPR6EY-11	4228	10	LPG 2
Corolla (EE90,97,AE92,95)	1.3	55	4	.90-	.92	2E-E	0,8	BPR5EY	2828	9	LPG 2
Corolla (EE105)	1.3	63	4	07.97-	.07	2E	0,8	BPR6EY	6427		LPG 2
Corolla 1.33 (NRE150)	1.33	74	4	10.08-		1NR-FE	1,1	ILKAR7B11	4912		
Corolla (EE100,101,105,AE101,102)	1.3		4	.92-	.97	4E-FE	0,8	BKR5EYA	2087		LPG 1
Corolla (EE100,101,105,AE101,102)	1.3		4	.93-	.97	2E	0,8	BPR6EY	6427		LPG 2
Corolla (EE100,101,105,AE101,102)	1.3		4	.94-	.07	2E	0,8	BPR6EY	6427		LPG 2
Corolla (AE110,111,112,115)	1.3		4	.98-12.99		2E	0,8	BPR6EY	6427		LPG 2
Corolla (AE110,111,112,115)	1.3		4	.98-12.99		4E-FE	1,1	BKR5EKB-11	3967		
Corolla (EE110,111)	1.3		4	.98-12.99		2E	0,8	BPR6EY	6427		LPG 2
Corolla (EE110,111)	1.3		4	.98-12.99		4E-FE (16V DOHC)	1,1	BKR5EKB-11	3967		
Corolla (EE110,111,AE110-112,115,ZZE111,112)	1.3		4	01.00-	.07	2E	0,8	BPR6EY	6427		LPG 2
Corolla (EE110,111,AE110-112,115,ZZE111,112)	1.3		4	01.00-	.07	4E-FE	1,1	BKR5EKB-11	3967		
Corolla (NZE120,121)	1.3		4	10.01-	.07	2NZ-FE	1,1	BKR5EYA-11	2526	39	LPG 1
Corolla (ZZE120,121,122,123)	1.3		4	10.01-	.07	2NZ-FE	1,1	BKR5EYA-11	2526	39	LPG 1
Corolla (EE100,101,105,AE101,102)	1.4	65	4	.92-	.94	4E-FE	0,8	BKR6EYA	2249		LPG 1
Corolla (EE110,111,AE110-112,115,ZZE111,112)	1.4	71	4	01.00-	.07	4ZZ-FE	1,1	BKR5EYA-11	2526	39	LPG 1
Corolla (NZE120,121 ZZE120,121,122,123)	1.4	71	4	01.02-	.07	4ZZ-FE	1,1	BKR5EYA-11	2526	39	LPG 1
Corolla EE110,111,AE110,111,112,115	1.4		4	01.98-	.07	4E-FE	1,1	BKR5EKB-11	3967		
Corolla (NZE120,121)	1.4		4	10.01-	.07	4ZZ-FE	1,1	BKR5EYA-11	2526	39	LPG 1
Corolla (ZZE120,121,122,123)	1.4		4	10.01-	.07	4ZZ-FE	1,1	BKR5EYA-11	2526	39	LPG 1
Corolla (AE110,111,112,115)	1.5		4	.98-12.99		5A-FE	1,1	BKR5EYA-11	2526	39	LPG 1
Corolla (EE110,111)	1.5		4	.98-12.99		5A-FE	1,1	BKR5EYA-11	2526	39	LPG 1
Corolla (EE110,111,AE110-112,115,ZZE111,112)	1.5		4	01.00-	.07	5A-FE	1,1	BKR5EYA-11	2526	39	LPG 1
Corolla (NZE120,121)	1.5		4	10.01-	.07	1NZ-FE	1,1	BKR5EYA-11	2526	39	LPG 1
Corolla (ZZE120,121,122,123)	1.5		4	10.01-	.07	1NZ-FE	1,1	BKR5EYA-11	2526	39	LPG 1
Corolla (EE90,97,100,101,105,AE92,95,101,102)	1.6	66	4	.87-12.99		4A-F	0,8	BCRE527Y	2074		
Corolla (EE90,97,AE92,95)	1.6	77	4	.89-	.91	4A-FE Cat.	0,8	BCPR5EY	1266		LPG 3
Corolla	1.6	81	4	07.97-	.07	4A-FE	1,1	BKR5EYA-11	2526	39	LPG 1
Corolla (EE110,111,AE110-112,115,ZZE111,112)	1.6	81	4	01.00-	.07	3ZZ-FE	1,1	BKR5EYA-11	2526	39	LPG 1
Corolla (NZE120,121)	1.6	81	4	10.01-	.07	3ZZ-FE	1,1	BKR5EYA-11	2526	39	LPG 1
Corolla (ZZE120,121,122,123)	1.6	81	4	10.01-	.07	3ZZ-FE	1,1	BKR5EYA-11	2526	39	LPG 1
Corolla (ZZE121)	1.6	81	4	11.01-	.07	3ZZ-FE	1,1	BKR5EYA-11	2526	39	LPG 1
Corolla (EE100,101,105,AE101,102)	1.6	84	4	.92-	.94	4A-FE	0,8	BKR6EYA	2249		LPG 1



e kW  
C  
y  
l

0201



Stock-No

VLINE

LPG/CNG

**TOYOTA****COROLLA**

Corolla (EE90,97,AE92,95)	1.6	85	4	.90-	4A-GE Cat.	0,8	BKR6EP-8	2215		LPG 1
Corolla 1.6 (ZRE151)	1.6	91	4	11.06-12.08	1ZR-FE	1,1	ILKAR7B11	4912		
Corolla 1.6 (ZRE151)	1.6	97	4	01.09-	1ZR-FAE / 1ZR-FE	1,1	ILKAR7B11	4912		
Corolla (EE100,101,105,AE101,102)	1.6		4	.95-12.99	4A-FE	0,8	BKR6EYA	2249		LPG 1
Corolla (AE110,111,112,115)	1.6		4	.98-12.99	4A-F	0,8	BCRE527Y	2074		
Corolla (AE110,111,112,115)	1.6		4	.98-12.99	4A-FE	0,8	BKR6EYA	2249		LPG 1
Corolla (EE110,111)	1.6		4	.98-12.99	4A-F	0,8	BCRE527Y	2074		
Corolla (EE110,111)	1.6		4	.98-12.99	4A-FE	0,8	BKR6EYA	2249		LPG 1
Corolla (EE110,111,AE110-112,115,ZZE111,112)	1.6		4	01.00- .07	4A-F	0,8	BCRE527Y	2074		
Corolla (EE110,111,AE110-112,115,ZZE111,112)	1.6		4	01.00- .07	4A-FE	0,8	BKR6EYA	2249		LPG 1
Corolla Spacio (AE111)	1.6		4	01.00- .07	4A-FE	0,8	BKR6EYA	2249		LPG 1
Corolla (NZE120,121)	1.8	99	4	10.01- .07	1ZZ-FE	1,1	BKR5EYA-11	2526	39	LPG 1
Corolla (ZZE120,121,122,123)	1.8	99	4	10.01- .07	1ZZ-FE	1,1	BKR5EYA-11	2526	39	LPG 1
Corolla (NZE120,121)	1.8	141	4	10.01- .07	2ZZ-GE	1,1	IFR6T11	4589		
Corolla (ZZE120,121,122,123)	1.8	141	4	10.01- .07	2ZZ-GE	1,1	IFR6T11	4589		
Corolla (ZZE123) Sport	1.8	141	4	.02- .07	2ZZ-GE	1,1	IFR6T11	4589		
Corolla (ZZE123) Sport	1.8	160	4	10.05-02.07	2ZZ-GE	1,1	IFR6T11	4589		
Corolla (EE100,101,105,AE101,102)	1.8		4	.93-12.99	7A-FE	0,8	BKR6EYA	2249		LPG 1
Corolla (AE110,111,112,115)	1.8		4	.98-12.99	7A-FE	0,8	BKR6EYA	2249		LPG 1
Corolla (EE110,111)	1.8		4	.98-12.99	7A-FE	0,8	BKR6EYA	2249		LPG 1
Corolla (EE110,111,AE110-112,115,ZZE111,112)	1.8		4	01.00-	7A-FE	0,8	BKR6EYA	2249		LPG 1
Corolla 4WD	1.6	84	4	.93-	4A-FE	0,8	BCPR5EY	1266		LPG 3
Corolla 4WD	1.6		4	.95-	4A-FE	0,8	BCPR5EY	1266		LPG 3

**COROLLA VERSO**

Corolla Verso (ZZE121, 122)	1.6		4	09.01- .07	3ZZ-FE	1,1	BKR5EYA-11	2526	39	LPG 1
Corolla Verso (ZNR10)	1.6		4	08.05- .07	3ZZ-FE	1,1	BKR5EYA-11	2526	39	LPG 1
Corolla Verso (ZNR10)	1.8	99	4	08.05- .07	1ZZ-FE	1,1	BKR5EYA-11	2526	39	LPG 1
Corolla Verso (ZZE121, 122)	2.0		4	09.01- .07	1ZZ-FE	1,1	BKR5EYA-11	2526	39	LPG 1

**CORONA**

Corona (AT171,177,ST171)	1.6	66	4	.88- .92	4A-F Cat.	0,8	BCRE527Y	2074		
Corona	1.6	70	4		4A-F Cat. not Europe	1,1	BCPR5EY-11	4120		LPG 3
Corona (AT171,177,ST171)	1.6	70	4		4A-F	0,8	BCRE527Y	2074		
Corona (AT171,177,ST171)	1.6	72	4	.90- .92	4A-FE	1,1	BCPR6EIX-11	4919		LPG 3
Corona (AT171,177,ST171)	1.6	75	4	.90- .92	4A-FE	0,8	BCPR5EY	1266		LPG 3
Corona (AT220,221,ST220)	1.6	81	4	04.98-	4A-FE	1,3	BKR6EP-13	2550		
Corona (AT190,ST191)	1.6		4	.93-	4A-FE	1,1	BKR5EYA-11	2526	39	LPG 1
Corona (ST210, AT210)	1.6		4	01.00-	4A-FE	0,8	BKR6EYA	2249		LPG 1
Corona (AZT220)	1.6		4	01.02-	3ZZ-FE	1,1	BKR5EYA-11	2526	39	LPG 1
Corona (ST220)	1.6		4	01.02-	3ZZ-FE	1,1	BKR5EYA-11	2526	39	LPG 1
Corona (ZZT220, 221)	1.6		4	01.02-	3ZZ-FE	1,1	BKR5EYA-11	2526	39	LPG 1
Corona (AT220,221,ST220)	1.8	81	4	01.98-	7A-FE	1,3	BKR6EP-13	2550		
Corona	1.8		4		1S-I	1,1	BRE527Y-11	6029		
Corona (AZT220)	1.8		4	01.02-	1ZZ-FE	1,1	BKR5EYA-11	2526	39	LPG 1
Corona (ST220)	1.8		4	01.02-	1ZZ-FE	1,1	BKR5EYA-11	2526	39	LPG 1
Corona (ZZT220, 221)	1.8		4	01.02-	1ZZ-FE	1,1	BKR5EYA-11	2526	39	LPG 1
Corona (AT171,177,ST171)	2.0	89	4	- .92	3S-FE Cat.	1,1	BCPR6EY-11	3720		LPG 3
Corona (AT220,221,ST220)	2.0	94	4	01.98-	3S-FE	1,1	BKR6EKP-11	3452		
Corona (AT190,191,ST191)	2.0	98	4	.93-	3S-FE	1,1	BKR6EYA-11	4073		LPG 1
Corona (AT171,177,ST171)	2.0	116	4	.92-	3S-GE	0,8	BKR6EP-8	2215		LPG 1
Corona (AT171,177,ST171)	2.0		4	- .92	3S-F	1,1	BCPR6EY-11	3720		LPG 3

e kw  
C  
Y  
I

0201



Stock-No

VLINE

LPG / CNG

**TOYOTA  
CORONA**

Corona (ST210, AT210)	2.0		4	01.00-	3S-FE	1,1	BKR6EKB-11	3583		
Corona (AZT220)	2.0		4	01.02-	3S-FE	1,1	BKR6EKB-11	3583		
Corona (ST220)	2.0		4	01.02-	3S-FE	1,1	BKR6EKB-11	3583		
Corona (ZZT220, 221)	2.0		4	01.02-	3S-FE	1,1	BKR6EKB-11	3583		

**CROWN**

Crown	2.0		4	.93-	1G-FE	0,8	BKR6EYA	2249		LPG 1
Crown (GS151)	2.0		4	.98-	1G-FE	1,1	BKR5EYA-11	2526	39	LPG 1
Crown (JZS155)	2.0		4	.98-	1G-FE	1,1	BKR5EYA-11	2526	39	LPG 1
Crown	2.8		6	.86-	5M-GE	0,8	BPR5EY	2828	9	LPG 2
Crown (GS151)	2.9		6	.98-	2JZ-GE with 3way cat.	1,1	BKR5EKB-11	3967		
Crown (GS151)	2.9		6	.98-	2JZ-GE without 3way cat.	0,8	BKR6EYA	2249		LPG 1
Crown (JZS155)	2.9		6	.98-12.99	2JZ-GE with 3way cat.	1,1	BKR5EKB-11	3967		
Crown (JZS155)	2.9		6	.98-	2JZ-GE without 3way cat.	0,8	BKR6EYA	2249		LPG 1
Crown	3.0		6	.93-12.99	2JZ-GE	0,8	BKR6EYA	2249		LPG 1
Crown (JZS155)	3.0		6	01.00-	2JZ-GE	1,1	BKR5EKP-11	4302		

**ECHO**

Echo (SCP10, NCP10, 11, 12, 13)	1.0		4	01.99-	1SZ-FE	0,8	BKR5EYA	2087		LPG 1
Echo Verso (NCP20, 21, 22)	1.3	63	4	08.99-	2NZ-FE	1,1	BKR5EYA-11	2526	39	LPG 1
Echo (NCP10, 11, 12, 13, SCP10)	1.3		4	01.01-	2NZ-FE	1,1	BKR5EYA-11	2526	39	LPG 1
Echo (NCP10, 11, 12, 13, SCP10)	1.5	78	4	01.01-12.01	1NZ-FE	1,1	BKR5EYA-11	2526	39	LPG 1
Echo (NCP10, 11, 12, 13, SCP10)	1.5	78	4	01.02-	1NZ-FE	0,8	BKR5EYA	2087		LPG 1
Echo (NCP20, 21, 22)	1.5	78	4	01.02-	1NZ-FE	0,8	BKR5EYA	2087		LPG 1

**HIACE**

Hiace	1.8		4	.95-	2Y o.Cat.	0,8	BPR5EY	2828	9	LPG 2
Hiace (RZH102, 103, 104, 109, 112-115, 119, 125)	2.0	74	4	.90-.98	1R-Z	0,8	BPR5EY	2828	9	LPG 2
Hiace (RZH102-105, 112-115, 125, 135, 153, 155)	2.0		4	.98-	1RZ	0,8	BP5EY	7327		LPG 2
Hiace (RZH102, 103, 104, 109, 112-115, 119, 125)	2.4	88	4	.90-	2R-ZE	1,1	BPR5EP-11	3971		
Hiace (RZH102, 103, 104, 109, 112-115, 119, 125)	2.4		4	.90-	2R-Z	0,8	BP5EY	7327		LPG 2
Hiace (RZH102-105, 112-115, 125, 135, 153, 155)	2.4		4	.98-	2RZ	0,8	BP5EY	7327		LPG 2
Hiace (RZH102-105, 112-115, 125, 135, 153, 155)	2.4		4	.98-	2RZ-E	1,1	BPR5EP-11	3971		
Hiace (RCH12, 13, 19, 22, 23, 29)	2.4		4	01.00-	2RZ-E	1,1	BPR5EP-11	3971		
Hiace (RCH12, 13, 19, 22, 23, 29)	2.7	105	6	01.00-.03	3RZ-FE	0,8	IFR5T-8N	3508		
Hiace (RCH 13, 19, 23, 29)	2.7		4	01.04-	3RZ-FE	1,1	IFR5T11	4996		

**HILUX**

Hilux	1.8	61	4	.88-.94	2Y	0,8	BPR5EY	2828	9	LPG 2
Hilux	1.8		4		2Y-C	0,8	BPR5EY	2828	9	LPG 2
Hilux	1.8		4	.95-	2Y	0,8	BP5EY	7327		LPG 2
Hilux (TGN10, 11, 15, 16, 26, 36)	2.0	100	4	07.05-	1TR-FE	1,1	LFR6C-11	5788		
Hilux	2.0		4	.88-.94	3Y, 3Y-C	0,8	BPR5EY	2828	9	LPG 2
Hilux	2.0		4	.95-	3Y	0,8	BP5EY	7327		LPG 2
Hilux (RZN142, 144, 147-149, 154, 168, 169, 173, 174, 193)	2.0		4	01.01-	1RZ	0,8	BP5EY	7327		LPG 2
Hilux (RZN142, 144, 147-149, 154, 168, 169, 173, 174, 193)	2.0		4	01.01-	1RZ-E	0,8	BPR5EY	2828	9	LPG 2
Hilux (VZN 167, 172)	2.0		4	01.01-	1RZ	0,8	BP5EY	7327		LPG 2
Hilux	2.2		4	.88-.94	4Y, 4Y-C	0,8	BPR5EY	2828	9	LPG 2
Hilux	2.2		4	.95-	4Y	0,8	BP5EY	7327		LPG 2
Hilux	2.4	84	4	.88-	22R-E Cat.	0,8	BPR5EY	2828	9	LPG 2
Hilux	2.4		4	.88-	22R	0,8	BPR5EY	2828	9	LPG 2



l kW  
C  
y  
i

0201



Stock-No

VALUE

LPG / CNG

**TOYOTA**

**HILUX**

Hilux (VZN 167, 172)	2.4		6	01.01-	2RZ-FE	0,8	BKR5EYA	2087		LPG 1
Hilux (RZN142,144,147-149,154,168,169,173,174,193)	2.4		6	01.01-	2RZ-FE	0,8	BKR5EYA	2087		LPG 1
Hilux (TNG10,11,15,16,26,36)	2.7	118	4	07.05-	2TR-FE	1,1	LFR6C-11	5788		
Hilux	2.7		6	.96-	3RZ-FE	0,8	BKR5EYA	2087		LPG 1
Hilux (RZN142,144,147-149,154,168,169,173,174,193)	2.7		6	01.01-	3RZ-F	0,8	BKR5EYA	2087		LPG 1
Hilux (RZN142,144,147-149,154,168,169,173,174,193)	2.7		6	01.01-	3RZ-FE	0,8	BKR5EYA	2087		LPG 1
Hilux	3.0	105	6	.89-	3VZ-E	0,8	BKR5EYA	2087		LPG 1
Hilux	3.4		6	.96-	5VZ-FE	1,1	BKR5EKB-11	3967		
Hilux (GGN15,25)	4.0	175	6	07.05-	1GR-FE	1,1	LFR6C-11	5788		
Hilux (GRN215W)	4.0		6	08.05-	1GR-FE	1,1	LFR6C-11	5788		

**iQ**

iQ 1.0 VVT-i (KGJ10)	1.0	50	3	11.08-	1KR-FE	1,1	ILFR5T11	96779		
iQ 1.3 (NGJ10)	1.33	72	4	05.09-	1NR-FE	1,1	ILKAR7B11	4912		

**LAND CRUISER**

Land Cruiser	2.4	77	4	-12.96	22R-E	0,8	BPR5EY	2828	9	LPG 2
Land Cruiser (FJ62,70,73,75,RJ70)	2.4	77	4		22R	0,8	BPR5EY	2828	9	LPG 2
Land Cruiser (RZJ90,95, VZJ90,95)	2.7		6	05.96-	3RZ-F	0,8	BKR5EYA	2087		LPG 1
Land Cruiser (RZJ90,95, VZJ90,95)	2.7		6	05.96-	3RZ-FE	0,8	BKR5EYA	2087		LPG 1
Land Cruiser (RZJ120,125)(GRJ120,125)	2.7		4	01.03-	3RZ-FE with 3way cat.	1,1	BKR5EYA-11	2526	39	LPG 1
Land Cruiser (RZJ120,125)(GRJ120,125)	2.7		4	01.03-	3RZ-FE without 3way cat.	0,8	BKR5EYA	2087		LPG 1
Land Cruiser (TRJ120,125)(GRJ120, 125)	2.7		6	01.05-	2TR-FE	1,1	ILFR6T11	4904		
Land Cruiser (RZJ90,95, VZJ90,95)	3.4	131	6	05.96-	5VZ-FE	1,1	BKR5EKB-11	3967		
Land Cruiser (FJ62,70,73,75,RJ70)	4.0	107	6	.88-	3F	0,8	BPR4EY	2128		LPG 2
Land Cruiser (RZJ120,125)(GRJ120,125)	4.0	183	6	.02-	1GR-FE	1,1	LFR6C-11	5788		
Land Cruiser (20W/121W)	4.0		6	08.05-	1GR-FE	1,1	LFR6C-11	5788		
Land Cruiser (TRJ120, 125)(GRJ120, 125)	4.0		6	01.05-	1GR-FE	1,1	LFR6C-11	5788		
Land Cruiser 150 (J15) 4.0 V6 VVTi	4.0	183	6	01.10-	1GR-FE	1,1	ILFR6T11	4904		
Land Cruiser 150 (J15) 4.0 V6 Dual VVTi	4.0	205	6	01.10-	1GR-FE	1,1	ILFR6T11	4904		
Land Cruiser 150 (J15) 4.0 V6 VVTi	4.0	207	6	01.10-	1GR-FE	1,1	ILFR6T11	4904		
Land Cruiser	4.5		6	.93-	1FZ-FE	0,8	BKR5EYA	2087		LPG 1
Land Cruiser (FZJ80)	4.5		6	.96-	1FZ-F	0,8	BKR5EYA	2087		LPG 1
Land Cruiser (FZJ100,105)	4.5		6	.98-12.99	1FZ-FE	1,1	BKR5EKB-11	3967		
Land Cruiser (FZJ70,73,75)	4.5		6	.98-12.99	1FZ-F	0,8	BKR5EYA	2087		LPG 1
Land Cruiser (FZJ70,73,75)	4.5		6	.98-12.99	1FZ-FE	0,8	BKR5EYA	2087		LPG 1
Land Cruiser (UZJ100)	4.5		6	.98-12.99	1FZ-FE	1,1	BKR5EKB-11	3967		
Land Cruiser (FZJ71,74,78,79)	4.5		6	01.00-	1FZ-FE	1,1	BKR5EKB-11	3967		
Land Cruiser (UZJ100,FZJ100,105)	4.5		6	01.01-	1FZ-FE	1,1	BKR5EKB-11	3967		
Land Cruiser (FZJ100,105)	4.5		6	01.02-	1FZ-FE	1,1	BKR5EKB-11	3967		
Land Cruiser (UZJ100)	4.5		6	01.02-	1FZ-FE	1,1	BKR5EKB-11	3967		
Land Cruiser (URJ202W)	4.6		8	.09-	1UR-FE	1,1	LFR6AIX-11	6619		
Land Cruiser 4.7 V8 (FZJ100,105)	4.7	173	8	01.98-	2UZ-FE	1,1	IFR6T11	4589		
Land Cruiser 4.7 V8 (UZJ100)	4.7	173	8	01.98-	2UZ-FE	1,1	IFR6T11	4589		
Land Cruiser 4.7 V8 (UZJ100,FZJ100,105)	4.7		8	01.01-	2UZ-FE with 3way cat.	1,1	IFR6T11	4589		
Land Cruiser 4.7 V8 (UZJ200)	4.7	212	8	08.07-	2UZ-FE	1,1	IFR6T11	4589		



e kW C Y I

0201



Stock-No

VLINE

LPG / CNG

**TOYOTA  
LITEACE**

Liteace (KR41,42)	1.5		4	.98-	5K	0,8	BPR5EY	2828	9	LPG 2
Liteace (SR40)	1.5		4	.98-	5K	0,8	BPR5EY	2828	9	LPG 2
Liteace (KM30,36,37, YM30,35,40,41)	1.8		4	.89-	2Y-C	0,8	BP5EY	7327		LPG 2
Liteace (KM30,36,37, YM30,35)	1.8		4	.90-	2Y Cat.	0,8	BP5EY	7327		LPG 2
Liteace (KM30,36,37, YM30,35)	1.8		4	.90-	2Y-C Cat.	1,1	BPR5EP-11	3971		
Liteace (KM30,36,37, YM30,35)	1.8		4	.90-	2Y-CU Cat.	0,8	BP5EY	7327		LPG 2
Liteace (KR41,42)	1.8		4	.98-	7K	0,8	BPR5EY	2828	9	LPG 2
Liteace (SR40)	1.8		4	.98-	7K	0,8	BPR5EY	2828	9	LPG 2
Liteace (KM30,36,37, YM30,35,40,41)	2.0		4		3Y-CU	1,1	BPR5EP-11	3971		
Liteace (KM30,36,37, YM30,35,40,41)	2.0		4	.93-	3Y	0,8	BP5EY	7327		LPG 2
Liteace (KR41,42)	2.0		4	.98-	3S-FE	1,1	BKR6EKB-11	3583		
Liteace (SR40)	2.0		4	.98-	3S-FE	1,1	BKR6EKB-11	3583		
Liteace	2.2		4	.93-	4Y-E	1,1	BPR5EP-11	3971		

**MODEL F**

Model F (YR21,22,31)	2.0	65	4		3Y-C	0,8	BPR5EY	2828	9	LPG 2
Model F	2.0		4		3Y-EC	0,8	BPR5EY	2828	9	LPG 2
Model F	2.2		4	.90-	4Y-E	0,8	BPR5EY	2828	9	LPG 2

**MR 2**

MR 2	1.6		4		4A-GZE	1,1	BCPR6EP-11	3350		LPG 3
MR 2 (ZZW30)	1.8	103	4	12.99-	1ZZ-FE	1,1	BKR5EYA-11	2526	39	LPG 1
MR 2 (SW20)	2.0	115	4	.90- .93	3S-GE Cat.	0,8	BKR6EP-8	2215		LPG 1
MR 2 (SW20)	2.0	118	4	.89- .92	3S-GE	0,8	BKR6EYA	2249		LPG 1
MR 2 (SW20)	2.0	129	4	.94-	3S-GE	0,8	BKR6EP-8	2215		LPG 1
MR 2 (SW20)	2.0		4	.93-	3S-GTE	0,8	BKR6EP-8	2215		LPG 1
MR 2 (SW20)	2.2	89	4	.90-	3S-FE Cat.	1,1	BKR6EYA-11	4073		LPG 1
MR 2	2.2		4	.93-	5S-FE	1,1	BKR6EP-11	2978		LPG 1

**PASEO**

Paseo (EL54)	1.5	66	4	07.95-12.97	5E-FE (only Europe)	0,8	BKR5EYA	2087		LPG 1
Paseo (EL54)	1.5		4	01.98-07.99	5E-FE (only Europe)	1,1	BKR5EP-11	3440		LPG 1

**PICNIC**

Picnic (SXM10)	2.0	94	4	09.96-09.01	3S-FE	1,1	BKR6EKP-11	3452		
Picnic (ACM20)	2.0	110	4	05.01-	1AZ-FE	1,1	IFR6T11	4589		

**PREVIA**

Previa (TCR10,11,20,21)	2.4	97	4	05.90- .00	2TZ-FE Cat.	1,1	BKR5EP-11	3440		LPG 1
Previa (TCR10,11,20,21)	2.4	97	4	05.90-	2TZ-FE 3 way Cat.	0,8	BKR5EYA	2087		LPG 1
Previa (ACR30,50)	2.4	115	4	03.00-	2AZ-FE	1,1	IFR6T11	4589		
Previa (TCR10,11,20,21)	2.4		4	.96-	2TZ-FE without Cat.	0,8	BKR5EYA	2087		LPG 1

**PRIUS**

Prius (Hybrid) (NHW11)	1.5	53	4	05.00- .03	1NZ-FXE	1,1	IFR5T11	4996		
Prius (Hybrid) (NHW20)	1.5	57	4	.03- .09	1NZ-FXE	1,1	IFR5T11	4996		
Prius (ZVW30)	1.8	72	4	04.09-	2ZR-FXE	1,1	ILKAR7B11	4912		

**PRIUS PLUS**

Prius Plus 1.8 Hybrid (ZVW40)	1.8	73	4	03.12-	2ZR-FXE	1,1	ILKAR7B11	4912		
-------------------------------	-----	----	---	--------	---------	-----	-----------	------	--	--

**RAV 4**

RAV 4 (ZCA25,26, ACA20,21,22,23)	1.8	92	4	05.00-	1ZZ-FE	1,1	BKR5EYA-11	2526	39	LPG 1
RAV 4 (SXA10,11)	2.0	95	4	06.94-09.97	3S-FE	1,1	BKR6EKB-11	3583		
RAV 4 (SXA10,11)	2.0	95	4	10.97-06.00	3S-FE	1,1	BKR6EKP-11	3452		



e kW C y I

0201



Stock-No

VLINE

LPG / CNG

**TOYOTA****RAV 4**

RAV 4 (ZSA30 / ZSA35)	2.0	116	4	12.08-	3ZRFAE	1,1	ILKAR7B11	4912		
RAV 4 (ZCA25,26, ACA20,21,22,23)	2.0		4	05.00-	1AZ-FE	1,1	IFR6T11	4589		
RAV 4 (ACA30, 33, 38)	2.0		4	11.05-01.07	1AZ-FE	1,1	IFR6T11	4589		
RAV 4 (ACA 30,31, 33,38)	2.0		4	01.07-	1AZ-FE	1,1	IFR6T11	4589		
RAV 4 (ZCA25,26, ACA20,21,22,23)	2.4		4	01.04-	2AZ-FE	1,1	IFR6T11	4589		
RAV 4 (ACA31, 33, 38)	2.4	125	4	11.05-	2AZ-FE	1,1	IFR6T11	4589		
RAV 4 (ACA31W/36W)	2.4		4	11.05-	2AZ-FE	1,1	IFR6T11	4589		
RAV 4 (ACA 30,31,33,38)	2.4		4	01.07-	2AZ-FE	1,1	IFR6T11	4589		

**STARLET**

Starlet (EP70,EP71,EP76,EP80,EP81)	1.0	40	4	.85- .92	1E	0,8	BPR6EY	6427		LPG 2
Starlet (EP80,81)	1.3	53	4	.93-	2E	0,8	BPR6EY	6427		LPG 2
Starlet (EP70,71,76)	1.3	55	4	.88-	2E-C	1,1	BPR6EY-11	4228	10	LPG 2
Starlet (EP80,81)	1.3	55	4	.90-12.95	2E-E Cat.	0,8	BPR5EY	2828	9	LPG 2
Starlet	1.3	55	4	.93-	4A-FE	1,1	BKR5EYA-11	2526	39	LPG 1
Starlet (EP80,81)	1.3	55	4	02.96-03.97	4E-FE	0,8	BKR5EYA	2087		LPG 1
Starlet (EP90,91)	1.3	55	4	.98- .99	4E-FE	0,8	BKR5EYA	2087		LPG 1
Starlet	1.3		4	.95-	2E-E	0,8	BPR4EY	2128		LPG 2
Starlet (EP90,91)	1.3		4	.98-	2E	0,8	BPR6EY	6427		LPG 2

**SUPRA**

Supra	2.8		6		5M-GE	0,8	BPR6EY	6427		LPG 2
Supra (JZA80)	3.0	165	6	.93- .94	2JZ-GE	1,1	BKR5EP-11	3440		LPG 1
Supra Turbo (MA70)	3.0	175	6	.87- .92	7M-GTE	0,8	BCPR6EPN-8	5275		LPG 3
Supra V6 Biturbo (JZA80)	3.0	243	6	.93- .94	2JZ-GTE	1,1	BKR6EP-11	2978		LPG 1
Supra (MA70)	3.0		6	.90- .92	7M-GE	0,9	BCPR6EY	1146		LPG 3
Supra (JZA80)	3.0		6	.95- .95	2JZ-GE	1,1	BKR6EP-11	2978		LPG 1
Supra (JZA80)	3.0		6	.95-	2JZ-GTE	1,1	BKR6EP-11	2978		LPG 1
Supra (JZA80)	3.0		6	.96-	2JZ-GE	0,8	BKR6EYA	2249		LPG 1

**TARAGO**

Tarago	2.4	97	4	.90-	2TZ-FE	1,1	BKR5EP-11	3440		LPG 1
Tarago (ACR30)	2.4		4	03.00-	2AZ-FE	1,1	IFR6T11	4589		

**TERCEL**

Tercel	1.3		4		2E	0,8	BPR6EY	6427		LPG 2
Tercel (EL50,53)	1.3		4	.98-	2E	0,8	BPR6EY	6427		LPG 2
Tercel (EL50,53)	1.5		4	.98-	5E-FE	1,1	BKR5EKB-11	3967		

**TOWNACE**

Townace (KR41,42)	1.5		4	.98-	5K	0,8	BPR5EY	2828	9	LPG 2
Townace (SR40)	1.5		4	.98-	5K	0,8	BPR5EY	2828	9	LPG 2
Townace (KR41,42)	1.8		4	.98-	7K	0,8	BPR5EY	2828	9	LPG 2
Townace (SR40)	1.8		4	.98-	7K	0,8	BPR5EY	2828	9	LPG 2
Townace (KR41,42)	2.0		4	.98-	3S-FE	1,1	BKR6EKB-11	3583		
Townace (SR40)	2.0		4	.98-	3S-FE	1,1	BKR6EKB-11	3583		

**URBAN CRUISER**

Urban Cruiser 1.3 (NSP110)	1.33	73	4	04.10-	1NR-FE	1,1	ILKAR7B11	4912		
Urban Cruiser 1.3 (NSP110)	1.33	74	4	01.09-	1NR-FE	1,1	ILKAR7B11	4912		

e kW C  
Y I

0201



Stock-No

VLINE

LPG / CNG

**TOYOTA****VERSO**

Verso (ZGR20)	1.6	81	4	04.09-	1ZRFAE	1,1	ILKAR7B11	4912		
Verso (ZGR20)	1.6	97	4	04.09-	1ZRFAE	1,1	ILKAR7B11	4912		
Verso (ZGR21)	1.8	95	4	04.09-	2ZRFAE	1,1	ILKAR7B11	4912		
Verso (ZGR21)	1.8	108	4	04.09-	2ZRFAE	1,1	ILKAR7B11	4912		

**VERSO S**

Verso S 1.33 VTI (NSP120)	1.33	73	4	11.10-	1NR-FE	1,1	ILKAR7B11	4912		
---------------------------	------	----	---	--------	--------	-----	-----------	------	--	--

**YARIS**

Yaris 1.0 16V(NCP10,11,12,13)	1.0	48	4	01.99-	1SZ-FE	0,8	BKR5EYA	2087		LPG 1
Yaris 1.0 16V(SCP10) Japan production	1.0	48	4	01.99-	1SZ-FE	0,8	BKR5EYA	2087		LPG 1
Yaris 1.0 16V(SCP10) France production	1.0	48	4	01.01-	1SZ-FE	1,1	BKR6EYA-11	4073		LPG 1
Yaris 1.0 (KSP90) VVTi	1.0	51	3	08.05-	1KR-FE	1,1	LFR6C-11	5788		
Yaris 1.0 (NCP90,91) VVTi	1.0	51	3	08.05-	1KR-FE	1,1	LFR6C-11	5788		
„Yaris 1.0 (SCP90, NCP90; 91 ZSP90)“	1.0		3	11.05-	1KR-FE	1,1	LFR6C-11	5788		
Yaris 1.0 (KSP130) VVTi	1.0	51	3	09.11-	1KR-FE	1,1	ILFR5T11	96779		ILFR6T11
Yaris 1.3 16V(NCP10,11,12,13)(SCP10	1.3	63	4	01.01-	2NZ-FE	1,1	BKR5EYA-11	2526	39	LPG 1
Yaris 1.3 (NCP10,11,12,13)(SCP10,12)	1.3	64	4	04.02-	2SZ-FE	0,8	BKR5EYA	2087		LPG 1
Yaris 1.3 (KSP90 )(ZSP90 ) VVTi	1.3	64	4	08.05-11.06	2NZ-FE	1,1	BKR5EYA-11	2526	39	LPG 1
Yaris 1.3 (NCP90,91) VVTi	1.3	64	4	08.05-11.06	2NZ-FE	1,1	BKR5EYA-11	2526	39	LPG 1
Yaris 1.3 (KSP90)(SCP90)	1.3		4	11.05-	2SZ-FE	0,8	BKR5EYA	2087		LPG 1
Yaris 1.3 (NCP 92, 93)	1.3		4	01.06-	2NZ-FE	1,1	BKR5EYA-11	2526	39	LPG 1
Yaris 1.3 (KSP130) VVTi	1.33	73	4	09.11-	1NR-FE	1,1	ILKAR7B11	4912		
Yaris 1.5 (NCP10,11,12,13)(SCP10)	1.5	78	4	01.01-12.01	1NZ-FE	1,1	BKR5EYA-11	2526	39	LPG 1
Yaris 1.5 (NCP20, 21, 22)	1.5	78	4	01.02-	1NZ-FE	0,8	BKR5EYA	2087		LPG 1
Yaris 1.5TS (NCP10,11,12,13)(SCP10)	1.5	78	4	01.02-	1NZ-FE	0,8	BKR5EYA	2087		LPG 1
Yaris 1.5 (KSP90)(ZSP90)	1.5	78	4	08.05-11.06	1NZ-FE	0,8	BKR5EYA	2087		LPG 1
Yaris 1.5 (NCP90,91)	1.5	78	4	02.06-11.06	1NZ-FE	0,8	BKR5EYA	2087		LPG 1
Yaris 1.5 (NCP92, 93)	1.5		4	01.06-	1NZ-FE	0,8	BKR5EYA	2087		LPG 1
Yaris TS (ZSP90)	1.8	97	4	11.06-	2ZR-FE	1,1	ILKAR7B11	4912		
Yaris Verso ( NCP20,21,22 )	1.5	78	4	.01-12.00	1NZ-FE	1,1	BKR5EYA-11	2526	39	LPG 1

**TRABANT**

601	1.1	29	4	05.90-12.91	VW-Motor	0,7	BP6ES	7811	4	LPG 2
-----	-----	----	---	-------------	----------	-----	-------	------	---	-------

**TVR**

280 i	2.8		6			0,8	BPR6ES	7822	2	LPG 2
280 s	2.8		6			0,8	BPR6ES	7822	2	LPG 2
290 i	2.9		6			0,8	BPR6ES	7822	2	LPG 2
350 i	3.5		8			0,8	BPR6ES	7822	2	LPG 2
400	4.0		8			0,8	B7ECS	2528		
450	4.5		8			0,8	B7ECS	2528		
Cerbera	4.0		6	09.98-	IL6 4.0L	0,9	DCPR8E	4339		LPG 8
Cerbera	4.2	306	8	.95-	AJP (TVR engine)	0,7	BKR5EYU	3964		
Chimaera	4.0		8		V8 Rover	0,8	B7ECS	2528		
Chimaera	4.3		8		V8 Rover	0,8	B7ECS	2528		
Chimaera	5.0		8		V8 Rover	0,8	B7ECS	2528		
Griffith	3.9		8			0,8	B7ECS	2528		
Griffith	4.3		8			0,8	B7ECS	2528		
Griffith	4.5		8			0,8	B7ECS	2528		



l kW  
C  
y  
i

0201



Stock-No

VALVE

LPG / CNG

**TVR**

Griffith 500	5.0		8	.95-	V8 Rover	0,8	B7ECS	2528		
S2			6			0,8	BCPR6ES	2330	12	LPG 3
S3			6		non Cat.	0,8	BCPR6ES	2330	12	LPG 3
S3			6		With Cat.	1,0	BPR6EFS	3623	7	LPG 5
S3C	2.9		6			1,0	BPR6EFS	3623	7	LPG 5
Speed	3.9		8		39	0,8	B7ECS	2528		
Speed	4.3		8		43	0,8	B7ECS	2528		
Tamora	3.6		6		IL6	0,9	DCPR8E	4339		LPG 8
Tasmin	2.0		4			0,6	APR6FS	2922		
Tasmin	2.8		6			0,8	BCPR6ES	2330	12	LPG 3
Tuscan	3.5		8			0,9	BPR5ES	7422	6	LPG 2
Tuscan Speed Six	4.0		6	09.98-		0,9	DCPR8E	4339		LPG 8

**VOLVO**

**240**

240i	P242/P244/P245	2.0	77	4	08.88-08.92		0,8	BPR6ES	7822	2	LPG 2
240i	P242/P244/P245	2.0	86	4	08.87-07.92	B200E	0,8	BPR6ES	7822	2	LPG 2
240i	P242/P244/P245	2.3	85	4	08.84-08.93	B230F Cat.	0,8	BPR6ES	7822	2	LPG 2
240i	P242/P244/P245	2.3	96	4	08.87-07.92	B230E	0,8	BPR6ES	7822	2	LPG 2
240i	P242/P244/P245	2.3		4	08.92-	B230FD	0,8	BPR6ES	7822	6	LPG 2

**440**

440i	445	1.6	62	4	02.92-12.95	B16F Cat.	0,7	ZGR5B	7345		
440	445	1.7	58	4	09.88-12.96	B18K/B Cat.	0,8	BPR6ES	7822	2	LPG 2
440	445	1.7	58	4	09.89-12.91	B18KD Cat.	0,7	ZGR5B	7345		
440	445	1.7	64	4	09.88-02.92	B18KPD Cat.	0,7	ZGR5B	7345		
440i	445	1.7	70	4	09.88-03.92	B18F Cat.	0,7	ZGR5B	7345		
440i	445	1.7	75	4	09.89-12.96	B18FP Cat.	0,7	ZGR5B	7345		
440i	445	1.7	88	4	09.88-07.96	B18FTM/FT Cat.	0,8	BPR7ES	2023	19	BPR8EIX
440i	445	1.8	66	4	09.91-07.96	B18U Cat.	0,7	ZGR5B	7345		
440i	445	1.8	69	4	09.91-12.95	B18 u. Cat.	0,8	BPR6ES	7822	2	LPG 2
440i	445	2.0	81	4	08.92-07.95	B20F Cat.	0,8	BPR7ES	2023	19	BPR8EIX
440i	445	2.0	81	4	09.92-	B20U Cat.	0,8	BPR7ES	2023	19	BPR8EIX

**460**

460	464	1.7	64	4	01.90-09.91	B18KPD Cat.	0,7	ZGR5B	7345		
460 / 460i	464	1.7	66	4	03.90-12.95	B18KP/EP/ Cat	0,8	BPR6ES	7822	2	LPG 2
460i	464	1.7	75	4	01.90-09.92	B18FP Cat.	0,7	ZGR5B	7345		
460i	464	1.7	88	4	01.90-12.95	B18FT Cat.	0,8	BPR7ES	2023	19	BPR8EIX
460i	464	1.8	66	4	09.91-12.95	B18U Cat.	0,7	ZGR5B	7345		
460i	464	1.8	69	4	09.91-12.95	B18 u. Cat.	0,8	BPR6ES	7822	2	LPG 2
460i	464	2.0	81	4	09.92-12.95	B20F Cat.	0,8	BPR7ES	2023	19	BPR8EIX

**480**

480i		1.7	75	4	10.89-09.92	B18FP Cat.	0,7	ZGR5B	7345		
480i		1.7	88	4	03.88-07.96	B18FT Cat.	0,8	BPR7ES	2023	19	BPR8EIX
480i		2.0	81	4	09.92-12.95	B20F Cat.	0,8	BPR7ES	2023	19	BPR8EIX

**740**

740i	744 / 745	2.0	76	4	08.83-07.91	B19E/B200E	0,8	BPR6ES	7822	2	LPG 2
740i 16V Italy	744 / 745	2.0	76	4	08.88-07.91	B204E	0,8	BPR6ES	7822	2	LPG 2
740i	744 / 745	2.0	82	4	08.89-07.91	B200F Cat.	0,8	BPR6ES	7822	2	LPG 2
740i Turbo	744 / 745	2.0	105	4	08.86-07.92	B200ET/FT Cat.	0,8	BPR6ES	7822	2	LPG 2
740i	744 / 745	2.3	85	4	08.87-07.95	B230F Cat.	0,8	BPR6ES	7822	2	LPG 2
740i	744 / 745	2.3	96	4	08.84-07.92	B230E/B230F Cat.	0,8	BPR6ES	7822	2	LPG 2
740i 16V	744 / 745	2.3	111	4	04.88-08.92	B234F Cat.	0,8	BPR6ES	7822	2	LPG 2

e kW  
C  
Y  
I

0201



Stock-No

VLINE

LPG / CNG

**VOLVO****740**

740i Turbo	744 / 745	2.3	114	4	08.86-07.91	B230FT Cat.	0,8	BPR6ES	7822	2	LPG 2
------------	-----------	-----	-----	---	-------------	-------------	-----	--------	------	---	-------

**760**

760i Turbo	704/764/765	2.3	114	4	08.84-07.92	B230ET/FT Cat.	0,8	BPR6ES	7822	2	LPG 2
760i	704/764/765	2.8	100	6	08.82-08.91	B28F/B280F Cat.	1,0	BPR6EFS	3623	7	LPG 5
760i / 780i	704/764/765	2.8	108	6	05.86-07.91	B280E	0,6	BP7EFS	3526		

**780**

780i		2.8	108	6	05.86-07.91	B280F Cat.	1,0	BPR6EFS	3623	7	LPG 5
------	--	-----	-----	---	-------------	------------	-----	---------	------	---	-------

**850**

850 2.0	LS / LW	2.0	93	5	08.94-12.96	B5202S	0,6	BKR6ETUC	3384		LPG 1
850 2.0	LS / LW	2.0	105	5	09.91-12.96	B5204F/B5204S	0,6	BKR6ETUC	3384		LPG 1
850 2.0 T	LS / LW	2.0	154	5	02.93-12.96	B5204T	0,8	BCPR6ES	2330	12	LPG 3
850 2.3 T5 R	LS / LW	2.3	177	5	.94-	B5234T5	0,8	PFR6G-13E	2341		LPG 1
850 2.3 T5 R	LS / LW	2.3	184	5	08.95-12.96	B5234T	0,8	PFR6G-13E	2341		LPG 1
850 2.5	LS / LW	2.5	103	5	06.91-07.94	B5252	0,6	BKR6ETUC	3384		LPG 1
850 2.5	LS / LW	2.5	106	5	08.94-12.96	B5252S	0,6	BKR6ETUC	3384		LPG 1
850 2.5	LS / LW	2.5	125	5	09.91-12.96	B5254F	0,6	BKR6ETUC	3384		LPG 1
850 2.5 AWD	LS / LW	2.5	142	5	04.96-12.96	B5254T	0,7	PFR6B	3500		PFR7B

**940**

940i	944 / 945	2.0	82	4	09.90-07.94	B200E/B200F	0,8	BPR6ES	7822	2	LPG 2
940i Turbo	944 / 945	2.0	105	4	01.91-07.94	B200FT	0,8	BPR6ES	7822	2	LPG 2
940i	944 / 945	2.3	96	4	09.90-12.94	B230F	0,8	BPR6ES	7822	2	LPG 2
940i	944 / 945	2.3	96	4	08.90-12.94	B230FB	0,8	BPR6ES	7822	2	LPG 2
940	944 / 945	2.3	99	4	12.94-	B230GK	0,8	BPR6ES	7822	2	LPG 2
940i 16V	944 / 945	2.3	114	4	09.90-07.91	B234F	0,8	BPR6ES	7822	2	LPG 2
940i Turbo Intercooler	944 / 945	2.3	121	4	08.90-07.94	B230FT	0,8	BPR6ES	7822	2	LPG 2
940i	944 / 945	2.3	126	4	08.94-10.98	B230FT / FK	0,8	BPR6ES	7822	2	LPG 2

**960**

960i 16V Turbo Intercooler	964 / 965	2.0	140	4	09.90-	B204FT	0,8	BPR6ES	7822	2	LPG 2
960i Turbo Intercooler	964 / 965	2.3	121	4	09.90-	B230FT / FK	0,8	BPR6ES	7822	2	LPG 2
960	964 / 965	2.5	125	6	09.94-12.96	B6254F/G/S	0,8	BCPR6ES	2330	12	LPG 3
960i	964 / 965	2.8	110	6	09.90-08.91	B280F	1,0	BPR6EFS	3623	7	LPG 5
960i	964 / 965	2.8	125	6	09.90-	B280E	0,6	BP7EFS	3526		
960 2.9	964 / 965	2.9	150	6	09.90-07.94	B6304F	0,8	BCPR6ES	2330	12	LPG 3
960 2.9	964	2.9	150	6	07.94-12.96	B6304S	0,6	BKR6ETUC	3384		LPG 1
960	964 / 965	3.0	135	6	09.94-	B6304F	0,8	BCPR6ES	2330	12	LPG 3
960	964 / 965	3.0	150	6	09.94-	B6304F/G	0,8	BCPR6ES	2330	12	LPG 3

**C 30**

C 30 1.6		1.6	74	4	11.06-	B4164S3	1,3	TR5B-13	4559	45	LPG 4
C 30 1.8		1.8	92	4	11.06-	B4184S11	1,3	TR6AP-13	5809		LPG 5
C 30 1.8 Flexfuel		1.8	92	4	01.07-	B4184S8	1,3	TR6AP-13	5809		LPG 5
C 30 2.0		2.0	107	4	11.06-	B4204S3	1,3	TR6AP-13	5809		LPG 5
C 30 2.0 Flexfuel		2.0	107	4	01.10-	B4204S4	1,3	TR6AP-13	5809		LPG 5
C 30 2.4		2.4	125	5	11.06-	B5244S4	0,6	LFR6D	4704		
C 30 T 5		2.5	162	5	10.06-	B5254T3	0,8	ILFR6B	6481		
C 30 T 5		2.5	169	5	03.07-	B5254T7	0,8	ILFR6B	6481		

**C 70 1**

C 70 2.0 T		2.0	120	5	03.00-10.05	B5204T4	0,8	PFR6B	3500		PFR7B
C 70 2.0		2.0	132	5	03.97-10.05	B5204T2	0,8	BCPR7ES	3330		BCPR7EIX
C 70 2.0 T		2.0	166	5	01.97-10.05	B5204T3	0,8	BCPR7ES	3330		BCPR7EIX





l kW  
C  
y  
i

0201



Stock-No

VALVE

LPG/CNG

**VOLVO**

**C 70 1**

C 70 2.3 T5	2.3	176	5	03.97-10.05	B5234T3	0,8	PFR6B	3500		PFR7B
C 70 2.3 T5	2.3	180	5	07.02-10.05	B5234T9	0,8	PFR6B	3500		PFR7B
C 70 2.4 T	2.4	142	5	08.99-10.05	B5244T	0,8	PFR6B	3500		PFR7B
C 70 2.4 T	2.4	147	5	07.02-10.05	B5244T7	0,8	PFR6B	3500		PFR7B
C 70 2.5	2.5	121	5	03.99-09.02	B5254S	0,6	BKR6ETUC	3384		LPG 1
C 70 2.5	2.5	125	5	11.99-10.05	B5244S	0,6	BKR6ETUC	3384		LPG 1
C 70 2.5 T	2.5	142	5	03.97-10.05	B5254T	0,8	PFR6B	3500		PFR7B

**C 70 2**

C 70 2.4	2.4	103	5	03.06-	B5244S5	0,6	LFR6D	4704		
C 70 2.4	2.4	125	5	03.06-	B5244S4	0,6	LFR6D	4704		
C 70 T5	2.5	162	5	03.06-	B5254T3	0,8	ILFR6B	6481		
C 70 T5	2.5	169	5	11.05-	B5254T7	0,8	ILFR6B	6481		

**S 40 1**

S 40 1.6	VS	1.6	77	4	09.95-08.99	B4164S	0,6	BKR6ETUC	3384		LPG 1
S 40 1.6	VS	1.6	80	4	03.99-12.03	B4164S2	0,6	BKR6ETUC	3384		LPG 1
S 40 1.8	VS	1.8	85	4	07.95-08.99	B4184S	0,6	BKR6ETUC	3384		LPG 1
S 40 1.8 Bi-Fuel	VS	1.8	90	4	03.99-12.03	B4184S9	0,6	BKR6ETUC	3384		LPG 1
S 40 1.8	VS	1.8	90	4	03.99-12.03	B4184S2	0,6	BKR6ETUC	3384		LPG 1
S 40 1.8 GDI	VS	1.8	92	4	06.01-12.03	B4184SJ	0,6	IZFR6B	3116		
S 40 T4	VS	1.9	147	4	05.97-07.00	B4194T / T2	0,8	PFR6G	4793		PFR7G
S 40 2.0	VS	2.0	100	4	07.95-12.03	B4204S/B4204S2	0,6	BKR6ETUC	3384		LPG 1
S 40 2.0	VS	2.0	103	4	07.95-08.99	B4204S	0,6	BKR6ETUC	3384		LPG 1
S 40 2.0 T	VS	2.0	120	4	10.97-12.03	B4204T3	0,8	PFR6B	3500		PFR7B
S 40 T4	VS	2.0	147	4	07.00-12.03	B4204T5	0,8	PFR6B	3500		PFR7B

**S 40 2**

S 40 II 1.6	MS	1.6	74	4	01.05-	B4164S3	1,3	TR5B-13	4559	45	LPG 4
S 40 II 1.8	MS	1.8	92	4	04.04-09.10	B4184S11	1,3	TR6AP-13	5809		LPG 5
S 40 II 1.8 Flexfuel	MS	1.8	92	4	04.04-09.10	B4184S8	1,3	TR6AP-13	5809		LPG 5
S 40 II 2.0	MS	2.0	107	4	10.06-	B4204S3	1,3	TR6AP-13	5809		LPG 5
S 40 II 2.0 Flexfuel	MS	2.0	107	4	01.10-	B4204S4	1,3	TR6AP-13	5809		LPG 5
S 40 II 2.4	MS	2.4	103	5	01.04-09.10	B5244S5	0,6	LFR6D	4704		
S 40 II 2.4i	MS	2.4	125	5	01.04-09.10	B5244S4	0,6	LFR6D	4704		
S 40 II T5	MS	2.5	162	5	01.04-05.08	B5254T3	0,8	ILFR6B	6481		
S 40 II T5	MS	2.5	169	5	03.07-	B5254T7	0,8	ILFR6B	6481		

**S 60 1**

S 60 2.0 T		2.0	132	5	09.01-07.04	B5204T5	0,8	PFR6B	3500		PFR7B
S 60 2.0 T		2.0	132	5	08.04-03.10	B5204T5	0,8	ILFR6B	6481		
S 60 2.3 T		2.3	147	5	.00-	B5234T7	0,8	PFR6B	3500		PFR7B
S 60 T5		2.3	184	5	11.00-04.10	B5234T3	0,8	PFR6B	3500		PFR7B
S 60 2.4		2.4	103	5	11.00-	B5244S2	0,6	BKR6ETUC	3384		LPG 1
S 60 Bi-Fuel CNG (DK)		2.4	103	5	06.00-	B5244SG	0,6	BKR6ETUC	3384		LPG 1
S 60 Bi-Fuel LPG		2.4	103	5	06.02-	B5244SG2	0,6	BKR6ETUC	3384		LPG 1
S 60 2.4		2.4	125	5	11.00-	B5244S	0,6	BKR6ETUC	3384		LPG 1
S 60 2.4 T		2.4	147	5	11.00-	B5244T3	0,8	PFR6B	3500		PFR7B
S 60 T5		2.4	191	5	04.04-	B5244T5	0,8	ILFR6B	6481		
S 60		2.4		5	10.00-	B5244T	0,8	PFR6B	3500		PFR7B
S 60 2.5T		2.5	154	5	02.04-04.10	B5254T2	0,8	PFR6B	3500		PFR7B
S 60 R 2.5T		2.5	220	5	03.03-	B5254T4	0,8	ILFR6B	6481		

e kW  
C  
y  
i

Stock-No



LPG / CNG

**VOLVO****S 60 2**

S 60 II T3	1.6	110	4	04.10-	B4164T3	0,8	ILZTR6A8G	94769		
S 60 II T4	1.6	132	4	04.10-	B4164T	0,8	ILZTR6A8G	94769		
S 60 II T4F Flexfuel	1.6	132	4	04.11-	B4164T2	0,8	ILZTR6A8G	94769		

**S 70**

S 70 2.0	P80	2.0	93	5	01.97-11.00	B5202S	0,6	BKR6ETUC	3384		LPG 1
S 70 2.0	P80	2.0	105	5	01.97-11.00	B5204F	0,6	BKR6ETUC	3384		LPG 1
S 70 2.0	P80	2.0	120	5	01.97-11.00	B5204T4	0,8	PFR6B	3500		PFR7B
S 70 2.0	P80	2.0	132	5	01.97-11.00	B5204T2	0,8	BCPR7ES	3330		BCPR7EIX
S 70 2.0 Turbo	P80	2.0	154	5	01.97-11.00	B5204T	0,8	BCPR7ES	3330		BCPR7EIX
S 70 2.0 Turbo	P80	2.0	166	5	01.97-11.00	B5204T3	0,8	BCPR7ES	3330		BCPR7EIX
S 70	P80	2.3	120	5	.99-	B5234S	0,8	BKR6ES	3783	28	LPG 1
S 70	P80	2.3	166	5	09.97-	B5234T	0,8	BCPR7ES	3330		BCPR7EIX
S 70	P80	2.3	177	5	.99-	B5234T5	0,8	BCPR7ES	3330		BCPR7EIX
S 70	P80	2.3	177	5	.99-	B5234T6	0,8	BCPR7ES	3330		BCPR7EIX
S 70	P80	2.3	184	5	01.97-11.00	B5234T3	0,8	PFR6G-13E	2341		LPG 1
S 70	P80	2.3	184	5	01.97-11.00	B5234T4	0,9	BKR7E	6097		BKR8EIX
S 70	P80	2.3	184	5	01.97-11.00	B5234T8	0,9	BKR7E	6097		BKR8EIX
S 70 2.4	P80	2.4	103	5	08.99-11.00	B5244S2	0,6	BKR6ETUC	3384		LPG 1
S 70 2.4 Blu-Fuel	P80	2.4	103	5	07.97-09.00	B5244S2/B5244SG	0,6	BKR6ETUC	3384		LPG 1
S 70 2.4	P80	2.4	125	5	01.97-11.00	B5244S	0,6	BKR6ETUC	3384		LPG 1
S 70 2.4 T	P80	2.4	142	5	01.97-11.00	B5244T	0,8	PFR6B	3500		PFR7B
S 70	P80	2.4	195	5	.99-	B5244T2	0,8	BCPR7ES	3330		BCPR7EIX
S 70 2.5 BiFuel	P80	2.5	103	5	07.99-11.00	B5244SG	0,6	BKR6ETUC	3384		LPG 1
S 70 2.5 10V	P80	2.5	106	5	01.97-11.00	B5252S	0,6	BKR6ETUC	3384		LPG 1
S 70 2.5 BiFuel	P80	2.5	106	5	10.98-11.00	GB5252S	0,6	BKR6ETUC	3384		LPG 1
S 70 2.5 20V	P80	2.5	121	5	06.98-11.00	B5254S	0,6	BKR6ETUC	3384		LPG 1
S 70 2.5 T5	P80	2.5	142	5	11.96-04.99	B5254T	0,8	PFR6B	3500		PFR7B

**S 80 1**

S 80 2.0 T	TS	2.0	132	5	12.99-12.04	B5204T5	0,8	PFR6B	3500		PFR7B
S 80 2.0 T	TS	2.0	132	5	01.05-07.06	B5204T5	0,8	ILFR6B	6481		
S 80 2.0 T	TS	2.0	166	5	06.98-07.06	B5204T3	0,8	BCPR7ES	3330		BCPR7EIX
S 80 2.3 T	TS	2.3	147	5	.99-07.06	B5234T7	0,8	PFR6B	3500		PFR7B
S 80 2.4	TS	2.4	103	5	01.99-07.06	B5244S2	0,6	BKR6ETUC	3384		LPG 1
S 80 2.4	TS	2.4	125	5	05.98-07.06	B5244S	0,6	BKR6ETUC	3384		LPG 1
S 80 2.4	TS	2.4	147	5	08.00-09.03	B5244T3	0,8	PFR6B	3500		PFR7B
S 80 2.4 T	TS	2.4	147	5	06.00-07.06	B5244T3	0,8	PFR6B	3500		PFR7B
S 80 2.5 T AWD	TS	2.5	154	5	07.03-07.06	B5254T2	0,8	PFR6B	3500		PFR7B
S 80 2.8 T6	TS	2.8	200	6	05.98-07.06	B6284T	0,8	PFR6B	3500		PFR7B
S 80 2.9	TS	2.9	144	6	06.01-07.06	B6294S / S2	0,6	BKR6ETUC	3384		LPG 1
S 80 2.9	TS	2.9	147	6	03.99-07.06	B6294S	0,6	BKR6ETUC	3384		LPG 1
S 80 3.0	TS	3.0	147	6	05.98-07.06	B6304S3	0,6	BKR6ETUC	3384		LPG 1
S 80 3.0	TS	3.0	150	6	06.99-07.06	B6304S	0,8	BKR6ES	3783	28	LPG 1
S 80 3.0 T6	TS	3.0	200	6	06.01-07.06	B6294T	0,8	PFR6B	3500		PFR7B

**S 80 2**

S 80 II T4	AS	1.6	132	4	10.10-	B4164T	0,8	ILZTR6A8G	94769		
S 80 II T4F Flexfuel	AS	1.6	132	4	05.11-	B4164T2	0,8	ILZTR6A8G	94769		
S 80 II 2.0	AS	2.0	107	4	11.07-	B4204S3	1,3	TR6AP-13	5809		LPG 5
S 80 II 2.0 Flexfuel	AS	2.0	107	4	01.08-	B4204S4	1,3	TR6AP-13	5809		LPG 5
S 80 II 2.5 T	AS	2.5	147	5	11.07-	B5254T6 / T8	0,8	ILFR6K8	94040		
S 80 II 2.5 T FlexFuel	AS	2.5	170	5	01.10-	B5254T11	0,8	ILFR6K8	94040		
S 80 II T6 AWD	AS	3.0	210	6	05.07-03.10	B6304T2	0,8	ILFR6B	6481		

e kW  
C  
Y  
I

0201



Stock-No

VLINE

LPG/CNG

**VOLVO****S 80 2**

S 80 II 3.2 S	AS	3.2	175	6	01.08-03.10	B6324S	0,8	ILFR6B	6481		
---------------	----	-----	-----	---	-------------	--------	-----	--------	------	--	--

**S 90**

S 90		2.4	120	6	.97-	B6244F	0,8	BCPR6ES	2330	12	LPG 3
S 90		2.5	125	6	.97-	B6254F	0,8	BCPR6ES	2330	12	LPG 3
S 90		2.5	125	6	.97-	B6254G	0,8	BCPR6ES	2330	12	LPG 3
S 90 3.0		3.0	132	6	01.97-05.98	B6304S	0,8	BKR6ES	3783	28	LPG 1
S 90		3.0	150	6	.97-	B6304F	0,8	BCPR6ES	2330	12	LPG 3
S 90		3.0	150	6	01.97-05.98	B6304G	0,8	BCPR6ES	2330	12	LPG 3
S 90 3.0		3.0	150	6	01.97-	B6304S	0,8	BKR6ES	3783	28	LPG 1

**V 40 1**

V 40 1.6	VW	1.6	77	4	12.95-08.99	B4164S	0,6	BKR6ETUC	3384		LPG 1
V 40 1.6	VW	1.6	80	4	03.99-05.04	B4164S2	0,6	BKR6ETUC	3384		LPG 1
V 40 1.8	VW	1.8	85	4	07.95-08.99	B4184S	0,6	BKR6ETUC	3384		LPG 1
V 40 1.8 Bi-Fuel	VW	1.8	90	4	03.99-06.04	B4184S9	0,6	BKR6ETUC	3384		LPG 1
V 40 1.8	VW	1.8	90	4	03.99-06.04	B4184S2	0,6	BKR6ETUC	3384		LPG 1
V 40 1.8 GDI	VW	1.8	92	4	08.97-04.04	B4184SJ	0,6	IZFR6B	3116		
V 40 1.8 i	VW	1.8	92	4	04.98-09.00	B4184SM/SJ	0,8	IZFR6B	3116		
V 40 T4	VW	1.9	147	4	05.97-07.00	B4194T / T2	0,8	PFR6G	4793		PFR7G
V 40 2.0	VW	2.0	100	4	07.95-06.04	B4204S/B4204S2	0,6	BKR6ETUC	3384		LPG 1
V 40 2.0	VW	2.0	103	4	07.95-08.99	B4204S	0,6	BKR6ETUC	3384		LPG 1
V 40 2.0 T	VW	2.0	120	4	06.00-04.04	B4204T3	0,8	PFR6B	3500		PFR7B
V 40 2.0 T4	VW	2.0	147	4	07.00-06.04	B4204T5	0,8	PFR6B	3500		PFR7B

**V 40 2**

V 40 II T3		1.6	110	4	03.12-	B4164T3	0,8	ILZTR6A8G	94769		
V 40 II T4		1.6	132	4	03.12-	B4164T	0,8	ILZTR6A8G	94769		

**V 50**

V 50 1.6	MW	1.6	74	4	01.05-	B4164S3	1,3	TR5B-13	4559	45	LPG 4
V 50 1.8	MW	1.8	92	4	04.04-	B4184S11	1,3	TR6AP-13	5809		LPG 5
V 50 1.8 Flexfuel	MW	1.8	92	4	01.05-	B4184S8	1,3	TR6AP-13	5809		LPG 5
V 50 2.0	MW	2.0	107	4	10.06-	B4204S3	1,3	TR6AP-13	5809		LPG 5
V 50 2.0 Flexfuel	MW	2.0	107	4	01.10-	B4204S4	1,3	TR6AP-13	5809		LPG 5
V 50 2.4	MW	2.4	103	5	04.04-	B5244S5	0,6	LFR6D	4704		
V 50 2.4i	MW	2.4	125	5	04.04-	B5244S4	0,6	LFR6D	4704		
V 50 T5	MW	2.5	162	5	04.04-	B5254T3	0,8	ILFR6B	6481		
V 50 T5	MW	2.5	169	5	03.07-	B5254T7	0,8	ILFR6B	6481		

**V 60**

V 60 T3		1.6	110	4	09.10-	B4164T3	0,8	ILZTR6A8G	94769		
V 60 T4		1.6	132	4	09.10-	B4164T	0,8	ILZTR6A8G	94769		
V 60 T4F Flexfuel		1.6	132	4	04.11-	B4164T2	0,8	ILZTR6A8G	94769		

**V 70 1**

V 70 1 2.0	P80	2.0	93	5	01.97-03.00	B5202S	0,8	BKR6ES	3783	28	LPG 1
V 70 1 2.0	P80	2.0	105	5	01.97-03.00	B5204S	0,8	BKR6ES	3783	28	LPG 1
V 70 1 2.0 T	P80	2.0	120	5	01.97-08.00	B5204T4	0,8	PFR6G-13E	2341		LPG 1
V 70 1 2.0 T	P80	2.0	132	5	01.97-03.00	B5204T2	0,8	PFR6G-13E	2341		LPG 1
V 70 1 2.0 T	P80	2.0	155	5	01.97-03.00	B5204T	0,8	BCPR7ES	3330		BCPR7EIX
V 70 1 2.0 T	P80	2.0	166	5	01.97-03.00	B5204T3	0,8	BCPR7ES	3330		BCPR7EIX
V 70 1 2.3 T5	P80	2.3	176	5	.99-03.00	B5234T5	0,8	BCPR7ES	3330		BCPR7EIX
V 70 1 2.3 T5	P80	2.3	176	5	.99-03.00	B5234T6	0,8	BCPR7ES	3330		BCPR7EIX
V 70 1 2.3 T	P80	2.3	184	5	04.97-03.00	B5234T4	0,8	PFR6G-13E	2341		LPG 1

e kW  
C  
y  
i

0201



Stock-No

VELINE

LPG / CNG

**VOLVO****V 70 1**

V 70 1 2.3 T	P80	2.3	184	5	01.97-03.00	B5234T8	0,8	PFR6G-13E	2341		LPG 1
V 70 1 2.3 T	P80	2.3	184	5	01.97-03.00	B5234T3	0,8	BKR7EIX	2667		BKR8EIX
V 70 1 2.4	P80	2.4	103	5	08.99-03.00	B5244S2	0,8	BKR6ES	3783		LPG 1
V 70 1 2.4 Bi-Fuel CNG	P80	2.4	103	5	08.99-03.00	B5244SG		LPG 1	1496	28	LPG 1
V 70 1 2.4 Bi-Fuel LPG	P80	2.4	103	5	08.99-03.00	B5244SG2		LPG 1	1496		LPG 1
V 70 1 2.4 T	P80	2.4	142	5	01.97-03.00	B5244T	0,8	PFR6G-13E	2341		LPG 1
V 70 1 2.4 T	P80	2.4	195	5	03.99-03.00	B5244T2	0,8	BCPR7ES	3330		BCPR7EIX
V 70 1 2.5 10V	P80	2.5	106	5	01.97-03.00	B5252S	0,8	BKR6ES	3783	28	LPG 1
V 70 1 2.5 20V	P80	2.5	125	5	01.97-05.00	B5254S	0,8	BKR6ES	3783	28	LPG 1
V 70 1 2.5 T	P80	2.5	142	5	01.97-03.00	B5254T	0,8	PFR6G-13E	2341		LPG 1

**V 70 2**

V 70 II 2.0	P80	2.0	107	4	10.07-	B4204S3	1,3	TR6AP-13	5809		LPG 5
V 70 II 2.0 Flexfuel	P80	2.0	107	4	01.08-	B4204S4	1,3	TR6AP-13	5809		LPG 5
V 70 II 2.0 T	P80	2.0	132	5	07.01-08.07	B5204T5	0,8	PFR6B	3500		PFR7B
V 70 II 2.3 T5	P80	2.3	184	5	03.00-08.07	B5234T3	0,8	PFR6B	3500		PFR7B
V 70 II 2.4	P80	2.4	125	5	03.00-	B5244S	0,8	BKR6ETUC	3384		LPG 1
V 70 II 2.4 T	P80	2.4	147	5	03.00-08.07	B5244T3	0,8	PFR6B	3500		PFR7B
V 70 II 2.4 T5	P80	2.4	191	5	04.04-07.07	B5244T5	0,8	ILFR6B	6481		
V 70 II 2.5 T	P80	2.5	154	5	04.04-08.07	B5254T2	0,8	PFR6B	3500		PFR7B
V 70 II R 2.5 T AWD	P80	2.5	220	5	03.03-	B5254T4	0,8	ILFR6B	6481		

**V 70 3**

V 70 III T4		1.6	132	4	10.10-	B4164T	0,8	ILZTR6A8G	94769		
V 70 III T4F Flexfuel		1.6	132	4	05.11-	B4164T2	0,8	ILZTR6A8G	94769		
V 70 III 2.5 T		2.5	147	5	08.07-	B5254T6 / T8	0,8	ILFR6K8	94040		
V 70 III 2.5 T FlexFuel		2.5	170	5	10.09-	B5254T11	0,8	ILFR6K8	94040		
V 70 III T6 AWD		3.0	210	6	08.07-	B6304T2	0,8	ILFR6B	6481		
V 70 III 3.2		3.2	175	6	08.07-	B6324S	0,8	ILFR6B	6481		

**V 90**

V 90		2.4	120	6	.97-	B6244F	0,8	BCPR6ES	2330	12	LPG 3
V 90		2.5	125	6	.97-	B6254F	0,8	BCPR6ES	2330	12	LPG 3
V 90		2.5	125	6	.97-	B6254G	0,8	BCPR6ES	2330	12	LPG 3
V 90		2.9	150	6	.97-	B6304F	0,8	BCPR6ES	2330	12	LPG 3
V 90		2.9	150	6	.97-	B6304G	0,8	BCPR6ES	2330	12	LPG 3
V 90 3.0		3.0	132	6	01.97-	B6304S2	0,8	BKR6ES	3783	28	LPG 1
V 90 3.0		3.0	150	6	01.97-	B6304S	0,8	BKR6ES	3783	28	LPG 1

**XC60**

XC60 3.0 T6 AWD		3.0	210	6	10.08-	B6304T2	0,8	ILFR6B	6481		
-----------------	--	-----	-----	---	--------	---------	-----	--------	------	--	--

**XC70 1**

XC70 2.4T		2.4	147	5	09.00-09.02	B5244T3	0,8	PFR6B	3500		PFR7B
XC70 2.5T		2.5	154	5	09.02-08.07	B5254T2	0,8	PFR6B	3500		PFR7B
XC70 3.0 T6 AWD		3.0	210	6	01.08-	B6304T2	0,8	ILFR6B	6481		
XC70 3.2 AWD		3.2	175	6	02.07-	B6324S	0,8	ILFR6B	6481		

**XC90**

XC90 2.5T		2.5	154	5	10.02-	B5254T2	0,8	PFR6G-13E	2341		LPG 1
XC90 T6 Biturbo		2.9	200	6	10.02-	B6294T	0,8	PFR6G-13E	2341		LPG 1
XC90 3.2		3.2	175	6	05.06-	B6324S	0,8	ILFR6B	6481		
XC90 4.4		4.4	232	8	11.04-	B8444S	1,1	IFR6B-11	5368		



l kW  
C  
Y  
I

0201



Stock-No

VALUE

LPG / CNG

VW

**AMAROK**

Amarok 2.0 TSI	2HA / 2HB	2.0	118	4	12.10-	CFPA	0,8	PFR7S8EG	1675		PFR8S8EG
----------------	-----------	-----	-----	---	--------	------	-----	----------	------	--	----------

**BEETLE (NEW BEETLE)**

Beetle 1.4	9C1 / 1C1	1.4	55	4	08.01-	BCA	1,1	PZFR5D-11	7968	34	LPG 6
Beetle 1.6	9C1 / 1C1	1.6	74	4	11.99-10.00	AWH	1,0	BKUR6ET-10	2397	24	LPG 1
Beetle 1.6	9C1 / 1C1	1.6	74	4	06.00-	AYD	1,0	BKUR6ET-10	2397	24	LPG 1
Beetle 1.6	9C1 / 1C1	1.6	75	4	06.02-	BFS	1,0	BKUR6ET-10	2397	24	LPG 1
Beetle 1.8 T	9C1 / 1C1	1.8	110	4	01.98-06.00	AGU	0,8	PFR6Q	6458	37	LPG 1
Beetle 1.8 T	9C1 / 1C1	1.8	110	4	01.99-06.00	APH	0,8	PFR6Q	6458	37	LPG 1
Beetle 1.8 T	9C1 / 1C1	1.8	110	4	07.99-10.00	AVC	0,8	PFR6Q	6458	37	LPG 1
Beetle 1.8 T	9C1 / 1C1	1.8	110	4	10.00-	AWU	0,8	PFR6Q	6458	37	LPG 1
Beetle 1.8 T	9C1 / 1C1	1.8	110	4	06.00-06.04	AWV	0,8	PFR6Q	6458	37	LPG 1
Beetle 1.8 T	9C1 / 1C1	1.8	110	4	07.04-	BKF	0,8	PFR6Q	6458	37	LPG 1
Beetle 1.8 T	9C1 / 1C1	1.8	132	4	06.02-06.04	AWP	0,8	PFR6Q	6458	37	LPG 1
Beetle 2.0	9C1 / 1C1	2.0	85	4	01.98-05.01	AEG	1,0	BKUR6ET-10	2397	24	LPG 1
Beetle 2.0	9C1 / 1C1	2.0	85	4	08.98-	AQY	1,0	BKUR6ET-10	2397	24	LPG 1
Beetle 2.0	9C1 / 1C1	2.0	85	4	03.00-	APK	1,0	BKUR6ET-10	2397	24	LPG 1
Beetle 2.0	9C1 / 1C1	2.0	85	4	06.01-	AZJ	1,1	PZFR5D-11	7968	34	LPG 6
Beetle 2.0	9C1 / 1C1	2.0	85	4	06.02-07.03	AZG	1,1	PZFR5D-11	7968	34	LPG 6
Beetle 2.0	9C1 / 1C1	2.0	85	4	01.03-	BER	1,1	PZFR5D-11	7968	34	LPG 6
Beetle 2.0	9C1 / 1C1	2.0	85	4	07.04-	BEV	1,1	PZFR5D-11	7968	34	LPG 6
Beetle 2.0	9C1 / 1C1	2.0	85	4	03.07-	CBPA	1,0	BKUR6ET-10	2397	24	LPG 1
Beetle 2.0	9C1 / 1C1	2.0	85	4	07.05-	BHP	1,0	BKUR6ET-10	2397	24	LPG 1
Beetle 2.3 V5	9C1 / 1C1	2.3	125	5	10.00-	AQN	1,1	PZFR5D-11	7968	34	LPG 6
Beetle 2.5 VIN --> 1C-6-413 286*	9C1 / 1C1	2.5	110	5	07.05-	BPR	1,1	PZFR5J-11	7743		LPG 6
Beetle 2.5 VIN --> 1C-6-413 286*	9C1 / 1C1	2.5	110	5	07.05-	BPS	1,1	PZFR5J-11	7743		LPG 6
Beetle 3.2 RSI	9C1 / 1C1	3.2	165	6	10.00-05.01	AXJ	1,1	PZFR5D-11	7968	34	LPG 6

**BEETLE**

Beetle 2 1.2 TSI BlueMotion	5C1	1.2	77	4	12.14-	CYVD	0,8	PZKER7A8EGS	94968		
Beetle 2 1.2 TSI	5C1	1.2	77	4	10.11-	CBZB	0,7	IZFR6P7	97153		
Beetle 2 1.4 TSI	5C1	1.4	118	4	10.11-	CAVD	0,8	SIZFR6B8EG	96209		
Beetle 2 1.4 TSI	5C1	1.4	118	4	10.11-	CNWA	0,8	SIZFR6B8EG	96209		
Beetle 2 1.4 TSI	5C1/5C7	1.4	118	4	10.11-	CTHD	0,8	SIZFR6B8EG	96209		
Beetle 2 1.4 TSI	5C1/5C7	1.4	118	4	10.11-	CTKA	0,8	SIZFR6B8EG	96209		
Beetle 2 1.4 TSI BlueMotion	5C1	1.4	110	4	12.14-	CZDA	0,8	PZKER7A8EGS	94968		
Beetle 2 2.0 TSI	5C1	2.0	147	4	10.11-	CBFA	0,8	PFR7S8EG	1675		PFR8S8EG
Beetle 2 2.0 TSI	5C1	2.0	147	4	10.11-	CCTA	0,8	PFR7S8EG	1675		PFR8S8EG
Beetle 2 TSi BlueMotion	5C1	2.0	162	4	12.14-	CULC	0,8	PLFER7A8EG	94833		
Beetle 2 TSI	5C1	2.0	147	4	12.10-	CCZA	0,8	PFR7S8EG	1675		PFR8S8EG
Beetle 2 TSI	5C1	2.5	125	5	04.11-	CBTA	1,1	ZFR6T-11G	5960	44	
Beetle 2 TSI	5C1	2.5	125	5	04.11-	CBUA	1,1	ZFR6T-11G	5960	44	
Beetle 2 TSI	5C1	2.5	125	5	04.11-	CCCA	1,1	ZFR6T-11G	5960	44	

**BORA**

Bora 1.4	1J2 / 1J6	1.4	55	4	10.98-05.05	AHW	1,0	BKUR6ET-10	2397	24	LPG 1
Bora 1.4	1J2 / 1J6	1.4	55	4	05.00-10.01	AXP	1,0	BKUR6ET-10	2397	24	LPG 1
Bora 1.4	1J2 / 1J6	1.4	55	4	10.01-05.05	BCA	1,0	BKUR6ET-10	2397	24	LPG 1
Bora 1.4 16V	1J2 / 1J6	1.4	55	4	09.98-05.00	AKQ	1,0	BKUR6ET-10	2397	24	LPG 1
Bora 1.4 16V	1J2 / 1J6	1.4	55	4	05.99-05.00	APE	1,0	BKUR6ET-10	2397	24	LPG 1
Bora 1.4 Automatic	1J2 / 1J6	1.4	55	4	05.00-10.01	AXP	1,1	PZFR5D-11	7968	34	LPG 6
Bora 1.6 (China)	1J2 / 1J6	1.6	74	4	10.04-	BJH	0,9	BKR6E	6962	28	LPG 1

e kW  
C  
y  
i

0201



Stock-No

VLINE

LPG / CNG

**VW****BORA**

Bora 1.6	1J2 / 1J6	1.6	74	4	09.98-06.02	AEH	1,0	BKUR6ET-10	2397	24	LPG 1
Bora 1.6	1J2 / 1J6	1.6	74	4	09.98-05.03	AKL	1,0	BKUR6ET-10	2397	24	LPG 1
Bora 1.6	1J2 / 1J6	1.6	74	4	05.99-09.00	APF	1,0	BKUR6ET-10	2397	24	LPG 1
Bora 1.6	1J2 / 1J6	1.6	74	4	09.00-04.02	AVU	1,0	BKUR6ET-10	2397	24	LPG 1
Bora 1.6	1J2 / 1J6	1.6	75	4	05.02-05.05	BFQ	1,0	BKUR6ET-10	2397	24	LPG 1
Bora 1.6 16V	1J2 / 1J6	1.6	77	4	11.99-05.00	ATN	1,0	BKUR6ET-10	2397	24	LPG 1
Bora 1.6 16V	1J2 / 1J6	1.6	77	4	05.00-10.00	AUS	1,0	BKUR6ET-10	2397	24	LPG 1
Bora 1.6 16V	1J2 / 1J6	1.6	77	4	11.01-05.05	BCB	1,1	PZFR5D-11	1664	34	LPG 6
Bora 1.6 16V	1J2 / 1J6	1.6	77	4	09.00-11.01	AZD	1,1	PZFR5D-11	1664	34	LPG 6
Bora 1.6 FSI	1J2 / 1J6	1.6	81	4	08.01-05.05	BAD	0,5	ZFR6S-Q	6449		
Bora 1.8	1J2 / 1J6	1.8	92	4	09.98-10.00	AGN	1,0	BKUR6ET-10	2397	24	LPG 1
Bora 1.8 T	1J2 / 1J6	1.8	110	4	09.00-05.03	AGU	0,8	PFR6Q	6458	37	LPG 1
Bora 1.8 T	1J2 / 1J6	1.8	110	4	09.00-04.01	ARX	0,8	PFR6Q	6458	37	LPG 1
Bora 1.8 T	1J2 / 1J6	1.8	110	4	09.00-05.05	AUM	0,8	PFR6Q	6458	37	LPG 1
Bora 1.8 T	1J2 / 1J6	1.8	132	4	05.02-05.05	AUQ	0,8	PFR6Q	6458	37	LPG 1
Bora 2.0	1J2	2.0	85	4	09.98-05.05	AZG	1,1	PZFR5D-11	7968	34	LPG 6
Bora 2.0	1J2 / 1J6	2.0	85	4	11.98-05.05	APK	1,0	BKUR6ET-10	2397	24	LPG 1
Bora 2.0	1J2 / 1J6	2.0	85	4	09.98-05.05	AQY	1,0	BKUR6ET-10	2397	24	LPG 1
Bora 2.0	1J2 / 1J6	2.0	85	4	04.00-06.01	AZH	1,0	BKUR6ET-10	2397	24	LPG 1
Bora 2.0	1J2 / 1J6	2.0	85	4	05.01-05.05	AZJ	1,1	PZFR5D-11	7968	34	LPG 6
Bora 2.3 V5	1J2 / 1J6	2.3	110	5	09.98-02.01	AGZ	0,6	BKR5EKUP	2890		
Bora 2.3 V5	1J2 / 1J6	2.3	125	5	09.00-05.05	AQN	1,1	PZFR5D-11	7968	34	LPG 6
Bora 2.8 V6 4motion	1J2 / 1J6	2.8	150	6	05.01-05.03	BDE	1,1	PZFR5D-11	7968	34	LPG 6
Bora 2.8 V6 4motion	1J2 / 1J6	2.8	150	6	05.99-05.00	AQP	1,1	PZFR5D-11	7968	34	LPG 6
Bora 2.8 V6 4motion	1J2 / 1J6	2.8	150	6	05.00-04.01	AUE	1,1	PZFR5D-11	7968	34	LPG 6

**CADDY 1**

Caddy 1 1.8		14	1.8	70	4	08.85-07.92	JH	0,8	BUR6ET	3172	1	LPG 2
-------------	--	----	-----	----	---	-------------	----	-----	--------	------	---	-------

**CADDY 2**

Caddy 2 1.4	9K9A / 9K9B	1.4	44	4	11.95-12.97	AEX	0,8	BUR6ET	3172	1	LPG 2
Caddy 2 1.4	9K9A / 9K9B	1.4	44	4	11.97-09.00	AKV	0,8	BUR6ET	3172	1	LPG 2
Caddy 2 1.4	9K9A / 9K9B	1.4	44	4	12.97-06.03	APQ	0,8	BUR6ET	3172	1	LPG 2
Caddy 2 1.4	9K9A / 9K9B	1.4	44	4	09.00-06.03	AUD	1,1	PZFR5D-11	7968	34	LPG 6
Caddy 2 1.4	9K9A / 9K9B	1.4	55	4	09.00-06.03	AUA	1,0	BKUR6ET-10	2397	24	LPG 1
Caddy 2 1.6	9K9A / 9K9B	1.6	55	4	11.95-05.97	1F	0,8	BUR5ET	3377	22	LPG 2
Caddy 2 1.6	9K9A / 9K9B	1.6	55	4	06.96-12.00	AEE	0,8	BUR6ET	3172	1	LPG 2

**CADDY 3**

Caddy 3 1.2 TSI	2KB/2KJ/2KA/2KH	1.2	63	4	09.10-	CBZA	0,7	IZFR6P7	97153		
Caddy 3 1.2 TSI	2KB/2KJ/2KA/2KH	1.2	77	4	09.10-	CBZB	0,7	IZFR6P7	97153		
Caddy 3 1.4	2KB/2KJ/2KA/2KH	1.4	55	4	02.04-05.06	BCA	1,0	BKUR6ET-10	2397	24	LPG 1
Caddy 3 1.4	2KB/2KJ/2KA/2KH	1.4	59	4	05.06-	BUD	1,1	ZFR6T-11G	5960	44	
Caddy 3 1.6	2KB/2KJ/2KA/2KH	1.6	75	4	04.04-05.05	BGU	1,0	BKUR6ET-10	2397	24	LPG 1
Caddy 3 1.6	2KB/2KJ/2KA/2KH	1.6	75	4	06.05-	BSE	1,0	BKUR6ET-10	2397	24	LPG 1
Caddy 3 1.6 Bi fuel	2CB	1.6	75	4	05.11-05.15	CHGA	1,0	BKUR6ET-10	2397	24	LPG 1
Caddy 3 1.6	2KB/2KJ/2KA/2KH	1.6	75	4	06.05-	BSF	1,0	BKUR6ET-10	2397	24	LPG 1
Caddy 3 1.6 China	2KB/2KJ/2KA/2KH	1.6	74	4	.05-	BRY	0,9	BKR6E	6962	28	LPG 1
Caddy 3 2.0 EcoFuel CNG	2KB/2KJ/2KA/2KH	2.0	80	4	04.06-	BSX	0,9	BKR6E	6962	28	LPG 1

**CADDY 4**

Caddy 4 TGI BlueMotion	SAA	1.4	92	4	05.15-	CZCB	0,75	PZKER7A8EGS	94968		
Caddy 4 TGI BlueMotion	SAA	1.4	81	4	06.15-	CPWA	0,75	PZKER7A8EGS	94968		
Caddy 4 TSi BlueMotion	SAA	1.2	62	4	06.15-	CYVC	0,75	PZKER7A8EGS	94968		



l kW  
C  
y  
i

0201



Stock-No

VALUE

LPG / CNG

VW

**CC**

CC 1.4 TSI	358	1.4	118	4	11.11-	CKMA	0,6	SIZFR6A6D	91629		
CC TSi/TSi BlueMotion	358	1.4	118	4	11.11-	CTHD	0,8	SIZFR6B8EG	96209		
CC TSi BlueMotion	358	1.4	110	4	05.15-	CZDA	0,8	PLFER7A8EG	94833		
CC TFSI	358	1.8	112	4	11.11-	CDAB	0,8	PFR7S8EG	1675		PFR8S8EG
CC 1.8 TSI	358	1.8	118	4	11.11-10.12	CDA	0,8	PFR7S8EG	1675		PFR8S8EG
CC 2.0 TSI	358	2.0	155	4	11.11-	CCZB	0,8	PFR7S8EG	1675		PFR8S8EG
CC 3.6 FSI V6 4motion	358	3.6	220	6	11.11-	BWS	0,8	ILZKR8A	94290		

**CORRADO**

Corrado 1.8 16V	53l	1.8	98	4	04.89-07.92	KR	0,9	BCPR7ET	2164		BCPR7EIX
Corrado 2.0	53l	2.0	85	4	04.93-09.94	2E	0,8	BUR6ET	3172	1	LPG 2
Corrado 2.0	53l	2.0	85	4	07.94-07.95	ADY	0,8	BUR6ET	3172	1	LPG 2
Corrado 2.0 16V	53l	2.0	100	4	08.91-07.95	9A	0,8	BKUR7ET	7873		PFR7Q
Corrado 2.8 VR6	53l	2.8	128	6	08.91-01.96	AAA	0,6	BKR5EKUP	2890		
Corrado 2.8 VR6	53l	2.8	132	6	08.91-06.95	AAA	0,7	BKR5EKU	3964		
Corrado 2.8 VR6	53l	2.8	132	6	07.95-01.96	AAA	0,6	BKR5EKUP	2890		
Corrado 2.9 VR6	53l	2.9	140	6	08.91-07.95	ABV	0,7	BKR5EKU	3964		

**EOS 1**

Eos 1.4 TSI	1F7	1.4	90	4	11.07-10.10	CAXA	0,9	PZFR6R	5758		
Eos 1.4 TSI	1F7	1.4	118	4	05.08-10.10	CAVD	0,9	PZFR6R	5758		
Eos TSi	1F7	1.4	118	4	05.08-	CTHD	0,9	PZFR6R	5758		
Eos 1.6 FSI	1F7	1.6	85	4	05.06-05.08	BLF	0,5	ZFR6S-Q	6449		
Eos 2.0 FSI	1F7	2.0	110	4	05.06-05.08	BVY	1,1	PZFR5N-11T	7742		
Eos 2.0 FSI	1F7	2.0	110	4	05.06-05.08	BVZ	0,9	BKR6E	6962	28	LPG 1
Eos 2.0 TSi	1F7	2.0	147	4	05.06-11.10	BWA	0,8	PFR7S8EG	1675		PFR8S8EG
Eos 2.0 TSi	1F7	2.0	147	4	11.07-11.10	CCTA	0,8	PFR7S8EG	1675		PFR8S8EG
Eos 2.0 TSi	1F7	2.0	147	4	05.08-11.10	BPY	0,8	PFR7S8EG	1675		PFR8S8EG
Eos 2.0 TSi	1F7	2.0	147	4	05.08-11.10	CAWB	0,8	PFR7S8EG	1675		PFR8S8EG
Eos 2.0 TSi	1F7	2.0	147	4	05.09-11.10	CCZA	0,8	PFR7S8EG	1675		PFR8S8EG
Eos 2.0 TSi	1F7	2.0	155	4	11.09-11.10	CCZB	0,8	PFR7S8EG	1675		PFR8S8EG
Eos 3.2 V6	1F7	3.2	184	6	05.06-05.09	BUB	0,9	IZKR7B	7563		
Eos 3.2 V6	1F7	3.2	184	6	05.06-05.09	CBRA	0,9	IZKR7B	7563		
Eos 3.6 V6	1F7	3.6	191	6	05.09-10.10	CDVA	0,9	ILZKR7A	1961		

**EOS 2**

Eos 1.4 TSi	1F8	1.4	90	4	11.10-	CAXA	0,9	PZFR6R	5758		
Eos 1.4 TSi	1F8	1.4	118	4	11.10-	CAVD	0,8	SIZFR6B8EG	96209		
Eos 2.0 TSi	1F8	2.0	155	4	11.10-	CCZB	0,8	PFR7S8EG	1675		PFR8S8EG

**FOX**

Fox 1.2	5Z1 / 5Z3	1.2	40	3	04.05-	BMD	0,9	ZFR5P-G	6893	41	LPG 6
Fox 1.2	5Z1 / 5Z3	1.2	40	3	04.05-	CHFB	1,1	ZFR6T-11G	5960	44	
Fox 1.2	5Z1 / 5Z3	1.2	44	3	09.10-	CHFA	1,1	ZFR6T-11G	5960	44	
Fox 1.4	5Z1 / 5Z3	1.4	55	4	04.05-	BKR	1,1	PZFR5D-11	7968	34	LPG 6

**GOLF 2**

Golf 2 1.0	19E / 1G1	1.0	37	4	08.89-10.91	HZ	0,8	BUR6ET	3172	1	LPG 2
Golf 2 1.3	19E / 1G1	1.3	40	4	01.89-07.92	2G	0,8	BUR6ET	3172	1	LPG 2
Golf 2 1.3	19E / 1G1	1.3	40	4	08.89-08.91	MH	0,8	BUR6ET	3172	1	LPG 2
Golf 2 1.3	19E / 1G1	1.3	40	4	08.89-07.92	NZ	0,8	BUR6ET	3172	1	LPG 2
Golf 2 1.6	19E / 1G1	1.6	51	4	08.85-07.92	PN	1,0	BUR5ET-10	7264	21	LPG 2
Golf 2 1.6	19E / 1G1	1.6	53	4	07.91-07.92	ABX	1,0	BP5ET-10	5156		LPG 2
Golf 2 1.6	19E / 1G1	1.6	53	4	08.86-10.91	RF	1,0	BUR5ET-10	7264	21	LPG 2

e kW  
C  
y  
i

0201



Stock-No

VLINE

LPG / CNG

VW

## GOLF 2

Golf 2 1.6	19E / 1G1	1.6	55	4	08.83-07.92	EW	1,0	BUR5ET-10	7264	21	LPG 2
Golf 2 1.6	19E / 1G1	1.6	55	4	08.83-07.91	EZ	1,0	BUR5ET-10	7264	21	LPG 2
Golf 2 1.6	19E / 1G1	1.6	55	4	08.86-07.92	ABN	1,0	BUR5ET-10	7264	21	LPG 2
Golf 2 1.8	19E / 1G1	1.8	66	4	08.83-07.93	EX	0,8	BUR6ET	3172	1	LPG 2
Golf 2 1.8	19E / 1G1	1.8	66	4	08.83-10.91	GU	0,8	BUR6ET	3172	1	LPG 2
Golf 2 1.8	19E / 1G1	1.8	66	4	01.84-10.91	RP	0,8	BUR6ET	3172	1	LPG 2
Golf 2 1.8 Synchro	19E / 1G1	1.8	72	4	08.88-07.91	1P	0,8	BUR6ET	3172	1	LPG 2
Golf 2 1.8 Synchro	19E / 1G1	1.8	72	4	08.89-07.93	2H	0,8	BUR6ET	3172	1	LPG 2
Golf 2 1.8 GTI	19E / 1G1	1.8	77	4	08.87-10.91	RV	0,8	BUR6ET	3172	1	LPG 2
Golf 2 1.8 GTI	19E / 1G1	1.8	79	4	01.87-10.91	PF	0,8	BUR6ET	3172	1	LPG 2
Golf 2 1.8 GTI	19E / 1G1	1.8	82	4	01.87-10.91	PB	0,8	BUR6ET	3172	1	LPG 2
Golf 2 1.8 GTI 16V	19E / 1G1	1.8	95	4	02.86-10.91	PL	0,8	BKUR7ET	7873		PFR7Q
Golf 2 1.8 GTI 16V	19E / 1G1	1.8	102	4	02.86-10.91	KR	0,9	BCPR7ET	2164		BCPR7EIX
Golf 2 2.0 (USA)	19E / 1G1	2.0	100	4	07.89-07.92	9A	0,8	BKUR7ET	7873		PFR7Q

## GOLF 3

Golf 3 1.4	1H1 / 1H5	1.4	44	4	11.91-07.95	ABD	0,8	BUR5ET	3377	22	LPG 2
Golf 3 1.4	1H1 / 1H5	1.4	44	4	07.95-12.97	AEX	0,8	BUR6ET	3172	1	LPG 2
Golf 3 1.6	1H1 / 1H5	1.6	55	4	08.92-09.94	ABU	0,8	BUR6ET	3172	1	LPG 2
Golf 3 1.6	1H1 / 1H5	1.6	55	4	10.94-07.95	AEA	0,8	BUR6ET	3172	1	LPG 2
Golf 3 1.6	1H1 / 1H5	1.6	55	4	07.95-12.97	AEE	0,8	BUR6ET	3172	1	LPG 2
Golf 3 1.6	1H1 / 1H5	1.6	74	4	10.94-12.95	AEK	0,8	BKUR5ET	2789	29	LPG 1
Golf 3 1.6	1H1 / 1H5	1.6	74	4	01.96-10.00	AFT	1,0	BKUR6ET-10	2397	24	LPG 1
Golf 3 1.6	1H1 / 1H5	1.6	74	4	04.97-10.00	AKS	0,8	BKUR5ET	2789	29	LPG 1
Golf 3 1.8	1H1 / 1H5	1.8	55	4	07.91-10.00	AAM	0,8	BUR5ET	3377	22	LPG 2
Golf 3 1.8	1H1 / 1H5	1.8	55	4	12.97-10.00	ANN	0,8	BUR5ET	3377	22	LPG 2
Golf 3 1.8	1H1 / 1H5	1.8	66	4	12.97-10.00	ANP	0,8	BUR6ET	3172	1	LPG 2
Golf 3 1.8	1H1 / 1H5	1.8	66	4	11.91-07.95	ABS	0,8	BUR6ET	3172	1	LPG 2
Golf 3 1.8	1H1 / 1H5	1.8	66	4	08.91-12.97	ACC	0,8	BUR6ET	3172	1	LPG 2
Golf 3 1.8	1H1 / 1H5	1.8	66	4	10.94-10.00	ADZ	0,8	BUR6ET	3172	1	LPG 2
Golf 3 1.8	1H1 / 1H5	1.8	66	4	01.98-	ADD	0,8	BUR6ET	3172	1	LPG 2
Golf 3 2.0 (GUS)	1H1 / 1H5	2.0	79	4	01.95-12.97	AEP	0,8	BUR6ET	3172	1	LPG 2
Golf 3 2.0 (USA)	1H1 / 1H5	2.0	85	4	03.92-07.95	ABA	1,3	PFR5G-13E	2761		LPG 1
Golf 3 2.0	1H1 / 1H5	2.0	85	4	11.91-09.94	2E	0,8	BUR6ET	3172	1	LPG 2
Golf 3 2.0	1H1 / 1H5	2.0	85	4	10.94-05.96	ADY	0,8	BUR6ET	3172	1	LPG 2
Golf 3 2.0	1H1 / 1H5	2.0	85	4	07.95-12.01	AGG	0,8	BUR6ET	3172	1	LPG 2
Golf 3 2.0	1H1 / 1H5	2.0	85	4	04.97-04.00	AKR	0,8	BUR6ET	3172	1	LPG 2
Golf 3 2.0 (USA)	1H1 / 1H5	2.0	85	4	02.94-07.98	ADC	1,3	PFR5G-13E	2761		LPG 1
Golf 3 2.0 GTI 16V	1H1 / 1H5	2.0	110	4	08.92-07.94	ABF	1,0	BKUR6ET-10	2397	24	LPG 1
Golf 3 2.8 VR6	1H1 / 1H5	2.8	128	6	01.92-06.95	AAA	0,7	BKR5EKU	3964		
Golf 3 2.8 VR6	1H1 / 1H5	2.8	128	6	07.95-12.97	AAA	0,6	BKR5EKUP	2890		
Golf 3 2.9 VR6 Synchro	1H1 / 1H5	2.9	140	6	10.94-12.97	ABV	0,7	BKR5EKU	3964		

## GOLF 4

Golf 4 1.4	1J1 / 1J5	1.4	44	4	12.97-05.98	APQ	0,8	BUR6ET	3172	1	LPG 2
Golf 4 1.4	1J1 / 1J5	1.4	55	4	10.97-06.06	AHW	1,0	BKUR6ET-10	2397	24	LPG 1
Golf 4 1.4	1J1 / 1J5	1.4	55	4	10.97-05.00	AKQ	1,0	BKUR6ET-10	2397	24	LPG 1
Golf 4 1.4	1J1 / 1J5	1.4	55	4	05.99-05.00	APE	1,0	BKUR6ET-10	2397	24	LPG 1
Golf 4 1.4	1J1 / 1J5	1.4	55	4	10.01-06.06	BCA	1,0	BKUR6ET-10	2397	24	LPG 1
Golf 4 1.4 Automatic	1J1 / 1J5	1.4	55	4	05.00-10.01	AXP	1,1	PZFR5D-11	7968	34	LPG 6
Golf 4 1.4 Manual	1J1 / 1J5	1.4	55	4	05.00-10.01	AXP	1,0	BKUR6ET-10	2397	24	LPG 1





ℓ kW  
C  
y  
l

0201



Stock-No

VALVE

LPG/CNG

VW

**GOLF 4**

Golf 4 1.6 (China)	1J1 / 1J5	1.6	74	4	11.05-	BJH	0,9	BKR6E	6962	28	LPG 1
Golf 4 1.6	1J1 / 1J5	1.6	74	4	10.97-05.03	AKL	1,0	BKUR6ET-10	2397	24	LPG 1
Golf 4 1.6	1J1 / 1J5	1.6	74	4	01.98-05.04	AEH	1,0	BKUR6ET-10	2397	24	LPG 1
Golf 4 1.6	1J1 / 1J5	1.6	74	4	05.99-08.00	APF	1,0	BKUR6ET-10	2397	24	LPG 1
Golf 4 1.6	1J1 / 1J5	1.6	74	4	09.00-04.02	AVU	1,0	BKUR6ET-10	2397	24	LPG 1
Golf 4 1.6	1J1 / 1J5	1.6	75	4	05.02-06.06	BFQ	1,0	BKUR6ET-10	2397	24	LPG 1
Golf 4 1.6	1J1 / 1J5	1.6	77	4	11.99-05.00	ATN	1,0	BKUR6ET-10	2397	24	LPG 1
Golf 4 1.6	1J1 / 1J5	1.6	77	4	05.00-10.00	AUS	1,0	BKUR6ET-10	2397	24	LPG 1
Golf 4 1.6	1J1 / 1J5	1.6	77	4	09.00-11.01	AZD	1,1	PZFR5D-11	1664	34	LPG 6
Golf 4 1.6	1J1 / 1J5	1.6	77	4	11.01-06.06	BCB	1,1	PZFR5D-11	1664	34	LPG 6
Golf 4 1.6 (China)	1J1 / 1J5	1.6	78	4	.04-	AWB	0,8	BKR5E	7938	35	LPG 1
Golf 4 1.6 FSI	1J1 / 1J5	1.6	81	4	08.01-06.06	BAD	0,5	ZFR6S-Q	6449		
Golf 4 1.6 FSI	1J1 / 1J5	1.6	85	4	10.03-07.04	BAG	0,5	ZFR6S-Q	6449		
Golf 4 1.8	1J1 / 1J5	1.8	92	4	07.98-10.00	AGN	1,0	BKUR6ET-10	2397	24	LPG 1
Golf 4 1.8 (China)	1J1 / 1J5	1.8	92	4	09.05-	BAF	1,0	BKUR6ET-10	2397	24	LPG 1
Golf 4 1.8 T	1J1 / 1J5	1.8	110	4	05.99-04.01	ARZ	0,8	PFR6Q	6458	37	LPG 1
Golf 4 1.8 T	1J1 / 1J5	1.8	110	4	09.00-05.06	AUM	0,8	PFR6Q	6458	37	LPG 1
Golf 4 1.8 T (USA)	1J1 / 1J5	1.8	110	4	12.99-09.00	AWD	0,8	PFR6Q	6458	37	LPG 1
Golf 4 1.8 T GTI	1J1 / 1J5	1.8	110	4	10.97-05.03	AGU	0,8	PFR6Q	6458	37	LPG 1
Golf 4 1.8 T (USA)	1J1 / 1J5	1.8	110	4	08.00-	AWW	0,8	PFR6Q	6458	37	LPG 1
Golf 4 1.8 T GTI	1J1 / 1J5	1.8	132	4	06.01-05.04	AUQ	0,8	PFR6Q	6458	37	LPG 1
Golf 4 2.0	1J1 / 1J5	2.0	85	4	08.98-05.03	APK	1,0	BKUR6ET-10	2397	24	LPG 1
Golf 4 2.0	1J1 / 1J5	2.0	85	4	08.98-06.06	AQY	1,0	BKUR6ET-10	2397	24	LPG 1
Golf 4 2.0	1J1 / 1J5	2.0	85	4	06.99-06.00	ATU	0,8	PFR6Q	6458	37	LPG 1
Golf 4 2.0	1J1 / 1J5	2.0	85	4	04.00-06.01	AZH	1,0	BKUR6ET-10	2397	24	LPG 1
Golf 4 2.0	1J1 / 1J5	2.0	85	4	05.01-04.02	AZG	1,1	PZFR5D-11	7968	34	LPG 6
Golf 4 2.0	1J1 / 1J5	2.0	85	4	05.01-06.06	AZJ	1,1	PZFR5D-11	7968	34	LPG 6
Golf 4 2.0	1J1 / 1J5	2.0	85	4	05.02-06.06	BEH	1,1	PZFR5D-11	7968	34	LPG 6
Golf 4 2.0 (USA)	1J1 / 1J5	2.0	85	4	06.98-	AEG	1,0	BKUR6ET-10	2397	24	LPG 1
Golf 4 2.0 Cabrio	1J1 / 1J5	2.0	85	4	06.00-06.02	AWF	0,8	PFR6Q	6458	37	LPG 1
Golf 4 2.0 Cabrio	1J1 / 1J5	2.0	85	4	06.00-06.02	AWG	0,8	PFR6Q	6458	37	LPG 1
Golf 4 2.3 V5	1J1 / 1J5	2.3	110	5	10.97-02.01	AGZ	0,6	BKR5EKUP	2890		
Golf 4 2.3 V5	1J1 / 1J5	2.3	125	5	09.00-05.06	AQN	1,1	PZFR5D-11	7968	34	LPG 6
Golf 4 2.8 V6 (USA)	1J1 / 1J5	2.8	130	6	03.98-05.00	AFP	0,6	BKR5EKUP	2890		
Golf 4 2.8 V6	1J1 / 1J5	2.8	150	6	05.01-06.05	BDE	1,1	PZFR5D-11	7968	34	LPG 6
Golf 4 2.8 V6	1J1 / 1J5	2.8	150	6	05.99-05.00	AQP	1,1	PZFR5D-11	7968	34	LPG 6
Golf 4 2.8 V6	1J1 / 1J5	2.8	150	6	01.00-04.01	AUE	1,1	PZFR5D-11	7968	34	LPG 6
Golf 4 3.2 V6 R32	1J1 / 1J5	3.2	177	6	06.02-05.04	BFH	0,9	IZKR7B	7563		
Golf 4 3.2 V6 R32	1J1 / 1J5	3.2	177	6	11.03-06.06	BML	0,9	IZKR7B	7563		

**GOLF 5**

Golf 5 1.4	1K1 / 1K5	1.4	55	4	01.05-05.06	BCA	1,0	BKUR6ET-10	2397	24	LPG 1
Golf 5 1.4	1K1 / 1K5	1.4	59	4	05.06-11.08	BUD	1,1	ZFR6T-11G	5960	44	
Golf 5 1.4 FSI	1K1 / 1K5	1.4	66	4	10.03-12.04	BKG	0,5	ZFR6S-Q	6449		
Golf 5 1.4 FSI	1K1 / 1K5	1.4	66	4	11.04-07.06	BLN	0,5	ZFR6S-Q	6449		
Golf 5 1.4 TSI	1K1 / 1K5	1.4	90	4	07.07-11.08	CAXA	0,9	PZFR6R	5758		
Golf 5 1.4 TSI	1K1 / 1K5	1.4	103	4	05.06-05.07	BMY	0,9	PZFR6R	5758		
Golf 5 1.4 TSI GT	1K1 / 1K5	1.4	125	4	11.05-11.08	BLG	0,9	PZFR6R	5758		
Golf 5 1.6	1K1 / 1K5	1.6	75	4	01.04-06.05	BGU	1,0	BKUR6ET-10	2397	24	LPG 1
Golf 5 1.6	1K1 / 1K5	1.6	75	4	05.05-11.08	BSE	1,0	BKUR6ET-10	2397	24	LPG 1
Golf 5 1.6	1K1 / 1K5	1.6	75	4	05.05-11.08	BSF	1,0	BKUR6ET-10	2397	24	LPG 1
Golf 5 1.6	1K1 / 1K5	1.6	75	4	11.07-12.08	CCSA	1,0	BKUR6ET-10	2397	24	LPG 1

e kW  
C  
Y  
I

0201



Stock-No

VLINE

LPG / CNG

## VW

## GOLF 5

Golf 5 1.6 FSI	1K1 / 1K5	1.6	85	4	10.03-07.04	BAG	0,5	ZFR6S-Q	6449		
Golf 5 1.6 FSI	1K1 / 1K5	1.6	85	4	05.04-07.05	BLP	0,5	ZFR6S-Q	6449		
Golf 5 1.6 FSI	1K1 / 1K5	1.6	85	4	01.05-01.09	BLF	0,5	ZFR6S-Q	6449		
Golf 5 2.0 FSI	1K1 / 1K5	2.0	110	4	10.03-05.04	AXW	1,1	PZFR5N-11T	7742		
Golf 5 2.0 FSI	1K1 / 1K5	2.0	110	4	05.04-07.07	BLX	1,1	PZFR5N-11T	7742		
Golf 5 2.0 FSI	1K1 / 1K5	2.0	110	4	05.04-07.07	BLY	0,9	BKR6E	6962	28	LPG 1
Golf 5 2.0 FSI	1K1 / 1K5	2.0	110	4	01.05-07.07	BLR	1,1	PZFR5N-11T	7742		
Golf 5 2.0 FSI	1K1 / 1K5	2.0	110	4	11.05-11.08	BVX	1,1	PZFR5N-11T	7742		
Golf 5 2.0 FSI	1K1 / 1K5	2.0	110	4	05.05-11.08	BVY	1,1	PZFR5N-11T	7742		
Golf 5 2.0 FSI	1K1 / 1K5	2.0	110	4	11.05-11.08	BVZ	0,9	BKR6E	6962	28	LPG 1
Golf 5 GTI	1K1 / 1K5	2.0	147	4	09.04-01.06	AXX	0,8	PFR7S8EG	1675		PFR8S8EG
Golf 5 GTI	1K1 / 1K5	2.0	147	4	11.05-02.09	BWA	0,8	PFR7S8EG	1675		PFR8S8EG
Golf 5 GTI	1K1 / 1K5	2.0	147	4	03.08-02.09	CAWB	0,8	PFR7S8EG	1675		PFR8S8EG
Golf 5 GTI	1K1 / 1K5	2.0	169	4	09.06-11.08	BYD	0,8	PFR7S8EG	1675		PFR8S8EG
Golf 5 GTI	517	2.0	162	4	11.13-	CULC	0,8	PLFER7A8EG	94833		
Golf 5 R32	1K1 / 1K5	3.2	184	6	05.05-11.08	BUB	0,9	IZKR7B	7563		

## GOLF 6

Golf 6 1.2 TSI	5K1 / AJ5	1.2	63	4	05.10-11.12	CBZA	0,7	IZFR6P7	97153		
Golf 6 1.2 TSI	5K1 / AJ5	1.2	77	4	05.09-11.12	CBZB	0,7	IZFR6P7	97153		
Golf 6 1.4	5K1 / AJ5	1.4	59	4	01.09-11.12	CGGA	1,1	ZFR6T-11G	5960	44	
Golf 6 1.4 TSI	5K1 / AJ5	1.4	90	4	05.08-11.12	CAXA	0,9	PZFR6R	5758		PZFR6R
Golf 6 1.4 TSI (OE Ref 03C905601A)	AJ5	1.4	118	4	07.09-07.13	CTKA	0,8	SIZFR6B8EG	96209		
Golf 6 1.4 TSI (OE Ref 101905626)	AJ5	1.4	118	4	07.09-07.13	CTKA	0,8	PZFR6R	5758		PZFR6R
Golf 6 1.4 TSI	5K1 / AJ5	1.4	118	4	07.08-11.12	CAVD	0,8	SIZFR6B8EG	96209		
Golf 6 1.4 TSI	5K1 / AJ5	1.4	118	4	10.08-11.12	CNWA	0,8	SIZFR6B8EG	96209		
Golf 6 1.4 TSI	5K1 / AJ5	1.4	118	4	10.08-11.12	CTHD	0,8	SIZFR6B8EG	96209		
Golf 6 1.6	5K1 / AJ5	1.6	75	4	11.08-11.12	CCSA	1,0	BKUR6ET-10	2397	24	LPG 1
Golf 6 1.6 BiFuel (LPG)	5K1 / AJ5	1.6	75	4	03.09-11.12	CHGA	1,0	BKUR6ET-10	2397	24	LPG 1
Golf 6 1.6	5K1 / AJ5	1.6	75	4	05.10-11.12	CMXA	1,0	BKUR6ET-10	2397	24	LPG 1
Golf 6 1.8 TSI	5K1	1.8	118	4	06.09-01.11	CDA A	0,8	PFR7S8EG	1675		PFR8S8EG
Golf 6 2.0 TFSI	5K1	2.0	147	4	07.09-11.13	CCTA	0,8	PFR7S8EG	1675		PFR8S8EG
Golf 6 2.0 TFSI	5K1	2.0	147	4	07.09-11.13	CBFA	0,8	PFR7S8EG	1675		PFR8S8EG
Golf 6 2.0 GTI	5K1	2.0	155	4	04.09-11.12	CCZB	0,8	PFR7S8EG	1675		PFR8S8EG
Golf 6 2.0 GTI	5K1	2.0	173	4	05.11-11.12	CDLG	0,8	PFR7S8EG	1675		PFR8S8EG
Golf 6 2.0 TSI R 4motion	5K1	2.0	188	4	11.09-11.12	CDLC	0,8	PFR7S8EG	1675		PFR8S8EG
Golf 6 2.0 TSI R 4motion	5K1	2.0	199	4	11.09-11.12	CDLF	0,8	PFR7S8EG	1675		PFR8S8EG

## GOLF 6 CABRIOLET

Golf 6 Cabriolet 1.2 TSI	517	1.2	77	4	06.11-	CBZB	0,7	IZFR6P7	97153		
Golf 7 Cabriolet Si BlueMotion	517	1.2	77	4	11.13-	CJZA	0,8	PZKER7A8EGS	94968		
Golf 6 Cabriolet 1.4 TSI	517	1.4	90	4	06.11-	CAXA	0,9	PZFR6R	5758		
Golf 6 Cabriolet 1.4 TSI	517	1.4	118	4	03.11-	CAVD	0,8	SIZFR6B8EG	96209		
Golf 6 Cabriolet 2.0 TSI GTI	517	2.0	155	4	06.11-	CCZB	0,8	PFR7S8EG	1675		PFR8S8EG

## GOLF 7

Golf 7 1.0 TSI	5G1/BA5	1.0	85	3	.15-	CHZD	0,8	PKER7A8EGS	94968		
Golf 7 1.2 TSI	5G1/BA5	1.2	77	4	08.12-	CJZA	0,8	PZKER7A8EGS	94968		
Golf 7 1.2 TSI	5G1/BA5	1.2	63	4	08.12-	CJZB	0,8	PZKER7A8EGS	94968		
Golf 7 1.2 TSI	5G1/BA5	1.2	81	4	05.14-	CYVB	0,8	PZKER7A8EGS	94968		
Golf 7 1.4 TGI CNG	5G1/BA5	1.4	81	4	06.13-	CPWA	0,8	PZKER7A8EGS	94968		
Golf 7 1.4 TSI	5G1/BA5	1.4	103	4	08.12-	CHPA	0,8	PZKER7A8EGS	94968		
Golf 7 1.4 TSi BlueMotion	BA5	1.4	103	4	05.13-	CHPA	0,8	PZKER7A8EGS	94968		

e kW  
C  
Y  
I

0201



Stock-No

VLINE

LPG/CNG

VW

**GOLF 7**

Golf 7 1.4 TSI ACT BlueMotion/TSi BlueMotion	5G1/BA5	1.4	110	4	05.14-	CHPB	0,8	PZKER7A8EGS	94968		
Golf 7 1.4 TSI	5G1/BA5	1.4	90	4	11.12-	CMBA	0,8	PZKER7A8EGS	94968		
Golf 7 1.4 TSI	5G1/BA5	1.4	103	4	08.12-	CPTA	0,8	PZKER7A8EGS	94968		
Golf 7 1.4 TSI	5G1/BA5	1.4	90	4	11.12-	CXSA	0,8	PZKER7A8EGS	94968		
Golf 7 1.4 TSI	5G1/BA5	1.4	92	4	05.14-	CZCA	0,8	PZKER7A8EGS	94968		
Golf 7 1.4 TSI	5G1/BA5	1.4	110	4	05.14-	CZDA	0,8	PZKER7A8EGS	94968		
Golf 7 1.4 TSI GTE Hybrid	5G1/BA5	1.4	110	4	05.14-	CUKB	0,8	PZKER7A8EGS	94968		
Golf 7 1.4 TSI Multifuel	5G1/BA5	1.4	90	4	11.12-	CPVA	0,8	PZKER7A8EGS	94968		
Golf 7 1.4 TSI Multifuel	5G1/BA5	1.4	92	4	05.14-	CPVB	0,8	PZKER7A8EGS	94968		
Golf 7 1.6 SRE Only for cylinder without pressure sensor	5G1	1.6	81	4	05.14-	CWVA	1,0	ZKER6A-10EG	96596		
Golf 7 2.0 GTI	5G1	2.0	162	4	04.13-	CHHB	0,8	PLFER7A8EG	94833		
Golf 7 2.0 GTI Performance	5G1	2.0	169	4	04.13-	CHHA	0,8	PLFER7A8EG	94833		
Golf 7 2.0 R 4motion	5G1	2.0	206	4	11.13-	CJXB	0,8	PLFER7A8EG	94833		
Golf GTI	5G1	2.0	155	4	11.13-	CNTA	0,8	PLFER7A8EG	94833		
Golf 7 2.0 R 4motion	5G1	2.0	221	4	11.13-	CJXC	0,8	PLFER7A8EG	94833		

**GOLF PLUS**

Golf Plus 1.2 TSI	5M1	1.2	63	4	05.10-	CBZA	0,7	IZFR6P7	97153		
Golf Plus 1.2 TSI	5M1	1.2	77	4	11.09-	CBZB	0,7	IZFR6P7	97153		
Golf Plus 1.4	5M1	1.4	55	4	01.05-05.06	BCA	1,0	BKUR6ET-10	2397	24	LPG 1
Golf Plus 1.4	5M1	1.4	59	4	05.06-	BUD	1,1	ZFR6T-11G	5960	44	
Golf Plus 1.4	5M1	1.4	59	4	10.08-	CGGA	1,1	ZFR6T-11G	5960	44	
Golf Plus 1.4 FSI	5M1	1.4	66	4	11.04-07.06	BLN	0,5	ZFR6S-Q	6449		
Golf Plus 1.4 TSI	5M1	1.4	90	4	07.07-	CAXA	0,9	PZFR6R	5758		
Golf Plus 1.4 TSI	5M1	1.4	103	4	05.06-06.08	BMV	0,9	PZFR6R	5758		
Golf Plus 1.4 TSI	5M1	1.4	118	4	07.08-	CAVD	0,9	PZFR6R	5758		
Golf Plus 1.4 TSI	5M1	1.4	125	4	05.06-06.08	BLG	0,9	PZFR6R	5758		
Golf Plus 1.6	5M1	1.6	75	4	05.05-	BSE	1,0	BKUR6ET-10	2397	24	LPG 1
Golf Plus 1.6	5M1	1.6	75	4	05.05-	BSF	1,0	BKUR6ET-10	2397	24	LPG 1
Golf Plus 1.6	5M1	1.6	75	4	11.07-12.08	CCSA	1,0	BKUR6ET-10	2397	24	LPG 1
Golf Plus 1.6 BiFuel (LPG)	5M1	1.6	75	4	05.09-	CHGA	1,0	BKUR6ET-10	2397	24	LPG 1
Golf Plus 1.6 FSI	5M1	1.6	85	4	01.05-05.08	BLF	0,5	ZFR6S-Q	6449		
Golf Plus 2.0 FSI	5M1	2.0	110	4	05.05-07.07	BLR	1,1	PZFR5N-11T	7742		
Golf Plus 2.0 FSI	5M1	2.0	110	4	05.05-07.07	BLY	0,9	BKR6E	6962	28	LPG 1
Golf Plus 2.0 FSI	5M1	2.0	110	4	05.05-06.08	BVY	1,1	PZFR5N-11T	7742		
Golf Plus 2.0 FSI	5M1	2.0	110	4	05.05-06.08	BVZ	0,9	BKR6E	6962	28	LPG 1

**GOLF SPORTSVAN**

Golf Sportsvan 1.0 TSI	AM1	1.0	85	3	.15-	CHZD	0,8	PKER7A8EGS	94968		
Golf Sportsvan TSi BlueMotion	AM1	1.2	63	4	05.14-	CYVA	0,8	PZKER7A8EGS	94968		
Golf Sportsvan 1.2 TSI	AM1	1.2	63	4	05.14-	CYVA	0,8	PZKER7A8EGS	94968		
Golf Sportsvan 1.2 TSI	AM1	1.2	81	4	04.14-	CYVB	0,8	PZKER7A8EGS	94968		
Golf Sportsvan 1.4 TSI	AM1	1.4	92	4	04.14-	CZCA	0,8	PZKER7A8EGS	94968		
Golf Sportsvan 1.4 TSI	AM1	1.4	110	4	02.14-	CZDA	0,8	PZKER7A8EGS	94968		

**JETTA 2**

Jetta 2 1.3	19E / 1G2	1.3	40	4	06.87-12.91	2G	0,8	BUR6ET	3172	1	LPG 2
Jetta 2 1.3	19E / 1G2	1.3	40	4	06.87-12.91	MH	0,8	BUR6ET	3172	1	LPG 2
Jetta 2 1.3	19E / 1G2	1.3	40	4	06.87-12.91	NZ	0,8	BUR6ET	3172	1	LPG 2
Jetta 2 1.6	19E / 1G2	1.6	51	4	10.86-10.91	PN	1,0	BUR5ET-10	7264	21	LPG 2
Jetta 2 1.6	19E / 1G2	1.6	53	4	03.86-10.91	RF	1,0	BUR5ET-10	7264	21	LPG 2

e kW  
C  
y  
i

Stock-No



LPG / CNG

**VW****JETTA 2**

Jetta 2 1.6	19E / 1G2	1.6	55	4	01.84-07.92	EZ	1,0	BUR5ET-10	7264	21	LPG 2
Jetta 2 1.6	19E / 1G2	1.6	55	4	01.86-07.92	ABN	1,0	BUR5ET-10	7264	21	LPG 2
Jetta 2 1.8	19E / 1G2	1.8	66	4	08.84-10.91	GU	0,8	BUR6ET	3172	1	LPG 2
Jetta 2 1.8	19E / 1G2	1.8	66	4	08.87-10.91	RP	0,8	BUR6ET	3172	1	LPG 2
Jetta 2 1.8 Synchro	19E / 1G2	1.8	72	4	08.88-07.91	1P	0,8	BUR6ET	3172	1	LPG 2
Jetta 2 1.8	19E / 1G2	1.8	79	4	01.87-10.91	PF	0,8	BUR6ET	3172	1	LPG 2
Jetta 2 1.8	19E / 1G2	1.8	82	4	01.84-10.91	PB	0,8	BUR6ET	3172	1	LPG 2
Jetta 2 1.8 16V	19E / 1G2	1.8	95	4	08.86-10.91	PL	0,8	BKUR7ET	7873		PFR7Q
Jetta 2 1.8 16V	19E / 1G2	1.8	102	4	06.87-12.89	KR	0,9	BCPR7ET	2164		BCPR7EIX

**JETTA 3**

Jetta 3 1.4 TSI	1K2	1.4	90	4	07.07-10.10	CAXA	0,9	PZFR6R	5758		
Jetta 3 1.4 TSI	1K2	1.4	103	4	07.06-06.08	BMV	0,9	PZFR6R	5758		
Jetta 3 1.4 TSI	1K2	1.4	118	4	07.08-10.10	CAVD	0,9	PZFR6R	5758		
Jetta 3 1.4 TSI	1K2	1.4	125	4	07.06-06.08	BLG	0,9	PZFR6R	5758		
Jetta 3 1.6	1K2	1.6	75	4	08.05-10.10	BSE	1,0	BKUR6ET-10	2397	24	LPG 1
Jetta 3 1.6	1K2	1.6	75	4	10.05-10.10	BSF	1,0	BKUR6ET-10	2397	24	LPG 1
Jetta 3 1.6 FSI	1K2	1.6	85	4	09.05-06.08	BLF	0,5	ZFR6S-Q	6449		
Jetta 3 2.0 FSI	1K2	2.0	110	4	08.05-11.05	BLR	1,1	PZFR5N-11T	7742		
Jetta 3 2.0 FSI	1K2	2.0	110	4	10.05-11.05	BLY	0,9	BKR6E	6962	28	LPG 1
Jetta 3 2.0 FSI	1K2	2.0	110	4	12.05-06.08	BVY	1,1	PZFR5N-11T	7742		
Jetta 3 2.0 FSI	1K2	2.0	110	4	12.05-06.08	BVZ	0,9	BKR6E	6962	28	LPG 1
Jetta 3 2.0 TSI	1K2	2.0	147	4	09.05-10.10	BPY	0,8	PFR7S8EG	1675		PFR8S8EG
Jetta 3 2.0 TSI	1K2	2.0	147	4	09.05-10.10	BWA	0,8	PFR7S8EG	1675		PFR8S8EG
Jetta 3 2.0 TSI	1K2	2.0	147	4	09.05-10.10	CAWB	0,8	PFR7S8EG	1675		PFR8S8EG
Jetta 3 2.0 TSI	1K2	2.0	147	4	09.05-10.10	CBFA	0,8	PFR7S8EG	1675		PFR8S8EG
Jetta 3 2.5	1K2	2.5	110	5	06.05-06.08	BTK	1,1	PZFR5Q-11	6458		
Jetta 3 2.5 FSI	1K2	2.5	125	5	07.07-10.10	CBTA	1,1	ZFR6T-11G	5960	44	
Jetta 3 2.5 FSI	1K2	2.5	110	5	01.05-06.08	BGP	1,1	PZFR5Q-11	6458		
Jetta 3 2.5	1K2	2.5	125	5	07.07-	CCCA	1,1	ZFR6T-11G	5960	44	

**JETTA 4**

Jetta 4 1.2 TSI	162	1.2	77	4	02.11-	CBZB	0,7	IZFR6P7	97153		IZFR6P7
Jetta 4 1.2 TSI	163	1.2	77	4	08.14-	CYVD	0,8	PZKER7A8EGS	94968		
Jetta 4 1.4 TSI	162	1.4	110	4	02.11-07.14	CAVA	0,8	SIZFR6B8EG	96209		
Jetta 4 1.4 TSI	162	1.4	90	4	05.11-	CAXA	0,9	PZFR6R	5758		PZFR6R
Jetta 4 1.4 TSI	162	1.4	90	4	05.11-	CMSB	0,9	PZFR6R	5758		PZFR6R
Jetta 4 1.4 TSI	162	1.4	118	4	02.11-	CAVD	0,8	SIZFR6B8EG	96209		
Jetta 4 1.4 TSI	162	1.4	110	4	02.11-07.14	CTHA	0,8	SIZFR6B8EG	96209		
Jetta 4 1.4 TSI	162	1.4	110	4	02.11-07.14	CTHA	0,8	SIZFR6B8EG	96209		
Jetta 4 1.4 TSI	163	1.4	92	4	08.14-	CZCA	0,8	PZKER7A8EGS	94968		
Jetta 4 1.4 TSI	163	1.4	110	4	08.14-	CZDA	0,8	PZKER7A8EGS	94968		
Jetta 4 1.4 TSI Hybrid	162	1.4	110	4	07.12-	CNLA	0,8	PZKER7A8EGS	94968		
Jetta 4 1.6	162	1.6	77	4	12.11-	CFNA	1,1	ZFR6T-11G	5960	44	
Jetta 4 1.6	162	1.6	63	4	03.14-	CFNB	1,1	ZFR6T-11G	5960	44	
Jetta 4 1.6	162	1.6	77	4	12.11-	CLRA	1,1	ZFR6T-11G	5960	44	
Jetta 4 2.0 TSI	162	2.0	147	4	02.11-	CBFA	0,8	PFR7S8EG	1675		PFR8S8EG
Jetta 4 2.0 TSI	162	2.0	147	4	02.11-	CCTA	0,8	PFR7S8EG	1675		PFR8S8EG
Jetta 4 2.0 TSI	162	2.0	147	4	02.11-	CCZA	0,8	PFR7S8EG	1675		PFR8S8EG
Jetta 4 2.5 TSI	162	2.5	125	5	04.10-	CBTA	1,1	ZFR6T-11G	5960	44	
Jetta 4 2.5 TSI	162	2.5	125	5	04.10-	CBUA	1,1	ZFR6T-11G	5960	44	



l kW  
C  
y  
i

0201



Stock-No

VALE

LPG / CNG

VW

### KÄFER

Käfer (MEXICO IMPORT)	1.6	34	4	01.93-	ACD	0,8	BP5ESA	2285		
-----------------------	-----	----	---	--------	-----	-----	--------	------	--	--

### LT

LT	2.3	105	4	05.96-11.01	AGL	0,8	BKUR5ET	2789	29	LPG 1
LT	2.4	66	6	08.82-07.92	DL	0,7	BP6ESZ	7639		LPG 2
LT	2.4	70	6	08.88-12.95	1E	0,7	BP6ESZ	7639		LPG 2

### LUPO

Lupo 1.0	6X1 / 6E1	1.0	37	4	10.98-05.00	AHT	1,0	BKR6ETA-10	7998		
Lupo 1.0	6X1 / 6E1	1.0	37	4	10.98-05.00	ALL	0,8	BUR6ET	3172	1	LPG 2
Lupo 1.0	6X1 / 6E1	1.0	37	4	01.99-05.00	AER	0,8	BUR6ET	3172	1	LPG 2
Lupo 1.0	6X1 / 6E1	1.0	37	4	05.99-07.05	ALD	0,9	ZFR5P-G	6893	41	LPG 6
Lupo 1.0	6X1 / 6E1	1.0	37	4	05.99-05.00	ANV	0,9	ZFR5P-G	6893	41	LPG 6
Lupo 1.0	6X1 / 6E1	1.0	37	4	05.00-07.05	AUC	0,9	ZFR5P-G	6893	41	LPG 6
Lupo 1.4	6X1 / 6E1	1.4	44	4	09.00-07.05	AUD	0,9	PZFR5D-11	7968	34	LPG 6
Lupo 1.4	6X1 / 6E1	1.4	55	4	07.98-05.99	AKQ	1,0	BKUR6ET-10	2397	24	LPG 1
Lupo 1.4	6X1 / 6E1	1.4	55	4	01.99-07.05	AHW	1,0	BKUR6ET-10	2397	24	LPG 1
Lupo 1.4	6X1 / 6E1	1.4	55	4	05.99-09.00	APE	1,0	BKUR6ET-10	2397	24	LPG 1
Lupo 1.4	6X1 / 6E1	1.4	55	4	05.00-04.02	AUA	1,0	BKUR6ET-10	2397	24	LPG 1
Lupo 1.4	6X1 / 6E1	1.4	55	4	04.02-07.05	BBY	1,0	BKUR6ET-10	2397	24	LPG 1
Lupo 1.4	6X1 / 6E1	1.4	74	4	05.99-10.00	AFK	1,0	BKUR6ET-10	2397	24	LPG 1
Lupo 1.4	6X1 / 6E1	1.4	74	4	05.99-05.00	ANM	1,0	BKUR6ET-10	2397	24	LPG 1
Lupo 1.4	6X1 / 6E1	1.4	74	4	05.99-05.00	AQQ	1,0	BKUR6ET-10	2397	24	LPG 1
Lupo 1.4	6X1 / 6E1	1.4	74	4	05.00-07.05	AUB	1,0	BKUR6ET-10	2397	24	LPG 1
Lupo 1.4 FSI	6X1 / 6E1	1.4	77	4	09.00-11.03	ARR	0,5	ZFR6S-Q	6449		
Lupo 1.6 GTI	6X1 / 6E1	1.6	92	4	06.00-07.05	AVY	1,0	BKUR6ET-10	2397	24	LPG 1

### PASSAT 3

Passat 3 1.6	35i/3A2/3A5	1.6	53	4	04.88-07.91	1F	1,0	BUR5ET-10	7264	21	LPG 2
Passat 3 1.6	35i/3A2/3A5	1.6	53	4	08.89-07.92	EZ	1,0	BUR5ET-10	7264	21	LPG 2
Passat 3 1.6	35i/3A2/3A5	1.6	55	4	08.89-09.91	ABN	1,0	BUR5ET-10	7264	21	LPG 2
Passat 3 1.6	35i/3A2/3A5	1.6	74	4	10.94-12.95	AEK	0,8	BKUR5ET	2789	29	LPG 1
Passat 3 1.6	35i/3A2/3A5	1.6	53	4	04.88-07.91	RF	1,0	BUR5ET-10	7264	21	LPG 2
Passat 3 1.6	35i/3A2/3A5	1.6	74	4	12.95-12.96	AFT	1,0	BKUR6ET-10	2397	24	LPG 1
Passat 3 1.8	35i/3A2/3A5	1.8	55	4	08.90-12.96	AAM	0,8	BUR5ET	3377	22	LPG 2
Passat 3 1.8	35i/3A2/3A5	1.8	66	4	04.88-07.91	RP	0,8	BUR6ET	3172	1	LPG 2
Passat 3 1.8	35i/3A2/3A5	1.8	66	4	08.91-09.94	ABS	0,8	BUR6ET	3172	1	LPG 2
Passat 3 1.8	35i/3A2/3A5	1.8	66	4	08.94-12.96	ADZ	0,8	BUR6ET	3172	1	LPG 2
Passat 3 1.8	35i/3A2/3A5	1.8	79	4	04.88-07.93	PF	0,8	BUR6ET	3172	1	LPG 2
Passat 3 1.8	35i/3A2/3A5	1.8	82	4	04.88-07.92	PB	0,8	BUR6ET	3172	1	LPG 2
Passat 3 1.8 GUS	35i/3A2/3A5	1.8	85	4	01.97-04.00	AFY	1,0	BKUR6ET-10	2397	24	LPG 1
Passat 3 1.8 16V	35i/3A2/3A5	1.8	100	4	04.88-07.92	KR	0,9	BCPR7ET	2164		BCPR7EIX
Passat 3 2.0	35i/3A2/3A5	2.0	79	4	03.95-12.96	AEP	0,8	BUR6ET	3172	1	LPG 2
Passat 3 2.0	35i/3A2/3A5	2.0	85	4	03.90-09.94	2E	0,8	BUR6ET	3172	1	LPG 2
Passat 3 2.0	35i/3A2/3A5	2.0	85	4	10.94-12.95	ADY	0,8	BUR6ET	3172	1	LPG 2
Passat 3 2.0	35i/3A2/3A5	2.0	85	4	07.96-12.96	AGG	0,8	BUR6ET	3172	1	LPG 2
Passat 3 2.0 16V	35i/3A2/3A5	2.0	100	4	04.88-10.93	9A	0,8	BKUR7ET	7873		PFR7Q
Passat 3 2.0 16V	35i/3A2/3A5	2.0	110	4	07.94-12.96	ABF	1,0	BKUR6ET-10	2397	24	LPG 1
Passat 3 2.8 VR6	35i/3A2/3A5	2.8	128	6	06.91-06.95	AAA	0,7	BKR5EKU	3964		
Passat 3 2.8 VR6	35i/3A2/3A5	2.8	128	6	07.95-12.96	AAA	0,6	BKR5EKUP	2890		
Passat 3 2.8 VR6 USA	35i/3A2/3A5	2.8	142	6	10.94-12.95	AHA	0,5	BKR6EKUB	3584		LPG 1
Passat 3 2.9 VR6 Synchro	35i / 3A5	2.9	135	6	07.94-06.95	ABV	0,7	BKR5EKU	3964		
Passat 3 2.9 VR6 Synchro	35i / 3A5	2.9	135	6	07.95-12.96	ABV	0,6	BKR5EKUP	2890		

e kW  
C  
y  
i

0201



Stock-No

VLINE

LPG / CNG

VW

## PASSAT 4

Passat 4 1.6	3B2 / 3B5	1.6	74	4	10.96-08.00	AHL	1,0	BKUR6ET-10	2397	24	LPG 1
Passat 4 1.6	3B2 / 3B5	1.6	74	4	01.97-10.97	ADP	1,0	BKUR6ET-10	2397	24	LPG 1
Passat 4 1.6	3B2 / 3B5	1.6	74	4	07.99-08.00	ANA	1,0	BKUR6ET-10	2397	24	LPG 1
Passat 4 1.6	3B2 / 3B5	1.6	74	4	01.99-08.00	ARM	1,0	BKUR6ET-10	2397	24	LPG 1
Passat 4 1.6	3B3 / 3B6	1.6	75	4	10.00-05.05	ALZ	1,0	BKUR6ET-10	2397	24	LPG 1
Passat 4 1.8	3B2 / 3B5	1.8	92	4	12.96-01.99	ADR	1,0	BKUR6ET-10	2397	24	LPG 1
Passat 4 1.8	3B2 / 3B5	1.8	92	4	01.99-08.00	APT	1,0	BKUR6ET-10	2397	24	LPG 1
Passat 4 1.8	3B2 / 3B5	1.8	92	4	02.99-08.00	ARG	1,0	BKUR6ET-10	2397	24	LPG 1
Passat 4 1.8 T	3B2 / 3B5	1.8	110	4	10.96-12.98	AEB	0,8	PFR6Q	6458	37	LPG 1
Passat 4 1.8 T	3B2 / 3B5	1.8	110	4	01.99-08.00	ANB	0,8	PFR6Q	6458	37	LPG 1
Passat 4 1.8 T	3B2 / 3B5	1.8	110	4	01.99-08.00	APU	0,8	PFR6Q	6458	37	LPG 1
Passat 4 1.8 T	3B3 / 3B6	1.8	110	4	10.00-05.05	AWT	0,8	PFR6Q	6458	37	LPG 1
Passat 4 1.8 T (China)	3B3 / 3B6	1.8	110	4	12.05-	BGC	0,8	PFR6Q	6458	37	LPG 1
Passat 4 1.8 T (USA)	3B2 / 3B5	1.8	110	4	08.99-05.00	ATW	0,8	PFR6Q	6458	37	LPG 1
Passat 4 1.8 T (USA)	3B2 / 3B5	1.8	110	4	05.00-08.00	AUG	0,8	PFR6Q	6458	37	LPG 1
Passat 4 1.8 T (USA)	3B3 / 3B6	1.8	125	4	02.01-05.05	AWM	0,8	PFR6Q	6458	37	LPG 1
Passat 4 2.0	3B3 / 3B6	2.0	85	4	10.00-05.05	AZM	1,0	BKUR6ET-10	2397	24	LPG 1
Passat 4 2.0	3B3 / 3B6	2.0	85	4	12.05-	BFF	0,8	PFR6Q	6458	37	LPG 1
Passat 4 2.0 20V	3B3 / 3B6	2.0	96	4	11.01-05.05	ALT	1,0	BKUR5ET-10	7553		LPG 1
Passat 4 2.3 V5	3B2 / 3B5	2.3	110	5	10.96-08.00	AGZ	0,6	BKR5EKUP	2890		
Passat 4 2.3 V5	3B3 / 3B6	2.3	125	5	01.01-05.05	AZX	1,1	PZFR5D-11	7968	34	LPG 6
Passat 4 2.8 V6 (China / GUS)	3B2/3B3/3B5/3B6	2.8	132	6	09.97-09.99	AGE	0,5	BKR6EKUB	3584		LPG 1
Passat 4 2.8 V6 (China)	3B2/3B3/3B5/3B6	2.8	140	6	10.00-05.05	BBG	0,5	BKR6EKUB	3584		LPG 1
Passat 4 2.8 V6	3B2 / 3B5	2.8	142	6	06.97-12.98	ACK	0,5	BKR6EKUB	3584		LPG 1
Passat 4 2.8 V6 Synchro	3B2 / 3B5	2.8	142	6	08.97-12.98	ALG	0,5	BKR6EKUB	3584		LPG 1
Passat 4 2.8 V6	3B2 / 3B5	2.8	142	6	01.99-08.00	APR	0,5	BKR6EKUB	3584		LPG 1
Passat 4 2.8 V6 4motion	3B2 / 3B5	2.8	142	6	01.99-08.00	AQD	0,5	BKR6EKUB	3584		LPG 1
Passat 4 2.8 4motion	3B3 / 3B6	2.8	142	6	10.00-05.05	AMX	0,5	BKR6EKUB	3584		LPG 1
Passat 4 2.8 4motion	3B3 / 3B6	2.8	142	6	10.00-05.05	ATQ	0,5	BKR6EKUB	3584		LPG 1
Passat 4 W8	3B3 / 3B6	4.0	202	8	05.02-09.04	BDP	0,5	BKR6EKUE	7892		
Passat 4 4.0 W8 4motion	3B3 / 3B6	4.0	202	8	09.01-09.04	BDN	0,5	BKR6EKUE	7892		

## PASSAT 5

Passat 5 1.4 TSI	3C2 / 3C5	1.4	90	4	05.07-	CAXA	0,9	PZFR6R	5758		
Passat 5 1.4 TSI	3C2 / 3C5	1.4	118	4	11.12-	CTHD	0,8	SIZFR6B8EG	96209		
Passat 5 1.6	3C2 / 3C5	1.6	75	4	05.05-05.07	BSE	1,0	BKUR6ET-10	2397	24	LPG 1
Passat 5 1.6	3C2 / 3C5	1.6	75	4	05.05-	BSF	1,0	BKUR6ET-10	2397	24	LPG 1
Passat 5 1.6 FSI	3C2 / 3C5	1.6	85	4	03.05-	BLF	0,5	ZFR6S-Q	6449		
Passat 5 1.8 TSI	3C2 / 3C5	1.8	112	4	11.08-05.10	CGYA	0,8	PFR7S8EG	1675		PFR8S8EG
Passat 5 1.8 TSI	3C2 / 3C5	1.8	118	4	06.07-11.10	BZB	0,8	PFR7S8EG	1675		PFR8S8EG
Passat 5 1.8 TSI	3C2 / 3C5	1.8	118	4	11.09-10.12	CDA A	0,8	PFR7S8EG	1675		PFR8S8EG
Passat 5 1.8 TSI	3C2/3C5	1.8	112	4	11.08-11.14	CDAB	0,8	PFR7S8EG	1675		PFR8S8EG
Passat 5 2.0 FSI	3C2 / 3C5	2.0	110	4	03.05-11.05	BLR	1,1	PZFR5N-11T	7742		
Passat 5 2.0 FSI	3C2 / 3C5	2.0	110	4	09.05-11.05	BLX	1,1	PZFR5N-11T	7742		
Passat 5 2.0 FSI	3C2 / 3C5	2.0	110	4	03.05-11.05	BLY	0,9	BKR6E	6962	28	LPG 1
Passat 5 2.0 FSI	3C2 / 3C5	2.0	110	4	11.05-11.10	BVX	1,1	PZFR5N-11T	7742		
Passat 5 2.0 FSI	3C2 / 3C5	2.0	110	4	11.05-11.10	BVY	1,1	PZFR5N-11T	7742		
Passat 5 2.0 FSI	3C2 / 3C5	2.0	110	4	11.05-11.10	BVZ	0,9	BKR6E	6962	28	LPG 1
Passat 5 2.0 TSI	3C2 / 3C5	2.0	125	4	12.07-11.10	CCTA	0,8	PFR7S8EG	1675		PFR8S8EG
Passat 5 2.0 TSI	3C2 / 3C5	2.0	147	4	07.05-11.05	AXX	0,8	PFR7S8EG	1675		PFR8S8EG
Passat 5 2.0 TSI	3C2 / 3C5	2.0	147	4	11.07-01.10	CAWB	0,8	PFR7S8EG	1675		PFR8S8EG
Passat 5 2.0 TSI	3C2 / 3C5	2.0	147	4	11.09-11.10	CCZA	0,8	PFR7S8EG	1675		PFR8S8EG



l kW  
C  
y  
i

0201



Stock-No

VLINE

LPG/CNG

VW

### PASSAT 5

Passat 5 2.0 FSI	3C2 / 3C5	2.0	147	4	08.05-07.10	BPY	0,8	PFR7S8EG	1675		PFR8S8EG
Passat 5 2.0 FSI	3C2 / 3C5	2.0	147	4	11.05-12.07	BWA	0,8	PFR7S8EG	1675		PFR8S8EG
Passat 5 2.0 TSI	3C2 / 3C5	2.0	155	4	11.10-	CCZB	0,8	PFR7S8EG	1675		PFR8S8EG
Passat 5 2.0 TSI	3C2/3C5	2.0	125	4	12.07-11.10	CCTB	0,8	PFR7S8EG	1675		PFR8S8EG
Passat 5 2.0 FSI/TFSi/Tsi	3C2	2.0	147	4	07.05-11.10	CBFA	0,8	PFR7S8EG	1675		PFR8S8EG
Passat 5 3.2 FSI 4motion	3C2 / 3C5	3.2	184	6	09.05-05.07	AXZ	0,9	ILZKR7A	1961		
Passat 5 FSI	3C2/3C5	3.6	206	6	09.05-	BLV	0,9	ILZKR7A	1961		
Passat 5 3.6 R36 4motion	3C2 / 3C5	3.6	220	6	04.07-11.10	BWS	0,8	ILZKR8A	94290		

### PASSAT 6 / ALLTRACK

Passat 6 1.4 TSi ACT BlueMotion/TSi BlueMotion 3G2	3G2/3G5	1.4	110	4	08.14-	CZDA	0,8	PZKER7A8EGS	94968		
Passat 6 1.4 TSi	3G2/3G5	1.4	92	4	11.14-	CZCA	0,8	PZKER7A8EGS	94968		
Passat 6 1.4 TSi ACT	3G2/3G5	1.4	110	4	08.14-	CZEA	0,8	PZKER7A8EGS	94968		
Passat 6 1.4 TSi GTE Hybrid		1.4	115	4	.14-	CUKC	0,75	PZKER7A8EGS	94968		
Passat 6 2.0 TFSi BlueMotion	3G5	2.0	162	4	05.15-	CHHB	0,8	PLFER7A8EG	94833		

### PHAETON

Phaeton 3.2 V6	3D2	3.2	177	6	05.02-05.05	AYT	0,9	IZKR7B	7563		
Phaeton 3.2 V6	3D2	3.2	177	6	08.03-10.08	BKL	0,9	IZKR7B	7563		
Phaeton 3.6 V6	3D2	3.6	206	6	11.08-05.10	CHNA	0,9	ILZKR7A	1961		
Phaeton 3.6 V6	3D2	3.6	206	6	05.10-	CMVA	0,9	ILZKR7A	1961		
Phaeton 4.2 V8	3D2	4.2	246	8	08.03-	BGH	0,5	BKR6EQUA	6872		LPG 1
Phaeton 4.2 V8	3D2	4.2	246	8	05.03-07.03	BGJ	0,5	BKR6EQUA	6872		LPG 1
Phaeton 6.0 W12	3D2	6.0	309	12	05.02-05.05	BAN	1,1	PZFR6J-11	3586		LPG 6
Phaeton 6.0 W12	3D2	6.0	309	12	10.03-	BAP	1,1	PZFR6J-11	3586		LPG 6
Phaeton 6.0 W12	3D2	6.0	331	12	05.05-10.08	BRN	1,1	PZFR6J-11	3586		LPG 6
Phaeton 6.0 W12	3D2	6.0	331	12	05.05-10.08	BTT	1,1	PZFR6J-11	3586		LPG 6

### POLO 2

Polo 2 1.0	86C	1.0	33	4	08.89-12.92	ACM	0,8	BUR6ET	3172	1	LPG 2
Polo 2 1.0	86C	1.0	33	4	08.89-01.92	HZ	0,8	BUR6ET	3172	1	LPG 2
Polo 2 1.0	86C	1.0	33	4	10.90-07.94	AAU	0,8	BUR5ET	3377	22	LPG 2
Polo 2 1.3	86C	1.3	40	4	01.89-07.94	2G	0,8	BUR6ET	3172	1	LPG 2
Polo 2 1.3	86C	1.3	40	4	08.89-08.91	MH	0,8	BUR6ET	3172	1	LPG 2
Polo 2 1.3	86C	1.3	40	4	08.89-12.92	NZ	0,8	BUR6ET	3172	1	LPG 2
Polo 2 1.3	86C	1.3	40	4	01.91-07.94	AAV	0,8	BUR5ET	3377	22	LPG 2
Polo 2 1.3	86C	1.3	55	4	01.90-07.94	3F	0,8	BUR6ET	3172	1	LPG 2

### POLO 3

Polo 3 1.0	6N1	1.0	33	4	10.94-06.96	AEV	0,8	BUR6ET	3172	1	LPG 2
Polo 3 1.0	6N1	1.0	37	4	07.96-12.99	AER	0,8	BUR6ET	3172	1	LPG 2
Polo 3 1.0	6N1	1.0	37	4	08.97-12.99	ALL	0,8	BUR6ET	3172	1	LPG 2
Polo 3 1.0	6N2	1.0	37	4	10.99-09.01	ALD	1,1	PZFR5D-11	7968	34	LPG 6
Polo 3 1.0	6N2	1.0	37	4	10.99-09.01	AUC	1,1	PZFR5D-11	7968	34	LPG 6
Polo 3 1.3	6N1	1.3	40	4	10.94-04.97	ADX	0,8	BUR6ET	3172	1	LPG 2
Polo 3 1.4	6N2	1.4	40	4	10.99-09.01	AKP	1,1	PZFR5D-11	7968	34	LPG 6
Polo 3 1.4	6N2	1.4	44	4	01.98-12.99	ANX	0,8	BUR6ET	3172	1	LPG 2
Polo 3 1.4	6N1	1.4	44	4	07.95-12.97	AEX	0,8	BUR6ET	3172	1	LPG 2
Polo 3 1.4	6N1	1.4	44	4	05.97-12.99	AKV	0,8	BUR6ET	3172	1	LPG 2
Polo 3 1.4	6N1	1.4	44	4	11.97-12.99	APQ	0,8	BUR6ET	3172	1	LPG 2
Polo 3 1.4	6N2	1.4	44	4	10.99-09.01	AKK	1,1	PZFR5D-11	7968	34	LPG 6
Polo 3 1.4 Variant	6KV2 / 6KV5	1.4	44	4	10.99-08.00	ANW	1,1	PZFR5D-11	7968	34	LPG 6

e kW  
C  
y  
i

0201



Stock-No

VLINE

LPG / CNG

VW

## POLO 3

Polo 3 1.4	6N2	1.4	44	4	10.99-09.01	AUD	1,1	PZFR5D-11	7968	34	LPG 6
Polo 3 1.4 16V	6N2	1.4	55	4	10.99-09.01	AHW	1,0	BKUR6ET-10	2397	24	LPG 1
Polo 3 1.4 16V	6N2	1.4	55	4	10.99-06.00	APE	1,0	BKUR6ET-10	2397	24	LPG 1
Polo 3 1.4 16V	6N2	1.4	55	4	10.99-01.02	AUA	1,0	BKUR6ET-10	2397	24	LPG 1
Polo 3 1.4 16V	6N1	1.4	74	4	04.96-12.99	AFH	1,0	BKUR6ET-10	2397	24	LPG 1
Polo 3 1.4 16V	6N2	1.4	74	4	10.99-09.01	AFK	1,0	BKUR6ET-10	2397	24	LPG 1
Polo 3 1.4 16V	6N2	1.4	74	4	07.99-05.00	AQQ	1,0	BKUR6ET-10	2397	24	LPG 1
Polo 3 1.4 16V	6N2	1.4	74	4	05.00-06.02	AUB	1,0	BKUR6ET-10	2397	24	LPG 1
Polo 3 1.6	6N1	1.6	55	4	10.94-07.95	AEA	0,8	BUR6ET	3172	1	LPG 2
Polo 3 1.6	6N1	1.6	55	4	07.95-12.99	AEE	0,8	BUR6ET	3172	1	LPG 2
Polo 3 1.6 GTI	6N1	1.6	88	4	08.98-12.99	AJV	1,0	BKUR6ET-10	2397	24	LPG 1
Polo 3 1.6 GTI	6N2	1.6	92	4	11.99-09.01	ARC	1,0	BKUR6ET-10	2397	24	LPG 1
Polo 3 1.6 GTI	6N2	1.6	92	4	05.00-09.01	AVY	1,0	BKUR6ET-10	2397	24	LPG 1

## POLO 4

Polo 4 1.2	9N	1.2	40	3	01.02-05.04	AWY	0,9	ZFR5P-G	6893	41	LPG 6
Polo 4 1.2	9N	1.2	40	3	05.04-05.07	BMD	0,9	ZFR5P-G	6893	41	LPG 6
Polo 4 1.2	9N	1.2	44	3	05.07-11.09	BBM	0,9	ZFR5P-G	6893	41	LPG 6
Polo 4 1.2	9N	1.2	47	3	11.04-07.07	BME	0,9	ZFR5P-G	6893	41	LPG 6
Polo 4 1.2 12V (OE 101000060AA)	9N	1.2	47	3	11.01-05.04	AZQ	0,9	BKUR5ET-10	7553		LPG 1
Polo 4 1.2 12V (EXC. 101000060AA)	9N	1.2	47	3	11.01-05.04	AZQ	0,9	ZFR5P-G	6893	41	LPG 6
Polo 4 1.2	9N	1.2	52	3	05.07-11.09	BZG	0,9	ZFR5P-G	6893	41	LPG 6
Polo 4 1.4 16V	9N	1.4	55	4	11.01-05.04	BBY	1,0	BKUR6ET-10	2397	24	LPG 1
Polo 4 1.4 16V	9N	1.4	55	4	05.04-05.08	BKY	0,9	ZFR5P-G	6893	41	LPG 6
Polo 4 1.4 16V Automatic	9N	1.4	55	4	11.01-05.04	BBY	1,1	PZFR5D-11	7968	34	LPG 6
Polo 4 1.4 16V	9N	1.4	59	4	05.06-11.09	BUD	1,1	ZFR6T-11G	5960	44	
Polo 4 1.4 FSI	9N	1.4	63	4	02.02-07.06	AXU	0,5	ZFR6S-Q	6449		ZFR6S-Q
Polo 4 1.4 16V	9N	1.4	74	4	05.02-05.08	BBZ	1,0	BKUR6ET-10	2397	24	LPG 1
Polo 4 1.6 16V	9N	1.6	77	4	05.06-11.09	BTS	1,1	ZFR6T-11G	5960	44	
Polo 4 1.8 GTI	9N	1.8	110	4	09.05-11.09	BJX	0,8	PFR6Q	6458	37	LPG 1
Polo 4 1.8 GTI Cup Edition	9N	1.8	132	4	05.06-11.09	BBU	0,8	PFR6Q	6458	37	LPG 1

## POLO 5

Polo 5 1.0	6R	1.0	44	3	01.14-	CHYA	1,0	ZKER6A-10EG	96596		
Polo 5 1.0	6R	1.0	55	3	01.14-	CHYB	1,0	ZKER6A-10EG	96596		
Polo 5 1.0 TSI	6R	1.0	81	3	11.14-	CHZC	0,8	PKER7A8EGS	94968		
Polo 5 1.0 TSI BlueMotion	6R	1.0	70	3	11.14-	CHZB	0,8	PKER7A8EGS	94968		
Polo 5 1.2	6R	1.2	44	3	06.09-	CGPB	1,1	ZFR6T-11G	5960	44	
Polo 5 1.2	6R	1.2	51	3	06.09-	CGPA	1,1	ZFR6T-11G	5960	44	
Polo 5 1.2 TSI	6R	1.2	63	4	11.09-14	CBZA	0,7	IZFR6P7	97153		
Polo 5 1.2 TSI	6R	1.2	66	4	05.11-	CBZC	0,7	IZFR6P7	97153		
Polo 5 1.2 TSI	6R	1.2	77	4	06.09-	CBZB	0,7	IZFR6P7	97153		
Polo 5 1.2 TSI	6R	1.2	55	3	03.10-	CJLA	1,1	ZFR6T-11G	5960	44	
Polo 5 1.2 TSI	6R	1.2	66	4	02.14-	CJZC	0,8	PZKER7A8EGS	94968		
Polo 5 1.2 TSI	6R	1.2	81	4	02.14-	CJZD	0,8	PZKER7A8EGS	94968		
Polo 5 1.4	6R	1.4	125	4	05.10-	CAVB	0,9	PZFR6R	5758		
Polo 5 1.4	6R	1.4	63	4	06.09-	CGGB	1,1	ZFR6T-11G	5960	44	
Polo 5 1.4 BiFuel	6R	1.4	60	4	03.10-01.11	CMAA	1,1	ZFR6T-11G	5960	44	
Polo 5 1.4 TSI GTI	6R	1.4	132	4	05.10-	CAVE	0,8	SIZFR6B8EG	96209		
Polo 5 1.4 Gti	6R	1.4	132	4	05.10-05.14	CTHE	0,8	SIZFR6B8EG	96209		
Polo 5 1.4 TSI BlueGT	6R	1.4	103	4	07.12-05.14	CPTA	0,8	PZKER7A8EGS	94968		
Polo 5 1.4 TSI BlueGT	6R	1.4	110	4	05.14-	CZEA	0,8	PZKER7A8EGS	94968		





e kW C y i

0201



Stock-No

VLINE

LPG/CNG

VW

**POLO 5**

Polo 5 1.6 BiFuel	6R	1.6	60	4	01.11-	CNKA	1,1	ZFR6T-11G	5960	44	
Polo 5 1.6 RUS	6R	1.6	63	4	11.10-04.12	CFNB	1,1	ZFR6T-11G	5960	44	
Polo 5 1.6 RUS	6R	1.6	77	4	05.10-	CFNA	1,1	ZFR6T-11G	5960	44	
Polo 6 1.6	6R	1.6	66	4	05.15-	CWVB	1,0	ZKER6A-10EG	96596		
Polo 6 1.6	6R	1.6	81	4	05.15-	CWVA	1,0	ZKER6A-10EG	96596		
Polo 5 1.8 TSI GTI	6R	1.8	141	4	11.14-	DAJA	0,8	PLFER7A8EG	94833		
Polo 5 1.8 TSI GTI	6R	1.8	141	4	11.14-	DAJB	0,8	PLFER7A8EG	94833		
Polo 5 2.0 TSI WRC	6R	2.0	162	4	08.13-05.14	CDLJ	0,8	PFR7S8EG	1675		PFR8S8EG

**SCIROCCO 2**

Scirocco 2 1.6	53B	1.6	55	4	01.83-07.91	EW	1,0	BUR5ET-10	7264	21	LPG 2
Scirocco 2 1.8	53B	1.8	66	4	08.83-07.92	EX	0,8	BUR6ET	3172	1	LPG 2
Scirocco 2 1.8	53B	1.8	70	4	08.83-07.92	JH	0,8	BUR6ET	3172	1	LPG 2
Scirocco 2 1.8	53B	1.8	82	4	08.82-07.92	DX	0,8	BUR6ET	3172	1	LPG 2
Scirocco 2 1.8	53B	1.8	82	4	08.82-07.91	JJ	0,8	BUR6ET	3172	1	LPG 2
Scirocco 2 1.8	53B	1.8	82	4	08.83-07.91	KT	0,8	BUR6ET	3172	1	LPG 2
Scirocco 2 1.8 16V	53B	1.8	95	4	02.86-07.92	PL	0,8	BKUR7ET	7873		PFR7Q

**SCIROCCO 3**

Scirocco 3 1.4 TSI	137	1.4	90	4	11.08-	CAXA	0,9	PZFR6R	5758		
Scirocco 3 1.4 TSI	137	1.4	118	4	08.08-	CAVD	0,9	PZFR6R	5758		
Scirocco 3 1.4 TSI	137	1.4	90	4	08.08-05.14	CMSB	0,9	PZFR6R	5758		
Scirocco 3 1.4 TSI	137	1.4	118	4	06.08-05.14	CNWA	0,8	SIZFR6B8EG	96209		
Scirocco 3 1.4 TSI	137	1.4	118	4	06.08-05.14	CTHD	0,8	SIZFR6B8EG	96209		
Scirocco 3 1.4 TSI	137	1.4	118	4	06.08-05.14	CTKA	0,8	SIZFR6B8EG	96209		
Scirocco 3 2.0 TSI	137	2.0	132	4	11.13-	CULA	0,8	PLFER7A8EG	94833		
Scirocco 3 2.0 TSI	137	2.0	147	4	08.08-	CAWB	0,8	PFR7S8EG	1675		PFR8S8EG
Scirocco 3 2.0 TSI	137	2.0	155	4	11.09-	CCZB	0,8	PFR7S8EG	1675		PFR8S8EG
Scirocco 3 2.0 TSI R	137	2.0	188	4	11.09-	CDLC	0,8	PFR7S8EG	1675		PFR8S8EG
Scirocco 3 2.0 TSI R	137	2.0	206	4	.14-	CDLK	0,8	PFR7S8EG	1675		PFR8S8EG
Scirocco 3 2.0 TSI R	137	2.0	195	4	11.09-	CDLA	0,8	PFR7S8EG	1675		PFR8S8EG

**SCIROCCO 4**

Scirocco 4 2.0 TFSi BlueMotion	138	2.0	162	4	11.13-	CULC	0,8	PLFER7A8EG	94833		
--------------------------------	-----	-----	-----	---	--------	------	-----	------------	-------	--	--

**SHARAN 1**

Sharan 1 1.8 T		1.8	110	4	11.97-02.00	AJH	0,8	PFR6Q	6458	37	LPG 1
Sharan 1 2.0		2.0	85	4	09.95-02.00	ADY	1,0	BKUR6ET-10	2397	24	LPG 1
Sharan 1 2.8 VR6		2.8	128	6	09.95-03.98	AAA	0,6	BKR5EKUP	2890		
Sharan 1 2.8 VR6		2.8	128	6	04.98-02.00	AMY	0,6	BKR5EKUP	2890		

**SHARAN 2**

Sharan 2 1.8 T		1.8	110	4	04.00-05.05	AWC	0,8	PFR6Q	6458	37	LPG 1
Sharan 2 2.0 LPG		2.0	85	4	04.00-03.10	ATM	1,0	BKUR6ET-10	2397	24	LPG 1
Sharan 2 2.8 V6		2.8	150	6	04.00-03.10	AYL	1,1	PZFR5D-11	7968	34	LPG 6

**SHARAN 3**

Sharan 3 1.4 TSI	7N	1.4	110	4	05.10-	CAVA	0,9	PZFR6R	5758		
Sharan 3 1.4 TSi BlueMotion	7N	1.4	110	4	05.15-	CZDA	0,75	PZKER7A8EGS	94968		
Sharan 3 TSi BlueMotion	7N	2.0	162	4	05.15-	DEDA	0,8	PLFER7A8EG	94833		
Sharan 3 2.0 TSI	7N	2.0	147	4	11.10-	CCZA	0,8	PFR7S8EG	1675		PFR8S8EG

e kW  
C  
y  
i

0201



Stock-No

VLINE

LPG / CNG

**VW  
TRANSPORTER**

T 3 1.9	1.9	44	4	08.89-07.92	DF	0,8	BUR6ET	3172	1	LPG 2
T 3 1.9	1.9	57	4	08.82-07.92	DG	0,8	BUR6ET	3172	1	LPG 2
T 3 2.1	2.1	64	4	08.86-07.92	SR	0,7	B6ES	7310		
T 3 2.1	2.1	68	4	08.85-07.92	SS	0,7	B6ES	7310		
T 3 2.1	2.1	70	4	08.85-07.92	MV	0,7	B6ES	7310		
T 3 2.1	2.1	82	4	08.84-07.92	DJ	0,8	BUR6ET	3172	1	LPG 2
T 4 1.8	1.8	49	4	09.90-07.92	PD	0,8	BUR6ET	3172	1	LPG 2
T 4 2.0	2.0	62	4	09.90-06.03	AAC	0,8	BUR5ET	3377	22	LPG 2
T 4 2.5	2.5	81	5	09.90-12.93	AAF	0,7	BPR5EKU	5685		LPG 2
T 4 2.5	2.5	81	5	08.93-10.96	ACU	0,8	BUR5ET	3377	22	LPG 2
T 4 2.5	2.5	81	5	05.95-12.95	AEN	0,8	BUR5ET	3377	22	LPG 2
T 4 2.5	2.5	81	5	08.96-09.03	AET	0,8	BUR5ET	3377	22	LPG 2
T 4 2.5 (China / GUS)	2.5	81	5	08.96-06.03	AEU	0,8	BUR5ET	3377	22	LPG 2
T 4 2.5	2.5	85	5	05.99-12.99	APL	0,8	BKUR5ET	2789	29	LPG 1
T 4 2.5	2.5	85	5	12.99-06.03	AVT	0,8	BKUR5ET	2789	29	LPG 1
T 4 2.8 VR6	2.8	103	6	01.96-05.00	AES	0,6	BKR5EKUP	2890		
T 4 2.8 V6	2.8	150	6	05.00-09.03	AMV	1,1	PZFR5D-11	7968	34	LPG 6
T 4 2.8 V6 (USA)	2.8	150	6	05.00-06.03	AXK	1,1	PZFR5D-11	7968	34	LPG 6
T 5 2.0	2.0	85	4	11.03-05.07	AXA	1,0	BKUR6ET-10	2397	24	LPG 1
T 5 2.0 TSI	2.0	110	4	07.12-08.15	CJKB	0,8	PFR7S8EG	1675		PFR8S8EG
T 5 2.0 TSI	2.0	110	4	04.15-	CJKB	0,8	PFR7S8EG	1675		PFR8S8EG
T5 2.0 TSI	2.0	150	4	05.11-	CJKA	0,8	PFR7S8EG	1675		PFR8S8EG
T 5 3.2 V6	3.2	170	6	02.04-05.07	BDL	0,9	IZKR7B	7563		
T 5 3.2 V6	3.2	173	6	02.04-	BKK	0,9	IZKR7B	7563		

**TIGUAN**

Tiguan 1.4 TSI	5N	1.4	90	4	08.10-	CAXA	0,9	PZFR6R	5758	PZFR6R
Tiguan 1.4 TSI	5N	1.4	110	4	11.07-11.08	BWK	0,9	PZFR6R	5758	PZFR6R
Tiguan 1.4 TSI	5N	1.4	110	4	05.08-	CAVA	0,9	PZFR6R	5758	PZFR6R
Tiguan 1.4 TSI	5N	1.4	118	4	05.11-	CAVD	0,8	SIZFR6B8EG	96209	
Tiguan 1.4 TSI BlueMotion	5N2	1.4	110	4	05.15-	CZDA	0,75	PZKER7A8EGS	94968	
Tiguan TSI BlueMotion	5N2	1.4	92	4	05.15-	CZDB	0,75	PZKER7A8EGS	94968	
Tiguan 2.0 TSI	5N	2.0	125	4	11.07-	CCTA	0,8	PFR7S8EG	1675	PFR8S8EG
Tiguan 2.0 TSI	5N	2.0	125	4	01.08-	CAWA	0,8	PFR7S8EG	1675	PFR8S8EG
Tiguan 2.0 TSI	5N	2.0	125	4	11.09-	CCZC	0,8	PFR7S8EG	1675	PFR8S8EG
Tiguan 2.0 TSI	5N	2.0	132	4	05.11-	CCZD	0,8	PFR7S8EG	1675	PFR8S8EG
Tiguan 2.0 TSI	5N	2.0	147	4	11.07-05.10	CAWB	0,8	PFR7S8EG	1675	PFR8S8EG
Tiguan 2.0 TSI	5N	2.0	147	4	11.09-	CCZA	0,8	PFR7S8EG	1675	PFR8S8EG
Tiguan 2.0 TSI	5N	2.0	155	4	05.11-	CCZB	0,8	PFR7S8EG	1675	PFR8S8EG

**TOUAREG 1**

Touareg 3.2	7LA/7L6/7L7	3.2	162	6	11.02-05.04	AZZ	0,9	IZKR7B	7563	
Touareg 3.2	7LA/7L6/7L7	3.2	162	6	05.03-05.04	BKJ	0,9	IZKR7B	7563	
Touareg 3.2	7LA/7L6/7L7	3.2	162	6	05.04-11.06	BMV	0,9	IZKR7B	7563	
Touareg 3.2	7LA/7L6/7L7	3.2	162	6	05.04-11.06	BMX	0,9	IZKR7B	7563	
Touareg 3.2 (USA)	7LA/7L6/7L7	3.2	162	6	08.03-05.04	BAA	0,9	IZKR7B	7563	
Touareg 3.6 FSI	7LA/7L6/7L7	3.6	206	6	10.05-05.10	BHK	0,9	ILZKR7A	1961	
Touareg 4.2	7LA/7L6/7L7	4.2	228	8	12.02-11.06	AXQ	0,5	BKR6EQUA	6872	LPG 1
Touareg 4.2	7LA/7L6/7L7	4.2	258	8	12.06-05.10	BAR	0,9	PFR6W-TG	5547	
Touareg	7LA/7L6/7L7	6.0	331	12	08.04-05.10	CFRA	1,1	PZFR6J-11	3586	LPG 6
Touareg WR 12	7LA/7L6/7L7	6.0	316	12	08.04-05.10	BJN	1,1	PZFR6J-11	3586	LPG 6



l kW  
C  
Y  
I

0201



Stock-No

U-TIME

LPG/CNG

VW

**TOUAREG 2**

Touareg 3.0 Hybrid	7P5	3.0	245	6	04.10-	CGEA	0,8	PFR8S8EG	94460		PFR8S8EG
Touareg 3.0 Hybrid	7P5	3.0	245	6	04.10-	CGFA	0,8	PFR8S8EG	94460		PFR8S8EG
Touareg Fsi	7P5/7P6	3.6	183	6	08.10-	CMTA	0,9	ILZKR7A	1961		
Touareg 3.6 FSI	7P5	3.6	206	6	04.10-	CGRA	0,9	ILZKR7A	1961		
Touareg 2 4.2 V8 FSI	7P5	4.2	265	8	01.11-	CGNA	0,9	PFR6W-TG	5547		

**TOURAN**

Touran 1.2 TSI	1T3	1.2	77	4	05.10-	CBZB	0,7	IZFR6P7	97153		
Touran 1 1.4 TSI (OE Ref 101905626)	1T1/1T2	1.4	103	4	02.06-05.10	BMV	0,8	PZFR6R	5758		
Touran 1 1.4 TSI (OE Ref 03C905601A)	1T1/1T2	1.4	103	4	02.06-05.10	BMV	0,8	SIZFR6B8EG	96209		
Touran 1.4 TSI	1T2/1T3	1.4	103	4	11.08-	CAVC	0,8	SIZFR6B8EG	96209		
Touran 1.4 TSI	1T2	1.4	125	4	11.06-11.08	BLG	0,9	PZFR6R	5758		
Touran 1.4 TSI	1T2/1T3	1.4	125	4	11.08-	CAVB	0,9	PZFR6R	5758		
Touran 2 1.4 TSI		1.4	110	4	.15-	CZDA	0,75	PZKER7A8EGS	94968		
Touran 1 1.4 TSI	1T3	1.4	125	4	05.10-05.15	CTHB	0,8	SIZFR6B8EG	96209		
Touran 1 1.4 TSI	1T3	1.4	125	4	05.10-05.15	CTHC	0,8	SIZFR6B8EG	96209		
Touran 1.6	1T1/1T2	1.6	75	4	07.03-05.05	BGU	1,0	BKUR6ET-10	2397	24	LPG 1
Touran 1.6	1T1/1T2	1.6	75	4	06.05-05.10	BSE	1,0	BKUR6ET-10	2397	24	LPG 1
Touran 1.6	1T1/1T2	1.6	75	4	06.05-05.10	BSF	1,0	BKUR6ET-10	2397	24	LPG 1
Touran 1.6 FSI	1T1/1T2	1.6	85	4	02.03-05.04	BAG	0,5	ZFR6S-Q	6449		
Touran 1.6 FSI	1T1/1T2	1.6	85	4	05.04-05.05	BLP	0,5	ZFR6S-Q	6449		
Touran 1.6 FSI	1T1/1T2	1.6	85	4	02.05-01.07	BLF	0,5	ZFR6S-Q	6449		
Touran TSi BlueMotion	5T1	1.8	132	4	12.15-	CJSA	0,8	PLFER7A8EG	94833		
Touran 2.0 Ecofuel CNG	1T1/1T2	2.0	80	4	02.06-05.09	BSX	0,9	BKR6E	6962	28	LPG 1
Touran 2.0 FSI	1T1	2.0	110	4	10.03-05.04	AXW	1,1	PZFR5N-11T	7742		
Touran 2.0 FSI	1T1	2.0	110	4	10.03-01.04	BHD	1,1	PZFR5N-11T	7742		
Touran 2.0 FSI	1T1	2.0	110	4	05.04-11.05	BLX	1,1	PZFR5N-11T	7742		
Touran 2.0 FSI	1T1	2.0	110	4	05.04-11.05	BLY	0,9	BKR6E	6962	28	LPG 1
Touran 2.0 FSI	1T1	2.0	110	4	02.05-11.05	BLR	1,1	PZFR5N-11T	7742		
Touran 2.0 FSI	1T1	2.0	110	4	11.05-01.07	BVY	1,1	PZFR5N-11T	7742		
Touran 2.0 FSI	1T1	2.0	110	4	11.05-01.07	BVZ	0,9	BKR6E	6962	28	LPG 1

**UP**

Up 1.0	121	1.0	44	3	08.11-	CHYA	1,0	ZKER6A-10EG	96596		
Up 1.0	121	1.0	55	3	08.11-	CHYB	1,0	ZKER6A-10EG	96596		
Up 1.0 BlueMotion	121	1.0	44	3	08.11-	DAFA	1,0	ZKER6A-10EG	96596		
Up 1.0 Ecofuel CNG	121	1.0	50	3	11.12-	CPGA	0,8	PZKER7A8EGS	94968		

**VENTO**

Vento 1.4	1H2	1.4	44	4	11.91-07.95	ABD	0,8	BUR5ET	3377	22	LPG 2
Vento 1.4	1H2	1.4	44	4	07.95-12.97	AEX	0,8	BUR6ET	3172	1	LPG 2
Vento 1.4	1H2	1.4	44	4	01.92-12.97	APQ	0,8	BUR6ET	3172	1	LPG 2
Vento 1.6	1H2	1.6	55	4	08.92-09.94	ABU	0,8	BUR6ET	3172	1	LPG 2
Vento 1.6	1H2	1.6	55	4	10.94-07.95	AEA	0,8	BUR6ET	3172	1	LPG 2
Vento 1.6	1H2	1.6	55	4	07.95-12.97	AEE	0,8	BUR6ET	3172	1	LPG 2
Vento 1.6	1H2	1.6	74	4	10.94-12.95	AEK	0,8	BKUR5ET	2789	29	LPG 1
Vento 1.6	1H2	1.6	74	4	01.96-10.00	AFT	1,0	BKUR6ET-10	2397	24	LPG 1
Vento 1.6	1H2	1.6	74	4	10.94-12.97	AKS	0,8	BKUR5ET	2789	29	LPG 1
Vento 1.8	1H2	1.8	55	4	07.91-10.00	AAM	0,8	BUR5ET	3377	22	LPG 2
Vento 1.8	1H2	1.8	66	4	11.91-07.95	ABS	0,8	BUR6ET	3172	1	LPG 2
Vento 1.8	1H2	1.8	66	4	10.94-10.00	ADZ	0,8	BUR6ET	3172	1	LPG 2
Vento 2.0	1H2	2.0	79	4	08.95-12.97	AEP	0,8	BUR6ET	3172	1	LPG 2



l kW C  
y  
i



Stock-No



LPG / CNG

**VW**  
**VENTO**

Vento 2.0	1H2	2.0	85	4	11.91-09.94	2E	0,8	BUR6ET	3172	1	LPG 2
Vento 2.0	1H2	2.0	85	4	10.94-05.96	ADY	0,8	BUR6ET	3172	1	LPG 2
Vento 2.0	1H2	2.0	85	4	07.95-12.01	AGG	0,8	BUR6ET	3172	1	LPG 2
Vento 2.0	1H2	2.0	85	4	04.97-04.00	AKR	0,8	BUR6ET	3172	1	LPG 2
Vento 2.8 VR6	1H2	2.8	128	6	01.92-06.95	AAA	0,7	BKR5EKU	3964		

**WARTBURG AWE**

1.3		1.3	43	4	09.88-05.91	VW	0,7	BP6ES	7811		LPG 2
-----	--	-----	----	---	-------------	----	-----	-------	------	--	-------

**WIESMANN**

Coupè GT MF4		4.8	270	8	09.05-	N62 B48	1,1	IZFR6H11	4294		
Coupè GT MF5		5.0	373	10	.07-	S85 B50	0,9	LKR8AP	4471		
Roadster MF28		2.8	142	6	.95-	M52 B28	0,9	BKR6EK	2288	20	LPG 1
Roadster MF3		3.2	236	6	.95-11.01	S50 B32	0,7	PKR7A	3641		
Roadster MF3		3.2	252	6	12.01-	S54 B32	0,9	DCPR8EKP	7415		
Roadster MF4-S		4.0	309	8	03.09-	S65 B40	0,9	LKR8AP	4471		



l kW C y i 0201



Stock-No D-POWER

## ALFA ROMEO

<b>6</b>										
6 TD	2.5	105		06.83-02.87		11,0	Y-909R	4602		
<b>30</b>										
30 AR 8, 35 AR 8, 40 AR 8 D	2.5	72		10.83-12.89		11,0	Y-924J	7906	1	
<b>33</b>										
33 TD	1.8	55	4	09.86-03.94		11,0	Y-909R	4602		
33 TD	1.8	62	3	09.86-03.94	VM HR-392	11,0	Y-909R	4602		
33 TD	1.8	62	4	02.90-03.94	VM 82 A	11,0	Y-909R	4602		
33 TD Sport Wagon	1.8	62	4	01.90-03.94	VM 96 A	11,0	Y-909R	4602		
<b>75</b>										
75 TD	2.0	70	4	05.85-02.92	VM 80 A	11,0	Y-909R	4602		
75 TD	2.4	81	4	10.88-02.92	VM 81 A	11,0	Y-909R	4602		
<b>145</b>										
145 TD	1.9	66	4	04.94-09.96	AR67.501	11,0	Y-924J	7906	1	
145 TD	1.9	66	4	10.96-09.97	AR33.601	11,0	Y-924J	7906	1	
145 JTD	1.9	77	4	11.99-01.01	AR32.302 from engine 1716459 -->	11,0	Y-534J	3413	36	
145 JTD	1.9	77	4	02.99-10.99	AR32.302 to engine -->1716458	11,0	Y-747U	4694	26	
<b>146</b>										
146 TD	1.9	66	4	02.95-09.96	AR67 501	11,0	Y-924J	7906	1	
146 TD	1.9	66	4	10.96-09.97	AR33.601	11,0	Y-924J	7906	1	
146 JTD	1.9	77	4	11.99-01.01	AR32.302 from engine 1716459 -->	11,0	Y-534J	3413	36	
146 JTD	1.9	77	4	02.99-10.99	AR32.302 to engine -->1716458	11,0	Y-747U	4694	26	
<b>147</b>										
147 1.9 JTD	1.9	74	4	11.00-05.03	182B9000	11,0	Y-534J	3413	36	
147 1.9 JTD	1.9	85	4	06.03-06.05	937A2000	11,0	Y-534J	3413	36	
147 1.9 JTDM	1.9	85	4	10.04-09.07	939A7000	11,0	Y1030J	90828	70	
147 1.9 JTDM 8V	1.9	88	4	07.05-	937A3000	11,0	Y1030J	90828	70	
147 1.9 JTD 16V	1.9	93	4	09.03-05.05	937A4000	11,0	YE07	6092		
147 1.9 JTD 16V	1.9	100	4	10.04-	192B1000	11,0	YE07	6092		
147 1.9 JTD 16V	1.9	103	4	11.03-	192A5000	11,0	YE07	6092		
147 1.9 JTD Mjet 16V	1.9	110	4	07.04-	937A5000	11,0	YE07	6092		
<b>155</b>										
155 TD	1.9	68	4	04.93-04.96	AR67.501	11,0	Y-924J	7906	1	
155 TD	2.0	66	4	08.93-04.96	AR67.502	11,0	Y-924J	7906	1	
155 TD	2.5	92	4	04.93-04.95	VM 425 CLIEA	11,0	Y-924J	7906	1	
155 TD	2.5	92	4	05.95-10.97	VM 425 CLIEA	11,0	Y-741U	6943	20	
<b>156</b>										
156 JTD	1.9	77	4	10.97-09.00	AR32.302	11,0	Y-747U	4694	26	
156 JTD	1.9	81	4	10.00-05.01	AR37.101	11,0	Y-534J	3413	36	
156 JTD	1.9	85	4	05.01- .05	937A2000	11,0	Y-534J	3413	36	
156 1.9 JTD	1.9	100	4	11.02-11.04	192B1000	11,0	YE07	6092		
156 1.9 JTD	1.9	93	4	11.03-09.05	937A4000	11,0	YE07	6092		
156 1.9 JTD 16V	1.9	103	4	11.02-09.05	192A5000	11,0	YE07	6092		
156 1.9 JTD 16V	1.9	110	4	07.04-09.05	937A5000	11,0	YE07	6092		
156 JTD	2.4	100	5	10.97-09.00	AR32.501	11,0	Y-747U	4694	26	
156 JTD	2.4	103	5	10.00-02.02	839A6000	11,0	Y-534J	3413	36	



## ALFA ROMEO

<b>156</b>											
156 JTD		2.4	110	5	03.02-01.04	841C000		11,0	Y-534J	3413	36
156 2.4 JTD	932	2.4	120	5	06.03-09.05	841M000 / 841N000		11,0	YE07	6092	
156 2.4 JTD 20V		2.4	129	5	11.03-05.06	841G000		11,0	YE07	6092	
<b>159</b>											
159 1.9 JTDM 8V		1.9	85	4	09.05-11.11	937A7000 / 939A7000		11,0	Y1030J	90828	70
159 1.9 JTDM 8V		1.9	88	4	09.05-11.11	939A1000		11,0	Y1030J	90828	70
159 1.9 JTDM 16V		1.9	100	4	09.05-12.10	937A8000 / 939A8000		11,0	YE07	6092	
159 1.9 JTDm 16V		1.9	110	4	07.05-11.11	939A2000		11,0	YE07	6092	
159 2.0 JTDM		2.0	100	4	06.10-11.11	939B4000		4,4	Y9003AS	94251	78
159 2.0 JTDM		2.0	120	4	05.09-11.11	844A2000		4,4	Y9003AS	94251	78
159 2.0 JTDM		2.0	125	4	03.09-11.11	939B3000		4,4	Y9003AS	94251	78
159 2.4 JTDm 20V		2.4	147	5	12.05-04.07	939A3000		11,0	YE07	6092	
159 2.4 JTDm 20V		2.4	154	5	05.07-12.08	939A9000		11,0	YE07	6092	
<b>164</b>											
164 TD		2.5	85	4	06.87-08.92	VM 84 A		11,0	Y-909R	4602	
164 TD Super		2.5	92	4	09.92-04.95	VM 425-SLIRA		11,0	Y-924J	7906	1
164 TD		2.5	92	4	05.95-10.98	VM 425 SLIRA		11,0	Y-741U	6943	20
<b>166</b>											
166 2.4 JTD		2.4	100	5	10.98-10.00	AR34.202		11,0	Y-747U	4694	26
166 2.4 JTD		2.4	103	5	11.00-03.02	839A600		11,0	Y-534J	3413	36
166 2.4 JTD		2.4	110	5	04.02-10.03	841C000		11,0	Y-534J	3413	36
166 2.4 JTD		2.4	129	5	10.03-06.08	841G000 / 841H000		11,0	YE07	6092	
166 2.4 JTD Mjet 20V		2.4	132	5	07.06-06.08	936B000 / 841M000		11,0	YE07	6092	
166 2.4 JTD Mjet 20V		2.4	136	5	07.05-06.08	936B000 / 841M000		11,0	YE07	6092	
<b>BRERA</b>											
Brera 2.0 JTDM		2.0	120	4	03.08-12.11	844A2000		4,4	Y9003AS	94251	78
Brera 2.0 JTDM		2.0	125	4	03.09-03.11	939B3000		4,4	Y9003AS	94251	78
Brera 2.4 JTDM 20V		2.4	147	5	01.06-03.11	939A3000		11,0	YE07	6092	
<b>GIULIETTA</b>											
Giulietta 1.6 JTDM	940	1.6	77	4	03.10-	940A3000		4,4	Y9003AS	94251	78
Giulietta 2.0 JTDM	940	2.0	100	4	04.10-	940A8000		4,4	Y9003AS	94251	78
Giulietta 2.0 JTDM	940	2.0	103	4	04.10-	940A5000		4,4	Y9003AS	94251	78
Giulietta 2.0 JTDM	940	2.0	120	4	04.10-	940A7000		4,4	Y9003AS	94251	78
Giulietta 2.0 JTDM	940	2.0	125	4	03.10-	940A4000		4,4	Y9003AS	94251	78
Giulietta 2.0 JTDM	940	2.0	129	4	11.13-	940B4000		4,4	Y9003AS	94251	78
<b>GT</b>											
GT 1.9 JTDm 16V		1.9	110	4	12.03-	937A5000		11,0	YE07	6092	
GT 1.9 JTDm 16V		1.9	125	4	05.08-	937A6000		11,0	YE07	6092	
<b>MITO</b>											
MITO 1.3 JTDM 16V Eco	955	1.3	62	4	01.11-	199B4000		4,3	Y9001AS	97719	72
MITO 1.3 JTDM	955	1.3	66	4	10.08-	199A3000		11,0	Y8003J	97256	62
MITO 1.3 JTDM 16V	955	1.3	70	4	10.09-	199B1000		4,3	Y9001AS	97719	72
MITO 1.6 JTDM 16V	955	1.6	85	4	08.08-	955A4000		4,4	Y9003AS	94251	78
MITO 1.6 JTDM 16V	955	1.6	88	4	08.08-	955A3000		4,4	Y9003AS	94251	78
<b>SPIDER</b>											
Spider 2.0 JTDM		2.0	120	4	12.11-	844A2000		4,4	Y9003AS	94251	78
Spider 2.0 JTDM		2.0	125	4	12.11-	939B3000		4,4	Y9003AS	94251	78
Spider 2.4 JTDM		2.4	147	5	02.06-	939A3000		11,0	YE07	6092	



l kW C y l 0201



STOCK-NO  
D-POWER™

## ALFA ROMEO

### SPIDER

Spider 2.4 JTDM	2.4	154	5	03.08-	939A9000	11,0	YE07	6092	
-----------------	-----	-----	---	--------	----------	------	------	------	--

## ALPINA

### D 3

D 3	E90	2.0	147	4	02.07-	N47D20 L1	5,0	Y-547AS	5968	47
-----	-----	-----	-----	---	--------	-----------	-----	---------	------	----

## ASIA MOTORS

Rocsta	2.2		4	03.94-12.97	R2	10,5	Y-107R	1229	
--------	-----	--	---	-------------	----	------	--------	------	--

## AUDI

### 80 4 (B4)

80 (4) 1.9 TD	B4	1.9	55	4	09.91-07.95	AAZ	12,0	Y-918J	6285	2
80 (4) 1.9 TDI	B4	1.9	66	4	09.91-07.95	1Z	12,0	Y-732J	5605	4

### 100 4 (C4)

100 (4) 2.4 D	4A/C4	2.4	60	5	12.90-07.94	AAS	12,0	Y-918J	6285	2
100 (4) 2.5 TDI	4A/C4	2.5	85	5	12.90-07.94	AAT	12,0	Y-732J	5605	4
100 (4) 2.5 TDI	4A/C4	2.5	85	5	12.90-07.92	ABP	12,0	Y-732J	5605	4

### A 1 (8X)

A 1 1.4 TDI	8XK/8XF	1.4	66	3	11.14-	CUSB	4,4	Y1002AS	8888	57
Only for cylinder without pressure sensor										
A 1 1.6 TDI	8XK/8XF	1.6	85	4	11.14-	CXMA	4,4	Y1002AS	8888	57
Only for cylinder without pressure sensor										
A 1 1.6 TDI	8X1 / 8XA	1.6	66	4	11.10-	CAYB	4,4	Y1002AS	8888	57
A 1 1.6 TDI	8X1 / 8XA	1.6	77	4	05.10-	CAYC	4,4	Y1002AS	8888	57
A 1 2.0 TDI	8X1 / 8XA	2.0	100	4	05.12-	CFHB	4,4	Y1002AS	8888	57
A 1 2.0 TDI	8X1 / 8XA	2.0	105	4	08.11-	CFHD	4,4	Y1002AS	8888	57

### A 2 (8Z)

A 2 1.2 TDI	8Z0	1.2	45	3	03.01-08.05	ANY	11,0	Y-741U	6943	20
A 2 1.4 TDI	8Z0	1.4	55	3	06.00-08.03	AMF	11,0	Y-741U	6943	20
A 2 1.4 TDI	8Z0	1.4	55	3	09.03-08.05	BHC	11,0	Y-741U	6943	20
A 2 1.4 TDI	8Z0	1.4	66	3	11.03-08.05	ATL	5,0	Y-607AS	7560	50

### A 3 1 (8L)

A 3 (1) 1.9 TDI	8L1	1.9	66	4	09.96-08.00	AGR	12,0	Y-732J	5605	4
A 3 (1) 1.9 TDI	8L1	1.9	66	4	08.97-06.01	ALH	12,0	Y-732J	5605	4
A 3 (1) 1.9 TDI	8L1	1.9	81	4	01.97-04.02	AHF	12,0	Y-732J	5605	4
A 3 (1) 1.9 TDI	8L1	1.9	81	4	09.99-06.01	ASV	12,0	Y-732J	5605	4
A 3 (1) 1.9 TDI VIN --> 8L-2-037-877	8L1	1.9	74	4	01.01-06.03	ATD	12,0	Y-732J	5605	4
A 3 (1) 1.9 TDI VIN --> 8L-2-037-877	8L1	1.9	74	4	11.01-06.03	AXR	12,0	Y-732J	5605	4
A 3 (1) 1.9 TDI VIN --> 8L-2-037-877	8L1	1.9	96	4	05.00-06.03	ASZ	12,0	Y-732J	5605	4
A 3 (1) 1.9 TDI VIN 8L-2-037-878 -->	8L1	1.9	74	4	01.01-06.03	ATD	11,0	Y-741U	6943	20
A 3 (1) 1.9 TDI VIN 8L-2-037-878 -->	8L1	1.9	74	4	11.01-06.03	AXR	11,0	Y-741U	6943	20
A 3 (1) 1.9 TDI VIN 8L-2-037-878 -->	8L1	1.9	96	4	05.00-06.03	ASZ	11,0	Y-741U	6943	20

### A 3 2 (8P)

A 3 (2) 1.6 TDI	8P1	1.6	66	4	05.09-	CAYB	4,4	Y1002AS	8888	57
A 3 (2) 1.6 TDI	8P1	1.6	77	4	05.09-	CAYC	4,4	Y1002AS	8888	57
A 3 (2) 1.9 TDI	8P1	1.9	77	4	06.03-05.06	BKC	5,0	Y-607AS	7560	50

**AUDI****A 3 2 (8P)**

A 3 (2) 1.9 TDI	8P1	1.9	77	4	10.05-05.07	BLS	5,0	Y-607AS	7560	50
A 3 (2) 1.9 TDI	8P1	1.9	77	4	06.06-	BXE	5,0	Y-607AS	7560	50
A 3 (2) 2.0 TDI	8P1	2.0	100	4	05.03-05.07	AZV	4,4	YE14	7768	48
A 3 (2) 2.0 TDI	8P1	2.0	100	4	04.08-05.10	CBAA	4,4	Y-609AS	5849	49
A 3 (2) 2.0 TDI	8P1	2.0	100	4	11.09-	CFFA	4,4	Y1002AS	8888	57
A 3 (2) 2.0 TDI	8P1	2.0	103	4	05.03-05.07	BKD	4,4	YE14	7768	48
A 3 (2) 2.0 TDI 1 from VIN: 8P-6A138001 until VIN: 8P-6B01900	8P1/8PA	2.0	103	4	02.05-06.08	BMM	5,0	Y-607AS	7560	50
A 3 (2) 2.0 TDI from VIN: 8P-6A138000 until VIN: 8P-6B019000	8P1/8PA	2.0	103	4	02.05-06.08	BMM	7,0	CZ104	9826	52
A 3 (2) 2.0 TDI	8P1	2.0	103	4	04.08-05.10	CBAB	4,4	Y-609AS	5849	49
A 3 (2) 2.0 TDI	8P1	2.0	103	4	11.09-	CFFB	4,4	Y1002AS	8888	57
A 3 (2) 2.0 TDI	8P1	2.0	103	4	02.10-	CLJA	4,4	Y1002AS	8888	57
A 3 (2) 2.0 TDI	8P1	2.0	120	4	06.06-05.07	BUY	7,0	CZ304	9864	55
A 3 (2) 2.0 TDI	8P1	2.0	125	4	03.06-	BMN	7,0	CZ304	9864	55
A 3 (2) 2.0 TDI	8P1	2.0	125	4	07.08-05.10	CBBB	4,4	Y-609AS	5849	49
A 3 (2) 2.0 TDI	8P1	2.0	125	4	05.10-	CFGB	4,4	Y1002AS	8888	57

**A 3 3 (8V)**

A 3 (3) 1.6 TDI Only for cylinder without pressure sensor	8V1/8VA	1.6	77	4	09.12-	CLHA	4,4	Y1002AS	8888	57
A 3 (3) 1.6 TDI Only for cylinder without pressure sensor	8V1/8VA/8VS/8V7	1.6	81	4	09.13-	CRKB	4,4	Y1002AS	8888	57
A 3 (3) 2.0 TDI Only for cylinder without pressure sensor	8V1/8VA/8VS	2.0	100	4	05.13-	CRBD	4,4	Y1002AS	8888	57
A 3 (3) 2.0 TDI V Only for cylinder without pressure sensor Euro	8V1/8VA	2.0	81	4	01.13-	CRFA	4,4	Y1002AS	8888	57
A 3 (3) 2.0 TDI Only for cylinder without pressure sensor	8V1/8VA	2.0	105	4	09.12-	CRFC	4,4	Y1002AS	8888	57
A 3 (3) 2.0 TDI Only for cylinder without pressure sensor Euro V	8V1/8VA	2.0	110	4	04.12-	CRBC	4,4	Y1002AS	8888	57
A 3 (3) 2.0 TDI Only for cylinder without pressure sensor Euro V	8V1/8VA	2.0	110	4	04.12-	CRLB	4,4	Y1002AS	8888	57
A 3 (3) 2.0 TDI Only for cylinder without pressure sensor Euro V	8V1/8VA	2.0	135	4	12.12-	CUPA	4,4	Y1002AS	8888	57
A 3 (3) 2.0 TDI Only for cylinder without pressure sensor	8V1/8VA	2.0	135	4	12.12-	CUNA	4,4	Y1002AS	8888	57

**A 4 1 (B5)**

A 4 (1) 1.9 TDI	8D2/8D5 B5	1.9	55	4	03.96-06.00	AFF	12,0	Y-732J	5605	4
A 4 (1) 1.9 TDI	8D2/8D5 B5	1.9	66	4	11.94-07.96	1Z	12,0	Y-732J	5605	4
A 4 (1) 1.9 TDI	8D2/8D5 B5	1.9	66	4	08.96-06.00	AHU	12,0	Y-732J	5605	4
A 4 (1) 1.9 TDI	8D2/8D5 B5	1.9	66	4	04.97-09.01	AHH	12,0	Y-732J	5605	4
A 4 (1) 1.9 TDI	8D2/8D5 B5	1.9	81	4	02.96-07.99	AFN	12,0	Y-732J	5605	4
A 4 (1) 1.9 TDI	8D2/8D5 B5	1.9	81	4	08.99-06.00	AVG	12,0	Y-732J	5605	4
A 4 (1) 1.9 TDI	8D2/8D5 B5	1.9	85	4	08.98-09.01	AJM	12,0	Y-732J	5605	4
A 4 (1) 1.9 TDI	8D2/8D5 B5	1.9	85	4	01.00-09.01	ATJ	12,0	Y-732J	5605	4
A 4 (1) 2.5 V6 TDI	8D2/8D5 B5	2.5	110	6	11.97-06.00	AFB	11,0	Y-501U	4187	31
A 4 (1) 2.5 V6 TDI	8D2/8D5 B5	2.5	110	6	07.98-09.01	AKN	11,0	Y-501U	4187	31

**A 4 2 (B6)**

A 4 (2) 1.9 TDI VIN 8E-5-070251 -->	8E2/8E5 B6	1.9	85	4	06.04-12.05	BKE	5,0	Y-607AS	7560	50
A 4 (2) 1.9 TDI VIN --> 8E-2-148-697	8E2/8E5 B6	1.9	74	4	04.01-05.04	AVB	12,0	Y-732J	5605	4





l kW  
C  
y  
i

0201



Stock-No  
D-POWER™

**AUDI**

**A 4 2 (B6)**

A 4 (2) 1.9 TDI VIN --> 8E-2-148-697	8E2/8E5 B6	1.9	96	4	11.00-12.04	AVF	12,0	Y-732J	5605	4
A 4 (2) 1.9 TDI VIN --> 8E-2-148-697	8E2/8E5 B6	1.9	96	4	12.00-06.03	AWX	12,0	Y-732J	5605	4
A 4 (2) 1.9 TDI VIN 8E-2-148-698 -->	8E2/8E5 B6	1.9	74	4	04.01-05.04	AVB	11,0	Y-741U	6943	20
A 4 (2) 1.9 TDI VIN 8E-2-148-698 -->	8E2/8E5 B6	1.9	96	4	11.00-12.04	AVF	11,0	Y-741U	6943	20
A 4 (2) 1.9 TDI VIN 8E-2-148-698 -->	8E2/8E5 B6	1.9	96	4	12.00-06.03	AWX	11,0	Y-741U	6943	20
A 4 (2) 2.5 V6 TDI	8E2/8E5 B6	2.5	114	6	04.01-06.02	AYM	11,0	Y-501U	4187	31
A 4 (2) 2.5 V6 TDI	8E2/8E5 B6	2.5	120	6	07.02-05.03	BFC	11,0	Y-501U	4187	31
A 4 (2) 2.5 V6 TDI	8E2/8E5 B6	2.5	120	6	06.03-12.05	BCZ	11,0	Y-501U	4187	31
A 4 (2) 2.5 V6 TDI	8E2/8E5 B6	2.5	120	6	06.03-10.04	BDG	11,0	Y-501U	4187	31
A 4 (2) 2.5 V6 TDI	8E2/8E5 B6	2.5	132	6	12.00-05.03	AKE	11,0	Y-501U	4187	31
A 4 (2) 2.5 V6 TDI	8E2/8E5 B6	2.5	132	6	06.03-12.04	BAU	11,0	Y-501U	4187	31
A 4 (2) 2.5 V6 TDI	8E2/8E5 B6	2.5	132	6	06.03-12.04	BDH	11,0	Y-501U	4187	31

**A 4 3 (8EC)**

A 4 (3) 1.9 TDI	8EC/8ED	1.9	85	4	11.05-	BRB	7,0	CZ104	9826	52
A 4 (3) 2.0 TDI	8EC/8ED	2.0	89	4	01.06-09.06	BVG	7,0	CZ304	9864	55
A 4 (3) 2.0 TDI	8EC/8ED	2.0	93	4	11.05-11.06	BVF	7,0	CZ304	9864	55
A 4 (3) 2.0 TDI	8EC/8ED	2.0	100	4	11.04-10.05	BNA	4,4	YE14	7768	48
A 4 (3) 2.0 TDI	8EC/8ED	2.0	100	4	11.05-	BRF	7,0	CZ304	9864	55
A 4 (3) 2.0 TDI	8EC/8ED	2.0	103	4	11.04-11.05	BLB	4,4	YE14	7768	48
A 4 (3) 2.0 TDI	8EC/8ED	2.0	103	4	11.04-	BPW	7,0	CZ104	9826	52
A 4 (3) 2.0 TDI	8EC/8ED	2.0	103	4	10.05-	BRE	7,0	CZ304	9864	55
A 4 (3) 2.0 TDI	8EC/8ED	2.0	120	4	06.06-	BVA	7,0	CZ304	9864	55
A 4 (3) 2.0 TDI	8EC/8ED	2.0	125	4	06.06-	BRD	7,0	CZ304	9864	55
A 4 (3) 2.5 V6 TDI	8EC/8ED	2.5	120	6	11.04-05.06	BDG	11,0	Y-501U	4187	31
A 4 (3) 2.7 V6 TDI	8EC/8ED	2.7	120	6	11.05-06.08	BSG	4,4	Y-609AS	5849	49
A 4 (3) 2.7 V6 TDI	8EC/8ED	2.7	132	6	01.06-03.09	BPP	4,4	Y-609AS	5849	49
A 4 (3) 3.0 V6 TDI	8EC/8ED	3.0	150	6	11.04-03.09	BKN	4,4	Y-609AS	5849	49
A 4 (3) 3.0 V6 TDI	8EC/8ED	3.0	171	6	01.06-03.09	ASB	4,4	Y-609AS	5849	49

**A 4 4 (8K)**

A 4 (4) 2.0 TDI	8K2/8K5	2.0	110	4	05.13-	CMFB	4,4	Y1002AS	8888	57
Only for cylinder without pressure sensor										
A 4 (4) 2.0 TDI	8K2/8K5	2.0	110	4	05.13-	CJCD	4,4	Y1002AS	8888	57
Only for cylinder without pressure sensor										
A 4 (4) 2.0 TDI	8K2/8K5	2.0	140	4	09.13-	CNHA	4,4	Y1002AS	8888	57
Only for cylinder without pressure sensor										
A 4 (4) 2.0 TDI	8K2/8K5	2.0	88	4	06.08-	CAGC	4,4	Y-609AS	5849	49
A 4 (4) 2.0 TDI	8K2/8K5	2.0	100	4	11.07-	CAGB	4,4	Y-609AS	5849	49
A 4 (4) 2.0 TDI	8K2/8K5	2.0	100	4	11.10-	CJCB	4,4	Y1002AS	8888	57
A 4 (4) 2.0 TDI	8K2/8K5	2.0	105	4	11.07-	CAGA	4,4	Y-609AS	5849	49
A 4 (4) 2.0 TDI	8K2/8K5	2.0	105	4	05.10-	CMEA	4,4	Y1002AS	8888	57
A 4 (4) 2.0 TDI	8K2/8K5	2.0	120	4	08.08-	CAHB	4,4	Y-609AS	5849	49
A 4 (4) 2.0 TDI	8K2/8K5	2.0	125	4	08.08-	CAHA	4,4	Y-609AS	5849	49
A 4 (4) 2.0 TDI	8K2/8K5	2.0	130	4	11.11-	CGLC	4,4	Y1002AS	8888	57
A 4 (4) 2.7 V6 TDI	8K2/8K5	2.7	120	6	11.07-05.08	CAMB	4,4	Y-609AS	5849	49
A 4 (4) 2.7 V6 TDI	8K2/8K5	2.7	140	6	11.07-05.08	CAMA	4,4	Y-609AS	5849	49
A 4 (4) 3.0 V6 TDI	8K2/8K5	3.0	155	6	06.08-05.10	CCWB	4,4	Y-609AS	5849	49
A 4 (4) 3.0 V6 TDI	8K2/8K5	3.0	176	6	11.07-05.08	CAPA	4,4	Y-609AS	5849	49
A 4 (4) 3.0 V6 TDI	8K2/8K5	3.0	176	6	04.08-	CCWA	4,4	Y-609AS	5849	49
A 4 (4) 3.0 V6 TDI	8K2/8K5	3.0	150	6	11.11-	CLAB	4,4	Y1002AS	8888	57
Only for cylinder without pressure sensor										



l kW C y i 0201



Stock-No  
D-POWER

## AUDI

### A 4 4 (8K)

A 4 (4) 3.0 V6 TDI	8K2/8K5	3.0	180	6	11.11-	CKVB		4,4	Y1002AS	8888	57
Only for cylinder without pressure sensor											
A 4 (4) 3.0 V6 TDI	8K2/8K5	3.0	180	6	11.11-	CKVC		4,4	Y1002AS	8888	57
Only for cylinder without pressure sensor											

### A 5

A 5 2.0 TDI	8TA	2.0	105	4	09.09-05.13	CMFA		4,4	Y1002AS	8888	57
A 5 2.0 TDI	8TA	2.0	110	4	05.13-	CMFB		4,4	Y1002AS	8888	57
Only for cylinder without pressure sensor											
A 5 2.0 TDI	8TA	2.0	100	4	09.09-	CJCB		4,4	Y1002AS	8888	57
A 5 2.0 TDI	8T3/8TA	2.0	100	4	09.09-	CAGB		4,4	Y-609AS	5849	49
A 5 2.0 TDI	8T3/8TA	2.0	105	4	09.09-	CAGA		4,4	Y-609AS	5849	49
A 5 2.0 TDI	8T3/8TA	2.0	105	4	05.10-	CMEA		4,4	Y1002AS	8888	57
A 5 2.0 TDI	8T3/8TA	2.0	120	4	08.08-	CAHB		4,4	Y-609AS	5849	49
A 5 2.0 TDI	8T3/8TA	2.0	125	4	08.08-	CAHA		4,4	Y-609AS	5849	49
A 5 2.0 TDI	8T3/8TA	2.0	130	4	10.11-	CGLC		4,4	Y1002AS	8888	57
A 5 2.0 TDI	8T3/8TA	2.0	120	4	09.09-	CNHC		4,4	Y1002AS	8888	57
Only for cylinder without pressure sensor											
A 5 2.0 TDI	8T3/8TA	2.0	140	4	09.13-	CNHA		4,4	Y1002AS	8888	57
Only for cylinder without pressure sensor											
A 5 2.0 TDI	8T3/8TA	2.0	120	4	08.08-	CGLD		4,4	Y1002AS	8888	57
Only for cylinder without pressure sensor											
A 5 2.0 TDI	8F7/8TA	2.0	105	4	09.09-	CJCA		4,4	Y1002AS	8888	57
Only for cylinder without pressure sensor											
A 5 2.0 TDI	8F7/8TA	2.0	110	4	05.13-	CJCD		4,4	Y1002AS	8888	57
Only for cylinder without pressure sensor											
A 5 2.7 V6 TDI	8T3/8TA	2.7	120	6	09.07-05.08	CAMB		4,4	Y-609AS	5849	49
A 5 2.7 V6 TDI	8T3/8TA	2.7	120	6	05.08-	CGKB		4,4	Y-609AS	5849	49
A 5 2.7 V6 TDI	8T3/8TA	2.7	140	6	07.07-05.08	CAMA		4,4	Y-609AS	5849	49
A 5 2.7 V6 TDI	8T3/8TA	2.7	140	6	05.08-	CGKA		4,4	Y-609AS	5849	49
A 5 3.0 V6 TDI	8T3/8TA	3.0	155	6	03.08-05.10	CCWB		4,4	Y-609AS	5849	49
A 5 3.0 V6 TDI	8T3/8TA	3.0	176	6	03.08-	CCWA		4,4	Y-609AS	5849	49
A 5 3.0 V6 TDI	8T3/8TA	3.0	177	6	06.07-05.08	CAPA		4,4	Y-609AS	5849	49
A 5 3.0 V6 TDI	8T3/8TA	3.0	180	6	09.11-	CDUC		4,4	Y1002AS	8888	57
Only for cylinder without pressure sensor											
A 5 3.0 V6 TDI	8T3/8TA	3.0	180	6	09.11-	CKVB		4,4	Y1002AS	8888	57
Only for cylinder without pressure sensor											

### A 6 1 (C4)

A 6 (1) 1.9 TDI	4A/C4	1.9	66	4	07.94-06.96	1Z		12,0	Y-732J	5605	4
A 6 (1) 1.9 TDI	4A/C4	1.9	66	4	07.96-10.97	AHU		12,0	Y-732J	5605	4
A 6 (1) 2.5 TDI	4A/C4	2.5	85	5	06.94-10.97	AAT		12,0	Y-732J	5605	4
A 6 (1) 2.5 TDI	4A/C4	2.5	103	5	10.94-10.97	AEL		12,0	Y-732J	5605	4

### A 6 2 (C5)

A 6 (2) 1.9 TDI	4B/C5	1.9	81	4	04.97-04.01	AFN		12,0	Y-732J	5605	4
A 6 (2) 1.9 TDI	4B/C5	1.9	81	4	08.99-10.00	AVG		12,0	Y-732J	5605	4
A 6 (2) 1.9 TDI	4B/C5	1.9	85	4	11.00-04.01	AJM		11,0	Y-741U	6943	20
A 6 (2) 1.9 TDI	4B/C5	1.9	96	4	06.01-01.05	AVF		12,0	Y-732J	5605	4
A 6 (2) 1.9 TDI	4B/C5	1.9	96	4	06.01-01.05	AWX		11,0	Y-741U	6943	20
A 6 (2) 2.5 TDI	4B/C5	2.5	110	6	04.97-05.00	AFB		11,0	Y-501U	4187	31
A 6 (2) 2.5 TDI	4B/C5	2.5	110	6	10.98-05.01	AKN		11,0	Y-501U	4187	31



ℓ kW C y i  
0201



Stock-No  
D-POWER™

**AUDI**

**A 6 2 (C5)**

A 6 (2) 2.5 TDI	4B/C5	2.5	114	6	06.01-06.02	AYM	11,0	Y-501U	4187	31
A 6 (2) 2.5 TDI	4B/C5	2.5	120	6	07.02-08.03	BFC	11,0	Y-501U	4187	31
A 6 (2) 2.5 TDI	4B/C5	2.5	120	6	02.03-08.05	BCZ	11,0	Y-501U	4187	31
A 6 (2) 2.5 TDI	4B/C5	2.5	120	6	02.03-01.05	BDG	11,0	Y-501U	4187	31
A 6 (2) 2.5 TDI	4B/C5	2.5	132	6	11.99-08.03	AKE	11,0	Y-501U	4187	31
A 6 (2) 2.5 TDI	4B/C5	2.5	132	6	02.03-08.05	BAU	11,0	Y-501U	4187	31
A 6 (2) 2.5 TDI	4B/C5	2.5	132	6	02.03-01.05	BDH	11,0	Y-501U	4187	31

**A 6 3 (4F)**

A 6 (3) 2.0 TDI	4F2/4F5	2.0	89	4	09.05-06.06	BVG	7,0	CZ304	9864	55
A 6 (3) 2.0 TDI	4F2/4F5	2.0	100	4	07.04-11.05	BNA	4,4	YE14	7768	48
A 6 (3) 2.0 TDI	4F2/4F5	2.0	100	4	09.05-	BRF	7,0	CZ304	9864	55
A 6 (3) 2.0 TDI	4F2/4F5	2.0	100	4	10.08-	CAGB	4,4	Y-609AS	5849	49
A 6 (3) 2.0 TDI	4F2/4F5	2.0	103	4	07.04-11.05	BLB	4,4	YE14	7768	48
A 6 (3) 2.0 TDI	4F2/4F5	2.0	103	4	09.05-10.08	BRE	7,0	CZ304	9864	55
A 6 (3) 2.0 TDI	4F2/4F5	2.0	120	4	04.09-	CAHB	4,4	Y-609AS	5849	49
A 6 (3) 2.0 TDI	4F2/4F5	2.0	125	4	11.08-	CAHA	4,4	Y-609AS	5849	49
A 6 (3) 2.7 TDI	4F2/4F5	2.7	120	6	06.05-	BSG	4,4	Y-609AS	5849	49
A 6 (3) 2.7 TDI	4F2/4F5	2.7	120	6	10.08-	CANB	4,4	Y-609AS	5849	49
A 6 (3) 2.7 TDI	4F2/4F5	2.7	120	6	10.08-	CAND	4,4	Y-609AS	5849	49
A 6 (3) 2.7 TDI	4F2/4F5	2.7	132	6	11.04-10.08	BPP	4,4	Y-609AS	5849	49
A 6 (3) 2.7 TDI	4F2/4F5	2.7	140	6	10.08-	CANA	4,4	Y-609AS	5849	49
A 6 (3) 2.7 TDI quattro	4F2/4F5	2.7	140	6	10.08-	CANC	4,4	Y-609AS	5849	49
A 6 (3) 3.0 TDI	4F2/4F5	3.0	155	6	03.05-10.08	BNG	4,4	Y-609AS	5849	49
A 6 (3) 3.0 TDI	4F2/4F5	3.0	155	6	10.08-	CDYB	4,4	Y-609AS	5849	49
A 6 (3) 3.0 TDI quattro	4F2/4F5	3.0	165	6	04.04-05.06	BMK	4,4	Y-609AS	5849	49
A 6 (3) 3.0 TDI quattro	4F2/4F5	3.0	171	6	05.06-10.08	ASB	4,4	Y-609AS	5849	49
A 6 (3) 3.0 TDI quattro	4F2/4F5	3.0	176	6	10.08-	CDYA	4,4	Y-609AS	5849	49
A 6 (3) 3.0 TDI quattro	4F2/4F5	3.0	176	6	10.08-	CDYC	4,4	Y-609AS	5849	49

**A 6 4 (4G)**

A 6 (4) 2.0 TDI	4G2/4G5	2.0	140	4	11.13-	CNHA	4,4	Y1002AS	8888	57
Only for cylinder without pressure sensor										
A 6 (4) 2.0 TDI	4G2/4G5	2.0	100	4	01.12-	CGLE	4,4	Y1002AS	8888	57
A 6 (4) 2.0 TDI	4G2/4G5	2.0	120	4	03.11-	CGLD	4,4	Y1002AS	8888	57
A 6 (4) 2.0 TDI	4G2/4G5	2.0	130	4	04.11-	CGLC	4,4	Y1002AS	8888	57
A 6 (4) 2.0 TDI	4G2/4G5	2.0	130	4	04.11-	CMGB	4,4	Y1002AS	8888	57
A 6 (4) 3.0 V6 TDI	4G2/4G5	3.0	150	6	04.11-	CLAA	4,4	Y1002AS	8888	57
A 6 (4) 3.0 V6 TDI	4G2/4G5	3.0	150	6	04.11-	CLAB	4,4	Y1002AS	8888	57
A 6 (4) 3.0 V6 TDI	4G2/4G5	3.0	180	6	04.11-	CDUC	4,4	Y1002AS	8888	57
A 6 (4) 3.0 V6 TDI quattro	4G2/4G5	3.0	230	6	11.11-	CGQB	4,4	Y1002AS	8888	57
A 6 (4) 3.0 V6 TDI	4G2/4G5	3.0	180	6	04.11-	CDUD	4,4	Y1002AS	8888	57
Only for cylinder without pressure sensor										
A 6 (4) 3.0 V6 TDI	4G2/4G5	3.0	176	6	05.13-	CPNB	4,4	Y1002AS	8888	57
Only for cylinder without pressure sensor										
A 6 (4) 3.0 V6 TDI quattro	4G2/4G5	3.0	230	6	11.11-	CGQB	4,4	Y1002AS	8888	57
A 6 (4) 3.0 V6 TDI quattro	4G2/4G5	3.0	180	6	04.11-	CKVB	4,4	Y1002AS	8888	57
Only for cylinder without pressure sensor										
A 6 (4) 3.0 V6 TDI quattro	4G2/4G5	3.0	180	6	01.12-	CKVC	4,4	Y1002AS	8888	57
Only for cylinder without pressure sensor										

Stock-No  
D-POWER**AUDI****A 7**

A 7 Sportback 3.0 TDI	4GA	3.0	180	6	07.10-	CDUC	4,4	Y1002AS	8888	57
A 7 Sportback 3.0 TDI	4GA	3.0	180	6	07.10-	CDUD	4,4	Y1002AS	8888	57
A 7 Sportback 3.0 TDI	4GA	3.0	150	6	11.10-	CLAB	4,4	Y1002AS	8888	57
A 7 Sportback 3.0 TDI	4GA	3.0	150	6	12.10-	CLAA	4,4	Y1002AS	8888	57
A 7 Sportback 3.0 TDI	4GA	3.0	230	6	11.11-	CGQB	4,4	Y1002AS	8888	57
A 7 Sportback 3.0 TDI	4GA	3.0	155	6	07.14-	CRTF	4,4	Y1002AS	8888	57
A 7 Sportback 3.0 TDI	4GA	3.0	155	6	07.14-	CTCB	4,4	Y1002AS	8888	57
A 7 Sportback 3.0 TDI	4GA	3.0	160	6	07.14-	CTCC	4,4	Y1002AS	8888	57
A 7 Sportback 3.0 TDI	4GA	3.0	160	6	07.14-	CRTE	4,4	Y1002AS	8888	57
A 7 Sportback 3.0 TDI	4GA	3.0	180	6	07.10-	CKVB	4,4	Y1002AS	8888	57
Only for cylinder without pressure sensor										
A 7 Sportback 3.0 TDI	4GA	3.0	180	6	07.10-	CKVC	4,4	Y1002AS	8888	57
Only for cylinder without pressure sensor										
A 7 Sportback 3.0 TDI	4GA	3.0	176	6	05.13-	CPNB	4,4	Y1002AS	8888	57
Only for cylinder without pressure sensor										
A 7 Sportback 3.0 TDI quattro	4GA	3.0	200	6	05.14-	CRTD	4,4	Y1002AS	8888	57
A 7 Sportback 3.0 TDI quattro	4GA	3.0	235	6	05.14-	CVUA	4,4	Y1002AS	8888	57
A 7 Sportback 3.0 TDI quattro	4GA	3.0	240	6	09.14-	CVUB	4,4	Y1002AS	8888	57

**A 8 1 (4D)**

A 8 (1) 2.5 TDI	4D2	2.5	110	6	06.97-04.00	AFB	11,0	Y-501U	4187	31
A 8 (1) 2.5 TDI	4D2	2.5	110	6	11.97-09.02	AKN	11,0	Y-501U	4187	31
A 8 (1) 2.5 TDI	4D2	2.5	132	6	11.99-09.02	AKE	11,0	Y-501U	4187	31
A 8 (1) 3.3 TDI	4D2	3.3	165	8	12.99-09.02	AKF	11,0	Y-501U	4187	31

**A 8 2 (4E)**

A 8 (2) 3.0 TDI VIN 4E-5-003 301 -->	4E	3.0	155	6	11.03-07.10	BNG	4,4	Y-609AS	5849	49
A 8 (2) 3.0 TDI VIN 4E-5-003 301 -->	4E	3.0	171	6	01.04-07.10	ASB	4,4	Y-609AS	5849	49
A 8 (2) 4.0 TDI quattro	4E	4.0	202	8	05.03-07.05	ASE	11,0	Y-501U	4187	31
A 8 (2) 4.2 TDI quattro	4E	4.2	235	8	01.05-06.05	BMC	4,4	Y-609AS	5849	49
A 8 (2) 4.2 TDI quattro	4E	4.2	240	8	07.05-07.10	BVN	4,4	Y-609AS	5849	49

**A 8 3 (4H)**

A 8 (3) 3.0 TDI quattro	4H	3.0	184	6	07.10-	CDTA	4,4	Y1002AS	8888	57
A 8 (3) 3.0 TDI quattro	4H	3.0	184	6	07.10-	CMHA	4,4	Y1002AS	8888	57
A 8 (3) 3.0 TDI quattro	4H	3.0	155	6	08.10-	CDTB	4,4	Y1002AS	8888	57
A 8 (3) 3.0 TDI quattro	4H	3.0	190	6	10.13-	CTBA	4,4	Y1002AS	8888	57
A 8 (3) 3.0 TDI quattro	4H	3.0	176	6	11.12-	CPNA	4,4	Y1002AS	8888	57
Only for cylinder without pressure sensor										
A 8 (3) 4.2 TDI quattro	4H	4.2	258	8	11.09-	CDSB	4,4	Y1002AS	8888	57
A 8 (3) 4.2 TDI quattro	4H	4.2	283	8	09.13-	CTEC	4,4	Y1002AS	8888	57

**CABRIO**

Cabrio 1.9 TDI		1.9	66	4	07.95-07.96	1Z	12,0	Y-732J	5605	4
Cabrio 1.9 TDI		1.9	66	4	07.96-08.00	AHU	12,0	Y-732J	5605	4

**Q 3**

Q 3 2.0 TDI	8UB	2.0	100	4	09.11-	CFFA	4,4	Y1002AS	8888	57
Q 3 2.0 TDI	8UB	2.0	103	4	09.11-	CFFB	4,4	Y1002AS	8888	57
Q 3 2.0 TDI	8UB	2.0	120	4	06.11-	CFGD	4,4	Y1002AS	8888	57
Q 3 2.0 TDI	8UB	2.0	130	4	06.11-	CFGC	4,4	Y1002AS	8888	57
Q 3 2.0 TDI	8UB	2.0	130	4	06.11-	CLLB	4,4	Y1002AS	8888	57

**Q 5**

Q 5 2.0 TDI	8R	2.0	100	4	08.09-	CAGB	4,4	Y-609AS	5849	49
-------------	----	-----	-----	---	--------	------	-----	---------	------	----



l kW C y i 0201



Stock-No D-POWER

**AUDI**

**Q 5**

Q 5 2.0 TDI	8R	2.0	100	4	05.10-	CJCB	4,4	Y1002AS	8888	57
Q 5 2.0 TDI	8R	2.0	105	4	08.09-	CAGA	4,4	Y-609AS	5849	49
Q 5 2.0 TDI	8R	2.0	105	4	05.10-	CJCA	4,4	Y1002AS	8888	57
Q 5 2.0 TDI	8R	2.0	120	4	11.08-09.10	CAHB	4,4	Y-609AS	5849	49
Q 5 2.0 TDI	8R	2.0	120	4	05.10-	CGLA	4,4	Y1002AS	8888	57
Q 5 2.0 TDI	8R	2.0	125	4	11.08-09.10	CAHA	4,4	Y-609AS	5849	49
Q 5 2.0 TDI	8R	2.0	125	4	05.10-	CGLB	4,4	Y1002AS	8888	57
Q 5 2.0 TDI	8R	2.0	125	4	11.10-	CMGA	4,4	Y1002AS	8888	57
Q 5 2.0 TDI	8R	2.0	130	4	07.12-	CGLC	4,4	Y1002AS	8888	57
Q 5 2.0 TDI	8R	2.0	130	4	07.12-	CGMB	4,4	Y1002AS	8888	57
Q 5 2.0 TDI	8R	2.0	110	4	05.13-	CJCD	4,4	Y1002AS	8888	57
Only for cylinder without pressure sensor										
Q 5 2.0 TDI	8R	2.0	140	4	11.13-	CNHA	4,4	Y1002AS	8888	57
Only for cylinder without pressure sensor										
Q 5 3.0 V6 TDI	8R	3.0	190	6	06.12-	CTBA	4,4	Y1002AS	8888	57
Only for cylinder without pressure sensor										
Q 5 3.0 V6 TDI SQ5 quattro	8R	3.0	230	6	12.12-	CGQB	4,4	Y1002AS	8888	57
Only for cylinder without pressure sensor										
Q 5 3.0 V6 TDI	8R	3.0	155	6	11.08-	CCWB	4,4	Y-609AS	5849	49
Q 5 3.0 V6 TDI	8R	3.0	176	6	11.08-	CCWA	4,4	Y-609AS	5849	49
Q 5 3.0 V6 TDI	8R	3.0	180	6	06.12-	CDUD	4,4	Y1002AS	8888	57

**Q 7**

Q 7 3.0 TDI	4L	3.0	155	6	03.06-	BUN	4,4	Y-609AS	5849	49
Q 7 3.0 TDI	4L	3.0	155	6	11.07-05.10	CASB	4,4	Y-609AS	5849	49
Q 7 3.0 TDI	4L	3.0	165	6	06.09-05.12	CATA	4,4	Y1002AS	8888	57
Only for cylinder without pressure sensor										
Q 7 3.0 TDI	4L	3.0	180	6	05.11-	CLZB	4,4	Y1002AS	8888	57
Only for cylinder without pressure sensor										
Q 7 3.0 TDI --->VIN 4L_7_036115	4L	3.0	171	6	03.06-	BUG	4,4	Y-609AS	5849	49
Q 7 3.0 TDI	4L	3.0	176	6	11.07-05.10	CASA	4,4	Y-609AS	5849	49
Q 7 3.0 TDI	4L	3.0	180	6	05.11-	CJGD	4,4	Y1002AS	8888	57
Q 7 3.0 TDI	4L	3.0	180	6	05.11-	CRCA	4,4	Y1002AS	8888	57
Q 7 4.2 TDI	4L	4.2	230	8	03.07-	BTR	4,4	Y-609AS	5849	49
Q 7 4.2 TDI	4L	4.2	250	8	05.10-	CCFC	4,4	Y1002AS	8888	57
Q 7 4.2 TDI	4L	4.2	250	8	06.09-05.10	CCFA	4,4	Y-609AS	5849	49
Q 7 6.0 TDI	4L	6.0	368	12	09.08-	CCGA	4,4	Y-609AS	5849	49

**TT 2 (8J)**

TT (2) 2.0 TDI quattro	8J3/8J9	2.0	125	4	06.08-	CBBB	4,4	Y1002AS	8888	57
TT (2) 2.0 TDI quattro	8J3/8J9	2.0	125	4	05.10-	CFGB	4,4	Y1002AS	8888	57
TT (2) 2.0 TDI quattro	8J3/8J9	2.0	125	4	06.08-06.10	CBBB	4,4	Y-609AS	5849	49

**TT 3 (FV)**

TT (3) 2.0 TDI	FV3/FV9	2.0	135	4	07.14-	CUNA	4,4	Y1002AS	8888	57
Only for cylinder without pressure sensor										

**AUSTIN**

Austin TAXI				4	08.83-		11,0	Y-208T	1250	
-------------	--	--	--	---	--------	--	------	--------	------	--

**AVIA**

A21.1 D				4	10.90-		11,0	Y-208T	1250	
---------	--	--	--	---	--------	--	------	--------	------	--

**BEDFORD**

Brava Pickup 4x4	2.2			12.98-		5,0	Y-306R	6244	
------------------	-----	--	--	--------	--	-----	--------	------	--

**BMW****1ER E (SERIES)**

118 d	E87	2.0	90	4	09.04-	M47 N204D4	5,0	Y-547AS	5968	47
120 d	E87	2.0	120	4	09.04-	M47 N204D4	5,0	Y-547AS	5968	47
120 d	E87	2.0	130	4	11.03-09.12	M47 D20	5,0	Y-547AS	5968	47
118 d	E87	2.0	105	4	11.03-09.12	M47 D20A	5,0	Y-547AS	5968	47

**3ER E30 (SERIES)**

324 d	E30	2.4	63	6	09.85-08.91	M21 D24	11,0	Y-924J	7906	1
324 Td	E30	2.4	85	6	09.87-12.93	M21 D24	11,0	Y-924J	7906	1

**3ER E36 (SERIES)**

318 Tds	E36	1.8	66	4	11.94-02.98	M41 D18	11,0	Y-924J	7906	1
325 Td	E36	2.5	85	6	01.91-02.98	M51 D25	11,0	Y-924J	7906	1
325 Tds	E36	2.5	105	6	06.93-05.99	M51 D25	11,0	Y-924J	7906	1

**3ER E46 (SERIES)**

318 d	E46	2.0	85	4	09.01-11.03	M47 D20	11,0	Y-507J	2691	32
318 d	E46	2.0	85	4	08.02-01.05	M47 N D20	5,0	Y-547AS	5968	47
318 d Touring	E46	2.0	85	4	09.01-11.03	M47 D20	11,0	Y-507J	2691	32
318 d Touring	E46	2.0	85	4	08.02-07.05	M47 N D20	5,0	Y-547AS	5968	47
318 td Compact	E46	2.0	85	4	08.02-12.04	M47 N D20	5,0	Y-547AS	5968	47
320 Cd	E46	2.0	110	4	03.03-05.06	M47 N D20	5,0	Y-547AS	5968	47
320 Cd Cabrio	E46	2.0	110	4	06.04-08.06	M47 N D20	5,0	Y-547AS	5968	47
320 d	E46	2.0	100	4	07.97-08.01	M47 D20	11,0	Y-507J	2691	32
320 d	E46	2.0	110	4	10.00-01.05	M47 N D20	5,0	Y-547AS	5968	47
320 d Touring	E46	2.0	100	4	02.99-08.01	M47 D20	11,0	Y-507J	2691	32
320 d Touring	E46	2.0	110	4	06.99-07.05	M47 N D20	5,0	Y-547AS	5968	47
320 td Compact	E46	2.0	110	4	05.00-12.04	M47 N D20	5,0	Y-547AS	5968	47
330 Cd Cabrio	E46	3.0	150	6	11.04-08.06	M57 N D30	5,0	Y-547AS	5968	47
330 Cd Coupé	E46	3.0	150	6	08.02-05.06	M57 N D30	5,0	Y-547AS	5968	47
330 d	E46	3.0	135	6	09.00-11.03	M57 D30	11,0	Y-507J	2691	32
330 d	E46	3.0	150	6	03.03-02.05	M57 N D30	5,0	Y-547AS	5968	47
330 d Touring	E46	3.0	135	6	06.98-03.03	M57 D30	11,0	Y-507J	2691	32
330 d Touring	E46	3.0	150	6	09.02-07.05	M57 N D30	5,0	Y-547AS	5968	47
330 Xd	E46	3.0	135	6	01.00-02.03	M57 D30	11,0	Y-507J	2691	32
330 Xd	E46	3.0	150	6	09.02-12.04	M57 N D30	5,0	Y-547AS	5968	47
330 Xd Touring	E46	3.0	150	6	08.02-05.05	M57 N D30	5,0	Y-547AS	5968	47
330 Xd Touring	E46	3.0	135	6	01.00-03.03	M57 D30	11,0	Y-507J	2691	32

**3ER E90 (SERIES)**

318 d	E90	2.0	90	4	09.05-09.07	M47 N204D4	5,0	Y-547AS	5968	47
320 d	E90	2.0	120	4	03.05-05.07	M47 N204D4	5,0	Y-547AS	5968	47
325 d	E90	3.0	145	6	03.06-	M57 N2 D30	5,0	Y-547AS	5968	47
330 d	E90	3.0	170	6	01.06-	M57 N2 D30	5,0	Y-547AS	5968	47
330 d	E90	3.0	180	6	01.09-12.11	M57 N2 306 D3	5,0	Y-547AS	5968	47
335 d	E90	3.0	210	6	09.06-	M57 N2 D30	5,0	Y-547AS	5968	47

**3ER E91 (SERIES)**

318 d Touring	E91	2.0	90	4	09.05-09.07	M47 N204D4	5,0	Y-547AS	5968	47
---------------	-----	-----	----	---	-------------	------------	-----	---------	------	----



l kW  
C  
y  
i

0201



Stock-No  
D-POWER™

**BMW**

**3ER E91 (SERIES)**

320 d Touring	E91	2.0	120	4	09.05-11.07	M47 N204D4	5,0	Y-547AS	5968	47
325 d Touring	E91	3.0	145	6	03.06-	M57 N2 D30	5,0	Y-547AS	5968	47
330 d Touring	E91	3.0	170	6	09.05-	M57 N2 D30	5,0	Y-547AS	5968	47
335 d Touring	E91	3.0	210	6	09.06-	M57 N2 D30	5,0	Y-547AS	5968	47

**3ER E92 (SERIES)**

325 d Coupé	E92	3.0	145	6	03.06-	M57 N2 D30	5,0	Y-547AS	5968	47
330 Cd	E92	3.0	170	6	09.06-	M57 N2 D30	5,0	Y-547AS	5968	47
335 d Coupé	E92	3.0	210	6	09.06-	M57 N2 D30	5,0	Y-547AS	5968	47

**3ER E93 (SERIES)**

330 d Cabrio	E93	3.0	170	6	04.07-	M57 N2 D30	5,0	Y-547AS	5968	47
--------------	-----	-----	-----	---	--------	------------	-----	---------	------	----

**5ER E34 (SERIES)**

524 Td	E34	2.4	85	6	03.88-08.91	M21 D24	11,0	Y-924J	7906	1
525 Td	E34	2.5	85	6	06.92-06.96	M51 D25	11,0	Y-924J	7906	1
525 Tds	E34	2.5	105	6	01.90-06.96	M51 D25	11,0	Y-924J	7906	1

**5ER E39 (SERIES)**

520 d	E39	2.0	100	4	09.99-08.03	M47 D20	11,0	Y-507J	2691	32
520 d Touring	E39	2.0	100	4	09.99-08.03	M47 D20	11,0	Y-507J	2691	32
525 Tds	E39	2.5	105	6	03.95-10.00	M51 D25	11,0	Y-924J	7906	1
525 d	E39	2.5	120	6	03.00-12.03	M57 D25	11,0	Y-507J	2691	32
525 d Touring	E39	2.5	120	6	03.00-12.03	M57 D25	11,0	Y-507J	2691	32
530 d	E39	3.0	142	6	09.98-12.03	M57 D30	11,0	Y-507J	2691	32
530 d Touring	E39	3.0	142	6	02.99-03.04	M57 D30	11,0	Y-507J	2691	32

**5ER E60 (SERIES)**

520 d	E60	2.0	120	4	02.05-09.07	M47 N204D4	5,0	Y-547AS	5968	47
525 d	E60	2.5	130	6	03.04-11.06	M57 N D25	5,0	Y-547AS	5968	47
525 d	E60	2.5	145	6	12.06-	M57 N2 D25	5,0	Y-547AS	5968	47
530 d	E60	3.0	155	6	07.03-03.10	M57 D30	5,0	Y-547AS	5968	47
530 d	E60	3.0	160	6	08.02-10.05	M57 N D30	5,0	Y-547AS	5968	47
530 Xd	E60	3.0	160	6	10.05-	M57 N D30	5,0	Y-547AS	5968	47
530 d	E60	3.0	170	6	02.05-	M57 N2 D30	5,0	Y-547AS	5968	47
535 d	E60	3.0	200	6	09.04-02.05	M57 N D30	5,0	Y-547AS	5968	47
535 d	E60	3.0	210	6	09.05-	M57 N2 D30	5,0	Y-547AS	5968	47

**5ER E61 (SERIES)**

520 d Touring	E61	2.0	120	4	11.05-	M47 N204D4	5,0	Y-547AS	5968	47
525 d Touring	E61	2.5	130	6	05.04-	M57 N D25	5,0	Y-547AS	5968	47
530 d Touring	E61	3.0	160	6	11.02-10.05	M57 N D30	5,0	Y-547AS	5968	47
530 d Touring	E61	3.0	173	6	02.05-	M57 N2 D30	5,0	Y-547AS	5968	47
530 d Touring	E61	3.0	180	6	02.10-	M57 N2 D30	5,0	Y-547AS	5968	47
535 d Touring	E61	3.0	200	6	09.04-	M57 N D30	5,0	Y-547AS	5968	47

**6ER E63 (SERIES)**

635 Cd	E63	3.0	210	6	05.06-	M57 N2 D30	5,0	Y-547AS	5968	47
--------	-----	-----	-----	---	--------	------------	-----	---------	------	----

**7ER E38 (SERIES)**

725 Tds	E38	2.5	105	6	09.95-11.00	M51 D25	11,0	Y-924J	7906	1
730 d	E38	3.0	142	6	09.98-12.01	M57 D30	11,0	Y-507J	2691	32

**7ER E65 (SERIES)**

730 d	E65	3.0	150	6	11.01-02.05	M57 N D30	5,0	Y-547AS	5968	47
730 d	E65	3.0	170	6	07.04-	M57 N2 D30	5,0	Y-547AS	5968	47



l kW C y i **0201**



Stock-No  
D-POWER

## BMW

### X3 E83

X 3 xDrive20d 4x4	E83	2.0	110	4	09.04-	M47 N D20	5,0	Y-547AS	5968	47
X 3 xDrive30d 4x4	E83	3.0	150	6	01.03-09.05	M57 N D30	5,0	Y-547AS	5968	47
X 3 xDrive30d 4x4	E83	3.0	160	6	10.04-	M57 N2 D30	5,0	Y-547AS	5968	47
X 3 xDrive35d 4x4	E83	3.0	210	6	09.06-	M57 N2 D30	5,0	Y-547AS	5968	47

### X5 E53

X 5d 4x4	E53	3.0	142	6	08.01-11.03	M57 D30	11,0	Y-507J	2691	32
X 5d 4x4	E53	3.0	160	6	01.03-09.06	M57 N D30	5,0	Y-547AS	5968	47

### X5 E70

X 5d 4x4	E70	3.0	173	6	.07-	M57 N2 D30	5,0	Y-547AS	5968	47
X 5 3.0 sd 4x4	E70	3.0	210	6	.07-	M57 N2 D30	5,0	Y-547AS	5968	47

## CADILLAC

BLS 1.9 D		1.9	110	4	04.06-	Z19DTH	11,0	YE07	6092	
-----------	--	-----	-----	---	--------	--------	------	------	------	--

## CHEVROLET

### CAPTIVA

Captiva 2.0 D		2.0	110	4	10.06-	Z20S	4,4	Y8009AS	96478	
---------------	--	-----	-----	---	--------	------	-----	---------	-------	--

### CRUZE

Cruze 2.0 D	J300 / J305	2.0	110	4	05.09-	Z20S1	4,4	Y8009AS	96478	
Cruze 2.0 D	J300 / J305	2.0	92	4	05.09-05.11	Z20S1	4,4	Y8009AS	96478	

### EPICA

Epica 2.0 D		2.0	110	4	01.07-	Z20DMH	4,4	Y8009AS	96478	
-------------	--	-----	-----	---	--------	--------	-----	---------	-------	--

### LACETTI

Lacetti 2.0 D		2.0	89	4	01.07-	Z20DM	4,4	Y8009AS	96478	
---------------	--	-----	----	---	--------	-------	-----	---------	-------	--

### NUBIRA

Nubira 2.0 D		2.0	89	4	01.07-	Z20DM	4,4	Y8009AS	96478	
--------------	--	-----	----	---	--------	-------	-----	---------	-------	--

## CHRYSLER

### 300C

300 C 3.0 CRD		3.0	160	6	09.05-12.10	M664	4,4	Y8002AS	6287	51
---------------	--	-----	-----	---	-------------	------	-----	---------	------	----

### PT CRUISER

PT Cruiser 2.2 CRD		2.2	89	4	03.02-	EDJ	11,5	Y-745U	6346	11
PT Cruiser 2.2 CRD		2.2	110	4	08.05-		11,5	Y-745U	6346	11

### SEBRING

Sebring 2.0 CRD		2.0	103	4	.07-	engine by VW	5,0	Y-607AS	7560	50
-----------------	--	-----	-----	---	------	--------------	-----	---------	------	----

### VOYAGER 2

Voyager 2 2.5 TD		2.5	88	4	04.92-04.95	VM 425 CLIRE	11,0	Y-924J	7906	1
Voyager 2 2.5 TD		2.5	88	4	04.92-04.95	VM HR-492	11,0	Y-924J	7906	1
Voyager 2 2.5 TD		2.5	88	4	05.95-01.01	VM HR425 CLIEE	11,0	Y-741U	6943	20

### VOYAGER 4

Voyager 4 2.5 CRD	RG	2.5	88	4	08.05-05.07	EDK / ENJ	11,0	Y1031J	95970	71
Voyager 4 2.5 CRD	RG	2.5	105	4	02.00-05.07	ENC	11,0	Y1031J	95970	71
Voyager 4 2.8 CRD	RG	2.8	110	4	06.04-02.08	ENR	11,0	Y1031J	95970	71





Stock-No  
D-POWER™

## CITROËN

### AX

AX D	1.4	39	4	09.88-09.94	TUD 3 L	11,5	Y-910J	3617	3
AX D	1.5	40	4	10.94-12.99	TUD 5 VJZ	11,0	Y-503J	1009	10

### BERLINGO

Berlingo Hdi	1.4	55	4	01.05-	DV4TD	11,0	YE04	1684	40
Berlingo 1.6 Hdi 75	1.6	55	4	04.08-	DV6BUTED4	11,0	YE05	91322	73
Berlingo 1.6 Hdi 75	1.6	55	4	04.08-	DV6ETED / DV6ETEDM	5,0	Y8001AS	8904	58
Berlingo 1.6 Hdi 90	1.6	92	4	07.10-	DV6DTED/DV6DTEDM	5,0	Y8001AS	8904	58
Berlingo 1.6 Hdi	1.6	66	4	07.06-	DV6	11,0	YE04	1684	40
Berlingo 1.6 Hdi 90	1.6	66	4	04.08-	DV6ATED4	11,0	YE05	91322	73
Berlingo 1.6 Hdi 110	1.6	80	4	04.08-	DV6TED4	11,0	YE05	91322	73
Berlingo 1.6 Hdi 110	1.6	82	4	07.10-	DV6C	5,0	Y8001AS	8904	58
Berlingo 1.8 D	1.8	43	4	07.96-08.98	XUD7 A9A	11,0	Y-924J	7906	1
Berlingo 1.8 D	1.8	43	4	09.98-03.99	XUD7 A9A	11,0	Y-924J	7906	1
Berlingo 1.8 D	1.8	51	4	09.98-03.99	DW8 WJZ	11,0	Y-503J	1009	10
Berlingo 1.8 D	1.8	66	4	09.98-03.99	DW8TD	11,0	Y-503J	1009	10
Berlingo 1.9 D	1.9	51	4	07.96-09.98	XUD9A D9B / DJY	11,0	Y-924J	7906	1
Berlingo 1.9 D	1.9	52	4	09.98-12.02	XUD9A	11,0	Y-924J	7906	1
Berlingo Multispace 1.9 D	1.9	51	4	01.97-09.98	XUD9A D9B / DJY	11,0	Y-924J	7906	1
Berlingo Multispace 1.9 D	1.9	51	4	09.98-12.02	DW8 WJZ	11,0	Y-503J	1009	10
Berlingo 2.0 Hdi	2.0	66	4	10.99-	DW10TD	11,0	Y-504J	1441	24
Berlingo 2.0 Hdi	2.0	81	4	05.02-10.06	DW10ATED4	11,0	Y1005J	7957	56
Berlingo 2.0 Hdi	2.0	88	4	11.06-	DW10UTED4	11,0	Y1005J	7957	56
Berlingo 2.0 Hdi	2.0	100	4	11.06-	DW10BTED4	11,0	Y1005J	7957	56
Berlingo Multispace 2.0 Hdi	2.0	66	4	10.99-	DW10TD	11,0	Y-504J	1441	24

### BX

BX 17 D	1.8	44	4	07.85-01.93	XUD 7	11,0	Y-924J	7906	1
BX 17 TD, TRD	1.8	66	4	03.88-01.93	XUD 7 TE	11,0	Y-924J	7906	1
BX 19 D, TD, TRD	1.9	51	4	03.87-	XUD 9 A/L	11,0	Y-924J	7906	1

### C1

C1 Hdi	1.4	40	4	05.06-	DV4	11,0	YE04	1684	40
C1 Hdi	1.4	50	4	06.05-	DV4TD	11,0	YE05	91322	73

### C15

C15 D	1.8	44	4	10.84-05.95	XUD7	11,0	Y-924J	7906	1
C15 D	1.8	44	4	06.95-	XUD7	11,0	Y-924J	7906	1
C15 D	1.9	44	4	12.00-	DW8	11,0	Y-503J	1009	10

### C2

C2 1.4 Hdi	1.4	51	4	12.04-	DV4TD	11,0	YE05	91322	73
C2 1.6 Phase 2	1.6	80	4	05.08-	DV6TED4	11,0	YE05	91322	73

### C25

C25 D	1.9	70	4	07.87-01.94	D9B	11,0	Y-924J	7906	1
C25 D	2.5	73	4	07.81-01.94	CRD93	11,0	Y-208T	1250	
C25 TD	2.5	95	4	08.87-01.94	CRD93LS	11,0	Y-208T	1250	

### C3 1

C3 1.4 Hdi	1.4	51	4	12.04-	DV4TD	11,0	YE05	91322	73
C3 1.4 Hdi	1.4	52	4	03.02-12.04	DV4TD	11,0	YE04	1684	40
C3 1.4 Hdi 16V	1.4	68	4	03.02-12.04	DV4TED4	11,0	YE04	1684	40
C3 1.4 Hdi	1.4	68	4	12.04-06.08	DV4TED4	11,0	YE05	91322	73
C3 1.4 Hdi 16V X-TR	1.4	68	4	.04-12.04	DV4ETD4	11,0	YE04	1684	40



e kW C y i **0201**



Stock-No  
D-POWER™

## CITROEN

### C3 1

C3 1.6 HdI	1.6	66	4	10.05-	DV6TED4	11,0	YE05	91322	73
C3 1.6 HdI	1.6	81	4	03.06-	DV4TED6	11,0	YE05	91322	73

### C3 2

C3 II 1.4 HdI 70	1.4	50	4	11.09-	DV4C / DV4TD	11,0	YE05	91322	73
C3 II 1.6 HdI 90	1.6	66	4	11.09-	DV6ATED4	11,0	YE05	91322	73
C3 II 1.6 HdI	1.6	68	4	11.09-	DV6DTEd	11,0	YE05	91322	73
C3 II 1.6 HdI 110	1.6	82	4	11.09-	DV6CTED4	5,0	Y8001AS	8904	58
C3 II 1.6 HdI 115	1.6	114	4	09.12-	DV6C	5,0	Y8001AS	8904	58

### C3 PICASSO

C3 Picasso 1.6 HdI 90	1.6	66	4	12.08-	DV6ATED4	11,0	YE05	91322	73
C3 Picasso 1.6 HdI 110	1.6	80	4	12.08-	DV6TED4	11,0	YE05	91322	73
C3 Picasso 1.6 HdI 110	1.6	112	4	07.10-	DV6C	5,0	Y8001AS	8904	58
C3 Picasso 1.6 HdI 115	1.6	114	4	01.13-	DV6C	5,0	Y8001AS	8904	58
C3 Picasso 1.6 HdI 90	1.6	92	4	07.10-	DV6DTEd	5,0	Y8001AS	8904	58

### C4

C4 Coupé 1.6 HdI	1.6	68	4	12.04-		11,0	YE04	1684	40
C4 Coupé 1.6 HdI	1.6	80	4	12.04-06.06	DV6TED4	11,0	YE04	1684	40
C4 2.0 HdI	2.0	100	4	09.04-	DW10BTED4	11,0	Y1005J	7957	56
C4 2.0 HdI	2.0	103	4	07.08-	DW10BTED4	11,0	Y1005J	7957	56

### C4 2

C4 II 1.6 HDi 90	1.6	68	4	11.09-	DV6DTEd / DV6DTEdM	5,0	Y8001AS	8904	58
C4 II 1.6 HDi 110	1.6	82	4	11.09-	DV6C	5,0	Y8001AS	8904	58
C4 II 2.0 HDi	2.0	110	4	11.09-	DW10CTED4	5,0	Y8001AS	8904	58

### C4 3

C4 III 1.6	1.6	68	4	08.13-	DV6DTEd	5,0	Y8001AS	8904	58
------------	-----	----	---	--------	---------	-----	---------	------	----

### C4 AIRCROSS

C4 Aircross 1.6 HDi 115	1.6	84	4	04.12-	DV6C	5,0	Y8001AS	8904	58
-------------------------	-----	----	---	--------	------	-----	---------	------	----

### C4 GRAND PICASSO

C4 Grand Picasso 1.6 HdI 110	1.6	80	4	09.06-	DV6TED4	11,0	YE05	91322	73
C4 Grand Picasso 1.6 HdI 110	1.6	82	4	09.10-	DV6C	5,0	Y8001AS	8904	58
C4 Grand Picasso 2.0 HdI	2.0	100	4	02.07-	DW10BTED4	11,0	Y1005J	7957	56
C4 Grand Picasso 2.0 HdI	2.0	102	4	09.06-	DW10TD	11,0	Y-504J	1441	24
C4 Grand Picasso 2.0 HdI 150	2.0	110	4	06.09-	DW10CTED4	5,0	Y8001AS	8904	58
C4 Grand Picasso 2.0 HdI 165	2.0	120	4	11.10-	DW10CTED4	5,0	Y8001AS	8904	58

### C4 PICASSO I

C4 Picasso I 1.6 HdI	1.6	81	4	03.07-	DV6TED	11,0	YE05	91322	73
C4 Picasso I 1.6 HdI	1.6	81	4	02.07-	DV6TED4	11,0	YE05	91322	73
C4 Picasso I 1.6 HdI	1.6	82	4	09.10-	DV6C	5,0	Y8001AS	8904	58
C4 Picasso I 1.6 HdI	1.6		4	12.08-	DV6	11,0	YE05	91322	73
C4 Picasso I 1.6 HdI	1.6		4	12.08-	DV6	11,0	YE05	91322	73
C4 Picasso I 2.0 HdI	2.0	100	4	10.06-	DW10BTED4	11,0	Y1005J	7957	56
C4 Picasso I 2.0 HdI	2.0	102	4	02.07-	DW10TD	11,0	Y-504J	1441	24
C4 Picasso I 2.0 HdI 150	2.0	110	4	06.09-	DW10CTED4	5,0	Y8001AS	8904	58
C4 Picasso I 2.0 HdI 165	2.0	120	4	11.10-	DW10CTED4	5,0	Y8001AS	8904	58

### C4 PICASSO II

C4 Picasso II 1.6 e-HDi 115	1.6	115	4	02.13-	DV6C	5,0	Y8001AS	8904	58
C4 Picasso II 1.6 HDi 90	1.6	92	4	02.13-	DV6DTEd	5,0	Y8001AS	8904	58
C4 Picasso II 2.0 BlueHdi 150	2.0	150	4	08.13-	DW10FD	5,0	Y8001AS	8904	58



Stock-No  
D-POWER™

## CITROËN

### C5

C5 1.6 Hdi	1.6	81	4	03.06-	DV6	11,0	YE05	91322	73
C5 2.0 Hdi	2.0	66	4	06.02-	DW10ATD	11,0	Y-504J	1441	24
C5 2.0 Hdi	2.0	81	4	02.01-	DW10ATED	11,0	Y-504J	1441	24
C5 2.0 Hdi	2.0	66	4	05.01-10.03	DW10	11,0	Y-504J	1441	24
C5 2.0 Hdi	2.0	66	4	05.01-10.03	DW10TD	11,0	Y-504J	1441	24
C5 2.0 Hdi	2.0	100	4	09.04-	DW10BTED4	11,0	Y1005J	7957	56
C5 2.2 Hdi	2.2	98	4	09.04-08.05	DW12TED4	11,0	Y1005J	7957	56
C5 2.2 Hdi	2.2	100	4	10.00-08.04	DW12TED4	11,0	Y1005J	7957	56
C5 2.2 Hdi	2.2	100	4	02.01-	DW12TED4	11,0	Y-504J	1441	24
C5 2.2 Hdi	2.2	125	4	05.06-	DW12BTED4	11,0	YE08	4966	

### C5 3

C5 III 1.6 HDi	1.6	80	4	02.08-	DV6TED4	11,0	YE05	91322	73
C5 III 1.6 Hdi 110	1.6	82	4	07.10-	DV6C	5,0	Y8001AS	8904	58
C5 III 1.6 Hdi 115	1.6	84	4	01.12-	DV6C	5,0	Y8001AS	8904	58
C5 III 2.0 HDi	2.0	100	4	02.08-	DW10BTED4	11,0	Y1005J	7957	56
C5 III 2.0 HDi 140	2.0	103	4	04.09-	DW10BTED4	11,0	Y1005J	7957	56
C5 III 2.0 HDi 165	2.0	120	4	04.09-	DW10CTED4	5,0	Y8001AS	8904	58
C5 III 2.2 HDi	2.2	125	4	02.08-	DW12BTED4	11,0	YE08	4966	
C5 III 2.7 V6 HDi	2.7	150	6	02.08-	DT17TED4	11,0	YE12	7794	

### C6

C6 2.2 Hdi	2.2	125	4	11.06-	DW12BTED4	11,0	YE08	4966	
C6 2.7 V6 Hdi	2.7	150	6	12.05-	DT17	11,0	YE12	7794	

### C8

C8 2.0 Hdi 16V	2.0	80	4	07.02-	DW10TED4/RHT	11,0	Y-504J	1441	24
C8 2.0 Hdi	2.0	100	4	03.06-	DW10BTED4	11,0	Y1005J	7957	56
C8 2.0 Hdi	2.0	79	4	04.02-08.07	DW10ATED4	11,0	Y1005J	7957	56
C8 2.0 Hdi	2.0	80	4	10.02-02.07	DW10UTED4	11,0	Y1005J	7957	56
C8 2.0 Hdi	2.0	81	4	04.02-	DW10ATED4	11,0	Y1005J	7957	56
C8 2.0 Hdi	2.0	88	4	03.07-	DW10UTED4	11,0	Y1005J	7957	56
C8 2.0 Hdi 160	2.0	120	4	04.10-	DW10CTED4	5,0	Y8001AS	8904	58
C8 Hdi 16V	2.2	128	4	07.02-	DW12TED4/4HW	11,0	Y-504J	1441	24
C8 2.2 Hdi	2.2	94	4	04.02-07.06	DW12TED4	11,0	Y1005J	7957	56
C8 2.2 Hdi	2.2	96	4	.02-	DW12	11,0	Y-504J	1441	24
C8 2.2 Hdi	2.2	125	4	06.06-	DW12BTED4	11,0	YE08	4966	

### C-CROSSER

C-Crosser Hdi	2.2	115	4	06.07-	DW12MTED4	11,0	YE08	4966	
---------------	-----	-----	---	--------	-----------	------	------	------	--

### C-ELYSEE

C-Elysée 1.6 HDi 92	1.6	68	4	.12-	DV6DTEd / DV6DTEdM	5,0	Y8001AS	8904	58
---------------------	-----	----	---	------	--------------------	-----	---------	------	----

### DISPATCH

Dispatch	1.6	66	4	11.06-	DV6UTED4	11,0	YE05	91322	73
Dispatch	1.9		4	09.96-07.98	XUD9A, XUD9TE	11,0	Y-924J	7906	1
Dispatch	1.9		4	09.98-	DW8, DW8B	11,0	Y-503J	1009	10
Dispatch	1.9		4	09.98-	XUD9A, XUD9TE	11,0	Y-924J	7906	1
Dispatch	2.0		4	03.00-	DW10	11,0	Y-504J	1441	24

### DS3

DS3 1.6 Hdi 90	1.6	68	4	11.09-	DV6C	5,0	Y8001AS	8904	58
DS3 1.6 Hdi 110	1.6	82	4	11.09-	DV6CTED4	5,0	Y8001AS	8904	58
DS3 1.6 e-Hdi 90	1.6	92	4	01.13-	DV6DTEd	5,0	Y8001AS	8904	58



e kW C  
y i **0201**



Stock-No  
D-POWER™

## CITROEN

### DS4

DS4 1.6 e-Hdi 110	1.6	81	4	04.11-	DV6C	5,0	Y8001AS	8904	58
DS4 1.6 Hdi 110	1.6	82	4	04.11-	DV6C	5,0	Y8001AS	8904	58
DS4 1.6 Hdi	1.6	92	4	05.11-	DV6DTEd	5,0	Y8001AS	8904	58
DS4 2.0 Hdi 140	2.0	136	4	04.11-	DW10CB	5,0	Y8001AS	8904	58
DS4 2.0 Hdi 160	2.0	120	4	04.11-	DW10CTED4	5,0	Y8001AS	8904	58

### DS5

DS5 1.6 e-Hdi 110	1.6	82	4	11.11-	DV6C	5,0	Y8001AS	8904	58
DS5 2.0 Blue HDi 180	2.0	180	4	08.13-	DW10FC	5,0	Y8001AS	8904	58
DS5 2.0 HDi 140	2.0	136	4	11.11-	DW10CBDTR	5,0	Y8001AS	8904	58
DS5 2.0 HDi 165	2.0	120	4	11.11-	DW10CTED4	5,0	Y8001AS	8904	58
DS5 2.0 HDi 165 Hybrid4	2.0	120	4	11.11-	DW10CTED4	5,0	Y8001AS	8904	58

### EVASION

Evasion 1.9 TD	1.9	66	4	03.94-08.98	XUD9TF	11,0	Y-924J	7906	1
Evasion 1.9 TD	1.9	68	4	09.98-09.02	XUD9TF, XUD9BTF	11,0	Y-924J	7906	1
Evasion 2.0 Hdi	2.0	81	4	09.98-09.02	DW10ATED	11,0	Y-504J	1441	24
Evasion 2.0	2.0	80	4	09.99-10.02	DW10ATED4	11,0	Y1005J	7957	56
Evasion 2.1 TD	2.1	80	4	05.96-04.97	XUD11BTE	11,0	Y-924J	7906	1
Evasion 2.1 TD	2.1	80	4	05.97-12.98	XUD11BTE	11,0	Y-924J	7906	1

### JUMPER

Jumper 1.9 D	1.9	52	4	03.94-05.95	XUD9AU	11,0	Y-924J	7906	1
Jumper 1.9 D	1.9	52	4	06.95-	XUD9AU	11,0	Y-924J	7906	1
Jumper 1.9 TD	1.9	68	4	03.94-08.98	XUD9TF	11,0	Y-924J	7906	1
Jumper 1.9 TD	1.9	68	4	09.98-	XUD9TF	11,0	Y-924J	7906	1
Jumper 2.0 Hdi	2.0	66	4	09.98-	DW10TD	11,0	Y-504J	1441	24
Jumper 2.2 Hdi	2.2	74	4	04.02-	DW12TED	11,0	Y-504J	1441	24
Jumper 2.2 Hdi	2.2	76	4	09.98-	DW10TED4	11,0	Y-504J	1441	24
Jumper 2.2 Hdi	2.2	100	4	09.98-	DW12TED4	11,0	Y-504J	1441	24
Jumper 2.2 Hdi	2.2	74	4	02.02-06.06	DW12UTED	11,0	Y1005J	7957	56
Jumper 2.2 Hdi 100	2.2	74	4	04.06-	4HV	11,5	Y-548J	94832	75
Jumper 2.2 Hdi 120	2.2	88	4	04.06-	4HU	11,5	Y-548J	94832	75
Jumper 2.5 D	2.5	63	4	03.94-	DJ5	11,0	Y-924J	7906	1
Jumper 2.5 TD	2.5	76	4	03.94-08.96	DJ5T	11,0	Y-924J	7906	1
Jumper 2.5 Tdi	2.5	78	4	09.96-	DJ5TED	11,0	Y-738U	5390	
Jumper 2.8 Hdi	2.8	93	4	09.00-04.02	4HY	11,0	Y-502R	3852	
Jumper 3.0 Hdi 145	3.0	107	4	07.10-	F30DT	11,0	Y8005J	96853	64
Jumper 3.0 Hdi 160	3.0	116	4	06.09-	F30DT	11,0	Y8005J	96853	64

### JUMPY

Jumpy 1.6 Hdi	1.6	66	4	02.07-	DV6UTED4	11,0	YE05	91322	73
Jumpy 1.8 D	1.8	51	4	09.98-	DW8	11,0	Y-503J	1009	10
Jumpy 1.9 D	1.9	51	4	01.96-08.98	XUD9A	11,0	Y-924J	7906	1
Jumpy 1.9 D	1.9	51	4	09.98-	DW8	11,0	Y-503J	1009	10
Jumpy 1.9 D	1.9	51	4	09.98-	XUD9A	11,0	Y-924J	7906	1
Jumpy 1.9 TD	1.9	68	4	01.96-08.98	XUD9TF/BTF	11,0	Y-924J	7906	1
Jumpy 1.9 TD	1.9	68	4	09.96-	XUD9TF/BTF	11,0	Y-924J	7906	1
Jumpy 2.0 Hdi	2.0	70	4	02.00-	DW10TED	11,0	Y-504J	1441	24
Jumpy 2.0 Hdi	2.0	70	4	02.00-	DW10TED	11,0	Y-504J	1441	24
Jumpy 2.0 Hdi 95	2.0	72	4	07.11-	DW10CE	5,0	Y8001AS	8904	58
Jumpy 2.0 Hdi	2.0	81	4	02.00-	DW10ATED	11,0	Y-504J	1441	24
Jumpy 2.0 Hdi	2.0	81	4	02.00-	DW10ATED	11,0	Y-504J	1441	24
Jumpy 2.0 Hdi	2.0	81	4	05.02-10.06	DW10ATED4	11,0	Y1005J	7957	56



l kW C y i 0201



Stock-No  
D-POWER™

**CITROËN**

**JUMPY**

Jumpy 2.0 Hdi	2.0	88	4	11.06-	DW10UTED4	11,0	Y1005J	7957	56
Jumpy 2.0 Hdi	2.0	90	4	02.07-		11,0	YE05	91322	73
Jumpy 2.0 Hdi 125	2.0	94	4	07.11-	DW10CD	5,0	Y8001AS	8904	58
Jumpy 2.0 Hdi	2.0	102	4	02.07-		11,0	YE05	91322	73
Jumpy 2.0 Hdi	2.0	100	4	11.06-	DW10BTED4	11,0	Y1005J	7957	56
Jumpy 2.0 Hdi 165	2.0	120	4	07.10-	DW10CTED4	5,0	Y8001AS	8904	58

**NEMO**

Nemo 1.3 HDi 75	1.3	55	4	10.10-	F13DTE5 (FHZ)	4,3	Y9001AS	97719	72
Nemo 1.4 Hdi	1.4	51	4	02.08-	DV4TD	11,0	YE05	91322	73

**RELAY**

Relay	1.9		4	03.94-08.98	XUD9TF, 9AU	11,0	Y-924J	7906	1
Relay	1.9		4	09.98-	XUD9TF	11,0	Y-924J	7906	1
Relay	2.0		4	09.98-	DW10TD/DU	11,0	Y-504J	1441	24
Relay	2.5		4	03.94-	DJ5, DJ5T	11,0	Y-924J	7906	1
Relay	2.5		4	09.96-	DJ5TED 12V	11,0	Y-738U	5390	

**SAXO 1**

Saxo 1 1.5 D	1.5	43	4	05.96-08.99	TUD 5	11,0	Y-503J	1009	10
--------------	-----	----	---	-------------	-------	------	--------	------	----

**SAXO 2**

Saxo 2 1.5 D	1.5	43	4	09.99-05.03	TUD 5	11,0	Y-503J	1009	10
--------------	-----	----	---	-------------	-------	------	--------	------	----

**SYNERGIE**

Synergie	2.0	80	4	09.99-02.03	DW10ATED4	11,0	Y1005J	7957	56
Synergie	1.9		4	10.95-08.98	XUD9BTF/L3	11,0	Y-924J	7906	1
Synergie	1.9		4	09.98-10.00	XUD9TE, XUD9BTF	11,0	Y-924J	7906	1
Synergie	2.0		4	08.99-	DW10TED	11,0	Y-504J	1441	24

**XANTIA**

Xantia 1.9 D	1.9	51	4	03.93-01.96	XUD 9 A/L	11,0	Y-924J	7906	1
Xantia 1.9 D	1.9	55	4	05.94-	XUD9A	11,0	Y-924J	7906	1
Xantia 1.9 D	1.9	55	4	09.98-	XUD9A/L	11,0	Y-924J	7906	1
Xantia 1.9 TD	1.9	68	4	06.93-08.98	XUD9TF	11,0	Y-924J	7906	1
Xantia 1.9 TD	1.9	68	4	09.98-12.00	XUD9BTF, XUD9BSD	11,0	Y-924J	7906	1
Xantia 2.0 Hdi	2.0	66	4	10.98-	DW10TD	11,0	Y-504J	1441	24
Xantia 2.0 Hdi	2.0	81	4	10.98-12.01	DW10ATED	11,0	Y-504J	1441	24
Xantia 2.1 TD	2.1	80	4	06.95-08.98	XUD11BTE	11,0	Y-924J	7906	1
Xantia 2.1 TD	2.1	80	4	09.98-	XUD11BTF	11,0	Y-924J	7906	1

**XM**

XM 2.1 D 12D	2.1	60	4	05.89-06.94	XUD11A/L	11,0	Y-924J	7906	1
XM 2.1 D 12TD	2.1	80	4	05.89-08.98	XUD11ATE/L/BTE	11,0	Y-924J	7906	1
XM 2.1 D 12TD	2.1	80	4	09.98-12.00	XUD11ATE/L/BTE	11,0	Y-924J	7906	1
XM 2.5 TD	2.5	96	4	07.94-12.00	DK5ATE	11,0	Y-924J	7906	1

**XSARA**

Xsara 1.5 D	1.5	43	4	09.97-08.00	TUD5	11,0	Y-503J	1009	10
Xsara 1.6 D	1.6	66	4	09.05-12.11	DV6ATED4	11,0	YE05	91322	73
Xsara 1.8 D	1.8	43	4	10.97-09.00	XUD7	11,0	Y-924J	7906	1
Xsara 1.9 D	1.9	50	4	09.97-09.00	XUD9A DJY	11,0	Y-924J	7906	1
Xsara 1.9 D	1.9	51	4	06.99-08.00	DW8	11,0	Y-503J	1009	10
Xsara 1.9 TD	1.9	66	4	10.97-09.00	XUD9TE DHY	11,0	Y-924J	7906	1
Xsara 2.0 Hdi	2.0	66	4	04.99-08.00	DW10TD	11,0	Y-504J	1441	24



## CITROEN

### XSARA

Xsara 2 1.4 Hdi	1.4	51	4	02.03-12.04	DV4TD	11,0	YE04	1684	40
Xsara 2 1.4 Hdi	1.4	51	4	12.04-	DV4TD	11,0	YE05	91322	73
Xsara 2 1.5 Hdi	1.5	43	4	09.00-	TUD5	11,0	Y-503J	1009	10
Xsara 2 1.9 D	1.9	52	4	09.00-	DW8 WJZ	11,0	Y-503J	1009	10
Xsara 2 2.0 Hdi	2.0	66	4	09.00-12.02	DW10TD RHY	11,0	Y-504J	1441	24
Xsara 2 2.0 Hdi	2.0	81	4	05.01-	DW10ATED RHZ	11,0	Y-504J	1441	24
Xsara Picasso 1.6 Hdi	1.6	66	4	09.05-	DV6	11,0	YE05	91322	73
Xsara Picasso 1.6 Hdi	1.6	81	4	05.04-06.06	DV6	11,0	YE04	1684	40
Xsara Picasso 2.0 Hdi	2.0	66	4	01.00-.07	DW10TD	11,0	Y-504J	1441	24
Xsara Picasso 2.0 Hdi	2.0	81	4	01.00-.07	DW10TD	11,0	Y-504J	1441	24

### ZX

ZX 1.8 D	1.8	44	4	03.91-	XUD 7 A9A	11,0	Y-924J	7906	1
ZX 1.8 D	1.8	44	4	03.91-04.94	XUD 7 A9A	11,0	Y-924J	7906	1
ZX 1.8 D	1.8	44	4	05.94-07.98	XUD7	11,0	Y-924J	7906	1
ZX 1.9 D	1.9	38	4	05.94-07.98	XUD9A/L	11,0	Y-924J	7906	1
ZX 1.9 D	1.9	47	4	03.91-04.94	XUD 9 A/L D9B	11,0	Y-924J	7906	1
ZX 1.9 TD	1.9	68	4	09.92-04.94	XUD 9 T/L D8A	11,0	Y-924J	7906	1
ZX 1.9 TD	1.9	68	4	05.94-07.98	XUD9T/L	11,0	Y-924J	7906	1

## DACIA

### DOKKER

Dokker 1.5 dCi	1.5	55	4	11.12-	K9K 612	4,4	Y1035AS	94103	77
Dokker 1.5 dCi	1.5	66	4	11.12-	K9K 612	4,4	Y1035AS	94103	77

### DUSTER 2

Duster 1.5 dCi	1.5	80	4	08.13-	K9K 856 / 858	4,4	Y1035AS	94103	77
Duster 1.5 dCi	1.5	63	4	04.10-	K9K 796	12,0	Y-732J	5605	4
Duster 1.5 dCi 4x2	1.5	66	4	10.10-	K9K 892	4,4	Y1035AS	94103	77
Duster 1.5 dCi 4x4	1.5	66	4	10.10-	K9K 884	12,0	Y-732J	5605	4
Duster 1.5 dCi	1.5	79	4	06.10-	K9K 896 / 898	4,4	Y1035AS	94103	77
Duster 1.5 dCi	1.5	81	4	06.10-	K9K 898	4,4	Y1035AS	94103	77

### LODGY

Lodgy 1.5 dCi	1.5	66	4	03.12-	K9K 612	4,4	Y1035AS	94103	77
Lodgy 1.5 dCi	1.5	79	4	03.12-	K9K 846	4,4	Y1035AS	94103	77

### LOGAN I

Logan I 1.5 dCi	1.5	48	4	09.05-	K9K 790	12,0	Y-732J	5605	4
Logan I 1.5 dCi	1.5	50	4	01.06-	K9K 792	12,0	Y-732J	5605	4
Logan I 1.5 dCi	1.5	55	4	05.10-	K9K 892	4,4	Y1035AS	94103	77
Logan I 1.5 dCi	1.5	63	4	09.07-	K9K 796	12,0	Y-732J	5605	4

### LOGAN II

Logan II 1.5 dCi 75	L8	1.5	55	4	11.12-	K9K 612	4,4	Y1035AS	94103	77
Logan II 1.5 dCi 90	L8	1.5	66	4	11.12-	K9K 612	4,4	Y1035AS	94103	77



l kW C y i 0201



Stock-No  
D-POWER™

**DACIA**

**LOGAN MCV I**

Logan MCV I 1.5 dCi	KS	1.5	50	4	08.06-06.13	K9K 792	12,0	Y-732J	5605	4
Logan MCV I 1.5 dCi	KS	1.5	63	4	09.07-12.12	K9K 796	12,0	Y-732J	5605	4
Logan MCV I 1.5 dCi	KS	1.5	55	4	05.10-06.13	K9K 892	4,4	Y1035AS	94103	77
Logan MCV I 1.5 dCi	KS	1.5	65	4	05.10-06.13	K9K 892	4,4	Y1035AS	94103	77

**LOGAN MCV II**

Logan MCV II 1.5 dCi 75	K8	1.5	55	4	02.13-	K9K 612	4,4	Y1035AS	94103	77
Logan MCV II 1.5 dCi 90	K8	1.5	66	4	02.13-	K9K 612	4,4	Y1035AS	94103	77

**LOGAN PICK-UP**

Logan Pick-up 1.5 dCi	US	1.5	50	4	03.08-	K9K 792	12,0	Y-732J	5605	4
Logan Pick-up 1.5 dCi	US	1.5	63	4	03.08-	K9K 796	12,0	Y-732J	5605	4
Logan Pick-up 1.5 dCi	US	1.5	55	4	05.10-	K9K 892	4,4	Y1035AS	94103	77
Logan Pick-up 1.5 dCi	US	1.5	65	4	05.10-	K9K 892	4,4	Y1035AS	94103	77

**SANDERO I**

Sandero I 1.5 dCi		1.5	50	4	11.08-	K9K 792	12,0	Y-732J	5605	4
Sandero I 1.5 dCi		1.5	55	4	05.10-	K9K 892	4,4	Y1035AS	94103	77
Sandero I 1.5 dCi		1.5	63	4	11.08-	K9K 796	12,0	Y-732J	5605	4
Sandero I 1.5 dCi		1.5	65	4	05.10-	K9K 892	4,4	Y1035AS	94103	77

**SANDERO II**

Sandero II 1.5 dCi 75	B8	1.5	55	4	01.13-	K9K 838	4,4	Y1035AS	94103	77
Sandero II 1.5 dCi 90	B8	1.5	66	4	01.13-	K9K 612	4,4	Y1035AS	94103	77

**SOLENZA**

Solenza 1.9 D		1.9	46	4	02.03-	F8Q 630	11,0	Y-516J	6416	12
---------------	--	-----	----	---	--------	---------	------	--------	------	----

**DAEWOO**

**KORANDO**

Korando TD		2.3	74	4	04.00-		11,5	Y-916J	5906	6
Korando TD, Cabriolet		2.9	88	5	04.00-		11,5	Y-916J	5906	6
Korando		2.9		4	04.00-		11,5	Y-916J	5906	6

**MUSSO**

Musso 2.3 SLTD		2.3	74	4	04.00-		11,5	Y-916J	5906	6
Musso 2.9 SELTD		2.9	88	5	04.00-		11,5	Y-916J	5906	6
Musso 2.9		2.9		4	04.00-		11,5	Y-916J	5906	6

**DAF**

400 Serie D		2.5	53	4	04.89-08.93		11,0	Y-924J	7906	1
400 Serie TD		2.5	71	4	04.89-08.93		11,0	Y-924J	7906	1

**DAIHATSU**

**CHARADE CL**

Charade CL10,60		1.0	27	4	.86-	CL	11,0	Y-703R	3782	
Charade CL50		1.0		4	.86-	CL	11,0	Y-703R	3782	

**FOURTRAK**

Fourtrak		2.8		4	.84- .93	DL50	7,0	Y-146R	7492	
Fourtrak		2.8		4	10.89- .93	DL-T	7,0	Y-146R	7492	



## DAIHATSU

### ROCKY

Rocky	2.8	67	4	12.87-04.93	DL51	7,0	Y-146R	7492	
Rocky TD	2.8	67	4	12.87-04.93	DL 51	7,0	Y-146R	7492	
Rocky TD	2.8	72	4	05.93-	DL 52	7,0	Y-146R	7492	
Rocky TD	2.8	75	4	09.91-	DL 52	7,0	Y-146R	7492	

## FIAT

### 500

500 1.3 JTD Multijet	312	1.3	56	4	07.07-	169A1000	11,0	Y8003J	97256	62
500 1.3 JTD Multijet	312	1.3	70	4	11.09-	199B1000	4,3	Y9001AS	97719	72

### 500C

500C 1.3 JTD Multijet	312	1.3	55	4	06.09-	169A1000	11,0	Y8003J	97256	62
500C 1.3 JTDM	312	1.3	70	4	11.09-	199B1000	4,3	Y9001AS	97719	72

### 500L

500L 1.3 16V JTD Multijet	199	1.3	62	4	09.12-	199B4000	4,3	Y9001AS	97719	72
500L 1.3 JTD Multijet	199	1.3	70	4	06.14-	330A1000	4,3	Y9001AS	97719	72
500L 1.6 16V Multijet	199	1.6	77	4	09.12-	199B5000	4,3	Y9001AS	97719	72
500L 1.6 16V Multijet	199	1.6	88	4	09.13-	955A3000	4,4	Y9003AS	94251	78

### 500X

500X 1.6 Multijet	334	1.6	85	4	09.14-	55260384	4,4	Y9003AS	94251	78
500X 2.0 Multijet	334	2.0	103	4	09.14-	55263087	4,4	Y9003AS	94251	78
500X 2.0 Multijet	334	2.0	103	4	09.14-	55263088	4,3	Y9003AS	94251	78

## ALBEA/ SIENA

Albea / Siena 1.3 JTD Multijet	178	1.3	51	4	06.03-12.11	188A9000	11,0	Y8003J	97256	62
Albea / Siena 1.7 TD	178	1.7	51	4	02.06-12.12	176A3000	11,0	Y-924J	7906	1
Albea / Siena 1.9 D	178	1.9	46	4	11.00-	223A6000	11,0	Y-939J	5059	43

## BRAVA/ BRAVO (182)

Brava / Bravo 1.9 D	182	1.9	55	4	09.95-05.97	160A7000	11,0	Y-924J	7906	1
Brava / Bravo 1.9 JTD to Engine no. -->1716459	182	1.9	77	4	09.98-11.99	182B4000	11,0	Y-747U	4694	26
Brava / Bravo 1.9 JTD from Engine no. 1716460-->	182	1.9	77	4	12.99-09.00	182B4000	11,0	Y-534J	3413	36
Brava / Bravo 1.9 JTD	182	1.9	74	4	09.00-10.01	182B9000	11,0	Y-534J	3413	36
Brava / Bravo TD	182	1.9	55	4	04.96-11.99	182A8000	11,0	Y-928U	4389	29

## BRAVO (198)

Bravo 1.6 JTD Multijet	198	1.6	77	4	03.08-12.14	844A3000	4,4	Y9003AS	94251	78
Bravo 1.6 JTD Multijet	198	1.6	66	4	03.08-12.14	198A6000	4,4	Y9003AS	94251	78
Bravo 1.6 JTD Multijet	198	1.6	77	4	03.08-12.14	198A3000	4,4	Y9003AS	94251	78
Bravo 1.6 JTDM	198	1.6	88	4	03.08-12.14	198A2000	4,4	Y9003AS	94251	78
Bravo 1.6 JTDM	198	1.6	85	4	11.08-12.14	955A4000	4,4	Y9003AS	94251	78
Bravo 1.9 JTD	198	1.9	88	4	04.07-12.14	192A8000	11,0	Y1030J	90828	70
Bravo 1.9 JTD	198	1.9	66	4	04.07-12.08	192B5000	11,0	Y1030J	90828	70
Bravo 1.9 JTD	198	1.9	110	4	01.07-12.14	937A5000	11,0	YE07	6092	
Bravo 1.9 JTD Multijet	198	1.9	85	4	01.07-12.09	192A1000	11,0	Y-534J	3413	36
Bravo 1.9 JTD Multijet	198	1.9	85	4	04.07-12.09	192B4000/192A1000	11,0	Y1030J	90828	70
Bravo 2.0 JTDM	198	2.0	121	4	09.08-12.14	198A5000	4,4	Y9003AS	94251	78
Bravo 2.0 JTDM	198	2.0	120	4	09.08-12.14	844A2000	4,4	Y9003AS	94251	78



**FIAT****CROMA (154)**

Croma 1.9 TD	154	1.9	69	4	07.90- .98	154C6000;154D1000	11,0	Y-739R	6639	
Croma 1.9 Turbo D	154	1.9	66	4	03.88-06.90	154B	11,0	Y-739R	6639	
Croma 2.5 Td	154	2.5	85	4	02.89-12.92	814497200/2200	11,0	Y-924J	7906	1

**CROMA (194)**

Croma 1.9 MJTD	194	1.9	88	4	06.05-08.06	939A1000	11,0	Y-534J	3413	36
Croma 1.9 MJTD	194	1.9	88	4	09.06-12.11	939A1000	11,0	Y1030J	90828	70
Croma 1.9 MJTD	194	1.9	110	4	06.05-12.11	939A2000	11,0	YE07	6092	
Croma 1.9 MJTD	194	1.9	85	4	06.05-08.06	939A7000	11,0	Y-534J	3413	36
Croma 1.9 MJTD	194	1.9	85	4	09.06-12.11	939A7000	11,0	Y1030J	90828	70
Croma 1.9 MJTD	194	1.9	100	4	10.05-10.07	939A8000	11,0	YE07	6092	
Croma 2.4 MJTD	194	2.4	147	5	06.05-12.11	939A3000	11,0	YE07	6092	

**DOBLO (119)**

Doblò 1.3 JTD Multijet	119	1.3	51	4	11.03-12.05	188A9000	11,0	Y8003J	97256	62
Doblò 1.3 JTD Multijet	119	1.3	55	4	08.05-08.13	199A2000	11,0	Y8003J	97256	62
Doblò 1.3 JTD Multijet	119	1.3	62	4	11.05-07.09	223A9000	11,0	Y8003J	97256	62
Doblò 1.9 D	119	1.9	46	4	11.00-04.04	223A6000	11,0	Y-939J	5059	43
Doblò 1.9 JTD	119	1.9	74	4	10.01-06.03	182B9000	11,0	Y-534J	3413	36
Doblò 1.9 JTD	119	1.9	77	4	07.03-09.05	223A7000	11,0	Y-534J	3413	36
Doblò 1.9 JTD	119	1.9	77	4	07.03-09.05	223B1000	11,0	Y-534J	3413	36
Doblò 1.9 JTD	119	1.9	74	4	10.01-06.03	223B2000	11,0	Y-534J	3413	36
Doblò 1.9 JTD-/Multijet	119	1.9	88	4	10.05-07.09	186A9000	11,0	Y1030J	90828	70

**DOBLO (152)**

Doblò 1.3 JTD Multijet	152	1.3	66	4	02.10-	199A3000	4,3	Y9001AS	97719	72
Doblò 1.3 JTD Multijet	152	1.3	66	4	02.10-	263A2000	4,3	Y9001AS	97719	72
Doblò 1.6 JTD Multijet	152	1.6	66	4	02.10-	263A4000	4,4	Y9003AS	94251	78
Doblò 1.6 JTD Multijet/Multijet	152	1.6	77	4	02.10-	198A3000	4,4	Y9003AS	94251	78
Doblò 1.6 JTD Multijet/Multijet	152	1.6	74	4	02.10-	263A3000	4,4	Y9003AS	94251	78
Doblò 2.0 JTD Multijet	152	2.0	99	4	02.10-	263A1000	4,4	Y9003AS	94251	78

**DOBLO (263)**

Doblò 1.6	263	1.6	70	4	07.15-	263A7000	4,4	Y9003AS	94251	78
Doblò 1.6 Multijet	263	1.6	88	4	07.15-	940C1000	4,4	Y9003AS	94251	78

**DUCATO**

Ducato 1.9		1.9	52	4	06.90-05.94	149B1000	11,0	Y-924J	7906	1
Ducato 1.9 D		1.9	51	4	03.94-08.98	230A2000	11,0	Y-924J	7906	1
Ducato 1.9 TD		1.9	59	4	03.94-04.98	230A4000	11,0	Y-924J	7906	1
Ducato 1.9 TD		1.9	60	4	03.94-08.98	230A3000	11,0	Y-924J	7906	1
Ducato 1.9 TD		1.9	60	4	01.90-02.94	280A1000	11,0	Y-924J	7906	1
Ducato 2.0 D		2.0	52	4	02.87-	149B1000	11,0	Y-924J	7906	1
Ducato 2.0 TD		2.0	60	4	01.90-02.94	280A1000	11,0	Y-924J	7906	1
Ducato 2.0 JTD		2.0	62	4	07.01-04.02	RHV	11,0	Y-504J	1441	24
Ducato 2.0 Multijet		2.0	85	4	06.11-	250A1000	4,4	Y9003AS	94251	78
Ducato 2.2 Multijet		2.2	74	4	07.06-05.11	4HV	11,5	Y-548J	94832	75
Ducato 2.3 JTD		2.3	88	4	04.02-	F1AE0481C	11,0	Y8005J	96853	64
Ducato 2.3 JTD		2.3	88	4	04.02-	F1AE0481D	11,0	Y8005J	96853	64
Ducato 2.3 JTD		2.3	88	4	04.02-	F1AE0481N	11,0	Y8005J	96853	64
Ducato 2.3 Multijet		2.3	96	4	03.14-	F1AE3481D	11,0	Y8005J	96853	64
Ducato 2.3 Multijet		2.3	83	4	10.11-07.14	F1AE3481G	11,0	Y8005J	96853	64
Ducato 2.3 Multijet		2.3	109	4	06.11-	F1AE3481E	11,0	Y8005J	96853	64
Ducato 2.4 TD		2.4	68	4	01.86-02.94	814421220	11,0	Y-924J	7906	1



## FIAT

### DUCATO

Ducato 2.5D	2.5	53	4	01.86-02.94	814467	11,0	Y-924J	7906	1
Ducato 2.5 D	2.5	55	4	01.86-02.94	814467220	11,0	Y-924J	7906	1
Ducato 2.5 JTD	2.5	70	4	06.90-05.94	814027	11,0	Y-924J	7906	1
Ducato 2.5 TD	2.5	62	4	03.94-04.98	8140672200	11,5	Y-910J	3617	3
Ducato 2.8	2.8	64	4	05.98-09.01	814063	11,0	Y-502R	3852	
Ducato 3.0 Multijet	3.0	115	4	07.06-	F1CE0481D	11,0	Y8005J	96853	64
Ducato 3.0 Multijet	3.0	107	4	04.10-07.14	F1CE3481N	11,0	Y8005J	96853	64
Ducato 3.0 Multijet	3.0	130	4	06.11-	F1CE3481E	11,0	Y8005J	96853	64

### EGEA

Egea 1.3 Multijet	356	1.3	70	4	10.15-	330A1000	4,3	Y9001AS	97719	72
Egea 1.6 Multijet	356	1.6	88	4	10.15-	955A3000	4,4	Y9003AS	94251	78

### FIORINO

Fiorino 1.3 D	1.3	33	4	06.90-08.93	146B1000	11,0	Y-924J	7906	1
Fiorino 1.3 JTD Multijet	1.3	70	4	07.09-	199B1000	4,3	Y9001AS	97719	72
Fiorino 1.3 JTD Multijet EURO IV	1.3	55	4	02.08-	199A2000	11,0	Y8003J	97256	62
Fiorino 1.3 JTD Multijet EURO V	1.3	55	4	05.05-08.13	199A2000	4,3	Y9001AS	97719	72
Fiorino 1.7	1.7	44	4	10.93-10.99	146B2000	11,0	Y-924J	7906	1
Fiorino 1.7 D	1.7	43	4	12.87-	149B3000	11,0	Y-924J	7906	1
Fiorino 1.7 D	1.7	42	4	01.88-	149B4046	11,0	Y-924J	7906	1
Fiorino 1.7 Pick Up	1.7	42	4	10.93-12.99	146B2000	11,0	Y-924J	7906	1
Fiorino 1.7 TD	1.7	46	4	11.96-05.01	146D7000	11,0	Y-924J	7906	1

### FREEMONT

Freemont 2.0 JTDM	JC	2.0	120	4	08.11-	940A4000	4,4	Y9003AS	94251	78
Freemont 2.0 JTDM	JC	2.0	125	4	08.11-	940A4000/939B5000	4,4	Y9003AS	94251	78
Freemont 2.0 JTDM	JC	2.0	100	4	08.11-	940A5000	4,4	Y9003AS	94251	78
Freemont 2.0 JTDM	JC	2.0	103	4	08.11-	940A5000	4,4	Y9003AS	94251	78

### GRANDE PUNTO (199)

Grande Punto 1.3 JTD Multijet	199	1.3	55	4	09.05-	199A2000	11,0	Y8003J	97256	62
Grande Punto 1.3 JTD Multijet	199	1.3	66	4	12.05-08.10	199A3000	11,0	Y8003J	97256	62
Grande Punto 1.3 JTD Multijet	199	1.3	51	4	07.08-02.12	199B2000	11,0	Y8003J	97256	62
Grande Punto 1.3 JTD Multijet	199	1.3	62	4	04.10-12.12	199B4000	4,3	Y9001AS	97719	72
Grande Punto 1.3 JTD Multijet	199	1.3	62	4	04.10-12.12	223A9000	11,0	Y8003J	97256	62
Grande Punto 1.6 Multijet	199	1.6	88	4	01.08-12.09	955A3000	4,4	Y9003AS	94251	78
Grande Punto 1.9 JTD	199	1.9	96	4	10.05-12.12	199A5000	11,0	Y1030J	90828	70
Grande Punto 1.9 JTD	199	1.9	88	4	10.05-07.12	939A1000	11,0	Y1030J	90828	70
Grande Punto 1.9 JTD	199	1.9	85	4	06.06-12.12	939A7000	11,0	Y1030J	90828	70

### IDEA (350)

Idea 1.3 JTD	350	1.3	51	4	06.03-12.11	188A9000	11,0	Y8003J	97256	62
Idea 1.3 JTD Multijet	350	1.3	66	4	04.05-12.10	199A3000	11,0	Y8003J	97256	62
Idea 1.3 JTD Multijet EURO V	350	1.3	68	4	04.09-12.12	199B1000	4,3	Y9001AS	97719	72
Idea 1.6 MJTD	350	1.6	88	4	07.08-12.12	350A2000	4,4	Y9003AS	94251	78
Idea 1.9 JTD	350	1.9	74	4	10.03-12.10	188B2000	11,0	Y-534J	3413	36

### LINEA (323)

Linea 1.3 JTD Multijet	323	1.3	70	4	09.09-	199A3000	4,3	Y9001AS	97719	72
Linea 1.6 JTD Multijet	323	1.6	77	4	06.09-	198A3000	4,4	Y9003AS	94251	78



l kW C y i  
0201



Stock-No  
D-POWER™

**FIAT**

**MAREA**

Marea 1.9 JTD to Eng. no. 1713819	185	1.9	77	4	04.99-11.99	182B4000	11,0	Y-747U	4694	26
Marea 1.9 JTD from Eng. no. 1713820	185	1.9	77	4	12.99-01.01	182B4000	11,0	Y-534J	3413	36
Marea 1.9 JTD	185	1.9	81	4	03.99-08.02	186A6000	11,0	Y-534J	3413	36
Marea 1.9 S.W. / Weekend JTD	185	1.9	74	4	08.96-06.03	182B9000	11,0	Y-534J	3413	36
Marea 1.9 TD	185	1.9	55	4	09.96-12.00	182A8000	11,0	Y-928U	4389	29
Marea 1.9 TD/JTD	185	1.9	74	4	09.96-12.00	182A7000	11,0	Y-928U	4389	29
Marea 2.4 JTD	185	2.4	91	5	09.96-12.00	185A2000	11,0	Y-928U	4389	29
Marea 2.4 JTD to Eng. no. 1713819	185	2.4	100	5	03.99-11.99	185A6000	11,0	Y-747U	4694	26
Marea 2.4 JTD from Eng. no. 1713820	185	2.4	100	5	12.99-09.02	185A6000	11,0	Y-534J	3413	36

**MARENGO**

Marengo 1.9 D	185	1.9	48	4	01.92-	160A7000	11,0	Y-924J	7906	1
Marengo 1.9 JTD to Eng. no. 1713819	185	1.9	77	4	04.99-11.99	182B4000	11,0	Y-747U	4694	26
Marengo 1.9 JTD from Eng. no. 1713820	185	1.9	77	4	12.99-01.01	182B4000	11,0	Y-534J	3413	36
Marengo 1.9 JTD	185	1.9	81	4	03.99-08.02	186A6000	11,0	Y-534J	3413	36
Marengo 1.9 TD	185	1.9	66	4	01.92-	160A6000	11,0	Y-924J	7906	1

**MULTIPLA**

Multipla 1.9 JTD to Eng. no. 1692991	186	1.9	77	4	11.98-11.99	182B4000	11,0	Y-747U	4694	26
Multipla 1.9 JTD from Eng. no.1692992	186	1.9	77	4	12.99-02.01	182B4000	11,0	Y-534J	3413	36
Multipla 1.9 JTD	186	1.9	81	4	02.01-07.02	186A6000	11,0	Y-534J	3413	36
Multipla 1.9 JTD	186	1.9	88	4	04.02-06.10	186A9000	11,0	Y1030J	90828	70
Multipla 1.9 JTD EURO III	186	1.9	85	4	07.02-09.05	186A8000	11,0	Y-534J	3413	36
Multipla 1.9 JTD EURO IV	186	1.9	85	4	10.03-12.10	186A8000	11,0	Y1030J	90828	70

**PALIO**

Palio 1.7 TD	178	1.7	51	4	07.96-12.09	176A3000	11,0	Y-924J	7906	1
Palio 1.7 TD	178	1.7	53	4	09.01-01.12	176A5000	11,0	Y8003J	97256	62
Palio 1.9 D	178	1.9	46	4	03.98-08.02	223A6000	11,0	Y-939J	5059	43

**PANDA (169)**

Panda / Panda 4x4 1.3 JTD Multijet	169	1.3	51	4	09.03-12.12	188A8000	11,0	Y8003J	97256	62
Panda 1.3 JTD Multijet	169	1.3	51	4	12.03-12.12	188A8000	11,0	Y8003J	97256	62
Panda 1.3 JTD Multijet	169	1.3	51	4	08.04-12.12	188A8000	11,0	Y8003J	97256	62
Panda 1.3 JTD Multijet	169	1.3	55	4	06.06-12.12	169A5000	11,0	Y8003J	97256	62
Panda 1.3 JTD Multijet	169	1.3	51	4	09.03-12.12	188A9000	11,0	Y8003J	97256	62
Panda 1.3 JTD Multijet 4x4	169	1.3	55	4	01.06-12.09	169A1000	11,0	Y8003J	97256	62
Panda 1.3 JTD Multijet 4x4	169	1.3	55	4	01.10-12.12	169A1000	4,3	Y9001AS	97719	72

**PANDA (312)**

Panda 1.3 JTD Multijet	312	1.3	59	4	06.14-	312A8000	4,3	Y9001AS	97719	72
Panda 1.3 JTD Multijet	312	1.3	70	4	04.15-	312B1000	4,3	Y9001AS	97719	72
Panda 1.3 JTD Multijet	312	1.3	70	4	04.15-	330A1000	4,3	Y9001AS	97719	72
Panda 1.3 JTD Multijet	312	1.3	55	4	01.12-	169A1000/169A9000	4,3	Y9001AS	97719	72
Panda 1.3 JTD Multijet 4x4	312	1.3	55	4	06.12-	199A9000	4,3	Y9001AS	97719	72

**PRATICO (263)**

Pratico 1.3 JTD Multijet	263	1.6	77	4	02.10-	198A3000	4,3	Y9003AS	94251	78
Pratico 1.3 JTD Multijet	263	2.0	99	4	02.10-	263A1000	4,3	Y9003AS	94251	78

**PUNTO (176)**

Punto 1 1.7 D	176	1.7	42	4	11.94-09.97	176B3000	11,0	Y-924J	7906	1
Punto 1 1.7 TD	176	1.7	51	4	06.93-09.96	176A3000	11,0	Y-924J	7906	1
Punto 1 1.7 TD	176	1.7	52	4	10.96-12.99	176A5000	11,0	Y-924J	7906	1



l kW C  
y i **0201**



Stock-No  
D-POWER

## FIAT

### PUNTO (188)

Punto 2 1.3 JTD Multijet	188	1.3	51	4	12.03-10.09	188A9000	11,0	Y8003J	97256	62
Punto 2 1.9 D	188	1.9	44	4	09.99-10.03	188A3000	11,0	Y-939J	5059	43
Punto 2 1.9 JTD	188	1.9	59	4	10.99-12.00	188A2000	11,0	Y-534J	3413	36
Punto 2 1.9 JTD	188	1.9	63	4	01.01-06.03	188A7000	11,0	Y-534J	3413	36
Punto 2 1.9 JTD	188	1.9	63	4	07.03-10.05	188A7000	11,0	Y1030J	90828	70
Punto 2 1.9 MJTD	188	1.9	74	4	07.03-06.05	188B2000	11,0	Y1030J	90828	70

### PUNTO (199)

Punto 3 1.3 JTD Multijet	199	1.3	59	4	12.13-	199B8000	4,3	Y9001AS	97719	72
Punto 3 1.3 JTD Multijet EURO IV	199	1.3	55	4	03.12-	199A2000	11,0	Y8003J	97256	62
Punto 3 1.3 JTD Multijet EURO IV	199	1.3	55	4	03.12-	199A9000	11,0	Y8003J	97256	62
Punto 3 1.3 JTD Multijet EURO IV	199	1.3	70	4	03.12-	199B1000	11,0	Y8003J	97256	62
Punto 3 1.3 JTD Multijet EURO IV	199	1.3	62	4	03.12-	199B4000	11,0	Y8003J	97256	62
Punto 3 1.3 JTD Multijet EURO V	199	1.3	55	4	03.12-	199A2000/199A9000	4,3	Y9001AS	97719	72
Punto 3 1.3 JTD Multijet EURO V	199	1.3	70	4	03.12-	199B1000	4,3	Y9001AS	97719	72
Punto 3 1.3 JTD Multijet EURO V	199	1.3	62	4	03.12-	199B4000	4,3	Y9001AS	97719	72
Punto 3 1.6 Multijet	199	1.6	88	4	01.08-12.09	955A3000	4,4	Y9003AS	94251	78

### PUNTO EVO (199)

Punto EVO 1.3 JTD Multijet	199	1.3	66	4	06.09-02.12	199A3000	11,0	Y8003J	97256	62
Punto EVO 1.3 JTD Multijet	199	1.3	70	4	06.09-02.12	199B1000	4,3	Y9001AS	97719	72
Punto EVO 1.3 JTD Multijet	199	1.3	51	4	10.09-02.12	199B2000	4,3	Y9001AS	97719	72
Punto EVO 1.3 JTD Multijet	199	1.3	62	4	10.09-02.12	199B4000	4,3	Y9001AS	97719	72
Punto EVO 1.3 JTD Multijet	199	1.3	62	4	10.09-02.12	223A9000	4,3	Y9001AS	97719	72
Punto EVO 1.3 JTD Multijet EURO IV	199	1.3	55	4	06.09-02.12	199A2000	11,0	Y8003J	97256	62
Punto EVO 1.3 JTD Multijet EURO V	199	1.3	55	4	06.09-02.12	199A9000	4,3	Y9001AS	97719	72
Punto EVO 1.6 Multijet	199	1.6	88	4	09.09-02.12	955A3000	4,4	Y9003AS	94251	78

### QUBO

Qubo 1.3 JTD Multijet	225	1.3	70	4	11.09-	199B1000	4,3	Y9001AS	97719	72
Qubo 1.3 JTD Multijet EURO IV	225	1.3	55	4	09.08-	199A2000	11,0	Y8003J	97256	62
Qubo 1.3 JTD Multijet EURO V	225	1.3	55	4	09.08-	199A2000	4,3	Y9001AS	97719	72

### SCUDO

Scudo 1.9		1.9	51	4	09.98-10.06	DW8	11,0	Y-503J	1009	10
Scudo 1.9		1.9		4	09.98-10.06	WJY	11,0	Y-503J	1009	10
Scudo 1.9 D		1.9	51	4	03.96-07.98	D9B	11,0	Y-924J	7906	1
Scudo 1.9 TD		1.9	68	4	03.96-10.06	D8B	11,0	Y-924J	7906	1
Scudo 2.0		2.0	88	4	11.06-	RHG	11,0	Y1005J	7957	56
Scudo 2.0 JTD		2.0	81	4	05.99-05.03	RHM	11,0	Y-504J	1441	24
Scudo 2.0 JTD		2.0	81	4	06.03-12.06	RHM	11,0	Y1005J	7957	56
Scudo 2.0 JTD		2.0	81	4	05.99-05.03	RHW	11,0	Y-504J	1441	24
Scudo 2.0 JTD		2.0	81	4	06.03-12.06	RHW	11,0	Y1005J	7957	56
Scudo 2.0 JTD		2.0	80	4	12.99-12.06	RHZ	11,0	Y-504J	1441	24
Scudo 2.0 JTD		2.0	69	4	09.99-10.06	RHX	11,0	Y-504J	1441	24
Scudo 2.0 Multijet		2.0	94	4	05.11-	RH02	11,0	Y1005J	7957	56
Scudo 2.0 Multijet		2.0	120	4	07.10-	RHH	11,0	Y1005J	7957	56
Scudo 2.0 Multijet		2.0	88	4	11.06-	RHK	11,0	Y1005J	7957	56
Scudo 2.0 Multijet		2.0	100	4	11.06-	RHR	11,0	Y1005J	7957	56

### SEDICI

Sedici 1.9 JTD	189	1.9	88	4	01.06-	D19AA	11,0	Y-534J	3413	36
Sedici 2.0 MJTD	189	2.0	99	4	09.09-	D20AA	4,4	Y9003AS	94251	78



l kW C y i 0201



Stock-No  
D-POWER™

**FIAT**

**STILO**

Stilo 1.9 JTD	192	1.9	85	4	10.01-12.07	192A1000	11,0	Y-534J	3413	36
Stilo 1.9 JTD	192	1.9	59	4	09.01-08.04	192A3000	11,0	Y-534J	3413	36
Stilo 1.9 JTD	192	1.9	103	4	01.04-09.05	192A5000	11,0	YE07	6092	
Stilo 1.9 JTD	192	1.9	88	4	09.05-08.08	192A8000	11,0	Y1030J	90828	70
Stilo 1.9 JTD	192	1.9	74	4	09.04-07.05	192A9000	11,0	Y-534J	3413	36
Stilo 1.9 JTD	192	1.9	100	4	04.04-11.06	192B1000	11,0	YE07	6092	
Stilo 1.9 JTD	192	1.9	66	4	09.04-12.10	192B5000	11,0	Y1030J	90828	70
Stilo 1.9 JTD	192	1.9	93	4	09.03-11.06	937A4000	11,0	YE07	6092	
Stilo 1.9 JTD	192	1.9	110	4	09.05-08.08	937A5000	11,0	YE07	6092	
Stilo 1.9 JTD	192	1.9	85	4	07.05-12.07	937A7000	11,0	Y1030J	90828	70

**STRADA**

Strada 1.3 Multijet	178	1.3	63	4	05.06-	223A9000	11,0	Y8003J	97256	62
Strada 1.3 Multijet	278	1.3	70	4	10.10-	199B1000	4,3	Y9001AS	97719	72
Strada 1.7 TDs	178	1.7	51	4	06.99-	176A3000	11,0	Y-924J	7906	1
Strada 1.9 D	178	1.9	46	4	12.00-03.03	223A6000	11,0	Y-939J	5059	43
Strada 1.9 JTD	178	1.9	59	4	04.03-06.05	188A2000	11,0	Y-534J	3413	36

**TALENTO**

Talento 1.9 D		1.9	51	4	03.88-	149B1000	11,0	Y-924J	7906	1
---------------	--	-----	----	---	--------	----------	------	--------	------	---

**TEMPRA**

Tempra 1.9 TD	159	1.9	59	4	07.90-07.96	160B6046	11,0	Y-924J	7906	1
Tempra 1.9 TD	159	1.9	68	4	06.93-09.96	160D1000	11,0	Y-924J	7906	1
Tempra 1.9 TD	159	1.9	59	4	05.92-07.96	160B6046	11,0	Y-924J	7906	1
Tempra 1.9 TD /SW	159	1.9	66	4	02.90-07.96	160A6000	11,0	Y-924J	7906	1
Tempra 1.9 TD /SW	159	1.9	48	4	02.90-06.96	160A7000	11,0	Y-924J	7906	1

**TIPO**

Tipo 1.6 Multijet	356	1.6	88	4	01.16-	955A3000	4,4	Y9003AS	94251	78
Tipo 1.7 D	160	1.7	42	4	07.87-03.93	149B4000	11,0	Y-924J	7906	1
Tipo 1.9 D	160	1.9	48	4	07.89-03.93	149A1000	11,0	Y-924J	7906	1
Tipo 1.9 TD	160	1.9	68	4	07.87-03.93	149A1000	11,0	Y-924J	7906	1
Tipo 1.9 TD	160	1.9	66	4	07.87-	160D1000	11,0	Y-924J	7906	1

**ULYSSE**

Ulysse 1.9 TD	220	1.9	68	4	05.97-12.99	D8B	11,0	Y-924J	7906	1
Ulysse 2.0 JTD	179	2.0	80	4	09.02-	DW10ATED4/RHT	11,0	Y-504J	1441	24
Ulysse 2.0 JTD	179	2.0	80	4	06.03-08.06	RHM	11,0	Y1005J	7957	56
Ulysse 2.0 JTD	179	2.0	79	4	06.03-08.06	RHM(DW10ATED4)	11,0	Y1005J	7957	56
Ulysse 2.0 JTD VIN to 9666	179	2.0	80	4	09.02-05.03	RHW(DW10ATED4)	11,0	Y-504J	1441	24
Ulysse 2.0 JTD VIN from 9667	179	2.0	80	4	06.03-11.06	RHW(DW10ATED4)	11,0	Y1005J	7957	56
Ulysse 2.0 Multijet	179	2.0	88	4	05.06-03.10	RHK	11,0	Y1005J	7957	56
Ulysse 2.0 Multijet	179	2.0	100	4	05.06-	RHR	11,0	Y1005J	7957	56
Ulysse 2.2 JTD	179	2.2	96	4	06.02-07.07	4H01	11,0	Y1005J	7957	56
Ulysse 2.2 JTD	179	2.2	120	4	03.08-03.10	4HP	11,0	YE08	4966	
Ulysse 2.2 JTD	179	2.2	120	4	03.08-03.10	4HR	11,0	YE08	4966	
Ulysse 2.2 JTD	179	2.2	125	4	02.08-03.10	4HT/DW12BTED4	11,0	YE08	4966	
Ulysse 2.2 JTD VIN to 9666	179	2.2	94	4	09.02-05.03	4HW(DW12ATED4)	11,0	Y-504J	1441	24
Ulysse 2.2 JTD VIN from 9667	179	2.2	94	4	06.03- .06	4HW(DW12ATED4)	11,0	Y1005J	7957	56

**UNO**

Uno 60 TD		1.4	51	4	03.86-09.92	146B	11,0	Y-924J	7906	1
Uno 60 D		1.7	40	4	09.89-09.92	146B2000	11,0	Y-924J	7906	1
Uno 70 TD		1.4	51	4	03.86-08.89	146A653,146B	11,0	Y-924J	7906	1



l kW C y i **0201**



Stock-No  
D-POWER

**FIAT**

**UNO**

Uno D Van		1.7	42	4	09.89-03.96	146B2000		11,0	Y-924J	7906	1
Uno TD		1.4	52	4	09.89-12.95	146B3000		11,0	Y-924J	7906	1

**FORD**

**B-MAX**

B-Max 1.5 TDCi	JK	1.5	55	4	10.12-	UGJC		5,0	Y8001AS	8904	58
B-Max 1.6 TDCi	JK	1.6	70	4	10.12-	T3JB		5,0	Y8001AS	8904	58

**C-MAX**

C-Max '11 1.6 TDCi Norm EU V	BJ	1.6	70	4	12.10-	T3DA / T3DB		5,0	Y8001AS	8904	58
C-Max '11 1.6 TDCi Norm EU V	BJ	1.6	85	4	12.10-	T1DA / T1DB		5,0	Y8001AS	8904	58
C-Max '11 2.0 TDCi Norm EU V	BJ	2.0	120	4	12.10-	TXDB		5,0	Y8001AS	8904	58
C-Max '11 2.0 TDCi Norm EU V	BJ	2.0	85	4	02.11-	TYDA		5,0	Y8001AS	8904	58
C-Max '11 2.0 TDCi Norm EU V	BJ	2.0	100	4	02.11-	UKDB		5,0	Y8001AS	8904	58
C-Max '11 2.0 TDCi Norm EU V	BJ	2.0	103	4	02.11-	UFDB		5,0	Y8001AS	8904	58

**COURIER**

Courier 11.8 D		1.8	66	4	03.93-			11,5	Y-910J	3617	3
----------------	--	-----	----	---	--------	--	--	------	--------	------	---

**ESCORT '86**

Escort '86 1.6 D		1.6	40	4	01.86-07.90	LTC		11,5	Y-907R	4479	
Escort '86 1.8 D		1.8	44	4	01.86-07.90	RTA		11,5	Y-910J	3617	3
Escort '86 1.8 D		1.8	44	4	01.86-07.90	RTB		11,5	Y-910J	3617	3

**ESCORT '91**

Escort '91 1.8 D		1.8	44	4	08.90-09.01	RTE		11,5	Y-910J	3617	3
Escort '91 1.8 D		1.8	44	4	08.90-09.01	RTF		11,5	Y-910J	3617	3
Escort '91 1.8 D		1.8	44	4	08.90-09.01	RTH		11,5	Y-910J	3617	3
Escort '91 1.8 D		1.8	51	4	08.90-09.01	RVA Endura-DE (TC)		10,0	Y-937J	6792	5
Escort '91 1.8 TD		1.8	66	4	08.90-09.01	RFD		11,5	Y-910J	3617	3
Escort '91 1.8 TD		1.8	66	4	08.90-09.01	RFK		11,5	Y-910J	3617	3
Escort '91 1.8 TD		1.8	66	4	08.90-09.01	RFS Endura-DE (TC)		10,0	Y-937J	6792	5

**FIESTA '89**

Fiesta '89 1.8 D	GFJ	1.8	44	4	03.89-06.96	RTC D		11,5	Y-910J	3617	3
Fiesta '89 1.8 D	GFJ	1.8	44	4	03.89-06.96	RTD D		11,5	Y-910J	3617	3
Fiesta '89 1.8 D	GFJ	1.8	44	4	03.89-06.96	RTG D		11,5	Y-910J	3617	3

**FIESTA '96**

Fiesta '96 1.8 D	JA / JB	1.8	44	4	11.95-02.02	RTJ		10,0	Y-937J	6792	5
Fiesta '96 1.8 D	JA / JB	1.8	44	4	11.95-02.02	RTK		10,0	Y-937J	6792	5
Fiesta '96 1.8 DI	JA / JB	1.8	55	4	11.95-02.02	RTN		10,0	Y-524J	4520	27
Fiesta '96 1.8 DI	JA / JB	1.8	55	4	11.95-02.02	RTP		10,0	Y-524J	4520	27
Fiesta '96 1.8 DI	JA / JB	1.8	55	4	11.95-02.02	RTQ		10,0	Y-524J	4520	27

**FIESTA '01**

Fiesta '01 1.4 TDCi	JH / JD	1.4	50	4	11.01-12.04	F6JA DuraTorq-TDCi		11,0	YE04	1684	40
Fiesta '01 1.4 TDCi	JH / JD	1.4	50	4	11.01-12.04	F6JB DuraTorq-TDCi		11,0	YE04	1684	40
Fiesta '01 1.4 TDCi	JH / JD	1.4	50	4	01.05-	F6JA DuraTorq-TDCi		11,0	YE04	1684	40
Fiesta '01 1.4 TDCi	JH / JD	1.4	50	4	01.05-	F6JB DuraTorq-TDCi		11,0	YE04	1684	40
Fiesta '01 1.6 TDCi	JH / JD	1.6	66	4	03.05-	HHJA DuraTorq-TDCi		11,0	YE04	1684	40
Fiesta '01 1.6 TDCi	JH / JD	1.6	66	4	03.05-	HHJB DuraTorq-TDCi		11,0	YE04	1684	40

**FORD****FIESTA '08**

Fiesta '08 1.4 TDCi	JDG / JDJ	1.4	50	4	08.08-	F6JB	11,0	YE05	91322	73
Fiesta '08 1.4 TDCi	JDG / JDJ	1.4	51	4	07.10-	F6JD / KVJA	11,0	YE05	91322	73
Fiesta '08 1.5 TDCi		1.5	55	4	09.12-	UGJC	5,0	Y8001AS	8904	58
Fiesta '08 1.6 TDCi	JDG / JDJ	1.6	55	4	08.08-	HHJF / UBJA	11,0	YE05	91322	73
Fiesta '08 1.6 TDCi	JDG / JDJ	1.6	66	4	08.08-	HHJC / HHJD	11,0	YE05	91322	73
Fiesta '08 1.6 TDCi Norm EU V	JDG / JDJ	1.6	70	4	03.10-	TZJA / TZJB	5,0	Y8001AS	8904	58

**FOCUS '98**

Focus '98 1.8 DI	DAW / DBW	1.8	55	4	08.98-12.04	BHDA Endura-DI	10,0	Y-524J	4520	27
Focus '98 1.8 DI	DAW / DBW	1.8	55	4	08.98-12.04	BHDB Endura-DI	10,0	Y-524J	4520	27
Focus '98 1.8 Turbo DI	DAW / DBW	1.8	66	4	08.98-12.04	C9DA Endura-DI	10,0	Y-524J	4520	27
Focus '98 1.8 Turbo DI	DAW / DBW	1.8	66	4	08.98-12.04	C9DB Endura-DI	10,0	Y-524J	4520	27
Focus '98 1.8 Turbo DI	DAW / DBW	1.8	66	4	08.98-12.04	C9DC Endura-DI	10,0	Y-524J	4520	27
Focus '98 1.8 16V	DAW / DBW	1.8	74	4	08.98-12.04	FFDA DuraTorq-TDCi	10,0	Y-524J	4520	27
Focus '98 1.8 TDCi	DAW / DBW	1.8	85	4	08.98-12.04	F9DB DuraTorq-TDCi	10,0	Y-524J	4520	27
Focus '98 1.8 TDCi	DAW / DBW	1.8	85	4	08.98-12.04	F9DA DuraTorq-TDCi	10,0	Y-524J	4520	27

**FOCUS '02**

Focus / C-Max 1.6 TDCi	DAW / DBW	1.6	66	4	06.03-	HHDA DuraTorq-TDCi	11,0	YE04	1684	40
Focus / C-Max 1.6 TDCi	DAW / DBW	1.6	66	4	06.03-	HHDB DuraTorq-TDCi	11,0	YE04	1684	40
Focus / C-Max 1.6 TDCi	DAW / DBW	1.6	80	4	06.03-	G8DA DuraTorq-TDCi	11,0	YE04	1684	40
Focus / C-Max 1.6 TDCi	DAW / DBW	1.6	80	4	06.03-	G8DB DuraTorq-TDCi	11,0	YE04	1684	40
Focus / C-Max 2.0 TDCi	DAW / DBW	2.0	98	4	06.03-	G6DC DuraTorq-TDCi	11,0	Y1005J	7957	56
Focus / C-Max 2.0 TDCi	DAW / DBW	2.0	98	4	06.03-	G6DE DuraTorq-TDCi	11,0	Y1005J	7957	56
Focus / C-Max 2.0 TDCi	DAW / DBW	2.0	98	4	06.03-	G6DF DuraTorq-TDCi	11,0	Y1005J	7957	56
Focus / C-Max 2.0 TDCi	DAW / DBW	2.0	100	4	06.03-	G6DA	11,0	Y1005J	7957	56
Focus / C-Max 2.0 TDCi	DAW / DBW	2.0	100	4	06.03-	G6DB	11,0	Y1005J	7957	56

**FOCUS '02**

Focus / C-Max 2.0 TDCi	DAW / DBW	2.0	100	4	06.03-	G6DD	11,0	Y1005J	7957	56
------------------------	-----------	-----	-----	---	--------	------	------	--------	------	----

**FOCUS '04**

Focus '04 1.6 TDCi	DA / DAW	1.6	66	4	07.04-	HHDA DuraTorq-TDCi	11,0	YE04	1684	40
Focus '04 1.6 TDCi	DA / DAW	1.6	66	4	07.04-	HHDB DuraTorq-TDCi	11,0	YE04	1684	40
Focus '04 1.6 TDCi	DA / DAW	1.6	80	4	07.04-	G8DA DuraTorq-TDCi	11,0	YE04	1684	40
Focus '04 1.6 TDCi	DA / DAW	1.6	80	4	07.04-	G8DB DuraTorq-TDCi	11,0	YE04	1684	40
Focus '04 1.8 TDCi	DA / DAW	1.8	85	4	07.04-	KKDA / KKDB	10,0	Y-524J	4520	27
Focus '04 2.0 TDCi	DA / DAW	2.0	81	4	02.08-	IXDA	11,0	Y1005J	7957	56
Focus '04 2.0 TDCi	DA / DAW	2.0	98	4	07.04-	G6DC DuraTorq-TDCi	11,0	Y1005J	7957	56
Focus '04 2.0 TDCi	DA / DAW	2.0	98	4	07.04-	G6DE DuraTorq-TDCi	11,0	Y1005J	7957	56
Focus '04 2.0 TDCi	DA / DAW	2.0	98	4	07.04-	G6DF DuraTorq-TDCi	11,0	Y1005J	7957	56
Focus '04 2.0 TDCi	DA / DAW	2.0	100	4	07.04-	G6DA	11,0	Y1005J	7957	56
Focus '04 2.0 TDCi	DA / DAW	2.0	100	4	07.04-	G6DB	11,0	Y1005J	7957	56
Focus '04 2.0 TDCi	DA / DAW	2.0	100	4	07.04-	G6DD	11,0	Y1005J	7957	56

**FOCUS '11**

Focus '11 1.6 TDCi Norm EU V	DYM	1.6	70	4	04.11-	T3DA / T3DB	5,0	Y8001AS	8904	58
Focus '11 1.6 TDCi Norm EU V	DYM	1.6	85	4	04.11-	T1DA / T1DB	5,0	Y8001AS	8904	58
Focus '11 2.0 TDCi Norm EU V	DYM	2.0	85	4	04.11-	TYDA	5,0	Y8001AS	8904	58
Focus '11 2.0 TDCi Norm EU V	DYM	2.0	100	4	04.11-	UKDB	5,0	Y8001AS	8904	58
Focus '11 2.0 TDCi Norm EU V	DYM	2.0	103	4	04.11-	UFDB	5,0	Y8001AS	8904	58
Focus '11 2.0 TDCi Norm EU V	DYM	2.0	120	4	04.11-	TXDB	5,0	Y8001AS	8904	58

**FORD****FOCUS C-MAX '11**

Focus C-Max '11 1.6 TDCi Norm EU V	BJ	1.6	70	4	12.10-	T3DA / T3DB	5,0	Y8001AS	8904	58
Focus C-Max '11 1.6 TDCi Norm EU V	BJ	1.6	85	4	12.10-	T1DA / T1DB	5,0	Y8001AS	8904	58
Focus C-Max '11 2.0 TDCi Norm EU V	BJ	2.0	85	4	02.11-	TYDA	5,0	Y8001AS	8904	58
Focus C-Max '11 2.0 TDCi Norm EU V	BJ	2.0	100	4	02.11-	UKDB	5,0	Y8001AS	8904	58
Focus C-Max '11 2.0 TDCi Norm EU V	BJ	2.0	103	4	02.11-	UFDA	5,0	Y8001AS	8904	58
Focus C-Max '11 2.0 TDCi Norm EU V	BJ	2.0	120	4	12.10-	TXDB	5,0	Y8001AS	8904	58

**FUSION**

Fusion 1.4 TDCi	JU	1.4	50	4	06.02-12.04	F6JA DuraTorq-TDCi	11,0	YE04	1684	40
Fusion 1.4 TDCi	JU	1.4	50	4	06.02-12.04	F6JB DuraTorq-TDCi	11,0	YE04	1684	40
Fusion 1.4 TDCi	JU	1.4	50	4	01.05-	F6JA DuraTorq-TDCi	11,0	YE04	1684	40
Fusion 1.4 TDCi	JU	1.4	50	4	01.05-	F6JB DuraTorq-TDCi	11,0	YE04	1684	40
Fusion 1.6 TDCi	JU	1.6	66	4	06.02-	HHJA DuraTorq-TDCi	11,0	YE04	1684	40
Fusion 1.6 TDCi	JU	1.6	66	4	06.02-	HHJB DuraTorq-TDCi	11,0	YE04	1684	40

**GALAXY '95**

Galaxy 1.9 TDI	WGR	1.9	66	4	02.95-02.96	1Z	12,0	Y-732J	5605	4
Galaxy 1.9 TDI	WGR	1.9	66	4	02.95-03.00	ANU	12,0	Y-732J	5605	4
Galaxy 1.9 TDI	WGR	1.9	66	4	03.96-03.00	1Z	12,0	Y-732J	5605	4
Galaxy 1.9 TDI	WGR	1.9	66	4	09.96-03.00	AHU	12,0	Y-732J	5605	4
Galaxy 1.9 TDI	WGR	1.9	81	4	02.95-08.99	AFN	12,0	Y-732J	5605	4
Galaxy 1.9 TDI	WGR	1.9	81	4	09.99-03.00	AVG	12,0	Y-732J	5605	4
Galaxy 1.9 TDI	WGR	1.9	81	4	02.95-08.99	ANF	12,0	Y-732J	5605	4
Galaxy 1.9 TDI	WGR	1.9		4	06.95-	AJM	12,0	Y-732J	5605	4

**GALAXY 2000**

Galaxy 1.9 TDI	WGR	1.9	66	4	04.00-02.06	ANU	12,0	Y-732J	5605	4
Galaxy 1.9 TDI	WGR	1.9	85	4	04.00-02.06	AUY	12,0	Y-732J	5605	4
Galaxy 1.9 TDI	WGR	1.9	96	4	04.00-02.06	ASZ	12,0	Y-732J	5605	4
Galaxy 1.9 TDI	WGR	1.9	110	4	04.00-02.06	BTB	12,0	Y-732J	5605	4

**GALAXY '06**

Galaxy '06 1.6 TDCi Norm EU V	WM	1.6	85	4	02.11-	T1WA / T1WB	5,0	Y8001AS	8904	58
Galaxy '06 1.8 TDCi	WM	1.8	74	4	05.06-	FFWA	10,0	Y-524J	4520	27
Galaxy '06 2.0 TDCi	WM	2.0	85	4	11.07-	KLWA	11,0	Y1005J	7957	56
Galaxy '06 2.0 TDCi	WM	2.0	85	4	11.07-	TYWA	5,0	Y8001AS	8904	58
Galaxy '06 2.0 TDCi	WM	2.0	96	4	05.06-	AZWA	11,0	Y1005J	7957	56
Galaxy '06 2.0 TDCi	WM	2.0	100	4	04.06-	AZWC / UKWA	5,0	Y8001AS	8904	58
Galaxy '06 2.0 TDCi	WM	2.0	103	4	05.06-	QXWA / QXWB / QXWC	11,0	Y1005J	7957	56
Galaxy '06 2.0 TDCi	WM	2.0	103	4	05.06-	UFWA	5,0	Y8001AS	8904	58
Galaxy '06 2.0 TDCi Norm EU V	WM	2.0	120	4	03.10-	TXWA	5,0	Y8001AS	8904	58
Galaxy '06 2.2 TDCi	WM	2.2	129	4	03.08-	Q4BA / Q4WA	11,0	YE08	4966	
Galaxy '06 2.2 TDCi	WM	2.2	147	4	07.10-		11,0	YE08	4966	

**GRANADA '85**

Granada '85		2.5	51	4	05.85-10.94	STR D	11,0	Y-924J	6305	1
Granada '85		2.5	68	4	05.85-10.94	SFA D TURBO	11,0	Y-924J	6305	1
Granada '85		2.5	68	4	05.85-10.94	SFB D TURBO	11,0	Y-924J	6305	1

**GRAND C-MAX '11**

Grand C-Max '11 1.6 TDCi Norm EU V	BH	1.6	70	4	12.10-	T3DA / T3DB	5,0	Y8001AS	8904	58
Grand C-Max '11 1.6 TDCi Norm EU V	BH	1.6	85	4	12.10-	T1DA / T1DB	5,0	Y8001AS	8904	58
Grand C-Max '11 2.0 TDCi Norm EU V	BH	2.0	120	4	12.10-	TXDB	5,0	Y8001AS	8904	58





l kW C y i 0201



Stock-No D-POWER

**FORD**

**GRAND C-MAX '11**

Grand C-Max '11 2.0 TDCi Norm EU V	BH	2.0	85	4	02.11-	TYDA	5,0	Y8001AS	8904	58
Grand C-Max '11 2.0 TDCi Norm EU V	BH	2.0	100	4	02.11-	UKDB	5,0	Y8001AS	8904	58
Grand C-Max '11 2.0 TDCi Norm EU V	BH	2.0	103	4	02.11-	UFDB	5,0	Y8001AS	8904	58

**KA '08**

Ka '08 1.3 TDCi	JDU	1.3	55	4	02.09-10.10	FD4	11,0	Y8003J	97256	62
Ka '08 1.3 TDCi	JDU	1.3	55	4	11.10-	FD4	11,0	Y8003J	97256	62

**KUGA 1**

Kuga 1 2.0 TDCi	DR	2.0	100	4	03.08-	G6DG / UKDA	11,0	Y1005J	7957	56
Kuga 1 2.0 TDCi Norm EU V	DR	2.0	103	4	03.10-	UFDA	5,0	Y8001AS	8904	58
Kuga 1 2.0 TDCi	DR	2.0	120	4	03.10-	DuraTorq-TDCi	11,0	Y1005J	7957	56

**KUGA 2**

Kuga 2 2.0 TDCi	MA	2.0	100	4	11.12-	UKMA	5,0	Y8001AS	8904	58
Kuga 2 2.0 TDCi	MA	2.0	103	4	11.12-	UFMA	5,0	Y8001AS	8904	58
Kuga 2 2.0 TDCi	MA	2.0	120	4	11.12-	TXMA	5,0	Y8001AS	8904	58

**MAVERICK '93**

Maverick '93 2.7	UDS / UNS	2.7	74	4	04.93-04.98	TD27	11,0	Y-712RS	6140	
Maverick '93 2.7	UDS / UNS	2.7	92	4	05.96-04.98	TD27E	11,0	CZ261	97009	

**MONDEO '93**

Mondeo '93 1.8 TD		1.8	65	4	01.93-07.96	RFM D TCI	11,5	Y-910J	3617	3
Mondeo '93 1.8 TD		1.8	65	4	01.93-07.96	RFN D TCI	11,5	Y-910J	3617	3

**MONDEO '97**

Mondeo '97 1.8 TD		1.8	66	4	08.96-09.00	RFN Endura-De TCI	10,0	Y-937J	7503	5
-------------------	--	-----	----	---	-------------	-------------------	------	--------	------	---

**MONDEO '01**

Mondeo '01 2.0 TDCi		2.0	66	4	10.00-08.07	D5BA DuraTorq-DI	11,5	Y-548J	94832	75
Mondeo '01 2.0 TDCi		2.0	85	4	10.00-08.07	D6BA DuraTorq-DI	11,5	Y-548J	94832	75
Mondeo '01 2.0 TDCi		2.0	85	4	10.00-08.07	HJBA DuraTorq-TDCi	11,5	Y-548J	94832	75
Mondeo '01 2.0 TDCi		2.0	85	4	10.00-08.07	HJBB DuraTorq-TDCi	11,5	Y-548J	94832	75
Mondeo '01 2.0 TDCi		2.0	85	4	10.00-08.07	HJBC DuraTorq-TDCi	11,5	Y-548J	94832	75
Mondeo '01 2.0 TDCi		2.0	85	4	10.00-08.07	SDBA DuraTorq-TDCi	11,5	Y-548J	94832	75
Mondeo '01 2.0 TDCi		2.0	96	4	10.00-08.07	FMBA DuraTorq-TDCi	11,5	Y-548J	94832	75
Mondeo '01 2.0 TDCi		2.0	96	4	10.00-08.07	N7BA DuraTorq-TDCi	11,5	Y-548J	94832	75
Mondeo '01 2.2 TDCi		2.2	110	4	09.04-08.07	QJBC DuraTorq-TDCi	11,5	Y-548J	94832	75
Mondeo '01 2.2 TDCi		2.2	110	4	09.04-08.07	QJBD DuraTorq-TDCi	11,5	Y-548J	94832	75
Mondeo '01 2.2 TDCi		2.2	114	4	09.04-08.07	QJBA DuraTorq-TDCi	11,5	Y-548J	94832	75
Mondeo '01 2.2 TDCi		2.2	114	4	09.04-08.07	QJBB DuraTorq-TDCi	11,5	Y-548J	94832	75

**MONDEO '07**

Mondeo '07 1.8 TDCi		1.8	74	4	02.07-	FFBA DuraTorq-TDCi	10,0	Y-524J	4520	27
Mondeo '07 2.0 TDCi		2.0	85	4	02.07-	KLBA / LPBA / TYBA	11,0	Y1005J	7957	56
Mondeo '07 2.0 TDCi		2.0	96	4	02.07-	AZBA	11,0	Y1005J	7957	56
Mondeo '07 2.0 TDCi		2.0	100	4	03.07-	AZBC	11,0	Y1005J	7957	56
Mondeo '07 2.0 TDCi		2.0	103	4	02.07-	QXBB / UFBA	11,0	Y1005J	7957	56
Mondeo '07 2.0 TDCi Norm EU V		2.0	120	4	03.10-	TXBA	5,0	Y8001AS	8904	58
Mondeo '07 2.2 TDCi		2.2	129	4	03.08-10.10	Q4BA	11,0	YE08	4966	

**MONDEO '11**

Mondeo '11 1.6 TDCi	DYK/DYL	1.6	85	4	09.14-	NGCA	5,0	Y8001AS	8904	58
Mondeo '11 2.0 TDCi	DYK/DYL	2.0	110	4	09.14-	T7CC	5,0	Y8001AS	8904	58
Mondeo '11 2.0 TDCi	DYK/DYL	2.0	132	4	09.14-	T8CC	5,0	Y8001AS	8904	58

**FORD****ORION '86**

Orion '86 1.6	1.6	40	4	01.86-07.90	LTC	11,5	Y-907R	4479	
Orion '86 1.8	1.8	44	4	01.86-07.90	RTA	11,5	Y-910J	3617	3
Orion '86 1.8	1.8	44	4	01.86-07.90	RTB	11,5	Y-910J	3617	3

**ORION '91**

Orion '91 1.8 D	1.8	44	4	08.90-07.93	RTE	11,5	Y-910J	3617	3
Orion '91 1.8 D	1.8	44	4	08.90-07.93	RTF	11,5	Y-910J	3617	3
Orion '91 1.8 D	1.8	44	4	08.90-07.93	RTH	11,5	Y-910J	3617	3
Orion '91 1.8 TD	1.8	66	4	08.90-07.93	RFD	11,5	Y-910J	3617	3
Orion '91 1.8 TD	1.8	66	4	08.90-07.93	RFK	11,5	Y-910J	3617	3

**SCORPIO '85**

Scorpio '85 2.5 D	2.5	51	4	05.85-10.94	STR D	11,0	Y-924J	6305	1
Scorpio '85 2.5 TD	2.5	68	4	05.85-10.94	SFA D TURBO	11,0	Y-924J	6305	1
Scorpio '85 2.5 TD	2.5	68	4	05.85-10.94	SFB D TURBO	11,0	Y-924J	6305	1
Scorpio '85 2.5 TD	2.5		4	11.94-07.98	SCB	11,0	Y-741U	6943	20

**SCORPIO '95**

Scorpio '95 2.5 TD	2.5	85	4	10.94-06.98	SCC TCI	11,0	Y-741U	6943	20
Scorpio '95 2.5 TD	2.5	92	4	10.94-06.98	SCD TCI	11,0	Y-741U	6943	20

**SIERRA '87**

Sierra '87 1.8 TD	1.8	55	4	01.87-12.92	RFA	11,5	Y-910J	3617	3
Sierra '87 1.8 TD	1.8	55	4	01.87-12.92	RFB	11,5	Y-910J	3617	3
Sierra '87 1.8 TD	1.8	55	4	01.87-12.92	RFL	11,5	Y-910J	3617	3
Sierra '87 2.3 D	2.3	49	4	01.87-12.92	YTR	11,0	Y-924J	6305	1

**S-MAX**

S-MAX 1.6 TDCi Norm EU V	WS	1.6	85	4	02.11-		5,0	Y8001AS	8904	58
S-MAX 1.8 TDCi	WS	1.8	74	4	03.06-	FFWA	10,0	Y-524J	4520	27
S-MAX 1.8 TDCi	WS	1.8	92	4	03.06-	QYWA	10,0	Y-524J	4520	27
S-MAX 2.0 TDCi	WS	2.0	85	4	11.07-	KLWA	11,0	Y1005J	7957	56
S-MAX 2.0 TDCi	WS	2.0	85	4	11.07-	TYWA	5,0	Y8001AS	8904	58
S-MAX 2.0 TDCi	WS	2.0	96	4	03.06-	AZWA	11,0	Y1005J	7957	56
S-MAX 2.0 TDCi	WS	2.0	100	4	05.06-	AZWC / UKWA	11,0	Y1005J	7957	56
S-MAX 2.0 TDCi	WS	2.0	103	4	03.06-	QXWA Duratorq-TDCi	11,0	Y1005J	7957	56
S-MAX 2.0 TDCi	WS	2.0	103	4	03.06-	QXWB ohne DPF	11,0	Y1005J	7957	56
S-MAX 2.0 TDCi	WS	2.0	103	4	03.06-	UFWA	5,0	Y8001AS	8904	58
S-MAX 2.0 TDCi	WS	2.0	120	4	03.10-	TXWA	11,0	Y1005J	7957	56
S-MAX 2.2 TDCi	WS	2.2	129	4	03.08-	Q4WA	11,0	YE08	4966	
S-MAX 2.2 TDCi	WS	2.2	147	4	07.10-	KNWA	11,0	YE08	4966	

**TOURNEO CONNECT I**

Tourneo Connect I 1.8		1.8	55	4	06.02-	BHPA Endura-DI	10,0	Y-524J	4520	27
Tourneo Connect I 1.8		1.8	66	4	06.02-	HCPA Duratorq-TDCi	10,0	Y-524J	4520	27
Tourneo Connect I 1.8		1.8	66	4	06.02-	HCPB Duratorq-TDCi	10,0	Y-524J	4520	27
Tourneo Connect I 1.8		1.8	81	4	06.02-	RWPA Duratorq-TDCi	10,0	Y-524J	4520	27

**TOURNEO CONNECT II**

Tourneo Connect II 1.6 TDCi	GAD	1.6	55	4	09.13-	UBGA	5,0	Y8001AS	8904	58
Tourneo Connect II 1.6 TDCi	GAD	1.6	70	4	09.13-	TZGA / TZGB	5,0	Y8001AS	8904	58
Tourneo Connect II 1.6 TDCi	GAD	1.6	85	4	09.13-	T1GA	5,0	Y8001AS	8904	58



l kW C y i 0201



Stock-No  
D-POWER™

**FORD**

**TRANSIT CONNECT I**

Transit Connect		1.8	55	4	06.02-	BHPA Endura-DI	10,0	Y-524J	4520	27
Transit Connect		1.8	66	4	06.02-	HCPA Duratorq-TDCi	10,0	Y-524J	4520	27
Transit Connect		1.8	66	4	06.02-	HCPB Duratorq-TDCi	10,0	Y-524J	4520	27
Transit Connect		1.8	81	4	06.02-	RWPA Duratorq-TDCi	10,0	Y-524J	4520	27

**TRANSIT CONNECT II**

Transit Connect II 1.6 TDCi	GCD	1.6	55	4	09.13-	UBGA	5,0	Y8001AS	8904	58
Transit Connect II 1.6 TDCi	GCD	1.6	70	4	09.13-	TZGA / TZGB	5,0	Y8001AS	8904	58
Transit Connect II 1.6 TDCi	GCD	1.6	85	4	09.13-	T1GA	5,0	Y8001AS	8904	58

**TRANSIT 2000**

Transit 2000.5 (FW)		2.0	55	4	08.00-05.06	D3FA	11,5	Y-548J	94832	75
Transit 2000.5 (FW)		2.0	63	4	08.00-05.06	F3FA	11,5	Y-548J	94832	75
Transit 2000.5 (FW)		2.0	74	4	08.00-05.06	ABFA	11,5	Y-548J	94832	75
Transit 2000.5 (FW)		2.0	92	4	08.00-05.06	F1FA	11,5	Y-548J	94832	75
Transit 2000.5 (RW)		2.4	55	4	01.00-05.06	F4FA	11,5	Y-548J	94832	75
Transit 2000.5 (RW)		2.4	66	4	01.00-05.06	D2FA	11,5	Y-548J	94832	75
Transit 2000.5 (RW)		2.4	66	4	01.00-05.06	D2FB	11,5	Y-548J	94832	75
Transit 2000.5 (RW)		2.4	85	4	01.00-05.06	FXFA	11,5	Y-548J	94832	75
Transit 2000.5 (RW)		2.4	88	4	01.00-05.06	D4FA	11,5	Y-548J	94832	75
Transit 2000.5 (RW)		2.4	92	4	01.00-05.06	DOFA	11,5	Y-548J	94832	75
Transit 2000.5 (RW)		2.4	101	4	01.00-05.06	H9FA	11,5	Y-548J	94832	75

**TRANSIT 2006**

Transit 2006.5 (FW)		2.2	63	4	04.06-	P8FA	11,5	Y-548J	94832	75
Transit 2006.5 (FW)		2.2	81	4	04.06-	QVFA	11,5	Y-548J	94832	75
Transit 2006.5 (FW)		2.2	96	4	04.06-	QWFA	11,5	Y-548J	94832	75
Transit 2006.5 (RW)		2.4	74	4	04.06-	PHFA	11,5	Y-548J	94832	75
Transit 2006.5 (RW)		2.4	85	4	04.06-	JXFA	11,5	Y-548J	94832	75

**TRANSIT 2006**

Transit 2006.5 (RW)		2.4	103	4	04.06-	H9FB	11,5	Y-548J	94832	75
---------------------	--	-----	-----	---	--------	------	------	--------	-------	----

**FSO**

Polonez Caro D		1.9	51	4	10.92-	XUD Cat.	11,0	Y-924J	6305	1
----------------	--	-----	----	---	--------	----------	------	--------	------	---

**HONDA**

**ACCORD**

Accord Tdi		2.0	77	4	05.95-08.99	Rover (L-Serie)	11,0	Y-730U	6158	17
Accord Tdi	CF1	2.0	77	4	09.99-	20TN2	11,0	Y-730U	6158	17

**CIVIC**

Civic 1.7 CTDi	EP4	1.7	74	4	.02-	4EE2	11,0	Y-541J	1983	42
----------------	-----	-----	----	---	------	------	------	--------	------	----

**CONCERTO**

Concerto TD	HW	1.8	64	4	10.94-12.95	XUD 7 TE	11,0	Y-924J	6305	1
-------------	----	-----	----	---	-------------	----------	------	--------	------	---

**HYUNDAI**

**ACCENT**

Accent TDI		1.5	55	3	04.02-		11,0	Y-749J	5013	
Accent 12V CRDi		1.5	60	3	04.02-	D3EA	11,0	Y-749J	5013	
Accent III 1.5 CRDi	MC	1.5	81	4	11.05-	D4FA	11,0	Y-527J	96187	67



e kW C y i 0201



Stock-No  
D-POWER

## HYUNDAI

### ELANTRA

Elantra 1.6 CRDi	XD	1.6	85	4	02.06-	D4FB	11,0	Y-527J	96187	67
Elantra CRDi	XD	2.0	83	4	.01-	D4EA	11,0	Y-749J	5013	

### GALLOPER

Galopper		2.5	57	4	-01.94	4D55	12,0	Y-115T1	2189	
Galopper TC, TCI		2.5	65	4	11.95-	4D56	11,0	CZ257	97284	83
Galopper TD		2.5	65	4	11.97-06.03	D4BA	11,0	CZ257	97284	83
Galopper TDCi		2.5	73	4	11.97-06.03	D4BH	11,0	CZ257	97284	83

### GETZ

Getz 1.5 CRDi	TB	1.5	60	3	02.03-07.05	D3EA	11,0	Y-749J	5013	
Getz 1.5 CRDi	TB	1.5	60	3	08.05-10.06	D3EA	11,0	Y-749J	5013	
Getz 1.5 CRDi	TB	1.5	65	4	11.06-	D4FA	11,0	Y-527J	96187	67
Getz 1.5 CRDi	TB	1.5	81	4	11.06-	D4FA	11,0	Y-527J	96187	67

### H 1

H 1 Starex TD		2.5	59	4	10.97-	D4BF	11,0	CZ257	97284	83
H 1 TD		2.5	59	4	06.97-04.04	D4BF	11,0	CZ257	97284	83
H 1 TD		2.5	73	4	10.97-12.07	D4BH	11,0	CZ257	97284	83
H 1 TDiC		2.6	79	4	10.97-08.00	D4BB	11,0	CZ257	97284	83

### H 100

H 100		2.5	55	4	07.93-12.94	D4BX	11,0	CZ257	97284	83
H 100 AU Truck TDCi		2.5	73	4	08.03-10.06	D4BH	11,0	CZ257	97284	83
H 100 D		2.5	57	4	- .96	4D56	11,0	CZ257	97284	83
H 100 D		2.5	57	4	- .96	D4BA 4D55	11,0	CZ257	97284	83
H 100 D intercooler		2.5	63	4	07.93-03.00	D4BF	11,0	CZ257	97284	83
H 100 Truck TDCi		2.5	73	4	02.04-10.06	D4BH	11,0	CZ257	97284	83
H 100 Truck TD		2.5	74	4	11.06-	4D56T	11,0	CZ257	97284	83

### H 100

H 100 AU Truck TD		2.6	63	4	04.96-12.98	D4BB	11,0	CZ257	97284	83
-------------------	--	-----	----	---	-------------	------	------	-------	-------	----

### H 200

H 200 TDiC		2.5	59	4	06.97-12.02	D4BF	11,0	CZ257	97284	83
H 200 TD		2.5	57	4	10.97-07.01	D4BF	11,0	CZ257	97284	83
H 200 TDCi		2.5	73	4	10.97-10.05	D4BH	11,0	CZ257	97284	83
H 200 TDCi		2.5	74	4	10.01-09.05	D4BH	11,0	CZ257	97284	83

### i10

i10 1.1 CRDi	PA	1.1	55	3	03.08-	D3FA	11,0	Y-527J	96187	67
--------------	----	-----	----	---	--------	------	------	--------	-------	----

### i20

i20 1.4 CRDi	PB	1.4	55	4	12.08-	D4FC	11,0	Y-527J	96187	67
i20 1.4 CRDi	PB	1.4	66	4	05.09-	D4FC	11,0	Y-527J	96187	67
i20 1.6 CRDi	PB	1.6	85	4	12.08-	D4FB	11,0	Y-527J	96187	67

### i30 1

i30 1 1.6 CRDi	FD	1.6	66	4	10.07-	D4FB	11,0	Y-527J	96187	67
i30 1 1.6 CRDi	FD	1.6	85	4	10.07-	D4FB	11,0	Y-527J	96187	67
i30 1 1.6 CRDi	FD	1.6	94	4	02.08-	D4FB	11,0	Y-527J	96187	67
i30 1 2.0 CRDi	FD	2.0	103	4	07.07-	D4EA	11,0	Y-749J	5013	



l kW C y i 0201



Stock-No D-POWER™

**HYUNDAI**

**i30 2**

i30 2 1.4 CRDi	GD	1.4	66	4	11.11-	D4FC	11,0	Y-527J	96187	67
i30 2 1.6 CRDi	GD	1.6	94	4	11.11-	D4FB	11,0	Y-527J	96187	67

**i30 CW 1**

i30 CW 1 1.6 CRDi		1.6	94	4	02.08-	D4FB	11,0	Y-527J	96187	67
-------------------	--	-----	----	---	--------	------	------	--------	-------	----

**i40**

i40 CW 1.7 CRDi		1.7	85	4	06.11-	D4FD	11,0	CZ203	95232	68
i40 CW 1.7 CRDi		1.7	100	4	06.11-	D4FD	11,0	CZ203	95232	68

**ix20**

ix20 1.4 CRDi	JC	1.4	57	4	11.10-	D4FC	11,0	Y-527J	96187	67
ix20 1.4 CRDi	JC	1.4	66	4	11.10-	D4FC	11,0	Y-527J	96187	67
ix20 1.6 CRDi	JC	1.6	85	4	11.10-	D4FB	11,0	Y-527J	96187	67

**ix35 (LM)**

ix35 1.7 CRDi	LM	1.7	85	4	09.10-	D4FD	11,0	CZ203	95232	68
ix35 2.0 CRDi Euro III / Euro IV	LM	2.0	100	4	08.09-	D4HA	5,0	Y1003AS	92283	
ix35 2.0 CRDi Euro V	LM	2.0	100	4	08.09-	D4HA	7,0	CZ105	90007	
ix35 2.0 CRDi Euro III / Euro IV	LM	2.0	135	4	08.09-	D4HA	5,0	Y1003AS	92283	
ix35 2.0 CRDi Euro V	LM	2.0	135	4	08.09-	D4HA	7,0	CZ105	90007	

**LANTRA**

Lantra D		1.9	50	4	.98-	XUD9A	11,0	Y-924J	6305	1
----------	--	-----	----	---	------	-------	------	--------	------	---

**MATRIX**

Matrix 1.5 CRDi	FC	1.5	60	3	10.01-02.05	D3EA	11,0	Y-527J	96187	67
Matrix 1.5 CRDi	FC	1.5	75	4	12.04-	D4FA	11,0	Y-527J	96187	67
Matrix 1.5 CRDi VGT	FC	1.5	81	4	08.05-	D4FA	11,0	Y-527J	96187	67

**SANTA FE 1**

Santa Fe CRDi	SM	2.0	83	4	04.01-.05	D4EA	11,0	Y-749J	5013	
Santa Fe CRDi 4x4	SM	2.0	92	4	08.03-	D4EA	11,0	Y-749J	5013	
Santa Fe CRDi	SM	2.2	102	4	03.06-	D4EB	11,0	Y-749J	5013	
Santa Fe CRDi	SM	2.2	110	4	10.05-	D4EB	11,0	Y-749J	5013	
Santa Fe CRDi	SM	2.2	114	4	03.06-	D4EB	11,0	Y-749J	5013	

**SANTA FE 2**

Santa Fe II 2.0 CRDi Euro IV	CM	2.0	110	4	12.10-	D4HA	5,0	Y1003AS	92283	
Santa Fe II 2.0 CRDi Euro V	CM	2.0	110	4	12.10-	D4HA	7,0	CZ105	90007	

**SATELLITE**

Satellite TDCi		2.5	59	4	10.97-11.02	D4BF	11,0	CZ257	97284	83
Satellite TDCi		2.5	59	4	10.97-11.02	D4BH	11,0	CZ257	97284	83
Satellite TDCi		2.5	73	4	03.01-10.05	D4BH	11,0	CZ257	97284	83
Satellite TDCi		2.5	74	4	11.01-10.05	D4BH	11,0	CZ257	97284	83

**SONATA**

Sonata 2.0 CRDi		2.0	103	4	02.06-	D4EA	11,0	Y-749J	5013	
-----------------	--	-----	-----	---	--------	------	------	--------	------	--

**STAREX**

Starex 2.5TD		2.5	59	4	06.97-		11,0	Y-722JS	9974	
Starex TDiC		2.5	59	4	06.97-04.04	D4BF	11,0	CZ257	97284	83
Starex TDCi		2.5	74	4	09.00-08.07	D4BH	11,0	CZ257	97284	83
Starex TDiC		2.6	63	4	10.97-04.04	D4BB	11,0	CZ257	97284	83



e kW C y i 0201



Stock-No  
D-POWER

## HYUNDAI TERRACAN

Terracan 2.5TD	HP	2.5	74	4	06.01-	D4BH	11,0	CZ257	97284	83
Terracan	HP	2.9	120	4	11.03-	J3	11,0	CZ257	97284	83
Terracan TDiC		2.5	74	4	06.01-10.03	D4BHG	11,0	CZ257	97284	83

## TERRACAN

Terracan Van TDiC		2.5	74	4	06.01-10.03	D4BHG	11,0	CZ257	97284	83
-------------------	--	-----	----	---	-------------	-------	------	-------	-------	----

## TRAJET

Trajat 2.0 CRDI	FO	2.0	83	4	04.01- .04	4DEA	11,0	Y-749J	5013	
-----------------	----	-----	----	---	------------	------	------	--------	------	--

## TUCSON

Tucson 2.0 D	JM	2.0	83	4	09.04-	D4EA	11,0	Y-749J	5013	
Tucson 2.0 D	JM	2.0	103	4	02.06-	D4EA	11,0	Y-749J	5013	

## INNOCENTI

Elba D		1.7	42	4	09.92-	146 B 2.000	11,0	Y-924J	6305	1
--------	--	-----	----	---	--------	-------------	------	--------	------	---

## ISUZU

Trooper TD		2.8	71	4	10.87-12.91	4JB1T	11,0	Y-904M1	7995	
Trooper TD		2.8	78	4	10.88-12.91	4JB1TC	11,0	Y-904M1	7995	
Trooper TD		3.1	83	4	06.92-	4JG2T	11,0	Y-711J	4467	28

## IVECO

Daily TDi		2.8	90	6	09.97-		11,0	Y-502R	3852	
-----------	--	-----	----	---	--------	--	------	--------	------	--

## JAGUAR

### S-TYPE

S-Type 2.7 D		2.7	152	6	06.04-		11,0	YE12	7794	
--------------	--	-----	-----	---	--------	--	------	------	------	--

### XF

XF 2.7 D		2.7	152	6	03.08-		11,0	YE12	7794	
----------	--	-----	-----	---	--------	--	------	------	------	--

### XJ6

XJ6 2.7 TDVi		2.7	152	6	10.05-		11,0	YE12	7794	
--------------	--	-----	-----	---	--------	--	------	------	------	--

### X-TYPE

X-Type 2.2 D		2.2	114	4	10.05-	L J46G	11,0	YE08	4966	
X-Type 2.0 D		2.0	96	4	07.03-10.05	R4-X404	11,5	Y-548J	94832	75

## JEEP

### CHEROKEE

Cherokee 2.5 CRD	KJ	2.5	105	4	09.01-10.02	ENJ	11,0	Y1031J	95970	71
Cherokee 2.8 CRD	KJ	2.8	110	4	09.02-09.04	ENR	11,0	Y1031J	95970	71
Cherokee 2.8 CRD	KJ	2.8	120	4	11.04-04.08	ENR	11,0	Y1031J	95970	71
Cherokee TD		2.1	65	4	01.87-01.91	Renault J8S 814, J8S 890	11,0	Y-924J	6305	1
Cherokee TD		2.1	65	4	02.91-08.94	J8S 890	11,0	Y-913J	5317	15
Cherokee TD		2.5	85	4	05.95-07.99	VM HR 425	11,0	Y-741U	6943	20

### COMMANDER

Commander 3.0 CRD		3.0	160	6	04.06-12.10	EXL	4,4	Y8002AS	6287	51
-------------------	--	-----	-----	---	-------------	-----	-----	---------	------	----

### COMPASS

Compass CRD		2.0	103	4	.06-		7,0	CZ304	9864	55
-------------	--	-----	-----	---	------	--	-----	-------	------	----



l kW C y i 0201



Stock-No D-POWER

**JEEP**

**GRAND CHEROKEE**

Grand Cherokee TD	2.5	88	4	01.93-	VM HR 425 CLIRE	11,0	Y-924J	6305	1
Grand Cherokee TD	2.5	88	4	01.93-	VM HR-492	11,0	Y-924J	6305	1
Grand Cherokee TD	2.5	110	4	04.99-	ENC	11,0	Y-741U	6943	20

**GRAND CHEROKEE**

Grand Cherokee 3.0 CRD	WH	3.0	155	6	05.06-12.10	EXL	4,4	Y8002AS	6287	51
Grand Cherokee 3.0 CRD	WH	3.0	160	6	06.05-12.10	EXL	4,4	Y8002AS	6287	51
Grand Cherokee TD / Limited		3.1	103	5	04.98-	EXA	11,0	Y-741U	6943	20

**WRANGLER**

Wrangler Laredo, Sahara, Texan TD		2.1	65	4	07.88-		11,0	Y-924J	6305	1
Wrangler		2.5		6	07.88-		11,0	Y-924J	6305	1
Wrangler,Laredo,Sahara		2.5		6	07.88-		11,0	Y-924J	6305	1
Wrangler,Texan D		2.5		6	07.88-		11,0	Y-924J	6305	1

**KIA**

**BESTA**

Besta		2.2	48	4	02.96-	R2	11,0	Y-701J	1566	39
Besta 2.2		2.2	52	4	03.90-07.99	HW	11,0	Y-701J	1566	39
Besta 2.7		2.7	60	4	03.90-07.99	VN	11,0	Y-701J	1566	39

**CARENS 1**

Carens 2.0 CRDi EX	FC	2.0	83	4	.02-	D4EA	11,0	Y-749J	5013	
--------------------	----	-----	----	---	------	------	------	--------	------	--

**CARENS 3**

Carens III 1.6 CRDi	UN	1.6	85	4	06.10-	D4FB	11,0	Y-527J	96187	67
Carens III 1.6 CRDi	UN	1.6	94	4	07.10-	D4FB	11,0	Y-527J	96187	67
Carens III 2.0 CRDi	UN	2.0	85	4	05.06-	D4EA	11,0	Y-749J	5013	
Carens III 2.0 CRDi	UN	2.0	103	4	.06-	D4EA	11,0	Y-749J	5013	
Carens III 2.0 CRDi	UN	2.0	136	4	05.06-	D4EA	11,0	Y-749J	5013	

**CARENS 4**

Carens IV 1.7 CRDi		1.7	85	4	03.13-	D4FD	11,0	CZ203	95232	68
Carens IV 1.7 CRDi		1.7	100	4	03.13-	D4FD	11,0	CZ203	95232	68

**CARNIVAL 3**

Carnival III 2.2 CRDi	VQ	2.2	110	4	01.10-	D4HB	7,0	CZ105	90007	
Carnival III 2.2 CRDi	VQ	2.2	143	4	01.10-	D4HB	7,0	CZ105	90007	
Carnival III 2.9 CRDi	VQ	2.9	136	4	06.06-	J3	11,0	Y-535J	91416	

**CEE'D (ED)**

Cee'd 1.6 CRDi	ED	1.6	66	4	12.06-10.10	D4FB-L	11,0	CZ203	95232	68
Cee'd 1.6 CRDi	ED	1.6	66	4	11.10-	D4FB-L	11,0	CZ203	95232	68
Cee'd 1.6 CRDi	ED	1.6	85	4	12.06-10.10	D4FB	11,0	CZ203	95232	68
Cee'd 1.6 CRDi	ED	1.6	85	4	11.10-	D4FB	11,0	CZ203	95232	68
Cee'd 1.6 CRDi	ED	1.6	94	4	06.10-10.10	D4FB	11,0	CZ203	95232	68
Cee'd 1.6 CRDi	ED	1.6	94	4	11.10-	D4FB	11,0	CZ203	95232	68
Cee'd 2.0 CRDi	ED	2.0	103	4	01.07-	D4EA-F	11,0	Y-749J	5013	

**CERATO**

Cerato 1.5 CRDi	LD	1.5	75	4	08.04-08.06	D4FA	11,0	Y-527J	96187	67
Cerato 1.6 CRDi	LD	1.6	85	4	06.05-06.08	D4FB	11,0	Y-527J	96187	67
Cerato 2.0 CRDi	LD	2.0	83	4	04.04-	D4EA	11,0	Y-749J	5013	

**K 2500**

K2500 TDCi		2.5	69	4	.05-	D4BH	11,0	CZ257	97284	83
------------	--	-----	----	---	------	------	------	-------	-------	----



<b>KIA</b>											
<b>K 2900</b>											
K 2900 2.9 D		2.9	92	4	08.07-	J3		11,0	Y-535J	91416	
<b>MAGENTIS</b>											
Magentis CRDi	MG	2.0	103	4	04.06- .09	D4EA		11,0	Y-749J	5013	
<b>OPTIMA</b>											
Optima 1.7 CRDi	TF	1.7	100	4	03.12-	D4FD		11,0	CZ203	95232	68
<b>PICANTO (BA)</b>											
Picanto 1.1 CRDi	BA	1.1	55	3	11.05-	D3FA		11,0	Y-527J	96187	67
<b>PREGIO</b>											
Pregio		2.7	60	4	06.96-	J2		11,0	Y-701J	1566	39
Pregio TDCi		2.5	69	4	08.01-07.06	D4BH		11,0	CZ257	97284	83
Pregio		3.0	66	4	06.97-	W3 / NB9		11,0	Y-701J	1566	39
<b>RETONA</b>											
Retona	CE	2.0	61	4	04.00-			11,0	Y-721J	6919	
<b>RIO 2</b>											
Rio II 1.5 CRDi	JB	1.5	81	4	06.05-	D4FA		11,0	Y-527J	96187	67
<b>RIO 3</b>											
Rio III 1.1 CRDi	UB	1.1	55	3	06.11-	D3FA		11,0	Y-527J	96187	67
Rio III 1.4 CRDi	UB	1.4	66	4	06.11-	D4FC		11,0	Y-527J	96187	67
<b>SEDONA 2</b>											
Sedona MkII 2.2 CRDi	VQ	2.2	143	4	01.10-	D4HB		7,0	CZ105	90007	
<b>SORENTO 1</b>											
Sorento 2.5 CRDi	JC	2.5	103	4	08.02-			11,0	Y-508J	3709	
<b>SORENTO 2</b>											
Sorento 2.0 CRDi	XM	2.0	110	4	07.09-	D4HA		5,0	Y1003AS	92283	
Sorento 2.2 CRDi Hot Climate Zone	XM	2.2	145	4	11.09-	D4HB		5,0	Y1003AS	92283	
Sorento 2.2 CRDi Cold Climate Zone	XM	2.2	145	4	11.09-	D4HB		7,0	CZ105	90007	
<b>SOUL</b>											
Soul 1.6 CRDi	AM	1.6	85	4	02.09-	D4FB		11,0	Y-527J	96187	67
Soul 1.6 CRDi	AM	1.6	94	4	02.09-	D4FB		11,0	Y-527J	96187	67
<b>SPORTAGE 1</b>											
Sportage TD	K00	2.0	61	4	07.96-08.99	Mazda engine		11,0	Y-701J	1566	39
<b>SPORTAGE 2</b>											
Sportage 2.0	JE	2.0	83	4	11.04-	D4EA		11,0	Y-749J	5013	
Sportage 2.0 CRDi	JE	2.0	103	4	.06-	D4EA		11,0	Y-749J	5013	
<b>SPORTAGE 3</b>											
Sportage 1.7 CRDi	SL	1.7	85	4	11.10-	D4FD		11,0	CZ203	95232	68
Sportage 2.0 CRDi 4x4 Automatik C	SL	2.0	110	4	07.10-	D4HA		5,0	Y1003AS	92283	
Sportage 2.0 CRDi	SL	2.0	110	4	07.10-	D4HA		7,0	CZ105	90007	
<b>VENGA</b>											
Venga 1.4 CRDi Euro III / Euro IV	YN	1.4	55	4	02.10-	D4FC		11,0	Y-527J	96187	67
Venga 1.4 CRDi Euro V	YN	1.4	55	4	02.10-	D4FC		11,0	CZ203	95232	68
Venga 1.4 CRDi Euro IV	YN	1.4	57	4	02.10-	D4FC		11,0	Y-527J	96187	67
Venga 1.4 CRDi Euro V	YN	1.4	57	4	02.10-	D4FC		11,0	CZ203	95232	68
Venga 1.4 CRDi Euro III / Euro IV	YN	1.4	66	4	02.10-	D4FC		11,0	Y-527J	96187	67
Venga 1.4 CRDi Euro V	YN	1.4	66	4	02.10-	D4FC		11,0	CZ203	95232	68
Venga 1.6 CRDi Euro IV	YN	1.6	85	4	02.10-	D4FB		11,0	Y-527J	96187	67
Venga 1.6 CRDi Euro V	YN	1.6	85	4	02.10-	D4FB		11,0	CZ203	95232	68
Venga 1.6 CRDi Euro IV	YN	1.6	94	4	02.10-	D4FB		11,0	Y-527J	96187	67



**KIA****VENGA**

Venga 1.6 CRDi Euro V	YN	1.6	94	4	02.10-	D4FB	11,0	CZ203	95232	68
-----------------------	----	-----	----	---	--------	------	------	-------	-------	----

**LADA (AVTOVAZ)**

Aleko D		1.8	44	4		Ford RTE, RTS	11,5	Y-910J	3617	3
Niva D		1.9	47	4	10.93-	Peugeot XUD 9L	11,0	Y-924J	6305	1
Sagona D		1.5	40	4	01.95-	TUD5	11,0	Y-503J	1009	10
Samara D		1.5	40	4	01.95-	TUD 5	11,0	Y-503J	1009	10

**LANCIA****DEDRA**

Dedra TD		1.9	66	4	03.89-09.94	835A4000	11,0	Y-924J	6305	1
Dedra TD ds		1.9	66	4	10.94-	160D1000	11,0	Y-924J	6305	1
Dedra Eco LE TD		1.9	68	4	06.93-	160D1000	11,0	Y-924J	6305	1

**DELTA**

Delta TD		1.9	59	4	06.86-06.91	831D1000	11,0	Y-924J	6305	1
Delta HPE TD		1.9	66	4	10.94-	160D1000	11,0	Y-924J	6305	1
Delta TD ds		1.9	66	4	10.94-	160D1000	11,0	Y-924J	6305	1
Delta TD- ds LE		1.9	66	4	10.94-	160D1000	11,0	Y-924J	6305	1
Delta TD LS		1.9	66	4	10.94-	160D1000	11,0	Y-924J	6305	1
Delta HPE Td		1.9	66	4	10.96-		11,0	Y-928U	4389	29

**DELTA III**

Delta 3 1.6 D Mjet	844	1.6	77	4	04.11-	844A3000	4,4	Y9003AS	94251	78
Delta 3 1.6 D Mjet	844	1.6	85	4	09.08-	955A4000	4,4	Y9003AS	94251	78
Delta 3 1.6 D Mjet	844	1.6	88	4	07.08-	198A2000	4,4	Y9003AS	94251	78
Delta 3 1.9 D MJet	844	1.9	140	4	09.08-	844A1000	4,4	Y9003AS	94251	78
Delta 3 2.0 D MJet	844	2.0	120	4	09.08-	844A2000	4,4	Y9003AS	94251	78
Delta 3 2.0 D Mjet	844	2.0	121	4	07.08-	198A5000	4,4	Y9003AS	94251	78

**KAPPA (K)**

KAPPA / SW / Coupé 2i4 JTD		2.4	100	5	06.98-10.99	838A8000 to engine --> 1713818	11,0	Y-747U	4694	26
KAPPA / SW / Coupé 2i4 JTD		2.4	100	5	11.99- .04	838A8000 from engine 1713819 -->	11,0	Y-534J	3413	36
KAPPA TD		2.4		5	10.94-12.98	838A3000	11,5	Y-910J	3617	3

**LYBRA**

Lybra 1.9 JTD		1.9	77	4	09.98-11.99	AR32302 to engine --> 1713818	11,0	Y-747U	4694	26
Lybra 1.9 JTD		1.9	77	4	12.99-09.00	AR32302 from engine 1713819 -->	11,0	Y-534J	3413	36
Lybra 1.9 JTD		1.9	81	4	09.00-05.01	AR 37101	11,0	Y-534J	3413	36
Lybra 1.9 JTD		1.9	85	4	06.01- .04	937A2000	11,0	Y-534J	3413	36
Lybra 2.4 JTD		2.4	100	5	11.99-12.00	AR 32501 from engine 1713819 -->	11,0	Y-534J	3413	36
Lybra 2.4 JTD		2.4	100	5	09.99-11.99	AR 32501 to engine --> 1713818	11,0	Y-747U	4694	26
Lybra 2.4 JTD		2.4	103	5	09.00-05.02	839A6000	11,0	Y-534J	3413	36

**LYBRA**

Lybra 2.4 JTD		2.4	110	5	05.02- .04	841C000	11,0	Y-534J	3413	36
---------------	--	-----	-----	---	------------	---------	------	--------	------	----

**MUSA**

Musa 1.3 D Mjet EURO IV		1.3	51	4	09.04-12.12	188A9000	11,0	Y8003J	97256	62
Musa 1.3 D Mjet EURO V		1.3	51	4	.11-12.12	188A9000	4,3	Y9001AS	97719	72
Musa 1.3 D Mjet		1.3	66	4	02.05-	199A3000	11,0	Y8003J	97256	62
Musa 1.3 D Mjet EURO V		1.3	66	4	.11-	199A3000	4,3	Y9001AS	97719	72
Musa 1.3 D Mjet EURO V		1.3	70	4	03.09-	199B1000	4,3	Y9001AS	97719	72
Musa 1.6 D Mjet		1.6	85	4	07.08-12.12	350A3000	4,4	Y9003AS	94251	78
Musa 1.6 D Mjet		1.6	88	4	06.08-	350A2000	4,4	Y9003AS	94251	78



## LANCIA

### MUSA

Musa 1.9 D Mjet	1.9	73	4	10.04-12.12	188B2000	11,0	Y-534J	3413	36
-----------------	-----	----	---	-------------	----------	------	--------	------	----

### PHEDRA

Phedra JTD	2.0	79	4	09.02-05.03	RHM (DW10ATED4) to VIN--> 9666	11,0	Y-504J	1441	24
Phedra JTD	2.0	80	4	09.02-	DW10ATED4/RHT, RHW	11,0	Y-504J	1441	24
Phedra JTD	2.0	80	4	09.02-05.03	RHW (DW10ATED4) to VIN --> 9666	11,0	Y-504J	1441	24
Phedra 2.2 JTD	2.2	94	4	09.02-05.03	4HW (DW12ATED4) to VIN--> 9666	11,0	Y-504J	1441	24
Phedra 2.2 JTD	2.2	94	4	06.03-	DW12ATED4/4HW	11,0	Y-504J	1441	24
Phedra 2.2 JTD	2.2	120	4	04.06-11.10	4HP / 4HR	11,0	YE08	4966	
Phedra 2.2 D Mjet	2.2	125	4	02.08-11.10	4HT / 4HS	11,0	YE08	4966	

### THEMA

Thema TD	2.4	74	4	01.93-		11,0	Y-924J	6305	1
Thema TD	2.5	85		01.94-12.94		11,0	Y-924J	6305	1

### THESIS

Thesis 2.4 JTD	2.4	110	5	07.02-04.03	841C000	11,0	Y-534J	3413	36
Thesis 2.4 JTD 20V	2.4	120	5	05.03-10.03	841M000 / 841N000	11,0	YE07	6092	
Thesis 2.4 JTD 20V	2.4	129	5	05.03-06.09	841G000 / 841H000	11,0	YE07	6092	
Thesis 2.4 D Mjet 20V	2.4	136	5	09.05-06.09	841P000	11,0	YE07	6092	

### YPSILON (843)

Ypsilon MJT	843	1.3	51	4	10.03- .06	188A4000	11,0	Y8003J	97256	62
Ypsilon 1.3 D Mjet EURO IV	843	1.3	55	4	09.06-	199A2000	11,0	Y8003J	97256	62
Ypsilon 1.3 D Mjet EURO V	843	1.3	55	4	.11-	199A2000	4,3	Y9001AS	97719	72
Ypsilon 1.3 D Mjet	843	1.3	66	4	09.06-	199A3000	11,0	Y8003J	97256	62
Ypsilon 1.3 D Mjet	843	1.3	77	4	09.07-	199A3000	11,0	Y8003J	97256	62

### YPSILON (846)

Ypsilon 1.3 D Multijet	846	1.3	70	4	05.11-	199B1000	4,3	Y9001AS	97719	72
------------------------	-----	-----	----	---	--------	----------	-----	---------	-------	----

### ZETA

Zeta TD	1.9	68	4	04.95-	XUD 9TE	11,0	Y-924J	6305	1
Zeta TD	2.1	80	4	07.96-	XUD11ATE	11,0	Y-924J	6305	1

## LAND ROVER

### COUNTRY

Country TD	2.5	83	4	01.89-		11,0	Y-909R	4602	
------------	-----	----	---	--------	--	------	--------	------	--

### DEFENDER

Defender TDI	2.5	83	4	11.89-10.98	200/300 Gemini 1	11,5	Y-729U	4119	34
Defender 2.5 Td5	2.5	90	4	11.98-09.07	Td5	11,0	Y-605J	4309	
Defender TDI 90 & 110	2.5	102	4	01.99-		11,0	Y-924J	6305	1

### DISCOVERY

Discovery TDi ES	2.5	83	4	09.89-		11,5	Y-729U	4119	34
Discovery TDI	2.5	83	4	09.89-01.99	200/300 Gemini 1	11,5	Y-729U	4119	34
Discovery TDi Vogue ES	2.5	90	4	10.93-08.98		11,5	Y-729U	4119	34
Discovery 2.5 Td5	2.5	102	4	09.98-08.04	Td5	11,0	Y-605J	4309	

### FREELANDER 1

Freelander 2.0 TD	2.0	71	4	10.97-08.98	20 T2R	11,0	Y-730U	6158	17
Freelander 2.0 TD4	2.0	80	4	08.98-	M47D20 (BMW)	11,0	Y-507J	2691	32
Freelander 2.5 Tdi	2.5	102	5	05.98-		11,0	Y-924J	6305	1



l kW C y i  
0201



Stock-No  
D-POWER™

## LAND ROVER

### FREELANDER 2

Freelander 2 2.2 TD4 to chassis no. AH999999	2.2	110	4	08.10-	DW12BTED4	11,0	YE08	4966	
Freelander 2 2.2 TD4 to chassis no. AH999999	2.2	112	4	01.07-	224DT	11,0	YE08	4966	
Freelander 2 2.2 TD4 to chassis no. AH999999	2.2	118	4	10.06-	224DT	11,0	YE08	4966	
Freelander 2 2.2 SD4 to chassis no. AH999999	2.2	140	4	08.10-		11,0	YE08	4966	

### RANGE ROVER

Range Rover	2.5	66	4	04.86-10.92	VM UNIT (NOT GEMINI ENG.)	11,0	Y-909R	4602	
Range Rover TDI	2.5	83	4	01.86-12.94	ETC 9091 N	11,5	Y-729U	4119	34
Range Rover Vogue TD	2.5	87	4	01.90-09.94	VM 425 SLIRR	11,0	Y-924J	6305	1
Range Rover Vogue TD	2.5	87	4	01.90-09.94	VM HR-492	11,0	Y-924J	6305	1
Range Rover	2.5	100	6	09.94-	M51 D25 (BMW)	11,0	Y-924J	6305	1
Range Rover	2.5		4	09.89-	200/300 Gemini 1	11,5	Y-729U	4119	34
Range Rover 3	3.0	130	6	03.02-	M57 D30 BMW	11,0	Y-507J	2691	32
Range Rover 3	3.0		6	.02-	M57 D30 (BMW)	11,0	Y-507J	2691	32

### MAHINDRA

CJ 340 Classic D	2.1	48	4	.93-	XD 4.90	11,0	Y-208T	1250	
CJ 540 D	2.1	48	4	.93-	XD 4.90	11,0	Y-208T	1250	

### MAZDA

#### 121

121	1.8	44	4	03.96-	RTJ / RTK	11,5	Y-910J	3617	3
-----	-----	----	---	--------	-----------	------	--------	------	---

#### 2

2 Di Turbo DY VIN 3*00001-->	1.4	50	4	04.03- .07	MZ-CD-SOHC F6JA	11,0	YE04	1684	40
2 1.4 MZ-CD	1.4	50	4	.07-	F6JA	11,0	YE04	1684	40
2 1.5	1.5	103	4	12.14-	S5Y2	7,0	CZ165	93218	87

#### 3

3 2.0 MZR-CD	BK	2.0	105	4	09.07-01.09	RF7J	11,0	Y-529J	4664	
--------------	----	-----	-----	---	-------------	------	------	--------	------	--

#### 323

323 TD BF-->VIN 300001	1.7	60	4	.99-	4EE1-T	11,0	Y-603J	8838	60
323	1.7		4			11,0	Y-603J	8838	60
323 F (BJ)	2.0	100	4	10.00-10.03	RF4F	11,0	Y-529J	4664	

#### 5

5 2.0 CD	CR19	2.0	81	4	02.05-05.10	RF7J	11,0	Y-529J	4664	
5 2.0 CD	CR19	2.0	105	4	02.05-05.10	RF7J	11,0	Y-529J	4664	

#### 6

6 2.0 DI	GG	2.0	89	4	10.02-09.07	RF5C	11,0	Y-529J	4664	
6 2.0 DI	GG	2.0	100	4	10.02-09.07	RF5C	11,0	Y-529J	4664	
6 2.0 DI	GG	2.0	105	4	03.05-09.05	RF7J	11,0	Y-529J	4664	
6 2.2 D Skyactiv-D 150 i-ELoop	GJ2/GJ9	2.2	110	4	10.12-	SHY1	7,0	CZ163	92703	82
6 2.2 D Skyactiv-D 175 i-ELoop	GJ2/GJ9	2.2	129	4	10.12-	SHY1	7,0	CZ163	92703	82

#### 626

626 (GF) 2.0 DITD		2.0	66	4	04.98-10.02	RF3F	11,0	Y-529J	4664	
626 (GF) 2.0 Turbo DI		2.0	74	4	04.98-10.02	RF2A	11,0	Y-529J	4664	
626 DITD GF VIN 186527-->		2.0	74	4	09.98-	RF	11,0	Y-529J	4664	
626 DITD Kombi GF VIN 116329-->		2.0	74	4	09.98-	RF	11,0	Y-529J	4664	
626 (GF) 2.0 TD		2.0	81	4	10.00-10.02	RF4F	11,0	Y-529J	4664	



l kW C y i **0201**



Stock-No  
D-POWER

## MAZDA

### B SERIE

B 2200	2.2		4		S 2	8,5	Y-107T	1253	
B 2200	2.2		4	01.85-10.96	R 2	10,5	Y-107R	1229	
B 2500 UF VIN 702487-->	2.5	57	4	.99-	WL	11,0	Y-701J	1566	39
B2500 TD	2.5	80	4	06.99-07.06	WL84	11,0	CZ262	90919	
B2500 TD	2.5	80	4	06.99-07.06	WLF1	11,0	CZ262	90919	
B2500 TD	2.5	80	4	06.99-07.06	WLF2	11,0	CZ262	90919	
B2500	2.5	62	4	12.02-07.06	WLE7	11,0	CZ262	90919	
B2500	2.5	57	4	09.98-07.06	WL81	11,0	CZ262	90919	
B Serie				.97-11.02	WLT	11,0	Y-701J	1566	39

### BT-50

BT-50 2.5 MRZ-CD (CD)	2.5	105	4	08.06-	WLAA	11,0	Y-526J1	93283	69
BT-50 3.0 CDVi (CD)	3.0	115	4	10.06-	WEAT	11,0	Y-526J1	93283	69

### CX-3

CX-3 1.5	1.5	103	4	02.15-	S5Y5	7,0	CZ165	93218	87
----------	-----	-----	---	--------	------	-----	-------	-------	----

### CX-5

CX-5 2.2 D Skyactiv-D 150	KE	2.2	110	4	02.12-	SHY1	7,0	CZ163	92703	82
CX-5 2.2 D Skyactiv-D 175	KE	2.2	129	4	04.12-	SHY1	7,0	CZ163	92703	82

### E SERIE

E 2000	2.0		4	.93-	RF	10,5	Y-107R	1229	
E 2200	2.2		4	02.83- .92	F2	10,5	Y-107R	1229	
E 2200	2.2		4	.93- .96	R2	10,5	Y-107R	1229	
E 3000	3.0			.93-	L4DE	11,0	Y-721RS	3687	
E 3000	3.0			.93-	VS	11,0	Y-721RS	3687	
E Serie				.97-	R2	11,0	Y-721RS	3687	

### MPV

MPV	2.0	100	4	.97-06.02	WLT	11,0	Y-701J	1566	39
-----	-----	-----	---	-----------	-----	------	--------	------	----

### PREMACY

Premacy 2.0 TD	CP	2.0	66	4	03.99-03.00	RF3F	11,0	Y-529J	4664	
Premacy 2.0 TD	CP	2.0	74	4	07.00-06.05	RF4F	11,0	Y-529J	4664	

### RANGER

Ranger					S 2	8,5	Y-107T	1253	
--------	--	--	--	--	-----	-----	--------	------	--

### T SERIE

T 3000	3.0			.93-	HA	24,0	Y-771R	4262	
T 3000	3.0			.93-	L4DE	24,0	Y-771R	4262	
T Serie				.97-	VS	24,0	Y-771R	4262	

## MERCEDES

### 190 W201

190 D	201	2.0	53	4	02.89-05.93	OM 601.911	11,5	Y-916J	5906	6
190 D	201	2.5	66	5	02.89-05.93	OM 602.911	11,5	Y-916J	5906	6
190 Turbo-D 2.5	201	2.5	90	5	02.89-05.93	OM 602.961	11,5	Y-916J	5906	6
190 Turbo-D 2.5	201	2.5	90	5	02.89-05.93	OM 602.961	12,0	Y-918J	6285	2

### A W168

A 160 CDI	168	1.7	44	4	10.97-02.01	OM 668.941	11,5	Y-746J	3078	38
A 160 CDI	168	1.7	55	4	02.01-08.04	OM 668.940	11,5	Y-746J	3078	38
A 170 CDI	168	1.7	66	4	08.98-02.01	OM 668.940	11,5	Y-746J	3078	38

**MERCEDES****A W168**

A 170 CDI	168	1.7	70	4	02.01-08.04	OM 668.942	11,5	Y-746J	3078	38
-----------	-----	-----	----	---	-------------	------------	------	--------	------	----

**A W169**

A 160 CDI	169	2.0	60	4	09.04-	OM 640.942	4,4	Y8002AS	6287	51
A 180 CDI	169	2.0	80	4	09.04-	OM 640.940	4,4	Y8002AS	6287	51
A 200 CDI	169	2.0	103	4	09.04-	OM 640.941	4,4	Y8002AS	6287	51

**A W176**

A 160 CDI	176	1.5	66	4	06.13-	OM 607.951	4,4	Y1035AS	94103	77
A 180 CDI	176	1.8	80	4	06.12-	OM 651.901	7,0	CZ303	7865	54
A 200 CDI	176	1.8	100	4	06.12-	OM 651.901	7,0	CZ303	7865	54
A 220 CDI	176	2.2	125	4	06.12-	OM 651.930	7,0	CZ303	7865	54

**B W245**

B 180 Cdl	245	2.0	80	4	04.05-10.07	OM 640.940	4,4	Y8002AS	6287	51
B 180 Cdl	245	2.0	80	4	11.07- .11	OM 640.940	7,0	CZ303	7865	54
B 200 Cdl	245	2.0	100	4	04.05-11.07	OM 640.941	4,4	Y8002AS	6287	51
B 200 Cdl	245	2.0	100	4	12.07- .11	OM 640.941	7,0	CZ303	7865	54
B 200 Cdl	245	2.0	103	4	04.05-11.07	OM 640.941	4,4	Y8002AS	6287	51
B 200 Cdl	245	2.0	103	4	12.07- .11	OM 640.941	7,0	CZ303	7865	54

**B W246**

B 160 CDI	246	1.5	66	4	05.13-	OM 607.951	4,4	Y1035AS	94103	77
B 180 CDI	246	1.8	80	4	11.11-	OM 651.901	7,0	CZ303	7865	54
B 200 CDI	246	1.8	100	4	11.11-	OM 651.901	7,0	CZ303	7865	54
B 220 CDI	246	2.2	125	4	11.11-	OM 651.930	7,0	CZ303	7865	54

**C W/S 202**

C 200 D	202	2.0	55	4	07.93-05.00	OM 601.913	11,5	Y-916J	5906	6
C 200 D	202	2.0	65	4	10.96-05.00	OM 604.915	11,5	Y-925J	6848	16
C 220 D	202	2.2	70	4	06.95-05.00	OM 604.910	11,5	Y-925J	6848	16

**C W/S 202**

C 200 CDI	202	2.2	75	4	03.98-05.00	OM 611.960	11,5	Y-745U	6346	11
C 220 CDI	202	2.2	75	4	06.98-05.00	OM 611.961	11,5	Y-745U	6346	11
C 220 CDI	202	2.2	92	4	09.97-03.01	OM 611.960	11,5	Y-745U	6346	11
C 250 D	202	2.5	83	5	02.95-08.95	OM 605.910	11,5	Y-925J	6848	16
C 250 Turbo-D	202	2.5	110	5	05.96-05.00	OM 605.960	11,5	Y-925J	6848	16

**C W/S 203**

C 200 CDI	203	2.2	75	4	03.01-03.03	OM 646.962	11,5	Y-745U	6346	11
C 200 CDI	203	2.2	85	4	05.00-03.04	OM 611.962	11,5	Y-745U	6346	11
C 200 CDI	203	2.2	90	4	04.03-03.07	OM 646.962	11,5	Y-745U	6346	11
C 220 CDI	203	2.2	105	4	05.00-12.04	OM 611.962	11,5	Y-745U	6346	11
C 220 CDI	203	2.2	110	4	04.03-10.07	OM 646.963	11,5	Y-745U	6346	11
C 270 CDI	203	2.7	125	5	12.00-12.04	OM 612.962	11,5	Y-745U	6346	11
C 320 CDI	203	3.0	165	6	12.04-11.07	OM 642.910	4,4	Y8002AS	6287	51

**C COUPÉ C203**

CLC 200 CDI	203	2.2	90	4	05.08-	OM 646.962	11,5	Y-745U	6346	11
CLC 220 CDI	203	2.2	110	4	05.08-	OM 646.963	11,5	Y-745U	6346	11

**C W/S 204**

C 180 CDI	204	2.2	88	4	01.10-	OM 651.913	7,0	CZ303	7865	54
C 200 CDI	204	2.2	100	4	08.07-12.09	OM 646.811	7,0	CZ106	9957	53
C 200 CDI	204	2.2	100	4	01.10-	OM 651.913	7,0	CZ303	7865	54



## MERCEDES

### C W/S 204

C 200 CDI	204	2.2		4	10.07-12.09	OM 646.812	7,0	CZ106	9957	53
C 220 CDI	204	2.2	125	4	05.07-11.08	OM 646.811	7,0	CZ106	9957	53
C 220 CDI	204	2.2	125	4	12.08-	OM 651.911	7,0	CZ303	7865	54
C 220 CDI	204	2.2	150	4	12.08-	OM 651.911	7,0	CZ303	7865	54
C 250 CDI	204	2.2	150	4	01.08-	OM 651.911	7,0	CZ303	7865	54
C 250 CDI 4-matic	204	2.2	150	4	01.11-	OM 651.912	7,0	CZ303	7865	54
C 300 CDI 4-Matic	204	3.0	170	6	01.11-	OM 642.832	7,0	CZ303	7865	54
C 320 CDI	204	3.0	165	6	07.07-	OM 642.960 / 961	4,4	Y8002AS	6287	51
C 350 CDI	204	3.0	165	6	07.09-	OM 642.960 / 961	4,4	Y8002AS	6287	51
C 350 CDI	204	3.0	170	6	09.09-	OM 642.830	7,0	CZ303	7865	54
C 350 CDI 4-Matic	204	3.0	170	6	04.09-	OM 642.832	7,0	CZ303	7865	54

### C W/S 205

C 180 BlueTec	205	1.6	85	4	05.14-	OM 626.951		Y1010AS	97618	
C 200 BlueTec	205	1.6	85	4	05.14-	OM 626.951		Y1010AS	97618	
C 220 BlueTEC Euro V	205	2.2	125	4	12.13-	OM 651.921	7,0	CZ303	7865	54
C 220 BlueTEC Euro VI	205	2.2	125	4	12.13-	OM 651.921	12	CZ551	91584	85
C 250 BlueTEC Euro V	205	2.2	150	4	02.14-	OM 651.921	7,0	CZ303	7865	54
C 250 BlueTEC Euro VI	205	2.2	150	4	02.14-	OM 651.921	12	CZ551	91584	85

### CLA W/S 117

CLA 200 CDI Euro V	117	1.8	100	4	06.13-	OM 651.901	7,0	CZ303	7865	54
CLA 200 CDI Euro VI	117	2.2	100	4	07.14-	OM 651.930	12	CZ551	91584	85

### CLK C209

CLK 220 CDI	209	2.2	110	4	01.05-	OM 646.963	11,5	Y-745U	6346	11
CLK 220 CDI	209	2.2	110	4	01.05-	OM 646.966	11,5	Y-745U	6346	11
CLK 270 CDI	209	2.7	125	5	10.02-07.05	OM 612.962	11,5	Y-745U	6346	11
CLK 270 CDI	209	2.7	125	5	10.02-07.05	OM 612.967	11,5	Y-745U	6346	11
CLK 320 CDI	209	3.0	165	6	01.05-	OM 642.910	4,4	Y8002AS	6287	51

### CLS C219

CLS 320 CDI not for USA	219	3.0	165	6	01.05-	OM 642.920	4,4	Y8002AS	6287	51
CLS 320 CDI only for USA	219	3.0	165	6	01.05-	OM 642.920	7,0	CZ303	7865	54
CLS 350 CDI not for USA	219	3.0	165	6	04.09-	OM 642.920	4,4	Y8002AS	6287	51
CLS 350 CDI only for USA	219	3.0	165	6	04.09-	OM 642.920	7,0	CZ303	7865	54

### CLS C218

CLS 250 BlueTEC 4-matic Euro VI	218	2.2	150	4	05.14-	OM 651.924	12,0	CZ551	91584	85
CLS 250 CDI Euro V	218	2.2	150	4	10.10-	OM 651.924	7,0	CZ303	7865	54
CLS 350 CDI	218	3.0	195	6	01.11-	OM 642.853	7,0	CZ159	95398	84
CLS 350 CDI 4-matic	218	3.0	195	6	09.11-	OM 642.854	7,0	CZ159	95398	84
CLS 350 BlueTEC	218	3.0	185	6	02.13-	OM 642.858	12,0	CZ551	91584	85
CLS 350 BlueTEC	218	3.0	190	6	06.14-	OM 642.853	12,0	CZ551	91584	85

### E W/S 124

200 D	124	2.0	53	4	02.89-06.93	OM 601.912	11,5	Y-916J	5906	6
250 D	124	2.5	66	5	02.89-06.93	OM 602.912	11,5	Y-916J	5906	6
250 D Turbo	124	2.5	93	5	02.89-06.93	OM 602.962	11,5	Y-916J	5906	6
300 D	124	3.0	80	6	02.89-06.93	OM 603.912	11,5	Y-916J	5906	6
300 D 4-Matic	124	3.0	80	6	02.89-06.93	OM 603.913	11,5	Y-916J	5906	6
300 TD	124	3.0	92	6	02.89-06.93	OM 603.960	11,5	Y-916J	5906	6
300 TD	124	3.0	108	6	02.89-06.93	OM 603.960	11,5	Y-916J	5906	6

**MERCEDES****E W/S 124**

300 TD 4-Matic	124	3.0	105	6	02.89-06.93	OM 603.963	11,5	Y-916J	5906	6
E 200 D	124	2.0	53	4	07.93-05.95	OM 601.912	11,5	Y-916J	5906	6
E 250 D	124	2.5	66	5	07.93-	OM 602.912/962	11,5	Y-916J	5906	6
E 250 D	124	2.5	83	5	07.93-04.96	OM 605.911/912	11,5	Y-925J	6848	16
E 250 Turbo-D	124	2.5	93	5	07.93-05.95	OM 602.962	11,5	Y-916J	5906	6
E 300 D	124	3.0	100	6	06.95-06.96	OM 606.910	11,5	Y-925J	6848	16
E 300 Turbo-D	124	3.0	108	6	07.93-	OM 603.960	11,5	Y-916J	5906	6

**E W/S 210**

E 200 D	210	2.0	65	4	01.96-03.02	OM 604.917	11,5	Y-925J	6848	16
E 200 CDI	210	2.2	75	4	06.98-06.99	OM 611.961	11,5	Y-745U	6346	11
E 200 CDI	210	2.2	85	4	07.99-03.03	OM 611.961	11,5	Y-745U	6346	11
E 220 D	210	2.2	55	4	05.96-03.02	OM 611.913	11,5	Y-925J	6848	16
E 220 D	210	2.2	70	4	03.95-03.02	OM 604.912	11,5	Y-925J	6848	16
E 220 CDI	210	2.2	92	4	06.98-06.99	OM 611.961	11,5	Y-745U	6346	11
E 220 CDI	210	2.2	105	4	07.99-03.03	OM 611.961	11,5	Y-745U	6346	11
E 250 D	210	2.5	83	5	03.95-07.99	OM 605.912	11,5	Y-925J	6848	16
E 250 Turbo-D	210	2.5	110	5	06.97-07.99	OM 605.962	11,5	Y-925J	6848	16
E 270 CDI	210	2.7	105	5	07.99-03.03	OM 612.961	11,5	Y-745U	6346	11
E 290 Turbo-D	210	2.9	95	5	06.95-07.99	OM 602.982	11,5	Y-929U	1749	41
E 300 D	210	3.0	100	6	03.95-06.97	OM 606.912	11,5	Y-925J	6848	16
E 300 Turbo-D	210	3.0	130	6	03.97-07.99	OM 606.962	11,5	Y-925J	6848	16
E 320 CDI	210	3.2	145	6	07.99-03.03	OM 613.961	11,5	Y-745U	6346	11

**E W/S 211**

E 200 CDI	211	2.2	90	4	07.02-07.09	OM 646.951	11,5	Y-745U	6346	11
E 200 CDI	211	2.2	100	4	04.06-07.09	OM 646.820 / 821	7,0	CZ106	9957	53
E 220 CDI	211	2.2	110	4	03.03-07.09	OM 646.961	11,5	Y-745U	6346	11
E 220 CDI	211	2.2	125	4	04.06-07.09	OM 646.821	7,0	CZ106	9957	53
E 270 CDI	211	2.7	130	5	03.03-07.09	OM 647.961	11,5	Y-745U	6346	11

**E W/S 211**

E 280 4-matic	211	3.0	140	6	03.05-07.09	OM 642.921	7,0	CZ303	7865	54
E 280 CDI	211	3.2	130	6	05.04-07.09	OM 648.961	11,5	Y-745U	6346	11
E 280 CDI (not for USA)	211	3.0	140	6	03.05-07.09	OM 642.920 / 921	4,4	Y8002AS	6287	51
E 280 CDI (only for USA)	211	3.0	140	6	03.05-07.09	OM 642.920 / 921	7,0	CZ303	7865	54
E 300 CDI Bluetec	211	3.0	165	6	.08-07.09	OM 642.920	7,0	CZ303	7865	54
E 320 CDI	211	3.2	150	6	03.03-07.09	OM 648.961	11,5	Y-745U	6346	11
E 320 CDI (not for USA)	211	3.0	165	6	03.05-07.09	OM 642.920	4,4	Y8002AS	6287	51
E 320 CDI (only for USA)	211	3.0	165	6	03.05-07.09	OM 642.920	7,0	CZ303	7865	54
E 320 CDI 4-matic (not for USA)	211	3.0	165	6	03.05-07.09	OM 642.921	4,4	Y8002AS	6287	51
E 320 CDI 4-matic (only for USA)	211	3.0	165	6	03.05-07.09	OM 642.921	7,0	CZ303	7865	54
E 400 CDI	211	4.0	191	8	02.03-07.09	OM 628.961	11,5	Y-745U	6346	11
E 420 CDI	211	4.0	231	8	09.05-07.09	OM 629.910	4,4	Y8002AS	6287	51
E 420 CDI	211	4.0	231	8	01.06-07.09	OM 629.910	4,4	Y8002AS	6287	51

**E W/S 212**

E 200 CDI	212	2.2	100	4	05.09-	OM 651.925	7,0	CZ303	7865	54
E 220 CDI	212	2.2	125	4	03.09-	OM 651.924	7,0	CZ303	7865	54
E 250 CDI	212	2.2	150	4	03.09-	OM 651.924	7,0	CZ303	7865	54
E 300 CDI	212	3.0	170	6	03.10-	OM 642.850	7,0	CZ303	7865	54
E 350 CDI BlueEfficiency	212	3.0	170	6	03.09-	OM 642.850	7,0	CZ303	7865	54
E 350 CDI BlueTec	212	3.0	155	6	03.09-	OM 642.850	7,0	CZ303	7865	54



e kW C y i **0201**



Stock-No  
D-POWER

## MERCEDES

### E COUPÉ/CABRIOLET C/A 207

E 220 CDI Coupé / Cabriolet	207	2.2	125	4	01.10-	OM 651.911	7,0	CZ303	7865	54
E 250 CDI Coupé / Cabriolet	207	2.2	150	4	01.10-	OM 651.911	7,0	CZ303	7865	54
E 350 CDI Coupé / Cabriolet	207	3.0	170	4	01.10-	OM 642.836	7,0	CZ303	7865	54
E 350 CDI Coupé / Cabriolet	207	3.0	170	6	01.09-	OM 642.836	7,0	CZ303	7865	54

### G W461

250 GD	461	2.5	69	5	04.92-	OM 602.939	11,5	Y-916J	5906	6
290 GD	461	2.9	70	5	04.92-	OM 602.942	11,5	Y-916J	5906	6
290 GD Turbo	461	2.9	72	6	08.93-.94	OM 602.942/947	11,5	Y-916J	5906	6
290 GD Turbo	461	2.9	90	5	07.97-	OM 602.983	11,5	Y-929U	1749	41

### G W463

250 GD	463	2.5	62	5	06.90-	OM 602.931	11,5	Y-916J	5906	6
300 GD	463	3.0	83	6	02.89-06.93	OM 603.931	11,5	Y-916J	5906	6
350 GD	463	3.5	100	6	09.91-06.93	OM 603.972	11,5	Y-916J	5906	6
G 270 CDI	463	2.7	115	5	10.01-	OM 612.965	11,5	Y-745U	6346	11
G 300 D	463	3.0	83	6	08.93-	OM 603.931	11,5	Y-916J	5906	6
G 300 Turbo-D	463	3.0	130	6	08.96-	OM 606.964	11,5	Y-925J	6848	16
G 320 CDI	463	3.0	165	6	09.06-	OM 642.970	7,0	CZ303	7865	54
G 400 CDI	463	4.0	184	8	12.00-	OM 628.962	11,5	Y-745U	6346	11

### GLA X156

GLA 180 CDI	X156	1.5	80	4	07.14-	OM 607.951	4,4	Y1035AS	94103	77
GLA 200 CDI	X156	2.2	100	4	12.13-	OM 651.930	12,0	CZ551	91584	85

### GL X164

GL 320 CDI (not for USA)	X164	3.0	165	6	01.06-	OM 642.940	4,4	Y8002AS	6287	51
GL 320 CDI (only for USA)	X164	3.0	165	6	01.06-	OM 642.940	7,0	CZ303	7865	54
GL 350 CDI Bluetec	X164	3.0	155	6	06.09-	OM 642.820	7,0	CZ303	7865	54

### GL X164

GL 350 CDI (not for USA)	X164	3.0	165	6	05.09-	OM 642.940	4,4	Y8002AS	6287	51
GL 350 CDI (only for USA)	X164	3.0	165	6	05.09-	OM 642.940	7,0	CZ303	7865	54
GL 420 CDI	X164	4.0	225	8	01.06-	OM 629.912	4,4	Y8002AS	6287	51
GL 450 CDI	X164	4.0	225	8	05.09-	OM 629.912	4,4	Y8002AS	6287	51

### GLK X204

GLK 200 CDI	X204	2.2	105	4	07.10-	OM 651.913	7,0	CZ303	7865	54
GLK 220 CDI	X204	2.2	120	4	06.08-	OM 651.912	7,0	CZ303	7865	54
GLK 220 CDI	X204	2.2	120	4	06.08-	OM 651.916	7,0	CZ303	7865	54
GLK 220 CDI	X204	2.2	125	4	08.08-	OM 651.916	7,0	CZ303	7865	54
GLK 220 CDI	X204	2.2	125	4	06.08-	OM 651.912	7,0	CZ303	7865	54
GLK 250 CDI	X204	2.2	150	4	10.08-	OM 651.912	7,0	CZ303	7865	54
GLK 320 CDI	X204	3.0	165	6	08.08-	OM 642.961	4,4	Y8002AS	6287	51
GLK 350 CDI	X204	3.0	165	6	06.09-	OM 642.832	7,0	CZ303	7865	54

### MB 100

MB 100		2.4	43	4	02.89-	OM 615.970	11,0	Y-924J	7906	1
MB 100 D		2.4	56	4	02.89-	OM 616.963	11,5	Y-916J	5906	6



**MERCEDES****M W163**

ML 270 CDI	163	2.7	120	5	12.99-06.05	OM 612.963	11,5	Y-745U	6346	11
ML 400 CDI	163	4.0	184	8	09.00-06.05	OM 628.963	11,5	Y-745U	6346	11

**M W164**

ML 280 CDI (not for USA)	164	3.0	140	6	10.05-	OM 642.940	4,4	Y8002AS	6287	51
ML 280 CDI (only for USA)	164	3.0	140	6	10.05-	OM 642.940	7,0	CZ303	7865	54
ML 300 CDI (not for USA)	164	3.0	140	6	06.09-	OM 642.940	4,4	Y8002AS	6287	51
ML 300 CDI (only for USA)	164	3.0	140	6	06.09-	OM 642.940	7,0	CZ303	7865	54
ML 300 CDI	164	3.0	150	6	06.09-	OM 642.820	7,0	CZ303	7865	54
ML 320 CDI (not for USA)	164	3.0	165	6	07.05-	OM 642.940	4,4	Y8002AS	6287	51
ML 320 CDI (only for USA)	164	3.0	165	6	07.05-	OM 642.940	7,0	CZ303	7865	54
ML 350 CDI	164	3.0	155	6	09.09-	OM 642.820	7,0	CZ303	7865	54
ML 350 CDI (not for USA)	164	3.0	165	6	06.09-	OM 642.940	4,4	Y8002AS	6287	51
ML 350 CDI (not for USA)	164	3.0	170	6	02.10-	OM 642.940	4,4	Y8002AS	6287	51
ML 350 CDI (only for USA)	164	3.0	165	6	06.09-	OM 642.940	7,0	CZ303	7865	54
ML 350 CDI (only for USA)	164	3.0	170	6	02.10-	OM 642.940	7,0	CZ303	7865	54
ML 420 CDI	164	4.0	225	8	02.06-	OM 629.912	4,4	Y8002AS	6287	51
ML 450 CDI	164	4.0	225	8	06.09-	OM 629.912	4,4	Y8002AS	6287	51

**M W166**

ML 250 CDI	166	2.2	150	4	06.11-	OM 651.960	7,0	CZ303	7865	54
------------	-----	-----	-----	---	--------	------------	-----	-------	------	----

**R W251**

R 280 CDI (not for USA)	251	3.0	140	6	05.06-	OM 642.950	4,4	Y8002AS	6287	51
R 280 CDI (only for USA)	251	3.0	140	6	05.06-	OM 642.950	7,0	CZ303	7865	54
R 300 CDI (not for USA)	251	3.0	140	6	07.09-	OM 642.950	4,4	Y8002AS	6287	51
R 300 CDI (only for USA)	251	3.0	140	6	07.09-	OM 642.950	7,0	CZ303	7865	54
R 320 CDI (not for USA)	251	3.0	165	6	02.06-	OM 642.950	4,4	Y8002AS	6287	51
R 320 CDI (only for USA)	251	3.0	165	6	02.06-	OM 642.950	7,0	CZ303	7865	54
R 350 CDI Bluetec	251	3.0	155	6	07.09-	OM 642.950	7,0	CZ303	7865	54
R 350 CDI	251	3.0	165	6	07.09-	OM 642.950	7,0	CZ303	7865	54

**S W140**

S 300 Turbo-D	140	3.0	130	6	05.96-10.98	OM 606.961	11,5	Y-916J	5906	6
S 300	140	3.0	130	6	05.96-10.98	OM 606.961	11,5	Y-925J	6848	16
S 350 Turbo-D	140	3.5	110	6	01.93-10.98	OM 603.971	11,5	Y-916J	5906	6

**S W220**

S 320 CDI	220	3.2	145	6	08.99-09.02	OM 613.960	11,5	Y-745U	6346	11
S 320 CDI	220	3.2	150	6	09.02-08.05	OM 648.960	11,5	Y-745U	6346	11
S 400 CDI	220	4.0	184	8	06.00-08.05	OM 628.960	11,5	Y-745U	6346	11
S 400 CDI	220	4.0	191	8	06.03-08.05	OM 628.960	11,5	Y-745U	6346	11

**S W221/W222**

S 300 BlueTEC hybrid Euro V	222	2.2	150	4	02.14-	OM 651.921	7,0	CZ303	7865	54
S 300 BlueTEC hybrid Euro V	222	2.2	170	4	02.14-	OM 651.921	7,0	CZ303	7865	54
S 300 BlueTEC hybrid Euro VI	222	2.2	150	4	02.14-	OM 651.921	12,0	CZ551	91584	85
S 300 BlueTEC hybrid Euro VI	222	2.2	170	4	02.14-	OM 651.921	12,0	CZ551	91584	85
S 250 CDI	221	2.2	150	4	01.11-	OM 651.961	7,0	CZ303	7865	54
S 320 CDI	221	3.0	173	6	03.06-	OM 642.930	4,4	Y8002AS	6287	51
S 320 CDI 4-Matic	221	3.0	173	6	10.06-	OM 642.932	4,4	Y8002AS	6287	51
S 350 CDI	221	3.0	190	6	06.10-	OM 642.862	7,0	CZ159	95398	84
S 350 CDI 4-matic	221	3.0	190	6	06.10-	OM 642.868	7,0	CZ159	95398	84



e kW C y I 0201



Stock-No D-POWER

## MERCEDES

### S W221/W222

S 350 BlueTEC 4-matic	222	3.0	185	6	02.14-	OM 642.867	12,0	CZ551	91584	85
S 350 BlueTEC 4-matic	222	3.0	190	6	02.14-	OM 642.867	12,0	CZ551	91584	85
S 350 CDI Bluetec	222	3.0	190	6	05.13-	OM 642.861	12,0	CZ551	91584	85
S 420 CDI	221	4.0	235	8	10.06-	OM 629.911	4,4	Y8002AS	6287	51

### SLK R172

SLK 250 Cdi	172	2.2	150	4	01.12-	OM 651.980	7,0	CZ303	7865	54
-------------	-----	-----	-----	---	--------	------------	-----	-------	------	----

### SPRINTER 901 / 902

Sprinter 208 CDI	901/902	2.2	60		04.00-		11,5	Y-745U	6346	11
Sprinter 208 D	901/902	2.3	58	4	04.95-	OM 601....	11,5	Y-916J	5906	6
Sprinter 211 CDI	901/902	2.2	80		04.00-		11,5	Y-745U	6346	11
Sprinter 212 D	901/902	2.9	90	5	04.95-	OM 602.980.10 DELA ->9849	11,0	Y-924J	7906	1
Sprinter 212 D	901/902	2.9	90	5	04.95-	OM 602.980.10 DELA 9850->	11,5	Y-929U	1749	41
Sprinter 212 D	901/902	2.9	90	5	04.95-	OM 602.980.12 DELA ->136	11,0	Y-924J	7906	1
Sprinter 212 D	901/902	2.9	90	5	04.95-	OM 602.980.12 DELA 137 ->	11,5	Y-929U	1749	41
Sprinter 213 CDI	901/902	2.1	95		04.00-		11,5	Y-745U	6346	11
Sprinter 216 CDI	901/902	2.7	115		04.00-		11,5	Y-745U	6346	11

### SPRINTER 903

Sprinter 308 CDI	903	2.2	60		04.00-		11,5	Y-745U	6346	11
Sprinter 308 D	903	2.3	58	4	04.95- .00	OM 601.....	11,5	Y-916J	5906	6
Sprinter 311 CDI	903	2.1	80	4	04.00-	OM 611.981	11,5	Y-745U	6346	11
Sprinter 312 D	903	2.9	90	5	04.95-04.00	OM 602.980.10 DELA ->9849	11,0	Y-924J	7906	1
Sprinter 312 D	903	2.9	90	5	04.95-04.00	OM 602.980.10 DELA9850->	11,5	Y-929U	1749	41
Sprinter 312 D	903	2.9	90	5	04.95-04.00	OM 602.980.12 DELA ->136	11,0	Y-924J	7906	1
Sprinter 312 D	903	2.9	90	5	04.95-04.00	OM 602.980.12 DELA 137 ->	11,5	Y-929U	1749	41
Sprinter 313 CDI	903	2.1	95		04.00-		11,5	Y-745U	6346	11
Sprinter 316 CDI	903	2.7	115		04.00-		11,5	Y-745U	6346	11

### SPRINTER 904

Sprinter 412 D	904	2.9	90	5	04.95-	OM 602.980.10 DELA ->9849	11,0	Y-924J	7906	1
Sprinter 412 D	904	2.9	90	5	04.95-	OM 602.980.10 DELA 9850 ->	11,5	Y-929U	1749	41
Sprinter 412 D	904	2.9	90	5	04.95-	OM 602.980.12 DELA ->136	11,0	Y-924J	7906	1
Sprinter 412 D	904	2.9	90	5	04.95-	OM 602.980.12 DELA 137 ->	11,5	Y-929U	1749	41

### SPRINTER 906

Sprinter 209 CDI	906	2.2	65	4	06.06-	OM 646.984	11,5	Y-745U	6346	11
Sprinter 209 CDI	906	2.2	80	4	06.06-	OM 646.985	11,5	Y-745U	6346	11
Sprinter 209 CDI	906	3.0	135	4	06.06-	OM 642.992	7,0	CZ303	7865	54
Sprinter 209 CDI	906	3.0		4	06.06-	OM 642.896	7,0	CZ303	7865	54
Sprinter 210 CDI	906	2.2	70	4	03.09-	OM 651.955	7,0	CZ303	7865	54
Sprinter 213 CDI	906	2.2	95	4	03.09-	OM 651.956	7,0	CZ303	7865	54
Sprinter 216 CDI	906	2.2	120	4	03.09-	OM 651.957	7,0	CZ303	7865	54
Sprinter 218 CDI	906	3.0	135	6	06.06-	OM 642.992	4,4	Y8002AS	6287	51
Sprinter 219 CDI	906	3.0	140	6	03.09-	OM 642.992	7,0	CZ303	7865	54
Sprinter 310 CDI	906	2.2	70	4	03.09-	OM 651.955	7,0	CZ303	7865	54
Sprinter 313 CDI	906	2.2	95	4	06.06-	OM 651.956	7,0	CZ303	7865	54
Sprinter 313 CDI	906	2.2	95	4	08.11-	OM 651.955	7,0	CZ303	7865	54
Sprinter 316 CDI	906	2.2	120	4	03.09-	OM 651.957	7,0	CZ303	7865	54
Sprinter 318 CDI	906	3.0	135	6	06.06-	OM 642.992	4,4	Y8002AS	6287	51
Sprinter 319 CDI	906	3.0	140	6	03.09-	OM 642.992	4,4	Y8002AS	6287	51
Sprinter 413 CDI	906	2.2	95	4	06.06-	OM 651.956	4,4	Y8002AS	6287	51
Sprinter 416 CDI	906	2.2	120	4	03.09-	OM 651.957	7,0	CZ303	7865	54

**MERCEDES****SPRINTER 906**

Sprinter 419 CDI	906	3.0	140	6	03.09-	OM 642.992	4,4	Y8002AS	6287	51
Sprinter 510 CDI	906	2.2	70	4	03.09-	OM 651.955	7,0	CZ303	7865	54
Sprinter 513 CDI	906	2.2	95	4	03.09-	OM 651.956	7,0	CZ303	7865	54
Sprinter 516 CDI	906	2.2	120	4	03.09-	OM 651.957	7,0	CZ303	7865	54
Sprinter 518 CDI	906	3.0	135	6	06.06-	OM 642.992	4,4	Y8002AS	6287	51
Sprinter 519 CDI	906	3.0	140	6	03.09-	OM 642.992	4,4	Y8002AS	6287	51

**UNIMOG**

Unimog 100 L		2.9	71	5	11.92-	OM 602.948	11,5	Y-916J	5906	6
Unimog 600/650		2.4	38	4	01.88-	OM 616.	11,0	Y-924J	7906	1
Unimog U 90		3.0	65	5	11.92-	OM 602.941	11,5	Y-916J	5906	6

**VANEO 414**

Vaneo CDI	414	1.7	55	4	01.02-	OM 668.914	11,5	Y-746J	3078	38
Vaneo CDI	414	1.7	67	4	01.02-	OM 668.914	11,5	Y-746J	3078	38

**VIANO 639**

Viano 2.0l CDI	639	2.2	80	4	07.03-	OM 646.982	11,5	Y-745U	6346	11
Viano 2.2l CDI	639	2.2	100	4	07.10-	OM 651.940	7,0	CZ303	7865	54
Viano 2.2l CDI	639	2.2	110	4	09.03-	OM 646.983	11,5	Y-745U	6346	11
Viano 2.2l CDI	639	2.2	120	4	07.10-	OM 651.940	7,0	CZ303	7865	54
Viano 3.0l CDI	639	3.0	150	6	08.05-	OM 642.990	4,4	Y8002AS	6287	51
Viano 3.0l CDI	639	3.0	165	6	07.10-	OM 642.990	4,4	Y8002AS	6287	51

**VITO 638**

Vito 108 D	638	2.3	60	4	02.96-	OM 601.942	11,5	Y-916J	5906	6
Vito 110 D	638	2.3	72	4	02.96-	OM 601.970	11,5	Y-916J	5906	6

**VITO 639**

Vito 110 CDI	639	2.2	70	4	09.10-	OM 651.940	7,0	CZ303	7865	54
Vito 113 CDI	639	2.2	100	4	07.10-	OM 651.940	7,0	CZ303	7865	54
Vito 116 CDI	639	2.2	120	4	09.10-	OM 651.940	7,0	CZ303	7865	54
Vito 120 CDI	639	3.0	150	6	03.06-	OM 642.990	4,4	Y8002AS	6287	51
Vito 122 CDI	639	3.0	165	6	09.10-	OM 642.990	4,4	Y8002AS	6287	51

**VITO 447**

Vito 109 BlueTec / CDI	447	1.6	85	4	10.14-	OM 626.951	4,5	Y1010AS	97618	
Vito 111 BlueTec / CDI	447	1.6	85	4	10.14-	OM 626.951	4,5	Y1010AS	97618	
Vito 160 CDI	447	1.6	85	4	03.15-	OM 626.951	4,5	Y1010AS	97618	
Vito 180 CDI	447	1.6	85	4	03.15-	OM 626.951	4,5	Y1010AS	97618	

**V 638**

V 200 CDI	638	2.2	75	4	03.99-07.03	OM 611.980	11,5	Y-745U	6346	11
V 220 CDI	638	2.2	90	4	03.99-07.03	OM 611.980	11,5	Y-745U	6346	11
V 230 TD	638	2.3	72	4	09.96-	OM 601.970	11,5	Y-916J	5906	6

**MG**

ZR TD		2.0		4	06.01-		11,0	Y-730U	6704	17
ZR TD		2.0		4	12.02-		11,0	Y-730U	6704	17
ZS TD		2.0		4	08.02-		11,0	Y-730U	6704	17
ZS TD		2.0		4	12.02-		11,0	Y-730U	6704	17
ZT CDTi		2.0		4	07.02-	M47R (BMW)	11,0	Y-507J	2691	32
ZT CDTi		2.0		4	10.02-	M47R (BMW)	11,0	Y-507J	2691	32



l kW C y i **0201**



Stock-No  
D-POWER

## MG

ZT-T CDTi	2.0		4	07.02-	M47R (BMW)	11,0	Y-507J	2691	32
ZT-T CDTi	2.0		4	10.02-	M47R (BMW)	11,0	Y-507J	2691	32

## MINI

Mini D	R50	1.4	55	4	03.03-	W17 D14	11,0	Y-542J	5513	45
Mini D	R50	1.4	65	4	03.03-	W17 D14	11,0	Y-542J	5513	45
Mini One D	R56	1.6	66	4	06.09-07.10	9HZ (DV6TED4)	11,0	YE05	91322	73
Mini Cooper D	R56	1.6	80	4	03.07-09.10	W16 D16	11,0	YE05	91322	73
Mini Coupe Cooper SD	R58	2.0	100	4	09.11-	N47 C20A	4,4	Y1039AS	91648	80
Mini Coupe Cooper SD	R58	2.0	105	4	09.11-	N47 C20A	4,4	Y1039AS	91648	80
Mini Countryman Cooper D	R60	1.6	82	4	06.10-	N47 C16A	4,4	Y1039AS	91648	80
Mini Countryman Cooper D	R60	2.0	82	4	02.11-	N47 C20A	4,4	Y1039AS	91648	80
Mini Countryman Cooper SD	R60	2.0	105	4	02.11-	N47 C20A	4,4	Y1039AS	91648	80
Mini Countryman Cooper SD ALL4	R60	2.0	100	4	02.11-	N47 C20A	4,4	Y1039AS	91648	80
Mini Countryman One D	R60	1.6	66	4	06.10-	N47 C16A	4,4	Y1039AS	91648	80

## MITSUBISHI

### CANTER

Canter (N-FE301, 311, 321, 331)			4	10.85-10.03	4D30	23,0	Y-971M	5035	
Canter (N-FE401)			4	10.85-10.03	4D30	23,0	Y-971M	5035	
Canter FB35	2.5	55	4	09.92-09.96	4D56	11,0	CZ257	97284	83
Canter	3.0	92		09.01-02.05	4M42-OAT	11,0	Y1007J	3040	59
Canter	3.0	92		09.01-02.05	4M42-OAT	11,0	Y1007J	3040	59

### CARISMA

Carisma TD	1.9	66	4	10.96-	F8Q	11,0	Y-933J	7947	25
Carisma 1.9 DI-D(DA..)	1.9	75	4	09.00-		12,0	Y-732J	5605	4
Carisma 1.9 DI-D(DA..)	1.9	85	4	09.00-		12,0	Y-732J	5605	4

### CHARIOT

Chariot TD	2.0	60	4	01.92-12.97	4D68T	11,0	CZ257	97284	83
------------	-----	----	---	-------------	-------	------	-------	-------	----

### COLT

Colt DID (6) Z38A	1.5	50	3	04.05-09.08	639 938	11,5	YE13	8643	
Colt DID (6) Z39A	1.5	70	3	04.05-09.08	639 939	11,5	YE13	8643	

### GALANT

Galant TD (E5..8)	2.0	66	4	11.92-10.96	4D68 SOHC	11,0	CZ257	97284	83
Galant TD (EA)	2.0	66	4	10.96-07.01	4D68	11,0	CZ257	97284	83

### GALLOPER

Galopper TD	2.5	65	4	11.97-06.03	D4BA	11,0	CZ257	97284	83
Galopper TDCi	2.5	73	4	11.97-06.03	D4BH	11,0	CZ257	97284	83
Galopper TDCi	2.5	77	4	11.97-06.03	D4BH	11,0	CZ257	97284	83

### GRANDIS

Grandis 2.0 DI-D Without particle filter	2.0	100	4	09.05-03.10	BSY ( VW engine)	4,4	YE14	7768	48
Grandis 2.0 DI-D With particle filter	2.0	100	4	06.07-03.10	BSY ( VW engine)	7,0	CZ304	9864	55
Grandis 2.0 DI-D Without particle filter	2.0	103	4	02.07-03.10	BWC	4,4	YE14	7768	48
Grandis 2.0 DI-D With particle filter	2.0	103	4	06.07-03.10	BWC	7,0	CZ304	9864	55

### L200

L200 (KOT-K3T)	2.5	51	4	09.96-12.07	4D56 SOHC	11,0	CZ257	97284	83
L200 2.5 DI-D	2.5	94	4	04.10-	4D56HP	11,0	CZ251	91238	76
L200 2.5 DI-D	2.5	100	4	11.05-	4D56HP	11,0	CZ251	91238	76



l kW C y i  
0201



Stock-No  
D-POWER™

## MITSUBISHI

### L200

L200 2.5 DI-D Euro III + IV	2.5	123	4	08.07-	4D56HP	11,0	CZ251	91238	76
L200 2.5 DI-D	2.5	131	4	06.09-	4D56HP	11,0	CZ251	91238	76

### L300

L300 TD (P)	2.5	64	4	06.93- .96	4D56 SOHC	11,0	CZ257	97284	83
L300	2.5		4	- .92	4D5	12,0	Y-115T1	2189	
L300	2.5		4	.97-	4D56	11,0	CZ257	97284	83
L300 / 4WD QGS Type	2.3		4		4D55	6,0	Y-115R1	2161	

### L400

L400			4	12.94-03.03	4D56	11,0	CZ257	97284	83
L400 TD	2.5	73	4	12.94-03.03	4D56T	11,0	CZ257	97284	83
L400	2.5		4	.98-	4D56	11,0	CZ257	97284	83

### LANCER

Lancer (CB/CD)	2.0	50	4	06.92-08.03	4D68	11,0	CZ257	97284	83
----------------	-----	----	---	-------------	------	------	-------	-------	----

### MONTERO

Montero			4	.92- .93	4D56	11,0	CZ257	97284	83
Montero			4	03.91-04.00	4D56	11,0	CZ257	97284	83
Montero			4	.96-	4D56	11,0	CZ257	97284	83
Montero Sport			4	.97-		11,0	Y-733J	6592	13

### OUTLANDER

Outlander 2.0 DI-D	2.0	103	4	11.06-06.10	BSY	7,0	CZ304	9864	55
Outlander 2.2 DI-D	2.2	115	4	-	4HK / 4HN	11,0	YE08	4966	

### PAJERO

Pajero			4		4D56 S-QGS Type	11,0	CZ257	97284	83
Pajero			4	.92- .93	4D56	11,0	CZ257	97284	83
Pajero Sport			4	.97- .99	4D56-QGS	11,0	CZ257	97284	83
Pajero TD Intercooler (IV)	2.5	62	4	08.93-05.99	4D56 T	11,0	CZ257	97284	83
Pajero TD Intercooler (V)	2.5	73	4	12.90-10.99	4D56 T	11,0	CZ257	97284	83
Pajero (V4)	2.8	92	4	06.94-04.00	4M40	11,0	CZ256	90066	
Pajero 3.2 DI-D V88W/V98W	3.2	118	6	02.07-	4M41	11,0	CZ251	91238	76
Pajero 3.2 DI-D V88W/V98W	3.2	125	6	02.07-	4M41	11,0	CZ251	91238	76
Pajero 3.2 DI-D V88W/V98W	3.2	147	6	01.09-	4M41	11,0	CZ251	91238	76

### PAJERO

Pajero Classic	3.2	118		05.05-	4M41	11,0	Y1007J	3040	59
Pajero III	3.2	118		10.01-	4M41	11,0	Y1007J	3040	59
Pajero III	3.2	121		04.00-10.01	4M41	11,0	Y1007J	3040	59

### SHOGUN

Shogun	2.5		4	03.91-04.00	4D56	11,0	CZ257	97284	83
Shogun	2.5		4	01.96-03.00	4D56	11,0	CZ257	97284	83

### SPACE GEAR

Space Gear TD	2.5	73	4	05.95-05.00	4D56	11,0	CZ257	97284	83
Space Gear TDiC	2.5	73	4	06.94-05.95	4D56 Turbo	11,0	CZ257	97284	83
Space Gear TDiC	2.5		4	.98-	4D56 Turbo	11,0	CZ257	97284	83

### SPACE RUNNER

Space Runner TD	2.0	60	4	06.91-09.99	4D68	11,0	CZ257	97284	83
-----------------	-----	----	---	-------------	------	------	-------	-------	----



e kW C y i **0201**



Stock-No  
D-POWER

## MITSUBISHI

### SPACE STAR

Space Star 1.9 DI-D	1.9	75	4	08.00-12.04	F9Q1	12,0	Y-732J	5605	4
Space Star 1.9 DI-D	1.9	85	4	08.02-12.04	F9Q2	12,0	Y-732J	5605	4

### SPACE WAGON

Space Wagon (N)	2.0	60	4	10.92-10.98	4D68	11,0	CZ257	97284	83
-----------------	-----	----	---	-------------	------	------	-------	-------	----

## NISSAN

### ALMERA 1

Almera 2.0 D	N15	2.0	55	4	07.95- .00	CD20E	11,0	CZ260	91904
--------------	-----	-----	----	---	------------	-------	------	-------	-------

### ALMERA 2

Almera 1.5 dCi	N16	1.5	60	4	01.03-	K9K	12,0	Y-732J	5605	4
Almera 2.2 dCi	N16	2.2	82	4	09.03-	YD22DDTi	11,0	Y-519J	93293	61
Almera 2.2 dCi	N16	2.2	100	4	09.03-	YD22DDTi	11,0	Y-519J	93293	61

### ALMERA TINO

Almera Tino 2.2 dCi	V10	2.2	82	4	09.03-	YD22DDTi	11,0	Y-519J	93293	61
Almera Tino 2.2 dCi	V10	2.2	100	4	09.03-	YD22DDTi	11,0	Y-519J	93293	61

### CABSTAR

Cabstar 2.5 dCi	F24M	2.5	96	4	10.06-	YD25DDTi	4,5	Y1010AS	97618
Cabstar 2.5 dCi	F24M	2.5	100	4	10.11-	YD25DDTi	4,5	Y1010AS	97618

### CUBE

Cube 1.5 dCi	Z12	1.5	78	4	03.10-	K9K	4,4	Y1035AS	94103	77
Cube 1.5 dCi	Z12	1.5	81	4	03.10-	K9K	4,4	Y1035AS	94103	77

### D 21

D21		2.5			.93-	TD25	11,0	Y-707RS	4937
D21		2.7			.93-	TD27	11,0	Y-707RS	4937
D21		2.7			.93-	TD27T	11,0	Y-712RS	6140

### EVALIA

Evalia 1.5 dCi	M20M	1.5	66	4	04.11-	K9K	4,4	Y1035AS	94103	77
Evalia 1.5 dCi	M20M	1.5	81	4	04.11-	K9K	4,4	Y1035AS	94103	77

### INTERSTAR

Interstar dCi 80	X70	1.9	60	4	07.02-	F9Q772	12,0	Y-732J	5605	4
Interstar dCi 90	X70	2.2	66	4	07.02-	G9T722	11,0	Y-517J	91766	66
Interstar dCi 100	X70	2.5	74	4	04.06-	G9U754	11,0	Y-517J	91766	66

### INTERSTAR

Interstar dCi 115	X70	2.5	84	4	04.02-	G9U720	11,0	Y-517J	91766	66
Interstar dCi 120	X70	2.5	88	4	09.06-	G9U650	11,0	Y-517J	91766	66
Interstar dCi 150	X70	2.5	107	4	09.06-	G9U632	11,0	Y-517J	91766	66

### JUKE

Juke 1.5 dCi	F15E	1.5	81	4	06.10-	K9K	4,4	Y1035AS	94103	77
--------------	------	-----	----	---	--------	-----	-----	---------	-------	----

### KUBISTAR

Kubistar Cdi	X76	1.5	48	4	08.03-	K9K	12,0	Y-732J	5605	4
Kubistar Cdi	X76	1.5	60	4	08.03-	K9K	12,0	Y-732J	5605	4

**NISSAN****MICRA 2**

Micra 1.5 dCi	K11	1.5	42	4	.98-	.00	VJX	11,0	Y-503J	1009	10
Micra 1.5 dCi	K11	1.5	42	4	.98-	.00	VJZ	11,0	Y-503J	1009	10

**MICRA 3**

Micra dCi	K12	1.5	48	4	04.03-		K9K	12,0	Y-732J	5605	4
Micra dCi	K12	1.5	60	4	09.03-		K9K	12,0	Y-732J	5605	4

**NAVARA**

Navara 2.5 dCi d22		2.5	128	4	.05-		YD25DDTi	4,5	Y1010AS	97618	
--------------------	--	-----	-----	---	------	--	----------	-----	---------	-------	--

**NOMAD**

Nomad		2.0					LD20	11,0	CZ259	94154	
-------	--	-----	--	--	--	--	------	------	-------	-------	--

**NOTE**

Note I 1.5 dCi	E11	1.5	50	4	03.06-09.12		K9K 700	12,0	Y-732J	5605	4
Note I 1.5 dCi	E11	1.5	63	4	03.06-09.12		K9K	12,0	Y-732J	5605	4
Note I 1.5 dCi	E11	1.5	76	4	07.08-12.10		K9K 278 / 292	12,0	Y-732J	5605	4
Note I 1.5 dCi	E11	1.5	66	4	09.10-08.13		K9K 276	4,4	Y1035AS	94103	77
Note II 1.5 dCi	E12	1.5	66	4	06.13-		K9K	4,4	Y1035AS	94103	77

**NT400**

NT400 Cabstar 2.5 dCi	F24M	2.5	107	4	02.14-		YD25DDTi	4,5	Y1010AS	97618	
NT400 Cabstar 2.5 dCi	F24M	2.5	90	4	02.14-		YD25DDTi	4,5	Y1010AS	97618	

**NV 200**

NV200 1.5 dCi	M20M	1.5	66	4	04.11-		K9K	4,4	Y1035AS	94103	77
NV200 1.5 dCi	M20M	1.6	81	4	04.11-		K9K	4,4	Y1035AS	94103	77

**PATHFINDER**

Pathfinder 2.5 dCi		2.5	128	4	01.10-		YD25DDTi	4,5	Y1010AS	97618	
Pathfinder	D21	2.5		4	.93-		TD25	11,0	Y-707RS	4937	
Pathfinder	D21	2.7		4	.93-		TD27	11,0	Y-707RS	4937	
Pathfinder	D21	2.7		4	.93-		TD27T	11,0	Y-712RS	6140	

**PATROL**

Patrol		2.7		6	02.93-		TD27	11,0	Y-707RS	4937	
Patrol (4,5,6 Cyl CX51.)(1,2,3 Cyl.CZ51)	Y61	2.8	95	6	04.98-		RD28 only if NGK is OE		CX51+	2896+	
Patrol (4,5,6 Cyl CX51.)(1,2,3 Cyl.CZ51)	Y60 / 160	2.8		6			RD28T		CX51+	2896+	
Patrol 3.0 Di	Y61	3.0	116	4	05.00-	.06	ZD30DDTi only if NGK is OE	11,0	CZ258	95173	
Patrol 3.0 Di	Y61	3.0	116	4	.06-	.09	ZD30DDTi only if NGK is OE	11,0	Y-522J	5939	
Patrol		3.3		6	11.84-		SD33 12V	11,0	Y-705RS	1249	
Patrol		3.3		6	11.84-		SD33 24V	24,0	Y-755RS	7771	

**PATROL**

Patrol		3.3		6	11.84-		SD33T 12V	11,0	Y-705RS	1249	
Patrol		3.3		6	11.84-		SD33T 24V	24,0	Y-755RS	7771	
Patrol	160	4.2		6	-12.98		TD42 12V	11,0	Y-707RS	4937	
Patrol	160	4.2		6	-12.98		TD42 24V	24,0	Y-757RS	4018	

**PICK UP**

Pick-Up	720	2.3		4	.87-		SD23	11,0	Y-705RS	1249	
Pick Up		2.5	98	4	12.01-		YD25DDTi		Y1010AS	97618	
Pick-Up	720	2.5		4	.87-		SD25	11,0	Y-705RS	1249	



## NISSAN

### PRIMASTAR

Primastar dCi 80	X83	1.9	60	4	03.01-	F9Q762	12,0	Y-732J	5605	4
Primastar dCi 100	X83	1.9	74	4	03.01-	F9Q760	12,0	Y-732J	5605	4
Primastar dCi 140	X83	2.5	99	4	09.03-	G9U730	11,0	Y-517J	91766	66
Primastar dCi 150	X83	2.5	107	4	09.06-	G9U632	11,0	Y-517J	91766	66

### PRIMERA 1

Primera 2.0	P10	2.0	55	4	07.90-04.96	CD20	11,0	CZ260	91904	
Primera 2.0	P10	2.0	55	4	01.91-06.96	CD20	11,0	CZ260	91904	

### PRIMERA 3

Primera 1.9 dCi	P12	1.9	88	4	09.03-	F9Q...	12,0	Y-732J	5605	4
Primera 2.2 Di	P12	2.2	93	4	03.02-	YD22ET	11,0	Y-519J	93293	61
Primera 2.2 dCi	P12	2.2	102	4	04.03-	YD22DDT	11,0	Y-519J	93293	61

### QASHQAI

Qashqai 1.5 dCi	J10	1.5	76	4	07.08-06.10	K9K	12,0	Y-732J	5605	4
Qashqai 1.5 dCi	J10	1.5	78	4	02.07-06.10	K9K	12,0	Y-732J	5605	4
Qashqai 1.6 dCi	J11E	1.6	96	4	02.14-	R9M	4,5	Y1010AS	97618	
Qashqai I 1.6 dCi	J10	1.6	96	4	07.11-01.14	R9M	4,5	Y1010AS	97618	

### SERENA

Serena 2.0 D	C23M	2.0	49	4	07.92-01.96	LD20	11,0	CZ259	94154	
Serena 2.3 D	C23M	2.3	55	4	01.95-02.98	LD23	11,0	Y-712RS	6140	
Serena 2.3 D	C23M	2.3	55	4	03.98-	LD23	11,0	Y-530J	6586	

### SUNNY

Sunny 1.7 D	B13	1.7	40	4	.93- .96	CD17	11,0	CZ259	94154	
Sunny 2.0 D	B14	2.0	55	4	10.90-	CD20	11,0	CZ260	91904	
Sunny 2.0 D	B14	2.0		4		CD20	11,0	CZ259	94154	
Sunny 1.7 D	N14	1.7		4	.91- .91	CD17	11,0	CZ260	91904	
Sunny 2.0 D	N14	2.0	55	4	10.90- .95	CD20	11,0	CZ260	91904	
Sunny 2.0 D	N15	2.0	55	4	10.90- .95	CD20	11,0	CZ260	91904	
Sunny 1.7 D	Y10	1.7	40	4	.93- .96	CD17	11,0	CZ259	94154	
Sunny 2.0 D	Y10	2.0	55	4	10.90- .00	CD20	11,0	CZ260	91904	
Sunny 1.7 D	Y11	1.7	40	4	05.92-04.98	CD17	11,0	CZ259	94154	

### TERRANO 1

Terrano 1	WD21	2.5		4	- .95	TD25	11,0	Y-707RS	4937	
Terrano 1	WD21	2.7		4	- .95	TD27	11,0	Y-707RS	4937	

### TERRANO 2

Terrano 2 Tdi (only Europe)	R20	2.7	92	4	05.96- .02	TD27T For EU	11,0	CZ261	97009	
Terrano 2 (not Europe)	R20	2.7		4	07.93- .02	TD27T	11,0	Y-712RS	6140	
Terrano 2	R20	3.0	113	4	05.02-	ZD30DDTI only if NGK is OE	11,0	CZ258	95173	

### TINO

Tino 2.0 16V V10		2.2	84	4	07.00-	YD22DT	11,0	Y-519J	93293	61
------------------	--	-----	----	---	--------	--------	------	--------	-------	----

### URVAN

Urvan	E23 / E24	2.5		4	.93- .97	TD25	11,0	Y-707RS	4937	
Urvan QGS Type 2	E23 / E24	2.3		4	05.82-	SD23	11,0	Y-112M1	2531	
Urvan	E23 / E24	2.3		4	- .97	TD23	11,0	Y-707RS	4937	
Urvan	E23 / E24	2.3		4	05.82- .97	SD23	23,0	Y-162R1	2431	
Urvan	E23 / E24	2.7		4	.87- .97	TD27	11,0	Y-707RS	4937	
Urvan QGS Type 1	E23 / E24	2.0		4	05.82- .97	LD20T	6,5	Y-204RS	4573	
Urvan QGS Type 1	E23 / E24	2.3		4	05.82- .97	SD23	10,5	Y-112R1	1032	





l kW C y i 0201



Stock-No  
D-POWER™

## NISSAN

### VANETTE

Vanette	2.0		4		CD20	11,0	CZ260	91904	
Vanette	2.3	55	4	05.98-	LD23	11,0	Y-530J	6586	
Vanette	C22	2.0	44	4	04.87-11.94		LD20 II OHV	11,0	CZ259 94154
Vanette	C22	2.0	47	4	01.91-11.94		LD20 IIL	11,0	CZ259 94154
Vanette	C22	2.0	47	4	09.86-03.93		LD20 OHV	11,0	CZ259 94154
Vanette Cargo	2.0	49	4	07.92-09.94	LD20 OHV	11,0	CZ259	94154	

### X-TRAIL

X-Trail 1.6 dCi	T32	1.6	96	4	04.14-		R9M	4,5	Y1010AS	97618	
X-Trail 2.2 dCi	T30	2.2	84	4	09.01-10.03		YD22DDTi	11,0	Y-519J	93293	61
X-Trail 2.2 dCi	T30	2.2	100	4	11.03-		YD22DDTi	11,0	Y-519J	93293	61

## OPEL

### AGILA

Agila 1.3 CDTI	1.3	51	4	08.03-04.08	Z13DT	11,0	Y8003J	97256	62
----------------	-----	----	---	-------------	-------	------	--------	-------	----

### ANTARA

Antara 2.0 CDTI	2.0	93	4	09.08-12.11	Z20DM	4,4	Y8009AS	96478	
Antara 2.0 CDTI	2.0	110	4	05.06-12.11	Z20DMH	4,4	Y8009AS	96478	

### ARENA

Arena 1.9D	1.9	44	4	01.98-04.03	F8Q600/F8Q606	11,0	Y-506J	2419	7
Arena 2.5D	2.5	55	4	07.98-02.01	S8U758	11,0	Y-924J	7906	1
Arena 2.5D	2.5	55	4	07.98-02.01	S8U780/S8U782	11,0	Y-924J	7906	1

### ASTRA F

Astra F 1.7 D	1.7	42	4	09.91-09.92	17 D	11,0	Y-924J	7906	1
Astra F 1.7 D	1.7	44	4	09.92-08.94	17 DR	11,0	Y-924J	7906	1
Astra F 1.7 TD from engine no. 956633-->	1.7	60	4	12.91-02.98	17DT TC4 EE1	11,0	Y-603J	8838	60
Astra F 1.7 TD	1.7	50	4	08.94-02.98	X17 DTL	11,0	Y-924J	7906	1

### ASTRA G

Astra G 1.7 CDTI	1.7	59	4	04.03-01.05	Z17DTL	11,0	Y-541J	1983	42
Astra G 1.7 DTI	1.7	55	4	02.00-01.05	Y17DT	11,0	Y-541J	1983	42
Astra G 1.7 TD	1.7	50	4	02.98-08.00	X17DTL	11,0	Y-924J	7906	1
Astra G 2.0 DI	2.0	60	4	02.98-01.05	X20DTL	11,0	Y-748U	6649	14
Astra G 2.0 DI	2.0	60	4	08.00-01.05	Y20DTL	11,0	Y-748U	6649	14
Astra G 2.0 DTI to chassis no. 2H999999	2.0	74	4	08.00-01.05	Y20DTH	11,0	Y-748U	6649	14
Astra G 2.0 DTI from chassis no. 3H000001	2.0	74	4	08.00-01.05	Y20DTH	11,0	Y-523J	6298	37
Astra G 2.2 DTI	2.2	92	4	09.02-01.05	Y22DTR	11,0	Y-523J	6298	37

### ASTRA H

Astra H 1.3 CDTI	1.3	66	4	06.04-	Z13DTH	11,0	Y8003J	97256	62
Astra H 1.7 CDTI	1.7	92	4	02.07-12.12	A17DTR	11,0	Y-541J	1983	42
Astra H 1.7 CDTI	1.7	74	4	03.04-12.12	Z17DTH	11,0	Y-541J	1983	42
Astra H 1.7 CDTI	1.7	59	4	03.04-12.09	Z17DTL	11,0	Y-541J	1983	42
Astra H 1.7 CDTI	1.7	92	4	03.07-	Z17DTR	11,0	Y-541J	1983	42
Astra H 1.9 CDTI	1.9	88	4	04.05-12.12	Z19DTJ	11,0	YE07	6092	
Astra H 1.9 CDTI 16V	1.9	110	4	09.04-12.12	Z19DTH	11,0	YE07	6092	
Astra H 1.9 CDTI to VIN. 72045139	1.9	88	4	04.04-12.12	Z19DT	11,0	Y-534J	3413	36
Astra H 1.9 CDTI from VIN. 72045140	1.9	88	4	04.04-12.12	Z19DT	11,0	Y1030J	90828	70
Astra H 1.9 CDTI to VIN. 72045139	1.9	74	4	09.05-12.12	Z19DTL	11,0	Y-534J	3413	36
Astra H 1.9 CDTI from VIN. 72045140	1.9	74	4	09.05-12.12	Z19DTL	11,0	Y1030J	90828	70



l kW C y i **0201**



Stock-No  
D-POWER

## OPEL

### ASTRA J

Astra J 1.3 CDTI for cylinder without pressure sensor	1.3	70	4	12.09-10.15	A13DTE	4,4	Y9004AS	90860	
Astra J 1.7 CDTI	1.7	81	4	10.09-10.15	A17DTJ	11,0	Y-541J	1983	42
Astra J 1.7 CDTI	1.7	92	4	10.09-10.15	A17DTR	11,0	Y-541J	1983	42

### CAMPO

Campo 2.5 TD	2.5	56	4	07.94-07.01	4JA1T (25 DT)	11,0	Y-904M1	7995	
Campo 3.1 TD	3.1	80	4	09.92-12.02	4JG2T (31 TD/TDS)	11,0	Y-719RS1	6900	

### COMBO

Combo 1.3 CDTI	1.3	51	4	10.04-01.12	Y13DT	11,0	Y8003J	97256	62
Combo 1.3 CDTI	1.3	55	4	10.05-01.12	Y13DTJ	11,0	Y8003J	97256	62
Combo 1.7	1.7	44	4	07.94-10.01	17D 4EE1	11,0	Y-603J	8838	60
Combo 1.7	1.7	44	4	04.96-10.01	X17D (4EE1)	11,0	Y-603J	8838	60
Combo 1.7 CDTI 16V	1.7	74	4	12.04-12.12	Z17DTH	11,0	Y-541J	1983	42
Combo 1.7 DI 16V	1.7	48	4	10.01-06.04	Y17DTL	11,0	Y-541J	1983	42
Combo 1.7 DTI 16V	1.7	55	4	10.01-06.04	Y17DT	11,0	Y-541J	1983	42

### CORSA A

Corso A 1.5 D (Isuzu-Engine) --> Eng. 804 794	1.5	37	4	09.87-03.93	15 D/4 EC1 AAD	5,0	Y-306R	6244	
Corso A 1.5 D (Isuzu-Engine) Eng. 804795 -->	1.5	37	4	09.87-03.93	15 D/4 EC1 AAD	11,0	Y-710J	7880	
Corso A 1.5 TD (Isuzu-Eng.) Eng. 804795-->	1.5	49	4	02.88-03.93	15DT/T4 EC1-AADT	11,0	Y-711J	4467	28

### CORSA B

Corso B 1.5 D	1.5	37	4	03.93-08.00	15D (4EC1)	11,0	Y-603J	8838	60
Corso B 1.5 D	1.5	49	4	04.96-08.01	X15DT (4EE1)	11,0	Y-603J	8838	60
Corso B 1.5 TD	1.5	49	4	03.93-08.00	X15DT (T4EC1)	11,0	Y-603J	8838	60
Corso B 1.7 D	1.7	44	4	04.96-08.01	X17D (4EE1)	11,0	Y-603J	8838	60
Corso B 1.7 TD	1.7	44	4	03.93-08.00	17D (4EE1)	11,0	Y-603J	8838	60

### CORSA C

Corso C 1.3 CDTI	1.3	51	4	06.03-07.06	Z13DT	11,0	Y8003J	97256	62
Corso C 1.7 CDTI	1.7	74	4	06.03-07.06	Z17DTH	11,0	Y-541J	1983	42
Corso C 1.7 DI 16V	1.7	48	4	08.00-07.03	Y17DTL	11,0	Y-541J	1983	42
Corso C 1.7 DTI 16V	1.7	55	4	08.00-07.03	Y17DT	11,0	Y-541J	1983	42

### CORSA D

Corso D 1.3 CDTI	1.3	70	4	06.10-08.14	A13DTR	4,4	Y9004AS	90860	
Corso D 1.3 CDTI	1.3	70	4	06.10-08.14	Z13DTR	4,4	Y9004AS	90860	
Corso D 1.3 CDTI	1.3	66	4	07.05-08.14	Z13DTH	11,0	Y8003J	97256	62
Corso D 1.3 CDTI ECOTEC	1.3	70	4	06.10-08.14	Z13DTE	4,4	Y9004AS	90860	
Corso D 1.3 CDTI for cylinder without pressure sensor	1.3	55	4	06.10-08.14	A13DTC	4,4	Y9004AS	90860	
Corso D 1.3 DTI 16V	1.3	55	4	07.06-08.14	Z13DTJ	11,0	Y8003J	97256	62
Corso D 1.7 CDTI	1.7	92	4	07.06-08.14	Z17DTR	11,0	Y-541J	1983	42

### FRONTERA A

Frontera A 2.3 TD	2.3	74	4	09.91-02.95	23 DTR	11,0	Y-924J	7906	1
Frontera A 2.3 TD	2.3	74	4	03.92-09.95	DTR	11,0	Y-924J	7906	1
Frontera A 2.5 TDI	2.5	85	4	06.96-08.98	25TD VM41B (25TDS)	11,0	Y-741U	6943	20
Frontera A 2.5 TDI	2.5	85	4	09.96-10.98	25TD/TDS/OHC	11,0	Y-741U	6943	20
Frontera A 2.8 TDI	2.8	83	4	02.95-11.98	28TD 4JB1T (28TDI)	11,0	Y-904M1	7995	

### FRONTERA B

Frontera B 2.2 DTI 16V	2.2	85	4	10.98-09.02	X22DTH	11,0	Y-748U	6649	14
Frontera B 2.2 DTI 16V	2.2	85	4	10.98-09.02	Y22DTH	11,0	Y-523J	6298	37

**OPEL****KADETT E**

Kadett E 1.7 D	1.7	42	4	02.89-09.92	17 D	11,0	Y-924J	7906	1
Kadett E 1.7 D	1.7	44	4	09.92-09.93	17 DR	11,0	Y-924J	7906	1

**MERIVA A**

Meriva A 1.3 CDTI ECOTEC	1.3	55	4	09.03-05.10	Z13DTJ	11,0	Y8003J	97256	62
Meriva A 1.7 CDTI	1.7	92	4	01.08-05.10	A17DTR	11,0	Y-541J	1983	42
Meriva A 1.7 CDTI	1.7	74	4	09.03-05.10	Z17DTH	11,0	Y-541J	1983	42
Meriva A 1.7 CDTI	1.7	92	4	09.06-05.10	Z17DTR	11,0	Y-541J	1983	42
Meriva A 1.7 DTI	1.7	55	4	09.03-05.10	Y17DT	11,0	Y-541J	1983	42

**MERIVA B**

Meriva B 1.3 CDTI for cylinder without pressure sensor	1.3	55	4	06.10-	A13DTC	4,4	Y9004AS	90860	
Meriva B 1.3 CDTI for cylinder without pressure sensor	1.3	70	4	03.10-	A13DTE	4,4	Y9004AS	90860	
Meriva B 1.7 CDTI	1.7	74	4	03.10-	A17DT	11,0	Y-541J	1983	42

**MONTEREY**

Monterey A 3.1 TD	3.1	84	4	11.91-02.98	4JG2-TC	11,0	Y-719RS1	6900	
Monterey B 3.0 DTI	3.0	117	4	02.98-10.99	4JX1	11,0	Y1038J	94542	

**MOVANO**

Movano 1.9 DTI	1.9	59	4	09.00-	F9Q M7	12,0	Y-732J	5605	4
Movano 2.2 DTI	2.2	66	4	09.00-	G9T C7	11,0	Y-517J	3319	66
Movano 2.5 CDTi	2.5	74	4	08.06-	G9U 650	11,0	Y-517J	3319	66
Movano 2.5 CDTi	2.5	88	4	08.06-	G9U 650	11,0	Y-517J	3319	66
Movano 2.5 CDTi	2.5	107	4	08.06-	G9U 650	11,0	Y-517J	3319	66
Movano 2.5 D	2.5	59	4	10.98-10.00	S8U W7	11,5	Y-910J	3617	3
Movano 2.5 DTi	2.5	84	4	10.01-	G9U 720 / 724	11,0	Y-517J	3319	66
Movano 2.5 DTi	2.5	73	4	10.03-	G9U 754	11,0	Y-517J	3319	66

**OMEGA A**

Omega A 2.3 D	2.3	54	4	09.86-02.94	23 YD	11,0	Y-924J	7906	1
Omega A 2.3 TD	2.3	74	4	09.88-02.94	23 DTR	11,0	Y-924J	7906	1

**OMEGA B**

Omega B 2.0 D	2.0	74	4	10.98-09.00	X20DTH	11,0	Y-748U	6649	14
Omega B 2.0 DTI	2.0	74	4	09.99-04.02	Y20DTH	11,0	Y-523J	6298	37
Omega B 2.0 DTI 16V	2.0	74	4	09.97-07.00	X20DTH	11,0	Y-748U	6649	14
Omega B 2.2 DTI 16V	2.2	88	4	08.01-04.02	Y22DTH	11,0	Y-523J	6298	37
Omega B 2.2 DTI 16V	2.2	88	4	05.01-07.03	Y22DTR	11,0	Y-523J	6298	37
Omega B 2.5 TD	2.5	96	6	02.94-02.96	U25TD	11,0	Y-924J	7906	1
Omega B 2.5 TD	2.5	96	6	08.96-10.01	X25DT	11,0	Y-924J	7906	1

**SIGNUM**

Signum 1.9 CDTI 16V	1.9	110	4	04.04-02.08	Z19DTH	11,0	YE07	6092	
Signum 1.9 CDTI to VIN 71021891	1.9	88	4	04.04-10.08	Z19DT	11,0	Y-534J	3413	36
Signum 1.9 CDTI from VIN 71021892	1.9	88	4	04.04-10.08	Z19DT	11,0	Y1030J	90828	70
Signum 1.9 CDTI to VIN 71021891	1.9	74	4	08.05-02.08	Z19DTL	11,0	Y-534J	3413	36
Signum 1.9 CDTI from VIN 71021892	1.9	74	4	08.05-02.08	Z19DTL	11,0	Y1030J	90828	70
Signum 2.0 DTI 16V	2.0	74	4	05.03-04.04	Y20DTH	11,0	Y-523J	6298	37
Signum 2.2 DTI 16V	2.2	92	4	05.03-04.04	Y22DTR	11,0	Y-523J	6298	37



e kW C y i **0201**



Stock-No  
D-POWER

## OPEL

### SINTRA

Sintra 2.2 DTI	2.2	85	4	01.98-	X22DTH	11,0	Y-748U	6649	14
----------------	-----	----	---	--------	--------	------	--------	------	----

### TIGRA

Tigra B 1.3 CDTI	1.3	52	4	06.04-12.10	Z13DT	11,0	Y8003J	97256	62
------------------	-----	----	---	-------------	-------	------	--------	-------	----

### VECTRA A

Vectra A 1.7 D	1.7	42	4	02.88-09.92	17D	11,0	Y-924J	7906	1
----------------	-----	----	---	-------------	-----	------	--------	------	---

Vectra A 1.7 TD	1.7	60	4	10.92-08.95	17DT Isuzu TC4EE1	11,0	Y-603J	8838	60
-----------------	-----	----	---	-------------	-------------------	------	--------	------	----

Vectra A 1.7 TD	1.7	60	4	03.90-	TC4EC1 817253-->	11,0	Y-743U	5642	
-----------------	-----	----	---	--------	------------------	------	--------	------	--

### VECTRA B

Vectra B 1.7 TD	1.7	60	4	08.95-12.98	X17TD / TC4 EE1 Isuzu	11,0	Y-603J	8838	60
-----------------	-----	----	---	-------------	-----------------------	------	--------	------	----

Vectra B 2.0 Di	2.0	60	4	08.96-07.99	X20DTL	11,0	Y-604J	6157	
-----------------	-----	----	---	-------------	--------	------	--------	------	--

Vectra B 2.0 Di	2.0	60	4	08.99-04.02	X20DTL	11,0	Y-748U	6649	14
-----------------	-----	----	---	-------------	--------	------	--------	------	----

Vectra B 2.0 DTI	2.0	74	4	09.97-07.99	X20DILC	11,0	Y-748U	6649	14
------------------	-----	----	---	-------------	---------	------	--------	------	----

Vectra B 2.0 DTI	2.0	74	4	08.97-04.02	X20DTH	11,0	Y-748U	6649	14
------------------	-----	----	---	-------------	--------	------	--------	------	----

Vectra B 2.0 DTI	2.0	74	4	08.00-04.02	Y20DTH	11,0	Y-523J	6298	37
------------------	-----	----	---	-------------	--------	------	--------	------	----

Vectra B 2.2 DTI	2.2	92	4	08.00-04.02	Y22DTR	11,0	Y-523J	6298	37
------------------	-----	----	---	-------------	--------	------	--------	------	----

### VECTRA C

Vectra C 1.9 CDTI	1.9	110	4	04.04-08.08	Z19DTH	11,0	YE07	6092	
-------------------	-----	-----	---	-------------	--------	------	------	------	--

Vectra C 1.9 CDTI to VIN 71021891	1.9	88	4	04.04-08.08	Z19DT	11,0	Y-534J	3413	36
-----------------------------------	-----	----	---	-------------	-------	------	--------	------	----

Vectra C 1.9 CDTI from VIN 71021892	1.9	88	4	04.04-08.08	Z19DT	11,0	Y1030J	90828	70
-------------------------------------	-----	----	---	-------------	-------	------	--------	-------	----

Vectra C 1.9 CDTI to VIN 71021891	1.9	74	4	06.05-08.08	Z19DTL	11,0	Y-534J	3413	36
-----------------------------------	-----	----	---	-------------	--------	------	--------	------	----

Vectra C 1.9 CDTI from VIN 71021892	1.9	74	4	06.05-08.08	Z19DTL	11,0	Y1030J	90828	70
-------------------------------------	-----	----	---	-------------	--------	------	--------	-------	----

Vectra C 2.0 DTI	2.0	74	4	04.02-08.05	Y20DTH	11,0	Y-523J	6298	37
------------------	-----	----	---	-------------	--------	------	--------	------	----

Vectra C 2.0 DTI	2.2	92	4	04.02-07.04	Y22DTR	11,0	Y-523J	6298	37
------------------	-----	----	---	-------------	--------	------	--------	------	----

### VIVARO

Vivaro 1.6 CDTi	1.6	85	4	06.14-	R9M408	4,5	Y1010AS	97618	
-----------------	-----	----	---	--------	--------	-----	---------	-------	--

Vivaro 1.6 CDTi	1.6	107	4	03.16-	R9M450	4,5	Y1010AS	97618	
-----------------	-----	-----	---	--------	--------	-----	---------	-------	--

Vivaro 1.9 DTI	1.9	74	4	09.01-07.14	F9Q 760	12,0	Y-732J	5605	4
----------------	-----	----	---	-------------	---------	------	--------	------	---

Vivaro 2.5 CDTI	2.5	107	4	08.06-	G9U 630	11,0	Y-517J	3319	66
-----------------	-----	-----	---	--------	---------	------	--------	------	----

Vivaro 2.5 CDTI	2.5	84	4	08.06-03.10	G9U 720 / 730	11,0	Y-517J	3319	66
-----------------	-----	----	---	-------------	---------------	------	--------	------	----

Vivaro 2.5 DTI	2.5	98	4	05.03-07.14	G9U 730	11,0	Y-517J	3319	66
----------------	-----	----	---	-------------	---------	------	--------	------	----

### ZAFIRA A

Zafira A 2.0 DI	2.0	60	4	09.99-11.00	X20DTL	11,0	Y-748U	6649	14
-----------------	-----	----	---	-------------	--------	------	--------	------	----

Zafira A 2.0 DTI	2.0	74	4	04.99-	X20DILC	11,0	Y-748U	6649	14
------------------	-----	----	---	--------	---------	------	--------	------	----

Zafira A 2.0 DTI	2.0	74	4	08.00-06.05	Y20DTH	11,0	Y-523J	6298	37
------------------	-----	----	---	-------------	--------	------	--------	------	----

Zafira A 2.0 DTI	2.0	74	4	08.99-06.05	Y20DTL	11,0	Y-748U	6649	14
------------------	-----	----	---	-------------	--------	------	--------	------	----

Zafira A 2.2 DTI	2.2	92	4	01.02-06.05	Y22DTR	11,0	Y-523J	6298	37
------------------	-----	----	---	-------------	--------	------	--------	------	----

### ZAFIRA B

Zafira B 1.7 CDTI	1.7	92	4	01.08-	A17DTR	11,0	Y-541J	1983	42
-------------------	-----	----	---	--------	--------	------	--------	------	----

Zafira B 1.7 CDTI/ CDTI ECOTEC	1.7	81	4	01.08-	A17DTJ	11,0	Y-541J	1983	42
--------------------------------	-----	----	---	--------	--------	------	--------	------	----

Zafira B 1.9 CDTI	1.9	110	4	07.05-	Z19DTH	11,0	YE07	6092	
-------------------	-----	-----	---	--------	--------	------	------	------	--

Zafira B 1.9 CDTI to VIN 62999999	1.9	88	4	07.05-	Z19DT	11,0	Y-534J	3413	36
-----------------------------------	-----	----	---	--------	-------	------	--------	------	----

Zafira B 1.9 CDTI from VIN 72000001	1.9	88	4	07.05-	Z19DT	11,0	Y1030J	90828	70
-------------------------------------	-----	----	---	--------	-------	------	--------	-------	----

Zafira B 1.9 CDTI to VIN 62999999	1.9	74	4	07.05-12.10	Z19DTL	11,0	Y-534J	3413	36
-----------------------------------	-----	----	---	-------------	--------	------	--------	------	----

Zafira B 1.9 CDTI from VIN 72000001	1.9	74	4	07.05-	Z19DTL	11,0	Y1030J	90828	70
-------------------------------------	-----	----	---	--------	--------	------	--------	-------	----



l kW C y I **0201**



Stock-No  
D-POWER™

**PEUGEOT**

**106 1.VERSION**

106 D	1.4	37	4	08.91-06.94	TUD3/L	11,5	Y-910J	3617	3
106 D	1.5	42	4	07.94-03.96	TUD5	11,0	Y-503J	1009	10
106 D	1.5	42	4	04.96-10.03	TUD5B	11,0	Y-503J	1009	10

**107**

107 Hdi	1.4	51	4	01.05-	DV4	11,0	YE05	91322	73
107 Hdi	1.4	51	4	01.05-	DV4TD	11,0	YE04	1684	40
107 Hdi	1.6	68	4	04.05-	DV6TD	11,0	YE04	1684	40

**205**

205 D	1.8	44	4	10.83-08.98	XUD7	11,0	Y-924J	7906	1
205 D	1.8	44	4	09.98-12.99	XUD7	11,0	Y-924J	7906	1
205 TD	1.8	58	4	07.85-08.98	XUD7T	11,0	Y-924J	7906	1
205	1.8	58	4	09.98-12.99	XUD7T	11,0	Y-924J	7906	1
205 D	1.9	47	4	10.87-08.98	XUD9	11,0	Y-924J	7906	1
205	1.9	51	4	09.98-12.99	XUD9A	11,0	Y-924J	7906	1

**206**

206 & SW	1.4	51	4	12.04-	DV4TD	11,0	YE05	91322	73
206	1.4	50	4	01.09-06.13	DV4C	11,0	YE05	91322	73
206 D	1.9	51	4	09.98-	DW8/ DW8B	11,0	Y-503J	1009	10
206 & SW Hdi	2.0	66	4	10.99-	DW10TD	11,0	Y-504J	1441	24

**206 SW**

206 SW Hdi	1.4	51	4	09.01-12.04	DV4TD	11,0	YE04	1684	40
206 SW Hdi	1.6	81	4	.04-06.06	DV6TED4	11,0	YE04	1684	40
206 SW Hdi	2.0	66	4	10.99-	DW10TD	11,0	Y-504J	1441	24

**207**

207 Hdi	1.4	51	4	07.06-	DV4TD	11,0	YE04	1684	40
207 Hdi	1.4	50	4	04.06-12.15	DV4C	11,0	YE05	91322	73
207 Hdi	1.4	50	4	01.12-10.13	DV4C	11,0	YE05	91322	73
207 Hdi	1.6	68	4	11.09-12.12	DV6DTED	5,0	Y8001AS	8904	58
207 Hdi	1.6	66	4	07.06-	DV6TED	11,0	YE04	1684	40
207 Hdi	1.6	66	4	07.06-	DV6TD	11,0	YE04	1684	40
207 1.6 Hdi 90	1.6	66	4	06.07-12.12	DV6ATED4	11,0	YE05	91322	73
207 & SW	1.6	80	4	06.07-12.12	DV6TED4	11,0	YE05	91322	73
207 Hdi	1.6	81	4	07.06-	DV6	11,0	YE05	91322	73

**207**

207 Hdi 16V	1.6	81	4	07.06-01.15	DV6TED4	11,0	YE04	1684	40
207 1.6 Hdi 110	1.6	82	4	08.09-10.13	DV6C	5,0	Y8001AS	8904	58

**208**

208 1.6 HDi 92	1.6	68	4	03.12-	DV6DTED	5,0	Y8001AS	8904	58
208 1.6 HDi 115	1.6	84	4	03.12-	DV6C	5,0	Y8001AS	8904	58
208 Hdi	1.6	68	4	03.12-	DV6DTEDM	5,0	Y8001AS	8904	58

**301**

301 1.6 HDi 92	1.6	68	4	10.12-	DV6DTED4	5,0	Y8001AS	8904	58
----------------	-----	----	---	--------	----------	-----	---------	------	----

**306**

306	1.8	43	4	10.93-08.98	XUD7	11,0	Y-924J	7906	1
306	1.8	44	4	09.98-	XUD7	11,0	Y-924J	7906	1
306 D	1.8	44	4	09.98-07.02	DW8	11,0	Y-503J	1009	10
306 TD	1.8	59	4	09.98-07.02	DW8TD	11,0	Y-503J	1009	10
306 D	1.9	51	4	02.93-08.98	XUD9A	11,0	Y-924J	7906	1



e kW C  
y i **0201**



Stock-No  
D-POWER

## PEUGEOT

### 306

306	1.9	51	4	09.98-07.02	DW8	11,0	Y-503J	1009	10
306	1.9	51	4	09.98-12.99	XUD9A/XUD9BSD	11,0	Y-924J	7906	1
306 D	1.9	68	4	03.93-08.98	XUD9TE	11,0	Y-924J	7906	1
306 D	1.9	68	4	09.98-12.99	XUD9TE	11,0	Y-924J	7906	1
306 Hdi	2.0	66	4	04.99-07.02	DW10TD	11,0	Y-504J	1441	24
306 D	2.0	80	4	09.98-	DW10TD	11,0	Y-504J	1441	24

### 307

307 Hdi	1.4	51	4	01.02-12.04	DV4TD	11,0	YE04	1684	40
307 Hdi	1.4	51	4	01.02-12.04	DV4TD	11,0	YE04	1684	40
307	1.4	51	4	12.04-05.05	DV4TD	11,0	YE05	91322	73
307 1.6 Hdi	1.6	66	4	04.05-	DV6ATED4	11,0	YE05	91322	73
307 Hdi	1.6	68	4	07.06-	DV6TD	11,0	YE04	1684	40
307 Hdi	1.6	81	4	03.04-06.06	DV6TED4	11,0	YE04	1684	40
307 Hdi	1.6	81	4	07.06-	DV6	11,0	YE05	91322	73
307 Hdi	2.0	66	4	04.01-	DW10TD	11,0	Y-504J	1441	24
307 Hdi	2.0	81	4	09.01-	DW10ATED	11,0	Y-504J	1441	24
307 Hdi	2.0	100	4	03.04-	DW10TED	11,0	Y-504J	1441	24
307 2.0 Hdi	2.0	100	4	11.03-11.07	DW10BTED4	11,0	Y1005J	7957	56
307 CC 2.0 Hdi	2.0	100	4	11.03-04.09	DW10BTED4	11,0	Y1005J	7957	56
307 SW 2.0 Hdi	2.0	100	4	11.03-04.08	DW10BTED4	11,0	Y1005J	7957	56

### 308

308 1.6 e-HDi 115	1.6	85	4	09.13-	DV6C	5,0	Y8001AS	8904	58
308 1.6 Hdi	1.6	66	4	09.07-	DV6TD	11,0	YE05	91322	73
308 1.6 Hdi	1.6	68	4	11.09-	DV6DTED	5,0	Y8001AS	8904	58
308 1.6 Hdi	1.6	80	4	09.07-	DV6TED4	11,0	YE05	91322	73
308 1.6 Hdi	1.6	82	4	02.09-10.14	DV6CM	5,0	Y8001AS	8904	58
308 1.6 Hdi 110	1.6	82	4	12.09-	DV6CTED4	5,0	Y8001AS	8904	58
308 2.0 Hdi	2.0	100	4	09.07-	DW10BTED4	11,0	Y1005J	7957	56
308 2.0 Hdi	2.0	100	4	09.07-	DW10BTED	11,0	Y1005J	7957	56
308 2.0 Hdi 140	2.0	103	4	07.10-	DW10BTED	11,0	Y1005J	7957	56
308 2.0 Hdi 165	2.0	120	4	07.09-	DW10CTED4	5,0	Y8001AS	8904	58

### 308CC

308 CC 2.0 Hdi 165	2.0	120	4	06.09-	DW10CTED4	5,0	Y8001AS	8904	58
--------------------	-----	-----	---	--------	-----------	-----	---------	------	----

### 309

309	1.5	42	4	03.94-12.95	TUD5	11,0	Y-503J	1009	10
-----	-----	----	---	-------------	------	------	--------	------	----

### 309

309 D	1.8	44	4	06.86-12.93	XUD7	11,0	Y-924J	7906	1
309 TD	1.8	58	4	11.89-12.93	XUD7T	11,0	Y-924J	7906	1
309 D	1.9	47	4	06.86-12.93	XUD9 / XUD9Y	11,0	Y-924J	7906	1

### 405

405 TD	1.8	68	4	03.88-12.92	XUD7TE	11,0	Y-924J	7906	1
405 GLD	1.9	47	4	07.88-12.92	XUD9Y	11,0	Y-924J	7906	1
405 D	1.9	51	4	03.88-	XUD9A	11,0	Y-924J	7906	1
405	1.9	51	4	09.98-12.99	XUD9A	11,0	Y-924J	7906	1
405	1.9	55	4	10.95-	XUD9SD	11,0	Y-924J	7906	1
405 TD	1.9	68	4	09.92-12.97	XUD9TE / XUD9TF	11,0	Y-924J	7906	1



l kW C y i  
0201



Stock-No  
D-POWER™

**PEUGEOT**

**406**

406 TD	1.9	68	4	10.95-08.98	XUD9TE/TF/BTF	11,0	Y-924J	7906	1
406	1.9	68	4	09.98-12.99	XUD9TE /TF/BTF	11,0	Y-924J	7906	1
406 Hdi	2.0	81	4	12.98-04.04	DW10ATED	11,0	Y-504J	1441	24
406 TD	2.1	80	4	10.95-08.98	XUD11BTE	11,0	Y-924J	7906	1
406	2.1	80	4	09.98-12.99	XUD11BTE	11,0	Y-924J	7906	1
406 Coupé Hdi	2.2	100	4	03.01-	DW12TED4	11,0	Y-504J	1441	24

**406 PHASE 2**

406 TD Phase 2	2.0	66	4	04.99-04.04	DW10TD	11,0	Y-504J	1441	24
406 TD Phase 2	2.0	81	4	04.99-04.04	DW10ATED	11,0	Y-504J	1441	24
406 2.2 Hdi	2.2	98	4	03.00-10.04	DW12TED4	11,0	Y1005J	7957	56
406 Coupe 2.2 Hdi	2.2	98	4	09.00-12.04	DW12TED4	11,0	Y1005J	7957	56
406 Hdi Phase 2	2.2	100	4	09.00-05.03	DW12TED4	11,0	Y-504J	1441	24

**407**

407 Hdi	1.6	81	4	04.04-06.06	DV6TED	11,0	YE04	1684	40
407 Hdi	1.6	81	4	03.06-	DV6TED4	11,0	YE05	91322	73
407 Hdi	2.0	93	4	04.04-	DW10TED	11,0	Y-504J	1441	24
407 2.0 Hdi	2.0	100	4	08.05-05.09	DW10BTED4	11,0	Y1005J	7957	56
407 2.0 Hdi	2.0	120	4	06.09-	DW10CTED4	5,0	Y8001AS	8904	58
407 2.2 Hdi	2.2	125	4	05.06-	DW12BTED4	11,0	YE08	4966	
407 2.7 V6 Hdi	2.7	150	6	10.05-	DT17TED4	11,0	YE12	7794	

**408**

408 Hdi	2.0	110	4	.10-	DW10CTED4	5,0	Y8001AS	8904	58
---------	-----	-----	---	------	-----------	-----	---------	------	----

**508**

508 1.6 Hdi 110	1.6	82	4	11.10-	DV6C	5,0	Y8001AS	8904	58
508 1.6 Hdi 110	1.6	84	4	02.12-	DV6C	5,0	Y8001AS	8904	58
508 2.0 Hdi 140	2.0	103	4	11.10-	DW10BTED4	11,0	Y1005J	7957	56
508 2.0 Hdi 165	2.0	120	4	11.10-	DW10CTED4	5,0	Y8001AS	8904	58
508 Blue Hdi	2.0	110	4	04.14-	DW10FD	5,0	Y8001AS	8904	58
508 2.0 Hdi RXH HYbrid4	2.0	120	4	12.11-	DW10CTED4	5,0	Y8001AS	8904	58

**605**

605 D	2.1	60	4	09.89-06.94	XUD11A/L	11,0	Y-924J	7906	1
605 TD	2.1	80	4	09.89-06.94	XUD11ATE/L, BTE	11,0	Y-924J	7906	1
605 TD	2.1	80	4	09.98-07.00	XUD11ATE/BTE	11,0	Y-924J	7906	1
605 TD	2.5	96	4	07.94-05.99	DK5ATE	11,0	Y-924J	7906	1

**607**

607 2.0 Hdi	2.0	100	4	09.05-	DW10BTED4	11,0	Y1005J	7957	56
607 2.2 Hdi	2.2	98	4	12.99-02.06	DW12TED4	11,0	Y1005J	7957	56
607 Hdi 16V	2.2	100	4	05.00-	DW12TED4	11,0	Y-504J	1441	24
607 Hdi	2.2	125	4	06.06-	DW12BTED4	11,0	YE08	4966	
607 2.7 V6 Hdi	2.7	150	6	12.04-	DT17	11,0	YE12	7794	

**806**

806 TD	1.9	68	4	06.94-08.98	XUD9TF	11,0	Y-924J	7906	1
806 D	1.9	68	4	09.98-	XUD9BTF	11,0	Y-924J	7906	1
806 TD	1.9	68	4	06.94-08.98	XUD9TE	11,0	Y-924J	7906	1
806 D	1.9	68	4	09.98-01.01	XUD9TF	11,0	Y-924J	7906	1
806 D	2.0	80	4	09.98-	DW10TED	11,0	Y-504J	1441	24
806 D Hdi	2.0	81	4	09.99-	DW10ATED	11,0	Y-504J	1441	24
806 D	2.1	80	4	06.96-08.98	XUD11BTE	11,0	Y-924J	7906	1



e kW C y i **0201**



Stock-No  
D-POWER

## PEUGEOT

### 806

806 TD	2.1	80	4	07.96-	XUD11ATE	11,0	Y-924J	7906	1
806 D	2.1	80	4	09.98-01.01	XUD11BTE	11,0	Y-924J	7906	1

### 807

807 2.0 Hdi	2.0	79	4	08.02-05.06	DW10ATED4	11,0	Y1005J	7957	56
807 2.0 Hdi	2.0	80	4	06.02-	DW10ATED4/RHT	11,0	Y-504J	1441	24
807 2.0 Hdi	2.0	80	4	04.04-05.06	DW10ATED4	11,0	Y1005J	7957	56
807 2.0 Hdi	2.0	88	4	11.06-	DW10UTED4	11,0	Y1005J	7957	56
807 2.0 Hdi	2.0	100	4	06.06-	DW10BTED4	11,0	Y1005J	7957	56
807 2.0 Hdi	2.0	120	4	06.09-	DW10CTED4	5,0	Y8001AS	8904	58
807 2.2 Hdi	2.2	94	4	06.02-	DW12TED4/4HW	11,0	Y-504J	1441	24
807 2.2 Hdi	2.2	94	4	08.02-05.06	DW12TED4	11,0	Y1005J	7957	56
807 2.2 Hdi	2.2	125	4	06.06-	DW12BTED4	11,0	YE08	4966	

### 1007

1007 Hdi	1.4	51	4	01.05-	DV4TD	11,0	YE05	91322	73
1007 Hdi	1.4	68	4		DV6TD	11,0	YE05	91322	73
1007 1.6 Hdi	1.6	80	4	06.07-	DV6TED4	11,0	YE05	91322	73

### 2008

2008 1.6 e-HDi 115	1.6	84	4	03.13-	DV6C	5,0	Y8001AS	8904	58
2008 1.6 e-HDi 92	1.6	68	4	03.13-	DV6TED4	5,0	Y8001AS	8904	58

### 3008

3008 1.6 HDI	1.6	80	4	05.09-	DV6TED4	11,0	YE05	91322	73
3008 1.6 Hdi 110	1.6	82	4	08.10-	DV6CTED4~9HZ	5,0	Y8001AS	8904	58
3008 1.6 HDi 115	1.6	84	4	03.13-	DV6C	5,0	Y8001AS	8904	58
3008 Hdi	2.0	80	4	06.09-	DW10CTED4	5,0	Y8001AS	8904	58
3008 2.0 Hdi 150	2.0	110	4	04.09-	DW10CTED4~RHE, RHH	5,0	Y8001AS	8904	58
3008 2.0 HDI 165	2.0	120	4	06.09-	DW10CTED4	5,0	Y8001AS	8904	58
3008 2.0 Hdi	2.0	100	4	02.11-	DW10CB	5,0	Y8001AS	8904	58
3008 2.0 HDI Hybrid4	2.0	120	4	09.11-	DW10CTED4	5,0	Y8001AS	8904	58

### 4007

4007 2.2 Hdi	2.2	115	4	07.07-	DW12MTED4	11,0	YE08	4966	
--------------	-----	-----	---	--------	-----------	------	------	------	--

### 4008

4008 1.6 Hdi 115	1.6	84	4	04.12-	DV6	5,0	Y8001AS	8904	58
------------------	-----	----	---	--------	-----	-----	---------	------	----

### 5008

5008 1.6 Hdi 110	1.6	80	4	09.09-	DV6TED4	5,0	Y8001AS	8904	58
5008 1.6 HDi 110	1.6	82	4	08.10-	DV6C	5,0	Y8001AS	8904	58
5008 1.6 Hdi 110	1.6	80	4	09.09-	DV6CTED4	5,0	Y8001AS	8904	58

### 5008

5008 2.0 Hdi	2.0	100	4	09.09-	DW10FD	5,0	Y8001AS	8904	58
5008 2.0 HDi 140	2.0	100	4	02.12-	DW10CTED4	5,0	Y8001AS	8904	58
5008 2.0 Hdi 150	2.0	110	4	09.09-	DW10CTED4	5,0	Y8001AS	8904	58
5008 2.0 Hdi 165	2.0	121	4	09.09-	DW10CTED4	5,0	Y8001AS	8904	58
5008	2.0	100	4	09.09-	DW10CB	5,0	Y8001AS	8904	58

### BIPPER

Bipper 1.3 HDi 75	1.3	55	4	10.10-	F13DTE5	4,3	Y9001AS	97719	72
Bipper Tepee 1.3 HDi 75	1.3	55	4	10.10-	F13DTE5	4,3	Y9001AS	97719	72
Bipper 1.4 Hdi	1.4	50	4	02.08-	DV4TD	11,0	YE05	91322	73





l kW C y i  
0201



Stock-No  
D-POWER™

## PEUGEOT

### BOXER

Boxer D	1.8	44	4	09.98-	XUD7	11,0	Y-924J	7906	1
Boxer D	1.9	51	4	03.94-08.98	XUD9A	11,0	Y-924J	7906	1
Boxer D	1.9	51	4	09.98-	XUD9AU	11,0	Y-924J	7906	1
Boxer TD	1.9	68	4	03.94-08.98	XUD9TF	11,0	Y-924J	7906	1
Boxer	1.9	68	4	09.98-	XUD9TF	11,0	Y-924J	7906	1
Boxer 2 Hdi	2.0	66	4	09.98-	DW10TD	11,0	Y-504J	1441	24
Boxer 2 Hdi	2.2	100	4	03.01-	DW10TED4	11,0	Y-504J	1441	24
Boxer 2.2 Hdi	2.2	74	4	12.01-06.06	DW12UTED	11,0	Y1005J	7957	56
Boxer 2.2 Hdi 100	2.2	74	4	04.06-	4HV	11,5	Y-548J	94832	75
Boxer 2.2 Hdi 120	2.2	88	4	04.06-	4HU	11,5	Y-548J	94832	75
Boxer	2.5	63	4	03.94-08.98	DJ5	11,0	Y-924J	7906	1
Boxer TD	2.5	76	4	03.94-08.96	DJ5T	11,0	Y-924J	7906	1
Boxer Tdi	2.5	76	4	09.96-	DJ5TED	11,0	Y-738U	5390	
Boxer Hdi	2.8	93	4	10.97-	Sofim	11,0	Y-924J	7906	1
Boxer 3.0 Hdi	3.0	107	4	04.10-	F30DT	11,0	Y8005J	96853	64
Boxer 3.0 Hdi 160	3.0	116	4	04.06-	F30DT	11,0	Y8005J	96853	64

### EXPERT

Expert 1.6 Hdi	1.6	66	4	01.07-	DV6UTED4	11,0	YE05	91322	73
Expert	1.8	44	4	09.98-	DW8	11,0	Y-503J	1009	10
Expert TD	1.8	59	4	09.98-	DW8TD	11,0	Y-503J	1009	10
Expert	1.9	51	4	01.96-08.98	XUD9A	11,0	Y-924J	7906	1
Expert	1.9	51	4	09.98-	XUD9A	11,0	Y-924J	7906	1
Expert TD	1.9	66	4	09.95-08.98	XUD 9TE	11,0	Y-924J	7906	1
Expert	1.9	68	4	01.96-08.98	XUD9BTF	11,0	Y-924J	7906	1
Expert	1.9	68	4	01.96-08.98	XUD9TF	11,0	Y-924J	7906	1
Expert TD	1.9	68	4	09.98-	XUD9BTF	11,0	Y-924J	7906	1
Expert TD	1.9	68	4	09.98-	XUD9TF	11,0	Y-924J	7906	1
Expert Hdi	2.0	70	4	02.00-	DW10TED	11,0	Y-504J	1441	24
Expert 2.0 Hdi 100	2.0	72	4	03.11-	DW10CE	5,0	Y8001AS	8904	58
Expert Hdi	2.0	81	4	02.00-	DW10ATED	11,0	Y-504J	1441	24
Expert Hdi	2.0	88	4	11.06-	DW10UTED4	11,0	Y1005J	7957	56
Expert 2.0 Hdi 130	2.0	94	4	03.11-	DW10CD	5,0	Y8001AS	8904	58
Expert Hdi	2.0	100	4	11.06-	DW10BTED4	11,0	Y1005J	7957	56
Expert	2.0	80	4	10.00-10.06	DW10ATED4	11,0	Y1005J	7957	56
Expert 2.0 Hdi 165	2.0	120	4	09.09-	DW10CTED4	5,0	Y8001AS	8904	58
Expert	2.1	80	4	07.96-	XUD11ATE	11,0	Y-924J	7906	1

### J5

J5	1.9	51	4	11.87-01.94	XUD9A	11,0	Y-924J	7906	1
J5 D	1.9	51	4	11.87-	XUD9A	11,0	Y-924J	7906	1
J5 D	2.5	54	4	09.81-06.91	CRD93	11,0	Y-208T	1250	

### J5

J5	2.5	54	4	07.91-03.94	CRD93	11,0	Y-924J	7906	1
J5 TD	2.5	70	4	07.87-06.91	CRD93LS	11,0	Y-208T	1250	
J5	2.5	70	4	07.91-03.94	CRD93LS	11,0	Y-924J	7906	1

### PARTNER

Partner 1.4 Hdi	1.4	55	4	03.06-	DV6	11,0	YE05	91322	73
Partner 1.6 Hdi	1.6	55	4	04.08-	DV6BTED4	11,0	YE05	91322	73
Partner 1.6 Hdi	1.6	66	4	03.06-	DV6	11,0	YE05	91322	73
Partner	1.6	68	4	04.10-	DV6ATED4	11,0	YE05	91322	73
Partner	1.6	68	4	04.10-	DV6AUTED4	11,0	YE05	91322	73



e kW C y i **0201**



Stock-No  
D-POWER

## PEUGEOT

### PARTNER

Partner	1.6	68	4	05.11-	DV6DTEd	5,0	Y8001AS	8904	58
Partner 1.6 Hdi	1.6	80	4	04.08-	DV6TED4	11,0	YE05	91322	73
Partner	1.6	68	4	05.11-	DV6DTEdM	5,0	Y8001AS	8904	58
Partner Combi	1.8	43	4	07.96-08.98	XUD7	11,0	Y-924J	7906	1
Partner Combi	1.8	44	4	09.98-03.02	XUD7	11,0	Y-924J	7906	1
Partner Combi	1.8	44	4	09.98-03.02	DW8	11,0	Y-503J	1009	10
Partner Combi	1.8	59	4	09.98-03.02	DW8TD	11,0	Y-503J	1009	10
Partner Combi	1.9	51	4	08.08-12.13	DW8B	11,0	Y-503J	1009	10
Partner Combi	1.9	51	4	07.96-08.98	XUD9A	11,0	Y-924J	7906	1
Partner Combi	1.9	51	4	09.98-03.02	XUD9A	11,0	Y-924J	7906	1
Partner Combi	1.9	51	4	09.98-03.02	DW8 / DW8B	11,0	Y-503J	1009	10
Partner Combi Hdi	2.0	66	4	10.99-03.02	DW10TD	11,0	Y-504J	1441	24
Partner Multispace	1.9	51	4	01.97-09.98	XUD9A	11,0	Y-924J	7906	1
Partner Multispace	1.9	51	4	09.98-	DW8 / DW8B	11,0	Y-503J	1009	10
Partner Multispace Hdi	2.0	66	4	10.99-	DW10TD	11,0	Y-504J	1441	24

### RCZ

RCZ 2.0 Hdi 165	2.0	120	4	03.10-	DW10CTED4	5,0	Y8001AS	8904	58
-----------------	-----	-----	---	--------	-----------	-----	---------	------	----

## PORSCHE

### CAYENNE SERIE 955

Cayenne	955	2.5	128	5	.04-	BAC	11,0	Y-741U	6943	20
Cayenne 3.0 TDI	955	3.0	176	6	02.09-05.10	M05.9D	4,4	Y1002AS	8888	57

### CAYENNE SERIE 958

Cayenne 3.0 D	958	3.0	155	6	06.10-	MCR.CB	4,4	Y1002AS	8888	57
Cayenne 3.0 D	958	3.0	176	6	06.10-	M05.9E / MCN.RB	4,4	Y1002AS	8888	57
Cayenne 3.0 D	958	3.0	180	6	06.10-	MCR.CA	4,4	Y1002AS	8888	57
Cayenne 4.2 D S	958	4.2	281	8	10.12-	MCU.DB	4,4	Y1002AS	8888	57

### MACAN

Macan 3.0 D	95	3.0	155	6	02.14-	MCT.BB	4,4	Y1002AS	8888	57
Macan 3.0 D	95	3.0	184	6	02.14-	MCT.BC	4,4	Y1002AS	8888	57
Macan 3.0 D	95	3.0	190	6	02.14-	MCT.BA	4,4	Y1002AS	8888	57

### PANAMERA

Panamera 3.0 D	970	3.0	155	6	08.11-	MCR.CB	4,4	Y1002AS	8888	57
Panamera 3.0 D	970	3.0	184	6	08.11-	MCR.CC	4,4	Y1002AS	8888	57

## RENAULT

### AVANTIME

Avantime 2.2 dCi	2.2	110	4	06.02-05.03	G9T 712	11,0	Y-517J	91766	66
------------------	-----	-----	---	-------------	---------	------	--------	-------	----

### CLIO 1

Clio	1.9	47	4	05.90-02.91		11,0	Y-924J	7906	1
Clio	1.9	48	4	05.90-09.98	F8Q 714/730/732	11,0	Y-913J	5317	15
Clio	1.9	48	4	03.91-08.98	F8Q 672/676/678/692/696	11,0	Y-927J	4916	19

### CLIO 2

Clio 2	1.9	48	4	03.98-12.03	F8Q 630/ 662 BBOEOF	11,0	Y-503J	1009	10
Clio 2	1.9	48	4	03.99-12.03	F8Q 632	11,0	Y-516J	6416	12
Clio 2 Dti	1.9	59	4	01.99-12.03	F9Q 716	11,0	Y-740U	4818	22
Clio 2 Dti	1.9	59	4	03.99-12.03	F9Q 780	12,0	Y-732J	5605	4
Clio 2 Dti	1.9	59	4	01.99-06.01	F9Q 782	11,0	Y-740U	4818	22



l kW C y i 0201



Stock-No D-POWER

## RENAULT

### CLIO 2 PHASE 2

Clio 2 Phase 2 1.5 Dci	1.5	48	4	06.01-02.08	K9K 700/704/710	12,0	Y-732J	5605	4
Clio 2 Phase 2 1.5 Dci	1.5	50	4	08.04-	K9K 714	12,0	Y-732J	5605	4
Clio 2 Phase 2 1.5 Dci	1.5	59	4	11.01-	K9K 702	12,0	Y-732J	5605	4
Clio 2 Phase 2 1.5 Dci	1.5	60	4	11.03-04.05	K9K 702/710/716	12,0	Y-732J	5605	4
Clio 2 Phase 2 1.5 Dci	1.5	74	4	.04-	K9K 712	12,0	Y-732J	5605	4
Clio 2 Phase 2 1.5 Dci	1.5	62	4	02.07-06.09	K9K 718	12,0	Y-732J	5605	4

### CLIO 3

Clio 3 1.5 Dci	1.5	47	4	06.05-	K9K 752	12,0	Y-732J	5605	4
Clio 3 1.5 Dci	1.5	48	4	05.05-10.06	K9K 752	12,0	Y-732J	5605	4
Clio 3 1.5 Dci	1.5	50	4	06.05-	K9K 768	12,0	Y-732J	5605	4
Clio 3 1.5 Dci	1.5	55	4	08.10-	K9K 770	4,4	Y1035AS	94103	77
Clio 3 1.5 Dci	1.5	60	4	11.07-	K9K 750	12,0	Y-732J	5605	4
Clio 3 1.5 Dci	1.5	63	4	06.05-	K9K 766	12,0	Y-732J	5605	4
Clio 3 1.5 Dci	1.5	65	4	08.10-	K9K 770	4,4	Y1035AS	94103	77
Clio 3 1.5 Dci	1.5	76	4	06.05-	K9K 772	12,0	Y-732J	5605	4
Clio 3 1.5 Dci	1.5	78	4	06.05-	K9K 764	12,0	Y-732J	5605	4

### CLIO 4

Clio 4 1.5 dCi 75	1.5	55	4	10.12-	K9K 612	4,4	Y1035AS	94103	77
Clio 4 1.5 dCi 90	1.5	66	4	10.12-	K9K 608	4,4	Y1035AS	94103	77

### ESPACE 2

Espace 2	2.2	85	4	.91-10.96	G8T 714/716/760	11,0	Y-740U	4818	22
----------	-----	----	---	-----------	-----------------	------	--------	------	----

### ESPACE 3

Espace 3 Dci	1.9	74	4	02.99-12.02	F9Q 722	12,0	Y-732J	5605	4
Espace 3 Dti	1.9	74	4	02.99-12.02	F9Q 716/730/734	11,0	Y-740U	4818	22
Espace 3 DT	2.2	81	4	10.96-08.00	G8T 714/716	11,0	Y-730U	6704	17
Espace 3 Dci	2.2	85	4	06.00-12.02	G9T 710	11,0	Y-517J	91766	66
Espace 3 Dci	2.2	96	4	06.00-12.02		11,0	Y-517J	91766	66

### ESPACE 4

Espace dCi	1.6	96	4	06.15-	R9M409	4,5	Y1010AS	97618	
Espace dCi	1.6	118	4	06.15-	R9M452	4,5	Y1010AS	97618	
Espace 4 Dci	1.9	86	4	10.02-	F9Q	12,0	Y-732J	5605	4
Espace 4 Dci	2.2	110	4	.03-	G9T	11,0	Y-517J	91766	66

### EXPRESS 1

Express	1.6	40	4	07.86-03.98	F8M 720/730/736/760	11,0	Y-913J	5317	15
Express	1.9	48	4	09.91-03.98	F8Q 684/722/724/774/776	11,0	Y-913J	5317	15
Express	1.9	48	4	09.94-12.95	F8Q 640/644/646/648	11,0	Y-927J	4916	19

### FLUENCE

Fluence 1.6 dCi	1.6	96	4	06.13-	R9M402	4,5	Y1010AS	97618	
Fluence 1.5 dCi	1.5	63	4	02.10-	K9K 830	4,4	Y1035AS	94103	77
Fluence 1.5 dCi	1.5	66	4	02.10-	K9K 834	4,4	Y1035AS	94103	77
Fluence 1.5 dCi	1.5	78	4	02.10-	K9K 832	4,4	Y1035AS	94103	77
Fluence 1.5 dCi	1.5	81	4	02.10-	K9K 836	4,4	Y1035AS	94103	77

### GRAND ESPACE

Grand Espace Dti	1.9	74	4	01.00-	F9Q 730/734	11,0	Y-740U	4818	22
Grand Espace 4 Dci	1.9	86	4	04.03-10.10	F9Q820	12,0	Y-732J	5605	4
Grand Espace 4 Dci	1.9	86	4	04.03-01.15	F9Q820	12,0	Y-732J	5605	4
Grand Espace Dci	2.2	110	4	.03-	G9T743	11,0	Y-517J	91766	66
Grand Espace Dci 16S	2.2	85	4	06.00-09.02	G9T 710	11,0	Y-517J	91766	66



e kW C  
y i **0201**



Stock-No  
D-POWER™

## RENAULT

### GRAND ESPACE

Grand Espace DT	2.2	81	4	01.98-08.00	G8T 716	11,0	Y-730U	6704	17
Grand Espace DT	2.2	81	4	01.98-08.00	G8T 716	11,0	Y-730U	6704	17
Grand Espace 3 Dci 16S	2.2	95	4	06.00-09.02	G9T 710	11,0	Y-517J	91766	66
Grand Espace 4 Dci	2.2	110	4	10.02-	G9T743	11,0	Y-517J	91766	66

### GRAND SCENIC

Grand Scenic	1.6	96	4	04.11-	R9M402	4,5	Y1010AS	97618	
Grand Scenic	1.6	96	4	04.11-	R9M404	4,5	Y1010AS	97618	
Grand Scenic	1.6	96	4	04.11-	R9M414	4,5	Y1010AS	97618	
Grand Scenic 1.9 Dci	1.9	88	4	03.04-	F9Q 812	12,0	Y-732J	5605	4

### KADJAR

Kadjar	1.6	96	4	05.15-	R9M410	4,5	Y1010AS	97618	
Kadjar	1.6	96	4	05.15-	R9M414	4,5	Y1010AS	97618	
Kadjar	1.6	96	4	06.15-	R9M412	4,5	Y1010AS	97618	
Kadjar	1.6	96	4	06.15-	R9M414	4,5	Y1010AS	97618	

### KANGOO

Kangoo 1.5 Dci	1.5	42	4	12.02-	K9K 704	12,0	Y-732J	5605	4
Kangoo 1.5 Dci	1.5	48	4	06.01-	K9K 700/704	12,0	Y-732J	5605	4
Kangoo 1.5 Dci	1.5	50	4	06.05-	K9K 714	12,0	Y-732J	5605	4
Kangoo 1.5 Dci	1.5	50	4	02.08-	K9K 840	12,0	Y-732J	5605	4
Kangoo 1.5 Dci	1.5	60	4	07.02-	K9K 702/710	12,0	Y-732J	5605	4
Kangoo 1.5 Dci	1.5	62	4	06.05-	K9K 718	12,0	Y-732J	5605	4
Kangoo 1.5 Dci	1.5	63	4	02.08-	K9K 800/802	12,0	Y-732J	5605	4
Kangoo Express D	1.9	40	4	03.98-	F8Q 662	11,0	Y-506J	2419	7
Kangoo Express D	1.9	48	4	03.98-	F8Q 630	11,0	Y-506J	2419	7
Kangoo Express D	1.9	48	4	03.99-	F8Q 632	11,0	Y-516J	6416	12
Kangoo Dti	1.9	59	4	03.98-	F9Q 780	12,0	Y-732J	5605	4
Kangoo Dci 4X4	1.9	59	4	11.01-		12,0	Y-732J	5605	4
Kangoo Express Dci	1.5	48	4	07.03-	K9K	12,0	Y-732J	5605	4
Kangoo Express Dci	1.5	59	4	.04-	K9K	12,0	Y-732J	5605	4
Kangoo Express Dci	1.9	62	4	.04-	F9Q	12,0	Y-732J	5605	4

### LAGUNA 1

Laguna / Nevada D	2.2	62	4	09.94-	G8T	11,0	Y-730U	6704	17
Laguna / Nevada DT	2.2	85	4	03.96-	G8T Turbo	11,0	Y-730U	6704	17
Laguna 2	2.2	110	4	01.02-	G9T 702	11,0	Y-517J	91766	66

### LAGUNA 1 PHASE 2

Laguna / Nevada Phase2 Dti	1.9	74	4	10.97-	F9Q 716/730/734	11,0	Y-740U	4818	22
Laguna / Nevada Phase 2	1.9	75	4	10.97-02.01	F9Q 716	11,0	Y-740U	4818	22
Laguna / Nevada Phase 2	1.9	75	4	02.99-02.01	F9Q 710	12,0	Y-732J	5605	4
Laguna / Nevada Phase2 DT	2.2	80	4	04.98-	G8T Turbo	11,0	Y-730U	6704	17

### LAGUNA 2

Laguna	1.9	74	4	03.01-05.05	F9Q650	12,0	Y-732J	5605	4
Laguna 2 1.9 dCi	1.9	68	4	10.03-05.05	F9Q 664	12,0	Y-732J	5605	4
Laguna 2 1.9 dCi	1.9	74	4	03.99-	F9Q 710/717/718	12,0	Y-732J	5605	4
Laguna 2 1.9 dCi	1.9	77	4	06.01-05.05	F9Q 752	12,0	Y-732J	5605	4
Laguna 2 1.9 dCi	1.9	77	4	06.01-05.05	F9Q 752	12,0	Y-732J	5605	4
Laguna 2 1.9 dCi	1.9	81	4	01.05-08.07	F9Q 758/674	12,0	Y-732J	5605	4
Laguna 2 1.9 dCi	1.9	88	4	01.01-	F9QC 750	12,0	Y-732J	5605	4



Stock-No  
D-POWER™

## RENAULT

### LAGUNA 2

Laguna 2 1.9 dCi	1.9	96	4	03.05-12.07	F9Q 758/759	12,0	Y-732J	5605	4
Laguna 2 2.2 dCi	2.2	110	4	01.02-	G9T 702	11,0	Y-517J	91766	66
Laguna 2 2.2 dCi 115	2.2	85	4	04.04-10.05	G9T 600	11,0	Y-517J	91766	66
Laguna 2 2.2 dCi 140	2.2	102	4	04.04-	G9T 706 / 707	11,0	Y-517J	91766	66
Laguna 2 2.2 dCi 150	2.2	110	4	01.02-	G9T 710	11,0	Y-517J	91766	66

### LAGUNA 3

Laguna 3 1.5 Dci	1.5	80	4	10.07-	K9K 780	12,0	Y-732J	5605	4
------------------	-----	----	---	--------	---------	------	--------	------	---

### MASTER

Master T28 , T33 , T35			4	07.98-		11,0	Y-502R	3852	
Master Dci	1.9	59	4	06.00-	F9Q 770	12,0	Y-732J	5605	4
Master D T30	2.1	45	4	11.81- .96	852	11,0	Y-924J	7906	1
Master Dci 16S	2.2	66	4	05.01-	G9T 720 / 722 / 750	11,0	Y-517J	91766	66
Master Dci	2.2	85	4	.00-	G9T 710	11,0	Y-517J	91766	66
Master D T 30	2.4	52	4	06.82- .96	8140 / S8U	11,0	Y-924J	7906	1
Master Turbo D T35	2.5	55	4	06.82- .96	S9U	11,0	Y-924J	7906	1
Master D	2.5	59	4	07.98-	S8U 770/772	11,0	Y-502R	3852	
Master D	2.5	69	4	09.97-	S8V 748	11,5	Y-910J	3617	3
Master 2.5 dCi 100 T28, T33, T35	2.5	73	4	10.03-	G9U 754	11,0	Y-517J	91766	66
Master 2.5 dCi 100 T28, T33, T35	2.5	74	4	08.06-	G9U 754	11,0	Y-517J	91766	66
Master 2.5 dCi 115 T28, T35, T39	2.5	84	4	10.01-	G9U 720 / 750	11,0	Y-517J	91766	66
Master 2.5 dCi 120 T28, T35, T39	2.5	88	4	08.06-	G9U 650	11,0	Y-517J	91766	66
Master 2.5 dCi 150 T28, T35, T39	2.5	107	4	08.06-	G9U 632	11,0	Y-517J	91766	66
Master Dti	2.8	85	4	09.97-	S8W 700/702	11,0	Y-502R	3852	
Master dCi	3.0	96	4	01.07-	ZD30CDTi	11,0	Y-522J	5939	

### MEGANE 1

Mégane / Classic D	1.9	48	4	01.96-	F8Q 620/624	11,0	Y-927J	4916	19
Mégane / Classic D	1.9	48	4	03.98-	F8Q 788	11,0	Y-506J	2419	7
Mégane / Classic D	1.9	48	4	03.99-02.01	F8Q 622	11,0	Y-516J	6416	12
Mégane 1.9 Dti	1.9	59	4	02.01-	F9Q 744	12,0	Y-732J	5605	4
Mégane / Classic Di	1.9	66	4	01.96-08.99	F9Q 730/734	11,0	Y-740U	4818	22
Mégane / Classic DT	1.9	66	4	01.96-	F8Q 784/786	11,0	Y-933J	7947	25
Mégane / Classic Dti	1.9	74	4	01.96-	F9Q 716/730/734	11,0	Y-740U	4818	22
Mégane / Classic Dci	1.9	77	4	03.99-	F9Q 731/732/736/740	12,0	Y-732J	5605	4

### MEGANE 1 PHASE 2

Mégane Phase 2 D	1.9	48	4	09.99-	F8Q 620/624	11,0	Y-927J	4916	19
Mégane Phase 2 D	1.9	48	4	03.99-	F8Q 622/790	11,0	Y-516J	6416	12
Mégane Phase 2 Dti	1.9	59	4	04.01-	F9QT 770	12,0	Y-732J	5605	4
Mégane Phase 2 Dti	1.9	74	4	01.96-	F9Q 716/730/734	11,0	Y-740U	4818	22
Mégane Phase 2 Dci	1.9	77	4	03.99-	F9Q 718/722/731/736/780	12,0	Y-732J	5605	4

### MEGANE 2

Mégane 2 1.5 Dci	1.5	59	4	09.02-	K9K 722	12,0	Y-732J	5605	4
Mégane 2 1.5 Dci Berline	1.5	59	4	09.03-	K9K 722	12,0	Y-732J	5605	4
Mégane 2 1.5 Dci Break	1.5	59	4	09.03-	K9K 722	12,0	Y-732J	5605	4
Mégane 2 1.5 Dci	1.5	63	4	05.05-02.08	K9K 724	12,0	Y-732J	5605	4
Mégane 2 Coupé	1.5	74	4	.04-	K9K	12,0	Y-732J	5605	4
Mégane 2 1.5 Dci	1.5	76	4	05.05-07.09	K9K 728	12,0	Y-732J	5605	4
Mégane 2 1.5 Dci	1.5	78	4	05.05-07.09	K9K 732/734	12,0	Y-732J	5605	4
Mégane 2 1.9 Dci	1.9	81	4	05.05-	F9Q 803/804/818	12,0	Y-732J	5605	4
Mégane 2 1.9 Dci	1.9	85	4	11.02-03.09	F9Q 804/816/818	12,0	Y-732J	5605	4



e kW C y i **0201**



Stock-No  
D-POWER™

## RENAULT

### MEGANE 2

Mégane 2 Coupe Dci	1.9	88	4	09.02-	F9Q 800	12,0	Y-732J	5605	4
Mégane 2 1.9 Dci	1.9	96	4	05.05-	F9Q 803/816	12,0	Y-732J	5605	4

### MEGANE 3

Mégane 3 1.5 dCi	1.5	63	4	12.09-	K9K 830	4,4	Y1035AS	94103	77
Mégane 3 1.5 dCi	1.5	66	4	11.08-	K9K 834	4,4	Y1035AS	94103	77
Mégane 3 1.5 dCi	1.5	78	4	02.09-	K9K 832	4,4	Y1035AS	94103	77
Mégane 3 1.5 dCi	1.5	81	4	02.09-	K9K 836	4,4	Y1035AS	94103	77
Mégane 3	1.6	96	4	04.11-	R9M402	4,5	Y1010AS	97618	
Mégane 3	1.6	96	4	04.11-	R9M404	4,5	Y1010AS	97618	
Mégane 3	1.6	96	4	11.15-	R9M409	4,5	Y1010AS	97618	
Mégane 3	1.6	96	4	11.15-	R9M410	4,5	Y1010AS	97618	
Mégane 3	1.6	96	4	11.15-	R9M412	4,5	Y1010AS	97618	
Mégane 3	1.6	96	4	11.15-	R9M452	4,5	Y1010AS	97618	
Mégane 3 1.9 dCi	1.9	96	4	06.08-	F9Q 870 / 872	4,4	Y1036AS	96062	

### MEGANE SCENIC

Mégane Scenic	1.9	48	4	10.96-08.99	F8Q 620/624	11,0	Y-927J	4916	19
Mégane Scenic	1.9	48	4	03.98-	F8Q 788	11,0	Y-506J	2419	7
Mégane Scenic	1.9	48	4	03.99-	F8Q 622/790	11,0	Y-516J	6416	12
Mégane Scenic	1.9	66	4	01.96-	F8Q 784/786	11,0	Y-933J	7947	25
Mégane Scenic Di	1.9	66	4	10.96-08.99	F9Q 716/730/734	11,0	Y-740U	4818	22
Mégane Scenic Dti	1.9	74	4	01.96-	F9Q 716/730/734	11,0	Y-740U	4818	22

### MODUS

Modus 1.5 Dci	1.5	48	4	09.04-	K9K	12,0	Y-732J	5605	4
Modus 1.5 Dci	1.5	50	4	12.04-	K9K 768	12,0	Y-732J	5605	4
Modus 1.5 Dci 75	1.5	55	4	10.10-	K9K 770	4,4	Y1035AS	94103	77
Modus 1.5 Dci	1.5	60	4	09.04-	K9K 750	12,0	Y-732J	5605	4
Modus 1.5 Dci	1.5	63	4	12.04-	K9K 766	12,0	Y-732J	5605	4
Modus 1.5 Dci 90	1.5	65	4	10.10-	K9K 770	4,4	Y1035AS	94103	77
Modus 1.5 Dci	1.5	76	4	05.07-	K9K 772	12,0	Y-732J	5605	4
Modus 1.5 Dci	1.5	78	4	05.05-	K9K 764	12,0	Y-732J	5605	4

### R 19

R 19 D	1.9	48	4	06.88-02.91	F8Q	11,0	Y-924J	7906	1
R 19 D	1.9	48	4	03.91-12.95	F8Q 706/742/764	11,0	Y-913J	5317	15
R 19 TD	1.9	66	4	09.90-06.96	F8Q 610/740/744/768	11,0	Y-933J	7947	25

### R 21

R 21 D / Nevada	1.9	48	4	09.89-02.91	F8Q	11,0	Y-924J	7906	1
R 21 D / Nevada	1.9	48	4	03.91- .95	F8Q 710	11,0	Y-924J	7906	1
R 21 D / Nevada	2.1	53	4	09.89-12.93	J8S	11,0	Y-924J	7906	1
R 21 TD / Nevada	2.1	65	4	03.86-12.93	J8S	11,0	Y-924J	7906	1

### R 25

R 25 D	2.1	47	4	01.84-12.92	J8S 736	11,0	Y-924J	7906	1
R 25 TD	2.1	63	4	01.84-12.92	J8S 708/738	11,0	Y-924J	7906	1

### RAPID

Rapid Express	1.9	34	4	09.94-	F8Q 640	11,0	Y-927J	4916	19
---------------	-----	----	---	--------	---------	------	--------	------	----

**RENAULT****SAFRANE**

Safrane DT	2.1	65	4	06.92-09.96	J8S 760	11,0	Y-924J	7906	1
Safrane DT	2.5	83	4	03.93-09.96	S8U 762/763	11,0	Y-924J	7906	1

**SAFRANE PHASE 2**

Safrane Phase 2 DT	2.2	85	4	10.96-11.00	G8T 740	11,0	Y-730U	6704	17
--------------------	-----	----	---	-------------	---------	------	--------	------	----

**SCENIC 1**

Scénic D	1.9	48	4	10.96-08.99	F8Q 620/624	11,0	Y-927J	4916	19
Scénic D	1.9	48	4	03.98-	F8Q 788	11,0	Y-506J	2419	7
Scénic D	1.9	48	4	03.99-	F8Q 622/790	11,0	Y-516J	6416	12
Scénic Di	1.9	66	4	10.96-08.99	F9Q 716730/734	11,0	Y-740U	4818	22
Scénic Dti	1.9	74	4	01.96-	F9Q 716/730/734	11,0	Y-740U	4818	22
Scénic DT	1.9	66	4	01.96-	F8Q 784/786	11,0	Y-933J	7947	25
Scénic dci RX4	1.9	75	4	.99-		12,0	Y-732J	5605	4

**SCENIC 1 PHASE 2**

Scénic Phase 2 D	1.9	48	4	09.99-		11,0	Y-927J	4916	19
Scénic Phase 2 Dti	1.9	59	4	06.01-	F9Q T770	12,0	Y-732J	5605	4
Scénic Phase 2 Dti	1.9	74	4	09.99-	F9Q 730/734/744	11,0	Y-740U	4818	22
Scénic Phase 2 Dci	1.9	77	4	03.99-	F9Q 718/731/736/740	12,0	Y-732J	5605	4
Scénic Phase 2 Dci RX4	1.9	77	4	09.00-	F9Q 740	12,0	Y-732J	5605	4

**SCENIC 2**

Scénic 2 1.5 Dci	1.5	59	4	.03-	K9K	12,0	Y-732J	5605	4
Scénic 2 1.5 Dci	1.5	63	4	05.05-11.08	K9K 722/724	12,0	Y-732J	5605	4
Scénic 2 1.5 Dci	1.5	74	4	04.04-	K9K 728/729	12,0	Y-732J	5605	4
Scénic 2 1.9 Dci	1.9	81	4	05.05-	F9Q 803/812	12,0	Y-732J	5605	4
Scénic 2 1.9 Dci	1.9	88	4	04.04-	F9Q 812	12,0	Y-732J	5605	4
Scénic 2 1.9 Dci	1.9	96	4	05.05-02.08	F9Q 803/804/816/818	12,0	Y-732J	5605	4

**SCENIC 3**

Scénic 3 1.5 dCi	1.5	63	4	04.09-	K9K 830	4,4	Y1035AS	94103	77
Scénic 3 1.5 dCi	1.5	70	4	11.10-	K9K 846	4,4	Y1035AS	94103	77
Scénic 3 1.5 dCi	1.5	78	4	02.09-	K9K 832	4,4	Y1035AS	94103	77
Scénic 3 1.5 dCi	1.5	81	4	04.09-	K9K 836	4,4	Y1035AS	94103	77
Scénic 3 1.6 dCi	1.6	96	4	04.11-	R9M414	4,5	Y1010AS	97618	
Scénic 3 1.6 dCi	1.6	96	4	06.13-	R9M402	4,5	Y1010AS	97618	
Scénic 3 1.6 dCi	1.6	96	4	06.13-	R9M404	4,5	Y1010AS	97618	
Scénic 3 1.9 dCi	1.9	96	4	12.08-	F9Q 870	4,4	Y1036AS	96062	

**THALIA / SYMBOL**

Thalia / Symbol 1.5 dCi (LB0/1/2)	1.5	47	4	06.05-	K9K 740	12,0	Y-732J	5605	4
Thalia / Symbol 1.5 dCi (LB0/1/2)	1.5	48	4	04.02-10.05	K9K 700	12,0	Y-732J	5605	4
Thalia / Symbol 1.5 dCi (LB0/1/2)	1.5	50	4	02.03-	K9K 700/714	12,0	Y-732J	5605	4
Thalia / Symbol 1.5 dCi (LB0/1/2)	1.5	60	4	06.01-	K9K 702	12,0	Y-732J	5605	4
Thalia / Symbol 1.9 D (LB0/1/2)	1.9	48	4	02.98-05.01	F8Q 630	11,0	Y-506J	2419	7
Thalia / Symbol II 1.5 dCi	1.5	47	4	09.08-	K9K 740	12,0	Y-732J	5605	4
Thalia / Symbol II 1.5 dCi	1.5	62	4	09.08-	K9K 718	12,0	Y-732J	5605	4

**TRAFIC**

Trafic D T 1000	1.9	45	4	11.97-	F8Q 600/606	11,0	Y-506J	2419	7
Trafic Dci	1.9	60	4	05.01-	F9Q 762	12,0	Y-732J	5605	4
Trafic 1.9 Dci	1.9	74	4	05.01-	F9Q 760	12,0	Y-732J	5605	4
Trafic D P1000, P1200, 4x4	2.1	43	4	11.81-10.97	852/720/750	11,0	Y-924J	7906	1
Trafic D T 1000	2.1	56	4	11.97-	S8U 758/780/782	11,5	Y-910J	3617	3



e kW C y i **0201**



Stock-No  
D-POWER

## RENAULT TRAFIC

Trafic D	2.5	52	4	10.82-10.97	S8U	11,0	Y-208T	1250	
Trafic D	2.5	55	4	03.90-10.97	Sofim 8140	11,0	Y-924J	7906	1
Trafic 2.5 dCi 115	2.5	84	4	08.07-	G9U 630	11,0	Y-517J	91766	66
Trafic 2.5 dCi 135	2.5	99	4	03.03-	G9U 730	11,0	Y-517J	91766	66
Trafic 2.5 dCi 150	2.5	107	4	08.06-	G9U 630	11,0	Y-517J	91766	66
Trafic 3 dCi	1.6	66	4	06.14-	R9M408	4,5	Y1010AS	97618	
Trafic 3 dCi	1.6	85	4	06.14-	R9M408	4,5	Y1010AS	97618	
Trafic 3 dCi	1.6	103	4	06.14-	R9M450	4,5	Y1010AS	97618	
Trafic 3 dCi	1.6	88	4	06.14-	R9M450	4,5	Y1010AS	97618	

## TWINGO 2

Twingo 2 1.5 DCI	1.5	47	4	06.07-	K9K 740	12,0	Y-732J	5605	4
Twingo 2 1.5 DCI 75	1.5	55	4	10.10-	K9K 820	4,4	Y1035AS	94103	77
Twingo 2 1.5 DCI	1.5	62	4	04.08-	K9K 718	12,0	Y-732J	5605	4
Twingo 2 1.5 DCI 90	1.5	63	4	10.10-	K9K 820	4,4	Y1035AS	94103	77

## VEL SAVIS

Vel Satis 2.2 Dci	2.2	85	4	03.02-08.09	G9T703	11,0	Y-517J	91766	66
Vel Satis 2.2 Dci	2.2	85	4	03.02-12.03	G9T600	11,0	Y-517J	91766	66
Vel Satis 2.2 Dci	2.2	110	4	03.02-12.03	G9T 702	11,0	Y-517J	91766	66

## ROVER

### 25

25 2.0 iDT	2.0	74	4	11.99-		11,0	Y-730U	6704	17
------------	-----	----	---	--------	--	------	--------	------	----

### 45

45 2.0 TD	2.0	73	4	11.99-		11,0	Y-730U	6704	17
-----------	-----	----	---	--------	--	------	--------	------	----

### 75

75 2.0 CDT	2.0	85	4	.99-	M47R (BMW)	11,0	Y-507J	2691	32
------------	-----	----	---	------	------------	------	--------	------	----

## SERIE 100

115 SD/CSD	1.5	57	4	01.95- .98	TUD 5	11,0	Y-503J	1009	10
------------	-----	----	---	------------	-------	------	--------	------	----

## SERIE 200

218 TD	1.8	65	4	09.91-	XUD 7 TE	11,0	Y-924J	7906	1
217 SD, 218 SD/SLD	1.9	49	4	09.91-	XUD 9	11,0	Y-924J	7906	1
218 D	1.9	49	4	09.91-	XUD 9	11,0	Y-924J	7906	1
220 SDi	2.0	63	4	10.95-	20 T2R	11,0	Y-730U	6704	17
220 SDi	2.0	77	4	10.95-	20T2N (Intercooled)	11,0	Y-730U	6704	17

## SERIE 400

400 D				01.87-		11,0	Y-924J	7906	1
418 SLD, GSD TD	1.8	65	4	09.91-03.96	XUD 7 T	11,0	Y-924J	7906	1
420 SDi, SLDi TD	2.0		4	10.95- .99	20 T2R, 20T2N (Intercooled)	11,0	Y-730U	6704	17
420 D / SD	2.0	63	4	07.95-		11,0	Y-730U	6704	17
420 Di / Sdi	2.0	77	4	07.95-		11,0	Y-730U	6704	17

## SERIE 600

620 SDi, SLDi TD	2.0		4	10.95- .99	20 T2R, 20T2N (Intercooled)	11,0	Y-730U	6704	17
------------------	-----	--	---	------------	-----------------------------	------	--------	------	----

## SERIE 800

825 SD TD	2.5	87	4	01.93-	VM HR-492/VM 425 SLIRR	11,0	Y-924J	7906	1
825 D/SD/SLD	2.5		4	.90-03.96	VM	11,0	Y-924J	7906	1
825	2.5		4	03.96-10.99	VM	11,0	Y-741U	6943	20

## MAESTRO

Maestro Van TD	2.0	60	4	01.86-		11,0	Y-924J	7906	1
Maestro TD	2.0	60	4	07.89-	Perkins-Prima 80 T	11,0	Y-924J	7906	1





l kW C y i 0201



Stock-No D-POWER™

## ROVER

### METRO

Metro D	1.4	39	4	01.92-01.95	Peugeot TUD 3	11,5	Y-910J	3617	3
---------	-----	----	---	-------------	---------------	------	--------	------	---

### MONTEGO

Montego 2.0 TD	2.0	60	4	09.88-	Perkins-Prima 80 T	11,0	Y-924J	7906	1
----------------	-----	----	---	--------	--------------------	------	--------	------	---

### STREETWISE

Streetwise 2.0 TD	2.0		4	07.03-		11,0	Y-730U	6704	17
-------------------	-----	--	---	--------	--	------	--------	------	----

## SAAB

### 9-3 1

9-3 2.2 TiD	YS3D	2.2	85	4	02.98-11.00	D223L / X22DTH Opel	11,0	Y-748U	6649	14
-------------	------	-----	----	---	-------------	---------------------	------	--------	------	----

9-3 2.2 TiD	YS3D	2.2	92	4	11.00-09.02	D223L	11,0	Y-523J	6298	37
-------------	------	-----	----	---	-------------	-------	------	--------	------	----

### 9-3 2

9-3 1.9 TiD	YS3F	1.9	88	4	03.05-07.12	Z19DT Fiat	11,0	Y-534J	3413	36
-------------	------	-----	----	---	-------------	------------	------	--------	------	----

9-3 1.9 TTiD	YS3F	1.9	96	4	12.07-07.12	A19DTR	4,4	Y9003AS	94251	78
--------------	------	-----	----	---	-------------	--------	-----	---------	-------	----

9-3 1.9 TiD	YS3F	1.9	110	4	03.05-07.12	Z19DTH	11,0	YE07	6092	
-------------	------	-----	-----	---	-------------	--------	------	------	------	--

9-3 1.9 TTiD	YS3F	1.9	118	4	12.07-07.12	A19DTR	4,4	Y9003AS	94251	78
--------------	------	-----	-----	---	-------------	--------	-----	---------	-------	----

9-3 2.2 TiD	YS3F	2.2	92	4	09.02-07.12	D223L	11,0	Y-523J	6298	37
-------------	------	-----	----	---	-------------	-------	------	--------	------	----

### 9-3 X

9-3X 1.9 TTiD	YS3F	1.9	132	4	02.09-07.12	Z19DTR	4,4	Y9003AS	94251	78
---------------	------	-----	-----	---	-------------	--------	-----	---------	-------	----

### 9-5 1

9-5 1.9 TiD	YS3E	1.9	110	4	01.06-05.10	Z19DTH	11,0	YE07	6092	
-------------	------	-----	-----	---	-------------	--------	------	------	------	--

9-5 2.2 TiD	YS3E	2.2	88	4	01.02-08.05	D223L	11,0	Y-748U	6649	14
-------------	------	-----	----	---	-------------	-------	------	--------	------	----

## SEAT

### ALHAMBRA 1

Alhambra 1.9 TDI	7V8 / 7V9	1.9	66	4	04.95-07.96	1Z	12,0	Y-732J	5605	4
------------------	-----------	-----	----	---	-------------	----	------	--------	------	---

Alhambra 1.9 TDI	7V8 / 7V9	1.9	66	4	07.96-02.00	AHU	12,0	Y-732J	5605	4
------------------	-----------	-----	----	---	-------------	-----	------	--------	------	---

Alhambra 1.9 TDI	7V8 / 7V9	1.9	81	4	09.97-02.00	AFN	12,0	Y-732J	5605	4
------------------	-----------	-----	----	---	-------------	-----	------	--------	------	---

Alhambra 1.9 TDI	7V8 / 7V9	1.9	66	4	06.00-03.10	ANU	12,0	Y-732J	5605	4
------------------	-----------	-----	----	---	-------------	-----	------	--------	------	---

Alhambra 1.9 TDI	7V8 / 7V9	1.9	85	4	06.00-03.10	AUY	12,0	Y-732J	5605	4
------------------	-----------	-----	----	---	-------------	-----	------	--------	------	---

Alhambra 2.0 TDI	7V8 / 7V9	1.9	96	4	06.05-05.06	ASZ	11,0	Y-741U	6943	20
------------------	-----------	-----	----	---	-------------	-----	------	--------	------	----

Alhambra 2.0 TDI	7V8 / 7V9	2.0	103	4	11.05-03.10	BRT	7,0	CZ104	9826	52
------------------	-----------	-----	-----	---	-------------	-----	-----	-------	------	----

### ALHAMBRA 2

Alhambra 2.0 TDI	710	2.0	85	4	06.11-	CFFE	4,4	Y1002AS	8888	57
------------------	-----	-----	----	---	--------	------	-----	---------	------	----

Alhambra 2.0 TDI	710	2.0	100	4	06.10-	CFFA	4,4	Y1002AS	8888	57
------------------	-----	-----	-----	---	--------	------	-----	---------	------	----

Alhambra 2.0 TDI	710	2.0	103	4	06.10-	CFFB	4,4	Y1002AS	8888	57
------------------	-----	-----	-----	---	--------	------	-----	---------	------	----

Alhambra 2.0 TDI	710	2.0	125	4	06.10-	CFGB	4,4	Y1002AS	8888	57
------------------	-----	-----	-----	---	--------	------	-----	---------	------	----

### ALTEA

Altea 1.6 TDI	5P1	1.6	77	4	10.09-	CAYC	4,4	Y1002AS	8888	57
---------------	-----	-----	----	---	--------	------	-----	---------	------	----

Altea 1.9 TDI	5P1	1.9	66	4	08.09-	BXF	5,0	Y-607AS	7560	50
---------------	-----	-----	----	---	--------	-----	-----	---------	------	----

Altea 1.9 TDI	5P1	1.9	77	4	04.04-09.05	BJB	5,0	Y-607AS	7560	50
---------------	-----	-----	----	---	-------------	-----	-----	---------	------	----

Altea 1.9 TDI	5P1	1.9	77	4	04.04-05.06	BKC	5,0	Y-607AS	7560	50
---------------	-----	-----	----	---	-------------	-----	-----	---------	------	----

Altea 1.9 TDI	5P1	1.9	77	4	10.05-	BLS	7,0	CZ104	9826	52
---------------	-----	-----	----	---	--------	-----	-----	-------	------	----

Altea 1.9 TDI	5P1	1.9	77	4	02.06-	BXE	5,0	Y-607AS	7560	50
---------------	-----	-----	----	---	--------	-----	-----	---------	------	----

Altea 2.0 TDI 16V	5P1	2.0	100	4	04.04-05.09	AZV	4,4	YE14	7768	48
-------------------	-----	-----	-----	---	-------------	-----	-----	------	------	----

Altea 2.0 TDI 16V	5P1	2.0	103	4	03.04-	BKD	4,4	YE14	7768	48
-------------------	-----	-----	-----	---	--------	-----	-----	------	------	----

Altea 2.0 TDI	5P1	2.0	103	4	11.05-	BMM	5,0	Y-607AS	7560	50
---------------	-----	-----	-----	---	--------	-----	-----	---------	------	----

Altea 2.0 TDI	5P1	2.0	125	4	02.06-	BMN	7,0	CZ304	9864	55
---------------	-----	-----	-----	---	--------	-----	-----	-------	------	----

Altea 2.0 TDI	5P1	2.0	125	4	03.09-09.10	CEGA	4,4	Y-609AS	5849	49
---------------	-----	-----	-----	---	-------------	------	-----	---------	------	----

**SEAT****ALTEA**

Altea XL 1.6 TDI	5P5	1.6	77	4	10.09-	CAYC		4,4	Y1002AS	8888	57
------------------	-----	-----	----	---	--------	------	--	-----	---------	------	----

**AROSA**

Arosa 1.4 TDI VIN >>6H-2-009 700	6H	1.4	55	3	09.99-06.04	AMF		12,0	Y-732J	5605	4
Arosa 1.4 TDI VIN 6H-2-009 701>>	6H	1.4	55	3	09.99-06.04	AMF		11,0	Y-741U	6943	20
Arosa 1.7 SDI	6H	1.7	44	4	08.97-10.03	AKU		12,0	Y-732J	5605	4

**CORDOBA**

Cordoba TDI		1.4	51	3	05.05-	BNM		11,0	Y-741U	6943	20
Cordoba TDI		1.4	55	3	10.02-04.04	AMF		11,0	Y-741U	6943	20
Cordoba TDI		1.4	58	3	05.05-	BNV		11,0	Y-741U	6943	20
Cordoba TDI PD		1.4	59	3	06.06-12.06	BMS		7,0	CZ104	9826	52
Cordoba / Vario D		1.9	47	4	02.93-	1Y		12,0	Y-918J	6285	2
Cordoba / Vario SDI		1.9	47	4	07.96-	AEY		12,0	Y-732J	5605	4
Cordoba SDI		1.9	47	4	09.02-04.04	ASY		12,0	Y-732J	5605	4
Cordoba SDI		1.9	50	4	04.99-08.02	AGP		12,0	Y-732J	5605	4
Cordoba SDI		1.9	50	4	06.99-08.02	AQM		12,0	Y-732J	5605	4
Cordoba / Vario TD		1.9	55	4	02.93-08.97	AAZ		12,0	Y-918J	6285	2
Cordoba / Vario TDI		1.9	66	4	07.95-12.96	1Z		12,0	Y-732J	5605	4
Cordoba / Vario TDI		1.9	66	4	12.96-	AHU		12,0	Y-732J	5605	4
Cordoba TDI		1.9	66	4	04.99-08.02	AGR		12,0	Y-732J	5605	4
Cordoba TDI		1.9	66	4	10.99-05.01	ALH		12,0	Y-732J	5605	4
Cordoba TDI		1.9	74	4	09.02-04.04	ATD		11,0	Y-741U	6943	20
Cordoba TDI		1.9	74	4	05.05-	AXR		11,0	Y-741U	6943	20
Cordoba TDI		1.9	74	4	09.06-12.06	BMT		7,0	CZ104	9826	52
Cordoba / Vario TDI		1.9	81	4	03.97-	AFN		12,0	Y-732J	5605	4
Cordoba TDI		1.9	81	4	03.99-08.02	ASV		12,0	Y-732J	5605	4
Cordoba TDI		1.9	96	4	10.02-04.04	ASZ		11,0	Y-741U	6943	20
Cordoba TDI		1.9	96	4	05.05-	BLT		11,0	Y-741U	6943	20

**EXEO**

Exeo 2.0 TDI	3R2 / 3R5	2.0	88	4	12.08-05.13	CAGC		4,4	Y1002AS	8888	57
Exeo 2.0 TDI	3R2 / 3R5	2.0	88	4	12.08-05.13	CJCC		4,4	Y1002AS	8888	57
Exeo 2.0 TDI	3R2 / 3R5	2.0	105	4	12.08-05.13	CAGA		4,4	Y1002AS	8888	57
Exeo 2.0 TDI	3R2 / 3R5	2.0	105	4	12.08-05.13	CJGA		4,4	Y1002AS	8888	57
Exeo 2.0 TDI	3R2 / 3R5	2.0	125	4	02.09-05.13	CAHA		4,4	Y1002AS	8888	57
Exeo 2.0 TDI	3R2 / 3R5	2.0	125	4	02.09-05.13	CGLB		4,4	Y1002AS	8888	57

**IBIZA 1**

Ibiza 1 1.7 D	021A	1.7	40	4	09.87-05.93	022A5000		11,0	Y-924J	7906	1
---------------	------	-----	----	---	-------------	----------	--	------	--------	------	---

**IBIZA 2**

Ibiza 2 1.9 D	6K1	1.9	47	4	02.93-08.96	1Y		12,0	Y-918J	6285	2
Ibiza 2 1.9 SDI	6K1	1.9	47	4	07.96-08.99	AEY		12,0	Y-732J	5605	4
Ibiza 2 1.9 TD	6K1	1.9	55	4	02.93-08.97	AAZ		12,0	Y-918J	6285	2
Ibiza 2 1.9 TDI	6K1	1.9	66	4	07.96-12.96	1Z		12,0	Y-732J	5605	4
Ibiza 2 1.9 TDI	6K1	1.9	66	4	12.96-08.99	AHU		12,0	Y-732J	5605	4
Ibiza 2 1.9 TDI	6K1	1.9	81	4	03.97-08.99	AFN		12,0	Y-732J	5605	4

**IBIZA 3**

Ibiza 3 1.9 SDI	6K1	1.9	50	4	04.99-05.02	AGP		12,0	Y-732J	5605	4
Ibiza 3 1.9 SDI	6K1	1.9	50	4	05.99-05.02	AQM		12,0	Y-732J	5605	4
Ibiza 3 1.9 TDI	6K1	1.9	66	4	04.99-05.02	AGR		12,0	Y-732J	5605	4
Ibiza 3 1.9 TDI	6K1	1.9	66	4	05.99-05.02	ALH		12,0	Y-732J	5605	4
Ibiza 3 1.9 TDI	6K1	1.9	81	4	03.99-05.02	ASV		12,0	Y-732J	5605	4



ℓ kW C y i 0201



Stock-No  
D-POWER™

**SEAT**

**IBIZA 4**

Ibiza 4 1.4 TDI	6L1	1.4	51	3	05.05-11.09	BNM	11,0	Y-741U	6943	20
Ibiza 4 1.4 TDI	6L1	1.4	55	3	05.05-12.05	AMF	11,0	Y-741U	6943	20
Ibiza 4 1.4 TDI	6L1	1.4	59	3	05.05-11.09	BNV	11,0	Y-741U	6943	20
Ibiza 4 1.9 SDI	6L1	1.9	47	4	05.05-12.05	ASY	12,0	Y-732J	5605	4
Ibiza 4 1.9 TDI	6L1	1.9	74	4	09.06-11.09	BMT	7,0	CZ104	9826	52
Ibiza 4 1.9 TDI	6L1	1.9	74	4	05.05-11.09	AXR	11,0	Y-741U	6943	20
Ibiza 4 1.9 TDI	6L1	1.9	96	4	05.05-11.09	BLT	11,0	Y-741U	6943	20
Ibiza 4 1.9 TDI VIN 6L-2-001 501>>	6L1	1.9	74	4	05.05-05.05	ATD	11,0	Y-741U	6943	20
Ibiza 4 1.9 TDI VIN 6L-2-001 501>>	6L1	1.9	96	4	05.05-09.05	ASZ	11,0	Y-741U	6943	20
Ibiza 4 1.9 TDI Cupra R	6L1	1.9	118	4	03.04-02.08	BPX	11,0	Y-741U	6943	20
Ibiza 4 1.9 TDI Cupra R	6L1	1.9	118	4	11.05-02.08	BUK	11,0	Y-741U	6943	20

**IBIZA 5**

Ibiza 5 1.2 TDI	6J5	1.2	55	3	05.10-	CFWA	4,4	Y1002AS	8888	57
Ibiza 5 1.4 TDI	6J5	1.4	59	3	07.08-06.10	BMS	7,0	CZ104	9826	52
Ibiza 5 1.6 TDI	6J5	1.6	55	4	05.10-	CAYA	4,4	Y1002AS	8888	57
Ibiza 5 1.6 TDI	6J5	1.6	66	4	05.09-	CAYB	4,4	Y1002AS	8888	57
Ibiza 5 1.6 TDI	6J5	1.6	77	4	05.09-	CAYC / CLNA	4,4	Y1002AS	8888	57
Ibiza 5 1.9 TDI	6J5	1.9	66	4	06.08-06.10	BXJ	5,0	Y-607AS	7560	50
Ibiza 5 1.9 TDI	6J5	1.9	77	4	02.08-06.10	BLS	5,0	Y-607AS	7560	50
Ibiza 5 2.0 TDI	6J5	2.0	105	4	01.10-	CFHD	4,4	Y1002AS	8888	57

**INCA**

Inca D	6K9	1.7	42	4	07.96-09.00	AHB	12,0	Y-918J	6285	2
Inca D	6K9	1.9	47	4	11.95-06.03	1Y	12,0	Y-918J	6285	2
Inca SDI	6K9	1.9	47	4	11.95-09.00	AEY	12,0	Y-732J	5605	4
Inca SDI	6K9	1.9	47	4	09.00-06.03	AYQ	12,0	Y-732J	5605	4

**LEÓN 1**

León 1 1.9 SDI	1M1	1.9	50	4	03.00-10.03	AQM	12,0	Y-732J	5605	4
León 1 1.9 TDI	1M1	1.9	74	4	10.05-06.06	AXR	11,0	Y-741U	6943	20
León 1 1.9 TDI	1M1	1.9	66	4	04.99-09.02	AGR	12,0	Y-732J	5605	4
León 1 1.9 TDI	1M1	1.9	66	4	03.99-10.05	ALH	12,0	Y-732J	5605	4
León 1 1.9 TDI	1M1	1.9	81	4	10.98-09.02	AHF	12,0	Y-732J	5605	4
León 1 1.9 TDI	1M1	1.9	81	4	11.99-10.05	ASV	12,0	Y-732J	5605	4
León 1 1.9 TDI	1M1	1.9	96	4	05.03-06.06	ASZ	11,0	Y-741U	6943	20
León 1 1.9 TDI VIN >>1M-2-062000	1M1	1.9	110	4	09.00-	ARL	12,0	Y-732J	5605	4
León 1 1.9 TDI VIN 1M-2-062001 >>	1M1	1.9	110	4	09.00-12.05	ARL	11,0	Y-741U	6943	20

**LEÓN 2**

León 2 1.6 TDI	1P1	1.6	77	4	02.10-	CAYC	4,4	Y1002AS	8888	57
León 2 1.9 TDI	1P1	1.9	66	4	06.07-	BXF	5,0	Y-607AS	7560	50
León 2 1.9 TDI	1P1	1.9	77	4	07.05-02.06	BKC	5,0	Y-607AS	7560	50
León 2 1.9 TDI	1P1	1.9	77	4	11.05-	BLS	7,0	CZ104	9826	52
León 2 1.9 TDI	1P1	1.9	77	4	02.06-	BXE	5,0	Y-607AS	7560	50

**LEÓN 2**

León 2 2.0 TDI	1P1	2.0	100	4	07.05-03.09	AZV	4,4	YE14	7768	48
León 2 2.0 TDI	1P1	2.0	103	4	10.05-	BMM	5,0	Y-607AS	7560	50
León 2 2.0 TDI	1P1	2.0	125	4	05.06-03.09	BMN	7,0	CZ304	9864	55
León 2 2.0 TDI	1P1	2.0	125	4	03.09-09.10	CEGA	4,4	Y-609AS	5849	49
León 2 2.0 TDI 16V	1P1	2.0	103	4	07.05-	BKD	4,4	YE14	7768	48

**SEAT****LEÓN 3**

León 3 1.6 TDI	5F1	1.6	66	4	11.12-	CLHB		4,4	Y1002AS	8888	57
Only for cylinder without pressure sensor Euro V											
León 3 1.6 TDI	5F1	1.6	77	4	09.12-	CLHA		4,4	Y1002AS	8888	57
Only for cylinder without pressure sensor Euro V											
León 3 1.6 TDI	5F1	1.6	81	4	09.13-	CRKB		4,4	Y1002AS	8888	57
Only for cylinder without pressure sensor											
León 3 2.0 TDI	5F1	2.0	135	4	03.13-	CUNA		4,4	Y1002AS	8888	57
Only for cylinder without pressure sensor Euro V											
León 3 2.0 TDI	5F1	2.0	105	4	05.13-	CRVC		4,4	Y1002AS	8888	57
Only for cylinder without pressure sensor Euro V											
León 3 2.0 TDI	5F1	2.0	110	4	10.12-	CRBC		4,4	Y1002AS	8888	57
Only for cylinder without pressure sensor Euro V											
León 3 2.0 TDI	5F1	2.0	110	4	10.12-	CRLB		4,4	Y1002AS	8888	57
Only for cylinder without pressure sensor Euro V											
León 3 2.0 TDI	5F1	2.0	81	4	02.13-	CRVA		4,4	Y1002AS	8888	57
Only for cylinder without pressure sensor Euro V											
León 3 2.0 TDI	5F1	2.0	110	4	10.12-	CKFC		4,4	Y1002AS	8888	57
Only for cylinder without pressure sensor Euro V											
León 3 2.0 TDI	5F1	2.0	110	4	10.12-	CRMB		4,4	Y1002AS	8888	57
Only for cylinder without pressure sensor Euro V											
León 3 2.0 TDI	5F1	2.0	135	4	09.12-	CUPA		4,4	Y1002AS	8888	57
Only for cylinder without pressure sensor Euro V											

**TERRA**

Terra D		1.4	35	4	01.90-			12,0	Y-918J	6285	2
Terra D		1.4	35	4	10.90-			12,0	Y-918J	6285	2
Terra Kombi D		1.4		4	10.91-	1W		12,0	Y-918J	6285	2

**TOLEDO 1**

Toledo 1 1.9 D	1L	1.9	47	4	03.91-03.99	1Y		12,0	Y-918J	6285	2
Toledo 1 1.9 TD	1L	1.9	55	4	03.91-04.97	AAZ		12,0	Y-918J	6285	2
Toledo 1 1.9 TDI	1L	1.9	66	4	08.93-12.96	1Z		12,0	Y-732J	5605	4
Toledo 1 1.9 TDI	1L	1.9	81	4	12.96-03.99	AFN		12,0	Y-732J	5605	4

**TOLEDO 2**

Toledo 2 1.9 SDI	1M2	1.9	50	4	05.01-10.03	AQM		12,0	Y-732J	5605	4
Toledo 2 1.9 TDI	1M2	1.9	66	4	05.99-09.02	AGR		12,0	Y-732J	5605	4
Toledo 2 1.9 TDI	1M2	1.9	66	4	03.99-10.05	ALH		12,0	Y-732J	5605	4
Toledo 2 1.9 TDI	1M2	1.9	81	4	05.99-09.02	AHF		12,0	Y-732J	5605	4
Toledo 2 1.9 TDI	1M2	1.9	81	4	10.99-10.05	ASV		12,0	Y-732J	5605	4
Toledo 2 1.9 TDI	1M2	1.9	110	4	10.00-12.05	ARL		12,0	Y-732J	5605	4

**TOLEDO 3**

Toledo 3 1.9 TDI	5P2	1.9	77	4	09.04-09.05	BJB		5,0	Y-607AS	7560	50
Toledo 3 1.9 TDI	5P2	1.9	77	4	09.04-02.06	BKC		5,0	Y-607AS	7560	50
Toledo 3 1.9 TDI	5P2	1.9	77	4	10.05-05.09	BLS		7,0	CZ104	9826	52
Toledo 3 1.9 TDI	5P2	1.9	77	4	02.06-05.09	BXE		5,0	Y-607AS	7560	50
Toledo 3 2.0 TDI	5P2	2.0	100	4	09.04-05.09	AZV		4,4	YE14	7768	48
Toledo 3 2.0 TDI	5P2	2.0	103	4	11.05-05.09	BMM		5,0	Y-607AS	7560	50
Toledo 3 2.0 TDI	5P2	2.0	125	4	01.06-05.09	BMN		7,0	CZ304	9864	55
Toledo 3 2.0 TDI	5P2	2.0	125	4	03.09-05.09	CEGA		4,4	Y-609AS	5849	49
Toledo 3 2.0 TDI 16V	5P2	2.0	103	4	04.04-05.09	BKD		4,4	YE14	7768	48



STOCK-NO  
D-POWER™

**SEAT**

**TOLEDO 4**

Toledo 4 1.6 TDI	KG3	1.6	77	4	10.12-	CAYC	4,4	Y1002AS	8888	57
Toledo 4 1.6 TDI	KG3	1.6	77	4	10.12-	CLNA	4,4	Y1002AS	8888	57

**SKODA**

**FABIA 1**

Fabia 1 1.4 TDI	6Y2 / 6Y5	1.4	55	3	04.03-10.05	AMF	11,0	Y-741U	6943	20
Fabia 1 1.9 SDI	6Y2 / 6Y5	1.9	47	4	11.99-03.08	ASY	12,0	Y-732J	5605	4
Fabia 1 1.9 TDI	6Y2 / 6Y5	1.9	74	4	01.00-10.05	ATD -->6Y-2-451087	12,0	Y-732J	5605	4
Fabia 1 1.9 TDI	6Y2 / 6Y5	1.9	74	4	01.00-10.05	ATD 6Y-2-451088 -->	11,0	Y-741U	6943	20
Fabia 1 1.9 TDI	6Y2 / 6Y5	1.9	74	4	10.05-12.07	AXR	11,0	Y-741U	6943	20
Fabia 1 1.9 TDI RS	6Y2 / 6Y5	1.9	96	4	06.03-10.05	ASZ	11,0	Y-741U	6943	20
Fabia 1 1.9 TDI RS	6Y2 / 6Y5	1.9	96	4	10.05-04.07	BLT	11,0	Y-741U	6943	20

**FABIA 2**

Fabia 2 1.2 TDI	542 / 545	1.2	55	3	03.10-	CFWA	4,4	Y1002AS	8888	57
Fabia 2 1.4 TDI	542 / 545	1.4	51	3	10.05-03.10	BNM	11,0	Y-741U	6943	20
Fabia 2 1.4 TDI	542 / 545	1.4	59	3	10.05-03.10	BNV	11,0	Y-741U	6943	20
Fabia 2 1.4 TDI	542 / 545	1.4	59	3	01.07-03.10	BMS	7,0	CZ104	9826	52
Fabia 2 1.6 TDI	542 / 545	1.6	55	4	04.10-	CAYA	4,4	Y1002AS	8888	57
Fabia 2 1.6 TDI	542 / 545	1.6	66	4	03.10-	CAYB	4,4	Y1002AS	8888	57
Fabia 2 1.6 TDI	542 / 545	1.6	77	4	03.10-	CAYC	4,4	Y1002AS	8888	57
Fabia 2 1.9 TDI	542 / 545	1.9	77	4	04.07-03.10	BLS	7,0	CZ104	9826	52
Fabia 2 1.9 TDI	542 / 545	1.9	77	4	04.07-03.10	BSW	11,0	Y-741U	6943	20
Fabia 3 1.4 TDI	NJ3/NJ5	1.4	66	3	10.14-	CUSB	4,4	Y1002AS	8888	57
Only for cylinder without pressure sensor										
Fabia 3 1.4 TDI	NJ3/NJ5	1.4	77	3	10.14-	CUTA	4,4	Y1002AS	8888	57
Only for cylinder without pressure sensor										

**FELICIA**

Felicia D		1.9	47	4	10.95-08.01	AEF	12,0	Y-918J	6285	2
Felicia D		1.9	47	4	.97-	AEY	12,0	Y-732J	5605	4

**OCTAVIA 1**

Octavia 1 1.9 SDI	1U2 / 1U5	1.9	50	4	05.97-12.03	AGP	12,0	Y-732J	5605	4
Octavia 1 1.9 SDI	1U2 / 1U5	1.9	50	4	08.00-12.03	AQM	12,0	Y-732J	5605	4
Octavia 1 1.9 TDI	1U2 / 1U5	1.9	66	4	10.96-03.10	AGR	12,0	Y-732J	5605	4
Octavia 1 1.9 TDI	1U2 / 1U5	1.9	66	4	08.00-03.10	ALH	12,0	Y-732J	5605	4
Octavia 1 1.9 TDI	1U2 / 1U5	1.9	81	4	08.97-01.06	AHF	12,0	Y-732J	5605	4
Octavia 1 1.9 TDI	1U2 / 1U5	1.9	81	4	10.00-01.06	ASV	12,0	Y-732J	5605	4
Octavia 1 1.9 TDI	1U2 / 1U5	1.9	96	4	09.02-09.04	ASZ	11,0	Y-741U	6943	20
Octavia 1 1.9 TDI	1U2/1U5	1.9	66	4	.97-	1Z	12,0	Y-732J	5605	4
Octavia 1 1.9 TDI	1U2/1U5	1.9	81	4	.97-	AFN	12,0	Y-732J	5605	4
Octavia 1 1.9 SDI	1U2/1U5	1.9	47	4	09.96-	AEY	12,0	Y-732J	5605	4
Octavia 1 1.9 TDI 4x4	1U5	1.9	74	4	08.00-01.06	ATD	12,0	Y-732J	5605	4
Octavia 1 1.9 TDI	1U2 / 1U5	1.9	74	4	10.05-12.10	AXR	12,0	Y-732J	5605	4
VIN --> 1U-22598796 VIN --> 1U-28558122										
Octavia 1 1.9 TDI	1U2 / 1U5	1.9	74	4	10.05-12.10	AXR	11,0	Y-741U	6943	20
VIN 1U-22598797--> VIN 1U-28558123-->										

**OCTAVIA 2**

Octavia 2 1.6 TDI	1Z3 / 1Z5	1.6	77	4	06.09-	CAYC	4,4	Y1002AS	8888	57
Octavia 2 1.9 TDI	1Z3 / 1Z5	1.9	77	4	05.04-12.10	BJB	5,0	Y-607AS	7560	50
Octavia 2 1.9 TDI	1Z3 / 1Z5	1.9	77	4	05.04-02.06	BKC	5,0	Y-607AS	7560	50



## SKODA OCTAVIA 2

Octavia 2 1.9 TDI	1Z3 / 1Z5	1.9	77	4	05.06-12.10	BLS	5,0	Y-607AS	7560	50
Octavia 2 1.9 TDI	1Z3 / 1Z5	1.9	77	4	03.06-12.10	BXE	5,0	Y-607AS	7560	50
Octavia 2 2.0 TDI	1Z3 / 1Z5	2.0	81	4	03.10-06.13	CFHF	4,4	Y1002AS	8888	57
Octavia 2 2.0 TDI	1Z3 / 1Z5	2.0	81	4	03.10-06.13	CLCA	4,4	Y1002AS	8888	57
Octavia 2 2.0 TDI	1Z3 / 1Z5	2.0	100	4	05.04-10.08	AZV	4,4	YE14	7768	48
Octavia 2 2.0 TDI 16V	1Z3 / 1Z5	2.0	100	4	05.04-	BKD	4,4	YE14	7768	48
Octavia 2 2.0 TDI	1Z3 / 1Z5	2.0	103	4	11.05-05.10	BMM	5,0	Y-607AS	7560	50
Octavia 2 2.0 TDI 16V	1Z3 / 1Z5	2.0	103	4	03.10-	CFHC	4,4	Y1002AS	8888	57
Octavia 2 2.0 TDI 16V	1Z3 / 1Z5	2.0	103	4	02.10-	CLCB	4,4	Y1002AS	8888	57
Octavia 2 2.0 TDI RS	1Z3 / 1Z5	2.0	125	4	04.06-05.08	BMN	7,0	CZ304	9864	55
Octavia 2 2.0 TDI RS	1Z3 / 1Z5	2.0	125	4	06.08-	BMN	4,4	Y1002AS	8888	57
Octavia 2 2.0 TDI RS	1Z3 / 1Z5	2.0	125	4	04.06-	CEGA	4,4	Y1002AS	8888	57

## OCTAVIA 3

Octavia 3 1.6 TDI	5E3/5E5	1.6	66	4	11.12-	CLHB	4,4	Y1002AS	8888	57
Only for cylinder without pressure sensor										
Octavia 3 1.6 TDI	5E3/5E5	1.6	66	4	11.12-	CRKA	4,4	Y1002AS	8888	57
Only for cylinder without pressure sensor										
Octavia 3 1.6 TDI	5E3/5E5	1.6	77	4	11.12-	CLHA	4,4	Y1002AS	8888	57
Only for cylinder without pressure sensor										
Octavia 3 1.6 TDI	5E3/5E5	1.6	81	4	05.13-	CRKB	4,4	Y1002AS	8888	57
Only for cylinder without pressure sensor										
Octavia 3 2.0 TDI	5E3/5E5	2.0	105	4	11.12-	CKFB	4,4	Y1002AS	8888	57
Only for cylinder without pressure sensor										
Octavia 3 2.0 TDI	5E3/5E5	2.0	105	4	11.12-	CRVC	4,4	Y1002AS	8888	57
Only for cylinder without pressure sensor										
Octavia 3 2.0 TDI	5E3/5E5	2.0	110	4	11.12-	CKFC	4,4	Y1002AS	8888	57
Only for cylinder without pressure sensor										
Octavia 3 2.0 TDI RS	5E3/5E5	2.0	135	4	06.13-	CUNA	4,4	Y1002AS	8888	57
Only for cylinder without pressure sensor										
Octavia 3 2.0 TDI RS	5E3/5E5	2.0	135	4	06.13-	CUPA	4,4	Y1002AS	8888	57
Only for cylinder without pressure sensor										

## PICKUP

Pickup		1.9	47	4	.97-	AEY	12,0	Y-732J	5605	4
--------	--	-----	----	---	------	-----	------	--------	------	---

## RAPID

Rapid 1.6 TDI	NH3	1.6	77	4	07.12-	CAYC	4,4	Y1002AS	8888	57
Rapid 1.6 TDI	NH3	1.6	66	4	10.12-	CAYB	4,4	Y1002AS	8888	57

## ROOMSTER

Roomster 1.2 TDI	5J	1.2	55	3	03.10-	CFWA	4,4	Y1002AS	8888	57
Roomster 1.4 TDI	5J	1.4	51	3	07.06-	BNM	11,0	Y-741U	6943	20
Roomster 1.4 TDI	5J	1.4	59	3	07.06-	BMS	7,0	CZ104	9826	52
Roomster 1.4 TDI	5J	1.4	59	3	05.06-	BNV	11,0	Y-741U	6943	20
Roomster 1.6 TDI	5J	1.6	66	4	03.10-	CAYB	4,4	Y1002AS	8888	57
Roomster 1.6 TDI	5J	1.6	77	4	03.10-	CAYC	4,4	Y1002AS	8888	57
Roomster 1.9 TDI	5J	1.9	74	4	03.06-05.06	AXR	11,0	Y-741U	6943	20
Roomster 1.9 TDI	5J	1.9	77	4	11.06-	BLS	7,0	CZ104	9826	52
Roomster 1.9 TDI	5J	1.9	77	4	05.06-	BSW	11,0	Y-741U	6943	20

## SUPERB 1

Superb 1 1.9 TDI	3U4	1.9	74	4	06.02-10.05	AVB	11,0	Y-741U	6943	20
Superb 1 1.9 TDI	3U4	1.9	77	4	10.05-05.07	BSV	7,0	CZ104	9826	52



STOCK-NO  
D-POWER™

## SKODA

### SUPERB 1

Superb 1 1.9 TDI	3U4	1.9	85	4	01.07-03.08	BPZ	7,0	CZ104	9826	52
Superb 1 1.9 TDI	3U4	1.9	96	4	10.01-03.08	AWX	11,0	Y-741U	6943	20
Superb 1 1.9 TDI	3U4	1.9	96	4	01.04-03.08	AVF	11,0	Y-741U	6943	20
Superb 1 2.0 TDI	3U4	2.0	103	4	10.05-03.08	BSS	7,0	CZ104	9826	52
Superb 1 2.5 V6 TDI	3U4	2.5	114	6	12.01-08.03	AYM	11,0	Y-501U	4187	31
Superb 1 2.5 V6 TDI	3U4	2.5	120	6	06.03-03.08	BDG	11,0	Y-501U	4187	31

### SUPERB 2

Superb 2 1.6 TDI	3T4 / 3T5	1.6	77	4	09.10-	CAYC	4,4	Y1002AS	8888	57
Superb 2 1.9 TDI	3T4 / 3T5	1.9	77	4	07.08-	BLS	5,0	Y-607AS	7560	50
Superb 2 1.9 TDI	3T4 / 3T5	1.9	77	4	03.08-	BXE	5,0	Y-607AS	7560	50
Superb 2 2.0 TDI	3T4 / 3T5	2.0	100	4	01.09-	BKD	4,4	YE14	7768	48
Superb 2 2.0 TDI	3T4 / 3T5	2.0	103	4	03.08-03.10	BMP	7,0	CZ104	9826	52
Superb 2 2.0 TDI	3T4 / 3T5	2.0	103	4	03.10-	CFFB	4,4	Y1002AS	8888	57
Superb 2 2.0 TDI	3T4 / 3T5	2.0	103	4	02.10-	CLJA	4,4	Y1002AS	8888	57
Superb 2 2.0 TDI	3T4 / 3T5	2.0	125	4	06.08-05.10	CBBB	4,4	Y1002AS	8888	57
Superb 2 2.0 TDI	3T4 / 3T5	2.0	125	4	05.10-	CFGB	4,4	Y1002AS	8888	57

### YETI

Yeti 1.6 TDI	5L	1.6	77	4	11.10-	CAYC	4,4	Y1002AS	8888	57
Yeti 2.0 TDI	5L	2.0	81	4	11.09-	CFHA	4,4	Y1002AS	8888	57
Yeti 2.0 TDI	5L	2.0	81	4	11.09-	CFHA	4,4	Y1002AS	8888	57
Yeti 2.0 TDI	5L	2.0	81	4	11.09-	CFHF	4,4	Y1002AS	8888	57
Yeti 2.0 TDI	5L	2.0	103	4	05.09-11.09	CBDB	4,4	Y1002AS	8888	57
Yeti 2.0 TDI	5L	2.0	103	4	11.09-	CFHC	4,4	Y1002AS	8888	57
Yeti 2.0 TDI 4x4	5L	2.0	125	4	11.09-05.10	CEGA	4,4	Y1002AS	8888	57
Yeti 2.0 TDI 4x4	5L	2.0	125	4	11.09-	CFJA	4,4	Y1002AS	8888	57

## SMART

### CITY-COUPÉ

Smart CDI	MC01	0.8	29	3	07.98-01.04	OM 660 DE 08 LA	11,0	Y-543J	5618	46
-----------	------	-----	----	---	-------------	-----------------	------	--------	------	----

### FORTWO 1

Smart fortwo Cdi	450	0.8	30	3	01.04-	OM 660	11,0	Y-543J	5618	46
------------------	-----	-----	----	---	--------	--------	------	--------	------	----

### FORTWO 2

Fortwo Cabrio	451	.8	40	3	08.09-06.14	OM 660.951	7,0	CZ158	94171	
Fortwo Coupe	451	.8	40	3	08.09-06.14	OM 660.951	7,0	CZ158	94171	

### FORFOUR

Smart forfour Cdi	454	1.5	50	3	09.04-	OM 639.939	11,5	YE13	8643	
Smart forfour Cdi	454	1.5	70	3	09.04-	OM 639.939	11,5	YE13	8643	

## SSANGYONG

### ACTYON

Actyon 200 Xdi		2.0	100	4	07.07-	D20DT	11,0	Y-536J	95061	81
Actyon Sports 200 Xdi		2.0	104	4	10.06-	D20DT	11,0	Y-536J	95061	81

### KORANDO

Korando D		2.2	51	4	01.93-	DC 23	11,0	Y-710J	7880	
Korando D		2.3	55	4	03.97-	OM 601 DM	11,5	Y-916J	5906	6
Korando TD		2.3	73	4	03.99-03.00		11,5	Y-916J	5906	6



## SSANGYONG KORANDO

Korando D	2.9	73	5	12.96-	MB-OM 602	11,5	Y-916J	5906	6
Korando TD	2.9	88	5	03.99-03.00		11,5	Y-916J	5906	6

## KYRON

Kyron 2.0 Xdi	2.0	100	4	01.10-	D20DT	11,0	Y-536J	95061	81
Kyron 2.0 Xdi	2.0	104	4	05.05-	D20DT	11,0	Y-536J	95061	81
Kyron 2.7 Xdi	2.7	120	5	03.06-	D27DT	11,0	Y-536J	95061	81
Kyron 2.7 Xdi	2.7	121	5	05.05-	D27DT	11,0	Y-536J	95061	81

## MUSSO

Musso 601 D	2.3	58	4	07.93-01.00	MB-OM 601	11,5	Y-916J	5906	6
Musso TD	2.3	73	4	03.99-03.00		11,5	Y-916J	5906	6
Musso 602 D	2.9	73	5	07.93-01.00	MB-OM 602	11,5	Y-916J	5906	6
Musso TD	2.9	88	5	03.99-		11,5	Y-916J	5906	6
Musso Sports 290S TD	2.9	88	5	03.04-		11,5	Y-916J	5906	6

## REXTON

Rexton 2.7 Xdi 4x4	2.7	118	5	03.11-	D27DT	11,0	Y-536J	95061	81
Rexton 2.7 Xdi	2.7	120	5	07.04-	D27DT	11,0	Y-536J	95061	81
Rexton 2.7 Xdi	2.7	121	5	03.05-08.06		5,0	Y-537AS	9994	
Rexton 2.7 Xdi Turbo 4x4	2.7	132	5	03.11-	D27DTP	11,0	Y-536J	95061	81
Rexton 2.7 D 4x4	2.7	137	5	05.06-		5,0	Y-537AS	9994	
Rexton RX 290s	2.9	88	5	-	OM662LA	11,5	Y-916J	5906	6

## RODIUS

Rodius 2.7 Xdi	2.7	120	5	05.05-	D27DT	11,0	Y-536J	95061	81
Rodius 2.7 Xdi	2.7	121	5	05.05-	D27DT	11,0	Y-536J	95061	81

## STEYR

Puch 290 GD	2.9	72	5	08.93-	OM602	11,5	Y-916J	5906	6
Puch 300 GD	3.0	83	6	09.89-	OM617/603	11,5	Y-916J	5906	6
Puch 350 GTD	3.5	100	6	09.91-	OM617/603	11,5	Y-916J	5906	6

## SUZUKI

### BALENO

Baleno D	1.9	46	4	.98-		11,0	Y-924J	7906	1
Baleno TD	1.9	55	4	.98-		11,0	Y-924J	7906	1

### GRAND VITARA

Grand Vitara TDiC (SQ420D)	FT / GT	2.0	64	4	05.00-	RF	11,0	Y-701J	1566	39
Grand Vitara Tdi II (SQ420D)	FT / GT	2.0	80	4	03.01-	RHZ	11,0	Y-504J	1441	24
Grand Vitara TD XL7(JA420D)	FT / GT	2.0	80	4	.04-	RHW	11,0	Y-504J	1441	24
Grand Vitara 2.0 HDI	FT / GT	2.0	80	4	04.01-	HDi PSA	11,0	Y-504J	1441	24
Grand Vitara 1.9 DDIS (JB419D)	JT	1.9	95	4	10.05-	F9Q	12,0	Y-732J	5605	4
Grand Vitara 1.9 DDIS Euro V	JT	1.9	95	4	03.06-08.08	F9QB	4,4	Y1036AS	96062	

### IGNIS

Ignis II 1.3 DDiS	RM413D	1.3	51	4	09.03-	Z13DT	11,0	Y8003J	97256	62
-------------------	--------	-----	----	---	--------	-------	------	--------	-------	----





STOCK-NO  
D-POWER™

## SUZUKI

### JIMNY

Jimny DDiS (SN415D)	FJ	1.5	48	4	12.03-	K9K	12,0	Y-732J	5605	4
Jimny DDiS (SN415D)	FJ	1.5	63	4	08.05-	K9K 266	12,0	Y-732J	5605	4

### LIANA

Liana DDiS (RH414D)	ER	1.4	66	4	07.04-	DV4 8HY	11,0	YE04	1684	40
---------------------	----	-----	----	---	--------	---------	------	------	------	----

### SAMURAI

Samurai TD		1.9	46	4	09.98-	XUD9	11,0	Y-924J	7906	1
------------	--	-----	----	---	--------	------	------	--------	------	---

### SPLASH

Splash 1.3 DDiS (A5B413D)		1.3	55	4	01.08-	D13A	11,0	Y8003J	97256	62
---------------------------	--	-----	----	---	--------	------	------	--------	-------	----

### SWIFT

Swift III 1.3 DDiS	RS413D	1.3	52	4	08.05-	Z13DT	11,0	Y8003J	97256	62
Swift III 1.3 DDiS	RS413D	1.3	55	4	10.07-	D13A / Z13DTJ	11,0	Y8003J	97256	62

### SX4

SX4 II 1.6 DDiS S-Cross	AKK416D	1.6	88	4	08.13-	D16AA	4,4	Y9003AS	94251	78
SX4 1.9 DDiS	RW419D	1.9	88	4	06.06-	D19AA	11,0	Y1030J	90828	70
SX4 2.0 DDiS	RW420D	2.0	99	4	07.09-	D20AA	4,4	Y9003AS	94251	78

### VITARA

Vitara TD		1.9	50	4	04.96-03.98	XUD9A	11,0	Y-924J	7906	1
Vitara TD		1.9	55	4	.97- .98		11,0	Y-924J	7906	1
Vitara TD		1.9	66	4	05.00-	XUD... PSA Group	11,0	Y-924J	7906	1
Vitara D		2.0	52	4	12.94-03.98	RFL-4	11,0	Y-701J	1566	39

### WAGON R+

Wagon R+ DDiS (RB413D)		1.3	51	4	09.03-	Z13DT	11,0	Y8003J	97256	62
------------------------	--	-----	----	---	--------	-------	------	--------	-------	----

## TOYOTA

### 4 RUNNER

4 Runner D		2.4		4		2L	7,0	Y-118R	2187	
4 Runner TD		2.4		4	01.90-12.96	2L-T	11,0	Y-715R	5376	
4 Runner D		2.5		4	01.93-	2L-T	11,0	Y-715R	5376	
4 Runner		2.8		4	.93- .96	3L	11,0	Y-715R	5376	
4 Runner D		2.8		4	01.93- .96	3L	11,0	Y-715R	5376	
4 Runner (.../KZN185)		3.0	92	4	10.93-03.96	1KZ-T	11,0	Y1013J	94470	63

### AURIS

Auris 1.4 D-4D (ADE150,157)(NDE150,151)		1.4	66	4	03.07-	1ND-TV	11,0	Y-542J	5513	45
---	--	-----	----	---	--------	--------	------	--------	------	----

### AVENSIS

Avensis (CT220)		2.0	66	4	01.98-	2C-T	11,0	Y-532J	7782	
Avensis (CT220)		2.0	66	4	01.98-	2C-TE	11,0	Y-532J	7782	
Avensis 2 (CDT250) D- Cat		2.0	85	4	03.03-04.06	1CD-FTV	11,0	Y-531J	5467	44

### AYGO

Aygo	B10	1.4	52	4	06.05-		11,0	YE05	91322	73
------	-----	-----	----	---	--------	--	------	------	-------	----

### CAMRY

Camry		2.0	62	4	.90- .91	2C-T	11,0	Y-703R	3782	
Camry		2.0		4	- .92	1-CT	7,0	Y-146R	7492	

### CARINA E

Carina E		2.0		4	02.92-	2C	11,0	Y-703R	3782	
----------	--	-----	--	---	--------	----	------	--------	------	--



e kW C y i **0201**



Stock-No  
D-POWER

## TOYOTA CARINA II

Carina II	2.0		4	- .92	2C	7,0	Y-146R	7492	
Carina II	2.0		4	.93-	2C	11,0	Y-703R	3782	

## COROLLA

Corolla Luna D-4D	1.4	66	4	.04- .07	1ND-TV	11,0	Y-542J	5513	45
Corolla	1.5		4		1N,1NT	7,0	Y-118R	2187	
Corolla	1.8		4	- .92	1C	7,0	Y-146R	7492	
Corolla	1.8		4	12.92-	1C	11,0	Y-703R	3782	
Corolla 2.0 D-4D (E11,CDE110)	2.0	66	4	09.00-01.02	1CD-FTV	11,0	Y-531J	5467	44
Corolla 2.0 D-4D (E12,CDE120)	2.0	66	4	01.02-05.04	1CD-FTV	11,0	Y-531J	5467	44
Corolla 2.0 D-4D (E12,CDE120)	2.0	81	4	11.01-04.03	1CD-FTV	11,0	Y-531J	5467	44
Corolla 2.0 D-4D (E12,CDE120)	2.0	85	4	05.03-05.08	1CD-FTV	11,0	Y-531J	5467	44

## COROLLA VERSO

Corolla Verso D-4D(E12,CDE120)	2.0	66	4	01.02-05.04	1CD-FTV	11,0	Y-531J	5467	44
Corolla Verso D-4D(CE120,CDE120)	2.0	85	4	10.01- .07	1CD-FTV	11,0	Y-531J	5467	44
Corolla Verso D-4D(ZER,CUR10)	2.0	85	4	04.04-08.05	1CD-FTV	11,0	Y-531J	5467	44

## CORONA

Corona	2.0		4	- .92	2C	7,0	Y-146R	7492	
Corona	2.0		4	.93-	2C	11,0	Y-703R	3782	
Corona	2.4		4		2L / 2L-T	7,0	Y-118R	2187	

## CROWN

Crown			4	09.83- .91	2L	11,0	Y-118T1	2951	
Crown	2.5		4	.93-	2L	11,0	Y-715R	5376	

## DYNA

Dyna (KDY220,230,250,260)	2.5	65	4	08.01-08.06	2KD-FTV	11,0	Y-531J	5467	44
Dyna (KDY220,230,250,260)	2.5	75	4	08.01-	2KD-FTV	11,0	Y-531J	5467	44
Dyna 2500	2.4	55	4	.93-	2L	11,0	Y-715R	5376	
Dyna 2800	2.8	61	4	.93-	3L	11,0	Y-715R	5376	
Dyna 3000	3.0		4	.90- .91	B	20,5	Y-178T	3030	
Dyna 3000	3.0		4	.93-	B / 11B	10,5	Y-147T	7493	

## ECHO

Echo NLP10	1.4	55	4	.02-	1ND-TV	11,0	Y-542J	5513	45
Echo Verso NLP20/22	1.4		4	.02-	1ND-TV	11,0	Y-542J	5513	45

## HIACE

Hiace	2.4		4	- .92	2L 12V	7,0	Y-118R	2187	
Hiace	2.4		4	09.83- .92	2L	11,0	Y-118T1	2951	
Hiace Super Glow System	2.4		4	09.83- .92	2L	7,0	Y-118R	2187	
Hiace Super Glow System	2.4		4	09.83- .92	2L	7,0	Y-118R	2187	
Hiace 2500 (LH102-104,112-115,125)	2.4		4	.93-	2L	11,0	Y-715R	5376	
Hiace (KLH12,KLH18,KLH22,KLH28)	2.5	65	4	08.01-08.06	2KD-FTV	11,0	Y-531J	5467	44
Hiace 2.5 D-4D (KLH12,KLH22)	2.5	70	4	09.06-	2KD-FTV	11,0	Y-531J	5467	44
Hiace (KLH12,KLH18,KLH22,KLH28)	2.5	75	4	08.01-08.06	2KD-FTV	11,0	Y-531J	5467	44
Hiace 2.5 D-4D (KLH12,KLH22)	2.5	86	4	09.06-	2KD-FTV	11,0	Y-531J	5467	44
Hiace (LH102-104,112-115,125)	2.5		4	.98-	2L	11,0	Y-715R	5376	
Hiace 2800	2.8		4	.93-	3L	11,0	Y-715R	5376	
Hiace (LH102-104,112-115,125)	2.8		4	.98-	3L	11,0	Y-715R	5376	
Hiace 3000	3.0		4	.93-	B / 11B 12V	10,5	Y-147T	7493	



l kW C y i 0201



Stock-No D-POWER

**TOYOTA**

**HIACE**

Hiace 3000	3.0		4	.93-	B / 11B 24V	23,0	Y-197T	2190	
------------	-----	--	---	------	-------------	------	--------	------	--

**HILUX**

Hilux			4	09.83-	.92 2L	11,0	Y-118T1	2951	
Hilux Super Glow System			4	09.83-	.92 2L	7,0	Y-118R	2187	
Hilux	2.4		4	-	.92 2L 12V	7,0	Y-118R	2187	
Hilux Super Glow System	2.4		4	09.83-	.92 2L	7,0	Y-118R	2187	
Hilux 2500	2.4		4	.93-	2L	11,0	Y-715R	5376	
Hilux 2.5 D-4D (KDN145,150,165,170,190)	2.5	65	4	08.01-	08.05 2KD-FTV	11,0	Y-531J	5467	44
Hilux 2.5 D-4D (KUN15)	2.5	75	4	06.06-	2KD-FTV	11,0	Y-531J	5467	44
Hilux 2.5 D-4D (KUN15)	2.5	88	4	06.06-	2KD-FTV	11,0	Y-531J	5467	44
Hilux 2.5 D-4D (KUN25)	2.5	106	4	12.07-	2KD-FTV	11,0	Y-531J	5467	44
Hilux 2800	2.8		4	.93-	3L	11,0	Y-715R	5376	
Hilux 3.0 D-4D (KUN26)	3.0	126	4	08.05-	1KD-FTV	11,0	Y-531J	5467	44

**IQ**

iQ 1.4 D-4D (NUJ10)	1.4	66	4	11.08-	1ND-TV	11,0	Y-542J	5513	45
---------------------	-----	----	---	--------	--------	------	--------	------	----

**LAND CRUISER**

Land Cruiser	2.4		4		2L 2.4L	7,0	Y-118R	2187	
Land Cruiser (HZJ70,73,75)	2.5		4		2L-T	11,0	Y-715R	5376	
Land Cruiser	2.5		4	.90-	2L 2.5L	11,0	Y-715R	5376	
Land Cruiser	2.5		4	.93-	2L-T	11,0	Y-715R	5376	
Land Cruiser	2.8		4	.93-	3L	11,0	Y-715R	5376	
Land Cruiser (KZJ90,95)	2.8		4	.98-	3L	11,0	Y-715R	5376	
Land Cruiser (LJ90,95)	2.8		4	.98-	3L	11,0	Y-715R	5376	
Land Cruiser (KZJ90,95)	3.0	92	4	.98-	1KZ-T	11,0	Y1013J	94470	63
Land Cruiser (KZJ90,95)	3.0	92	4	.98-	1KZ-TE	11,0	Y1013J	94470	63
Land Cruiser (LJ90,95)	3.0	92	4	.98-	1KZ-T	11,0	Y1013J	94470	63
Land Cruiser (LJ90,95)	3.0	92	4	.98-	1KZ-TE	11,0	Y1013J	94470	63
Land Cruiser D-4D (KDJ90,KDJ95,J9)	3.0	120	4	10.00-	08.02 1KD-FTV	11,0	Y-531J	5467	44
Land Cruiser 3.0 D-4D (KDJ 120,KDJ125,J12)	3.0	120	4	09.02-	10.06 1KD-FTV	11,0	Y-531J	5467	44
Land Cruiser 3.0 D-4D (KDJ125,J12)	3.0	122	4	08.04-	10.06 1KD-FTV	11,0	Y-531J	5467	44
Land Cruiser 3.0 D-4D (KDJ120,KDJ125,J12)	3.0	127	4	01.07-	1KD-FTV	11,0	Y-531J	5467	44
Land Cruiser 3.0 D-4D (KDJ 150,J15))	3.0	127	4	01.10-	1KD-FTV	11,0	Y-531J	5467	44
Land Cruiser 3.0 D-4D (KDJ 150,KDJ155,J15))	3.0	140	4	01.10-	1KD-FTV	11,0	Y-531J	5467	44
Land Cruiser (KZJ120)	3.0		4	09.02-	1KD-FTV	11,0	Y-531J	5467	44
Land Cruiser (LJ120,125)	3.0		4	09.02-	1KD-FTV	11,0	Y-531J	5467	44
Land Cruiser (HDJ100)	4.2		6	.98-	1HD-T	11,0	Y-532J	7782	
Land Cruiser (HZJ105)	4.2		6	.98-	1HD-T	11,0	Y-532J	7782	

**LITEACE**

Liteace 2000	1.8		4		1C	7,0	Y-146R	7492	
Liteace 2000	2.0		4		2C	11,0	Y-703R	3782	

**MODEL F**

Model F / Tarago	2.0		4		2C	7,0	Y-146R	7492	
------------------	-----	--	---	--	----	-----	--------	------	--

**PICNIC**

Picnic TD (CXM10)	2.2	66	4	.98-	3C-TE	11,0	Y1013J	94470	63
-------------------	-----	----	---	------	-------	------	--------	-------	----

**PREVIA**

Previa 2.0 D-4D (ACR3,CLR30)	2.0	85	4	03.01-	12.05 1CD-FTV	11,0	Y-531J	5467	44
------------------------------	-----	----	---	--------	---------------	------	--------	------	----

**RAV 4**

RAV 4 2.0 D	2.0	85	4	06.01-	10.05 1CD-FTV	11,0	Y-531J	5467	44
-------------	-----	----	---	--------	---------------	------	--------	------	----



## TOYOTA

### STARLET

Starlet	1.5		4	.90- .92	1N	11,0	Y-715R	5376	
Starlet	1.5		4	.93-	1N	11,0	Y-715R	5376	

### URBAN CRUISER

Urban Cruiser 1.4 D-4D (NSP110)	1.4	66	4	01.09-	1ND-TV	11,0	Y-542J	5513	45
---------------------------------	-----	----	---	--------	--------	------	--------	------	----

### YARIS

Yaris 1.4 D-4D (NLP10)	1.4	55	4	12.01-	1ND-TV	11,0	Y-542J	5513	45
Yaris 1.4 (NLP90)	1.4	55	4	11.05-	1ND-TV	11,0	Y-542J	5513	45
Yaris 1.4 D-4D	1.4	66	4	02.06-	1ND-TV	11,0	Y-542J	5513	45

## VOLVO

### 440

440 TD	445	1.9	66	4	01.93-12.96	Renault F8Q Turbo	11,0	Y-933J	7947	25
--------	-----	-----	----	---	-------------	-------------------	------	--------	------	----

### 460

460 TD	464	1.9	66	4	06.94-08.97	D 19 T	11,0	Y-933J	7947	25
--------	-----	-----	----	---	-------------	--------	------	--------	------	----

### 740

740 D	744 / 745	2.4	60	6	04.84-07.92	D 24	12,0	Y-918J	6285	2
740 TD	744 / 745	2.4	80	6	04.87-07.92	D 24 T	12,0	Y-918J	6285	2
740 TD (air condition)	744 / 745	2.4	85	6	08.87-07.92	D 24 TIC	12,0	Y-918J	6285	2

### 760

760 TD	704/764/765	2.4	85	6	08.87-07.92	D 24 TIC	12,0	Y-918J	6285	2
--------	-------------	-----	----	---	-------------	----------	------	--------	------	---

### 780

780 TD		2.4	85	6	08.85-	D 24 TIC	12,0	Y-918J	6285	2
--------	--	-----	----	---	--------	----------	------	--------	------	---

### 850

850 2.5 TDi	LS / LW	2.5	103	5		D5252 (Audi)	12,0	Y-732J	5605	4
-------------	---------	-----	-----	---	--	--------------	------	--------	------	---

### 940

940 TD	944 / 945	2.4	80	6	09.90-08.93	D 24 T	12,0	Y-918J	6285	2
940 GL, GLE TD	944 / 945	2.4	85	6	09.90-	D 24 TIC	12,0	Y-918J	6285	2
940 TD Interc., Kombi	944 / 945	2.4	90	6	01.94-	D 24 T	12,0	Y-918J	6285	2

### 960

960 TD Intercooler	964 / 965	2.4	85	6	09.91-	D 24 TIC	12,0	Y-918J	6285	2
--------------------	-----------	-----	----	---	--------	----------	------	--------	------	---

### C 30

C 30 1.6 D		1.6	80	4	11.06-	D4164T	11,0	YE04	1684	40
C 30 2.0 D		2.0	100	4	11.06-	D4204T	11,0	Y1005J	7957	56
C 30 D 5 to chassis no. 62745		2.4	120	5	11.06-07.10	D5244T9	11,0	Y8008AS	91440	74
C 30 D 5 to chassis no. 62745		2.4	132	5	11.06-07.10	D5244T8 / T13	11,0	Y8008AS	91440	74

### C 70 2

C 70 2.0 D		2.0	100	4	03.07-	D4204T	11,0	Y1005J	7957	56
C 70 D5 to chassis no. 49640		2.4	132	5	03.06-	D5244T8 / T13	11,0	Y8008AS	91440	74

### S 40 1

S 40 1.9D	VS	1.9	66	4	07.95-08.99	D4192T	11,0	Y-933J	7947	25
S 40 1.9D	VS	1.9	75	4	07.00-12.03	D4192T4 / Di	12,0	Y-732J	5605	4
S 40 1.9D	VS	1.9	85	4	07.00-12.03	D4192T3 / Di	12,0	Y-732J	5605	4

### S 40 2

S 40 II 1.6 D to engine no. 16125	MS	1.6	81	4	01.05-12.11	D4164T	11,0	YE04	1684	40
S 40 II 1.6 D from engine no. 16126	MS	1.6	81	4	01.05-12.11	D4164T	11,0	YE05	91322	73
S 40 II 2.0 D	MS	2.0	98	4	07.05-12.06	D4204T2	11,0	Y1005J	7957	56
S 40 II 2.0 D	MS	2.0	100	4	01.04-09.10	D4204T	11,0	Y1005J	7957	56
S 40 II 2.4 D5 to chassis no. 380303	MS	2.4	132	5	03.06-07.10	D5244T8	11,0	Y8008AS	91440	74



l kW C y i  
0201



Stock-No  
D-POWER™

**VOLVO**

**S 60 1**

S 60 2.4 D		2.4	93	5	09.05-03.10	D5244T7	11,0	Y8008AS	91440	74
S 60 2.4 D		2.4	96	5	12.01-	D5244T2	11,0	YE12	7794	
S 60 2.4 D		2.4	120	5	07.01-	D5244T	11,0	YE12	7794	
S 60 2.4 D		2.4	120	5	01.07-03.10	D5244T5	11,0	Y8008AS	91440	74
S 60 2.4 D5		2.4	136	5	09.05-03.10	D5244T4	11,0	Y8008AS	91440	74

**S 60 2**

S 60 II D3		2.0	120	5	04.10-	D5204T2 / T3	11,0	Y8008AS	91440	74
S 60 II D5		2.4	151	5	04.10-07.11	D5244T10	11,0	Y8008AS	91440	74
S 60 II D5		2.4	158	5	06.11-	D5244T11 / T15	11,0	Y8008AS	91440	74

**S 70**

S 70 2.5 TDi	P80	2.5	103	5	01.97-	D5252 (Audi)	12,0	Y-732J	5605	4
--------------	-----	-----	-----	---	--------	--------------	------	--------	------	---

**S 80 1**

S 80 2.4 D	TS	2.4	96	5	10.01-07.06	D5244T2	11,0	YE12	7794	
S 80 2.4 D	TS	2.4	120	5	08.01-07.06	D5244T	11,0	YE12	7794	
S 80 2.5 D	TS	2.5	103	5	01.99-07.06	D5252T	12,0	Y-732J	5605	4

**S 80 2**

S 80 II 2.0 D	AS	2.0	100	4	11.07-	D4204T	11,0	Y1005J	7957	56
S 80 II D3	AS	2.0	120	5	01.10-	D5204T2 / T3	11,0	Y8008AS	91440	74
S 80 II 2.4 D	AS	2.4	120	5	03.06-03.11	D5244T5 / T19	11,0	Y8008AS	91440	74
S 80 II D5	AS	2.4	136	5	03.06-05.09	D5244T4	11,0	Y8008AS	91440	74

**V 40 1**

V 40 1.9 D	VW	1.9	66	4	02.96-06.04	D4192T	11,0	Y-933J	7947	25
V 40 1.9 DI	VW	1.9	70	4	03.99-07.00	D4192T2	11,0	Y-740U	4818	22
V 40 1.9 D	VW	1.9	75	4	07.00-06.04	D4192T4 / DI	12,0	Y-732J	5605	4
V 40 1.9 D	VW	1.9	85	4	07.00-06.04	D4192T3 / DI	12,0	Y-732J	5605	4
V 40 1.9 DCI	VW	1.9		4	07.00-06.04	dCi Renault	12,0	Y-732J	5605	4

**V 50**

V 50 1.6 D to chassis no. 16125	MW	1.6	80	4	01.05-	D4164T	11,0	YE04	1684	40
V 50 1.6 D from chassis no. 16126	MW	1.6	80	4	01.05-	D4164T	11,0	YE05	91322	73
V 50 2.0 D	MW	2.0	98	4	07.05-12.06	D4204T2	11,0	Y1005J	7957	56
V 50 2.0 D	MW	2.0	100	4	04.04-09.10	D4204T	11,0	Y1005J	7957	56
V 50 2.4 D to chassis no. 396178	MW	2.4	120	5	05.07-09.10	D5244T9	11,0	Y8008AS	91440	74
V 50 2.4 D5 to chassis no. 396178	MW	2.4	132	5	03.06-	D5244T8 / T13	11,0	Y8008AS	91440	74

**V 60**

V 60 D3		2.0	120	5	09.10-08.11	D5204T2 / T3	11,0	Y8008AS	91440	74
V 60 D5		2.4	151	5	09.10-	D5244T10	11,0	Y8008AS	91440	74
V 60 2.4 D5		2.4	158	5	06.11-	D5244T11 / T15	11,0	Y8008AS	91440	74

**V 70 1**

V 70 I 2.5 D	P80	2.5	103	5	01.97-03.00	D5252T	12,0	Y-732J	5605	4
--------------	-----	-----	-----	---	-------------	--------	------	--------	------	---

**V 70 2**

V 70 II 2.4 D	P80	2.4	93	5	05.05-07.07	D5244T7	11,0	Y8008AS	91440	74
V 70 II 2.4 D	P80	2.4	96	5	12.01-	D5244T2	11,0	YE12	7794	
V 70 II 2.4 D5	P80	2.4	120	5	08.01-07.06	D5244T	11,0	YE12	7794	
V 70 II 2.4 D5	P80	2.4	120	5	08.06-07.07	D5244T5	11,0	Y8008AS	91440	74
V 70 II 2.4 D5	P80	2.4	136	5	12.05-07.07	D5244T4	11,0	Y8008AS	91440	74

**V 70 3**

V 70 III 2.0 D		2.0	100	4	08.07-12.10	D4204T	11,0	Y1005J	7957	56
V 70 III D3		2.0	120	5	03.10-	D5204T2 / T3	11,0	Y8008AS	91440	74
V 70 III 2.4 D		2.4	120	5	08.07-	D5244T5	11,0	Y8008AS	91440	74



e kW C y I 0201



Stock-No  
D-POWER

## VOLVO

### V 70 3

V 70 III 2.4 D	2.4	129	5	05.09-	D5244T14	11,0	Y8008AS	91440	74
V 70 III D5	2.4	136	5	08.07-	D5244T4	11,0	Y8008AS	91440	74
V 70 III D5	2.4	158	5	06.11-	D5244T11 / T15	11,0	Y8008AS	91440	74

### XC60

XC60 2.4 D only for EURO III and EURO IV	2.4	120	5	05.08-	D5244T5 / T16	11,0	Y8008AS	91440	74
XC60 D5 AWD only for EURO III and EURO IV	2.4	136	5	05.08-12.09	D5244T4	11,0	Y8008AS	91440	74

### XC70 1

XC70 2.4D5	2.4	120	5	09.02-	D5244T5	11,0	YE12	7794	
XC70 2.4 D5 AWD	2.4	136	5	05.05-07.07	D5244T4	11,0	Y8008AS	91440	74

### XC70 2

XC70 II D3 AWD	2.0	120	5	08.11-	D5204T2 / T3	11,0	Y8008AS	91440	74
XC70 II 2.4 D AWD	2.4	120	5	08.07-	D5244T5 / T16	11,0	Y8008AS	91440	74
XC70 II 2.4 D	2.4	129	5	01.10-	D5244T14	11,0	Y8008AS	91440	74
XC70 II D5 AWD	2.4	136	5	08.07-	D5244T4	11,0	Y8008AS	91440	74
XC70 II D5 AWD	2.4	158	5	06.11-	D5244T11 / T15	11,0	Y8008AS	91440	74

### XC90

XC90 D5	2.4	120	5	02.03-	D5244T	11,0	YE12	7794	
---------	-----	-----	---	--------	--------	------	------	------	--

## VW

### AMAROK

Amarok 2.0 TDI	2HA / 2HB	2.0	90	4	09.10-	CDBA	4,4	Y1002AS	8888	57
Amarok 2.0 BiTDI	2HA / 2HB	2.0	120	4	09.10-	CDCA	4,4	Y1002AS	8888	57
Amarok 2.0 BiTDI 4motion	2HA/2HB	2.0	132	4	11.11-	CNEA	4,4	Y1002AS	8888	57
Amarok 2.0 BiTDI 4motion	2HA/2HB	2.0	132	4	11.11-	CSHA	4,4	Y1002AS	8888	57
Amarok 2.0 TDI /BlueMotion	2HA/2HB	2.0	90	4	09.10-10.13	CNFA	4,4	Y1002AS	8888	57
Amarok 2.0 TDI /BlueMotion	2HA/2HB	2.0	103	4	05.12-	CNFB	4,4	Y1002AS	8888	57

### BEETLE (NEW BEETLE)

Beetle 1.9 TDI	9C1 / 1C1	1.9	66	4	01.98-06.04	ALH	12,0	Y-732J	5605	4
Beetle 1.9 TDI	9C1 / 1C1	1.9	74	4	10.00-	ATD	11,0	Y-741U	6943	20
Beetle 1.9 TDI	9C1 / 1C1	1.9	74	4	10.00-10.01	ATD	12,0	Y-732J	5605	4
Beetle 1.9 TDI	9C1 / 1C1	1.9	74	4	06.03-	AXR	11,0	Y-741U	6943	20
Beetle 1.9 TDI	9C1 / 1C1	1.9	74	4	07.05-12.06	BEW	7,0	CZ104	9826	52
Beetle 1.9 TDI	9C1 / 1C1	1.9	77	4	07.05-	BSW	11,0	Y-741U	6943	20

### BEETLE

Beetle 2 1.6 TDI	5C1	1.6	77	4	10.11-	CAYC	4,4	Y1002AS	8888	57
Beetle 2 TDi BlueMotion	5C1	2.0	110	4	07.14-	DELA	4,4	Y1002AS	8888	57
Only for cylinder without pressure sensor										
Beetle 2 2.0 TDI	5C1/5C7	2.0	103	4	04.11-	CFFB	4,4	Y1002AS	8888	57
Only for cylinder without pressure sensor										
Beetle 2 2.0 TDI	5C1/5C7	2.0	103	4	04.11-	CJAA	4,4	Y1002AS	8888	57
Only for cylinder without pressure sensor										
Beetle 2 2.0 TDI	5C1/5C7	2.0	110	4	07.14-	CUUB	4,4	Y1002AS	8888	57
Only for cylinder without pressure sensor										
Beetle 2 2.0 TDI	5C1/5C7	2.0	110	4	07.14-	CVCA	4,4	Y1002AS	8888	57
Only for cylinder without pressure sensor										
Beetle 2 2.0 TDI	5C1/5C7	2.0	81	4	12.14-	CUUA	4,4	Y1002AS	8888	57
Only for cylinder without pressure sensor										



Stock-No  
D-POWER™

VW

### BORA

Bora 1.9 SDI	1J2 / 1J6	1.9	50	4	11.98-05.05	AQM	12,0	Y-732J	5605	4
Bora 1.9 SDI	1J2 / 1J6	1.9	50	4	05.00-04.01	AGP	12,0	Y-732J	5605	4
Bora 1.9 TDI	1J2 / 1J6	1.9	66	4	10.98-09.02	AGR	12,0	Y-732J	5605	4
Bora 1.9 TDI	1J2 / 1J6	1.9	66	4	09.98-05.03	ALH	12,0	Y-732J	5605	4
Bora 1.9 TDI VIN --> 1J-2-600000	1J2 / 1J6	1.9	74	4	05.00-05.05	ATD	12,0	Y-732J	5605	4
Bora 1.9 TDI VIN --> 1J-2-600000	1J2 / 1J6	1.9	74	4	05.01-05.05	AXR	12,0	Y-732J	5605	4
Bora 1.9 TDI VIN 1J-2-600001 -->	1J2 / 1J6	1.9	74	4	05.00-05.05	ATD	11,0	Y-741U	6943	20
Bora 1.9 TDI VIN 1J-2-600001 -->	1J2 / 1J6	1.9	74	4	05.01-05.05	AXR	11,0	Y-741U	6943	20
Bora 1.9 TDI	1J2 / 1J6	1.9	81	4	09.98-05.05	AHF	12,0	Y-732J	5605	4
Bora 1.9 TDI	1J2 / 1J6	1.9	81	4	05.00-05.05	ASV	12,0	Y-732J	5605	4
Bora 1.9 TDI	1J2 / 1J6	1.9	85	4	11.98-07.01	AJM	12,0	Y-732J	5605	4
Bora 1.9 TDI	1J2 / 1J6	1.9	85	4	05.00-07.01	AUY	12,0	Y-732J	5605	4
Bora 1.9 TDI VIN --> 1J-2-600000	1J2 / 1J6	1.9	96	4	04.01-05.05	ASZ	12,0	Y-732J	5605	4
Bora 1.9 TDI VIN 1J-2-600001 -->	1J2 / 1J6	1.9	96	4	04.01-05.05	ASZ	11,0	Y-741U	6943	20
Bora 1.9 TDI VIN --> 1J-2-600000	1J2 / 1J6	1.9	110	4	09.00-05.05	ARL	12,0	Y-732J	5605	4
Bora 1.9 TDI VIN 1J-2-600001 -->	1J2 / 1J6	1.9	110	4	09.00-05.05	ARL	11,0	Y-741U	6943	20

### CADDY 1

Caddy 1 1.6 D		14	1.6	40	4	08.90-07.92	ME	12,0	Y-918J	6285	2
---------------	--	----	-----	----	---	-------------	----	------	--------	------	---

### CADDY 2

Caddy 2 1.9 D	9K9A / 9K9B	1.9	47	4	11.95-06.03	1Y	12,0	Y-918J	6285	2
Caddy 2 1.9 D	9K9A / 9K9B	1.9	47	4	06.96-12.00	AEF	12,0	Y-918J	6285	2
Caddy TDI	9K9	1.9	66	4	10.96-06.03	1Z	12,0	Y-732J	5605	4
Caddy 2 1.9 SDI	9K9A / 9K9B	1.9	47	4	11.95-09.00	AEY	12,0	Y-732J	5605	4
Caddy 2 1.9 SDI	9K9A / 9K9B	1.9	47	4	09.00-06.03	AYQ	12,0	Y-732J	5605	4
Caddy 2 1.9 TDI	9K9A / 9K9B	1.9	66	4	10.96-09.00	AHU	12,0	Y-732J	5605	4
Caddy 2 1.9 TDI	9K9A / 9K9B	1.9	66	4	09.97-09.00	ALE	12,0	Y-732J	5605	4
Caddy 2 1.9 TDI	9K9A / 9K9B	1.9	66	4	09.00-06.03	ALH	12,0	Y-732J	5605	4

### CADDY 3

Caddy 3 1.6 TDI	2KB/2KJ/2KA/2KH	1.6	55	4	08.10-	CAYE	4,4	Y1002AS	8888	57
Caddy 3 1.6 TDI	2KB/2KJ/2KA/2KH	1.6	75	4	08.10-	CAYD	4,4	Y1002AS	8888	57
Caddy 3 1.9 TDI	2KB/2KJ/2KA/2KH	1.9	55	4	09.05-	BSU	5,0	Y-607AS	7560	50
Caddy 3 1.9 TDI	2KB/2KJ/2KA/2KH	1.9	77	4	02.04-	BJB	5,0	Y-607AS	7560	50
Caddy 3 1.9 TDI	2KB/2KJ/2KA/2KH	1.9	77	4	06.05-	BLS	5,0	Y-607AS	7560	50
Caddy 3 2.0 SDI	2KB/2KJ/2KA/2KH	2.0	52	4	02.04-	BDJ	11,0	Y-741U	6943	20
Caddy 3 2.0 SDI	2KB/2KJ/2KA/2KH	2.0	52	4	06.05-	BST	11,0	Y-741U	6943	20
Caddy 3 2.0 TDI	2KB/2KJ/2KA/2KH	2.0	103	4	09.07-	BMM	5,0	Y-607AS	7560	50
Caddy 3 2.0 TDI	2KB/2KJ/2KA/2KH	2.0	103	4	11.10-	CFHC	4,4	Y1002AS	8888	57
Caddy 3 2.0 TDI	2KB/2KJ/2KA/2KH	2.0	125	4	05.12-05.15	CFJA	4,4	Y1002AS	8888	57
Caddy 3 2.0 TDI 4motion	2KB/2KJ/2KA/2KH	2.0	81	4	10.10-	CFHF	4,4	Y1002AS	8888	57
Caddy 3 2.0 TDI 4motion	2CA	2.0	81	4	08.10-05.15	CLCA	4,4	Y1002AS	8888	57
Caddy 3 2.0 TDI 4motion	2CA	2.0	62	4	11.10-05.15	CFHE	4,4	Y1002AS	8888	57
Caddy 3 2.0 TDI 4motion	2CA	2.0	103	4	11.10-05.15	CLCB	4,4	Y1002AS	8888	57

### CADDY 4

Caddy 4 TDI BlueMotion	SAA	2.0	55	4	05.15-	CUUC	4,4	Y1002AS	8888	57
Only for cylinder without pressure sensor										
Caddy 4 TDI BlueMotion	SAA	2.0	75	4	05.15-	CUUD	4,4	Y1002AS	8888	57
Only for cylinder without pressure sensor										



l kW C y i **0201**



Stock-No  
D-POWER

## VW

### CADDY 4

Caddy 4 TDI BlueMotion Only for cylinder without pressure sensor	SAA	2.0	90	4	05.15-	CUUE	4,4	Y1002AS	8888	57
Caddy 4 TDI BlueMotion Only for cylinder without pressure sensor	SAA	2.0	55	4	05.15-	CUUF	4,4	Y1002AS	8888	57
Caddy 4 TDI BlueMotion Only for cylinder without pressure sensor	SAA	2.0	110	4	05.15-	CUUB	4,4	Y1002AS	8888	57
Caddy 4	SAA	2.0	55	4	11.15-	DFSC	4,4	Y1002AS	8888	57

### CC

CC 2.0 TDI	358	2.0	100	4	11.11-	CFFA	4,4	Y1002AS	8888	57
CC 2.0 TDI	358	2.0	103	4	11.11-	CFFB	4,4	Y1002AS	8888	57
CC 2.0 TDI	358	2.0	125	4	11.11-	CFGB	4,4	Y1002AS	8888	57
CC 2.0 TDI	358	2.0	125	4	11.11-	CLLA	4,4	Y1002AS	8888	57
CC TDI BlueMotion Only for cylinder without pressure sensor	358	2.0	110	4	05.15-	CUVC	4,4	Y1002AS	8888	57
CC TDI BlueMotion Only for cylinder without pressure sensor	358	2.0	135	4	05.15-	CUWA	4,4	Y1002AS	8888	57
CC 2.0 TDI	358	2.0	130	4	12.12-	CFGC	4,4	Y1002AS	8888	57

### CRAFTER

Crafter 2.5 TDI	2E/2F	2.0	80	4	05.11-	CKTB	4,4	Y1002AS	8888	57
Crafter 2.5 TDI	2E/2F	2.0	100	4	05.11-	CKTC	4,4	Y1002AS	8888	57
Crafter 2.5 TDI	2E/2F	2.0	105	4	10.11-	CKUC	4,4	Y1002AS	8888	57
Crafter 2.5 TDI	2E/2F	2.0	120	4	07.11-	CKUB	4,4	Y1002AS	8888	57
Crafter TDi/BlueMotion	2E/2F	2.0	84	4	11.13-	CSLB	4,4	Y1002AS	8888	57
Crafter TDi/BlueMotion	2E/2F	2.0	120	4	07.11-	CSNA	4,4	Y1002AS	8888	57
Crafter 2.5 TDI	2E/2F	2.5	65	5	04.06-07.11	BJJ	5,0	Y-607AS	7560	50
Crafter 2.5 TDI Only for vehicle with ceramic GP	2E/2F	2.5	65	5	04.06-07.11	BJJ	7,0	CZ104	9826	52
Crafter 2.5 TDI	2E/2F	2.5	65	5	05.09-07.11	CEBA	5,0	Y-607AS	7560	50
Crafter 2.5 TDI Only for vehicle with ceramic GP	2E/2F	2.5	65	5	05.09-07.11	CEBA	7,0	CZ104	9826	52
Crafter 2.5 TDI	2E/2F	2.5	80	5	04.06-07.11	BJK	5,0	Y-607AS	7560	50
Crafter 2.5 TDI Only for vehicle with ceramic GP	2E/2F	2.5	80	5	04.06-07.11	BJK	7,0	CZ104	9826	52
Crafter 2.5 TDI	2E/2F	2.5	80	5	05.09-07.11	CEBB	5,0	Y-607AS	7560	50
Crafter 2.5 TDI Only for vehicle with ceramic GP	2E/2F	2.5	80	5	05.09-07.11	CEBB	7,0	CZ104	9826	52
Crafter 2.5 TDI	2E/2F	2.5	100	5	04.06-	BJL	5,0	Y-607AS	7560	50
Crafter 2.5 TDI Only for vehicle with ceramic GP	2E/2F	2.5	100	5	04.06-	BJL	7,0	CZ104	9826	52
Crafter 2.5 TDI	2E/2F	2.5	100	5	05.09-	CECA	5,0	Y-607AS	7560	50
Crafter 2.5 TDI Only for vehicle with ceramic GP	2E/2F	2.5	100	5	05.09-	CECA	7,0	CZ104	9826	52
Crafter 2.5 TDI	2E/2F	2.5	120	5	04.06-07.11	BJM	5,0	Y-607AS	7560	50
Crafter 2.5 TDI	2E/2F	2.5	120	5	04.06-07.11	BJM	7,0	CZ104	9826	52
Crafter 2.5 TDI Only for vehicle with ceramic GP	2E/2F	2.5	120	5	05.09-07.11	CECB	5,0	Y-607AS	7560	50
Crafter 2.5 TDI Only for vehicle with ceramic GP	2E/2F	2.5	120	5	05.09-07.11	CECB	7,0	CZ104	9826	52





l kW C y i 0201



Stock-No  
D-POWER™

VW

**EOS 1**

Eos 2.0 TDI	1F7	2.0	103	4	05.06-05.08	BMM	5,0	Y-607AS	7560	50
Eos 2.0 TDI	1F7	2.0	103	4	05.08-11.10	CBAB	4,4	Y-609AS	5849	49

**EOS 2**

Eos 2.0 TDI	1F8	2.0	100	4	11.10-	CFHB	4,4	Y1002AS	8888	57
Eos 2.0 TDI	1F8	2.0	100	4	11.10-	CFFA	4,4	Y1002AS	8888	57
Eos 2.0 TDI	1F8	2.0	103	4	11.10-	CFFB	4,4	Y1002AS	8888	57
Eos 2.0 TDI	1F8	2.0	103	4	11.10-	CFHC	4,4	Y1002AS	8888	57

**FOX**

Fox 1.4 TDI	5Z1 / 5Z3	1.4	51	3	04.05-	BNM	11,0	Y-741U	6943	20
-------------	-----------	-----	----	---	--------	-----	------	--------	------	----

**GOLF 2**

Golf 2 1.6 D	19E / 1G1	1.6	40	4	01.84-10.91	JP	12,0	Y-918J	6285	2
Golf 2 1.6 TD	19E / 1G1	1.6	44	4	08.89-07.92	1V	12,0	Y-918J	6285	2
Golf 2 1.6 TD	19E / 1G1	1.6	51	4	08.83-10.91	JR	12,0	Y-918J	6285	2
Golf 2 1.6 TD	19E / 1G1	1.6	59	4	04.89-10.91	RA	12,0	Y-918J	6285	2
Golf 2 1.6 TD	19E / 1G1	1.6	59	4	08.89-10.91	SB	12,0	Y-918J	6285	2

**GOLF 3**

Golf 3 1.9 SDI	1H1 / 1H5	1.9	47	4	07.95-02.99	AEY	12,0	Y-732J	5605	4
Golf 3 1.9 D	1H1 / 1H5	1.9	48	4	11.91-08.98	1Y	12,0	Y-918J	6285	2
Golf 3 1.9 TD	1H1 / 1H5	1.9	55	4	11.91-08.98	AAZ	12,0	Y-918J	6285	2
Golf 3 1.9 TDI	1H1 / 1H5	1.9	66	4	07.93-07.96	1Z	12,0	Y-732J	5605	4
Golf 3 1.9 TDI	1H1 / 1H5	1.9	66	4	07.96-06.00	AHU	12,0	Y-732J	5605	4
Golf 3 1.9 TDI	1H1 / 1H5	1.9	66	4	05.96-12.01	ALE	12,0	Y-732J	5605	4
Golf 3 1.9 TDI	1H1 / 1H5	1.9	81	4	02.96-08.99	AFN	12,0	Y-732J	5605	4

**GOLF 4**

Golf 4 1.9 SDI	1J1 / 1J5	1.9	50	4	10.97-04.01	AGP	12,0	Y-732J	5605	4
Golf 4 1.9 SDI	1J1 / 1J5	1.9	50	4	11.98-05.06	AQM	12,0	Y-732J	5605	4
Golf 4 1.9 TDI	1J1 / 1J5	1.9	66	4	10.97-09.02	AGR	12,0	Y-732J	5605	4
Golf 4 1.9 TDI	1J1 / 1J5	1.9	66	4	10.97-05.03	ALH	12,0	Y-732J	5605	4
Golf 4 1.9 TDI VIN --> 1J-2-600000	1J1 / 1J5	1.9	74	4	02.00-06.06	ATD	12,0	Y-732J	5605	4
Golf 4 1.9 TDI VIN --> 1J-2-600000	1J1 / 1J5	1.9	74	4	05.01-06.06	AXR	12,0	Y-732J	5605	4
Golf 4 1.9 TDI VIN 1J-2-600001 -->	1J1 / 1J5	1.9	74	4	02.00-06.06	ATD	11,0	Y-741U	6943	20
Golf 4 1.9 TDI VIN 1J-2-600001 -->	1J1 / 1J5	1.9	74	4	05.01-06.06	AXR	11,0	Y-741U	6943	20
Golf 4 1.9 TDI	1J1 / 1J5	1.9	81	4	10.97-05.06	AHF	12,0	Y-732J	5605	4
Golf 4 1.9 TDI	1J1 / 1J5	1.9	81	4	08.99-10.00	AVG	12,0	Y-732J	5605	4
Golf 4 1.9 TDI	1J1 / 1J5	1.9	81	4	05.00-05.06	ASV	12,0	Y-732J	5605	4
Golf 4 1.9 TDI	1J1 / 1J5	1.9	85	4	05.99-07.01	AJM	12,0	Y-732J	5605	4
Golf 4 1.9 TDI	1J1 / 1J5	1.9	85	4	01.00-07.01	AUY	12,0	Y-732J	5605	4
Golf 4 1.9 TDI VIN --> 1J-2-600000	1J1 / 1J5	1.9	96	4	04.01-05.06	ASZ	12,0	Y-732J	5605	4
Golf 4 1.9 TDI VIN 1J-2-600001 -->	1J1 / 1J5	1.9	96	4	04.01-05.06	ASZ	11,0	Y-741U	6943	20
Golf 4 1.9 TDI VIN --> 1J-2-60 0000	1J1 / 1J5	1.9	110	4	09.00-05.06	ARL	12,0	Y-732J	5605	4
Golf 4 1.9 TDI VIN 1J-2-600001 -->	1J1 / 1J5	1.9	110	4	09.00-05.06	ARL	11,0	Y-741U	6943	20

**GOLF 5**

Golf 5 1.9 TDI	1K1 / 1K5	1.9	66	4	05.04-02.06	BRU	5,0	Y-607AS	7560	50
Golf 5 1.9 TDI	1K1 / 1K5	1.9	66	4	02.06-01.09	BXF	5,0	Y-607AS	7560	50
Golf 5 1.9 TDI	1K1 / 1K5	1.9	66	4	05.07-01.09	BXJ	5,0	Y-607AS	7560	50
Golf 5 1.9 TDI	1K1 / 1K5	1.9	77	4	10.03-05.06	BKC	5,0	Y-607AS	7560	50
Golf 5 1.9 TDI	1K1 / 1K5	1.9	77	4	02.06-11.08	BXE	5,0	Y-607AS	7560	50
Golf 5 1.9 TDI only with DPF	1K1 / 1K5	1.9	77	4	06.05-05.07	BLS	7,0	CZ104	9826	52
Golf 5 1.9 TDI without DPF	1K1 / 1K5	1.9	77	4	06.05-05.07	BLS	5,0	Y-607AS	7560	50



l kW C y i **0201**



Stock-No  
D-POWER

**VW**

**GOLF 5**

Golf 5 2.0 SDI	1K1 / 1K5	2.0	55	4	01.04-05.07	BDK	5,0	Y-607AS	7560	50
Golf 5 2.0 TDI	1K1 / 1K5	2.0	100	4	10.03-05.07	AZV	4,4	YE14	7768	48
Golf 5 2.0 TDI	1K1 / 1K5	2.0	100	4	10.08-11.09	CBAA	4,4	Y1002AS	8888	57
Golf 5 2.0 TDI	1K1 / 1K5	2.0	100	4	07.08-11.08	CBDA	4,4	Y1002AS	8888	57
Golf 5 2.0 TDI	1K1 / 1K5	2.0	103	4	10.03-05.07	BKD	4,4	YE14	7768	48
Golf 5 2.0 TDI	1K1 / 1K5	2.0	103	4	12.04-11.08	BMM	5,0	Y-607AS	7560	50
Golf 5 2.0 TDI	1K1 / 1K5	2.0	103	4	02.08-	CBDB	4,4	Y1002AS	8888	57
Golf 5 2.0 TDI	1K1 / 1K5	2.0	125	4	11.05-11.08	BMN	7,0	CZ304	9864	55

**GOLF 6**

Golf 6 1.6 TDI	5K1 / AJ5	1.6	66	4	12.08-11.12	CAYB	4,4	Y1002AS	8888	57
Golf 6 1.6 TDI	5K1 / AJ5	1.6	77	4	02.09-11.12	CAYC	4,4	Y1002AS	8888	57
Golf 6 2.0 TDI	5K1 / AJ5	2.0	81	4	10.08-11.12	CBDC	4,4	Y1002AS	8888	57
Golf 6 2.0 TDI	5K1 / AJ5	2.0	100	4	10.08-11.12	CBAA	4,4	Y1002AS	8888	57
Golf 6 2.0 TDI	5K1 / AJ5	2.0	100	4	10.08-11.12	CFFA	4,4	Y1002AS	8888	57
Golf 6 2.0 TDI	5K1 / AJ5	2.0	103	4	10.08-11.12	CFFB	4,4	Y1002AS	8888	57
Golf 6 2.0 TDI	5K1 / AJ5	2.0	103	4	10.08-11.12	CBAB	4,4	Y1002AS	8888	57
Golf 6 2.0 TDI	5K1/AJ5	2.0	81	4	01.09-08.14	CLCA	4,4	Y1002AS	8888	57
Golf 6 2.0 TDI	AJ5	2.0	103	4	11.09-	CFHC	4,4	Y1002AS	8888	57
Golf 6 2.0 TDI	5K1/AJ5	2.0	100	4	07.09-07.13	CFHB	4,4	Y1002AS	8888	57
Golf 6 2.0 TDI GTD	5K1	2.0	125	4	04.09-11.09	CBBB	4,4	Y1002AS	8888	57
Golf 6 2.0 TDI GTD	5K1	2.0	125	4	05.10-11.12	CFGB	4,4	Y1002AS	8888	57

**GOLF 6 CABRIOLET**

Golf 6 Cabriolet 1.6 TDI	517	1.6	77	4	06.11-	CAYC	4,4	Y1002AS	8888	57
Golf 6 Cabriolet 2.0 TDI	517	2.0	103	4	11.11-	CFHC	4,4	Y1002AS	8888	57

**GOLF 7**

Golf 7 1.6 TDI	5G1	1.6	77	4	08.12-	CLHA	4,4	Y1002AS	8888	57
Only for cylinder without pressure sensor										
Golf 7 1.6 TDI	5G1/BA5	1.6	66	4	04.13-	CLHB	4,4	Y1002AS	8888	57
Only for cylinder without pressure sensor										
Golf 7 1.6 TDI	5G1/BA5	1.6	66	4	04.13-	CRKA	4,4	Y1002AS	8888	57
Only for cylinder without pressure sensor										
Golf AllTrack 7 1.6 TDI	5G1/BA5	1.6	81	4	01.13-	CRKB	4,4	Y1002AS	8888	57
Only for cylinder without pressure sensor										
Golf 7 1.6 TDI BlueMotion	5G1	1.6	81	4	01.13-	CVRA	4,4	Y1002AS	8888	57
Only for cylinder without pressure sensor										
Golf 7 1.6 TDI	5G1/BA5	1.6	81	4	01.13-	CRKB	4,4	Y1002AS	8888	57
Only for cylinder without pressure sensor										
Golf 7 1.6 TDI	5G1/BA5	1.6	66	4	04.13-	CXXA	4,4	Y1002AS	8888	57
Only for cylinder without pressure sensor										
Golf 7 1.6 TDI	BA5	1.6	81	4	05.13-	DBKA	4,4	Y1002AS	8888	57
Only for cylinder without pressure sensor										
Golf 7 1.6 TDI	5G1/BA5	1.6	81	4	05.13-	CXXB	4,4	Y1002AS	8888	57
Only for cylinder without pressure sensor										
Golf 7 2.0 GTD	5G1	2.0	135	4	04.13-	CUNA	4,4	Y1002AS	8888	57
Only for cylinder without pressure sensor										
Golf 2.0 TDI BlueMotion	5G1	2.0	81	4	11.12-	CYKB	4,4	Y1002AS	8888	57
Only for cylinder without pressure sensor										



Stock-No  
D-POWER™

VW

### GOLF 7

Golf 7 2.0 TDi/TDi BlueMotion Only for cylinder without pressure sensor	5G1	2.0	81	4	11.13-	CUUA	4,4	Y1002AS	8888	57
Golf 7 2.0 TDI Only for cylinder without pressure sensor	5G1/BA5	2.0	105	4	08.12-	CRBB	4,4	Y1002AS	8888	57
Golf 7 2.0 TDI Only for cylinder without pressure sensor	5G1	2.0	110	4	08.12-	CRBC	4,4	Y1002AS	8888	57
Golf 7 2.0 TDI Only for cylinder without pressure sensor	5G1	2.0	110	4	08.12-	CRLB	4,4	Y1002AS	8888	57
Golf 7 2.0 TDI Only for cylinder without pressure sensor	5G1/BA5	2.0	81	4	11.12-	CRVA	4,4	Y1002AS	8888	57
Golf 7 2.0 TDI Only for cylinder without pressure sensor	5G1/BA5	2.0	81	4	08.12-	CRVC	4,4	Y1002AS	8888	57
Golf 7 2.0 TDI BlueMotion Only for cylinder without pressure sensor	5G1	2.0	110	4	08.12-	CKFC	4,4	Y1002AS	8888	57

### GOLF PLUS

Golf Plus 1.6 TDI	5M1	1.6	66	4	02.09-	CAYB	4,4	Y1002AS	8888	57
Golf Plus 1.6 TDI	5M1	1.6	77	4	02.09-	CAYC	4,4	Y1002AS	8888	57
Golf Plus 1.9 TDI	5M1	1.9	66	4	05.05-02.06	BRU	5,0	Y-607AS	7560	50
Golf Plus 1.9 TDI	5M1	1.9	66	4	02.06-12.08	BXF	5,0	Y-607AS	7560	50
Golf Plus 1.9 TDI	5M1	1.9	66	4	05.07-12.08	BJX	5,0	Y-607AS	7560	50
Golf Plus 1.9 TDI	5M1	1.9	77	4	01.05-05.06	BKC	5,0	Y-607AS	7560	50
Golf Plus 1.9 TDI only with DPF	5M1	1.9	77	4	06.05-05.07	BLS	7,0	CZ104	9826	52
Golf Plus 1.9 TDI without DPF	5M1	1.9	77	4	06.05-05.07	BLS	5,0	Y-607AS	7560	50
Golf Plus 1.9 TDI	5M1	1.9	77	4	02.06-01.09	BXE	5,0	Y-607AS	7560	50
Golf Plus 2.0 TDI	5M1	2.0	81	4	03.09-	CBDC	4,4	Y1002AS	8888	57
Golf Plus 2.0 TDI	5M1	2.0	81	4	03.09-	CLCA	4,4	Y1002AS	8888	57
Golf Plus 2.0 TDI	5M1	2.0	100	4	05.05-05.07	AZV	4,4	YE14	7768	48
Golf Plus 2.0 TDI	5M1	2.0	100	4	01.09-	CBDA	4,4	Y1002AS	8888	57
Golf Plus 2.0 TDI	5M1	2.0	100	4	01.09-	CFHB	4,4	Y1002AS	8888	57
Golf Plus 2.0 TDI	5M1	2.0	103	4	10.03-01.05	BKD	4,4	YE14	7768	48
Golf Plus 2.0 TDI	5M1	2.0	103	4	12.05-05.09	BMM	5,0	Y-607AS	7560	50
Golf Plus 2.0 TDI	5M1	2.0	103	4	10.08-	CBDB	4,4	Y1002AS	8888	57
Golf Plus 2.0 TDI	5M1	2.0	103	4	10.08-	CFHC	4,4	Y1002AS	8888	57
Golf Plus 2.0 TDI	5M1	2.0	96	4	05.05-05.07	BEE	4,4	YE14	7768	48

### GOLF SPORTSVAN

Golf Sportsvan 1.6 TDI BlueMotion Only for cylinder without pressure sensor	AM1	1.6	81	4	02.14-	CXXB	4,4	Y1002AS	8888	57
Golf Sportsvan 1.6 TDI BlueMotion Only for cylinder without pressure sensor	AM1	1.6	81	4	02.14-	DBKA	4,4	Y1002AS	8888	57
Golf Sportsvan 1.6 TDI Only for cylinder without pressure sensor	AM1	1.6	66	4	02.14-	CRKA	4,4	Y1002AS	8888	57
Golf Sportsvan 1.6 TDI Only for cylinder without pressure sensor	AM1	1.6	81	4	02.14-	CRKB	4,4	Y1002AS	8888	57
Golf Sportsvan 2.0 TDI Only for cylinder without pressure sensor	AM1	2.0	110	4	02.14-	CRLB	4,4	Y1002AS	8888	57
Golf Sportsvan 2.0 TDI Only for cylinder without pressure sensor	AM1	2.0	81	4	05.14-	CRVA	4,4	Y1002AS	8888	57

### JETTA 2

Jetta 2 1.6 D	19E / 1G2	1.6	40	4	01.84-10.91	JP	12,0	Y-918J	6285	2
Jetta 2 1.6 TD	19E / 1G2	1.6	44	4	01.90-10.91	1V	12,0	Y-918J	6285	2



e kW C  
y i  
0201



Stock-No  
D-POWER

## VW

### JETTA 2

Jetta 2 1.6 TD	19E / 1G2	1.6	59	4	08.89-10.91	SB		12,0	Y-918J	6285	2
----------------	-----------	-----	----	---	-------------	----	--	------	--------	------	---

### JETTA 3

Jetta 3 1.9 TDI	1K2	1.9	77	4	08.05-02.06	BKC		5,0	Y-607AS	7560	50
Jetta 3 1.9 TDI	1K2	1.9	77	4	08.05-	BLS		7,0	CZ104	9826	52
Jetta 3 1.9 TDI	1K2	1.9	77	4	09.05-	BXE		5,0	Y-607AS	7560	50
Jetta 3 1.9 TDI (USA)	1K2	1.9	74	4	01.05-	BRM		7,0	CZ104	9826	52
Jetta 3 2.0 TDI	1K2	2.0	100	4	09.05-	AZV		4,4	YE14	7768	48
Jetta 3 2.0 TDI	1K2	2.0	103	4	08.05-06.08	BKD		4,4	YE14	7768	48
Jetta 3 2.0 TDI	1K2	2.0	103	4	10.05-06.08	BMM		5,0	Y-607AS	7560	50
Jetta 3 2.0 TDI	1K2	2.0	100	4	09.05-10.10	CBDA		4,4	Y1002AS	8888	57
Jetta 3 2.0 TDI	1K2	2.0	100	4	05.05-10.10	CBDB		4,4	Y1002AS	8888	57
Jetta 3 2.0 TDI	1K2	2.0	125	4	06.06-06.08	BMN		7,0	CZ304	9864	55

### JETTA 4

Jetta 4 1.6 TDI	162	1.6	77	4	02.11-	CAYC		4,4	Y1002AS	8888	57
Jetta 4 2.0 TDI	162	2.0	103	4	02.11-	CFFB		4,4	Y1002AS	8888	57
Jetta 4 2.0 TDI	162	2.0	103	4	02.11-	CLCB		4,4	Y1002AS	8888	57
Jetta 4 2.0 TDI	162	2.0	81	4	10.10-	CLCA		4,4	Y1002AS	8888	57
Jetta 4 2.0 TDI	163	2.0	81	4	10.10-	CUUA		4,4	Y1002AS	8888	57
Only for cylinder without pressure sensor											
Jetta 4 2.0 TDI	163	2.0	110	4	12.10-	CUUB		4,4	Y1002AS	8888	57
Only for cylinder without pressure sensor											
Jetta 4 2.0 TDI	163	2.0	110	4	07.14-	CVCA		4,4	Y1002AS	8888	57
Only for cylinder without pressure sensor											
Jetta TDi BlueMotion	163	2.0	110	4	07.14-	DELA		4,4	Y1002AS	8888	57
Only for cylinder without pressure sensor											

### LT

LT		2.4	51	6	08.92-12.95	ACT		12,0	Y-918J	6285	2
LT		2.4	51	5	08.89-03.96			12,0	Y-918J	6285	2
LT TD 4X4		2.4	55	5	09.85-03.96			12,0	Y-918J	6285	2
LT TD		2.4	55	6	12.82-07.92	DW		12,0	Y-918J	6285	2
LT TD		2.4	68	5	12.82-03.96			12,0	Y-918J	6285	2
LT Td		2.4	68	6	08.88-07.91	1G		12,0	Y-918J	6285	2
LT TD		2.4	70	6	08.91-12.95	ACL		12,0	Y-918J	6285	2
LT TD		2.4	75	6	12.82-07.92	DV		12,0	Y-918J	6285	2
LT 28 D		2.4	51	6	08.88-12.95	1S		12,0	Y-918J	6285	2
LT 31 D		2.4	51	6	08.88-12.95	1S		12,0	Y-918J	6285	2
LT 40 D		2.4	51	6	08.88-12.95	1S		12,0	Y-918J	6285	2
LT		2.5	65	5	04.06-	BJJ		7,0	CZ104	9826	52
LT TDI		2.5	61	5	04.01-07.06	BBE		12,0	Y-732J	5605	4
LT TDI		2.5	66	5	05.99-04.01	APA		12,0	Y-732J	5605	4
LT TDI		2.5	70	5	04.01-07.06	BBF		12,0	Y-732J	5605	4
LT TDI		2.5	75	5	05.96-05.99	AHD		12,0	Y-732J	5605	4
LT TDI		2.5	80	5	05.99-07.06	ANJ		12,0	Y-732J	5605	4
LT TDI		2.5	80	5	12.02-07.06	AVR		12,0	Y-732J	5605	4
LT 28 SDI		2.5	55	5	05.96-			12,0	Y-732J	5605	4
LT 28 TDi		2.8	92	6	05.96-			12,0	Y-732J	5605	4
LT 35 SDI		2.5	55	5	05.96-04.01	AGX		12,0	Y-732J	5605	4
LT 35 TDi		2.8	92	5	05.96-			12,0	Y-732J	5605	4
LT TDI		2.5	80	5	04.06-	BJK		7,0	CZ104	9826	52



l kW C y i 0201



Stock-No  
D-POWER™

VW

**LT**

LT TDI		2.5	100	5	04.06-	BJL		7,0	CZ104	9826	52
LT TDI		2.5	120	5	04.06-	BJM		7,0	CZ104	9826	52

**LUPO**

Lupo 1.2 TDI 3L	6X1 / 6E1	1.2	45	3	06.99-11.00	ANY		12,0	Y-732J	5605	4
Lupo 1.2 TDI 3L >>>6x-2-005 000	6X1 / 6E1	1.2	45	3	11.00-07.05	AYZ		12,0	Y-732J	5605	4
Lupo 1.2 TDI 3L 6x-2-005 001>>>	6X1 / 6E1	1.2	45	3	11.00-07.05	AYZ		11,0	Y-741U	6943	20
Lupo 1.4 TDI VIN >>>6x-2-005 000	6X1 / 6E1	1.4	55	3	05.99-07.05	AMF		12,0	Y-732J	5605	4
Lupo 1.4 TDI VIN 6x-2-005 001>>>	6X1 / 6E1	1.4	55	3	05.99-07.05	AMF		11,0	Y-741U	6943	20
Lupo 1.7 SDI	6X1 / 6E1	1.7	42	3	10.98-07.05	AKU		12,0	Y-732J	5605	4

**PASSAT 3**

Passat 3 1.6 TD	35i/3A2/3A5	1.6	59	4	08.89-10.93	SB		12,0	Y-918J	6285	2
Passat 3 1.9 D	35i/3A2/3A5	1.9	50	4	05.89-10.93	1Y		12,0	Y-918J	6285	2
Passat 3 1.9 TD	35i/3A2/3A5	1.9	55	4	03.91-12.96	AAZ		12,0	Y-918J	6285	2
Passat 3 1.9 TDI	35i/3A2/3A5	1.9	66	4	10.93-12.96	1Z		12,0	Y-732J	5605	4
Passat 3 1.9 TDI	35i/3A2/3A5	1.9	66	4	10.93-08.96	AHU		12,0	Y-732J	5605	4
Passat 3 1.9 TDI	35i/3A2/3A5	1.9	81	4	03.96-08.96	AFN		12,0	Y-732J	5605	4

**PASSAT 4**

Passat 4 1.9 TDI	3B2 / 3B5	1.9	66	4	05.98-08.00	AHH		12,0	Y-732J	5605	4
Passat 4 1.9 TDI VIN --> 3B-2-350-000	3B2/3B3/3B5/3B6	1.9	74	4	10.00-05.05	AVB		12,0	Y-732J	5605	4
Passat 4 1.9 TDI VIN 3B-2-350-001 -->	3B2/3B6	1.9	74	4	10.00-05.05	AVB		11,0	Y-741U	6943	20
Passat 4 1.9 TDI	3B2 / 3B5	1.9	81	4	08.99-08.00	AVG		12,0	Y-732J	5605	4
Passat 4 1.9 TDI	3B2 / 3B5	1.9	85	4	01.99-12.99	AJM		12,0	Y-732J	5605	4
Passat 4 1.9 TDI	3B2 / 3B5	1.9	85	4	01.00-08.00	ATJ		12,0	Y-732J	5605	4
Passat 4 1.9 TDI VIN --> 3B-2-350-000	3B3 / 3B6	1.9	96	4	10.00-05.05	AVF		12,0	Y-732J	5605	4
Passat 4 1.9 TDI VIN 3B-2-350-001 -->	3B3 / 3B6	1.9	96	4	10.00-05.05	AVF		11,0	Y-741U	6943	20
Passat 4 1.9 TDI VIN --> 3B-2-350-000	3B3 / 3B6	1.9	96	4	10.00-05.05	AWX		12,0	Y-732J	5605	4
Passat 4 1.9 TDI VIN 3B-2-350-001 -->	3B3 / 3B6	1.9	96	4	10.00-05.05	AWX		11,0	Y-741U	6943	20
Passat 4 2.5 TDI V6	3B2 / 3B6	2.5	110	6	08.98-08.00	AFB		11,0	Y-501U	4187	31
Passat 4 2.5 TDI V6	3B2 / 3B6	2.5	110	6	05.99-05.03	AKN		11,0	Y-501U	4187	31
Passat 4 2.5 TDI V6	3B3 / 3B6	2.5	120	6	05.03-05.05	BDG		11,0	Y-501U	4187	31
Passat 4 2.5 TDI V6 4motion	3B3 / 3B6	2.5	132	6	01.03-05.05	BAU		11,0	Y-501U	4187	31
Passat 4 2.5 TDI V6 4motion	3B3 / 3B6	2.5	132	6	01.03-05.05	BDH		11,0	Y-501U	4187	31

**PASSAT 5**

Passat 5 1.6 TDI	3C2 / 3C5	1.6	77	4	08.09-	CAYC		4,4	Y1002AS	8888	57
Passat 5 1.9 TDI	3C2 / 3C5	1.9	77	4	03.05-02.06	BKC		5,0	Y-607AS	7560	50
Passat 5 1.9 TDI	3C2 / 3C5	1.9	77	4	06.05-05.07	BLS		5,0	Y-607AS	7560	50
Passat 5 1.9 TDI	3C2 / 3C5	1.9	77	4	02.06-11.08	BXE		5,0	Y-607AS	7560	50
Passat 5 2.0 TDI	3C2 / 3C5	2.0	81	4	11.08-11.10	CBDC		4,4	Y1002AS	8888	57
Passat 5 2.0 TDI	3C2 / 3C5	2.0	88	4	11.05-05.07	BWV		7,0	CZ304	9864	55
Passat 5 2.0 TDI	3C2 / 3C5	2.0	90	4	06.05-	BVD		7,0	CZ104	9826	52
Passat 5 2.0 TDI	3C2 / 3C5	2.0	90	4	06.05-02.06	BVE		7,0	CZ304	9864	55
Passat 5 2.0 TDI	3C2 / 3C5	2.0	100	4	03.05-05.07	BMA		7,0	CZ304	9864	55

**VW****PASSAT 5**

Passat 5 2.0 TDI	3C2 / 3C5	2.0	100	4	06.07-04.09	BMA	4,4	YE14	7768	48
Passat 5 2.0 TDI	3C2 / 3C5	2.0	100	4	01.08-	CBAA	4,4	Y-609AS	5849	49
Passat 5 2.0 TDI	3C2 / 3C5	2.0	100	4	11.10-	CFFA	4,4	Y1002AS	8888	57
Passat 5 2.0 TDI	3C2 / 3C5	2.0	103	4	03.05-05.07	BKP	7,0	CZ304	9864	55
Passat 5 2.0 TDI	3C2 / 3C5	2.0	103	4	06.07-11.10	BKP	4,4	YE14	7768	48
Passat 5 2.0 TDI	3C2 / 3C5	2.0	103	4	03.05-05.08	BMP	7,0	CZ104	9826	52
Passat 5 2.0 TDI	3C2 / 3C5	2.0	103	4	05.07-11.10	CBAB	4,4	Y-609AS	5849	49
Passat 5 2.0 TDI	3C2 / 3C5	2.0	103	4	08.10-	CFFB	4,4	Y1002AS	8888	57
Passat 5 2.0 TDI	3C2 / 3C5	2.0	105	4	01.09-	CBAC	4,4	Y1002AS	8888	57
Passat 5 2.0 TDI	3C2 / 3C5	2.0	120	4	10.05-05.09	BUZ	7,0	CZ304	9864	55
Passat 5 2.0 TDI	3C2 / 3C5	2.0	125	4	02.06-11.10	BMR	7,0	CZ304	9864	55
Passat 5 2.0 TDI	3C2 / 3C5	2.0	125	4	05.08-11.10	CBBB	4,4	Y-609AS	5849	49
Passat 5 2.0 TDI	3C2 / 3C5	2.0	125	4	08.10-	CFGB	4,4	Y1002AS	8888	57
Passat 5 2.0 TDI	3C2 / 3C5	2.0	125	4	08.10-	CLLA	4,4	Y1002AS	8888	57
Passat 5 2.0 TDI	3C2/3C5	2.0	130	4	12.12-12.14	CFGC	4,4	Y1002AS	8888	57

**PASSAT 6 / ALLTRACK**

Passat 6 1.6 TDI	3G2/3G5	1.6	88	4	08.14-	DCZA	4,4	Y1002AS	8888	57
Only for cylinder without pressure sensor										
Passat 6 1.6 TDI	3G2/3G5	1.6	88	4	08.14-	DCXA	4,4	Y1002AS	8888	57
Only for cylinder without pressure sensor										
Passat 6 2.0 TDi BlueMotion	3G5	2.0	176	4	05.15-	CUPA	4,4	Y1002AS	8888	57
Only for cylinder without pressure sensor										
Passat 6 2.0 BiTDI	3G2/3G5	2.0	176	4	08.14-	DBGA	4,4	Y1002AS	8888	57
Only for cylinder without pressure sensor										
Passat 6 2.0 TDi BlueMotion	3G5	2.0	176	4	05.15-	CUAA	4,4	Y1002AS	8888	57
Only for cylinder without pressure sensor										
Passat 6 2.0 BiTDI	3G2/3G5	2.0	176	4	08.14-	CUAA	4,4	Y1002AS	8888	57
Only for cylinder without pressure sensor										
Passat 6 2.0 TDi BlueMotion	3G5	2.0	110	4	05.15-	CRLB	4,4	Y1002AS	8888	57
Only for cylinder without pressure sensor										
Passat 6 2.0 TDI	3G2/3G5	2.0	110	4	08.14-	CRLB	4,4	Y1002AS	8888	57
Only for cylinder without pressure sensor										
Passat 6 2.0 TDi BlueMotion	3G5	2.0	140	4	05.15-	DDAA	4,4	Y1002AS	8888	57
Only for cylinder without pressure sensor										
Passat 6 2.0 TDi BlueMotion	3G2	2.0	140	4	11.14-	DFCA	4,4	Y1002AS	8888	57
Only for cylinder without pressure sensor										
Passat 6 2.0 TDI	3G2/3G5	2.0	140	4	11.14-	DDAA	4,4	Y1002AS	8888	57
Only for cylinder without pressure sensor										

**PHAETON**

Phaeton 3.0 V6 TDI	3D2	3.0	171	6	09.04-05.07	BMK	4,4	Y-609AS	5849	49
Phaeton 3.0 V6 TDI	3D2	3.0	172	6	06.07-10.08	CARA	4,4	Y-609AS	5849	49
Phaeton 3.0 V6 TDI	3D2	3.0	176	6	05.08-05.10	CEXA	4,4	Y-609AS	5849	49
Phaeton 5.0 V10 TDI	3D2	5.0	230	10	12.02-10.06	AJS	11,0	Y-741U	6943	20

**POLO 2**

Polo 2 1.4 D	86C	1.4	35	4	10.90-07.94	1W	12,0	Y-918J	6285	2
--------------	-----	-----	----	---	-------------	----	------	--------	------	---

**POLO 3**

Polo 3 1.4 TDI	6N2	1.4	55	3	10.99-05.05	AMF	11,0	Y-741U	6943	20
Polo 3 1.7 SDI	6N1	1.7	42	4	04.97-12.99	AHG	12,0	Y-732J	5605	4
Polo 3 1.7 SDI	6N1 / 6N2	1.7	44	3	08.97-09.01	AKU	12,0	Y-732J	5605	4
Polo 3 1.9 D	6N1 / 6N2	1.9	47	4	10.94-12.99	AEF	12,0	Y-918J	6285	2

**VW****POLO 3**

Polo 3 1.9 SDI	6N1 / 6N2	1.9	47	4	07.96-09.01	AGD	12,0	Y-732J	5605	4
Polo 3 1.9 SDI	6N2	1.9	47	4	10.99-09.01	ASX	12,0	Y-732J	5605	4
Polo 3 1.9 SDI Variant	6KV2 / 6KV5	1.9	50	4	10.99-09.01	AGP	12,0	Y-732J	5605	4
Polo 3 1.9 SDI Variant	6KV2 / 6KV5	1.9	50	4	10.99-09.01	AQM	12,0	Y-732J	5605	4
Polo 3 1.9 TDI Variant	6KV2 / 6KV5	1.9	66	4	01.97-08.99	AHU	12,0	Y-732J	5605	4
Polo 3 1.9 TDI Variant	6KV2 / 6KV5	1.9	66	4	11.97-08.99	ALE	12,0	Y-732J	5605	4
Polo 3 1.9 TDI Variant	6KV2 / 6KV5	1.9	66	4	10.99-09.01	AGR	12,0	Y-732J	5605	4
Polo 3 1.9 TDI Variant	6KV2 / 6KV5	1.9	66	4	10.99-09.01	ALH	12,0	Y-732J	5605	4
Polo 3 1.9 TDI Variant	6KV2 / 6KV5	1.9	81	4	06.98-08.99	AFN	12,0	Y-732J	5605	4
Polo 3 1.9 TDI Variant	6KV2 / 6KV5	1.9	81	4	10.99-09.01	ASV	12,0	Y-732J	5605	4

**POLO 4**

Polo 4 1.4 TDI	9N	1.4	51	3	04.05-11.09	BNM	11,0	Y-741U	6943	20
Polo 4 1.4 TDI	9N	1.4	51	3	05.06-11.09	BWB	7,0	CZ104	9826	52
Polo 4 1.4 TDI	9N	1.4	55	3	11.01-05.05	BAY	11,0	Y-741U	6943	20
Polo 4 1.4 TDI	9N	1.4	59	3	10.05-11.09	BMS	7,0	CZ104	9826	52
Polo 4 1.4 TDI	9N	1.4	59	3	04.05-11.09	BNV	11,0	Y-741U	6943	20
Polo 4 1.9 SDI	9N	1.9	47	4	11.01-11.09	ASY	12,0	Y-732J	5605	4
Polo 4 1.9 TDI	9N	1.9	74	4	11.01-11.09	ATD	11,0	Y-741U	6943	20
Polo 4 1.9 TDI	9N	1.9	74	4	11.01-11.09	AXR	11,0	Y-741U	6943	20
Polo 4 1.9 TDI	9N	1.9	74	4	05.06-11.09	BMT	5,0	Y-607AS	7560	50
Polo 4 1.9 TDI	9N	1.9	96	4	11.03-11.09	ASZ	11,0	Y-741U	6943	20
Polo 4 1.9 TDI	9N	1.9	96	4	05.04-11.09	BLT	11,0	Y-741U	6943	20

**POLO 5**

Polo 5 1.2 TDI	6R	1.2	55	3	10.09-	CFWA	4,4	Y1002AS	8888	57
Polo 5 1.4 TDI	6R	1.4	55	3	03.14-	CUSA	4,4	Y1002AS	8888	57
Only for cylinder without pressure sensor										
Polo 5 1.4 TDI	6R	1.4	66	3	03.14-	CUSB	4,4	Y1002AS	8888	57
Only for cylinder without pressure sensor										
Polo 5 1.4 TDI	6R	1.4	77	3	03.14-	CUTA	4,4	Y1002AS	8888	57
Only for cylinder without pressure sensor										
Polo 5 1.4 TDI	6R	1.4	55	3	03.14-	CYZB	4,4	Y1002AS	8888	57
Only for cylinder without pressure sensor										
Polo 5 1.6 TDI	6R	1.6	55	4	05.09-	CAYA	4,4	Y1002AS	8888	57
Polo 5 1.6 TDI	6R	1.6	66	4	06.09-	CAYB	4,4	Y1002AS	8888	57
Polo 5 1.6 TDI	6R	1.6	77	4	05.09-	CAYC	4,4	Y1002AS	8888	57
Polo 5 1.6 TDI	6R	1.6	77	4	05.09-	CLNA	4,4	Y1002AS	8888	57

**SCIROCCO 3**

Scirocco 3 2.0 TDI	137	2.0	103	4	08.08-	CBDB	4,4	Y1002AS	8888	57
Scirocco 3 2.0 TDI	137	2.0	130	4	01.13-	CFGC	4,4	Y1002AS	8888	57
Scirocco 3 2.0 TDI	137	2.0	100	4	11.10-05.14	CFHB	4,4	Y1002AS	8888	57
Scirocco 3 2.0 TDI	137	2.0	100	4	11.10-05.14	CFHC	4,4	Y1002AS	8888	57
Scirocco 3 2.0 TDI	137	2.0	125	4	05.09-05.14	CFGB	4,4	Y1002AS	8888	57
Scirocco 3 2.0 TDI	137	2.0	125	4	05.09-	CBBB	4,4	Y1002AS	8888	57

**SCIROCCO 4**

Scirocco 4 2.0 TDI BlueMotion Cylinder	138	2.0	110	4	11.13-	CUUB	4,4	Y1002AS	8888	57
Only for cylinder without pressure sensor										
Scirocco 4 2.0 Tdi/ BlueMotion DI Cylinder	138	2.0	135	4	05.14-	CUWA	4,4	Y1002AS	8888	57
Only for cylinder without pressure sensor										

**VW****SCIROCCO 4**

Scirocco 4 2.0 TDi BlueMotion Cylinder Only for cylinder without pressure sensor	138	2.0	132	4	11.13-	CUXA	4,4	Y1002AS	8888	57
---	-----	-----	-----	---	--------	------	-----	---------	------	----

**SHARAN 1**

Sharan 1 1.9 TDI	1.9	66	4	09.95-07.96	1Z	12,0	Y-732J	5605	4
Sharan 1 1.9 TDI	1.9	66	4	08.96-02.00	AHU	12,0	Y-732J	5605	4
Sharan 1 1.9 TDI	1.9	66	4	03.99-02.00	ANU	11,0	Y-741U	6943	20
Sharan 1 1.9 TDI	1.9	81	4	02.96-07.99	AFN	12,0	Y-732J	5605	4
Sharan 1 1.9 TDI	1.9	81	4	08.99-02.00	AVG	12,0	Y-732J	5605	4

**SHARAN 2**

Sharan 2 1.9 TDI	1.9	85	4	04.00-03.10	AUY	11,0	Y-741U	6943	20
Sharan 2 1.9 TDI	1.9	85	4	11.05-03.10	BVK	11,0	Y-741U	6943	20
Sharan 2 1.9 TDI	1.9	96	4	11.02-03.10	ASZ	11,0	Y-741U	6943	20
Sharan 2 1.9 TDI	1.9	110	4	01.05-05.07	BTB	11,0	Y-741U	6943	20
Sharan 2 2.0 TDI	2.0	100	4	11.05-03.10	BVH	7,0	CZ104	9826	52
Sharan 2 2.0 TDI	2.0	103	4	11.05-03.10	BRT	7,0	CZ104	9826	52

**SHARAN 3**

Sharan 3 2.0 TDI	7N	2.0	130	4	01.13-	CFGC	4,4	Y1002AS	8888	57
Sharan 3 2.0 TDI BlueMotion	7N	2.0	85	4	05.11-	CUVA	4,4	Y1002AS	8888	57
Sharan 3 2.0 TDI Only for cylinder without pressure sensor	7N	2.0	110	4	.15-	CUVC	4,4	Y1002AS	8888	57
Sharan 3 2.0 TDI Only for cylinder without pressure sensor	7N	2.0	135	4	.15-	CUWA	4,4	Y1002AS	8888	57
Sharan 3 2.0 TDI	7N	2.0	85	4	06.11-	CFFE	4,4	Y1002AS	8888	57
Sharan 3 2.0 TDI	7N	2.0	100	4	05.10-	CFFA	4,4	Y1002AS	8888	57
Sharan 3 2.0 TDI	7N	2.0	103	4	05.10-	CFFB	4,4	Y1002AS	8888	57
Sharan 3 2.0 TDI	7N	2.0	125	4	08.10-	CFGB	4,4	Y1002AS	8888	57

**TRANSPORTER**

T 3 1.7 D	1.7	42	4	10.86-07.92	KY	12,0	Y-918J	6285	2
T 4 1.9 D	1.9	44	4	09.90-12.95	1X	12,0	Y-918J	6285	2
T 4 1.9 TD	1.9	50	4	10.92-04.02	ABL	12,0	Y-918J	6285	2
T 4 2.4 D	2.4	57	5	09.90-04.98	AAB	12,0	Y-918J	6285	2
T 4 2.4 D	2.4	55	5	04.97-06.03	AJA	12,0	Y-918J	6285	2
T 4 2.5 TDI	2.5	65	5	05.98-09.03	AJT	12,0	Y-732J	5605	4
T 4 2.5 TDI	2.5	65	5	10.01-09.03	AYY	12,0	Y-732J	5605	4
T 4 2.5 TDI	2.5	75	5	11.99-09.03	AUF	12,0	Y-732J	5605	4
T 4 2.5 TDI	2.5	75	5	04.01-09.03	AXL	12,0	Y-732J	5605	4
T 4 2.5 TDI	2.5	111	5	07.99-09.00	AHY	12,0	Y-732J	5605	4
T 4 TDI	2.5	75	5	09.95-06.03	ACV	12,0	Y-732J	5605	4
T 4 TDI	2.5	75	5	04.01-09.03	AYC	12,0	Y-732J	5605	4
T 4 TDI	2.5	111	5	09.00-09.03	AXG	12,0	Y-732J	5605	4
T 5 1.9 TDI	1.9	62	4	01.06-	BRR	5,0	Y-607AS	7560	50
T 5 1.9 TDI	1.9	63	4	04.03-05.07	AXC	11,0	Y-741U	6943	20
T 5 1.9 TDI	1.9	75	4	01.06-	BRS	5,0	Y-607AS	7560	50
T 5 1.9 TDI	1.9	77	4	04.03-05.07	AXB	11,0	Y-741U	6943	20
T 5 2.0 TDI	2.0	62	4	09.09-	CAAA	4,4	Y1002AS	8888	57
T 5 2.0 TDI	2.0	75	4	09.09-	CAAB	4,4	Y1002AS	8888	57
T 5 2.0 TDI	2.0	84	4	05.11-08.15	CAAD	4,4	Y1002AS	8888	57
T 5 2.0 TDI	2.0	100	4	05.10-08.15	CCHB	4,4	Y1002AS	8888	57
T 5 2.0 TDI	2.0	100	4	05.10-08.15	CAAE	4,4	Y1002AS	8888	57





Stock-No  
D-POWER™

VW

### TRANSPORTER

T 5 2.0 TDI		2.0	103	4	09.09-	CCHA		4,4	Y1002AS	8888	57
T 5 2.0 TDI		2.0	103	4	09.09-	CAAC		4,4	Y1002AS	8888	57
T 5 2.0 BitDI		2.0	132	4	09.09-	CFCA		4,4	Y1002AS	8888	57
T 5 2.5 TDI		2.5	96	5	04.03-05.07	AXD		11,0	Y-741U	6943	20
T 5 2.5 TDI		2.5	96	5	01.06-	BNZ		7,0	CZ104	9826	52
T 5 2.5 TDI		2.5	120	5	11.03-	BLJ		11,0	Y-741U	6943	20
T 5 2.5 TDI		2.5	128	5	04.03-05.07	AXE		11,0	Y-741U	6943	20
T 5 2.5 TDI		2.5	128	5	01.06-	BPC		7,0	CZ104	9826	52

### TIGUAN

Tiguan 2.0 TDI	5N	2.0	81	4	05.10-	CFFD		4,4	Y1002AS	8888	57
Tiguan 2.0 TDI	5N	2.0	100	4	11.07-05.10	CBAA		4,4	Y-609AS	5849	49
Tiguan 2.0 TDI	5N	2.0	100	4	05.10-	CFFA		4,4	Y1002AS	8888	57
Tiguan 2.0 TDI	5N	2.0	103	4	11.07-	CBAB		4,4	Y-609AS	5849	49
Tiguan 2.0 TDI	5N	2.0	103	4	11.09-	CFFB		4,4	Y1002AS	8888	57
Tiguan 2.0 TDI	5N	2.0	130	4	11.12-	CFGC		4,4	Y1002AS	8888	57
Tiguan 2.0 TDI	5N	2.0	103	4	11.10-	CLJA		4,4	Y1002AS	8888	57
Tiguan 2.0 TDI	5N	2.0	120	4	02.08-05.10	CBBA		4,4	Y-609AS	5849	49
Tiguan 2.0 TDI	5N	2.0	125	4	02.08-07.09	CBBB		4,4	Y-609AS	5849	49
Tiguan 2.0 TDI	5N	2.0	125	4	05.10-	CFGB		4,4	Y1002AS	8888	57
Tiguan 2.0 TDI	5N	2.0	135	4	05.15-	CUWA		4,4	Y1002AS	8888	57
Tiguan 2.0 TDI für Only for cylinder without pressure sensor	5N	2.0	81	4	05.15-	CUVE		4,4	Y1002AS	8888	57
Tiguan 2.0 TDI für Only for cylinder without pressure sensor	5N	2.0	110	4	05.15-	CUVC		4,4	Y1002AS	8888	57

### TOUAREG 1

Touareg 2.5 TDI	7LA/7L6/7L7	2.5	120	5	07.03-11.06	BLK		11,0	Y-741U	6943	20
Touareg 2.5 TDI	7LA/7L6/7L7	2.5	120	5	01.06-05.10	BPD		7,0	CZ104	9826	52
Touareg 2.5 TDI	7LA/7L6/7L7	2.5	128	5	01.03-11.06	BAC		11,0	Y-741U	6943	20
Touareg 2.5 TDI	7LA/7L6/7L7	2.5	128	5	01.06-05.10	BPE		7,0	CZ104	9826	52
Touareg 3.0 TDI	7LA/7L6/7L7	3.0	155	6	04.06-11.07	BUN		4,4	Y-609AS	5849	49
Touareg 3.0 TDI	7LA/7L6/7L7	3.0	155	6	11.07-05.10	CASB		4,4	Y-609AS	5849	49
Touareg 3.0 TDI	7LA/7L6/7L7	3.0	165	6	11.04-05.08	BKS		4,4	Y-609AS	5849	49
Touareg 3.0 TDI	7LA/7L6/7L7	3.0	176	6	01.08-05.10	CASC		4,4	Y-609AS	5849	49
Touareg 3.0 TDI	7LA/7L6/7L7	3.0	177	6	11.07-05.10	CASA		4,4	Y-609AS	5849	49
Touareg 5.0 V10 TDI	7LA/7L6/7L7	5.0	230	10	11.04-05.10	BLE		7,0	CZ104	9826	52
Touareg 5.0 V10 TDI	7LA/7L6/7L7	5.0	230	10	11.02-11.06	AYH		11,0	Y-741U	6943	20
Touareg 1 5.0 V10 TDI	7LA/7L6/7L7	5.0	258	10	08.07-	CBWA		7,0	CZ104	9826	52

### TOUAREG 2

Touareg 2 3.0 TDI	7P5	3.0	180	6	05.11-	CJGD		4,4	Y1002AS	8888	57
Touareg 2 3.0 TDI	7P5	3.0	180	6	05.11-	CRCA		4,4	Y1002AS	8888	57
Touareg 2 3.0 TDI Only for cylinder without pressure sensor	7P5	3.0	165	6	05.12-	CATA		4,4	Y1002AS	8888	57

### TOURAN

Touran 1.6 TDI	1T3	1.6	66	4	05.10-	CAYB		4,4	Y1002AS	8888	57
Touran 1.6 TDI	1T3	1.6	77	4	05.10-	CAYC		4,4	Y1002AS	8888	57
Touran 2 1.6 TDI Only for cylinder without pressure sensor		1.6	81	4	.15-	CRKB		4,4	Y1002AS	8888	57
Touran 1.9 TDI	1T1/1T2	1.9	66	4	11.04-02.06	BRU		5,0	Y-607AS	7560	50
Touran 1.9 TDI	1T1/1T2	1.9	66	4	02.06-05.10	BXF		5,0	Y-607AS	7560	50



**Cross Reference Guide\***

Note : This chart is furnished as a guide. Due to differences in design, materials, etc., products by various manufacturers may not match. See therefore our recommendation for the proper use of the acquired product.



ACDelco	→ NGK	V-Line
41-101	ITR4A15	
41-600	TR55IX	
41-601	BPR6ES	2
41-602	FR5	
41-603	FR4	
41-606	TR55	
41-608	FR45	
41-610	FR4	
41-611	FR45	
41-627	BKR4E-11	
41-628	FR4	
41-812	TR6IX	
41-900	TR5	
41-902	TR55	
41-904	TR5	
41-905	UR4	
41-906	TR5	
41-907	TR5	
41-908	BPR5EFIX-13P	
41-910	TR5	
41-913	TR55	
41-919	TR55	
41-921	TR55	
41-928	TR55-1	
41-929	TR55	
41-932	TR55	
41-933	PTR4B-15	
41-936	TR55	
41-940	TR55	
41-942	TR55	
41-943	TR55	
41-947	TR55	
41-948	TR4IX	
41-950	PTR5C-13	
41-952	BPR5EFIX-13P	
41-963	PTR5C-13	
41-974	PZTR5A-15	
41-983	PZTR5A-15	
41-987	PTR5C-13	
40 TS	BP7FS	
41 F	B6HS-10	
41 TS	BP6FS	
41 XL	B9ES	
41 XLS	BP7ES	
42 F	B6HS	
42 FF	B6HS	
42 FS	BP6HS	18
42 S	BP6S	
42 TS	BP6FS	
42 XL	B8ES	
42 XLS	BP6ES	4
43 F	B6HS	

ACDelco	→ NGK	V-Line
43 FFS	BP6HS	18
43 FS	BP6HS	18
43 N	B7ES	
43 S	BP6S	
43 TS	BP6FS	
43 XL	B7ES	
43 XLS	BP6ES	4
44	B6S	
44 F	B5HS	
44 FF	B5HS	
44 FFS	BP5HS	
44 N	B6ES	
44 NS	BP5ES	8
44 S	BP5S	
44 TS	BP5FS	
44 XL	B6ES	
44 XLO	BP5ES	8
44 XLS	BP5ES	8
45	B-4	
45 F	B5HS	
45 FF	B5HS	
45 FFS	BP5HS	
45 L	B-4L	
45 NS	BP5ES	8
45 S	BP5S	
45 TS	BP4FS	
45 XL	B6ES	
45 XLS	BP5ES	8
46	B-4	
46 F	B5HS	
46 FF	B5HS	
46 FFS	BP5HS	
46 N	B5ES	
46 S	BP5S	
46 TS	BP4FS	
46 XL	B5ES	
46 XLS	BP4ES	
47 FF	B-4H	
47 S	BP-4	
47 XL	B4ES	
48	B-4	
83 CTS	AP6FS	
83 TS	AP6FS	
84 T	A6FS	
84 TS	AP5FS	
85 TS	AP5FS	
86 TS	AP5FS	
412 XLS	BP7ES	
414 XLS	BP6ES	4
420 Z	B-4H	
422 Z	B5HS	
425 F	B6HS	



ACDelco	→ NGK	V-Line
425 Z	B6HS	
426 FS	BP6HS	18
430 Z	B7HS	
436 XLS	BP9ES	
438 XLS	BP8ES	
440 T	B7FS	
440 XLS	BP8ES	
445 Z	B8HS	
B 43	B6S	
B 44 FS	BP5HS	
B 44 S	BP5S	
B 45	B-4	
B 4021	B6S	
B 4031	B-4	
C 41	B7S	
C 42 CFS	BP6HS	18
C 42 CLTS	BP6EFS	5
C 42 CXLS	BP6ES	4
C 42 LTS	BP6EFS	5
C 42 N	B7ES	
C 42 XLS	BP5ES	8
C 43	B6S	
C 43 CXLS	BP6ES	4
C 43 L	B-6L	
C 43 N	B6ES	
C 44	B6S	
C 44 N	B6ES	
C 44 NS	BP5ES	8
C 44 S	BP5S	
C 44 XL	B6ES	
C 45	B-4	
C 45 L	B-4L	
C 46	B-4	
C 47	B-4	
C 47 W	B-4	
C 49	B-2	
C 73	G-2Z	
C 75	G-2Z	
C 81	AB-8	
C 82	AB-7	
C 82 T	A7FS	
C 83	AB-7	
C 83 T	A6FS	
C 84 T	A6FS	
C 85	AB-6	
C 85 TS	AP5FS	
C 86	AB-6	
C 87	AB-6	
C 88	AB-2	
C 88 L	AB-2	
C 421	B6S	
CFR 1 CLS	BCPR7ES	

ACDelco	→ NGK	V-Line
CFR 2 CLS	BKR6ES	28
CR 42 CFS	BPR6FS	
CR 42 CXLS	BPR6ES	2
CR 42 N	BR7ES	
CR 43	BR6S	
CR 43 CXLS	BPR6ES	2
CR 43 K	BR6S	
CR 43 N	BR6ES	
CR 43 S	BP6S	
CR 43 TS	BPR5FS-11	
CR 43 TSM	BPR5FS-11	
CR 44 N	BR6ES	
CR 44 NS	BPR5ES	6
CR 44 TS	BPR5FS-11	
CR 45 TS	UR4	
CR 83 T	AR6FS	
CS 40	BM7A	
CS 41	BM7A	
CS 41 T	BM7F	
CS 42	BM7A	
CS 42 S	BM7A	
CS 42 T	BM6F	
CS 45	BM6A	
CS 45 T	BM6F	
CS 49	BM4A	
CSR 45	BMR6A	
FR 2 LS	BKR6ES	28
FR 2 LSK	BKR6ES	28
FR 3 CLS	BKR5ES	35
FR 3 CLS 6	BKR5ES-11	33
FR 3 LM	ZFR5A-11	
FR 3 LS	BKR5ES	35
FR 3 LS 6	BKR5ES-11	33
FR 3 LSJ	BKR4E-11	
FR 3 LSK	BKR5ES	35
FR 4 LE	ZFR4F-11	
FR 4 LSJ	BKR4E-11	
FR 5 LS	BKR5ES	35
LM 46	B4-LM	
LM 49	B4-LM	
M 40 FF	B9HS	
M 40 FFX	B9HS-10	
M 41 FF	B8HS	
M 41 K	B8S	
M 42 FF	B7HS	
M 42 K	B7S	
M 43 FF	B6HS	
M 43 S	BP6S	
M 44 B	B6S	
M 44 C	B6S	
M 44 L	B-6L	
M 45	B-4	



ACDelco	→ NGK	V-Line
M 45 FF	B5HS	
M 47	B-4	
M 86	AB-6	
MB 42 K	B6S	
MC 41	B8S	
MC 41 F	B8HS	
MC 42	B8S	
MC 42 F	B7HS	
MC 44	B7S	
MC 104 F	C6HSA	
MC 121 F	D10HS	
MC 122 F	D8HA	
MC 124 FS	D6HA	
MR 42 K	BR6S	
MR 42 LTS	BPR6EFS	7
MR 43 LTS	BPR6EFS	7
MR 43 T	BR6FS	
MR 44 C	BR6S	
MR 44 T	BR5FS	
MR 45	B-4	
R 41 CF	BR7HS	
R 41 CXL	BR9ES	
R 41 CXLS	BPR7ES	19
R 41 TS	BPR6FS	
R 42 CF	BR6HS	
R 42 CFS	BPR6HS	3
R 42 CLTS	BPR6EFS	7
R 42 CT	BR6FS	
R 42 CTS	BPR6FS	
R 42 CXL	BR8ES	
R 42 CXLS	BPR6ES	2
R 42 FS	BPR6HS	3
R 42 LTS	BPR6EFS	7
R 42 LTSM	BPR5EFS-13	
R 42 S	BP6S	
R 42 T	BR6FS	
R 42 TS	BPR6FS	
R 42 TSM	BPR6FS	
R 42 TX	BR6FS	
R 42 XL	BR8ES	
R 42 XLS	BPR6ES	2
R 42 XLSM	ZGR5C	
R 43	BR6S	
R 43 C	BR6S	
R 43 CFS	BPR6HS	3
R 43 CNTSE	TR5-1	
R 43 CS	BP6S	
R 43 CT	BR6FS	
R 43 CTS	BPR6FS	
R 43 CTS 6	BPR6FS	
R 43 CXL	BR7ES	
R 43 CXLS	BPR6ES	2

ACDelco	→ NGK	V-Line
R 43 FS	BPR6HS	3
R 43 LTS	BPR6EFS	7
R 43 LTSE	TR4	
R 43 LTSX	BPR6EFS-13	
R 43 N	BR7ES	
R 43 NTSE	TR5-1	
R 43 S	BP6S	
R 43 T	BR6FS	
R 43 TS	BPR6FS	
R 43 TSK	BPR6FS	
R 43 TSX	BPR6FS	
R 43 TX	BR6FS	
R 43 XL	BR7ES	
R 43 XLS	BPR6ES	2
R 44	BR6S	
R 44 CF	BR5HS	
R 44 CNTSE	TR5-1	
R 44 CXL	BR6ES	
R 44 CXLS	BPR5ES	6
R 44 F	BR5HS	
R 44 LTS	BPR5EFS	
R 44 LTS 6	BPR5EFS-13	
R 44 LTS 6K	BPR5EFS-13	
R 44 LTSM	TR4	
R 44 LTSM 6	TR4	
R 44 N	BR6ES	
R 44 NS	BPR5ES	6
R 44 NTSE	TR5-1	
R 44 S	BP5S	
R 44 T	BR5FS	
R 44 TS	BPR5FS	
R 44 TSX	BPR5FS-15	
R 44 TX	BR5FS	
R 44 XL	BR6ES	
R 44 XLS	BPR5ES	6
R 44 XLS 6	BPR4ES-13	
R 44 XLSE	ZGR5C	
R 44 XLSM	ZGR5C	
R 45	BR6S	
R 45 LTS 6	BPR5EFS-13	
R 45 LTS 6K	BPR5EFS-13	
R 45 NS	BPR5ES	6
R 45 NSX	BPR5ES-13	
R 45 NTSE	TR5-1	
R 45 S	BP5S	
R 45 T	BR5FS	
R 45 TS	BPR4FS	
R 45 TSX	BPR4FS-15	
R 45 XL	BR6ES	
R 45 XLS	BPR5ES	6
R 46	BR6S	
R 46 LTS	BPR5EFS	



ACDelco	→ NGK	V-Line
R 46 N	BR5ES	
R 46 S	BP-4	
R 46 SZ	XR45IX	
R 46 T	BR5FS	
R 46 TS	BPR4FS	
R 46 TSX	BPR4FS-15	
R 46 TX	BR5FS	
R 46 XL	BR5ES	
R 46 XLS	BPR4ES	
R 47 S	BP-4	
R 83 CT	AR6FS	
R 83 CTS	APR6FS	
R 83 TS	APR6FS	
R 84 TS	APR5FS	
R 85 TS	APR5FS	
R 415 TS	BPR6FS	
R 425 LTS	BPR6EFS	7
R 425 TS	BPR6FS	
R 426 FS	BPR6HS	3
S 40 F	B9HS	
S 40 FR	BR9HS	
S 40 XL	B10ES	
S 40 XLG	B9ECS	
S 40 XLR	BR8ES	
S 41 F	B8HS	
S 41 FG	B7HCS	
S 41 FR	BR8HS	
S 41 XL	B9ES	
S 41 XLG	B8ECS	
S 41 XLR	BR9ES	
S 42	B7S	
S 42 F	B7HS	
S 42 FR	BR7HS	
S 42 XL	B8ES	
S 42 XLR	BR8ES	
S 43 XL	B7ES	
S 43 XLR	BR7ES	
S 44	B6S	
S 44 F	B5HS	
S 44 XL	B6ES	
S 45 F	B5HS	
S 46	B-4	
S 81 F	AB-8	
S 82 F	AB-8	
S 83 F	AB-7	
S 85 F	AB-6	
S 102 F	C7HSA	
S 104 F	C6HSA	
S 121 F	D8HA	
S 121 XL	D8EA	
S 122 F	D8HA	
S 123 XL	D7EA	

ACDelco	→ NGK	V-Line
S 124 FS	D6HA	
S 404 XLG	B10EG	
S 408 XLG	B9EG	
SB 41	B7S	
SN 46	B-4	
SV 4 XL	BUE	
SV 41 XL	BUE	
TC 42	B8S	
TC 45	B6S	
TC 49	B-2	
TC 81	AB-8	
TC 82	AB-8	
TC 83	AB-7	
TC 85	AB-6	
TC 86	AB-6	
V 40 FFK	BUHW-2	
V 40 FFM	BUHW	
V 40 FFS	BUH	
VB 40 FFM	BUHXW-1	
VR 40 FFK	BUZHW-2	
VR 40 FFM	BUZHW	
ASTON MARTIN	→ NGK	V-Line
723 116	BCPR6E	12
AUTOLITE / TUNER	→ NGK	V-Line
12	BP7FS	
13	BP6FS	
14	BP6FS	
15	BP5FS	
16	BP4FS	
23	BPR6FS	
24	BPR6FS	
25	BPR5FS	
26	BPR4FS-15	
27	BPR4FS-15	
32	AP7FS	
33	AP6FS	
34	AP6FS	
35	AP5FS	
36	AP5FS	
37	AP5FS	
43	APR6FS	
44	APR6FS	
45	APR5FS	
46	APR5FS	
52	BP7ES	
53	BP6ES	4
54	BP6ES	4
55	BP5ES	8



AUTOLITE / TUNER → NGK	V-Line
56	BP5ES 8
57	BP4ES
62	BP7ES
63	BPR6ES 2
64	BPR6ES 2
65	BPR5ES 6
66	BPR5ES 6
67	BPR4ES
73	BP6S
74	BP6S
75	BP5S
76	BP5S
77	BP-4
84	BP6S
85	BP5S
86	BP-4
87	BP-4
94	BP7EFS
102	BP7EFS
103	BPR6EFS 7
104	BPR6EFS 7
105	BPR5EFS
106	BPR5EFS
112	A9FS
113	A7FS
115	A6FS
117	A6FS
124	AR6FS
135	B7FS
136	BR6FS
143	BR6FS
144	BR6FS
145	BR6FS
146	BR5FS
147	BR5FS
156	AP5FS
166	APR5FS
175	BP5S
203	BPR6FS
215	B-6L
216	B-6L
217	B-4L
218	B-4L
235	BM6A
245	BMR6A
253	BM7A
254	BM6A
255	BM6A
258	BM4A
273	BP6HS 18
274	BP6HS 18
275	BP5HS

AUTOLITE / TUNER → NGK	V-Line
276	BP5HS
283	BPR7HS
284	BPR6HS 3
292	B8S
294	B6S
295	B-4
297	B-4
298	B-2
302	BR6S
303	BR6S
304	BR6S
306	B-4
308	B-2
312	B8S
313	B7S
314	B6S
315	B6S
316	B6S
317	B-4
318	B-2
344	AR6FS
353	B8S
354	B6S
355	B6S
356	B-4
357	B-4
358	B-2
363	BR6S
372	AB-8
373	AB-7
374	AB-7
375	AB-6
376	AB-6
377	AB-6
378	AB-6
379	AB-2
386	AB-6
393	B7ES
394	B6ES
395	B5ES
396	B5ES
397	B5ES
398	B4ES
402	BR8ES
403	BR6ES
404	BR6ES
405	BR5ES
406	BR5ES
411	B9HS
413	B7HS
414	B6HS
415	B5HS





AUTOLITE / TUNER → NGK	V-Line
416	B5HS
417	B-4H
424	B6HS
425	BR5HS
426	BR5HS
436	B-6L
437	B-4L
456	B4-LM
458	B2-LM
472	B9EFS
483	BR7EFS
494	B-6L
495	B-6L
497	B-4L
515	BP5HS
516	BP5HS
517	BP-4H
535	B5HS
536	B-4H
584	AR6FS
603	BPR6EFS-13
604	BPR6EFS-13
605	BPR6EFS-13
646	BPR5ES-13
664	BPR6FS
665	BPR5FS-15
666	BPR4FS-15
667	BPR4FS-15
683	BR6FS
684	BR6FS
685	BR6FS
687	BR5FS
723	BPR6FS
724	BPR6FS
725	BPR5FS-11
726	BPR4FS
727	BPR4FS-11
744	APR5FS
746	APR5FS
747	APR5FS
763	TR5-1
764	BPR6EFS
765	BPR5EFS
766	BPR5EFS
784	AR6FS
804	AR6FS
865	BPR5EFS
884	BPR6EFS-13
915	ZGR5C
925	ZGR5C
935	BPR5ES
945	BPR5ES

AUTOLITE / TUNER → NGK	V-Line
985	ZFR4F-11
996	B-6L
2272	AB-7
2413	B10EGP
2414	B10EG
2415	B9EG
2416	B8EG
2417	B7ECS
2543	TR5-1
2544	TR5-1
2545	TR5-1
2546	TR5-1
2585	BPR5ES
2592	B10ES
2593	B9ES
2594	B9ES
2611	B10ES
2612	B9ES
2613	B9ES
2614	B8ES
2615	B7ES
2616	B6ES
2634	B9HS-10
2635	B8HS
2636	B7HS
2652	B9HS-10
2653	B7HS
2654	B7HS
2655	B6HS
2656	B5HS
2675	B-6L
2676	B-6L
2695	AB-8
2696	AB-7
2697	AB-6
2715	D8HA
2716	D6HA
2735	D6HA
2755	D8EA
2772	AB-8
2775	AB-6
2794	C8HSA
2795	C7HSA
2796	C6HSA
2852	BUH
2872	BUHW
2892	BUHX
2932	BUE
2954	BM7F
2956	BM6F
2974	BPM7A
2976	BPMR7A

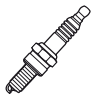

AUTOLITE / TUNER → NGK	V-Line	
3012	B8S	
3013	B7S	
3014	B6S	
3017	B-4	
3035	AB-6	
3036	BPR4FS-15	
3055	A6FS	
3074	G-2Z	
3075	G-2Z	
3116	AB-6	
3203	BPR6ES	2
3204	BPR6ES	2
3205	BPR5ES	6
3206	BPR5ES	6
3207	BPR5ES	6
3224	BP6S	
3225	BP5S	
3226	BP5S	
3227	BP5S	
3243	BPR6EFS	7
3244	BPR6EFS	7
3245	BPR5EFS	
3246	BPR5EFS	
3264	B7FS	
3265	BR6FS	
3266	BR5FS	
3267	BR5FS	
3286	APR6FS	
3303	BPR6FS	
3325	B-6L	
3327	B-4L	
3345	BMR7A	
3364	BPR6HS	3
3382	BR6S	
3383	BR6S	
3384	BR6S	
3386	BR6S	
3388	BR6S	
3404	AR6FS	
3423	B8S	
3426	BR6S	
3462	BR7ES	
3463	BR6ES	
3464	BR6ES	
3465	BR5ES	
3466	BR5ES	
3485	BR5HS	
3486	BR5HS	
3507	B-6L	
3565	BPR5EFS	
3586	BPR5ES-13	
3604	BPR5FS-15	

AUTOLITE / TUNER → NGK	V-Line	
3605	BPR4FS-15	
3606	BPR4FS-15	
3607	BPR4FS-15	
3624	BR6FS	
3625	BR6FS	
3627	BR5FS	
3666	B4-LM	
3684	BR7HS	
3686	BR6HS	
3702	BR9ES	
3703	BR9ES	
3704	BR8ES	
3705	BR6ES	
3706	BR6ES	
3724	BPR5EFS	
3885	ZGR5C	
3896	ZGR5C	
3922	BCPR7ES	
3924	BKR6ES	28
3926	BKR5ES	35
3954	D8EA	
3964	DR8ES-L	
3985	BPR5FS-15	
4043	BPR6ES-11	13
4052	B9ES	
4053	B9ES	
4054	B8ES	
4055	B7ES	
4056	B6ES	
4062	BR9ES	
4063	BR9ES	
4092	B7HS	
4093	B7HS	
4113	BP6HS	18
4114	BP6HS	18
4123	BPR6HS	3
4132	D8EA	
4143	DR8ES-L	
4152	DP9EA-9	
4153	DP8EA-9	
4162	DPR7EA-9	
4163	DR8ES-L	
4164	D7EA	
4173	D8HA	
4193	C7HSA	
4203	CR7HS	
4251	BP8ES	
4252	BP7ES	
4253	BP6ES	4
4263	BPR6ES	2
4265	BPR5ES	6
4275	BP5S	



<b>AUTOLITE / TUNER → NGK</b>		<b>V-Line</b>
5143	TR5-1	
5224	BKR5E	35
9062	BUR6ET	1
9063	BUR6ET	1
9064	BP5ET	
9921	BCPR6ET	
AP 63	PFR6B	
APP 392 411	BKR5EP-11	
<b>BERU → NGK</b>		<b>V-Line</b>
12-5 DU	D7EA	
12 ZR-6 SP2	PLZKBR7B8DG	
12 ZR-6 SP03	PLZKBR7B8DG	
12 ZR-6 SPP21	PLZKBR7B8DG	
12 ZR-7 SP03	PLZKBR7B8DG	
14-2 AS1	B9HCS	
14-3 A1	B8HS	
14-3 AS1	BR8HIX	
14-3 AU	B8HS	
14-3 CS1	BR8EIX	
14-3 DP2	BR8EIX	
14-4 A1	B8HS	
14-4 A2	B7HS	
14-4 AS1	BR8HIX	
14-4 AU	B7HS	
14-4 B2	BP7HS	
14-4 C1	B8ES	
14-4 C2	B7ES	
14-4 CS1	BR8EIX	
14-4 DPO	BP7ES	
14-5 A	B7HS	
14-5 AU	B7HS	
14-5 B	BP7HS	
14-5 BU	BP7HS	
14-5 C	B7ES	
14-5 CS	B7ECS	
14-5 D	BP7ES	
14-5 D1	BP7ES	
14-5 DP1	BP7ES	
14-5 DTU	BUR6ET	1
14-5 DU	BP7ES	
14-5 DU0	BP7ES	
14-5 E	B7S	
14-5 F	BP6S	
14-6 B	BP6HS	18
14-6 BU	BP6HS	18
14-6 C	B6ES	
14-6 D	BP6ES	4
14-6 D1	BP6ES	4
14-6 DPO	BP6ES	4
14-6 DTU	BUR6ET	1
14-6 DU	BP6ES	4

<b>BERU → NGK</b>		<b>V-Line</b>
14-6 DU0	BP6ESZ	
14-7 A	B6HS	
14-7 AU	B6HS	
14-7 B	BP6HS	18
14-7 BU	BP6HS	18
14-7 C	B6ES	
14-7 CU	B6ES	
14-7 D	BP6ES	4
14-7 DTU	BUR6ET	1
14-7 DU	BP6ES	4
14-7 DU0	BP6ESZ	
14-7 E	B6S	
14-7 F	BP6S	
14-8 A	B5HS	
14-8 AU	B5HS	
14-8 B	BP5HS	
14-8 BU	BP5HS	
14-8 C	B5ES	
14-8 C1	B6ES	
14-8 D	BP5ES	8
14-8 DTU	BP5ET-10	
14-8 DU	BP5ES	8
14-8 DU0	BP5ESZ	
14-8 E	B-4	
14-8 F	BP5S	
14-8 LUR	ZGR5A	15
14-9 C	B5ES	
14-9 D	BP5ES	8
14-9 DTU	BP5ET	
14-9 DU	BP5ES	8
14-9 DU0	BP5ESZ	
14-9 EU0	B4-LM	
14-10 A	B-4H	
14-10 B	BP4HS	
14-10 C	B4ES	
14-10 D	BP4ES	
14-10 E	B-4	
14-10 F	BP-4	
14 F-5 DU	BCP7ES	
14 F-6 DPUR021	PFR7Q	
14 F-6 DSR	BKR6ES	28
14 F-6 DTU	BCP6ET	
14 F-6 DU0	BCP6ES	17
14 F-6 DU0R	BKR6ES	28
14 F-7 DPUR02	PFR6Q	37
14 F-7 DPURX2	IFR6D10	
14 F-7 DU	BCP6ES	17
14 F-7 DU0	BCP6ES	17
14 F-7 DU0R	BKR6ES	28
14 F-7 HPURX2	PZFR5D-11	34
14 F-7 HUR2	ZFR5P-G	41
14 F-7 LDUR	BKR6EK	20



<b>BERU</b>	<b>→ NGK</b>	<b>V-Line</b>
14 F-7 LDUR4	BKR6EK	20
14 F-8 DU	BCP5ES	16
14 F-8 DU0	BCP5ES	16
14 F-8 DU4	BCP5ES	16
14 F-8 DUR	BKR6EZB	
14 F-8 LDUSR	BKR6EK	20
14 F-8 LUR	ZFR5F	
14 F-9 DU0	BCP5ES	16
14 FGH-6 DTUR	BKUR6ET	27
14 FGH-7 DPURX2	IFR6D10	
14 FGH-7 DTURX	BKUR6ET-10	24
14 FGH-7 DTURX	BKUR6ET-10	24
14 FGH-8 DPURX2	IFR5D10	
14 FGH-8 DTURW	BKUR5ET	29
14 FGH-8 DTURX0	BKUR5ET-10	
14 FGR-6 DDU	BKR6EKUB	
14 FGR-7 CTU	BCPR7ET	
14 FR-5 DTU	BCPR7ET	
14 FR-5 DU	BCPR7ES	
14 FR-6 DU	BKR6ES	28
14 FR-6 DUX	BKR6ES-11	14
14 FR-6 LDU	BKR6EK	20
14 FR-6 LDU3	BKR6EKE	
14 FR-6 LDUW	BKR6EKC	26
14 FR-7 DQUP7	BKR6EQUP	30
14 FR-7 DU	BKR6ES	28
14 FR-7 DUX	BKR6ES-11	14
14 FR-7 KPU	BKR6EP-8	
14 FR-7 KPUV	BCPR6EP-11	
14 FR-7 KPUX	BCPR6EP-11	
14 FR-7 KU	BKR6EY	
14 FR-7 KU0	BKR6EYA	
14 FR-7 KUOX	BKR6EYA-11	
14 FR-7 LDU	BKR6EK	20
14 FR-7 LUX	ZFR6F-11	
14 FR-7 MU2	LFR6B	
14 FR-8 DU	BKR5ES	35
14 FR-8 DUX	BKR5ES-11	33
14 FR-8 HU	BCRE527Y	
14 FR-8 KU	BKR5EY	
14 FR-8 KU0U	BKR5EYA-11	39
14 FR-8 KU0	BKR5EYA	
14 FR-8 LDUOX4	BKR5EK	23
14 FR-8 LU2	ZFR5F-11	40
14 G-8 DTU	BUR5ET	22
14 GH-7 DTUR	BUR6ET	1
14 GH-8 DTUR	BUR5ET	22
14 GH-8 DTURX	BUR5ET-10	21
14 GR-8 DTU	BPR5EKU	
14 K-5 DU	BP7EFS	
14 K-5 DU0	BP7EFS	
14 K-6 D	BP6EFS	5

<b>BERU</b>	<b>→ NGK</b>	<b>V-Line</b>
14 K-6 DU	BP6EFS	5
14 K-6 DU0	BP6EFS	5
14 K-7 D	BP6EFS	5
14 K-7 DU	BP6EFS	5
14 K-7 DU0	BP6EFS	5
14 K-8 DU	BP5EFS	
14 K-8 DU0	BP5EFS	
14 K-9 DU	BP5EFS	
14 K-9 DU0	BP5EFS	
14 KGR-6 KQU	BUR6EFSZ	
14 KR-6 BU	BPR6FS	
14 KR-6 DU	BPR6EFS	7
14 KR-7 DU	BPR6EFS	7
14 KR-7 DUX	BPR6EFS-13	
14 KR-8 DPU0V	TR55IX	
14 KR-8 MPX	PTR5A-13	25
14 KR-8 MUV	PTR5A-13	25
14 KR-8 STUX	LTR6B-10T	
14 R-5 DU	BPR7ES	19
14 R-6 B	BPR6HS	3
14 R-6 BU	BPR6HS	3
14 R-6 D	BPR6ES	2
14 R-6 DU	BPR6ES	2
14 R-6 DUX	BPR6ES-11	13
14 R-7 B	BPR6HS	3
14 R-7 BU	BPR6HS	3
14 R-7 CU	BR6ES	
14 R-7 D	BPR6ES	2
14 R-7 DU	BPR6ES	2
14 R-7 DUX	BPR6ES-11	13
14 R-8 DU	BPR5ES	6
14 R-8 DUX	BPR5ES-11	
14 R-9 DU	BPR5ES	6
14 R-9 EU0	BR4-LM	
14 R-11 F	BP-4	
14 S-5 F	BPM7A	
14 S-7 F	BPM6A	
14 S-8 F	BPM6A	
14 SR-6 F	BPMR6A	
14 X-AU	B6HS	
14 Z-2 C1	BR9EIX	
14 Z-3 A1	B9HS	
14 Z-3 AU	B9HS	
14 Z-3 C1	B9ES	
14 Z-3 CU	B9ES	
14 Z-4 AU	B8HS	
14 Z-6 A2	B6HS	
14 Z-7 AU	B7HS	
18-4 A1	AB-7	
18-4 A2	AB-7	
18-5 A	AB-7	
18-5 AS	AB-7	



<b>BERU</b>	<b>→ NGK</b>	<b>V-Line</b>
18-5 AU	AB-7	
18-7 A	AB-6	
18-7 AU	AB-7	
18-8 A	AB-6	
18-10 A	AB-6	
18-10 AU	AB-6	
18-12 B	AB-2	
18 K-6 BU	AP6FS	
18 K-7 B	AP6FS	
18 K-7 BU	AP6FS	
18 K-8 B	AP5FS	
18 K-8 BU	AP5FS	
18 K-12 B	AP5FS	
45/18	AP5FS	
95/14	B-4H	
95/14/3	B4ES	
95/14/3A	BP4ES	
95/14/5	B-4	
95/14/5A	BP-4	
95/14A	BP4HS	
95/18	AB-6	
Z 1	BP5ES	8
Z 2	BP5ET-10	
Z 3	ZGR5A	15
Z 4	ZFR5F	
Z 5	BCP5ES	16
Z 6	BP5EFS	
Z 7	BP5EFS	
Z 8	BPR5ES	6
Z 9	BPR5ES-11	
Z 10	BP6HS	18
Z 11	BP6ES	4
Z 12	BUR6ET	1
Z 13	BKR6ES	28
Z 14	BKR6EK	20
Z 15	BKR6ES	28
Z 16	BKR6ES-11	14
Z 17	BP6EFS	5
Z 18	BP6EFS	5
Z 19	BPR6HS	3
Z 20	BPR6ES	2
Z 21	BPR6ES-11	13
Z 22	BP6ES	4
Z 23	BKR6ES	28
Z 24	BKR6ES	28
Z 25	BP6EFS	5
Z 26	BPR6EFS	7
Z 27	BPR6ES	2
Z 28	BPR6ES-11	13
Z 29	BCP7ES	
Z 30	BCPR7ES	
Z 31	BP7EFS	

<b>BERU</b>	<b>→ NGK</b>	<b>V-Line</b>
Z 32	AP6FS	
Z 33	AP6FS	
Z 35	D7EA	
Z 37	B9HS	
Z 38	B9ES	
Z 39	B8HS	
Z 40	B7HS	
Z 41	BP7HS	
Z 42	BP7ES	
Z 43	BP7ES	
Z 44	BUR6ET	1
Z 45	BCPR7ET	
Z 46	BP7EFS	
Z 47	BPR7ES	19
Z 48	BP6HS	18
Z 49	BPR6FS	
Z 50	BP6ESZ	
Z 51	BUR6ET	1
Z 52	BCP6ET	
Z 53	BCP6ET	
Z 54	BCP6ES	17
Z 55	BP6EFS	5
Z 56	BP6EFS	5
Z 57	B6HS	
Z 58	B6ES	
Z 59	BR6ES	
Z 60	BCPR7ET	
Z 61	BP6ESZ	
Z 62	BP6ESZ	
Z 63	BCP6ES	17
Z 64	BCP6ES	17
Z 67	BPR6EFS-13	
Z 68	B5HS	
Z 69	BP5ESZ	
Z 70	BP5ESZ	
Z 71	BCP5ES	16
Z 72	BKR5ES	35
Z 73	BKR5ES-11	33
Z 74	BKR5EK	23
Z 75	BUR5ET	22
Z 76	BP5ES	8
Z 77	BP5ESZ	
Z 78	BP5ET	
Z 79	BCP5ES	16
Z 80	BP5EFS	
Z 81	BP5EFS	
Z 82	BPR5ES	6
Z 83	B4-LM	
Z 84	BR4-LM	
Z 85	B6HS	
Z 86	AB-7	
Z 87	AB-7	



<b>BERU</b>	<b>→ NGK</b>	<b>V-Line</b>
Z 88	AB-6	
Z 89	BKUR6ET	27
Z 90	BKUR6ET-10	24
Z 90	BKUR6ET-10	24
Z 91	BUR6ET	1
Z 92	BUR5ET	22
Z 93	BUR5ET-10	21
Z 94	BPR5EKU	
Z 95	BPR6EFS	7
Z 97	PTR5A-13	25
Z 98	BKR6EK	20
Z 99	BKR6ES-11	14
Z 100	BCP5ES	16
Z 101	BKR6EK	20
Z 103	BP7ES	
Z 104	BP6ES	4
Z 105	BKR6ES	28
Z 106	BPMR6A	
Z 107	BP-4	
Z 112	B-4	
Z 116	BKR6EK	20
Z 118	BP5HS	
Z 121	BKUR5ET-10	
Z 122	IFR5D10	
Z 132	BPM6A	
Z 144	BUR6EFSZ	
Z 145	BKR6EKUB	
Z 148	TR55IX	
Z 149	BCPR6EP-11	
Z 150	BCPR6EP-11	
Z 151	BKR6EP-8	
Z 152	BCRE527Y	
Z 153	BKR5EY	
Z 154	BKR5EYA	
Z 155	BKR6EY	
Z 156	BKR6EYA	
Z 157	BKR6EYA-11	
Z 158	ZFR6F-11	
Z 171	IFR6D10	
Z 176	PZFR5D-11	34
Z 177	PTR5A-13	25
Z 184	LFR6B	
Z 185	PFR7Q	
Z 188	PFR6Q	37
Z 194	BKR6EKE	
Z 200	ZFR5P-G	41
Z 203	ZFR5F-11	40
Z 222	LTR6B-10T	
Z 227	BKR6EZB	
Z 233	PLZKBR7B8DG	
Z 237	BKR6EQUP	30
Z 245	BKR6EKC	26

<b>BERU</b>	<b>→ NGK</b>	<b>V-Line</b>
Z 246	BKUR5ET	29
Z 249	BKR5EYA-11	39
Z 265	BPM7A	
Z 282	IFR6D10	
Z 288	PLZKBR7B8DG	
Z 336	PLZKBR7B8DG	
125/14/3	B5ES	
125/14/3A	BP5ES	8
145/14	B5HS	
145/14/3	B5ES	
145/14/3A	BP5ES	8
145/14/5	B-4	
145/14/5A	BP5S	
145/14/5AMX	BPM6A	
145/18	AB-6	
145/18K	AP5FS	
145/1A	BP5HS	
160/14/3	B6ES	
175/14	B6HS	
175/14/3	B6ES	
175/14/3A	BP6ES	4
175/14/5	B6S	
175/14/5A	BP6S	
175/14/5AMX	BPM6A	
175/14A	BP6HS	18
175/18	AB-6	
175/18K	AP6FS	
190/14 Z	B6HS	
200/14/3	B6ES	
200/14/3A	BP6ES	4
200/14/3K	BP6EFS	5
200/14A	BP6HS	18
215/14/3A	BP6ES	4
225/14	B7HS	
225/14/3	B7ES	
225/14/3A	BP7ES	
225/14/3S	B7ECS	
225/14/5	B7S	
225/14/5A	BP6S	
225/14/5AMX	BPM7A	
225/14A	BP7HS	
225/18	AB-7	
225/18S	AB-7	
230/14/3A	BP7ES	
235/14/3P	BP7ES	
240/14	B7HS	
240/14/3	B7ES	
240/14 A	BP7HS	
240/14 S	BR8HIX	
240/18	AB-7	
260/14	B8HS	
260/14/3	B8ES	



BERU	→ NGK	V-Line
260/14 S	BR8HIX	
260/18	AB-8	
265/14/3P	BR8EIX	
280/14	B8HS	
280/14/3S	BR8EIX	
280/14/3Z	B9ES	
280/14Z	B9HS	
310/14/3Z	BR9EIX	
310/14S	B9HCS	
D 175/14	B6HS	
D 175/14/3	B6ES	
D 200/14/3A	BP6ES	4
D 215/14/3	B7ES	
D 230/14/3A	BP7ES	
RS 16	BPR6HIX	
RS 18	BPR7HIX	
RS 33	BPR5EIX	
RS 35	BPR6EIX	
RS 37	BPR7EIX	
RS 39	BPR7EIX	
0 001 245 700	D7EA	
0 001 325 701	BP5ES	8
0 001 325 704	BP5ESZ	
0 001 325 705	BCP5ES	16
0 001 325 710	BP5ET	
0 001 330 104	BUR5ET	22
0 001 330 112	BUR5ET-10	21
0 001 330 113	BUR5ET	22
0 001 330 116	BKUR5ET-10	
0 001 330 119	BKUR5ET	29
0 001 330 501	BKR6EK	20
0 001 330 702	BP5ES	8
0 001 330 707	BCP5ES	16
0 001 330 709	BP5ET-10	
0 001 330 713	BP5ESZ	
0 001 330 717	ZFR5F	
0 001 330 718	ZGR5A	15
0 001 330 725	BCP5ES	16
0 001 330 726	BP5ESZ	
0 001 330 731	BCP5ES	16
0 001 330 780	BKR6EZB	
0 001 330 904	IFR5D10	
0 001 335 107	BKUR6ET-10	24
0 001 335 107	BKUR6ET-10	24
0 001 335 108	BUR6ET	1
0 001 335 702	BP6ES	4
0 001 335 707	B6ES	
0 001 335 709	BUR6ET	1
0 001 335 714	BP6ESZ	
0 001 335 721	BCP6ES	17
0 001 335 725	BCP6ES	17
0 001 335 729	BKR6ES	28

BERU	→ NGK	V-Line
0 001 335 732	BKR6EK	20
0 001 335 737	BP6ESZ	
0 001 335 742	ZFR5P-G	41
0 001 335 905	IFR6D10	
0 001 335 910	IFR6D10	
0 001 335 911	PZFR5D-11	34
0 001 335 914	PFR6Q	37
0 001 340 103	BKUR6ET	27
0 001 340 702	BP6ES	4
0 001 340 704	BUR6ET	1
0 001 340 706	BCP6ET	
0 001 340 707	BP6ESZ	
0 001 340 716	BCP6ES	17
0 001 340 717	BCP6ET	
0 001 340 723	BKR6ES	28
0 001 340 806	BKR6ES	28
0 001 340 903	BP6ES	4
0 001 340 908	PFR7Q	
0 001 345 702	BP7ES	
0 001 345 704	BUR6ET	1
0 001 345 711	BP7ES	
0 001 345 720	BCP7ES	
0 001 350 903	BP7ES	
0 001 355 700	B9ES	
0 001 400 701	B6HS	
0 001 430 700	BP5HS	
0 001 430 701	B5HS	
0 001 435 700	BP6HS	18
0 001 435 705	B6HS	
0 001 440 700	BP6HS	18
0 001 445 700	BP7HS	
0 001 445 702	B7HS	
0 001 450 702	B8HS	
0 001 455 702	B9HS	
0 001 529 302	B-4	
0 001 625 700	BP5EFS	
0 001 625 702	BP5EFS	
0 001 630 700	BP5EFS	
0 001 630 704	BP5EFS	
0 001 635 700	BP6EFS	5
0 001 635 709	BP6EFS	5
0 001 640 700	BP6EFS	5
0 001 640 704	BP6EFS	5
0 001 640 705	BP6EFS	5
0 001 645 700	BP7EFS	
0 001 645 703	BP7EFS	
0 001 735 700	AP6FS	
0 001 740 700	AP6FS	
0 001 820 700	AB-6	
0 001 835 700	AB-7	
0 001 845 700	AB-7	
0 002 235 901	PLZKBR7B8DG	

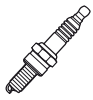

<b>BERU</b>	<b>→ NGK</b>	<b>V-Line</b>
0 002 240 902	PLZKBR7B8DG	
0 002 240 907	PLZKBR7B8DG	
0 002 240 911	PLZKBR7B8DG	
0 002 325 700	BPR5ES	6
0 002 330 204	BKR5EYA-11	39
0 002 330 701	BPR5ES	6
0 002 330 702	BPR5ES-11	
0 002 330 703	BKR5ES	35
0 002 330 704	BKR5ES-11	33
0 002 330 706	BPR5EKU	
0 002 330 710	BKR5EK	23
0 002 330 712	BCRE527Y	
0 002 330 713	BKR5EY	
0 002 330 714	BKR5EYA	
0 002 330 794	ZFR5F-11	40
0 002 335 100	BCPR7ET	
0 002 335 500	BKR6EK	20
0 002 335 701	BPR6ES	2
0 002 335 704	BR6ES	
0 002 335 706	BPR6ES-11	13
0 002 335 707	BKR6ES	28
0 002 335 708	BKR6ES-11	14
0 002 335 712	BKR6EY	
0 002 335 713	BKR6EYA	
0 002 335 714	BKR6EYA-11	
0 002 335 715	ZFR6F-11	
0 002 335 719	LF6B	
0 002 335 902	BCPR6EP-11	
0 002 335 903	BCPR6EP-11	
0 002 335 904	BKR6EP-8	
0 002 335 911	BKR6EQUP	30
0 002 340 102	BKR6EKUB	
0 002 340 500	BKR6EK	20
0 002 340 501	BKR6EKE	
0 002 340 504	BKR6EKC	26
0 002 340 701	BPR6ES	2
0 002 340 702	BKR6ES	28
0 002 340 703	BPR6ES-11	13
0 002 340 704	BKR6ES-11	14
0 002 345 701	BPR7ES	19
0 002 345 702	BCPR7ES	
0 002 345 704	BCPR7ET	
0 002 435 701	BPR6HS	3
0 002 515 400	BP-4	
0 002 630 701	PTR5A-13	25
0 002 630 715	LTR6B-10T	
0 002 630 900	TR55IX	
0 002 635 700	BPR6EFS	7
0 002 635 701	BPR6EFS-13	
0 002 640 100	BUR6EFSZ	
0 002 640 700	BPR6EFS	7
0 002 640 701	BPR6FS	

<b>BERU</b>	<b>→ NGK</b>	<b>V-Line</b>
0 002 640 900	PTR5A-13	25
0 004 525 700	B4-LM	
0 004 525 701	BR4-LM	
0 004 535 402	BPM6A	
0 004 540 401	BPMR6A	
0 004 545 401	BPM7A	
<b>BMW</b>	<b>→ NGK</b>	<b>V-Line</b>
11 12 7 675 485	KR9CI	
12 12 0 022 902	DCPR8EKP	
12 12 0 030 548	BKR6EQUP	30
12 12 0 031 708	BKR7EQUP	
12 12 0 032 134	IZFR6H11	
12 12 0 032 136	BKR6EQU	
12 12 0 032 137	ILZFR6D11	
12 12 0 032 273	LKR8AP	
12 12 0 034 091	ZKBR7A-HTU	
12 12 0 034 094	R6601-9	
12 12 0 034 098	PLZKBR7B8DG	
12 12 0 035 531	PLZKBR7B8DG	
12 12 0 035 747	PFR7B	
12 12 0 035 915	PLZFR6A-11S	
12 12 0 037 581	SILZKBR8D8S	
12 12 0 037 607	BKR6EQUP	30
12 12 0 037 608	BKR6EQUP	30
12 12 0 038 349	ZKBR7A-HTU	
12 12 0 038 507	SIZKBR8A8HS	
12 12 0 038 704	SILZKBR8D8S	
12 12 0 038 896	SILZKBR8D8S	
12 12 0 039 664	SILZKBR8D8S	
12 12 0 037 663	LZFR6AP11GS	
12 12 0 141 871	BKR6EQUP	30
12 12 1 342 836	BKR7EKC	
12 12 1 404 310	PKR7A	
12 12 1 435 955	BKR6EQUP	30
12 12 1 435 956	BKR6EQUP	30
12 12 1 704 399	BKR6EK	20
12 12 2 158 252	IZFR6H11	
12 12 2 158 253	PLZFR6A-11S	
12 12 2 343 144	D8EA	
12 12 7 521 111	PLZFR6A-11S	
12 12 7 521 112	ILZFR6D11	
12 12 7 523 457	BKR6EQU	
12 12 7 526 799	IZFR6H11	
12 12 7 534 226	PLZKBR7B8DG	
12 12 7 550 011	ZKBR7A-HTU	
12 12 7 550 011 02	ZKBR7A-HTU	
12 12 7 556 979	BKR7EQUP	
12 12 7 570 106	ILZKBR7B8DG	
12 12 7 570 106.02	ILZKBR7B8DG	
12 12 7 600 994	SIZKBR8A8HS	
12 12 7 650 676	BKR7EKC	





<b>BMW</b>	<b>→ NGK</b>	<b>V-Line</b>
12 12 7 650 676.3	BKR7EKC	
12 12 7 653 439	CR8EB	
12 12 7 653 771	BKR7EKC	
12 12 7 664 404	DR8EB	
12 12 7 671 301	DCPR8EKC	
12 12 7 671 302	BKR7EKC	
12 12 7 677 560	DCPR8EKC	
12 12 7 681 415	BKR7EKC	
12 12 7 699 116	KR9CI	
12 12 7 710 636	CR9EKB	
12 12 7 710 681	MAR9B-JDS	
12 12 7 719 772	LMAR9D-J	
12 12 7 722 278	MAR9B-JDS	
12 12 7 726 112	MAR8B-JDS	
12 12 7 728 634	DCPR8EKC	
12 12 7 728 635	KR9CI	
12 12 7 728 657	LMAR8AI-8	
12 12 7 830 787	DCPR8EKP	
12 12 7 830 787.3	DCPR8EKP	
12 12 7 835 198	LKR8AP	
12 12 8 532 942	LMAR8D-J	
12 12 9 061 870	ZFR5F	
12 12 9 063 428	BKR6EK	20
12 12 9 064 617	BKR6EK	20
12 12 9 064 619	BKR6EK	20
12 12 9 064 656	BKR6EK	20
12 12 9 065 366	BKR6EK	20
12 12 9 069 048	PKR7A	
12 12 9 071 003	BKR6EQU	30
75 34 2 26A 104	PLZKBR7B8DG	
91 47 1 210 043	PFR7B	
<b>BOSCH</b>	<b>→ NGK</b>	<b>V-Line</b>
877 1207	R2349-10	
888 1101	R2349-11	
D 6 BC	AP6FS	
D 7 AC	A6FS	
D 7 BC	AP6FS	
D 8 BC	AP5FS	
D 9 BC	AP5FS	
D 10 BC	AP5FS	
DR 6 BC	APR6FS	
DR 7 BC	APR6FS	
DR 8 BC	APR5FS	
DR 9 BC	APR5FS	
DR 10 BC	APR5FS	
F 03 DAR	BKR6EK	20
F 04 DAR	BKR6EK	20
F 2 CS	R7433-9	
F 2 DTC	R6888A-9	
F 3 CS	R7433-9	

<b>BOSCH</b>	<b>→ NGK</b>	<b>V-Line</b>
F 4 CS	R7433-8	
F 5 DC	BCP7ES	
F 5 DP 0 R	PFR7B	
F 5 DTC	BCP7ET	
F 5 KPP 332SB	PFR7S8EG	
F 6 DC	BCP6ES	17
F 6 DC 0	BCP6ES	17
F 6 DCOR	BKR6ES	28
F 6 DCX	BCP6ES-11	
F 6 DPOR	PFR6Q	37
F 6 DSR	BKR6EIX	
F 6 DTC	BCP6ET	
F 6 KPP 332 S	PFR6Q	37
F 6 LTCR	BKUR7ET	
F 6 MPP 332	ILFR6A	
F 7 DC	BCP6ES	17
F 7 DC 0	BCP6ES	17
F 7 DCOR	BKR6ES	28
F 7 DCX	BCP6ES-11	
F 7 DER	BKR6ES	28
F 7 DPER	PFR6G-11	
F 7 DPP 332	IFR6D10	
F 7 DTC	BCP6ET	
F 7 HER 02	ZFR6T-11G	44
F 7 HER 2	ZFR5P-G	41
F 7 HPP 22	PFR6Q	37
F 7 HPP 222	PZFR5D-11	34
F 7 HPP 222U	PZFR6J-11	
F 7 HPPRX	PZFR5D-11	34
F 7 KTCR	BKUR6ET-10	24
F 7 KTCR	BKUR6ET-10	24
F 7 LCOR 2	ZFR6F-11	
F 7 LCR	ZFR6A-11	
F 7 LDOR	BKR6EK	20
F 7 LTCR	BKUR6ET-10	24
F 7 LTCR	BKUR6ET-10	24
F 8 DC	BCP5ES	16
F 8 DC 0	BCP5ES	16
F 8 DCOR	BKR5ES	35
F 8 DC 4	BCP5ES	16
F 8 DCX	BCP5ES-11	
F 8 DPER	IFR5D10	
F 8 DPP 332	IFR5D10	
F 8 KTCR	BKUR5ET	29
F 8 LCR	ZFR5F	
F 8 LCR 2	ZFR5F	
F 8 LDOR	BKR6EK	20
F 9 DC 0	BCPR4ES-11	
F 9 LCR	ZFR4F-11	
FGR 5 KQE 0	BKR7EQU	
FGR 6 HQE 0	ZFR6S-Q	
FGR 6 KQC	BKR6EQU	30



<b>BOSCH</b>	<b>→ NGK</b>	<b>V-Line</b>
FGR 6 KQE	BKR6EQUP	30
FGR 7 DPP 10	BKR6EIX-11P	
FGR 7 DQE+	BKR6EKUB	
FGR 7 DQEO	BKR6EKUB	
FGR 7 DQP	BKR6EQUP	30
FGR 7 DQP+	BKR6EQUP	30
FGR 7 KQC	BKR6EQUP	30
FGR 7 KQE	BKR6EQUP	30
FGR 7 KQE 0	BKR6EQUA	
FGR 8 KQE	BKR5EKUP	
FGR 8 KQE 0	BKR5EQUPA	
FGR 8 MQPE	PLFR5A-11	
FLR 8 LDCU	BKR5EK	23
FLR 8 LDCU+	BKR5EK	23
FQ 5 NIPP 332 S	PLFER7A8EG	
FQ 5 NPP 332 S	PLFER7A8EG	
FQR 8 DE	BKR6EZB	
FQR 8 LEU 2	ZFR5F-11	40
FR 5 DC	BCPR7ES	
FR 5 DCX	BCPR7ES-11	
FR 5 DTC	BCPR7ET	
FR 5 KPP 332 S	PFR7S8EG	
FR 5 LDC	BKR7EKC	
FR 6 D 133	IFR6J11	
FR 6 DC	BKR6ES	28
FR 6 DC+	BKR6ES	28
FR 6 DC 0	BKR6EK	20
FR 6 DC 2	BKR6ES	28
FR 6 DCX	BKR6ES-11	14
FR 6 DDC	BKR7EKC	
FR 6 DTC	BCPR6ET	
FR 6 DTCW	BKR5EKC	
FR 6 HI 332	PZFR6R	
FR 6 KDC	BKR6EZ	38
FR 6 KDC+	BKR6EZ	38
FR 6 KDE 0	BKR6EKE	
FR 6 KTC	BKUR6ET	27
FR 6 LDC	BKR6EK	20
FR 6 MPP 10	PLFR6A-11	
FR 6 MPP 332	ILFR6A	
FR 7 DC	BKR6ES	28
FR 7 DC+	BKR6ES	28
FR 7 DC 0	BKR6ES	28
FR 7 DC 2	BKR6ES	28
FR 7 DC 4	BKR6ES	28
FR 7 DCX	BKR6ES-11	14
FR 7 DCX+	BKR6ES-11	14
FR 7 DE	BKR6EZ	38
FR 7 DPP+	PFR6B	
FR 7 DPP 10	BKR6EIX	
FR 7 DPP 22U	PFR6N-11	
FR 7 DPP 33	PFR6Q	37

<b>BOSCH</b>	<b>→ NGK</b>	<b>V-Line</b>
FR 7 DQP	BKR6EQUP	30
FR 7 DTC	BCPR6ET	
FR 7 HC+	ZFR6T-11G	44
FR 7 HC 0 X	ZFR5E-11	
FR 7 HE 2	ZFR5P-G	41
FR 7 HPP 33+	PZFR5D-11	34
FR 7 KC	BKR6EY	
FR 7 KC+	BKR6EY	
FR 7 KCU	BKR6EYA-11	
FR 7 KCW	BKR6EP-13	
FR 7 KCX	BKR6EY-11	
FR 7 KCX+	BKR6EY-11	
FR 7 KDC	BKR6EZ	38
FR 7 KI30	FR6EI	
FR 7 KPP 33+	PFR6Q	37
FR 7 KPP 332	IZFR6H11	
FR 7 KPP 332 U	PFR6X-11	
FR 7 LC 2	BKR6ES	28
FR 7 LCX	ZFR6F-11	
FR 7 LCX+	ZFR6F-11	
FR 7 LDC	BKR6EK	20
FR 7 LDC+	BKR6EK	20
FR 7 LDU	BKR6EK	20
FR 7 ME	LFR6A	
FR 7 MPP 10	PLFR6A	
FR 7 NI 33	ILFR6B	
FR 7 NI 332S	ILFR6K8	
FR 7 NPP 332	ILZFR6D11	
FR 7 SI 30	ILZFR6C-11K	
FR 8 DC	BKR5ES	35
FR 8 DC+	BKR5ES	35
FR 8 DC 0	BKR5ES	35
FR 8 DCX	BKR5ES-11	33
FR 8 DCX+	BKR5ES-11	33
FR 8 DE	BKR5ES	35
FR 8 DPP 33	PFR5R-11	
FR 8 DPP 33+	PFR5R-11	
FR 8 DS	BKR5EIX	
FR 8 DX	BKR5ES-11	33
FR 8 HDC	BKR5EKB-11	
FR 8 HDC+	BKR5EKB-11	
FR 8 KCU	BKR5EYA-11	39
FR 8 KDC	BKR5EK	23
FR 8 LCX	ZFR6F-11	
FR 8 LDC	BKR5EK	23
FR 8 LDC 4	BKR5EK	23
FR 8 LTC	BKUR5ET-10	
FR 8 ME	LFR5B	
FR 8 SC+	LFR6B	
FR 8 SPP 332	ILFR5B11	
FR 9 DC	BKR5ES	35
FR 9 DCX	BCPR4ES-11	



<b>BOSCH</b>	<b>→ NGK</b>	<b>V-Line</b>
FR 9 HC	ZFR4F-11	
FR 10 DCX	BCPR4ES-11	
H 2 CS	B9EFS	
H 3 CS	B8EFS	
H 5 DC	BP7EFS	
H 5 DC 0	BP7EFS	
H 6 BC	BP6FS	
H 6 DC	BP6EFS	5
H 6 DC 0	BP6EFS	5
H 7 CC	BR6EF	
H 7 DC	BP6EFS	5
H 7 DC 0	BP6EFS	5
H 8 BC	BP5FS	
H 8 DC	BP5EFS	
H 8 DC 0	BP5EFS	
H 9 BC	BP4FS	
H 9 BCY	BPR4FS-15	
H 9 DC	BP5EFS	
H 9 DC0	BP5EFS	
H 10 BC	BP4FS	
H 10 C	BP4FS	
HGR 6 KQC	BUR6EFSZ	
HGR 7 KQC	BUR6EFSZ	
HLR 8 STEX	LTR6B-10T	
HR 6 BC	BPR6FS	
HR 6 DC	BPR6EFS	7
HR 6 DC+	BPR6EFS	7
HR 6 DS	BPR6EFS	7
HR 7 DC	BPR6EFS	7
HR 7 DC+	BPR6EFS	7
HR 7 DCX	BPR6EFS-13	
HR 7 DCX+	BPR6EFS-13	
HR 7 MPP+	PTR5A-13	25
HR 7 MPP 302	PTR5A-13	25
HR 7 MPP 302 X	PTR5A-13	25
HR 8 AC	BR5FS	
HR 8 ACY	BR5FS	
HR 8 BC	BPR5FS	
HR 8 BCY	BPR5FS-15	
HR 8 DC+	BPR5EFS	
HR 8 DPP 22U	PTR5D-10	31
HR 8 LCO	TR5-1	
HR 8 MCV+	TR5B-13	45
HR 8 MEV	TR5B-13	45
HR 9 AC	BR5FS	
HR 9 ACY	BR5FS	
HR 9 BC	BPR4FS	
HR 9 BC+	BPR4FS	
HR 9 BCY	BPR4FS-15	
HR 9 BCY+	BPR4FS-15	
HR 9 DC	BPR5EFS	
HR 9 DCX	BPR5EFS-13	

<b>BOSCH</b>	<b>→ NGK</b>	<b>V-Line</b>
HR 9 DCY+	TR55	
HR 10 AC	BR5FS	
HR 10 ACY	BR5FS	
HR 10 BC	BPR4FS	
HR 10 BCX	BPR4FS-11	
HR 10 BCY	BPR4FS-15	
HS 5 E	BM7F	
HS 8 E	BM6F	
M 4 AC	AB-7	
M 5 AC	AB-7	
M 7 AC	AB-7	
M 8 AC	AB-6	
M 8 AC0	AB-6	
M 10 AC	AB-6	
M 10 AC0	AB-6	
M 12 B	AP5FS	
U 3 CC	C7E	
U 4 AC	C6HSA	
U 5 AC	C5HSA	
U 6 AC	CR4HSA	
UR 2 AS	CR8HS	
UR 2 CC	CR8E	
UR 3 AC	CR7HSA	
UR 3 AS	CR7HS	
UR 3 CC	CR7E	
UR 4 AS	CR6HS	
UR 6 AC	CR6HS	
USR 7 AC	CMR6H	
VR 8 SE	LZKAR7A	
VR 8 SEW	LZKAR7A	
W 2 A	B9HS	
W 2 AC	B9HS	
W 2 AS	BR9HIX	
W 2 C	B10ES	
W 2 C 0	B10ES	
W 2 CC	B10ES	
W 2 CS	BR10EIX	
W 2 D	BP9ES	
W 3 A	B8HS	
W 3 A 0	B8HS	
W 3 AC	B8HS	
W 3 AP	B8HS	
W 3 AS	BR8HIX	
W 3 C	B9ES	
W 3 C0	B9ES	
W 3 CC	B9ES	
W 3 CP	B9ES	
W 3 CS	BR9EIX	
W 3 D	BP8ES	
W 3 DP	BPR8EIX	
W 3 DPO	BPR8EIX	
W 3 DP 2	BP8ES	



<b>BOSCH</b>	<b>→ NGK</b>	<b>V-Line</b>
W 4 A	B8HS	
W 4 A 1	B8HS	
W 4 A 2	B8HS	
W 4 A 5	B8HS	
W 4 AC	B8HS	
W 4 AP	B8HS	
W 4 AS	BR8HIX	
W 4 C	B8ES	
W 4 C 1	B8ES	
W 4 C 2	B7ES	
W 4 C 3	B7HS	
W 4 CC	B8ES	
W 4 CP	BR8EIX	
W 4 CPX	B8ES	
W 4 CS	BR8EIX	
W 4 DP	BPR7EIX	
W 4 DP 0	BPR8EIX	
W 4 E2	B7S	
W 5 A	B7HS	
W 5 AC	B7HS	
W 5 AP	B7HS	
W 5 AS	BR7HIX	
W 5 B	BP7HS	
W 5 BC	BP7HS	
W 5 BP	BP7HS	
W 5 C	B7ES	
W 5 CC	B7ES	
W 5 CCX	B7ES-11	
W 5 CP	B7ES	
W 5 CPX	B7ES-11	
W 5 CS	BR7EIX	
W 5 D	BP7ES	
W 5 D 1	BP7ES	
W 5 DC	BP7ES	
W 5 DC0	BP7ES	
W 5 DCX	BP7ES-11	
W 5 DP	BP7ES	
W 5 DPX	BP7ES-11	
W 5 DTC	BUR6ET	1
W 5 E	B7S	
W 5 EC	B7S	
W 5 EP	B7S	
W 6 AC	B6HS	
W 6 B	BP6HS	18
W 6 BC	BP6HS	18
W 6 BP	BP6HS	18
W 6 D	BP6ES	4
W 6 D 1	BP6ES	4
W 6 DC	BP6ES	4
W 6 DC 0	BP6ESZ	
W 6 DCX	BP6ES-11	
W 6 DP	BPR6EIX	

<b>BOSCH</b>	<b>→ NGK</b>	<b>V-Line</b>
W 6 DPX	BPR6EVX-11	
W 6 DTC	BUR6ET	1
W 6 LTCR	BUR6ET	1
W 7 A	B6HS	
W 7 A 0	B6HS	
W 7 AC	B6HS-5	
W 7 A0 0	B6HS	
W 7 AP	B6HS	
W 7 B	BP6HS	18
W 7 BC	BP6HS	18
W 7 BP	BP6HS	18
W 7 C	B6ES	
W 7 CC	B6ES	
W 7 CC 0	B6ES	
W 7 CCX	B6ES-11	
W 7 CP	B6ES	
W 7 CPX	B6ES-11	
W 7 CX	B6ES-11	
W 7 D	BP6ESZ	
W 7 D 0	BP6ES	4
W 7 DC	BP6ES	4
W 7 DC 0	BP6ESZ	
W 7 DCR	BPR6ES	2
W 7 DCX	BP6ES-11	
W 7 DP	BP6ES	4
W 7 DPX	BP6ES-11	
W 7 DTC	BUR6ET	1
W 7 DX	BP6ES-11	
W 7 E	B6S	
W 7 EC	B6S	
W 7 EP	B6S	
W 7 F	BP6S	
W 7 FC	BP6S	
W 7 LTCR	BUR6ET	1
W 8 A	B5HS	
W 8 A 0	B5HS	
W 8 AC	B5HS	
W 8 AP	B5HS	
W 8 B	BP5HS	
W 8 BC	BP5HS	
W 8 BP	BP5HS	
W 8 C	B5ES	
W 8 C 0	B5ES	
W 8 CC	B5ES	
W 8 CCX	B5ES	
W 8 CP	B5ES	
W 8 D	BP5ES	8
W 8 DC	BP5ES	8
W 8 DC 0	BP5ES	8
W 8 DCX	BP5ES-11	
W 8 DCY	BP5ES-13	
W 8 DP	BP5ES	8



<b>BOSCH</b>	<b>→ NGK</b>	<b>V-Line</b>
W 8 DPX	BP5ES-11	
W 8 DTC	BP5ET	
W 8 DX	BP5ES-11	
W 8 E	B6S	
W 8 EC	B6S	
W 8 F	BP5S	
W 8 FC	BP5S	
W 8 LCR	ZGR5A	15
W 8 LDCR	BUR6ET	1
W 8 LPR	ZGR5A	15
W 8 LTCR	BUR5ET-10	21
W 9 A	B-4H	
W 9 A0	B-4H	
W 9 AC	B5HS	
W 9 AC 0	B5HS	
W 9 C	B4ES	
W 9 CC	B4ES	
W 9 D	BP5ES	8
W 9 DC	BP5ES	8
W 9 DC0	BP5ES	8
W 9 DCX	BP5ES-11	
W 9 DP	BP5ES	8
W 9 DPX	BP5ES-11	
W 9 DTC	BP5ET	
W 9 E	B-4	
W 9 E0	B4-LM	
W 9 EC	B-4	
W 9 EC 0	B4-LM	
W 9 F	BP5S	
W 9 FC	BP5S	
W 9 LC	ZGR5A	15
W 06 CS	B11EGV	
W 07 AS	BR10HIX	
W 07 CS	B10EGV	
W 08 AS	BR9HIX	
W 08 CS	B10EGV	
W 10 A	B-4H	
W 10 AC	B-4H	
W 10 C	B4ES	
W 10 CC	B4ES	
W 10 D	BP4ES	
W 10 DC	BP4ES	
W 10 E	B-4	
W 10 EC	B-4	
W 10 F	BP-4	
W 10 FC	BP-4	
W 12 A	B-4H	
W 12 E	B-2	
W 45 T1	B-4H	
W 45 T3	B-4	
W 95 T1	B-4H	
W 95 T2	B4ES	

<b>BOSCH</b>	<b>→ NGK</b>	<b>V-Line</b>
W 95 T3	B-4	
W 95 T6	BP-4	
W 95 T30	BP4ES	
W 95 TR6	BP-4	
W 125 T1	B-4H	
W 125 T2	B4ES	
W 125 T3	B-4	
W 125 T4	B-4H	
W 125 T6	BP5S	
W 125 T30	BP5ES	8
W 125 TR2	BR5ES	
W 125 TR3	BR6S	
W 125 TR6	BP5S	
W 125 TR30	BPR5ES	6
W 145 M1	B5HS	
W 145 M2	B5ES	
W 145 T1	B5HS	
W 145 T2	B5ES	
W 145 T3	B6S	
W 145 T6	BP5S	
W 145 T11	B5HS	
W 145 T30	BP5ES	8
W 145 T35	BP5HS	
W 145 TR2	BR5ES	
W 145 TR3	BR6S	
W 145 TR6	BP5S	
W 145 TR30	BPR5ES	6
W 160 T2	B6ES	
W 160 T30	BP5ES	8
W 175 T1	B6HS	
W 175 T2	B6ES	
W 175 T3	B6S	
W 175 T6	BP6S	
W 175 T7	BP6HS	18
W 175 T30	BP6ES	4
W 175 T35	BP6HS	18
W 175 TR1	BR6HS	
W 175 TR2	BR6ES	
W 175 TR30	BPR6ES	2
W 175 TR35	BPR6HS	3
W 175 Z1	B6HS	
W 190 M11S	BR6HIX	
W 200 T27	BP6ES	4
W 200 T30	BP6ES	4
W 200 T35	BP6HS	18
W 200 TR30	BPR6ES	2
W 215 P21	BPR7EIX	
W 215 T30	BP6ES	4
W 220 T30	BP6ES	4
W 225 S1S	BR7HIX	
W 225 S2S	BR7EIX	
W 225 T1	B7HS	



<b>BOSCH</b>	<b>→ NGK</b>	<b>V-Line</b>
W 225 T2	B7ES	
W 225 T3	B7S	
W 225 T7	BPR7HS	
W 225 T30	BP8ES	
W 225 T35	BP7HS	
W 225 TR1	BR7HS	
W 225 TR2	BR7ES	
W 225 TR30	BPR7ES	19
W 230 T30	BP7ES	
W 235 P21	BP7ES	
W 235 T28	BP8ES	
W 240 M1	B8HS	
W 240 MZ1	B8HS	
W 240 T1	B8HS	
W 240 T2	B8ES	
W 240 T3	B7S	
W 240 T28	B8ES	
W 250 P21	BP7ES	
W 250 T1	B8HS	
W 250 T2	B8ES	
W 250 TR2	BR8ES	
W 255 T30	BP7ES	
W 260 M1	B8HS	
W 260 MZ1	B8HS	
W 260 MZ2	B9ES	
W 260 S1S	BR8HIX	
W 260 S2S	BR8EIX	
W 260 T1	B8HS	
W 260 T2	B8ES	
W 260 T20	B8ES	
W 260 T30	BP8ES	
W 265 P21	BPR9EIX	
W 275 T1	B8HS	
W 275 T2	B9ES	
W 280 MZ1	B8HS	
W 280 MZ2	B9ES	
W 280 P21	BP8ES	
W 280 S1S	BR9HIX	
W 280 S2S	BR9EIX	
W 280 T30	BP8ES	
W 300 MZ2	B10ES	
W 300 T1	B9HS	
W 300 T2	B10ES	
W 300 T30	BP9ES	
W 310 S1S	BR9HIX	
W 310 S2S	BR10EIX	
W 330 T1	B9HS	
W 340 S1S	BR9HIX	
W 340 S2S	B10EGV	
W 370 S1S	BR10HIX	
W 370 S2S	B10EGV	
W 400 S1S	BR10HIX	

<b>BOSCH</b>	<b>→ NGK</b>	<b>V-Line</b>
W 400 S2S	B11EGV	
WA 95 T40	BP4FS	
WA 95 TR4	BR5FS	
WA 95 TR40	BPR4FS	
WA 125 T30	BP5EFS	
WA 125 T40	BP4FS	
WA 125 TR4	BR5FS	
WA 125 TR30	BPR5EFS	
WA 125 TR40	BPR4FS	
WA 145 T40	BP5FS	
WA 145 TR4	BR5FS	
WA 145 TR40	BPR5FS	
WA 175 T30	BP6EFS	5
WA 200 T30	BP6EFS	5
WA 200 T40	BP6FS	
WA 200 TR30	BPR6EFS	7
WA 200 TR40	BPR6FS	
WA 225 T30	BP7EFS	
WAK 145 T3	BM6F	
WAK 225 T3	BM7F	
WEA	BUH	
WEC	BUE	
WET 1	BUH	
WET 2	BUE	
WG 235 T28	BP7ES	
WG 250 P21	BPR9EIX	
WG 250 T28	BPR8EIX	
WG 250 T30	BP8ES	
WG 265 T2SP	BPR9EIX	
WKA 145 T3	BM6A	
WKA 145 T6	BPM6A	
WKA 145 TR6	BPMR6A	
WKA 175 T3	BM6A	
WKA 175 T6	BPM6A	
WKA 200 TR6	BPMR6A	
WKA 225 T3	BM7A	
WKA 225 T6	BPM7A	
WR 2 CC	BR10ES	
WR 3 CC	BR9ES	
WR 3 CS	BR9EIX	
WR 3 CTC	BR9ET	
WR 4 AC	BR8HS	
WR 4 CC	BR8ES	
WR 5 A	BR7HS	
WR 5 AC	BR7HS	
WR 5 C	BR7ES	
WR 5 CC	BR7ES	
WR 5 DC	BPR7ES	19
WR 5 DC+	BPR7ES	19
WR 5 DS	BPR7EIX	
WR 6 BC	BPR6HS	3
WR 6 DC	BPR6ES	2



<b>BOSCH</b>	<b>→ NGK</b>	<b>V-Line</b>
WR 6 DC+	BPR6ES	2
WR 6 DCX	BPR6ES-11	13
WR 6 DS	BPR6EIX	
WR 6 DTC	BUR6ET	1
WR 7 A	BR6HS	
WR 7 AC	BR6HS	
WR 7 BC	BPR6HS	3
WR 7 BC+	BPR6HS	3
WR 7 C	BR6ES	
WR 7 CC	BR6ES	
WR 7 CCX	BR6ES-11	
WR 7 DC	BPR6ES	2
WR 7 DC+	BPR6ES	2
WR 7 DC2	BPR6ES	2
WR 7 DCX	BPR6ES-11	13
WR 7 DCX+	BPR6ES-11	13
WR 7 DS	BPR6EIX	
WR 7 DTC	BUR6ET	1
WR 7 EC	BR6S	
WR 7 F	BP6S	
WR 7 LTC+	BUR6ET	1
WR 8 AC	BR5HS	
WR 8 BC	BPR5HS	
WR 8 BC+	BPR5HS	
WR 8 C	BR5ES	
WR 8 CC	BR5ES	
WR 8 DC	BPR5ES	6
WR 8 DC+	BPR5ES	6
WR 8 DC0	BPR5ES	6
WR 8 DC4	BPR5ES	6
WR 8 DCX	BPR5ES-11	
WR 8 DCX+	BPR5ES-11	
WR 8 DPY	BPR5ES-13	
WR 8 DS	BPR5EIX	
WR 8 E	BR6S	
WR 8 EC	BR6S	
WR 8 EP	BR6S	
WR 8 F	BP5S	
WR 8 FC	BP5S	
WR 8 FP	BP5S	
WR 8 FPY	BP5S	
WR 8 HP	ZGR5C	
WR 8 LC+	ZGR5A	15
WR 8 LTC+	BUR5ET-10	21
WR 9 A0	BR5HS	
WR 9 C	BR5ES	
WR 9 CC	BR5ES	
WR 9 DC	BPR5ES	6
WR 9 DC+	BPR5ES	6
WR 9 DCX	BPR5ES-11	
WR 9 DCX+	BPR5ES-11	
WR 9 DCY	BPR5ES-13	

<b>BOSCH</b>	<b>→ NGK</b>	<b>V-Line</b>
WR 9 DS	BPR5EIX	
WR 9 DY	BPR5ES-13	
WR 9 E	BR6S	
WR 9 E0	BR6S	
WR 9 EC	BR6S	
WR 9 ECO	BR6S	
WR 9 F	BP5S	
WR 9 FC	BP5S	
WR 9 FCY	BP5S	
WR 9 FY	BP5S	
WR 9 H	ZGR5C	
WR 9 HC	ZGR5C	
WR 9 HP	ZGR5C	
WR 9 LC	ZGR5A	15
WR 9 LS	ZGR5A	15
WR 10 A	BR4HS	
WR 10 AC	BR4HS	
WR 10 E	BR6S	
WR 10 F	BP-4	
WR 10 FC	BP-4	
WR 10 FCY	BP-4	
WR 10 FY	BP-4	
WR 10 LC	ZGR5B	
WR 10 LCV	BPR4ES-13	
WR 11 E 0	BR4-LM	
WS 5 E	BM7A	
WS 5 F	BPM7A	
WS 6 E	BM6A	
WS 6 F	BPM6A	
WS 7 E	BM6A	
WS 7 F	BPM6A	
WS 8 E	BM6A	
WS 8 F	BPM6A	
WS 9 EC	BM4A	
WSR 5 F	BPMR7A	
WSR 6 E	BMR6A	
WSR 6 F	BPMR7A	
WSR 7 F	BPMR6A	
WSR 9 E	BMR4A	
WSR 9 EC	BMR4A	
X 3 CP 0	D9EA	
X 4 CS	D8EA	
X 5 CC	D8EA	
X 5 DC	DP7EA-9	
XR 2 AS	DR8HS	
XR 2 CS	DR8ES	
XR 4 AS	DR8HS	
XR 4 CS	DR8ES	
XR 4 DC	DPR8EA-9	
XR 5 DC	DPR7EA-9	
XR 6 CC	DR7EA	
XR 7 LDC	DPR7EA-9	



<b>BOSCH</b>	<b>→ NGK</b>	<b>V-Line</b>
Y 5 KPP 332 S	PZKER7A8EGS	
YR 5 DDE	KR9CI	
YR 5 LDE	DCPR8EKC	
YR 6 LDE	DCPR8EKC	
YR 6 NPP 332	PLKR7B8E	
YR 6 TII 330 T	ILZKR7A	
YR 7 DC+	ZKR7A-10	42
YR 7 DE	DCPR8E-N	
YR 7 MPP 33	PLKR7A	
ZMR 5 TPP 33	SILZKBR8D8S	
ZQR 8 SI 302	PLZKBR7B8DG	
ZR 7 SI 332 S	PLZKBR7B8DG	
+1	BPR6ES	2
+2	BUR6ET	1
+3	BPR5ES	6
+4	BUR5ET-10	21
+5	BPR6EFS	7
+6	BKR5ES	35
+7	BKR6EK	20
+8	BKR6ES	28
+9	BKR5EK	23
+10	BPR6HS	3
+11	BKR6ES-11	14
+12	BPR6ES	2
+13	BKR6ES	28
+14	BPR5EFS	
+15	BPR7ES	19
+16	BPR5ES	6
+17	PTR5A-13	25
+18	BPR6EFS	7
+19	BKR5ES-11	33
+20	BPR5HS	
+21	BPR6ES-11	13
+22	BPR5ES-11	
+23	BKR6EKUB	
+24	PFR6B	
+25	BPR4FS	
+26	TR55	
+27	BPR5ES-11	
+31	BKR6EY-11	
+32	ZFR6F-11	
+33	BPR4FS-15	
+34	ZGR5A	15
+36	BKR5EKB-11	
+39	TR5B-13	45
+41	ZKR7A-10	42
+42	LFR6B	
+45	PFR5R-11	
+46	BPR6EFS-13	
+47	BKR6EY	
+48	BKR6EQUP	30
+50	PFR6Q	37

<b>BOSCH</b>	<b>→ NGK</b>	<b>V-Line</b>
+51	ZFR6T-11G	44
+52	PZFR5D-11	34
+53	BKR6EZ	38
0 241 040 501	CR4HSA	
0 241 045 001	C5HSA	
0 241 045 003	C5HSA	
0 241 045 502	C5HSA	
0 241 050 002	C6HSA	
0 241 056 501	C7E	
0 241 140 522	SILZKFR8D7S	
0 241 145 003	DP7EA-9	
0 241 145 500	DP7EA-9	
0 241 145 504	DP7EA-9	
0 241 145 507	D8EA	
0 241 145 515	PZKER7A8EGS	
0 241 150 502	D8EA	
0 241 200 500	BUH	
0 241 209 003	B-4H	
0 241 219 536	BP-4	
0 241 219 537	BP4FS	
0 241 219 540	B-4H	
0 241 219 541	B4ES	
0 241 219 542	BP4ES	
0 241 219 543	B-4H	
0 241 219 554	B-4	
0 241 219 555	BP4ES	
0 241 225 013	BP5ES	8
0 241 225 543	BP4FS	
0 241 225 545	BP5ES	8
0 241 225 547	B4ES	
0 241 225 548	B-4	
0 241 225 549	B5HS	
0 241 225 550	BP5ES	8
0 241 225 551	B4-LM	
0 241 225 555	BPR4FS-15	
0 241 225 556	BP5ES	8
0 241 225 558	BP5EFS	
0 241 225 573	BP5EFS	
0 241 225 574	BCPR4ES-11	
0 241 225 576	BP5ET	
0 241 225 582	BP5ES-11	
0 241 225 585	ZGR5A	15
0 241 225 589	BM4A	
0 241 225 590	B4-LM	
0 241 225 593	BP5ES	8
0 241 229 059	ZGR5A	15
0 241 229 060	BP5ET-10	
0 241 229 061	BP5ES	8
0 241 229 062	BP5ES	8
0 241 229 541	BM6F	
0 241 229 560	BM6A	
0 241 229 561	BPM6A	





<b>BOSCH</b>	<b>→ NGK</b>	<b>V-Line</b>
0 241 229 574	BP5ES	8
0 241 229 578	BP5HS	
0 241 229 579	B5ES	
0 241 229 580	B6S	
0 241 229 588	BP5ES	8
0 241 229 593	BP5S	
0 241 229 594	BP5FS	
0 241 229 596	BP5ES-11	
0 241 229 604	B5HS	
0 241 229 612	B5HS	
0 241 229 617	BP5EFS	
0 241 229 619	BP5ET	
0 241 229 634	BCP5ES	16
0 241 229 639	ZFR5F	
0 241 229 641	BP5HS	
0 241 229 649	BP5EFS	
0 241 229 657	ZFR5F	
0 241 229 661	BUR6ET	1
0 241 229 663	BUR5ET-10	21
0 241 229 665	BUR5ET	22
0 241 229 666	BKR6EK	20
0 241 229 676	BKUR5ET	29
0 241 229 682	BCP5ES-11	
0 241 229 684	BKR5ES	35
0 241 229 704	IFR5D10	
0 241 229 712	BCP5ES	16
0 241 229 713	BCP5ES	16
0 241 229 714	BP5HS	
0 241 229 715	BP5ES	8
0 241 229 716	BP5ET	
0 241 229 926	BP5ES	8
0 241 235 089	B6ES	
0 241 235 098	B6ES	
0 241 235 099	BPR6ES	2
0 241 235 103	BP6ESZ	
0 241 235 108	BCP6ET	
0 241 235 563	BP6ES	4
0 241 235 564	BP6HS	18
0 241 235 566	BM6A	
0 241 235 567	BPM6A	
0 241 235 574	B6ES	
0 241 235 585	BP6HS-10	
0 241 235 594	B6S	
0 241 235 602	BP6ES	4
0 241 235 607	B6HS-5	
0 241 235 610	BP6ES-11	
0 241 235 619	B6HS-5	
0 241 235 623	BP6S	
0 241 235 633	BUR6ET	1
0 241 235 635	BP6EFS	5
0 241 235 636	BP6EFS	5
0 241 235 638	BR6EF	

<b>BOSCH</b>	<b>→ NGK</b>	<b>V-Line</b>
0 241 235 643	BUR6ET	1
0 241 235 668	BP6EFS	5
0 241 235 673	BCP6ES	17
0 241 235 674	ZFR6A-11	
0 241 235 676	BCP6ES	17
0 241 235 681	BP6EFS	5
0 241 235 685	BCP6ES-11	
0 241 235 690	BKR6EK	20
0 241 235 692	ZFR6F-11	
0 241 235 693	BP6ESZ	
0 241 235 698	BUR6ET	1
0 241 235 705	BP6ESZ	
0 241 235 706	BKUR6ET-10	24
0 241 235 706	BKUR6ET-10	24
0 241 235 715	PZFR5D-11	34
0 241 235 735	ZFR5P-G	41
0 241 235 736	BKR6ES	28
0 241 235 739	IFR6D10	
0 241 235 750	BCP6ES	17
0 241 235 751	BKR6EK	20
0 241 235 752	BKUR6ET-10	24
0 241 235 752	BKUR6ET-10	24
0 241 235 753	BP6EFS	5
0 241 235 754	BP6HS	18
0 241 235 755	BP6ES	4
0 241 235 756	BUR6ET	1
0 241 235 757	BUR6ET	1
0 241 240 057	BP6ESZ	
0 241 240 058	BP6ESZ	
0 241 240 524	BP6EFS	5
0 241 240 530	BP6ES	4
0 241 240 532	BP6HS	18
0 241 240 539	BP6ES	4
0 241 240 542	BCP6ES	17
0 241 240 543	BP6FS	
0 241 240 558	BUR6ET	1
0 241 240 563	BP6EFS	5
0 241 240 564	BCP6ET	
0 241 240 569	BCP6ES-11	
0 241 240 574	BP6ES-11	
0 241 240 578	BP6EFS	5
0 241 240 585	BKR6EIX	
0 241 240 587	BKR6ES	28
0 241 240 592	BKUR7ET	
0 241 240 600	BM6A	
0 241 240 601	BPM6A	
0 241 240 603	B6HS	
0 241 240 608	BCP6ES	17
0 241 240 609	BCP6ET	
0 241 240 611	BP6ES	4
0 241 240 631	ILFR6A	
0 241 243 501	BPR6EIX	



<b>BOSCH</b>	<b>→ NGK</b>	<b>V-Line</b>
0 241 245 070	BUR6ET	1
0 241 245 539	BM7F	
0 241 245 552	BP7ES	
0 241 245 553	BP7HS	
0 241 245 554	BM7A	
0 241 245 555	BPM7A	
0 241 245 570	BP7EFS	
0 241 245 574	BR7HIX	
0 241 245 575	BR7EIX	
0 241 245 580	B7HS	
0 241 245 581	B7ES	
0 241 245 592	B7S	
0 241 245 599	BP7ES	
0 241 245 602	B7HS	
0 241 245 603	B7ES	
0 241 245 619	BP7HS	
0 241 245 636	BP7EFS	
0 241 245 641	PFR7B	
0 241 245 642	BCP7ES	
0 241 245 646	BP7HS-10	
0 241 245 655	BCP7ES	
0 241 245 656	BP7HS	
0 241 245 673	PLFER7A8EG	
0 241 247 500	BPR7EIX	
0 241 248 531	B8HS	
0 241 248 534	B8ES	
0 241 248 538	B8ES	
0 241 248 540	B8HS	
0 241 250 502	BPR8EIX	
0 241 250 512	BPR8EIX	
0 241 250 526	R7433-8	
0 241 252 521	BR8HIX	
0 241 252 522	BR8EIX	
0 241 255 505	B8EFS	
0 241 255 507	R7433-9	
0 241 256 512	B8HS	
0 241 256 513	B9ES	
0 241 256 514	BR8HIX	
0 241 256 515	BR9EIX	
0 241 256 517	BPR8EIX	
0 241 256 519	B8HS	
0 241 256 522	B9ES	
0 241 260 507	B9HS	
0 241 260 508	B10ES	
0 241 260 510	B9EFS	
0 241 260 512	R7433-9	
0 241 262 505	BR9HIX	
0 241 262 506	BR10EIX	
0 241 268 505	BR9HIX	
0 241 268 506	B10EGV	
0 241 274 504	BR10HIX	
0 241 274 505	B10EGV	

<b>BOSCH</b>	<b>→ NGK</b>	<b>V-Line</b>
0 241 280 503	B11EGV	
0 241 309 501	AP5FS	
0 241 319 510	AP5FS	
0 241 319 512	AB-6	
0 241 319 513	AB-6	
0 241 325 509	AP5FS	
0 241 329 520	AP5FS	
0 241 329 525	AB-6	
0 241 329 526	AB-6	
0 241 335 516	AP6FS	
0 241 335 520	A6FS	
0 241 335 524	AB-7	
0 241 335 526	AB-7	
0 241 335 528	AP6FS	
0 241 340 501	AP6FS	
0 241 345 512	AB-7	
0 241 350 505	AB-7	
0 242 035 500	CMR6H	
0 242 040 500	CR6HS	
0 242 050 500	CR6HS	
0 242 055 500	CR7HS	
0 242 055 501	CR7HSA	
0 242 055 502	CR7E	
0 242 055 505	CR7HSA	
0 242 060 500	CR8HS	
0 242 060 501	CR8E	
0 242 129 503	LZKAR7A	
0 242 129 508	LZKAR7A	
0 242 129 512	PLZKBR7B8DG	
0 242 129 804	PLZKBR7B8DG	
0 242 135 500	DPR7EA-9	
0 242 135 501	DCPR8E-N	
0 242 135 509	PLKR7A	
0 242 135 515	ZKR7A-10	42
0 242 135 518	PLZKBR7B8DG	
0 242 140 500	DR7EA	
0 242 140 504	DCPR8EKC	
0 242 140 512	PLKR7B8E	
0 242 140 528	ILZKR7A	
0 242 145 500	DPR7EA-9	
0 242 145 501	DPR7EA-9	
0 242 145 503	DCPR8EKC	
0 242 145 504	KR9CI	
0 242 145 516	DPR7EA-9	
0 242 145 517	SILZKBR8D8S	
0 242 150 500	DR8HS	
0 242 150 501	DR8ES	
0 242 150 505	DPR8EA-9	
0 242 160 501	DR8ES	
0 242 215 502	BR4-LM	
0 242 219 004	BR4HS	
0 242 219 511	BPR4FS-15	



<b>BOSCH</b>	<b>→ NGK</b>	<b>V-Line</b>
0 242 219 512	BP-4	
0 242 219 513	BP-4	
0 242 219 514	BR5FS	
0 242 219 515	BR5FS	
0 242 219 516	BPR4FS	
0 242 219 517	BPR4FS-11	
0 242 219 519	BCPR4ES-11	
0 242 219 520	BP-4	
0 242 219 529	ZGR5B	
0 242 219 530	BPR4ES-13	
0 242 225 522	BR6S	
0 242 225 523	BR5ES	
0 242 225 524	BPR5ES	6
0 242 225 525	BPR5ES-13	
0 242 225 526	BP5S	
0 242 225 527	BP5S	
0 242 225 528	ZGR5C	
0 242 225 529	BR5FS	
0 242 225 530	BR5FS	
0 242 225 531	BPR4FS	
0 242 225 532	BPR4FS-15	
0 242 225 533	BPR5EFS	
0 242 225 534	BPR5EFS-13	
0 242 225 536	BR6S	
0 242 225 537	ZFR4F-11	
0 242 225 538	BPR5EIX	
0 242 225 539	ZGR5A	15
0 242 225 548	BPR5ES-11	
0 242 225 549	BCPR4ES-11	
0 242 225 550	BPR5ES	6
0 242 225 553	BPR5ES	6
0 242 225 554	BPR5ES-11	
0 242 225 560	BPR4FS-11	
0 242 225 563	BP5S	
0 242 225 564	BP5S	
0 242 225 566	BPR4FS-15	
0 242 225 571	TR5IX	
0 242 225 573	BPR4FS	
0 242 225 578	TR55IX	
0 242 225 582	BKR5ES	35
0 242 225 599	BPR5ES	6
0 242 225 612	BMR4A	
0 242 225 622	BPR4FS	
0 242 225 623	TR55	
0 242 225 624	BPR5ES-11	
0 242 225 641	BPR4FS-15	
0 242 225 859	BPR5ES	6
0 242 225 861	BPR5ES	6
0 242 229 524	BR6S	
0 242 229 525	BP5S	
0 242 229 526	BR5FS	
0 242 229 528	BPR5FS	

<b>BOSCH</b>	<b>→ NGK</b>	<b>V-Line</b>
0 242 229 529	BPR5FS-15	
0 242 229 530	BKR5ES-11	33
0 242 229 531	BPR5ES	6
0 242 229 533	BR5ES	
0 242 229 534	BR5HS	
0 242 229 537	BPR5EIX	
0 242 229 538	BPR5ES	6
0 242 229 543	BKR5ES-11	33
0 242 229 544	ZFR5F-11	40
0 242 229 548	BPR5FS	
0 242 229 549	BPR5FS-11	
0 242 229 555	BPR5ES	6
0 242 229 556	BR5ES	
0 242 229 557	BPR5ES-11	
0 242 229 566	BPR5ES-11	
0 242 229 568	BKR5ES	35
0 242 229 570	BPR5ES	6
0 242 229 576	ZFR6F-11	
0 242 229 587	BKR5ES	35
0 242 229 589	BPR5HS	
0 242 229 591	BKR5EK	23
0 242 229 594	BKR5ES	35
0 242 229 598	BKR5EIX	
0 242 229 605	BKR5EK	23
0 242 229 607	BPR5ES	6
0 242 229 610	BPR5HS	
0 242 229 613	BKR5EKUP	
0 242 229 625	BKUR5ET-10	
0 242 229 626	BKR5EK	23
0 242 229 628	BKR5EK	23
0 242 229 630	LFR5B	
0 242 229 634	PLFR5A-11	
0 242 229 635	BKR5EYA-11	39
0 242 229 641	PTR5D-10	31
0 242 229 648	BKR5EQUPA	
0 242 229 650	TR5B-13	45
0 242 229 654	BKR5EK	23
0 242 229 655	BPR5EFS	
0 242 229 656	BPR5ES	6
0 242 229 657	BPR5HS	
0 242 229 658	BUR5ET-10	21
0 242 229 659	BKR5ES	35
0 242 229 660	BKR5ES-11	33
0 242 229 661	LTR6B-10T	
0 242 229 671	BKR5EKB-11	
0 242 229 673	BKR5ES	35
0 242 229 687	BPR5ES-11	
0 242 229 699	ZFR5F-11	40
0 242 229 708	ILFR5B11	
0 242 229 713	PFR5R-11	
0 242 229 724	BKR6EZB	
0 242 229 779	ZGR5A	15



<b>BOSCH</b>	<b>→ NGK</b>	<b>V-Line</b>
0 242 229 781	BKR5EKB-11	
0 242 229 782	BKR5EKB-11	
0 242 229 785	TR5B-13	45
0 242 229 797	LFR6B	
0 242 229 878	BKR5EK	23
0 242 229 879	BPR5EFS	
0 242 229 880	BPR5ES	6
0 242 229 881	BPR5HS	
0 242 229 882	BUR5ET-10	21
0 242 229 883	BKR5ES	35
0 242 229 884	BKR5ES-11	33
0 242 229 885	BPR5ES-11	
0 242 229 887	BKR5EK	23
0 242 229 888	BKR5ES	35
0 242 229 902	TR5B-13	45
0 242 229 923	LFR6B	
0 242 229 925	PFR5R-11	
0 242 229 982	BPR5ES	6
0 242 230 500	PFR5R-11	
0 242 230 806	ZFR5F-11	40
0 242 235 511	BPR6ES	2
0 242 235 522	BPR6HS	3
0 242 235 525	BPR6EIX	
0 242 235 529	BPR6ES	2
0 242 235 530	BPR6ES-11	13
0 242 235 532	BR6ES	
0 242 235 533	BR6HS	
0 242 235 535	BPR6HS	3
0 242 235 537	BPR6ES	2
0 242 235 538	BPR6EFS	7
0 242 235 541	BPR6EIX	
0 242 235 542	BPR6EFS	7
0 242 235 543	BR6ES-11	
0 242 235 544	BKR6ES-11	14
0 242 235 545	BR6ES-11	
0 242 235 546	BR6ES	
0 242 235 547	BKR6ES-11	14
0 242 235 551	BKR6ES	28
0 242 235 554	BR6S	
0 242 235 556	BKR6ES	28
0 242 235 564	BCPR6ET	
0 242 235 567	ZFR6F-11	
0 242 235 571	BUR6ET	1
0 242 235 579	BKR6ES	28
0 242 235 587	BKR6ES	28
0 242 235 588	BKR6ES	28
0 242 235 589	BKR6EK	20
0 242 235 590	BUR6ET	1
0 242 235 592	BPR6EFS-13	
0 242 235 597	BKR6ES	28
0 242 235 599	BKR6EY	
0 242 235 602	BKR6EY-11	

<b>BOSCH</b>	<b>→ NGK</b>	<b>V-Line</b>
0 242 235 605	BKR6EK	20
0 242 235 607	BUR6EFSZ	
0 242 235 609	BKR6EZ	38
0 242 235 610	BKR6EP-13	
0 242 235 616	BKR6ES	28
0 242 235 617	BKR6EQUP	30
0 242 235 624	BKR6ES	28
0 242 235 630	BPR6ES	2
0 242 235 636	LFR6A	
0 242 235 640	BKR6EZ	38
0 242 235 642	BKR6EKUB	
0 242 235 651	BPMR6A	
0 242 235 656	BKR6EQUP	30
0 242 235 659	BKR6EYA-11	
0 242 235 661	BPR6EFS	7
0 242 235 662	PTR5A-13	25
0 242 235 663	BPR6ES	2
0 242 235 664	BUR6ET	1
0 242 235 665	BPR6HS	3
0 242 235 666	BKR6ES	28
0 242 235 667	BKR6ES-11	14
0 242 235 668	BKR6EK	20
0 242 235 690	PFR6N-11	
0 242 235 692	ZFR5E-11	
0 242 235 699	BKR6EIX	
0 242 235 707	BPR6ES-11	13
0 242 235 715	BKR6EQUA	
0 242 235 740	PFR6Q	37
0 242 235 743	PLFR6A	
0 242 235 748	BKR6EKUB	
0 242 235 749	PFR6B	
0 242 235 761	ZFR5P-G	41
0 242 235 767	PTR5A-13	25
0 242 235 769	ILZFR6C-11K	
0 242 235 776	IZFR6H11	
0 242 235 908	BPR6EFS	7
0 242 235 909	BPR6ES	2
0 242 235 910	BUR6ET	1
0 242 235 911	BPR6HS	3
0 242 235 912	BKR6ES	28
0 242 235 913	BKR6ES-11	14
0 242 235 914	BKR6EK	20
0 242 235 915	BPR6ES-11	13
0 242 235 916	PTR5A-13	25
0 242 235 917	BKR6EKUB	
0 242 235 918	PFR6B	
0 242 235 925	BKR6ES	28
0 242 235 930	BPR6ES	2
0 242 235 931	BUR6ET	1
0 242 235 979	BPR6EFS-13	
0 242 235 980	BKR6EY	
0 242 235 981	BKR6EQUP	30





<b>BRISK</b>	<b>→ NGK</b>	<b>V-Line</b>
D 15 Y	BCP6ES	17
D 15 YC	BCP6ES	17
D 17 Y	BCP5ES	16
D 17 YC	BCP5ES	16
DOX 15 LE 1	ZFR6T-11G	44
DR 12 YC	BKR7E	
DR 14 YC	BKR7E	
DR 14 ZC	ZFR7F-11	
DR 14 ZC 1	BCPR7ES-11	
DR 15 TC	BKUR5ET-10	
DR 15 YC	BKR6ES	28
DR 15 Z	BKR6ES	28
DR 15 Z 1	BKR6ES-11	14
DR 17 YC	BKR5ES	35
F 14 YC	AP7FS	
F 15 YC	AP6FS	
FR 14 YC	APR6FS	
FR 15 YC	APR6FS	
G 12 YC	BP7EFS	
G 14 Y	BP7EFS	
G 14 YC	BP7EFS	
G 15 Y	BP6EFS	5
G 15 YC	BP6EFS	5
G 17 Y	BP5EFS	
G 17 YC	BP5EFS	
GR 15 YC	BPR6EFS	7
GR 17 YC	BPR5EFS	
J 17	B4-LM	
J 19	B2-LM	
JR 17	BR4-LM	
JR 19	BR2-LM	
K 15 YC	BP6S	
K 17 C	B6S	
K 17 Y	BP5S	
K 19	B-4	
L 08 JW	B10EGV	
L 08 W	B11EGV	
L 10 JW	B8EGV	
L 12 W	BR9EIX	
L 12 Y	BP8ES	
L 12 YC	BP8ES	
L 14	B8ES	
L 14 C	B8ES	
L 14 Y	BP7ES	
L 14 YC	BP7ES	
L 15	B7ES	
L 15 C	B7ES	
L 15 W	BR7EIX	
L 15 Y	BP6ES	4
L 15 YC	BP6ES	4
L 17	B6ES	
L 17 C	B6ES	

<b>BRISK</b>	<b>→ NGK</b>	<b>V-Line</b>
L 17 W	BR7EIX	
L 17 Y	BP5ES	8
L 17 YC	BP5ES	8
L 19 C	B5ES	
LR 12 YC	BPR8ES	
LR 12 ZC	BPR8ES	
LR 14 TXS	BUR6ET	1
LR 14 YC	BPR7ES	19
LR 14 ZC	BPR7ES	19
LR 14 ZC 1	BPR7ES-11	
LR 15 TXS	BUR6ET	1
LR 15 YC	BPR6ES	2
LR 15 Z	BPR6ES	2
LR 15 Z 1	BPR6ES-11	13
LR 17 YC	BPR5ES	6
N 08 W	BR10HIX	
N 12 W	BR9HIX	
N 12 Y	BP8HS	
N 12 YC	BP8HS	
N 14	B8HS	
N 14 C	B8HS	
N 14 Y	BP7HS	
N 14 YC	BP7HS	
N 15	B7HS	
N 15 C	B7HS	
N 15 W	BR8HIX	
N 15 Y	BP6HS	18
N 15 YC	BP6HS	18
N 17	B6HS	
N 17 C	B6HS	
N 17 W	BR7HIX	
N 17 Y	BP5HS	
N 17 YC	BP5HS	
N 19	B5HS	
N 19 C	B5HS	
NR 12 YC	BPR8HS	
NR 15 YC	BPR6HS	3
P 15	BM7A	
P 15 Y	BPM7A	
P 17	BM6A	
P 17 Y	BPM6A	
PR 15 Y	BPMR7A	
PR 17 Y	BPMR6A	
U 15	BM7F	
U 17	BM6F	
UR 17	BMR6F	
<b>CHAMPION</b>	<b>→ NGK</b>	<b>V-Line</b>
860	A6FS	
2301	BPR5ES-11	
2322	BPR4ES-11	
2332	BPR6ES	2



CHAMPION	→ NGK	V-Line
2338	BKR6ES	28
2415	BPR5ES	6
2430	BKR5E-11	33
3322	BPR5EIX-11	
3344	BKR6EIX-11	
3407	TR5-1IX	
5828	BZ7HS-10	
5843	BM7A	
5846	BM6A	
5847	BM6F	
5861	B2-LM	
88 091	DPR7EA-9	
9 179 100	PFR6G	
9 202 064	BKR6EKUB	
A 4 HC	DP9EA-9	
A 5 YC	DP9EA-9	
A 6	D8EA	
A 6 G	DR8EIX	
A 6 GC	DR8EIX	
A 6 HC	DP8EA-9	
A 6 Y	DP8EA-9	
A 6 YC	DP8EA-9	
A 8	D7EA	
A 8 Y	DP7EA-9	
A 8 YC	DP7EA-9	
A 10	D7EA	
A 50 R	R2525-11	
A 51 R	R2525-10	
A 53 C	R2525-11	
A 53 R	R2525-11	
A 55 C	R2525-10	
A 55 R	R2525-10	
A 55 V	R2349-11	
A 57 CST	R2525-10	
A 57 G	R2525-10	
A 59 C	D9EA	
A 59 G	DR9EIX	
A 59 GC	DCPR9EIX	
A 61	D9EA	
A 61 G	DR9EIX	
BL 4	B7FS	
BL 5	B7FS	
BL 6	BR6FS	
BL 7 Y	BP7FS	
BL 8	BR6FS	
BL 9 Y	BP6FS	
BL 11 Y	BP5FS	
BL 13 Y	BP5FS	
BN 2	B9EFS	
BN 6 Y	BP7EFS	
BN 7 Y	BP6EFS	5
BN 9 Y	BP6EFS	5

CHAMPION	→ NGK	V-Line
BN 12 Y	BP5EFS	
BN 89 Y	BP6EFS	5
C 6 BYC	BCP7ET	
C 6 VPYC	BKR7EIX-11	
C 6 YCC	BCP7ES	
C 7 Y	BCP7ES	
C 7 YC	BCP7ES	
C 7 YCC	BCP7ES	
C 7 YCX	BCP7ES	
C 9 MCC	ZFR5F	
C 9 Y	BCP6ES	17
C 9 YC	BCP6ES	17
C 9 YCC	BCP6ES	17
C 9 YCX	BCP6ES	17
C 10 YCC	BCP6ES	17
C 11 YCC	BCP5ES	16
C 12 YCC	BK5E	
C 55	R7436-10	
C 55 R	R7436-10	
C 57	R7436-9	
C 57 A	R7436-10	
C 57 C	R7436-9	
C 57 CX	R7434-10	
C 57 JC 4	R7436-10	
C 57 YCST	R7436-9	
C 59	R7436-9	
C 59 C	R7436-9	
C 61	R7436-8	
C 281 YC	BCP6ES	17
CJ 3	BM7A	
CJ 4	BM7A	
CJ 6	BM7A	
CJ 6 Y	BPM7A	
CJ 7 Y	BPM7A	
CJ 8	BM6A	
CJ 8 Y	BPM6A	
CJ 11	BM6A	
CJ 14	BM4A	
CJ 17 LM	B4-LM	
CJ 86	BM6A	
D 6	AB-8	
D 9	AB-6	
D 9 J	AB-6	
D 10	AB-6	
D 14	AB-6	
D 16	AB-6	
D 16 J	AB-6	
D 21	AB-6	
D 23	AB-6	
DJ 6 J	BM7F	
DJ 6 Y	BPM7F	
DJ 7 J	BM6F	

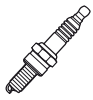

CHAMPION	→ NGK	V-Line
DJ 7 Y	BPM6F	
DJ 8 J	BM6F	
EON 1	BKR6ES	28
EON 2	BKR5ES	35
EON 3	BPR5EFS	
EON 4	TR5A-10	
EON 5	BPR6ES	2
EON 6	BPR5ES	6
F 7 Y	AP7FS	
F 7 YC	AP7FS	
F 7 YCC	AP7FS	
F 9 Y	AP6FS	
F 9 YC	AP6FS	
F 10	A6FS	
F 10 C	A6FS	
F 11 Y	AP5FS	
F 11 YC	AP5FS	
F 14 Y	AP5FS	
F 62 Y	AP8FS	
F 81 Y	AP8FS	
F 82	A8FS	
F 83 Y	AP8FS	
FN 507 Y	BCP7ES	
G 1	C9E	
G 2	C8E	
G 54 V	R0045J-10	
G 55	C9E	
G 56 R	R0373A-10	
G 58	C9E	
G 59 C	C7E	
G 61	C8E	
G 63	C8E	
G 63 R	CR8EIX	
H 03	B6S	
H 8	B-6L	
H 8 C	B-6L	
H 8 J	B-6L	
H 10	B-6L	
H 10 C	B-6L	
H 10 J	B-6L	
H 11	B-4L	
H 12	B-4L	
J 4	B7S	
J 4 C	B7S	
J 4 J	B7S	
J 5	B7S	
J 6	B6S	
J 6 C	B6S	
J 6 J	B6S	
J 7	B6S	
J 7 J	B6S	
J 8	B6S	

CHAMPION	→ NGK	V-Line
J 8 C	B6S	
J 8 J	B6S	
J 10 Y	BP6S	
J 11	B-4	
J 11 C	B-4	
J 11 J	B-4	
J 11 Y	BP5S	
J 12 J	B-2	
J 12 Y	BP5S	
J 12 YC	BP5S	
J 13 Y	BP5S	
J 14	B-2	
J 14 J	B-2	
J 14 Y	BP5S	
J 14 YC	BP5S	
J 17 LM	B4-LM	
J 18 Y	BP-4	
J 18 YC	BP-4	
J 19 LM	B2-LM	
K 3 G	AB-8	
K 5 G	AB-8	
K 7	AB-8	
K 8	AB-8	
K 8 G	AB-8	
K 9	AB-7	
K 13	AB-6	
K 15 J	AB-6	
L 2 G	BR9HIX	
L 3 G	BR8HIX	
L 4 G	BR7HIX	
L 4 J	B7HS	
L 5	B7HS	
L 6 G	BR7HIX	
L 6 VC	BU8H	
L 7 J	B6HS	
L 9 G	BR6HIX	
L 9 J	B6HS	
L 10	B6HS	
L 12 Y	BP5HS	
L 14	B-4H	
L 15 Y	BP4HS	
L 19 V	BUH	
L 20 V	BUH	
L 55 G	BR10HIX	
L 61 Y	BP8HS	
L 64 Y	BP7HS	
L 66 Y	BP6HS	18
L 76 V	BUHW	
L 77 J	B7HS	
L 77 J 4	B7HS-10	
L 77 JC	B7HS	
L 77 JC 4	B7HS-10	





CHAMPION	→ NGK	V-Line
L 77 V	BUHW	
L 78	B7HS	
L 78 C	B7HS	
L 78 V	BUHW-2	
L 78 YC	BP7HS-10	
L 78 YC 6	BP8HS-15	
L 81	B7HS	
L 81 Y	BP7HS	
L 82	B6HS	
L 82 C	B6HS	
L 82 Y	BP6HS	18
L 82 YC	BP6HS	18
L 82 YCC	BP6HS	18
L 85	B6HS	
L 85 Y	BP6HS	18
L 86	B6HS	
L 86 C	B6HS	
L 86 CC	B6HS	
L 87 Y	BP6HS	18
L 87 YC	BP6HS	18
L 87 YCC	BP6HS	18
L 90	B5HS	
L 90 C	B5HS	
L 92 LCC	BP5HA	
L 92 Y	BP5HS	
L 92 YC	BP5HS	
L 92 YC 4	BP5HS-10	
L 95 Y	BP4HS	
L 288	B5HS	
N 1	B10ES	
N 1 C	B10ES	
N 2	B9ES	
N 2 C	B9ES	
N 2 G	BR9EIX	
N 3	B8ES	
N 3 C	B8ES	
N 3 G	BR8EIX	
N 4	B7ES	
N 4 C	B7ES	
N 4 G	BR7EIX	
N 4 YC	BP9ES	
N 5	B6ES	
N 5 C	B6ES	
N 6	B6ES	
N 6 BYC	BUR6ET	1
N 6 GY	BPR8EIX	
N 6 Y	BP8ES	
N 6 YC	BP8ES	
N 6 YCC	BP8ES	
N 7	B7ES	
N 7 BMC	BUR6ET	1
N 7 BYC	BUR6ET	1

CHAMPION	→ NGK	V-Line
N 7 GY	BPR7EIX	
N 7 Y	BP7ES	
N 7 YC	BP7ES	
N 7 YCC	BP7ES	
N 7 YCX	BP7ES	
N 8	B6ES	
N 8 GY	BPR6EIX	
N 8 L	ZGR5C	
N 8 Y	BP6ES	4
N 9 BMC	BPR5EIKU	
N 9 BYC	BUR6ET	1
N 9 BYC 4	BP5ET-10	
N 9 Y	BP6ES	4
N 9 YC	BP6ES	4
N 9 YC 4	BP6ES-11	
N 9 YCC	BP6ES	4
N 9 YCE	BP5ES	8
N 9 YCX	BP6ES	4
N 10 PY	BPR6EIX	
N 10 Y	BP6ES	4
N 10 Y 4	BP6ES-11	
N 10 YC	BP5ES	8
N 11 Y	BP5ES	8
N 11 YC	BP5ES	8
N 11 YC 4	BP5ES-11	
N 11 YCC	BP5ES	8
N 12 Y	BP5ES	8
N 12 YC	BP5ES	8
N 12 YCC	BP5ES	8
N 13 L	ZGR5C	
N 13 Y	BP5ES	8
N 14 LY	ZGR5C	
N 14 Y	BP5ES	8
N 16 Y	BP4ES	
N 16 YC	BP4ES	
N 19 V	BUE	
N 21	B4ES	
N 54 R	B10EG	
N 55 G	B105EGV	
N 56 R	B105EGP	
N 57	B10ES	
N 57 G	B105EGV	
N 57 R	B10EG	
N 59 G	B95EGV	
N 60	B9ES	
N 60 R	B8EG	
N 60 Y	BPR10EVX	
N 62 R	B8EG	
N 63 Y	BP9ES	
N 64 Y	BP8ES	
N 65 Y	BP7ES	
N 66 Y	BP6ES	4



CHAMPION	→ NGK	V-Line
N 74 C	BUR6EB-11	
N 79 Y	BP6ES	4
N 80	B10EG	
N 80 G	B11EGV	
N 82	B10EG	
N 82 G	B105EGV	
N 84	B9EG	
N 84 G	B95EGV	
N 86	B9EG	
N 86 G	B9EGV	
N 87	B8EG	
N 87 G	B8EGV	
N 89 GY	BP6ES	4
N 89 Y	BP5ES	8
N 92 Y	BP4ES	
N 178 B	BR8EM	
N 180 B	B7EM	
N 279 YC	BP7ES	
N 281 YC	BP6ES	4
N 288	B5ES	
OBL 9 Y	BPR6FS	
OE 001	BP6ES	4
OE 002	BKR6ES	28
OE 003	BCP6ES	17
OE 004	BPR6ES	2
OE 005	BKR6ES	28
OE 006	BPR6ES	2
OE 007	BP6HS	18
OE 008	BPR7ES	19
OE 009	BP6EFS	5
OE 010	BP7ES	
OE 011	BPR6EFS	7
OE 012	BUR6ET	1
OE 013	BKR5ES	35
OE 014	BCPR7ES	
OE 015	BP5ES	8
OE 016	BKR6ES	28
OE 017	BCP7ES	
OE 018	BPR7ES	19
OE 019	BKR5EK	23
OE 020	BPR6EFS	7
OE 021	BCPR6ET	
OE 022	BP6ES	4
OE 023	BCP6ES	17
OE 024	BKR6E-11	14
OE 025	BUR6ET	1
OE 026	BKR6EK	20
OE 027	BUR5ET-10	21
OE 028	BP5ET-10	
OE 030	BKR6EKC	26
OE 031	PTR5A-13	25
OE 032	BKUR6ET-10	24

CHAMPION	→ NGK	V-Line
OE 032	BKUR6ET-10	24
OE 033	BKR6EZ	38
OE 034	BKR6ES	28
OE 035	LFR5B	
OE 036	BP6EFS	5
OE 037	B6HS	
OE 038	BP6HS	18
OE 039	BKR6ES-11	14
OE 040	B9ES	
OE 041	ZFR5F	
OE 042	BPR5ES	6
OE 043	BCPR7ES	
OE 044	BUR6ET	1
OE 045	BPR5ES	6
OE 046	BP7ES	
OE 048	BPR6ES-11	13
OE 049	BPR5ES-11	
OE 050	BP7EFS	
OE 051	BPR5ES	6
OE 052	DCPR9EIX	
OE 053	APR6FS	
OE 054	APR6FS	
OE 055	BP5ES	8
OE 056	BKR7ES-11	
OE 057	BCP5ES	16
OE 058	BCP7ES	
OE 059	BP5HS	
OE 060	ZGR5B	
OE 061	AP7FS	
OE 063	BKR6ES-11	14
OE 064	BPR6HS	3
OE 065	BP5ES	8
OE 067	BP7EFS	
OE 068	B8ES	
OE 070	BP6HS	18
OE 071	BPR6HS	3
OE 074	B6ES	
OE 075	BCP7ES	
OE 076	BCP7ET	
OE 077	BCPR6ET	
OE 078	BR8EIX	
OE 079	B7ES	
OE 080	BKR7ES-11	
OE 084	BP8ES	
OE 085	BKR5EKU	
OE 086	BR6HS	
OE 087	BP8ES	
OE 088	BKR5E	35
OE 089	ZFR6F-11	
OE 090	BP7EFS	
OE 091	BR9ES	
OE 092	CR9E	



CHAMPION	→ NGK	V-Line
OE 093	BKR5EZ	36
OE 094	BCPR7ES	
OE 095	BUR6ET	1
OE 096	B6HS	
OE 098	BR7ES	
OE 100	BPR5EKU	
OE 102	BKR6EZ	38
OE 103	DCPR9EIX	
OE 104	BP6HS	18
OE 105	GR4	
OE 106	BP5ES	8
OE 107	BPR7ES-11	
OE 108	BR8ES	
OE 109	BUR6ET	1
OE 110	BCPR7ES	
OE 111	BPR6ES	2
OE 112	DR8EIX	
OE 114	BRE527Y-11	
OE 115	ZFR5N	
OE 116	BPR8ES	
OE 119	BKR6ES	28
OE 120	BKUR5ET-10	
OE 122	PMR7A	
OE 124	PFR5J-11	
OE 125	BR9EIX	
OE 127	BKR5E	35
OE 129	BKR7EIX-11	
OE 130	LZKAR7B	
OE 132	DP8EA-9	
OE 134	PFR5J-11	
OE 136	PFR6J-11	
OE 138	PFR5G-11	
OE 141	BKR6EIX	
OE 143	PFR6G-9	
OE 144	BKUR6ET-10	24
OE 144	BKUR6ET-10	24
OE 146	PFR5G-13E	
OE 151	BPR5EFS	
OE 152	BKR5E-11	33
OE 154	ZFR5F-11	40
OE 155	APR6FS	
OE 156	ZGR5C	
OE 160	ZFR4F-11	
OE 161	GR4	
OE 162	BR6ES	
OE 163	LZTR4A-11	
OE 165	R7436-9	
OE 166	C7E	
OE 167	PLZTR5A-13	
OE 168	TR5IX	
OE 169	R5724-9	
OE 171	BPR6FS	

CHAMPION	→ NGK	V-Line
OE 172	B9EG	
OE 173	R2525-10	
OE 174	PTR5A-13	25
OE 175	LFR5AP-11	
OE 178	LFR5B	
OE 190	IFR5G11	
OE 197	PLKR7A	
OE 198	ZFR6V-G	
OE 199	DCPR8E	
OE 201	LZKR6B-10E	
OJ 11 Y	BP6S	
OJ 12 Y	BP5S	
OJ 13 Y	BP5S	
ON 3	BR8ES	
ON 11 Y	BP5ES	8
ON 12 Y	BP5ES	8
P 6	D10HS	
P 7	D8HA	
P 7 G	DR8HS	
P 7 Y	D8HA	
P 8 Y	D6HA	
P 10 Y	D6HA	
PA 5 HC	D7EA	
PA 7 HC	D7EA	
PG 2 PHP	PMR8A	
PG 4 PHP	PMR7A	
PG 7 C	C7E	
PL 7 YC 4	BP6HS-10	
PL 9 YC	BP6HS	18
PN 5 C	B8ES	
PRL 5 SC	BR6HSA	
PRL 9 SC	BR4HSA	
PRZ 9 HC	CR7HSA	
PZ 7 HC	C7HSA	
PZ 9 HC	C6HSA	
Q 504 V	R2349-10	
QC 9 MC 4	ZFR6F-11	
QC 10 PEPB	IZFR6N-E	
QC 10 WEP	IZFR6F11	
QC 12 PEP	PZFR6H	
QC 12 PEPB	IZFR6N-E	
QC 12 YC	BKR5ES	35
QC 501 V	R7434-10	
QJ 17 LM	BR4-LM	
QJ 19 LM	BR2-LM	
QL 6 VC	BU8H	
QL 7 J 5	BR6HS	
QL 16 V	BUZ8H	
QL 76 V	BUZHW	
QL 77 CC	BR8HS	
QL 77 J 4	BZ7HS-10	
QL 77 JC 4	BZ7HS-10	



CHAMPION	→ NGK	V-Line
QL 78 C	BR7HS	
QL 78 V	BUZHW-2	
QL 78 YC	BPR7HS	
QL 82 C	BR6HS	
QL 82 YC	BPR6HS	3
QL 86	BR6HS	
QL 86 C	BR6HS	
QL 87 YC	BPR6HS	3
QL 92 LCC	BP8HS-10	
QN 2	BR9ES	
QN 2 C	BR9ES	
QN 2 G	BR9EIX	
QN 3	BR8ES	
QN 3 C	BR8ES	
QN 84	BR9EG	
QN 86	BR8EG	
R 6	D8EA	
R 6 G	DR8EIX	
R 6 J	D8EA	
R 8	D7EA	
R 10	D6EA	
R 54 G	R2525-10	
RA 2 HC	DPR7EA-9	
RA 4 HCC	DCPR8E	
RA 4 HCX	DCPR9EIX	
RA 6	DR8ES-L	
RA 6 Y	DPR7EA-9	
RA 6 YC	DPR7EA-9	
RA 7 YC	DCPR8E	
RA 8 GHC	DCPR6E	
RA 8 HC	DCPR7E	
RA 8 Y	DPR7EA-9	
RA 8 YC	DPR7EA-9	
RA 59 GC	DCPR9EIX	
RA 59 PP	DCPR9EIX	
RAX 92 C	DR9EA	
RAX 92 DC	JR9C	
RAX 92 YC	DPR7EA-9	
RAX 94 C	DR8EA	
RAX 94 YC	DPR7EA-9	
RAX 96 C	DR7EA	
RAX 96 YC	DPR7EA-9	
RBL 8	BR6FS	
RBL 9 Y	BPR6FS	
RBL 11 Y	BPR5FS	
RBL 11 Y 6	BPR5FS-15	
RBL 12	BR5FS	
RBL 13 Y	BPR5FS	
RBL 13 Y 6	BPR5FS-15	
RBL 15 Y	BPR4FS	
RBL 15 Y 4	BPR4FS-11	
RBL 15 Y 6	BPR4FS-15	

CHAMPION	→ NGK	V-Line
RBL 16 Y	BPR4FS	
RBL 17 Y	BPR4FS	
RBL 17 Y 6	BPR4FS-15	
RBL 86	BR6FS	
RBL 126	BR5FS	
RBN 9 Y	BPR6EFS	7
RBN 12 Y	BPR5EFS	
RBN 13 Y	BPR5EFS	
RBN 14 Y	BPR5EFS	
RC 6 VPYC	BKR7EIX-11	
RC 6 YC	BCPR7ES	
RC 6 YCC	BCPR7ES	
RC 7 BMC	BCPR6ET	
RC 7 BYC 4	BCPR6ET	
RC 7 GYC	BKR7EIX-11	
RC 7 GYG	BKR6EIX	
RC 7 Y	BCPR7ES	
RC 7 YC	BCPR7ES	
RC 7 YC 4	BKR7ES-11	
RC 7 YCC	BCPR7ES	
RC 7 YCC 4	BKR7ES-11	
RC 8 BYC	BKR6EKC	26
RC 8 DMC	BKR6EK	20
RC 8 PYCB	PFR6G-9	
RC 8 PYP	PFR6J-11	
RC 8 PYP 4	PFR6G-11	
RC 8 PYPB 4	PFR5G-13E	
RC 8 VTYC 4	BKUR6ET-10	24
RC 8 VTYC 4	BKUR6ET-10	24
RC 8 YC	BKR5E	35
RC 8 YC 4	BKR5E-11	33
RC 8 YCC	BKR6ES	28
RC 8 YCL	BKR6ES	28
RC 9 BMC	BKR5EKU	
RC 9 MC 4	ZFR5F-11	40
RC 9 MCC 4	ZFR6F-11	
RC 9 TMC	BKR6EKUB	
RC 9 YC	BKR6ES	28
RC 9 YC 4	BKR6ES-11	14
RC 9 YC 5	BKR6E-11	14
RC 9 YCC	BKR6ES	28
RC 9 YCC 4	BKR6E-11	14
RC 9 YCN 4	BKR6E-11	14
RC 10 DMC	BKR5EK	23
RC 10 ECC	ZFR6F-11	
RC 10 MCC	ZFR6V-G	
RC 10 PYC	BKR6EIX	
RC 10 PYP 4	PFR5J-11	
RC 10 PYPB 4	PFR5G-11	
RC 10 YC	BKR5E	35
RC 10 YC 4	BKR6ES-11	14
RC 10 YCC	BKR6ES	28



CHAMPION	→ NGK	V-Line
RC 10 YCL	BKR5EZ	36
RC 11 LCC 4	BRE527Y-11	
RC 11 PYPB 4	PFR5G-11	
RC 12 ECC	ZFR5N	
RC 12 LYC	ZFR5F	
RC 12 MC4	PZFR5F-11	
RC 12 MC 5	ZFR5F-11	40
RC 12 MCC 4	ZFR5F-11	40
RC 12 PEC5	ZFR5LP-13G	
RC 12 PYP	PFR5J-11	
RC 12 YC	BKR5ES	35
RC 12 YC5	FR45	
RC 14 ES	ZFR5LP-13G	
RC 14 YC	BKR5ES	35
RC 14 YC 4	BKR5E-11	33
RC 87 PYC	BKUR6ET-10	24
RC 87 PYC	BKUR6ET-10	24
RC 87 YC	BKR6ES	28
RC 87 YCC	BKR6EZ	38
RC 87 YCL	BKR6EZ	38
RC 89 TMC	BKUR5ET-10	
RC 89 YCC	BKR5EZ	36
RC 503 C	R7433-8	
RCJ 4	BMR7A	
RCJ 6	BMR7A	
RCJ 6 Y	BPMR7A	
RCJ 7 Y	BPMR7A	
RCJ 8	BMR6A	
RCJ 8 Y	BPMR6A	
RCJ 501 H	BPMR4A	
RD 9	AB-6	
RD 14	AB-6	
RD 16	AB-6	
RD 16 J	AB-6	
RDJ 6 J	BM7F	
RDJ 7 J	BMR6F	
RDJ 7 Y	BPMR6F	
RDJ 8 J	BMR6F	
RE 7 PYC 5	PTR5A-13	25
RE 7 YCC	PTR5A-13	25
RE 10 LC	TR5-1IX	
RE 10 PMC 5	PTR5A-13	25
RE 10 YC 4	BKR5ES-11	33
RE 14 MCC 4	LZTR4A-11	
RE 14 MCC 5	LZTR4A-11	
RE 14 PLP 5	PLZTR5A-13	
REA 8 MCL	LZKAR7B	
REA 8 MX	LZKAR7B	
REA 12 WMB 4	LZKAR6AP-11	
REC 9 MCLX	LF5B	
REC 9 YCL	LF5B	
REC 10 PYC 4	LF5AP-11	

CHAMPION	→ NGK	V-Line
REC 10 WYPB 4	IFR5G11	
RER 8 MC	LZKR6B-10E	
RER 8 YC	PLKR7A	
RES 9 YCC 4	PTR5A-13	25
RF 7 YC	APR6FS	
RF 7 YCC	APR6FS	
RF 9 Y	APR6FS	
RF 9 Y 5	APR6FS	
RF 9 YC	APR6FS	
RF 10	AR6FS	
RF 10 C	AR6FS	
RF 11 Y	APR6FS	
RF 11 YC	APR6FS	
RF 14 Y	APR5FS	
RFN 14 LY	ZFR4F-11	
RG 2 PHP	CR8EIX	
RG 4 HC	CR9E	
RG 4 PHP	PMR7A	
RG 6 YC	CR8EB	
RG 6 YCA	CPR8E	
RG 6 YCH	CPR8E	
RG 92 C	CR9E	
RG 92 DC	CR9EK	
RG 94 C	CR8E	
RGU 92 C	CR9EH-9	
RGU 94 C	CR8EH-9	
RH 10 C	B-6L	
RH 18 Y	B-4L	
RJ 6	BR6S	
RJ 6 C	BR6S	
RJ 6 J	BR6S	
RJ 7	BR6S	
RJ 8	BR6S	
RJ 8 C	BR6S	
RJ 8 J	BR6S	
RJ 10 Y	BP6S	
RJ 11	BR6S	
RJ 11 Y	BP5S	
RJ 12	BR6S	
RJ 12 Y	BP5S	
RJ 12 YC	BP5S	
RJ 14 CC	XR4	
RJ 14 Y	BP5S	
RJ 14 YC	BP5S	
RJ 17 LM	BR4-LM	
RJ 18 Y	BP-4	
RJ 18 YC	BP-4	
RJ 18 YC 6	XR45IX	
RJ 19 LMC	BR2-LM	
RJ 20 Y	BP-4	
RL 4 J	BR7HS	
RL 7 J	BR6HS	



CHAMPION	→ NGK	V-Line
RL 12 Y	BPR6HS	3
RL 19	BR5HS	
RL 77 J	BR7HS	
RL 78	BR7HS	
RL 78 C	BR7HS	
RL 82	BR6HS	
RL 82 C	BR6HS	
RL 82 Y	BPR6HS	3
RL 82 YC	BPR6HS	3
RL 82 YCC	BPR6HS	3
RL 85	BR6HS	
RL 86	BR6HS	
RL 86 C	BR6HS	
RL 87 Y	BPR6HS	3
RL 87 YC	BPR6HS	3
RL 90	BR5HS	
RL 95 YC	BPR5HS	
RN 1 C	BR10ES	
RN 2	BR9ES	
RN 2 C	BR9ES	
RN 2 G	BR9EIX	
RN 3	BR8ES	
RN 3 C	BR8ES	
RN 3 G	BR8EIX	
RN 4	BR7ES	
RN 4 C	BR7ES	
RN 5	BR6ES	
RN 5 C	BR6ES	
RN 6	BR6ES	
RN 6 Y	BPR8ES	
RN 6 YC	BPR8ES	
RN 7 GY	BPR7EIX	
RN 7 Y	BPR7ES	19
RN 7 YC	BPR7ES	19
RN 7 YCC	BPR7ES	19
RN 7 YCC 4	BPR7ES-11	
RN 8	BR5ES	
RN 8 L	ZGR5C	
RN 8 VTYC 4	BUR6ET	1
RN 9 BMC	BPR5EKU	
RN 9 GY	BPR6EIX	
RN 9 LCC	ZGR5B	
RN 9 Y	BPR6ES	2
RN 9 YC	BPR6ES	2
RN 9 YC 4	BPR6ES-11	13
RN 9 YCC	BPR6ES	2
RN 10 GY	BPR6EIX	
RN 10 PYP 4	PGR5A-11	
RN 10 VTYC	BUR5ET	22
RN 10 VTYC 4	BUR5ET-10	21
RN 10 Y	BPR6ES	2
RN 10 Y 4	BPR6ES-11	13

CHAMPION	→ NGK	V-Line
RN 10 YC	BPR6ES	2
RN 11 Y	BPR5ES	6
RN 11 YC	BPR5ES	6
RN 11 YC 4	BPR5ES-11	
RN 11 YCC	BPR5ES	6
RN 12 GY	BPR5EIX	
RN 12 MC 4	BPR4EY-11	
RN 12 Y	BPR5ES	6
RN 12 YC	BPR5ES	6
RN 12 YC 4	BPR5ES-11	
RN 12 YC 6	BPR5ES-13	
RN 12 YCC	BPR5ES	6
RN 13 L	ZGR5C	
RN 13 LYC	ZGR5C	
RN 14 LY	ZGR5C	
RN 14 MC 5	BPR4EY-11	
RN 14 PMP 5	GR4	
RN 14 Y	BPR5ES	6
RN 14 Y 6	BPR5ES-13	
RN 14 YC	GR4	
RN 16 Y	BPR4ES	
RN 16 YC 5	BPR4ES-13	
RN 16 YC 6	BPR4EY-11	
RN 57 YC	BR10EG	
RN 74 C	BUR6EB-11	
RN 180 B	BR7EM	
RP 7	DR8HS	
RP 10 HC	DR5HS	
RS 5 C	BR7EFS	
RS 9 YC	BPR6EFS	7
RS 9 YCC	BPR6EFS	7
RS 10 LC	TR5-1	
RS 12 PYP	TR5IX	
RS 12 YC	BPR5EFS	
RS 12 YC 6	BPR5EFS-13	
RS 13 LYC	TR4	
RS 14 LC	TR5-1	
RS 14 LYC	TR4	
RS 14 PYP	TR4IX	
RS 14 YC	BPR5EFS	
RS 14 YC6	TR55IX	
RS 15 LYC	TR4	
RS 16 YC	TR4	
RS 17 YX	TR4	
RV 8 C	BR6FS	
RV 8 C 6	BR6FS	
RV 9 YC	BPR6FS	
RV 12 C	BR5FS	
RV 12 C 6	BR5FS	
RV 12 YC	BPR5FS	
RV 12 YC 6	BPR5FS-15	
RV 15 YC	BPR4FS	



CHAMPION	→ NGK	V-Line
RV 15 YC4	BPR4FS-11	
RV 15 YC6	BPR4FS-15	
RV 17 YC	BPR4FS	
RV 17 YC6	BPR4FS-15	
RV 91 MC	BR6FS	
RV 92 YC	BPR5FS	
RZ 7 C	CMR7H	
RZ 94 C	CR8HSA	
RZ 96 C	CR7HSA	
RZN 12 Y	BPR5EFS	
RZN 12 Y 5	BPR5EFS	
S 6 YC	BP7EFS	
S 7 YC	BP7EFS	
S 7 YCC	BP7EFS	
S 9 YC	BP6EFS	5
S 9 YCC	BP6EFS	5
S 59 C	R5724-9	
S 59 CST	R5724-9	
S 279 YC	BP6EFS	5
S 281 YC	BP6EFS	5
S 379 YC	BP7EFS	
UD 16	AB-6	
UF 9 Y	AP6FS	
UF 11 Y	AP6FS	
UJ 2 J	B8S	
UJ 4 J	B7S	
UJ 6	B6S	
UJ 8	B6S	
UJ 12	B-2	
UJ 81 C	B7S	
UJ 81 J	B7S	
UK 10	AB-6	
UL 4 J	B7HS	
UL 17 V	BUHXW-1	
UL 18 V	BUHX	
UL 77 V	BUHXW-1	
UL 81 C	B7HS	
UL 81 J	B7HS	
UL 82 Y	BP7HS	
UN 19 V	BUE	
UN 79 Y	BP6ES	4
V 4 C	B7FS	
V 9 YC	BP6FS	
V 12 YC	BP5FS	
V 61	R5673-8	
V 63 C	R5673-7	
XC 12 PEPB	PZFR6H	
XC 92 YC	BKR5E	35
XJ 10 Y	BP6S	
Y 82	CM-6	
Z 6	C8HSA	
Z 7 G	CR7HIX	

CHAMPION	→ NGK	V-Line
Z 8	C7HSA	
Z 9 Y	C7HSA	
Z 10	C6HSA	
Z 10 G	CR7HIX	
Z 12	C6HSA	
CHRYSLER	→ NGK	V-Line
04606 402 AB	LZTR4A-11	
04606 591 AB	ZFR5LP-13G	
04886 204	BP5HS	
04886 205	BP5ES-A	
04886 206	BP6ES	4
04886 207	BP5FS	
04886 208	BP4FS	
04886 210	BP5EFS	
04886 211	TR4	
04886 213	BPR5ES-11	
04886 214	BPR4ES-11	
04886 215	BCPR5ES	32
04886 219	BKR6ES	28
04887 030	ZFR5F-11	40
04887 031	BKR5ES-11	33
04887 032	PFR5J-11	
S2LZT R4A 11	LZTR4A-11	
DAIHATSU	→ NGK	V-Line
90048-51006-000	B8ES	
90048-51008-000	B7ES	
90048-51015-000	B6ES	
90048-51020-000	B-4H	
90048-51022-000	B6HS	
90048-51033-000	B5ES	
90048-51034-000	BP6ES	4
90048-51034-010	BP6ES	4
90048-51035-000	BP6EY	
90048-51038-000	B6ES	
90048-51039-000	BPR6EK-A	
90048-51040-000	BPR6EK-A	
90048-51041-000	BPR6EY	
90048-51044-000	BPR5EY	9
90048-51047-010	BP5EY	
90048-51048-000	BPR5EY	9
90048-51049-000	BPR4EY-11	
90048-51050-000	BPR5EY-11	
90048-51053	BP5EY	
90048-51053-000	BP5EY	
90048-51054	BPR5EY	9
90048-51054-000	BPR5EY	9
90048-51055-000	BP6ES	4
90048-51058-000	BE527Y-11	



DAIHATSU	→ NGK	V-Line
90048-51059	BPR6EY	
90048-51059-000	BPR6EY	
90048-51062-000	BPR5EY-11	
90048-51063	BPR5EY-11	
90048-51063-000	BPR5EY-11	
90048-51069-000	BP6EY	
90048-51072-000	BP5ES	8
90048-51073-000	BPR6EK-A	
90048-51074-000	BPR6EK-A	
90048-51077-000	BPR6EKN	
90048-51079-000	BKR7E-11	
90048-51081-000	BPR5EY-11	
90048-51082-000	BPR5EY	9
90048-51084-000	BPR7EKN	
90048-51086-000	BPR6EK-A	
90048-51087-000	BPR6EK-A	
90048-51091-000	BPR5EY-11	
90048-51092-000	BPR6EY-11	10
90048-51093-000	BPR5EY-11	
90048-51093-A	BPR5EY-11	
90048-51095-000	BPR6ES	2
90048-51096-000	BPR6ES	2
90048-51097	BP-2E	
90048-51097-000	BP-2E	
90048-51099-000	BKR6E-11	14
90048-51100	BKR6E-11	14
90048-51100-000	BKR6E-11	14
90048-51101-000	BPR5EY	9
90048-51102-000	BPR6EKN	
90048-51103-000	BPR7EKN	
90048-51104-000	BPR6EKN	
90048-51105-000	BPR7EKN	
90048-51107-000	BPR6EKB-L	
90048-51108-000	BPR6EKB-L	
90048-51108-1	BPR6EKB-L	
90048-51110-000	BCPR7EKD	
90048-51111-000	BCPR6ED	
90048-51112	BCPR7EKD	
90048-51112-000	BCPR7EKD	
90048-51113	BCPR6ED	
90048-51113-000	BCPR6ED	
90048-51114	BPR5ES	6
90048-51114-000	BPR5ES	6
90048-51115-000	BPR6EKB-L	
90048-51116	BPR6EKB	
90048-51116-000	BPR6EKB	
90048-51117-000	PFR6B-11	
90048-51118-000	PFR6B-11	
90048-51121-000	BPR4EY	
90048-51123	BKR6EY-11	
90048-51123-000	BKR6EY-11	
90048-51125-000	BPR5EJ	

DAIHATSU	→ NGK	V-Line
90048-51126	BPR5EJ	
90048-51126-000	BPR5EJ	
90048-51130-000	BPR5EKB	
90048-51131	BPR5EKB	
90048-51131-000	BPR5EKB	
90048-51131-1	BPR5EKB	
90048-51133-000	BCPR6EKD	
90048-51134	BCPR6EKD	
90048-51134-000	BCPR6EKD	
90048-51134-1	BCPR6EKD	
90048-51136-000	BKUR6EK	
90048-51137	BKUR6EK	
90048-51137-000	BKUR6EK	
90048-51140	BPR6EKB	
90048-51143-000	BKUR7EK	
90048-51144	BKUR7EK	
90048-51144-000	BKUR7EK	
90048-51145	BKR4E	
90048-51151-000	BKR6E	28
90048-51152	BKR6E	28
90048-51152-000	BKR6E	28
90048-51154-000	BKR6EKC	26
90048-51155	BKR7EKC	
90048-51155-000	BKR6EKC	26
90048-51156-000	R7433-9	
90048-51158-000	BKR5E-11	33
90048-51158-008	BKR5E-11	33
90048-51159-000	BKUR6EK-9	
90048-51160	BKUR6EK-9	
90048-51160-000	BKUR6EK-9	
90048-51161	BKR7E	
90048-51161-000	BKR7E	
90048-51162	IFR7F-6D	
90048-51162-000	PFR7N-D	
90048-51163-000	BKR6EYA-11	
90048-51165	BKR5EKC	
90048-51165-000	BKR5EKC	
90048-51166	PFR6G	
90048-51166-000	PFR6G	
90048-51168	BKUR6ETB-10	
90048-51168-000	BKUR6ETB-10	
90048-51169-000	BKUR6ETB-10	
90048-51172-000	BKR6EIX-11P	
90048-51173	IFR6J11	
90048-51173-000	IFR6J11	
90048-51175-000	BKR6EKPA	
90048-51185-000	ILFR6T11	
90048-51187	IKR7C	
90048-51196	DCPR7EA-9	
90048-51197	DCPR7EA-9	
90048-51200	IKR7D	
90919-01026-000	BP5EY	





DAIHATSU	→ NGK	V-Line
90919-01056-000	BP4EY	
90919-01059-000	BP5EY	
90919-01060-000	BP4EY	
90919-01061-000	BP5EY	
90919-01065-000	BPR4EY	
90919-01085-000	BP4EY-11	
90919-01086-000	BP4EY-11	
90919-01087-000	BP5EK-A	
90919-01106-000	BP4EY-11	
90919-01115-000	BPR5EP-11	
90919-01116-000	BPR5EP-11	
90919-01117-000	BE529Y-11	
90919-01118-000	BE529Y-11	
90919-01177-000	BKR5EYA	
90919-01181-000	BKR6EP-8	
90919-01202-000	BKR6EKB-11	
99113-39236-10	AB-6	
99113-39236-200	AB-6	
99123-11236-100	AB-7	
99123-11236-220	AB-7	
99251-30200-100	B-4	
99520-21236-132	B8HS	
99906-850P9-006	BPR6HS	3
99906-850P9-009	BR7ES	
99906-850P9-011	BPR5ES-11	
99906-850P9-012	BPR6ES-11	13
99906-850P9-013	BPR5ES-13	
99906-850P9-015	BPR5EIX-11	
99906-850P9-017	BRE527Y-11	
99906-850P9-018	BRE529Y-11	
99906-910P9-002	BR6HS	
99906-910P9-003	BR8HS	
99906-910P9-004	BPR5HS	
99906-910P9-005	BPR6HS	3
99906-910P9-006	BR5ES	
99906-910P9-007	BR6ES	
99906-910P9-008	BR7ES	
99906-910P9-009	BR8ES	
99906-910P9-011	BPR5ES-11	
99906-910P9-012	BPR6ES-11	13
99906-910P9-013	BPR5EIX-11	
99906-910P9-015	BPR4EY-11	
99906-910P9-017	BPR6EY-11	10
99906-910P9-020	BPR6E	2
99906-910P9-021	BCPR5E-11	
99906-910P9-022	BCPR5EY-11	
99906-910P9-023	BCPR6E-11	11
99906-910P9-024	BCPR6EY-11	
99906-910X9-001	BPR5EIX-11	
99906-910X9-002	BPR6EIX-11	
99906-910X9-003	BPR7EIX	
99906-910X9-004	BCPR5EIX-11	

DAIHATSU	→ NGK	V-Line
99906-910X9-005	BCPR6EIX-11	
99906-910X9-006	BKR5EIX-11	
99906-910X9-007	BKR6EIX-11	
99906-910X9-008	BPR6HIX	
99906-910X9-009	BPR7HIX	
99906-910X9-010	BR6HIX	
99906-910X9-011	BR7HIX	
99906-910X9-012	BR8EIX	
99906-910X9-013	BR9EIX	
99906-910X9-014	DR8EIX	
99906-910X9-015	DR9EIX	
99906-910X9-016	DPR8EIX-9	
99906-910X9-017	DPR9EIX-9	
99906-910X9-018	DCPR7EIX	
99906-910X9-019	ZFR5FIX-11	
99906-910X9-020	ZFR6FIX-11	
99906-910X9-021	CR8EHIX-9	
99906-910X9-022	CR9EHIX-9	
99906-910X9-023	CR8EIX	
99906-910X9-024	B8HCS	
99906-910X9-026	BPR5EIX	
99906-910X9-027	BPR6EIX	
99906-910X9-028	BKR5EIX	
99906-910X9-029	BKR6EIX	
99906-910X9-030	BKR7EIX-11	
99906-910X9-031	BCPR7EDIX	
99906-910X9-035	BKR6EIX-11P	
99934-00691-100	BPR6EIX	
99934-01691-100	BPR5EIX	
99934-03691-100	BR7EIX	
99934-05691-100	BP5ES-11	
99934-06691-100	BP6ES-11	
99934-07685-100	BP5EY-11	
99934-07691-100	BP5HS	
99934-08685-100	BP6EY-11	
99934-08691-100	BP5ES-13	
99934-09685-100	BP6HS	18
99934-09691-100	BP6HS	18
99934-10685-100	BP-2E	
99934-10691-100	BP4EY	
99934-12685-100	BP5HS	
99934-13685-100	BP6ES-11	
99934-14685-100	BP5ES-13	
NDIK 16	BKR5EIX-11	
NDIK 16 A	BKR5EIX-11	
NDIK 20	BKR6EIX-11	
NDIK 20 A	BKR6EIX-11	
NDIQ 16	BCPR5EIX-11	
NDIQ 16 A	BCPR5EIX-11	
NDIQ 20	BCPR6EIX-11	
NDIQ 20 A	BCPR6EIX-11	
NDIW 16	BPR5EIX-11	



<b>DAIHATSU</b>	<b>→ NGK</b>	<b>V-Line</b>
NDIW 16 A	BPR5EIX-11	
NDIW 20	BPR6EIX-11	
NDIW 20 A	BPR6EIX-11	
NDIW 22	BPR7EIX	
NDIW 22 A	BPR7EIX	
NDIXU 22	DCPR7EIX	
NDIXU 22 A	DCPR7EIX	
NDVK 20	BKR6EIX-11P	
NDVK 20 A	BKR6EIX-11P	
NDVQ 16	BCPR5EIX-11P	
NDVQ 16 A	BCPR5EIX-11P	
NDVQ 20	BCPR6EIX-11P	
NDVQ 20 A	BCPR6EIX-11P	
NDVXU 22	DCPR7EIX-P	
NDVXU 22 A	DCPR7EIX-P	
<b>DELPHI</b>	<b>→ NGK</b>	<b>V-Line</b>
41970	PTR5C-13	
<b>DENSO</b>	<b>→ NGK</b>	<b>V-Line</b>
FK 20 HBR 11	DFH6B-11A	
FXE 20 HR 11	DILKAR6A11	
FXE 22 HR 11	DF7H-11B	
FXE 24 HR 11	DF8H-11B	
IA 01-32	R7282A-105	
IA 01-34	R7282A-11	
IAE 01-32	R7282-105	
IAE 01-34	R7282-11	
IK 01-24	R7434-8	
IK 01-27	R7434-9	
IK 01-31	R7434-10	
IK 02-24	R7434-8	
IK 02-27	R7434-9	
IK 02-31	R7434-10	
IK 16	BKR5EIX-11	
IK 20	BKR6EIX-11	
IK 24 C 11	FR8BI-11	
IK 27 C 11	FR9BI-11	
IKH 01-24	R7438-8	
IKH 01-27	R7438-9	
IKH 01-31	R7438-10	
IKH 16	LFR5AIX-11	
IKH 20	LFR6AIX-11	
IQ 01-24	R7436-8	
IQ 01-27	R7436-9	
IQ 01-31	R7436-10	
IQ 02-24	R7436-8	
IQ 02-27	R7436-9	
IQ 02-31	R7436-10	
IQ 16	BCPR5EIX-11	

<b>DENSO</b>	<b>→ NGK</b>	<b>V-Line</b>
IQ 20	BCPR6EIX-11	
IRE 01-34	R7420-11	
IT 16	TR5IX	
IT 20	TR6IX	
IT 22	TR7IX	
IT 24	TR8IX	
ITF 16	UR5IX	
ITF 20	UR6IX	
IU 01-27	R0373A-9	
IU 01-31	R0373A-10	
IU 01-34	R0373A-11	
IU 22	CR7EIX	
IU 24	CR8EIX	
IU 27	B8HCS	
IU 27 D	CR9EIA-9	
IUF 22	CR7HIX	
IUF 24	CR8HIX	
IUH 24	CR8EHIX-9	
IUH 27	CR9EHIX-9	
IUH 27 D	IMR9A-9H	
IW 01-24	R7376-8	
IW 01-27	R7376-9	
IW 01-31	R7376-10	
IW 06-27	R7376-9	
IW 06-31	R7376-10	
IW 16	BPR5EIX-11	
IW 20	BPR6EIX-11	
IW 22	BPR7EIX	
IW 24	BR8EIX	
IW 27	BR9EIX	
IW 31	BR10EIX	
IWF 20	BPR6HIX	
IWF 22	BR7HIX	
IWF 24	BR8HIX	
IWF 27	BR9HIX	
IWM 01-32	R7282-105	
IWM 24	BR8ECMIX	
IWM 27	BR9ECMIX	
IWM 31	BR10ECMIX	
IX 22	DR7EIX	
IX 22 B	DPR7EIX-9	
IX 24	DR8EIX	
IX 24 B	DPR8EIX-9	
IX 27	DR9EIX	
IX 27 B	DPR9EIX-9	
IXU 01-27	R2525-9	
IXU 01-31	R2525-10	
IXU 01-34	R2349-11	
IXU 22	DCPR7EIX	
IXU 22 C	KR7AI	
IY 24	ER8EHIX	
IY 27	ER9EHIX	



DENSO	→ NGK	V-Line
J 16 AR-U 11	BRE527Y-11	
J 16 A-U 11	BE527Y-11	
J 16 AY	BPR5EY-11	
J 16 AYR	BPR5EJ	
J 16 BR-U	BRE529Y	
J 16 BR-U 11	BRE529Y-11	
J 16 B-U 11	BE529Y-11	
J 16 CR-U	ZGR5A	15
J 16 C-U	BPR5EY	9
J 20 AY	BPR6EY-11	10
K 14 PR-U 11	BKR4E-11	
K 14 P-U 11	BKR5E-11	33
K 16 DTR-S 11	ZFR5G	
K 16 GPR-U 11	ZFR5E-11	
K 16 HPR-U 11	LFR5A-11	
K 16 PR-L 11	BKR5E-N-11	
K 16 PR-P 11	BKR5EIX	
K 16 PR-TP 11	BKR5EIX-11	
K 16 PR-U	BKR5E	35
K 16 PR-U 11	BKR5E-11	33
K 16 PRUR	BKR5E	35
K 16 PRZ-U 11	BKR5EIX-11	
K 16 PSR-B 8	FR5EI	
K 16 P-U	BK5E	
K 16 P-U 11	BK5E-11	
K 16 R-U	BKR5EYA	
K 16 R-U 11	BKR5EYA-11	39
K 16 RZ-U 11	BKR5EIX-11	
K 16 TNRS 9	BKR5EKC	
K 16 TR 11	BKR5EKB-11	
K 16 U	BKR5EYA	
K 16 U 11	BKR5EYA-11	39
K 20 DTR-S 11	ZFR6G	
K 20 HR-U	LFR6B	
K 20 HR-U 11	LFR6C-11	
K 20 PBR	BKUR6ET	27
K 20 PBR-S 10	BKUR6ET-10	24
K 20 PBR-S 10	BKUR6ET-10	24
K 20 PR-L 11	BKR6E-N-11	
K 20 PR-TP 11	BKR6EIX-11	
K 20 PR-U	BKR6E	28
K 20 PR-U 11	BKR6E-11	14
K 20 PR-U 9 S	BKR6E-9S	
K 20 PRUR	BKR6E	28
K 20 PRZ-U 11	BKR6EIX-11	
K 20 PSR-B 8	FR6EI	
K 20 P-U	BK6E	
K 20 P-U 11	BK6E-11	
K 20 R-U	BKR6EYA	
K 20 R-U 11	BKR6EY-11	
K 20 RZ	BKR6EIX	
K 20 RZ-U 11	BKR6EIX-11	

DENSO	→ NGK	V-Line
K 20 TMR 11	BKR6EKC-N-11	
K 20 TNR	BKR6EKC	26
K 20 TNR-S	BKUR6EK	
K 20 TNRS 9	BKUR6EK-9	
K 20 TR 11	BKR6EKB-11	
K 20 TRX	BKR6EKU	
K 20 TXR	BKR6EKUB	
K 20 U	BKR6EYA	
K 20 U 11	BKR6EYA-11	
K 22 P 11	BK7EK-N-11	
K 22 PB	BCP7ET	
K 22 PBR-S	BKUR7ET	
K 22 PR-L 11	BKR7E-N-11	
K 22 PR-TP 11	BKR7EIX-11	
K 22 PR-U	BKR7E	
K 22 PR-U 11	BKR7E-11	
K 22 PRUR	BKR7E	
K 22 PRZ-U	BKR7EIX	
K 22 PRZ-U 11	BKR7EIX-11	
K 22 P-U 11	BK7E-11	
K 22 TM 11	BK7EK-N-11	
K 22 TMR	BKR7EKC-N	
K 22 TMR 11	BKR7EKC-N-11	
K 22 TNR	BKR7EKC	
K 22 TNRS	BKUR7EK	
K 24 PR-U 11	BKR8E-11	
K 29 AZ	R7434-10	
KJ 14 CR 11	ZFR4F-11	
KJ 14 CR-L 11	ZFR4F-11	
KJ 16 CR	ZFR5F	
KJ 16 CR 11	ZFR5J-11	
KJ 16 CR-L 11	ZFR5F-11	40
KJ 16 CR-U 11	ZFR5F-11	40
KJ 20 CR 11	ZFR6J-11	
KJ 20 CR-L 11	ZFR6F-11	
KJ 20 CR-U 11	ZFR6F-11	
KJ 20 DR-M 11	ZFR6K-11	
KJ 20 SR 11	ZFR6FIX-11	
KJ 22 CR 11	ZFR7F-11	
KJ 22 CR-L 8	ZFR7F	
KJ 22 CR-L 11	ZFR7F-11	
KJ 206 CR-L 11	ZFR6F-11	
L 14 U	AB-6	
M 17	AB-6	
M 22	AB-7	
M 24 S	AB-8	
MA 14 P-U	AP5FS	
MA 16 PR-U	APR5FS	
MA 16 PR-U 11	APR5FS	
MA 16 PR-U 15	APR5FS	
MA 16 P-U	AP5FS	
MA 17 P-U	AP6FS	



DENSO	→ NGK	V-Line
MA 20 PR-U	APR6FS	
MA 20 P-U	AP6FS	
MA 20 R-U	AR6FS	
MA 20 R-U 11	AR6FS	
MW 9	AB-2	
MW 17	AB-6	
MW 22	AB-7	
P 16 PR 8	PGR5A	
P 16 PR 11	PGR5A-11	
P 16 R	BPR5EP-11	
P 16 R 13	BPR5EP-11	
P 20 PR 8	PGR6A	
P 20 PR 11	PGR6A-11	
P 20 R 8	BPR6EP-8	
P 22 PR 8	PGR7A	
PK 16 PR 11	PFR5B-11	
PK 16 PR-L 11	PFR5G-11	
PK 16 PR-P 11	PFR5J-11	
PK 16 R 11	BKR5EP-11	
PK 16 TR 11	BKR5EKP-11	
PK 16 TR 13	BKR5EKP-13	
PK 20 GR 8	BKR6EPA-8	
PK 20 PR 11	PFR6B-11	
PK 20 PR-L 11	PFR6G-11	
PK 20 PR-L 13	PFR6G-13	
PK 20 PRP	PFR6J	
PK 20 PR-P 8	PFR6J	
PK 20 PR-P 11	PFR6J-11	
PK 20 PRTP	PFR6M	
PK 20 PTR-S 9	BKR6EKPA	
PK 20 R 8	BKR6EP-8	
PK 20 R 11	BKR6EP-11	
PK 20 R 13	BKR6EP-13	
PK 20 RP 8	BKR6EP-N-8	
PK 20 TR 11	BKR6EKP-11	
PK 22 PR 8	PFR7B	
PK 22 PR 11	PFR7B-11	
PK 22 PR-L 11	PFR7G-11	
PK 22 PR-L 11 S	PFR7G-11S	
PK 22 PRTP	PFR7M	
PKJ 16 CR 8	PZFR5F	
PKJ 16 CR-L 11	PZFR5F-11	
PKJ 16 CR-L 13	PZFR5F-13	
PKJ 20 CR 8	PZFR6F	
PKJ 20 CR-L 11	PZFR6F-11	
PKJ 20 CR-M 11	PZFR6F-11	
PQ 16 R	BCPR5EIX-11	
PQ 16 R 8	BCPR5EP-8	
PQ 16 R 13	BCPR5EIX-11	
PQ 20 R	BCPR6EP-11	
PQ 20 R 8	BCPR6EP-8	
PQ 20 R 13	BCPR6EIX-11	

DENSO	→ NGK	V-Line
PQ 20 R-P 8	BCPR6EP-N-8	
PQ 20 R-P 11	BCPR6EIX-11	
PT 16 EPR-C 13	PTR5C-13	
PT 16 EPR-L 13	PTR5D-10	31
PT 16 VR 13	PTR5A-13	25
PTJ 16 R 15	PZTR5A-15	
Q 14 R-U 11	BCPR4EY-11	
Q 16 PR-TP 11	BCPR5EIX-11	
Q 16 PR-U	BCPR5E	32
Q 16 PR-U 11	BCPR5EY-11	
Q 16 PRZ-U 11	BCPR5EIX-11	
Q 16 P-U 11	BCPR5EY-11	
Q 16 R-U	BCPR5EY	
Q 16 R-U 11	BCPR5EY-11	
Q 16 RZ-U 11	BCPR5EIX-11	
Q 16 U 11	BCPR5EY-11	
Q 16 Z-U 11	BCPR5EIX-11	
Q 20 PR-P 11	BCPR6EIX-11	
Q 20 PR-U	BKR6E	28
Q 20 PR-U 11	BCPR6EY-11	
Q 20 PRU-L 11	BCPR6EY-N-11	
Q 20 PRZ-U 11	BCPR6EIX-11	
Q 20 P-U	BCP6ES	17
Q 20 P-U 11	BKR6E-11	14
Q 20 R-U	BCPR6EY	
Q 20 R-U 11	BCPR6EY-11	
Q 20 RZ-U 11	BCPR6EIX-11	
Q 20 U	BCP6E	17
Q 20 U 11	BKR6E-11	14
Q 20 Z-U 11	BCPR6EIX-11	
Q 22 PR-P 11	BKR7EIX-11	
Q 22 PR-U	BCPR7ES	
Q 22 PR-U 11	BCPR7ES-11	
Q 22 PRU-L 11	BCPR7EY-N-11	
Q 22 PRZ-U 11	BKR7EIX-11	
Q 22 P-U	BCP7ES	
Q 22 P-U 11	BKR7E-11	
Q 27 AZ	R7435-9	
QJ 16 AR-U	BCRE527Y	
QJ 16 C 11	ZFR5A-11	
QJ 16 CR 11	ZFR5A-11	
QJ 20 C 11	ZF6A-11	
QJ 20 CR 11	ZFR6A-11	
QJ 22 CR 11	ZFR7F-11	
QL 20 PR-U	BCPR6ED	
QL 20 TRS	BCPR6EKD	
QL 22 TRS	BCPR7EKD	
RU 01-31	R0045Q-10	
RU 01-34	R0045Q-11	
S 22 PR-A 7	IGR7A	
S-29 A	SD10A	
S-31 A	SD11A	



DENSO	→ NGK	V-Line
SC 20 HR 11	ILKR7B11	
SD 29 A	SD10A	
SF 10	BUHX	
SF 24	BU8H	
SF 50	BUHW	
SF 51	BUHW-2	
SK 16 PR-A 11	IFR5E11	
SK 16 PR-E11	IFR5E11	
SK 16 PR-E13	IFR5E13	
SK 16 PR-L 11	IFR5G-11K	
SK 16 R-P 8	IFR5T-8N	
SK 20 BGR 11	HB6AIX-11P	
SK 20 BR 11	HB6BIX-11P	
SK 20 HPR-L 11	ILFR6J-11K	
SK 20 HR 11	ILFR6T11	
SK 20 PR-A8	IFR6S	
SK 20 PR-A 11	IFR6E11	
SK 20 PR-L9	IFR6C	
SK 20 R 8-G	LPG1	
SK 20 R 11	IFR6T11	
SK 20 R-P 11	BKR6EIX-11P	
SK 22 PR-M 11	IFR7G-11KS	
SKJ 16 DR-M 11	IZFR5K11	
SKJ 20 DR-M 11	IZFR6K11	
SKJ 20 DR-M 11 S	IZFR6K11NS	
SKJ 20 DR-M 13	IZFR6K13	
SVK 20 RZ 8	BKR6EP-8	
SVK 20 RZ 11	IFR6J11	
SXU 22 HCR 11 S	ILZKR7B11GS	
SXU 22 HDR 8	ILKR7B8	
SXU 22 PR 9	IKR7C	
T 14 PR-U	BPR4FS	
T 14 PR-U 15	BPR4FS-15	
T 16 EPR-U	BPR5EFS	
T 16 EX-U	BP5EFS	
T 16 PR-U	BPR5FS	
T 16 PR-U 11	BPR5FS-11	
T 16 PR-U 15	BPR5FS-15	
T 16 P-U	BP5FS	
T 16 R-U	BR5FS	
T 16 RU 15	BR5FS	
T 16 U 15	YR55IX	
T 20 EPR-U	BPR6EFS	7
T 20 EP-U	BP6EFS	5
T 20 EX-U	BP6EFS	5
T 20 MP-U	BPM6F	
T 20 M-U	BM6F	
T 20 PR-U	BPR6FS	
T 20 PR-U 15	BPR6FS	
T 20 P-U	BP6FS	
T 20 R-U	BR6FS	
T 20 R-U 15	BR6FS	

DENSO	→ NGK	V-Line
T 22 EP-U	BP7EFS	
T 22 MP-U	BPM7F	
T 22 M-U	BM7F	
TR 20	B6HS	
TR 22	B7HS	
TR 22-10	B7HS-10	
TR 24	B8HS	
TR 24-10	B8HS-10	
U 14 FSRUB	CR4HSB	
U 14 FSUB	C4HSB	
U 16 FER-9	CR5EH-9	
U 16 FSL	C5HSA	
U 16 FSRL	CR5HSA	
U 16 FSR-U	CR5HSA	
U 16 FSRUB	CR5HSB	
U 16 FS-U	C5HSA	
U 16 FSUB	C5HSB	
U 17 F	C5HSA	
U 20 EPR-9	CPR6EA-9	
U 20 ESR-N	CR6E	
U 20 FS	C6HSA	
U 20 FSL	C6HSA	
U 20 FSRL	CR6HS	
U 20 FSR-U	CR6HSA	
U 20 FS-U	C6HSA	
U 20 M-U	CM-6	
U 21 FB	C6HSA	
U 22 EPR-U	CPR7EA-9	
U 22 ESN	C7E	
U 22 ESRN	CR7E	
U 22 ETR	CR7EK	
U 22 FER 9	CR7EH-9	
U 22 FS	C7HSA	
U 22 FSG-U	CR7HIX	
U 22 FSL	C7HSA	
U 22 FSRL	CR7HS	
U 22 FSR-U	CR7HSA	
U 22 FS-U	C7HSA	
U 22 FSZ-U	CR7HIX	
U 24 ESN	C8E	
U 24 ESRN	CR8E	
U 24 ESRNB	CR8EB	
U 24 ESRNZ-U	CR8EIX	
U 24 ETR	CR8EK	
U 24 FB	C8HSA	
U 24 FE 9	C8EH-9	
U 24 FER 9	CR8EH-9	
U 24 FER 9 S	CR8EH-9S	
U 24 FERZ-U 9	CR8EHIX-9	
U 24 FS	C8HSA	
U 24 FSL	C8HSA	
U 24 FSR-U	CR8HS	



DENSO	→ NGK	V-Line
U 24 FSRZ-U	CR8HVX	
U 24 FS-U	C8HSA	
U 24 FSZ-U	CR8HVX	
U 27 ESN	C9E	
U 27 ESNZ-U	CR9EIX	
U 27 ESRN	CR9E	
U 27 ESRNB	CR9EB	
U 27 ESRNZ-U	CR9EIX	
U 27 ETR	CR9EK	
U 27 FE 9	C9EH-9	
U 27 FER 9	CR9EH-9	
U 27 FERZ-U 9	CR9EHIX-9	
U 27 FEZ-U 9	CR9EHIX-9	
U 31 ESRN	CR10E	
U 31 ETR	CR10EK	
VK 16 J	ZFR5FIX-11P	
VK 16 PRZ 11	IFR5L11	
VK 20	IZFR6H11	
VK 20 PRZ 11	IFR6L11	
VK 20 T	LPG1	
VK 22	IFR7F-6D	
VK 24 PRZ 11	IFR8H11	
VK 27 PRZ 11	IFR9H11	
VKA 20	HB6AIX-11P	
VKB 20	HB6BIX-11P	
VKH 16	ILZFR5B	
VKH 20	ILZFR6D11	
VKH 20 Y	LFR6AIX-P	
VKH 22	LFR7AIX-P	
VKJ 20 RZ-M 11	IZFR6F11	
VNH 27 Z	IMR9B-9H	
VQ 16	BCPR5EIX-11P	
VQ 20	BCPR6EIX-11P	
VUH 24 D	IMR8C-9H	
VUH 27 D	IMR9C-9H	
VUH 27 ES	IMR9C-9HES	
VUH 27 Z	IMR9A-9H	
VW 20 T	LPG2	
VX 22 BC	IJR7A9	
VX 22 BZ	IJR7A9	
VXU 22	DCPR7EIX-P	
W 9	B-2	
W 9 EP	BP-2E	
W 9 EPR	BPR2ES	
W 9 EXR-U	BPR2ES	
W 9 EX-U	BP-2E	
W 9 FP	BP-2H	
W 9 FPL	BP2HS	
W 9 FPLUL	BP2HS	
W 9 FPUL	BP2HS	
W 9 LMRUS	BR2-LM	
W 9 LMUS	B2-LM	

DENSO	→ NGK	V-Line
W 9 P	BP-4	
W 9 PR-U	BP-4	
W 9 P-U	BP-4	
W 9 U	B-2	
W 14	B-4	
W 14 E	B4ES	
W 14 EKR-S 11	BUR4EB-11	
W 14 EP	BP4ES	
W 14 EPR	BPR4ES	
W 14 EPR 11	BPR4ES-11	
W 14 EPR-U	BPR4ES	
W 14 EP-U	BP4ES	
W 14 EXR-U	BPR4EY	
W 14 EXR-U 11	BPR4EY-11	
W 14 EXR-U 13	BPR4ES-13	
W 14 EXRZ-U	GR4IX	
W 14 EX-U	BP4EY	
W 14 EX-U 11	BP4EY-11	
W 14 EX-U 13	BPR4ES-13	
W 14 EXZ-U	GR4IX	
W 14 F	B-4H	
W 14 FP	BP-4H	
W 14 FPL	BP4HS	
W 14 FPLUL	BP4HA	
W 14 FPR	BPR-4H	
W 14 FPRL	BPR4HS	
W 14 FPR-U	BPR-4H	
W 14 FPR-UL	BPR4HS	
W 14 FPR-UL 10	BPR4HS-10	
W 14 FP-U	BP-4H	
W 14 FP-UL	BP4HS	
W 14 FP-UL 10	BP4HS-10	
W 14 FRL	BR4HSA	
W 14 FR-U	BR4HS	
W 14 F-U	B-4H	
W 14 F-U 10	B-4H-10	
W 14 L	B-4L	
W 14 LMR-US	BR4-LM	
W 14 LM-U	B4-LM	
W 14 LM-US	B4-LM	
W 14 MPR-U 10	BPMR4A	
W 14 MP-U 10	BPM4A-10	
W 14 MR-U	BMR4A	
W 14 M-U	BM4A	
W 14 M-US	BM4A	
W 14 P	BP5S	
W 14 PR-U	BP-4	
W 14 P-U	BP-4	
W 14 U	B-4	
W 14 U 10	B-4	
W 14 US	B-4	
W 16 DTRS	BPR5EKB	



DENSO	→ NGK	V-Line
W 16 EKR-S 11	BUR5EB-11	
W 16 EK-S 11	BUR5EB-11	
W 16 EP	BP5ES	8
W 16 E-P 11	BP5ES-11	
W 16 EPB	BP5EY	
W 16 EPB 10	BP5ET-10	
W 16 EPG-U	BPR5EIX	
W 16 EPR	BPR5ES	6
W 16 EPR 11	BPR5ES-11	
W 16 EPR-S 11	BUR5EA-11	
W 16 EPR-U	BPR5ES	6
W 16 EPR-U 10	BPR5E-11	
W 16 EPR-U 11	BPR5ES-11	
W 16 EP-U	BP5ES	8
W 16 EP-U 10	BP5ES-11	
W 16 EP-U 11	BP5EY-11	
W 16 EPZ-U	BPR5EIX	
W 16 ES	B5ES	
W 16 ES-L 11	BR5ES	
W 16 ESRL	BR5ES	
W 16 ESR-L 11	BUR5EB-11	
W 16 ESR-U	BR5ES	
W 16 ES-U	B5ES	
W 16 ETL	BPR5EY	9
W 16 ETRS	BPR5EIX-11	
W 16 ETS	BP5EK-A	
W 16 EX	BP5EY	
W 16 EXR-U	BPR5EY	9
W 16 EXR-U 11	BPR5EY-11	
W 16 EXR-U 13	BPR5ES-13	
W 16 EXRZ-U	BPR5EIX	
W 16 EX-U	BP5EY	
W 16 EX-U 11	BP5EY-11	
W 16 EX-U 13	BP5ES-13	
W 16 EXZ-U	BPR5EIX	
W 16 FP	BP5HS	
W 16 FPL	BP5HA	
W 16 FPR	BPR5HS	
W 16 FPR-U	BPR5HS	
W 16 FP-U	BP5HS	
W 16 FPU 10	BP5HS-10	
W 16 FPUL	BP5HA	
W 16 FS	B5HS	
W 16 FSR	BR5HS	
W 16 FS-U	B5HS	
W 16 LS	B-6L	
W 16 PR-U	BP5S	
W 16 P-U	BP5S	
W 17	B6S	
W 17 ES	BR6ES	
W 17 FP	BP6HS	18
W 17 P	BP6S	

DENSO	→ NGK	V-Line
W 17 PR-U	BP6S	
W 17 P-U	BP6S	
W 20 DTRSA	BPR6EKB-L	
W 20 EKR-S 11	BUR6EB-11	
W 20 EK-S 11	BUR6EB-11	
W 20 EP	B6ES	
W 20 E-P 11	BP6ES-11	
W 20 EPB	BUR6ET	1
W 20 EPBR-S	BUR6ET	1
W 20 EPG-U	BPR6EIX	
W 20 EPR	BPR6ES	2
W 20 EPR 11	BPR6ES-11	13
W 20 EPR-S 11	BUR6EA-11	
W 20 EPR-U	BPR6ES	2
W 20 EPR-U 10	BPR6ES-11	13
W 20 EPR-U 11	BPR6ES-11	13
W 20 EPRZ-U	BPR6EIX	
W 20 EPRZ-U 11	BPR6EVX-11	
W 20 EP-S 11	BUR6EA-11	
W 20 EP-U	BP6ES	4
W 20 EP-U 10	BP6ES-11	
W 20 EP-U 11	BP6ES-11	
W 20 EPZ-U	BPR6EIX	
W 20 ES	B6ES	
W 20 ESL	BR6ES	
W 20 ES-L 11	BUR6EB-11	
W 20 ESR	BR6ES	
W 20 ESRL	BR6ES	
W 20 ESR-L 11	BUR6EB-11	
W 20 ESR-U	BR6ES	
W 20 ES-U	B6ES	
W 20 ES-U 11	B6ES-11	
W 20 ET	BPR6EK-A	
W 20 ETL	BPR6EKN	
W 20 ETR	BPR6EK-A	
W 20 ETR-L	BPR6EKN	
W 20 ETR-L 8	BPR6EKN	
W 20 ETRS	BPR6EK-A	
W 20 ETS	BPR6EK-A	
W 20 EXR-U	BPR6EY	
W 20 EXR-U11	BPR6EY-11	10
W 20 EXR-U 13	BPR6EVX-11	
W 20 EXRZ-U	BPR6EIX	
W 20 EX-U	BP6EY	
W 20 EX-U 11	BP6EY-11	
W 20 EX-U 13	BP6ES-13	
W 20 EXZ-U	BPR6EIX	
W 20 FP	BP6HS	18
W 20 FPL	BP6HSA	
W 20 FPR	BPR6HS	3
W 20 FPRL	BPR6HSA	
W 20 FPR-U	BPR6HS	3

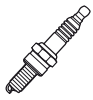

DENSO	→ NGK	V-Line
W 20 FPR-U 10	BPR6HS-10	
W 20 FPRU-L 10	BPR6HS-10	
W 20 FP-U	BP6HS	18
W 20 FP-U 10	BP6HS-10	
W 20 FRL	BR6HSA	
W 20 FS	B6HS	
W 20 FSG-U	BR6HIX	
W 20 FSR	BR6HS	
W 20 FSR-U	BR6HS	
W 20 FS-U	B6HS	
W 20 FSU 10	B6HS-10	
W 20 FSZ-U	BR6HIX	
W 20 M	BM6A	
W 20 MPRU 10	BPMR6A-10	
W 20 MP-U	BPM6A	
W 20 MPU 10	BPM6A-10	
W 20 MR-U	BMR6A	
W 20 M-U	BM6A	
W 20 MUS	BM6A	
W 20 PR-U	BP6S	
W 20 P-U	BP6S	
W 20 S	B6S	
W 20 SR-U	BR6S	
W 20 S-U	B6S	
W 21 ES-L 11	BR6EB-L-11	
W 21 ESR-L 11	BR6EB-L-11	
W 22	B7S	
W 22 EA	B7EM	
W 22 EAR	BR7EM	
W 22 EB	BR7ET	
W 22 EBR	BR7ET	
W 22 EDR	BR7EQ	
W 22 EDR 14	BR7EQ-14	
W 22 EKR-S 11	BUR7EB-11	
W 22 EK-S 11	BUR7EB-11	
W 22 EP	BP7ES	
W 22 E-P 11	BP7ES-11	
W 22 EPB	BP7ET	
W 22 EPG-U	BPR7EIX	
W 22 EPR	BPR7ES	19
W 22 EPR 11	BPR7ES-11	
W 22 EPR-S 11	BUR7EA-11	
W 22 EPR-U	BPR7ES	19
W 22 EPR-U 11	BPR7ES-11	
W 22 EPRZ-U	BPR7EIX	
W 22 EP-S 11	BUR7EA-11	
W 22 EP-U	BP7ES	
W 22 EP-U 11	BP7ES-11	
W 22 EPZ-U	BPR7EIX	
W 22 ES	B7ES	
W 22 ESG-U	BR7EIX	
W 22 ESL	BR7ES	

DENSO	→ NGK	V-Line
W 22 ES-L 11	BUR7EB-11	
W 22 ESR	BR7ES	
W 22 ESRL	BR7ES	
W 22 ESR-L 11	BUR7EB-11	
W 22 ESR-U	BR7ES	
W 22 ES-U	B7ES	
W 22 ES-U 11	B7ES-11	
W 22 ESZ-U	BR7EIX	
W 22 ETL	BPR7EKN	
W 22 ETRL	BPR7EKN	
W 22 ETR-L 8	BPR7EKN	
W 22 EXR-U	BPR7EIX	
W 22 EXR-U 11	BPR7EY-11	
W 22 EX-U	BP7EY	
W 22 FP	BP7HS	
W 22 FPR	BPR7HS	
W 22 FPR-U	BPR7HS	
W 22 FPRZ-U	BPR7HIX	
W 22 FP-U	BP7HS	
W 22 FP-U 10	BP7HS-10	
W 22 FPUS	BP7HS	
W 22 FS	B7HS	
W 22 FSG-U	BR7HIX	
W 22 FSR	BR7HS	
W 22 FSR-U	BR7HS	
W 22 FS-U	B7HS	
W 22 FSZ-U	BR7HIX	
W 22 M	BM7A	
W 22 MPR-U	BPMR7A	
W 22 MP-U	BPM7A	
W 22 MPUS	BPM7A	
W 22 M-U	BM7A	
W 22 MUS	BM7A	
W 22 S	B7S	
W 22 S-U	B7S	
W 24	B8S	
W 24 EMRC	BR8ECM	
W 24 EP	BP8ES	
W 24 E-P 11	BP8ES	
W 24 EPR	BPR8ES	
W 24 EPR-U	BPR8ES	
W 24 EPRZ-U	BPR8EIX	
W 24 EP-U	BP8ES	
W 24 ES	B8ES	
W 24 ESG-U	BR8EIX	
W 24 ESR	BR8ES	
W 24 ESR-U	BR8ES	
W 24 ESRV	BR8EG	
W 24 ESRZ-U	BR8EIX	
W 24 ES-U	B8ES	
W 24 ES-U 11	B8ES	
W 24 ESV	B8EG	





DENSO	→ NGK	V-Line
W 24 ESZ-U	B8EGV	
W 24 FP	BP8HS	
W 24 FPL	BPR8HSA	
W 24 FPR	BPR8HS	
W 24 FPRL	BPR8HSA	
W 24 FPR-U 10	BPR8HS-10	
W 24 FP-U	BP8HS	
W 24 FRL	BR8HSA	
W 24 FS	B8HS	
W 24 FSG-U	BR8HIX	
W 24 FSR	BR8HS	
W 24 FSR-U 10	BR8HS-10	
W 24 FS-U	B8HS	
W 24 FS-U 10	B8HS-10	
W 24 FSZ-U	BR8HIX	
W 24 S	B8S	
W 24 S-U	B8S	
W 25 EA	BR8EM	
W 25 EAR	BR8EM	
W 25 EB	BR8ET	
W 25 EBR	BR8ET	
W 25 EDR	BR8EQ	
W 25 EDR 14	BR8EQ-14	
W 25 EN	B8EG	
W 25 EPT	B8EGP	
W 25 FC	B8HCS	
W 25 FN	BR8HIX	
W 27 EBR	BR9ET	
W 27 EDR	BR9EQ-14	
W 27 EDR 14	BR9EQ-14	
W 27 EMRC	BR9ECM	
W 27 EMRZ-U	BR9ECMIX	
W 27 EN	B9EG	
W 27 EPT	BR9EIX	
W 27 ES	B9ES	
W 27 ESC	B9ECS	
W 27 ESG-U	BR9EIX	
W 27 ESR	BR9ES	
W 27 ESR-U	BR9ES	
W 27 ESRV	BR9EG	
W 27 ESRZ-U	BR9EIX	
W 27 ES-U	B9ES	
W 27 ESV	B9EG	
W 27 ESZ-U	B9EGV	
W 27 FC	B9HCS	
W 27 FN	BR9HIX	
W 27 FS	B9HS	
W 27 FSG-U	BR9HIX	
W 27 FSR	BR9HS	
W 27 FSR-U 10	BR9HS-10	
W 27 FS-U	B9HS	
W 27 FS-U 10	B9HS-10	

DENSO	→ NGK	V-Line
W 27 FSZ-U	BR9HIX	
W 29 EBR	BR10ET	
W 29 EPT	B95EGP	
W 29 ESG-U	B95EGV	
W 29 ESRV	BR10EG	
W 29 ESV	B10EG	
W 29 ESZ-U	B95EGV	
W 31 EMRC	BR10ECM	
W 31 EMRZ-U	BR10ECMIX	
W 31 EN	B10EG	
W 31 EPT	B10EGP	
W 31 ES	B10ES	
W 31 ESG-U	BR10EIX	
W 31 ESR-U	BR10ES	
W 31 ESRZ-U	BR10EVX	
W 31 ES-U	B10ES	
W 31 ESZ-U	B10EGV	
W 31 FS	B10HS	
W 31 FSG-U	BR10HIX	
W 31 FSZ-U	BR10HIX	
W 32 EPT	B105EGP	
W 34 EN	B11EG	
W 34 ESZ-U	B11EGV	
WA 20 M	BM6F	
WA 20 M-U	BM6F	
WA 22 M	BM7F	
WA 22 M-U	BM7F	
X 16 EPR-U 9	DPR5EA-9	
X 16 EP-U 9	DPR5EA-9	
X 16 FSR-U	DR5HS	
X 16 FS-U	D5HS	
X 20 EPR-U 9	DPR6EA-9	
X 20 EP-U 9	DP6EA-9	
X 20 ES-U	D6EA	
X 20 FSR-U	DR6HS	
X 20 FS-U	D6HA	
X 22 EPRGL	PJR7A	
X 22 EPR-U 9	DPR7EA-9	
X 22 EPRZ-U 9	DPR7EIX-9	
X 22 EP-U	DP7EA-9	
X 22 EP-U 9	DP7EA-9	
X 22 EPZ-U 9	DPR7EIX-9	
X 22 ESG-U	DR7EIX	
X 22 ESR-U	DR7ES	
X 22 ES-U	D7EA	
X 22 ESZ-U	DR7EIX	
X 22 GPR-U	DPR7Z	
X 22 GP-U	DPR7Z	
X 24 EPR-U 9	DPR7EA-9	
X 24 EPRZ-U 9	DPR8EIX-9	
X 24 EP-U	DP8EA-9	
X 24 EP-U 9	DP8EA-9	



DENSO	→ NGK	V-Line
X 24 EPZ-U 9	DPR8EIX-9	
X 24 ESG-U	DR8EIX	
X 24 ESR-U	DR8ES-L	
X 24 ESRZ-U	DR8EIX	
X 24 ESRZ-U 9	DR8EIX	
X 24 ES-U	D8EA	
X 24 ESZ-U	DR8EIX	
X 24 ESZ-U 9	DR8EIX	
X 24 FSR-U	DR8HS	
X 24 FS-U	D8HA	
X 24 GPR-U	DPR8Z	
X 24 GP-U	DP8Z	
X 27 EPR-U 9	DPR7EA-9	
X 27 EPRZ-U 9	DPR9EIX-9	
X 27 EP-U 9	DP9EA-9	
X 27 EPZ-U 9	DPR9EIX-9	
X 27 ESR-U	DR8ES	
X 27 ESRZ-U	DR9EIX	
X 27 ESRZ-U 9	DR9EIX	
X 27 ES-U	D9EA	
X 27 ESZ-U	DR9EIX	
X 27 ESZ-U 9	DR9EIX	
X 27 ET	J9A	
X 27 ETR	JR9B	
X 27 GPR-U	DPR9Z	
X 27 GP-U	DP9Z	
X 29 ESZ-U	DR9EIX	
X 31 ES-U	D10EA	
X 31 ETR	JR10B	
XE 20 HR-U 9	LZKAR7A	
XU 20 EPR-U	DCPR6E	
XU 22 EPR	DCPR7E	
XU 22 EPRP	DCPR7EVX	
XU 22 EPR-U	DCPR7E	
XU 22 EPRZ-U	DCPR7EVX	
XU 22 EP-U	DCP7E	
XU 22 HDR 9	LKR7B-9	
XU 22 PR 9	DCPR7EA-9	
XU 24 EPRP	DCPR8EIX	
XU 24 EPR-U	DCPR8E	
XU 24 EPRZ-U	DCPR8EIX	
XU 24 EP-U	DCPR8E	
XU 24 EPZ-U	DCPR8EIX	
XU 27 EPR-U	DCPR9E	
XU 27 EPRZ-U	DCPR9EIX	
Y 24 FERC	ER8EH	
Y 27 FER	ER9EH	
Y 27 FERC	ER9EH	
Y 31 FERC	ER10EH	
Z 20 ES-U	D6EA	
ZC 20 HPR 11	ILKAR7L11	
ZXU 20 PR 11	IKR6G11	

DENSO	→ NGK	V-Line
ZXU 22 PR 11	IKR6G11	
D 1	BUR6ET	1
D 2	BPR6ES	2
D 3	BPR6HS	3
D 4	BP6ES	4
D 5	BP6EFS	5
D 6	BPR5ES	6
D 7	BPR6EFS	7
D 8	BP5ES	8
D 9	BPR5EY	9
D 10	BPR6EY-11	10
D 11	BCPR6EY-11	
D 12	BKR6E	28
D 13	BPR6ES-11	13
D 14	BKR6E-11	14
D 15	ZGR5A	15
D 17	BCP6ES	17
D 18	BP6HS	18
D 19	BPR7ES	19
D 20	BKR6EKUB	
D 21	BKR5E-11	33
D 22	BKR6E	28
D 23	BCPR7ES	
D 24	BP5EY	
D 25	BP6EY	
D 26	BPR6EY	
D 27	BP7ES	
D 28	AP6FS	
D 29	BUR6ET	1
D 30	BKR5EYA	
D 31	BKR6EYA	
D 32	BKR5EYA-11	39
D 33	BKR6EY-11	
D 34	ZFR4F-11	
D 35	ZFR5F-11	40
D 36	ZFR5E-11	
D 37	ZFR5J-11	
D 38	ZFR6J-11	
D 39	BCPR5EY	
D 40	BCPR5EY-11	
D 41	BCPR6EY-11	
D 42	BCPR5E	32
D 43	BCPR5EY-11	
D 44	ZFR6A-11	
D 45	BP4EY	
D 47	BP5EY-11	
D 49	BP6EY-11	
D 51	BUR6EB-11	
D 53	BR8EQ-14	
D 54	B5ES	
D 55	B6ES	
D 56	B7ES	



DENSO	→ NGK	V-Line
D 57	B5HS	
D 58	B6HS	
D 59	BPR5EFS	
D 62	BP5FS	
D 63	BPR5FS	
D 64	BPR5FS-11	
D 65	BPR5FS-15	
D 66	BR5FS	
D 67	BPR6FS	
D 69	BPR6FS	
D 71	BP5HS	
D 73	BPR4FS	
D 74	BP7HS	
D 76	BKUR6ET-10	24
D 76	BKUR6ET-10	24
D 77	BKR5E	35
D 79	SD10A	
D 80	SD11A	
D 81	APR6FS	
D 85	BP4ES	
D 86	BPR5EY-11	
D 89	BRE529Y	
D 93	BP5S	
D 94	BKR6EKB-11	
D 95	BRE529Y-11	
D 96	BCPR5EY-11	
D 98	APR5FS	
D 99	BKR5EKB-11	
D 100	BPR5ES-11	
D 101	BKR5E-N-11	
D 102	BCPR6EY	
D 103	BKR5EIX	
D 104	BKUR6EK	
D 105	BKUR6ET	27
D 106	ZFR6F-11	
D 109	BR9EQ-14	
D 110	ZFR6K-11	
D 112	BKR6EKC	26
D 116	BKR7E-11	
D 117	BKR6E-N-11	
D 118	LFR6C-11	
D 130	BP5EY-11	
D 135	BR6ES	
D 135	BR8ES	
D 136	BR7ES	
D 137	BPR4EY-11	
D 138	BUR6EA-11	
D 139	BPR5E-11	
D 140	BPR4ES	
D 143	BCRE527Y	
D 144	BR6FS	
D 145	BRE527Y-11	

DENSO	→ NGK	V-Line
D 148	BKR7E	
D 149	BKR5EIX-11	
D 150	BUR7EB-11	
D 151	BCPR4EY-11	
D 152	ZFR4F-11	
D 153	BCPR7ES-11	
D 155	ZFR5A-11	
D 156	BKR8E-11	
D 160	BPR4FS-15	
D 162	BP6FS	
D 163	BP7EFS	
D 164	BKUR7ET	
D 165	BP7ET	
D 166	LFR5A-11	
D 167	LZKAR7A	
D 168	FR6EI	
D 171	LKR7B-9	
I 01	BCPR5EIX-11	
I 02	BCPR6EIX-11	
I 03	BKR5EIX-11	
I 04	BKR6EIX-11	
I 05	BPR5EIX-11	
I 06	BPR6EIX-11	
I 07	BPR7EIX	
I 08	DCPR7EIX	
I 16	BR8EIX	
I 17	BR9EIX	
I 19	BR10EIX	
I 25	TR5IX	
I 26	TR6IX	
I 27	TR7IX	
I 28	TR8IX	
I 30	UR5IX	
I 31	UR6IX	
I 35	FR8BI-11	
I 36	FR9BI-11	
I 43	LFR5AIX-11	
I 44	LFR6AIX-11	
I 61	CR7EIX	
I 62	CR8EIX	
I 63	B8HCS	
I 68	CR8EHIX-9	
I 69	CR9EHIX-9	
I 71	DR7EIX	
I 72	DR8EIX	
I 73	DR9EIX	
I 75	DPR7EIX-9	
I 76	DPR8EIX-9	
I 77	DPR9EIX-9	
I 78	BPR6HIX	
I 79	BR7HIX	
I 80	BR8HIX	



DENSO	→ NGK	V-Line
I 81	BR9HIX	
I 83	CR7HIX	
I 84	CR8HIX	
I 88	IMR9A-9H	
I 90	CR9EIA-9	
I 91	BR8ECMIX	
I 92	BR9ECMIX	
I 93	BR10ECMIX	
I 100	ER8EHIX	
I 101	ER9EHIX	
P 1	BCPR6EP-11	
P 2	BCPR5EIX-11	
P 3	BPR5EP-11	
P 6	BKR6EP-11	
P 8	BKR5EP-11	
P 10	PZFR5F-11	
P 11	PZFR6F-11	
P 12	BKR6EKPB-11	
P 13	PGR5A-11	
P 14	PFR6J-11	
P 15	PFR6G-11	
P 16	PTR5A-13	25
P 17	BKR5EKPB-11	
P 18	PTR5D-10	31
P 19	PZFR5F	
P 21	PGR6A-11	
P 22	PFR5B-11	
P 23	BCPR6EP-8	
P 24	PGR5A	
P 25	BKR6EP-13	
P 26	BKR6EP-8	
P 27	PFR6J	
P 28	PFR6B-11	
P 29	BCPR6EIX-11	
P 30	PFR7G-11S	
P 31	PFR7B	
P 32	BKR6EPA-8	
P 35	PZTR5A-15	
P 36	BCPR6EP-N-8	
P 38	BKR5EKPB-13	
P 40	PGR6A	
P 41	PFR5J-11	
P 46	PZFR5F-13	
P 47	PZFR6F-11	
P 50	PFR6G-13	
P 51	BCPR5EP-8	
P 52	PZFR6F	
P 53	BPR6EP-8	
P 54	BPR5EP-11	
P 55	PGR7A	
P 62	BCPR6EIX-11	
P 63	PFR7B-11	

DENSO	→ NGK	V-Line
P 80	BKR6EKPA	
R 01	R7434-8	
R 02	R7434-9	
R 03	R7434-10	
R 05	R7434-9	
R 06	R7434-10	
R 24	R7282A-105	
R 25	R7282A-11	
R 31	R2525-9	
R 32	R2525-10	
R 33	R2349-11	
R 47	R7282-105	
R 48	R7282-11	
S 2	IFR6T11	
S 3	IFR5T-8N	
S 7	IFR6C	
S 11	HB6BIX-11P	
S 12	BKR6EIX-11P	
S 13	IGR7A	
S 14	IFR5E11	
S 17	IFR7G-11KS	
S 18	BKR6EP-8	
S 19	IZFR6K11	
S 20	ZFR6FIX-11	
S 21	IFR6S	
S 22	IFR5E11	
S 24	IZFR6K13	
S 25	IFR6E11	
S 32	IZFR5K11	
S 33	ILFR6T11	
S 34	IFR5G-11K	
S 37	IKR7C	
S 41	IZFR6K11NS	
S 42	ILFR6J-11K	
S 43	ILKR7B8	
S 45	DILKAR6A11	
S 48	ILKAR7B11	
S 49	DF7H-11B	
S 52	IFR6J11	
S 54	IKR6G11	
S 59	DF8H-11B	
S 61	ILZKR7B11GS	
S 64	HB6AIX-11P	
S 65	DFH6B-11A	
V 01	BCPR5EIX-11P	
V 02	BCPR6EIX-11P	
V 04	IZFR6H11	
V 08	DCPR7EIX-P	
V 10	IFR7F-6D	
V 14	IJR7A9	
V 17	ILZFR5B	
V 18	ILZFR6D11	



DENSO	→ NGK	V-Line
V 19	LFR7AIX-P	
V 25	HB6BIX-11P	
V 26	IMR8C-9H	
V 27	IMR9C-9H	
V 31	IMR9B-9H	
V 33	IZFR6F11	
V 39	LFR6AIX-P	
V 42	IMR9C-9HES	
3004	BPR5EP-11	
3005	BCPR5EIX-11	
3006	BCPR5EY-11	
3009	BCPR6EY-11	
3011	BP4EY	
3013	BPR4EY	
3018	BP5ES	8
3025	B5ES	
3027	BP5EY	
3032	BPR5EY-11	
3034	B5HS	
3036	BP5S	
3043	BP6ES	4
3046	BUR6EA-11	
3049	BPR6ES-11	13
3051	B6ES	
3057	BR6ES	
3062	BP6EY	
3066	BPR6EY	
3067	BPR6EY-11	10
3068	BP6HS	18
3070	BPR6HS	3
3073	B6HS	
3074	BR6HIX	
3075	B6S	
3085	BP7ES	
3088	BPR7ES	19
3089	BPR7ES-11	
3093	B7ES	
3095	BR7EIX	
3098	BR7ES	
3103	BR8ET	
3107	BR9ET	
3110	BR5ES	
3111	SD11A	
3112	ZFR6A-11	
3113	BCPR6EP-N-8	
3114	PGR5A-11	
3115	PGR6A-11	
3117	BCPR6EP-11	
3119	BKR5EYA	
3120	BKR5EYA-11	39
3121	BKR6E-11	14
3122	BKR6EYA	

DENSO	→ NGK	V-Line
3123	BCPR5EP-8	
3125	BCP6ES	17
3127	BKR6EP-8	
3128	BKR6EP-11	
3129	BCPR5EY	
3130	BKR5E-11	33
3131	ZFR5J-11	
3132	ZFR5F-11	40
3133	ZFR6J-11	
3134	BKR5EP-11	
3135	ZFR5E-11	
3139	BKR6EY-11	
3140	BCPR6EY	
3141	PFR6J-11	
3142	PFR6G-11	
3144	BKR6E-N-11	
3156	BCPR5EIX-11	
3157	BCPR6EIX-11	
3161	BKR5EIX-11	
3163	BKR6EIX-11	
3165	BKR7E	
3167	ZFR4F-11	
3168	PFR6B-11	
3169	ZFR6F-11	
3172	PFR6G-13	
3174	PFR5J-11	
3175	PZFR5F	
3179	DCPR7E	
3184	BCPR5EY-11	
3186	BCPR5EY-11	
3187	BCPR6EY-11	
3192	BKR7E-11	
3194	BKR5EKB-11	
3195	BKR6EKB-11	
3196	BKUR6EK	
3197	BKUR7EK	
3199	BP5EY-11	
3201	BPR5ES-11	
3210	BPR5EY	9
3213	BPR5ES-13	
3226	BKR6EP-13	
3231	BPR5EIX	
3235	BCRE527Y	
3239	BPR5EP-11	
3242	DCPR7EVX	
3244	BCPR6EIX-11	
3245	PFR6J	
3246	PZFR5F-11	
3247	PZFR6F-11	
3253	BKR6EKPB-11	
3255	BCP7ES	
3256	ZGR5A	15



DENSO	→ NGK	V-Line
3262	BKR6EIX-11	
3264	PFR5B-11	
3273	PFR7B	
3275	PFR5G-11	
3277	BPR6EKN	
3281	BPR7EIX	
3285	BPR5EIX-11	
3289	BKR5EKP-11	
3290	BKR7EIX	
3291	BPR6EIX	
3293	BKR5EIX	
3297	IFR6T11	
3299	BKR7E-N-11	
3302	PGR7A	
3303	IFR5T-8N	
3304	BKR6EKC	26
3305	BKUR6EK-9	
3306	PGR6A	
3307	IFR6C	
3310	BR10ET	
3312	DCPR8E	
3313	DCPR9E	
3314	DCPR9EIX	
3323	BPR6EVX-11	
3333	BKR6E	28
3344	BPR6ES	2
3345	BPR5ES	6
3346	BCPR5E	32
3347	BCPR7ES	
3348	ZFR7F-11	
3349	BKR5E	35
3354	IGR7A	
3372	IFR7G-11KS	
3373	BKR6EP-8	
3374	ZFR6K-11	
3377	IZFR6K11	
3378	ZFR6FIX-11	
3379	BCPR7ES-11	
3380	BKR6EKPA	
3381	LFR6C-11	
3398	BKR6EIX-11P	
3400	IFR5E11	
3403	IFR6S	
3412	IFR5E11	
3413	ZFR5F	
3418	IFR6E11	
3424	BKR6E	28
3427	LZKAR7A	
3432	IZFR6K11NS	
3434	IKR7C	
3437	FR5EI	
3439	DILKAR6A11	

DENSO	→ NGK	V-Line
3441	ILKR7B8	
3444	ILKAR7B11	
3449	IFR6J11	
4019	BP5HS	
4021	BP7HS	
4025	B7HS	
4026	BR7HIX	
4027	B7S	
4028	BP8ES	
4030	B8ES	
4032	B8EGV	
4048	B9EGV	
4057	B95EGV	
4093	DP8EA-9	
4097	DPR8EIX-9	
4136	BPR8ES	
4167	DR8EIX	
4172	DR9EIX	
4189	CR8EIX	
4201	CR7EK	
5008	APR5FS	
5012	AP6FS	
5013	APR6FS	
5022	BPR5EFS	
5027	BPR5FS-15	
5031	BP6EFS	5
5032	BPR6EFS	7
5035	BPR6FS	
5040	BP7EFS	
5060	BKUR6ET	27
5061	BKUR6ET-10	24
5061	BKUR6ET-10	24
5062	BKUR7ET	
5063	BKR6EKUB	
5064	BP5ET-10	
5065	BUR6ET	1
5066	BP7ET	
5067	BUR6ET	1
5068	PTR5A-13	25
5069	BCP7ET	
5070	PTR5D-10	31
5077	PZTR5A-15	
5301	BCPR5EIX-11	
5302	BCPR6EIX-11	
5303	BKR5EIX-11	
5304	BKR6EIX-11	
5305	BPR5EIX-11	
5306	BPR6EIX-11	
5307	BPR7EIX	
5308	DCPR7EIX	
5316	BR8EIX	
5317	BR9EIX	



DENSO	→ NGK	V-Line
5325	TR5IX	
5326	TR6IX	
5327	TR7IX	
5328	TR8IX	
5330	UR5IX	
5331	UR6IX	
5343	LFR5AIX-11	
5344	LFR6AIX-11	
5361	CR7EIX	
5362	CR8EIX	
5372	DR8EIX	
5376	DPR8EIX-9	
5378	BPR6HIX	
5379	BR7HIX	
5601	BCPR5EIX-11P	
5602	BCPR6EIX-11P	
5604	IZFR6H11	
5608	DCPR7EIX-P	
5615	IFR6L11	
5616	IFR8H11	
5617	ILZFR5B	
5618	ILZFR6D11	
5619	LFR7AIX-P	
5623	HB6AIX-11P	
5625	HB6BIX-11P	
5630	IFR9H11	
5639	LFR6AIX-P	
6054	B6HS	
6076	LFR5A-11	
ENKER	→ NGK	V-Line
F 45 CP	BP4HS	
F 50 C	B5HS	
F 55 CP	BP5HS	
F 65 CP	BP6HS	18
F 75 C	B6HS	
F 80 C	B7HS	
F 85 CP	BP7HS	
F 100 C	B8HS	
FA 50	B-4L	
FA 70	B-6L	
FE 30 C	B4ES	
FE 35 CP	BP4ES	
FE 45 CP	BP5ES	8
FE 50 C	B5ES	
FE 55 CP	BP5ES	8
FE 55 CPD	BP5ET	
FE 65 CP	BP6ES	4
FE 65 CPD	BUR6ET	1
FE 70 C	B6ES	
FE 75 C	B7ES	

ENKER	→ NGK	V-Line
FE 80 C	B8ES	
FE 85 CP	BP7ES	
FE 85 CPD	BP7ET	
FE 85 CPU	BP7ET	
FE 95 CP	BP8ES	
FE 100 C	B9ES	
FET 65 CP	BP5EFS	
FET 75 CP	BP6EFS	5
FS 20	B-2	
FS 30	B-4	
FS 50 CP	BP5S	
FS 55 CP	BP6S	
FS 70	B6S	
FS 75 C	B7S	
FS 80	B8S	
FSC 50 C	BM6A	
FSC 50 P	BPM6A	
FSC 70 P	BPM6A	
FSC 75 CP	BPM7A	
FT 45 CP	BP5FS	
FT 55 CP	BP6FS	
FT 85 CP	BP7FS	
M 30	AB-2	
M 60	AB-6	
M 75	AB-7	
M 80	AB-8	
MT 45 CP	AP5FS	
MT 55 CP	AP6FS	
MT 65 CP	AP7FS	
SFE 55 CP	BKR5ES	35
SFE 65 CP	BKR6ES	28
SFE 65 CPD	BCP6ET	
SFE 65 CPR	BPR5ES	6
SFE 85 CP	BCPR7ES	
SFE 85 CPD	BCP7ET	
T 70	C6HSA	
T 90	C7HSA	
EYQUEM	→ NGK	V-Line
30 AM	B-4L	
50 AM	B-6L	
50 M	B5HS	
70 M	B6HS	
75 LM	B6ES	
75 M	B6HS	
100 M	B8HS	
200	B-4H	
202 CT	B2-LM	
300 AM	B-4L	
400 J	BR5FS	
406	BP6HS	18

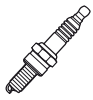

EYQUEM	→ NGK	V-Line
450 JS	BPR4FS-15	
450 L	B5ES	
480 CS	BP5S	
500 AM	B-6L	
500 C	B6S	
500 CJT	BM6F	
500 CM	B6S	
500 CS	BP5S	
500 CT	BM6A	
500 J	BR6FS	
500 JS	BPR4FS	
500 M	B5HS	
502 CT	B4-LM	
505 JS	BP5FS	
520 CS	BP5S	
550 CS	BP5S	
550 JS	BPR5FS	
550 LS	BP5ES	8
550 S	BP4HS	
580 LS	BP5ES	8
580 S	BP4HS	
600 CS	BP5S	
600 JS	BPR6FS	
600 L	B6ES	
600 LS	BP6ES	4
600 S	BP5HS	
700	B6HS	
700 CM	B6S	
700 CTS	BPM6A	
705 JS	BP7FS	
705 L	B6ES	
705 S	BP6HS	18
707 LS	BP6ES	4
750	BP6HS	18
750 L	B6ES	
750 LJS	BP6EFS	5
750 LS	BP6ES	4
753 LJS	BP6EFS	5
755	B6HS	
755 CJT	BM7F	
755 CM	B6S	
755 CT	BM7A	
755 L	B6ES	
755 LJS	BP6EFS	5
755 LS	BP6ES	4
755 M	B6HS	
755 S	BP6HS	18
775 SX	BP6HS	18
775 X	B6HS	
800 L	B6ES	
800 LJS	BP6EFS	5
800 LS	BP6ES	4

EYQUEM	→ NGK	V-Line
802 L	B6ES	
803 LJS	BP6EFS	5
805 L	B6ES	
805 LJS	BP7EFS	
805 LJSP	TR7IX	
805 LP	BR8EIX	
850	B7HS	
850 LS	BP7ES	
883 LJP	B8EFS	
1000	B8HS	
1000 CM	B7S	
1000 L	B8ES	
1000 M	B8HS	
1100	B9HS	
1100 L	B8ES	
1150 L	B9ES	
C 32	B5HS	
C 32 LS	BP5ES	8
C 32 S	BP5HS	
C 42 LJS 3	BP6EFS	5
C 42 S	BP6HS	18
C 52 LS	BP5ES	8
C 62	B7HS	
C 62 LJS	BP6EFS	5
C 62 LS	BP6ES	4
C 62 LS 3 X	BP5ET	
C 62 S	BP7HS	
C 72 LJS	BP7EFS	
C 72 LS	BP7ES	
C 72 LS 3 X	BUR6ET	1
C 82 LJS	BP7EFS	
C 82 LS	BP7ES	
C 82 LS 3 X	BP7ET	
C 92 LS	BP8ES	
D 775	D6HA	
D 800 L	D7EA	
D 900 L	D8EA	
D 1000	D8HA	
D 1000 L	D9EA	
D 1050 L	D9EA	
FC 42 LS	BCP5ES	16
FC 52 LS	BCP5ES	16
FC 58 LS	BCP6ES	17
FC 62 LS	BCP6ES	17
FC 62 LS 2	BCP6ES	17
FC 62 LS 3	BCP6ET	
FC 62 LS 3 X	BCP6ET	
FC 72 LS	BCP7ES	
FC 82 LS	BCPR7E	
FC 82 LS 1	BCP7ES	
FC 82 LS 2	BCP7ES	
FN 52 LS	BK5ESZ	





EYQUEM	→ NGK	V-Line
K 200 M	AB-6	
K 300 JS	AP5FS	
K 300 M	AB-6	
K 350 JS	AP5FS	
K 450 JS	AP5FS	
K 500 M	AB-6	
K 550 JS	AP6FS	
K 600 M	AB-6	
K 750 M	AB-7	
KC 62 JS	AP6FS	
R 850	BR7HS	
R 1000	BR8HS	
R 1000 L	BR8ES	
RC 32 LS 5	BPR4ES-11	
RC 42 S	BPR6HS	3
RC 52 LS	BPR5EY	9
RC 52 LS 5	BPR5EY-11	
RC 52 LZ 3 EX	BUR5ET	22
RC 52 LZE	ZGR5A	15
RC 58 LZ 3 EX	BUR6ET	1
RC 62 HJSDP	PTR5A-13	25
RC 62 LJS	BPR6EFS	7
RC 62 LS	BPR6ES	2
RC 62 LS 5	BPR6ES-11	13
RC 62 S	BPR7HS	
RC 82 LS	BPR7ES	19
RC 82 LS 5	BPR7EY-11	
RFC 42 LS	BKR5ES	35
RFC 42 LS 2 E	BKR5EK	23
RFC 42 LZ 2 E	BKR6EK	20
RFC 50 LZ 2 E	BKR5EK	23
RFC 52 LS	BKR5ES	35
RFC 52 LS 3	BKR6ETUC	
RFC 52 LS 5	BKR5ES-11	33
RFC 52 LSP	BKR6EK	20
RFC 52 LZ 3 EX	BKUR5ET	29
RFC 52 LZE	ZFR5F	
RFC 52 LZK	BKR5EZ	36
RFC 57 LS 3	BCPR6ET	
RFC 58 LS	BKR6ES	28
RFC 58 LS 2 E	BKR6EK	20
RFC 58 LS 3	BCPR6ET	
RFC 58 LS 5	BKR6ES-11	14
RFC 58 LSP	BKR6EZ	38
RFC 58 LZ	BKR6EY	
RFC 58 LZ 2	BKR6EKC	26
RFC 58 LZ 2 E	BKR6EK	20
RFC 58 LZ 3 EX	BKUR6ET	27
RFC 58 LZ 5	BKR6EY-11	
RFC 58 LZDP	PFR6G-9	
RFC 58 LZE 5	ZFR6F-11	
RFC 62 LS 3	BKR6ES-11	14

EYQUEM	→ NGK	V-Line
RFC 62 LS 3 X	BCPR6ET	
RFC 62 LS 5	BKR6ES-11	14
RFC 62 LZ 3 X	BKUR7ET	
RFC 82 LS	BCPR7ES	
RFC 82 LS 5	BCPR7ES-11	
RFCLZ 3 X	BKUR7ET	
RFN 52 HZ	LFR5B	
RFN 52 HZ 3 A	LFR5B	
RFN 58 HZ	LFR6B	
RFN 58 LZ	BKR6EK	20
T 850	C7HSA	
XKC 62 JS	APR6FS	

FIAT Group	→ NGK	V-Line
15 57 43	PKR9B	
16 83 25	PMR8A	
16 94 83	PMR7A	
19 26 37	PMR8B	
19 45 03	PMR8C-H	
23 92 42	PMR8C-H	
24 66 15	SPMR8A6HDG	
31 2A 20 00	ILKR9G8	
31 32 53 225	DCPR8E	
46 14 47 31	DCPR8E	
46 22 92 51	BP6ES	4
46 41 33 860	BKR6EKC	26
46 41 70 10	BKR6E	28
46 44 96 90	BKR6EKPA	
46 46 38 01	BKR6EKC	26
46 47 10 78	BKUR6ETB	
46 47 20 21	BKR6EKC	26
46 47 51 64	BCPR7ET	
46 48 03 07	BKR6EKC	26
46 48 03 09	BKR5EKC	
46 48 03 62	BKR6E	28
46 48 12 73	DCPR8E	
46 48 42 73	DCPR8E	
46 52 15 29	BKR6EKPA	
46 52 15 30	PMR7A	
46 53 19 17	DCPR8EKC	
46 53 19 18	BKR5EZ	36
46 54 84 78	BKR6EZ	38
46 54 95 76	BKR6EKPA	
46 54 95 77	PMR7A	
46 55 09 91	BKUR6ETB	
46 55 09 92	CR7EKC	
46 75 05 45	DCPR8E-N	
46 75 96 88	BP6E	4
46 82 32 99	DCPR7E-N-10	43
50 40 82 651	IFR7F-6D	
55 18 26 23	FR5CP	
55 18 88 57	DCPR7E-N-10	43



FIAT Group	→ NGK	V-Line
55 19 07 88	ZKR7A-10	42
55 21 06 85	IKR9J8	
55 21 72 32	ILKAR7D6G	
55 23 23 60	ZKR7AI-8	
00 55 23 39 97	ILKR9G8	
55 24 00 46	LKR7DI-12	
55 24 21 87	ILKR9G8	
55 24 98 68	IKR9J8	
58 94 58 5	BPR7ES	19
58 94 58 6	BKR6E	28
58 94 58 8	BCPR7ES	
58 96 17 7	BKR6EKC	26
58 96 82 4	BKR6EKC	26
58 96 82 41	BKR6EKC	26
59 84 03 6	BPR6ES	2
60 33 02 211	BP7HS	
60 50 45 63	BP6ES	4
60 51 28 48	BCP6ET	
60 51 29 29	B7ES	
60 56 90 86	PGR6A	
60 56 99 57	PFR6B	
60 57 99 03	PFR6B	
60 59 74 90	BCP7ES	
60 59 94 95	PMR7A	
60 80 03 25	BPR7ES	19
60 80 60 24	BUR6ET	1
60 81 06 89	PFR6B	
71 71 16 38	BKR6E	28
71 71 16 39	BPR6ES	2
71 71 16 40	BPR6ES	2
71 71 18 06	BPR6ES	2
71 71 18 08	BKR6E	28
71 73 98 67	ZFR5F-11	40
71 75 02 23	IFR6J11	
75 46 51 9	BKR6E	28
75 54 43 6	BPR7ES	19
75 54 44 2	BP6ES	4
75 54 44 4	BPR6ES	2
75 54 44 5	BP6HS	18
75 65 47 6	BR8ES	
76 86 64 3	BUR6ET	1
77 60 38 1	BPR7ES	19
77 60 38 2	BPR6ES	2
77 60 38 3	BKR6E	28
77 60 38 4	BCPR7ES	
77 69 24 3	BKR6EKC	26
77 72 45 3	BKR6E	28
77 72 51 5	BPR7ES	19
79 10 24 72 04	BPR6EFS	7
7FY SR	BPR7ES	19
7FY SSR	BPR7ES	19
7GB YSR4	BCPR7ET	

FIAT Group	→ NGK	V-Line
7GY SSR	BCPR7ES	
96 02 46 0780	BKR6EKC	26
96 04 08 2480	BKR6EKC	26
96 08 86 6980	BKR6EKC	26
96 08 92 2080	BKR6EKC	26
96 14 73 86 80	BKR6EKC	26
96 18 49 45 80	BKR6EKC	26
96 18 57 18 80	BKR6EKC	26
96 19 62 45 80	BKR6EKC	26
96 26 575 480	BKR6EKC	26
96 28 00 0280	BKR6EKC	26
96 38 10 5780	BKR6EKC	26
96 39 81 43 80	BKR6EKC	26
9FY SSR	BPR6ES	2
9GY SSR	BKR6E	28
FORD	→ NGK	V-Line
1032 705	BKR5EKUP	
1077 002	PTR5A-13	25
1120 170	PZFR5D-11	34
1202 935	PLTR6A-10G	
1204 572	PTR6F-13	
1219 309	TR5B-13	45
1255 464	TR5B-13	45
1307 093	PTR6D-13G	
1315 691	ITR6F13	
1362 012	TR5B-13	45
1369 704	TR6AP-13	
1379 739	ILTR5A-13G	
1493 001	TR5B-13	45
1505 812	PLFR6A	
1542 499	ZKR7A-10	42
1685 720	ILZTR6A8G	
1770 305	SILZNR8C7H	
3539 125	PTR5D-10	31
4331 810	PTR5D-13	
5100 429	ILTR6G8G	
1M50-12405-CA	PLTR6A-10G	
1S7J-12405-DA	PTR6F-13	
1S7J-12405-EB	PTR6D-13G	
1S7J-18344-EB	PTR6D-13G	
3S4J-12405-AB	ITR6F13	
3S4J-18344-AB	ITR6F13	
4M5G-12405-XC	TR5B-13	45
4M5G-12405-XE	TR5B-13	45
5M5G-12405-AA	TR6AP-13	
5M5G-18344-AA	TR6AP-13	
6118-61240-5BB	ILTR5A-13G	
6M5J-12405-AA	PLFR6A	
6M8G-12405-BB	ILTR5A-13G	
95VW-12405-DA	BKR5EKUP	



<b>FORD</b>	<b>→ NGK</b>	<b>V-Line</b>
9A6G-12405-AA	ILTR6G8G	
9A6G-12405-BA	ILTR6H8G	
9A6G-12405-CA	ILTR6H8G	
9S51-12405-AA	ZKR7A-10	42
AYFS-092FE-C	PLTR6A-10G	
BM5G-12405-CA	ILZTR6A8G	
CM5G-12405-CE	SILZNR8C7H	
CV6E-12405-AA	ILTR5K13	
CM5E-12405-BA	LTR6BI-9	
CB5E-12405-AA	LTR6DI-8	
F43E-12405-EB	PTR5D-13	
XS4F-12405-DA	PTR5A-13	25
YM21-12405-AA	PZFR5D-11	34
YN2F-12405-A2A	TR5B-13	45
YN2J-12405-AA	TR5B-13	45

<b>GM</b>	<b>→ NGK</b>	<b>V-Line</b>
12 14 046	PFR6T-G	
12 14 060	PFR6D10G	
12 14 065	DILFR7B10G	
12 14 066	IFR7X7G	
12 14 528	ZFR6BP-G	
48 11 581	ILTR5D	
9 399 866	PFR6H-10	
12 556 183	PTR5C-13	
12 561 466	PTR5C-13	
12 563 707	PZTR5A-15	
12 565 030	PTR4B-15	
12 568 387	ITR4A15	
12 571 535	PTR5C-13	
12 578 277	PZTR5A-15	
12 620 540	ILTR5D	
12 787 099	PFR6T-10G	
12 788 884	PLFR6C-10G	
24 504 873	PTR4B-15	
30 520 467	BCPR6ES-11	11
32 000 330	BCPR7ES-11	
55 182 623	FR5CP	
55 562 534	PFR6T-G	
55 564 215	BKR7ESC-11	
55 564 748	DILFR7B10G	
55 564 763	ZFR6BP-G	
55 565 219	ZFR6V-G	
55 571 391	PFR6D10G	
55 576 026	IFR7X7G	
93 161 199	PFR6G-9	
96 464 000	DCPR8E	

<b>HONDA</b>	<b>→ NGK</b>	<b>V-Line</b>
1 633 098	R0409B-10	
30717002 / 0	DR9EA	

<b>HONDA</b>	<b>→ NGK</b>	<b>V-Line</b>
12260-RL6-G010	ILZKR7B11GS	
12290-P5M-A000	PZFR6F-11	
12290-P73-J001	PFR7G-11	
12290-PCX-0000	PFR7G-11S	
12290-PCX-9999-TA	PFR7G-11S	
12290-PCX-J000	PFR7G-11S	
12290-PFD-J000	IFR6C	
12290-PGE-A01	PZFR6F-11	
12290-PNA-0030	IZFR6K13	
12290-PND-A01	IZFR6K11	
12290-PND-A010-M1	IZFR6K11	
12290-PNE-0030	ZFR6K-11	
12290-PRB-A010-M1	IFR7G-11KS	
12290-R2C-T01	SILZKR7C11DS	
12290-R1A-H01	SILZKR7C11S	
12290-R60-U010-M1	IZFR6K11NS	
12290-RB0-J01	DIFR6D13	
12290-RB0-J110-M1	DIFR6D13	
12290-RB0-JB11	DIFR6D13	
12290-RB1-0030	IZFR6K13	
12290-RB1-0031	IZFR6K13	
12290-RB0-J11	DIFR6D13	
12290-RL6-G01	ILZKR7B11GS	
12290-RL6-G010-M1	ILZKR7B11GS	
12290-RMX-0030	ILFR6J-11K	
12290-RMX-0130	ILFR6J-11K	
12290-RSH-0030	IFR6G-11K	
12290-RW0-003	DILFR6J11	
12290-RW0-003	DILFR6J11	
31901-NN2-0030	BR6ES	
31901-NX4-7020-M1	R7376-10	
31901-NX4-9010	R7376-10	
31908-KRN-A41	R0451B-8	
31908-KRN-A410-M1	R0451B-8	
31908-KTW-901	LMAR8A-9	
31908-KTW-9010-M1	LMAR8A-9	
31908-KTW-9011-M1	LMAR8A-9	
31908-MGC-003	LMAR8A-9S	
31908-MGC-0031	LMAR8A-9S	
31908-MGC-A0000	LMAR8A-9S	
31908-ZZ3-0030	LMAR6C-9	
31908-ZZ3-A0031	LMAR6C-9	
31909-MEN-A31	SILMAR9A9S	
31909-MEN-A310-M1	SILMAR9A9S	
31909-MGC-0031	LMAR8A-9S	
31910-MEE-R110-M1	R0409B-10	
31910-MEN-A31	SILMAR10A9S	
31911-HW1-671	IMR9D-9H	
31911-HW1-6710-M1	IMR9D-9H	
31911-KRN-731	R0409B-8	
31911-KRN-7310-M1	R0409B-8	
31911-KSK-731	BR9EG-N-8	



HONDA	→ NGK	V-Line
31911-KSK-7310-M1	BR9EG-N-8	
31911-MBT-F21	IJR8B9	
31911-MBT-F210-M1	IJR8B9	
31911-MBW-E11	IMR8C-9H	
31911-MBW-E111-M1	IMR8C-9H	
31911-MBW-E112-M1	IMR8C-9H	
31911-MEE-J01	IMR8C-9HES	
31911-MEE-J010-M1	IMR8C-9HES	
31911-MEE-J011-M1	IMR8C-9HES	
31912-KRN-731	R0409B-9	
31912-MBW-E11	IMR9C-9H	
31912-MBW-E110	IMR9C-9H	
31912-MBW-E111-M1	IMR9C-9H	
31912-MBW-E112-M1	IMR9C-9H	
31912-MCW-0030	IMR9B-9H	
31912-MEE-0000	IMR9C-9H	
31912-MEE-J01	IMR8C-9HES	
31912-MEL-0030	IMR9C-9HES	
31912-MEL-A	IMR9C-9HES	
31912-MFL-0030	IMR9E-9HES	
31912-MGH-641	IMR8E-9HES	
31914-Z8Y-0030	LR4C-E	
31914-Z8Y-A0030	LR4C-E	
31915-Z0H-0030	CMR5H	
31915-Z0H-0031	CMR5H	
31916-KPH-901	CPR6EA-9	
31916-KPH-9010-M1	CPR6EA-9	
31916-KRM-841	CPR8EA-9	
31916-KRM-8410-M1	CPR8EA-9	
31916-KRM-8413-M1	CPR8EA-9	
31916-KWB-601	CPR6EA-9S	
31916-MEH-0030	SIMR8A9	
31916-Z0H-003	CMR6H	
31916-ZX2-003	ZFR6K-11E	
31916-ZY3-0030	IZFR6F11	
31916-ZY3-0032	IZFR6F11	
31916-ZY3-004	IZFR6F11	
31917-KPH-901	CPR7EA-9	
31918-MEB-671	IFR8H11	
31918-MEB-6710-M1	IFR8H11	
31918-MEB-672	IFR9H11	
31919-MEB-671	IFR9H11	
31919-MEB-6710-M1	IFR9H11	
31919-MEB-672	IFR8H11	
31919-ZX2-0030	ZFR6K-11E	
3191W-Z0M-5400	BPR4ES	
3191W-Z0M-5500	BPR5ES	6
3191W-Z0M-5600	BPR6ES	2
31921-MBW-E12	IMR8C-9H	
31922-MBW-E12	IMR9C-9H	
31922-MEL-003	IMR9C-9HES	
31922-MFL-003	IMR9E-9HES	

HONDA	→ NGK	V-Line
31922-MOW-004	IMR9B-9H	
31926-KRM-841	CPR9EA-9	
31940-NX5-7520-M1	R7282-105	
31940-NX5-9410	R7282-105	
31988-GEV-761	ER8EH-N	
31988-GEV-7611-M1	ER8EH-N	
31999-KW6-6500	B9ECS	
89819-99010	BPR5ES	6
89839-99010	BPR6ES	2
94701-00408	CR9EIA-9	
98049-58716	ER8EH	
98049-59716	ER9EH	
98049-59726	ER9EH	
98049-60716	ER10EH	
98052-56471	CM-6	
98056-54718	CR4HSA	
98056-54750	C4HSB	
98056-54757	CR4HSB	
98056-54770	C4HSB	
98056-54777	CR4HSB	
98056-55713	C5HSA	
98056-55718	CR5HSA	
98056-55726	CR5HSA	
98056-55750	C5HSB	
98056-55757	CR5HSB	
98056-55770	C5HSB	
98056-55777	CR5HSB	
98056-56713	C6HSA	
98056-56713-00	C6HSA	
98056-56713-01	C6HSA	
98056-56716	CR6HS	
98056-56717	C6HA	
98056-56717-00	CR6HSA	
98056-56718	CR6HSA	
98056-5671R-00	CR6HSA	
98056-56723	C6HSA	
98056-56726	CR6HSA	
98056-57713	C7HSA	
98056-57713-00	C7HSA	
98056-57713-0A	C7HSA	
98056-57716	CR7HS	
98056-57718	CR7HSA	
98056-5771R-00	CR7HSA	
98056-57726	CR7HSA	
98056-57918	CR7HSA-9	
98056-58713	C8HSA	
98056-58716	CR8HS	
98056-58717	C8HA	
98056-58718	CR8HSA	
98059-55916	CR5EH-9	
98059-56916	CR6EH-9	
98059-57817-00	CR7E	



HONDA	→ NGK	V-Line
98059-57910	CR7EH-9	
98059-57916	CR7EH-9	
98059-57916-00	CR7E	
98059-57926	CR7EH-9	
98059-58816	CR8E	
98059-58816-H0	CR8E	
98059-58817-00	CR8E	
98059-58910	C8EH-9	
98059-58916	CR8EH-9	
98059-58916-00	CR8E	
98059-5891F	CR8EHIX-9	
98059-58920	C8EH-9	
98059-58926	CR8EH-9	
98059-5892D	IMR8C-9H	
98059-589J6	CR8EH-9S	
98059-589K6	CR8EH-9S	
98059-59816	CR9E	
98059-59816-H0	CR9E	
98059-59910	C9EH-9	
98059-59916	CR9EH-9	
98059-5991F	CR9EHIX-9	
98059-5991U	IMR9A-9H	
98059-5992U	IMR9C-9H	
98059-599U	CR9EHI-9	
98059-60916	CR10EH-9	
98061-57611	DPR7Z	
98061-57616	DPR7Z	
98061-58611	DP8Z	
98061-58616	DPR8Z	
98061-59611	DP9Z	
98061-59616	DPR9Z	
98066-54710	DR4HS	
98066-54716	DR4HS	
98066-55710	D5HS	
98066-55716	DR5HS	
98066-55740	D5HS	
98066-56710	D6HA	
98066-56716	DR6HS	
98066-56717	D6HA	
98066-56726	DR6HS	
98066-58710	D8HA	
98066-58714	D8HA	
98066-58716	DR8HS	
98066-58717	D8HA	
98066-60710	D10HS	
98069-38716	DR8ES-L	
98069-38719	DR8ES-L	
98069-55911	DPR5EA-9	
98069-55916	DPR5EA-9	
98069-56717	D6EA	
98069-56911	DP6EA-9	
98069-56916	DPR6EA-9	

HONDA	→ NGK	V-Line
98069-5691U	IJR6A9	
98069-5697Q	DCPR6E	
98069-5697Q-HE	DCPR6EIX	
98069-57716	DR7ES	
98069-57717	D7EA	
98069-57717-00	D7EA	
98069-57717-02	D7EA	
98069-57719	DR7ES	
98069-5771P	DR7EA	
98069-5771P-00	DR7EA	
98069-5771R	DR8EA	
98069-57726	DR7EA	
98069-5777P	DR7EB	
98069-57911	DP7EA-9	
98069-57912	DPR7EIX-9	
98069-57916	DPR7EA-9	
98069-57916-00	DPR7EA-9	
98069-5791U	IJR7A9	
98069-57922	DPR7EIX-9	
98069-5792U	IJR7A9	
98069-5797Q	DCPR7E	
98069-58716	DR8ES	
98069-58717	D8EA	
98069-58717-01	D8EA	
98069-58719	DR8ES	
98069-5871P	DR8EA	
98069-5871P-00	DR8EA	
98069-58726	DR8EA	
98069-58911	DP8EA-9	
98069-58912	DPR8EIX-9	
98069-58916	DPR8EA-9	
98069-58916-03	DPR8EA-9	
98069-5891F	DPR8EIX-9	
98069-58922	DPR8EIX-9	
98069-58926	DPR7EA-9	
98069-59717	D9EA	
98069-59911	DP9EA-9	
98069-59912	DPR9EIX-9	
98069-59916	DPR9EA-9	
98069-5991F	DPR9EIX-9	
98069-59926	DPR7EA-9	
98069-60717	D10EA	
98073-52710	B-2	
98073-54710	B-4	
98073-54740	BM4A	
98073-54744	BMR4A	
98073-54750	BM4A	
98073-54754	BMR4A	
98073-54771	BPM4A	
98073-54776	BPMR4A	
98073-54941	BPM4A-10	
98073-54944	BPMR4A-10	



HONDA	→ NGK	V-Line
98073-54951	BPM4A-10	
98073-56740	BM6A	
98073-56741	BPM6A	
98073-56744	BMR6A	
98073-56750	BM6A	
98073-56941	BPM6A-10	
98073-56944	BPMR6A-10	
98073-57944	BPMR7A	
98076-52711	BP2HS	
98076-52716	BPR2HS	
98076-52717	BPR2HS	
98076-52719	BP2HS	
98076-54710	B-4H	
98076-54711	BP4HS	
98076-54715	BPR4HSA	
98076-54716	BR4HS	
98076-54716-00	BR4HS	
98076-54717	BPR4HS	
98076-54719	BP4HS	
98076-5471G	BR4HSA	
98076-54720	BR4HS	
98076-54746	BR4HS	
98076-54747	BPR4HS	
98076-54770	B-4H	
98076-54780	B-4H	
98076-54821-CDI	BR4HS	
98076-54911	BP4HS-10	
98076-54911-CDI	BR4HS	
98076-54914	BPR4HS-10	
98076-54917	BPR4HS-10	
98076-54919	BP4HS-10	
98076-54921	BP4HS-10	
98076-54921-CDI	BR4HS	
98076-54944	BPR4HS-10	
98076-54947	BPR4HS-10	
98076-55711	BP5HS	
98076-55716	BR5HS	
98076-55717	BPR5HS	
98076-55719	BP5HS	
98076-55747	BPR5HS	
98076-56710	B6HS	
98076-56711	B6HS	
98076-56711-00	BP6HSA	
98076-56713	BP6HSA	
98076-56715	BPR6HSA	
98076-56716	BR6HS	
98076-56717	BPR6HS	3
98076-56719	BP6HS	18
98076-56719-02	BP6HS	18
98076-5671G	BR6HSA	
98076-5671G-00	BR6HSA	
98076-5671M	B6HSA	

HONDA	→ NGK	V-Line
98076-56721	BP6HS	18
98076-56725	BPR6HSA	
98076-56729	BPR6HS	3
98076-5672G	BR6HSA	
98076-56740	B6HS	
98076-56741	B6HS	
98076-56747	BPR6HS	3
98076-56756	BPR6HS	3
98076-56917	BPR6HS-10	
98076-56927	BPR6HS-10	
98076-57710	B7HS	
98076-57711	BP7HS	
98076-57716	BR7HS	
98076-57717	BPR7HS	
98076-57719	BP7HS	
98076-57719-01	BP7HS	
98076-57740	B7HS	
98076-58710	B8HS	
98076-58711	BP8HS	
98076-58713	BPR8HSA	
98076-58715	BPR8HSA	
98076-58716	BR8HS	
98076-58717	BPR8HS	
98076-58719	BP8HS	
98076-5871G	BR8HSA	
98076-5871G-00	BR8HSA	
98076-5871G-01	BR8HSA	
98076-5872G	BR8HSA	
98076-58740	B8HS	
98076-58747	BPR8HS	
98076-59710	B9HS	
98076-59716	BR9HS	
98076-59740	B9HS	
98078-561BW	IZFR6K-11S	
98078-561CW	IZFR6K-11S	
98079-52876	BPR2ES	
98079-54148	BCPR4ES-11	
98079-5414G	ZFR4F-11	
98079-54173	BUR4EB-11	
98079-54817	BPR4ES	
98079-54841	BP4ES	
98079-54846	BPR4ES	
98079-55132	BPR5EY-11	
98079-55140	BCPR5EY-11	
98079-55141	BP5EY-11	
98079-55144	BP5ES-11	
98079-55145	BPR5ES-11	
98079-55146	BPR5EY-11	
98079-55147	BCPR5ES-11	
98079-55148	BCPR5E-11	
98079-55149	BCPR5EY-11	
98079-5514B	BCPR5E-11	



HONDA	→ NGK	V-Line
98079-5514E	BKR5E-11	33
98079-5514E-H0	BKR5E-11	33
98079-5514F	BCPR5EIX-11	
98079-5514G	ZFR5F-11	40
98079-5514G-01	ZFR5F-11	40
98079-5514H	PFR5G-11	
98079-5514J	BKR5E-N-11	
98079-5514N	PZFR5F-11	
98079-5514N-01	PZFR5F-11	
98079-5514P	ZFR5J-11	
98079-5514P-H0	ZFR5J-11	
98079-55155	BPR5E-11	
98079-55158	BCPR5E-11	
98079-5515E	BKR5E-11	33
98079-5515G	ZFR6F-11	
98079-5515H	PFR5G-11	
98079-5515J	BKR5E-N-11	
98079-5515N	PZFR5F-11	
98079-5515U	IFR5L11	
98079-55173	BUR5EB-11	
98079-55174	BUR5EB-11	
98079-55176	BUR5EB-11	
98079-55178	BUR5EB-11	
98079-5517S	PFR5L-11	
98079-5517U	IFR5L11	
98079-5517V	IFR5G-11K	
98079-55183	BUR5EB-11	
98079-55810	B5ES	
98079-55811	BP5ES	8
98079-55816	BR5ES	
98079-55817	BPR5ES	6
98079-55840	B5ES	
98079-55841	BP5ES	8
98079-55841-03	BP5ES	8
98079-55844	BPR5EIX	
98079-55846	BPR5ES	6
98079-55847	BR5ES	
98079-55848	BR5ES	
98079-55849	BR5ES	
98079-55855	BPR5E	6
98079-5585C	BKR5E	35
98079-5585V	ZGR5A	15
98079-55876	BPR5ES	6
98079-55876-H0	BPR5ES	6
98079-5587G	ZFR5F	
98079-5587V	ZGR5A	15
98079-55941	BP5EY	
98079-55946	BPR5EY	9
98079-55A4N	PZFR5F-13	
98079-55A5N	PZFR5F-13	
98079-56115	BPR6ES-11	13
98079-5611R-00	ZFR6F-11	

HONDA	→ NGK	V-Line
98079-56132	BPR6EY-11	10
98079-56140	BKR6E-11	14
98079-56144	BP6ES-11	
98079-56145	BPR6ES-11	13
98079-56146	BPR6EY-11	10
98079-56147	BCPR6ES-11	11
98079-56148	BCPR6E-11	11
98079-56149	BCPR6EY-11	
98079-5614A	BCPR6EY-N-11	
98079-5614B	BKR6E-11	14
98079-5614E	BKR6E-11	14
98079-5614F	BCPR6EIX-11	
98079-5614G	ZFR6F-11	
98079-5614G-01	ZFR6F-11	
98079-5614H	PFR6G-11	
98079-5614J	BKR6E-N-11	
98079-5614J-01	BKR6E-N-11	
98079-5614N	PZFR6F-11	
98079-5614P	ZFR6J-11	
98079-5614P-00	ZFR6J-11	
98079-56155	BPR6ES-11	13
98079-56158	BCPR6EY-11	
98079-5615E	BKR6E-11	14
98079-5615F	BCPR6EIX-11	
98079-5615G	ZFR6F-11	
98079-5615H	PFR6G-11	
98079-5615J	BKR6E-N-11	
98079-5615N	PZFR6F-11	
98079-5615U	IFR6L11	
98079-56173	BUR6EB-11	
98079-56174	BUR6EB-11	
98079-56175	BP6EY-11	
98079-56179	BUR6EB-11	
98079-5617T	PFR6N-11	
98079-5617U	IFR6L11	
98079-5617V	IFR6G-11K	
98079-56183	BUR6EB-11	
98079-56810	B6ES	
98079-56811	BP6ES	4
98079-56817	BR6ES	
98079-56832	BPR6EY	
98079-56840	B6ES	
98079-56841	BP6ES	4
98079-56844	BPR6EIX	
98079-56846	BPR6ES	2
98079-56847	BR6ES	
98079-56849	BR6ES	
98079-56854	BP6ES	4
98079-56855	BPR6ES	2
98079-5685C	BKR6E	28
98079-56871-H0	BP6ES	4
98079-56876-H0	BPR6ES	2

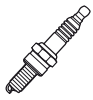

HONDA	→ NGK	V-Line
98079-56941	BP6EY	
98079-56946	BPR6EY	
98079-5695U	IFR6C	
98079-5697U	IFR6C	
98079-569BE	BKR6E-9S	
98079-569CE	BKR6E-9S	
98079-56A7H	PFR6G-13	
98079-56A7S	PFR6L-13	
98079-57144	BP7ES-11	
98079-57145	BPR7ES-11	
98079-57146	BPR7EY-11	
98079-57147	BCPR7ES-11	
98079-57148	BCPR7E-11	
98079-57149	BCPR7EY-11	
98079-5714A	BCPR7EY-N-11	
98079-5714B	BCPR7E-11	
98079-5714E	BKR7E-11	
98079-5714F	BKR7EIX-11	
98079-5714G	ZFR7F-11	
98079-5714H	PFR7G-11	
98079-5714J	BKR7E-N-11	
98079-5714P	ZFR7J-11	
98079-57155-01	BPR7ES-11	
98079-57158	BCPR7E-11	
98079-5715E	BKR7E-11	
98079-5715F	BKR7EIX-11	
98079-5715G	ZFR7F-11	
98079-5715H	PFR7G-11	
98079-5715J	BKR7E-N-11	
98079-5715V	IFR7G-11KS	
98079-57171	BPR7EY-11	
98079-57173	BUR7EB-11	
98079-57174	BUR7EB-11	
98079-57175	BR6EB-L-11	
98079-57176	BR6ES	
98079-57177	BUR7EB-11	
98079-57178	BUR7EB-11	
98079-57179	BPR7EY-11	
98079-5717V	IFR7G-11KS	
98079-57183	BUR7EB-11	
98079-571BH	PFR7G-11S	
98079-571BV	IFR7G-11KS	
98079-571CH	PFR7G-11S	
98079-571CV	IFR7G-11KS	
98079-57614	BR7EIX	
98079-57810	B7ES	
98079-57811	BP7ES	
98079-57811-01	BP7ES	
98079-57816	BR7ES	
98079-57840	B7ES	
98079-57841	BP7ES	
98079-57846	BPR7ES	19

HONDA	→ NGK	V-Line
98079-57847	BR7ES	
98079-57848	BR7ES	
98079-57849	BR7ES	
98079-57855	BPR7ES	19
98079-5785C	BKR7E	
98079-5785G	ZFR7F	
98079-57874	BR7EIX	
98079-57876	BR7ES	
98079-57877	BR7ES	
98079-5787G	ZFR7F	
98079-5787T	PFR7N-D	
98079-57941	BP7EY	
98079-57946	BPR7EIX	
98079-5814E	BKR8E-11	
98079-5815E	BKR8E-11	
98079-5815U	FR8BI-11	
98079-5817U	FR8BI-11	
98079-58644	BR8EIX	
98079-58646	BR8EIX	
98079-58648	B8EG	
98079-58649	BR8EG	
98079-58678	B8EG	
98079-58679	BR8EG	
98079-58810	B8ES	
98079-58810-01	B8ES	
98079-58812	B9ECS	
98079-58816	BR8ES	
98079-58819	BR8ECS	
98079-58840	B8ES	
98079-58841	BP8ES	
98079-58842	B8ECS	
98079-58845	BR8ECM	
98079-58846	BR8ES	
98079-58847	BPR8ES	
98079-58857	BR8ES	
98079-58870	B8ES	
98079-58872	B8ECS	
98079-58875	BR8ECM	
98079-58876	BR8ES	
98079-5915U	FR9BI-11	
98079-5917U	FR9BI-11	
98079-59644	BR9EIX	
98079-59646	BR9EIX	
98079-59648	B9EG	
98079-59649	BR9EG	
98079-59659	BR9EG	
98079-59678	B9EG	
98079-59679	BR9EG	
98079-59810	B9ES	
98079-59811	B9ES	
98079-59812	B9ECS	
98079-59816	BR9ES	





HONDA	→ NGK	V-Line
98079-59819	BR9ECS	
98079-59840	B9ES	
98079-59842	B9ECS	
98079-59845	BR9ECM	
98079-59847	BR9ES	
98079-59855	BR9ECM	
98079-59870	B9ES	
98079-59872	B9ECS	
98079-59875	BR9ECM	
98079-59876	BR9ES	
98079-60616	BR10EVX	
98079-60646	BR10EVX	
98079-60648	B10EG	
98079-60649	BR10EG	
98079-60676	BR10EVX	
98079-60678	B10EG	
98079-60679	BR10EG	
98079-60817	BR10ES	
98079-60819	BR10ECS	
98079-60842	B10ECS	
98079-60845	BR10ECM	
98079-60872	B10ECS	
98079-60875	BR10ECM	
9807B-5515W	IZFR5K11	
9807B-5517W	IZFR5K11	
9807B-5615P	ZFR6K-11	
9807B-5615W	IZFR6K11	
9807B-5617C-00	IZFR6K-11E	
9807B-5617P	ZFR6K-11	
9807B-5617P-00	ZFR6K-11	
9807B-5617W	IZFR6K11	
9807B-561BW	IZFR6K-11S	
9807B-56A5W	IZFR6K13	
9807B-56A7W	IZFR6K13	
98179-56841	BP6ES	4
9859-5998H	IMR9A-9H	
9861-5515J	ZFR5FIX-11	
9861-5515K	BKR5EIX-11	
9861-5615J	ZFR6FIX-11	
9861-5615K	BKR6EIX-11	
9861-5615Q	BCPR6EIX-11	
9868-5615K	BKR6EIX-11	
9869-5798B	IJR7A9	
98735-4776	BPMR4A	
9879-5518J	ZFR5FIX-11P	
9879-5518Q	BCPR5EIX-11P	
9879-5618J	ZFR6FIX-11P	
9879-5618K	BKR6EIX-11P	
9879-5618Q	BCPR6EIX-11P	
9880-5518J	ZFR5FIX-11P	
9880-5518Q	BCPR5EIX-11P	
9880-5618J	ZFR6FIX-11P	

HONDA	→ NGK	V-Line
9880-5618K	BKR6EIX-11P	
9880-5618Q	BCPR6EIX-11P	
9881-5615J	ZFR6FIX-11P	
9881-5615K	BKR6EIX-11P	
9888-5618K	BKR6EIX-11P	
H9859-5998H	IMR9A-9H	
H9861-5515J	ZFR5FIX-11	
H9861-5515K	BKR5EIX-11	
H9861-5615J	ZFR6FIX-11	
H9861-5615K	BKR6EIX-11	
H9861-5615Q	BCPR6EIX-11	
H9868-5615K	BKR6EIX-11	
H9869-5798B	IJR7A9	
H9879-5518J	ZFR5FIX-11P	
H9879-5518Q	BCPR5EIX-11P	
H9879-5618J	ZFR6FIX-11P	
H9879-5618K	BKR6EIX-11P	
H9879-5618Q	BCPR6EIX-11P	
H9880-5518J	ZFR5FIX-11P	
H9880-5518Q	BCPR5EIX-11P	
H9880-5618J	ZFR6FIX-11P	
H9880-5618K	BKR6EIX-11P	
H9880-5618Q	BCPR6EIX-11P	
H9881-5615J	ZFR6FIX-11P	
H9881-5615K	BKR6EIX-11P	
H9888-5618K	BKR6EIX-11P	

HYUNDAI/KIA	→ NGK	V-Line
00259-18110	BP6ES	4
09482-00538	IFR5G11	
OK01A-18110	BKR5E	35
OK01C-18110	BKR6E-11	14
OK2AA-18110	BKR6E	28
OK558-18110	PFR6N-11	
18811-08061	BPR6ES	2
18811-11051	BPR5ES-11	
18814-08061	BKR6ES	28
18814-08062	BKR6ES	28
18814-11051	BKR5ES-11	33
18814-11061	BKR6ES-11	14
18814-25000	IFR5E11	
18817-11051	PFR5N-11	
18822-08091	BP6ES-11	
18823-11091	BKR5ES-11	33
18827-09080	PLKR7A	
18829-11050	ZFR5F-11	40
18840-11051	ILFR5B11	
18841-11051	LFR5A-11	
18842-08061	PLFR6A	
18843-10062	LKR6D-10E	
18846-10060	SILZKR6B10E	
18846-11070	SILZKR7B11	

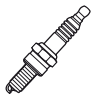

<b>HYUNDAI/KIA</b>	<b>→ NGK</b>	<b>V-Line</b>
18854-10080	LZKR6B-10E	
18855-10060	LZKR6B-10E	
27410-23700	IFR5G11	
<b>ISOLATOR</b>	<b>→ NGK</b>	<b>V-Line</b>
6 B	BP6HS	18
7 A	B6HS	
7 B	BP6HS	18
7 D	BP6ES	4
A 5 D	BP7EFS	
A 7 D	BP6EFS	5
FM 14145 / 2	BP5ES	8
FM 14175 / 2	BP6ES	4
FM 14200 / 2	BP6ES	4
FM 14225 / 2	BP7ES	
M 14145	B5HS	
M 14175	B6HS	
M 14175 / 2	B6ES	
M 14225	B7HS	
M 14240	B8HS	
M 14260	B9HS	
M 1495	B-4H	
M 18225	AB-7	
M 18240	AB-7	
PM 14225	BP7HS	
U 7 D	BCP6ES	17
U 8 D	BCP5ES	16
ZM 14-260	B8HS	
<b>ISUZU</b>	<b>→ NGK</b>	<b>V-Line</b>
5-8138-0001-0	BPR5ES	6
5-8138-0003-0	BPR5EIX	
5-8138-0004-0	BPR6EIX	
5-8138-0005-0	BP5ES	8
5-8138-0006-0	BP6ES	4
5-8138-0007-0	BP5EY	
5-8138-0008-0	BP6EY	
5-8138-0012-0	BP5EY	
5-8138-0013-0	BP6EY	
5-8600-3122-0	ZFR5F-11	40
5-8600-3124-0	ZFR6F-11	
5-8600-7635-0	BKR5E-11	33
5-8600-7636-0	ZFR5J-11	
5-8600-7639-0	ZFR6J-11	
5-8600-7642-0	ZFR7J-11	
5-8601-3957-0	PZFR5F-13	
5-8610-3379-0	BPR4ES-11	
5-8610-3380-0	BPR5ES-11	
5-8610-3381-0	BPR6ES-11	13
5-8610-3382-0	BPR7ES-11	

<b>ISUZU</b>	<b>→ NGK</b>	<b>V-Line</b>
5-8610-3385-0	PFR5B-11	
5-8610-3386-0	PFR6B-11	
5-8610-3387-0	PFR7B-11	
5-8610-3389-0	PGR5A-11	
5-8610-3390-0	PGR6A-11	
5-8610-3391-0	PGR7A-11	
5-8612-1749-0	BKR5ES-11	33
5-8612-1750-0	BKR6ES-11	14
5-8612-3951-0	BKR5E-11	33
5-8612-3952-0	BKR6E-11	14
5-8612-3953-0	BKR7E-11	
8-9412-0560-0	BPR5ES-11	
8-9412-0561-0	BPR5EY-11	
8-9412-0562-0	BPR6EY-11	10
8-9416-0627-0	BPR6EY	
8-9421-7232-0	BPR6ES-11	13
8-9421-9943-0	BPR6ES	2
8-9423-5966-0	BP5ES-11	
8-9423-7203-0	BP5EY-11	
8-9424-1059-0	BP6ES-11	
8-9425-2270-0	BP6EY-11	
8-9432-8372-0	BKR6E-11	14
8-9432-8373-0	BKR7E-11	
8-9432-8374-0	BKR6E-11	14
8-9432-8375-0	BKR7E-11	
8-9701-2928-0	BKR6E	28
8-9701-2930-0	BKR6E	28
8-9701-2931-0	BKR7E	
8-9711-1376-0	PFR5B-11	
8-9717-0268-0	BKR5EIX-11	
9-8251-3103-0	BP6ES	4
9-8251-3105-0	B6ES	
9-8251-3106-0	BP5ES	8
9-8251-3107-0	B5ES	
9-8251-3113-0	B7ES	
<b>IVECO</b>	<b>→ NGK</b>	<b>V-Line</b>
50 40 82 651	IFR7F-6D	
88 03 24 15	IFR7F-6D	
88 03 34 33	IGR7E-3D	
<b>JAGUAR</b>	<b>→ NGK</b>	<b>V-Line</b>
7R83-12405-AA	TR6AP-13E	
8W-12405-AAA	ILKAR7C10	
8W93-12405-ABB	ILKAR7C10	
AJ 84575	IFR5N10	
AJ 812146	ILKAR7C10	
AJ812988	SILZKAR7E8S	
C2A 1535	IFR5N10	
C2P 23089	ILKAR7C10	



<b>JAGUAR</b>	<b>→ NGK</b>	<b>V-Line</b>
C2S 46895	TR6AP-13E	
EAC 8554	BR7EFS	
EBC 004021	BR7EF	
EBC 4021	BR7EF	
LR 019 484	ILKAR7C10	
NCA 3850 DA / 2	BKR6EIX-11	
NCA 3850 FA / 2	BKR6EVXA-13	
NCA 3850 HA / 2	PFR6G-13E	
<b>LAND ROVER</b>	<b>→ NGK</b>	<b>V-Line</b>
4550 157	IFR5N10	
LR 005 483	ILFR6B	
LR 019 484	ILKAR7C10	
LR 025605	ILTR6G8G	
LR 032 080	ILKAR7C10	
<b>LOTUS</b>	<b>→ NGK</b>	<b>V-Line</b>
A 100 E 6277 S	BKR6E	28
A 910 E 7009 F	BPR6EKN	
<b>MAGNETI MARELLI</b>	<b>→ NGK</b>	<b>V-Line</b>
061 830 072 304	BCPR7ES	
061 830 085 304	BPR7ES	19
061 830 086 304	BKR6E	28
061 830 175 304	BP7ES	
061 830 176 304	BP6HS	18
061 830 210 304	BP6ES	4
061 830 211 304	BPR6ES	2
061 830 215 304	BP6EFS	5
061 830 254 304	BKR6E	28
061 830 257 304	BPR6HS	3
061 830 258 304	BP5HS	
061 830 262 304	BPR6EFS	7
061 850 023 304	PTR5A-13	25
062 000 611 304	B6HS	
062 000 654 304	BP6HS	18
062 000 739 304	BP6ES	4
062 000 740 304	BPR6ES	2
062 000 754 304	BP6HS	18
7 LCR	BKR6E	28
7 LPR	BKR6E	28
8 LCR	BCPR7ES	
8 LDCR	PTR5A-13	25
8 LPR	BCPR7ES	
AW 5 C	BM6A	
AW 56 C	BM7A	
CM 1 N	AB-2	
CM 2 N	AB-2	
CM 3 N	AB-6	
CM 4 N	AB-6	
CM 5 N	AB-6	

<b>MAGNETI MARELLI</b>	<b>→ NGK</b>	<b>V-Line</b>
CM 6 N	AB-7	
CU 7 N	C7HSA	
CW 2 C	B-2	
CW 2 CJ	B-2	
CW 2 L	B4ES	
CW 2 N	B-4H	
CW 3 C	B-4	
CW 3 CJ	B-4	
CW 3 CP	BP-4	
CW 3 L	B4ES	
CW 3 N	B-4H	
CW 4 A	B5ES	
CW 4 C	B-4	
CW 4 CJ	B-4	
CW 4 CP	BP-4	
CW 4 L	B4ES	
CW 4 LP	BP4ES	
CW 4 N	B-4H	
CW 4 NJ	B-4H	
CW 5 C	B-4	
CW 5 CP	BP5S	
CW 5 L	B5ES	
CW 5 LJ	B5ES	
CW 5 LP	BP5ES	8
CW 5 LS	B5ES	
CW 5 LSZ	B5ES	
CW 5 N	B5HS	
CW 5 NJ	B5HS	
CW 5 NP	BP5HS	
CW 5 NR	BR5HS	
CW 5 NS	B5HS	
CW 5 NSZ	B5HS	
CW 6 C	B6S	
CW 6 CE	BM6A	
CW 6 CJ	B6S	
CW 6 L	B5ES	
CW 6 LJ	B5ES	
CW 6 LP	BP5ES	8
CW 6 LR	BR5ES	
CW 6 LS	B5ES	
CW 6 LSZ	B5ES	
CW 6 N	B6HS	
CW 6 NE	BM6A	
CW 6 NJ	B6HS	
CW 6 NP	BP6HS	18
CW 6 NPR	BPR6HS	3
CW 6 NR	BR6HS	
CW 7 C	B6S	
CW 7 L	B6ES	
CW 7 LCR	BKR6E	28
CW 7 LJ	B6ES	
CW 7 LP	BP6ES	4





MARCHAL / VALEO → NGK		V-Line
20 C	AB-6	
20 E	AB-6	
20 L	AB-6	
21 C	AB-6	
21 E	AB-6	
21 L	AB-6	
22 L	AB-2	
22 LM	AB-2	
23 F	A6FS	
32 LM	AB-2	
34 / 5 HS	BP6ES	4
34 C	B7S	
34 CM	B7S	
34 HS	B7ES	
34 HSM	B7ES	
34 S	B7HS	
35	B6HS	
35 / 1	BP6HS	18
35 / 1 B	BP6HS	18
35 / 1 D	BP6HS	18
35 / 36 D	B6HS	
35 / 36 P	B6HS	
35 / 36 R	B6HS	
35 B	B6HS	
35 C	B6S	
35 CM	B6S	
35 HA	BP6ES	4
35 HS	B6ES	
35 M	B6HS	
35 P	B6HS	
36	B5HS	
36 B	B5HS	
36 C	B-4	
36 CM	B-4	
36 D	B5HS	
36 HS	B5ES	
36 M	B5HS	
36 P	B5HS	
37 S	B5HS	
41 306	AB-8	
4 N	B7HS	
5 H	B7ES	
5 N	BP6HS	18
5 NCYCLO	BP6HS	18
64 H	BP7ES	
67 HP	BR8EIX	
6 H	BP7ES	
6 N	BP5HS	
70 H	BP6ES	4
76 H	BP5ES	8
7 H	BP6ES	4
84 H	BP5ES	8

MARCHAL / VALEO → NGK		V-Line
88 N	B5HS	
8 H	BP6ES	4
9 H	BP5ES	8
C 64 H	BP6EFS	5
C 68 H	BP6EFS	5
C 7 H	BP6EFS	5
F 70 H	BCP7ES	
F 74 H	BCP6ES	17
F 80 H	BCP7ES	
GT 34	BP7HS	
GT 34 / 2 H	BP6ES	4
GT 34 / 5	BP6HS	18
GT 34 / 5 D	BP6HS	18
GT 34 / 5 H	BP6ES	4
GT 34 / 5 HA	BP6ES	4
GT 34 / 5 HD	BP6ES	4
GT 34 D	BP7HS	
GT 34 H	BP7ES	
GT 34 HD	BP6ES	4
GT 35	BP5HS	
GT 35 D	BP5HS	
GT 35 H	BP5ES	8
GT 35 HD	BP5ES	8
H 32 RG	B9EG	
H 33 RG	B8EG	
H 34 F	B8ES	
HA 32 / 2	B8ES	
HA 32 RS	B9EG	
HF 34	B7ES	
HF 34 F	B8ES	
RR 31 HS	B10EG	
RR 32 HS	B9EGV	
RR 33 HSS	B8EGV	
SCGT 34 / 5H	BP6EFS	5
SCGT 35 H	BP6EFS	5
V 36 A	B5HS	
V 6 NSOLEX	B5HS	
MAZDA → NGK		V-Line
0000-18-1690	BPR6ES	2
0000-18-3648	BR7ET	
0000-18-3649	BR8ET	
0000-18-8914	BPR5ES	6
0000-18-B601	BPR5ES-11	
0000-18-BP01	BKR5E-11	33
0000-18-BP03	BKR6E-11	14
0000-18-BP47	BKR5E	35
0000-18-F201	ZFR6A-11	
0000-18-F203	ZFR5A-11	
0000-18-F285	ZFR6F-11	
0000-18-F287	ZFR5F-11	40



MAZDA	→ NGK	V-Line
0000-18-JE41	BKR5EIX-11	
0000-18-KJ11	PZFR6F	
0000-18-KJ13	PZFR5F	
0000-18-L3Y1	ILTR6A-13G	
0000-18-L3Y2	ILTR5A-13G	
0000-18-L3Y3	ILTR6A-8G	
0000-18-N201	BR8EQ-14	
0000-18-N203	BR9EQ-14	
0000-18-N328	BUR8EQ	
0000-18-N329	BUR6EQ	
0000-18-N342	BUR9EQ	
0000-18-N343	BUR7EQ	
0000-18-N3A1	BUR9EQP	
0000-18-N3A2	BUR7EQP	
0000-18-N3A3	BUR8EQP	
0000-18-N3A4	BUR6EQP	
0000-18-N3Y1	RE9B-T	
0000-18-N3Y2L	RE7C-L	
0000-18-N3Y8	RE7C-L	
0190-18-110	B6HS	
0222-18-110	BP6EY	
0243-18-110	C6HA	
0259-18-110	BP6ES	4
0370-18-110	BPR6EIX	
0371-18-110	BPR5EIX	
0376-18-110	BPR7EIX	
0418-18-110A	B7ES	
0419-18-110	B7ES	
0420-18-110	B8ES	
0512-18-110	B6ES	
0660-18-110	BP5ES	8
0745-18-110	BP7ES	
0802-18-600	BR7EM	
0803-18-600	BR8EM	
0866-18-600	B7EM	
0867-18-600	BR8EM	
1001-77-550	BP4EY	
1002-77-550	BP5EY	
1003-77-550	BP6EY	
1409-18-110	BP5ES-13	
1410-18-110	BP5ES-13	
1482-18-600A	BR8EQ	
1483-18-600	BR8EQ	
1534-18-110	BP5EY	
1690-18-110	BPR6ES	2
1A01-18-110	PGR5A	
1A02-18-110	KR7AI	
1A03-18-110	IKR7A	
1A04-18-110	DCPR6E	
1A06-18-110	DCPR8E	
1A08-18-110	ZGR5A	15
1A50-18-110	BKR6E	28

MAZDA	→ NGK	V-Line
1A53-18-110	BKR6E-11	14
1A61-18-110	DCPR7EVX	
1N00-18-110	BKR4E-11	
1N04-18-110	BKR5EY-11	
1N06-18-110	BKR6EY-11	
1N07-18-110	PFR4G-11	
1N08-18-110	PFR5G-11	
1N09-18-110	PFR6G-11	
1N11-18-110	FR7AI-D	
1N15-18-110	LFR5A-11	
1N17-18-110	LFR6A-11	
1N19-18-110	LZKAR6AP-11	
1N21-18-110	LFR4AP-11	
1N22-18-110	LFR5AP-11	
1UD0-18-110	BPR5EIX-11	
1UD1-18-110	BPR6EIX-11	
1UD2-18-110	BPR7EIX	
1UD3-18-110	BKR5EIX-11	
1UD4-18-110	BKR6EIX-11	
1UD6-18-110	BCPR5EIX-11	
1UD7-18-110	BCPR6EIX-11	
1UD9-18-110	DCPR7EIX	
1UN0-18-110	BPR5EIX	
1UN1-18-110	BPR6EIX	
1UN2-18-110	BPR7EIX	
1UN3-18-110	BPR5EIX-11	
1UN4-18-110	BPR6EIX-11	
1UN6-18-110	BKR5EIX	
1UN7-18-110	BKR6EIX	
1UN9-18-110	BKR5EIX-11	
1UNA-18-110	BKR6EIX-11	
1UNC-18-110	BCPR5EIX-11	
1UND-18-110	BCPR6EIX-11	
1UNF-18-110	DCPR7EIX	
1UNG-18-110	ZFR5FIX-11	
1UNH-18-110	ZFR6FIX-11	
1UT4-18-110	BKR6EIX-11P	
1UT6-18-110	BCPR5EIX-11P	
1UT7-18-110	BCPR6EIX-11P	
1UT9-18-110	DCPR7EIX-P	
1UXA-18-110	BKR6EIX-11P	
1UXC-18-110	BCPR5EIX-11P	
1UXD-18-110	BCPR6EIX-11P	
1UXF-18-110	DCPR7EIX-P	
1UXG-18-110	ZFR5FIX-11P	
1UXH-18-110	ZFR6FIX-11P	
1UXJ-18-110	BPR5EFIX-13P	
1Y00-18-110	BPR5ES	6
1Y01-18-110	BPR6ES	2
1Y03-18-110	BPR5ES-11	
1Y06-18-110	BKR5E	35
1Y07-18-110	BKR6E	28



MAZDA	→ NGK	V-Line
1Y09-18-110	BKR5E-11	33
1Y0A-18-110	BKR6E-11	14
1Y0B-18-110	BKR7E-11	
1Y0F-18-110	DCPR7E	
1Y0G-18-110	ZFR5F-11	40
1Y0H-18-110	ZFR6F-11	
1Y0K-18-110	BPR5ES-13	
1Y0L-18-110	BRE527Y-11	
1YRA-18-110	BKR6EIX-11P	
1YRF-18-110	DCPR7EIX-P	
1YRG-18-110	ZFR5FIX-11P	
1YRH-18-110	ZFR6FIX-11P	
2182-18-600	BR7EM	
2183-18-600	BR8EM	
2328-18-600	B7EM	
2359-18-600	BR8EM	
242-18-110	C6HSA	
3648-18-600	BR7ET	
3649-18-600	BR8ET	
3710-18-110	BP6ES-13	
3743-18-600	BR7ET	
3744-18-600	BR8ET	
3953-18-110	BPR5EY	9
3954-18-110	BPR6EY	
4075-18-110	BP4ES	
4095-18-110	BP4EY	
4096-18-110A	BPR4ES-13	
418-18-110	B7ES	
4882-18-110	BP-2E	
4884-18-110	BPR2ES	
4885-18-110	BPR2ES	
4894-18-110	BP-2E	
6M8G-12-405BB	ILTR5A-13G	
8042-18-110	BPR6EVX-11	
8182-18-600	BR7EQ	
8248-18-600	BRE813L	
8344-18-600	BR9ET	
8914-18-110	BPR5ES	6
A501-18-110	BP6E	4
A502-18-110	BP6ES	4
AY02-18-110	DCP7E	
AY01-18-110	DCP7E	
AZ08-18-110	BPR5E	6
AZ09-18-110	BPR5E	6
B601-18-110	BPR5ES-11	
B602-18-110	BPR5EY-11	
B64N-18-110	BRE527Y-11	
B64P-18-110	BRE527Y-11	
B660-18-110	BKR6E-11	14
B667-18-110	BKR6E-11	14
B672-18-110	BPR5ES	6
B695-18-110	BCPR6E	12

MAZDA	→ NGK	V-Line
B696-18-110	BCPR6E	12
B6B3-18-110	BCPR5E-11	
B6B4-18-110	BCPR5E-11	
BBYV-18-110	R7436-10	
BBYV-18-11Z	R7436-9	
BP01-18-110	BKR5E-11	33
BP02-18-110	BKR5E-11	33
BP03-18-110	BKR6E-11	14
BP04-18-110	BKR6E-11	14
BP05-18-110	BKR7E-11	
BP06-18-110	BKR7E-11	
BP07-18-110	BKR6ES-11	14
BP09-18-110	BKR6ES-11	14
BP47-18-110	BKR5E	35
BP47-18-110P00	BKR5E	35
BP48-18-110	BKR5E	35
BP49-18-110	BKR6E	28
BP50-18-110	BKR6E	28
BP51-18-110	BKR7E	
BPY1-18-110	BKR5E-11	33
BPY3-18-110	BKR6E-11	14
E356-18-110	BE527Y-11	
E357-18-110	BE527Y-11	
F201-18-110	ZFR6A-11	
F202-18-110A	ZFR6A-11	
F203-18-110	ZFR5A-11	
F204-18-110	ZFR5A-11	
F205-18-110	ZFR7F-11	
F210-18-110	BCPR5E	32
F211-18-110	BCPR5E	32
F220-18-110	BCPR6E-11	11
F221-18-110	BCPR6EY-11	
F261-18-110	ZFR6F-11	
F285-18-110	ZFR6F-11	
F286-18-110	ZFR6J-11	
F287-18-110	ZFR5F-11	40
F288-18-110	ZFR5J-11	
F289-18-110	ZFR7F-11	
F293-18-110	ZFR5F-11	40
F2C5-18-110	ZFR6F-11	
F2C7-18-110	ZFR6F-11	
F806-18-110	BPR4ES-13	
F8B1-18-110	ZF6A-11	
F8B2-18-110A	ZF6A-11	
F8B3-18-110	ZFR5F-11	40
F8B5-18-110	ZFR7F-11	
F8B7-18-110	ZFR4F-11	
F8L6-18-110	ZFR4F-11	
F8L7-18-110	ZFR4F-11	
F8L8-18-110	BPR4ES-13	
F8L9-18-110	BPR4ES-13	
FE3N-18-110	BCPR7E-11	



MAZDA	→ NGK	V-Line
FE6E-18-110	BCPR7E-11	
FE6F-18-110	BCPR7E-11	
FE79-18-110	BPR6ES-11	13
FE82-18-110	BPR6EY-11	10
FEDK-18-110	BPR5ES-13	
FEDM-18-110	BPR5ES-13	
FEEG-18-110	BPR6ES-13	
FEEH-18-110	BPR6EVX-11	
FEFB-18-110	BPR6ES-11	13
JE03-18-110	BCPR7E	
JE26-18-110	BCPR5EIX-11	
JE27-18-110	BCPR6EIX-11	
JE28-18-110	BCPR5EIX-11	
JE41-18-110	BKR5EIX-11	
JE42-18-110	BKR5EIX-11	
JE43-18-110	BKR6EIX-11	
JE44-18-110	BKR6EIX-11	
JE45-18-110	BKR7EIX-11	
JE46-18-110	BKR7EIX-11	
JF03-18-110	BCPR5E-11	
JF04-18-110	BCPR5E-11	
KJ11-18-110	PZFR6F	
KJ12-18-110	PZFR6F	
KJ13-18-110	PZFR5F	
KJ14-18-110	PZFR5F	
L303-18-110	TR5AI-13	
L341-18-110	ITR6F13	
L3BD-18-110	SILTR6A7G	
L3G2-18-110	ILTR6A-13G	
L3K9-18-110	ILTR6A-8G	
L3K9-18-110A	ILTR6A-8G	
L3Y1-18-110	ILTR6A-13G	
L3Y2-18-110	ILTR5A-13G	
L3Y3-18-110	ILTR6A-8G	
L3Y4-18-110	ITR6F13	
L3YD-18-110	SILTR6A7G	
L813-18-110	ITR6F13	
L845-18-110	TR5AI-13	
LFG1-18-110	ILTR5A-13G	
LFY1-18-110	TR5B-13	45
LFY3-18-110	BPR5EFS-13	
N201-18-600	BR8EQ-14	
N202-18-600	BR8EQ-14	
N203-18-600	BR9EQ-14	
N212-18-600	BR7EQ-14	
N212-18-600A	BR7EQ-14	
N218-18-600	BR8EQ-14	
N225-18-600A	BUR9EQ	
N236-18-600	BUR9EQ	
N238-18-600	BUR8EQ	
N245-18-600	SD10A	
N246-18-600	BR9EQ-14	

MAZDA	→ NGK	V-Line
N253-18-600	BR9EQ-14	
N322-18-110	BR10ET	
N328-18-110	BUR8EQ	
N329-18-110	BUR6EQ	
N331-18-110	SD10A	
N333-18-110	SD11A	
N335-18-110	SD9A	
N338-18-110	SD11A	
N339-18-110	SD10A	
N340-18-110	BUR9EQ	
N341-18-110	BUR7EQ	
N342-18-110	BUR9EQ	
N343-18-110	BUR7EQ	
N390-18-110	BUR5EQ	
N3A1-18-110	BUR9EQP	
N3A2-18-110	BUR7EQP	
N3A3-18-110	BUR8EQP	
N3A4-18-110	BUR6EQP	
N3H1-18-110C	RE9B-T	
N3H1-18-110D	RE9B-T	
N3H2-18-110C	RE7C-L	
N3H5-18-110	RE7C-L	
N3H5-18-110A	RE7C-L	
N3H8-18-110A	RE9B-T	
N3H8-18-110B	RE9B-T	
N3H9-18-110A	RE8C-L	
N3J1-18-110	RE8C-L	
N3J1-18-110A	RE8C-L	
N3M1-18-1BXA	RE7C-L	
N3M1-18-1BXB	RE7C-L	
N3Y1-18-110	RE9B-T	
N3Y1-18-110A	RE9B-T	
N3Y1-18-110A9U	RE9B-T	
N3Y1-18-S30	RE7C-L	
N3Y1-18-S30	RE9B-T	
N3Y1-18-S30L	RE7C-L	
N3Y1-18-S30T	RE9B-T	
N3Y2-18-110	RE7C-L	
N3Y2-18-110L	RE7C-L	
N3Y2-18-S30	RE8C-L	
N3Y2-18-S30	RE9B-T	
N3Y2-18-S30L	RE8C-L	
N3Y2-18-S30T	RE9B-T	
N3Y3-18-S30	RE7C-L	
N3Y3-18-S30	RE9B-T	
N3Y4-18-110	RE9B-T	
N3Y4-18-110A	RE9B-T	
N3Y4-18-S30	RE8C-L	
N3Y4-18-S30	RE9B-T	
N3Y5-18-110	RE8C-L	
N3Y5-18-110L	RE8C-L	
N3Y6-18-110	RE7C-L	





<b>MAZDA</b>	<b>→ NGK</b>	<b>V-Line</b>
N3Y6-18-110L	RE7C-L	
N3Y8-18-110	RE7C-L	
N3Y8-18-110A	RE7C-L	
N3Y8-18-110A9U	RE7C-L	
N3Z1-18-110	RE8C-L	
N3Z1-18-110A	RE8C-L	
N3Z2-18-110	RE7C-L	
N3Z2-18-110A	RE7C-L	
N3Z4-18-110	RE7C-L	
N3Z5-18-110	RE8C-L	
N3ZZ2-18-110A	RE7C-L	
PBP01-18-110AA	BKR5E-11	33
PE5R-18-110	ILKAR7L11	
PE5S-18-110	ILKAR7L11	
TF50-18-110	BKR6EIX	
ZJY6-18-110	IFR5E13	
ZR03-18-110	R6725-115	
ZZS1-18-110	DCPR7E	
ZZS2-18-110	DCPR7E	
ZZS4-18-110	BPR5EY	9
ZZSI-18-110	DCPR7E	

<b>MERCEDES</b>	<b>→ NGK</b>	<b>V-Line</b>
A 002 159 18 03	BP7ES	
A 002 159 22 03	BP5ES	8
A 002 159 24 03	BP6ES	4
A 002 159 27 03	BP7ES	
A 002 159 28 03	BP6ES	4
A 002 159 29 03	BP5ES	8
A 002 159 31 03	BP5ES	8
A 002 159 41 03	BP6ES	4
A 002 159 42 03	BP6ES	4
A 002 159 48 03	BP5ES	8
A 002 159 49 03	BP6EFS	5
A 002 159 56 03	BP6EFS	5
A 002 159 57 03	BP5EFS	
A 002 159 58 03	BP5EFS	
A 002 159 64 03	BP7EFS	
A 002 159 65 03	BP7EFS	
A 002 159 68 03	BP6EFS	5
A 002 159 69 03	BP6EFS	5
A 002 159 76 03	BP5EFS	
A 002 159 77 03	BCP5ES	16
A 003 159 04 03	BP5EFS	
A 003 159 05 03	BP5EFS	
A 003 159 06 03	BP6EFS	5
A 003 159 07 03	BP6EFS	5
A 003 159 08 03	BP7EFS	
A 003 159 10 03	BP5ESZ	
A 003 159 11 03	BP5ESZ	
A 003 159 12 03	BP6ESZ	

<b>MERCEDES</b>	<b>→ NGK</b>	<b>V-Line</b>
A 003 159 13 03	BP6ESZ	
A 003 159 14 03	BP7ES	
A 003 159 16 03	BCP6ES	17
A 003 159 30 03	BCP5ES	16
A 003 159 31 03	BCP6ES	17
A 003 159 33 03	BP7EFS	
A 003 159 34 03	BP6EFS	5
A 003 159 35 03	BP6EFS	5
A 003 159 36 03	BP5EFS	
A 003 159 37 03	BCP5ES	16
A 003 159 40 03	BP5EFS	
A 003 159 41 03	BP5EFS	
A 003 159 42 03	BCP5ES	16
A 003 159 45 03	BP6ESZ	
A 003 159 46 03	BP5ESZ	
A 003 159 47 03	BP5ESZ	
A 003 159 56 03	BP7ES	
A 003 159 57 03	BP6ESZ	
A 003 159 75 03	BKUR5ET	29
A 003 159 76 03	BKUR5ET	29
A 003 159 78 03	BKR6ES	28
A 003 159 81 03	PFR5R-11	
A 003 159 90 03	BKUR5ET	29
A 003 159 91 03	BKR5EKUP	
A 003 159 92 03	BKR6EKE	
A 003 159 94 03	PFR5R-11	
A 003 159 96 03	IFR5D10	
A 003 159 96 03 26	IFR5D10	
A 003 159 97 03	IFR6D10	
A 003 159 97 03 26	IFR6D10	
A 004 159 13 03	ILFR6A	
A 004 159 14 03	IFR6Q-G	
A 004 159 15 03	LKR8A	
A 004 159 19 03	PFR5R-11	
A 004 159 25 03	SILZKR7A-S	
A 004 159 25 63	SILZKR7A-S	
A 004 159 30 03	BKR6EZB	
A 004 159 34 03	PLKR6A	
A 004 159 36 03	BKR6EZB	
A 004 159 39 03	ILZKAR7A10	
A 004 159 44 03	PLKR7B8E	
A 004 159 45 03	ILFR6A	
A 004 159 49 03	PLKR7A	
A 004 159 50 03	PFR5R-11	
A 004 159 58 03	PLKR7B8E	
A 004 159 68 03	SILZKFR8D7S	
A 004 159 65 03	SILZKFR8D7S	
A 004 159 72 03	SILZKFR8D7S	
A 004 159 75 03	SILZKFR8D7S	
A 004 159 70 03	SILZKFR8E7S	
A 004 159 79 03	SILZKFR8E7S	
A 122 159 00 03	ILZFR6C-K	



<b>MERCEDES</b>	<b>→ NGK</b>	<b>V-Line</b>
A 132 159 00 03	LKR7B-9	
A 376 159 72 03	T7204A	
MN 195 922	ILZFR6C-11K	
Q0 003 085 V005 00 000	BKR6EKE	
Q0 012 468 V001 00 0000	LKR8A	
Q0 012 468 V002 00 0000	LKR8A	
<b>MERCURY</b>	<b>→ NGK</b>	<b>V-Line</b>
121 27	BP6HS-10	
123 43	BP8HS-10	
123 43 B	BP8HS-10	
136 86 B2	BU8H	
136 86 Q	BU8H	
141 035 50	BUZHW	
141 035 68	BUZ8H	
141 03 Q	BUZHW-2	
148 145 68	BPZ8HS-15	
148 14 Q	BPZ8HS-10	
177 195 47	BPR7HS-10	
194 24	BP8HS-15	
197 96	BPR6HS-10	
338 432 20	IZFR6J	
338 432 20 Q	IZFR6J	
338 892 46 Q39	ILFR6G-E	
338 895 97 Q	IZFR5G	
338 896 80	ILFR6G	
338 896 80 001	ILFR6G	
412 63 B	B7HS-10	
412 63 M	B7HS-10	
595 71 B	BR6FS	
803 507	DCPR6E	
803 990	TR5IX	
803 991	BR6FVX	
809 679	BR9ES	
809 679 B	BR9ES	
809 680	BR8ES	
809 680 B	BR8ES	
810 883	BPR6ES	2
813 413	B7S	
813 414 1	BP7HS	
813 415	B8S	
813 421 4	R5673-8	
813 423	BPR6HS	3
813 469	B6S	
813 471 1	BR6ES	
816 336 Q	BPR6EFS	7
816 737 B2	BP8H-N-10	
816 737 Q	BP8H-N-10	
816 837 B2	BPZ8H-N-10	
816 837 Q	BPZ8H-N-10	
821 916	BR7HS	
823 70 M1	B6HS	

<b>MERCURY</b>	<b>→ NGK</b>	<b>V-Line</b>
823 71 B	B7HS	
823 71 M	B7HS	
823 72 M	B8HS	
824 406 8	BR8HS-10	
824 406 8 B	BR8HS-10	
827 858 Q	DPR6EA-9	
827 859	CR6HS	
828 938	BR7ES	
828 942	BR7HS-10	
828 943	BPR8ES	
828 945	BR8HS	
828 987	B8ES	
843 220 Q	IZFR6J	
843 825	BR9ECS	
846 75 M	B5HS	
852 868 140	DR5HS	
855 717 1	ZFR5F-11	40
859 495 Q	LFR5A-11	
881 284 Q	LFR6A-11	
885 185	BPR8EIX	
889 246 Q39	ILFR6G	
889 423	PZFR6H	
889 597 Q	IZFR5G	
892 567 Q	IZFR5J	
896 322	B6HS-10	
898 829 001	LFR4A-E	
8M 000 6613	ILFR6G-E	
8M 000 7910	IZFR7M	
8M 000 7919	IZFR7M	
8M 000 9927	IZFR7M	
971 80 B	BUHW	
971 80 Q	BUHW	
971 82 B	BUHW-2	
971 82 Q	BUHW-2	
971 84	BP7HS-10	
971 86	B9HS-10	
971 86 B	B9HS-10	
973 89	BPR6FS	
<b>MITSUBISHI</b>	<b>→ NGK</b>	<b>V-Line</b>
1822 A002	IFR6B-K	
1822 A005	ILZFR6C-K	
1822 A011	ILKR7B8	
1822 A021	ILKR8E6	
1822 A022	ILFR7H	
1822 A030	FR5EI	
1822 A068	DIFR5C11	
1822 A069	DIFR6C11	
1822 A075	LZFR6BI-11	
1822 A079	DILKR8B6	
1822 A085	DILFR5A11	
1822 A086	LZFR5BI-11	



MITSUBISHI	→ NGK	V-Line
1822 A088	DILKR6D11G	
801 001	B-4	
801 033	B7HS	
MD 313 442	PFR5G-11	
MD 313 443	PFR6G-11	
MD 314 766	BKR7EKC-N	
MD 319 517	PFR6G	
MD 320 543	BKR7EKC-N-11	
MD 320 572	BKR5E	35
MD 321 150	BKR6EKC-N-11	
MD 322 771	PFR6B-11	
MD 331 057	ZFR5F-11	40
MD 336 367	IZFR6B	
MD 338 492	BPR4ES	
MD 338 991	PGR7A	
MD 342 386	PZFR5F-11	
MD 343 277	PGR6A	
MD 348 296	PZFR5B	
MD 351 467	PZFR5C	
MD 355 067	BKR6EKUC	
MD 357 531	PFR6J	
MD 358 200	ZFR6F-11	
MD 358 201	ZFR6F-11	
MD 358 202	ZFR6F-11	
MD 360 019	IZFR6B	
MD 360 383	IZFR5B	
MD 361 067	IFR5E11	
MD 362 097	ZFR5F-11	40
MD 362 098	ZFR5F-11	40
MD 362 902	BKR5EKUC	
MD 365 108	BPR5EKU	
MD 366 819	IZFR5C	
MD 371 434	IGR7A	
MD 371 435	IGR7A	
MD 372 421	BKR5EKUD	
MD 372 422	BKR6EKUD	
MD 372 553	IFR5E11	
MD 372 588	IFR6E11	
MD 373 645	IFR6E11	
MD 374 841	IGR7A-G	
MD 375 642	BKR5ETUA	
MD 378 582	IFR6B	
MN 119 256	ILZFR5B	
MN 119 487	IFR6S	
MN 119 500	IGR6A11	
MN 128 362	LFR6C-11	
MN 158 596	LZFR6AI	
MN 163 235	FR5EI	
MN 163 236	FR6EI	
MN 163 807	FR6EI	
MN 176 628	ILZFR6C-11K	
MN 1822 A002	IFR6B-K	

MITSUBISHI	→ NGK	V-Line
MN 195 922	ILZFR6C-11K	
MS 851 022	BP5ES	8
MS 851 023	BP6ES	4
MS 851 024	BP7ES	
MS 851 027	BP5ES-11	
MS 851 028	BP6ES-11	
MS 851 029	BP7ES-11	
MS 851 097	BP5EY	
MS 851 101	BP4EY	
MS 851 102	BP5EY	
MS 851 104	BP6EY	
MS 851 106	BP4EY-11	
MS 851 107	BP5EY-11	
MS 851 108	BP6EY-11	
MS 851 111	B-4	
MS 851 113	B6S	
MS 851 121	BP-4	
MS 851 126	BPR6E	2
MS 851 132	B5HS	
MS 851 133	B6HS	
MS 851 134	B7HS	
MS 851 162	B5ES	
MS 851 163	B6ES	
MS 851 164	B7ES	
MS 851 165	B8ES	
MS 851 174	BR7ES	
MS 851 181	BP4ES	
MS 851 182	BP5ES	8
MS 851 182 A	BP5ES	8
MS 851 183	BP6ES	4
MS 851 184	BP7ES	
MS 851 187	BP5ES-11	
MS 851 188	BP6ES-11	
MS 851 189	BP7ES-11	
MS 851 192	BP6ES	4
MS 851 207	BP5ES-11	
MS 851 208	BP6ES-11	
MS 851 212	BP5ES	8
MS 851 213	BP6ES	4
MS 851 215	BP7ES	
MS 851 217	BPR5ES	6
MS 851 218	BPR6ES	2
MS 851 219	BPR7ES	19
MS 851 227	BPR5ES-11	
MS 851 228	BPR6ES-11	13
MS 851 229	BPR7ES-11	
MS 851 230	BPR4ES-11	
MS 851 232	BPR5ES	6
MS 851 233	BPR6ES	2
MS 851 234	BPR7ES	19
MS 851 235	BPR5ES	6
MS 851 236	BPR6ES	2



<b>MITSUBISHI</b>	<b>→ NGK</b>	<b>V-Line</b>
MS 851 237	BPR5ES-11	
MS 851 238	BPR6ES-11	13
MS 851 239	BPR7ES-11	
MS 851 242	BP4EY	
MS 851 243	BP5EY	
MS 851 244	BP6EY	
MS 851 246	BP4EY-11	
MS 851 247	BP5EY-11	
MS 851 248	BP6EY-11	
MS 851 253	BUR6EA-11	
MS 851 254	BUR7EA-11	
MS 851 263	G-2Z	
MS 851 272	BUR5EA-11	
MS 851 273	BUR6EA-11	
MS 851 274	BUR7EA-11	
MS 851 283	BP6E	4
MS 851 286	BP5EY	
MS 851 287	BP6EY	
MS 851 292	PGR6A-11	
MS 851 301	PGR5A-11	
MS 851 302	PGR6A-11	
MS 851 316	DCPR6E	
MS 851 317	DCPR7E	
MS 851 327	DCPR7EVX	
MS 851 332	PFR6B-11	
MS 851 335	PFR5J-11	
MS 851 336	PFR6J-11	
MS 851 346	PFR6M	
MS 851 347	PFR7M	
MS 851 351	BK5E	
MS 851 352	BK6E	
MS 851 353	BK6E	
MS 851 354	BK5E	
MS 851 357	BKR5E-11	33
MS 851 358	BKR6E-11	14
MS 851 359	BKR7E-11	
MS 851 361	BK5E-11	
MS 851 362	BK6E-11	
MS 851 363	BK7E-11	
MS 851 364	BK5E-11	
MS 851 365	BK6E-11	
MS 851 366	BK7E-11	
MS 851 367	BKR5E	35
MS 851 368	BKR6E	28
MS 851 382	BKR6E	28
MS 851 387	BKR5E-11	33
MS 851 388	BKR6E-11	14
MS 851 396	DCPR6E	
MS 851 397	DCPR7E	
MS 851 402	BPR5E	6
MS 851 403	BPR6ES-11	13
MS 851 408	BPR6ES-11	13

<b>MITSUBISHI</b>	<b>→ NGK</b>	<b>V-Line</b>
MS 851 412	BPR5ES	6
MS 851 413	BPR6ES	2
MS 851 414	BPR7ES	19
MS 851 417	BPR5ES-11	
MS 851 418	BPR6ES-11	13
MS 851 419	BPR7ES-11	
MS 851 428	BUR6EA-11	
MS 851 429	BUR7EA-11	
MS 851 437	BP5EY	
MS 851 438	BP6ES	4
MS 851 439	BP7ES	
MS 851 447	BUR6EA-11	
MS 851 448	BUR5EA-11	
MS 851 454	BR7ES	
MS 851 463	PGR6A-11	
MS 851 473	PFR6B-11	
MS 851 478	BPR6ES-11	13
MS 851 486	DCPR6E	
MS 851 487	DCPR7E	
MS 851 497	DCPR7EVX	
MS 851 501	PFR5J-11	
MS 851 502	PFR6J-11	
MS 851 506	PFR6J	
MS 851 721	BK5E	
MS 851 722	BK6E	
MS 851 727	BKR5E-11	33
MS 851 728	BKR6E-11	14
MS 851 729	BKR7E-11	
MS 851 732	BK6E-11	
MS 851 737	BKR5E	35
MS 851 738	BKR6E	28
MS 851 783	BK7EK-N-11	
MS 851 861	PFR6J	
MS 851 872	BK7EK-N-11	
MS 851 881	BPR6EKN	
MS 851 882	BPR7EKN	
MZ 602 020	BKR5EIX-11	
MZ 602 021	BKR6EIX-11	
MZ 602 026	BCPR5EIX-11	
MZ 602 027	BCPR6EIX-11	
MZ 602 032	BPR5EIX-11	
MZ 602 033	BPR6EIX-11	
MZ 602 034	BPR7EIX	
MZ 602 035	BR8EIX	
MZ 602 036	BR9EIX	
MZ 602 037	DCPR7EIX	
MZ 602 041	BKR6EIX-11P	
MZ 602 043	BCPR5EIX-11P	
MZ 602 044	BCPR6EIX-11P	
MZ 602 049	DCPR7EIX-P	
MZ 602 060	BPR5EIX-11	
MZ 602 061	BPR6EIX-11	



<b>MITSUBISHI</b>	<b>→ NGK</b>	<b>V-Line</b>
MZ 602 062	BPR7EIX	
MZ 602 063	BCPR5EIX-11	
MZ 602 064	BCPR6EIX-11	
MZ 602 065	BKR5EIX-11	
MZ 602 066	BKR6EIX-11	
MZ 602 067	DCPR7EIX	
MZ 602 068	ZFR5FIX-11	
MZ 602 069	ZFR6FIX-11	
MZ 602 070	BPR5EIX	
MZ 602 071	BPR6EIX	
MZ 602 072	BKR5EIX	
MZ 602 073	BKR6EIX	
MZ 602 074	LPG2	
MZ 602 075	LPG1	
MZ 602 077	BKR6EIX-11P	
MZ 602 078	BCPR5EIX-11P	
MZ 602 079	BCPR6EIX-11P	
MZ 602 080	DCPR7EIX-P	
MZ 602 081	BKR7EIX-11	
MZ 602 084	ZFR5FIX-11P	
MZ 602 085	ZFR6FIX-11P	
S MD 313 443	PFR6G-11	
S MN 158 596	LZFR6AI	
SS MS 851 364	BK5E-11	
Z2 152 944	BPR6ES-11	13
Z2 152 945	BPR6ES	2
Z2 152 946	BR7ES	
Z2 152 947	BPR7ES	19
Z2 152 948	BPR7ES-11	
Z2 152 949	BCPR7ES-11	
Z2 152 950	BCPR6ES-11	11
<b>MOTORCRAFT</b>	<b>→ NGK</b>	<b>V-Line</b>
1 Y 00	BPR5ES	6
1 Y 01	BPR6ES	2
1 Y 03	BPR5ES-11	
1 Y 06	BKR5E	35
1 Y 07	BKR6E	28
1 Y 09	BKR5E-11	33
1 Y 0 A	BKR6E-11	14
1 Y 0 B	BKR7E-11	
1 Y 0 F	DCPR7E	
1 Y 0 G	ZFR5F-11	40
1 Y 0 H	ZFR6F-11	
1 Y 0 K	BPR5ES-13	
1 Y 0 L	BRE527Y-11	
1 YRA	BKR6EIX-11P	
1 YRF	DCPR7EIX-P	
1 YRG	ZFR5FIX-11P	
1 YRH	ZFR6FIX-11P	
A 1	B8S	

<b>MOTORCRAFT</b>	<b>→ NGK</b>	<b>V-Line</b>
A 11	B-2	
A 11 NX	BM4A	
A 11 U	B-2	
A 11 X	B-2	
A 1 CU	B8S	
A 1 X	B8S	
A 2	B7S	
A 21 X	B8S	
A 22	BP6S	
A 22 CU	BP6S	
A 22 NX	BPM7A	
A 2 NX	BM7A	
A 2 X	B7S	
A 3	B6S	
A 32	BP6S	
A 3 CU	B6S	
A 3 NX	BM6A	
A 3 X	B6S	
A 4	B6S	
A 42	BP5S	
A 42 CU	BP5S	
A 5	B6S	
A 52	BP5S	
A 52 CU	BP5S	
A 5 CU	B6S	
A 5 X	B6S	
A 7	B-4	
A 7 LM	B4-LM	
A 7 N	BM6A	
A 7 NU	BM6A	
A 7 NX	BM6A	
A 7 U	B-4	
A 7 X	B-4	
A 82	BP-4	
A 9	B-4	
A 901	B8S	
A 9 X	B-4	
AE 1 C	B7HS	
AE 1 X	B7HS	
AE 2	B7HS	
AE 22	BP6HS	18
AE 22 C	BP6HS	18
AE 2 C	B7HS	
AE 2 X	B7HS	
AE 3	B6HS	
AE 32	BP6HS	18
AE 32 C	BP6HS	18
AE 3 C	B6HS	
AE 3 X	B6HS	
AE 4	B5HS	
AE 42	BP5HS	
AE 4 X	B5HS	



MOTORCRAFT	→ NGK	V-Line
AE 52	BP5HS	
AE 6	B5HS	
AE 62	BP5HS	
AE 7	B-4H	
AE 8	B-4H	
AE 901	B9HS	
AE 901 X	B9HS-10	
AE 92	BP-4H	
AER 32	BPR6HS	3
AER 4	BR5HS	
AER 4 X	BR5HS	
AF 12	BP7FS	
AF 2	B7FS	
AF 22	BP6FS	
AF 3	BR6FS	
AF 32	BP6FS	
AF 3 NX	BM7F	
AF 42	BP5FS	
AF 52	BP4FS	
AF 5 NX	BM6F	
AG 1	B8ES	
AG 12	BP7ES	
AG 12 C	BP7ES	
AG 12 CU	BP7ES	
AG 1 C	B8ES	
AG 1 X	B8ES	
AG 2	B7ES	
AG 203	B11EGP	
AG 22	BP6ES	4
AG 224	BP6ES-11	
AG 22 C	BP6ES	4
AG 22 CU	BP6ES	4
AG 23	B7ECS	
AG 252	BP6ES	4
AG 252 C	BP6ES	4
AG 25 C	B7EM	
AG 2 C	B7ES	
AG 2 CU	B7ES	
AG 2 X	B7ES	
AG 3	B6ES	
AG 32 A	BP6ES	4
AG 32 C	BP6ES	4
AG 32 CU	BP6ES	4
AG 34 CU	BP6EY	
AG 34 CU 11	BP6EY-11	
AG 3 C	B6ES	
AG 3 X	B6ES	
AG 4	B5ES	
AG 403	B10EGP	
AG 403 C	B10EGP	
AG 42	BP5ES	8
AG 42 CU	BP5ES	8

MOTORCRAFT	→ NGK	V-Line
AG 44	ZGR5C	
AG 44 CU	BP5EY	
AG 5	B5ES	
AG 501	B10ES	
AG 501 X	B10EGV	
AG 52	BP5ES	8
AG 54	ZGR5C	
AG 54 CU	BP4EY	
AG 5 CU	B5ES	
AG 603	BR9EIX	
AG 603 C	BR9EIX	
AG 7	B5ES	
AG 701	B9ES	
AG 701 C	B9ES	
AG 701 CU	B9ES	
AG 701 X	B9EGV	
AG 82	BP4ES	
AG 9	B4ES	
AG 901	B9ES	
AG 901 C	B9ES	
AG 901 CU	B9ES	
AG 901 X	B8EGV	
AG 902	BP8ES	
AG 903	B8EG	
AG 9 U	B4ES	
AGF 12	BP7EFS	
AGF 12 C	BP7EFS	
AGF 22 C	BP6EFS	5
AGF 32 CU	BP6EFS	5
AGFS 22 C 1	BPR6EFS	7
AGFS 22 FE 1	PTR6F-13	
AGFS 22 FE 13 J	PTR6D-13G	
AGFS 22 IPJ	ITR6F13	
AGFS 22 YPC	ITR6F13	
AGFS 32 C 1	BPR6EFS	7
AGKO	BUE	
AGN 42	BP5ES	8
AGP 12 C	BCP7ES	
AGP 22 C	BCP6ES	17
AGP 701 C	R7436-10	
AGPR 12 C	BCPR7ES	
AGPR 12 P	BKR7EIX-11	
AGPR 12 PP	PFR7B-11	
AGPR 12 PP 11	PFR7B-11	
AGPR 12 PP 8	PFR7B	
AGPR 22 C	BKR6ES	28
AGPR 22 C 1	BKR6ES-11	14
AGPR 22 CD	BKR6ES	28
AGPR 22 CD 1	BKR6ES-11	14
AGPR 22 P	BKR6EIX-11	
AGPR 22 PP	PFR6B-11	
AGPR 22 PPJ	PFR6B-11	



MOTORCRAFT	→ NGK	V-Line
AGPR 32 C	BKR6ES	28
AGPR 32 CD 1	BKR6ES-11	14
AGPR 32 PD	BKR5EKUP	
AGPR 902 C	BCPR9ES-11	
AGPR 902 P	R7436-9	
AGPS 12 C	BCPR7ES	
AGPS 12 P 1	BKR7EIX-11	
AGPS 22 C	BKR6ES	28
AGPS 22 C 1	BKR6ES-11	14
AGPS 22 P	BKR6EIX-11	
AGPS 22 P 1	BKR6EIX-11	
AGPS 22 PP 1	PFR6B-11	
AGPS 32 C	BKR6ES	28
AGPS 32 C 1	BKR6ES-11	14
AGPS 44 F	PZFR5D-11	34
AGPS 44 F 11	PZFR5D-11	34
AGPS 44 F 11 J	PZFR5D-11	34
AGR 12 C	BPR7ES	19
AGR 16 C	BR8ET	
AGR 1 X	BR8ES	
AGR 21	BR6ES	
AGR 22	BPR6ES	2
AGR 22 C	BPR6ES	2
AGR 22 CU	BPR6ES	2
AGR 2 C	BR7ES	
AGR 31	BR6ES	
AGR 32	BPR6ES	2
AGR 32 C	BPR6ES	2
AGR 32 CU	BPR6ES	2
AGR 34 CU	BPR6EY	
AGR 3 X	BR6ES	
AGR 41	BR5ES	
AGR 42	BPR5ES	6
AGR 42 C	BPR5ES	6
AGR 42 CU	BPR5ES	6
AGR 44 CU	BPR5EY	9
AGR 44 CU 11	BPR5EY-11	
AGR 47 CU 11	ZGR5B-11	
AGR 51	BR5ES	
AGR 52	BPR5ES	6
AGR 54 CU	BPR5EY	9
AGR 701 X	BR9EIX	
AGR 82	BPR4ES	
AGR 901 X	BR8EIX	
AGRF 22	BPR6EFS	7
AGRF 226	BPR6EFS-13	
AGRF 22 C	BPR6EFS	7
AGRF 22 C 1	BPR6EFS	7
AGRF 22 PP 1	PTR5D-10	31
AGRF 32	BPR6EFS	7
AGRF 326	BPR6EFS-13	
AGRF 32 C 1	BPR6EFS	7

MOTORCRAFT	→ NGK	V-Line
AGRF 42	BPR5EFS	
AGRF 52	BPR5EFS	
AGRP 52	ZFR4F-11	
AGS 22 C	BPR6ES	2
AGS 32 C	BPR5ES	6
AGS 32 C 11	BPR5ES-11	
AGS 42 CC	BPR4ES	
AGSF 22 FM 1	TR5IX	
AGSF 22 FSCM	PTR6D-13G	
AGSF 22 PGM	PTR6F-13	
AGSF 22 PM	PTR6F-13	
AGSF 22 PP	PTR6F-13	
AGSF 22 PPJ	PTR6F-13	
AGSF 22 PPM	PTR6F-13	
AGSF 22 WM	BPR5EFS	
AGSF 22 YPC	ITR6F13	
AGSF 24 C	TR5-1	
AGSF 24 N	TR55-1	
AGSF 32 C	BPR5EFS	
AGSF 32 FEC	PTR5F-11	
AGSF 32 FEM	PTR5D-10	31
AGSF 32 FM	PTR5D-13	
AGSF 32 W	TR55IX	
AGSF 32 WM	ITR6F13	
AGSF 32 YPC	TR5AI-13	
AGSF 34 C	TR5-1	
AGSP 32	BKR6ES-11	14
AGSP 32 C	BKR6ES-11	14
AGSP 32 FP	PFR5G-11	
AGSP 32 PR	PFR6B-11	
AGSP 33 C	ZFR6F-11	
AGSP 52	BKR5ES	35
AL 11	B-4L	
AL 5	B-6L	
AL 5 X	B-6L	
AL 7	B-6L	
AL 7 U	B-6L	
AL 7 X	B-6L	
AL 9	B-4L	
AL 9 X	B-4L	
AR 21 X	BR6S	
AR 31	BR6S	
AR 32	BP6S	
AR 41	BR6S	
AR 42	BP5S	
AR 51	BR6S	
AR 52	BP5S	
AR 7 N	BMR6A	
AR 82	BP-4	
ARF 2	BR6FS	
ARF 22	BPR6FS	
ARF 22 C	BPR6FS	

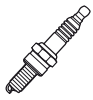

MOTORCRAFT	→ NGK	V-Line
ARF 22 CU	BPR6FS	
ARF 26	BR6FS	
ARF 3	BR6FS	
ARF 32	BPR6FS	
ARF 326	BPR6FS	
ARF 32 C 6	BPR6FS	
ARF 32 M	BPR6FS	
ARF 36	BR6FS	
ARF 4	BR5FS	
ARF 41 CU 15	BR5FS	
ARF 42	BPR5FS	
ARF 426	BPR5FS-15	
ARF 42 CU	BPR5FS	
ARF 46	BR5FS	
ARF 52	BPR4FS	
ARF 526	BPR4FS-15	
ARF 6	BR5FS	
ARF 62	BPR4FS	
ARF 626	BPR4FS-15	
ARF 8	BR5FS	
ARF 86	BR5FS	
ASF 32	BPR6FS	
ASF 32 C	BPR6FS	
ASF 32 M	BPR6FS	
ASF 32 P	UR5IX	
ASF 42	BPR5FS-11	
ASF 426 C	BPR5FS-15	
ASF 42 C	BPR5FS-11	
ASF 42 P	UR4IX	
ASF 44 P	UR4IX	
ASF 52	BPR4FS	
ASF 526	BPR4FS-15	
AT 1	B8S	
AT 10	B-2	
AT 2	B7S	
AT 3	B6S	
AT 4	B6S	
AT 42	BP5S	
AT 42 M	BP5S	
AT 4 A	B6S	
AT 6	B6S	
AT 8	B-4	
ATL 3	B-6L	
ATL 4	B-6L	
ATL 8	B-4L	
AV 1 X	B8HS	
AV 22 CU	BP6HS	18
AV 2 CU	B7HS	
AV 2 X	B7HS	
AV 3 CU	B6HS	
AV 4	B5HS	
AV 42	BP5HS	

MOTORCRAFT	→ NGK	V-Line
AV 52	BP5HS	
AV 6	B-4H	
AV 6 CU	B-4H	
AV 701 CU 10	B9HS-10	
AV 82	BP-4H	
AV 901 CU	B9HS	
AV 901 X 4	B9HS-10	
AVKO	BUH	
AVKOD	BUHW	
AVZKO	BUHX	
AWRF 32	BPR6EFS	7
AWRF 325	BPR6EFS-13	
AWRF 42	BPR5EFS	
AWSF 22 C	BPR6EFS	7
AWSF 22 E	TR6IX	
AWSF 22 F	PTR6D-13	
AWSF 22 FM	TR5IX	
AWSF 22 FM 1	TR5IX	
AWSF 22 FS	PTR6D-13G	
AWSF 24 C	TR5-1	
AWSF 32	BPR6EFS	7
AWSF 32 C	BPR6EFS	7
AWSF 32 E	TR55IX	
AWSF 32 EE	TR55IX	
AWSF 32 F	PTR5D-10	31
AWSF 32 FM	TR5IX	
AWSF 32 P	TR5IX	
AWSF 32 PM	TR5IX	
AWSF 32 PP	TR5IX	
AWSF 34	TR5-1	
AWSF 34 C	TR5-1	
AWSF 34 PP	TR5-1IX	
AWSF 42	BPR5EFS	
AWSF 42 C	BPR5EFS	
AWSF 42 EE	TR55IX	
AWSF 42 PP	TR55IX	
AWSF 44 C	TR5-1	
AWSF 52 C	BPR5EFS	
AWSF 54	TR5-1	
AWSF 54 C	TR5-1	
AWSFA 32 C	BPR5EFS	
AYFS 22 C	PTR5A-13	25
AYFS 22 FE 1 J	PLTR6A-10G	
AYFS 22 FPM 1	PTR5A-13	25
AYFS 22 PP	PTR5A-13	25
AYFS 22 PP 1	PTR5A-13	25
AYFS 32 CJ	TR5B-13	45
AYRF 22 P	PTR5A-13	25
AYRF 22 PP	PTR5A-13	25
AYSF 32 YPC	ILTR5A-13G	
AZ 2	B7S	
AZ 3	B6S	





MOTORCRAFT	→ NGK	V-Line
AZ 9	B-4	
AZ 901	B8S	
AZFS 22 C	PTR5A-13	25
AZFS 22 PP	PTR5A-13	25
AZFS 32 FE	PTR5A-13	25
B 2	AB-8	
B 2 W	AB-8	
B 3 W	AB-7	
B 3 X	AB-7	
B 4	AB-7	
B 4 X	AB-7	
B 6	AB-6	
B 6 W	AB-6	
B 8	AB-6	
B 8 X	AB-6	
B 9	AB-6	
BF 1	A7FS	
BF 12	AP8FS	
BF 22	AP6FS	
BF 22 C	AP6FS	
BF 22 CU	AP6FS	
BF 22 CX	AP6FS	
BF 22 X	AP6FS	
BF 3	A6FS	
BF 32	AP6FS	
BF 32 CU	AP6FS	
BF 32 CX	AP6FS	
BF 32 X	AP6FS	
BF 42	AP5FS	
BF 42 CU	AP5FS	
BF 601	A9FS	
BF 82	AP5FS	
BF 901	A8FS	
BF 92	AP5FS	
BFS 22 C	APR6FS	
BFS 32 C	APR6FS	
BFS 32 C 1	APR6FS	
BR 8	AB-6	
BRF 22	APR6FS	
BRF 22 C	APR6FS	
BRF 31	AR6FS	
BRF 314	AR6FS	
BRF 32	APR6FS	
BRF 3 M	AR6FS	
BRF 42	APR5FS	
BRF 82	APR5FS	
BSF 31	AR6FS	
BSF 314	AR6FS	
BSF 82	APR5FS	
BSF 92	APR5FS	
BT 10	AB-6	
BT 15	AB-2	

MOTORCRAFT	→ NGK	V-Line
BT 2	AB-8	
BT 3	AB-7	
BT 4	AB-7	
BT 6	AB-6	
BT 8	AB-6	
BT 9	AB-6	
BTF 1	A7FS	
BTF 3	A6FS	
BTF 31	A6FS	
BTF 42	AP5FS	
BTF 6	A6FS	
BTRF 42	APR5FS	
BZ 8	AB-6	
HE 1	D10HS	
HE 2	D8HA	
HE 3	D6HA	
HG 2	D8EA	
HG 22	D8EA	
HG 2 CU	D8EA	
HGR 2 C	DR8ES-L	
HV 2	D8HA	
HV 22	D6HA	
HV 3	D6HA	
PE 3	C6HSA	
PV 2	C7HSA	
PV 3	C6HSA	
TT 4	G-2Z	
TT 8	G-2Z	

NISSAN	→ NGK	V-Line
22401-01B14	BPR5ES-11	
22401-01P14	BCPR4ES-11	
22401-01P15	BCPR5ES-11	
22401-01P16	BCPR6ES-11	11
22401-01P17	BCPR7ES-11	
22401-01P75	BCPR5ES-11	
22401-01P76	BCPR6ES-11	11
22401-01P90	BCPR5ES-11	
22401-01P91	BCPR6ES-11	11
22401-02P15	BCPR5E-11	
22401-02P16	BCPR6E-11	11
22401-02P17	BCPR7E-11	
22401-03300	B-4	
22401-08U15	PFR5K-11	
22401-08U75	PFR5K-11	
22401-0P615	PFR5F-11A	
22401-0P616	PFR6F-11A	
22401-0P675	PFR5F-11A	
22401-0P676	PFR6F-11A	
22401-10F14	BCPR4ES-11	
22401-10F15	BCP5ES	16
22401-10F16	BCP6ES	17



NISSAN	→ NGK	V-Line
22401-10F17	BCP7ES	
22401-10P15	BCPR5E-11	
22401-10P16	BKR6E-11	14
22401-10P17	BCPR7E-11	
22401-11200	BC6ES	
22401-12E14	BCPR4ES-11	
22401-12E15	BCPR5ES	32
22401-12E16	BCPR6ES	12
22401-12E17	BCPR7ES	
22401-12E76	BCPR6ES	12
22401-18V15	PGR5A	
22401-18V16	PGR6A	
22401-18V17	PGR7A	
22401-19V15	BCP5ES	16
22401-19V16	BCP6ES	17
22401-19V17	BCP7ES	
22401-19V65	BCPR5ES	32
22401-19V66	BCPR6ES	12
22401-1A50A	ILFR5B11	
22401-1F720	BKR5E-11	33
22401-1HC1B	LZKAR6AP-11	
22401-1KC1C	DILKAR7C9H	
22401-1KC7C	DILKAR7C9H	
22401-1KT1B	DILZKAR6A11	
22401-1KT7B	DILZKAR6A11	
22401-1LA1C	DILKAR7B11	
22401-1LA7C	DILKAR7B11	
22401-1N506	BKR6E-N	
22401-1N516	BKR6E-N	
22401-1N567	PFR7G-11	
22401-1P114	PFR4G-11	
22401-1P115	PFR5G-11	
22401-1P116	PFR6G-11	
22401-1P117	PFR7G-11	
22401-1P175	PFR5G-11	
22401-1P175-Q0	PFR5G-11	
22401-1P175-VA	PFR5G-11	
22401-1P176	PFR6G-11	
22401-1P176-VA	PFR6G-11	
22401-1P176-WS	PFR6G-11	
22401-1W615	FR5AP-10	
22401-1W675	FR5AP-10	
22401-20J04	BKR4E	
22401-20J05	BKR5E	35
22401-20J05-Q0	BKR5E	35
22401-20J05-SN	BKR5E	35
22401-20J05-VA	BKR5E	35
22401-20J05-W0	BKR5E	35
22401-20J06	BKR6E	28
22401-20J07	BKR7E	
22401-20J16	BKR6E	28
22401-21B15	BPR5E	6

NISSAN	→ NGK	V-Line
22401-21B16	BPR6E	2
22401-21B17	BPR7E	19
22401-27N15	PFR5B-11	
22401-27N15-VA	PFR5B-11	
22401-27N15-VB	PFR5B-11	
22401-27N16	PFR6B-11	
22401-27N65	PFR5B-11	
22401-27N66	PFR6B-11	
22401-27N67	PFR7B-11	
22401-27T15	PGR5A-11	
22401-27T65	PGR5A-11	
22401-27T66	PGR6A-11	
22401-2J200	BKR5EY-11	
22401-2J200-Q0	BKR5EY-11	
22401-2J200-VA	BKR5EY-11	
22401-2J206	BKR6EY-11	
22401-2J206-VA	BKR6EY-11	
22401-30R14	ZFR4E-11	
22401-30R15	ZFR5E-11	
22401-30R16	ZFR6E-11	
22401-30R75	ZFR5E-11	
22401-30R75-W1	ZFR5E-11	
22401-37P16	PFR6B-11C	
22401-37P76	PFR6B-11C	
22401-40F15	ZFR5D-11	
22401-40P15	PFR5B-11B	
22401-40P65	PFR5B-11B	
22401-40P66	PFR6B-11B	
22401-40V05	BCP5E	16
22401-40V06	BCP6E	17
22401-40V07	BCPR7E	
22401-50Y04	BKR4E-11	
22401-50Y05	BKR5E-11	33
22401-50Y05-Q0	BKR5E-11	33
22401-50Y05-VA	BKR5E-11	33
22401-50Y05-W0	BKR5E-11	33
22401-50Y06	BKR6E-11	14
22401-50Y07	BKR7E-11	
22401-50Y75	BKR5E-11	33
22401-50Y75-W0	BKR5E-11	33
22401-53J04	BKR4EY	
22401-53J05	BKR5EY	
22401-53J05-VA	BKR5EY	
22401-53J06	BKR6EY	
22401-53J06-RB	BKR6EY	
22401-53J06-VA	BKR6EY	
22401-53J07	BKR7EY	
22401-53J15	PFR5B-9	
22401-53J65	PFR5B-9	
22401-53J66	PFR6B-9	
22401-53J67	PFR7B-9	
22401-53V15	PFR5B-9	



NISSAN	→ NGK	V-Line
22401-53V16	PFR6B	
22401-53V17	PFR7B	
22401-54C68	PFR8B-9	
22401-55V17	PFR7B-D	
22401-58S15	PFR5A-11	
22401-58S16	PFR6A-11	
22401-58S17	PFR7A-11	
22401-59S16	PFR6A-11	
22401-5M015	PLFR5A-11	
22401-5M016	PLFR6A-11	
22401-5M075	PLFR5A-11	
22401-5M075-Q0	PLFR5A-11	
22401-5M075-SN	PLFR5A-11	
22401-5M075-VA	PLFR5A-11	
22401-5M075-W0	PLFR5A-11	
22401-60V06	BCPR6ES-11	11
22401-6N215	LZFR5AQP	
22401-85E15	BKR5ES-11	33
22401-85E16	BKR6ES-11	14
22401-85E17	BKR7ES-11	
22401-85E75	BKR5ES-11	33
22401-85E76	BKR6ES-11	14
22401-88G75	BKR5EY	
22401-88G75-WS	BKR5EY	
22401-88G76	BKR6EY	
22401-88G76-WS	BKR6EY	
22401-8H314	LFR4AP-11	
22401-8H315	LFR5AP-11	
22401-8H375	LFR5AP-11	
22401-8H375-VA	LFR5AP-11	
22401-8H515	LFR5A-11	
22401-8H516	LFR6A-11	
22401-8H575	LFR5A-11	
22401-8H575-Q0	LFR5A-11	
22401-8H616	PLFR6A-9	
22401-8H676	PLFR6A-9	
22401-97E15	PFR5C-11	
22401-97E65	PFR5C-11	
22401-98E06	BKR6ES-11	14
22401-9E075	FR5AP-10	
22401-AG215	PFR5P-11	
22401-AG275	PFR5P-11	
22401-AG315	BKR5EQUA	
22401-AJ415	FR5AP-11	
22401-AL615	LFR5AQP	
22401-AL875	LFR5BP-11	
22401-AR015	LFR5AQP	
22401-AR716	LFR6A	
22401-BC01B	LFR5E-11	
22401-CK81	PLZKAR6A-11	
22401-CK81B	PLZKAR6A-11	
22401-CK87B	PLZKAR6A-11	

NISSAN	→ NGK	V-Line
22401-CK87B-VA	PLZKAR6A-11	
22401-EA015	PLZKAR6A-11	
22401-ED815	LZKAR6AP-11	
22401-ED875	LZKAR6AP-11	
22401-ED875-Q0	LZKAR6AP-11	
22401-ED875-SN	LZKAR6AP-11	
22401-ED875-VA	LZKAR6AP-11	
22401-EW61B	DILKAR6A11	
22401-EW61C	DF7H-11B	
22401-EW67B	DILKAR6A11	
22401-F6516	PFR6A-11A	
22401-FU412	FR2A-D	
22401-FU42A	FR2B-D	
22401-HC000	BPR5ES-13	
22401-HC001	BPR6ES-13	
22401-JA01B	DILKAR6A11	
22401-JA07B	DILZKAR6A11	
22401-JK01D	DF8H-11B	
22401-L1600	BP-2E	
22401-M7714	B4ES	
22401-M7715	B5ES	
22401-M7716	B6ES	
22401-M7717	B7ES	
22401-M7915	BR5ES	
22401-M7916	BR6ES	
22401-M7917	BR7ES	
22401-N8714	BP4ES-11	
22401-N8715	BP5ES-11	
22401-N8716	BP6ES-11	
22401-N8717	BP7ES-11	
22401-N8785	BP5ES-11	
22401-N8786	BP6ES-11	
22401-N8789	BP6ES-11	
22401-N8790	BP5ES-11	
22401-N8791	BP6ES-11	
22401-P8314	BPR4ES-11	
22401-P8315	BPR5ES-11	
22401-P8316	BPR6ES-11	13
22401-P8317	BPR7ES-11	
22401-P8385-PC	BPR5ES-11	
22401-P8386-PC	BPR6ES-11	13
22401-P8389	BPR4ES-11	
22401-P8390	BPR5ES-11	
22401-P8391	BPR6ES-11	13
22401-P8614	BR4ES	
22401-P8616	BR6ES-11	
22401-P8617	BR7ES	
22401-P8816	B6ES-11	
22401-P8817	B7ES-11	
22401-S6015	BP5ES-13	
22401-S6016	BP6ES-13	
22401-V0515	BP5ES	8





OPEL	→ NGK	V-Line
12 14 013	LTR6B-10T	
12 14 014	PZTR5A-15	
12 14 016	ZFR6V-G	
12 14 030	PFR6T-10G	
12 14 031	ZFR5F-11	40
12 14 046	PFR6T-G	
12 14 060	PFR6D10G	
12 14 065	DILFR7B10G	
12 14 066	IFR7X7G	
12 14 149	BKR5EK	23
12 14 527	PLFR6C-10G	
12 14 528	ZFR6BP-G	
44 13 288	PFR6G-9	
47 08 892	IKR6G11	
48 11 581	ILTR5D	
09 195 109	BKR5EK	23
09 195 868	BKR5EQUPA	
09 199 038	LTR6B-10T	
12 563 707	PZTR5A-15	
12 620 540	ILTR5D	
12 787 099	PFR6T-10G	
12 788 884	PLFR6C-10G	
25 324 618	LTR6B-10T	
55 182 623	FR5CP	
55 562 534	PFR6T-G	
55 564 215	BKR7ESC-11	
55 564 748	DILFR7B10G	
55 564 763	ZFR6BP-G	
55 565 219	ZFR6V-G	
55 571 391	PFR6D10G	
55 576 026	IFR7X7G	
90 239 568	BPR6ES	2
90 239 569	BPR6HS	3
90 336 461	BKR6ES	28
90 338 179	BCPR6ET	
90 355 136	BPR6ES	2
90 356 323	BPR5ES	6
90 357 729	BKR6EK	20
90 357 780	BKR6ES	28
90 423 215	BKR6ES	28
90 512 989	BKR5EK	23
93 161 199	PFR6G-9	
93 193 723	IKR6G11	
PIAGGIO	→ NGK	V-Line
638 852	CR7EB	
638 853	CR8EB	
639 687	CR8EKB	
641 387	ER9EH-6N	
828 209	CR9EB	
829 981	CR7EKB	

PIAGGIO	→ NGK	V-Line
847 085	B8ES	
861 612	BR8ES	
887 016	LMAR8F-9	
896 472	PMR9B	
AP 0297 542	DR8EA	
AP 0297 547	DR8EB	
AP 0297 830	BR10EG	
AP 0297 942	DCPR9E	
AP 2BEN 000088	BPR7HS	
AP 2BEN 000276	CPR8E	
AP 2BEN 000319	ZMR7AP	
AP 8176 075	BPR4HS	
AP 8206 870	BR7HS	
AP 8206 871	BR8HS	
AP 8206 915	BR9ES	
AP 8520 007	CR7E	
AP 8600 008	BR9ECM	
PORSCHE	→ NGK	V-Line
95 517 022 090	ILZKR7A	
958 170 222 90	ILZKR8A	
999 170 223 90	BKR7EQUP	
PRESTOLITE	→ NGK	V-Line
10 E 2	C7HSA	
10 E 3	C7HSA	
10 E 4	C6HSA	
12 E 2	D8HA	
12 E 3	D8HA	
12 E 22	D6HA	
12 E 42	D6HA	
12 G 2	D8EA	
12 G 3	D8EA	
14 2 X	B6S	
14 3	B6S	
14 3 N	BM7A	
14 3 X	B6S	
14 4	B6S	
14 5	B6S	
14 5 X	B6S	
14 7	B-4	
14 7 N	BM6A	
14 7 X	B-4	
14 9	B-4	
14 9 X	B-4	
14 11	B-2	
14 11 N	BPM6A	
14 11 X	B-2	
14 32	BP6S	
14 42	BP5S	





PSA	→ NGK	V-Line
5960.G4	PLZKBR7B8DG	
5960.H9	PLZKBR7B8DG	
5960.L0	PLZKBR7B8DG	
5960.L5	ILZKBR7B8DG	
5962.00	BCP6ES	17
5962.05	BP6EFS	5
5962.09	BP6EFS	5
5962.13	BP6ES	4
5962.14	BP6EFS	5
5962.15	BP6EFS	5
5962.16	BP6ES	4
5962.21	BUR6ET	1
5962.22	BPR6EIX	
5962.2A	BPR6ES	2
5962.2T	BKR6EKC	26
5962.2X	BKR6ES	28
5962.5G	BKR6EZ	38
5962.71	BKR6ES	28
5962.72	BP6EFS	5
5962.7S	BKR6EZ	38
5962.7W	LFR6B	
5962.7Y	LFR6B	
5962.80	BP6HS	18
5962.82	BP6ES	4
5962.87	BP6EFS	5
5962.88	BP8ES	
5962.90	BP6HS	18
5962.94	BP7ES	
5962.98	BP7ES	
5962.A1	BP7ES	
5962.A2	BP6ES	4
5962.A3	BP6HS	18
5962.A5	PLZKBR7B8DG	
5962.A0	BP7ES	
5962.C5	BKR6ES	28
5962.C6	BKR6ES	28
5962.C0	BP5EFS	
5962.F7	BCP6ES	17
5962.F8	BCP6ES	17
5962.G8	BP7ES	
5962.H2	BKR6ES	28
5962.H8	BKR5ES	35
5962.H9	BKR5ES	35
5962.IA	BP5ET	
5962.IK	BKR6EK	20
5962.IL	BKR5EK	23
5962.J9	BKR6ES	28
5962.J0	BCP6ES	17
5962.K1	BCPR7ES	
5962.K3	BCP7ET	
5962.K4	BKR6ES	28
5962.K6	BKR6ES	28

PSA	→ NGK	V-Line
5962.K7	BCPR6ET	
5962.K0	BCPR7ES	
5962.OE	BKR6EK	20
5962.R5	BCPR6ET	
5962.R9	BKR6ES	28
5962.S2	BKR6ES	28
5962.S4	BKR5ES	35
5962.S7	BP5ES	8
5962.T8	BKR6ES	28
5962.TO	BKR6ES	28
5962.V6	BKR5ES	35
5962.V7	BKR6ES	28
5962.V8	BCPR7ES	
5962.W1	BKR5ES	35
5962.W4	BCPR6ET	
5962.W6	BCPR7ES	
5962.W7	BCPR7ES	
5962.W9	BKR5EK	23
5962.X5	BCP6ES	17
5962.X8	BCP6ES	17
5962.Y2	BKR5EK	23
5962.Y8	BKR6EK	20
5962.Z1	BKR6EK	20
5962.Z6	BKR5EK	23
5962.Z0	BKR6EK	20
7267.52	BR6HSA	
7343.71	BR8HS	
7355.92	BPR6HS	3
7369.54	BR7HS	
7369.75	BR7ES	
7370.27	BPR5HS	
7381.55	BR8ES	
7423.80	CR7E	
7443.61	CPR8E	
7461.74	CR7EB	
7540.50	BR9ES	
7567.56	DPR7EA-9	
7567.57	B6HS	
7567.58	BP5HS	
7567.59	B7HS	
7567.60	B8HS	
7567.61	BP6HS	18
7567.62	B9ES	
7567.63	B9HS	
7567.66	B8ES	
7567.67	CPR8EB-9	
7567.68	BR9HS	
7567.70	B6ES	
7581.44	CR7HSA	
7598.74	CR7EKB	
7604.64	BPR7ES	19
7616.05	CR9EB	



PSA	→ NGK	V-Line
7664.20	CR7EKA	
7682.28	CR8EKB	
7696.18	CR8EB	
11 737 027 00	BPR5HS	
16 075 776 80	DILFR5A11	
95 496 692	BP6HS	18
95 605 398	B6HS	
95 611 941	BP6EFS	5
95 619 043	BP6ES	4
96 000 090	BCP5ES	16
96 037 952	BCP5ES	16
96 039 962	BCP6ET	
96 064 890	BKR5ES	35
96 097 486	BCP7ET	
96 145 071	BCPR6ET	
96 762 881 80	LZKR6AI-10G	
97 533 994	BP7EFS	
AM 212 207 A	B6HS	
MKP 00073	BP7ES	
V7 534 226 80	PLZKBR7B8DG	
V7 534 226 80-03	PLZKBR7B8DG	
V7 570 106 80	ILZKBR7B8DG	
ZC 986 209 0U	BP5ES	8
ZCT 000 011	BP6HS	18
ZCT 000 012	BP7ES	

RENAULT	→ NGK	V-Line
22401-1KC1C	DILKAR7C9H	
22401-2047R	ILKAR7F7G	
22 40 191 33R	ILKAR7J7G	
22 40 192 02R	LZKAR7B	
22 40 1EA 015	PLZKAR6A-11	
22 40 1JA 01B	DILKAR6A11	
74 39 146 775	BCPR5ET	
77 00 101 401	BKR5ES	35
77 00 103 502	BPR5ES	6
77 00 103 503	BPR5ES	6
77 00 103 533	BKR5EK	23
77 00 107 916	BKR5EK	23
77 00 115 827	BKR6EK	20
77 00 260 637	BCP7ET	
77 00 266 295	BPR6EFS	7
77 00 267 140	BPR6EFS	7
77 00 267 805	TR7IX	
77 00 273 462	BKR6ES	28
77 00 273 698	BKR6EIX	
77 00 500 132	BKR6ETUC	
77 00 500 168	BKR6E	28
77 00 553 622	BP6ES	4
77 00 565 155	BR9EIX	
77 00 587 168	BP6HS	18

RENAULT	→ NGK	V-Line
77 00 714 540	BPR6EFS	7
77 00 722 095	BP6EFS	5
77 00 724 821	BP6ES	4
77 00 725 302	BPR5ES	6
77 00 726 503	BP7EFS	
77 00 727 383	BPR6ES	2
77 00 731 583	BP7EFS	
77 00 732 626	BP8ES	
77 00 733 422	BP5HS	
77 00 736 149	BP7EFS	
77 00 736 150	BP7EFS	
77 00 737 457	BP7EFS	
77 00 737 458	BP6EFS	5
77 00 737 459	BP7ES	
77 00 737 612	BCP5ES	16
77 00 742 094	BPR7ES	19
77 00 743 137	BCP5ES	16
77 00 743 920	BP5ES	8
77 00 749 163	BCP5ES	16
77 00 824 821	BP6ES	4
77 00 852 522	BP6EFS	5
77 00 852 543	TR7IX	
77 00 855 463	BCP6ET	
77 00 855 918	BP5EFS	
77 00 856 342	BCP6ET	
77 00 859 910	BCP5ES	16
77 00 859 967	BP5ES	8
77 00 860 235	BP5ESZ	
77 00 861 471	BP7ES	
77 00 861 472	BP6ESZ	
77 00 862 054	BP5ES	8
77 00 868 864	BPR7ES	19
77 00 869 200	BK5ESZ	
77 00 871 617	BCPR6ET	
77 01 021 767	BP6EFS	5
77 01 041 021 4	BP5ES	8
77 01 041 214	BP5ES	8
77 01 041 215	BP6EFS	5
77 01 042 816	BKR6ES	28
77 01 043 624	BCPR6ET	
77 01 045 018	BP7EFS	
77 01 065 085	PLZKAR6A-11	
77 01 366 057	BP6HS	18
77 01 366 084	BR8EIX	
77 01 366 085	BR7EIX	
77 01 366 086	BP6ES	4
77 01 366 087	BP7ES	
77 01 366 137	BP6EFS	5
77 01 366 267	BP6HS	18
77 01 366 268	BP7ES	
77 01 366 269	BP6ES	4
77 01 366 270	BP6EFS	5





<b>RENAULT</b>	<b>→ NGK</b>	<b>V-Line</b>
77 01 366 513	BP5HS	
77 01 366 514	BP6EFS	5
77 01 366 515	BP6HS	18
77 01 366 516	BP6ES	4
77 01 366 533	B6HS	
77 01 366 539	BP5ES	8
77 01 366 903	BP5ES	8
77 01 414 022	BP5HS	
77 01 414 025	BP6ES	4
77 01 414 026	BP7EFS	
77 01 414 027	BP7EFS	
77 01 414 031	BPR6ES	2
77 01 414 105	BP5ESZ	
82 00 020 791	BKR6EZ	38
82 00 027 363	BKR5EK	23
82 00 030 765	LZKAR7B	
82 00 046 337	PFR6G-9	
82 00 239 321	PFR6E-10	
82 00 314 928	PFR7G-9	
82 00 322 273	LZKAR7A	
82 00 332 273	LZKAR7B	
82 00 363 364	PFR6G-9	
82 00 363 384	PFR6G-9	
82 00 492 426	PFR7Z-TG	
82 00 587 901	ILKAR7A7	
82 00 592 215	LZKAR7B	
82 00 662 185	LZKAR7B	
82 01 001 947	IFR7X8G	
83 04 504 277	ZFR5F	
86 71 016 890	LZKAR7B	
88 03 343 3	IGR7E-3D	
89 33 003 862	BKR6ES	28
96 26 575 480	BKR6EK	20
96 32 182 880	PFR6E-10	
<b>ROLLS ROYCE</b>	<b>→ NGK</b>	<b>V-Line</b>
RH12 050	GR4IX	
RH13 439	BKR4EVX	
RH13 998	BKR5EIX	
<b>ROVER</b>	<b>→ NGK</b>	<b>V-Line</b>
NLP 100 260	BPR6E	2
NLP 100 290	PFR6N-11	
<b>SAAB</b>	<b>→ NGK</b>	<b>V-Line</b>
12 14 060	PFR6D10G	
12 14 065	DILFR7B10G	
45 71 808	PFR7H-10	
48 11 581	ILTR5D	
88 19 294	BCP6ES	17
88 19 328	BPR7EIX	

<b>SAAB</b>	<b>→ NGK</b>	<b>V-Line</b>
91 12 541	BCPR7ES-11	
91 16 385	BCP5ES	16
91 17 565	BCPR6ES-11	11
91 71 307	BKR7ES-11	
91 85 398	PFR7H-10	
91 88 681	PFR7H-10	
91 95 109	BKR5EK	23
91 95 868	BKR5EQUPA	
93 99 866	PFR6H-10	
12 620 540	ILTR5D	
12 787 099	PFR6T-10G	
12 788 884	PLFR6C-10G	
15 885 210	BCPR7ES-11	
30 520 467	BCPR6ES-11	11
32 000 330	BCPR7ES-11	
55 564 215	BKR7ESC-11	
55 564 748	DILFR7B10G	
55 564 763	ZFR6BP-G	
55 571 391	PFR6D10G	
83 500 768	BCP7ES	
<b>SSANGYONG</b>	<b>→ NGK</b>	<b>V-Line</b>
A 172 159 00 03	BCP5ES	16
A 162 159 31 03	BKUR5ETZ-10	
<b>SUBARU</b>	<b>→ NGK</b>	<b>V-Line</b>
22401-AA000	BP5ES-11	
22401-AA010	BP6ES-11	
22401-AA020	BP6ES	4
22401-AA030	BP6ES	4
22401-AA080	BP6EY	
22401-AA090	BP7ES	
22401-AA100	BE527Y-11	
22401-AA110	BE527Y-11	
22401-AA120	BPR6ES-11	13
22401-AA130	BPR6ES-11	13
22401-AA200	BPR6ES	2
22401-AA210	BPR7ES	19
22401-AA220	BPR6ES	2
22401-AA230	BPR7E	19
22401-AA310	BKR6E-11	14
22401-AA320	BKR6E-11	14
22401-AA360	PFR7B	
22401-AA370	PFR6B-11	
22401-AA380	BRE527Y-11	
22401-AA390	BRE527Y-11	
22401-AA400	PFR6B	
22401-AA460	BPR5EY-11	
22401-AA470	BPR6EY-11	10
22401-AA480	BPR5ES-11	
22401-AA500	BKR6EIX-11	
22401-AA510	BKR6EIX	



SUBARU	→ NGK	V-Line
22401-AA520	PFR6G-11	
22401-AA530	PFR6G	
22401-AA531	PFR6G	
22401-AA570	PFR5B-11	
22401-AA580	PLFR6A-11	
22401-AA600	PFR7G	
22401-AA610	ZFR6FIX-11	
22401-AA630	ILFR6B	
22401-AA650	FR5AP-11	
22401-AA65A	FR5AP-11	
22401-AA670	SILFR6A	
22401-AA680	ILFR6B	
22401-AA720	SILFR6A11	
22401-AA730	SIFR6A11	
22401-AA750	SILFR6C11	
22401-AA780	SILZKAR7B11	
22401-KA000	BUR6EA-11	
22401-KA010	BKR6E-11	14
22401-KA030	BKR6E-11	14
22401-KA050	BUR6EA-11	
22401-KA060	BUR6EA-11	
22401-KA080	BKR6E	28
22401-KA090	BCPR6E	12
22401-KA100	BCPR6E	12
22401-KA130	BPR6ES	2
22401-KA140	ZFR6G	
22401-KA150	BKR6E	28
22401-KA160	ZFR6G	
22401-KA170	ZFR5G	
22401-KA180	ZFR5G	
22401-KA190	BPR5E-11	
22401-KA200	BKR5E-11	33
22401-KA210	BKR5E-11	33
22401-KA240	DCPR7E	
22401-KA260	DCPR7E	
22401-KA290	BKR4E-11	
22401-KA310	DCPR8E	
22401-KA320	DCPR8EIX	
22401-KA340	KR8BI	
22401-KA430	BKR6EKPA	
22401-KA440	BKR5E	35
22401-KA450	LKR7AI	
32054-0800	B6ES	
32054-1110	B7ES	
32054-1120	BR7EIX	
32054-5700	BR6ES	
38028-0102	BP6EY	
38242-0800	B5ES	
42054-3200	BP5ES	8
42054-5502	BP6ES	4
42054-5602	BP5EY-11	
42054-5702	BP6ES-11	

SUBARU	→ NGK	V-Line
42054-5800	BE529Y-11	
42054-5802	BE529Y-11	
42054-7102	BP5EY	
42054-7302	BP5EY-11	
48028-7100	BP4EY-11	
49001-0003	BPR5EIX	
49001-0013	BPR6EIX	
49001-0023	BPR7EIX	
49001-0033	BPR5ES	6
49001-0043	BP5EY	
49001-0053	BP6EY	
49001-0082	BPR5EY	9
49001-0092	BPR6EY	
82054-1810	B6HS	
82054-1812	B6HS	
82054-6010	B8HS	
82054-7820	BR6HIX	
82054-8020	BR8HIX	
82054-8600	B6ES	
82054-9310	B7HS	
82054-9312	B7HS	
82054-9320	BR7HIX	
88241-7800	B5HS	
89057-3400	B6S	
SAB 330 DE 0720	BKR6EIX-11P	
SAB 330 DE 0800	DCPR7EIX-P	
SAB 330 DE 2640	LFR6AIX-11	
SAB 330 DE 2670	LFR6AIX-11P	
SAB 330 DE 2680	LFR7AIX-P	
SAB 330 DE 3360	BKR5EIX-11	
SAB 330 DE 3370	BKR6EIX-11	
SAB 330 DE 3430	DCPR7EIX	
SAB 330 DE 3720	BKR6EIX-11P	
SAB 330 DE 3800	DCPR7EIX-P	
SAB 330 DE 4540	LFR6AIX-P	
SAB 330 DE 5140	LFR6AIX-11	
SAB 330 DE 5150	LFR6AIX-11P	
SAB 330 DE 5170	LFR7AIX-P	
SAB 330 DE 5260	LFR6AIX-P	
SAB 330 DE 5270	LFR7AIX-P	
SAB 330 DE 8640	IFR5E11	
SAB 330 DE 8680	BKR5EIX-11	
SAB 330 DE 8690	BKR6EIX-11	
SAB 330 DE 8720	DCPR7EIX	
SUZUKI	→ NGK	V-Line
09482-00006	B-4	
09482-00011	B-4H	
09482-00036	BP-4H	
09482-00051	B6S	
09482-00053	B7S	
09482-00054	B6ES	



SUZUKI	→ NGK	V-Line
09482-00056	B8ES	
09482-00059	BP6HS	18
09482-00060	BP7HS	
09482-00064	BR6HIX	
09482-00065	BR7HIX	
09482-00066	B9ES	
09482-00074	BP6HS	18
09482-00079	BR6ES	
09482-00082	B7HS	
09482-00083	B7HS	
09482-00084	BP6HS	18
09482-00088	BR6HS	
09482-00089	B7ES	
09482-00091	B8ES	
09482-00095	B6HS	
09482-00096	BR8EIX	
09482-00097	BR9EIX	
09482-00098	BR9ES	
09482-00102	BR8HS	
09482-00105	BP7HS	
09482-00114	BR8EIX	
09482-00115	BR9EIX	
09482-00116	BR7HS	
09482-00117	BR7ES	
09482-00118	BP6ES	4
09482-00120	BP5HS	
09482-00121	BR8ES	
09482-00123	BP5EY	
09482-00124	BP5HS	
09482-00125	BPR-4H	
09482-00127	BR9ES	
09482-00128	B6ES	
09482-00129	BP4EY	
09482-00130	BP4EY	
09482-00131	BP5ES	8
09482-00136	BPR-4H	
09482-00139	BP7ES	
09482-00141	BPR6HS	3
09482-00142	B-4H	
09482-00143	BR5HS	
09482-00144	D8EA	
09482-00145	D8EA	
09482-00147	BPR5HS	
09482-00149	DR8ES-L	
09482-00151	B8HS	
09482-00153	B7HS	
09482-00155	BPR5ES	6
09482-00157	BR8HS	
09482-00159	BPR4EY	
09482-00161	BP4HS	
09482-00163	BP5HA	
09482-00167-000	BPR5EY	9

SUZUKI	→ NGK	V-Line
09482-00167-001	BPR5ES	6
09482-00170	BP4HA	
09482-00171	BP4HS	
09482-00172	BP2HS	
09482-00175	BP8ES	
09482-00177	BP6ES	4
09482-00181	BR10EVX	
09482-00182	D7EA	
09482-00183	D7EA	
09482-00184	D9EA	
09482-00185	D9EA	
09482-00186	BP-4H	
09482-00188	BP6HS	18
09482-00189	BP7HS	
09482-00190	B6HS	
09482-00191	B7HS	
09482-00192	B8HS	
09482-00195	B7ES	
09482-00196	B8ES	
09482-00198	B8HS	
09482-00205	BPR4HS	
09482-00206	BPR4HS	
09482-00208	B8EGV	
09482-00209	B9EGV	
09482-00210	B10EGV	
09482-00216	BP4EY-11	
09482-00217	BP5EY-11	
09482-00218	BP4EY-11	
09482-00219	BP5EY-11	
09482-00220	DR7ES	
09482-00221	DR8ES	
09482-00222	DR7EA	
09482-00223	DR8EA	
09482-00225	B8ES	
09482-00226	BP7ES	
09482-00227	CM-6	
09482-00228	BP5HS	
09482-00229	BPR6HS	3
09482-00230	BR8HS	
09482-00233-111	BR9ES	
09482-00234	DR9EA	
09482-00237	B8HS	
09482-00239	BPR8ES	
09482-00240-111	BPR8ES	
09482-00244-111	BPR7HS	
09482-00247-111	BR8ES	
09482-00255	BPR7HS	
09482-00258	BPMR6A	
09482-00259	BP6HS	18
09482-00260	BPM4A	
09482-00261	BPMR4A	
09482-00262	BP5HS-10	



SUZUKI	→ NGK	V-Line
09482-00263	BP5HS-10	
09482-00264	BP6HS-10	
09482-00265	BP6HS-10	
09482-00268	BP8HS	
09482-00269	B7HS-10	
09482-00277	BR7HS-10	
09482-00278	B8HS-10	
09482-00279	B8HS-10	
09482-00280	BR8HS-10	
09482-00281	BPR6HS	3
09482-00282	B5HS	
09482-00284	BP6EY-11	
09482-00285	BPR6ES-11	13
09482-00286	BPR6EY-11	10
09482-00287	BP5ES-11	
09482-00288	BP4ES	
09482-00289	B-4H	
09482-00290	BP-4H	
09482-00291	BP4HS	
09482-00294	C6HA	
09482-00295	C6HSA	
09482-00299	BPR6ES	2
09482-00302-111	BPR6HS	3
09482-00303	BP6EY-11	
09482-00305	BP5HS	
09482-00306	BPR6HS	3
09482-00308	BR5HS	
09482-00309	B5HS	
09482-00312	BPR5EY-11	
09482-00314	CR7HSA	
09482-00316	BPR5HS	
09482-00317	C8HA	
09482-00320-111	CR8HSA	
09482-00321	C8HSA	
09482-00322	BPR5EIX	
09482-00325	BR8EIX	
09482-00327	BR6HS-10	
09482-00328	DP9EA-9	
09482-00330	DPR9EA-9	
09482-00331-111	DPR7EA-9	
09482-00332	DP8EA-9	
09482-00333-111	DP8EA-9	
09482-00334	DPR8EA-9	
09482-00335-111	DPR7EA-9	
09482-00338	B6HS-10	
09482-00339	B6HS-10	
09482-00340	CR6HS	
09482-00341	BR6HS-10	
09482-00348	BR8ES	
09482-00349	BR9ES	
09482-00351	B9ES	
09482-00352	DP7EA-9	

SUZUKI	→ NGK	V-Line
09482-00354	DPR7EA-9	
09482-00355-111	DPR7EA-9	
09482-00358	BR4HS	
09482-00359	BPR5HS	
09482-00360	BR10ES	
09482-00362	ZGR5A	15
09482-00363	BPR5EY	9
09482-00365	J9A	
09482-00366	JR9B	
09482-00367	BPR4HS	
09482-00368	DCP7E	
09482-00369	DCP7E	
09482-00370	BR8HS-10	
09482-00371	J10A	
09482-00372	JR10B	
09482-00375	B8HS-10	
09482-00376	B8HS	
09482-00378	DCPR8E	
09482-00379	DCPR8E	
09482-00381	PJR7A	
09482-00383	DCPR8EIX	
09482-00384	DCPR8EIX	
09482-00385	BP7ES	
09482-00388	JR9B	
09482-00389	JR9B	
09482-00390	JR10B	
09482-00391	JR10B	
09482-00392	BP6ES	4
09482-00395	ZG5E	
09482-00397	JR9C	
09482-00398	DR7EA	
09482-00399	DR8EA	
09482-00400	DR9EA	
09482-00401	JR8C	
09482-00406	CR6HSA	
09482-00407	CR6HSA	
09482-00408	CR7HSA	
09482-00409	BPR6ES	2
09482-00410	CR9EK	
09482-00411	CR9EK	
09482-00412	CR8EK	
09482-00413	CR8EK	
09482-00414	CR7EK	
09482-00416-111	BPR5HS	
09482-00419	R2525-11	
09482-00420-111	BPR-4H	
09482-00421	BPR6ES-11	13
09482-00422	R5184-95	
09482-00423	R5184-10	
09482-00424	R5184-105	
09482-00426	BK6E	
09482-00427	BKR6E	28



SUZUKI	→ NGK	V-Line
09482-00429	BKR6E	28
09482-00430	R0373A-10	
09482-00431	R0373A-11	
09482-00432	BPR5E	6
09482-00433	BPR5EY-11	
09482-00434	BP7ES	
09482-00446	DCPR6E	
09482-00447	DCPR6E	
09482-00448	DCPR7E	
09482-00449	DCPR7E	
09482-00450	DCPR8E	
09482-00452	ZGR5A	15
09482-00456	CR8E	
09482-00457	CR8E	
09482-00458	CR9E	
09482-00459	CR9E	
09482-00460	CR10E	
09482-00461	CR10E	
09482-00462	CR10EK	
09482-00463	CR10EK	
09482-00464	BR8HCS-10	
09482-00467	BR9HS-10	
09482-00468	BPR5E	6
09482-00470	BR8ECM	
09482-00472	BR9ECM	
09482-00473	BR9ECM	
09482-00474	BR10ECM	
09482-00476	BKR5E	35
09482-00477	BKR5E	35
09482-00478	B10ES	
09482-00479	DCPR7EVX	
09482-00481	DCPR8EIX	
09482-00482	DCPR7EVX	
09482-00484	DCPR8EIX	
09482-00485	CR8HSA	
09482-00486	BR8HCS-10	
09482-00487	BPR6ES	2
09482-00488	DCPR7E	
09482-00491	JR8B	
09482-00493	BPR5E-11	
09482-00494	BKR6E-11	14
09482-00495	BPR7ES	19
09482-00496	BPR5E-11	
09482-00497	BKR5E-11	33
09482-00498	BPR7ES	19
09482-00499	R4118S-8	
09482-00500	R4118S-9	
09482-00501	BPR6EY	
09482-00502	BP5EY	
09482-00504	BPR5EY	9
09482-00508	BKR6E-11	14
09482-00509	R6918B-8	

SUZUKI	→ NGK	V-Line
09482-00511	R6918B-7	
09482-00513	R0045J-10	
09482-00514	R0045J-11	
09482-00515	CR7E	
09482-00516	CR7E	
09482-00519	BR9EYA	
09482-00521	PGR5A	
09482-00522	BPR7HS-10	
09482-00523	BPR8HS	
09482-00525	IKR7A	
09482-00526	BR10EYA	
09482-00527	KR7AI	
09482-00528	CR6E	
09482-00530	BPR6HS	3
09482-00531	BP6HS	18
09482-00532	B7HS-10	
09482-00533	BR7HS-10	
09482-00534	B6HS-10	
09482-00535	BR6HS-10	
09482-00537	DCPR9EIX	
09482-00540	PFR5G-11	
09482-00547	IFR5E11	
09482-00548	IFR6E11	
09482-00549	IFR5J11	
09482-00550	IFR6J11	
09482-00556	CR8EIA-9	
09482-00557	CR9EIA-9	
09482-00558	CR9EIA-9	
09482-00561	BR8EG	
09482-00562	IFR5E11	
09482-00564	BR9EYA	
09482-00565	KR8AI	
09482-00566	BKR5E-11	33
09482-00570	CR8EB	
09482-00581	CR8EKB	
09482-00582	CR9EKB	
09482-00584	CR8EIB-10	
09482-00597	CR8EIA-10	
09482-00600-000	DIMR8A10	
09482-00602	IKR6G11	
09482-00603	IKR6G11	
09482-00606	SILFR6A11	
09482-00612	MR8AI9	
09482-69001	BPR6HS	3
09482-M0061-1	IKR6G11	
27118-50000	R7433-8	
94820-01197	B9ES	
94820-0550	IFR6J11	
99000-69257-000	R0161-10	
99000-69257-001	R2525-10	
99000-69571	C7HSA	
99000-69835-B6R	BR6HIX	



SUZUKI	→ NGK	V-Line
99000-69835-B7R	BR7HIX	
99000-69835-B8R	BR8HIX	
99000-69835-BP6	BPR6HIX	
99000-69835-BP7	BPR7HIX	
99000-69835-BR1	BR10EIX	
99000-69835-BR8	BR8EIX	
99000-69835-BR9	BR9EIX	
99000-69835-C6R	CR6HIX	
99000-69835-C7R	CR7HIX	
99000-69835-C8R	CR8HIX	
99000-69835-CR7	CR7EIX	
99000-69835-CR8	CR8EIX	
99000-69835-CR9	B8HCS	
99000-69835-DC7	DPR7EIX-9	
99000-69835-DC8	DCR8EIX	
99000-69835-DR8	DR8EIX	
99000-69835-DR9	DR9EIX	
99000-69835-PR8	DPR8EIX-9	
99000-69835-PR9	DPR9EIX-9	
99000-79A37-16E	BPR5EIX	
99000-79A37-20F	BR6HIX	
99000-79A37-22E	BR7EIX	
99000-79A37-24E	BR8EIX	
99000-79A37-24R	BR8EIX	
99000-79A37-27R	BR9EIX	
99000-79A37-29E	BR10EIX	
99000-79A37-31E	BR10EIX	
99000-79A37-K0P	BKR6EIX-11	
99000-79A37-U2F	CR7HIX	
99000-79A37-U4R	CR8HVX	
99000-79A37-U7E	CR9EIX	
99000-79A37-W6X	BPR5EIX	
99000-79A45-B0E	BR10EIX	
99000-79A45-B6H	BR6HIX	
99000-79A45-B7E	BR7EIX	
99000-79A45-B7H	BR7HIX	
99000-79A45-B8E	BR8EIX	
99000-79A45-B8H	BR8HIX	
99000-79A45-B9E	BR9EIX	
99000-79A45-P8E	BPR8EIX	
99000-79B56	BPR4EY-11	
99000-79J80-K16	BKR5EIX-11	
99000-79J80-K20	BKR6EIX-11	
99000-79J80-U22	DCPR7EIX	
99000-79J80-W16	BPR5EIX-11	
99000-79J80-W20	BPR6EIX-11	
99000-79J80-W22	BPR7EIX	
99000-79K24-22B	DPR7EIX-9	
99000-79K24-24B	DPR8EIX-9	
99000-79K24-27B	DPR9EIX-9	
99000-79K24-F22	CR7HIX	
99000-79K24-F24	CR8HIX	

SUZUKI	→ NGK	V-Line
99000-79K24-H24	CR8EHIX-9	
99000-79K24-H27	CR9EHIX-9	
99000-79K24-IW4	BR8EIX	
99000-79K24-IW7	BR9EIX	
99000-79K24-U22	CR7EIX	
99000-79K24-U24	CR8EIX	
99000-79K24-U27	B8HCS	
99000-79K24-W22	BR7HIX	
99000-79K24-W24	BR8HIX	
99000-79K24-W27	BR9HIX	
99000-79K24-W31	BR10EIX	
99000-79K24-X24	DR8EIX	
99000-79K24-X27	DR9EIX	
99000-79K60-BP6	BPR6EIX-11	
99000-79K60-DC7	DCPR7EIX	
99000-79K60-K5R	BKR5EIX	
99000-79K60-K6R	BKR6EIX	
99000-79K60-KR6	BKR6EIX-11	
99000-79K60-P5R	BPR5EIX	
99000-79K60-P6R	BPR6EIX	
99000-79K60-P7R	BPR7EIX	
99000-79K60-PR5	BPR5EIX-11	
99000-79K73-K20	BKR6EIX-11P	
99000-79K73-U22	DCPR7EIX-P	
99000-79L65-001	BKR6EIX-11P	
99000-79L65-004	DCPR7EIX-P	

TORCH	→ NGK	V-Line
5 580	BUR6ET	1
8 012	BPR6EIX	
A 6 RTC	CR6HSA	
A 6 TC	C6HSA	
A 7 RTC	CR7HSA	
A 7 T	C7HSA	
A 7 TC	C7HSA	
A 8 RTC	CR8HSA	
A 8 TC	C8HSA	
B 8 RC	CR8E	
C 6 RTC	D6HA	
CMR 7 H	CMR7H	
D 6 RTC 9	DPR6EA-9	
D 7	D7EA	
D 7 CA	D7EA	
D 7 RC	D7EA	
D 7 RTC	DPR7EA-9	
D 7 RTC 9	DPR7EA-9	
D 7 TC	DP7EA-9	
D 8 C	D8EA	
D 8 RC	DR8EA	
D 8 RTC	DR8EA	
D 8 T	D8EA	
DK 7 RTC	DCPR7E	



TORCH	→ NGK	V-Line
E 4 RTC	BPR4HS	
E 4 TC	BP4HS	
E 5 RTC	BPR5HS	
E 5 T	BP-4H	
E 5 TC	BP5HS	
E 6 RC	BR6HS	
E 6 RTC	BPR6HS	3
E 6 T	BP4HS	
E 7 C	B6HS	
E 7 TJC	BUR6ET	1
E 8 RC	BR8HS	
E 8 RTC	BPR8HS	
F 5 C	B4ES	
F 5 RF	BPR5EY	9
F 5 RTC	BPR5ES	6
F 5 T	BP4ES	
F 5 TC	BP5ES	8
F 6 RF	BPR6EY	
F 6 RTC	BPR6ES	2
F 6 T	BP6ES	4
F 7 C	B7ES	
F 7 RC	BR7ES	
F 7 RTC	BPR7ES	19
F 7 RTJC	BUR6ET	1
F 8 RC	BR8ES	
F 8 RTC	BP8ES	
G 3 F	B-4	
G 3 TC	BP-4	
G 4 C	B-4	
G 4 RC	B-4	
G 5 RC	BR6S	
G 6	B6S	
G 6 C	B6S	
G 6 RC	BR6S	
GL 4	B4-LM	
H 5	B6S	
K 4 RTC 3	ZFR5F	
K 5 RF 11	BKR5E-11	33
K 5 RTC 11	BKR5ES-11	33
K 5 RTS	ZFR5P-G	41
K 5 TC	BKR5ES-11	33
K 6 RF	BKR6ES	28
K 6 RF 11	BKR6E-11	14
K 6 RTC	BKR5E-11	33
K 6 RTC 11	BKR6ES-11	14
K 7 RTC	BKR6ES	28
K 7 TC	BCP6ES	17
K 7 TJC	BCP6ET	
L 5 C	BM4A	
L 5 T	BPM4A	
L 6	BM6A	
L 6 C	BM6A	

TORCH	→ NGK	V-Line
L 6 RC	BMR6A	
L 6 RTC	BPMR6A	
L 6 T	BPM6A	
L 6 TC	BPM6A	
L 7	BM7A	
L 7 RTC	BPMR7A	
L 7 T	BPM7A	
L 7 TC	BPM7A	
L 7 Y	BM7A	
L 8 RT	BPMR7A	
L 9	BM7A	
L 9 T	BPM7A	
N 6	BM6F	
N 6 C	BM6F	
N 6 RC	BMR6F	
N 6 RTC	BPMR6F	
N 6 TC	BPM6F	
N 7 C	BM7F	
N 7 RC	BM7F	
N 9	BM7F	
P 5 RTC	BPR5FS	
P 5 TC	BP5FS	
P 6 RTC	BPR6FS	
P 6 TC	BP6FS	
P 7 RTC	BP7FS	
P 7 TC	BP7FS	
Q 5 RTC	BPR5EFS	
Q 5 TC	BP5EFS	
Q 6 RTC	BPR6EFS	7
Q 6 TC	BP6EFS	5
Q 7 TC	BP5EFS	
R 4 C	AB-6	
T 5 TC	AP5FS	
T 6 RTC	APR6FS	
T 6 TC	AP6FS	
T 1137 C	C7HSA	
TOYOTA	→ NGK	V-Line
04195-34140	BP5ES	8
04195-34150	BP6ES	4
04195-34280	BPR5EY	9
04195-34320	BPR5EY-11	
08922-01016-83	BPR5EY	9
08922-01017-83	BPR6EY-11	10
08922-01019-83	BPR5EY-11	
08922-01020-83	BCPR6EY-11	
90048-51054	BPR5EY	9
90048-51059	BPR6EY	
90048-51063	BPR5EY-11	
90048-51093-A	BPR5EY-11	
90048-51108-1	BPR6EKB-L	
90048-51126	BPR5EJ	



TOYOTA	→ NGK	V-Line
90048-51131	BPR5EKB	
90048-51131-1	BPR5EKB	
90048-51134	BCPR6EKD	
90048-51134-1	BCPR6EKD	
90048-51140	BPR6EKB	
90048-51158	BKR5E-11	33
90048-51187	IKR7C	
90080-91116	BKR6EKP-11	
90098-00835	BUHX	
90098-00845	BUHW	
90098-00855	BUHW-2	
90098-09026	AB-2	
90098-09036	B-2	
90098-09115	BP-2H	
90098-09125	BP-2E	
90098-09685	BP2HS	
90098-09775	BP-4	
90098-09815	BP-4	
90098-14055	B4ES	
90098-14395	BP4EY	
90098-14425	BPR4EY	
90098-14515	BP-4H	
90098-14545	BPR4ES-13	
90098-14595	BP4EY	
90098-14615	BP4EY-11	
90098-14645	B-4H	
90098-14665	BPR4EY-11	
90098-14685	BP4HS	
90098-14715	B-4	
90098-14775	BP-4	
90098-14785	BPR4FS	
90098-14805	BPR4FS-15	
90098-14815	BP-4	
90098-16145	AP5FS	
90098-16325	BPR5ES	6
90098-16395	BP5EY	
90098-16415	C5HSA	
90098-16425	BPR5EY	9
90098-16455	B5ES	
90098-16505	B5ES	
90098-16515	BP5HS	
90098-16545	BP5ES-13	
90098-16595	BP5EY	
90098-16615	BP5EY-11	
90098-16635	BP5EFS	
90098-16645	B5ES	
90098-16655	BUR5EB-11	
90098-16675	BPR5EY	9
90098-16695	BP5EY	
90098-16705	BP5FS	
90098-16735	APR5FS	
90098-16745	BPR5E	6

TOYOTA	→ NGK	V-Line
90098-16775	BP5S	
90098-16785	BPR5FS	
90098-16795	BPR5FS-11	
90098-16805	BPR5FS-15	
90098-16815	BP5S	
90098-16865	BR5FS	
90098-16875	YR55IX	
90098-16895	BPR6EFS	7
90098-16925	BP5HS-10	
90098-16935	BR5ES	
90098-16955	BE527Y-11	
90098-16975	BUR5EB-11	
90098-16985	BCPR5EY-11	
90098-17015	AB-6	
90098-17025	AB-6	
90098-20145	AP6FS	
90098-20276	B6S	
90098-20325	BPR6ES	2
90098-20355	BM6A	
90098-20395	BP6EY	
90098-20415	C6HSA	
90098-20425	BPR6EY	
90098-20455	B6ES	
90098-20465	D6EA	
90098-20485	D6HA	
90098-20495	DR6HS	
90098-20505	B6ES	
90098-20515	BP6HS	18
90098-20525	BP6HSA	
90098-20545	BPR6EVX-11	
90098-20595	BP6EY	
90098-20615	BP6EY-11	
90098-20625	BPR6EK-A	
90098-20635	BP6EFS	5
90098-20645	B6HS	
90098-20655	BUR6EB-11	
90098-20665	BPR6EY-11	10
90098-20675	BPR6EY	
90098-20695	BP6ES	4
90098-20705	BP6FS	
90098-20735	APR6FS	
90098-20745	BPR6ES	2
90098-20755	BUR6EA-11	
90098-20765	C6HSA	
90098-20775	BP6S	
90098-20785	BPR6FS	
90098-20865	BR6FS	
90098-20885	BP6EFS	5
90098-20895	BPR6EFS	7
90098-20905	BR6ES	
90098-20915	BUR6EB-11	
90098-20925	BP6HS-10	





TOYOTA	→ NGK	V-Line
90098-20935	BR6ES	
90098-20975	BUR6EB-11	
90098-20985	BCPR6EY-11	
90098-21655	BR6EB-L-11	
90098-21915	BR6EB-L-11	
90098-22015	AB-7	
90098-22025	AB-7	
90098-22276	B7S	
90098-22325	BPR7ES	19
90098-22355	BM7A	
90098-22415	C7HSA	
90098-22455	B7ES	
90098-22465	D7EA	
90098-22475	DR7EA	
90098-22505	B7ES	
90098-22515	BP7HS	
90098-22595	BP7EY	
90098-22645	B7HS	
90098-22655	BUR7EB-11	
90098-22745	BPR7ES	19
90098-22755	BUR7EA-11	
90098-22765	C7HSA	
90098-22885	BP7EFS	
90098-22905	BR7ES	
90098-22915	BUR7EB-11	
90098-22935	BR7ES	
90098-22975	BUR7EB-11	
90098-24125	BP8ES	
90098-24276	B8S	
90098-24465	D8EA	
90098-24475	DR8EA	
90098-24485	D8HA	
90098-24495	DR8HS	
90098-24505	B8ES	
90098-24645	B8HS	
90098-24695	BP8ES	
90098-24935	BR8ES	
90098-25305	B8EG	
90098-25375	BR8HIX	
90098-27305	B9EG	
90098-27465	D9EA	
90098-27475	DR9EA	
90098-27505	B9ES	
90098-27645	B9HS	
90098-27935	BR9ES	
90098-31305	B10EG	
90098-31465	D10EA	
90098-31505	B10ES	
90098-33034	BCPR5EY-11	
90098-34305	B11EG	
90098-64017	B4-LM	
90098-64018	B-4L	

TOYOTA	→ NGK	V-Line
90098-64032	GR4IX	
90098-64033	GR4IX	
90098-64050	BPR4ES-13	
90098-64065	ZFR4F-11	
90098-64066	ZFR4F-11	
90098-64112	BUR4EB-11	
90098-66001	BP5EY-11	
90098-66004	BPR5E-11	
90098-66005	BCPR5EY-11	
90098-66006	BUR5EB-11	
90098-66007	BP5EY-11	
90098-66011	DR5HS	
90098-66016	B-6L	
90098-66024	BR5HS	
90098-66031	BPR5EY-11	
90098-66032	BPR5EIX	
90098-66033	BPR5EIX	
90098-66038	BCPR5EIX-11	
90098-66039	BCPR5EIX-11	
90098-66040	BCPR5EY-11	
90098-66045	BCPR5EIX-11	
90098-66047	BKR5E-11	33
90098-66050	BPR5ES-13	
90098-66053	BKR5E	35
90098-66054	BKR5EIX-11	
90098-66056	BKR5EYA-11	39
90098-66058	BPR5E	6
90098-66059	BKR5E-N-11	
90098-66064	PFR5J-11	
90098-66065	ZFR5J-11	
90098-66066	ZFR5F-11	40
90098-66069	BPR5EKB	
90098-66070	PFR5B-11	
90098-66071	BKR5EYA	
90098-66075	ZFR5E-11	
90098-66077	BKR5EIX-11	
90098-66080	PZFR5F-11	
90098-66081	PZFR5F	
90098-66082	BCPR5E	32
90098-66108	PGR5A-11	
90098-66109	BPR5EJ	
90098-66113	PTR5C-13	
90098-66114	BKR5EIX-11	
90098-66115	BCPR5EIX-11	
90098-66116	BPR5EIX-11	
90098-70001	BP6ES-11	
90098-70002	BUR6EA-11	
90098-70003	BPR6ES-11	13
90098-70004	BPR6ES-11	13
90098-70005	BKR6E-11	14
90098-70007	BP6ES-11	
90098-70023	CR6HSA	



TOYOTA	→ NGK	V-Line
90098-70024	BR6HS	
90098-70025	BR6S	
90098-70026	BP6S	
90098-70027	AR6FS	
90098-70030	BPM6A	
90098-70031	BPR6EY-11	10
90098-70032	BPR6EIX	
90098-70033	BPR6EIX	
90098-70034	BCPR6EY-11	
90098-70038	BCPR6EIX-11	
90098-70039	BCPR6EIX-11	
90098-70040	BKR6E-11	14
90098-70041	ZF6A-11	
90098-70043	BP6ES	4
90098-70044	ZFR6A-11	
90098-70046	BCPR6EIX-11	
90098-70047	BKR6E-11	14
90098-70048	BPR6EKN	
90098-70049	BPR6EKB-L	
90098-70050	BPR6EVX-11	
90098-70051	DCPR6E	
90098-70053	BKR6E	28
90098-70054	BKR6EIX-11	
90098-70056	BKR6EYA-11	
90098-70058	BPR6ES	2
90098-70059	BKR6E-N-11	
90098-70060	PFR6G-11	
90098-70064	PFR6J-11	
90098-70065	ZFR6J-11	
90098-70066	ZFR6F-11	
90098-70067	BCPR6EKD	
90098-70069	BPR6EKB	
90098-70070	PFR6B-11	
90098-70071	BKR6EYA	
90098-70074	ZFR6G	
90098-70077	BKR6EIX-11	
90098-70080	PZFR6F-11	
90098-70081	PZFR6F	
90098-70082	BCPR6E	12
90098-70085	BUR6ET	1
90098-70086	PFR6J	
90098-70105	BPR6EKN	
90098-70106	BPR6HS-10	
90098-70108	PGR6A-11	
90098-70114	BKR6EIX-11	
90098-70115	BCPR6EIX-11	
90098-70116	BPR6EIX-11	
90098-72019	DPR7Z	
90098-72021	DPR7EA-9	
90098-72023	CR7HSA	
90098-72024	BR7HS	
90098-72030	BPM7A	

TOYOTA	→ NGK	V-Line
90098-72036	BR7EIX	
90098-72037	DR7EIX	
90098-72042	DCP7E	
90098-72047	BKR7E-11	
90098-72051	DCPR7E	
90098-72067	BCPR7EKD	
90098-72068	BCPR6ED	
90098-72070	PFR7B-11	
90098-72078	BK7EK-N-11	
90098-72116	BPR7EIX	
90098-74013	B8EG	
90098-74014	B8HS-10	
90098-74019	DP8Z	
90098-74021	DPR7EA-9	
90098-74024	BR8HS	
90098-74036	BR8EIX	
90098-74037	DR8EIX	
90098-74042	DP8EA-9	
90098-74051	DCPR8E	
90098-74052	DCPR8EIX	
90098-77013	B9EG	
90098-77014	B9HS-10	
90098-77019	DPR9Z	
90098-77021	DPR7EA-9	
90098-77024	BR9HS	
90098-77036	BR9EIX	
90098-77037	DR9EIX	
90098-77063	BR9HS-10	
90098-77088	C9E	
90098-77102	JR9B	
90098-77111	CR9EHIX-9	
90098-79036	BR10EIX	
90098-79037	DR9EIX	
90098-81036	BR10EIX	
90098-81089	CR10EK	
90098-99201	BCPR6EP-11	
90098-99202	BCPR5EIX-11	
90098-99203	BPR5EP-11	
90098-99204	BCPR6EP-N-8	
90098-99205	BKR6EP-11	
90098-99206	BKR6EP-N-8	
90098-99207	BKR5EP-11	
90098-99208	BKR6EKPB-11	
90919-01051	BPR5ES	6
90919-01055	BP-2E	
90919-01056	BP4EY	
90919-01059	BP5EY	
90919-01061	BP5EY	
90919-01063	BPR6EK-A	
90919-01064	BPR5EY	9
90919-01065	BPR5EY	9
90919-01073	B5ES	



TOYOTA	→ NGK	V-Line
90919-01083	BP6EY	
90919-01084	BPR6EY	
90919-01085	BP4EY-11	
90919-01087	BP5EK-A	
90919-01088	BPR6EK-A	
90919-01089	BPR6EK-A	
90919-01091	BPR5EY	9
90919-01092	BPR6EK-A	
90919-01094	BP5EY-11	
90919-01095	BPR5EIX-11	
90919-01096	BPR5EIX-11	
90919-01097	BPR6EK-A	
90919-01098	BPR6EY	
90919-01099	BP4EY	
90919-01100	BP5EFS	
90919-01101	BP5EY	
90919-01102	BPR5EY	9
90919-01103	BPR4EY	
90919-01104	BPR5EY-11	
90919-01108	BPR4EY-11	
90919-01109	BPR4EY-11	
90919-01113	BRE527Y-11	
90919-01114	BRE527Y-11	
90919-01115	BPR5EP-11	
90919-01116	BPR5EP-11	
90919-01117	BE529Y-11	
90919-01118	BE529Y-11	
90919-01119	BRE529Y	
90919-01120	BRE529Y	
90919-01121	BCPR5EIX-11	
90919-01122	BCPR5EIX-11	
90919-01123	BRE529Y-11	
90919-01125	BPR6EY-11	10
90919-01126	BPR6EY-11	10
90919-01127	BCPR6EP-11	
90919-01128	BCPR6EP-11	
90919-01129	BCPR5EY-11	
90919-01130	BCPR5EY-11	
90919-01131	BCPR6EY-11	
90919-01132	BCPR6EY-11	
90919-01133	BPR5EP-11	
90919-01134	BPR5EP-11	
90919-01135	BCPR6EIX-11	
90919-01136	BCPR6EIX-11	
90919-01138	BP6EY	
90919-01139	BP6EY-11	
90919-01143	BPR5EP-11	
90919-01144	BPR5EP-11	
90919-01145	BCPR6EP-N-8	
90919-01146	BCPR6EP-N-8	
90919-01147	BPR6EP-8	
90919-01148	BPR6EP-8	

TOYOTA	→ NGK	V-Line
90919-01149	BCPR6EY	
90919-01150	BCPR6EY	
90919-01151	BCPR5EP-8	
90919-01152	BCPR5EP-8	
90919-01153	BCPR5EY-11	
90919-01154	BCPR5EY	
90919-01155	BCRE527Y	
90919-01156	BCRE527Y	
90919-01157	BCPR6EIX-11	
90919-01158	BCPR5EIX-11	
90919-01159	BCPR5EY-11	
90919-01162	BCPR6EP-8	
90919-01164	BKR5EYA-11	39
90919-01165	BKR5EYA-11	39
90919-01166	BKR6EYA-11	
90919-01167	BKR6EYA	
90919-01168	BKR5EP-11	
90919-01169	BKR5EP-11	
90919-01170	BCPR4EY-11	
90919-01172	BKR6EP-N-8	
90919-01173	BKR6EP-N-8	
90919-01176	BKR5EYA	
90919-01177	BKR5EYA	
90919-01178	BKR6EP-11	
90919-01179	BKR6EP-11	
90919-01180	BKR6EP-8	
90919-01181	BKR6EP-8	
90919-01182	BCPR6EIX-11	
90919-01184	BKR6EY-11	
90919-01185	BKR6EYA-11	
90919-01187	BKR6EP-13	
90919-01188	BKR6EP-13	
90919-01191	ILFR6T11	
90919-01192	BKR5EKB-11	
90919-01193	BKR5EKB-11	
90919-01194	BKR6EKP-11	
90919-01195	BKR6EKP-11	
90919-01196	BKR5EKP-11	
90919-01197	BKR5EKP-11	
90919-01198	BKR6EKB-11	
90919-01201	BKR5EKP-13	
90919-01202	BKR6EKB-11	
90919-01207	BKR6EIX-11P	
90919-01208	BKR6EPA-8	
90919-01210	IFR6T11	
90919-01211	IFR6T11	
90919-01213	BKR6EPA-8	
90919-01218	IFR5T11	
90919-01220	BKR6EP-11	
90919-01221	HB6AIX-11P	
90919-01225	BKR6EIX-11P	
90919-01226	HB6BIX-11P	



TOYOTA	→ NGK	V-Line
90919-01230	HB6BIX-11P	
90919-01233	ILFR5T11	
90919-01234	ILFR5T11	
90919-01235	LFR6C-11	
90919-01236	LFR6C-11	
90919-01237	IFR6T11	
90919-01238	IFR6T11	
90919-01242	BKR5EYA-11	39
90919-01244	BKR5EYA	
90919-01245	BKR5EYA	
90919-01249	DFH6B-11A	
90919-01253	ILKAR7B11	
90919-YZZAA	BCP5E	16
90919-YZZAB	BCP6E	17
90919-YZZAC	BKR6E-11	14
90919-YZZAD	BKR5EYA	
90919-YZZAE	BKR5EYA-11	39
90919-YZZAF	BKR6EYA	
90919-YZZAG	BKR6EYA-11	
90999-09006	BP5EY	
90999-09007	BP6EY	
99098-22695	BP7ES	

UNIPART, SUREFIRE → NGK	V-Line	
GSP 30	B6S	
GSP 96 SZ	PFR6N-11	
GSP 130	B5ES	
GSP 131	BP5ES	8
GSP 141	BP5ES	8
GSP 151	BP6ES	4
GSP 160	B6ES	
GSP 163	BP6ES	4
GSP 171	BP6ES	4
GSP 181	BP7ES	
GSP 191	BP8ES	
GSP 244	BPR5ES	6
GSP 263	BPR6ES	2
GSP 264	BPR5ES	6
GSP 281	BPR7ES	19
GSP 331	BP5EFS	
GSP 351	BP5EFS	
GSP 361	BP6EFS	5
GSP 381	BP7EFS	
GSP 461	BPR6EFS	7
GSP 531	BP5HS	
GSP 540	B5HS	
GSP 541	BP6HS	18
GSP 550	B6HS	
GSP 560	B7HS	
GSP 571	BP7HS	
GSP 634	BKR5ES	35
GSP 664	BKR6ES	28

UNIPART, SUREFIRE → NGK	V-Line	
GSP 665	BCP6ES	17
GSP 684	BCPR7ES	
GSP 685	BCP7ES	
GSP 761	BP6FS	
GSP 881	BPR6FS	
GSP 981	AP6FS	
GSP 2004	ZFR6F-11	
GSP 2007	BKR6ES	28
GSP 4154	AP6FS	
GSP 4266	B5HS	
GSP 4352	BP6ES	4
GSP 4356	BP6HS	18
GSP 4362	BP6ES	4
GSP 4366	BP6HS	18
GSP 4372	BP5ES	8
GSP 4376	BP5HS	
GSP 4382	BP5ES	8
GSP 4452	BPR7ES	19
GSP 4462	BPR6ES	2
GSP 4472	BPR5ES	6
GSP 4552	BCP7ES	
GSP 4562	BCP6ES	17
GSP 4563	BP6EFS	5
GSP 4573	BP5EFS	
GSP 4652	BCPR7ES	
GSP 4662	BKR6ES	28
GSP 4663	BPR6EFS	7
GSP 6356	BP6HS	18
GSP 6382	BP5ES	8
GSP 6452	BPR7ES	19
GSP 6462	BPR6ES	2
GSP 6468	BPR6ES-11	13
GSP 6472	BPR5ES	6
GSP 6651	PTR5A-13	25
GSP 6652	BKR6ES	28
GSP 6658	BCPR7ES-11	
GSP 6662	BKR6ES	28
GSP 6663	BPR6EFS	7
GSP 6668	BKR6ES-11	14
GSP 9652	PFR6J	
GSP 46515	PTR5A-13	25

VAUXHALL → NGK	V-Line	
12 14 527	PLFR6C-10G	
44 13 288	PFR6G-9	
48 11 581	ILTR5D	
93 99 866	PFR6H-10	
12 620 540	ILTR5D	
12 787 099	PFR6T-10G	
12 788 884	PLFR6C-10G	
30 520 467	BCPR6ES-11	11



<b>VAUXHALL</b>	<b>→ NGK</b>	<b>V-Line</b>
32 000 330	BCPR7ES-11	
55 564 748	DILFR7B10G	
55 564 763	ZFR6BP-G	
91 132 006	BKR5EK	23
93 161 199	PFR6G-9	
93 176 801	ZFR5F	
<b>VOLVO</b>	<b>→ NGK</b>	<b>V-Line</b>
1150 278	IFR6B11	
1367 528	BPR6ES	2
1367 529	BPR6ES	2
22401 AA670	IFR6B11	
2707 46	BPR6ES	2
2712 39	IZFR6B	
2716 03	BKR6E	28
2717 27	BKR6E	28
3063 7308	PFR6B	
3063 7308 791	PFR6B	
3063 7308 887	PFR6B	
3063 7385	LFR6D	
3063 7385 496 A	LFR6D	
3065 0843	LFR6D	
3071 3859	LFR6D	
3073 1383	IFR6B11	
3073 1425	TR5B-13	45
3073 1878	TR6AP-13	
3075 1468 889	ILFR6B	
3075 1469	LFR6D	
3075 1805	ILFR6B	
3075 1806	ILFR6B	
3075 8130	ILTR6G8G	
3077 7349	TR6AP-13	
3121 6183	ILFR6B	
3121 6184	ILFR6B	
3121 6297	ITR6F13	
3121 6525	ITR6F13	
3121 6674	ILFR6K8	
3127 2399	ILFR6K8	
3133 0450	ILZTR6A8G	
3517 980	BKR6ES	28
3650 843	LFR6D	
8642 660	BKR6ETUC	
8642 661	BKR6EQUA	
8670 058	BKR6EIX	
8687 990 H 939	IFR6B11	
8692 070	PFR6B	
8692 071	PFR6B	
8692 072	PFR6B	
8694 749	ITR6F13	
9146 775	BKR6ETUC	
9146 7759 01	BKR6EQUA	
9146 7759 07	BKR6EQUA	

<b>VW Group</b>	<b>→ NGK</b>	<b>V-Line</b>
03C 905 601 A	SIZFR6B8EG	
03C 905 601 B	SIZFR6B8EG	
03F 905 600 A	IZFR6P7	
04C 905 606	ZKER6A-10EG	
04C 905 606 A	ZKER6A-10EG	
04E 905 601	PZKER7A8EGS	
04E 905 612	PZKER7A8EGS	
06H 905 601 A	PFR7S8EG	
06K 905 601 B	PLFER7A8EG	
06K 905 611 C	PLFER7A8EG	
101 000 000 AB	BP6ESZ	
101 000 001 AB	BUR6ET	1
101 000 001 AC	BUR6ET	1
101 000 001 AD	BP5ET-10	
101 000 001 AE	BP5ET	
101 000 002 AB	BP6ESZ	
101 000 003 AA	BCP7ET	
101 000 004 AA	BCP7ET	
101 000 005 AA	BUR6ET	1
101 000 005 AB	BUR6ET	1
101 000 005 AC	BP7ET	
101 000 005 AD	BP5ET-10	
101 000 005 AE	BP5ET	
101 000 005 AF	BP5ET	
101 000 006 AB	BP6ESZ	
101 000 006 AC	BP6ESZ	
101 000 007 AA	BUR6ET	1
101 000 007 AB	BUR6ET	1
101 000 007 AC	BP5ET-10	
101 000 007 AD	BUR6ET	1
101 000 016 AA	PFR7B	
101 000 016 AB	PFR6Q	37
101 000 017 AA	BCP7ET	
101 000 026 AA	BUR5ET	22
101 000 026 AB	BUR6ET	1
101 000 027 AA	BUR6ET	1
101 000 027 AB	BP5ET	
101 000 027 AC	BP5ET-10	
101 000 028 AA	BCP7ET	
101 000 029 AA	BU6EFSZ	
101 000 029 AB	BUR6EFSZ	
101 000 033 AA	BKUR6ET-10	24
101 000 033 AA	BKUR6ET-10	24
101 000 033 AB	BKUR7ET	
101 000 033 AC	BKUR5ET	29
101 000 033 AF	BKUR6ET	27
101 000 033 AG	BKUR5ET-10	
101 000 034 AA	BP6ESZ	
101 000 035 AA	BKR5EKU	
101 000 035 AB	BKR5EKU	
101 000 035 AE	BKR7EKU	
101 000 035 AF	BKR7EKU	



VW Group	→ NGK	V-Line
101 000 035 AH	BKR5EKUP	
101 000 035 HJ	BKR6EKUB	
101 000 036 AA	BUR6ET	1
101 000 036 AB	BUR5ET	22
101 000 036 AC	BUR5ET-10	21
101 000 038 AA	BPR5EKU	
101 000 038 AB	BPR5EKU	
101 000 039 AA	BPR5EKU	
101 000 039 AB	BPR5EKU	
101 000 040 AC	BUR5ET	22
101 000 040 AD	BUR6ET	1
101 000 040 AE	BUR5ET-10	21
101 000 041 AC	BKUR6ET-10	24
101 000 041 AC	BKUR6ET-10	24
101 000 041 AD	BKUR6ET	27
101 000 041 AE	BKUR7ET	
101 000 047 AA	BP5ES-A	
101 000 047 AB	PGR6D	
101 000 048 AA	BP5HS	
101 000 049 AD	BKR6ETA-10	
101 000 050 AA	BUR5ET	22
101 000 050 AB	BUR5ET-10	21
101 000 050 AC	BUR6ET	1
101 000 051 AA	BKUR6ET-10	24
101 000 051 AA	BKUR6ET-10	24
101 000 051 AB	BKUR7ET	
101 000 052 AA	BUR6EFSZ	
101 000 055 AA	BKR6EK	20
101 000 060 AA	BKUR5ET-10	
101 000 062 AB	PZFR5D-11	34
101 000 063 AA	PFR6Q	37
101 000 063 AC	PFR7Q	
101 000 065 AA	BKR6ETA-10	
101 100 068 AA	ZFR6S-Q	
101 905 600	PZFR5J-11	
101 905 600 A	PZFR6J-11	
101 905 600 R1	PZFR5J-11	
101 905 601	PZFR5D-11	34
101 905 601 F	ZFR6T-11G	44
101 905 602	KR8BI	
101 905 606	IZKR7B	
101 905 606 A	IZKR7B	
101 905 607	BKR6EKUE	
101 905 611	PFR6U-11G	
101 905 611 A	PFR6X-11	
101 905 611 C	PFR7G	
101 905 611 G	PFR8S8EG	
101 905 615 A	BKR6EQUA	
101 905 616	BKR6EQUA	
101 905 617	ZFR5P-G	41
101 905 617 C	ZFR6T-11G	44
101 905 617 R1	ZFR5P-G	41

VW Group	→ NGK	V-Line
101 905 618 A	ZFR6T-11G	44
101 905 621	PFR7W-T	
101 905 621 B	PFR6W-TG	
101 905 621 C	PFR7W-TG	
101 905 622	ILZKR7A	
101 905 622 A	ILZKR8A	
101 905 626	PZFR6R	
101 905 626 A	SIZFR6A6D	
101 905 631 G	PFR8S8EG	
101 905 631 H	PFR7S8EG	
325 86	ZFR6S-Q	
400 905 619	PFR7G	
410 905 619	KR8BI	
N 017 8011	B5HS	
XL	→ NGK	V-Line
C 6 RTC	DR6HS	
D 7 RTC	DR7EA	
D 8 RTC-9	DPR8EA-9	
D 8 TC-9	DP8EA-9	
D 9 RTC-9	DPR9EA-9	
DK 7 RTC	DCPR7E	
DK 7 TC	DCP7E	
E 4 C	B-4H	
E 4 C-10	B-4H-10	
E 4 TC-10	BP4HS-10	
E 5 RTC	BPR5HS	
E 5 TC	BP5HS	
E 5 TC-10	BP5HS-10	
E 6 C	B6HS	
E 6 C-10	B6HS-10	
E 6 TC-10	BP6HS-10	
E 7 C	B7HS	
E 7 C-10	B7HS-10	
E 8 C-10	B8HS-10	
E 8 RC-10	BR8HS-10	
E 9 C-10	B9HS-10	
E 9 RC	BR9HS	
E 58 C	B5HS	
EL 4 C	B-4L	
F 2 TC	BP-2E	
F 4 TC-13	BPR4ES-13	
F 5 C	B5ES	
F 5 C-11	B5ES	
F 5 TC-13	BP5ES-13	
F 5 TJC	BP5ET	
F 5 TKC	BP5EK-A	
F 6 C-11	BR6ES	
F 6 RTC	BPR6ES	2
F 6 RTC-13	BPR6ES-13	
F 6 TC-13	BP6ES-13	
F 6 TJC	BP6ET	





<b>BERU</b>	<b>→ NGK</b>	<b>D-Power</b>
105 MN	Y-208T	
107 MJ	Y-810	
108 MJ	Y-810	
141 MJ	Y-207T	
151 MJ	Y-208T	
161 MJ	Y-208T	
162 MJ	Y-207T	
171 MJ	Y-810	
601 MJ	Y-918J	2
602 MJ	Y-208T	
603 MJ	Y-924J	1
609 MJ	Y-924J	1
613 MJ	Y-924J	1
624 MJ	Y-924J	1
631 MJ	Y-907R	
633 MJ	Y-924J	1
636 MJ	Y-924J	1
642 MJ	Y-924J	1
657 MJ	Y-909R	
661 MJ	Y-910J	3
663 MJ	Y-924J	1
666 MJ	Y-910J	3
673 MJ	Y-115T1	
678 MJ	Y-128T	
685 MJ	Y-117RS	
688 MJ	Y-118T1	
689 MJ	Y-204TS1	
705 MJ	Y-107R	
719 MJ	Y-924J	1
730 MJ	Y-739R	
749 MJ	Y-306R	
783 MJ	Y-729U	34
844 MJ	Y-933J	25
852 MJ	Y-913J	
853 MJ	Y-712RS	
854 MJ	Y-712RS	
855 MJ	Y-732J	4
857 MJ	Y-918J	2
858 MJ	Y-916J	6
860 MJ	Y-930U	30
880 MJ	Y-157R	
886 MJ	Y-146R	
887 MJ	Y-181T	
888 MJ	Y-204RS	
889 MJ	Y-112M1	
890 MJ	Y-162R1	
892 MJ	Y-112R1	
894 MJ	Y-118R	
895 MJ	Y-197R	
896 MJ	Y-168R	
897 MJ	Y-147T	
898 MJ	Y-115R1	

<b>BERU</b>	<b>→ NGK</b>	<b>D-Power</b>
905 MJ	Y-730U	17
908 MJ	Y-924J	1
909 MJ	Y-924J	1
912 MJ	Y-503J	10
917 MJ	Y-924J	1
920 MJ	Y-705RS	
921 MJ	Y-707RS	
922 MJ	Y-757RS	
925 MJ	Y-926U	
927 MJ	Y-910J	3
944 MJ	Y-604J	
945 MJ	Y-307R	
946 MJ	Y-710J	
947 MJ	Y-711J	28
948 MJ	Y-925J	16
950 MJ	Y-732J	4
954 MJ	Y-924J	1
955 MJ	Y-722JS	
959 MJ	Y-933J	25
961 MJ	Y-929U	41
963 MJ	Y-506J	7
964 MJ	Y-738U	
967 MJ	Y-703R	
968 MJ	Y-715R	
969 MJ	Y-197T	
970 MJ	Y-928U	29
991 MJ	Y-927J	19
999 MJ	Y-740U	22
CGP 002	CZ104	52
GE 100	Y-607AS	50
GE 101	YE14	48
GE 102	Y-547AS	47
GE 105	Y8002AS	51
GE 108	Y-609AS	49
GE 110	Y1035AS	77
GE 111	Y1036AS	
GE 112	Y9004AS	
GE 114	Y9003AS	78
GE 124	Y1010AS	
GE 115	Y-609AS	49
GE 118	Y1039AS	80
GE 121	Y8001AS	58
GE 121 A	Y8001AS	58
GN 003	Y-745U	11
GN 005	Y-701J	39
GN 007	Y-741U	20
GN 008	Y-501U	31
GN 010	Y-746J	38
GN 012	Y-502R	
GN 013	Y-924J	1
GN 015	Y-543J	46
GN 016	Y-503J	10





BERU	→ NGK	D-Power
GN 017	Y-747U	26
GN 018	Y-732J	4
GN 019	Y-516J	12
GN 022	Y-937J	
GN 024	Y-507J	32
GN 026	Y-517J	
GN 027	Y-504J	24
GN 030	Y-939J	43
GN 033	Y-523J	37
GN 035	Y-749J	
GN 037	Y8005J	64
GN 039	Y-530J	
GN 041	Y-534J	36
GN 042	Y-542J	45
GN 043	Y-532J	
GN 044	Y-755RS	
GN 045	YE12	
GN 046	Y-741U	20
GN 047	YE04	40
GN 053	Y8003J	62
GN 054	Y1005J	56
GN 055	Y1031J	71
GN 056	YE05	73
GN 057	Y-508J	
GN 058	YE13	
GN 059	YE07	
GN 060	Y-536J	81
GN 061	Y-904M1	
GN 062	Y-527J	67
GN 063	YE08	
GN 064	Y-529J	
GN 065	Y-531J	44
GN 072	CZ258	
GN 095	Y1001J1	
GN 097	Y1030J	70
GN 101	CZ259	
GN 102	CZ260	
GN 103	Y-603J	60
GN 104	Y-541J	42
GN 107	Y-733J	13
GN 108	Y1012J	65
GN 109	Y-519J	61
GN 110	Y1013J	63
GN 853	Y-712RS	
GN 854	Y-712RS	
GN 855	Y-732J	4
GN 857	Y-918J	2
GN 858	Y-916J	6
GN 860	Y-930U	30
GN 905	Y-730U	17
GN 908	Y-924J	1
GN 909	Y-924J	1

BERU	→ NGK	D-Power
GN 912	Y-503J	10
GN 917	Y-924J	1
GN 925	Y-926U	
GN 927	Y-910J	3
GN 939	Y-548J	75
GN 944	Y-604J	
GN 948	Y-925J	16
GN 954	Y-924J	1
GN 955	Y-722JS	
GN 959	Y-933J	25
GN 961	Y-929U	41
GN 963	Y-506J	7
GN 964	Y-738U	
GN 970	Y-928U	29
GN 985	Y-605J	
GN 991	Y-927J	19
GN 992	Y-748U	14
GN 993	Y-524J	27
GN 994	CZ261	
GN 997	Y1038J	
GN 999	Y-740U	22
GV 105	Y-208T	
GV 107	Y-810	
GV 108	Y-810	
GV 602	Y-208T	
GV 603	Y-924J	1
GV 631	Y-907R	
GV 636	Y-924J	1
GV 642	Y-924J	1
GV 657	Y-909R	
GV 661	Y-910J	3
GV 663	Y-924J	1
GV 666	Y-910J	3
GV 673	Y-115T1	
GV 678	Y-128T	
GV 685	Y-117RS	
GV 688	Y-118T1	
GV 689	Y-204TS1	
GV 705	Y-107R	
GV 719	Y-924J	1
GV 730	Y-739R	
GV 749	Y-306R	
GV 783	Y-729U	34
GV 844	Y-933J	25
GV 852	Y-913J	
GV 880	Y-157R	
GV 886	Y-146R	
GV 887	Y-181T	
GV 888	Y-204RS	
GV 889	Y-112M1	
GV 890	Y-162R1	
GV 892	Y-112R1	



BERU	→ NGK	D-Power
GV 894	Y-118R	
GV 895	Y-197R	
GV 896	Y-168R	
GV 897	Y-147T	
GV 898	Y-115R1	
GV 920	Y-705RS	
GV 921	Y-707RS	
GV 922	Y-757RS	
GV 945	Y-307R	
GV 946	Y-710J	
GV 947	Y-711J	28
GV 967	Y-703R	
GV 968	Y-715R	
GV 969	Y-197T	
0 100 220 103	Y-207T	
0 100 220 113	Y-204RS	
0 100 220 114	Y-112M1	
0 100 220 115	Y-112R1	
0 100 220 118	Y-705RS	
0 100 221 102	Y-208T	
0 100 221 103	Y-208T	
0 100 221 105	Y-918J	2
0 100 221 106	Y-208T	
0 100 221 107	Y-924J	1
0 100 221 132	Y-907R	
0 100 221 133	Y-924J	1
0 100 221 135	Y-924J	1
0 100 221 141	Y-909R	
0 100 221 144	Y-910J	3
0 100 221 145	Y-924J	1
0 100 221 146	Y-910J	3
0 100 221 147	Y-115T1	
0 100 221 148	Y-128T	
0 100 221 149	Y-117RS	
0 100 221 151	Y-118T1	
0 100 221 152	Y-204TS1	
0 100 221 154	Y-107R	
0 100 221 163	Y-924J	1
0 100 221 170	Y-739R	
0 100 221 186	Y-306R	
0 100 222 101	Y-118R	
0 100 222 102	Y-168R	
0 100 222 106	Y-508J	
0 100 222 301	Y-810	
0 100 222 302	Y-810	
0 100 226 129	Y-729U	34
0 100 226 163	Y-913J	
0 100 226 164	Y-933J	25
0 100 226 170	Y-712RS	
0 100 226 171	Y-712RS	
0 100 226 173	Y-918J	2
0 100 226 180	Y-146R	

BERU	→ NGK	D-Power
0 100 226 182	Y-147T	
0 100 226 183	Y-115R1	
0 100 226 184	Y-730U	17
0 100 226 185	Y-924J	1
0 100 226 186	Y-924J	1
0 100 226 188	Y-503J	10
0 100 226 189	Y-924J	1
0 100 226 194	Y-707RS	
0 100 226 198	Y-910J	3
0 100 226 206	Y-604J	
0 100 226 207	Y-710J	
0 100 226 208	Y-711J	28
0 100 226 209	Y-307R	
0 100 226 227	Y-732J	4
0 100 226 229	Y-924J	1
0 100 226 233	Y-722JS	
0 100 226 234	Y-916J	6
0 100 226 235	Y-925J	16
0 100 226 237	Y-933J	25
0 100 226 238	Y-740U	22
0 100 226 242	Y-703R	
0 100 226 243	Y-715R	
0 100 226 245	Y-506J	7
0 100 226 246	Y-738U	
0 100 226 249	Y-928U	29
0 100 226 250	Y-929U	41
0 100 226 255	Y-605J	
0 100 226 258	Y-930U	30
0 100 226 299	Y-927J	19
0 100 226 300	Y-748U	14
0 100 226 302	CZ261	
0 100 226 312	Y1038J	
0 100 226 336	Y-701J	39
0 100 226 338	Y-501U	31
0 100 226 343	Y-741U	20
0 100 226 344	Y-504J	24
0 100 226 351	Y-517J	
0 100 226 352	Y-530J	
0 100 226 354	Y-502R	
0 100 226 362	Y-507J	32
0 100 226 365	Y-746J	38
0 100 226 366	Y-924J	1
0 100 226 371	Y-503J	10
0 100 226 372	Y-747U	26
0 100 226 373	Y-732J	4
0 100 226 375	Y-516J	12
0 100 226 379	Y-745U	11
0 100 226 381	Y-937J	
0 100 226 384	Y-524J	27
0 100 226 385	Y-548J	75
0 100 226 391	Y-939J	43
0 100 226 392	Y-543J	46



<b>BERU</b>	<b>→ NGK</b>	<b>D-Power</b>
0 100 226 417	Y-523J	37
0 100 226 422	Y-749J	
0 100 226 432	Y-926U	
0 100 226 436	Y-534J	36
0 100 226 475	Y-532J	
0 100 226 480	Y-542J	45
0 100 226 482	Y-741U	20
0 100 226 492	Y1005J	56
0 100 226 494	Y1031J	71
0 100 226 495	Y-603J	60
0 100 226 497	Y-541J	42
0 100 226 504	Y-732J	4
0 100 226 511	Y-733J	13
0 100 226 513	CZ260	
0 100 226 514	CZ259	
0 100 226 517	Y-536J	81
0 100 226 520	Y-904M1	
0 100 226 522	Y-527J	67
0 100 226 526	Y-529J	
0 100 226 527	Y-531J	44
0 100 226 538	Y1012J	65
0 100 226 568	Y1013J	63
0 100 226 577	Y1001J1	
0 100 226 639	Y1030J	70
0 100 230 101	Y-181T	
0 100 230 102	Y-162R1	
0 100 230 107	Y-755RS	
0 100 231 104	Y-157R	
0 100 231 107	Y-197R	
0 100 231 109	Y-757RS	
0 100 231 114	Y-197T	
0 100 266 002	Y-547AS	47
0 100 266 008	Y-607AS	50
0 100 266 009	YE14	48
0 100 266 011	Y8002AS	51
0 100 266 016	Y-609AS	49
0 100 266 031	Y9004AS	
0 100 266 032	Y1035AS	77
0 100 266 033	Y1036AS	
0 100 266 034	Y9003AS	78
0 100 266 037	Y1039AS	80
0 100 266 040	Y-609AS	49
0 100 266 068	Y8001AS	58
0 100 276 003	Y8005J	64
0 100 276 004	YE04	40
0 100 276 005	YE12	
0 100 276 008	Y8003J	62
0 100 276 012	YE05	73
0 100 276 014	YE13	
0 100 276 015	YE07	
0 100 276 024	YE08	
0 100 800 031	Y-519J	61

<b>BERU</b>	<b>→ NGK</b>	<b>D-Power</b>
0 100 800 035	CZ258	
0 106 671 108	CZ104	52
<b>BMW</b>	<b>→ NGK</b>	<b>D-Power</b>
12 23 1 288 245	Y-924J	1
12 23 2 241 389	Y-924J	1
12 23 2 248 059	Y-507J	32
12 23 7 786 869	Y-547AS	47
12 23 7 798 001	Y1039AS	80
<b>BOSCH</b>	<b>→ NGK</b>	<b>D-Power</b>
GLP 001	Y-924J	1
GLP 002	Y-918J	2
GLP 003	Y-732J	4
GLP 004	Y-503J	10
GLP 005	Y-924J	1
GLP 006	Y-916J	6
GLP 007	Y-534J	36
GLP 008	Y-745U	11
GLP 009	Y-506J	7
GLP 010	Y-910J	3
GLP 011	Y-516J	12
GLP 012	Y-937J	
GLP 013	Y-504J	24
GLP 014	Y-730U	17
GLP 015	Y-924J	1
GLP 016	Y8003J	62
GLP 017	Y-925J	16
GLP 019	Y-748U	14
GLP 020	Y-927J	19
GLP 021	Y-929U	41
GLP 022	Y-745U	11
GLP 023	Y-741U	20
GLP 024	Y-524J	27
GLP 025	Y-930U	30
GLP 026	Y-928U	29
GLP 030	Y-523J	37
GLP 031	Y-501U	31
GLP 032	Y-747U	26
GLP 033	Y-741U	20
GLP 034	Y-115T1	
GLP 035	Y-603J	60
GLP 036	Y-933J	25
GLP 037	Y-913J	
GLP 038	Y-701J	39
GLP 039	CZ257	83
GLP 040	Y-507J	32
GLP 041	Y-739R	
GLP 042	Y-118T1	
GLP 043	YE07	
GLP 045	Y-939J	43



<b>BOSCH</b>	<b>→ NGK</b>	<b>D-Power</b>
GLP 046	Y-711J	28
GLP 047	Y-909R	
GLP 048	Y-729U	34
GLP 049	Y-712RS	
GLP 050	Y-607AS	50
GLP 051	Y-548J	75
GLP 054	Y-733J	13
GLP 055	Y1005J	56
GLP 057	Y-517J	
GLP 059	YE04	40
GLP 063	Y-810	
GLP 066	Y1030J	70
GLP 070	Y-547AS	47
GLP 072	Y-710J	
GLP 074	Y-532J	
GLP 078	Y-604J	
GLP 092	Y-541J	42
GLP 093	YE14	48
GLP 094	YE05	73
GLP 096	Y-306R	
GLP 098	Y-755RS	
GLP 101	Y-531J	44
GLP 102	Y-746J	38
GLP 103	Y-904M1	
GLP 105	CZ260	
GLP 108	CZ259	
GLP 109	Y1031J	71
GLP 111	Y1005J	56
GLP 115	YE12	
GLP 116	Y-118R	
GLP 117	Y-107R	
GLP 120	Y-307R	
GLP 121	Y-910J	3
GLP 124	Y-146R	
GLP 125	Y-103	
GLP 127	Y-705RS	
GLP 132	Y-197T	
GLP 136	Y-197R	
GLP 137	Y1007J	59
GLP 138	Y-162R1	
GLP 142	Y-147T	
GLP 144	Y8008AS	74
GLP 148	Y-112R1	
GLP 152	Y-178T	
GLP 155	Y-112T	
GLP 156	Y1006J	
GLP 159	Y-128T	
GLP 167	Y-117RS	
GLP 169	Y-157R	
GLP 179	Y8009AS	
GLP 185	Y-181T	
GLP 186	Y-907R	

<b>BOSCH</b>	<b>→ NGK</b>	<b>D-Power</b>
GLP 194	Y1002AS	57
GLP 196	Y9003AS	78
GLP 202	Y8002AS	51
GLP 203	Y-749J	
GLP 205	Y8005J	64
GLP 210	YE08	
GLP 212	Y1012J	65
GLP 221	Y1035AS	77
GLP 222	Y1036AS	
GLP 224	Y-732J	4
GLP 225	Y-605J	
GLP 237	Y1010AS	
GSA 91	Y-810	
GSA 101	Y-810	
0 250 200 014	Y-810	
0 250 200 020	Y-810	
0 250 200 049	Y-207T	
0 250 200 052	Y-207T	
0 250 200 053	Y-909R	
0 250 200 054	Y-208T	
0 250 200 055	Y-810	
0 250 200 056	Y-208T	
0 250 200 058	Y-208T	
0 250 200 059	Y-208T	
0 250 200 060	Y-208T	
0 250 200 063	Y-207T	
0 250 200 065	Y-208T	
0 250 200 068	Y-208T	
0 250 200 069	Y-924J	1
0 250 200 420	Y-810	
0 250 200 454	Y-208T	
0 250 200 456	Y-208T	
0 250 200 465	Y-208T	
0 250 200 468	Y-208T	
0 250 201 001	Y-924J	1
0 250 201 004	Y-918J	2
0 250 201 005	Y-924J	1
0 250 201 006	Y-924J	1
0 250 201 008	Y-924J	1
0 250 201 009	Y-924J	1
0 250 201 011	Y-918J	2
0 250 201 012	Y-909R	
0 250 201 013	Y-924J	1
0 250 201 015	Y-918J	2
0 250 201 017	Y-907R	
0 250 201 019	Y-924J	1
0 250 201 021	Y-918J	2
0 250 201 026	Y-916J	6
0 250 201 027	Y-924J	1
0 250 201 029	Y-913J	
0 250 201 032	Y-918J	2
0 250 201 033	Y-924J	1



<b>BOSCH</b>	<b>→ NGK</b>	<b>D-Power</b>
0 250 201 034	Y-909R	
0 250 201 035	Y-930U	30
0 250 201 038	Y-925J	16
0 250 201 039	Y-924J	1
0 250 201 041	Y-916J	6
0 250 201 042	Y-924J	1
0 250 201 043	Y-913J	
0 250 201 049	Y-937J	
0 250 201 050	Y-933J	25
0 250 201 053	Y-939J	43
0 250 201 054	Y-925J	16
0 250 201 055	Y-916J	6
0 250 201 405	Y-924J	1
0 250 201 415	Y-918J	2
0 250 202 001	Y-910J	3
0 250 202 002	Y-739R	
0 250 202 003	Y-115T1	
0 250 202 004	Y-128T	
0 250 202 005	Y-117RS	
0 250 202 006	Y-118T1	
0 250 202 007	Y-107R	
0 250 202 008	Y-306R	
0 250 202 009	Y-732J	4
0 250 202 013	Y-204RS	
0 250 202 015	Y-103	
0 250 202 017	Y-112R1	
0 250 202 018	Y-910J	3
0 250 202 020	Y-503J	10
0 250 202 022	Y-732J	4
0 250 202 023	Y-741U	20
0 250 202 024	Y-927J	19
0 250 202 025	Y-730U	17
0 250 202 026	Y-929U	41
0 250 202 027	Y-604J	
0 250 202 028	Y-747U	26
0 250 202 029	Y-745U	11
0 250 202 032	Y-504J	24
0 250 202 033	Y-910J	3
0 250 202 034	Y-928U	29
0 250 202 035	Y-506J	7
0 250 202 036	Y-534J	36
0 250 202 038	Y1031J	71
0 250 202 039	Y-745U	11
0 250 202 040	Y-729U	34
0 250 202 041	Y-746J	38
0 250 202 042	Y-748U	14
0 250 202 043	Y-523J	37
0 250 202 045	Y-745U	11
0 250 202 046	Y-741U	20
0 250 202 048	Y1005J	56
0 250 202 051	Y-146R	
0 250 202 054	Y-118R	

<b>BOSCH</b>	<b>→ NGK</b>	<b>D-Power</b>
0 250 202 058	Y-147T	
0 250 202 064	Y-755RS	
0 250 202 065	Y-904M1	
0 250 202 069	Y-162R1	
0 250 202 071	Y-181T	
0 250 202 076	Y-197R	
0 250 202 077	Y-705RS	
0 250 202 085	Y-710J	
0 250 202 086	Y-307R	
0 250 202 087	Y-711J	28
0 250 202 089	Y-701J	39
0 250 202 090	Y1006J	
0 250 202 092	Y-733J	13
0 250 202 093	Y-712RS	
0 250 202 094	Y-115T1	
0 250 202 095	Y-532J	
0 250 202 096	Y-118T1	
0 250 202 097	Y-197T	
0 250 202 102	Y-501U	31
0 250 202 103	Y-507J	32
0 250 202 107	Y-157R	
0 250 202 110	Y-112T	
0 250 202 119	Y-178T	
0 250 202 124	Y1007J	59
0 250 202 125	Y-531J	44
0 250 202 128	Y-517J	
0 250 202 129	Y-516J	12
0 250 202 130	Y-548J	75
0 250 202 131	Y-524J	27
0 250 202 132	Y1030J	70
0 250 202 135	Y1005J	56
0 250 202 137	Y-541J	42
0 250 202 140	Y-929U	41
0 250 202 141	Y-745U	11
0 250 202 142	Y-745U	11
0 250 202 143	Y-605J	
0 250 203 001	YE07	
0 250 203 002	Y8003J	62
0 250 203 004	YE12	
0 250 203 009	Y8005J	64
0 250 203 012	YE08	
0 250 204 001	YE04	40
0 250 204 002	YE05	73
0 250 212 006	Y-749J	
0 250 212 009	Y-732J	4
0 250 212 011	Y-527J	67
0 250 312 001	CZ259	
0 250 312 002	CZ260	
0 250 312 003	Y-603J	60
0 250 312 007	CZ257	83
0 250 402 001	Y-607AS	50
0 250 402 002	Y-547AS	47



<b>BOSCH</b>	<b>→ NGK</b>	<b>D-Power</b>
0 250 402 005	Y-607AS	50
0 250 403 001	Y8008AS	74
0 250 403 002	YE14	48
0 250 403 007	Y1002AS	57
0 250 403 008	Y8002AS	51
0 250 403 009	Y1002AS	57
0 250 403 010	Y8009AS	
0 250 403 011	Y9003AS	78
0 250 403 012	Y1035AS	77
0 250 403 013	Y1036AS	
0 250 403 014	Y9001AS	72
0 250 403 021	Y1010AS	
0 250 404 001	Y8001AS	58
F 01 G 00000 P	Y1012J	65

<b>BRISK</b>	<b>→ NGK</b>	<b>D-Power</b>
21 N 21	Y-208T	
21 N 22	Y-208T	
21 N 51	Y-909R	
21 R 01	Y-918J	2
21 R 02	Y-907R	
21 R 06	Y-918J	2
21 R 21	Y-924J	1
21 R 22	Y-924J	1
21 R 23	Y-924J	1
21 R 26	Y-913J	
21 R 51	Y-909R	
21 R 71	Y-910J	3

<b>CHAMPION</b>	<b>→ NGK</b>	<b>D-Power</b>
CH 60	Y-207T	
CH 63	Y-208T	
CH 65	Y-810	
CH 68	Y-523J	37
CH 69	Y-918J	2
CH 70	Y-909R	
CH 78	Y-208T	
CH 79	Y-907R	
CH 88	Y-924J	1
CH 90	Y-739R	
CH 94	Y-115T1	
CH 95	Y-146R	
CH 96	Y-204RS	
CH 97	Y-107R	
CH 98	Y-117RS	
CH 99	Y-117SS	
CH 101	Y-115R1	
CH 102	Y-112M1	
CH 103	Y-118T1	
CH 104	Y-197R	
CH 105	Y-204SS	
CH 121	Y-118T1	

<b>CHAMPION</b>	<b>→ NGK</b>	<b>D-Power</b>
CH 137	Y-924J	1
CH 147	Y-910J	3
CH 154	Y-715R	
CH 158	Y-711J	28
CH 159	Y-924J	1
CH 160	Y-918J	2
CH 161	Y-755RS	
CH 162	Y-707RS	
CH 163	Y-924J	1
CH 166	Y-747U	26
CH 167	Y-928U	29
CH 169	Y-730U	17
CH 170	Y-504J	24
CH 171	Y-732J	4
CH 172	Y-740U	22
CH 173	Y-913J	
CH 174	Y-924J	1
CH 175	Y-930U	30
CH 176	Y-916J	6
CH 177	Y-925J	16
CH 178	Y-729U	34
CH 179	Y-933J	25
CH 181	Y-741U	20
CH 184	Y-732J	4
CH 185	Y-503J	10
CH 189	Y-924J	1
CH 196	Y-524J	27
CH 203	Y-507J	32
CH 204	Y-929U	41
CH 205	Y-937J	
CH 206	Y-927J	19
CH 207	Y-748U	14
CH 208	Y-738U	
CH 215	Y-501U	31
CH 216	Y-502R	
CH 217	Y-506J	7
CH 218	Y-745U	11
CH 219	Y-746J	38
CH 221	Y-115T1	
CH 223	Y8003J	62
CH 224	YE07	
CH 263	Y1007J	59
CH 268	Y1005J	56
CH 601	Y-603J	60

<b>CHRYSLER</b>	<b>→ NGK</b>	<b>D-Power</b>
05066 840 AA	Y1031J	71
5175 756 AA	Y8002AS	51

<b>DAIHATSU</b>	<b>→ NGK</b>	<b>D-Power</b>
19850-54050-000	Y-118R	
19850-54071-000	Y-146R	



<b>DAIHATSU</b>	<b>→ NGK</b>	<b>D-Power</b>
19850-54090-000	Y-715R	
19850-56010-000	Y-178	
19850-56012-000	Y-178T	
19850-58030-000	Y-128T	
19850-58040-000	Y-178T	
19850-64010-000	Y-146R	
19850-64020-000	Y-703R	
19850-68010-000	Y-147T	
19850-68040-000	Y-178T	
19850-68060-000	Y-197R	
19850-87303-000	Y-108	
19850-87309-000	Y-128T	
19850-87701-000	Y-146R	
19850-87702-000	Y-703R	
19850-87801	Y-706R	
<b>DENSO</b>	<b>→ NGK</b>	<b>D-Power</b>
DG-001	Y-924J	1
DG-002	Y-204TS1	
DG-003	Y-503J	10
DG-004	Y-910J	3
DG-005	Y-732J	4
DG-006	Y-913J	
DG-007	Y-937J	
DG-008	Y-506J	7
DG-009	Y-927J	19
DG-010	Y-916J	6
DG-012	Y-918J	2
DG-101	Y-740U	22
DG-102	Y-928U	29
DG-103	Y-933J	25
DG-105	Y-115T1	
DG-106	Y-925J	16
DG-108	Y-904M1	
DG-109	Y-741U	20
DG-110	Y-929U	41
DG-111	Y-502R	
DG-112	Y-516J	12
DG-113	YE04	40
DG-114	Y-107R	
DG-115	Y-729U	34
DG-116	Y-504J	24
DG-117	Y-925J	16
DG-118	Y-748U	14
DG-119	Y-930U	30
DG-120	Y-707RS	
DG-121	Y-524J	27
DG-122	Y-534J	36
DG-123	Y-907R	
DG-124	Y-710J	
DG-126	Y-517J	

<b>DENSO</b>	<b>→ NGK</b>	<b>D-Power</b>
DG-127	Y-747U	26
DG-129	Y-939J	43
DG-130	Y-548J	75
DG-133	Y-604J	
DG-137	Y-712RS	
DG-140	YE12	
DG-142	Y-523J	37
DG-144	Y-732J	4
DG-145	Y-507J	32
DG-146	Y-701J	39
DG-155	Y-746J	38
DG-157	Y-705RS	
DG-159	Y-307R	
DG-161	Y-924J	1
DG-170	YE07	
DG-171	Y8003J	62
DG-172	Y-722JS	
DG-173	Y-749J	
DG-176	Y1031J	71
DG-177	Y-607AS	50
DG-178	Y-547AS	47
DG-180	YE05	73
DG-181	Y1005J	56
DG-182	Y-605J	
DG-184	Y-543J	46
DG-185	Y-910J	3
DG-186	Y1038J	
DG-187	Y1007J	59
DG-188	Y-536J	81
DG-189	Y-508J	
DG-190	YE14	48
DG-193	Y1002AS	57
DG-194	Y8002AS	51
DG-195	Y8005J	64
DG-196	Y1030J	70
DG-197	Y-519J	61
DG-202	Y-909R	
DG-211	Y-715R	
DG-214	Y-532J	
DG-215	Y-118R	
DG-216	Y-703R	
DG-217	Y-531J	44
DG-221	Y-118T1	
DG-222	Y-197R	
DG-223	Y-146R	
DG-226	Y-178	
DG-227	Y-128	
DG-232	Y-147T	
DG-233	Y-197T	
DG-234	Y-128T	
DG-235	Y-178T	
DG-239	Y-168R	



<b>DENSO</b>	<b>→ NGK</b>	<b>D-Power</b>
DG-240	Y-542J	45
DG-245	Y-531J	44
DG-300	Y-603J	60
DG-305	Y1013J	63
DG-306	CZ256	
DG-307	CZ259	
DG-502	Y-529J	
067100-0160	DG-211	
067100-1042	Y-402-2	
067100-1043	Y-452-1	
067100-1070	Y-176	
067100-1071	Y-176	
067100-1090	Y-108	
067100-1120	Y-178	
067100-1130	Y-128	
067100-1161	Y-178T	
067100-1170	Y-128T	
067100-1171	Y-128T	
067100-1270	Y-118T1	
067100-1330	Y-147T	
067100-1340	Y-197T	
067100-1350	Y-128T	
067100-1360	Y-178T	
067100-1370	Y-118R	
067100-1380	Y-168R	
067100-1430	Y-146R	
067100-1460	Y-197R	
067100-1530	Y-146R	
067100-1630	Y-118T1	
067100-1690	Y-703R	
067100-1710	Y-715R	
067100-1860	Y-532J	
<b>EUROCARB</b>	<b>→ NGK</b>	<b>D-Power</b>
111	Y-918J	2
<b>FIAT Group</b>	<b>→ NGK</b>	<b>D-Power</b>
46 44 76 10	Y-928U	29
46 45 19 51	Y-747U	26
46 75 17 64	Y-939J	43
46 75 41 54	Y-534J	36
46 79 23 55	YE07	
46 79 23 59	YE07	
46 79 60 50	Y8003J	62
50 03 16 493	Y-502R	
50 03 51 992	Y8005J	64
55 18 78 63	YE07	
55 20 07 55	Y9003AS	78
55 20 08 17	Y1030J	70
55 21 00 51	Y9001AS	72
60 50 71 23	Y-909R	

<b>FIAT Group</b>	<b>→ NGK</b>	<b>D-Power</b>
60 81 22 92	Y-924J	1
60 81 46 13	Y-747U	26
71 71 90 15	Y-924J	1
76 32 58 7	Y-739R	
77 35 92 0	Y-924J	1
96 33 21 43 80	Y-924J	1
96 38 98 59 80	Y-504J	24
96 51 02 97 80	Y-504J	24
96 51 58 36	Y1005J	56
96 51 58 36 80	Y1005J	56
96 52 54 82 80	YE08	
96 59 27 92 80	Y-548J	75
98 46 24 92	Y-926U	
<b>FORD</b>	<b>→ NGK</b>	<b>D-Power</b>
1148 105	YE04	40
1313 809	Y1005J	56
1427 905	YE08	
1447 128	YE05	73
1459 460	Y-548J	75
1473 356	Y1005J	56
1542 845	Y8003J	62
1682 276	Y8001AS	58
4025 139	Y-701J	39
2S6Q-6M090-AA	YE04	40
2S6Q-6M090-BA	YE05	73
2S6Q-6M090-BB	YE05	73
3M5Q-6M090-AB	Y1005J	56
3M5Q-6M090-AC	Y1005J	56
6G9Q-6M090-AA	YE08	
7C16-6M090-AA	Y-548J	75
9S51-6M090-AA	Y8003J	62
AV6Q-6M090-BA	Y8001AS	58
BS51-6M090-AA	Y9001AS	72
XM341-2A342-BA	Y-701J	39
<b>GM</b>	<b>→ NGK</b>	<b>D-Power</b>
1 214 034	YE07	
4 805 511	Y8009AS	
55 664 219	Y9001AS	72
93 178 411	YE07	
94 133 759	Y-904M1	
94 439 218	Y-306R	
96 440 144	Y8009AS	
97 080 554	Y-603J	60
<b>HINO</b>	<b>→ NGK</b>	<b>D-Power</b>
19110-1040	Y-176	
1985A-56010	Y-178	
1985A-56012	Y-178T	
1985A-56022	Y-128T	





<b>HINO</b>	<b>→ NGK</b>	<b>D-Power</b>
1985A-68060	Y-197R	
60543-30901	Y-173	
63013-30010	Y-176	
<b>HKT</b>	<b>→ NGK</b>	<b>D-Power</b>
CP 01	CZ259	
PD 99	Y-108	
PD 190	Y-146R	
PD 191	Y-703R	
PH 20	Y-173	
PH 21	Y-176	
PI 40	Y-874-1	
PI 42	Y-104	
PI 44	Y-271-2	
PI 49	Y-904M1	
PI 50	Y-954M1	
PI 58	Y-710J	
PM 60	Y-172	
PM 61	Y-175-2	
PM 62	Y-102	
PM 66	Y-180	
PM 71	Y-172	
PM 73	Y-274	
PM 75	Y-115T1	
PM 78	Y-971M	
PM 79	Y-114T	
PM 160	Y-274R	
PM 161	Y-115R1	
PN 81	Y-103	
PN 82	Y-252	
PN 84	Y-202	
PN 85	Y-103-1	
PN 86	Y-103-2	
PN 87	Y-112T	
PN 88	Y-177-1	
PN 89	Y-204TS1	
PN 120	Y-181T	
PN 121	Y-204RS	
PN 122	Y-202-2	
PN 123	Y-112M1	
PN 124	Y-162R1	
PN 125	Y-272R1	
PN 126	Y-117RS	
PN 127	Y-117SS	
PN 128	Y-112R1	
PN 129	Y-204SS	
PN 131	Y-755RS	
PN 132	Y-705RS	
PN 135	Y-707RS	
PN 136	Y-757RS	
PN 137	Y-955RS	

<b>HKT</b>	<b>→ NGK</b>	<b>D-Power</b>
PN 138	Y-712RS	
PS 201	Y-103V	
PS 202	Y-106V	
PS 204	Y-106-1	
PS 206	YE01	
PS 207	Y-709R	
PS 208	Y-716RS	
PS 209	Y-119V	
PS 210	Y-702U	
PT 90	Y-402-2	
PT 93	Y-128	
PT 94	Y-178	
PT 100	Y-128T	
PT 101	Y-178T	
PT 103	Y-118T1	
PT 104	Y-128T	
PT 107	Y-146R	
PT 108	Y-197T	
PT 109	Y-178T	
PT 140	Y-118R	
PT 141	Y-197R	
PT 142	Y-168R	
PT 144	Y-118T1	
PT 145	Y-147T	
PT 147	Y-146R	
PT 150	Y-703R	
PT 151	Y-715R	
PZ 30	Y-107T	
PZ 31	Y-157R	
PZ 33	Y-107R	
PZ 34	Y-122	
<b>HYUNDAI/KIA</b>	<b>→ NGK</b>	<b>D-Power</b>
OK04S-18140-A	Y-721J	
OK054-18140	Y-701J	39
36710-27000	Y-749J	
36710-27010	Y-749J	
36710-2A100	Y-527J	67
36710-2A200	Y-527J	67
36710-2A700	CZ203	68
36710-2F000	CZ105	
36710-2F100	Y1003AS	
36710-42000	Y-722JS	
36710-42020	Y-722JS	
36710-4A000	Y-508J	
36710-4A100	Y-508J	
36710-4X900	Y-535J	
36710-42500	CZ257	83
36710-42510	CZ257	83



<b>ISUZU</b>	<b>→ NGK</b>	<b>D-Power</b>
9417-5158	Y-904M1	
5-8610-1642-0	CZ261	
5-8610-1643-0	Y-712RS	
5-8610-1644-0	Y-707RS	
5-8611-5977-0	Y-757RS	
8-8440-2303-1	Y-711J	28
8-9413-5377-3	Y-954M1	
8-9417-5158-0	Y-904M1	
8-9417-5158-1	Y-904M1	
8-9417-5158-2	Y-904M1	
8-9422-1719-3	Y-954M1	
8-9431-9700-1	Y-710J	
8-9431-9700-2	Y-710J	
8-9431-9700-4	Y-710J	
8-9703-3761-0	Y-954M1	
8-9703-3761-1	Y-954M1	
8-9703-3761-2	Y-954M1	
8-9708-0554-0	Y-603J	60
8-9708-0554-1	Y-603J	60
8-9710-6549-1	Y-720U1	
8-9710-6549-4	Y-720U1	
8-9714-3674-1	Y1038J	
8-9801-3392-0	Y1001J1	
8-9817-4898-0	Y1001J1	
9-8251-1945-0	Y-874-1	
9-8251-1978-0	Y-104	
9-8251-1978-1	Y-104	
9-8251-1994-0	Y-874-1	
9-8251-3928-2	Y-271-2	
<b>IVECO</b>	<b>→ NGK</b>	<b>D-Power</b>
50 03 51 992	Y8005J	64
<b>JEEP</b>	<b>→ NGK</b>	<b>D-Power</b>
050 66 840 AA	Y1031J	71
517 57 56 AA	Y8002AS	51
<b>LAND ROVER</b>	<b>→ NGK</b>	<b>D-Power</b>
ERR 6066	Y-605J	
LR 001 302	YE08	
<b>MAGNETI MARELLI</b>	<b>→ NGK</b>	<b>D-Power</b>
061 830 024 304	Y-918J	2
061 830 025 304	Y-924J	1
061 830 078 304	Y-924J	1
TIX 1 A	Y-207T	
TIX 2 A	Y-208T	
TIX 4 A	Y-208T	
TIX 6 A	Y-208T	
UX 1 A	Y-918J	2

<b>MAGNETI MARELLI</b>	<b>→ NGK</b>	<b>D-Power</b>
UX 2 A	Y-924J	1
UX 4 A	Y-924J	1
<b>MAZDA</b>	<b>→ NGK</b>	<b>D-Power</b>
1304-18-140	Y-172	
1353-18-140	Y-107T	
1353-18-140A	Y-107T	
1N01-18-601A	CZ259	
4869-18-140	Y-122	
4869-18-140A	Y-122	
R2L2-18-601	Y-721RS	
RF2A-18-601	Y-529J	
RFG1-18-601	Y-701J	39
RFJ5-18-601	Y-701J	39
RFS5-18-601	Y1006J	
RFS5-18-601A	Y1006J	
S201-18-140	Y-107R	
S210-18-140	Y-701J	39
S501-18-140A	Y-107R	
S550-18-601	CZ165	87
SE01-18-140A	Y-157R	
SEM1-18-601	Y-771R	
SH01-18-601A	CZ163	82
VS01-18-601	Y-721RS	
WE01-18-601	Y-526J1	69
WL03-18-601	Y-701J	39
WL81-18-601	Y-701J	39
WLY8-18-601	CZ262	
WLE7-18-601	CZ262	
WLE8-18-601	CZ262	
Y701-18-601	Y-603J	60
<b>MERCEDES</b>	<b>→ NGK</b>	<b>D-Power</b>
A 000 159 81 01	Y-924J	1
A 001 159 15 01	Y-930U	30
A 001 159 20 01	Y-925J	16
A 001 159 21 01	Y-925J	16
A 001 159 26 01	Y-929U	41
A 001 159 27 01	Y-746J	38
A 001 159 28 01	Y-745U	11
A 001 159 35 01	Y-924J	1
A 001 159 36 01	Y-916J	6
A 001 159 37 01	Y-745U	11
A 001 159 38 01	Y-745U	11
A 001 159 42 01	Y-745U	11
A 001 159 46 10	YE13	
A 001 159 48 01	Y-745U	11
A 001 159 49 01	Y-745U	11
A 001 159 50 01	Y8002AS	51
A 001 159 56 01	CZ106	53
A 001 159 57 01	CZ303	54



<b>MERCEDES</b>	<b>→ NGK</b>	<b>D-Power</b>
A 001 159 58 01	CZ106	53
A 001 159 66 01	CZ303	54
A 001 159 68 01	CZ106	53
A 001 159 73 01	CZ551	85
A 001 159 80 01	CZ551	85
A 415 159 00 01	Y1035AS	77
A 622 159 00 01	Y1010AS	
A 642 159 01 01	CZ159	84
A 660 159 02 01	Y-543J	46
A 660 159 04 01	CZ158	
A 665 159 02 01	Y-536J	81
A 667 159 00 01	Y-537AS	
CO 004 562 V003	Y-543J	46
QO 004 562 V003 00 0000	Y-543J	46
<b>MITSUBISHI</b>	<b>→ NGK</b>	<b>D-Power</b>
1820 A009	CZ251	76
30666-57301	Y-114T	
30666-57302	Y-114T	
30666-57303	Y-114T	
30L66-00300	Y-723R	
30L66-00301	Y-723R	
30L66-00302	Y-723R	
30L66-00400	Y-723U	
30L66-00400-9V	Y-723U	
30L66-00401	Y-723U	
30L66-00402	Y-723U	
31A66-03100	Y-701U	
31A66-03101	Y-701U	
31A66-03102	Y-701U	
32A66-07010	Y-904M1	
32A66-07020	Y-954M1	
32A66-07021	Y-954M1	
32A66-07100	Y-904M1	
32A66-07200	Y-954M1	
32C98-55808	Y-722JS	
34466-21300	Y-182T	
34466-21301	Y-182T	
34466-31301	Y-182T1	
91304-04300	Y-701J	39
EE 960 01	Y-173	
EE 960 02	Y-104	
M 816 732	Y-933J	25
MD 014 997	Y-115R1	
MD 050 212	Y-115T1	
MD 077 167	Y-707RS	
MD 197 511	CZ257	83
MD 301 950	Y-733J	13
MD 344 469	Y-733J	13
ME 017 009	Y-274R	
ME 017 010	Y-274	
ME 017 013	Y-274	

<b>MITSUBISHI</b>	<b>→ NGK</b>	<b>D-Power</b>
ME 017 057	Y-971M	
ME 200 970	CZ256	
ME 201 638	CZ256	
ME 203 539	Y1007J	59
ME 203 754	CZ256	
MM 401 621	Y-110	
MM 401 621 01	Y-110	
MM 401 621 02	Y-110	
MM 431 439 01	Y-142T	
MM 432 148	Y-145T	
MN 960 270	YE13	
MN 960 296	YE13	
MN 980 234	YE14	48
MN 980 406	CZ304	55
MR 577 131	Y-733J	13
<b>MOTORCRAFT</b>	<b>→ NGK</b>	<b>D-Power</b>
10 56 857	Y-937J	
10 79 401	Y-524J	27
10 96 527	Y-548J	75
16 90 048	Y-741U	20
32 52 725	Y-107R	
50 23 372	Y-208T	
50 31 006	Y-924J	1
61 32 246	Y-907R	
61 54 593	Y-924J	1
70 88 988	Y-910J	3
84BB6-M090-AA	Y-924J	1
84FF6-M090-B2A	Y-907R	
93FF6-M090-AA	Y-910J	3
96FF6-M090-CA	Y-937J	
EZD 1	Y-810	
EZD 5	Y-924J	1
EZD 10	Y-918J	2
EZD 18	Y-115T1	
EZD 19	Y-128T	
EZD 20	Y-117RS	
EZD 21	Y-118T1	
EZD 22	Y-107T	
EZD 30	Y-924J	1
EZD 40	YE04	40
EZD 41	Y-504J	24
V94DX-6M090-AA	Y-924J	1
V95DD-6M090-AA	Y-741U	20
XS4U-6M090-AB	Y-524J	27
XS7U-6M090-BA	Y-548J	75
<b>NISSAN</b>	<b>→ NGK</b>	<b>D-Power</b>
11065-00Q0A	Y-517J	
11065-00Q0E	Y1035AS	77



NISSAN	→ NGK	D-Power
11065-00Q0H	Y1010AS	
11065-00Q0L	Y1010AS	
11065-00QAG	Y-732J	4
11065-02T00	Y-955RS	
11065-0W801	CZ261	
11065-10G00	Y-705RS	
11065-10T01	Y-757RS	
11065-16A00	Y-117SS	
11065-16A05	Y-117RS	
11065-16A10	Y-117SS	
11065-16A15	Y-117RS	
11065-1749R	Y1010AS	
11065-2TB0A	Y-519J	61
11065-2W202	CZ258	
11065-31N00	Y-712RS	
11065-31W00	Y-112T	
11065-31W01	Y-112T	
11065-31W02	Y-112TS	
11065-34W00	Y-112M1	
11065-37506	Y-103	
11065-37507	Y-103	
11065-43G01	Y-707RS	
11065-5C900	CZ260	
11065-57J00	CZ260	
11065-63G00-GW	Y-707RS	
11065-65N01	CZ261	
11065-7C000	Y-530J	
11065-89TA1	Y-954M1	
11065-9C600	Y-712RS	
11065-AD200	Y-519J	61
11065-AD201	Y-519J	61
11065-AD220	Y-519J	61
11065-C8600	Y-755RS	
11065-D2800	Y-120RS	
11065-DB000	Y-522J	
11065-G2400	Y-712RS	
11065-G2460	Y-712RS	
11065-G5501	CZ259	
11065-HC200	Y-701J	39
11065-HC251	Y-721RS	
11065-J2000	Y-202	
11065-J5501	Y-202-2	
11065-J5502	Y-202-2	
11065-J5570	Y-222T	
11065-0W801	CZ261	
11065-Q4001	Y-112T1	
11065-T3400	Y-177-1	
11065-T3401	Y-177-1	
11065-T3470	Y-181T	
11065-T8200	Y-112R1	
11065-T8201	Y-162R1	
11065-T8202	Y-112R1	

NISSAN	→ NGK	D-Power
11065-T8203	Y-162R1	
11065-T9000	Y-272R1	
11065-T9001	Y-272R1	
11065-V0700	Y-204TS1	
11065-V0710	Y-204TS1	
11065-V7202	CX51	
11065-V7203	CZ51	
11065-W2500	Y-204RS	
11065-W2510	Y-204RS	
11065-W3400	Y-204SS	
11065-W3410	Y-204SS	
11065-Y1400	Y-103-1	
11065-Y1401	Y-103-1	
11065-Y1402	Y-103-2	
11065-Y1403	Y-103-2	
11065-Y1404	Y-103-2	
11065-Z5000	Y-252	
RFJ5-18601	Y-701J	39
OPEL	→ NGK	D-Power
12 14 032	Y8003J	62
12 14 034	YE07	
12 14 040	Y-534J	36
12 14 063	Y-541J	42
12 14 300	Y-810	
12 14 301	Y-541J	42
12 14 304	Y-208T	
12 14 305	Y-523J	37
12 14 308	Y-306R	
12 14 309	Y-307R	
12 14 310	Y-719RS1	
12 14 311	Y-710J	
12 14 315	Y-719RS1	
12 14 316	Y-603J	60
12 14 319	Y-924J	1
12 14 321	Y-904M1	
12 14 323	Y-904M1	
12 14 324	Y-924J	1
12 14 334	Y9003AS	78
12 14 427	Y-741U	20
12 14 457	Y-748U	14
12 14 459	Y1038J	
18 26 357	Y9004AS	
44 03 145	Y-910J	3
44 23 206	Y1010AS	
48 05 511	Y8009AS	
09 111 145	Y-910J	3
09 118 201	Y-748U	14
09 196 669	Y-523J	37
46 792 355	YE07	
46 792 359	YE07	
55 564 162	Y9003AS	78



OPEL	→ NGK	D-Power
55 564 219	Y9004AS	
90 093 867	Y-208T	
90 093 897	Y-208T	
90 510 924	Y-924J	1
90 540 864	Y-924J	1
91 153 919	Y-741U	20
93 178 047	Y8003J	62
93 178 411	YE07	
93 190 433	Y1030J	70
94 133 759	Y-904M1	
94 175 158	Y-904M1	
94 319 700	Y-710J	
94 402 303	Y-307R	
94 439 218	Y-306R	
94 481 972	Y-719RS1	
95 518 024	Y1010AS	
95 514 173	Y1010AS	
96 440 144	Y8009AS	
97 044 037	Y-719RS1	
97 210 818	Y-541J	42
97 725 357	Y-810	

PSA	→ NGK	D-Power
5960.12	YE05	73
5960.19	YE05	73
5960.64	Y1005J	56
5960.65	Y1005J	56
5960.66	Y-504J	24
5960.67	Y-504J	24
5960.76	YE12	
5960.77	YE12	
5960.78	YE05	73
5960.79	YE05	73
5960.88	Y-548J	75
5960.89	Y-548J	75
5960.99	YE08	
5960.A0	YE08	
5960.A3	Y8005J	64
5960.A4	Y8005J	64
5960.E6	Y8001AS	58
5960.E9	YE05	73
5960.F4	Y-504J	24
5960.F5	Y-504J	24
5960.F8	YE12	
5960.F9	YE05	73
5960.G6	YE08	
5960.K4	Y8005J	64
5960.L4	Y9001AS	72
5961.22	Y-810	
5961.35	Y-810	
5961.39	Y-924J	1

PSA	→ NGK	D-Power
5961.53	Y-208T	
5961.54	Y-208T	
5961.58	Y-208T	
5961.A3	Y8005J	64
5961.A4	Y8005J	64
5961.K4	Y8005J	64
5962.03	Y-924J	1
5962.1Q	Y-738U	
5962.2Y	Y-503J	10
5962.2Z	Y-503J	10
5962.3C	Y-504J	24
5962.3E	Y-504J	24
5962.3H	Y-924J	1
5962.7F	Y-504J	24
5962.7G	Y-504J	24
5962.J3	Y-910J	3
5962.T1	Y-910J	3
5962.T2	Y-933J	25
79 325 658 82	Y-810	
79 325 677 18	Y-208T	
91 508 602 80	Y-924J	1
91 908 610 80	Y-924J	1
95 493 206	Y-208T	
95 534 788	Y-208T	
96 236 383	Y-504J	24
96 374 699 80	YE04	40
96 389 858	Y-504J	24
96 501 000 80	YE05	73
96 525 482 80 00	YE08	
96 831 952 80	Y8001AS	58
HG 2621	Y-810	

RENAULT	→ NGK	D-Power
11065-5687R	Y1035AS	77
11065-0819R	Y1010AS	
11065-1749R	Y1010AS	
50 01 001 587	Y-208T	
77 00 100 558	Y-506J	7
77 00 100 586	Y-740U	22
77 00 100 635	Y-516J	12
77 00 105 290	Y-927J	19
77 00 111 323	Y-732J	4
77 00 662 199	Y-208T	
77 00 733 076	Y-924J	1
77 00 741 144	Y-924J	1
77 00 854 538	Y-933J	25
77 00 855 865	Y-913J	
77 00 856 238	Y-913J	
77 00 856 292	Y-933J	25
77 00 861 906	Y-730U	17
77 01 039 387	Y-924J	1



<b>RENAULT</b>	<b>→ NGK</b>	<b>D-Power</b>
77 01 058 142	Y-522J	
77 01 349 475	Y-924J	1
82 00 090 817	Y-913J	
82 00 426 227	Y-516J	12
82 00 490 950	Y-732J	4
82 00 682 592	Y1035AS	77
82 00 787 721	Y-516J	12
82 00 794 920	Y1036AS	
85 49 971 00	Y-810	

<b>ROVER</b>	<b>→ NGK</b>	<b>D-Power</b>
ETC 8847	Y-729U	34

<b>SAAB</b>	<b>→ NGK</b>	<b>D-Power</b>
93 178 411	YE07	
93 191 771	Y9003AS	78

<b>SSANGYONG</b>	<b>→ NGK</b>	<b>D-Power</b>
A 665 159 02 01	Y-536J	81
A 667 159 00 01	Y-537AS	

<b>SUZUKI</b>	<b>→ NGK</b>	<b>D-Power</b>
09900-F8Q01	Y-516J	12
09900-RF001	Y-701J	39
18550-79J50	Y1030J	70
18550-79J80	Y9003AS	78
18550-79J81	Y9003AS	78
18550-80KA0	Y1036AS	

<b>TOYOTA</b>	<b>→ NGK</b>	<b>D-Power</b>
19850-0R010	Y1012J	65
19850-0R020	Y1012J	65
19850-0R022	Y1012J	65
19850-0W010	Y-542J	45
19850-26010	Y1012J	65
19850-26020	Y1012J	65
19850-26021	Y1012J	65
19850-26022	Y1012J	65
19850-27010	Y-531J	44
19850-30010	Y-531J	44
19850-54030	Y-118T1	
19850-54031	Y-118T1	
19850-54050	Y-118R	
19850-54060	Y-168R	
19850-54090	Y-715R	
19850-56012	Y-178T	
19850-56021	Y-128T	
19850-56022	Y-128T	
19850-64010	Y-146R	
19850-64020	Y-703R	

<b>TOYOTA</b>	<b>→ NGK</b>	<b>D-Power</b>
19850-64031	Y-532J	
19850-64050	Y-532J	
19850-67030	Y1013J	63
19850-68010	Y-147T	
19850-68020	Y-197T	
19850-68030	Y-128T	
19850-68040	Y-178T	
19850-68060	Y-197R	

<b>VAUXHALL</b>	<b>→ NGK</b>	<b>D-Power</b>
12 14 040	Y-534J	36
12 14 334	Y9003AS	78
12 14 459	Y1038J	
55 564 162	Y9003AS	78
93 190 433	Y1030J	70

<b>VOLVO</b>	<b>→ NGK</b>	<b>D-Power</b>
3072 5069	Y1005J	56
3121 6248	YE04	40
8631 607	YE12	
8653 698	Y1005J	56
8653 880	Y8008AS	74

<b>VW Group</b>	<b>→ NGK</b>	<b>D-Power</b>
03L 963 319 A	Y1002AS	57
059 963 319 A	Y-501U	31
059 963 319 E	Y-609AS	49
059 963 319 F	Y-609AS	49
060 963 319 F	Y1002AS	57
N 019 1001	Y-207T	
N 019 1002	Y-207T	
N 019 1005	Y-918J	2
N 019 1006	Y-918J	2
N 101 401 04	Y-732J	4
N 101 401 05	Y-732J	4
N 102 130 01	Y-918J	2
N 102 130 02	Y-918J	2
N 105 792 01	Y-741U	20
N 105 792 02	Y-741U	20
N 105 798 02	YE14	48
N 105 798 03	CZ304	55
N 105 798 05	CZ304	55
N 105 916 02	Y-607AS	50
N 105 916 03	Y-607AS	50
N 105 916 04	CZ104	52
N 105 916 08	CZ104	52

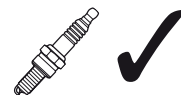
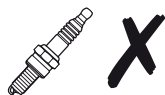
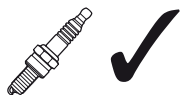

A-6	AB-6
A-7	AB-7
A-8	AB-8
A-8F	A8FS
A-9F	A9FS
APR5FS-11	APR5FS
B10EV	BR10EIX
B10EVX	BR10EIX
B10H	B10HS
B10HN	R5525-10
B10HP	R5530-10
B10HV	BR10HIX
B10HVX	BR10HIX
B11EN	B11EGV
B11HN	R5525-11
B11HP	R5525-11
B5ES-11	B5ES
B6EB-L-11	BR6ES
B6EFS	BR6EF
B6EMV	B6EM
B6ET	B6EM
B6EV	B6EVX
B6HV	BR6HIX
B6HVX	BR6HIX
B7EB	BR7ES
B7EB-11	BUR7EB-11
B7ET	BR7ET
B7EV	BR7EIX
B7EVX	BR7EIX
B7HV	BR7HIX
B7HVX	BR7HIX
B8EM	BR8EM
B8EMV	BR8ET
B8EN	B8EGV
B8ES-11	B8ES
B8ET	BR8ET
B8EV	BR8EIX
B8EVX	BR8EIX
B8HN	R5525-8
B8HV	BR8HIX
B8HVX	BR8HIX
B9EGP	BR9EIX
B9EN	B9EGV
B9EV	BR9EIX
B9EVX	BR9EIX
B9HCV	BR9HIX
B9HN	R5525-9
B9HP	R5530-9
B9HV	BR9HIX
B9HVX	BR9HIX
BCP4ES	BCPR4ES-11
BCP5E-11	BCPR5E-11
BCP5EV	BCP5EVX

BCP5EV-11	BCPR5EIX-11
BCP5EVX-11	BCPR5EIX-11
BCP5EY-11	BCPR5EY-11
BCP6E-11	BKR6E-11
BCP6EV	BCP6EVX
BCP6EV-11	BCPR6EIX-11
BCP6EVX-11	BCPR6EIX-11
BCP7E	BCPR7E
BCP7EV	BCP7EVX
BCPR5EP-11	BCPR5EIX-11
BCPR5EP-11	BCPR5EIX-11
BCPR5EP-13	BCPR5EIX-11
BCPR5EP-13	BCPR5EIX-11
BCPR5EVX-11	BCPR5EIX-11
BCPR6EP-13	BCPR6EIX-11
BCPR6EP-13	BCPR6EIX-11
BCPR6EP-N-11	BCPR6EIX-11
BCPR6EP-N-11	BCPR6EIX-11
BCPR6ER	BKR6EK
BCPR6EVX-11	BCPR6EIX-11
BCPR7ER	BKR6EK
BCPR7EVX-11	BKR7EIX-11
BCPR7EY	BCPR7E
BK5EKU	BKR5EKU
BK7EKU	BKR7EKU
BKR5EVX	BKR5EIX
BKR5EVX-11	BKR5EIX-11
BKR6EIX-LPG	LPG1
BKR6EVX	BKR6EIX
BKR6EVX-11	BKR6EIX-11
BKR6EVXA-11	BKR6EIX-11
BKR7EVX	BKR7EIX
BKR7EVX-11	BKR7EIX-11
BP10EV	BPR10EVX
BP4EFS	TR4
BP4ES-13	BPR4ES-13
BP5EA	BP4EY
BP5EA-11	BP4EY-11
BP5EA-L	BP5EY
BP5EA-L	BP5EY
BP5EA-L-11	BP5EY-11
BP5EJ	BPR5EY-11
BP5EKN	BPR5EY
BP5EV	BPR5EIX
BP5EVX	BPR5EIX
BP5EVX-11	BPR5EIX-11
BP6EA	BP6EY
BP6EA-11	BP6EY-11
BP6EK	BPR6EK-A
BP6EK-A	BPR6EK-A
BP6EKA-V	BPR6EK-A
BP6EKN	BPR6EKN
BP6EV	BPR6EIX

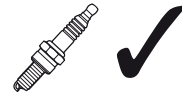
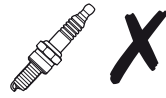
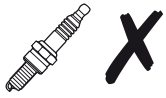

BP6EVX	BPR6EIX
BP6EVX-11	BPR6EIX-11
BP6HV	BPR6HIX
BP6HVX	BPR6HIX
BP7E	BPR7E
BP7EFVX	TR7IX
BP7EKN	BPR7EKN
BP7EV	BPR7EIX
BP7EVX	BPR7EIX
BP7EY-11	BPR7EY-11
BP7HV	BPR7HIX
BP7HVX	BPR7HIX
BP8ES-11	BP8ES
BP8EV	BPR8EIX
BP8EVX	BPR8EIX
BP8FS	R5674-8
BP8HSA	BPR8HSA
BP8HVX	BPR8HIX
BP9EV	BPR9EIX
BPR-2E	BPR2ES
BPR4EVX	GR4IX
BPR4S	BP-4
BPR4S-15	BP-4
BPR5EA	BPR5EY
BPR5EA-11	BPR5EY-11
BPR5EA-L	BPR5EY
BPR5EF-13	BPR5EFS-13
BPR5EFVX	TR5IX
BPR5EK-A	BPR5EIX-11
BPR5EP-13	BPR5EP-11
BPR5EV	BPR5EIX
BPR5EVX	BPR5EIX
BPR5EVX-11	BPR5EIX-11
BPR5S	BP5S
BPR6EA	BPR5EY
BPR6EV	BPR6EIX
BPR6EVX	BPR6EIX
BPR6FS-15	BPR6FS
BPR6HVX	BPR6HIX
BPR6S	BP6S
BPR7EVX	BPR7EIX
BPR7HVX	BPR7HIX
BPR9EVX	BPR9EIX
BR10ECMVX	BR10ECMIX
BR10EV	BR10EIX
BR5EB	BR5ES
BR5EB-11	BUR5EB-11
BR5ES-11	BR5ES
BR5FS-15	BR5FS
BR6EB	BR6ES
BR6EB-11	BUR6EB-11
BR6ET	B6EM
BR7EB	BR7ES

BR7EB-11	BUR7EB-11
BR7ES-11	BR7ES
BR7EVX	BR7EIX
BR8ECMVX	BR8ECMIX
BR8EV	BR8EIX
BR8EVX	BR8EIX
BR8EVX	BR8EIX
BR8HV	BR8HIX
BR8HVX	BR8HIX
BR9ECMVX	BR9ECMIX
BR9EV	BR9EIX
BR9EVX	BR9EIX
BR9EVX	BR9EIX
BU6EA-11	BUR6EA-11
BU6EB-11	BUR6EB-11
BU7EA-11	BUR7EA-11
BUEW	BUE
BUR5EBVX-11	BUR5EB-11
BZ8ES	BR8ES
C10H	R0161-10
C6H	C6HSA
C6M	C6HSA
C7EH-9	CR7EH-9
C7HV	CR7HIX
C7HVX	CR7HIX
C8EHVX-9	CR8EHIX-9
C8EVX	CR8EIX
C8HV	CR8HIX
C9EHVX-9	CR9EHIX-9
C9EVX	CR9EIX
C9H	C8HSA
CR8EHVX-9	CR8EHIX-9
CR8EVX	CR8EIX
CR9EHVX-9	CR9EHIX-9
CR9EVX	CR9EIX
D12E	R2349-11
D-4H	DR4HS
D6ES	D6EA
D6HS	D6HA
D6HV	D6HA
D7EV	DR7EIX
D7EVX	DR7EIX
D8EV	DR8EIX
D8EVX	DR8EIX
D8HS	D8HA
D8HV	D8HA
D9EV	DR9EIX
D9EVX	DR9EIX
DCP8E	DCPR8E
DCP8EVX	DCPR8EIX
DCPR7E-N	DCPR7E-N-10
DCPR8EVX	DCPR8EIX
DCPR9EVX	DCPR9EIX



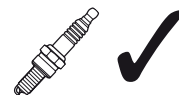
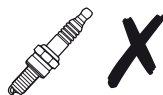
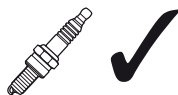

DIMR8B10	DIMR8A10
DP5EA-9	DPR5EA-9
DP7Z	DPR7Z
DP8EV-9	DPR8EIX-9
DP8EVX-9	DPR8EIX-9
DP9EV-9	DPR9EIX-9
DP9EVX-9	DPR9EIX-9
DPR7EV-9	DPR7EIX-9
DPR7EVX-9	DPR7EIX-9
DPR8EV-9	DPR8EIX-9
DPR8EVX-9	DPR8EIX-9
DPR9EV-9	DPR9EIX-9
DPR9EVX-9	DPR9EIX-9
DR8EVX	DR8EIX
DR9EVX	DR9EIX
GR4VX	GR4
IFR7G-11K	IFR7G-11KS
IKR9F8	IKR9J8
ILKAR6C10	ILKAR7C10
ILZKBR7A-8G	ILZKBR7B8DG
ITR5F13	TR5AI-13
JR10A	JR10B
JR9A	JR9B
LKR9CI-8	ILKR9G8
PFR5B	PFR5B-9
PFR5B	PFR5B-9
PGR6B	PGR6A-11
PGR6B	PGR6A-11
PLZKBR7A-G	PLZKBR7B8DG
PZFR6B	IZFR6B
PZFR6R8EG	SIZFR6B8EG
R0045A-10	R0045J-10
R0045A-11	R0045J-11
R015-10	R0373A-10
R015-8	CR8EIX
R015-9	R0373A-10
R015-95	R0373A-10
R016-10	R0373A-10
R016-105	R0373A-9
R016-11	R0373A-11
R016-11	R0373A-11
R016-8	CR8EIX
R016-8	CR8EIX
R016-9	R0373A-10
R016E-11P	R0373A-11
R017-10	R0373A-10
R017-11	R0373A-11
R017-8	CR8EIX
R017-9	R0373A-9
R017-S11	R0373A-11
R017-S12	R017-12
R0256K-11	R0373A-11
R0256R-10	R0373A-10

R2097-11P	R2525-10
R216-10	R2525-10
R216-11	R2525-10
R216-12	R2349-11
R216-9	R2525-9
R217-10	R2525-10
R217-11	R2525-10
R217-12	R2349-11
R217-9	R2525-9
R2198-12P	R2349-11
R2270-11	R2349-11
R2270-9	R2349-9
R2430-10	R2349-10
R2430-9	R2349-9
R4118M-10	R4118S-10
R4118-M8	R4118S-8
R4118-M9	R4118S-9
R4339-9	B9EG
R4452D-10	B10EGP
R4452D-105	B105EGP
R4452D-11	B11EGP
R4452D-8	B8EGP
R4452D-85	B85EGP
R4452D-9	BR9EIX
R4452D-95	B95EGP
R4468A-11	R6725-11
R4468A-115	R6725-115
R4630A-10	R7376-10
R4630A-105	R7376-10
R4630A-11	R7376-10
R4630A-8	R7376-8
R4630A-9	R7376-9
R5184-11	R7282-11
R5300A-105	R7282-105
R5300A-11	R7282-11
R5300A-9	R7282-9
R5300N-105	R7282-105
R5400-10	R7435-10
R5400-7	BCPR7EIX
R5400-8	R7435-8
R5400-9	R7435-9
R5540-10	R5540F-10
R5540F-11	R7282-11
R5649-10	R6712-10
R5649-9	R6712-9
R5671-8	R5671A-8
R5671-9	R5671A-9
R5672-8	R5672A-8
R5672-9	R5672A-9
R5686-10	R7436-10
R5686-11	R7436-10
R5686-8	R7436-8
R5686-9	R7436-9





## PS/HP ↔ kW

PS/HP	kW	kW	PS/HP	PS/HP	kW	kW	PS/HP
1	1,36	1	0,736	1	1,36	1	0,736
50	37	40	54	325	239	315	428
55	40	45	61	330	243	320	435
60	44	50	68	335	246	325	442
65	48	55	75	340	250	330	448
70	51	60	82	345	254	335	455
75	55	65	88	350	257	340	462
80	59	70	95	355	261	345	469
85	63	75	102	360	265	350	476
90	66	80	109	365	268	355	482
95	70	85	115	370	272	360	489
100	74	90	122	375	276	365	496
105	77	95	129	380	279	370	503
110	81	100	136	385	283	375	510
115	85	105	143	390	287	380	516
120	88	110	149	395	290	385	523
125	92	115	156	400	294	390	530
130	96	120	163	405	298	395	537
135	99	125	170	410	301	400	543
140	103	130	177	415	305	405	550
145	107	135	183	420	309	410	557
150	110	140	190	425	313	415	564
155	114	145	197	430	316	420	571
160	118	150	204	435	320	425	577
165	121	155	211	440	324	430	584
170	125	160	217	445	327	435	591
175	129	165	224	450	331	440	598
180	132	170	231	455	335	445	605
185	136	175	238	460	338	450	611
190	140	180	245	465	342	455	618
195	143	185	251	470	346	460	625
200	147	190	258	475	349	465	632
205	151	195	265	480	353	470	639
210	154	200	272	485	357	475	645
215	158	205	279	490	360	480	652
220	162	210	285	495	364	485	659
225	165	215	292	500	368	490	666
230	169	220	299	505	371	495	673
235	173	225	306	510	375	500	679
240	176	230	313	515	379	505	686
245	180	235	319	520	382	510	693
250	184	240	326	525	386	515	700
255	188	245	333	530	390	520	707
260	191	250	340	535	393	525	713
265	195	255	346	540	397	530	720
270	199	260	353	545	401	535	727
275	202	265	360	550	404	540	734
280	206	270	367			545	740
285	210	275	374			550	747
290	213	280	380				
295	217	285	387				
300	221	290	394				
305	224	295	401				
310	228	300	408				
315	232	305	414				
320	235	310	421				

WHEN  
**PERFORMANCE**  
MEETS  
**PRECISION**



IGNITION  
PARTS



VEHICLE  
ELECTRONICS