



By National Cycle

**INSTALLATION AND OWNER'S MANUAL**  
 For P9BR003 and Supplemental Bag No. 950 (bag 950 used when mounting P9BR003 with Cruiselineer Bags).  
 HONDA® VT750 C(D) American Classic Edition

**NOTE:** Right and Left side of Motorcycle is determined while sitting on the bike.

**PARTS LIST for Kit P9BR003**

Index	Part No.	Description	Qty.
1	37-371152-000	Side Plate Assembly, Left	1
2	37-371153-000	Side Plate Assembly, Right	1

**BAG 362**

3	49-495682-000	Spacer, 7/8" OD x 1/4"L	2
4	49-495681-000	Spacer, 7/8" OD x 7/16"L	2

Index	Part No.	Description	Qty.
<b>BAG 362 Continued</b>			
5	34-342715-000	Guide Washer Inside	4
6	34-342725-000	Guide Washer Outside	4
7	80-871015-000	Spring, Curved	4
8	49-490205-000	Washer, Flat	4
9	51-516461-000	Screw, Button Head M8 x 60	4
10	42-483020-000	Nut, Acorn*	4

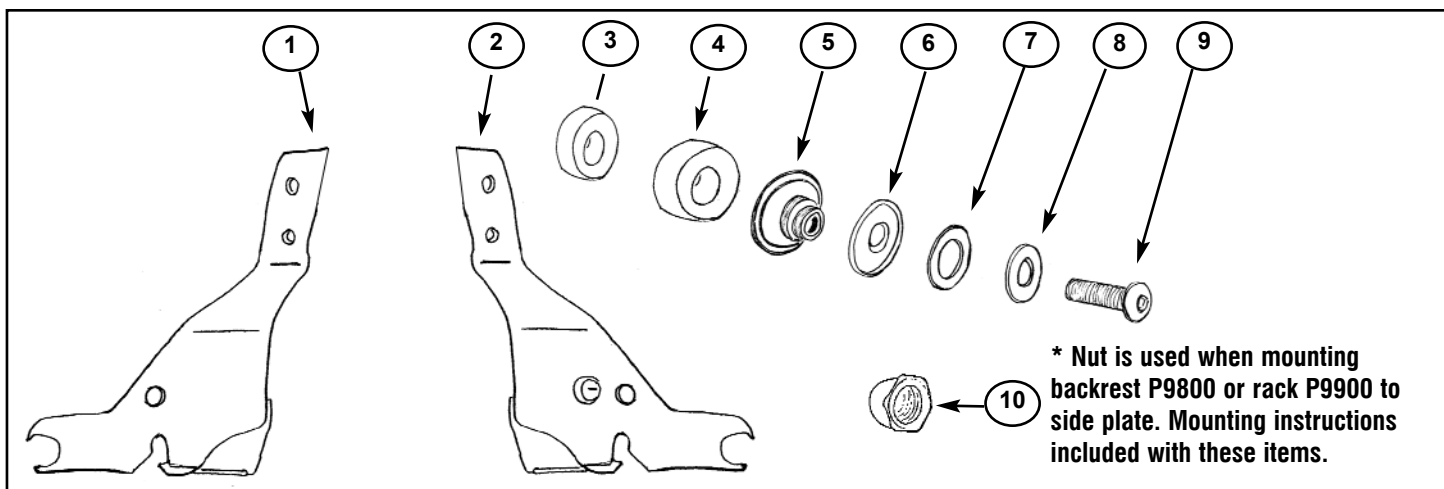

**PARTS LIST for Supplemental Bag 950 (Not included with this kit)**  
 Use bag 950 when mounting Paladin P9BR003 with Cruiselineer Saddlbags.

Index	Part No.	Description	Qty.
11	49-495533-000	Spacer, .75 OD x .875 L	2
12	51-515775-000	Screw, Socket Head M8 x 75	2
13	51-515976-000	Screw, Socket Head M10 x 75	2

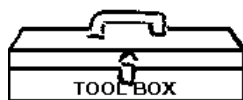
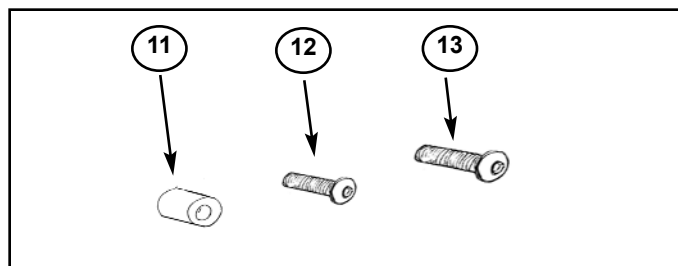

Wrench, 12mm  
 Wrench, 14mm  
 Hex Key Wrench, 5mm

**Additional tools required when mounting Paladin Backrest with National Cycle Cruiselineer Saddlbags:**  
 Hex Key Wrench, 6mm  
 Hex Key Wrench, 8mm

**PREPARATION**



\*Apply a coat of high quality polish or wax to the chrome side plates before assembly.

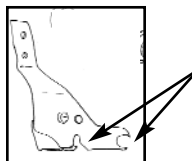

\*This will keep latches gliding smoothly onto guide washers.

\*Position the motorcycle securely so it cannot fall.

## INSTALLING THE GUIDE WASHERS, WITHOUT CRUISELINER SADDLEBAGS

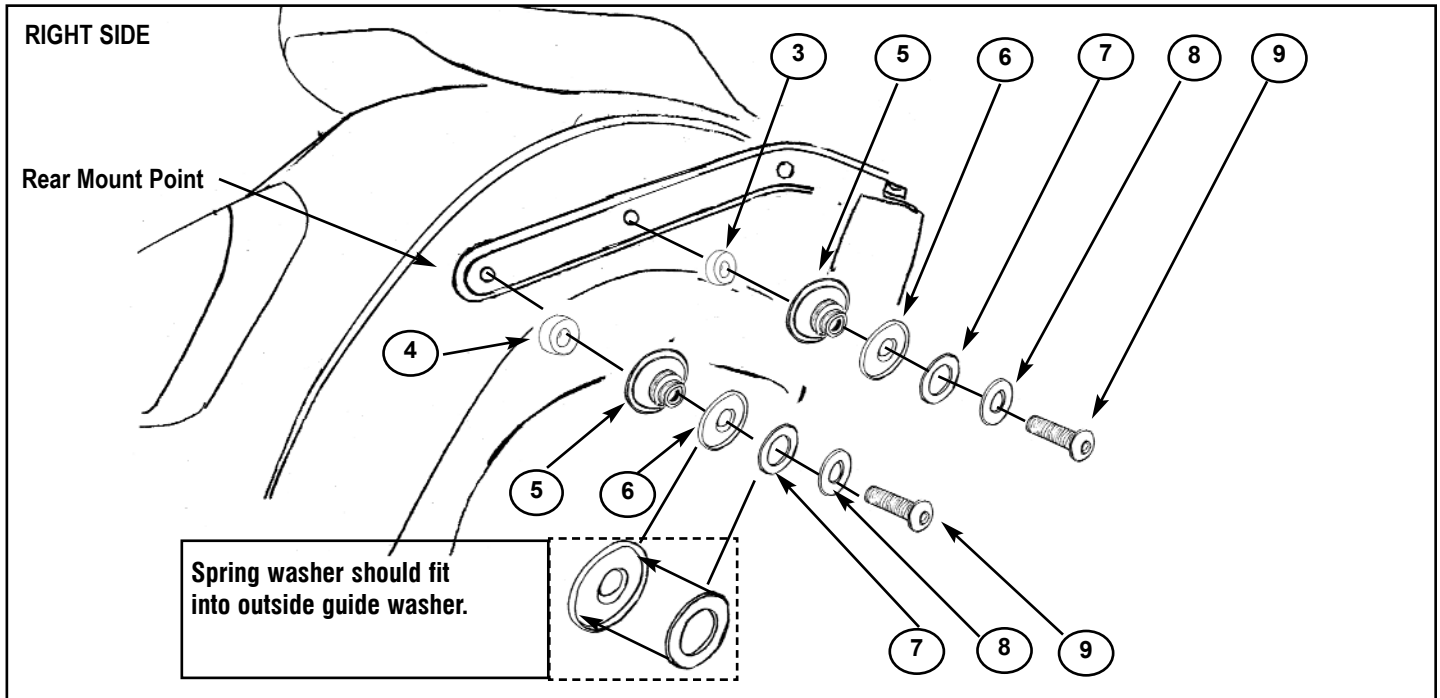

1. Remove the *rear* bolts from the fender struts.
2. Install the guide washer assembly using the M8 x 60 button head screws and the 7/16" long spacer. **Do not tighten.**
3. Remove the *center* bolts from the fender struts.
4. Install the guide washer assembly using the M8 x 60 button head screws and the 1/4" long spacer. **Do not tighten.**
5. **After all screws are started** tighten the front fender strut bolts to 20 ft lbs torque
6. Tighten the center and rear fender strut screws to 13 ft lbs torque.

## INSTALLING THE GUIDE WASHERS, WITH CRUISELINER SADDLEBAGS (Written instruction continued on page 3.)

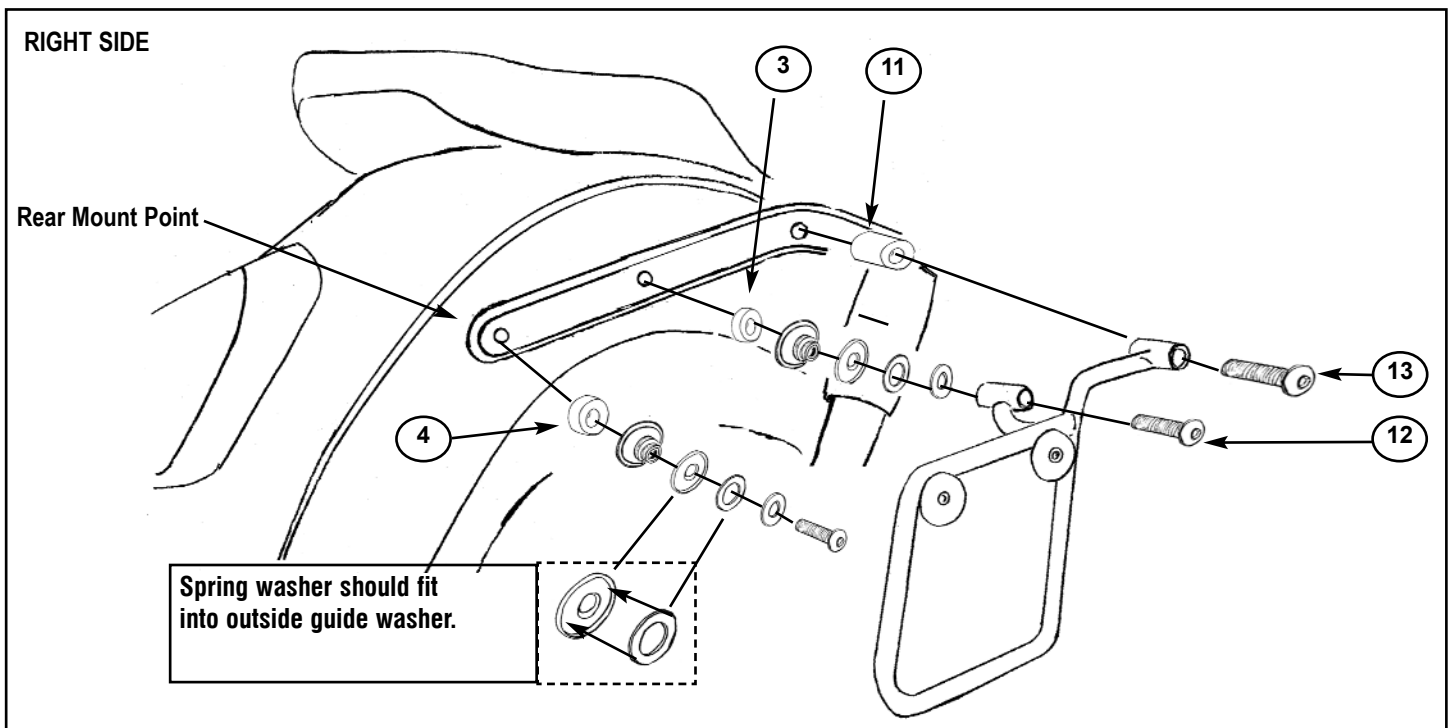

1. Remove the *rear* bolts from the fender struts.
2. Assemble and install the guide washer assembly using the M8 x 60 Button Head screws and the 7/16" long spacers. **Do not tighten.**
3. Remove the *center* and front bolts from the fender struts.
4. Insert an M8 x 75 screw (from Bag 950) through the rear saddlebag frame mount. Add the guide washer assembly and the 1/4" long spacer (from Bag 362) to the screw. Position the saddlebag frame and start the screw into the center bolt hole in the fender strut. **Do not tighten.**
5. With the .875 spacer (from Bag 950) between the *front* saddlebag frame mount and the fender strut, insert an M10 x 75 screw (from Bag 950) through the saddlebag frame mount, the spacer and into the *front* bolt hole in the fender strut. **Do not tighten.**
6. Repeat steps 4 and 5 on the other side of the motorcycle.
7. Tighten the front screws to 20 ft lbs. Tighten the center and rear screws to 13 ft lbs.

**MAINTENANCE** The high quality chrome finish of your National Cycle Paladin rack assembly can be maintained with any quality chrome cleaner and /or polish.

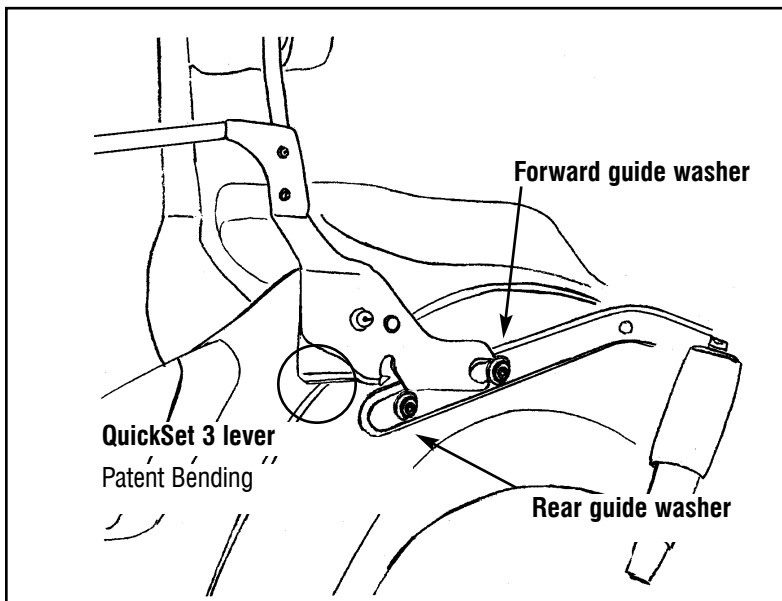

**Using the QuickSet 3® feature to remove your Paladin System.**

Check that QuickSet 3 is unlocked. Stand at the rear of the motorcycle and grab ahold of the system at the side plates. Lift up on the QuickSet 3 lever while rotating the system up and pull back and out of the forward guide washer.

For re-installation, first make sure the QuickSet 3 feature is unlocked. Holding the system as you do in removal, guide the side plate into the forward guide washer. Make sure you fully seat the notch of the side plate into the washer. Lift the Quickset 3 lever and guide the rear notch in the side plate back onto the rear guide washer.

**When mounting the luggage rack or backrest assembly, listen for the audible "click" indicating that the latches are in place and side plate is completely seated onto guide washers.**

**⚠ WARNING**

Maximum load for the Luggage Rack is 5 Kg (11 lbs).

When mounting the Backrest assembly, listen for the audible "click" indicating that the latches are in place. Always lock the QuickSet 3® Side Plate Assembly before using your motorcycle. This insures the utmost in safety.

Never ride your motorcycle with loose accessory mounting hardware. Check the hardware for tightness regularly.

Today's motorcycles are built with enough frame rigidity to withstand the moderate loads imposed on them by the foreseeable addition of an accessory. If the accessory(ies) adversely affects your motorcycle's stability, immediately remove the accessory(ies). Do not ride a motorcycle that exhibits unsafe handling traits.

Have experienced service personnel correct any problem before riding with the accessory(ies) installed. For further questions concerning handling problems associated with an accessory(ies), contact your dealer, motorcycle manufacturer, or accessory manufacturer.