



Lexan® Hardcoated Polycarbonate
 VStream+® Windscreen
 N20316, Short Dark Tint
 N20317, Mid Size Light Tint
 N20318, Tall Clear
 for Yamaha FJ-09 / MT-09

Thank you for purchasing a National Cycle product. Read these instructions carefully and thoroughly before beginning work. Dealers, if installing this windscreen for a customer, please give them this manual. It contains information needed to properly maintain and use this product.



Attention:

Special notes and cautionary measures which can prevent damage to the accessory or motorcycle.



Note:

Tips for facilitation of operation, control and adjustment, as well as maintenance work.

CONTENTS OF KIT

Item	Description	Part No.	Qty.	Tools and Notes
1	VStream+® Windscreen		1	Part number will vary depending on model
HARDWARE KIT				
2	Bracket	37-374476-000	1	
Bag#1205				
3	Grommet	44-447350-000	4	
4	Cap, Aluminum, Black	34-346047-000	4	
5	Screw, Flat, M6 x 25	51-514227-000	4	4mm Hex Key
6	Nut, Hex	42-483005-000	4	10mm Open End Box, Tape
7	Bushing, Black, Upper	49-495277-000	4	
8	Bushing, Black, Lower	49-495276-000	4	
9	Screw, Truss M6	51-519423-000	4	4mm Hex Key
10	Cap, Plastic	44-448840-000	4	

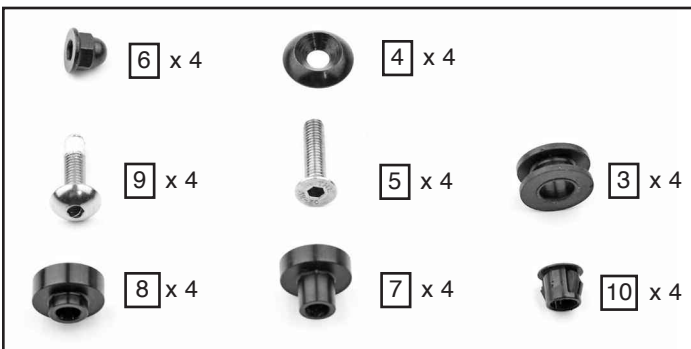

TOOLS

- Phillips Screwdriver or JIS Screw Bit for Removal of OEM Windshield
- 4mm Hex Key
- 10mm Open End Box Wrench (Must be angled at box end)
- Tape

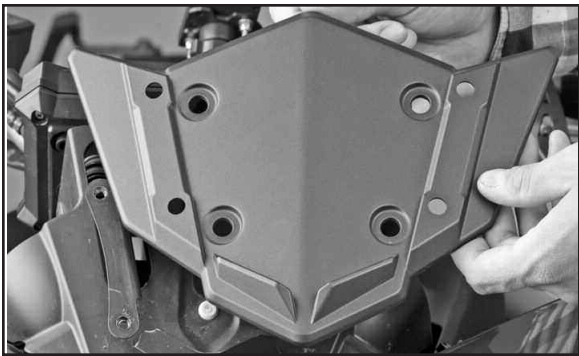

Figure 1

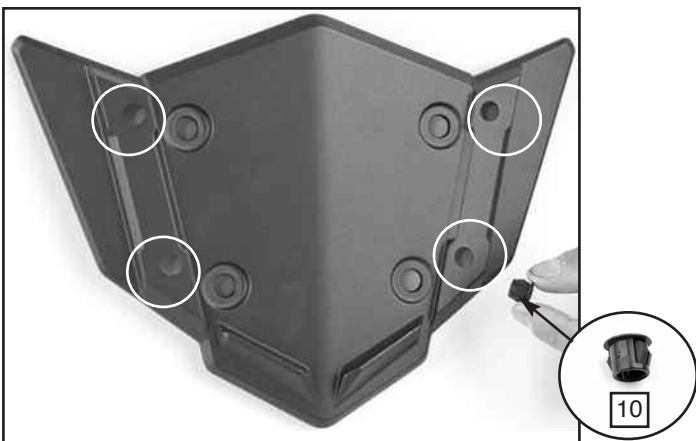

Figure 2



Figure 3

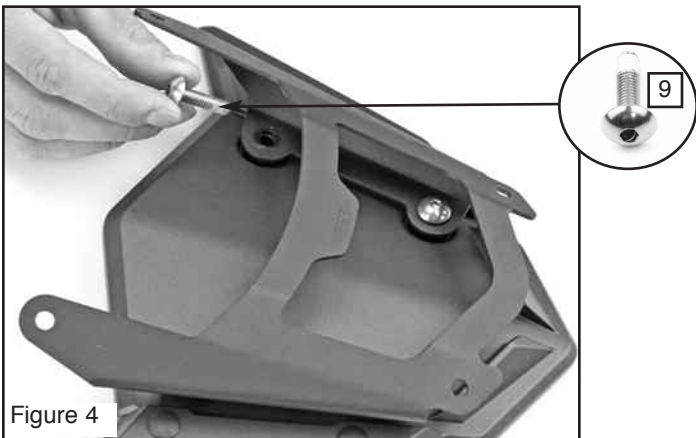

Figure 4

PREPARATION

1. Position motorcycle securely on its side stand.
2. Remove the 4 JIS bolts (yamaha part number 90150-05024-00) holding windshield to the windshield frame. (**Phillips Screwdriver or JIS Screw Bit**)
3. Remove the 4, M6 bolts (yamaha part number 90111-06029-00) holding the OEM plastic frame into place. Remove plastic frame and lay flat on a table. Frame will be re-used. (**4mm Hex Key**) **Figure 1**

INSTALLATION

Bracket (2) to OEM Frame

1. Install 1, Cap (10) into each hole of OEM plastic frame as shown. **Figure 2**

2. Install 1, Lower Bushings (8) into each hole of the OEM plastic frame. **Figure 3**

3. Place 1, M6 Truss Screw (9) through hole in Bracket (2) and into OEM frame. Repeat at all 4 locations. **Figure 4**

Install Bracket Assembly to Motorcycle

4. Loosely Install the Bracket and Frame Assembly to the motorcycle using the M6 Truss Screws (9). (**4mm Hex Key**) **Figure 5 and 6**



Figure 5



Figure 6



Figure 7

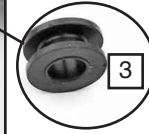
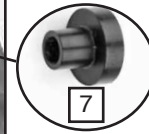

Figure 8

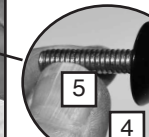
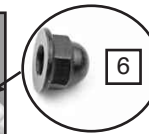

Figure 8 a

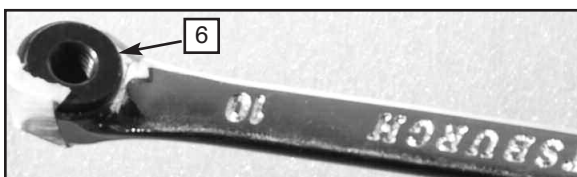
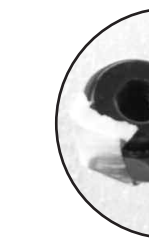

Figure 9



Install Bracket Assembly to Motorcycle

5. When Bracket Assembly is properly positioned tighten M6 Truss Screws (9) firmly. (4mm Hex Key) Figure 6

Windshield Assembly

6. Take the VStream windshield and place it front side down on a table. Figure 7

7. Install 1, Grommet (3) into each hole in windshield, and then firmly push a Long Shouldered Bushing (7) into each grommet. Figure 7

8. Make 4 Screw assemblies using 1, M6 Flat Screw (5) and 1, Cap (4). Figure 8 a.

Install Windshield at Upper Two Holes

9. By hand loosely secure Windscreen at the 2 upper mount holes using a Screw Assembly and 1 Nut (6). Figure 8 and 8a.

Install Windshield at Lower Two Holes

10. Tape one Nut (6) into the box end of your 10mm wrench. (Tape) Figure 9

11. Insert a Screw Assembly into a lower hole. With box wrench angled toward the center of the windshield, hold Nut (6) with box end of wrench while you spin a M6 Screw Assembly to secure shield. (4mm Hex Key, Box Wrench) Figure 10

12. Repeat procedure on second lower hole.

13. Tighten all 4 M6 Flat Screws firmly. (4mm Hex Key, Box Wrench) Figure 10

Enjoy your new VStream® Windshield

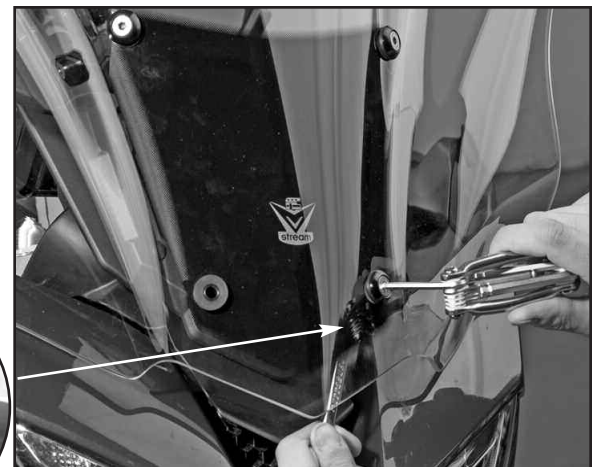

Figure 10



CLEANING AND MAINTENANCE

To clean the screen, wash with a clean soft cloth, plenty of warm water and if necessary, a non-abrasive soap such as dishwashing liquid. Flannel or soft chamois make good cleaning cloths. **Paint, glue residue or grease removal:** Moisten cotton with naphtha or turpentine followed by a wash as above.

National Cycle **Shield Wash™** (N1401-01) makes a good daily cleaner and comes with a handy travel size bottle. Shield Wash is safe for all windshields and helmet visors.

Do not clean polycarbonate in hot sun or high temperatures. Do not clean the screen with glass cleaners.

Do not allow brake fluid, alcohol, or strong solvents to contact the screen.

RAIN REPELLENT

Do not use rain protective products made for glass. We recommend National Cycle's **RainZip®** (N1410-01) to keep your windshield clear in rainy weather.



National Cycle 3-Year Limited Warranty

National Cycle hereby warrants to the original registered owner of a National Cycle polycarbonate windshield for a period of three years from the date of purchase against breakage. This limited warranty is expressly limited to the replacement of the polycarbonate windscreen. This limited warranty does not include scratches, coating failure, cosmetic wear and tear, replacement of hardware, or any consequential damages or expenses including labor cost of installation, removal and/or replacement, inconvenience, inbound freight expenses or damage to any other component of the motorcycle or any other accessories. Certain chemicals, generally known as acidic hydrocarbons, are known to cause polycarbonate damage and will not be covered under this limited warranty. Please refer to the cleaning instructions supplied with all National Cycle windshields.

! WARNING

Never ride your motorcycle with loose accessory mounting hardware. Check the hardware for tightness regularly.

Today's motorcycles are built with enough frame rigidity to withstand the moderate loads imposed on them by the foreseeable addition of an accessory(ies). If an accessory(ies) adversely affects your motorcycle's stability, immediately remove the accessory(ies). Do not ride a motorcycle that exhibits unsafe handling traits.

Have experienced service personnel correct any problem before riding with the accessory(ies) installed. For further questions concerning handling problems associated with an accessory(ies), contact your dealer, motorcycle manufacturer, or accessory manufacturer.

Sunlight reflected off the inside curvature of the windshield can, at certain times of day, cause extreme heat buildup on the motorcycle's instruments and possibly even melt them. Exercise care in parking to avoid this. Park your motorcycle facing the sun or place an opaque object over this area.