

Global [Marine](#) Catalog

MARINCO
MASTERVOLT



Actuant
ELECTRICAL

Dear Channel Partners & Customers,

It gives us great pleasure to introduce the new Global Marine Products Catalog. We've taken great care to provide you with a reference tool that organizes products clearly to make selection and comparison easier.

Welcome, Mastervolt

Actuant Corporation, the parent company of Marinco, acquired the Mastervolt brand in December 2010 to complement its line of the marine and harsh-duty products. Since Marinco and Mastervolt have branded products and services that support the marine and mobile markets, these elements have been folded into a single entity that provide a number of benefits:

- A broader product selection,
- A single solution for virtually every marine electrical need,
- Enhanced customer service
- Global distribution

Three Geographic Regions to serve you better.

In addition to the newly designed catalog, we have organized our Global Marine Business into three geographic regions: the Americas, EMEA (Europe/Middle East/Africa) and APAC (Asia Pacific/China). Each region will support all brands locally, enabling us to meet your needs in a convenient time zone.

Focused on being the best in the world.

We are confident the union of Mastervolt and Marinco brands will strengthen our approach in the marine and mobile markets. More important, it will better position Actuant Electrical to elevate support and enhance market and customer growth. It is a process that will take both collaboration and time to complete, as does any merger or business consolidation. However, rest assured that throughout this process our focus will remain on our customers and channel partners.

We welcome your feedback on the new Global Marine Products Catalog, and we look forward to serving you in the years ahead.

Best Regards,

Your Global Marine Team

MARINCO **MASTERVOLT** **GUEST** **ANCOR** **NICRO** **BEP** **AFI**



Table of Contents

Connect	4
Inlets	6
Cordsets & Adapters	17
Devices & Accessories	23
International	28
DC Connections	33
Generate	38
GPX Hybrid Generator	40
Alternators & Regulators	43
Convert	48
Battery Chargers	50
Sine Wave Inverters	62
Inverter / Charger Combinations	68
DC-DC Converters	74
Shore Transformers	80
Store	84
Batteries	86
Manage	92
Battery Switches	94
Circuit Protection & Panels	113
Distribution Components	145
Transfer Switches	150
MasterBus	154
CZone™	164
Monitoring	181
Wire & Wire Management	188
Propel	224
Electric Propulsion	226
Accessories	232
Wiper Systems	234
Horns	248
Lighting	257
Ventilation	268
Index	274



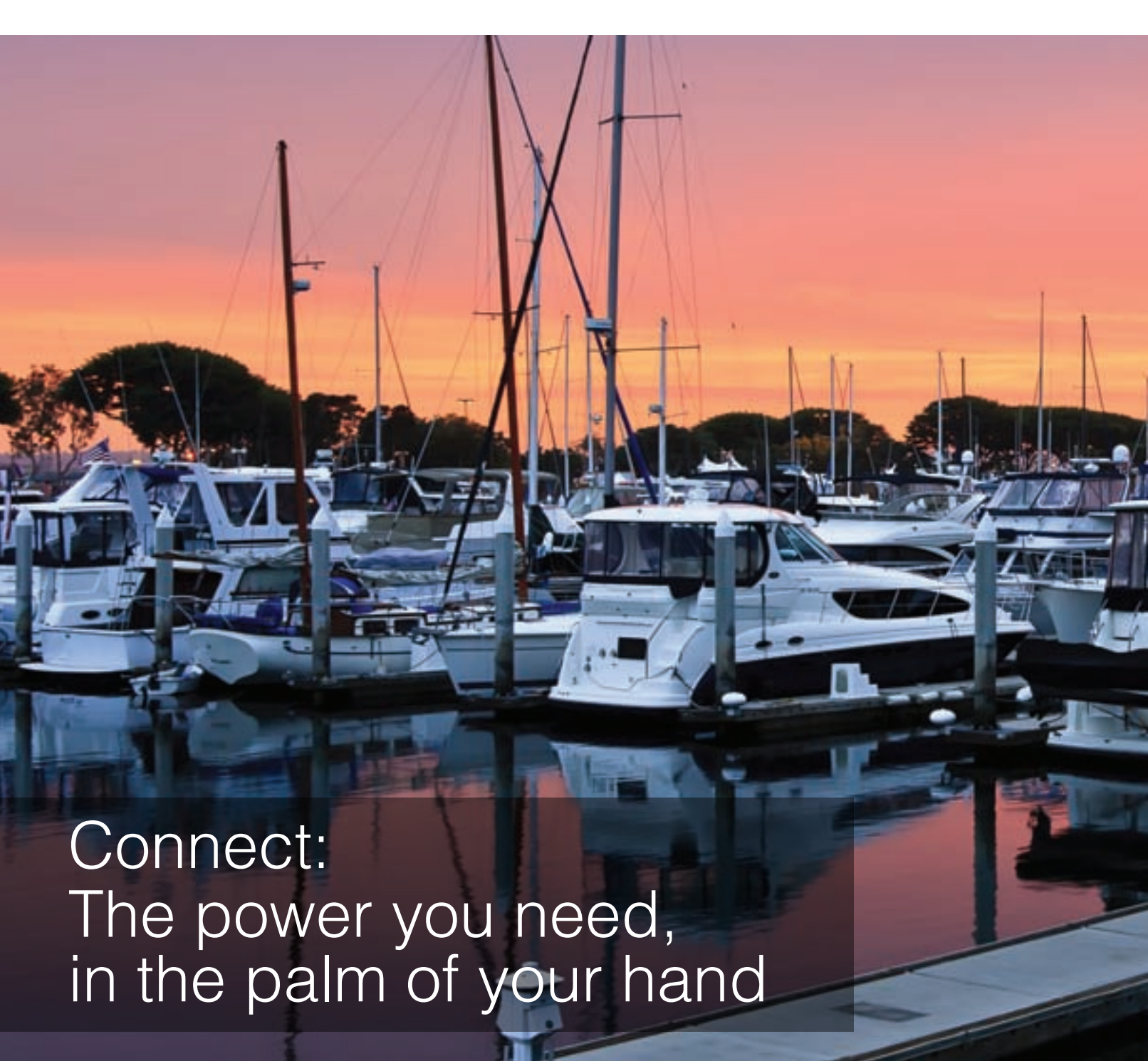

Connect: The power you need, in the palm of your hand

At the end of the day, it's comforting to know that the next port will be a safe haven for the night—and a time to recharge both literally and figuratively. Because as your vessel reaches its slip, you know you can connect to a shore power station with the sure power of Marinco and Mastervolt products.

Regardless of the location, trust our inlets, cordsets, adapters and accessories to keep you connected to reliable shore power, whether you're in South Beach or South Africa. That's because there is no other company that provides as many solutions to keep you connected as the Global Marine Group of Actuant Electrical.

Our inlets and cordsets provide a convenient and secure manner of connecting to power sources. Adapters ensure no matter the port of call you'll get the power you need. A complete array of accessories enables you to adapt the connection you need to the power source available.

International or domestic, AC or DC, Actuant Electrical provides the power you need, right in the palm of your hand.



Marinco® Shore Power Systems _____	6
Marinco® Power Inlets _____	8
30 Amp/125V Inlets _____	10
50 Amp/125V Inlets _____	11
50 Amp 125V/250V Inlets _____	12
ELCI Inlets & Ignition Protected Breakers _____	13
Cable TV/Internet _____	15
Cordsets _____	17
Shore Power Adapters _____	18
30 Amp Devices _____	23
50 Amp Devices _____	24
15 & 20 Amp Devices _____	25
20 Amp Devices & Accessories _____	26
Boxes / Covers / Replacement Parts _____	27
International Shore Power _____	28
100 Amp Devices _____	32
DC Connections _____	33



| Dockside Products

| Cordsets

<p>Marine Receptacles Corrosion resistant reinforced nylon construction</p>	<p>Weatherproof Covers Yellow LEXAN® polycarbonate with lift lid, for use with Marinco receptacles</p>	<p>Male Plugs Superior strain-relief system. Dust seal keeps contaminants out of terminals</p>	<p>Weatherproof Covers Heavy duty vinyl construction, use with male plugs for superior seal</p>	<p>Shore Power Cord Sets Marine Grade cable, watertight molded plug and connector, line-up ridge for easy blade alignment</p>
--	---	---	--	--

<p>30A 125V 2 Pole 3-Wire Locking</p> <p>305CRR</p> 	<p>7420CR</p> 	<p>305CRPN</p> 	<p>102N</p> 	<p>50SPP</p> 
--	---	--	--	--

<p>50A 125V 2 Pole 3-Wire Locking</p> <p>6370CR</p> 	<p>7788CR</p> 	<p>6361CRN</p> 	<p>7717N</p> 	<p>6153SPP</p> 
---	--	---	--	---

<p>50A 125/250V 3 Pole 4-Wire Locking</p> <p>6369CR</p> 	<p>7788CR</p> 	<p>6365CRN</p> 	<p>7717N</p> 	<p>6152SPP</p> 
--	---	--	---	--

<p>Cable TV / Internet</p>	<p>TV97</p> 	<p>PH6623</p> 	<p>TVHD</p> 
-----------------------------------	---	--	---

Marinco® Color Coding System

<p>products for 15 AMP</p>	<p>products for 20 AMP</p>	<p>products for 30 AMP</p>	<p>products for 50 AMP 125V</p>	<p>products for 50 AMP 125V/250V</p>
--------------------------------	--------------------------------	--------------------------------	-------------------------------------	--

LEXAN® is a registered trademark of Sabic Innovative Plastics IP B.V., Netherlands

| Boatside Products

Weatherproof Covers

Heavy duty vinyl construction, use with female connector for superior seal

Female Connectors

Ribbed nylon construction, color coded terminal pockets and screws

Power Inlets

Styled to complement any boat, Marinco® power inlets are simple to install and feature a protective rear safety enclosure that provides safe, reliable strain relief

103RN



305CRCN



303SSEL-B



301EL-B



304EL-B



7715CRN



6360CRN



6371EL-B



6351EL-B



6343EL-B



7715CRN



6364CRN



6373EL-B



6353EL-B



6344EL-B



PH6624



TV6592



TV6574



TV6444





Inlets

Marinco® Power Inlets are the industry standard. Offered in three styles, they all feature robust construction and corrosion-resistant materials for long life in the harsh marine environment. Each has technical features that make them easy to install and a pleasure to use for the marine professional or the casual recreational boater.

Stainless Steel

Marinco® stainless steel inlets are solid cast marine grade 316 stainless steel and include a heavy duty cap strap for strength and durability.



Contoured

Marinco® contoured inlets feature UV stabilized glass-filled polyester construction for long-lasting strength.



Standard

Marinco® standard inlets feature UV stabilized glass-filled polyester construction for long-lasting strength.



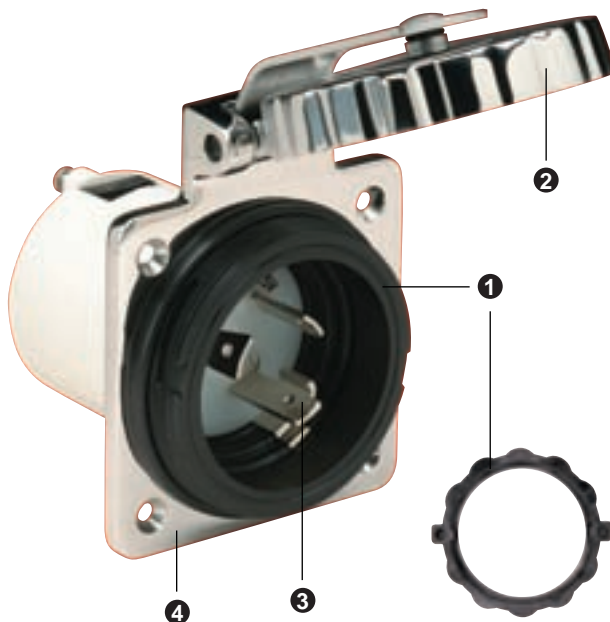

1 Easy Lock™—Marinco’s exclusive Easy Lock™ System has been designed to make hook-up quick and easy. Just connect the cordset (with an Easy Lock™ locking ring installed) to the inlet and turn the locking ring less than a quarter turn. The tabs on the locking ring lock into the inlet for a positive watertight hook-up while eliminating any chance of cross threading. The locking ring features lock locators positioned at 180° to improve finger grip during attachment.

Easy Lock™ inlets have a threaded boss that will accept threaded cordsets as well. The Easy Lock™ system is a standard feature on some Marinco® 30 amp and 50 amp inlets and cordsets.

2 The covers on all Marinco® inlets are designed to stay hinged open when the cover is lifted up. This allows the boater to connect their shore power cord while the cover remains open and out of the way. A soft touch unlocks it for closing.

3 Blades are nickel plated brass for maximum corrosion resistance.

4 Interior hardware is marine-grade stainless steel.

Rear Enclosure

- Made of flame-resistant UL94V0 plastic.
- All rear enclosures are glass-filled polyester for strength.
- Integral strain relief complies with ABYC requirements.
- Multiple positions allow for maximum installation flexibility.



Connect: **30 Amp/125V Inlets**



30 AMP 125V

Stainless Steel Power Inlet

- Cast 316 stainless steel

Item # 303SSEL-B
OEM # 303SSEL-B.OEM



30 AMP 125V

Countour Chrome Power Inlet

- Chrome finish cover

Item # 304EL-BCR
OEM # 304EL-BCR.OEM



30 AMP 125V

Contour Power Inlet

- Stainless steel trim

Item # 304EL-B
OEM # 304EL-B.OEM
Item # 304ELCB cap & bezel



30 AMP 125V

Contour Power Inlet

- Without stainless steel trim

Item # 304EL-B.NT white
Item # 199136 black



30 AMP 125V

Power Inlet

- Stainless steel trim

Item # 301EL-B white
OEM # 301EL-B.OEM white
Item # 301EL-B.GRAY gray
Item # 301ELCB cap & bezel



30 AMP 125V

Power Inlet

- ABYC shore power warning label on cap

Item # 301EL-B.W/L



30 AMP 125V

Power Inlet

- Stainless steel trim
- Hole at rear enclosure

Item # 301EL-B.FR



30 AMP 125V

Breaker Inlet

- Includes cap & bezel and breaker plate
- Breaker not included

Item # 3050BI



30 AMP 125V

Stainless Steel Power Outlet

- Female 30A 125V configuration

Item # 303SSO



50 AMP 125V

Stainless Steel Power Inlet

Item # 6371EL-B
OEM # 6371EL-B.OEM



50 AMP 125V

Stainless Steel Power Inlet

• Without rear safety enclosure
Item # 6371EL



50 AMP 125V

Contour Power Outlet

• With stainless steel trim
Item # 6343EL-B



50 AMP 125V

Power Inlet

• Stainless steel trim
• Without rear safety enclosure
Item # 6351EL



50 AMP 125V

Power Inlet

• With out stainless steel trim
• ABYC shore power warning label on cap
Item # 6351EL-B

There are two categories of 50A devices: 50A 125V (50A 3-wire) and 50A 125/250V (50A 4-wire). The 4-wire devices have two "hot" legs, each carrying 50A 125V. These two categories are not interchangeable. A 3-wire plug must never be altered to insert into a 4-wire connector or receptacle.

Connect: 50 Amp 125V/250V Inlets



50 AMP
125/250V

Stainless Steel Power Inlet

Item # 6373EL-B
OEM # 6373EL-B.OEM



50 AMP
125/250V

Stainless Steel Power Inlet

- Without rear safety enclosure

Item # 6373EL
OEM # 6373EL.OEM



50 AMP
125/250V

Countour Chrome Power Inlet

- Chrome finish cover

Item # 6344EL-BCR
OEM # 6344EL-BCR.OEM



50 AMP
125/250V

Contour Power Inlet

- Stainless steel trim

Item # 6344EL-B
OEM # 6344EL-B.OEM



50 AMP
125/250V

Contour Power Inlet

- Without stainless steel trim

Item # 6344EL-B.NT



50 AMP
125/250V

Power Inlet

- Stainless steel trim

Item # 6353EL-B
OEM # 6353EL-B.OEM
Item # 6353ELCB Cap & Bezel



50 AMP
125/250V

Power Inlet

- Stainless steel trim
- Black

OEM # 6353EL-B.BLACK.OEM



50 AMP
125/250V

Power Inlet

- Stainless steel trim
- Gray

Item # 6353EL-B.GRAY



50 AMP
125/250V

Power Inlet

- Stainless steel trim
- Without rear safety enclosure

Item # 6353EL

There are two categories of 50A devices: 50A 125V (50A 3-wire) and 50A 125/250V (50A 4-wire). The 4-wire devices have two "hot" legs, each carrying 50A 125V. These two categories are not interchangeable. A 3-wire plug must never be altered to insert into a 4-wire connector or receptacle.



ELCI inlets

Marinco's solution to the ABYC E-11 requirement is based on our industry-standard marine inlets. We have taken the best available technology and built it into our inlets to provide boat builders and owners with the safest, best looking and most durable solution possible.

We provide two modules in addition to the standard inlet. One houses the ELCI Marine Sensing Module, the other the breaker. Unlike competing systems, our ELCI Marine sensing module has a 3/4" diameter coil that accepts up to three 6 gauge conductors. This sensing module, which also incorporates a test circuit, is compatible with 30A 125V, 50A 125V and 50A 125V/250V systems. There is a different breaker for 30A and 50 systems.

Ignition protected breakers & kits

Boat manufacturers that want to comply with ABYC standards should already be aware that potential electrical sources of ignition should not be located in certain compartments that contain gasoline machinery, gasoline tanks or potential gasoline/propane storage containers. To take the guess work out of which breaker fits your application, Marinco is pleased to offer all of our ELCI inlets with ignition protected breakers.

Single Phase 120V AC 30A (Hot, Neutral, Ground)

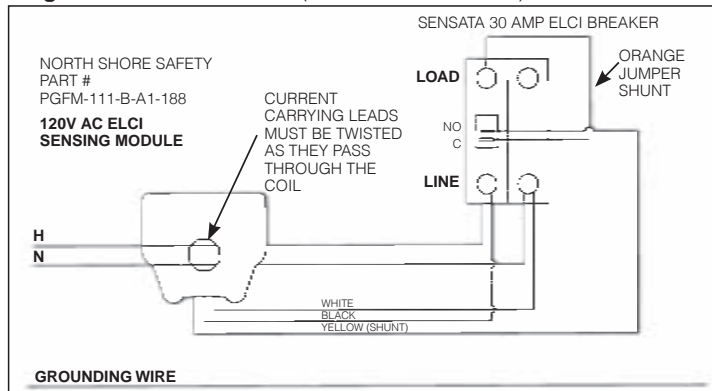

Split Phase 120/240V AC 50A (Line 1, Line 2, Neutral, Ground)

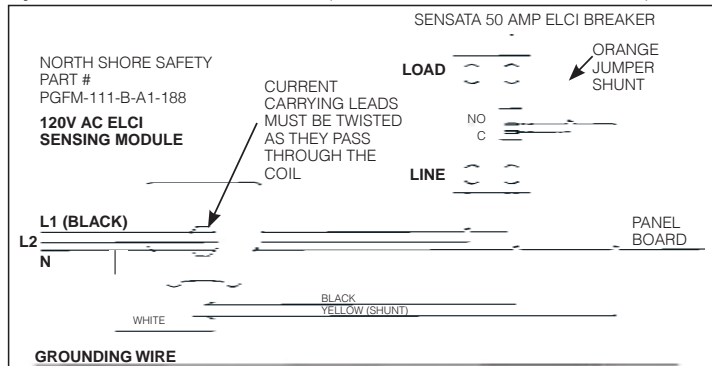



Stainless Steel Sensing Breaker

OEM # 303SSBKRIGN.OEM 30A
 OEM # 6373BKRIGN.OEM 50A



Stainless Steel Sensing Module

OEM # 303SSRCD.OEM 30A
 OEM # 6373RCD.OEM 50A

Stainless Steel Housing

Sensing Module Housing

OEM # 303SSRCDPL.OEM

Breaker Housing

OEM # 303SSBKRPL.OEM

Stainless Steel Sensing Module & Breaker Kits

- Module & breaker packaged together

OEM # 303SSRCDKITIGN.OEM 30A

OEM # 6373RCDKITIGN.OEM 50A



Contour Sensing Breaker

OEM # 304BKRIGN.OEM 30A
 OEM # 6344BKRIGN.OEM 50A



Contour Sensing Module

OEM # 304RCD.OEM 30A
 OEM # 6344RCD.OEM 50A

Contour Housing

Sensing Module Housing

OEM # 304RCDPL.OEM

Breaker Housing

OEM # 304BKRPL.OEM

Contour Sensing Module & Breaker Kits

- Module & breaker packaged together

OEM # 304RCDKITIGN.OEM 30A

OEM # 6344RCDKITIGN.OEM 50A



Standard Breaker

OEM # 301BKRIGN.OEM 30A
 OEM # 6353BKRIGN.OEM 50A



Standard Sensing Module

OEM # 301RCD.OEM 30A
 OEM # 6353RCD.OEM 50A

Standard Housing

Sensing Module Housing

OEM # 301RCDPL.OEM

Breaker Housing

OEM # 301BKRPL.OEM

Standard Sensing Module & Breaker Kits

- Module & breaker packaged together

OEM # 301RCDKITIGN.OEM 30A

OEM # 6353RCDKITIGN.OEM 50A



**Stainless Steel
Phone & Cable TV Inlet**

Item # PH6592TV-SS
OEM # PH6592TV-SS.OEM



Phone & Cable TV Inlet

- Stainless steel trim

Item # PH6574TV
OEM # PH6574TV.OEM
Item # PH6574TV.W/L w/ warning label



**Contour Phone &
Cable TV Inlet**

Item # PH6444TV



**Stainless Steel
Cable TV / Internet Inlet**

Item # TV6592



Cable TV / Internet Inlet

Item # TV6574



**Contour Cable TV / Internet
Inlet**

Item # TV6444



Telephone Adapter

- Use to hook up telephone to cordset PH6599. No inlet installation required.

Item # PH6600



Telephone Adapter

- Use to hook up a locking type inlet to a modular telephone connection

Item # PH6601



Female Phone Plug

- MARINEGUARD II Cover

Item # PH6629



HDTV / Internet Cable

- 50 ft yellow cable
- 75 ohm, 3G Hz RG6 Quad Shield cable with gasket sealed
- Weatherproof F-type connections on both ends

Item # **TVHD**



Combo TV/Phone Cordset

- Both cables are jacketed together.
- Telephone and TV connections are molded on each end
- Features 18" of spliced cable at dockside for connections which are in separate power centers

Item # **PHTV6599** 50'

Item # **PHTV6599-25** 25'



Telephone Cordset

- 3 conductor #16SJTO vinyl cord provides portable telephone connection for RV's and pleasure boats.

Item # **PH6599** 50'

Item # **PH6599-25** 25'



NEW USB Port

- 6 ft
- USB extension cable with weatherproof cap

Item # **USBA6**

OEM # **USBA6.OEM**



Cable TV Outlet

- Spring-loaded lift cover
- Weatherproof closure
- Fits FS & FD boxes

Item # **TV97**

OEM # **TV97.OEM**



Telephone Outlet

- Spring-loaded lift cover
- Weatherproof closure
- Fits FS & FD boxes

Item # **PH6597**



Telephone & Cable TV Outlet

- Spring-loaded lift cover
- Fits FS & FD boxes

Item # **PH6597TV**

OEM # **PH6597TV.OEM**

All Marincó® cordsets are made of the highest quality, marine-grade construction with features you won't find on other power cords.

- ❶ Watertight molded plug and connector for safety and durability
- ❷ Heavy duty, super flexible marine-grade cable (30 amp 10 gauge, 50 amp 6 gauge)
- ❸ All models include a standard threaded ring for hook-up to ordinary threaded inlets
- ❹ Corrosion resistant, nickel plated contacts
- ❺ **Power Indicator Light:** Boatside connector features a molded-in LED light. When it glows red, you know you have power to the boat.
- ❻ **Contour Grip with Thumbprint Locator:** Both plug and connector ends are molded to fit the contour of your hand. When the thumbprint is in the 12 o'clock position, the blades line up for easy connection.
- ❼ **Marincó's Easy Lock™ system:** Quickly locks the cord set to the inlet in just 1/8 of a turn. The exclusive locking tabs engage slots built into all Marincó® inlets.

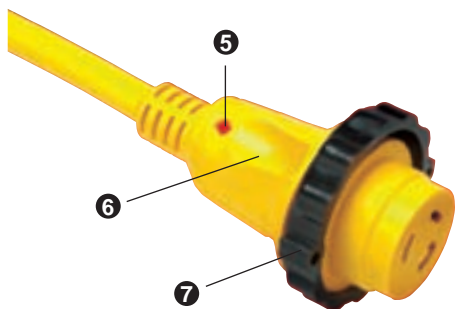

❻ Contoured Grip



❼ Easy Lock™



Length	Color	Pkg	Item #	OEM #
30 Amp Power Cord Plus® Cordsets				
12 ft	yellow	sleeve pack	199116	—
25 ft	yellow	sleeve pack	199117	25SPP.OEM
25 ft	white	sleeve pack	—	25SPPW.OEM
35 ft	yellow	sleeve pack	—	35SPP.OEM
50 ft	yellow	sleeve pack	199119	50SPP.OEM
50 ft	white	sleeve pack	199120	50SPPW.OEM
75 ft	yellow	box	—	75SPP.OEM
50 Amp 125 Volt Power Cord Plus® Cordsets (3-Wire)				
25 ft	yellow	box	6153SPP-25	—
50 ft	yellow	box	6153SPP	—
50 ft	white	box	6153SPPW	—
50 Amp 125/250 Volt PowerCord Plus® Cordsets (4-Wire)				
12 ft	yellow	box	6152SPP-12SC	—
25 ft	yellow	box	6152SPP-25	—
25 ft	white	box	6152SPPW-25	—
50 ft	yellow	box	6152SPP	—
50 ft	white	box	6152SPPW	—
50 Amp Plug End Only Cordsets				
55 ft	white	box	6152SPPW-55.P/O	—
75 ft	white	box	6152SPPW-75.P/O	—



6153SPPW



6152SPP

5 YEAR WARRANTY



Connect: Shore Power Adapters

The Marincó® Shore Power Adapters give you more power hook-up flexibility and resolve a variety of dockside power center / boat side inlet power incompatibility problems.

Types of Adapters



Straight Adapters are high-quality, one-piece adapters similar in usage to Pigtail Adapters. However, they do not have sealing collars and are not recommended for use in wet locations. Use only in an enclosed, dry location, such as powering your boat from a 15A power receptacle inside your house.



Pigtail Adapters allow you to connect from one dockside receptacle (or other power source receptacle) to one boatside inlet or equipment of dissimilar power configuration. These adapters are fully molded and equipped with Marincó's unique sealing collar (where indicated) and covers for use in wet locations.



"Y" Adapters let you split one dock side receptacle between two boat inlets of similar or dissimilar power configurations. "Y" adapters are fully molded and equipped with Marincó's unique sealing collar and covers (where indicated) for use in wet locations.

The Reverse "Y" Adapter (Item # RY504-2-30) The reverse "Y" provides 50A 125/250V power when only two 30A 125V receptacles are available.

Choosing the Correct Adapter

1 Boat Side – Identify your boat's Inlet Electrical System



The voltage and amperage should be printed on the outside cover of your existing boat inlet(s)



Check the blade orientation of the various inlets pictured and compare to your boat inlet(s)

50A 125V



The voltage and amperage should be printed inside the boat inlet(s) next to the blades

30A 125V



Pay special attention to the differences in the 50A 125V and the 50A 125/250V. The blades look similar, but they are different. The plugs and receptacles for these systems are NOT interchangeable!!

50A 125/250V

Notice the additional grounding blade on the 50A 125/250V inlets.

2 Identify the Dock Side Power Source



20A 125V Locking



50A 125V Locking



30A 125V Locking



50A 125/250V Locking

IMPORTANT 50 AMP INFORMATION:

If you are connecting to 50A dockside power service, it is CRITICAL to know the dockside receptacle's voltage rating (50A 125V or 50A 125/250V). An adapter designed for 50A 125V will not plug into a dockside receptacle rated for 50A 125/250V service, and vice versa.

3 Choose a Marincó® Adapter from page 19–22

Match your boat side inlet(s) to the appropriate dock side receptacle or other power source. Adapter ends are color coded for easier selection.

When using any adapter remember:

1. Outlet and equipment must be of the same voltage rating.
2. Total amperage drawn should not exceed amperage rating of the lowest rated component of the adapter.
3. Polarity and grounding must be maintained both dock side and boat side.
4. A single cordset should only draw power from a single receptacle (exception is the Reverse "Y" Adapter).

Straight Adapters

Not recommended for use in wet locations.

Item #

80A



81A



83A



84A



BOAT SIDE

FEMALE CONNECTOR

Attaches to boat inlet or cordset

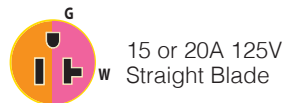
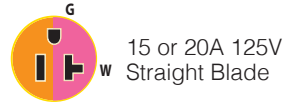

DOCK SIDE

MALE PLUG

Attaches to dockside receptacle or cordset



Pigtail Adapters

These adapters are equipped with covers and sealing collars (where indicated), and are for use in wet locations.

Item #

104SPP

Features an LED Power-on indicator and thumbgrip locator

25 ft
104SPP-25.OEM

50 ft
104SPP-50.OEM



BOAT SIDE

FEMALE CONNECTOR

Attaches to boat inlet or cordset



DOCK SIDE

MALE PLUG

Attaches to dockside receptacle or cordset

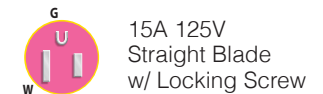

105SPP

Features a power-on indicator and thumbgrip locator



Pigtail Adapters





















BOAT SIDE

FEMALE CONNECTOR
Attaches to boat inlet
or cordset

DOCK SIDE

MALE PLUG
Attaches to dockside
receptacle or cordset

Item #

110A		 30A 125V Locking w/ Sealing Collar System	 50A 125V Locking
111A		 50A 125V Locking w/ Sealing Collar System	 30A 125V Locking
115A		 50A 125V Locking w/ Sealing Collar System	 15 125V Straight Blade w/ Locking Screw
117A		 50A 125/250V Locking w/ Sealing Collar System	 30A 125V Locking
118A		 50A 125/250V Locking w/ Sealing Collar System	 50A 125V Locking
121A		 30A 125V Locking w/ Sealing Collar System	 50A 125/250V Locking
123A		 50A 125V Locking w/ Sealing Collar System	 50A 125/250V Locking

“Y” Adapters

These adapters are equipped with covers and sealing collars (where indicated), and are for use in wet locations.

Item #

152AY



BOAT SIDE
FEMALE CONNECTOR
 Attaches to boat inlet or cordset



2-30A 125V Locking w/ Sealing Collar System

DOCK SIDE
MALE PLUG
 Attaches to dockside receptacle or cordset



50A 125V Locking

153AY



2-30A 125V Locking w/ Sealing Collar System



50A 125/250V Locking

154AY



2-50A 125V Locking w/ Sealing Collar System



50A 125/250V Locking

157AY



2-30A 125V Locking w/ Sealing Collar System



30A 125V Locking

162AY



2-50A 125V Locking w/ Sealing Collar System



50A 125V Locking

165AY



2-50A 125/250V Locking w/ Sealing Collar System



50A 125/250V Locking

Reverse “Y” Adapter

Item #

RY504-2-30



BOAT SIDE
FEMALE CONNECTOR
 Attaches to boat inlet or cordset



50A 125/250V w/ Sealing Collar System

DOCK SIDE
MALE PLUG
 Attaches to dockside receptacle or cordset

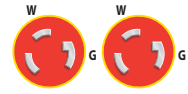

2-30A 125V Locking

The Reverse “Y” Adapter has two male plugs with special power isolation circuitry for added safety. When one plug is connected to a receptacle, the circuitry isolates the second plug. The reverse “Y” provides 50A 125/250V power when only two 30A 125V receptacles are available.

Note: Reverse “Y” will NOT work with 50A, 125V, 3-wire inlets. Power is provided in both circuits to the 4-wire inlet, but the dock side receptacles limit the current in each circuit to 30A. The two 30A 125V receptacles must be supplied from a single power source providing from 208V to 250V between them for proper operation.

Right Angle Adapters

Item #

1RPC
(30 amp)

1RPC50
(50 amp)



BOAT SIDE

FEMALE CONNECTOR

Attaches to boat inlet or cordset



30A 125V
Locking w/
Sealing
Collar System



50A 125/250V
Locking w/
Sealing
Collar System

DOCK SIDE

MALE PLUG

Attaches to dockside receptacle or cordset



30A 125V
Locking



50A 125/250V
Locking

GalvanAlert® Shore Power Corrosion Detector

Item #

G30



BOAT SIDE

FEMALE CONNECTOR

Attaches to boat inlet or cordset



30A 125V
Locking w/
Sealing
Collar System

DOCK SIDE

MALE PLUG

Attaches to dockside receptacle or cordset



30A 125V
Locking

The world's only shore power corrosion detector with reverse polarity indicator. GalvanAlert® easily attaches to your existing 30A shore power inlet and cordset to constantly monitor unsafe corrosion activity or a reverse polarity condition.

- Can save you thousands of dollars in potential corrosive damage to your boat
- Detects reverse polarity that can create a shock or fire hazard

How does GalvanAlert® work?

GalvanAlert® incorporates sensor-based technology that monitors unsafe galvanic or stray current corrosion flowing through the green ground wire of your shore power system.

Why GalvanAlert® if I have a galvanic isolator?

Galvanic isolators only protect against galvanic action. They will not block corrosion currents driven by more than 1.5 volts that can be highly destructive to your boat. GalvanAlert® will detect such currents so you can protect your boat in instances where galvanic isolators do not.

Dockside 30A to 15A Adapter with GFI

Item #

199128



3-15A 125V
Straight Blade

BOAT SIDE

FEMALE CONNECTOR

Attaches to boat inlet or cordset

DOCK SIDE

MALE PLUG

Attaches to dockside receptacle or cordset



30A 125V
Locking

- Provides safer hook-up to 30A dockside power
- Provides protection against harmful electric shock
- Reduces the possibility of fire
- Offers protection for up to 3 attached tools
- Corrosion resistant and rain-proof rated for outdoor use
- GFI trip level of 4-6 mA

- Can also be used for other outdoor, harsh environments such as construction sites or wherever ground fault protection is desired.
- Note: A Ground Fault Circuit Interrupter (GFCI) limits the duration of an electrical shock to a period considered safe for healthy people. It does not prevent electric shock. This device does not protect against electric shock due to contact with both circuit conductors or a fault in any wiring supplying this device.



30 AMP
125V

Male Plug

Item # 305CRPN
OEM # 305CRPN.OEM



30 AMP
125V

Female Connector

Item # 305CRCN
OEM # 305CRCN.OEM



30 AMP
125V

Male Plug & Cover

- Weather resistant cover

Item # 305CRPN.VPK



30 AMP
125V

Female Connector w/ Cover & Rings

- Weather resistant cover with threaded sealing ring
- Easy Lock™ sealing ring

Item # 305CRCN.VPK



30 AMP
125V

Locking Receptacle

- Corrosion resistant
- Reinforced nylon construction
- Yellow

Item # 305CRR



30 AMP
125V

Locking Receptacle

- Corrosion resistant
- Reinforced nylon construction
- Black

Item # 305CRRB
OEM # 305CRRB.OEM



30 AMP
125V

Weatherproof Cover w/ Threaded Sealing Ring

- Use with 305CRCN or 205CRCN

Item # 103RN
OEM # 103RN.OEM



30 AMP
125V

Weatherproof Cover w/ Easy Lock™ Sealing Ring

- Use with 305CRCN or 205CRCN

Item # 103ELN



30 AMP
125V

Weatherproof Cover

- Use with 305CRPN or 205CRPN

Item # 102N



30 AMP
125V

Easy Lock™ Sealing Ring

- Use with 30 amp Maringo Inlets

Item # 100EL



30 AMP
125V

Threaded Sealing Ring

- Use with 30 amp systems

Item # 100R



30 AMP
125V

Sealing Collar w/ Threaded Ring

- Provides maximum moisture protection between cordset & adapter
- Use with 20 & 30 amp locking systems

Item # 110R



50 AMP
125V

Male Plug

- 2 pole, 3 wire

Item # 6361CRN



50 AMP
125V

Female Connector

- 2 pole, 3 wire

Item # 6360CRN
OEM # 6360CRN.OEM



50 AMP
125V

Wire Dockside Receptacle

- 2 pole, 3 wire

Item # 6370CR



50 AMP
125/250V

Male Plug

- 3 pole, 4 wire

Item # 6365CRN
OEM # 6365CRN.OEM



50 AMP
125/250V

Female Connector

- 3 pole, 4 wire

Item # 6364CRN
OEM # 6364CRN.OEM



50 AMP
125/250V

Wire Dockside Receptacle

- 3 pole, 4 wire

Item # 6369CR
OEM # 6369CR.OEM



Weatherproof Cover w/ Threaded Sealing Ring

- Use with 6360CRN or 6364CRN

Item # 7715CRN
OEM # 7715CRN.OEM



Weatherproof Cover w/ Easy Lock™ Sealing Ring

- Use with 6360CRN or 6364CRN

Item # 7715ELN
OEM # 7715ELN.OEM



Weatherproof Cover

- Use with 6361CRN or 6365CRN
- Can be used on both Male & Female ends

Item # 7717N yellow
OEM # 7717N.OEM yellow
Item # 102182 white



Easy Lock™ Sealing Ring

- Use with 50 amp Marinco Inlets

Item # 500EL



Threaded Locking Sealing Ring

- Use with 50 amp systems

Item # 500R



Sealing Collar w/ Threaded Ring

- Provides maximum moisture protection between cordset & adapter
- Use with 50 amp only systems

Item # 510R



15 AMP 125V

Male Plug

- Straight blade

Item # 5266CR



15 AMP 125V

Female Connector

- Straight blade

Item # 5269CR



15 AMP 125V

Male Plug

- Locking type

Item # 4721CR



15 AMP 125V

Female Connector

- Locking type

Item # 4731CR



15 AMP 125V

Duplex Locking Receptacle

- Yellow

Item # 4700CR



15 AMP 125V

Duplex Straight Receptacle

Item # 5262CRR yellow
Item # 5262CRR.GRY gray



20 AMP 125V

Male Plug

- Straight blade

Item # 5366CR
OEM # 5369CR.OEM



20 AMP 125V

Female Connector

- Straight blade

OEM # 5369CR.OEM



20 AMP 125V

Male Plug

- Locking type
- Uses weatherproof cover 102N

Item # 205CRPN



20 AMP 125V

Female Connector

- Locking type
- Uses weatherproof cover 103RN

Item # 205CRCN



20 AMP 125V

Locking Receptacle

Item # 205CRR



20 AMP 125V

Duplex Straight Receptacle

Item # 5739CR

Connect: 20 Amp Devices & Accessories



Weatherproof Cover

- Use with 5366CR or 5266CR

Item # 6017Y



Weatherproof Cover

- Use with 5369CR or 5269CR plugs

Item # 6018Y



Weatherproof Cover

- Can be used on 15 & 20 amp

OEM # 1520BI.OEM



Watertight Connector Cap

- For use on 16 or 32 amp products for CE compliance
- For use on 30 or 50 amp products to protect the connector when not in use

Item # 199109PK 16A/30A

OEM # 199109 16A/30A

Item # 199110PK 32A/50A

OEM # 199110 32A/50A



Ground Fault Circuit Interrupter (GFCI)

CAUTION: Ground Fault Circuit Interrupter protection is required when using electrical products outdoors or near water. GFCI Protection is required by the ABYC where a receptacle is in a head, galley, machinery space or weather deck.

Item # 1591-FI ivory

Item # 1591-FI.WHT white

OEM # 1591-FI.GRY.OEM gray



Cable Clips

- Includes 6 Cable Clips with stainless steel mounting screws
- Keeps shore power cable out of the water
- Holds 10 gauge 30A cable
- Easy to install
- Use on deck or edge of dock
- Organize shore power cable

Item # CLIP

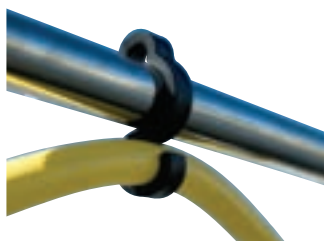

Shore Power Cord Clips

- For 30A cords
- Organize shore power cords quickly and easily
- Fits 30A cordsets securely
- Can be used on tube or wire rails
- Packaged as set of 6 clips
- UV stable
- Practically unbreakable

Item # CLIP-01 black



Organizer Bag

- Heavy duty nylon zippered bag with handle
- Ideal for storing cordsets and adapters

Item # BAG

Shore Power Cord Cloak

- Keep shore power cables neat and bundled
- Holds 50A or 30A cordsets, can hold multiple cables
- UV resistant, machine washable marine grade fabric
- 24 ft

Item # ZIP-01 black





FS Box

- Black non-metallic, with two 3/4" K.O. holes
- Accepts 15A, 20A and 30A receptacles, and 7420CR weatherproof covers

Item # 6080



FD Box with 3/4" or 1" K.O. Holes

- Yellow fiberglass, with two K.O. holes
- Accepts 15A, 20A, 30A & 50A receptacles, and 7420CR & 7788CR covers

Item # 6083CR 3/4" holes
Item # 6084CR 1" holes



Weatherproof Cover

- Yellow LEXAN® polycarbonate with lift lid
- Fits 15A, 20A, & 30A single receptacles

Item # 7420CR
OEM # 7420CR.OEM



Weatherproof Cover

- Yellow LEXAN® polycarbonate with lift lid
- Fits 50A receptacles 6369CR & 6370CR

Item # 7788CR



Plastic Switch/Outlet Box

- 3-9/32" x 2-3/16" x 2.5" D
- Can be secured against the back of wall or wall facing
- Accepts 15A, 20A & 30A receptacles, telephone outlets and TV coax connectors

Item # 6079



Stainless Steel Weatherproof Cover with Lift Lid

- Fits 4700CR, 5262CRR, & 5739CR duplex receptacles

Item # 7879CR



Stainless Steel Weatherproof Cover with Lift Lid

- Fits GFCI duplex receptacles

Item # 7879CR-FI
OEM # 7879CR-FI.OEM



Replacement Interior

- Fits 50A 125/250V Easy Lock 4-wire stainless steel or standard inlets manufactured after 8-1-93

Item # 6373ELMB



Replacement Interior

- Fits 303SSEL-B, 303SSI-B & 301EL-B boat inlets

Item # 305CRMB



Replacement Interior

- Fits 30A standard non-metallic inlets manufactured prior to 1/1/91

Item # 301CRMB



Replacement Boss Ring

- For use on 30A or 50A stainless steel inlets

Item # 102164 30A
Item # 102167 50A



Warning Labels

- For use on standard inlets
- For warning label placement use per ABYC standards

Item # INLET.LABEL.30A 30A
Item # INLET.LABEL.50A 50A

16 Amp/230V, 50Hz Locking



Stainless Steel Inlet

- 316 stainless steel
- Easy Lock™ system
- Soft touch cap design
- Rear safety enclosure with strain relief

Item # 303SSEL-BXPK
OEM # 303SSEL-BX



Standard Inlet

- Easy Lock™ system
- Glass-filled polyester
- Watertight
- Rear safety enclosure with strain relief

Item # 301EL-BXPK
OEM # 301EL-BX



Contour Inlet

- Easy Lock™ system
- Glass-filled polyester
- Watertight
- Rear safety enclosure with strain relief

OEM # 304EL-BX.NT
OEM # 301EL-BX stainless steel trim



Female Connector

- Corrosion resistant contacts and terminals
- Use with cover 103RN and cap 199109

Item # 305CRCXNPK
OEM # 305CRCXN



Weatherproof Cover w/ Threaded Ring

- Use with 305CRCXN

Item # 103RNXPK
OEM # 103RNX



Connector Kit

- Includes female connector, weatherproof cover with threaded ring and watertight cap

Item # 199114



Locking Shore Power Cordset

- H07BQ-F 3G 2,50 mm² harmonized cable
- IEC 60309 plug 2P+E [6H], 250V/50Hz
- Watertight connector sealing cap for CE compliance
- NEMA L5-30 moulded connector with LED power indicator light

Item # 25MSPPXP 25 meters
Item # 20MSPPXP 20 meters
Item # 15MSPPXP 15 meters
Item # 10MSPPXP 10 meters
Item # 1MSPPXP 1 meters



Locking Shore Power Cordset

- Blunt cut
- H07BQ-F 3G 2,50 mm² harmonized cable
- IEC 60309 plug 2P+E [6H], 250V/50Hz
- Watertight connector sealing cap for CE compliance
- NEMA L5-30 moulded connector with LED power indicator light

Item # 25MSPPX 25 meters
Item # 20MSPPX 20 meters
Item # 15MSPPX 15 meters
Item # 10MSPPX 10 meters
Item # 1MSPPX 1 meters



Locking Shore Power Cordset

- Male end blunt cut
- 12/3 (3.3 mm²) cable 16A/220V 50Hz
- Watertight connector sealing cap for CE compliance
- NEMA L5-30 moulded connector with LED power indicator light

Item # 50SPPX 50 ft
Item # 25SPPX 25 ft

32 Amp/230V, 50Hz Locking



Stainless Steel Inlet

- 316 stainless steel
- Easy Lock™ system
- Soft Touch cap design
- Rear safety enclosure with strain relief
- No rear safety enclosure

Item # 6371EL-BX.UK
OEM # 6371ELX



Standard Inlet

- Easy Lock™ system
- Glass-filled polyester
- Watertight
- Rear safety enclosure with strain relief

OEM # 6351EL-BX



Contour Inlet

- Easy Lock™ system
- Glass-filled polyester
- Watertight
- Rear safety enclosure with strain relief

OEM # 6343EL-BX



Female Connector

- Corrosion resistant contacts and terminals
- Use with cover 7715CRN and sealing cap 199110

Item # 6360CRNXPK
OEM # 6360CRNX



Weatherproof Cover w/ Threaded Ring

- Use with 6360CRNX, 6401CRCX, 6401CRPX, 6402CRCX, or 6402CRPX

Item # 7715CRNXPK
OEM # 7715CRNX



Connector Kit

- Includes female connector, weatherproof cover with treaded ring and watertight cap

Item # 199115



Locking Shore Power Cordset

- H07BQ-F 3G2,50 mm² harmonized cable
- IEC 60309 plug 2P+E [6H], 250V/50Hz
- Watertight connector sealing cap for CE compliance
- NEMA SS-1 moulded connector with LED power indicator light

Item # 15M32AXP 15 meters
Item # 1M32AXP 1 meters



Locking Shore Power Cordset

- Blunt cut
- H07BQ-F 3G2,50 mm² harmonized cable
- IEC 60309 plug 2P+E [6H], 250V/ 50Hz
- Watertight connector sealing cap for CE compliance
- NEMA SS-1 moulded connector with LED power indicator light

Item # 15M32AX 15 meters



Locking Shore Power Cordset

- Male end blunt cut
- 8/3 (8.6 mm²) cable
- Moulded connector with LED power indicator light

Item # 6153SPPX 50 ft

**63 Amp/230V, 50Hz Locking
Single Phase, 3 Wire**



Stainless Steel Inlet

- 316 stainless steel
- Easy Lock™ System
- Soft touch cap design
- Rear safety enclosure with strain relief

Item # 6401EL-BX



Female Connector

- Corrosion resistant contacts and terminals

Item # 6401CRCX



Male Connector

- Corrosion resistant contacts and terminals

Item # 6401CRPX

**63 Amp/230V, 50Hz Locking
Three Phase, 4 Wire**



Stainless Steel Inlet

- 316 Stainless steel
- Easy Lock™ system
- Soft touch cap design
- Rear safety enclosure with strain relief

Item # 6402EL-BX



Female Connector

- Corrosion resistant contacts and terminals

Item # 6402CRCX



Male Connector

- Corrosion resistant contacts and terminals

Item # 6402CRPX



**Weatherproof Cover
w/ Threaded Ring**

- Use with 6360CRNX, 6401CRCX, 6401CRPX, 6402CRCX, or 6402CRPX

Item # 7715CRNXPK

OEM # 7715CRNX

16 Amp IEC Configuration



16A 230V Shore Power Cable

- Wear-proof, UV resistant cable
- Molded IEC60309 3-pole plug and connector
- LED power indicator
- 2.5 mm² harmonized cable

Item # **121160150** 15 meters



16A 230V Shore Power Extension Cord

- Wear-proof, UV resistant cable
- Molded IEC60309 3-pole plugs
- LED power indicator
- 2.5 mm² harmonized cable

Item # **121160151** 15 meters
Item # **121160251** 25 meters



16A 230V Inlet

- Solid cast 316 stainless steel cap and bezel

Item # **121160000** 2+PE



Adapter

- CEE-7/7 connector to CE plug
- LED power indicator
- Wear-proof, UV resistant cable

Item # **121160900**



Adapter

- CE connector to CEE-7/7 plug
- Wear-proof, UV resistant cable

Item # **121160910**



Splitter

- LED power indicator
- Wear-proof, UV resistant cable

Item # **121160920**

32 Amp IEC Configuration



32A 230V Shore Power Cable

- Wear-proof, UV resistant cable
- Molded IEC60309 3-pole plug and connector
- LED power indicator
- 4.0 mm² harmonized cable

Item # **121320250** 25 meters



32A 230V Inlet

- Solid cast 316 stainless steel cap and bezel

Item # **121320000**

Practical tips

- Based on the maximum load for onboard power consumption, choose either a 16A or a 32A connection.
- For high loads choose multiple parallel connections to shore.
- Choose the appropriate connection to the shore: Standard is an earthed two-pole plug or the more familiar blue CEE three-pole plug.

Connect: 100 Amp Devices

100 Amp 125V/250V 3 Pole 4-Wire



Plug w/ Gasketed Locking Ring

- Mate with M4100R12 Receptacle

Item # M4100P12



Connector Body

- Mate with plug on extension cords or adapters. Note: It does not mate with shore power inlet.

Item # M4100C12



Connector Body w/ Gasketed Locking Ring

- Mate with M4100B12R Inlet

Item # M4100C12R

Dockside Receptacle

- Spring loaded cover providing a IP67 watertight rating when tightened.

Item # M4100R12



Dockside Receptacle

- Spring loaded cover providing a IP67 watertight rating when tightened.

Item # M4100R12



100 Amp 3ØY 120V/208V 4 Pole 5-Wire



Plug w/ Gasketed Locking Ring

- Mate with M5100R9 receptacle

Item # M5100P9



Connector Body

- Mate with plug on extension cords or adapters. Note: It does not mate with shore power inlet.

Item # M5100C9



Connector Body w/ Gasketed Locking Ring

- Mate with M5100B9R Inlet

Item # M5100C9R

Dockside Receptacle

- Spring loaded cover providing a IP67 watertight rating when tightened.

Item # M5100R9



Dockside Receptacle

- Spring loaded cover providing a IP67 watertight rating when tightened.

Item # M5100B9R





The importance of a quality DC electrical system

There's an old axiom that states, "The strongest chain is only as reliable as its weakest link," and the same analogy can be applied to your boat's DC electrical system. Put it in a harsh salt water or fresh water environment, where a vessel's wiring and components are subjected to more concentrated abuse in one season than your family car would experience in five years, and it's easy to realize that small electrical problems can get out of hand very quickly.

Safety onboard starts with a reliable DC electrical system that is installed and designed with the proper high quality wiring, components and connections to fulfill all of your intended DC tasks. If you're tempted to take shortcuts when wiring your boat, don't, as these types of cost-cutting measures can come back to bite you at the worst possible moments, potentially compromising the safety of your boat and crew.

So, whether you ply fresh water lakes, back bays, coastal areas or make long distance blue water runs to the edge of the continental shelf, Marinc® offers a wide selection of high quality, low voltage DC electrical products designed specifically for the harsh marine environments.

Now you can spend more time enjoying your boating experience and less time dealing with unwanted electrical hassles.

SeaLink® 12 Volt

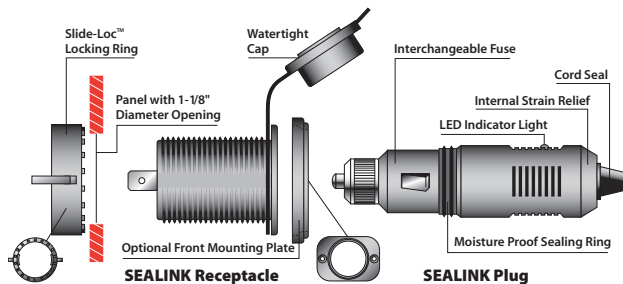

The SeaLink® 12 volt family of products are manufactured from corrosion resistant marine grade materials. Exclusive to SeaLink® products is a unique interconnecting system that securely locks the plug into the receptacle resulting in a positive and moisture-proof connection. The plug and receptacle feature optimized metal connection points for maximum conductivity.

ConnectPro® Charging & Trolling

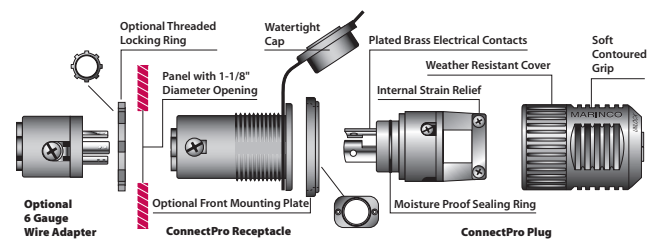

The ConnectPro® trolling motor plug and receptacle is a revolutionary concept in trolling motor DC connections. The ConnectPro® system has superior electric current carrying capacity that eliminates problems that rob motors of power and reduce battery life. The ConnectPro® system features locking plug and receptacle and spring clamping connection which provides a secure electrical contact.



SeaLink® Deluxe 12 Volt Receptacle

- Available in black or white
- Watertight sealing cap
- Easy to install, with supplied mounting plate for front panel installation, or locking ring for rear access installation (mounting plate not included with 12VRC.OEM)
- Compatible with standard 12V plugs

Item # 12VRC black
 Item # 12VRC.PG black w/gasket
 Item # 12VRCW white



SeaLink® Deluxe 12 Volt Receptacle

- Available in black or white
- Watertight sealing cap
- Easy to install with locking ring for rear access installation
- Compatible with standard 12V plugs
- No mounting plate

OEM # 12VRC.OEM black
 OEM # 12VRCW.OEM white



SeaLink® Deluxe 12 Volt Receptacle w/ Old Style Ring

- Available in black or white
- Watertight sealing cap
- Easy to install, with supplied mounting plate for front panel installation, or locking ring for rear access installation (mounting plate not included with 12VRC.OEM)
- Compatible with standard 12V plugs

Item # 12VRCO black
 Item # 12VRCO.PG black w/gasket



SeaLink® Deluxe 12 Volt Plug

- Moisture proof sealing ring
- LED power indicator light
- Interchangeable 10A fuse
- Internal strain relief and cord seal
- Compatible with standard 12V receptacles
- Max. rating is 10 amps

Item # 12VPG
 OEM # 12VPG.OEM



SeaLink® Deluxe 12 Volt Sealed Receptacle

- Sealed seams at electrical connections
- 4mm hole directs water away from electrical connections

OEM # 12VRCY



SeaLink® Deluxe 12 Volt Receptacle & Plug

- 12VRC and 12VPG packaged together

Item # 12VPK



SeaLink® Deluxe 12 Volt Extension Cord

- Heavy duty 18 gauge wire, extends to over 6 feet
- Watertight cap
- Plug features an LED indicator light, moisture proof sealing ring, strain relief and built-in 10A fuse
- SeaLink® locking system
- Works with any standard 12V plug and receptacle

Item # 12VXT



SeaLink® Deluxe 12 Volt Dual Outlet Cord

- Heavy duty 18 gauge wire, extends to over 1 foot
- Watertight caps
- Plug features an LED indicator light, moisture proof sealing ring, strain relief and built-in 10A fuse
- SeaLink® locking system
- Works with any standard 12V plug and receptacle

Item # 12VAD



SeaLink® Receptacle with Alligator Clips

- 6 feet heavy duty straight cable wire
- Watertight cap
- Corrosion resistant alligator clips
- Accepts SeaLink® plug or standard 12V plug

Item # 12VXC

5 YEAR WARRANTY



SeaLink® Mounting Plate for 12VRC.OEM

- Easy to install or retrofit
- OEM # 12MP.OEM
OEM # 300259 white



SeaLink® Receptacle Mounting Bracket

- Bracket for under dash mounting of the SeaLink® or ConnectPro® receptacles
- Receptacle installs with rear mounting threaded nut
- Marine grade anodized aluminum
- Dimensions: 2" W x 2-1/2" H

Item # 12BKT

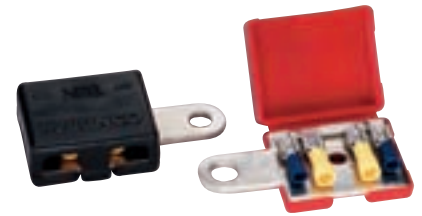

Battery Direct Connect™ Multi Connection Battery Terminals

- Terminate up to four electronic instruments on each set of terminals
- Comes complete with quick-connect terminals
- Positive molded in red, negative molded in black
- All one piece, no screws or parts to lose
- Cover snaps tight when closed

Item # 12VTR

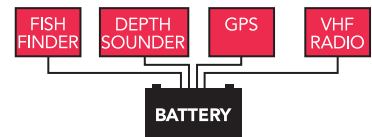

Trolling Motor Adapter Terminal

- 6 guage
- Item # 12VPL.OEM**



Boot

- For use with 12V products
- Creates a weatherproof seal

Item # 300275

5 YEAR WARRANTY



3-Wire ConnectPro® Charging / Trolling System



PATENTED

ConnectPro® Receptacle

- Universal design for 2 or 3-wire configuration 12, 24, 12/24, 24/36 or 36 volt systems
- Watertight sealing cap
- Corrosion resistant, plated brass electrical components
- Drain holes in receptacle keep water away from electrical components
- Perma-Lock™ screw terminals will not loosen under extreme hull vibration
- Standard 1-1/8" diameter mounting hole
- Easy to install, with supplied mounting plate for front panel installation, or locking ring for rear access installation
- Accepts 10 and 8 gauge wire
- Easily replaces other trolling motor plugs and receptacles

Item # 12VBR

Item # 12VBR.PG w/ gasket

OEM # 12VBR.OEM

w/ Old Style Ring

Item # 12VBRO



ConnectPro® Plug

- O-ring seal for waterproof connections
- Weather resistant plug cover
- Corrosion resistant, plated brass electrical components
- Accepts 16 to 8 gauge wire
- Ergonomic contoured grip for easy hook-up and ground blade alignment

Item # 12VBP

OEM # 12VBP.OEM



6 Gauge ConnectPro® Wire Receptacle Adapter

- Allows 6 gauge wire connection to ConnectPro® receptacle

Corrosion resistant, plated brass electrical components

Item # 12VBRAD

OEM # 12VBRAD.OEM



ConnectPro® Receptacle & Plug

- 12VBR and 12VBP packaged together

Item # 12VCP



ConnectPro® Receptacle, Plug & 6 Gauge Adapter

- 12VBR and 12VCP and 12 VBRAD packaged together
- Max. rating is 40 amps

Item # 12VCP6

2-Wire ConnectPro™ Charging / Trolling System / Downrigger

5 YEAR WARRANTY



ConnectPro® Receptacle

- Works with 12, 24, or 36 volt 2-wire systems
- For front mount panel installations
- Weather resistant sealing cap
- Drain holes in receptacle keep water away from electrical components
- Perma-Lock™ screw terminals will not loosen under extreme hull vibration
- Fits standard 1-1/8" diameter mounting hole
- Accepts up to 10 gauge wire

Item # 12VBRS2

OEM # 12VBRS2.OEM



ConnectPro® Plug

- O-ring seal for waterproof connections
- Weather resistant plug cover
- Corrosion resistant, plated brass electrical components
- Accepts 16 to 8 gauge wire
- Ergonomic contoured grip for easy hook-up and ground blade alignment
- Max. rating is 40 amps

Item # 12VBPS2

OEM # 12VBPS2.OEM



ConnectPro® Receptacle & Plug

- 12VBRS2 and 12VBPS2 packaged together

Item # 12VCP2

3-wire 30 Amp/125V Locking Charging/Trolling System



Male Plug

Short housing, black nylon with internal strain relief system and recessed fasteners

Item # 305BP
OEM # 305BP.OEM



Female Connector

Short housing, black nylon with internal strain relief system and recessed fasteners

Item # 305BC



Receptacle

Corrosion resistant reinforced nylon. Accepts 8 gauge stranded wire or up to 6 gauge with ring terminals

Item # 305CRRB
OEM # 305CRRB.OEM

5 YEAR WARRANTY



4-Wire 12/24V Locking Charging / Trolling System

The 4-wire Trolling/Charging System eliminates the need for a charge/run switch. Install the receptacle on the boat, mount the black trolling motor plug on the trolling motor, and the red charger plug on the leads of the battery charger. Simply plug in the black plug to troll, or plug in the red plug to charge.



Charger Plug (Male)

- Connects to a 12V battery charger to allow simultaneous charging of two 12V batteries when plugged into the receptacle. Red

Item # 2018BP-12
OEM # 2018BP-12.OEM



Trolling Motor Plug (Male)

- Connects to trolling motor
- Jumpered internally to supply 12V & 24V power to the trolling motor when plugged into the receptacle. Black
- Max. rating is 40 amps

Item # 2018BP-24
OEM # 2018BP-24.OEM



Receptacle & Bracket

- Spring loaded flip lid cover and 2018BR receptacle, pre assembled

Item # 2018BR-MB



Bracket

- Spring loaded flip lid cover, without receptacle

Item # 2018MB
OEM # 2018MB.OEM



Trolling-Charging System Package

- Includes the 2018BP-12, 2018BP-24, and 2018BR-MB

Item # 2018PKG



Receptacle

- Glass-reinforced corrosion resistant nylon. Accepts 8 gauge stranded wire or up to 6 gauge with ring terminals.

Item # 2018BR
OEM # 2018BR.OEM
OEM # 2018BR.OEM.BPS (case pack)

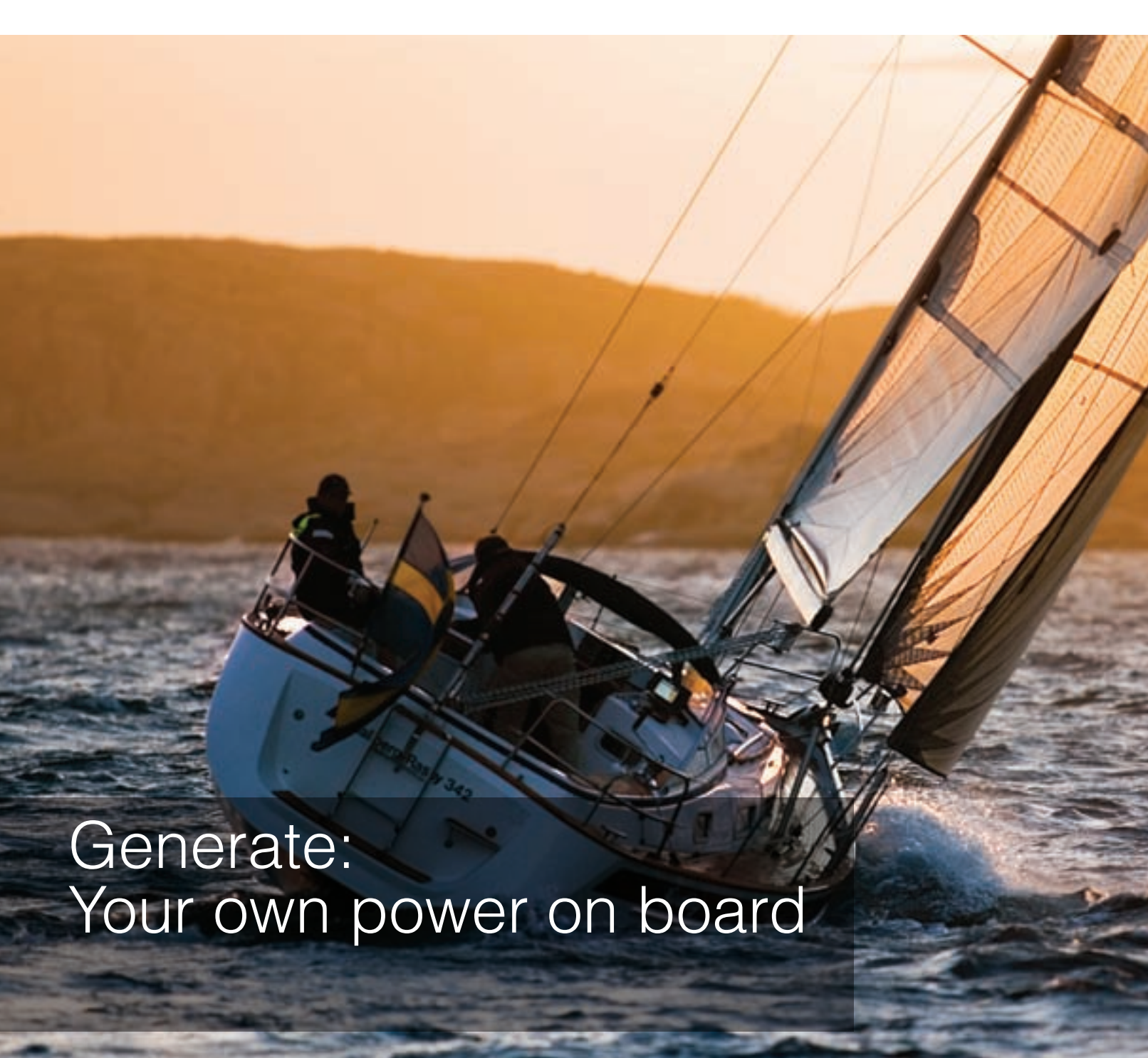

Generate: Your own power on board

Mastervolt powers your independence; whether for a single night at anchor or during a complete world trip. Being independent for a long period of time requires a great deal of power, and your batteries will often be insufficient on their own. Ultimately you require an energy source that generates its own power, and Mastervolt offers you a wide range of solutions.

The most comfortable option is to install a GPX. This combined charger/inverter/generator will provide you with independent power on board. When required, the ultra-efficient generator automatically starts up to charge your batteries or supply major consumers with power. Let your GPX do the work for you and enjoy an entirely carefree stay onboard...

If you don't have the space for a compact GPX, you can also choose to install a high-output alternator on your main engine. The accompanying intelligent 3-step regulator ensures that your batteries are charged quickly and safely. This allows you to

keep your batteries sufficiently powered on only an hour of energy (depending on system design).

A Solar ChargeMaster provides the quietest power generation, using the available energy from your solar panels to charge your batteries. The Solar ChargeMaster is completely independent, and works on the very first rays.

For sailyachts Mastervolt offers an even quieter way of generating power: The HybridMaster Ultra electric drive contains a regeneration mode that captures energy from the free spinning propeller.

For a more detailed description see the E-Propulsion segment in this catalog.



Hybrid Power _____	40
Alternators & Charge Regulators _____	43
Solar ChargeMaster _____	46





Hybrid Power: Just like home

Can a generator that is between two and four times smaller still meet your onboard power demands? Can such a generator start your air conditioning, while you are also cooking dinner and turning on the lights, as is the case at home? The answer is a resounding yes.

Meet the Mastervolt GPX, the first hybrid marine power system to include a generator, inverter, battery charger and generator/inverter/shore transfer system. Unlike a 'classic' setup, the GPX reduces volume by 40% and weight by 50%, providing you with a pure sine wave 230V onboard AC power. You can even combine shore power with power from the generator and batteries.

Smaller generator, more efficiency, less budget

In conventional setups the size of the generator is dictated by the highest load demand. Although the average load on the generator is much lower, you end up with a generator that is far too big for your power needs. The result is a waste of budget and space, and way too much time spent running at an inefficient low load level. The new Mastervolt GPX brings an end to this over-specification, and reduces fuel consumption and noise levels in the process.

Full automatic operation

With the Mastervolt GPX you have no more concerns about peak loads. For instance, there is no need to start the generator itself first to switch on your air conditioning. The inverter will power this load from the batteries for the first 30 seconds, after which the generator will start automatically. And it's all fully automatic. The GPX will operate according to your chosen user profile: Silent, Normal or Power.

Easy installation

Installing a Mastervolt GPX is easy as it consists of a compact box that includes all the essentials for your power needs. Via MasterBus, Mastervolt's intelligent one-cable system, you can connect all components on your boat quickly and without fuss. The MasterView Easy or MasterView System touchscreen displays allow you to operate and monitor your system, even from a distance with GPRS/SMS text messages.

Green at heart

Green at heart and with 10 kW of starting power, the GPX offers 2 kW of continuous power via the Mastervolt batteries. The diesel engine is only activated in case of a continuous load of more than 2 kW. This way the GPX saves fuel, materials, space and weight.

- Smaller generator required due to auxiliary batteries for peak loads.
- No inefficient running of the generator, lower fuel consumption.
- 10 to 20% more efficient conversion of the rotating diesel power via the permanent magnet generator.
- No power loss due to conversion of generator energy via the batteries to the inverter.
- Compact size saves space and weight.



Combined power

Combines shore power, battery power and generator power in the most economical way.

Perfect AC power

The AC output is controlled by power electronics and ensures a perfect AC power. Even while running the generator and turning on and off heavy loads.



State-of-the-art technology

Variable speed generator with ultra-efficient permanent magnet alternator.



Total energy system

The GPX fits perfectly in an e-propulsion system, thanks to the smart integration of inverter, generator, battery charger and transfer system. To use the Mastervolt GPX in a system, check the Mastervolt Powerbook Systems.

PRELIMINARY SPECS





GPX-6.5



GPX-8E*



GPX-12E*

Item #	--	--	--
General Specifications			
Output voltage	230V / 50Hz	230V / 50Hz	230V / 50Hz
Peak output (silent)	10 kW (5 seconds)	10 kW (5 seconds)	10 kW (5 seconds)
Output power (silent)	2.5 kW cont.	2.5 kW cont.	2.5 kW cont.
Propulsion* power (silent)	n.a.	4 kW cont.	8 kW cont.
Output power (running)	6.5 kW cont.	6.5 kW cont.	6.5 kW cont.
Propulsion* power (running)	n.a.	8 kW cont.	12 kW cont.
Dimensions, hwxwd	27.6"x17.9"x20.7" 700x455x525 mm	31.5"x17.9"x20.7" 800x455x525 mm	35.4"x17.9"x20.7" 900x455x525 mm
Weight (dry weight)	176.4 lbs / 80 kg	194 lbs / 88 kg	211.6 lbs / 96 kg
Low Voltage DC Specifications			
Battery voltage	12/24/48V	12/24/48V	12/24/48V
Battery charging current	120/80/40A	120/80/40A	120/80/40A
Min. battery capacity	320/160/80 Ah	400/200/100 Ah	600/320/160 Ah
Battery type settings	open lead / gel / traction / AGM / spiral / Li-Ion		
Charge characteristic	standard Mastervolt 3-stepⓈ	standard Mastervolt 3-stepⓈ	standard Mastervolt 3-stepⓈ
Alternator Specifications			
Type	brushless permanent magnet alternator		
Cont. rated power	3000 rpm 4.2 kW	3000 rpm 4.2 kW	3000 rpm 4.2 kW
Diesel Engine Specifications			
Number of cylinders	1	1	1
Cylinder capacity	300 cc	300 cc	300 cc
Engine cooling	indirect water cooled	indirect water cooled	indirect water cooled
Governing system	electronic	electronic	electronic
Specifications Transfer System Shore Power			
Max. current	32A	32A	32A
Ground relay	yes	yes	yes
Transfer relay & RCD	yes	yes	yes
Technical Specifications			
Temperature range operational	-20°C to 40°C, >40°C derating / -4°F to 104°F, >104°F derating		
Protection degree	IP23	IP23	IP23
Relative humidity	max. 95% non condensing, protected against humidity and condensing air by conformal coating on both sides of all PCB's		
AC connections	terminal block	terminal block	terminal block
DC connections	screw terminal M10	screw terminal M10	screw terminal M10
Communication ports MasterBus	2x RJ45	2x RJ45	2x RJ45
Connection temperature sensor	1x RJ11	1x RJ11	1x RJ11
Options			
MasterView Easy 77010305		delivered as standard touch screen to control and monitor all MasterBus compatible products	delivered as standard
MasterView System 77010400		optional color touch screen to control and monitor your complete Mastervolt system	optional
MasterShunt 77020100		provides state of charge information	
Temperature sensor	delivered as standard	delivered as standard	delivered as standard

* The GPX 'E' contains an additional module, which is the controller for the electric motor in an E-propulsion system. Now it is a real 'one box for all' solution; just connect the power cables of your electric motor to the GPX and you can drive the boat. Another advantage of the integrated motor control is the high overall efficiency, by taking the power directly from the source (grid, batteries, or diesel) with minimal conversion steps. A true hybrid power solution saving labor, costs, and energy, resulting in a simple and reliable installation.



Alternators and Charge Regulators: For rapidly recharged batteries

The already present alternator on the main engine is designed to charge the starter battery. As a result the combination is not ideal for fast and full charging of other batteries such as the service or bowthruster battery. Especially if you want to charge the batteries over a short time or when the batteries and onboard network require a little more power.

There are two options to solve this issue:

Equip the standard alternator with a Mastervolt Alpha Pro charge regulator. This will ensure that the existing alternator works in accordance with the 3-step charge technology instead of its standard 1-step method, and that the batteries are charged faster within a shorter period.

You can also choose a powerful second Mastervolt Alpha alternator with Alpha Pro charge regulator. This combination was specifically designed for charging service batteries, and allows you to charge quickly and turn off your engine when you moor.

Alpha alternator series

- Fast & complete charging of starter/service/bowthruster batteries.
- Power supply for all consumers.
- 12V and 24V versions.
- 75A to 150A charge current.
- Standard delivered with Alpha Pro charge regulator for an optimal performance and longer-lasting batteries.

Alpha Pro charge regulators

- Alpha alternator kit with connection cable.
- B-model for Bosch alternators, delivered with plug & play connection.

The charge voltage is automatically adjusted if there is any risk of gas formation. Electronics permanently regulate the voltage, ensuring that the battery is always kept in good condition.

Tip: Become independent of shore power and choose a powerful charge system on your main engine.

Fast charging, even at a stationary rpm

Standard alternator only supply the specified capacity at a high rpm. The Mastervolt Alpha generator was specifically designed to charge powerfully, even with a low engine rpm.



For all engine types

Alpha alternators are equipped with several fixations for customized alternator brackets, available from your installer or engine supplier. Some engine brands come with Mastervolt alternator brackets as an option.



Multi-belt pulley

The 12/130 and 24/75 models are also available with a multi-belt pulley.



Performs above 40°C

Forced cooling via the ventilator action of the pulley provides a lot of power in higher temperatures, even in enclosed engine rooms where the temperature can easily rise above 40°C.



**Alpha Pro charge regulator:
Easy to install**

The Alpha Pro charge regulator is equipped with a microprocessor for Mastervolt's 3-step charging method and fastening connections for the included cable to the alternator. Also included is a telejack plug for the temperature sensor that is to be connected to the largest and warmest battery. The charge regulator has a functional, waterproof design (IP65) and features electronics housed inside synthetic material.

Alpha Alternator Specifications



	12/90	12/130*	24/75*	24/95C	24/110	24/150
Item #	48012090	48012130	48024075	46020950	48024110	48024150
Type cabinet	A	B	B	D	B	C
Charge current	90A	130A	75A	95A	110A	150A
Alpha Pro charge regulator	standard	standard	standard	standard	standard	standard
Charge voltage absorption	14.25V	14.25V	28.5V	28.5V	28.5V	28.5V
Charge voltage float	13.25V	13.25V	26.5V	26.5V	26.5V	26.5V
Cable length regulator/alternator	1.5 meter / 4.9 ft, oil resistant marine connection cable — delivered as standard					
Pulley (double) diameter	ø 73 mm	ø 88 mm	ø 88 mm	ø 76,4 mm	ø 88 mm	ø 92 mm
Belt section	2xA	2xA	2xA	2xA	2xA	2xA
Isolated from mass	yes	yes	yes	yes	yes	yes
Directions of revolutions	2	2	2	1 (clockwise)	2	2
Weight	12.1 lbs 5.5 kg	22.3 lbs 10.1 kg	22.3 lbs 10.1 kg	17.4 lbs 7.9 kg	22.3 lbs 10.1 kg	28.9 lbs 13.1 kg
Dimensions						
Mounting	five to six, six o'clock & five past six	six o'clock	six o'clock	five past six	six o'clock	five to six, six o'clock & five past six
Charge regulation	the Alpha Pro regulator is standard with all models, see table hereunder					

* Available with multi-belt pulley (12/130 model = **48012131**, 24/75 model = **48024076**).

Alpha Pro Regulators Specifications



	45511000	45511200	45511400	45511600
Charge voltage – bulk/absorption*	14.25V	28.5V	14.25V	28.5V
Charge voltage – float*	13.25V	26.5V	13.25V	26.5V
Adjustability bulk	13–15V	27–31V	13–15V	27–31V
Adjustability float	13–13.9V	26–28.8V	13–13.9V	26–28.8V
Temperature compensation	-30 mV/°C -17 mV/°F	-60 mV/°C -33 mV/°F	-30 mV/°C -17 mV/°F	-60 mV/°C -33 mV/°F
Absorption time	4 hours, adjustable from 2 minutes to 12 hours			
Cable length regulator/alternator	1.5 metre / 4.9 ft, oil resistant marine connection cable — delivered as standard			
Connection plug regulator/alternator	Alpha/Mastervolt	Alpha/Mastervolt	Alpha/Bosch	Alpha/Bosch
Cable length temperature sensor	19.7' / 6 m	19.7' / 6 m	19.7' / 6 m	19.7' / 6 m
Protection degree	IP65	IP65	IP65	IP65
Dimensions, hxxwx d	3.5"x3.7"x1.2" 90x95x30 mm	3.5"x3.7"x1.2" 90x95x30 mm	3.5"x3.7"x1.2" 90x95x30 mm	3.5"x3.7"x1.2" 90x95x30 mm
Weight	0.9 lbs / 0.4 kg	0.9 lbs / 0.4 kg	0.9 lbs / 0.4 kg	0.9 lbs / 0.4 kg
Suitable for alternator type	various	various	Bosch	Bosch

* Voltage at 25°C / 77°F (with connected temperature sensor 14.4/28.8V at 20°C / 68°F).

In Q2 2012 also available with MasterBus. Please check the Mastervolt site for the latest information.





The sun as extra energy source

As photovoltaic cells generate energy when exposed to sunlight, they can provide a sustainable energy source and charge the batteries on your yacht. All Mastervolt's know-how in the field of solar power has been included in the Solar ChargeMaster, which offers maximum efficiency from the often irregular availability of sunlight. Power electronics provide a pure charge current in all conditions while the 3-step charging method ensures a safe charging process and a longer lifespan for your batteries.

Features

- Works with nearly all solar panels (PV-modules).
- Suitable for 12V and 24V.
- Clear LCD display and graphics.
- 3-Step charging method adjustable for all battery types.
- Automatic night detection.
- Extensive alarm system (buzzer).
- Automatically switches off load when battery current is low.
- Comes as standard with temperature sensor for batteries.
- Optional PC-Link for PC and laptop.

Solar ChargeMaster Specifications



SCM-N 20



SCM-N 40

Item #	131802000	131804000
Charge current	20A	40A
Max. DC load	20A	40A
Solar input voltage window	12-50V DC	12-50V DC
System voltage (battery)	12/24V auto detect	12/24V auto detect
No load	< 4 mA	< 4 mA
Functions LCD display	battery status/V/A/charge & discharge	
Connections	screw terminal	screw terminal
Settings	load/disconnect, 3-step charge characteristic	
Dimensions, hxxwxd	5.5"x4.1"x1.6" 140x105x41 mm	5.5"x4.1"x1.6" 140x105x41 mm
Protection degree cabinet	IP20	IP20
Weight	2 lbs / 189 gr	2 lbs / 189 gr
PC-Link	21730400 option	21730400 option





Convert: The latest technology for maximum pleasure

It is only right that you wish to enjoy the same luxuries onboard as you have at home, including a microwave, LCD TV, coffee maker, phone charger and music system – all without glitches, dips or errors and in complete safety. Mastervolt has the solution you require. All our power conversion products are based on the latest technologies, and designed for a maritime environment. This results in smarter, smaller, lighter and quieter products. What's more, you benefit from the reliability and long lifespan for which Mastervolt products have been renowned for over 20 years.

While all our products work very well with other brands, a perfect synergy is achieved when you exclusively combine Mastervolt products. Most are equipped with a MasterBus communication protocol with high-speed CANbus technology.

This ensures seamless synchronisation and all the necessary system information via the MasterView control panels at a glance. Add in the astonishing ease of installation and Mastervolt standards of reliability and you have an integrated electrical system onboard offering far more than the sum of its parts. It is this that sets Mastervolt apart from all other brands!



Battery Chargers _____	50
ChargeMaster Specifications – 12V _____	52
ChargeMaster Specifications – 24V _____	54
Mass Specifications – 12, 24 & 48V _____	56
ICS Battery Chargers – 120V _____	58
Charge Pro™ Chargers _____	59
ConnectCharge™ Inlets & Cruising Series Chargers _____	60
Maintainers/Chargers _____	61
Sine Wave Inverters _____	62
AC Master Specifications – 230V _____	64
Mass Sine Specifications – 230V / 120V _____	66
Mass Combi _____	68
DC–DC Converters _____	74
DC Master Specifications _____	76
Mac & Magic Specifications _____	78
Isolation Transformers _____	80





Battery Chargers: A long life for your battery!

Do you want to charge your batteries safely, reliably, and preferably, quickly, even when you are in a marina with poor shore power or a limited power supply? Do you also value batteries that have a long lifespan while maintaining their capacity? Mastervolt offers you the best possible solution. The Mastervolt 3-step[®] charging method ensures more power and a longer life for your batteries. Our battery chargers integrate multiple functions, charging your battery safely and completely even when they are depleted. Fast battery charging is guaranteed by the efficient use of the available shore or generator power (all Mastervolt battery chargers have a power factor correction). Mastervolt is Green by Heart.

Which battery charger best meets your needs?

We offer three types of battery chargers:

ICS, Charge Pro™, and Cruising Series: range of waterproof battery chargers for recreational use and sport fisherman. Multiple outputs allow for flexibility.

ChargeMaster: Suitable for recreational and semi-professional use. Easy to install, it includes a detailed display and easy three-button controls. The ChargeMaster safely charges multiple battery banks at the same time.

Mass: For the tougher tasks in professional and semi-professional situations. With its integrated alarm functions and various certificates, the Mass is the best choice for professionals.



Choosing your battery charger?

Determine:

- How many battery banks do I want to charge?
- What voltage do I need to supply. The battery charger must have the same voltage as the battery bank.
- Rule of thumb is that 25% of the battery capacity (up to 50% for gel batteries) as a charge capacity is sufficient to safely and quickly charge batteries while still supplying power to the onboard network. For instance, a battery charger of 50 amps is sufficient for a 200 Ah battery.

The best battery charger for every application

The ChargeMaster can charge multiple battery banks at once, providing the ease and comfort of combined functionalities. The Mass battery charger has one main outlet to optimally charge a battery bank and guarantee a long lifespan for your batteries even with daily and intensive use. The second outlet is used for the maintenance charge of your starter battery.



Charging Lithium Ion batteries

Although Lithium Ion batteries are increasingly popular, there can be a lack of clarity when it comes to the charging process. This is not a problem with a Mastervolt system as the Mastervolt battery charger communicates directly with the Li-ion battery.



Make the most of your shore power

The current control function allows you to easily switch the battery charger back to shore power to prevent blowing the shore fuse, even when the shore power drops.



MasterBus compatible

All ChargeMaster & Mass battery chargers can be easily connected to a MasterBus network with only one cable and one connection. What's more, you have the option for central, local or remote monitoring, configuration and control of your system.



Robust connections

Solid metal-to-metal connections prevent corrosion and/or overheating.

Convert: ChargeMaster Specifications – 12V







ChargeMaster
12/10-1



ChargeMaster
12/15-2



ChargeMaster
12/25-3

Item #	43011000	43011500	44010250
General Specifications			
Nominal output voltage	12V	12V	12V
Total charge current	10A at 14.25V	15A at 14.25V	25A at 13.25V
Number of battery outlets	1	2	3
Charge current second output	n.a.	15A	25A
Charge current third output	n.a.	n.a.	25A
Recommended battery capacity	25–100 Ah	30–150 Ah	50–250 Ah
Nominal input voltage	230V (180–265V) – 50/60Hz	230V (180–265V) – 50/60Hz	120/230V (90–265V) – 50/60Hz
AC connection	socket	socket	2 mtr AC cable
Supplies your system without battery	no	no	yes
Display/read-out	1 LED	1 LED	LED display
Dimensions, hwxwx	7.1"x4.8"x2" 180x121x50 mm	8.1"x4.8"x2" 206x121x50 mm	9.2"x5.2"x2.4" 234x132x60 mm
Weight	1 kg / 2.2 lbs	1 kg / 2.2 lbs	1,8 kg / 4 lbs
Fastening	screw	screw	screw
Approvals	CE, E-mark, ABYC A-31	CE, E-mark, ABYC A-31	CE, E-mark, ABYC A-31, SAE...
Technical Specifications			
Charge characteristic**	IUoUo, automatic / 3-step [⊙] for gel/AGM/wet/Lithium Ion		
Charge voltage Bulk (25°C)***	14.25V (6 hours)	14.25V (6 hours)	14.4V (8 hours)
Charge voltage Absorption (25°C)***	14.25V (6 hours)	14.25V (6 hours)	14.25V (4 hours)
Charge voltage Float – wet (25°C)***	13.25V	13.25V	13.25V
Charge voltage Float – gel/AGM (25°C)***	13.8V	13.8V	13.8V
Temperature compensation	no	no	-30 mV/°C or -17 mV/°F
Voltage compensation	automatic	automatic	automatic
DC consumption	<1 mA	<1 mA	<2 mA
Full load consumption (230V AC)	170 W	250 W	450 W
Current Control function	no	no	no
Cos phi	>0.95	>0.95	≥0.98
Temperature range (ambient temp.)	-25°C–60°C, >40°C derating -13°F–140°F, >104°F derating	-25°C–60°C, >40°C derating -13°F–140°F, >104°F derating	-25°C–60°C, >25°C derating -13°F–140°F, >77°F derating
Cooling	natural cooling	maintenance vario fan to ensure optimized cooling	
Sound level	<30 dbA at 1 mtr	<52 dbA at 1 mtr	<52 dbA at 1 mtr
Protection degree	IP65	IP21	IP23
Protections	over temperature, over load, short circuit, high battery, low battery		
MasterBus compatible	no	no	yes
CSI/DC alarm	no	no	yes, using a...
Options			
MasterView Read-out 77010050	 n.a.	n.a.	Remote panel for reading the charge status of your battery...
MasterView Easy 77010305	 n.a.	n.a.	Touch screen panel for reading charge status, current fold-back...
MasterShunt 77020100	 n.a.	n.a.	MasterBus integrated battery monitor, with detailed...
MasterBus USB Interface 77030100	 n.a.	n.a.	Communication port between MasterBus and the USB port of...
Multipurpose Contact Output 77030500	 n.a.	n.a.	MasterBus controllable potential-free contact, with...

* At request also available with 90–400V DC input voltage.

** The charge characteristic can be set to your requirements.

*** The battery charge current can sometimes be specified at 20°C/68°F, so take temperature compensation into account.



ChargeMaster
12/35-3

44010350



ChargeMaster
12/50-3

44010500



ChargeMaster
12/70-3*

44010700



ChargeMaster
12/100-3*

44011000

12V	12V	12V	12V
35A at 14.4V	50A at 14.4V	70A at 14.4V	100A at 14.4V
3	3	3	3
35A	50A	10A	10A
35A	50A	10A	10A
70–350 Ah	100–500 Ah	140–700 Ah	200–1000 Ah
120/230V (90–265V) – 50/60Hz	120/230V (90–265V) – 50/60Hz	120/230V (90–265V) – 50/60Hz	120/230V (90–265V) – 50/60Hz
connector strips	connector strips	connector strips	connector strips
yes	yes	yes	yes
LED display	LED display	LCD display	LCD display
11.5"x8.3"x5.2" 291x210x131 mm	11.5"x8.3"x5.2" 291x210x131 mm	14.3"x11"x5.9" 362x277x150 mm	14.3"x11"x5.9" 362x277x150 mm
4 kg / 9 lbs	4 kg / 9 lbs	7 kg / 16 lbs	7 kg / 16 lbs
with the supplied mounting bracket or 4x screw for wall mounting or 4x screw for floor installation			
J1171/ISO 8846 ignition protected			

IUoUo, automatic / 3-step© for gel/AGM/wet/Lithium Ion			
14.4V (8 hours)	14.4V (8 hours)	14.4V (8 hours)	14.4V (8 hours)
14.25V (4 hours)	14.25V (4 hours)	14.25V (4 hours)	14.25V (4 hours)
13.25V	13.25V	13.25V	13.25V
13.8V	13.8V	13.8V	13.8V
-30 mV/°C or -17 mV/°F	-30 mV/°C or -17 mV/°F	-30 mV/°C or -17 mV/°F	-30 mV/°C or -17 mV/°F
automatic	automatic	automatic	automatic
<5 mA	<5 mA	<5 mA	<5 mA
575 W	825 W	1200 W	1700 W
yes, through MasterBus	yes, through MasterBus	yes, through MasterBus	yes, through MasterBus
≥0.98	≥0.98	≥0.98	≥0.98
-25°C–60°C, >40°C derating -13°F–140°F, >104°F derating	-25°C–60°C, >40°C derating -13°F–140°F, >104°F derating	-25°C–60°C, >40°C derating -13°F–140°F, >104°F derating	-25°C–60°C, >40°C derating -13°F–140°F, >104°F derating
maintenance vario fan to ensure optimized cooling			
<52 dBA at 1 mtr	<52 dBA at 1 mtr	<52 dBA at 1 mtr	<52 dBA at 1 mtr
IP23	IP23	IP23	IP23
over temperature, over load, short circuit, high battery, low battery			
yes	yes	yes	yes
Multipurpose Contact Output (Item # 77030500)			

charger, including error notifications.

and/or Power Sharing setting.

information on the status of your batteries for a optimized charging process, incl. voltage, current, remaining time and consumption capacity in percentage.

your PC; makes possible reading and configuration of your MasterBus system on the PC when combined with MasterView System software (free to download).

alarm notification on the onboard system (low voltage or no AC), replacement of the CSI alarm contact.

Convert: ChargeMaster Specifications – 24V



ChargeMaster
24/6-1







ChargeMaster
24/12-3



ChargeMaster
24/20-3



ChargeMaster
24/30-3

Item #	43020600	44020120	44020200	44020300
General Specifications				
Nominal output voltage	24V	24V	24V	24V
Total charge current	6A at 28.5V	12A at 26.5V	20A at 28.8V	30A at 28.8V
Number of battery outlets	1	3	3	3
Charge current second output	n.a.	12A	20A	30A
Charge current third output	n.a.	12A	20A	30A
Recommended battery capacity	25–70 Ah	24–120 Ah	40–200 Ah	60–300 Ah
Nominal input voltage	230V (180–265V) – 50/60Hz	120/230V (90–265V) – 50/60Hz	120/230V (90–265V) – 50/60Hz	120/230V (90–265V) – 50/60Hz
AC connection	socket	2 mtr AC cable	connector strips	connector strips
Supplies your system without battery	no	yes	yes	yes
Display/read-out	1 LED	LED display	LED display	LED display
Dimensions, hwxwd	7.1"x4.8"x2" 180x121x50 mm	9.2"x5.2"x2.4" 234x132x60 mm	11.5"x8.3"x5.2" 291x210x131	11.5"x8.3"x5.2" 291x210x131
Weight	1 kg / 2.2 lbs	1.8 kg / 4 lbs	4 kg / 9 lbs	4 kg / 9 lbs
Fastening	4x screw	4x screw	4x screw	4x screw
Approvals	CE, E-mark, ABYC A-31	CE, E-mark, ABYC A-31, SAE J1171/ISO 8846 ignition protected		
Technical Specifications				
Charge characteristic**	IUoUo, automatic / 3-step [Ⓞ] for gel/AGM/wet/Lithium Ion			
Charge voltage Bulk (25°C)***	28.5V (6 hours)	28.8V (8 hours)	28.8V (8 hours)	28.8V (8 hours)
Charge voltage Absorption (25°C)***	28.5V (6 hours)	28.5V (4 hours)	28.5V (4 hours)	28.5V (4 hours)
Charge voltage Float – wet (25°C)***	26.5V	26.5V	26.5V	26.5V
Charge voltage Float – gel/AGM (25°C)***	27.6V	27.6V	27.6V	27.6V
Temperature compensation	no	-60 mV/°C or -33 mV/°F	-60 mV/°C or -33 mV/°F	-60 mV/°C or -33 mV/°F
Voltage compensation	automatic	automatic	automatic	automatic
DC consumption	<1 mA	<2 mA	<2.5 mA	<2.5 mA
Full load consumption (230V AC)	210 W	435 W	660 W	925 W
Current Control function	no	no	yes, through MasterBus	yes, through MasterBus
Cos phi	>0.95	≥0.98	≥0.98	≥0.98
Temperature range (ambient temp.)	-25°C–60°C, >40°C derating -13°F–140°F, >104°F derating	-25°C–60°C, >25°C derating -13°F–140°F, >77°F derating	-25°C–60°C, >40°C derating -13°F–140°F, >104°F derating	-25°C–60°C, >40°C derating -13°F–140°F, >104°F derating
Cooling	natural cooling	-13°F–140°F, >77°F derating		
Sound level	<30 dBA at 1 mtr	<52 dBA at 1 mtr	<52 dBA at 1 mtr	<52 dBA at 1 mtr
Protection degree	IP65	IP23	IP23	IP23
Protections	over temperature, over load, short circuit, high battery, low battery			
MasterBus compatible	no	yes	yes	yes
CSI/DC alarm	no	yes, using a Multipurpose Contact Output		
77030500				
Options				
MasterView Read-out 77010050		n.a.	Remote panel for reading the charge status of your battery charger, incl. error notifications.	
MasterView Easy 77010305		n.a.	Touch screen panel for reading charge status, current fold-back and/or Power Sharing setting.	
MasterShunt 77020100		n.a.	MasterBus integrated battery monitor, with detailed information on the status of your batteries for a optimized charging process, incl. voltage, current, remaining time...	
MasterBus USB Interface 77030100		n.a.	Communication port between MasterBus and the USB port of your PC; makes possible reading and configuration of your MasterBus system on the PC when...	
Multipurpose Contact Output 77030500		n.a.	MasterBus controllable potential-free contact, with alarm notification on the onboard system (low voltage or no AC), replacement of the CSI alarm contact.	

* At request also available with 90–400V DC input voltage. ** The charge characteristic can be set to your requirements.

*** The battery charge current can sometimes be specified at 20°C/68°F, so take temperature compensation into account.



ChargeMaster
24/40-3*



ChargeMaster
24/60-3*



ChargeMaster
24/80-3*



ChargeMaster
24/100-3*

44020400	44020600	44020800	44021000
24V	24V	24V	24V
40A at 28.8V	60A at 28.8V	80A at 28.8V	100A at 28.8V
3	3	3	3
10A	10A	10A	10A
10A	10A	10A	10A
80–400 Ah	120–600 Ah	160–800 Ah	200–1000 Ah
120/230V (90–265V) – 50/60Hz	120/230V (90–265V) – 50/60Hz	120/230V (90–265V) – 50/60Hz	120/230V (90–265V) – 50/60Hz
connector strips	connector strips	connector strips	connector strips
yes	yes	yes	yes
LCD display	LCD display	LCD display	LCD display
14.3"x11"x5.9" 362x277x150	14.3"x11"x5.9" 362x277x150	17"x11"x5.9" 432x277x150	17"x11"x5.9" 432x277x150
7 kg / 16 lbs	7 kg / 16 lbs	8 kg / 18 lbs	8 kg / 18 lbs
with the supplied mounting bracket or 4x screw for wall mounting or 4x screw for floor installation			
CE, E-mark, ABYC A-31, SAE J1171/ISO 8846 ignition protected			
IUoUo, automatic / 3-step© for gel/AGM/wet/Lithium Ion			
28.8V (8 hours)	28.8V (8 hours)	28.8V (8 hours)	28.8V (8 hours)
28.5V (4 hours)	28.5V (4 hours)	28.5V (4 hours)	28.5V (4 hours)
26.5V	26.5V	26.5V	26.5V
27.6V	27.6V	27.6V	27.6V
-60 mV/°C or -33 mV/°F	-60 mV/°C or -33 mV/°F	-60 mV/°C or -33 mV/°F	-60 mV/°C or -33 mV/°F
automatic	automatic	automatic	automatic
<5 mA	<5 mA	<5 mA	<5 mA
1400 W	2000 W	2700 W	3375 W
yes, through MasterBus	yes, through MasterBus	yes, through MasterBus	yes, through MasterBus
≥0.98	≥0.98	≥0.98	≥0.98
-25°C–60°C, >40°C derating -13°F–140°F, >104°F derating		-25°C–60°C, >40°C derating -13°F–140°F, >104°F derating	
maintenance free vario fan for optimal cooling			
<52 dBA at 1 mtr	<52 dBA at 1 mtr	<52 dBA at 1 mtr	<52 dBA at 1 mtr
IP23	IP23	IP23	IP23
over temperature, over load, short circuit, high battery, low battery			
yes	yes	yes	yes
yes, using a Multipurpose Contact Output			
Remote panel for reading the charge status of your battery charger, incl. error notifications.			
Touch screen panel for reading charge status, current fold-back and/or Power Sharing setting.			
and consumption capacity in percentage.			
combined with MasterView System software (free to download).			
MasterBus controllable potential-free contact, with alarm notification on the onboard system (low voltage or no AC), replacement of the CSI alarm contact.			

Convert: Mass Specifications – 12, 24 & 48V



Mass
12/60-2









Mass
12/80-2



Mass
24/15-2



Mass
24/25-2

Item #	40010606	40010806	40020156	40020256
General Specifications				
Nominal output voltage	12V	12V	24V	24V
Total charge current	60A at 14.25V	80A at 14.25V	15A at 28.5V	25A at 28.5V
Number of battery outlets	2	2	2	2
Charge current second output	3A	3A	3A	3A
Recommended battery capacity	120–600 Ah	160–800 Ah	30–150 Ah	50–250 Ah
Nominal input voltage	230V (180–265V) – 50/60Hz		230V (180–265V) – 50/60Hz	
Supplies your system without battery	yes	yes	yes	yes
Display/read-out	LED display	LED display	LED display	LED display
Dimensions, hwxwd	13.4"x10.3"x5.1" 340x261x130 mm	13.4"x10.3"x5.1" 340x261x130 mm	12.8"x8.7"x4.4" 325x220x111 mm	12.8"x8.7"x4.4" 325x220x111 mm
Weight	4.6 kg / 10.1 lbs	4.6 kg / 10.1 lbs	3.3 kg / 7.3 lbs	3.3 kg / 7.3 lbs
Approvals**	CE, E-mark, ABYC A-31 / RRR, RS, DNV, Lloyds, Bureau Veritas, Germanischer Lloyds			
Technical Specifications				
Charge characteristic***	IUoUo, automatic / 3-step® for gel/AGM/wet/Lithium Ion			
Charge voltage Bulk (25°C)****	14.25V (8 hours)	14.25V (8 hours)	28.5V (8 hours)	28.5V (8 hours)
Charge voltage Absorption (25°C)****	14.25V (4 hours)	14.25V (4 hours)	28.5V (4 hours)	28.5V (4 hours)
Charge voltage Float – wet (25°C)****	13.25V	13.25V	26.5V	26.5V
Charge voltage Float – gel/AGM (25°C)****	13.8V	13.8V	27.6V	27.6V
Temperature compensation	-30 mV/°C or -17 mV/°F	-30 mV/°C or -17 mV/°F	-60 mV/°C or -33 mV/°F	-60 mV/°C or -33 mV/°F
Voltage compensation	voltage drop compensation in DC cables up to 3 volt			
DC consumption	<1 mA	<1 mA	<1 mA	<1 mA
Full load consumption (230V AC)	1100 W	1400 W	550 W	880 W
Cos phi	>0.95	>0.95	>0.95	>0.95
Temperature range (ambient temp.)	-25°C–80°C, >45°C derating			
Cooling	vario fan	vario fan	vario fan	vario fan
Sound level	<48 dBA at 1 mtr	<48 dBA at 1 mtr	<48 dBA at 1 mtr	<48 dBA at 1 mtr
Protection degree	IP23	IP23	IP23	IP23
Protections	over temperature, over load, short circuit, high battery, low battery			
MasterBus compatible	yes	yes	yes	yes
CSI/DC alarm (Charger Status Interface)	integrated in the battery charger as standard			
GMDSS function	GMDSS panel is available for all models			
Options				
MasterView Read-out 77010050		Remote panel for reading the charge status of your battery charger, including error notifications.		
MasterView Easy 77010305		Touch screen panel for reading charge status, current fold-back and/or Power Sharing setting.		
MasterShunt 77020100		MasterBus integrated shunt, with detailed information on the status of your batteries for a optimized charging process, incl. voltage, current, remaining time and consumption capacity in percentage.		
MasterBus USB Interface 77030100		Communication port between MasterBus and the USB port of your PC; makes possible reading and configuration of your MasterBus system on the PC when combined with MasterView System software...		
MasterVision panels	Model C3-RS 70403040		Masterlink MICC 70403105	

* Available as option: second output 3A (Item # **21711000**).

** Check our website for the certificates per model.

*** The charge characteristic can be set to your requirements.

**** The battery charge current can sometimes be specified at 20°C/68°F, so take temperature compensation into account.



Mass
24/50-2

Mass
24/75

Mass
24/100

Mass
24/100-3ph

Mass
48/25

Mass
48/50

40020506

40020756

40021006

40031006

40040256

40040506

24V

24V

24V

24V

48V

48V

50A at 28.5V

75A at 28.5V

100A at 28.5V

100A at 28.5V

25A at 57V

50A at 57V

2

1

1

1

1

1

3A

n.a.*

n.a.*

n.a.*

n.a.

n.a.

100–500 Ah

150–750 Ah

200–1000 Ah

200–1000 Ah

100–500 Ah

100–500 Ah

230V (180–265V) – 50/60Hz

3x400V (360–485V)

230V (180–250V) – 50/60Hz

yes

yes

yes

yes

yes

yes

LED display

LED display

LED display

LED display

LED display

LED display

13.4"x10.3"x5.1"
340x261x130 mm

13.4"x10.3"x5.1"
340x261x130 mm

13.4"x10.3"x5.1"
340x261x130 mm

16.5"x12.5"x5.1"
420x318x130 mm

16.5"x12.5"x5.1"
420x318x130 mm

16.5"x12.5"x5.1"
420x318x130 mm

4.6 kg / 10.1 lbs

7.7 kg / 17 lbs

7.7 kg / 17 lbs

7.7 kg / 17 lbs

4.6 kg / 10.1 lbs

7.7 kg / 17 lbs

CE, E-mark, ABYC A-31 / RRR, RS, DNV, Lloyds, Bureau Veritas, Germanischer Lloyds

IUoUo, automatic / 3-step© for gel/AGM/wet/Lithium Ion

28.5V (8 hours)

28.5V (8 hours)

28.5V (8 hours)

28.5V (8 hours)

57V (8 hours)

57V (8 hours)

28.5V (4 hours)

28.5V (4 hours)

28.5V (4 hours)

28.5V (4 hours)

57V (4 hours)

57V (4 hours)

26.5V

26.5V

26.5V

26.5V

53V

53V

27.6V

27.6V

27.6V

27.6V

55.2V

55.2V

-60 mV/°C or -33 mV/°F

-60 mV/°C or -33 mV/°F

-60 mV/°C or -33 mV/°F

-60 mV/°C or -33 mV/°F

-120 mV/°C or -62 mV/°F

-120 mV/°C or -62 mV/°F

voltage drop compensation in DC cables up to 3 volt

<1 mA

<1 mA

<1 mA

<1 mA

<1 mA

<1 mA

1800 W

2600 W

3500 W

3500 W

1800 W

3500 W

>0.95

>0.95

>0.95

>0.95

>0.95

>0.95

-25°C–80°C, >45°C derating

vario fan

vario fan

vario fan

vario fan

vario fan

vario fan

<48 dBA at 1 mtr

<48 dBA at 1 mtr

<48 dBA at 1 mtr

<48 dBA at 1 mtr

<48 dBA at 1 mtr

<48 dBA at 1 mtr

IP23

IP23

IP23

IP23

IP23

IP23

over temperature, over load, short circuit, high battery, low battery

yes

yes

yes

yes

yes

yes

integrated in the battery charger as standard

GMDSS panel is available for all models

Remote panel for reading the charge status of your battery charger, including error notifications.

Touch screen panel for reading charge status, current fold-back and/or Power Sharing setting.

MasterBus integrated shunt, with detailed information on the status of your batteries for a optimized charging process, incl. voltage, current, remaining time and consumption capacity in percentage.

(free to download).



Waterproof battery chargers

The ICS chargers are designed so user communication with the microprocessor happens at the touch-pad control center. Positioned at the top of the charger, the control center provides easy viewing of charge status, along with user selectable controls to tailor each charge output for specific battery types (AGM, Flooded, Gel or hi-performance AGM).

Advanced microprocessor control for each output ensures that each battery onboard receives the precise charging profile to optimize available power and extend battery life. Tri-color LED displays provide easy viewing of charge status for each battery, plus warning indicators that alert boaters to small problems before they become large ones.

- Best charging output
- Battery type selectable (Flooded, Gel, AGM or hi-performance AGM)
- Remote indicator ready
- Timer in second stage prevents overcharging of bad batteries
- Water resistant for harsh environment performance



6 Amp Single Output



12 Amp Dual Output



18 Amp Triple Output
On-Board Battery Charger



20 Amp Dual Output
On-Board Battery Charger

Item #	16061	16102	16153	16202
Remote Indicator	16001-RI	16003-RI	16003-RI	16003-RI
Total Amps	6	12	18	20
Outputs	1	2	3	2
Amps per out	6	6/6	6/6/6	10/10
Battery System	12V only	12V+12V or 24V	12V+12V+12V or 12V+24V or 36V	12V, 12V, 12V+12V or 24V
Input Voltage	95–135V AC / 60Hz, 2.5A	95–135V AC / 60Hz, 3.5A	95–135V AC/60Hz, 4.5A	95–135V AC, 50/60Hz, 5A
Output Voltage	12V	12V DC	12V DC	12V DC
AC	6' cord w/ ConnectCharge™ plug	6' cord w/ ConnectCharge™ plug	6' cord w/ ConnectCharge™ plug	6' cord w/ ConnectCharge™ plug
DC	4' with ring terminals	4' with ring terminals	4' with ring terminals	4' with ring terminals
Dimensions	2.4" x 4.9" x 7.0" 61x124x178 mm	3.0" x 7.1" x 6.6" 76x180x168 mm	3.0" x 7.1" x 9.8" 76x180x251 mm	3.0" x 7.1" x 9.9" 76x180x251 mm
Weight	3.0 lbs	4.5 lbs	6.0 lbs	6.75 lbs



Remote Indicator

For use with ICS battery chargers

- 15' cable included
- Easy installation - plugs right into ICS battery chargers

Item # 16001-RI



Remote Indicator

For use with ICS battery chargers

- 15' cable included
- Easy installation - plugs right into ICS battery chargers

Item # 16003-RI



6 Amp Single Output



6 Amp Dual Output



10 Amp Dual Output



10 Amp Dual Output

Item #	2608A	2607A	2610A	2611A
OEM #	2608A-B	2607A-B	2610A-B	2611A-B
Total Amps	6	6	10	10
Outputs	1	2	2	2
Amps per out	6	3/3	5/5	5/5
Battery System	12V	12V+12V or 24V	12V+12V	12V+12V or 24V
Input Voltage	100–130V AC / 60Hz	100–130V AC / 60Hz	100–130V AC / 60Hz	100–130V AC / 60Hz
Output Voltage	12V	12V	12V	12V
AC	6' cord w/ ConnectCharge™ plug	6' cord w/ ConnectCharge™ plug	Studs	6' cord w/ ConnectCharge™ plug
DC	4' with ring terminals	4' with ring terminals	Studs	4' with ring terminals
Dimensions	3.50" x 6.40" x 2.25" 89x163x57 mm	3.50" x 6.40" x 2.25" 89x163x57 mm	5.50" x 7.75" x 2.42" 140x197x61 mm	5.50" x 7.75" x 2.42" 140x197x61 mm
Weight	4.0 lbs	4.0 lbs	5.6 lbs	5.6 lbs



15 Amp Triple Output



20 Amp Dual Output



25 Amp Triple Output



30 Amp Triple Output

Item #	2613A	2620A	2623A	2631A
Total Amps	15	20	25	30
Outputs	3	2	3	3
Amps per out	5/5/5	10/10	10/5/10	10/10/10
Battery System	12V+12V+12V or 24V+12V	12V+12V or 24V	12V+12V+12V or 24V+12V	12V+12V+12V or 24V+12V or 36V
Input Voltage	100–130V AC / 60Hz	100–130V AC / 60Hz	100–130V AC / 60Hz	100–130V AC / 60Hz
Output Voltage	12V	12V	12V	12V
AC	6' cord w/ ConnectCharge™ plug	6' cord w/ ConnectCharge™ plug	6' cord w/ ConnectCharge™ plug	6' cord w/ ConnectCharge™ plug
DC	4'/4'/6' with ring terminals	6' with ring terminals	6' with ring terminals	6' with ring terminals
Dimensions	7.0" x 9.60" x 2.60" 178x244x66 mm	7.0" x 9.60" x 2.60" 178x244x66 mm	7.0" x 13.0" x 2.60" 178x330x66 mm	7.0" x 13.0" x 2.60" 178x330x66 mm
Weight	8.0 lbs	8.0 lbs	13.0 lbs	13.0 lbs



35 Amp Four Output



10 Amp Single Output

OEM #	2635-B	2611A-1-B
Total Amps	35	10
Outputs	4	1
Amps per out	5/10/10/10	10
Battery System	12V+12V+12V+12V or 24V+12V+12V or 36V+12V	12V
Input Voltage	100–130V AC / 60Hz	100–130V AC / 60Hz
Output Voltage	12V	12V
AC	6' cord w/ ConnectCharge™ plug	6' cord w/ ConnectCharge™ plug
DC	6' with ring terminals	4' with ring terminals
Dimensions	6.5" x 16.10" x 2.50" 165x409x64 mm	5.50" x 7.75" x 2.42" 140x197x61 mm
Weight	24.0 lbs	5.6 lbs

Convert: ConnectCharge™ Inlets & Cruising Series Chargers

ConnectCharge™ Inlets



Universal Mount

- Mount to dash from rear with threaded locking ring or from the front with three screws through the face plate

Item # **150CCI**



Rear Mount

- Mounts to dash from rear with threaded locking ring
- Eliminates rewiring, plug snaps into Inlet locking tab
- Watertight lid protects AC plug

OEM # 150CCTM.OEM



Front Mount

- Mounts to panel from front with three screws through the face plate

OEM # 150CC.OEM

For use with
Battery chargers with
ConnectCharge™ Plug only!

Exclusive
molded notch on
plug locks into
ConnectCharge™ inlet



Cruising Series

Guest Cruising Chargers are made specifically for a coastal, blue water environment where top quality, rugged equipment is required. They feature individual circuit boards, which provide each battery its own specific charging circuit. The benefit is a well-designed charging system that protects your battery investment. Guest Cruising Chargers also function as a continuous 12 volt power supply to run your DC accessories while at the dock.

- Dedicated output per battery, each battery receives individual attention
- Provides different charging amperages as required by each battery



15 Amp Dual Output



20 Amp Dual Output



20 Amp Triple Output



30 Amp Triple Output



30 Amp Dual Output

Item #	2614A	2622A	2621A	2632A	2633A
Total Amps	15	20	20	30	30
Outputs	2	2	3	3	2
Amps per out	5/10	10/10	5/5/10	5/5/20	10/20
Battery System	12V+12V	12V+12V	12V+12V+12V	12V+12V+12V	12V+12V
Input Voltage	100-130V AC / 60Hz	100-130V AC / 60Hz	100-130V AC / 60Hz	100-130V AC / 60Hz	100-130V AC / 60Hz
Output Voltage	12V	12V	12V	12V	12V
AC	Studs	Studs	Studs	Studs	Studs
DC	Studs	Studs	Studs	Studs	Studs
Dimensions	2.92" x 9.60" x 9.84" 74x244x250 mm	2.92" x 9.60" x 9.84" 74x244x250 mm	2.92" x 9.60" x 9.84" 74x244x250 mm	2.92" x 12.96" x 9.84" 74x329x250 mm	2.92" x 12.96" x 9.84" 74x329x250 mm
Weight	10.8 lbs / 4.9 kg	10.8 lbs / 4.9 kg	10.8 lbs / 4.9 kg	15.6 lbs / 7.1 kg	15.6 lbs / 7.1 kg

230V 50/60Hz
input model

Item # **2622A-230**

230V 50/60Hz
input model

Item # **2632A-230**



Name:	.5 Amp Battery Maintainer	2 Amp Battery Charger	3 Amp Battery Charger
Item #	2602	2602A-12	2603
Total Amps:	0.5	2	3
Outputs:	1	1	1
Amps per out:	500mA/250mA	2	3
Battery System:	12V	12V	12V
Input Voltage:	100–130V AC/60Hz	100–130V AC/60Hz	100–130V AC/60Hz
Output Voltage:	12V	12V	12V
AC:	6' AC cord with standard plug	6' cord with ConnectCharge plug	6' AC cord with standard plug
DC:	4' with battery clips	4' with ring terminals	4' with battery clips
Dimensions:	1.50" x 3.0" x 2.0" 38x76x51 mm	2.75" x 4.50" x 1.50" 70x114x38 mm	3.10" x 3.50" x 2.34" 79x89x59 mm
Weight:	0.5 lbs / 0.2 kg	2.0 lbs / 0.9 kg	1.0 lbs / 0.5 kg



Name:	2 Amp Battery Charger	6 Amp Battery Charger	10 Amp Battery Charger
Item #	—	2606A	2612A
OEM #	2602A-24-B	2606A-B	—
Total Amps:	2	6	10
Outputs:	1	1	1
Amps per out:	2	6	10
Battery System:	24V	12V	12V
Input Voltage:	100–130V AC / 60Hz	100–130V AC / 60Hz	100–130V AC / 60Hz
Output Voltage:	24V	12V	12V
AC:	6' AC cord with standard plug	6' AC cord with standard plug	6' AC cord with standard plug
DC:	4' with battery clips	4' with battery clips	4' with battery clips
Dimensions:	2.75" x 4.50" x 1.50" 70x114x38 mm	5.5" x 5.0" x 2.4" 140x127x61 mm	7.5" x 5.0" x 2.4" 191x127x61 mm
Weight:	2.0 lbs / 0.9 kg	3.5 lbs / 1.6 kg	4.5 lbs / 2 kg



Mastervolt sine wave inverters: Enjoy the comforts of home

An onboard AC installation offers you a wealth of benefits by making possible the use of any domestic appliance, from microwave oven to hair dryer, DVD player to power tools. A Mastervolt inverter allows you to easily convert the voltage of your 12V or 24V battery to 230V/50Hz or 120V/60Hz, so you enjoy all the comforts of home wherever you choose to cruise.

Complete range

Mastervolt offers a complete range of inverters from 300 Watt to 15 kWatt in **AC Master** and **Mass Sine** models. The AC Master is ideal for small and medium-sized vessels, while Mass Sine inverters are mainly intended for larger systems on superyachts and for (semi-) professional purposes. Mastervolt offers inverters for 230V/50Hz as well as 120V/60Hz (American voltage). This Powerbook only includes the 230V models. For 120V models, see mastervolt.com/inverters.

Proven technology

Mastervolt's Mass Sine sine wave inverters have proven themselves in the most extreme conditions for over ten years. Although the dimensions and connections of the various models have remained the same, the technology has evolved with the times, resulting in a fast, efficient, one-on-one replacement with minimal downtime.

The Mastervolt AC Master inverters are small, lightweight and silent. Installation and operation are incredibly easy.

Completely independent on shore power

Shore power regularly fluctuates and can cause your lights to flicker. Sometimes it may even drop below 180 volt, causing some onboard devices to stop functioning. The Mastervolt sine wave inverter ensures a perfect 230 volt onboard, and makes shore power problems a thing of the past. The pure sine wave current also helps protect your equipment against failures, humming or lines on your TV and ensure a longer lifespan. Do make sure you have the correct match between your inverter power and the connected load.

An end to humming with HF technology

Our use of high-frequency switch technology means you can say goodbye to humming transformers. Mastervolt inverters are also small and lightweight to ensure easy installation.

High peak power during start up

The Mastervolt sine wave inverter can provide up to 200% capacity to equipment that requires extra power during start up.



Simple and safe to connect

The inverters benefit from robust connection technology with internal connections for the larger models and a cable and plug & play inlet for smaller models.



Efficient use of batteries

A high degree of efficiency when inverting and the automatic economy mode when there is no consumption gives you longer use of your batteries and more hours on the water.



MasterBus compatible

Thanks to the MasterBus Inverter Interface or AC power analyser, every Mass Sine inverter can be easily connected to a MasterBus network with only one cable and one connection. You can also choose for central, local or remote monitoring, configuration and control of your system.



Optimal ease of operation

Mastervolt's Mass Sine inverters are easy to operate via controls on the device, via a control panel or remote control text messaging. Plus numerous options for central or local control and monitoring via the MasterBus platform.

Convert: AC Master Specifications – 230V



AC Master
12/300



AC Master
12/500



AC Master
12/750*

Item # 230V (universal socket)	28010300	28010500	27510700
General Specifications			
Nominal battery voltage	12V	12V	12V
Recommended battery capacity	≥60 Ah	≥100 Ah	≥150 Ah
Output voltage (± 5%)	230V – 50Hz (± 0.1%)	230V – 50Hz (± 0.1%)	230V – 50Hz (± 0.1%)
Continuous power at 25°C, cos phi 1	300 W	500 W	750 W
Continuous power at 40°C, cos phi 1	250 W	400 W	600 W
Peak load	600 W	800 W	1200 W
Output waveform	true sine	true sine	true sine
Efficiency	90%	90%	90%
Display/read out	LED display	LED display	LED display
Dimensions, hxxwxd	8.3"x5.1"x2.4" 210x130x60 mm	8.3"x5.1"x2.4" 210x130x60 mm	10.8"x6.1"x3" 275x155x75 mm
Weight	1.16 kg / 2.55 lbs	1.22 kg / 2.69 lbs	2.7 kg / 5.4 lbs
Approvals	CE, E-mark, ABYC A-31	CE, E-mark, ABYC A-31	CE, E-mark, ABYC A-31
Technical Specifications			
Technology	HF switch mode	HF switch mode	HF switch mode
Low battery voltage, switches off at	10V, ± 0.5V	10V, ± 0.5V	10V, ± 0.5V
Low battery voltage, switches on at	11V, ± 0.5V	11V, ± 0.5V	12V, ±0.5V
High battery voltage, switches off at	16V, ± 0.5V	16V, ± 0.5V	15.3V, ±0.5V
High battery voltage, switches on at	14.5V, ± 0.5V	14.5V, ± 0.5V	14.2V, ±0.5V
Max. ripple on DC (battery)	10% RMS	10% RMS	5% RMS
Input current (nominal load)	22.5A	37.5A	64A
No load power consumption:			
• on mode (230V)	0.58A – 7 W	0.58A – 7 W	0.75A – 9 W
• standby (scan mode)	0.33A – 4 W	0.33A – 4 W	0.37A – 4.5 W
Minimal DC fuse (slow blow)**	40A	80A	100A
Minimal cable size	included	included	25 mm ²
Harmonic distortion typical	<6%	<6%	<3%
Cos Phi	all power factors allowed	all power factors allowed	all power factors allowed
Temperature range (ambient temp.)	-25°C–60°C, >25°C derating -13°F–140°F, >77°F derating	-25°C–60°C, >25°C derating -13°F–140°F, >77°F derating	-25°C–60°C, >25°C derating -13°F–140°F, >77°F derating
Cooling	natural/forced	natural/forced	natural/forced
Sound level	53 dBA at 1 mtr	53 dBA at 1 mtr	53 dBA at 1 mtr
Protection degree	IP23	IP23	IP23
Protections	over temperature, over load, short circuit, high battery, low battery		
MasterBus compatible	no	no	no
AC connection	universal	universal	fixed connection

* The AC Master 750 will be available in 2012, until that date a 700 W version is available.

** DC fuse depends on the cable size.



AC Master
24/300

28020300



AC Master
24/500

28020500



AC Master
24/750*

27520700

24V	24V	24V
≥30 Ah	≥50 Ah	≥75 Ah
230V – 50Hz (± 0.1%)	230V – 50Hz (± 0.1%)	230V – 50Hz (± 0.1%)
300 W	500 W	750 W
250 W	400 W	600 W
600 W	800 W	1200 W
true sine	true sine	true sine
91%	91%	90%
LED display	LED display	LED display
8.3"x5.1"x2.4" 210x130x60 mm	8.3"x5.1"x2.4" 210x130x60 mm	10.8"x6.1"x3" 275x155x75 mm
1.16 kg / 2.55 lbs	1.22 kg / 2.69 lbs	2.7 kg / 5.4 lbs
CE, E-mark, ABYC A-31	CE, E-mark, ABYC A-31	CE, E-mark, ABYC A-31
HF switch mode	HF switch mode	HF switch mode
20V, ± 0.5V	20V, ± 0.5V	21V, ± 0.5V
22V, ± 0.5V	22V, ± 0.5V	25V, ± 0.5V
32V, ± 0.5V	32V, ± 0.5V	30.6V, ± 0.5V
29V, ± 0.5V	29V, ± 0.5V	28.4V, ± 0.5V
10% RMS	10% RMS	5% RMS
11A	19A	32A
0.29A – 7 W 0.16A – 4 W	0.29A – 7 W 0.16A – 4 W	0.38A – 9 W 0.19A – 4.5 W
20A	40A	50A
included	included	10 mm ²
<6%	<6%	<3%
all power factors allowed	all power factors allowed	all power factors allowed
-25°C–60°C, >25°C derating -13°F–140°F, >77°F derating	-25°C–60°C, >25°C derating -13°F–140°F, >77°F derating	-25°C–60°C, >25°C derating -13°F–140°F, >77°F derating
natural/forced	natural/forced	natural/forced
53 dBA at 1 mtr	53 dBA at 1 mtr	53 dBA at 1 mtr
IP23	IP23	IP23
over temperature, over load, short circuit, high battery, low battery		
no	no	no
universal	universal	fixed connection

Convert: Mass Sine Specifications – 230V / 120V



Mass Sine
12/800







Mass Sine
12/1200



Mass Sine
12/2000



Mass Sine
24/800

Item # 230V	24010800	24011200	24012000	24020800
Item # 120V	—	—	25012000	—
General Specifications				
Nominal battery voltage	12V	12V	12V	24V
Minimum battery capacity	>100 Ah	>150 Ah	>200 Ah	>50 Ah
Output voltage (± 5%)	230V – 50Hz (± 0 .01Hz)	230V – 50Hz (± 0 .01Hz)	230V – 50Hz (± 0 .01Hz)	230V – 50Hz (± 0 .01Hz)
P30 power at 40°C, cos phi 1	800 W	1200 W	2000 W	800 W
Continuous power at 40°C, cos phi 1	650 W	1000 W	1800 W	650 W
Peak load	1600 W	2400 W	4000 W	1600 W
Output waveform	true sine	true sine	true sine	true sine
Efficiency	92%	92%	92%	92%
Display/read-out	LED display	LED display	LED display	LED display
Dimensions, hwxwd	12.8"x8.7"x4.4" 325x220x111 mm	13.4"x10.3"x5.1" 340x261x130 mm	16.5"x12.5"x5.4" 420x318x136 mm	12.8"x8.7"x4.4" 325x220x111 mm
Weight	3.9 kg / 8.6 lbs	8 kg / 17.4 lbs	14.6 kg / 32.2 lbs	3.9 kg / 8.6 lbs
Approvals	CE, E-mark, ABYC A-31	CE, E-mark, ABYC A-31	CE, E-mark, ABYC A-31	CE, E-mark, ABYC A-31
Technical Specification				
Technology	HF switch mode	HF switch mode	HF switch mode	HF switch mode
Low battery voltage, switches off at	10V, ± 0.5V	10V, ± 0.5V	10V, ± 0.5V	19V, ± 0.5V
Low battery voltage, switches on at	11V, ± 0.5V	11V, ± 0.5V	11V, ± 0.5V	22V, ± 0.5V
High battery voltage, switches off at	15.5V, ± 0.5V	15.5V, ± 0.5V	15.5V, ± 0.5V	32V, ± 0.5V
High battery voltage, switches on at	14.5V, ± 0.5V	14.5V, ± 0.5V	14.5V, ± 0.5V	30V, ± 0.5V
Max. ripple on DC (battery)	5% RMS	5% RMS	5% RMS	5% RMS
Input current (nominal load)	73A	110A	183A	36A
No load power consumption:				
• 'on' mode (230V)	470 mA – 5.6 W	450 mA – 5 W	480 mA – 6 W	240 mA – 5.6 W
• stand-by (scan mode)	65 mA – 0.8 W	43 mA – 0.5 W	50 mA – 0.6 W	35 mA – 0.8 W
Minimal DC fuse (slow blow)*	100A	150A	250A	63A
Minimal cable size	25 mm ²	50 mm ²	70 mm ²	16 mm ²
Harmonic distortion typical	<5%	<5%	<5%	<5%
Cos Phi	all power factors allowed	all power factors allowed	all power factors allowed	all power factors allowed
Temperature range (ambient temp.)	-25°C–80°C, >40°C derating -13°F–176°F, >104°F derating		-25°C–80°C, >40°C derating -13°F–176°F, >104°F derating	
Cooling	natural/forced	natural/forced	natural/forced	natural/forced
Sound level	48 dBA at 1 mtr	48 dBA at 1 mtr	48 dBA at 1 mtr	48 dBA at 1 mtr
Protection degree	IP23	IP23	IP23	IP23
Protections	over temperature, over load, short circuit, high battery, low battery			
MasterBus compatible	yes, using a MasterBus Inverter Interface or AC power analyser			
AC connection	internal	internal	internal	internal
Options				
Model C4-RI 70404110		Remote control on/off for the Mass Sine sine wave inverter.		
Masterlink/MICC 70403105		Battery consumption meter for 2 batteries, 12/24V DC with LCD read-out, remote control for Mass Sine inverter and Mass battery charger or Mass Combi.		
MasterBus Inverter Interface 77030700		Integrates the Mass Sine inverter in a MasterBus network in a MasterBus network.		
AC power analyser 77031200		Integrates the Mass Sine inverter in a MasterBus network and measures the AC voltage, current and power.		
Transfer system	The Masterswitch and Systems switch can be connected to all inverters.			

* DC fuse depends on the cable size.



Mass Sine
24/1500

Mass Sine
24/2500

Mass Sine
24/5000

Mass Sine
24/10kVA

Mass Sine
24/15kVA

24021500

24022500

24095100

24026000

24027000

—

25022500

—

—

—

24V

24V

24V

24V

24V

>150 Ah

>200 Ah

>400 Ah

>500 Ah

>800 Ah

230V – 50Hz (± 0.01Hz)

230V – 50Hz (± 0.01Hz)

230V – 50Hz (± 0.01Hz)

230V – 50Hz (± 0.01Hz)

230V – 50Hz (± 0.01Hz)

1500 W

2500 W

5000 W

10 kW

15 kW

1200 W

2000 W

4000 W

8 kW

13 kW

2900 W

5000 W

9000 W

20 kW

30 kW

true sine

true sine

true sine

true sine

true sine

92%

92%

92%

92%

92%

LED display

LED display

LED display

LED display

LED display

13.4"x10.3"x5.1"
340x261x130 mm

16.5"x12.5"x5.1"
420x318x130 mm

18.5"x12.4"x10"
470x315x254 mm

2x 460.5x318x143 +
475.5x318x254 mm

3x 460.5x318x143 +
475.5x318x254 mm

8 kg / 17.4 lbs

14.6 kg / 32.2 lbs

25 kg / 55.1 lbs

44 kg / 97 lbs

55 kg / 121.3 lbs

CE, E-mark, ABYC A-31

CE, E-mark, ABYC A-31

CE, E-mark, ABYC A-31

CE, ABYC A-31

CE, ABYC A-31

HF switch mode

HF switch mode

HF switch mode

HF switch mode

HF switch mode

19V, ± 0.5V

19V, ± 0.5V

19V, ± 0.5V

19V, ± 0.5V

19V, ± 0.5V

22V, ± 0.5V

22V, ± 0.5V

22V, ± 0.5V

22V, ± 0.5V

22V, ± 0.5V

32V, ± 0.5V

33V, ± 0.5V

32V, ± 0.5V

32V, ± 0.5V

32V, ± 0.5V

30V, ± 0.5V

31V, ± 0.5V

30V, ± 0.5V

31V, ± 0.5V

31V, ± 0.5V

5% RMS

5% RMS

5% RMS

5% RMS

5% RMS

68A

115A

230A

4x 120A

6x 120A

200 mA – 5 W
25 mA – 0.6 W

250 mA – 6 W
25 mA – 0.6 W

250 mA – 6 W
n.a.

180 W
<10 W, 412 mA

180 W
<10 W, 412 mA

100A

160A

1x 250A or 2x 125A

4x 160A

6x 160A

25 mm²

50 mm²

2x 70 mm²

4x 50 mm²

6x 50 mm²

<5%

<5%

<5%

2,5%

2,5%

all power factors allowed

all power factors allowed

all power factors allowed

all power factors allowed

all power factors allowed

-25°C–80°C, >40°C derating
-13°F–176°F, >104°F derating

-25°C–80°C, >40°C derating
-13°F–176°F, >104°F derating

natural/forced

natural/forced

natural/forced

natural/forced

natural/forced

48 dBA at 1 mtr

48 dBA at 1 mtr

48 dBA at 1 mtr

48 dBA at 1 mtr

48 dBA at 1 mtr

IP23

IP23

IP23

IP23

IP23

over temperature, over load, short circuit, high battery, low battery

yes, using a MasterBus Inverter Interface or AC power analyser

internal

internal

internal

internal

internal

Remote control on/off for the Mass Sine sine wave inverter.

Battery consumption meter for 2 batteries, 12/24V DC with LCD read-out, remote control for Mass Sine inverter and Mass battery charger or Mass Combi.

Integrates the Mass Sine inverter in a MasterBus network in a MasterBus network.

Integrates the Mass Sine inverter in a MasterBus network and measures the AC voltage, current and power.

The Masterswitch and Systems switch can be connected to all inverters.



Mass Combi: Charging, inverting and power support in one device

The Mastervolt Mass Combi combines the best of both worlds with an advanced battery charger and a silent inverter rolled into one compact device; ideal for most vessels from launches to 16-metre yachts. Mastervolt also now offers two 48V models that are ideal for electric sailing.

Versatility in power supply

One of the key reasons for the Mass Combi's popularity is its versatile power supply. The starter and service batteries are charged quickly and completely. The inverter provides a silent and clean power supply. The Combi also has two separate AC outputs for light and heavy equipment. Heavy consumers, such as a washing machine or boiler, are only supplied with power if there is shore power or a generator present. This prevents any unintentional depletion of the battery.

Modern technology

The design of the Mass Combi is both unique and characteristic of Mastervolt. Rather than installing heavy transformers, our lightweight, high-frequency technology offers major benefits in terms of size, weight and sound (no hum!). The technology also ensures an exceptionally high efficiency with a minimal conversion loss and a low no-load consumption. The Mass Combi meets all your requirements and more!

Perfect in a MasterBus system

The Mastervolt Mass Combi fits perfectly within a MasterBus system. The platform allows all components to be connected easily, provides a simple and intuitive operation, and requires far fewer cables for installation. One MasterView Easy touch screen panel controls the entire system, displays information about the Combi as well as the batteries (via the MasterShunt) and operates the generator. The system can also be combined with Mastervolt's decentralised Digital Switching system.

Combined functionality

- Power boost from battery when shore power is limited (shore/generator support).
- Charging two individual battery terminals.
- Invert to 230V/50Hz pure sine wave voltage.
- Supplies 12, 24 or 48 volt onboard power.
- Multiple distribution and switching systems.
- Two Combis parallel switched for more power.
- The Mass Combi meets the ABYC A-31 guideline.

Save space, weight and battery power

With its intelligent design including high frequency switch mode technology and an anodized aluminum housing, the Mass Combi is compact, lightweight and efficient. For instance, the 2500 Watt unit weighs only 24.3 lbs. Designed for the marine environment with multiple safety features, the Mass Combi has a very low amp draw when turned on and no load is present decreasing the drain on the batteries. Connection points are within easy reach and external mounting key hole slots allow speedy installation. Customizing a system is easily accomplished through MasterBus (see 'Mass Combi in a MasterBus System' on the next page). Mass Combi inverter/chargers meet global industry standards including CE, ABYC and UL.



Intuitive operation

Each Mass Combi can be operated easily and intuitively. The Mass Combi includes LED indication of charging phase and charge current, the 230/120V system load and 12/24 or 48V system, 'yes/no' availability of 120/230V and 'failure'. It features an on/off switch with a 'charge only' position when the boat is in storage. Mastervolt also offers a complete selection of control panels, ranging from the compact 3.5 inch panel called MasterView Easy (picture) to a large 10.4-inch touchscreen panel. This requires a MasterBus Combi Interface, with the exception of the 2500W and 48V models.

The Mass Combi for extra power

If you require more power than the shore can provide, the Mass Combi will take this from the battery. The Mass Combi also ensures that the battery is recharged once consumption drops.



Not just any battery charger

The built-in battery charger uses Mastervolt's proven 3-step⁺ charging technology to allow easy charging of all battery types, including Lithium Ions. The battery charger supplies a maximum charge current, even with a higher charge voltage, and speeds up the recharging of your batteries. The Mass Combi also functions as DC supply if there is no battery, allowing you, for instance, to use your lighting when your boat is hauled up for winter.

Convert: Mass Combi Specifications – 120V



Mass Combi
12/2500-100







Mass Combi
12/4000-200



Mass Combi
24/2500-60

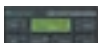

Mass Combi
24/4000-100

Item #	37012505	37014005	37022505	37024005	
General Specifications Sine Wave Inverter					
Nominal DC voltage	12V (10–15V)	12V (10–15V)	24V (20–31V)	24V (20–31V)	
Continuous power at 25°C/77°F, cos phi 1	2500 W - 10.9A	3750 W - 16.5A	2500 W - 10.9A	3750 W - 16.5A	
Surge capability (5 sec, resistive)	5000 W - 21.8A	7500 W - 32A	5000 W - 21.8A	7500 W - 32A	
Parallel use (to double the power)	yes	no	yes	no	
Parallel with shore/generator (for more power)	yes	yes	yes	yes	
Output voltage (± 5%)	120V – 60Hz, ±0,05%	120V – 60Hz, ±0,05%	120V – 60Hz, ±0,05%	120V – 60Hz, ±0,05%	
Output waveform	true sine	true sine	true sine	true sine	
Efficiency	90%	90%	93%	93%	
DC consumption at 230V	<9 W	<18 W	<9 W	<18 W	
Search mode consumption	0.5 W	1 W	0.5 W	1 W	
General Specifications Battery Charger					
Nominal input voltage	120V – 45–65Hz	120V – 45–65Hz	120V – 45–65Hz	120V – 45–65Hz	
Max. charge current (adjustable)	100A at 14.25V	200A at 14.25V	60A at 28.5V	100A at 28.5V	
Primary AC consumption (full charge)	1700 W – 14.5A	3400 W - 29A	2000 W - 17A	3500 W - 29A	
Charge voltage 25°C/77°F (absorption/float)*	14.25/13.25V	14.25/13.25V	28.5/26.5V	28.5/26.5V	
Charge characteristic	IUoUo, automatic / 3-step© for gel/AGM/wet/Lithium Ion				
Second charge output, 3-step	5A	2x 5A	5A	2x 5A	
Temperature sensor battery	delivered as standard with 6 metre cable and telejack plug				
General Specifications					
Display/read-out	LED display	LED display	LED display	LED display	
Dimensions, hwxwd	19.5x12.5x6.1 inch 496x318x156 mm	19.5x12.5x11 inch 496x318x279 mm	19.5x12.5x6.1 inch 496x318x156 mm	19.5x12.5x11 inch 496x318x279 mm	
Weight	11 kg / 24.3 lbs	21 kg / 46.3 lbs	11 kg / 24.3 lbs	21 kg / 46.3 lbs	
Approvals	CE, ABYC A-31	CE, ABYC A-31	CE, ABYC A-31	CE, ABYC A-31	
Technical Specifications					
Max. current first output	50A	50A	50A	50A	
Max. current shortbreak / inverter output	35A	35A	35A	35A	
Transfer time	10 ms	10 ms	10 ms	10 ms	
Grounding	yes, adjustably by DIP switch		yes, adjustably by DIP switch		
Temperature range (ambient temp.)	-25 °C–80 °C, > 25 °C derating / -13°F–176°F, >77°F derating				
Cooling	maintenance free vario fans		maintenance free vario fans		
Sound level	≤ 48 dBA at 1 mtr	≤ 48 dBA at 1 mtr	≤ 48 dBA at 1 mtr	≤ 48 dBA at 1 mtr	
Protection degree	IP23	IP23	IP23	IP23	
Protections	over temperature, over load, short circuit, high battery, low battery				
MasterBus compatible	yes**	yes**	yes**	yes**	
Options					
Remote ICC 70405000		delivered as standard	delivered as standard	delivered as standard	delivered as standard
Remote APC 70405050		option	option	option	option
Masterlink/MICC 70403105		option	option	option	option
MasterView Easy 77010305		option**	option**	option**	option**
MasterBus Combi Interface 77030475		option**	option**	option**	option**

* The charge characteristic can be set to your requirements. ** In combination with a MasterBus Combi Interface – item # 77030475.

Mastervolt Mass Combi in a MasterBus System

The Mastervolt Mass Combi fits perfectly within a MasterBus system. The system allows all components to be connected easily, provides a simple and intuitive operation and requires far fewer cables for installation. One MasterView Easy touch screen panel controls the entire system, displays information about the Combi as well as the batteries (via the MasterShunt) and operates the generator. The system can also be combined with Mastervolt's decentralised Digital Switching system.

For more MasterBus information, check the Digital Distribution pages in the Manage section of this catalogue.

- ❶ 3 kW generator
- ❷ MasterView Easy
- ❸ Mass Combi
- ❹ Masterswitch
- ❺ Shore connection
- ❻ AGM starter battery
- ❼ MVG gel battery
- ❽ MasterShunt
- ❾ DC Distribution

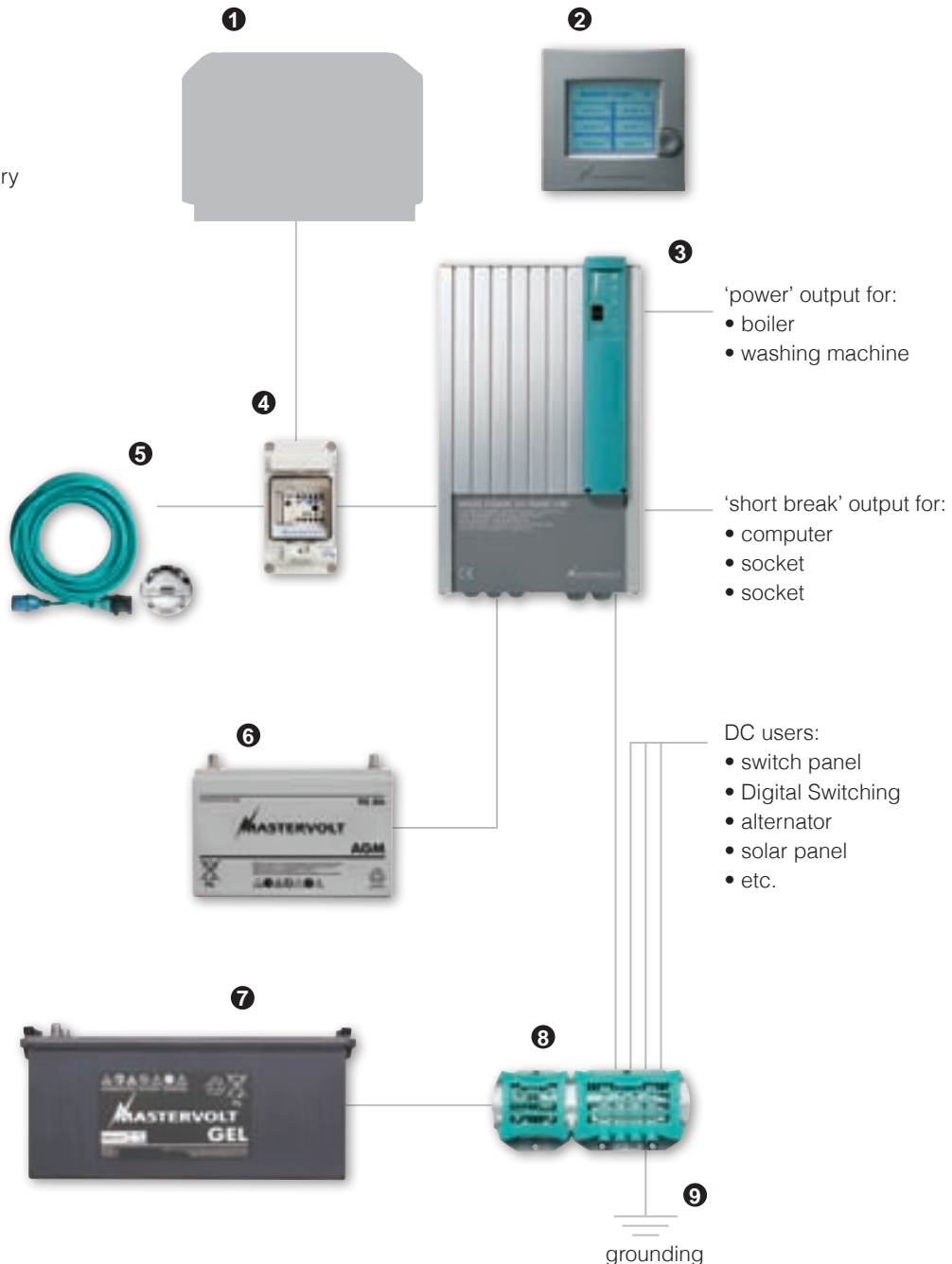

Convert: Mass Combi Specifications – 230V



Mass Combi
12/1200-60



Mass Combi
12/2000-100



Mass Combi
12/2500-100



Mass Combi
12/4000-200

Item #	36011205	36012005	36012505	36014005
General Specifications (sine wave inverter)				
Nominal DC voltage	12V (10–15V)	12V (10–15V)	12V (10–15V)	12V (10–15V)
Continuous power at 25°C/77°F, cos phi 1	1200 W - 5.3A	2000 W - 8.7A	2500 W - 10.9A	3750 W - 16.5A
Surge capability (5 sec, resistive)	2400 W - 10.5A	4000 W - 17.5A	5000 W - 21.8A	7500 W - 32A
Parallel use (to double the power)	no	yes	yes	no
Parallel with shore/generator (for more power)	yes	yes	yes	yes
Output voltage (± 5%)	230V – 50Hz, ±0,05% (60Hz adjustable, ±0,05%)			
Output waveform	true sine	true sine	true sine	true sine
Efficiency	90%	90%	90%	90%
DC consumption at 230V	<9 W	<9 W	<9 W	<9 W
Search mode consumption	0.5 W	0.5 W	0.5 W	1 W
General Specifications (battery charger)				
Nominal input voltage	230V (180–265V) – 45–65Hz			
Max. charge current (adjustable)	60A at 14.25V	100A at 14.25V	100A at 14.25V	200A at 14.25V
Primary AC consumption (full charge)	1035 W - 4.5A	1656 W - 7.2A	1656 W - 7.2A	3312 W - 14.4A
Charge voltage 25°C/77°F (absorption/float)*	14.25/13.25V	14.25/13.25V	14.25/13.25V	14.25/13.25V
Charge characteristic	IUoUo, automatic / 3-step® for gel/AGM/wet/Lithium Ion			
Second charge output, 3-step	5A	5A	5A	2x 5A
Temperature sensor battery	delivered as standard with 6 metre cable and telejack plug			
General Specifications				
Display/read-out	LED display	LED display	LED display	LED display
Dimensions, hxxwxd	14.6"x12.5"x5.6" 371x318x143 mm	19.5"x12.5"x6.1" 496x318x156 mm	19.5"x12.5"x6.1" 496x318x156 mm	19.5"x12.5"x11" 496x318x279 mm
Weight	7.8 kg / 17.2 lbs	11 kg / 24.3 lbs	11 kg / 24.3 lbs	21 kg / 46.3 lbs
Approvals	CE, E-mark, ABYC A-31	CE, E-mark, ABYC A-31	CE, E-mark, ABYC A-31	CE, E-mark, ABYC A-31
Technical Specifications				
Max. current first output	50A	50A	50A	50A
Max. current shortbreak / inverter output	25A	25A (35A at 120V)	25A	25A (35A at 120V)
Transfer time	10 ms	10 ms	10 ms	10 ms
Grounding	yes, adjustably by DIP switch		yes, adjustably by DIP switch	
Temperature range (ambient temp.)	-25°C–80°C, >25°C derating / -13°F–176°F, > 77°F derating			
Cooling	maintenance free vario fans		maintenance free vario fans	
Sound level	≤ 48 dBA at 1 mtr	≤ 48 dBA at 1 mtr	≤ 48 dBA at 1 mtr	≤ 48 dBA at 1 mtr
Protection degree	IP23	IP23	IP23	IP23
Protections	over temperature, over load, short circuit, high battery, low battery			
MasterBus compatible	yes**	yes**	yes**	yes**
Options				
Remote ICC 70405000		option delivered as standard	option delivered as standard	option delivered as standard
Remote APC 70405010		option Indication of DC consumption, charge phase, AC present, failure, with on/off/'charger only' switch...	option Indication of AC consumption, AC voltage, fuse value of the shore/generator connection, with...	option Indication of AC consumption, AC voltage, fuse value of the shore/generator connection, with...
Masterlink/MICC 70403105		option Battery consumption metre for 2 batteries, 12/24V DC with LCD read-out, remote control for Mass Sine...	option Battery consumption metre for 2 batteries, 12/24V DC with LCD read-out, remote control for Mass Sine...	option Battery consumption metre for 2 batteries, 12/24V DC with LCD read-out, remote control for Mass Sine...
MasterView Easy 77010305		option** Touch screen panel for reading charge status, current fold-back and/or Power Sharing setting.	option** Touch screen panel for reading charge status, current fold-back and/or Power Sharing setting.	option** Touch screen panel for reading charge status, current fold-back and/or Power Sharing setting.
MasterBus Combi Interface 77030475		option** Integrates the Mass Combi in a MasterBus network.	option** Integrates the Mass Combi in a MasterBus network.	delivered as standard Integrates the Mass Combi in a MasterBus network.

* The charge characteristic can be set to your requirements

** In combination with a MasterBus Combi Interface – Item # **77030475**.

Mass Combi
24/1200-35Mass Combi
24/2000-60Mass Combi
24/2500-60Mass Combi
24/4000-120Mass Combi
48/2500-35Mass Combi
48/5000-70**36021205****36022005****36022505****36024005****36042505****36045005**

24V (20–31V)

24V (20–31V)

24V (20–31V)

24V (20–31V)

48V (40–62V)

48V (40–62V)

1200 W - 5.3A

2000 W - 8.7A

2500 W - 10.9A

3750 W - 16.5A

2500 W - 10.9A

5000 W - 21.8A

2400 W - 10.5A

4000 W - 17.5A

5000 W - 21.8A

7500 W - 32A

5000 W - 21.8A

8000 W - 35A

no

yes

yes

no

yes

no

yes

yes

yes

yes

yes

yes

230V – 50Hz, ±0,05% (60Hz adjustable, ±0,05%)

true sine

true sine

true sine

true sine

true sine

true sine

92%

93%

93%

93%

93%

93%

<9 W

<9 W

<9 W

<9 W

<9 W

<9 W

0.5 W

0.5 W

0.5 W

1 W

0.5 W

1 W

230V (180–265V) – 45–65Hz

35A at 28.5V

60A at 28.5V

60A at 28.5V

120A at 28.5V

35A at 57V

70A at 57V

1170 W - 5.1A

1965 W - 8.5A

1965 W - 8.5A

3900 W - 17A

2295 W - 10A

4590 W - 20A

28.5/26.5V

28.5/26.5V

28.5/26.5V

28.5/26.5V

57/53V

57/53V

IUoUo, automatic / 3-step[⊙] for gel/AGM/wet/Lithium Ion

5A

5A

5A

2x 5A

n.a.

n.a.

delivered as standard with 6 metre cable and telejack plug

LED display

LED display

LED display

LED display

LED display

LED display

14.6"x12.5"x5.6"
371x318x143 mm19.5"x12.5"x6.1"
496x318x156 mm19.5"x12.5"x6.1"
496x318x156 mm19.5"x12.5"x11"
496x318x279 mm19.5"x12.5"x6.1"
496x318x156 mm19.5"x12.5"x11"
496x318x279 mm

7.8 kg / 17.2 lbs

11 kg / 24.3 lbs

11 kg / 24.3 lbs

21 kg / 46.3 lbs

11 kg / 24.3 lbs

21 kg / 46.3 lbs

CE, E-mark, ABYC A-31

CE, E-mark, ABYC A-31

CE, E-mark, ABYC A-31

CE, E-mark, ABYC A-31

CE, E-mark, ABYC A-31

CE, E-mark, ABYC A-31

50A

50A

50A

50A

50A

50A

25A

25A (35A at 120V)

25A

25A (35A at 120V)

25A

25A

10 ms

10 ms

10 ms

10 ms

10 ms

10 ms

yes, adjustably by DIP switch

yes, adjustably by DIP switch

yes, adjustably by DIP switch

-25°C–80°C, >25°C derating / -13°F–176°F, > 77°F derating

maintenance free vario fans

maintenance free vario fans

maintenance free vario fans

≤ 48 dBA at 1 mtr

≤ 48 dBA at 1 mtr

≤ 48 dBA at 1 mtr

≤ 48 dBA at 1 mtr

≤ 48 dBA at 1 mtr

≤ 48 dBA at 1 mtr

IP23

IP23

IP23

IP23

IP23

IP23

over temperature, over load, short circuit, high battery, low battery

yes**

yes**

yes**

yes**

yes**

yes**

option
& 6 metre cable.

delivered as standard

option

delivered as standard

option

option

option
Power Sharing.

option

option

option

option

option

option
inverter and Mass battery charger or Mass Combi.

option

option

option

option

option

option**

option**

option**

option**

option**

option**

option**

option**

delivered as standard

option**

delivered as standard

delivered as standard



Mastervolt DC-DC converters: For 12, 24 and 48V

The voltage required for direct current (DC) can vary considerably onboard a yacht. A bowthruster or a winch often works at 24V, while navigation and communication equipment mostly requires 12V. By using a DC-DC converter, other voltages than applied in your basic system can be reached. They also ensure that all your onboard equipment has a stable power supply with the right voltage.

DC Master series

- Recreational and semi-professional use.
- Easy to install using included mounting bracket.
- Excellent price/performance ratio.
- More power available for two minute intervals, ideal for active marine telephone use.

Mac & Magic series

- Professional use.
- Battery charger and dimmer function.
- Parallel connection.
- Adjustable output voltage.
- Voltage stabilization for a longer lifespan of halogen lights, etc.

The Magic models can regulate the voltage both up and down to ensure an optimal voltage stabilization, even when the battery voltage fluctuates due to heavy loads. The galvanic isolation between input and output prevents disruptions to, for instance, communication equipment.

Masterstrokes

- No unnecessary heat development due to the use of smart electronics.
- Continuous output voltage.
- Easy to install.

Please note:

- Choose the right input/output voltage.
- Do you require galvanic isolation?
- Desired capacity.

Programmable via a desktop or laptop PC

Remote control the Mac or Magic via your laptop or PC or configure your personal preferences. The device has a communication port and easy installation with a PC-Link and MasterAdjust software.

3-Step⁺ battery charger

Connected to the 24V main battery, the converter can also be used as an advanced 3-step⁺ chargers for 12/24V gel, AGM, wet or Lithium Ion batteries (Mac & Magic models only).



Energy-saving dimmer function

Many standard light dimmers convert part of the energy to heat and also lose unnecessary energy. The Mastervolt Mac & Magic converters regulate the power supply efficiently and without excessive heat build-up, up to 250 Watt for optimal safety (multiple Mac or Magic converters can be used for multiple lamps).



Over 90% efficiency

Advanced high-frequency technology with modern microprocessors ensures minimum power loss when switching from 24 to 12V and vice versa. If you have many power-consuming devices on-board, the parallel use of several units allows capacities of 40, 60 or more amps.



Solid connections





Chrome-plated brass connection block with screw terminal or chrome-plated fast-on for DC in/out.







Complete package DC Master

All DC Master converters are delivered with mounting bracket, screws and fasteners.





Convert: DC Master Specifications



				
Item #	81400100	81400200	81400300	81400330
Input Specifications				
Nominal input voltage	24V	24V	24V	24V
Input range	20–32V DC	20–32V DC	20–32V DC	20–32V DC
Output Specifications				
Nominal output voltage	13.6V	13.6V	13.6V	13.6V
Maximum power	82 W	136 W	245 W	408 W
Nominal power	41 W	82 W	164 W	326 W
Current max. 2 minutes* / continuous	6A / 3A	10A / 6A	18A / 12A	30A / 24A
DC consumption	<10 mA	<10 mA	<10 mA	<10 mA
General Specifications				
Dimensions, hwxwd	2.6"x3.4"x2" 67x87x50 mm	3.5"x3.4"x2" 89x87x50 mm	5"x3.4"x2" 127x87x50 mm	5"x3.4"x2" 167x87x50 mm
Weight	225 gr / 0.5 lbs	270 gr / 0.6 lbs	405 gr / 0.9 lbs	635 gr / 1.4 lbs
Approvals	CE, E-mark	CE, E-mark	CE, E-mark	CE, E-mark
Galvanic isolation	no	no	no	no
Stabilized	yes	yes	yes	yes
Connections input/output	fast-on	fast-on	fast-on	fast-on
Temperature range (ambient temp.)	-25°C–80°C, >30°C derating / -13°F–176°F, >86°F derating			
Cooling	natural cooling	natural cooling	natural cooling	natural cooling
Sound level	<30 dBA at 1 mtr	<30 dBA at 1 mtr	<30 dBA at 1 mtr	<30 dBA at 1 mtr
Protection degree	IP53	IP53	IP53	IP53

				
Item #	81500600	81500700	81500100	81500200
Input Specifications				
Nominal input voltage	12V	12V	24V	24V
Input range	10–15.5V DC	10–15.5V DC	20–32V DC	20–32V DC
Output Specifications				
Nominal output voltage	13.6V	13.6V	13.6V	13.6V
Maximum power	54 W	108 W	82 W	136 W
Nominal power	41 W	81 W	41 W	82 W
Current max. 2 minutes* / continuous	3A / 4A	8A / 6A	6A / 3A	10A / 6A
DC consumption	<100 mA	<100 mA	<10 mA	<10 mA
General Specifications				
Dimensions, hwxwd	3.5"x3.4"x2" 89x87x50 mm	8.5"x3.4"x2" 217x87x50 mm	3.5"x3.4"x2" 89x87x50 mm	5"x3.4"x2" 127x87x50 mm
Weight	290 gr / 0.6 lbs	820 gr / 1.8 lbs	290 gr / 0.6 lbs	410 gr / 0.9 lbs
Approvals	CE, E-mark	CE, E-mark	CE, E-mark	CE, E-mark
Galvanic isolation	yes	yes	yes	yes
Stabilized	yes	yes	yes	yes
Connections input/output	fast-on	fast-on	fast-on	fast-on
Temperature range (ambient temp.)	-25°C–80°C, >30°C derating / -13°F–176°F, >86°F derating			
Cooling	natural cooling	natural cooling	natural cooling	natural cooling
Sound level	<30 dBA at 1 mtr	<30 dBA at 1 mtr	<30 dBA at 1 mtr	<30 dBA at 1 mtr
Protection degree	IP53	IP53	IP53	IP53

* More power available for two minute intervals, ideal for active marine telephone use.

• All DC Master converters come with a mounting bracket, screws and fast-ons.

no picture available yet					
24/12-50A	12/24-3A	12/24-7A	48/12-6A	48/12-9A	48/12-20A
81400350	81400400	81400500	81400600	81400700	81400800
24V	12V	12V	48V	48V	48V
20-32V DC	10-15.5V DC	10-15.5V DC	40-62V DC	40-62V DC	40-62V DC
13.6V	27.2V	27.2V	13.6V	13.6V	13.6V
720 W	109 W	245 W	109 W	132 W	326 W
500 W	82 W	191 W	82 W	108 W	272 W
60A / 50A	4A / 3A	9A / 7A	8A / 6A	11A / 9A	24A / 20A
<10 mA	<110 mA	<120 mA	<15 mA	<15 mA	<15 mA
11.8"x3"x4.3" 300x76x110 mm	3.5"x3.4"x2" 89x87x50 mm	6.6"x3.4"x2" 167x87x50 mm	3.5"x3.4"x2" 89x87x50 mm	5"x3.4"x2" 127x87x50 mm	5"x3.4"x2" 217x87x50 mm
1.2 kg / 2.6 lbs	290 gr / 0.6 lbs	610 gr / 1.3 lbs	415 gr / 0.9 lbs	415 gr / 0.9 lbs	765 gr / 1.7 lbs
CE, E-mark	CE, E-mark	CE, E-mark	CE, E-mark	CE, E-mark	CE, E-mark
no	no	no	no	no	no
yes	yes	yes	yes	yes	yes
fast-on	fast-on	fast-on	fast-on	fast-on	fast-on
-25°C-80°C, >30°C derating / -13°F-176°F, >86°F derating					
natural cooling	natural cooling	natural cooling	natural cooling	natural cooling	natural cooling
<30 dBA at 1 mtr	<30 dBA at 1 mtr	<30 dBA at 1 mtr	<30 dBA at 1 mtr	<30 dBA at 1 mtr	<30 dBA at 1 mtr
IP53	IP53	IP53	IP53	IP53	IP53

			
24/12-12A	24/12-24A	24/24-3A	24/24-7A
81500300	81500350	81500400	81500500
24V	24V	24V	24V
20-32V DC	20-32V DC	20-32V DC	20-32V DC
13.6V	13.6V	27.2V	27.2V
245 W	408 W	109 W	245 W
164 W	326 W	82 W	191 W
18A / 12A	24A / 30A	4A / 3A	9A / 7A
<10 mA	<10 mA	<25 mA	<25 mA
6.6"x3.4"x2" 167x87x50 mm	8.5"x3.4"x2" 217x87x50 mm	5"x3.4"x2" 127x87x50 mm	7"x3.4"x2" 185x87x50 mm
590 gr / 1.3 lbs	850 gr / 1.9 lbs	590 gr / 1.3 lbs	820 gr / 1.8 lbs
CE, E-mark	CE, E-mark	CE, E-mark	CE, E-mark
yes	yes	yes	yes
yes	yes	yes	yes
fast-on	fast-on	fast-on	fast-on
-25°C-80°C, >30°C derating / -13°F-176°F, >86°F derating			
natural cooling	natural cooling	natural cooling	natural cooling
<30 dBA at 1 mtr	<30 dBA at 1 mtr	<30 dBA at 1 mtr	<30 dBA at 1 mtr
IP53	IP53	IP53	IP53

Convert: Mac & Magic Specifications





Mac 24/12-20



Magic 24/12-20



Magic 24/24-20

Item #	81200100	81300100	81300200
Specifications Input			
Nominal input voltage	24V	24V	24V
Input range	20–32V DC	19–32V DC	19–32V DC
Input range, 3-step charge mode	24–32V DC	24–32V DC	24–32V DC
Lower input set point	20V DC*	20V DC*	20V DC*
Delay lower input set point	30 sec.*	30 sec.*	30 sec.*
Specifications Output			
Factory setting	13.6V DC*	13.6V DC*	27.2V DC*
Voltage adjustable*	10–15V DC	10–15V DC	20–28.5V DC
Output voltage dimmer*	4–13V DC	4–13V DC	8–26V DC
Stabilized	2% at extremes of temperatures, load and input		
Ripple	max. 1% peak peak	max. 1% peak peak	max. 1% peak peak
Power (max./nominal)	300 / 270 W	300 / 300 W	580 / 580 W
Max. current	20A	20A	20A
Charge current – 3-step mode	16A	16A	16A
General Specifications			
Galvanic isolation	no	yes	yes
Voltage limited	yes	yes	yes
Efficiency	>90% (at nominal input voltage, full load); 92% peak		
Protected against over load	yes	yes	yes
Protected against over temperature	yes	yes	yes
Dimmer function	yes, by external momentary switch via fast-on connection, to be activated by DIP-switch setting		
Alarm contact	no	yes (fast-on connector)	yes (fast-on connector)
Dimensions, hwxwx d	7.5"x5.1"x2.4" 190x130x61 mm	8.9"x6.1"x3.2" 227x154x81 mm	8.9"x6.1"x3.2" 227x154x81 mm
Weight	1.0 kg / 2.2 lbs	1.8 kg / 4 lbs	1.8 kg / 4 lbs
Approvals	CE	CE	CE
Technical Specifications			
3-Step charge option	yes (DIP switch settings)	yes (DIP switch settings)	yes (DIP switch settings)
DC consumption	<30 mA	<115 mA	<115 mA
Connections input/output	screw terminals, maximum wire size 16 mm ² / AWG5		
Temperature range (ambient temp.)	-25°C–80°C, >40°C derating / -13°F–176°F, >104°F derating		
Cooling	natural cooling	maintenance free vario fans	
Sound level	<30 dBA at 1 mtr	<48 dBA at 1 mtr	<48 dBA at 1 mtr
Protection degree	IP21	IP21	IP21
MasterBus compatible	yes, by means of MasterBus Serial Interface (Item # 77030450)		
Options			
PC-Link 21730100		Interface between Magic converter and PC, in combination with the MasterAdjust software (free to download). The PC-Link can be directly connected to a computer serial port.	
MasterView Easy 77010305		Touch screen panel for reading status and dimmer function settings.	
MasterBus Serial Interface 77030450		Integrates the Mac & Magic converters in a MasterBus network.	

* Adjustable with MasterAdjust software.



Magic 12/12-20

81300400



Magic 12/24-10

81300300

12V	12V
11–16V DC	11–16V DC
12–16V DC	12–16V DC
10V DC*	10V DC*
30 sec.*	30 sec.*
13.6V DC*	27.2V DC*
10–15V DC	20–28.5V DC
4–13V DC	8–26V DC
2% at extremes of temperatures, load and input	
max. 1% peak peak	
300 / 300 W	300 / 300 W
20A	10A
16A	8A
yes	yes
yes	yes
>90% (at nominal input voltage, full load); 92% peak	
yes	yes
yes	yes
yes, by external momentary switch via fast-on connection, to be activated by DIP-switch setting	
yes (fast-on connector)	yes (fast-on connector)
8.9"x6.1"x3.2" 227x154x81 mm	8.9"x6.1"x3.2" 227x154x81 mm
1.8 kg / 4 lbs	1.8 kg / 4 lbs
CE	CE
yes (DIP switch settings)	yes (DIP switch settings)
<115 mA	<115 mA
screw terminals, maximum wire size 16 mm ² / AWG5	
-25°C–80°C, >40°C derating / -13°F–176°F, >104°F derating	
maintenance free vario fans	
<48 dBA at 1 mtr	<48 dBA at 1 mtr
IP21	IP21
yes, by means of MasterBus Serial Interface (Item # 77030450)	
Interface between Magic converter and PC, in combination with the MasterAdjust software (free to download). The PC-Link can be directly connected to a computer serial port.	
Touch screen panel for reading status and dimmer function settings.	
Integrates the Mac & Magic converters in a MasterBus network.	

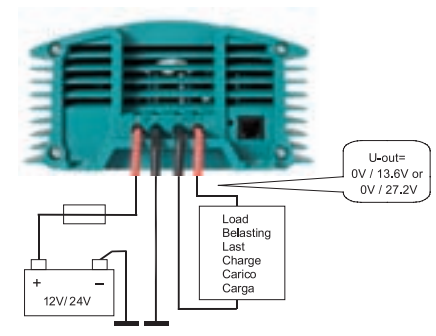

Magic as power supply

The Magic models can be fully used as a stabilised power supply: From 12–24V, from 24–12V or from 24–24V. Inputs and outputs are galvanically isolated.

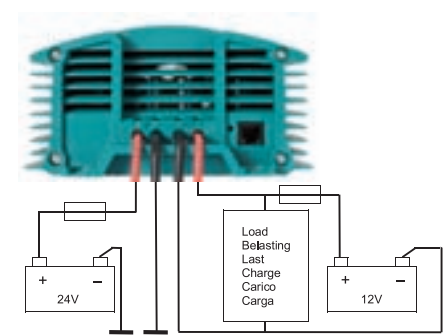

Mac & Magic as battery charger

A 12V starter or emergency power battery can be charged as well as maintained by Mac or Magic units. The charging method is identical to the Mass 3-step with voltage levels adjustable by means of MasterBus PC-Link/MasterAdjust software.

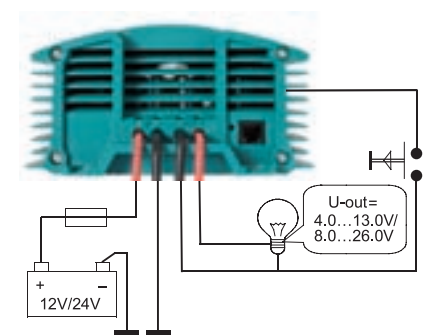

Mac & Magic as dimmer

Light can be dimmed by means of a push button or plus switch, with a maximum load of 250 Watt for the Mac. A second Mac can be installed if there are multiple lamps.



From shore power to onboard network: Mastervolt isolation transformers

You need to be careful when introducing shore power onboard, especially when the yacht is made of aluminium or steel. An incorrectly configured system can result in electrolysis, which will slowly but surely corrode the metal components. It is also important to protect the engine, rudder, rudderstock, propeller and thruster on composite yachts. A Mastervolt isolation transformer will help preserve your valuable boat and provide you with the security of a correctly earthed 230V system.

Select the right transformer for your system:

Lightweight Mass GI transformer

- Ultramodern high-frequency electronic switch technology.
- Lightweight and compact.
- Integrated Soft Start function.
- Connect to currents from 90–255V and from 45–65Hz.
- Units can be parallel coupled for higher capacity.
- Higher efficiency, limited heat development.

IVET-D isolation transformers

- High-quality toroidal transformer in robust casing, including circuit breaker.
- Standard Soft Start for the suppression of inrush current at shore connection.
- Multi-tap version for both 230V/50Hz and 120V/60Hz shore voltage.

IVET heavy-duty series

- High-quality isolation transformers without casing (for self installation).
- Optional Soft Start, in synthetic casing.
- Capacities of 2.5–22 kW.

**Modern transformer technology:****Light, silent, reliable and easy**

Mastervolt's Mass GI offers the latest high-frequency switching technology as well as Soft Start for peak loads when connecting to the shore.

Weighing a mere six kilos, LED lights on the casing indicate load and overload. The transformer can be remote controlled via a panel and has the option of automatically starting the generator when there is a shore current overload.

Higher capacity via parallel switching

Parallel switching of the Mass GI units increases the shore power capacity. Two 16A/3.5 kW units ensures 32A/7 kW, four units give 64A/14 kW.

Global solution

The IVET-D multi-tap is suitable for 230V/50Hz and 120V/60Hz (American or Caribbean).

Install anywhere

With its maritime, aluminium casing, this isolation transformer can be fitted in any position on a wall or floor. No rubber mountings are necessary because the unit does not vibrate or hum. The Mass GI also features professional connections with strain relief cable glands.

Practical tips:

- Determine shore and onboard current: 230V, 120V or both.
- Determine the capacity. Maximum load with onboard power usage: Amount of amps and kW.
- Note sizes and weight; the Mass GI is 75% lighter and 60% smaller compared to low frequency transformers.

Remember:

- Detection system for IVET heavy duty automatically supplies onboard system with 230V in case of a 120V/60Hz shore connection (or vice versa).
- Systemswitch or Masterswitch for integrating shore power, generator and/or inverter.
- Connects to 12V or 24V system, battery charger or Mass Combi.

Convert: Isolation Transformers Specifications



Mass GI 3.5



Mass GI 7



IVET-D 16A
3.5 kVA multi tap

Item #	88000350	88000705	86050351
Input			
Input voltage	90–255V	90–255V	220–240V (110–120V adjustable)
Input frequency	45–65Hz	45–65Hz	45–65Hz
Nominal input current at 230V	16A	32A	16A
No load consumption	22 W	44 W	<10 W
Earth leakage protection	no	no	no
Output			
Output voltage (equal to input)	90–255V, ± 5%	90–255V, ± 5%	220–240V, ± 5% (110–120V adjustable)
Output frequency (equal to input)	45–65Hz	45–65Hz	45–65Hz
Soft Start	yes	yes	yes
Switch off behaviour breaker	B-characteristic	B-characteristic	B-characteristic
Efficiency	>93%	>93%	>93%
General Specifications			
Power	3500 W*	7000 W	3500 W
Technology	high frequency	high frequency	torroidal
Dimensions, hwxwd	13.4"x10.3"x5.7" 340x261x144 mm	13.4"x10.3"x9.8" 340x261x250 mm	16"x11.6"x8.7" 407x295x220 mm
Weight	6 kg / 13.2 lbs	10 kg / 22 lbs	23 kg / 50.7 lbs
Ambient temperature	0–40°C, derating with 5% per °C (40–60°C) / 32–104°F, derating with 5% per °F (104–140°F)		
Switch off at	80°C / 176°F	80°C / 176°F	120°C / 248°F
Cooling	variofan	variofan	natural cooling forced cooling >80°C / 176°F
Operating humidity	max. 95%	max. 95%	max. 95%
Protection degree	IP23	IP23	IP23
MasterBus compatible	yes	yes	no
Optional remote control	 yes, MasterView Easy	no	no

* Up to 4 units parallel (14 kW).

Automatically adjust shore power to the onboard system

Mastervolt supplies three automatic switching systems for capacities of 6, 9 and 13 kW that — combined with an IVET transformer — adjust shore power to the onboard system. As a result a 230V/50Hz system can easily function with an American or Caribbean shore connection. Do ensure that the frequency on board (50 or 60Hz) is the same as the frequency of the shore current.

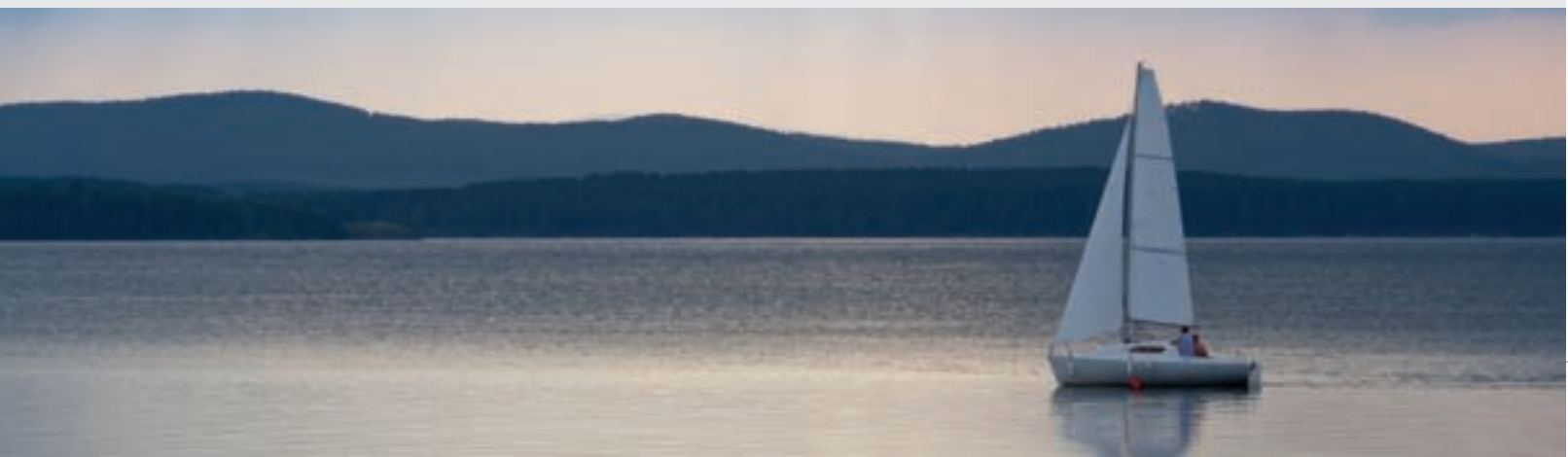



IVET 6



IVET 8



IVET 10



IVET 13

85000600	85000800	85001000	85001300
110/220/240V	110/220/240V (adjustable)	110/220/240V (adjustable)	110/220/240V (adjustable)
45–65Hz	45–65Hz	45–65Hz	45–65Hz
26A	35A	44A	57A
<10 W	<10 W	<10 W	<10 W
no	no	no	no
120/220/240V, ± 5%	120/220/240V, ± 5%	120/220/240V, ± 5%	120/220/240V, ± 5%
45–65Hz	45–65Hz	45–65Hz	45–65Hz
option	option	option	option
n.a.	n.a.	n.a.	n.a.
>93%	>93%	>93%	>93%
6000 W	8000 W	10 kW	13 kW
E-core	E-core	E-core	E-core
15"x9.5"x8.5" 380x240x215 mm	16.9"x11"x8.3" 430x280x210 mm	16.9"x11"x9.5" 430x280x240 mm	19.3"x12.6"x9" 490x320x230 mm
50 kg / 110.2 lbs	59 kg / 130 lbs	75 kg / 165.4 lbs	90 kg / 198.4 lbs
0–40°C, derating with 5% per °C (40–60°C) / 32–104°F, derating with 5% per °F (104–140°F)			
n.a.	n.a.	n.a.	n.a.
natural cooling	natural cooling	natural cooling	natural cooling
max. 95%	max. 95%	max. 95%	max. 95%
IP00	IP00	IP00	IP00
no	no	no	no
no	no	no	no



Transfer systems with Soft Start and automatic detection of the input voltage



Soft Start
13 kVA



Soft Start
22 kVA

	6 kVA	9 kVA	13 kVA	13 kVA	22 kVA
Item #	55010600	55010900	55011300	55003300	55003400
Voltage	120/230V	120/230V	120/230V	230V	230V
Power	6 kW	9 kW	13 kW	2.5–13 kW	13–22 kW
Max. input current	60A at 120V 30A at 230V	80A at 120V 40A at 230V	130A at 120V 70A at 230V	n.a.	n.a.
Dimensions, hwxwd	15.7"x11.8"x8.3" 400x300x210 mm	15.7"x11.8"x8.3" 400x300x210 mm	15.7"x11.8"x8.3" 400x300x210 mm	7.9"x7.1"x4.5" 200x180x115 mm	7.9"x7.1"x4.5" 200x180x115 mm
Weight	12 kg / 26.5 lbs	12.5 kg / 27.6 lbs	13 kg / 28.7 lbs	1.2 kg / 2.6 lbs	1.5 kg / 3.3 lbs



Store: Constant Power with Mastervolt Batteries

When choosing the right batteries for your system, the key issue is not what you need but what you wish to have left over.

Mastervolt makes selecting the right battery easy. Whether you choose a low priced battery such as the AGM or an innovative and technologically advanced Lithium Ion battery, Mastervolt has the power solution for every application.

What's more, our batteries are extremely safe (no gas formation), maintenance free and very easy to install.

To make the choice even simpler, Mastervolt has divided its entire battery range of 32 types into six series and four different battery technologies. Each series has specific benefits as well as variations in price, capacity, dimensions, volume and lifespan.



Batteries	86
AGM Batteries	88
Gel Batteries	89
Lithium Ion Batteries	91

Mastervolt – Exclusive Supplier of Batteries for Camper Emirates Team New Zealand in the Volvo Ocean Race 2011





Reinforced Batteries

All Mastervolt batteries are equipped with shock-proof positive and negative battery plates with rubber separation, while the electrolyte is absorbed in gel or glass fibre (AGM). A high-grade lead/calcium compound guarantees you a constant capacity and minimum self-discharging. Mastervolt has the right battery for every marine application.

Mastervolt batteries are:

- Maintenance-free.
- Safe; no gas formation.
- Easy to install.
- Designed for cyclic use (charge/discharge).
- Leak-proof.
- With a two-year warranty.

Issues to take into account:

- Determining the correct battery capacity for your new battery/batteries is very important.
- Choosing the right battery charger lengthens the lifespan of your batteries considerably. Fastervolt's modern 3-step+ charge technology charges your batteries safely and quickly.
- A control panel is the best way to make the most of your batteries.

To choose the right battery, go to the table on the opposite page.



Which battery is best for your application?

	traditional open batteries	① AGM semi-traction	② MVG gel semi-traction	③ MVSV 2V gel traction	④ MLI Lithium Ion
Maintenance free	-	++++	++++	++++	++++
Gas formation during charging	+	+++	+++	+++	+++++
Self discharge while inactive	-	+++	++++	++++	+++
Lifespan with complete discharge	+	++	+++	++++	+++++
Lifespan with limited discharge	++	+++	++++	++++	+++++
Sensitivity to excessive charge voltage	++	++	+++	++++	+++++
Suitable for selection of battery bank with high capacity	+	++	+++	++++	++++
Suitable for E-propulsion	+	++++	+++	++++	+++++
Starting motors	++	++++	+++	++	++++
Shock-resistance	+	++++	++++	++++	++++
Number of charge/discharge cycles	+	++	+++	++++	+++++
Temperature-resistance	+	++	++++	++++	++++
Installation/angle of inclination	-	++++	++++	++++	++++
Return on investment with limited use	+	+++	+++	++++	+++
Return on investment with intensive use	+	++	+++	++++	+++++
Product warranty	± 1 year	2 year	2 year	7 year	2 year
Worldwide onboard service	+	++++	++++	++++	++++

+++++ = excellent ++++ = very good +++ = good ++ = adequate + = inadequate - = poor

① AGM battery

In AGM batteries, the electrolyte (mixture of water and sulphuric acid) is largely absorbed in glass fibre. This type of battery is entirely maintenance-free and there is no gas formation with normal use. Not requiring any ventilation, these batteries can be installed anywhere. Their construction gives a very fast discharge at very high currents so AGM batteries are ideal for systems that require high currents (for instance when starting an engine).

The battery poles can be unscrewed and this type of battery can be combined with every standard battery terminal.



② Gel batteries

In gel batteries, the electrolyte is absorbed by a gel. This type of battery is entirely maintenance-free and has no gas formation with normal use. As no extra ventilation is required gel batteries can be installed anywhere. They are ideal as service battery and for cyclical use, and can be charged very quickly.



③ Traction batteries

This robust gel battery is designed for regular and deep discharging (1000 full cycles), and is ideal for large systems that require intensive use and a very long lifespan.



④ Lithium Ion batteries

Lithium ion batteries have a high energy density and are perfect for cyclic applications. They offer savings of up to 70% in volume and weight compared to traditional lead-acid batteries, with three times as many charging cycles (2000 full cycles).

Another major benefit of the Mastervolt Li-ion battery is that it is equipped with a Battery Management System (BMS), which automatically compensates for any imbalance between the cells. This guarantees you a constant high capacity and longer battery lifespan.



AGM Series

- Ideal universal battery.
- Excellent starter function.
- Perfect upgrade for wet lead acid batteries.
- Same initial power surge in an AGM 12/90 Ah as in a 180 Ah wet lead-acid battery.
- Glass-fibre technology ensures low internal resistance.
- Use of thicker plates allows deep discharging.
- Also for cyclic use.
- Two year warranty



	AGM 12/55	AGM 12/70	AGM 12/90	AGM 12/130	AGM 12/160	AGM 12/225	AGM 12/270
Item #	62000550	62000700	62000900	62001300	62001600	62002250	62002700
Nominal voltage	12V	12V	12V	12V	12V	12V	12V
Capacity C20*	55 Ah	70 Ah	90 Ah	130 Ah	160 Ah	225 Ah	270 Ah
CCA to DIN	300A	385A	535A	585A	630A	815A	1000A
CCA to SAE	480A	615A	850A	935A	1000A	1300A	1600A
Max. outer Dimensions** l x w x h	10.1x5.2x8.2" 257x132x207 mm	13.7x6.6x7.1" 348x167x181 mm	13x6.8x9.3" 330x173x237 mm	16.1x7x9" 410x177x228 mm	19.1x6.7x9.6" 485x170x245 mm	20.6x9.4x9.5" 522x240x241 mm	20.6x10.6x9.6" 522x268x243 mm
Weight	37.5 lbs / 17 kg	47 lbs / 21.5 kg	62 lbs / 28 kg	83 lbs / 37.6 kg	93 lbs / 42.3 kg	140 lbs / 63.5 kg	161 lbs / 73 kg

* C20 = battery capacity at a discharge time of 20 hours, till 1.75V per cell. **Including terminals and grip handles

AGM SlimLine Series

- Ideal universal battery; also for starter functions.
- Compressed AGM technology.
- Saves up to 15% in volume.
- Saves up to 15% in weight.
- Miniscule footprint; 2x 200 Ah for a 200 Ah battery footprint.
- Two-year warranty.



	AGM-SL 12/115	AGM-SL 12/150	AGM-SL 12/200
Item #	63001150	63001500	63001851
Nominal voltage	12V	12V	12V
Capacity C20*	115 Ah	150 Ah	200 Ah
CCA to DIN	545A	610A	750A
CCA to SAE	910A	1020A	1250A
Max. outer Dimensions** l x w x h	22x4.3x9.2 in 560x110x233 mm	22x4.3x11 in 560x110x280 mm	22x5x11 in 560x126x280 mm
Weight	78 lbs / 35.6 kg	89 lbs / 40.5 kg	119 lbs / 54 kg

* C20 = battery capacity at a discharge time of 20 hours, till 1.75V per cell.

**Including terminals and grip handles

AGM 6 Volt Series

- Ideal solution for cyclic applications, such as electric propulsion, wheelchairs, golf carts, etc.
- Easy configuration of 12/24/48V battery terminals, with high capacity.
- Double pole for easy installation.
- No gas formation with normal use.
- Two-year warranty.



	AGM 6/260 Ah	AGM 6/340 Ah	AGM 6/400 Ah
Item #	61002600	61003400	61004000
Nominal voltage	6V	6V	6V
Capacity C20*	260 Ah	340 Ah	400 Ah
Max. outer Dimensions** l x w x h	11.6x7.1x11.7 in 295x180x298 mm	11.6x7.1x14.4 in 295x180x366 mm	11.6x7.1x16.9 in 295x180x428 mm
Weight	79.3 lbs / 36 kg	107.7 lbs / 48.9 kg	122.7 lbs / 55.7 kg

* C20 = battery capacity at a discharge time of 20 hours, till 5.25V.

**Including terminals and grip handles

MVG Gel Series

- Perfect service battery for medium and large 12V and 24V systems.
- Extremely long lifespan.
- No gas formation with normal use.
- Fast recharge, high charge current possible.
- For intensive cycle use with a high number of charge/discharge cycles.
- Very low self discharge.
- Two-year warranty.



	MVG 12/25	MVG 12/55	MVG 12/85	MVG 12/120	MVG 12/140	MVG 12/200
Item #	64000250	64000550	64000850	64001200	64001400	64002000
Nominal voltage	12V	12V	12V	12V	12V	12V
Capacity C20*	25 Ah	55 Ah	85 Ah	120 Ah	140 Ah	200 Ah
CCA to DIN	110A	230A	270A	450A	540A	630A
CCA to SAE	175A	380A	450A	760A	920A	1100A
Max. outer Dimensions** l x w x h	6.6x6.9x5 in 167x176x126 mm	10.3x5.4x9 in 261x136x230 mm	13x6.7x9.3 in 330x171x236 mm	20.2x7.4x8.8 in 513x189x223 mm	20.2x8.8x8.8 in 513x223x223 mm	20.4x10.8x9.4 in 518x274x238 mm
Weight	21.2 lbs / 9.6 kg	41.9 lbs / 19 kg	71.9 lbs / 32.6 kg	90.4 lbs / 41 kg	108 lbs / 49 kg	154.3 lbs / 70 kg

* C20 = battery capacity at a discharge time of 20 hours, till 10.5V.

**Including terminals and grip handles



MVSV 2 Volt Gel Series

- Long lifespan.
- Many charging and discharging cycles.
- Charges quickly.
- Extremely sustainable battery for large installations.
- Robust build for longer lifespan.
- Deep discharging without problems.
- Can be installed horizontally or vertically.
- Seven-year warranty (pro rata).



MVSV 280



MVSV 420



MVSV 500



MVSV 580



MVSV 750



MVSV 1000

Item #	68000280	68000420	68000500	68000580	68000750	68001000
Nominal voltage	2V	2V	2V	2V	2V	2V
Capacity C10*	280 Ah	420 Ah	500 Ah	580 Ah	750 Ah	1000 Ah
Max. outer Dimensions** lwxwxh	4.9"x8.2"x15.8" 125x207x401 mm	4.9"x8.2"x20.4" 125x207x517 mm	5.7"x8.2"x20.4" 146x207x517 mm	6.4"x8.2"x20.4" 167x207x517 mm	5.7"x8.2"x27.3" 146x207x693 mm	8.3"x7.6"x27.3" 211x192x693 mm
Weight	22 kg / 48.5 lbs	32 kg / 70.5 lbs	37 kg / 81.6 lbs	42 kg / 92.6 lbs	50 kg / 110.2 lbs	68 kg / 150 lbs

* C10 = battery capacity at a discharge time of 10 hours, till 1.80V per cell. **Including terminals and grip handles



MVSV 1250



MVSV 1500



MVSV 1650



MVSV 2200



MVSV 2700

Item #	68001250	68001500	68001650	68002200	68002700
Nominal voltage	2V	2V	2V	2V	2V
Capacity C10*	1250 Ah	1500 Ah	1650 Ah	2200 Ah	2700 Ah
Max. outer Dimensions** lwxwxh	8.3"x9.2"x27.3" 211x234x693 mm	8.3"x10.9"x27.3" 211x276x693 mm	8.3"x10.9"x33.2" 211x276x843 mm	8.4"x15.7"x32.3" 214x399x819 mm	8.4"x19.2"x32.2" 214x488x819 mm
Weight	82 kg / 180.8 lbs	98 kg / 216 lbs	112 kg / 247 lbs	153 kg / 337.3 lbs	196 kg / 432.1 lbs

* C10 = battery capacity at a discharge time of 10 hours, till 1.80V per cell. **Including terminals and grip handles

Lithium Ion Series

Lithium Ion batteries have a high energy density and are perfect for cyclic applications. Compared to traditional lead-acid batteries, Lithium Ion batteries offer savings of up to 70% in volume and weight, while the number of charging cycles is three times as large. Another major benefit of the Mastervolt Li-ion battery is that it is equipped with a Battery Management System, which automatically compensates for any imbalance between the cells to guarantee a longer battery lifespan.

- Highly advanced technology.
- Multifunctional battery of 4.3 kWh.
- 12 and 24 volt available.
- Saves up to 70% in space.
- Saves up to 70% in weight.
- Triple the lifespan.
- Ultra-fast charging and discharging (up to one C).
- High efficiency.
- MasterBus communication with every Mastervolt battery charger.
- Integrated system for battery management including cell balancing.
- Safest Li-ion available.
- Designed for systems up to 250V DC.
- Suitable for onboard AC networks and electric sailing.



	MLI 12/320	MLI 24/160
Item #	66010320	66020160
Nominal voltage	13.25V	26.5V
Capacity*	320 Ah / 4,3 kWh	160 Ah / 4,3 kWh
Max. outer Dimensions** l x w x h	24.5x7.8x13.6 in 623x199x345 mm	24.5x7.8x13.6 in 623x199x345 mm
Weight	± 55 kg, 90 Wh/kg 121 lbs	± 55 kg, 90 Wh/kg 121 lbs

* Battery capacity at a discharge time of 1 till 20 hours.

**Including terminals and grip handles



Extensive testing of the Mastervolt Li-ion battery by Team Emirates resulted in Mastervolt becoming their official supplier.



Manage: Everything under control with the right information

Ease of use is ease of comfort. We understand that you want to enjoy your peace and freedom without a care in the world. From battery monitors to intelligent digital systems, Mastervolt systems require minimum attention.

The BTM-III battery monitor is a combination of Mastervolt's comprehensive battery expertise and complex analyses and algorithms. This provides you with a simple system, indicating the battery status from 0 to 100 percent or in time remaining. Know precisely how long you can keep using your battery at the same level of consumption.

Our digital switching systems integrate battery monitoring as well as the operation and monitoring of all consumers. Whether operating the system from home by text message or switching on your reading light in your cabin, everything works fast and fully digitally.

Moreover, you benefit from endless possibilities for configuring your system or adapting it to your wishes without requiring a large number of extra components or wiring. Instead of a complex puzzle you can expect ease of installation and maintenance, leaving you free to enjoy what you love most and explore the world.

The Power to be Independent!



Battery Switches	94
Battery Distribution Clusters	100
Battery Distribution Panels	104
Traditional Battery Switches	109
Battery Management Panels	112
Battery Isolators & Dynaplates	113
Fuses & Fuse Holders	115
Circuit Breakers	119
DC / AC Circuit Breaker Panels	124
Labels–Circuit Breaker Panels	133
Switch Panels & Switches	139
Battery Distribution Accessories	145
Transfer Systems	150
MasterBus	154
CZone™	164
Monitoring–DC / AC / Tank / Gas	181
Wire & Cable	193
Terminals & Lugs	201
Heat Shrink Tubing	209
Cable Ties & Wire Management	211
Kits, Tools & Testers	217





701



701S



700

Contour Battery Master Switch

- The 701 Contour Battery Master Switch offers a number of unique features, the highlight being the patented Contour Locking System, allowing it to be a stand alone unit, or locked together with other switches.
- Features a control knob which cannot be removed while in the ON or OFF position, however, can be removed by switching to an counter-clockwise 45° position. The control knob also features an interchangeable labeling system allowing a full range of applications (Part number 713 or 715: 136).
- Removable side plates on 4 sides for access of up to 1/0 cables plus a rear cover insulating the rear terminals against any short circuits. This ensures the switch meets ABYC requirements.
- Can be either surface or recess mounted by cutting a 2.1" (52 mm) hole.

Battery Selector Switch

The 701S is the most compact selector switch available on the market. Housed in the same dimensions as the 701, and includes the same removable side plates and back cover. While BEP recommends isolated battery systems as outlined with our distribution clusters, the 701S offers a simple economical way of separating two batteries.

Please note selector switches will not separate electronics from harmful engine starting spikes.

Easyfit™ Battery Switch

Following customer feedback about installations where switches need to be recessed through varying thicknesses of panels, we developed the 700 Easyfit™ switch. It achieves this through an easily removable threaded ring allowing for panel thicknesses up to 3/4" (19 mm). It uses the same features as the 701 with the removable key 45° past the off position, labelled handle and a removable back cover covering exposed terminals to meet ABYC specifications.

The switch can also be surface mounted offering a unique style compared to other switches available on the market. The 700 Easyfit™ switch can easily be retro - fitted in place of most European post and lever type switches.

Panel-Mounted Switches

The panel mount range of battery switches are designed specifically for panel mount applications. This range gives a very compact, versatile solution.

- Compact, lightweight
- Removable key on 701-PM
- Countersunk recesses for surface mount application
- Standard 2-1/16" (52 mm) hole cut out (same as standard gauge hole)
- Inside: captive inserts for 3/16" (4.8 mm) nuts; full access for cables - no restrictions
- Standard BEP™ interchange label system (see 136)

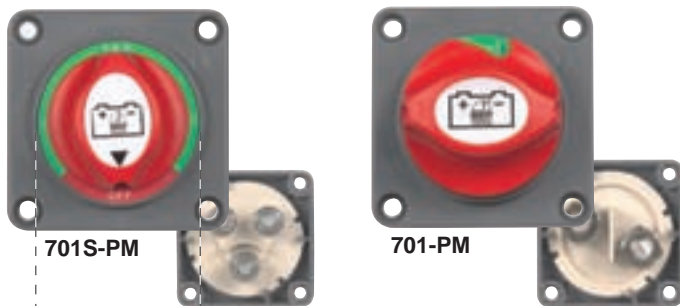

701S-PM

701-PM

Item #	OEM #	Specs
701-PM	701B-PM	Same as 701
701S-PM	701S-B-PM	Same as 701S

Mounting Plates

Single recessed. Supplied with all the mounting hardware and come in a matching grey finish.

For	Item #	LxW
701	BSP-1	3.75"x3.75" / 95x95 mm



As shown in Contour Connect panels

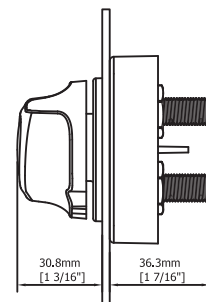

panel



720

Heavy-duty Battery Switch

The 720 Heavy-duty Battery Switch fits into the same contour lock system as used on the battery distribution system. Rated at 600A continuous and 2500A cranking. It is well suited to larger vessels.

As with the 701, the 720 can be recessed or surface mounted. The 720 uses the same style of self cleaning sliding contact as used in the 701 and uses the same label sheet (part number 713 or 715 refer 136).

BEP's patented Contour Locking System is an innovative feature that allows for multiple battery management components to be connected to each other providing for a clean finished installation. These locking tabs can be found on battery switches, heavy-duty buss bars, fuse holders, distribution studs and breaker modules.

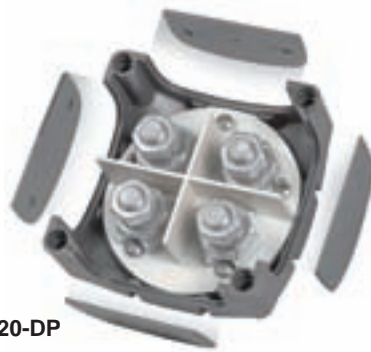

720-DP

Double Pole Battery Switch

The 720-DP Double pole battery switch is a welcome addition to the BEP™ battery switch range. It has the same dimensions and features as the 720 battery switch, but also meets the needs of systems where positive and negative supplies must be isolated at the same time.

SAFETY NOTE: BEP recommends the 720-DP for isolating positive and negative circuits. **We do not recommend it for switching house and start battery systems at the same time. We recommend separate switches for house and start for safety reasons. You may need to isolate your engine battery in an emergency and not your house battery, which typically powers the communications.**

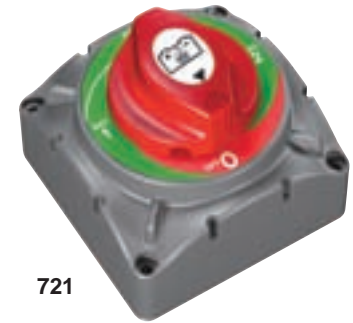

721

Battery Selector Switch

The 721 Battery Selector Switch is our heavy-duty selector switch. Housed in the same module as the 720, it includes the same removable plates and back cover. While BEP recommends isolated battery systems as outlined with our distribution clusters, the 721 offers a simple economical way of separating two batteries.

Please note selector switches will not separate electronics from harmful engine starting spikes.

BEP Marine Battery Switch Test

Procedures (UL 1107) Continuous (1 hour), intermittent (5 minutes) & Cranking (engine starting – 10 seconds). The test is to determine the maximum current the switch can handle for the stated time, without the rear terminals exceeding 100°C (212°F) above the ambient temperature. The continuous and intermittent ratings are tested at 110% of specified ratings. All BEP switches are tested Independently to this specification by a 3rd party laboratory

Specifications - All recessed or surface mount, tin-plated copper studs & nuts, ignition-protected

Item #	OEM #	in LxWxH	mm LxWxH	Rating (A DC)			Voltage (V DC)	Operation	Stud size Studs x (in/mm)
				Continuous	Intermittent	Cranking			
700	700B	2.7"x2.7"x4.3"	68x68x110 mm	275	455	1250	48	On/Off	2 x (3/8" / 10 mm)
701	701B	2.75"x2.75"x3"	69x69x75 mm	275	455	1250	48	On/Off	2 x (3/8" / 10 mm)
701S	701S-B	2.75"x2.75"x3"	69x69x75 mm	200	300	1000	48	1-2-Both-Off	3 x (5/16" / 8 mm)
720	720B	4"x4"x3.5"	102x102x90 mm	600	800	2500	48	On/Off	2 x (1/2" / 12 mm)
720-DP	720-DP/B	4"x4"x3.5"	102x102x90 mm	400	525	1500	48	On/Off 2 poles	4 x (1/2" / 12 mm)
721	721B	4"x4"x3.5"	102x102x90 mm	350	500	1500	48	1-2-both-Off	3 x (3/8" / 10 mm)

Battery Knob Options for 701 Switch

For applications where emergency parallel switch needs to be highlighted.

Order separately - replaces existing knob.



701-KEY-EP



701-KEY

Remote Operated Battery Switches

Due to the increased load requirements and large increases in the cost of copper battery cable, the MD range of battery switches allows you to install the battery switch very close to the battery, reducing cable lengths to the starter motor. They are also ideal for remote isolation of bow thrusters. The 720-MDO has been enhanced to include internal optical sensors providing even more operational functionality to this innovative master switch.

- Remote operation
- Battery switch can be mounted alongside battery, reducing cable lengths and cable sizes to starter motor. (Large cost saving in copper cables)
- Reduced installation labor, due to shorter battery cable runs
- Manual override option to meet CE requirements
- Power Draw: Switch off: 12mA. Switch on: 15mA, switch operating 120mA for 3 seconds @ 12V nominal
- LED status identification for remote control switch
- Same capacities/specifications and mounting options as standard BEP™ battery switches
- Uses same interchangeable labeling system as BEP™ battery switches (136)

Optical sensor benefits (720-MDO only)

- Can be used to switch in positive or negative lines
- Low stand by current draw (7mA) (zero if aux control switch used. See instruction sheet)
- Main contacts isolated from control circuit allowing operation via another battery source



720-MDO



701-MD

Specifications - All recessed or surface mount, tin-plated copper studs & nuts, ignition-protected

Item #	in LxWxH	mm LxWxH	Rating (A DC)			Voltage (V DC)	Function	Stud size Studs x (in/mm)
			Continuous	Intermittent	Cranking			
701-MD	2.7"x2.7"x4"	68x68x101 mm	275	455	1250	9.5-32	On/Off	2 x (3/8" / 10 mm)
720-MDO	4"x4"x4.33"	102x102x110 mm	500	700	2500	9.5-32	On/Off	2 x (1/2" / 12 mm)

NEW Terminal Link Kits (TLK's)

Now available for the 701 and 720 size switches, the TLK's allow for cable connections to be made outside of the body of the switches. Image not available yet.

Item # 80-708-0017-00 701-MD

Item # 80-708-0013-00 720-MDO

Wireless Remote Control

You can now wirelessly operate your BEP™ motorized battery switches from a distance of up to 250 feet (80 meters) away

- Control up to 4 separate 5A circuits; eg, 701-MD/720-MDO battery switches, anchor light, navigation lights, and courtesy lights
- No more lifting hatches to turn on battery switches — it's now all controlled from the remote key fob
- Control battery switches easily (On/Off) from the dock
- Remote has a rolling code, for security

Item # 80-911-0045-00

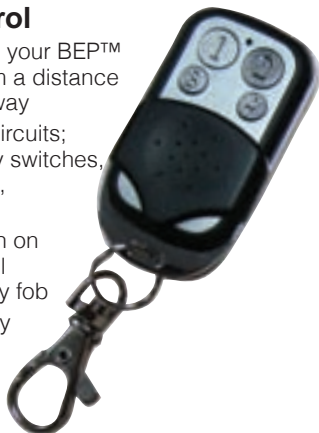

Remote On/Off Key Switch

For the remote operation of the 701-MD and 720-MDO battery switches (above). It can be mounted standalone or within the Contour Connect panel range.

Item # 80-724-0006-00



Dual Operation VSS (Voltage Sensitive Switch) and Emergency Parallel

- Incorporates the same auto charging functionality as the BEP VSR
- Dual battery sensing
- Remote emergency parallel function: the 701-MDVS and 720-MDVS can be operated through a momentary button on the dash which will parallel the batteries for a preset time of 10 minutes. Once this 10 minutes has passed, if the voltage is up high enough for the voltage sensitive switch to operate, it will stay engaged. If not, it will disengage.
- Engine run sensing: VSS will engage when the voltage on either the start or house battery reaches 13.7 volts. If the combined battery voltage drops below 13.0 volts and the engine is not running, after 5 seconds the contacts will open and stay open until the start or house battery voltage exceeds 13.7 volts. If the combined battery voltage drops below 12.2 volts and the engine is running, after 5 minutes the contacts will open and stay open until the start or house battery voltage exceeds 13.7 volts. If voltage drops below 13 volts and stays above 12.2 volts on either start or house battery while engine is running, the VSS will stay engaged.

- Manual override option
- The advantages of using a high current VSS is that it will cover your dual battery charging requirements and emergency parallel operation in one unit.
- Also available in Emergency parallel only (no voltage sensitive function). See table below.

NEW Optical benefits now available for the motor driven VSS and emergency parallel switches

Optical sensor benefits (720-MDVSO, 720-MDVSO-24V & 720-MDO-EP only)

- Can be used to switch in positive or negative lines
- Low stand by current draw (7mA) (zero if aux control switch used. See instruction sheet)
- Main contacts isolated from control circuit allowing operation via another battery source

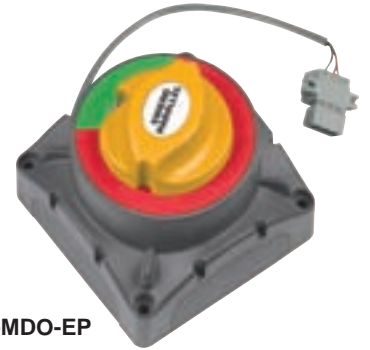

720-MDO-EP



80-701-0018-00

Item #	in LxWxH	mm LxWxH	Volts (V)	Rating (A)	Engages (V DC)	Disengages (V DC)
701-MDVS	2.7"x2.7"x4"	68x68x101 mm	12	275	13.7	12.2-13.00
720-MDVSO	4"x4"x4.3"	102x102x110 mm	12	500	13.7	12.2-13.00
701-MDVS-24V	2.7"x2.7"x4"	68x68x101 mm	24	275	27.4	24.4-26.00
720-MDVSO-24V	4"x4"x4.3"	102x102x110 mm	24	500	27.4	24.4-26.00
80-701-0018-00	2.7"x2.7"x4"	68x68x101 mm	12/24	275	Emergency Parallel Only	
720-MDO-EP	4"x4"x4.3"	102x102x110 mm	12/24	500	Emergency Parallel Only	

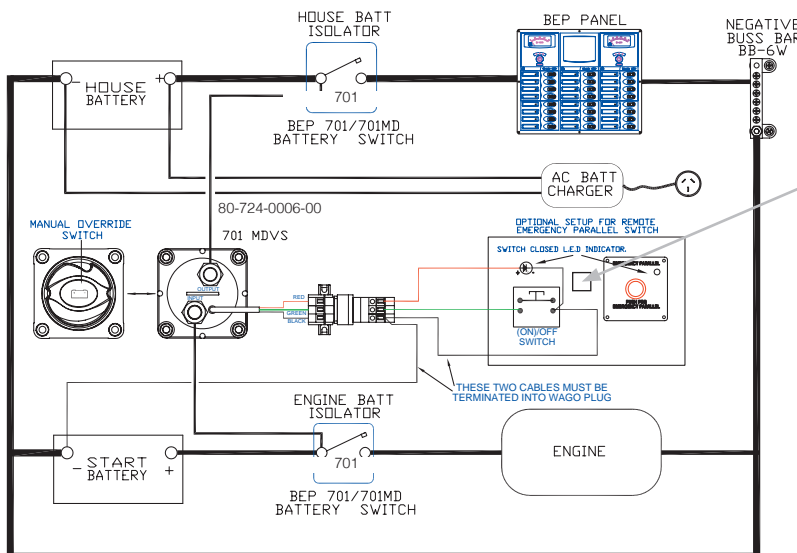

Remote Emergency Parallel Switch

For the remote operation of the 701-MDVS and 720-MDVS voltage sensitive battery switches. It can be mounted standalone or within the Contour Connect panel range.

Item # 80-724-0007-00

Digital Voltage Sensing Relay (DVSR)

The new Digital VSR (Voltage Sensing Relay) combines all of the market proven features of the existing VSR with a host of new functionality.

The Voltage Sensing Relay (VSR) allows the charging of a second battery from a single charging source. When the voltage on the start battery rises to a level indicating a 60% charge, the VSR engages allowing the 2nd battery to charge. When charging stops and voltage falls the VSR will disengage isolating the two batteries from each other.

Dual sensing functionality enables the sensing of two battery banks allowing two way charging.

- Safely charge two or more independent battery banks from one charge source (alternator, battery charger...)
- Charges engine starting batteries before combining auxiliary bank for charging
- Protects start batteries from becoming flattened by domestic loads
- Isolates electronics from harmful electrical surges from starter and winch motors
- Simple to install 3 wire connection, leaves alternator wiring intact
- No volt drop vs. diode isolators
- Ignition protected
- Surface or panel mountable
- **Replaces previous models 710-125A and 710-125A-DS**

2011 Digital enhancements:

- Remote status LED output
- Remote sensing circuitry for isolated control from secondary supply
- Zero stand by current draw when remote sensing circuit utilized with switch fitted (switch in open position)
- Multi voltage, auto selects between 12 and 24V DC operation



Item #	OEM #	in LxWxH	mm LxWxH	Volts (V)	Rating (A) Continuous	Engages (V DC)	Disengages (V DC)
710-140A	—	2.75"x2.75"x2"	69x69x50 mm	12	140	13.2	12.7
—	710-140A-B	2.75"x2.75"x2"	69x69x50 mm	24	140	26.4	25.4

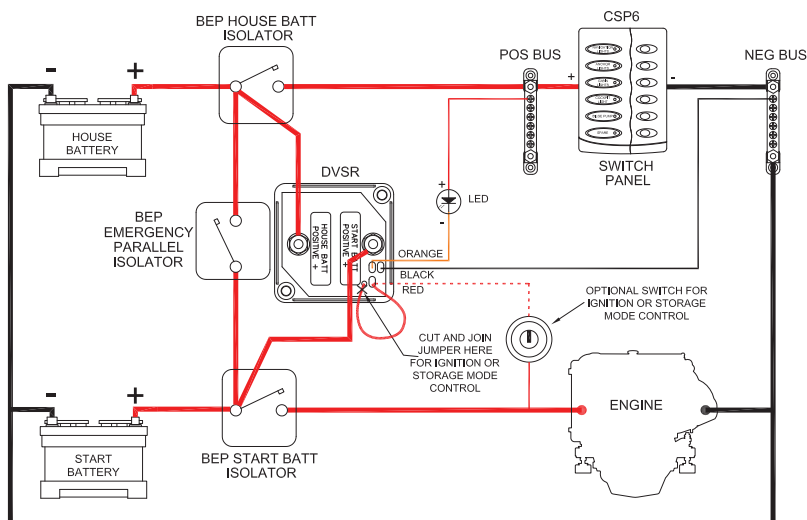

Wiring diagrams indicative of installation only.

Charge Mate

An auxiliary onboard power supply is increasingly common. As a second battery can prevent the main battery from depleting and being unable to start, this seems like a safe and reliable solution. The second battery, however, also has to be charged regularly. Mastervolt has the solution: The Charge Mate connects both batteries with a voltage relay while charging, and keeps them isolated at other times. The Charge Mate is especially practical for small systems.



	Charge Mate 1202	Charge Mate 2505
Item #	83301202	83302502
Battery voltage	12/24V	12/24V
Continuous power	120A	500A
Inrush current (250ms)	2000A	2000A
Switch on voltage	13...15V (12V) 26...30V (24V)	13...15V (12V) 26...30V (24V)
Switch on delay	5 sec	30 sec
Switch off voltage	< 12.75V (12V) < 25.5V (24V)	< 12.25... > 15V (12V) < 25.5... > 30V (24V)
Switch off delay	no	3 minutes
Ambient temperature	-40-65°C	-40-60°C
Dimensions, hxwx d	3"x1.8"x1.8" 76x46x46 mm	3.5x3.1x3.3" 90x80x85 mm
Weight	0.28 lbs / 0.125 kg	1.4 lbs / 0.65 kg
Protection degree	IP21	IP21
Number of modes	n.a.	on, off, auto, start assist
Power consumption	switch open: < 1mA at 12/24V DC	switch open: < 1mA at 12/24V DC

Battery Distribution Clusters

With the successful release of the BEP™ battery distribution system, BEP saw the need for ready assembled clusters for different applications to make the installation within the battery area even easier. Following is the range as outlined in each diagram, which are overviews only.

All clusters are completely bused and pre-wired internally and are supplied with mounting fastenings along with easy to follow instructions. These include all connecting points clearly marked with ABC labels as shown in all illustrations.

All existing VSR enabled Battery Distribution Clusters now come standard with the new Digital Voltage Sensing relays. Replace suffix "-100A" with "-140A-DVSR(-B)".

**Now Incorporating
NEW Digital VSR**

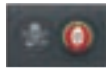

See pages 105 & 106
for panel versions

Single Engine, Two Battery Banks

The 714-140A-DVSR uses a dual sensing DVSR (710-140A). This system ensures you will always have a fully charged reserve battery. When the switch is in position one, it becomes the sensing battery for the VSR. Battery two, which is in isolation, will be charged via the VSR when the engine is running ensuring it is always fully charged. When the switch is in battery two position, this becomes the sensing battery and battery one is charged via the VSR. The fact that there is always a fully charged battery in reserve is a huge safety factor.

Please note: With the 714-140A-DVSR the electronic loads are run off the same battery as the engine starting battery.

Item # 714-140A-DVSR
OEM # 714-140A-DVSR-B

See table on following page for specifications

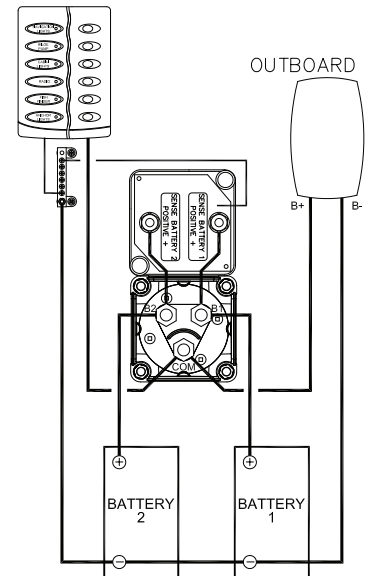

See pages 105 & 106
for panel versions

Single Engine Two Dedicated Battery Banks

Available as Horizontal or Vertical units.

To be used in the following systems:

- 1) Single outboard dual battery bank
- 2) Single alternator dual battery bank
- 3) Twin alternator dual battery bank

Item # 715-V

See table on following page for specifications

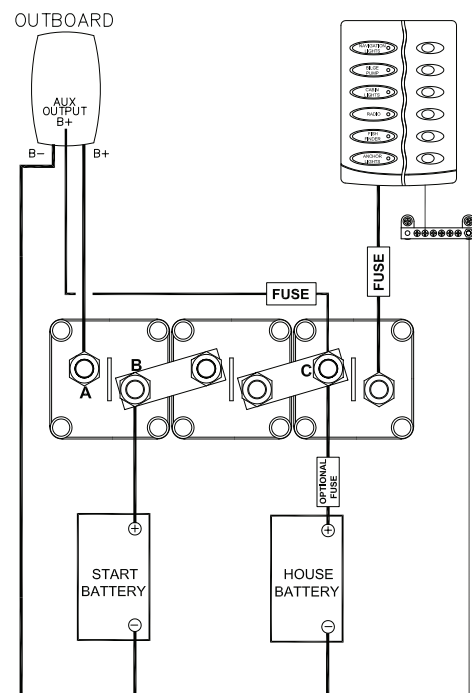

Single Engine, Two Battery Banks

An ideal replacement for a Battery Selector Switch. Just remove selector switch and connect existing wires to a 716 cluster, no extra wires are required for a fully automatic battery management system. No more flat start batteries.

Electronics protection from harmful engine start spikes. The 716 cluster is for use on charging systems up to 150A. To be used in the following systems:

1. Single outboard dual battery bank.
2. Single alternator inboard engine dual battery bank.

The 716 cluster replaces battery isolator systems. For VSR operation, see page 98.



716-SQ-140A-DVSR

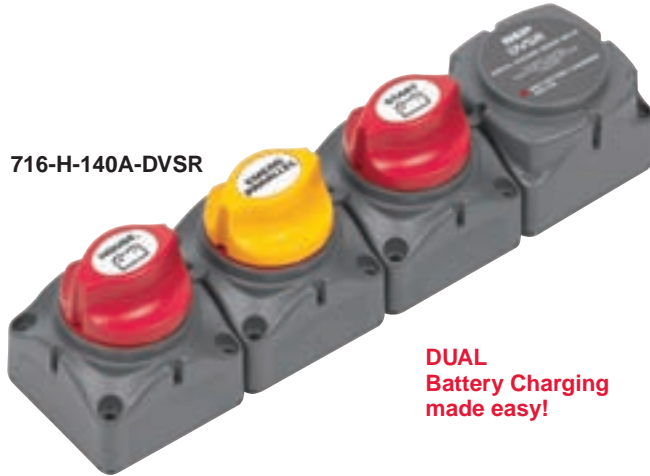

716-H-140A-DVSR

**DUAL
Battery Charging
made easy!**

 See pages 105 & 106 for panel versions

Dimension guide

Clusters are made from uniformly square switches, each side 2.7" (69 mm)

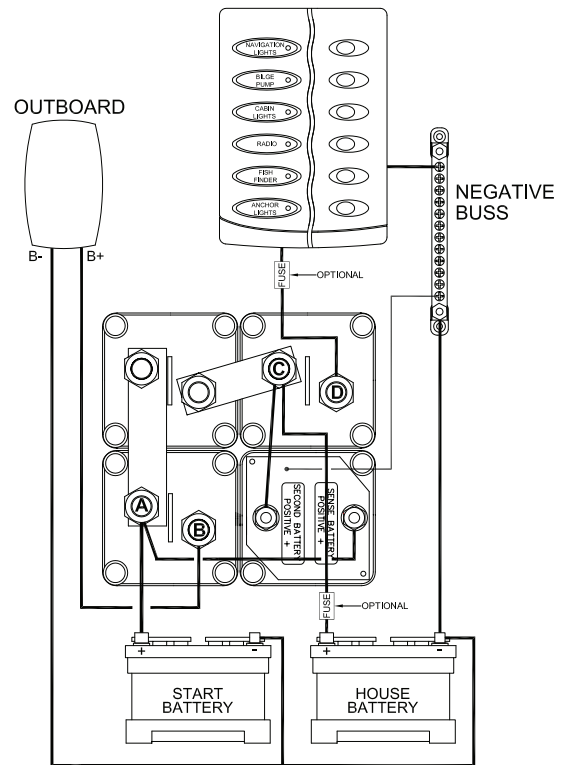

Engine type	Battery (banks)	Item #	in LxWx3	mm LxWx75
Single inboard or outboard	2	714-140A-DVSR	5.4"x2.75"	138x69
		715-H	8.1"x2.75"	207x69
		715-V	2.75"x8.1"	69x207
		716-SQ-140A-DVSR	5.4"x5.4"	138x138
		716-H-140A-DVSR	10.85"x2.75"	276x69
Twin inboard or outboard	2	715-S	8.1"x2.75"	210x69
Twin outboard	3	717-140A-DVSR	5.4"x8.1"	138x207
Twin inboard	3	718-140A-DVSR	8.1"x5.4"	207x138
Triple outboard	4	719-140A-DVSR	8.1"x 8.1"	207x207

VSR Charging Current: 150A Battery Switch Rating: 275A



Twin Engine, Two Banks

The 715-S allows the house loads to be switched between port and starboard batteries. The selector switch can also be used to parallel the batteries when in both positions.

See table on previous page for specifications.

Item # 715-S



Twin Engine, Three Banks

The 718-140A-DVSR is designed for twin inboard systems when it is not practical to have both engine alternators in parallel because of the types of regulators used on these alternators. The house battery is charged from the port engine when the VSR is engaged. (for VSR operation read see page 98)

See table on previous page for specifications.

Item # 718-140A-DVSR



See pages 105 & 106
for panel versions



Twin Engine, Three Banks

This system is designed for twin engine installations. It will allow the port engine to charge the port start battery and the house battery when the VSR is engaged. It will also allow the starboard engine to charge the starboard start battery and the house battery when the starboard VSR is engaged, giving a combined charge from two engines into the house battery until the voltage regulators on both engines control the charge. It will also allow the house battery to be charged if steaming on one engine.

See table on previous page for specifications.

Item # 717-140A-DVSR



Triple Engine, Four Banks

This system is designed for triple engine installations. Once again using multiple VSR's off each start battery giving combined charge from all 3 engines into the house battery via VSRs.

See table on previous page for specifications.

Item # 719-140A-DVSR



Single Engine, Two Battery Banks with Motorized VSR

Offers the same features as the 716-SQ-140A-DVSR (see page 101), with two important differences.

The VSR and Emergency parallel switch are combined into one voltage-sensitive switch, and that switch is able to be remote-operated. For features of the motorized VSR, see page 97. The layout allows all cables to be attached from the bottom of the cluster.

Item # 80-716-0017-00



Twin Engine, Three Banks with Motorized VSR

Offers the same features as the 717-140A-DVSR (see page 101).

The VSR and Emergency parallel switch are combined into one voltage-sensitive switch, and that switch is able to be remote-operated. For features of the motorized VSR, see page 97. The layout allows all cables to be attached from the bottom of the cluster.

Item # 80-716-0018-00

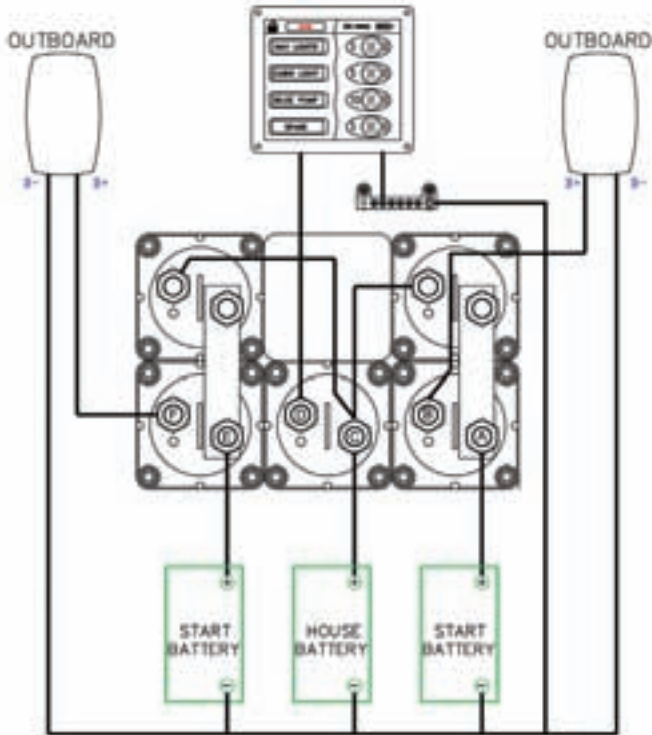
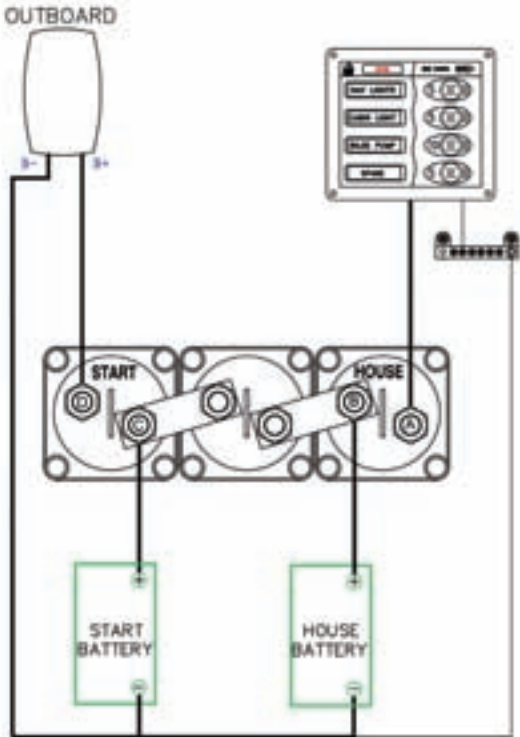

See pages 105 & 106 for panel versions

Battery Control Center

Sophisticated Electrical Systems Need Reliable Automation. That's Key. Centralize power handling with the BEP™ Battery Control Center...

...and BEP's latest line of rugged remote-operated switching banks, Cluster or Contour Connect mounted, delivers hard-handling, good-looking power management where it's needed. The Battery Control Center (BCC) is equipped with locks on each battery switch position. This ensures group operation at the turn of the key. Any switch can be isolated by disengaging its lock and toggling the switch off.

- Control all battery switches from one convenient position
- Isolate each battery via key switch or designated battery banks via breaker
- LED Status indicators for battery switch status.
- Uses Contour Connect molding to match other BEP products. (see Contour Connect panel range)

Essential Circuits

If you're installing a single engine system, there will be 2 spare CBs which can be used for essential circuits, eg. stereo memory, bilge pumps. If installing a dual system, only one CB is available.



80-700-0051-00

Description	Item #
Single engine remote	80-700-0050-00
Twin engine remote	80-700-0051-00
Triple engine remote	80-700-0052-00

Remote Battery Management Systems

- Complete system including all cable links (Battery Control Center ordered separately)
- Offers all features of motorized battery switches and Motorized VSRs in one kit. Makes ordering easy!
- Contour Connect panels can be flush-mounted for tidy installation and can be combined with other Contour Connect products on following pages.
- Clusters are surface mount, and can be rearranged to meet specific needs, such as port and starboard configurations and can be combined with other battery distribution products.
- Available in single, dual and triple engine configurations

Triple Engine

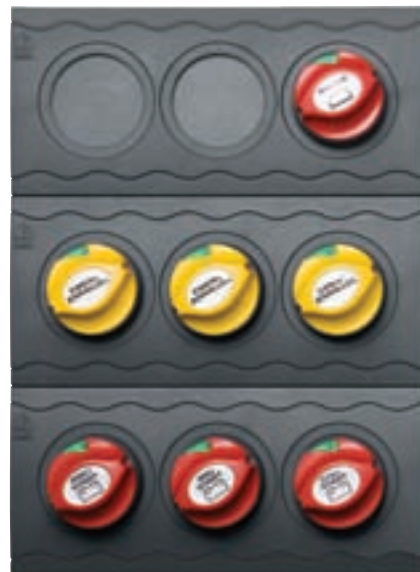

80-700-0053-00

Dual Engine



80-700-0048-00

Single Engine



80-700-0047-00



80-716-0014-00



80-716-0015-00



80-716-0016-00



Single Engine, Two Battery Banks

The CC-801 incorporates a version of our very successful 714-140A-DVSR cluster (see page 100).
 The CC-801 is supplied pre-wired with back cover and with a CC-J joiner to allow it to be combined with other modules.
 The CC-801 is supplied standard in charcoal with light grey wave strip. Other trim colors are available for volume OEM orders.

Item # CC-801

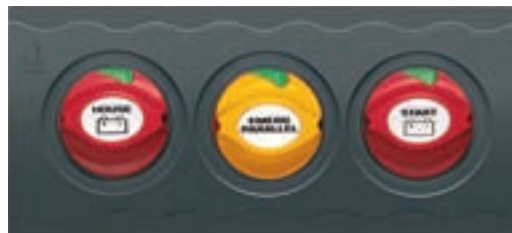

Single Engine, Two Battery Banks

The CC-810 is supplied standard with 3 x 701-PM battery switches pre-assembled. Ideal for installing alongside any other Contour Connect Modules.

Item # CC-810

Single Engine, Two Battery Banks

The CC-802 incorporates a version of our very successful single engine battery switch cluster (page 101).
 The CC-802 is supplied loosely assembled with links and joiners to allow it to be assembled in either the vertical or horizontal orientation as shown in illustrations.
 Full wiring instructions are supplied to allow pre assembly for both orientations.

Item # CC-802



Twin Engine, Three Battery Banks

The CC-803N incorporates a version of our very successful dual engine battery switch cluster (page 102).
 The CC-803N is supplied with cables to allow for horizontal or vertical configurations.
 The components can also be easily removed and reconfigured if the factory layout does not suit your application.

Item # CC-803N



Dimensions for these panels are on following page



Single Engine, Two Battery Banks

The 80-700-0054-00 offers the same features as the CC-802. The VSR and Emergency parallel switch are combined into one voltage-sensitive switch, and that switch is able to be remote-operated.

Fewer components, more compact.

The layout allows all cables to be attached from the bottom of the cluster.

For features of the voltage sensitive relay, see page 97.

Item # 80-700-0054-00



Twin Engine, Three Battery Banks

The 80-700-0055-00 offers the same features as the CC-803N. The VSR and Emergency parallel switch are combined into one voltage-sensitive switch, and that switch is able to be remote-operated.

Fewer components, more compact.

The layout also allows all cables to be attached from the bottom of the cluster.

Item # 80-700-0055-00

Dimensions for Contour Connect Panels

Item #	LxWxH in		LxWxH mm	
	Module	Cut-out	Module	Cut-out
CC-801	6.5"x4.2"x2.2"	5.75"x3.4"	166x106x55 mm	146x86 mm
CC-810	9.2"x4.2"x2.2"	8.5"x3.4"	233x106x55 mm	213x86 mm
CC-802	6.5"x8.3"x2.2"	5.75"x7.5"*	166x212x55 mm	126x192 mm*
CC-803N	9.2"x8.3"x2.2"	8.5"x3.4"*	223x212x55 mm	213x86 mm*
80-700-0054-00	9.2"x4.2"x2.2"	8.5"x3.4"*	223x106x55 mm	213x86 mm*
80-700-0055-00	9.2"x8.3"x2.2"	8.5"x3.4"*	223x212x55 mm	213x86 mm*

*Single hole only.



Blanking Plate

The CC-BLANK will cover an unused hole in CC-1 and CC-2. Attached from the rear of the panel, it allows for expanding with other options at a later date.

Item # CC-BLANK



DC Outlet

The CC-12VRC allows a DC outlet socket to be placed within the Contour Connect panels. It will fit into the CC-1, CC-2 or CC-5 panels.

Item # CC-12VRC

Panels can be joined together to create a clean and compact system.



CC-810

CC-811PR



CC-811T

CC-801

All panels are prewired and include back cover and SET-CC-1 labels (see page 136).



Battery Switch w/ Toggle CB's

- Battery switch, 2 x 10A and 2 x 15A toggle circuit breakers

Item # CC-805T



Battery Switch w/ Push CB's

- Battery switch, 1 x 5A, 2 x 10A and 1 x 15A push reset circuit breakers

Item # CC-805PR



Selector Switch w/ Push Reset CB's

- Selector battery switch, 1 x 5A, 2 x 10A and 1 x 15A push reset circuit breakers

Item # CC-806PR



8 Way Toggle CB panel

- An economical 8 way circuit breaker panel option. Stackable for vertical or horizontal mounting.
- 2 x 5A, 2 x 10A, 3 x 15A and 1 x 20A toggle CBs

Item # CC-807T



8 Way Push reset CB panel

- Suitable for essential circuits where circuit breaker needs to be left on. Ideal for helm area giving protection for switching
- 2 x 5A, 2 x 10A, 3 x 15A and 1 x 20A push reset circuit breakers

Item # CC-807PR



8 Way CB Panel

- 8 Way CB Panel, 4x Toggle, 4x Push Reset
- 2 x 10A, and 2 x 15A toggle circuit breakers and 2x 10A and 2 x 15A push reset circuit breakers

Item # CC-807T-PR



5 Way CB Panel

- 1x Heavy-Duty CB, 1x Toggle, 3x Push Reset
- Equipped to cover essential circuits requirements (bilge, pumps etc)
- 50A CB for DC mains or treatment systems
- 135A 185 Series CB for anchor windlass
- Compliments the other modules for either single or dual engine installations

Item # CC-804



4 Way Push Reset CB panel

- 2 x 10A and 2 x 15A push-reset CBs, ideal for protecting essential circuits where circuits need to remain on (bilge, pump 24Hour etc)
- Can be mounted as a stand alone panel or attached to other Contour Connect Panels using the supplied CC-J joiner

Item # CC-811PR



4 Way Toggle CB panel

- 2 x 10A and 2 x 15A toggle CBs, provides switchable protection for general circuits such as lights and pumps
- Can be mounted as a stand alone panel or attached to other Contour Connect Panels using the supplied CC-J joiner

Item # CC-811T

The Contour Connect Kit set Panels are designed for applications where the OEM or panel builder wishes to construct a custom system. They're supplied as empty panels with all necessary mounting hardware, including one CC-joiner.

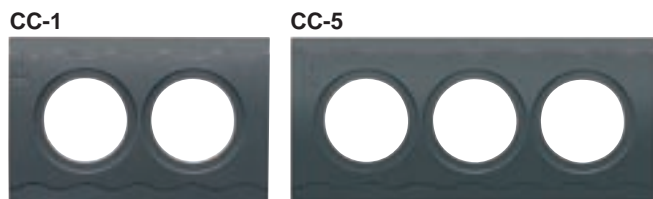

CC-1 & CC-5 Modules

Will house the following components:

- 701-PM Panel mount battery on/off (page 94).
- 701S-PM Panel mount battery selector switch (page 94).
- 185 Series Heavy-duty circuit breakers (page 120). (CC-HDBM must be ordered with 185 circuit breakers, one per breaker).
- 710-140A Voltage Sensitive Relay (page 98).



CC-2 Module

Will house the following components:

- CLB series (push reset) Carling circuit breakers (page 120).
- Toggle Magnetic Hydraulic Carling circuit breakers (page 119).



CC-3 Module

Will house the following components:

- CLB series (push reset) Carling circuit breakers (page 120).
- Toggle Magnetic Hydraulic Carling circuit breakers (page 119).



CC-HDBM

BEP™ CB Panel Mount

The CC-HDBM module must be ordered separately if ordering BEP™ 184 & 185 series circuit breakers. Mounting hardware for CB and panel attachment is supplied with module.

Flexible Links

Flexible links are supplied pre-connected with spare links for different orientations (horizontal or vertical) of Contour Connect panels.

Must be ordered separately when ordering CC Kitset panels.



Link (mm x mm, g)	Terminals (mm, mm)	Item #
6x120 mm, 10g	6, 10 mm	LD-6R-120-CE
6x150 mm, 10g	6, 10 mm	LD-6R-150-BD
6x210 mm, 10g	6, 10 mm	LD-6R-210-BD
6x300 mm, 10g	6, 10 mm	LD-6R-300-BD
25x150 mm, 4g	6, 10 mm	709-150/BD
25x250 mm, 4g	6, 10 mm	709-250/BD
25x300 mm, 4g	6, 10 mm	709-300/BD
25x150 mm, 4g	2 x 10 mm	709-150/DD
25x250 mm, 4g	2 x 10 mm	709-250/DD
25x300 mm, 4g	2 x 10 mm	709-300/DD

Solid Links

708-42.5 Solid terminal links supplied pre-connected with spare links for different orientations (horizontal or vertical) of Contour Connect panels.

Must be ordered separately when ordering CC Kitset panels.



Item #	Application
708-42.5	For horizontal linking of battery switches in the same panel
708-70.0	For horizontal linking of battery switches studs between 2 separate panels
708-107	For vertical linking of battery switches between panels

Link Bar

NCB-CC Link bar between circuit breakers. Same bar fits toggle or push reset CBs. Bar can be cut to bring multiple feeds to circuit breakers. Supplied with 800 Series panels or CC-Kitset panel.

Item # NCB-CC



Wave Strips

The Contour Connect panels are supplied standard. Wave strips can be ordered separately and are supplied in pairs of top and bottom strips. Available in single, double, and triple lengths.

Item # CC-3WS/CH



Universal Mount Switches

- Longer stud lengths for improved assembly and easier cable routing
- Built with heavy-duty copper sweep contacts to ensure positive circuit control
- Rugged internal components protected by a tough, impact resistant polycarbonate housing that is impervious to the elements
- Cable Lug Size: 3/8"
- Dimensions: 5.0"x2.75"

Selector Switch w/out AFD



Continuous amps: 230
Momentary amps: 345

Item # 2111A
OEM # 2111A-B

Selector Switch with AFD



Continuous amps: 230
Momentary amps: 345

Item # 2110A
OEM # 2110A-B

On/Off Switch w/out AFD



Continuous amps: 230
Momentary amps: 345

Item # 2112A
OEM # 2112A-B

Battery Selector Switches

- Polycarbonate case
- For 6, 12, 24 or 36V systems
- Surface mount
- Cable Lug Size: 3/8"
- Dimensions: 5.50"x2.63"

Selector Switch with AFD



Continuous amps: 230
Momentary amps: 345

Item # 2100
OEM # 2100-B

Selector Switch w/out AFD



Continuous amps: 230
Momentary amps: 345

Item # 2101
OEM # 2101-B

On/Off Switch w/out AFD



Continuous amps: 230
Momentary amps: 345

Item # 2102
OEM # 2102-B
OEM # 2102-3-B black

Heavy-duty Diesel Power Battery Switches

- For 6, 12, 24 or 36V systems
- Built with heavy-duty copper sweep contacts to ensure positive circuit control
- Rugged internal components protected by a tough, impact resistant polycarbonate housing that is impervious to the elements
- All feature Alternator Field Disconnect (AFD) allowing selection of any position, including "off", without damage to alternator or electrical system

* NOTE: OEM comes with old style black knob.

Heavy-duty On/Off Switch



Continuous amps: 450
Momentary amps: 800

Item # 2303A
OEM # 2303A-B *(black knob)

Extra-duty On/Off Switch



Continuous amps: 600
Momentary amps: 1000

Item # 2304A
OEM # 2304A-B *(black knob)

Battery Selector Switch



Continuous amps: 360
Momentary amps: 600

Item # 2300A
OEM # 2300A-B *(black knob)

Manage: Wiring System Diagrams

As more and more electronics and electrical accessories are added to your boat (autopilot, refrigeration, etc.) the use of multi-batteries becomes a necessity. Guest components allow you to set up the system (from simple to complex) for your boat's application. The following diagrams are for use in identifying and designing the right system for your boating needs. Detailed installation schematics are available. Request Guest form I-21681.

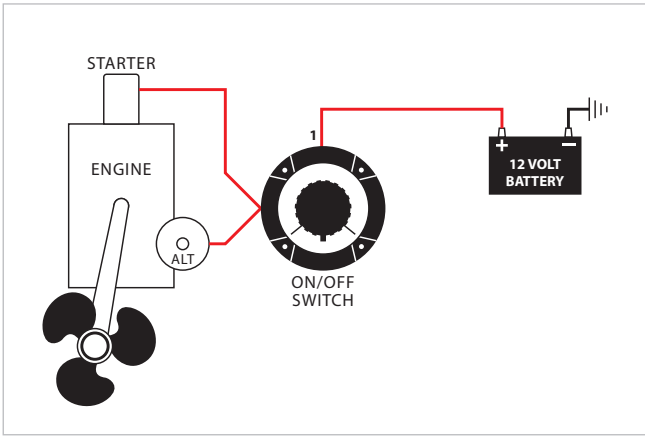

Single battery

Installation: To shut off all power at source. Recommended installation by approved authorities.

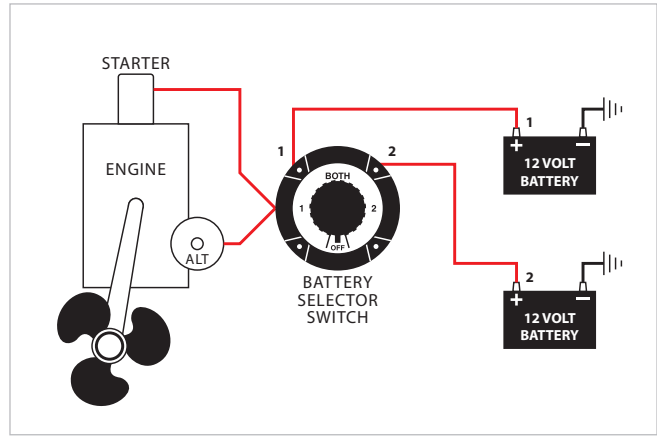

Two battery with out isolator

Installation: To select a starter battery and ship service battery. Manually isolates each battery, parallels both batteries for emergency start, master disconnect, manually selects batteries for charging.

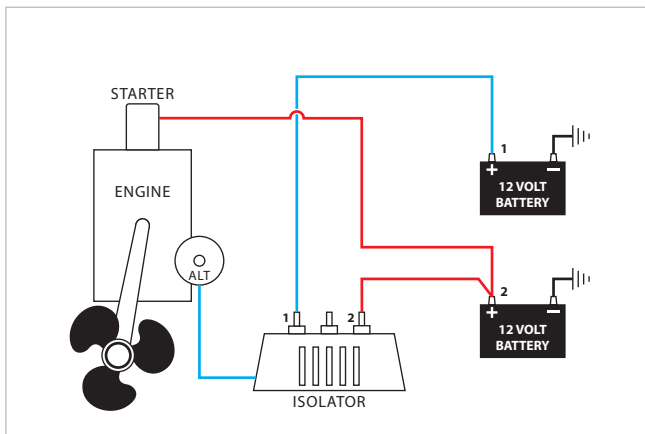

Two battery with isolator

Installation: Isolator automatically selects lower charged battery to be charged first. Full battery can't discharge to drained battery. Dedicated system, no flexibility, no emergency parallel or disconnect function.

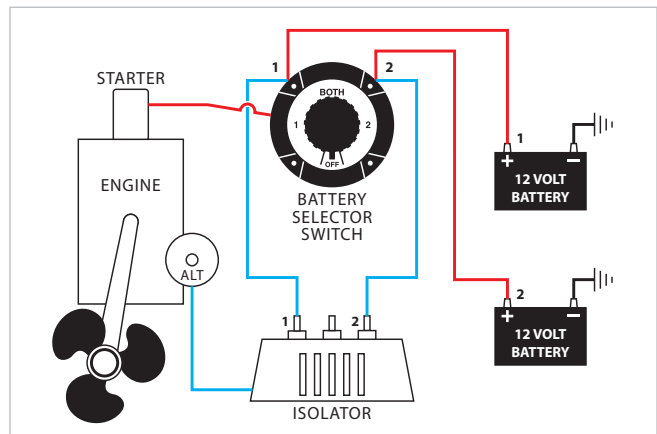

Two battery with emergency parallel

Installation: An isolator automatically isolates each battery, lower charged battery will automatically be charged first. Two different size batteries can be used, larger for ship services, smaller for engine cranking. Switch selects usage, master disconnect, emergency parallel function.

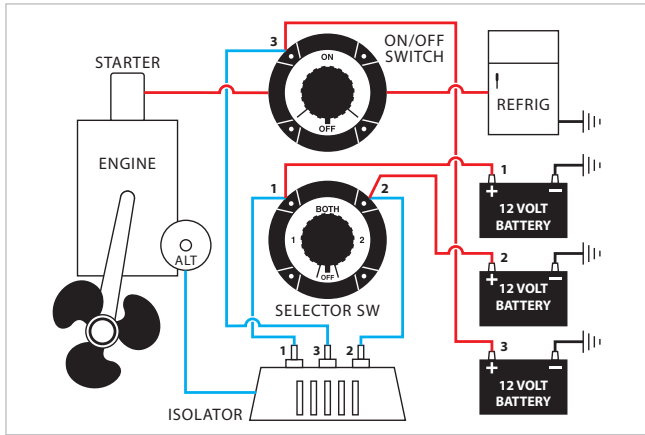

One battery selector switch, one On/Off selector switch automatic battery isolation and automatically charges three batteries

Installation: Use for sailboats and trawlers. Third battery isolated from other ship circuits. All batteries being automatically charged while running through isolator. To be used for refrigeration or other heavy load devices. Isolator protects other batteries.

Switch selector usage:

- 1. Master disconnect
- 2. Emergency parallel function

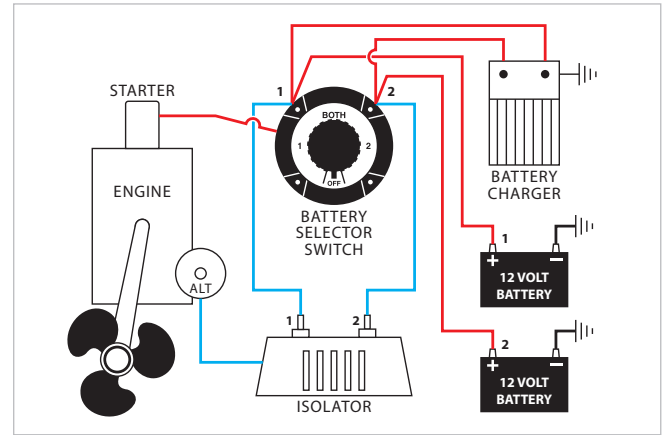

Adding automatic battery charger/converters to system

Installation: At dockside multi-bank charger built in isolator which will automatically charge lower battery.

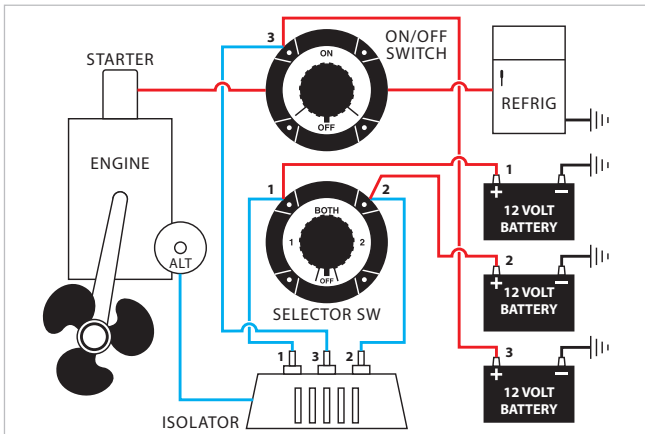

Three batteries, one battery selector switch, one On/Off or selector switch, two alternators, one isolator

Installation: Isolator separates both alternators so both alternators will charge simultaneously. Automatically charges lowest battery first. All batteries can be used for start, third battery, ship's source.

Alternator Field Disconnect (AFD)

Allows selection of any position, including "Off," without damage to alternator or electrical system. AFD is required on some electrical systems.

- Heavy-duty copper sweep contacts
- Positive click-stop on all positions
- "Make before break" contacts allow selection of all positions except "Off" while engine is running
- New design is easy to retrofit into existing hole patterns
- Use with 6, 12, 24 or 36V systems
- Built-in skirt protects connections
- Surface or rear panel mounting
- Marine grade construction

Important Note: The boater's electrical needs and problems should be discussed with your boatyard's electrical technician.

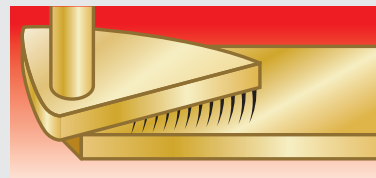

Exclusive flat 360 "sweep" contact design provides up to 60% more contact area than other switch designs.

Battery Management Panels

- Essential circuits, 24 hour supply
- Mains breakers for control panels, davit winches, or treatment systems
- Panels are supplied with a BEP™ 703-300A/B heavy-duty negative bus, to accommodate all the negative connections at the battery. (Please note: 800-MS4 is supplied with 702B negative stud)
- Heavy-duty breakers for anchor winches
- Powder coated aluminum panel
- Supplied with a full label set for panel circuit breakers - Item # SET-MSP; additional label sets available (see page 135)
- Spare positions for additional battery switches and circuit breakers for extras such as radio batteries and genset batteries

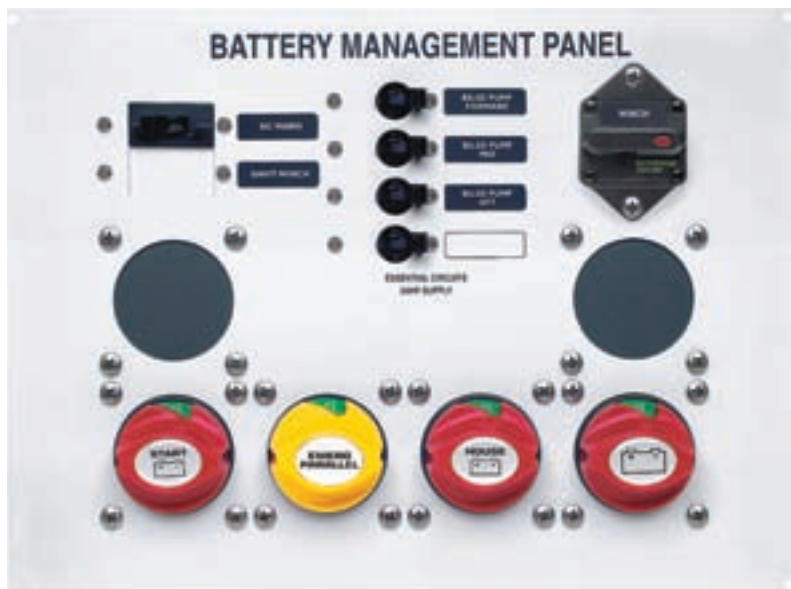

800-MS1

The 800-MS1 panel is designed for power or sail boats between 10–12m (32.9-39.5 ft) with single engines. 260x351x75 mm (10.25"x13.8"x2.9")

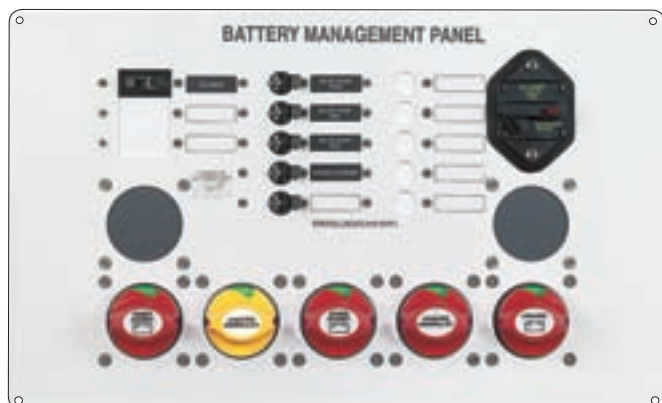

800-MS2

The 800-MS2 panel is designed for power boats between 10–12 m (32.9–39.5 ft) with twin engines. 281x463x75 mm (11.1"x18.25"x2.9")



800-MS4

The 800-MS4 panel is designed for sail boats up to 14 m (46 ft) and power boats up to 10 m (32.9 ft) with single engine. 160x239x75 mm (6.3"x9.4"x2.9")

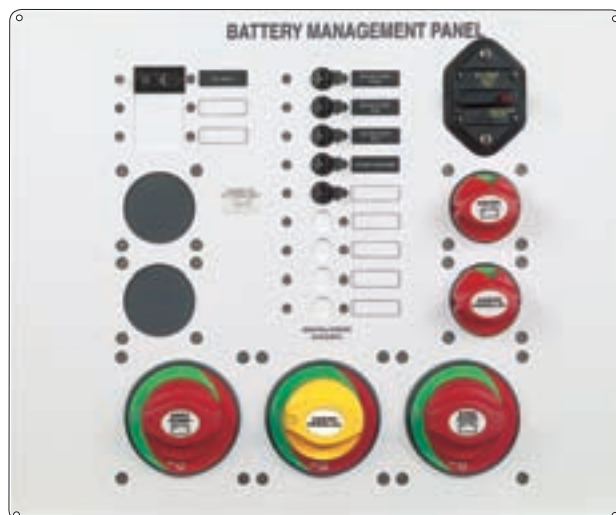

800-MS3

The 800-MS3 panel is designed for power boats between 12 –16 m (39.5 – 52.5 ft) with larger diesels. 380x463x95 mm (15"x18.25"x3.75")

Auxiliary Parts (ordered separately)

- Item # 701 Battery switches to fit panel cutouts
- Item # 713 Battery switch label sheet

Circuit Breakers

For treatment systems, davit winches and sub-mains.

- Item # CBL-50A-SP 50A
- Item # CBL-75A-SP 75A
- Item # CBL-100A-SP 100A

BI Battery Isolators

Mastervolt's BI battery isolators are based on conventional diode technology. The diode voltage drop (ca. 0.6V) can be compensated for by adapting the output current of the connected charger. Mastervolt battery chargers and Alpha Pro alternator regulators come as standard with automatic compensation for voltage drops.



	BI 702-S	BI 703	BI 1202-S	BI 1203-S
Item #	83007021	83007030	83012021	83012031
Max. output charger	25/50A	25/50A	80A	80A
Max. output alternator	70A	70A	120A	120A
Compensation diode	yes	no	yes	yes
Dimensions, hxwx d	6.2"x5.5"x3.2" 157x140x80 mm	8.2"x5.5"x3.2" 207x140x80 mm	8.2"x5.5"x3.2" 207x140x80 mm	8.2"x5.5"x3.2" 207x140x80 mm
Weight	1.3 lbs / 0.58 kg	2.4 lbs / 1.1 kg	2.65 lbs / 1.2 kg	2.9 lbs / 1.3 kg
# of battery banks	2	3	2	3

Battery Mate

The Battery Mate is compatible with any type of alternator/battery charger, in both existing and new systems. As the voltage loss between the alternator and battery is negligible, the Battery Mate performs far better than conventional battery isolators. This ensures fast and complete charging of your batteries without having to make additional adjustments to the alternator.



	Battery Mate IG 1602	Battery Mate IG 1603	Battery Mate IG 2503
Item #	83116025	83116035	83125035
Max. output charger	120A	120A	200A
Max. output alternator	160A	160A	250A
Dimensions, hxwx d	8.2"x5.5"x3.2" 207x140x80 mm	8.2"x5.5"x3.2" 207x140x80 mm	8.2"x5.5"x3.2" 207x140x80 mm
Weight	2.2 lbs / 1 kg	2.2 lbs / 1 kg	2.2 lbs / 1 kg
# of battery banks	2	3	3

Battery Isolators

- Optimized heat sink design for maximum performance
- Minimized voltage drop across isolation barrier using Schottky type diodes
- Each output individually capable of carrying the full alternator load
- Fixed cable posts for secure connections
- Fully potted, marine grade construction
- Waterproof components for harsh environment performance - year after year

2 YEAR WARRANTY

NOTE: If used on a 24V system, boat must be equipped with 24V DC alternator



	2501	2502	2504	2505	2530	2532
Max. output alternator	70A	70A	70A	70A	120A	120A
Operation	12-48V	12-48V	12-48V	12-48V	12-48V	12-48V
Dimensions	5.4"x4.5"x2.6"	10"x5.5"x3.7"	5.4"x4.5"x2.6"	10"x5.5"x3.7"	10"x5.5"x3.7"	15"x5.5"x3.7"
# of alternators	1	2	1	2	1	2
# of battery banks	2	2	3	3	2	3

Fail-Safe Galvanic Isolators

- Gold plated terminals provide superior corrosion resistance for harsh environment exposure
- Prevent galvanic corrosion due to dissimilar metals between boats
- Block DC current from flowing through shore power cable
- Ignition Protected

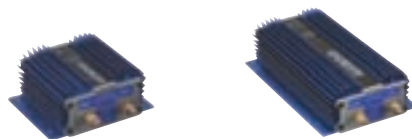

Item #	4531001	4531011
Voltage Rating	115/230V AC	115/230V AC
Frequency Rating	50/60Hz	50/60Hz
Current Rating	30A at 50°C	50/60A at 50°C
Operating Temp	-20 to 50°C	-20 to 50°C

Battery Watch

The Battery Watch is an essential element of any well-equipped battery system, offering you a 600-gram electronic watchdog that ensures a much longer lifespan for your batteries. The unit switches off loads when batteries are nearly empty, to keep your batteries in optimum condition. LED lights provide a clear read out and the undervoltage can be set using DIP switches.



Battery Watch

Item #	83200150
Max. load	150A
Input voltage	8-32V DC
Switch off under voltage 12V	9-12V DC
Switch off under voltage 24V	18-24V DC
Dimensions, l x w x h	6.2"x5.5"x3.2" 157x140x80 mm
Weight	1.3 lbs / 0.6 kg

Dynaplates for Hull Bonding & Grounding

- Improves performance of electronics and reduces RF interference
- Offers the best path for hull bonding without long runs of copper foil
- Provides a direct, low resistance path for improved lightning protection
- Deters electrolysis and galvanic corrosion
- Sintered porous bronze sphere construction for maximum conductivity in a compact size
- Low drag, non-fouling shape
- Easy to clean with wire brush
- Conforms to ABYC standards
- Mounting hardware included
- Gold plated mounting bolt
- Bronze mounting nuts
- Copper washers



	Standard	Large	Giant	Super
Item #	4006	4008	4012	4018
Use for	bonding and grounding	bonding, grounding and Loran use	bonding, grounding and Loran use	SSB radio
Dimensions	6"x2"x.5" 152x51x13 mm	8"x2.5"x.5" 203x64x13 mm	12"x3"x.5" 305x76x13 mm	18"x6"x.5" 457x152x13 mm
Mounting holes	2-1/2" center to center	4" center to center	6" center to center	9.875" center to center; 3" top to bottom
Weight	3 lbs / 1.4 kg	5 lbs / 2.3 kg	7 lbs / 3.2 kg	13 lbs / 5.9 kg

Accessories for dynaplates

Part	Material	Use with:	Dimensions	Item #
washer	Bronze	4006/4008	1/4" x 20	P-11D03
		4012/4018	3/8" x 16	P-11D04
bolt	Bronze	4006/4008	1/4" x 20	P-12D34
		4012/4018	3/8" x 16	P-12D36
	Bronze Gold Plate	4006/4008	1/4" x 20	P-12D35
		4012/4018	3/8" x 16	P-12D37

Part	Material	Use with:	Dimensions	Item #
nut	Bronze	4006/4008	1/4" x 20	P-13A27
		4012/4018	3/8" x 16	P-13A29
	Bronze Gold Plate	4006/4008	1/4" x 20	P-13A28
		4012/4018	3/8" x 16	P-13A2A

Marine Fuses

- Fast-acting, corrosion resistant fuses open quickly to protect circuits from overloads and short-circuits.
- Time-delayed to allow temporary, harmless in-rush currents to pass but open on sustained overloads and short-circuits.
- Each fuse tested twice to ensure highest quality.



ATM Fuses

Diameter: 5/16" (7.9 mm)
Length: 7/16" (11 mm)
Maximum voltage: 32V DC

Rating (A)	Qty/ Pkg	Item #
5	2	603905
10	2	603910
15	2	603915
20	2	603920
30	2	603930
Kit		
1 of ea	5	601110



ATM Fuses (BEP)

Diameter: 7/16" (11 mm)
Length: 5/8" (16 mm)
Maximum voltage: 32V DC

Rating (A)	Qty/ Pkg	Item #
5	2	JJ05A
10	2	JJ10A
15	2	JJ15A
20	2	JJ20A
30	2	JJ30A

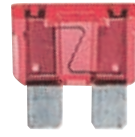

ATO/ATC Fuses

Diameter: 13/16" (21 mm)
Length: 3/4" (19 mm)
Maximum voltage: 32V DC

Rating (A)	Qty/ Pkg	Item #
3	2	604003
5	2	604005
7.5	2	604007
10	2	604010
15	2	604015
20	2	604020
25	2	604025
30	2	604030
Kit		
5-30	6	601114

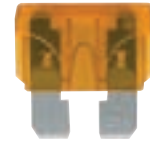

ATC Fuses (BEP)

Diameter: 3/4" (19 mm)
Length: 3/4" (19 mm)
Maximum voltage: 32V DC

Rating (A)	Qty/ Pkg	Item #
3	1	J03A
5	1	J05A
7.5	1	J7.5A
10	1	J10A
15	1	J15A
20	1	J20A
25	1	J25A
30	1	J30A



AGC Fuses

Diameter: 1/4" (6.4 mm)
Length: 1-1/4" (32 mm)
UL 248-14

Rating (A)	Qty/ Pkg	Item #
250V AC max		
1/2	5	601005
1	5	601010
1.5	5	601015
2	5	601020
2.5	5	601025
3	5	601030
4	5	601040
5	5	601050
7	5	601070
7.5	5	601075
8	5	601080
10	5	601100
32V AC max		
15	5	601150
20	5	601200
25	5	601250
30	5	601300
Kits		
5-30	5	601300
1-30	41	601300



MDL Fuses

Slow Blow
Diameter: 1/4" (6.4 mm)
Length: 1-1/4" (32 mm)
UL 248-18

Rating (A)	Qty/ Pkg	Item #
250V AC max		
3	2	602030
5	2	602050
6.25	2	602062
7.5	2	602075
10	2	602100
125V AC max		
15	2	602150
20	2	602200
25	2	602250
30	2	602300



GMA Fuses

Diameter: 3/16" (5 mm)
Length: 13/16" (20 mm)
Maximum voltage: 125V AC
UL 248-14

Rating (A)	Qty/ Pkg	Item #
1	3	605010
2	3	605020
3	3	605030
5	3	605050
7	3	605070
10	3	605100
15	3	605150



AGA Fuses

Diameter: 1/4" (6.4 mm)
Length: 5/8" (16 mm)
Maximum voltage: 32V AC
UL 248-14

Rating (A)	Qty/ Pkg	Item #
20	5	604200
30	5	604300



ANL Fuses (BEP)

- Ignition protected
- Tin plated
- Visible fuse status window
- 6000A interrupt capacity
- Maximum voltage 32V DC
- Uses 3/8" (10 mm) stud

Rating (A)	Qty/Pkg	Item #	OEM #
80	1	IP80A	IP80/DSP
100	1	IP100A	IP100/DSP
150	1	IP150A	IP150/DSP
200	1	IP200A	IP200/DSP
250	1	IP250A	IP250/DSP
300	1	IP300A	IP300/DSP
425	1	IP425A	IP425/DSP
500	1	IP500A	IP500/DSP



ANL Fuses (Mastervolt)

Suitable for DC Distribution (item # **77020200**) and ANL Fuse Blocks (item # **607006**).

Diameter: 3.19" (81 mm)

Length: 0.88" (22 mm)

Uses 5/16" (8 mm) stud

Rating (A)	Qty/Pkg	Item #
40	1	77049040
50	1	77049050
60	1	77049060
80	1	77049080
100	1	77049100
125	1	77049125
160	1	77049160
175	1	77049175
200	1	77049200
250	1	77049250
300	1	77049300
400	1	77049400



MasterShunt Fuse

T-fuse 500A / 160V DC, current limiting capability 50 kA

Diameter: 1.62" (41 mm)

Length: 3.06" (77 mm)

Rating (A)	Qty/Pkg	Item #
500	1	77049000



Maxi-Blade Fuses

Fuses available: 30-80A

Interrupt capacity: 1000A DC

Maximum voltage: 32V DC

Rating (A)	Qty/Pkg	Item #	OEM #
30	1	BFHD-30A/DSP	BFHD-30A
40	1	BFHD-40A/DSP	BFHD-40A
50	1	BFHD-50A/DSP	BFHD-50A
60	1	BFHD-60A/DSP	BFHD-60A
70	1	BFHD-70A/DSP	BFHD-70A
80	1	BFHD-80A/DSP	BFHD-80A



Maxi Fuse Holder

An economical way of fusing heavy loads 30-80A. Ideal for battery charger outputs or mains feeds.

1/4" (6 mm) studs accept ring terminals and cables up to 25 mm² (4 gauge).

Fuse is clamped between tinned brass clamps for positive connection. Covers enclose exposed terminals to meet ABYC standards. 2.8"x2"x1.42" (71x53x36 mm)

Item # **702-MFH**
OEM # 702-MFH-B



HDBFH Inline Heavy-duty Fuse Holder

For installations where space is tight and fuse needs to be installed inline with the cable. Supplied with 8 mm (8G) tails for inline connections.

An economical solution to heavy-duty fusing. 3.15"x2.15"x.6" (80x55x15 mm)

Item # **HDBFH**

ATC Fuse Holders

The BEP™ ATC Fuse Holder provides compact, easy access to fuses with the design integrity only BEP can offer.

- Allows for multiple fuse holders and bus bars to be joined together, increasing the number of circuits protected
- Fuse holder inputs can be linked together to form a single continuous fuse holder
- Includes patented Contour Lock system, see-thru clip-on cover and label set
- Available with screw terminals or quick connect terminals
- Max. current/circuit: 30A;
Max. current/block: 100A;
Max. voltage: 32V DC;
Base & cover material: polycarbonate
- Positions for spare fuses
- ATC Fuse holder: 80x90x47 mm (3.1"x3.6"x1.9")
- ATC Bus bar: 35x90x47 mm



ATC-6W

Description	Pack Qty	Item #	OEM #
6 Way fuse holder screw terminals w/ cover & link	1/blister	ATC-6W	—
6 Way fuse holder Quick Connect w/ cover & link	1/blister	ATC-6WQC	—
6 Way bus w/ 5 mm input stud, cover, joiners	1/blister	80-712-0039-00	—
6 Way fuse holder screw terminals w/ cover	24/pack	—	ATC-6W/B
6 Way fuse holder Quick Connect w/ cover	24/pack	—	ATC-6WQC/B
6 Way bus w/ 5 mm input stud, cover, joiners	24/pack	—	80-712-0039-01

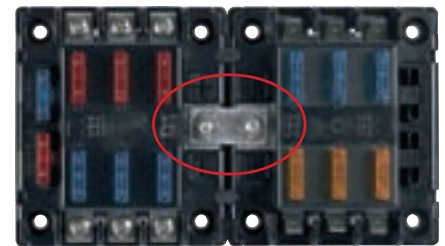

BB-LINK17MM

allows two 6 way ATC fuse holders to be joined together providing twelve fused positions running off one feed

ATC Bus Bar

The expandable ATC negative Bus uses the BEP™ Contour Lock system to allow it to be joined to the ATC fuse holder. This keeps wiring tidy and conveniently located. Current rating 100A.

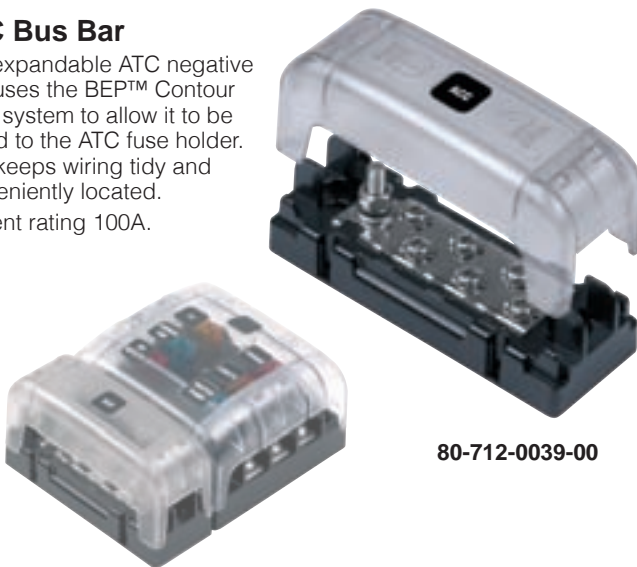

80-712-0039-00



ATO/ATC Fuse Panels

- Common negative bus with "push-on" tabs
- Common positive feed
- Each branch handles up to 30 amps (160A max total)

Item # **607122** 6 Gang

Item # **607123** 12 Gang

Fuse Holders

Figure Letter	Description	AWG Wire	Fuse Style	Rating (Max Amps)	Item #
A	Panel Mount		AGC & MDL	15	607010
	Panel Mount Fuse Holder Cap for 607010				607011
B	Crimp-On	12-18 (3-8 mm ²)	AGC & MDL	30	607012
C	Waterproof In-Line	12-18 (3-8 mm ²)	AGC & MDL	30	607013
D	Waterproof In-Line	10 (5 mm ²)	AGU	30	607014
E	Waterproof In-Line	12 (3 mm ²)	AGC & MDL	20	607015
F	Heavy-duty In-Line	12 (3 mm ²)	AGC & MDL	30	607016
G	In-Line	12 (3 mm ²)	ATC	30	607017
H	Waterproof In-Line	12 (3 mm ²)	ATO/ATC	30	607019
I	Waterproof In-Line	12 (3 mm ²)	ATM	30	607020
J	Waterproof In-Line	16 (1 mm ²)	ATM	15	607021
K	In-Line		ATO/ATC	15	607022
L	In-Line	10 (5 mm ²)	ATO/ATC	30	607023

With weather resistant cap and tinned copper wire for corrosion resistance

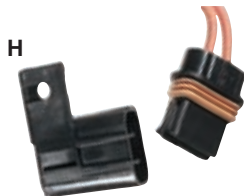

Fuse viewing window

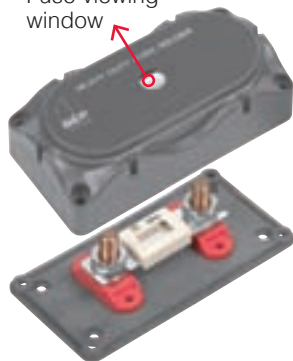

ANL Fuse Holder Heavy-duty

- Allows fusing of heavy-duty accessories between 80-500A.
- Mounted in Contour lock mouldings with removable sides.
- Meets ABYC Standards for exposed terminals.

Item # **704-ANL**

ANL Fuse Blocks

- Glass filled nylon base for durability.
- Fits all ANL and ANN fuses up to 800 amps.
- UL approved
- Rating: 800 max amps

Item # **607006**

IEG Magnetic CBs

IEG magnetic circuit breakers provide reliable circuit protection and accurate circuit control for equipment in the international market place. Designed using the latest in sensitive hydraulic magnetic technology, the IEG line adapts itself to many applications and environments. They are ideal for marine applications, data processing and business machines, as well as medical instrumentation, broadcast equipment, vending and amusement machines, military applications and wherever precision operation is required. Temperature differences which affect fuses and other thermal devices are not a concern. One important feature of this breaker line is a 'trip free' action, which means the circuit will trip in the presence of an overload even though the handle is held in the ON position. The delay mechanism senses the fault and the contacts open.

- Spacing compliance: IEC specification 601, 950; VDE 0804, 0805
- UL recognized; CSA certified; VDE 0660 approved; Part 101 & CE compliant
- Available in single or double pole; triple pole available on special orders



CBS-50A-SP-IG

CBS-50A-DP

Single pole	Rating (A)	Double pole	Rating (A)	Triple pole	Rating (A)
CBS-5A-SP	5	CBS-10A-DP	10	CBS-50A-TP / 50	50
CBS-10A-SP	10	CBS-15A-DP	15		
CBS-15A-SP	15	CBS-20A-DP	20	D / Pole trip coil	Volts (V)
CBS-20A-SP	20	CBS-25A-DP	25	CBS-15A-DP-TC230	230
CBS-25A-SP	25	CBS-30A-DP	30	CBS-20A-DP-TC230	230
CBS-30A-SP	30	CBS-40A-DP	40	CBS-30A-DP-TC230	230
CBS-40A-SP	40	CBS-50A-DP	50	CBS-50A-DP-TC230	230
CBS-50A-SP-IG	50				

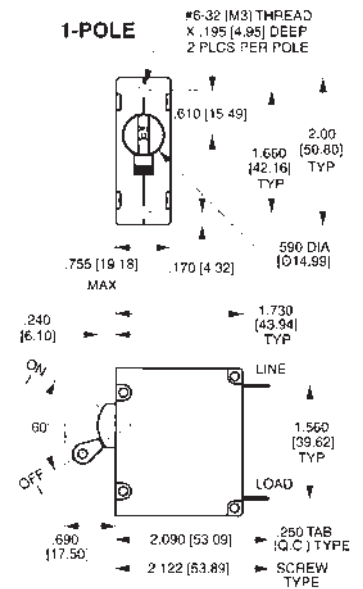

IUL Magnetic CBs

Provide reliable circuit protection and accurate circuit control for equipment in the international market place. BEP uses the IUL range of circuit breakers where current requirements exceed 50A and are within 100A. Available in single and double pole with triple pole available on special orders.



CBL-50A-SP

CBL-100A-DP

Single pole	Rating (A)	Double pole	Rating (A)	Triple pole	Rating (A)
CBL-50A-SP	50	CBL-50A-DP	50	CBL-80A-TP	80
CBL-60A-SP	60	CBL-60A-DP	60	CBL-100A-TP	100
CBL-75A-SP	75	CBL-75A-DP	75		
CBL-100A-SP	100	CBL-100A-DP	100		

BEP™ Heavy-duty Single Pole Thermal Type Breakers

- **Ratings:** 50–150A; 30V DC, 3000A interrupt capacity
- **Operating Temperature:** -25°F (-32°C) to 180°F (82°C)
- **Storage Temperature:** -30°F (-34°C) to 300°F (149°C)
- **Applications:** Auxiliary and accessory circuits – trucks, buses, RVs and marine applications, battery chargers and DC audio systems. Series 181, 184 & 185 are sealed for engine compartment and bilge area applications.
- **Housing:** Thermoset plastic; UL rated 94V0; 311°F (155°C). Stud insulators are provided on covered units with F (Surface Mount) bases
- **Mounting:** Panel or surface
- **Indicator:** Series 184 & 185 have a unique reset mechanism providing visible indication of tripped condition
- **Approvals:** Complies with SAEJ1625



184150P-01-1



185100F-01-1

Rating (A)	Mount (P)anel / (F)lush	Item #	OEM #
50	P	—	185050P-01-1
70	P	—	185070P-01-1
80	P	—	185080P-01-1
100	P	—	185100P-01-1
135	P	—	185135P-01-1
150	P	—	185150P-01-1
50	F	185050F/DSP	185050F-01-1
80	F	185080F/DSP	185080F-01-1
100	F	—	185100F-01-1
150	F	—	185150F-01-1
30	F	—	185030F-01-1
40	F	—	185040F-01-1
40	P	—	185040P-01-1
60	P	—	185060P-01-1
120	P	—	185120P-01-1

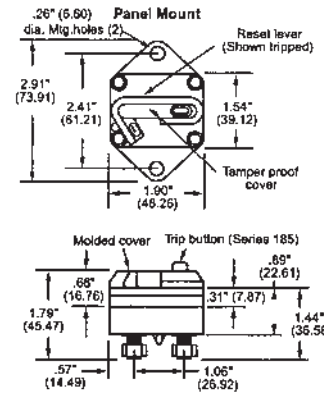
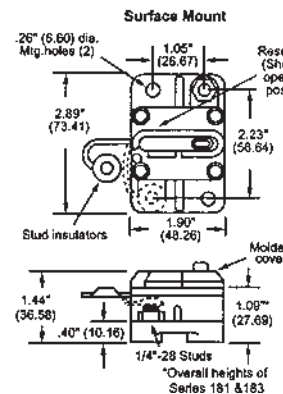

CLB Series Push Reset Thermal Circuit Breakers

- **Ratings:** 5–40A; 200A @ 250V AC Interrupt Capacity
- **Operating Temperature:** 14–140°F (-10–60°C)
- **Interrupting capacity:** 2500A
- **Resettable overload capacity:** 10 x rated current
- **Approvals:** UL, CUL, TUV, CE, UL1500ISO8846 for ignition protection/marine

Rating (A)	Item #	OEM #
5	CLB-05/DSP	CLB-05
10	CLB-10/DSP	CLB-10
15	CLB-15/DSP	CLB-15
20	—	CLB-20
25	CLB-25/DSP	—
30	—	CLB-30
40	CLB-40/DSP	CLB-40
BOOT	CLB-BOOT/DSP	CLB-BOOT

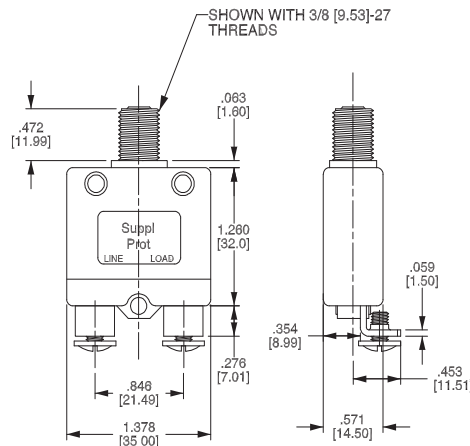

Boot required to install breaker. **CLB-BOOT**



CLB-20

World Circuit Breakers

- Now certified in North America and Europe, meets the needs of all worldwide markets!
- Tested and certified by most widely recognized international regulatory agencies including UL (Underwriters Laboratory), CSA (Canadian Standards Association), CE (European Union), VDE (German government approval) and TVU Certified
- Designed for applications requiring higher amperage and voltage handling capability in a compact design
- Protects wiring, motors, generators, telecommunication systems, batteries, and many other applications in the harsh marine environment, fits common panel cutouts
- Mechanical Endurance: 10,000 On-Off operations @ 6 per minute; with rated current & voltage
- Breakers will trip on overload even when actuator is forcibly held in the ON position
- Enhanced, upgraded design of Ancor™ standard single and double pole breakers
- Maximum voltage 250V AC, 65V DC

Magnetic Single Pole AC/DC Circuit Breakers

UL 489A, UL 1077 Recognized, VDE Certified, CE Marked, TVU Certified

Design Amps	Toggle Color	Qty/Pkg	Item #	Design Amps	Toggle Color	Qty/Pkg	Item #
5	Black	1	551505	20	Black	1	551520
	Red	1	551605		Red	1	551620
	White	1	551705		White	1	551720
10	Black	1	551510	25	Black	1	551525
	Red	1	551610		Red	1	551625
	White	1	551710		White	1	551725
15	Black	1	551515	30	Black	1	551530
	Red	1	551615		Red	1	551630
	White	1	551715		White	1	551730
	Black	1	551540	40	Black	1	551540
	Red	1	551640		Red	1	551640
	White	1	551740		White	1	551740
	Black	1	551550	50	Black	1	551550
	Red	1	551650		Red	1	551650
	White	1	551750		White	1	551750

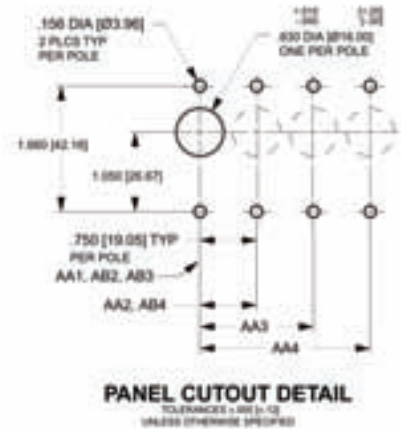
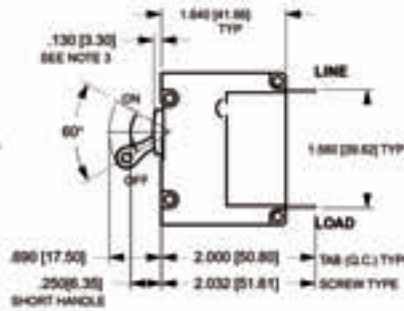
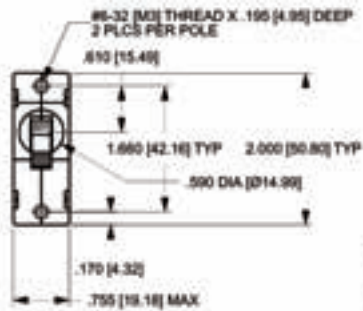

Magnetic Double Pole AC Circuit Breakers

UL 489A, UL 1077 Recognized, VDE Certified, CE Marked, TVU Certified

Design Amps	Toggle Color	Qty/ Pkg	Item #
20	white	1	552820
30	white	1	552830
50	white	1	552850

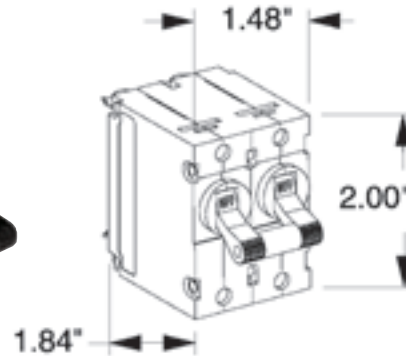

Circuit Breakers with Neutral

Description	Item #	Description	Item #
DPN 6 A-B, 1 P+N	6387000600	DPN 20 A-B, 1 P+N	6387002000
DPN 10 A-B, 1 P+N	6387001000	DPN 25 A-B, 1 P+N	6387002500
DPN 16 A-B, 1 P+N	6387001600	DPN 32 A-B, 1 P+N	6387003200



RCD Panels

We supply two Residual Current Device (RCD) ratings (16 & 32 A). Due to the difference in style of the RCD's, these panels are made to be mounted separately from the main AC panel.

Item #	Rating (A)	HxWx2.5"	HxWx65 mm
900-RCD-16A	16	4.5"x5"	115x127 mm
900-RCD-1X16-32A	32	4.5"x5"	115x127 mm
900-RCD-2X16A	16x2	4.5"x5"	115x127 mm
900-RCD-2X32A	32x2	4.5"x5"	115x127 mm
900-RCD-32A	16x1, + 32x1	4.5"x5"	115x127 mm

Cutout size - 3/8" (10 mm) inside all external edges



900-RCD-16A



900-RCD-2X16A

CB Options

Item #	Rating (A)	Type
RCD16A30MA	16	Residual CB Overload
RCD32A30MA	32	Residual CB Overload
RCD63A30MA	63	Residual CB Overload
MCB16A	16	Miniature CB
MCB32A	32	Miniature CB
MCB63A	63	Miniature CB
124001000	16	Shore Fix 30 mA



RCD
(see chart)



MCB
(see chart)



MCB-3WENC
6.3"x3.6"x3.5"
160x92x90 mm



124001000
7.87"x4.33"x4.53"
200x110x115 mm

For installations in Australia and New Zealand to comply with AS/NZ3004 an approved double pole mains circuit breaker must be mounted upstream of the BEP™ Control Panel in the form of a RCD or MCB. The MCB-3WENC is an enclosure with IP65 rating. The enclosure and CB is ordered separately. The Shore Fix is already assembled, no additional item parts need to be ordered.



Panel Plugs

- 5/8" (15.9 mm)
- Black
- Used in electrical control panels
- Pkg qty 2

Item # 553020



Line-to-Line Jumper

- Used in terminal blocks with 5/8" (15.9 mm) between holes
- 100 amps total capacity
- Pkg qty 5

Item # 553021



Circuit Breaker Bus Bar

- Gangs up to 8 Single Pole breakers with 3/4" (19 mm) between notches

Item # 553022



Mounting Screws

- Black
- Nylon
- 5-32"x 5/16" (4x7.9 mm)
- Used in mounting circuit breakers to electrical control panel

Item # 553041

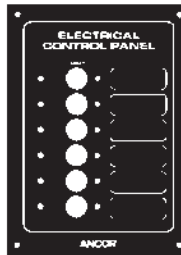

Electrical Control Panels

- Control panels for standard toggle breakers
- Panel color: black
- 1/8" thickness

Gang	Width	Height	Item #
2	2-11/16" 6.8 cm	4-1/4" 10.8 cm	553002
4	5-3/8" 13.7 cm	4-1/4" 10.8 cm	553004
6	5-3/8" 13.7 cm	7-3/8" 18.7 cm	553005
8	5-3/8" 13.7 cm	8-1/2" 21.2 cm	553008



Handle Lock

Image shows "handle lock" as used in all our battery management panels for essential CBs to prevent accidental or unintended actuation of essential circuits CB's from either the "on" or "off" position. (ordered separately)

Item # 121-710-1101/1



Modular Brackets

- Black

Item # 554000 end
Item # 554001 middle

Manage: DC Circuit Breaker Panels

DC No Meters

- Red systems on LED
- 12V
- Marine grade powder coated aluminium
- ABYC standard voltage indication
- Green LED backlit labels
- Stylish clip on contour fascia
- Label sets and buss bar supplied with panels; for additional labels see page 133–134



901V



902NMV



904NMV



900-DC



901H



902NMH



904NMH

# of Circuits	Direction	in HxWx2.5	mm HxWx65	Label Sheet	CB's - Single Pole						Neg Bus	Item #
					5	10	15	20	25	30		
4	square	4.5"x5"	115x127	1	1	2	1				6 way	900-DC
8	horizontal	4.5"x9.75"	115x239	1	2	2	3	1			6 way	901H
	vertical	7.9"x5"	200x127	1	2	2	3	1			6 way	901V
12	horizontal	4.5"x13.9"	115x351	1	3	4	4		1		6 way	902NMH
	vertical	11.25"x5"	285x127	1	3	4	4		1		6 way	902NMV
16	square	7.9"x9.75"	200x239	1	4	5	5	1	1		12 way	904NM
	horizontal	4.5"x18.25"	115x463	1	4	5	5	1	1		12 way	904NMH
24	square	7.9"x13.9"	200x351	1-3	5	8	8	1	1	1	12 way	905NM
	vertical	11.25"x9.75"	285x239	1-3	5	8	8	1	1	1	12 way	905NMV
32	horizontal	7.9"x18.25"	200x463	1-4	7	11	11	1	1	1	24 way	906NMH
	vertical	14.6"x9.75"	370x239	1-4	7	11	11	1	1	1	24 way	906NMV
36	square	11.25"x13.9"	285x351	1-4, 6	8	12	12	2	1	1	24 way	NC36NM

Cutout size - 3/8" (10 mm) inside all external edges



904NM



905NMV



NC36NM



906NMV



905NM

Resistors

For changing 12V panels to 24V backlighting

# of Circuits	Item #
4 way	RES-4WAY
8 way	RES-8WAY
12 way	RES-12WAY
16 way	RES-16WAY
20 way	RES-20WAY
24 way	RES-24WAY
28 way	RES-28WAY
32 way	RES-32WAY
36 way	RES-36WAY
44 way	RES-44WAY
56 way	RES-56WAY



906NMH

DC Analog/Digital Meters

- Ammeters available in other scales (page 186).
- All panels are available with either Analog or Digital meters
- Label set and bus bar supplied with panel; for additional label sets see page 133–134



900-AM



901V-DCSM



902V-DCSM



M28-DCSM



M28-DCSM



M28-DCSM



902-AM

# of Circuits	Direction	mm HxWx65	in HxWx2.5	Label Sheet	CB's - Single Pole						Neg Bus	Digital Item #	Analog Item #
					5	10	15	20	25	30			
4	vertical	200x127	7.9x5	1	1	2	1				6 way	900V-DCSM	900-AM
8	vertical	295x127	11.6x5	1	2	2	3	1			6 way	901V-DCSM	901V-AM
12	square	200x239	7.9x9.75	1	3	4	4		1		6 way	902-DCSM	902-AM
	vertical	380x127	15x5	1	3	4	4		1		6 way	902V-DCSM	902V-AM
16	vertical	295x239	11.6x9.75	1–2	4	5	5	1	1		12 way	904-DCSM	904-AM
20	horizontal	200x351	7.9x9.75	1–3	5	6	7	1		1	12 way	903-DCSM	903-AM
24	square	295x351	11.6x13.9	1–3	5	8	8	1	1	1	12 way	905-DCSM	905-AM
	vertical	380x239	15x9.75	1–3	5	8	8	1	1	1	12 way	905V-DCSM	905V-AM
32	horizontal	295x463	11.6x18.25	1–4	7	11	11	1	1	1	24 way	906-DCSM	906-AM
	vertical	455x239	18x9.75	1–4	7	11	11	1	1	1	12 way	906V-DCSM	906V-AM
48	square	380x463	15x18.25	1–5	12	15	15	3	1	2	2 x 24 way	—	907-AM

All analog panels supplied with one shunt, extra shunts ordered separately. Digital panels supplied with 450A-50mV shunt.

Cutout size - 10 mm (3/8") inside all external edges

All panels available in 12 or 24V configuration. All part numbers shown are 12V backlighting. If 24V is required, please specify when ordering by adding -24V to part number.



903-DCSM



907-AM



905-AM



906-AM

Cruiser Series

- 12V / 24V
- Mimic panel for quick reference of systems in operation
- Blank space for addition of extra meter
- Digital or analog readouts



NC32Y-DCSM



NC36L-DCSM

# of Circuits	in HxWx2.5	mm HxWx65	Label Sheet	CB's - Single Pole						Digital Item #	Analog Item #
				5	10	15	20	25	30		
32	15x13.9	380x351	1-4, 6	7	11	11	1	1	1	NC32Y-DCSM	NC32Y-AM
36	15x13.9	380x351	1-4, 6	8	12	12	2	1	1	NC36L-DCSM	NC36L-AM

All analog panels supplied with one shunt, extra shunts ordered separately. Digital panels supplied with 450A – 50mV shunt. Cutout size – 3/8" (10 mm) inside all external edges

All panels available in 12 or 24V configuration. If 24V is required, please specify when ordering by adding –24V to part number.

Double Pole Panel

- Double pole panels available in all panel sizes.
- Double pole CBs use twice the space of single pole breakers; an 8-way panel can become a 4-way
- AC or DC versions available
- Single toggle



DP PANEL

Millennium Series

- 12V / 24V
- Compact sizing
- Battery monitoring using BEP™ multifunction meter (voltage on 3 battery banks, charge, discharge amps and amp-hours remaining on main battery bank)



M28-DCSM



M44-DCSM



M56-DCSM



M44H-DCSM



M32-DCSM

# of Circuits	Direction	in HxWx2.5	mm HxWx65	Label Sheet	CB's - Single Pole						Digital Item #
					5	10	15	20	25	30	
28	vertical	14.6"x9.75"	370x239 mm	1-4	8	8	8	2		2	M28-DCSM
32	horizontal	11.25"x13.9"	285x351 mm	1-4, 6	7	11	11	1	1	1	M32-DCSM
44	vertical	14.6"x13.9"	370x351 mm	1-4, 6	10	14	14	3	1	2	M44-DCSM
	horizontal	11.25"x18.25"	285x463 mm	1-4, 6	10	14	14	3	1	2	M44H-DCSM
56	vertical	18"x13.9"	455x351 mm	1-4, 6	12	18	18	4	2	2	M56-DCSM

No Meters

- Ideal for AC shore power installations and on board inverter installations.



900-ACM2W



900-AC1



900-ACM6W



900-ACCH

For standard twin input systems, eg: one shore power and one genset input.



Reverse Polarity Auto Trip Breaker

Now standard on all 230V, 50Hz panels (Euro and Asia-Pacific).

This will automatically trip when it detects reverse polarity.

Item # CBS-20A-DP-TC230

Volts	in HxWx2.5	mm HxWx65	Label Sheet	CB's - Single Pole						CB's - Double Pole					Neg Bus	Item #
				5	10	15	20	25	30	20	25	30	50	80		
230	7.9"x5"	200x127 mm	5	2	2						2				IS-6MM-2	900-ACM2-AM
110	4.5"x9.75"	115x239 mm	5			2	2					2			IS-6MM-2	900-AC1-110V
230	4.5"x5"	115x 27 mm	5	2							1				IS-6MM-2	900-ACM2W
110	4.5"x5"	115x127 mm	5			2						1			IS-6MM-2	900-ACM2W-110V
230	7.9"x5"	200x127 mm	5	2	3	1					1				IS-6MM-2	900-ACM6W
110	7.9"x5"	200x127 mm	5			3	2	1				1			IS-6MM-2	900-ACM6W-110V
230	7.9"x5"	115x127 mm	5								2				IS-6MM-2	900-ACCH
110	7.9"x5"	115x127 mm	5									2			IS-6MM-2	900-ACCH-110V

Analog/Digital Meters

- All available in 110V/60 Hz or 230V/50 Hz.
- All supplied with transducers
- Reverse polarity indicator
- Double pole mains input CBs with side lockout
- Digital meter shows volts, amps and frequency
- LED wired to indicate live panel with mains breaker either on or off
- AC source selector ensures no cross over between AC inputs (ship or shore power)
- AC voltage/frequency label to comply with ABYC Standards



900-ACM2-AM



900-ACM6V-AM



900-AC2V-ACSM



900-AC4-ACSM



900-AC3-ACSM



900-AC2H-AM

Volts	in HxWx2.5	mm HxWxL	Label Sheet	CB's – Single Pole						CB's – Double Pole					Neg Bus	Item #
				5	10	15	20	25	30	20	25	30	50	80		
Analog																
230	7.9"x5"x2.5"	200x127x65 mm	5		2					2				IS-6MM-2	900-ACM2-AM	
110	7.9"x5"x2.5"	200x127x65 mm	5			2					1			IS-6MM-2	900-ACM2-AM-110	
230	11.6"x5"x2.5"	295x127x65 mm	5		2	3	1			1				IS-6MM-2	900-ACM6V-AM	
110	11.6"x5"x2.5"	295x127x65 mm	5	1	3	3	1			1	1			IS-6MM-2	900-ACM6V-AM-110	
230	7.9"x9.75"x2.5"	200x239x65 mm	5	1	3	3	1			1	1			2x6 way	900-AC2H-AM	
110	7.9"x9.75"x2.5"	200x239x65 mm	5		2	3	2	1			1	1		2x6 way	900-AC2H-AM-110	
230	15"x5"x2.5"	380x127x65 mm	5	1	3	3	1			1	1			2x6 way	900-AC2V-AM	
110	15"x5"x2.5"	380x127x65 mm	5	1	2	3	2	1			1	1		2x6 way	900-AC2V-AM-110	
230	7.9"x13.9"x2.5"	200x351x65 mm	5	1	4	5	1	1		1	1			2x12 way	900-AC3-AM	
110	7.9"x13.9"x2.5"	200x351x65 mm	5	1	3	4	3	1	1		1	1		2x12 way	900-AC3-AM-110	
Digital																
230	7.9"x9.75"x2.5"	200x239x65 mm	5	1	3	3	1			1	1			2x6 way	900-AC2H-ACSM	
110	7.9"x9.75"x2.5"	200x239x65 mm	5		2	3	2	1			1	1		2x6 way	900-AC2H-ACSM-110	
230	15"x5"x2.5"	380x127x65 mm	5	1	3	3	1			1	1			2x6 way	900-AC2V-ACSM	
110	15"x5"x2.5"	380x127x65 mm	5	1	2	3	2	1			1	1		2x6 way	900-AC2V-ACSM-110	
230	7.9"x13.9"x2.5"	200x351x65 mm	5	1	4	5	1	1		1	1			2x12 way	900-AC3-ACSM	
110	7.9"x13.9"x2.5"	200x351x65 mm	5	1	3	4	3	1	1		1	1		2x12 way	900-AC3-ACSM-110	
230	7.9"x13.9"x2.5"	200x351x65 mm	5	1	5	7	2	1		1		1		2x6 way	900-AC4-ACSM	
110	7.9"x13.9"x2.5"	200x351x65 mm	5		5	8	2	1			1	1		2x6 way	900-AC4-ACSM-110	

Cutout size – 3/8" (10 mm) inside all external edges. All panels available in 12 or 24V backlighting configuration.

Panel Configurator

The BEP™ Panel Configurator is a software program designed for do-it-yourself creation and modification of standard circuit breaker panels. The user friendly software is available to both account and non-account holders.

Designed for the creation and modification of standard panels, the software provides the end user prompt turn around for panel requirements. Additionally, the built-in communication tool allows for customer created drawings to be transferred with ease to BEP customer service for quotation. The use of the software greatly streamlines the entire panel production process – reducing design and modification time, decreasing correspondence and cutting lead time.

To learn more and to download the software, go to bepmarine.com.



Back Panel Covers

- Designed to insulate exposed rear terminals.
- Flame retardant PVC in two styles.
- Flange Mount: for access to control panel back when mounted in place. Attaches to the rear of the same mounting surface as the panel.
- Panel Mount: for access only when panel is removed. Supplied with mounting pedestals.

Item #	Mount type	Cover Description	in LxWx3.5	mm LxWx90
BC-FM1	Flange	1 column 8-12 CBs + meter	15"x5"	380x127
BC-FM2	Flange	2 column 8-12 CBs + meter	15"x9.4"	380x239
BC-FM3	Flange	1 column 8-12 CBs	15"x5"	285x127
BC-FM4	Flange	2 column 8-12 CBs	15"x9.4"	285x239
BC-PM1	Panel	1 column 8-12 CBs + meter	15"x4.2"	360x107
BC-PM2	Panel	2 column 8-12 CBs + meter	15"x8.6"	360x219



BC-PM1



BC-FM1



BC-FM2



BC-PM2

ACCESSORIES

SET-1N

Accessories
Anchor Light
Auto Pilot
Bilge Pump
Cabin Lights
Cabin Lights
Cockpit Lights
Compass Lights
DC Outlets
Depthsounder
Freezer
Freshwater Pump
GPS
Instruments
LPG Control
Mast Light
Navigation Lights
Saltwater Pump
Shower Drain Pump
Spare
Spotlight
Spreader Light
Steaming Light
Stereo
Trim Tabs
VHF
Winch
Wiper

BAIT TANK PUMP

SET-2N

Bait Tank Pump
Bilge Pump Aft
Bilge Pump Forward
Bilge Pump Mid
Bilge Pump Port
Bilge Pump Starboard
Blower
Boarding Light
Cabin Lights Aft
Cabin Lights Fwd
Cabin Lights Mid
Cabin Lights Port
Cabin Lights Starboard
Deck Wash Pump
Electric Toilet
Engine Room Lights
Fridge
Horn
Nav Lt's Port
Nav Lights Starboard
Panel Lights
Radar
Saloon Lights
SSB
Start
Stern Light
Stop
Tri Light

12V OUTLETS

SET-3N

12V Outlets
24V Outlets
Aft Deck Light
Bilge Auto Man.
Bow Lights
Docking Lights
Emergency Parallel
Engine Alarm
Engine Blowers
Extraction Fan
Flood Lights
Fore Deck Light
Galley Lt
Generator Lights
Holding Tank Pump
House Batteries
Lazerette Light
Port
Radio Battery
Search Light
Starboard
Start Batteries
Step Light
Strobe Light
Toilet Lt
Weather Fax
Windex Light
Window Washers

AFT LIGHTS

SET-4N

Aft Lights
Bedroom/Converter
Davit Winch
Engine Alternator
Fire System
Fish Finder
Fishing Light
Galley/Bath
House Alternator
Intercom
Load
Locker Light
Mid Wiper
Mid Lights
Mizzen Spreader Light
Plotter
Port Wiper
Preheat
Sole Light
Heater Fans
Starboard Wiper
Sub Main
Sump Pump
Tank Room Lights
Toilet Pump
Towing Light
TV/Stereo
Walvac

AC MAINS

SET-5N

AC Mains
AC Outlets
AC Outlets
Air Conditioning
Battery Charger
Cook Top
Dishwasher
Dive Compressor
Dryer
Frequency
Genset
Heater
Hotwater Cylinder
Ice Maker
Inverter
Inverter Outlets
Microwave
Oven
Refrigeration
Reverse Polarity
Ships Power
Shore Power
Trash Compactor
TV
Video
Washing Machine
Waste Master
Water Maker

AC MAINS

SET-6N

AC Mains
Accessories
Anchor Wash
Automatic
Autopilot
Auxiliary
Bilge Auto Manual
Bilge Lights
Boom Furl
Bridge Lights
Burglar Alarm
Cabin Fan
CB Radio
Cell Phone
Computer
DC Mains
Fuel Transfer
Galley Fan
Hatch Controls
Hydraulics
Loud Hailer
Macerator
Manual
Night Lights
Pelmet Lights
Solar Panel
Stove
TV Antenna

AFT PEAK LIGHT

SET-7N

Aft Peak Light
Deck Flood Lights Fwd
Deck Flood Lights Aft
Deck Lights
Deck Lights Port
Deck Lights Starboard
Deck Lights Forward
Deck Lights Aft
Fishing Lights
Fishing Lights White
Fishing Lights Red
Fishing Lights Green
Fish Room Lights
Fish Room Pump
Fore Deck Light
Focsls Light
Mast Flood Lights Fwd
Mast Flood Lights Aft
Net Recorder
Not Under Command
NUC Lights
Plotter
Port Flood Lights
Shower Lights
Stbd Flood Lights
Toilet Fan
Toilet Light
Winch Flood Lights

ANCHOR LIGHT

SET-8N

Anchor Light
Baragraph Power
Cabin Fans
Cabin Fans Fwd
Cabin Fans Aft
Courtesy Lts
Courtesy Lts Fwd
Courtesy Lts Mid
Courtesy Lts Aft
Diesel Heater
Fire System
Fuel Pump
Hailer
Lectrasan
Lectrasan Fwd
Lectrasan Stbd
Port Engine Controls
Port Ignition
Sat Com
Shower Light
Saloon Lights
Spare
Spare
Stabilizer
Stbd Engine Controls
Stbd Ignition
Toilet Light
Waste Treatment

BOILER/HEATER

SET-9N

Boiler / Heater
Bow Thruster
DC/DC Converter
Deck Lights Forward
Deck Lights Aft
Deck Lights Mid
Deck Lights Upper
Defroster
Galley Lights
Grey Water Pump
Guest State Lights
Head Pump 1
Head Pump 2
Master State Lights
Nav Lights
Oil Pump
Pilot House Lights
Saloon Lights
Search Light
Spare
Spare
Stereo
Trim Tab Control
V-Berth Lights
VHF Lower
VHF Upper
Wash Down Pump
Windlass

AIR COMPRESSOR

SET-10N

Air Compressor
Air Con Galley
Air Con Guest Room
Air Con Master State
Air Con Pilot House
Air Con Salon
Air Con Saloon
Air Con State Room
Air Con V-Berth
Air Conditioning
Air Conditioning 1
Air Conditioning 2
Air Conditioning 3
Central Vacuum
Charger Generator
Charger House
Charger Inverter
Compactor
Engine Room Fans
Hot Circ Pump
Ice Maker Lower
Ice Maker Upper
Outlets Engine Room
Outlets External
Outlets Galley
Outlets Lower Deck
Outlets Upper Deck
Water Heater

12-12V REDUCER

SET-12N

24-12V Reducer
Aerator
Ballast Aft
Ballast Control
Ballast Fwd
Black Tank Aft
Black Tank Fwd
Black Water Pump
Boom Light
Bridge Lights
Bridge Supply
Dining Lights
Fire Alarm
Flow Alarm
Interior Lights
Luff Light
Modem
Nav Area Fan
Outlets Aft
Outlets Fwd
Outlets Mid
Outlets Port
Outlets Stbd
Port Engine
Stbd Engine
Step Lights
Strobe
Riding Light

AFT BILGE ALARM

SET-13N

Aft Bilge Alarm
 Bilge Alarm
 Bilge Alarm Test
 Bilge Auto
 Bilge Lights
 Bilge Manual
 Bilge Pump Auto/
 Manual
 Fwd Bilge Alarm
 High Water Alarm
 Mid Bilge Alarm
 Port Aft Bilge Alarm
 Port Aft Bilge Auto
 Port Aft Bilge Manual
 Port Fwd Bilge Alarm
 Port Fwd Bilge Auto
 Port Fwd Bilge Manual
 Port Mid Bilge Alarm
 Port Mid Bilge Auto
 Port Mid Bilge Manual
 Stbd Aft Bilge Alarm
 Stbd Aft Bilge Auto
 Stbd Aft Bilge Manual
 Stbd Fwd Bilge Alarm
 Stbd Fwd Bilge Auto
 Stbd Fwd Bilge Manual
 Stbd Mid Bilge Alarm
 Stbd Mid Bilge Auto
 Stbd Mid Bilge Manual

210KHz TX

SET-14N

210KHz TX
 33KHz TX
 Aft Hold Light
 Cockpit Freezer
 Engine Controls
 Fridge/Freezer
 Fire Pump
 Fluxgate Compass
 Flybridge Freezer
 Fuel Gauge
 Fuel Transfer Port
 Fuel Transfer Stbd
 Fwd Hold Light
 Gantry Lights
 Holding Tank Port
 Holding Tank Stbd
 Masthead Light
 Pilot Light Red
 Pilot Light White
 Port Fuel Filter
 Rudder Indicator
 Stbd Fuel Filter
 Steering
 Toilet Aft
 Toilet Fwd
 Towing Light Amber
 Towing Light White
 Tuna Tubes

**12V OUTLETS
FLYBRIDGE**

SET-15N

12v Outlet Flybridge
 Arch Lights
 Bilge Pump Clutch
 Cabin Heater
 Compass
 Dry Head Pump
 Demister
 Engine Clutch Pump
 Flybridge Hatch
 Flybridge Wipers
 Freezer Clutch
 Fwd Stateroom Lights
 Greywater Pump 1
 Greywater Pump 2
 Guest Cabin Stereo
 Inmarsat
 Instrument Lights
 Instruments Flybridge
 Instruments Pilothouse
 Master Head Lights
 Nav Area Lights
 Overhead Lights
 Overhead Saloon Lights
 Saloon Wipers
 Security System
 Underfloor Lights
 24v DC Mains
 Bow Bilge High Water

AC OUTLETS AFT

SET-16N

AC Outlets Aft
 AC Outlets Aft Cabin
 AC Outlets Cockpit
 AC Outlets Deck
 AC Outlets Fwd
 AC Outlets Fwd Cabin
 AC Outlets Galley
 AC Outlets Guest Cabin
 AC Outlets Mid
 AC Outlets Port
 AC Outlets Salon
 AC Outlets Saloon
 AC Outlets Staterooms
 AC Outlets Stbd
 AC Outlets Wheelhouse
 Aircon Aft
 Aircon Aft Deck
 Aircon Cabin
 Aircon Fwd
 Aircon Fwd Deck
 Aircon Helm
 Aircon Pump
 Aircon Port
 Aircon Stbd
 Airhandler Fwd
 Stateroom
 Airhandler Mstr
 Stateroom
 Airhandler Pilothouse
 Airhandler Saloon

24 HOUR CIRCUITS

SET-17N

24 Hour Circuits
 Aft Bilge Pump Auto /
 Man
 Aft Head
 Alarm Mute
 Depth / Speed
 Electronics
 Engine Alarm
 Fans
 Fwd Bilge Pump Auto /
 Man
 Fwd Head
 Galley / Head Vent
 Galley Fridge
 Gas Stove
 Gauges
 Head Pump
 Level Indicator
 Lights
 Mid Bilge Pump Auto /
 Man
 Nav & Inst Lights
 Oil Pressure
 Pt Engine
 Pt Engine Start / Stop
 Stbd Engine
 Stbd Engine Start / Stop
 Sum Log
 Synchronizer
 Water Temp
 Windshield

27 MEG

SET-18N

27 Meg
 Aft Holding Tank
 Aft Water Heater
 Cabin Outlets
 Cockpit Fridge
 DC Mains 1
 DC Mains 2
 Dehumidifier
 DVD
 Engine Blower
 Engine Room Outlets
 Entertainment
 Flybridge Main
 FWD Holding Tank
 FWD Water Heater
 Galley
 Gas Solenoid
 Generator
 GFCI Outlet
 Hatch Lifter
 Helm Main
 Hour Meter
 Laundry
 LPG/Cooktop
 Navigation
 Range
 TV /DVD
 UHF

**12V BATTERY
CHARGER**

SET-19N

12V Battery Charger
 24hr Bilge Pump
 24V Battery Charger
 12V Battery Charger
 Bilge Pump Port Fwd
 Bilge Pump Port Mid
 Bilge Pump Stbd Aft
 Bilge Pump Stbd Fwd
 Bilge Pump Stbd Mid
 Boarding Platform
 Bulwark Lights
 Bunk Lights
 Cable Master
 Desalinator
 Dishwasher
 Electric Windows
 Engine Controls
 Macerator
 Oil Pump
 Pitch Control
 Port Air Con
 Port Engine
 Sonar
 Storerom Lights
 Spa
 Stbd Air Con
 Stbd Engine
 TV

12V AUX HORN

SET-20N

12V Aux Horn
 Aft Fridge
 Alternator
 Anchor Winch
 Bathroom Fan
 Bathroom Outlets
 Bridge Supply
 Docking Lights
 Engine Room Bilge
 Alarm
 Fax
 Fish Finder
 Holding Tank Gauge
 Icemaker
 Inverter/Charger
 Lake Water
 Master Head
 RCD
 Reset
 Salon Lights
 Shaver Outlets
 Sounder
 Speed
 Sum Log
 Toilet Port
 Toilet Stbd
 TV lift
 Wind Instruments

BOILER/HEATER

SET-22N

Alarms
 CCTV
 Cockpit Fridge
 Communications
 Control Max 2.0
 Deck Lights
 Earth Leakage Lights
 Emergency Paralel
 Engine Room Main
 Equipment Room
 Flybridge Lights
 Fresh Water Pump Port
 Fresh Water Pump Stbd
 Genset Start
 Genset Stop
 Grill
 Head/Galley Vent
 HF Radio
 Ignition Start
 Mid Hold Lights
 Radio Light
 Radios
 Refrigerator
 Reverse Polarity Test
 UHF Radio
 VHF Radio
 Wheelhouse Lights
 Wine Cooler

**AIR CON
FLYBRIDGE**

SET-23N

Air Con Flybridge
 Air Con Fwd
 Air Con Port
 Air Con Stbd
 Berth Lights
 Blower
 Cabin Lights Main
 Cooling Pump 1
 Cooling Pump 2
 Discharge
 Discharge
 Discharge
 Discharge
 Emergency Lights
 Gallery Fridge
 Helm Lights
 Macerator
 Master Cabin Lights
 Port Engine Controls
 Port Engine Controls
 Port Engine Controls
 Quartz Lights
 Stbd Engine Controls
 Stbd Engine Controls
 Stbd Engine Controls
 Stereo Memory
 Storage Bin Pump
 Waterblaster

CABINE AVANT

SET-FRENCH

Cabine Avant
 Cabine Babord
 Cabine Tribord
 Dessalinisateur
 Divers
 ECL Interieur
 Essuie-Glace
 Feu De Hune
 Feu De Mouillage
 Feu De Pont
 Feux De Navigation
 Flaps Trim Tabs
 GPS
 Groupe D'Eau
 Guindeau
 Instruments
 Pilote Automatique
 Pompe De Cale
 Prise 12V
 Refrigerateur
 Salle De Bain
 Salle Machine
 Sondeur
 Stereo
 Table A Carte
 Timonerie
 Ventilateur De Cale
 VHF

AUXILIARE 1

SET-FRENCH 2

Auxiliaire 1
 Auxiliaire 2
 Avertisseur
 Cabin 2
 Cabin 3
 Cabin I
 Centrale Nav
 Chauffage
 Chauffe-Eau
 Confort
 Congelateur
 Divers
 Eclairage Babord
 Eclairage Carre
 Eclairage Nacelle
 Eclairage Tribord
 Electronique
 Feu Tricolore
 Hi-Fi
 Micro-Ondes
 Pompe Babord
 Pompe De Lavage
 Pompe Douche
 Pompe Tribord
 Radar
 Spots
 Toilettes
 Winch

CSP6

ANCHOR LIGHT

SET-2SP

- Anchor Light
- Bilge Auto Man
- Boom Light
- Cabin Light
- Cockpit Lights
- Compass Light
- Deck Lights
- Depth Sounder
- E/R Blower
- Freezer
- Hot Tub Light
- Hot Tub Pump
- Instruments
- Locker Lights
- Nav Lights
- Port Nav Lights
- Port wiper
- Shower Drain Pump
- Spare 1
- Spare 2
- Spare 3
- Stbd Nav Lights
- Stbd Wiper
- Steaming Light
- Stern Light
- Sumlog
- Transom Lights
- Tri Light

800-MS1-4

24 HOUR LIGHTS

SET-MSP3

- 24 Hour Lights
- Bow Bilge Pump
- Bow bilge Override
- Bow Thruster
- Cathodic Protection
- Charts/Sounder
- Cockpit Main
- CO Detector
- Cockpit Fridge
- Electronics Main
- Electric Controls
- Electric Head
- Genset Battery Charger
- Hatch Lifter
- Helm Main
- Head Macerator
- Port Battery Charger
- Port Engine Blower
- Port Controls
- Saloon Mains
- Stbd Controls
- Stereo
- Stereo Amplifier
- Stbd Battery Charger
- Stbd Engine Blower
- Wiper Mid
- Wiper Port
- Wiper Stbd
- Accessories
- Controls

CSP6

ACCESSORIES

SET-1SP/F

- <Mouillage Navigation>
- Accessories
- Accessories
- Aerateur
- Appliques De Cockpit
- Appliques Interieures
- Avertisseur
- Essuie-Glace 1
- Essuie-Glace 2
- Essuie-Glace 3
- Feu De Mouillage
- Feu De Navigation
- Frigo
- GPS
- Groupe D'Eau
- Instruments
- Lecteurs De Cartes
- Pilote Automatique
- Pompe Cale <Auto Manuel>
- Pompe De Cale
- Pompe De Lavage
- Pompe De Vidange
- Prises De Courant
- Radio
- Sondeur
- Spots
- Ventilateur
- Winch

800-MS1-4

24V HOUSE VOLTMETER FEED

SET-MSP4

- 24V House Voltmeter Feed
- Bilge Alarm
- Bilge Pump 24 hr
- Bilge Pump Aft High Water
- Bilge Pump Fwd High Water
- Bilge Pump Mid High Water
- Bilge Pumps
- Bilge Pumps Main
- Flybridge 12V Mains
- Flybridge 24V Mains
- Genset Blower
- High Water Alarm
- House Battery Charger
- House Battery Meter
- House Main
- Lower 12V Mains
- Lower 24V Mains
- Port Aft Bilge Pump
- Port Batter Meter
- Port Fwd Bilge Pump
- Port Mid Bilge Pump
- Shower Sump
- Stbd Aft Bilge Pump
- Stbd Battery Meter
- Stbd Fwd Bilge Pump
- Stbd Mid Bilge Pump
- Toilet
- Twin Disk
- Twin Disk Port
- Twin Disk Stbd

900-6WP

NAVIGATION LIGHTS

SET- LBL-WP

- Accessories
- Aerator
- Anchor Lights
- Autopilot
- Bait Tank Pump
- Bilge Pump
- Blower
- Cabin Lights
- Cockpit Lights
- DC Outlets
- Deck Wash
- Depth Sounder
- Freshwater Pump
- Fridge
- GPS
- Horn
- Inst. Lights
- Instruments
- Log
- Navigation lights
- Radar
- Spare
- Spot Lights
- Stereo
- Stern Light
- Trim Tabs
- VHF
- Wiper

706 - 707

WINCH

SET-714

- Anchor Winch
- Bilge Pump Aft
- Bilge Pump Fwd
- Bilge Pump Mid
- Bilge Pump Port
- Bilge Pump Starb
- Bow Thruster
- Davit Winch
- DC Mains 1
- DC Mains 2
- Halyard Winch
- Head 1
- Head 2
- Holding Tank
- Inverter
- Memory Circuits
- Security System
- Sheet Winch
- Spare
- Waste Treatment 1
- Waste Treatment 2

CMP-6WP

FRESHWATER PUMP

SET- LBL-CMP

- Accessories
- Aerator
- Anchor Lights
- Autopilot
- Bait Tank Pump
- Bilge Pump
- Blower
- Cabin Lights
- Cockpit Lights
- DC Outlets
- Deck Wash
- Depth Sounder
- Freshwater Pump
- Fridge
- GPS
- Horn
- Inst. Lights
- Instruments
- Log
- Navigation lights
- Radar
- Spare
- Spot Lights
- Stereo
- Stern Light
- Trim Tabs
- VHF
- Wiper

Interior Series Switch Plates

SET-IN

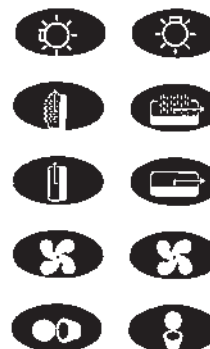

Battery Switches 701-720

713

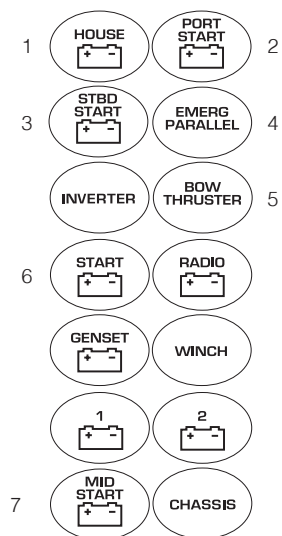

Some labels can be purchased separately under the following item numbers

- 1 **713-HB**
- 2 **713-PS**
- 3 **713-SS**
- 4 **713-EP**
- 5 **713-BT**
- 6 **713-SB**
- 7 **713-MS**

SET-715



SET-715 contains the 3 most commonly requested labels out of set 713 without the need to purchase a full label set.

Battery Control Center

SET-CC-BCC-1

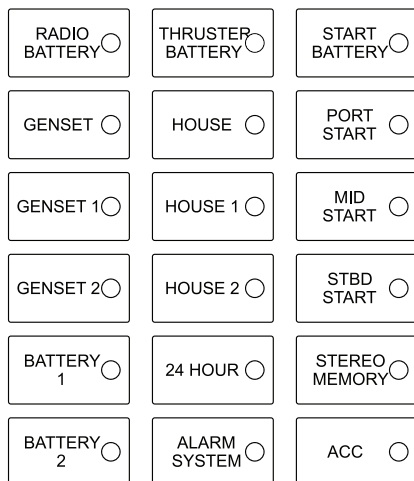

Circuit Breaker Modules

SET-CC-1

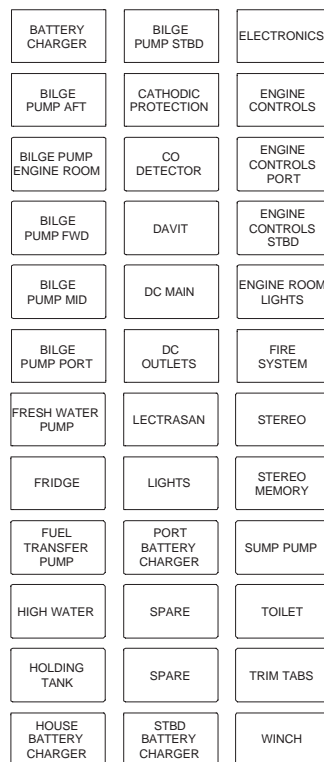

SET-CC-1 labels are supplied standard with any 800 series module containing toggle or push reset circuit breakers.

Heavy-duty Circuit Breaker Modules

SET-CC-A

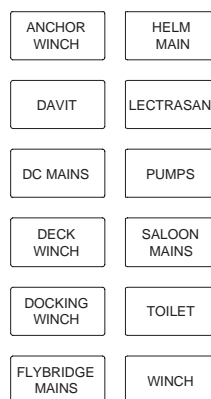

SET-CC-A labels are supplied standard with any 800 series module containing the heavy-duty Busman circuit breaker.

Spray-Proof Panels Generation II (140)

Label Set SET-G2-1



- ACCESSORIES
- AERATOR
- ANCHOR LT
- BAIT TANK
- BILGE PUMP
- AUTO B/P MAN
- BLOWER
- CABIN LIGHTS
- COCKPIT LTS
- DC OUTLETS
- DECK WASH
- DN WINCH UP
- ELECTRONICS
- ENGROOM LTS
- FLOOD LIGHTS



- FW PUMP
- FRIDGE
- GPS
- HORN
- INST. LIGHTS
- INSTRUMENTS
- NAV LIGHTS
- RADIO
- SW PUMP
- SPOT LIGHTS
- UP PORT DN
- UP STBD DN
- WIPER

Label Set SET-G2-2



- B/PUMP PORT
- B/PUMP STBD
- B/PUMP FWD
- B/PUMP MID
- B/PUMP AFT
- B/PUMP ENG RM
- COMPASS LT
- DECK LTS
- STEAMING LT
- NAV LTS PT
- NAV LTS STBD
- STEP LTS
- STERN LT
- WIPER PT
- WIPER MID



- WIPER STBD
- WASHERS
- FREEZER
- H/TANK PUMP
- SUMP PUMP
- LOCKER LTS
- PANEL LTS
- TRI LT
- BOW LTS
- SHOWER LT
- SHOWER PUMP
- SPARE
- SPARE

Sprayproof Switch Panels - Micro

LBL-MIC1

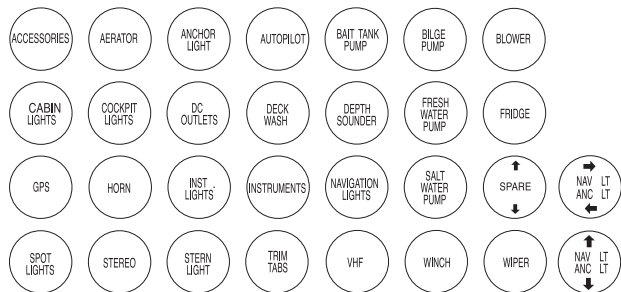

LBL-MICSYM

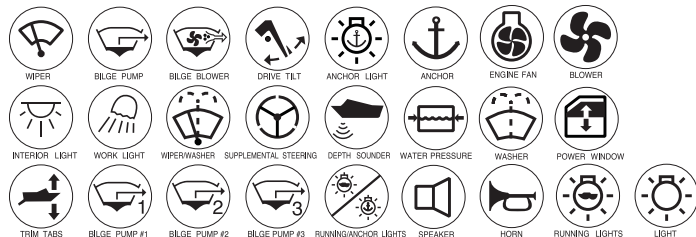

Contour Interior Series Monitor Panels

SET-1001



SET-1002



Custom Panel Layouts

Although the panels shown in this catalog are our standard range, there are a number of changes that can be made to fit the needs of custom and production boatbuilders. For example,

a panel can be made up with eight circuit breakers, four systems in operation lights plus a meter, or a panel can consist of a mixture of analog and digital meters if required.



See label index starting on page 133

Circle your selections:						
Voltage:	AC	DC	12V	24V	110V	230V
Backlighting:	12V	24V				
Meters:	Yes	Blank				
Digital:	ACSM (page 181)	DCSM (page 182)	600-VM3	600-TG	600-SOM	
Meter Position:	1	2	3	4		

Anlg Volts DC:	8-16	16-32			Meter Position:	1	2	3	4
Anlg Amps DC:	0- 50	0-100	0-150		Meter Position:	1	2	3	4
Anlg Volts AC:	0-150	0- 300			Meter Position:	1	2	3	4
Anlg Amps AC:	0-60	0-100AAC			Meter Position:	1	2	3	4

If the panel involves a total custom layout, as described above, a specific Item # will be applied to that panel and quoted accordingly.

If the design is unable to be achieved we will notify the customer.

Alternatively a customer may request a standard panel with circuit breakers laid out to their requirements with labels factory fitted. This involves a personalized layout charge with the following part numbers applying, eg:

901V is ordered as NPF-901V.

902A-12V-12V is ordered as NPF-902A-12V-12V

When ordering personalized panels see our label selection that starts on page 133. We can also do specific label sets, priced per-job.

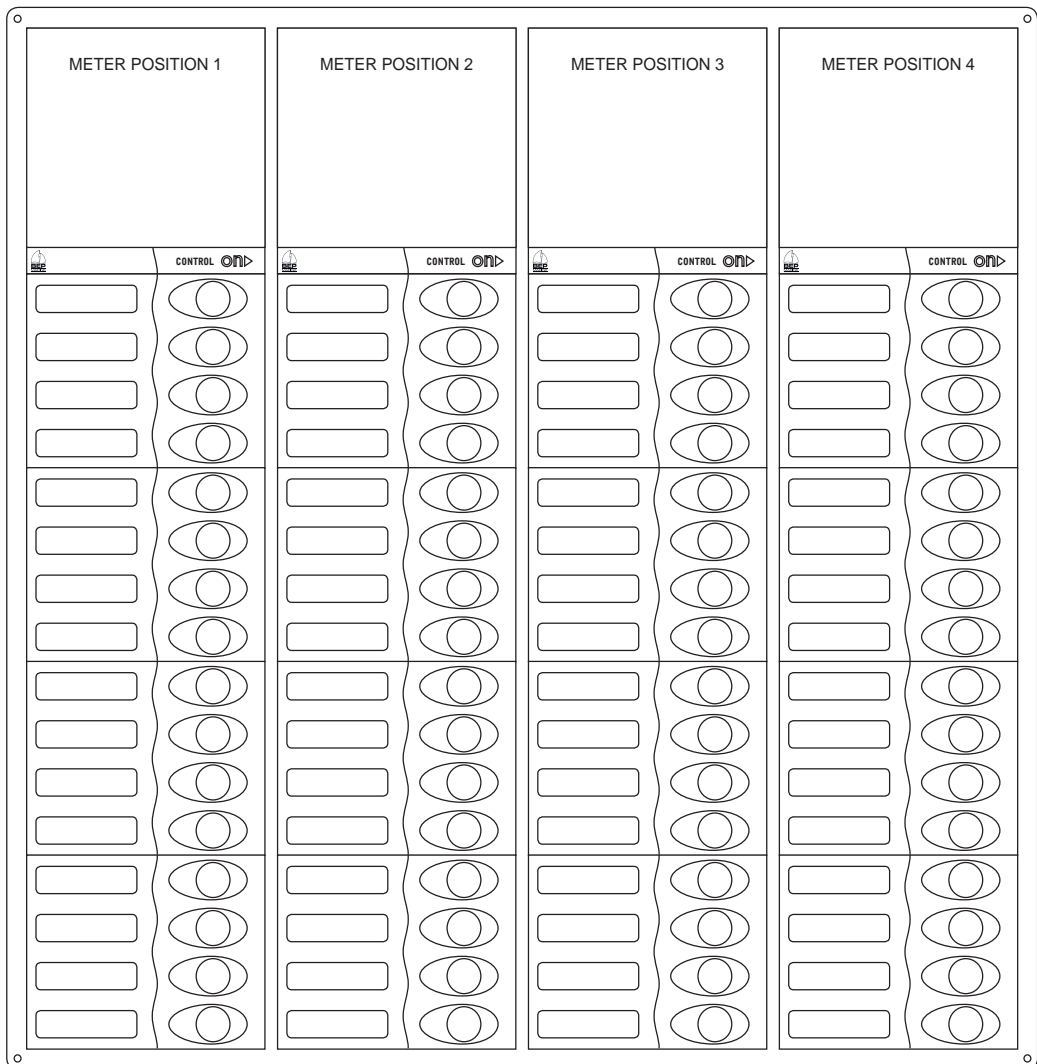

Compact Marine Panels

- Molded gasket incorporates fastening covers
- Switches clip easily into rear of panel and can be removed to replace with different function switches eg. on/on, on/off/on, off/(on) and (on)off(on)
- Mini fuses accessible from front of panel with removable cartridge
- Custom designed toggle cover with unique sealing feature
- Switches rated at 20A DC
- LxWxH is 3.7"x4.25"x2.5" (95x107x65 mm)
- Panel supplied with label SET-LBL-CMP

Switches	Color	Item #
4	black	CMP-4WP
6	black	CMP-6WP
5	black	CMP-5WPS



CMP-4WP



CMP-6WP



CMP-5WPS

Waterproof Series

- Compact panel size
- Sprayproof inline fuse holders with fuses included
- Waterproof power receptacles (16A) in five and three way models
- Waterproof to IP56
- Switches rated at 20A DC
- LxWxH is 3.75"x4.25"x2.9" (95x107x75 mm)
- Panel supplied with label LBL-WP

Switches	Color	Item #
3	black	900-3WPS
	white	900-3WPSW
4	black	900-4WP
	white	900-4WPW
5	black	900-5WPS
	white	900-5WPSW
6	black	900-6WP
	white	900-6WPW



900-4WP



900-6WPW



900-5WP

Spare parts for above panels and panels on page 141

Item #	Type	Operation
SW-32111	Switch	on/off
SW-32113	Switch	on/on
SW-32114	Switch	on/off/on
SW-32115	Switch	(on)off/ momentary
SW-32120	Switch	(on)off(on) momentary
SW-32123	Switch	on/off/on double pole
SW-M331	Boot	Splash proof cover
12VPG	Plug	16A



Contour Generation II

The Contour Generation II Spray Proof Range offers unique styling using the latest techniques in injection molding. The switch tray is molded plastic with a rubber gasket and seal molded into the plastic. The cover is molded in a clear plastic with a rubber over-mold allowing the flexibility to operate the switches through the front of the panel while providing a clear window for label backlighting. The contour wave strip is interchangeable allowing for custom colors for OEM applications. Standard color supplied is black panel with charcoal strip.

G2 can be mounted vertically or horizontally and is available in 2, 4 and 6 way configurations.

A joiner (CG2-JB) is available for multiple panel installations.

Supplied complete with on/off switches, these can be interchanged with a variety of different switch options.

- Replaceable clip-on contour wave (customized colors available for OEMs)
- Mounting screws covered by switch cover
- Backlit LEDs
- Flexible overshoot cover allows for easy switch operation
- Ribbed gasket provides watertight seal with switch cover
- Molded gasket on panel base creates watertight seal against mounting surface
- Unique design allows labels to be read whether mounted vertically or horizontally.
- Switches rated at 16A DC
- Panel supplied standard with label SET-G2-1 (labels SET-G2-2 ordered separately, page 137)



Switches	Color	Fuses	Label Sheet	Item #
2	Black	No	SET-G2-1	CG2-2W
2	Black	1	SET-G2-1	CG2-2W-F
4	Black	No	SET-G2-1	CG2-4W
4	Black	2	SET-G2-1	CG2-4W-F
6	Black	No	SET-G2-1	CG2-6W
6	Black	3	SET-G2-1	CG2-6W-F
2	White	No	SET-G2-1	CG2-2W-W
2	White	1	SET-G2-1	CG2-2W-F-W
4	White	No	SET-G2-1	CG2-4W-W
4	White	2	SET-G2-1	CG2-4W-F-W
6	White	No	SET-G2-1	CG2-6W-W
6	White	3	SET-G2-1	CG2-6W-F-W

Available upon request: Different custom color combinations for Contour strip and rubber over-mold.



Spare Switches for Contour Generation II

Item #	Switch type
SW-CG1	On/Off
SW-CG2	On/Off Momentary
SW-CG3	On/Off/On
SW-CG4	Momentary On/Off/ Momentary On
SW-CG5	On/On

Micro Series

- Green LED backlit labels; red when on
- Full range of text or graphic labels available; mix n' match labels and panels to suit
- Switches rated 20A DC
- 3.4"x2.3"x1.2" (86x58x28 mm)
- Waterproof to IP56
- Label see LBL-MIC included; additional label sets available (page 137)



900-2WPOFO
1 x 2 way switch, 1 x 3 way double pole switch



900-2WP
2 x 2 way switches



900-2WPMOM
1 x 2 way switch, 1 x 3 momentary switch



900-SOP
2 x 10 mm LEDs showing systems in operation



900-BA
Bilge alarm and bilge pump control panel includes: 1 on/off/on switch for auto manual control; 1 warning light and alarm for high water level alarm. (Float switch ordered separately – Item # SB1-FS)

Contour Switch Panel

- CSP6-PTC uses the latest in overload protection technology - Positive Temperature Co-efficient
- Green LED backlit labels; red systems on indicator
- Switches rated 20A DC
- Removable cover plates conceal screws & water drain
- Label set SET-1SP included, additional label sets available, see page 135
- **CSP6** Includes 6 switches unfused for installation where separate fused supply is available.
- **CSP6-F** Includes 6 switches and 3 inline fuse holders with fuses behind panel.
- **CSP6-PTC** fuses are solid state resettable fuses which change to a high resistance device on over-current. The panel is supplied with 6 x 9A PTC fuses mounted internally. No more changing fuses!

Item #	in LxWxH	mm LxWxH	Label Sheet	Fuses	PTC
CSP6	6.25"x4.4"x2.5"	158x112x65	SET-1SP	No	No
CSP6-F	6.25"x4.4"x2.5"	158x112x75	SET-1SP	3	No
CSP6-PTC	6.25"x4.4"x2.5"	158x112x75	SET-1SP	No	6



CSP6

Contour Interior Switch Panel 1000 Series

The smart, economical interior option for smaller vessels. Fully modular and built with ease of access in mind.

- Removable frame conceals mounting screws
- Concealed ATC fuses accessible from front of panel; ATC fuses supplied
- 16A rocker switches
- Panels are modular and square for vertical or horizontal stacking.
- LED Systems On light
- Supplied with: Spacer for accurate mounting placement, label sheet Item # SET-1000
- Maximum panel load 50A

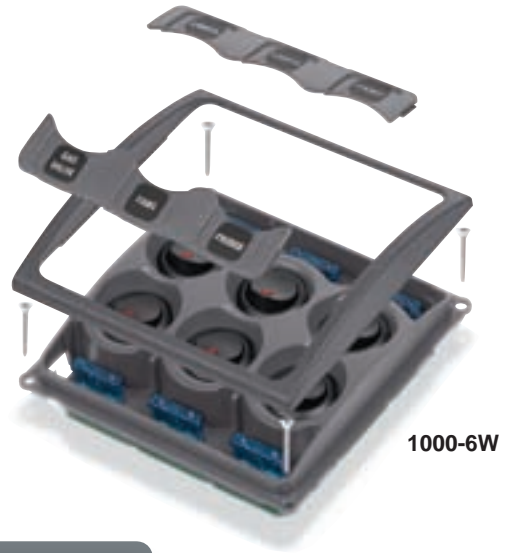

Item #	Switches	Fuses	Voltage
1000-6W	6	6	12



1000-VM-12V Voltmeter

1000-AM50 Ammeter

1000-6W Switch Panel



SW-RVS2 ON/OFF

Description	Item #
10A Ammeter (internal shunt)	1000-AM10
20A Ammeter (internal shunt)	1000-AM20
50A Ammeter (external shunt, supplied)	1000-AM50
12 Volt Systems	1000-VM-12V
24 Volt Systems	1000-VM-24V
DC Systems Monitor	1000-DCSM
AC Systems Monitor	1000-ACSM

NEW Now available with digital AC and DC systems monitors

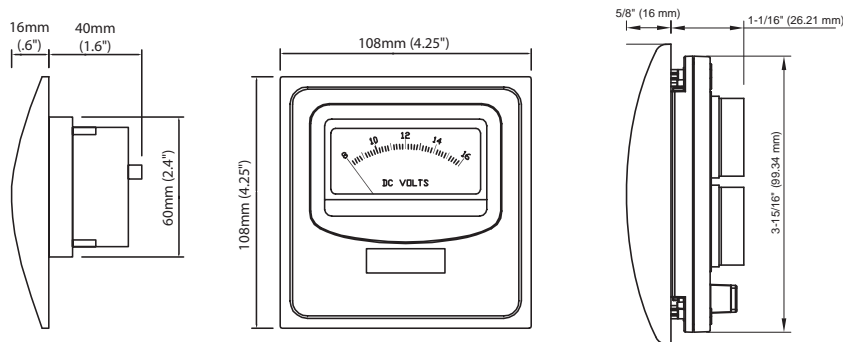

Side profile systems panel

Contour 1100 Series

The Contour Interior switch can be either surface or recess mounted. The interior series is supplied standard with a three terminal on/on switch which can be used for on/off circuits or two way light installations. For applications, eg: shower drain pumps or electric toilets, momentary switches can be interchanged into the switch plate. Switches can be turned 90° for horizontal mounting, and all are current rated at 10A DC. All switches include a label sheet For reference, see page 135

Replacement and/or different Operational Switch

Description	Item #
On/On (On/Off)	SW-6064B3P
On/Off/On	SW-6064C3P
On/Off Spring-loaded in "on" position	SW-6064D3P



Item #	1100-BK	1101-BK	1100-BK-TS	1101-BK-TS
Interior/Exterior	Interior	Interior	Exterior	Exterior
Single/Double	Single	Double	Single	Double
Rated	10A	10A	20A	20A
LxWxH	2.4"x1.2"x0.75" 60x30x18 mm	3.6"x1.2"x0.75" 91x30x18 mm	2.4"x1.2"x0.75" 60x30x18 mm	3.6"x1.2"x0.75" 91x30x18 mm

Sealed Rocker Switches UL 1077 Recognized

- Certified for prolonged submersion under pressure (front panel sealing) and UL Ignition Protected. Certified to IP66/IP68.
- Withstands extreme temperatures from -40°C to + 85°C.
- Endurance: 150,000 cycles minimum. Rating: 20A at 12V, 10A at 250V AC, 15A at 125V AC

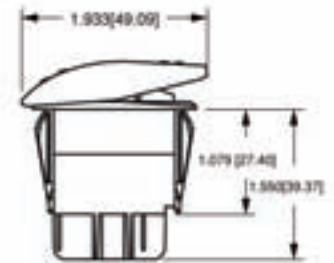

without Light

Description	Function	Item #
Single Pole Single Throw	on-off	554010
	(on)-off	554022
Single Pole Double Throw	on-off-on	554026
	(on)-off-(on)	554028
Double Pole Single Throw	on-off	554030
	on-on	554038
Double Pole Double Throw	on-off-on	554033
	(on)-off-(on)	554035

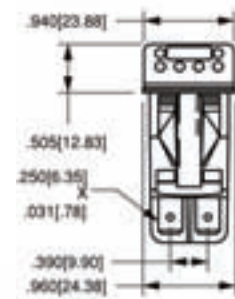

with Light

Description	Function	Item #
Single Pole Single Throw	on-off	554024
	(on)-off	554011
Single Pole Double Throw	(on)-off-on	554012
	on-off-on	554027
	(on)-off-(on)	554029
Double Pole Single Throw	on-off	554032
Double Pole Double Throw	on-off-on	554036
	(on)-off-(on)	554016



Red Lens, Clear Lamp



(on) = Momentary

Nylon Toggle Switches UL 1077 Recognized

Toggle Style	Description	Function	Item #
Paddle w/ 1/4" Tab 6.4 mm	Single Pole Single Throw	on-off	556010
		(on)-off	556022
	Single Pole Double Throw	(on)-off-(on)	556028

(on) = Momentary

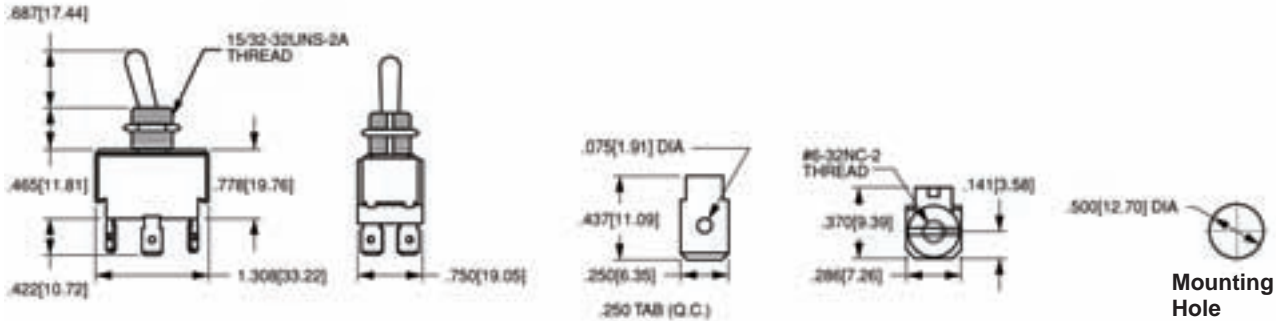

Nickel Plated Brass Toggle Switches UL 1077 Recognized

Toggle Style	Description	Function	Item #
Bat w/ 1/4" Tab 6.4 mm	Single Pole Single Throw	on-off	555010
		(on)-off	555022
	Single Pole Double Throw	(on)-off-on	555025
		on-off-on	555026
		(on)-off-(on)	555028
	Double Pole Double Throw	on-off-on	555033

(on) = Momentary

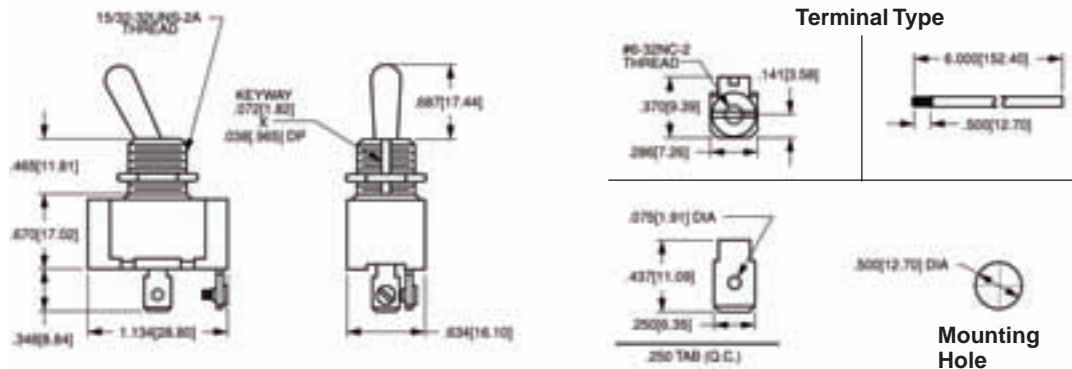

Terminal Type



Waterproof Toggle Switch Boot UL 1077

- For use with Nickel Plated Toggle Switches
- Black
- Pkg qty 5

Item # **555105**

Bus Bars

- Now with easy-fit covers to ABYC standards, with polarity ID
- 5/32" (4 mm) stainless steel screws with shakeproof washers
- 2 x 1/4" (6 mm) input studs
- Tin-plated, brass-insulated mounting bases with recessed mounting holes to avoid accidental shorts on aluminum surfaces
- Supplied standard with all BEP™ AC & DC control panels
- Display pack versions supplied with cover

Item #	OEM #	Bus Type	Output screws	Input studs	Rating (A)
BB-6W-2S/DSP	BB-6W-2S	Single	6	2	100
BB-12W-2S/DSP	BB-12W-2S	Single	12	2	100
BB-24W-2S/DSP	BB-24W-2S	Single	24	2	150
BB-6W-2NC/DSP	BB-6W-2NC	Double	2 x 2	2 x 6 way	100
BB-12W-2NC/DSP	BB-12W-2NC	Double	2 x 12	2 x 12 way	100
BB-4S-150A/DSP	—	4 -way	1 x 4	4 x 6 mm (1/4 stud)	150

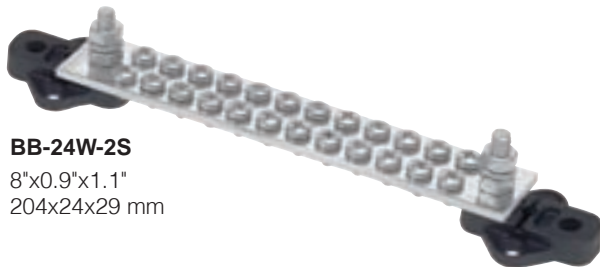
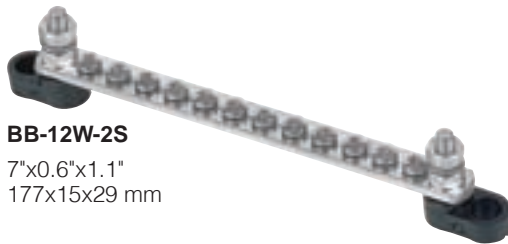
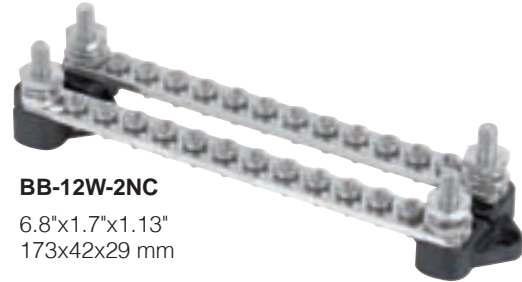

Covers

- Flame-resistant flexible plastic
- Color-coded for polarity
- Unique push-on fit
- Supplied standard with bus bars when ordered in display packs (for bulk packaging ordered separately)



Item #	Description
BBC-6WR	Positive
BBC-6WBK	Negative



Item #	Description
BBC-12WR	Positive
BBC-12WBK	Negative



Item #	Description
BBC-24WR	Positive
BBC-24WBK	Negative

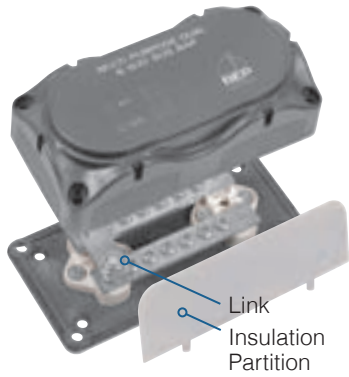

Multi purpose Bus Bar (Rated 100A)

Allows for Bus bars to be separated using insulation partition as supplied (as illustrated) or Bus bars can be combined using the link supplied. For DC negative & positive common or separated, or AC Neutral Earth (linked or separate).

Item # **BB-6W-2**

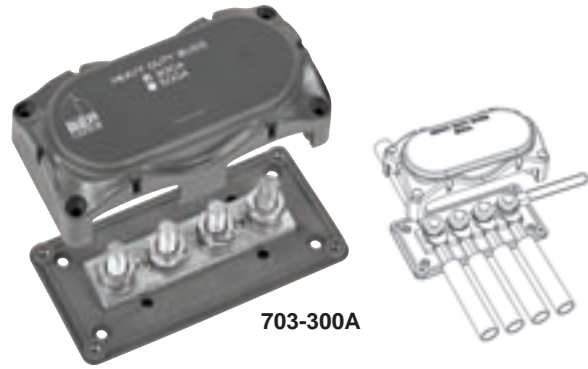

Distribution Bus

Allows multiple terminations for heavy-duty negative or positive connections. Modular sizing with Contour Lock housing allows easy grouping and meets ABYC standards for exposed terminals.

Item # **703-300A**

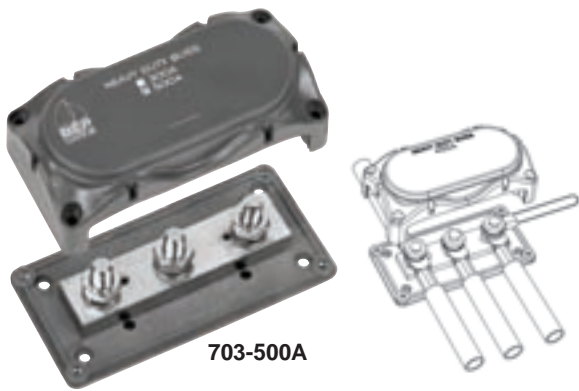

Distribution Bus

Designed to take loads from Heavy-duty Starter Circuits. Taller cover allows for more bulky cables and lugs.

Item # **703-300A**



Ammeter Shunt Enclosure

Provides a protective housing for shunt termination meeting ABYC standards. Shunts ordered separately (see page 179).

- Digital large: 450A - 50mV
- Analog small: 50A - 50mV, 100A - 50mV, 150A - 50mV
- Takes 2 small or one large shunt

Item # **711L**

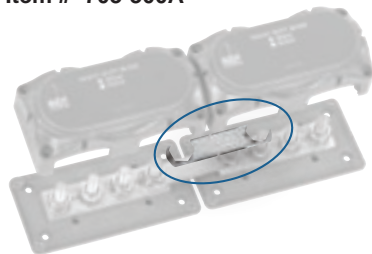

Use the 708-64.5 link (page 148 for 708 link bar reference chart) for optional expansion on either the 703-300A or the 703-500A.

Item #	OEM #	Rating (A)	in LxWxH	mm LxWxH	Stud Size	Terminal screws
BB-6W-2	—	100	5.4"x2.71"x2"	138x69x50 mm	1/4" 6 mm	5/32" / 4 mm
703-300A	703-300A/B	300	5.4"x2.71"x2"	138x69x50 mm	4"x3/8" 4x10 mm	—
703-500A	703-500A/B	500	5.4"x2.71"x2.9"	138x69x75 mm	3"x3/8" 3x10 mm	—
711L	—		5.4"x2.71"x2"	138x69x50 mm		

Insulated Studs & Covers

- Made with high temperature plastic bases
- Stud covers push securely over the threaded stud covering to ABYC standards
- Dual studs ideal for +ve / -ve connections, branch circuits, windlass or inverter installations.
- Covers supplied with display versions.



IS-6MM-1

IS-6MM-2

IS-10MM-1

IS-10MM-1R



IS-10MM-2

IS-10MM-2/L



ISC-10R



ISC-10BK



ISC-6-2



IS-10MM-8MM

Designed for Yamaha engine installations where the positive cable is supplied with a 3/8" (10 mm) lug and the negative cable is supplied with an 5/16" (8 mm) lug.

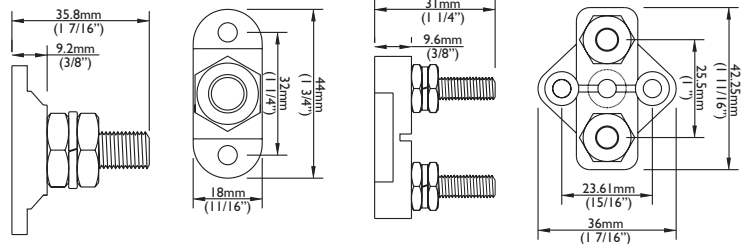

Studs

Item #	OEM #	Stud Size	Polarity
Single Studs			
IS-6MM-1R/DSP*	IS-6MM-1R	1/4" / 6 mm	Positive
IS-6MM-1/DSP*	IS-6MM-1	1/4" / 6 mm	Negative
IS-8MM-1R/DSP*	IS-8MM-1R	5/16" / 8 mm	Positive
IS-8MM-1/DSP*	IS-8MM-1	5/16" / 8 mm	Negative
IS-10MM-1R/DSP*	IS-10MM-1R	3/8" / 10 mm	Positive
IS-10MM-1/DSP*	IS-10MM-1	3/8" / 10 mm	Negative
Dual Studs			
IS-10MM-2/DSP*	IS-10MM-2	2 x [3/8" / 10 mm]	
IS-10MM-2/L/DSP*	IS-10MM-2/L	2 x [3/8" / 10 mm] linked	
IS-10MM-8MM/DSP*	IS-10MM-8MM	1 x [3/8" / 10 mm], 1 x [5/16" / 8 mm]	
IS-6MM-2/DSP*	IS-6MM-2	2 x [1/4" / 6 mm]	

*Item #'s come with cover, OEM #'s do not.

Covers

Item #	Description
ISC-10R	Red positive 10 mm
ISC-10BK	Black negative 10 mm
ISC-6-2	Double 6 mm



Reducing Sleeve

For 8 mm studs, supplied in display packs. **Order separately.**

Item #	Color
ISC-10BK-S	black
ISC-10R-S	red

Terminal Blocks

Ideal for isolated connections up to 30A. Suitable for connecting tails from AC and DC panels.

Base material: Phenolic; Current rating 30A; Max. voltage rating: 300V AC/DC; Screw size: 0.25" (6.3 mm)

Item # **TB-118-6P** 6 connections

Item # **TB-118-10P** 10 connections

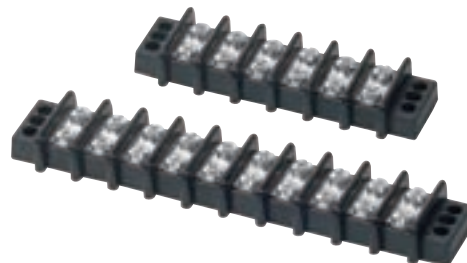

Distribution Stud

The Contour Distribution Stud allows terminating of heavy-duty cables for one or more connections. Contour Lock housing has removable side plates which allows for connections from all sides.



702

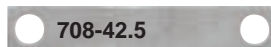

708-42.5

19 mm
Suits 701

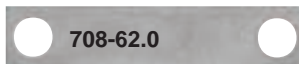

708-62.0

25 mm
Suits 720

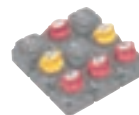

Terminal Links

The 708 links are designed for space saving interconnections of terminals when battery distribution modules are linked together. Four standard solid links are available for interconnection of the 701 battery switch with other Battery Distribution products and two larger links which are intended for the heavy-duty battery switch.

Item #	Distance		Hole diameter	
	between centers			
708-42.5	1.7"	43 mm	3/8"	10 mm
708-54.5	2.2"	55 mm	3/8"	10 mm
708-64.5	2.6"	65 mm	3/8"	10 mm
708-68.5	2.7"	69 mm	3/8"	10 mm
708-62.0	2.45"	62 mm	1/2"	12 mm
708-102	2.45"	102 mm	1/2"	12 mm

Dual Distribution Stud

Designed specifically for transom areas for connecting battery cables from outboards. It also has many other applications where heavy-duty positive and negative connections need to be terminated.



702-2S



Secondary Bus

Fitted to Distribution Stud 702 allows for small wire connections without cluttering main stud. Terminal screws 1/8" (4 mm).

Item # 702SB

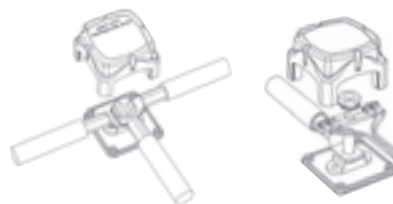

Four Way Distribution Stud

The 704-4S was designed for multiple heavy-duty connections which need to be isolated from each other. This model completes the range of heavy-duty connectors and meets ABYC standards for exposed terminals.



704-4S

Description	Stud Size	Item #	OEM #	LxWxH	
Distribution Stud	10 mm, 3/8"	702	702B	2.75"x2.75"x2"	69x69x50 mm
	1 x (8 mm, 5/16")	702-8	702-8-B	2.75"x2.75"x2"	69x69x50 mm
Dual Distribution Stud	2 x (10 mm, 3/8")	702-2S	702-2S/B	2.75"x2.75"x2"	69x69x50 mm
	1 x (8 mm, 5/16") 1 mm x (10 mm, 3/8")	702-8-10	702-8-10-B	2.75"x2.75"x2"	69x69x50 mm
Four Way Distribution Stud	4 x (10 mm, 3/8")	704-4S	704-4S/B	5.3"x2.75"x2"	138x69x50 mm
	10 mm, 3/8"	704-ANL	704-ANLB	5.3"x2.75"x2"	138x69x50 mm

The patented Contour Locking System is an innovative feature that allows for multiple battery management components to be connected to each other providing for a clean finished installation. These locking tabs can be found on battery switches, heavy-duty buss bars, fuse holders, distribution studs and breaker modules.



Circuit Breaker Module

Provides 3 CBs ideal for medium duty loads, like waste treatment systems and electric toilets. Designed to separate these loadings from the main DC panel, avoiding voltage spikes. Supplied standard with 1 x 50A and 2 x 25A B Series CBs in a Contour Lock housing for easy modulation. Extra CBs available (119).

Labels ordered separately: SET-714.

Item # 707



705

Contour Circuit Breaker HD

Allows switchable protection for heavy-duty circuits like Windlasses or Davit winches using Busman Heavy-duty thermal circuit breakers (120). Modular sizing with Contour Lock housing allows easy grouping. LED to indicate circuit is on. Five standard ratings available.

Item # 705



24hr Service Circuit Breaker Module (4W)

Consists of one 5A and three 15A push to reset Carling CLB Series thermal CBs. Suitable for essential circuits such as bilge pump, auto float switch supplies and stereo memory circuits. The push to reset function ensures essential 24hr circuits cannot be switched off inadvertently. This is contained in the contour lock double module. For spare circuit breakers see 120.

Labels: SET-714

Item # 706-4W

OEM # 706-4WB



24hr Essential Circuit Module

Designed for smaller systems where only 2 circuit breakers are required. Supplied with 2 x 10A Carling CLB Series circuit breakers – push to reset.

Item # 706-2W

Item #	OEM #	Rating (A)	in LxWxH	mm LxWxH	Stud Size
707	—	1 x 50A, 2 x 25A	5.4"x2.71"x3"	138x69x75 mm	3/16" 5 mm
705-50A	705-50A/B	50	5.4"x2.71"x3"	138x69x75 mm	1/4" 6 mm
705-80A	705-80A/B	80	5.4"x2.71"x3"	138x69x75 mm	1/4" 6 mm
705-100A	705-135A/B	100	5.4"x2.71"x3"	138x69x75 mm	1/4" 6 mm
705-135A	—	135	5.4"x2.71"x3"	138x69x75 mm	1/4" 6 mm
705-150A	—	150	5.4"x2.71"x3"	138x69x75 mm	1/4" 6 mm
706-4W	706-4WB	1 x 5A, 3 x 15A	5.4"x2.71"x3"	138x69x75 mm	5/32" 4 mm
706-2W	—	2x10A	2.71"x2.71"x2.75	69x69x70 mm	5/32" 4 mm



Mastervolt transfer systems: Regulates 120V & 230V power sources

The Mastervolt transfer system helps you regulate your shore, generator or inverter power and automatically selects the right power sources at the right time. With Mastervolt you can cook and do laundry at the same time or watch TV with the airco on full blast. In addition, Mastervolt transfer systems are suitable for every installation. Mastervolt makes onboard 230V a breeze.

Masterswitch: The simple solution

- Two AC inputs: Inverter, shore power or generator.
- One outlet to AC power group.
- Automatic switching.
- Power transfer up to 25 kW, input/output from 20–125A.
- Can be combined with circuit breakers (Masterswitch Fuses).
- Functional casing.

Mass Systemswitch: The complete system solution

- Three 230V inputs: Inverter, shore power and generator.
- Three or four outlets to 230V power groups.
- Automatic switching.
- Power transfer from 4.5–16 kW, input/output from 25–63A.
- Information source for central energy management via the MasterBus data network.
- Optional automatic fuses; for larger systems this usually requires an extra casing.
- Luxury C-casing or installation casing (System Manager model).
- MasterBus compatible.

The Mastervolt transfer system controls the following:

- Switching on and selecting 230V sources: Shore power, inverter and generator (adjustable to amperage of shore power, for instance 6A).
- Stable transfer to connected groups.
- Prevents damaging contact between the inverter and other 230V sources.
- Fully compatible with Mastervolt systems, and suitable for installations from other brands, other generators and/or inverters.



LED indications on Systemswitch

Read out of the basic functions on the display, including indication of available power source, generator, shore power or inverter and 'load on inverter' function.



Smart electronics

The intelligent electronics control the switching to ensure equipment does not use too much power. Its double-pole relay is sustainable and incredibly safe.



Central energy management

The MasterView Easy indicates AC current, amperage and frequency including the 'load on inverter' mode. The 12/24V read out shows current, power (charge/discharge) and battery monitoring, and has a start/stop generator.



Suitable for MasterBus

As the Mass Systemswitch is suitable for MasterBus, all the information can also be read out on, for instance, a MasterView display, including the status of the charge current and the inverter.

Manage: Transfer Systems



Masterswitch
5 kW



Masterswitch
10 kW



Masterswitch
25 kW



Masterswitch
Fuses 5 kW

Item #	55006010	55006015	55003500	55006060
Input				
Nominal input voltage	230V (50/60Hz)	230V (50/60Hz)	230V (50/60Hz)	230V (50/60Hz)
Input voltage range	200-250V AC	200-250V AC	200-250V AC	200-250V AC
Number of inputs	2	2	2	2
Number of outputs	1	1	1	2
Dimensions, hwxwd	7.9"x4.3"x4.5" 200x110x115 mm	7.9"x4.3"x4.5" 200x110x115 mm	11.5"x9.5"x6.6" 291x241x168 mm	7.9"x10"x4.5" 200x255x115 mm
Weight	2.6 lbs / 1.2 kg	2.9 lbs / 1.3 kg	8.4 lbs / 3.8 kg	4.6 lbs / 2.1 kg
Version				
With automatic circuit breakers	no	no	no	no
Connection for remote control	no	no	no	no
MasterBus compatible	no	no	no	no
LED indication on cabinet	no	no	no	no
Nominal input current generator	20A	40A	125A	16A
Nominal input current shore	20A	40A	125A	16A
Nominal input current inverter	n.a.	n.a.	n.a.	20A
Earth leakage switch	n.a.	n.a.	n.a.	yes (1x)
Generator input switch	no	no	no	no
Time delay generator input	0-10 sec (adjustable)	0-10 sec (adjustable)	0-10 sec (adjustable)	0-10 sec (adjustable)
Output				
Nominal current shortbreak output	n.a.	n.a.	n.a.	6A + 6A + 6A
Nominal current power output	20A	40A	125A	6A + 10A
Nominal current generator output	n.a.	n.a.	n.a.	n.a.
Automatic circuit breakers	no, system dependent	no, system dependent	no, system dependent	yes
Technical Specifications				
Power consumption (AC all inputs)	7VA	7VA	26VA	7VA
Power consumption (only inverter power)	no load consumption	no load consumption	no load consumption	no load consumption
Temperature range (specified)	-5°C to 60°C	-5°C to 60°C	-5°C to 60°C	-5°C to 60°C
Temperature range (allowed)	-25°C to 70°C (may not meet the specified tolerancies)			
Temperature range (storage/non operating)	-60°C to 80°C	-60°C to 80°C	-60°C to 80°C	-60°C to 80°C
Relative humidity	maximum 95%, non condensing		maximum 95%, non condensing	
Transfer time	switch on 12-22 ms / switch off 4-19 ms		switch on 12-22 ms / switch off 4-19 ms	
Frequency watch	no	no	no	no
Mechanical				
Cable size	0.5-10 mm ² /AWG 20-7	0.5-10 mm ² /AWG 20-7	4-50 mm ² /AWG 10-1/0	0.5-10 mm ² /AWG 20-7
Protection degree	IP55	IP55	IP55	IP55

* Also available in 9 kW, Item # 55106200. Specifications identical to 7 kW, except current is 80A.



Mass Systemswitch
6 kW

Mass Systemswitch
10 kW

Mass Systemswitch
16 kW

Masterswitch
3 kW

Masterswitch
7 kW

55008005

55008105

55008205

55106000

55106100*

230V (50/60Hz)

230V (50/60Hz)

230V (50/60Hz)

120V (50/60Hz)

120V (50/60Hz)

200-250V AC

200-250V AC

200-250V AC

100-125V AC

100-125V AC

3

3

3

2

2

3

4

4

1

1

13.4"x10.3"x5.7"
340x261x144 mm

13.4"x10.3"x5.7"
340x261x144 mm

13.4"x10.3"x5.7"
340x261x144 mm

7.9"x4.3"x4.5"
200x110x115 mm

7.9"x6.1"x5.8"
200x154x148 mm

9.7 lbs / 4.4 kg

10.8 lbs / 4.9 kg

11 lbs / 5 kg

2.6 lbs / 1.2 kg

5.5 lbs / 2.5 kg

no

no

no

no

no

yes

yes

yes

no

no

yes

yes

yes

no

no

indication voltage sources present and 'load on inverter' mode

no

no

25A

40A

63A

25A

60A

25A

25A

40A

25A

60A

25A

25A

25A

n.a.

n.a.

no

no

no

n.a.

n.a.

continuous monitoring of voltage and frequency

no

no

0-10 sec (adjustable)

0-10 sec (adjustable)

0-10 sec (adjustable)

0-10 sec (adjustable)

0-10 sec (adjustable)

25A

25A

25A

n.a.

n.a.

25A

25A

40A

n.a.

n.a.

n.a.

40A

63A

25A

60A

no, system dependent

no, system dependent

no, system dependent

no, system dependent

no, system dependent

27VA

33VA

33VA

7VA

7VA

<1VA

<1VA

<1VA

no load

no load

-5°C to 60°C

-5°C to 60°C

-5°C to 60°C

-5°C to 60°C

-5°C to 60°C

-25°C to 70°C (may not meet the specified tolerancies)

-60°C to 80°C

-60°C to 80°C

-60°C to 80°C

-60°C to 80°C

-60°C to 80°C

maximum 95%, non condensing

maximum 95%, non condensing

switch on 12-22 ms / switch off 4-19 ms

switch on 12-22 ms / switch off 4-19 ms

yes

yes

yes

no

no

0.5-10 mm²/AWG 20-7, remote control: 0.14-2.5 mm²/AWG 26-13

0.5-10 mm²/AWG 20-7

0.5-10 mm²/AWG 20-7

IP23

IP23

IP23

IP55

IP55



Digital switching, the future is now

By de-centralizing your installation, it is possible to create smarter systems with less cables and installation work. Central switchboards are replaced by de-centralized power outputs, which are controlled via a bus system. These outputs power equipment like lights, pumps and navigation equipment. Different input modules can be connected to this bus as well. These input modules – from switches to touch screen panels – control the output modules. This way you can control your yacht from anywhere, even from your mobile phone via text messages.

With digital switching systems you have greater flexibility and more intelligence to be integrated. Without additional components like relays, timer modules and extensive cable trees, it is possible to design a smart system.

Digital switching systems result in systems that are easy to operate.

Two systems available: CZone™ and MasterBus

The CZone™ digital control and monitoring system utilizes the NMEA 2000 architecture for its network, fit as a standalone system or add NMEA 2000 compliant components to build a fully integrated system including the latest Simrad and B&G multifunction marine displays (Chartplotters, fishfinder, radar, Autopilot). Carrying a high Ingress protection level (IPX5 and higher) CZone™ components are ideal for harsh environment installations.

MasterBus is based on the proprietary MasterBus network, used for all Mastervolt products. This system is perfectly suited for integration of Digital switching with the power electronics from Mastervolt.

Both systems can be interconnected via an interface.

The ease of digital distribution

The MasterBus and CZone™ systems bring features and automated functionality normally reserved for superyachts to the everyday boat user. CZone™ and MasterBus systems provide intelligent automation of complex onboard systems leaving the boat user free to enjoy their boating experience.

Customizeable modes of operation allow the boat to be configured to suit the use of the boat, at the push of a single button the boats systems can be transformed from 'Dock Mode' to 'Cruise Mode' preparing the boat for a day at sea.

Thanks to galvanic isolation, nearly all devices can supply power to the MasterBus, ensuring a safe and stable network. The wide range of interfaces and modules allows you to connect any equipment you wish to your MasterBus system and manage, monitor or operate it locally, centrally or even from your home address.

Professional perspective

The MasterBus and CZone™ systems make life easier for designers, builders and installers of power systems with less material, less work, less fuss and an easy testing method. Moreover, the MasterBus system is available in ten languages. Both systems provide a range of displays for controlling and monitoring on board systems such as inverters, chargers, circuits, power and tank levels. The range of displays offer a consistent, intuitive user interface.

Digital switching makes your life easier.

See page 180 for the NEW CZone™-MasterBus Bridge Interface



MasterView Control Panels: Well informed and in full control!



Fast and clear information is essential if you are to enjoy the sun, water, wind and fresh air to the max, either actively or passively. After all, the boat is supposed to be there for you, not the other way round.

With MasterView panels you only require one panel, even for larger electrical systems, and can save time on making connections, interpreting data and finding the latest system information.

The smartest solution: MasterView System

Mastervolt's intelligent MasterView System brings an end to cluttered, unclear and excessive information. The system is based on our in-house developed software combined with a user-friendly 10.4-inch colour touchscreen. The simple yet brilliant set-up of the MasterView System intelligently connects all the power sources and loads (generator, charger, bilge pump, engine, lighting, air conditioning, etc.) via the MasterBus. It provides all the information you need on your electric system in one clear overview on an organised, intuitively operated panel. The MasterView System is the next step up from simpler options such as MasterView Read-out (for load status) and MasterView Easy (status of a limited number of products) in terms of practicality and ease of operation.

Multifunctional touch screen remote panel: MasterView Easy

This multifunctional display can monitor every MasterBus product. Connected to the Mastershunt it functions as a battery monitor, connected to the generator as a generator panel. These and other functions can also take place simultaneously and you can create a favourites page showing all your main information.





MasterView System

This full color graphical display helps installers to configure the electrical onboard system, and is extremely easy to reproduce. Configuration, monitoring and operation becomes easier, cheaper, lighter, faster & good looking. The software makes complicated electrical systems understandable for ship owners. Electricity has become fun to operate!



System overview

This screen gives a dynamic graphical overview of your electric system, answering any questions you have in an instant. Incorrect line voltages are shown in red, inactive circuits in grey: It couldn't be easier.

Item #	77010400
Display	10.4" colour touch screen
Dimensions, h x w	8.7"x10.8" / 222x276 mm
MasterBus connection	by means of System Panel Controller (delivered as standard)
Power	by means of System Panel Controller (delivered as standard)
Power consumption	28W
Protection degree	IP65 (front)
Weight	3.1 lbs / 1.4 kg
Languages	ENG, NL, DE, SP, IT, FRA, FIN, SWE, DEN, NOR



Home screen

The home screen provides a status overview of power sources like shore connections, inverters, generators and batteries. A basic form of control is possible, for example turning on and off your inverter.



Digital switching screen

This screen shows the layout of your yacht, lights and selected pumps. You manage the loads by clicking the icons. The background image can be uploaded for full customisation. Alarm notifications are shown via eye-catching pop-ups.



Tank level screen

Stop guessing and know immediately the contents of up to 20 tanks. You can also install your own warning signals for full or (nearly) empty tanks. All you need to do is connect the MasterBus Tanklevel Interface to the MasterBus system.



Favourites screen

The favourites screen can be custom designed to meet your specific needs for information and control. Any information that is available on the MasterBus network can be shown in the most logical way. Multiple pages can display information, for example, one overview page, one or two breaker pages, an engine information page and a NMEA2000 information page.



System Panel Controller

- Connect the MasterView System or your PC with the MasterBus network.
- Provides the power and software license key for the MasterView System panel.
- Delivered as a standard with MasterView System (also separately available).

Item # 77031900



MasterView Easy

Control panel for all MasterBus products

This touch screen panel offers excellent readability and easy operation. The grey button allows you to turn the display on and off or (un)lock the touch screen. Further operation is via the touch screen. The first (of three) operation level shows a quick system overview - the information you need on a day-to-day basis. Product overview & configuration offers more detailed information and the option to change settings. As the MasterBus plug & play connection offers both data and power, only one cable is needed to connect the panel.

Benefits:

- Clearly lit display.
- Push button for on/off and blockade for unwanted operation.
- Touchscreen operation for all functions.
- White background lighting - red colour for alarm function or night lights.
- Buzzer and alarm function.
- Installation requires only one MasterBus cable for both data and power supply.
- Low power consumption.
- Easy to install, the panel can be flush and surface mounted.

Item #	77010305
Display	3.5" touch screen
Dimensions, hwx	4.3"x4.3" / 110x110 mm
MasterBus connection	yes
Powered by	MasterBus
Power consumption	160 mW
Protection degree	IP21
Weight	0.51 lbs / 230 gr
Languages	ENG, NL, DE, SP, IT, FRA, FIN, SWE, DEN, NOR

MasterView Read-out

Remote panel for reading the charge status of your battery charger, including error notifications.

Item #	77010050
Display	7 LEDs
Dimensions, hwx	2.4"x2"x6" / 60x65 mm
MasterBus connection	yes
Powered by	MasterBus
Power consumption	144 mW
Protection degree	IP21
Weight	0.15 lbs / 70 gr

MasterView Read-out OEM

If your dashboard is full and does not offer space for a MasterView panel, this module allows you to integrate the MasterBus Read-out into your own control panel.

Item # 77010030



The MasterView series will be expanded in the course of 2011.



MasterShunt

This ultra-modern battery monitor provides detailed information on the status of your batteries, including voltage, current, remaining time and used capacity in percentages so no more unpleasant surprises. With an intelligent connection system, the MasterShunt is easily connected to the DC Distribution. The integrated system clock combined with command-based events automates your system according to your needs. A good example of such system automation: The generator should start automatically when the batteries are almost depleted. The MasterShunt also has a built-in robust main fuse that can safely break short-circuit currents of 50,000 amps.

MasterShunt 500	
Item #	77020100
Dimensions, hxwx	5.9"x5.9"x2.5" / 150x150x65 mm
Weight	2.2 lbs / 1 kg
Battery types	gel, AGM, wet, Lithium Ion, spiral
Battery voltage	12, 24 or 48V DC
Current	300A continuous / 500A for 5 minutes
MasterBus powering	yes
Main fuse	500A T-fuse (300A continuous at 40 °C)
System functionality	alarm, timers, auto start/stop for the generator
Programmable alarms	warning low voltage, warning low state of charge, high voltage
Protection degree	IP21
Delivered with	MasterShunt, temperature sensor, MasterBus Terminator, MasterBus cable, cable protections for DC connections

Digital DC 10x10A

As the pinnacle of system intelligence, the Mastervolt Digital DC 10x10A has ten 10A outputs for all functions including lighting, pumps or electronics. It comes standard with intelligent alarm functions and luxury options include:

- Follow me home (light stays on for a specific time after you leave the vessel).
- (Delayed) dimming of lights (including ten built-in dimmers).
- Alarm signal for overload.
- Every output has a hardware and software fuse.
- Reset the fuses via the MasterBus network.
- Possibility of higher currents (up to 100A) with parallel switching of multiple outputs.



DC Distribution 500	
Item #	77020200
Dimensions, hxwx	5.9"x7.9"x2.5" / 150x216x65 mm
Weight	2.6 lbs / 1.2 kg
Battery voltage	12, 24 or 48V DC
Current	300A continuous / 500A for 5 minutes
MasterBus powering	yes
Standard fuses	80, 80, 125, 160A - ANL type (deviating values can be ordered separately)
Spare fuse	125A ANL type
Alarm	fuse monitoring
Protection degree	IP21
Delivered with	5 fuses, hex tool, MasterBus Terminator, MasterBus cable, cable protections for DC connections



DC Distribution 500

The DC Distribution 500 is the smallest distribution model available. It connects up to four DC devices to the DC groups, such as a battery charger, inverter, alternators and solar panels. With the included plug & play cable it can be easily connected to the MasterBus network. The MasterView panel gives all fuses logical names, for instance, referring to the connected equipment, to ensure you receive understandable error notifications (for example: battery charger fuse defect).



	Digital DC 10x10A
Item #	77020400
MasterBus powering	yes
Power consumption	<2 mA at 12V / <2 mA at 24V (off board situation)
Protection degree	IP21
Weight	1.7 lbs / 750 gr
DC Output	
Connection	cable max. 4 mm ²
Maximum software fuse current	10A per channel
Hardware fuse current	15A per channel
DC Input	
Connections	max. 95 mm ² or directly connected to MasterShunt or DC Distribution
Maximum current	100A
Supply voltage	8-30V DC





MasterBus Interfaces



The special MasterBus Interfaces increase the versatility of your MasterBus network. Connect multiple components to distribute information to your MasterBus products or connect products that require information from the MasterBus network, such as a NMEA2000 or Modbus network, and vice versa.

All interfaces (and modules) can be installed in various ways, from DIN rails to surface mounting. Available in ten languages: English, Dutch, German, French, Spanish, Italian, Norwegian, Swedish, Finnish and Danish.



USB Interface

Allows you to read and configure your MasterBus system from your PC.

Item # 77030100



Modbus Interface

The MasterBus Modbus Interface can provide all information from the 'closed' MasterBus network for other monitoring and operating systems by means of the Modbus protocol.

Item # 77030800



Inverter Interface

The MasterBus Inverter Interface integrates the Mastervolt Mass Sine inverter in a MasterBus network and allows it to be operated and monitored via MasterView or PC.

Item # 77030700



Combi Interface

This interface integrates a Mastervolt Mass Combi in a MasterBus network and allows it to be operated or monitored via a MasterView panel or PC.

Item # 77030475



Serial Interface

The MasterBus Serial Interface connects conventional Mastervolt products to the MasterBus. Data becomes permanently available to allow configuration, operation and monitoring via MasterView panels.

Item # 77030450



NMEA2000 Interface

The MasterBus NMEA2000 Interface provides the MasterBus network with NMEA2000 information, and vice versa.

Item # 77031800

Specifications for MasterBus Interfaces on page 162.



GPRS Module

The GPRS module communicates with your vessel via mobile phone, allowing you to monitor current information or operate the system by remote control via a text message or easy shortcuts. Alarm notifications per text message are optional.

Item # 77031000



Switch Input 3 PCB

The Switch Input 3 makes watertight Carling switches compatible with MasterBus. Multiple functions can be easily linked with this module. Distance between switches is 1.03" (26.1 mm).

Item # 77031300



Switch Input 4 PCB

Provides LED indications for additional information, such as when a light stops working. Distance between switches is 1.07" (27.3 mm).

Item # 77031400



Digital Input

Connect up to four switches to the MasterBus network. Delivery includes cables from interface to switches.

Item # 77030900



Digital AC 1x6A

The Digital AC 1x6A switches all AC loads up to 6A directly and higher loads via a relay, anywhere on board. Max. relay current is 6A (230V AC single pole).

Item # 77031500



Multipurpose Contact Output

This programmable free switch contact provides your MasterBus network with unprecedented options, such as controlling a ventilator in the engine room or operating a generator from a different brand. Potential free contact is NO-C-NC - 1A / 30V DC.

Item # 77030500



Tank Level Interface

This interface converts analogue sensor input signals to MasterBus data. Selectable input signals: 4-20 mA, 0-300 Ω, 8-70V DC.

Item # 77030300



Battery Contactor Interface

This interface allows MasterBus to control latching relays. Saves batteries as a current is only drawn during switching.

Item # 77031700



Repeater

Extends the maximum length of your MasterBus network. With integrated isolated power supply to power the MasterBus.

Item # 77031100

Specifications for MasterBus Interfaces on page 162.



AC power analyser

The AC power analyser is a multifunctional measuring device which can visualize the AC current and AC voltage, frequency, Cos Phi and the power of the system. On top of that it features the "inverter control" and a free programmable "potential free contact".

Item # 77031200

System Panel Controller

Connect the MasterView System or your PC with the MasterBus network. Provides the power and software license key for the MasterView System panel.

Item # 77031900

MasterBus Interfaces Specifications

Item #	MasterBus powering	Dimensions HxWxD	Weight	Protection Degree	Delivered with
77030100	yes (when the PC is switched on)	2.6"x3.1"x1.3" 66x78x32 mm	0.18 lbs ± 80 gr	IP21	USB connection cable, MasterBus cable, MasterBus Terminator, user's manual
77030800	no	2.6"x3.1"x1.3" 66x78x32 mm	0.18 lbs ± 80 gr	IP21	MasterBus cable, MasterBus Terminator, user's manual
77030700	no	2.6"x3.1"x1.3" 66x78x32 mm	0.18 lbs ± 80 gr	IP21	Interface connection cable, MasterBus cable, MasterBus Terminator, user's manual
77030475	yes	2.6"x3.1"x1.3" 66x78x32 mm	0.18 lbs ± 80 gr	IP21	Interface connection cable, MasterBus Terminator, user's manual
77030450	no	2.6"x3.1"x1.3" 66x78x32 mm	0.18 lbs ± 80 gr	IP21	Interface connection cable, MasterBus cable, MasterBus Terminator, user's manual
77031800	no	2.6"x3.1"x1.3" 66x78x32 mm	0.22 lbs ± 100 gr	IP21	NMEA connection cable, MasterBus cable, MasterBus Terminator, user's manual
77031000	no	2.6"x3.1"x1.3" 66x78x32 mm	0.18 lbs ± 80 gr	IP21	GPRS antenna, MasterBus cable, MasterBus Terminator, user's manual; SIM card not included
77031300	no	2"x3.4"x2.3" 54x86x58 mm (incl. mounting frame)	0.08 lbs 35 gr (incl. MasterBus Terminator)	IP21	MasterBus Terminator, user's manual; switches and mounting frame not included
77031400	no	2.2"x4.7"x2.6" 56x120x65 mm (incl. mounting frame)	0.1 lbs 45 gr (incl. MasterBus Terminator)	IP21	MasterBus Terminator, user's manual; switches and mounting frame not included
77030900	no	2.6"x3.1"x1.3" 66x78x32 mm	0.18 lbs ± 80 gr	IP21	cable with plug, MasterBus cable, MasterBus Terminator, user's manual
77031500	no	2.6"x3.1"x1.3" 66x78x32 mm	0.18 lbs ± 80 gr	IP21	MasterBus cable, MasterBus Terminator, user's manual
77030500	no	2.6"x3.1"x1.3" 66x78x32 mm	0.18 lbs ± 80 gr	IP21	MasterBus cable, MasterBus Terminator, user's manual
77030300	no	2.6"x3.1"x1.3" 66x78x32 mm	0.18 lbs ± 80 gr	IP21	MasterBus cable, MasterBus Terminator, user's manual
77031700	no	2.6"x3.1"x1.3" 66x78x32 mm	0.22 lbs ± 100 gr	IP21	cable with plug, MasterBus cable, MasterBus Terminator, user's manual
77031100	yes	2.6"x3.1"x1.3" 66x78x32 mm	0.20 lbs ± 90 gr	IP21	MasterBus cable, MasterBus Terminator, user's manual
77031200	no	3.1"x7.1"x1.1" 80x181x28 mm	1.17 lbs ± 530 gr	IP65	MasterBus cable, MasterBus Terminator, current transformer 100:5, user's manual
77031900	yes (when the PC is switched on)	3.6"x7.3"x1.3" 91x185x33 mm	1.65 lbs ± 750 gr	IP65	USB cable, SPC cable, MasterBus cable, MasterBus Terminator, user's manual



MasterBus DIY Kit

Cut your own cables to length and finish, comprising:

- Professional RJ45 crimping tool
- 50 x MasterBus RJ45 connectors
- 50 x green MasterBus RJ45
- protection boots
- 100 m green MasterBus
- CAT5E UTP cable

Item # 77050000

Separately available:

MasterBus RJ45 Connectors

- 8-pole
- 25 pcs

Item # 77040010

Green Isolation Caps for RJ45 Connector

- 25 pcs

Item # 77040015



MasterBus Communication Cable

Suitable for data traffic and powering peripheral equipment, this is the only cable you need for your MasterBus network. MasterBus compatible products come standard with two ports, while other equipment requires an interface. A DIY kit is optional.

Length	Item #
0.2 m	77040020
0.5 m	77040050
1 m	77040100
3 m	77040300
6 m	77040600
10 m	77041000
15 m	77041500
20 m	77042000
25 m	77042500
100 m	77045000



MasterBus Terminator

The Terminators at both ends of the cable ensure interference-free operation, prevent reflection of data signals and ensure high communication speeds.

Item # 77040000



DC Distribution Fuses

The DC Distribution standard comes with four ANL fuses: 80, 80, 125 and 160A, and a spare fuse of 125A. Replacement fuses and other amps:

Amps	Item #
40	77049040
50	77049050
60	77049060
80	77049080
100	77049100
125	77049125
160	77049160
175	77049175
200	77049200
250	77049250
300	77049300
400	77049400



MasterShunt Fuse

The robust fuse (500A/160V DC, 50 kA short circuit current) is suitable for high short circuit currents from the batteries. Spare fuse available separately.

Item # 77049000



The CZone™ digital control & monitoring system is designed for manufacturers and installers of Marine, RV and Specialty Vehicles. It simplifies installation of electrical systems through the replacement of complicated, cumbersome wiring to switch and fuse panels, with state of the art, robust interfaces and light NMEA 2000 network cable. It also provides the end user a sophisticated solution through the automation of complicated control and monitoring issues associated with today's on board systems.

Installation

Builders recognize an immediate benefit with reductions in cable usage, harness weights and installation times. The CZone™ system also integrates many stand alone components into one intuitive system. Wiring is dramatically simplified, because the CZone™ system is designed to remove complex switching clusters and wiring runs. Integrated diagnostics ensures fault finding is simple. The CZone™ system is the digital networking system that is both cost-effective and scalable. Modules can easily be added into the system to best suit the OEM and end-users' needs.



Traditional Electrical DC Wiring

Wiring DC systems can be complex and installation time can be extensive. The larger the system, the more wire is required, which creates weight and space concerns, not to mention increased cost and complexity of design and manufacturing. Basic maintenance and trouble shooting of traditional wiring systems can be difficult to manage.

- Switch panel wiring is complicated and extremely labor intensive to install
- Cable runs are long and have multiple conductors. Switching of common circuits is complex
- Long wire runs require larger cable, adding weight, increasing cost and reducing space

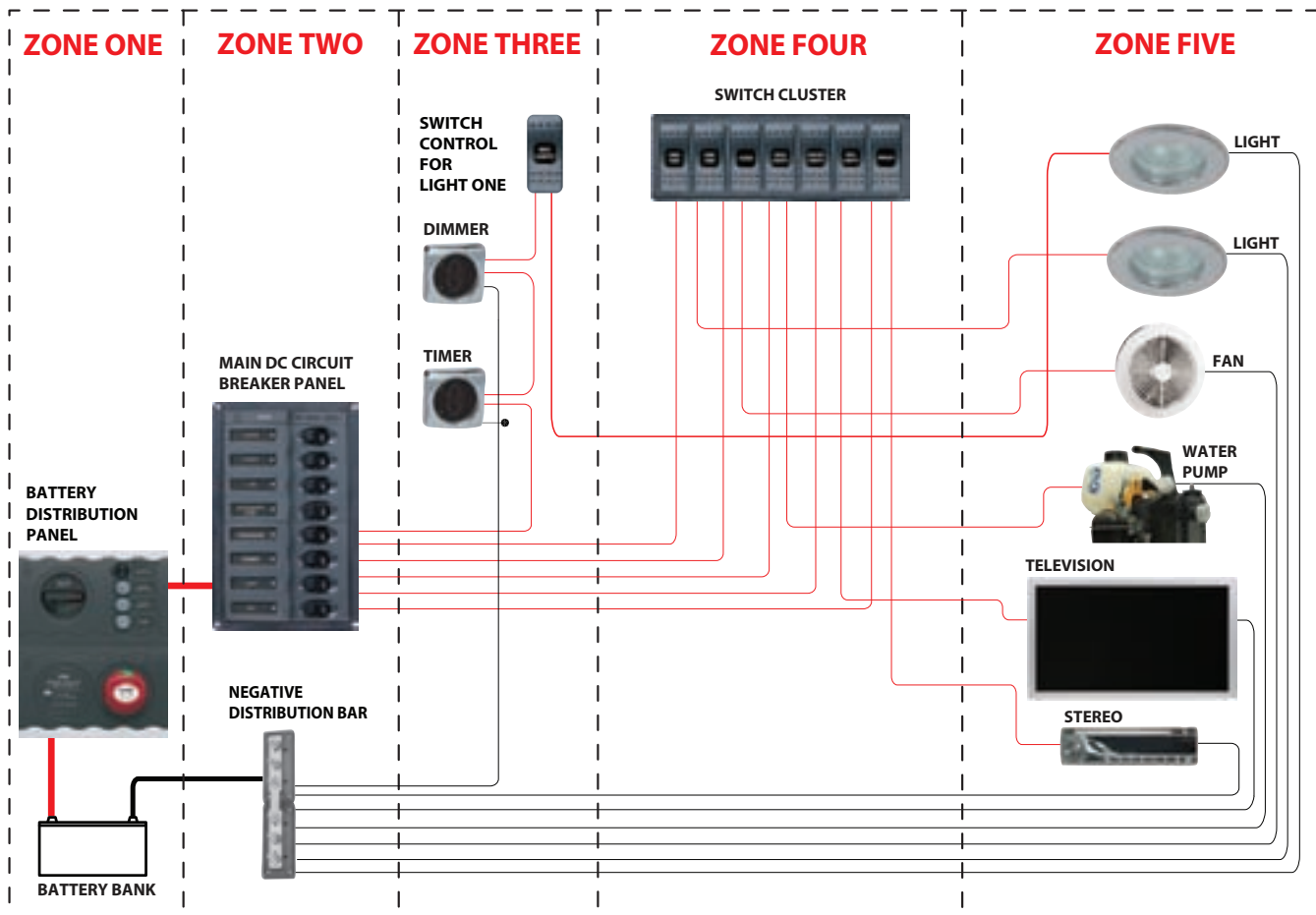



Configuration

We provide the tools to help you determine the modules needed based on your specific requirements. Then, simply program with the CZone™ intuitive configuration tool.

Integration

The CZone™ system is NMEA 2000 compliant and uses the standard Micro cables and connectors. Being NMEA 2000 compliant you can have trust in the network. This also allows a single network backbone to be installed for multiple systems (CZone™ and other NMEA 2000 devices). Additionally, the CZone™ system can share certain monitoring functions with other NMEA 2000 compliant screens.

Versatility & Security

The CZone™ system, designed for 9-32V systems, features built-in timers, dimmers (including support for halogen lighting), alarms, voltage reducers and load shedding. With safety in mind, the CZone™ system features a manual bypass. Our No-Single-Failure-Point technology ensures a plug-n-play system that is designed to handle mishaps. If a module is damaged, the system will automatically program the replacement module, when it is plugged in. This means any module can be replaced without using high tech service people. Our security features allow custom configurations that can be locked.



DC Wiring

The CZone™ system decentralizes the DC power distribution system, locates circuit control and protection modules closer to loads to shorten cable runs and reduce the size of conductors, significantly decreasing the cost and weight of the electrical wiring harness. The system replaces complex wiring with a single data wire.

- Complex switch panel wiring removed, replaced with single data cable connection
- The grouping of multiple loads into common areas (Zones) with Output Interfaces is the key to the system
- Heavy-duty battery mains cable, replaced by multiple smaller conductors

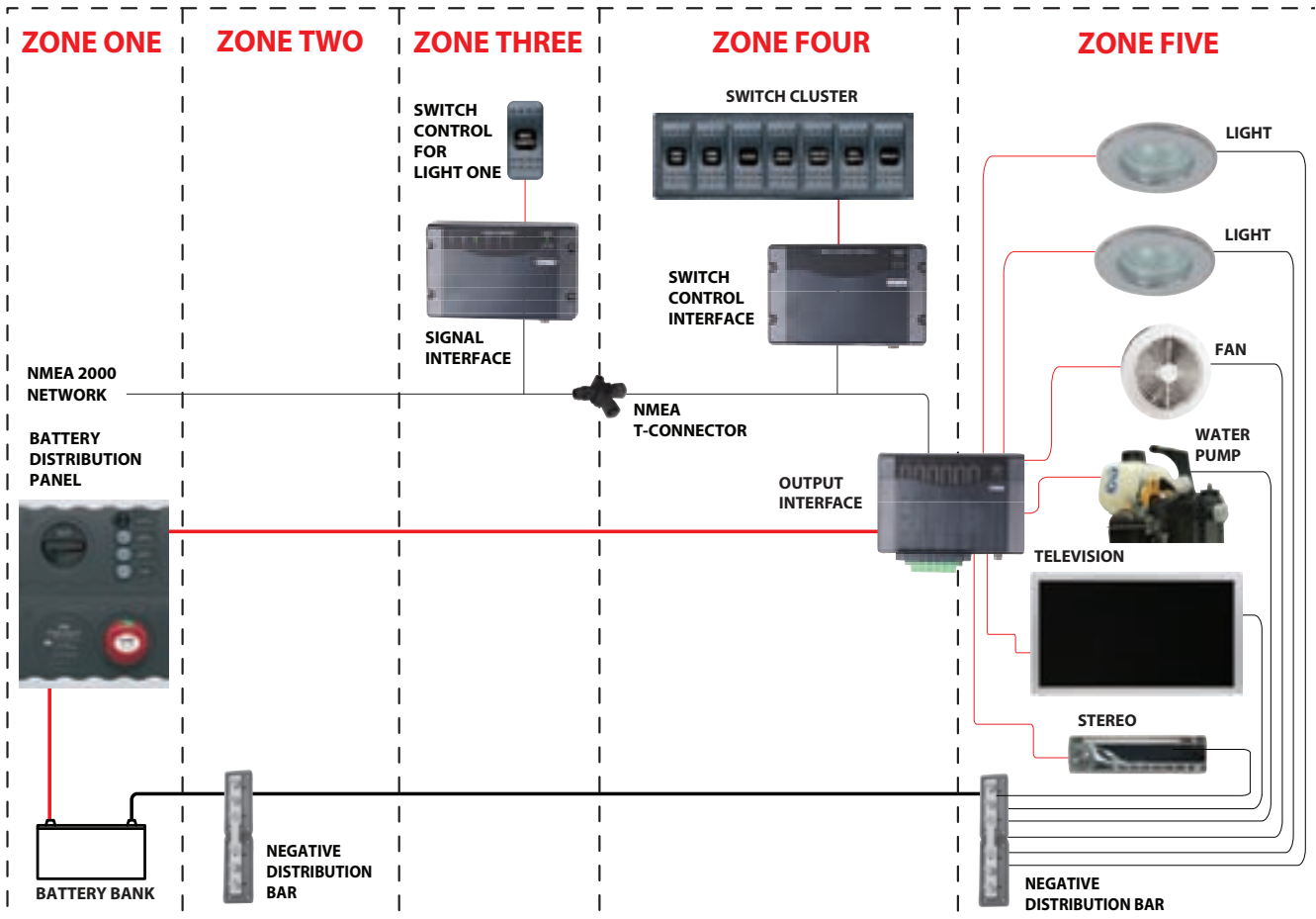



CZone™ LCD Displays

The CZone™ Displays are the interface between the CZone™ network and the user. They offer full control of circuits as well as the ability to view important on board systems information such as tank levels and power levels (for both AC and DC supplies), they also provide audible and visual alarms with systems diagnostics. The displays are extremely intuitive to use with simple controls and a menu structure that is easy to follow.

The “modes of operation” feature allows the control of multiple circuits with a single push of a button. For instance, “night running” mode turns pre-selected lights on to dim levels. These modes are all user configurable. The CZone™ displays can be used to set the CZone™ system parameters for initial installation and future system maintenance (DI only).

3.5" Display Interface

- 3.5" Transflective QVGA LCD
- IpX7 water ingress Protection
- Rotary Knob for easy menu navigation
- Simple User Interface
- Power consumption @12V: 180mA (standby 130mA)
- Dimensions (WxHxD):
4-3/32"x6-7/16"x2-13/32"
105x165x62 mm



3.5" Display

8" Touch Screen

- Screen size 8.4" (SVGA)
- IP Level IP64
- Touch screen operation
- Dimensions (WxHxD):
9.212"x7.244"x1.65"
234x184x42 mm
- Brightness (cd/m2) 450
- Input voltage 12V DC
- Power Consumption 20W



8" Touch Screen

10" Touch Screen

- Screen size 10.4" (SVGA)
- IP Level IP64
- Dimensions (WxHxD):
10.866"x8.93"x1.99"
276x227x50.7 mm
- Brightness (cd/m2) 400
- Input voltage 12V DC
- Power Consumption 25W



10" Touch Screen

Item #	Description
80-911-0001-00	Display Interface, w/power cable, black bezel
80-911-0002-00	Display Interface, w/power cable, grey bezel
80-911-0003-00	Display Interface only, black
80-911-0004-00	Display Interface only, grey
80-911-0064-00	CZone™ 8" Touch Screen
80-911-0065-00	CZone™ 10" Touch Screen



CZone™ LCD Displays

The CZone™ Displays are designed with both the manufacturer and end-user in mind. The easy to use display screens put the control of all components directly at your fingertips. Multiple

Display Interfaces can be used in the same system. The scroll and click interface is simple to use in the roughest of seas or bumpiest of roads.

Power Control:

- Turn circuits on and off including timer and light dimming control
- Set modes of operation

Monitoring:

DC Power Meter:

- Displays voltages of multiple battery banks, includes low and high voltage alarms
- Displays charge and discharge (amps) of multiple battery banks
- Displays battery capacity in ampere hours and % charge/discharge, includes low ampere hour alarm
- Logging of battery minimum and maximum voltage levels
- Logging of minimum battery capacity level

AC Power Meter:

- Displays multiple line voltages (230 and 110V), includes high and low voltage alarm
- Displays AC line frequencies, includes high and low frequency alarm and AC power consumption in kW
- Logging of minimum and maximum voltage and frequency levels
- Logging of maximum AC Current

Tank Levels:

- View tank level information for multiple tanks and fluid types

Data:

- Displays standard NMEA 2000 information
- Displays temperature and pressure values

Alarms/diagnostics:

- Logging of circuit run time and on cycles
- CZone™ network status reporting
- Presents alarms for on board faults in audible and visual form (bilge pump running, smoke alarm)



Control: Breaks down the circuits into easy to identify groups for quick control, ie. to turn on fresh water pump open "pumps" group. User can open pumps group and select fresh water pump. This screen also allows the user to monitor the status of the circuit i.e. on, off, fault and current draw.



Monitoring: Allows user to easily monitor AC and DC power, tanks, data, alarms, and circuit status. Presents data in analog and digital form.



Modes: Key to the ease of operation. With one key press the user can turn on a group of circuits, without having to scroll, search for, and turn on the individual circuits that they need for operation of their vessel/vehicle. When leaving vessel or vehicle, simply press "systems off" to turn off all non-essential circuits. Entertainment mode allows preset activation of salon lights, music etc... All functions can be controlled remotely with The CZone™ system remote.



Settings: Allows OEM or technician access to the configuration (via password) of a system. No need for computer to set or change configuration settings such as circuit labels, circuit breaker sizes, etc. (DI only)



NEW AC Mains interface (ACMI)

Designed to function as the AC mains selector (transfer) switch, the ACMI can be operated using any of the CZone™ displays to select which mains power device (e.g. generators, inverters or shore power) will supply power to the vessel.

The ACMI can be set to automatically change supplies when one supply current rating is exceeded – for example switching from shore power to larger onboard generator when the shore power supply max current is exceeded. The ACMI has a manual bypass and an easy-to-understand display screen for easy selection and operation. Developed primarily as part of the CZone™ system, the ACMI can also be used as a stand-alone AC mains control system, making it an ideal option for new builds or retrofit installations.

Fully automatic, the ACMI unit provides six monitored, protected mains power supply inputs and includes a bypass for manual operation. Reverse polarity protection and automatic shut off protects the onboard system from damage.

Features

- 6 x Source inputs up to 100 amps (Eg. 2 x shore power, 2 x generator)
- 2 x Outputs (Load Groups). Allows for two separate load groups with parallel option for use with single source
- Provides circuit protection and control
- Current, voltage, frequency and power monitoring incorporated (six channels)
- Monitoring of channel status (on/off/fault)
- Reverse polarity and bad power supply alarms including auto disconnect and lockouts
- Status LED's at enclosure
- Physical and software lockouts between source controls (prevents two sources from becoming connected)
- Manual override at enclosure and via remote panel
- Customizable to suit installation requirements
- Pre wired for quick connection
- Utilizes standard DIN rail mounted components for circuit protection and control
- Supports multiple pole designs, i.e. double, triple, four pole
- Provision for RCD's
- Load shedding
- Timer controls
- Auto changeover
- 110V
- 240V
- 110/220V
- 50 or 60 Hertz
- IPX5 enclosure

Dimensions (WxHxD):

15.8"x24.8"x5.1" (403x630x130 mm)

Enclosure dimensions may change depending on installation requirements



80-911-0068-00





NEW AC Output Interface (ACOI)

The CZone™ ACOI provides complete on/off control and power distribution protection for AC devices on a vessel. Full control of the ACOI is provided using any of the CZone™ displays. In the event of a short, the ACOI trips the circuit breaker ensuring power is stopped to the malfunctioning device and eliminates the potential for fire. When power demand exceeds the limits of a connected power supply, the module can be programmed to automatically switch off low priority circuits (load shedding) removing the potential for overloads and annoying tripping of mains breakers.

The ACOI includes eight 50-amp outputs and provides on/off control and complete circuit-overload protection. CZone™ user-configurable modes, such as “night running” or “at anchor” allow the control of multiple circuits with a single button push, and can include manual or automatic operation selection for both the ACMI and ACOI components. Each device includes easy-to-understand LED indicators which show the status of circuits such as on, off and fault.

Features

- 8 outputs at up to 50 amps each
- Provides circuit protection and control
- Circuit status and run current displayed for each circuit
- Status LED's at Enclosure
- Manual bypass at enclosure
- Customizable to suit installation requirements
- Pre wired for quick connection
- Utilizes standard DIN rail mounted components for circuit protection and control
- Supports multiple pole designs, i.e. double, triple, four pole
- Can support two separate buss feeds i.e. 2 load groups in one box
- Provision for MCB/RCD's
- Staggered start up of loads
- Delay before circuits come on to allow Generators to come up to speed
- Timers
- 110V
- 240V
- 110/220V
- 50 or 60 Hertz
- IPX5 enclosure

Dimensions (WxHxD):

11.61"x18"x5.1" (295x458x130 mm)

Enclosure dimensions may change depending on installation requirements



80-911-0069-00



CZone™ Integration Partners

Continuing with BEPs passion to deliver the customer a seamlessly integrated boating experience BEP has teamed up with the industry's best to bring you more control and versatility via the CZone™ system:

Simrad and B&G marine electronics:

Simrad and B&G have added CZone™ control and monitoring to their award winning fully networked Chartplotter/ multifunction displays.

View CZone™ monitoring data, Tank levels battery voltage, alongside radar, fish finder, video and chartplotter information or navigate to the CZone™ page to operate any circuit from the intuitive control page.



B&G



SIMRAD

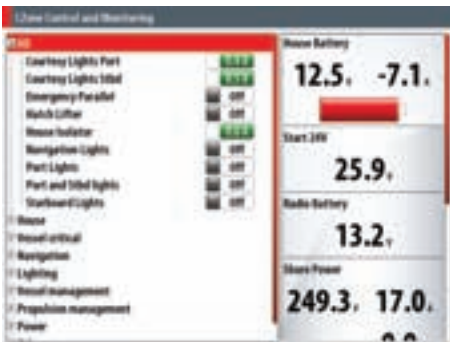



Switch Control Interface

The Switch Control Interface (SCI) provides an interface between the CZone™ network and traditional mechanical switches that manufacturers and users are familiar with. This interface converts the signal from those switches into the Control Area Network (CAN) signal needed across a digital network. No need to change existing designs.

Diagnostics are important. Fault codes are provided to quickly identify issues with the network or switches. Information is provided on the Switch Control Interface as well as sent to the CZone™ Display Interface.

The SCI simplifies your wiring, supports your existing choice of switches, protects against failures and allows for expanding installation options.

Backlighting and systems in operation lights are dimmable to ensure your night vision is not impaired by bright lights on your control area, level control of these can be linked to the backlighting level of any Display Interfaces in close proximity of the SCI.

- Single switch position can control multiple OI channels
- Attaches to switch panels via custom SCI cable
- Multiple SCI switches can control single OI channel
- Output for backlighting of switch labels (dimnable)
- Outputs systems on and function/ fault codes to systems on LED of switches (dimnable)
- Dimensions (WxHxD): 6-3/32"x3-29/32"x1-5/8"
156x100x42 mm
- IPX5 water ingress protection
- Programmable switch types
- 8 inputs per module (16 individual controls)
- Sequential button press functionality



Item #	Description
80-911-0011-00	Switch Control Interface w/seal
80-911-0012-00	Switch Control Interface only



8-Way Connector Bank for SCI Cable Assembly to Switches



Waterproof Cable Seal



NMEA 2000 Connector



Signal Interface

The Signal Interface (SI) connects the CZone™ system to your external sensors, alarms and switching devices. The SI allows intelligent, automated operation of circuits depending on the state of the input. For example, the SI can be easily programmed to allow a fluid transfer pump and an alarm to turn on simultaneously when the SI detects that a low tank level has been reached.

Connect standard switches to the SI to allow control of the CZone™ system outputs.

The module provides LED status indications for each input. This allows fast diagnostics while providing information back to the CZone™'s Display Interface.

- Accepts inputs from traditional switch types being used to control outputs
- Accepts inputs from switches to trigger alarm i.e. high water float switch
- Accepts inputs from industry standard tank senders (0-5V, 10-180Ohm, 240-330hm)
- Accepts inputs from general voltaic or resistive signals can be used for controlling outputs or to display a physical position i.e. show a hatch is partially open
- LED status indicators for each input
- Dimensions (WxHxD): 6-3/32"x3-29/32"x1-5/8"
156x100x42 mm
- IPX5 water ingress protection
- Outputs standard NMEA 2000 sentences
- Resistive input range 0–1000 Ohms
- Voltage sensing input range 0–34VDC



Item #	Description
80-911-0013-00	Signal Interface w/seals, connector
80-911-0014-00	Signal Interface only

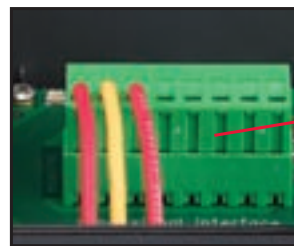
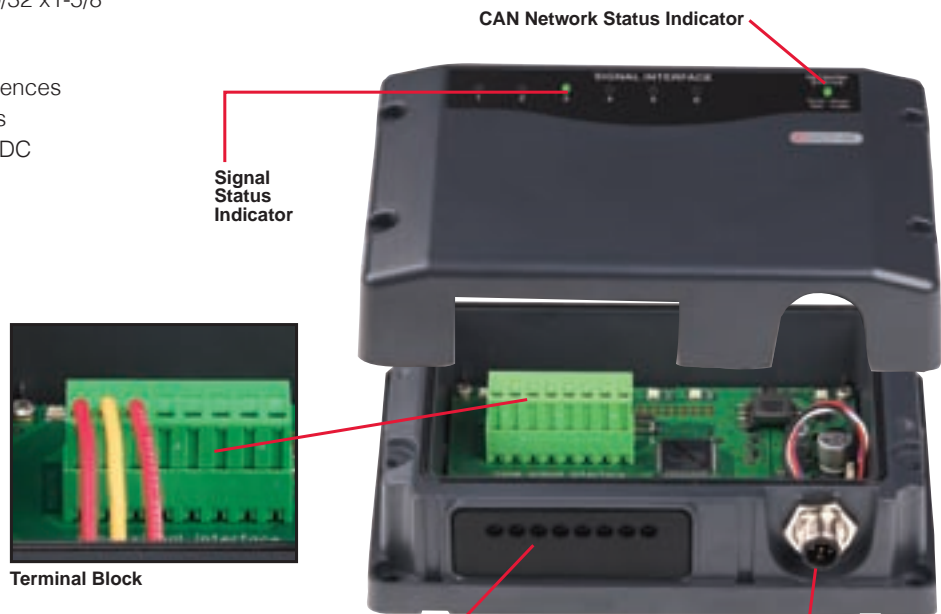

Terminal Block



Waterproof Cable Seal



NMEA 2000 Connector



Meter Interface

The Meter Interface (MI) accepts inputs from external AC and DC power metering sensors. It then processes and converts the analog signals into digital strings that can then be presented, by the display, to the user, as one of several, easy-to-understand formats such as:

- AC and DC voltage and amps
- AC Kilowatts
- DC battery capacity in amp hours and % remaining
- All with user definable high and low alarms

Intelligence is built into the CZone™ system. The MI can calculate the battery capacity as ampere hours and/or percentage of charge remaining. Since the CZone™ system provides both monitoring and control for DC systems, it can be configured to turn off non-essential circuits in the event that the battery is discharged to a low level. This helps to ensure that there is enough charge left in the battery to power safety critical circuits.

AC

- 3 x AC voltage inputs (multi voltage)
- 2 x AC current inputs
- Calculates true RMS power

DC

- 3 x DC voltage inputs (multi voltage)
- 2 x DC current inputs
- Calculates battery capacity as ampere hours and percentage charge remaining
- Resolution for current metering down to 0.1A

General

- Dimensions (WxHxD): 6-3/32"x3-29/32"x1-5/8"
156x100x42 mm
- IPX5 water ingress protection
- Outputs standard NMEA 2000 power monitoring sentences

Note: High and low alarm levels can be set for all inputs



Item #	Description
80-911-0005-00	Meter Interface, w/seal & plug
80-911-0006-00	Meter Interface only

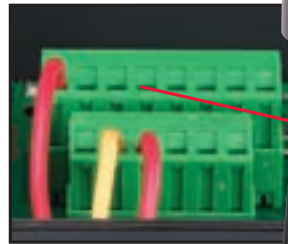
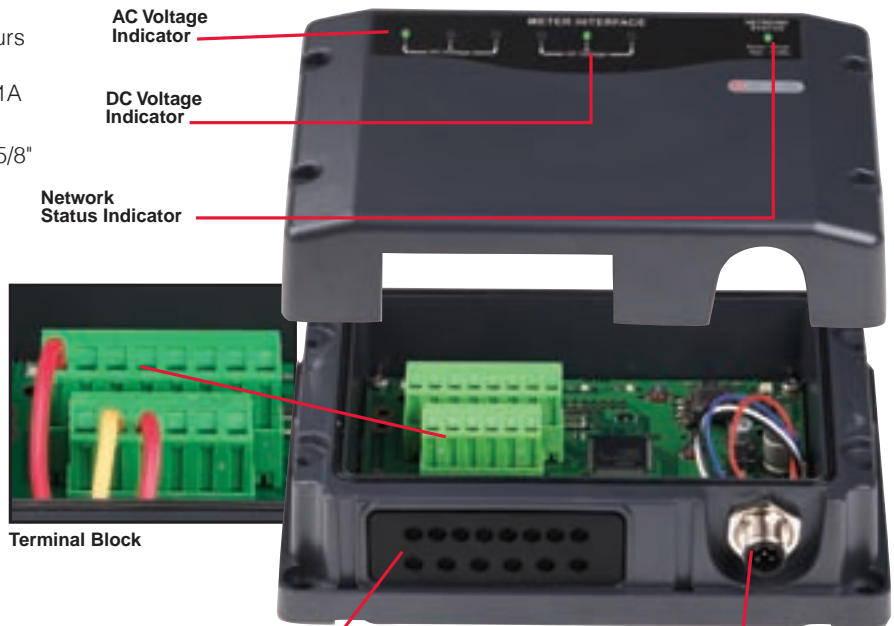

Terminal Block



Waterproof Cable Seal



NMEA 2000 Connector



Output Interface

The Output Interface (OI) provides an intelligent replacement for traditional circuit breaker and fuse panels. It has 6x high power, robust output channels which provide the power supply, control and fusing for a circuit as well as integrating many other built in features such as timers and dimmers.

The OI is behind the CZone™ system concept of decentralizing the power distribution, compared to traditional electrical layouts which are typically based around a large, centralised circuit breaker or fuse panel. The OI's allow the installer to move the circuit control and protection closer to the loads which significantly shortens cable runs and reduces the size of the conductors. This equates to a reduction in the cost and weight of the electrical wiring harness, ie. less copper.

Connection to the unit is simple: a large 6 way plug allows connections to cables of up to 16mm² (6AWG) in size, or multiple smaller conductors. No need for specialized crimp terminals and expensive crimp tools to be carried for terminations to CZone™, just a blade screwdriver. A protective flexible boot offers protection to the connections from harsh environment conditions.

- 4 levels of backup fusing including manual override (as required by ABYC)
- 6 x 20 amp circuits
- Programmable software "fuse" sizes
- Multiple channels can be bridged together to offer higher current switching
- Small, non metallic, easy to install case
- IPX5 water ingress protection
- Dimensions (WxHxD): 7-29/32"x5"x1-3/4" 200x128x45 mm
- Power consumption @12V: 85mA (standby 60mA)



Item #	Description
80-911-0009-00	Output interface w/connector, boot
80-911-0010-00	Output interface only

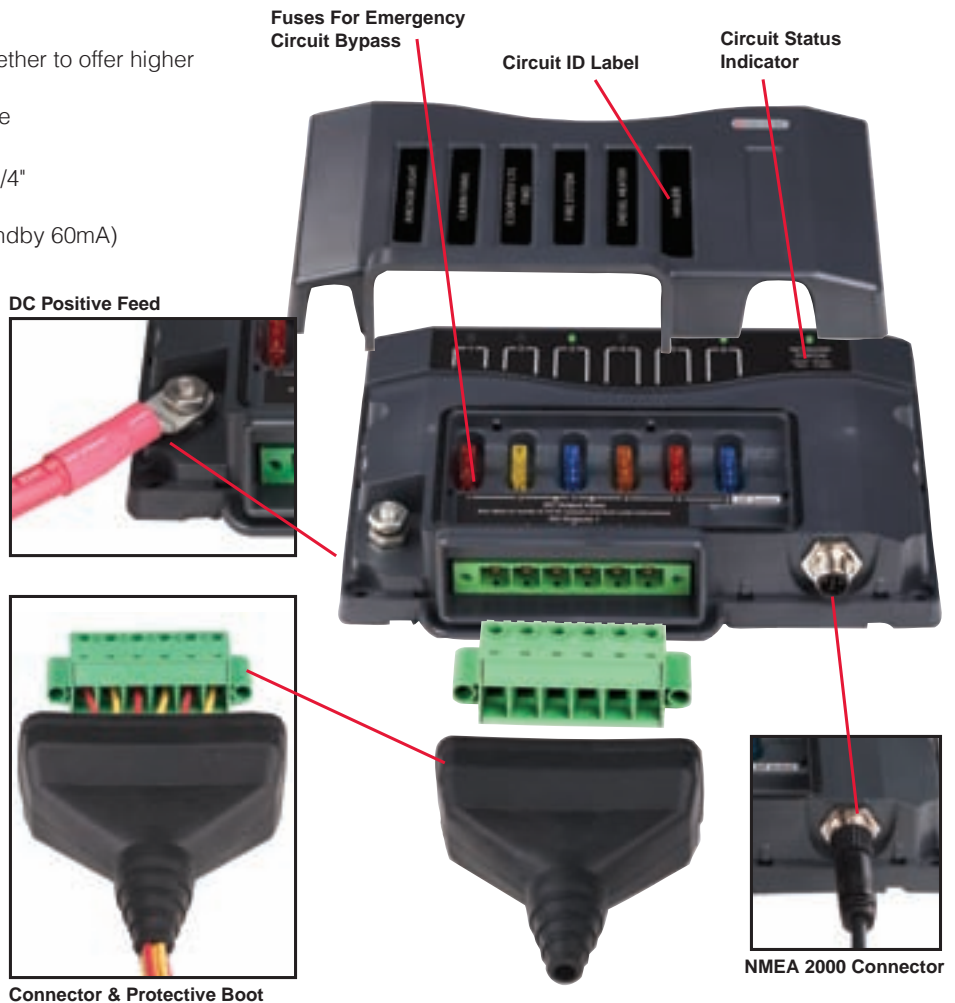



Motor Output Interface

The Motor Output Interface (MOI) has an output pair for controlling DC motors which require a reversal of polarity to change the direction of their mechanical operation. For example, a DC motor for an electric window mechanism will move the window up or down depending on the polarity of the feed to the motor.

Historically the wiring and control circuitry for such installations is complicated and requires a number of individual components. Often controls for these devices are mounted remotely to the motor so wiring runs can be long. The MOI replaces all of these devices with one simple solution that can be mounted close to the motor further reducing cable runs.

The MOI can be configured to deliver a "soft start" so that motor driven devices don't start with a sudden and abrupt motion.

The MOI also incorporates two standard output channels such as is found on the OI.

- Single motor control and two normal channels per unit, 20A per output
- Built In circuit protection
- IPX5 water ingress protection
- Dimensions (WxHxD): 7-29/32"x5"x1-3/4" 200x128x45 mm



Item #	Description
80-911-0007-00	Motor Output Interface w/ connector, boot
80-911-0008-00	Motor Output Interface only

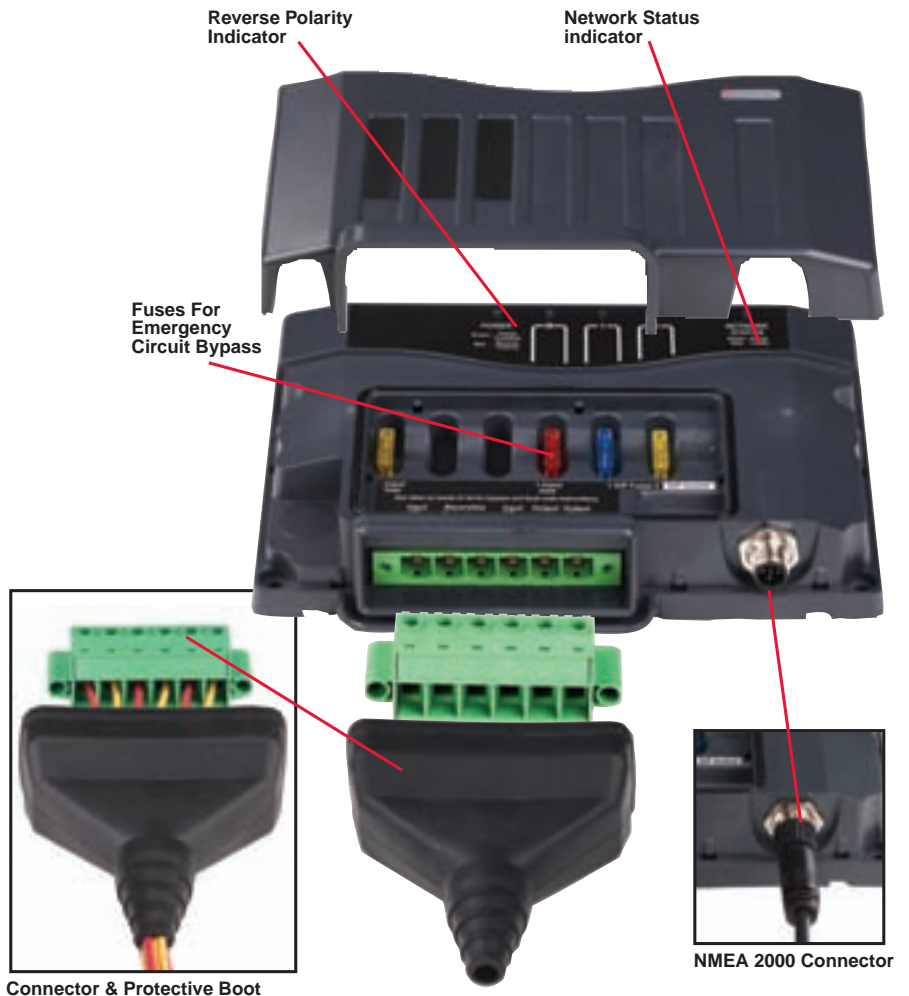



Configuration Made Easy

Historically, generating a configuration for and programming a system is a chore that requires a significant amount of training. The configuration tool of the CZone™ system offers simple, straightforward programming that is easy to learn and to use.

The CZone™ system Configuration Tool allows the manufacturer to set up programming parameters on a standard PC, (use USB CAN Adapter #80-911-0044-00) upload a saved configuration into the CZone™ network and simultaneously program every interface on-board. Changes and customizations can also be made from the Display Interface and downloaded back to the PC overriding the master configuration. The master template file is now ready to go and can be used on multiple vessels or vehicles during manufacturing.

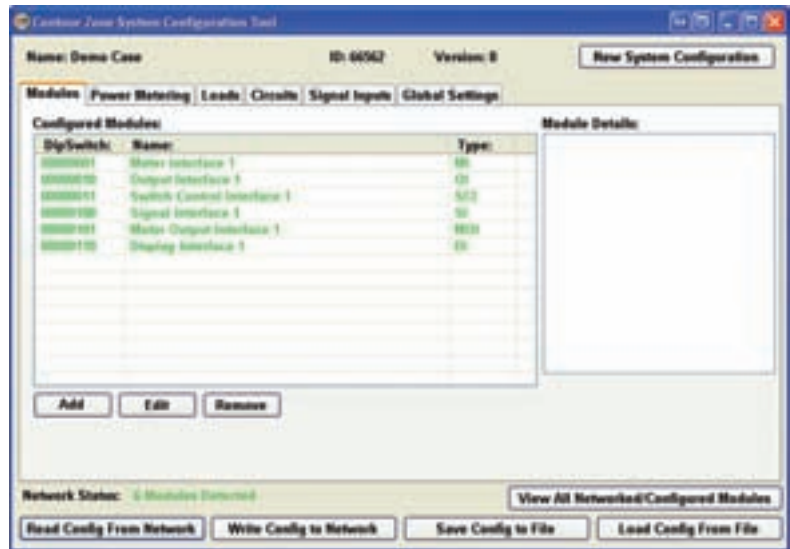
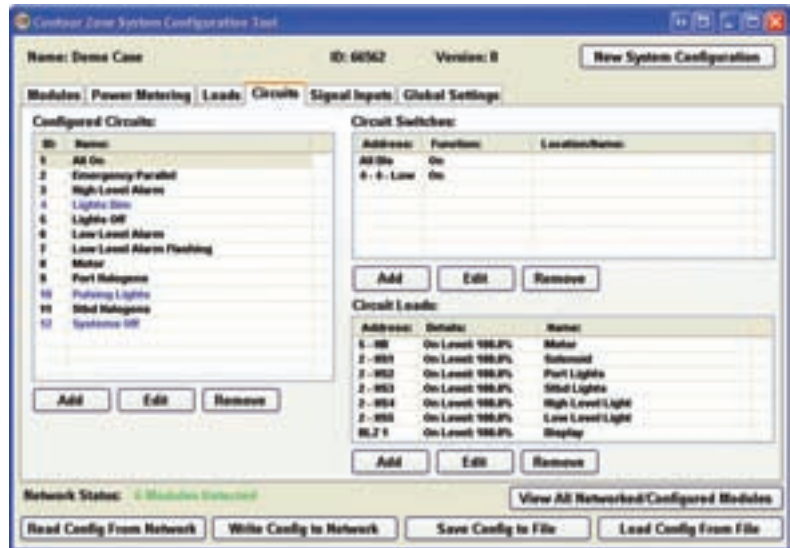



NMEA 2000 Micro C Accessories



Ext. Cable

- NMEA 2000 Network

Item #	80-911-0024-00	16 ft	5 m
Item #	80-911-0025-00	32 ft	10 m
Item #	80-911-0026-00	1.6 ft	.5 m
Item #	80-911-0027-00	6.5 ft	2 m



Power Cable for Display Interface, 2 Pin, 2 Meters

- 6.5 ft, 2 meters

Item # **80-911-0032-00**



Power Cable

- NMEA 2000 Network
- 3.2 ft, 1 meters

Item # **80-911-0028-00**



Single Tee Connector

- NMEA 2000 Network

Item # **80-911-0029-00**



90° Elbow Connector

- NMEA 2000 Network

Item # **80-911-0046-00**



Single Tee Connector w/ 0.5 m (19.5") Extension Cable

- NMEA 2000 Network

Item # **80-911-0049-00**



2 Way Tee Connector

- NMEA 2000 Network

Item # **80-911-0047-00**



4 Way Tee Connector

- NMEA 2000 Network

Item # **80-911-0048-00**



Terminating Resistors

- NMEA 2000 Network

Item # **80-911-0030-00** Female

Item # **80-911-0031-00** Male

Banking Caps

- NMEA 2000 Network



Male Cap

Item # **80-911-0050-00**



Female Cap

Item # **80-911-0051-00**



NMEA 2000 Micro C Accessories



Cable Gland for SCI Silicon
Item # 80-911-0035-00



Cable Gland SI, Blk Silicon
Item # 80-911-0036-00



Cable Gland, MI, Blk Silicon
Item # 80-911-0033-00

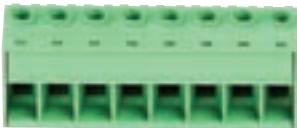

Terminal Block SI/MI, 8 Way
Item # 80-911-0043-00

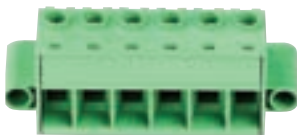

Terminal Block OI/MOI, 6 Way
Item # 80-911-0041-00

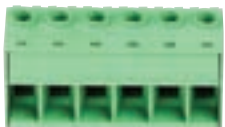

Terminal Block for MI, 6 Way
Item # 80-911-0042-00



Seal Boot for OI/MOI 6-Wire, Blk Silicon
Item # 80-911-0034-00



Through Bulkhead Adaptor
• NMEA 2000 Network
Item # 80-911-0052-00



Female Field Serviceable Connector
• NMEA 2000 Network
Item # 80-911-0053-00



Male Field Serviceable Connector
• NMEA 2000 Network
Item # 80-911-0054-00



Hole Plugs, Blk
Item # 80-911-0016-00 3.2 mm
Item # 80-911-0017-00 5 mm
3.2 mm for MI and SI cable glands
5 mm for SCI cable glands



CZone™ Wireless Remote Kit

- Simple to set up, wireless remote control
- Buttons are configurable for momentary on or latching control of circuits
- 80m (250 ft) operating range
- Rolling code

Item # 80-911-0045-00



USB CAN Adapter

- Connects PC to the CZone™ network for configuration and system set up

Item # 80-911-0044-00



Cable Assembly, SCI to suit switches above

- Item # 80-911-0018-00 .5 meter
- Item # 80-911-0019-00 1 meter
- Item # 80-911-0020-00 2 meter
- Item # 80-911-0021-00 3 meter
- Item # 80-911-0022-00 4 meter
- Item # 80-911-0023-00 5 meter



80-911-0062-00



80-911-0061-00

Push Buttons

- Momentary and latched actuation options available
- Blue and red circuit status indication LED options
- 19mm mounting hole
- IP 67 environmental protection
- Stainless Steel components

For use with CZone™ systems only

- Item # 80-911-0060-00 Momentary (ON)OFF red LED
- Item # 80-911-0063-00 Momentary ON/OFF red LED
- Item # 80-911-0062-00 Momentary (ON)OFF blue LED
- Item # 80-911-0061-00 Momentary ON/OFF blue LED



Custom Switches

- Red or blue systems in operation and backlighting LED's

- Item # 80-911-0037-00 ON/OFF red LED
- Item # 80-911-0038-00 mom ON/OFF red LED
- Item # 80-911-0039-00 ON/OFF/ON red LED
- Item # 80-911-0040-00 mom ON/OFF/mom ON red LED
- Item # 80-911-0066-00 mom ON/OFF blue LED
- Item # 80-911-0071-00 mom ON/OFF/mom ON blue LED



DC Current Shunt

- 450A / 50 mV shunt supplied with 80-600-0021-00
- 3.25"Lx2.8"Wx2.75"H (83Lx45Wx44H mm)

Item # LB-450-50

CZONE™ CZone™ Digital Control Accessories



NEW CZone™-MasterBus Bridge Interface

The CZone™-MasterBus bridge has been developed to connect two great systems together to bring you the best of both worlds. The bridge physically connects the MasterBus and CZone™ networks together, enabling the two networks to communicate and act as one, providing seamless control and monitoring of devices on both networks from either Masterbus or CZone™ displays.

Features/Functions

- Control Mastervolt inverters and chargers from CZone™ displays and switches
- Control of MasterBus output devices (turn lights, pumps, etc. on/off)
- Control of CZone™ output devices (turn lights, pumps, etc. on/off) via MasterBus displays and switches
- Display CZone™ acquired systems information such as tank and power levels on Masterbus displays
- Display MasterBus acquired systems information such as tank and power levels on CZone™ displays
- Transfers alarms between both systems
- 2.75"x2.75"x2" (69x69x50)

Item # 80-911-0072-00

CZone™ Network Bridge Interface

- For isolating sections of an NMEA 2000 network to decrease standby current draw
- Isolation when bridging between two CAN networks, (eg connecting CZone™ to Simrad Simnet)
- For expansion of the NMEA 2000 network when the maximum node limit (node = any device connected to the NMEA 2000 network) for the network has been reached
- Once fitted, a further 40 nodes can be added

Item # 80-911-0057-00

AC Transducer

- The AC-VSEN-4 includes 3 voltage transformers for up to 3 voltage inputs.
- Dimensions: 2.75"x5.5"x2" (69x140x50 mm)



Item # AC-VSEN-4

Surge Protection Module

Protect your electronics from becoming damaged by harmful high voltage spikes. When fitted to the battery supply, these modules look for sudden increases in voltage then switch into protection mode to absorb and suppress the high energy spike.

Item # 80-707-00004-00 12V DC

Item # 80-707-00005-00 24V DC



Heavy-duty Current Transformer

- Maximum current 150A AC
- CT-HD is available for systems with large mains cables, too large for CT-10-3 (ordered separately).
- CT-HD dimensions: Ø 1.85 x 0.4" (Ø 47 x 10.5 mm)
- Hole size: 1.25" (32 mm)

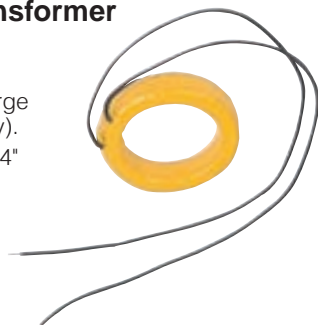

Item # CT-HD

Current Transformer

- Maximum current 150A AC
- One CT-10-3 current transformer is supplied with ACSM. If a twin line system is in use, a second CT must be ordered.
- Dimensions: 1.5"x1.55"x.55" (37.5x39.2x13.7 mm)
- Hole size: 0.5" (12 mm)
- Supplied with 80-600-0023-00

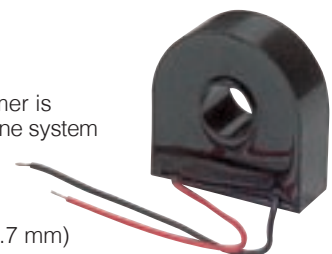

Item # CT-10-3

DC Systems Monitor (DCSM)

Designed and manufactured by BEP, these state of the art full color monitors are made to meet the systems monitoring requirements of today's modern vessel and recreational vehicle. Complex AC and DC electrical installations onboard are becoming more common place. Additionally the increase in tank monitoring requirements for fuel, fresh, grey and black water, accurate monitoring of these systems is essential. The DCSM and ACSM displays feature clear, extra large type face. This allows for more detailed on-screen information and increased clarity. The screen has backlighting for easy night time viewing.

See sample screens below.

Specifications:

- 2.8" Color QVGA LCD
- Input voltage 8-32VDC
- Dimensions WxH: 90x100 mm
- Backlit keypad

Monitors:

- Charge/discharge amps for two banks
- Capacity remaining in A/h and %
- Battery condition
- Tank fluid level
- Circuit status

Features:

- 8 Generic, user configurable inputs
- Programmable high/low audio/visual alarms for volts, amps and tank levels
- Backlit keypad and dimmable screen
- Can be panel or surface mounted



80-600-0021-00
(DCSM including 1x shunt and cable)

80-600-0022-00
(DCSM excluding shunt)

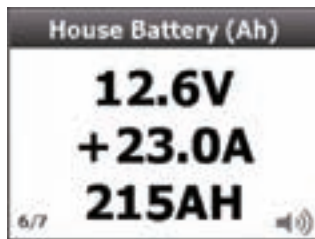

DC Power Meter

- Displays voltages of multiple battery banks (0-32V DC)
- Displays charge and discharge (amps) of 2 battery banks
- Displays battery capacity in amp hours
- High/Low level alarms

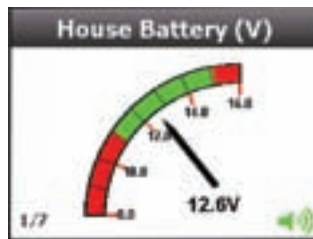

Display Type

- Configure the DCSM to show the data in analog, digital and graphic form

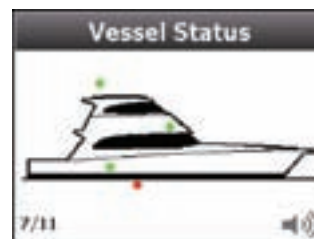

Circuit Status

- View the status of important circuits (on/off)
- In graphic and numeric form

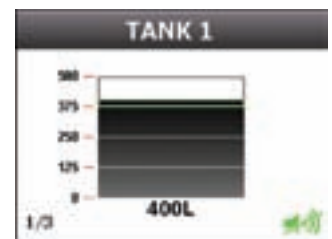

Tank Level

- View tank level information for multiple tanks in numeric and graphic forms. Resettable when leaving boat



Installation Cable Kit

- 2 core screened cable in 2 lengths pre-terminated

Item # 600-DCM-5M 16.45" (5 m)
Item # 600-DCM-10M 32.9" (10 m)



DC Current Shunt

- 450A / 50 mV shunt supplied with 80-600-0021-00
- 3.25"Lx2.8"Wx2.75"H (83Lx45Wx44H mm)

Item # LB-450-50



Sprayproof Gasket

When fitted the gasket provides a water ingress protection level of IPX5 (Protection against low pressure jets of water) for the AC and DC systems monitors

Item # GAS-SM

AC Systems Monitor (ACSM)

Specifications:

- 2.8" Color QVGA LCD
- Input voltage 8-32V DC
- Dimensions (WxH): 90x100 mm
- Backlit keypad

Monitors:

- AC volts, amps and frequency

Features:

- 3 user configurable inputs
- Displays data in analog, digital and graphic forms
- Output for load shedding
- Programmable high/low audio/visual alarms for each input



80-600-0023-00

(ACSM) includes 1x AC-VSEN-4 and 2x CT-10-3



AC Power Meter

- Displays AC volts, amps frequency and power for two supplies with a third position for monitoring AC volts and frequency of a third supply
- Displays AC power in kW (true RMS)



AC Volts/Frequency

- Displays AC voltage and frequency, 80-264V AC 50 & 60Hz



AC Amps

- Displays Current for 3x AC supplies (0-75A)



Alarms

- High and low alarms for each input
- User selectable alarm levels
- Mutable



AC Transducer

- The AC-VSEN-4 includes 3 voltage transformers for up to 3 voltage inputs.
- Dimensions: 2.75"x5.5"x2" (69x140x50 mm)

Item # **AC-VSEN-4**

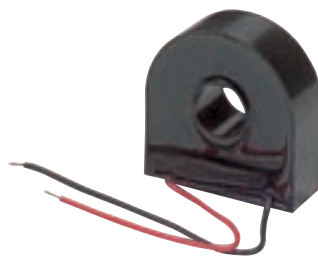

Current Transformer

- Maximum current 150A AC
- One CT-10-3 current transformer is supplied with ACSM. If a twin line system is in use, a second CT must be ordered.
- Dimensions: 1.5"x1.55"x.55" (37.5x39.2x13.7 mm)
- Hole size: 0.5" (12 mm)
Supplied with 80-600-0023-00

Item # **CT-10-3**



Heavy-duty Current Transformer

- Maximum current 150A AC
- CT-HD is available for systems with large mains cables, too large for CT-10-3 (ordered separately).
- CT-HD dimensions: Ø 1.85 x 0.4" (Ø 47 x 10.5 mm)
- Hole size: 1.25" (32 mm)

Item # **CT-HD**



Masterlink BTM-III Battery Monitor

Provides an accurate indication of the current, amperage, remaining time and remaining capacity of battery bank 1, and the current and estimated capacity of battery banks 2 and 3. The built-in microprocessor calculates the remaining capacity and stores historic data.

Item #	70403163
Number of battery sets	service (fully), starter & bowthruster
Max. amp-hour capacity	9999Ah
Voltage read-out	yes
Current read-out	yes
Amp-hours read-out	yes
Time remaining indication	yes
Battery capacity in %	yes
Current consumption (backlight off)	14 mA/12V - 11 mA/24V
Current consumption (backlight on)	100 mA/12V - 50 mA/24V
Supply voltage	9-35V DC
Voltage range measurement	7-35V DC
Voltage resolution	0.01V
Voltage deviation	± 0.6% ± 1 figure
Amps measurement range	0-500A (optional 1000A/50mV)
Shunt specification	500A / 50mV (included)
Dimensions instrument, wxh	4.7"x2.6" / 120x65 mm
Built-in depth incl./excl. cover box	2.2"/1.6" / 55/40 mm
Weight instrument incl. shunt	2 lbs / 0.9 kg
Dimensions shunt, hxwx	3.3"x1.7"x1.7" / 84x44x44 mm - M8

Tank Level Senders



Tank Sender Interface Module

- Is only required when using VDO (10-180) or Teleflex (240-33) senders to produce a 0-5V signal to operate the 600-TLM-N.
- Switchable link for VDO or Teleflex signal. 10-32V supply.
- One unit per sender required.
- Dimensions: 2.4"x1.3"x.9" (60x34x22 mm)

Item # 600-TLM-SIF



LED Tank Gauge

The 600-TG offers economical monitoring for fresh or grey water tanks (plastic or fiberglass only). Using 600-TGSK strategically mounted well nuts will give 4 tank levels. Supplied with one sender kit. Second sender ordered separately.

Also available is the RV-TS-5M Tank sender. Only one hole is required for installation, the sender is sealed via external lock nuts. Suitable for tanks with maximum depth of 280 mm.

- Item # RV-TG** 1 tank
- Item # RV-TG-2T** 2 tank
- Item # RV-TG-3T** 3 tank



Tank Sender

Suits tanks with maximum depth of 280 mm and a maximum wall thickness of 10 mm, and a maximum hole size of 22 mm. Comes with 5 m cable.

Item # RV-TS-5M



Tank Sender

- Well nut hole size 3/8" (9 mm).
- Cable length 5 m.
- One kit supplied with 600-TG.

Item # 600-TGSK

BEP™ Ultrasonic Tank Sender—No Moving Parts

- Handles common outputs – 240-33, 10-180, Vetus 10-300 and 0-5V tanks from BEP, Teleflex, Faria, VDO and many other popular instrument brands. (When connecting to non-adjustable gauges the TS1 must be pre-calibrated)
- Low Profile Design and standard SAE 5 hole mounting pattern, allowing it to be retrofitted to practically all other sender brands.
- Can be set for tank dimensions via computer using BEP™ Marine's proprietary TS1 software, avoiding experimental tank filling on site
- Connects directly to the DC systems monitors (80-600-0021-00 & 80-600-0022-00 page 181) when configured to a 0-5V output
- Is set for 0-2000 mm depth off the shelf (not suitable for tank depths less than 200 mm) 8".
- Operating voltage: 10-32V
- Current draw: 25 mA with 5V gauge output
- Measurement method: Acoustic sonic measurement
- Tank depth: 0–6.5 ft (2000 mm)
- Accuracy Distance: 0–6.5 ft (2000 mm) at 2 mm accuracy
- Mounting: SAE 5 stud mounting pattern with gasket, seal and screws (top mount only).
- Environmental temperature: 39.2–149°F (4–65°C)
- Chemical resistance: Petrol, diesel, water, toilet chemicals
- Tank type style: Metal and plastic with non linear capacity
- Works with petrol, diesel, fresh water, grey water and black water

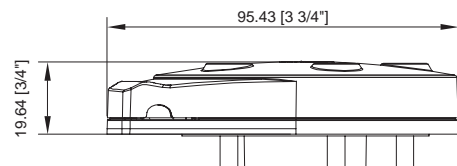

...the most unique and sophisticated system of any tank monitor tested... the ultrasonic technology is extremely accurate.

Practical Sailor Magazine, July 2009

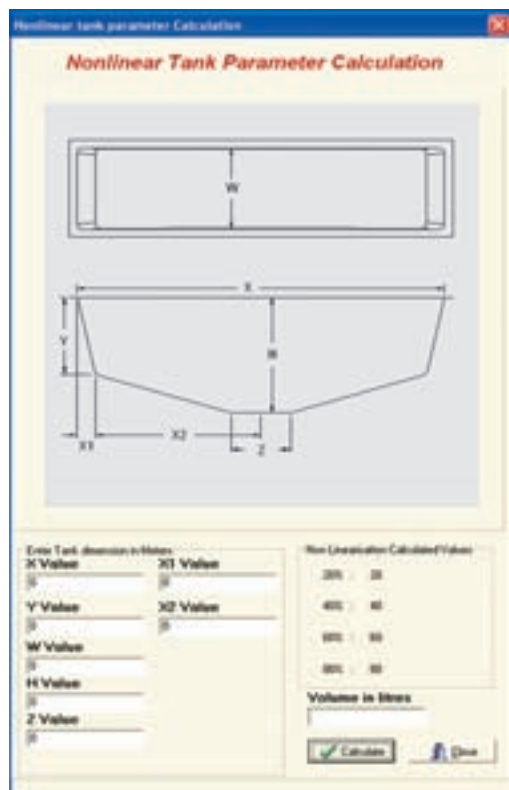

BEP's proprietary Window's based software application allows for TS1 senders to be programmed specific to tank shape, size and fluid type via a computer's USB port. Programming is a simple process and can be carried out by downloading free software and purchasing a programming kit **TS1-PK**.

Once programmed, the specific tank parameters are stored in the non-volatile memory of the TS1.



TS1 Programing Device

Item # **TS1-PK**

Gas Detectors

The BEP™ Detectors use microprocessor control to ensure correct sensor sensitivity. The Detectors have the capability to control two sensors which detect both LPG and Petrol, with visual and audible alarms.

- Dual sensors for LPG and Petrol
- Visual and audible alarms; provision for external alarm
- Automatic shut-off solenoid control with pulse and hold circuit for low power draw (600-GDL only)
- Self-testing
- Provision of bilge blower
- 2.4"x3.5"x0.7" (67x88x17 mm)

600-GD, 600-GDL, & FD-2 Specifications

Voltage (V DC)	10–32
Current (mA)	350 max.
Alarm Sensitivity	20% lower explosive limit
Current@Out (mA)	800 max.
Solenoid (mA)	700 pulse, 250 hold



600-GD
600-GD will detect LPG, Petrol and CNG fumes. Supplied with one sensor, with an option for a second sensor, Item # BL-SL-L output for remote alarm and blower unit. 600-GD can be used on 12 or 24V systems.



600-GDL
Same features as the 600-GD, with the ability to switch a valve on. It contains a unique "Pulse & Hold" circuit within the detector. This allows the valve to be pulled in at 12V and then once energized it will step down to hold the valve in place. This reduces power consumption and heat while the gas is turned on.



BL-SL-L
One Sensor lead supplied (5 m) with GD & GDL.
Second Sensor lead ordered separately



600-LPG
600-LPG is a stand alone gas shut-off system with no gas detection ability. For 12V systems order VR2.2 separately. For 24V systems order VR2.2-24V.



600-GDRV
600-GDRV has the sensor mounted in the front facia creating a stand alone unit. The unit is designed to be surface mounted at the vessel's lowest point.



FD-2
FD-2 is designed for an economic in-dash installation. Supplied with sensor (5 m cable) which is capable of detecting combustible gases.

Solenoid Valve & Regulator Kit

Compatible with 600-GDL Gas Detector or 600-LPG.

Solenoid voltage: 12 V or 24 V
Gas outlet: 3/8 BSP
Gas inlet: POL Thread
Current draw: 800 mA
Current draw with GDL or PH-12V: 0.2 A
Regulator Flow Rate: 3 kPa.

Note: The VR2.2 may not comply in some countries, and does not comply with USCG requirements. Please check with your local gas installer. Not for sale in the USA.



Solenoid Valve

The SA296COMP-12V is suitable for countries where VR2.2 is not approved. The CE approved SA296COMP-12V can be installed by an approved gas installer using approved components from within specific markets. 12V or 24V options available. Uses 1/4" BSP thread.

Note: A separate regulator will need to be installed with the SA296 valves.

Item # SA296COMP-12 12V
Item # SA296COMP-24 24V



Analog

- Analog meters as used in BEP™ Contour circuit breaker panels.
- All analog meters accurate to within 2.5%



N816DCV

NO300ACV

NO100A

NO60ACT

Meters	Item #	Range	Division Marks	Shunt Type
Amp (DC)	N010A	0-10A DC	0.5A	Internal
	N020A	0-20A DC	1A	Internal
	N050A	0-50A DC	2A	50A-50mV
	N0100A	0-100A DC	5A	100A-50mV
	N0150A	0-150A	1A	150A-50mV



When ordering optional external shunt ammeters, shunts must be ordered separately.

Meters	Item #	Range	Division Marks
Volt (DC)	N816DCV	8-16V DC	0.2V
	N1632DCV	16-32V DC	0.4V
Volt (AC)	N0150ACV	0-150V AC	10V
	N0300ACV	0-300V AC	20V
Amp (AC)	N060ACT	0-60A AC	5A
	N0100ACT	0-100A AC	5A



CT-10-AN must be ordered when using N060ACT or N0100ACT.

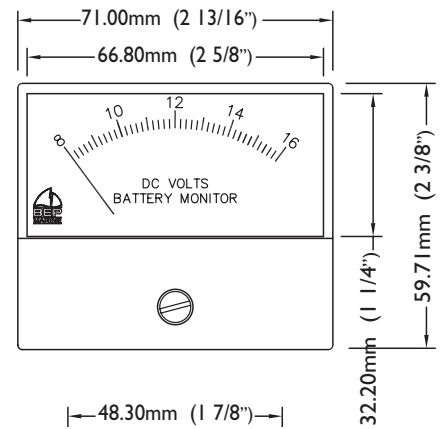

Systems in Operation Panels

- 10 mm red LED's giving important systems on information
- Ideal for flybridge or remote dash position. Also available with alarm and mute switch.
- Backlit labels

Item #	in LxWx1.6	mm LxWx40	Label Sheet	LEDs	Alarm	Mute switch
SOP1	4.5"x5"	115x127	1	4	No	No
SOP1-AL	4.5"x5"	115x127	1	3+1 switch	Yes	Yes
SOP2	4.5"x9"	115x239	1-2	8	No	No
SOP2-AL	4.5"x9"	115x239	1-2	7+1 switch	Yes	Yes



SOP1



SOP2

Analog & Digital

- Contour panel/front facia complements contour range
- All Contour Matrix monitors can fit into this style of panel



80-601-0020-00

Panel Mounted Analog Battery Condition Meter (expanded scale)

- Panel switchable to show 3 different battery banks
- Available 12V (8-16V) or 24V (16-32V)

Item #	Range	Inputs
80-601-0020-00	8–16V DC	3
80-601-0021-00	16–32V DC	3
80-601-0022-00	0–150V AC	1
80-601-0023-00	0–300V AC	1



80-601-0025-00

Panel Mounted Analog Ammeter Panel

- Panel switchable for use on up to 3 different ammeter shunts
- Supplied with 1 shunt, meter scales available, 0-50A 0-100A 0-150A

Item #	Range	Inputs
80-601-0024-00	0–50A DC	3
80-601-0025-00	0–100A DC	3
80-601-0026-00	0–150A DC	3

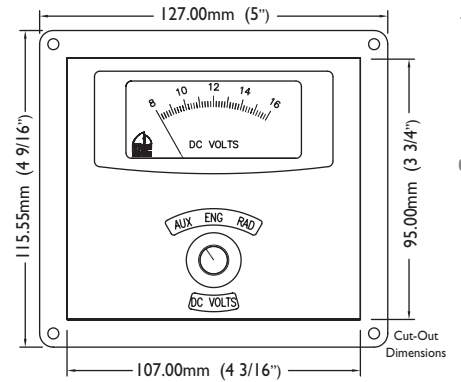

Dimensions for analog and digital panels



Panel Mounted DC Systems Monitor

- See page 181 for DCSM functionality
- Supplied with 450A-50mV shunt

Item # 80-600-0027-00



Panel Mounted AC Systems Monitor

- See page 182 for ACSM functionality
- Supplied with voltage and current transducers

Item # 80-600-0028-00

“Can I use ‘regular wire’ for my boat?” The answer to this common question is a qualified “yes,” if the wire is SAE (Society of Automotive Engineering) J378, J1127 or J1128. These wires are designed for “surface vehicles,” not for the special requirements of the marine industry, but meet the minimum standards for boats in limited circumstances. Even if tinned copper, they should not be run in bilge spaces or other areas subject to moisture from spray or dripping. They should not be run in engines spaces, unless marked “oil resistant” and “75°C”. They should not be used in applications where subjected to vibration or frequent flexing and must never be used for 110 volt applications. For safety, use only wire which is marked with size and type.

Most importantly, SAE wire is up to 12% smaller than AWG Boat Cable which means that, in many applications, larger

gauge wire must be used to stay within the voltage drop limits recommended by experts (see Tables C & D). The wire charts found in “Chapman’s Piloting” and other publications are all for “AWG” wire like Ancor™, not “SAE” type wire.

Using the wrong type of wire can cost you more in the long run. Insist on Marine Grade Boat Cable by Ancor. It is UL approved for the corrosive marine environment and charter boat service. Marine Grade Boat Cable is specially designed to exceed all test standards for cold bend, moisture and oil resistance, heat shock and flammability. This ensures the safest, easiest to install, longest lasting and ultimately the least expensive electrical system you can buy. Only Ancor offers a complete line of Marine Grade Boat Cable for every need.

Table A: Marine Color Code

Color	Item	Use
Red	DC Positive Conductor	Positive Mains
Black or Yellow	DC Negative Conductor	Return, Negative Mains
Green or Green w/ Yellow Stripe	DC Grounding Conductor	Bonding System Bonding Wires (if insulated)
Light Blue	Oil Pressure	Oil Pressure Sender to Gauge
Dark Blue	Cabin & Instrument Lights	Fuse or Switch to Lights
Brown	Generator Armature	Generator Armature to Regulator
	Alternator Charge Light	Generator Terminal/Alternator Auxiliary Terminal to Light to Regulator
	Pumps	Fuse or Switch to Pumps
Grey	Navigation Lights	Fuse or Switch to Lights
	Tachometer	Tachometer Sender to Gauge
Orange	Accessory Feed	Ammeter to Alternator or Generator Output and Accessory Fuses or Switches
	Common Feed	Distribution Panel to Accessory Switch
Pink	Fuel Gauge	Fuel Gauge Sender to Gauge
Purple	Ignition	Ignition Switch to Coil & Electrical Instruments
	Instrument Feed	Distribution Panel to Electric Instruments
Brown w/ Yellow Stripe	Bilge Blowers	Fuse or Switch to Blower
Yellow w/ Red Stripe	Starting Circuit	Starting Switch to Solenoid
Tan	Water Temperature	Water Temperature Sender to Gauge
Green/Stripe (G/x) (except G/Y)	Tilt Down and/or Trim In	Tilt and/or Trim Circuits
Blue/Stripe (BI/x)	Tilt Up and/or Trim Out	Tilt and/or Trim Circuits

Table B: Conductors Sized (AWG) for 3% Voltage Drop

Use 3% voltage drop for any "critical application" affecting the safety of the vessel or its passengers: bilge pumps, navigation lights, electronics, etc....

IMPORTANT!

Length (feet): Determined by measuring the length of the conductor from the positive (+) power source connection to the electrical device and back to the negative (-) power source connection. Note that the power source connection may be either the battery, panelboard or switchboard.

Current (amps): Determined by adding the total amps on a circuit.

Conductor sizes not covered in Table B or Table C may be calculated by using the following formula:

$$CM = \frac{K \times I \times L}{E}$$

After calculating the Circular Mil Area (CM), use Table E to determine the proper conductor size (National Fire Protection Agency and Coast Guard require that the next larger conductor be used when the calculated CM area falls between the two conductor sizes).

CM = Circular Mil Area of Conductors

K = 10.75 (Constant representing the mil-foot resistance of copper)

I = Current - amps / **L** = Length - feet

E = Voltage drop at load (in voltage drop in a decimal expression)

For Example...

Q: A bilge pump draws 10 amps. The positive run is 11 feet from the power panel, including the float switch. The negative run is only 10 feet. What size is the wire?

A: Use the formula to reach the correct answer:

Table D shows that 12 AWG wire has a CM area of 6,500 and is the correct choice. However, SAE wire has a CM area of only 5,833. Under NFPA and USCG regulations, 10 SAE wire must be used.

3% Voltage Drop at 12 Volts

		Current (Amps)												
Length		5	10	15	20	25	30	40	50	60	70	80	90	100
10'	3 m	18	14	12	10	10	8	6	6	6	6	6	4	4
15'	5 m	16	12	10	10	8	8	6	6	4	4	4	2	2
20'	6 m	14	10	10	8	6	6	6	4	4	2	2	2	2
25'	8 m	12	10	8	6	4	4	4	2	2	2	2	1	1
30'	9 m	12	10	8	6	6	6	4	4	2	2	2	1	1
40'	12 m	10	8	6	6	4	4	2	2	1	1/0	1/0	2/0	2/0
50'	15 m	10	6	6	4	4	2	2	1	1/0	2/0	3/0	4/0	4/0
60'	18 m	10	6	6	4	2	2	1	1/0	2/0	3/0	3/0	4/0	4/0
70'	21 m	8	6	4	2	2	1	1/0	2/0	3/0	3/0	4/0	4/0	
80'	24 m	8	6	4	2	2	1	1/0	2/0	3/0	4/0	4/0		
90'	27 m	8	4	2	2	1	1/0	2/0	3/0	4/0	4/0			
100'	30 m	6	4	2	2	1	1/0	2/0	3/0	4/0				
110'	33 m	6	4	2	2	1	1/0	2/0	3/0	4/0				
120'	36 m	6	4	2	1	1/0	2/0	3/0	4/0					
130'	40 m	6	2	2	1	1/0	2/0	3/0	4/0					
140'	43 m	6	2	2	1/0	2/0	3/0	4/0						
150'	46 m	6	2	1	1/0	2/0	3/0	4/0						
160'	49 m	6	2	1	1/0	2/0	3/0	4/0						
170'	52 m	6	2	1	2/0	3/0	3/0	4/0						

3% Voltage Drop at 24 Volts

		Current (Amps)												
Length		5	10	15	20	25	30	40	50	60	70	80	90	100
10'	3 m	18	18	16	14	12	12	10	10	10	8	8	8	6
15'	5 m	18	16	14	12	12	10	10	8	8	6	6	6	6
20'	6 m	18	14	12	10	10	10	8	6	6	6	6	4	4
25'	8 m	16	12	12	10	10	8	6	6	6	4	4	4	4
30'	9 m	16	12	10	10	8	8	6	6	4	4	4	2	2
40'	12 m	14	10	10	8	6	6	6	4	4	2	2	2	2
50'	15 m	12	10	8	6	6	6	4	4	2	2	2	1	1
60'	18 m	12	10	8	6	6	4	4	2	2	1	1	1/0	1/0
70'	21 m	12	8	6	6	4	4	2	2	1	1	1/0	1/0	2/0
80'	24 m	10	8	6	6	4	4	2	2	1	1/0	1/0	2/0	2/0
90'	27 m	10	8	6	4	4	2	2	1	1/0	1/0	2/0	2/0	3/0
100'	30 m	10	6	6	4	4	2	2	1	1/0	2/0	2/0	3/0	3/0
110'	33 m	10	6	6	4	2	2	1	1/0	1/0	2/0	3/0	3/0	4/0
120'	36 m	10	6	4	4	2	2	1	1/0	2/0	3/0	3/0	4/0	4/0
130'	40 m	8	6	4	2	2	2	1	1/0	2/0	3/0	3/0	4/0	4/0
140'	43 m	8	6	4	2	2	1	1/0	2/0	3/0	3/0	4/0	4/0	
150'	46 m	8	6	4	2	2	1	1/0	2/0	3/0	3/0	4/0	4/0	
160'	49 m	8	6	4	2	2	1	1/0	2/0	3/0	4/0	4/0	4/0	
170'	52 m	8	6	2	2	1	1	2/0	3/0	3/0	4/0	4/0		

3% Voltage Drop at 32 Volts

		Current (Amps)												
Length		5	10	15	20	25	30	40	50	60	70	80	90	100
10'	3 m	18	18	16	16	14	14	12	12	10	10	10	8	8
15'	5 m	18	16	14	14	12	12	10	10	8	8	8	6	6
20'	6 m	18	16	12	12	12	10	10	8	8	6	6	6	6
25'	8 m	18	14	12	12	10	10	8	8	6	6	6	6	4
30'	9 m	16	14	10	10	10	8	8	6	6	6	4	4	4
40'	12 m	16	12	10	10	8	8	6	6	4	4	4	2	2
50'	15 m	14	12	8	8	8	6	6	4	4	2	2	2	2
60'	18 m	14	10	8	8	6	6	4	4	2	2	2	2	1
70'	21 m	12	10	6	6	6	6	4	2	2	2	1	1	0
80'	24 m	12	10	6	6	6	4	4	2	2	1	1	0	0
90'	27 m	12	8	6	6	6	4	2	2	2	1	1/0	1/0	2/0
100'	30 m	12	8	6	6	4	4	2	2	1	1/0	1/0	2/0	2/0
110'	33 m	10	8	6	6	4	4	2	2	1	1/0	1/0	2/0	2/0
120'	36 m	10	8	6	4	4	2	2	1	1/0	1/0	2/0	2/0	3/0
130'	40 m	10	8	6	4	4	2	2	1	1/0	2/0	2/0	3/0	3/0
140'	43 m	10	6	6	4	2	2	1	1/0	1/0	2/0	3/0	3/0	3/0
150'	46 m	10	6	6	4	2	1	1	1/0	2/0	2/0	3/0	3/0	4/0
160'	49 m	10	6	4	4	2	1	1	1/0	2/0	3/0	3/0	4/0	4/0
170'	52 m	8	6	4	2	2	1	1	1/0	2/0	3/0	3/0	4/0	4/0

Table C: Conductors Sized (AWG) for 10% Voltage Drop

Use 10% voltage drop for any "non-critical" applications: windlass, cabin lights, etc....

10% Voltage Drop at 12 Volts

Length		Current (Amps)												
		5	10	15	20	25	30	40	50	60	70	80	90	100
10'	3 m	18	18	18	16	16	14	14	12	12	10	10	10	10
15'	5 m	18	18	16	14	14	12	12	10	10	8	8	8	8
20'	6 m	18	16	14	14	12	12	10	10	8	8	8	6	6
25'	8 m	18	16	14	12	12	10	10	8	8	6	6	6	6
30'	9 m	18	14	12	12	10	10	8	8	6	6	6	6	4
40'	12 m	16	14	12	10	10	8	8	6	6	6	4	4	4
50'	15 m	16	12	10	10	8	8	6	6	4	4	4	2	2
60'	18 m	14	12	10	8	8	6	6	4	4	2	2	2	2
70'	21 m	14	10	8	8	6	6	6	4	2	2	2	2	1
80'	24 m	14	10	8	8	6	6	4	4	2	2	2	1	1
90'	27 m	12	10	8	6	6	6	4	2	2	2	1	1	1/0
100'	30 m	12	10	8	6	6	4	4	2	2	1	1	1/0	1/0
110'	33 m	12	8	8	6	6	4	2	2	2	1	1/0	1/0	1/0
120'	36 m	12	8	6	6	4	4	2	2	1	1	1/0	1/0	2/0
130'	40 m	12	8	6	6	4	4	2	2	1	1/0	1/0	2/0	2/0
140'	43 m	10	8	6	6	4	2	2	1	1	1/0	2/0	2/0	2/0
150'	46 m	10	8	6	4	4	2	2	1	1/0	1/0	2/0	2/0	3/0
160'	49 m	10	8	6	4	4	2	2	1	1/0	2/0	2/0	3/0	3/0
170'	52 m	10	6	6	4	2	2	2	1	1/0	2/0	2/0	3/0	3/0

10% Voltage Drop at 24 Volts

Length		Current (Amps)												
		5	10	15	20	25	30	40	50	60	70	80	90	100
10'	3 m	18	18	18	18	18	18	16	16	14	14	14	12	12
15'	5 m	18	18	18	18	16	16	14	14	12	12	12	10	10
20'	6 m	18	18	18	16	16	14	14	12	12	10	10	10	10
25'	8 m	18	18	16	16	14	14	12	12	10	10	10	8	8
30'	9 m	18	18	16	14	14	12	12	10	10	8	8	8	8
40'	12 m	18	16	14	14	12	12	10	10	8	8	8	6	6
50'	15 m	18	16	14	12	12	10	10	8	8	6	6	6	6
60'	18 m	18	14	12	12	10	10	8	8	6	6	6	6	4
70'	21 m	16	14	12	10	10	8	8	6	6	6	6	4	4
80'	24 m	16	14	12	10	10	8	8	6	6	6	4	4	4
90'	27 m	16	12	10	10	8	8	6	6	6	4	4	4	2
100'	30 m	16	12	10	10	8	8	6	6	4	4	4	2	2
110'	33 m	14	12	10	8	8	8	6	6	4	4	2	2	2
120'	36 m	14	12	10	8	8	6	6	4	4	2	2	2	2
130'	40 m	14	12	10	8	8	6	6	4	4	2	2	2	2
140'	43 m	14	10	8	8	6	6	6	4	2	2	2	2	1
150'	46 m	14	10	8	8	6	6	4	4	2	2	2	2	1
160'	49 m	14	10	8	8	6	6	4	4	2	2	2	1	1
170'	52 m	12	10	8	6	6	6	4	2	2	2	2	1	1

10% Voltage Drop at 32 Volts

Length		Current (Amps)												
		5	10	15	20	25	30	40	50	60	70	80	90	100
10'	3 m	18	18	18	18	18	18	18	16	16	14	14	14	14
15'	5 m	18	18	18	18	18	18	16	14	14	14	12	12	12
20'	6 m	18	18	18	18	16	16	14	14	12	12	12	10	10
25'	8 m	18	18	18	16	16	14	14	12	12	10	10	10	10
30'	9 m	18	18	18	16	14	14	12	14	10	10	10	10	8
40'	12 m	18	18	16	14	14	12	12	10	10	8	8	8	8
50'	15 m	18	16	14	14	12	12	10	10	8	8	8	6	6
60'	18 m	18	16	14	12	12	10	10	8	8	8	6	6	6
70'	21 m	18	14	14	12	10	10	8	8	8	6	6	6	6
80'	24 m	18	14	12	12	10	10	8	8	6	6	6	6	4
90'	27 m	18	14	12	10	10	10	8	6	6	6	6	4	4
100'	30 m	16	14	12	10	10	8	8	6	6	6	4	4	4
110'	33 m	16	14	12	10	10	8	8	6	6	6	4	4	4
120'	36 m	16	12	10	10	8	8	6	6	6	4	4	4	2
130'	40 m	16	12	10	10	8	8	6	6	6	4	4	2	2
140'	43 m	14	12	10	8	8	8	6	6	4	4	2	2	2
150'	46 m	14	12	10	8	8	6	6	6	4	4	2	2	2
160'	49 m	14	12	10	8	8	6	6	4	4	2	2	2	2
170'	52 m	14	12	10	8	8	6	6	4	4	2	2	2	2

ABYC Recommends...

"Conductors used for panelboard or switchboard main feeders, bilge blowers, electronic equipment, navigation lights, and other circuits where voltage drop must be kept to a minimum, shall be sized for a voltage drop not to exceed three percent. Conductors used for lighting, other than navigation lights, and other circuits where voltage drop is not critical, shall be sized for a voltage drop not to exceed 10 percent." 11.16.1.2.7.

Table D: Conductor Sizes

AWG	mm ²	AWG		Ampacity Engine Space	
		CM area	SAE CM area	Outside	Inside
18	0.8	1,600	1,537	20	17
16	1	2,600	2,336	25	21
14	2	4,100	3,702	35	30
12	3	6,500	5,833	45	38
10	5	10,500	9,343	60	51
8	8	16,800	14,810	80	68
6	13	26,600	24,538	120	102
4	21	42,000	37,360	160	136
2	34	66,500	62,450	210	178
1	42	83,690	77,790	245	208
1/0	53	105,600	98,980	285	242
2/0	68	133,100	125,100	330	280
3/0	85	167,800	158,600	385	327
4/0	107	211,600	205,500	445	378

Table E: Temperature Rating of Conductor Insulation

The Law

The Code of Federal Regulations (CFR) 183.425 Conductors

- (b) Except for intermittent surges each conductor must not carry a current greater than that specified in Table E for the conductor's gauge and temperature rating.
- (c) For conductors in engine spaces, amperages must be corrected by the appropriate correction factor in note 1 of Table E.

Due to engine heat, the ambient temperature in engine spaces is usually higher than in other spaces of the boat. Wiring in and passing through engine spaces must be able to operate at these higher ambient temperatures. The ampacity values in Table E are based on an ambient temperature of 86°F (30°C) which is considered reasonable for use on boats except in engine spaces. The correction factors in Note 1 in Table E convert the ampacities to Table E to acceptable values in an ambient temperature of 122°F (50°C). This higher temperature has been selected as satisfactory for engine spaces. Note 1 is supplied to eliminate the need for calculating the corrections to Table E. The values are already corrected.

Conductor Size AWG	Ampacity Outside of Engine Space	Ampacity Inside of Engine Space (Note 1)
18	20	17
16	25	21
14	35	30
12	45	38
10	60	51
8	80	68
6	120	102
4	160	136
3	180	153
2	210	178
1	245	208
1/0	285	242
2/0	330	280
3/0	385	327
4/0	445	378

*De-rating for engine space is 0.85 for 221°F (105°C) rated wire.

Table F: Allowable Amperage of Conductors of 50 Volts or More

The current values shown in Table F and also on Table D do not consider voltage drop for conductors under 50 volts. The values shown on the ampacity table are the maximum safe amperages which the conductor can carry on a continuous basis. They do not apply to intermittent starting loads such as motor start currents. Since all Ancor™ Boat Cable is 105°C insulated, only that temperature rating is shown.

Due to the higher ambient temperatures in engine spaces and the heat retention of large wire bundles, a “correction factor” must be used to de rate the wire by increasing conductor size. Table F takes into consideration these factors and should be used to select conductor sizes for circuits over 50 volts. Note that for electrical systems under 50 volts, voltage drop is the controlling factor and the tables on 189 and 190 should be used.

Conductor Size AWG	2 Conductors 221°F (105°C) Engine Space		3 Conductors 221°F (105°C) Engine Space		4–6 Conductors 221°F (105°C) Engine Space		7–24 Conductors 221°F (105°C) Engine Space	
	Outside	Inside	Outside	Inside	Outside	Inside	Outside	Inside
18	20	17.0	14.0	11.9	12.0	10.2	10.0	8.5
16	25	21.3	17.5	14.9	15.0	12.8	12.5	10.6
14	35	29.8	24.5	20.8	21.0	17.9	17.5	14.9
12	45	38.3	31.5	26.8	27.0	23.0	22.5	19.1
10	60	51.0	42.0	35.7	36.0	30.6	30.0	25.5
8	80	68.0	56.0	47.6	48.0	40.8	40.0	34.0
6	120	102.0	84.0	71.4	72.0	61.2	60.0	51.0
4	160	136.0	112.0	95.2	96.0	81.6	80.0	68.0
3	180	153.0	126.0	107.1	108.0	91.8	90.0	76.5
2	210	178.5	147.0	125.0	126.0	107.1	105.0	89.3
1	245	208.3	171.5	145.8	147.0	125.0	122.5	104.1
1/0	285	242.3	199.5	169.6	171.0	145.4	142.5	121.1
2/0	330	280.5	231.0	196.4	198.0	168.3	165.0	140.3
3/0	385	327.3	269.5	229.1	231.0	196.4	192.5	163.6
4/0	445	378.3	311.5	264.8	267.0	227.0	222.5	189.1

Number of current carrying conductors:	Correction Factor
3	0.70
4 to 6	0.60
7 to 24	0.50
25 and above	0.40

Table F is supplied to eliminate the need for calculating the corrections for multi-conductor cable bundles to Table E. The values are already corrected.

Note: These tables only apply for 221°F (105°C) wire and other premium wire and should not be used for lesser grades of wire and cable.

Reprinted at the courtesy of the United States Coast Guard Electrical System Compliance Guideline.

* There is NO LIMIT on conductors in a bundle under 50 volts.



Wire & Cable

- Ancor Marine Grade™ wire is manufactured from tinned copper stranding for maximum protection against corrosion and electrolysis. Ultra flexible (Type 3) stranding resists fatigue due to vibration and flexing.
- Ancor's proprietary premium vinyl insulation stays flexible even in extreme cold (-40°C) and resists salt water, battery acid, oil, gasoline and ultra-violet radiation. Exclusive insulation is rated at 600 volts, 105°C dry and 75°C wet, and is resistant to heat and abrasion.
- Exceeds all UL 1426, US Coast Guard Charter boat (CFR Title 46) and ABYC standards.

18–10 Battery Cable

Color	Spool Length	Item #
18 AWG 0.8 mm²		
Black	35'	180003
	100'	100010
	500'	100050
Dk. Blue	100'	100110
Brown	100'	100210
Green	100'	100310
Grey	100'	100410
Orange	35'	180503
	100'	100510
Pink	100'	100610
Purple	35'	180703
	100'	100710
Red	35'	180803
	100'	100810
	500'	100850
White	35'	180903
	100'	100910
Yellow	100'	101010
16 AWG 1 mm²		
Lt. Blue	100'	101910
Black	100'	102010
	250'	102025
	500'	102050
	1000'	102099
Dk. Blue	25'	182103
	500'	102150
Brown	100'	102210
	500'	102250
Green	25'	182303
	100'	102310
	500'	102350
Grey	100'	102410
Orange	25'	182503
	100'	102510

Color	Spool Length	Item #	
Pink	100'	102610	
Purple	100'	102710	
Red	25'	182803	
	100'	102810	
	250'	102825	
	500'	102850	
	1000'	102899	
White	25'	182903	
	100'	102910	
	1000'	102999	
Yellow	25'	183003	
	100'	103010	
	1000'	103099	
14 AWG 2 mm²			
Lt. Blue	100'	103910	
Black	18'	184003	
	100'	104010	
	250'	104025	
	500'	104050	
	1000'	104099	
Dk. Blue	18'	184103	
	100'	104110	
	1000'	104199	
Brown	100'	104210	
	1000'	104299	
	Green	18'	184303
	100'	104310	
	500'	104350	
Grey	100'	104410	
Orange	18'	184503	
	100'	104510	
Pink	100'	104610	
Purple	18'	184703	
	100'	104710	

Color	Spool Length	Item #	
Red	18'	184803	
	100'	104810	
	250'	104825	
	500'	104850	
	1000'	104899	
White	18'	184903	
	100'	104910	
	500'	104950	
Yellow	18'	185003	
	100'	105010	
	1000'	105099	
12 AWG 3 mm²			
Black	12'	186003	
	100'	106010	
	250'	106025	
	400'	106040	
	1000'	106099	
Dk. Blue	100'	106110	
Brown	100'	106210	
Green	100'	106310	
	400'	106340	
Orange	100'	106510	
Pink	100'	106610	
Purple	100'	106710	
	Red	12'	186803
	100'	106810	
	250'	106825	
	400'	106840	
	1000'	106899	
White	100'	106910	
	400'	106940	
Yellow	100'	107010	

Color	Spool Length	Item #
10 AWG 5 mm²		
Black	8'	188003
	25'	108002
	100'	108010
	250'	108025
	500'	108050
Dk. Blue	100'	108110
	500'	108150
Brown	100'	108210
	500'	108250
Green	100'	108310
	250'	108325
	1000'	108399
Grey	250'	108425
Orange	100'	108510
Red	8'	188803
	25'	108802
	100'	108810
	250'	108825
	500'	108850
	1000'	108899
White	100'	108910
	1000'	108999
Yellow	100'	109010
Green w/Yellow	100'	109310
	1000'	109399

8–4/0 AWG Battery Cable **UL 1426 Tinned Boat Cable**

Color	Spool Length	Item #
8 AWG (8 mm²)		
Black	25'	111002
	100'	111010
	250'	111025
	500'	111050
	1000'	111099
Green	100'	111310
	250'	111325
	500'	111350
Red	25'	111502
	100'	111510
	250'	111525
	500'	111550
	1000'	111599
White	100'	111710
	1000'	111799
Yellow	100'	111910
	1000'	111999
6 AWG (13 mm²)		
Black	25'	112002
	50'	112005
	100'	112010
	250'	112025
	500'	112050
Green	750'	112075
	100'	112310
	750'	112375
Red	25'	112502
	50'	112505
	100'	112510
	250'	112525
	500'	112550
White	750'	112575
	100'	112710
	Yellow	100'
750'	112975	

Color	Spool Length	Item #
4 AWG (21 mm²)		
Black	25'	113002
	50'	113005
	100'	113010
	250'	113025
	500'	113050
Red	25'	113502
	50'	113505
	100'	113510
	250'	113525
	500'	113550
Yellow	100'	113910
	500'	113950
	2 AWG (34 mm²)	
Black	25'	114002
	50'	114005
Red	100'	114010
	250'	114025
	400'	114040
	25'	114502
	50'	114505
Yellow	100'	114510
	250'	114525
	400'	114540
Black	50'	114905
	100'	114910
	400'	114940
	1 AWG (42 mm²)	
Black	25'	115002
	50'	115005
	100'	115010
	300'	115030
Red	25'	115502
	50'	115505
	100'	115510
300'	115530	

Color	Spool Length	Item #
Yellow	25'	115902
	50'	115905
	100'	115910
	300'	115930
1/0 AWG (53 mm²)		
Black	25'	116002
	50'	116005
	100'	116010
	250'	116025
Red	25'	116502
	50'	116505
	100'	116510
	250'	116525
Yellow	25'	116902
	50'	116905
	100'	116910
	250'	116925
2/0 AWG (68 mm²)		
Black	25'	117002
	50'	117005
	100'	117010
	200'	117020
Red	25'	117502
	50'	117505
	100'	117510
Yellow	200'	117520
	25'	117902
	50'	117905
100'	117910	
200'	117920	

Color	Spool Length	Item #
3/0 AWG (85 mm²)		
Black	25'	118002
	50'	118005
	100'	118010
	150'	118015
Red	25'	118502
	50'	118505
	100'	118510
Yellow	150'	118515
	50'	118905
4/0 AWG (107 mm²)		
Black	25'	119002
	50'	119005
	100'	119010
Red	25'	119502
	50'	119505
	100'	119510
Yellow	25'	119902
	50'	119905
	100'	119910



Battery Cable Stripper

- Adjustable blade cutting height, comes with extra blades.
- Easily adjusts to various cable thickness. Swivel blade for stripping up wire as well as around.
- Good for stripping duplex and triplex.
- Comes with extra swivel blade.

Item # 702065

Marine Grade™ 18 – 4/0 AWG Wire and Cable Specifications

Wire Size	Nominal O.D.	Wt. per 1000'	Stranding No. of 30 AWG	Cir. Mil Area	mm ²	Ohms per 1000'
18 AWG .08 mm ²	7/64" 3 mm	12 lbs 5.4 kg	16	1600	.0823	6.48
16 AWG 1 mm ²	1/8" 3 mm	16 lbs 7.3 kg	26	2600	1.31	4
14 AWG 2 mm ²	9/64" 4 mm	23 lbs 10.4 kg	41	4100	2.08	2.53
12 AWG 3 mm ²	5/32" 4 mm	31 lbs 14 kg	65	6500	3.31	1.75
10 AWG 5 mm ²	7/32" 6 mm	44 lbs 20 kg	105	10,500	5.26	2.98
8 AWG 8 mm ²	5/16" 8 mm	86 lbs 39 kg	168	16,800	8.37	0.62
6 AWG 13 mm ²	11/32" 9 mm	118 lbs 53.5 kg	266	26,600	13.3	0.04
4 AWG 21 mm ²	13/32" 10 mm	178 lbs 81 kg	420	42,000	21.15	0.24
2 AWG 34 mm ²	15/32" 12 mm	277 lbs 126 kg	665	66,500	33.62	0.157
1 AWG 42 mm ²	17/32" 14 mm	350 lbs 159 kg	836	83,690	44.21	0.127
1/0 AWG 53 mm ²	9/16" 14 mm	437 lbs 198 kg	1064	105,600	53.49	0.099
2/0 AWG 68 mm ²	5/8" 16 mm	549 lbs 249 kg	1330	133,000	67.43	0.077
3/0 AWG 85 mm ²	11/16" 18 mm	675 lbs 306 kg	1665	167,800	85.01	0.062
4/0 AWG 107 mm ²	13/16" 21 mm	837 lbs 380 kg	2109	211,600	107.2	0.049

Safety Duplex Cable UL 1426 Tinned Boat Cable

Features red and yellow Marine Grade™ primary conductors in a white common jacket.

Spool Length	Item #
18/2 AWG (2x0.8 mm²)	
100'	124910
250'	124925
500'	124950
1000'	124999
16/2 AWG (2x1 mm²)	
100'	124710
250'	124725
500'	124750
1000'	124799
14/2 AWG (2x2 mm²)	
25'	124502
100'	124510
250'	124525
500'	124550
1000'	124599

Spool Length	Item #
12/2 AWG (2x3 mm²)	
100'	124310
250'	124325
500'	124350
10/2 AWG (2x5 mm²)	
25'	124102
100'	124110
250'	124125
400'	124140
800'	124180
8/2 AWG (2x8 mm²)	
50'	123905
100'	123910
6/2 AWG (2x13 mm²)	
50'	123705
100'	123710



Cable Size (AWG)	Nominal O.D.	Wt. per 1000'
18/2	3/16"x9/32" 5x7 mm	49 lbs 22.2 kg
16/2	3/16"x5/16" 5x8 mm	51 lbs 23.1 kg
14/2	7/32"x11/32" 6x9 mm	65 lbs 29.5 kg
12/2	7/32"x3/8" 6x10 mm	82 lbs 37.3 kg
10/2	1/4"x15/32" 6x12 mm	128 lbs 58.2 kg
8/2	11/32"x5/8" 9x16 mm	230 lbs 104.5 kg
6/2	13/32"x3/4" 10x19 mm	364 lbs 165.5 kg

Safety Duplex Cable

Spool Length	Item #
16/2 AWG (2x1 mm ²)	
100'	126710
250'	126725
500'	126750
1000'	126799
14/2 AWG (2x2 mm ²)	
100'	126510

Spool Length	Item #
250'	126525
500'	126550
1000'	126599
12/2 AWG (2x3 mm ²)	
100'	126310
250'	126325
500'	126350

Round Safety



Cable Size (AWG)	Nominal O.D.	Wt. per 1000'
16/2	5/16"	49 lbs
	8 mm	22.2 kg
14/2	11/32"	63 lbs
	9 mm	28.6 kg
12/2	13/32"	80 lbs
	10 mm	36.3 kg

Flat Duplex Cable

Spool Length	Item #
18/2 AWG (2x0.8 mm ²)	
100'	121910
250'	121925
500'	121950
16/2 AWG (2x1 mm ²)	
100'	121710
250'	121725
500'	121750
1000'	121799
14/2 AWG (2x2 mm ²)	
100'	121510
250'	121525
500'	121550
1000'	121599

Spool Length	Item #
12/2 AWG (2x3 mm ²)	
100'	121310
250'	121325
500'	121350
10/2 AWG (2x5 mm ²)	
100'	121110
250'	121125
400'	121140
800'	121180
8/2 AWG (2x8 mm ²)	
50'	120905
100'	120910
250'	120925
6/2 AWG (2x13 mm ²)	
50'	120705
100'	120710

Flat Cable



Cable Size (AWG)	Nominal O.D.	Wt. per 1000'
18/2	3/16"x9/32"	49 lbs
	5x7 mm	22.2 kg
16/2	3/16"x5/16"	51 lbs
	5x8 mm	23.1 kg
14/2	7/32"x11/32"	65 lbs
	6x9 mm	29.5 kg
12/2	7/32"x3/8"	82 lbs
	6x10 mm	37.3 kg
10/2	1/4"x15/32"	128 lbs
	6x12 mm	58.2 kg
8/2	11/32"x5/8"	230 lbs
	9x16 mm	104.5 kg
6/2	13/32"x3/4"	364 lbs
	10x19 mm	165.5 kg

Triplex Cable

Spool Length	Item #
16/3 AWG (3x1 mm ²)	
100'	131710
250'	131725
500'	131750
1000'	131799
14/3 AWG (3x2 mm ²)	
100'	131510
250'	131525
500'	131550
900'	131590
12/3 AWG (3x3 mm ²)	
25'	131302
100'	131310

Spool Length	Item #
250'	131325
700'	131370
10/3 AWG (3x5 mm ²)	
100'	131110
300'	131130
500'	131150
8/3 AWG (3x8 mm ²)	
25'	130902
50'	130905
100'	130910
6/3 AWG (3x13 mm ²)	
50'	130705
100'	130710

Flat Cable



Cable Size (AWG)	Nominal O.D.	Wt. per 1000'
16/3	3/16"x15/32"	75 lbs
	5x12 mm	34 kg
14/3	7/32"x1/2"	96 lbs
	6x13 mm	43.6 kg
12/3	7/32"x17/32"	125 lbs
	6x14 mm	56.8 kg
10/3	1/4"x21/32"	186 lbs
	6x17 mm	84.5 kg
8/3	3/8"x1"	287 lbs
	10x25 mm	130.4 kg
6/3	7/16"x1-3/16"	470 lbs
	11x30 mm	213.6 kg

Spool Length	Item #
16/3 AWG (3x1 mm ²)	
100'	133710
250'	133725
14/3 AWG (3x2 mm ²)	
100'	133510
250'	133525
900'	133590

Spool Length	Item #
12/3 AWG (3x3 mm ²)	
100'	133310
250'	133325

Round Cable



Cable Size (AWG)	Nominal O.D.	Wt. per 1000'
16/3	11/32"	75 lbs
	9 mm	34 kg
14/3	13/32"	96 lbs
	10 mm	43.6 kg
12/3	7/16"	125 lbs
	11 mm	56.8 kg

European Color Code AC Cable
Premium Tinned Copper, Class K Stranding



Spool Length	Item #
10/3 AWG (3x5 mm ²)	
500'	131151

Cable Size (AWG)	Nominal O.D.	Wt. per 1000'
10/3	1/4"x21/32"	186 lbs
	6x17 mm	84.5 kg

Flat Trailer Cable
Tinned Boat Cable



Conductor Colors	Spool Length	Item #
16/4 AWG (3x3 mm ²)		
Yellow, White, Green, Brown	100'	154010
	300'	154030

Cable Size (AWG)	Nominal O.D.	Wt. per 1000'
16/4	3/16"x9/16"	105 lbs
	4x14 mm	47.7 kg

Signal Cable
Tinned Boat Cable



Conductor Colors	Spool Length	Item #
20/2 AWG (2x0.5 mm ²)		
Black, Red	25'	189303
	100'	122010
	500'	122050

Cable Size (AWG)	Nominal O.D.	Wt. per 1000'
20/2	5/32"x1/4"	18 lbs
	4x6.4 mm	8.1 kg

Round Signal
100% Mylar Foil Shield and Drain Wire
Tinned Boat Cable



Conductor Colors	Spool Length	Item #
20/8 AWG (8x0.5 mm ²)		
Black, Red, Green, Blue, Brown, Orange, Purple, Yellow	100'	158010
	250'	158025

Cable Size (AWG)	Nominal O.D.	Wt. per 1000'
20/8	5/16"	63 lbs
	7.9 mm	28.6 kg

Twisted Pairs w/ Shield
Premium Tinned Copper

- For all metal boats and around sensitive electronics
- Ultra flexible stranding is tinned for corrosion resistance
- 93% Tinned copper shield for maximum EMI and RFI rejection
- 2-3" lay for interference cancellation



Spool Length	Item #
14/2 AWG (2x2 mm ²)	
100'	141410
250'	141425

Cable Size (AWG)	Nominal O.D.	Wt. per 1000'
14/2	.330"	73.2 lbs
	8.4 mm	33.3 kg

Round Instrument Cable
100% Mylar Foil Shield & Drain Wire
UL 1426 Tinned Boat Cable

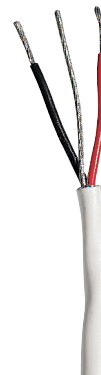

Conductor Colors	Spool Length	Item #
20/3 AWG (3x0.5 mm ²)		
Black, Red	100'	153010
	500'	153050

Cable Size (AWG)	Nominal O.D.	Wt. per 1000'
20/3	7/32"	30 lbs
	5.6 mm	13.6 kg

Flat Ribbon Bonded Cable

Premium Tinned Bonded Copper



Conductor Colors	Spool Length	Item #
16/2 AWG (3x3 mm²)		
Black, Red	100'	153110
	500'	153150

Cable Size (AWG)	Nominal O.D.	Wt. per 1000'
16/2	1/8"x1/4"	32 lbs
	3.2x6.4 mm	14.5 kg



Conductor Colors	Spool Length	Item #
16/4 AWG (4x1 mm²)		
Brown, Green, White, Yellow	100'	154510
	250'	154525

Cable Size (AWG)	Nominal O.D.	Wt. per 1000'
16/4	1/8"x1/2"	62 lbs
	3.2x12.7 mm	28 kg

Round Mast

UL 1426 Tinned Boat Cable

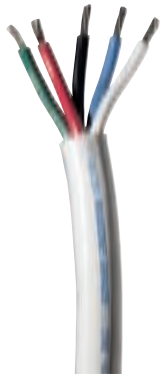

Conductor Colors	Spool Length	Item #
14/5 AWG (5x2 mm²)		
Black, Blue, Green, Brown, Red	100'	155010
	500'	155050

Cable Size (AWG)	Nominal O.D.	Wt. per 1000'
14/5	1/2"	160 lbs
	12.7 mm	79.5 kg

Bilge Pump Cable

Premium Tinned Copper

- Bilge Pump Cable grey insulation with black, brown and red conductors specifically for bilge pumps. Oil resistant.
- STOW - A - Water resistant jacket.



Spool Length	Item #
16/3 AWG (3x1 mm²)	
100'	156610
250'	156625
14/3 AWG (3x2 mm²)	
100'	156410
250'	156425
500'	156450

Cable Size (AWG)	Nominal O.D.	Wt. per 1000'
16/3	.348"	78 lbs
	8.85 mm	35.5 kg
14/3	.377"	99 lbs
	9.6 mm	45.0 kg

Super Flex Audio Cable

Premium Tinned Copper

- Super Flexible, easy to run. Clear jacket to blend into the environment.
- Drawn copper, unidirectional lay for ultimate in sound quality.
- Tinned copper for corrosion resistance in the marine environment.

Spool Length	Item #
18/2 AWG (2x0.8 mm²)	
100'	142810
16/2 AWG (2x1 mm²)	
100'	142610
250'	142625
500'	142650

Spool Length	Item #
14/2 AWG (2x2 mm²)	
100'	142410
250'	142425
250'	142425
1000'	142499



Cable Size (AWG)	Nominal O.D.	Wt. per 1000'
16/2	.319"	51 lbs
	8.1 mm	23.1 kg
14/2	.345"	65 lbs
	8.8 mm	29.5 kg

Coaxial Cable

Premium Tinned Copper

- Features signal loss ratios of up to 50% less than other coaxial cables.
- Tinned copper center conductor as well as tinned copper outer braid for corrosion resistance and easy soldering.
- 96% braid for best signal strength and least interference with UV inhibited white jacket for longest life.

Spool Length	Item #
RG 58CU	
100'	150510
250'	150525
RG 59U	
250'	151025
500'	151050

Spool Length	Item #
RG 213	
100'	151710
250'	151725
500'	151750
RG 8X	
100'	151510
250'	151525
500'	151550
1000'	151560



Ancor Recommends

- RG 58CU for interconnecting electronic equipment.
- RG 59U for TVs and some SAT NAVs.
- RG 8X for VHF runs less than 50 feet.

Shore Power Cord

- High visibility yellow jacket is oil and sunlight resistant.
- Ultra flexible insulation is abrasion resistant for "hard service" applications.
- 600 volt rated for extra heavy-duty service.
- 16/3 is 300 volt cable.

Cable Size	Conductor Colors	Spool Length	Item #
16/3 Phone	Black, White, Green	300	153530
10/3 STOW	Black, White, Green	250	153725
10/3 STW	Black, White, Green	250	SPC103
6/3 STOW	Black, White, Green	250	153925
		per/ft	100320
6/4 STW	Black, White, Green, Red	per/ft	100319



Cable Size (AWG)	Nominal O.D.	Wt. per 1000'
16/3 Phone	5/16"	75 lbs
	6 mm	34 kg
10/3 STOW	21/32"	284 lbs
	17 mm	129 kg
6/3 STOW	7/8"	540 lbs
	22 mm	254.4 kg
6/4 SEOW-A	29/32"	695 lbs
	23 mm	316 kg

Premium Battery Cable Assemblies UL-1426 Tinned Boat Cable

Ancor™ Marine Grade Standard Battery Cable Assemblies are manufactured with Ancor's premium UL1426 tinned copper battery cable. The battery cable is fine stranded to produce maximum conductivity and flexibility. In addition, all Ancor™ battery cable is flame retarded, UV inhibited, rated to 600V and 105°C. The lugs are tinned copper to avoid corrosion and last longer. Each end has a piece of Ancor's adhesive lined 3:1 heatshrink tubing placed over the electrical connection. The heatshrink tubing seals out moisture and other corrosive elements found in the marine environment, and provides strain relief to ensure a longer lasting battery connection.



Color	Length	Stud Size	Item #
4 AWG (21 mm²)			
Black	18" 45.7 cm	5/16" 7.93 mm	189130
	32" 81.2 cm	5/16" 7.93 mm	189134
	48" 121.9 cm	5/16" 7.93 mm	189136
Red	18" 45.7 cm	3/8" 9.5 mm	189131
	32" 81.2 cm	3/8" 9.5 mm	189135
	48" 121.9 cm	3/8" 9.5 mm	189137
2 AWG (34 mm²)			
Black	18" 45.7 cm	5/16" 7.93 mm	189140
	32" 81.2 cm	5/16" 7.93 mm	189144
	48" 121.9 cm	5/16" 7.93 mm	189146
Red	18" 45.7 cm	3/8" 9.5 mm	189141
	32" 81.2 cm	3/8" 9.5 mm	189145
	48" 121.9 cm	3/8" 9.5 mm	189147

For Continuous Current Draws up to:	Use Battery Cable Assemblies
136 amps	4 AWG
178 amps	2 AWG

Coaxial Cable Assemblies

Premium Tinned Copper

- All assemblies come with Ancor™ Adhesive Lined Heat Shrink to seal out moisture, provide strain relief and fight corrosion.
- 96% Tinned copper braid for optimum protection against signal loss.
- 100% Tinned Copper Center Conductor and Braid
- One end pre-assembled coaxial cable packages for RG58 and RG8X come with Ancor's twist-on UHF plugs for easy installation.
- No solder or special tools required.
- Special low loss SAT NAV extensions.

Ends Description	Wire Length	Item #
RG58CU		
Two ends assembled	3'	189800
RG8X		
One end assembled	50'	189849

Wire Type	RG58C/U	RG59U	RG8X	RG8U
Insulation Material	PVC*	PVC	PVC	PVC
Nominal O.D.	3/16" / 4.8 mm	1/4" / 6.4 mm	1/4" / 6.4 mm	13/32" / 10.3 mm
AWG	20	23	16	13
Conductor Stranding	19/33	Solid**	19/29	7/21
Braid Coverage	96%	96%	96%	96%
Wt. per 1000'	26 lbs / 11.8 kg	36 lbs / 16.3 kg	40 lbs / 18.1 kg	110 lbs / 50 kg
Impedance (Ohms)	50	75	50	52
Capacitance/Ft.	30.8 pF	20.5 pF	26.0 pF	29.5pF
Attenuation/100'				
@50MHz	3.3db	2.4db	2.5db	1.3db
@100MHz	4.9db	3.4db	3.7db	2.2db
@1000MHz	21.5db	12.0db	13.5db	8.9db
Velocity of Propagation	66%	66%	78%	66%



Marine Grade Terminals

- Ancor's Marine Grade™ terminals differ from automotive terminals by being designed for the harsh marine environment.
- Nylon insulators are easy to crimp and will not split.
- Barrels are designed to tightly grip the wire with the least effort.
- Tinned copper gives the least electrical resistance but the most corrosion protection.

Ring Terminals

Nylon Insulated with Insulation Grip
Double Crimp, Funnel Entry • UL 486C

Screw Size	Qty/Pkg	Item #
22-18 AWG 0.3-0.8 mm²		
6"	3.6 mm	6 230201
22 AWG 4 mm²		
8"	4 mm	6 230202
		25 210202
		100 220202
10"	4.8 mm	6 230203
		25 210203
		100 220203
1/4"	6.4 mm	25 210204
5/16"	7.9 mm	5 230205
3/8"	9.5 mm	5 230206
16-14 AWG 1-2 mm²		
6"	3.6 mm	6 230211
		25 210211
8"	4 mm	6 230212
		25 210212
		100 220212
10"	4.8 mm	6 230213
		25 210213
		100 220213
1/4"	6.4 mm	5 230214
		25 210214
		100 220214
5/16"	7.9 mm	5 230215
		25 210215
		100 220215
3/8"	9.5 mm	5 230216
		25 210216
		100 220216

Screw Size	Qty/Pkg	Item #
12-10 AWG 3-5 mm²		
6"	3.6 mm	5 230221
8"	4 mm	5 230222
		25 210222
		100 220222
10"	4.8 mm	5 230223
		25 210223
		100 220223
1/4"	6.4 mm	4 230224
		25 210224
		100 220224
5/16"	7.9 mm	4 230225
		25 210225
		100 220225
3/8"	9.5 mm	4 230226
		25 210226
		100 220226
1/2"	12.7 mm	3 230227
		25 210227
8 AWG 8 mm²		
10"	4.8 mm	2 230233
		25 210233
1/4"	6.4 mm	2 230234
		25 210234
		25 210234
5/16"	7.9 mm	2 230235
		25 210235
3/8"	9.5 mm	2 230236
		25 210236
1/2"	12.7 mm	1 230237

Screw Size	Qty/Pkg	Item #
6 AWG 13 mm²		
10"	4.8 mm	1 230243
1/4"	6.4 mm	1 230244
5/16"	7.9 mm	1 230245
3/8"	9.5 mm	1 230246
4 AWG 21 mm²		
1/4"	6.4 mm	1 230254
5/16"	7.9 mm	1 230255
1/2"	12.7 mm	1 230257



Flanged Spades

Nylon Insulated with Insulation Grip
Double Crimp, Funnel Entry
UL 486A



Screw Size	Qty/ Pkg	Item #
22-18 AWG 0.3-0.8 mm²		
6" 3.6 mm	6	230301
8" 4 mm	6	230302
	25	210302
10" 4.8 mm	6	230303
16-14 AWG 1-2 mm²		
6" 3.6 mm	6	230311
8" 4 mm	6	230312
	25	210312
	100	220312
10" 4.8 mm	6	230313
	25	210313
	100	220313
12-10 AWG 3-5 mm²		
8" 4 mm	5	230322
	25	210322
	100	220322
10" 4.8 mm	5	230323
	25	210323
	100	220323

Disconnects

.250 /6.4 mm Tab Size
UL 310
Nylon Insulated with Insulation Grip
Double Crimp, Funnel Entry



Gender	Qty/ Pkg	Item #
16-14 AWG 1-2 mm²		
Female	5	230818
	25	210818
	100	220818
Male	5	230819
	25	210819
	100	220819
12-10 AWG 1-2 mm²		
Female	4	230828
	25	210828
	100	220828
Male	4	230829
	25	210829

Fully Insulated Disconnects

.250 /6.4 mm Tab Size
Nylon Insulated with Insulation Grip
Double Crimp, Funnel Entry
UL 310



Gender	Qty/ Pkg	Item #
22-18 AWG 0.3-0.8 mm²		
Female	4	231408
	25	211408
	100	221408
Male	4	231409
	25	211409
	100	221409
16-14 AWG 1-2 mm²		
Female	4	231418
	25	211418
	100	221418
Male	4	231419
	25	211419
	100	221419
12-10 AWG 3-5 mm²		
Female	3	231428
	25	211428
	100	221428
Male	3	231429
	25	211429
	100	221429

Pin Terminal Blocks

Meets ABYC standards: has a stainless steel wire protector to prevent damage from screw.
Recessed terminal body and zinc plated, yellow chromated screws prevent accidental short circuits.
UL and CSA listed
Molding is polyimide and self extinguishing to UL94.



Amps	Volts	Gang	HxWxL	Qty/Pkg	Item #
26	380	4	0.65"x0.83"x1.50" 16.5x21x38 mm	1	553091
		8	0.65"x0.83"x3.07" 16.5x21x78 mm	1	553093
		12	0.65"x0.83"x3.70" 16.5x21x94 mm	1	553095

Butt Connectors - Single Crimp

Nylon Insulated Seamless
UL 486C



Qty/Pkg	Item #
22-18 AWG 0.3-0.8 mm²	
7	230100
25	210100
100	220100
16-14 AWG 1-2 mm²	
7	230110
25	210110
100	220110
500	222110
12-10 AWG 3-5 mm²	
5	230120
25	210120
100	220120

Butt Connectors - Double Crimp

Nylon Insulated with Insulation Grip
Funnel Entry
UL 486C

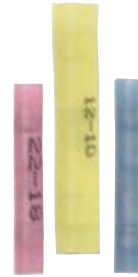

Qty/Pkg	Item #
22-18 AWG 0.3-0.8 mm²	
25	210161
100	220161
16-14 AWG 1-2 mm²	
25	210162
100	220162
500	222162
12-10 AWG 3-5 mm²	
25	210163
100	220163

Snap Plugs

Nylon Insulated with Insulation Grip
UL 310
Double Crimp, Funnel Entry



Gender	Qty/Pkg	Item #
22-18 AWG 0.3-0.8 mm²		
Male	4	230708
Female	4	230709
16-14 AWG 1-2 mm²		
Male	4	230718
	25	210718
Female	4	230719
	25	210719
	100	220719

Specialty Connectors



3-Way Connector

Nylon Insulated with Insulation Grip
Double Crimp, Funnel Entry
UL 310



Multi-stack Connector

Nylon Insulated with Insulation Grip
Double Crimp, Funnel Entry
.250 tab 6.4 mm
UL 310

Butt Connectors

Vinyl Insulated
UL 486C



Qty/Pkg	Item #
8 AWG 8 mm²	
2	230130
25	210130
6 AWG 13 mm²	
1	230140
25	210140
4 AWG 21 mm²	
1	230150



Double Male-Female Adapter

.250 tab 6.4 mm

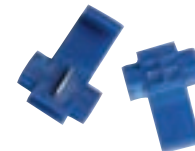

Splice Connectors

Step-Down Butt Connectors

Vinyl Insulated
UL 486C



Qty/Pkg	Item #
16-14 to 22-18 AWG 1-2 mm² to 0.3-0.8 mm²	
3	230164
25	210164
12-10 to 16-14 AWG 3-5 mm² to 1-2 mm²	
3	230165
25	210165

Wire Range	Qty/Pkg	Item #
3-Way Connector		
16-14 1-2 mm ²	1	230510
12-10 3-5 mm ²	1	230520
Multi-Stack Connector		
16-14 1-2 mm ²	3	230612
	25	210612
	100	220612
Double Male-Female Adapter		
	25	210613
Splice Connectors		
18-14 0.8-2 mm ²	4	230615
	100	220615

Adhesive Lined Heat Shrink Connectors

- Ancor heat shrink connectors offer heat activated adhesive built into the sleeve of the heat shrink tubing
- Shrinks to form a water tight seal and the ultimate vibration and strain relief.
- Tinned for corrosion resistance.
- Pure copper for maximum current flow. Brazed seam for maximum strength.
- UL Listed and CSA Recognized

Adhesive Lined Heat Shrink Ring Terminals

UL 486C

Screw Size		Qty/ Pkg	Item #	Screw Size		Qty/ Pkg	Item #
22–18 AWG 0.3–0.8 mm²				12–10 AWG 3–5 mm²			
8	4 mm	3	310203	8	4 mm	3	312203
		25	310225			25	312225
		100	310299			100	312299
10	4.8 mm	3	310303	10	4.8 mm	3	312303
		25	310325			25	312325
		100	310399			100	312399
16–14 AWG 1–2 mm²				1/4	6.4 mm	3	312403
8	4 mm	3	311203			25	312425
		25	311225			100	312499
		100	311299	5/16	7.9 mm	3	312503
10	4.8 mm	3	311303	25	312525		
		25	311325	100	312599		
		100	311399	3/8	9.5 mm	3	312603
1/4	6.4 mm	3	311403	25	312625		
		25	311425	100	312699		
		100	311499				
5/16	7.9 mm	3	311503				
		25	311525				
		100	311599				



Adhesive Lined Heat Shrink Flanged Spade Terminals

UL 486A

Screw Size		Qty/ Pkg	Item #
16–14 AWG 1–2 mm²			
8	4 mm	25	314225
		100	314299
10	4.8 mm	25	314325
		100	314399
12–10 AWG 3–5 mm²			
8	4 mm	25	315225
		100	315299
10	4.8 mm	25	315325



Adhesive Lined Heat Shrink Disconnects

UL 310

Gender	Tab		Qty/ Pkg	Item #
22-18 AWG 0.3-0.8 mm ²				
Female	.250	6.4 mm	3	316803
			25	316825
			100	316899
Male	.250	6.4 mm	25	316925
16-14 AWG 3-5 mm ²				
Female	.250	6.4 mm	3	317803
			25	317825
			100	317899
Male	.250	6.4 mm	3	317903
			25	317925
			100	317999



Adhesive Lined Heat Shrink Butt Connectors

UL 486C

Qty/Pkg	Item #
22-18 AWG 0.3-0.8 mm ²	
3	309003
25	309025
100	309099
500	309002
16-14 AWG 1-2 mm ²	
3	309103
25	309125
100	309199
500	309102
12-10 AWG 3-5 mm ²	
3	309203
25	309225
100	309202
500	309202

Length	Pkg/Qty	Item #
2-10	10	300000



Adhesive Lined Heat Shrink Snap Plugs

UL 310

Gender	Tab		Qty/ Pkg	Item #
22-18 AWG 0.3-0.8 mm ²				
Female	.157	4 mm	25	318825
Male	.157	4 mm	25	318925
16-14 AWG 3-5 mm ²				
Female	.197	5 mm	25	319825
			100	319899
Male	.197	5 mm	25	319925
			100	319999



Splash Proof Snap Plugs w/ Inserts

UL 310

Gender	Qty/ Pkg	Item #
22-18 AWG 0.3-0.8 mm ²		
Male/Female	25	211480
16-14 AWG 1-2 mm ²		
Male/Female	25	211490





DrySeal™ Connectors

- Truly submersible, rated operable from -40°F to 221°F, under conditions of salt water spray and severe vibration.
- Sealing integrity is maintained even with exposure to gasoline, diesel fuel, anti-freeze, ozone and ultraviolet light to 3 feet.
- Seals intact under harsh conditions. Resistant to chemical exposure. One-piece, molded body.

Cable Size	Description	Conductor Colors	Qty/Pkg	Item #	
14/2	2x2 mm ²	Two Conductor	Red, Yellow	1	249003

Flanged Plug with Mounting Plate

- 14 AWG Rated to 400V AC, 15 amps.
- 6 AWG Rated to 400V AC, 85 amps.
- Temp. rated -40° to 221°F (-40° to 105°C).

Cable Size	Description	Conductor Colors	Qty/Pkg	Item #	
14/2	2x2 mm ²	Two Conductor	Red, Yellow	1	249007

ABYC Recommends:

“Current-carrying conductors shall be routed as high as practicable above the bilge water level and other areas where water may accumulate. If conductors must be routed in the bilge or other areas where water may accumulate, the connections shall be watertight.” 11.16.4.1.6. “Current-carrying conductors shall be routed as high as practicable above the bilge water level and other areas where water may accumulate. If conductors must be routed in the bilge or other areas where water may accumulate, the connections shall be watertight.” 11.16.4.1.6.

Coax Cable Fittings

Description	Hex	Wire Size	Qty/Pkg	Item #
BNC Connectors				
Crimp-On Male Plug	.320/.250	RG59	1	203100
UHF Connectors				
Crimp-On UHF Male Plug (PL259)		RG58	1	202175
		RG8X	1	202176
Solder On UHF Male Plug (PL259)		RG8U	1	200259
Double Female (PL258)			1	200258
Deck Bulkhead Feed (PL258)			1	200250
Cap for Deck Bulkhead Feed (2.5" long)			1	200252



Installation Instructions for Twist-On Connectors

To install Ancor™ twist-on connectors, strip the cable to expose 9/16" of the center conductor. Strip the outer jacket to expose 1/4" of the braid. Make sure that the braided shield does not touch the inner conductor.

Insert the cable into the connector until the center conductor protrudes through the center of the connector.

Twist the small knurled end while gently pushing the connector onto the cable until resistance is felt. Crimp or solder the center conductor.

Cut off any excess. It is strongly recommended that a piece of Ancor™ 3/4" heat shrink be installed on all exterior UHF connectors to waterproof and relieve strain.

Heavy-duty Lugs

- Ancor Marine Grade™ lugs are manufactured from heavy-duty annealed tinned copper, providing for maximum current flow.
- 100% tin plated copper resists corrosion from salt and moisture.
- Seamless barrel design allows for maximum strength when crimped.
- Closed end design seals out moisture so cables stay dry and corrosion free.
- 100% Tinned Copper
- UL 486A



Screw Size	Qty/Pkg	Item #
8 AWG 8 mm²		
10" 4.8 mm	2	252233
	25	242233
	100	244233
1/4" 6.4 mm	2	252234
	25	242234
	100	244234
5/16" 7.9 mm	2	252235
	25	242235
	100	244235
3/8" 9.5 mm	2	252236
	25	242236
	100	244236
1/2" 12.7 mm	2	252237
	10	242237
6 AWG 13 mm²		
10" 4.8 mm	2	252243
	25	242243
1/4" 6.4 mm	2	252244
	25	242244
5/16" 7.9 mm	2	252245
	25	242245
	100	244245
3/8" 9.5 mm	2	252246
	25	242246
	100	244246
5/16" 7.9 & 9.5 & 3/8" mm	1/1	252241
4 AWG 21 mm²		
10" 4.8 mm	2	252253
	25	242253
1/4" 6.4 mm	2	252254
	25	242254
	100	244254
5/16" 7.9 mm	2	252255
	25	242255
	100	244255
3/8" 9.5 mm	2	252256
	25	242256
	100	244256
1/2" 12.7 mm	2	252257
	10	242257
5/16" 7.9 & 9.5 & 3/8" mm	1/1	252251

Screw Size	Qty/Pkg	Item #
2 AWG 34 mm²		
1/4" 6.4 mm	2	252264
	25	242264
5/16" 7.9 mm	2	252265
	25	242265
	100	244265
3/8" 9.5 mm	2	252266
	25	242266
	100	244266
1/2" 12.7 mm	2	252267
5/16" 7.9 & 9.5 & 3/8" mm	1/1	252261
1 AWG 42 mm²		
1/4" 6.4 mm	2	252274
5/16" 7.9 mm	2	252275
	25	242275
3/8" 9.5 mm	2	252276
	25	242276
1/2" 12.7 mm	2	252277
1/0 AWG 53 mm²		
1/4" 6.4 mm	2	252284
	25	242284
5/16" 7.9 mm	2	252285
	25	242285
	100	244285
3/8" 9.5 mm	2	252286
	25	242286
	100	244286
1/2" 12.7 mm	2	252287
2/0 AWG 68 mm²		
1/4" 6.4 mm	25	242294
5/16" 7.9 mm	2	252295
	25	242295
	100	244295
3/8" 9.5 mm	2	252296
	25	242296
	100	244296
1/2" 12.7 mm	2	252297
	10	242297

Screw Size	Qty/Pkg	Item #
3/0 AWG 85 mm²		
5/16" 7.9 mm	10	242715
3/8" 9.5 mm	2	252716
	10	242716
1/2" 12.7 mm	2	252717
4/0 AWG 107 mm²		
5/16" 7.9 mm	2	252725
	10	242725
	100	244725
3/8" 9.5 mm	2	252726
	10	242726
	100	244726
1/2" 12.7 mm	2	252727
	10	242727



Heavy-duty Butt Connectors

100% Tinned Copper • UL 486A

Qty/Pkg	Item #
8 AWG 8 mm²	
2	252130
6 AWG 13 mm²	
2	252140
4 AWG 21 mm²	
2	252150
2 AWG 34 mm²	
2	252160
1 AWG 42 mm²	
2	252170
1/0 AWG 53 mm²	
2	252180
2/0 AWG 68 mm²	
2	252190

Lead Battery Terminals

Description	Positive / Negative	Stud Size		Qty/ Pkg	Item #
Wing Nut Style	Negative	5/16"	8 mm	1	260100
Yellow Brass Nut	Positive	3/8"	10 mm	1	260200
	Pos/Neg	5/16" & 3/8"	8 & 10 mm	1/1	260325



Tinned Copper Battery Terminals

Description	Positive / Negative	Stud Size		Qty/ Pkg	Item #
Wing Nut Style	Negative	5/16"	8 mm	1	260010
Yellow Brass Nut					
Tin Plated Terminal	Positive	3/8"	10 mm	1	260012
	Pos/Neg	5/16" & 3/8"	8 & 10 mm	1/1	260322













Battery Terminal Boots

Description	Size	Color	Qty/ Pkg	Item #
Wing Nut Style	4 & 2	19 & 32 mm ²	Black/Red	1/1 260350
Right Angle	8-2	8-32 mm ²	Red	1 260381



Battery Terminals and Covers

	Description	Terminal Item #		Cover Item #	Cover Color
	with nut M8 plus	68060100		68456902	red
	with nut M8 min	68060200		68456914	black
	plus flat	68060300		68454002	red
	min flat	68060400		68453014	black
	double plus flat	68060500		68451902	red
	double min flat	68060600		68451914	black
	with bolt M10 plus	68060700		68457302	red
	with bolt M10 min	68060800		68457314	black
	with bolt M12 plus	68060900		68457302	red
	with bolt M12 min	68061000		68457314	black

Battery Clips

Color	Size	Qty/Pkg	Item #
Red/Black	10A	1/1	260505



Adhesive Lined Heat Shrink Tubing (ALT)

- Cross Linked polyolefin tubing is much stronger than PVC tubing and will not burn like PVC.
- Heat activated adhesive lining provides impervious seal to salt water, oil, acids, and sunlight as well as providing strain relief.
- Highest shrink ratio - shrinks to 1/3 original size.
- Shrinks at 257°F / 125°C.
- Operating temperature range of -40°C to 110°C.
- UL 224



Color	Length	Qty/ Pkg	Item #
1/8" ALT Dia 3.2 mm			
Black	3"	7.6 cm	3 301103
	6"	15.2 cm	10 301106
	12"	30.5 cm	10 301124
	48"	122 cm	1 301148
3/16" ALT Dia 4.8 mm			
Black	3"	7.6 cm	3 302103
	6"	15.2 cm	10 302106
	12"	30.5 cm	10 302124
	48"	122 cm	1 302148
1/4" ALT Dia 6.4 mm			
Black	3"	7.6 cm	3 303103
	6"	15.2 cm	10 303106
	12"	30.5 cm	10 303124
	48"	122 cm	1 303148
Clear	3"	7.6 cm	1 303303
Black/Red	3"	7.6 cm	1/1 303602
Red	48"	122 cm	1 303648
Yellow	48"	122 cm	1 303948
3/8" ALT Dia 9.5 mm			
Black	3"	7.6 cm	3 304103
	6"	15.2 cm	5 304106
	12"	30.5 cm	5 304124
	48"	122 cm	1 304148
Clear	3"	7.6 cm	1 304303
Blue	3"	7.6 cm	3 304403
	12"	30.5 cm	5 304424
Black/Red	3"	7.6 cm	1/1 304602
Red	3"	7.6 cm	3 304603
	6"	15.2 cm	5 304606
	12"	30.5 cm	5 304624
	48"	122 cm	1 304648
1/2" ALT Dia 12.7 mm			
Black	3"	7.6 cm	3 305103
	6"	15.2 cm	5 305106
	12"	30.5 cm	5 305124
	48"	122 cm	1 305148
Red	3"	7.6 cm	3 305603
	12"	30.5 cm	5 305624
	48"	122 cm	1 305648

Color	Length	Qty/ Pkg	Item #
3/4" ALT Dia 19 mm			
Black	3"	7.6 cm	3 306103
	6"	15.2 cm	4 306106
	12"	30.5 cm	4 306124
	48"	122 cm	1 306148
Black/Red	3"	7.6 cm	1/1 306602
Red	3"	7.6 cm	3 306603
	6"	15.2 cm	4 306606
	12"	30.5 cm	4 306624
	48"	122 cm	1 306648
Yellow	48"	122 cm	1 306948
1" ALT Dia 25.4 mm			
Black	3"	7.6 cm	3 307103
	12"	30.5 cm	3 307124
	48"	122 cm	1 307148
	48"	122 cm	1 307648
Yellow	48"	122 cm	1 307948

Kits

Color	Length	Qty/ Pkg	Item #
3/16"-3/4" ALT Dia 4.8-19 mm			
Black	3"	7.6 cm	8 301503
	6"	15.2 cm	8 301506
3/8" ALT Dia 9.5 mm			
Assorted	3"	30.5 cm	5 304503
	6"	122 cm	5 304506
3/4" ALT Dia 19 mm			
Assorted	3"	7.6 cm	4 306503
	6"		4 306506
	12"		4 306524

Adhesive Lined Tubing Specifications (3:1 ratio)

Size	Shrinks to	Wire Range (AWG)
1/8" 3.2 mm	1/32" 0.8 mm	<18 < 0.8 mm ²
3/16" 4.8 mm	1/16" 1.6 mm	20-12 0.5-3 mm ²
1/4" 6.4 mm	5/64" 2 mm	16-10 1-5 mm ²
3/8" 9.5 mm	1/8" 3.2 mm	12-8 3-8 mm ²
1/2" 12.7 mm	5/32" 4 mm	8-4 8-19 mm ²
3/4" 19 mm	1/4" 6.4 mm	8-2/0 13-62 mm ²
1" 25.4 mm	5/16" 7.9 mm	2-4/0 32-103 mm ²

Adhesive Lined Heavy Wall Battery Cable Tubing (BCT)

3:1 ratio
UL 224



BCT Dia.	BCT Color	Length	Qty/ Pkg	Item #		
3/4"	Black	3"	7.6 cm	3	326103	
		12"	30.5 cm	3	326124	
		48"	122 cm	1	326148	
	Black/Red	3"	7.6 cm	1/1	326202	
	Red	3"	7.6 cm	3	326603	
		12"	30.5 cm	3	326624	
48"		122 cm	1	326648		
1"	Black	12"	30.5 cm	2	327124	
		Black/Red	3"	7.6 cm	1/1	327202
		Red	6"	15.2 cm	2	327606
	12"		30.5 cm	2	327624	

Size	Shrinks to	Wire Range (AWG)
3/4"	1/4" 6 mm	8-2/0 8-62 mm ²
1"	3/8" 9 mm	2-4/0 32-103 mm ²
1-1/2"	1/2" 12 mm	4/0-500 MCM 103-253 mm ²

Micro Therm Heat Gun

- Features Piezo electronic ignition system, providing flame less heat, safe to use around chemicals or by wire bundles when using deflector.
- Powered by refillable cell.
- Flame temperature up to 1300°F (650°C).
- Ideal for work in the bilge where open flame should not be used.

Item # **702027**



Mini Pocket Butane Torch

- Electronic ignition system with safety locking switch.
- Flame temperature up to 2500°F (1300°C)
- Compact size allows unit to fit easily into any toolbox.
- Refillable butane cartridge included.
- Butane Not Included.

Item # **702024**



Cable Ties

Marinco® offers a wide variety of materials, styles, and sizing options. A patented, DoubleLock™ design offers increased tensile strength that is 33% stronger than the industry standard cable tie.

With a unique design and high-quality construction, Marinco® cable ties provide a great solution for bundling wire, cable, hoses, cords and countless other applications.





Standard Cable Ties

Length	Color	Unit Qty	Item #			Bundle Dia Max	Tensile Strength
4"	natural	25	199200	no	yes	13/16"	18 lbs
	natural	100	199201	no	yes	13/16"	18 lbs
	UVB*	25	199202	no	yes	13/16"	18 lbs
	UVB*	100	199203	no	yes	13/16"	18 lbs
6"	natural	25	199246	yes	yes	1-3/8"	45 lbs
	natural	100	199247	yes	yes	1-3/8"	45 lbs
	UVB*	25	199248	yes	yes	1-3/8"	45 lbs
	UVB*	100	199249	yes	yes	1-3/8"	45 lbs
8"	natural	25	199204	yes	yes	2"	75 lbs
	natural	100	199205	yes	yes	2"	75 lbs
	UVB*	25	199206	yes	yes	2"	75 lbs
	UVB*	100	199207	yes	yes	2"	75 lbs
	UVB*	1000	199254	yes	yes	2"	75 lbs
11"	natural	25	199208	yes	yes	3"	75 lbs
	natural	100	199209	yes	yes	3"	75 lbs
	UVB*	25	199210	yes	yes	3"	75 lbs
	UVB*	100	199211	yes	yes	3"	75 lbs
14"	natural	25	199212	yes	yes	4"	75 lbs
	natural	100	199213	yes	yes	4"	75 lbs
	UVB*	25	199214	yes	yes	4"	75 lbs
	UVB*	100	199215	yes	yes	4"	75 lbs
	UVB*	1000	199256	yes	yes	4"	75 lbs

* UV Resistant





Heavy-duty Cable Ties

Length	Color	Unit Qty	Item #			Bundle Dia Max	Tensile Strength
15"	UVB*	25	199259	yes	yes	4"	120 lbs
	UVB*	100	199260	yes	yes	4"	120 lbs
17"	natural	10	199216	no	yes	4-9/10"	175 lbs
	UVB*	10	199217	no	yes	4-9/10"	175 lbs
24"	natural	10	199218	no	yes	7"	175 lbs
	UVB*	10	199219	no	yes	7"	175 lbs
36"	natural	10	199220	no	yes	10-3/10"	175 lbs
	UVB*	10	199221	no	yes	10-3/10"	175 lbs
48"	natural	10	199222	no	yes	14-3/10"	175 lbs
	UVB*	10	199223	no	yes	14-3/10"	175 lbs

* UV Resistant





Releasable Cable Ties

Length	Color	Unit Qty	Item #			Bundle Dia Max	Tensile Strength
8"	natural	25	199240	no	yes	1-3/4"	50 lbs
	UVB*	25	199241	no	yes	1-3/4"	50 lbs
16"	UVB*	4	199242	no	yes	4"	175 lbs
28"	UVB*	3	199243	no	yes	8"	175 lbs

* UV Resistant





Mounting Cable Ties

Length	Color	Unit Qty	Item #			Bundle Dia Max	Tensile Strength
4"	natural	25	199244	no	yes	3/4"	18 lbs
	UVB*	25	199245	no	yes	3/4"	18 lbs
6"	natural	25	199250	no	yes	1-3/8"	30 lbs
	natural	100	199251	no	yes	1-3/8"	30 lbs
	UVB*	25	199252	no	yes	1-3/8"	30 lbs
	UVB*	100	199253	no	yes	1-3/8"	30 lbs
8"	natural	25	199226	no	yes	2"	50 lbs
	natural	100	199227	no	yes	2"	50 lbs
	UVB*	25	199228	no	yes	2"	50 lbs
	UVB*	100	199229	no	yes	2"	50 lbs
14"	natural	25	199230	no	yes	4"	50 lbs
	UVB*	25	199257	no	yes	4"	50 lbs
	UVB*	100	199258	no	yes	4"	50 lbs

* UV Resistant





Specialty Cable Ties

Length	Description	Unit Qty	Item #			Bundle Dia Max	Tensile Strength
8"	natural I.D. tie	25	199237	no	yes	2"	50 lbs
11"	stainless steel*	10	199238	no	yes	3-3/4"	100 lbs
	black grip strip	5	199239	no	no	n/a	n/a
	blue grip strip	5	199255	no	no	n/a	n/a

* UV Resistant

Cable Tie Kits

Length	Description	Unit Qty	Item #			Bundle Dia Max	Tensile Strength
8"	assorted colors	24	199224	yes	yes	2"	75 lbs
4", 6", 8"	assorted colors	500	199225	yes	yes	13/16", 1-1/2", 2"	18, 45, 75 lbs
4", 8"	natural/UVB*	25	199261	yes	yes	13/16", 2"	18, 75 lbs

* UV Resistant

Mounting Bases



Description	Unit Qty	Item #
#8 screw, natural	25	199231
	100	199232
#10 screw, natural	25	199262
	100	199263
natural	5	199233
	25	199234
UVB*	5	199235
	25	199236

* UV Resistant

Stainless Steel Cushion Clamps

- Prevents corrosion
- Resistant to oils, acids, salt water
- Temperatures range from -50° to 300°F
- Absorbs shock and vibration
- Reduces unwanted noise



Nominal Diameter		Qty/ Pkg	Item #
3/16"	5 mm	10	403182
1/4"	6 mm	10	403252
5/16"	8 mm	10	403312
3/8"	10 mm	10	403372
7/16"	11 mm	10	403432
1/2"	13 mm	10	403502
9/16"	14 mm	10	403562
5/8"	16 mm	10	403622
3/4"	19 mm	10	403752

Nominal Diameter		Qty/ Pkg	Item #
7/8"	22 mm	10	403872
1"	25 mm	10	403892
1-1/4"	32 mm	10	403902
1-1/2"	38 mm	10	404152
1-3/4"	44 mm	10	404172
2"	51 mm	10	404202
2-1/2"	64 mm	10	404252
3"	76 mm	10	404302

Nylon Cable Clamps

- Made from nylon for maximum strength
- Resistant to solvents, oils, acids and moisture.
- Unique screw hole alignment feature to speed installation.
- Absorbs shock and vibration; reduces unwanted noise



Nominal Diameter		Color	Qty/ Pkg	Item #
1/8"	3 mm	Natural	25	401122
			25	401182
3/16"	5 mm	Natural	25	401182
			6	401251
1/4"	6 mm	Natural	25	401252
			100	401255
			25	402252
			25	402312
5/16"	7 mm	Natural	25	401312
			25	402312
3/8"	9 mm	Natural	25	401372
			100	401375
			25	402372
			25	401432
7/16"	11 mm	Natural	25	401432
			25	401502
1/2"	12 mm	Natural	25	401502
			25	402502
5/8"	15 mm	Natural	25	401622
			25	402622
3/4"	19 mm	Natural	25	401752
			25	402752
1"	25 mm	Natural	25	401892
			25	402892
1-1/4"	32 mm	Natural	25	401912
1-1/2"	38 mm	Natural	25	401932

Kit

Description	Qty/ Pkg	Item #
1/8"-1/2" (3-12 mm) Natural	54	400000

Nominal Diameter	Thickness	Screw Width	Size
3/16"	5 mm	0.04	3/8" 10 mm #8 4 mm
1/4"	6 mm	0.04	3/8" 10 mm #8 4 mm
5/16"	8 mm	0.04	3/8" 10 mm #8 4 mm
3/8"	10 mm	0.04	3/8" 10 mm #8 4 mm
7/16"	11 mm	0.06	1/2" 13 mm #10 5 mm
1/2"	13 mm	0.06	1/2" 13 mm #10 5 mm
5/8"	16 mm	0.06	1/2" 13 mm #10 5 mm
3/4"	19 mm	0.06	1/2" 13 mm #10 5 mm
1"	25 mm	0.06	1/2" 13 mm #10 5 mm
1-1/4"	32 mm	0.06	1/2" 13 mm #10 5 mm
1-1/2"	38 mm	0.06	1/2" 13 mm #10 5 mm
1-3/4"	44 mm	0.06	1/2" 13 mm #10 5 mm
2"	51 mm	0.06	1/2" 13 mm #10 5 mm
2-1/2"	64 mm	0.06	1/2" 13 mm #10 5 mm
3"	76 mm	0.06	1/2" 13 mm #10 5 mm

#8 = 0.167 / #10 = 0.203

NEW Cable Wraptor®

Simple Design. Endless Solutions.

- "T" handle feature allows for easy carrying ropes, cordsets and extension cords.
- Large hang hole is perfect to store and hang.
- Stainless steel hinge and spring to prevent rusting.
- Large teeth design for secure locking system.
- Easy release trigger.
- Cable tie looping hole for permanent attachment.
- Spring-loaded hinge helps close tail.



Description	Qty/ Pkg	Item #
Register Pack		
Cable Wraptor® Small	50	CW-T1RR50
Cable Wraptor® Medium	25	CW-T2RR25
Cable Wraptor® Large	25	CW-T3RR25
Cable Wraptor® X-Large	20	CW-T4RR20
2 Pack Carded		
Cable Wraptor® 2 Medium	2	CW-T2R2
Cable Wraptor® 2 Large	2	CW-T3R2
Cable Wraptor® 1 Medium/1 Large	2	CW-T2T3R2

Description	Qty/ Pkg	Item #
Displays		
Cable Wraptor® Desktop Display, Small	50	CW-T1M50
Cable Wraptor® Desktop Display, Medium	25	CW-T2M25
Cable Wraptor® Desktop Display, Large	25	CW-T3M25
Cable Wraptor® Gravity Feed, Medium	75	CW-T2M75
Cable Wraptor® Gravity Feed, Large	50	CW-T3M50
Cable Wraptor® Gravity Feed, X-Large	40	CW-T4M20
Cable Wraptor® Stackout Display, 100 M / 150 L / 40 XL	290	CW-290

Wire Seals

- Made of Nylon 6/6 flame resistant, self extinguishing Buna-N form seal.
- All seals exceed NEMA 4 x or 6 specs
- Overlapping clamping spines allow for superior pull-out protection and resistance
- Strain relief fittings are resistant to salt water, acids, alkalis, alcohol, oils and are non-corrosive for use in the marine environment.
- Good underwater to 300 feet /91.4 m (150 PSIG) provided there is a liquid tight seal between body and housing.
- Provide low cost cable entries into panels and junction boxes.
- UL 94 v-0



Description	For Use with	Thread Size	Cable Range	Clearance Hole	Body Length	Thread Length	Qty/ Pkg	Item #
Round Cable	18–10 AWG	3/8" NPT	.08"-.24" 2–6 mm	.68"	.87"	.59"	1	764998
Round Cable	20–1 AWG	1/2" NPT	.00"-.47" 0–12 mm	.83"	1.06"	.51"	1	765000
Round or Flat Cable	4–1, 14/2–10/2, 16/3–12/3 AWG	1/2" NPT	.24"-.55" 6–14 mm	.83"	1.10"	.51"	1	765002
Round Cable	1–3/0 AWG	3/4" NPT	.51"-.71" 13–18 mm	1.05"	1.22"	.51"	1	765004
Round Cable	4/0 AWG	1" NPT	.71"-.98" 18–25 mm	1.35"	1.53"	.75"	1	765006



Split Loom & Spiral Wrap

- Permits flexible routing of cable harnesses.
- Provides abrasion protection for wire and cable.
- Allows lead outs at any point for greatest ease of installation.

Self-extinguishing Split Loom

Diameter	Ft/Pkg	Item #
3/8"	10 mm	10' 453382
		100' 453386
1/2"	13 mm	10' 453502
3/4"	19 mm	10' 453752
		100' 453756
1"	25 mm	5' 453901

Marine Grade™ Spiral Wrap

Diameter	Ft/Pkg	Item #
1/4"	6 mm	10' 452251
		100' 452255
3/8"	10 mm	10' 452381
		100' 452385
1/2"	13 mm	10' 452501
		100' 452505
3/4"	19 mm	10' 452751
		100' 452755
1"	25 mm	5' 452900
		100' 452905



ABYC Recommends:

"Conductors that may be exposed to physical damage shall be protected by self-draining; loom, conduit, tape, raceways, or other equivalent protection." 11.16.4.1.8.

"When AC and DC conductors are run together, the AC conductors shall be sheathed, bundled, or otherwise kept separate from the DC conductors." 11.16.4.1.5.

"Loom used to cover conductors shall be self-extinguishing. The base product (or resin) shall be classified as V-2 or better, in accordance with UL 94, Tests For Flammability Of Plastic Materials." 11.16.4.1.9.

Spiral Wrap Specifications

Nominal Diameter	Bundle Range	
	Min.	Max.
1/4"	0.188	2.0
6 mm	4.8 mm	5 cm
3/8"	0.313	3.0
10 mm	8 mm	7.6 cm
1/2"	0.375	4.0
13 mm	10 mm	10.2 cm
3/4"	0.750	5.0
19 mm	19 mm	12.7 cm
1"	1.000	7.0
25 mm	25 mm	17.8 cm



Grommets

- Provide instant abrasion resistance to wires passing through panel holes.
- Flexible black vinyl makes installation simple.

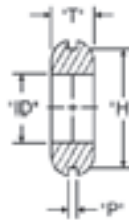

Hole Size	Inside Diameter	Panel Width	Qty/Pkg	Item #
3/8"	10 mm	1/4" 6 mm	3/32" 2 mm	5 760375
1/2"	13 mm	3/8" 10 mm	1/16" 2 mm	5 760500
1/4-3/4" Assortment Combo Pack			45	750000



600 Piece Nylon Insulated Connector Kit

- 150 pcs assorted 22-10 butt connectors
- 300 pcs assorted 22-10 ring terminals
- 25 pcs 16-14 fully insulated male and female disconnects
- 25 pcs 16-14 #8 and #10 flanged spade connectors
- 25 pcs 16-14 female disconnects
- 25 pcs 12-10 fully insulated female disconnects

Item # 250001



257 Piece Heat Shrink Connector Kit w/ Crimper & Mini Torch

- 110 pcs assorted 22-10 heat shrink butt connectors
- 145 pcs assorted 16-10 ring terminals
- 1 single crimp ratchet tool
- 1 mini butane pocket torch

Item # 320001



100 Piece Tinned Copper Lug Kit w/ Crimper

- 10 pcs #8 5/16" & 3/8" tinned lug
- 10 pcs #6 5/16" & 3/8" tinned lug
- 10 pcs #4 5/16" & 3/8" tinned lug
- 10 pcs #2 5/16" & 3/8" tinned lug
- 5 pcs 1/0 5/16" & 3/8" tinned lug
- 5 pcs 2/0 5/16" & 3/8" tinned lug
- 1 heavy-duty lug crimper

Item # 255001



314 Piece ATO ATC & AGC Fuse Kit

- 20 pcs 1, 7.5, 25 and 30A AGC fuses
- 25 pcs 2, 3, 5, 10, 15 and 20A AGC fuses
- 15 pcs 5, 10, 15 and 20A ATO/ATC fuses
- 5 pcs 25 and 30A ATO/ATC fuses
- 4 AGC panel mount fuse holders
- 4 AGC waterproof fuse holders
- 3 AGC in-line fuse holders
- 2 ATO/ATC in-line fuse holders
- 1 Fuse Puller/Installer

Item # 608001



Promotional Kit Cabinet

Buy 4 kits get a 4 drawer tray for FREE

Item # P33307



Coastal Electrical Kit

- 1 spool #16 & #12 Black, Red UL 1426 boat cable
- 100 pcs 22–18 to 12–10 various connectors
- 20 pcs 22–18 to 12–10 heat shrink butt connectors
- 2 pcs 1/4" & 3/8" black heat shrink tubing
- 30 pcs 8" & 11" 75 lbs natural and UV black cable tie
- 15 pcs 1/4" & 3/8" natural clamps
- 10 pcs Trade #90, 1004, 1142, 211-2 & 10806 bulbs
- 15 pcs 10, 15 & 20 amp AGC fuse
- 4 ea Marine Grade™ tools
- 5 ea #8 screw adjustable clamp
- 1 AGC in-line & waterproof fuse holder
- 2 adhesive backed cable tie mount
- 1 ATC fuse asst. pack
- 1 emergency clamp on terminal
- 1 coil 15' 16/2 duplex UL 1426 boat cable

Item # 220007



Premium Connector Kits

- Nylon Insulated with Insulation Grip
- Double Crimp, Funnel Entry

Description	Qty/Pkg	Item #
Connector, Assorted Butt, Ring, Spade and Male and Female Disconnects (18–10 AWG) plus Crimp Tool	31	220002
Connector, Assorted Butt, Ring, Spade and Male, Female Disconnects (18–10 AWG)	120	220003
Connector, Assorted Butt, Ring, Spade and Male and Female Disconnects (18–10 AWG) plus Crimp Tool	121	220004

225 Piece Twin Kit Electrical Repair Kit with Strip/Crimp Tool

- 55 pcs assorted butt connectors
- 95 pcs assorted ring terminals
- 35 pcs assorted disconnects
- 35 pcs assorted nylon cable ties
- Assorted, 10' spools of UL 1426 boat cable
- 5 pcs (3"x3/8") 3:1 shrink ratio, colored heat shrink tubing
- Opens both sides

Item # 220020



Heavy-Duty, Voltage-Continuity Tester

Heavy-duty voltage and continuity tester designed for any number of electrical applications.

- Tests voltage from 80–480V AC/DC (4-range indication)
- Dual function voltage and continuity tester
- Snap-in leads are spaced to fit standard outlet for “hands-free” operation
- Sta-Flex™ 36" cold weather leads
- 4 Hi-Vis™ indicators
- Integrated probe storage
- Operates from (2) LR44 batteries

Item # **ET6207**

Specifications	Range
AC Voltage	80–480V
DC Voltage	80–480V
Frequency	60Hz
Polarity	✓
Continuity	✓
CAT Rating	III 600V



Wire Tracker™ Wire Tracer

A must-have tester for avid boaters and marine technicians.

- Multi-purpose wire tracer for identifying wires such as coax, CAT 5, speaker, phone, or any non-energized (non-live) wires
- Adapter plugs include: RJ-45, RJ-11, coax, automotive fuse blade, and insulated clamps
- Adjustable sensitivity positively identifies a single wire when multiple wires are routed in close proximity
- Audible and visual indication
- Operates from (2) AAA batteries (transmitter) and (4) LR44 batteries (receiver)
- Auto off function included with transmitter to save battery life

Item # **ET64220**

Specifications	Range
Audible	✓
Visual	✓
Receiver Storage	✓
Belt Clip	✓
Tracer	✓

LIFETIME WARRANTY Patented



5 Function Analog Multimeter

- Manual range
- Compact, lightweight design
- AC/DC voltage
- DC Current
- Accurate needle deflection
- Operates from one AA battery

Item # HSP5

Specifications	Range	Accuracy
DC Voltage:	0-10/50/150/300V	4.0%
AC Voltage:	0-10/50/150/300V	5.0%
DC Current:	0-0.5/50/150 mA	4.0%
Resistance:	0-1MΩ	4.0%
Decibels:	✓	-20dB to +56dB
CAT Rating:	II 300V	-



6 Function Digital Snap-Around

- 400 amp non-contact AC/DC current reading
- Data hold capability to maintain reading on display
- Auto power off functionality to save battery life
- Compact lightweight design
- Includes convenient carrying case
- Operates from (2) AAA batteries

Item # DSA540A

Specifications	Range	Accuracy	Resolution	Overload Protection
DC Voltage	400/600V	1.5%	100mV	720VAC/DC
AC Voltage	400/600V	2%	100mV	720VAC/DC
DC Current	40/400	3%±8dgt (0-40A) 4%±6dgt (40-400A)	10mA	480A
AC Current	40-400	3%±8dgt (0-40A) 4%±6dgt (40-400A)	10mA	480A
Resistance	400/4000Ω	2%	100mΩ	300VAC/DC
Cont Buzzer	0-600 Ohms	Buzzer Sounds @ 100 Ohms or less		
CAT Rating	II 600, III 300V AC	-	-	-



Includes Carrying Case

True RMS 10 Function Digital Snap-Around

- Precise True RMS circuitry
- 1000 Amp non-contact current reading
- Integrated non-contact voltage detection
- Min/Max function to hold either minimum reading or maximum reading on the display
- Data hold capability to maintain reading on display
- Backlit display for low light applications
- Peak hold function to display in-rush current
- Capacitance and temperature measurement functionality
- Auto power off functionality to save battery life
- Includes convenient carrying case
- Operates from (2) AAA batteries

Item # DSA1020TRMS

Specifications	Range	Accuracy	Resolution	Overload Protection
DC Voltage	600mV/6/60/600V	1% ±3dgt	100µV	720V AC/DC
AC Voltage	6/60/600V	1.5% ± 4dgt	1mV	720V AC/DC
DC Current	600/1000A	±1.5%rdg ± 5dgt	100mA	1200A AC/DC
AC Current	600/1000A	2%±5dgt	100mA	1200A AC/DC
Resistance	600/6K/60K/600K/6M/60MΩ	1% ±5dgt (600~6MΩ) 5% ±8dgt (6M~60M)	100mΩ	600V AC/DC
Frequency	10/100/1000/10K	0.5%±5dgt	–	–
Diode Test	✓	–	–	–
Cont Buzzer	0–600 Ohms	Buzzer Sounds @ 100 Ohms or less	–	–
Capacitance	40nF–4000µF	2.5%±20dgt (400nF–40µF) NA (40nF, 40µF–4000µF)	–	–
Temperature	50° to 700°C/ 58° to 1292°F	°C ±5°/ °F±9°	–	–
CAT Rating	IV 600	–	–	–



7 Function Digital Multimeter

- Auto ranging capability allows the meter to automatically determine the resolution based on the application
- Compact, lightweight design
- AC/DC voltage capable with temperature measurement functionality
- Impact resistant housing with protective rubber overmold
- Operates from (2) AAA batteries

Item # DM6250

Specifications	Range	Accuracy
DC Voltage	200mV, 2V, 20V, 200V, 600V	200mV & 600V (1.0%+5dgt) 2V 20V 200V (0.5%+5dgt)
AC Voltage	200mV, 2V, 20V, 200V, 500V	500V (1.5%+5dgt) 2V 30V 200V (0.8%+5dgt)
Resistance	200, 2K, 200k, 2M, 20M	200Ω 20M (1.5%+2dgt) 2K 20K 200K 2M (1.0%+2dgt)
Battery Testing	1.5V (2V)	–
Temperature	-40°F–752°F	8%+5dgt
Diode Test	✓	–
Continuity	✓	–
CAT Rating	III 600V	–



9 Function Digital Multimeter

- Test Lead Input Icons for correct lead placement
- Industry leading LCD display size
- Relative Delta displays change in readings
- Low Impedance Function to trace ghost voltage
- Impact resistant housing with protective rubber boot
- Operates from one 9 volt battery

Item # **DM6450**

Specifications	Range	Accuracy
DC Voltage	400mV, 4V, 40V, 400V, 1000V	400mV (0.8%+3dgt) 4V 40V 400V (0.8%+1dgt) 1000V (1.0%+3dgt)
AC Voltage	4V, 40V, 400V, 750V	4V 40V 400V (1.0%+ 5dgt) 750V (1.2%+5dgt)
DC Amps	400µA, 4000µA, 40mA, 400mA, 4A, 10A	400µA 4000µA (1.0%+2dgt) 40mA 400mA (1.2%+3dgt) 4A 10A (1.5%+5dgt)
AC Amps	400uA, 4000uA, 40mA, 400mA, 4A, 10A	400µA 4000µA (1.2%+2dgt) 40mA 400mA (1.5%+3dgt) 4A 10A ±(2.0%+3dgt)
Frequency	10Hz–10MHz	0.1% +3dgt
Capacitance	40nF, 400nF, 4µF, 40µF, 100µF	40nF (3%+10dgt) 400nF, 4µF, 40µF (3%+5dgt) 100µF (4%+5dgt)
Resistance	400, 4K, 40K, 400k, 4M, 40M	400O 4M (1.2%+2dgt) 4K 40K 400K (1.0%+2dgt) 40M (1.5%+2dgt)
Diode Test	✓	–
Continuity	✓	–
CAT Rating	III 600V, II 1000V	–



Automatic Wire Stripper

- Made of reinforced polyimide
- Automatically adjusts to different wire sizes
- Strips without damage or marking of conductors, slim jaw for easy access, steel side cutter
- Strips and cuts wire from 24–12 AWG / 0.2–3 mm²
- Wire stop adjusts length of strip from 3/8"–1/2" (9.5–12.7 mm)



Item # **702030**

Battery Cable Stripper

- Made of fiberglass reinforced polyimide, swivel blade for circular and longitudinal cuts
- Adjustable blade cutting height, comes with extra blades
- Strips 8–4/0 AWG / 8–103 mm² battery cable
- Slits outer jacket from 14/2–6/2 AWG / 2x2–2x13 mm² duplex and 16/3–6/3 AWG / 3x1–3x13 mm² triplex wire



Item # **702065**

Heavy-duty Lug Crimper

- Spring loaded pivot bar, designed for use with a hammer or vise
- Makes UL approved crimps
- Made from steel with a hardened pivot pin
- Capacity: Crimps 6 - 4/0 AWG /13-103 mm² lugs and 6 - 3/0 AWG /13-81 mm² terminals

Item # 701010



Dielectric Silicone Compound

- Fights oxidation to improve conductivity.
- Penetrates aluminum oxide to maintain current paths.
- Temperature rated 40°-500°F.
- 1/3 oz tube.

Item # 700115



Stainless Steel Cut/Strip/Crimp Tool

- Crimp 10-22 AWG insulated and non-insulated terminals and coaxial connectors
- Cut and strip 8-22 AWG solid and 10-24 AWG stranded wire
- Cut and re thread 4-40, 5-40, 6-32, 8-32, 10-24, 10-32 screws
- Stainless steel blade resists corrosion and nicking
- Precision ground plier nose

Item # 701009

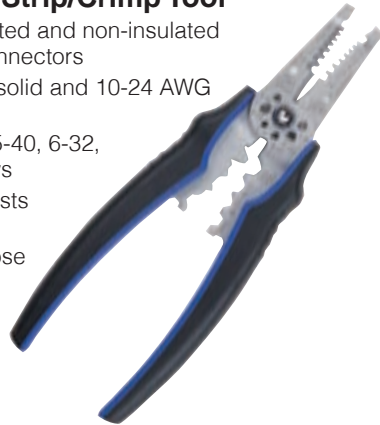

Heavy-duty Lug / Terminal Crimper

- Calibrated adjustment screw
- Compound lever action prevents operator fatigue
- Capacity: Crimps 8-4/0 AWG / 8-103 mm² lugs and terminals

Item # 702040



Cut/Strip/Crimp Tool

- Precision ground cutters and stripping station, wide crimp range of insulated and non-insulated terminals
- "Box" crimp works with Ancor™ double crimp terminals, marking is embossed and paint filled
- Capacity: Crimps 22-10 AWG / 0.3-5 mm² insulated and non-insulated terminals, connectors and spark plug terminals in special cavities
- Strips insulation from 22-10 AWG / 0.3-5 mm² solid and stranded wires
- Cuts (4) 40/2 mm, (6) 32/4 mm, (8) 32/4.8 mm, (10) 32 / 6.4 mm and 10-24/6.4 mm bolts

Item # 701007



Double Crimp Ratchet Tool

- UL and ABYC recommended crimps. Will not release until proper crimp is made
- Jaws are hardened 4150 steel with hardened center less ground pins adjustable for wear
- Has two nests within each cavity to simultaneously crimp the conductor and make a swage type crimp on wire insulation
- Crimps 22–10 AWG / 0.3-5 mm² terminals and connectors in two color-coded cavities

Item # 702015

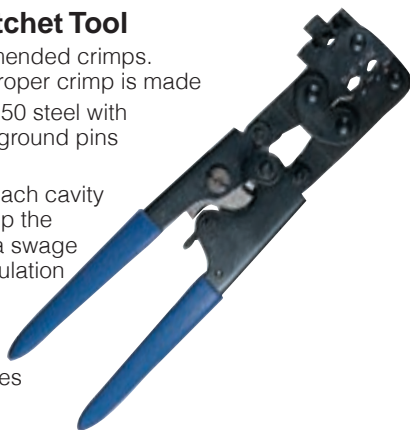
**Double Crimp Ratchet Tool**

- Ratchet mechanism crimps stranding and insulation grip portion of ANCOR connectors all in one motion for superior strain relief.
- Tool has adjustment feature to allow for wear, and a release lever in event of incorrectly placed terminal.
- Crimps 22–10 AWG insulated terminals in three cavities.

Item # 701030

**Wire Strip Crimp Tool**

- Strips 26–10 AWG stranded wire.
- Automatic jaw-load wire stripper self-adjusts to strip wire.
- Crimps 22–10 AWG insulated terminals.

Item # 702033

**Turbo Lite**

- Child resistant piezo electronic ignition system
- Powered by butane, inexpensive and readily available
- Flame temperature up to 2500°F (1300°C)
- Windproof and weatherproof flame
- Flame may be locked in “on” position

Item # 702064

**Micro Therm Heat Gun**

- Features Piezo electronic ignition system, providing flame less heat, safe to use around chemicals or by wire bundles when using deflector
- Powered by refillable cell
- Flame temperature up to 650°C (1300°F)
- Ideal for work in the bilge where open flame should not be used

Item # 702027

**Mini Pocket Butane Torch**

- Electronic ignition system with safety locking switch
- Flame temperature up to 1300°C (2500°F)
- Compact size allows unit to fit easily into any toolbox
- Refillable butane cartridge included.
- Butane Not Included

Item # 702024



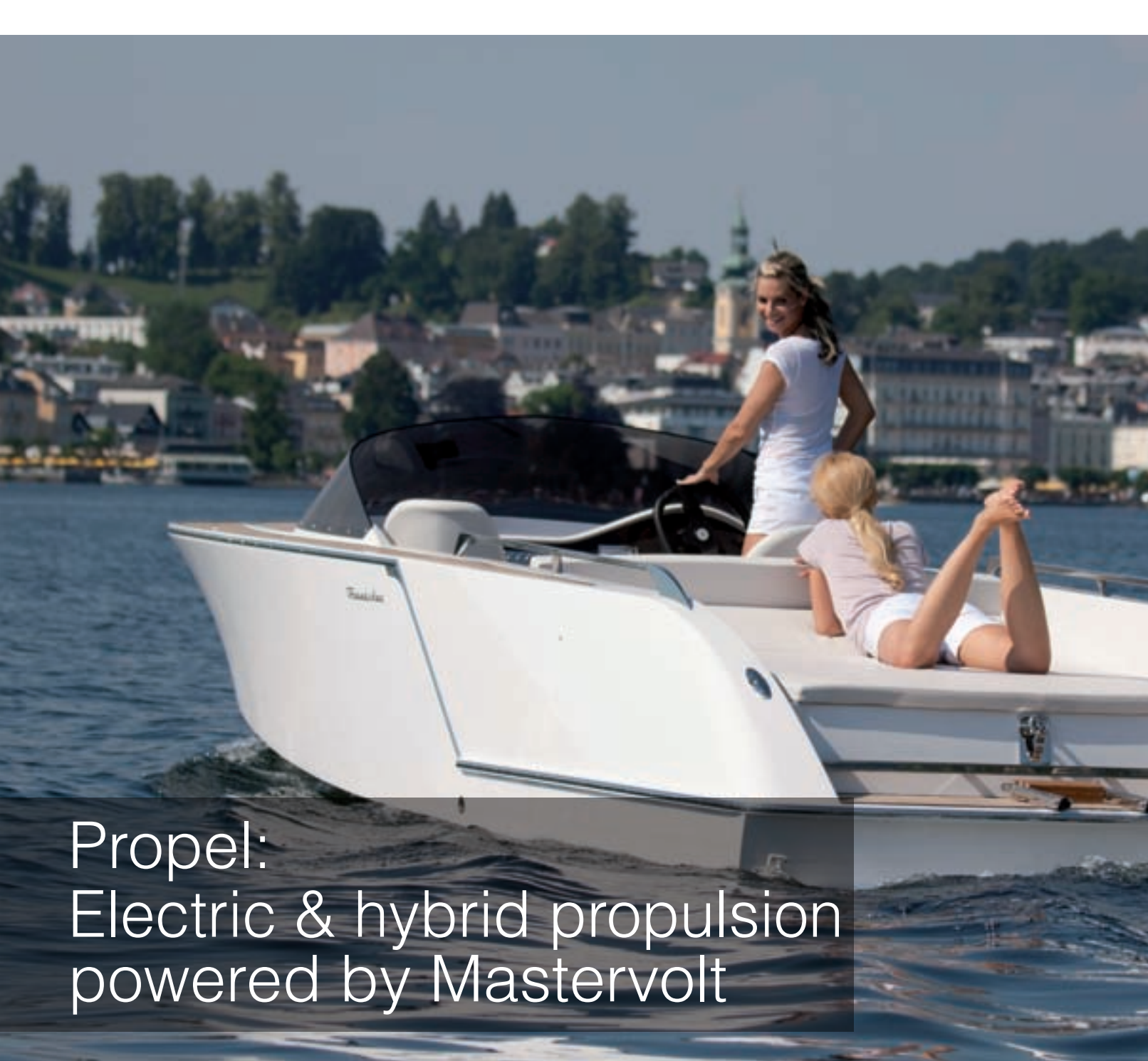

Propel: Electric & hybrid propulsion powered by Mastervolt

Electric sailing is becoming ever more popular. Perhaps it is the peace and comfort that comes from saying goodbye to engine vibrations and noise.

Our desire to be eco-friendly is certainly playing a key role. And then there is also the fact that many of the world's 'green zones' can only be accessed with silent and emission-free e-propulsion.

Mastervolt offers you complete system solutions for all kinds of electric and hybrid propulsion applications. Whether you choose to go all-electric or to combine e-propulsion with a diesel or generator in a hybrid installation, we have the answer.

Making clever use of advances in technology and in-house developments, the efficiency of our e-propulsion systems is an impressive 90%, far higher than traditional systems. Propeller efficiency is also significantly enhanced, which means that the same amount of energy takes you a great deal further.

You now have an even more complete system solution for your vessel, with quieter smoother sailing, more relaxed maneuvering and all the other advantages that come with electric power.



Electric Propulsion _____	226
Choose your Propulsion Kit & Throttle Control _____	227
Propulsion Kits _____	228





Adding a new dimension to Green by Heart

The Green by Heart philosophy marks a new era at Mastervolt, emphasizing our commitment to intelligent and environmentally friendly products and systems. We have developed ingenious solutions for supplying power in vehicles and onboard vessels with our advanced solar products and introduced a new way of sailing with our e-propulsion solutions.

Enjoy all the benefits of electric and hybrid sailing

- Propulsion with electric engines is pleasantly quiet.
- A generator makes far less noise than a diesel engine with propeller shaft.
- The power of an electric engine is directly and fully available and can be regulated with a great degree of precision, allowing for easy manoeuvring.
- Power consumption is up to 20% lower with dedicated electric propulsion than with conventional systems (depending on water and weather conditions).
- You save money as well as the environment.

Choosing your electric or hybrid solution

Having developed our e-propulsion products in partnership with the experts in this field, Mastervolt offers complete electric systems up to 65 kW or customized solutions with higher capacities. In addition to propulsion, some systems can also supply power to the batteries, battery chargers and battery monitoring devices. And we have a range of intelligent, integrated solutions for hybrid sailing. Choose your own system elements and Mastervolt will provide an intelligent bespoke solution.

Two-year warranty and global service

All Mastervolt systems for electric sailing come with a two-year warranty as well as global service.



Choose your propulsion kit and throttle control

The overview below provides several system recommendations based on weight and application. These recommendations are intended as guidelines only; always consult your Mastervolt specialist for the best configuration. Heavier vessels from around 55 ft for motor and sailyachts and from around 60 ft for catamarans always require a bespoke solution. Contact your Mastervolt dealer, yard or the specialists at Mastervolt.

Required Capacity (guideline)

Weight	Motoryacht		Sailyacht		Catamaran	
	Length	Power	Length	Power	Length	Power
1 T / 1000 kg	≤ 16' / 5 m	2.5 kW	≤ 20' / 6 m	2.0 kW	≤ 20' / 6 m	2x 1.0 kW
2 T / 2000 kg	≤ 23' / 7 m	5.0 kW	≤ 30' / 9 m	4.0 kW	≤ 30' / 9 m	2x 2.0 kW
3 T / 3000 kg	≤ 30' / 9 m	7.5 kW	≤ 36' / 11 m	6.0 kW	≤ 36' / 11 m	2x 3.0 kW
4 T / 4000 kg	≤ 36' / 11 m	10.0 kW	≤ 39' / 12 m	8.0 kW	≤ 39' / 12 m	2x 4.0 kW
5 T / 5000 kg	≤ 39' / 12 m	12.5 kW	≤ 43' / 13 m	10.0 kW	≤ 43' / 13 m	2x 5.0 kW
6 T / 6000 kg	≤ 43' / 13 m	15.0 kW	≤ 46' / 14 m	12.0 kW	≤ 46' / 14 m	2x 6.0 kW
7 T / 8000 kg	≤ 46' / 14 m	20.0 kW	≤ 49' / 15 m	15.0 kW	≤ 49' / 15 m	2x 7.5 kW

Propulsion kits

Mastervolt supplies propulsion systems as kits. A kit includes:

- Motor and motor controls.
- Cables between motor and controls.
- Display/monitor, key, main switch and main fuse.

Throttle controls

The Mastervolt ControlMaster throttle controls were specifically designed for electric sailing and ensure that the speed of your vessel can be subtly and carefully controlled. Another important issue is an easily identifiable neutral gear. Your choice of throttle controls will depend on your preference. All our throttle controls were developed using corrosion-proof materials and are easily installed. The kits can be equipped with all available throttle controls.

Practical tips:

- Permanent Magnet (PM) motors are very compact and silent; Asynchronous motors are exceptionally quiet and have a very high torque.
- A proper battery charger is essential for the maintenance and lifespan of your batteries.
- A reliable battery monitor is a must.
- The number of sailing hours depends on your battery kit combined with the generated capacity. For six to eight hours sailing, you require 4.6 x kW motor capacity in kWh. Example: 4.6 x 3.5 kW = 16.1 kWh; this is the capacity required for six to eight hours sailing.

ControlMaster Casual

Item # 141500010



ControlMaster Sport

Item # 141500030



ControlMaster Sport TD

Item # 141500220



DriveMaster

This compact, lightweight and powerful propeller drive is available in 11 models, ranging from 2.5 to 65 kW. Mastervolt's DriveMasters can be easily built-in and come standard with all the essential components, with exception of the propeller and propeller shaft. With minimum maintenance and noise, the **DriveMaster Ultra** with its brushless technology is top of the DriveMaster line.



Complete system

All motor controllers are micro-processor controlled and secured against short circuiting, overload and incorrect polarity. The controller constantly monitors the entire system and adjusts power where necessary. The display is connected to the controller, and the motor is protected by an aluminium/stainless steel hood with an integrated cooling fan.

Type	Capacity*	Motor	Voltage technology	Max. RPM regulator	Required battery capacity for		Item #
					3–4 hrs sailing	6–8 hrs sailing	
DriveMaster 2.5	2.5 kW	PM	24V	1100	7 kWh	11.5 kWh	140100250
DriveMaster 3.6	3.6 kW	PM	36V	1600	10 kWh	16.5 kWh	140100360
DriveMaster 5	5.0 kW	PM	48V	1050	14 kWh	23.0 kWh	140100500
DriveMaster 3.5 Ultra**	3.5 kW	asynchronous	48V	1450	9.8 kWh	16.0 kWh	140300350
DriveMaster 5 Ultra**	5.0 kW	asynchronous	48V	1450	14 kWh	23.0 kWh	140300500
DriveMaster 7.5 Ultra**	7.5 kW	asynchronous	48V	1450	21 kWh	34.5 kWh	140300750
DriveMaster 10 Ultra**	10.0 kW	asynchronous	48V	1450	28 kWh	46.0 kWh	140301000
DriveMaster 16 Ultra**	16.0 kW	asynchronous	96V	2500	45 kWh	74.0 kWh	140301600
DriveMaster 20 Ultra**	20.0 kW	asynchronous	96V	1450	56 kWh	92.0 kWh	140302000
DriveMaster 25 Performance	25.0 kW	synchronous	180V	1450	70 kWh	115.0 kWh	customer-specific product, please contact Mastervolt
DriveMaster 40 Performance	40.0 kW	synchronous	230V	2500	112 kWh	184.0 kWh	
DriveMaster 65 Performance	65.0 kW	synchronous	300V	3000	182 kWh	299.0 kWh	

* Supplied capacity.

** As an option, the DriveMaster Ultra can also be supplied with an adjustable motor support.

PodMaster

Mastervolt's ideal solution for motor or sailyachts is installed under the hull to save space and minimize sound and vibrations. Enjoy the sound of silence with one of the 12 available PodMasters, ranging from 2 to 10 kW, including seven steerable models and two heavy-duty versions for professional applications.

Solid motor for minimal resistance

The PodMaster is made of seawater-proof aluminium and given six layers of epoxy coating for extra protection. The heavy duty Professional models have a steel housing for extra durability. Its shape has been designed to ensure minimal resistance and optimize the propeller water flow. Depending on the model, the bulb contains an ultra-modern, sensor-free, 3-phase permanent magnet synchronised motor or a highly efficient permanent magnet DC motor.

The motor, bearings and plugs were designed for professional use and guarantee years of sailing enjoyment and minimum maintenance. The PodMaster models are equipped with a suitable propeller, while the Professional models come without a propeller to allow perfect matching with various boat hulls. The shaft and tail fin were developed to minimise resistance and can be used as rudder for the steerable PodMaster models. To allow installation or use in limited drafts, the PodMaster can be fitted with a stainless steel anti-cavitation plate. Its high capacity and exceptional efficiency ensure that virtually the entire capacity is transferred to the propeller.



PodMaster



PodMaster Professional



PodMaster Steerable

Type	Capacity	Motor	Voltage technology	Max. RPM regulator	Required battery capacity for		Item #
					3-4 hrs sailing	6-8 hrs sailing	
PodMaster 2.0*	2.0 kW	PM	24V	1800	5.6 kWh	9.2 kWh	140600200
PodMaster 2.5*	2.5 kW	PM	36V	1800	7.0 kWh	11.5 kWh	140600250
PodMaster 4.2	4.2 kW	synchronous	48V	1500	11.8 kWh	19.3 kWh	140600420
PodMaster 6.5	6.5 kW	synchronous	48V	1500	18.2 kWh	30.0 kWh	140600650
PodMaster 10	10.0 kW	synchronous	48V	1800	28.0 kWh	46.0 kWh	140601050
PodMaster 2 Steerable**	2.0 kW	PM	24V	1800	5.6 kWh	9.2 kWh	140700200
PodMaster 2.5 Steerable**	2.5 kW	PM	36V	2000	7.0 kWh	11.5 kWh	140700250
PodMaster 4.2 Steerable**	4.2 kW	synchronous	48V	1500	11.8 kWh	19.3 kWh	140700420
PodMaster 6.5 Steerable**	6.5 kW	synchronous	48V	1500	18.2 kWh	30.0 kWh	140700650
PodMaster 10 Steerable**	10.0 kW	synchronous	48V	1800	28.0 kWh	46.0 kWh	140701050
PodMaster 6.5 Professional***	6.5 kW	synchronous	48V	950	18.2 kWh	30.0 kWh	141100650
PodMaster 10 Professional***	10.0 kW	synchronous	48V	1050	28.0 kWh	46.0 kWh	141101000

* Delivered with fixed propeller, also available with folding propeller.

** This PodMaster model is also as Sterndrive available.

*** Supplied without propeller.

SailMaster

As the name indicates, this propulsion solution is specifically for sailyachts. The SailMaster asynchronous propulsion systems were developed for application with the standard saildrive propulsions from, for instance, Selva. With a very low resistance, the systems are delivered with a capacity of 5 or 7.5 kW at 48V. The standard delay in the saildrive causes the propeller to run relatively slowly: This allows for a larger propeller with increased thrust and efficiency, while also compensating for any transfer loss and minimizing vibrations. Although the installation inside the vessel means there is some audible sound, it is nothing compared to the noise of a normal diesel engine. Enjoy the peace...



Type	Capacity	Voltage regulator	Max. RPM	Required battery capacity for		Item #*
				3–4 hrs sailing	6–8 hrs sailing	
SailMaster 5	5.0 kW	48V	1000	7.0 kWh	14.0 kWh	140500500
SailMaster 7.5	7.5 kW	48V	1000	9.8 kWh	19.6 kWh	140500750

* Supplied without propeller.



HybridMaster

The HybridMaster is Mastervolt's solution for hybrid propulsion: combining the advantages of electric propulsion with the sailing radius of a diesel engine. The HybridMaster series has an electric power rating ranging from 3.5 to 10 kW, allowing them to be combined with diesel engines of up to 150 hp. When sailing electrically, the HybridMaster gets its energy from the batteries. When sailing on the motor, the batteries are recharged up to a maximum of 150A. With the Mastervolt HybridMaster you can enjoy the best of both worlds.

The HybridMaster is universally applicable and can be installed parallel to the propeller shaft. The gear ratio between the rpm of the electric motor and the propeller shaft can be adapted, which is crucial as it ensures that the electric propulsion is optimally adjusted to the existing propeller and motor. The HybridMaster Ultra is the top end of the line, using completely silent and maintenance-free brushless asynchronous motor technology.



Type	Capacity	Motor technology	Voltage regulator	Item #
HybridMaster 4.8	4.8 kW	PM	48V	140103000
HybridMaster 9.6	9.6 kW	PM	48V	140104000
HybridMaster 3.5 Ultra	3.5 kW	asynchronous	48V	140320350
HybridMaster 5 Ultra	5 kW	asynchronous	48V	140320500
HybridMaster 7.5 Ultra	7.5 kW	asynchronous	48V	140320750
HybridMaster 10 Ultra	10 kW	asynchronous	48V	140321000

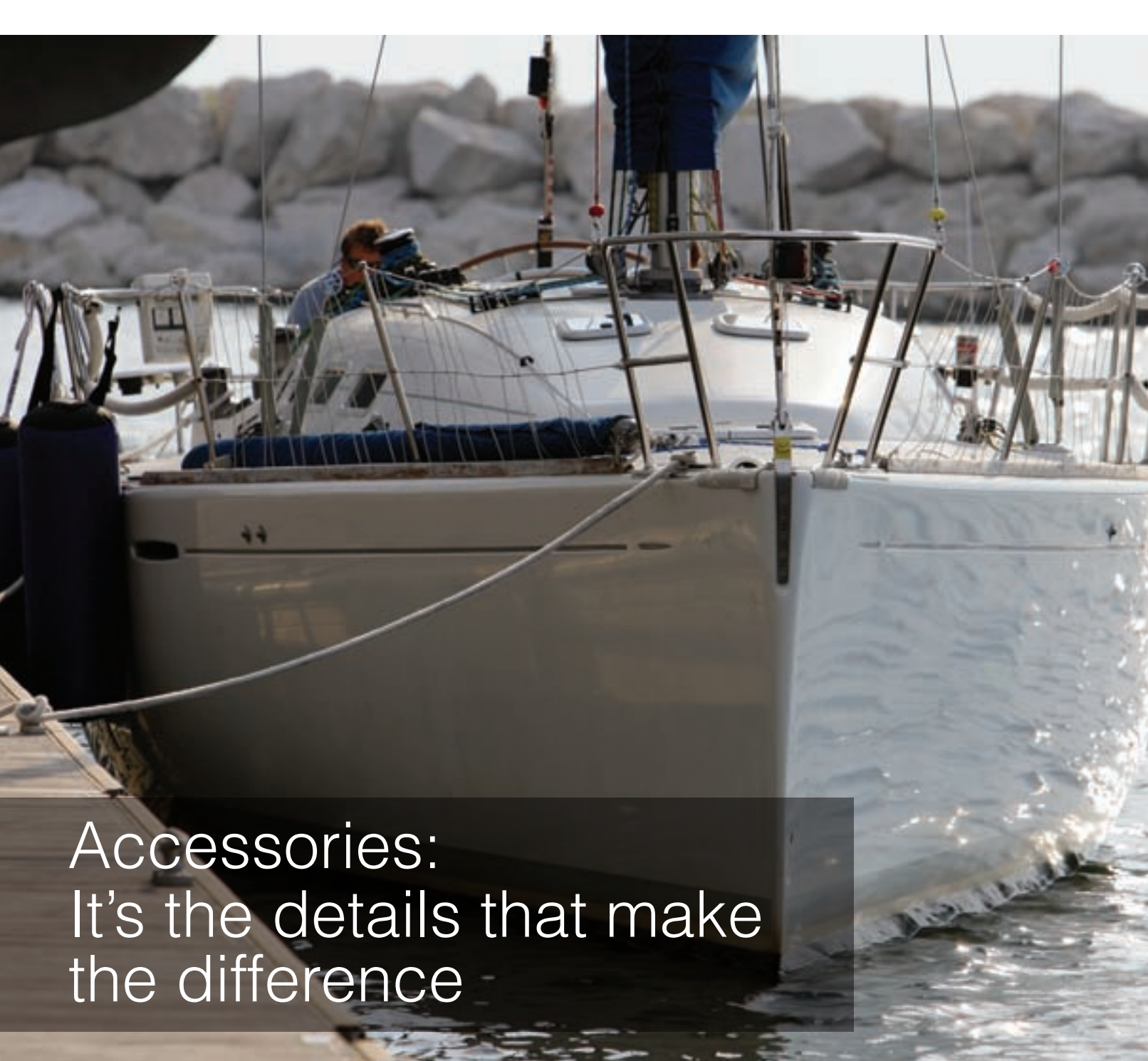

Accessories: It's the details that make the difference

Before you leave shore, double check that your equipment is ready to go. Because once you're on the water, you rarely get second chances. Genuine Marinco and Mastervolt parts and accessories are manufactured to the highest standards, ensure compatibility with your shipboard systems, and are guaranteed to perform.

Whether you need common maintenance products, solutions that make life at sea more convenient, or accessories that say a little about your sense of style, Marinco and Mastervolt accessories are the perfect complement.

From fuses to lights, wiper blades to stainless steel components, our product designers have an uncanny insight into the form and function of every accessory, giving you the confidence to enjoy your vessel under all conditions.

Choose genuine Marinco and Mastervolt parts and accessories. It's all in the details.



Wiper Motors _____	234
Wiper Arms _____	241
Wiper Blades _____	245
Horns _____	248
Compact Horns _____	250
Trumpet Horns _____	252
Surface Mount Horns _____	255
Wireless Remote Spot Light _____	257
Beamer™ Remote Control Halogen Spot _____	258
Beamer™ Remote Control Halogen Spot/Flood _____	259
Stainless Steel Spot/Floods & Deck Lamps _____	260
Deck Lamps & Spotlight Accessories _____	261
Lamps _____	262
Ventilation Basics _____	268
Solar Vents _____	270
Solar & Cowl Vents _____	271
Clam Vents & Deck Plates _____	272
Fans _____	273



Wiper Motors

The motor choice is based primarily on the size of the windshield and where the motor is to be installed, either in an exterior or interior location. Marinco® motors are split into three categories, Standard, Heavy-Duty, and Heavy-Duty Plus, with the categories being defined by the power range of the motors in those categories. Within the three categories, there are motors designed for interior or protected installations, and motors designed for exterior installations. With the addition of the 3.0 motor, we offer wiper motors for all windshield sizes up to 45", which could be covered by a 30" arm and 30" blade combination, driven by a 3.0 motor.





The Standard motor category includes the STD, WMW, and 500, which are all designed for light duty use, defined as being able to drive a 14" arm and a 14" blade. The differences in the motors relate to their casings and the appropriate installation applications. The STD is designed to be used in interior or well protected locations. The WMW, with its chrome-plated brass outer housing, provides protection for exterior installations that have some protection. The 500 motor, with its thermoplastic, watertight housing, is ideal for any light-duty, external installation where the motor is constantly exposed to the elements.

When coverage of a larger windshield is required, Marinco offers the Heavy-Duty motors, which are capable of driving a wide range of arm and blade sizes, up to a 26" x 26" Deluxe arm and blade combination, which would cover windshields up to 39" with

the 2.5 motor. The MRV is built for interior or well-protected locations, and has the power to pull a 22" X 22" Deluxe arm and blade combination. It has two speeds, with adjustable sweep set and adjustable parking. The 1000 motor can pull up to a 16" x 16" Deluxe arm and blade combination. While not as powerful as the MRV, it is waterproof, with the high-density thermoplastic housing offering complete protection from the elements. The 1000 motor is a one-speed motor, with adjustable park and adjustable sweep settings. The third motor in this category, the 1.5 motor has the power to pull a 22" x 22" Deluxe arm and blade combination like the MRV, but is waterproof and built for exposed installations. The 1.5 motor has a powder-coated aluminum base and housing for greater operating efficiency and durability, with two-speed operation, and adjustable park and sweep sets. The fourth motor is the 2.5 motor and has the same features as the 1.5 motor (waterproof, powder-coated aluminum housing, etc.), with the added power to drive a longer (26") Deluxe arm and blade combination.

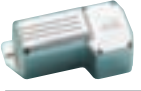
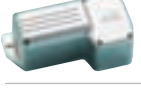
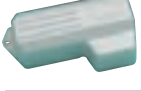
The 3.0 motor is the motor that makes up the Heavy-Duty Plus category. A wiper motor for internal installations, the 3.0 motor has an external linkage shaft drive that gives it the power and torque to drive a 30" Premier pantographic arm and Premier blade combination. See the following catalog pages for a full set of specifications on this, and all of the other wiper motors.

Choosing the Right Motor

	Model	Voltage	Speeds	Stall Torque/ Stall Current	Compatible Blade Lengths	Available Shaft Lengths	Sweep Angles	Housing
	3.0	12 & 24V	single	165 in-lbs 12.5–14.5 amps	30" Premier Plus single or pantographic	2.5" 3.5"	Factory preset to 110° Adjustable to 45°, 60°	external linkage – no housing
	2.5	12 & 24V	2 speed	139 in-lbs 9–10.5 amps	26" Deluxe 24" Premier	1.5" 2.5"	Factory preset: 80° or 110° Adjustable: 45° or 60°	fully sealed powder coated aluminum
	1.5	12 & 24V	2 speed	109 in-lbs 11.5–13 amps	22" Deluxe 20" Premier	1.5" 2.5" 3.5"	Factory preset: 80° or 110° Adjustable: 45° or 60°	fully sealed powder coated aluminum
	1000	12V	single	55 in-lbs 9.8–10 amps	16" Deluxe 18" Premier	1.5" 2.5"	Factory preset: 80° or 110° Adjustable: 50°, 65°, 80° or 110°	fully sealed, UV stabilized hi-temp thermoplastic
	MRV	12 & 24V	2 speed (but can be operated as 1)	109 in-lbs 11.5–13 amps	22" Deluxe 20" Premier (at 80° sweep)	1.5" 2.5" 3.5"	Factory preset: 80° or 110° Adjustable: 45°, 60°, 80°, or 110°	Corrosion resistant cast housing
	500	12V	single	—	14" Deluxe	2.5"	Factory preset: 80° or 110°	fully sealed, UV stabilized hi-temp thermoplastic
	WMW	12V	single	—	14" Deluxe	2.5"	Factory preset: 110°	chrome plated brass case
	STD	12V	single	—	14" Deluxe	2.5" 3.5"	Factory preset: 80° or 110° Adjustable: 80° or 110°	corrosion proof aluminum alloy case

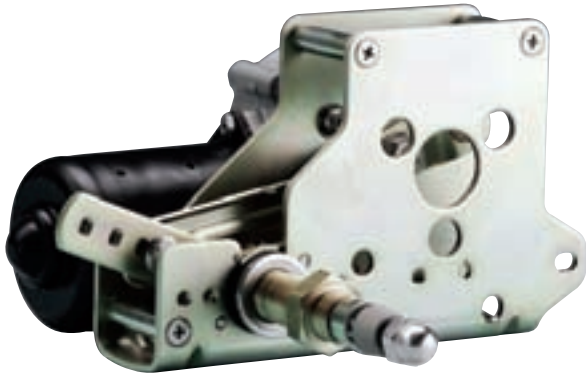

3 YEAR WARRANTY

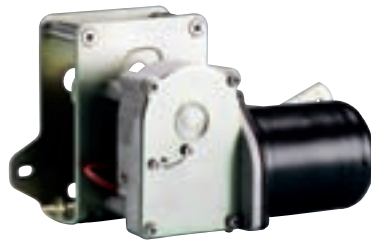

Heavy Duty Plus 3.0 Motor

The Heavy Duty Plus 3.0 Motor is Marinco's only external linkage motor. This design easily powers a 30" Premier arm and 30" Premier blade combination to provide coverage up to 45" of windshield area.

- Available in two shaft lengths: 2.5" and 3.5" (knurled arm fitting adds 2" to overall length)
- Tapered knurled drive shaft
- Factory pre-set sweep angle of 110°, with easy adjustment to 45° or 60°
- Sealed 6" wire leads, 16 AWG
- For interior installations
- Adjustable right or left self parking
- 18 mm diameter shaft
- Measures approximately 8.5" L x 4.625" W x 4.375" D (See below for detailed dimensional drawings)
- Stall torque: 165 in-lbs (190 kgf/cm; 18.6 Nm)
- Stall current: 12.5–14.5 amps
- No load current: 0.8–2.0 amps
- Recommended fuse: 6 amp fuse
- Available in 12V and 24V models
- Coast to park
- RF shielded circuitry

	Voltage	Sweep	OEM #
2.5" Shaft	12V	110°	73112
	24V	110°	73312
3.5" Shaft	12V	110°	73113
	24V	110°	73313

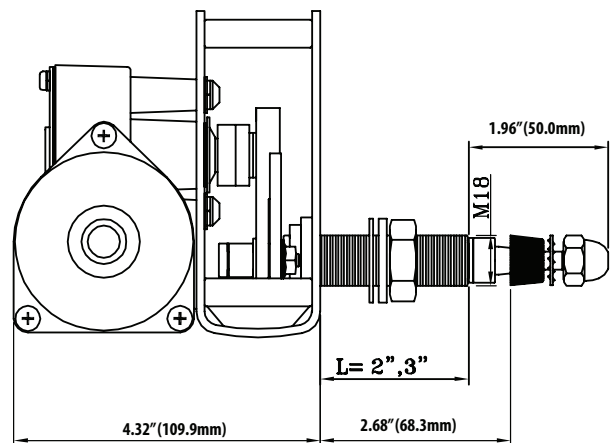
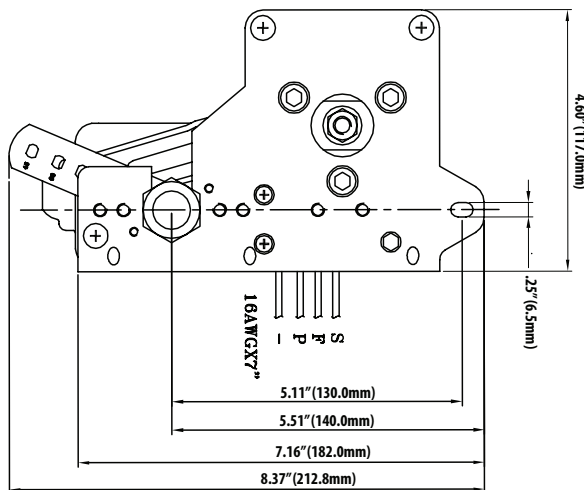



3 YEAR WARRANTY
CE

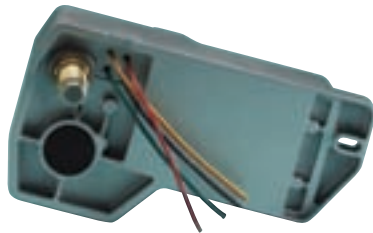

2.5 Waterproof Wiper Motor

- Fully sealed powder coated aluminum waterproof base and housing
- Powers a 26" Deluxe arm and Deluxe blade combination or a 24" Premier arm and Premier blade combination
- Available in two shaft lengths: 1.5" and 2.5" (includes .5" length of knurled arm fitting)
- Factory pre-set sweep angles of 80° or 110°, with easy adjustment to 45° or 60°
- Chrome plated solid brass knurled drive nut with brass and stainless steel drive shaft
- Two speed motor
- Sealed 6" wire leads, 16 AWG
- Adjustable right or left self parking
- .625" diameter shaft (16 mm)
- Available in 12V and 24V models
- Coast to park
- RF shielded circuitry
- Includes 6 amp fuse and holder (operating switch not included)
- Measures approximately 7.875" L x 4.25" W x 3" D (see below for detailed dimensional drawings)
- Stall torque: 139 in-lbs (160 kgf/cm; 15.7 Nm)
- Stall current: 9.0-10.5 amps
- No load current: 1.0 -1.6 amps

	Voltage	Sweep	Item #	OEM #
1.5" Shaft	12V	80°	82081	82181
	12V	110°	82011	—
2.5" Shaft	12V	80°	82082	82182
	12V	110°	82012	82112
	24V	110°	82312	82212

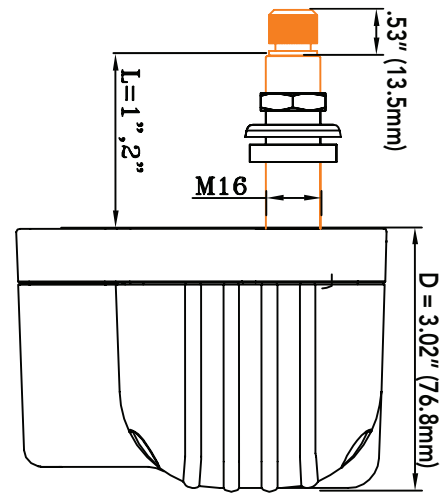
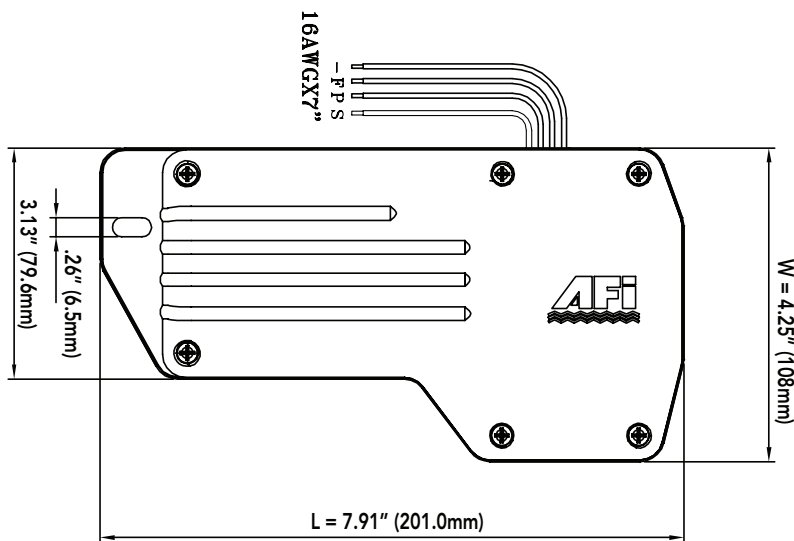



3 YEAR WARRANTY
 CE



1.5 Waterproof Wiper Motor

- Fully sealed powder coated aluminum waterproof base and housing
- Powers a 22" Deluxe arm and 22" Deluxe blade combination or a 20" Premier arm and 20" Premier blade combination
- Available in three shaft lengths: 1.5", 2.5" and 3.5" (includes .5" length of knurled arm fitting)
- Factory pre-set sweep angles of 80° or 110°, with easy adjustment to 45° or 60°
- Chrome plated solid brass knurled drive nut with brass and stainless steel drive shaft
- Two speed motor
- Sealed 6" wire leads, 16 AWG
- Adjustable right or left self parking
- .625" diameter shaft (16 mm)
- Available in 12V and 24V models
- Coast to park
- RF shielded circuitry
- Includes 5 amp fuse and holder (operating switch not included)
- Measures approximately 7.75" L x 4" W x 2.75" D (see below for detailed dimensional drawings)
- Stall torque: 109 in-lbs (125 kgf/cm; 12.3 Nm)
- Stall current: 11.5–13.0 amps
- No load current: 0.5–1.2 amps
- Replaces AFI 2000 motor

	Voltage	Sweep	Item #	OEM #
1.5" Shaft	12V	80°	71081	71181
	12V	110°	71011	71111M
2.5" Shaft	12V	80°	71082	71182
	12V	110°	71012	71112
	24V	110°	71212	71312
3.5" Shaft	12V	110°	—	71113

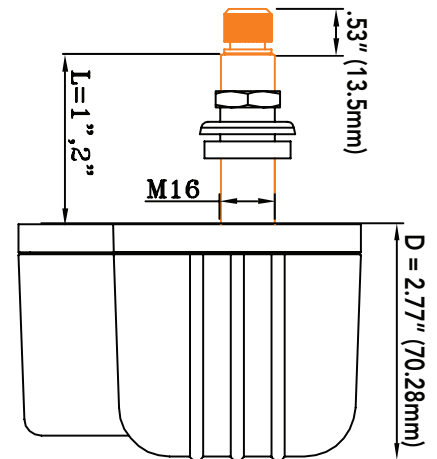
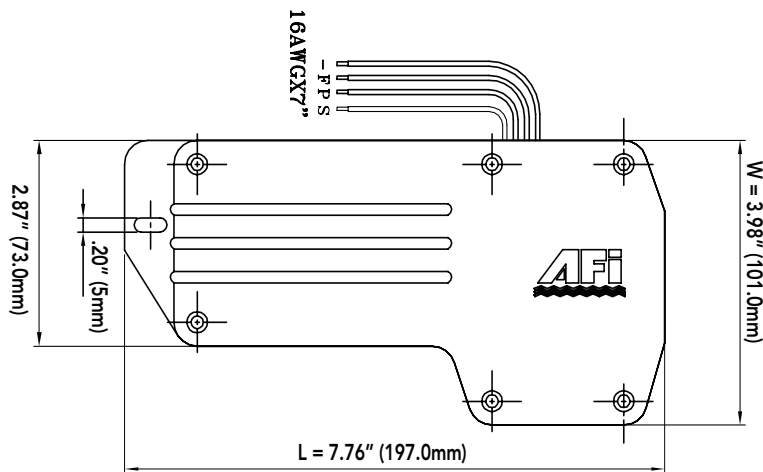



3 YEAR WARRANTY
CE

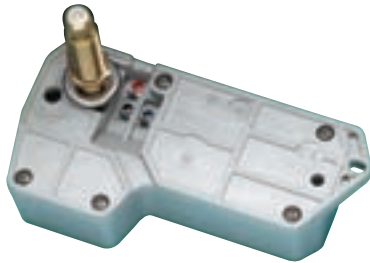

1000 Waterproof Wiper Motor

- Powers 18" Deluxe arm and 18" Deluxe blade combination at sweep sets of 80° or less
- Powers 16" Deluxe arm and 16" Deluxe blade combinations at a sweep set of 110°
- Factory pre-set sweep of 80° or 110° adjustable to 50°, 65°, 80°, or 110°
- .625" diameter shaft (16 mm)
- Fully sealed waterproof housing made of UV stabilized, high-temperature, high-impact thermoplastic
- 12 volt heavy-duty motor with anti-rotation drive shaft
- Knurled drive shaft and solid brass arm drive nut
- Coast to park with adjustable right or left self parking
- Includes 5 amp fuse and holder (on/off switch not included)
- RF shielded circuitry
- Weight: 1.75 lbs
- Available in two shaft lengths: 1.5" and 2.5" (includes .5" length of knurled arm fitting)
- Measures approximately 6.625" L x 3.375"W x 2" D
- Stall torque: 55 in-lbs (63 kgf/cm; 6.2 Nm)
- Stall current: 9.8–10.0 amps
- No load current: 0.8–1.2 amps

	Voltage	Sweep	Item#	OEM #
1.5" Shaft	12V	65°	—	36161
		80°	36180	36181
		110°	36110	36111
2.5" Shaft	12V	65°	—	37161
		80°	37180	37181
		110°	37110	37111
2.5" Shaft Kits	12V	80°	37100	—
		110°	37200	—

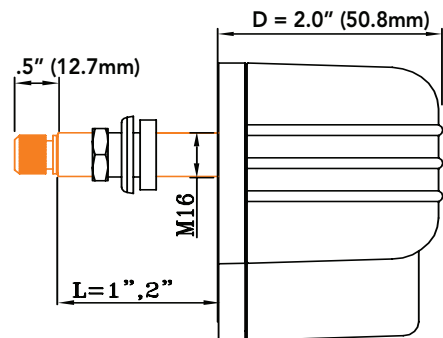
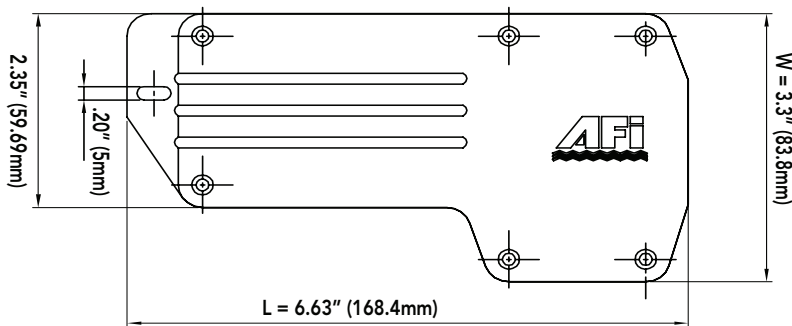

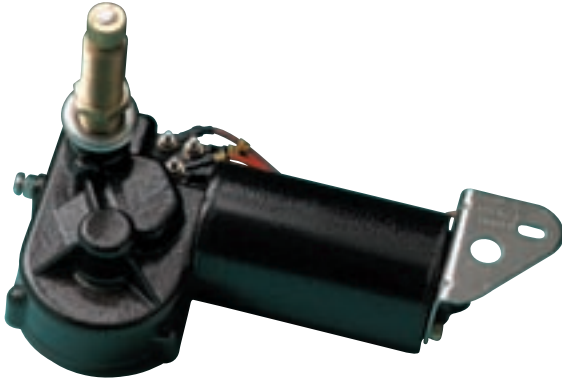

3 YEAR WARRANTY
CE

MRV Wiper Motor

- Easily powers 22" x 22" deluxe arm/blade combinations, or a 20" x 20" premier arm/blade combination at sweep sets of 80° or less
- Factory pre-set sweep of 80° or 110° adjustable to 45°, 60°, 80° or 110°
- .625" diameter shaft (16 mm)
- Available in 3 shaft lengths: 1.5", 2.5" and 3.5" (includes .5" length of knurled arm fitting)
- Corrosion-resistant casing
- Heavy-duty motor with right angle drive
- Two-speed motor, can be operated as one speed
- Solid brass knurled drive nut with brass and stainless steel drive shaft
- Adjustable right or left self parking, coast to park
- Includes 5 amp fuse and holder
- Stainless steel fasteners and mounting bracket
- Use with three-position switch (not included)
- Compact size – 7.625" L x 4" W x 2" D
- Stall torque: 109 in-lbs (125 kgf/cm: 12.3 Nm)
- Stall current: 11.5–13.0 amps
- No load current: 0.5–1.2 amps

	Voltage	Sweep	Item#	OEM #
1.5" Shaft	12V	80°	34001	38001
		110°	34011	38011
2.5" Shaft	12V	80°	34000	38000
		110°	34010	38010
		24V	110°	34210
3.5" Shaft	12V	80°	34005	38005
		110°	34015	—

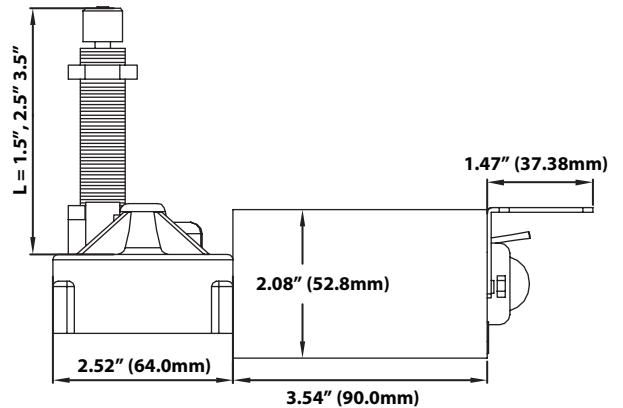
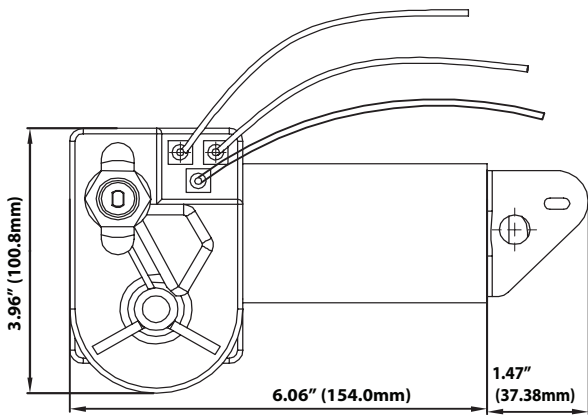

MRV Wiper Motor Cover

- Constructed of white ABS plastic
- Easily installed

Item # **33025**
OEM # 33125

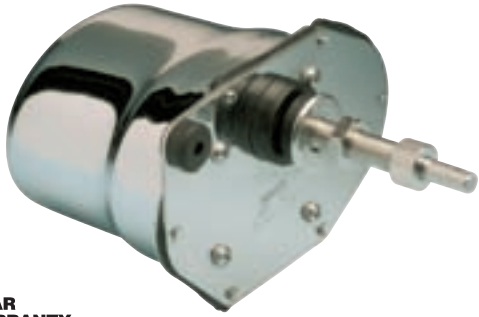

3 YEAR WARRANTY

WMW Wiper Motor

Windshield Mount: .5" Shaft diameter

- Powers up to 14" x 14" arm/blade combinations
- Water-resistant sealed motor
- Chrome-plated brass case and shaft housing
- Stainless steel front plate and wiper shaft
- Maximum current draw: 2 amps
- Shaft diameter: .375"
- For external use in open cabin boats
- Dimensions: 4.25" L x 2.75" W x 3.5" D

	Voltage	Sweep	OEM #
2.5" Shaft	12V	110°	35010



3 YEAR WARRANTY

WMW Wiper Kit

Windshield Mount: .375" shaft diameter

- WMW Wiper Motor with 11.5" Deluxe stainless steel curved blade (33004) and Deluxe adjustable (6.75" to 10.5") stainless steel arm (33006AS)

	Voltage	Sweep	Item #
Kit	12V	80°	30000
		110°	30002

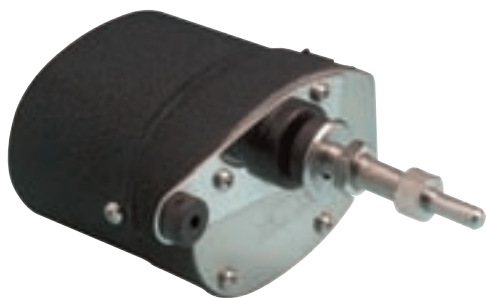

3 YEAR WARRANTY

Recommended for interior installations only

STD Wiper Motor

- Powers up to 14" x 14" arm/blade combinations
- Corrosion-proof aluminum alloy case with black crackle finish
- Base & mounting plates are chrome plated naval brass
- Maximum current draw: 2 amps
- 80° or 110° adjustable sweep, adjustable right or left self-parking
- Shaft diameter: .375" windshield mount, .5" deck mount
- Dimensions: 3.875" L x 2.25" W x 3.5" D

	Voltage	Sweep	OEM #
2.5" Shaft	12V	80°	35040
3.5" Shaft	12V	80°	35050



3 YEAR WARRANTY

Standard Wiper Kit

Windshield Mount: .375" shaft diameter

Deck Mount: .5" shaft diameter

- STD Wiper Motor with 11.5" Deluxe stainless steel curved blade (33004) and Deluxe adjustable (6.75" to 10.5") stainless steel arm (33006AS)
- Deck Mount version includes deck mount adapter kit (33000)

	Voltage	Sweep	Item #
Kit – 2.5" Shaft	12V	80°	32000
		110°	32002
Kit – 3.5" Shaft	12V	80°	32001

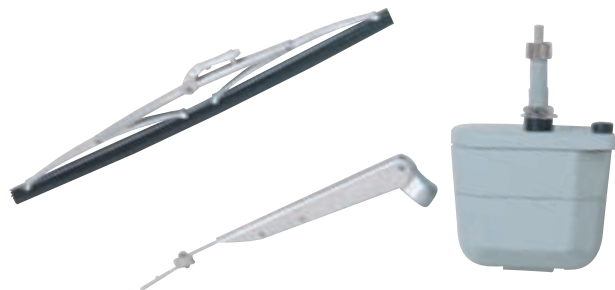

3 YEAR WARRANTY

500 Wiper Kit

Windshield Mount: .5" shaft diameter

500 Waterproof Wiper Motor with 11.5" Deluxe stainless steel curved blade (33004) and Deluxe adjustable (6.75" to 10.5") stainless steel arm (33006AS)

	Voltage	Sweep	Item #
Kit	12V	80°	30004
		110°	30005

Wiper Arms

Wiper arms are available in Standard, Deluxe, and Premier styles and the primary construction material in all wiper arms is stainless steel. Standard arms are used with Standard blades and can only be used with the line of Standard motors, while the Deluxe arms are used on Standard and Heavy-Duty motors. When choosing arms (and blades) it is very important to use only the recommended lengths for the motor that you are using.

The arms are available in a wide range of sizes, in both black and stainless steel finish, and regular and pantographic models. Pantographic arms use a set of two arms joined together to give a flatter and somewhat wider sweep pattern. The Deluxe arms are offered in either with a polished stainless steel finish or a black powder-coated finish. Premier arms are the top of the line product in this category, utilizing heavy-duty stainless steel tubing and components, and they can only be used with the Heavy Duty and Heavy Duty Plus motors. Premier arms come in adjustable length sizes, ranging from 10" to 30", in both regular and pantographic versions. The longer length Premier arms (25" – 30" long) have been designed for added strength and have a tapered wiper shaft fitting made especially to fit the larger, more powerful 3.0 wiper motor. These arms also have a saddle style tip for a stronger connection with the longer length Premier blades (26", 28", and 30" lengths).

Premier arms are also available as "wet arm" versions, with the water hose and sprayer nozzle built into the wiper arm. All that is needed is a water delivery system that the arm can be tied into. For those wanting a windshield washer system for the Deluxe arms, there is a complete washer kit system that is made especially to fit the Deluxe arms.



Wiper Arm Compatibility Chart

Style	Wet/ Dry	Length (adjustable)	Color	Material	Item #	OEM #	Motor Compatibility Chart					
							3.0	2.5	1.5	1000	MRV	
Premier Plus												
single	dry	25"-30"	stainless	stainless	33088	33188	✓	-	-	-	-	-
pantographic	dry	26"-30"	stainless	stainless	33096	33196	✓	-	-	-	-	-
single	wet	25"-30"	stainless	stainless	33088W	33188W	✓	-	-	-	-	-
pantographic	wet	26"-30"	stainless	stainless	33096W	33196W	✓	-	-	-	-	-
Premier												
single	dry	10"-15"	stainless	stainless	33082	33182	-	✓	✓	-	-	✓
single	dry	15"-20"	stainless	stainless	33084	33184	-	✓	✓	-	-	✓
single	dry	20"-25"	stainless	stainless	33086	33186	-	✓	-	-	-	-
single	wet	15"-20"	stainless	stainless	33084W	33184W	-	✓	✓	-	-	✓
single	wet	20"-25"	stainless	stainless	33086W	33186W	-	✓	-	-	-	-
pantographic	dry	12"-17"	stainless	stainless	33090	33190	-	✓	✓	-	-	✓
pantographic	dry	17"-22"	stainless	stainless	33092	33192	-	✓	-	-	-	max 20°
pantographic	dry	22"-26"	stainless	stainless	33094	33194	-	-	-	-	-	-
pantographic	wet	12"-17"	stainless	stainless	33090W	33190W	-	✓	✓	-	-	✓
pantographic	wet	17"-22"	stainless	stainless	33092W	33192W	-	✓	-	-	-	max 20° ≤ 80°
pantographic	wet	22"-26"	stainless	stainless	33094W	33194W	-	-	-	-	-	-
Deluxe Adjustable												
single	dry	6.75"-10.5"	stainless	stainless	33006A	33106A	-	✓	✓	✓	✓	✓
single	dry	10"-14"	stainless	stainless	33007A	33107A	-	✓	✓	✓	✓	✓
single	dry	14"-20"	stainless	stainless	33010A	33110A	-	✓	✓	-	max 18° ≤ 80° max 16° @ 110°	✓
single	dry	10"-14"	black	stainless	33012A	33112A	-	✓	✓	✓	✓	✓
single	dry	14"-20"	black	stainless	33014A	33114A	-	✓	✓	-	max 18° ≤ 80° max 16° @ 110°	✓
single	dry	18"-24"	black	stainless	33070A	33170A	-	✓	-	-	-	max 22°
Deluxe Pantographic												
pantographic	dry	12"-17"	black	stainless	33032A	33132A	-	✓	✓	-	-	✓
pantographic	dry	17"-22"	black	stainless	33037A	33137A	-	✓	✓	-	-	✓

Premier Plus Stainless Steel Adjustable Single and Pantographic Wiper Arm

- Heavy-duty component design for use with the 3.0 wiper motor
- Stainless steel and chrome-plated die cast construction
- Motor shaft mount with notched "teeth" and tapered design for secure operation
- Features "Articulating/Bend Back" design that locks arm in upright position for windshield cleaning



single – adjusts 25" to 30"



pantographic – adjusts 26" to 30"

Style	Wet/Dry	Length (adjustable)	Color	Material	Item #	OEM #
single	dry	25"-30"	stainless	stainless	33088	33188
pantographic	dry	26"-30"	stainless	stainless	33096	33196

Premier Plus Stainless Steel Single and Pantographic Wet Arms

- Premier wet arms add a built-in washer system to the high-end, heavy duty construction of the Premier wiper arms
- Premier wet arms feature a black PVC hose that runs up the center of the arm and ends in a four-nozzle fixture that is part of the arm itself
- Each solid brass nozzle is adjustable for maximum coverage



Single

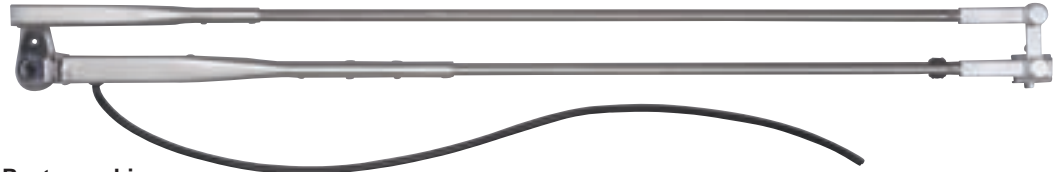

Pantographic

Style	Wet/Dry	Length (adjustable)	Color	Material	Item #	OEM #
single	wet	25"-30"	stainless	stainless	33088W	33188W
pantographic	wet	26"-30"	stainless	stainless	33096W	33196W

Pantographic wiper arms will only function properly with wiper motor sweep angles 80° or less

Premier Stainless Steel Single and Pantographic Dry Arms

- Heavy-duty component design for use with most Marinco® motors
- Stainless steel construction
- Features "Articulating/Bend Back" design that locks arm in upright position for windshield cleaning
- Motor shaft mount with notched teeth



Single



Pantographic

Style	Wet/Dry	Length (adjustable)	Color	Material	Item #	OEM #
single	dry	10"-15"	stainless	stainless	33082	33182
single	dry	15"-20"	stainless	stainless	33084	33184
single	dry	20"-25"	stainless	stainless	33086	33186
pantographic	dry	12"-17"	stainless	stainless	33090	33190
pantographic	dry	17"-22"	stainless	stainless	33092	33192
pantographic	dry	22"-26"	stainless	stainless	33094	33194

Pantographic wiper arms will only function properly with wiper motor sweep angles 80° or less

Premier Stainless Steel Wiper Wet Arms

Combine the heavy-duty construction and materials of the Premier wiper arm line with a built-in wet arm system that allows for a clean and easy installation of a washer system. A simple and easy way to keep your windshield clean, the Premier wet arms feature a black PVC hose that runs up the center of the arm and ends in a four-nozzle fixture that is an integral part of the wiper arm itself. Each solid brass nozzle is adjustable to provide a maximum coverage spray pattern for most any windshield.



Style	Wet/Dry	Length (adjustable)	Color	Material	Item #	OEM #
single	wet	15"-20"	stainless	stainless	33084W	33184W
single	wet	20"-25"	stainless	stainless	33086W	33186W
pantographic	wet	12"-17"	stainless	stainless	33090W	33190W
pantographic	wet	17"-22"	stainless	stainless	33092W	33192W
pantographic	wet	22"-26"	stainless	stainless	—	33194W

Pantographic wiper arms will only function properly with wiper motor sweep angles 80° or less

Deluxe Adjustable Wiper Arm

- All arms are stainless steel
- Arm has "articulating/bend-back" feature
- Motor shaft mounting has additional set screw clamping



Style	Wet/Dry	Length (adjustable)	Color	Material	Item #	OEM #
single	dry	6.75"-10.5"	stainless	stainless	33006A	33106A
single	dry	10"-14"	stainless	stainless	33007A	33107A
single	dry	14"-20"	stainless	stainless	33010A	33110A
single	dry	10"-14"	black	stainless	33012A	33112A
single	dry	14"-20"	black	stainless	33014A	33114A
single	dry	18"-24"	black	stainless	33070A	33170A

Deluxe Adjustable Pantographic Arm

- For Use with 2.5, 1.5 and MRV Motors
- Stainless steel
- Arm has "articulating/bend-back" feature
- Motor shaft mounting has additional set screw clamping



Style	Wet/Dry	Length (adjustable)	Color	Material	Item #	OEM #
pantographic	dry	12"-17"	black	stainless	33032A	33132A
pantographic	dry	17"-22"	black	stainless	33037A	33137A

Wiper Blades

Standard, Premier, and Deluxe wiper blades are offered in different sizes and styles to fit all of the different types of wiper arms.

Standard styles have plastic frame construction and marine grade rubber squeegees.

Premier and Deluxe styles have stainless steel frame construction and high-end silicone rubber squeegees. These two styles have multiple frame construction, allowing for equal pressure of the entire length of the blade and silicone rubber squeegees that are durable and create a smoother wiping motion. In addition, longer length Premier blades (26", 28", and 30") are specifically designed with a saddle style attachment for the longer length Premier arms. (25"-30").

For maximum performance of all blade styles, replacement of wiper blades is recommended every 6 months.

	Color/Material	Premier Plus Blades						
		Stainless/Stainless			Black/Stainless			
		Length	26"	28"	30"	26"	28"	30"
		Item #	33026S	33028S	33030S	33026B	33028B	33030B
OEM #	33126S	—	33130S	33126B	—	—		
Premier Plus Wiper Arms								
Single Arm	Dry	33088 , 33188	✓	✓	✓	✓	✓	✓
	Wet	33088W , 33188W	✓	✓	✓	✓	✓	✓
Pantograph Arm	Dry	33096 , 33196	✓	✓	✓	✓	✓	✓
	Wet	33096W , 33196W	✓	✓	✓	✓	✓	✓

	Color/Material	Premier Blades						Deluxe Blades								Standard Blades						
		Stainless/Stainless			Black/Stainless			Stainless/Stainless								Black						
		Length	20"	22"	24"	20"	22"	11.5"	14"	16"	18"	20"	22"	24"	26"	12"	14"	16"	18"	20"	22"	24"
		Item #	33021S	33022S	33024S	33021B	33022B	33004	33005	33015	33016	33017	33022	33023	33024	31012B	31014B	31016B	31018B	31020B	31022B	31024B
OEM #	33121S	33122S	33124S	33121B	33122B	33104	33105	33115	33116	33117	—	—	—	31112B	31114B	31016B	31118B	31120B	31122B	31124B		
Premier Wiper Arms																						
Single Arm	33082 , 33182	✓			✓		✓	✓	✓	✓	✓			✓	✓	✓	✓	✓				
	33084 , 33184, 33084W , 33184W	✓	✓	✓	✓	✓	✓	✓	✓	✓	✓	✓	✓	✓	✓	✓	✓	✓	✓	✓	✓	
	33086 , 33186, 33086W , 33186W	✓	✓	✓	✓	✓	✓	✓	✓	✓	✓	✓	✓	✓	✓	✓	✓	✓	✓	✓	✓	✓
Pantograph Arm	33090 , 33190, 33090W , 33190W	80° only			80° only		✓	✓	80° only	80° only	80° only			✓	✓	80° only	80° only	80° only				
	33092 , 33192, 33092W , 33192W	✓	✓	✓	✓	✓	✓	✓	✓	✓	✓	80° only		✓	✓	✓	✓	✓	✓	✓	80° only	
	33094 , 33194, 33094W , 33194W	✓	✓	✓	✓	✓	✓	✓	✓	✓	✓	✓	✓	✓	✓	✓	✓	✓	✓	✓	✓	✓
Deluxe Wiper Arms																						
Single Arm	33006A 33106A						✓	✓	✓					✓	✓	✓						
	33007A 33107A						✓	✓	✓	✓	✓			✓	✓	✓	✓	✓				
	33010A 33110A	80° only	80° only	80° only	80° only	80° only	✓	✓	✓	✓	✓	✓	✓	✓	✓	✓	✓	✓	✓	✓	✓	
	33012A 33112A						✓	✓	✓	✓	✓			✓	✓	✓	✓	✓				
	33014 330114A	80° only	80° only	80° only	80° only	80° only	✓	✓	✓	✓	✓	✓	✓	✓	✓	✓	✓	✓	✓	✓	✓	✓
	33070A 33170A						✓	✓	✓	✓	✓	✓	✓	✓	✓	✓	✓	✓	✓	✓	✓	✓
Pantograph Arm	33032A 33132A	80° only			80° only		✓	✓	✓	✓	✓			✓	✓	✓	✓	✓				
	33037A 33137A	80° only	80° only	80° only	80° only	80° only	✓	✓	✓	✓	✓	✓	✓	✓	✓	✓	✓	✓	✓	✓	✓	

Pantographic wiper arms will only function properly with wiper motor sweep angles 80° or less

Premier Plus Stainless Steel Wiper Blades

- All Stainless Steel Construction
- Marine Grade Silicone Squeegee
- Extra squeegee “claws” spread pressure evenly over the length of the blade, allowing the blade to conform to a curved windshield.



Length	Color	Material	Item #	OEM #
26"	stainless	stainless	33026S	33126S
28"	stainless	stainless	33028S	—
30"	stainless	stainless	33030S	33130S
26"	black	stainless	33026B	33126B
28"	black	stainless	33028B	—
30"	black	stainless	33030B	—

Premier Stainless Steel Wiper Blades

- All Stainless Steel Construction
- Marine Grade Silicone Squeegee
- Extra squeegee “claws” spread pressure evenly over the length of the blade, allowing the blade to conform to a curved windshield.



Length	Color	Material	Item #	OEM #
20"	stainless	stainless	33021S	33121S
22"	stainless	stainless	33022S	33122S
24"	stainless	stainless	33024S	33124S
20"	black	stainless	33021B	33121B
22"	black	stainless	33022B	33122B
24"	black	stainless	33024B	33124B

Deluxe Stainless Steel Curved Wiper Blades

- Works well on curved or flat windshields



Length	Color	Material	Item #	OEM #
11.5"	stainless	stainless	33004	33104
14"	stainless	stainless	33005	33105
16"	stainless	stainless	33015	33115
18"	stainless	stainless	33016	33116
20"	stainless	stainless	33017	33117
22"	stainless	stainless	33022	—
24"	stainless	stainless	33023	—
26"	stainless	stainless	33024	—

Polymer Wiper Blades

- Black glass poly-impregnated construction
- Marine-grade rubber squeegee



Length	Color	Material	Item #	OEM #
12"	black	polymer	31012B	31112B
14"	black	polymer	31014B	31114B
16"	black	polymer	31016B	31116B
18"	black	polymer	31018B	31118B
20"	black	polymer	31020B	31120B
22"	black	polymer	31022B	31122B
24"	black	polymer	31024B	31124B

Add-On Windshield Washer Kit

- Can be used on new or existing AFI™ Deluxe wiper arm and blade sets
- Kit includes parts to outfit two wiper arms
- Sprayer fittings (kit includes two) each have four adjustable brass nozzles to provide maximum spray coverage for most any windshield
- Plastic parts are numbered to make installation easy



Complete Windshield Washer Kit

Includes:

- Water tank with mounting bracket
- 12 volt pump motor
- Under deck tee fitting
- Thru deck fitting and hardware
- Below deck clear tubing (16 ft.)
- Above deck black tubing (6 ft.)
- Large and small rivet clips
- Wiper arm clips
- Sprayer fittings with clamps

Item # 33505

OEM # 33515

Above Deck Windshield Washer Kit

Includes:

- Thru deck fitting and hardware
- Above deck black tubing (6 ft.)
- Large and small rivet clips
- Wiper arm clips
- Sprayer fittings with clamps

OEM # 33514

Below Deck Windshield Washer Kit

Includes:

- Water tank with mounting bracket
- 12 volt pump motor
- Under deck tee fitting
- Thru deck fitting and hardware
- Below deck clear tubing (16 ft.)

OEM # 33513

Intelligent Wiper Switches

Microcontroller based "intelligent" switch provides all necessary wiper motor functions in one small component

- Settings for two continuous speed functions and three intermittent speed functions (2 second delay, 4 second delay, 8 second delay)
- Washer system operation function
- Blinking LED lights in switch indicate operating function
- Dual motor switch synchronizes both motors in each mode and deactivates each motor individually
- Works with 12V or 24V DC motors
- Fits standard switch size openings, requires 2.65"/67.5 mm depth
- Includes one ten pole connector with female pins and two female quick-connects

Single Motor **Item # 76030** OEM # 76130



Marinco® Horns

Marinco is the leading supplier of horns to the marine industry, with over fifty years of experience in designing and manufacturing sound devices specifically for use in harsh marine environments. Stainless steel is used for all critical components such as trumpets, motor cover, diaphragms, and assembly and mounting hardware. In the case of the XLP trumpet horns, the horn is given extra protection through the complete over-molding of the internal motor cover housing. It is this extra process that provides the added protection needed to back up the five-year warranty.

Marinco offers a complete line of marine horn products designed to meet almost any need, including electric and air trumpet horns, compact horns, electric and air below deck horns, and a comprehensive line of drop-in horns with a wide assortment of grill options. After developing the first below deck horn for the marine industry in the late 1980's, the offering of that product line has continued to expand. The latest addition is the "H" Horn Phase II, which is the loudest drop-in horn available today.

Notes:

- **Marinco® electric horns meet the American Boat & Yacht Council (ABYC) Regulation #A23 for boats up to 12 meters.**
- **All Marinco® air horns meet the U.S. Coast Guard's C.O.L.R.E.G.S. and U.S. Inland Navigation Rules, Annex III Regulations for boats up to 20 meters.**
- **Marinco® horns are listed in the National Marine Manufacturers Association (NMMA) Certification Program "type accepted" list**
- **All Marinco® horns are listed for boats up to 12 meters and all Marinco® air horns are listed for boats up to 20 meters.**
- **Horn motors and compressors are 12 volt unless otherwise indicated.**
- **Marinco® horns are set at a lower frequency to provide greater range as the sound travels across the water.**
- **Horns should be mounted facing forward whenever possible. The NMMA Certification Program requires this for boats 39' or longer.**

Notice Concerning Marine Horns, CE, and Electromagnetic Interference

In order to operate, an electric horn rapidly makes and breaks an electric circuit. This operation creates electromagnetic disturbance, which may cause electrical "noise" in communications equipment. Because a horn is only used temporarily, any interference in electronic equipment is stopped when the horn is turned off.

The International Marine Certification Institute (IMCI), which certifies boats to the European Community Regulations (CE), has determined that boats using electric horns can comply with CE requirements on electromagnetic compatibility provided the above message is given to the boat owners in their manual.

Marinco® Horn Relative Loudness Comparison Chart

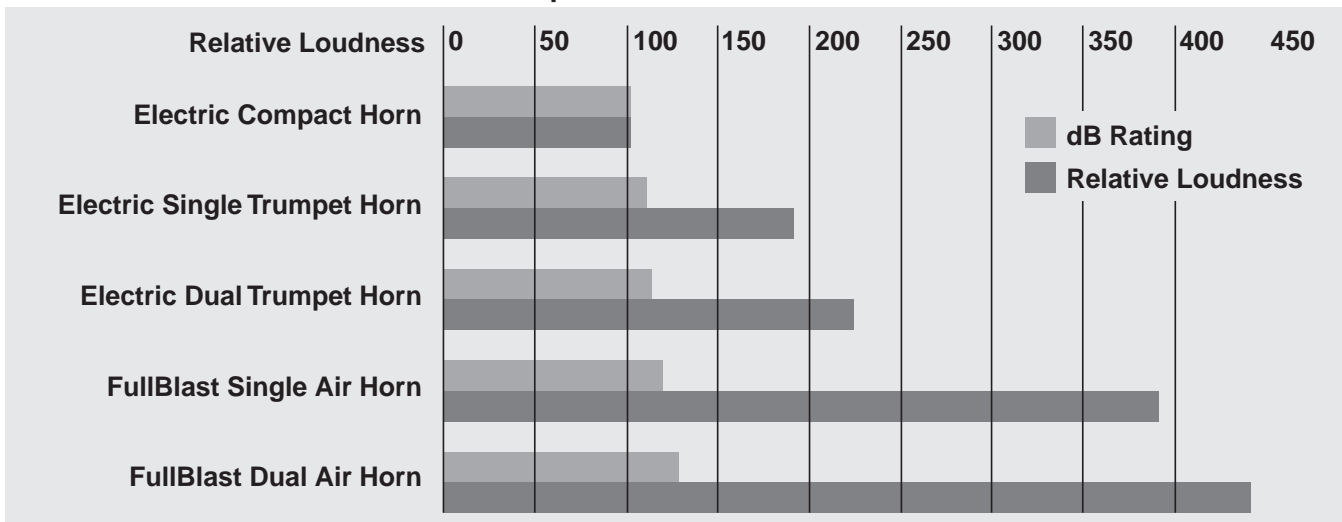

Marinco, the inventor of the first below deck horns, offers a full line of below deck horn products. Concealed horns utilize an upright horn installation and a large grill opening to offer greater sound volume. Drop-In Hidden Horns use a fabric lined grill for water-resistant installations. The concealed trumpet horns are all air horns and provide the maximum amount of sound available in a below deck horn installation.

Important: Please note the space requirement dimensions on some of the below deck models to ensure there is adequate room on the interior of the mounting area to house the horn assembly. Concealed horn models require a minimum 45° mounting angle to ensure proper drainage.

“H” Horn Phase II Drop-In Hidden Horn with Black and White Grills

- Comes with both white ASA and black ABS screw-in grills
- Grills have water resistant fabric liners
- Easy installation: 2.75" diameter hole x 1" deep
- 12 volt, maximum amp draw: 4 amps
- New louder dB(A) rating: 111 at one meter
- Fundamental frequency: 370±20Hz
- Mounts from the outside, grill screws on for easy install
- Easy retrofit

Item # 10080

“H” Horn Phase II Drop-In Hidden Horn without Grill

- Same as 10080 without grill
- When purchasing bulk version, grill must be ordered separately

OEM # 11080

Grills for Drop-In Hidden Horn 11080

- Water resistant fabric liner
- Grill dimensions: 5.25" W x 3.375" H x .75" D
- Screw-in

White ASA OEM # 11187
Off-White ASA OEM # 11194
Black ABS OEM # 11188

Stainless Steel Grill Cover for 11080

- Installs over plastic grill 11187, 11194, or 11188
- Installation requires plastic grill
- Grill dimensions: 5.3125" W x 3.4375" H x .875" D

OEM # 11196

Stainless Steel Grill Kit for 11080

- Includes stainless steel grill cover and plastic screw-in grill (11187)

OEM # 11096

Marinco's Drop-In Hidden Horns combine a number of desired features into one unit including:

- Simple, drop-in installation
- Stylish snap-on grill with water-resistant fabric
- Authentic marine sound
- Easy aftermarket retrofit



11187



11194



11188



11196



Electronic Horn with White Grill

- Electronic Piezo horn sound
- One piece water resistant housing, grill is molded to horn
- 107 dB(A) at one meter
- Fundamental frequency: 550±100Hz
- Mounts in a standard 2.25" opening
- Draws less than one amp, maximum draw: 0.8 amp
- Internal space requirements: 2.25" W x 2.25" H x 2" D
- Grill dimensions: 4.875" W x 2.75" H x .5"D
- Stainless steel grill cover 11185 sold separately

Item # 10082



Stainless Steel Grill Cover for Electronic Horn 10082

- Grill dimensions: 4.9375" W x 2.8125" H x .5" D

OEM # 11185



Drop-In "H" Horn with Grills

- Comes with both black ABS and white ASA snap-in grills
- dB(A) rating: 107 at one meter
- Fundamental frequency: 370±20Hz
- Internal space requirements: 2" H x 3.375" W x 3.25" D
- Distinctive marine horn sound
- Enclosed sound unit
- Easy installation or retrofit, mounts from the outside
- 12 volt, maximum amp draw: 4 amps
- Stainless Steel grill cover #11124 sold separately

Item # 10079



Drop-In "H" Horn without Grill

- Same as 10079 without grill
- When purchasing 11079, grill must be ordered separately

OEM # 11079



Drop-In Hidden Horn without Grill

- Internal space requirements: 2.25" H x 3.625" W x 3.5" D
- Maximum amp draw: 3 amps
- dB(A) rating: 105 at one meter
- Fundamental frequency: 440±20Hz
- Mounts from the outside, horn grill snaps on for easy installation
- Easy retrofit
- Grill must be ordered separately

OEM # 11095



PATENTED

Grills for Drop-In Hidden Horns 11079 and 11095

- Water resistant fabric liner
- Grill dimensions: 5" W x 2.625" H x .375" D

Snap-In

- White ASA OEM # 11090
- Black ABS OEM # 11091
- Chrome Plated ABS OEM # 11225

Screw-In

- White ASA OEM # 11190
- Black ABS OEM # 11191
- Chrome Plated ABS OEM # 11226 (not pictured)

11225



11091



11090



11191



11190



Stainless Steel Grill Cover

- Installs over screw-in plastic grill
- Requires plastic screw-in grill for installation
- Grill dimensions: 5.0625 W x 2.75 H x .5 D

OEM # 11124

Stainless Steel Grill Kit

- Includes stainless steel grill cover and plastic screw-in grill
- Grill (with cover installed) dimensions: 5.0625" W x 2.75" H x .5" D

OEM # 11024



Mini Hidden Horn

- Type 304 stainless steel diaphragm
- Dimensions: 3.25" W x 1.75" H x 3" L
- Maximum amp draw: 3 amps
- dB(A) rating: 105 at one meter
- Fundamental frequency: 440±20Hz
- This horn is not designed for installation in exposed areas.

Item # 10031

OEM # 11031



Mini Hidden Horn with Grill Bracket

- Same horn motor as 11031 but includes grill mounting bracket
- Grill must be ordered separately

OEM # 11034



Screw-In Black ABS Grill with Gasket for 11034

- Grill dimensions: 5" W x 2.625" H x .375" D

OEM # 11168



Screw-In Stainless Steel Grill for 11034

- Grill dimensions: 5" W x 2" H x .25" D

OEM # 11088



Accessories: Trumpet Horns

Concealed Compact Electric Horn

- Grill dimensions: 3.875" W x 4.25" H
- Internal space requirements: 5.5"W x 6" H x 4" D
- Maximum amp draw: 3 amps
- dB(A) rating: 109 at one meter
- Fundamental frequency: 415±20Hz
- Grill must be ordered separately

OEM # 11050



Stainless Steel Grill for 11050

OEM # 11060

Concealed Single Mini Air Horn

- Solid brass construction
- Includes compressor, air tubing, fittings, and hardware
- Internal space requirements: 13" H x 5" W x 3.75" D
- Air compressor dimensions: 2.625" D x 5" L
- Maximum amp draw: 20 amps
- dB rating: 126 at one meter, 1/3 octave band
- Fundamental frequency: 630±15Hz
- Grill must be ordered separately

OEM # 11059



Stainless Steel Grill for 11059

- Dimensions: 4.6875" H x 4.6875" W

OEM # 11064

Concealed Dual Trumpet Air Horn

- Solid brass construction
- Can be mounted side by side with dual grill 11066 or separately with two single grills 11064
- Includes compressor, air tubing, fittings, and hardware
- Internal space requirements: 10" W x 18.5" H x 3.75" D
- Air compressor dimensions: 5" L x 2.625" D
- Maximum amp draw: 20 amps
- dB rating: 121 at one meter, 1/3 octave band
- Fundamental frequency: 375±15/315±15Hz

OEM # 11058



Stainless Steel Grill for 11058

OEM # 11066

Marinco's FullBlast compressor driven air horns are the loudest and most complete line of 12V air horns available. All of our air horns produce sound levels ranging between 120 and 127dB, which means all of our air horns meet the ABYC and NMMA regulations for boats up to 20 meters/66 feet. Both 12 and 24 volt compressors are CE listed.

Loudest Single Air Horn at 126 dB



Single Trumpet Mini Air Horns

Solid brass construction

- Non-corrosive Lexan® polycarbonate diaphragm
- Includes compressor, air tubing, fittings, and hardware
- Dimensions: 9.5" L x 3.5" W x 3.5" H
- Maximum amp draw: 12 volt: 20 amps, 24 volt: 10 amps
- dB rating: 126 at one meter, 1/3 octave band
- Fundamental frequency: 630±15Hz

Chrome Plated **Item # 10107** OEM # 11107

White Epoxy Coated **Item # 10104**

12V compressor produces 9-11 PSI

Loudest Dual Tone Air Horn at 127 dB



Dual Trumpet Mini Air Horns

- Solid brass construction
- Non-corrosive Lexan® polycarbonate diaphragm
- Includes compressor, air tubing, fittings, and hardware
- Dimensions: 9.5" L x 5" W x 3.75" H
- Maximum amp draw: 12 volt: 20 amps, 24 volt: 10 amps
- dB(A) rating: 127 at one meter, 1/3 octave band
- Fundamental frequency: 630±15/525±15Hz

Chrome Plated **Item # 10108**

White Epoxy Coated **Item # 10121**

12V compressor produces 9-11 PSI



Single Trumpet Air Horns

- Solid brass construction
- Non-corrosive Lexan® polycarbonate diaphragm
- Includes compressor, air tubing, fittings, and hardware
- Dimensions: 17" L x 3.75" W x 3.75" H
- Maximum amp draw: 12 volt: 20 amps, 24 volt: 10 amps
- dB rating: 120 at one meter, 1/3 octave band
- Fundamental frequency: 315±15Hz

12 Volt **Item # 10105**

24 Volt **Item # 10524**

12V compressor produces 9-11 PSI

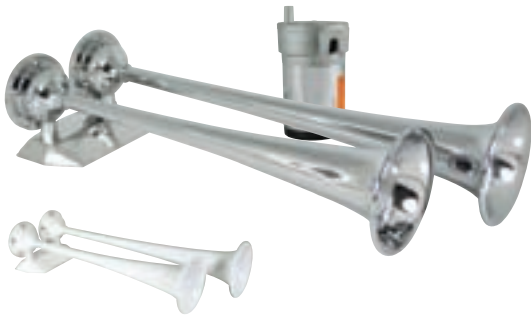

Dual Trumpet Air Horns

- Non-corrosive Lexan® polycarbonate diaphragm
- Includes compressor, air tubing, fittings, and hardware
- Dimensions: 17" L x 7" W x 3.75" H
- Maximum amp draw: 12 volt: 20 amps, 24 volt: 10 amps
- dB rating: 121 at one meter, 1/3 octave band
- Fundamental frequency: 375±15/315±15Hz

12V Chrome Plated **Item # 10106** OEM # 11106

12V White Epoxy Coated **Item # 10122**

24V Chrome Plated **Item # 10624**

24V White Epoxy Coated **Item # 10104** OEM # 22224

12V compressor produces 9–11 PSI



Air Compressor

- Replacement compressor fits all AFI™ Air Horns
- Dimensions: 2.625" D x 5" L
- Includes mounting bracket
- Maximum amp draw: 20 amps, Produces 9–11 PSI

12V OEM # 10102

24V OEM # 10224



Single Trumpet Electric Horn

- 5 Year Warranty
- 100% stainless steel exterior
- Includes laminated horn signal card and stainless steel mounting screws
- Type 304 stainless steel diaphragm
- Dimensions: 16.5" L x 4" W x 4.75" H
- Maximum amp draw: 5 amps
- dB(A) rating: 118 at one meter
- Fundamental frequency: 390±15Hz

Our Loudest Electric Single Trumpet Horn at 118 dB

5 YEAR WARRANTY

Premium XLP

12V **Item # 10028XLP** OEM # 11028XLP

24V **Item # 10017XL** OEM # 11017XLP Max amp draw: 2.5 amps

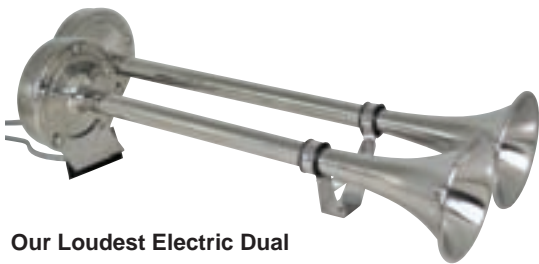

Dual Trumpet Electric Horn

- 5 Year Warranty
- 100% stainless steel exterior
- Includes laminated horn signal card and stainless steel mounting screws
- Type 304 stainless steel diaphragm
- Dimensions: 18.5" L x 8" W x 5" H
- Maximum amp draw: 10 amps
- dB(A) rating: 123 at one meter
- Fundamental frequency: 390±15/330±15Hz

Our Loudest Electric Dual Trumpet Horn at 123 dB

5 YEAR WARRANTY

Premium XLP

12V **Item # 10029XLP** OEM # 11029XLP

24V **Item # —** OEM # 11018XLP Max amp draw: 5 amps



Compact Design Easier to Install In Smaller Spaces

Compact Single Trumpet Electric Horn

- 100% stainless steel exterior
- Type 304 stainless steel diaphragm
- Dimensions: 14" L x 3.5" W x 4" H
- Maximum amp draw: 3.5 amps
- 12 volt
- dB(A) rating: 108 at one meter
- Fundamental frequency: 460±15Hz

Item # 10010



Compact Design Easier to Install In Smaller Spaces

Compact Dual Trumpet Electric Horn

- 100% stainless steel exterior
- Type 304 stainless steel diaphragm
- Dimensions: 16" L x 7.5" W x 4" H
- Maximum amp draw: 7 amps,
- 12 volt
- dB(A) rating: 110 at one meter
- Fundamental frequency: 460±15/415±15Hz

Item # 10011



MiniBlast™ Compact Electric Horns

- Long lasting, non-corrosive ASA plastic cover
- Sealed sound unit with stainless steel diaphragm
- Mounts in same hole pattern as the 10035 horn
- Dimensions: 4.375" L x 3.375" W x 2" H
- Maximum amp draw: 3 amps, 12 volt
- dB(A) rating: 106 at one meter (3 feet)
- Fundamental frequency: 440±20Hz

White **Item # 10099** OEM # 11099

Black **Item # 10098** OEM # 11098



Mini Compact Electric Horn

- Totally sealed sound unit
- Type 304 stainless steel cover, diaphragm, mounting bracket
- Dimensions: 3" L x 3.25" W x 1.75" H
- Maximum amp draw: 3 amps, 12 volt
- dB(A) rating: 106 at one meter
- Fundamental frequency: 440±20Hz

Item # 10035

OEM # 11035



Mini Twin Electric Horn

- Type 304 stainless steel covers, diaphragms, and mounting bracket
- Dimensions: 3" L x 8" W x 1.75" H
- Maximum amp draw: 6 amps, 12 volts
- dB(A) rating: 109 at one meter
- Fundamental frequency: 490±20/440±20Hz

Item # 10001

OEM # 11001



Compact Single Horn with Black Cover

- Stainless steel diaphragm and mounting bracket
- Black polypropylene cover
- Dimensions: 4.5" L x 4" W x 3" H
- Maximum amp draw: 4 amps, 12 volt
- dB(A) rating: 108 at one meter
- Fundamental frequency: 350±15Hz

Item # 10023



International Shorty Horn

- Stainless steel diaphragm and mounting bracket
- ABS, triple chrome-plated housing
- Dimensions: 4.25" L x 5" W x 6.5" H
- Maximum amp draw: 4 Amps, 12 Volt
- Fundamental frequency: 290±15 Hz
- Loudest Marinco® compact electric horn
- dB(A) rating: 123 at one meter

Item # 10036



5 YEAR WARRANTY

Bulb:	100 Watt, H3 Halogen
Power (Input voltage):	12V or 24V
Current draw (idle/in use):	0.03 amps / 7.0 amps
Peak Beam Intensity:	210,000 Cp
Peak Beam Distance:	3,000 ft (917 m)
Lux @ 82' (25 m):	226 Lux
Coverage at 82' (25 m):	180 sq ft (15'H x 12'W) (16.7 sq m [4.6 m x 3.6 m])
Rotation:	370° (built in limit stops)
Tilt:	120° Tilt (75° up & 45° down)
Wireless range:	200 ft (65 m)
Dimensions:	7.5"W x 7.5"H x 9.25"D (19cm x 19cm x 23.5cm)
Weight:	3.30 lbs (1.5 kg)
Housing material:	UV resistant PC/ASA
Lens material:	UV resistant Lexan®
operating temp range:	5°F–113°F (-15°C–45°C)
IP Rating:	IP56

NEW Wireless Remote Spot Light

- Universal 12/24 volt circuit with bright 100W, H3 halogen bulb
- UV resistant, IP56 Weatherproof ABS housing and Lexan® lens
- Double O-ring sealed housing, designed for the harsh marine environment – moisture, salt, shock and vibration tested
- Universal snap-in mounting system (can be mounted upside down)
- Super-quiet, all-weather motor with limit stops provides a full range of coverage
- 370° sweep and 120° Tilt (75° up and 45° down)
- One touch auto sweep and S.O.S. function
- Wireless dash mount remote standard; (hard wired & handheld remotes are optional)
- 5-Year limited warranty
- Available in white, black and chrome



Description	Color	Item #	OEM #
12/24 Volt, 100 Watt	white	SPL-12W	—
12/24 Volt, 100 Watt	black	SPL-12B	—
12/24 Volt, 100 Watt	chrome	SPL-12C	—
12 Volt, 100 Watt	white	—	SPL-12W.OEM
12 Volt, 100 Watt	black	—	SPL-12B.OEM
12 Volt, 100 Watt	chrome	—	SPL-12C.OEM
24 Volt, 100 Watt	white	—	SPL-24W.OEM
24 Volt, 100 Watt	black	—	SPL-24B.OEM
24 Volt, 100 Watt	chrome	—	SPL-24C.OEM

Replacement Bulbs

Description	Item #
12 Volt, H3 Halogen	202319
24 Volt, H3 Halogen	202320



Remote Options



SPRL-2

Included



SPRL-1

(optional)



SPRL-3

(optional)

	SPRL-2 Included	SPRL-1 (optional)	SPRL-3 (optional)
Remote Specifications	Wireless Bridge Remote	Hand Held Bridge Remote	Wired Bridge Remote
Power	12 or 24 volt (hard wired)	CR2540 button cell battery	12 or 24 volt (hard wired)
Current draw (idle / in use)	negligible	negligible	negligible
Wireless range	200 ft (65m)	200 ft (65m)	—
Estimated battery life	—	> 40 hours (continuous use)	—
Dimensions	3.5"Wx2.25"Hx.75"D 88x57x19 mm	2.0"Wx3.78"Hx1"D 51x96x25 mm	3.5"Wx2.25"Hx.75"D 88x57x19 mm
Weight	2.12 oz (60g)	2.82 oz (80g)	2.12 oz (60g)
Housing material	UV resistant PC/ASA	UV resistant PC/ASA	UV resistant PC/ASA
Button material	Silicone (glow in the dark)	Silicone (glow in the dark)	Silicone (glow in the dark)
Operating temp range	5°F–113°F (-15°C–45°C)	5°F–113°F (-15°C–45°C)	5°F–113°F (-15°C–45°C)
IP Rating	IP56	IP56	IP56



- Illuminates objects up to a mile away
- Marine grade construction
- One year warranty
- Light can be directed manually without damaging motors

Amp Draw:	8 amps, up to 10 on start
Operation:	12V Halogen
Bulb:	Replaceable 100 watt Halogen bulb
Overall Dimensions:	10.375" H x 7.375" W x 9.25" D
Base Dimensions:	5.75" W x 6.25" D
Weight:	3.75 Lbs.

Beamer™ Spot with Push Button Control

Item # 502A

Beamer™ Spot with Joystick Control

Item # 502-1

Beamer™ Spot with Wireless Remote

- Wireless transmitter controls spotlight functions
- Remote control works up to 150 ft. away
- Easy to install
- Security code on remote unit prevents unauthorized use
- Wireless secondary station may be added, see page 261

Item # 501A

Beamer™ Spot with Single Wire Remote

- Designed for mounting in locations where wiring may be difficult
- Install with common 22 gauge wire
- Small gauge control line easy to snake through bow rails
- Console control mounts on the surface with 1/4" wiring outlet

Item # 500A

Beamer™ 24V Spot with Joystick

- 15 ft. wiring harness included
- Smaller diameter wiring harness is easy to install
- Secondary station may be added, see page 261
- Console control mounts on the surface with 1/4" wiring outlet
- Joystick control requires 1.625" H x 2.75" L cutout

Item # 502-2

Replacement Bulb

- 12V, 100 Watt Halogen

Item # 729493





- Illuminates objects up to a mile away
- Marine grade construction
- One-year warranty
- Light can be directed manually without damaging motors
- 100 watt spotlight with 55 watt floodlight
- Includes 15 ft. wiring harness

Amp Draw:	8 amps, up to 10 on start
Operation:	12V Halogen
Bulb:	Replaceable Halogen bulb
Overall Dimensions:	10.375" H x 7.375" W x 9.25" D
Base Dimensions:	5.75" W x 6.25" D
Weight:	3.75 Lbs.

Beamer™ Spot/Flood with Push Button Control

- Secondary station may be added, see page 261
- Console control mounts on the surface with 1/4" wiring outlet

Item # 503A

Beamer™ Spot/Flood with Joystick Control

- Secondary station may be added, see page 261
- Joystick control requires 1.625" H x 2.75" L cutout

Item # 503-1

Beamer™ 24V Spot/Flood with Joystick

- Secondary station may be added, see page 261
- Joystick control requires 1.625" H x 2.75" L cutout

Item # 503-2

Replacement Bulb

- 12V, Halogen

Item # 729494

Beamer™ 12V Xenon Spot with Wireless Remote

- Twice as bright as Halogen spotlights
- Wireless remote control – works from 100 feet away
- Built-in RF receiver – no extra pieces to maintain or install
- Waterproof bullet connectors for ease of installation
- Fortified “neck” bracing to resist damage due to side impact

Item # 505

Xenon Replacement Bulb

- 12V, Xenon

Item # 730192

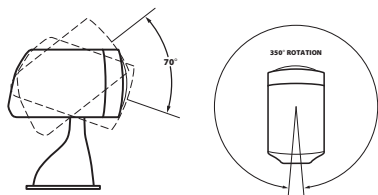

Spot kit includes joystick control and 15' wiring cable with easy to install plug ends



Spot kit includes joystick control and 15' wiring cable with easy to install plug ends

Stainless Steel Spot/Floods

- Remote control, joystick operation
- 316 stainless steel base, 304 stainless steel head
- One year warranty
- Dual station option available
- Light can be directed manually without damaging motors

5" Spot/Flood Kit

Item # 22040A

Spot Power:	72,000 CP
Flood Power:	30,000 CP
Amp Draw:	7 amps
Operation:	12V Incandescent
Bulb:	Replaceable Incandescent
Lamp Dimensions:	9.5" H x 4.5" W x 7.5" L
Base Dimensions:	5.5" L x 3.5" W
Weight:	6 Lbs.
Joystick requires:	2.75" installation hole

5" Spot/Flood Only

Item # 22041A

Replacement Bulb

- 12V Incandescent

Item # 22014-P

6" Spot/Flood Kit

Item # 22044

Spot Power:	200,000 CP
Flood Power:	50,000 CP
Amp Draw:	10 amps
Operation:	12V Incandescent
Bulb:	Replaceable Incandescent
Lamp Dimensions:	11" H x 6" W x 9" L
Base Dimensions:	5.5" L x 3.5" W
Weight:	9 Lbs.
Joystick requires:	2.75" installation hole

Replacement Bulb

- 12V Incandescent

Item # P-14302

Universal Halogen Deck Lamps

State-of-the-art free form lens reflector technology allows for 30% more light output than comparable 55W lamps. Universal mounting brackets and compact size make for easy installation anywhere. Lamp housing is made of UV stabilized plastic and all hardware is 316 chrome plated stainless steel. Includes 12V, 55W halogen bulb and is 24V, 70W compatible.



Bulbs:	Replaceable H3 12V 55W/H3 24V 70W
Dimensions:	3.75" H x 3.375" W x 5.5" L
Mounting Height:	4" with bracket

Item # **ML-005BW/DSP** OEM # ML-005BW-STC Black
 Item # **ML-005WW/DSP** OEM # ML-005WW-STC White



Flush Mount Deck Lamp

In addition to our highly popular conventional halogen deck lamps, we now offer a flush mount version. Ideally suited for fiberglass hardtop installations and allows for a very clean and finished installation. Free Form lens reflector technology guarantees maximum output. Lamp is completely waterproof and constructed of impact resistant UV stable plastic. Comes complete with 12V 55W halogen H3 bulb. Also suitable for 24V 70W bulbs.

Bulbs:	Replaceable H3 12V 55W/H3 24V 70W
Dimensions:	3.375" H x 1.5" W x 5.625" L
Cutout:	3" hole

Item # **ML-005NWW**

Beamer™ Parts and Accessories

Model Number	Control Panel	Dual Station Control Kit	Replacement Bulb Kit	Extension Cable Kit	Wires in Cable
500, 500A	729823-P	729823-P	729493	—	1
501, 501A	729825	729825	729493	—	Wireless
502, 502A	729827-P	729828-P	729493	729528	5
502-1	U-3605	729488	729493	729528	5
502-2	729489	729489	729493	729528	5
503, 503A	729829-P	729830-P	729494	729528	6
503-1	U-3606	729491	729494	729528	6
503-2	22208-24	729492	729494	729528	6

Stainless Steel Spot/Flood Parts and Accessories

Model Number	Oval Panel	Rectangular Control	Dual Station Control Kit	Replacement Bulb Kit
22040A	22240	22208A	22218A	22014-P
22041A	22240	22208A	22218A	22014-P
22044	22240	22208A	22218A	P-14302
22045	22240	22208A	22218A	P-14302

M-100 Remote Halogen Spot Parts and Accessories

Model Number	Joystick Control	Dual Station Control Kit	Replacement Bulb Kit
22200	22209	22219A	22230-P
22201	22209	22219A	22230-P

Extension Cables

Length	Male to Male	Male to Female
25 Ft.	22011A-P	22011MA-P
35 Ft.	22012A-P	22012MA-P

Use with: 22040A, 22041A, 22044, 22045, 22200 or 22201 Lights



Lamps

- Heavy duty glass envelope for break resistance.
- Nickel-plated brass bases prevent corrosion while insuring a positive point-of-contact.
- Filaments, with “rough service” design, permit hours of reliable burning.
- Not rated for navigation.

LED Festoon Bulbs

Figure Letter	Line #	System Dimensions	Volts	Amps	CP	Life	Qty/ Pkg	Item #
A	1	.39" x 1.73"	12	80 mA	2000MCD*8	50,000	1	529417
B	2	.39" x 1.73"	12	80 mA	2000MCD*8	50,000	1	529419

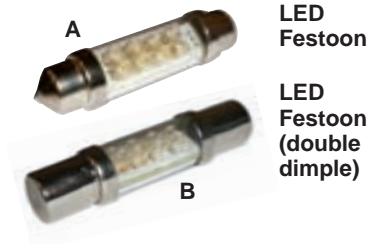

LED 360° Bayonet Base Bulbs

Figure Letter	Line #	System Volts	Amps	Current Draw	Life	Qty/ Pkg	Item #
C	3	12.00	2200MCD*20	200 mA	50,000	1	529412
	4	12.00	2200MCD*36	240 mA	50,000	1	529413
D	5	12.00	2200MCD*16	160 mA	50,000	1	529414

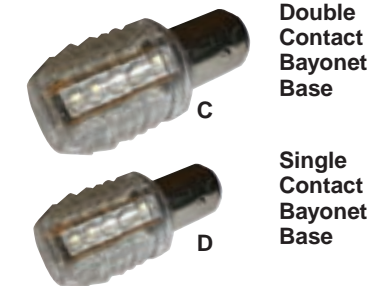

LED 360° Double Contact Index Base Bulbs

Figure Letter	Line #	System Volts	Light Output	Current Draw	Life	Qty/ Pkg	Item #
E	6	10–30V	75 Lumens	190 mA	50,000	1	529416
	7	10–30V	110 Lumens	180 mA	50,000	1	529420



LED Wedge Base Bulbs

Figure Letter	Line #	System Volts	Light Output	Current Draw	Life	Qty/ Pkg	Item #
F	8	12.00	4000MCD	20 mA	50,000	1	529410
G	9	12.00	6000MCD	40 mA	50,000	1	529411

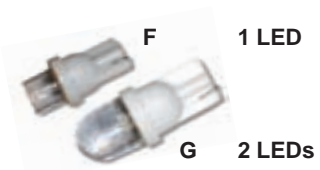

LED G4 Bulb w/ Radial Leads 90° Radiation of Light

Figure Letter	Line #	System Volts	Current Draw	CP	Life	Qty/ Pkg	Item #
H	10	12.00	80 mA	2500MCD*8	50,000	1	529421
	11	12.00	80 mA	2500MCD*12	50,000	1	529422
I	12	12.00	180 mA	2500MCD*27	50,000	1	529423



LED MR16 Bulb

Figure Letter	Line #	System Volts	Current Draw	CP	Life	Qty/ Pkg	Item #
J	13	12.00	140 mA	2500MCD*20	50,000	1	529424



General Lamps

Figure Letter	Line #	Trade #	System Volts	Design Volts	Design Amps	Design Watts	CP	Life	Qty/Pkg	Item #
K	14		4.80	4.80	.62	3.00	4.06		2	521128
L	15	194	12.00	14.00	.27	3.80	2.00	1500	2	520194
	16	168	12.00	14.00	.35	4.90	3.00	1500	2	520168
	17		12.00	12.80	1.0	12.8	12.00		2	520912
M	18	906	12.00	13.00	.69	9.00	6.00	1000	2	520906
N	19	53	12.00	14.40	.12	1.70	1.00	1000	2	520053
	20		12.00	14.00	.35	5.0	3.0		2	521126
O	21	57	12.00	14.00	.24	3.40	2.00	500	2	520057
P	22	1816	12.00	13.00	.33	4.30	3.00	1000	2	521816
Q	23	1416	12.00	12.80	.80	10.20	8.00	1000	2	521416
	24		12.00	13.50	2.08	25.00	30.00		1	521159
R	25	1004	12.00	12.80	.94	12.00	15.00	200	2	521004
S	26	82	6.00	6.50	1.02	6.60	6.00	500	2	520082
	27	68	12.00	13.50	.59	8.00	4.00	5000	2	520068
	28	90	12.00	13.00	.58	7.50	6.00	750	2	520090
	29	1224	32.00	34.00	.16	5.10	3.80	500	2	521224
T	30	94	12.00	12.80	1.04	13.30	15.00	700	2	520094
	31	1076	12.00	12.80	1.80	23.00	32.00	200	2	521076
	32	1142	12.00	12.80	1.44	18.40	21.00	1000	2	521142
	33	1142R	12.00	12.80	1.44	18.40	21.00	1000	2	521140
	34	1176	12.00	12.8/14	1.34/.39	17.20	21/6	300/1500	2	521176
	35	1204	24.00	28.00	.71	19.90	21.00	400	2	521204
	36	1228	32.00	34.00	.45	15.30	15.00	150	2	521228
U	37	1003	12.00	12.80	.94	12.00	15.00	200	2	521003

Miniature Flange Base

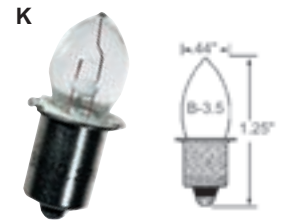

Wedge Base

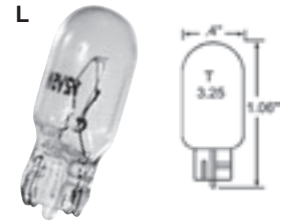

Wedge Base

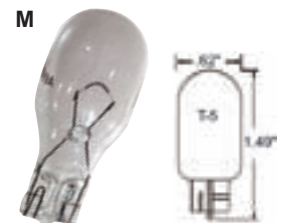

Miniature Bayonet Base



Miniature Bayonet Base



Miniature Bayonet Base

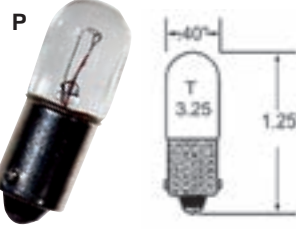

Miniature Bayonet Base



Double Contact Bayonet Base



Double Contact Bayonet Base

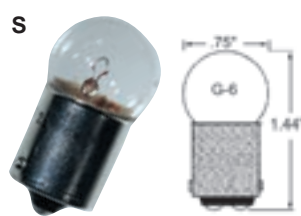

Double Contact Bayonet Base



Single Contact Bayonet Base



General Lamps

Figure Letter	Line #	Trade #	System Volts	Design Volts	Design Amps	Design Watts	CP	Life	Qty/ Pkg	Item #
V	38	97	12.00	13.50	.69	9.30	4.00	5000	2	520097
	39	67	12.00	13.50	.59	8.00	4.00	5000	2	520067
W	40	1383	12.00	13.00	1.54	20.00	300		1	521383
	41	93	12.00	12.80	1.04	13.30	15.00	700	2	520093
	42	1141	12.00	12.80	1.44	18.40	21.00	500	2	521141
X	43	1156	12.00	12.80	2.10	26.90	32.00	1200	2	521156
Y	44	1034	12.00	12.8	1.8	23/8.2	32/3	200/5000	2	521034
	45	1157	12.00	12.8/14	2.1/.59	27/8		200/5000	2	521157
	46		12.00	13.50	.83	10.00	12.00	1000	1	521158
	47		24.00	24.00	.41	10.00	12.00		1	521162
Z	48		120.00	120.00	.25	30.00	20.00		1	521164

Single Contact Bayonet Base V

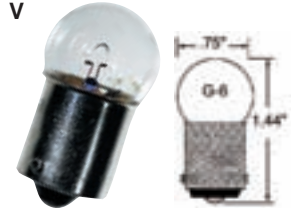

Single Contact Bayonet Base W



Single Contact Bayonet Base X



Double Contact Index Base Y



Double Contact Bayonet Base Z



Festoon End Caps

Figure Letter	Line #	Trade #	System Volts	Design Volts	Design Amps	Design Watts	CP	Life	Qty/ Pkg	Item #
AA	49		12.00	13.50	.39	4.75	2.00		2	522124
AB	50		12.00	13.50	.83	10.00	8.00	1000	2	529102
	51		12.00	13.50	.83	10.00	(Red)	1000	2	529200
	52		24.00	24.00	.41	10.00	8.0		2	522129
AC	53		12.00	13.50	.50	6.00	2.00	1000	2	529095
AD	54		12.00	13.50	.83	10.00	8.00	2000	2	529104
	55		12.00	13.50	.83	10.00	8.00 (Red)		2	522127
	56		12.00	13.50	.83	10.00	8.00		2	522126
AE	57		12.00	13.50	1.42	15.00	8.00		2	522131
AF	58	211-2	12.00	12.80	.97	15.00	12.00	1000	2	522112
	59	212-2	12.00	13.50	.74	10.00	6.00	2000	2	522122
AG	60		12.00	13.50	.83	10.00	8.00	2000	2	529333

AA

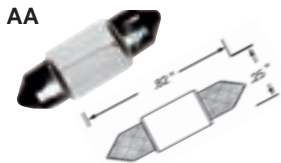

AB



AC

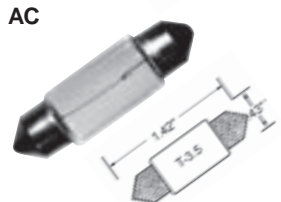

AD

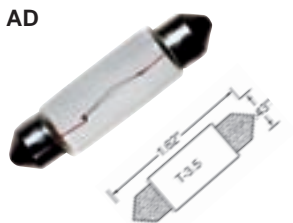

AE

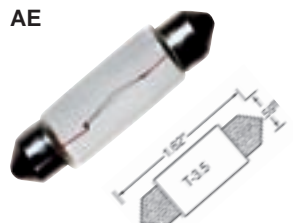

AF

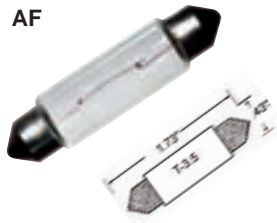

AG



Medium Screw Base

Figure Letter	Line #	Trade #	System Volts	Design Volts	Design Amps	Design Watts	Life	Qty/ Pkg	Item #
AH	81	15G12/12	12.00	13.50	1.25	15.00	1000	1	511016
AI	82	15A17/12	12.00	13.50	1.25	15.00	1000	2	531015
	83	25A17/12	12.00	13.50	2.08	25.00	1000	2	531025
	84	50A17/12	12.00	13.50	4.17	50.00	1000	2	531050
	85	75A17/12	12.00	13.50	6.25	75.00	1000	2	531075
	86	100A17/12	12.00	13.50	8.33	100.00	1000	2	531100
	87	25A17/24	24.00	27.00	1.04	25.00	1000	2	532025
	88	15A17/34	32.00	36.00	.44	15.00	1000	2	533015
	89	25A17/34	32.00	36.00	.74	25.00	1000	2	533025
	90	50A17/34	32.00	36.00	1.47	50.00	1000	2	533050
	91	75A17/34	32.00	36.00	2.21	75.00	1000	2	533075

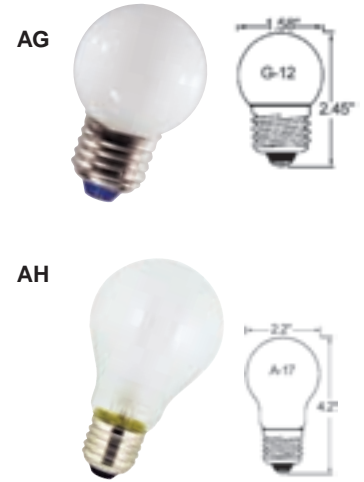

Navigation Lamps

Figure Letter	Line #	System Volts	Design Volts	Design Amps	Design Watts	CP	Life	Qty/ Pkg	Item #
AJ	92	12.00	12.00	2.50	30.00	26.00	1200	1	529300
	93	24.00	24.00	1.67	40.00	28.00	1200	1	521166
AK	95	12.00	12.00	2.08	25.00	24.00	1200	1	529340
	96	24.00	24.00	1.04	25.00	24.00	1200	1	529341
	97	24.00	24.00	.42	10.00	12.00	1200	1	529344

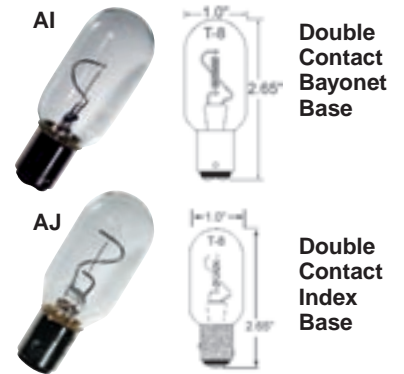

Fluorescent Tubes

Figure Letter	Line #	Trade #	Volts	Watts	M.O.L.	M.O.D.	Life	Qty/ Pkg	Item #
AL	98	F8T5/CW	13.5	8.00	11.3"	.5"	7500	2	529405
	99	F15T8/CW	13.5	15.00	18"	1.0"	7500	2	529406
	100	F13T5/CW	13.5	13.00	20.86"	.5"	7500	2	529407



Miniature Halogen Lamps

Figure Letter	Line #	System Volts	Design Volts	Design Amps	Design Watts	CP	Life	Qty/ Pkg	Item #
AM	102	12.00	12.00	.42	5.00	5.00	2000	2	529361
	103	12.00	12.00	.83	10.00	11.00	2000	1	529362
	104	12.00	12.00	1.67	20.00	20.00	2000	1	529367
	105	24.00	24.00	.42	10.00	11.00	2000	1	529338
	106	24.00	24.00	.83	20.00	20.00	2000	1	529368
	106	12.00	12.00	.83	10.00		1000	2	529370
AN	107	12.00	12.00	1.67	20.00	20.00	2000	1	529337
	108	12.00	12.00	.42	5.00	5.00	2000	1	529355
AO	107	12.00	12.00	.83	10.00			2	529385

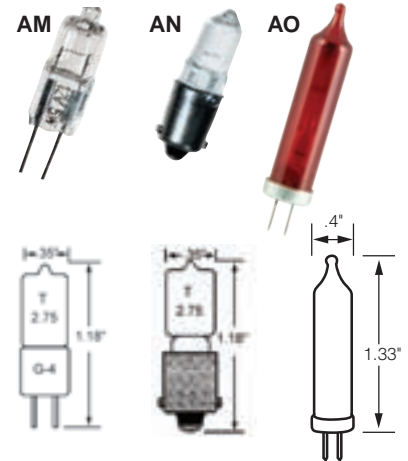

H2/H3 Halogen Lamps

Figure Letter	Line #	Bulb Type	System Volts	Design Volts	Design Amps	Design Watts	CP	Qty/ Pkg	Item #
AP	109	H2	12.00	13.50	4.58	55.00	225.00	1	529168
	110	H3	12.00	13.50	8.30	100.00	100.00	1	529386



Halogen Lamp Adapter Bases

The nickel-plated brass base Halogen Lamp Adapter allows the use of all V style miniature halogen lamps in standard single contact, double contact or medium screw base sockets.

Figure Letter	Line #	Description	Qty/ Pkg	Item #
AQ	112	D C Bayonet	1	529381



Life Lamp Calculator

This lamp life nomograph shows relationship between voltage, current, candle power and life. Each lamp has a design voltage as well as a nominal operating voltage. This allows the designer of the lamp to tailor the life/output/current draw to meet specific needs, within certain industry standards. We have chosen to emphasize life brightness. The rated life is based on the average life of 50% of the lamps tested under laboratory conditions – no vibration, stable voltage, room temperature, and in a vertical position. Any other condition will adversely affect lamp life.

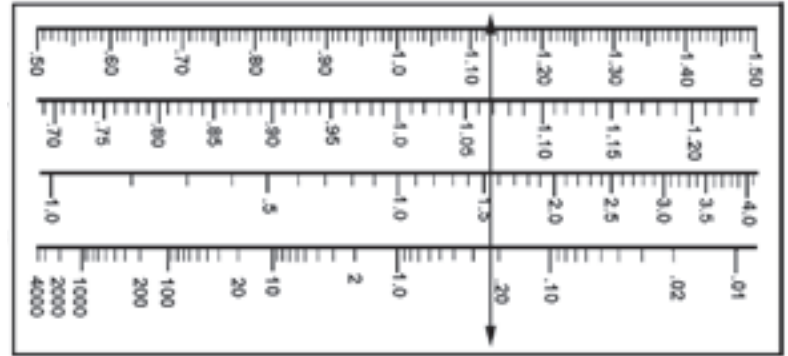

Example: To find the effect of under or over voltage on life, current draw and candle power, read in a horizontal line under % of rated voltage. Thus, a #90 bulb rated at 13V but operating at 14.70v (113% of rated voltage – a high charge rate) would have 107% of rated current draw, 155% of rated candle power, but would only last 23% of its rated life.

Cross Reference Listing

Item #	Line #	Figure Letter	Item #	Line #	Figure Letter	Item #	Line #	Figure Letter	Item #	Line #	Figure Letter
511016	81	AH	521159	24	Q	529338	105	AM	529421	10	H
520053	19	N	521162	47	Y	529340	95	AK	529422	11	H
520057	21	O	521164	48	Z	529341	96	AK	529423	12	I
520067	39	V	521166	93	AJ	529344	97	AK	529424	13	J
520068	27	S	521176	34	T	529355	108	AN	531015	82	AI
520082	26	S	521204	35	T	529361	102	AM	531025	83	AI
520090	28	S	521224	29	S	529362	103	AM	531050	84	AI
520093	41	W	521228	36	T	529367	104	AM	531075	85	AI
520094	30	T	521383	40	W	529368	106	AM	531100	86	AI
520097	38	V	521416	23	Q	529370	106	AM	532025	87	AI
520168	16	L	521816	22	P	529371	106	AM	533015	88	AI
520194	15	L	522112	58	AF	529381	112	AQ	533025	89	AI
520906	18	M	522122	59	AF	529385	107	AO	533050	90	AI
520912	17	L	522124	49	AA	529386	110	AP	533075	91	AI
521003	37	U	522126	56	AD	529405	98	AL			
521004	25	R	522127	55	AD	529406	99	AL			
521034	44	Y	522129	52	AB	529407	100	AL			
521076	31	T	522131	57	AE	529410	8	F			
521126	20	N	529095	53	AC	529411	9	G			
521128	14	K	529102	50	AB	529412	3	C			
521140	33	T	529104	54	AD	529413	4	C			
521141	42	W	529168	109	AP	529414	5	D			
521142	32	T	529200	51	AB	529416	6	E			
521156	43	X	529300	92	AJ	529417	1	A			
521157	45	Y	529333	60	AG	529419	2	B			
521158	46	Y	529337	107	AN	529420	7	E			

How Solar Vents Work

Maintenance Ventilation

In most climates, boats that have been closed for a period of time will become “stuffy.” The temperature differential that develops between the boat cabin and the outdoor environment will cause the humidity level inside the boat cabin to rise. When the humidity level in the closed cabin rises, moisture forms, resulting in mold, mildew and musty air. In these conditions, fabrics, boat electronics and even the boat’s fiberglass structure can be damaged. By consistently replacing trapped, stale air in the closed boat with fresh outside air, the humidity equalizes from inside to outside, resulting in effective maintenance ventilation.

Comfort Ventilation

Combining different types of vents, with one vent providing “intake” air flow while another vent provides “exhaust” air flow, creates cross-flow ventilation. A cross-flow ventilation system will make the interior cabin more comfortable and pleasurable because air is constantly moving throughout the cabin. No matter what your boat size or cabin configuration is, you can increase your boating enjoyment with the addition of ventilation.

Safety Ventilation

Most boaters are unaware of the hazards that exist in the boating environment. Any number of serious ventilation problems can occur when a boat is left unattended. And even if you are underway, these problems don’t go away. Fumes and gasses, ranging from carbon monoxide to hydrogen gas from battery charging, to gasoline, propane or solvents stored below, are unpleasant, and can sometimes be dangerous. Also, any open flame devices in the cabin require proper ventilation. Ventilation helps to eliminate these hazards by providing constant air circulation resulting in effective safety ventilation.

How Much Ventilation Is Required For Your Boat?

Ideally, the air in the interior of a boat should be circulated once every hour. A typical 30-foot boat contains approximately 800 cubic feet of air. As you will see, our solar powered models can move between 600 and 1,000 cubic feet of air every hour. The general guidelines for providing maintenance ventilation are as follows:

Boat Size	Recommended Ventilation
Up to 24 ft.	1 Exhaust Vent*
24 to 40 ft.	1 Exhaust Vent & 1 Intake Vent
40 ft. and larger	2 Exhaust Vents & 1 Intake Vent

* For effective maintenance ventilation, one vent assumes there will be access for air to get into the cabin (i.e., cowl vent, clamshell vent or louvered panel)

It is important to evaluate the cabin layout of your boat to determine optimal locations for both intake and exhaust ventilation. These illustrations suggest placement for Marinco™ solar powered vents and Marinco™ passive vents.

Note how the placement of the vents creates cross flow ventilation.

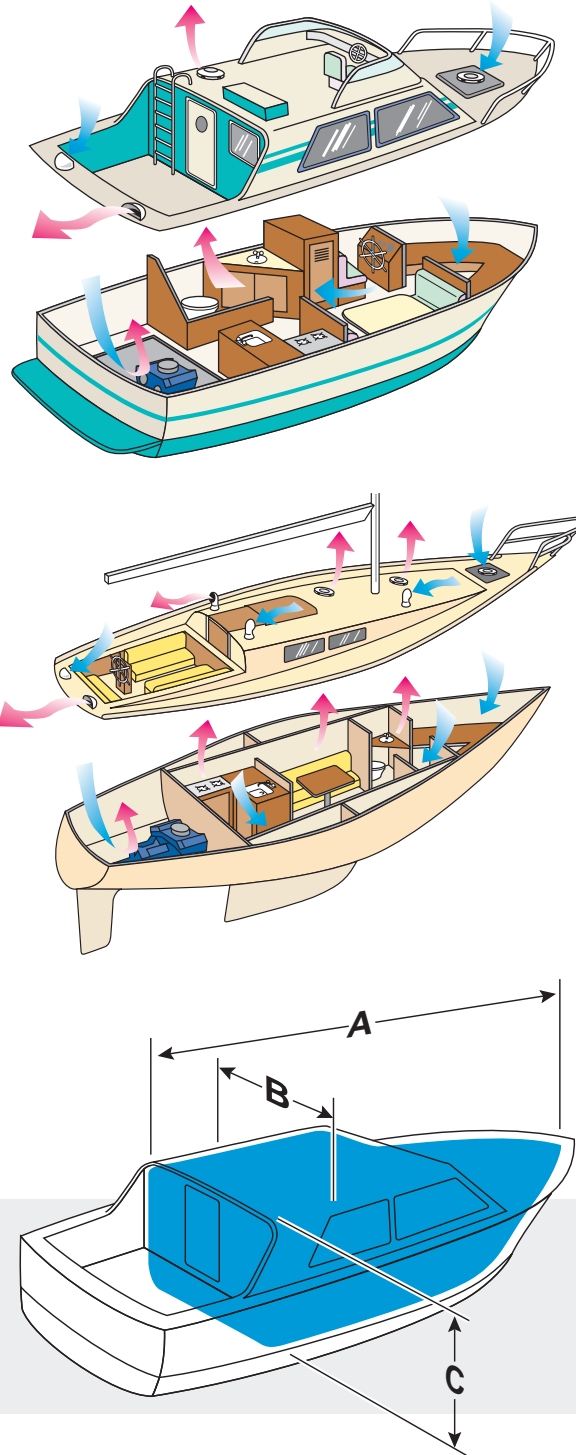

To Specifically Calculate Your Boat’s Air Volume, Use This Simple Formula:

$$A \times B \times C \times 70\% = \text{Boat Interior Volume}$$

A Dimension is the interior length (excluding cockpit)

B Dimension is the boat width

C Dimension is the average interior height

Installation

All Marincó™ ventilation products include clear, easy-to-understand installation instructions. These instructions address all of the key factors of a professional installation, such as:

- Proper hole measurement and cutting procedures
- Proper deck plate installation
- Use of sealants to waterproof your vent installation
- Installing vents in hatches
- Installing vents in “cambered” or slightly curved decks
- Use of interior trim rings to “dress up” the cabin

The high quality level of Marincó™ Ventilation products must be combined with a sound installation to guarantee that your vent performs in all conditions. Marincó will make sure that your installation will be easy and successful so that you can enjoy the benefits of installation for a long time to come.

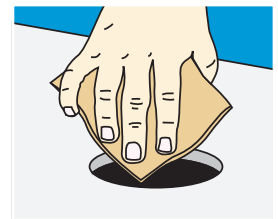
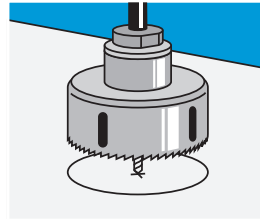
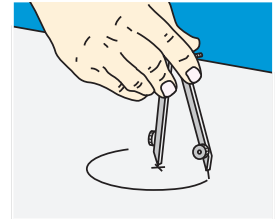
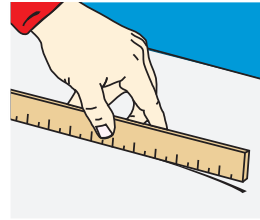

Marincó™ Ventilation Installation Systems Snap-In Deck Plate Installation



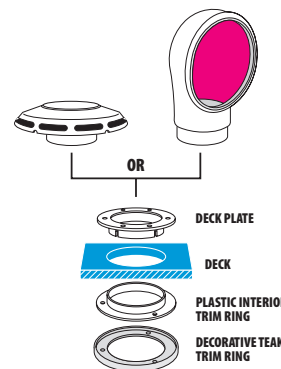























The 12 volt vent, 12 volt combo vent and cowl vents use the Marincó™ Snap-In deck plate system. The Snap-In system allows the easy exchange of any Snap-In part for upgrading or convenience, as well as the use of a Snap-In cover that completely seals the deck plate making it water tight.



Snap-In deck plates are used to install the 12 Volt Vents, 12 Volt Combo Vents and Cowl Vents only. Models with threaded deck plates have different installation requirements. Please consult installation instructions for these models.

Direct-To-Deck Installation

The Day/Night Plus, MiniVent 1000 and AirVent 500 are designed to be installed directly to the deck without the requirement for a deck plate. All of these vent systems have built-in shut-off dampers that operate from below.

	Airflow Size	Hole Size Dia	Deck Plate	Mounting Flange Depth	Operation		Cubic Feet of Air	Intake	Exhaust
					Day	Night			
	4" / 102 mm	4-3/4"	None (Direct to Deck Mounting)	1.75"	 Solar	 Rechargeable Battery Power	1000 ft ³ /hour 20 m ³ 24,400 ft ³ /day 672 m ³	 Fan	 Fan
	3" / 76 mm	3-3/4"	None (Direct to Deck Mounting)	1.75"	 Solar	 Rechargeable Battery Power	600 ft ³ /hour 17 m ³ 16,800 ft ³ /day 408 m ³	 Fan	 Fan
	3" / 76 mm	3-3/4"	None (Direct to Deck Mounting)	1"	 Solar	 Passive	700 ft ³ /hour 20 m ³ 5,600 ft ³ /day 160 m ³	Exhaust fan only	 Fan
	3" / 76 mm	3-3/4"	None (Direct to Deck Mounting)	1"	 Passive	 Passive	600 ft ³ /hour 17 m ³ In a 15 Knot Breeze	Exhaust fan only	 Passive
	4" / 102 mm	4-3/4"	Snap-In (6" Outer Diameter)	1"	 Passive	 Passive	—	 Passive	 Passive
	3" / 76 mm	3-3/4"	Snap-In (5" Outer Diameter)	1"	 Passive	 Passive	—	 Passive	 Passive

Day/Night Plus Vent with Stainless Steel Cover

- Circulates fresh air in boat cabin eliminating mold, mildew and musty air
- Moves 1,000 cubic feet of air/hour or 24,000 cubic feet of air/day (4" model)
- Rechargeable battery allows for 24-hour continuous operation
- Whisper quiet fan operation
- No wiring required
- Interchangeable intake and exhaust fans
- High capacity NiMh battery operates vent for up to 40 hours without sunlight on a full charge
- 2 year limited warranty
- Direct to deck installation
- Built-in on/off fan switch
- Complete air and green water shut-off from below
- All Day/Night PLUS models come complete with two fan blades, white plastic interior trim ring, insect screen, mounting hardware and an easy-to-understand installation manual
- **Replaces NICRO 3" & 4" snap-in deck plates (fits existing holes once snap-in deck plates are removed)**

3" White **Item # N20703W** 4" White **Item # N20704W**
3" Stainless Steel **Item # N20703S** 4" Stainless Steel **Item # N20704S**

Replacement NiMh Nickel Metal Hybrid Battery for Day/Night Plus Vents

- High capacity C-cell battery
- 1.2 volts, 2.0 amp-hours
- Replacement battery for current Day/Night Plus vents, as well as, older model PowerVent 3000 and Day/Night 2000 Vents
- Average life: 3-5 years
- Environmentally friendly

Item # N20790

Mini Vent 1000

The MiniVent 1000 is the smallest and most economical solar vent in the Maringo™ line. At just 7" in diameter and approximately 1-3/4" high, the MiniVent 1000 is compact yet effective. This solar powered model is an exhaust vent only. It will keep the boat cabin cool when you need it most, during the hot sunlight hours. Under solar power, the Mini Vent 1000 will move 700 cubic feet of air an hour. At night, even a light breeze will continue to ventilate the boat passively.

Built-in shut-off damper prevents water intrusion in rough seas. Fits a 3-3/4" diameter installation hole. The vent can be retrofitted to an existing hole of up to 6" in diameter. Available in white ABS plastic or stainless steel. Optional stainless steel cover is also available separately.

- Solar powered exhaust ventilation during daylight and passive exhaust at night
- No batteries or wiring required
- Whisper-quiet fan operation
- Durable white ABS construction
- Shut-off damper to prevent water intrusion in rough seas
- 2-year limited warranty and 5-year qualified warranty
- Dimensions: 7" diameter X 1-3/4" high
- All MiniVent 1000 models come complete with white plastic interior trim ring, mounting hardware and an easy-to-understand installation manual

3" White **Item # N20020**
3" Stainless Steel **Item # N20030**

Stainless Steel Cover for Mini Vent 1000

Item # N28830

Now with more power!



CE



CE



Air Vent 500 Passive Exhaust Ventilation

Marinco offers the AirVent 500 as a non-solar ventilation option that can passively move 600 to 1,000 cubic feet of air per hour in a 15 knot breeze. Marinco's engineering expertise created this vent to be strong, compact and effective. The AirVent 500 is an economical way to provide ventilation in your boat or it can be used in conjunction with other solar powered or 12V vents to create cross flow air circulation.

- Compact size: 7" diameter x 1-3/4" high
- High Air Flow volume 1,000 cu. ft./hour in a 15 knot breeze
- Strong U.V. stabilized white ABS construction
- Center panel is translucent plastic allowing light to pass through it below deck
- Center damper shuts vent off from below
- Easy installation – attaches directly to deck in compact 3-3/4" diameter hole and can be retrofitted to an existing hole of up to 6" in diameter

Item # N28810

Stainless Steel Cover for Air Vent 500

Item # N28830



Cowl Vents

Cowl Vents are available in both low profile and standard height contours. These vents are a perfect air intake supplement to solar ventilation, and are also commonly used as a bilge ventilating system with or without a mechanical blower. Marinco was the first supplier of soft, durable PVC vents that are flexible and safe. For interchangeability, Marinco™ 4" cowl vent models fit into the same 4" Snap-In deck plates used by the Combo and 12V vents (3" or 4" sizes).

- Soft and durable PVC construction returns to original shape if stepped on
- Safer than metal cowl vents – prevents injury and resists snagging lines
- Snap-In vents include deck plate and cover
- 4" models interchangeable with Marinco™ Combo and 12V Vent 4" snap-in deck plates
- Marinco™ adapter accessories make installing below-deck duct hose easy

Snap-In Deluxe Low Profile PVC Cowl Vent

- White with bright red interior
- Available in 3" or 4" sizes
- 3" size measures 4-1/2" high
- 4" size measures 5-1/2" high
- Includes white Snap-In deck plate and cover

3" **Item # N10863**

4" **Item # N10864**



Snap-In Deluxe Standard PVC Cowl Vent

- White with bright red interior
- Available in 3" or 4" sizes
- 3" size measures 8" high
- 4" size measures 10" high
- Includes white Snap-In deck plate and cover

3" **Item # N10963**

4" **Item # N10964**



Clam Shell Vents

- Ideal for ventilation needs where a taller vent would foul lines or restrict crew movement
- Work well as stern mounted ventilators for engine compartment
- Can be used for cabin ventilation with dorade boxes
- Flexible PVC construction
- Small clam shell dimensions: 2-1/2" H x 4-1/2" W x 5" L
- Large clam shell dimensions: 3" H x 5-3/8" W x 6-3/4" L

Small **Item # N10873**

Large **Item # N10874**

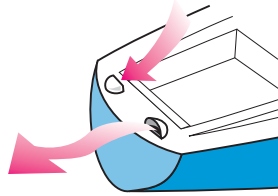

White Snap-In Deck Plate

- Includes Snap-In watertight cover
- Use with any Marinco™ Snap-In vent system
- N10863DW requires a 3-3/4" diameter hole cutout
- N10864DW requires a 4-3/4" diameter hole cutout

3" **Item # N10863DW**

4" **Item # N10864DW**



Plastic Interior Trim Ring

- Finishes off interior installation of vent
- Can be installed in decks between 1" and 2" thick
- Available in 3" and 4" sizes
- White plastic construction
- **Note: Interior trim rings are not compatible with threaded deck plates**

3" **Item # N10866**

4" **Item # N10867**



Thru Bulkhead Hose Adapter

- For termination attachment of hose to bulkhead
- For attaching hose to cowl vent
- Can be used with Snap-In or threaded deck plates
- For use in decks or bulk heads of more than 1" thick

3" **Item # N10869**

4" **Item # N10870**

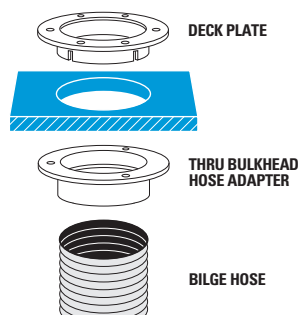



1 YEAR WARRANTY

Marine Fan

- 120° adjustable oscillating fan
- Can be set for stationary operation
- Mount on wall, ceiling or dash
- Built-in on/off switch
- Installation hardware included
- 12 volt DC operation, 1.2 amp draw
- Translucent fan blades
- 7.5" vinyl-coated fan guard
- Mounting base dimensions: 3.375" L x 1.5" W
- Stands 8" from mounting surface

Item # 900



1 YEAR WARRANTY

Folding Fan

- Fan folds out of the way when not in use
- Rotating louver directs air flow
- Mount on wall, ceiling or dash
- Built-in on/off switch
- Installation hardware included
- 12 volt DC operation, .8 amp draw
- Dimensions: 6.75" W x 5.06" H x 1.93" D

Item # 902



1 YEAR WARRANTY

Personal Fan

- 180° adjustable swivel fan
- Mount on wall, ceiling or dash
- Built-in on/off switch
- Installation hardware included
- 12 volt DC operation
- Compact design installs anywhere
- Great for windshield defogging
- Base Dimensions: 3" diameter
- Stands 5" from mounting surface

Item # 903-5

Index

100010	193	10105	253	104099	193	107010	193
10001	256	10106	254	104110	193	108002	193
100050	193	10107	253	104199	193	108010	193
1000-6W	142	10108	253	104210	193	108025	193
1000-ACSM	142	10121	253	104299	193	108050	193
1000-AM10	142	10122	254	104310	193	108099	193
1000-AM20	142	101910	193	104350	193	108110	193
1000-AM50	142	102010	193	104410	193	108150	193
1000-DCSM	142	102025	193	104510	193	108210	193
1000-VM-12V	142	102050	193	104610	193	108250	193
1000-VM-24V	142	102099	193	104710	193	108310	193
10010	255	102150	193	104810	193	108325	193
100110	193	102164	27	104825	193	108399	193
10011	255	102167	27	104850	193	108425	193
10017XL	254	102182	24	104899	193	108510	193
100210	193	102210	193	104910	193	108802	193
10023	256	10224	254	104950	193	108810	193
10028XLP	254	102250	193	104SPP-25.OEM	19	108825	193
10029XLP	254	102310	193	104SPP-50.OEM	19	108850	193
100310	193	102350	193	104SPP	19	108899	193
100319	199	102410	193	105010	193	108910	193
10031	251	102510	193	105099	193	108999	193
100320	199	102610	193	10524	253	109010	193
10035	255	102710	193	105SPP	19	109310	193
10036	256	102810	193	106010	193	109399	193
100410	193	102825	193	106025	193	10MSPPXP	28
100510	193	102850	193	106040	193	10MSPPX	28
100610	193	102899	193	106099	193	11001	256
100710	193	102910	193	106110	193	1100-BK-TS	143
10079	250	102999	193	106210	193	1100-BK	143
10080	249	102N	23	10624	254	11017XLP	254
100810	193	103010	193	106310	193	11018XLP	254
10082	250	103099	193	106340	193	1101-BK-TS	143
100850	193	103910	193	106510	193	1101-BK	143
100910	193	103ELN	23	106610	193	11024	251
10098	255	103RN.OEM	23	106710	193	11028XLP	254
10099	255	103RNXP	28	106810	193	11029XLP	254
100EL	23	103RNX	28	106825	193	11031	251
100R	23	103RN	23	106840	193	11034	251
101010	193	104010	193	106899	193	11035	255
10102	254	104025	193	106910	193	11050	252
10104	253, 254	104050	193	106940	193	11058	252

11059	252	111999	194	114540	194	118002	194
11060	252	111A	20	114905	194	118005	194
11064	252	112002	194	114910	194	118010	194
11066	252	112005	194	114940	194	118015	194
11079	250	112010	194	115002	194	118502	194
11080	249	112025	194	115005	194	118505	194
11088	251	112050	194	115010	194	118510	194
11090	251	112075	194	115030	194	118515	194
11091	251	11225	251	115502	194	118905	194
11095	250	11226	251	115505	194	118A	20
11096	249	112310	194	115510	194	119002	194
11098	255	112375	194	115530	194	119005	194
11099	255	112502	194	115902	194	119010	194
110A	20	112505	194	115905	194	119502	194
110R	23	112510	194	115910	194	119505	194
111002	194	112525	194	115930	194	119510	194
111010	194	112550	194	115A	20	119902	194
111025	194	112575	194	116002	194	119905	194
111050	194	112710	194	116005	194	119910	194
11106	254	112910	194	116010	194	120705	196
11107	253	112975	194	116025	194	120710	196
111099	194	113002	194	116502	194	120905	196
11124	251	113005	194	116505	194	120910	196
111310	194	113010	194	116510	194	120925	196
111325	194	113025	194	116525	194	121110	196
111350	194	113050	194	116902	194	121125	196
111502	194	113502	194	116905	194	121140	196
111510	194	113505	194	116910	194	121160000	31
111525	194	113510	194	116925	194	121160150	31
111550	194	113525	194	117002	194	121160151	31
111599	194	113550	194	117005	194	121160251	31
11168	251	113910	194	117010	194	121160900	31
111710	194	113950	194	117020	194	121160910	31
111799	194	114002	194	117502	194	121160920	31
11185	250	114005	194	117505	194	121180	196
11187	249	114010	194	117510	194	121310	196
11188	249	114025	194	117520	194	121320000	31
11190	251	114040	194	117902	194	121320250	31
111910	194	114502	194	117905	194	121325	196
11191	251	114505	194	117910	194	121350	196
11194	249	114510	194	117920	194	121510	196
11196	249	114525	194	117A	20	121525	196

Index

121550_____	196	126350_____	196	130705_____	196	140320500_____	231
121599_____	196	126510_____	196	130710_____	196	140320750_____	231
121710_____	196	126525_____	196	130902_____	196	140321000_____	231
121725_____	196	126550_____	196	130905_____	196	140500500_____	230
121750_____	196	126599_____	196	130910_____	196	140500750_____	230
121799_____	196	126710_____	196	131110_____	196	140600200_____	229
121910_____	196	126725_____	196	131130_____	196	140600250_____	229
121925_____	196	126750_____	196	131150_____	196	140600420_____	229
121950_____	196	126799_____	196	131151_____	197	140600650_____	229
121-710-1101/1 _____	123	12BKT_____	35	131302_____	196	140601050_____	229
121A_____	20	12MP.OEM_____	35	131310_____	196	140700200_____	229
122010_____	197	12VAD _____	34	131325_____	196	140700250_____	229
122050_____	197	12VBP.OEM_____	36	131370_____	196	140700420_____	229
123705_____	195	12VBPS2.OEM _____	36	131510_____	196	140700650_____	229
123710_____	195	12VBPS2 _____	36	131525_____	196	140701050_____	229
123905_____	195	12VBP_____	36	131550_____	196	141100650_____	229
123910_____	195	12VBR.OEM _____	36	131590_____	196	141101000_____	229
123A_____	20	12VBR.PG _____	36	131710_____	196	141410_____	197
124001000_____	122	12VBRAD.OEM_____	36	131725_____	196	141425_____	197
124102_____	195	12VBRAD_____	36	131750_____	196	141500010_____	227
124110_____	195	12VBRO _____	36	131799_____	196	141500030_____	227
124125_____	195	12VBRS2.OEM _____	36	131802000_____	46	141500220_____	227
124140_____	195	12VBRS2 _____	36	131804000_____	46	142410_____	199
124180_____	195	12VBR _____	36	133310_____	196	142425_____	199
124310_____	195	12VCP6 _____	36	133325_____	196	142499_____	199
124325_____	195	12VCPS2 _____	36	133510_____	196	142610_____	199
124350_____	195	12VCP _____	36	133525_____	196	142625_____	199
124502_____	195	12VPG.OEM _____	34	133590_____	196	142650_____	199
124510_____	195	12VPG _____	34, 139	133710_____	196	142810_____	199
124525_____	195	12VPK_____	34	133725_____	196	150510_____	199
124550_____	195	12VPL.OEM_____	35	140100250_____	228	150525_____	199
124599_____	195	12VRC.OEM _____	34	140100360_____	228	150CC.OEM _____	60
124710_____	195	12VRC.PG _____	34	140100500_____	228	150CCI_____	60
124725_____	195	12VRCO.PG _____	34	140103000_____	231	150CCTM.OEM_____	60
124750_____	195	12VRCO_____	34	140104000_____	231	151025_____	199
124799_____	195	12VRCW.OEM_____	34	140300350_____	228	151050_____	199
124910_____	195	12VRCW_____	34	140300500_____	228	151510_____	199
124925_____	195	12VRCY _____	34	140300750_____	228	151525_____	199
124950_____	195	12VRC _____	34	140301000_____	228	151550_____	199
124999_____	195	12VTR_____	35	140301600_____	228	151560_____	199
126310_____	196	12VXC _____	34	140302000_____	228	151710_____	199
126325_____	196	12VXT_____	34	140320350_____	231	151725_____	199

151750 _____	199	180503 _____	193	199109PK _____	26	199231 _____	213
1520BI.OEM _____	26	180703 _____	193	199110 _____	26	199232 _____	213
152AY _____	21	180803 _____	193	199110PK _____	26	199233 _____	213
153010 _____	197	180903 _____	193	199114 _____	28	199234 _____	213
153050 _____	197	182103 _____	193	199115 _____	29	199235 _____	213
153110 _____	198	182303 _____	193	199116 _____	17	199236 _____	213
153150 _____	198	182503 _____	193	199117 _____	17	199237 _____	212
153530 _____	199	182803 _____	193	199119 _____	17	199238 _____	212
153725 _____	199	182903 _____	193	199120 _____	17	199239 _____	212
153925 _____	199	183003 _____	193	199128 _____	22	199240 _____	212
153AY _____	21	184003 _____	193	199136 _____	10	199241 _____	212
154010 _____	197	184103 _____	193	199200 _____	211	199242 _____	212
154030 _____	197	184150P-01-1 _____	120	199201 _____	211	199243 _____	212
154510 _____	198	184303 _____	193	199202 _____	211	199244 _____	212
154525 _____	198	184503 _____	193	199203 _____	211	199245 _____	212
154AY _____	21	184703 _____	193	199204 _____	211	199246 _____	211
155010 _____	198	184803 _____	193	199205 _____	211	199247 _____	211
155050 _____	198	184903 _____	193	199206 _____	211	199248 _____	211
156410 _____	198	185003 _____	193	199207 _____	211	199249 _____	211
156425 _____	198	185050F/DSP _____	120	199208 _____	211	199250 _____	212
156450 _____	198	185080F/DSP _____	120	199209 _____	211	199251 _____	212
156610 _____	198	185100F-01-1 _____	120	199210 _____	211	199252 _____	212
156625 _____	198	186003 _____	193	199211 _____	211	199253 _____	212
157AY _____	21	186803 _____	193	199212 _____	211	199254 _____	211
158010 _____	197	188003 _____	193	199213 _____	211	199255 _____	212
158025 _____	197	188803 _____	193	199214 _____	211	199256 _____	211
1591-FI.GRY.OEM _____	26	189130 _____	200	199215 _____	211	199257 _____	212
1591-FI.WHT _____	26	189131 _____	200	199216 _____	211	199258 _____	212
1591-FI _____	26	189134 _____	200	199217 _____	211	199259 _____	211
15M32AXP _____	29	189135 _____	200	199218 _____	211	199260 _____	211
15M32AX _____	29	189136 _____	200	199219 _____	211	199261 _____	212
15MSPPXP _____	28	189137 _____	200	199220 _____	211	199262 _____	213
15MSPPX _____	28	189140 _____	200	199221 _____	211	199263 _____	213
16001-RI _____	58	189141 _____	200	199222 _____	211	1M32AXP _____	29
16003-RI _____	58	189144 _____	200	199223 _____	211	1MSPPXP _____	28
16061 _____	58	189145 _____	200	199224 _____	212	1MSPPX _____	28
16102 _____	58	189146 _____	200	199225 _____	212	1RPC50 _____	22
16153 _____	58	189147 _____	200	199226 _____	212	1RPC _____	22
16202 _____	58	189303 _____	197	199227 _____	212	200250 _____	206
162AY _____	21	189800 _____	200	199228 _____	212	200252 _____	206
165AY _____	21	189849 _____	200	199229 _____	212	200258 _____	206
180003 _____	193	199109 _____	26	199230 _____	212	200259 _____	206

Index

2018BP-12.OEM_____ 37	210215_____ 201	21730100_____ 78	220819_____ 202
2018BP-12_____ 37	210216_____ 201	21730400_____ 46	220828_____ 202
2018BP-24.OEM_____ 37	210222_____ 201	220002_____ 217	221408_____ 202
2018BP-24_____ 37	210223_____ 201	220003_____ 217	221409_____ 202
2018BR-MB_____ 37	210224_____ 201	220004_____ 217	221418_____ 202
2018BR.OEM.BPS_____ 37	210225_____ 201	220007_____ 217	221419_____ 202
2018BR.OEM_____ 37	210226_____ 201	220020_____ 217	221428_____ 202
2018BR_____ 37	210227_____ 201	220100_____ 203	221429_____ 202
2018MB.OEM_____ 37	210233_____ 201	220110_____ 203	22200_____ 261
2018MB_____ 37	210234_____ 201	22011A-P_____ 261	22201_____ 261
2018PKG_____ 37	210235_____ 201	22011MA-P_____ 261	22208-24_____ 261
202175_____ 206	210236_____ 201	220120_____ 203	22208A_____ 261
202176_____ 206	2102-3-B_____ 109	22012A-P_____ 261	22209_____ 261
202319_____ 257	2102-B_____ 109	22012MA-P_____ 261	222110_____ 203
202320_____ 257	2102_____ 109	22014-P_____ 260, 261	222162_____ 203
203100_____ 206	210302_____ 202	220161_____ 203	22218A_____ 261
205CRCN_____ 25	210312_____ 202	220162_____ 203	22219A_____ 261
205CRPN_____ 25	210313_____ 202	220163_____ 203	222213_____ 201
205CRR_____ 25	210322_____ 202	220202_____ 201	22224_____ 254
20MSPPXP_____ 28	210323_____ 202	220203_____ 201	22230-P_____ 261
20MSPPX_____ 28	210612_____ 203	220212_____ 201	22240_____ 261
2100-B_____ 109	210613_____ 203	220213_____ 201	2300A-B_____ 109
2100_____ 109	210718_____ 203	220214_____ 201	2300A_____ 109
210100_____ 203	210719_____ 203	220215_____ 201	230100_____ 203
210110_____ 203	210818_____ 202	220216_____ 201	230110_____ 203
210120_____ 203	210819_____ 202	220222_____ 201	230120_____ 203
210130_____ 203	210828_____ 202	220223_____ 201	230130_____ 203
210140_____ 203	210829_____ 202	220224_____ 201	230140_____ 203
210161_____ 203	2110A-B_____ 109	220225_____ 201	230150_____ 203
210162_____ 203	2110A_____ 109	220226_____ 201	230164_____ 203
210163_____ 203	2111A-B_____ 109	220312_____ 202	230165_____ 203
210164_____ 203	2111A_____ 109	220313_____ 202	230201_____ 201
210165_____ 203	2112A-B_____ 109	220322_____ 202	230202_____ 201
2101-B_____ 109	2112A_____ 109	220323_____ 202	230203_____ 201
2101_____ 109	211408_____ 202	22040A_____ 260, 261	230205_____ 201
210202_____ 201	211409_____ 202	22041A_____ 260, 261	230206_____ 201
210203_____ 201	211418_____ 202	22044_____ 260, 261	230211_____ 201
210204_____ 201	211419_____ 202	22045_____ 261	230212_____ 201
210211_____ 201	211428_____ 202	220612_____ 203	230213_____ 201
210212_____ 201	211429_____ 202	220615_____ 203	230214_____ 201
210213_____ 201	211480_____ 205	220719_____ 203	230215_____ 201
210214_____ 201	211490_____ 205	220818_____ 202	230216_____ 201

230221	201	230829	202	242715	207	252237	207
230222	201	231408	202	242716	207	252241	207
230223	201	231409	202	242725	207	252243	207
230224	201	231418	202	242726	207	252244	207
230225	201	231419	202	242727	207	252245	207
230226	201	231428	202	244233	207	252246	207
230227	201	231429	202	244234	207	252251	207
230233	201	24010800	66	244235	207	252253	207
230234	201	24011200	66	244236	207	252254	207
230235	201	24012000	66	244245	207	252255	207
230236	201	24020800	66	244246	207	252256	207
230237	201	24021500	66	244254	207	252257	207
230243	201	24022500	66	244255	207	252261	207
230244	201	24026000	66	244256	207	252264	207
230245	201	24027000	66	244265	207	252265	207
230246	201	24095100	66	244266	207	252266	207
230254	201	242233	207	244285	207	252267	207
230255	201	242234	207	244286	207	252274	207
230257	201	242235	207	244295	207	252275	207
230301	202	242236	207	244296	207	252276	207
230302	202	242237	207	244725	207	252277	207
230303	202	242243	207	244726	207	252284	207
230311	202	242244	207	249003	206	252285	207
230312	202	242245	207	249007	206	252286	207
230313	202	242246	207	250001	216	252287	207
230322	202	242253	207	25012000	66	252295	207
230323	202	242254	207	2501	113	252296	207
2303A-B	109	242255	207	25022500	66	252297	207
2303A	109	242256	207	2502	113	252716	207
2304A-B	109	242257	207	2504	113	252717	207
2304A	109	242264	207	2505	113	252725	207
230510	203	242265	207	252130	207	252726	207
230520	203	242266	207	252140	207	252727	207
230612	203	242275	207	252150	207	2530	113
230615	203	242276	207	252160	207	2532	113
230708	203	242284	207	252170	207	255001	216
230709	203	242285	207	252180	207	25MSPPXP	28
230718	203	242286	207	252190	207	25MSPPX	28
230719	203	242294	207	252233	207	25SPP.OEM	17
230818	202	242295	207	252234	207	25SPPW.OEM	17
230819	202	242296	207	252235	207	25SPPX	28
230828	202	242297	207	252236	207	260010	208

Index

260012	208	300000	205	303SSEL-BXPK	28	305BP.OEM	37
260100	208	30000	240	303SSEL-BX	28	305BP	37
260200	208	30002	240	303SSEL-B	10	305CRCN.OEM	23
2602A-12	61	30004	241	303SSO	10	305CRCN.VPK	23
2602A-24-B	61	30005	241	303SSRCD.OEM	14	305CRCN	23
2602	61	300259	35	303SSRCDKITIGN.OEM	14	305CRCXNPK	28
260322	208	300275	35	303SSRCDPL.OEM	14	305CRCXN	28
260325	208	301103	209	304103	209	305CRMB	27
260350	208	301106	209	304106	209	305CRPN.OEM	23
260381	208	301124	209	304124	209	305CRPN.VPK	23
2603	61	301148	209	304148	209	305CRPN	23
260505	208	301503	209	304303	209	305CRRB.OEM	23, 37
2606A-B	61	301506	209	304403	209	305CRRB	23, 37
2606A	61	301BKRIGN.OEM	14	304424	209	305CRR	23
2607A-B	59	301BKRPL.OEM	14	304503	209	306103	209
2607A	59	301CRMB	27	304506	209	306106	209
2608A-B	59	301EL-B.FR	10	304602	209	306124	209
2608A	59	301EL-B.GRAY	10	304603	209	306148	209
2610A-B	59	301EL-B.OEM	10	304606	209	306503	209
2610A	59	301EL-B.W/L	10	304624	209	306506	209
2611A-1-B	59	301EL-BXPK	28	304648	209	306524	209
2611A-B	59	301EL-BX	28	304BKRIGN.OEM	14	306602	209
2611A	59	301EL-B	10	304BKRPL.OEM	14	306603	209
2612A	61	301ELCB	10	304EL-B.NT	10	306606	209
2613A	59	301RCD.OEM	14	304EL-B.OEM	10	306624	209
2614A	60	301RCDKITIGN.OEM	14	304EL-BCR.OEM	10	306648	209
2620A	59	301RCDPL.OEM	14	304EL-BCR	10	306948	209
2621A	60	302103	209	304EL-BX.NT	28	307103	209
2622A-230	60	302106	209	304EL-B	10	307124	209
2622A	60	302124	209	304ELCB	10	307148	209
2623A	59	302148	209	304RCD.OEM	14	307648	209
2631A	59	303103	209	304RCDKITIGN.OEM	14	307948	209
2632A-230	60	303106	209	304RCDPL.OEM	14	309002	205
2632A	60	303124	209	3050BI	10	309003	205
2633A	60	303148	209	305103	209	309025	205
2635-B	59	303303	209	305106	209	309099	205
27510700	64	303602	209	305124	209	309102	205
27520700	64	303648	209	305148	209	309103	205
28010300	64	303948	209	305603	209	309125	205
28010500	64	303SSBKRIGN.OEM	14	305624	209	309199	205
28020300	64	303SSBKRPL.OEM	14	305648	209	309202	205
28020500	64	303SSEL-B.OEM	10	305BC	37	309203	205

309225	205	312399	204	326624	210	33090W	242, 244
309299	205	312403	204	326648	210	33090	242, 243
31012B	247	312425	204	327124	210	33092W	242, 244
31014B	247	312499	204	327202	210	33092	242, 243
31016B	245, 247	312503	204	327606	210	33094W	242
31018B	247	312525	204	327624	210	33094	242, 243
310203	204	312599	204	33004	246	33096W	242, 243
31020B	247	312603	204	33005	246	33096	242
310225	204	312625	204	33006A	242, 244	33104	245, 246
31022B	247	312699	204	33007A	242, 244	33105	245, 246
31024B	247	314225	204	33010A	242, 244	33106A	244
310299	204	314299	204	33012A	242, 244	33107A	244
310303	204	314325	204	33014A	242, 244	33110A	244
310325	204	314399	204	33015	246	33112A	244
310399	204	315225	204	33016	246	33114A	244
31112B	245, 247	315299	204	33017	246	33115	245, 246
31114B	245, 247	315325	204	33021B	246	33116	245, 246
31116B	247	316803	205	33021S	246	33117	245, 246
31118B	245, 247	316825	205	33022B	246	33121B	245, 246
311203	204	316899	205	33022S	246	33121S	245, 246
31120B	245, 247	316925	205	33022	246	33122B	245, 246
311225	204	317803	205	33023	246	33122S	245, 246
31122B	245, 247	317825	205	33024B	246	33124B	246
31124B	245, 247	317899	205	33024S	246	33124S	245, 246
311299	204	317903	205	33024	246	33125	239
311303	204	317925	205	33025	239	33126B	245, 246
311325	204	317999	205	33026B	245, 246	33126S	245, 246
311399	204	318825	205	33026S	245, 246	33130S	245, 246
311403	204	318925	205	33028B	245, 246	33132A	244
311425	204	319825	205	33028S	245, 246	33137A	244
311499	204	319899	205	33030B	245, 246	33170A	244
311503	204	319925	205	33030S	245, 246	33182	243
311525	204	319999	205	33032A	242, 244	33184W	244
311599	204	320001	216	33037A	242, 244	33184	243
311603	204	32000	240	33070A	242, 244	33186W	244
311625	204	32001	240	33082	242, 243	33186	243
311699	204	32002	240	33084W	242, 244	33188W	243
312203	204	326103	210	33084	242, 243	33188	242
312225	204	326124	210	33086W	242, 244	33190W	244
312299	204	326148	210	33086	242, 243	33190	243
312303	204	326202	210	33088W	242, 244	33192W	244
312325	204	326603	210	33088	242	33192	243

Index

33194W _____	244	37180 _____	238	402622 _____	213	452755 _____	215
33194 _____	243	37181 _____	238	402752 _____	213	452900 _____	215
33196W _____	243	37200 _____	238	402892 _____	213	452905 _____	215
33196 _____	242	38000 _____	239	403182 _____	213	4531001 _____	114
33505 _____	247	38001 _____	239	403252 _____	213	4531011 _____	114
33513 _____	247	38005 _____	239	403312 _____	213	453382 _____	215
33514 _____	247	38010 _____	239	403372 _____	213	453386 _____	215
33515 _____	247	38011 _____	239	403432 _____	213	453502 _____	215
34000 _____	239	400000 _____	213	403502 _____	213	453752 _____	215
34001 _____	239	40010606 _____	57	403562 _____	213	453756 _____	215
34005 _____	239	40010806 _____	57	403622 _____	213	453901 _____	215
34010 _____	239	40020156 _____	57	403752 _____	213	45511000 _____	45
34011 _____	239	40020256 _____	57	403872 _____	213	45511200 _____	45
34015 _____	239	40020506 _____	57	403892 _____	213	45511400 _____	45
34210 _____	239	40020756 _____	57	403902 _____	213	45511600 _____	45
35010 _____	240	40021006 _____	57	404152 _____	213	46020950 _____	45
35040 _____	240	40031006 _____	57	404172 _____	213	4700CR _____	25
35050 _____	240	40040256 _____	57	404202 _____	213	4721CR _____	25
35SPP.OEM _____	17	40040506 _____	57	404252 _____	213	4731CR _____	25
36011205 _____	73	4006 _____	114	404302 _____	213	48012090 _____	45
36012005 _____	73	4008 _____	114	43011000 _____	52	48012130 _____	45
36012505 _____	73	401122 _____	213	43011500 _____	52	48024075 _____	45
36014005 _____	73	401182 _____	213	43020600 _____	55	48024110 _____	45
36021205 _____	73	401251 _____	213	44010250 _____	52	48024150 _____	45
36022005 _____	73	401252 _____	213	44010350 _____	52	500, 500A _____	261
36022505 _____	73	401255 _____	213	44010500 _____	52	500A _____	258
36024005 _____	73	4012 _____	114	44010700 _____	52	500EL _____	24
36042505 _____	73	401312 _____	213	44011000 _____	52	500R _____	24
36045005 _____	73	401372 _____	213	44020120 _____	55	501, 501A _____	261
36110 _____	238	401375 _____	213	44020200 _____	55	501A _____	258
36111 _____	238	401432 _____	213	44020300 _____	55	502-1 _____	258, 261
36161 _____	238	401502 _____	213	44020400 _____	55	502-2 _____	258, 261
36180 _____	238	401622 _____	213	44020600 _____	55	502, 502A _____	261
36181 _____	238	401752 _____	213	44020800 _____	55	502A _____	258
37012505 _____	70	401892 _____	213	44021000 _____	55	503-1 _____	259, 261
37014005 _____	70	4018 _____	114	452251 _____	215	503-2 _____	259, 261
37022505 _____	70	401912 _____	213	452255 _____	215	503, 503A _____	261
37024005 _____	70	401932 _____	213	452381 _____	215	503A _____	259
37100 _____	238	402252 _____	213	452385 _____	215	505 _____	259
37110 _____	238	402312 _____	213	452501 _____	215	50SPP.OEM _____	17
37111 _____	238	402372 _____	213	452505 _____	215	50SPPW.OEM _____	17
37161 _____	238	402502 _____	213	452751 _____	215	50SPPX _____	28

50SPP _____	17	522126 _____	264, 267	529421 _____	262, 267	551625 _____	121
510R _____	24	522127 _____	264, 267	529422 _____	262, 267	551630 _____	121
511016 _____	265, 267	522129 _____	264, 267	529423 _____	262, 267	551640 _____	121
520053 _____	263, 267	522131 _____	264, 267	529424 _____	262, 267	551650 _____	121
520057 _____	263, 267	5262CRR.GRY _____	25	531015 _____	265, 267	551705 _____	121
520067 _____	264, 267	5262CRR _____	25	531025 _____	265, 267	551710 _____	121
520068 _____	263, 267	5266CR _____	25	531050 _____	265, 267	551715 _____	121
520082 _____	263, 267	5269CR _____	25	531075 _____	265, 267	551720 _____	121
520090 _____	263, 267	529095 _____	264, 267	531100 _____	265, 267	551725 _____	121
520093 _____	264, 267	529102 _____	264, 267	532025 _____	265, 267	551730 _____	121
520094 _____	263, 267	529104 _____	264, 267	533015 _____	265, 267	551740 _____	121
520097 _____	264, 267	529168 _____	266, 267	533025 _____	265, 267	551750 _____	121
520168 _____	263, 267	529200 _____	264, 267	533050 _____	265, 267	552820 _____	122
520194 _____	263, 267	529300 _____	265, 267	533075 _____	265, 267	552830 _____	122
520906 _____	263, 267	529333 _____	264, 267	5366CR _____	25	552850 _____	122
520912 _____	263, 267	529337 _____	266, 267	5369CR.OEM _____	25	553002 _____	123
521003 _____	263, 267	529338 _____	266, 267	55003300 _____	83	553004 _____	123
521004 _____	263, 267	529340 _____	265, 267	55003400 _____	83	553005 _____	123
521034 _____	264, 267	529341 _____	265, 267	55003500 _____	152	553008 _____	123
521076 _____	263, 267	529344 _____	265, 267	55006010 _____	152	553020 _____	123
521126 _____	263, 267	529355 _____	266, 267	55006015 _____	152	553021 _____	123
521128 _____	263, 267	529361 _____	266, 267	55006060 _____	152	553022 _____	123
521140 _____	263, 267	529362 _____	266, 267	55008005 _____	152	553041 _____	123
521141 _____	264, 267	529367 _____	266, 267	55008105 _____	152	553091 _____	202
521142 _____	263, 267	529368 _____	266, 267	55008205 _____	152	553093 _____	202
521156 _____	264, 267	529370 _____	266, 267	55010600 _____	83	553095 _____	202
521157 _____	264, 267	529371 _____	266, 267	55010900 _____	83	554000 _____	123
521158 _____	264, 267	529381 _____	266, 267	55011300 _____	83	554001 _____	123
521159 _____	263, 267	529385 _____	266, 267	55106000 _____	152	554010 _____	143
521162 _____	264, 267	529386 _____	266, 267	55106100* _____	152	554011 _____	143
521164 _____	264, 267	529405 _____	265, 267	551505 _____	121	554012 _____	143
521166 _____	265, 267	529406 _____	265, 267	551510 _____	121	554016 _____	143
521176 _____	263, 267	529407 _____	265, 267	551515 _____	121	554022 _____	143
521204 _____	263, 267	529410 _____	262, 267	551520 _____	121	554024 _____	143
521224 _____	263, 267	529411 _____	262, 267	551525 _____	121	554026 _____	143
521228 _____	263, 267	529412 _____	262, 267	551530 _____	121	554027 _____	143
521383 _____	264, 267	529413 _____	262, 267	551540 _____	121	554028 _____	143
521416 _____	263, 267	529414 _____	262, 267	551550 _____	121	554029 _____	143
521816 _____	263, 267	529416 _____	262, 267	551605 _____	121	554030 _____	143
522112 _____	264, 267	529417 _____	262, 267	551610 _____	121	554032 _____	143
522122 _____	264, 267	529419 _____	262, 267	551615 _____	121	554033 _____	143
522124 _____	264, 267	529420 _____	262, 267	551620 _____	121	554035 _____	143

Index

554036 _____	143	602050 _____	115	607022 _____	118	6344RCDKITIGN.OEM ____	14
554038 _____	143	602062 _____	115	607023 _____	118	6351EL-BX _____	29
555010 _____	144	602075 _____	115	607122 _____	117	6351EL-B _____	11
555022 _____	144	602100 _____	115	607123 _____	117	6351EL _____	11
555025 _____	144	602150 _____	115	6079 _____	27	6353BKRIGN.OEM _____	14
555026 _____	144	602200 _____	115	608001 _____	216	6353EL-B.BLACK.OEM ____	12
555028 _____	144	602250 _____	115	6080 _____	27	6353EL-B.GRAY _____	12
555033 _____	144	602300 _____	115	6083CR _____	27	6353EL-B.OEM _____	12
555105 _____	144	603905 _____	115	6084CR _____	27	6353EL-B _____	12
556010 _____	144	603910 _____	115	61002600 _____	88	6353ELCB _____	12
556022 _____	144	603915 _____	115	61003400 _____	88	6353EL _____	12
556028 _____	144	603920 _____	115	61004000 _____	88	6353RCD.OEM _____	14
5739CR _____	25	603930 _____	115	6152SPP-12SC _____	17	6353RCDKITIGN.OEM ____	14
600-DCM-10M _____	181	604003 _____	115	6152SPP-25 _____	17	6360CRN.OEM _____	24
600-DCM-5M _____	181	604005 _____	115	6152SPPW-25 _____	17	6360CRNXPX _____	29
600-GDL _____	185	604007 _____	115	6152SPPW-55.P/O _____	17	6360CRNX _____	29
600-GDRV _____	185	604010 _____	115	6152SPPW-75.P/O _____	17	6360CRN _____	24
600-GD _____	185	604015 _____	115	6152SPPW _____	17	6361CRN _____	24
600-LPG _____	185	604020 _____	115	6152SPP _____	17	6364CRN.OEM _____	24
600-TGSK _____	183	604025 _____	115	6153SPP-25 _____	17	6364CRN _____	24
600-TLM-SIF _____	183	604030 _____	115	6153SPPW _____	17	6365CRN.OEM _____	24
601005 _____	115	604200 _____	115	6153SPPX _____	29	6365CRN _____	24
601010 _____	115	604300 _____	115	6153SPP _____	17	6369CR.OEM _____	24
601015 _____	115	605010 _____	115	62000550 _____	88	6369CR _____	24
601020 _____	115	605020 _____	115	62000700 _____	88	6370CR _____	24
601025 _____	115	605030 _____	115	62000900 _____	88	6371EL-B.OEM _____	11
601030 _____	115	605050 _____	115	62001300 _____	88	6371EL-BX.UK _____	29
601040 _____	115	605070 _____	115	62001600 _____	88	6371EL-B _____	11
601050 _____	115	605100 _____	115	62002250 _____	88	6371ELX _____	29
601070 _____	115	605150 _____	115	62002700 _____	88	6371EL _____	11
601075 _____	115	607006 _____	118	63001150 _____	88	6373BKRIGN.OEM _____	14
601080 _____	115	607010 _____	118	63001500 _____	88	6373EL-B.OEM _____	12
601100 _____	115	607011 _____	118	63001851 _____	88	6373EL-B _____	12
601110 _____	115	607012 _____	118	6343EL-BX _____	29	6373EL.OEM _____	12
601114 _____	115	607013 _____	118	6343EL-B _____	11	6373ELMB _____	27
601150 _____	115	607014 _____	118	6344BKRIGN.OEM _____	14	6373EL _____	12
601200 _____	115	607015 _____	118	6344EL-B.NT _____	12	6373RCD.OEM _____	14
601250 _____	115	607016 _____	118	6344EL-B.OEM _____	12	6373RCDKITIGN.OEM ____	14
601300 _____	115	607017 _____	118	6344EL-BCR.OEM _____	12	6387000600 _____	122
6017Y _____	26	607019 _____	118	6344EL-BCR _____	12	6387001000 _____	122
6018Y _____	26	607020 _____	118	6344EL-B _____	12	6387001600 _____	122
602030 _____	115	607021 _____	118	6344RCD.OEM _____	14	6387002000 _____	122

6387002500	122	68456914	208	703-300A	146	71011	237
6387003200	122	68457302	208	703-500A/B	146	71012	237
64000250	89	68457314	208	703-500A	146	71081	237
64000550	89	700115	222	70403105	57, 66, 70, 73	71082	237
64000850	89	700B	95	70403163	183	710-140A-B	98
64001200	89	700	94, 95	70404110	66	710-140A	98
64001400	89	701007	222	70405000	70, 73	71111M	237
64002000	89	701009	222	70405010	73	71112	237
6401CRCX	30	701010	222	70405050	70	71113	237
6401CRPX	30	701030	223	704-4S/B	148	71181	237
6401EL-BX	30	701-KEY-EP	95	704-4S	148	71182	237
6402CRCX	30	701-KEY	95	704-4S	148	711L	146
6402CRPX	30	701-MDVS-24V	97	704-ANLB	148	71212	237
6402EL-BX	30	701-MDVS	97	704-ANL	118	71312	237
66010320	91	701-MD	96	704-ANL	148	713-BT	136
66020160	91	701-PM	94	705-100A	149	713-EP	136
68000280	90	701B	95	705-135A/B	149	713-HB	136
68000420	90	701S-B	95	705-135A	149	713-MS	136
68000500	90	701S-PM	94	705-150A	149	713-PS	136
68000580	90	701S	94, 95	705-50A/B	149	713-SB	136
68000750	90	701	94, 95, 112	705-50A	149	713-SS	136
68001000	90	702015	223	705-80A/B	149	713	112, 136
68001250	90	702024	210, 223	705-80A	149	714-140A-DVSR-B	100
68001500	90	702027	210, 223	705	149	714-140A-DVSR	100, 101
68001650	90	702030	221	706-2W	149	715-H	101
68002200	90	702033	223	706-4WB	149	715-S	101, 102
68002700	90	702040	222	706-4W	149	715-V	100, 101
68060100	208	702064	223	707	149	716-H-140A-DVSR	101
68060200	208	702065	194, 221	708-102	148	716-SQ-140A-DVSR	101
68060300	208	702-2S/B	148	708-107	108	717-140A-DVSR	101, 102
68060400	208	702-2S	148	708-42.5	108, 148	718-140A-DVSR	101, 102
68060500	208	702-2S	148	708-54.5	148	719-140A-DVSR	101, 102
68060600	208	702-8-10-B	148	708-62.0	148	720-DP/B	95
68060700	208	702-8-10	148	708-64.5	148	720-DP	95
68060800	208	702-8-B	148	708-68.5	148	720-MDO-EP	97
68060900	208	702-8	148	708-70.0	108	720-MDO	96
68061000	208	702-MFH-B	116	709-150/BD	108	720-MDVSO-24V	97
68451902	208	702-MFH	116	709-150/DD	108	720-MDVSO	97
68451914	208	702B	148	709-250/BD	108	720B	95
68453014	208	702SB	148	709-250/DD	108	720	95
68454002	208	702	148	709-300/BD	108	721B	95
68456902	208	703-300A/B	146	709-300/DD	108	721	95

Index

729488 _____	261	77030450 _____	78, 160, 162	7715CRN.OEM _____	24	80-712-0039-01 _____	117
729489 _____	261	77030475 _____	70, 73, 160, 162	7715CRNXPX _____	29, 30	80-716-0014-00 _____	104
729491 _____	261	77030500 _____	52, 53, 55, 161, 162	7715CRNX _____	29, 30	80-716-0015-00 _____	104
729492 _____	261	77030700 _____	66, 160, 162	7715CRN _____	24	80-716-0016-00 _____	104
729493 _____	258, 261	77030800 _____	160, 162	7715ELN.OEM _____	24	80-716-0017-00 _____	103
729494 _____	259, 261	77030900 _____	160, 162	7715ELN _____	24	80-716-0018-00 _____	103
729528 _____	261	77031000 _____	160, 162	7717N.OEM _____	24	80-724-0006-00 _____	96
729823-P _____	261	77031100 _____	160, 162	7717N _____	24	80-724-0007-00 _____	97
729825 _____	261	77031200 _____	66, 162	7788CR _____	27	80-911-0001-00 _____	166
729827-P _____	261	77031300 _____	160, 162	7879CR-FI.OEM _____	27	80-911-0002-00 _____	166
729828-P _____	261	77031400 _____	160, 162	7879CR-FI _____	27	80-911-0003-00 _____	166
729829-P _____	261	77031400 _____	160, 162	7879CR _____	27	80-911-0004-00 _____	166
729830-P _____	261	77031500 _____	160, 162	800-MS1 _____	112	80-911-0005-00 _____	173
730192 _____	259	77031700 _____	160, 162	800-MS2 _____	112	80-911-0006-00 _____	173
73112 _____	235	77031800 _____	160, 162	800-MS3 _____	112	80-911-0007-00 _____	175
73113 _____	235	77031900 _____	156, 162	800-MS4 _____	112	80-911-0008-00 _____	175
73312 _____	235	77040000 _____	163	80-600-0021-00 _____	181	80-911-0009-00 _____	174
73313 _____	235	77040010 _____	163	80-600-0022-00 _____	181	80-911-0010-00 _____	174
7420CR.OEM _____	27	77040015 _____	163	80-600-0023-00 _____	182	80-911-0011-00 _____	171
7420CR _____	27	77040020 _____	163	80-600-0027-00 _____	187	80-911-0012-00 _____	171
750000 _____	215	77040050 _____	163	80-600-0028-00 _____	187	80-911-0013-00 _____	172
75SPP.OEM _____	17	77040100 _____	163	80-601-0020-00 _____	187	80-911-0014-00 _____	172
76030 _____	247	77040300 _____	163	80-601-0021-00 _____	187	80-911-0016-00 _____	178
760375 _____	215	77040600 _____	163	80-601-0022-00 _____	187	80-911-0017-00 _____	178
760500 _____	215	77041000 _____	163	80-601-0023-00 _____	187	80-911-0018-00 _____	179
76130 _____	247	77041500 _____	163	80-601-0024-00 _____	187	80-911-0019-00 _____	179
764998 _____	214	77042000 _____	163	80-601-0025-00 _____	187	80-911-0020-00 _____	179
765000 _____	214	77042500 _____	163	80-601-0026-00 _____	187	80-911-0021-00 _____	179
765002 _____	214	77045000 _____	163	80-700-0047-00 _____	104	80-911-0022-00 _____	179
765004 _____	214	77049000 _____	116, 163	80-700-0048-00 _____	104	80-911-0023-00 _____	179
765006 _____	214	77049040 _____	116, 163	80-700-0050-00 _____	104	80-911-0024-00 _____	177
77010030 _____	157	77049050 _____	116, 163	80-700-0051-00 _____	104	80-911-0025-00 _____	177
77010050 _____	52, 55, 57, 157	77049060 _____	116, 163	80-700-0052-00 _____	104	80-911-0026-00 _____	177
77010305 _____	42, 52, 55, 57, 70, 73, 78, 82, 157	77049080 _____	116, 163	80-700-0053-00 _____	104	80-911-0027-00 _____	177
77010400 _____	42, 156	77049100 _____	116, 163	80-700-0054-00 _____	106	80-911-0028-00 _____	177
77020100 _____	42, 52, 55, 57, 158	77049125 _____	116, 163	80-700-0055-00 _____	106	80-911-0029-00 _____	177
77020200 _____	158	77049160 _____	116, 163	80-701-0018-00 _____	97	80-911-0030-00 _____	177
77020400 _____	159	77049175 _____	116, 163	80-707-00004-00 _____	180	80-911-0031-00 _____	177
77030100 _____	52, 55, 57, 160, 162	77049200 _____	116, 163	80-707-00005-00 _____	180	80-911-0032-00 _____	177
77030300 _____	161, 162	77049250 _____	116, 163	80-708-0013-00 _____	96	80-911-0033-00 _____	178
		77049300 _____	116, 163	80-708-0017-00 _____	96	80-911-0034-00 _____	178
		77049400 _____	116, 163	80-712-0039-00 _____	117	80-911-0035-00 _____	178
		77050000 _____	163				

80-911-0036-00 _____	178	81400400 _____	77	900-2WPMOM _____	141	900-RCD-1X16-32A _____	122
80-911-0037-00 _____	179	81400500 _____	77	900-2WPOFO _____	141	900-RCD-2X16A _____	122
80-911-0038-00 _____	179	81400600 _____	77	900-2WP _____	141	900-RCD-2X32A _____	122
80-911-0039-00 _____	179	81400700 _____	77	900-3WPSW _____	139	900-RCD-32A _____	122
80-911-0040-00 _____	179	81400800 _____	77	900-3WPS _____	139	900-SOP _____	141
80-911-0041-00 _____	178	81500100 _____	76	900-4WPW _____	139	900V-DCSM _____	126
80-911-0042-00 _____	178	81500200 _____	76	900-4WP _____	139	900 _____	273
80-911-0043-00 _____	178	81500300 _____	76	900-5WPSW _____	139	901H _____	124
80-911-0044-00 _____	179	81500350 _____	76	900-5WPS _____	139	901V-AM _____	126
80-911-0045-00 _____	96, 179	81500400 _____	76	900-6WPW _____	139	901V-DCSM _____	126
80-911-0046-00 _____	177	81500500 _____	76	900-6WP _____	139	901V _____	124
80-911-0047-00 _____	177	81500600 _____	76	900-AC1-110V _____	130	902-AM _____	126
80-911-0048-00 _____	177	81500700 _____	76	900-AC1 _____	130	902-DCSM _____	126
80-911-0049-00 _____	177	81A _____	19	900-AC2H-ACSM-110 _____	131	902NMH _____	124
80-911-0050-00 _____	177	82011 _____	236	900-AC2H-ACSM _____	131	902NMV _____	124
80-911-0051-00 _____	177	82012 _____	236	900-AC2H-AM-110 _____	131	902V-AM _____	126
80-911-0052-00 _____	178	82081 _____	236	900-AC2H-AM _____	131	902V-DCSM _____	126
80-911-0053-00 _____	178	82082 _____	236	900-AC2V-ACSM-110 _____	131	902 _____	273
80-911-0054-00 _____	178	82112 _____	236	900-AC2V-ACSM _____	131	903-5 _____	273
80-911-0057-00 _____	180	82181 _____	236	900-AC2V-AM-110 _____	131	903-AM _____	126
80-911-0060-00 _____	179	82182 _____	236	900-AC2V-AM _____	131	903-DCSM _____	126, 127
80-911-0061-00 _____	179	82212 _____	236	900-AC3-ACSM _____	131	904-AM _____	126
80-911-0062-00 _____	179	82312 _____	236	900-AC3-AM-110 _____	131	904-DCSM _____	126
80-911-0063-00 _____	179	83007021 _____	113	900-AC3-AM _____	131	904NMH _____	124
80-911-0064-00 _____	166	83007030 _____	113	900-AC3-ASCM-110 _____	131	904NMV _____	124
80-911-0065-00 _____	166	83012021 _____	113	900-AC4-ACSM-110 _____	131	904NM _____	124, 125
80-911-0066-00 _____	179	83012031 _____	113	900-AC4-ACSM _____	131	905-AM _____	126, 127
80-911-0068-00 _____	168	83116025 _____	113	900-ACCH-110V _____	130	905-DCSM _____	126
80-911-0069-00 _____	169	83116035 _____	113	900-ACCH _____	130	905NMV _____	124, 125
80-911-0071-00 _____	179	83125035 _____	113	900-ACM2-AM-110 _____	131	905NM _____	124, 125
80-911-0072-00 _____	180	83200150 _____	114	900-ACM2-AM _____	130, 131	905V-AM _____	126
80A _____	19	83301202 _____	99	900-ACM2W-110V _____	130	905V-DCSM _____	126
81200100 _____	78	83302502 _____	99	900-ACM2W _____	130	906-AM _____	126, 127
81300100 _____	78	83A _____	19	900-ACM6V-AM-110 _____	131	906-DCSM _____	126
81300200 _____	78	84A _____	19	900-ACM6V-AM _____	131	906NMH _____	124, 125
81300300 _____	78	85000600 _____	82	900-ACM6W-110V _____	130	906NMV _____	124, 125
81300400 _____	78	85000800 _____	82	900-ACM6W _____	130	906V-AM _____	126
81400100 _____	77	85001000 _____	82	900-AM _____	126	906V-DCSM _____	126
81400200 _____	77	85001300 _____	82	900-AM _____	126	907-AM _____	126, 127
81400300 _____	77	86050351 _____	82	900-BA _____	141	AC-VSEN-4 _____	180, 182
81400330 _____	77	88000350 _____	82	900-DC _____	124	ATC-6W/B _____	117
81400350 _____	77	88000705 _____	82	900-RCD-16A _____	122	ATC-6WQC/B _____	117

Index

ATC-6WQC _____	117	CBL-100A-SP _____	112, 119	CLB-05/DSP _____	120	ET6207 _____	218
ATC-6W _____	117	CBL-50A-DP _____	119	CLB-05 _____	120	ET64220 _____	218
BAG _____	26	CBL-50A-SP _____	112, 119	CLB-10/DSP _____	120	FD-2 _____	185
BB-12W-2NC/DSP _____	145	CBL-60A-DP _____	119	CLB-10 _____	120	G30 _____	22
BB-12W-2NC _____	145	CBL-60A-SP _____	119	CLB-15/DSP _____	120	GAS-SM _____	181
BB-12W-2S/DSP _____	145	CBL-75A-DP _____	119	CLB-15 _____	120	HDBFH _____	116
BB-12W-2S _____	145	CBL-75A-SP _____	112, 119	CLB-20 _____	120	HSP5 _____	219
BB-24W-2S/DSP _____	145	CBS-20A-DP-TC230 _____	130	CLB-25/DSP _____	120	INLET.LABEL.30A _____	27
BB-24W-2S _____	145	CBS-50A-DP _____	119	CLB-30 _____	120	INLET.LABEL.50A _____	27
BB-4S-150A/DSP _____	145	CBS-50A-SP-IG _____	119	CLB-40/DSP _____	120	IP100/DSP _____	116
BB-6W-2NC/DSP _____	145	CC-12VRC _____	106	CLB-40 _____	120	IP100A _____	116
BB-6W-2NC _____	145	CC-1 _____	108	CLB-BOOT/DSP _____	120	IP150/DSP _____	116
BB-6W-2S/DSP _____	145	CC-3WS/CH _____	108	CLB-BOOT _____	120	IP150A _____	116
BB-6W-2S _____	145	CC-5 _____	108	CLIP-01 _____	26	IP200/DSP _____	116
BB-6W-2 _____	146	CC-801 _____	105, 106	CLIP _____	26	IP200A _____	116
BB-LINK17MM _____	117	CC-802 _____	105, 106	CMP-4WP _____	139	IP250/DSP _____	116
BBC-12WBK _____	145	CC-803N _____	105, 106	CMP-5WPS _____	139	IP250A _____	116
BBC-12WR _____	145	CC-804 _____	107	CMP-6WP _____	139	IP300/DSP _____	116
BBC-24WBK _____	145	CC-805PR _____	107	CSP6-F _____	141	IP300A _____	116
BBC-24WR _____	145	CC-805T _____	107	CSP6-PTC _____	141	IP425/DSP _____	116
BBC-6WBK _____	145	CC-806PR _____	107	CSP6 _____	141	IP425A _____	116
BBC-6WR _____	145	CC-807PR _____	107	CT-10-3 _____	180, 182	IP500/DSP _____	116
BC-FM1 _____	132	CC-807T-PR _____	107	CT-HD _____	180, 182	IP500A _____	116
BC-FM2 _____	132	CC-807T _____	107	CW-290 _____	214	IP80/DSP _____	116
BC-FM3 _____	132	CC-810 _____	105, 106	CW-T1M50 _____	214	IP80A _____	116
BC-FM4 _____	132	CC-811PR _____	106, 107	CW-T1RR50 _____	214	IS-10MM-1/DSP _____	147
BC-PM1 _____	132	CC-811T _____	106, 107	CW-T2M25 _____	214	IS-10MM-1R/DSP _____	147
BC-PM2 _____	132	CC-BLANK _____	106	CW-T2M75 _____	214	IS-10MM-1R _____	147
BFHD-30A/DSP _____	116	CC-HDBM _____	108	CW-T2R2 _____	214	IS-10MM-1 _____	147
BFHD-30A _____	116	CG2-2W-F-W _____	140	CW-T2RR25 _____	214	IS-10MM-2/DSP _____	147
BFHD-40A/DSP _____	116	CG2-2W-F _____	140	CW-T2T3R2 _____	214	IS-10MM-2/L/DSP _____	147
BFHD-40A _____	116	CG2-2W-W _____	140	CW-T3M25 _____	214	IS-10MM-2/L _____	147
BFHD-50A/DSP _____	116	CG2-2W _____	140	CW-T3M50 _____	214	IS-10MM-2 _____	147
BFHD-50A _____	116	CG2-4W-F-W _____	140	CW-T3R2 _____	214	IS-10MM-8MM/DSP _____	147
BFHD-60A/DSP _____	116	CG2-4W-F _____	140	CW-T3RR25 _____	214	IS-10MM-8MM _____	147
BFHD-60A _____	116	CG2-4W-W _____	140	CW-T4M20 _____	214	IS-6MM-1/DSP _____	147
BFHD-70A/DSP _____	116	CG2-4W _____	140	CW-T4RR20 _____	214	IS-6MM-1R/DSP _____	147
BFHD-70A _____	116	CG2-6W-F-W _____	140	DM6250 _____	220	IS-6MM-1R _____	147
BFHD-80A/DSP _____	116	CG2-6W-F _____	140	DM6450 _____	221	IS-6MM-1 _____	147
BFHD-80A _____	116	CG2-6W-W _____	140	DP PANEL _____	128	IS-6MM-2/DSP _____	147
BL-SL-L _____	185	CG2-6W _____	140	DSA1020TRMS _____	220	IS-6MM-2 _____	147
CBL-100A-DP _____	119	CG2-JB _____	140	DSA540A _____	219	IS-8MM-1/DSP _____	147

IS-8MM-1R/DSP _____	147	MCB16A _____	122	NC32Y-DCSM _____	128	RES-24WAY _____	125
IS-8MM-1R _____	147	MCB32A _____	122	NC36L-AM _____	128	RES-28WAY _____	125
IS-8MM-1 _____	147	MCB63A _____	122	NC36L-DCSM _____	128	RES-32WAY _____	125
ISC-10BK-S _____	147	MCB-3WENC _____	122	NC36NM _____	124, 125	RES-36WAY _____	125
ISC-10BK _____	147	ML-005BW-STC _____	260	NCB-CC _____	108	RES-44WAY _____	125
ISC-10R-S _____	147	ML-005BW/DSP _____	260	NO100A _____	186	RES-4WAY _____	125
ISC-10R _____	147	ML-005NWW _____	261	NO300ACV _____	186	RES-56WAY _____	125
ISC-6-2 _____	147	ML-005WW-STC _____	260	NO60ACT _____	186	RES-8WAY _____	125
J03A _____	115	ML-005WW/DSP _____	260	P33307 _____	216	RV-TG-2T _____	183
J05A _____	115	N0100ACT _____	186	P-11D03 _____	114	RV-TG-3T _____	183
J10A _____	115	N0100A _____	186	P-11D04 _____	114	RV-TG _____	183
J15A _____	115	N010A _____	186	P-12D34 _____	114	RV-TS-5M _____	183
J20A _____	115	N0150ACV _____	186	P-12D35 _____	114	RY504-2-30 _____	21
J25A _____	115	N0150A _____	186	P-12D36 _____	114	SA296COMP-12 _____	185
J30A _____	115	N020A _____	186	P-12D37 _____	114	SET-1001 _____	137
J7.5A _____	115	N0300ACV _____	186	P-13A27 _____	114	SET-1002 _____	137
JJ05A _____	115	N050A _____	186	P-13A28 _____	114	SET-10N _____	133
JJ10A _____	115	N060ACT _____	186	P-13A29 _____	114	SET-12N _____	133
JJ15A _____	115	N10863DW _____	272	P-13A2A _____	114	SET-13N _____	134
JJ20A _____	115	N10863 _____	271	P-14302 _____	260, 261	SET-14N _____	134
JJ30A _____	115	N10864DW _____	272	PH6444TV _____	15	SET-15N _____	134
LB-450-50 _____	179, 181	N10864 _____	271	PH6574TV.OEM _____	15	SET-16N _____	134
LBL-MIC1 _____	137	N10866 _____	272	PH6574TV.W/L _____	15	SET-17N _____	134
LBL-MICSYM _____	137	N10867 _____	272	PH6574TV _____	15	SET-18N _____	134
LD-6R-120-CE _____	108	N10869 _____	272	PH6592TV-SS.OEM _____	15	SET-19N _____	134
LD-6R-150-BD _____	108	N10870 _____	272	PH6592TV-SS _____	15	SET-1N _____	133
LD-6R-210-BD _____	108	N10873 _____	272	PH6597TV.OEM _____	16	SET-1SP/F _____	135
LD-6R-300-BD _____	108	N10874 _____	272	PH6597TV _____	16	SET-20N _____	134
M28-DCSM _____	126, 129	N10963 _____	271	PH6597 _____	16	SET-22N _____	134
M32-DCSM _____	129	N10964 _____	271	PH6599-25 _____	16	SET-23N _____	134
M4100C12R _____	32	N1632DCV _____	186	PH6599 _____	16	SET-2N _____	133
M4100C12 _____	32	N20020 _____	270	PH6600 _____	15	SET-2SP _____	135
M4100P12 _____	32	N20030 _____	270	PH6601 _____	15	SET-3N _____	133
M4100R12 _____	32	N20703S _____	270	PH6629 _____	15	SET-4N _____	133
M44-DCSM _____	129	N20703W _____	270	PHTV6599-25 _____	16	SET-5N _____	133
M44H-DCSM _____	129	N20704S _____	270	PHTV6599 _____	16	SET-6N _____	133
M5100B9R _____	32	N20704W _____	270	RCD16A30MA _____	122	SET-714 _____	135
M5100C9R _____	32	N20790 _____	270	RCD32A30MA _____	122	SET-715 _____	136
M5100C9 _____	32	N28810 _____	271	RCD63A30MA _____	122	SET-7N _____	133
M5100P9 _____	32	N28830 _____	270, 271	RES-12WAY _____	125	SET-8N _____	133
M5100R9 _____	32	N816DCV _____	186	RES-16WAY _____	125	SET-9N _____	133
M56-DCSM _____	129	NC32Y-AM _____	128	RES-20WAY _____	125	SET-CC-1 _____	136

Index

SET-CC-A _____	136	SW-M331 _____	139
SET-CC-BCC-1 _____	136	SW-RVS2 _____	142
SET-FRENCH 2 _____	134	TB-118-10P _____	147
SET-FRENCH _____	134	TB-118-6P _____	147
SET-G2-1 _____	137	TS1-PK _____	184
SET-G2-2 _____	137	TS1 _____	184
SET-IN _____	135	TV6444 _____	15
SET-MSP3 _____	135	TV6574 _____	15
SET-MSP4 _____	135	TV6592 _____	15
SET- LBL-CMP _____	135	TV97.OEM _____	16
SET- LBL-WP _____	135	TV97 _____	16
SOP1-AL _____	186	TVHD _____	16
SOP1 _____	186	U-3605 _____	261
SOP2-AL _____	186	U-3606 _____	261
SOP2 _____	186	USBA6.OEM _____	16
SPC103 _____	199	USBA6 _____	16
SPL-12B.OEM _____	257	VR2.2 _____	185
SPL-12B _____	257	WAFH-14 _____	139
SPL-12C.OEM _____	257	ZIP-01 _____	26
SPL-12C _____	257		
SPL-12W.OEM _____	257		
SPL-12W _____	257		
SPL-24B.OEM _____	257		
SPL-24C.OEM _____	257		
SPL-24W.OEM _____	257		
SPRL-1 _____	257		
SPRL-2 _____	257		
SPRL-3 _____	257		
SW-32111 _____	139		
SW-32113 _____	139		
SW-32114 _____	139		
SW-32115 _____	139		
SW-32120 _____	139		
SW-32123 _____	139		
SW-6064B3P _____	143		
SW-6064C3P _____	143		
SW-6064D3P _____	143		
SW-CG1 _____	140		
SW-CG2 _____	140		
SW-CG3 _____	140		
SW-CG4 _____	140		
SW-CG5 _____	140		

MARINCO[®]

MASTERVOLT

Today, Actuant Electrical provides electrical tools, transformers, sockets and switches, wiring devices and other power management products for the professional, retail/do-it-yourself (DIY), harsh environment, marine, and diverse OEM end-market channels. Our focus is to create innovative electrical products using consistent, high quality processes. We deliver these products wherever our customers need them, anywhere in the world. Whether we power life-saving medical machines or alternative energy sources or create electrical products for marine on-board applications or industrial environments, the varied experience behind our products translates into quality for our customers.

