



# INSTALLATION INSTRUCTIONS

## LEGACY CLASSIC | SOFTAIL®

### MINIMUM REQUIRED TOOLS:



FLAT HEAD SCREWDRIVER



1/2", 9/16", 14mm, 7/8" or 22mm WRENCHES



5/16", 1/2", 9/16" SOCKETS AND RATCHET



SNAP RING PLIERS



3/16", 1/4", 5/16" ALLEN WRENCH



TORQUE WRENCH



SYSTEM SHOWN IN CHROME

### INCLUDED HARDWARE:

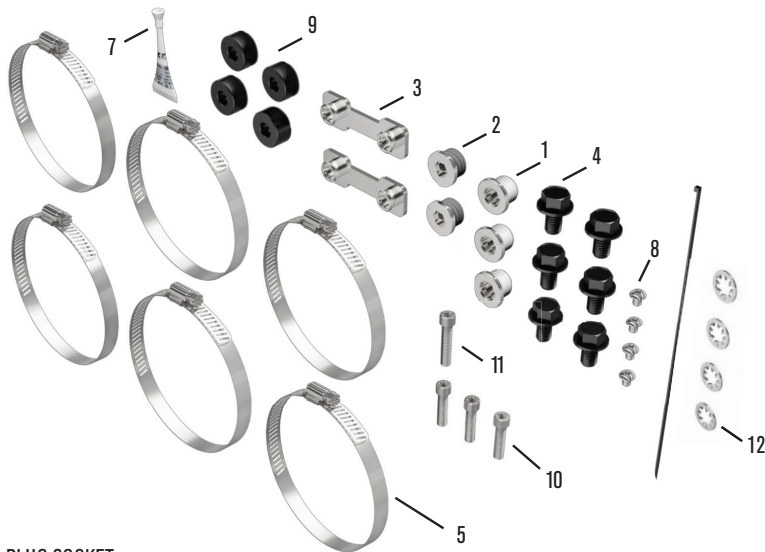

- 1. (3) O2 PLUG SOCKET
- 2. (2) O2 ADAPTER
- 3. (2) NUT PLATE 3/8-16
- 4. (6) BOLT HEX FLNG SER BLK 3/8-16 X 5/8
- 5. (6) CLAMP 1.75 BAND HS SS
- 6. (1) NYLON ZIP TIE
- 7. (1) THREADLOCKER
- 8. (4) SCREW BHCS 10-24 X 1/4
- 9. (4) SOFTAIL FLOOR BOARD SPACERS BLK
- 10. (3) SCREW SHCS 3/8-16 X 1 1/2 ZINC
- 11. (1) SCREW SHCS 3/8-16 X 1 3/4 ZINC
- 12. (4) STAR WASHER

- CHROME PART # 7211707 • 7210907
- BLACK PART # 7213402 • 7211702

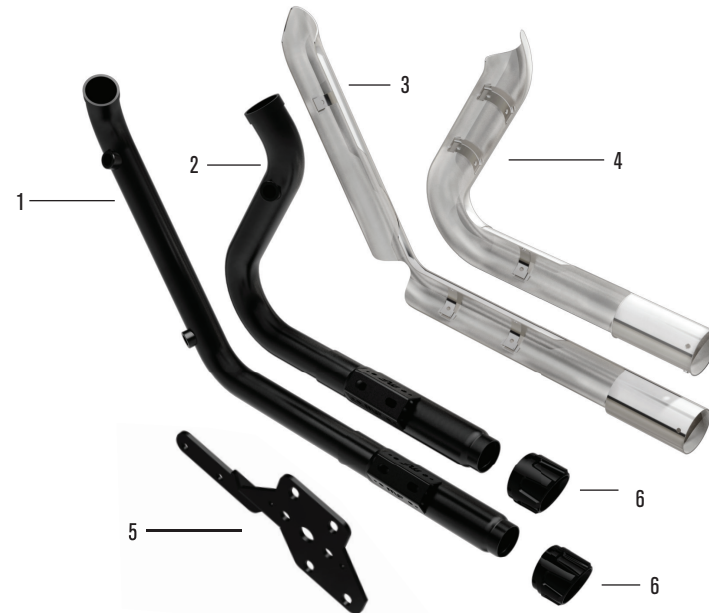

- 1. FRONT HEAD PIPE
- 2. REAR HEAD PIPE
- 3. FRONT HEAT SHIELD
- 4. REAR HEAT SHIELD
- 5. MOUNTING BRACKET
- 6. TIP



## IMPORTANT INFORMATION

1. Register your new product.
2. When installing new MagnaFlow exhaust systems, be sure your hands are clean and free of oil, lotion or similar products. After installation is completed and before starting the motorcycle, thoroughly clear the new exhaust system with a clean, soft cloth and cleaning solvent that leaves no residue. Debris, residue or fingerprints left on the system may cause damage to the finish. Damage or discoloration to finish is not covered by warranty.
3. MagnaFlow advises replacing worn or damaged gaskets.
4. Make sure there are no exhaust leaks at the junctions and connecting points of the exhaust pipes and/or mufflers, or at the cylinder.
5. Leaks due to improper installation may cause the engine to overheat. This may cause discoloration.

Maximize your motorcycles performance and efficiency by complementing your new MagnaFlow exhaust system with a fuel tuner management system and or EFI remapping. Remapping is suggested to optimize performance while reducing the possibility of damage to your motor or new exhaust system.

NOTICE: MagnaFlow makes every effort to design exhaust systems which enhance the riding experience. However, due to restraints on some models, tolerances, ground and or cornering clearance may not improve and in some cases may be reduced. Adjustments to the motorcycle not listed here may be required for proper fitment. Be sure to carefully follow all installation instructions.

**DISCLAIMER: NOT LEGAL FOR SALE OR USE IN CALIFORNIA ON ANY POLLUTION CONTROLLED MOTOR VEHICLES.**

Some part numbers not available in California. The California Air Resources Board (CARB) does not permit the use of aftermarket emission-related part(s) that alter the performance of OEM emission-related devices unless CARB has issued an Executive Order. Check Federal, State and local laws for compliance.

Platforms, model names and descriptions including but not limited to Dyna®, Softail®, Sportster®, Touring®, Fat Boy®, Road Glide®, Heritage® and Harley® are registered trademarks of The Harley-Davidson Motor Company®, Milwaukee, WI, U.S.A.

### CALIFORNIA EMISSIONS NOTICE

Some part numbers are not legal for sale or use in California. The California Air Resources Board (CARB) does not permit the use of aftermarket emission-related part(s) that alter the performance of OEM emission-related devices unless CARB has issued an Executive Order, other than on racing vehicles on closed courses. Check your local laws and manufacturer's information.

In California, the sale and installation of motorcycle aftermarket exhaust parts that may have the potential to impact emissions are regulated by the California Air Resources Board (CARB). The sale, installation and use of emissions related aftermarket exhaust parts on motorcycles is prohibited unless the exhaust part is either an OEM "replacement part" as defined by the state of California, or is specifically permitted for use by an Executive Order issued by CARB.

#### (1) Replacement Parts

Replacement Parts are aftermarket parts that are functionally identical to the stock OEM part they are intended to replace, and therefore do not adversely impact emissions when installed and in use. Replacement Parts are permitted for sale, installation and use on motorcycles used on or off the public highways in California. For motorcycles, these parts fall in to two categories:

### CALIFORNIA EMISSIONS NOTICE (CONT.)

\* No emission control - If the motorcycle's stock exhaust system does not contain any emission control components, then an aftermarket exhaust part is a Replacement Part and no EO is required.

\* Upstream emission control devise. If the motorcycle's stock exhaust system contains a catalytic converter, then an aftermarket exhaust part positioned downstream from the catalytic converter (i.e. cat-back) is a Replacement Part as long as it does not remove, replace or adversely affect any emission control equipment originally attached to the stock exhaust system.

#### (2) Executive Order Parts

All exhaust parts that incorporate or impact any emission control devise require a CARB issued Executive Order allowing the parts to be advertised, sold, offered for sale and installed in California, pursuant to specific application.



## STOCK EXHAUST REMOVAL INSTRUCTIONS

### PLEASE NOTE:

Several MagnaFlow motorcycle exhaust systems are designed to be used with O2 and non-O2 sensor applications. If your motorcycle does not come equipped with O2 sensors, simply skip any steps referring to them.

Also, make sure to retain all factory hardware and brackets as they may be used during the installation process.

1. Locate both the front and rear O2 sensors and unplug them from the factory wiring harness. Remove any cable ties holding them in place. Note the wiring location and routing.
2. Carefully remove the two mounting nuts located at each flange holding the head pipes to the cylinders. It may be necessary to loosen or remove the heat shields for better access. Make sure to retain the nuts as they will be used during the installation.
3. Locate and remove the mounting bracket connecting the frame and exhaust crossbar to retain the nuts as they will be used during the installation.
4. On each muffler, remove the bolts attaching them to the exhaust crossbar and remove the stock exhaust pipes, and mufflers. Make sure to prevent any damage to the O2 sensors since they will be reused.
5. Remove the two O2 sensors from the head pipes. To insure continued performance from your stock O2 sensors, keep any fingerprints, debris or chemicals from the tip.
6. Locate and remove the two exhaust mounting studs from the frame (Figure 1).



Fig. 1

7. From the stock exhaust system, remove the circlips and mounting flanges to reuse with the new system. Be sure to replace any reused hardware that is worn or damaged before installing your MagnaFlow motorcycle exhaust system.

## INSTALLATION INSTRUCTIONS

### PLEASE NOTE:

Several MagnaFlow motorcycle exhaust systems are designed to be used with O2 and non-O2 sensor applications. If your motorcycle does not come equipped with O2 sensors, simply skip any steps referring to them. It will be necessary to install the supplied O2 sensor plugs during the installation process.

1. Install the new MagnaFlow exhaust mounting bracket using two of the supplied 3/8-16 x 5/8 inch bolts. Do not tighten at this time to allow for adjustment. (Figure 2)

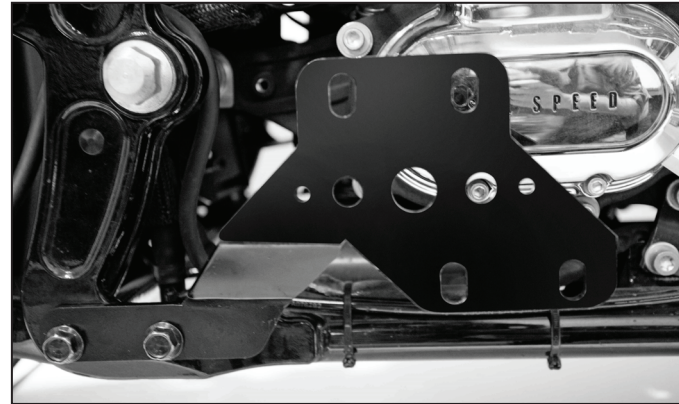

Fig. 2

2. Install the factory mounting flanges and circlips, removed from the factory system, on the new head pipes. (Figure 3)



Fig. 3

3. Carefully install the factory O2 sensors into the new head pipes.

4. Install the front and rear head pipe to the exhaust port using the factory exhaust port nuts. Do not tighten the nuts at this time to allow for adjustment. (Figure 4a, 4b)

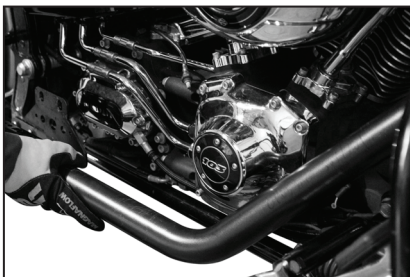

Fig. 4a

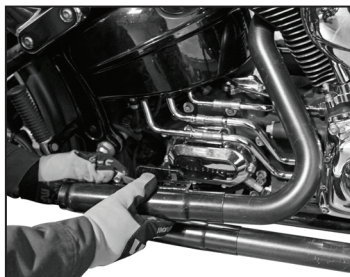

Fig. 4b

5. Insert the supplied nut plates into the muffler mounting braces and attach the head pipe assemblies to the new mounting bracket using the four 3/8-16 x 5/8 bolts. Do not tighten at this time to allow for adjustment. (Figure 5)



Fig. 5

6. Re-route and plug in the O2 sensors to the factory harness. Secure the harness wire using the supplied cable tie.
7. Insert the supplied heat shield clamps to the heat shields by inserting the end of the clamp through the retaining bracket. (Figure 6)



Fig. 6

8. Attach the front heat shield to the front head pipe using the heat shield clamps. Do not tighten the clamp at this time to allow for adjustment. (Figure 7a, 7b)

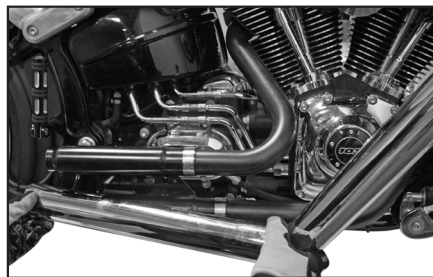

Fig. 7a

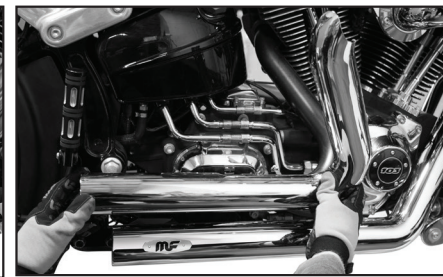

Fig. 7b

9. Insert the supplied muffler tips into the front and rear heat shields making sure to fully engage the end of the muffler. Lining up the screw holes on the tip with the holes in the heat shield; attach the tip using the supplied 10-24 x 1/4 inch screws, locktite and star washer. The tips can be rotated in four different positions allowing you to customize your exhaust. (Figure 8a, 8b)



Fig. 8a



Fig. 8b

10. Adjust the exhaust system as necessary and tighten all of the bolts and clamps.
11. Before starting the motorcycle, make sure to check that all of the exhaust components including O2 wiring have been properly installed and have proper clearance to avoid damage. Make sure that all hardware has been tightened to factory specifications. Please reference item 2 on the Important Information page.

Note: Remapping the EFI unit is suggested to optimize performance while reducing the possibility of damage to your engine or new exhaust system.