

White Paper: Research and Development Efforts towards the Production of the Leatt[®] C-Frame Carbon Knee Brace

by

Dr. Chris Leatt

Mr. Cornel de Jongh

Mr. Pieter André Keevy

prepared for / by

Leatt Corporation[®]

Research and Development Department - Biomedical Engineering Division

Last Draft July 2014

PUBLIC RELEASE Aug 2014

Draft Reviewed by

Dr. Spike Erasmus

(Orthopedic Surgeon - Knee Specialist, Stellenbosch)

Prof. Cornie Scheffer

(Professor and Leader Biomedical Engineering Research Group BERG, Stellenbosch
University)

Declaration by Independent Reviewers

We, the undersigned, hereby acknowledge the credibility of the work conducted in this document and declare that the work contained in this white paper is the authors' own original work.

Signature:

Dr. Spike Erasmus - Knee Surgeon, Stellenbosch. Head of The Knee Clinic, Stellenbosch.

Signature:

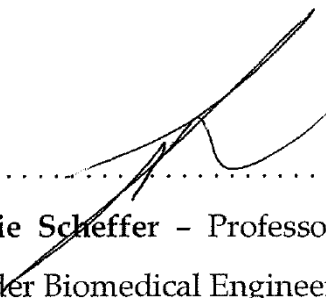

Prof. Cornie Scheffer - Professor of Mechanical and Mechatronic Engineering and Group Leader Biomedical Engineering Research Group, University of Stellenbosch.

Date: August 2014

Legal Notice

The copyright, trademarks and other intellectual property rights in this document (including, but not limited to, information, data, photographs and graphical images) are owned by Leatt Corporation®. You may print material from this site only if such material is not stored on any medium other than for subsequent viewing, or it is not reproduced, modified, adapted or processed in any way. No part of this document may be reproduced or stored in any other website or included in any public or private document without Leatt Corporation®'s prior written permission. No license, express or implied, is hereby granted regarding any of the copyright, trademarks or other intellectual property rights.

Declaration

We, the undersigned, hereby declare that the scientific work described in this white paper is our own original work.

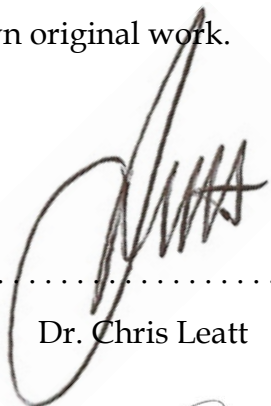
Signature: 

Dr. Chris Leatt

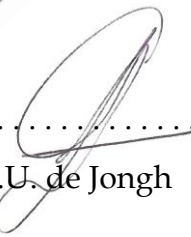
Signature: 

C.U. de Jongh

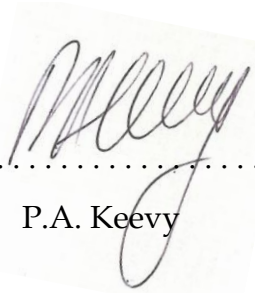
Signature: 

P.A. Keevy

Date: **July 2014**

Legal Notice

The copyright, trademarks and other intellectual property rights in this document (including, but not limited to, information, data, photographs and graphical images) are owned by Leatt Corporation®. You may print material from this site only if such material is not stored on any medium other than for subsequent viewing, or it is not reproduced, modified, adapted or processed in any way. No part of this document may be reproduced or stored in any other website or included in any public or private document without Leatt Corporation®'s prior written permission. No license, express or implied, is hereby granted regarding any of the copyright, trademarks or other intellectual property rights.

Abstract

White Paper: Research and Development Efforts towards the Production of the Leatt® C-Frame Carbon Knee Brace

C.J. Leatt; C.U. de Jongh; P.A. Keevy

Knee injuries are common in active sports and may have a high incidence in particular categories and disciplines. These injuries may cause pain, deformity or be serious enough to limit future sporting endeavors. Until the advent of prophylactic knee braces (PKB's) there was no effective device to mitigate the injury risk associated with potentially high impact, and extreme sports such as off-road motorcycle riding (MX, SX or Enduro), downhill mountain biking or even the various skiing disciplines.

This White Paper summarizes research, development, and performance verification activities conducted by Leatt Corporation. Individuals involved in the work include Dr. Chris Leatt, biomedical engineers Cornel de Jongh and Pieter Keevy, and industrial designer Carel Meyer. Field trials were also conducted from an early stage in the development process to help develop and assess the Leatt® C-Frame Carbon Knee Brace.

Background research provided information on knee trauma, knee dynamics, and the coupled forces and motions involved in dynamic events resulting in an understanding of injury mechanisms and injury tolerance levels associated with loading of the knee. Tests were conducted with the proposed device to ensure that the device would fail within the appropriate corridors¹, during typical injury

producing load applied to the device in a test environment. Some components of the device were required to fail above (or above a certain percentage of) the injury threshold for hyperextension and valgus deformation (the most common injury mechanisms), whilst another was required to fail before the injury threshold for tibial hyperextension is reached.

This document is intended to answer common questions asked by users, institutions and the public. In AMA (American Motorcycle Association) sanctioned MotoCross and SuperCross events, the total number of knee injuries may be as high as 9% of all injuries [Table 2-2]. 40% of these injuries are ligamentous and relate mostly to ACL, MCL and Meniscus injury [1]. Knee protection lowers the incidence and severity of these knee injuries. Encouraging is the fact that, it has been shown that prophylactic knee braces do offer protection to riders/athletes, especially for MCL and capsular injuries. The Leatt[®] C-Frame Carbon Knee Brace was envisaged to reduce common modalities of injury namely MCL, ACL and meniscus injury.

Acknowledgements

We would like to express our sincere thanks to the following people and organizations, whom have contributed to this project:

- Dr. Spike Erasmus - Orthopaedic Surgeon - Knee Specialist and motorcyclist. MBChB; MMed (Ortho) Cum Laude and elected member of the College of Orthopaedic Surgeons. Founder of The Knee Clinic.
- Prof Cornie Scheffer - BEng (Mech); MEng (Cum Laude); PhD. Professor of Mechanical and Mechatronic Engineering and Head of Biomedical Engineering Research Group (BERG), Stellenbosch University.
- All the volunteers taking their time to ride with the device and fill out valuable questionnaires during the development process.

Dedications

To all of those who have shown a keen interest and belief in what Leatt Corporation stands for: "Their ability to incorporate pure science, engineering and passion into the development of motorsport safety products."

Contents

Declaration by Independent	i
Reviewers	i
Declaration	ii
Abstract	iii
Acknowledgements	i
Dedications	ii
Contents	1
List of Figures	4
List of Tables	6
Nomenclature	7
Chapter 1	8
Introduction	8
1.1 Background	8
1.2 Motivation	9
1.3 Objectives.....	9
1.4 Outline	10
Chapter 2	12
Literature Review.....	12
2.1 Anatophysiology of the Knee	12
2.1.1 Anatomy of the Knee	12
2.1.2 Knee Kinetics and Kinematics	16
2.2 Knee Injury Modalities	22
Chapter 3	2
Rationale for the Design of the Leatt® C-Frame Carbon.....	2
3.1 Introduction	2

3.2	Allowable ROM.....	4
3.3	3 Point Force Distribution System	4
3.4	Material / Absorption Considerations	6
3.5	Hinge Design	7
3.6	Designed for Adjustability.....	8
3.7	Shin Load Pad Strut Design.....	8
Chapter 4	10
	Testing of the Leatt® C-Frame Carbon PKB	10
4.1	Quasi-Static Testing.....	10
4.1.1	Introduction	10
4.1.2	Valgus Deformation Test	13
4.1.3	Hyperextension Deformation Test	17
4.1.4	Hinge fatigue test	22
4.1.5	Clinical Study Comparison.....	24
4.2	FEM Component Failure Analysis.....	28
4.3	Hazard Analysis	30
4.3.1	Applicable Documents	31
4.3.1.1	Design Standards and Procedures.....	31
4.3.1.2	Reference Documentation.....	32
4.3.2	Introduction	32
4.3.2.1	Scope	32
4.3.2.2	Process.....	32
4.3.2.3	Preliminary Hazard Analysis	32
4.3.2.4	Hazard Severity Categories	33
4.3.2.5	Hazard Probability Levels	34
4.3.2.6	Reliability Data	34
4.3.2.7	Severity and Risk Classification	35
4.3.2.8	Ground Rules and Assumptions.....	36
4.3.3	System Description	36

4.3.3.1 Leatt® Knee C-Frame Carbon System	36
4.4 Preliminary Hazard Analysis (Potential Failure Modes)	36
4.4.1 Failure to transfer an acceptable level of hyperextension force away from the knee 37	
4.4.2 Failure to completely transfer valgus injury threshold force away from the knee 37	
4.4.3 Failure of engineered fracture point of shin load pad to fracture prior to tibial injury threshold being reached	38
4.4.4 Failure of engineered fracture point (strut below hinge) to fail or failure of the hinge to fracture prior to femoral injury threshold being reached.....	38
4.5 FMEA Results	39
4.5.1 Catastrophic/Critical Failures.....	39
4.5.2 Marginal Failures	40
4.6 Fault Tree Analysis Results.....	41
4.7 Conclusions and Recommendations	41
Chapter 5.....	43
Work in Progress.....	43
Chapter 6.....	44
Conclusions.....	44
List of References.....	46
Appendix A	50
Appendix B.....	53

List of Figures

Figure 2-1: Anatomy (Osteology) of the knee.....	13
Figure 2-2: Menisci of the knee	14
Figure 2-3: Ligaments of the knee.....	15
Figure 2-4: Knee planes of rotation.....	16
Figure 2-5: Joint reaction forces of the knee	18
Figure 2-6: Force diagram describing joint contact forces during Valgus or Varus impact	19
Figure 2-7: Varus or Valgus force diagram used to calculate reaction force required via bracing.....	20
Figure 2-8: Free body diagram of a knee in flexion illustrating 11 interdependent forces [10].	21
Figure 2-9: Progression of ligament failure due to lateral impact resulting in valgus deformation of the knee [13]	23
Figure 3-1: 3 Point Force Distribution (3PFD).....	5
Figure 3-2: 3 PFD and Engineered Fracture Zone	6
Figure 3-3: Hinge mechanism	7
Figure 3-4: C-Frame Sizing Chart	8
Figure 4-1: Valgus Deformation Test	14
Figure 4-2: Fracture of carbon shin load pad strut at force above minimum required force of 1400 N.....	15
Figure 4-3: Valgus deformation test graph - force over time.....	16
Figure 4-4: Hyperextension and Tibial Tolerance Test Setup.....	18
Figure 4-5: Hyperextension and Tibial Tolerance Test Setup Top View	19
Figure 4-6: Hyperextension and Femoral Tolerance Test Setup	19
Figure 4-7: Hyperextension and Femoral Tolerance Test Setup Top View	20
Figure 4-8: Fracture of carbon shin load pad strut at force above minimum required force of 416.5 N and below maximum allowable force of 750 N	20

Figure 4-9: Hyperextension force graph with Tibial Injury Threshold.....	21
Figure 4-10: Fracture of carbon shin load pad strut at force above minimum required force of 682 N and below maximum allowable force of 3780 N	21
Figure 4-11: Hyperextension force graph with Femoral Injury Threshold	22
Figure 4-12: Fatigue test in motion	23
Figure 4-13: (a) Unilateral Bar & (b) Bilateral Bar	25
Figure 4-14: Basic PKB [20]	26
Figure 4-15: Leatt® Knee C-frame Carbon	26
Figure 4-16: FEM of the C-Arm for 3 design iterations	29

List of Tables

Table 2-1: Knee Injury Classification System [11]	22
Table 2-2: Knee Injury Statistics in Off-Road Motorcycle Riding	24
Table 2-3: Injury Criteria for relevant injury mechanisms	25
Table 4-1: Applicable Documents for FMEA	31
Table 4-2: Reference Documentation for FMEA	32
Table 4-3: Hazard Severity Categories	34
Table 4-4: Hazard Probability Levels	34
Table 4-5: Risk Classification	35

Nomenclature

Variables

N	newton
Nm	newton-meter
MPa	Megapascal

Abbreviations

PKB	Prophylactic Knee Brace
MCL	Medial Collateral Ligament
LCL	Lateral Collateral Ligament
PCL	Posterior Cruciate Ligament
ACL	Anterior Cruciate Ligament
3 PFD	3 Point Force Distribution
IAR	Instantaneous Axis of Rotation
ROM	Range Of Motion
DOF	Degrees Of Freedom
PU	Polyurethane
MX	Motocross
SX	Supercross
MDD	Medical Device Directive
UTS	Ultimate Tensile Stress
PPE	Personal Protective Equipment
FTA	Fault Tree Analysis
FMEA	Failure Modes and Effect Analysis
H III ATD	Hybrid III Anthropomorphic Test Device

Chapter 1

Introduction

1.1 Background

The human knee is one of the most commonly injured areas in the human body in extreme sports such as MotoCross or SuperCross (MX or SX) and is constantly exposed to loading and bending and/or rotation acting in coupled fashion. Prophylactic knee bracing has to a large degree, kept pace with other facets of safety equipment development, and today there are quite a number of devices on the market that show varying degrees of efficacy. The common conclusion is that most prophylactic knee braces (PKB's) do offer at least some form of protection to the user ranging from reduced risk of MCL, ACL, PCL or meniscus injuries in combination or alone [1],[2],[3]. These studies do not however focus only on off road motorcycling, but on extreme sports in general. PKB's are intended to stabilize knees during rotational, antero-posterior forces, valgus deformation, flexion and extension of the leg [1],[2],[3],[4].

The incidence of knee injuries in off-road motorcycling can be as high as 9% of all injury types. ACL injuries account for about 40% of knee injuries, meniscus injuries 20% and MCL injuries 15% [2].

A PKB should be designed as to stabilize the knee, and transfer the loading mechanisms which may result in above mentioned injuries, away from the knee. The design rationale of the Leatt® C-Frame Carbon included consideration of methods to unload the ligamentous structures of the knee complex using a 3 point load transfer system during typical injury mechanism type loading, whilst transferring these forces away from the knee in a safe way. This included consideration of the secondary effects of load transfer such as the effect of loading on the tibia (taking the

Tibia Index into consideration). These effects were evaluated through testing of the device and comparison to existing injury criteria for valgus deformation, hyperextension of the knee, impact tolerance of the patella and the tolerance to injury of the tibia (tibia index).

The Leatt® C-Frame Carbon PKB has been designed by a team of specialized professionals to optimize its performance for knee protection in extreme sports. The design includes input from orthopedic surgery, biomedical engineering and mechanical engineering and from competitive sporting professionals. This, in conjunction with testing and constant reference to human reaction to and tolerance of various quasi-static loading scenarios, ensured that the device design was optimized through multiple design iterations.

1.2 Motivation

Knee injuries are one of the most common injury types in extreme sports such as off road motorcycling. Injuries in this area may often cause a rider great discomfort, significant recovery times and even permanent disability or an inability to continue his/her sporting discipline. It was for these reasons that a device was designed to help protect people from the aforementioned knee injuries.

1.3 Objectives

The research, design, and testing underlying the Leatt® C-Frame Carbon focused on overall efficacy in creating an effective and reliable product. The Leatt® C-Frame Carbon Research and Development (R&D) rationale is presented in this paper **Error! Reference source not found.**, and the objective is to elaborate on each phase of development. Common questions regarding various aspects of the Leatt® C-Frame Carbon, such as injury mechanisms and the product's ability to prevent them from occurring, are addressed.

The specific objectives for this study can be summarized as:

- The identification of relevant knowledge in the fields of knee anatomy, kinematics, impact mechanics and injury mechanisms through an extensive literature review.
- The presentation of the Leatt® C-Frame Carbon design rationale.
- The presentation of representative tests conducted on the Leatt® C-Frame Carbon and discussion of their results.
- The discussion of a Risk Assessment in the form of a Failure Modes and Effects Analysis (FMEA) conducted for the purposes of Medical Device Certification according to the Medical Device Directive (MDD-93-42-EEC)

1.4 Outline

Chapter 2 discusses some of the relevant literature reviewed for this study, including literature on the anatomy and physiology of the knee. The injury modalities and mechanisms of injury associated with the knee are discussed. Options for the protection of the knee and associated challenges are also described.

In Chapter 3 the general and specific rationales for the design of the Leatt® C-Frame Carbon are discussed. The general rationale includes considerations such as fit and comfort, 3 point force distribution without adjacent anatomical structure compromise and impact protection. The discussion of specific design considerations includes factors such as the omission of a medial component (hinge only on the lateral side), hinge kinematics (offset twin hinge points) and C-arm construction.

Chapter 4 forms the body of the document and offers a presentation of the testing conducted on the Leatt® C-Frame Carbon. This includes the quasi-static testing done with reference to the effect on injury thresholds of the knee in hyperextension, valgus deformation as well as the Tibia Index. Further analysis was conducted by means of fatigue testing of the hinge component under riding

conditions. Lastly, FEM analysis of two important strength-dependent components are discussed.

Chapter 2

Literature Review

This chapter discusses knee biomechanics, focusing on the main knee injuries sustained in extreme sports such as off road motorcycling. A short introduction to knee anatomy is presented, followed by knee injury modalities along with knee protection options and their challenges.

2.1 Anatophysiology of the Knee

2.1.1 Anatomy of the Knee

Osteology

The knee joint complex consists of 4 bones, namely the femur above the knee, the tibia and fibula below the knee and the patella (**Error! Reference source not found.**). The distal end of the femur widens to form the convex lateral and medial condyles which articulate with the tibia and patella. Anteriorly the two condyles forms a groove, the trochlea, which receives the patella. The proximal end of the tibia is called the tibial plateau and articulates with the condyles of the femur via two shallow concavities. These concavities are separated by the popliteal notch which has a roughened area where the cruciate ligaments attach called the tibial spine **Error! Reference source not found..**

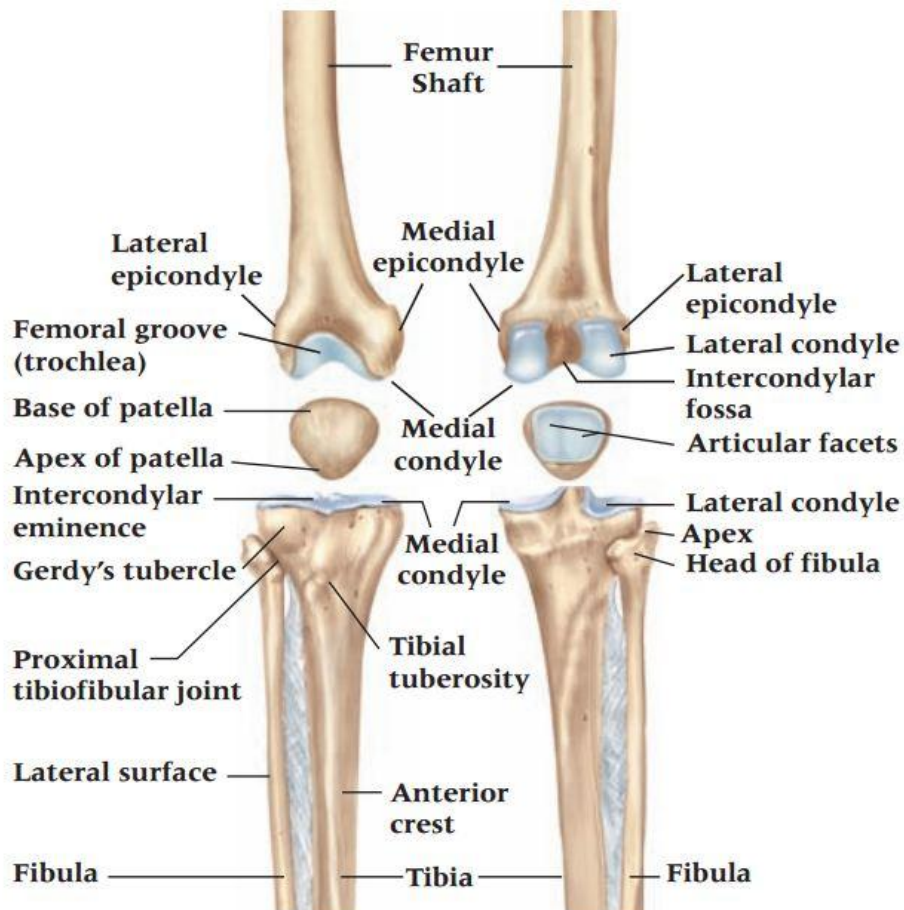

Figure 2-1: Anatomy (Osteology) of the knee

The patella is the largest sesamoid (surrounded by tendon) bone in the body and is surrounded by the tendon of the quadriceps femoris muscle. It consists of a medial facet and a lateral facet - which is the longest of the facets. The patella articulates in the trochlea (femoral groove) between the two femoral condyles. Tracking in this groove is dependent on the pull of the quadriceps muscle and the patellar tendon as well as the depth of the groove and the shape of the patella **Error! Reference source not found.**

Meniscus

The menisci are two oval shaped fibro-cartilages that deepen the articular facets of the tibia and aids in cushioning stresses placed on the knee joint. The lateral meniscus transfers more contact force than the medial meniscus. The menisci aid in knee joint stabilization when the knee is flexed, especially the medial meniscus [5].

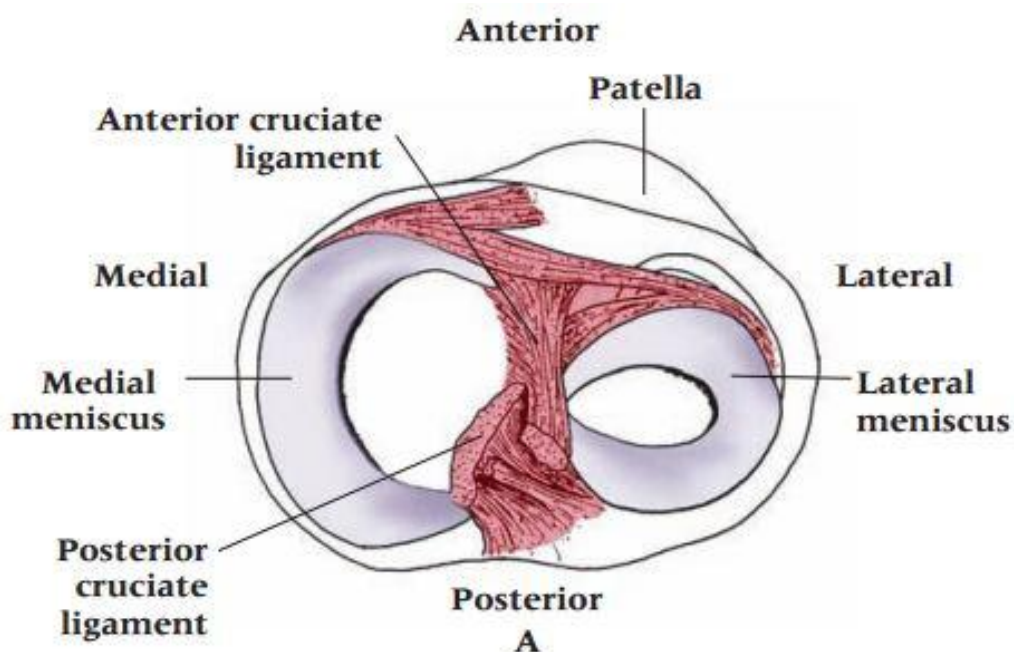

Figure 2-2: Menisci of the knee

Ligaments

The major stabilizing ligaments of the knee are the cruciate ligaments (anterior cruciate ligament, posterior cruciate ligament), the collateral ligaments (medial collateral ligament, lateral collateral ligament) and the capsular ligament.

The cruciate ligaments are the main stabilizing ligaments in the knee. They consist of two bands crossing one another. The anterior cruciate ligament or ACL attaches

below and anteriorly on the tibia and passes posteriorly where it attaches to the medial surface of the lateral condyle. The posterior cruciate ligament or PCL, the stronger of the two cruciate ligaments, crosses from the posterior surface of the tibia, upwards and anteriorly and attaches to the anterior portion of the lateral surface of the medial condyle. The ACL resists anterior motion of the tibia on a static femur as well as extreme knee extension. The PCL resists posterior motion of the tibia on a static femur as well as hyperflexion of the knee [6].

The collateral and capsular ligaments provide additional stability to the knee as well as providing direct movement in a correct path. The medial collateral ligament or MCL connects the medial epicondyle of the femur to the distal medial portion of the tibia. This ligament is more prone to injury during valgus deformation due to loading in tension, and is therefore more likely to rupture than the lateral collateral ligament or LCL [7].

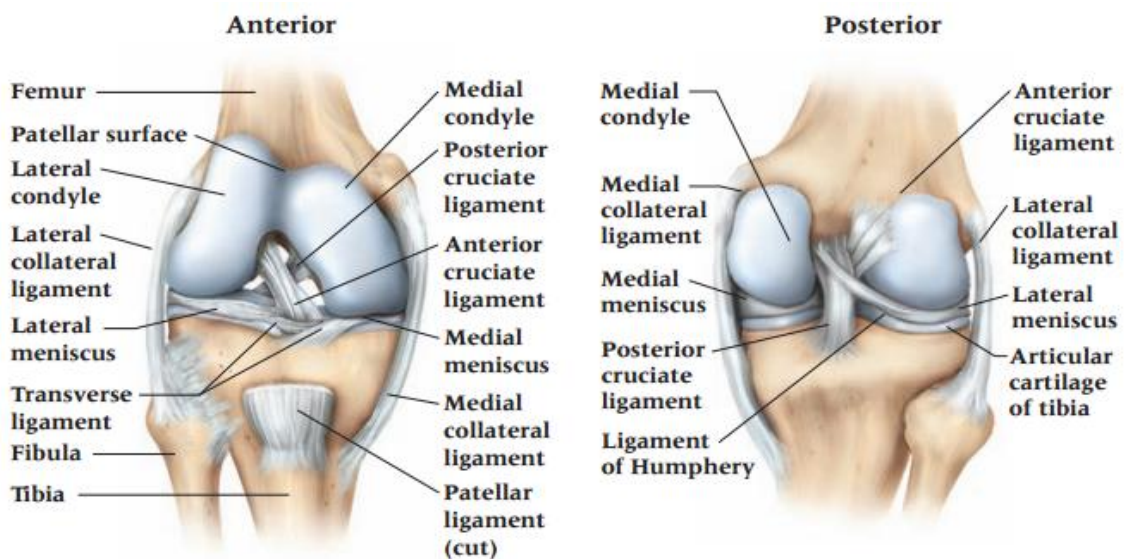

Figure 2-3: Ligaments of the knee

2.1.2 Knee Kinetics and Kinematics

The knee is the most complex joint in the body as it transmits load and participates in motion whilst aiding in the conservation of momentum during movement. All ground forces need to be transferred through the knee joint when moving and this can happen with the knee in various degrees of flexion or extension as well rotation [8].

The knee has six directions of freedom (6 DOF) with the following range in each plane:

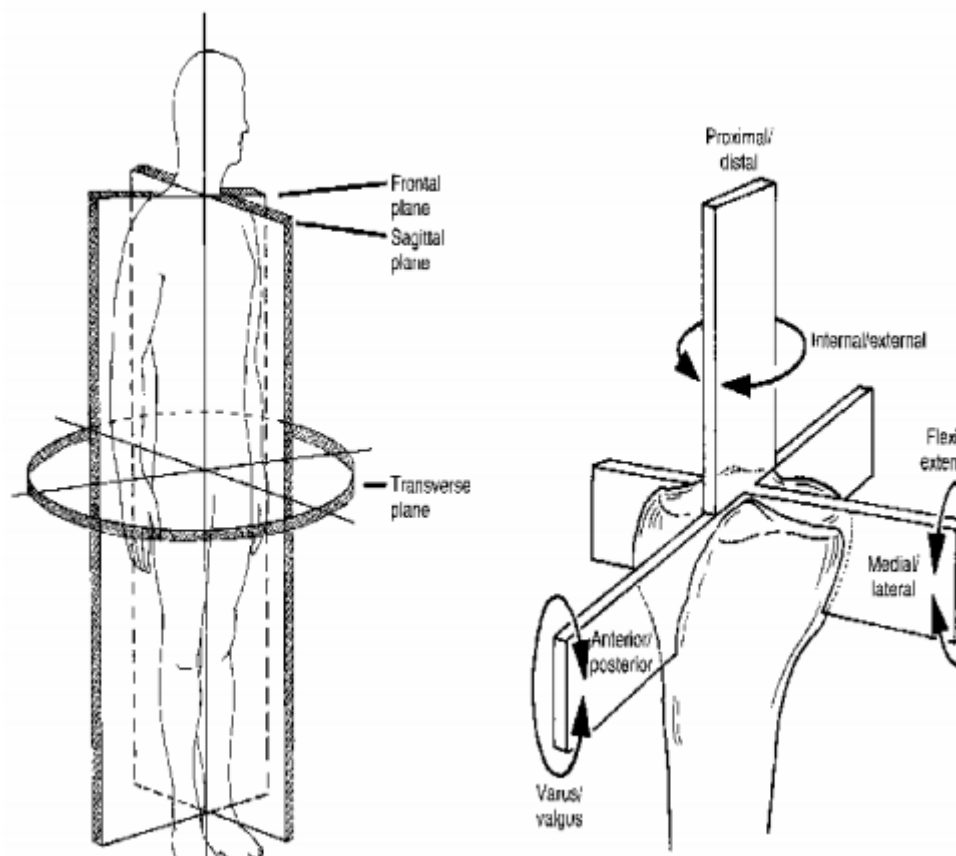

Figure 2-4: Knee planes of rotation

- Sagittal plane (0 - 140 degrees)
- Transverse plane - rotation effected by position of the knee in the sagittal plane. If the knee is fully extended rotation is limited due to constraints via interlocking of the femoral condyles to the tibia. Rotation increases as knee flexion is increased. At 90 degrees flexion, internal rotation is about 30 degrees and external rotation about 45 degrees. As the knee is further flexed beyond 90 degrees, the ROM in the transverse plane decreases due to soft tissue restriction.
- Rotation in the frontal plane is dependent on the degree of knee flexion. Full extension of the knee prohibits motion in the frontal plane whilst passive abduction and adduction is allowed up to about 30 degrees with increased knee flexion.

Joint contact forces

During a normal foot strike, as the ground reaction force is carried up through the tibia, it is counteracted by a force through the patellar ligament as well as the femoral condyles (Figure 2-5). This would result in equal force distribution without varus or valgus stresses being present.

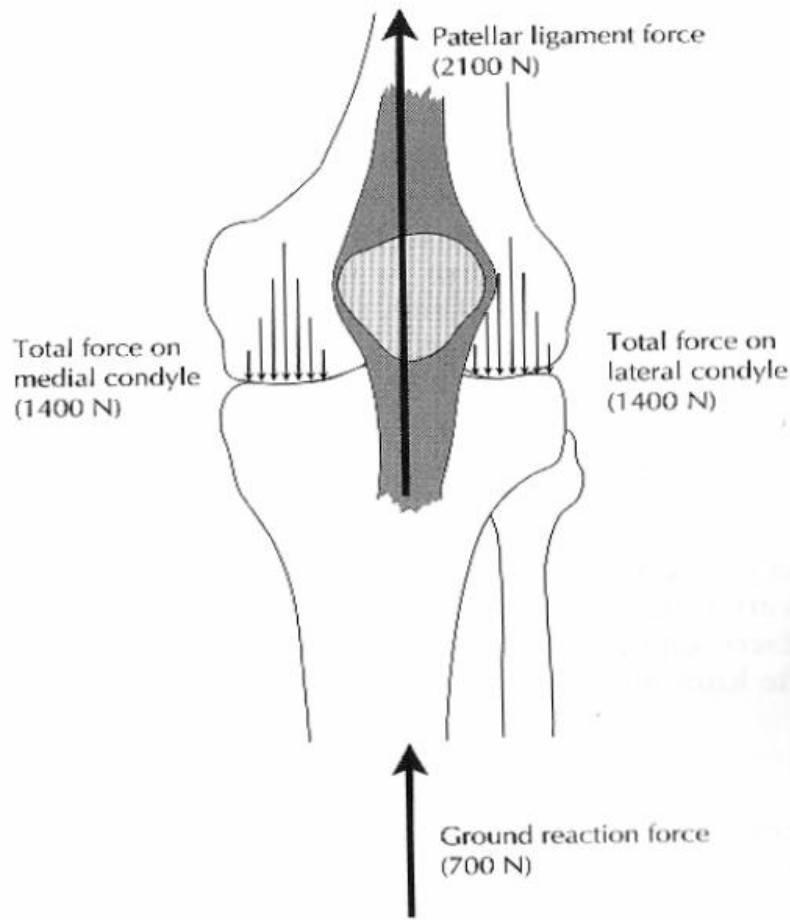

Figure 2-5: Joint reaction forces of the knee

During varus stress on the knee, the LCL tension increases in order to balance the knee which results in an increase in contact pressure imparted to the medial condyle. If the fracture limit of the medial condyle (condyle and femur tissue) is surpassed, the condyle will fracture. If the LCL ligament maximum tensile strength is reached prior to the medial condyle limit, the LCL will rupture **Error! Reference source not found.**

During valgus stress, the opposite than above will occur. The ACL tension will increase as the valgus level increases, which will result in an increase in lateral condyle contact pressure. If the lateral condyle fracture limit is surpassed, it will fracture, given that this event occurs before the tensile limit of the MCL is surpassed,

in which case the MCL will rupture. MCL rupture is the most common scenario in this impact mechanism **Error! Reference source not found.**

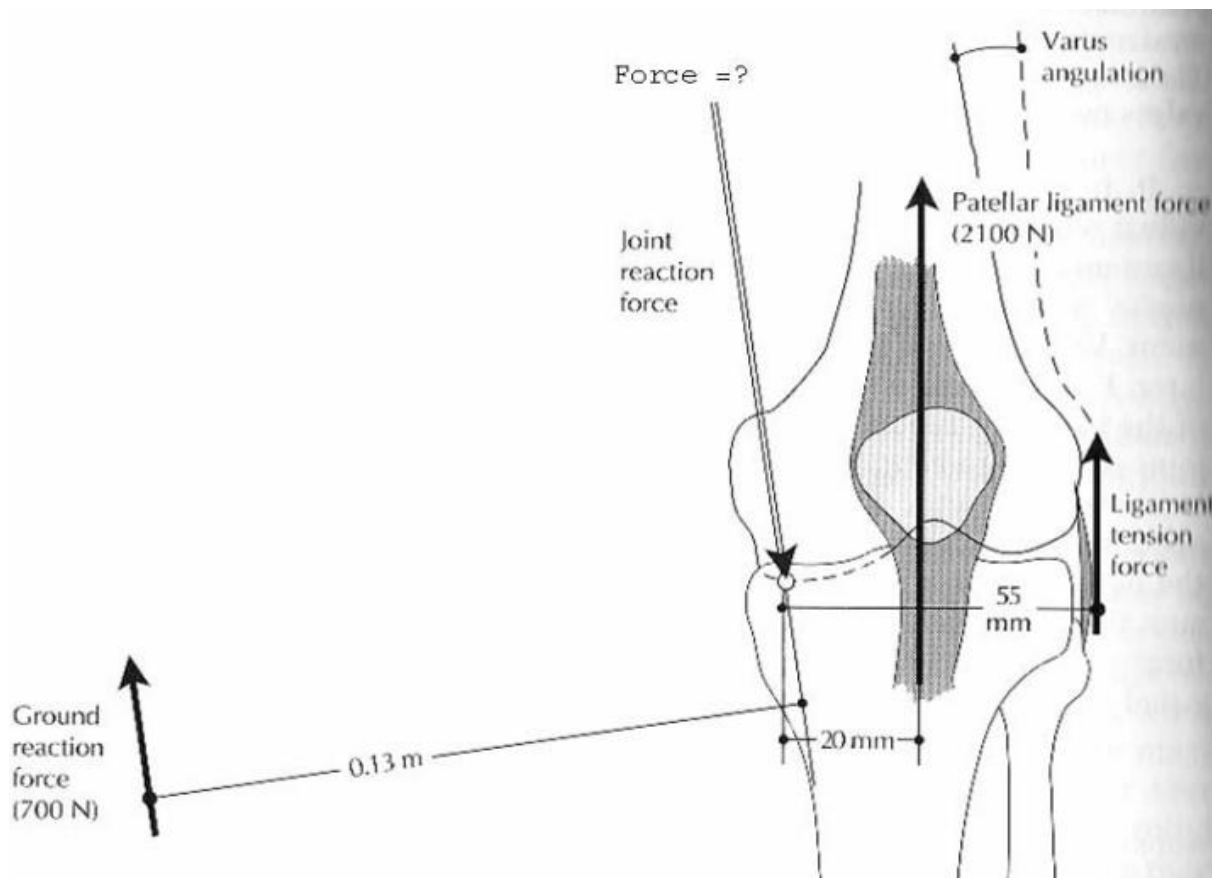

Figure 2-6: Force diagram describing joint contact forces during Valgus or Varus impact

The following force diagram can be used to calculate the forces required to counteract valgus and varus deformation of the knee [9]:

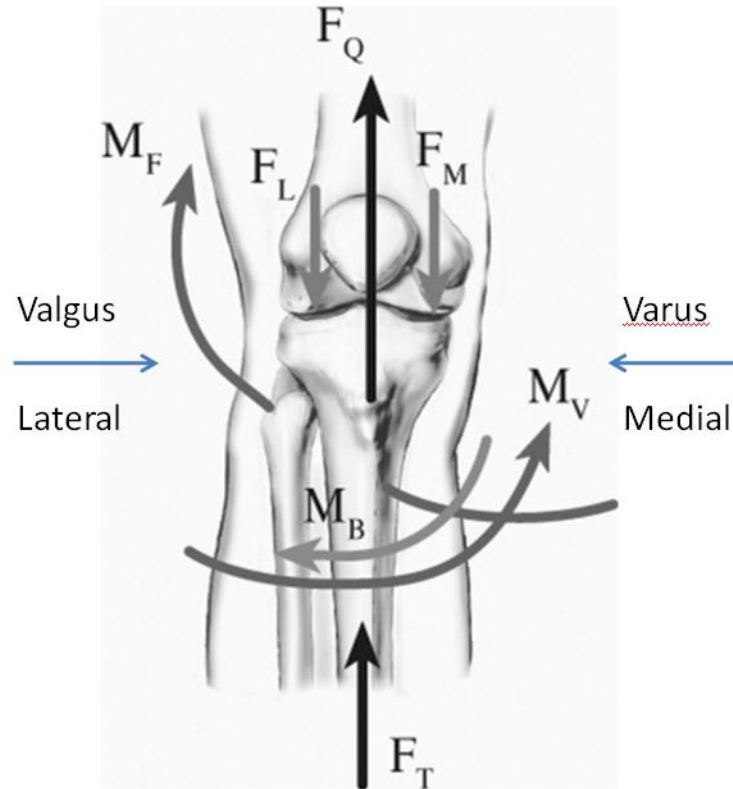

Figure 2-7: Varus or Valgus force diagram used to calculate reaction force required via bracing

Where:

F_T is ground reaction force

M_F is the external flexion moment resulting from valgus deformation

F_Q is the quadriceps reaction force required to counteract the external flexion moment

F_M and F_L represent the medial and lateral condyle (compartment) reaction forces

M_V represents the external varus moment as a result of the ground reaction force

M_B is the moment generated by the brace to counteract the valgus deformation (will have a negative value according to this image)

The application of the basic force principle as shown above will be further discussed as it applies to the Leatt® C-Frame Carbon in Chapter 3.

In general knee kinematics is a complex field, and to account for all the variables and inter-dependant forces and angles during a typical impact, even when only considering one plane of motion, is significantly complex. Figure 2-8 below shows an example of just how complex the dynamic behavior of a knee is when looking at sagittal plane motion in isolation. This complexity increases dramatically when looking at coupled impact mechanisms ranging over more than one plane of motion [10].

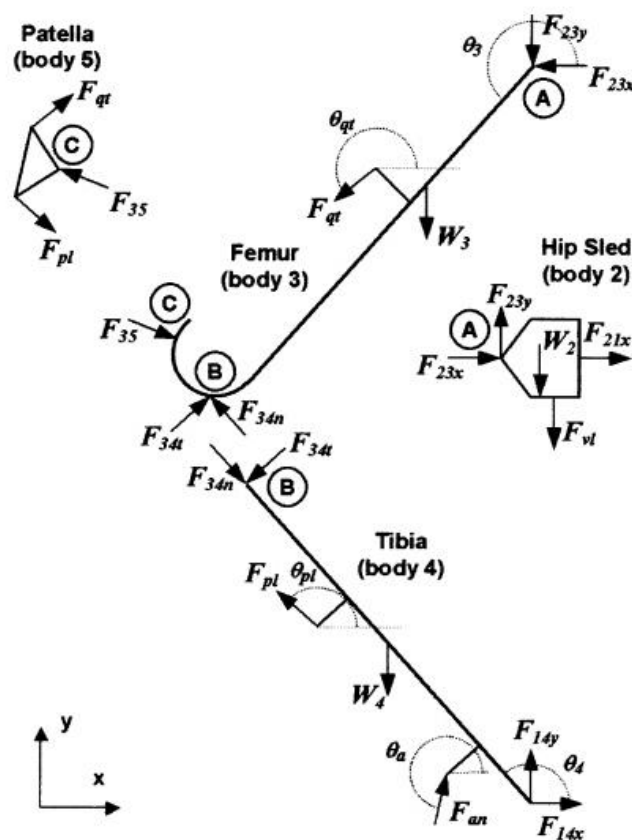

Figure 2-8: Free body diagram of a knee in flexion illustrating 11 interdependent forces [10].

In order to design a knee bracing system, it is important to identify and isolate only the most important and relevant forces that may contribute to injury limits

being exceeded. For the design of the Leatt® C-Frame Carbon, forces related to MCL and lateral meniscus injuries during valgus as well as ACL injuries during hyperextension was considered the most important. Thus for the remainder of this study, the focus will be on the structures mentioned above and the forces and mechanisms related to injury of these structures. Consideration of methods used to restrict excessive force to these structures is thus given in this study and results in the presentation of the Leatt® C-Frame Carbon as it stands today.

2.2 Knee Injury Modalities

To develop a PKB, it is necessary to understand the mechanisms of knee injury and major injury vectors. The design rationale behind the Leatt® C-Frame Carbon has been modeled on a common classification systems (Table 2-1) derived by Kennedy of knee injury mechanisms in use worldwide by knee surgeons [11].

TABLE 2-1: KNEE INJURY CLASSIFICATION SYSTEM [11]

Table 1. CLASSIFICATION SYSTEM ADAPTED FROM KENNEDY¹⁷

Direction	Mechanism	Injury Pattern
Anterior*	Hyperextension	Posterior capsule → PCL → ACL tears
Posterior†	“Dashboard”	PCL torn
Medial	Varus/rotation	Collaterals, cruciate
Lateral	Valgus	Collaterals, cruciate
Rotatory‡	Flexion/adduction Rotation around PLC	MCL, ACL, PCL

*Most common.

†Second most common.

‡Posterolateral most common.

PLC = posterolateral corner; PCL = posterior cruciate ligament; ACL = anterior cruciate ligament; MCL = medial collateral ligament.

Adapted from Kennedy J: Complete dislocation of the knee joint. J Bone Joint Surg 45A:389-904, 1963; with permission.

Table 2-1 above indicates the direction of force related to its mechanism of causation as well as the resultant typical injury pattern. It can be seen that it is

common for the MCL, LCL, ACL and PCL to rupture alone or in combination during hyperextension, hyperflexion and valgus deformation of the knee. It is commonly agreed that hyperextension may cause ACL tears, hyperflexion PCL tears and valgus deformation may cause MCL and/or meniscus injuries **Error! Reference source not found.** It has been postulated by Paulos et al. [12] that the progression of tension through the structures of the knee during valgus deformation are as follows; direct loading of the MCL, followed by a stabilizing effect by the PCL and ACL, and upon an increase in valgus bending, a subsequent tearing of the ACL followed by the PCL as the joint line continues to open. This has been confirmed by Teresinski et al. [13] and is illustrated in the figure below.

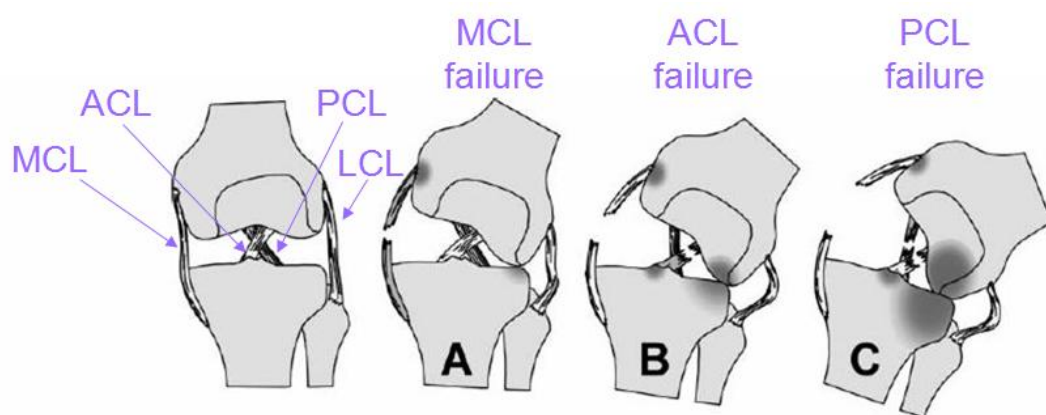

Figure 2-9: Progression of ligament failure due to lateral impact resulting in valgus deformation of the knee [13]

In a study conducted by Sanders et al. [2] on the effects of PKB's on the major injuries associated with injury mechanisms resultant from off-road motorcycling, in a group of 2115 riders with 89 knee injuries, *43% were ACL, 20% meniscus and 15% MCL* (Table 2-2). Typical mechanisms for these injuries may include using the boot as a pivot when sticking out the foot around a corner and landing after a high-speed

jump with the knee extended. This can then be classified as hyperextension, hyperflexion and valgus deformation. These were identified as the major mechanisms to be reduced by the Leatt® C-Frame Carbon.

**TABLE 2-2: KNEE INJURY STATISTICS IN OFF-ROAD MOTORCYCLE RIDING
2115 RIDERS WITH 89 KNEE INJURIES [2]**

7-9%	Of Off Road Motorcycle Injuries
>40%	Ligamentous Injuries
43%	ACL Injuries
20%	Meniscus Injuries (mostly lateral due to valgus)
15%	MCL Injuries (valgus)

Injury thresholds for the knee

Once the mechanisms of injury to be minimized together with the prevalence of each of these mechanisms are understood, an understanding of the tolerance limits of knee structures exposed to these mechanisms is needed. This enabled the authors to design a PKB system that would keep loading transferred to the knee due to typical injury mechanisms within the acceptable load limits and thereby reduce the risk for injury associated with exterior overloading mechanisms.

Injury thresholds for the knee are well published in literature and are commonly used in the design of various systems including PKB's and motor vehicle interior (dashboard design etc) design. The injury criteria for the injury mechanisms found to be relevant to the development of the Leatt® C-Frame Carbon are summarized in Table 2-3 below [14],[15],[16],[17],[18].

**TABLE 2-3: INJURY CRITERIA FOR RELEVANT INJURY MECHANISMS
[14],[15],[16],[17],[18],[19]**

Mechanism	Loading Tolerance / Limit Injury Criteria	Injury Type
Hyperextension [14],[15]	108 +- 46 Nm @ 33.6deg +- 11deg	ACL
Valgus [16]	120 Nm @ 13 deg	MCL/Meniscus Mid Tibial Shaft
Mid Tibial Bending [17],[18]	225 Nm	Fracture
Mid Femoral Bending [19],[20]	348 Nm / 3780 N	Mid Femoral Shaft Fracture

Tolerance limits for hyperextension and valgus deformation of the knee were used to evaluate the Leatt® C-Frame Carbon's ability to withstand loading mechanisms related to knee hyperextension and valgus deformation. It should be noted that no allowance for muscle reaction was made with the values reported in Table 2-3. Soni et al. [21] reported a significant increase in knee joint loading tolerance with the onset of muscle activation during impact. The choice to use passive (no muscle activation) values as injury tolerances was made to ensure a worst-case scenario, resulting in a PKB with a significant safety tolerance of about 3-4.

The mid-tibial bending moment was used to evaluate the severity of load transfer of the Leatt® C-Frame Carbon onto the mid-tibial shaft subsequent to external hyperextension force redirection. It is important that no excessive load is placed onto adjacent body structures (such as the tibia) whilst transferring load paths away from the knee joint.

The tests conducted on the Leatt® C-Frame Carbon to evaluate these effects are discussed in Chapter 3 and Chapter 4.

Chapter 3

Rationale for the Design of the Leatt® C-Frame Carbon

3.1 Introduction

The design rationale of the Leatt® C-Frame Carbon is based on common knee injury classification systems as presented in Section 2.2 and as used by knee surgeons and biomedical engineers.

The design criteria used in the development of the Leatt® C-Frame Carbon are as follows:

- To decrease the number and severity of the most significant knee injuries through injury prevention or the reduction of the grade of injury without compromising adjacent body structures such as the tibia and femur.
- To find the best compromise between decreasing dangerous ranges of motion, knee forces and impulse momentum relationships, whilst maintaining driver/rider usability.
- To prevent extreme ranges of motion producing / associated with injury.
- To maintain ROM in flexion as well as rotation of the knee to optimize comfort and ride-ability.
- To transfer lateral impact forces which would result in valgus deformation through the device.
- To transfer extension forces imposed on the knee joint through the device.
- To transfer these valgus and hyperextension forces through the device and offload them via a *3 point load transfer system* to less vulnerable loading zones

with more musculature over large force distribution areas, namely the outer thigh, the outer calf and the inner thigh.

- To create a dynamic device with a built-in ability to collapse at pre-determined forces relating to commonly used injury thresholds of the knee and tibia, thereby preserving the recommended range of safe movement without collateral injuries.
- To be easily integrated with all boot types via a very slim bottom shin load pad.
- To mimic anatomical flexion and extension of the knee via a twin-hinge system allowing for an anatomically correct instantaneous axis of rotation (IAR).
- To ensure that the device accommodates a wide range of body types while still allowing safe and comfortable use with the intended safety functions not being compromised.
- Allowing medial knee contact by the rider with the motorcycle, without an intervening medial hinge mechanism, so as to have better feel and control of the motorcycle.
- To protect against impact related injuries to the knee, especially the patella, through a CE certified patella cup protector with incorporated handle bar protectors above and below.

The Leatt® C-Frame Carbon, designed with these parameters in mind, fulfills these design criteria.

3.2 Allowable ROM

The Leatt® C-Frame Carbon allows a large range of motion (approximately 150 degrees), which can be adjusted by Polyurethane extension stoppers to accommodate personal preference in terms of lockout position for each rider. Stoppers include 5°, 10°, 15° and 20° stoppers. These stoppers effectively reduce the range of motion by limiting it to a maximum ROM of about 130° (with a 20° stopper in place).

Internal and external rotation is not limited by the Leatt® C-Frame Carbon.

The Leatt® C-Frame Carbon was designed to be compatible with most motorcycle types and allows riders an adequate range of knee joint movement. Leatt® C-Frame Carbon prototypes were tested extensively by riders under racing conditions and the test riders reported a good range of movement and comfort.

3.3 3 Point Force Distribution System

3 Point Force Distribution (3PFD) refers to the ability of the Leatt® C-Frame Carbon to redirect to other structures, the forces applied to the knee joint in crashes or collisions initiating lateral loading to the knee joint which will, in most instances, result in a valgus mechanism in the knee [13]. The system incorporates a triangular truss system carrying and redirecting load in a similar manner to a roof truss structure with a direct opposite reaction force at one of the reaction points and tension in the two members connecting the 2nd and 3rd reaction points (**Error! Reference source not found.**). This force diagram creates a stable system which transfers loading resulting in valgus deformation, away from the knee joint and into enlarged load bearing areas in the form of load pads on the dense musculature of the outer calf, the inner thigh and outer thigh.

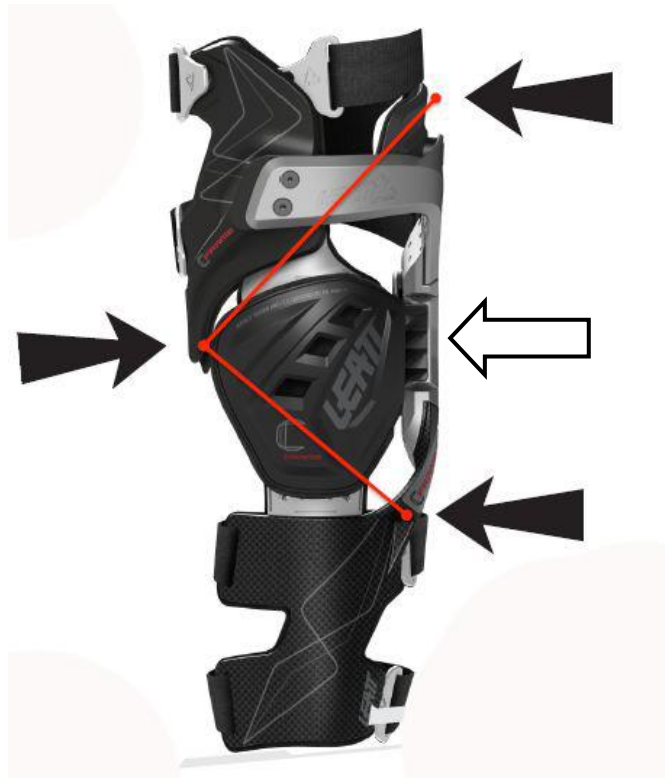

Figure 3-1: 3 Point Force Distribution (3PFD)

The design rationale of the Leatt® C-Frame Carbon is to control forces imparted to the knee joint through 3 *PFD* and hyperextension limitation. This is attained through the utilization of stiff materials and engineered contoured surfaces to increase stiffness of the system and increase load transfer efficiency. This system should be effective without compromising the adjacent load bearing structures of the leg. The 3rd "beam" connecting the 3 load transfer points (the "beam" incorporating the hinge) is thus designed to yield just below the hinge at pre-determined anatomical loading forces to reduce further injuries to the potentially vulnerable tibia (Figure 3-2 below). Specifics on loading parameters and force reductions will be presented in Chapter 4.

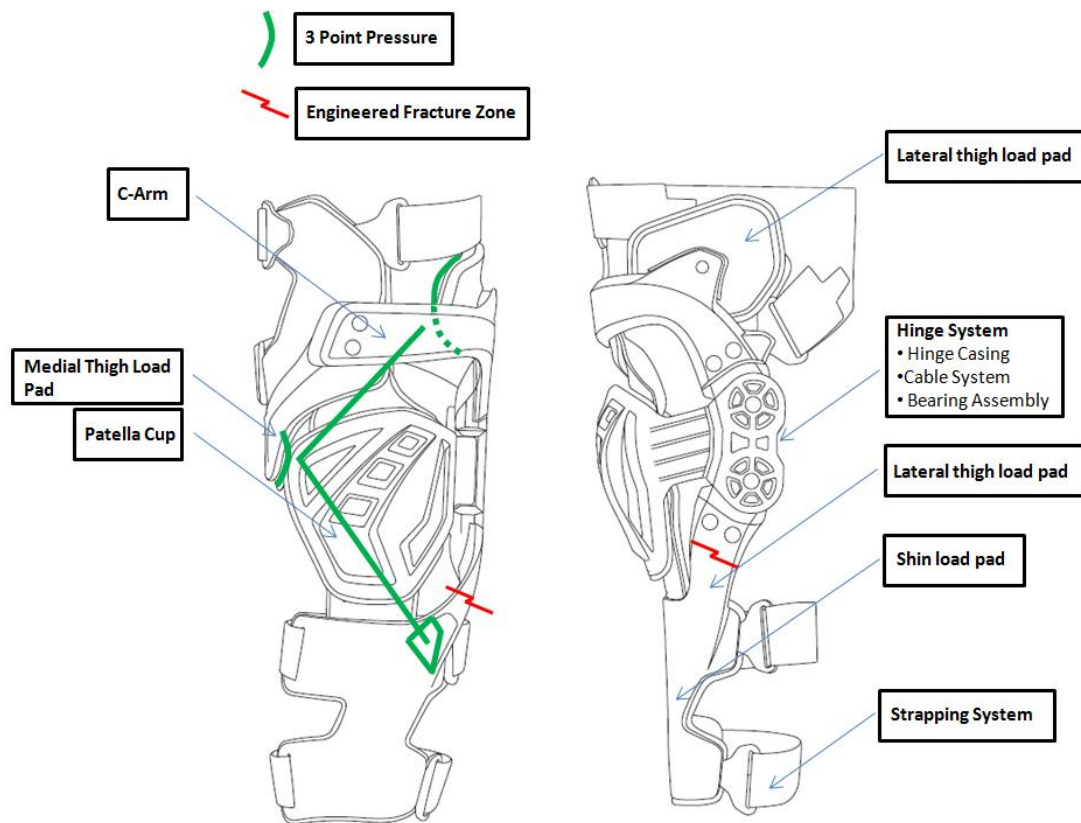

Figure 3-2: 3 PFD and Engineered Fracture Zone

3.4 Material/Absorption Considerations

The Leatt® C-Frame Carbon is designed to bring the hyper-extended knee to a controlled stop upon load transfer through soft PU stoppers.

All materials comprising the Leatt® C-Frame Carbon are Carbon Fibre Composite and very stiff Die-Cast Aluminum. This allows for optimal load transfer away from the knee joint.

3.5 Hinge Design

The Leatt® C-Frame Carbon is designed with a lateral hinge that incorporates a dual hinge pivot point for correct anatomical alignment with the knee's IAR and replication of the rotation arch of the knee joint. The movement of this hinge is controlled by a system of wire ligaments (BioLink™ Ligaments).

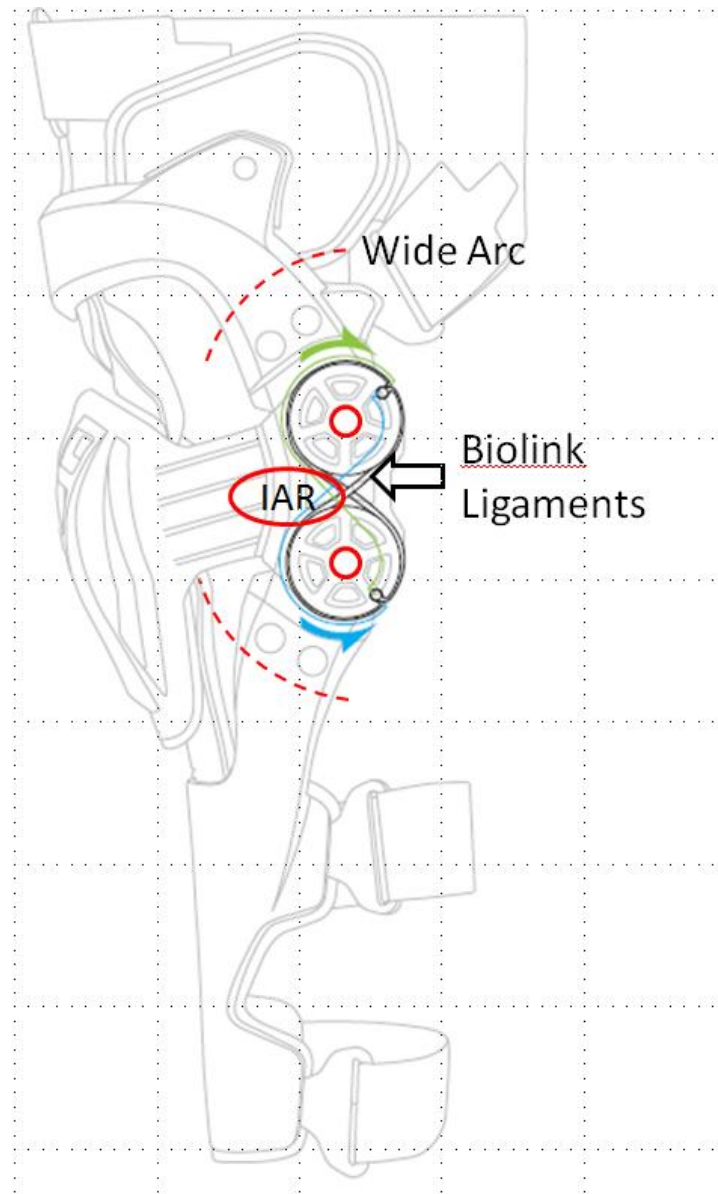

Figure 3-3: Hinge mechanism

3.6 Designed for Adjustability

The Leatt® C-Frame Carbon is designed to fit the body types of most of the motorcycling population. Multi-dimensional adjustability allows the device to be customized to suit the specific rider’s body configuration and comfort level. The C-Arm can be adjusted via its connection to the inner thigh load pad to adjust for varying upper thigh diameters. Interchangeable pads for the inner and outer thigh load pads allow for extra manipulation of the upper thigh diameter. Two sizes are designed and with adjustability, will fit approximately 95% of the user population. The knee brace sizing chart is shown in Figure 3-4 below

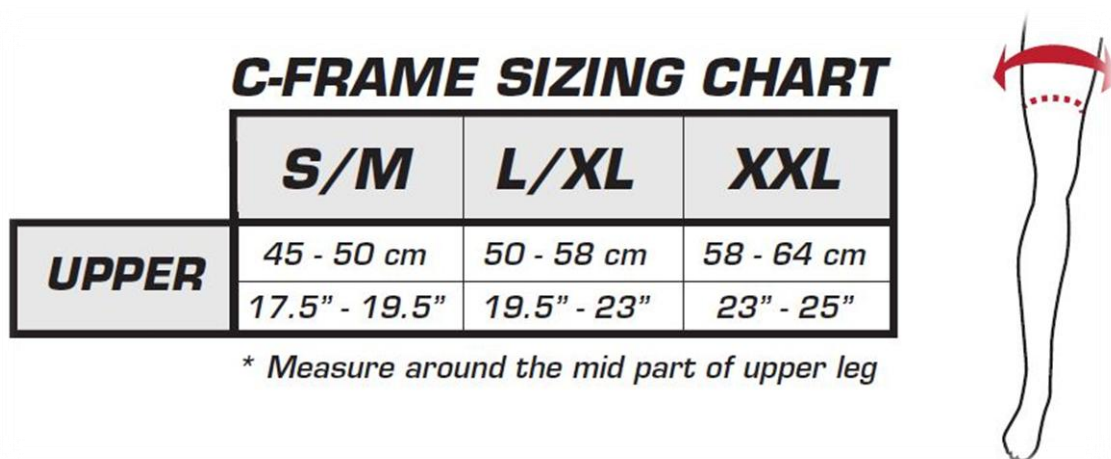

Figure 3-4: C-Frame Sizing Chart

Because the device employs a modular design, various parts can be replaced as needed.

3.7 Shin Load Pad Strut Design

The shin load pad strut of the Leatt® C-Frame Carbon was designed to enable adequate load transfer through the device during valgus mechanism as well as

hyperextension loading of the knee joint without fracture. However it is also of vital importance that this component fractures well before the mid-tibial injury threshold in bending of 225 Nm (as discussed in Section 2.2 and indicated in Table 2-3) is reached. It was important that this component be designed to exhibit this two-fold design criterion. This will further be discussed in Chapter 4 under testing.

Chapter 4

Testing of the Leatt® C-Frame Carbon PKB

4.1 Quasi-Static Testing

4.1.1 Introduction

The rationale for these tests is derived from the “design rationale” (Chapter 3) that underpins the Leatt® C-Frame Carbon design, and incorporates the beliefs, theories, and expertise (gained through biomechanical knowledge and experience in the field) of the physiologically correct dynamic interaction between a rider and a prophylactic knee protection device.

It is believed that correct device/leg interaction at the appropriate time is crucial during a crash event and that when a hyperextension, valgus mechanism or impact force is imparted to the leg, that the C-Frame will intervene and transfer force through the device and onto lesser vulnerable body components such as the soft and muscular upper outer thigh, the more stiff outer lower leg and the bony prominence of the medial condyle of the tibia. This is achieved through large contact areas utilizing the 3 PFD system as described in Chapter 2 .

It should thus be the primary function of a prophylactic knee brace system such as the Leatt® C-Frame Carbon to prevent or reduce the likelihood of the following injuries:

- Hyperextension related injuries such as posterior Cruciate Ligament ruptures (PCL) Anterior Cruciate Ligament ruptures (ACL).

- Valgus deformation injuries such as Medial Colateral Ligament (MCL), Meniscus injuries and Patellofemoral injury.
- Injuries as a result of impact, such as soft tissue injuries, bruising, contusions, cuts and abrasions during off-road motorcycling and biking activities.

This process is the basis of Leatt Corporation's 3 PFD load transfer construction to which it is hypothesised any PKB should adhere in order to be effective.

In addition to reducing the causation of primary injuries caused by hyperextension and valgus deformation, it is essential that a prophylactic knee brace system does not impart excessive force to other potentially vulnerable areas of the body through excessive load transfer. One of the components to be assessed here is the outer calf load pad, which transfers around the leg and ends close to the mid-tibial region, from which load is transferred to the mid-tibia during hyperextension of the leg. The strut connecting the outer calf load pad to the hinge should fracture in the correct range of force. Another component to be assessed is the upper thigh loading area, which extends upwards from the hinge in the form of the C-Arm component. Seeing that the C-Arm is designed as a very rigid load transferring beam, the engineered fracture points to prevent femoral fracture is the hinge and/or the strut connecting the outer calf load pad to the hinge. It is important that these components of the Leatt® Knee C-Frame Carbon fractures prior to potentially fracturing the mid-tibial shaft or the femur during an extreme hyperextension loading of the leg. It is therefore that a test was devised incorporating existing injury criteria and tolerance limits of the tibia (Table 2-3) and femur together with the orientation of the tibial (outer calf) and thigh load pads relative to the mid-tibial and femoral shaft in order to establish the risk for tibia or femur fracture by load transfer from the respective loading pads. These engineered fracture points are required to fracture prior to the injury threshold of the tibia or femur in bending as depicted in Table 2-3 is reached.

The ability of the Leatt® C-Frame Carbon PKB to effectively reduce forces on the knee joint via 3 PFD as well as the subsequent effect on the mid-tibial and femoral shaft by the tibial and upper thigh load pad is evaluated in these tests.

It has been determined, by experimentation with different combinations of materials and fabrics that, in addition to the above, device constituent materials and fabrics used as padding and coverings play a significant role in the dynamics of force attenuation, transmission, duration and redirection away from the knee joint complex through the device and towards the larger and stiffer body structures of the upper leg and lower leg respectively (discussed in Chapter 3). These factors however have not been isolated for separate evaluation in these tests. All devices therefore are tested as sold and as a system, adjusted as closely as practicable to their optimal described working configuration.

Lastly, the device is evaluated using fatigue analysis in a fatigue test rig. The ability of the device's hinge to withstand ingress of soil and moisture whilst being operated is evaluated.

As part of an ongoing investigation into the efficacy of the Leatt® C-Frame Carbon from a clinical point of view, a number of clinical studies with significant sample size over a significant evaluation period are presented. A comparison (with regards to the Leatt® C-Frame Carbon) is made in essential functioning of the devices reviewed in these studies, and it is shown that the positive clinical outcomes of these devices are indeed *highly probable and to be expected for and exceeded by* the Leatt® C-Frame Carbon over a period of use.

4.1.2 Valgus Deformation Test

Test Objective

To determine the efficacy of the device to reduce the forces transferred to the knee joint complex and more specifically the MCL via valgus deformation. This test will indicate the efficacy of the 3 PFD system. Load Cell force is measured.

Evaluation Criteria

The device shall withstand and transfer a bending moment of at least 100% of the maximum allowable valgus injury tolerance of 120 Nm (Table 2-3) away from the knee joint complex during bending. Using the dimensions of the device and moment arm of force application, this equates to a minimum value of 1400 N of force that the device shall withstand.

Notes

One Leatt® Knee C-Frame Carbon PKB was used per test. The device was fitted to a quasi-static test rig as described below in **Error! Reference source not found.** .

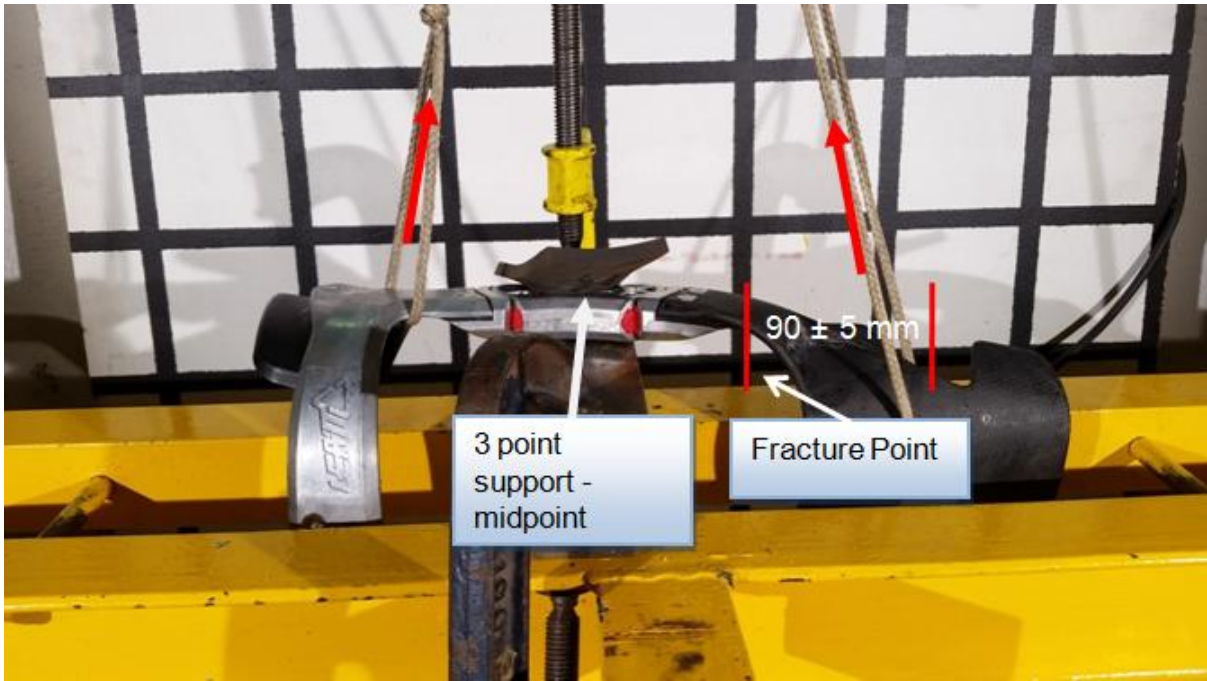

Figure 4-1: Valgus Deformation Test

Data Presentation and Evaluation

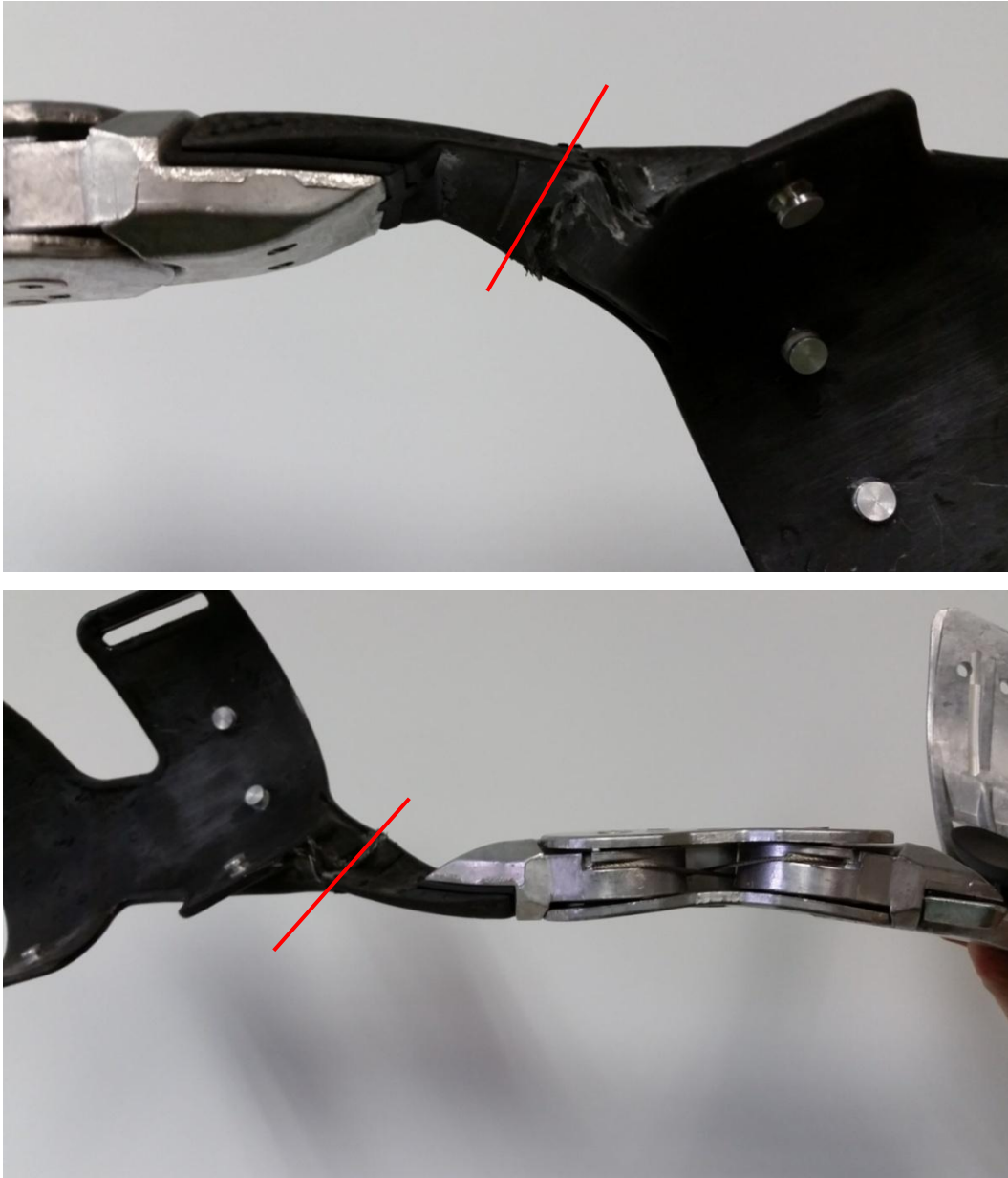

Figure 4-2: Fracture of carbon shin load pad strut at force above minimum required force of 1400 N

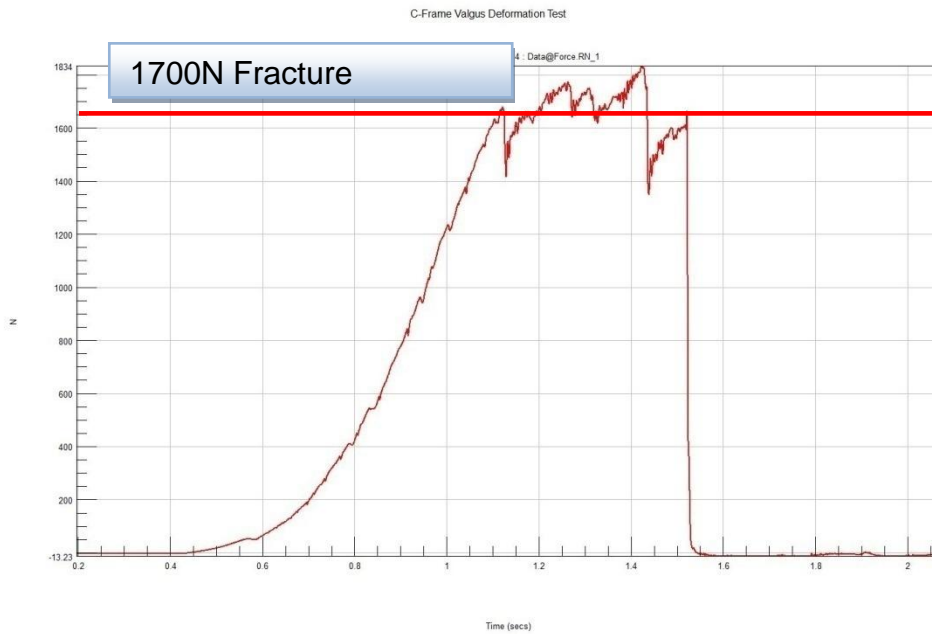

Figure 4-3: Valgus deformation test graph - force over time

Conclusions

The Leatt® C-Frame Carbon surpassed preset threshold values for valgus deformation. The device transfers 1700 N through its supporting structures and away from the knee joint, exceeding the 1200 N which will result in a bending moment of 100% of the maximum allowable valgus injury tolerance of 120 Nm (Table 2-3).

4.1.3 Hyperextension Deformation Test

Test Objective

To determine the efficacy of the device to reduce the forces transferred to the knee joint complex and more specifically the ACL and PCL via hyperextension loading on the leg.

Secondarily to determine the fracture force of the engineered bottom shin load pad connecting strut as well as components connecting to the upper thigh load pad in order to evaluate whether they fracture below the existing mid-tibial and femoral injury thresholds of 750 N and 3780 N respectively (Table 2-3). For the tibia, this is worst case scenario as it takes only the tibia bone into account, no soft tissue stiffening effects or resistance of the fibula (about 20 Nm [17]) are taken into account. For the femur the threshold was determined with the surrounding tissue intact [19],[20], although no muscle reaction was present. Load Cell force is measured.

Evaluation Criteria

To maintain a reasonable likelihood that the device will not cause mid-tibial fracture, the device shall withstand and transfer a bending moment of at least more than 50% of the maximum allowable hyperextension injury tolerance of 150 Nm away from the knee joint complex during bending. Using the dimensions of the device and moment arm of force application, this equates to a minimum value of 416.5 N of force that the device shall withstand. The device must subsequently fracture before the mid-tibial Injury Threshold of 225 Nm is reached (Table 2-3). This equates to 750 N of force below which the component shall fracture.

$$416.5 N < fracture < 750 N$$

To evaluate the components related to possible femur fracture, the device shall fracture before the injury threshold of 3780 N (Table 2-3) of force to the femur is surpassed. It should also transfer a minimum of 50% of the maximum allowable hyperextension injury tolerance of 150 Nm away from the knee joint complex during bending. Using the equation for a moment about a loaded point (equation 4.1 below) in a 3 point bending arrangement , with loading in the form of a support at the midpoint or hinge (at $x = L/2$), this equates to a minimum value of 682 N of force that the device shall withstand (with force applied through the C-Arm component).

$$M = Fx/2 \quad (\text{eq 4.1})$$

$$682 \text{ N} < \text{fracture} < 3780 \text{ N}$$

Notes

One Leatt® C-Frame Carbon knee brace was used per test. The device was fitted to a quasi-static test rig as described below in Figure 4-4, Figure 4-5, Figure 4-6 and Figure 4-7.

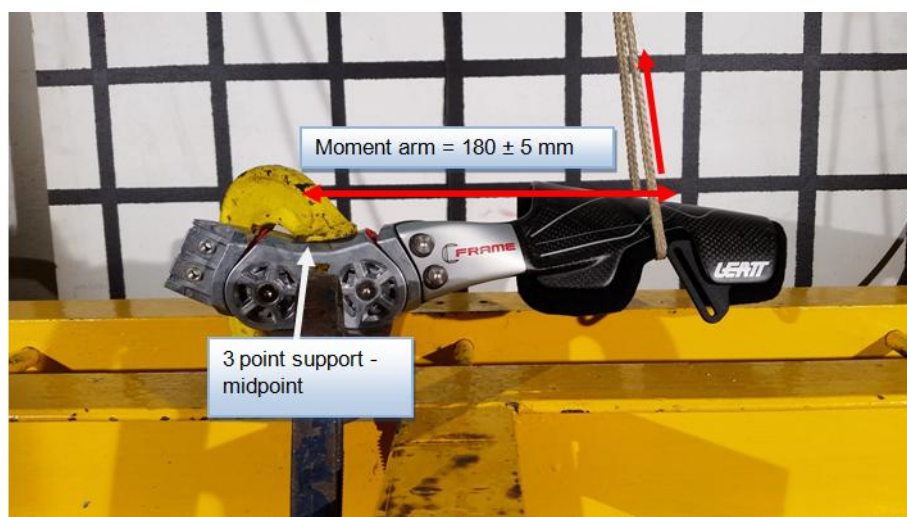

Figure 4-4: Hyperextension and Tibial Tolerance Test Setup



Figure 4-5: Hyperextension and Tibial Tolerance Test Setup Top View

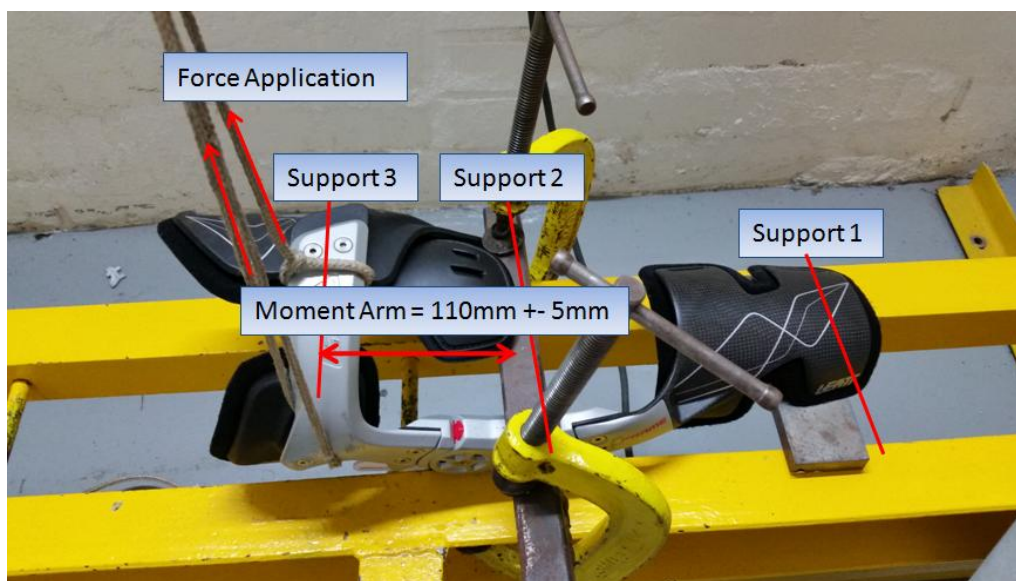

Figure 4-6: Hyperextension and Femoral Tolerance Test Setup



Figure 4-7: Hyperextension and Femoral Tolerance Test Setup Top View

Data Presentation and Evaluation

Hyperextension with Tibial Tolerance Test



Figure 4-8: Fracture of carbon shin load pad strut at force above minimum required force of 416.5 N and below maximum allowable force of 750 N

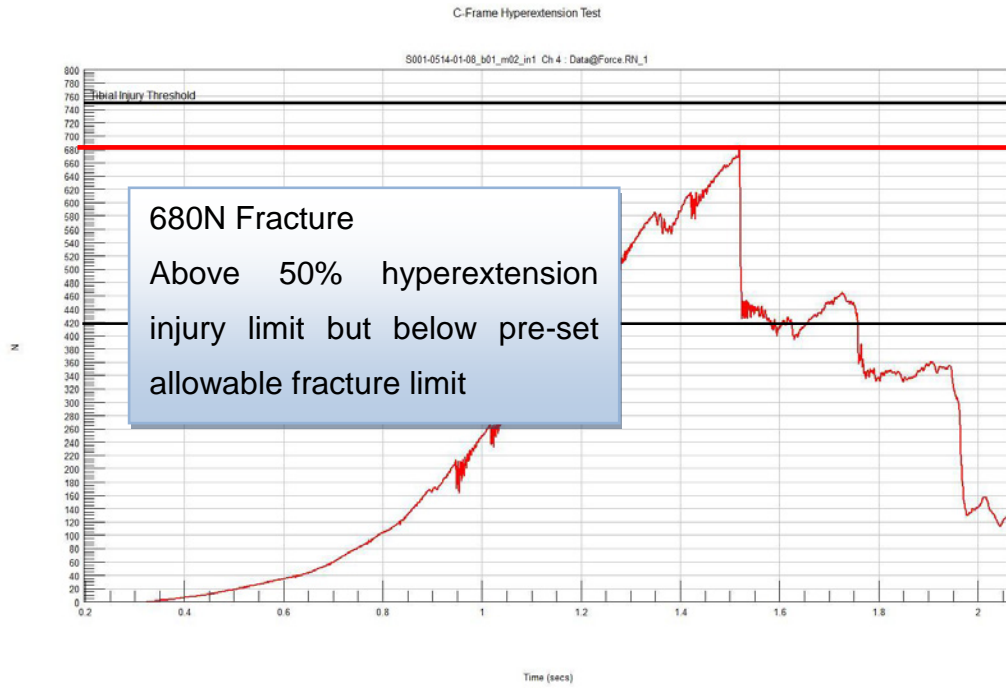

Figure 4-9: Hyperextension force graph with Tibial Injury Threshold

Hyperextension with Femoral Tolerance Test



Figure 4-10: Fracture of carbon shin load pad strut at force above minimum required force of 682 N and below maximum allowable force of 3780 N

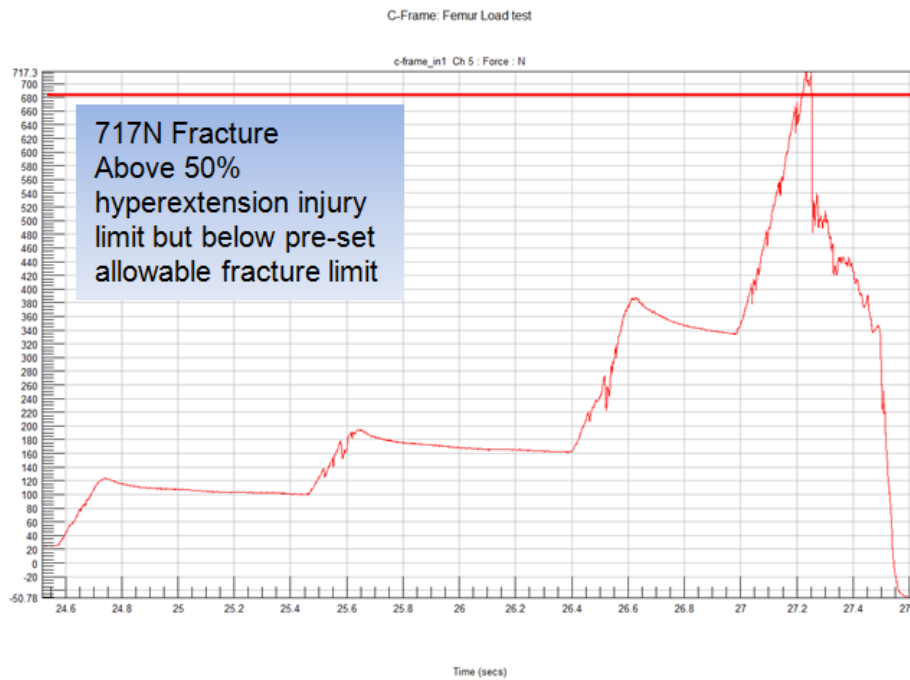

Figure 4-11: Hyperextension force graph with Femoral Injury Threshold

Conclusions

The device successfully mitigates at least 50% of hyperextension force by directing it through the device and away from the knee joint. In addition to this the device does not transfer force above the allowable maximum force for tibial and/or femoral fractures as set out by commonly used injury criteria to the tibia and/or femur.

4.1.4 Hinge fatigue test

Test Objective

To determine the ability of the device's hinge to withstand ingress of soil and moisture whilst being operated for a minimum of 10000 cycles.

Evaluation Criteria

The device hinge shall withstand 10000 cycles of induced flexion/extension whilst being continually filled with wet sand.

Notes

One Leatt C-Frame Carbon knee brace was used per test. The device was fitted to a dynamic fatigue test rig as described below.



Figure 4-12: Fatigue test in motion

4.1.5 Clinical Study Comparison

Prophylactic Knee Bracing use in Off-road Motorcycling and Action Sports

The aim of this section is to indicate through literature survey, that the Leatt® Knee C-Frame Carbon is in fact intended to function as a PKB and fulfils, at the very least, the expected requirements for a PKB, and in most areas outperform other competitive PKB's in the market.

As discussed in former chapters, a PKB is normally defined as a knee brace that is designed to prevent knee injuries and defined as any knee brace worn by a rider with the intent of preventing an injury to the knee. They are worn by athletes who participate in high-risk sports in an effort to minimize their risk of sustaining knee injuries.

The Leatt® Knee C-Frame Carbon is also classified as a PKB and operates in a similar fashion to other off-the-shelf and custom made products that are available in the market place.

Currently, most prophylactic knee braces use either a unilateral or a bilateral bar with hinges.



Figure 4-13: (a) Unilateral Bar & (b) Bilateral Bar

Figure 4-14 below illustrates a basic PKB with two supporting bars on each medial and lateral side (C) and polycentric knee hinges (B). It includes thigh and calf plastic cuffs (A & D) and accompanying leg strapping (1 & 4). *The Leatt PKB has all of these elements and more and follows at least the most basic design principles of other PKBs (Figure 4-15).*

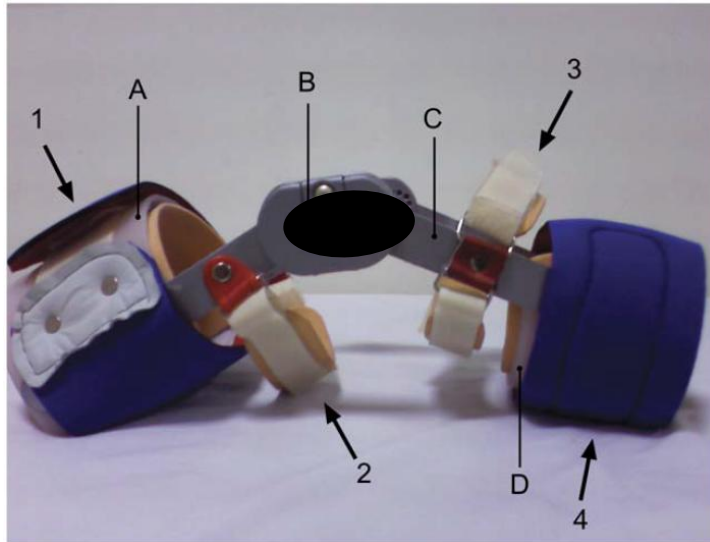

Figure 4-14: Basic PKB [22]

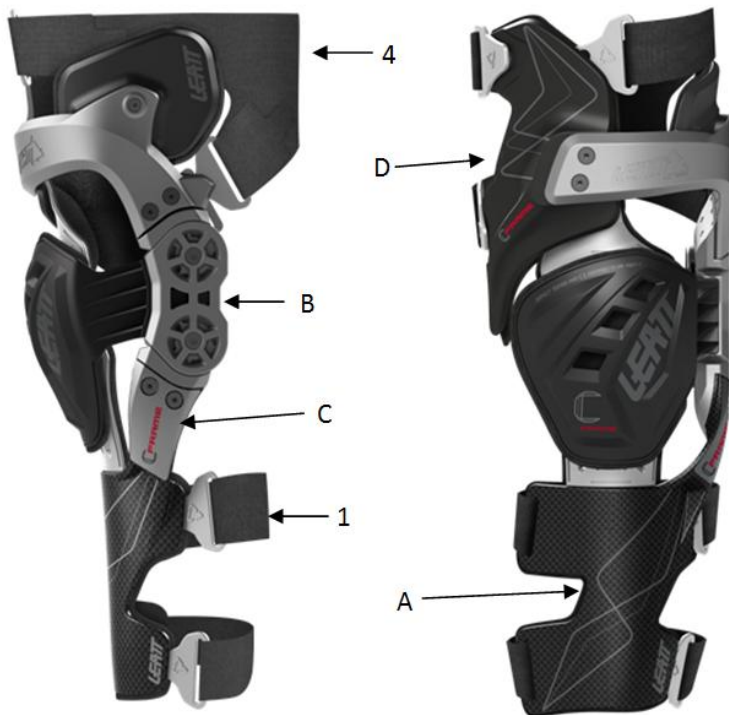

Figure 4-15: Leatt® Knee C-frame Carbon

PKB's are intended to stabilize knees during rotational, antero-posterior forces, valgus deformation, flexion and extension of the leg.

Regular tightening of straps helps reduce unwanted brace migration and ensure correct fit and placement of the PKB. Correctly placing the hinge(s) relative to the femoral condyles is essential for optimal brace performance with minimal range of motion reduction. Extension stops are usually fitted to limit hyperextension.

Various studies have been done with commercially available and custom knee braces. Sanders et al. [2] found that the use of PKB resulted in a 50% reduction in ACL injury rates and a 7-fold decrease in MCL injury rates. Meyer et al. [3] did PMHS (Post Mortem Human Surrogate) studies using two PKBs; a dual upright and single knee stabilizer and found that both braces offered modest but statistically significant degrees of MCL protection.

Other biomechanical studies on off-the-shelf PKBs using surrogate knee models were done by Paulos et al. [12], France et al. [23], Brown et al. [24], Meyer et al. [25] and Daley et al. [26]. Some PKB's appeared better than others, but the authors found that they generally provided 20% to 30% greater MCL resistance to a lateral blow causing valgus deformation. The authors also found that any knee brace is more effective when it displays sufficient stiffness to distribute the force of a valgus blow away from the knee (see previous Sections in Chapter on the testing of the Leatt® Knee C-Frame Carbon) to the thigh and tibia because contact of the brace with the knee at the joint line reduces its effectiveness.

The Leatt® Knee C-Frame Carbon exhibits all the attributes of an efficient PKB as discussed above and has been shown through evaluation to be in excess of minimum force transfer requirements as governed by current injury thresholds.

4.2 FEM Component Failure Analysis

In addition to the testing conducted, finite element method (FEM) analysis was conducted using MSC. SimOffice™ (Nastran Solver). Analyses were conducted on the most structurally important component of the Leatt® Knee C-Frame Carbon to assess the strength and material properties of the designed component. Inputs to the model included material properties such as the moduli of elasticity (E), density (ρ), ultimate tensile strength (UTS in MPa) and yield strength (MPa).

The C-Arm of the Leatt® Knee C-Frame Carbon was subjected to FEM analysis. According to the authors, this component is crucial when one considers the loading modalities imposed on it during impact and loading. It is important that the stresses and strains on this component remain below the allowable material limits for the given force and motion inputs to ensure not only that the component does not shatter or fail at forces below the impact forces but yield at the designed forces. The yield forces are designed to be lower than injury levels for body structures.

C-Arm

The C-Arm was analyzed using the material properties of aluminum. A tetrahedral (*Tet 10*) mesh was used. It was determined that a typical force directed to the C-Arm during a worst-case lateral impact scenario would be in the region of 1000 N. Appropriate constraints were applied and the Von Mises tensile strength was evaluated.

After 3 minor design iterations, the aluminum C-Arm showed satisfactory Von Mises stresses and strain for the applied loading and constraints (Figure 4-16).

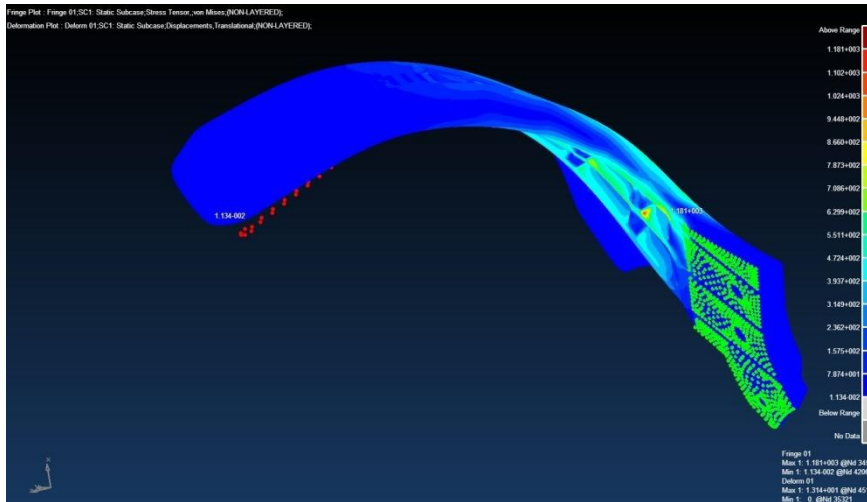
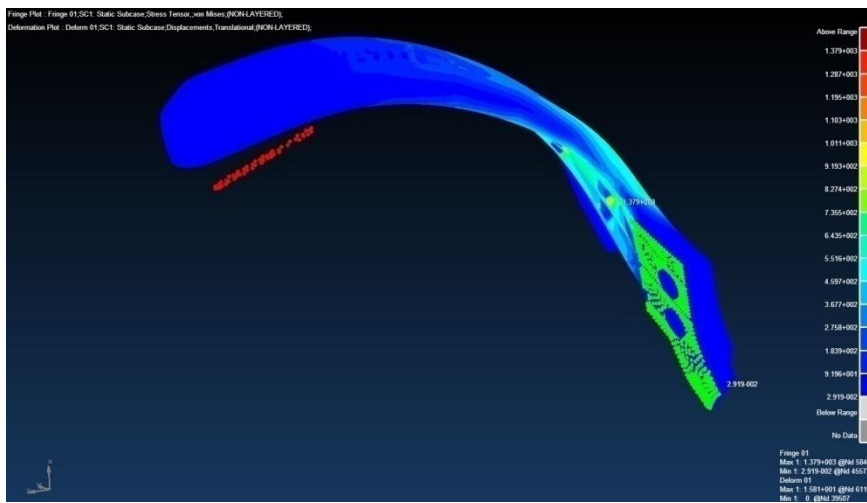
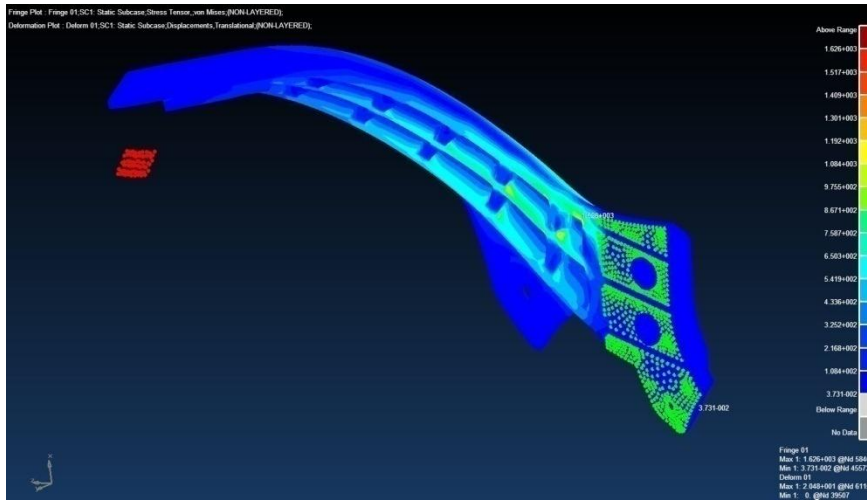

Figure 4-16: FEM of the C-Arm for 3 design iterations

4.3 Hazard Analysis

A Preliminary Hazard Analysis was performed to identify the most severe hazards in operating the Leatt® Knee C-Frame Carbon. The Leatt® Knee C-Frame Carbon was analyzed for loss of intended function through fracture or failure of critical safety components or loss of components through either human error or prolonged usage. A Fault Tree Analysis was performed on these hazards to identify how critical they are. The full Hazard Analysis is documented in the internal Leatt® Corporation document entitled: "Leatt® Knee C-Frame Carbon - Hazard Analysis - LFMEA514-001". Only the main findings are documented in this document.

The following hazards were identified:

- Failure to transfer an acceptable level (50%) of hyperextension force away from the knee.
- Failure to completely transfer valgus injury threshold force away from the knee.
- Failure of engineered fracture point of shin load pad to fracture prior to tibial injury threshold being reached.
- Failure of engineered fracture point/s connecting to the thigh load pad to fracture prior to femoral threshold being reached.

A Failure Modes Effect Analysis (FMEA) was performed on all of the major components of the device to identify any potential hidden failures or hazards that might have been overlooked in the Preliminary Hazard Analysis. The following failures were identified as potentially hazardous:

- Bottom Shin Load Pad Strut failure - too early or too late.
- Hinge Mechanism failure.

- Medial Thigh Load Pad failure.
- Lateral Thigh Load Pad failure.
- C-Arm failure.
- Patellar Cup failure.
- Screws - failure or loss.

Assumptions

The Hazard Analysis Process assumes that the device is fitted, operated and maintained according to specification.

Conclusions and Recommendations

All of the components that were subjected to the Hazard Analysis Process complies with acceptable risk requirements and were designed and manufactured using best practise techniques and tested under worst case scenario using existing injury criteria as well as common engineering test specifications for PPE. No component or combination of hazards warrants an engineering investigation.

4.3.1 Applicable Documents

4.3.1.1 Design Standards and Procedures

TABLE 4-1: APPLICABLE DOCUMENTS FOR FMEA

DOCUMENT NR	TITLE
LMTS0514-001	LEATT CORPORATION KNEE BRACE C-FRAME CARBON TEST (C001) PROTOCOL

4.3.1.2 Reference Documentation

TABLE 4-2: REFERENCE DOCUMENTATION FOR FMEA

DOCUMENT NR	TITLE
LMTS0514-001	LEATT CORPORATION KNEE BRACE C-FRAME CARBON TEST (C001) PROTOCOL

4.3.2 Introduction

4.3.2.1 Scope

The results of the Hazard Analysis that was performed on the Leatt® knee C-Frame Carbon is presented. The results consist of a Preliminary Hazard Analysis and Fault Tree Analysis (FTA) on the 3 undesired top events and a Failure Modes Effects Analysis (FMEA) on the major components of the device.

4.3.2.2 Process

The process is based on guidelines as set out in EN ISO 14971 as well the document entitled "Guidance Document Technical Files / Design Dossiers Non Active Medical Devices" by TUV Product Service.

4.3.2.3 Preliminary Hazard Analysis

A qualitative hazard analysis was conducted for the components of the Leatt® knee C-Frame Carbon that are the most likely to cause critical failure should they fail out of accordance to their engineered / design intent. The hazard analysis considered the effects of the following for each critical safety function of the device:

- Failure to transfer an acceptable level of hyperextension force away from the knee:
 - The shin load pad fractures too early during hyperextension of the knee
- Failure to completely transfer valgus injury threshold force away from the knee:
 - The device does not protect against valgus deformation of the knee due to premature failure of the shin load pad laterally, the hinge, the C-arm, the medial thigh load pad or the lateral thigh load pad
- Failure of engineered fracture point of shin load pad to fracture prior to tibial injury threshold being reached:
 - The shin load pad does not fracture at a point prior to the tibial injury threshold is reached during hyperextension of the leg, resulting in fracture of the tibia
- Failure of engineered fracture point (strut below hinge) to fail or failure of the hinge to fracture prior to femoral injury threshold being reached:
 - The strut below the hinge or the hinge itself does not fracture at a point prior to the anterior to posterior femoral injury threshold force is reached during hyperextension of the leg, resulting in fracture of the femur

4.3.2.4 Hazard Severity Categories

All components or component groups will be classified according to the Hazard Severity Categories provided in Table 4-3 below [MIL-STD-882C].

TABLE 4-3: HAZARD SEVERITY CATEGORIES

DESCRIPTION	CATEGORY	DEFINITION
CATASTROPHIC	I	Death
CRITICAL	II	Severe lower limb injury (knee, tib/fib, femur)
MARGINAL	III	Minor injury
NEGLIGIBLE	IV	Less than minor injury

4.3.2.5 Hazard Probability Levels

TABLE 4-4: HAZARD PROBABILITY LEVELS

LEVEL	DESCRIPTION	SPECIFIC INDIVIDUAL ITEM	P Value
A	FREQUENT	likely to occur frequently	0.1
B	PROBABLE	Will occur several times in the life of the component	0.01
C	OCCASIONAL	Likely to occur at some time in the life of the component	0.001
D	REMOTE	Unlikely but possible to occur in the life of the component	0.0001
E	IMPROBABLE	So unlikely, it can be assumed occurrence may not be experienced	0.00001
F	EXTREMELY REMOTE	So unlikely, it can be assumed occurrence will not be experienced	0.000001

4.3.2.6 Reliability Data

The following assumptions were made when the probability of a failure was determined:

- Failures in components will be viewed independently.

- Probabilities of a top level event to take place will be determined by *adding OR gate* probabilities and *multiplying AND gate* probabilities.
- Table 4-4 Hazard Probability levels will be applied.

4.3.2.7 Severity and Risk Classification

The Hazard Severity Categories and Probability Levels are presented in Section 4.3.2.4 & Section 4.3.2.5.

In order to introduce the notion of risk, the combination of probability and severity of a failure is taken into account. All identified failures with a high severity or high probability of occurrence are allocated a risk classification.

TABLE 4-5: RISK CLASSIFICATION

	CATASTROPHIC	CRITICAL	MARGINAL	NEGLIGIBLE
PROBABLE	A	A	B	C
OCCASIONAL	A	B	B	D
REMOTE	B	B	C	D
IMPROBABLE	C	C	C	D
EXTREMELY REMOTE	D	D	E	F

Where:

Risk Class A - Intolerable

Risk Class B - Undesirable and shall only be accepted when risk reduction is not possible

Risk Class C - Tolerable with the endorsement of the Leatt® Lab

Risk Class D - Tolerable with the endorsement of the normal product reviews

(design review meetings)

Risk Class E - Tolerable

4.3.2.8 Ground Rules and Assumptions

FMEA Approach

MIL-STD-1629A was used as general guide towards the FMEA conducted in this paper. It also follows the broad guidelines as set out in EN ISO 14971.

4.3.3 System Description

4.3.3.1 Leatt® Knee C-Frame Carbon System

The Leatt® knee C-Frame Carbon as a system was described in Chapter 1 to Chapter 3 in detail, including amongst other, system description, design rationale and testing.

4.4 Preliminary Hazard Analysis (Potential Failure Modes)

The unwanted top events for the device are:

- Failure to transfer an acceptable level of hyperextension force away from the knee.
- Failure to completely transfer valgus injury threshold force away from the knee.
- Failure of engineered fracture point of shin load pad to fracture prior to tibial injury threshold being reached.

- Failure of engineered fracture point (strut below hinge) to fail or failure of the hinge to fracture prior to femoral injury threshold being reached

4.4.1 Failure to transfer an acceptable level of hyperextension force away from the knee

This failure is unwanted as it is one of the main functions of the device. Such a failure would result in the device not protecting the user during an extreme hyperextension impact event. This event is classified as **Critical (Category II - Table 4-3)**.

The probability of this failure is subject to the following conditions:

- Bottom shin load pad fracturing prior to 50% of the injury threshold. force in hyperextension is transferred through the device.
- Medial load pad fracturing too early.
- C-Arm fracturing too early.
- Hinge assembly fracturing too early.

4.4.2 Failure to completely transfer valgus injury threshold force away from the knee

This failure is unwanted as it is one of the main functions of the device. Such a failure would result in the device not protecting the user during valgus deformation causing impact event. This event is classified as **Critical (Category II - Table 4-3)**.

The probability of this failure is subject to the following conditions:

- Bottom shin load pad fracturing prior to 100% of the injury threshold force in valgus deformation is transferred through the device.
- Medial thigh load pad fracturing too early.
- Lateral thigh load pad fracturing too early.
- C-Arm fracturing too early.
- Hinge assembly fracturing too early.

4.4.3 Failure of engineered fracture point of shin load pad to fracture prior to tibial injury threshold being reached

This failure is unwanted as it is one of the primary potential harmful side effects of the device during hyperextension load transfer. Such a failure would result in the device not fracturing early enough to protect the user from a fractured tibia during an extreme hyperextension impact event. This event is classified as **Critical (Category II - Table 4-3)**.

The probability of this failure is subject to the following condition:

- Bottom shin load pad fracturing subsequently to the tibial injury threshold force being reached in hyperextension. In other words the component is too strong and in effect causes a tibial fracture.

4.4.4 Failure of engineered fracture point (strut below hinge) to fail or failure of the hinge to fracture prior to femoral injury threshold being reached

This failure is unwanted as it is one of the primary potential harmful side effects of the device during hyperextension load transfer. Such a failure would result in the device not fracturing early enough to protect the user from a femur fracture during an extreme hyperextension impact event. This event is classified as **Critical (Category II - Table 4-3)**.

The probability of this failure is subject to the following condition:

- The strut below the hinge or the hinge itself does not fracture at a point prior to the anterior to posterior femoral injury threshold force is reached during hyperextension of the leg, resulting in fracture of the femur.

4.5 FMEA Results

The detailed FMECA results are presented in Appendix A.

The following failure modes have been identified to have a severity classification higher than *negligible*:

4.5.1 Catastrophic/Critical Failures

Failure in hyperextension before 50% of hyperextension injury threshold is transferred through device

The occurrence of such an event during a crash is *remote*. Testing has been conducted and reported in Section 4.1 . This testing shows that the shin load pad component comfortably surpasses the prescribed 416.5 N of force applied to it in hyperextension. Other knee braces with similar construction has been shown to reduce hyperextension related injuries such as ACL and PCL injuries significantly [1].

Failure to completely transfer valgus injury threshold force away from the knee

The occurrence of such an event during a crash is *improbable*. Testing has been conducted and reported in Section 4.1 . This testing shows that the component comfortably surpasses the prescribed 1400 N of force applied to it laterally. Other

knee braces with similar construction has been shown to reduce valgus related injuries (such as MCL injuries) during dynamic valgus loading significantly [2],[3].

Failure of engineered fracture point of shin load pad to fracture prior to tibial injury threshold being reached

The occurrence of such an event during a crash is *remote*. Testing has been conducted and reported in Section 4.1. This testing shows that the component fails well before the prescribed 1400 N of force.

Failure of engineered fracture point (strut below hinge) to fail or failure of the hinge to fracture prior to femoral injury threshold being reached

The occurrence of such an event during a crash is *improbable*. Testing has been conducted and reported in Section 4.1. This testing shows that the component fails very well before the prescribed 3780 N of force.

4.5.2 Marginal Failures

Failure of Patella Cup Protector

The occurrence of this event is *negligible*. The component passes the specifications as set out in EN 1621-1:2012 – “Motorcyclists' protective clothing against mechanical impact - Part 1: Motorcyclists' limb joint impact protectors.”

Failure/loss of screws on device

The occurrence of this event is *negligible*. All screws are secured with Locktite™.

Failure of one of Securing Straps

The occurrence of this event is *negligible*. There are 4 straps that are connected with plastic securing clips as well as hook and loop fastener connections. The probability of one OR all of the straps coming loose are negligible.

4.6 Fault Tree Analysis Results

The Fault Tree Analysis for the Leatt® Knee C-Frame Carbon is presented in Appendix B.

The probability of any of the top events occurring during a crash is the following:

- Failure in hyperextension before 50% of hyperextension injury threshold is transferred through device:

$$Q = 0.001221$$

- Failure to completely transfer valgus injury threshold force away from the knee:

$$Q = 0.00023$$

- Failure of engineered fracture point of shin load pad to fracture prior to tibial injury threshold being reached:

$$Q = 0.000101$$

4.7 Conclusions and Recommendations

There are no failure events that are likely to occur.

The occurrence of a failure to transfer more than 50% of the injury threshold force for hyperextension through the device is *occasional*. This is based purely on a mathematical product of a range of possibilities related to failure of the hinge

system. It therefore seems that the probability is relatively high for a failure during the lifetime of the device based on

Table 4-4, but in actual fact it may rather be seen as a very remote probability failure.

The occurrence of a failure to completely transfer the valgus injury threshold force away from the knee is *remote*.

The occurrence of a failure of the engineered fracture point of the shin load pad to fracture prior to the tibial injury threshold being reached is *remote*.

The occurrence of a failure of the engineered fracture point (strut below hinge) to fail or failure of the hinge to fracture prior to femoral injury threshold being reached is *improbable*.

It is recommended that the device is fitted and used as instructed by the user manual. This device is considered safe to use for extreme motorcycle riding and downhill mountain biking.

Chapter 5

Work in Progress

Simulations and Hybrid III ATD Testing

Next steps in evaluating the efficacy of the Leatt® Knee C-Frame Carbon will include whole body dynamic simulations using a software program such as LifeMod™. In addition to this instrumented Hybrid III ATD testing will be conducted to assess the efficacy of the Leatt® Knee C-Frame Carbon in valgus deformation mechanisms as well as hyperextension impacts.

In addition to this, Leatt® Corporation is always looking for new methods of evaluating protective devices, especially with increasingly effective simulation techniques. Simulation models are useable in a wide range of applications, so time spent researching, developing and evaluating new products is also time invested in modeling development.

For example, different material types are currently being investigated and tested for different applications. In addition, the capability of FEM analysis of composite materials has recently been added to the already extensive list of capabilities of the organization.

Chapter 6

Conclusions

This document summarizes research and development underlying the design of the Leatt® Knee C-Frame Carbon.

A detailed discussion of the relevant literature was provided, as well as of the relevant injury mechanisms pertaining to motorcycle crashes.

The design rationale behind the Leatt® Knee C-Frame Carbon was discussed, and details such as 3 PFD with alternative load distribution areas, the C-Arm and hinge design were presented.

A presentation of the validation tests conducted during the development of the Leatt® Knee C-Frame Carbon was provided.

Through this study it was shown that the Leatt® Knee C-Frame Carbon is an effective PKB. It conforms to and surpasses all commonly accepted criteria for PKB's, as discussed in the comparative literature survey presented in Section 4.5, through significant reduction in bending moments and impact force typically applied by common injury mechanisms. Specific areas in which the device's efficacy is demonstrated are:

- Reduction in injury causing lateral shear forces and bending moments applied by valgus deformation to the knee joint, through 3 PFD, energy transfer (alternate loadpath theory), and physical reduction in range of motion.
- Reduction in injury causing bending moments applied by hyperextension loading to the knee joint, through 3 PFD, energy transfer (alternate loadpath theory), and physical reduction in range of motion.

- A bottom shin load pad strut that fractures at a pre-determined load (below the mid-tibia injury index) in order to prevent a catastrophic mid-tibial fracture.
- Reduction in impact force transfer to the patellar area of the knee through a padded patellar cup.
- Reduction of the likelihood of the handlebars contacting the knee during an impact through the presence of top and bottom handlebar protector cups.

Finally, this document serves as a reference for interested readers in terms of understanding the research, development and design rationale behind the Leatt® Knee C-Frame Carbon.

Appendix A

FAILURE MODES EFFECT ANALYSIS (FMEA)

for the

Leatt® Knee C-Frame Carbon

No	COMPONENT	FAILURE MODE	POTENTIAL FAILURE CAUSE	FAILURE EFFECT	END EFFECT	FAILURE CLASSIFICATION	FAILURE ID	CORRECTIVE ACTION
1.0	Bottom Shin Load Pad	Fracture at fracture point prior to 50% of hyperextension injury limit is reached	Hyperextension of the leg	Increased likelihood to reach hyperextension and/or valgus injury threshold	ACL and PCL and/or MCL rupture	Negligible/Remote	Fracture Shin Load Pad Strut	After the fact - Replace component
		Fracture of bottom shin load pad in lateral direction (outwards fracture) prior to 100% of valgus injury threshold is reached	Valgus deformation imparted to the leg					
2.0	Bottom Shin Load Pad	Failure of the engineered fracture point fracturing prior to Tibial injury threshold being reached	Hyperextension of the leg AND component is too stiff/strong	Increased likelihood to reach Tibial injury threshold	Tibial Mid shaft Fracture	Negligible	Fracture Shin Load Pad Strut	After the fact - Replace component
3.0	Hinge Mechanism	Casing Failure	Extreme Valgus Deformation	Functioning of knee brace compromised in hyperextension and valgus reduction	Replace hinge	Marginal	Hinge Casing Damage	After the fact - Replace component
		Cable Failure	Extreme Hyperextension	Functioning of knee brace compromised Increased likelihood to reach hyperextension injury threshold - Stability of knee brace compromised - increased likelihood of posterior shear injuries such as ACL rupture	Replace hinge	Marginal	Hinge Cable Failure	After the fact - Replace component
		Bearings	Extreme overuse	Knee brace stiffens up - increased load transfer to leg and knee joint during normal operation	Replace hinge	Negligible	Bearing failure	Replace component
4.0	Medial Thigh Load Pad	Fracture/Crack of component	Valgus deformation imparted to the leg	Increased likelihood to reach Valgus injury threshold	ACL and PCL rupture	Negligible	Fracture/Crack of Medial thigh pad	After the fact - Replace component

5.0	C-Arm	Fracture/Crack of component	Extreme Crash	Functioning of knee brace compromised - Increased likelihood to reach hyperextension and/or valgus injury threshold	Reaplice knee brace	Negligible	Fracture/Crack of C-Arm	After the fact - Replace entire device
6.0	Lateral Thigh Load Pad	Fracture/Crack of component	Extreme Crash	Functioning of knee brace compromised	Replace lateral thigh load pad	Negligible	Fracture/Crack of lateral thigh pad	After the fact - Replace component
		CV-Damper failure	Extreme overuse	Functioning of knee brace compromised	Replace damper component	Negligible	Failure of damper	Replace component
7.0	Hyperextension stoppers	Loss of hyperextension stoppers	Accidental	Hyperextension lockout angle increased - loss of soft lockout	Replace stopper/s	Marginal	Stopper loss	Replace component
8.0	Patella Cup Protector	Fracture of Patella Cup Protector	Extreme Impact	Loss of impact protection	Replace Protector	Negligible	Patella Cup Protector Fracture	Replace component
9.0	Securing Straps	Failure of Securing Straps	Extreme Hyperextension	Increased likelihood to reach hyperextension injury threshold	Replace strapping system	Negligible	Strapping system failure	Replace component
10.0	Patella Cup Protector	Fracture of Patella Cup Protector	Extreme Impact		Replace Protector	Negligible	Patella Cup Protector Fracture	Replace component
11.0	Screws	Failure of screws on assembly or sub-assemblies	Extreme Impact	Functioning of knee brace compromised	Reaplice knee brace	Negligible	Screw/s loss	After the fact - Replace entire device

Appendix B

FAULT TREE ANALYSIS (FTA)

for the

Leatt[®] Knee C-Frame Carbon



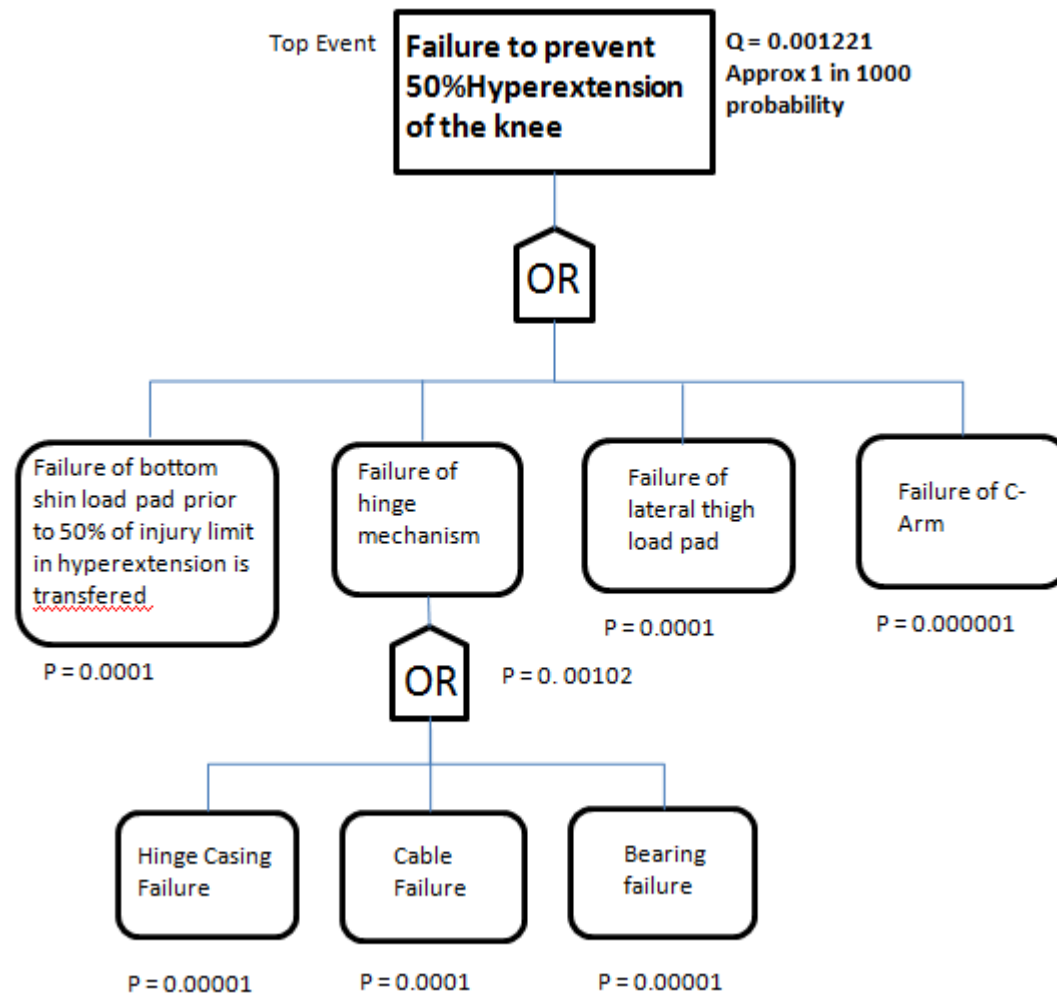

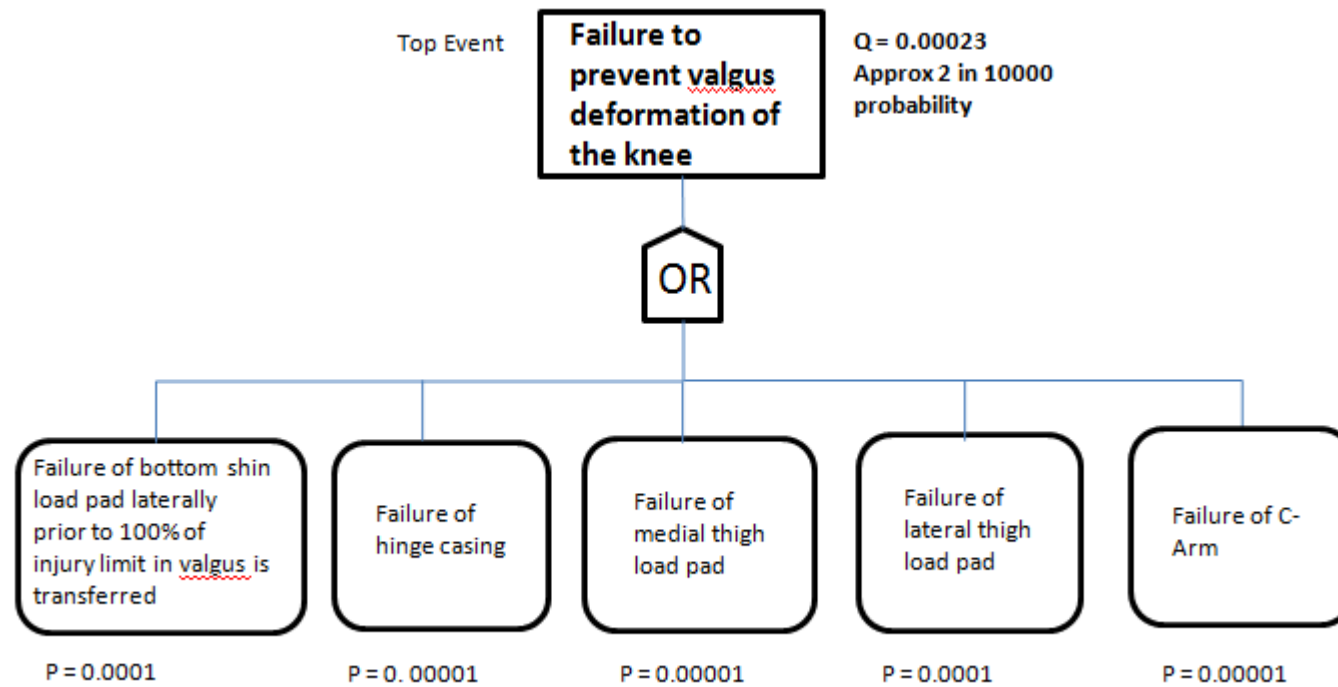

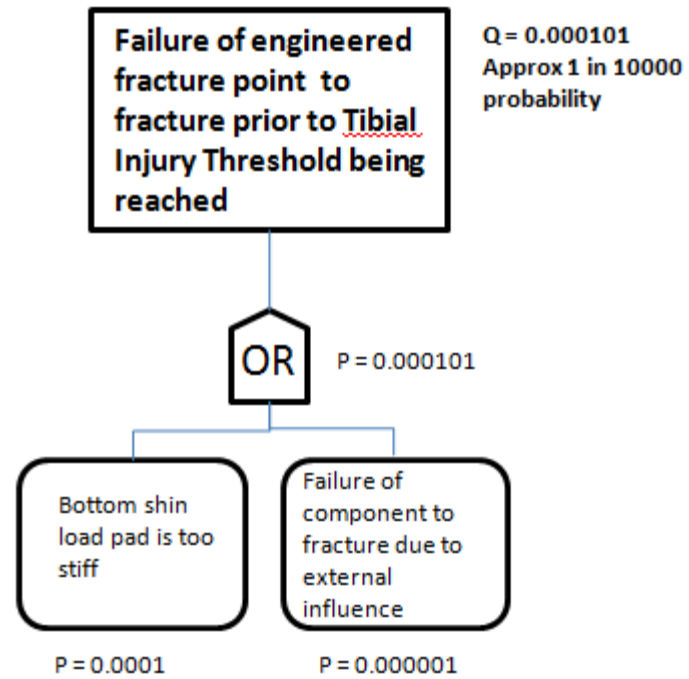

Failure of engineered fracture point (strut below hinge) to fail or failure of the hinge to fracture prior to femoral injury threshold being reached

Q = 0.000011
Approx 1 in 100000 probability

OR P = 0.000011

Engineered strut below hinge is too stiff

P = 0.00001

Failure of component to fracture due to external influence

P = 0.000001