



INSTALLATION INSTRUCTIONS

Part Number: RT-3910

This fit kit fits: RK-3909 assembly

Congratulations, you have purchased the finest [Air Filter](#) Kit that money can buy. With proper care, this Air Filter Kit can last many seasons. This Air Filter Kit replaces the K&N Filtercharger® on the RK-3909 air cleaner assembly and provides a taller K&N Filtercharger®. The following procedure **MUST** be followed to ensure a proper fit and seal of the Air Filter Kit.

PARTS LIST:

Description	Qty.	Part#
A RK-3909 Back Plate	Not Included	01903-1
B Bolt; Button Socket	Not included	07706
C K&N air filter	1	E-3037
D Spacer; .375"ODx.25"IDx2.0"L	3	06500
Not Shown		
Thread Locker	1	Roush-482

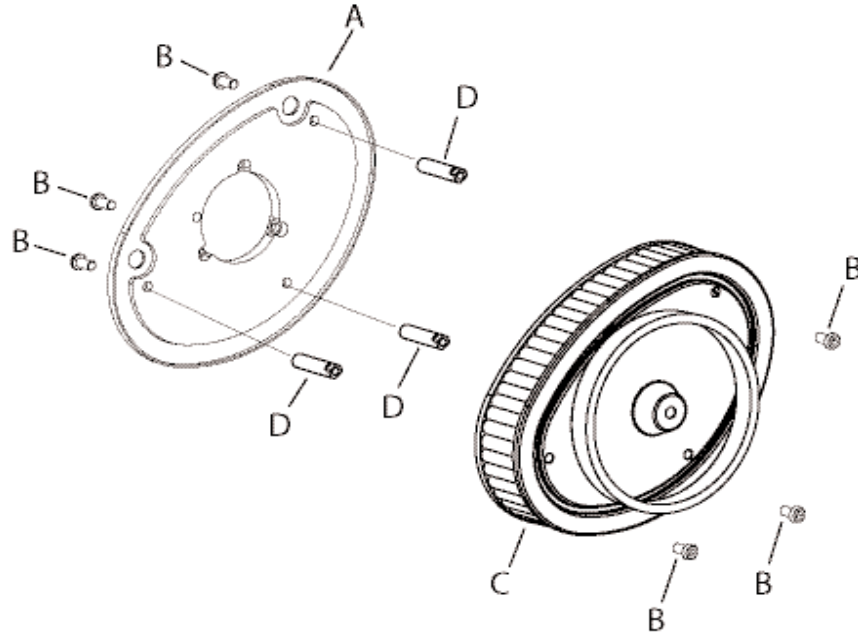

1. Remove the air cleaner cover.



2. Remove the three button socket bolts on the K&N® air filter.

3. Remove the K&N® air filter from the back plate.

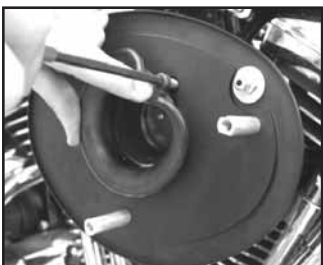

4. Remove the three socket head bolts from the back plate.



5. Remove the two stock breather bolts.

6. Remove the back plate from the motorcycle.

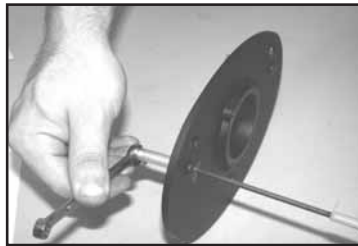

7. Unbolt the spacers from the back plate.

NOTE: Apply thread locker to the threads of the three button socket bolts that were removed.

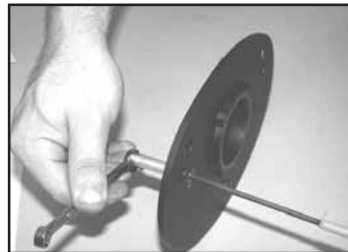

8. Install the three bolts from step 7 into the back plate and thread the bolts through the provided spacers.



9. Reinstall the velocity stack onto the back plate.

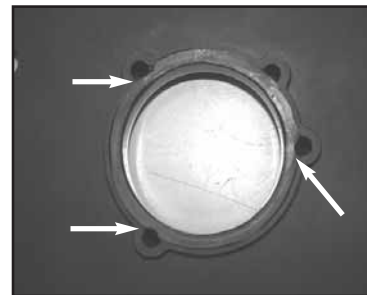

10. Align the notches on the velocity stack with the bolt holes in the back plate.

11. Reinstall the stock air cleaner gasket if it came off of the carburetor or throttle body.

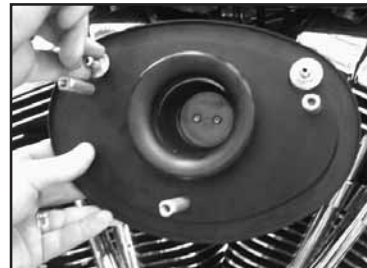

12. Reinstall the back plate and thread the stock breather bolts into the breather bolt extensions. Do not tighten at this time. **Note: For 2006-2007 fuel injected models, reinstall a washer in between the back plate and each of the provided breather bolt extensions. Thread the stock breather bolts into the breather bolt extensions. There should be a washer on each side of the provided breather bolt.**

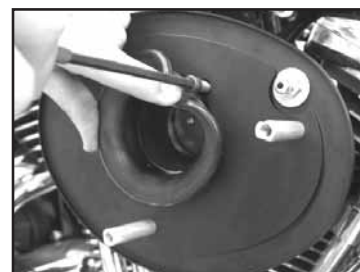

13. Reinstall the three socket head screws into the carburetor or throttle body. **Note: It is necessary to pull the velocity stack back for access.**

14. Recheck the velocity stack to make sure it is properly seated.

15. Completely tighten the stock breather bolts.



16. Install the K&N® air filter onto the base plate.



17. Reinstall the three button socket bolts. (Reuse the button head bolts removed from step 2) Do not completely tighten.

18. Check the perimeter of the back plate to ensure the K&N® air filter is completely seated.

19. Completely tighten the button socket bolts from step 18.



20. Reinstall the stock air cleaner cover and completely tighten.