



PROFESSIONAL TOOLS & EQUIPMENT



HEAVYWEIGHT QUALITY. KNOCKOUT PRICE.

TABLE OF CONTENTS

Hand Tools

Chrome Sockets, Impact Sockets, Spline Sockets, Crowsfoot, Torx Sockets (internal /external), Flip Sockets, Spindle Nut Sockets, Hex Bit Sockets, Spark Plug Sockets, Universal Joints, Adapters, Reducers, Extensions, Ratchets, Breaker Bars, T-handles, Spinner Handles, Standard and Professional Series Screwdrivers, Torq Screwdrivers, Nut Drivers, Hex Bits, Pry Bars (bent head, rolling head), Files, Taper Punches, Center Punches, Pin Punches, Chisel, and Brass Punches, Raised Panel Combination, High Polish Combination, Stubby, Flare Nut, Ratcheting Box, Ratcheting Combination and Reversible Ratcheting, Adjustable Wrenches, Pipe Wrenches, Aluminum Pipe Wrenches, Allen/Hex Wrenches, Needle Nose, Diagonal, Slip Joint, Groove Joint, Locking, Snap Ring Pliers, Ball Pein Hammers, Claw Hammer, Rubber Mallet, Brass Hammers, Tape Measures

Tool Storage

Service Carts, Creepers, Creeper Seats, Magnetic Tool Storage and Organization

Lighting

Hand Held, Work Lights, Work Light Accessories, Extension Cords and Reels

Cutting/Threading/Abrasives

Drill Bits, Extractors, Knives, Utility Knives, Scrapers, Tube Cutters, Tube Benders, Bolt Cutters, Tin Snips, Hack Saws, Cut-Off Wheels, Wire Wheel and Cup Brushes, Utility Brushes

Air Tools & Electric Tools

Ratchets, Impact Wrenches, Drills, Hammers, Air Tool Accessories, Die Grinders, Sanders and Polishers, Sanders and Polishers Accessories, Blow Guns, Scalars, Cut-Off Tools, Rivet Guns, Air Hoses, Grinders

Shop Tools

Bottle Jacks, Service Jacks, Transmission Jacks, Jack Stands, Underhoist Stands, Engine Stands, Support Bars and Slings, Ram Kits, Shop Presses, Creepers, Stools & Fender Covers, Material Handling, Tow Straps, Recovery Ropes, Tie Downs and Straps, Nylon Ties, Heating, Welding & Soldering, TPMS Tools & Accessories, Hoses, Cleaning Supplies, Adhesives & Tapes, Fluids and Grease

Battery Testers & Booster Cables

Battery Testers, Booster Cables, Clamps

Vehicle Specialty

Flaring Tools, Brake Tools, Fittings and Accessories, Tire and Wheel Tools, Steering & Suspension Tools and Fittings, Drive Shaft & Axle Tools, Oil Filter Wrenches and Accessories, Vacuum Caps, Pullers, Fittings and Accessories, Tubing, Cutting & Bending Tools, Inspection Tools, Fuel System Tools and Fittings, Electrical Tools, Fuses, and Connectors, Strippers, Crimpers, Circuit Testers

Paint & Body Tools

Spray Guns, Regulators and Filters, Clip Removers, Riveters, Impact Drivers, Wedges

Displays

Wall, Floor, Counter Displays, Hooks, Hangers, Display Boards

Icon Legend

Product is proudly made in the USA
Product is 1/4-inch drive
Product is 3/8-inch drive
Product is 1/2-inch drive
Product is 3/4-inch drive
Product is 1-inch drive
Product has 6 internal points of contact
Product has 12 internal points of contact
Repair or replacement parts are available
Product is also sold individually
Product is covered by lifetime warranty (does not cover case, containers etc) - Does not cover abuse.
Oversized product ships via freight company
Sets & Kits are not covered by warranty; See individual pieces for warranty.





HEAVYWEIGHT QUALITY. KNOCKOUT PRICE.



TAKE THE K-TOOL KO CHALLENGE!

Get the "K-TOOL KO Challenge Kit" . . .

And give your customers a ringside for the "K-TOOL KO Challenge" – a 5/8" wrench from Snap-On (we'll call the champion, for now), the second place competitor of the time, and of course ours (currently, the contender). It's simple. Look at them. Same quality. Same functionality. Feel them. Some will say the Snap-On feels better in their hands. But the difference, they will admit is small. The price difference, however is big. K-TOOL is substantially lower. It is rare for someone with a ringside seat to put their money anywhere, but on the challenger – K-TOOL. What can we say, that's who we are. We're not champions yet, but we're giving the competition a helluva beating. Call your K-TOOL rep today and get your "K-TOOL KO Challenge Kit." And give your retailers a ringside seat.



HAND TOOLS



1/4" Drive Chrome | Complete Sets 1/4"

KTI21044

44-piece Fractional and Metric 6-point Socket Set 1/4" Drive

• Chrome vanadium, heat-treated, packaged in blow molded case
Includes a 1/4" drive pro ratchet, 2" extension, 6" extension, standard length fractional sockets 3/16" to 9/16", deep fractional sockets 1/4" to 9/16", standard length metric sockets from 4mm to 15mm, deep metric sockets 6mm to 15mm.



Set includes (also available individually):

KTI21106 - 3/16"
KTI21107 - 7/32"
KTI21108 - 1/4"
KTI21109 - 9/32"
KTI21110 - 5/16"
KTI21111 - 11/32"
KTI21112 - 3/8"
KTI21114 - 7/16"
KTI21116 - 1/2"

KTI21118 - 9/16"
KTI21208 - 1/4" deep
KTI21209 - 9/32" deep
KTI21210 - 5/16" deep
KTI21211 - 11/32" deep
KTI21212 - 3/8" deep
KTI21214 - 7/16" deep
KTI21216 - 1/2" deep
KTI21218 - 9/16" deep

KTI26104 - 4mm
KTI26105 - 5mm
KTI26155 - 5.5mm
KTI26106 - 6mm
KTI26107 - 7mm
KTI26108 - 8mm
KTI26109 - 9mm
KTI26110 - 10mm
KTI26111 - 11mm

KTI26112 - 12mm
KTI26113 - 13mm
KTI26114 - 14mm
KTI26115 - 15mm
KTI26206 - 6mm deep
KTI26207 - 7mm deep
KTI26208 - 8mm deep
KTI26209 - 9mm deep
KTI26210 - 10mm deep

KTI26211 - 11mm deep
KTI26212 - 12mm deep
KTI26213 - 13mm deep
KTI26214 - 14mm deep
KTI26215 - 15mm deep
KTI21092 - Ratchet
KTI21002 - 2" Extension
KTI21006 - 6" Extension



KTI21000

21-Piece Fractional 6-point Socket Set 1/4" Drive

• All sockets are 6-point chrome vanadium
• Packaged blow-molded case
Includes 9 short sockets from 3/16" to 1/2", 7 deep sockets from 1/4" to 1/2", push button ratchet, universal joint, 2" and 4" extensions and spinner.



Set includes (also available individually):

KTI21106 - 3/16"
KTI21107 - 7/32"
KTI21108 - 1/4"
KTI21109 - 9/32"
KTI21110 - 5/16"
KTI21111 - 11/32"
KTI21112 - 3/8"

KTI21114 - 7/16"
KTI21116 - 1/2"
KTI21208 - 1/4" deep
KTI21209 - 9/32" deep
KTI21210 - 5/16" deep
KTI21211 - 11/32" deep
KTI21212 - 3/8" deep

KTI21214 - 7/16" deep
KTI21216 - 1/2" deep
KTI21091 - Ratchet
KTI21002 - 2" Extension
KTI21004 - 4" Extension
KTI21050 - Universal Joint
KTI21060 - Spinner Handle



KTI26000

21-Piece Metric 6-point Socket Set 1/4" Drive

• 6-point chrome vanadium steel
Includes 9 short sockets from 4mm to 11mm, 7 deep sockets from 5.5mm to 11mm, push button ratchet, universal joint, 2" and 4" extensions and spinner.



Set includes (also available individually):

KTI26104 - 4mm
KTI26105 - 5mm
KTI26155 - 5.5mm
KTI26106 - 6mm
KTI26107 - 7mm
KTI26108 - 8mm
KTI26109 - 9mm

KTI26110 - 10mm
KTI26111 - 11mm
KTI26255 - 5.5mm deep
KTI26206 - 6mm deep
KTI26207 - 7mm deep
KTI26208 - 8mm deep
KTI26209 - 9mm deep

KTI26210 - 10mm deep
KTI26211 - 11mm deep
KTI21091 - Ratchet
KTI21002 - 2" Extension
KTI21004 - 4" Extension
KTI21050 - Universal Joint
KTI21060 - Spinner Handle

Open Stock 1/4"

1/4" Drive Chrome Sockets		
Fractional		
	Standard	Deep
Size	6 pt	6 pt
3/16"	KTI21106	KTI21206
7/32"	KTI21107	KTI21207
1/4"	KTI21108	KTI21208
9/32"	KTI21109	KTI21209
5/16"	KTI21110	KTI21210
11/32"	KTI21111	KTI21211
3/8"	KTI21112	KTI21212
7/16"	KTI21114	KTI21214
1/2"	KTI21116	KTI21216
9/16"	KTI21118	KTI21218

1/4" Drive Chrome Sockets		
Metric		
	Standard	Deep
Size	6 pt	6 pt
4mm	KTI26104	
5mm	KTI26105	
5.5mm	KTI26155	KTI26255
6mm	KTI26106	KTI26206
7mm	KTI26107	KTI26207
8mm	KTI26108	KTI26208
9mm	KTI26109	KTI26209
10mm	KTI26110	KTI26210
11mm	KTI26111	KTI26211
12mm	KTI26112	KTI26212
13mm	KTI26113	KTI26213
14mm	KTI26114	KTI26214
15mm	KTI26115	KTI26215

HAND TOOLS

1/4" Drive Chrome | Complete Sets 1/4"

KT121200 8-Piece Fractional 6-Point Socket Set 1/4" Drive - Deep

- 6-point sockets
- Chrome vanadium steel
- Heat-treated
- Packaged on a socket rail



Set includes (also available individually):

- | | |
|-----------------------|------------------------|
| KT121207 - 7/32" deep | KT121211 - 11/32" deep |
| KT121208 - 1/4" deep | KT121212 - 3/8" deep |
| KT121209 - 9/32" deep | KT121214 - 7/16" deep |
| KT121210 - 5/16" deep | KT121216 - 1/2" deep |

KT126200 8-Piece Metric 6-Point Socket Set 1/4" Drive - Deep

- Chrome vanadium steel
- Heat-treated
- Packaged on socket rail



Set includes (also available individually):

- | | |
|---------------------|----------------------|
| KT126206 - 6mm deep | KT126210 - 10mm deep |
| KT126207 - 7mm deep | KT126211 - 11mm deep |
| KT126208 - 8mm deep | KT126212 - 12mm deep |
| KT126209 - 9mm deep | KT126213 - 13mm deep |

KT126100 8-Piece Metric 6-Point Socket Set 1/4" Drive - Short

- 6-point sockets
- Chrome vanadium steel
- Heat-treated
- Packaged on socket rail



Set includes (also available individually):

- | | |
|----------------|-----------------|
| KT126106 - 6mm | KT126110 - 10mm |
| KT126107 - 7mm | KT126111 - 11mm |
| KT126108 - 8mm | KT126112 - 12mm |
| KT126109 - 9mm | KT126113 - 13mm |

KT121100 8-Piece Fractional 6-Point Socket Set 1/4" Drive - Short

- 6-point sockets
- Chrome vanadium steel
- Heat-treated
- Packaged on socket rail



Set includes (also available individually):

- | | |
|------------------|------------------|
| KT121106 - 3/16" | KT121110 - 5/16" |
| KT121107 - 7/32" | KT121112 - 3/8" |
| KT121108 - 1/4" | KT121114 - 7/16" |
| KT121109 - 9/32" | KT121116 - 1/2" |

3/8" Drive Chrome | Complete Sets 3/8"

KT120045 45-Piece Fractional and Metric Spline Socket Set 3/8" Drive

- The universal spline socket design works on various fasteners such as spline, 6-point, 12-point, female torx and square
- It will even work on 50% rounded fasteners! It's like having six sockets in one!
- Features high-polish chrome-vanadium finish, which provides for long life and maximum corrosion resistance
- Packaged in a blow-molded case

Set Includes: standard and deep fractional (5/16" to 7/8") and metric (7mm to 19mm) sockets, 3/8" drive ratchet and 3- and 6-inch wobble extensions

Set includes (also available individually):

- | | | | | |
|-------------------|------------------------|----------------------|----------------------|-------------------------|
| KT120210 - 5/16" | KT120228 - 7/8" | KT120428 - 7/8" deep | KT120318 - 18mm | KT120714 - 14mm deep |
| KT120212 - 3/8" | KT120412 - 3/8" deep | KT120310 - 10mm | KT120319 - 19mm | KT120715 - 15mm deep |
| KT120214 - 7/16" | KT120414 - 7/16" deep | KT120311 - 11mm | KT120707 - 7mm deep | KT120716 - 16mm deep |
| KT120216 - 1/2" | KT120416 - 1/2" deep | KT120312 - 12mm | KT120708 - 8mm deep | KT120717 - 17mm deep |
| KT120218 - 9/16" | KT120418 - 9/16" deep | KT120313 - 13mm | KT120709 - 9mm deep | KT120718 - 18mm deep |
| KT120220 - 5/8" | KT120420 - 5/8" deep | KT120314 - 14mm | KT120710 - 10mm deep | KT120719 - 19mm deep |
| KT120222 - 11/16" | KT120422 - 11/16" deep | KT120315 - 15mm | KT120711 - 11mm deep | KT122092 - Ratchet |
| KT120224 - 3/4" | KT120424 - 3/4" deep | KT120316 - 16mm | KT120712 - 12mm deep | KT122003 - 3" Extension |
| KT120226 - 13/16" | KT120426 - 13/16" deep | KT120317 - 17mm | KT120713 - 13mm deep | KT122006 - 6" Extension |



3/8" Drive Chrome | Complete Sets 3/8"

KT122047

47-Piece Fractional and Metric 6-point Socket Set 3/8" Drive

- Manufactured with heat-treated chrome vanadium steel
- Packaged in custom blow-molded carrying case

Includes: short fractional sockets from 1/4"-7/8"; deep fractional sockets from 3/8"-7/8"; short metric sockets from 6mm - 19mm; deep metric sockets from 10mm - 19mm; 3/8 drive pro ratchet; 3" extension; 6" extension.

Set includes (also available individually):

KT122108 - 1/4"	KT122128 - 7/8"	KT127106 - 6mm	KT127116 - 16mm	KT127216 - 16mm deep
KT122110 - 5/16"	KT122212 - 3/8" deep	KT127107 - 7mm	KT127117 - 17mm	KT127217 - 17mm deep
KT122112 - 3/8"	KT122214 - 7/16" deep	KT127108 - 8mm	KT127118 - 18mm	KT127218 - 18mm deep
KT122114 - 7/16"	KT122216 - 1/2" deep	KT127109 - 9mm	KT127119 - 19mm	KT127219 - 19mm deep
KT122116 - 1/2"	KT122218 - 9/16" deep	KT127110 - 10mm	KT127210 - 10mm deep	KT127211 - 11mm deep
KT122118 - 9/16"	KT122220 - 5/8" deep	KT127111 - 11mm	KT127211 - 11mm deep	KT122003 - 3" Extension
KT122120 - 5/8"	KT122222 - 11/16" deep	KT127112 - 12mm	KT127212 - 12mm deep	KT122006 - 6" Extension
KT122122 - 11/16"	KT122224 - 3/4" deep	KT127113 - 13mm	KT127213 - 13mm deep	
KT122124 - 3/4"	KT122226 - 13/16" deep	KT127114 - 14mm	KT127214 - 14mm deep	
KT122126 - 13/16"	KT122228 - 7/8" deep	KT127115 - 15mm	KT127215 - 15mm deep	



6 PT

LIFETIME WARRANTY*

KT122547

47-Piece Fractional and Metric 12-point Socket Set 3/8" Drive

- Manufactured with heat-treated chrome vanadium steel
- Packaged in custom blow-molded carrying case

Includes: short fractional sockets from 1/4" - 7/8"; deep fractional sockets from 3/8"-7/8"; short metric sockets from 6mm - 19mm; deep metric sockets from 10mm - 19mm; 3/8 drive pro ratchet; 3" extension; 6" extension.

Set includes (also available individually):

KT122508 - 1/4"	KT122528 - 7/8"	KT127506 - 6mm	KT127516 - 16mm	KT127416 - 16mm deep
KT122510 - 5/16"	KT122412 - 3/8" deep	KT127507 - 7mm	KT127517 - 17mm	KT127417 - 17mm deep
KT122512 - 3/8"	KT122414 - 7/16" deep	KT127508 - 8mm	KT127518 - 18mm	KT127418 - 18mm deep
KT122514 - 7/16"	KT122416 - 1/2" deep	KT127509 - 9mm	KT127519 - 19mm	KT127419 - 19mm deep
KT122516 - 1/2"	KT122418 - 9/16" deep	KT127510 - 10mm	KT127410 - 10mm deep	KT122092 - Ratchet
KT122518 - 9/16"	KT122420 - 5/8" deep	KT127511 - 11mm	KT127411 - 11mm deep	KT122003 - 3" Extension
KT122520 - 5/8"	KT122422 - 11/16" deep	KT127512 - 12mm	KT127412 - 12mm deep	KT122006 - 6" Extension
KT122522 - 11/16"	KT122424 - 3/4" deep	KT127513 - 13mm	KT127413 - 13mm deep	
KT122524 - 3/4"	KT122426 - 13/16" deep	KT127514 - 14mm	KT127414 - 14mm deep	
KT122526 - 13/16"	KT122428 - 7/8" deep	KT127515 - 15mm	KT127415 - 15mm deep	



LIFETIME WARRANTY*

12 PT

KT127000

26-Piece Metric 6-Point Socket Set 3/8" Drive

- All sockets are 6-point chrome vanadium steel
- Packaged in a blow-molded case

Includes 14 short sockets from 8mm to 21mm, 9 deep sockets from 10mm to 19mm, push button ratchet, spark plug socket and extension.

Set includes (also available individually):

KT127108 - 8mm	KT127117 - 17mm	KT127214 - 14mm deep
KT127109 - 9mm	KT127118 - 18mm	KT127216 - 16mm deep
KT127110 - 10mm	KT127119 - 19mm	KT127217 - 17mm deep
KT127111 - 11mm	KT127120 - 20mm	KT127218 - 18mm deep
KT127112 - 12mm	KT127121 - 21mm	KT127219 - 19mm deep
KT127113 - 13mm	KT127210 - 10mm deep	KT122219 - 5/8" Spark Plug
KT127114 - 14mm	KT127211 - 11mm deep	KT122091 - Ratchet
KT127115 - 15mm	KT127212 - 12mm deep	KT122003 - 3" Extension
KT127116 - 16mm	KT127213 - 13mm deep	



6 PT

LIFETIME WARRANTY*

KT122000

20-Piece Fractional 6-Point Socket Set 3/8" Drive

- All sockets are 6-point chrome vanadium steel
- Packaged in a blow-molded case

Includes 9 short sockets from 3/8" to 7/8", 8 deep sockets from 3/8" to 13/16", push button ratchet plus 2" and 3" extensions.

Set includes (also available individually):

KT122112 - 3/8"	KT122126 - 13/16"	KT122222 - 11/16" deep
KT122114 - 7/16"	KT122128 - 7/8"	KT122224 - 3/4" deep
KT122116 - 1/2"	KT122212 - 3/8" deep	KT122226 - 13/16" deep
KT122118 - 9/16"	KT122214 - 7/16" deep	KT122091 - Ratchet
KT122120 - 5/8"	KT122216 - 1/2" deep	KT122002 - 2" Extension
KT122122 - 11/16"	KT122218 - 9/16" deep	KT122003 - 3" Extension
KT122124 - 3/4"	KT122220 - 5/8" deep	



6 PT

LIFETIME WARRANTY*

HAND TOOLS

3/8" Drive Chrome | Complete Sets 3/8"



12 PT **LIFETIME WARRANTY***

KTI22023 23 Piece 3/8" Drive Chrome Socket Set

- All sockets are 12-point
- Features high polish chrome vanadium finish, which provides for long life and maximum corrosion resistance
- Packaged in a blow-molded plastic case

Includes: 3/8" drive pro-series ratchet, flex handle and speed handle, Short fractional sockets from 3/8" to 7/8"; deep fractional sockets from 1/2" to 13/16", universal joint, 1/2" and 9/16" universal sockets, 6" and 12" extensions

Set includes (also available individually):

- | | |
|-----------------------------------|-------------------------|
| KTI22512 - 3/8" short | KTI22514 - 7/16" short |
| KTI22516 - 1/2" short | KTI22518 - 9/16" short |
| KTI22520 - 5/8" short | KTI22522 - 11/16" short |
| KTI22524 - 3/4" short | KTI22526 - 13/16" short |
| KTI22528 - 7/8" short | |
| KTI22416 - 3/8" deep | KTI22418 - 9/16" deep |
| KTI22420 - 5/8" deep | KTI22422 - 11/16" deep |
| KTI22424 - 3/4" deep | KTI22426 - 13/16" deep |
| KTI22006 - 6" Extension | |
| KTI22012 - 12" Extension | |
| KTI22716 - 1/2" Universal Socket | |
| KTI22718 - 9/16" Universal Socket | |
| KTI22500 - Universal Joint | |
| KTI22091 - Pro-Series Ratchet | |
| KTI22071 - Speed Handle | |
| KTI22080 - Flex Handle | |



LIFETIME WARRANTY* **6 PT**

KTI22100 10-Piece Fractional 6-Point Socket Set 3/8" Drive - Short

- Chrome vanadium steel
 - Heat-treated and packaged on a socket rail
- Includes 6-point sockets from 5/16" to 7/8"

Set includes (also available individually):

- | | |
|------------------|-------------------|
| KTI22110 - 5/16" | KTI22120 - 5/8" |
| KTI22112 - 3/8" | KTI22122 - 11/16" |
| KTI22114 - 7/16" | KTI22124 - 3/4" |
| KTI22116 - 1/2" | KTI22126 - 13/16" |
| KTI22118 - 9/16" | KTI22128 - 7/8" |

KTI22501 13-Piece Fractional 12-Point Socket Set 3/8" Drive - Short

- Chrome vanadium steel
 - Heat-treated and packaged on a socket rail
- Includes 12-point sockets from 1/4" to 1"

Set includes (also available individually):

- | | | |
|------------------|-------------------|-------------------|
| KTI22508 - 1/4" | KTI22518 - 9/16" | KTI22528 - 7/8" |
| KTI22510 - 5/16" | KTI22520 - 5/8" | KTI22530 - 15/16" |
| KTI22512 - 3/8" | KTI22522 - 11/16" | KTI22532 - 1" |
| KTI22514 - 7/16" | KTI22524 - 3/4" | |
| KTI22516 - 1/2" | KTI22526 - 13/16" | |

LIFETIME WARRANTY* **12 PT**



KTI27501 15-Piece Metric 12-Point Socket Set 3/8" Drive - Short

- Chrome vanadium steel, heat-treated, packaged on a socket rail
- Includes: 12-point sockets from 7mm to 21mm

Set includes (also available individually):

- | | | |
|-----------------|-----------------|-----------------|
| KTI27507 - 7mm | KTI27512 - 12mm | KTI27517 - 17mm |
| KTI27508 - 8mm | KTI27513 - 13mm | KTI27518 - 18mm |
| KTI27509 - 9mm | KTI27514 - 14mm | KTI27519 - 19mm |
| KTI27510 - 10mm | KTI27515 - 15mm | KTI27520 - 20mm |
| KTI27511 - 11mm | KTI27516 - 16mm | KTI27521 - 21mm |

LIFETIME WARRANTY* **12 PT**

KTI27101 13-Piece Metric 6-Point Socket Set 3/8" Drive - Short

- Chrome vanadium steel
 - Heat-treated and packaged on a socket rail
- Includes 6-point sockets from 7mm to 19mm

Set includes (also available individually):

- | | | |
|-----------------|-----------------|-----------------|
| KTI27107 - 7mm | KTI27112 - 12mm | KTI27117 - 17mm |
| KTI27108 - 8mm | KTI27113 - 13mm | KTI27118 - 18mm |
| KTI27109 - 9mm | KTI27114 - 14mm | KTI27119 - 19mm |
| KTI27110 - 10mm | KTI27115 - 15mm | |
| KTI27111 - 11mm | KTI27116 - 16mm | |

LIFETIME WARRANTY* **6 PT**

3/8" Drive Chrome | Complete Sets 3/8"

KTI22700

8-Piece Universal 12-Point Socket Set 3/8" Drive

- Use with an extension to turn bolts or nuts in difficult-to-access areas
 - Chrome vanadium steel, heat-treated
 - All universal joints are 3/8" drive, 12-point sockets.
- Includes: 5/16" to 3/4" universal joints

Set includes (also available individually):

KTI22710 - 5/16"
KTI22712 - 3/8"

KTI22714 - 7/16"
KTI22716 - 1/2"

KTI22718 - 9/16"
KTI22720 - 5/8"

KTI22722 - 11/16"
KTI22724 - 3/4"



LIFETIME WARRANTY*

12 PT



LIFETIME WARRANTY*

6 PT

KTI27201

9-Piece Metric

6-Point Socket Set 3/8" Drive - Deep

- Chrome vanadium steel, heat-treated, packaged on a socket rail
- Includes: 6-point sockets from 10mm to 18mm

Set includes (also available individually):

KTI27210 - 10mm
KTI27211 - 11mm
KTI27212 - 12mm
KTI27213 - 13mm
KTI27214 - 14mm

KTI27215 - 15mm
KTI27216 - 16mm
KTI27217 - 17mm
KTI27218 - 18mm



KTI22401

13-Piece Fractional

12-Point Socket Set 3/8" Drive - Deep

- Chrome vanadium steel, heat-treated, packaged on a socket rail
- Includes: 12-point sockets from 1/4" to 1"

Set includes (also available individually):

KTI22408 - 1/4" deep
KTI22410 - 5/16" deep
KTI22412 - 3/8" deep
KTI22414 - 7/16" deep
KTI22416 - 1/2" deep
KTI22418 - 9/16" deep

KTI22420 - 5/8" deep
KTI22422 - 11/16" deep
KTI22424 - 3/4" deep
KTI22426 - 13/16" deep
KTI22428 - 7/8" deep
KTI22430 - 15/16"

KTI22432 - 1" deep

LIFETIME WARRANTY*

12 PT



LIFETIME WARRANTY*

12 PT

KTI27401

15-Piece Metric 12-Point Socket Set

3/8" Drive - Deep

- Chrome vanadium steel, heat-treated, packaged on a socket rail
- Includes: 12-point sockets from 7mm to 21mm

Set includes (also available individually):

KTI27407 - 7mm deep
KTI27408 - 8mm deep
KTI27409 - 9mm deep
KTI27410 - 10mm deep
KTI27411 - 11mm deep
KTI27412 - 12mm deep
KTI27413 - 13mm deep

KTI27414 - 14mm deep
KTI27415 - 15mm deep
KTI27416 - 16mm deep
KTI27417 - 17mm deep
KTI27418 - 18mm deep
KTI27419 - 19mm deep
KTI27420 - 20mm deep
KTI27421 - 21mm deep



KTI22201

9-Piece Fractional

6-Point Socket Set 3/8" Drive - Deep

- Chrome vanadium steel
 - Heat-treated and packaged on a socket rail
- Includes 6-point sockets from 3/8" to 7/8"

Set includes (also available individually):

KTI22212 - 3/8" deep
KTI22214 - 7/16" deep
KTI22216 - 1/2" deep
KTI22218 - 9/16" deep
KTI22220 - 5/8" deep

KTI22222 - 11/16" deep
KTI22224 - 3/4" deep
KTI22226 - 13/16" deep
KTI22228 - 7/8" deep

LIFETIME WARRANTY*

6 PT

3/8" Drive Chrome | Specialty Sockets

Spark Plug Sockets:

6-point with rubber plug holder, hex top for wrench in tight areas.

KTI22221 - 5/8" KTI22227 - 13/16"



LIFETIME WARRANTY*

6 PT

Flex Spark Plug Sockets:

Flex joint 3/8" drive, chrome plated, chrome vanadium steel, heat-treated.

KTI22521 - 5/8"
KTI22527 - 13/16"



6 PT

LIFETIME WARRANTY*

KTI22133

3/8" Drive "2-in-1" Oil Sender Socket

- For oil sending units or stoplight switch replacement



LIFETIME WARRANTY*

KTI32229

3/8" Drive Oxygen Sensor Socket

- Used to remove and install oxygen sensors on most domestic and some imported vehicles



LIFETIME WARRANTY*

HAND TOOLS

3/8" Drive Chrome | Open Stock 3/8"

3/8" Drive Chrome Sockets - Fractional						
Size	Standard			Deep		
	6 pt	12 pt	Spline	6 pt	12 pt	Spline
1/4"	KTI22108	KTI22508		KTI22208	KTI22408	
5/16"	KTI22110	KTI22510	KTI20210	KTI22210	KTI22410	
3/8"	KTI22112	KTI22512	KTI20212	KTI22212	KTI22412	KTI20412
7/16"	KTI22114	KTI22514	KTI20214	KTI22214	KTI22414	KTI20414
1/2"	KTI22116	KTI22516	KTI20216	KTI22216	KTI22416	KTI20416
9/16"	KTI22118	KTI22518	KTI20218	KTI22218	KTI22418	KTI20418
5/8"	KTI22120	KTI22520	KTI20220	KTI22220	KTI22420	KTI20420
11/16"	KTI22122	KTI22522	KTI20222	KTI22222	KTI22422	KTI20422
3/4"	KTI22124	KTI22524	KTI20224	KTI22224	KTI22424	KTI20424
13/16"	KTI22126	KTI22526	KTI20226	KTI22226	KTI22426	KTI20426
7/8"	KTI22128	KTI22528	KTI20228	KTI22228	KTI22428	KTI20428
15/16"	KTI22130	KTI22530		KTI22230	KTI22430	
1"	KTI22132	KTI22532		KTI22232	KTI22432	

3/8" Drive Chrome Sockets - Metric						
Size	Standard			Deep		
	6 pt	12 pt	Spline	6 pt	12 pt	Spline
6mm	KTI27106	KTI27506		KTI27206		
7mm	KTI27107	KTI27507		KTI27207	KTI27407	KTI20707
8mm	KTI27108	KTI27508		KTI27208	KTI27408	KTI20708
9mm	KTI27109	KTI27509		KTI27209	KTI27409	KTI20709
10mm	KTI27110	KTI27510	KTI20310	KTI27210	KTI27410	KTI20710
11mm	KTI27111	KTI27511	KTI20311	KTI27211	KTI27411	KTI20711
12mm	KTI27112	KTI27512	KTI20312	KTI27212	KTI27412	KTI20712
13mm	KTI27113	KTI27513	KTI20313	KTI27213	KTI27413	KTI20713
14mm	KTI27114	KTI27514	KTI20314	KTI27214	KTI27414	KTI20714
15mm	KTI27115	KTI27515	KTI20315	KTI27215	KTI27415	KTI20715
16mm	KTI27116	KTI27516	KTI20316	KTI27216	KTI27416	KTI20716
17mm	KTI27117	KTI27517	KTI20317	KTI27217	KTI27417	KTI20717
18mm	KTI27118	KTI27518	KTI20318	KTI27218	KTI27418	KTI20718
19mm	KTI27119	KTI27519	KTI20319	KTI27219	KTI27419	KTI20719
20mm	KTI27120	KTI27520		KTI27220	KTI27420	
21mm	KTI27121	KTI27521		KTI27221	KTI27421	
22mm	KTI27122			KTI27222		
23mm	KTI27123			KTI27223		
24mm	KTI27124			KTI27224		
25mm	KTI27125			KTI27225		
26mm	KTI27126			KTI27226		

3/8" Drive Impact | Complete Sets 3/8"

KTI37042 42-piece Fractional and Metric Impact Socket Set 3/8" Drive

- Manufactured from heat-treated chrome-moly steel for wear in professional, rugged environments.
- All sockets are 6-point, 3/8" drive.
- Laser engraved for quick identification
- Packaged in a convenient blow-molded case

Includes: 8 short fractional sockets sized from 5/16" to 3/4", 8 deep fractional sockets sized from 5/16" to 3/4", 12 short metric sockets sized from 8mm to 19mm, 12 deep metric sockets sized from 8mm to 19mm, universal joint and 3" extension.

Set includes (also available individually):

KTI32110 - 5/16"	KTI32212 - 3/8" deep	KTI37110 - 10mm	KTI37119 - 19mm	KTI37216 - 16mm deep
KTI32112 - 3/8"	KTI32214 - 7/16" deep	KTI37111 - 11mm	KTI37208 - 8mm deep	KTI37217 - 17mm deep
KTI32114 - 7/16"	KTI32216 - 1/2" deep	KTI37112 - 12mm	KTI37209 - 9mm deep	KTI37218 - 18mm deep
KTI32116 - 1/2"	KTI32218 - 9/16" deep	KTI37113 - 13mm	KTI37210 - 10mm deep	KTI37219 - 19mm deep
KTI32118 - 9/16"	KTI32220 - 5/8" deep	KTI37114 - 14mm	KTI37211 - 11mm deep	KTI32003 - 3" Extension
KTI32120 - 5/8"	KTI32222 - 11/16" deep	KTI37115 - 15mm	KTI37212 - 12mm deep	KTI32013 - Universal Joint
KTI32122 - 11/16"	KTI32224 - 3/4" deep	KTI37116 - 16mm	KTI37213 - 13mm deep	
KTI32124 - 3/4"	KTI37108 - 8mm	KTI37117 - 17mm	KTI37214 - 14mm deep	
KTI32210 - 5/16" deep	KTI37109 - 9mm	KTI37118 - 18mm	KTI37215 - 15mm deep	



LIFETIME WARRANTY* 6 PT

KTI32100 9-Piece Fractional Impact Socket Set 3/8" Drive - Short

- Chrome moly steel, thin wall impact
- Heat-treated
- Packaged in a blow-molded case

Includes: 6-point sockets from 3/8" to 7/8"

Set includes (also available individually):

KTI32112 - 3/8"	KTI32122 - 11/16"
KTI32114 - 7/16"	KTI32124 - 3/4"
KTI32116 - 1/2"	KTI32126 - 13/16"
KTI32118 - 9/16"	KTI32128 - 7/8"
KTI32120 - 5/8"	



LIFETIME WARRANTY* 6 PT

KTI37100 10-Piece Metric Impact Socket Set 3/8" Drive - Short

- Chrome moly steel, thin wall impact
- Heat-treated
- Packaged in a blow-molded case

Includes: 6-point sockets from 10mm to 19mm

Set includes (also available individually):

KTI37110 - 10mm	KTI37115 - 15mm
KTI37111 - 11mm	KTI37116 - 16mm
KTI37112 - 12mm	KTI37117 - 17mm
KTI37113 - 13mm	KTI37118 - 18mm
KTI37114 - 14mm	KTI37119 - 19mm



LIFETIME WARRANTY*

KTI32200 9-Piece Fractional Impact Socket Set 3/8" Drive - Deep

- Chrome moly steel, thin wall impact
- Heat-treated
- Packaged in a blow-molded case

Includes: 6-point sockets from 3/8" to 7/8"

Set includes (also available individually):

KTI32212 - 3/8" deep	KTI32222 - 11/16" deep
KTI32214 - 7/16" deep	KTI32224 - 3/4" deep
KTI32216 - 1/2" deep	KTI32226 - 13/16" deep
KTI32218 - 9/16" deep	KTI32228 - 7/8" deep
KTI32220 - 5/8" deep	



LIFETIME WARRANTY* 6 PT

KTI37200 10-Piece Metric Impact Socket Set 3/8" Drive - Deep

- Chrome moly steel, thin wall impact
- Heat-treated
- Packaged in a blow-molded case

Includes: 6-point sockets from 10mm to 19mm

Set includes (also available individually):

KTI37210 - 10mm deep	KTI37215 - 15mm deep
KTI37211 - 11mm deep	KTI37216 - 16mm deep
KTI37212 - 12mm deep	KTI37217 - 17mm deep
KTI37213 - 13mm deep	KTI37218 - 18mm deep
KTI37214 - 14mm deep	KTI37219 - 19mm deep



LIFETIME WARRANTY* 6 PT

HAND TOOLS

3/8" Drive Impact | Complete Sets 3/8"

KT132500 6-Piece Fractional Impact Flex Socket Set 3/8" Drive - Short



- Chrome moly steel, close quarter, thin wall, heat-treated
 - Packaged in a blow-molded case
- Includes: 6-point sockets from 7/16" to 3/4"



Set includes (also available individually):
KT132514 - 7/16" **KT132520** - 5/8"
KT132516 - 1/2" **KT132522** - 11/16"
KT132518 - 9/16" **KT132524** - 3/4"

KT132400 6-Piece Fractional Impact Flex Socket Set 3/8" Drive - Deep



- Chrome moly steel, close quarter, thin wall, heat-treated
 - Packaged in a blow-molded case
- Includes: 6-point sockets from 7/16" to 3/4"



Set includes (also available individually):
KT132414 - 7/16" deep **KT132420** - 5/8" deep
KT132416 - 1/2" deep **KT132422** - 11/16" deep
KT132418 - 9/16" deep **KT132424** - 3/4" deep

KT137500 6-Piece Metric Impact Flex Socket Set 3/8" Drive - Short



- Chrome moly steel, close quarter, thin wall, heat-treated
 - Packaged in a blow-molded case
- Includes: 6-point sockets from 10mm to 15mm



Set includes (also available individually):
KT137510 - 10mm **KT137513** - 13mm
KT137511 - 11mm **KT137514** - 14mm
KT137512 - 12mm **KT137515** - 15mm



KT137400 10-Piece Metric Impact Flex Socket Set 3/8" Drive - Deep

- Chrome moly steel, close quarter, thin wall, heat-treated
 - Packaged in a blow-molded case
- Includes: 6-point sockets from 10mm to 19mm

Set includes (also available individually):
KT137410 - 10mm deep **KT137415** - 15mm deep
KT137411 - 11mm deep **KT137416** - 16mm deep
KT137412 - 12mm deep **KT137417** - 17mm deep
KT137413 - 13mm deep **KT137418** - 18mm deep
KT137414 - 14mm deep **KT137419** - 19mm deep

3/8" Drive Impact Sockets - Fractional

Size	Standard		Deep	
	6 pt	6 pt Flex	6 pt	6 pt Flex
1/4"				
5/16"	KT132110		KT132210	
3/8"	KT132112		KT132212	
7/16"	KT132114	KT132514	KT132214	KT132414
1/2"	KT132116	KT132516	KT132216	KT132416
9/16"	KT132118	KT132518	KT132218	KT132418
5/8"	KT132120	KT132520	KT132220	KT131420
11/16"	KT132122	KT132522	KT132222	KT132422
3/4"	KT132124	KT132524	KT132224	KT132424
13/16"	KT132126		KT132226	
7/8"	KT132128		KT132228	

3/8" Drive Impact Sockets - Metric

Size	Standard		Deep	
	6 pt	6 pt Flex	6 pt	Flex
8mm	KT137108		KT137208	
9mm	KT137109		KT137209	
10mm	KT137110	KT137510	KT137210	KT137410
11mm	KT137111	KT137511	KT137211	KT137411
12mm	KT137112	KT137512	KT137212	KT137412
13mm	KT137113	KT137513	KT137213	KT137413
14mm	KT137114	KT137514	KT137214	KT137414
15mm	KT137115	KT137515	KT137215	KT137415
16mm	KT137116		KT137216	KT137416
17mm	KT137117		KT137217	KT137417
18mm	KT137118		KT137218	KT137418
19mm	KT137119		KT137219	KT137419

1/2" Drive Chrome | Complete Sets 1/2"

6 PT **LIFETIME WARRANTY***

KTI23000 16-Piece Fractional 6-Point Socket Set 1/2" Drive - Short

• All sockets are 6-point chrome vanadium • Packaged in a blow-molded case
Includes: 13 sockets from 7/16" through 1 1/4", ratchet, breaker bar and extension.

Set includes (also available individually):

KTI23114 - 7/16"	KTI23126 - 13/16"	KTI23140 - 1-1/4"
KTI23116 - 1/2"	KTI23128 - 7/8"	KTI23091 - Ratchet
KTI23118 - 9/16"	KTI23130 - 15/16"	KTI23005 - 5" Extension
KTI23120 - 5/8"	KTI23132 - 1"	KTI23080 - 17" Breaker bar
KTI23122 - 11/16"	KTI23134 - 1-1/16"	
KTI23124 - 3/4"	KTI23136 - 1-1/8"	



6 PT **LIFETIME WARRANTY***

KTI28000 17-Piece Metric 6-Point Socket Set 1/2" Drive - Short

• All sockets are 6-point chrome vanadium
• Packaged in a blow-molded case
Includes: 14 sockets from 15mm to 28mm, push button ratchet, breaker bar and 5" extension

Set includes (also available individually):

KTI28115 - 15mm	KTI28121 - 21mm	KTI28127 - 27mm
KTI28116 - 16mm	KTI28122 - 22mm	KTI28128 - 28mm
KTI28117 - 17mm	KTI28123 - 23mm	KTI23091 - Ratchet
KTI28118 - 18mm	KTI28124 - 24mm	KTI23005 - 5" Extension
KTI28119 - 19mm	KTI28125 - 25mm	KTI23080 - 17" Breaker bar
KTI28120 - 20mm	KTI28126 - 26mm	



KTI23110 13-Piece Fractional 6-Point Socket Set, 1/2" Drive - Short

• Chrome vanadium steel, heat-treated
Includes: 6-point sockets from 7/16" to 1 1/4"

Set includes (also available individually):

KTI23114 - 7/16"	KTI23124 - 3/4"	KTI23134 - 1-1/16"
KTI23116 - 1/2"	KTI23126 - 13/16"	KTI23136 - 1-1/8"
KTI23118 - 9/16"	KTI23128 - 7/8"	KTI23140 - 1-1/4"
KTI23120 - 5/8"	KTI23130 - 15/16"	
KTI23122 - 11/16"	KTI23132 - 1"	



6 PT **LIFETIME WARRANTY***

KTI28100 14-Piece Metric 6-Point Socket Set 1/2" Drive - Short

• Chrome vanadium steel, heat-treated, packaged on a socket rail.
Includes: 6-point sockets from 15mm to 28mm

Set includes (also available individually):

KTI28115 - 15mm	KTI28120 - 20mm	KTI28125 - 25mm
KTI28116 - 16mm	KTI28121 - 21mm	KTI28126 - 26mm
KTI28117 - 17mm	KTI28122 - 22mm	KTI28127 - 27mm
KTI28118 - 18mm	KTI28123 - 23mm	KTI28128 - 28mm
KTI28119 - 19mm	KTI28124 - 24mm	



KTI23200 8-Piece Fractional 6-Point Socket Set 1/2" Drive - Deep

• Chrome vanadium steel, heat-treated
Includes: 6-point sockets from 1/2" to 15/16"

Set includes (also available individually):

KTI23216 - 1/2" deep	KTI23224 - 3/4" deep
KTI23218 - 9/16" deep	KTI23226 - 13/16" deep
KTI23220 - 5/8" deep	KTI23228 - 7/8" deep
KTI23222 - 11/16" deep	KTI23230 - 15/16" deep



6 PT **LIFETIME WARRANTY***

KTI28200 10-Piece Metric 6-Point Socket Set 1/2" Drive - Deep

• Chrome vanadium steel, heat-treated, packaged on a socket rail
Includes: 6-point sockets from 15mm to 24mm

Set includes (also available individually):

KTI28215 - 15mm deep	KTI28220 - 20mm deep
KTI28216 - 16mm deep	KTI28221 - 21mm deep
KTI28217 - 17mm deep	KTI28222 - 22mm deep
KTI28218 - 18mm deep	KTI28223 - 23mm deep
KTI28219 - 19mm deep	KTI28224 - 24mm deep



KTI23800 4-Piece Fractional Stud Remover Set, 1/2" Drive

• Chrome vanadium steel, heat-treated
• Packaged in a blow-molded case

Set includes (also available individually):

KTI23808 - 1/4"
KTI23810 - 5/16"
KTI23812 - 3/8"
KTI23814 - 7/16"



LIFETIME WARRANTY*

KTI23900 4-Piece Metric Stud Remover Set 1/2" Drive

• Chrome vanadium steel, heat-treated
• Packaged in a blow-molded case

Set includes (also available individually):

KTI23906 - 6mm
KTI23908 - 8mm
KTI23910 - 10mm
KTI23912 - 12mm



LIFETIME WARRANTY*

HAND TOOLS

1/2" Drive Chrome | Open Stock 1/2"

1/2" Drive Chrome Sockets - Fractional			
Size	Standard		Deep
	6 pt	12 pt	6 pt
3/8"	KTI23112	KTI23512	
7/16"	KTI23114		KTI23214
1/2"	KTI23116	KTI23516	KTI23216
9/16"	KTI23118		KTI23218
5/8"	KTI23120		KTI23220
11/16"	KTI23122		KTI23222
3/4"	KTI23124		KTI23224
13/16"	KTI23126		KTI23226
7/8"	KTI23128		KTI23228
15/16"	KTI23130		KTI23230
1"	KTI23132		KTI23232
1-1/16"	KTI23134		KTI23234
1-1/8"	KTI23136		KTI23236
1-1/4"	KTI23140		KTI23240
1-5/16"	KTI23142		KTI23242
1-3/8"	KTI23144		KTI23244
1-7/16"	KTI23146		KTI23246
1-1/2"	KTI23148		KTI23348

1/2" Drive Chrome Sockets - Metric		
Size	Standard	Deep
	6 pt	6 pt
10mm	KTI28110	KTI28210
11mm	KTI28111	KTI28211
12mm	KTI28112	KTI28212
13mm	KTI28113	KTI28213
14mm	KTI28114	KTI28214
15mm	KTI28115	KTI28215
16mm	KTI28116	KTI28216
17mm	KTI28117	KTI28217
18mm	KTI28118	KTI28218
19mm	KTI28119	KTI28219
20mm	KTI28120	KTI28220
21mm	KTI28121	KTI28221
22mm	KTI28122	KTI28222
23mm	KTI28123	KTI28223
24mm	KTI28124	KTI28224
25mm	KTI28125	KTI28225
26mm	KTI28126	KTI28226
27mm	KTI28127	KTI28227
28mm	KTI28128	KTI28228

1/2" Drive Impact | Complete Sets 1/2"

KTI33100

12-Piece Fractional Impact Socket Set 1/2" Drive - Short

- Chrome moly steel, thin wall impact, heat-treated
 - Packaged in a blow-molded case
- Includes: 6-point sockets from 1/2" to 1-1/4"



Set includes (also available individually):

- | | | |
|-------------------|-------------------|--------------------|
| KTI33116 - 1/2" | KTI33124 - 3/4" | KTI33132 - 1" |
| KTI33118 - 9/16" | KTI33126 - 13/16" | KTI33134 - 1-1/16" |
| KTI33120 - 5/8" | KTI33128 - 7/8" | KTI33136 - 1-1/8" |
| KTI33122 - 11/16" | KTI33130 - 15/16" | KTI33140 - 1-1/4" |

KTI33104

Socket Impact Add-On Set 1/2" Drive

- 6-point 1/2" drive
 - Laser engraved for quick identification
 - Carded on socket rail.
- Includes: shallow sockets 1-5/16", 1-3/8", 1-7/16" and 1-1/2"



Set includes (also available individually):

- | | |
|--------------------|-------------------|
| KTI33142 - 1-5/16" | KTI33144 - 1-3/8" |
| KTI33146 - 1-7/16" | KTI33148 - 1-1/2" |



KTI33101

19-Piece Fractional Impact Socket Set 1/2" Drive - Short

- Chrome moly steel, thin wall impact, heat-treated
- Includes: 6-point sockets from 3/8" to 1-1/2"



Set includes (also available individually):

- | | | |
|-------------------|--------------------|--------------------|
| KTI33112 - 3/8" | KTI33126 - 13/16" | KTI33140 - 1-1/4" |
| KTI33114 - 7/16" | KTI33128 - 7/8" | KTI33142 - 1-5/16" |
| KTI33116 - 1/2" | KTI33130 - 15/16" | KTI33144 - 1-3/8" |
| KTI33118 - 9/16" | KTI33132 - 1" | KTI33146 - 1-7/16" |
| KTI33120 - 5/8" | KTI33134 - 1-1/16" | KTI33148 - 1-1/2" |
| KTI33122 - 11/16" | KTI33136 - 1-1/8" | |
| KTI33124 - 3/4" | KTI33138 - 1-3/16" | |

1/2" Drive Impact | Complete Sets 1/2"

KTI33200 12-Piece Fractional Impact Socket Set 1/2" Drive - Deep

- Chrome moly steel, thin wall impact, heat-treated
- Packaged in a blow-molded case

Includes: 6-point sockets from 1/2" to 1 1/4"



Set includes (also available individually):

KTI33216 - 1/2"	KTI33224 - 3/4"	KTI33232 - 1"
KTI33218 - 9/16"	KTI33226 - 13/16"	KTI33234 - 1-1/16"
KTI33220 - 5/8"	KTI33228 - 7/8"	KTI33236 - 1-1/8"
KTI33222 - 11/16"	KTI33230 - 15/16"	KTI33240 - 1-1/4"

KTI33204 4 Piece 6 Point Fractional Deep Impact Socket Set

Includes: 1-5/16", 1-3/8", 1-7/16" and 1-1/2"



Set includes (also available individually):

KTI33242 - 1-5/16" - deep	KTI33244 - 1-3/8" - deep
KTI33246 - 1-7/16" - deep	KTI33248 - 1/2" - deep

KTI33202 19-Piece Fractional Impact Socket Set 1/2" Drive - Deep

- Chrome moly steel, thin wall impact, heat-treated
- Includes: 6-point sockets from 3/8" to 1-1/2"



Set includes (also available individually):

KTI33212 - 3/8"	KTI33226 - 13/16"	KTI33240 - 1-1/4"
KTI33214 - 7/16"	KTI33228 - 7/8"	KTI33242 - 1-5/16"
KTI33216 - 1/2"	KTI33230 - 15/16"	KTI33244 - 1-3/8"
KTI33218 - 9/16"	KTI33232 - 1"	KTI33246 - 1-7/16"
KTI33220 - 5/8"	KTI33234 - 1-1/16"	KTI33248 - 1-1/2"
KTI33222 - 11/16"	KTI33236 - 1-1/8"	
KTI33224 - 3/4"	KTI33238 - 1-3/16"	

KTI38100 12-Piece Metric Impact Socket Set 1/2" Drive - Short

- Chrome moly steel, thin wall impact, heat-treated
 - Packaged in a blow-molded case
- Includes: 6-point sockets from 10mm to 21mm



Set includes (also available individually):

KTI38110 - 10mm	KTI38114 - 14mm	KTI38118 - 18mm
KTI38111 - 11mm	KTI38115 - 15mm	KTI38119 - 19mm
KTI38112 - 12mm	KTI38116 - 16mm	KTI38120 - 20mm
KTI38113 - 13mm	KTI38117 - 17mm	KTI38121 - 21mm

KTI38200 12-Piece Metric Impact Socket Set 1/2" Drive - Deep

- Chrome moly steel, thin wall impact, heat-treated
 - Packaged in a blow-molded case.
- Includes: 6-point sockets from 10mm to 21mm



Set includes (also available individually):

KTI38210 - 10mm	KTI38214 - 14mm	KTI38218 - 18mm
KTI38211 - 11mm	KTI38215 - 15mm	KTI38219 - 19mm
KTI38212 - 12mm	KTI38216 - 16mm	KTI38220 - 20mm
KTI38213 - 13mm	KTI38217 - 17mm	KTI38221 - 21mm

KTI38201 9 Piece 1/2" Drive 6 Point Metric Impact Socket Set

Includes: sizes: 22mm to 30mm



Set includes (also available individually):

KTI38222 - 22mm	KTI38223 - 23mm	KTI38224 - 24mm
KTI38225 - 25mm	KTI38226 - 26mm	KTI38227 - 27mm
KTI38228 - 28mm	KTI38229 - 29mm	KTI38230 - 30mm

KTI38101 26-Piece Metric Impact Socket Set 1/2" Drive - Short

- Chrome moly steel, thin wall impact, heat-treated
- Includes: 6-point sockets from 10mm to 36mm



Set includes (also available individually):

KTI38110 - 10mm	KTI38119 - 19mm	KTI38128 - 28mm
KTI38111 - 11mm	KTI38120 - 20mm	KTI38129 - 29mm
KTI38112 - 12mm	KTI38121 - 21mm	KTI38130 - 30mm
KTI38113 - 13mm	KTI38122 - 22mm	KTI38132 - 32mm
KTI38114 - 14mm	KTI38123 - 23mm	KTI38133 - 33mm
KTI38115 - 15mm	KTI38124 - 24mm	KTI38134 - 34mm
KTI38116 - 16mm	KTI38125 - 25mm	KTI38135 - 35mm
KTI38117 - 17mm	KTI38126 - 26mm	KTI38136 - 36mm
KTI38118 - 18mm	KTI38127 - 27mm	

KTI38202 26-Piece Metric Impact Socket Set 1/2" Drive - Deep

- Chrome moly steel, thin wall impact, heat-treated.
- Includes: 6-point sockets from 10mm to 36mm



Set includes (also available individually):

KTI38210 - 10mm	KTI38219 - 19mm	KTI38228 - 28mm
KTI38211 - 11mm	KTI38220 - 20mm	KTI38229 - 29mm
KTI38212 - 12mm	KTI38221 - 21mm	KTI38230 - 30mm
KTI38213 - 13mm	KTI38222 - 22mm	KTI38232 - 32mm
KTI38214 - 14mm	KTI38223 - 23mm	KTI38233 - 33mm
KTI38215 - 15mm	KTI38224 - 24mm	KTI38234 - 34mm
KTI38216 - 16mm	KTI38225 - 25mm	KTI38235 - 35mm
KTI38217 - 17mm	KTI38226 - 26mm	KTI38236 - 36mm
KTI38218 - 18mm	KTI38227 - 27mm	

HAND TOOLS

1/2" Drive Impact | Complete Sets 1/2"

KTI33500 7-Piece Fractional Impact Flex Socket Set 1/2" Drive



- Chrome moly steel, thin wall, heat-treated
 - Packaged in a blow-molded case
- Includes: 6-point sockets from 1/2" to 7/8"



Set includes (also available individually):
KTI33516 - 1/2" **KTI33524** - 3/4"
KTI33518 - 9/16" **KTI33526** - 13/16"
KTI33520 - 5/8" **KTI33528** - 7/8"
KTI33522 - 11/16"

KTI38500 6-Piece Metric Impact Flex Socket Set 1/2" Drive



- Chrome moly steel, thin wall, heat-treated
 - Packaged in a blow-molded case
- Includes: 6 point sockets from 13mm to 19mm



Set includes (also available individually):
KTI38513 - 13mm **KTI38517** - 17mm
KTI38514 - 14mm **KTI38518** - 18mm
KTI38515 - 15mm **KTI38519** - 19mm

1/2" Drive Impact | 1/2" Open Stock

1/2" Drive Impact Sockets - Fractional

	Standard		Deep
Size	6 pt	6 pt Flex	6 pt
3/8"	KTI33112		KTI33212
7/16"	KTI33114		KTI33214
1/2"	KTI33116	KTI33516	KTI33216
9/16"	KTI33118	KTI33518	KTI33218
5/8"	KTI33120	KTI33520	KTI33220
11/16"	KTI33122	KTI33522	KTI33222
3/4"	KTI33124	KTI33524	KTI33224
13/16"	KTI33126	KTI33526	KTI33226
7/8"	KTI33128	KTI33528	KTI33228
15/16"	KTI33130		KTI33230
1"	KTI33132		KTI33232
1-1/16"	KTI33134		KTI33234
1-1/8"	KTI33136		KTI33236
1-3/16"	KTI33138		KTI33238
1-1/4"	KTI33140		KTI33240
1-5/16"	KTI33142		KTI33242
1-3/8"	KTI33144		KTI33244
1-7/16"	KTI33146		KTI33246
1-1/2"	KTI33148		KTI33248

1/2" Drive Flip Impact Socket

KTI33050 - 3/4" x 13/16"
KTI38050 - 19mm-21mm



1/2" Drive Impact Sockets - Metric

	Standard		Deep
Size	6 pt	6 pt Flex	6 pt
10mm	KTI38110		KTI38210
11mm	KTI38111		KTI38211
12mm	KTI38112		KTI38212
13mm	KTI38113	KTI38513	KTI38213
14mm	KTI38114	KTI38514	KTI38214
15mm	KTI38115	KTI38515	KTI38215
16mm	KTI38116		KTI38216
17mm	KTI38117	KTI38517	KTI38217
18mm	KTI38118	KTI38518	KTI38218
19mm	KTI38119	KTI38519	KTI38219
20mm	KTI38120		KTI38220
21mm	KTI38121		KTI38221
22mm	KTI38122		KTI38222
23mm	KTI38123		KTI38223
24mm	KTI38124		KTI38224
25mm	KTI38125		KTI38225
26mm	KTI38126		KTI38226
27mm	KTI38127		KTI38227
28mm	KTI38128		KTI38228
29mm	KTI38129		KTI38229
30mm	KTI38130		KTI38230
31mm			
32mm	KTI38132		KTI38232
33mm	KTI38133		KTI38233
34mm	KTI38134		KTI38234
35mm	KTI38135		KTI38235
36mm	KTI38136		KTI38236

3/4" Drive Chrome | Complete Sets 3/4"



6 PT **LIFETIME WARRANTY***

KTI24121 20-Piece Fractional 6-Point Socket Set 3/4" Drive

- 6-point high polished chrome vanadium steel
- Packaged in blow-molded case

Includes: 16 sockets from 3/4" to 2", ratchet, T-handle and 4" and 8" extensions

Set includes (also available individually):

KTI24124 - 3/4"	KTI24140 - 1-1/4"	KTI24160 - 1-7/8"
KTI24128 - 7/8"	KTI24142 - 1-5/16"	KTI24164 - 2"
KTI24130 - 15/16"	KTI24144 - 1-3/8"	KTI24090 - Ratchet
KTI24132 - 1"	KTI24146 - 1-7/16"	KTI24004 - 4" Extension
KTI24134 - 1-1/16"	KTI24148 - 1-1/2"	KTI24008 - 8" Extension
KTI24136 - 1-1/8"	KTI24152 - 1-5/8"	KTI24070 - T-handle
KTI24138 - 1-13/16"	KTI24156 - 1-3/4"	



KTI24105 5-Piece Fractional 6-Point Socket Set 3/4" Drive

- Socket assortment is a perfect addition to the KTI24121 3/4" drive socket set
- Chrome vanadium

Includes: 5 sockets from 2-1/16" to 2-3/8"

Set includes (also available individually):

KTI24166 - 2-1/16"
KTI24168 - 2-1/8"
KTI24170 - 2-3/16"
KTI24172 - 2-1/4"
KTI24176 - 2-3/8"

6 PT **LIFETIME WARRANTY***

3/4" Drive Chrome | 3/4" Open Stock

3/4" Drive Chrome Sockets		
Standard		
Size	6 pt	12 pt
3/4"	KTI24124	
7/8"	KTI24128	
15/16"	KTI24130	
1"	KTI24132	
1-1/16"	KTI24134	
1-1/8"	KTI24136	
1-3/16"	KTI24138	
1-1/4"	KTI24140	
1-5/16"	KTI24142	
1-3/8"	KTI24144	
1-7/16"	KTI24146	
1-1/2"	KTI24148	
1-5/8"	KTI24152	
1-3/4"	KTI24156	
1-7/8"	KTI24160	
2"	KTI24164	
2-1/16"	KTI24166	
2-1/8"	KTI24168	
2-3/16"	KTI24170	
2-1/4"	KTI24172	KTI24173
2-3/8"	KTI24176	



HAND TOOLS

3/4" Drive Impact | Complete Sets 3/4"

KTI34100 8-Piece Fractional Impact Socket Set 3/4" Drive - Short



- Chrome moly steel, heat-treated
 - Packaged in a blow-molded case
- Includes: 6 point sockets from 1" to 1-1/2"



Set includes (also available individually):

KTI34132 - 1"	KTI34142 - 1-5/16"
KTI34134 - 1-1/16"	KTI34144 - 1-3/8"
KTI34136 - 1-1/8"	KTI34146 - 1-7/16"
KTI34140 - 1-1/4"	KTI34148 - 1-1/2"

KTI34200 8-Piece Fractional Impact Socket Set 3/4" Drive - Deep



- Chrome moly steel, heat-treated
 - Packaged in a blow-molded case
- Includes: 6-point sockets from 1" to 1-1/2"



Set includes (also available individually):

KTI34232 - 1"	KTI34242 - 1-5/16"
KTI34234 - 1-1/16"	KTI34244 - 1-3/8"
KTI34236 - 1-1/8"	KTI34246 - 1-7/16"
KTI34240 - 1-1/4"	KTI34248 - 1-1/2"

KTI34101 12-Piece Fractional Impact Socket Set 3/4" Drive - Short



- Chrome moly steel, heat-treated
- Includes: 6-point sockets from 1-9/16" to 2-3/8"



Set includes (also available individually):

KTI34150 - 1-9/16"	KTI34158 - 1-13/16"	KTI34166 - 2-1/16"
KTI34152 - 1-5/8"	KTI34160 - 1-15/16"	KTI34168 - 2-1/8"
KTI34154 - 1-11/16"	KTI34162 - 1-7/8"	KTI34172 - 2-1/4"
KTI34156 - 1-3/4"	KTI34164 - 2"	KTI34176 - 2-3/8"

KTI34201 8-Piece Fractional Impact Socket Set 3/4" Drive - Deep



- Chrome moly steel, heat-treated
- Includes: 6-point sockets from 1-9/16" to 2"



Set includes (also available individually):

KTI34250 - 1-9/16"	KTI34258 - 1-13/16"
KTI34252 - 1-5/8"	KTI34260 - 1-15/16"
KTI34254 - 1-11/16"	KTI34262 - 1-7/8"
KTI34256 - 1-3/4"	KTI34264 - 2"

KTI39100 15-Piece Metric Impact Socket Set 3/4" Drive - Short



- This set is capable of handling larger applications, such as removal of truck wheels and lug nuts
 - Manufactured from heat-treated chrome-moly steel
 - Packaged in a convenient blow-molded case
- Includes: metric sockets sized 17mm to 46mm and replacement o-rings and pins.

Set includes (also available individually):

KTI39117 - 17mm	KTI39130 - 30mm	KTI39138 - 38mm
KTI39119 - 19mm	KTI39131 - 31mm	KTI39140 - 40mm
KTI39120 - 20mm	KTI39132 - 32mm	KTI39146 - 46mm
KTI39122 - 22mm	KTI39134 - 34mm	KTI39001 - O-rings 1.42"/36mm
KTI39124 - 24mm	KTI39135 - 35mm	KTI39003 - Pins 1.375"/35mm
KTI39127 - 27mm	KTI39136 - 36mm	



3/4" Drive Impact | 3/4" Open Stock

3/4" Drive Impact Sockets - Fractional & Metric				
	Standard	Deep		Standard
Size	6 pt	6 pt	Size	6 pt
1"	KTI34132	KTI34232	17mm	KTI39117
1-1/16"	KTI34134	KTI34234	19mm	KTI39119
1-1/8"	KTI34136	KTI34236	20mm	KTI39120
1-1/4"	KTI34140	KTI34240	22mm	KTI39122
1-5/16"	KTI34142	KTI34242	24mm	KTI39124
1-3/8"	KTI34144	KTI34244	27mm	KTI39127
1-7/16"	KTI34146	KTI34246	30mm	KTI39130
1-1/2"	KTI34148	KTI34248	31mm	KTI39131
1-9/16"	KTI34150	KTI34250	32mm	KTI39132
1-5/8"	KTI34152	KTI34252	34mm	KTI39134
1-11/16"	KTI34154	KTI34254	35mm	KTI39135
1-3/4"	KTI34156	KTI34256	36mm	KTI39136
1-13/16"	KTI34158	KTI34258	38mm	KTI39138
1-7/8"	KTI34162	KTI34262	40mm	KTI39140
1-15/16"	KTI34160	KTI34260	46mm	KTI39146
2"	KTI34164	KTI34264		
2-1/16"	KTI34166			
2-1/8"	KTI34168			
2-1/4"	KTI34172			
2-3/8"	KTI34176			

1" Drive Impact | 1" Open Stock

1" Drive Impact Sockets		
	Standard	Deep
Size	6 pt	6 pt
3/4"	KTI35124	
13/16"	KTI35126	
7/8"	KTI35128	
15/16"	KTI35130	
1"	KTI35132	
1-1/16"	KTI35134	KTI35234
1-1/8"	KTI35136	KTI35236
1-3/16"	KTI35138	
1-1/4"	KTI35140	KTI35240
1-5/16"	KTI35142	KTI35242
1-7/16"	KTI35146	
1-1/2"	KTI35148	
1-5/8"	KTI35152	
1-11/16"	KTI35154	
1-13/16"	KTI35158	
1-7/8"	KTI35160	
2"	KTI35164	
2-1/16"	KTI35166	
2-1/4"	KTI35172	
2-7/16"	KTI35178	
2-5/8"	KTI35184	
3"	KTI35196	

1" Drive Impact | Complete Sets 1"

KTI35100 18-Piece Fractional Impact Socket Set 1" Drive - Short

**LIFETIME
WARRANTY***

- Manufactured from heat-treated chrome-moly steel
- Packaged in a convenient blow-molded case

Includes: fractional sockets sized 3/4" to 2" and replacement o-rings and pins.

Set includes (also available individually):

- | | | |
|--------------------|---------------------|-------------------------------|
| KTI35124 - 3/4" | KTI35142 - 1-5/16" | KTI35007 - 7" Extension |
| KTI35126 - 13/16" | KTI35146 - 1-7/16" | KTI35013 - 13" Extension |
| KTI35128 - 7/8" | KTI35148 - 1-1/2" | KTI35001 - O-rings 1.75"/45mm |
| KTI35130 - 15/16" | KTI35152 - 1-5/8" | KTI35002 - O-rings 2"/51mm |
| KTI35132 - 1" | KTI35154 - 1-11/16" | KTI35003 - Pins 1.75"/45mm |
| KTI35134 - 1-1/16" | KTI35158 - 1-13/16" | KTI35004 - Pins 2"/51mm |
| KTI35136 - 1-1/8" | KTI35160 - 1-7/8" | |
| KTI35140 - 1-1/4" | KTI35164 - 2" | |



HAND TOOLS

1/4" Chrome | Accessories 1/4"

KT121091

1/4" Drive Push Button Ratchet

- High polish chrome finish, chrome vanadium steel, premium gears



LIFETIME WARRANTY*

KT121092

1/4" Drive 4-1/2" Professional Series Chrome Ratchet

- High polished chrome
- New design push button socket release
- Thumb lever directional switch
- Fine tooth thin design
- Knurled handles



LIFETIME WARRANTY*

R KT121092RK

KT121095

1/4" Drive 7" Long Handed Professional Series Chrome Ratchet

- High polished chrome
- New design push button socket release
- Thumb lever directional switch
- Fine tooth thin design • Knurled handles



LIFETIME WARRANTY*

KT121060

Spinner Handle 1/4" Drive

- Screwdriver style drive tool for quick spin down/off
- Oversize polypropylene handle and chrome vanadium shaft



LIFETIME WARRANTY*

KT122001

Speed T-Handle Set

- Aluminum sleeve for fast turning
- Locking end to hold socket securely in place
- Pivoting end to reach odd angles
- Includes adapter to use with any 1/4" hex bit



LIFETIME WARRANTY*

A 3/8" drive end allows the speed T-handle to be used with a ratchet like and extension. The speed T-handle set includes 1/4" and 3/8" speed T-handles and a posi-lock adapter that allows the use of any 1/4" hex bit.

KT121070

1/4" Drive Speed T-Handle

- Aluminum sleeve for fast turning
- Locking end to hold socket securely in place
- Pivoting end to reach odd angles
- 3/8" drive end for use with a ratchet - use like an extension



LIFETIME WARRANTY*

KT121061

1/4" Drive Spinner Handle

- 1/4" drive female square in handle
- Black Handle



LIFETIME WARRANTY*

KT121080

Flex Handle 1/4" Drive

- Provides extra leverage for breaking loose rusted or high torque fasteners
- Smooth action flex joint for hard-to-reach fasteners
- Knurled handle for secure grip
- Pivoting head allows the handle to avoid obstructions when being turned in a cramped space
- Chrome vanadium steel for long life and maximum corrosion resistance
- 6" length



LIFETIME WARRANTY*

Standard Extensions

- Chrome vanadium steel, heat-treated

1/4" Drive

KT121002 - 2" Extension

KT121004 - 4" Extension

KT121006 - 6" Extension



LIFETIME WARRANTY*

KT121010 - 10" Extension

KT121014 - 14" Extension

KT121040

Wobble Extension Set 1/4" Drive

- Chrome vanadium steel, heat-treated • Available individually

Set includes (also available individually):

KT121043 - 4" Wobble Extension

KT121046 - 6" Wobble Extension

KT121048 - 9" Wobble Extension



LIFETIME WARRANTY*

KT121055

1/4" Female to 3/8" Male Chrome Socket Adapter

- Chrome vanadium steel, heat treated



LIFETIME WARRANTY*

KT121050

1/4" Drive Universal Joint

- Chrome vanadium steel, heat treated
- Carded



LIFETIME WARRANTY*

3/8" Chrome | Accessories 3/8"



LIFETIME WARRANTY*

KT122091 3/8" Drive Push Button Ratchet

- High polish chrome finish, chrome vanadium steel



Professional Series Ratchets

- High-polished chrome
- Push-button design socket release
- Thumb lever directional switch
- Fine-tooth thin design with knurled handles

LIFETIME WARRANTY*



3/8" Drive

KT122092* - 7-7/8" Pro Series

KT122093 - 10½" Flex Head

KT122095 - 11-3/8" Long Handle

KT122092RK - Repair Kit



KT122070 3/8" Drive Speed T-Handle

- Aluminum sleeve for fast turning
- Locking end to hold socket securely in place
- Pivoting end to reach odd angles
- 3/8" drive end for use with a ratchet - use like an extension

LIFETIME WARRANTY*



LIFETIME WARRANTY*

KT122080 Flex Handle 3/8" Drive 8" Overall Length

- High polish chrome finish, chrome vanadium steel
- Provides extra leverage for breaking loose rusted or high torque fasteners
- Smooth action flex joint for hard-to-reach fasteners
- Knurled handle for secure grip
- Pivoting head allows the handle to avoid obstructions when being turned in a cramped space
- Chrome vanadium steel for long life and maximum corrosion resistance



KT122071 Speed Handle 3/8" Drive

- Speed handle is designed to reach tough access points that a standard ratchet cannot reach
- Tightens or removes a variety of fasteners
- Lightweight design makes any job quick and easy

LIFETIME WARRANTY*

KT122071A - Speed Handle 3/8" Drive, Ext 6.4"



3/8" Drive Standard Extensions

- Chrome vanadium steel, heat-treated

LIFETIME WARRANTY*

KT122002 - 2" Extension

KT122005 - 5" Extension

KT122008 - 8" Extension

KT122012 - 12" Extension

KT122024 - 24" Extension

KT122003 - 3" Extension

KT122006 - 6" Extension

KT122010 - 10" Extension

KT122018 - 18" Extension



KT122041 Wobble Extension Set 3/8" Drive

- Chrome vanadium steel, heat-treated. Available individually.

Set includes (also available individually):

KT122043 - 3" Wobble Extension

KT122046 - 6" Wobble Extension

KT122048 - 8" Wobble Extension

LIFETIME WARRANTY*

KT122060 3/8" Female to 1/4" Male Socket Adapter

- Chrome vanadium steel, heat-treated



KT122055 3/8" Female to 1/2" Male Socket Adapter

- Chrome vanadium steel, heat-treated



KT122500 3/8" Drive Socket Universal Joint

- Chrome vanadium steel, heat-treated
- Carded

LIFETIME WARRANTY*



HAND TOOLS

1/2" Chrome | Accessories 1/2"



KT123091

1/2" Drive Push Button Ratchet

- High polish chrome finish
- Premium gears
- Chrome vanadium steel
- 9-7/8" in length

LIFETIME WARRANTY*



1/2" Drive

Professional Series Chrome Ratchet

- High-polished chrome
- Thumb lever directional switch
- Knurled handles
- Push-button design socket release
- Fine-tooth thin design

KT123092* - 9-7/8" Long Handle

KT123095 - 15" Long Handle

KT123092RK

LIFETIME WARRANTY* R



KT123070

1/2" Sliding T-Handle

- Made with high-polish, chrome vanadium steel
- Allows you accessibility to hard-to-reach areas

LIFETIME WARRANTY*



Flex Handle

- Provides extra leverage for breaking loose rusted or high torque fasteners
- Smooth action flex joint for hard-to-reach fasteners
- Knurled handle for secure grip
- Pivoting head allows the handle to avoid obstructions when being turned in a cramped space
- Chrome vanadium steel for long life and maximum corrosion resistance

LIFETIME WARRANTY*

1/2" Drive

KT123080 - 17" Flex Handle

KT123081 - 24" Flex Handle

KT123082 - 18" to 25" Extending Flex Handle

KT123083 - 10" Flex Handle



1/2" Drive

Standard Extensions

- Chrome vanadium steel, heat-treated.

LIFETIME WARRANTY*

KT123003 - 3" Extension

KT123010 - 10" Extension

KT123020 - 20" Extension

KT123005 - 5" Extension

KT123015 - 15" Extension

Reducers and Adapters

- Chrome vanadium steel, heat-treated.

KT122050 - 1/2" Female to 3/8" Male

KT122075 - 1/2" Female to 3/4" Male



KT123500

1/2" Drive Socket Universal Joint

- Chrome vanadium steel, heat treated
- Carded



LIFETIME WARRANTY*

KT123248

Heating Element Socket 1/2" Drive

- 1/2" drive 1-1/2" deep socket
- Fits heating element in many electric water heaters



LIFETIME WARRANTY*

3/4" Chrome | Accessories 3/4"



LIFETIME WARRANTY*

KT124090

3/4" Drive Ratchet

- Push button release
- High polish chrome finish, chrome vanadium steel, premium gears
- 19-7/8" length

R KT124090RK - 3/4" Drive Ratchet Repair Kit



KT124092

3/4" Drive

Professional Series Chrome Ratchet

- Lightweight alloy handle for ease of use
- High polished chrome
- New design push button socket release
- Thumb lever directional switch
- Fine tooth thin design
- Knurled handle
- 19-5/8" length

LIFETIME WARRANTY*

3/4" Chrome I Accessories 3/4"



LIFETIME WARRANTY*

KTi24080

3/4" Drive Flex Head Breaker Bar - 20"

- Extra leverage for breaking loose rusted or high torque fasteners
- Features high polish chrome finish, knurled handle for sure grip and ball detent to fasten socket to handle without slippage



3/4" Drive Standard Extensions

- Chrome vanadium steel, heat-treated

- KTi24004 - 4" Extension
- KTi24008 - 8" Extension
- KTi24016 - 16" Extension

LIFETIME WARRANTY*



KTi24070

3/4" Drive Sliding T-Handle Socket

- Made with high polish, chrome vanadium steel
- Allows you accessibility to hard to reach areas

LIFETIME WARRANTY*

KTi24070B

Sliding T-Handle 3/4" Black Finish

- Black oxide finish

LIFETIME WARRANTY*

KTi24500

3/4" Drive Universal Joint

- Chrome vanadium steel, heat treated for wear and resistance
- Built for rugged, professional environments
- Laser engraved for easy identification

LIFETIME WARRANTY*



KTi24050

3/4" Female to 1/2" Male Socket Adapter

- Chrome vanadium steel, heat treated for wear and resistance
- Laser engraved



LIFETIME WARRANTY*

3/8" Impact I Accessories 3/8"

KTi32016

3/8" Female 1/2" Male Impact Socket Adapter

- Heat treated



LIFETIME WARRANTY*

KTi32012

3/8" Drive Impact Socket Universal Joint

- Chrome moly steel, heat treated, short overall length



LIFETIME WARRANTY*

KTi32003

3/8" Drive Impact Extension, 3" Long

LIFETIME WARRANTY*



1/2" Impact I Accessories 1/2"

Impact Reducers and Adapters

- Heat-treated



KTi33012 - 1/2" female x 3/8" male

KTi33041 - 1/2" female x 3/8" male (wobble)

KTi33024 - 1/2" female x 3/4" male

LIFETIME WARRANTY*

KTi33016

1/2" Drive Impact Socket Universal Joint

- Chrome moly steel, heat treated, short overall length



LIFETIME WARRANTY*

1/2" Drive Impact Socket Extension

- Features ball detent for easy removal
- Heat-treated chrome-moly steel

KTi33003 - 3"

KTi33006 - 6"

LIFETIME WARRANTY*



HAND TOOLS

3/4" Impact | 3/4" Accessories

Impact Reducers and Adapters

- Heat-treated



- KTI34016 - 3/4" female x 1/2" male
- KTI34032 - 3/4" female x 1" male
- KTI24085 - 3/4" ratcheting

LIFETIME WARRANTY*

KTI34050 3/4" Drive Impact Socket Universal Joint

- Ball/swivel action universal joints give sockets access to tight areas.
- Heat-treated chrome-moly steel
- Laser etched for quick identification



LIFETIME WARRANTY*

1" Impact | 1" Accessories

KTI35024 1" Female 3/4" Male Impact Socket Adapter

- Black oxide finish
- Ball retainer style



LIFETIME WARRANTY*

1" Drive Impact Extension

- KTI35007 - 7"
- KTI35013 - 13"



LIFETIME WARRANTY*

Torx/Torq/Hex Sockets | Sets

KTI22970 7-Piece Fractional Hex Bit Set 3/8" Drive

- Chrome vanadium steel, heat-treated
 - Packaged on a socket rail
- Includes 7 pieces 1/8" through 3/8"



LIFETIME WARRANTY*

Set includes (also available individually):

- KTI22904 - 1/8" Hex Bit
- KTI22905 - 5/32" Hex Bit
- KTI22906 - 3/16" Hex Bit
- KTI22907 - 7/32" Hex Bit

- KTI22908 - 1/4" Hex Bit
- KTI22910 - 5/16" Hex Bit
- KTI22912 - 3/8" Hex Bit

KTI27970 7-Piece Metric Hex Bit Set 3/8" Drive

- Chrome vanadium steel, heat-treated
 - Packaged on a socket rail
- Includes 7 pieces 3mm through 10mm



LIFETIME WARRANTY*

Set includes (also available individually):

- KTI27903 - 3mm Hex Bit
- KTI27904 - 4mm Hex Bit
- KTI27905 - 5mm Hex Bit
- KTI27906 - 6mm Hex Bit

- KTI27907 - 7mm Hex Bit
- KTI27908 - 8mm Hex Bit
- KTI27910 - 10mm Hex Bit

KTI27955 3/8" Drive, 5.5mm Hex Bit Socket

- Made of chrome vanadium steel and heat treated for durability

LIFETIME WARRANTY*

KTI27902 3-Piece Metric Brake Caliper Set 3/8" Drive

- Use on disc brake calipers to remove and install brake pads
 - Disk brake caliper set features hardened and tempered chrome vanadium steel sockets with professional sand finish
 - Bits are heat-treated and precision machined
- Includes: 7mm, 8mm and 10mm hex bits. Available for individual purchase.



Set includes (also available individually):

- KTI27907 - 7mm Hex Bit
- KTI27908 - 8mm Hex Bit
- KTI27910 - 10mm Hex Bit

LIFETIME WARRANTY*

KTI22902 3-Piece Fractional Brake Caliper Set 3/8" Drive

- Use on disc brake calipers to remove and install brake pads
 - Disk brake caliper set features hardened and tempered chrome vanadium steel sockets with professional sand finish
 - Bits are heat-treated and precision machined
- Includes: 1/4", 5/16" and 3/8" hex bits. Available for individual purchase



Set includes (also available individually):

- KTI22908 - 1/4" Hex Bit
- KTI22910 - 5/16" Hex Bit
- KTI22912 - 3/8" Hex Bit

LIFETIME WARRANTY*

Torx/Torq/Hex Sockets | Sets

KTI22802

3-Piece Brake Caliper Torq Bit Set 3/8" Drive

- Use on disc brake calipers to remove and install brake pads
- Fits most GM and Ford brake caliper torx bolts
- Bits are heat-treated and precision machined

Includes: T-40, T-45 and T-50 Torq bits

Set includes (also available individually):

KTI22840 - T40 Internal Torq

KTI22845 - T45 Internal Torq

KTI22850 - T50 Internal Torq

LIFETIME WARRANTY*



KTI22671

10-Piece External Torx Socket Set

- Chrome vanadium steel, heat-treated
- Packaged on a socket rail

Set includes (also available individually):

1/4" Drive

KTI22675 - E5 External Torx

KTI22676 - E6 External Torx

KTI22677 - E7 External Torx

KTI22678 - E8 External Torx

1/2" Drive

KTI22688 - E18 External Torx

KTI22689 - E20 External Torx

3/8" Drive

KTI22680 - E10 External Torx

KTI22682 - E12 External Torx

KTI22684 - E14 External Torx

KTI22686 - E16 External Torx



LIFETIME WARRANTY*



KTI22870

10-Piece External Torq Socket Set

- Chrome vanadium steel, heat-treated
- Packaged on a socket rail

Set includes (also available individually):

1/4" Drive

KTI22874 - E4 External Torq

KTI22875 - E5 External Torq

KTI22876 - E6 External Torq

KTI22877 - E7 External Torq

KTI22878 - E8 External Torq

3/8" Drive

KTI22880 - E10 External Torq

KTI22882 - E12 External Torq

KTI22884 - E14 External Torq

KTI22886 - E16 External Torq

KTI22888 - E18 External Torq

LIFETIME WARRANTY*

Torx/Torq Impact Sockets - External					
U.S.A. - Torx					
1/4" Drive		3/8" Drive		1/2" Drive	
Size	Part #	Size	Part #	Size	Part #
E5	KTI22675	E10	KTI22680	E18	KTI22688
E6	KTI22676	E12	KTI22682	E20	KTI22689
E7	KTI22677	E14	KTI22684		
E8	KTI22678	E16	KTI22686		
Import - Torque					
1/4" Drive		3/8" Drive			
Size	Part #	Size	Part #		
E4	KTI22874	E10	KTI22880		
E5	KTI22875	E12	KTI22882		
E6	KTI22876	E14	KTI22884		
E7	KTI22877	E16	KTI22886		
E8	KTI22878	E18	KTI22888		

KTI22601

12-Piece Internal Torx Socket Set

- Heat-treated alloy steel
- Vinyl holder
- U.S.A. made



LIFETIME WARRANTY*

Set includes (also available individually):

1/4" Drive

KTI21610 - T10 Internal Torx

KTI21615 - T15 Internal Torx

KTI21620 - T20 Internal Torx

KTI21625 - T25 Internal Torx

KTI21627 - T27 Internal Torx

KTI21630 - T30 Internal Torx

3/8" Drive

KTI22640 - T40 Internal Torx

KTI22645 - T45 Internal Torx

KTI22647 - T47 Internal Torx

KTI22650 - T50 Internal Torx

KTI22655 - T55 Internal Torx

1/2" Drive

KTI22660 - T60 Internal Torx

KTI22600

9-Piece Internal Torx Socket Set

- Heat-treated alloy steel
- Vinyl holder
- U.S.A. made



LIFETIME WARRANTY*

Set includes (also available individually):

1/4" Drive

KTI21610 - T10 Internal Torx

KTI21615 - T15 Internal Torx

KTI21620 - T20 Internal Torx

KTI21625 - T25 Internal Torx

KTI21627 - T27 Internal Torx

KTI21630 - T30 Internal Torx

3/8" Drive

KTI22640 - T-40 Internal Torx

KTI22645 - T-45 Internal Torx

KTI22650 - T-50 Internal Torx

HAND TOOLS

Torx/Torq | Sets

KTI22801 12-Piece Internal Torq Socket Set

- Chrome vanadium steel, heat-treated
- Carded on socket rail



LIFETIME WARRANTY*

Set includes (also available individually):

1/4" Drive

- KTI21810 - T10 Internal Torq
- KTI21815 - T15 Internal Torq
- KTI21820 - T20 Internal Torq
- KTI21825 - T25 Internal Torq
- KTI21827 - T27 Internal Torq
- KTI21830 - T30 Internal Torq

3/8" Drive

- KTI22840 - T40 Internal Torq
- KTI22845 - T45 Internal Torq
- KTI22847 - T47 Internal Torq
- KTI22850 - T50 Internal Torq
- KTI22855 - T55 Internal Torq
- KTI22860 - T60 Internal Torq

KTI22800 9-Piece Internal Torq Socket Set

- Chrome vanadium steel, heat-treated
- Carded on socket rail



LIFETIME WARRANTY*

Set includes (also available individually):

1/4" Drive

- KTI21810 - T10 Internal Torq
- KTI21815 - T15 Internal Torq
- KTI21820 - T20 Internal Torq
- KTI21825 - T25 Internal Torq
- KTI21827 - T27 Internal Torq
- KTI21830 - T30 Internal Torq

3/8" Drive

- KTI22840 - T40 Internal Torq
- KTI22845 - T45 Internal Torq
- KTI22850 - T50 Internal Torq

KTI21500 10-Piece

Tamper-Proof Torx Socket Set

- Heat-treated alloy steel
- Vinyl holder
- U.S.A. made



LIFETIME WARRANTY*

Set includes (also available individually):

1/4" Drive

- KTI21510 - T10 Tamper-proof
- KTI21515 - T15 Tamper-proof
- KTI21520 - T20 Tamper-proof
- KTI21525 - T25 Tamper-proof
- KTI21527 - T27 Tamper-proof
- KTI21530 - T30 Tamper-proof
- KTI18008 - Bit Holder (T10-T30)

3/8" Drive

- KTI21540 - T40 Tamper-proof
- KTI21545 - T45 Tamper-proof
- KTI21550 - T50 Tamper-proof
- KTI21555 - T55 Tamper-proof
- KTI18012 - Bit Holder (T40-T60)

Torx Impact Sockets - Tamperproof

1/4" Drive		3/8" Drive	
Size	Part #	Size	Part #
T10	KTI21510	T40	KTI21540
T15	KTI21515	T45	KTI21545
T20	KTI21520	T50	KTI21550
T25	KTI21525	T55	KTI21555
T27	KTI21527		
T30	KTI21530		

Torx/Torq Impact Sockets - Internal

U.S.A. - Torx

1/4" Drive		3/8" Drive		1/2" Drive	
Size	Part #	Size	Part #	Size	Part #
T10	KTI21610	T40	KTI22640	T60	KTI22660
T15	KTI21615	T45	KTI22645	T70	KTI22670
T20	KTI21620	T47	KTI22647		
T25	KTI21625	T50	KTI22650		
T27	KTI21627	T55	KTI22655		
T30	KTI21630				

Import - Torque

1/4" Drive		3/8" Drive	
Size	Part #	Size	Part #
T10	KTI21810	T40	KTI22840
T15	KTI21815	T45	KTI22845
T20	KTI21820	T47	KTI22847
T25	KTI21825	T50	KTI22850
T27	KTI21827	T55	KTI22855
T30	KTI21830	T60	KTI22860



**HEAVYWEIGHT QUALITY.
KNOCKOUT PRICE.**

Hex Keys | Sets

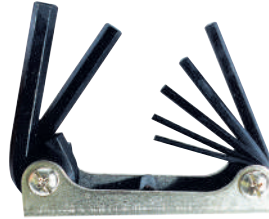

KTI71400

7-Piece Folding Hex Bit Set Fractional

- Fold-up sets include a variety of popular sizes in one convenient handle
- Fold a key out to a right angle to get maximum leverage
- Fold a key out completely to operate like a screwdriver
- Fold-up sets are compact and easily fit in your pocket or tool box

Includes 1/8" to 3/8" fractional sizes

**LIFETIME
WARRANTY***



KTI71420

10-Piece Hex Key Set on Ring Fractional

- Hex keys featuring quality workmanship and value
- Manufactured with heat-treated alloy steel with black finish
- Precision formed to exact dimensional tolerances for precise fit
- Carded on a ring

Includes fractional "L" hex sizes from 1/16" to 3/8"

**LIFETIME
WARRANTY***

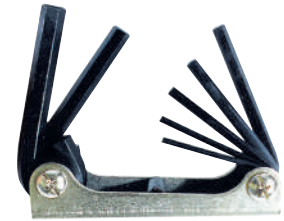

KTI71475

7-Piece Folding Hex Key Set Metric

- Fold-up sets include a variety of popular sizes in one convenient handle
- Fold a key out to a right angle to get maximum leverage
- Fold a key out completely to operate like a screwdriver
- Fold-up sets are compact and easily fit in your pocket or tool box

Includes 2.5mm to 10mm metric sizes

**LIFETIME
WARRANTY***



KTI71480

10-piece Hex Key Set on Ring Metric

- Hex keys featuring quality workmanship and value
- Manufactured with heat-treated alloy steel with black finish
- Precision formed to exact dimensional tolerances for precise fit
- Carded on a ring

Includes metric "L" hex sizes from 1.5mm to 10mm

**LIFETIME
WARRANTY***

KTI71425

25-Piece Hex Key Set (in pouch)

- Hex keys featuring quality workmanship and value
- Set features a convenient package design that provides easy transport and storage
- Manufactured with heat-treated alloy steel with black finish
- Precision formed to exact dimensional tolerances for precise fit
- Packaged in roll-up storage pouch

Includes: long fractional "L" hex sizes from 1/16" to 3/8" and short metric "L" hex sizes from 1.5mm to 10mm

**LIFETIME
WARRANTY***

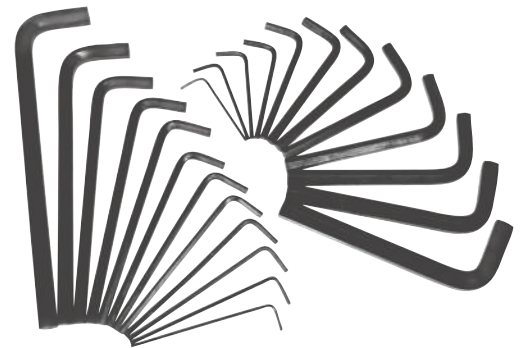

HAND TOOLS

Screwdrivers | Sets



KTI11035

34 Piece Screwdriver Set

• Made of Chrome Vanadium steel

Includes: 7 Phillips (#3x6", #2x4", #1x6", #1x3", #0x4", #0x3", #2x1-1/2"), 8 Slotted (5/16"x6", 1/4"x4", 3/16"x6", 3/16"x3", 5/32"x4", 1/8"x4", 1/8"x3", 1/4"x1-1/2"), 4 Torx (T10x4", T15x4", T20x4", T25x4"), 2 Square (S1x4", S2x4"), Bits Driver, 12 Bits (4 Slotted 1/8", 5/32", 3/16", 1/4"; 4 Phillips #0, #1, #2, #3; 4 Torx T10, T15, T20, T25)

KTI11226 - Phillips #3 x 6"

KTI11224 - Phillips #2 x 4"

KTI11230 - Phillips #1 x 6"

KTI11223 - Phillips #1 x 3"

KTI11231 - Phillips #0 x 4"

KTI11229 - Phillips #0 x 3"

KTI11221 - Phillips #2 x 1-1/2"

KTI11009 - Slotted 5/16" x 6"

KTI11011 - Slotted 1/4" x 4"

KTI11006 - Slotted 3/16" x 6"

KTI11012 - Slotted 3/16" x 3"

KTI11005 - Slotted 5/32" x 4"

KTI11004 - Slotted 1/8" x 4"

KTI11003 - Slotted 1/8" x 3"

KTI11010 - Slotted 1/4" x 1-1/2"

KTI11211 - Torx T10 x 4"

KTI11215 - Torx T15 x 4"

KTI11220 - Torx T20 X 4"

KTI11225 - Torx T25 x 4"

KTI11001 - Square S1" x 4"

KTI11002 - Square S2" x 4"

KTI18000 - Bits Set 12 Piece

KTI18009 - Bits Driver

KTI18904 - Slotted 1/8"

KTI18905 - Slotted 5/32"

KTI18906 - Slotted 3/16"

KTI18907 - Slotted 1/4"

KTI18900 - Phillips #0

KTI18901 - Phillips #1

KTI18902 - Phillips #2

KTI18903 - Phillips #3

KTI18910 - Torx T10

KTI18915 - Torx T15

KTI18920 - Torx T20

KTI18925 - Torx T25

KTI11018

18 Piece Screwdriver Set

• Made of Chrome Vanadium steel

Includes: 4 Slotted (5/16"x6", 1/4"x4", 3/16"x3", 1/4"x1-1/2"), 4 Phillips (#3x6", #2x4", #1x3", #2x1-1/2"), 10 Precision (6 Torx T5x1-9/16", T6x1-9/16", T7x1-9/16", T8x1-9/16", T9x1-9/16", T10x1-9/16"; 2 Slotted 3/32"x1-9/16", 1/8"x1-9/16"; 2 Phillips #0x1-9/16", #00x1-9/16")



KTI11009 - Slotted 5/16" x 6"

KTI11011 - Slotted 1/4" x 4"

KTI11012 - Slotted 3/16" x 3"

KTI11010 - Slotted 1/4" x 1-1/2"

KTI11226 - Phillips #3 x 6"

KTI11224 - Phillips #2 x 4"

KTI11223 - Phillips #1 x 3"

KTI11221 - Phillips #2 x 1-1/2"

KTI11205 - Torx Precision T5 x 1-9/16"

KTI11206 - Torx Precision T6 x 1-9/16"

KTI11207 - Torx Precision T7 x 1-9/16"

KTI11208 - Torx Precision T8 x 1-9/16"

KTI11209 - Torx Precision T9 x 1-9/16"

KTI11210 - Torx Precision T10 x 1-9/16"

KTI11201 - Slotted Precision 3/32" x 1-9/16"

KTI11202 - Slotted Precision 1/8" x 1-9/16"

KTI11203 - Phillips Precision #0 x 1-9/16"

KTI11204 - Phillips Precision #00 x 1-9/16"

KTI11008

8 Piece Screwdriver Set

• Made of Chrome Vanadium steel

Includes: 4 Slotted (5/16"x6", 3/16"x4", 1/8"x3", 1/4"x1-1/2"), 4 Phillips (#2x6", #1x4", #0x3", #2x1-1/2")



KTI11009 - Slotted 5/16" x 6"

KTI11007 - Slotted 3/16" x 4"

KTI11003 - Slotted 1/8" x 3"

KTI11010 - Slotted 1/4" x 1-1/2"

KTI11227 - Phillips #2 x 6"

KTI11228 - Phillips #1 x 4"

KTI11229 - Phillips #0 x 3"

KTI11221 - Phillips #2 x 1-1/2"

LIFETIME WARRANTY*

LIFETIME WARRANTY*

Screwdrivers | Sets

KTI16000

10-Piece

Professional Screwdriver Set

- Ten-piece professional screwdriver set includes the perfect assortment of slotted and Phillips screwdrivers for a variety of projects
- Comfortable triangular grip, non-slip material and chrome vanadium blades
- Ultimate professional quality

Includes: 3" slotted, 4" slotted, 6" slotted, 8" slotted and 1-1/2" stubby slotted and #1 Phillips, #3 Phillips, #2 x 4" Phillips, #2 x 10" Phillips and 1-1/2" stubby Phillips. Also sold in 5-piece slotted set, 5-piece Phillips set or individually.

Available in sets or individually:

KTI16001 - 5-piece Slotted Set

KTI16201 - stubby slotted

KTI16203 - 3" slotted

KTI16204 - 4" slotted

KTI16206 - 6" slotted

KTI16208 - 8" slotted



LIFETIME WARRANTY*



KTI16002 - 5-piece Phillips Set

KTI16113 - #1 Phillips 3"

KTI16121 - #2 Phillips Stubby 1.5"

KTI16124 - #2 Phillips 4"

KTI16129 - #2 Phillips 10"

KTI16136 - #3 Phillips 6"

LIFETIME WARRANTY*

LIFETIME WARRANTY*

KTI19000

8-Piece

Black Screwdriver Set

- Feature high quality chrome vanadium blades, heavy-duty colored handles and hex bolsters for wrench assist
- Packaged with plastic tray • Black handles

Includes: 1# Phillips 3" blade; #2 Phillips 1-1/2" stubby; #2 Phillips 4" blade; stubby slotted; 3" slotted; 4" slotted; 6" slotted; 8" slotted

Set includes (also available individually):

KTI19113 - #1 Phillips 3"

KTI19121 - #2 Phillips Stubby

KTI19124 - #2 Phillips 4"

KTI19201 - Stubby slotted

KTI19203 - 3" slotted

KTI19204 - 4" slotted

KTI19206 - 6" slotted

KTI19208 - 8" slotted



LIFETIME WARRANTY*

KTI19700

8-Piece

Orange Screwdriver Set

- Feature high quality chrome vanadium blades, heavy-duty colored handles and hex bolsters for wrench assist
- Packaged with plastic tray • Orange handles

Includes: 1# Phillips 3" blade; #2 Phillips 1-1/2" stubby; #2 Phillips 4" blade; stubby slotted; 3" slotted; 4" slotted; 6" slotted; 8" slotted

Set includes (also available individually):

KTI19713 - #1 Phillips 3"

KTI19721 - #2 Phillips Stubby

KTI19724 - #2 Phillips 4"

KTI19701 - Stubby slotted

KTI19703 - 3" slotted

KTI19704 - 4" slotted

KTI19706 - 6" slotted

KTI19708 - 8" slotted



LIFETIME WARRANTY*

KTI19800

8-Piece

Red Screwdriver Set

- Feature high quality chrome vanadium blades, heavy-duty colored handles and hex bolsters for wrench assist
- Packaged with plastic tray • Red handles

Includes: 1# Phillips 3" blade; #2 Phillips 1-1/2" stubby; #2 Phillips 4" blade; stubby slotted; 3" slotted; 4" slotted; 6" slotted; 8" slotted

Set includes (also available individually):

KTI19813 - #1 Phillips 3"

KTI19821 - #2 Phillips Stubby

KTI19824 - #2 Phillips 4"

KTI19801 - Stubby slotted

KTI19803 - 3" slotted

KTI19804 - 4" slotted

KTI19806 - 6" slotted

KTI19808 - 8" slotted



LIFETIME WARRANTY*

KTI19900

8-Piece

Green Screwdriver Set

- Feature high quality chrome vanadium blades, heavy-duty colored handles and hex bolsters for wrench assist
- Packaged with plastic tray • Green handles

Includes: 1# Phillips 3" blade; #2 Phillips 1-1/2" stubby; #2 Phillips 4" blade; stubby slotted; 3" slotted; 4" slotted; 6" slotted; 8" slotted.

Set includes (also available individually):

KTI19913 - #1 Phillips 3"

KTI19921 - #2 Phillips Stubby

KTI19924 - #2 Phillips 4"

KTI19901 - Stubby slotted

KTI19903 - 3" slotted

KTI19904 - 4" slotted

KTI19906 - 6" slotted

KTI19908 - 8" slotted



HAND TOOLS

Screwdrivers | Sets

KTI11100

Interchangeable Screwdriver Set

- Features three dual-sided interchangeable inserts - 3 slotted, 3 phillips bits
 - Each screwdriver bit boasts a 2-5/8" blade at each end (6" overall bit length) and a hex bolster for wrench assist (7/16" fractional or 11mm metric)
 - Plastic contoured handle for maximum torque and comfort
 - Anodized alloy shank for high durability
 - Rubber o-ring provides a secure, non-slip grip
- Includes: #1 phillips and 3/16" slotted; #2 phillips and 1/4" slotted; #3 phillips and 5/16" slotted. Storage pouch for convenience and flexibility.

LIFETIME WARRANTY*

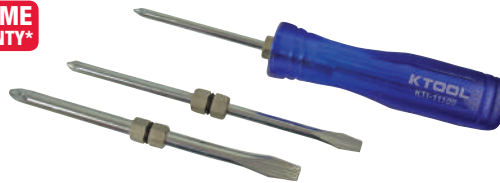

KTI11110

Pocket Screwdriver

- 5-3/16" length
- 1/8" blade width
- Easy to grip handle
- Polished steel



LIFETIME WARRANTY*



LIFETIME WARRANTY*

KTI19138

8" Black Screwdriver #4 Phillips

- #4 Phillips Screwdriver
- Sturdy, black handle
- 8" Length



KTI14219

19" Jumbo Screwdriver

- Features a 19" x 1/2" blade
- Extra large handles and shafts for use on hard to reach areas of large machinery, farm equipment, manufacturing equipment, automobiles and more
- Square shank allows for use with wrenches for larger torque jobs
- Black oxide finish

LIFETIME WARRANTY*



KTI72180

1/4" Female Adjustable Torque Screwdriver

- Screwdriver handle contains viewable torque scale 5-40 inch-pounds (.504 Nm)
- 1/4" Female hex
- Heavy duty black plastic storage case included

Torq Screwdrivers

- Large grip handle and chrome vanadium blades make light work of headlight and trim screws

Sold separately:

KTI11310 - T10 Torq screwdriver

KTI11315 - T15 Torq screwdriver

KTI11320 - T20 Torq screwdriver

LIFETIME WARRANTY*



W*

KTIPREPACKQ1

Hand Tools Floor Display Prepack Q1

- Floor Display consisting of five prepacked KTI hand tool sets (2 each)
- (2) KTI19000 - 8Pc Screwdriver Set (Black)
- (2) KTI21044 - 44Pc Socket Set, 1/4" Drive, SAE & Metric, Shallow & Deep
- (2) KTI22047 - 47Pc Socket Set, 6 Point, 3/8" Drive SAE & Metric
- Two Wrench Sets; (2) KTI41300 - 9pc High Polish, Smooth Finish, Sizes 3/8" to 7/8" and (2) KTI41800 - 13Pc High Polish, Smooth Finish, Sizes 7mm to 19mm

Display setup size: Height: 40.9", Width: 26.3", Depth: 16.7".

All hand tools are covered by a Lifetime Warranty.

Nut Drivers | Sets



KT114400 7-Piece Fractional Nut Driver Set

**LIFETIME
WARRANTY***

- Rugged and designed for shop environments, tools feature hollow shafts, ergonomic soft grip handles, and alloy steel sockets and shafts
- Set is color coded for easy identification
- Tools packaged in handy plastic hanging organizer

Includes sizes: 3/16" x 3", 1/4" x 3", 5/16" x 3", 11/32" x 3", 3/8" x 3", 7/16" x 3" and 1/2" x 3"

Set includes (also available individually):

KT114406 - 3/16" x 3"

KT114408 - 1/4" x 3"

KT114410 - 5/16" x 3"

KT114411 - 11/32" x 3"

KT114412 - 3/8" x 3"

KT114414 - 7/16" x 3"

KT114416 - 1/2" x 3"



**LIFETIME
WARRANTY***

KT114500 7-Piece Metric Nut Driver Set

- Rugged and designed for shop environments
- Feature hollow shafts, ergonomic soft grip handles and alloy steel sockets and shafts
- Set is color coded for easy identification
- Tools packaged in handy plastic hanging organizer

Includes sizes: 5 mm x 75, 6 mm x 75, 7 mm x 75, 8 mm x 75, 9 mm x 75, 10 mm x 75 and 11 mm x 75

Set includes (also available individually):

KT114505 - 5mm x 75mm

KT114506 - 6mm x 75mm

KT114507 - 7mm x 75mm

KT114508 - 8mm x 75mm

KT114509 - 9mm x 75mm

KT114510 - 10mm x 75mm

KT114511 - 11mm x 75mm

Nut Drivers			
Fractional		Metric	
Part #	Size	Part #	Size
KT114406	3/16" x 3"	KT114505	5mm x 75mm
KT114408	1/4" x 3"	KT114506	6mm x 75mm
KT114410	5/16" x 3"	KT114507	7mm x 75mm
KT114411	11/32" x 3"	KT114508	8mm x 75mm
KT114412	3/8" x 3"	KT114509	9mm x 75mm
KT114414	7/16" x 3"	KT114510	10mm x 75mm
KT114416	1/2" x 3"	KT114511	11mm x 75mm

Hooks, Picks, & Awls | Sets



KT170070 4-Piece Pick Set with Neon Orange Handles

- Includes four picks for removing, installing, aligning, probing and piercing
- Use to ease removal of O-rings, split pins, seals and bushes and loose parts
- Set contains orange-handled straight, 45°, 90° and hook picks.

Set includes (also available individually):

KT170071 - Straight Neon Orange Pick

KT170072 - 45 Degree Neon Orange Pick

KT170073 - 90 Degree Neon Orange Pick

KT170074 - Hook Neon Orange Pick

**LIFETIME
WARRANTY***



KT170075 4-Piece Pick Set with Neon Green Handles

- Includes four picks for removing, installing, aligning, probing and piercing
- Use to ease removal of O-rings, split pins, seals and bushes and loose parts
- Set contains green-handled straight, 45°, 90° and hook picks

Set includes (also available individually):

KT170076 - Straight Neon Green Pick

KT170077 - 45 Degree Neon Green Pick

KT170078 - 90 Degree Neon Green Pick

KT170079 - Neon Green Hook Pick

**LIFETIME
WARRANTY***

HAND TOOLS

Pry Bars | Sets

KTI71600

4-Piece Pry Bar Set - Lady Slipper Style

- Superior quality, heat-treated pry bars
 - Tools feature high leverage rolling head and long tapered body to align drift
- Includes 6", 12", 16" and 20" pry bars.



LIFETIME WARRANTY*

Set includes (also available individually):

KTI71606 - 6"

KTI71612 - 12"

KTI71616 - 16"

KTI71620 - 20"

KTI19240

4-Piece Bent-End Pry Bar Set

- Tools feature smooth, comfortable square handles
 - Packaged in plastic formed box
- Includes: 9", 12", 18", 24"



LIFETIME WARRANTY*

Set includes (also available individually):

KTI19209 - 9"

KTI19212 - 12"

KTI19218 - 18"

KTI19224 - 24"

Scrapers | Sets

KTI70004

4-Piece Putty Knife / Scraper Set

- Use to apply adhesives, filler, compound, spackles and more
 - Ideal for removing paint, rust, gaskets, carbon, filler and undercoating
 - All blades are high carbon, heat-treated, tempered, polished to mirror finish and full tang
 - Tools fitted with grommets brass, solvent-resistant, riveted wood handles
 - Features 15° sharp chisel edge on stiff scrapers
- Includes: 1" stiff edge; 1-1/2" stiff edge; 1-1/2" flex edge; and 3" flex edge



LIFETIME WARRANTY*

Set includes (also available individually):

KTI70014 - Scraper Putty Knife 1" Stiff

KTI70017 - Scraper Putty Knife 1-1/2" Flexible

KTI70015 - Scraper Putty Knife 1-1/2" Stiff

KTI70018 - Scraper Putty Knife 3" Flexible

KTI70005

4-Piece Putty Knife / Scraper Set

- Features a combination of flexible and stiff scrapers for the needs of any automotive body application or home improvement job
 - Constructed of stainless steel blades that taper at tip to provide great flexibility and blade action
 - Ergonomic, comfort-grip, non-slip handles
- Includes an upholstery tucking tool, 2" flexible scraper, 1.25" flexible scraper and 1.25" stiff chisel.



LIFETIME WARRANTY*

Set includes (also available individually):

KTI70006 - Putty Knife, Upholstery Tucking Tool with Stainless Steel Blade and Comfort Grip Handle

KTI70007 - Putty Knife, 2" Flexible with Stainless Steel Blade and Comfort Grip Handle

KTI70008 - Putty Knife, 1.25" Flexible with Stainless Steel Blade and Comfort Grip Handle

KTI70009 - Putty Knife, 1.25" Stiff Chisel with Stainless Steel Blade and Comfort Grip Handle

Scrapers | Sets



KTI70023 4-Piece Scraper Set

Set includes: stubby scraper; 1" carbon scraper; combination offset scraper; and 5/8" scraper. Also available individually.

Set includes (also available individually):

KTI70019 - Stubby Scraper

KTI70021 - 1" Carbon Scraper

KTI70022 - Combination Offset Scraper

KTI70027 - 5/8" Scraper

**LIFETIME
WARRANTY***

Scrapers/Putty Knives	
Part #	Type/Size
KTI70006	Putty Tucking
KTI70007	2" Flexible Putty
KTI70008	1-1/4" Flexible Putty
KTI70009	1-1/4" Stiff Putty
KTI70014	1" Stiff Putty
KTI70015	1-1/2" Stiff Putty
KTI70017	1-1/2" Flexible Putty
KTI70018	3" Flexible Putty
KTI70019	Stubby
KTI70020	1" Long Handled
KTI70021	1" Carbon Scraper
KTI70022	Combination Offset
KTI70024	3/4" Chisel
KTI70025	1-1/2" Flexible
KTI70026	1-1/2" Chisel
KTI70027	5/8" Scraper
KTI70028	Putty Knife
KTI70029	3" Flexible

Punches & Chisels | Sets



KTI72901 (in tray) or **KTI72901K** (in kit bag)

15-Piece Punch & Chisel Set

Set includes five pin punches, five taper punches, three chisels and two center punches. Packaged in your choice of plastic tray or kit bag. Components available individually.

KTI72901 (in tray) or **KTI72901K** (in kit bag)

**LIFETIME
WARRANTY***

Pin Punches Punches

KTI72911 - 3/32"

KTI72912 - 1/8"

KTI72913 - 5/32"

KTI72914 - 3/16"

KTI72915 - 1/4"

Taper

KTI72921 - 3/32"

KTI72922 - 1/8"

KTI72923 - 5/32"

KTI72924 - 3/16"

KTI72925 - 1/4"

Chisels

KTI73012 - 3/8"

KTI73016 - 1/2"

KTI73020 - 5/8"

Center Punches

KTI72931 - 1/8"

KTI72932 - 3/16"

KTI72900

6-Piece

Pin Punch Set

Sizes include: 3/32", 1/8", 5/32", 3/16", 1/4" and 5/16". Packaged in plastic tray. Available individually.

Set includes (also available individually):

KTI72911 - 3/32"

KTI72912 - 1/8"

KTI72913 - 5/32"

KTI72914 - 3/16"

KTI72915 - 1/4"

KTI72916 - 5/16"

**LIFETIME
WARRANTY***



KTI72980

4-Piece

Brass Punch Set

Set includes sizes: 3/8"; 1/2"; 5/8"; and 3/4". Tools feature knurled handles. Designed for rugged shop environment. Packaged in vinyl case.

Set includes (also available individually):

KTI72982 - 3/8" punch

KTI72984 - 1/2" punch

KTI72986 - 5/8" punch

KTI72988 - 3/4" punch



**LIFETIME
WARRANTY***

HAND TOOLS

Punches & Chisels | Sets

KT173000

5-piece Chisel Set

Sizes include: 3/8", 1/2", 5/8", 3/4" and 7/8".
Packaged in plastic tray. Available individually.



Set includes (also available individually):

KT173012 - 3/8"

KT173016 - 1/2"

KT173020 - 5/8"

KT173024 - 3/4"

KT173028 - 7/8"

LIFETIME WARRANTY*

Punches

Part #	Type	Size
KT172931	Center	1/8"
KT172932	Center	3/16"
KT170002	Center - Brass Automatic	
KT172921	Taper	3/32"
KT172922	Taper	1/8"
KT172923	Taper	5/32"
KT172924	Taper	3/16"
KT172925	Taper	1/4"
KT172911	Pin	3/32"
KT172912	Pin	1/8"
KT172913	Pin	5/32"
KT172914	Pin	3/16"
KT172915	Pin	1/4"
KT172916	Pin	5/16"
KT172982	Brass	3/8"
KT172984	Brass	1/2"
KT172986	Brass	5/8"
KT172988	Brass	3/4"

Chisels

Part #	Type	Size
KT173012	Flat Chisel	3/8"
KT173016	Flat Chisel	1/2"
KT173020	Flat Chisel	5/8"
KT173024	Flat Chisel	3/4"
KT173028	Flat Chisel	7/8"

LIFETIME WARRANTY*

KT172505

5-Piece File Set

Sets includes: 6" mill file; 10" mill file; 8" bastard file; 8" half-round file; and 8" round file.

Set includes (also available individually):

KT172512 - 6" mill file

KT172514 - 10" mill file

KT172523 - 8" bastard file

KT172543 - 8" half-round file

KT172553 - 8" round file



Wrenches | Combination Non-Ratcheting



KT41300

9-Piece

Wrench Set High Polish

Fractional 3/8" to 7/8"

- High-polish, smooth-finish, heat-treated chrome vanadium steel
- Tools are longer than standard combination wrenches to enable access to hard-to-reach places
- Wrenches sized from 3/8"-7/8"
- Packaged in kit bag. Available individually



LIFETIME WARRANTY*



KT41304

14-Piece Wrench Set

High Polish Fractional 3/8" to 1-1/4"

- Features high-polish, smooth-finish, heat-treated chrome vanadium steel
- Tools are longer than standard combination wrenches to enable access to hard-to-reach places
- Wrenches sized from 3/8"-1-1/4"
- Packaged in kit bag. Available individually.



LIFETIME WARRANTY*

Wrenches | **Combination Non-Ratcheting**



KTI41305

24-Piece

High Polish Combination Wrench Set

- Professional Series Fractional Wrench Set
- High-polish, smooth-finish, heat-treated chrome-vanadium steel
- Heavy duty pocketed roll pouch with two velcro bands
- Wrench sizes: 1/4", 5/16", 11/32", 3/8", 7/16", 1/2", 9/16", 5/8", 11/16", 3/4", 13/16", 7/8", 15/16", 1", 1-1/16", 1-1/8", 1-3/16", 1-1/4", 1-5/16", 1-3/8", 1-7/16", 1-1/2", 1-9/16" and 1-5/8"



KTI41301

12-Piece Combination Wrench Set

Set includes sizes: 5/16", 3/8", 7/16", 1/2", 9/16", 5/8", 11/16", 3/4", 13/16", 7/8", 15/16" & 1"



Raised Panel Metric Wrenches 12-point

- Made of drop forged steel, wrench is chrome-plated and heat-treated to achieve maximum wear
- A raised panel provides additional strength and durability
- All wrenches are marked with part number and size for ease of identification

Sold separately:	KTI41611 - 11mm	KTI41616 - 16mm
KTI41607 - 7mm	KTI41612 - 12mm	KTI41617 - 17mm
KTI41608 - 8mm	KTI41613 - 13mm	KTI41618 - 18mm
KTI41609 - 9mm	KTI41614 - 14mm	KTI41619 - 19mm
KTI41610 - 10mm	KTI41615 - 15mm	



KTI41800

13-Piece Professional Combination Wrench Set

High Polish Metric 7mm to 19mm

- Features high-polish, smooth-finish, heat-treated chrome vanadium steel
- Tools are longer than standard combination wrenches to enable access to hard-to-reach places
- Wrenches sized from 7mm-19mm.
- Packaged in kit bag. Available individually.



KTI41802

8-Piece Professional Combination Wrench Set

High Polish Metric 29mm to 36mm

- Features high-polish, smooth-finish, heat-treated chrome vanadium steel
- Tools are longer than standard combination wrenches to enable access to hard-to-reach places
- Wrenches sized from 29mm through 36mm. Available individually



KTI41200

7-Piece

Combination Wrench Set Fractional Short 3/8" to 3/4"

- High polish chrome vanadium steel
- Heat treated
- 12 point on box end
- Packaged in a plastic tray



Includes sizes: 3/8", 7/16", 1/2", 9/16", 5/8", 11/16", and 3/4" wrenches.

HAND TOOLS

Wrenches | Combination Non-Ratcheting



KT141801 9-Piece Professional Combination Wrench Set High Polish Metric 20mm to 28mm

- Features high-polish, smooth-finish, heat-treated chrome vanadium steel
- Tools are longer than standard combination wrenches to enable access to hard-to-reach places
- Wrenches sized from 20mm through 28mm.
- Also available individually.



KT141700 7-Piece Combination Wrench Set Metric Short 10mm to 18mm

- High polish, smooth-finish, heat-treated chrome vanadium steel
 - 12 point hex on box end
 - Packaged in a plastic tray
- Sizes include: 10mm, 12mm, 13mm, 14mm, 15mm, 17mm, and 18mm wrenches



Open-end High Polish Wrenches

- Professional series fractional wrenches features high-polish, smooth-finish, heat-treated chrome vanadium steel.

Sold separately:

Fractional:

KT142316 - 1/2" x 9/16"

KT142318 - 9/16" x 5/8"

KT142320 - 5/8" x 3/4"

KT142348 - 1-1/2" x 1-5/8"



Metric:

KT142818 - 16mm x 18mmv



KT141011 11-Piece Combination Wrench Set Raised Panel Fractional 3/8" to 1"

- Made of drop forged steel, wrenches are chrome-plated and heat-treated to achieve maximum wear
 - A raised panel provides additional strength and durability
 - Packaged in kit bag organizer. Available individually.
- Includes sizes 3/8", 7/16", 1/2", 9/16", 5/8", 11/16", 3/4", 13/16", 7/8", 15/16" and 1"



KT141013 13-Piece Combination Wrench Set Raised Panel Fractional 1/4" to 1"

- Made of drop forged steel, wrenches are chrome-plated and heat-treated to achieve maximum wear
 - A raised panel provides additional strength and durability
 - Packaged in heavy duty kit bag organizer. Available individually.
- Includes sizes 1/4", 5/16", 3/8", 7/16", 1/2", 9/16", 5/8", 11/16", 3/4", 13/16", 7/8", 15/16" and 1"

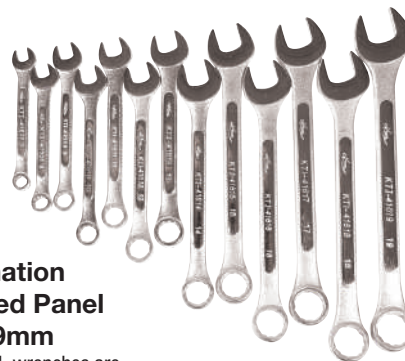

KT141513 13-Piece Combination Wrench Set Raised Panel Metric 7mm to 19mm

- Made of drop forged steel, wrenches are chrome-plated and heat-treated to achieve maximum wear
 - A raised panel provides additional strength and durability
 - Packaged in kit bag organizer. Available individually.
- Thirteen-piece metric set includes sizes 7mm, 8mm, 9mm, 10mm, 11mm, 12mm, 13mm, 14mm, 15mm, 16mm, 17mm, 18mm and 19mm

Wrenches | **Combination Non-Ratcheting**



KTI41014 14-Piece Combination Wrench Set Raised Panel Fractional 3/8" to 1-1/4"

- Made of drop forged steel, wrenches are chrome-plated and heat-treated to achieve maximum wear
 - A raised panel provides additional strength and durability
 - Packaged in kit bag organizer. Available individually.
- Includes sizes 3/8", 7/16", 1/2", 9/16", 5/8", 11/16", 3/4", 13/16", 7/8", 15/16", 1", 1-1/16", 1-1/8" and 1-1/4"



KTI41016 16-Piece Combination Wrench Set Raised Panel Fractional 1/4" to 1-1/4"

- Made of drop forged steel, wrenches are chrome-plated and heat-treated to achieve maximum wear
 - A raised panel provides additional strength and durability
 - Packaged in kit bag organizer. Available individually.
- Includes sizes 1/4", 5/16", 3/8", 7/16", 1/2", 9/16", 5/8", 11/16", 3/4", 13/16", 7/8", 15/16", 1", 1-1/16", 1-1/8" and 1-1/4"



KTI41004 4-Piece Jumbo Wrench Set Raised Panel Fractional 2-1/8" to 2-1/2"

- KTI's jumbo wrenches, made of drop forged steel, are chrome-plated and heat-treated to achieve maximum wear
 - A raised panel provides additional strength and durability
 - Jumbo wrenches are designed specifically to meet the needs of the professional who services heavy-duty trucks, tractors and commercial equipment
- Includes sizes 2-1/8", 2-1/4", 2-3/8", 2-1/2". Available individually.

Jumbo Wrenches			
Size	Standard	Size	Standard
1-5/16"	KTI41142	1-7/8"	KTI41160
1-3/8"	KTI41144	2"	KTI41164
1-7/16"	KTI41146	2-1/8"	KTI41168
1-1/2"	KTI41148	2-1/4"	KTI41172
1-5/8"	KTI41152	2-3/8"	KTI41176
1-3/4"	KTI41156	2-1/2"	KTI41180
1-13/16"	KTI41158		



KTI41006 6-Piece Jumbo Wrench Set Raised Panel Fractional 1-3/8" to 2"

- Jumbo wrenches, made of drop forged steel, are chrome-plated and heat-treated to achieve maximum wear
 - A raised panel provides additional strength and durability
 - Jumbo wrenches are designed specifically to meet the needs of the professional who services heavy-duty trucks, tractors and commercial equipment
- Includes sizes 1-3/8", 1-1/2", 1-5/8", 1-3/4", 1-7/8", 2"

HAND TOOLS

Wrenches | Combination Non-Ratcheting

Full Polish Chrome Wrenches					
Fractional			Metric		
	Standard	Stubby		Standard	Stubby
Size	12 pt	12 pt	Size	12 pt	12 pt
1/4"	KTI41308		7mm	KTI41807	
5/16"	KTI41310		8mm	KTI41808	KTI41708
11/32"	KTI41311		9mm	KTI41809	
3/8"	KTI41312	KTI41212	10mm	KTI41810	KTI41710
7/16"	KTI41314	KTI41214	11mm	KTI41811	
1/2"	KTI41316	KTI41216	12mm	KTI41812	KTI41712
9/16"	KTI41318	KTI41218	13mm	KTI41813	KTI41713
5/8"	KTI41320	KTI41220	14mm	KTI41814	KTI41714
11/16"	KTI41322	KTI41222	15mm	KTI41815	KTI41715
3/4"	KTI41324	KTI41224	16mm	KTI41816	
13/16"	KTI41326		17mm	KTI41817	KTI41717
7/8"	KTI41328		18mm	KTI41818	KTI41718
15/16"	KTI41330		19mm	KTI41819	
1"	KTI41332		20mm	KTI41820	
1-1/16"	KTI41334		21mm	KTI41821	
1-1/8"	KTI41336		22mm	KTI41822	
1-3/16"	KTI41338		23mm	KTI41823	
1-1/4"	KTI41340		24mm	KTI41824	
1-5/16"	KTI41342		25mm	KTI41825	
1-3/8"	KTI41344		26mm	KTI41826	
1-7/16"	KTI41346		27mm	KTI41827	
1-1/2"	KTI41348		28mm	KTI41828	
1-9/16"	KTI41350		29mm	KTI41829	
1-5/8"	KTI41352		30mm	KTI41830	
2-1/4"	KTI41372		31mm	KTI41831	
			32mm	KTI41832	
			33mm	KTI41833	
			34mm	KTI41834	
			35mm	KTI41835	
			36mm	KTI41836	

Raised Panel Combination Wrenches				
Fractional			Metric	
Size	6 pt	12 pt	Size	12 pt
1/4"		KTI41108	6mm	KTI41807
5/16"		KTI41110	7mm	KTI41808
3/8"	KTI41412	KTI41112	8mm	KTI41809
7/16"	KTI41414	KTI41114	9mm	KTI41810
1/2"	KTI41416	KTI41116	10mm	KTI41811
9/16"	KTI41418	KTI41118	11mm	KTI41812
5/8"	KTI41420	KTI41120	12mm	KTI41813
11/16"	KTI41422	KTI41122	13mm	KTI41814
3/4"	KTI41424	KTI41124	14mm	KTI41815
13/16"		KTI41126	15mm	KTI41816
7/8"		KTI41128	16mm	KTI41817
15/16"		KTI41130	17mm	KTI41818
1"		KTI41132	18mm	KTI41819
1-1/16"		KTI41134	19mm	KTI41820
1-1/8"		KTI41136	20mm	KTI41821
1-1/4"		KTI41140	21mm	KTI41822
			22mm	KTI41823
			23mm	KTI41824
			24mm	KTI41825
			25mm	KTI41826
			26mm	KTI41827
			27mm	KTI41828
			28mm	KTI41829
			29mm	KTI41830
			30mm	KTI41831
			31mm	KTI41832
			32mm	KTI41833
			33mm	KTI41834
			34mm	KTI41835
			35mm	KTI41836



Wrenches | **Combination Non-Ratcheting**



LIFETIME WARRANTY*

Flare Nut Wrenches Fractional

- Made of heat-treated steel
- Each socket is marked with size for ease of use
- Ideal for gas, brake and air conditioning lines, flare wrenches provide more power and torque where needed
- High-polished, heat-treated chrome vanadium
- Lifetime warranty

Sold separately:

KTI44412 - 3/8" x 7/16"
KTI44420 - 5/8" x 11/16"

KTI44416 - 1/2" x 9/16"



KTI44003

3-Piece Wrench Flare Nut Wrench Set SAE

- Ideal for gas, brake and air conditioning lines, flare wrenches provide more power and torque where needed
- High-polished, heat-treated chrome vanadium steel
- Available individually

Includes double-ended wrenches sized 3/8" x 7/16", 1/2" x 9/16" and 5/8" x 11/16"

KTI44500

3-Piece Flare Nut Wrench Set Metric

Includes double-ended wrenches sized 10mm x 12mm, 13mm x 14mm and 15mm x 17mm. Available individually.

Sold separately:

KTI44910 - 10mm x 12mm
KTI44917 - 15mm x 17mm

KTI44913 - 13mm x 14mm



LIFETIME WARRANTY*



KTI22300

8-Piece Fractional Flare Nut Crowfoot Wrench Set 3/8" Drive

LIFETIME WARRANTY*

- Used for air conditioning, fuel and hydraulic line fittings
- Heat treated, carded with socket rail. Available individually.

Set includes (also available individually):

KTI22312 - 3/8"
KTI22314 - 7/16"
KTI22316 - 1/2"
KTI22318 - 9/16"

KTI22320 - 5/8"
KTI22322 - 11/16"
KTI22324 - 3/4"
KTI22328 - 7/8"



KTI27300

10-Piece Metric Flare Nut Crowfoot Wrench Set 3/8" Drive

- Used for air conditioning, fuel and hydraulic line fittings
- Heat treated, carded with socket rail. Available individually.

Set includes (also available individually):

KTI27310 - 10mm
KTI27311 - 11mm
KTI27312 - 12mm
KTI27313 - 13mm
KTI27314 - 14mm

LIFETIME WARRANTY*

KTI27315 - 15mm
KTI27316 - 16mm
KTI27317 - 17mm
KTI27318 - 18mm
KTI27319 - 19mm



HAND TOOLS

Wrenches | Combination Non-Ratcheting



Adjustable Wrenches

- Manufactured with drop-forged, heat-treated alloy steel for maximum strength and light weight. Chrome plated.

LIFETIME WARRANTY*

Sold separately:

- KTI48004** - 4" jaw capacity: 1/2"
- KTI48006** - 6" jaw capacity: 3/4"
- KTI48008** - 8" jaw capacity: 1"
- KTI48010** - 10" jaw capacity: 1-13/16"
- KTI48012** - 12" jaw capacity: 1-1/2"
- KTI48015** - 15" jaw capacity: 1-7/8"
- KTI48018** - 18" jaw capacity: 2-1/4"
- KTI48008T** - 8" jaw capacity: 1/2"
- KTI48012T** - 12" jaw capacity: 1-1/2"
- KTI48018T** - 18" jaw capacity: 2-1/4"

KTI48012BTW

12" Adjustable Wrench Black Finish

- Chrome vanadium drop forged steel
- Adjustable opening to 1-1/2"
- Length 12"
- Black finish



LIFETIME WARRANTY*

KTI48004T

4" Adjustable Wrench

- 1/2" jaw capacity
- Drop-forged, heat-treated alloy steel for maximum strength and light weight
- Chrome Vanadium steel



LIFETIME WARRANTY*



LIFETIME WARRANTY*

Aluminum Pipe Wrenches

- Weighs 40% less than its cast iron counterpart - a lighter tool is easier to handle and causes less hand fatigue and arm stress
- Features strong hardened jaws, nuts and teeth, and drop forged steel jaws
- A versatile head design provides a flat surface for hammering

Sold separately:

- KTI49112** - 12" jaw capacity: 2-1/4"
- KTI49114** - 14" jaw capacity: 2-5/8"
- KTI49118** - 18" jaw capacity: 3-1/4"
- KTI49124** - 24" jaw capacity: 3-1/2"
- KTI49136** - 36" jaw capacity: 4"



KTI49000

4-Piece Pipe Wrench Set

- Strong, durable and versatile cast iron with drop forged steel jaws
 - Perfect for a variety of applications
- Includes 8", 10", 14" and 18" pipe wrenches

Sold separately:

- KTI49008** - 8" jaw capacity: 1-1/2"
- KTI49010** - 10" jaw capacity: 1-7/8"
- KTI49014** - 14" jaw capacity: 1-1/2"
- KTI49018** - 18" jaw capacity: 3"

LIFETIME WARRANTY*



LIFETIME WARRANTY*

Pipe Wrenches

- Constructed from the highest grade cast iron, forged and heat-treated to ensure maximum durability
- Tough red enamel finish. Tool is strong and versatile

Sold separately:

- KTI49012** - 12" jaw capacity: 2-3/8"
- KTI49024** - 24" jaw capacity: 1-1/2"
- KTI49036** - 36" jaw capacity: 3-1/2"



KTI49309

9" Auto Wrench (Monkey Wrench)

- Auto wrench (monkey wrench)
- 9" Length
- Adjustable opening to 2-1/2"
- Black Oxide

LIFETIME WARRANTY*



KTI49315

15" Auto Wrench (Monkey Wrench)

- 15" Length
- Adjustable opening to 3-1/4"
- Black Oxide

LIFETIME WARRANTY*



K TOOL
INTERNATIONAL
KTI-49124



PROFESSIONAL TOOLS & EQUIPMENT

HAND TOOLS

Wrenches | Combination Ratcheting



KTI45400 7-Piece Ratcheting Wrench Set Fractional 5/16" to 3/4"



- Ratcheting box end needs as little as 5 degrees to move fastener
 - Designed to reduce fastener rounding
 - Wrenches feature a sleek head design for tight access points and all metal construction for durability and strength
- Includes sizes 5/16, 3/8", 7/16", 1/2", 9/16", 5/8" and 3/4"

KTI45500 7-Piece Ratcheting Wrench Set Metric 8mm - 18mm



Includes sizes 8mm, 10mm, 12mm, 13mm, 14mm, 15mm and 18mm.



KTI45600 16-Piece Reversible Ratcheting Wrench Set Metric 8mm - 24mm

- Enjoy the speed of a ratchet with the accessibility of a wrench in this version with a reversing mechanism
- Ratcheting box end needs as little as 5 degrees to move fastener
- Reduce fastener rounding
- Wrenches feature a sleek head design for tight access points and all metal construction for durability and strength

Includes sizes 8mm, 9mm, 10mm, 11mm, 12mm, 13mm, 14mm, 15mm, 16mm, 17mm, 18mm, 19mm, 20mm, 21mm, 22mm, 24mm,



KTI45601 12-Piece Reversible Ratcheting Metric Wrench Set

Includes: 8mm - 19mm



KTI45602 7-Piece Reversible Ratcheting Metric Wrench Set

Includes: 8mm - 18mm



Ratcheting Wrenches - Combination				
	Fractional		Metric	
	Standard	Stubby	Standard	Standard
Size	12 pt	12 pt	Size	12 pt
5/16"	KTI45410		8mm	KTI45508
3/8"	KTI45412		10mm	KTI45510
7/16"	KTI45414		12mm	KTI45512
1/2"	KTI45416		13mm	KTI45513
9/16"	KTI45418	KTI45318	14mm	KTI45514
5/8"	KTI45420		15mm	KTI45515
3/4"	KTI45424		18mm	KTI45518

Wrenches | Combination Ratcheting



KTI45900 13-Piece Reversible Ratcheting Wrench Set Fractional 1/4" to 1"

- Enjoy the speed of a ratchet with the accessibility of a wrench in this version with a reversing mechanism
 - Ratcheting box end needs as little as 5 degrees to move fastener
 - Reduce fastener rounding
 - Wrenches feature a sleek head design for tight access points and all metal construction for durability and strength
- Includes sizes 1/4", 5/16, 3/8", 7/16", 1/2", 9/16", 5/8", 11/16", 3/4", 13/16", 7/8", 15/16" and 1".



KTI45901 9 Piece Reversible Ratcheting SAE Wrench Set

- Ratcheting box end needs as little as 5° to move fastener
 - Reduce fastener rounding
 - Wrenches feature a sleek head design for tight access points and all metal construction for durability and strength
- Includes: 1/4" - 3/4"



KTI45902 7 Piece Reversible Ratcheting SAE Wrench Set

- All metal construction for durability and strength
- Ratcheting box end needs as little as 5° to move fastener
- Designed to reduce fastener rounding
- Sleek head design for tight access points



Set includes: 5/16", 3/8", 7/16", 1/2", 9/16", 5/8" and 3/4"



Ratcheting Wrenches - Reversible			
Fractional		Metric	
Standard		Standard	
Size	12 pt	Size	12 pt
1/4"	KTI45908	8mm	KTI45608
5/16"	KTI45910	9mm	KTI45609
3/8"	KTI45912	10mm	KTI45610
7/16"	KTI45914	11mm	KTI45611
1/2"	KTI45916	12mm	KTI45612
9/16"	KTI45918	13mm	KTI45613
5/8"	KTI45920	14mm	KTI45614
11/16"	KTI45922	15mm	KTI45615
3/4"	KTI45924	16mm	KTI45616
13/16"	KTI45926	17mm	KTI45617
7/8"	KTI45928	18mm	KTI45618
15/16"	KTI45930	19mm	KTI45619
1"	KTI45932	20mm	KTI45620
		21mm	KTI45621
		22mm	KTI45622
		24mm	KTI45624



Ratcheting Box Wrenches Fractional

- Combines the ratcheting action of a socket with the low profile of a box wrench, making those hard to reach jobs quick and easy



12 PT

Sold separately:

KTI45208 - 1/4" x 5/16"

KTI45212 - 3/8" x 7/16"

KTI45216 - 1/2" x 9/16"

KTI45220 - 5/8" x 3/4"

HAND TOOLS

Wrenches | Combination Ratcheting



KTI43500

5-Piece Metric

X-Long Double Box Ratcheting

Flexible Reversible Spline Wrench Set

- These extra-long, flexible and reversible double box ratcheting wrenches are forged of chrome-vanadium steel and heat-treated for durability
 - Wrenches in this 5-piece set feature a 72-tooth design with a high polish finish and are nearly 40% longer
 - Ratcheting box end needs as little as 5 degrees to move fastener
 - Sleek head design and slim dimensions further ease of working in confined areas
- Includes the following metric sizes: 8mm x 10mm, 12mm x 13mm, 14mm x 15mm, 16mm x 18mm and 17mm x 19mm. Packaged in a blow-molded case.



KTI43100

4-Piece Fractional

X-Long Double Box Ratcheting

Flexible Reversible Spline Wrench Set

- These extra-long, flexible and reversible double box ratcheting wrenches are forged of chrome vanadium steel and heat-treated for durability
 - Wrenches in this 4-piece set feature a 72-tooth design with a high-polish finish and are nearly 40% longer
 - Ratcheting box end needs as little as 5 degrees to move fastener
 - Sleek head design and slim dimensions further ease of working in confined areas
 - Packaged in a blow-molded case
- Includes sizes: 5/16" x 3/8", 7/16" x 1/2", 9/16" x 5/8" and 11/16" x 3/4"



Ratcheting Wrenches - Double Box	
Size	Extra Long Flex
5/16"	KTI43112 - (5/16" x 3/8")
7/16"	KTI43116 - (7/16" x 1/2")
9/16"	KTI43120 - (9/16" x 5/8")
11/16"	KTI43124 - (11/16" x 3/4")



X-Long Double Box

Ratcheting / Flexible / Reversible Spline

Metric Wrenches

- This extra-long, flexible and reversible double box ratcheting wrench is forged of chrome vanadium steel and heat-treated for durability
- It features a 72-tooth design with a high-polish finish and is nearly 40% longer
- Ratcheting box end needs as little as 5 degrees to move fastener
- Sleek head design and slim dimensions further ease of working in confined areas

Sold separately:

KTI43510 - 8mm x 10mm

KTI43513 - 12mm x 13mm

KTI43515 - 14mm x 15mm

KTI43518 - 16mm x 18mm

KTI43519 - 17mm x 19mm



Ratcheting-style Torque Wrenches

- Ratcheting style torque wrench “clicks” when proper torque is achieved.
- Accuracy: $\pm 4\%$. Works in clockwise direction
- Packaged in blow-molded case

KTI72117	30-150 in./lbs.	1/4" drive	7-3/4" length
KTI72100	20-200 in./lbs.	3/8" drive	11" length
KTI72101	10-150 ft./lbs.	1/2" drive	18" length
KTI72102	25-250 ft./lbs.	1/2" drive	25" length
KTI72175	100-600 ft./lbs.	3/4" drive	42" length

Warranty information:
90-day limited warranty. Repairable item.
Half-price replacement option after 90-days.

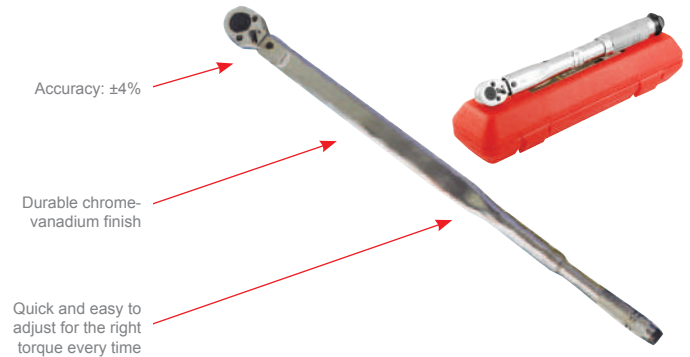

Micrometer-style Adjustable Torque Wrenches - U.S.-made



- Dual scale, calibrated dual direction
- Positive lock with spring loaded pull down lock ring
- Fast, accurate and easy to set with ergonomic comfort-grip
- Easy-to-read laser marked scales
- Individually serialized with matching certificate of calibration traceable to N.I.S.T.
- Most feature quick release buttons which provide good socket retention as well as easy socket removal (except KTI72176A)
- Each comes in a blow molded case
- Accuracy: $\pm 4\%$ clockwise $\pm 6\%$ CCW of indicated value, CW, from 20% to 100% of full scale
- Meets or exceeds ASME B107.14M-1994, ISO 6789 Standards
- Covered by a 1-Year limited warranty

KTI72118A	20-150 in./lbs.	1/4" drive	10" length
KTI72120A	30-250 in./lbs.	3/8" drive	11.2" length
KTI72121A	10-100 ft./lbs.	3/8" drive	16" length
KTI72125A	20-150 ft./lbs.	1/2" drive	19" length
KTI72126A	30-250 ft./lbs.	1/2" drive	24.5" length
KTI72176A	100-600 ft./lbs.	3/4" drive	41" length



Micrometer-style Adjustable Torque Wrenches

- Achieve the proper torque with KTI's click-style torque wrenches
- Torque wrenches are extremely accurate and easy-to-use: Simply adjust the torque specification on the wrench by releasing the red knob and turning the handle of the torque wrench while holding the shaft of the torque wrench
- Torque wrenches feature a ball detent socket retainer with push-button release for quick socket changes
- Works in clockwise and counter-clockwise directions
- Accuracy: $\pm 4\sim 6\%$
- Packaged in a blow-molded case

KTI72140	50-250 in./lbs.	3/8" drive	8-3/4" length
KTI72143	10-100 ft./lbs.	3/8" drive	16-1/4" length
KTI72141	30-150 ft./lbs.	1/2" drive	18-3/4" length
KTI72142	30-250 ft./lbs.	1/2" drive	21-1/2" length
KTI72145	100-600 ft./lbs.	3/4" drive	39" length

Warranty information:
90-day limited warranty. Repairable item.
Half-price replacement option after 90-days.

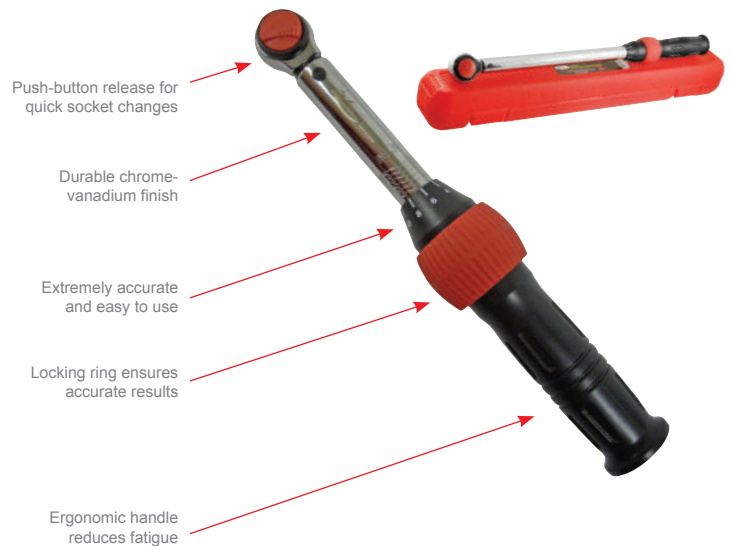

HAND TOOLS



KT172149 Torque Wrench 3/8" Drive 150-750 in./lbs

- 3/8" drive ratcheting torque wrench
- 150 - 750 in./lbs. in 5 lb increments
- Calibration certificate included
- Comes in a black blow-mold case
- 90-day limited warranty



Digital Torque Wrenches

- Eliminates the possibility of human error with a series of lights and alarms that immediately alert the user to torque readings that are "over or under" entered values
- Easy to use, exceedingly accurate (plus/minus 1 percent CW, plus/minus 2 % CCW)
- High contrast, backlit LCD screen display, users press only four buttons to operate the tool: power on/off; unit of measurement (ft./lbs., in./lbs., N-m); torque target up; and torque target down.
- Technicians can quickly switch among three types of measurement, eliminating the need to have three separate tools
- The wrench boasts a non-slip grip, a rugged, durable housing, a 36-tooth gear and a lever-type ratchet to ease directional switching
- Estimated battery life: 110 hours
- Blow-molded case

KT172130	10-100 ft./lbs.	3/8" drive	16-1/4" length
KT172133	14.8-73.8 ft./lbs.	3/8" drive	15" length
KT172132	20-250 ft./lbs.	1/2" drive	25" length
KT172134	29.5-147.5 ft./lbs.	1/2" drive	19-1/16" length
KT172135	25-250 ft./lbs.	1/2" drive	22-1/4" length

Warranty information:

1-year warranty. Repair or replace at discretion of repair center.

KT172138 Digital Torque Adaptor 1/2" Drive

- Use with 1/2" drive ratchet
- Static torque measurement
- Three standard functions: torque setting, measurement setting and mode setting
- Operates in clockwise and counter-clockwise directions
- Torque range is 29.5 - 147.5 ft-lbs
- Digital torque adaptor turns a regular ratchet into a digital ratchet
- Tool length: 3". Comes in a black blow-mold storage case



Warranty information: 1-year warranty.



KT172190 Torque Multiplier

- Converts low torque into high torque, reducing amount of strength required to loosen or tighten when using only a torque wrench
 - Input Square: 3/4" drive and Output Square: 1" drive
 - Input: 730 ft-lbs. (1000 NM) and Output: 2200 ft-lbs. (3000 NM)
 - Increases range of torque 3:1
 - Tool length: 19.500", body length 6.500", reaction bar length: 15.625", head width: 3.750", female depth: .750", male depth: 1.125", head depth from female to male: 4.500"
 - Comes in a convenient plastic, blow-molded carrying/storage case
- 1-year warranty.

KT149400 Universal Drum Bung Wrench, Bronze Non-Sparking

- Universal drum bung wrench
- Manufactured of bronze alloy
- Non-sparking for flammable materials
- Fits all types of industrial drum nut plugs and bungs in metal and plastic
- Corrosion resistant

**LIFETIME
WARRANTY***



KT149405 Universal Drum Plug Bung Wrench, Ductile Iron

- Universal drum plug bung wrench
- Manufactured of ductile iron
- One-piece construction for long-lasting and durability
- Use to open and close all steel and plastic hex-head and round-head bung nut plugs
- Corrosion resistant

**LIFETIME
WARRANTY***





LIFETIME WARRANTY*

KTI71771
13 oz. Fiberglass Claw Hammer

- Fiberglass handle and rubber grip

Solid Brass Hammers

- Non-sparking brass hammer prevents damage to delicate parts

Sold separately:

KTI71782 - 27oz., 1-1/16" head diameter

KTI71783 - 48oz., 1-1/4" head diameter



LIFETIME WARRANTY*



LIFETIME WARRANTY*

Brass Hammers with Hickory Handles

- Non-sparking brass hammer prevents damage to delicate parts

Sold separately:

KTI71714 - 16oz., 1-1/4" head diameter

KTI71715 - 24oz., 1-1/4" head diameter

KTI71733 - 32oz., 1-1/2" head diameter

KTI71700
Impact Driver
with 4-Piece Bit Set
3/8" Drive

- A 3/8" driver with four (4) 5/16" hex bits (small slotted, large slotted, #2 Phillips and #3 Phillips) for loosening rusted screws, nuts and bolts
- Packaged in a metal box

Bits also available individually:

KTI18801 - Small Slotted Bit

KTI18802 - Large Slotted Bit

KTI18702 - #2 Phillips Bit

KTI18703 - #3 Phillips Bit



LIFETIME WARRANTY*



KTI71751
Rubber Mallet 24oz.

- Non-marking rubber mallet

LIFETIME WARRANTY*



Ball Pein Hammers

- Hammer features drop forged, heat-treated steel head and fiberglass handle for strength and reliability
- Tool boasts contoured, nonslip rubber grip for user comfort

Sold separately:

KTI71708 - 8oz.

KTI71725 - 24oz.

KTI71716 - 16oz.

KTI71732 - 32oz.

LIFETIME WARRANTY*



LIFETIME WARRANTY*

KTI71704
4 oz Ball Pein Hammer

- Fiberglass handle and rubber grip



KTI71724
4lb. Cross Pein Hammer

- Fiberglass handle and rubber grip. Overall length: 15-1/4"

LIFETIME WARRANTY*



HEAVYWEIGHT QUALITY. KNOCKOUT PRICE.

KT123308

Bit Holder 1/2 drive

- 1/4" Hex Male to 1/2" Male Square Drive



KT118000

12 Piece Bit Set

- 12 Piece Bit set includes: Slotted 1/8", 5/32", 3/16", 1/4"; Phillips #0, #1, #2, #3, Torx T-10, T-15, T-20, T-25
- All packaged in convenient organizer case



KT118007

Bit holder, Interior Clip

1/4" Drive x 1/4" Hex Female

- Chrome plating finish



LIFETIME WARRANTY*

KT118013

Bit Holder, Exterior Clip

3/8" Drive x 1/4" Hex Female

- Chrome plating finish



LIFETIME WARRANTY*

KT118014

Bit Holder, Exterior Clip

3/8" Drive x 5/16" Hex Female

- Chrome plating finish



LIFETIME WARRANTY*

KT122914

3/8" Drive Hex Bit

9/64" x 1" Length

- Hex bit socket made of chrome vanadium steel
- Heat treated for durability



LIFETIME WARRANTY*

KT118992

#2 Phillips Power Bit, 2" Long 1/4" Shank

LIFETIME WARRANTY*

Groove Joint Pliers

- Can be adjusted to grip or turn objects
- Ideal for grasping nuts or pipe
- Manufactured from chrome vanadium steel with chrome finish
- Ergonomic vinyl handle for user comfort
- Available in three sizes



Sold separately:

KT154006 - 6"

KT154010 - 10"

KT154012 - 12"

LIFETIME WARRANTY*

KT153006T

Slip Joint Pliers 6" Long



LIFETIME WARRANTY*

Slip Joint Pliers

- Designed for gripping and turning round objects
- Manufactured from chrome vanadium steel with chrome finish
- Ergonomic vinyl handle for user comfort
- Available in three sizes



Sold separately:

KT153004 - 4"

KT153006 - 6"

KT153008 - 8"

LIFETIME WARRANTY*

KT151103

3-Piece

11" Needle Nose Plier Set

- These extra long needle nose pliers reach into even the tightest places
- Pliers manufactured with heat-treated chrome vanadium steel for long wear
- Tools feature soft comfort grip handles. Packaged in handy storage pouch
- Set includes 15° offset, 45° bent nose and 90° bent nose



Set includes (also available individually):

KT151111 - 90° bent nose

KT151211 - 45° offset

KT151311 - 15° offset

LIFETIME WARRANTY*

HAND TOOLS

Needle Nose Pliers

- Needle nose pliers reach into even the tightest places
- Tool features side cutter and non-slip vinyl grip
- Manufactured from heat-treated chrome vanadium for durability
- Each sold separately

Sold separately:

KTI51006 - 6"

KTI51206 - 6" bent end

KTI51007 - 7"

KTI51008 - 8"

**LIFETIME
WARRANTY***



KTI51006T Needle Nose Plier 6", with Side Cutter, Vinyl Grips

**LIFETIME
WARRANTY***

KTI58705 Locking Plier Curved Jaw 5"

- Curved-jaw pliers apply maximum torque for any application
- Manufactured from high-grade heat-treated alloy steel for strength and durability
- Hardened teeth provide superior grip at any angle
- Adjusting screw tightens to adjust pressure for a secure, firm grip every time
- Quick-release trigger. Overall length: 5". Meets or exceeds ANSI standards.



**LIFETIME
WARRANTY***

KTI58710 Locking Plier Curved Jaw 10"

- Curved-jaw pliers apply maximum torque for any application
- Manufactured from high-grade heat-treated alloy steel for strength and durability
- Hardened teeth provide superior grip at any angle
- Adjusting screw tightens to adjust pressure for a secure, firm grip every time
- Quick-release trigger. Overall length: 10". Meets or exceeds ANSI standards.

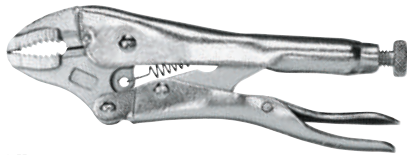

**LIFETIME
WARRANTY***

KTI58707 Locking Plier Curved Jaw 7"

- Curved-jaw pliers apply maximum torque for any application
- Manufactured from high-grade heat-treated alloy steel for strength and durability
- Hardened teeth provide superior grip at any angle
- Adjusting screw tightens to adjust pressure for a secure, firm grip every time
- Quick-release trigger. Overall length: 7". Meets or exceeds ANSI standards.



**LIFETIME
WARRANTY***

KTI58717 Locking Plier Straight Jaw 7"

- Straight-jaw pliers apply maximum torque for flat, square or hex applications
- Manufactured from high-grade heat-treated alloy steel for strength and durability
- Hardened teeth provide superior grip at any angle
- Adjusting screw tightens to adjust pressure for a secure, firm grip every time
- Quick-release trigger. Overall length: 7". Meets or exceeds ANSI standards.



**LIFETIME
WARRANTY***

KTI58809 Locking Welding Clamp Plier 9"

- Locking welding clamp features U-shaped jaws for improved visibility and less obstruction to work area
- Perfect for welding applications or securing awkward-shaped work pieces
- Manufactured from high-grade heat-treated alloy steel for strength and durability
- Superior grip to hold work pieces in proper alignment
- Adjusting screw tightens to adjust pressure for a secure, firm grip every time
- Quick-release trigger. Overall length: 9". Meets or exceeds ANSI standards.



**LIFETIME
WARRANTY***

KTI58811 Locking C-Clamp Plier 11"

- Locking C-clamp plier features wide-opening jaws to accommodate a variety of shapes and sizes for any application
- Manufactured from high-grade heat-treated alloy steel for strength and durability
- Adjusting screw tightens to adjust pressure for a secure, firm grip every time
- Quick-release trigger. Overall length: 11". Meets or exceeds ANSI standards.



**LIFETIME
WARRANTY***

KTI54055 Exhaust Grommet Pliers

- Heavy duty auto tool for removal of exhaust components from rubber-style hangers
- Self-locating forcing pin
- Cushioned slip-resistant handles
- 25° offset for easy access



**LIFETIME
WARRANTY***

KTI55112

12-Piece

Reversible Snap Ring Plier Set

- Set includes the four most popular tip sizes in straight, 45 and 90° angle configurations
- These versatile, heavy duty pliers are designed for the removal and installation of either internal or external snap rings on a wide range of applications
- Packaged in blow-molded case. Available individually.

Set includes (also available individually):

KTI55120 - straight tip .038

KTI55122 - straight tip .070

KTI55121 - straight tip .047

KTI55123 - straight tip .090

KTI55130 - 45° bent tip .038

KTI55132 - 45° bent tip .070

KTI55131 - 45° bent tip .047

KTI55133 - 45° bent tip .090

KTI55140 - 90° bent tip .038

KTI55142 - 90° bent tip .070

KTI55141 - 90° bent tip .047

KTI55143 - 90° bent tip .090



LIFETIME WARRANTY*

KTI55001

5-Piece

Reversible Snap Ring Plier Set

- Set includes: short straight small tip (2 pieces); long straight large tip; short 90 degree small tip; and long 90° large tip
- These versatile, heavy duty pliers are designed for the removal and installation of either internal or external snap rings on a wide range of applications
- Packaged in blow-molded case. Available individually.

Set includes (also available individually):

KTI55012 - short, straight small tip (2 pc.)

KTI55912 - short 90° small tip

KTI55034 - long, straight large tip

KTI55934 - long 90° large tip



LIFETIME WARRANTY*

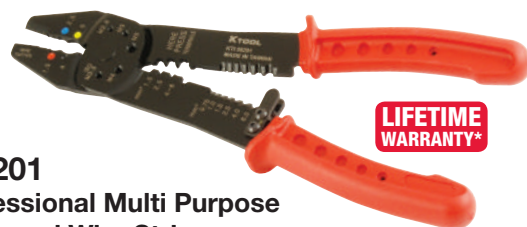

LIFETIME WARRANTY*

KTI56201

9" Professional Multi Purpose Crimper and Wire Stripper

- 9" Length
- Wire cutter, bolt cutter, and wire stripper in one
- Crimps insulated and open barrel terminals



KTI56207

9.75" Professional 8-in-1 Quick and Easy Wire Stripper

- 9.75" Length
- Wire cutter, bolt cutter, wire stripper, and bending wire
- Crimps insulated, non-insulated, and pin terminals

LIFETIME WARRANTY*



KTI56208

Self Adjusting Wire Stripper

- Automatically adjusts to the diameter of the wire
- Strips, cuts and crimps wire for solderless terminals
- Capacity range: 22 to 10 awg
- Curved back handle design with comfort grip
- Tool length: 10"

LIFETIME WARRANTY*



KTI56202

8.5" Professional Multi Purpose Crimper and Wire Stripper

- 8.5" Length
- 3.2mm thickness
- Wire cutter, bolt cutter, and wire stripper in one
- Crimps open barrel terminals

LIFETIME WARRANTY*

HAND TOOLS



KT156205

8.7" Ratcheting Terminal Crimper

- For insulated terminal
- Carbon steel head
- Polypropylene and thermoplastic rubber handle
- Tool capacity: Red 22-18 AWG, Blue 16-14 AWG, Yellow 12-10 AWG
- Adjusted by screwdriver

LIFETIME WARRANTY*



KT156203

Professional Crimping Tool - 0.5/1.5/2.5/4.0/6.0 MM2

- Crimps non-insulated terminals
- Easy to grip handles

LIFETIME WARRANTY*



KT156204

Professional Multipurpose Crimping and Wire Stripper - 1.5/2.5/6.0/10/16 MM2

- Crimps non-insulated terminals
- Easy to grip handles

LIFETIME WARRANTY*



KT156209

Wire Stripper / Crimper

- Can be used as wire stripper, machine screw cutter, wire cutter, insulated crimper or solderless terminal crimper.

LIFETIME WARRANTY*



KT152009

Heavy Duty Cable Cutters

- Heavy duty
- For use in cutting copper and aluminum
- 9-1/4" Length
- Jaws open to approximately 2"
- Do not use on steel wire or ACSR cable

LIFETIME WARRANTY*

Diagonal Cutters

- Manufactured from chrome vanadium steel
- Ergonomic handle for user comfort
- Available in three sizes

Sold separately:

KT152006 - 6"

KT152006T - 6"

KT152007 - 7"

KT152007T - 7"

KT152107 - 7" heavy-duty

LIFETIME WARRANTY*



KT154050

Cannon Plug Pliers

- Cannon plug pliers fit A-N electrical connectors from 3/4" to 2-1/2"
- Slip-joint design with 4 adjustment positions and dipping handle
- Soft, non-marring white nylon jaw inserts with serrations
- Jaw width: 3/8" and open capacity: 3/4" to approximately 2-1/2"
- Plier length: 10"

LIFETIME WARRANTY*



KT172380

8" Straight Cut Tin Snips

- One piece drop forged construction of high carbon steel
- Cushion handle with smooth, comfortable bows for ease in use and safety
- Designed for cutting straight and wide curves to the left or right
- Cuts up to .61mm cold rolled steel or .41mm stainless steel
- Cutting blades open to approximately 4" wide
- Induction hardened cutting edges 54-58 HRC

LIFETIME WARRANTY*



Clipper Side Cut



KT157324

24" Clipper Cut Bolt Cutters

- Cutting head is manufactured from chrome-vanadium steel
- Can be used for cutting chains, padlocks, bolts and wire mesh
- The clipper-cut style blades are flush against one face for cutting against flat surfaces

LIFETIME WARRANTY*



LIFETIME WARRANTY*

KTI59000

Auto Return Wire Twister Pliers 9"

- Includes an automatic spring return for quick and efficient operation
- Overall length of 8-3/4" and wire capacity of .041"
- Reversible action for left and right twists.
- Diagonal nose to reach tight areas on your aircraft or other machinery



LIFETIME WARRANTY*

KTI72644

Steel Folding Rule 3' Length

- Stainless steel folding rule
- Multiple folding joints every 6"
- Width: 19/32" (15mm) • Thickness: 0.6mm
- Etched with SAE measurements on one side

Tape Measure

- SAE and metric markings
- Blade material is spring-tempered steel
- Top lock for blade with automatic blade return
- Removable spring-tempered steel belt clip
- Lifetime warranty

- KTI72606 - 6' x 1/2"
- KTI72608 - 8' x 1/2"
- KTI72610 - 10' x 3/4"
- KTI72612 - 12' x 1/2"
- KTI72616 - 16' x 3/4"
- KTI72625 - 25' x 1"

LIFETIME WARRANTY*





TOOL STORAGE



Service Carts



KTI75146

4 Drawer Locking Service Cart

- 500 lb. load capacity
- Ball bearing drawer slides. Drawer liners for all drawers and trays
- 5 " Heavy-duty casters
- Side impact bumpers
- Gas shocks for lid
- Cart dimensions: 148 lbs, 35.2" length, 20.6" width, 40.3" height.
Top drawer depth (2) 3", Middle drawer depth 3", Bottom drawer depth 6"
- 1 Year Warranty on material and workmanship



KTI75105

One-Drawer Steel Service Tool Cart with 2 Lined Shelves

- Durable construction for rugged shop environments
- Sturdy, one-piece drawer handle. Cart provides ample storage.
- Large, fully-lined top and bottom storage trays to organize tools, shop accessories and parts for greater accessibility
- Fully-lined drawer with lock to securely store tools when not in use
- Four casters allow steady, quick movement; two casters feature easy-to-operate locking mechanism
- Warranty information: 1-year warranty



TOOL STORAGE

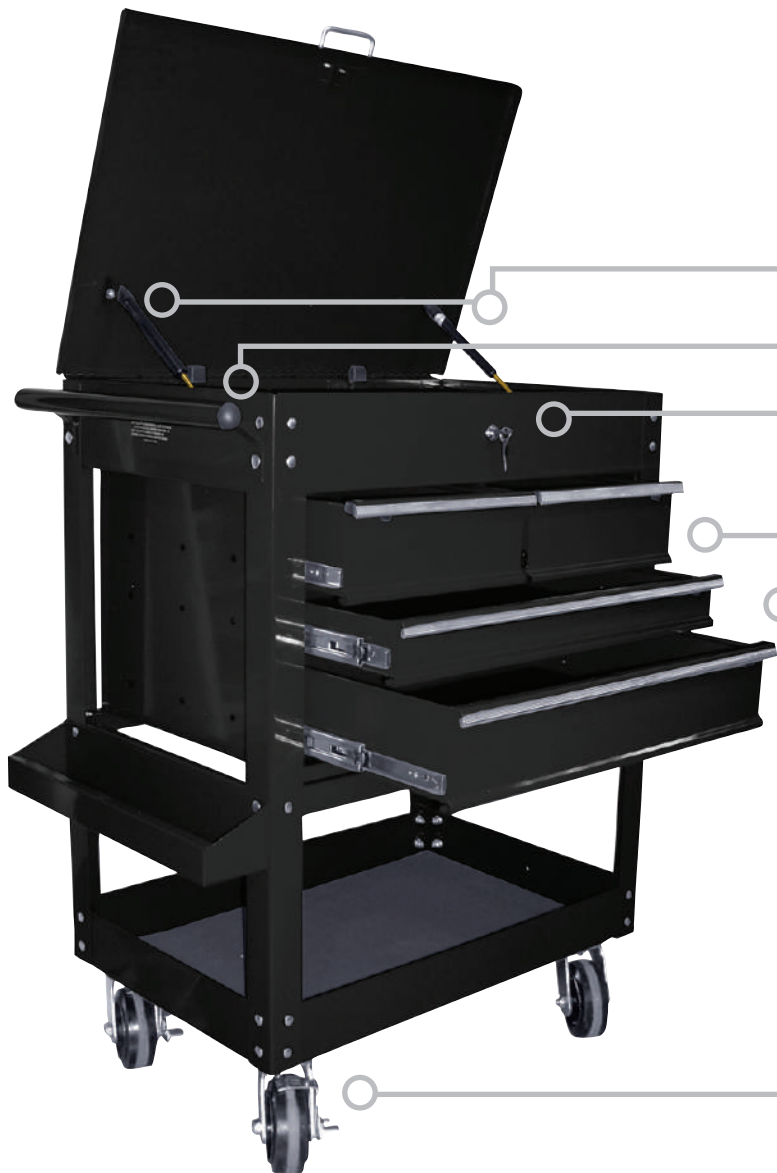

Two gas struts in lid for ease in opening or closing. Hinged lid opens completely for greater access to tools. Piano-style hinge for added durability.

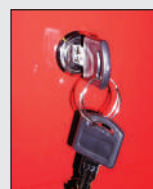

Top locking tray keeps tools safe and secure when not in use. Drawers will not function when top storage tray is closed.

Top drawer dimensions (each)
11-1/2" W x 16-7/8" D x 4-1/2" H

Middle drawer dimensions
24-1/2" W x 16-7/8" D x 2-1/2" H

Bottom drawer dimensions
24-1/2" W x 16-7/8" D x 4-1/2" H

4-drawer overall dimensions
39" W x 19-1/2" D x 41-1/4" H

Heavy-duty 5" x 2" casters. Two casters feature easy-to-operate locking mechanism to keep cart from rolling.



4-drawer Utility Carts

Part numbers:

KTI75140 - Red

KTI75141 - Blue

KTI75142 - Teal

KTI75143 - Yellow

KTI75145 - Black

Warranty info: 1-year warranty.



Features 22-slot screwdriver and/or prybar holder allowing handles to be stowed in top locking tray.

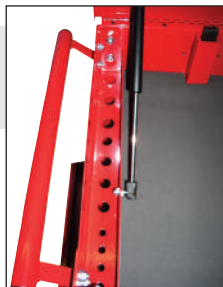

Store large-handle pry bars (up to 10") that won't fit in the top storage tray. Piano-style hinge folds down completely for easy access to pry bars, screwdrivers and other tools. Includes 22 slots and measures 18½" x 12" x 4".

Features side storage tray. Perfect for storage of tall items including aerosol cans.



Large drawers and trays to hold and organize tools. All drawers and trays include liners made of non-toxic EVA.



Drawers feature all steel ball bearing slides for smooth, quiet operation.



Keep drawers closed securely until needed. Easy, one-hand operation. Drawer locks can only be operated when top lid is open.

Large bottom storage tray. Extra storage for oversized items. Great for shop towels, gallon-size containers and other large shop accessories.



Service Carts | Parts & Accessories

KTI72451 Magnetic Tool Hanger for Air Impact - 20 lb. Capacity

- Effortlessly holds most pistol-type impact wrenches.
- Screw-hole design allow for easy mounting to nonferrous surface.
- Magnetic mount supports up to 20 lbs.

**LIFETIME
WARRANTY***



KTI72465 Magnetic Tool Holder Multipurpose 15 lb. Capacity

- Holds a variety of screwdrivers, pliers, sockets, wrenches, hammers and more
- Firmly attaches to metal surface
- Extends up to 20" wide
- Each socket seat encases a powerful magnet
- Special hooks hold wrenches, keys and other hard to store items
- Permanently mount using screw holes or built in magnets support up to 15 lbs
- Stores up to 71 tools

**LIFETIME
WARRANTY***



KTI72450 Magnetic Tool Hanger 11 lb. Capacity

- Holds heavy and irregularly shaped tools, such as hammers, mallets and wrenches.
- Ideal for storing cords, shovels, and more.
- Screw-hole design allow for easy mounting to nonferrous surfaces.
- Magnetic mount supports up to 11 lbs.

**LIFETIME
WARRANTY***



KTI72460 Magnetic Tool Box 33 lb. Capacity

- Powder-coating finish protects holder even in rugged, professional environments.
- Chamfer design holds various tools, such as cans, brushes and tape.
- Organize workshops, garages and manufacturing sites.
- Screw-hole design allows for easy mounting to nonferrous surfaces.
 - Portable holder goes from job to job.
- Holds up to 33 lbs.

**LIFETIME
WARRANTY***



TOOL STORAGE

Trays | Socket Rails & Socket Holders



KTI72470

3 Piece SAE Socket Holder Set - Red

- 1/4", 3/8" and 1/2" drive socket trays
- Impact resistant ABS plastic

Set Includes:

KTI72471 - 1/4" Drive SAE - Holds 26 sockets (13 short & 13 deep)
Socket sizes: 1/8" - 5/8" each

KTI72472 - 3/8" Drive SAE - Holds 26 sockets (13 short & 13 deep)
Socket sizes: 1/4" - 1" each

KTI72473 - 1/2" Drive SAE - Holds 28 sockets (14 short & 14 deep)
Socket sizes: 3/8" - 1-1/4" each



KTI72475

3 Piece Metric Socket Holder Set, Gray

- 1/4", 3/8" and 1/2" drive socket trays
- Impact resistant ABS plastic

Set Includes:

KTI72476 - 1/4" Drive Metric - Holds 28 sockets (14 short & 14 deep)
Socket sizes: 4-15mm each

KTI72477 - 3/8" Drive Metric - Holds 30 sockets (15 short & 15 deep)
Socket sizes: 6 - 20mm each

KTI72478 - 1/2" Drive Metric - Holds 34 sockets (17 short & 17 deep)
Socket sizes: 10 - 27mm each

MAG-CLIP

By K-Tool International®

Original Mag-Clip Strip

Magnetic socket holders hold sockets tight without magnetizing them. Hangs or mounts on any smooth metal surface.

Other Features:

- Shallow or deep socket
- Standard or metric sockets
- Holds socket tight and secure on any smooth metal surface
- Will not magnetize sockets
- Magnets retain strength permanently
- Grease, oil and chemical resistant
- Tough polymer base
- Rust resistant

MCP72401 - 1/4" drive

MCP72402 - 3/8" drive

MCP72403 - 1/2" drive

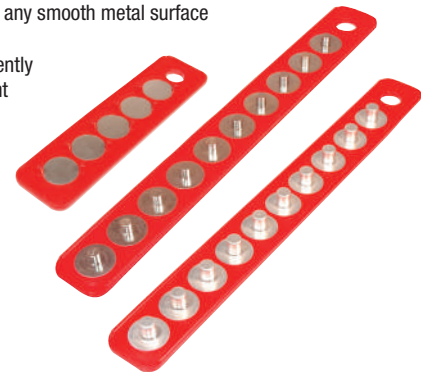

LIFETIME WARRANTY*

MAG-CLIP

By K-Tool International®

Interchangeable Mag-Clip Strip

Magnetic socket holders hold sockets tight without magnetizing them. Use with additional Power Pegs (sold separately) in any combination of 3 drive sizes to customize your workspace.

Other Features:

- Shallow or deep socket
- Standard or metric sockets
- Holds socket tight and secure on any smooth metal surface
- Will not magnetize sockets
- Magnets retain strength permanently
- Grease, oil and chemical resistant
- Tough polymer base
- Rust resistant

Includes 10 interchangeable Power Pegs.

MCP72400 - 1/4" drive

MCP72404 - 3/8" drive

MCP72405 - 1/2" drive

LIFETIME WARRANTY*

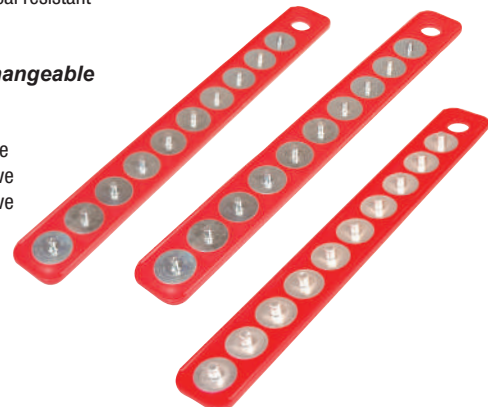

MAG-CLIP

By K-Tool International®



Socket Caddy

This organizer allows users to customize the storage and organization of some of the messiest areas of the average tool box, such as the socket drawer. The base of this product is made out of a high impact plastic magnetic grid. Use with additional Power Pegs (sold separately) in any combination of 3 drive sizes to customize your workspace.

Other Features:

- Shallow or deep sockets
- Standard or metric sockets
- Will not magnetize sockets
- Magnets retain strength permanently
- Grease, oil and chemical resistant
- Tough polymer base
- Rust resistant

Includes 28 interchangeable Power Pegs.

- MCP72421** - 1/4" drive
- MCP72422** - 3/8" drive
- MCP72423** - 1/2" drive



MCP72460 Universal Mag-Clip

Use the Universal Mag-Clip Strip to hold wrenches, screwdrivers, pliers and other hand tools to keep them at your fingertips.

Other Features:

- Mounts on any smooth metal surface
- Holds tools tight and secure
- Reverse polarity magnetic power
- Magnets retain strength permanently
- Grease, oil and chemical resistant
- Tough polymer base
- Rust resistant

LIFETIME WARRANTY*

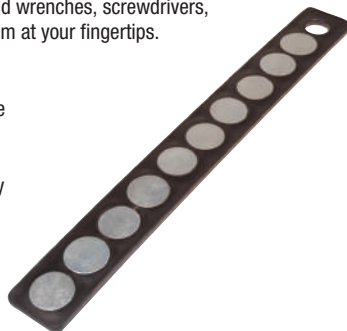

Power Pegs

- Interchangeable steel posts available in 1/4", 3/8" and 1/2" drive sizes
- Use Power Pegs with MagKanic Mat, Power Mat, Socket Caddy or Interchangeable Mag-Clip Strip for the ultimate storage system
- Available in packs of 10

- MCP72441** - 1/4" drive
- MCP72442** - 3/8" drive
- MCP72443** - 1/2" drive



LIFETIME WARRANTY*

Magnetic Mat

- Magnetic, convertible and interchangeable means for storing and organizing sockets
- Organize sockets or simply flip the mat over to the rubber side and store a variety of other tools in a vertical position
- High powered magnets are imbedded in a flexible, high impact poly-pro body
- May be used with Power Pegs (sold separately) in any combination of 3 drive sizes (1/4", 3/8" or 1/2") to customize your workspace

- MCP72424** - 2-panel MagKanic Mat
- MCP72425** - 3-panel Power Mat
- MCP72426** - 3-panel Power Mat with 84 assorted power pegs

Mag Mount

- Magnetic tool storage and/or mounting system for use with pegboard
- The Mag Mount will hold tools securely without the use of hooks or bars
- This design will work with 1/8" and 1/4" pegboard and features "super duty" magnetic power
- Includes screws for 1/8" and 1/4" pegboard

- MCP72453** - 3 pack
- MCP72455** - 5 pack





LIGHTING



Hand Held

KTI73389 **Slimline 6 LED** **Rechargeable Inspection Light**

- Super slim head at 1/4" thick by 11/16" wide
- Up to 7 hours of light on a single charge
- Generates 200 lumens at 15 feet
- Micro USB receiver allows for multiple charging options
- 3.7 volt Li-ion / 2200 mah rechargeable battery

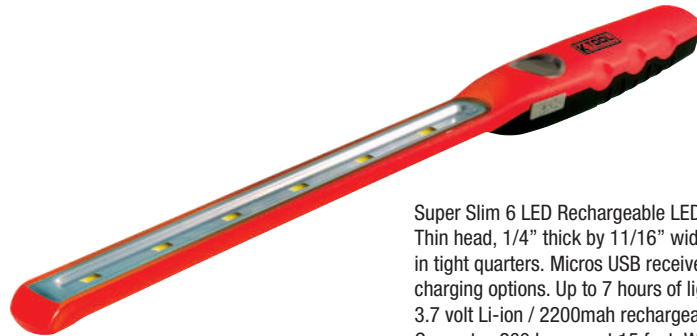

Super Slim 6 LED Rechargeable LED Inspection Lamp. Thin head, 1/4" thick by 11/16" wide allows for inspection in tight quarters. Micros USB receiver allows for multiple charging options. Up to 7 hours of light on a single charge. 3.7 volt Li-ion / 2200mah rechargeable battery. Generates 200 lumens at 15 feet. Weighs only 6 oz.

KTI73399 **Rechargeable 12 SMD** **LED Worklight**

- ABS and rubberized housing with a magnet on the back side and a rotating hook on the top
- Hi / Low / Off switch
- Charge time: 5 hours
- Run time: 2 hours



KTI73387 **Rechargeable Worklight** **3W COB with Pivot Head**

- Rechargeable 3W COB LED
- 3.7 volt 2200 mAh Li battery
- 5 hours with run time being approximately 2 hours
- ABS and rubberized housing
- Super strong magnetic base
- Rotating hook at the top that can be turned down
- 80 degree pivoting head with 180 degree rotating light
- AC & DC chargers included



LIGHTING

Hand Held

KTI73388

3 Watt COB

LED Rechargeable Worklight

- 3.7 volt / 22000 mAh Li battery
- Charge time about 5 hours with 2 hour run time
- ABS and rubberized housing with a magnet on the back side and a clip for hanging
- AC & DC chargers included



KTI73396

Aluminum 16 LED Flashlight

- 16 LED (96 lumens) flashlight
- Aerospace grade aluminum body
- Rubber grip handle
- Belt holster included
- 3 - AAA batteries included



Exclusive Folding Option



KTI73386

Underhood Rechargeable 24 Element 600 Lumen Worklight

- Aluminum and ABS housing
- 7.4 Volt / 2000mAh Lithium-Ion battery with 6 hour charge time and approximately 3.5 hrs run time
- Telescopic ends slide to a maximum of 74.75 inches with soft rubber ends that allow attachment to work area
- AC and DC chargers included
- High-low-off switch
- Full extension length: 50.375 inches; Folded length: 26.875 inches



KTI73398A

Hands-Free LED Head Lamp 3W 120 Lumen

- Powerful 3 watt COB LEDs
- Operating modes: high (100%), low (50%), flashing, off
- Adjustable ratcheting headlamp, 180° up/down, for light direction
- 3 "AAA" batteries included





KTI79800

Emergency Safety Flare

- Non-chemical, environmentally safe
- Nine flash patterns including the USCG approved SOS
- Runtime up to 100 hours depending on flash pattern
- Shatter-proof, crush-proof, and water resistant
- Positive buoyancy
- 1 CR-123 battery included

Applications in automotive, industrial, and marine. Nine distinctive flash patterns for emergency situations and work areas. Includes a magnet on one side for attaching to metal surfaces.



KTI79801

Rechargeable Emergency Safety Flare

- Non-chemical safety flare
- Runtime up to 50 hours depending on flash pattern
- Nine flash patterns including the USCG approved SOS
- Shatter-proof, crush-proof, and water resistant
- Non-chemical safety flare
- Positive buoyancy
- Charger adapter included

A non-chemical, environmentally safe flare. Applications in automotive, industrial, and marine. Nine distinctive flash patterns for emergency situations and awareness in work areas. Includes a magnet on one side for attaching to metal surfaces.

Work Lights

KTI73373

24 SMD LED Rechargeable Worklight

- 24 SMD LED (800 lumens) Rechargeable Worklight
- Heavy duty face plate
- Features a ratcheting head
- Foam insulated handle
- On / Off switch
- Charge time: 2 hours
- Run Time: 2 hours full strength

Rechargeable worklight. 24 element SMD LED with 800 lumen output. The face plate is heavy duty that contains the on/off switch on the reverse side. Has a ratcheting head and foam insulated handle. Weight: 4.85 lbs, length: 10.75" width: 9.75", height: 15"



KTI73374

24 SMD LED A/C Power Worklight with 3 foot 18/3 SJTW Cord

- 24 SMD LED (800 lumen) A/C Power Worklight with 3 foot 18/3 SJTW cord
- Heavy duty face plate
- Features a ratcheting head
- Foam insulated handle
- On / Off switch

A/C Power worklight with 3 ft. 18/3 SJTW cord. 24 element SMD LED with 800 lumen output. The face plate is heavy duty that contains the on/off switch on the reverse side. Has a ratcheting head and foam insulated handle. Worklight LED 800 Lumen 3ft 18/. Weight: 4.85 lbs, length: 10.75" width: 9.75", height: 15"



LIGHTING

Work Lights

KTI73303 **Fluorescent** **Tube Light 25'** **13 Watt 18/2**

- Fluorescent work lights are cool to the touch and energy efficient
- All fluorescent lights are UL and cUL approved
- Adjustable hanging hook swivels 360 degree for easy hanging
- On/off switch located in handle.

Length: 25'
Cord: 18/2 SJT
Bulb: 13 watt



KTI73304 **Replacement Head** **13 Watt Fluorescent** **Tube Light**

- Light head only, no cords attached
- Complete with bulb

R



KTI73359 **Trouble Light 50'** **Metal Cage** **Standard Duty**

- Incandescent trouble lights are ideal for workshops or garages
- Heavy duty metal cage features 360° rotating hanging hook for maximum flexibility
- Switch and outlet in handle.

Length: 50'
Cord: 18/3 SJT
Watt: 1250
Amp: 10



KTI73360 **Trouble Light 25'** **Metal Cage Heavy Duty**

- Incandescent trouble lights are ideal for workshops or garages
- Heavy-duty metal cage features 360° rotating hanging hook for maximum flexibility
- Switch and outlet in handle

Length: 25'
Cord: 16/3 SJT
Watt: 1625
Amp: 13



KTI73362 **75W Incandescent** **Trouble Light with** **Heavy Duty Metal Cage**

- 13 Amp, 1625 Watt Nema 5-15 receptacle outlet in handle
- SJT 16/3 AWG, 50 foot cord
- Heavy duty metal cage features rotating hanging hook
- 75 Watt bulb
- 120 Volt



KTI73358 **Trouble Light 25'** **Metal Cage Standard Duty**

- Incandescent trouble lights are ideal for workshops or garages
- Heavy duty metal cage features 360 degree rotating hanging hook for maximum flexibility

Length: 25'
Cord: 18/3 SJT
Watt: 1250
Amp: 10

Standard Trouble Light **Replacement Parts**

KTI73350 - Replacement metal guard only

KTI73351 - Replacement handle/switch assembly only

KTI73355 - Replacement metal guard with handle/switch assembly



R

KTI73311
Fluorescent Angle
Work Light 25'
13 Watt 16/3

- Fluorescent work lights are cool to the touch and energy efficient
- UL and cUL approved and have circuit breaker protection and grounded outlet
- All angle lights have 360 degree swivel magnet, rotating clip for hanging and feature protective bumper and special ergonomic grip
- On/off switch

Length: 25'
 Cord: 16/3 SJT
 Bulb: 13 watt
 Amp: 13
 Watt: 1625



KTI73305
Replacement Head
13 Watt Fluorescent
Angle Light

- Light head only, no cords attached
- Complete with bulb

R



KTI73306
Replacement Head
26 Watt Fluorescent
Angle Light

- Light head only, no cords attached
- Complete with bulb

R



KTI73357
Replacement Lens
Angle Light 13 Watt

- Replacement part for fluorescent light

R



KTI73356
Replacement Lens
Angle Light 26 Watt

- Replacement part for fluorescent light

R

KTI73312
Fluorescent Angle
Work Light 25'
26 Watt 16/3

- Fluorescent work lights are cool to the touch and energy efficient
- UL and cUL approved and have circuit breaker protection and grounded outlet
- All angle lights have 360 degree swivel magnet, rotating clip for hanging and feature protective bumper and special ergonomic grip
- On/off switch

Length: 25'
 Cord: 16/3 SJT
 Bulb: 26 watt
 Amp: 13
 Watt: 1625



KTI73397
LED Worklight 48 LED 25ft 16/3

- Super bright 48 LED with 25' 16/3 SJT power cord
- 15 AMP outlet in handle
- Clamped magnet attaches to the center for changing light positions
- Two swivel hooks that fold down can be used for hanging the light

KTI3379A
Trouble Light Retrofit
500 Lumens

- A twist on module that converts an incandescent trouble light in a LED light
- 30 high powered SMD LED (500 lumens)
- Rubber bumper to protect unit
- Folding hanging hook that fits into head



LIGHTING

Work Lights

KTI73370

Halogen Work Light 500 Watt

- Illuminate the workshop, garage or job site with the power of bright halogen light
- All KTI fixtures use a 500-watt quartz halogen bulb (included), which emits brighter, whiter light and uses less energy
- Features include: 5-foot power cord and small floor stand

Length: 5'

Cord: 18/3 SJTW

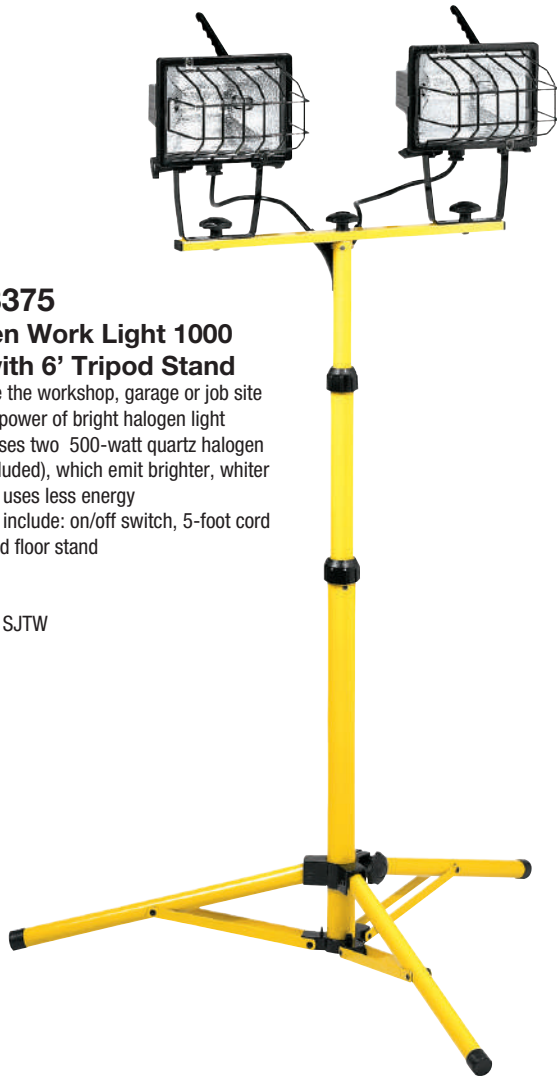

KTI73375

Halogen Work Light 1000 Watt with 6' Tripod Stand

- Illuminate the workshop, garage or job site with the power of bright halogen light
- Fixture uses two 500-watt quartz halogen bulb (included), which emit brighter, whiter light and uses less energy
- Features include: on/off switch, 5-foot cord and tripod floor stand

Length: 5'

Cord: 18/3 SJTW

KTI73372

Halogen Work Light 500 Watt with 6' Tripod Stand

- Illuminate the workshop, garage or job site with the power of bright halogen light
- All KTI fixtures use a 500-watt quartz halogen bulb (included), which emits brighter, whiter light and uses less energy
- Features include: on/off switch, 5-foot cord and 6-foot tripod floor stand

Length: 5'

Cord: 18/3 SJTW

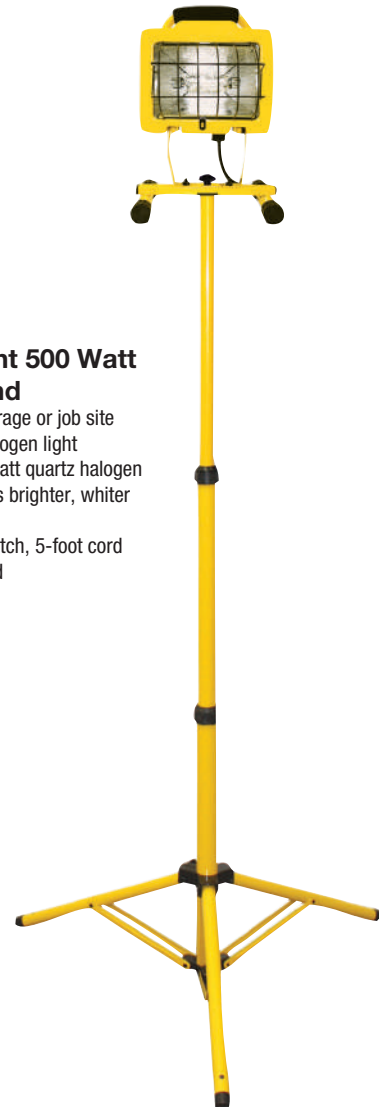

KTI73363
Trouble Light 25'
Metal Cage
Industrial Duty

- Incandescent trouble lights are ideal for workshops or garages
- Heavy-duty industrial cage features 360 degree rotating hanging hook for maximum flexibility
- Switch and outlet in handle

Length: 25'
 Cord: 14/3 SJT
 Watt: 1875
 Amp: 15



KTI73349
Replacement
Metal Cage for
Industrial Trouble Light

- Metal guard and cage for use with incandescent trouble lights
- Bulb and light not included

R

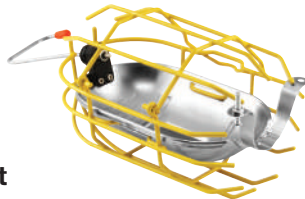

KTI73315
13W Fluorescent
Angle Light, reel has
30' retractable cord

- Fluorescent work lights are cool to the touch and energy efficient
- Fluorescent light is cULus approved
- Angle light has 360° swivel magnet, 2 rotating clips for hanging and feature protective bumper and special ergonomic grip
- On/off switch and outlet in handle
- 9 amp, 1125 watt, 125 volt cable reel made of metal
- Retractable SJT cable, 16/3 AWG, 30 foot cord
- 13 watt bulb



KTI73318
Fluorescent Tube Light
on Reel 50'
13 Watt 18/2

- Fluorescent work lights are cool to the touch and energy efficient
- All fluorescent lights are UL and cUL approved
- Adjustable hanging hook swivels 360 for easy hanging
- On/off switch located in handle

Length: 50' with reel
 Cord: 18/2 SJT
 Bulb: 13 watt



KTI73330
75W Incandescent Trouble Light
with Reel, 30' Cord

- Incandescent trouble light with metal housing reel with 9 amps, 125 volt, 1125 watt
- Metal cage protects the 75 watt bulb and has a 360 degree rotating hanging hook
- Circuit breaker protection and Nema 5-15 receptacle grounded outlet in handle
- Reel contains retractable cable 16/3 SJT, 30 foot with 75 watt trouble light
- cULus approval



KTI73335
Industrial Trouble Light on Reel

- Incandescent trouble lights are ideal for workshop or garage environments
- Heavy duty metal shades have 360 rotating hanging hooks provide flexibility for all applications
- Work lights feature circuit breaker protection and grounded outlet in handle

Length: 50'
 Cord: 14/3 SJT
 Dual industrial cage.



LIGHTING

Work Lights



KT173335 Industrial Trouble Light on Reel

- Incandescent trouble lights are ideal for workshop or garage environments
- Heavy duty metal shades have 360° rotating hanging hooks provide flexibility for all applications
- Work lights feature circuit breaker protection and grounded outlet in handle

Length: 50'
Cord: 14/3 SJT
Dual industrial cage.



KT173333 26W Fluorescent Angle Light Reel with 50' Cord

- Fluorescent work lights are cool to the touch and energy efficient
- Fluorescent light has cULus approval
- All angle lights have 360 degree swivel magnet, 2 rotating clips for hanging and feature protective bumper and special ergonomic grip
- On/off switch and outlet in handle
- 8 amp, 125 volt, 1000 watt cable reel is made of plastic with circuit breaker on reel body
- Retractable SJT 14/3, 50 foot cord 26 watts, (2) 13 watt bulbs

Work Light | Accessories

KT173307 Replacement Bulb 13 Watt Fluorescent

- Replacement bulb for all KTI 13 watt work lights (angle and compact tube)



KT173371 Replacement Bulb 500 Watt Halogen

- Replacement bulb for all KTI halogen work lights (models 73370, 73372 and 73375)



Power Reels & Extension Cords



KT173341 Retractable Extension Cord Reel 50'

- Extension reel features oil and water resistant cord, retractable reel, power indicator, lighted end and circuit breaker protection

Length: 50'
Cord: 14/3 SJE0W tri-tap
Amp: 13
Watt: 1625

Power Reels & Extension Cords

KTI73340 **Retractable** **Extension Cord Reel 30'**

- Extension reel features oil and water resistant cord, retractable reel, metal housing and circuit breaker protection

Length: 30'
Cord: 16/3 SJT tri-tap
Amp: 10
Watt: 1250

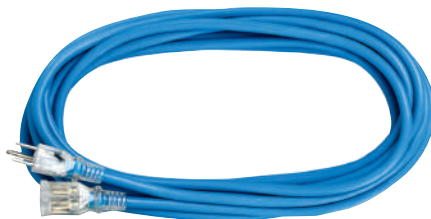

All-Weather **Extension Cords**

- All-weather extension cord features 16/3 SJE0W single tap blue cord
- LED mounted in end of cord lights up when cord is plugged into 110V power
- Cord stays flexible even in extreme temperatures (-58°F to 221°F)
- 16/3 cord; Watt: 1625; Amp: 13

KTI73380 - 25' extension cord
KTI73381 - 50' extension cord

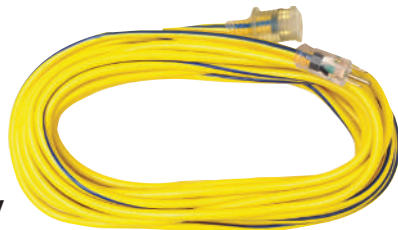

KTI73348 **Extra-heavy-duty** **Extension Cord**

- Extra-heavy-duty extension cord features 12/3 SJTW single tap orange/black cord
- LED mounted in end of cord lights up when cord is plugged into 110V power
- Length: 50'; Watt: 1875; Amp: 15

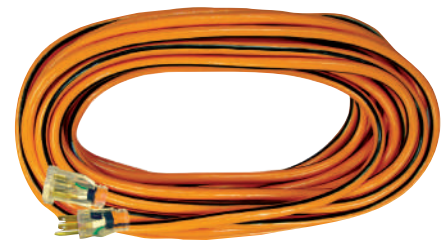

Heavy-duty **Extension Cords**

- Heavy duty extension cord features 14/3 SJTW single tap orange/black cord
- LED mounted in end of cord lights up when cord is plugged into 110V power
- Watt: 1875; Amp: 15

KTI73345 - 25' extension cord
KTI73346 - 50' extension cord

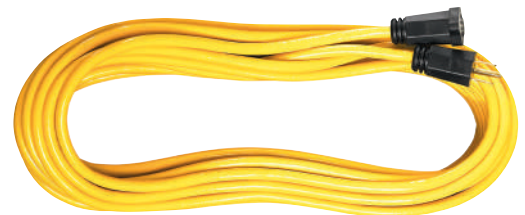

Standard-duty Extension Cords

- Standard outdoor extension cord features 16/3 SJTW single tap yellow cord
- Medium-duty capacity
- Flexible to -40°F. Water and weather resistant
- UL listed; Watt: 1625; Amp: 13; Volt: 125

KTI73342 - 25' extension cord
KTI73343 - 50' extension cord



CUTTING/THREADING/ABRASIVES



KTI10330
326-Piece
Master Drill Bit Set

KTI's Master Drill Bit is a comprehensive set of drill bits and accessories. This 326-piece set includes bits and accessories for nearly every job. The unique storage case fully opens to access the bit and accessories you need. Two (2) bottom trays fold and slide into portable carrying case. Transport from job to job quickly and easily!

Warranty: 90 Day warranty on materials and workmanship.



326-Piece Master Drill Bit Set	
Qty	Description of Contents
64	HSS Twist Drill Bits: 3/64" (8), 1/16" (8), 5/64" (5), 3/32" (5), 7/64" (5), 1/8" (5), 9/64" (5), 5/32" (5), 3/16" (4), 7/32" (4), 15/64", 1/4", 17/64", 9/32", 5/16", 11/32", 3/8", 7/16", 15/32" and 1/2"
54	Titanium Coated High Speed Drill Bits: 3/64" (6), 1/16" (6), 5/64" (4), 3/32" (4), 7/64" (4), 1/8" (4), 9/64" (4), 5/32" (4), 11/64" (4), 3/16" (2), 7/32" (2), 15/64", 1/4", 17/64", 9/32", 5/16", 11/32", 3/8", 7/16", 15/32" and 1/2"
10	Nutdrivers: 5/32", 3/16", 7/32", 1/4", 9/32", 5/16", 11/32", 3/8", 7/16" and 1/2"
37	2" Screwdriver Bits: 7 Slotted, 6 Phillips, 6 Pozi, 8 Star, 7 Metric Hex and 8 Square
64	1" Screwdriver Bits: 14 Slotted, 10 Phillips, 10 Pozi, 8 Star, 7 Hex, 9 Metric Hex and 6 Square
3	14" Masonry Drill Bits: 5/16", 3/8" and 1/2"
21	Masonry Drill Bits: 5/32" (2), 11/64" (2), 3/16" (2), 7/32" (2), 15/64" (2), 1/4" (2), 17/64", 9/32", 5/16", 21/64", 11/32", 3/8", 7/16", 15/32" and 1/2"
4	Nail Punches: 1/32", 1/16", 3/32" and 1/8"
6	Drill Stoppers: 1/8", 5/32", 3/16", 1/4", 5/16" and 3/8"
1	Allen Key - 2.5mm
1	Magnetic Holder
1	Counter Sink
64	HSS Twist Drill Bits: 3/64" (8), 1/16" (8), 5/64" (5), 3/32" (5), 7/64" (5), 1/8" (5), 9/64" (5), 5/32" (5), 3/16" (4), 7/32" (4), 15/64", 1/4", 17/64", 9/32", 5/16", 11/32", 3/8", 7/16", 15/32" and 1/2"
54	Titanium Coated High Speed Drill Bits: 3/64" (6), 1/16" (6), 5/64" (4), 3/32" (4), 7/64" (4), 1/8" (4), 9/64" (4), 5/32" (4), 11/64" (4), 3/16" (2), 7/32" (2), 15/64", 1/4", 17/64", 9/32", 5/16", 11/32", 3/8", 7/16", 15/32" and 1/2"
10	Nutdrivers: 5/32", 3/16", 7/32", 1/4", 9/32", 5/16", 11/32", 3/8", 7/16" and 1/2"
37	2" Screwdriver Bits: 7 Slotted, 6 Phillips, 6 Pozi, 8 Star, 7 Metric Hex and 8 Square
64	1" Screwdriver Bits: 14 Slotted, 10 Phillips, 10 Pozi, 8 Star, 7 Hex, 9 Metric Hex and 6 Square
3	14" Masonry Drill Bits: 5/16", 3/8" and 1/2"
21	Masonry Drill Bits: 5/32" (2), 11/64" (2), 3/16" (2), 7/32" (2), 15/64" (2), 1/4" (2), 17/64", 9/32", 5/16", 21/64", 11/32", 3/8", 7/16", 15/32" and 1/2"
4	Nail Pouch: 1/32", 1/16", 3/32" and 1/8"
6	Drill Stoppers: 1/8", 5/32", 3/16", 1/4", 5/16" and 3/8"
1	Allen Key - 2.5mm
1	Magnetic Holder
1	Counter Sink
1	Gauge

4	Hole Saws: 1-3/4", 2-1/8", 2-3/8" and 2-1/2"
1	Hole Saw Adapter
44	Wood Boring Drill Bits: 1/8" (3), 5/32" (4), 11/64" (8), 3/16" (4), 13/64" (4), 7/32" (4), 15/64" (4), 1/4" (4), 17/64", 9/32", 5/16", 11/32", 3/8", 7/16", 15/32" and 1/2"
5	Flat Wood Bits: 1/2", 5/8", 3/4", 7/8" and 1-1/4"
4	12" Flat Wood Bits: 5/16", 3/8", 1/2" and 9/16"



KTI71200
10-Pack
Double-Ended Drill Bits
 Double-ended, 2" long bits are made of high-speed steel. Ideal for auto body work and sheet metal drilling.

CUTTING/THREADING/ABRASIVES

KT171233

3-Piece Set Step Drill Bits

- Titanium coated
- High-speed steel (HSS) 4241
- HRC 60-63 (Rockwell Scale)
- Sizes: 1/8" to 1/2", 3/16" to 1/2" & 1/4" to 3/4"
- 1 Year Warranty

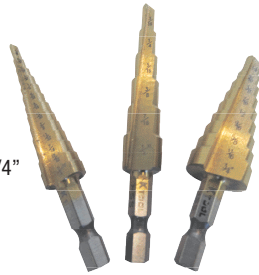

Sold separately:

KT171235 - 1/8" to 1/2"

KT171236 - 3/16" to 1/2"

KT171237 - 1/4"-3/4"

LIFETIME WARRANTY*

KT170040

5-Piece

Spiral Extractor Set

- Made of high carbon steel
- Aggressive spiral design for extra grip on stubborn broken bolts



Sizes include: 1/8" - 1/4", 1 - 6mm; 1/4" - 5/16", 6 - 8mm; 5/16" - 7/16", 8 - 11mm; 7/16" - 9/16", 11 - 14mm; 9/16" - 3/4", 14 - 18mm.

KT170045

5-Piece

Fluted Extractor Set

- Quickly and easily remove broken screws, pipes, bolts and studs
- Manufactured with heat-treated chrome-moly steel for long wear and durability



LIFETIME WARRANTY*

Sizes range from 1/8"-3/8" and 3 mm-9.5 mm.

KT173155

Folding Knife - Stainless Steel Satin Finish Blade

- 9Cr18MOV stainless steel satin finished blade
- Stainless steel blade partially serrated with assist opening
- Folded knife length: 4.750", width: 1.438, height: .563; blade shaft length: 3.6875", open knife length: 8.4375"
- G10 handle • Reversible pocket clip



LIFETIME WARRANTY*



KT173150

Folding Knife - Stainless Steel, Black Finish Blade, Partially Serrated With Assist Opening

- 9Cr18MOV stainless steel black finish blade
- Stainless steel blade partially serrated with assist opening
- Folded knife length: 4.750", width: 1.438", height: .563"; blade shaft length: 3.6875", open knife length: 8.4375"
- G10 handle • Reversible pocket clip

LIFETIME WARRANTY*

KT173110

Spring Action Scissors

- Spring action soft touch scissors are 10-1/4" long
- Stainless steel blade, spring and screw
- ABS lock
- Nylon fiber handle with soft TPR grips
- Ergonomically designed handle with spring action for lasting use and reducing hand fatigue

LIFETIME WARRANTY*



Spring action scissors are perfect for cutting fabric, ribbon, paper, corrugated paper, string, light cardboard, garden plants and many more items.

KT173102

Quick Change Folding Utility Knife

- Quick change and folding
- Folded knife length: 4.3125", blade shaft length: 2.750", open knife length: 6.5"
- Plastic body with rubber grip.
- Blade case with 3 blades included.

LIFETIME WARRANTY*



KT173103

Auto Loading Folding Utility Knife

- Auto loading
- Folded knife length: 4.375", blade shaft length: 2.750", open knife length: 7"
- Zinc body, ABS and rubber grip
- 3 blades included
- Black and red handle

LIFETIME WARRANTY*





KTI73105

Utility Knife

- Retractable 6" utility knife with extra blade storage in handle.

Replacement parts:

KTI70546 - Replacement blades 6-pack



LIFETIME WARRANTY*

KTI73104

Jumbo Monster Knife

- Extra-large grip for added control
- Quick-change blade system
- Includes six (6) snap-off blades
- Knife measures a whopping 8" x 2.5" x 1"

Replacement parts:

KTI73104-1 - Replacement blades 10-pack



KTI70016

Mini Scraper

- Grip-coated handle for better comfort and control
- Angled tip for increased accuracy
- Blade locks securely in place
- Quick and easy blade changes
- Reversible blade for safe storage. Includes one (1) single edge blade.
- Length: 4-1/2" Assorted colors.

KTI72310

Tube Cutter Mini - Range 1/8" to 5/8" OD

- Cuts 1/8" to 5/8" OD tubing
- Compact size for use in confined areas
- Features rollers to ease operation.

LIFETIME WARRANTY*



KTI72330

Tubing Cutter Heavy-duty

- Cuts 1/8" to 1-1/8" OD tubing
- Heavy-duty rollers smooth operation

LIFETIME WARRANTY*



LIFETIME WARRANTY*



KTI72355

Ratcheting Hose and Pipe Cutter

- Cut a variety of material
- Ratcheting action makes cutting smooth and easy
- Cuts material up to 1-1/2" diameter
- One-touch, quick-release lever opens pliers instantly
- Built-in clasp securely locks handles when not in use for added safety

Replacement parts:

KTI72355-1 - Replacement blade



KTI72320

Tubing Bender - U.S.-made

Bends 3/16", 1/4", 5/16" and 3/8" diameter tubing. Features aluminum mandrel.



LIFETIME WARRANTY*

KTI72340

Tubing Bender

Bends 1/4", 5/16" and 3/8" OD aluminum, steel and copper tubing.

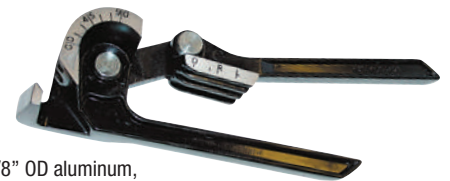

LIFETIME WARRANTY*

KTI72345

Tubing Bender Heavy-duty Pliers

Bends 3/16", 1/4", 5/16" and 3/8" diameter copper and steel tubing without collapsing or kinking.



LIFETIME WARRANTY*

CUTTING/THREADING/ABRASIVES

Center Cut Bolt Cutters

- Heavy duty cutters
- Heat-treated chrome vanadium alloy jaws
- Specially designed curved handles for more efficient strength application and comfortable rubber handles for firm and safe grip

Sold separately:

KTI57124 - 24" Center Cut Bolt Cutter

KTI57130 - 30" Center Cut Bolt Cutter

KTI57136 - 36" Center Cut Bolt Cutter

Replacement parts:

KTI57224 - Replacement head 24"

KTI57236 - Replacement head 36"



LIFETIME WARRANTY*

KTI57514

14" Wire & Rope Cutter

- Shear-cut blades hold and lock cable in cutting position for a clean, sharp cut
- Chrome-vanadium cutting head
- Designed for cutting wire rope, piano wire, steel wire, ACSR cable and aircraft cable
- 14" overall length

LIFETIME WARRANTY*



Center Cut



Clipper Cut Bolt Cutters

- Blades are flush against one face for cutting against flat surfaces
- Heavy duty cutters
- Heat-treated chrome vanadium alloy jaws
- Specially designed curved handles for more efficient strength application and comfortable rubber handles for firm and safe grip

Sold separately:

KTI57318 - 18" Clipper Cut Bolt Cutter

KTI57324 - 24" Clipper Cut Bolt Cutter

KTI57330 - 30" Clipper Cut Bolt Cutter

KTI57336 - 36" Clipper Cut Bolt Cutter

LIFETIME WARRANTY*



Clipper Side Cut



Angled Head Clipper Cut Bolt Cutters

- Angled for easier insertion and keeping work in view
- Heavy duty cutters
- Heat-treated chrome vanadium alloy jaws
- Specially designed curved handles for more efficient strength application and comfortable rubber handles for firm and safe grip

Sold separately:

KTI57414 - 14" Clipper Cut Bolt Cutter

KTI57424 - 24" Clipper Cut Bolt Cutter

KTI57436 - 36" Clipper Cut Bolt Cutter

LIFETIME WARRANTY*



Clipper Side Cut





K **TOOL**®
INTERNATIONAL

PROFESSIONAL TOOLS & EQUIPMENT

CUTTING/THREADING/ABRASIVES



KT173400 Number and Letter Stamp Set - Size 3/16"

- Combination set includes 3/16" set of numbers and 3/16" set of letters
- Includes convenient storage case

**LIFETIME
WARRANTY***



KT170010 Tapered Scratch Awl

- High quality chrome vanadium steel
- Ergonomic, contoured handle
- Used for scribing, punching holes and lining up panels or holes.

**LIFETIME
WARRANTY***



KT172380 8" Straight Cut Tin Snips

- One piece drop forged construction of high carbon steel
- Cushion handle with smooth, comfortable bows for ease in use and safety
- Designed for cutting straight and wide curves to the left or right
- Cuts up to .61mm cold rolled steel or .41mm stainless steel
- Cutting blades open to approximately 4" wide
- Induction hardened cutting edges 54-58 HRC



KT172801 12" Tubular Hacksaw

- Top quality, sturdy hacksaw
- Adjustable tensioner
- Includes one (1) saw blade.

**LIFETIME
WARRANTY***



KT172802 Extra Heavy Duty Hacksaw

- All metal heavy duty frame
- High leverage tensioner blade can be set at 45 degrees or vertical
- Handle with blade storage compartment

**LIFETIME
WARRANTY***





KTI71303



KTI71306

Abrasive Cut-off Discs

- KTI71303 - 3" x 1/32" - 6 pack
- KTI71306 - 3" x 1/16" - 6 pack
- KTI71301 - 3" x 1/16" - 25 pack
- KTI71300 - 3" x 1/16" - 50 pack

KTI70013

Cut-off Wheel Arbor

Drill adapter for cut-off discs. Fits any drill with a chuck capacity of 1/4" or larger.



KTI74103

3-Piece Mini Brush Set

Set includes one brass, nylon and stainless steel brush. Features molded poly handles. Overall length: 7"



Set includes (also available individually):

- KTI74106 - Brass
- KTI74107 - Nylon
- KTI74108 - Steel

Spindle Adapters

KTI87140

3/8" - 24 ID thread
5/8" - 11 OD thread



KTI87141

10mm - 1.25mm ID thread
5/8" - 11 OD thread



WIRE WHEEL AND CUP BRUSHES

Part #	Type	Diameter	RPM	Type of Mount
KTI79200	Crimped wire wheel - narrow face	6" diameter	6,000 maximum	1/2" x 5/8" hole center mount
KTI79201	Crimped wire wheel - medium face	6" diameter	6,000 maximum	1/2" x 5/8" hole center mount
KTI79205	Crimped wire wheel - wide face	8" diameter	6,000 maximum	1/2" x 5/8" hole center mount
KTI79210	Crimped wire cup - coarse	1" diameter	4,500 maximum	1/4" stem mount
KTI79215	Crimped wire cup - coarse	2" diameter	4,500 maximum	1/4" stem mount
KTI79216	Crimped wire cup - coarse	3" diameter	4,500 maximum	1/4" stem mount
KTI79217	Crimped wire wheel - coarse	3" diameter	4,500 maximum	1/4" stem mount
KTI79220	Knotted wire cup - extra coarse	2 3/4" diameter	12,500 maximum	5/8" x 11 thread
KTI79225	Crimped wire cup - coarse	3" diameter	12,500 maximum	5/8" x 11 thread

Note: Always wear eye protection. Keep loose articles of clothing and jewelry from moving parts.

Utility Brushes

Wood handle brushes have natural bristles not affected by thinners or other solvents.

- Sold separately:
- KTI74005 - 1/2" width
 - KTI74010 - 1" width
 - KTI74015 - 1-1/2" width
 - KTI74020 - 2" width
 - KTI74025 - 2-1/2" width
 - KTI74030 - 3" width





AIR TOOLS & ELECTRIC TOOLS



Air Tools | Ratchets

1/4"

KT182500A 1/4" Drive Air Ratchet

- 25 ft./lb. ultimate torque
- 250 rpm
- 2 CFM air consumption
- 7" overall length
- 90 PSI air pressure (recommended)



Warranty: Repair only up to 1 year

3/8"

KT182503A 3/8" Drive Air Ratchet

- 50 ft./lb. ultimate torque
- 170 rpm
- Designed for reliability and superior performance
- 6 CFM air consumption, 90 PSI air pressure recommended
- 10" overall length



Warranty: Repair only up to 1 year

3/8"

KT182504 3/8" Drive Heavy Duty Air Ratchet

- 55 ft./lb. ultimate torque
- Designed for reliability and superior performance
- 170 RPM, 6 CFM air consumption, 90 PSI air pressure recommended
- 11" overall length



Warranty: Repair only up to 1 year

AIR RATCHET SPECIFICATIONS

Part #	RPMs	Sq. Drive	Working Torque	Ultimate Torque	Length	Weight	CFMs
KT182500A	250 rpm	1/4"	5-20 ft./lbs.	25 ft./lbs.	7"	1.00 lb.	2 CFM
KT182503A	170 rpm	3/8"	10-60 ft./lbs.	50 ft./lbs.	10"	2.60 lb.	6 CFM
KT182504	170 rpm	3/8"	10-55 ft./lbs.	55 ft./lbs.	11"	3.00 lb.	6 CFM

AIR TOOLS & ELECTRIC TOOLS

Air Tools | Impact Wrenches

KT181550

Butterfly

3/8" Drive Impact Wrench

The popular Butterfly 3/8" drive with built-in power regulator features instant forward and reverse throttle speed. Streamline design eliminates 2 piece housing construction for excellent power-to-weight ratio. Rear exhaust.

- 11,000 rpm;
- 3/8" square drive
- 5-50 ft./lbs. working torque
- 75 ft/lbs Ultimate Torque
- 3 CFM average air consumption

Warranty: Repairable up to 1 year



KT181565

3/8" Drive

Air Impact Wrench

- 320 ft./lb. ultimate torque
- 9000 rpm
- 3 CFM air consumption
- 90 PSI air pressure (recommended)

Warranty: Repairable up to 1 year



KT181560

Pistol Grip

3/8" Drive Impact Wrench

Unlike "nose heavy" pistols, this tool is perfectly balanced.

- 11,000 rpm
- 3/8" square drive
- 5-50 ft./lbs. working torque
- 75 ft./lbs. ultimate torque
- 5" length; 2.5 lbs.
- 3 CFM average air consumption

Warranty: Repairable up to 1 year



KT181622

1/2" Drive Impact Wrench

Features a full polished tool, reversing trigger, "Rocking Dog" clutch and built-in power regulator. Working torque range of 25-180 ft/lbs.

Applications: transmissions, body shops and general repair.

- 260 ft./lb. ultimate torque
- 7000 rpm
- 4 CFM air consumption
- 90 PSI air pressure (recommended)

Warranty: Repairable up to 1 year



KT181631A

1/2" Drive

Air Impact Wrench

- 450 ft./lb. ultimate torque
- 7500 rpm
- 7 CFM air consumption
- 90 PSI air pressure (recommended)

Warranty: Repairable up to 1 year



KT181632A

1/2" Drive Air Impact with Extended Anvil

- 450 ft./lb. ultimate torque
- 7500 rpm
- 7 CFM air consumption
- 90 PSI air pressure (recommended)

Warranty: Repairable up to 1 year



IMPACT WRENCH SPECIFICATIONS

Part #	RPMs	Sq. Drive	Working Torque	Ultimate Torque	Length	Weight	CFMs
KT181550	11,000	3/8"	5-50 ft./lbs.	75 ft./lbs.	5-1/2"	2.00 lbs.	3 CFM
KT181560	11,000	3/8"	5-50 ft./lbs.	75 ft./lbs.	5"	2.50 lbs.	3 CFM
KT181565	9,000	3/8"	25-300 ft./lbs.	320 ft./lbs.	8"	3.0 lbs.	3 CFM
KT181622	7,000	1/2"	25-180 ft./lbs.	260 ft./lbs.	7"	5.50 lbs.	4 CFM
KT181631A	7,500	1/2"	25-350 ft./lbs.	450 ft./lbs.	8"	6.0 lbs.	7 CFM
KT181632A	7,500	1/2" - 2" ext	25-300 ft./lbs.	450 ft./lbs.	10"	5.60 lbs.	7 CFM

KTI81772A
3/4" Drive
High Performance
Impact Wrench

- 4,500 rpm
- 3/4" square drive
- 100-500 ft./lbs. working torque
- 800 ft./lbs. ultimate torque
- 11.25" length; 11.55 lbs.
- 5 CFM average air consumption
- High torque developing clutch

Warranty: Repairable up to 1 year



KTI81775
3/4" Drive Heavy-Duty
High Power Impact Wrench

- 900 ft./lb. ultimate torque
- 7000 rpm
- 8 CFM air consumption
- 90 PSI air pressure (recommended)

The ultimate in 3/4" impacts. The big brother to the KTI81631 with the high power twin hammer clutch, making this the wrench for all 3/4" applications, including all the hardest jobs, such as springs, tractor pad removal, farm equipment, truck tires, truck suspension and construction equipment.

Warranty: Repairable up to 1 year



KTI81774
3/4" Drive
Air Impact Wrench

- 1200 ft./lb. ultimate torque
- 4500 rpm
- 8 CFM air consumption
- 90 PSI air pressure (recommended)

Warranty: Repairable up to 1 year



KTI81798A
1" Drive
Impact Wrench
with 6" Extension Anvil

- 1600 ft/lbs of torque
- 6" extended anvil for extra access
- 3 forward and 3 reverse power settings
- D Side handle for ease of use
- Side exhaust directs air away from the job

Covered by a 1 year limited warranty. Repairable under warranty up to a year.



KTI81795
1" Drive
Air Impact Wrench with
13 Piece SAE Socket Set

- 1500 ft./lb. ultimate torque
- 3500 rpm
- 8 CFM air consumption
- 90 PSI air pressure (recommended)

KTI's air tools are designed for reliability and superior performance. Includes 13-piece 1" drive short fractional impact socket set including sizes 3/4" to 3" (KTI35113).

Warranty: Repairable up to 1 year



KTI81797A
Composite Heavy Duty
Air Impact Wrench 1"

- Clutch Type: Twin Hammer
- Air consumption: 47 SCFM
- Free Speed: 4500 rpm
- Working Torque: 1600 ft-lbs
- Maximum Torque: 1800 ft-lbs



IMPACT WRENCH SPECIFICATIONS

Part #	RPMs	Sq. Drive	Working Torque	Ultimate Torque	Length	Weight	CFMs
KTI81772A	4,500	3/4"	100-500 ft./lbs.	800 ft./lbs.	11-1/4"	11.55 lbs.	5 CFM
KTI81774	4,500	3/4"	100-950 ft./lbs.	1,200 ft./lbs.	14"	15 lbs.	8 CFM
KTI81775	7,000	3/4"	200-600 ft./lbs.	900 ft./lbs.	15-5/8"	11.50 lbs.	8 CFM
KTI81795	3,500	1"	100-1,100 ft./lbs.	1,500 ft./lbs.	20"	15 lbs.	8 CFM
KTI81797A	4,500	1"	1,600 ft./lbs.	1,800 ft./lbs.	16"	14.123 lbs.	47 SCFM
KTI81798A	4,000	1"	100-1,200 ft./lbs.	1,600 ft./lbs.	22-1/2"	26.2 lbs.	10 CFM

AIR TOOLS & ELECTRIC TOOLS

Air Tools | Drills

KT184218 3/8" Air Drill

- 2,200 rpm
- 3/8" Keyed Chuck
- Whisper Quiet



Lightweight whisper quiet 3/8" drill, with all ball and needle bearing spindle component support and machined planetary gearing.

Warranty: Repairable up to 1 year

KT184228 3/8" Reversible Air Drill

- 2,000 rpm
- 3/8" Keyed Chuck
- 4 CFM air consumption
- Handle exhaust
- 3/8"-24 spindle



Features through handle muffled exhaust, controllable speed through the teasing trigger and all ball and needle bearing component support.

Warranty: Repairable up to 1 year

KT187130 1/4" Straight Air Drill without Chuck

- 2,500 rpm
- 4 CFM air consumption
- 1/4" air inlet • 1.9 lbs.



Capacity designed for work in close quarters. Durable, light-weight design.

Warranty: Repairable up to 1 year

KT184229 1/2" Heavy-Duty Reversible Drill

- 800 rpm
- 1/2" Keyed Chuck
- Reversible
- Trigger Speed Control
- Handle exhaust
- 4 CFM air consumption



This 1/2" reversible drill is unsurpassed with its whisper quiet through handle exhaust, controllable speed through the teasing trigger and all ball and needle bearing spindle component support.

Warranty: Repairable up to 1 year

DRILL SPECIFICATIONS

Part #	RPMs	Chuck Size	Spindle	Length	Weight	CFMs
KT187130	2,500 rpm	1/4" chuck	3/8" - 24 spindle	7" length	1.9 lbs.	4 CFM
KT184218	2,200 rpm	3/8" chuck	3/8" - 24 spindle	6 1/2" length	2.25 lbs.	4 CFM
KT184228	2,000 rpm	3/8" chuck	3/8" - 24 spindle	7 1/2" length	3.00 lbs.	4 CFM
KT184229	800 rpm	1/2" chuck	3/8" - 24 spindle	9" length	4.00 lbs.	4 CFM

Air Tools | Air Hammers

KT183275 Regulated Air Hammer

- Independent power regulators and teasing throttle for operator control
- All metal one-piece housing with hardened alloy steel barrel and standard .401" shank opening
- 3500 BPM; 2-5/8" stroke; 3/4" bore; 6-3/4" length; 3.5 lbs; 4 cfm



Warranty: Repairable up to 1 year

KT183277 Regulated Long Air Hammer

- Extra long barrel provides a harder hitting blow
- Independent power regulators
- Teasing throttle for operator control
- All metal 1-piece housing
- Hardened alloy steel barrel and standard .401" shank opening.



Warranty: Repairable up to 1 year

AIR HAMMER SPECIFICATIONS

Part #	BPM's	Shank	Stroke	Bore	Length	Weight	CFMs
KT183277	2,000 blows per min.	.401" shank	3-1/2" stroke	3/4" bore	9" length	4.00 lbs.	4 CFM
KT183275	3,500 blows per min.	.401" shank	2-5/8" stroke	3/4" bore	6-3/4" length	3.50 lbs.	4 CFM

Air Tools | Accessories

KT181900 4-Piece Pneumatic Bit Set

Includes panel cutter, cold chisel, hammer bit and scraper.



LIFETIME WARRANTY*

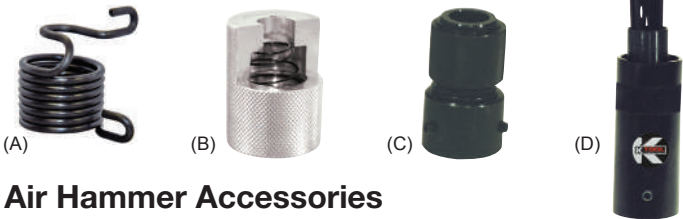

Air Hammer Accessories

KT183091
Bee hive quick-change retainer. (A)

KT183092
One-piece safety bit retainer. (B)

KT183093
Heavy-duty quick-change retainer. (C)

KT183090
Needle scaler attachment. (D)

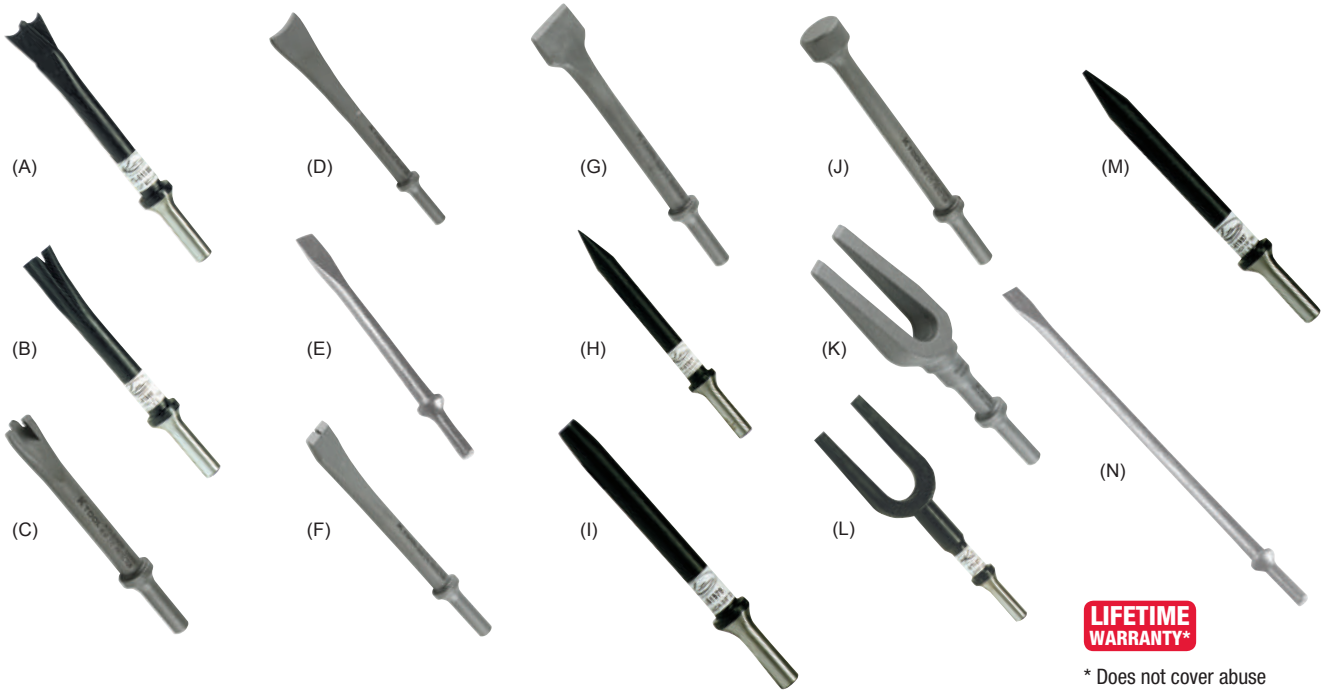

LIFETIME WARRANTY*

* Does not cover abuse

PNEUMATIC BITS					
Part #	Description	Part #	Description	Part #	Description
KT181956	Double cut body ripper (A)	KT181974	10" cold chisel (E)	KT181995	Tie rod separator (K)
KT181958	Slotted panel cutter (B)	KT181975	Rivet and bolt cutter (F)	KT181996	Ball joint separator (L)
KT181959	Sheet metal trimmer (C)	KT181976	Scraper (G)	KT181997	1/8" Taper punch (M)
KT181968	Tail pipe cut-off (D)	KT181977	Taper punch sharp point (H)	KT181986	18" Cold chisel (N)
KT181972	6" cold chisel	KT181979	3/8" Taper punch (I)		
KT181973	8" cold chisel	KT181982	Long hammer (J)		

AIR TOOLS & ELECTRIC TOOLS

Air Tools | Die Grinders

KT187132 Rear Exhaust Die Grinder

- 22,000 rpm
- 1/4" collet
- 2 CFM average air consumption



Die grinder features a powerful 1/2 HP motor, built-in power regulator, variable speed throttle control and full ball bearing construction. Standard with 1/4" collet. Specifications: 22,000 rpm; 1/4" collet; 5-1/2" length; 14 oz. weight; 2 cfm average air consumption.

Warranty: Repairable up to 1 year

KT187125 Mini Rear Exhaust Die Grinder

- 25,000 rpm
- 1/4" collet
- 2 CFM air consumption



Die grinder features full bearing support air motor, rear exhaust independent power regulator and variable speed throttle. Complete with 1/4" collet. Angle head is full bearing construction with a grease fitting for external lubrication. Specifications: 25,000 rpm; 5 1/2" length; 1/4" collet; 2 cfm air consumption.

Warranty: Repairable up to 1 year

KT187126 Rear Exhaust Angle Die Grinder

- 18,000 rpm
- 1/4" collet
- 4 CFM air consumption



Die grinder features full bearing support air motor, rear exhaust independent power regulator and variable speed throttle. Complete with 1/4" collet. Angle head is full bearing construction with a grease fitting for external lubrication. Specifications: 18,000 rpm; 5-3/4" length; 1/4" collet; 4 CFM air consumption.

Warranty: Repairable up to 1 year

KT187128 Gearless Angle Die Grinder

- 25,000 rpm
- 1/4" collet
- 4 CFM air consumption



Tool features drop-in motor, rear exhaust and enhanced muffler system. Lightweight, thermally insulated composite housing reduces vibration. Hardened steel cylinder maximizes air utilization. Grinder's 1/4" collet accepts 1/8", 1/4", 3mm and 6mm shanks.

Warranty: Repairable up to 1 year

KT187135 Die Grinder

- Air die grinder, 3/4 HP with front exhaust system
- Free Speed: 24,000rpm
- Collet size: 1/8" - 1/4"
- Air inlet: 1/4", suggested air pressure: 90psi, average air consumption: 12cfm
- Low vibration facilitates improved working conditions, vibration level less than 2.5m/s²
- 1 Year Warranty

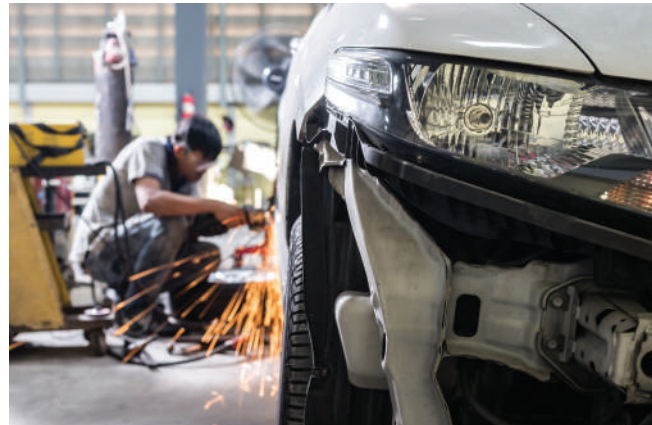

DIE GRINDER SPECIFICATIONS

Part #	RPMs	Collet Size	Length	Weight	CFMs
KT187132	22,000 rpm	1/4" collet	5-1/2" length	1.00 lb.	2 CFM
KT187125	25,000 rpm	1/4" collet	5-1/2" length	14 oz.	2 CFM
KT187126	18,000 rpm	1/4" collet	5-1/2" length	14 oz.	4 CFM
KT187128	25,000 rpm	1/4" collet	6-1/4" length	14 oz.	4 CFM
KT187135	24,000 rpm	1/8" - 1/4" collet	???? length	?? oz.	12 CFM

Air Tools | Sanders & Polishers

KT185800

Dual Piston In-line Sander / File

- Sander features a four-cylinder systems
- Double acting pistons constantly work in opposition to each other, resulting in more power and a smoother, more reliable tool
- Specifications: 3,000 rpm; 1" stroke; 2-3/4" x 15-3/4" pad; 15-3/4" length; 6.5 lbs.; 6 CFM average air consumption.

Warranty: Repairable up to 1 year

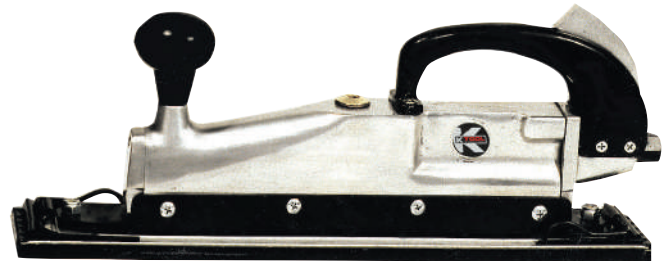

KT185265

Air Sander

High Speed 5"

- 2,000 - 18,000 rpm variable
- 3 Pad sizes included

Variable speed (2,000-18,000) pistol grip 1/2 HP sander features one-piece all metal housing, independent power regulator and teasing trigger. Includes 3", 4" and 5" pads. Ideal for removing paint and rust, shaping filler patches and smoothing welds. Specifications: 18,000 rpm; 6 1/2" length; 3.5 lbs.; 6 CFM average air consumption.

Warranty: Repairable up to 1 year



KT185746

"Quiet" Dual-Action Sander

- Built-in speed regulator and variable speed trigger
- Shielded ball bearing for longer life with smooth harmonics
- 6" flexible foam sanding pad with vinyl
- Specifications: 10,000 rpm; 6" pad; 8-1/4" length; 4 lbs.; 4 CFM average air consumption.

Warranty: Repairable up to 1 year



KT185846

High Performance

"Quiet" Dual-action Sander

- Produce a far superior blending and smoothing of filler, feather edging and pre-paint preparation
- High efficiency motor and an all steel balancer body and steel spindle lock nut
- Crossbolt-style hub mounting which minimizes vibration
- Specifications: Heavy Duty, 6" Diameter Pad, 10,000 RPM, 90 PSI, 1/2 HP, 4 CFM, 3/8" hose inlet, Length: 8-1/4", Weight: 4 lbs

Warranty: Repairable up to 1 year

AIR TOOLS & ELECTRIC TOOLS

Air Tools | Sanders & Polishers

KT185807

7" Horizontal Air Sander

- 7" diameter pad
- Includes a multiposition handle for a variety of uses and ergonomic comfort
- Designed for reliability and superior performance
- 2800 RPM
- 1/4" NPT air inlet, 7 cfm air consumption
- 90 PSI air pressure recommended.



Warranty: Repair only up to 1 year

SANDERS & POLISHERS SPECIFICATIONS

Part #	RPMs/Strokes	Pad Size	Length	Weight	CFMs
KT185265	18,000 rpm	3", 4" and 5" inch pads	6-1/2"	3.50 lbs.	6 CFM
KT185746	10,000 rpm	6" pad	8-1/4"	4.00 lbs.	4 CFM
KT185846	10,000 rpm	6" pad	8-1/4"	4.00 lbs.	4 CFM
KT185800	3,000 rpm	2-3/4" x 15-3/4" pad	15-3/4"	6.50 lbs.	6 CFM
KT185807	2,800 rpm	7" pad	16"	6.00 lbs.	7 CFM

Air Sander Accessories

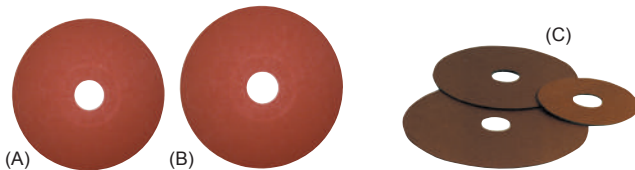

KT185004

High Speed Sander - 4-1/2" pad (A)

KT185005

High Speed Sander - 5" pad (B)

KT185006

3-Piece
High Speed Sander Pad Set (3", 4-1/2", 5") (C)

KT185811

Aluminum Pad Assembly
Jitterbug Sander



KT185811

Air Polisher Accessories

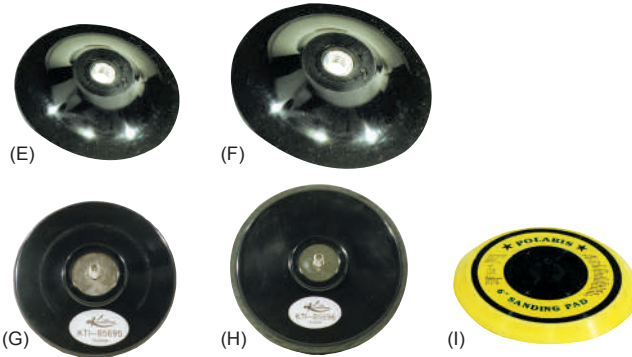

KT185007

5" Deluxe Phenolic Pad (E)

KT185008

7" Deluxe Phenolic Pad (F)

KT185695

5" Dual-Action Bonded Pad. Vinyl face (G)

KT185696

6" Dual-Action Bonded Pad. Vinyl face (H)

KT185697

6" Dual-Action Flex Pad. Yellow Vinyl (I)

Air Tools | Specialty Tools



KT189275 Needle Scaler Standard Duty

- Standard duty, pistol grip
- 3,500 BPM with teasing trigger
- Independent regulators

Warranty: Repairable up to 1 year



KT189257 Straight Line Needle Scaler

- Straight line needle scaler with lever throttle
- 3500 RPM, 4000 bpm, average air consumption 3.5 CFM, air inlet 1/4", air hose 3/8"
- 3mm diameter needles, 6" needle length, 19 needles included
- Bore diameter 1"
- Tool length 18"

Warranty: Repairable up to 1 year



KT183280 Industrial Weld Flux Needle Scaler

- Converts to a standard scaler in seconds
- Simple "J" slot adjustment for needle wear or to provide more needle exposure
- Positive lock retainer
- 4,600 blows per minute.

Warranty: Repairable up to 1 year



KT189276 Pneumatic Scaler

- Pneumatic needle scaler with double spring pistol grip; 3400-4200 bpm
- Lever throttle contains O-rings to limit air leakage
- Clamp on style side handle pivots 360° and is lockable
- Uses 3mm diameter needles
- Comes in black blowmold case and includes 1 side handle grip, 1 oil pot, 1 steel bushing 3/8" NPT x 1/4" NPT, tube of grease lubricant, 2 replacement O-rings and 19 needles (3mm)

Warranty: Repairable up to 1 year

NEEDLE SCALER SPECIFICATIONS

Part #	BPMs	Stroke Length	Length	Weight	CFMs
KT189275	3,500 blows per min.	2-5/8" stroke	12"	4.50 lbs.	4 CFM
KT183280	4,600 blows per min.	1-1/8" stroke	15"	6.00 lbs.	5 CFM
KT189257	4,000 blows per min.	1/8" stroke	18"	6.2 lbs.	3.5 CFM
KT189276	4,200 blows per min.	1-3/10" stroke	18.25"	9 lbs.	2 CFM

AIR TOOLS & ELECTRIC TOOLS

Air Tools | Specialty Tools



KTI88255 Utility / Muffler Cut-off Tool

- 20,000 rpm
- Use with 3" Diameter Abrasive Discs
- Cutting shield

Cuts through muffler clamps, hangers, sheet metal, radiator hose clamps, rusted bumper bolts and steel rods up to 3/4" thick. Standard equipment includes an abrasive 3" disc cutter, independent power regulator, a hand guard trigger and see through cutting shield.

Warranty: Repairable up to 1 year



KTI89218 Air Shear Cutter

- Cut up to 180" per minute
- 18 gauge capacity
- 360° head rotation

Pistol grip, through handle exhaust, high speed 180" per minute cutting capacity in 18 gauge sheet metal. This tool features variable speed control, full ball bearing construction and hardened planetary gear system. The shear head can be positioned in any 360° rotation from the handle for ease of work.

Warranty: Repairable up to 1 year

Replacement parts:

KTI89220 - Replacement Shear Head Attachment



KTI89110 Air Hydraulic 3/16" Rivet Gun

- 4 nose pieces
- Air relief valve

Rugged tool sets rivets up to 3/16" OD. Includes 4 standard-size nose pieces: 3/32", 1/8", 5/32" and 3/16". Air relief prevents overloading and increase life. Side air inlet. Specifications: 75-80 recommended psi; 3/16" capacity; 4.5 CFM average air consumption.

Warranty: Repairable up to 1 year



KTI89115 Air Hydraulic 1/4" Rivet Gun

- 6 nose pieces
- Includes a separate head assembly for steel rivets up to 3/16"

Rugged tool sets rivets up to 1/4" OD. Includes 6 standard-size nose pieces: 3/32", 1/8", 5/32", 3/16", 7/32", 1/4". Includes complete head assembly (jaws and pusher) for 3/32" through 3/16" steel rivets. Specifications: 75-80 recommended psi; 1/4" capacity; 4.5 lbs.; 4.5 CFM average air consumption.

Warranty: Repairable up to 1 year

SPECIFICATIONS

Part #	Strokes/RPMs/PSI	Capacity	Length	Weight	CFMs
KTI89218	2,800 strokes per min.	18 gauge capacity	8-1/2" length	3.50 lbs.	4 CFM
KTI88255	20,000 rpm	3/4" capacity	8" length	2.05 lbs.	4 CFM
KTI89110	75-80 psi (recommended)	3/16" capacity	10.8 Length	3.25 lbs.	4.5 CFM
KTI89115	75-80 psi (recommended)	1/4" capacity	12.5 Length	4.50 lbs.	4.5 CFM

Air Tools | Blow Guns



KTI71010

Air Blow Gun Rubber Tip 1/2"

- Air blow gun with heavy duty aluminium die cast body
- Exclusive Venturi mechanism combines ambient air with compressed air boosting output by 15%
- Output air discharge can be varied by the pistol handle
- Conforms to OSHA standard for both safety & noise
- Inlet threaded 1/4" NPT (F)
- 1 year warranty



KTI71011

Air Blow Gun Standard

- Air blow gun with heavy duty aluminium die cast body
- Exclusive Venturi mechanism combines ambient air with compressed air boosting output by 15%
- Output air discharge can be varied by the pistol handle
- Conforms to OSHA standard for both safety & noise
- Inlet threaded 1/4" NPT (F)
- 1 year warranty



KTI71012

Air Blow Gun High Flow Safety

- Air blow gun with heavy duty aluminium die cast body
- Exclusive Venturi mechanism combines ambient air with compressed air boosting output by 15%
- Output air discharge can be varied by the pistol handle
- Conforms to OSHA standard for both safety & noise
- Inlet threaded 1/4" NPT (F)
- 1 year warranty



KTI71013

Air Blow Gun Soft Rubber Star Tip

- Air blow gun with heavy duty aluminium die cast body
- Exclusive Venturi mechanism combines ambient air with compressed air boosting output by 15%
- Output air discharge can be varied by the pistol handle
- Conforms to OSHA standard for both safety & noise
- Inlet threaded 1/4" NPT (F)
- 1 year warranty



KTI71015

Air Blow Gun Kit - 4 Tips

- General purpose air blow gun kit. Includes 4 popular field interchangeable tips
- Exclusive Venturi mechanism combines ambient air with compressed air boosting output by 15%
- Output air discharge can be varied by the pistol handle
- Conforms to OSHA standard for both safety & noise
- Inlet threaded 1/4" NPT (F)
- 1 year warranty



KTI71016

Air Blow Gun Kit - 7 Tips

- Industrial air blow gun kit. Includes 7 popular field interchangeable tips
- Exclusive Venturi mechanism combines ambient air with compressed air boosting output by 15%
- Output air discharge can be varied by the pistol handle
- Conforms to OSHA standard for both safety & noise
- Inlet threaded 1/4" NPT (F)
- 1 year warranty

AIR TOOLS & ELECTRIC TOOLS



BluBird Rubber Air Hoses

- 100% rubber air hose
- Heavy duty, ultra light weight and super strong
- 300 PSI, NPT fittings with brass ferrules and a bend restrictor to reduce kinking
- Stays flexible in temperatures from -50° to 180° F
- Ozone and abrasion resistant EPDM blended cover
- 10 year warranty



Part #	Description
KTI72013	1/4" x 50' - 1/4" NPT BluBird Rubber Hose
KTI72014	3/8" x 25' - 1/4" NPT BluBird Rubber Hose
KTI72015	3/8" x 50' - 1/4" NPT BluBird Rubber Hose
KTI72016	1/2" x 50' - 1/2" NPT BluBird Rubber Hose



BluBird Rubber Air Hoses

- 100% rubber air hose
- Heavy duty, ultra light weight and super strong
- 300 PSI, NPT fittings with brass ferrules and a bend restrictor to reduce kinking
- Stays flexible in temperatures from -50° to 190° F
- Ozone and abrasion resistant EPDM blended cover
- 10 year warranty

Part #	Description
KTI72036	3/8" x 100' - 1/4" MNPT BluBird Rubber Hose
KTI72037	1/2" x 25' - 1/2" MNPT BluBird Rubber Hose
KTI72038	1/2" x 100' - 1/2" MNPT BluBird Rubber Hose
KTI72048	3/8" x 25' - 1/4" MNPT BluBird Oil Shield Air Hose
KTI72049	3/8" x 35' - 1/4" MNPT BluBird Air Hose

Rubber Air Hose

- Solid brass end MNPT fittings
- Protective PVC bend restrictor ends
- Abrasion-resistant rubber outer jacket
- 300 PSI working pressure
- 1 year warranty



Part #	Description
KTI72001	3/8" x 25' - 1/4" MNPT Rubber Air Hose - Red
KTI72002	3/8" x 50' - 1/4" MNPT Rubber Air Hose - Red
KTI72003	1/2" x 25' - 3/8" MNPT Rubber Air Hose - Red
KTI72004	1/2" x 50' - 3/8" MNPT Rubber Air Hose - Red
KTI72005	1/2" x 25' - 1/2" MNPT Rubber Air Hose - Red
KTI72006	1/2" x 50' - 1/2" MNPT Rubber Air Hose - Red
KTI72010	3/8" x 25' - 1/4" MNPT Rubber Air Hose - Yellow
KTI72011	3/8" x 35' - 1/4" MNPT Rubber Air Hose - Yellow
KTI72012	3/8" x 50' - 1/4" MNPT Rubber Air Hose - Yellow
KTI72025	3/8" x 25' - 1/4" MNPT Rubber Air Hose - Red
KTI72035	3/8" x 35' - 1/4" MNPT Rubber Air Hose - Red
KTI72050	3/8" x 50' - 1/4" MNPT Rubber Air Hose - Red





BluBird
RUBBER AIR HOSE

AIR TOOLS & ELECTRIC TOOLS



AvaGard Rubber Air Hoses, Red

- AvaGard premium 300 PSI professional rubber air hose with 1/4" NPT
- Very light, super strong and super agile
- Stays flexible in extreme conditions from -40 to 180° F
- Oil resistant core tube meets RMA Class C oil resistance and ozone resistant cover resists extreme weather, abrasions & kinks
- Ultimate durability • Color: red • 5 year warranty

Part #	Description
KT172020	AvaGard 3/8" x 25' Air Hose, Red
KT172021	AvaGard 3/8" x 50' Air Hose, Red

Part #	Description
KT172022	AvaGard 1/2" x 25' Air Hose, Red
KT172023	AvaGard 1/2" x 50' Air Hose, Red



KT172042

BluBird Oil Shield 3/4" x 25' Air Hose

- BluBird Oil Shield with Dino Hide wrapping 3/4" x 25' 300 PSI 100% rubber air hose with 3/4" MNPT
- Ultra lightweight, extreme durability resists abrasion and ultra high strength exceeds RMA IP-2
- Stays flexible in extreme conditions from -30 to 190° Fahrenheit
- Oil resistant core tube and cover meets RMA Class A oil resistance
- Four finger grip bend restrictor for easy use and better durability
- Color: Yellow
- 3-Year Warranty



BluBird Oil Shield Air Hose

- BluBird Oil Shield 300 PSI 100% rubber air hose
- Ultra lightweight, extreme durability resists abrasion and ultra high strength exceeds RMA IP-2
- Stays flexible in extreme conditions from -30 to 190° Fahrenheit
- Oil resistant core tube and cover meets RMA Class A oil resistance
- Four finger grip bend restrictor for easy use and better durability
- Color: Yellow
- 3 Year Warranty

Part #	Description
KT172017	3/8" x 35' - 1/4" NPT BluBird Oil Shield Air Hose
KT172018	3/8" x 50' - 1/4" NPT BluBird Oil Shield Air Hose
KT172019	1/2" x 50' - 1/2" NPT BluBird Oil Shield Air Hose
KT172039	3/8" x 100' - 1/4" MNPT BluBird Oil Shield Air Hose
KT172048	3/8" x 25' - 1/4" MNPT BluBird Oil Shield Air Hose
KT172047	1/2" x 25' - 1/2" MNPT BluBird Oil Shield Air Hose
KT172041	1/2" x 100' - 1/2" MNPT BluBird Oil Shield Air Hose



KT172043

BluBird Oil Shield 3/4" x 50' Air Hose

- BluBird Oil Shield with Dino Hide wrapping 3/4" x 50' 300 PSI 100% rubber air hose with 3/4" MNPT
- Ultra lightweight, extreme durability resists abrasion and ultra high strength exceeds RMA IP-2
- Stays flexible in extreme conditions from -30 to 190° Fahrenheit
- Oil resistant core tube and cover meets RMA Class A oil resistance
- Four finger grip bend restrictor for easy use and better durability
- Color: Yellow
- 3-Year Warranty



• BluBird air hoses are heavy duty, ultra light weight and super strong. Stay flexible in temperatures from -50 to 190° fahrenheit. Ozone, UV & abrasion resistant. Covered by a 10 year warranty

• BluBird Oil Shield air hoses are ultra lightweight, extreme durability resists abrasion and ultra high strength exceeds RMA IP-2. Stay flexible in extreme conditions from -30 to 190° fahrenheit. Oil resistance core tube and cover meets RMA Class A oil resistance. Covered by a 3 year warranty

KT171005

BluBird And Oil Shield Air Hose Promo Pack

Contains 8 air hoses:

- (2) - **KT172015** - BluBird 3/8" x 50'
- (2) - **KT172018** - Oil Shield 3/8" x 50'
- (1) - **KT172049** - BluBird 3/8" x 35'
- (1) - **KT172017** - Oil Shield 3/8" x 35'
- (1) - **KT172014** - BluBird 3/8" x 25'
- (1) - **KT172048** - Oil Shield 3/8" x 25'

• Size of promotional pack on display:
Width: 24", Depth: 11", Height: 26"



KT172044

BluBird Oil Shield Whip Hose 3/8" x 3'

- 1/4" FNPT
- 1/4" MNPT Ball Swivel 360 degrees
- Oil resistant core tube and cover meets RMA Class A oil resistance
- Color: Yellow • 3 Year Warranty

KT172045

BluBird Oil Shield Whip Hose 3/8" x 5'



KT172007

3/8" x 3' Whip Hose 1/4" Swivel

- Red rubber whip hose with brass ferrule
- 1/4" Swivel + 1/4" Fixed NPT Male Fittings
- 1 Year Warranty on material and workmanship • 300 PSI

KT172008

3/8" x 6' Whip Hose 1/4" Swivel

- 1 Year Warranty on material and workmanship

KT172000

Rubber Whip Hose 3/8" x 3', 1/4" NPT

- Solid brass 1/4" NPT male ends
- 300 PSI
- 1 Year Warranty on material and workmanship



KT172009

BluBird Whip Hose 3/8" x 3', 1/4" FNPT

- 1/4" FNPT
- 1/4" MNPT Ball Swivel 360°
- Ozone, UV & abrasion resistant
- Color: Blue
- 10-Year Warranty



AIR TOOLS & ELECTRIC TOOLS



KT172046 BluBird Whip Hose 3/8" x 5', 1/4" FNPT

- 1/4" FNPT
- 1/4" MNPT Ball Swivel 360°
- Ozone, UV and abrasion resistant
- Color: Blue
- Covered by a 10-Year Warranty

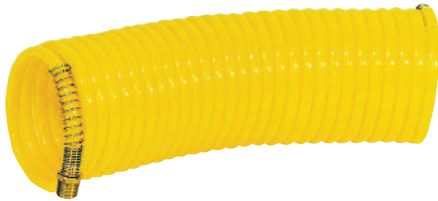

LIFETIME WARRANTY*

KT171025 Nylon Recoil Hose

These K-Tool International nylon recoil air hoses will provide your air-operated tools with consistent airflow. They are manufactured from heavy-duty nylon to perform great in all weather conditions. Extends out to 25 ft., but as small as 2 ft. when coiled up.

KT171000 Black Steel Hose Reel With 3/8" x 50 Foot Rubber Air Hose

- All steel constructed black reel with 300 PSI red rubber hose (50 foot)
- Slotted mounting base for easy installation
- Automatic spring powered recoil
- 8 position ratchet gear locks reel at desired hose length
- 3/8" I.D., 1/4" male NPT
- 1 year warranty on material and workmanship



Heavy duty, steel construction air hose reel. Reinforced side plates are powder coated to resist corrosion. Comes with 3/8" diameter, 50 ft. rubber air hose which features a 1/4" male NPT, PVC bend restrictor, and brass ferrule. The eight position ratchet gear locks the reel at desired hose length. An automatic spring powered recoil system retracts air hose easily. Multi-direction rollers prevent snagging and reduced wear. The pre-slotted base can be installed trouble-free with 3 positions for installation where convenient (bench, ceiling, floor or wall).



BluBird Air Hose Reels

- 300 PSI retractable rubber air hose reel with lead in hose and 1/4" NPT fittings
- Smooth auto-rewind with locking 12 point ratchet gearing system which helps to lock at various lengths
- Heavy duty steel construction with powder coated, corrosion proof finish
- Four rollers reduce hose wear
- Horizontal and vertical wall mount options with adjustable guide arm
- 2 Year warranty

KT171001 - 3/8" x 50' BlueBird Air Hose

KT171002 - 1/2" x 50' BlueBird Air Hose



KT171003 BluBird HD Air Hose Reel 3/8" x 50'

- BluBird Oil Shield 3/8" x 50' 300 PSI Heavy Duty retractable rubber air hose reel with 3' lead in hose and 1/4" NPT fittings
- Smooth auto-rewind with locking 12 point ratchet gearing system which helps to lock at various lengths
- Heavy duty steel construction with powder coated, corrosion proof finish
- Four rollers reduce hose wear
- Horizontal and vertical wall mount options with adjustable guide arm

2-Year Warranty on Reel with 3-Year Warranty on the included yellow Oil Shield hose.



KTI10010
4-1/2" Angle Grinder
650 Watt

- Features a compact design for improved handling
- Spindle lock makes changing the grinder wheel quick and easy
- Grinder also includes a grinding wheel guard, wrench and flange
- Ergonomic, removable side handle adds versatility for any job
- UL listed; One-year limited warranty.

Specifications: 5 amp; 11,000 rpm no-load speed; 120 volt AC rating. A spindle lock makes changing the grinder wheel quick and easy. Grinder also includes a grinding wheel guard, wrench and flange. The ergonomic, removable side handle adds versatility for any job!



KTI10210
10" Random Orbit Polisher/Waxer

- 10-inch pad to reduce waxing and polishing time
- For use on cars, RVs, vans, SUVs and boats
- High-impact ABS shell for added durability
- Includes one (1) terry cloth bonnet and one (1) synthetic wool bonnet
- UL listed
- One-year limited warranty

Polisher maintains that "new car finish" and protects and restores older finishes. Specifications: 0.75 amp; 3,000 rpm no load speed; 120V/60Hz rated voltage; 10-inch cord.



KTI81380
1/2" Electric Impact Wrench

- 7 amp tool features 120 volts, 2100 RPM and double insulation
- Up to 235 ft/lbs. of torque
- Complete with an extra set of easy-change screw in brushes
- 1 Year Warranty on material and workmanship

This heavy-duty 7 amp tool features 120V, 2100 rpm, double insulation and up to 235 ft./lbs. of torque. Packaged with an extra set of easy change screw-in brushes.

Warranty: Repairable up to 1 year



KTI10215
7" Variable Speed Polisher

- 7" Pad
- Variable speeds: 1,000 to 3,000 rpm
- Soft start
- Overload protection and trigger lock
- UL listed
- One-year limited warranty

The electric 7" polisher/sander features variable speed control which allows users to set maximum speeds from 1,000 to 3,000rpm for different polishing applications. Polisher boasts a repositionable handle for a variety of jobs. Specifications: 11 amp; 120V/60Hz; variable speeds: 1,000 to 3,000 rpm; soft start; overload protection and trigger lock.

Includes: one (1) 7" rubber polishing pad; one (1) 7" sanding pad and one (1) wool bonnet.



SHOP TOOLS



Shop Tools | Lifting

KTI63201 2 Ton Bottle Jack

- Capacity: 2 Tons
- Lifting Range: 6.2" to 12.1"
- Ram extension screw adjusts low height to get full use of ram travel
- Load-limiting and bypass valves prevent against over loading and over extension
- Ductile iron hydraulic base for added strength
- 1 Year Warranty on material and workmanship
- Complies With ASME PASE/2014 Safety Standards



KTI63207 6 Ton Bottle Jack

- Capacity: 6 Tons
- Lifting Range: 7.75" - 15.04"
- Ram extension screw adjusts low height to get full use of ram travel
- Load-limiting and bypass valves prevent against over loading and over extension
- Ductile iron hydraulic base for added strength
- 1 Year Warranty on material and workmanship
- Complies With ASME PASE/2014 Safety Standards



XD Bottle Jacks

- Ram extension screw adjusts low height to get full use of ram travel
- Load-limiting and bypass valves prevent against over loading and over extension
- Ductile iron hydraulic base for added strength
- 2 Year Warranty on material and workmanship
- Complies With ASME PASE/2014 Safety Standards

KTI63213 Capacity: 12 Tons, Lifting Range: 8.46" - 15.75"

KTI63221 Capacity: 20 Tons, Lifting Range: 9.6" - 16.65"



Short XD Bottle Jacks

- Ram extension screw adjusts low height to get full use of ram travel
- Load-limiting and bypass valves prevent against over loading and over extension
- Ductile iron hydraulic base for added strength
- 2 Year Warranty on material and workmanship
- Complies With ASME PASE/2014 Safety Standards

KTI63214 Capacity: 12 Tons, Lifting Range: 7.48" - 13.78"

KTI63224 Capacity: 20 Tons, Lifting Range: 7.25" - 13.39"



KTI63230 30 Ton Bottle Jack

- 30 ton bottle jack with lift range from 11.2" to 18.27"
- Thick steel hydraulic base for maximum strength
- Three-piece snap-fit pump handle for easy pumping and storage
- Carrying handle included
- Load-limiting and bypass valves prevent against over loading and over extension of ram
- 2 Year Warranty on material and workmanship
- Complies With ASME PASE/2014 Safety Standards



KTI63250 50 Ton Bottle Jack

- 50 ton bottle jack with lift range from 11.8" to 18.8"
- Thick steel hydraulic base for maximum strength
- Three-piece snap-fit pump handle for easy pumping and storage
- Carrying handle included
- Load-limiting and bypass valves prevent against over loading and over extension of ram
- 2 Year Warranty on material and workmanship
- Complies With ASME PASE/2014 Safety Standards



KTI63228

20 Ton Air Hydraulic Bottle Jack

- Lifting Range: 10.43" - 19.88"
- Air/hydraulic pump with air valve lever reduces lifting time and provides ease of operation
- Load limiting and bypass valves prevent use beyond rated capacity and over extension of ram
- Additional adjustable screw 3.25"
- 2 Year Warranty on material and workmanship
- Complies With ASME PASE/2014 Safety Standards



KTI63100

1.5 Ton Scissor Jack

- For tire changing and snow chain installation
- Lifting range from 4.1" to 15.2"
- Large base for added stability
- Long crank handle for ease of turning under load
- All steel construction in a compact design for storage
- 1 Year Warranty on material and workmanship
- Complies With ASME PASE/2014 Safety Standards

KTI63103

2 Ton Trolley Jack

- Lifting Capacity: 2 Tons
- Lifting Range: 5.3" to 13.2"
- Lightweight and compact design for easy handling and storage
- Load-limiting and bypass valves prevent against over loading and over extension
- Grab handle for easy positioning and carrying
- 1 Year Warranty on material and workmanship
- Complies With ASME PASE/2014 Safety Standards



KTI63131

3 Ton

Compact Service Jack

- Capacity: 3 Tons
- Lifting range: 5.3" - 18.5 "
- Sealed hydraulic power unit prevents contaminants from entering system
- Load-limiting and bypass valves prevent use beyond rated capacity and over extension of ram
- Wide track front wheels and rear swivel casters for easy maneuverability
- 1 Year Warranty on material and workmanship
- Complies With ASME PASE/2014 Safety Standards



KTI63098

2 Ton Aluminum Service Jack

- Very strong, 2 ton capacity, but weights only 42.1 lbs. ASME PALD 2009
- Dual pump system for quick lifting (7 strokes to top under no load)
- Lifting range 3 1/4" - 18 1/2"
- Side handle for easy positioning
- 2 pc handle for easy storage. Includes handle pad for protecting the vehicle
- 2 Year Warranty
- Complies With ASME PASE/2014 Safety Standards



KTI63099

3 Ton Aluminum Service Jack

- Very strong, 3 ton capacity, but only weights 55.8 lbs. ASME PALD 2009
- Dual pump system for quick lifting (7 strokes to top under no load)
- Lifting range 3 3/4" - 19 1/4"
- "D" Side handle for easy positioning
- 2 piece handle for easy storage. Includes handle pad for protecting the vehicle
- 2 Year warranty
- Complies With ASME PASE/2014 Safety Standards



KT163101

2 Ton Low Profile Service Jack

- Allows for easy access under low ground clearance vehicles
- Lift range from 3.5" to 18.1"
- 45.25" long pump handle for easy pumping under load
- Dual pump piston power unit raises saddle to maximum height in 6.5" full incremental pump strokes with no load
- Load-limiting and bypass valves to prevent use beyond rated capacity and over-extension of ram
- Saddle diameter 4.3"
- 2 Year Warranty on material and workmanship
- Complies With ASME PASE/2014 Safety Standards



KT163133

3.33 Ton Low Profile Service Jack

- 3.33 ton capacity low profile service jack for easy access under low ground clearance vehicles
- Lift range from 3.5" to 21.375"
- 50" long pump handle for easy pumping under load
- Dual pump piston power unit raises saddle to maximum height in 8 full incremental pump strokes with no load
- Load-limiting and bypass valves to prevent use beyond rated capacity and over-extension of ram
- 2 Year Warranty on material and workmanship
- Complies With ASME PASE/2014 Safety Standards



KT163105

2 Ton Extra Long Low Profile Service Jack

- Allows for easy access under low ground clearance vehicles
- Lift range from 2.75" to 24" • Saddle diameter 3.85"
- 45.25" long pump handle for easy pumping under load
- Dual pump piston power unit raises saddle to maximum height in 8 full incremental pump strokes with no load
- Load-limiting and bypass valves to prevent use beyond rated capacity and over-extension of ram
- 2 Year Warranty on material and workmanship
- Complies With ASME PASE/2014 Safety Standards



KT163155

5 Ton Service Jack

- 5 ton capacity service jack with a lift range from 5.75" to 22"
- 45.75" long pump handle with release knob works independently of handle position
- Raise the saddle quickly to the load with additional foot pedal
- Load-limiting and bypass valves prevent jack from being used beyond rated capacity and over-extension of ram
- Handle locks in either vertical, 45°, or horizontal positions
- 2 Year Warranty on material and workmanship
- Complies With ASME PASE/2014 Safety Standards

KT163186

10 Ton Service Jack

- 10 ton capacity service jack with a lift range from 6.25" to 22.5"
- 45.75" long pump handle with release knob works independently of handle position
- Raise the saddle quickly to the load with additional foot pedal
- Load-limiting and bypass valves prevent jack from being used beyond rated capacity and over-extension of ram
- Handle locks in either vertical, 45°, or horizontal positions
- 2 Year Warranty on material and workmanship
- Complies With ASME PASE/2014 Safety Standards





KTI63194

22 Ton Air Hydraulic Truck Jack

- 22 ton capacity truck jack with a lift range from 9.06" to 17.94"
- Narrow width fits between tandem wheels
- Load-limiting and bypass valves prevent use beyond rated capacity and overextension of ram
- Spring activated self retracting ram
- Release knob at the top of the T-handle works at any handle position
- 2 Year Warranty on material and workmanship
- Complies With ASME PASE/2014 Safety Standards



KTI63198

50 Ton Air Hydraulic Truck Jack

- 50 ton capacity truck jack with lift range from 11.4" to 21.25"
- Narrow width fits between tandem wheels
- Load-limiting and bypass valves prevent use beyond rated capacity and over-extension of ram
- Spring activated self-retracting ram
- Release knob at top of T handle works at any handle position
- 2 Year Warranty on material and workmanship
- Complies With ASME PASE/2014 Safety Standards



KTI63194COMBO

22 Ton Air Hydraulic Jack w/1" Air Impact

- A combination package including a 22 ton capacity truck jack (KTI63194) with a lift range from 9.06" to 17.94" and a 1" drive air impact wrench with 6" extended anvil (KTI81798A)
- The air hydraulic jack has load-limiting and bypass valves which prevent use beyond rated capacity and overextension of ram with spring activated self retracting ram. Has release knob at the top of the T handle works at any handle position and narrow width fits between tandem wheels
- The air impact wrench has a 6" extended anvil for extra access, 1,600 ft/lbs of torque, 3 forward and 3 reverse power settings, a D side handle for ease of use and side exhaust which directs air away from the job
- The hydraulic jack complies with ASME PASE/2014 Safety Standards and is covered by a 2 year warranty on material and workmanship
- The 1" air impact wrench is covered by a 1 year warranty



SERVICE JACKS SPECIFICATIONS						
Supplier	Part #	Capacity (tons)	Minimum Height	Maximum Height	Air Assist	Special Features
K Tool	KTI63103	2	3.5"	18.1"	N	Low Profile
K Tool	KTI63098	2	3.25"	18.5"	N	Aluminum
K Tool XD	KTI63101	2	3.5"	18.1"	N	Low Profile
K Tool XD	KTI63105	2	2.75"	24"	N	Extra Long, Low Profile
K Tool	KTI63131	3	5.3"	18.5"	N	Compact
K Tool	KTI63099	3	3.75"	19.25"	N	Aluminum
K Tool XD	KTI63133	3.33	3.5"	21.375"	N	Low Profile
K Tool HD	KTI63155	5	5.75"	22"	N	Heavy Duty
K Tool HD	KTI63186	10	6.25"	22.5"	N	Heavy Duty

KTI63500
700 lb Pedestal
Transmission Jack

- Capacity: 700 lbs.
- Hand pumped, long stroke, single stage bottle jack, with a release lever to discharge the load
- Load-limiting and bypass valves prevent against over loading and over extension
- Adaptable saddle, with four angle brackets that can adjust to fit transmission pan flanges
- Adjustable safety chain included to aid in load restraint
- 1 Year Warranty on material and workmanship
- Complies With ASME PASE/2014 Safety Standards



KTI63502
1000 Lb Single Stage
Transmission Jack

- Capacity: 1,000 lbs.
- Lifting Range: 43.625" - 71"
- Saddle tilt: 23 degrees forward and 16 degrees backward
- For automotive use up to light duty pickup trucks
- Foot pedal activation easily raises single ram under load
- 2 Year Warranty on material and workmanship
- Complies With ASME PASE/2014 Safety Standards



KTI63505
1000 Lb. 2-Stage Telescopic
Transmission Jack

- Capacity: 1,000 Lbs
- Lifting Range: 35" to 74.2"
- Speedy pump foot pedal raises telescopic rams to load quickly
- Foot pump and release pedals provide hands free operation to align saddle with transmission
- Four caster wheels for easy transportation and maneuverability
- 2 Year Warranty on material and workmanship
- Complies With ASME PASE/2014 Safety Standards



SHOP TOOLS

KTOOL INTERNATIONAL **XD**



KTI63515 1200 Lb Low Profile Transmission Jack

- 1200 pound capacity transmission jack with a lift range from 5.75" to 31.5"
- For automotive use up to pickup truck transmissions
- Wide front-open chassis for lower profile when loaded
- Full swivel pump handle can be accessed in any work position
- Fully adjustable universal saddle with load securing hardware
- 2 Year Warranty on material and workmanship
- Complies With ASME PASE/2014 Safety Standards

KTOOL INTERNATIONAL **XD**



KTI63134 Transmission Jack Adapter for Service Jacks

- Capacity: 700 lbs
- Saddle Forward Tilt: 35°
- Saddle Backward Tilt: 35°
- Designed for jacks with a slip in saddle
- Easily transforms your service jack into a transmission jack; fits KTI63131 - 3 Ton Compact Service Jack
- Weight: 34.5 lbs
- 2 Year Warranty on material and workmanship
- Complies With ASME PASE/2014 Safety Standards

KTOOL INTERNATIONAL **HD**



KTI63517 1.5 Ton Truck Transmission Jack

- 1.5 ton capacity truck transmission jack with lift range from 8.62" to 36.625"
- Front and back swivel casters allow for trouble-free positioning and maneuverability
- Pump handle rotates 360° for multiple work positions
- Universal saddle with tilt features
- Load restraint system included
- 2 Year Warranty on material and workmanship
- Complies With ASME PASE/2014 Safety Standards

KTOOL INTERNATIONAL **XD**



KTI63136 Fuel Tank Adapter

- Quick and easy installation to all underhoist transmission jack saddles
- Universal adapter plate included for mounting to all other under hoist jack saddles
- Length, width, and height adjustments to handle any fuel tank configuration up to 40 gallon capacity
- Four 3" by 5.5" foam support pads self adjust and protect the tank from damage
- Ground wire assembly can be used with older metal tanks to prevent against static electric discharge
- 2 Year Warranty on material and workmanship
- Complies With ASME PASE/2014 Safety Standards



Jack Stands

- Designed to be used in pairs
- Steel base with four feet pads for stability
- Ratchet action design with ductile iron support column
- 2 Year Warranty on material and workmanship
- Complies With ASME PASE/2014 Safety Standards

KTI61202 3 Ton Jack Stands, Lifting Range: 11.6" to 16.7"

KTI61205 6 Ton Jack Stands, Lifting Range: 15.75" to 24"



KTI61211 12 Ton Jack Stands

- Capacity: 12 Tons
- Lifting Range: 19.63" to 30.25"
- Steel square base with foot pads for added strength and stability
- Ductile iron column supports load off the ground
- Weight: 52.9 lbs
- 2 Year Warranty on material and workmanship
- Complies With ASME PASE/2014 Safety Standards

JACK STANDS SPECIFICATIONS

Supplier	Part #	Capacity	Minimum Height	Maximum Height	Style
K Tool HD	KTI61222	22 Ton	11-7/8"	19-3/4"	Pin Style
K Tool XD	KTI61202	3 Ton	11-3/4"	16-3/4"	Ratchet
K Tool XD	KTI61205	6 Ton	15-3/4"	24"	Ratchet
K Tool XD	KTI61211	12 Ton	19-5/8"	30-1/4"	Ratchet

KTI61222 22 Ton Jack Stands

- Pair of 22 ton capacity pin type jack stands with support range from 11.825" to 19.75"
- Height adjustment pin connected to base by way of lanyard to prevent against loss
- Steel plate and structural tubing for added strength and stability
- V-shaped saddle to cradle axles and other truck components
- Sold and to be used in pairs
- 2 Year Warranty on material and workmanship
- Complies With ASME PASE/2014 Safety Standards



SHOP TOOLS



KT161076

3/4 Ton Utility Underhoist Stand

- 3/4 ton under hoist stand designed to support under car components
- Support range from 53" to 79"
- Acme threaded screw for self-locking positioning
- Bearing mounted spin handle for easy raising and lowering of screw
- 12" diameter base with 1.63" x 5.5" saddle provide additional support
- 2 Year Warranty on material and workmanship
- Complies With ASME PASE/2014 Safety Standards



KT161077

3/4 Ton Utility Underhoist Stand with Pedal

- 3/4 ton under hoist stand designed to support under car components
- Support range from 53" to 79"
- Acme threaded screw for self-locking positioning and foot pedal to raise screw another 1.25" under 400 pounds of load
- Bearing mounted spin handle for easy raising and lowering of screw
- 12" diameter base with 1.63" x 5.5" saddle provide additional support
- 2 Year Warranty on material and workmanship
- Complies With ASME PASE/2014 Safety Standards



KT161002

2 Ton Tripod Underhoist Stand

- 2 ton under hoist stand designed to help stabilize a vehicle suspended by an above-ground lift
- Support range from 68" to 76"
- Acme threaded screw for 8" of fine adjustment
- Bearing mounted spin handle for easy raising and lowering of screw
- 24" triangle shaped base and 3.25" square saddle provide additional stability
- 2 Year Warranty on material and workmanship
- Complies With ASME PASE/2014 Safety Standards



KTOOL XD
INTERNATIONAL



KTi62108
800 Lb. H-Style Engine Stand

- Capacity: 800 lbs
- H-frame design base with four wheels provides stability
- Stand made of structural steel tubing for strength and light enough for easy maneuverability
- Fully adjustable mounting head and adapter fingers
- Weight: 49.8 lbs
- 2 Year Warranty on material and workmanship
- Complies With ASME PASE/2014 Safety Standards

KTOOL XD
INTERNATIONAL

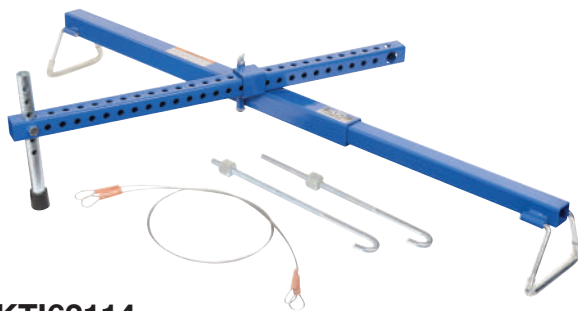

KTi62114
700 Lb Engine Support Bar

- Transverse support bar adjusts from 34.5" to 61"
- Designed to support front wheel drive engines for repair or motor mount replacement
- Includes support leg for heavier engines or engines requiring three point support
- Engine attachment and adjustment hardware provided
- 2 Year Warranty on material and workmanship
- Complies With ASME PASE/2014 Safety Standards

KTOOL XD
INTERNATIONAL



KTi62110
1000 Lb Geared Engine Stand

- 1000 pound capacity foldable engine stand for convenient storage when not in use
- Worm gear driven mounting plate with adjustable fingers rotates for desired engine position
- Four wheel design with locking caster wheels to prevent stand from moving
- Made of structural steel plate and tubing for added strength
- Weighs 96 lbs
- 2 Year Warranty on material and workmanship
- Complies With ASME PASE/2014 Safety Standards

KTOOL HD
INTERNATIONAL



KTi62116
1000 Lb Engine Support Bar

- Designed to support front wheel drive engines for repairs or servicing of engine mounts
- Includes a 1000 pound capacity transverse bar that extends from 34.5" to 61"
- Includes a support leg for handling larger engines or engines requiring three support points
- Engine attachment and adjustment hardware included
- Weight 41.9 lbs
- 2 Year Warranty on material and workmanship
- Complies With ASME PASE/2014 Safety Standards

SHOP TOOLS



KT162115 1500 Lb. Engine Sling

- 1500 pound capacity engine sling for use with an engine crane
- Designed to level a load or adjust at a specific angle for installation and removal
- Hand crank and bearing mounted drive screw for easy adjustment
- Four mounting chains and brackets for quick attachment to engine
- Weighs 14.3 lbs
- 2 Year Warranty on material and workmanship
- Complies With ASME PASE/2014 Safety Standards



KT163414 4 Ton Long Ram

- 4 ton long ram bottle jack for farm applications and replacement power unit for engine cranes
- Lift range from 19.7" to 34.7".
 - * Release valve slowly controls the lowering of load
- Load-limiting and bypass valves to prevent overloading and over extension of ram
- Long handle for easy pumping effort under load
- Hole in top of ram for receiving mounting bolt
- 2 Year Warranty on material and workmanship
- Complies With ASME PASE/2014 Safety Standards



KT163427 8 Ton Long Ram

- 8 ton long ram bottle jack for farm applications and replacement power unit for engine cranes
- Lift range from 24" to 42.7".
 - * Release valve slowly controls the lowering of load
- Load-limiting and bypass valves to prevent overloading and over extension of ram
- Long handle for easy pumping effort under load
- Hole in top of ram for receiving mounting bolt
- 2 Year Warranty on material and workmanship
- Complies With ASME PASE/2014 Safety Standards



KT163421 1.5 Ton Foldable Engine Crane with Fast Rise

- 750 Lbs. / 1,500 Lbs. / 2,250 Lbs. / 3,000 Lbs. capacity engine crane with four different boom positions
- Legs and boom fold quickly for storage
- Fast rise pump without a load
- 48" long boom with chain and swivel hook included
- 4.25" low profile base for easy access under low ground clearance vehicles
- 2 Year Warranty on material and workmanship
- Complies With ASME PASE/2014 Safety Standards



KTI63703

4 Ton Portable Ram Kit

- 4 ton portable ram kit for spreading, bending, pushing, and clamping applications
- 7,250 PSI hand pump and 10.5" long ram with 4.75" stroke
- Basic attachments, .5 ton spreader ram, and five extension tubes included
- Force gauge to measure force applied to work
- Snap-fit design for quick attachment and tube connections
- 2 Year Warranty on material and workmanship
- Complies With ASME PASE/2014 Safety Standards



KTI63709

10 Ton Portable Ram Kit

- 10 ton portable ram kit for spreading, bending, pushing, and clamping applications
- 8,050 PSI hand pump and 12.6" long ram with 5.12" stroke
- Basic attachments, .5 ton spreader ram, and four extension tubes included
- Force gauge to measure force applied to work
- Snap-fit design for quick attachment and tube connections
- 2 Year Warranty on material and workmanship
- Complies With ASME PASE/2014 Safety Standards



KTI63716

Air Hydraulic Foot Pump

- 10,000 PSI air/hydraulic foot pump requires 90 PSI air pressure
- Designed to be used with single acting cylinders
- Provides hands free operation for pumping and releasing load
- Usable fluid capacity 98 cubic inches
- Flow rate 42 cu. in. with no load, 8.5 cu. in. with load
- 2 Year Warranty on material and workmanship
- Complies With ASME PASE/2014 Safety Standards





KT163611 12 Ton Shop Press

- 12 ton capacity shop press made of structural steel channel for added strength
- Pump, 7.1" stroke self-retracting ram and hose with glycerine filled gauge
- Vertical throat opening between 0" to 36.5", 17.75" throat width
- 3.375" opening between movable bolster channels
- 53" frame height, 21.5" width, and 27.5" base leg length
- 2 Year Warranty on material and workmanship
- Complies With ASME PASE/2014 Safety Standards



KT163619 20 Ton Shop Press

- 20 ton capacity shop press made of structural steel channel for added strength
- Pump, 7.28" stroke self-retracting ram and hose with glycerine filled gauge
- Vertical throat opening between 0" to 38", 21.25" throat width
- 4.25" opening between movable bolster channels
- 59.5" frame height, 25.25" width, and 27.5" base leg length
- 2 Year Warranty on material and workmanship
- Complies with ASME PASE/2014 Safety Standards

KT160060 Heavy-Duty 6" Bench Grinder

- 1/3 HP, 115 volt with 3450 RPM no load speed
- Cast iron motor housing for heavy duty applications and long life
- Two grinding wheels (1 course 36-grit and 1 wire for grinding and sharpening)
- Two adjustable tool rests to accommodate a variety of uses and provide additional stability for precision grinding
- Fully adjustable acrylic eye shields deflect sparks away from operator for added safety
- UL listed
- Warranty information: 1-year limited warranty



Shop Tools | Creepers, Stools & Fender Covers

Metal Frame Creeper with Rubber Casters

- Metal frame creeper features a fully padded seat for comfort
- Rugged, durable construction for a lifetime of use
- Six (6) 2-inch oil-resistant rubber casters provide smooth mobility
- Steel frame is epoxy-coated to prevent rusting
- Four (4) cross rails provide added support
- Assembly required

Warranty information: 90-day limited warranty.

KTI74951 - 36"
KTI74956 - 40"

Replacement parts:
KTI74959 - replacement caster



KTI74961

40" Metal Frame Creeper with Adjustable Headrest

- KTI 40" metal frame creeper features a fully padded seat for comfort
- Adjustable headrest is comfortable and convenient for every use
 - Rugged, durable construction for a lifetime of use
 - Six (6) 2-inch oil-resistant rubber casters provide smooth mobility
 - Steel frame is epoxy-coated to prevent rusting
 - Four (4) cross rails provide added support
 - Assembly required

Warranty information: 90-day limited warranty.

Replacement parts:
KTI74959 - replacement caster



KTI74971 Padded Mechanic's Creeper Seat with Pneumatic Lift

- Adjustable mechanic's seat features fully padded 12" seat for added comfort
- Seat is adjustable by pneumatic cylinder from 14" to 19"
- Large steel base also serves as storage for tools while working
- Features five (5) 2-1/2" oil-resistant rubber casters for smooth mobility
- Assembly required

Warranty information: 90-day limited warranty.

Replacement parts:
KTI74957 - replacement caster



KTI74981 Padded Mechanic's Creeper Seat with Storage Tray

- Mechanic's seat with plastic storage tray
- Fully padded seat measures 7" x 14"
- Plastic tray has three sections to store tools or small parts
- Features four (4) 2-1/2" oil-resistant rubber casters for smooth mobility
- Metal frame is epoxy-coated to prevent rusting
- Assembly required

Warranty information: 90-day limited warranty.

Replacement parts:
KTI74958 - replacement caster



Deluxe Fender Cover

Vinyl-backed foam cover is designed to protect/cover fenders to avoid scratching, marring or damaging vehicle finish. Available in black or red.

Sold separately:
KTI73201 - Black
KTI73202 - Red



SHOP TOOLS

Shop Tools | Material Handling



KTI63820 1250 Lb Capacity Car Dollies

- Pair of 1250 pound capacity car dollies used to move a disabled vehicle
- Made of steel structural tubing for durability
- Four bearing mounted swivel caster wheels for easy maneuverability
- Two locking caster wheels on each dolly to prevent vehicle from moving
- Weight: 49 lbs
- 2 Year Warranty on material and workmanship
- Complies With ASME PASE/2014 Safety Standards

KTI63800 Hand Pallet Jack

High quality welded steel construction and powder-coated finish.

- Capacity: 6500 lbs.
- Max lift height: 7"
- Lowered fork height: 3"
- Fork width: 27"
- Fork length: 48"
- Turning radius: 210°
- Weight: 187 lbs.

Warranty information:
1-year warranty. Repair or replace at discretion of repair center.



Tow Straps

Heavy-duty nylon web construction with reinforced stitching. Available with looped end or forged hooks. Abrasion and cut resistant. Strongest, longest-lasting webbing tow straps on the market. Meet or exceed all DOT specifications.

Part #	Type of Ends	Capacity	Width	Length
KTI73801	Forged hooks	7,000 lb. capacity	2" width	10' length
KTI73802	Forged hooks	10,000 lb. capacity	2" width	15' length
KTI73803	Forged hooks	10,000 lb. capacity	2" width	25' length



Heavy-duty Tow Straps

Heavy duty nylon web construction with reinforced stitching and looped ends. Abrasion and cut resistant. Strongest, longest-lasting webbing tow straps on the market. Meet or exceed all DOT specifications.

Part	Type of Ends	Capacity	Width	Length
KTI73810	Looped ends	15,000 lb. capacity	2" width	20' length
KTI73811	Looped ends	22,500 lb. capacity	3" width	20' length
KTI73812	Looped ends	30,000 lb. capacity	3" width	30' length
KTI73813	Looped ends	40,000 lb. capacity	4" width	30' length
KTI73814	Looped ends	60,000 lb. capacity	6" width	30' length



Shop Tools | Material Handling

Recovery Tow Rope

High strength to weight ratio provides maximum pulling strength, and still allows for easy handling. Covered by a 1 year warranty.

- Double braided nylon rope is extremely strong and flexible
- Durable, UV resistant waterproof polymer coating is soaked deep into the rope fibers
- High elasticity is ideal for off-road recovery and snatching applications
- Rubber coated eye tips provide extra protection and maximum grip

Part #	Size	Eye Color	Capacity
KTI73818	1/2" x 20'	Yellow	Rating: 7,400 lbs.
KTI73819	3/4" x 20'	Black	Rating: 19,000 lbs.
KTI73822	7/8" x 20'	Blue	Rating: 28,600 lbs.
KTI73823	7/8" x 30'	Red	Rating: 28,600 lbs.
KTI73824	1-1/4" x 30'	Orange	Rating: 52,300 lbs.
KTI73825	1-1/2" x 30'	Green	Rating: 74,000 lbs.



Stretch Cords

Braided cover prevents abrasions and provides added durability. Vinyl covered hooks prevents scratches. Designed for professional use.



Part #	Description	Diameter	Length	Color	Qty
KTI73830	General purpose	3/8" diameter	18" length	Yellow	10-pack
KTI73831	General purpose	3/8" diameter	24" length	Yellow	10-pack
KTI73832	General purpose	3/8" diameter	30" length	Yellow	10-pack
KTI73833	General purpose	13/32" diameter	40" length	Yellow	10-pack
KTI73834	General purpose	13/32" diameter	48" length	Yellow	10-pack

RUBBER STRAPS					
Part #	Description	Width	Length	Max. Stretch	Qty
KTI73849	EPDM Rubber Strap	3/8" wide	15" length	22" max stretch	10-pack
KTI73850	EPDM Rubber Strap	3/8" wide	21" length	31" max stretch	10-pack
KTI73851	EPDM Rubber Strap	3/8" wide	31" length	46" max stretch	10-pack



SHOP TOOLS

Shop Tools | Material Handling

TIE DOWNS & STRAPS

Part #	Description	Capacity	Width	Length	Qty
KTI73862	Ratcheting Tie Down (endless loop)	900 lb.	1" width	13' length	1-pack
KTI73861	Ratcheting Tie Down (PVC-coated hooks)	900 lb.	1" width	15' length	1-pack
KTI73870	Ratcheting Tie Down (PVC-coated hooks) (each)	900 lb.	1" width	15' length	4-pack
KTI73864	Motorcycle Tie Down (1 chrome and 1 PVC-coated hook)	1,200 lb.	1" width	6' length	1-pack
KTI73871	Universal Tie Down (PVC-coated hooks)	900 lb.	1" width	10' length	1-pack
KTI73873	Cam Buckle Tie Down (Cam buckles)	900 lb.	1" width	13' length	1-pack

K-Tool International recommends that the working load never exceed 1/3 of the rated capacity. Any strap assembly is only as strong as its weakest component, including the point of attachment or anchor.



KTI73862



KTI73861



KTI73870



KTI73864



KTI73871



KTI73873

Nylon Cable Ties

Hundreds of uses, including electrical, auto, marine, home and garden. Available in black or natural. Many sizes for a variety of applications. Professional quality. Temperature rating: 185° F (85° C).



Part #	Length	Bundle Diameter	Tensile Strength	Color	Qty
KTI76040	4"	7/8"	18 lb.	Natural	100
KTI78040	4"	7/8"	18 lb.	Black	100
KTI76070	7"	1-7/8"	50 lb.	Natural	100
KTI78070	7"	1-7/8"	50 lb.	Black	100
KTI77070	7" with mounting head	1-7/8"	50 lb.	Natural	100
KTI76110	11"	31/16"	50 lb.	Natural	100
KTI78110	11"	31/16"	50 lb.	Black	100
KTI76140	14"	4"	50 lb.	Natural	100
KTI78140	14"	4"	50 lb.	Black	100
KTI77140	14" with mounting head	4"	50 lb.	Natural	100
KTI76145	14" heavy-duty	41/16"	120 lb.	Natural	100
KTI78145	14" heavy-duty	41/16"	120 lb.	Black	100
KTI76180	18" heavy-duty	51/4"	120 lb.	Natural	25
KTI78180	18" heavy-duty	51/4"	120 lb.	Black	25
KTI76240	24" heavy-duty	73/16"	175 lb.	Natural	25
KTI78240	24" heavy-duty	73/16"	175 lb.	Black	25
KTI76360	36" heavy-duty	11"	175 lb.	Natural	25
KTI78360	36" heavy-duty	11"	175 lb.	Black	25

Shop Tools | Material Handling



Nylon Cable Tie Assortments

Convenient dispenser type package allows access to each compartment separately. Hundreds of uses, including electrical, auto, marine, home and garden. Available in black or natural. Many sizes for a variety of applications. Professional quality.

KTI76004 (Natural)
KTI78004 (Black)



Each package includes 4" (qty: 200), 7" (qty: 100) and 11" (qty: 100).



KTI76000 Nylon Tie Tightening Tool

Grips nylon cable ties and tightens with very secure grip. Also cuts excess with thumb lever.

LIFETIME WARRANTY*

Shop Tools | Heating, Welding, Soldering

KTI00035 85 Piece Shrink Tube Kit

- Multi-compartment plastic storage case
- Includes wide range of product
- Contains product assortment map
- Includes most popular sizes



This 85-piece kit contains shrink tubes in most popular sizes: 1/8" Shrink Tube, 3/16" Shrink Tube, 1/4" Shrink Tube, 3/8" Shrink Tube, 1/2" Shrink Tube.



KTI07740 235-piece Heat Shrink Tube Kit

Assortment includes eight different sizes in five colors, ranging in width from 3/32" to 3/4" and 6" in length.

Size: 1/8"	Qty:	Size: 1/4"	Qty:	Size: 5/8"	Qty:
Blue.....	11	Blue.....	11	Blue.....	1
Black.....	11	Black.....	11	Black.....	1
Orange.....	11	Orange.....	11	Orange.....	1
Green.....	11	Green.....	11	Green.....	1
Yellow.....	11	Yellow.....	11	Yellow.....	1
Size: 3/32"	Qty:	Size: 3/8"	Qty:	Size: 3/4"	Qty:
Blue.....	8	Blue.....	2	Blue.....	1
Black.....	8	Black.....	2	Black.....	1
Orange.....	8	Orange.....	2	Orange.....	1
Green.....	8	Green.....	2	Green.....	1
Yellow.....	8	Yellow.....	2	Yellow.....	1
Size: 3/16"	Qty:	Size: 1/2"	Qty:		
Blue.....	11	Blue.....	2		
Black.....	11	Black.....	2		
Orange.....	11	Orange.....	2		
Green.....	11	Green.....	2		
Yellow.....	11	Yellow.....	2		



KTI70048 Micro Butane Turbo-Lite

- CPSC (Consumer Product Safety Commission) compliant multit-purpose micro-torch/lighter
- Piezo electronic ignition system
- Protective flip-open cap
- Covered by a 1-year warranty
- Flame temperature: 2,400° F (1,300° C)
- Stylish see through fuel tank
- Reliable windproof lighter

KTI70052 Hand Held Butane Torch Lighter

- Handy pocket butane torch
- Light duty soldering such as:
 - shrinking heat seal tubing, craft projects,
 - thawing frozen locks, lighting camp stoves
- 1 Year Warranty on material and workmanship



Shop Tools | Heating, Welding, Soldering

KT170054

Mini Butane Torch

- Mini butane torch with solder head
- Piezo-electric ignition with locking safety mechanism
- Temperature and flame control, up to 2372° F jet flame
- Removeable safety stand
- 1 Year Warranty on material and workmanship



Mini butane torch with solder head has many uses: solder copper pipes, thaw frozen pipes, repair gutters, remove paint and putty, light fireplaces, cooking torch and all other professional repair jobs.

KT170058

Hand-Held Pro Butane Torch

- The original hand-held, lightweight and sturdy professional torch
- Piezo ignition and safety kill/off switch
- Adjustable air flow and gas flow control valves
- Tank contains fuel for 190 minutes of operation at mid setting
- Alloy die casting housing covered with a protective grip and sturdy removable base for added safety
- Covered by a 1-year warranty
- Flame temperature: 2,400° F (1,300° C)



KT170057

Self Igniting

Propane Torch Head

- Self igniting propane torch head with piezo igniter for instant flame
- Safety lock feature to prevent accidental ignition
- Ignition button lock for continuous use
- Replacement brass tip
- Ergonomic handle design
- 1 Year Warranty on material and workmanship



Self Igniting Propane Torch Head for use with MAPP or propane gas.

KT170056

Self Igniting

Propane Torch Head

- Portable and lightweight
- Easy on/off valve
- High energy flame
- Angled swivel tube to reach difficult areas
- 1 Year Warranty on material and workmanship



Self Igniting Propane Torch Head for use with MAPP or propane gas.

KT170050

Butane Fuel

- 1.5 fl.oz. (42g) professional-grade butane fuel
- Universal filling tip for use with most refillable butane products
- Adapters are not normally required when refilling tanks
- Double scrubbed and triple filtered for trouble-free use
- Use for pocket torches, lighters, lanterns, table torches and other butane-powered tools



KT170461

Child Safety Blanket

- Made from Kovenex® flame resistant fabric
- Protects infants from heat and flame
- Patented fabric is made with inherently flame resistant fibers with no chemical treatment for an infinite shelf life
- Soft, durable and light weight
- Machine washable, no bleach
- Weight: 7.0 oz /yd2



KT170440

Torch Shield

- Size: 10" x 18"
- Carbon fiber flame blocking fabric
- Protect surfaces from sparks or open flame from gas torches with this patented Pavenex® carbon fiber shield
- Withstands even the extreme heat of acetylene torches



KT170450

Welding Blanket

- Extreme protection
- Size: 50" x 80"
- A high-tech carbon fiber welding blanket made with the Pavenex® fabric (US Patent # 6,696,374)
- Lightweight, soft, and flexible
- Provides protection against direct contact with flame, sparks, and weld spatter
- Withstands temperatures up to 2200°F without shrinking

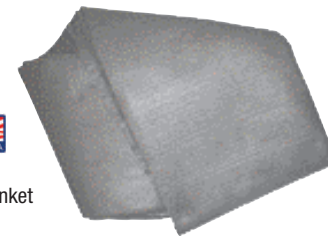

Reduces the chance of sparks damaging fabrics, pitting glass, or marring paint. Will not scratch any painted surface. Can be used in emergencies to smother small fires in a car or anywhere in the shop. Warning: Avoid contact with flammable liquids. Flammable liquids will ignite when exposed to sparks or flame. Always inspect welding blankets for damage before use. Avoid sharp edges or other obstructions to prevent damage to blanket. Clean blanket after each use. To clean, shake the blanket and replace in the original bag. DO NOT clean with water or other liquids. Do not use when wet.

Shop Tools | TPMS



KTI71999 Master TPMS Kit

- The most complete TPMS shop solution available and includes the only sensor activation tool you need

Kit includes the Programming Interface Module (with one year of updates), tool holster, "Guide to TPMS" Training DVD, 2010 PST-TIPS Quick Reference Guide on CD-ROM, TPMS Quick Spec Flip Chart, valve core torque tool and TPMS four-way valve tool. Also includes Service Procedure Poster; an easy to read step-by-step guide for servicing vehicles with Tire Pressure Monitoring Systems (TPMS).



KTI71989 Essential TPMS Combination Kit

- Everything you need in one handy, economical kit
- Universal sensor activation - only tool you need
- Audio and visual confirmation - no guesswork
- Digital protocol upgrades available - never out of date
- Handy and easy to use - no special training required

Contains TPMS tool, instructional DVD, programming interface module (PIM) with one year of updates.



KTI71990A Sensor Activation Tool with Quick Reference Guide on CD-ROM and Quick Spec Flip Chart

- The only patented universal triggering tool you need for testing and resetting the TPM system
- Eliminates the need for multiple tools to service various makes and models of vehicles
- TPMS Quick Reference Guide on CD-ROM is a comprehensive listing of today's TPM systems, reset procedures and sensor learn procedures through the 2010 model year
- The guide includes a quick reference table designed to provide a single point of reference for determining when TPM systems require resetting as well as sensor nut torque requirements

The laminated TPMS Quick Spec Flip Chart is designed for the shop environment, and provides a quick but comprehensive snapshot of today's TPM systems.



KTI71991 Programming Interface Module

- Provides the critical link to update your PST or TIPS tool
- One cable connects to a USB port on your computer and the other to a mini-USB located within the battery compartment of the tool

The PIM is a required accessory, allowing you to download updates to your TPM tool. Each PIM is shipped with a software license valid for one TPM tool for one year from date of purchase. TPM tool must be registered to receive software updates.

Warranty information for KTipst, PIM and TPMS Scan Tool:
3-year warranty. Repair or replace at the discretion of the repair center. Consumable items are not covered.

SHOP TOOLS

Shop Tools | TPMS



KTI71993 KTIpst Instructional DVD

- Provides an excellent overview of Tire Pressure Monitoring Systems (TPMS,) as well as step-by-step instructions on how to use PST tool.



KTI71992 Heavy-duty Holster for KTIpst

- Provides the perfect blend of utility and protection for your TPM tool
- Unique design allows operation of tool without removing it from the holster
- Can be easily removed
- Clips comfortably to your belt
- Features elastic pockets for easy storage of your accessory tools (tire pressure gauge, tire crayon, tire tread depth gauge, etc.)
- Made of a durable fabric that provides protection from drops and spills



KTI71981 TPMS T-10 Torque Limited Screwdriver

- Facilitates installation of snap-in valves on some Schrader rubber-stemmed sensors
- Installs screws to recommended torque for proper sealing and secure installation
- Assists mechanics to consistently achieve proper torque
- Easy to use • Stored in handy plastic case

LIFETIME WARRANTY*

Replacement parts:

KTI18810 - T-10 Replacement Bit



KTI71996 TPMS Valve Core Torque Tool

- Durable, precision torque tool used to remove and install TR C1 valve cores
- Safely tightens valve cores to meet manufacturer's requirements for proper torque requirements

LIFETIME WARRANTY*

Vehicle manufacturers recommend replacing TPMS electroless, nickel-plated valve cores whenever a tire with TPMS is serviced.



KTI71982 TPMS T-20 Torque Limited Screwdriver

- Used to tighten the torx screw in Beru and other similar TPMS sensors
- The torx screw secures the valve stem to the sensor body
- Preset to 35 in./lbs. (4.0Nm) so the torx screw cannot be over-tightened which may lead to sensor damage and/or incorrect operation
- Also used to remove the torx screws

LIFETIME WARRANTY*

Replacement parts:

KTI18820 - T-20 Replacement Bit



LIFETIME WARRANTY*



KTI71997 TPMS Valve Nut Tool

- Durable, all-in-one tool used for removing the sensor nuts and seating the sensor grommets
- Ergonomically design
- Quickly removes both 11 mm and 12 mm nuts
- Easily seats both beveled and non-beveled grommets

Vehicle manufacturers recommend replacing TPMS sensor nuts and grommets whenever a tire with TPMS is serviced.

DynamicTM

TPMS Solutions

- Dual Valve Technology
- Installs right out of the box
- Works with all TPMS scan tools
- Saves time
- Saves money
- Reduces inventory
- Increases shop productivity and profits



DVT – Dual Valve Technology Multi-Vehicle-Application Sensors

DVT-Sensors are designed to work with either a rubber snap-in valve stem or the metal clamp-in valve stem. The technology makes the DVT-Sensor very versatile. It's easy to match the valve style on TPMS equipped vehicles without requiring an additional part number. Just remove the DVT snap-in or clamp-in stem and replace it with the required valve.

DVT-Sensors for domestic applications are supplied with the rubber snap-in valve stem. Asian and European applications are supplied with the metal clamp-in valve stem.



DVT-Sensors provide over 90% coverage for Domestic, Asian and some European cars and light trucks.

Multi-Vehicle Applications

DVT-sensors have the ability to work on more than one vehicle application. Each DVT-Sensor contains multiple vehicle protocols which provide a wider range of coverage. One DVT-Sensor can replace many OEM sensors.

Part #	MHz	Multi-Vehicle Application	DVT Valve
ABDDVT-1000	315 MHz	2004-06 Chevy, GMC, Hummer	DVT-CV-1
ABDDVT-1001H	315 MHz	GM	DVT-SV-1
ABDDVT-1002H	315 MHz	Ford/Chrysler	DVT-SV-1
ABDDVT-1003A	433 MHz	Ford/Chrysler	DVT-SV-1
ABDDVT-1004A	315 MHz	Toyota/Nissan	DVT-CV-1
ABDDVT-1005	315 MHz	Honda/Toyota	DVT-CV-1
ABDDVT-1006	315 MHz	Hyundai/Kia	DVT-CV-1
ABDDVT-1007	315 MHz	Audi/Mercedes/Subaru/VW/Volvo	DVT-SV-1
Part #	MHz	1:1 Vehicle Application (Hi-Line)	Valve
ABDDY-2416	315 MHz	Ford/Chrysler	Metal
ABDDY-2116	433 MHz	Ford/Chrysler	Metal

ALWAYS complete the vehicle relearn procedure when replacing a TPMS sensor or servicing TPMS.

Dynamic Dual Valves Replacements

ABDDVT-SV-1

Snap-in Valve for DVT-Sensors.
Includes S7 nut and cap. Box of 4.



ABDDVT-CV-1

Clamp-in Valve for DVT-Sensors.
Includes nut, grommet, cap and T10 screw. Box of 4.





TPMS Solutions



The OEM requires that the valve stem components are replaced every time the tire is serviced on vehicles with TPMS.



Clamp-in Kit Component	Replacement Reason	Result
(A) Grommet/seal	Crack, deteriorate and leak over time	Leak path at valve stem
(B) Hex nut	Plating worn off, threads corrode	Leak path at valve stem
(C) Valve core	Nickel plating strips leading to galvanic corrosion and seized valve cores	Leak at valve core, potential broken valve stem
(D) Valve cap w/seal	Valve cap seal wear	Allows moisture into core
(E) Metal washer (some applications)	Washer conforms to rim during installation	Leak path at valve stem
Snap-in Kit Component	Replacement Reason	Result
(F) Rubber TPMS snap-in valve	Crack, deteriorate and leak over time	Leak path at valve stem

Refer to manufacturer's specifications for proper torque requirements when replacing hex nuts and valve cores. These specifications can be found in the Dynamic TPMS Service Kit Application Guide.

ABD6-102

Buick, Cadillac, Chevy, GMC, Isuzu, Pontiac, Saab

Cross-reference: 20004, 1070K, 92-0125



ABD6-110

Audi, BMW, Land Rover, Mercedes, Mini, Porsche, VW

Cross-reference: 20023, 1090K, 92-0261



ABD6-117

Lexus

Cross-reference: 20033, 1120K, 92-0155



ABD6-103

Cadillac, Chevy, Chrysler, Dodge, Infinity, Isuzu, Jeep, Mitsubishi, Nissan, Subaru

Cross-reference: 20003, 1080K, 92-0140



ABD6-111

Acura, Honda, Lexus, Pontiac, Scion, Toyota

Cross-reference: 20032, 1100K, 92-0215



ABD6-120

Chrysler, Dodge, Infinity, Jeep, Lincoln, Mazda, Mercury, Pontiac, Saturn, Subaru, Suzuki

Cross-reference: 20016, 2030K, 92-202



ABD6-106

Ford, Lincoln, Mercury, Mercedes

Cross-reference: 20002, 1060K, 92-0115



ABD6-112

Honda, Infiniti, Mitsubishi, Nissan

Cross-reference: 20010, 1130K, 92-0130



ABD6-122

Saab, Saturn, Suzuki, Volvo

Cross-reference: 20009, 2010K, 92-0195



ABD6-108

Buick, Cadillac, Chevy, Chrysler, Dodge, GMC, Hyundai, Jaguar, Jeep

Cross-reference: 20030, 1050K, 92-0150



ABD6-115

Audi, VW

Cross-reference: 20017, 1030K, 92-0235



ABD6-125

Cadillac, Chevy, GM, GMC

Cross-reference: 20015, 2020K



ABD6-109

Acura, Honda, Hyundai, Kia

Cross-reference: 20021, 2000K, 92-0246



ABD6-116

GMC, Hummer, Lexus, Toyota, VW

Cross-reference: 20031, 1110K, 92-0135



ABD6-127

Acura, Honda, Hyundai, Kia

Cross-reference: 20019, 2040K, 92-0244



DynamicTM

TPMS Solutions

ABD6-129

VW
Cross-reference:
20017, 1031K



ABD6-138

Honda, Hyundai, Jaguar,
Kia, Land Rover, Mazda,
Mitsubishi, Suzuki,
VW, Volvo
Cross-reference:
20032, 7020K, 92-3312



ABD6-139

Chrysler, Dodge, Jeep,
Nissan
Cross-reference:
20013, 7000K, 92-3311



ABDDVT-493

S7 Nut for DVT Snap-In Valve

Box of 50



ABDDVT-806

T10 Torx Screw for DVT Clamp-In Valve

Box of 50



ABDDY-128G

Valve Cap— Nylon (Grey)

Box of 50



ABDDY-158

Black Valve Cap for Schrader 20008

Box of 50



ABDDY-128B

Valve Cap— Nylon (Black)

Box of 50



ABDDY-1400

TPMS Nickel Plated Valve Core

Box of 50



ABDDY-TPMS-16

Valve Maintenance Kit Assortment

ABDDY-TPMS-16 Valve Maintenance Kit contains 15 of the most popular kits for most domestic and imported cars and light trucks. Also included are 50 each of the TPMS valve caps and nickel plated valve cores.



Kit #	General Application	Qty
ABD6-102	General Motors	10
ABD6-103	Chrysler, Dodge, Mitsubishi	10
ABD6-106	Ford	10
ABD6-108	GM, Chrysler, Dodge, Mazda, Volvo	10
ABD6-109	Acura, Honda, Hyundai, Kia	10
ABD6-110	Audi, BMW, Mercedes	10
ABD6-111	Honda, Lexus, Pontiac, Toyota, Scion	10
ABD6-115	Audi, VW	10
ABD6-116	Lexus, Toyota	10
ABD6-120	Chrysler, Dodge, Jeep	10
ABD6-122	Mitsubishi, Saab, Suzuki, Volvo	10
ABD6-127	Acura, Honda, Kia	10
ABD6-138	Honda, Hyundai, Kia, Mitsubishi	10
ABD6-139	Chrysler, Dodge, Jeep, Nissan	10
ABD6-207A	GM, Ford	10
ABDDY-1400	TPMS Nickel Plated Valve Cores	50
ABDDY-128G	Valve Cap – Nylon (Grey)	50

SHOP TOOLS

ABD6-201

Chrysler, Dodge
Jeep, Mitsubishi
Cross-reference:



ABD6-203

Chrome Valve for Ford Shelby Cobra
Optional replacement for 6-207A
Cross-reference:
VS-925C



ABD6-204

Acura, Honda (Long Valve)
Cross-reference:
20035, 1097K



ABD6-205

Acura, Honda (Short Valve)
Cross-reference:
20036, 1096K



ABD6-206B

Mercedes, Smart
Cross-reference:
20023, 1040K, 92-1170



ABD6-207A

Chrysler, Dodge, Ford, GM,
Hummer, Jeep, Mazda, Mercury,
Subaru, Suzuki
Cross-reference:
20018, VS950, 92-0145



ABD6-208

Cadillac ATS, Dodge Dart
Cross-reference:
VS-90



ABD6-209

Hyundai
Cross-reference:
V1010



ABD6-210

Hyundai, Kia
Cross-reference:



ABD6-211

Dodge TRW Snap-In,
Jeep, Ram
Cross-reference:
VS65



ABD6-213

Ford 2015
Cross-reference:



ABD6-218

Dodge Sprinter
Cross-reference:
20036, 1098K, 92-1170



ABD6-220

Audi 4, BMW, Porsche
Gen I (Silver - 43 mm)
Cross-reference:
1092, RDV001



ABD6-221

BMW
Gen I (Green - 48 mm)
Cross-reference:
1093, RDV002



ABD6-222

BMW, Mercedes
Gen I (Black - 49 mm)
Cross-reference:
1094, RDV003



ABD6-223

BMW, Mercedes
Gen I (Orange - 51 mm)
Cross-reference:
1095, RDV004



ABD6-225

Aluminum Optional Replacement
Valve for 6-207A
Cross-reference:
VS925A, 34000



ABD6-228S

Chrysler, Dodge, Jeep,
Mercedes
Cross-reference:
9066K



ABD6-231C

Adjustable Valve for Chrysler,
Dodge, Honda, Jeep
Cross-reference:
VS-70



ABD6-236

Hyundai, Kia
Cross-reference:
VS965



ABD6-240

Audi, BMW, Mercedes, VW
Gen II (Silver - 43mm)
Cross-reference:
RDV021



ABD6-241

BMW
Gen II (Green - 48mm)
Cross-reference:
RDV022



ABD6-242

Audi, BMW, Porsche, VW
Gen II (Black - 49mm)
Cross-reference:
RDV023



ABD6-243

BMW
Gen II (Orange - 51mm)
Cross-reference:
RDV024



DynamicTM

TPMS Solutions

Kit #	General Application	Qty
ABD6-203	Chrome Valve for Ford Shelby Cobra	4
ABD6-204	Acura, Honda (Long Valve)	4
ABD6-205	Acura, Honda (Short Valve)	4
ABD6-206B	Mercedes, Smart	4
ABD6-207A	Ford, GM	10
ABD6-208	Cadillac ATS, Dodge Dart	4
ABD6-209	Hyundai Santa Fe	4
ABD6-211	Dodge Ram, Jeep	4
ABD6-218	Dodge Sprinter	2
ABD6-220	Audi, BMW, Porsche (Silver - 43 mm)	2
ABD6-222	BMW, Mercedes (Black - 49 mm)	2
ABD6-225	Aluminum Optional Valve Replacment for 6-207A	4
ABD6-228S	Chrysler, Dodge, Jeep	4
ABD6-231C	Adjustable Valve for Chrysler, Dodge, Honda, Jeep	4
ABD6-240	Audi, BMW, Porsche, VW (Silver - 43 mm)	2
ABD6-242	Audi, BMW, Porsche, VW (Black - 49 mm)	2

ABDDY-TPMS-16VS Valve Stem Assortment

For the replacement of corroded or broken TPMS valve stems. The ABDDY-TPMS-16VS assortment contains 16 of the most popular valve stems.



European TPMS Aftermarket Replacement Valve Stems

The OEM has two different designs of replaceable valve stems with their TPMS sensors – Generation I and Generation II. Gen I and Gen II valve stems utilize a different thread pitch and therefore the service repair kits use different components and cannot be interchanged. The difference in the valve stems and the service kits is detailed below.

Generation I



Dynamic Valve Kit w/ Valve Stem	Dynamic Service Kit w/o Valve Stem	OEM No.	Valve Length	Color Coded Noted at Base of Valve Stem
ABD6-220	ABD6-110	RDV001	43 mm	Silver
ABD6-221	ABD6-110	RDV002	48 mm	Green
ABD6-222	ABD6-110	RDV003	49 mm	Black
ABD6-223	ABD6-110	RDV004	51 mm	Orange



T-20 screw
(35in-lb torque)



10V2 thread hex nut
w/o shear collar

Only use ABD6-110 service kit with Gen I valve stems

Generation II



Dynamic Valve Kit w/ Valve Stem	Dynamic Service Kit w/o Valve Stem	OEM No.	Valve Length	Color Coded Noted at Base of Valve Stem
ABD6-240	ABD6-109	RDV021	43 mm	Silver
ABD6-241	ABD6-109	RDV022	48 mm	Green
ABD6-242	ABD6-109	RDV023	49 mm	Black
ABD6-243	ABD6-109	RDV024	51 mm	Orange



M5 square head
screw (torque set by hex nut)



7/16"-18 thread
hex nut with shear collar

Only use ABD6-109 service kit with Gen II valve stems

Start servicing TPMS vehicles now with these Dynamic TPMS starter kits.

Designed for lighter volume shops the ABDDVT-12SK contains all of the OEM aftermarket parts needed to start servicing TPMS equipped vehicles without making a large investment.

ABDDVT-12SK TPMS Valve Maintenance/Sensor Starter Kit



Part #	Qty
DVT-Sensors	
ABDDVT-1001H	2
ABDDVT-1002H	2
ABDDVT-1003A	2
ABDDVT-1004A	2
ABDDVT-1005	2
ABDDVT-1006	2
DVT Replacement Valves	
ABDDVT-SV-1	4
ABDDVT-CV-1	4
Torque Tool	
ABDDY-002A	1
Counter Card	
ABDDYN-0513*	1
Application Guide & Catalog	
ABDDVT-APP*	1
ABDDY-TPMS-13*	1

Part #	Qty
ABDDY-TPMS-16 TPMS Valve Maintenance Kit	
ABD6-102	10
ABD6-103	10
ABD6-106	10
ABD6-108	10
ABD6-109	10
ABD6-110	10
ABD6-111	10
ABD6-115	10
ABD6-116	10
ABD6-120	10
ABD6-122	10
ABD6-127	10
ABD6-138	10
ABD6-139	10
ABD6-207A	10
ABDDY-1400	50
ABDDY-128G	50

ABDDVT-SK12VS TPMS Valve Stem/Sensor Starter Kit



Part #	Qty
DVT-Sensors	
ABDDVT-1001H	2
ABDDVT-1002H	2
ABDDVT-1003A	2
ABDDVT-1004A	2
ABDDVT-1005	2
ABDDVT-1006	2
DVT Replacement Valves	
ABDDVT-SV-1	4
ABDDVT-CV-1	4
Torque Tool	
ABDDY-002A	1
Counter Card	
ABDDYN-0513*	1
Application Catalog	
ABDDVT-APP*	1
TPMS Catalog	
ABDDY-TPMS-13*	1

Part #	Qty
ABDDY-TPMS-16VS Valve Stem Replacement Kit	
ABDDY6-203	4
ABDDY6-204	2
ABDDY6-205	4
ABDDY6-206B	4
ABDDY6-207A	4
ABDDY6-208	4
ABDDY6-209	4
ABDDY6-211	4
ABDDY6-218	2
ABDDY6-220	2
ABDDY6-222	2
ABDDY6-225	4
ABDDY6-228S	4
ABDDY6-231C	4
ABDDY6-240	2
ABDDY6-242	2

* Indicates Parts Only Available In The Kit and Not Sold Separately

ABDDVT-802 TPMS Master Starter Kit



This master starter kit contains all of the parts needed to service TPMS vehicles including, DVT-Sensors, Valve Maintenance Kits and TPMS Replacement Valves.

The ABDDVT-802 includes: 32 DVT-sensors, 256 TPMS valve maintenance kits & replacement valve stems, torque tool and our ABDTPMS-72 storage cabinet.

Dynamic
TPMS Solutions

NOTE: Will be shipped in two boxes.

Part #	Description	Qty
DVT-Sensors		
ABDDVT-1000	TPMS Sensor - 2004-06 Chevy - GMC	2
ABDDVT-1001H	TPMS Sensor - GM 314.9/315 MHz	6
ABDDVT-1002H	TPMS Sensor - Ford/Chrysler 315 MHz	6
ABDDVT-1003A	TPMS Sensor - Ford/Chrysler 433 MHz	4
ABDDVT-1004A	TPMS Sensor - Toyota/Nissan 315 MHz	4
ABDDVT-1005	TPMS Sensor - Honda 315 MHz	4
ABDDVT-1006	TPMS Sensor - Hyundai/Kia 315 MHz	4
ABDDVT-1007	TPMS Sensor - Subaru/Suzuki/Volvo 315 MHz	2
DVT Replacement Valve Stems		
ABDDVT-SV-1	DVT Snap-In Valve Stem	4
ABDDVT-CV-1	DVT Clamp-In Valve Stem	4
DVT Valve Stem Torque Tool		
ABDDY-002A	TPMS Torque Tool	1
Replacement Valve Stems		
ABD6-203	TPMS Replacement Valve Stem	4
ABD6-204	TPMS Replacement Valve Stem	4
ABD6-205	TPMS Replacement Valve Stem	4
ABD6-206B	TPMS Replacement Valve Stem	4
ABD6-207A	TPMS Replacement Valve Stem	20
ABD6-208	TPMS Replacement Valve Stem	4
ABD6-209	TPMS Replacement Valve Stem	4
ABD6-211	TPMS Replacement Valve Stem	4
ABD6-228S	TPMS Replacement Valve Stem	4
ABD6-231C	TPMS Replacement Valve Stem	4

Part #	Description	Qty
TPMS Valve Maintenance Kits		
ABD6-102	TPMS Service Kit	10
ABD6-103	TPMS Service Kit	10
ABD6-106	TPMS Service Kit	10
ABD6-108	TPMS Service Kit	10
ABD6-109	TPMS Service Kit	10
ABD6-110	TPMS Service Kit	10
ABD6-111	TPMS Service Kit	10
ABD6-112	TPMS Service Kit	10
ABD6-115	TPMS Service Kit	10
ABD6-116	TPMS Service Kit	10
ABD6-117	TPMS Service Kit	10
ABD6-120	TPMS Service Kit	10
ABD6-122	TPMS Service Kit	10
ABD6-125	TPMS Service Kit	10
ABD6-127	TPMS Service Kit	10
ABD6-129	TPMS Service Kit	10
ABD6-138	TPMS Service Kit	10
ABD6-139	TPMS Service Kit	10
DVT Cabinet & Application Catalog		
ABDTPMS-72*	Storage Cabinet	1
ABDDVT-APP*	Application Catalog	1

* Indicates Parts Only Available In The Kit and Not Sold Separately

Service procedures for replacing TPMS sensors and installing TPMS service kits require the proper tools.

ABDDY-001A

Torque Wrench With Sockets



ABDDY-S11 & ABDDY-S12 Sockets sold separately.

Torque wrench is used for installing TPMS sensor nuts. Torque range is from 30 in-lbs (3.4 N-m) to 120 in-lbs (13.6 N-m). Includes 11 mm and 12 mm sockets. Comes in a plastic storage case.

ABDDY-002A

Torque Tool for Valve and Sensor



Torque tool is used for installing valves on DVT-sensors. Comes with T10 Torx bit for the clamp-in valve and a S7 socket for the snap-in valve. 12 in-lbs (1.4 N-m)

ABDDY-150

Valve Core Torque Tool

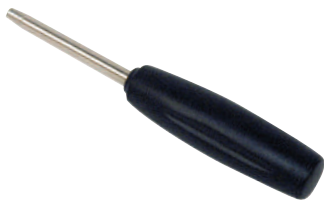

Tightens valve cores to OE specifications, 3.5-4 in-lbs (.45 N-m). Meets industry recommended torque values. Can also be used to remove valve cores.

ABDDY-164

Grommet Removal Tool

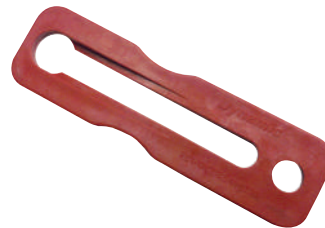

This tool is used to remove the old grommet from the TPMS aluminum valve stem.

ABDDY-172

Grommet Pick Tool



This tool is used to help remove old and broken grommets from the TPMS aluminum valve stem.

ABDDY-32VNT

TPMS 4-Way Valve Tool



Use this tool for removing sensor nuts and seating the sensor grommets. It can be used to remove 11 mm and 12 mm nuts.

ABDDY-312

Complete TPMS Service Tool Kit

The ABDDY-312 contains all of the tools needed to service and install TPMS sensors and service kits. All tools are stored and organized in a sturdy plastic case.

Kit includes:

ABDDY-001A	Torque Wrench with 11 mm & 12 mm sockets
ABDDY-002A	Torque Tool for Valve & Sensor
ABDDY-150	Valve Core Torque Tool 12 in-lbs (.45 N-m)
ABDDY-164	Grommet Removal Tool
ABDDY-172	Grommet Pick Tool



ABDDY-7

S7 Replacement Socket for ABDDY-0002A Tool

Pack of 2



Shop Tools | Water Hoses



theBlueHose Water Hoses

- 500 PSI 100% rubber water hose with 3/4" GHT couplings
- Ultra lightweight, durable and super strong premium grade hot water hose
- Constructed with high strength polyester braided reinforcement with ozone resistant cover providing protection from extreme weather, abrasions and kinks
- Flexibility in extreme conditions from -50 to 180° Fahrenheit
- Oil resistance core tube meets RMA Class C oil resistance and four finger grip bend restrictor for easy use and better durability
- 10 Year Warranty

Solid crush-proof chrome plated brass fittings and handles hot water up to 200° Fahrenheit.

Part #	Description
KTI72079	5/8" x 25' theBlueHose Water Hose
KTI72080	5/8" x 50' theBlueHose Water Hose
KTI72081	5/8" x 100' theBlueHose Water Hose
KTI72082	3/4" x 50' theBlueHose Water Hose
KTI72083	3/4" x 100' theBlueHose Water Hose
KTI72084	1" x 50' theBlueHose Water Hose
KTI72085	1" x 100' theBlueHose Water Hose

Shop Tools | Cleaning



KTD77601

GlassMaster Pro Kit

- The patented GlassMaster Pro effortlessly cleans hard-to-reach areas, including windshields, glass doors, dashboards and much more
- Great for cars, SUVs, RVs, trucks, minivans, boats, home and office
- Spray favorite cleaners directly on GlassMaster Pro, eliminating overspray on dashboards, sensitive electronics, furniture, etc
- Wand boasts super-strong I-beam construction and premium grade ABS materials
- Thick comfort grip handle
- Use one detachable head for wet cleaning / scrubbing. Use second head for drying/polishing

Kit includes the long-handled GlassMaster Pro wand, two interchangeable cleaning heads, three fitted bonnets, plus a bonus stow-and-go storage bag.

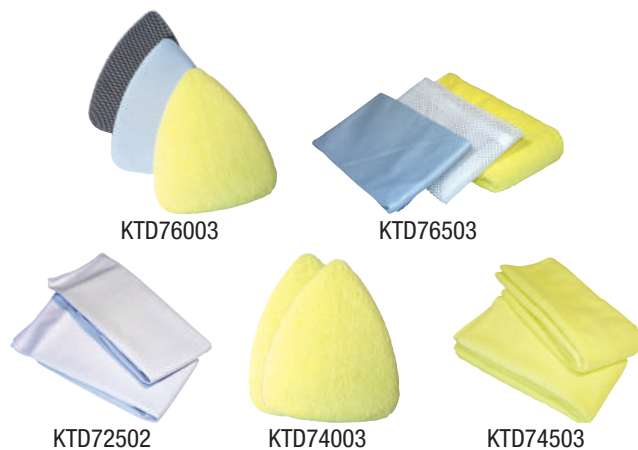

GlassMaster Pro Replacement Parts and Accessories:

- KTD72004 - GlassMaster Pro Microfiber Bonnets 3-pack
- KTD72502 - GlassMaster Pro Microfiber Cloth 2-pack
- KTD74003 - GlassMaster Pro Terry Cloth Bonnets 2-pack
- KTD74004 - GlassMaster Pro Terry Cloth Bonnets 3-pack
- KTD74503 - GlassMaster Pro Multipurpose Cloths 2-pack
- KTD76003 - GlassMaster Pro Assorted Bonnets 3-pack
- KTD76503 - GlassMaster Pro Assorted Cloths 3-pack

SHOP TOOLS

Shop Tools | Cleaning

KTD77604

Glassmaster Pro-Poly Bagged

- Professional glass and surface cleaner that cleans faster, easier, and with superior results
- Great for cars, trucks, SUV's, mini vans, RV's, boats, home and the work place
- Kit includes: 14" comfort grip handle, 2 multi-purpose cleaning heads, microfiber glass cleaning bonnet, multi-purpose microfiber cleaning bonnet and nylon mesh cleaning bonnet

KTD77610 - Glassmaster Extension Handle

KTD77621 - Mini-Pro Paddle IGRC - Yellow

KTD77622 - Mini-Pro Paddle GMP - Black



Shop Tools | Clamps & Vises



C-clamps

Adjustable C-clamps manufactured from ductile iron.

Sold separately:

KTI70182 - 2"

KTI70183 - 3"

KTI70184 - 4"

KTI70186 - 6"

KTI70188 - 8"

LIFETIME WARRANTY*

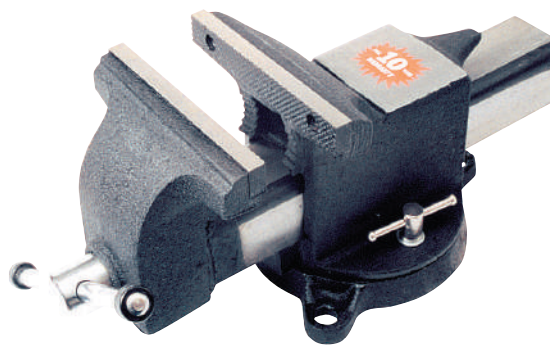

Steel Bench Vises

Rugged all-steel vise is stronger than its cast iron counterpart. Vise features swivel base and large anvil space for hammering.

Warranty information:

10-year limited warranty.

Jaws are not covered.

Part #	Vise Size	Center to Center Measurement	Usable Jaw Opening	Weight
KTI64105	5"	3-1/2"	5-1/4"	27 lbs.
KTI64106	6"	4-1/2"	6-1/2"	35 lbs.
KTI64108	8"	5-1/4"	8-1/2"	50 lbs.

Replacement parts:

KTI64001 - Replacement screws

KTI64005 - 5" jaws

KTI64006 - 6" jaws

KTI64008 - 8" jaws



Shop Tools | Adhesives & Tapes

Q-Bond®



KT190005

Q-Bond Large Repair Kit (QB3)

- Ultra-strong adhesive and reinforcing powders
- Repairs almost everything
- Rock solid in 10 seconds
- Q-Bond repairs are able to be grinded, filed, sanded and even painted

Kit includes six (6) bottles Q-Bond adhesive (0.35oz/10ml); two (2) bottles black reinforcing powder for plastics; one (1) bottle grey reinforcing powder for metals.

KT190002

Q-BOND Adhesive Kit

- Ultra-strong adhesive and reinforcing powders
- Repairs almost anything
- Rock solid in 10 seconds
- Q-Bond repairs are able to be grinded, filed, sanded and even painted
- Includes 2 Q-BOND adhesive; 1 black reinforcing powder; 1 grey reinforcing powder



Q-BOND can be used just as an adhesive or with the reinforcing powders that will help to repair almost anything. The Q-BOND kit includes two (2) bottles Q-BOND adhesive (0.35oz/10ml); one (1) bottle black reinforcing powder for plastics; one (1) bottle grey reinforcing powder for metals.

KT190002C

Q-Bond Adhesive Kit for Canada

- Ultra-strong adhesive and reinforcing powders
- Repairs almost anything
- Rock solid in 10 seconds
- Q-Bond repairs are able to be grinded, filed, sanded and even painted

The Q-BOND kit includes two (2) bottles Q-BOND adhesive (0.35oz/10ml); one (1) bottle black reinforcing powder for plastics; one (1) bottle grey reinforcing powder for metals.



KT190003

Q-Bond Adhesive Kit, 10 Pack with Display

- Ultra-strong adhesive and reinforcing powders
- Repairs almost anything
- Rock solid in 10 seconds
- Q-Bond repairs are able to be grinded, filed, sanded and even painted
- Hang tabs for pegboard and rack displays
- New package design with 10 kits per display. Each kit contains 2 Q-Bond adhesives, 1 black reinforcing powder and 1 grey reinforcing powder

New package design with 10 kits in this display. Q-BOND can be used just as an adhesive or with the reinforcing powders that will help to repair almost anything. Q-BOND repairs can be grinded, filed, sanded, and even painted. Each Q-BOND kit includes two (2) bottles Q-BOND adhesive (0.35oz/10ml); one (1) bottle black reinforcing powder for plastics; one (1) bottle grey reinforcing powder for metals.

KT190003C

Q-Bond Adhesive Kit - 10 Pack Display for Canada

KT173550

Pipe Sealing Tape 1/2" x 260"

- 1/2" x 260" for sealing threaded pipe
- Sold in a sleeve of 5 rolls

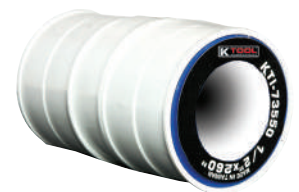

KT173560

2" x 60 Yards Duct Tape

- Multipurpose gray duct tape for numerous uses
- Roll measures 2" wide x 60 yards



KT173510

Black Electrical Tape

- 3/4" x 60" sleeve of 10 rolls



SHOP TOOLS

Shop Tools | Fluids & Grease



KT173900

Air-powered, Pistol-Grip Grease Gun

- Air pressure ranges from 1,200 psi to 6,000 psi
- Uses 400cc bulk loading or standard 14 oz. cartridge
- Includes rigid and flexible extensions
- Rugged, heavy-duty steel construction
- Portable and nearly effortless to use
- 90 Day Warranty on material and workmanship



KT173962

Continuous Flow Grease Gun, Air Operated

- Air operated continuous flow grease gun, 14 oz / minute
- 3-way loading: 14 oz cartridge, bulk and suction fill
- Develops up to 4,800 PSI
- Air inlet: 40 - 120 PSI
- Supplied complete with 6" steel extension & coupler
- 1-Year Warranty

KT173933

Heavy Duty Pistol Grip Grease Gun 14 oz

- Heavy duty pistol grip grease gun 14 oz
- Die cast aluminum head fitted with steel block nut
- Complete with 18" flexible hose extension & coupler
- 5,000 PSI
- 3-way loading: 14 oz cartridge, bulk and suction fill
- 1-Year Warranty



KT173930

Mini Pistol Grease Gun 3 oz

- 3 oz mini pistol grease gun
- Dual discharge ports with pull type pistol mechanism
- 3,500 PSI
- Complete with 4" steel extension & coupler
- 1-Year Warranty



KT173942

Heavy Duty Lever Grease Gun 14 oz

- Heavy duty aluminum die cast grease gun head fitted with bulk loaded & air release
- 3-way loading: 14 oz cartridge, bulk and suction fill
- Grease gun handle fitted with rubber grip
- Develops up to 10,000 PSI with built-in variable stroke
- Supplied complete with 6" steel extension & coupler
- 1-Year Warranty



KT173905

Standard Lever Grease Gun 14oz

- Standard lever grease gun 14 oz
- 6,000 PSI
- 3-Way loading 14 oz cartridge, bulk and suction fill
- Complete with 6" steel extension & coupler
- 1-Year Warranty

KT173910

Lube Combo Display Shelf Pack

- Pack includes: 3 each: Heavy Duty Pistol Grip Grease Guns (KT173933) 3 each: Heavy Duty Lever Grease Guns (KT173942)
- Aluminium die cast grease gun head
- Lever grease gun develops up to 10,000 PSI; pistol grease gun up to 5000 PSI
- For use with 14 oz. grease cartridges
- Lever gun (KT173942) includes 6" bent steel extension & coupler; pistol gun (KT173933) includes 18" flexible grease hose & coupler
- Covered by a 1-year warranty



KT173919

Suction Gun with 12" Vinyl Hose

- Transfer gun designed to get gear oils both into and out of gear boxes, transfer cases and differentials
- Capacity 16 oz.
- 1-Year Warranty



KT173959

Right Angle Grease Gun Coupler

- 1,000 PSI
- For use with hand grease guns only
- 1-Year Warranty



KTI73952
Professional 4 Jaw
Grease Gun Coupler

- 6,000 PSI
- For hand operated grease guns only
- 1-Year Warranty



KTI73952-54
Grease Gun Coupler
54 Pack Counter Display

- 6,000 PSI
- For use with hand grease guns only
- 1-Year Warranty



KTI73957
Grease Injector Needle

- For universal joints and sealed bearings
- Length: 1-1/2" • Diameter: 18G
- 1-Year Warranty



KTI73903
Needle Nose Dispenser
1-1/2" Narrow

- For use with hand grease guns only
- 1-1/2" x 0.156" needle
- 1-Year Warranty



Grease Gun Hose

- Working pressure: 3,500 PSI
- Burst pressure: 11,600 PSI
- For hand operated grease guns only
- 1-Year Warranty



KTI73912 - 12" KTI73918 - 18"

KTI72205
Barrel Pump - Lever Style

- Two-piece, self-adjusting telescoping suction tube fits 15, 30 or 55 gallon drums
- Removable threaded spout
- Pumps water based fluids, solvents, antifreeze, weak acids and all oil based fluids
- Pumps approximately 300cc liquid per stroke
- Zinc plated for lasting quality
- Features cushioned vinyl handle
- 90 Day Warranty



KTI72210
Lever Transfer Pump
15-55 Gallon Drums

- For use with DEF, antifreeze, detergents, windshield fluids, heavy oils, etc
- Delivers up to 1 pint per stroke
- 1-Year Warranty



KTI72215
Electric Rechargeable
Drum Pump 19.2V

- Cordless pump with 19.2V rechargeable battery
- Compact & lightweight polyacetal body
- Telescopic pump tube for use with 55 gal. (205 Litre) drums as well as 275-330 gal. (1000 to 1250 Litre) IBC's
- Built-in 2" bung & an additional bung converter (2.5" x 5 buttress) for use with plastic drums & IBC's
- Delivers up to 28 lpm (7.4 gpm) or up to 410 litre (110 gal.) on a single battery charge
- Covered by a 1-year warranty



Designed for pumping DEF, diesel, antifreeze, water, detergents, herbicides, pesticides, kerosene, light oils etc. Includes 19.2V Ni Cd rechargeable battery & UL lister quick battery charger.

KTI72250
Deluxe Siphon
Transfer Pump

- Multi use, transfers most liquids
- Pumps air for inflatables
- Use for changing oil, siphoning gas, inflating sports balls and beach toys
- Includes two 51" siphon hoses, 35" dipstick hose and adapter (for changing oil) and 17" air pressure hose



LIFETIME WARRANTY*

KTI72200
Hand Rotary Style Barrel Pump

- Easy to operate crank handle rotary pumps are used as a siphon
- Simply prime pump by turning crank handle several times: liquid automatically siphons to lower level
- Rotary hand pumps fit 15, 30 and 55 gallon drums
- Cast iron rotary pump is ideal for heavy oil, machine oil and non-corrosive liquids
- Barrel pump dispenses one gallon per 14 revolutions
- Made with a cast iron body with steel inlet and outlet tubing
- 2" bung adapter is perfect for drum openings
- 90 Day Warranty



KTI73993
Lever Action Bucket Pump
5 Gallon Pail

- Comes complete with 12" drum cover and 4' PVC hose with steel spout
- Designed for transferring transmission differentials & heavier oils
- Delivers 2.14 oz. (60 ml) per stroke
- 90 Day Warranty on material and workmanship



KTI74605

1-Qt Funnel with Splash Ring and Removeable Flexible Spout

- Removeable flexible spout
- Removeable screen
- Chemically resistant polyethylene

Polyethylene funnel, 1 quart with splash ring, screen and flexible 10-inch removable spout.



Funnel Safety Red with Screen

- Safety Red
- Chemically resistant polyethylene
- With screen

KTI74606 - 2 Quart

KTI74610 - 6 Quart



KTI74612

3 Quart Drum Funnel with Hinged Lid and 2" Bung

- Tough industrial quality
- Chemically resistant polyethylene
- Fits 2" thread
- Hinged lid and 2" bung



KTI74641

Drip Tray 22" x 22" x 1.5"

- Chemically resistant polyethylene
- Collects drips, leaks, and spills
- Dimensions: 22" x 22" x 1-1/2"



KTI74640

Axle Drain Pan

- Durable and lightweight HDPE plastic with built-in drop proof spouts that help to recycle oil
- Works for most dual and super single wheels, sizes 22.5 and 24.5
- Use with steel and aluminum wheels, hub piloted or stud piloted, drive or trailer axles
- Catches oil, axle nuts, bearings - most anything removed from the wheel end for service
- Attaches with a hand-tightened lug nut

Drain pan works for most dual and super single wheels sizes 22.5 and 24.5. Attaches with a hand-tightened lug nut. Will not tip or spill - virtually eliminating clean up. Works for steel or aluminum wheels, hub piloted or stud piloted, drive or trailer axles. Catches oil, axle nuts, bearings - most anything removed from the wheel end for service. Built in drop proof spouts help to recycle waste oil. Durable and lightweight HDPE plastic.



Double Cap Funnels

- Double capped funnel keeps the drips in and the dirt out
- This ultimate storage funnel eliminates spills and contaminants, reduces debris and is chemically resistant

KTI74607

1 Pint Double Cap Funnel - Orange

- Top ID: 3" • Spout OD: 1/2"
- Height (without cap): 8.75"



KTI74607



KTI74608



KTI74609



KTI74611



KTI74613

KTI74608

1.25 Quart Double Cap Funnel - Dark Blue

- Top ID: 4" • Spout OD: 3/4"
- Height (without cap): 10.5"

KTI74609

1.3 Quart Double Cap Funnel - Black

- Top ID: 4" • Spout OD: 1.375"
- Height (without cap): 16.5"

KTI74611

1.5 Quart Double Cap Funnel - Yellow

- Top ID: 4" • Spout OD: 3/4"
- Height (without cap): 14.25"

KTI74613

1.66 Quart Double Cap Funnel - Dark Red

- Top ID: 4" • Spout OD: 1.375"
- Height (without cap): 14.25"



KTI74647

Antifreeze Drain Pan 4.5 Gallon

- Built-in anti-splash lip & baffles
- Large spout for fast pouring. Includes spout cap for spill protection
- High density polyethylene construction, chemical & solvent resistant
- Green color provides visual identification for use with antifreeze
- Covered by a 1-year warranty



KTI74645

4.25 Gallon Capacity Oil Drain Pan

- Chemical / solvent resistant high density polyethylene construction
- Large spout for fast pouring complete with spout cap
- Built-in ant-splash lip and baffles
- Includes large handle • 1 year warranty

KTI73901

Pistol Style Oiler with Base 6 oz.

- Pistol style oil can with base
- Capacity: 6oz (180 ml)
- Flex spout
- 1-Year Warranty



KTI73902

Lever Oil Can with Flex Spout 1 Pint

- 1 pint (500ml) lever oil can
- Flex spout
- 1-Year Warranty



KTI74601-1

19-1/2" Long Rigid Funnel

- Super deluxe transmission funnel
- Large capacity prevents overflow
- 4-1/2" ID x 19-1/2" long



KTI74601-12

19-1/2" Long Rigid Funnel 12/Pk



KTI74602-1

Long Flexible Transmission Funnel

- Plastic
- With Flexible Hose

KTI74602-12

Long Flexible Transmission Funnel 12/Pk

KTI74603

Funnel Pivoting "The Guzzler"

Large capacity funnel directs flow without spilling. Features ball pivot at base.



KTI74604

Funnel for 55-gallon Drum

Large capacity funnel screws directly onto 55 gallon drums.



KTI74630

3-Piece Funnel Set

KTI's "funnel for every job" set includes 3-1/2", 5-1/2" and 7-1/2" sizes.



KTI74651

5-Liter Translucent Measuring Pitcher with Flexible Spout

- 5-Liter Measure Pitcher
- Flexible Spout
- Translucent

KTI74650

2-Liter Measure Pitcher with Flex Spout

KTI74652

Plastic Measure with Flex Spout - 8 Qt

- Translucent body
- Includes dust cover, flexible spout & cap
- Graduated in quarts & liters
- Covered by a 1-year warranty





KT100023

60-Piece Grease Fitting Kit (SAE)

- Grease fitting assortment kit (SAE) includes 1/4-28 sizes
- The 1/4-28 thread fitting is used on cars, light trucks and industrial machinery
- Requires a tapped hole for installation
- Max pressure is 8,000 psi
- Kit contains 60 pieces of the top 4 sizes: straight, 45° elbow, 90° elbow and long straight fittings

Part #	Description	Qty	Refill
KT104308	1/4" - 28 Straight	20	10
KT104309	1/4" - 28 45°	15	10
KT104310	1/4" - 28 90°	15	10
KT104311	1/4" - 28 Straight (Long)	10	10



KT100024

90-Piece Grease Fitting Kit (Metric)

- Grease fitting assortment kit (metric) includes 6 mm, 8 mm and 10 mm fittings in nine popular sizes
- Kit contains straight, 45° elbow, and 90° elbow fittings packaged in multicompart, refillable plastic case
- Contains product assortment map for easy identification of components

Part #	Description	Qty	Refill
KT104312	6mm x 1.0/Straight	10	10
KT104313	6mm x 1.0/45°	10	10
KT104314	6mm x 1.0/90°	10	10
KT104315	8mm x 1.0/Straight	10	10
KT104316	8mm x 1.0/45°	10	10
KT104317	8mm x 1.0/90°	10	10
KT104318	10mm x 1.0/Straight	10	10
KT104319	10mm x 1.0/45°	10	10
KT104320	10mm x 1.0/90°	10	10



KT100096

110-Piece Metric Grease Fitting Assortment

- 110-piece metric grease fitting assortment kit includes six popular sizes, ranging from 6mm to 10mm

Description	Qty	Description	Qty
6mm	30	10mm (90°)	20
6mm (45°)	15	10mm (45°)	15
6mm (90°)	15	10mm	15



KTI00074

110-Piece Hydraulic

Grease Fitting Assortment Fractional

- 110-piece hydraulic grease fitting assortment kit includes six popular sizes from 1/4"-28 to 1/8"-27
- Kit contains straight and 45° and 90° angled fittings

Description	Qty	Description	Qty
1/4"-28	30	1/8"-27 (90°)	15
1/4"-28 (45°)	15	1/8"-27 (45°)	15
1/4"-28 (90°)	15	1/8"-27	20



Grease Fittings		
Part #	Description	Qty
KTI04319	Grease Fittings Metric 10MM 45° Elbow	10
KTI04320	Grease Fittings Metric 10MM 90° Elbow	10
KTI04318	Grease Fittings Metric 10MM Straight	10
KTI04313	Grease Fittings Metric 6MM 45° Elbow	10
KTI04314	Grease Fittings Metric 6MM 90° Elbow	10
KTI04312	Grease Fittings Metric 6MM Straight	10
KTI04316	Grease Fittings Metric 8MM 45° Elbow	10
KTI04317	Grease Fittings Metric 8MM 90° Elbow	10
KTI04315	Grease Fittings Metric 8MM Straight	10
KTI04309	Grease Fittings SAE 1/4-28 45° Elbow	10
KTI04310	Grease Fittings SAE 1/4-28 90° Elbow	10
KTI04311	Grease Fittings SAE 1/4-28 Long Straight	10
KTI04308	Grease Fittings SAE 1/4-28 Straight	10



BATTERY TESTERS AND BOOSTER CABLES





LIFETIME WARRANTY*

**KTI70211
Antifreeze Tester**

- Hydrometer immediately and accurately tests strength of all permanent solutions (ethylene glycol), with engine hot or cold, and includes temperature adjustment scale for accurate interpretation of mixture strength
- Assists in preventing winter freezeup and summer boilover
- Two embedded scales show freeze point of radiator solution and boiling point of summer coolant
- 32°F thru -45°F

**KTI70212
Battery Tester**

- Hydrometer immediately and accurately tests battery life whether battery is hot or cold
- Helps extend battery life and detects overcharge
- Assists in preventing dead batteries
- Works on all 6-, 12- and 24-volt systems

LIFETIME WARRANTY*



**KTI70210
Carbon Pile Load Tester 500 AMP**

- KTI's 500 AMP carbon pile load tester is great for simulating actual cranking loads
- It tests 12 volt batteries rated as high as 1000 CCA or 160 AMP hour
- Quick 15 second test cycle with audible tone to indicate test completion
- Unit can also test alternators, regulators and starters
- Carbon pile load tester features 500 AMP side clamps and heavy-duty stranded copper cables
- The large, color-coded dual meters make the unit easy-to-use
- Also includes temperature compensation chart
- 1-year warranty; Repair or replace at discretion of repair center



**KTI70215
Battery Tester 100 AMP**

- Extremely handy and portable way to load test suspected low charging batteries
- Internal 100 AMP loading capacity
- Test 6- and 12-volt batteries
- Tool checks battery voltage, starter current draw, charging voltage and battery condition
- Features extra-heavy nickel-plated ventilated case, heavy-duty cable, copper-plated clamps, and load safety switch to prevent arcing
- 1-year warranty; Repair or replace at discretion of repair center



**KTI70216
Digital Battery Tester 125 AMP**

- Extremely handy and portable way to load test suspected low charging batteries
- Internal 125 AMP loading capacity. Digital voltage indicator with LED battery status
- Tests 12-volt batteries on or off the vehicle. Load safety switch prevents arcing
- Features extra-heavy nickel-plated ventilated case, heavy-duty cable, copper-plated clamps, and load safety switch to prevent arcing
- 1-year warranty; Repair or replace at discretion of repair center

BATTERY TESTERS AND BOOSTER CABLES



KTI74500

Economy

12' Battery Booster Cables

250 AMP - 10 Gauge

- Durable rubber booster cables that resist extreme temperatures, oil and chemicals
- Light-duty
- 1-year limited warranty



KTI74510

Heavy-duty

16' Battery Booster Cables

400 AMP - 6 Gauge

- KTI's durable rubber booster cables resist extreme temperatures, oil and chemicals, and meet or exceed all SAE standards
- Sixteen foot heavy-duty cables include side/top clamps and 6 gauge wires with 400 AMP clamps
- 1-year limited warranty



KTI74505

Medium-duty

12' Battery Booster Cables

250 AMP - 8 Gauge

- KTI's durable rubber booster cables resist extreme temperatures, oil and chemicals, and meet or exceed all SAE standards
- Twelve foot medium-duty cables include side/top clamps and 8 gauge wires with 250 AMP clamps
- 1-year limited warranty



KTI74530
Professional
25' Battery Booster Cables
500 AMP - 2 Gauge

- KTI's durable rubber booster cables resist extreme temperatures, oil and chemicals, and meet or exceed all SAE standards
- Twenty-five foot professional cables include parrot-jaw clamps and 2 gauge wires with 500 AMP clamps
- 1-year limited warranty



KTI74524
20' Heavy Duty
4 Gauge 400 Amp Clamps

- Booster cables have a tangle-free design
- Flexible to -40° Fahrenheit temperatures
- Vinyl coated clamps help prevent rust and corrosion
- For side and top battery post



KTI74523
20' Heavy Duty
4 Gauge 500 Amp Clamps

- Booster cables have a tangle-free design
- Flexible to -40° Fahrenheit temperatures
- Vinyl coated clamps help prevent rust and corrosion
- For side and top battery post



KTI74521
Extra-Heavy-Duty 16' Battery Booster
Cables 400 AMP - 4 Gauge

- KTI's durable rubber booster cables resist extreme temperatures, oil and chemicals, and meet or exceed all SAE standards
- Sixteen foot extra-heavy-duty cables include side/top clamps and 4 gauge wires with 400 AMP clamps
- 1-year limited warranty

BATTERY TESTERS AND BOOSTER CABLES



KTI74308 **Automotive OBD2** **Connector - Computer** **Memory Saver**

- KTI's OBDII Memory Saver retains a vehicle's electronic memory presets (radio, GPS, seats and accessories) while the vehicle battery is disconnected
- OBDII cord connects to any 12V portable power source
- Memory Saver will not interfere with the vehicle's fault codes
- A visual LED indicator illuminates when cord is properly connected to power source to ensure no loss of electronic memory due to improper connection
- An extra-long 8-foot cord makes it easy to use on any vehicle
- 1-year limited warranty



KTI74536 **400 Amp Booster Cable** **Replacement Clamps**

- Vinyl coated clamps help prevent rust and corrosion
- Sold in pairs



KTI74537 **500 Amp Booster Cable** **Replacement Clamps**

- Vinyl coated clamps help prevent rust and corrosion
- Sold in pairs



KTI74538 **800 Amp Booster Cable** **Replacement Clamps**

- Vinyl coated clamps help prevent rust and corrosion
- Sold in pairs



KTI74535 **Booster Cable** **Replacement Clamps** **500 AMP Parrot Jaw**

- Replacement side terminal extension cable clamps for professional grade booster cables
- Sold in pairs



KTI01651 **Battery Clips** **30 Amp - Qty 2**



KTI70220 **Battery Terminal** **Cleaner**

- All metal battery terminal cleaner promotes longer battery life

KTI01611
10 Amp Alligator Clips - Qty 2



KTI02411
Battery Terminal
Top Mount - Qty 2



KTI02421
Battery Terminal
Side Mount - Qty 2



KTI02431
Battery Terminal
Heavy Duty Side Mount - Qty 2



KTI02441
Battery Terminal
Heavy Duty Top Mount - Qty 2



KTI02451
Battery Terminal
Heavy Duty
Top Mount Marine - Qty 2



KTI02461
Battery Terminal
Side Mount
Charging Post - Qty 2



KTI02471
Battery Terminal
Side Mount
Adapters - Qty 2



KTI02481
Battery Terminal
Side Mount
Charging Post Extenders - Qty 2

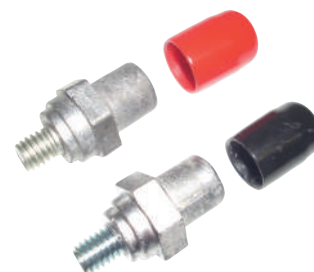

KTI02491
Battery Terminal
Side Mount
Battery Bolt 3/8" - Qty 2



KTI02511
Battery Bolt and Nut 3/8" - Qty 2

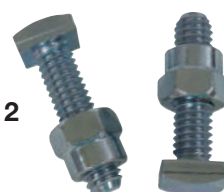



VEHICLE SPECIALTY



Vehicle Specialty | Flaring Tools



KT170081

Professional Brake Flaring Tool

- Easily form 45-degree double, single and bubble flares in OE steel, stainless steel, and soft metal tubing
- Use with 3/16"-, 1/4"-, 5/16"- and 3/8"-diameter lines
- All the brake-flaring forming dies are mounted right on the turret
- T-handle screw clamp securely holds line in place during forming
- Vise-mounted
- 1-Year Warranty



KT170082

Hydraulic Flaring Tool Kit

- Create precision 45 degree double, single and bubble flares in seconds
- Brake flaring tool works with stainless steel, steel, and soft metal tubing
- Use for brake lines, transmission cooler lines, and fuel lines
- Kit contains: brake flare forming tool, 3/16" and 1/4" tube retaining dies, adapters, handle, user manual, and storage/carrying case

Hydraulic flaring tool kit can be used for brake lines, transmission cooling lines and fuel lines. Works with stainless steel, steel and soft metal tubing.

Warranty: 1 year on material and workmanship

LIFETIME WARRANTY*



KT170085

ISO Flaring Tool

- Creates an ISO flare on brake lines without removing them from the vehicle
- Works on mild steel tubing (1.0 mm wall thickness)
- Packaged in blow-molded case • Weight: 2.8 lbs.

Kit includes yoke assembly, flaring bar, gauge/wrench and four adapters (4.75 mm 6 mm, 8 mm and 10 mm).

R LIFETIME WARRANTY*

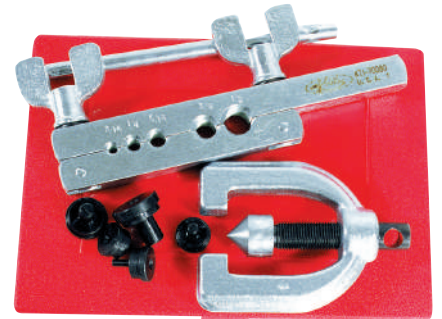

KT170060

Double Flaring Tool

- Specially designed for double or single flare in copper, aluminum or soft steel brake line and brass tubing
- Includes seven adapters in sizes ranging from 3/16"-5/8"
- Packaged in blow-molded case
- Adapters available individually • Weight: 2.25 lbs.

KT170060-1 - Wing Nut

KT170061 - 3/16" Adapter

KT170062 - 1/4" Adapter

KT170063 - 5/16" Adapter

KT170064 - 3/8" Adapter

KT170065 - 7/16" Adapter

KT170066 - 1/2" Adapter

KT170067 - 5/8" Adapter

KT170068 - Flaring Press

KT170069 - Sizing Clamp



LIFETIME WARRANTY*

KT170080

Double Flaring Tool

- Professional double flare tool kit for fabricating double-compression lines (brake lines) or single-compression lines (fuel lines) in copper, steel, or aluminum
- Kit features high-grade, alloy steel center screw; plated, heat-treated, precision-ground swivel, and drop-forged, heat-treated yoke
- Each adapter is laser engraved for easy identification
- Packaged in a blow molded case

VEHICLE SPECIALTY

Vehicle Specialty | Brake



KT170131 Brake Spring Pliers

- For taking off and re-installing the heavy center springs

LIFETIME WARRANTY*



KT170132 Brake Spring Tool

- For taking off and re-installing the heavy center springs

LIFETIME WARRANTY*



KT122802 3-Piece Brake Service Torq Socket Set - 3/8" Drive

- Set includes T-40, T-45 and T-50 Torq bits
- Use on disc brake calipers to remove and install brake pads
- Bits are heat treated and precision machined

Set includes (also available individually):

- KT122840 - T40 torq socket
- KT122845 - T45 torq socket
- KT122850 - T50 torq socket

LIFETIME WARRANTY*



KT127902 3-Piece Brake Caliper Hex Bit Set Metric - 3/8" Drive

- Set includes 7mm, 8 mm, 10 mm hex bits
- Use on disc brake calipers to remove and install brake pads
- Bits are heat treated and precision machined

Set includes (also available individually):

- KT127907 - 7mm hex bit
- KT127908 - 8mm hex bit
- KT127910 - 10mm hex bit

LIFETIME WARRANTY*



KT122902 3-Piece Brake Caliper Hex Bit Set SAE - 3/8" Drive

- Set includes 1/4", 5/16", 3/8" hex bits
- Use on disc brake calipers to remove and install brake pads
- Bits are heat treated and precision machined

Set includes (also available individually):

- KT122908 - 1/4" hex bit
- KT122910 - 5/16" hex bit
- KT122912 - 3/8" hex bit

LIFETIME WARRANTY*

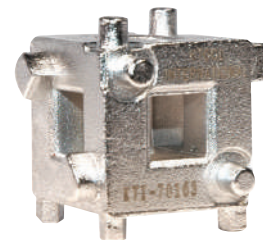

KT170163 Disc Brake Piston tool

- Rotates pistons back into brake calipers when replacing brake pads on vehicles with rear wheel disc brakes
- Provides 6-drive pin configurations to fit most Chrysler, Ford and GM cars and light trucks
- 3/8" square drive

LIFETIME WARRANTY*



**KTI72261
Automotive Test and Bleed Kit**

- Brake bleeder and auto tune-up kit
- Allows a single technician to quickly and cleanly bleed automotive brake and hydraulic clutch systems
- Technician can get answers to hundreds of automotive diagnostic and mechanical tests
- Powerful piston-style pump features a one-finger trigger vacuum release patented contoured molded grip and durable, lightweight, non-corrosive PVC construction
- Integrated diaphragm-style gauge displays Hg and kpa units and can be easily read by either right- or left-handed users
- 1 Year Warranty on material and workmanship

Kit contains pump and all components needed for one-person operation.



**KTI70816
Digital Disc Brake Caliper 0-6"**

- Digital display from 0-6" (150 mm)
- Accuracy to plus/minus .001" (0.1 mm)
- Stainless steel construction and shockproof
- Thumb wheel for accuracy and ease of use
- English/metric readout

LIFETIME WARRANTY*



Brake Bleeder Screws / Copper Washers		
Part #	Description	Qty
KTI04033	Brake Bleeder Screws Ford Truck 3/8-24 Long	5
KTI04034	Brake Bleeder Screws GM, Ford, Chrysler Cars 3/8-24	5
KTI04035	Brake Bleeder Screws GM Cars 1/16-24	5
KTI04036	Brake Bleeder Screws GM Cars M10 x 1.0	5
KTI04037	Brake Bleeder Screws Chevy, Chrysler, Import Cars M10 x 1.0	5
KTI04038	Brake Bleeder Screws Ford Truck 7/16-20	5
KTI04039	Brake Bleeder Screw Repair Insert 1/4-18 NPT	5
KTI04039R	Brake Bleeder Screw Repair Insert 1/8-27 NPT	5
KTI04040	Brake Bleeder Copper Washers 29/64 I.D. - 11/16 O.D.	5
KTI04041	Brake Bleeder Copper Washers 25/64 I.D. - 5/8 O.D.	5
KTI04042	Brake Bleeder Copper Washers 7/16 I.D. - 13/16 O.D.	5

VEHICLE SPECIALTY



KT100001 27 Piece Metric Brake Adapter Kit

- Multi-compartment plastic storage case
- Includes wide range of products
- Contains product assortment map
- Easily moves from job to job

This 27-piece kit contains components ranging in nine different sizes: F-3/16" M-M 10 x 1.0; F-3/16" M-M 11 x 1.0; F-3/16" M-M 12 x 1.0; F-3/16" M-M 13 x 1.0; F-3/16" 4.762 (3/16") M-M 10 x 1.25; F 3/16" (M10 x 1.0) M-M 13 x 1.5; F 3/16" (M10 x 1.0) M-M 11 x 1.5; and F 3/16" (M10 x 1.0) M-M 12 x 1.5.

KT100002 20 Piece Master Cylinder Adapter Assortment

- Multi-compartment plastic storage caseIncludes wide range of products
- Contains product assortment mapIncludes most popular sizes
- Easily moves from job to job



This 20-piece kit contains components ranging in nine different sizes: F-3/16" M-M 10 x 1.0; F 3/16" (M10 x 1.0) M-M 13 x 1.5; F 3/16" (M10 x 1.0) M-M 11 x 1.5; and F 3/16" (M10 x 1.0) M-M 12 x 1.5.



KT100005 64 Piece Brake Line Fitting Kit

- Multi-compartment plastic storage case includes wide range of products
- Contains product assortment map
- Includes most popular sizes
- Easily goes from job to job

This 64-piece kit includes brake line nuts and brake line unions in standard and metric sizes: Brake Line Nut 3/16", Brake Line Nut 1/4", Brake Line Nut (Long) 3/16", Brake Line Nut (Long) 1/4", Brake Line Nut 5/16", Brake Line Union 3/16", Brake Line Union 1/4", Brake Line Union 5/16", Metric Brake Line Nut 10mm x 1.0 Standard Flare, Metric Brake Line Nut 10mm x 1.0 Bubble Flare, Metric Brake Line Nut 3/8"-24 Bubble Flare, Metric Brake Union Nut 3/8"-24 for 7802 Nut, Metric Brake Union Nut 3/8"-24 for 7801 Nut, Metric Brake Union Nut 10mm x 1.0 for 7800 Nut.



KT100047 95 Piece Brake Line Fittings Assortment

- A general assortment of tubes nuts, unions and adapters
- Fittings include applications for British, European and Japanese systems
- Brake fitting assortments make it easy for any repair shop to keep the most popular fittings on hand and organized
- Save time and increase productivity
- Packaged in a refillable, multicompartament case featuring an easy-to-use product identification map



KTI00006
30 Piece Brake Bleeder Screw and Washer Assortment

- Multi-compartment plastic storage case
- Includes wide range of product
- Contains product assortment map
- Includes most popular sizes
- Easily goes from job to job

Kit Includes Brake Bleeder Screws and Brake Bleeder Copper Washers in different sizes: Brake Bleeder Screws Ford Truck 3/8-24 Long, Brake Bleeder Screws GM, Ford Chrysler Cars 3/8-24, Brake Bleeder Screws GM Cars 1/16-24, Brake Bleeder Screws GM Cars M10 x 1.0, Brake Bleeder Screws Chevy, Chrysler, Import Cars M10 x 1.0, Brake Bleeder Screws Ford Truck 7/16-20, Brake Bleeder Screw Repair Insert 1/8-27 NPT, Brake Bleeder Copper Washers 29/64 I.D. 11/16 O.D., Brake Bleeder Copper Washers 25/64 I.D. 5/8 O.D., Brake Bleeder Copper Washers 7/16 I.D. 13/16 O.D.



KTI00048
86-piece Master Brake Fittings Assortment

- Consists of 20 different types of tube nuts and unions
- Works on most import and domestic brake lines
- Fittings include application for British, European and Japanese vehicles



KTI00049
3/16" Master Fittings Assortment

- Master Brake Line Assortment plus 25' length of 3/16" copper-nickel brake line



KTI00050
3/16-1/4" Master Fittings Assortment

- Master Brake Fitting Asst plus 25' length of 3/16" and 25' length of 1/4" copper-nickel brake line

VEHICLE SPECIALTY

Vehicle Specialty | Brake



Copper-nickel brake lines are easy to bend, corrosion resistant and provide an excellent flare seal.



PVF (poly vinyl fluoride) coated lines feature 30X corrosion resistance over plain galvanized lines. PVF coated lines provide significant protection against all road elements.

Brake Line - Copper Nickel / Galfan Coated / PVF Coated Quantity		
Part #	Description	Qty.
KT103970	Brake Line - Copper Nickel 3/16" - 25'	1
KT103971	Brake Line - Copper Nickel 1/4" - 25'	1
KT103963	Brake Line - Galfan Coated 3/16" x 25' Coil	1
KT103964	Brake Line - Galfan Coated 1/4" x 25' Coil	1
KT103965	Brake Line - Galfan Coated 5/16" x 25' Coil	1
KT103966	Brake Line - Galfan Coated 3/8" x 25' Coil	1
KT103967	Brake Line - PVF Coated 3/16" x 25' Coil	1
KT103968	Brake Line - PVF Coated 1/4" x 25' Coil	1
KT103969	Brake Line - PVF Coated 5/16" x 25' Coil	1



Galfan coated brake lines provide extended corrosion and abrasion resistance by combining a hot dip coat of the alloy Galfan with an aluminum rich epoxy top coat.

Brake Line Fittings		
Part #	Description	Qty.
KT104023	3/16" Brake Line Nut 3/8"-24 Short Thread Inverted Flare	5
KT104024	3/16" Brake Line Nut 3/8"-24 Long Thread Inverted Flare	5
KT104025	1/4" Brake Line Nut 7/16"-24 Short Thread Inverted Flare	5
KT104026	1/4" Brake Line Nut 7/16"-24 Long Thread Inverted Flare	5
KT104027	5/16" Brake Line Nut 1/2"-20 Thread Inverted Flare	5
KT104008	3/16" Brake Line Nut Metric 10mm x 1.0 (Jap) Inverted Flare	5
KT104009	3/16" Brake Line Nut Metric 10mm x 1.0 (Eur) Bubble Flare	5
KT104010	3/16" Brake Line Nut 3/8"-24 (Brit) Bubble Flare	5
KT103972	3/16" Brake Line Nut Metric 11mm x 1.5 Bubble Flare	5
KT103973	3/16" Brake Line Nut Metric 12mm x 1.0 Bubble Flare	5
KT103974	3/16" Brake Line Nut Metric 13mm x 1.5 Bubble Flare	5
KT103975	3/16" Brake Line Nut 9/16"-18 Inverted Flare	5
KT103976	1/4" Brake Line Nut Metric 12mm x 1.0 Bubble Flare	5
KT103977	3/16" Brake Line Nut Metric 10mm x 1.0 Long Inverted Flare	5
KT103978	3/16" Brake Line Nut Metric 10mm x 1.0 Bubble Flare	5
KT103979	3/16" Brake Line Nut 7/16"-24 Inverted Flare	5
KT103980	3/16" Brake Line Nut 1/2"-20 Inverted Flare	5
KT103984	6mm Brake Line Nut Metric 12mm x 1.0 Bubble Flare	5
KT103985	6mm Brake Line Nut Metric 14mm x 1.5 Bubble Flare	5





Brake Line Adapters		
Part #	Description	Qty
KT104000	Brake Master Cylinder Adapter 3/16" Male x 3/16" Female	5
KT104001	Brake Metric Adapter 3/16 (3/8"-24) Female Inv Flare x 10mm x 1.0 Male Bubble Flare	5
KT104002	Brake Metric Adapter 3/16 (3/8"-24) Female Inv Flare x 10mm x 1.0 Male Inv Flare	5
KT104003	Brake Metric Adapter 3/16 (3/8"-24) Female Inv Flare x 11mm x 1.5 Male Bubble Flare	5
KT104004	Brake Metric Adapter 3/16 (3/8"-24) Female Inv Flare x 12mm x 1.0 Male Bubble Flare	5
KT104005	Brake Metric Adapter 3/16 (3/8"-24) Female Inv Flare x M13 x 1.5 Bubble Inv Flare	5
KT104006	Brake Metric Adapter 3/16 (3/8"-24) Female Inv Flare x 10mm x 1.25 Male Bubble Flare	5
KT104011	Brake Master Cylinder Adapter 3/16 (3/8"-24) Female x 1/4 (7/16"-24) Male Inv Flare	5
KT104012	Brake Master Cylinder Adapter 1/4 (7/16"-24) Female Inv Flare x 3/16 (3/8"-24) Male Inv Flare	5
KT104013	Brake Master Cylinder Adapter 1/4 (7/16"-24) Female Inv Flare x 5/16 (1/2"-20) Male Inv Flare	5
KT104014	Brake Master Cylinder Adapter 3/16 (9/16"-18) Male Inv Flare x 1/4 Female (7/16"-24) Inv Flare	5
KT104015	Brake Master Cylinder Adapter 5/16 (1/2"-20) Male Inv Flare x 3/16 (3/8"-24) Female Inv Flare	5
KT104016	Brake Master Cylinder Adapter 3/16 (9/16"-20) Male Inv Flare x 3/16 (3/8"-24) Female Inv Flare	5
KT104017	Brake Master Cylinder Adapter 3/16 (9/16"-18) Male Inv Flare x 3/16 (3/8"-24) Female Inv Flare	5
KT104018	Brake Master Cylinder Adapter 3/16 (9/16"-18) Male Inv Flare x 3/16 (1/2"-20) Female Inv Flare	5
KT104019	Brake Master Cylinder Adapter 1/4 Male x 5/16 Female Inv Flare	5
KT104020	Brake Metric Adapter 11mm x 1.5 Male Bubble Flare x 3/16 (10mm x 1.0) Female Inv Flare	5
KT104021	Brake Metric Adapter 12mm x 1.0 Male Bubble Flare x 3/16 (10mm x 1.0) Female Inv Flare	5
KT104022	Brake Metric Adapter 13mm x 1.5 Male Bubble x 3/16 (10mm x 1.0) Female Inv Flare	5



Brake Line Unions		
Part #	Description	Qty
KT104029	3/16" Brake Line Union 3/8"-24 Inverted	5
KT104030	1/4" Brake Line Union 7/16"-24 Inverted	5
KT104031	5/16" Brake Line Union 1/2"-20 Inverted	5
KT104007	3/16" Brake Union British to British Line 3/8"-24 Bubble Flare	5
KT104028	3/16" Brake Union Euro to Euro Line M10 x 1.0 Bubble Flare	5
KT104032	3/16" Brake Union Japan to Japan Line M10 x 1.0 Inverted Flare	5

VEHICLE SPECIALTY

Vehicle Specialty | Tire & Wheel



KT189001

Digital Tire Inflator Gauge

- Rugged die-cast body and a range of 2 to 150 psi with 0.1 psi resolution
- Programmed to work with various units of measurement (psi/bar/kpa/kg/cm2) and works on TPMS equipped wheels
- Features include a large face LCD digital display, anti-oil rubber casting and ergonomic grip
- Boasts a dual head chuck and is accurate to within $\pm 1\% + 0.5\text{psi}$ at 100psi and $\pm 2\% + 0.5\text{psi}$ at 150psi
- Backlit monitor is powered by two replaceable 3V lithium batteries
- 1-year warranty; Repair or replace at discretion of repair center

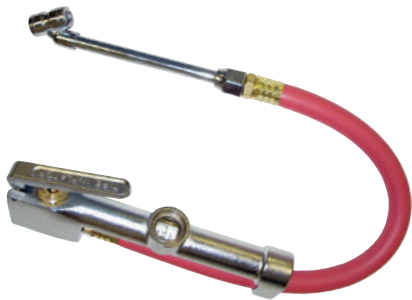

Tire Inflator Gauge with Dual-head Chuck

- Pressure range from 10 to 120 lbs. shown in 2 lb. increments, 15" air hose with 1/4" female NPT, 6" chrome-plated dual-head chuck and 3/8" - 24 thread air inlet
- Inflator gauge boasts a weatherproof aluminum body with corrosion-resistant brass valve
- Rugged construction to withstand everyday use and abuse
- Two steel washers provide an air-tight seal
- Gauge and valve cartridges are replaceable
- Easy-to-read and easy-to-use, magnifying bubble lens allows full view of scale
- Angled tip makes it easy to inflate tires on trucks with dual wheels
- 1-year warranty; Repair or replace at discretion of repair center

KT189002 - Packaged in color box

KT189003 - Packaged in color slip card



KT171940

4-way Lugnut Wrench - Fractional

- Sizes: 11/16", 3/4", 13/16" and 7/8"
- Drop-forged and heat-treated for strength and durability.
- Cross design provides improved leverage and extra torque.

LIFETIME WARRANTY*



KT171980

4-way Lugnut Wrench - Metric

- Sizes: 17mm, 19mm, 21mm and 23mm
- Drop-forged and heat-treated for strength and durability.
- Cross design provides improved leverage and extra torque.

LIFETIME WARRANTY*



KT171930

57-Piece Tire Repair Kit

- Easily and quickly repair punctures in tubeless tires
- Components designed for professional use in rugged shop environments
- Used to repair tires on cars, trucks, RVs, motor homes and more
- Includes: 2 heavy duty zinc alloy T-handles; 2 Allen wrenches; 1 steel insertion needle; 1 steel spiral reamer; 1 50-pack 4" tire string plugs; 1 tube of tire plug lube all in a blow-molded carrying case

KT171931 - Replacement Steel Plunger with T-Handle

KT171932 - Replacement Steel Reamer with T-Handle

KT171933 - Replacement 4" Strip 50-pack

KT171934 - Replacement Tire Plug Lube

R



KITI71910
Lugnut Removing Set

- Removes locking lug nuts and locking hubcaps on most vehicles
- For use with impact wrenches
- Packaged in blow-molded case

LIFETIME WARRANTY*



KITI71920
7-Piece Wheel Bearing Locknut Set

- 1/2" Drive
- Includes locknut sockets: 55 mm hex; 2-3/8" hex; 2-1/2" hex; 2-1/2" rounded hex; 2-3/4" rounded hex; 2-9/16" rounded hex; and 2-3/8" rounded hex.
- Packaged in blow-molded case.
- Sockets available individually.

LIFETIME WARRANTY*

Set includes (also available individually):

- KITI71921** - 55mm hex
- KITI71922** - 2-3/8" hex
- KITI71923** - 2-1/2" hex
- KITI71924** - 2-1/2" round hex

- KITI71925** - 2-3/4" round hex
- KITI71926** - 2-9/16" round hex
- KITI71927** - 2-3/8" round hex



KITI35005
5-Piece Budd Wheel Socket Set
1" Drive

- Remove both nut and stud with just one socket
- Use with 1" square drive impact wrench
- Set includes 33mm, 35mm, 38mm, 41mm and 1 1/2" hex Budd wheel sockets

Set includes (also available individually):

- KITI35233** - 33mm
- KITI35235** - 35mm
- KITI35238** - 38mm
- KITI35241** - 41mm
- KITI35028** - 1-1/2" - 13/16"

LIFETIME WARRANTY*



Impact Budd Wheel Sockets

- Chrome moly steel, heat-treated, short overall length

3/4" Drive

- KITI34026** - 13/16" Square
- KITI34027** - 13/16" Square x 1 1/2" Hex
- KITI39233** - 33mm Deep

LIFETIME WARRANTY*

1" Drive

- KITI35026** - 13/16" Square
- KITI35027** - 13/16" Sq. x 1 1/2" Hex Limited

VEHICLE SPECIALTY

KTI33300 7-Piece 1/2" Drive Thin Wall

Protective Socket Set

- Sockets made of chrome moly steel
- Complete set comes in a handy plastic case
- Set includes: 17mm blue color, 19mm gold color, 21mm red color, 13/16" purple color, 7/8" green color, 1" titanium color, 1-1/16" black color



Set includes (also available individually):

KTI33317	Thin Wall Protective Socket	17mm	Blue
KTI33319	Thin Wall Protective Socket	19mm	Gold
KTI33321	Thin Wall Protective Socket	21mm	Red
KTI33326	Thin Wall Protective Socket	13/16"	Purple
KTI33328	Thin Wall Protective Socket	7/8"	Green
KTI33332	Thin Wall Protective Socket	1"	Titanium
KTI33334	Thin Wall Protective Socket	1-1/16"	Black

KTI33350 7-Piece 1/2" Drive

Torque Extension Set

- For use with thin wall impact sockets.
- Prevent over torque of wheel nuts.
- Use with foreign or domestic cars and light trucks



LIFETIME WARRANTY*

Set includes (also available individually):

KTI33351	1/2" Drive Torque Extension	55 ft./lbs.	Red
KTI33352	1/2" Drive Torque Extension	65 ft./lbs.	Yellow
KTI33353	1/2" Drive Torque Extension	80 ft./lbs.	Green
KTI33354	1/2" Drive Torque Extension	100 ft./lbs.	Lt. Blue
KTI33355	1/2" Drive Torque Extension	120 ft./lbs.	White
KTI33356	1/2" Drive Torque Extension	140 ft./lbs.	Black
KTI33357	1/2" Drive Torque Extension	175 ft./lbs.	Orange

AccuTorq

ACC10-0314 4-Piece AccuTorq® Set Application: Ford

Set includes (also available individually):

ACC10-0308	Gray	1/2" drive	19mm	100 ft./lbs.
ACC10-0310	Light Brown	1/2" drive	21mm	80 ft./lbs.
ACC10-0311	Brown	1/2" drive	21mm	100 ft./lbs.
ACC10-0313	Turquoise	1/2" drive	7/8"	140 ft./lbs.



AccuTorq

ACC10-0315 4-Piece AccuTorq® Set Application: Cars, Vans and Light Trucks

Set includes (also available individually):

ACC10-0306	Yellow	1/2" drive	19mm	65 ft./lbs.
ACC10-0307	Blue	1/2" drive	19mm	80 ft./lbs.
ACC10-0308	Gray	1/2" drive	19mm	100 ft./lbs.
ACC10-0311	Brown	1/2" drive	21mm	100 ft./lbs.



LIFETIME WARRANTY*

LIFETIME WARRANTY*

ACC10-0317 5-Piece AccuTorq® Set

Set includes (also available individually):

ACC10-0305	Red	1/2" drive	17mm	80 ft./lbs.
ACC10-0307	Blue	1/2" drive	19mm	80 ft./lbs.
ACC10-0308	Gray	1/2" drive	19mm	100 ft./lbs.
ACC10-0310	Light Brown	1/2" drive	21mm	80 ft./lbs.
ACC10-0311	Brown	1/2" drive	21mm	100 ft./lbs.



LIFETIME WARRANTY*

LIFETIME WARRANTY*

ACC10-0319 9-Piece AccuTorq® Set

Set includes (also available individually):

ACC10-0304	Green	1/2" drive	17mm	55 ft./lbs.
ACC10-0305	Red	1/2" drive	17mm	80 ft./lbs.
ACC10-0306	Yellow	1/2" drive	19mm	65 ft./lbs.
ACC10-0307	Blue	1/2" drive	19mm	80 ft./lbs.
ACC10-0308	Gray	1/2" drive	19mm	100 ft./lbs.
ACC10-0310	Light Brown	1/2" drive	21mm	80 ft./lbs.
ACC10-0311	Brown	1/2" drive	21mm	100 ft./lbs.
ACC10-0312	White	1/2" drive	22mm	120 ft./lbs.
ACC10-0313	Turquoise	1/2" drive	7/8"	140 ft./lbs.





ACC10-0321

8-Piece

AccuTorq® Set

Set includes (also available individually):

ACC10-0304	Green	1/2" drive	17mm	55 ft./lbs.
ACC10-0305	Red	1/2" drive	17mm	80 ft./lbs.
ACC10-0306	Yellow	1/2" drive	19mm	65 ft./lbs.
ACC10-0307	Blue	1/2" drive	19mm	80 ft./lbs.
ACC10-0308	Gray	1/2" drive	19mm	100 ft./lbs.
ACC10-0310	Light Brown	1/2" drive	21mm	80 ft./lbs.
ACC10-0311	Brown	1/2" drive	21mm	100 ft./lbs.
ACC10-0313	Turquoise	1/2" drive	7/8"	140 ft./lbs.

LIFETIME WARRANTY*



ACC10-0324

5-Piece

AccuTorq® Set

Application: Ford

Set includes (also available individually):

ACC10-0308	Gray	1/2" drive	19mm	100 ft./lbs.
ACC10-0310	Light Brown	1/2" drive	21mm	80 ft./lbs.
ACC10-0311	Brown	1/2" drive	21mm	100 ft./lbs.
ACC10-0313	Turquoise	1/2" drive	7/8"	140 ft./lbs.
ACC10-0328	Charcoal	1/2" drive	21mm	147 ft./lbs.

LIFETIME WARRANTY*



ACC10-0326

6-Piece

AccuTorq® Set

Application: Ford

Set includes (also available individually):

ACC10-0308	Gray	1/2" drive	19mm	100 ft./lbs.
ACC10-0310	Light Brown	1/2" drive	21mm	80 ft./lbs.
ACC10-0311	Brown	1/2" drive	21mm	100 ft./lbs.
ACC10-0313	Turquoise	1/2" drive	7/8"	140 ft./lbs.
ACC10-0328	Charcoal	1/2" drive	21mm	147 ft./lbs.
ACC10-3898	Light Purple	1/2" drive	22mm	160 ft./lbs.

LIFETIME WARRANTY*



ACC10-0322

10-Piece

AccuTorq® Set

Set includes (also available individually):

ACC10-0304	Green	1/2" drive	17mm	55 ft./lbs.
ACC10-0305	Red	1/2" drive	17mm	80 ft./lbs.
ACC10-0306	Yellow	1/2" drive	19mm	65 ft./lbs.
ACC10-0307	Blue	1/2" drive	19mm	80 ft./lbs.
ACC10-0308	Gray	1/2" drive	19mm	100 ft./lbs.
ACC10-0310	Light Brown	1/2" drive	21mm	80 ft./lbs.
ACC10-0311	Brown	1/2" drive	21mm	100 ft./lbs.
ACC10-0312	White	1/2" drive	22mm	120 ft./lbs.
ACC10-0313	Turquoise	1/2" drive	7/8"	140 ft./lbs.
ACC10-3899	Light Green	1/2" drive	24mm	140 ft./lbs.

LIFETIME WARRANTY*



ACC10-0323

10-Piece

AccuTorq® Set

Set includes (also available individually):

ACC10-0327	Light Blue	1/2" drive	22mm	100 ft./lbs.
ACC10-0328	Charcoal	1/2" drive	21mm	147 ft./lbs.
ACC10-0329	Off White	1/2" drive	17mm	90 ft./lbs.
ACC10-0334	Light Yellow	1/2" drive	17mm	113 ft./lbs.
ACC10-0336	Orange	1/2" drive	22mm	75 ft./lbs.
ACC10-0340	Mud	1/2" drive	14mm	80 ft./lbs.
ACC10-0341	Quartz	1/2" drive	19mm	120 ft./lbs.
ACC10-0342	Light Tan	1/2" drive	19mm	90 ft./lbs.
ACC10-0343	Red Orange	1/2" drive	21mm	110 ft./lbs.
ACC10-3898	Light Purple	1/2" drive	22mm	160 ft./lbs.

LIFETIME WARRANTY*

VEHICLE SPECIALTY



ACC10-0450

4-Piece
AccuTorq® Set

Application: Deep Well Truck

Set includes (also available individually):

ACC10-0312	White	1/2" drive	22mm	120 ft./lbs.
ACC10-0313	Turquoise	1/2" drive	7/8"	140 ft./lbs.
ACC10-0328	Charcoal	1/2" drive	21mm	147 ft./lbs.
ACC10-3899	Light Green	1/2" drive	24mm	140 ft./lbs.



ACC10-0455

5-Piece
AccuTorq® Set
Application: Light Truck

Set includes (also available individually):

ACC10-0312	White	1/2" drive	22mm	120 ft./lbs.
ACC10-0313	Turquoise	1/2" drive	7/8"	140 ft./lbs.
ACC10-0328	Charcoal	1/2" drive	21mm	147 ft./lbs.
ACC10-3898	Light Purple	1/2" drive	22mm	160 ft./lbs.
ACC10-3899	Light Green	1/2" drive	24mm	140 ft./lbs.



ACC20-4100

4-Piece Heavy-duty
AccuTorq® Set
3/4" Drive



Set includes (also available individually):

ACC20-3918	Red	3/4" drive	1-1/4"	250 ft./lbs.
ACC20-3919	Brown	3/4" drive	33mm	475 ft./lbs.
ACC20-3920	Black	3/4" drive	1-1/2"	475 ft./lbs.
ACC20-3921	Yellow	3/4" drive	13/16"	475 ft./lbs.



ACC20-4000

4-Piece Heavy-duty
AccuTorq® Set
1" Drive



Set includes (also available individually):

ACC20-3908	Red	1" drive	1-1/4"	250 ft./lbs.
ACC20-3909	Brown	1" drive	33mm	475 ft./lbs.
ACC20-3910	Black	1" drive	1-1/2"	475 ft./lbs.
ACC20-3911	Yellow	1" drive	13/16"	475 ft./lbs.

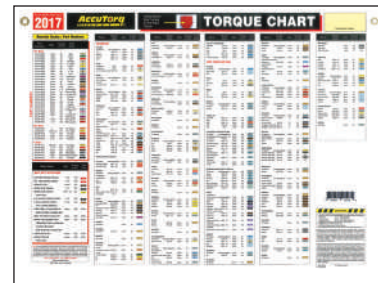

ACC10-0103 Torque Chart

Easy-to-read, color-coded torque chart. Lists applications for most foreign and domestic vehicles.



ACC2597Y1290 Empty Heavy Duty Case



ACC20-3100 4-Slot Heavy-Duty Storage Bracket

Heavy-duty wall bracket for convenient storage of heavy-duty torque sockets

ACC10-0100 5-Slot Storage Bracket

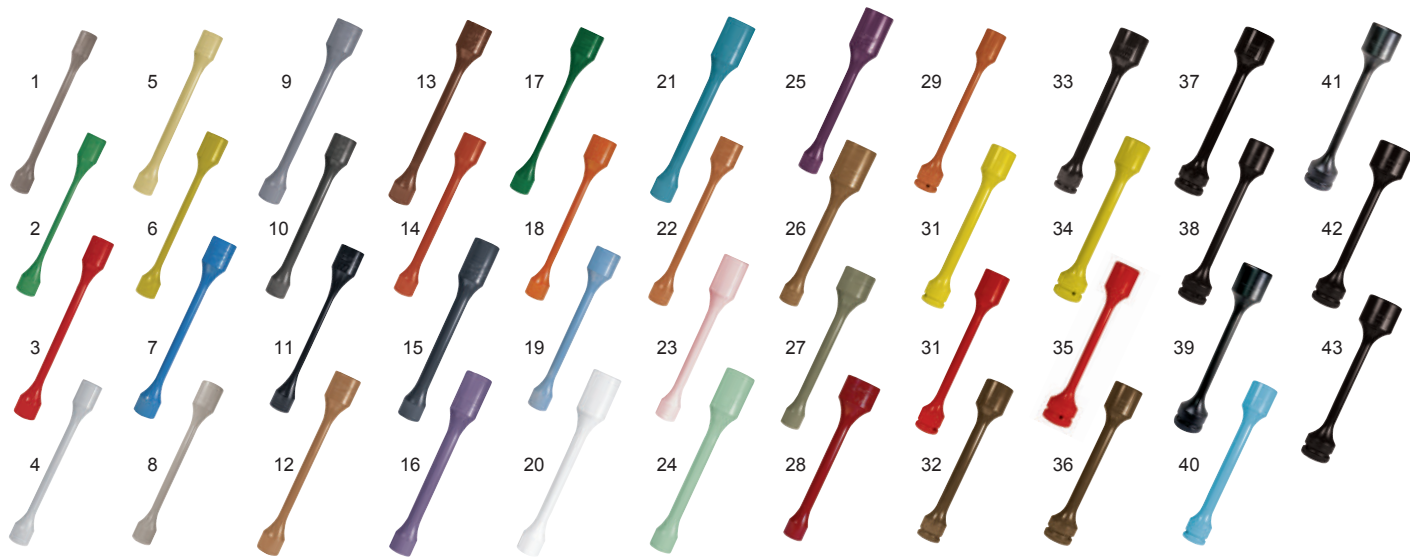

1/2" Drive			3/4" Drive		
Part #	Size/Torque Rating	Color	Part #	Size/Torque Rating	Color
ACC10-0340	14mm - 80 ft/lbs.	Mud (1)	ACC20-3904	1" - 175 ft/lbs. (Heavy-duty)	Orange (29)
ACC10-0304	17mm - 55 ft/lbs.	Green (2)	ACC20-3921	13/16" sq. - 475 ft/lbs. (Heavy-duty)	Yellow (30)
ACC10-0305	17mm - 80 ft/lbs.	Red (3)	ACC20-3918	1-1/4" - 250 ft/lbs. (Heavy-duty)	Red (31)
ACC10-0329	17mm - 90 ft/lbs.	Off White (4)	ACC20-3919	33mm - 475 ft/lbs. (Heavy-duty)	Brown (32)
ACC10-0334	17mm - 113 ft/lbs.	Light Yellow (5)	ACC20-3920	1-1/2" - 475 ft/lbs. (Heavy-duty)	Black (33)
ACC10-0306	19mm - 65 ft/lbs.	Yellow (6)	1" Drive		
ACC10-0307	19mm - 80 ft/lbs.	Blue (7)	Part #	Size/Torque Rating	Color
ACC10-0342	19mm - 90 ft/lbs.	Light Tan (8)	ACC20-3911	13/16" sq. - 475 ft/lbs. (Heavy-duty)	Yellow (34)
ACC10-0308	19mm - 100 ft/lbs.	Gray (9)	ACC20-3908	1-1/4" - 250 ft/lbs. (Heavy-duty)	Red (35)
ACC10-0335	19mm - 110 ft/lbs. - Deep Well	Purple	ACC20-3909	33mm - 475 ft/lbs. (Heavy-duty)	Brown (36)
ACC10-0341	19mm - 120 ft/lbs.	Quartz Gray (10)	ACC20-3910	1-1/2" - 475 ft/lbs. (Heavy-duty)	Black (37)
ACC10-0309	21mm - 60 ft/lbs.	Black (11)	ACC20-3045	30mm - 330 ft/lbs. (Heavy-duty)	Unpainted (38)
ACC10-0310	21mm - 80 ft/lbs.	Light Brown (12)	ACC20-3055	30mm - 400 ft/lbs.	Unpainted (39)
ACC10-0311	21mm - 100 ft/lbs.	Brown (13)	ACC20-3056	30mm - 400 ft/lbs. (Heavy-duty)	Light Blue (40)
ACC10-0343	21mm - 110 ft/lbs.	Red Orange (14)	ACC20-3345	33mm - 330 ft/lbs. (Heavy-duty)	Unpainted (41)
ACC10-0328	21mm - 148 ft/lbs.	Charcoal (15)	ACC20-3360	33mm - 440 ft/lbs. (Heavy-duty)	Unpainted (42)
ACC10-3898	21mm - 160 ft/lbs.	Light Purple (16)	ACC20-3913	33mm - 550 ft/lbs. (Heavy-duty)	Greyline
ACC10-0337	22mm - 60 ft/lbs.	Dark Green (17)	ACC20-3914	33mm - 550 ft/lbs. (Heavy-duty) Extended Depth	Greyline
ACC10-0336	22mm - 75 ft/lbs.	Orange (18)	ACC20-4155	41mm - 400 ft/lbs. (Heavy-duty)	Unpainted (43)
ACC10-0327	22mm - 100 ft/lbs.	Light Blue (19)	<p>Limiting Sockets Made of specially heat treated Swedish spring steel, making AccuTorq® the most accurate torque socket in the world. Patented AccuTorq® strobe marks stop turning at precisely the correct torque EVERY time. There is NO guess work and no recalibration. Solid one-piece construction of AccuTorq® automotive and commercial truck sockets eliminates the wide torque variances unavoidable with socket extensions and adapters. Features deep well sockets for those special applications where regular socket depth is just not enough. AccuTorq®'s ultrasonic inspection of EACH socket and its ISO 9001 quality certification of manufacturing processes, make it possible for each AccuTorq to come with a lifetime guarantee. Made in Sweden.</p>		
ACC10-0312	22mm - 120 ft/lbs.	White (20)			
ACC10-0313	22mm - 140 ft/lbs.	Turquoise (21)			
ACC10-0338	22mm - 110 ft/lbs.	Copper (22)			
ACC10-0339	22mm - 154 ft/lbs.	Pink (23)			
ACC10-3899	24mm - 140 ft/lbs.	Light Green (24)			
ACC20-3900	1" - 140 ft/lbs.	Purple (25)			
ACC20-3901	1-1/16" - 140 ft/lbs. (Medium-duty)	Tan (26)			
ACC20-3902	1-1/8" - 140 ft/lbs. (Medium-duty)	Olive (27)			
ACC20-3903	1-1/4" - 140 ft/lbs. (Medium-duty)	Burgundy (28)			

VEHICLE SPECIALTY

Vehicle Specialty I Steering & Suspension



KIT70300

Pulley Puller and Installer Set

- Complete set removes and installs most power steering and alternator pulleys on domestic vehicles
- Works with traditional V-shaped pulleys and serpentine belt system pulleys
- Packaged in blow-molded case
- Weight: 1.85 lbs

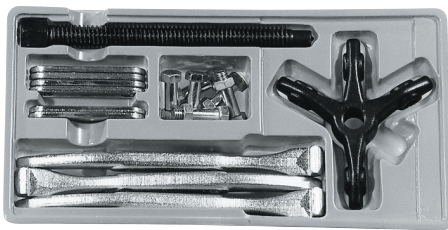

KIT70350

Long-Jaw Reversible Puller

- Five-ton reversible puller easily removes and installs pressed-on power steering, alternator and air pump pulleys
- Includes five-ton reversible puller that can be used as two or three-jaw puller in eight different combinations

KIT70348

Steering Wheel Puller

- Puller specially designed to prevent damage to steering shaft threads



KIT70360

Pitman Arm Puller

- Removes full-size Pitman arms from most cars and light trucks
- Features drop-forged frame and carbon-steel drive screw
- Opening: 1-5/16" (33 mm)
- Pull: 2-1/2" (64 mm)
- Weight: 1.85 lbs.



KIT70365

Pitman Arm Puller U.S.-Made

- Provides steady, smooth pull of a screw-type puller needed when tackling tougher, bigger jobs
- Features heat-treated center screw and heat-treated, alloy steel, heavy-duty yoke
- Weight: 2.1 lbs.



KIT70330

Steering Wheel Puller

- Pulls steering wheels on most common makes of automobiles and light/medium duty trucks
- Tool designed to avoid damage to steering shaft threads
- Includes five sets of side bolts
- Made in the U.S.A.

KIT70372

Universal Strut Spring Compressor

- Services a wide range of MacPherson struts without the need to use special adapter shoes
- Jaws are held in place by safety lock pins
- Tool can be driven by hand or with an impact wrench
- Compresses springs ranging from 4"-9" O.D. with wire diameters of 7/16"-11/16"
- Packaged in blow-molded storage case • Weight: 21 lbs.



KTI71519

Tie Rod End Tool

- Inexpensive and effective way to turn smooth tie rod ends
- Able to remove the inner tie rod without removing the outer tie rod
- Excellent for repairing rack seals
- Simply slide the tool over the end and tighten the collar to allow access with a 3/8" drive extension
- Fits most inner tie rods



LIFETIME WARRANTY*



KTI81995

Tie Rod Separator Air Chisel

- Pneumatic Bit, 21/32" Tie Rod Separator for .401 Shank Air Hammers

LIFETIME WARRANTY*



KTI81996

Ball Joint Separator Air Chisel

- 15/16" Ball Joint Separator for .401 Shank Air Hammers

LIFETIME WARRANTY*



LIFETIME WARRANTY*

KTI71556

Ball Joint Service Tool and Master Adapter Set

- For removing and replacing ball joints
- Remove and replace universal joints by using the C-Frame press
- Includes one live center forcing screw, receiver tubes, and removing/installing adapters
- Packaged in a red blow-molded case for storage and carrying

Ball joint service tool and master adapter contains: all new receiver tubes and removing/installing adapters required to work on a press-fit upper and lower ball joints on most Ford, GM, and Dodge 2 and 4 wheel drive pickups, vans and sport utility vehicles through 1997.

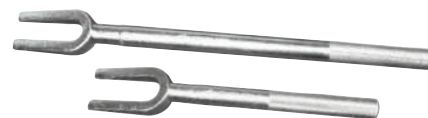

Tie Rod and Ball Joint Separators

LIFETIME WARRANTY*

KTI71501

- Use to replace worn out tie rods and separate shock absorber links
- Tine opening: 11/16" • Overall length: 15-3/4"

KTI71502

- Use to replace worn out ball joints and remove CV drive shafts on FWD vehicles
- Tine opening: 15/16" • Overall length: 11-3/4"

KTI71555

Ball Joint Master Service Adapter Set

LIFETIME WARRANTY*

- Kit includes all receiver tubes and removing/installing adapters needed to work on most GM, Ford and Dodge 2WD and 4WD pickups, vans and sport utility vehicles through 1997
- Works on press fit upper and lower ball joints



LIFETIME WARRANTY*

KTI71550

4-in-1 Ball Joint Service Set

- Removes and installs press fit parts, such as ball joints, universal joints and truck anchor pins without makeshift techniques
- Takes out even rusted and corroded parts
- Includes three receiver tubes (2-3/4" ID x 3" OD, 2-1/4" ID x 2-1/2" OD and 1-3/4" ID x 2" OD)



LIFETIME WARRANTY*



KTI70500

Heavy-duty 10 lb. Dent Puller Kit

- Kit contains 10 lb. slide hammer, two pipes (two-hole and hex nut), and chain with hook and five-plate puller attachments
- Packaged in blow-molded case

VEHICLE SPECIALTY

Vehicle Specialty I Steering & Suspension



KTI70510

Slide Hammer Puller Kit

- Easily removes flange-type axles, oil seals, bearings and other press fit parts
- Includes: 5 lb. slide hammer; 8-function/3-jaw puller; 2-jaw puller; puller hook; rear axle puller; dent puller; and grip wrench adapter

LIFETIME WARRANTY*



KTI70370

MacPherson Strut Spring Compressor

- Works with most MacPherson strut assemblies to quickly assist in replacement of bent struts, strut tubes and damaged filters while on or off the vehicle
- Tool manufactured with Acme threaded screw for durability
- Fits most automobiles, but should not be used on GM "A," "C," "J" or "X" body cars
- Weight: 7 lbs.

LIFETIME WARRANTY*

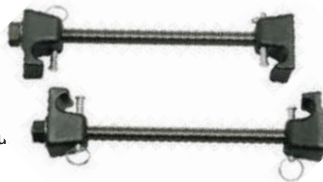

KTI70371

MacPherson Heavy-Duty Strut Spring Compressor

- Works with most MacPherson strut assemblies to quickly assist in replacement of bent struts, strut tubes and damaged filters while on or off the vehicle
- Tool manufactured with Acme threaded screw for durability
- Fits most automobiles, but should not be used on GM "A," "C," "J" or "X" body cars
- Weight: 7 lbs.

LIFETIME WARRANTY*



KTI70375

Coil Spring Compressor

- Single action tool boasts strong, steel jaws that securely hook into coil springs for their removal and installation
- Works with most domestic and some imported vehicles
- Should not be used on MacPherson struts
- Weight: 3.5 lbs.

LIFETIME WARRANTY*

Vehicle Specialty I Drive Shaft & Axle



KTI70390

MEGAHAMMER® 3-Piece Set

- Saves time and money while servicing 3/4 and 1 ton Chevrolet and Dodge pickups with Dana axles
- Unique 4-6-8 bolt head will accommodate most trucks
- Removes seized hubs & rotors
- Eliminates damage removing captured rotors
- Cut the job in half



The MEGAHAMMER™ is the ultimate contender for all your tough jobs. A must have tool to service all 4 - wheel vehicles with captured rotors. Use it for: Rotor Replacement, Hub and Bearing Work, Axle Service, and Ball joint service.

Over the years rust and corrosion will build up and make removal of a seized bearing assembly almost impossible. Technicians are left with little recourse other than time consuming and labor-intensive measures to attempt to remove the seized bearing assembly. Most methods of removal employed today risk damaging the vehicle which in turn will increase repair costs.

The MEGAHAMMER™ tool's unique, patented design cuts repair time in half by employing a less labor-intensive process and greatly reduces the risks of damaging the vehicle. The size and capabilities of MEGAHAMMER™ make even the most formidable jobs seem easy. Many shops will not provide service to 4-wheel drive vehicles with captured rotors because of the costs and risks involved.

Replacement parts:

KTI70395 - Replacement Slide and Stop Assembly

KTI70396 - Replacement Hammer Assembly

1 YEAR WARRANTY*



CAUTION: Lock nut on hub removal tool must be tight to protect against thread damage. Slide shaft thread to be engaged into base late thread so it is flush with inside edge of base plate thread. Use countersunk holes ONLY for proper grip on studs. Use outboard support to help prevent tool and wheel assembly from dropping to floor. Do not stand behind tool when in use. Tool is heavy. Use extreme caution when lifting. Keep extremities clear of pinch points. Always wear eye protection when using hub removal tool. Locking pin must be in place when not in use. Not responsible for damage to vehicle.

WARNING: Please follow instructions carefully to reduce risk of personal injury or possible damage to the vehicle.

KTI70390KIT MEGAHAMMER® Hub Removal Kit

- Removes seized bearing assemblies and associated components from a vehicle chassis for maintenance and repair
- Minimizes cost and potential damage
- Compatible with 3/4- and 1-ton American made trucks with 4-, 6- or 8-bolt patterns

MEGAHAMMER kit includes 4-, 6-, and 8-bolt head, slide and stop assembly and hammer assembly. 38" length. This kit also contains a 5-bolt head for servicing 1/2-ton Ford, GM and Dodge trucks, 8-bolt head for servicing Ford Super Duty F250/F350 4x4 trucks, and 6-bolt head for use primarily with Dodge Durango and Chevy Trailblazer. It will however, accommodate any 6-bolt patterns with bolt circle diameters from 4" up to 6.75".



R

KTI70397 MEGAHAMMER® 4-Bolt Head

- Primarily for use with Honda vehicles with 4-bolt patterns
- Will fit 4-bolt patterns with bolt circle diameters from 4.2" up to 5.26"



KTI70391 MEGAHAMMER® 5-Bolt Head

- Services 1/2-ton Ford, GM and Dodge trucks
- 8" diameter, 17-1/2 lbs.



KTI70393 MEGAHAMMER® 6-Bolt Head

- For use primarily with Dodge Durango and Chevy Trailblazer
- It will, however, accommodate any 6-bolt patterns with bolt circle diameters from 4" up to 6.75"



KTI70392 MEGAHAMMER® 8-Bolt Head

- Services Ford Super Duty F250/F350 4x4 trucks
- 8" diameter, 28-1/2 lbs.



KTI70394 MEGAHAMMER® 4-, 6-, 8-Bolt Head

- Services 3/4- and 1-ton American made trucks with 4-, 6- or 8-bolt patterns
- 8" diameter, 17-1/2 lbs.

1 YEAR WARRANTY*



LIFETIME WARRANTY*

KTI70356 Pilot Bearing Slide Hammer

- Center rod spreads forged steel jaws, pushing them out against the bearing for quick and easy removal of bearings and other parts located in tight spaces
- Spread: 1/2" to 1-1/2"
- Weight: 3.7 lbs

LIFETIME WARRANTY*



KTI70343 Harmonic Balancer Installer

- Easily installs balancers and drive pulleys that are pressed on the crankshaft
- Includes eight threaded adapters: 7/16"-20; 1/2"-20; 9/16"-20; 5/8"-20; 3/4"-16; M12-1.5; M14-1.5; and M16-2.0
- Comes in a blow molded case
- Weight: 2.7 lbs.

LIFETIME WARRANTY*



KTI70382 Bearing Separator 0 to 4-1/4"

- Removes generator gears, bearing cones, bearings and similar parts that puller jaws cannot reach
- Designed to reduce risk of damage to part
- Flush knife-edge blades get behind work where most puller jaws cannot fit or grip
- Manufactured with high quality, heat treated steel. Spread: 0"-4-1/4"
- Threaded holes: 5/8"-18"



KTI70383 Puller and Bearing Separator 0 to 2-1/4"

- Removes generator gears, bearing cones, bearings and similar parts that puller jaws cannot reach
- Designed to reduce risk of damage to part
- Flush knife-edge blades get behind work where most puller jaws cannot fit or grip
- Manufactured with high quality, heat treated steel. Spread: 0"-2-1/4"
- Threaded holes: 3/8"-16"

LIFETIME WARRANTY*



KTI70384 Puller and Bearing Separator 0 to 4-1/4"

- Removes generator gears, bearing cones, bearings and similar parts that puller jaws cannot reach
- Designed to reduce risk of damage to part
- Flush knife-edge blades get behind where most puller jaws cannot fit or grip
- Manufactured with high quality, heat treated steel
- Spread: 0"-4-1/4"
- Threaded holes: 5/8"-18"

LIFETIME WARRANTY*



VEHICLE SPECIALTY

Vehicle Specialty I Engine Mechanical



LIFETIME WARRANTY*

Adjustable Oil Filter Wrenches

- Removes oil filters in hard to reach areas
- Tool features a swivel heat treated handle for easy access and durability and a unique yolk and link assembly for positive grip on filter

KTI73601 - Oil Filter Wrench Adjustable from 2-7/8" to 3-1/4"

KTI73602 - Oil Filter Wrench Adjustable from 3-7/16" to 3-3/4"

KTI73603 - Oil Filter Wrench Adjustable from 4" to 4-3/8"

KTI73605 - Oil Filter Wrench for Trucks Adjustable from 4-5/16" to 4-3/4"

KTI73606 - Oil Filter Wrench for Trucks Adjustable from 5-1/4" to 5-3/4"



LIFETIME WARRANTY*

KTI73600 4-in-1 Oil Filter Wrench

- Vinyl handle that provides strength and better grip, and swivel movement to clear obstructions
- A wide studded band prevents crushed filters
- Mechanics who demand a tough and durable product can count on the 4-in-1's stainless, plated and easily interchangeable steel bands
- Includes bands sized from 2-3/8"-4-3/8" (61 mm-111 mm)



LIFETIME WARRANTY*

KTI73730 Filter Wrench Nylon Strap

- Fits all oil, air and fuel spin-on filters up to 6" diameter
- Tool can be turned by a 1/2" square drive ratchet or a 3/4" open end wrench

KTI73731 Heavy-duty Filter Wrench Nylon Strap

- Designed for high torque requirements of truck filters
- Forged steel handle, and extra length, sturdy strapping
- A no-strip strap grips filters tightly
- Wrench adapts to spin filters up to 9"

LIFETIME WARRANTY*



LIFETIME WARRANTY*



KTI73620 Oil Filter Pliers

- Self adjusting spring action allows for a full range of filter applications
- Heavy-duty forged handles with textured grip for strength and leverage
- Use with 2-1/4" - 6" filters.



LIFETIME WARRANTY*

KTI73621 Spring Loaded Truck/Tractor Filter Plier

- Truck and tractor filter pliers are capable of removing all agricultural and construction equipment and automotive canister-type filters
- They are ideal for loosening over-tightened or seized filters, providing superior leverage for high-torque applications
- Spring-loaded truck and tractor filter pliers work on auto filters as well as Cummins diesel filters
- Forged jaws and extra teeth ensure a strong, sure grip - range 4" to 7"
- 17" extended-reach handles allow users to access the toughest areas

LIFETIME WARRANTY*



KTI73635 17 Piece Master Oil Filter Wrench Set

- 3/8" drive cap oil filter wrenches.
- Fits 95% of domestic and import automotive applications.
- Complete set comes in a handy 10" x 13" plastic case.
- Kit includes: 80mm 15 flutes, 82mm 15 flutes, 86mm 14 flutes, 65/67mm 14 flutes, 68mm 14 flutes, 73/74mm 14 flutes, 64/65mm 14 flutes, 74/76mm 15 flutes, 76mm 14 flutes, 93mm 15 flutes, 76mm 30 flutes, 86mm 16 flutes, 88.4mm 15 flutes, 93mm 36 flutes, 93mm 45 flutes, 96mm 18 flutes, 100mm 15 flutes.



Cap Filter Wrenches

Cap style design allows easy removal and installation from the end of the filter, even in tight locations. Use with 3/8" square drive.

LIFETIME WARRANTY*

KTI73607	Cap Filter Wrench 80mm 15-flute
KTI73608	Cap Filter Wrench 82mm 15-flute
KTI73609	Cap Filter Wrench 86mm 14-flute
KTI73610	Cap Filter Wrench 65/67mm 14-flute
KTI73611	Cap Filter Wrench 68mm 14 flute
KTI73612	Cap Filter Wrench 73/74mm 14 flute
KTI73613	Cap Filter Wrench 65mm 14 flute
KTI73613N	Cap Filter Wrench 64/65mm 14 flute
KTI73614	Cap Filter Wrench 74/76mm 15 flute
KTI73615	Cap Filter Wrench 76mm 14 flute
KTI73616	Cap Filter Wrench 93mm 15 flute
KTI73617	Cap Filter Wrench 76mm 30-flute
KTI73623	Cap Filter Wrench 86mm 16 flute
KTI73624	Cap Filter Wrench 88.4mm 15 flute
KTI73625	Cap Filter Wrench 93mm 36 flute
KTI73626	Cap Filter Wrench 93mm 45 flute
KTI73627	Cap Filter Wrench 96mm 18 flute
KTI73628	Cap Filter Wrench 100mm 15 flute

KTI73630 Oil Filter Wrench Toyota/Lexus

LIFETIME WARRANTY*

- Aluminum oil filter wrench
- 64.5mm diameter with 14 flutes
- Use with 3/8" square drive
- Fits Toyota, Lexus, Scion, Honda and Nissan filters



Works on several models including, Toyota: Avalon 05-08, Camry 07-09, RAV4 06-08, Sienna 07-08 3.5L, Tundra 07-08 5.7L, Corolla, Matrix 09-10, Scion CD 08-10, Truck 07-10 & Lexus: GS, IS, LC 06-10, ES, RX 07-10. Also fits the following filters: Honda filter #15400-PLM-A02 and Nissan filter #15208 65FOC.

Oil Filter Cap Sockets

LIFETIME WARRANTY*

Designed to handle a variety of applications, oil filter cap socket is rugged, laser marked and works even in confined areas. Use to remove housings with cartridge-type oil filters.



KTI73618 - Oil Filter Cap Socket 32mm

Applications: GM Ecotec 2.2L; Saturn: L-series (2001), Ion and Vue (2002-later); GM: Cavalier, Sunfire, Grand Am, Sonoma, S10, Allero (2002-later), Malibu (2002-2006); Pontiac: G6 and Solstice (2006); Chevrolet: HHR, Cobalt, Cobalt SS (2006); Saab: some models.

KTI73619 - Oil Filter Cap Socket 35/36mm

Applications: 6.0L Ford diesel; F250, F350, F450 pickups; Excursion.

KTI00009 60-Piece Drain Plug Gasket Kit Poly and Fiber

General purpose gasket kit includes the 7 most popular sizes of poly and fiber gaskets.



Part #	Description	Qty	Refill
KTI04134	1/2" Fiber Drain Plug Gasket	20	10
KTI04135	1/2" Poly Drain Plug Gasket	10	10
KTI04136	12mm Poly Drain Plug Gasket	10	10
KTI04137	14mm Poly Drain Plug Gasket	5	10
KTI04138	16mm Fiber Drain Plug Gasket	5	10
KTI04139	18mm Fiber Drain Plug Gasket	5	10
KTI04140	20mm Fiber Drain Plug Gasket	5	10

VEHICLE SPECIALTY

Vehicle Specialty I Engine Mechanical



Vacuum Caps

Part #	Description	Qty
KT104262	Vacuum Caps 3/16"	10
KT104263	Vacuum Caps 1/4"	10
KT104264	Vacuum Caps 5/16"	10
KT104265	Vacuum Caps 3/8"	10
KT104266	Vacuum Caps 1/8"	10



Vacuum Tees

Part #	Description	Qty
KT104240	Vacuum Tees 1/8-1/8-1/8	10
KT104241	Vacuum Tees 3/16-3/16-3/16	10
KT104242	Vacuum Tees 1/4-1/4-1/4	10
KT104243	Vacuum Tees 5/16-5/16-5/16	10
KT104245	Vacuum Tees 3/16-3/16-1/8	10
KT104247	Vacuum Tees 3/16-3/16-1/4	10
KT104251	Vacuum Tees 3/16 x 3/16	10
KT104252	Vacuum Tees 1/4 x 1/4	10
KT104253	Vacuum Tees 5/16 x 5/16	10
KT104260	Vacuum Tees 4-Way 3/16	10
KT104261	Vacuum Tees 5-Way 3/16	10



KT100058

40-Piece Drain Plug Assortment

Contains 12 of the most popular drain plugs which provides excellent coverage for most domestic and imported cars and light trucks. Application guide is included. Gaskets sold separately. Drain plug assortments make it easy for any repair shop to keep the most popular drain plugs on hand and organized.

Part #	Description	Qty	Refill
KT104120	Drain Plug 12mm-1.75 Pilot Point with Gasket	3	5
KT104121	Drain Plug 14mm-1.50 Pilot Point with Gasket	3	5
KT104123	Drain Plug 14mm-1.50 Pilot Point with Gasket	5	5
KT104124	Drain Plug 12mm-1.75 Pilot Point with Gasket	3	5
KT104126	Drain Plug 14mm-1.50 Pilot Point with Gasket	3	5
KT104188	Drain Plug 12mm-1.25 Standard Zinc	3	5
KT104189	Drain Plug 12mm-1.75 Pilot Point	3	5
KT104190	Drain Plug 14mm-1.50 Standard Zinc	3	5
KT104193	Drain Plug 1/2-20 Pilot Point with Gasket	3	5
KT104195	Drain Plug 14mm-1.50 Standard Zinc	3	5
KT104196	Drain Plug 14mm-1.50 Pilot Point	3	5
KT104198	Drain Plug 12mm-1.75 Pilot Point with Gasket	3	5



KT100059

27-Piece Drain Plug Assortment

Contains 9 popular oversize drain plugs and gaskets for the repair of stripped drain pan threads. Six sizes including single, double and triple oversize plugs. Includes fiber gaskets. Contains a total of 12 drain plugs and 15 gaskets.



Part #	Description	Qty	Refill
KT104125	Drain Plug M14-1.50 Single Oversize	2	5
KT104141	Fiber Gasket 1/2" Double Oversize	5	10
KT104142	Fiber Gasket 1/2" Single Oversize	5	10
KT104168	Fiber Gasket M14	5	10
KT104181	Drain Plug 1/2" Single Oversize	2	5
KT104182	Drain Plug 1/2" Double Oversize	2	5
KT104183	Drain Plug 1/2" Triple Oversize	2	5
KT104184	Drain Plug 1/2" Single Oversize Piggyback	2	5
KT104185	Drain Plug 1/2" Double Oversize Piggyback	2	5



KT100040

75-Piece Vacuum Tee Cap Kit

Small vacuum tee assortment kit includes five popular diameters for capping lines and hoses while testing emission control systems, vacuum lines, etc.. Contains 1/8", 3/16", 1/4", 5/16" and 3/8" diameter caps.

Part #	Description	Qty	Refill
KT104262	Vacuum Cap 3/16"	25	10
KT104263	Vacuum Cap 1/4"	10	10
KT104264	Vacuum Cap 5/16"	10	10
KT104265	Vacuum Cap 3/8"	5	10
KT104266	Vacuum Cap 1/8"	25	10



KT100042

56-Piece Vacuum Tee Kit

Entry level vacuum tee assortment includes 13 different sizes of tees. These hard connectors are used with the soft flexible tubing found on today's vehicles.

Part #	Description	Qty	Refill
KT104240	Vacuum Tee 1/8"x 1/8"x 1/8"	5	10
KT104241	Vacuum Tee 3/16"x 3/16"x 3/16"	5	10
KT104242	Vacuum Tee 1/4"x 1/4"x 1/4"	4	10
KT104243	Vacuum Tee 5/16"x 5/16"x 5/16"	3	10
KT104245	Vacuum Tee 3/16"x 3/16"x 1/8"	5	10
KT104247	Vacuum Tee 3/16"x 3/16"x 1/4"	4	10
KT104251	Vacuum Connector 3/16" x 3/16"	5	10
KT104252	Vacuum Connector 1/4" x 3/16"	5	10
KT104253	Vacuum Connector 5/16" x 3/16"	5	10
KT104260	Vacuum Tee 4-Way 3/16"	5	10
KT104261	Vacuum Tee 5-Way 3/16"	5	10
KT104262	Vacuum Cap 3/16"	5	10
KT104263	Vacuum Cap 1/4"	5	10



KT170380

Rear Axle Bearing Puller Kit



- Make easy work of removing semifloating rear axle bearings
- Set includes three sizes to service most domestic cars
- Use with standard slide hammer



KT170344

Harmonic Balancer Puller

- Pulls harmonic balancers on most automobiles
- Tool can be used on flywheels, gears, pulleys and other parts with tapped holes
- Includes five sets of side bolts
- Weight: 2.7 lbs.

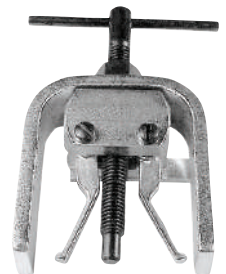

KT170355

Pilot Bearing Puller

- Use to remove fly wheel pilot bearings up to 7-1/2" long in tight spaces where a slide hammer just won't fit
- Versatile tool also works as a bearing and bushing puller for generators and starters
- Spread: 1/2" to 1-1/2" I.D.
- Weight: 2.3 lbs.



VEHICLE SPECIALTY



KT170301

Reversible Puller 3"

2-Jaw 2-Ton 4" Spread 3-1/4" Reach

- Reversible jaws feature a wide face on one end and a narrow face on the other - it's like two tools in one
- Grip tightens as pressure is applied
- Tool manufactured with heat-treated, drop-forged, alloy steel
- Spread: 4" • Reach: 3-1/4"

LIFETIME WARRANTY*



KT170303

Reversible Puller 4" 2-Jaw 5-Ton

6" Spread 3-1/4" Reach

- Reversible jaws feature a wide face on one end and a narrow face on the other - it's like two tools in one
- Grip tightens as pressure is applied
- Tool manufactured with heat-treated, drop-forged, alloy steel
- Spread: 6" • Reach: 3-1/4"

LIFETIME WARRANTY*



KT170305

Reversible Puller 6" 2-Jaw 5-Ton

6" Spread 3-1/4" Reach

- Reversible jaws feature a wide face on one end and a narrow face on the other - it's like two tools in one
- Grip tightens as pressure is applied
- Tool manufactured with heat-treated, drop-forged, alloy steel
- Spread: 6" • Reach: 3-1/4"

LIFETIME WARRANTY*



KT170302

Reversible Puller 3" 2- or 3-jaw 2-ton

4-3/4" Spread 3-1/2" Reach

- Reversible jaws feature a wide face on one end and a narrow face on the other - it's like two tools in one
- Grip tightens as pressure is applied
- Tool manufactured with heat-treated, drop-forged, alloy steel
- Spread: 4-3/4". Reach: 3-1/2".

LIFETIME WARRANTY*

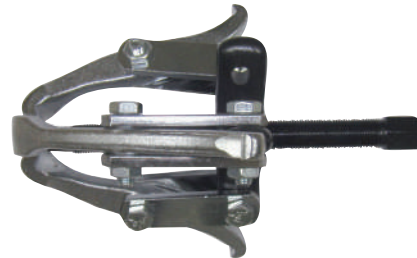

KT170304

Reversible Puller 4" 2- or 3-jaw 5-ton

7" Spread 3-1/4" Reach

- Reversible jaws feature a wide face on one end and a narrow face on the other - it's like two tools in one
- Grip tightens as pressure is applied
- Tool manufactured with heat-treated, drop-forged, alloy steel
- Spread: 7". Reach: 3-1/4".

LIFETIME WARRANTY*

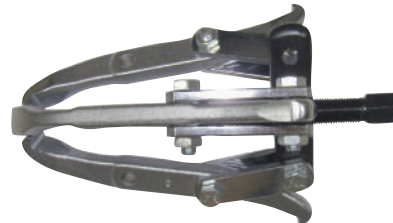

KT170306

Reversible Puller 6" 2- or 3-jaw 5-ton

6" Spread 3-1/4" Reach

- Reversible jaws feature a wide face on one end and a narrow face on the other - it's like two tools in one
- Grip tightens as pressure is applied
- Tool manufactured with heat-treated, drop-forged, alloy steel
- Spread: 6". Reach: 3-1/4".

LIFETIME WARRANTY*

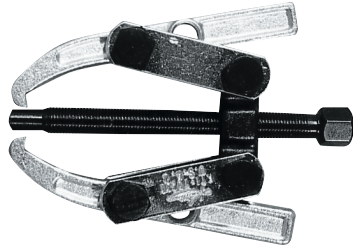

KTI70311
Adjustable Puller 4"
2-jaw 2-ton 4" Spread 3-1/2" Reach

- Ideal for light duty gear pulling, such as electric motors and refrigeration applications
- Spread: 4". Reach: 3-1/2"
- Capacity: 2 tons.

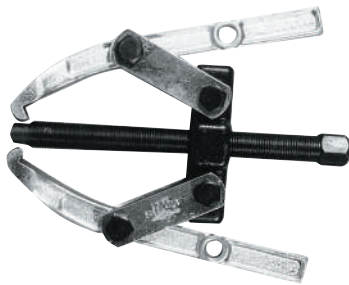

KTI70313
Adjustable Puller 7"
2-jaw 5-ton 7" Spread 5-1/2" Reach

- Ideal for most medium duty gear pulling tasks
- Offers a wide range of reach. Spread: 7". Reach: 5-1/2". Capacity: 5 tons.

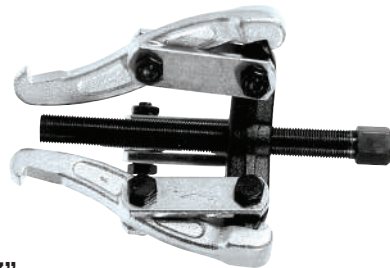

KTI70322
Reversible Puller 7"
2- or 3-jaw 5-ton 7" Spread 3-1/2" Reach

- Tool complete with versatile combination yoke that can be assembled to make either a 2-3 jaw puller
- Reversible jaws for internal or external pulls
- A 3-point pull provides extra power and stability when needed
- Spread: 7". Reach: 3-1/2". Capacity: 5 tons.



KTI70312
Adjustable Puller 6"
2-jaw 5-ton 6" Spread 3-1/2" Reach

- Ideal for most medium duty gear pulling tasks
- Designed for maximum utility
- Reversible jaws have a wide face on one end and a narrow face on the other
- Spread: 6". Reach: 3-1/2". Capacity: 5 tons.

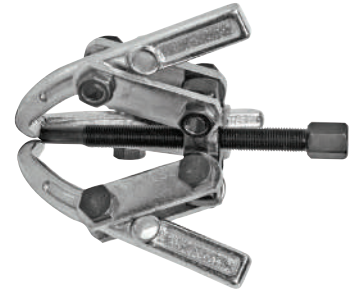

KTI70321
Adjustable Puller 4"
3-jaw 2-ton 4" Spread 3-1/2" Reach

- Three jaws provide extra stability, making this puller ideal for light duty gear pulling applications
- Spread: 4". Reach: 3-1/2". Capacity: 2 tons.



KTI70323
Adjustable Puller 8"
2- or 3-jaw 5-ton 8" Spread 5-1/2" Reach

- Tool complete with versatile combination yoke that can be assembled to make either a 2-3 jaw puller
- A 3-point pull provides extra power and stability when needed
- Spread: 8". Reach: 5-1/2". Capacity: 5 tons.



VEHICLE SPECIALTY

LIFETIME WARRANTY*



KTI71100

Hose Pinch-off Pliers

- Eliminates the need to drain coolant when servicing cooling systems
- Pliers squeeze shut heater or radiator hoses
- Jaws swivel for parallel clamping
- Features automatic locking ratchet and can also be used with vacuum and fuel lines

KTI71103

2-Piece Flexible Line Clamp Set

- Squeezes heater, radiator, vacuum or any flexible hose to assist with repairs or problem diagnosis
- Clamps lock in place
- Set includes one large and one small clamp

Set includes (also available individually):

- KTI71105 - small
- KTI71106 - large



LIFETIME WARRANTY*

KTI71108

Specialty Hose Clamp Plier

- This dual purpose plier, with side jaw design allows hose clamps to be applied or removed in confined areas
- Pincers are held parallel to the hose



LIFETIME WARRANTY*

KTI75320

4-Piece

Radiator Disconnect Tool Set

- Set includes 4 sizes to depress clips ranging from 5/8" to 1"
- Contains a GM-, Ford-, large- and extra-large radiator disconnect tools
- The tool is designed to completely fill the void in the connector to easily release the fastener
- Unique 40° offset design allows users to work around obstructions in tight spaces



LIFETIME WARRANTY*

Set includes (also available individually):

- KTI75321 - Ford Disconnect Removal Tool
- KTI75322 - GM Disconnect Removal Tool
- KTI75323 - Large Disconnect Removal Tool
- KTI75324 - X-Large Disconnect Removal Tool

KTI70600

Distributor Wrench

- Wrench is 3/8" drive and 1/2" x 9/16"



LIFETIME WARRANTY*

KTI70732

Tru-Grip Serpentine Belt Tool

- Clamping jaw allows user to position serpentine belt without the belt slipping from the tool's grip
- Tru-grip and long reach allows belt routing in limited-access areas
- Constructed of lightweight alloy steel for durability and strength
- Ergonomic handle for comfort and ease of use



LIFETIME WARRANTY*

KTI70720

Serpentine Belt Tool

- Removes and installs serpentine belts
- Releases tension on serpentine belts with spring loaded idler pulleys requiring a 15, 16 and 18 mm hex or 3/8 inch square drive
- Provides extra coverage for most applications



LIFETIME WARRANTY*

Set includes (also available individually):

- KTI70721 - Long Wrench
- KTI70722 - Short Wrench
- KTI70723 - 13MM U-Type Wrench
- KTI70724 - 14MM U-Type Wrench
- KTI70725 - 15MM U-Type Wrench
- KTI70726 - 15MM Socket
- KTI70727 - 16MM Socket
- KTI70728 - 18MM Socket

KTI70730

Stretch Belt Installation Tool

- Stretch belt installation tool is ideal for installing newer, patented Gates Micro-V Stretch Fit belts
- Stretch belts are found on many models of vehicles with drive systems that do not require a tensioner (i.e. power steering, air conditioning, water pumps)
- Installs belts without twisting or breaking internal belt fibers
- Durable construction features anodized aluminum body for corrosion resistance and a hardened steel pulley pivot

LIFETIME WARRANTY*



KTI70731

European Stretch Belt Installation Tool

- Stretch belt installation tool is ideal for installing stretch belts
- For use on vehicles with larger pulleys primarily found on European vehicles
- Stretch belts are found on many models of vehicles with drive systems that do not require a tensioner (i.e. power steering, air conditioning, water pumps)
- Installs belts without twisting or breaking internal belt fibers
- Durable construction features anodized aluminum body for corrosion resistance and a hardened steel pulley pivot

LIFETIME WARRANTY*



KT100071

150-piece Hitch Pin Assortment

- Assortment includes 150 hitch pins in six popular sizes from 5/32" x 2-15/16" to 3/32" x 1-3/16"
- Manufactured with chrome plated spring steel



Description	Qty	Description	Qty
5/32" x 2-15/16"	8	5/64" x 1-9/16"	25
9/64" x 1-3/4"	20	5/64" x 1-15/16"	30
7/64" x 1-5/8"	25	3/32" x 1-3/16"	42

KT100072

300-piece E-clip Assortment

- Assortment includes 300 pieces in 9 sizes from 1/16" to 7/8"



Description	Qty	Description	Qty
1/16"	30	1/2"	40
1/8"	30	5/8"	40
3/16"	40	3/4"	40
1/4"	50	7/8"	40
3/8"	50		

KT100075

555-piece Cotter Pin Assortment

- Assortment kit includes six popular sizes from 1/16" x 1" to 5/32" x 2-1/2"



Description	Qty	Description	Qty
1/16" x 1"	150	1/8" x 1-1/4"	75
3/32" x 1"	150	1/8" x 2"	50
3/32" x 1-1/2"	100	5/32" x 2-1/2"	30

10 Pack Blue A/C O-Rings

KT104458 - Air Conditioning O-Rings (Blue) - Qty 10

KT104471 - Air Conditioning O-Rings Compressor Switch Port/Oil Plug - Qty 10

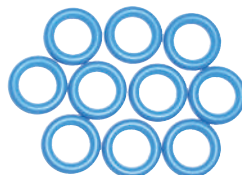

KT100078

144-piece Cotter Pin Assortment

- Assortment kit includes six popular products in six different sizes, ranging from 1/8" x 2" to 5/16" x 2-1/2"



Description	Qty	Description	Qty
1/8" x 2"	50	1/4" x 2"	20
5/32" x 2-1/2"	30	1/4" x 3"	16
3/16" x 3"	20	5/16" x 2-1/2"	8

KT100077

300-piece Snap Ring Assortment (18 different sizes)

- Assortment kit includes 300 pieces of six popular products in 18 different sizes, ranging from 1/8" to 1-1/4"

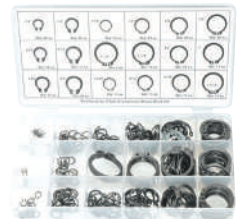

Description	Qty	Description	Qty
1/8"	20	1/2"	25
5/32"	10	1-1/8"	10
3/16"	15	9/16"	15
1/4"	25	5/8"	20
5/16"	15	3/4"	25
3/8"	20	13/16"	15
7/16"	15	7/8"	20
1-1/4"	5	1"	15
15/32"	15	1-1/16"	15

KT100084

170-piece U-clip and Screw Assortment

- 170-piece U-clip and screw assortment kit includes nine popular products in variety of sizes



Description	Qty	Description	Qty
#6 x 5/16" (3 x 8mm)	40	#6 (3mm) *large	20
#8 x 5/8" (4 x 16mm)	20	#8 (4mm)	20
#10 x 1/2" (5 x 13mm)	15	#10 (5mm)	15
1/4" x 3/4" (6 x 19mm)	10	1/4" (6mm)	10
#6 (3mm) *small	20		

VEHICLE SPECIALTY



KT100085 200-piece Hex Washer Drill Assortment

- Kit includes eight popular sizes, ranging from #8 x 3/4" to #10 x 1"

Description	Qty	Description	Qty
#8 x 3/4"	30	#10 x 1/2"	20
#8 x 1"	30	#10 x 5/8"	20
#8 x 1/2"	30	#10 x 3/4"	20
#8 x 5/8"	30	#10 x 1"	20



KT100086 270-piece HNBR O-Ring Assortment

- Includes wide variety of green O-rings in 18 sizes used in A/C applications

Description	Qty	Description	Qty
7/32" x 1/16" (5.29 x 1.78)	20	7/16" x 5/64" (11.00 x 2.00)	15
1/4" x 1/16" (6.07 x 1.78)	20	1/2" x 5/64" (12.00 x 2.00)	15
9/32" x 5/64" (6.80 x 1.90)	20	3/8" x 5/64" (10.00 x 2.00)	10
5/16" x 1/16" (7.65 x 1.78)	20	9/16" x 1/16" (13.90 x 1.80)	10
5/16" x 5/64" (7.80 x 1.90)	20	9/16" x 3/32" (13.95 x 2.62)	10
5/16" x 5/64" (8.00 x 2.00)	20	5/8" x 5/64" (15.00 x 2.00)	10
11/32" x 5/64" (8.80 x 1.90)	20	11/16" x 5/64" (17.00 x 2.00)	10
7/16" x 1/16" (10.82 x 1.78)	15	11/16" x 1/16" (17.17 x 1.78)	10
7/16" x 3/32" (10.77 x 2.62)	15	11/16" x 1/8" (17.04 x 3.53)	10



KT100089 110-piece Copper Washer Assortment

- Kit includes six popular products, ranging from 1/4" to 5/8"

Description	Qty	Description	Qty
1/4"	30	7/16"	15
5/16"	25	1/2"	10
3/8"	20	5/8"	10

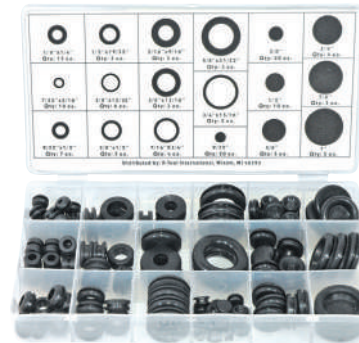

KT100091 125-piece Grommet Assortment

- Kit includes 18 popular products, ranging from 1/8" x 1/4" to 1"

Description	Qty	Description	Qty
1/8" x 1/4"	15	5/8" x 31/32"	3
7/32" x 5/16"	10	3/4" x 15/16"	2
9/32" x 1/2"	7	9/32"	20
1/2" x 19/32"	3	3/8"	20
3/8" x 15/32"	6	1/2"	10
3/8" x 1/2"	5	5/8"	5
5/16" x 9/16"	3	3/4"	4
3/8" x 13/16"	3	7/8"	3
7/16" x 3/4"	4	1"	2



KT100095
419-piece Metric
O-ring Assortment

- Huge assortment includes 32 different products, ranging in size from 3mm to 50mm ID

Description	Qty	Description	Qty
3mm x 1.5mm	20	20mm x 3.5mm	10
4.4mm x 2mm	20	22mm x 3.5mm	10
5mm x 2mm	18	23.5mm x 3.5mm	10
7mm x 1.5mm	23	25mm x 3.5mm	10
10mm x 1.5mm	23	26.5mm x 3.5mm	10
13mm x 1.5mm	23	28mm x 3.5mm	10
10mm x 2.5mm	14	30mm x 3.5mm	10
11mm x 2.5mm	13	31mm x 3.5mm	10
13mm x 2.5mm	14	33mm x 3.5mm	10
14mm x 2.5mm	13	34.5mm x 3.5mm	10
16mm x 2.5mm	14	36mm x 3.5mm	10
18mm x 2.5mm	14	38mm x 3.5mm	10
19mm x 2.5mm	13	41mm x 3.5mm	10
21mm x 2.5mm	14	44mm x 3.5mm	10
22mm x 2.5mm	13	47mm x 3.5mm	10
18mm x 3.5mm	10	50mm x 3.5mm	10

KT100093
120-piece
Roll Pin Assortment

- 120-piece roll pin assortment kit includes 30 of the most popular sizes



KT100094
407-piece Universal
O-ring Assortment

- 407-piece universal O-ring kit. Huge assortment includes 32 different products, ranging in size from 1/8" to 2" ID and 1/4" to 2-1/4" OD

Description	Qty	Description	Qty
1/8" x 1/4" x 1/16"	20	13/16" x 1-1/16" x 1/8"	10
3/16" x 5/16" x 1/16"	20	7/8" x 1-1/8" x 1/8"	10
1/4" x 3/8" x 1/16"	20	15/16" x 1-3/16" x 1/8"	10
5/16" x 7/16" x 1/16"	20	1" x 1-1/4" x 1/8"	10
3/8" x 1/2" x 1/16"	20	1-1/16" x 1-15/16" x 1/8"	10
1/2" x 5/8" x 1/16"	20	1-1/8" x 1-3/8" x 1/8"	10
3/8" x 9/16" x 3/32"	13	1-3/16" x 1-7/16" x 1/8"	10
7/16" x 5/8" x 3/32"	13	1-1/4" x 1-1/2" x 1/8"	10
1/2" x 11/16" x 3/32"	13	1-5/16" x 1-9/16" x 1/8"	10
9/16" x 3/4" x 3/32"	13	1-3/8" x 1-5/8" x 1/8"	10
5/8" x 13/16" x 3/32"	13	1-7/16" x 1-11/16" x 1/8"	10
11/16" x 7/8" x 3/32"	13	1-1/2" x 1-3/4" x 1/8"	10
3/4" x 15/16" x 3/32"	13	1-5/8" x 1-7/8" x 1/8"	10
13/16" x 1" x 3/32"	13	1-3/4" x 2" x 1/8"	10
7/8" x 1-1/16" x 3/32"	13	1-7/8" x 2-1/8" x 1/8"	10
3/4" x 1" x 1/8"	10	2" x 2-1/4" x 1/8"	10

Description	Qty	Description	Qty
5/32" x 5/8"	4	3/8" x 3/4"	2
5/32" x 1"	4	3/8" x 1-1/2"	2
5/32" x 1-1/2"	4	3/8" x 2"	2
1/4" x 5/8"	4	3/32" x 5/8"	4
1/4" x 1-1/4"	4	3/32" x 1"	4
1/4" x 1-3/4"	4	3/32" x 1-1/4"	4
5/64" x 1/4"	4	7/32" x 5/8"	4
5/64" x 1/2"	4	7/32" x 1-1/4"	4
5/64" x 1"	4	7/32" x 1-3/4"	4
1/16" x 3/16"	4	1/8" x 5/8"	4
1/16" x 5/16"	4	1/8" x 1"	2
1/16" x 3/4"	4	1/8" x 1-1/4"	2
5/16" x 3/4"	4	3/16" x 5/8"	2
5/16" x 1-1/2"	4	3/16" x 1"	4
5/16" x 2"	4	3/16" x 1-1/4"	4

VEHICLE SPECIALTY

Vehicle Specialty I Tubing, Cutting & Bending



KT172345

Tubing Bender Heavy-duty Pliers

- Bends 3/16", 1/4", 5/16" and 3/8" diameter copper and steel tubing without collapsing or kinking

LIFETIME WARRANTY*



LIFETIME WARRANTY*

KT172355

Ratcheting Hose and Pipe Cutter

- KT1's ratcheting hose and pipe cutting pliers accommodate a variety of materials up to 1-1/2" in diameter
- The ratcheting action makes cutting smooth and easy
- A one-touch, quick release lever opens pliers instantly
- Built-in clasp securely locks handles when not in use for added safety
- Cuts industrial air hose, multipurpose hose, heater and washer vacuum hose, non-metallic fuel line hose, PVC pipe, battery cables and much more
- Lifetime warranty

Replacement parts:

KT172355-1 - Replacement blade



KT172340

Tubing Bender

- Bends 1/4", 5/16" and 3/8" OD aluminum, steel and copper tubing

LIFETIME WARRANTY*

KT170715

Universal Nut Splitter

- Medium Duty Nut Splitter
- Rugged drop forged frame
- Splits rusted or frozen nuts 1/8" to 15/16" across flats
- Parallel action of pusher cracks nuts on one side without damage to bolt threads
- Compound angle design with 360° rotating cutter allows use in difficult to reach locations



LIFETIME WARRANTY*

Cutters never touch the bolt. A few turns of power screw with a 3/4" hand wrench cuts nut for easy removal. Length: 6-1/4".



KT100022

Retainer Clip

Quick Disconnect Kit - 60 Piece

- 60-piece quick disconnect repair clip assortment kit includes parts for GM, Ford and Chrysler vehicles



Description	Qty	Description	Qty
GM/Chrysler/Ford 3/8"	5	Chrysler 5/16"	5
GM/Chrysler/Ford 5/16"	5	Ford 1/2"	5
Ford 5/16"	5	Ford 10.5mm	5
Ford 3/8"	5	Ford 13mm	5
Ford 1/4"	5	GM/Ford 5/8"	5
Ford 5/16"	5	GM 3/4"	5



KT172310

Tube Cutter Mini -

Range 1/8" to 5/8" OD

- Cuts 1/8" to 5/8" OD tubing
- Compact size for use in confined areas
- Features rollers to ease operation

LIFETIME WARRANTY*



KT172330

Tubing Cutter Heavy-duty

- Cuts 1/8" to 1-1/8" OD tubing
- Heavy-duty rollers smooth operation

LIFETIME WARRANTY*



KT172320

Tubing Bender - U.S.-made

- Bends 3/16", 1/4", 5/16" and 3/8" diameter tubing
- Features aluminum mandrel



LIFETIME WARRANTY*

Vehicle Specialty | Inspection



KT170900 Magnet Wire Flex Retriever Tool 8lb. Pull

- Retriever goes where human hands cannot
- Extendable magnet easily picks up and retrieves dropped items
- Tool features an ergonomic grip, a bendable shapeable wire flex shaft, powder-coated steel casings to reduce side pull, and a powerful, lightweight magnet to reach tight places
- Length: 21". Pull: 8 lbs.



KT170903 Magnet Telescopic Tool Straight 14lb. Pull

- Retriever goes where human hands cannot
- Extendable magnet easily picks up and retrieves dropped items
- Tool features an ergonomic grip, a telescopic shaft, powder-coated steel casings to reduce side pull, and a powerful, lightweight magnet to reach tight places
- Length: 6-1/2" to 32". Pull: 14 lbs.



KT170905 Magnet Telescoping Pocket Retriever 3.5lb. Pull

- Pocket size retriever features a telescoping shaft that extends from 5-1/4" to 24"
- Pull: 3-1/2 lbs.



KT170901 Magnet Swivel Head Telescopic Tool 14lb. Pull

- Retriever goes where human hands cannot
- Extendable magnet easily picks up and retrieves dropped items
- Tool features an ergonomic grip, a 180 swivel head, a telescopic shaft, powder-coated steel casings to reduce side pull, and a powerful, lightweight magnet to reach tight places
- Length: 6-1/2" to 32". Pull: 14 lbs.



KT170904 Magnet Telescopic Tool Straight 5lb. Pull

- Retriever goes where human hands cannot
- Extendable magnet easily picks up and retrieves dropped items
- Tool features an ergonomic grip, a telescopic shaft, powder-coated steel casings to reduce side pull, and a powerful, lightweight magnet to reach tight places
- Length: 6-1/2" to 32". Pull: 5 lbs.



KT170909 Super-duty Magnet Telescoping Tool Straight 30lb. Pull

- Super-duty retriever goes where human hands cannot
- Extendable magnet easily picks up and retrieves dropped items
- Tool features an ergonomic grip, a telescopic shaft, powder-coated steel casings to reduce side pull, and a powerful, lightweight magnet to reach tight places
- Length: 16" to 28". Pull: 30 lbs.



VEHICLE SPECIALTY



KTI70910 Magnetic Pickup Tool

- Magnetic telescoping pickup tool extends from 5-1/4" to 22-3/4"
- Handy pocket-clip keeps the tool right at your fingertips!

**LIFETIME
WARRANTY***



KTI70920 Mirror Glass Telescoping Tool Rectangular

- Tool goes where human eyes cannot
- Highly polished and protected mirror is attached to an expandable telescopic, ergonomic handle for user convenience
- Rectangular mirror measures 1-1/4" x 2-1/4". Length: 6-1/2" to 32".



**LIFETIME
WARRANTY***



KTI70922 Mirror Glass Telescoping Tool Round

- Tool goes where human eyes cannot
- Highly polished and protected mirror is attached to an expandable telescopic, ergonomic handle for user convenience
- Round mirror measures 3-3/4". Length: 20" to 31"



**LIFETIME
WARRANTY***



KTI70999 Magnetic Parts Dish Stainless Steel

- Keeps small parts from spilling. Round, non-rusting stainless steel dish measures 5-3/4" diameter



KTI70915 Telescoping Pocket Magnet

- Extendable magnetic pickup tool extends from 13" to 20"
- Telescoping shaft is capable of lifting 3.5 pounds
- There isn't a lost nut or bolt this tool can't pick up!

**LIFETIME
WARRANTY***



KTI70921 Mirror Glass Telescoping Tool Square

- Tool goes where human eyes cannot
- Highly polished and protected mirror is attached to an expandable telescopic, ergonomic handle for user convenience
- Square mirror measures 1-3/4" x 1-3/4"
- Length: 6-1/2" to 32"



**LIFETIME
WARRANTY***



KTI70099 Two Way Radio

- 22 channels each with 38 privacy codes
- Up to 18 mile range
- Operating frequency 462.5625 MHz-462.7250 MHz
- Vox/DCM/Monitor/Scan/Squelch
- Roger beep & key tone on/off
- Adjustable volume control
- 5 ringing tones
- Key lock function
- Automatic battery save
- Ear/mic/charger jack
- Belt clip
- 1 Year Warranty on material and workmanship

Vehicle Specialty | Fuel



KTI75305 Mini Fuel Line Installation Tool

- Tool easily attaches all fuel line assemblies to original fuel lines
- Includes ratcheting 9/16" wrench
- Completely portable, moves from vehicle to vehicle
- Designed to fit in tight work areas

Warranty information: One-year warranty.

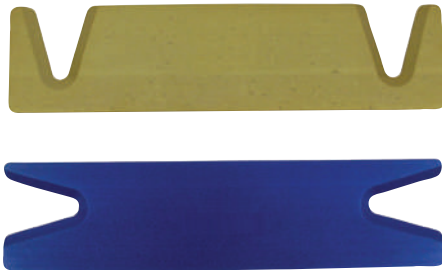

KTI75310 2-Piece Universal Fuel Line Disconnect Set

- Designed to remove stubborn fuel lines from high-tech cars and trucks
- Constructed of aircraft-grade aluminum for durability, yet makes them extremely lightweight and easy to use
- The low-profile design provides access to the tightest spaces
- The opening at the widest point is 3/4" and narrows to only 1/8"
- Set features a 90° fuel line disconnect tool and a straight fuel line disconnect tool

Set includes (also available individually):

KTI75311 - 90 Degree Universal Tool, from 1/8" to 3/4"

KTI75312 - Straight Universal Tool, from 1/8" to 3/4"



KTI04626 88-Piece Fuel Line Connector Assortment

- This kit contains everything you need to replace fuel line connectors on both steel and nylon line
- Assortment includes quick connectors (straight and 90°), brass connectors, compression unions, clamps, viton o-rings and connector removal tool

Part#	Description	Qty	Refill
KTI05100	Fuel Line Quick Connect Straight: F1/4 - M5/16	2	5
KTI05101	Fuel Line Quick Connect Straight: F5/16 - M5/16	2	5
KTI05102	Fuel Line Quick Connect Straight: F3/8 - M3/8	2	5
KTI05103	Fuel Line Quick Connect Straight: F5/16 - M3/8	2	5
KTI05104	Fuel Line Quick Connect Straight: F3/8 - M5/16	2	5
KTI05105	Fuel Line Quick Connect 90 Degree: F5/16 - M5/16	2	5
KTI05106	Fuel Line Quick Connect 90 Degree: F3/8 - M3/8	2	5
KTI05107	Fuel Line Quick Connect 90 Degree: F3/8 - M5/16	2	5
KTI05108	Fuel Line Quick Connect 90 Degree: F5/16 - M3/8	2	5
KTI05109	Fuel Line Connector Brass 1/4"	2	5
KTI05110	Fuel Line Connector Brass 5/16"	5	5
KTI05111	Fuel Line Connector Brass 3/8"	5	5
KTI05112	Brass Compression Union 1/4" Nylon to Nylon	2	5
KTI05113	Brass Compression Union 5/16" Nylon to Nylon	2	5
KTI05114	Brass Compression Union 3/8" Nylon to Nylon	2	5
KTI05115	Brass Compression Union 1/4" Nylon to Steel	2	5
KTI05116	Brass Compression Union 5/16" Nylon to Steel	2	5
KTI05117	Brass Compression Union 3/8" Nylon to Steel	2	5
KTI05118	Fuel Line Clamp 360 Degree 1/4"	5	10
KTI05119	Fuel Line Clamp 360 Degree 5/16"	10	10
KTI05120	Fuel Line Clamp 360 Degree 3/8"	10	10
KTI05186	Fuel System Connector Removal Tool 3/8" and 5/16"	1	5
KTI05257	Fuel Line Viton O-ring 3/8"	10	10
KTI05259	Fuel Line Viton O-ring 5/16"	10	10



**LIFETIME
WARRANTY***

VEHICLE SPECIALTY



KT175300 Fuel Line Quick Disconnect Press Kit

- Tool easily attaches fuel line (straight or 90°) connectors to OEM nylon fuel lines
- Includes four adapters
- Features large handle for smooth operation
- Can be moved from vehicle to vehicle or bench mounted

**LIFETIME
WARRANTY***

KT175306 Steel Line Stopper Kit

- Universal steel line stopper
- 5/16", 3/8", 1/2", and banjo fittings (10.4mm and 18mm)
- Suitable for clamping and sealing steel lines for all automotive fluids
- Provides an effective seal to steel lines when disconnected
- Prevents fluid loss and contamination of the work area



**LIFETIME
WARRANTY***



KT104627 Fuel Line Assortment with OEM



- 83-piece fuel line connector kit includes 24 different products for Ford, Chrysler and GM vehicles

Description	Qty	Description	Qty
Ford F1/4" M5/16"	2	All Vehicles Size 1/4"	2
GM/Chrysler/Ford F5/16" M5/16"	3	All Vehicles Size 5/16"	2
GM/Chrysler/Ford F3/8" M3/8"	3	All Vehicles Size 3/8"	2
Ford F5/16" M3/8"	2	All Vehicles Size 1/4"	2
GM/Chrysler/Ford F1/4" M5/16"	2	All Vehicles Size 5/16"	2
GM/Chrysler/Ford F3/8" M5/16"	2	All Vehicles Size 3/8"	2
GM/Chrysler/Ford F5/16" M5/16"	3	All Vehicles Size 1/4"	2
GM/Chrysler/Ford 3/8" M5/16"	2	All Vehicles Size 5/16"	2
GM/Chrysler/Ford F1/4" M3/8"	2	All Vehicles Size 3/8"	2
All Vehicles Size 1/4"	2	GM Size 5/16"	2
All Vehicles Size 5/16"	5	GM Size 3/8"	10
All Vehicles Size 3/8"	5	All Vehicles Size 5/16" & 3/8"	1



Fuel Line Quick Connect - Straight / 90-degree		
Part #	Description	Qty
KT105100	Fuel Line Quick Connect Straight: Female 1/4" - Male 5/16"	5
KT105101	Fuel Line Quick Connect Straight: Female 5/16" - Male 5/16"	5
KT105104	Fuel Line Quick Connect Straight: Female 3/8" - Male 5/16"	5
KT105103	Fuel Line Quick Connect Straight: Female 5/16" - Male 3/8"	5
KT105202	Fuel Line Quick Connect Straight: Female 5/16" - Male 3/8" Ford OE Style	5
KT105102	Fuel Line Quick Connect Straight: Female 3/8" - Male 3/8"	5
KT105124	Fuel Line Quick Connect Posi-Lock Straight Female 5/16" - Male 5/16"	5
KT105125	Fuel Line Quick Connect Posi-Lock Straight Female 3/8" - Male 3/8"	5
KT105105	Fuel Line Quick Connect 90-degree: Female 5/16" - Male 5/16"	5
KT105107	Fuel Line Quick Connect 90-degree: Female 3/8" - Male 5/16"	5
KT105108	Fuel Line Quick Connect 90-degree: Female 5/16" - Male 3/8"	5
KT105106	Fuel Line Quick Connect 90-degree: Female 3/8" - Male 3/8"	5
KT105126	Fuel Line Quick Connect Posi-Lock Bent Female 5/16" - Male 5/16"	5
KT105127	Fuel Line Quick Connect Posi-Lock Bent Female 3/8" - Male 3/8"	5



Fuel Line Retainer Clips		
Part #	Description	Qty
KT105375	Fuel Line Retainer Clip 3/8" GM	10
KT105376	Fuel Line Retainer Clip 5/16" GM	10
KT105377	Fuel Line Retainer Clip 5/16" Ford	10
KT105378	Fuel Line Retainer Clip 3/8" Ford	10
KT105379	Fuel Line Retainer Clip 1/4" Ford	10
KT105380	Fuel Line Retainer Clip 1/2" Ford	10
KT105381	Fuel Line Retainer Clip 10.5mm Ford Truck	10
KT105382	Fuel Line Retainer Clip 13mm Ford Truck	10
KT105383	Fuel Line Retainer Clip 5/16" Ford (White)	10
KT105384	Fuel Line Retainer Clip 3/8" Ford (Black)	10

VEHICLE SPECIALTY

Nylon Fuel Line

Part #	Description	Qty
KTI05205	Fuel System #12 Rated Nylon Fuel Line 1/4" - 25 Foot Roll	1
KTI05206	Fuel System #12 Rated Nylon Fuel Line 3/8" - 25 Foot Roll	1
KTI05207	Fuel System #12 Rated Nylon Fuel Line 5/16" - 25 Foot Roll	1



Fuel Sender Adapters

Part #	Description	Qty
KTI05370	Fuel Sender Adapter to Rubber Fuel Line Female 14mm to Male 5/16"	5
KTI05371	Fuel Sender Adapter to Rubber Fuel Line Female 16mm to Male 3/8"	5
KTI05226	Fuel Sender Adapter to Nylon Fuel Line Female 14mm to Male 5/16"	5
KTI05228	Fuel Sender Adapter to Nylon Fuel Line Female 16mm to Male 3/8"	5



Fuel Line Viton O-Ring

Part #	Description	Qty
KTI05257	Fuel Line Viton O-Ring 3/8" GM	2
KTI05259	Fuel Line Viton O-Ring 5/16" GM	2



Fuel Line Clamps

Part #	Description	Qty
KTI05118	Fuel Line Clamp 360° 1/4" for Nylon & Rubber Hose	10
KTI05119	Fuel Line Clamp 360° 5/16" (8mm) for Nylon & Rubber Hose	10
KTI05120	Fuel Line Clamp 360° 3/8" (10mm) for Nylon & Rubber Hose	10
KTI05177	Fuel System Fuel Injection Hose Clamps 1/4"	10
KTI05179	Fuel System Fuel Injection Hose Clamps 5/16" (8mm)	10
KTI05181	Fuel System Fuel Injection Hose Clamps 3/8" (10mm)	10



Fuel Filter Repair Lines

Part #	Description	Qty
KTI05225	Fuel Filter Repair Lines 180° 3/8" x 6-1/2" 16mm GM	5





Fuel Line Fittings		
Part #	Description	Qty
KTi05111	Fuel Line Connector Brass 3/8"	5
KTi05112	Brass Compression Union 1/4" Nylon to Nylon	5
KTi05113	Brass Compression Union 5/16" Nylon to Nylon	5
KTi05114	Brass Compression Union 3/8" Nylon to Nylon	5
KTi05115	Brass Compression Union 1/4" Nylon to Steel	5
KTi05116	Brass Compression Union 5/16" Nylon to Steel	5
KTi05117	Brass Compression Union 3/8" Nylon to Steel	5
KTi05109	Fuel Line Connector Brass 1/4"	5
KTi05110	Fuel Line Connector Brass 5/16"	2
KTi05111	Fuel Line Connector Brass 1/4"	5
KTi05159	Nylon Fuel Line Brass Splice Joiner 3/8"	1
KTi05165	Fuel System Rubber Hose Barbed Connector 3/16"	5
KTi05167	Fuel System Rubber Hose Barbed Connector 1/4"	5
KTi05169	Fuel System Rubber Hose Barbed Connector 5/16"	5
KTi05171	Fuel System Rubber Hose Barbed Connector 3/8"	5



Fuel System Adapters		
Part #	Description	Qty
KTi05136	Fuel System Adapter Steel to Rubber or Nylon Line 1/4"	5
KTi05138	Fuel System Adapter Steel to Rubber or Nylon Line 5/16"	5
KTi05141	Fuel System Adapter Steel to Rubber or Nylon Line 3/8"	5
KTi05143	Fuel System Adapter GM 14mm to 5/16" to Nylon or Rubber Line	5
KTi05145	Fuel System Adapter GM 16mm to 3/8" to Nylon or Rubber Line	5
KTi05149	Fuel System Adapter 3/8" Nylon to 3/8" Rubber	5

VEHICLE SPECIALTY

*except KTI05372, KTI05373 and KTI05374



Fuel Filter Line Repair Kits

Part #	Description	Qty
KTI05209	Steel Fuel Line Repair Kit w/14mm Fitting and O-ring 5/16 Line x 9" Length	5
KTI05211	Steel Fuel Line Repair Kit w/14mm Fitting and O-ring 5/16 Line x 18" Length	5
KTI05213	Steel Fuel Line Repair Kit w/14mm Fitting and O-ring 5/16 Line x 36" Length	5
KTI05215	Steel Fuel Line Repair Kit w/16mm Fitting and O-ring 3/8 Line x 9" Length	5
KTI05217	Steel Fuel Line Repair Kit w/16mm Fitting and O-ring 3/8 Line x 18" Length	5
KTI05219	Steel Fuel Line Repair Kit w/16mm Fitting and O-ring 3/8 Line x 36" Length	5
KTI05221	Steel Fuel Line Repair Kit w/Quick Disconnect 5/16" x 18 - GM/Ford	5
KTI05372	Nylon Fuel Line Repair Kit Straight 12" Length Female 3/8" x Male 5/16"	5
KTI05235	Nylon Fuel Line Repair Kit Straight 12" Length Female 3/8" x Male 3/8"	5
KTI05243	Nylon Fuel Line Repair Kit Straight 12" Length Female 5/16" x Male 5/16"	5
KTI05233	Nylon Fuel Line Repair Kit Straight 12" Length Female 5/16" x Male 3/8"	5
KTI05237	Nylon Fuel Line Repair Kit 90° 12" Length Female 3/8" to Male 3/8"	5
KTI05245	Nylon Fuel Line Repair Kit 90° 12" Length Female 5/16" to Male 5/16"	5
KTI05373	Nylon Fuel Line Repair Kit 90° 12" Length Female 3/8" x Male 5/16"	5
KTI05374	Nylon Fuel Line Repair Kit 90° 12" Length Female 5/16" x Male 3/8"	5
KTI05253	Fuel Line Nylon Splice 3/8 Line x 12" Long - GM/Ford/Chrysler	5
KTI05255	Fuel Line Nylon Splice 5/16 Line x 12" Long - GM/Ford/Chrysler	5



Vehicle Specialty I Electrical Service

KT170750 Spark Plug Boot Plier

- Plier features insulated grips
- Overall length: 8"



LIFETIME WARRANTY*



KT175201 Ford Triton Spark Plug Extractor Set

- KT1's spark plug extractor set is a must-have for servicing Ford Triton engines model year 2004 and later
- This set easily extracts frozen and broken off spark plug sleeves from cylinder heads without removing the actual heads
- A specially machined guide works with extra-long tap and extractor to ensure the job is done right
- Avoid engine damage by using the KT1 spark plug porcelain extractor set (KT175202) to remove broken porcelain before extracting spark plug sleeve

LIFETIME WARRANTY*

KT173701 Universal Spark Plug Gap Tool

- Measures in increments of one thousandth from .020 through .100

LIFETIME WARRANTY*



KT173701-50 - 50-piece bulk pack

KT175202 Ford Porcelain Spark Plug Extractor Set

- KT1's spark plug porcelain extractor set works in conjunction with the KT1 spark plug extractor set (KT175201)
- It is a must-have set for servicing Ford Triton engines model year 2004 and later
- This set easily extracts broken porcelain from spark plug sleeves
- Set uses a special bonding agent to extract porcelain from spark plug sleeve without pushing on the broken plug and potentially pushing it into the cylinder causing engine damage
- Meets Ford TSB specifications

LIFETIME WARRANTY*

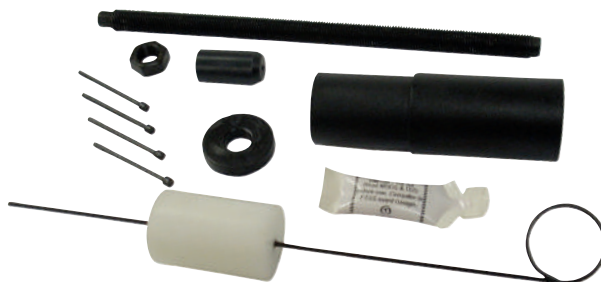

Specialty Sockets - 3/8" Drive

Spark Plug Sockets:

6-point with rubber plug holder, hex top for wrench in tight areas.

KT122221 - 5/8"
KT122227 - 13/16"

6 PT



LIFETIME WARRANTY*

Flex Spark Plug Sockets:

Flex joint 3/8" drive, chrome plated, chrome vanadium steel, heat-treated.

KT122521 - 5/8"
KT122527 - 13/16"

6 PT



LIFETIME WARRANTY*

KT122133 3/8" Drive "2-in-1" Oil Sender Socket

- For oil sending units or stoplight switch replacement

LIFETIME WARRANTY*



KT132229 3/8" Drive Oxygen Sensor Socket

- Used to remove and install oxygen sensors on most domestic and some imported vehicles

LIFETIME WARRANTY*



Fuse Holders

KT101641 12 Gauge Fuse Holder for ATO Fuse 1
KT101661 30 Amp Fuse Holder for AGC Fuse 2

Qty:



KT101671 Fuse Puller

Pull Auto, Glass and Mini Fuses



VEHICLE SPECIALTY

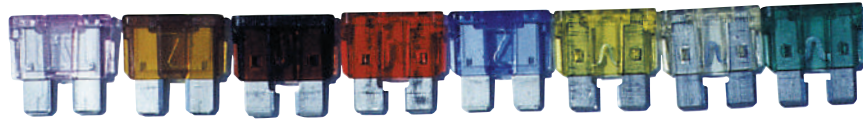

ATO Fuses/ATO Glo Fuses

- ATO fuses are color coded for amperage, have a recognizable body design, and standard footprint. ATO fuses snap into place without the need for special tools

Part #	Description	Qty
KT104282	10 Amp Glo-Fuse	5
KT104283	15 Amp Glo-Fuse	5
KT104284	20 Amp Glo-Fuse	5
KT104285	25 Amp Glo-Fuse	5
KT104286	30 Amp Glo-Fuse	5

Part #	Description	Qty
KT104209	3 Amp Fuses	5
KT104210	5 Amp Fuses	5
KT104211	7.5 Amp Fuses	5
KT104212	10 Amp Fuses	5
KT104213	15 Amp Fuses	5
KT104214	20 Amp Fuses	5
KT104215	25 Amp Fuses	5
KT104216	30 Amp Fuses	5



Mini Fuses / Low Profile Mini Fuses / Glo Mini Fuses



- The mini fuse style blade fuse is quickly becoming a new standard in the automotive industry
- The mini fuse allows for more circuits to be fused in the same space as either an ATO or ATC style fuse
- Mini fuses are offered in 2 to 30 amp current ratings

Part #	Description	Qty
KT104199	Fuses Mini 2 Amp	5
KT104200	Fuses Mini 3 Amp	5
KT104201	Fuses Mini 4 Amp	5
KT104202	Fuses Mini 5 Amp	5
KT104203	Fuses Mini 7.5 Amp	5
KT104204	Fuses Mini 10 Amp	5
KT104205	Fuses Mini 15 Amp	5
KT104206	Fuses Mini 20 Amp	5
KT104207	Fuses Mini 25 Amp	5
KT104208	Fuses Mini 30 Amp	5
KT104270	Low Profile Mini Fuse - 5 Amp	10
KT104271	Low Profile Mini Fuse - 7.5 Amp	10
KT104272	Low Profile Mini Fuse - 10 Amp	10
KT104273	Low Profile Mini Fuse - 15 Amp	10
KT104274	Low Profile Mini Fuse - 20 Amp	10
KT104275	Low Profile Mini Fuse - 25 Amp	10
KT104276	Low Profile Mini Fuse - 30 Amp	10
KT104277	Mini Glo-Fuse 10 Amp	5
KT104278	Mini Glo-Fuse 15 Amp	5
KT104279	Mini Glo-Fuse 20 Amp	5
KT104280	Mini Glo-Fuse 25 Amp	5
KT104281	Mini Glo-Fuse 30 Amp	5

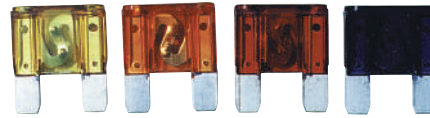

Maxi Fuses		
Part #	Description	Qty
KT104234	Fuses Maxi 20 Amp	3
KT104235	Fuses Maxi 30 Amp	3
KT104236	Fuses Maxi 40 Amp	3
KT104237	Fuses Maxi 50 Amp	3
KT104238	Fuses Maxi 60 Amp	3
KT104239	Fuses Maxi 80 Amp	3



Glass Fuses

- Although still used in older-model cars, glass fuses are found primarily in automotive accessory applications today
- Glass fuses are widely used in electronic and electrical applications where proper fuse selection is critical to performance
- Sold as a package of 5

Part #	Description	Qty
KT100811	Fuses Glass 10 Amp	5
KT100821	Fuses Glass 15 Amp	5
KT100831	Fuses Glass 20 Amp	5
KT100841	Fuses Glass 25 Amp	5
KT100851	Fuses Glass 30 Amp	5
KT100861	Fuses Glass 5 Amp	5



Jcase Fuses		
Part #	Description	Qty
KT104220	Jcase Fuse - 20 Amp	5
KT104221	Jcase Fuse - 30 Amp	5
KT104222	Jcase Fuse - 40 Amp	5
KT104223	Jcase Fuse - 50 Amp	5
KT104224	Jcase Fuse - 60 Amp	5



Low Profile Jcase Fuses		
Part #	Description	Qty
KT104226	Low Profile Jcase Fuse - 20 Amp	5
KT104227	Low Profile Jcase Fuse - 25 Amp	5
KT104228	Low Profile Jcase Fuse - 30 Amp	5
KT104229	Low Profile Jcase Fuse - 40 Amp	5
KT104230	Low Profile Jcase Fuse - 50 Amp	5
KT104231	Low Profile Jcase Fuse - 60 Amp	5



KT100020

118-piece Master Plug-in Style Fuse Kit

- This comprehensive 118-piece assortment contains the most popular 24 numbers of plug-in fuses - ATO, ATM and MAXI

Part #	Size/Type	Qty	Refill
KT104199	2A mini plug-in fuse	5	5
KT104200	3A mini plug-in fuse	5	5
KT104201	4A mini plug-in fuse	5	5
KT104202	5A mini plug-in fuse	5	5
KT104203	7.5A mini plug-in fuse	5	5
KT104204	10A mini plug-in fuse	5	5
KT104205	15A mini plug-in fuse	5	5
KT104206	20A mini plug-in fuse	5	5
KT104207	25A mini plug-in fuse	5	5
KT104208	30A mini plug-in fuse	5	5
KT104209	3A plug-in fuse	5	5
KT104210	5A plug-in fuse	5	5
KT104211	7.5A plug-in fuse	5	5
KT104212	10A plug-in fuse	5	5
KT104213	15A plug-in fuse	10	5
KT104214	20A plug-in fuse	10	5
KT104215	25A plug-in fuse	5	5
KT104216	30A plug-in fuse	5	5
KT104234	20A maxi plug-in fuse	3	3
KT104235	30A maxi plug-in fuse	3	3
KT104236	40A maxi plug-in fuse	3	3
KT104237	50A maxi plug-in fuse	3	3
KT104238	60A maxi plug-in fuse	3	3
KT104239	80A maxi plug-in fuse	3	3



KT100021

Fuse Kit- ATO Fuse 80 Pieces

- 80-piece ATO fuse assortment kit includes ten each of eight popular sizes from 3 to 30 amp
- Packaged in multicompartment, refillable plastic case
- Contains product assortment map for easy identification of components

Part #	Size	Qty	Refill
KT104209	3A plug-in fuse	10	5
KT104210	5A plug-in fuse	10	5
KT104211	7.5A plug-in fuse	10	5
KT104212	10A plug-in fuse	10	5
KT104213	15A plug-in fuse	10	5
KT104214	20A plug-in fuse	10	5
KT104215	25A plug-in fuse	10	5
KT104216	30A plug-in fuse	10	5

VEHICLE SPECIALTY



KT100080 120-Piece Auto Fuse Assortment (color-coded fuses)

- Kit includes auto fuses sized from 5A to 30A

Description	Qty	Description	Qty
5A Auto Fuses	20	20A Auto Fuses	20
10A Auto Fuses	20	25A Auto Fuses	20
15A Auto Fuses	20	30A Auto Fuses	20



KT100028 75-Piece Mini Fuse Kit

- Mini fuse kit contains 75 total pieces of 10 sizes including 2A, 3A, 4A, 5A, 7.5A, 10A, 15A, 20A, 25A and 30A fuses
- ATM mini fuses are used in many late-model OEM applications

Part #	Description	Qty	Refill
KT104199	2A mini fuse	10	5
KT104200	3A mini fuse	5	5
KT104201	4A mini fuse	5	5
KT104202	5A mini fuse	10	5
KT104203	7.5A mini fuse	5	5
KT104204	10A mini fuse	10	5
KT104205	15A mini fuse	10	5
KT104206	20A mini fuse	10	5
KT104207	25A mini fuse	5	5
KT104208	30A mini fuse	5	5

KT100081 120-Piece Mini Auto Fuse Assortment (color-coded fuses)

- Kit includes mini fuses sized from 2A to 30A



Description	Qty	Description	Qty
5A Auto Fuses	20	20A Auto Fuses	20
10A Auto Fuses	20	25A Auto Fuses	20
15A Auto Fuses	20	30A Auto Fuses	20

KT100082 56-Piece Maxi Auto Fuse Assortment (color-coded fuses)

- Includes maxi fuses sized from 20A to 100A



Description	Qty	Description	Qty
20A Auto Fuses	7	60A Auto Fuses	7
30A Auto Fuses	7	70A Auto Fuses	7
40A Auto Fuses	7	80A Auto Fuses	7
50A Auto Fuses	7	100A Auto Fuses	7

KT100027 16-Piece Maxi Fuse Kit

- Maxi fuse kit contains 16 pieces in the most popular 5 sizes including 20A, 30A, 40A, 50A and 60A
- Maxi fuses are used to protect circuits in the wiring harness - usually found under the hood, in a fuse panel or supplementary panel near the battery
- Primarily used in domestic cars, MAXI fuses also have some applications in imported models
- OEM applications currently range up to 60 amps, however, some aftermarket accessories require protection up to 80 amps



Part #	Description	Qty	Refill
KT104234	20A maxi plug-in fuse	3	10
KT104235	30A maxi plug-in fuse	4	10
KT104236	40A maxi plug-in fuse	4	10
KT104237	50A maxi plug-in fuse	3	10
KT104238	60A maxi plug-in fuse	2	10



KT100070
25-Piece ATO Glo-Fuse Assortment

- Finding open fuses is easy with these fuses that use LED technology to show that a fuse has opened - making them easy to spot in fuse panels tucked up under dark dashboards
- Same color coding and amp ratings as the ATO fuses
- Includes 25 pieces of the top 5 sizes including 10A, 15A, 20A, 25A and 30A

Part #	Description	Qty
KT104282	ATO Glo-Fuse 10 Amp	5
KT104283	ATO Glo-Fuse 15 Amp	5
KT104284	ATO Glo-Fuse 20 Amp	5
KT104285	ATO Glo-Fuse 25 Amp	5
KT104286	ATO Glo-Fuse 30 Amp	5



KT100068
30-Piece Low Profile Mini Fuse Assortment

- This is a low profile version of the ATM mini fuses
- Same color code and amp ratings
- Includes 30 pieces of the top 6 sizes - 7.5A, 10A, 15A, 20A, 25A and 30A

Part #	Description	Qty
KT104270	Low Profile Mini Fuse - 5 Amp	NA
KT104271	Low Profile Mini Fuse - 7.5 Amp	5
KT104272	Low Profile Mini Fuse - 10 Amp	5
KT104273	Low Profile Mini Fuse - 15 Amp	5
KT104274	Low Profile Mini Fuse - 20 Amp	5
KT104275	Low Profile Mini Fuse - 25 Amp	5
KT104276	Low Profile Mini Fuse - 30 Amp	5



KT100067
95-Piece AGC Glass Fuse Assortment

- These glass tube fuses are used in older-model cars and found primarily in automotive accessory applications
- Includes 95 total pieces of 6 popular sizes of AGC, AGW, SFE and GBC type fuses

Part #	Description	Qty
KT100811	10A glass fuse	10
KT100821	15A glass fuse	20
KT100831	20A glass fuse	20
KT100841	25A glass fuse	20
KT100851	30A glass fuse	20
KT100861	5A glass fuse	5



KT100069
25-Piece ATM Glo-Fuse Assortment

- Finding open fuses is easy with these fuses that use LED technology to show that a fuse has opened - making them easy to spot in fuse panels tucked up under dark dashboards
- Same color coding and amp ratings as the ATM mini blade fuses
- Includes 25 pieces of the top 5 sizes including 10A, 15A, 20A, 25A and 30A

Part #	Description	Qty
KT104277	ATM Glo-Fuse 10 Amp	5
KT104278	ATM Glo-Fuse 15 Amp	5
KT104279	ATM Glo-Fuse 20 Amp	5
KT104280	ATM Glo-Fuse 25 Amp	5
KT104281	ATM Glo-Fuse 30 Amp	5

VEHICLE SPECIALTY



KT100026 10-piece Jcase Fuse Assortment

- These high amp fuses are currently on many new domestic and Japanese model vehicles. Same color code and amp ratings
- Includes 10 pieces total of the most popular 5 sizes

Part #	Description	Qty	Refill
KT104220	Jcase Fuse - 20 Amp	2	5
KT104221	Jcase Fuse - 30 Amp	2	5
KT104222	Jcase Fuse - 40 Amp	2	5
KT104223	Jcase Fuse - 50 Amp	2	5
KT104224	Jcase Fuse - 60 Amp	2	5



KT100045 12-piece Low Profile Jcase Fuse Assortment

- This is the low profile version of the JCASE high amp fuses
- Same color code and amp ratings
- Includes 12 pieces total of the most popular 6 sizes

Part #	Description	Qty	Refill
KT104226	Low Profile Jcase Fuse - 20 Amp	2	5
KT104227	Low Profile Jcase Fuse - 25 Amp	2	5
KT104228	Low Profile Jcase Fuse - 30 Amp	2	5
KT104229	Low Profile Jcase Fuse - 40 Amp	2	5
KT104230	Low Profile Jcase Fuse - 50 Amp	2	5
KT104231	Low Profile Jcase Fuse - 60 Amp	2	5



KT100037 180-piece Solderless Terminal Kit

- Solderless terminal kit includes 180 pieces of the most popular terminal rings, spades, male and female disconnects and butt connectors

Part #	Description	Qty
KT104057	Ring Terminal Wire Size: 22-18 Stud Size: 10	10
KT104058	Ring Terminal Wire Size: 16-14 Stud Size: 6	10
KT104059	Ring Terminal Wire Size: 16-14 Stud Size: 10	10
KT104062	Ring Terminal Wire Size: 12-10 Stud Size: 10	10
KT104063	Ring Terminal Wire Size: 12-10 Stud Size: 1/4	10
KT104065	Spade Terminal Wire Size: 22-18 Stud Size: 10	10
KT104067	Spade Terminal Wire Size: 16-14 Stud Size: 10	10
KT104068	Ring Terminal Wire Size: 12-10 Stud Size: 10	10
KT104069	Butt Connector Wire Size: 22-18	10
KT104070	Butt Connector Wire Size: 16-14	10
KT104071	Butt Connector Wire Size: 12-10	10
KT104072	Male Slide Terminal Wire Size: 22-18 Tab Size: .250	10
KT104073	Female Slide Terminal Wire Size: 22-18 Tab Size: .250	10
KT104074	Male Slide Terminal Wire Size: 16-14 Tab Size: .250	10
KT104075	Female Slide Terminal Wire Size: 16-14 Tab Size: .250	10
KT104076	Male Slide Terminal Wire Size: 12-10 Tab Size: .250	10
KT104077	Female Slide Terminal Wire Size: 12-10 Tab Size: .250	10
KT104497	Ring Terminal Wire Size: 22-18 Stud Size: 6	10



KT100039 360-piece Professional Terminal Assortment

- Solderless terminal kit includes 24 of the top terminals including rings, spades, butt connectors, male and female slides, bullet terminals, 2-way and 3-way connectors

Part #	Description	Qty	Refill
KT104057	Ring Terminal Wire Size: 22-18 Stud Size: 10	20	10
KT104058	Ring Terminal Wire Size: 16-14 Stud Size: 6	20	10
KT104059	Ring Terminal Wire Size: 16-14 Stud Size: 10	20	10
KT104060	Ring Terminal Wire Size: 16-14 Stud Size: 1/4	10	10
KT104061	Ring Terminal Wire Size: 16-14 Stud Size 3/8	10	10
KT104062	Ring Terminal Wire Size: 12-10 Stud Size: 10	10	10
KT104063	Ring Terminal Wire Size: 12-10 Stud Size: 1/4	10	10
KT104064	Ring Terminal Wire Size: 12-10 Stud Size: 3/8	10	10
KT104066	Spade Terminal Wire Size: 16-14 Stud Size: 6	20	10
KT104067	Spade Terminal Wire Size: 16-14 Stud Size: 10	20	10
KT104068	Spade Terminal Wire Size: 12-10 Stud Size: 10	10	10
KT104069	Butt Connector 22-18	20	10
KT104070	Butt Connector 16-14	20	10
KT104071	Butt Connector 12-10	10	10
KT104074	Male Slide Terminal 16-14 Stud Size .250	20	10
KT104075	Female Slide Terminal 16-14 Stud Size .250	20	10
KT104078	Female Bullet 16-14 Stud Size .157	20	10
KT104079	Male Bullet 16-14 Stud Size .157	10	10
KT104080	3-Way 16-14	10	10
KT104081	2-way Female Bullet 16-14 .157	10	10
KT104082	Female Slide 16-14 Stud Size .250 Brass	20	10
KT104083	Male Slide 16-14 Stud Size .250 Brass	20	10
KT104084	Ins. Male Slide 16-14 Stud Size .250	10	10
KT104085	Ins. Female Slide 16-14 Stud Size .250	10	10

KT100087 360-piece Terminal Assortment

Kit contains 360 insulated PVC-sleeve, zinc-plated wire terminals and connectors. Essential for automotive, small-engine, appliance and electrical repair. Includes 13 of the most common wire connection sizes and styles.



Description	Qty	Description	Qty
10-32 ring 16-14 ga.	30	Butt connector 16-14 ga.	15
3/8" ring 16-14 ga.	20	Butt connector 12-10 ga	15
1/4" ring 16-14 ga.	20	Male bullet 16-14 ga.	10
10-32 ring 12-10 ga.	20	Female bullet 16-14 ga.	10
3/8" ring 12-10 ga.	15	Two-way line connector	10
1/4" ring 12-10 ga.	15	Male disconnect 18-14 ga.	10
10 spade 16-14 ga.	30	Female disconnect 18-14 ga.	10
10 spade 12-10 ga.	20	Male ins. disconnect 18-14	10
Butt connector 22-16 ga.	30	Female ins. disconnect 18-14	10



KT100038 120-piece Shrink Tube Solderless Terminal Kit

- Solderless terminal kit includes 24 popular terminal rings, spades, male and female disconnects, insulated slide terminals and butt connectors
- Heat shrink butt connectors make connections weatherproof

Part #	Description	Qty
KT104086	Ring Terminal 22-18 Stud Size 10	5
KT104087	Ring Terminal 16-14 Stud Size 6	5
KT104088	Ring Terminal 16-14 Stud Size 10	5
KT104089	Ring Terminal 12-10 Stud Size 10	5
KT104090	Ring Terminal 12-10 Stud Size 1/4"	5
KT104091	Ring Terminal 12-10 Stud Size 3/8"	5
KT104092	Spade Terminal 16-14 Stud Size 10	5
KT104093	Spade Terminal 12-10 Stud Size 10	5
KT104094	Butt Connector Heat Shrink 22-18	5
KT104095	Butt Connector Solder Seal 22-18	5
KT104096	Butt Connector Heat Shrink 16-14	5
KT104097	Butt Connector Solder Seal 16-14	5
KT104098	Butt Connector Heat Shrink 12-10	5
KT104099	Butt Connector Solder Seal 12-10	5
KT104100	Male Slide Terminal 22-18 Stud Size .250	5
KT104101	Female Slide Terminal 22-18 Stud Size .250	5
KT104102	Male Slide Terminal 16-14 Stud Size .250	5
KT104103	Female Slide Terminal 16-14 Stud Size .250	5
KT104104	Male Slide Terminal 12-10 Stud Size .250	5
KT104105	Female Slide Terminal 12-10 Stud Size .250	5
KT104106	Ins. Slide 16-14 Stud Size .250	5
KT104107	Ins. Slide 16-14 Stud Size .250	5
KT104108	Ins. Slide 12-10 Stud Size .250	5
KT104109	Ins. Slide 12-10 Stud Size .250	5

VEHICLE SPECIALTY

Electrical Solderless Terminals

Part #	Description	Qty
KTI04068	Electrical Solderless Terminals 12-10 #10 Spade	10
KTI04071	Electrical Solderless Terminals 12-10 Butt Connector	10
KTI04077	Electrical Solderless Terminals 12-10 Female Disconnect	10
KTI04109	Electrical Solderless Terminals 12-10 Female Full Insulated Weatherproof	5
KTI04076	Electrical Solderless Terminals 12-10 Male Disconnect	10
KTI04108	Electrical Solderless Terminals 12-10 Male Disconnect Full Insulated Weatherproof	5
KTI04063	Electrical Solderless Terminals 12-10, 1/4" Ring	10
KTI04064	Electrical Solderless Terminals 12-10, 3/8" Ring	10
KTI04062	Electrical Solderless Terminals 12-10 #10 Ring	10
KTI04066	Electrical Solderless Terminals 16-14 #6 Spade	10
KTI04067	Electrical Solderless Terminals 16-14 #10 Spade	10
KTI04081	Electrical Solderless Terminals 16-14 2-Way Snap Plug Receptacle	10
KTI04080	Electrical Solderless Terminals 16-14 3-Way Connector	10
KTI04070	Electrical Solderless Terminals 16-14 Butt Connector	10
KTI04075	Electrical Solderless Terminals 16-14 Female Disconnect	10
KTI04082	Electrical Solderless Terminals 16-14 Female Disconnect for Contact Body	10
KTI04084	Electrical Solderless Terminals 16-14 Female Disconnect Full Insulated	10
KTI04106	Electrical Solderless Terminals 16-14 Female Disconnect Full Insulated Weatherproof	5
KTI04074	Electrical Solderless Terminals 16-14 Male Disconnect	10
KTI04083	Electrical Solderless Terminals 16-14 Male Disconnect for Contact Body	10
KTI04085	Electrical Solderless Terminals 16-14 Male Disconnect Full Insulated	10
KTI04107	Electrical Solderless Terminals 16-14 Male Disconnect Full Insulated Weatherproof	5
KTI04079	Electrical Solderless Terminals 16-14 Universal Female Snap Plug	10
KTI04078	Electrical Solderless Terminals 16-14 Universal Snap Plug	10
KTI04060	Electrical Solderless Terminals 16-14, 1/4 Ring	10
KTI04061	Electrical Solderless Terminals 16-14, 3/8 Ring	10
KTI04058	Electrical Solderless Terminals 16-14 #6 Ring	10
KTI04059	Electrical Solderless Terminals 16-14 #10 Ring	10
KTI04057	Electrical Solderless Terminals 22-18 #10 Ring	10
KTI04065	Electrical Solderless Terminals 22-18 #10 Spade	10
KTI04497	Electrical Solderless Terminals 22-18 #6 Ring	10
KTI04069	Electrical Solderless Terminals 22-18 Butt Connector	10
KTI04073	Electrical Solderless Terminals 22-18 Female Disconnect	10
KTI04072	Electrical Solderless Terminals 22-18 Male Disconnect	10



KTI00631



KTI00641



KTI00611



KTI00621



KTI00651



KTI00661



KTIO0007

40-piece Copper Lug Terminal Assortment

- Copper lug terminal assortment kit includes five each of eight popular sized crimp-on copper lugs for use on 1 to 6 gauge wire
- Used for large cable applications like battery cables and grounding cables

Part #	Description	Qty	Refill
KTIO4049	Wire Size: 2 ga. Stud Size: 3/8"	5	10
KTIO4050	Wire Size: 4 ga. Stud Size: 3/8"	5	10
KTIO4051	Wire Size: 2 ga. Stud Size: 5/16"	5	10
KTIO4052	Wire Size: 4 ga. Stud Size: 5/16"	5	10
KTIO4053	Wire Size: 6 ga. Stud Size: 3/8"	5	10
KTIO4054	Wire Size: 1 ga. Stud Size: 3/8"	5	10
KTIO4055	Wire Size: 1 ga. Stud Size: 5/16"	5	10
KTIO4056	Wire Size: 6 ga. Stud Size: 5/16"	5	10



Electrical Copper Lugs		
Part #	Description	Qty
KTIO4054	Electrical Copper Lugs 1 Gauge x 3/8	10
KTIO4055	Electrical Copper Lugs 1 Gauge x 5/16	10
KTIO4049	Electrical Copper Lugs 2 Gauge x 3/8	10
KTIO4051	Electrical Copper Lugs 2 Gauge x 5/16	10
KTIO4050	Electrical Copper Lugs 4 Gauge x 3/8	10
KTIO4052	Electrical Copper Lugs 4 Gauge x 5/16	10
KTIO4053	Electrical Copper Lugs 6 Gauge x 3/8	10
KTIO4056	Electrical Copper Lugs 6 Gauge x 5/16	10



Electrical Shrink Tube Connectors / Terminals

Part #	Description	Qty
KTIO4098	Electrical Shrink Tube Butt Connector Heat Shrink 12-10	5
KTIO4096	Electrical Shrink Tube Butt Connector Heat Shrink 16-14	5
KTIO4094	Electrical Shrink Tube Butt Connector Heat Shrink 22-18	5
KTIO4099	Electrical Shrink Tube Butt Connector Solder Seal 12-10	5
KTIO4097	Electrical Shrink Tube Butt Connector Solder Seal 16-14	5
KTIO4095	Electrical Shrink Tube Butt Connector Solder Seal 22-18	5
KTIO4105	Electrical Shrink Tube Female Slide Terminal 12-10 Stud Size .250	5
KTIO4103	Electrical Shrink Tube Female Slide Terminal 16-14 Stud Size .250	5
KTIO4101	Electrical Shrink Tube Female Slide Terminal 22-18 Stud Size .250	5
KTIO4104	Electrical Shrink Tube Male Slide Terminal 12-10 Stud Size .250	5
KTIO4102	Electrical Shrink Tube Male Slide Terminal 16-14 Stud Size .250	5
KTIO4100	Electrical Shrink Tube Male Slide Terminal 22-18 Stud Size .250	5
KTIO4090	Electrical Shrink Tube Ring Terminal 12-10 Stud Size 1/4"	5
KTIO4089	Electrical Shrink Tube Ring Terminal 12-10 Stud Size 10	5
KTIO4091	Electrical Shrink Tube Ring Terminal 12-10 Stud Size 3/8"	5
KTIO4088	Electrical Shrink Tube Ring Terminal 16-14 Stud Size 10	5
KTIO4087	Electrical Shrink Tube Ring Terminal 16-14 Stud Size 6	5
KTIO4086	Electrical Shrink Tube Ring Terminal 22-18 Stud Size 6	5
KTIO4093	Electrical Shrink Tube Spade Terminal 12-10 Stud Size 10	5
KTIO4092	Electrical Shrink Tube Spade Terminal 16-14 Stud Size 10	5

VEHICLE SPECIALTY



KT100033 216-Piece Heat Shrink Tubing Assortment Set

- Protection and insulation of component and wires
- Color coordinated sizes
- Quick and simple to shrink by heat gun
- Shrink ratio 2:1
- Assortment includes sizes ranging from 2.5mm to 20mm

Description	Qty	Description	Qty
2.5mm x 45mm, Color black	50	6mm x 45mm, Color red	5
2.5mm x 45mm, Color red	20	10mm x 45mm, Color black	10
3.5mm x 45mm, Color black	30	10mm x 45mm, Color red	10
3.5mm x 45mm, Color red	15	13mm x 45mm, Color black	10
4.5mm x 45mm, Color black	20	13mm x 45mm, Color red	10
4.5mm x 45mm, Color red	10	20mm x 75mm, Color black	8
6mm x 45mm, Color black	10	20mm x 75mm, Color red	8



KT100035 85-piece Heat Shrink Tube Kit

- Shrink tube assortment kit includes five popular sizes
 - Ideal for weathertight seal of all electrical connections
 - Use for insulating, jacketing, bundling and identification
 - It is mechanically tough and has good abrasion and solvent resistance
 - Shrink temp - 250°F. Shrink ratio 2:1
- Kit contains five sizes (1/8", 3/16", 1/4", 3/8" and 1/2") for a total of 85 pieces

Part #	Description	Qty
KT102611	1/8" shrink tube	20
KT102621	3/16" shrink tube	20
KT102631	1/4" shrink tube	30
KT102641	3/8" shrink tube	10
KT104494	1/2" shrink tube	5



KT102651 Heat Shrink Tubing Assortment - Qty 8

- A high quality material which shrinks to 1/3 its size
 - It can be stored for extended periods of time without shrinkage
 - It remains flame retardant, and is very flexible
 - When heated, the sealant flows and physically encapsulates, creating a waterproof connection
- Includes (2) each of the following diameters: 1/8", 3/16", 1/4" and 3/8"

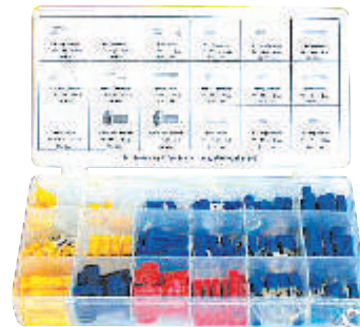

KT100097 157-piece Electric Wire Solderless Terminal Kit

- 157-piece electric wire solderless terminal kit includes 17 popular sizes for 10-18 gauge wire
- Products are color-coded for convenience

Description	Qty	Description	Qty
#8 ring terminal 16-14 ga.	11	Female connector 16-14 ga.	11
#10 ring terminal 16-14 ga.	11	Male connector 12-10 ga.	4
1/4" ring terminal 16-14 ga.	11	Female connector 12-10 ga.	4
5/16" ring terminal 12-10 ga.	8	Male bullet 16-14 ga.	11
3/8" ring terminal 12-10 ga.	4	Female bullet 16-14 ga.	11
Butt connect 22-18 ga.	11	#8 spade terminal 16-14 ga.	11
Butt connect 16-14 ga.	22	Quick splice and tap 16-14 ga	4
Butt connect 12-10 ga.	8	Quick splice and tap 22-18 ga	4
Male connector 16-14 ga.	11		



KT100034
105-Piece Dual-Wall
Heat Shrink Tubing Assortment Set

- Protection and insulation of component and wires
- Use for auto, marine, plane, home, industrial, computer, etc.
- Quick and simple to shrink by heat gun
- Waterproof; Shrink ratio: 3:1
- Assortment includes sizes ranging from 3.2mm to 25.4mm

Description	Qty
3.2mm x 45mm, Color black	28
3.2mm x 45mm, Color red	12
4.8mm x 45mm, Color black	16
4.8mm x 45mm, Color red	8
6.4mm x 45mm, Color black	7
6.4mm x 45mm, Color red	4
9.5mm x 45mm, Color black	6
9.5mm x 45mm, Color red	3
12.7mm x 75mm, Color black	5
12.7mm x 75mm, Color red	3
19.1mm x 75mm, Color black	3
19.1mm x 75mm, Color red	2
25.4mm x 75mm, Color black	4
25.4mm x 75mm, Color red	4



KT100003
100-piece Butt Connector Kit

- Vinyl solderless butt connector assortment kit includes three popular sizes for use on 10 to 22 gauge wire

Part #	Description	Qty
KT104069	Butt Connectors Vinyl 22-18 Gauge	20
KT104070	Butt Connectors Vinyl 16-14 Gauge	60
KT104071	Butt Connectors Vinyl 12-10 Gauge	20



KT107740
235-piece Heat Shrink Tube Kit

- 8 sizes, 3/32" to 3/4", 6" long
- 2:1 shrink ratio - inside diameter is measured before shrinking
- Heat rating: 257-degrees Fahrenheit (125-degrees Celsius)
- All sizes are provided in 6" lengths and can be cut to fit

Size: 1/8"	Qty	Size: 3/8"	Qty
Blue	11	Blue	2
Black	11	Black	2
Orange	11	Orange	2
Green	11	Green	2
Yellow	11	Yellow	2
Size: 3/32"	Qty	Size: 1/2"	Qty
Blue	8	Blue	2
Black	8	Black	2
Orange	8	Orange	2
Green	8	Green	2
Yellow	8	Yellow	2
Size: 3/16"	Qty	Size: 5/8"	Qty
Blue	11	Blue	1
Black	11	Black	1
Orange	11	Orange	1
Green	11	Green	1
Yellow	11	Yellow	1
Size: 1/4"	Qty	Size: 3/4"	Qty
Blue	11	Blue	1
Black	11	Black	1
Orange	11	Orange	1
Green	11	Green	1
Yellow	11	Yellow	1

VEHICLE SPECIALTY



KT100004

60-piece Butt Connector Kit with Shrink Tube

- Vinyl butt with shrink fit connector assortment kit includes three popular sizes for use in many applications including automotive and marine
- Heat shrink butt connectors make connections weatherproof

Part #	Description	Qty
KT104094	Butt Conn. Shrink Tubing 22-18Ga.	15
KT104096	Butt Conn. Shrink Tubing 16-14Ga.	30
KT104098	Butt Conn. Shrink Tubing 12-10Ga.	15



KT156201

9" Professional Multi Purpose Crimper and Wire Stripper

- Wire cutter, bolt cutter, and wire stripper in one
- Crimps insulated and open barrel terminals

LIFETIME WARRANTY*

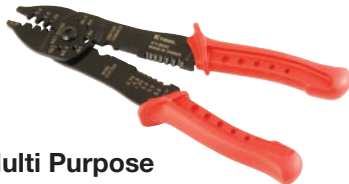

KT156202

8.5" Professional Multi Purpose Crimper and Wire Stripper

- Wire cutter, bolt cutter, and wire stripper in one
- Crimps open barrel terminals
- 3.2mm thickness

LIFETIME WARRANTY*



KT156203

Professional Crimping Tool - 0.5/1.5/2.5/4.0/6.0 MM2

- Crimps non-insulated terminals
- Easy to grip handles

LIFETIME WARRANTY*



KT156205

8.7" Ratcheting Terminal Crimper

- 8.7" Ratchet Crimper for insulated terminal
- Polypropylene and thermoplastic rubber handle
- Tool capacity: Red 22-18 AWG, Blue 16-14 AWG, Yellow 12-10 AWG
- Carbon steel head
- Adjusted by screwdriver
- Ratcheting Terminal Crimper

LIFETIME WARRANTY*



KT156207

9.75" Professional 8-in-1 Quick and Easy Wire Stripper

- Wire cutter, bolt cutter, wire stripper, and bending wire
- Crimps insulated, non-insulated, and pin terminals

LIFETIME WARRANTY*



Dyna Loom - Split Wire Loom

Part #	Size	Length
KT102751	1/2" I.D. Split Wire Loom	7'
KT102761	1/4" I.D. Split Wire Loom	10'
KT102771	3/4" I.D. Split Wire Loom	5'
KT102781	3/8" I.D. Split Wire Loom	10'
KT102791	5/8" I.D. Split Wire Loom	6'



Dyna Loom - Routing Clips

Part #	Description	Qty
KT102742	1/4" Wire Loom Clips	10
KT102743	3/8" Wire Loom Clips	10
KT102744	1/2" Wire Loom Clips	10
KT102745	5/8" and 3/4" Wire Loom Clips	10



Primary Wire			
Part #	Color	Gauge	Length
KT101912	Red	10 Gauge	8'
KT101920	Black	10 Gauge	8'
KT101939	White	10 Gauge	8'
KT102012	Red	12 Gauge	10'
KT102020	Black	12 Gauge	10'
KT102039	White	12 Gauge	10'
KT102112	Red	14 Gauge	15'
KT102127	Yellow	14 Gauge	15'
KT102130	Black	14 Gauge	15'
KT102149	White	14 Gauge	15'
KT102212	Red	16 Gauge	25'
KT102227	Yellow	16 Gauge	25'
KT102230	Black	16 Gauge	25'
KT102249	White	16 Gauge	25'
KT102312	Red	18 Gauge	30'
KT102327	Yellow	18 Gauge	30'
KT102330	Black	18 Gauge	30'
KT102349	White	18 Gauge	30'



LIFETIME WARRANTY*

KT172765 Mini Heavy-duty Circuit Tester

- Tester is 5" long and includes 2" tempered probe and replaceable bulb
- Works on 6 or 12 volt systems
- Features 60" heavy-duty flexible wire lead with ground clip

Replacement parts:

KT172781 - Replacement bulb for models 72765, 72780, 72790, 72791 and 72792



KT172782 Heavy-duty Circuit Tester with 10' Retractable Wire and Clip

- Can be used on cars, trucks, SUVs, boats, trailers, vans, RVs, motorcycles, snowmobiles and airplanes
- Use the heavy-duty circuit tester to check electrical circuits and accessories on all 6 and 12 volt systems
- Tester features a 10' retractable wire and battery clip, spring-supported strain relief, extra-sharp probe and a heavy-duty battery clip

LIFETIME WARRANTY*



LIFETIME WARRANTY*

KT172780 Heavy-duty Circuit Tester

- Tester features 5' heavy-duty flexible wire, ground clips, tempered probe and replaceable bulb
- Works on 6 or 12 volt systems. Spring strain relief on cord

Replacement parts:

KT172781 - Replacement bulb for models 72765, 72780, 72790, 72791 and 72792



LIFETIME WARRANTY*

KT172770 Circuit Tester

Tester features 48" extra long leads. Works on 6 or 12 volt systems.

Replacement parts:

KT172771 - Replacement bulb for model 72770



Extra-long Circuit Testers

- Specially designed to enable technicians to test hard to reach circuits that would not be accessible with standard testers
- Features extra long, colored, insulated 7-1/2" probe and 60" heavy gauge flexible wire
- Works on 6 or 12 volt systems

Sold separately:

KT172790 - Blue
KT172791 - Yellow
KT172792 - Red
KT172781 - Replacement bulb for models

72765, 72780, 72790, 72791 and 72792

LIFETIME WARRANTY*



PAINT & BODY TOOLS



PBE | Paint

KT180955 Touch-up Paint Gun

Includes plastic cup. For touch up, edging, shading or precision detail painting.

Warranty: Repair only up to 1 year



KT180995 Deluxe Spray Gun

This deluxe spray gun features a siphon feed, external mix, built-in regulator and dripless cup. Gun works with all types of automotive refinishing materials.

Warranty: Repair only up to 1 year



KT189194 2-pack Spray Gun Filters



KT189195 Filter Regulator & Lubricator, 2 Piece

- Miniature Filter regulator and lubricator 2 piece space saving combination
- 40 micron sintered bronze filter element, polycarbonate bowl with metal bowl guard
- 1/4" NPT, maximum flow 18 CFM (500 LPM)
- Semi automatic night time drain
- Pressure range: 7-145 PSI
- 1-Year Warranty



KT180998 Deluxe Production Spray Gun

Professional quality gun provides superior atomization of high solid base coats, clear coats, acrylic enamels, acrylic lacquers, and metallic and other coatings. Includes dripless cup.

Warranty: Repair only up to 1 year



KT180996 Dripless Spray Gun Cup



Air Regulators

KT189191 1/4 inch Air Regulator



KT189193 1/4 inch Air Regulator with Gauge



KT180989 Paint Spray Gun Cleaning Kit

Contains all necessary brushes and tools to effectively clean spray guns. Safe to use with chemicals and solvents.



PAINT & BODY TOOLS

PBE | Body



LIFETIME WARRANTY*

KT170031

5-Piece Upholstery Clip Remover Set

This set combines the most popular individual upholstery tools into one master set. Includes both "U" and "V" clip styles of tools as well as a reverse U-blade door panel clip removal tool. This is a complete set for anyone working on car upholstery or for removing panels from dash or door. Comes in a thermoformed tray for easy storage in any tool box. Available individually.

Set includes (also available individually):

KT170032 - "V" Blade Door Panel Tool with Stainless Steel Blade

KT170033 - "U" Blade Door Panel Tool with Stainless Steel Blade

KT170034 - "U" Blade Mini Trim Panel Tool with Stainless Steel Blade

KT170035 - "V" Blade Mini Trim Panel Tool with Stainless Steel Blade

KT170036 - Reverse "U" Blade Door Panel Tool with Stainless Steel Blade



LIFETIME WARRANTY*

KT150201

Universal Body Clip Plier

These specially designed, patented pliers will remove almost any clip found on trim, bumpers and other areas of the vehicle. The steel levers are enclosed in PMS plastic to prevent scratches. Specially sized and angled tip make these pliers the most versatile clip removal tool. Body clip pliers remove clips found on almost every vehicle - inside and out! Lifetime warranty.



KT170540

Windshield Removing Tool

Facilitates removal of windshields and backlights by cutting sealant around windows. Each tool includes an extra replacement blade.

R LIFETIME WARRANTY*

Replacement parts:

KT170541 - Replacement blade

KT170545

Professional Heavy-Duty Windshield Knife



Features professional-grade construction from heavy-duty steel and aluminum. Knife is lightweight and easy-to-use. Extra-long reach to cut hardened urethane all the way down to the dash line and offers increased leverage and greater control for a safer, smoother cut. The padded, ergonomic handle also features storage space for replacement blades. Blades can be easily changed by releasing a simple one-screw retaining clip.

R LIFETIME WARRANTY*

Replacement parts:

KT170546 - Replacement blades 6-pack



LIFETIME WARRANTY*

KT179100

Heavy-Duty Riveter

Features four different nose pieces to secure rivets: 3/32" (2.4 mm), 1/8" (3.2 mm), 5/32" (4.0 mm) and 3/16" (4.8 mm). Includes rivet samples.



LIFETIME WARRANTY*

KT179110

Super Heavy-Duty Riveter

Tool's 17" handles provide the leverage needed to effortlessly secure five different rivets: 1/8" (3.2 mm), 5/32" (4.0 mm), 3/16" (4.8 mm), 7/32" (6.0 mm) and 1/4" (6.4 mm).



KTI70037
Clip Lifter

- Clip lifter for plastic fasteners, upholstery, door panels, plastic clips
- Tool length: 7"
- Tool width: 3/4"
- Red rubber handle
- Covered by a 1-Year Warranty



KTI70037-10
Clip Lifter



- Clip lifter for plastic fasteners, upholstery, door panels, plastic clips
- Tool length: 7" • Tool width: 3/4"
- Red rubber handle
- Covered by a 1-Year Warranty



KTI70038
Combi Wedge

- Heavy duty universal combination wedge tool
- Use on dashboards and door cover clips
- Color: Red
- Tool length: 8.5", width: 1", height: 1"
- Covered by a 1 year warranty



KTI70038-10
Combi Wedge 10 Pack



- Counter display 10 pack of the heavy duty universal combination wedge tool
- Use on dashboards and door cover clips
- Color: Red
- Tool length: 8.5", width: 1", height: 1"
- Covered by a 1 year warranty
- Counter display measures: Height: 7.0" Width: 11.750", Depth: 7.50"

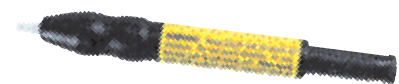

KTI70550
Sanding Pen

Over 20,000 glass fibers in a pen point reach where normal sand paper cannot. Includes one extra sanding point in rear cap.

Replacement parts:

KTI70551 - 2-pack refill for sanding pen





DISPLAYS



Displays | Wall

KT10805

1/4" Drive Tools & Sockets

Display assortments include the following hardware:

- Hooks, printed overlay, overlay fasteners
- Display boards must be purchased separately (KT1098)



1/4" Drive Tools & Sockets	Qty	
KT121000.....	1/4" DR SOCKET SET.....	1
KT121002.....	1/4" DR 2" EXTENSION.....	1
KT121004.....	1/4" DR 4" EXTENSION.....	1
KT121006.....	1/4" DR 6" EXTENSION.....	1
KT121010.....	1/4" DR EXTENSION 10".....	1
KT121014.....	1/4" DR EXTENSION 14".....	1
KT121043.....	4" WOBBLE EXTENSION 1/4" DR.....	1
KT121044.....	1/4" DR 44PC SOCKET SET.....	1
KT121046.....	6" WOBBLE EXTENSION 1/4" DR.....	1
KT121048.....	9" WOBBLE EXTENSION 1/4" DR.....	1
KT121050.....	1/4" DR UNIVERSAL JOINT.....	1
KT121060.....	1/4" DR SPINNER HANDLE.....	1
KT121080.....	1/4" DR 6" FLEX HANDLE.....	1
KT121091.....	1/4" DR PUSH BUTTON RATCHET.....	1
KT121092.....	1/4" PRO RATCHET.....	1
KT121095.....	LONG HANDLE 1/4" DR RATCHET.....	1
KT121106.....	1/4" DR SHORT SOCKET 3/16".....	1
KT121107.....	1/4" DR SHORT SOCKET 7/32".....	1
KT121108.....	1/4" DR SHORT SOCKET 1/4".....	1
KT121109.....	1/4" DR SHORT SOCKET 9/32".....	1
KT121110.....	1/4" DR SHORT SOCKET 5/16".....	1
KT121111.....	1/4" DR SHORT SOCKET 11/32".....	1
KT121112.....	1/4" DR SHORT SOCKET 3/8".....	1
KT121114.....	1/4" DR SHORT SOCKET 7/16".....	1
KT121116.....	1/4" DR SHORT SOCKET 1/2".....	1
KT121118.....	1/4" DR 6 POINT SHORT SOCKET 9/16".....	1
KT121206.....	1/4" DR DEEP SOCKET 3/16".....	1
KT121207.....	1/4" DR DEEP SOCKET 7/32".....	1
KT121208.....	1/4" DR DEEP SOCKET 1/4".....	1
KT121209.....	1/4" DR DEEP SOCKET 9/32".....	1
KT121210.....	1/4" DR DEEP SOCKET 5/16".....	1
KT121211.....	1/4" DR DEEP SOCKET 11/32".....	1
KT121212.....	1/4" DR DEEP SOCKET 3/8".....	1
KT121214.....	1/4" DR DEEP SOCKET 7/16".....	1
KT121216.....	1/4" DR DEEP SOCKET 1/2".....	1
KT121218.....	1/4" DR 6 POINT DEEP SOCKET 9/16".....	1
KT126000.....	1/4" DR METRIC SOCKET SET.....	1
KT126104.....	1/4" DR SHORT SOCKET 4MM.....	1
KT126105.....	1/4" DR SHORT SOCKET 5MM.....	1
KT126106.....	1/4" DR SHORT SOCKET 6MM.....	1
KT126107.....	1/4" DR SHORT SOCKET 7MM.....	1
KT126108.....	1/4" DR SHORT SOCKET 8MM.....	1
KT126109.....	1/4" DR SHORT SOCKET 9MM.....	1
KT126110.....	1/4" DR SHORT SOCKET 10MM.....	1
KT126111.....	1/4" DR SHORT SOCKET 11MM.....	1
KT126114.....	1/4" DR 6 POINT SHORT SOCKET 14MM.....	1
KT126115.....	1/4" DR 6 POINT SHORT SOCKET 15MM.....	1
KT126155.....	1/4" DR SHORT SOCKET 5.5MM.....	1



KT126206.....	1/4" DR DEEP SOCKET 6MM.....	1
KT126207.....	1/4" DR DEEP SOCKET 7MM.....	1
KT126208.....	1/4" DR DEEP SOCKET 8MM.....	1
KT126209.....	1/4" DR DEEP SOCKET 9MM.....	1
KT126210.....	1/4" DR DEEP SOCKET 10MM.....	1
KT126211.....	1/4" DR DEEP SOCKET 11MM.....	1
KT126212.....	1/4" DR DEEP SOCKET 12MM.....	1
KT126213.....	1/4" DR DEEP SOCKET 13MM.....	1
KT126214.....	1/4" DR 6 POINT SHORT SOCKET 14MM.....	1
KT126215.....	1/4" DR 6 POINT DEEP SOCKET 15MM.....	1
KT126255.....	1/4" DR DEEP SOCKET 5.5MM.....	1
KTI089.....	3" EXTENSION BAR.....	1
KTIHOOK11.....	PLASTIC HOOKS.....	12
KTIHOOK2.....	HOOKS.....	29
KTIHOOK3.....	HOOKS.....	2
KTIOL0805.....	DISPLAY OVERLAY.....	1
KTIOLF04333.....	OVERLAY FASTENERS (6 PACK).....	1

DISPLAYS

KT10806

3/8" Drive Tools

Display assortments include the following hardware:

- Hooks, printed overlay, overlay fasteners
- Display boards must be purchased separately (KT1098)



3/8" Drive Tools	Qty	
KT121055.....	1/4" F X 3/8" M ADAPTER.....	1
KT122000.....	3/8" DR SOCKET SET.....	1
KT122002.....	3/8" DR EXTENSION 2".....	1
KT122003.....	3/8" DR EXTENSION 3".....	1
KT122005.....	3/8" DR EXTENSION 5".....	1
KT122006.....	3/8" DR EXTENSION 6".....	1
KT122008.....	3/8" DR EXTENSION 8".....	1
KT122010.....	3/8" DR EXTENSION 10".....	1
KT122012.....	3/8" DR EXTENSION 12".....	1
KT122018.....	3/8" DR EXTENSION 18".....	1
KT122024.....	3/8" DR EXTENSION 24".....	1
KT122043.....	3/8" DR WOBBLE EXTENSION 3".....	1
KT122046.....	3/8" DR WOBBLE EXTENSION 6".....	1
KT122047.....	3/8" DR 47PC SOCKET SET 6 POINT.....	1
KT122048.....	3/8" DR WOBBLE EXTENSION 8".....	1
KT122050.....	1/2" F X 3/8" M ADAPTER.....	1
KT122055.....	3/8" F X 1/2" M ADAPTER.....	1
KT122060.....	3/8" F X 1/4" M ADAPTER.....	1
KT122071.....	3/8" DR SPEED HANDLE.....	1
KT122080.....	8" FLEX HANDLE.....	1
KT122091.....	3/8" DR PUSH BUTTON RATCHET.....	1
KT122092.....	3/8" PRO RATCHET.....	1
KT122093.....	3/8" DR FLEX HEAD RATCHET.....	1
KT122095.....	LONG HANDLE 3/8" DR RATCHET.....	1
KT122133.....	3/8" DR 2in1 SOCKET 1-1/16" DEEP.....	1
KT122219.....	EXTRA DEEP 5/8" SPARK PLUG SKT.....	1
KT122221.....	3/8" DR SPARKPLUG SKT 6PT 5/8".....	1
KT122227.....	3/8" DR SPARKPLUG SKT 6PT 13/16".....	1
KT122500.....	UNIVERSAL JOINT 3/8" DR.....	1
KT122521.....	5/8" SPARKPLUG SKT 3/8" DR UNIV.....	1
KT122527.....	13/16" SPARKPLUG SKT 3/8" DR UNV.....	1
KT127000.....	3/8" DR METRIC SOCKET SET.....	1
KT1089.....	3" EXTENSION BAR.....	1
KT1HOOK2.....	HOOKS.....	20
KT1HOOK3.....	HOOKS.....	4
KT1HOOK11.....	PLASTIC HOOKS.....	12
KT1OL0806.....	DISPLAY OVERLAY.....	1
KT1OLF04333.....	OVERLAY FASTENERS (6 PACK).....	1





KTI0807

3/8" Drive Sockets

Display assortments include the following hardware:

- Hooks, printed overlay, overlay fasteners
- **Display boards must be purchased separately (KTI098)**



3/8" Drive Sockets.....	Qty
KTI22110.....	1
KTI22112.....	1
KTI22114.....	1
KTI22116.....	1
KTI22118.....	1
KTI22120.....	1
KTI22122.....	1
KTI22124.....	1
KTI22126.....	1
KTI22128.....	1
KTI22130.....	1
KTI22132.....	1
KTI22210.....	1
KTI22212.....	1
KTI22214.....	1
KTI22216.....	1
KTI22218.....	1
KTI22220.....	1
KTI22222.....	1
KTI22224.....	1
KTI22226.....	1
KTI22228.....	1
KTI22230.....	1
KTI22232.....	1
KTI22408.....	1
KTI22410.....	1
KTI22412.....	1
KTI22414.....	1
KTI22416.....	1
KTI22418.....	1
KTI22420.....	1
KTI22422.....	1
KTI22424.....	1
KTI22426.....	1
KTI22428.....	1
KTI22430.....	1
KTI22432.....	1
KTI22508.....	1
KTI22510.....	1
KTI22512.....	1
KTI22514.....	1
KTI22516.....	1
KTI22518.....	1
KTI22520.....	1

3/8" Drive Sockets.....	Qty
KTI22522.....	1
KTI22524.....	1
KTI22526.....	1
KTI22528.....	1
KTI22530.....	1
KTI22532.....	1
KTI27107.....	1
KTI27108.....	1
KTI27109.....	1
KTI27110.....	1
KTI27111.....	1
KTI27112.....	1
KTI27113.....	1
KTI27114.....	1
KTI27115.....	1
KTI27116.....	1
KTI27117.....	1
KTI27118.....	1
KTI27119.....	1
KTI27120.....	1
KTI27121.....	1
KTI27122.....	1
KTI27123.....	1
KTI27124.....	1
KTI27125.....	1
KTI27126.....	1
KTI27207.....	1
KTI27208.....	1
KTI27209.....	1
KTI27210.....	1
KTI27211.....	1
KTI27212.....	1
KTI27213.....	1
KTI27214.....	1
KTI27215.....	1
KTI27216.....	1
KTI27217.....	1
KTI27218.....	1
KTI27219.....	1
KTI27220.....	1
KTI27221.....	1
KTI27222.....	1
KTI27223.....	1
KTI27224.....	1
KTI27225.....	1
KTI27226.....	1
KTI27407.....	1
KTI27408.....	1
KTI27409.....	1
KTI27410.....	1
KTI27411.....	1
KTI27412.....	1
KTI27413.....	1
KTI27414.....	1
KTI27415.....	1
KTI27416.....	1
KTI27417.....	1
KTI27418.....	1
KTI27419.....	1
KTI27420.....	1
KTI27421.....	1
KTI27507.....	1
KTI27508.....	1
KTI27509.....	1
KTI27510.....	1
KTI27511.....	1
KTI27512.....	1
KTI27513.....	1
KTI27514.....	1
KTI27515.....	1
KTI27516.....	1
KTI27517.....	1
KTI27518.....	1
KTI27519.....	1
KTI27520.....	1
KTI27521.....	1
KTIH00K2.....	60
KTIOL0807.....	1
KTIOLF04333.....	1

DISPLAYS

KT10808

1/2" Drive Tools & Sockets

Display assortments include the following hardware:

- Hooks, printed overlay, overlay fasteners
- Display boards must be purchased separately (KT1098)



1/2" Drive Tools & Sockets..... Qty

KT122075.....	CHROME ADAPTER 1/2" F X 3/4" M.....	1
KT123003.....	1/2" DR 3" EXTENSION.....	1
KT123005.....	1/2" DR 5" EXTENSION.....	1
KT123010.....	1/2" DR 10" EXTENSION.....	1
KT123015.....	1/2" DR EXTENSION 15".....	1
KT123020.....	1/2" DR EXTENSION 20".....	1
KT123070.....	1/2" DR SLIDING T-HANDLE.....	1
KT123080.....	1/2" DR 17" BREAKER BAR.....	1
KT123081.....	1/2" DR 24" BREAKER BAR.....	1
KT123082.....	1/2" DR EXTENDING BREAKER BAR.....	1
KT123083.....	1/2" DR 10" FLEX HANDLE.....	1
KT123091.....	1/2" DR PUSH BUTTON RATCHET.....	1
KT123092.....	1/2" PRO RATCHET.....	1
KT123095.....	PRO SERIES 1/2 LONG RATCHET.....	1
KT123112.....	1/2" DR 6 POINT SHORT SOCKET 3/8".....	1
KT123114.....	1/2" DR SHORT SOCKET 7/16".....	1
KT123116.....	1/2" DR SHORT SOCKET 1/2".....	1
KT123118.....	1/2" DR SHORT SOCKET 9/16".....	1
KT123120.....	1/2" DR SHORT SOCKET 5/8".....	1
KT123122.....	1/2" DR SHORT SOCKET 11/16".....	1
KT123124.....	1/2" DR SHORT SOCKET 3/4".....	1
KT123126.....	1/2" DR SHORT SOCKET 13/16".....	1
KT123128.....	1/2" DR SHORT SOCKET 7/8".....	1
KT123130.....	1/2" DR SHORT SOCKET 15/16".....	1
KT123132.....	1/2" DR SHORT SOCKET 1".....	1
KT123134.....	1/2" DR SHORT SOCKET 1-1/16".....	1
KT123136.....	1/2" DR SHORT SOCKET 1-1/8".....	1
KT123140.....	1/2" DR SHORT SOCKET 1-1/4".....	1
KT123142.....	1/2" DR 6 POINT SHORT SOCKET 1-5/16".....	1
KT123144.....	1/2" DR 6 POINT SHORT SOCKET 1-3/8".....	1
KT123146.....	1/2" DR 6 POINT SHORT SOCKET 1-7/16".....	1
KT123148.....	1/2" DR 6 POINT SHORT SOCKET 1-1/2".....	1
KT123214.....	1/2" DR 6 POINT DEEP SOCKET 7/16".....	1
KT123216.....	1/2" DR DEEP 6 PT.SOCKET 1/2".....	1
KT123218.....	1/2" DR DEEP 6 PT.SOCKET 9/16".....	1
KT123220.....	1/2" DR DEEP 6 PT.SOCKET 5/8".....	1
KT123222.....	1/2" DR DEEP 6 PT.SOCKET 11/16".....	1
KT123224.....	1/2" DR DEEP 6 PT.SOCKET 3/4".....	1
KT123226.....	1/2" DR DEEP 6 PT.SOCKET 13/16".....	1
KT123228.....	1/2" DR DEEP 6 PT.SOCKET 7/8".....	1
KT123230.....	1/2" DR DEEP 6 PT.SOCKET 15/16".....	1
KT123232.....	1/2" DR 6 POINT DEEP SOCKET 1".....	1
KT123234.....	1/2" DR 6 POINT DEEP SOCKET 1-1/16".....	1
KT123236.....	1/2" DR 6 POINT DEEP SOCKET 1-1/8".....	1
KT123240.....	1/2" DR 6 POINT DEEP SOCKET 1-1/4".....	1
KT123242.....	1/2" DR 6 POINT DEEP SOCKET 1-5/16".....	1
KT123244.....	1/2" DR 6 POINT DEEP SOCKET 1-3/8".....	1
KT123246.....	1/2" DR 6 POINT DEEP SOCKET 1-7/16".....	1
KT123248.....	1 1/2" HEATING ELEMENT SOCKET.....	1
KT123500.....	1/2" DR. UNIVERSAL.....	1
KT123808.....	1/4" STUD REMOVER 1/2" DR.....	1
KT123810.....	5/16" STUD REMOVER 1/2" DR.....	1
KT123812.....	3/8" STUD REMOVER 1/2" DR.....	1
KT123814.....	7/16" STUD REMOVER 1/2" DR.....	1
KT123906.....	6 MM STUD REMOVER 1/2" DR.....	1
KT123908.....	8 MM STUD REMOVER 1/2" DR.....	1
KT123910.....	10 MM STUD REMOVER 1/2" DR.....	1
KT123912.....	12 MM STUD REMOVER 1/2" DR.....	1
KT124050.....	3/4" F X 1/2" M ADAPTER.....	1
KT128110.....	1/2" DR 6 POINT SHORT SOCKET 10MM.....	1
KT128111.....	1/2" DR 6 POINT SHORT SOCKET 11MM.....	1
KT128112.....	1/2" DR 6 POINT SHORT SOCKET 12MM.....	1
KT128113.....	1/2" DR 6 POINT SHORT SOCKET 13MM.....	1
KT128114.....	1/2" DR 6 POINT SHORT SOCKET 14MM.....	1

1/2" Drive Tools & Sockets..... Qty

KT128115.....	1/2" DR SHORT SOCKET 15MM.....	1
KT128116.....	1/2" DR SHORT SOCKET 16MM.....	1
KT128117.....	1/2" DR SHORT SOCKET 17MM.....	1
KT128118.....	1/2" DR SHORT SOCKET 18MM.....	1
KT128119.....	1/2" DR SHORT SOCKET 19MM.....	1
KT128120.....	1/2" DR SHORT SOCKET 20MM.....	1
KT128121.....	1/2" DR SHORT SOCKET 21MM.....	1
KT128122.....	1/2" DR SHORT SOCKET 22MM.....	1
KT128123.....	1/2" DR SHORT SOCKET 23MM.....	1
KT128124.....	1/2" DR SHORT SOCKET 24MM.....	1
KT128125.....	1/2" DR SHORT SOCKET 25MM.....	1
KT128126.....	1/2" DR SHORT SOCKET 26MM.....	1
KT128127.....	1/2" DR SHORT SOCKET 27MM.....	1
KT128128.....	1/2" DR SHORT SOCKET 28MM.....	1
KT128210.....	1/2" DR 6 POINT DEEP SOCKET 10MM.....	1
KT128211.....	1/2" DR 6 POINT DEEP SOCKET 11MM.....	1
KT128212.....	1/2" DR 6 POINT DEEP SOCKET 12MM.....	1
KT128213.....	1/2" DR 6 POINT DEEP SOCKET 13MM.....	1
KT128214.....	1/2" DR 6 POINT DEEP SOCKET 14MM.....	1
KT128215.....	1/2" DR DEEP SOCKET 15MM.....	1
KT128216.....	1/2" DR DEEP SOCKET 16MM.....	1
KT128217.....	1/2" DR DEEP SOCKET 17MM.....	1
KT128218.....	1/2" DR DEEP SOCKET 18MM.....	1
KT128219.....	1/2" DR DEEP SOCKET 19MM.....	1
KT128220.....	1/2" DR DEEP SOCKET 20MM.....	1
KT128221.....	1/2" DR DEEP SOCKET 21MM.....	1
KT128222.....	1/2" DR DEEP SOCKET 22MM.....	1
KT128223.....	1/2" DR DEEP SOCKET 23MM.....	1
KT128224.....	1/2" DR DEEP SOCKET 24MM.....	1
KT128225.....	1/2" DR 6 POINT DEEP SOCKET 25MM.....	1
KT128226.....	1/2" DR 6 POINT DEEP SOCKET 26MM.....	1
KT128227.....	1/2" DR 6 POINT DEEP SOCKET 27MM.....	1
KT128228.....	1/2" DR 6 POINT DEEP SOCKET 28MM.....	1
KT1089.....	3" EXTENSION BAR.....	3
KT1HOOK2.....	HOOKS.....	23
KT1HOOK11.....	PLASTIC HOOKS.....	34
KT1IOL808.....	DISPLAY OVERLAY.....	1
KT1OLF04333.....	OVERLAY FASTENERS (6 PACK).....	1

KTI0809

Screwdrivers #1

Display assortments include the following hardware:

- Hooks, printed overlay, overlay fasteners
- Display boards must be purchased separately (KTI098)



Screwdrivers #1	Qty
KTI11310..... T-10 TORQ SCREWDRIVER.....	2
KTI11315..... T-15 TORQ SCREWDRIVER.....	2
KTI11320..... T-20 TORQ SCREWDRIVER.....	2
KTI16001..... 5 PC SLOTTED SCREWDRIVER SET.....	1
KTI16002..... 5 PC PHILLIPS SCREWDRIVER SET.....	1
KTI16113..... #1 PHILLIPS SCREWDRIVER.....	2
KTI16121..... #2 STUBBY PHILLIPS SCREWDRIVER.....	2
KTI16124..... #2 PHILLIPS SCREWDRIVER.....	2
KTI16129..... #2 LONG PHILLIPS SCREWDRIVER.....	1
KTI16136..... #3 PHILLIPS SCREWDRIVER.....	2
KTI16201..... STUBBY SLOTTED SCREWDRIVER.....	2
KTI16203..... 3" STANDARD SCREWDRIVER.....	2
KTI16204..... 4" STANDARD SCREWDRIVER.....	2
KTI16206..... 6" STANDARD SCREWDRIVER.....	2
KTI16208..... 8" STANDARD SCREWDRIVER.....	2
KTI19000..... 8 PC SCREWDRIVER SET BLACK.....	1
KTI19113..... #1 PHILLIPS SCREWDRIVER BLACK.....	2
KTI19121..... #2 PHILLIPS SCREWDRIVER STUBBY.....	2
KTI19124..... #2 PHILLIPS SCREWDRIVER BLACK.....	2
KTI19201..... STUBBY SCREWDRIVER BLACK.....	2
KTI19203..... 3" STANDARD SCREWDRIVER BLACK.....	2
KTI19204..... 4" STANDARD SCREWDRIVER BLACK.....	2
KTI19206..... 6" STANDARD SCREWDRIVER BLACK.....	2
KTI19208..... 8" STANDARD SCREWDRIVER BLACK.....	2
KTIHOOK2..... HOOKS.....	21
KTIHOOK8..... HOOKS.....	3
KTIOL0809..... DISPLAY OVERLAY.....	1
KTIOLF04333..... OVERLAY FASTENERS (6 PACK).....	1



KTI0850

Screwdrivers #2

Display assortments include the following hardware:

- Hooks, printed overlay, overlay fasteners
- Display boards must be purchased separately (KTI098)



Screwdrivers #2	Qty
KTI18000..... BITS SET 12 Piece.....	2
KTI11001..... SCREWDRIVER SQUARE S1" x 4".....	2
KTI11002..... SCREWDRIVER SQUARE S2" x 4".....	2
KTI11003..... SCREWDRIVER SLOTTED 1/8" x 3".....	2
KTI11005..... SCREWDRIVER SLOTTED 5/32" x 4".....	2
KTI11006..... SCREWDRIVER SLOTTED 3/16" x 6".....	2
KTI11008..... SCREWDRIVER SET 8 Piece.....	2
KTI11009..... SCREWDRIVER SLOTTED 5/16" x 6".....	2
KTI11010..... SCREWDRIVER SLOTTED 1/4" x 1-1/2".....	2
KTI11011..... SCREWDRIVER SLOTTED 1/4" x 4".....	2
KTI11012..... SCREWDRIVER SLOTTED 3/16" x 3".....	2
KTI11211..... SCREWDRIVER TORX T10 x 4".....	2
KTI11215..... SCREWDRIVER TORX T15 x 4".....	2
KTI11220..... SCREWDRIVER TORX T20 X 4".....	2
KTI11221..... SCREWDRIVER PHILLIPS #2 x 1-1/2".....	2
KTI11223..... SCREWDRIVER PHILLIPS #1 x 3".....	2
KTI11224..... SCREWDRIVER PHILLIPS #2 x 4".....	2
KTI11225..... SCREWDRIVER TORX T25 x 4".....	2
KTI11226..... SCREWDRIVER PHILLIPS #3 x 6".....	2
KTI11229..... SCREWDRIVER PHILLIPS #0 x 3".....	2
KTI11230..... SCREWDRIVER PHILLIPS #1 x 6".....	2
KTI18009..... BITS DRIVER.....	2
KTIHOOK2..... HOOKS.....	22
KTIHOOK8..... HOOKS.....	1
KTIOL0850..... DISPLAY OVERLAY.....	1
KTIOLF04333..... OVERLAY FASTENERS (6 PACK).....	1



DISPLAYS

KTI0810

Torq & Hex Sockets

Display assortments include the following hardware:

- Hooks, printed overlay, overlay fasteners
- Display boards must be purchased separately (KTI098)



Torq & Hex Sockets.....	Qty
KTI21810.....	2
KTI21815.....	2
KTI21820.....	2
KTI21825.....	2
KTI21827.....	2
KTI21830.....	2
KTI22800.....	1
KTI22801.....	1
KTI22840.....	2
KTI22845.....	2
KTI22847.....	2
KTI22850.....	2
KTI22855.....	2
KTI22860.....	2
KTI22870.....	1
KTI22874.....	1
KTI22875.....	1
KTI22876.....	1
KTI22877.....	1
KTI22878.....	1
KTI22880.....	1
KTI22882.....	1
KTI22884.....	1
KTI22886.....	1
KTI22888.....	1
KTI22904.....	1
KTI22905.....	1
KTI22906.....	1
KTI22907.....	1
KTI22908.....	1
KTI22910.....	1
KTI22912.....	1
KTI22970.....	1
KTI27903.....	1
KTI27904.....	1
KTI27905.....	1
KTI27906.....	1
KTI27907.....	1
KTI27908.....	1
KTI27910.....	1
KTI27955.....	1
KTI27970.....	1
KTIH00K2.....	42
KTIOL0810.....	1
KTIOLF04333.....	1



KTI0811

Torq & Hex Sockets

Display assortments include the following hardware:

- Hooks, printed overlay, overlay fasteners
- Display boards must be purchased separately (KTI098)



Torq & Hex Sockets.....	Qty
KTI21500.....	1
KTI21610.....	1
KTI21615.....	1
KTI21620.....	1
KTI21625.....	1
KTI21627.....	1
KTI21630.....	1
KTI22601.....	1
KTI22640.....	1
KTI22645.....	1
KTI22647.....	1
KTI22650.....	1
KTI22655.....	1
KTI22660.....	1
KTI22670.....	1
KTI22671.....	1
KTI22675.....	1
KTI22676.....	1
KTI22677.....	1
KTI22678.....	1
KTI22680.....	1
KTI22682.....	1
KTI22684.....	1
KTI22686.....	1
KTI22688.....	1
KTI22689.....	1
KTI22904.....	1
KTI22905.....	1
KTI22906.....	1
KTI22907.....	1
KTI22908.....	1
KTI22910.....	1
KTI22912.....	1
KTI22912.....	1
KTI22970.....	1
KTI27903.....	1
KTI27904.....	1
KTI27905.....	1
KTI27906.....	1
KTI27907.....	1
KTI27908.....	1
KTI27910.....	1
KTI27955.....	1
KTI27970.....	1
KTIH00K2.....	43
KTIOL0811.....	1
KTIOLF04333.....	1

KTI0812

Wrenches

Display assortments include the following hardware:

- Hooks, printed overlay, overlay fasteners
- **Display boards must be purchased separately (KTI098)**



Wrenches	Qty
KTI41110..... COMBINATION WRENCH 5/16".....	1
KTI41112..... COMBINATION WRENCH 3/8".....	2
KTI41114..... COMBINATION WRENCH 7/16".....	2
KTI41116..... COMBINATION WRENCH 1/2".....	3
KTI41118..... COMBINATION WRENCH 9/16".....	3
KTI41120..... COMBINATION WRENCH 5/8".....	2
KTI41122..... COMBINATION WRENCH 11/16".....	2
KTI41124..... COMBINATION WRENCH 3/4".....	2
KTI41126..... COMBINATION WRENCH 13/16".....	1
KTI41128..... COMBINATION WRENCH 7/8".....	1
KTI41130..... COMBINATION WRENCH 15/16".....	1
KTI41132..... COMBINATION WRENCH 1".....	1
KTI41134..... COMBINATION WRENCH 1-1/16".....	1
KTI41136..... COMBINATION WRENCH 1-1/8".....	1
KTI41140..... COMBINATION WRENCH 1-1/4".....	1
KTI41142..... JUMBO COMBO WRENCH 1-5/16".....	1
KTI41212..... 3/8" SHORT COMBINATON WRENCH.....	1
KTI41214..... 7/16" SHORT COMBINATION WRENCH.....	1
KTI41216..... 1/2" SHORT COMBINATION WRENCH.....	1
KTI41218..... 9/16" SHORT COMBINATION WRENCH.....	1
KTI41220..... 5/8" SHORT COMBINATION WRENCH.....	1
KTI41222..... 11/16" SHORT COMBINATION WRENCH.....	1
KTI41224..... 3/4" SHORT COMBINATION WRENCH.....	1
KTI41308..... 1/4" HIGH POLISH COMB. WRENCH.....	1
KTI41310..... 5/16" HIGH POLISH COMB. WRENCH.....	1
KTI41311..... 11/32" HIGH POLISH COMB. WRENCH.....	1
KTI41312..... 3/8" HIGH POLISH COMB. WRENCH.....	2
KTI41314..... 7/16" HIGH POLISH COMB. WRENCH.....	2
KTI41316..... 1/2" HIGH POLISH COMB. WRENCH.....	2
KTI41318..... 9/16" HIGH POLISH COMB. WRENCH.....	2
KTI41320..... 5/8" HIGH POLISH COMB. WRENCH.....	1
KTI41322..... 11/16" HIGH POLISH COMB. WRENCH.....	1
KTI41324..... 3/4" HIGH POLISH COMB. WRENCH.....	1
KTI41326..... 13/16" HIGH POLISH COMB. WRENCH.....	1
KTI41328..... 7/8" HIGH POLISH COMB. WRENCH.....	1
KTI41330..... 15/16" HIGH POLISH COMB. WRENCH.....	1
KTI41332..... 1" HIGH POLISH COMB. WRENCH.....	1
KTI41334..... 1-1/16" HIGH POLISH COMB. WRENCH.....	1
KTI41336..... 1-1/8" HIGH POLISH COMB. WRENCH.....	1
KTI41340..... 1-1/4" HIGH POLISH COMB. WRENCH.....	1
KTI41342..... 1-5/16" HIGH POLISH COMB. WRENCH.....	1
KTI41344..... 1-3/8" HIGH POLISH COMB. WRENCH.....	1
KTI41346..... 1-7/16" HIGH POLISH COMB. WRENCH.....	1
KTI41348..... 1-1/2" HIGH POLISH COMB. WRENCH.....	1
KTI41412..... 6PT COMBINATION WRENCH 3/8".....	1
KTI41414..... 6PT COMBINATION WRENCH 7/16".....	1
KTI41416..... 6PT COMBINATION WRENCH 1/2".....	1
KTI41418..... 6PT COMBINATION WRENCH 9/16".....	1
KTI41420..... 6PT COMBINATION WRENCH 5/8".....	1
KTI41422..... 6PT COMBINATION WRENCH 11/16".....	1
KTI41424..... 6PT COMBINATION WRENCH 3/4".....	1
KTI44412..... 3/8" x 7/16" FLARE NUT WRENCH.....	1
KTI44416..... 1/2" x 9/16" FLARE NUT WRENCH.....	1
KTI44420..... 5/8" x 11/16" FLARE NUT WRENCH.....	1
KTI089..... 3" EXTENSION BAR.....	1
KTIHOOK2..... HOOKS.....	41
KTIHOOK11..... PLASTIC HOOKS.....	16
KTIOL0812..... DISPLAY OVERLAY.....	1
KTIOLF04333..... OVERLAY FASTENERS (6 PACK).....	1

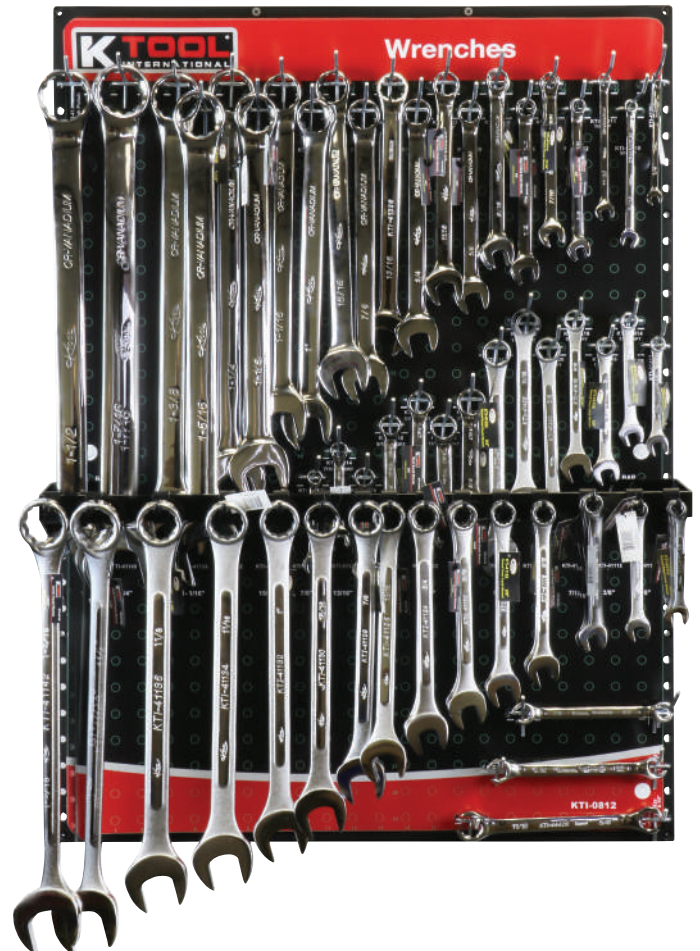

DISPLAYS

KTIO813

Metric Wrenches

Display assortments include the following hardware:

- Hooks, printed overlay, overlay fasteners
- Display boards must be purchased separately (KTIO98)

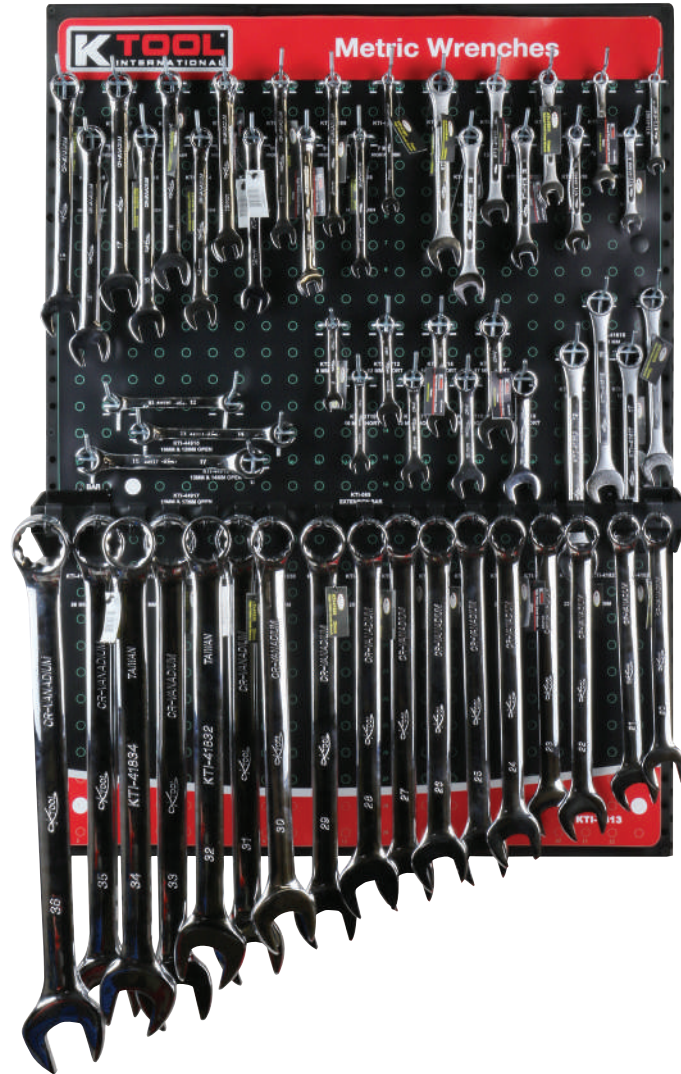

Metric Wrenches	Qty	
KT141607.....	METRIC COMB WRENCH 7MM.....	1
KT141608.....	METRIC COMB WRENCH 8MM.....	1
KT141609.....	METRIC COMB WRENCH 9MM.....	1
KT141610.....	METRIC COMB WRENCH 10MM.....	2
KT141611.....	METRIC COMB WRENCH 11MM.....	2
KT141612.....	METRIC COMB WRENCH 12MM.....	2
KT141613.....	METRIC COMB WRENCH 13MM.....	2
KT141614.....	METRIC COMB WRENCH 14MM.....	2
KT141615.....	METRIC COMB WRENCH 15MM.....	2
KT141616.....	METRIC COMB WRENCH 16MM.....	1
KT141617.....	METRIC COMB WRENCH 17MM.....	1
KT141618.....	METRIC COMB WRENCH 18MM.....	1
KT141619.....	METRIC COMB WRENCH 19MM.....	1
KT141708.....	8MM SHORT COMBINATION WRENCH.....	1
KT141710.....	10MM SHORT COMBINATION WRENCH.....	1
KT141712.....	12MM SHORT COMBINATION WRENCH.....	1
KT141713.....	13MM SHORT COMBINATION WRENCH.....	1
KT141714.....	14MM SHORT COMBINATION WRENCH.....	1
KT141715.....	15MM SHORT COMBINATION WRENCH.....	1
KT141717.....	17MM SHORT COMBINATION WRENCH.....	1
KT141718.....	18MM SHORT COMBINATION WRENCH.....	1
KT141807.....	7MM HIGH POLISH COMB. WRENCH.....	1
KT141808.....	8MM HIGH POLISH COMB. WRENCH.....	1
KT141809.....	9MM HIGH POLISH COMB. WRENCH.....	1
KT141810.....	10MM HIGH POLISH COMB. WRENCH.....	2
KT141811.....	11MM HIGH POLISH COMB. WRENCH.....	1
KT141812.....	12MM HIGH POLISH COMB. WRENCH.....	2
KT141813.....	13MM HIGH POLISH COMB. WRENCH.....	2
KT141814.....	14MM HIGH POLISH COMB. WRENCH.....	1
KT141815.....	15MM HIGH POLISH COMB. WRENCH.....	2
KT141816.....	16MM HIGH POLISH COMB. WRENCH.....	1
KT141817.....	17MM HIGH POLISH COMB. WRENCH.....	1
KT141818.....	18MM HIGH POLISH COMB. WRENCH.....	2
KT141819.....	19MM HIGH POLISH COMB. WRENCH.....	1
KT141820.....	METRIC COMB WRENCH 20MM (BULK).....	1
KT141821.....	METRIC COMB WRENCH 21MM (BULK).....	1
KT141822.....	METRIC COMB WRENCH 22MM (BULK).....	1
KT141823.....	METRIC COMB WRENCH 23MM (BULK).....	1
KT141824.....	METRIC COMB WRENCH 24MM (BULK).....	1
KT141825.....	METRIC COMB WRENCH 25MM (BULK).....	1
KT141826.....	METRIC COMB WRENCH 26MM (BULK).....	1
KT141827.....	METRIC COMB WRENCH 27MM (BULK).....	1
KT141828.....	METRIC COMB WRENCH 28MM (BULK).....	1
KT141829.....	METRIC COMB WRENCH 29MM (BULK).....	1
KT141830.....	METRIC COMB WRENCH 30MM (BULK).....	1
KT141831.....	METRIC COMB WRENCH 31MM (BULK).....	1
KT141832.....	METRIC COMB WRENCH 32MM (BULK).....	1
KT141833.....	METRIC COMB WRENCH 33MM (BULK).....	1
KT141834.....	METRIC COMB WRENCH 34MM (BULK).....	1
KT141835.....	METRIC COMB WRENCH 35MM (BULK).....	1
KT141836.....	METRIC COMB WRENCH 36MM (BULK).....	1
KT144910.....	FLARE NUT WRENCH 10MM x 12MM.....	1
KT144913.....	FLARE NUT WRENCH 13MM x 14MM.....	1
KT144917.....	FLARE NUT WRENCH 15MM x 17MM.....	1
KTIO89.....	3" EXTENSION BAR.....	1
KTHOOK11.....	PLASTIC HOOKS.....	17
KTHOOK2.....	HOOKS.....	40
KTIOLO813.....	DISPLAY OVERLAY.....	1
KTIOLOF04333.....	OVERLAY FASTENERS (6 PACK).....	1

KTI0814

Jumbo Wrenches

Display assortments include the following hardware:

- Hooks, printed overlay, overlay fasteners
- **Display boards must be purchased separately (KTI098)**



Jumbo Wrenches		Qty
KTI41144	JUMBO COMBO WRENCH 1-3/8"	1
KTI41146	JUMBO COMBO WRENCH 1-7/16"	1
KTI41148	JUMBO COMBO WRENCH 1-1/2"	1
KTI41152	JUMBO COMBO WRENCH 1-5/8"	1
KTI41156	JUMBO COMBO WRENCH 1-3/4"	1
KTI41160	JUMBO COMBO WRENCH 1-7/8"	1
KTI41164	JUMBO COMBO WRENCH 2"	1
KTI41168	JUMBO COMBO WRENCH 2-1/8" (BULK)	1
KTI41172	JUMBO COMBO WRENCH 2-1/4" (BULK)	1
KTI41176	JUMBO COMBO WRENCH 2-3/8" (BULK)	1
KTI41180	JUMBO COMBO WRENCH 2-1/2" (BULK)	1
KTI089	3" EXTENSION BAR	1
KTIHOOK11	PLASTIC HOOKS	5
KTIHOOK2	HOOKS	6
KTIOL0814	DISPLAY OVERLAY	1
KTIOLF04333	OVERLAY FASTENERS (6 PACK)	1

KTI0815

Nylon Ties

Display assortments include the following hardware:

- Hooks, printed overlay, overlay fasteners
- **Display boards must be purchased separately (KTI098)**



Nylon Ties		Qty
KTI76000	NYLON TIE TOOL	1
KTI76040	4" CABLE TIE NATURAL 100 PACK	2
KTI76070	7" CABLE TIE NATURAL 100 PACK	2
KTI76110	11" CABLE TIE NATURAL 100 PACK	2
KTI76140	14" CABLE TIE NATURAL 100 PACK	2
KTI76145	14" HD CABLE TIE NATUR. 100 PACK	1
KTI77070	7" NATURAL MT.HEAD 100 PACK	1
KTI77140	14" NATURAL MT.HEAD 100 PACK	1
KTI78040	4" CABLE TIE BLACK 100 PACK	2
KTI78070	7" CABLE TIE BLACK 100 PACK	2
KTI78110	11" CABLE TIE BLACK 100 PACK	2
KTI78140	14" CABLE TIE BLACK 100 PACK	2
KTI78145	14" HD CABLE TIE BLACK 100 PACK	1
KTIHOOK2	HOOKS	8
KTIOL0815	DISPLAY OVERLAY	1
KTIOLF04333	OVERLAY FASTENERS (6 PACK)	1

DISPLAYS

KTI0816

Pliers

Display assortments include the following hardware:

- Hooks, printed overlay, overlay fasteners
- Display boards must be purchased separately (KTI098)



Pliers.....	Qty
KTI51006..... 6" NEEDLE NOSE CHROME VANADIUM.....	1
KTI51007..... 7" NEEDLE NOSE CHROME VANADIUM.....	1
KTI51008..... 8" NEEDLE NOSE CHROME VANADIUM.....	1
KTI51111..... 11" NEEDLE NOSE PLIER 90 DEG.....	1
KTI51211..... 11" NEEDLE NOSE PLIER 45 DEG.....	1
KTI51311..... 11" NEEDLE NOSE PLIER "S".....	1
KTI52006..... 6" DIAGONALS CHROME VANADIUM.....	1
KTI52007..... 7" DIAGONALS CHROME VANADIUM.....	1
KTI52107..... 7" H.D. DIAGONALS CHROME VAN.....	1
KTI53004..... 4" CHROME PLIERS RED HANDLES.....	1
KTI53006..... 6" CHROME PLIERS RED HANDLES.....	1
KTI53008..... 8" CHROME PLIERS RED HANDLES.....	1
KTI54006..... 6" GROOVE JOINT PLIER.....	1
KTI54010..... 10" GROOVE JOINT PLIER.....	1
KTI54012..... 12" GROOVE JOINT PLIER.....	1
KTIHOOK2..... HOOKS.....	15
KTIOL0816..... DISPLAY OVERLAY.....	1
KTIOLF04333..... OVERLAY FASTENERS (6 PACK).....	1

KTI0817

Adjustable Wrenches & Locking Pliers/Clamps

Display assortments include the following hardware:

- Hooks, printed overlay, overlay fasteners
- Display boards must be purchased separately (KTI098)



Adjustable Wrenches & Locking Pliers/Clamps.....	Qty
KTI48004..... 4" ADJUSTABLE WRENCH.....	1
KTI48006..... 6" ADJUSTABLE WRENCH.....	1
KTI48008..... 8" ADJUSTABLE WRENCH.....	1
KTI48010..... 10" ADJUSTABLE WRENCH.....	1
KTI48012..... 12" ADJUSTABLE WRENCH.....	1
KTI48015..... 15" ADJUSTABLE WRENCH.....	1
KTI48018..... 18" ADJUSTABLE WRENCH.....	1
KTI58705..... 5" Locking Plier Curved Jaws.....	1
KTI58707..... 7" Locking Plier Curved Jaws.....	1
KTI58710..... 10" Locking Plier Curved Jaws.....	1
KTI58717..... 7" Locking Plier Straight Jaws.....	1
KTI58809..... 9" Welding Locking Clamp.....	1
KTI58811..... 11" Locking C-Clamp Plier.....	1
KTIHOOK2..... HOOKS.....	20
KTIHOOK8..... HOOKS.....	1
KTIOL0817..... DISPLAY OVERLAY.....	1
KTIOLF04333..... OVERLAY FASTENERS (6 PACK).....	1

KTI0819

Files & Scrapers

Display assortments include the following hardware:

- Hooks, printed overlay, overlay fasteners
- Display boards must be purchased separately (KTI098)



Files & Scrapers.....	Qty
KTI70020..... LONG HANDLED SCRAPER	1
KTI70023..... 4 PC SCRAPER SET - USA	1
KTI70024..... 3/4" CHISEL EDGE STIFF SCRAPER	1
KTI70025..... 1-1/2" FLEXIBLE SCRAPER	1
KTI70026..... 1-1/2" CHISEL EDGE STIFF SCRAPER.....	1
KTI70028..... 1-1/2" CHISEL SCRAPER.....	1
KTI70029..... 3" FLEX SCRAPER.....	1
KTI72505..... FILE SET 5 PIECE	1
KTI72512..... 6" MILL FILE.....	1
KTI72514..... 10" MILL FILE.....	1
KTI72523..... 8" BASTARD FILE.....	1
KTI72543..... 8" HALF ROUND FILE	1
KTI72553..... 8" ROUND FILE	1
KTIHOOK2..... HOOKS.....	14
KTIOL0819..... DISPLAY OVERLAY	1
KTIOLF04333..... OVERLAY FASTENERS (6 PACK).....	1

KTI0820

Hammers

Display assortments include the following hardware:

- Hooks, printed overlay, overlay fasteners
- Display boards must be purchased separately (KTI098)



Hammers.....	Qty
KTI71700..... 3/8" DR IMPACT DRIVER W/4 BITS.....	1
KTI71704..... 4 OZ. BALL PEIN HAMMER	1
KTI71708..... 8 OZ. BALL PEIN HAMMER	1
KTI71714..... 16 OZ. BRASS HAMMER,HICKORY.....	1
KTI71715..... 24 OZ. BRASS HAMMER,HICKORY	1
KTI71716..... 16 OZ. BALL PEIN HAMMER.....	1
KTI71724..... 4 LB. CROSS-PEIN HAMMER.....	1
KTI71725..... 24 OZ. BALL PEIN HAMMER.....	1
KTI71732..... 32 OZ. BALL PEIN HAMMER	1
KTI71733..... 32 OZ. BRASS HAMMER,HICKORY	1
KTI71751..... 24 OZ. RUBBER Mallet	1
KTIHOOK2..... HOOKS.....	21
KTIOL0820..... DISPLAY OVERLAY	1
KTIOLF04333..... OVERLAY FASTENERS (6 PACK).....	1

DISPLAYS

KTI0821

Snap Ring Pliers

Display assortments include the following hardware:

- Hooks, printed overlay, overlay fasteners
- Display boards must be purchased separately (KTI098)



Snap Ring Pliers	Qty
KTI55112..... 12 pc. Kit Universal Snap Ring	1
KTI55120..... Fixed .038 Tip Convertible Pliers S	1
KTI55121..... Fixed .047 Tip Convertible Pliers S	1
KTI55122..... Fixed .070 Tip Convertible Pliers S	1
KTI55123..... Fixed .090 Tip Convertible Pliers S	1
KTI55130..... Fixed .038 Tip Convertible Pliers 4	1
KTI55131..... Fixed .047 Tip Convertible Pliers 4	1
KTI55132..... Fixed .070 Tip Convertible Pliers 4	1
KTI55133..... Fixed .090 Tip Convertible Pliers 4	1
KTI55140..... Fixed .038 Tip Convertible Pliers 9	1
KTI55141..... Fixed .047 Tip Convertible Pliers 9	1
KTI55142..... Fixed .070 Tip Convertible Pliers 9	1
KTI55143..... Fixed .090 Tip Convertible Pliers 9	1
KTIH00K2..... HOOKS	14
KTIOL0821..... DISPLAY OVERLAY	1
KTIOLF04333..... OVERLAY FASTENERS (6 PACK)	1



KTI0822

Tie Downs & Tow Straps

Display assortments include the following hardware:

- Hooks, printed overlay, overlay fasteners
- Display boards must be purchased separately (KTI098)



Tie Downs & Tow Straps..... Qty

KTI73801.....	1-7/8" X 10' TOW STRAP 7000LBS.....	1
KTI73802.....	1-3/4" X 15' TOW STRAP 10,000LB.....	1
KTI73803.....	1-3/4" X 25' TOW STRAP 10,000LB.....	1
KTI73861.....	1" X 13' RATCHET TIE DOWN,HOOK.....	1
KTI73862.....	1" X 13' RATCHET TIE DOWN,LOOP.....	1
KTI73864.....	1" X 6' MOTORCYCLE TIE DOWN.....	1
KTI73870.....	4 PACK 1" X 10' RATCH.TIE DOWN.....	1
KTI73871.....	1" X 10' UNIVERSAL TIE DOWN.....	1
KTI73873.....	2 PACK 1" X 13'BUCKLE TIE DOWN.....	1
KTIHOOK2.....	HOOKS.....	12
KTIOL0822.....	DISPLAY OVERLAY.....	1
KTIOLF04333.....	OVERLAY FASTENERS (6 PACK).....	1

KTI0831

Punches & Chisels

Display assortments include the following hardware:

- Hooks, printed overlay, overlay fasteners
- Display boards must be purchased separately (KTI098)



Punches & Chisels..... Qty

KTI70002.....	AUTOMATIC CENTER PUNCH.....	2
KTI72900.....	6 PC PIN PUNCH SET.....	1
KTI72901.....	15PC PUNCH & CHISEL SET.....	1
KTI72911.....	3/32" PIN PUNCH.....	1
KTI72912.....	1/8" PIN PUNCH.....	1
KTI72913.....	5/32" PIN PUNCH.....	1
KTI72914.....	3/16" PIN PUNCH.....	1
KTI72915.....	1/4" PIN PUNCH.....	1
KTI72916.....	5/16" PIN PUNCH.....	1
KTI72921.....	3/32" TAPER PUNCH.....	1
KTI72922.....	1/8" TAPER PUNCH.....	1
KTI72923.....	5/32" TAPER PUNCH.....	1
KTI72924.....	3/16" TAPER PUNCH.....	1
KTI72925.....	1/4" TAPER PUNCH.....	1
KTI72931.....	1/8" CENTER PUNCH.....	1
KTI72932.....	3/16" CENTER PUNCH.....	1
KTI72982.....	3/8" BRASS PUNCH.....	1
KTI72984.....	1/2" BRASS PUNCH.....	1
KTI72986.....	5/8" BRASS PUNCH.....	1
KTI72988.....	3/4" BRASS PUNCH.....	1
KTI73000.....	5 PC CHISEL SET.....	1
KTI73012.....	3/8" COLD CHISEL.....	1
KTI73016.....	1/2" COLD CHISEL.....	1
KTI73020.....	5/8" COLD CHISEL.....	1
KTI73024.....	3/4" COLD CHISEL.....	1
KTI73028.....	7/8" COLD CHISEL.....	1
KTIHOOK2.....	HOOKS.....	29
KTIOL0831.....	DISPLAY OVERLAY.....	1
KTIOLF04333.....	OVERLAY FASTENERS (6 PACK).....	1

DISPLAYS

KT10832

Pneumatic Bits

Display assortments include the following hardware:

- Hooks, printed overlay, overlay fasteners
- Display boards must be purchased separately (KT1098)



KT10833

Pullers

Display assortments include the following hardware:

- Hooks, printed overlay, overlay fasteners
- Display boards must be purchased separately (KT1098)



Pneumatic Bits.....	Qty
KT181900..... 4 PC. PNEUMATIC BIT SET	1
KT181956..... DOUBLE CUT BODY RIPPER.....	1
KT181958..... SLOTTED PANEL CUTTER.....	2
KT181959..... SHEET METAL TRIMMER.....	2
KT181968..... TAIL PIPE CUT OFF.....	1
KT181972..... 6" COLD CHISEL.....	2
KT181973..... 8" COLD CHISEL.....	1
KT181974..... 10" COLD CHISEL.....	1
KT181975..... RIVET & BOLT CUTTER.....	2
KT181976..... SCRAPER.....	1
KT181977..... TAPER PUNCH SHARP POINT.....	1
KT181979..... 3/8" TAPER PUNCH.....	2
KT181982..... HAMMER.....	1
KT181986..... 18" COLD CHISEL.....	1
KT181995..... TIE ROD SEPARATOR-PNEUMATIC.....	1
KT181996..... BALL JOINT SEPARATOR-PNEUMATIC.....	1
KT181997..... 1/8" TAPER PUNCH.....	2
KT183091..... SPRING RETAINER FOR AIR TOOLS.....	2
KT183092..... SAFETY CHUCK.....	1
KT183093..... QUICK COUPLER RETAINER.....	1
KTIHOOK2..... HOOKS.....	22
KTIOL0832..... DISPLAY OVERLAY.....	1
KTIOLF04333..... OVERLAY FASTENERS (6 PACK).....	1

Pullers.....	Qty
KT170311..... 4" TWO JAW ADJUSTABLE PULLER.....	1
KT170312..... 6" TWO JAW REVERSIBLE PULLER.....	1
KT170313..... 7" TWO JAW ADJUSTABLE PULLER.....	1
KT170321..... 4" THREE JAW ADJUSTABLE PULLER.....	1
KT170322..... 7" 2-3 JAW REVERSIBLE PULLER.....	1
KT170323..... 8" 2-3 JAW ADJUSTABLE PULLER.....	1
KT170330..... STEERING WHEEL PULLER - USA.....	1
KT170344..... HARMONIC BALANCER PULLER - USA.....	1
KT170365..... PITMAN ARM PULLER - USA.....	1
KT170383..... BEARING SEPARATOR 1-1/4" - 2-1/4".....	1
KT170384..... BEARING SEPARATOR 3" - 4-1/2".....	1
KTIHOOK2..... HOOKS.....	10
KTIOL0833..... DISPLAY OVERLAY.....	1
KTIOLF04333..... OVERLAY FASTENERS (6 PACK).....	1

KTI0834

Popular Tools #1

Display assortments include the following hardware:

- Hooks, printed overlay, overlay fasteners
- Display boards must be purchased separately (KTI098)



Popular Tools #1	Qty
KTI21002.....	1/4" DR 2" EXTENSION..... 1
KTI21004.....	1/4" DR 4" EXTENSION..... 1
KTI21006.....	1/4" DR 6" EXTENSION..... 1
KTI21050.....	UNIVERSAL JOINT 1/4" DR..... 1
KTI21055.....	ADAPTER 1/4" F X 3/8" M..... 1
KTI21060.....	1/4" DR SPINNER HANDLE..... 1
KTI21091.....	1/4" DR RATCHET..... 1
KTI21092.....	1/4" DR PRO RATCHET..... 1
KTI21106.....	1/4" DR SHORT SOCKET 3/16"..... 1
KTI21107.....	1/4" DR SHORT SOCKET 7/32"..... 1
KTI21108.....	1/4" DR SHORT SOCKET 1/4"..... 1
KTI21109.....	1/4" DR SHORT SOCKET 9/32"..... 1
KTI21110.....	1/4" DR SHORT SOCKET 5/16"..... 1
KTI21111.....	1/4" DR SHORT SOCKET 11/32"..... 1
KTI21112.....	1/4" DR SHORT SOCKET 3/8"..... 1
KTI21114.....	1/4" DR SHORT SOCKET 7/16"..... 1
KTI21116.....	1/4" DR SHORT SOCKET 1/2"..... 1
KTI21118.....	1/4" DR SHORT SOCKET 9/16"..... 1
KTI21206.....	1/4" DR DEEP SOCKET 3/16"..... 1
KTI21207.....	1/4" DR DEEP SOCKET 7/32"..... 1
KTI21208.....	1/4" DR DEEP SOCKET 1/4"..... 1
KTI21209.....	1/4" DR DEEP SOCKET 9/32"..... 1
KTI21210.....	1/4" DR DEEP SOCKET 5/16"..... 1
KTI21211.....	1/4" DR DEEP SOCKET 11/32"..... 1
KTI21212.....	1/4" DR DEEP SOCKET 3/8"..... 1
KTI21214.....	1/4" DR DEEP SOCKET 7/16"..... 1
KTI21216.....	1/4" DR DEEP SOCKET 1/2"..... 1
KTI21218.....	1/4" DR DEEP SOCKET 9/16"..... 1
KTI22003.....	3/8" DR EXTENSION 3"..... 1
KTI22006.....	3/8" DR EXTENSION 6"..... 1
KTI22008.....	3/8" DR EXTENSION 8"..... 1
KTI22050.....	ADAPTER 1/2" F X 3/8" M..... 1
KTI22055.....	ADAPTER 3/8" F X 1/2" M..... 1
KTI22060.....	ADAPTER 3/8" F X 1/4" M..... 1
KTI22075.....	ADAPTER 1/2" F X 3/4" M..... 1
KTI22091.....	3/8" DR PUSH BUTTON RATCHET..... 1
KTI22092.....	3/8" DR PRO RATCHET..... 1
KTI22110.....	3/8" DR SHORT SOCKET 5/16"..... 1
KTI22112.....	3/8" DR SHORT SOCKET 3/8"..... 1
KTI22114.....	3/8" DR SHORT SOCKET 7/16"..... 1
KTI22116.....	3/8" DR SHORT SOCKET 1/2"..... 1
KTI22118.....	3/8" DR SHORT SOCKET 9/16"..... 1
KTI22120.....	3/8" DR SHORT SOCKET 5/8"..... 1
KTI22122.....	3/8" DR SHORT SOCKET 11/16"..... 1
KTI22124.....	3/8" DR SHORT SOCKET 3/4"..... 1
KTI22126.....	3/8" DR SHORT SOCKET 13/16"..... 1
KTI22128.....	3/8" DR SHORT SOCKET 7/8"..... 1
KTI22130.....	3/8" DR SHORT SOCKET 15/16"..... 1
KTI22132.....	3/8" DR SHORT SOCKET 1"..... 1
KTI22212.....	3/8" DR DEEP SOCKET 3/8"..... 1
KTI22214.....	3/8" DR DEEP SOCKET 7/16"..... 1
KTI22216.....	3/8" DR DEEP SOCKET 1/2"..... 1
KTI22218.....	3/8" DR DEEP SOCKET 9/16"..... 1
KTI22220.....	3/8" DR DEEP SOCKET 5/8"..... 1
KTI22222.....	3/8" DR DEEP SOCKET 11/16"..... 1
KTI22224.....	3/8" DR DEEP SOCKET 3/4"..... 1
KTI22226.....	3/8" DR DEEP SOCKET 13/16"..... 1
KTI22228.....	3/8" DR DEEP SOCKET 7/8"..... 1
KTI22230.....	3/8" DR DEEP SOCKET 15/16"..... 1
KTI22232.....	3/8" DR DEEP SOCKET 1"..... 1
KTI22500.....	UNIVERSAL JOINT 3/8" DR..... 1
KTI23003.....	1/2" DR 3" EXTENSION..... 1
KTI23005.....	1/2" DR 5" EXTENSION..... 1
KTI23010.....	1/2" DR 10" EXTENSION..... 1
KTI23091.....	1/2" DR PUSH BUTTON RATCHET..... 1

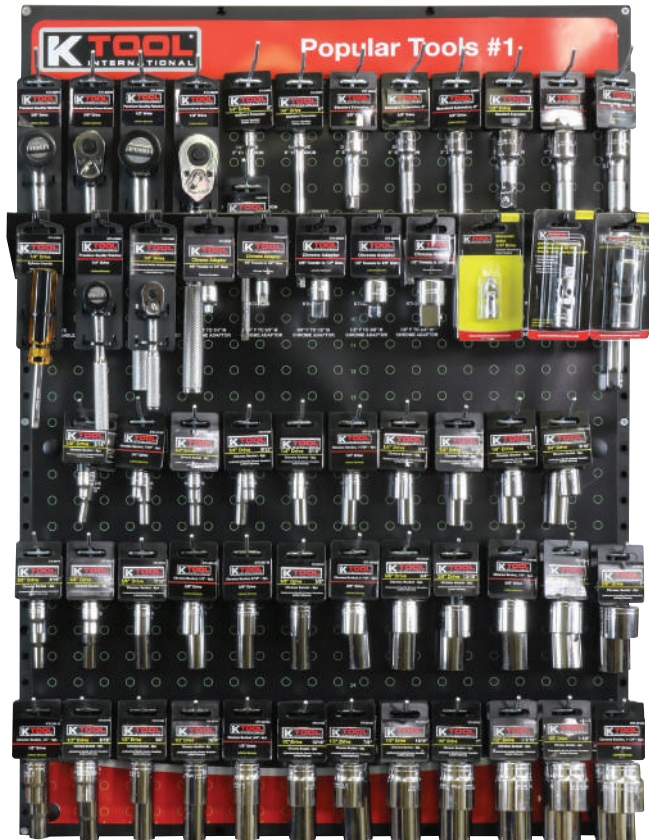

Popular Tools #1	Qty
KTI23092.....	1/2" DR PRO RATCHET..... 1
KTI23116.....	1/2" DR SHORT SOCKET 1/2"..... 1
KTI23118.....	1/2" DR SHORT SOCKET 9/16"..... 1
KTI23120.....	1/2" DR SHORT SOCKET 5/8"..... 1
KTI23122.....	1/2" DR SHORT SOCKET 11/16"..... 1
KTI23124.....	1/2" DR SHORT SOCKET 3/4"..... 1
KTI23126.....	1/2" DR SHORT SOCKET 13/16"..... 1
KTI23128.....	1/2" DR SHORT SOCKET 7/8"..... 1
KTI23130.....	1/2" DR SHORT SOCKET 15/16"..... 1
KTI23132.....	1/2" DR SHORT SOCKET 1"..... 1
KTI23134.....	1/2" DR SHORT SOCKET 1-1/16"..... 1
KTI23136.....	1/2" DR SHORT SOCKET 1-1/8"..... 1
KTI23140.....	1/2" DR SHORT SOCKET 1-1/4"..... 1
KTI23216.....	1/2" DR DEEP SOCKET 1/2"..... 1
KTI23218.....	1/2" DR DEEP SOCKET 9/16"..... 1
KTI23220.....	1/2" DR DEEP SOCKET 5/8"..... 1
KTI23222.....	1/2" DR DEEP SOCKET 11/16"..... 1
KTI23224.....	1/2" DR DEEP SOCKET 3/4"..... 1
KTI23226.....	1/2" DR DEEP SOCKET 13/16"..... 1
KTI23228.....	1/2" DR DEEP SOCKET 7/8"..... 1
KTI23230.....	1/2" DR DEEP SOCKET 15/16"..... 1
KTI23232.....	1/2" DR DEEP SOCKET 1"..... 1
KTI23234.....	1/2" DR DEEP SOCKET 1-1/16"..... 1
KTI23236.....	1/2" DR DEEP SOCKET 1-1/8"..... 1
KTI23240.....	1/2" DR DEEP SOCKET 1-1/4"..... 1
KTI23500.....	UNIVERSAL JOINT 1/2" DR..... 1
KTI089.....	3" EXTENSION BAR..... 1
KTIH00K2.....	HOOKS..... 47
KTIH00K11.....	PLASTIC HOOKS..... 11
KTIOL0834.....	DISPLAY OVERLAY..... 1
KTIOLF04333.....	OVERLAY FASTENERS (6 PACK)..... 1

DISPLAYS

KTI0835

Popular Tools #2

Display assortments include the following hardware:

- Hooks, printed overlay, overlay fasteners
- Display boards must be purchased separately (KTI098)



Popular Tools #2..... Qty

KTI22221.....	SPARK PLUG SOCKET 3/8" DR 5/8"	1
KTI22227.....	SPARK PLUG SOCKET 3/8" DR 13/16"	1
KTI26105.....	1/4" DR SHORT SOCKET 5MM	1
KTI26106.....	1/4" DR SHORT SOCKET 6MM	1
KTI26107.....	1/4" DR SHORT SOCKET 7MM	1
KTI26108.....	1/4" DR SHORT SOCKET 8MM	1
KTI26109.....	1/4" DR SHORT SOCKET 9MM	1
KTI26110.....	1/4" DR SHORT SOCKET 10MM	1
KTI26111.....	1/4" DR SHORT SOCKET 11MM	1
KTI26112.....	1/4" DR SHORT SOCKET 12MM	1
KTI26113.....	1/4" DR SHORT SOCKET 13MM	1
KTI26114.....	1/4" DR SHORT SOCKET 14MM	1
KTI26115.....	1/4" DR SHORT SOCKET 15MM	1
KTI26155.....	1/4" DR SHORT SOCKET 5.5MM	1
KTI26206.....	1/4" DR DEEP SOCKET 6MM	1
KTI26207.....	1/4" DR DEEP SOCKET 7MM	1
KTI26208.....	1/4" DR DEEP SOCKET 8MM	1
KTI26209.....	1/4" DR DEEP SOCKET 9MM	1
KTI26210.....	1/4" DR DEEP SOCKET 10MM	1
KTI26211.....	1/4" DR DEEP SOCKET 11MM	1
KTI26212.....	1/4" DR DEEP SOCKET 12MM	1
KTI26213.....	1/4" DR DEEP SOCKET 13MM	1
KTI26214.....	1/4" DR DEEP SOCKET 14MM	1
KTI26215.....	1/4" DR DEEP SOCKET 15MM	1
KTI26255.....	1/4" DR DEEP SOCKET 5.5MM	1
KTI27108.....	3/8" DR SHORT SOCKET 8MM	1
KTI27109.....	3/8" DR SHORT SOCKET 9MM	1
KTI27110.....	3/8" DR SHORT SOCKET 10MM	1
KTI27111.....	3/8" DR SHORT SOCKET 11MM	1
KTI27112.....	3/8" DR SHORT SOCKET 12MM	1
KTI27113.....	3/8" DR SHORT SOCKET 13MM	1
KTI27114.....	3/8" DR SHORT SOCKET 14MM	1
KTI27115.....	3/8" DR SHORT SOCKET 15MM	1
KTI27116.....	3/8" DR SHORT SOCKET 16MM	1
KTI27117.....	3/8" DR SHORT SOCKET 17MM	1
KTI27118.....	3/8" DR SHORT SOCKET 18MM	1
KTI27119.....	3/8" DR SHORT SOCKET 19MM	1
KTI27210.....	3/8" DR DEEP SOCKET 10MM	1
KTI27211.....	3/8" DR DEEP SOCKET 11MM	1
KTI27212.....	3/8" DR DEEP SOCKET 12MM	1
KTI27213.....	3/8" DR DEEP SOCKET 13MM	1
KTI27214.....	3/8" DR DEEP SOCKET 14MM	1
KTI27215.....	3/8" DR DEEP SOCKET 15MM	1
KTI27216.....	3/8" DR DEEP SOCKET 16MM	1
KTI27217.....	3/8" DR DEEP SOCKET 17MM	1
KTI27218.....	3/8" DR DEEP SOCKET 18MM	1
KTI27219.....	3/8" DR DEEP SOCKET 19MM	1
KTI28110.....	1/2" DR SHORT SOCKET 10MM	1
KTI28111.....	1/2" DR SHORT SOCKET 11MM	1
KTI28112.....	1/2" DR SHORT SOCKET 12MM	1
KTI28113.....	1/2" DR SHORT SOCKET 13MM	1
KTI28114.....	1/2" DR SHORT SOCKET 14MM	1
KTI28115.....	1/2" DR SHORT SOCKET 15MM	1
KTI28116.....	1/2" DR SHORT SOCKET 16MM	1
KTI28117.....	1/2" DR SHORT SOCKET 17MM	1
KTI28118.....	1/2" DR SHORT SOCKET 18MM	1
KTI28119.....	1/2" DR SHORT SOCKET 19MM	1
KTI28120.....	1/2" DR SHORT SOCKET 20MM	1
KTI28121.....	1/2" DR SHORT SOCKET 21MM	1
KTI28210.....	1/2" DR DEEP SOCKET 10MM	1
KTI28211.....	1/2" DR DEEP SOCKET 11MM	1
KTI28212.....	1/2" DR DEEP SOCKET 12MM	1
KTI28213.....	1/2" DR DEEP SOCKET 13MM	1
KTI28214.....	1/2" DR DEEP SOCKET 14MM	1
KTI28215.....	1/2" DR DEEP SOCKET 15MM	1

Popular Tools #2..... Qty

KTI28216.....	1/2" DR DEEP SOCKET 16MM	1
KTI28217.....	1/2" DR DEEP SOCKET 17MM	1
KTI28218.....	1/2" DR DEEP SOCKET 18MM	1
KTI28219.....	1/2" DR DEEP SOCKET 19MM	1
KTI28220.....	1/2" DR DEEP SOCKET 20MM	1
KTI28221.....	1/2" DR DEEP SOCKET 21MM	1
KTI41108.....	COMBINATION WRENCH 1/4"	1
KTI41110.....	COMBINATION WRENCH 5/16"	1
KTI41112.....	COMBINATION WRENCH 3/8"	2
KTI41114.....	COMBINATION WRENCH 7/16"	2
KTI41116.....	COMBINATION WRENCH 1/2"	3
KTI41118.....	COMBINATION WRENCH 9/16"	3
KTI41120.....	COMBINATION WRENCH 5/8"	2
KTI41122.....	COMBINATION WRENCH 11/16"	1
KTI41124.....	COMBINATION WRENCH 3/4"	2
KTI41126.....	COMBINATION WRENCH 13/16"	1
KTI41128.....	COMBINATION WRENCH 7/8"	1
KTI41130.....	COMBINATION WRENCH 15/16"	1
KTI41132.....	COMBINATION WRENCH 1"	1
KTI41134.....	COMBINATION WRENCH 1-1/16"	1
KTI41136.....	COMBINATION WRENCH 1-1/8"	1
KTI41608.....	COMBINATION WRENCH 8MM	1
KTI41609.....	COMBINATION WRENCH 9MM	1
KTI41610.....	COMBINATION WRENCH 10MM	2
KTI41611.....	COMBINATION WRENCH 11MM	2
KTI41612.....	COMBINATION WRENCH 12MM	2
KTI41613.....	COMBINATION WRENCH 13MM	2
KTI41614.....	COMBINATION WRENCH 14MM	2
KTI41615.....	COMBINATION WRENCH 15MM	2
KTI41616.....	COMBINATION WRENCH 16MM	2
KTI41617.....	COMBINATION WRENCH 17MM	2
KTI41618.....	COMBINATION WRENCH 18MM	2
KTI41619.....	COMBINATION WRENCH 19MM	2
KTI44412.....	3/8" X 7/16" FLARE NUT WRENCH	1
KTI44416.....	1/2" X 9/16" FLARE NUT WRENCH	1
KTI44420.....	5/8" X 11/16" FLARE NUT WRENCH	1
KTI089.....	3" EXTENSION BAR	1
KTIHOOK2.....	HOOKS	57
KTIHOOK11.....	PLASTIC HOOKS	14
KTIOL0835.....	DISPLAY OVERLAY	1
KTIOLF04333.....	OVERLAY FASTENERS (6 PACK)	1

KTI0836

Nutdrivers & Hex Keys

Display assortments include the following hardware:

- Hooks, printed overlay, overlay fasteners
- **Display boards must be purchased separately (KTI098)**



Nutdrivers & Hex Keys	Qty	
KTI14400	7-PIECE FRACTIONAL NUTDRIVER SET	1
KTI14406	3/16" x 3" FRACTIONAL NUTDRIVER	1
KTI14408	1/4" x 3" FRACTIONAL NUTDRIVER	1
KTI14410	5/16" x 3" FRACTIONAL NUTDRIVER	1
KTI14411	11/32" x 3" FRACTIONAL NUTDRIVER	1
KTI14412	3/8" x 3" FRACTIONAL NUTDRIVER	1
KTI14414	7/16" x 3" FRACTIONAL NUTDRIVER	1
KTI14416	1/2" x 3" FRACTIONAL NUTDRIVER	1
KTI14500	7-PIECE METRIC NUTDRIVER SET	1
KTI14505	5MM x 75MM METRIC NUTDRIVER	1
KTI14506	6MM x 75MM METRIC NUTDRIVER	1
KTI14507	7MM x 75MM METRIC NUTDRIVER	1
KTI14508	8MM x 75MM METRIC NUTDRIVER	1
KTI14509	9MM x 75MM METRIC NUTDRIVER	1
KTI14510	10MM x 75MM METRIC NUTDRIVER	1
KTI14511	11MM x 75MM METRIC NUTDRIVER	1
KTI70040	SPIRAL EXTRACTOR SET	1
KTI70070	4-PIECE PICK SET (NEON ORANGE)	1
KTI70075	4-PIECE PICK SET (NEON GREEN)	1
KTI71400	HEX KEY SET 1/8" - 3/8" FOLDING	1
KTI71420	HEX KEY SET 1/16" - 3/8" ON A RING	1
KTI71475	HEX KEY SET 2.5MM - 10MM FOLDING	1
KTI71480	HEX KEY SET 1.5MM - 10MM ON A RING	1
KTIHOOK2	HOOKS	20
KTIOL0836	DISPLAY OVERLAY	1
KTIOLF04333	OVERLAY FASTENERS (6 PACK)	1

KTI0837

Oil Filter Wrenches

Display assortments include the following hardware:

- Hooks, printed overlay, overlay fasteners
- **Display boards must be purchased separately (KTI098)**



Oil Filter Wrenches	Qty	
KTI73600	4-IN-1 FILTER WRENCH	1
KTI73601	OIL FILTER WRENCH FOR TRUCKS ADJ FROM 2-7/8"-3-1/4"	1
KTI73602	OIL FILTER WRENCH FOR TRUCKS ADJ FROM 3-7/16"-3-3/4"	1
KTI73603	OIL FILTER WRENCH FOR TRUCKS ADJ FROM 4"-4-3/8"	1
KTI73605	OIL FILTER WRENCH FOR TRUCKS ADJ FROM 4-5/16"-4-3/4"	1
KTI73606	OIL FILTER WRENCH FOR TRUCKS ADJ FROM 5-1/4"-5-3/4"	1
KTI73618	OIL FILTER CAP SOCKET 32MM	1
KTI73619	OIL FILTER CAP SOCKET 35-36MM	1
KTI73620	OIL FILTER PLIERS - ADJUSTABLE	1
KTI73621	TRUCK AND TRACTOR FILTER PLIER	1
KTI73630	OIL FILTER WRENCH TOYOTA/LEXUS	1
KTI73635	17 PC MASTER OIL FILTER WRENCH KIT	1
KTI73730	FILTER WRENCH NYLON STRAP 1/2"	1
KTI73731	HEAVY-DUTY STRAP OIL FILTER WRENCH	1
KTI089	3" EXTENSION BAR	1
KTIHOOK2	HOOKS	11
KTIHOOK11	PLASTIC HOOKS	5
KTIOL0837	DISPLAY OVERLAY	1
KTIOLF04333	OVERLAY FASTENERS (6 PACK)	1

DISPLAYS

KTI0838

Pullers & Separators

Display assortments include the following hardware:

- Hooks, printed overlay, overlay fasteners
- Display boards must be purchased separately (KTI098)



KTI0839

3/8" & 1/2" Drive Impact Sockets

Display assortments include the following hardware:

- Hooks, printed overlay, overlay fasteners
- Display boards must be purchased separately (KTI098)



Pullers & Separators	Qty
KTI70301..... 3" TWO-JAW TWO-TON PULLER	1
KTI70302..... 3" TWO/THREE-JAW TWO-TON PULLER	1
KTI70303..... 4" TWO-JAW FIVE-TON PULLER	1
KTI70304..... 3" TWO/THREE-JAW FIVE-TON PULLER	1
KTI70305..... 6" TWO-JAW FIVE-TON PULLER	1
KTI70306..... 6" TWO/THREE-JAW FIVE-TON PULLER	1
KTI70348..... STEERING WHEEL PULLER	1
KTI70383..... BEARING SEPARATOR 1 1/4"-2 1/4"	1
KTI70384..... BEARING SEPARATOR 3"-4 1/2"	1
KTIHOOK2..... HOOKS	11
KTIOL0838..... DISPLAY OVERLAY	1
KTIOLF04333..... OVERLAY FASTENERS (6 PACK)	1

3/8" & 1/2" Drive Impact Sockets	Qty
KTI32012..... Impact Universal Joint 3/8" Drive	1
KTI32016..... 3/8" Female x 1/2" Male Impact Adapter	1
KTI32110..... Socket Impact 3/8" Drive 5/16"	1
KTI32112..... Socket Impact 3/8" Drive 3/8"	1
KTI32114..... Socket Impact 3/8" Drive 7/16"	1
KTI32116..... Socket Impact 3/8" Drive 1/2"	1
KTI32118..... Socket Impact 3/8" Drive 9/16"	1
KTI32120..... Socket Impact 3/8" Drive 5/8"	1
KTI32122..... Socket Impact 3/8" Drive 11/16"	1
KTI32124..... Socket Impact 3/8" Drive 3/4"	1
KTI32126..... Socket Impact 3/8" Drive 13/16"	1
KTI32128..... Socket Impact 3/8" Drive 7/8"	1
KTI32210..... Socket Impact Deep 3/8" Drive 5/16"	1
KTI32212..... Socket Impact Deep 3/8" Drive 3/8"	1
KTI32214..... Socket Impact Deep 3/8" Drive 7/16"	1
KTI32216..... Socket Impact Deep 3/8" Drive 1/2"	1
KTI32218..... Socket Impact Deep 3/8" Drive 9/16"	1
KTI32220..... Socket Impact Deep 3/8" Drive 5/8"	1
KTI32222..... Socket Impact Deep 3/8" Drive 11/16"	1
KTI32224..... Socket Impact Deep 3/8" Drive 3/4"	1
KTI32226..... Socket Impact Deep 3/8" Drive 13/16"	1
KTI32228..... Socket Impact Deep 3/8" Drive 7/8"	1
KTI33003..... 1/2" Drive Impact Extension 3"	1
KTI33006..... 1/2" Drive Impact Extension 6"	1
KTI33012..... 1/2" Female x 3/8" Male Impact Adapter	1
KTI33016..... 1/2" Drive Universal Joint Impact	1
KTI33024..... 1/2" Female x 3/4" Male Impact Adapter	1
KTI33041..... 1/2" Female x 3/8" Male Wobble Adapter	1
KTI33050..... Socket Impact 1/2" Drive Flip 3/4" x 13/16"	1



3/8" & 1/2" Drive Impact Sockets Qty

KTI33112.....	Socket 1/2" Drive Short Impact 3/8"	1
KTI33114.....	Socket 1/2" Drive Short Impact 7/16"	1
KTI33116.....	Socket 1/2" Drive Short Impact 1/2"	1
KTI33118.....	Socket 1/2" Drive Short Impact 9/16"	1
KTI33120.....	Socket 1/2" Drive Short Impact 5/8"	1
KTI33122.....	Socket 1/2" Drive Short Impact 11/16"	1
KTI33124.....	Socket 1/2" Drive Short Impact 3/4"	1
KTI33126.....	Socket 1/2" Drive Short Impact 13/16"	1
KTI33128.....	Socket 1/2" Drive Short Impact 7/8"	1
KTI33130.....	Socket 1/2" Drive Short Impact 15/16"	1
KTI33132.....	Socket 1/2" Drive Short Impact 1"	1
KTI33134.....	Socket 1/2" Drive Short Impact 1-1/16"	1
KTI33136.....	Socket 1/2" Drive Short Impact 1-1/8"	1
KTI33138.....	Socket 1/2" Drive Short Impact 1-3/16"	1
KTI33140.....	Socket 1/2" Drive Short Impact 1-1/4"	1
KTI33142.....	Socket 1/2" Drive Short Impact 1-5/16"	1
KTI33144.....	Socket 1/2" Drive Short Impact 1-3/8"	1
KTI33146.....	Socket 1/2" Drive Short Impact 1-7/16"	1
KTI33148.....	Socket 1/2" Drive Short Impact 1-1/2"	1
KTI33212.....	Socket 1/2" Drive Impact Deep 3/8"	1
KTI33214.....	Socket 1/2" Drive Impact Deep 7/16"	1
KTI33216.....	Socket 1/2" Drive Impact Deep 1/2"	1
KTI33218.....	Socket 1/2" Drive Impact Deep 9/16"	1
KTI33220.....	Socket 1/2" Drive Impact Deep 5/8"	1
KTI33222.....	Socket 1/2" Drive Impact Deep 11/16"	1
KTI33224.....	Socket 1/2" Drive Impact Deep 3/4"	1
KTI33226.....	Socket 1/2" Drive Impact Deep 13/16"	1
KTI33228.....	Socket 1/2" Drive Impact Deep 7/8"	1
KTI33230.....	Socket 1/2" Drive Impact Deep 15/16"	1
KTI33232.....	Socket 1/2" Drive Impact Deep 1"	1
KTI33234.....	Socket 1/2" Drive Impact Deep 1-1/16"	1
KTI33236.....	Socket 1/2" Drive Impact Deep 1-1/8"	1
KTI33238.....	Socket 1/2" Drive Impact Deep 1-3/16"	1
KTI33240.....	Socket 1/2" Drive Impact Deep 1-1/4"	1
KTI33242.....	Socket 1/2" Drive Impact Deep 1-5/16"	1
KTI33244.....	Socket 1/2" Drive Impact Deep 1-3/8"	1
KTI33246.....	Socket 1/2" Drive Impact Deep 1-7/16"	1
KTI33248.....	Socket 1/2" Drive Impact Deep 1-1/2"	1
KTI34016.....	3/4" Female x 1/2" Male Impact Adapter	1
KTI37108.....	Socket Impact Metric Short 3/8" Drive 8mm	1
KTI37109.....	Socket Impact Metric Short 3/8" Drive 9mm	1
KTI37110.....	Socket Impact Metric Short 3/8" Drive 10mm	1
KTI37111.....	Socket Impact Metric Short 3/8" Drive 11mm	1
KTI37112.....	Socket Impact Metric Short 3/8" Drive 12mm	1
KTI37113.....	Socket Impact Metric Short 3/8" Drive 13mm	1
KTI37114.....	Socket Impact Metric Short 3/8" Drive 14mm	1
KTI37115.....	Socket Impact Metric Short 3/8" Drive 15mm	1
KTI37116.....	Socket Impact Metric Short 3/8" Drive 16mm	1
KTI37117.....	Socket Impact Metric Short 3/8" Drive 17mm	1
KTI37118.....	Socket Impact Metric Short 3/8" Drive 18mm	1
KTI37119.....	Socket Impact Metric Short 3/8" Drive 19mm	1
KTI37208.....	Socket Deep Impact 3/8" Drive 8mm	1
KTI37209.....	Socket Deep Impact 3/8" Drive 9mm	1
KTI37210.....	Socket Deep Impact 3/8" Drive 10mm	1
KTI37211.....	Socket Deep Impact 3/8" Drive 11mm	1
KTI37212.....	Socket Deep Impact 3/8" Drive 12mm	1
KTI37213.....	Socket Deep Impact 3/8" Drive 13mm	1
KTI37214.....	Socket Deep Impact 3/8" Drive 14mm	1
KTI37215.....	Socket Deep Impact 3/8" Drive 15mm	1
KTI37216.....	Socket Deep Impact 3/8" Drive 16mm	1

3/8" & 1/2" Drive Impact Sockets Qty

KTI37217.....	Socket Deep Impact 3/8" Drive 17mm	1
KTI37218.....	Socket Deep Impact 3/8" Drive 18mm	1
KTI37219.....	Socket Deep Impact 3/8" Drive 19mm	1
KTI38050.....	Socket Impact 1/2" Drive Flip 19mm x 21mm	1
KTI38110.....	Socket 1/2" Drive Short Impact 10mm	1
KTI38111.....	Socket 1/2" Drive Short Impact 11mm	1
KTI38112.....	Socket 1/2" Drive Short Impact 12mm	1
KTI38113.....	Socket 1/2" Drive Short Impact 13mm	1
KTI38114.....	Socket 1/2" Drive Short Impact 14mm	1
KTI38115.....	Socket 1/2" Drive Short Impact 15mm	1
KTI38116.....	Socket 1/2" Drive Short Impact 16mm	1
KTI38117.....	Socket 1/2" Drive Short Impact 17mm	1
KTI38118.....	Socket 1/2" Drive Short Impact 18mm	1
KTI38119.....	Socket 1/2" Drive Short Impact 19mm	1
KTI38120.....	Socket 1/2" Drive Short Impact 20mm	1
KTI38121.....	Socket 1/2" Drive Short Impact 21mm	1
KTI38122.....	Socket Impact Metric 1/2" Drive 22mm	1
KTI38123.....	Socket Impact Metric 1/2" Drive 23mm	1
KTI38124.....	Socket Impact Metric 1/2" Drive 24mm	1
KTI38125.....	Socket Impact Metric 1/2" Drive 25mm	1
KTI38126.....	Socket Impact Metric 1/2" Drive 26mm	1
KTI38127.....	Socket Impact Metric 1/2" Drive 27mm	1
KTI38128.....	Socket Impact Metric 1/2" Drive 28mm	1
KTI38129.....	Socket Impact Metric 1/2" Drive 29mm	1
KTI38130.....	Socket Impact Metric 1/2" Drive 30mm	1
KTI38132.....	Socket Impact Metric 1/2" Drive 32mm	1
KTI38133.....	Socket Impact Metric 1/2" Drive 33mm	1
KTI38134.....	Socket Impact Metric 1/2" Drive 34mm	1
KTI38135.....	Socket Impact Metric 1/2" Drive 35mm	1
KTI38136.....	Socket Impact Metric 1/2" Drive 36mm	1
KTI38210.....	Socket 1/2" Drive Impact Deep 10mm	1
KTI38211.....	Socket 1/2" Drive Impact Deep 11mm	1
KTI38212.....	Socket 1/2" Drive Impact Deep 12mm	1
KTI38213.....	Socket 1/2" Drive Impact Deep 13mm	1
KTI38214.....	Socket 1/2" Drive Impact Deep 14mm	1
KTI38215.....	Socket 1/2" Drive Impact Deep 15mm	1
KTI38216.....	Socket 1/2" Drive Impact Deep 16mm	1
KTI38217.....	Socket 1/2" Drive Impact Deep 17mm	1
KTI38218.....	Socket 1/2" Drive Impact Deep 18mm	1
KTI38219.....	Socket 1/2" Drive Impact Deep 19mm	1
KTI38220.....	Socket 1/2" Drive Impact Deep 20mm	1
KTI38221.....	Socket 1/2" Drive Impact Deep 21mm	1
KTI38222.....	Socket 1/2" Drive Impact Deep 22mm	1
KTI38223.....	Socket 1/2" Drive Impact Deep 23mm	1
KTI38224.....	Socket 1/2" Drive Impact Deep 24mm	1
KTI38225.....	Socket 1/2" Drive Impact Deep 25mm	1
KTI38226.....	Socket 1/2" Drive Impact Deep 26mm	1
KTI38227.....	Socket 1/2" Drive Impact Deep 27mm	1
KTI38228.....	Socket 1/2" Drive Impact Deep 28mm	1
KTI38229.....	Socket 1/2" Drive Impact Deep 29mm	1
KTI38230.....	Socket 1/2" Drive Impact Deep 30mm	1
KTI38232.....	Socket Impact Metric Deep 1/2" Drive 32mm	1
KTI38233.....	Socket Impact Metric Deep 1/2" Drive 33mm	1
KTI38234.....	Socket Impact Metric Deep 1/2" Drive 34mm	1
KTI38235.....	Socket Impact Metric Deep 1/2" Drive 35mm	1
KTI38236.....	Socket Impact Metric Deep 1/2" Drive 36mm	1
KTIH00K2.....	HOOKS.....	146
KTIOL0839.....	DISPLAY OVERLAY.....	1
KTIOLF04333.....	OVERLAY FASTENERS (6 PACK).....	1



DISPLAYS

KTIO840

3/4" Drive Impact Sockets

Display assortments include the following hardware:

- Hooks, printed overlay, overlay fasteners
- Display boards must be purchased separately (KTIO98)



3/4" Drive Impact Sockets..... Qty

KT134026.....	13/16" Square Budd Wheel Socket.....	1
KT134027.....	1-1/2" - 13/16" Budd Wheel Socket 3/4" Drive.....	1
KT134032.....	3/4" Female x 1" Male Impact Adapter.....	1
KT134050.....	Universal Joint 3/4" Drive Impact.....	1
KT134132.....	Socket 3/4" Drive Short Impact 1".....	1
KT134134.....	Socket 3/4" Drive Short Impact 1-1/16".....	1
KT134136.....	Socket 3/4" Drive Short Impact 1-1/8".....	1
KT134140.....	Socket 3/4" Drive Short Impact 1-1/4".....	1
KT134142.....	Socket 3/4" Drive Short Impact 1-5/16".....	1
KT134144.....	Socket 3/4" Drive Short Impact 1-3/8".....	1
KT134146.....	Socket 3/4" Drive Short Impact 1-7/16".....	1
KT134148.....	Socket 3/4" Drive Short Impact 1-1/2".....	1
KT134150.....	Socket 3/4" Drive Short Impact 1-9/16".....	1
KT134152.....	Socket 3/4" Drive Short Impact 1-5/8".....	1
KT134154.....	Socket 3/4" Drive Short Impact 1-11/16".....	1
KT134156.....	Socket 3/4" Drive Short Impact 1-3/4".....	1
KT134158.....	Socket 3/4" Drive Short Impact 1-13/16".....	1
KT134160.....	Socket 3/4" Drive Short Impact 1-15/16".....	1
KT134162.....	Socket 3/4" Drive Short Impact 1-7/8".....	1
KT134164.....	Socket 3/4" Drive Short Impact 2".....	1
KT134166.....	Socket 3/4" Drive Short Impact 2-1/16".....	1
KT134168.....	Socket 3/4" Drive Short Impact 2-1/8".....	1
KT134172.....	Socket 3/4" Drive Short Impact 2-1/4".....	1
KT134176.....	Socket 3/4" Drive Short Impact 2-3/8".....	1
KT134232.....	Socket 3/4" Drive Deep Impact 1".....	1
KT134234.....	Socket 3/4" Drive Deep Impact 1-1/16".....	1
KT134236.....	Socket 3/4" Drive Deep Impact 1-1/8".....	1
KT134240.....	Socket 3/4" Drive Deep Impact 1-1/4".....	1
KT134242.....	Socket 3/4" Drive Deep Impact 1-5/16".....	1
KT134244.....	Socket 3/4" Drive Deep Impact 1-3/8".....	1
KT134246.....	Socket 3/4" Drive Deep Impact 1-7/16".....	1
KT134248.....	Socket 3/4" Drive Deep Impact 1-1/2".....	1
KT134250.....	Socket 3/4" Drive Deep Impact 1-9/16".....	1
KT134252.....	Socket 3/4" Drive Deep Impact 1-5/8".....	1
KT134254.....	Socket 3/4" Drive Deep Impact 1-11/16".....	1
KT134256.....	Socket 3/4" Drive Deep Impact 1-3/4".....	1
KT134258.....	Socket 3/4" Drive Deep Impact 1-13/16".....	1
KT134260.....	Socket 3/4" Drive Deep Impact 1-15/16".....	1
KT134262.....	Socket 3/4" Drive Deep Impact 1-7/8".....	1
KT134264.....	Socket 3/4" Drive Deep Impact 2".....	1
KT135024.....	1" Female x 3/4" Male Impact Adapter.....	1
KT135026.....	Socket Impact 1" Drive 13/16" Square Budd Wheel.....	1
KT135027.....	Socket Impact 1" Drive 1-1/2" - 13/16" Budd Wheel.....	1
KT135233.....	Socket Impact Deep 1" Drive 33mm Hex Budd Wheel.....	1
KT1H00K8.....	HOOKS.....	30
KTIO88.....	PLEXIGLASS SHELF.....	6
KTIOLO840.....	DISPLAY OVERLAY.....	1
KTIOLF04333.....	OVERLAY FASTENERS (6 PACK).....	1





KTI0842
Reversible Ratcheting Wrenches

Display assortments include the following hardware:

- Hooks, printed overlay, overlay fasteners
- **Display boards must be purchased separately (KTI098)**



Reversible Ratcheting Wrenches.....	Qty
KTI45608..... Wrench Metric Ratcheting Reversible 8mm.....	1
KTI45609..... Wrench Metric Ratcheting Reversible 9mm.....	1
KTI45610..... Wrench Metric Ratcheting Reversible 10mm.....	1
KTI45611..... Wrench Metric Ratcheting Reversible 11mm.....	1
KTI45612..... Wrench Metric Ratcheting Reversible 12mm.....	1
KTI45613..... Wrench Metric Ratcheting Reversible 13mm.....	1
KTI45614..... Wrench Metric Ratcheting Reversible 14mm.....	1
KTI45615..... Wrench Metric Ratcheting Reversible 15mm.....	1
KTI45616..... Wrench Metric Ratcheting Reversible 16mm.....	1
KTI45617..... Wrench Metric Ratcheting Reversible 17mm.....	1
KTI45618..... Wrench Metric Ratcheting Reversible 18mm.....	1
KTI45619..... Wrench Metric Ratcheting Reversible 19mm.....	1
KTI45620..... Wrench Metric Ratcheting Reversible 20mm.....	1
KTI45621..... Wrench Metric Ratcheting Reversible 21mm.....	1
KTI45622..... Wrench Metric Ratcheting Reversible 22mm.....	1
KTI45624..... Wrench Metric Ratcheting Reversible 24mm.....	1
KTI45908..... Wrench SAE Ratcheting Reversible 1/4".....	1
KTI45910..... Wrench SAE Ratcheting Reversible 5/16".....	1
KTI45912..... Wrench SAE Ratcheting Reversible 3/8".....	1
KTI45914..... Wrench SAE Ratcheting Reversible 7/16".....	1
KTI45916..... Wrench SAE Ratcheting Reversible 1/2".....	1
KTI45918..... Wrench SAE Ratcheting Reversible 9/16".....	1
KTI45920..... Wrench SAE Ratcheting Reversible 5/8".....	1
KTI45922..... Wrench SAE Ratcheting Reversible 11/16".....	1
KTI45924..... Wrench SAE Ratcheting Reversible 3/4".....	1
KTI45926..... Wrench SAE Ratcheting Reversible 13/16".....	1
KTI45928..... Wrench SAE Ratcheting Reversible 7/8".....	1
KTI45930..... Wrench SAE Ratcheting Reversible 15/16".....	1
KTI45932..... Wrench SAE Ratcheting Reversible 1".....	1
KTI089..... 3" EXTENSION BAR.....	2
KTIHOOK2..... HOOKS.....	15
KTIHOOK11..... PLASTIC HOOKS.....	14
KTIOL0842..... DISPLAY OVERLAY.....	1
KTIOLF04333..... OVERLAY FASTENERS (6 PACK).....	1

KTI0843

Electrical & Hardware Component Assortment

Display assortments include the following hardware:

- **Display board, overlay, fastener and shelves must be purchased separately (KTI005)**



Electrical & Hardware Component Assortment Qty

KTI00071..... Hitch Pin Assortment (15 Piece).....	1
KTI00072..... E Clip Assortment (300 Piece).....	1
KTI00074..... Hydraulic Grease Fitting Assortment (110 Piece).....	1
KTI00075..... Cotter Pin Assortment (555 Piece).....	1
KTI00078..... Cotter Pin Assortment (144 Piece).....	1
KTI00080..... Auto Fuse Assortment (120 Piece).....	1
KTI00081..... Mini Fuse Assortment (120 Piece).....	2
KTI00086..... O-Ring Assortment HNBR (270 Piece).....	1
KTI00087..... Terminal Assortment (360 Piece).....	1
KTI00089..... Washer Assortment Copper (110 Piece).....	1
KTI00093..... Roll Pin Assortment (120 Piece).....	1
KTI00094..... O-Ring Assortment Universal (407 Piece).....	1
KTI00095..... Metric O-Ring Assortment (419 Piece).....	1
KTI00096..... Grease Fitting Assortment Metric (110 Piece).....	1
KTI00097..... Electric Wire Solderless Terminal Kit (157 Piece).....	1
KTI07740..... Heat Shrink Tube Kit (235 Piece).....	1

DISPLAYS

KTI0844 Pipe Wrenches

W*

NEW

Display assortments include the following hardware:

- Hooks, printed overlay, overlay fasteners
- Display boards must be purchased separately (KTI098)



Pipe Wrenches.....	Qty
KTI49008..... 8" PIPE WRENCH	1
KTI49010..... 10" PIPE WRENCH	1
KTI49012..... 12" PIPE WRENCH	1
KTI49014..... 14" PIPE WRENCH	1
KTI49018..... 18" PIPE WRENCH	1
KTI49024..... 24" PIPE WRENCH	1
KTI49112..... 12" Aluminum Pipe Wrench	1
KTI49114..... 14" Aluminum Pipe Wrench	1
KTI49118..... 18" Aluminum Pipe Wrench	1
KTI49124..... 24" Aluminum Pipe Wrench	1
KTIHOOK2..... HOOKS.....	10
KTIOL0844..... DISPLAY OVERLAY	1
KTIOLF04333..... OVERLAY FASTENERS (6 PACK).....	1

KTI0845 Wire Tools

W*

NEW

Display assortments include the following hardware:

- Hooks, printed overlay, overlay fasteners
- Display boards must be purchased separately (KTI098)



Wire Tools	Qty
KTI00003..... Butt Connector Kit - 100 Piece	1
KTI00004..... Butt Connector Kit with Shrink	1
KTI00035..... Shrink Tube Kit - 85 Pieces.....	1
KTI00037..... Solderless Terminal Kit-180Pc.....	1
KTI56201..... Multi Purpose Crimper & Wire Str 9".....	1
KTI56202..... Multi Purpose Crimper & Wire Str 8.5".....	1
KTI56203..... Professional Crimping Tool 0.5-6.0 MM	1
KTI56204..... Professional Crimping Tool 1.5-16.0 MM	1
KTI56205..... Ratcheting Terminal Crimper	1
KTI56207..... 8-in-1 Wire Stripper.....	1
KTI56208..... Wire Stripper - Self Adjusting.....	1
KTIHOOK2..... HOOKS.....	15
KTIOL0845..... DISPLAY OVERLAY	1
KTIOLF04333..... OVERLAY FASTENERS (6 PACK).....	1

KTI0846
Torches

W*

NEW

Display assortments include the following hardware:

- Hooks, printed overlay, overlay fasteners
- Display boards must be purchased separately (KTI098)



Torches	Qty
KTI70048..... Micro Butane Turbo-Lite	2
KTI70052..... Pocket Style Butane Torch	2
KTI70054..... Mini Butane Torch with Solder	2
KTI70056..... Swivel Tube Propane Torch Head	2
KTI70057..... Self Igniting Propane Torch	2
KTI70058..... Hand-Held Pro Butane Torch	2
KTI70440..... PYRO Torch Shield 10x18	2
KTIHOOK2..... HOOKS	7
KTIOL0846..... DISPLAY OVERLAY	1
KTIOLF04333..... OVERLAY FASTENERS (6 PACK)	1

KTI0847
Lighting

W*

NEW

Display assortments include the following hardware:

- Hooks, printed overlay, overlay fasteners
- Display boards must be purchased separately (KTI098)



Lighting	Qty
KTI73379..... 30-LED SMD Retrofit Light	2
KTI73387..... Recharg Worklight 3W COB with piv head	1
KTI73388..... Rechargeable Worklight 3W COB	1
KTI73389..... LED Slimline Inspection Light	1
KTI73394..... Rechargeable 60LED Worklight	1
KTI73396..... Flashlight 16LED AAA Aluminum	1
KTI73398..... Headlamp 14 LED AAA Batteries	2
KTI73399..... LED Rechargeable Worklight 12SMD	1
KTIHOOK2..... HOOKS	13
KTIHOOK3..... HOOKS	1
KTIOL0847..... DISPLAY OVERLAY	1
KTIOLF04333..... OVERLAY FASTENERS (6 PACK)	1

DISPLAYS

KTI0848 3/4" Drive Tools

Display assortments include the following hardware:

- Hooks, printed overlay, overlay fasteners
- Display boards must be purchased separately (KTI098)

W*

NEW

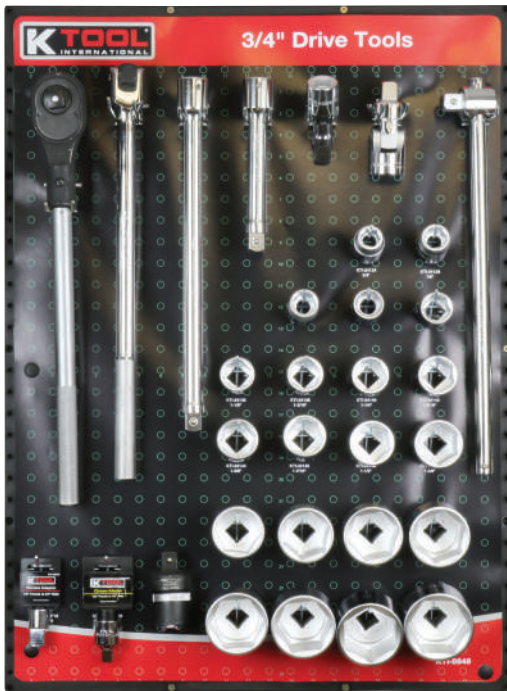

3/4" Drive Tools..... Qty

KTI22075.....	1/2" FEMALE x 3/4" MALE ADAPTER.....	1
KTI24004.....	3/4" DR SOCKET EXTENSION 4".....	1
KTI24008.....	3/4" DR SOCKET EXTENSION 8".....	1
KTI24016.....	3/4" DR CHROME EXTENSION 16".....	1
KTI24050.....	3/4" FEMALE x 1/2" MALE ADAPTER.....	1
KTI24070.....	3/4" DR SOCKET T-HANDLE SLIDING.....	1
KTI24080.....	3/4" DR BREAKER BAR 20".....	1
KTI24085.....	3/4" DR RATCHETING ADAPTER.....	1
KTI24092.....	3/4" DR RATCHET HD PRO.....	1
KTI24124.....	3/4" DR 6 PT SOCKET 3/4".....	1
KTI24128.....	3/4" DR 6 PT SOCKET 7/8".....	1
KTI24130.....	3/4" DR 6 PT SOCKET 15/16".....	1
KTI24132.....	3/4" DR 6 PT SOCKET 1".....	1
KTI24134.....	3/4" DR 6 PT SOCKET 1-1/16".....	1
KTI24136.....	3/4" DR 6 PT SOCKET 1-1/8".....	1
KTI24138.....	3/4" DR 6 PT SOCKET 1-3/16".....	1
KTI24140.....	3/4" DR 6 PT SOCKET 1-1/4".....	1
KTI24142.....	3/4" DR 6 PT SOCKET 1- 5/16".....	1
KTI24144.....	3/4" DR 6 PT SOCKET 1-3/8".....	1
KTI24146.....	3/4" DR 6 PT SOCKET 1-7/16".....	1
KTI24148.....	3/4" DR 6 PT SOCKET 1-1/2".....	1
KTI24152.....	3/4" DR 6 PT SOCKET 1-5/8".....	1
KTI24156.....	3/4" DR 6 PT SOCKET 1-3/4".....	1
KTI24160.....	3/4" DR 6 PT SOCKET 1-7/8".....	1
KTI24164.....	3/4" DR 6 PT SOCKET 2".....	1
KTI24166.....	3/4" DR 6 PT SOCKET 2-1/16".....	1
KTI24168.....	3/4" DR 6 PT SOCKET 2-1/8".....	1
KTI24170.....	3/4" DR 6 PT SOCKET 2-3/16".....	1
KTI24172.....	3/4" DR 6 PT SOCKET 2-1/4".....	1
KTI24176.....	3/4" DR 6 PT SOCKET 2-3/8".....	1
KTI24500.....	3/4" DR UNIVERSAL JOINT.....	1
KTIH00K2.....	HOOKS.....	23
KTIH00K7.....	HOOKS.....	7
KTIH00K8.....	HOOKS.....	1
KTIOL0848.....	DISPLAY OVERLAY.....	1
KTIOLF04333.....	OVERLAY FASTENERS (6 PACK).....	1



KTI0849 1" Drive Impact Tools

Display assortments include the following hardware:

- Hooks, printed overlay, overlay fasteners
- Display boards must be purchased separately (KTI098)

W*

NEW

1" Drive Impact Tools..... Qty

KTI35005.....	1" DR BUDD WHEEL SERVICE SET 5Pc.....	1
KTI35007.....	1" DR IMPACT EXTENSION 7".....	1
KTI35013.....	1" DR IMPACT EXTENSION 13".....	1
KTI35024.....	1" F X 3/4" M IMPACT ADAPTOR.....	1
KTI35026.....	1" DR SKT IMPACT 13/16" SQ BDWHL.....	1
KTI35027.....	1" DR SKT IMPACT 1-1/2"-13/16" BDWHL.....	1
KTI35028.....	1" DR 1 1/2"-13/16" BUDD SKT DP.....	1
KTI35124.....	1" DR SKT IMPACT SHORT 3/4".....	1
KTI35126.....	1" DR SKT IMPACT SHORT 13/16".....	1
KTI35128.....	1" DR SKT IMPACT SHORT 7/8".....	1
KTI35130.....	1" DR SKT IMPACT SHORT 15/16".....	1
KTI35132.....	1" DR SKT IMPACT SHORT 1".....	1
KTI35134.....	1" DR SKT IMPACT SHORT 1-1/16".....	1
KTI35136.....	1" DR SKT IMPACT SHORT 1-1/8".....	1
KTI35138.....	1" DR SKT IMPACT SHORT 1-3/16".....	1
KTI35140.....	1" DR SKT IMPACT SHORT 1-1/4".....	1
KTI35142.....	1" DR SKT IMPACT SHORT 1-5/16".....	1
KTI35146.....	1" DR SKT IMPACT SHORT 1-7/16".....	1
KTI35148.....	1" DR SKT IMPACT SHORT 1-1/2".....	1
KTI35152.....	1" DR SKT IMPACT SHORT 1-5/8".....	1
KTI35154.....	1" DR SKT IMPACT SHORT 1-11/16".....	1
KTI35158.....	1" DR SKT IMPACT SHORT 1-13/16".....	1
KTI35160.....	1" DR SKT IMPACT SHORT 1-7/8".....	1
KTI35164.....	1" DR SKT IMPACT SHORT 2".....	1
KTI35166.....	1" DR SKT IMPACT SHORT 2-1/16".....	1
KTI35172.....	1" DR SKT IMPACT SHORT 2-1/4".....	1
KTI35178.....	1" DR SKT IMPACT SHORT 2-7/16".....	1
KTI35184.....	1" DR SKT IMPACT SHORT 2-5/8".....	1
KTI35196.....	1" DR SKT IMPACT SHORT 3".....	1
KTI35233.....	1" DR SKT IMPACT DEEP 33MM HEXBDWHL.....	1
KTI35234.....	1" DR SKT IMPACT DEEP 1-1/16".....	1
KTI35235.....	1" DR SKT IMPACT DEEP 35MM HEXBDWHL.....	1
KTI35236.....	1" DR SKT IMPACT DEEP 1-1/8".....	1
KTI35238.....	1" DR SKT IMPACT DEEP 38MM HEXBDWHL.....	1
KTI35240.....	1" DR SKT IMPACT DEEP 1-1/4".....	1
KTI35241.....	1" DR SKT IMPACT DEEP 41MM HEXBDWHL.....	1
KTI35242.....	1" DR SKT IMPACT DEEP 1-5/16".....	1
KTIH00K2.....	HOOKS.....	2
KTIH00K8.....	HOOKS.....	22
KTI088.....	PLEXIGLASS SHELF.....	4
KTIOL0849.....	DISPLAY OVERLAY.....	1
KTIOLF04333.....	OVERLAY FASTENERS (6 PACK).....	1

KTI0852
Lubrication



Display assortments include the following hardware:

- Hooks, printed overlay, overlay fasteners
- **Display boards must be purchased separately (KTI098)**

Lubrication	Qty
KTI73903..... Needle Nose Dispenser 1-1/2" Narrow	2
KTI73912..... Grease Gun Hose 12".....	2
KTI73918..... Grease Gun Hose 18".....	2
KTI73919..... Suction Gun w/12" Vinyl Hose.....	1
KTI73930..... Mini Pistol Grease Gun 3 oz.....	1
KTI73933..... HD Pistol Grip Grease Gun 14 oz.....	1
KTI73942..... HD Level Grease Gun 14 oz.....	1
KTI73952..... Prof 4 Jaw Grease Gun Coupler.....	2
KTI73957..... Grease Injector Needle.....	2
KTI73959..... Right Angle Grease Gun Coupler.....	2
KTIHOOK2..... HOOKS.....	11
KTIOL0852..... DISPLAY OVERLAY.....	1
KTIOLF04333..... OVERLAY FASTENERS (6 PACK).....	1



ACC0881
AccuTorq



Display assortments include the following hardware:

- Hooks, printed overlay, overlay fasteners
- **Display boards must be purchased separately (KTI098)**

AccuTorq	Qty
ACC10-0304..... Green 1/2 Dr 17MM 55 Ft lbs.....	1
ACC10-0305..... Red 1/2 Dr 17MM 80 Ft lbs.....	1
ACC10-0306..... Yellow 1/2 Dr 19MM 65 ft lbs.....	1
ACC10-0307..... Blue 1/2 Dr 19MM 80 ft lbs.....	1
ACC10-0308..... Gray 1/2 Dr 19MM 100 ft lbs.....	1
ACC10-0310..... Light Brown 1/2 Dr 21MM 80 ft.....	1
ACC10-0311..... Brown 1/2 Dr 21MM 100 ft lbs.....	1
ACC10-0312..... White 1/2 Dr 22MM 120 ft lbs.....	1
ACC10-0313..... Turq 1/2 Dr 7/8 140 ft lbs.....	1
ACC10-3899..... Lt Green 1/2 Dr 24MM 140 Ft lb.....	1
ACC10-0103D..... 8.5" x 11" ACCUTORQ CHART.....	1
KTI33317..... Socket Thnwll Prctcv 17MM Blue.....	1
KTI33319..... Socket Thnwll Prctcv 19MM Gold.....	1
KTI33321..... Socket Thnwll Prctcv 21MM Red.....	1
KTI33326..... Socket Thnwll Prctcv 13/16 Pur.....	1
KTI33328..... Socket Thnwll Prctcv 7/8 Green.....	1
KTI33332..... Socket Thnwll Prctcv 1 Titanium.....	1
KTI33334..... Socket Thnwll Prctcv 1-1/16 Bk.....	1
KTI33351..... Torque Ext 55 ft.lbs. Red.....	1
KTI33352..... Torque Ext 65 ft.lbs. Yellow.....	1
KTI33353..... Torque Ext 80 ft.lbs. Green.....	1
KTI33354..... Torque Ext 100 ft.lbs. Lt Blue.....	1
KTI33355..... Torque Ext 120 ft.lbs. White.....	1
KTI33356..... Torque Ext 140 ft.lbs. Black.....	1
KTI33357..... Torque Ext 175 ft.lbs. Orange.....	1
KTI72138..... 1/2" DR DIGITAL TORQUE ADAPTER.....	1
KTI78040..... 4" CABLE TIE BLACK.....	1
KTIHOOK2..... HOOKS.....	9
KTIHOOK7..... HOOKS.....	17
KTIOL0881..... DISPLAY OVERLAY.....	1
KTIOLF04333..... OVERLAY FASTENERS (6 PACK).....	1



DISPLAYS

Displays | Accessories

KTIHOOK7

1" Wide Round Closed Hook



KTIHOOK8

Long U-Shaped Hook



KTIOLF04333

Display Overlay Fasteners (6 pack)



KTIHOOK11

1-1/2" Plastic Hook



KTIHOOK2

2" Single Short Hook



KTIHOOK3

6" Disc-Single Long Hook



KTI087

Slanted Wire Shelf 6" x 23.5" x 12.5"



KTI088

Black Acrylic Plexiglass Shelves

- Each Shelf Dimension 24" x 3-9/16" X 3/16"
- Quantity: 1 shelf
- Hooks not included



***NOTE: Only hardware,
product shown not included**

KTI005

Assortment

Display Hardware

- Electrical & Hardware Component Assortment must be purchased separately (KTI0843)
- *NOTE: Only hardware, product shown not included

Assortment Display Hardware	Qty
KTI087..... Slanted Wire Shelf - 6" x 23.5" each	5
KTI098..... Blank Board	1
KTIOL0843..... Display Overlay	1
KTIOLF04333..... Overlay Fasteners (6 Pack)	1



KT1089
3" Display Extension Bar

Add more room to any display with the 3" extension bar. Larger product can be displayed behind the display bar with plenty of clearance for easy shopping and visual appeal. Place smaller product on the extension to maximize display space and sales!

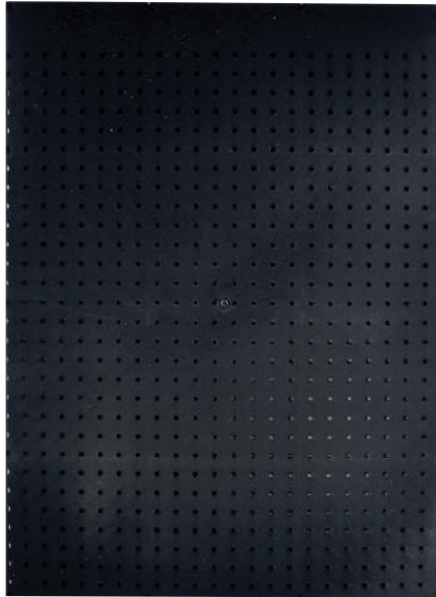

KT1098
Blank Display Board

Display boards can be used with any of the display overlay and merchandising kits or to create customized in-store merchandising programs. Blank display board measures 23.5" x 32".



KT1001
8-board
Rotary Merchandiser

KT's rotary merchandiser is the perfect way to display a maximum amount of product in a minimal amount of space. Rotary merchandiser will hold up to eight (8) displays! The rotary display requires a minimal amount of space - only 36" x 36". Display is complete with four (4) durable casters for added mobility. A must-have for professional, effective merchandising. Boards (KT1-098) sold separately.

*NOTE: Some displays are not recommended for use on the rotary merchandiser due to weight restrictions.

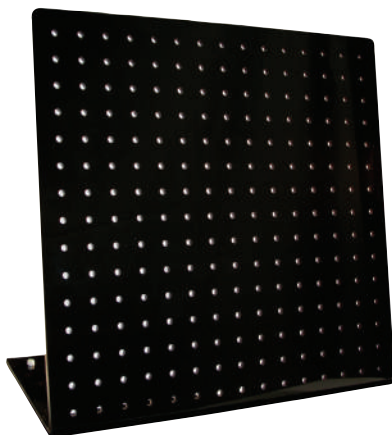

KT1004
Acrylic Counter Display

Acrylic counter display features a 15-11/16" x 15-13/16" display area to maximize product exposure. Compact design requires a minimal footprint (8" x 15-11/16"). A great way to generate 'impulse' buys. Utilizes 'dead' space behind point-of-sale terminals or computer monitors for additional merchandising area. Featuring two heightadjustable legs, the display area has a tilt range from 75-degrees to 87-degrees.

DISPLAYS

Displays | Floor & Counter

KTIPREPACKQ1

W*

Hand Tools Floor Display Prepack Q1

- Floor Display consisting of five prepacked KTI hand tool sets (2 each)
- (2) KTI19000 - 8Pc Screwdriver Set (Black)
- (2) KTI21044 - 44Pc Socket Set, 1/4" Drive, SAE & Metric, Shallow & Deep
- (2) KTI22047 - 47Pc Socket Set, 6 Point, 3/8" Drive SAE & Metric
- Two Wrench Sets; (2) KTI41300 - 9pc High Polish, Smooth Finish, Sizes 3/8" to 7/8" and (2) KTI41800 - 13Pc High Polish, Smooth Finish, Sizes 7mm to 19mm

Display setup size: Height: 40.9, Width: 26.3", Depth: 16.7".
All hand tools are covered by a Lifetime Warranty.

LIFETIME WARRANTY*



W*



- BluBird air hoses are heavy duty, ultra light weight and super strong. Stay flexible in temperatures from -50 to 190° fahrenheit. Ozone, UV & abrasion resistant. Covered by a 10 year warranty

- BluBird Oil Shield air hoses are ultra lightweight, extreme durability resists abrasion and ultra high strength exceeds RMA IP-2. Stay flexible in extreme conditions from -30 to 190° fahrenheit. Oil resistance core tube and cover meets RMA Class A oil resistance. Covered by a 3 year warranty

KT171005

BluBird And Oil Shield Air Hose Promo Pack

Contains 8 air hoses:

- (2) - **KT172015** - BluBird 3/8" x 50'
- (2) - **KT172018** - Oil Shield 3/8" x 50'
- (1) - **KT172049** - BluBird 3/8" x 35'
- (1) - **KT172017** - Oil Shield 3/8" x 35'
- (1) - **KT172014** - BluBird 3/8" x 25'
- (1) - **KT172048** - Oil Shield 3/8" x 25'

- Size of promotional pack on display:
Width: 24", Depth: 11", Height: 26"

W*

KTI90003
Q-Bond Adhesive Kit,
10 Pack with Display

- Ultra-strong adhesive and reinforcing powders
- Repairs almost anything!
- Rock solid in 10 seconds
- Q-Bond repairs are able to be grinded, filed, sanded and even painted
- Hang tabs for pegboard and rack displays
- Display measures: 11.5" x 6.25" x 6.5".



New package design with 10 kits in this display. Q-BOND can be used just as an adhesive or with the reinforcing powders that will help to repair almost anything. Q-BOND repairs can be grinded, filed, sanded, and even painted. Each Q-BOND kit includes two (2) bottles Q-BOND adhesive (0.35oz/10ml); one (1) bottle black reinforcing powder for plastics; one (1) bottle grey reinforcing powder for metals.

KTI90003C

Q-Bond Adhesive Kit - 10 Pack Display for Canada

- Display measures: 11.5" x 6.25" x 6.5".



W*

KTI73910

Lube Combo Display Shelf Pack

- Pack includes:
 - 3 each: Heavy Duty Pistol Grip Grease Guns (KTI73933)
 - 3 each: Heavy Duty Lever Grease Guns (KTI73942)
- Aluminium die cast grease gun head
- Lever grease gun develops up to 10,000 PSI; pistol grease gun up to 5000 PSI
- For use with 14 oz. grease cartridges
- Lever gun (KTI73942) includes 6" bent steel extension & coupler; pistol gun (KTI73933) includes 18" flexible grease hose & coupler
- Covered by a 1-year warranty
- Display shelf pack measures: 6" x 11.5" x 16"

Cut case shelf pack includes K-Tool International's most popular lever & pistol grip grease guns. Each pack includes 3 of each grease gun type.

W*

KTI73952-54
Grease Gun Coupler
54 Pack Counter Display

- 6,000 PSI
- For use with hand grease guns only
- 1-Year Warranty
- Counter display measures: 5.5" x 4.5" x 4.25"



W*



KTI70038-10
Combi Wedge 10 Pack

- Counter display 10 pack of the heavy duty universal combination wedge tool
- Use on dashboards and door cover clips
- Color: Red
- Tool length: 8.5", width: 1", height: 1"
- Covered by a 1 year warranty
- Counter display measures: Height: 7.0" Width: 11.750", Depth: 7.50"

W*



KTI70037-10
Clip Lifter

- Clip lifter for plastic fasteners, upholstery, door panels, plastic clips
- Tool length: 7" • Tool width: 3/4"
- Red rubber handle
- Counter display measures: 9-1/2" wide, 7" deep and 5" high
- Covered by a 1-Year Warranty

SAFETY INFORMATION

For your safety, please read and understand the following safety guidelines.

Never misuse a tool. Improper use of a tool will shorten its life.

ALWAYS wear safety goggles to protect eyes. Keep your tools clean.

Never use a broken tool. Keep all tools out of the reach of children.

AccuTorq®:

Wear protective goggles. Never hold with hands while tightening. Never use torque sockets to remove lug nuts. When tightening lug nuts, use the criss-cross wheel nut tightening sequence.

Grinders, Grinding Wheels and Air Tool Accessories:

Wear protective goggles. Do not operate power tools at speeds that exceed their maximum rated rpm. Power tool accessories can break, causing particles to fly. Avoid injury by using eye shields and guards.

Hammers:

Wear protective goggles. Always use a hammer that is suitable for the job. Head diameter should always exceed the object being struck, such as a punch or chisel. Do not strike a tool that shows distress.

KTip.s.t.® TPMS Activation Tool

Product emits magnetic and electromagnetic waves that may interfere with the safe operation of pacemakers. Individuals who have pacemakers should never use this product. Do not use any harsh chemical solvents to clean tool. Do not use tool where contact or immersion in water is possible. Never spill liquid of any kind on the tool. Do not use or store the tool where it is exposed to direct sunlight or excessive moisture. Do not operate tool in the vicinity of open containers or flammable liquids. Do not operate tool with battery cover removed.

Lifting Equipment:

Do not exceed the rated capacity of jack or jack stands. Use jacks only on strong level surfaces. Collapse of lifting equipment can cause serious injury. Do not work on a vehicle supported by a jack, use jack stands.

MEGAHAMMER®:

Lock nut on hub removal tool must be tight to protect against thread damage. Slide shaft thread to be engaged into base plate thread so it is flush with inside edge of base plate thread. Use countersunk holes ONLY for proper grip on studs. Use outboard support to help prevent tool and wheel assembly from dropping to floor. Do not stand behind tool when in use. Tool is heavy. Use extreme caution when lifting. Keep extremities clear of pinch points. Always wear eye protection when using hub removal tool. Locking pin must be in place when not in use. Not responsible for damage to vehicle.

Pliers:

Wear protective goggles. Broken tips or cut material can fly.

Power Tools:

Wear protective goggles. Always read instructions before using a power tool. Flying particles can cause injury. Use hearing protection when exposed to noise for prolonged periods of time. Do not misuse power tools.

Prybars:

Wear protective goggles. Do not strike a prybar. Prybars may cause loose material to fly. Do not use if chipped or cracked.

Pullers:

Wear protective goggles. Be sure that center screw threads are clean and well lubricated. Be sure the puller is seated properly, do not use on an angle. Do not overstress the puller, always use the largest size possible to do the job efficiently. Never use a puller with worn or damaged parts.

Punches/Chisels:

Always wear protective goggles. Regrind a dull chisel to its original shape when the cutting edge becomes dull. Use a punch or chisel holder to prevent injury. Never use a broken punch or chisel.

Ratchets:

Ratchet mechanism may slip or break if parts are worn or dirty. Frequently clean and lubricate.

Screwdrivers:

Wear protective goggles. Never use a screwdriver for prying, punching, chiseling or scraping. Be sure tip width and thickness are appropriate for slot size.

Sockets (Hand):

Wear protective goggles. Be sure to always choose the appropriate type of socket based on its application. Do not use hand sockets on power tools.

Sockets (Impact):

Wear protective goggles. Flexible sockets and swivel joint tools rotate under power during use and should not be held. Using broken tools can cause serious injury.

Spray Guns:

Wear protective goggles.

Tie Downs/Stretch Cords:

Wear protective goggles when stretching, fastening or releasing hooks. A rebounding hook is dangerous. Do not use if product appears frayed or worn, or if the hook has been bent or otherwise tampered with. Do not stretch a stretch cord beyond 50% of its unstretched length. Do not expose to extreme stress or incorrect use. Do not exceed the maximum working load.

Tow Straps/Ropes:

Do not expose to extreme stress or incorrect use. Working load requirement should be evaluated by user before choosing the appropriate assembly. Always check anchor points. Never use if webbing is worn or frayed.

Wrenches:

Wear protective goggles. Do not over-torque. Avoid excess force on crowfoot or flare nut wrenches. Always use correct size.



PROFESSIONAL TOOLS & EQUIPMENT

2018

JUNE

NEW PRODUCT SUPPLEMENT



**JACK
IT UP!**



**HAMMER
KITS!**

**POWER
BANKS
AND
STARTERS**



**600 LB
CAPACITY!**



**COOL
LOCKING
CARTS!**

HEAVYWEIGHT QUALITY. KNOCKOUT PRICE.



This professional tool cart provides massive storage and smooth mobility across shop floors. Bumpers on all four corners provide extra protection to avoid damage to painted surfaces. Hefty 600 lb. capacity, and extra storage in the lockable top compartment.

**600 LB
CAPACITY!**



KTI75146A
Tool Cart Locking Drawer, Red

KTI75147
Tool Cart Locking Drawer, Black

KTI75148
Tool Cart Locking Drawer, Green



- Professional heavy duty construction with protective bumpers on all four corners
- Massive 600 pound capacity
- Drawer front & lid 1.5mm thickness and 16 gauge steel, Post 2.0mm thickness and 12 gauge steel, Drawer body & tray 1.0mm thickness with 19 gauge steel
- Four Large 5" heavy duty swivel casters provide easy rolling and extra mobility across all types of shop floors
- 4 Drawers with locking top storage compartment and gas struts on top lid
- Compartment and drawer storage area measurements: Top 26.375" x 18.938" x 5.938"; (2) small drawers 10.625" x 17.250" x 2.750"; middle drawer 25.375" x 17.250" x 2.725"; bottom drawer 25.375" x 17.250" x 6.250"; bottom shelf 29.725" x 18.938" x 3.250"
- Drawer front & lid: 1.5mm thick, 16-gauge steel
- Post: 2 mm thick, 12-gauge steel
- Drawer body & tray: 1.0 mm thick, 19-gauge steel
- Covered by a 1-Year Warranty



KTI74906
Car Creeper Seat

- Heavy duty seven wheel creeper with adjustable headrest
- Overall dimensions: 40" L x 16-15/16" W x 3-7/8" H
- Maximum weight capacity: 250 lbs
- Caster wheels size: 2.5" and made of PP plastic, head & seat cushions made of high density foam, head cushion is 2.6" thick and seat cushion is 1.4" thick
- Covered by a 1-Year Warranty



KTI72462
Magnetic Toolbox Trays,
4 Piece Set

- Extra strong rubber coated magnets
- Won't scratch or damage work surfaces
- Heavy duty steel construction
- Covered by a 1-Year Warranty

Includes: (1) 6" rectangular tray, (1) 12" rectangular tray, (1) 2-piece paper towel holder, (1) 3 spray can holder with 7 screwdriver holes



Lifetime Warranty*

KTi20020
12 Piece, 1/4" Multi Plus
Close Quarter Spline Socket Set

- For use with standard 1/4" Drive Ratchet or with ratchet included in set
- Sockets can also be used with an 11mm wrench or 1/4" Drive square head tool
- Fits SAE, Metric, 6 point, 12 point, E-Torx and Square Drive sockets

Set includes: 5, 5.5, 6, 7, 8, 9, 10, 11, 12, 13 & 14mm close quarter spline sockets with 11mm hex shape & 1/4" internal drive and 72 Tooth 6" reversible ratchet wrench with socket retaining spring. All tools are covered by a Lifetime Warranty.



Lifetime Warranty*

KTi41803
23 Piece Pro-Series Metric Wrench Set

Set includes: 8mm, 9mm, 10mm, 11mm, 12mm, 13mm, 14mm, 15mm, 16mm, 17mm, 18mm, 19mm, 20mm, 21mm, 22mm, 23mm, 24mm, 25mm, 26mm, 27mm, 29mm, 30mm and 32mm, 12 point wrenches in a pouch.
 • All tools covered by a Lifetime Warranty.



Lifetime Warranty*

KTi25128
27 Piece, 1" Drive
12 point Socket Set with Accessories

- 1" female square drive
- Fractional sizes from 1-1/2" to 3-1/8"

Set contains: 1-1/2", 1-5/8", 1-11/16", 1-3/4", 1-13/16", 1-7/8", 1-15/16", 2", 2-1/8", 2-3/16", 2-1/4", 2-5/16", 2-3/8", 2-7/16", 2-1/2", 2-9/16", 2-5/8", 2-3/4", 2-13/16", 2-15/16", 3", 3-1/8", 3" extension, 16" extension, 26" flex handle, 22" sliding T-handle, 26" ratchet with 24 teeth all come in a 31.10" x 11.93" x 4.37" metal box weighing 114.64lbs. All tools covered by a Lifetime Warranty.



KTi20061
40 Piece, 1/4" Drive
Color Coded Bit Set

- Complete S2 Bit Set

Bits included: Pozi Bits: 1, 2, 3, Phillips Bits: 1, 2, 3, Metric Hex Bits: 1.5, 2, 2.5, 3, 4, 5, 6mm, SAE Hex Bits: 5/32, 3/16, 7/32, 1/4, Slotted Bits: 5/32, 3/16, 1/4, Torx Bits: T7, T8, T9, T10, T15, T20, T25, T27, T30, T40, Tamperproof Torx Bits: T7, T8, T9, T10, T15, T20, T25, T27, T30, T40



KTi20060
60 Piece, 1/4" Drive
Spline Socket Set

- 72 tooth quick release double ended bit ratchet, 1/4" square driver x 1/4" female hex
- 17 piece chrome vanadium spline sockets (8 SAE & 9 metric)
- 1/4" drive 2" chrome vanadium extension and quick release bit extension
- 40 bits, slotted, phillips, hex and torx
- Ratchet, sockets and extension covered under a Lifetime Warranty

Bits included: Pozi Bits: 1, 2, 3, Phillips Bits: 1, 2, 3, Metric Hex Bits: 1.5, 2, 2.5, 3, 4, 5, 6, SAE Hex Bits: 5/32, 3/16, 7/32, 1/4, Slotted Bits: 5/32, 3/16, 1/4, Torx Bits: T7, T8, T9, T10, T15, T20, T25, T27, T30, T40, Tamperproof Torx Bits: T7, T8, T9, T10, T15, T20, T25, T27, T30, T40.



KTi20800
51 Pc. Master
Torx Socket Set

- (8) 1/4", (5) 3/8" and (1) 1/2" Drive Torx bit sockets
- (5) 1/4", (6) 3/8" and (2) 1/2" Drive Torx external bit sockets
- (7) 1/4", (4) 3/8" and (1) 1/2" Drive Torx plus bit sockets
- (7) 1/4", (4) 3/8" and (1) 1/2" Drive Torx tamper resistant bits

Lifetime Warranty*

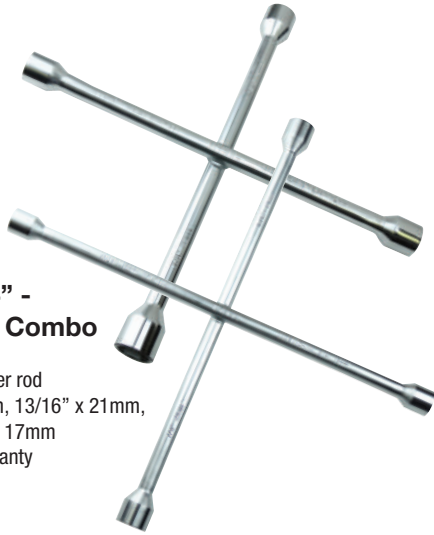

**KTI71941
Lugnut Wrench 14" -
4 Way SAE/Metric Combo**

- 14" four way cross wrench with 15.5mm outer diameter rod
- Sizes include: 7/8" x 22mm, 13/16" x 21mm, 3/4" x 19mm and 11/16" x 17mm
- Covered by a Lifetime Warranty

**KTI71942
Lugnut Wrench 18" - 4
Way SAE/Metric Combo**

**KTI41372
High Polish Combination Wrench 2-1/4"**

- Manufactured from chrome vanadium steel
- High polish finish resists rust and corrosion
- 12-point box end design
- Professional series fractional wrench
- Covered by a Lifetime Warranty

Lifetime Warranty*



**KTI42815
Double Open End Wrench**

- High polish chrome
- 13mm x 15mm
- Covered by a Lifetime Warranty

Lifetime Warranty*



**KTI70011
Seal Puller Tool**

- Two tips to fit all seal sizes
- Protects bearings and races
- Covered by a Lifetime Warranty
- Removes the seal easily without pounding or hammering



**KTI54053
Parrot Plier**

- Uniquely designed parrot nose jaws grip 3 sides of a fastener or pipe for a non slipping grip
- Heavy-duty chrome-molybdenum steel
- Gripping surface with file-cut for various use
- Length: 9" long; Jaw capacity: 15/64" to 1-1/4" (6-32mm)
- Covered by a Lifetime Warranty

Lifetime Warranty*

Lifetime Warranty*

**KTI56206
Ratcheting Spark Plug
Wire Crimper**

- 8.7" Ratchet Crimper • For spark plug connectors
- AWG 17, 1 mm2 • Lifetime Warranty
- Crimper styles include: M3 threaded bush, SAE ignition cable bush, SAE ignition bush 90°, and ignition distributor bush.



**KTI71760
3 Piece Hammer Kit**

- Hammer heads are forged from induction case hardened 50-58 HRC
- Ergonomic ozone resistant rubber grip handles absorb vibration and reduces fatigue
- Steel reinforced lanyard hole conforms to ANSI standard

Kit includes: Club hammer 2-1/2 lb x 12" long (KTI71767); Ball Pein hammer 24 oz x 14" long (KTI71761); Cross Pein hammer 2-1/2 lbs x 16" long (KTI71768). Each hammer is covered by a 1-Year Warranty



**KTI71765
Cross Pein Hammer, 3-1/2 lbs**

- Indestructible 16" handle is 75 times stronger than wood and fiberglass
- Covered by a 1-Year Warranty



**KTI71766
Ball Pein Hammer, 32 oz.**

- Indestructible 14" handle is 75 times stronger than wood and fiberglass
- Covered by a 1-Year Warranty



**Lifetime
Warranty***



KTI70150

Metal Brake Line Thickness Gauges

- Eight heavy duty steel brake lining thickness gauges
- Color coded brake gauge identifies thickness levels for quick inspection of brake linings
- 3 Green: 8, 10, 12 mm (0.3150" ~ 0.4720"); Brakes are still good
- 3 Yellow: 4, 5, 6 mm (0.1575" ~ 0.2382"); Brakes should be serviced soon
- 2 Red: 2, 3 mm (0.0787" ~ 0.1181"); Brakes need to be serviced!
- Lifetime Warranty



KTI72970

5 Piece Drift Brass Punch Set

- Includes 5 punches all 5-3/4" (147 mm) long, with the following punch diameters: 1/4" (6 mm) - (KTI72971), 3/8" (10 mm) - (KTI72972), 1/2" (12 mm) - (KTI72973), 5/8" (16 mm) - (KTI72974) & 3/4" (19 mm) - (KTI72975)



KTI72135A

1/2" Drive Digital Torque Wrench, 25-250 ft/lbs

- 1/2" drive, 72 teeth
- 25-250 ft./lbs.
- Guaranteed accuracy +/- 4%
- Tool length: 22.44"
- Head width: 1.54"
- Head depth: 1.76"
- Weight: 3.31 lbs.
- Comes in a black blow-mold storage case
- Covered by a 1-Year Warranty



KTI72346

Tube Straightener

- Tube straightener for 3/16" to 5/8" tubes
- Works on copper and cupronickel tubes (brake tubes)
- ABS wheels prevent the tubes from being scratched or marked
- 5 contacting points provide higher straight precision
- Covered by a 1-Year Warranty

KTI71557

5 Piece Tie-Rod/Ball-Joint Splitter Set

- Forks made of drop forged heavy duty chrome vanadium steel
- 3 drop forged forks: 1 1/16", 1 5/16" & 1-1/8"
- 1 Handle for use with hammer
- 1 Handle designed for use with pneumatic air hammer
- Both handles are interchangeable



KTI72902

17 Piece Power Punch Kit

- Metal-punching Tool Set
- Will pierce up to 14 gauge steel
- 7 sets of punches & dies: 3/32", 1/8", 5/32", 3/16", 7/32", 1/4", 9/32"



KTI70083

Flare Die Set 37 Degree

- For 3/16", 1/4", 5/16" and 3/8" brake, transmission and power steering lines
- Kit contains one-piece turret with seven adapters, and 4-piece tube retaining dies
- Create precision 37 degree double, single and bubble flares in seconds
- Use with Professional Brake Flaring Tool Kit (KTI70081)
- 1-Year Warranty

KTI63129

Service Jack 3-1/4 Ton Hydraulic Low Profile

- 4" low pick up height
- 21" maximum lift height
- Flanged side plates resist frame twisting
- Foam padded sleeve
- Complies to ASME/PASE 2014 current safety standards
- Covered by a 2-Year warranty



KTI63095

2 Ton Low Profile Service Jack

- Low height: 3.35"; Raised height: 14.96"; Handle length: 5.43"; Overall length: 22.24"; Over width: 8.31"; Weight: 33.5 lbs.
- High lift range / Extra long, low profile design for low clearance vehicles / Swivel saddle & swivel rear casters for easy positioning and safety
- Saddle diameter: 1.8"; Front wheel size: 2.6"; Rear caster wheel size: 1.6"
- Covered by a 1-Year Warranty



KTI63094

1.5 Ton Aluminum Racing Jack

- High lift range: 3-5/8" - 14-1/4"; Handle length: 37-2/5"; Saddle diameter: 3-4/5"
- High lift range / Extra long, low profile design for low clearance vehicles
- Swivel saddle & swivel rear casters for easy positioning and safety
- Front wheels diameter: 1-3/5" x 4-2/5" wide; Rear casters diameter: 1-3/5" x 3/5" wide
- Length: 19-5/8"; Width: 10"; Height: 8"; Weight: 31 lbs.
- Covered by a 1-Year Warranty



KTI63131A

3 Ton Compact Service Jack

- Lifting range: 5.5" - 18.75"
- Sealed hydraulic power unit prevents contaminants from entering system
- Length: 24"; Chassis Width: 13.4"; Handle Length: 39.4"; Saddle Diameter: 3.75"
- 1-year Warranty on material & workmanship

KTI63096

2.5 Ton SUV Jack

- Low height: 6.1"; Raised height: 21.65"; Handle length: 10.12"; Overall length: 24.84"; Overall width: 6.3"; Weight: 44.75 lbs.; Saddle diameter: 2.2"; Front wheel size: 3.5"; Rear caster wheel size: 2.1"
- High lift range
- Covered by a 1-Year Warranty

KTI61201

2 Ton Jack Stands (Pair)

- Minimum height: 10.75"; Maximum height: 16.73"
- Base dimension: 6.89" x 6.57"
- Weight: 11 lbs. (Pair)
- Covered by a 1-Year Warranty



KTI63097

2 Ton Trolley Jack & Jack Stands (pair) Set

- Trolley jack low height: 5.31"; raised height: 12.99"; Overall length: 17.72", Overall width: 7.87", Handle length: 16.53"; Saddle diameter: 2"; Front wheel size: 2.6"; Rear caster wheel size: 1.6"; Weight: 18.74 lbs
- Jack stands low height: 10.75"; Raised height: 16.73"; Base dimensions: 6.89" x 6.57"; Weight: 11 lbs. (Pair)
- Both covered by a 1-Year Warranty



KTI70046

Auto Darkening Welding Goggles Kit

- Adjustable shade 5-13 for grinding to TIG welding
- Time and sensitivity fully adjustable
- Hood includes bump cap for safety
- Lightweight and ideal for working in confined spaces
- Kit contains: fire retardant hood and bump cap, auto darkening welding goggles, protective shield and carrying bag
- Covered by a 1 Year warranty



KTI70046-1

Replacement Face Mask Shell

KTI70046-2

Replacement Front Cover Lens

KTI70046-3

Replacement Internal Bump Cap

KTI72204

Plastic Rotary Transfer Pump

- Glass filled, Polypropylene (PP) body with Ryton Rotor & Vanes and Viton seals
- For use with 15 - 55 gallon drums
- Delivers up to 1.30 gallons per 20 turns
- Includes drum bung for use with both metal and plastic drums
- For use with chemicals, DEF, antifreeze, detergents, etc.
- Not for use with gasoline, diesel, fuel oil, kerosene, etc.
- Covered by a 1-Year Warranty



KTI72202

Vertical Lift Chemical Pump

- Nylon Body, Stainless Steel Shaft and Polytetrafluoroethylene (PTFE) Seals
- For use with 55 gallon drums
- Delivers up to 14 oz. per stroke
- For use with Antifreeze, Detergent, DEF, Lacquer, Thinners, Acetone, etc.
- Not for use with gasoline, diesel, fuel oil, kerosene, etc.
- Covered by a 1-Year Warranty



KTI74656

Plastic Measure Flex Spout with Dust Cap, 6 Qt

- 18.25" long with spout attached
- 6 quart (6 liter) plastic measure with lid
- For transferring metered quantity of oil, fuel, antifreeze, water etc.
- Translucent body provides visibility to liquid level inside the measures
- Graduated in quarts and litres
- 1-Year Warranty



KTI74649

Plastic Measure Flex Spout with Dust Cap, 1 Quart

- 12" long with spout attached
- For transferring metered quantity of oil, fuel, antifreeze, water etc.
- Translucent body provides visibility to liquid level inside the measures
- Graduated in quarts and litres
- 1-Year Warranty



KTI74620

2 Piece Universal Oil Funnel

- Universal funnel and an adjustable plier clamp
- For refilling engine oil, coolants, etc. in passenger vehicles, commercial vehicle, tractors, earth moving equipment, etc.
- Fits on all Filler Necks with opening between 1" to 3.14"
- Covered by a 1-Year Warranty



19.2 VOLT



KT173970

**Battery Powered
19.2V Cordless Grease Gun**

- Includes two 1.5Ah Lithium Ion 19.2V battery packs, cUL listed 110V AC one hour quick charger, 30" high pressure grease hose and quick lock coupler
- Develops up to 6000 PSI
- Delivers up to 3 oz / minute. Dispenses up to 6 grease cartridges with a single charge
- 3 Way loading: 14 oz cartridge, bulk and suction fill
- You can use Ni Cd 18.5V (peak voltage is 19.2V) or Li Ion 19.2V battery with this product. Both are compatible, but you will need the appropriate charger
- Covered by a 1-Year Warranty

KT173975

Rechargeable Li Ion Battery - 19.2V

- Rechargeable Li Ion battery for Cordless Grease Gun (KT173970)
- 1.5 Ah



KT173976

Charger 19.2V Li Ion Battery

- Quick 1 hour battery charger for Li Ion battery (KT173975) which can be used with Drum Pump (KT172215) or Cordless Grease Gun KT173970
- 110V /60 Hz

KT173931

30" Replacement Hose

- Working Pressure: 10,000 PSI



KT173956

Quick Locking Grease Coupler

- Quick locking grease gun coupler with 1/8" NPT
- Coupler body is heat-treated to withstand high pressures without deformation and is 1-1/2 times stronger than regular couplers
- Case hardened rollers hold the coupler in position at 6 points
- Designed for quick & convenient disengagement of coupler from grease fittings under pressure • Allows hands free operation
- Covered by a 1-Year Warranty



KT189021

Air Compressor 1 Gallon

- Oil free **pancake** air compressor with induction motor
- 3 HP
- Maximum pressure: 100 PSI
- Light weight for easy carry
- Covered by a 1-Year Warranty

KT189023

**Air Compressor
3 Gallon**

- Oil free **horizontal** air compressor with induction motor
- 3 HP
- Maximum pressure: 100 PSI
- Light weight for easy carry
- Covered by a 1-Year Warranty



KT189030

Inflator 120V AC/12V DC, 200 PSI

- Three adapters
- Multi-function inflator (200 PSI) with operation under AC 120 volt AC or DC 12 volt
- Long-reaching cords: 9ft 10in (3m) with cigarette plug and 6ft 7in (2m) cord with AC plug
- Comes with portable, nylon carry bag
- Covered by a 1-Year Warranty



KT189006

Tire Inflator with 2" Gauge

- 1/4" (6.4mm) Male NPT
- Inflation gun, chuck, and gauge are all combined in one easy-to-use unit
- Built-in relief valve helps reduce pressure in over-inflated tires

KT189005

Professional Tire Inflator Gauge

- Aluminium die cast heavy duty body
- Fitted with 2-1/2" mechanical pressure gauge with protective shroud, 24" long flexible hose and rigid steel extension with grip, built in swivel & dual chuck for truck tires
- Inlet 1/4" NPT, maximum pressure 230 PSI
- Super accurate to within +/- 1.6%
- Covered by a 1-Year Repair or Replace Warranty



KT189007

Tire Buffer, Low Speed

- Tire buffer with exhaust tube to direct air away from the working area. Inlet threaded 1/4" NPT (F)
- 2500 RPM low speed is ideal for abrasive job requiring low speed such as tire buffing
- Safety lever to prevent accidental start up
- Non-slip rubber boot to prevent the worker's hand from being frozen during buffer is loading and causing the air condition effect
- Covered by Repair by a 1-Year Warranty



KT171035

Auto Plug 1/4" Male NPT

- Auto plug 1/4" male NPT
- Chrome finish
- "T" style



KT189008

1/4" NPT Female Ball Tire Air Chuck

- 1/4" NPT Female Ball Tire Air Chuck
- Build in shut-off valve seals prevent air from leaking when not in use
- 1/4" female NPT threads



KT172216

18.5V Ni Cd Battery Charger

- Quick 1 hour battery charger for Ni Cd battery (KT172214) which can be used with Drum Pump KT172215
- 110V/60 Hz
- 18.5 Volt; peak voltage is 19.2 V



KT172214

Rechargeable

Ni Cd Battery 18.5V

- Replacement battery for Electric Rechargeable Drum Pump (KT172215)
- 18.5 Volt; peak voltage is 19.2 V



KT181798S

1" Spline Drive Impact Wrench

- # 5 Spline Drive Anvil
- 1600 ft/lbs. of torque
- 6" Extended anvil for extra access
- 3 Forward and 3 reverse power settings with D side handle for ease of use
- This tool is a workhorse - it is very powerful and durable
- Covered by a 1-Year Warranty



KT181380A

Electric Impact Wrench 240 ft/lbs.

- Maximum torque: 240 ft/lbs
- 900 Watt, 7.5 Amps
- No Load speed: 2200rpm
- Impact per minute: 2700
- Covered by a 1-Year Warranty



KT187120

4 Piece Heavy Duty Industrial Quality Die Grinder Display Set

- (2) 1/2" HP 1/4" angle die grinders (KT187134)
- (2) 1/2" HP 1/4" straight die grinders (KT187124)
- Durable composite housing, rear exhaust systems
- Die grinders have the following specifications:
 - Collet Size: 3-6mm (1/8"-1/4")
 - Free Speed: 22,000 rpm's
 - Air Inlet: 1/4"
 - Suggested Air Pressure: 90psi
 - Average Air Consumption: 12cfm
- Each die grinder is covered by a 1-Year Repairable Warranty



KT187124

Heavy duty industrial quality 1/2" HP 1/4" Straight Die Grinder

- Durable composite housing
- Rear exhaust system
- Collet Size: 3-6mm (1/8"-1/4"), Free Speed: 22,000 rpm's, Air Inlet: 1/4", Suggested Air Pressure: • 90psi, Average Air Consumption: 12cfm
- Low vibration facilitates improved working conditions, safety trigger
- Covered by a 1-Year Repairable Warranty



KT187134

Heavy Duty industrial Quality 1/2" HP 1/4" Angle Die Grinder

- Durable composite housing
- Rear exhaust system
- Collet Size: 3-6mm (1/8"-1/4"), Free Speed: 22,000 rpm's, Air Inlet: 1/4", Suggested Air Pressure: • 90psi, Average Air Consumption: 12cfm
- Low vibration facilitates improved working conditions, safety trigger
- 1 Year Repairable Warranty





PROGRAMS 98.6% OF ALL SENSORS

KTITPMSPRO

KTi TPMS Pro Tool

- TPMS Tool for Sensor Activation, Programming and ECU Reset
- 98.6% TPMS sensor coverage
- Programs all major leading aftermarket TPMS sensor brands
- Vehicle make, model, year lookup and relearn procedures
- Activates and reads 100% TPMS sensors
- Displays all sensor data in seconds: ID, tire pressure, tire temperature, battery status, etc.
- Provides indirect, manual and auto relearn procedure information

Easy to operate with an icon interface and bright color display - Ideal for large tire shops looking for a versatile and upgradable tool to satisfy their TPMS needs. Checks Remote Keyless Entry signal, includes frequent database updates via PC desktop software and Interface and relearn procedures in 23 languages. Covered by a 1-Year Warranty with 1 Year FREE Updates and includes worldwide TPMS technical support.



KTITPMSPROKIT

KTi TPMS PRO Tool with U-Pro Sensors Kit

- Kit Includes KTITPMSPRO, 12 U-Pro 315mhz and 4 U-Pro 433mhz TPMS Sensors
- KTITPMSTOOL reads and activates all known TPMS sensors
- KTITPMSTOOL offers vehicle make, model, year look-up and relearn procedures
- U-Pro sensors program in 1-3 seconds - fastest programming sensor in the market
- U-Pro sensors are compatible with over 90% of the current TPMS enabled vehicles

Packaging includes both the snap-in and clamp-in valves
Programs in 1-3 seconds- fastest programming sensor in the market
"True Two Sku's" for reduced inventories
Compatibility with over 90% of the current TPMS enabled vehicles
115 psi/8 Bar Max Pressure
Market leading 3-Year sensor Warranty, 2-Year valve Warranty and 7-Year battery life span

KTi72765A

Circuit Tester 6-12-24 Volt

- Used for checking 6-, 12-, and 24- volt systems
- 4' insulated lead cable with ground clip
- Plastic handle lights up when circuit is good
- Probe length: 3" • Overall length: 6-1/2"
- Covered by a 1-Year Warranty



KTITPMSTOOL

TPMS Sensor Activation & Programming Tool

- Comprehensive make, model, year lookup with Multi-lingual, 19+ languages
- Activates and reads 100% TPMS sensors and includes TPMS sensor part number look-up (OE and aftermarket)
- Programs all leading aftermarket programmable sensors
- Displays TPMS sensor data (ID, tire pressure, tire temperature, battery status, frequency)

Its rugged casing and durable rechargeable battery is designed for medium sized tire shops and tough service station environments. Thanks to frequent updates, the newest TPMS sensors and vehicles are introduced each year. Covered by a 1-Year Warranty with 1 Year FREE Updates and includes worldwide TPMS technical support.



KTITPMSTOOLKIT

KTi TPMS Tool with U-Pro Sensors Kit

- Kit Includes KTITPMSTOOL, 6 U-Pro 315mhz and 2 U-Pro 433mhz TPMS Sensors
- KTITPMSTOOL reads and activates all known TPMS sensors (create or clone)
- KTITPMSTOOL offers vehicle make, model and year look-up
- U-Pro sensors program in 1-3 seconds - fastest programming sensor in the market
- U-Pro sensors are compatible with over 90% of the current TPMS enabled vehicles

Packaging includes both the snap-in and clamp-in valves
Programs in 1-3 seconds- fastest programming sensor in the market
"True Two Sku's" for reduced inventories
Compatibility with over 90% of the current TPMS enabled vehicles
115 psi/8 Bar Max Pressure
Market leading 3-Year sensor Warranty, 2-Year valve Warranty and 7-Year battery life span

KTiOBD6-000

OBD2 Interface Module

- OBD2 Interface Module
- Allows users to reset the Electronic Control Unit (ECU) in less than two minutes
- Can be used on all vehicles, but required for Asian and some European vehicles
- For use with KTITPMSOBD and KTITPMSPRO
- Covered by a 1-Year Warranty





KTITPMSOBD

KTITPMS PRO with OBD II and Softshell Case

- Includes KTITPMS PRO, plus OBD II module and softshell case
- OBD II module allows users to reset the Electronic Control Unit (ECU) in less than 2 minutes



KTITPMSOBDKIT

OBD2 Interface Module

- Kit Includes KTITPMSOBD, 16 U-Pro 315mhz and 4 U-Pro 433mhz TPMS Sensors
- KTITPMSOBD reads and activates all known TPMS sensors (cretes and clones)
- KTITPMSOBD offers vehicle make, model, year look-up and relearn procedures
- U-Pro sensors program in 1-3 seconds - fastest programming sensor in the market
- U-Pro sensors are compatible with over 90% of the current TPMS enabled vehicles

Packaging includes both the snap-in and clamp-in valves
 Programs in 1-3 seconds- fastest programming sensor in the market
 "True Two Sku's" for reduced inventories
 Compatibility with over 90% of the current TPMS enabled vehicles
 115 psi/8 Bar Max Pressure
 Market leading 3-Year sensor Warranty, 2-Year valve Warranty and
 7-Year battery life span

KTIT73270

Pocket Light COB LED 1.5W 180 Lumen

- Acrylonitrile-Butadiene-Styrene (ABS) plastic material
- 1.5 Watt COB LED, 180 Lumens
- Run time: 4 hrs
- On/Off switch and magnet on clip
- Light Size: 4.409" x 2.165" x 0.630"
- Weight: 0.194 lbs. with batteries
- 1-Year Warranty
- Includes 3 "AAA" batteries and instructions



KTIT74391

Jump Starter/Power Supply 12,000 mAh

- 12,000 mAh provides 250 amps cranking power and 500 peak amps
- Intelligent cables feature built-in short-out protection
- Able to jump start cars, SUVs, Light and Medium duty trucks
- 2 USB charging ports, in addition to 19V, 16V, and 12V outputs
- Covered by a 1-Year Warranty



KTIT74392

Jump Starter/Power Supply 15,500 mAh

- 15,500 mAh provides 400 cold-cranking amps and 800 peak amps
- Intelligent cables feature built-in short-out protection
- Able to jump start a wide range of both gas and diesel vehicles
- LCD digital read out for more precise functionality
- 19V, 16V, & 12V outputs
- Covered by a 1-Year Warranty

KTIT74393

Jump Starter/Power Supply 18,000 mAh

- 18,000 mAh provides 500 amps cranking power and 1000 peak amps
- Intelligent cables feature built-in overcharge and reverse polarity protection
- Able to jump start a wide range of gas-powered and diesel vehicles
- Includes 8 computer recharging tips and 3-in-1 pigtail phone charging cord
- 2 USB charging ports in addition to 19 V, 16V, & 12 V outputs and an OBD II memory saver cable
- Covered by a 1-Year Warranty



KTIT74394

Industrial Power Bank & Jump Starter Kit 30,000 mAh

- 30,000 mAh provides 800 amps cranking power and 1800 peak amps
- Intelligent cables feature built-in overcharge and reverse polarity protection
- Jump starts the widest variety of vehicles, including heavy-duty trucks, buses, tractors, and more
- Includes 8 computer recharging tips and 3-in-1 pigtail phone charging cord
- 2 USB charging ports in addition to 19 V, 16V, & 12 V outputs and an OBD II memory saver cable
- Covered by a 1-Year Warranty



HIGH POWER!



KTI73397A

20 Element SMD LED Worklight, 25' Cord

- High Power 20 SMD LED's Worklight, 500 Lumen
- 25', 16/3 SJTW gauge cord with 1-15amp plug
- 11 amp grounded outlet in handle
- Dual hanging hooks • Magnet included
- 1-Year Warranty

KTI73379A

Trouble Light Retrofit, 500 Lumens

- Twist on module that converts incandescent trouble light into a LED light
- 30 high powered SMD LED's (500 Lumens)
- Rubber bumper to protect unit
- Covered by a 1-Year Warranty



KTI73398M

Headlamp Motion Detection, 150 Lumens

- Adjustable head strap
- Adjustable light tilts up and down 180 degrees
- High Beam Distance: 65-1/2 ft (20 meters)
- Low Beam Distance: 26 ft (8 meters)
- Impact resistant: 3 ft (1 meter)
- Comes with the USB cable for charging
- Covered by a 1-Year Warranty



KTI73398B

Head Lamp LED 3W 120 Lumen BLUE

- Head Lamp LED 3W 120 Lumen BLUE
- 3 Watt, 120 lumen hands-free LED head lamp
- Powerful 3 watt COB LEDs
- 4 Operating modes: High (100%), Low (50%), Flashing, Off
- Adjustable ratcheting headlamp (Color: Blue)
- 3 AAA alkaline batteries, included
- Covered by a 1-Year Warranty



KTI73271

Rechargeable Thin Light COB LED 5W

- PC & aluminum tube construction with (ABS) & thermoplastic rubber (TPR) handle
- 5 Watt COB LED, 550 Lumens high mode and 250 Lumens low mode, Top light 0.5 Watt COB LED 50 Lumens
- Charge time: 3-1/2 hrs • Battery power indicator on handle
- Over charge and over discharge protection
- Bottom of handle contains a magnet • 1-Year Warranty



Contains: 1 worklight, 1pc charger, 1 USB cable and instructions.

KTIHLD

12 Piece FastTrack Head Light Display

- Dimensions of display: (2) 24" x 12" x 4"
- Hooks on rear of display for easy hanging
- Contains: (6) 3 Watt, 120 lumen adjustable ratcheting headlamps, red (KTI73398A); and (6) 3 Watt, 120 lumen adjustable ratcheting headlamps, blue (KTI73398B)
- Light operating modes: High (100%),
- Low (50%), Flashing, Off • 3 AAA batteries included
- Lights are covered by a 1 Year Warranty



RECHARGABLE!



KTI73272

Underhood Rechargeable Light 210SMD

- Aluminum tube construction with thermoplastic rubber (TPR) housing material
- Short circuit protection, over charge protection
- 1100 Lumens on high mode / 550 Lumens on low mode and 3.7Volt 8000mAh Li-ion rechargeable battery
- Charge time: approximately 4-1/2 hrs
- Run time: 3 hrs on high mode / 6 hrs on low mode
- Steel pipe light holder is adjustable from 47" to 76"
- Light includes 2 clamps and 2 magnetic hooks for positioning
- 1-Year Warranty

Contains: 1 210 SMD rechargeable worklight, 1 charger, 1 piece 2-section underhood holder, 2 clamps, 2 magnetic hooks and instructions.



KTI73385

Work Light Foldable Underhood 1500 Lumens

- 30W COB LED 1500 Lumens under hood rechargeable work light with foldable frame is more convenient for storage and carry
- Tough, lightweight aluminum alloy construction with soft foam covered ends on telescoping (48"-77") bracket
- Detachable from the frame, two lights (15W, 750 Lumens each) also can be used separately as hand held work light
- Charge time: about 4 hours; Run time: 2-1/2 hrs. (high mode) & 5 hrs. (low mode)
- 3.7V 800mAh Lithium ion rechargeable batteries. (2) AC chargers (5 volt, 1A) included
- Covered by a 1-Year Warranty

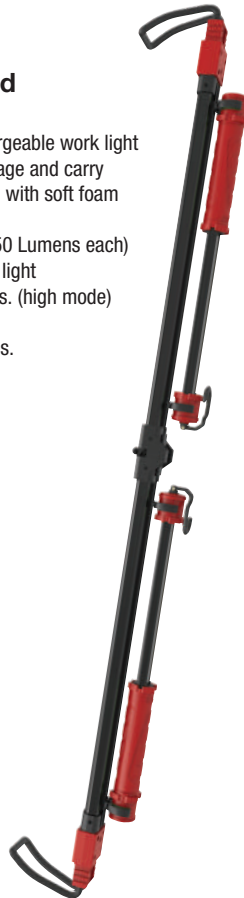

KTI73382

Work Light - Rechargeable 750 Lumens 120 SMD LED

- 15W COB LED 750 Lumens (high) / 375 Lumens (low) hand held rechargeable work light
- Lightweight compact design; comfortable rubber grip
- Charge time: approx. 4 hours ; Run time: 2-1/2 hrs (high mode) & 5 hrs (low mode)
- AC charger (5 volt, 1A) included
- Covered by a 1-Year Warranty



KTI73383

Work Light - Rechargeable 600 Lumens 92 SMD LED

- 10W COB LED 600 Lumens hand held rechargeable work light
- Charge time: approximately 4 hours; Run time: about 3-1/2 hours
- AC charger (5 volt, 1A) included
- Covered by a 1-Year Warranty



KTI73384

Work Light - Rechargeable 400 Lumens 62 SMD LED

- Charge time: approximately 4 hours; Run time: about 4-1/2 hours
- Overall length: 15.6"; Rechargeable 18650 3.7V 3600 MA Lithium-ion battery; AC charger (5 volt, 1A) included.
- Covered by a 1-Year Warranty



KTI71006

BluBird Air Hose Reel 3/8" x 25'

- Retractable air hose reel with BluBird air hose 3/8"x25' with 3' whip hose
- Powder Coated Steel - Corrosion Resistant
- 12 Point ratchet for locking at shorter intervals
- Covered by a 2-Year Warranty on hose reel and 10-Year Warranty on attached hose to any manufacturing defects



KTI71007

Water Hose Reel 5/8" x 50'

- Water hose reel 5/8" x 50' with 3' whip hose for easy installation
- Retractable hose reel with Bluseal water hose and nine mode spray gun
- Powder coated steel - corrosion resistant, heavy duty 18 gauge steel
- 12 Point ratchet for locking at shorter intervals
- Covered by a 2-Year Warranty on hose reel and 10-Year Warranty on attached hose to any manufacturing defects



KTI71008

BluBird Oil Shield Air Hose Reel 3/8"x75', 18 Gauge

- Retractable 18 gauge steel air hose reel with BluBird Oil Shield air hose 3/8" x 75'
- Powder Coated Steel - Corrosion resistant, heavy duty 18 gauge steel
- 12 Point ratchet for locking at shorter intervals
- 2-Year Warranty on Reel with 3-Year Warranty on the included yellow Oil Shield hose



KTI72053

BluBird OS Whip Hose - 1/2" x 5'

- Professional air tool lead in / snubber hose, 300 psi working pressure & comes with 1/2" MNPT 360° ball swivel & 1/2" FNPT revolving fittings
- Extends coupler service life & improves maneuverability
- Absorbs shock to air couplers from pneumatic tools
- Flexible rubber construction, with 4 finger-grip bend restrictor
- Covered by a 90 day material and workmanship Warranty



KTI71009

Swivel Mount for Hose Reels, 3/8" & 1/2" Reels

- Powder coated steel construction
- Heavy duty swivel joints • Suitable with most reels
- Covered by a 2-Year Warranty



KTI72063

BluBird Tire Inflator Fleet Edition Kit

- Fleet edition tire inflator kit with BluBird Air Hose, Phillips Glad Hand (Made in USA) and a Dual Foot Chuck Inflator
- Featuring the lightest, strongest, most flexible all-weather BluBird air hose 3/8" x 50' with 1/4" MNPT
- Includes Phillips heavy duty aluminium universal glad hand
- Includes a 1/4" to 1/2" adaptor for fitting to Phillips glad hand, Teflon™ tape and a carry bag for easy storage after use
- Dual foot chuck inflator, suitable in temperatures up to -50F
- Covered by a 10-Year Warranty



KTI72087

Water Hose Connector 1" x 15'

- Cold weather flexibility down to -50F and handles hot water up to 212F
- Ozone & UV resistant cover provides protection from extreme weather & abrasion
- Crush proof brass couplings
- Covered by a 10-Year Warranty



KTI72052

BluBird Whip Hose - 1/2" x 5'

- Professional air tool lead in / snubber hose, 300 psi working pressure & comes with 1/2" MNPT 360° ball swivel & 1/2" FNPT revolving fittings
- Extends coupler service life & improves maneuverability
- Absorbs shock to air couplers from pneumatic tools
- Reduces twisting and kinking
- Flexible rubber construction, with 4 finger-grip bend restrictor
- Covered by a 90 day material and workmanship Warranty



KTI72086

theBlueHose Water Hose 5/8" x 75'

- Lightweight & durable
- Crush proof brass couplings
- Cold weather flexibility down to -50F and handles hot water up to 212F
- Ozone & UV resistant cover provides protection from extreme weather & abrasion
- Covered by a 10-Year Warranty



KTI71027

3/8" x 50 ft Heavy Duty PVC Air Hose

- 3/8" x 50 ft Heavy Duty PVC Air Hose
- 1/4" (6.4mm) NPT Male
- 300 PSI maximum
- 0-103 degree fahrenheit max



KTI71028
18 Piece Air Hose
Accessory Kit
with Tape

Includes: (1) Air blow gun, (1) 10-50 PSI tire gauge, (1) Dual-foot tire chuck, (2) 1/8", 1/4" NPT female couplers, (2) 1/8", 1/4" NPT male plugs, (2) 1/8", 1/4" NPT female plugs, (2) Double female couplings, (1) Double male coupling, (2) Inflation needles, (1) Safety nozzle, (1) Tapered nozzle, (1) Thread seal tape, (1) Rubber tip. Comes in a clear plastic storage case



KTI71032
20 Piece Air Hose
Accessories Kit

Includes: (1) Dual head tire chuck, (1) Tire gauge, (1) Rubber blow gun nozzle, (1) Brass blow gun adapter, (1) 1/4" male double male connector, (1) 1/4" double female connector, (1) Blow gun safety nozzle, (1) blow gun tapered nozzle, (2) Inflation needles, (1) Blow gun head, (1) Thread seal tape, (1) 1/4" x 25 ft. air hose, (2) 1/4" industrial style quick-connect female coupler, (2) 1/4" industrial style quick-connect female plug, (3) 1/4" industrial style quick-connect male plug



KTI70059
Solder Kit Multi-Function

- Four function kit with auto-ignition tool for the professional user
- Ready to use in 15 seconds
- Equivalent to power range 25-80 Watt
- Tank can hold enough fuel for 120 minutes of operation
- Deflector nozzle for heat shrink tube maximum diameter 9mm
- Butane torch is covered by 1-Year Warranty
- Contents: Butane torch, solder, sponge, PS-14 orifice assembly, S-30 deflector, PS-10 heat blower, PS-3 2.4mm chisel, PS-9 hot knife.



KTI70531
Plastic O-Ring Seal Pick

- Remove O-ring seals without damaging parts
- Material: PC "Polycarbonate"
- Length 5-1/2" (14cm)



KTI70531-10
Plastic O-Ring Seal Pick - 10 Pack

- Packaged in clear plastic bag with UPC label

KTI83286-12
Caulking Gun, Steel Drip Free 12 Pack

- Case of 12 caulking gun open frame, all steel side loading design
- Lightweight & strong
- Drip free automatic ratchet advance; Push rod is quick release hex; includes a ladder hook
- Built in nozzle cutter and retractable seal puncture tool
- Thrust ratio: 10:1; Pushing Power: 269.771 lbs (1200N); Net weight: 1.036 lbs; Gun thickness: 0.067"; Rod diameter: 0.307"
- For use with sealants in standard tube cartridges: low to medium viscosity latex, vinyl, acrylic, siliconized acrylic and silicone caulks
- Covered by a 90 day warranty on material and workmanship



KTI83285-12
Caulking Gun, Steel Half Barrel Style 12 Pack

- Case of 12 caulking guns half barrel, all steel design
- Lightweight & strong
- Quick release push rod
- Retractable seal puncture tool
- Thrust ratio: 7:1; Pushing Power: 179.847 lbs (800N); Net weight: 0.650 lbs; Gun thickness: 0.024"; Rod diameter: 0.256"
- For use with sealants in standard tube cartridges: low viscosity latex, vinyl and acrylic caulks.
- Covered by a 90 Day warranty on material and workmanship





K TOOL
INTERNATIONAL
PROFESSIONAL TOOLS & EQUIPMENT

2018
JUNE

NEW PRODUCT SUPPLEMENT



**Auto Body
Dr. Rx**



**ABDRMBRDSET
Rotary Merchandiser &
8 ABD Displays, 10 Boxes**

- Rotary Merchandiser and eight (8) Auto Body Doctor Display Boards
- Display a maximum amount of product (holds up to eight displays) in a minimal amount of space, only 36" x 36"
- Complete with four (4) durable casters
- A must-have for professional, effective merchandising. Rotary ships in two pieces and each ABD display ships separately.
- Rotary merchandiser is FREE!

Ten different boxes will ship: (2) for the Rotary Merchandiser and (8) separate displays. The eight Auto Body Doctor displays are:
 ABDABD-1 Shield Retainers Display
 ABDABD-2 Shield & Door Retainers Display
 ABDABD-3 Push Retainers Display
 ABDABD-4 Trim Screws Display
 ABDABD-5 Body Bolts & Rivets Display
 ABDABD-6 Nuts & Grommets Display
 ABDABD-7 Hood/Door Lock/Windshield Display
 ABDABD-8 Headlight & Misc. Body Parts Display

**FREE
ROTARY!**



PROFESSIONAL TOOLS & EQUIPMENT

2019
JULY

NEW PRODUCT SUPPLEMENT



KT179750 Work Stand Adjustable & Foldable - 41 x 43 x 35"

- Folding Work Table: Length: 40.551" (103cm); Adjustable Width: 23.819" (60.5cm) - 43.307" (110cm); Adjustable Height: 29.134" (74cm) - 35.039" (89cm)
- Load Capacity: 500 lbs
- Sturdy powder coated tubular steel frame with machine-welded seam
- Heavy gauge chain has 6 connectors, which can be placed to adjust height and width
- Red legs with non-skid tips
- Covered by a 1-year warranty



KT179755 Work Stand Adjustable & Foldable - 31 x 36 x 41"

- Folding Work Table: Length: 31.102 (79cm); Adjustable Width: 20.866" (53cm) - 36.024" (91.5cm); Adjustable Height: 31.890" (81cm) - 41.339" (105cm)
- Load Capacity: 750 lbs
- Sturdy powder coated tubular steel frame with machine-welded seam
- Heavy gauge chain has 6 connectors, which can be placed to adjust height
- Red legs with non-skid tips
- Covered by a 1-year warranty

KT179400 Kneeling Mat Magnetic 24" x 16"

- Magnetic foam pad for kneeling
- 24" (length) x 16" (width) x 1.13" (thick)
- Anti-slip, oil proof and solvent-resistant
- Magnetic groove holds nuts, bolts and other spare parts
- 3 layer thick foam protects your knees from rough and hard surfaces
- Covered by a 1 Year Warranty



WARNING: Cancer and Reproductive Harm



Work Table Adjustable 30"

- 30" adjustable height work table from 34" - 47.75" with total weight capacity of 200 pounds
- Rubber bumper corners for protection and top work surface with liner included
- Work table dimensions: 29.3" x 20.2" x 34.5"; Tray size: 28.9" x 19.8" x 1.0"; Drawer size: 15" x 18.5" x 2.5"
- Four 2" x 1.25" swivel casters for easy moving
- 16 gauge steel tray, 22 gauge steel drawer and 13 gauge steel adjustable tube

- KT179700 - Red
- KT179701 - Green
- KT179702 - Black



KT175120 Professional Tool and Work Cart, 3 Shelf Aluminum and Black Plastic

- Dimension: 28.740" x 17.323" x 38.110" (740 x 440 x 968mm) with handle attached and 26.575" x 17.323" x 35.827" (675 x 440 x 910mm) without handle
- Anti-skid handle with matte finish
- Net Weight: 21.407 lbs (9.71 kg); Load Capacity: 330 lbs (150kg)
- 4" TPR Casters: Swivel x2, brake x 2
- High quality plastic, light weight aluminum and low maintenance
- Covered by a 1-year warranty

HEAVYWEIGHT QUALITY. KNOCKOUT PRICE.

NEW PRODUCTS



KTi70706 Air Lift Cooling System Refiller

- Cooling system vacuum purge & refill kit
- To pump radiator and cooling system liquids out of reservoirs
- Use vacuum to fill with new coolant into radiator

Kit contains: Main body with gauge (-1 -0 bar, -76 -0 cmHg); Vacuum Pump; (3) Rubber Buses (OD 35, 39 & 44mm); Coolant Hose



KTi71041 7 Piece Airvac Coolant Refiller

- Performs vacuum leak test on cooling system
- Refills cooling system free of trapped air quickly, efficiently and with no mess
- Muffler dampens noise output during operation
- Purges trapped air from cooling system to eliminate the possibility of engine damage due to overheating
- Covered by a 1-year warranty

KTi70112 Vacuum Brake Fluid Bleeder

- 3 Quart Capacity
- Uses standard workshop air supply
- Removes fluid via bleed nipples to allow bleeding or entire fluid replacement
- Maximum Air Supply: 120 PSI
- Weighs: 3.13 lbs
- Covered by a 1-year warranty



KTi71110 21 Piece Radiator Pressure Tester Kit

- Pressure tester to check leakage of radiator
- 0-35 psi, color-coded gauge with pressure release valve and all adapter come in a plastic carrying case
- Comprehensive operating instruction enclosed



KTi70120 LED Brake Fluid Tester

- Check quality of brake fluid
- Suitable for DOT 3, DOT 4, DOT 5.1 and for a specific brand of DOT 3 (AC Delco, Pennzoil, Prestone, Motorcraft & Toyota)
- Purpose of the tester is to examine the quality of the brake fluid, indicated by 5 LEDs
- Takes 1 second to test the fluid and automatically shuts off after 2 seconds
- Not for Class 8 Heavy Duty Trucks
- One 1.5v battery included
- Covered by a 1 Year warranty



KTi70130 Slack Adjuster Release Tool with 5/16" Wrench

- Truck air brake adjusting wrench set
- Used for adjusting automatic slack adjusters
- Fork-end designed tool able to fit securely under the pull pawl, allowing hands-free operation to release the tension button
- 5/16" offset square reversible wrench with E-Z Grip handle for adjusting the brake, and capable to release the anti-reverse mechanism without prying
- 1 Year Warranty on material and workmanship

KTi89011 Aluminum Die Cast Heavy Duty Tire Inflator Gauge

- 2-1/2" (63mm) digital gauge
- Swivel for convenience in use
- Deflation valve
- Dual chuck
- Covered by a 1-Year Warranty



KTi70707 Ford Broken Spark Plug Remover with Tap

- Spark Plug Rethreading Kit for Ford 4.6, 5.4, V10 2 Valve Engines
- Applicable: Ford 2004 and newer Triton 3 valve cylinder engines
- 1 Year Warranty on Material and Workmanship



KT127014

3/8" Drive 14mm BMW Spark Plug Socket

- Size: 3/8" drive x 9/16"(14mm) • Type: 12 point
- Heat treated chrome vanadium steel with rubber insert to hold the plugs when working
- 1 Year Warranty on Material and Workmanship

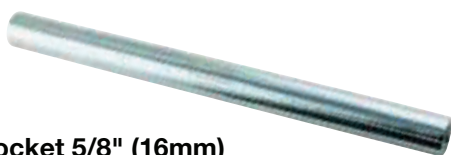

KT122525

10" Spark Plug Socket 5/8" (16mm)

- Deep spark plug socket 3/8" drive X 16mm (12 point)
- Size: 3/8" drive X 16mm
- Type: 12 point
- 1 Year Warranty on Material and Workmanship



KT172902

7 Piece Power Punch Kit

- Metal-punching tool set
- Punches and dies hardened to C50-52
- 7 sets of punches & dies: 3/32", 1/8", 5/32", 3/16", 7/32", 1/4", 9/32"
- Will pierce up to 14 gauge steel
- Handled punch tool is covered by a 1-Year warranty. 7 punch & dies are not covered by warranty



KT170003

51 Piece Universal Rethreading Set

- Set comes with 3 Thread Restoring Files, 25 Rethreading Dies and 23 Rethreading Taps all contained in a red blow molded storage case
- (2) SAE thread restoring files both with 8 pitches, (1) Metric thread restoring file with 8 pitches, (7) United States Standard Coarse Rethreading Dies, (7) SAE Fine Rethreading Dies, (11) Metric Rethreading Dies, (6) United States Standard Coarse Rethreading Taps, (6) SAE Fine Rethreading Dies, (11) Metric Rethreading Dies



KT173636

8 in 1 Drain Plug Key Wrench

- 6 Point, dimensions: S8, S10, S3/8, S1/2, H10, H12, H14, H17
- Suitable for use in most car brands
- 1 Year Warranty on Material and Workmanship



KT173637

8 in 1 Socket Wrench 12-19MM Hex

- 6 Point, dimensions: 12, 13, 14,15, 16, 17, 18 19mm
- 1 Year Warranty on Material and Workmanship



KT171701

12 Piece 1/2" Drive Professional Impact Driver Set

- Impact driver can be used with all 1/2" drive accessories
- Heat-treated and hardened alloy steel
- Professional design is good at rusted or frozen screws
- Includes: 1/2" Impact Driver, 1/2" Dr 5/16" Bit Holder, Phillips Bits: PH2, PH3 & PH3 Xtra long, Slotted Bits: 8mm & 10mm, Bolt Removers: M3-M6, M6-M8, M8-M11, M11-M14 & M14-M19



KT171517

Tie Rod Separator, Tempered Drop Forged Steel

- Tempered drop forged steel one piece construction for long & rough usage
- 21/32"(18mm) Fork, 16"(410mm) Length replaces worn out tie rods easily with a hammer striking
- Also can separate shock absorber links
- Covered by a lifetime warranty

LIFETIME WARRANTY*



KT171518

Tie Rod End Tool

- Redesigned to use on imports and any front wheel drive vehicles, including SUV with rack and pinion steering
- Live center tip on forcing screw swivels to align tool to tie rod stud to ease in removal and prevent damage to stud
- Covered by a lifetime warranty

LIFETIME WARRANTY*

NEW PRODUCTS



KTI71557

5 Piece Tie-Rod/Ball-Joint Splitter Set

- Forks made of drop forged heavy duty chrome vanadium steel
- 3 drop forged forks: 11/16", 15/16" & 1-1/8"
- 1 Handle designed for use with hammer
- 1 Handle designed for use with pneumatic air hammer
- Both handles are interchangeable
- Individual pieces covered by a lifetime warranty

KTI71559

Ball Joint Separator

- Special design 2-stage operation suits most cars and light trucks ball joints in steering & suspension
- Tempered drop forged steel body and offset lever provide an excellent performance and long usage
- Offset lever permits maximum jaw openings in 1-3/16" (30mm) & 2-3/16" (56mm)
- Jaw open: 7/8" (22mm)
- Covered by a lifetime warranty

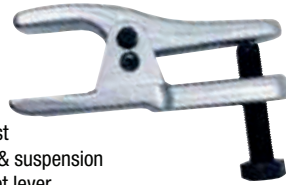

LIFETIME WARRANTY*

KTI71560

Ball Joint Separator, Tempered Drop Forged Steel

- Tempered drop forged steel one piece construction for long & rough usage
- 15/16"(24mm)Fork, 11-7/8"(300mm) length replaces worn out ball joints easily with a hammer striking
- Also can remove CV drive shafts on FWD vehicles
- Covered by a lifetime warranty



LIFETIME WARRANTY*

KTI73907

7 Piece Quick Connect Grease Gun Accessory Kit

- 7 Piece Ezee- Lube Kit comprised of the most commonly used Quick Disconnect Grease Dispensers
- Contents: Recessed Lube Adaptor, Grease Injector Needle, Angle Lube Adaptor, Narrow Needle Nose Adaptor, Seal Off Dispenser, Right Angled Grease Coupler, Heavy Duty Hose with Spring Guard & Coupler
- Packaged in pouch
- Covered by a 1 year warranty



KTI71570

Hydraulic Ball Joint Separator with 56mm Jaw

- Jaw open capacity: 2-3/16" (56mm)
- Jaw width: 7/8" (22mm), Hydraulic ram: 8 ton
- No impact! No hammer!
- Covered by a lifetime warranty



LIFETIME WARRANTY*

KTI71571

Hydraulic Ball Joint Separator - 70mm

- Jaw open capacity: 2-3/4" (70mm)
- Jaw width: 1-7/16" (36mm)
- Hydraulic ram: 12 ton
- Covered by lifetime warranty



LIFETIME WARRANTY*

LIFETIME WARRANTY*



KTI71561

Pitman Arm Puller & Ball Joint Separator Tie Rod Front End Service Tool Kit

- Made of heat-treated alloy steel, with great strength and durability
- Individual pieces covered by a lifetime warranty
- Kit includes: Large C-Shape: Jaw Spread 1-11/32" with Throat Depth 2-1/2"; Small C-Shape: Jaw Spread 1-1/8" with Throat Depth 2-1/8"; Large Swing Arm: Jaw Spread 0 to 2-1/2" with Throat Depth 3-1/4"; Small L-Shape: Jaw Spread 3/4" with Throat Depth 1-3/4"; Large Rocker Arm: Jaw Spread 7/8" with Throat Depth 2-1/4"

Individual Kit Items

Part #	Description
KTI70332	Inner Bearing Race Puller
KTI70361	Pitman Arm Puller
KTI71525	Tie Rod End Puller
KTI71503	Ball Joint Separator
KTI71526	Tie Rod End Remover

KTI73400A

36 Piece Steel Hand Stamp Set

- 3/16" (5.0mm) steel hand stamp set
- 26 letters "A-Z" plus "&" and 9 numbers "0-8", the "6" is used for "9"
- Stamps are CRV 6150 with sandblast treatment
- Front end font HRC 58-62 degrees and back side tempering HRC 38-46 degrees



KTI73401

9 Piece Steel Hand Stamps 0-8 Numbers

KTI72907

7 Piece Special Vibro Chisel Set

- Drop forged handle
- Soft tip air hammer set includes aluminum, brass, steel, and nylon air tipped tools
- Non sparking or marring for sensitive surfaces
- Replaceable hammer heads
- For aluminum body cars, 0.401" shank tools
- Covered by a 1-year warranty



KTI70326

GM Torsion Bar Unloader

- Drop forged frame
- This tool is required to safely release the tension on the front suspension torsion bar to service the front suspension
- Larger design to cover the 2011 and newer GM Trucks including HD C/K
- When servicing the lower control arm of the front suspension on GM trucks or replacing a torsion bar, it is necessary to remove the spring pressure from the suspension
- Covered by a 1-year warranty



KTI70327

GM Torsion Bar Unloading Tool

- Drop forged frame
- This rugged tool is built for GM's K-3500 series trucks with heavy-duty chassis and a larger torsion bar
- Applications: 1988-2003 GMC and Chevrolet 1/2, 3/4, and 1 ton pick-ups; the S-10 Blazer and S-15 Jimmy, 4WD pickups with 4.3L V6 engines and 1991-2001 Oldsmobile Bravada
- Covered by a 1-year warranty



KTI70325

Injector Puller Set for Cummins

- Drop forged body
- Two jaw design firmly grips the injector, with sliding hammer
- The two jaws have heat treatment
- Helpful puller will handle a variety of injectors found in Cummins engines: mechanical L-10 PDT and PTD top-stop 855NH
- Covered by a 1-year warranty



KTI49300

Heavy Duty Wrack Wrench Diameter 25mm-55mm

- Drop forged body • 1/2" square drive
- Universal design suits rack end diameters from 25mm-55mm (Hex drive, round with 2 drive flats, round with no drive flats)
- New larger size provides coverage for domestic and import light trucks and SUV
- Excenter tie rod track turing tool • U.S. Patent #: US D706,604 S
- Covered by a 1-year warranty



KTI81985

6 Piece Air Hammer Drifts Set

- Drop forged body
- CR-MO material for a more durable, longer lasting tool lifetime
- Pin punch by impact tool drive
- Rusted shock and strut bolts are no match for these Air Hammer Drifts
- 7" long parallel shaft
- Six common sizes: 1/2", 3/8", 5/16", 9/32", 1/4", 3/16"
- Individual pieces covered by a 1-year warranty



KTI28201

Toyota Front Hub Nut Socket

- Drop forged body
- For the removal and installation of the front hub lock nut
- Applications include: 2007 -2014 Toyota 4 Runner, 2WD, Tundra and 2008-2014 Toyota Sequoia
- Similar to Toyota factory tool #09318-12010-8PIN & 09602-60010
- Covered by a 1-year warranty



KTI27238

3/8" Drive Oxygen Sensor Thread Chaser

- Drop forged body • Studs may be reused
- Cleans threads in Oxygen Sensor holes
- Use with 3/4" hex socket and 3/8" square drive: size M18 x 1.5
- Also works on M18 x 1.5 spark plug threads
- Works even if only a few threads are exposed
- Covered by a 1-year warranty



KTI70385

Dual Wheel Separator

- Drop forged body
- This innovative "one-piece" pusher won't fall apart during use and is ball bearing-driven for near-zero turning resistance
- Forcing screw and pullers have powerful 1-1/8" diameter x 11 threads
- Includes two pullers to cover large truck, trailer and smaller light truck dual wheel applications
- Ideal for use on nearly every truck, bus, van or trailer that has dual steel wheels
- Covered by a 1-year warranty



KTI28202

Center-Lock Nut Socket for Porsche

- Center-lock nut socket 3/4" drive for Porsche
- Models: 997, 991, GT2 and GT3 • Drop forged body
- 3/4" drive tightening torque, maximum 369 ft/lbs (500 Nm)



NEW PRODUCTS



KT173604

Oil Filter Housing Wrench for Toyota / Lexus

- Designed for removing aluminum oil filters
- Size: 1/2" Dr. , 64.5mm, 14PT
- Made of high quality steel
- Applicable: TOYOTA: 3.5L since 2007; LEXUS: IS250, IS350, GS300, GS350, GS450HE, S350, RX350, LS460, LS600H
- 1 Year Warranty on Material and Workmanship

KT173631

Oil Filter Socket Toyota, 64.5mm-P14 1/2" Dr 21mm

- Fits most Toyota 1.8 & 2.0 liter vehicles
- Drop forged body, hard chrome plated
- 3/8" drive hole for ratchet handle or square drive handle
- Designed for use on Toyota models where 6 additional flutes help drive the wrench
- Covered by a Lifetime warranty



KT173644

6 Piece Aluminum Cap Wrench Set

- 6 piece aluminum cap wrench set to remove cartridge type oil filter
- Commonly used in Opel/Vauxhall, Mercedes, BMW and VAG. USE 1/2" drive wrench
- Sizes: 24mm, 27mm, 30mm, 32.5mm, 36mm, 38mm each with 6 Flutes
- Individual pieces covered by a Lifetime warranty



KT173645

5 Piece Oil Filter Cap Wrench Set

- Use with 1/2" drive wrench
- Material: Aluminum
- For light vehicles (Toyota, Nissan, BMW, Audi, VW, Opel, Kai, etc...)
- Light weight and durable
- Sizes: SW64m/m & SW74m/m each with 14 flute, SW78.5m/m, SW89m/m & SW99m/m each with 15 flutes
- Individual pieces covered by a Lifetime warranty

KT173203

Fender Cover Magnetic 41.2" x 22.8"

- Material: PU felt cloth
- Contains (2) magnets each with N45 rated strength
- Oil-proof, water proof and quick dry
- Magnetic cover washable and easy to clean
- Soft cotton cloth underlay for scratch prevention
- Covered by a 1 Year Warranty



WARNING: Cancer and Reproductive Harm

Filter Regulators

- Polycarbonate bowl with 40 micron sintered bronze filter element
- Covered by a 1-Year Warranty



Filter Regulators

Part #	Description	CFM
KT189181	Filter-Regulator Combination Miniature 1/4" NPT	20
KT189182	Filter-Regulator Combination Intermediate 3/8" NPT	77
KT189183	Filter-Regulator Combination Standard 1/2" NPT	106
KT189184	Filter-Regulator and Lubricator, Intermediate 1/2" NPT	63
KT189185	Filter-Regulator and Lubricator, Standard 1/2" NPT	99

LIFETIME WARRANTY*



Ratcheting Gear Pullers

- Quick convenient conversion from 2 to 3 jaws
- Ratcheting action holds jaws in position
- Easily reversible jaws for external or internal pulling of gears and bearings
- Chrome Molybdenum, heat-treated, forged construction
- Covered by a Lifetime Warranty

Ratcheting Gear Pullers

Part #	Safe Work Load	Jaw Spread Range
KT170307	2 Ton Capacity	2" to 3-1/8"
KT170308	5 Ton Capacity	4" to 6"
KT170309	7 Ton Capacity	5" to 8-5/8"

KT149401

Non Sparking Aluminum Drum Wrench for 2-3/4" Drum

- Wrench opens most 2-3/4" drum plugs
- Manufactured from non-sparking case aluminum
- Covered by a Lifetime Warranty



LIFETIME WARRANTY*

KT149402

Drum Faucet for 2" Holes

- Polyethylene construction
- Suitable for 2" threaded openings on 55 gallon drums
- Built-in bucket hanger and padlock hole
- Built in port for mounting sight glass to check fluid level in the drum
- Covered by a 1-Year Warranty



KTI74921

Band Dolly for 5 gallon Pails

- Four removable phenolic wheels
- Covered by a 1-Year Warranty



KTI74922

Band Dolly for 16 gallon Pails

KTI74923

Heavy Duty Drum Dolly for 55 Gallon Drums

- Load capacity 1200 pounds
- Four welded cast iron wheels
- Covered by a 1-Year Warranty



KTI72251

Siphon Pump for 55 Gallon Drums

- Works with water based media: detergents, soaps, antifreeze, some mild acids, etc.
- Delivers up to 7 GPM
- Polyethylene construction
- Covered by a 1-Year Warranty



KTI72201

Rotary Barrel Pump

- 3 piece threaded suction tube and 2" cast iron bung nut
- Delivers 1.3 gallons (5 liters) in 20 turns
- Dual Direction operation. Pumps in either direction by a few reverse turns of the handle
- For use on 15-55 gallon (50-205 liter) drums
- Recommended for dispensing diesel, kerosene, heating oil, motor oils, lubricating oils (up to SAE 90) and other non-corrosive media
- Covered by a 1-Year Warranty



KTI71017

6 Piece Interchangeable

Blow Gun Kit with Quick Connect Nozzle

- Maximum Pressure: 220 PSI (15 BAR); Operating Pressure: 160 PSI (11 BAR)
- Air Consumption: 10 CFM (280 LPM) • Inlet: 1/4" Female
- Locks and seals attachments by rotation of the collar in either direction
- Covered by a 1-Year Warranty



Kit contains air blow gun and 5 attachments: rubber tip (NBR) for steel extensions, turbo wide angle nozzle, angled steel extension 4" (100 mm) long, angled steel extension 6-5/16" (160mm) long and angled steel extension 12-5/8" (320mm) long.

KTI72206

Brass Hand Pump

- For use with water based media, antifreeze, oils, diesel etc.
- Comes complete with 40" (1 meter) long by 1/4" diameter suction hose and 24" x 1/2" diameter long discharge hose
- Self-priming action • Dispenses 3.2 oz (100 ml) per stroke
- High quality brass cylinder body and plunger
- 140° F maximum fluid temperature
- Covered by a 1-Year Warranty



Funnels

Part #	Description
KTI74618	8" Plastic Anti-Splash Funnel, 1.8 Quarts
KTI74619	9-1/2" Plastic Anti-Splash Funnel, 3.7 Quarts
KTI74621	1.2 gal. Fuel and Oil Funnel

Covered by a 1-Year Warranty

KTI72231

Extraction Filling Syringe - 1500 CC

- Hand operated fluid syringe (200C.C.)
- Translucent design allows easy inspection of oils and fluids
- Suitable for the transfer of oils/fluids to and from vehicle components
- Applicable such as gear oil and differential fluid
- Material: Polypropylene
- Covered by a 1 year warranty



KTI72232

Extraction/Filling Syringe - 200 CC



KTI70113

Manual Fluid Extractor

- Capacity: 7.9 Qt (7.5L)
- Maintenance free
- Transparent tank to see fluid level
- Modularized design to provide best performance
- Covered by a 1-year warranty



NEW PRODUCTS



KT173272A

Underhood Rechargeable Light 210SMD

- One piece aluminum tube with holding bar being one piece; extends from 47" to 76"
- New style end hooks with loop shape and cushion material to prevent scratching
- 210 super bright SMD LEDs: 1,100 Lumens (High mode) / 550 Lumens (Low mode)
- Run time: 3 hrs (High mode) / 6 hrs (Low mode)
- Charging time approximately 4 hrs; Low battery indicator
- Impact proof
- Covered by a 1 Year warranty



KT173322

6W COB Rechargeable

Slim Worklight - 120 Lumens

- Adjust light from 0-600 lumens as needed
- Rotating hook for full 360 degree adjustment
- 1 W SMD top torch up to 120 lumens
- Only 0.35" (9mm) wide at the top
- Micro USB slot for quick charge with 5 LED indicators to show charge level
- Charge time: 3 Hours • Run time: 1.5 Hours (high) / 16 Hours (low)
- Covered by a 1-Year Warranty



KT173319

12SMD 400 Lumens

Rechargeable Slim Foldable Worklight

- Intensity control switch to adjust light from 0-400 lumens
- 180 degree foldable design
- Light head very thin, only 0.24" (6mm)
- Three super strong magnets at the side and bottom
- Hook attached to the bottom to allow for hanging
- Charge time: 3 Hours • Run time: 3 Hours (high) / 88 Hours (low)
- Covered by a 1-Year Warranty



KT173317

Heavy Duty Rechargeable Floodlight - 10W 1000 Lumens

- Impact resistant construction: aluminum die-cast body
- 5 volt USB output: for use as powerbank
- Swivel handle: can be rotated 180 degrees and adjusted to any angle
- Super strong magnet: attaches onto any metallic surface leaving both hands free
- Charge time: 4 hours; Run time: 3 hours full intensity and 6 hours low intensity
- Covered by a 1-year Warranty



KT173369

Flashlight Rechargeable

CREE LED XML 700 Lumen

- Drop impact resistant • Dust and water resistant
- CREE LED XML T6 with 700 Lumen and 3.7 volt 2600mAh Li-ion battery
- Runtime: 1-1/2 Hrs (100% beam-700 LM) / 3 Hrs (50%-300 beam) / 6 Hrs (25%-150 beam); Charge time: 3-1/2 to 4 hrs
- Function: 25% - 50% - 100% - Off with sliding zoom beam
- Comes in a magnetic box, with nylon case, USB cable, USB wall adapter and USB car charger
- Covered by a 1 Year warranty



KT173368

Flashlight Rechargeable

CREE LED XPG 250 Lumen

- Drop impact resistant • Dust and water resistant
- CREE LED XPG with maximum 250 Lumen and 3.7 volt 2200mAh Li-ion battery
- Runtime: 3 Hrs (100% beam-250LM) / 5-1/2 Hrs (50% beam-125LM) / 11 Hrs (25% beam-65.5LM); Charge time: 3-1/2 hrs
- Function: 25% - 50% - 100% - Off with sliding zoom beam
- Comes in a magnetic box, with nylon case, USB cable, USB wall adapter and USB car charger
- Covered by a 1 Year warranty

KT173367

Flashlight CREE LED XPG 250 Lumen

- Comes in a magnetic box, with nylon case, and 4 AA batteries

KT173338

Pen Light Rechargeable CREE LED XPG 120 Lumen

- Drop impact resistant
- Dust and water resistant
- Runtime: 3-1/2 Hrs; Charge time: 3 Hrs
- Function: On-Off with sliding zoom beam
- Clip for easy carry
- Comes in a magnetic box, with nylon case, USB cable, USB wall adapter and USB car charger



KT173337

Pen Light CREE LED XPG 120 Lumen

- Drop impact resistant • Dust and water resistant
- Runtime: 6-1/2 Hrs • Clip for easy carry
- Function: On-Off with sliding zoom beam
- Runs on (2) AAA batteries



KT177700

Big Chill Blower (1200 CFM)

- Workforce Blower 1200 CFM
- 120V ~ 60Hz
- Max. Allowable Load for Receptacles 11 Amps
- 3 speed with 4-position adjustment for centralized airflow and quick drying
- For indoor or outdoor use • Heavy duty plastic housing
- Two grounded outlets with overload protection
- Covered by a 1 year warranty

KT177702

Chill Blower (300 CFM)



KT177708

Air Blower 8" Indoor Portable

- 6.6 feet (2M) power cord w/UL approved plug
- 120V / 60Hz / 1.7Amps
- Two speed for maximum energy efficiency
- High Speed: 3400 RPMs / 2114 CFM with power consumption 200 Watts
- Low Speed: 3381 RPMs / 1432 CFM with power consumption 154 Watts
- Complete metal structure
- Handle design and light weight enables easy portability
- Covered by a 1 year warranty on material and workmanship



KT177731

30" Non-Oscillating Wall Fan

- Three speeds • 120 Volt • 60Hz • 2.4 Amps
- High Speed: 1125 RPMs / 7930 CFM with power consumption 280 Watts
- Medium Speed: 1058 RPMs / 6144 CFM with power consumption 230 Watts
- Low Speed: 825 RPMs / 2880 CFM with power consumption 123 Watts
- 3 blade construction for maximum cooling plus pre punched holes for ease of mounting
- Covered by a 1 year warranty

KT177732

30" Oscillating Wall Fan



KT177720

4-Way Tilt High Velocity 20" Orbital Floor Fan

- High velocity floor fan with 3 speeds
- Tilts vertically and horizontally for optimal air direction
- 120 Volt / 60Hz • 1.35 Amps
- High Speed: 1465 RPMs / 5483 CFM with power consumption 153 Watts
- Medium Speed: 1392 RPMs / 4025 CFM with power consumption 139 Watts
- Low Speed: 1317 RPMs / 3059 CFM with power consumption 128 Watts
- Balanced aluminum blades for quiet operation plus tilts vertically & horizontally for optimal air direction
- Covered by 1 year warranty

KT177730

30" Pedestal Fan

- Pedestal Fan 30" with three speeds
- 120 Volt • 60 Hz • 1.4 Amps
- High Speed: 1110 RPMs / 5320 CFM with power consumption 160 Watts
- Medium Speed: 991 RPMs / 4272 CFM with power consumption 134 Watts
- Low Speed: 825 RPMs / 2880 CFM with power consumption 123 Watts
- Covered by a 1 year warranty



KT177742

42" Belt Drive Drum Fan

- Two speeds • 120 Volt
- 60Hz • 5.07 Amps
- High Speed: 537 RPMs / 13781 CFM with power consumption 606 Watts
- Low Speed: 440 RPMs / 9859 CFM with power consumption 481 Watts
- Rubber wheels provide ease of movement in shop plus cut-off protection from overheating
- Covered by a 1 year warranty

NEW PRODUCTS

BluBird



BLBBB3450

BluBird Pro 3/4" x 50' Rubber Air Hose

- Durable wrapped finish. Extreme resistance to ozone, UV, abrasion
- 3/4" NPT brass ends with 3/4" to 1/2" NPT reducer
- 40% lighter than any other rubber hose of same specifications



BluShield 3/8" Rubber Pressure Washer Hose

- BluShield rubber pressure washer hose with 3/8" revolving male NPT x 3/8" fixed NPT that are carbon steel
- 4100 PSI / 16400 PSI, RMA Class A tube and handles hot water up to 250° F
- 100% rubber & 30% lighter than traditional rubber wire-braided hoses
- Kevlar/Aramid braided hose helps eliminate the risk of electrical shock
- Covered by a 1 year warranty

BluShield Rubber Pressure Washer Hose

Part #	Size (Diameter x Length)
BLBPW3835	3/8" x 35'
BLBPW3850	3/8" x 50'
BLBPW38100	3/8" x 100'

BluBird



Flexibility in extreme conditions from -50°F to 190°F



Blubird Patriot Pro Air Hose - 300 PSI

- 40% lighter than others and as light as hybrid / PVC hoses
- Lays flat, does not kink under pressure, doesn't get sticky and dirty like plastic and hybrid hoses
- Remains as flexible at -50° F as the best hybrids do at 0° F
- Braided, not just spiraled, polyester gives 300PSI Working Pressure from -50° F to 200° F with a burst pressure of 1200PSI (Most '300PSI' hybrids have a 900PSI burst). Comes with 1/4" Brass M-NPT end fittings & 1/2" to 3/8" adaptor

Blubird Patriot Pro Air Hose

Part #	Size (Diameter x Length)
BLBPP3825	3/8" x 25'
BLBPP3850	3/8" x 50'
BLBPP38100	3/8" x 100'
BLBPP1225	1/2" x 25'
BLBPP1250	1/2" x 50'
BLBPP12100	1/2" x 100'

RMX



RAV Rubber Air Hose

- Abrasion resistant outer cover
- Stays flexible to -30°F, withstands high temperature up to 190°F
- Heavy duty construction with polyester braiding, 300 : 1200 PSI
- 1/4" NPT solid crush-proof brass ends
- 4 Finger grip bend-restrictor to prevent damage near ends
- Covered by a 1 Year Warranty

RAV Rubber Air Hose

Part #	Size (Diameter x Length)
BLBT3825	3/8" x 25'
BLBT3850	3/8" x 50'
BLBT38100	3/8" x 100'
BLBT1250	1/2" x 50'

BluBird



BLBBB3415

BluBird Rubber Air Hose 3/4" x 15'

- Ultra-light & Super-strong Rubber. 9lbs. lighter than a traditional 3/4" x 15' assembly
- Ozone resistant cover provides protection from extreme weather, abrasions & kink
- Factory crimped Stainless Steel Universal Claw Couplings for better durability
- Flexibility in extreme conditions from -50° F to 190° F
- Wrapped finish gives better flexibility and abrasion resistance
- 4 Finger Grip Bend Restrictors
- Covered by a 10 year warranty

BLBBB3425

BluBird Rubber Air Hose 3/4" x 25'





Flexibility in extreme conditions from - 0°F to 190°F



Avagard Rubber Air Hose

- Heavy Duty rubber hose that's 20% lighter than others conventional hoses
- Ozone & UV resistant to prevent cracking while in the sun
- Cold Weather Flexibility down to -40° F
- Handles Hot Water up to 190° F
- 4 Finger Grip Bend Restrictors
- Covered by a 5 year warranty



Avagard Rubber Air Hose	
Part #	Size (Diameter x Length)
BLBAVG1410	1/4" x 10'
BLBAVG1415	1/4" x 15'
BLBAVG1425	1/4" x 25'
BLBAVG1450	1/4" x 50'
BLBAVG14100	1/4" x 100'
BLBAVG3810	3/8" x 10'
BLBAVG3815	3/8" x 15'
BLBAVG38100	3/8" x 100'
BLBAVG1210	1/2" x 10'
BLBAVG1215	1/2" x 15'
BLBAVG12100	1/2" x 100'
BLBAVG3415	3/4" x 15'
BLBAVG3425	3/4" x 25'
BLBAVG3450	3/4" x 50'

BLBAVGGLD3803

Avagard Lead-in Hose 3/8" x 3'



BLBAVGJH3450

Avagard Jack Hammer HD Rubber Hose - 3/4" x 50'

- Heavy Duty Rubber Water Hose suitable for Commercial, Industrial, & Residential use
- Covered by a 5 year warranty



Avagard 13 Piece Air Compressor Kits

- Heavy Duty Industrial Type Couplers & Plugs in Brass
- Perfect for DIY & Contractors
- 4 Finger Grip Bend Restrictors
- Covered by a 5 year warranty

Kit Includes: Avagard Air Hose, Safety Blow gun (1), Tire gauge(1), Air Chuck (1), Male Plugs Industrial style 1/4" NPT (3), Female Plugs Industrial style 1/4" NPT (2), Male Coupler Industrial style 1/4" NPT (1), Female Coupler Industrial style 1/4" NPT (1), Teflon tape (1), Storage bag (1).

Avagard Air Compressor Kits	
Part #	Size (Diameter x Length)
BLBAVG1425KIT	1/4" x 25'
BLBAVG3825KIT	3/8" x 25'
BLBAVG3850KIT	3/8" x 50'



BLBBB3850KIT

13 Piece BluBird

Air Compressor Accessory Kit 3/8" x 50'

- 40% lighter than traditional Rubber Hoses, Resists kinks and extreme weather
- 4 finger grip bend restrictors, 300 PSI 1200 PSI, Flexible in -50°F
- Heavy Duty Industrial Type Couplers & Plugs in Brass
- 4 Finger Grip Bend Restrictors
- Covered by a 10 year warranty

Kit Includes:- 3/8" x 50' BluBird Air Hose, Safety Blow gun (1), Tire gauge(1), Air Chuck (1), Male Plugs Industrial style 1/4" NPT (3), Female Plugs Industrial style 1/4" NPT (2), Male Coupler Industrial style 1/4" NPT (1), Female Coupler Industrial style 1/4" NPT (1), Teflon tape (1), Storage bag (1).



BLBFFFX12

Fast Fix 1/2" Air Hose Assembly Repair Fitting

- Includes 1/2" MNPT Fixed
- Professional Duty Reusable Brass fittings for Air Hoses
- Works with all 1/2" RMX Hoses
- Brass construction - Resists corrosion, Ductility to high temperatures and low magnetic permeability



BLBFFSP12

Fast Fix 1/2" Air Hose Assembly Repair Splicer



NEW PRODUCTS

DINO HIDE
EDITION



Flexibility in extreme conditions from - 0°F to 190°F



Dino-Hide Rubber Air Hose

- Extremely durable & oil, grease & diesel resistant
- Resists kinks and extreme weather, Kink proof bend restrictors
- Cold Weather Flexibility down to -40° F
- Handles Hot Water up to 190° F
- Covered by a 3 year warranty



Dino-Hide Rubber Air Hose - 3/8"

Part #	Size (Diameter x Length)
BLBWLE3810	3/8" x 10'
BLBWLE3815	3/8" x 15'
BLBWLE3825	3/8" x 25'
BLBWLE3850	3/8" x 50'
BLBWLE1210	1/2" x 10'
BLBWLE1215	1/2" x 15'
BLBWLE1250	1/2" x 50'



Dino-Hide Lead-in Hose

Part #	Size (Diameter x Length)
BLBWLELD3803	3/8" x 3' Lead-in Hose
BLBWLELD1203	1/2" x 3' Lead-in Hose

DINO HIDE
EDITION



BLBWLERHD3850R

Dino-Hide Hose Reel HD Retractable 3/8" x 50'

- Heavy duty Retractable Hose Reel with Dino Hide 3/8" X 50' Air Hose
- Powder Coated Steel - Corrosion Resistant, Heavy Duty 18 Gauge Steel
- 12 Point Ratchet for locking at shorter intervals
- 4-way Roller Guides • 3' Whip Hose included
- Covered by a 3 year warranty

BLBWLERHD1250R

Dino-Hide Hose Reel HD Retractable 1/2" x 50'



BLBBSWR1250HRS

BluSeal Water Hose Reel Retractable 1/2" x 50'

- Retractable Hose Reel with BluSeal 1/2" X 50' water hose
- Powder Coated Steel - Corrosion Resistant, Heavy Duty 20 Gauge Steel
- 12 Point Ratchet for locking at shorter intervals
- 4-way Roller Guides
- 3' Whip Hose + Swivel Mount included
- Covered by a 3 year warranty



BLBBSWRSS1250

BluSeal Stainless Steel Heavy Duty Retractable Water Hose Reel 1/2" x 50' with HD 9 Pattern Metal Spray Nozzle

- 18 gauge stainless steel 304 construction
- 3/4" GHT inlet & outlet; includes 6' inlet hose.
- 12 point ratchet for precise resolution, adjustable outlet arm, 4 way roller guides, ceiling floor, wall mounting options
- Lightest, strongest, most flexible rubber water hose. 30% lighter, cold weather flex up to -50°F



BLBHRC01

BluSeal Hose Reel Cart for 5/8" x 400'

- Perfect for Professional / Commercial Garden / Landscaping needs
- Holds up to 400ft of 5/8" Water Hose
- 3/4" GHT inlet & outlet. Includes 6' inlet hose.
- Corrosion-resistant industrial powder coat finish
- Easy-rolling 10 inch flat free tires and solid axels for rough terrain
- Covered by a 1 year warranty



BLBBRDA3850
BluBird Heavy Duty Dual-Arm
Retractable Air Hose Reel 3/8" x 50'

- Powder Coated Steel - Corrosion Resistant, DUAL ARM Heavy Duty 18 Gauge steel
- 12 Point Ratchet for locking at shorter intervals
- 50% Wider Spring with Rubber Gasket for extreme durability
- 3' Whip hose included along with a 3/8" to 1/4" reducer
- Reel is covered by a 2 year warranty and hose is covered by a 10 year warranty

BLBBRDA1250
BluBird Heavy Duty Dual-Arm
Retractable Air Hose Reel 1/2" x 50'



BLBBRSS3850
BluBird Stainless Steel Heavy Duty
Retractable Air Hose Reel 3/8" x 50'

- 18 gauge stainless steel 304 construction
- Includes 3' inlet hose
- 12 point ratchet for precise resolution, adjustable outlet arm, 4 way roller guides, ceiling floor, wall mounting options
- 40% lighter, cold weather flex up to -50°F
- Covered by a 1 year warranty

BLBHR3812DA
BluBird Heavy Duty 140 Degree Hose Reel
Swivel Mount for RMX Dual Arm Reels

- Easy & Quick to install
- 20 Gauge Heavy Duty Powder Coated Steel
- 4 Slotted Holes for Reels & 4 Slotted Holes for Mounting
- Covered by a 1 year warranty



Hose Reel Roller Guide Sets

Part #	Description
BLBRG381250A	Hose Reel Roller Guide Set Black 20 Gauge Reels
BLBRS09	75', 65' & 50' Black HD Hose Reel Roller Guide Set
BLBRS06	50' Blue HD Hose Reel Roller Guide Set
BLBRS10	75' & 65' Blue HD Hose Reel Roller Guide Set
BLBRS08	50' Red HD Hose Reel Roller Guide Set

WARNING: Cancer and Reproductive Harm



BLBOSRDA3850
Oil Shield Heavy Duty Dual-Arm
Retractable Air Hose Reel 3/8" x 50'

- Powder Coated Steel - Corrosion Resistant, DUAL ARM Heavy Duty 18 Gauge Steel
- Meets RMA Class A Oil Resistance for worry-free Professional Use
- 12 Point Ratchet for locking at shorter intervals
- 50% Wider Spring with Rubber Gasket for extreme durability
- 3' whip hose include along with a 1/2" to 3/8" reducer
- Reel is covered by a 2 year warranty and hose is covered by a 10 year warranty

BLBOSRDA1250
Oil Shield Heavy Duty Dual-Arm
Retractable Air Hose Reel 1/2" x 50'



BLBOSRHD1265
Oil Shield HD Retractable Hose Reel 1/2" x 65'

- Powder Coated Steel - Corrosion Resistant, Heavy Duty 18 Gauge Steel Reel
- Blue reel with yellow Oil Shield 1/2" x 65' air hose
- 12 Point Ratchet for locking at shorter intervals
- 50% Wider Spring with Rubber Gasket for extreme durability
- 3' Whip Hose Included
- Includes 1/2" to 3/8" reducer
- Covered by a 2 year warranty



BLBLCKINRL
Hose Reel Latch Pawl
with Screws & Spring



BLBRBRSTP38A
Hose Reel Rubber Stopper 3/8"



BLBRBRSTP12A
Hose Reel Rubber Stopper 1/2"



BLBRS04
Hose Reel Rubber Stopper 5/8" & 3/4"

NEW PRODUCTS

BluBird®



BLBBBTB01

BluBird WORK GEAR - Carpenter's Tool Backpack with 48 Pockets and Padded Back Support

- This tool backpack has two main zippered compartments, one for tools and parts, one for a cordless drill and battery
- Adjustable compression pocket accepts bulky items. Comes with comfortable padded back support and shoulder straps with adjustable chest strap
- Convenient exterior pocket and dual handles at top
- 41 pockets inside and 7 pockets outside to organize a wide variety of tools and accessories. Heavy duty stitching and bar tacking at all stress points on this tool bag are included for added durability.

BluBird WORK GEAR - Large BigMouth Bags

- Opens wide for easy access to contents
- With padded reinforced web carrying handles and an adjustable shoulder strap, this tool bag is comfortable to carry
- Heavy duty stitching and bar tacking at all stress points on this tool bag are included for added durability



BLBBBTB02

BluBird WORK GEAR - Large BigMouth Bag with 22 Pockets

- 12 pockets inside, and 10 outside organize tools and accessories



BLBBBTB03

BluBird WORK GEAR - Large BigMouth Bag with 31 Pockets

- 12 pockets inside, and 19 outside organize tools and accessories

BLBBBTB13

BluBird WORK GEAR - Multi-Purpose Clip-on Zippered Poly Bags, 3 Pack

- 3 multi-purpose clip-on poly bags are 9" x 7", 7" x 6", and 6" x 5"
- Made of polyester fabric
- Durable clip on these tool bags hang on toolbelts, belt loops, etc.
- Carry and organize all your misc. parts, tools and accessories



BluBird®



BLBBBTB04

BluBird WORK GEAR - Medium and Large Utility Tote Bag Combo

- These utility tote bags are designed for plumbers, electricians, maintenance personnel, paint and general contractors
- Reinforced bottom panels for added durability
- Strong web carry handles on these utility tote bags will last through many jobs
- Separate and organize your small parts and hand tools with these medium and large utility tote bags



BLBBBTB12

BluBird WORK GEAR - Socket Tool Roll Pouch with 32 Pockets

- Heavy-duty elastic strap on this tool pouch roll keeps tools in place
- Adjustable quick-release buckle on this tool roll pouch fastens when not in use
- Hook and loop closure holds metric and standard sockets
- Heavy duty stitching and bar tacking at all stress points on this tool bag are included for added durability
- 600D polyester construction sewn together with heavy stitching
- This tool roll has a carrying handle for easy transport

KTI10010A

Angle Grinder 4-1/2"

- Wattage: 860 (120 volt)
- Load Speed: 11,000/minute
- 7 Amp
- 1 Piece side handle
- Covered by a 1 year warranty



KTI83278

Super Duty Air Hammer

- Blow per Minute: 3,200 RPM; Bore Size: 3/4"; Stroke Length: 2.6"; Air Inlet: 1/4" NPT; Hose Size: 3/8" ID
- Recommended air Pressure: 90 PSI; Average Air Consumption: 4 CFM
- Easy Change Retainer For Quick Accessory Change
- Covered by a 1 year warranty



KT181201

3/8" Drive Mini Impact Wrench

- Maximum Torque: 350 ft/lbs (470Nm); Free Speed: 8500 RPM; Air Pressure: 90 PSI; Average Air Consumption: 5.3 CFM; Weighs: 3.75 lbs
- Twin hammer structure, high torque output and stable
- Lightweight, powerful and compact
- Widely used for maintenance
- One hand control, easy to operate



KT181301

1/2" Drive Mini Impact Wrench

- Maximum Torque: 380 ft/lbs (520Nm); Free Speed: 8500 RPM; Air Pressure: 90 PSI; Average Air Consumption: 5.3 CFM; Weighs: 3.85 lbs
- Twin hammer structure, high torque output and stable
- Light weight but durable, design for heavy duty
- Widely used for maintenance
- Covered by a 1 year warranty



KT182210

3/8" Drive Mini Air Ratchet Wrench

- Torque: 30 Ft/lbs; Free Speed: 300 RPM; Air Inlet: 1/4"; Hose Size: 1/4" ID
- Recommended Air Pressure 90 PSI; Average Air Consumption: 2.5 CFM
- Free Speed: 300 RPM
- Covered by a 1 year warranty



KT187132A

1/4" Drive Mini Die Grinder

- Lock off throttle to prevent accidental start up
- Compact, lightweight design
- Free Speed: 25000 RPM; Collet and Air Inlet Size: 1/4"; Hose size: 3/8" ID; Recommended Air Pressure: 90 PSI; Average Air Consumption: 4 CFM
- Applications: blending, smoothing, porting and deburring
- Covered by a 1 Year warranty



KT187126A

1/4" Drive Mini Angle Die Grinder

- Collet Size: 1/4"; Inlet Threaded 1/4" NPT; Hose Size: 3/8" ID; Free Speed: 22,000 RPM; Recommended Air Pressure: 90 PSI; Average Air Consumption: 4 CFM
- Right Angle Head allows easier working within confined area
- Built-In Power Regulator allows precise control of the speed for multiple applications
- Rear Air Exhaust helps blow exhaust away from work surface
- Covered by a 1 Year warranty



KT184228A

3/8" Drive Reversible Air Drill

- Chuck Size: 3/8"; Recommended Air Pressure: 90 PSI; Average Air Consumption: 4 CFM
- Hose Size: 3/8" (10mm); Spindle Thread: 3/8"-24; Air Inlet: 1/4"
- Ergonomic Handle
- Covered by a 1 Year warranty



KT189110A

3/16" Hydraulic Air Riveter

- Blind Rivet Setting Capacity: 3/16" (4.8mm), 5/32" (4mm), 1/8" (3.2mm), 3/32" (2.4mm)
- Air Inlet: 1/4" NPT; Hose Size: 3/8" (10mm) ID; Traction Power: 1940 lbs; Stroke Length: 0.551" (14mm); Recommended Air Pressure: 90 PSI
- For general maintenance or light-duty production. Performs well at any angle.
- Powerful durable, high speed production tool
- Low vibration and low noise level
- Covered by a 1 year warranty



KT189115A

1/4" Heavy Duty Hydraulic Air Riveter

- Blind Rivet Setting Capacity: 1/4" (6.4mm), 7/32" (5.6mm), 3/16" (4.8mm), 5/32" (4mm), 1/8" (3.2mm), 3/32" (2.4mm)
- Air Inlet: 1/4" NPT; Hose Size: 3/8" (10mm) ID; Traction Power: 3055 lbs; Stroke
- Length: 0.551" (14mm); Recommended Air Pressure: 90 PSI
- Quick release air valve permits cylinder to return quickly for high speed assembly operations: Prevents overloading for long life
- Covered by a 1 Year warranty



KT185300

Air Belt Sander (1/2" x 18") with 3 Belts

- Belt Speed: 1320 (M/Min); Free speed: 20,000 RPMs; Average air consumption: 3.9 CFM (110 L/min)
- Length: 14.4" (365mm); Weight: 2lbs (0.92kg)
- Inlet threaded 1/4" NPT (F); Hose size: 3/8" ID
- Comfort grip and safety lever; swivel connector air inlet; quick change belt replacement
- Includes 3 belts: (40#, 60#, 80#) • Covered by a 1 year warranty



NEW PRODUCTS

Alignment Bars

- Forged from heavy duty chrome alloy steel
- Prying end is on one side with lining up on the other
- Covered by a Lifetime Warranty



LIFETIME WARRANTY*

Alignment Bars

Part #	Size (Diameter x Length)
KTI71631	5/8" x 18" Long
KTI71632	3/4" x 24" Long
KTI71633	7/8" x 30" Long
KTI71634	7/8" x 36" Long
KTI71635	1' x 48" Long
KTI71636	1' x 54" Long

KTI71604

3 Piece Roll Head Ladyfoot Pry Bar Set

- Set includes: 12" (300mm), 16" (400mm), 20" (500mm)
- Covered by a Lifetime Warranty



LIFETIME WARRANTY*

Roll Head Ladyfoot Pry Bars

Part #	Length
KTI71601	12" (300mm)
KTI71602	16" (400mm)
KTI71603	20" (500mm)

LIFETIME WARRANTY*

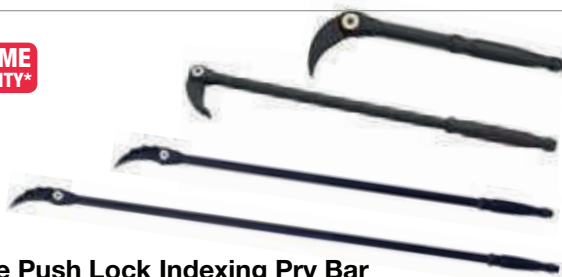

Double Push Lock Indexing Pry Bar

- Heavy duty forged chrome molybdenum head construction
- Head indexing through 180 degrees & 11 locking positions
- Industrial manganese phosphate finish to help protect against corrosion
- Versatile & adjustable access push button indexing head allows you to easily change the head position, maximizing the leverage point to get the job done
- Covered by a Lifetime Warranty

Double Push Lock Indexing Pry Bars

Part #	Length
KTI71641	8"
KTI71643	16"
KTI71644	24"
KTI71645	33"

LIFETIME WARRANTY*



KTI19230

4 Piece Handled Pry Bar Set (8", 12", 18", 24")

- Forged construction, chrome steel, heat treated, hardness 38-43 HRC
- Metal striking cap
- Blade is connected to the end cap
- Covered by a Lifetime Warranty

Handled Pry Bar with Steel Cap

Part #	Length
KTI19231	8" (200mm)
KTI19232	12" (300mm)
KTI19233	18" (450mm)
KTI19234	24" (600mm)
KTI19235	32" (800mm)
KTI19236	36" (900mm)



KTI19001

Pocket Screwdriver with Clip - Std 2/16", #1 Phillips

- Pocket screwdriver nickelplated with ABS handle and pocket clip
- Switchable magnetic heads with one end flat head and the other end Phillips head
- Standard: 2/16"; Phillips #1
- Total length of pocket screwdriver: 0.638"; Width: 1/2"
- Covered by a 1 Year warranty



KTI19001-50

Pocket Screwdriver Std 2/16" #1 Phillips 50 Pieces



KTI49403

Universal Wrench Extender Adaptor

- 1/2" drive or 21 mm hex drive
- Drop forged body with heat treatment
- Extendable for all kinds of wrenches
- Designed to extend your wrench with another wrench or power bar giving more leverage on stubborn nuts and bolts
- Covered by a 1-year warranty



KT173115
All Purpose Utility Shear

- All purpose utility shear for tough cutting jobs
- The angle design makes cutting more effortless
- Safe replacement blade; 1 + 5 pieces inside of storage area
- Measuring board design for cutting position
- All purpose utility shear great for: carpet, leather, rope, linoleum, rubber, cardboard and much more
- Covered by a 1 Year Warranty

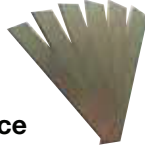

KT173116
Replacement Blades for KT173115, 6 Piece

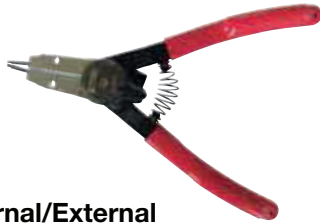

KT155008
Snap Ring Pliers 8" Internal/External

- Operates both internal and external rings
- Unique jaw design to easily remove for straight and 90 degree angle tips
- Alloy steel and PVC grip with storage for tips
- Includes 3 pairs of tips and hex key for storage: 1 set of straight tips for 1.2mm & 1.8mm 2-way (dual head) functions; 2 sets of 90 degree tips for 1.2mm & 1.8mm



KT156300
2 in 1 Multi-Tool

- Aluminum body with rubber grip carbon blade
- 3 functions wire tool with reverse switch action and built in safety lock
- Swivel to change tools. Easy one-hand selector switch
- Stripping capacity: 0.8, 1. 1.3, 1.6, 2, 2.6mm / 20, 18, 16, 14, 12, 10 AWG. Crimps insulated terminals in wire sizes: 22-18 (front cavity), 16-10 (middle cavity) and 12-10 (rear cavity)
- Covered by a 1 Year Warranty



KT173111
6" Professional Electrician Scissors

- 6" professional electrician scissors with cover
- Blade material: 4034 stainless steel from Japan, Thickness: 4.0mm, Hardness: 58+/-2, surface treatment: polishing
- Handle material: PP + TPR
- Includes Nylon sheath
- Covered by a 1 Year Warranty



KT173112
5" Multifunctional Professional Electrician Scissors

- Blade material: 420 J2 stainless steel from Japan, Thickness: 3.5mm, Hardness: 53+/-2, surface treatment: polishing
- Handle material: PP + TPR
- Covered by a 1 Year Warranty



KT173113
Electrician Peeling Knife

- Blade material: 4034 stainless steel from Japan, Thickness: 2.5mm, Hardness: 58+/-2, surface treatment: polishing
- Handle material: Polypropylene (PP) + Thermoplastic rubbers (TPR)
- Includes Nylon sheath
- Covered by a 1 Year warranty



KT173114
Multi-Function Scissors Set

- Set includes: 5" Professional Electrician Scissors, Electrician Peeling Knife and Electrician Tool Bag
- Set comes in a black carrying/storage pouch



KT120096
3 Piece Ratchet Set

- Three piece ratchet set in EVA for storage
- Drive sizes: 1/4", 3/8" and 1/2"
- 90 teeth, CR-V 6140 with mirror-polished finish
- Torque and hardness meet ANSI standard
- Covered by a lifetime warranty



KT143501
12 Piece X-Long Double Box Flex & Reversible Ratchet Wrench Set with 11 Bits

- Stop ring and magnetic
- Continuous tension design controls the 180° flex heads
- 72 teeth, forge, CR-V 6140, mirror-polished
- Manganese phosphate ratchet bit
- Ratchet Drive: 14 x 17MM
- 11 Bits: 14mm x S8, S10, H12, H14, T40, TT45: 17mm x m16, H17, M18, H19, TT70
- Comes in a color box w/EVA
- Ratchet wrench covered by a lifetime warranty

NEW PRODUCTS

XD



KTI63619A 20 Ton Shop Press (XD)

- H-frame for strength and precision
- Overall frame height: 59.5"; Frame width: 25.25"; Base depth: 27.75"; Ram stroke: 7.28"
- Throat height: 38"; Throat width: 21.25"; Distance between Bed Rails: 4.25"
- Includes solid steel press plates
- Bed height adjustments: 4.75" x 9"
- Covered by a 2 year warranty



XD



KTI62108A 800 lb. H Style Engine Stand (XD)

- 4-Wheel construction for more stability and easy rolling
- Adjustable mounting arms, accommodate a majority of engine blocks, both foreign and domestic
- Mounting plate rotate 360 degree and can be locked in 8 different positions
- Heavy gauge tubular steel construction
- Roll-around engine stand, assembles easily
- Covered by a 2 year warranty



KTI63500A 700 lb. Pedestal Transmission Jack

- Universal mounting head with a wide forward (14 degrees) and back tilt (72 degrees)
- Wide base for stability: 22-1/4" (length) & 21-3/8" (wide)
- 4 steel casters for easy mobility
- Ram travel: 19-1/8"
- Lifting range: 49-5/8" to 68-3/4"



XD



KTI63134A Transmission Jack Adaptor for Service Jacks (XD)

- Capacity: 1000 lbs
- Minimum lifting range: 49-5/8"; Maximum lifting range: 68-3/4"
- Saddle Forward Tilt: 14 Degrees; Saddle Backward Tilt: 72 Degrees
- Base Dimensions: 22-1/4" (length) and 21-3/8" (wide)
- Covered by a 2 year warranty



KT163201A

2 Ton Bottle Jack (Screw Type)

- Heat treated extension screw allows low pickup height adjustment and maximum lift
- Serrated, heat treated saddle provides generous lifting area and secure grip
- A wide, rugged base provides stability and strength
- All models critical stress points are reinforced
- Lifting range: 7-1/8" to 13-5/8"
- Adjustment Height: 1.89"; Lifting Height 4.57"
- Covered by a 1 year warranty



KT163207A

6 Ton Bottle Jack (Welded Type)

- Heat treated extension screw allows low pickup height adjustment and maximum lift
- Serrated, heat treated saddle provides generous lifting area and secure grip
- A wide, rugged base provides stability and strength
- All models critical stress points are reinforced
- Lifting range: 8.15" to 15.83"
- Adjustment height: 2.76; Lifting height: 4.92"
- Covered by a 1 year warranty



KT163213A

12 Ton Bottle Jack (Welded Type) (XD)

- Heat treated extension screw allows low pickup height adjustment and maximum lift
- Serrated, heat treated saddle provides generous lifting area and secure grip
- A wide, rugged base provides stability and strength
- All models critical stress points are reinforced
- Lifting range: 8.9" to 18"
- Adjustment Height: 5.91"; Lifting Height 3.15"
- Covered by a 2 year warranty

KT163214A

12 Ton Short Bottle Jack (Welded Type) (XD)

- Lifting range: 6.18" to 10.9"
- Adjustment height: 1.57"; Lifting height: 3.15"
- Covered by a 2 year warranty

XD



KT163221A

20 Ton Bottle Jack (Welded Type) (XD)

- Heat treated extension screw allows low pickup height adjustment and maximum lift
- Serrated, heat treated saddle provides generous lifting area and secure grip
- A wide, rugged base provides stability and strength
- All models critical stress points are reinforced
- Lifting range: 9.25" to 17.52"
- Adjustment Height: 2.36"; Lifting Height: 5.91"
- Covered by a 2 year warranty

KT163224A

20 Ton Short Bottle Jack (Welded Type) (XD)

- Lifting range: 6.5" to 11.22"
- Adjustment Height: 1.57"; Lifting Height: 3.15"
- Covered by a 2 year warranty

HD



KT163230A

30 Ton Bottle Jack (Welded Type) (HD)

- Heat treated extension screw allows low pickup height adjustment and maximum lift
- Serrated, heat treated saddle provides generous lifting area and secure grip
- A wide, rugged base provides stability and strength
- All models critical stress points are reinforced
- Lifting range: 10.24" to 16.54" • Lift Height: 6.3"
- Covered by a 2 year warranty

KT163250A

50 Ton Bottle Jack (Welded Type) (HD)

- Lifting range: 11.02" to 17.72" • Lifting Height: 6.7"
- Covered by a 2 year warranty

HD



KT162116A

1000 lb. Engine Support Bar (HD)

- Handle uses a manual threaded rod and features a couple grooved chain
- Heavy-duty steel Torin Big Red Engine Support Bar
- Chain length: 35.43"; Mountable from 28.74" - 48.27"; Holding hook has 0.79" thread rod
- Covered by a 1 year warranty

COMING SOON!

KTI75502 Plasma Cutter - Dual Voltage 120V / 240V

- Dual Input Voltage: 120V / 240V
- Output Current: 15-40A Amp
- Cutting torch PT40, ground cable, spare electrode, nozzle, air flowmeter Duty Cycle: 35%@40A
- Covered by a 2 Year Warranty



KTI75500 MIG Welder Portable 115V 120Amp

- Gas / No gas MIG 120A commercial portable 115V
- Input Voltage: 115 volt • Output: 30-115 volt
- Duty Cycle: 90A@35%
- Torch 8.5' (2.6m), earth clamp set (1.5m) adjustable gas regulator, mild steel 0.030" diameter wire, mask, chipper hammer and manual
- Covered by a 2 Year Warranty



KTI75501 MIG Welder Portable 230V 160Amp

- Gas / No gas MIG 160A Commercial portable 230V
- Input Voltage: 230 volt • Output: 30-160 Amp
- Duty Cycle: 35%@140A
- Covered by a 2 Year Warranty

Keep your eyes peeled for more in welding coming soon:
KTI75503 - Welding Cart, KTI75504 - Gas Regulator & KTI75505 - Spool Gun

KTI58730 10 Piece Locking Pliers Set

- Heat treated • Nickel plated corrosion resistance
- Improved jaw design for maximum gripping power
- Set includes: Alloy steel jaw (Curved steel Jaw: 5"7"/10" curved jaw with wire cutter, 5"6"/9" long nose with wire cutter, 7"/10" straight jaw, carbon steel jaw: 6"/11" C clamp with regular tip)
- Each locking plier is covered by a lifetime warranty



KTI21020 18 Piece 1/4" Drive, 6 Point Insulated Socket Wrench Set

- Set includes:
- (13) Sockets: 4, 4.5, 5, 5.5, 6, 7, 8, 9, 10, 11, 12, 13, 14mm
 - (4) Extension bars: 2", 3", 4", 6"
 - (1) Round type quick locking ratchet handle 72 teeth



KTI22025 19 Piece 3/8" Drive, 6 Point Insulated Socket Wrench Set

- Set includes:
- (15) Sockets: 6, 7, 8, 9, 10, 11, 12, 13, 14, 15, 16, 17, 18, 19, 20mm
 - (3) Extension bars: 3", 6", 10"
 - (1) Round type quick locking ratchet handle 72 teeth



KTI23025 24 Piece 1/2" Drive, 6 Point Insulated Socket Wrench Set

- Set includes:
- (20) Sockets: 10, 11, 12, 13, 14, 15, 16, 17, 18, 19, 20, 21, 22, 23, 24, 25, 27, 29, 30, 32mm
 - (3) Extension bars: 3", 5", 10"
 - (1) Round type quick locking ratchet handle 72 teeth



XD

KTI63092 2 Ton Aluminum Service Jack (XD)

- Low Profile with lifting range 3-1/4" to 18-1/2"
- Heavy-duty, 100% aluminum construction provides stability and endurance
- Swivel rear casters and saddle provide smooth maneuvering and positioning
- Built-in valve protects against jack over-loading
- Side frame carry handle for convenient transportation
- Covered by a 2 year warranty



XD



KTI63101A

2 Ton Aluminum Service Jack (XD)

- Low Profile with lifting range 3" to 19-15/16"
- Chassis Length: 26-1/5"; Chassis Height: 5-2/5"; Overall width: 13-4/5"; Handle Length: 45"; Saddle Diameter: 4-1/4", Caster Diameter: 2-2/5"; Front Wheels: 2-2/5"; Net Weight: 69.2 lbs
- Heavy-duty steel construction provides stability and endurance
- Swivel rear casters provide smooth maneuvering and positioning
- Built-in valve protects against jack over-loading
- Quick start double pump technology for fast operation to contact point
- Covered by a 2 year warranty



KTI63137

3 Ton Compact Service Jack

- Low Profile with lifting range 5-1/2" to 18-1/2"; Length: 24-3/5"; Chassis Height 39-2/5"; Saddle Diameter: 3-4/5"; Weight: 63.73lbs.
- Heavy-duty steel construction provides stability and endurance
- Swivel rear casters provide smooth maneuvering and positioning
- Built-in valve protects against jack over-loading
- Covered by a 1 year warranty



KTI63105A

2 Ton Extra Long Low Profile Service Jack (XD)

- Low Profile with lifting range 2-3/4" to 24"
- Pump stroke to load: 8; Cassis Length: 33-7/10"; Low clearance length: 15"; Overall Width: 14-3/5"; Chassis Height: 5-1/2"; Handle length: 49-1/5"; Saddle Diameter: 3-9/10"
- Heavy-duty steel construction provides stability and endurance
- Swivel rear casters provide smooth maneuvering and positioning
- Built-in valve protects against jack over-loading
- Covered by a 2 year warranty



KTI63103A

2 Ton Trolley Jack

- Lifting range 5-1/8" to 13"
- Heavy-duty steel construction provides stability and endurance
- Swivel rear casters and saddle provide smooth maneuvering and positioning
- Built-in valve protects against jack over-loading
- Hydraulic oil by-pass system protects ram from being over-extended
- Covered by a 1 year warranty



KTI63092

2 Ton Aluminum Service Jack (XD)

- Low Profile with lifting range 3-1/4" to 18-1/2"
- Heavy-duty, 100% aluminum construction provides stability and endurance
- Swivel rear casters and saddle provide smooth maneuvering and positioning
- Built-in valve protects against jack over-loading
- Side frame carry handle for convenient transportation
- Covered by a 2 year warranty

KTI61202A

3 Ton Jack Stands Pair

- Low Height: 11-2/5"
- Maximum height: 16-7/10"
- Base: 9-9/10" x 7-7/10"
- Weight: 15 lbs (pair)
- Covered by a 2 year warranty

XD



KTI61205A

6 Ton Jack Stands Pair

- Low Height: 15-3/4"
- Maximum height: 24-2/5"
- Base: 10-2/5" x 11-3/5"
- Weight: 33 lbs (pair)
- Covered by a 2 year warranty



KTI61222A

22 Ton Jack Stands Pair (HD)

- Minimum Height: 13-3/10" (338mm)
- Maximum Height: 19-7/10" (500mm)
- Base 10" x 10"
- Saddle Size: 2-3/4" x 3-3/20"
- Covered by a 2 year warranty

COMING SOON!

HD



KTI63194A

22 Ton Air/Hydraulic Truck Jack (HD)

- Built-in by-pass device to protect hydraulic system
- Minimum Height: 9" (228mm); Maximum Height: 18" (457mm); Hydraulic Lifting: 4-3/4" (122mm); Extension Screw: 4-1/4" (107mm); Saddle diameter: 1-3/4"; Wheel Diameter: 8"; Handle length: 48-2/5"
- Built-in muffler to promote quiet operation, High speed turbo motor for efficient effortless operation
- Welded cylinder and reservoir for added strength and durability
- Chrome plated rams to resist rust and wear
- Covered by a 2 year warranty



XD

KTI63427A

8 Ton Long Ram - Round Bottom (XD)

- Same as Bottle Jack feature but designed with larger hydraulic units and larger ram diameters to withstand side loads
- With built-in by-pass system to prevent ram from being over-extended
- Lifting range 24-1/16" to 43-11/16"
- Unique design with durable advantages
- Used for engine cranes and other special places
- Covered by a 2 year warranty



KTI63414A

4 Ton Long Ram - Round Bottom (XD)

- Lifting range 24-13/16" to 44-1/4"
- Covered by a 2 year warranty



KTI62115A

1500 lb. Engine Sling (XD)

- Overall length: 17-3/10"
- Covered by a 2 year warranty



Keep your eyes peeled for more in lifting coming soon:

KTI63133A - 3.33 Ton Low Profile Service Jack, KTI63421A - 1.5 Ton Foldable Engine Crane, KTI63228A - 20 Ton Air/Hydraulic Bottle Jack, KTI63505A - 1000 lb Two Stage Telescopic Transmission Jack, KTI63703A - 4 Ton Portable Ram Kit, KTI63709A - 10 Ton Portable Ram Kit, KTI63515A - 1200 lb. Low Profile Transmission Jack, KTI63155A - 5 Ton Service Jack, KTI63186A - 10 Ton Service Jack, KTI63517A - 1.5 Ton Truck Trans Jack, KTI63094A - 1.5 Ton Aluminum Service Jack, KTI63097A - 2 Ton Trolley/Jack Stands Combo, KTI63096A - 2.5 Ton SUV Jack, KTI63095A - 2 Ton Service Jack Low Profile & KTI61201A - 2 Ton Jack Stands

WARNING: Cancer and Reproductive Harm



KTI71770

6 Piece Hammer Set

- 16 oz and 32 oz ball hammers with fiberglass handle with TPR cover and carbon-steel forge heat treatment head
- 3 lb machinist "cross pein" hammer with fiberglass handle with TPR cover and carbon-steel forge heat treatment head
- 3 lb double-faced black smith "club/sledge" hammer with fiberglass handle with TPR cover and carbon-steel forge heat treatment head
- 32 oz rubber mallet with fiberglass handle
- 30 oz recoilless "dead blow" hammer
- Covered by a 1 year warranty

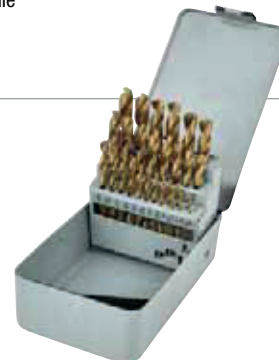

KTI10300

29 Piece Titanium Drill Bit Set

- For 3/8" Drills
- Material: Quality High Speed Steel
- Titanium Nitride "tin-coated" surface enhances anti-friction and increases the hardness of the drill bits
- Bits can be re-sharpened

Sizes include: 1/16, 5/64, 3/32, 7/64, 1/8, 9/64, 5/32, 11/64, 3/16, 13/64, 7/32, 15/64, 1/4, 17/64, 9/32, 19/64, 5/16, 21/64, 11/32, 23/64, 3/8, 25/64, 13/32, 27/64, 7/16, 29/64, 15/32, 31/64, 1/2

KTI74141

Nail Brush 5" x 2" x 2" with Magnet

- Material: PP handle+PP bristle
- Size: 4.921" x 1.575" x 1.772" / (12.5x4x4.5cm)
- Comfort grip design for more comfort and control
- Brush has a magnet on one end on the backside to hang for storage and easy access to use



KTI74140

3 Piece Nail Brush Set - 5" x 2" x 2" with Magnet



KTI74142

Nail Brush 4" x 1" x 2"

- Material: PP handle+PP bristle
- Size: 3.937" x 1.378" x 1.772" / (10x3.5x4.5cm) each
- High impact plastic non-slip handle



KTI74143

3 Piece Nail Brush Set - 4" x 1" x 2"



KTI45101

Wrench Eagle Head Spline 8-17mm

- Ratchet 72 teeth 5 degree. Drop forged. Material CR-V body.
- Eagle type mouth can be fit for 8-17 MM or 5/16"-11/16"
- Eagle type jaw can even work on 70% rounded bolts
- Torque comply with ANSI or DIN standards
- Eagle type jaw fit for several kind of bolt. Ex; 6 point, 12 point, star, and square
- Covered by a 2 year warranty

KTI45103

Wrench Eagle Head Spline 14-32mm

- Eagle type mouth can be fit for 14-32 MM or 9/16"-1-1/4"



KTI45102

Wrench Eagle Head 3/8 Drive 8-17mm

- Ratchet 72 teeth 5 degree. Drop forged. Material CR-V body.
- Eagle type mouth can be fit for 8-17 MM or 5/16"-11/16"
- Eagle type jaw can even work on 70% rounded bolts
- Torque comply with ANSI or DIN standards
- Eagle type jaw fit for several kind of bolt. Ex; 6 point, 12 point, star, and square
- Covered by a 2 year warranty

KTI45104

Wrench Eagle Head 1/2 Drive 14-32mm

- Eagle type mouth can be fit for 14-32 MM or 9/16"-1-1/4"



KTI45105

Wrench Double Eagle Head 8-17mm & 14-32mm

- Whole piece drop forged. Material CR-V body
- Double head Eagle wrench type mouth can be fit large end: 14-32 mm or 9/16"-1-1/4" and small end: 8-17mm
- Eagle type jaw can even work on 70% rounded bolts
- Torque comply with ANSI or DIN standards
- Eagle type jaw fit for several kind of bolt. Ex; 6 point, 12 point, star, and square
- Covered by a 2 year warranty

KTI70511

7 Piece Body and Fender Hammer Set

- Red fiberglass handles with comfort grips
- Machined hammer heads
- For pounding auto sheet metal before finishing. Use on flat and curved surfaces
- Includes: bumping hammer, pick hammer, chisel end hammer, heel dolly, shrinking dolly, double end dolly, curve dolly



LIFETIME WARRANTY*



KTI20022

12 Piece 1/4" Drive SAE Deep Spline Socket Set

- Socket lengths: 1-31/32"
- Chrome-vanadium steel construction with high-polish chrome finish
- Sizes: 5/32", 3/16", 7/32", 1/4", 9/32", 5/16", 11/32", 3/8", 7/16", 1/2", 9/16" and 5/8"
- Individual sockets are covered by a lifetime warranty

LIFETIME WARRANTY*



KTI20300

14 Piece 3/8" Drive Metric Deep Spline Socket Set

- Socket lengths: 63mm (2-31/64")
- Chrome-vanadium steel construction with high-polish chrome finish
- Sizes: 6, 7, 8, 9, 10, 11, 12, 13, 14, 15, 16, 17, 18, 19mm
- Individual sockets are covered by a lifetime warranty

LIFETIME WARRANTY*



KTI20400

13 Piece 3/8" Drive SAE Deep Spline Socket Set

- Socket lengths: 2-31/64"
- Chrome-vanadium steel construction with high-polish chrome finish
- Sizes: 1/4", 5/16", 3/8", 7/16", 1/2", 9/16", 5/8", 11/16", 3/4", 13/16", 7/8", 15/16" and 1"
- Individual sockets are covered by a lifetime warranty

LIFETIME WARRANTY*



KTI20600

14 Piece 1/4" Drive Metric Deep Spline Socket Set

- Socket lengths: 50mm (1-31/32")
- Chrome-vanadium steel construction with high-polish chrome finish
- Sizes: 4, 4.5, 5, 5.5, 6, 7, 8, 9, 10, 11, 12, 13, 14, and 15mm
- Individual sockets are covered by a lifetime warranty

**HEAT-TREATED
& HARDENED ALLOY STEEL**



KT171701
12 Piece 1/2" Drive
Professional Impact Driver Set

**3 SPEED
4-POSITION ADJUSTMENT**



KT177700
Big Chill Blower (1200 CFM)

**350
FT/LBS. OF MAX TORQUE**



KT181201
3/8" Drive
Mini Impact Wrench



**700
LUMEN**

KT173369
CREE LED XML
Rechargeable Flashlight

BluBird

HOSES / REELS / ACCESSORIES
100% Rubber. 40% Lighter

NEW!

**2019
EDITION**



**LIGHT AS A
FEATHER**

The lightest,
strongest, most flexible,
100% rubber, award-
winning air-water-hoses



Air Hoses

BluBird®

40% lighter than other rubber hoses & as light as hybrids



Flexibility in extreme conditions from -50°F to 190°F



BluBird® Air Hoses

Designed to offer the best of both worlds - the exceptional cold-weather flexibility, durability and premium feel of high-end rubber hoses and the light-weight comfort of premium hybrid hoses.

FEATURES

- Ultra light, super-strong rubber - resists abrasion and kinks
- Extreme ozone resistance provides protection from extreme weather
- Flexibility in extreme conditions from -50°F to 190°F
- Constructed with high strength polyester braided reinforcement
- 4 finger grip bend restrictor for better ergonomics
- 10 year warranty
- Available hose inner diameters: 1/4", 3/8", 1/2" and 3/4"
- Max. working pressure: 300 PSI
- Safety factor: 4:1

BluBird®

BluBird® Pro Rubber Air Hose
3/4" x 50'
BLBBB3450



- Durable wrapped finish
- Extreme resistance to ozone, UV, abrasion
- 3/4" NPT brass ends with 3/4" to 1/2" NPT reducer
- 40% lighter than any other rubber hose of same specs

Part #	Description	NPT
BLBBB14100	1/4" x 100'	1/4"
BLBBB1425	1/4" x 25'	1/4"
BLBBB1450	1/4" x 50'	1/4"
BLBBB3810	3/8" x 10'	1/4"
BLBBB38100	3/8" x 100'	1/4"
BLBBB3815	3/8" x 15'	1/4"
BLBBB3825	3/8" x 25'	1/4"
BLBBB3835	3/8" x 35'	1/4"
BLBBB3850	3/8" x 50'	1/4"
BLBBB1210	1/2" x 10'	1/4"
BLBBB12100	1/2" x 100'	1/2" to 3/8" NPT Reducer
BLBBB1215	1/2" x 15'	1/4"
BLBBB1225	1/2" x 25'	1/2" to 3/8" NPT Reducer
BLBBB1250	1/2" x 50'	1/2" to 3/8" NPT Reducer
BLBBB3415	3/4" x 15'	
BLBBB3425	3/4" x 25'	

Air Hoses & Reels



on Hoses



on Hose Reels



4:1
Safety
Factor



Flexibility in
extreme conditions
from -50°F to 190°F



BluBird® Heavy Duty 18 Gauge Steel Air Hose Reels

- Retractable hose reel with BluBird® air hose
- Powder coated steel - corrosion resistant, heavy duty 18 gauge steel
- 12 point ratchet for locking at shorter intervals
- 4-way roller guides • 3' whip hose included
- Covered by a 2 year warranty on reel with 10 year warranty on attached hose to any manufacturing defects



Part #	Description	
BLBBBRHD1250	1/2" x 50' Heavy Duty Air Hose Reel	3/8" inlet and 1/2" to 3/8" NPT Reducer Outlet
BLBBBRHD3850	3/8" x 50' Heavy Duty Air Hose Reel	3/8" inlet and 3/8" to 1/4" NPT Reducer Outlet

BLBBBRDA3850 BluBird Heavy Duty Dual-Arm Retractable Air Hose Reel 3/8" x 50'

- ULTIMATE SOLUTION FOR A PRO! Powder Coated Steel - Corrosion Resistant, Dual Arm Heavy Duty 18 Gauge
- 12 Point Ratchet for locking at shorter intervals
- 50% Wider Spring with Rubber Gasket for extreme durability
- 3' Whip hose included along with a 3/8" to 1/4" reducer
- Perfect for mounting on mobile applications
- Reel is covered by a 2 year warranty and hose is covered by a 10 year warranty



on Hose Reels



BLBBBRDA1250 BluBird Heavy Duty Dual-Arm Retractable Air Hose Reel 1/2" x 50'

BluBird® Air Hose Reels

- Smooth auto-rewind with locking 12 point ratchet gearing system which helps to lock at various lengths
- Heavy duty steel construction with powder coated, corrosion proof finish
- Four rollers reduce hose wear
- Horizontal and vertical wall mount options with adjustable guide arm



Part #	Description	
BLBBBR1450	1/4" x 50' Air Hose Reel	3/8" inlet and 1/4" NPT Outlet
BLBBBR3825	3/8" x 25' Air Hose Reel	3/8" inlet and 3/8" to 1/4" NPT Reducer Outlet
BLBBBR3850	3/8" x 50' Air Hose Reel	3/8" inlet and 3/8" to 1/4" NPT Reducer Outlet
BLBBBR3875	3/8" x 75' Air Hose Reel	3/8" inlet and 3/8" to 1/4" NPT Reducer Outlet
BLBBBR1225	1/2" x 25' Air Hose Reel	3/8" inlet and 1/2" to 3/8" NPT Reducer Outlet
BLBBBR1250	1/2" x 50' Air Hose Reel	3/8" inlet and 1/2" to 3/8" NPT Reducer Outlet
BLBBBR1265	1/2" x 65' Air Hose Reel	3/8" inlet and 1/2" to 3/8" NPT Reducer Outlet

WARNING: Cancer and Reproductive Harm

Air Hoses



Class A oil resistance: do you have grease, diesel, oil or welding-spatter? Bring it on!

Ideal for the shop environment.



Flexibility in extreme conditions from -30°F to 180°F



Oil Shield® Next-Gen Rubber Air Hoses

The Lightest Class A Oil Resistant Hose. Brings the same light weight and super strong properties of the original BluBird® to a hose that meets the RMA Class A Oil-Resistance standard. 30% lighter and much stronger than other hoses in the class, the Oil-Shield® is perfect for work areas where oil, diesel, grease spillage is a concern. It can remain in constant contact with oil for months and still function as good as new. Retards fire-sparks from welding etc. much better than hybrid or plastic or even other rubber hoses.

FEATURES

- Ultra light, super-strong rubber
- RMA Class A oil resistant core tube and cover
- Constructed with high strength polyester braided reinforcement
- Flexibility in extreme conditions from -30°F to 180°F
- 4 finger grip bend restrictor for better ergonomics
- Available hose inner diameters: 1/4", 3/8", 3/4" and 1/2"
- Max. working pressure: 300 PSI
- Safety factor: 4:1

Part #	Description	NPT	
BLBOS3810	3/8" x 10'	1/4"	
BLBOS3815	3/8" x 15'	1/4"	
BLBOS3825	3/8" x 25'	1/4"	
BLBOS3835	3/8" x 35'	1/4"	
BLBOS3850	3/8" x 50'	1/4"	
BLBOS38100	3/8" x 100'	1/4"	
BLBOS1225	1/2" x 25'	1/2"	Includes 1/2" to 3/8" NPT Reducer
BLBOS1250	1/2" x 50'	1/2"	Includes 1/2" to 3/8" NPT Reducer
BLBOS12100	1/2" x 100'	1/2"	Includes 1/2" to 3/8" NPT Reducer
BLBOSPRO3425	3/4" x 25'	3/4"	
BLBOSPRO3450	3/4" x 50'	3/4"	

Air Hoses & Reels



Oil Shield® Heavy Duty 18 Gauge Steel Air Hose Reels

- Retractable hose reel with Oil Shield® air hose
- Powder coated steel - corrosion resistant, heavy duty 18 gauge steel
- 12 Point ratchet for locking at shorter intervals
- 4-way roller guides
- 3' whip hose included
- Covered by a 2 year warranty on reel with 3 year warranty on attached hose to any manufacturing defects

Part #	Description	
BLBOSRHD3850	3/8" x 50' Oil Shield® Air Hose Reel	3/8" inlet with 3/8" to 1/4" NPT Reducer outlet
BLBOSRHD1250	1/2" x 50' Oil Shield® Air Hose Reel	3/8" inlet with 1/2" to 3/8" NPT Reducer outlet
BLBOSRHD1265	1/2" x 65' Oil Shield® Air Hose Reel	3/8" inlet with 1/2" to 3/8" NPT Reducer outlet



on Hoses



on Hose Reels



Flexibility in extreme conditions from -30°F to 180°F



4:1 Safety Factor



BLBOSRDA3850 Oil Shield Heavy Duty Dual-Arm Retractable Air Hose Reel 3/8" x 50'

- Powder Coated Steel - Corrosion Resistant, DUAL ARM Heavy Duty 18 Gauge Steel
- Perfect for mounting on mobile applications
- Meets RMA Class A Oil Resistance
- 12 Point Ratchet for locking at shorter intervals
- 50% Wider Spring with Rubber Gasket for extreme durability
- 3' whip hose include along with a 1/2" to 3/8" reducer
- Reel is covered by a 2 year warranty and hose is covered by a 3 year warranty

BLBOSRDA1250 Oil Shield Heavy Duty Dual-Arm Retractable Air Hose Reel 1/2" x 50'



Oil Shield® Air Hose Reels

- Retractable air hose reel with BluBird® Oil Shield® air hose
- Powder coated steel - corrosion resistant, heavy duty 18 gauge steel
- 12 point ratchet for locking at shorter intervals
- 4-way roller guides
- Covered by a 3 year warranty on the included yellow Oil Shield® hose



4:1 Safety Factor



Flexibility in extreme conditions from -30°F to 180°F



Part #	Description	
BLBOSR3825	3/8" x 25' Oil Shield® Air Hose Reel	3/8" NPT inlet and 1/4" outlet
BLBOSR3835	3/8" x 35' Oil Shield® Air Hose Reel	3/8" NPT inlet and 1/4" outlet
BLBOSR3850	3/8" x 50' Oil Shield® Air Hose Reel	3/8" NPT inlet and 1/4" outlet
BLBOSR3875	3/8" x 75' Oil Shield® Air Hose Reel	3/8" NPT inlet and 1/4" outlet
BLBOSR1225	1/2" x 25' Oil Shield® Air Hose Reel	3/8" NPT inlet and 1/2" NPT with 1/2" to 3/8" Reducer outlet
BLBOSR1250	1/2" x 50' Oil Shield Air Hose Reel	3/8" NPT inlet and 1/2" NPT with 1/2" to 3/8" Reducer outlet

WARNING: Cancer and Reproductive Harm

Air Hoses & Reels



Durability and premium feel of a high-end rubber hose.



Flexibility in extreme conditions from -40°F to 190°F

AVAGARD® Professional Rubber Air Hoses
The Red Rubber Hose done right. This product is designed to give a new perspective to Red Rubber Hoses - the exceptional cold-weather flexibility, the durability and premium feel of high-end rubber hose. The best of all this is one revolutionary but affordable rubber hose package.

FEATURES

- 80% the weight of traditional red rubber hoses
- Ozone resistant cover provides protection from extreme weather, abrasions & kinks
- Resists mild grease, oil & diesel
- Constructed with high strength polyester braided reinforcement
- Flexibility in extreme conditions from -40°F to 190°F
- 4 finger grip bend restrictor for better ergonomics
- Available hose inner diameters: 1/4", 3/8" and 1/2"
- Max. working pressure: 300 PSI
- Safety factor: 4:1



BLBAVGR3850 AVAGARD® Black Steel Hose Reel with 3/8" x 50' Rubber Air Hose

- All steel constructed black reel with 300 PSI red Avagard 50' rubber hose
- Slotted mounting base for easy installation
- Automatic spring powered recoil
- 12 position ratchet gear locks reel at shorter hose length
- 3/8" NPT inlet and 1/4" outlet



on Hoses



on Hose Reels



Flexibility in extreme conditions from -40°F to 190°F



Part #	Description	NPT
BLBAVG1410	AvaGard 1/4" x 10' Air Hose, Red	1/4"
BLBAVG1415	AvaGard 1/4" x 15' Air Hose, Red	1/4"
BLBAVG1425	AvaGard 1/4" x 25' Air Hose, Red	1/4"
BLBAVG1450	AvaGard 1/4" x 50' Air Hose, Red	1/4"
BLBAVG14100	AvaGard 1/4" x 100' Air Hose, Red	1/4"
BLBAVG3810	AvaGard 3/8" x 10' Air Hose, Red	1/4"
BLBAVG3815	AvaGard 3/8" x 15' Air Hose, Red	1/4"
BLBAVG3825	AvaGard 3/8" x 25' Air Hose, Red	1/4"
BLBAVG3850	AvaGard 3/8" x 50' Air Hose, Red	1/4"
BLBAVG38100	AvaGard 3/8" x 100' Air Hose, Red	1/4"
BLBAVG1210	AvaGard 1/2" x 10' Air Hose, Red	1/2"
BLBAVG1215	AvaGard 1/2" x 15' Air Hose, Red	1/2"
BLBAVG1225	AvaGard 1/2" x 25' Air Hose, Red	1/2"
BLBAVG1250	AvaGard 1/2" x 50' Air Hose, Red	1/2"
BLBAVG12100	AvaGard 1/2" x 100' Air Hose, Red	1/2"
BLBAVG3415	AvaGard 3/4" x 15' Air Hose, Red	3/4"
BLBAVG3425	AvaGard 3/4" x 25' Air Hose, Red	3/4"
BLBAVG3450	AvaGard 3/4" x 50' Air Hose, Red	3/4"

Stainless Steel Air Hose Reels

BluBird®

BLBBR553850 BluBird Heavy Duty Stainless Steel Retractable Air Hose Reel 3/8" x 50'

- 18 gauge stainless steel 304 construction
- Includes 3' inlet hose
- 12 point ratchet for precise resolution, adjustable outlet arm, 4 way roller guides, ceiling floor, wall mounting options
- 40% lighter, cold weather flex up to -50°F
- Covered by a 1 year warranty



Flexibility in extreme conditions from -50°F to 190°F



BLBHR553812 BluBird® Stainless Steel 304 140 Degree Hose Reel Swivel Mount

- Stainless Steel 304 Heavy Duty Construction
- 4 Slotted Holes for reels and mounting
- Can be mounted on wall or ceiling
- Mounting hardware NOT included



BLBBSWR551250 BluSeal Heavy Duty Stainless Steel Retractable Water Hose Reel 1/2" x 50' with HD 9 Pattern Metal Spray Nozzle

- 18 gauge stainless steel 304 construction
- 3/4" GHT inlet & outlet; includes 6' inlet hose
- 12 point ratchet for precise resolution, adjustable outlet arm, 4 way roller guides, ceiling floor, wall mounting options
- Lightest, strongest, most flexible rubber water hose
- 30% lighter, cold weather flex up to -50°F
- Covered by a 1 year warranty



Flexibility in extreme conditions from -50°F to 190°F



Air Hoses

BluBird
QUICKCONNECTS
 Making hose connections a snap!

edition

Light as a feather
 with industrial
 type quick connect
 coupler & plug



Flexibility in
 extreme conditions
 from -50°F to 190°F



BluBird® Pro Quick-Connects Edition
 Lightest, Strongest, Most Flexible, All-Weather Rubber Air Hose
 with Industrial Type Brass Quick Coupler and Plug

FEATURES

- 40% Lighter than traditional rubber hoses
- Extremely resistant to ozone, UV & abrasion
- Flexibility in extreme conditions from -50°F to 190°F
- 300 PSI working pressure with 4:1 safety factor where as hybrids have 3:1 safety factor
- Does not kink under pressure
- 3/8" NPT ends with 3/8" to 1/4" NPT reducer
- 4 finger grip bend-restrictor to prevent damage near ends
- Heavy-duty brass industrial type quick connects with 1/4" female ends

Part #	Description
BLBBB1450QC	1/4" x 50'
BLBBB14100QC	1/4" x 100'
BLBBB3850QC	3/8" x 50'
BLBBB3450	3/4" x 50'

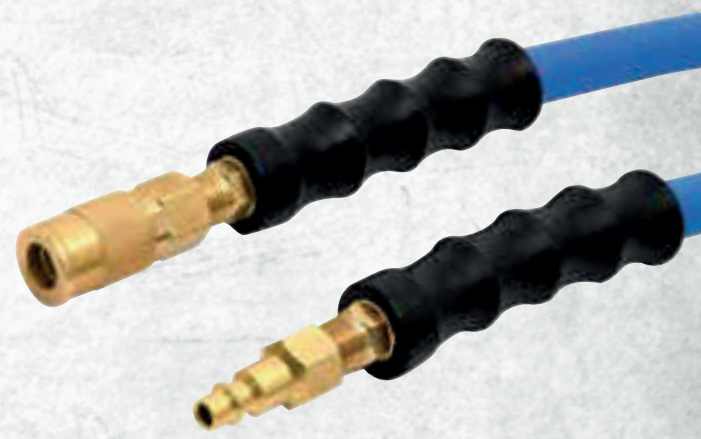

"Which Hose Are You Looking For?"



BluBird®

BluBird® Rubber Air Hose

Ultra-lightweight design - 40% Lighter
Extreme Strength & Durability exceeds RMA-IP2
Unmatched Cold Weather Flexible till **-50°F**
10 year warranty
Oil Resistant Tube & Cover
300 PSI, **4:1 Safety factor**



OIL SHIELD®

Oil Shield® Rubber Air Hose

RMA Class A Oil Resistant Tube & Cover
3 year warranty
Ultra-lightweight BluBird design
Extreme Strength exceeds RMA-IP2
300 PSI, **4:1 Safety factor**
Cold Weather Flexible till **-30°F**



AVAGARD®

Avagard® Premium Rubber Air Hose

The Red Rubber Hose done right
Very Light and **Super Strong**
RMA Class C Oil Resistance
5 year warranty
Cold Weather Flexible till **-40°F**
Exceeds RMA-IP2, 300 PSI, **4:1 Safety factor**

Pressure Washer & Inlet Hoses



BluShield® 3/8" Rubber Pressure Washer Hose

- 3/8" revolving male NPT x 3/8" fixed NPT that are carbon steel
- 4100 PSI / 16400 PSI, RMA Class A tube
- Handles hot water up to 250° F
- 100% rubber & 30% lighter than traditional rubber wire-braided hoses
- Kevlar/Aramid braided hose helps eliminate the risk of electrical shock
- Covered by a 1 year warranty



Part #	Description
BLBPW3835	BluShield 3/8" x 35' Pressure Washer Hose
BLBPW3850	BluShield 3/8" x 50' Pressure Washer Hose
BLBPW38100	BluShield 3/8" x 100' Pressure Washer Hose



Handles hot water up to 250° F



Flexibility in extreme conditions from -50°F to 190°F



Handles hot water up to 212° F

BluSeal Pressure Washer In-Let Hose
Better water flow, reducing wear and tear on the engine. Ultra lightweight & flexible rubber water hose suitable for use with most pressure washers.

FEATURES

- BluSeal pressure washer in-let hose with 3/4" standard fittings
- Lightweight & ultra durable
- Ozone resistant cover provides protection from extreme weather
- Constructed with high strength polyester braided reinforcement
- Flexibility in extreme conditions from -50°F to 190°F
- 4 finger grip bend restrictor for better ergonomics
- Handles hot water up to 212°F
- Minimum burst pressure: 500 PSI



Part #	Description
BLBBSIL5815	BluSeal 5/8" x 15' Pressure Washer In-Let Hose
BLBBSIL5825	BluSeal 5/8" x 25' Pressure Washer In-Let Hose
BLBBSIL5850	BluSeal 5/8" x 50' Pressure Washer In-Let Hose

Water Hose & Reels



on Hoses



on Hose Reels



BluSeal Water Hose Reel

Ultra lightweight & flexible rubber water hose

BLBBSWR5850

BluSeal Water Hose Reel 5/8" x 50'

- 18 gauge heavy-duty powder coated steel reel
- Comes with lightest, strongest, most flexible rubber water hose
- Includes 6' lead-in hose for easy installation
- 3/4" GHT inlet and outlet • Wall, ceiling, floor mountable
- Adjustable guide arm
- Retractable hose reel with AG-Lite water hose and nine mode spray gun • 4-way roller guides
- Class leading 12 point ratchet for locking at shorter intervals
- Covered by a 2 year warranty on hose reel and 10 year warranty on attached hose to any manufacturing defects

BLBRMXSPR001

9 Mode Metal Spray Gun

- 3/4" GHT female inlet includes universal quick connect plug
- Heavy duty, metal construction with chrome finish
- Rubberized ergonomic grip makes work and fun comfortable
- Clip can be switched when one wants to spray without having to press the trigger
- Covered by a 1 Year Warranty



RMX

BLBBSWR1250HRS

BluSeal Water Hose Reel Retractable 1/2" x 50'

- Retractable Hose Reel with Bluseal 1/2" X 50' water hose
- Powder Coated Steel - Corrosion Resistant, Heavy Duty 20 Gauge Steel
- 12 Point Ratchet for locking at shorter intervals
- 4-way Roller Guides
- 3' Whip Hose + Swivel Mount included
- Covered by a 2 year warranty on hose reel and 10 year warranty on attached hose to any manufacturing defects



on Hoses



on Hose Reels



 **WARNING:** Cancer and Reproductive Harm

Water Hoses

AG LITE®

Does not kink under pressure



Flexibility in extreme conditions from -50°F to 190°F

Handles hot water up to 212° F

AG Lite® All-Rubber Farm & Ranch Water Hose

The lightest and strongest, all-rubber water hose designed for rugged, every day use in farming, ranching and shop environments.

FEATURES

- Lightweight & ultra durable
- Ozone resistant cover provides protection from extreme weather, abrasions & kinks
- Constructed with high strength polyester braided reinforcement
- Flexibility in extreme conditions from -50°F to 190°F
- 4 finger grip bend restrictor for better ergonomics
- Handles hot water up to 212°F
- All hoses have 3/4" GHT brass fittings
- 1" ID hoses have 3/4" GHT brass fittings to fit conventional water outlets
- Available hose inner diameters: 1", 3/4" and 5/8"
- Minimum burst pressure: 500 PSI



Water Hose Flow

Hose I.D.	Gallons per minute (GPM) @ 65 PSI	Gallons per minute (GPM) @ 35 PSI
5/8"	11.90	10.30
3/4"	17.10	10.90
1"	24.70	19.80

AG Lite® Rubber Water Hose Extensions

Part #	Description
BLBBSAL5806	AG-Lite 5/8" x 6' Rubber Water Hose Extension
BLBBSAL3406	AG-Lite 3/4" x 6' Rubber Water Hose Extension

AG Lite® Rubber Water Hoses

Part #	Description
BLBBSAL5810	AG-Lite 5/8" x 10' Rubber Water Hose
BLBBSAL5815	AG-Lite 5/8" x 15' Rubber Water Hose
BLBBSAL5825	AG-Lite 5/8" x 25' Rubber Water Hose
BLBBSAL5850	AG-Lite 5/8" x 50' Rubber Water Hose
BLBBSAL5875	AG-Lite 5/8" x 75' Rubber Water Hose
BLBBSAL58100	AG-Lite 5/8" x 100' Rubber Water Hose
BLBBSAL3410	AG-Lite 3/4" x 10' Rubber Water Hose
BLBBSAL3415	AG-Lite 3/4" x 15' Rubber Water Hose
BLBBSAL3425	AG-Lite 3/4" x 25' Rubber Water Hose
BLBBSAL3450	AG-Lite 3/4" x 50' Rubber Water Hose

AG Lite® Rubber Water Hoses

Part #	Description
BLBBSAL3475	AG-Lite 3/4" x 75' Rubber Water Hose
BLBBSAL34100	AG-Lite 3/4" x 100' Rubber Water Hose
BLBBSALONE15	AG-Lite 1" x 15' Rubber Water Hose
BLBBSALONE25	AG-Lite 1" x 25' Rubber Water Hose
BLBBSALONE50	AG-Lite 1" x 50' Rubber Water Hose
BLBBSALONE100	AG-Lite 1" x 100' Rubber Water Hose



BluBird®

FLEET EDITION STAY ON THE ROAD!

Inflator Kit



on Hoses



on Accessories

BLBBFLT3850

BB Tire Inflator Fleet Edition Kit

- Featuring the lightest, strongest, most flexible all-weather BluBird® air hose 3/8" x 50' with 1/4" MNPT
- Includes Phillips heavy duty aluminum universal glad hand
- Includes a 1/4" to 1/2" adapter for fitting to Phillips glad hand
- Teflon™ tape and a carry bag for easy storage after use
- Dual foot chuck inflator
- Flexibility in extreme conditions from -50°F to 190°F
- Covered by a 10 year warranty on hose and a 2 year warranty on accessories



Flexibility in extreme conditions from -50°F to 190°F

Compressor Kits

BluBird®

AVAGARD®



BLBB1425KIT



Flexibility in extreme conditions from -50°F to 190°F

BLBAVG3850KIT



13 Piece BluBird® Air Compressor Kits

- Hose: 40% lighter than traditional rubber hoses, resists kinks and extreme weather, 4 finger grip bend restrictors, 300 PSI 1200 PSI, flexible in -50°F • Perfect for DIY & contractors
- Heavy duty industrial type couplers & plugs in brass
- 10 year warranty on hose and 2 year warranty on accessories

Kit Includes: 1/4" x 25' BluBird® air hose, safety blow gun (1), tire gauge(1), air chuck (1), male plugs industrial style 1/4" NPT (3), female plugs industrial style 1/4" NPT (2), male coupler industrial style 1/4" NPT (1), female coupler industrial style 1/4" NPT (1), Teflon tape (1), storage bag (1).

BLBB1425KIT
1/4" x 25'

BLBB3825KIT
3/8" x 25'

BLBB3850KIT
3/8" x 50'

Avagard 13 Piece Air Compressor Kits

- Hose:- Heavy Duty Rubber Hoses, Resists kinks and extreme weather, 4 finger grip bend restrictors
- Heavy Duty Industrial Type Couplers & Plugs in Brass
- Perfect for DIY & Contractors
- 4 Finger Grip Bend Restrictors

Kit Includes: Avagard Air Hose, Safety Blow gun (1), Tire gauge (1), Air Chuck (1), Male Plugs Industrial style 1/4" NPT (3), Female Plugs Industrial style 1/4" NPT (2), Male Coupler Industrial style 1/4" NPT (1), Female Coupler Industrial style 1/4" NPT (1), Teflon tape (1), Storage bag (1).

BLBAVG1425KIT
1/4" x 25'

BLBAVG3825KIT
3/8" x 25'

BLBAVG3850KIT
3/8" x 50'

Fastfix[®] Air Hoses & Fittings



Lightest, strongest, most flexible rubber hoses with fastfix fittings

BluBird[®] Rubber Air Hose with FastFix[®]
 40% lighter than traditional rubber hoses.
 Ideal for Roofers and Contractors.



Flexibility in extreme conditions from -50°F to 190°F



FEATURES

- Flexibility in extreme conditions from -50°F to 190°F
- FastFix fittings to repair damaged on-site in few minutes
- Comes with FastFix Field repair fittings
- 4 finger grip bend-restrictor to prevent damage near ends
- 1/4" NPT ends
- Covered by a 1 year warranty

Part #	Description
BLBBB14100FX	1/4" x 100' Rubber Air Hose with FastFix [®]
BLBBB1450FX	1/4" x 50' Rubber Air Hose with FastFix [®]

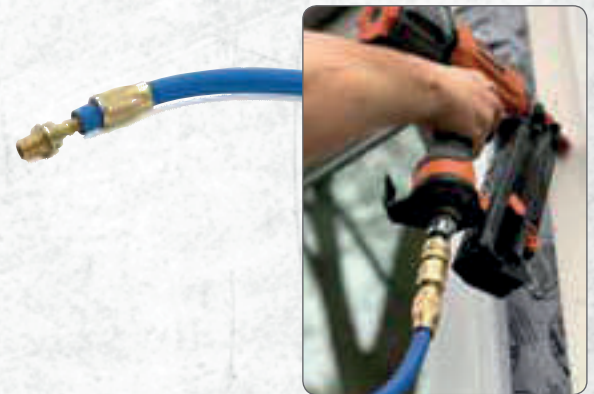

Professional Duty Reusable Brass Fittings for BluBird[®] Air Hoses

FEATURES

- Professional duty for replacing damaged fittings or for field repair of damaged BluBird[®] hoses
- Heavy duty brass construction - resists corrosion, ductility to high temperatures & low magnetic permeability
- Works with all 1/4" & 3/8" BluBird[®] hoses
- 1/4" and 3/8" FastFix[®] fittings have 1/4" NPT ends
- Easy installation
- Working pressure: 300 PSI
- Covered by a 6 month warranty on material and workmanship



FastFix[®] Air Hose Assembly Repair Splicers

Part #	Description	
BLBFFSP14	1/4"	1/4" NPT ends
BLBFFSP38	3/8"	1/4" NPT ends
BLBFFSP12	1/2"	



FastFix[®] Air Hose Assembly Repair Swivel

Part #	Description	
BLBFFSW14	1/4"	1/4" NPT ends
BLBFFSW38	3/8"	1/4" NPT ends



FastFix[®] Air Hose Assembly Repair Fittings

Part #	Description	
BLBFFFX14	1/4"	1/4" NPT ends
BLBFFFX38	3/8"	1/4" NPT ends
BLBFFFX12	1/2"	



Farm Fuel Hose



Oil Shield® Farm Fuel Hose

For use with diesel, gasoline, kerosene, biodiesel B10 and B20

- 8" Internal strain relief springs on each end to prevent kinking at the coupling
- 2x kink resistant than other fuel hoses
- Ozone and abrasion resistant cover
- RMA Class A oil-resistant tube & cover
- Factory crimped 3/4" NPT ends fits most fuel nozzles
- Static wire allows use with electric pumps
- For use where UL approval is not required
- Covered by a 1 year warranty



Part #	Description	NPT
BLBOSFHONE10	Oil Shield® Farm Fuel Hose Assembly 1" x 10'	1"
BLBOSFHONE12	Oil Shield® Farm Fuel Hose Assembly 1" x 12'	1"
BLBOSFHONE15	Oil Shield® Farm Fuel Hose Assembly 1" x 15'	1"
BLBOSFHONE20	Oil Shield® Farm Fuel Hose Assembly 1" x 20'	1"

Part #	Description	NPT
BLBOSFH3410	Oil Shield® Farm Fuel Hose Assembly 3/4" x 10'	3/4"
BLBOSFH3412	Oil Shield® Farm Fuel Hose Assembly 3/4" x 12'	3/4"
BLBOSFH3415	Oil Shield® Farm Fuel Hose Assembly 3/4" x 15'	3/4"
BLBOSFH3420	Oil Shield® Farm Fuel Hose Assembly 3/4" x 20'	3/4"



Agricultural Spray Hose



Flexibility in extreme conditions from -50°F to 190°F



Handles hot water up to 212° F



EPDM Agricultural Spray Hose Excellent for Insecticide, Fungicide, Herbicide Spraying

- Chemical resistant tube and cover
- 40% lighter and 100% rubber
- Lasso® /Alachor® resistant
- Extreme ozone and UV resistant cover
- High strength polyester braided reinforcement
- Available sizes: 3/8", 1/2", 3/4"
- Available lengths: 10ft., 15ft., 25ft., 50ft.
- Working pressure: 300PSI • Safety factor: 4:1
- Cold water flexibility down to -50°F
- Hot & cold water handling up to 212°F
- 1 year warranty

Part #	Description
BLBALAS3810	AG-Lite AG-Spray Hose 3/8" x 10'
BLBALAS3825	AG-Lite AG-Spray Hose 3/8" x 25'
BLBALAS3850	AG-Lite AG-Spray Hose 3/8" x 50'
BLBALAS1210	AG-Lite AG-Spray Hose 1/2" x 10'
BLBALAS1225	AG-Lite AG-Spray Hose 1/2" x 25'

Part #	Description
BLBALAS1250	AG-Lite AG-Spray Hose 1/2" x 50'
BLBALAS3410	AG-Lite AG-Spray Hose 3/4" x 10'
BLBALAS3425	AG-Lite AG-Spray Hose 3/4" x 25'
BLBALAS3450	AG-Lite AG-Spray Hose 3/4" x 50'

WARNING: Cancer and Reproductive Harm

Jack Hammer Hoses

BluBird®

BLBBJH3450

**BluBird® Pro Jack Hammer Hose
3/4" x 50' with Stainless Steel Ends**

- Ultra-light & super-strong rubber. 9 lbs. lighter than a traditional 3/4" x 50' assembly
- Ozone resistant cover provides protection from extreme weather, abrasions & kink
- Factory crimped stainless steel universal claw couplings for better durability
- Flexibility in extreme conditions from -50°F to 190°F
- Wrapped finish gives better flexibility and abrasion resistance
- Covered by a 2 year warranty



Flexibility in extreme conditions from -50°F to 190°F



AVAGARD®

BLBAVGJH3450

**Avagard® Jack Hammer
HD Rubber Hose - 3/4" x 50'**

- Heavy Duty Rubber Water Hose suitable for Commercial, Industrial, & Residential use
- Covered by a 5 year warranty



Utility Hoses



Yellow Rubber Air Hoses

- Solid brass end MNPT fittings
- Protective PVC bend restrictor ends
- Abrasion-resistant rubber outer jacket
- 300 PSI working pressure
- 1 year warranty

Part #	Description	NPT
BLBAVG3825YLKT	3/8" x 25' Air Hose, Red	1/4"
BLBAVG3835YLKT	3/8" x 35' Air Hose, Red	1/4"
BLBAVG3850YLKT	3/8" x 50' Air Hose, Red	1/4"



Red Rubber Air Hoses

- Solid brass end MNPT fittings
- Protective PVC bend restrictor ends
- Abrasion-resistant rubber outer jacket
- 300 PSI working pressure
- 1 year warranty



Part #	Description	NPT
BLBAVG3803KT	3/8" x 3' Air Hose, Red	1/4"
BLBAVG3825KT	3/8" x 25' Air Hose, Red	1/4"
BLBAVG3850KT	3/8" x 50' Air Hose, Red	1/4"
BLBAVG1225KT38	1/2" x 25' Air Hose, Red	3/8"
BLBAVG1225KT12	1/2" x 25' Air Hose, Red	1/2"
BLBAVG1250KT38	1/2" x 50' Air Hose, Red	3/8"
BLBAVG1250KT12	1/2" x 50' Air Hose, Red	1/2"

Whip-Snubber & Lead-In Hoses

BluBird®



BluBird® Whip Hoses

- Professional air tool snubber hose, 300 PSI working pressure & comes with 360° ball swivel revolving fittings
- Extends coupler service life & improves maneuverability
- Absorbs shock to air couplers from pneumatic tools
- Reduces twisting and kinking
- Flexible rubber construction, with 4 finger-grip bend restrictor
- Covered by a 90 day material and workmanship warranty

Part #	Description	NPT
BLBBBSR3802	3/8" x 2' with 360° Ball Swivel	1/4"
BLBBBSR3803	3/8" x 3' with 360° Ball Swivel	1/4"
BLBBBSR3805	3/8" x 5' with 360° Ball Swivel	1/4"
BLBBBSR1202	1/2" x 2' with 360° Ball Swivel	1/2"
BLBBBSR1205	1/2" x 5' with 360° Ball Swivel	1/2"

BluBird® OIL SHIELD®



Oil Shield® Whip Hoses

- Professional air tool lead in / snubber hose, 300 PSI working pressure
- Oil resistant core tube and cover meets RMA Class A oil resistance
- Absorbs shock to air couplers from pneumatic tools
- Reduces twisting and kinking. Extends coupler service life & improves maneuverability
- Flexible rubber construction, with 4 finger-grip bend restrictor
- Covered by a 90 day material and workmanship warranty

Part #	Description	NPT
BLBOSSR3802	3/8" x 2' Whip Hose with 360° Swivel	1/4"
BLBOSLD3803	3/8" x 3' Whip Hose	1/4"
BLBOSSR3805	3/8" x 5' Whip Hose with 360° Swivel	1/4"
BLBOSLD1203	1/2" x 2' Whip Hose	1/2"
BLBOSSR1205	1/2" x 5' Whip Hose	1/2"

AVAGARD®



Swivel Whip Hoses

- 300 PSI Red rubber whip hose with brass ferrule
- 1/4" swivel MNPT + 1/4" fixed FNPT fittings
- Covered by a 90 day material and workmanship warranty

Part #	Description	Swivel
BLBAVGSR3803KT	3/8" x 3' Swivel Whip Hose with 360° Ball Swivel	1/4"
BLBAVGSR3806KT	3/8" x 6' Swivel Whip Hose with 360° Ball Swivel	1/4"



Flexibility in extreme conditions from -50°F to 190°F

BluBird® Lead-in Hoses

- Ultra-light & super-strong: finally, a rubber hose that's 40% lighter than others and as light as hybrid / PVC hoses
- Makes a flexible connection from rigid supply line to hose reel
- Braided, not just spiraled, polyester gives 300PSI working pressure
- Flexibility in extreme conditions from -50°F to 190°F
- Comes with 1/4" brass MNPT end fittings
- Better against rust than steel, stronger than aluminum
- 4 finger grip bend restrictors
- Covered by a 1 year warranty

Part #	Description	NPT
BLBBBLD1203	1/2" x 3' Lead in Hose	1/2"
BLBBBLD3803	3/8" x 3' Lead in Hose	1/4"

AVAGARD®



BLBAVGLED3803 Avagard Lead-in Hose 3/8" x 3'

- Heavy Duty rubber hose that's 20% lighter than others conventional hoses
- Handles Hot Water up to 190°F
- 4 Finger Grip Bend Restrictors
- Ozone & UV resistant to prevent cracking while in the sun
- Makes a flexible connection from rigid supply line to hose reel to isolate vibrations
- Covered by a 5 year warranty

Heavy Duty Red Rubber Air Hose, 3/8" x 3', 1/4" MNPT, 1/4" NPT Brass fittings. Resistant to UV, Ozone and UV. Also resists abrasion and is Kink Resistant.

Work Gear



BLBBTB01 BluBird WORK GEAR - Carpenter's Tool Backpack with 48 Pockets and Padded Back Support

- This tool backpack has two main zippered compartments, one for tools and parts, one for a cordless drill and battery
- Adjustable compression pocket accepts bulky items
- Comfortable padded back support and shoulder straps with adjustable chest strap
- Convenient exterior pocket and dual handles at top
- 41 pockets inside and 7 pockets outside to organize a wide variety of tools and accessories. Heavy duty stitching and bar tacking at all stress points on this tool bag are included for added durability.



BluBird WORK GEAR - Large BigMouth Bags

- Opens wide for easy access to contents
- With padded reinforced web carrying handles and an adjustable shoulder strap, this tool bag is comfortable to carry
- Heavy duty stitching and bar tacking at all stress points on this tool bag are included for added durability



BLBBTB02 BluBird WORK GEAR - Large BigMouth Bag with 22 Pockets

- 12 pockets inside, and 10 outside organize tools and accessories



BLBBTB03 BluBird WORK GEAR - Large BigMouth Bag with 31 Pockets

- 12 pockets inside, and 19 outside organize tools and accessories



BLBBTB04 BluBird WORK GEAR - Medium and Large Utility Tote Bag Combo

- These utility tote bags are designed for plumbers, electricians, maintenance personnel, paint and general contractors
- Reinforced bottom panels for added durability
- Strong web carry handles on these utility tote bags will last through many jobs
- Separate and organize your small parts and hand tools with these medium and large utility tote bags

BLBBTB13 BluBird WORK GEAR - Multi-Purpose Clip-on Zippered Poly Bags, 3 Pack

- 3 multi-purpose clip-on poly bags are 9" x 7", 7" x 6", and 6" x 5"
- Made of polyester fabric
- Durable clip on these tool bags hang on toolbelts, belt loops, etc.
- Carry and organize all your misc. parts, tools and accessories



BLBBTB12 BluBird WORK GEAR - Socket Tool Roll Pouch with 32 Pockets

- Heavy-duty elastic strap on this tool pouch roll keeps tools in place
- Adjustable quick-release buckle on this tool roll pouch fastens when not in use
- Hook and loop closure holds metric and standard sockets
- Heavy duty stitching and bar tacking at all stress points for added durability
- 600D polyester construction sewn together with heavy stitching
- Includes carrying handle for easy transport

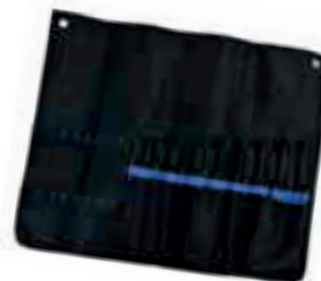

BluBird®

Hose Reel Replacement Parts



Part #	Description
BLBBBLD3803RL	Replacement Lead Hose for BLBBBR3850
BLBBBLD1203RL	Replacement Lead Hose for BLBBBR1250
BLBBB3850RL	Replacement Hose for BLBBBR3850

BluBird® OIL SHIELD®



Part #	Description
BLBOSLD3803RL	Replacement Lead Hose for BLBOSR3850

AVAGARD®



Part #	Description
BLBAVGLD3803RL	Replacement Lead Hose for BLBAVGR3850

BluBird®

BLBHR53812 Swivel Mount for Hose Reels - 1/4" 3/8" & 1/2" Reels

- Mounting bracket allows hose reels to be mounted to the wall and swung sideways for easy use while reducing pressure on the rollers
- All steel powder coated construction
- Heavy duty swivel joints
- Suitable with most reels
- Covered by a 2 year warranty



BLBHR53812 BluBird® Stainless Steel 304 140 Degree Hose Reel Swivel Mount

- Stainless Steel 304 Heavy Duty construction
- 4 Slotted Holes for reels and mounting
- Mounting hardware NOT included



BLBHR53812DA BluBird Heavy Duty 140 Degree Hose Reel Swivel Mount for RMX Dual Arm Reels

- Easy & Quick to install
- 20 Gauge Heavy Duty Powder Coated Steel
- 4 Slotted Holes for reels & 4 slotted holes for mounting
- Covered by a 1 year warranty

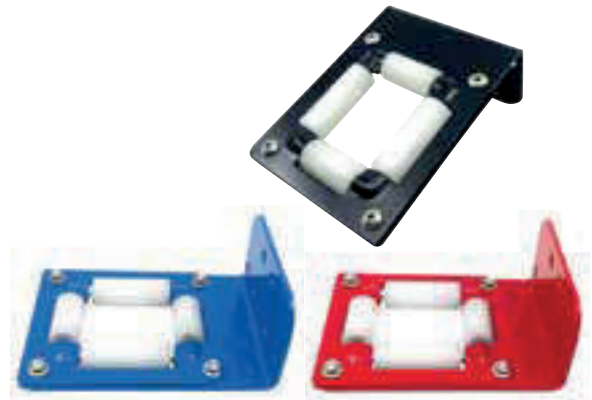

Hose Reel Roller Guides

Part #	Description
BLBRS05	Hose Reel Roller Guide Set Black 20 Gauge Reels
BLBRS09	75', 65' & 50' Black HD Hose Reel Roller Guide Set
BLBRS06	50' Blue HD Hose Reel Roller Guide Set
BLBRS10	75' & 65' Blue HD Hose Reel Roller Guide Set
BLBRS08	50' Red HD Hose Reel Roller Guide Set

Rubber Molded Stopper for Hose Reels



Part #	Description
BLBRS04	Rubber Molded Stopper for 5/8" & 3/4" Hose Reels
BLBRS03	Rubber Molded Stopper for 1/2" Hose Reels
BLBRS02	Rubber Molded Stopper for 3/8" Hose Reels

BLBRS01 Hose Reel Latch Pawl with Screws & Spring





Auto Body Dr. Rx

HARDWARE & TRIM catalog

2017

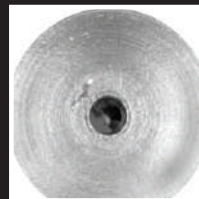
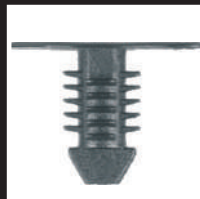

BODY BOLTS

DOOR HINGE PINS

DOOR LOCK CLIPS

HEADLIGHT PARTS

HOOD PROP CLIPS

RETAINERS

RIVETS

SPECIALTY NUTS
& GROMMETS

TRIM SCREWS

WINDSHIELD PARTS

MISCELLANEOUS



RETAINER KITS & ASSORTMENTS

ABD6000 90-piece Essential Kit GM Retainer Assortments



ABD6000

Description	Kit Qty.
Door Trim Panel Clips, Size: 1/4" (6.4mm), Stem: 3/4", Head: 7/8", GM 3065575.....	10
Panel Retainers, Size: 3/8" (9.5mm), Stem: 13/16", Head: 1", GM 1619321.....	10
Door Panel Clips, Size: 1/4" (6.4mm), Stem: 3/4", Head: 3/4" x 7/8", GM 20421800, 15600382.....	5
Panel Retainers, Size: 1/4" (6.4mm), Stem: 5/8", Head: 11/16", GM 332364.....	10
Shield Retainers, Size: 1/4" (6.4mm), Stem: 13/16", Head: 11/16", GM 1605396, GM 1595864.....	10
Dash Panel Retainers, Size: 3/16" (4.5mm), Stem: 13/16", Head: 7/16", GM 25016383, GM 20413107.....	10
Weatherstrip Retainer, Size: 3/16" (4.5mm), Stem: 3/8", Head: 3/8", GM 2964547.....	10
Weatherstrip Retainer, Size: 13/64" (5.3mm), Stem: 12mm, Head: 10mm, GM 20699808.....	5
Trim Panel Retainer, Size: 1/4" (6.4mm), Stem: 3/4", Head: 1/2", GM 411700.....	5
Shield Retainers, Size: 1/4" (6.4mm), Stem: 1-1/16", Head: 11/16", GM 10121502.....	5
Trim Panel Retainer, Size: 5/16" (7.8mm), Stem: 7/8", Head: 3/4", GM 21094146.....	5
Hood Seal Retainer, Size: 5/16" (7.8mm), Stem: 1-3/8", Head: 3/4", GM 14074081.....	5

Refill Options	
Refill Qty.	Clamshell Qty.
ABD6001... 10	ABD6001RX.....5
ABD6002... 10	ABD6002RX.....6
ABD6003... 10	ABD6003RX.....5
ABD6004... 10	ABD6004RX.....12
ABD6005... 10	ABD6005RX.....8
ABD6006... 10	ABD6006RX.....6
ABD6007... 10	ABD6007RX.....8
ABD6008... 10	ABD6008RX.....5
ABD6009... 10	ABD6009RX.....8
ABD6010... 10	ABD6010RX.....5
ABD6011... 10	ABD6011RX.....3
ABD6012... 10	ABD6012RX.....3

ABD6100 82-piece Essential Kit Ford Retainer Assortments



ABD6100

Description	Kit Qty.
Shield Retainers, Size: 1/4" (6.4mm), Stem: 13/16", Head: 11/16", Ford 388577-S.....	10
Shield Retainers, Size: 7/32" (5.3mm), Stem: 11/16", Head: 3/4", Ford N80101994-S.....	4
Shield Retainers, Size: 7/32" (5.3mm), Stem: 25/32", Head: 1", Ford N808370-S.....	4
Trim Panel Retainers, Size: 1/4" (6.4mm), Stem: 1-1/16", Head: 1", Ford 388930-S.....	10
Interior Trim Retainers, Size: 9/32" (7.1mm), Stem: 20mm, Head: 25mm, Ford N802734S.....	5
Shield Retainers, Size: 23/64" (9mm), Stem: 3/4", Head: 5/8", Ford N807721-S.....	10
Fascia Bumper Retainers, Size: 25/64" (4.5mm), Stem: 28mm, Head: 22mm, Ford N804379S.....	5
Door Trim Panel Clips, Size: 1/4" (6.4mm), Stem: 5/8", Head: 25/32", Ford N801925-S.....	10
Trim Panel Retainers, Size: 9/32" (7.1mm), Stem: 1-3/4", Head: 1", Ford E7EB5802354AAJABH.....	4
Hood Insulation Retainers, Size: 1/4" (6.4mm), Stem: 5/8", Head: 1/2" x 1-1/2", Ford D30Z-16776A.....	10
Door Trim Retainers, Size: 1/4" (6.4mm), Stem: 11/16", Head: 15/16", Ford 385661-S.....	5
Trim Panel Retainers, Size: 1/4" (6.4mm), Stem: 15/16", Head: 15/16", Ford 387496-S.....	5

Refill Options	
Refill Qty.	Clamshell Qty.
ABD6005... 10	ABD6005RX.....8
ABD6013... 10	ABD6013RX.....2
ABD6014... 10	ABD6014RX.....2
ABD6015... 10	ABD6015RX.....8
ABD6016... 10	ABD6016RX.....4
ABD6017... 10	ABD6017RX.....3
ABD6018... 10	ABD6018RX.....3
ABD6019... 10	ABD6019RX.....4
ABD6021... 10	ABD6021RX.....2
ABD6022... 10	ABD6022RX.....6
ABD6023... 10	ABD6023RX.....4
ABD6024... 10	ABD6024RX.....3

ABD6200 80-piece Essential Kit Chrysler Retainer Assortments



ABD6200

Description	Kit Qty.
Panel Retainers, Size: 1/4" (6.4mm), Stem: 5/8", Head: 11/16", Chrysler 3691590.....	10
Shield Retainers, Size: 1/4" (6.4mm), Stem: 13/16", Head: 11/16", Chrysler 6030441.....	10
Trim Panel Retainers, Size: 5/16" (7.8mm), Stem: 7/8", Head: 3/4", Chrysler 6501301.....	10
Hood Insulation Retainers, Size: 1/4" (6.4mm), Stem: 5/8", Head: 1/2" x 1-1/2", Chrysler 6003351.....	5
Door Trim Retainers, Size: 1/4" (6.4mm), Stem: 11/16", Head: 15/16", Chrysler 6032363.....	5
Weatherstrip Retainers, Size: 13/64" (5.3mm), Stem: 5/8", Head: 3/8", Chrysler 4658673.....	5
Shield Retainers, Size: 7/32" (5.5mm), Stem: 3/4", Head: 5/8", Chrysler 6501948.....	10
Fascia Panel Retainers, Size: 1/4" (6.4mm), Stem: 20mm, Head: 25mm, Chrysler 6501067.....	10
Shield Retainers, Size: 1/4" (6.4mm), Stem: 1-1/16", Head: 1", Chrysler 6502104.....	3
Panel Retainers, Size: 5/16" (7.8mm), Stem: 11/16", Head: 1/2", Chrysler 34202335.....	3
Door Trim Panel Retainers, Size: 11/32" (8.5mm), Stem: 8mm, Head: 20mm, Chrysler 6505292AA.....	4
Door Trim Panel Retainers, Size: 1/4" (6.4mm), Stem: 11/16", Head: 15/16", Chrysler 6003349.....	5

Refill Options	
Refill Qty.	Clamshell Qty.
ABD6004... 10	ABD6004RX... 12
ABD6005... 10	ABD6005RX..... 8
ABD6011... 10	ABD6011RX..... 3
ABD6022... 10	ABD6022RX..... 6
ABD6023... 10	ABD6023RX..... 4
ABD6025... 10	ABD6025RX..... 4
ABD6026... 10	ABD6026RX..... 5
ABD6027... 10	ABD6027RX..... 3
ABD6028... 10	ABD6028RX..... 2
ABD6029... 10	ABD6029RX..... 2
ABD6031... 10	ABD6031RX..... 2
ABD6035... 10	ABD6035RX..... 4

ABD7650 80-piece Honda Body Retainer Kit



ABD7650

Description	Kit Qty.
Weatherstrip Retainer, Size: 15/64" (6mm), Stem: 10mm, Head: 5mm x 15mm, Honda 915530-SP1-003.....	10
Honda Insulation Retainer, Size: 19/64" (7.5mm), Stem: 10mm, Head: 30mm, Acura 90700-SJ4-000.....	5
Hood/Trunk Moulding, Size: 15/64" (6mm), Stem: 9mm, Head: 12mm, Honda 91518-SM4-003.....	5
Push-type Retainers, Black Nylon, Size: 8mm, Stem: 11mm, Head: 20mm, Honda 91512-SX0-003.....	10
Push-type Retainers, Black Nylon, Size: 8mm, Stem: 21mm, Head: 18mm, Honda 90505-SM4-003.....	5
Fender Splash Shield Push-type Retainer, Size: 8mm, Stem: 9mm, Head: 20mm, Honda 91512-SM4-003.....	5
Front Bumper Retainer, Black Nylon, Size: 10mm, Stem: 27mm, Head: 20mm, Honda 91502-SM4-000.....	5
Front/Rear Bumper Retainer, Size: 10mm, Stem: 15mm, Head: 20mm, Acura 91503-SPO-003.....	5
Front/Rear Bumper Retainer, Size: 10mm, Stem: 25mm, Head: 20mm, Honda 91502-SPO-003.....	5
Bumper Fascia Retainer, Size: 10mm, Stem: 24mm, Head: 20mm, Honda 91504-SM4-000.....	5
Front Bumper Retainer, Size: 10mm, Stem: 20mm, Head: 13mm, Honda 91503-SZ5-003, Acura 91503-SZ3-003.....	10
Bumper Retainer, Size: 10mm, Stem: 18mm, Head: 20mm, Honda 91503-SZ5-003.....	10

Refill Options	
Refill Qty.	Clamshell Qty.
ABD6059... 10	ABD6059RX.....5
ABD6073... 10	ABD6073RX.....2
ABD6080... 10**
ABD6114... 10	ABD6114RX.....2
ABD6115... 10	ABD6115RX.....2
ABD6122... 10	ABD6122RX.....2
ABD6124... 10**
ABD6131... 10**
ABD6133... 10	ABD6133RX.....2
ABD6134... 10	ABD6134RX.....2
ABD6155... 10	ABD6155RX.....2
ABD6156... 10	ABD6156RX.....2

NOTES: **Not available in clamshell package / Refill part numbers available in bulk quantities of 100 / Add suffix "B" to refill part number for bulk orders

RETAINER KITS & ASSORTMENTS

ABD7750

80-piece Toyota Body Retainer Kit

Description	Kit Qty.
Hood Seal Retainer, Size: 13/64" (5.3mm), Stem: 11mm, Head: 13mm, Toyota 90467-08004, Toyota 90467-08011	10
Toyota/Nissan Retainer Clip, Size: 13/64" (5.3mm), Stem: 15mm, Head: 13mm, Toyota 90467-07050	5
Toyota Retainer Clip, Size: 13/64" (5.3mm), Stem: 15mm, Head: 13mm, Toyota 90467-07050	5
Hood Insulation Retainer, Size: 17/64" (7mm), Stem: 17mm, Toyota 90467-9006	5
Toyota Retainer Clip, Size: 17/64" (7mm), Head: 30mm, Stem: 17mm, Toyota 90467-09008	5
Door Panel Retainer, Size: 9mm, Size: 18mm, Stem: 14mm, Toyota 67771-01010	5
Push-type Retainers, Black Nylon, Size: 7mm, Stem: 12mm, Head: 15mm, Toyota 90467-06017	10
Bumper Cover Retainer, Size: 9mm, Stem: 12mm, Toyota 90467-01945	5
Rear Bumper Cover Retainer, Size: 9mm, Stem: 28mm, Head: 18mm, Toyota 52161-16010	10
Front Fender Liner, Size: 7mm, Size: 20mm, Stem: 8mm, Toyota 90467-07166	10
Door Trim Retainer, Size: 9mm, Stem: 14mm, Toyota 67771-01010	5
Door Trim Retainer, Size: 13mm, Stem: 11mm, Toyota 67771-30070	5

Refill Options	
Refill Qty.	Clamshell Qty.
ABD6074 .. 10	ABD6074RX.....5
ABD6075 .. 10	ABD6075RX.....5
ABD6076 .. 10	ABD6076RX.....4
ABD6077 .. 10	ABD6077RX.....1
ABD6078 .. 10**
ABD6087 .. 10	ABD6087RX.....4
ABD6118 .. 10	ABD6118RX.....4
ABD6128 .. 10	ABD6128RX.....2
ABD6150 .. 10	ABD6150RX.....1
ABD6152 .. 10	ABD6152RX.....2
ABD6171 .. 10**
ABD6174 .. 10**



ABD7750

ABD7850

75-piece Nissan Body Retainer Kit

Description	Kit Qty.
Panel Retainer, Size: 15/64" (6mm), Stem: 16mm, Nissan 76906-T3000	5
Hood Insulation Clip, Size: 3/16" (5mm), Stem: 9mm, Nissan 65846-30F00	5
Door Trim Retainer, Nissan 01553-S3500	5
Push-type Retainers, Black Nylon, Size: 10mm, Stem: 15mm, Head 18mm, Nissan 01553-09241	10
Cowl Panel Retainer, Size: 6mm, Stem: 16mm, Head: 14mm, Nissan 66860-01W01	5
Inner Fender Retainer, Size: 8mm, Stem: 18mm, Head: 20mm, Nissan 63844-01A00	10
Trim Retainer, Size: 7mm, Stem: 11mm, Head: 18mm, Nissan 6031390	5
Front/rear Bumper Retainer, Size: 8mm, Stem: 15mm, Head: 20mm, Nissan 01553-06721	5
Trim Retainer, Size: 8mm, Stem: 9mm, Head: 20mm, Nissan 01553-09321	10
Grill Retainer, Size: 15/64" (6mm), Stem: 8mm, Nissan 66814-01G00	5
Push-type Retainer, Size: 5/16" (8mm), Stem: 20mm, Nissan 76882-57A00	5
Fascia Retainer, Size: 7/16" (11mm), Stem: 14mm, Nissan 01553-03101	5

Refill Options	
Refill Qty.	Clamshell Qty.
ABD609410**
ABD609510**
ABD609610**
ABD611710**
ABD612610	ABD6126RX.. 2
ABD613210	ABD6132RX.. 4
ABD614110	ABD6141RX.. 2
ABD614310	ABD6143RX.. 2
ABD615310	ABD6153RX.. 2
ABD617210**
ABD617310**
ABD617510**



ABD7850

ABD6300

65-piece Push-type Retainer Kit (Ford, GM & Chrysler)

Description	Kit Qty.
Mud Skirt Blind Rivets, Size: 1/4", Stem: 9/16", Head: 11/16", GM 14019205	10
Splash Shield Blind Rivet, Size: 1/4", Stem: 7/8", Head: 1", GM 140193088	10
Push-type Retainer, Size: 8mm, Stem: 20mm, Head: 20mm, GM 21030249	5
Push-type Retainer, Size: 10mm, Stem: 16mm, Head: 12mm, Ford XL3Z17E971-AA	5
Bumper Pad Blind Rivets, Size: 1/2" (12.7mm), Stem: 3/4", Head: 1/8", GM 5973400	10
Radiator Shroud Blind Rivet, Size: 1/4" (6.4mm), Stem: 15/16", Head: 11/16", Ford N804570S	5
Door Panel Retainers, Size: 1/4" (6.4mm), Stem: 41/64", Head: 9/16", GM 15960325	5
Push-type Retainers, Size: 1/4" (6.4mm), Stem: 13/16", Head: 11/16", Chrysler 6501925	3
Splash Shield/Fascia Retainer, Size: 5/16", Stem: 7/8", Head: 1", Ford N803421S	4
Trim Fascia Retainer, Size: 1/4", Stem: 21/32", Head: 15/32", Ford N803494S	4
Push-type Retainer, Size: 1/4" (6.4mm), Stem: 1", Head: 7/8", Chrysler 6506106	2
Push-type Retainer, Size: 1/2" (12.7mm), Stem: 1-1/16", Head: 7/8" x 1-25/32", Chrysler 4630253	2

Refill Options	
Refill Qty.	Clamshell Qty.
ABD610110	ABD6101RX.....5
ABD610210	ABD6102RX.....4
ABD610310	ABD6103RX.....3
ABD610410	ABD6104RX.....2
ABD610510	ABD6105RX.....2
ABD610610	ABD6106RX.....4
ABD610710	ABD6107RX.....3
ABD610810	ABD6108RX.....3
ABD610910**
ABD611010**
ABD611110	ABD6111RX.....1
ABD611210	ABD6112RX.....1



ABD6300

ABD6900

100-piece Ergo Tuflok Retainer Kit

Description	Kit Qty.
Fender Apron Retainer, Size: 8.5mm, Stem: 14mm, Head: 19mm, GM 11609417	10
Ergo Tuflok Retainer, Size: 6.5mm, Stem: 22mm, Head: 18mm, GM 11589291, Ford W713331S300	10
Ergo Tuflok Retainer, Size: 6.5mm, Stem: 17.5mm, Head: 18mm, GM 11589289, Chrysler 6508863AA	10
Bumper Fascia Retainer, Size: 6.5mm, Stem: 22mm, Head: 18mm, GM 11589290	10
Ergo Tuflok Retainer, Size: 8mm, Stem: 16mm, Head: 19mm, GM15296830, Chrysler 0516530AA	5
Ergo Tuflok Retainer, Size: 8.5mm, Stem: 20mm, Head: 20mm, GM 11589292	10
Panel Retainer, Size: 9mm, Stem: 23mm, Head: 19mm, GM 11589294	10
Cowl & Fender Retainer, Size: 8.5mm, Stem: 22mm, Head: 20mm, GM 11589293, Ford W712196S300	10
Fender/Wheel/Bumper Retainer, Size: 9.5mm, Stem: 20mm, Head: 18mm, GM 11561368, Chrysler 065008712AA	10
Ergo Tuflok Retainer, Size: 10.5mm, Stem: 20mm, Head: 25mm, GM 11589295, Chrysler 5GUU9K11BA	5
Ergo Tuflok Retainer, Size: 10.5mm, Stem: 23mm, Head: 25mm, GM 11589296	10

Refill Options**	
Refill Qty.	Clamshell Qty.
ABD616010	ABD616010
ABD616110	ABD616110
ABD616210	ABD616210
ABD616310	ABD616310
ABD616410	ABD616410
ABD616510	ABD616510
ABD616610	ABD616610
ABD616710	ABD616710
ABD616810	ABD616810
ABD616910	ABD616910
ABD617010	ABD617010



ABD6900

NOTES: **Not available in clamshell package / Refill part numbers available in bulk quantities of 100 / Add suffix "B" to refill part number for bulk orders

RETAINER KITS & ASSORTMENTS



ABD7000

ABD7000 120-piece Master Kit GM Retainer Assortments

Description	Kit Qty.
Door Trim Panel Clips, Size: 1/4" (6.4mm), Stem: 3/4", Head: 7/8", GM 3065575.....	5
Panel Retainers, Size: 3/8" (9.5mm), Stem: 13/16", Head: 1", GM 1619321.....	5
Door Panel Clips, Size: 1/4" (6.4mm), Stem: 3/4", Head: 3/4" x 7/8", GM 20421800, 15600382.....	5
Panel Retainers, Size: 1/4" (6.4mm), Stem: 5/8", Head: 11/16", GM 332364.....	5
Shield Retainers, Size: 1/4" (6.4mm), Stem: 13/16", Head: 11/16", GM 1605396, GM 1595864.....	5
Dash Panel Retainers, Size: 3/16" (4.5mm), Stem: 13/16", Head: 7/16", GM 25016383, GM 20413107.....	5
Weatherstrip Retainer, Size: 3/16" (4.5mm), Stem: 3/8", Head: 3/8", GM 2964547.....	5
Weatherstrip Retainer, Size: 13/64" (5.3mm), Stem: 12mm, Head: 10mm, GM 20699808.....	5
Trim Panel Retainer, Size: 1/4" (6.4mm), Stem: 3/4", Head: 1/2", GM 411700.....	5
Shield Retainers, Size: 1/4" (6.4mm), Stem: 1-1/16", Head: 11/16", GM 10121502.....	5
Trim Panel Retainer, Size: 5/16" (7.8mm), Stem: 7/8", Head: 3/4", GM 21094146.....	5
Hood Seal Retainer, Size: 5/16" (7.8mm), Stem: 1-3/8", Head: 3/4", GM 14074081.....	5
Back Seat Shield Retainers, Black Nylon, Size: 17/64" (7mm), Stem: 15/16", Head: 25/32", GM 20319841.....	5
Interior Trim Panel Retainer, Natural Nylon, Size: 17/64" (7mm), Stem: 11/16", Head: 15/16", GM 2048248.....	5
Front End Stone Shield Retainers, Black Nylon, Size: 3/8" (9.5mm), Stem: 13/16", Head: 7/8", GM 22512276.....	5
Trim Panel Retainer, Black Nylon, Size: 1/4" (6.4mm), Stem: 1-7/16", Head: 1", GM 14027471.....	5
Hood Insulation Clips, Black Nylon, Size: 1/4" (6.4mm), Stem: 3/4", Head: 1-21/32", GM 20064875.....	5
Hood Insulation Clips, Black Poly, Size: 1/4" (6.4mm), Stem: 3/4", Head: 2", GM 3078511.....	5
Door Trim Panel Retainers, Black Nylon, Size: 1/4" (6.4mm), Stem: 1/2", Head: 3/4", GM 796255.....	5
Door Trim Panel Retainers, Natural Nylon, Size: 1/4" (6.4mm), Stem: 3/4", GM 12337920.....	5
Weatherstrip Fastener, Black Nylon, Size: 3/16" (4.5mm), Stem: 5/8", Head: 7/16", GM 20413107.....	5
Mud Shield Retainer, Black Nylon, Size: 1/4" (6.4mm), Stem: 1/2", Head: 3/4", GM 20413107.....	5
Bumper, Fender, Seat & Carpet Retainer, Size: 6.3mm, Stem: 11mm, Head: 18.5mm, GM 10182300.....	5
Door Trim Panel Retainer, Size: 7.5mm, Stem: 18mm, Head: 20mm, GM 21042045.....	5

Refill Options	
Refill Qty.	Clamshell Qty.
ABD600110	ABD6001RX....5
ABD600210	ABD6002RX....6
ABD600310	ABD6003RX....5
ABD600410	ABD6004RX....12
ABD600510	ABD6005RX....8
ABD600610	ABD6006RX....6
ABD600710	ABD6007RX....8
ABD600810	ABD6008RX....5
ABD600910	ABD6009RX....8
ABD601010	ABD6010RX....5
ABD601110	ABD6011RX....3
ABD601210	ABD6012RX....3
ABD602010	ABD6020RX....4
ABD603010	ABD6030RX....5
ABD603210	ABD6032RX....3
ABD603310**
ABD603410	ABD6034RX....4
ABD603610	ABD6036RX....2
ABD603710	ABD6037RX....2
ABD603810	ABD6038RX....5
ABD603910	ABD6039RX....2
ABD604010	ABD6040RX....3
ABD604110	ABD6041RX....3
ABD604210	ABD6042RX....2



ABD7100

ABD7100 120-piece Master Kit Ford Retainer Assortments

Description	Kit Qty.
Shield Retainers, Size: 1/4" (6.4mm), Stem: 13/16", Head: 11/16", Ford 388577-S.....	5
Shield Retainers, Size: 7/32" (5.3mm), Stem: 11/16", Head: 3/4", Ford N80101994-S.....	5
Shield Retainers, Size: 7/32" (5.3mm), Stem: 25/32", Head: 1", Ford N808370-S.....	5
Trim Panel Retainers, Size: 1/4" (6.4mm), Stem: 1-1/16", Head: 1", Ford 388930-S.....	5
Interior Trim Retainers, Size: 9/32" (7.1mm), Stem: 20mm, Head: 25mm, Ford N802734S.....	5
Shield Retainers, Size: 23/64" (9mm), Stem: 3/4", Head: 5/8", Ford N807721-S.....	5
Fascia Bumper Retainers, Size: 25/64" (4.5mm), Stem: 28mm, Head: 22mm, Ford N804379S.....	5
Door Trim Panel Clips, Size: 1/4" (6.4mm), Stem: 5/8", Head: 25/32", Ford N801925-S.....	5
Trim Panel Retainers, Size: 9/32" (7.1mm), Stem: 1-3/4", Head: 1", Ford E7EB5802354AAJABH.....	5
Hood Insulation Retainers, Size: 1/4" (6.4mm), Stem: 5/8", Head: 1/2" x 1-1/2", Ford D30Z-16776A.....	5
Door Trim Retainers, Size: 1/4" (6.4mm), Stem: 11/16", Head: 15/16", Ford 385661-S.....	5
Trim Panel Retainers, Size: 1/4" (6.4mm), Stem: 15/16", Head: 15/16", Ford 387496-S.....	5
Weatherstrip Fastener, Black Nylon, Size: 3/16" (4.5mm), Stem: 5/8", Head: 7/16", Ford 388246S.....	5
Mud Shield Retainer, Black Nylon, Ford 76-on, Size: 1/4" (6.4mm), Stem: 1/2", Head: 3/4", Ford 387258-S.....	5
Bumper, Fender, Seat & Carpet Retainer, Size: 6.3mm, Stem: 11mm, Head: 18.5mm, Ford N803678-S.....	5
Hood Insulation Retainers, Black Nylon, Size: 1/4" (6.4mm), Stem: 3/4", Head: 1-3/16", Ford 386553-S.....	5
Hood Insulation Retainers, Black Nylon, Size: 1/4" (6.4mm), Stem: 3/4", Head: 1-3/4", Ford 388908-S.....	5
Door Trim Panel Retainers, Black Nylon, Size: 9/32" (7.1mm), Stem: 3/4", Head: 3/4", Ford N805155-S.....	5
Door Trim Panel Retainers, Natural Nylon, Size: 1/4" (6.4mm), Stem: 1", Head: 3/4", Ford N805612-S100.....	5
Door Trim Panel Retainers, White Nylon, Size: 9/32" (7.1mm), Stem: 3/4", Head: 3/4", Ford 387477-S.....	5
Seat Back Panel Retainers, Black Nylon, Size: 9/32" (7.1mm), Stem: 5/8", Head: 5/8", Ford 387182-S.....	5
Door Trim Panel Retainers, Natural Nylon, Size: 1/4" (6.4mm), Stem: 13/16", Head: 3/4", Ford 389144-S.....	5
Hood Insulation Retainers, Black Nylon, Size: 1/4" (6.4mm), Stem: 17mm, Head: 32mm, Ford N808842-S.....	5
Fascia Retainer, Black Nylon, Mustang 84-on, Size: 3/16" (4.5mm), Stem: 1/2", Head: 7/16", Ford N803170-S.....	5

Refill Options	
Refill Qty.	Clamshell Qty.
ABD600510	ABD6005RX....8
ABD601310	ABD6013RX....2
ABD601410	ABD6014RX....2
ABD601510	ABD6015RX....8
ABD601610	ABD6016RX....4
ABD601710	ABD6017RX....3
ABD601810	ABD6018RX....3
ABD601910	ABD6019RX....4
ABD602110	ABD6021RX....2
ABD602210	ABD6022RX....6
ABD602310	ABD6023RX....4
ABD602410	ABD6024RX....3
ABD603910	ABD6039RX....2
ABD604010	ABD6040RX....3
ABD604110	ABD6041RX....3
ABD604310	ABD6043RX....7
ABD604410	ABD6044RX....3
ABD604510	ABD6045RX....2
ABD604610	ABD6046RX....3
ABD604710	ABD6047RX....3
ABD604810	ABD6048RX....3
ABD604910	ABD6049RX....4
ABD605010	ABD6050RX....4
ABD605810	ABD6058RX....5

NOTES: **Not available in clamshell package / Refill part numbers available in bulk quantities of 100 / Add suffix "B" to refill part number for bulk orders

RETAINER KITS & ASSORTMENTS

ABD7200

120-piece Master Kit Chrysler Retainer Assortments

Description	Kit Qty.
Panel Retainers, Size: 1/4" (6.4mm), Stem: 5/8", Head: 11/16", Chrysler 3691590.....	5
Shield Retainers, Size: 1/4" (6.4mm), Stem: 13/16", Head: 11/16", Chrysler 6030441.....	5
Trim Panel Retainers, Size: 5/16" (7.8mm), Stem: 7/8", Head: 3/4", Chrysler 6501301.....	5
Hood Insulation Retainers, Size: 1/4" (6.4mm), Stem: 5/8", Head: 1/2" x 1-1/2", Chrysler 6003351.....	5
Door Trim Retainers, Size: 1/4" (6.4mm), Stem: 11/16", Head: 15/16", Chrysler 6032363.....	5
Weatherstrip Retainers, Size: 13/64" (5.3mm), Stem: 5/8", Head: 3/8", Chrysler 4658673.....	5
Shield Retainers, Size: 7/32" (5.5mm), Stem: 3/4", Head: 5/8", Chrysler 6501948.....	5
Fascia Panel Retainers, Size: 1/4" (6.4mm), Stem: 20mm, Head: 25mm, Chrysler 6501067.....	5
Shield Retainers, Size: 1/4" (6.4mm), Stem: 1-1/16", Head: 1", Chrysler 6502104.....	5
Panel Retainers, Size: 5/16" (7.8mm), Stem: 11/16", Head: 1/2", Chrysler 34202335.....	5
Door Trim Panel Retainers, Size: 11/32" (8.5mm), Stem: 8mm, Head: 20mm, Chrysler 6505292AA.....	5
Interior Trim Panel Retainer, Natural Nylon, Size: 17/64" (7mm), Stem: 11/16", Head: 15/16", Chrysler 6003423.....	5
Door Trim Panel Retainers, Size: 1/4" (6.4mm), Stem: 11/16", Head: 15/16", Chrysler 6003349.....	5
Door Trim Panel Retainers, Black Nylon, Size: 1/4" (6.4mm), Stem: 3/4", Chrysler 6033862.....	5
Mud Shield Retainer, Black Nylon, Chrysler 76-on, Size: 1/4" (6.4mm), Stem: 1/2", Head: 3/4", Chrysler 3861577.....	5
Bumper, Fender, Seat & Carpet Retainer, Size: 6.3mm, Stem: 11mm, Head: 18.5mm, Chrysler 6033018.....	5
Hood Insulation Retainers, Black Nylon, Size: 1/4" (6.4mm), Stem: 17mm, Head: 32mm, Chrysler 6504098.....	5
Hood Insulation/Fender Retainer, Black Nylon, Size: 1/4" (6.4mm), Stem: 1/4", Head: 1-5/16", Chrysler 4341060.....	5
Weatherstrip Retainers, White Nylon, Size: 13/64" (5.3mm), Stem: 15/32", Head: 1/4" x 21/32", Chrysler 4696129.....	5
Door Panel Retainers, White Nylon, Size: 1/4" (6.4mm), Stem: 9/16", Head: 25/32", Chrysler 6504014.....	5
Trim Panel Retainers, Natural Nylon, Size: 3/16" (4.5mm), Stem: 3/4", Head: 3/4", Chrysler 6503709.....	5
Trim Panel Retainers, Green Nylon, Size: 1/2" (12.7mm), Stem: 1/4", Head: 23/32", Chrysler 6503204.....	5
Hood Insulation Retainers, Black Nylon, Size: 1/4" (6.4mm), Stem: 1/4", Head: 23/32", Chrysler 6503204.....	5
Hood Insulation Retainers, Black Nylon, Size: 1/4" (6.4mm), Stem: 12mm, Head: 30mm, Chrysler 4878883AA.....	5

Refill Options	
Refill Qty.	Clamshell Qty.
ABD6004... 10	ABD6004RX... 12
ABD6005... 10	ABD6005RX... 8
ABD6011... 10	ABD6011RX... 3
ABD6022... 10	ABD6022RX... 6
ABD6023... 10	ABD6023RX... 4
ABD6025... 10	ABD6025RX... 4
ABD6026... 10	ABD6026RX... 5
ABD6027... 10	ABD6027RX... 3
ABD6028... 10	ABD6028RX... 2
ABD6029... 10	ABD6029RX... 2
ABD6031... 10	ABD6031RX... 2
ABD6030... 10	ABD6030RX... 5
ABD6035... 10	ABD6035RX... 4
ABD6037... 10	ABD6037RX... 2
ABD6040... 10	ABD6040RX... 3
ABD6041... 10	ABD6041RX... 3
ABD6050... 10	ABD6050RX... 4
ABD6051... 10	ABD6051RX... 3
ABD6052... 10	ABD6052RX... 8
ABD6053... 10	ABD6053RX... 5
ABD6054... 10	ABD6054RX... 2
ABD6055... 10	ABD6055RX... 3
ABD6056... 10	ABD6056RX... 3
ABD6057... 10	ABD6057RX... 3



ABD7200

ABD7500

120-piece Master Push-type Retainer Assortment

Description	Kit Qty.
Mud Skirt Blind Rivets, Size: 1/4", Stem: 9/16", Head: 11/16", GM 14019205.....	5
Splash Shield Blind Rivet, Size: 1/4", Stem: 7/8", Head: 1", GM 140193088.....	5
Push-type Retainer, Size: 8mm, Stem: 20mm, Head: 20mm, GM 21030249.....	5
Push-type Retainer, Size: 10mm, Stem: 16mm, Head: 12mm, Ford XL3Z17E971-AA.....	5
Bumper Pad Blind Rivets, Size: 1/2" (12.7mm), Stem: 3/4", Head: 1/8", GM 5973400.....	5
Radiator Shroud Blind Rivet, Size: 1/4" (6.4mm), Stem: 15/16", Head: 11/16", Ford N804570S.....	5
Door Panel Retainers, Size: 1/4" (6.4mm), Stem: 41/64", Head: 9/16", GM 15960325.....	5
Push-type Retainers, Size: 1/4" (6.4mm), Stem: 13/16", Head: 11/16", Chrysler 6501925.....	5
Splash Shield/Fascia Retainer, Size: 5/16", Stem: 7/8", Head: 1", Ford N803421S.....	5
Trim Fascia Retainer, Size: 1/4", Stem: 21/32", Head: 15/32", Ford N803494S.....	5
Push-type Retainer, Size: 1/4" (6.4mm), Stem: 1", Head: 7/8", Chrysler 6506106.....	5
Push-type Retainer, Size: 1/2" (12.7mm), Stem: 1-1/16", Head: 7/8" x 1-25/32", Chrysler 4630253.....	5
Vent Panel Blind Rivets, Black Nylon, Size: 1/4" (6mm), Stem: 11mm, Head: 18mm, Honda 90688-SB0-003.....	5
Push-type Retainers, Black Nylon, Size: 8mm, Stem: 11mm, Head: 20mm, Honda 91512-SX0-003.....	5
Push-type Retainers, Black Nylon, Size: 8mm, Stem: 21mm, Head: 18mm, Honda 90505-SM4-003.....	5
Radiator/Windshield Bottle Retainer, Black Nylon, Size: 5/16" (7.8mm), Stem: 9/16", Head: 21/32", GM 14071289.....	5
Push-type Retainers, Black Nylon, Size: 10mm, Stem: 15mm, Head 18mm, Nissan 01553-09241.....	5
Push-type Retainers, Black Nylon, Size: 7mm, Stem: 12mm, Head: 15mm, Toyota 90467-06017.....	5
Bumper Cover/Blind Rivets, Black Nylon, Size: 23/64" (9mm), Stem: 27mm, Head: 15mm, Toyota 90467-09093.....	5
Rocker Panel Retainers, Black Nylon, Size: 8mm, Stem: 20mm, Head: 15mm, GM 21075686.....	5
Splash Shield Blind Rivets, Black Nylon, Size: 5/16" (8mm), Stem: 9mm, Head: 20mm, Honda 90675-SB3-003.....	5
Fender Splash Shield Push-type Retainer, Size: 8mm, Stem: 9mm, Head: 20mm, Honda 91512-SM4-003.....	5
Fascia Retainers, Black Nylon, Size: 3/8" (9.5mm), Stem: 23/32", Head: 1", GM 14045480, GM 8942981190.....	5
Bumper Fascia Retainers, Black Nylon, Size: 10mm, Stem: 27mm, Head: 20mm, Honda 91502-SM4-000.....	5

Refill Options	
Refill Qty.	Clamshell Qty.
ABD6101... 10	ABD6101RX... 5
ABD6102... 10	ABD6102RX... 4
ABD6103... 10	ABD6103RX... 3
ABD6104... 10	ABD6104RX... 2
ABD6105... 10	ABD6105RX... 2
ABD6106... 10	ABD6106RX... 4
ABD6107... 10	ABD6107RX... 3
ABD6108... 10	ABD6108RX... 3
ABD6109... 10**
ABD6110... 10**
ABD6111... 10	ABD6111RX... 1
ABD6112... 10	ABD6112RX... 1
ABD6113... 10	ABD6113RX... 4
ABD6114... 10	ABD6114RX... 2
ABD6115... 10	ABD6115RX... 2
ABD6116... 10	ABD6116RX... 3
ABD6117... 10**
ABD6118... 10	ABD6118RX... 4
ABD6119... 10	ABD6119RX... 2
ABD6120... 10	ABD6120RX... 3
ABD6121... 10	ABD6121RX... 4
ABD6122... 10	ABD6122RX... 2
ABD6123... 10	ABD6123RX... 2
ABD6124... 10**



ABD7500

ABD6500

120-piece SEMS Screw Kit (all makes)

Description	Kit Qty.
Phillips Oval Head Trim Screw, Size: 10 X 3/4", Head Size: #8, Finish: Black Phosphate.....	10
Phillips Oval Head Trim Screw, Size: 10 x 1", Head Size: #8, Finish: Black Phosphate.....	10
Phillips Oval Head Trim Screw, Size: 8 x 1", Head Size: #6, Finish: Black Oxide.....	10
Phillips Oval Head Trim Screw, Size: 8 x 3/4", Head Size: #6, Finish: Chrome.....	10
Phillips Oval Head Trim Screw, Size: 8 x 3/4", Head Size: #6, Finish: Black Phosphate.....	10
Phillips Oval Head Trim Screw, Size: 10 x 3/4", Head Size: #8, Finish: Chrome.....	10
Phillips Oval Head Trim Screw, Size: 10 X 1", Head Size: #8, Finish: Chrome.....	10
Phillips Oval Head Trim Screw, Size: 10 x 3/4", Head Size: #6, Finish: Black Phosphate.....	10
Phillips Oval Head Trim Screw, Size: 8 x 3/4", Head Size: #6, Finish: Black Phosphate.....	10
Phillips Oval Head Trim Screw, Size: 8 x 1", Head Size: #6, Finish: Black Phosphate.....	10
Phillips Oval Head Trim Screw, Size: 8 x 3/4", Head Size: #6, Finish: Chrome.....	10
Phillips Oval Head Trim Screw, Size: 8 x 1", Head Size: #6, Finish: Chrome.....	10

Refill Options	
Refill Qty.	Clamshell Qty.
ABD6301... 10	ABD6301RX... 5
ABD6302... 10	ABD6302RX... 4
ABD6303... 10**
ABD6304... 10**
ABD6305... 10**
ABD6306... 10	ABD6306RX... 3
ABD6307... 10	ABD6307RX... 3
ABD6308... 10**
ABD6309... 10	ABD6309RX... 4
ABD6310... 10	ABD6310RX... 8
ABD6311... 10	ABD6311RX... 3
ABD6312... 10	ABD6312RX... 6



ABD6500

NOTES: **Not available in clamshell package / Refill part numbers available in bulk quantities of 100 / Add suffix "B" to refill part number for bulk orders

RETAINER KITS & ASSORTMENTS

ABD6700 39-piece Stainless Steel Capped Bumper Bolt Assortment

Description	Kit Qty.
Stainless Steel Bumper Bolt, Round Head, Size: 5/16"-18 x 1", Head: 3/4"	8
Stainless Steel Bumper Bolt, Pan Head, Size: 3/8"-16 x 1", Head: 7/8", Chrysler 6026723	8
Stainless Steel Bumper Bolt, Round Head, Size: 3/8"-16 x 1", Head: 7/8"	5
Stainless Steel Bumper Bolt, Round Head, Size: 7/16"-14 x 1-1/2", Head: 29/32"	5
Stainless Steel Bumper Bolt, Round Head, Size: 1/2"-13 x 1-1/2", Head: 1-3/32"	5
Stainless Steel Bumper Bolt, Pan Head, Size: 8-1.25 x 25mm, Head: 19mm, GM 14003784	8

Refill Options	
Refill Qty.	Clamshell Qty.
ABD6361 10	ABD6361RX 1
ABD6362 10	ABD6362RX 1
ABD6363 10	ABD6363RX 1
ABD6364 10	ABD6364RX 1
ABD6365 10	ABD6365RX 1
ABD6366 10	ABD6366RX 1

ABD7400 120-piece Master Body Bolt, Hex Nut, Extruded U-nut Assortment

Description	Kit Qty.
Body Bolts Dog Point, Size: 6-1.00 x 22mm, Head: 8mm IND Hex, Finish: Black Phos., Ford N606676-S2	5
Body Bolts Dog Point, Size: 6-1.00 x 28mm, Head: 8mm IND Hex, Finish: Black Phos., Ford N606677-S	5
Body Bolts Dog Point, Size: 1/4"-20 x 15/16", Head: 7/16" IND Hex, Finish: Black Phos., Ford 57030-52	5
Hex Flange Nuts, Size: 5-.80mm, Head: 8mm Hex, Finish: Black Phos., GM11502722	5
Body Bolts CA Point, Size: 6-1.00 x 20mm, Head: 10mm IND Hex, Finish: Black Phos., GM 11502941	5
Body Bolts Flange Head, Size: 6-1.00 x 20mm, Head: 10mm IND Hex, Finish: Black Phos., GM 11503800	5
Body Bolts CA Point, Size: 6-1.00 x 20mm, Head: 10mm IND Hex, Finish: Black Phos., GM 11503982	5
Body Bolts CA Point, Size: 6-1.00 x 35mm, Head: 10mm IND Hex, Finish: Black Phos., GM 11505044	5
Body Bolts CA Point, Size: 6-1.00 x 25mm, Head: 10mm IND Hex, Finish: Black Phos., GM 11503834	5
Extruded U-nuts Short-type, Size: 6-1.00mm, Range: 0.010" - 0.165", Finish: Black Phos., GM 11503957	5
Extruded U-nuts Long-type, Size: 6-1.00mm, Range: 0.010" - 0.165", Finish: Black Phos., GM 11503715	5
Hex Flange Nuts Loose Washer, Size: 6-1.00mm, Head: 10mm Hex, Finish: Black Phos., GM11505329	5
Body Bolts CA Point, Size: 8-1.25 x 25mm, Head: 13mm IND Hex, Finish: Black Phos., GM 11503619	5
Body Bolts Flange Head, Size: 8-1.25 x 30mm, Head: 13mm IND Hex, Finish: Black Phos., GM 11500971	5
Sheet Metal Screws, Size: 6.3-1.81 x 20mm, Head: 10mm IND Hex, Finish: Black Phos., GM11500970	5
Sheet Metal Screws, Size: 6.3-1.81 x 25mm, Head: 10mm IND Hex, Finish: Black Phos., GM11500996	5
Body Bolts CA Point, Size: 8-1.25 x 30mm, Head: 13mm IND Hex, Finish: Black Phos., GM 11501188	5
Extruded U-nuts Short-type, Size: 8-1.25mm, Range: 0.010" - 0.165", Finish: Black Phos., GM 11500660	5
Extruded U-nuts Long-type, Size: 8-1.25mm, Range: 0.010" - 0.175", Finish: Black Phos., GM 11500661	5
Hex Nuts Loose Washer, Size: 8-1.25mm, Head: 13mm Hex, Finish: Black Phos., GM11503695	5
Body Bolts CA Point, Size: 10-1.50 x 40mm, Head: 15mm IND Hex, Finish: Black Phos., GM 11501193	5
Extruded U-nuts Short-type, Size: 10-1.50mm, Range: 0.035" - 0.232", Finish: Black Phos., GM 11500662	5
Hex Flange Nuts, Size: 10-1.25mm, Head: 15mm Hex, Finish: Black Phos., GM11501850	5
Body Bolts, Size: 8-1.25 x 25mm, Head: 13mm, IND Hex, Finish: Black Phos., GM11500970	5

Refill Options	
Refill Qty.	Clamshell Qty.
ABD6337 .. 10	ABD6337RX 4
ABD6338 .. 10	ABD6338RX 4
ABD6339 .. 10	ABD6339RX 3
ABD6340 .. 10	ABD6340RX 6
ABD6341 .. 10	ABD6341RX 3
ABD6342 .. 10	ABD6342RX 5
ABD6343 .. 10	ABD6343RX 3
ABD6344 .. 10	ABD6344RX 3
ABD6345 .. 10	ABD6345RX 4
ABD6346 .. 10	ABD6346RX 3
ABD6347 .. 10	ABD6347RX 3
ABD6348 .. 10	ABD6348RX 4
ABD6349 .. 10	ABD6349RX 2
ABD6350 .. 10	ABD6350RX 3
ABD6351 .. 10	ABD6351RX 4
ABD6352 .. 10	ABD6352RX 4
ABD6353 .. 10	ABD6353RX 2
ABD6354 .. 10	ABD6354RX 2
ABD6355 .. 10	ABD6355RX 2
ABD6356 .. 10	ABD6356RX 2
ABD6357 .. 10	ABD6357RX 1
ABD6358 .. 10	ABD6358RX 1
ABD6359 .. 10	ABD6359RX 4
ABD6360 .. 10	ABD6360RX 3

ABD7300 185-piece Master Universal Trim Screw Assortment

Description	Kit Qty.
Phillips Oval Head Wheel Opening Teks® Screws, Size: 8 x 1/2", 13/32" OD Washer, Finish: Chrome	5
Phillips Oval Head Wheel Opening Teks® Screws, Size: 8 x 1/2", 13/32" OD Washer, Finish: Black	5
Phillips Oval Head Teks® Screws, Size: 8 x 3/4", 13/32" OD Washer, Finish: Black	10
Indented Hex Head Teks® Screws, Size: 8 x 1/2", Head Size: 1/4", Finish: Zinc	5
Phillips Oval Head Sheet Metal Screws Size: 8 x 3/4", Head Size: #6, Finish: Chrome	10
Phillips Oval Head Sheet Metal Screws Size: 8 x 1", Head Size: #6, Finish: Chrome	10
Phillips Oval Head Sheet Metal Screws Size: 8 x 1-1/4", Head Size: #6, Finish: Chrome	10
Phillips Oval Head Sheet Metal Screws Size: 10 x 1", Head Size: #8, Finish: Chrome	10
Phillips Oval Head Sheet Metal Screws Size: 8 x 3/4", Head Size: #6, Finish: Black	10
Phillips Oval Head Sheet Metal Screws Size: 8 x 1", Head Size: #6, Finish: Black	10
Phillips Oval Pan Head Sheet Metal Screws Size: 8 x 3/4", Finish: Black	10
Phillips Oval Pan Head Sheet Metal Screws Size: 8 x 1", Finish: Black	10
Torx® Oval Head Trim Screws, Size: 4.2-1.41 x 30mm, Head Size: 7mm, Finish: Chrome	5
Torx® Oval Head Trim Screws, Size: 4.2-1.41 x 30mm, Head Size: 7mm, Finish: Black Stainless Steel	5
Torx® Oval Head Trim Screws, Size: 4.2-1.41 x 25mm, Head Size: 8mm, Finish: Chrome	5
Torx® Oval Head Trim Screws, Size: 4.2-1.41 x 25mm, Head Size: 8mm, Finish: Black Stainless Steel	5
Hex Head Teks® Screws, Size: 4.2-1.41 x 20mm, Head Size: 7mm, Finish: Black	5
Hex Head Teks® Screws, Size: 4.2-1.41 x 20mm, Head Size: 7mm, Finish: Black	5
Phillips Flat Top Trim Screws, Size: 8 x 1/2", 13/32" OD Washer, Finish: Black	10
Phillips Flat Top Trim Screws, Size: 8 x 3/4", 13/32" OD Washer, Finish: Black	10
Phillips Flat Top Trim Screws, Size: 8 x 3/4", 1/2" OD Washer, Finish: Black	10
Phillips Flat Top Trim Screws, Size: 10 x 3/4", 1/2" OD Washer, Finish: Black	10
Indented Hex Head Teks® Screws, Size: 8 x 3/4", Head Size: 3/4", Finish: Zinc	5
Indented Hex/Slotted License Plate Screws, Size: 14 x 3/4", Head Size: 3/8" IND, Finish: Zinc	5

Refill Options	
Refill Qty.	Clamshell Qty.
ABD6313 10 **
ABD6314 10 **
ABD6315 10 **
ABD6316 10	ABD6316RX 6
ABD6317 10	ABD6317RX 10
ABD6318 10	ABD6318RX 10
ABD6319 10	ABD6319RX 10
ABD6320 10	ABD6320RX 10
ABD6321 10	ABD6321RX 10
ABD6322 10	ABD6322RX 10
ABD6323 10	ABD6323RX 10
ABD6324 10	ABD6324RX 10
ABD6325 10 **
ABD6326 10 **
ABD6327 10 **
ABD6328 10 **
ABD6329 10 **
ABD6330 10	ABD6330RX 4
ABD6331 10	ABD6331RX 6
ABD6332 10	ABD6332RX 10
ABD6333 10 **
ABD6334 10	ABD6334RX 10
ABD6335 10	ABD6335RX 10
ABD6336 10	ABD6336RX 5

NOTES: **Not available in clamshell package / Refill part numbers available in bulk quantities of 100 / Add suffix "B" to refill part number for bulk orders

RETAINER KITS & ASSORTMENTS

ABD6800

60-piece Hex Nut / Extruded U-nut Assortment

Description	Kit Qty.
Hex Flange Nuts, Size: 5-.80mm, Head Size: 8mm, Finish: Black Phos., GM 11502722	5
Extruded U-nuts, Size: 6-1.00mm, Center to Edge: 17/32", Range: .010-.165, Finish: Black Phos., GM 11503957	5
Extruded U-nuts, Size: 6-1.00mm, Center to Edge: 25/32", Range: .010-.165, Finish: Black Phos., GM 11503715	5
Hex Flange Nuts, Size: 6-1.00mm, Head Size: 10mm, Finish: Black Phosphate, GM 11505329	5
Extruded U-nuts, Size: 8-1.25mm, Center to Edge: 9/16", Range: .010-.165, Finish: Black Phos., GM 11500660	5
Extruded U-nuts, Size: 8-1.25mm, Center to Edge: 13/16", Range: .010-.175, Finish: Black Phos., GM 11500661	5
Metric Hex Nuts, Size: 8-1.25mm, Head Size: 13mm, Finish: Black Phos., GM 11503695	5
Extruded U-nuts, Size: 10-1.50mm, Center to Edge: 3/4", Range: .035-.232, Finish: Black Phos., GM 11500662	5
Hex Flange Nuts, Size: 10-1.25mm, Head Size: 15mm, Finish: Black Phosphate, GM 11501850	5
Extruded U-nuts, Size: 1/4"-20, Center to Edge: 15/32", Range: .010-.165, Finish: Black Phos., GM 1494252	5
Extruded U-nuts, Size: 5/16"-18, Center to Edge: 27/32", Range: .010-.170, Finish: Black Phos., GM 1494258	5
Extruded U-nuts, Size: 3/8"-16, Center to Edge: 3/4", Range: .035-.205, Finish: Black Phos., GM 1494254	5

Refill Options	
Refill Qty.	Clamshell Qty.
ABD6340 ... 10	ABD6340RX...6
ABD6346 ... 10	ABD6346RX...3
ABD6347 ... 10	ABD6347RX...3
ABD6348 ... 10	ABD6348RX...4
ABD6354 ... 10	ABD6354RX...2
ABD6355 ... 10	ABD6355RX...2
ABD6356 ... 10	ABD6356RX...2
ABD6358 ... 10	ABD6358RX...1
ABD6359 ... 10	ABD6359RX...4
ABD6367 ... 10	ABD6367RX...3
ABD6368 ... 10	ABD6368RX...2
ABD6369 ... 10	ABD6369RX...1



ABD6800

ABDDPC-60

60-piece Hood Prop Clip Assortment

Description	Kit Qty.
Hood Prop Clip, Rod Diameter: M8, Hole: 5 x 14mm, GM 10271128	5
Hood Prop Clip, Rod Diameter: 9mm, Hole: 10mm, Toyota 53455-33010, Toyota 53455-33011	5
Hood Prop Clip, Rod Diameter: 5/16", GM 21097292	5
Hood Prop Clip, Rod Diameter: 7mm, Hole: M10, Chrysler 5027550AB, GM 15021761	5
Hood Prop Clip, Ford D5ZZ-16828B	5
Hood Prop Clip, Rod Diameter: 5/16", Ford 386299-S	5
Hood Prop Clip, Rod Diameter: 5/16", Ford E83Z-16828A	5
Hood Prop Clip, Rod Diameter: 6mm, Hole: 7mm, Ford W702380-S300	5
Hood Prop Clip, Rod Diameter: 8mm, Honda 90677-SE0-003	5
Hood Prop Clip, Chrysler 4103276	5
Hood Prop Clip, Ford F2UZ-16828A	5
Hood Prop Clip, Rod Diameter: 1/4", Ford E1FZ-16828C	5

Refill Options	
Refill Qty.	Clamshell Qty.
ABDH1201 ... 5	ABDH1201RX ... 1
ABDH1202 ... 5	ABDH1202RX ... 1
ABDH1203 ... 5	ABDH1203RX ... 2
ABDH1204 ... 5	ABDH1204RX ... 1
ABDH1205 ... 5	ABDH1205RX ... 2
ABDH1206 ... 5	ABDH1206RX ... 2
ABDH1207 ... 5	ABDH1207RX ... 2
ABDH1208 ... 5	ABDH1208RX ... 1
ABDH1209 ... 5	*****
ABDH1210 ... 5	ABDH1210RX ... 2
ABDH1211 ... 5	ABDH1211RX ... 1
ABDH1212 ... 5	ABDH1212RX ... 2



ABDDPC-60

ABDHPK-1

18-piece Door Hinge Pin Assortment

Description	Kit Qty.
Door Hinge Pin Bushings, Application: GM Cars 1980-98, ID: 0.345, OD: 0.489, HT: 0.362, GM 20429500	2
Door Hinge Pin Bushings, Application: GM Cars 1980-98, ID: 0.345, OD: 0.419, HT: 0.295, GM 9721917	2
Door Hinge Pin Kit, Application: GM C- and K-series Trucks 1988-03	2
Door Hinge Pin Kit, Application: GM S-10 Pickup / Blazer / Jimmy 1982-94	2
Door Hinge Pin Kit, Application: GM Cars / Trucks 1960-98	2
Door Hinge Pin Kit, Application: Ford F-series Trucks 1980-98	1
Door Hinge Pin Kit, Application: GM Cars / Trucks 1960-98	1
Door Hinge Pin Kit, Application: Ford Mustang / Capri 1979-98	1
Door Hinge Pin Kit, Application: Dodge / Plymouth Vans 1969-94	1
Door Hinge Pin Kit, Application: Dodge Trucks 1984-97	1
Door Hinge Pin Kit, Application: Dodge Cars / Minivans 1984-92	1
Door Hinge Pin Kit, Application: GM C- and K-series Trucks 1999-03	2

Refill Options**	
Refill Qty.	Clamshell Qty.
ABDHP0500	1
ABDHP0501	1
ABDHP1000	1
ABDHP1001	1
ABDHP1002	1
ABDHP1003	1
ABDHP1004	1
ABDHP1005	1
ABDHP1006	1
ABDHP1007	1
ABDHP1008	1
ABDHP1009	1



ABDHPK-1

NOTES: **Not available in clamshell package / Refill part numbers available in bulk quantities of 100 / Add suffix "B" to refill part number for bulk orders

AUTO BODY DOCTOR DISPLAY BOARDS

QTY.	PART NO.	DESCRIPTION
2	ABD6002RX	6-RADIATOR APRON PANEL RET.
2	ABD6004RX	12-FENDER/BUMPER SHIELD RET.
2	ABD6005RX	8-RADIATOR YOKE AND FENDER BUMPER
2	ABD6006RX	6-WEATHERSTRIP RET. GM/FORD
2	ABD6007RX	8-WEATHERSTRIP RET. CHRY 1977-ON
2	ABD6008RX	5-WEATHERSTRIP RET. GM 1974-ON
2	ABD6009RX	8-TRIM PANEL RET. GM 1968-ON
2	ABD6010RX	5-SPLASH SHIELD/RAD. AIR BAFFLE
2	ABD6011RX	3-TRIM PANEL SATURN 1991-ON/ CHRY MINI
2	ABD6012RX	3-REAR HOOD SEAL GM 1983-ON
2	ABD6013RX	2-FORD TRIM PANEL RET. 1982-ON
2	ABD6014RX	2-TAURUS/SABLE CARPET RET. 1996-ON
2	ABD6015RX	8-FORD TRIM PANEL RET 1980-ON
2	ABD6016RX	4-TRIM PANEL FORD 83-ON/ CHRY MINI VAN
2	ABD6017RX	3-TRIM PANEL FORD EXPL. 93-ON / TRUNK
2	ABD6018RX	3-BUMPER FASCIA RET. GM 81-ON
2	ABD6020RX	4-SEAT BACK RET. CAMARO/FIREBID 82-ON
2	ABD6021RX	2-FORD TRIM PANEL RET.
2	ABD6022RX	6-HOOD INS. RET. CHRY 72-ON / GRILLE TO
2	ABD6025RX	4-WEATHERSTRIP RET. NEON/GM 96-ON
2	ABD6026RX	5-CHRY FEND. / BUMP. RET. 1989-95
2	ABD6027RX	3-CHRY FASCIA RET. 1985-ON
2	ABD6028RX	2-HEADLIGHT/PANEL RET. CHRY 93-ON

QTY.	PART NO.	DESCRIPTION
2	ABD6029RX	2-CHRY PANEL RET.
2	ABD6032RX	3-FRONT END STONE RET. GM 81-ON
2	ABD6034RX	4-FRONT INS. RET GM 1980-ON
2	ABD6036RX	8-HOOD INS. RET GM 1964-ON
2	ABD6043RX	7-HOOD INS. FORD 1975-ON
2	ABD6044RX	7-HOOD INS. FORD 1975-ON
2	ABD6051RX	3-HOOD INS. / FENDER RET. CHRY 85-ON
2	ABD6052RX	8-WEATHERSTRIP RET. CHRY 93-ON
2	ABD6059RX	5-WEATHERSTRIP RET. HONDA/ACURA 92-ON
2	ABD6060RX	2-WEATHERSTRIP RET. HONDA CIVIC 95-ON
2	ABD6061RX	10-WEATHERSTRIP RET. GM
2	ABD6065RX	10-SHROUD VENT GRILLE TO PANEL RET
2	ABD6068RX	4-BUMPER FASCIA GM MINI VANS 93-ON
2	ABD6069RX	2-HONDA TRIM PANEL RET.
2	ABD6072RX	3-FIREWALL INS. RET. GM/AMC
2	ABD6074RX	5-HOOD SEAL RET. LEXUS.TOYOTA 85-ON
2	ABD6075RX	5-TOYOTA/NISSAN RET. CLIP
2	ABD6076RX	4-TOYOTA RET. CLIP
2	ABD6077RX	1-HOOD INS. RET. CAMRY/LEXUS 88-ON
1	ABDABDOL1	OVERLAY
1	KTI-OLF-04333	OVERLAY FASTENERS
42	KTI-HOOK2	HOOKS

ABD1 SHIELD RETAINERS



QTY.	PART NO.	DESCRIPTION
2	ABD6001RX	5-DOOR TRIM PANEL RET. GM 78-ON
2	ABD6003RX	5-DOOR TRIM PANEL RET. GM 83-ON
2	ABD6019RX	4-DOOR TRIM PANEL RET. FORD 81-ON
2	ABD6023RX	4-DOOR TRIM PANEL RET. FORD 81-ON
2	ABD6024RX	3-TRIM PANEL RET. FORD/CHRY 75-ON
2	ABD6030RX	5-INT. TRIM PANEL RET. GM/CHRY 1977-ON
2	ABD6031RX	2-DOOR TRIM PANEL RET. CHRY. VANS 98-ON
2	ABD6035RX	4-DOOR PANEL RET. GM/CHRY 76-ON
2	ABD6037RX	2-DOOR PANEL RET. GM 81-88 JEEP 91-ON
2	ABD6038RX	5-DOOR PANEL RET. CAMARO/FIREBIRD 89-ON
2	ABD6039RX	2-WEATHERSTRIP FASTENER GM/FORD
2	ABD6040RX	3-MUD SHIELD RET. GM/FORD/CHRY 76-ON
2	ABD6041RX	3-BUMP, FENDER, SEAT, CARPET RET.
2	ABD6042RX	2-DOOR PANEL RETAINER SATURN 91-ON
2	ABD6045RX	2-TRIM PANEL RET. FORD 85-ON
2	ABD6046RX	3-TRIM PANEL RET. FORD/GM/JEEP 88-ON
2	ABD6047RX	3-INT. DOOR TRIM RET. FORD 77-ON
2	ABD6048RX	3-SEAT BACK PANEL RET. FORD 77-ON
2	ABD6049RX	4-TRIM PANEL RET. FORD 81-ON
2	ABD6050RX	4-HOOD INS. RET CHRY/FORD 96-ON
2	ABD6053RX	5-DOOR TRIM PANEL RET. CHRY 95-ON
2	ABD6054RX	2-TRIM PANEL RET. DODGE RAM 94-ON
2	ABD6055RX	3-TRIM PANEL RET. CHRY. 95-ON
2	ABD6056RX	3-HOOD INS. RET CHRY. CIRUS 1995-ON

QTY.	PART NO.	DESCRIPTION
2	ABD6057RX	3-HOOD INS. RET CHRY LV/LHS 1997-ON
2	ABD6058RX	5-FASCIA RET MUSTANG/CAPRI 84-ON
2	ABD6062RX	7-WEATHERSTRIP RET. HONDA
2	ABD6064RX	2-SHIELD RET. HONDA
2	ABD6070RX	5-FASCIA TO BUMPER RET. FORD 81-ON
2	ABD6071RX	5-DOOR FRAME SPACER RET. CHRY 85-ON
2	ABD6073RX	2-HONDA INS. RET. ACURA 91-ON
2	ABD6082RX	2-NISSAN RET. CLIP
2	ABD6083RX	3-DOOR TRIM PANEL RET. FORD 81-ON
2	ABD6084RX	5-TRIM PANEL RET. GMC TRK. 76-ON
2	ABD6086RX	3-TRIM PANEL RET. GM 87-ON
2	ABD6087RX	4-DOOR PANEL RET. TOYOTA
2	ABD6088RX	2-TRIM PANEL RET. HONDA 1990-ON
2	ABD6089RX	4-DOOR TRIM PANEL RET. GM 82-ON
2	ABD6090RX	4-TRIM PANEL RET. GM 97-ON
2	ABD6091RX	8-DOOR TRIM/HEADLINER RET. GM 71-ON
2	ABD6092RX	3-TRIM PANEL RET. GM TRUCK 76-ON
2	ABD6093RX	2-CHRYSLER PANEL RET.
1	ABDABDOL2	OVERLAY
1	KTI-OLF-04333	OVERLAY FASTENERS
42	KTI-HOOK2	HOOKS

ABD2 SHIELD & DOOR RETAINERS



AUTOMOTIVE FASTENERS = FAST TURN / FAST PROFIT

- ❑ PROFESSIONAL, TURN-KEY MERCHANDISING
- ❑ SMALL FOOTPRINT - MEASURES 36" X 36"
- ❑ MARKED FOR EASY SET-UP AND RE-STOCKING
- ❑ SHIPS WITH ALL REQUIRED HARDWARE
- ❑ DURABLE CASTERS FOR ADDED MOBILITY



AUTO BODY DOCTOR DISPLAY BOARDS



**ABD3
PUSH
RETAINERS**



**ABD4
TRIM
SCREWS**

QTY.	PART NO.	DESCRIPTION
2	ABD6101RX	5-MUD SKIRT AND FENDER LINER GM/CHRY 81-ON
2	ABD6102RX	4-SPLASH SHIELD , FASCIA RET. GM/FORD 76-ON
2	ABD6103RX	3-AIR BAFFLE RET. SATURN 91-ON
2	ABD6104RX	2-FRONT BUMPER COVER FORD TRK
2	ABD6105RX	2-FASCIA RET. GM 79-ON
2	ABD6106RX	4-RAD. SHROUD TRIM RET. GM/FORD 82-ON
2	ABD6107RX	3-DOOR TRIM PANEL GM TRK. C,K,1,2,3 95-ON
2	ABD6108RX	3-COOL RECOVERY TANK GM/CHRY 92-ON
2	ABD6111RX	1-TRIM RET. JEEP GRAND CHEROKEE
2	ABD6112RX	1-TRIM RET. CHRY.CONCORDE
2	ABD6113RX	4-TRIM RET. HONDA
2	ABD6114RX	2-BUMPER RET. ACURA, HONDA 1994-ON
2	ABD6115RX	2-TRIM RETAINER HONDA ACCORD 90-ON
2	ABD6116RX	3-WASHER/OVERFLOW BOTTLE RET. GM-81-ON
2	ABD6118RX	4-TRIM RET. TOYOTA/MAZDA
2	ABD6119RX	2-BUMPER COVER RET. MAZDA LS400
2	ABD6120RX	3-ROCKER PANEL/WHEELLINER RET. SATURN 91 ON
2	ABD6121RX	4-TRIM RET. HONDA,MAZDA,NISSAN
2	ABD6122RX	2-TRIM RET. HONDA ACCORD 91-ON
2	ABD6123RX	2-FASCIA RETAINER GM 1992 ON
2	ABD6125RX	3-TRIM RET. GM, HONDA, MAZDA
2	ABD6126RX	2-COWL PANEL RET. NISSAN 80-ON
2	ABD6127RX	5-TRIM RET. HONDA, NISSAN, ISUZU
2	ABD6128RX	2-BUMPER COVER RET. TOYOTA CAMRY 92-ON
2	ABD6130RX	2-BUMPER COVER RET. MAZDA ES300 93-ON
2	ABD6132RX	4-INNER FENDER RET. NISSAN 80-ON
2	ABD6133RX	2-FRONT/REAR BUMPER RET. HONDA 90-ON
2	ABD6134RX	2-BUMPER FASCIA RET. HONDA ACCORD 90-ON
2	ABD6138RX	3-TAIL LIGHT RET. GM/CHRY
2	ABD6141RX	2-TRIM RETAINER TOYOTA/NISSAN
2	ABD6142RX	2-TRIM RET. HONDA, NISSAN
2	ABD6143RX	2-FRONT/REAR BUMPER RET. NISSAN/INFINITY
2	ABD6147RX	2-EXTERIOR BODY RET. GM 1994-ON
2	ABD6149RX	2-FRONT BUMPER RET. GM LT. TRK/OLDS 90-ON
2	ABD6150RX	1-REAR BUMP. COVER RET. TOYOTA TERCEL 88-ON
2	ABD6152RX	2-FRONT FENDER LINER TOYOTA TERCEL 94-ON
2	ABD6153RX	2-TRIM RET. NISSAN MAXIMA/300ZX
2	ABD6154RX	2- BUMPER SUPPORT RET. HONDA CIVIC 93-ON
2	ABD6155RX	2-FRONT BUMPER RET. ACURA/HONDA 96-ON
2	ABD6156RX	2-BUMPER RET. HONDA ACCORD/ODYSSEY 96-ON
2	ABD6158RX	3-SPLASH SHIELD, SEAT CUSH.,TIRE RET.
2	ABD6159RX	3-BUMPER FASCIA RET. GM 1987 ON
1	ABDABDOL3	OVERLAY
1	KTI-OLF-04333	OVERLAY FASTENERS
42	KTI-HOOK2	HOOKS

QTY.	PART NO.	DESCRIPTION
2	ABD6205RX	8-7MM-SHEET METAL SCREWS BLACK 12MM WASHER
2	ABD6207RX	4-7MM-SHEET METAL SCREWS BLACK 17MM
2	ABD6208RX	10-5/16"-INDENTED HEX HEAD TEX SCREW
2	ABD6209RX	5-1/2"-LIC PLATE SCREW SLOTTED TRUSS HD
2	ABD6210RX	5-1/2"-LIC PLATE SCREW PHILIPS PAN WASH HD
2	ABD6211RX	2-9/16"-LIC PLATE SCREW SLOTTED TRUSS HD
2	ABD6215RX	5-5/16"-LIC PLATE SCREW BLK. O.D. WASH.
2	ABD6216RX	8-9/16"-LIC PLATE SCREW SLOTTED TRUSS HD
2	ABD6284RX	8-#8-PHILIPS OVAL HD SHEET METAL SCREW
2	ABD6301RX	5-#8-PHILIPS OVAL HEAD TRIM SCREW
2	ABD6302RX	4-#8-PHILIPS OVAL HEAD TRIM SCREW
2	ABD6306RX	3-#8-PHILIPS OVAL HD TRIM SCREW
2	ABD6307RX	3-#8-PHILIPS OVAL HD TRIM SCREW
2	ABD6309RX	4-#6-PHILIPS OVAL HEAD TRIM SCREW
2	ABD6310RX	8-#6-PHILIPS OVAL HEAD TRIM SCREW
2	ABD6311RX	3-#6-PHILIPS OVAL HD TRIM SCREW
2	ABD6312RX	6-#6-PHILIPS OVAL HD TRIM SCREW
2	ABD6316RX	6-1/4"-INDENTED HEX HEAD TEX SCREW
2	ABD6317RX	10-#6-PHILIPS OVAL HD SHEET METAL SCREW
2	ABD6318RX	10-#6-PHILIPS OVAL HD SHEET METAL SCREW
2	ABD6319RX	10-#6-PHILIPS OVAL HD SHEET METAL SCREW
2	ABD6320RX	10-#8-PHILIPS OVAL HD SHEET METAL SCREW
2	ABD6321RX	10-#6-PHILIPS OVAL HD SHEET METAL SCREW
2	ABD6322RX	10-#6-PHILIPS OVAL HD SHEET METAL SCREW
2	ABD6323RX	10—PHILIPS PAN HD SHEET METAL SCREW-BLACK
2	ABD6324RX	10—PHILIPS PAN HD SHEET METAL SCREW-BLACK
2	ABD6330RX	4—TEXS SCREW 12MM O.D. LOOSE WASHER
2	ABD6331RX	6—PHILIPS FLAT TOP WASHER HEAD-GM
2	ABD6332RX	10—PHILIPS FLAT TOP WASHER HEAD
2	ABD6334RX	10—PHILIPS FLAT TOP WASHER HEAD
2	ABD6335RX	10-3/4"-INDENTED HEX HEAD TEX SCREW
2	ABD6336RX	5-3/8"-LIC PLATE SCRW BLK. ZINC 1/2" WASH
2	ABD6351RX	4-10MM-SHEET METAL SCREWS BLACK 17MM
2	ABD6352RX	4-10MM-SHEET METAL SCREWS BLK 11/16" WASH ER
2	ABD6380RX	10-#6-PHILIPS OVAL HD SHEET METAL SCREW
2	ABD6382RX	10-#6-PHILIPS OVAL HD SHEET METAL SCREW
2	ABD6383RX	10-#6-PHILIPS OVAL HD SHEET METAL SCREW
2	ABD6384RX	10—PHILIPS PAN HD SHEET METAL SCREW-BLACK
2	ABD6387RX	10—PHILIPS PAN HD SHEET METAL SCREW-BLACK
2	ABD6388RX	10—PHILIPS PAN HD SHEET METAL SCREW-BLACK
2	ABD6394RX	10—PHILIPS FLAT TOP WASHER HEAD
2	ABD6398RX	10—PHILIPS FLAT TOP WASHER HEAD-CHRYSLER
1	ABDABDOL4	OVERLAY
1	KTI-OLF-04333	OVERLAY FASTENERS
42	KTI-HOOK2	HOOKS

AUTO BODY DOCTOR DISPLAY BOARDS



**ABD5
BODY BOLTS
& RIVETS**

QTY.	PART NO.	DESCRIPTION
2	ABD6337RX	4-6-1.00 X 22MM-MET DOG POINT BOLT 19MM
2	ABD6338RX	4-6-1.00 X 28MM-MET DOG POINT BOLT 19MM
2	ABD6339RX	3-1/4-20 X15/16"-MET DOG POINT BOLT 3/4"
2	ABD6341RX	3-6-1.00 X 20MM-MET TYPE CA BOLT 17MM
2	ABD6342RX	5-6-1.00 X 20MM-MET TYPE CA FLANGE BOLT 13MM
2	ABD6343RX	3-6-1.00 X 25MM-MET TYPE CA BOLT 24MM
2	ABD6344RX	3-6-1.00 X 35MM-MET TYPE CA BOLT 17MM
2	ABD6345RX	4-6-1.00 X 25MM-MET TYPE CA BOLT 17MM
2	ABD6349RX	2-8-1.25 X 25MM-MET TYPE CA BOLT 24MM
2	ABD6350RX	3-8-1.25 X 30MM-MET TYPE CA BOLT 17MM
2	ABD6353RX	2-8-1.25 X 30MM-MET TYPE CA BOLT 28MM
2	ABD6357RX	1-10-1.50 X 40MM-MET TYPE CA BOLT 28MM
2	ABD6360RX	3-8-1.25 X 25MM-MET TYPE CA BOLT 16MM
2	ABD6361RX	1-5/16-18 X 1"-BUMPER BOLT RD. 3/4"
2	ABD6362RX	1-3/8-16 X 1"-BUMPER BOLT PAN 7/8"
2	ABD6363RX	1-3/8-16 X 1-1/4"-BUMPER BOLT RD. 7/8"
2	ABD6364RX	1-7/16-14 X 1-1/4"-BUMPER BOLT RD. 29/32"
2	ABD6365RX	1-1/2-13 X 1-1/2"-BUMPER BOLT RD. 13/32"
2	ABD6366RX	1-8-1.25 X 25MM-BUMPER BOLT PAN 19MM
2	ABD6370RX	1-1/4-20 X 1"-OUTSIDE MIRROR MT. BOLT CHROME GM
2	ABD6374RX	1-3/8-16 X 1-1/2"-CA BODY BOLT OD LOOSE WASH, BLK
2	ABD6375RX	3-6-1.00 X 28MM-MET DOG POINT BOLT 19MM
2	ABD6501RX	3-13/64"(5MM)-BLK NYL BLIND RIV GM 15/32"
2	ABD6503RX	4-3/16"(5MM)-BLK NYL BLIND RIV GM 15/32"
2	ABD6504RX	4-3/16"(5MM)-BLK NYL BLIND RIV CHRYSLER 15/32"
2	ABD6507RX	3-1/4"(6.3MM)-BLK NYL BLIND RIV GM 1/2"
2	ABD6508RX	3-1/4"(6.3MM)-BLK NYL BLIND RIV GM 1/2"
2	ABD6509RX	3-17/64"(6.6MM)-BLK NYL BLIND RIV GM 45/64"
2	ABD6510RX	5-1/4"(6.3MM)-BLK NYL BLIND RIV GM 43/64"
2	ABD6511RX	2-1/4"(6.3MM)-BLK NYL BLIND RIV FORD 43/64"
2	ABD6513RX	10-1/8"-ALL ALUMINUM POP RIVETS
2	ABD6514RX	7-3/16"-ALL ALUMINUM POP RIVETS
2	ABD6515RX	6-3/16"-ALL ALUMINUM POP RIVETS
2	ABD6521RX	2-3/16"-ALUMINUM BLACK SPLIT-TYPE RIVET
2	ABD6524RX	4-3/16"-ALUMINUM BLACK GRILLE/FASCIA
2	ABD6527RX	2-1/4"-ALUMINUM RIVET-STEEL MANDREL WINDOW
2	ABD6529RX	3-1/4"-ALUMINUM RIVET-MANDREL BLACK OUTSIDE
2	ABD6530RX	2-1/4"-ALUMINUM RIVET-MANDREL BLACK OUTSIDE
2	ABD6532RX	2-1/4"-ALL STEEL BLACK BUMPER
2	ABD6533RX	4-1/4"-ALUMINUM RIVET-STEEL MANDREL WINDOW
2	ABD6534RX	2-1/4"-BLACK ALUMINUM SPLIT TYPE RIVET
2	ABD6535RX	3-1/4"-ALUMINUM RIVET-STEEL MANDREL GLASS
1	ABDABDOL5	OVERLAY
1	KTI-OLF-04333	OVERLAY FASTENERS
42	KTI-HOOK2	HOOKS



**ABD6
NUTS &
GROMMETS**

QTY.	PART NO.	DESCRIPTION
2	ABD6220RX	10-#8 OR #10-GRILL SCREW NUTS NAT NYL
2	ABD6223RX	8-#6 OR #8-HEADLIGHT BEZEL NUTS NAT NYL GM
2	ABD6226RX	10-#8 OR #10-GRILL SCREW NUTS NAT NYL
2	ABD6227RX	8-#8 OR #10-HEADLIGHT BEZEL NUTS NAT NYL
2	ABD6228RX	3-#10-SCREW GROMMETS NAT NYL
2	ABD6232RX	8-1/4"(#14)-LIC PLATE NUTS WHITE PLASTIC GM
2	ABD6236RX	2-#6(14MM)-SCREW GROMMETS NAT NYL
2	ABD6238RX	5-#8(17MM)-SCREW GROMMETS NAT NYL HONDA
2	ABD6239RX	4-#10 18MM HD-SCREW GROMMETS NAT NYL TOYOTA
2	ABD6242RX	5-1/4"(#14) -SCREW GROMMETS BLACK NYL TOYOTA
2	ABD6244RX	3-6-1.00MM-MET HEX NUT BLK 19MM O.D.
2	ABD6246RX	5-8-1.25MM-MET HEX FLANGE NUT BLK 19MM
2	ABD6247RX	6-1-1.00MM-MET HEX FLANGE NUT BLK 16MM
2	ABD6249RX	2-1/4"-20-RUBBER WELL NUT FOR 1/2" HOLE GM
2	ABD6254RX	7-8-WIDE RANGE U NUT BLACK CTR OF
2	ABD6255RX	6-8-WIDE RANGE U NUT BLACK CTR OF
2	ABD6256RX	6-14-WIDE RANGE U NUT BLACK CTR OF
2	ABD6258RX	2-10-U TYPE RETAINER BACK CTR OF
2	ABD6260RX	3-1/4"-20-EXTRUDE U NUT BLACK CTR OF HOLE
2	ABD6261RX	1-3/8"-16-EXTRUDE U NUT BLACK CTR OF HOLE
2	ABD6266RX	7-3/16"-THR CUT NUTS 5/8" FLANGE ZINC
2	ABD6267RX	7-1/4"-THR CUT NUTS 19/32" FLANGE ZINC
2	ABD6268RX	4-5/16" -THR CUT NUTS 7/8" FLANGE ZINC
2	ABD6269RX	6-5MM-THR CUT NUTS 15MM FLANGE ZINC
2	ABD6270RX	6-6.3MM-THR CUT NUTS 20M FLANGE ZINC GM
2	ABD6272RX	8-1/4"-THR CUT NUTS 11/16" FLANGE ZINC
2	ABD6278RX	10-5/16" BOLT-PUSH ON TYPE RETAIN ZINC FINISH
2	ABD6280RX	10-1/2" STUD-PUSH ON TYPE RETAIN BLACK FINISH
2	ABD6282RX	10-8-1.25MM BOLT-PUSH ON TYPE BUMP STRIP RET
2	ABD6283RX	6-10-1.25MM BOLT-PUSH ON TYPE BUMP RET
2	ABD6340RX	6-5-.80MM-MET HEX FLANGE NUT BLK 11.8MM
2	ABD6346RX	3-6-1.00MM-EXTRUDE U NUT BLACK CTR OF HOLE
2	ABD6347RX	3-6-1.00MM-EXTRUDE U NUT BLACK CTR OF HOLE
2	ABD6348RX	4-6-1.00MM-MET HEX NUT BLK 16MM O.D.
2	ABD6354RX	2-8-1.25MM-EXTRUDE U NUT BLACK CTR OF HOLE
2	ABD6355RX	2-8-1.25MM-EXTRUDE U NUT BLACK CTR OF HOLE
2	ABD6356RX	2-8-1.25MM-MET HEX NUT BLK 24MM O.D.
2	ABD6358RX	1-10-1.50MM-EXTRUDE U NUT BLACK CTR OF HOLE
2	ABD6359RX	4-10-1.50MM-MET HEX FLANGE NUT BLK 21MM
2	ABD6367RX	3-1/4"-20-EXTRUDE U NUT BLACK CTR OF HOLE
2	ABD6368RX	2-5/16"-18-EXTRUDE U NUT BLACK CTR OF HOLE
2	ABD6369RX	1-3/8"-16-EXTRUDE U NUT BLACK CTR OF HOLE
1	ABDABDOL6	OVERLAY
1	KTI-OLF-04333	OVERLAY FASTENERS
42	KTI-HOOK2	HOOKS

AUTO BODY DOCTOR DISPLAY BOARDS



**ABD7
HOOD /
DOOR LOCK /
WINDSHIELD**















**ABD8
HEADLIGHTS
& MISC. BODY
PARTS**

QTY.	PART NO.	DESCRIPTION
2	ABD6602RX	2—REVEAL MOULDING CLIP REAR WIND. GM
2	ABD6603RX	3—REVEAL MOULDING CLIP REAR WIND. GM
2	ABD6604RX	3—REVEAL MOULDING CLIP WINDSHIELD
2	ABD6609RX	2—REVEAL MOULDING CLIP WINDSHIELD
2	ABD6613RX	3—REVEAL MOULDING CLIP WINDSHIELD
2	ABD6614RX	3—7/64", 13/64"-WIND WASH HOSE RET. HONDA
2	ABD6615RX	1—REVEAL MOULDING CLIP WINDSHIELD
2	ABD6616RX	1—HOSE CLIP WINDSHIELD WASH. HONDA
2	ABDH1201RX	1-5x14MM-HOOD PROP CLIP GM VENTURE VAN 97-UP
2	ABDH1202RX	1-10MM-HOOD PROP CLIP TOYOTA CAMRY 1996-UP
2	ABDH1203RX	2—HOOD PROP CLIP SATURN 97-UP
2	ABDH1204RX	1-M10-HOOD PROP CLIP CHRY. PT CRUISER 2000-UP
2	ABDH1205RX	2—HOOD PROP CLIP FORD CARS 1975 TO 83
2	ABDH1206RX	2—HOOD PROP CLIP FORE/MERC. CARS 75-UP
2	ABDH1207RX	2—HOOD PROP CLIP FORD 1998-ON
2	ABDH1208RX	1—HOOD PROP CLIP FORD CONTOUR
2	ABDH1210RX	2—HOOD PROP CLIP CHRYSLER 1981-UP
2	ABDH1211RX	1—HOOD PROP CLIP FORD ECONOLINE 92-UP
2	ABDH1212RX	2—HOOD PROP CLIP FORD TOPAZ/TEMPO/
2	ABDH1213RX	1—HOOS PROP CLIP CHRY. MINI VAN 97-UP
2	ABDH1214RX	2—DR LCK ROD CLIP FORD LEFT HAND SIDE
2	ABDH1215RX	2—DR LCK AND TAILGATE CLIP GM/FORD
2	ABDH1216RX	2—DR LCK ROD CLIP FORD PROD.
2	ABDH1217RX	1—DR LCK ROD CLIP FORD PROD.
2	ABDH1218RX	2—DR LCK ROD CLIP GM/FORD RIGHT SIDE
2	ABDH1219RX	2—DR LCK ROD CLIP FORD RIGHT SIDE
2	ABDH1220RX	2—DR LCK ROD CLIP GM/FORD 1972-ON
2	ABDH1221RX	2—DR LCK ROD CLIP CHRY/NEON/CIRRUS
2	ABDH1222RX	2—DR LCK ROD CLIP GM/CHRY LEFT SIDE
2	ABDH1223RX	2—DR LCK ROD CLIP GM CARS 92-UP
2	ABDH1224RX	2—DR LCK ROD CLIP GM RIGHT/LEFT SIDE
2	ABDH1225RX	2—DR LCK ROD CLIP GM CARS RIGHT SIDE
2	ABDH1226RX	2—DR LCK ROD CLIP GM/CHRY RIGHT SIDE
2	ABDH1227RX	2—DR LCK ROD CLIP 92-UP LEFT SIDE
2	ABDH1228RX	2—DOOR HANDLE ROD CLIP GM 91 UP 6MM HOLE
2	ABDH1229RX	2—DOOR HANDLE ROD CLIP CHRY 72 UP
2	ABDH1230RX	2—SLIDING DOOR LOCK ROD CLIP CHRY
2	ABDH1231RX	2— DOOR LOCK ROD CLIP CHRYSLER LEFT SIDE
2	ABDH1232RX	2—DOOR LOCK ROD CLIP CHRY/NEON/CIRRUS
2	ABDH1233RX	2—DOOR LOCK ROD CLIP CHRY RIGHT SIDE
2	ABDH1234RX	2—DOOR LOCK ROD CLIP CHRY RIGHT SIDE
2	ABDH1235RX	2—DOOR LOCK ROD CLIP CHRY 72 UP RT. SIDE
1	ABDABDOL7	OVERLAY
1	KTI-OLF-04333	OVERLAY FASTENERS
42	KTI-HOOK2	HOOKS

QTY.	PART NO.	DESCRIPTION
2	ABD6701RX	2—1/4-28 X 2"-HEADLIGHT ADJ.SCREW GM 73-
2	ABD6702RX	2—1/4-28 X 2"-HEADLIGHT ADJ.SCREW BL NYL NUT
2	ABD6703RX	2—1/4-28 X 2"-HEADLIGHT ADJ.SCREW GR NYL NUT
2	ABD6704RX	6—1/4-28 X 2"-HEADLIGHT ADJ. SCREW CHRYSLER
2	ABD6705RX	2—1/4-28 X 2"-HEADLIGHT ADJ.SCREW PK NYL NUT
2	ABD6706RX	4—#8-HEADLIGHT PANEL RETAINERS
2	ABD6707RX	2—HEADLIGHT COMP. RET. CLIP FORD
2	ABD6708RX	2—#8-REAR LIGHT ASSEMBLY RET. FORD
2	ABD6709RX	2—1/4-28 X 2"-HEADLIGHT ADJ. SCREW GM/TRUCKS
2	ABD6710RX	2—1/4-28 X 2"-HEADLIGHT ADJ. SCREW CHRY 78-94
2	ABD6712RX	1—HEADLIGHT BULB RET. 9004 BULB
2	ABD6713RX	1—HEADLIGHT BULB RET. 9004 / 9007 BULB
2	ABD6903RX	2—VINYL TOP MOULDING CLIP WHITE GM
2	ABD6904RX	4—QUARTER PANEL AND REVEAL
2	ABD6905RX	4—QUARTER PANEL DOOR AND REAR END
2	ABD6906RX	4—7/16"-QUARTER BELT REVEAL MOULD CLIP GM
2	ABD6907RX	4—BODY SIDE MOULDING CLIP GRAY GM
2	ABD6908RX	4—QUARTER BELT REVEAL MOULD CLIP
2	ABD6909RX	2—7/16"-ROCKER PANEL MOULD CLIP WHITE GM
2	ABD6910RX	2—ROCKER PANEL GROUND EFFECTS
2	ABD6911RX	2—BODY SIDE MOULDING CLIP HONDA WHITE
2	ABD6912RX	2—3/4"-ROCKER PANEL MOULD CLIP GREEN GM
2	ABD6914RX	1—BELT MOULDING CLIP WHITE HONDA
2	ABD6915RX	1—BELT MOULDING CLIP WHITE HONDA
2	ABD6917RX	2—17MM-FENDER MOULDING CLIP TOYOTA RED
2	ABD6919RX	1—10-24X3/4""-PLATE SIZE UNV, MOLD CLIP CHRY
2	ABD6920RX	1—10-24X3/4""-PLATE SIZE UNV, MOLD CLIP CHRY
2	ABD6922RX	2—10-24X1/2""-PLATE SIZE UNV, MOLD CLIP FORD
2	ABD6929RX	8—3/8"-FLUSH TYPE BLK PLASTIC HOLE PLUG 3/4"
2	ABD6930RX	8—1/2"-FLUSH TYPE BLK PLASTIC HOLE PLUG 7/8"
2	ABD6931RX	8—3/4"-FLUSH TYPE BLK PLASTIC HOLE PLUG 1"
2	ABD6937RX	4—1/16"-STEEL BODY SHIM BRIGHT ZINC
2	ABD6938RX	4—1/8"-STEEL BODY SHIM BRIGHT ZINC
2	ABD6939RX	4—1/8"-STEEL BODY SHIM BRIGHT ZINC
2	ABD6940RX	2—1/8"-STEEL BODY SHIM BRIGHT ZINC
2	ABD6946RX	2—5/8"-RUBBER BUMPERS GM
2	ABD6947RX	2—1/2"-RUBBER BUMPERS GM
2	ABD6948RX	1—RUBBER BUMPERS GM
2	ABD6950RX	1—RUBBER BUMPERS FORD
2	ABD6951RX	***No longer available***
2	ABD6952RX	1—1-1/4"-HOOD BUMPERS GM SMALL 1979 UP
2	ABD6953RX	1—1-29/32"-HOOD BUMPERS LARGE 1980 UP
1	ABDABDOL8	OVERLAY
1	KTI-OLF-04333	OVERLAY FASTENERS
42	KTI-HOOK2	HOOKS

RETAINERS - SHIELD RETAINERS

	Radiator Apron Panel Retainer GM 77-on			
	ABD6002	Qty: 10	Hole size: 3/8" (9.5mm)	Apps: GM 77-on
	ABD6002RX	Qty: 6	Head diameter: 1"	Interchange no.: GM1619321
ABD6002B	Qty: 100	Stem length: 13/16"		
	Fender/Bumper Shield Retainer GM/Ford/Chrysler			
	ABD6004	Qty: 10	Hole size: 1/4" (6.4mm)	Apps: GM/Ford/Chrysler
	ABD6004RX	Qty: 12	Head diameter: 11/16"	Interchange nos.: GM332364,
ABD6004B	Qty: 100	Stem length: 5/8"	CHRY60313231, CHRY3691590, F389358	
	Radiator Yoke/Fender Bumper GM/Ford/Chrysler			
	ABD6005	Qty: 10	Hole size: 1/4" (6.4mm)	Apps: GM/Ford/Chrysler
	ABD6005RX	Qty: 8	Head diameter: 11/16"	Interchange nos.: GM 1595864,
ABD6005B	Qty: 100	Stem length: 13/16"	GM1605396, CHRY6030441, F388577S	
	Weatherstrip Ret. GM/Ford			
	ABD6006	Qty: 10	Hole size: 3/16" (4.5mm)	Apps: GM/Ford
	ABD6006RX	Qty: 6	Head diameter: 7/16"	Interchange nos.: GM20413107,
ABD6006B	Qty: 100	Stem length: 13/16"	GM25016383, F388246S	
	Weatherstrip Ret. Chrysler 77-on			
	ABD6007	Qty: 10	Hole size: 3/16" (4.5mm) Head	Apps: Chrysler
	ABD6007RX	Qty: 8	diameter: 3/8"	Interchange no.: CHRY2964547
ABD6007B	Qty: 100	Stem length: 3/8"		
	Weatherstrip Ret. GM 74-on/Chrysler 94-on			
	ABD6008	Qty: 10	Hole size: 13/64"	Apps: GM/Chrysler
	ABD6008RX	Qty: 5	Head diameter: 10mm	Interchange nos.: GM20699808,
ABD6008B	Qty: 100	Stem length: 12mm	CHRY6502328	
	Trim Panel Ret. GM 68-on			
	ABD6009	Qty: 10	Hole size: 1/4" (6.4mm)	Apps: GM
	ABD6009RX	Qty: 8	Head diameter: 1/2"	Interchange no.: GM411700
ABD6009B	Qty: 100	Stem length: 3/4"		
	Battery Post Cable, Eng. Splash Shield/Rad. Air Baffle GM 80-on			
	ABD6010	Qty: 10	Hole size: 1/4" (6.4mm)	Apps: GM
	ABD6010RX	Qty: 5	Head diameter: 11/16"	Interchange nos: GM10121502,
ABD6010B	Qty: 100	Stem length: 1-1/16"	F390018S	
	Trim Panel Ret. Saturn 91-on/Slide Door and Lift Gate Chry Minivans 87-on			
	ABD6011	Qty: 10	Hole size: 5/16" (7.8mm)	Apps: Saturn/Chrysler
	ABD6011RX	Qty: 3	Head diameter: 3/4"	Interchange nos: GM21094146,
ABD6011B	Qty: 100	Stem length: 7/8"	CHRY6501301	
	Rear Hood Seal Ret. GM 83-on			
	ABD6012	Qty: 10	Hole size: 5/16" (7.8mm) Head	Apps: GM
	ABD6012RX	Qty: 3	diameter: 3/4"	Interchange no.: GM14074081
ABD6012B	Qty: 100	Stem length: 1-3/8"		
	Ford Trim Panel Ret. 82-on			
	ABD6013	Qty: 10	Hole size: 7/32" (5.3mm) Head	Apps: Ford
	ABD6013RX	Qty: 2	diameter: 3/4"	Interchange no.: F-N8010994-S100
ABD6013B	Qty: 100	Stem length: 11/16"		
	Taurus/Sable Carpet Ret. 96-on			
	ABD6014	Qty: 10	Hole size: 7/32" (5.3mm) Head	Apps: Taurus/Sable
	ABD6014RX	Qty: 2	diameter: 1"	Interchange no.: F-N803370S
ABD6014B	Qty: 100	Stem length: 25/32"		

RX indicates packaging suited for retail and merchandisers.

RETAINERS - SHIELD RETAINERS



Ford Trim Panel Ret. 80-on

ABD6015	Qty: 10	Hole size: 1/4" (6.4mm)	Apps: Ford
ABD6015RX	Qty: 8	Head diameter: 1"	Interchange no.: F-388930S
ABD6015B	Qty: 100	Stem length: 1-1/16"	



Trim Panel Ford 83-on/Chrysler Minivan Liftgate/Slide Door 87-on

ABD6016	Qty: 10	Hole size: 9/32" (7.1mm)	Apps: Liftgate/slide door 87-on
ABD6016RX	Qty: 4	Head diameter: 25mm	Interchange no.: F-802734S
ABD6016B	Qty: 100	Stem length: 20mm	



Trim Panel Ford Explorer 93-on/Trunk Lid Latch Chrysler 96-on

ABD6017	Qty: 10	Hole size: 23/64" (9mm)	Apps: Ford, Chrysler
ABD6017RX	Qty: 3	Head diameter: 5/8"	Interchange nos.: F-807721,
ABD6017B	Qty: 100	Stem length: 3/4"	CHRY6504043



Bumper Fascia Ret. GM 81-on/Ford 86-on

ABD6018	Qty: 10	Hole size: 25/64" (10mm)	Apps: Ford, Chrysler
ABD6018RX	Qty: 3	Head diameter: 22mm	Interchange nos.: F-N804379S
ABD6018B	Qty: 100	Stem length: 28mm	GM-1631564



Seat Back Ret. Camero/Firebird 82-on

ABD6020	Qty: 10	Hole size: 17/64" (7mm)	Apps: GM
ABD6020RX	Qty: 4	Head diameter: 25/32"	Interchange no.: GM20319841
ABD6020B	Qty: 100	Stem length: 15/16"	



Ford Trim Panel Ret.

ABD6021	Qty: 10	Hole size: 9/32" (7.1mm)	Apps: Ford
ABD6021RX	Qty: 2	Head diameter: 25/32"	Interchange no.: F-ER580235AAJABH
ABD6021B	Qty: 100	Stem length:	



Hood Ins. Ret. Chrysler 72-on/Grille to Radiator Ret. Ford 73-on

ABD6022	Qty: 10	Hole size: 1/4" (6.4mm)	Apps: Chrysler, Ford
ABD6022RX	Qty: 6	Head diameter: 1/2" x 1-1/2"	Interchange nos.: D30Z-16776A,
ABD6022B	Qty: 100	Stem length: 5/8"	F385330S, C-6003351



Weatherstrip Ret. Neon/GM 96-on

ABD6025	Qty: 10	Hole size: 13/64" (5.3mm)	Apps: Chrysler/GM
ABD6025RX	Qty: 4	Head diameter: 3/8" (10mm)	Interchange nos.:
ABD6025B	Qty: 100	Stem length: 5/8" (16mm)	



Chrysler Fend./Bump. Ret. 89-95

ABD6026	Qty: 10	Hole size: 7/32" (5.3mm)	Apps: Chrysler
ABD6026RX	Qty: 5	Head diameter: 5/8"	Interchange no: C-6501948
ABD6026B	Qty: 100	Stem length: 3/4"	



Chrysler Fascia Ret. 85-on

ABD6027	Qty: 10	Hole size: 1/4" (6.4mm)	Apps: Chrysler
ABD6027RX	Qty: 3	Head diameter: 25mm	Interchange no.: C-6501067
ABD6027B	Qty: 100	Stem length: 20mm	



Headlight Mount/Panel Ret. Dodge Daytona 93-on

ABD6028	Qty: 10	Hole size: 1/4" (6.4mm)	Apps: Chrysler
ABD6028RX	Qty: 2	Head diameter: 1"	Interchange no: C-6502104
ABD6028B	Qty: 100	Stem length: 1-1/16"	















Chrysler Panel Ret.

ABD6029	Qty: 10	Hole size: 5/16" (7.8mm)	Apps: Chrysler
ABD6029RX	Qty: 2	Head diameter:	Interchange no.: C-34202335
ABD6029B	Qty: 100	Stem length:	

RX indicates packaging suited for retail and merchandisers.

RETAINERS - SHIELD RETAINERS

	Int. Trim Panel Ret. GM/Chrysler 77-on	ABD6030 ABD6030RX ABD6030B	Qty: 10 Qty: 5 Qty: 100	Hole size: 17/64" (7mm) Head diameter: 15/16" Stem length: 11/16"	Apps: GM, Chrysler Interchange nos.: GM2048248, C6003423
	Front End Stone Ret. GM 81-on	ABD6032 ABD6032RX ABD6032B	Qty: 10 Qty: 3 Qty: 100	Hole size: 3/8" (9.5mm) Head diameter: 7/8" Stem length: 13/16"	Apps: GM Interchange no.: GM22512276
	Trim Panel Ret. GM Trucks 81-on	ABD6033 ABD6033B	Qty: 10 Qty: 100	Hole size: 1/4" (6.4mm) Head diameter: 1" Stem length: 1-7/16"	Apps: GM Interchange no.: GM14027471
	Hood Ins. Ret. GM 80-on	ABD6034 ABD6034RX ABD6034B	Qty: 10 Qty: 4 Qty: 100	Hole size: 1/4" (6.4mm) Head diameter: 1-21/32" Stem length: 3/4"	Apps: GM Interchange no.: GM20064875
	Hood Ins. Ret. GM 64-on	ABD6036 ABD6036RX ABD6036B	Qty: 10 Qty: 2 Qty: 100	Hole size: 1/4" (6.4mm) Head diameter: 2" Stem length: 3/4"	Apps: GM Interchange no.: GM3078511, GM3977775
	Weatherstrip Fastener GM/Ford	ABD6039 ABD6039RX ABD6039B	Qty: 10 Qty: 2 Qty: 100	Hole size: 3/16" (4.5mm) Head diameter: 7/16" Stem length: 5/8"	Apps: GM/Ford Interchange nos.: GM20413107, F388246S
	Mud Shield Ret. GM/Ford/Chrysler 76-on	ABD6040 ABD6040RX ABD6040B	Qty: 10 Qty: 3 Qty: 100	Hole size: 1/4" (6.4mm) Head diameter: 3/4" Stem length: 1/2"	Apps: GM/Ford/Chrysler Interchange nos.: GM20032850, F387258S, C3861577
	Bumper, Fender, Seat, Carpet Ret. GM/Ford/Chrysler 91-on	ABD6041 ABD6041RX ABD6041B	Qty: 10 Qty: 3 Qty: 100	Hole size: 6.3mm Head diameter: 18.5mm Stem length: 11mm	Apps: GM/Ford/Chrysler Interchange nos.: GM1018230, F6501301, C6033018
	Hood Ins. Ret. Ford 75-on	ABD6043 ABD6043RX ABD6043B	Qty: 10 Qty: 7 Qty: 100	Hole size: 1/4" (6.4mm) Head diameter: 1-3/16" Stem length: 3/4"	Apps: Ford Interchange no.: F-386553S
	Hood Ins. Ford 75-on	ABD6044 ABD6044RX ABD6044B	Qty: 10 Qty: 3 Qty: 100	Hole size: 1/4" (6.4mm) Head diameter: 1-3/4" Stem length: 3/4"	Apps: Ford Interchange no.: F-388908S
	Hood Ins. Chrysler Sebring/Ford 96-on	ABD6050 ABD6050RX ABD6050B	Qty: 10 Qty: 4 Qty: 100	Hole size: 1/4" (6.4mm) Head diameter: 32mm Stem length: 17mm	Apps: Chrysler/Ford Interchange nos.: G-N8088842S, C-6504098
	Hood Ins./Fender Ret. Chrysler 85-on	ABD6051 ABD6051RX ABD6051B	Qty: 10 Qty: 3 Qty: 100	Hole size: 1/4" (6.4mm) Head diameter: 1-5/16" Stem length: 3/4"	Apps: Chrysler Interchange no.: C-4341060

RX indicates packaging suited for retail and merchandisers.

RETAINERS - SHIELD RETAINERS



Weatherstrip Ret. Chrysler 93-on/GM 99-on

ABD6052	Qty: 10	Hole size: 13/64" (5.3mm)	Apps: Chrysler/GM
ABD6052RX	Qty: 8	Head diameter: 1/4" x 21/32"	Interchange nos.: GM21077575, C4696129
ABD6052B	Qty: 100	Stem length: 15/32"	



Trim Panel Ret. Dodge Ram 94-on

ABD6054	Qty: 10	Hole size: 3/16"	Apps: Chrysler
ABD6054RX	Qty: 2	Head diameter: 3/4"	Interchange no.: C6503709
ABD6054B	Qty: 100	Stem length: 3/4"	



Trim Panel Ret. Chrysler Cirrus/Stratus 95-on

ABD6055	Qty: 10	Hole size: 1/2"	Apps: Chrysler
ABD6055RX	Qty: 3	Head diameter: 23/32"	Interchange no.: C6503204
ABD6055B	Qty: 100	Stem length: 1/4"	



Hood Ins. Ret. Chrysler Cirrus/Stratus 95-on

ABD6056	Qty: 10	Hole size: 1/4"	Apps: Chrysler
ABD6056RX	Qty: 3	Head diameter: 23/32"	Interchange no.: C6503892
ABD6056B	Qty: 100	Stem length: 1/4"	



Hood Ins. Ret. Chrysler LN/LHS 97-on

ABD6057	Qty: 10	Hole size:	Apps: Chrysler
ABD6057RX	Qty: 3	Head diameter: 30mm	Interchange no.: C487883AA
ABD6057B	Qty: 100	Stem length: 12mm	



Fascia Ret. Mustang/Capri 84-on

ABD6058	Qty: 10	Hole size: 3/16" (4.5mm)	Apps: Ford
ABD6058RX	Qty: 5	Head diameter: 7/16"	Interchange no.: F-N803170S
ABD6058B	Qty: 100	Stem length: 1/2"	

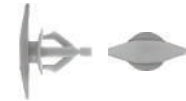

Weatherstrip Ret. Honda/Acura 92-on

ABD6059	Qty: 10	Hole size: 15/64" (6mm)	Apps: Honda
ABD6059RX	Qty: 5	Head diameter: 5 x 15mm	Interchange no.: H915530-SP1-003
ABD6059B	Qty: 100	Stem length: 10mm	



Weatherstrip Ret. Honda Civic 95-on

ABD6060	Qty: 10	Hole size: 15/64" (6mm)	Apps: Honda
ABD6060RX	Qty: 2	Head diameter: 5 x 15mm	Interchange no.: H915530-ST5-003
ABD6060B	Qty: 100	Stem length: 10mm	



Weatherstrip Ret. GM

ABD6061	Qty: 10	Hole size: 3/16" (4.5mm)	Apps: GM
ABD6061RX	Qty: 10	Head diameter: 3/16" x 1/2"	Interchange no: GM4876498
ABD6061B	Qty: 100	Stem length: 7/16"	



Weatherstrip Ret. Honda

ABD6062	Qty: 10	Hole size: 13/64" (5.3mm)	Apps: Honda
ABD6062RX	Qty: 7	Head diameter: 6 x 16mm	Interchange no.: H90644-671-003
ABD6062B	Qty: 100	Stem length: 10mm	



Weatherstrip Ret. GM 63-on













ABD6063	Qty: 10	Hole size: 5/32"	Apps: GM
ABD6063B	Qty: 100	Head diameter: 13/32"	Interchange no: GM8731909
		Stem length: 3/8"	



Shield Ret. Honda

ABD6064	Qty: 10	Hole size: 3/16" (5mm)	Apps: Honda
ABD6064RX	Qty: 2	Head diameter: 13mm	Interchange no.: H9066-SAO-0030
ABD6064B	Qty: 100	Stem length: 16mm	

RETAINERS - SHIELD RETAINERS

	Screen Shroud Vent Grille to Panel Ret. GM 85-on	ABD6065 ABD6065RX ABD6065B	Qty: 10 Qty: 10 Qty: 100	Hole size: 3/16" (5mm) Head diameter: 19/32" Stem length: 3/4"	Apps: GM Interchange no.: GM20514862
	Eng. Mount Heat Shield Ret. Taurus/Sable 86-on	ABD6066 ABD6066B	Qty: 10 Qty: 100	Hole size: 1/4" (6.4mm) Head diameter: 1/2" Stem length: 15/16"	Apps: Ford Interchange no.: N804448
	Fender/Bumper Shield Ret. GM 72-on	ABD6067 ABD6067B	Qty: 10 Qty: 100	Hole size: 1/4" (6.4mm) Head diameter: 11/16" Stem length: 5/8"	Apps: GM Interchange nos.: GM480534
	Bumper Fascia GM Minivans 93-on/Chrysler	ABD6068 ABD6068RX ABD6068B	Qty: 10 Qty: 4 Qty: 100	Hole size: 9/32" (7.1mm) Head diameter: 3/4" Stem length: 1-3/16"	Apps: GM, Chrysler Interchange nos.: GM10185925, C-6503768
	Honda Trim Panel Ret.	ABD6069 ABD6069RX ABD6069B	Qty: 10 Qty: 2 Qty: 100	Hole size: 3/16" (5mm) Head diameter: 20mm Stem length: 15mm	Apps: Honda Interchange nos.: H90667-SA7-0030, N89247-98070
	Fascia to Bumper Ret. Ford 81-on	ABD6070 ABD6070RX ABD6070B	Qty: 10 Qty: 5 Qty: 100	Hole size: 9/32" (7.1mm) Head diameter: 30mm Stem length: 6mm	Apps: Ford Interchange no.: F389443S
	Door Frame Spacer Ret. Chrysler 85-on/Bumper Ret. Ford 81-on	ABD6071 ABD6071RX ABD6071B	Qty: 10 Qty: 5 Qty: 100	Hole size: 17/64" (7mm) Head diameter: 1" Stem length: 13/16"	Apps: Chrysler, Ford Interchange nos.: F-388904S, C-6501086, 4381395
	Firewall Ins. Ret. GM/AMC	ABD6072 ABD6072RX ABD6072B	Qty: 10 Qty: 3 Qty: 100	Hole size: 13/32" (10.4mm) Head diameter: 1" Stem length: 1-7/16"	Apps: GM, AMC Interchange no: GM7642589
	Honda Ins. Ret. Acura 91-on	ABD6073 ABD6073RX ABD6073B	Qty: 10 Qty: 2 Qty: 100	Hole size: 19/64" (7.5mm) Head diameter: 30mm Stem length: 10mm	Apps: Acura Interchange no.: A90700-SJ4-000
	Hood Seal Ret. Lexus/Toyota 85-on	ABD6074 ABD6074RX ABD6074B	Qty: 10 Qty: 5 Qty: 100	Hole size: 13/64" (5.3mm) Head diameter: 13mm Stem length: 11mm	Apps: Toyota/GM Interchange nos.: GM94842841, T90467-08004, T90467-08011
	Toyota/Nissan Ret. Clip	ABD6075 ABD6075RX ABD6075B	Qty: 10 Qty: 5 Qty: 100	Hole size: 13/64" (5.3mm) Head diameter: 13mm Stem length: 15mm	Apps: Toyota/Nissan Interchange nos.: N01553-00172, T90467-07050
	Toyota Ret. Clip	ABD6076 ABD6076RX ABD6076B	Qty: 10 Qty: 4 Qty: 100	Hole size: 13/64" (5.3mm) Head diameter: 13mm Stem length: 15mm	Apps: Toyota Interchange no.: T90467-07050

RX indicates packaging suited for retail and merchandisers.

RETAINERS - SHIELD RETAINERS



Hood Ins. Ret. Avalon/Camry/Lexus 88-on

ABD6077 Qty: 10 Hole size: 17/64" (7mm)
 ABD6077RX Qty: 1 Head diameter: 30mm
 ABD6077B Qty: 100 Stem length: 17mm

Apps: Toyota
 Interchange no.: T90467-9006



Toyota Ret. Clip

ABD6078 Qty: 10 Hole size: 17/64" (7mm)
 ABD6078B Qty: 100 Head diameter: 30mm
 Stem length: 17mm

Apps: Toyota
 Interchange no.: T9046709008



Hood Ins. Ret. Clip Honda/Acura 90-on/Slider Door, Liftgate Chry Minivans 87-on

ABD6079 Qty: 10 Hole size: 15/64" (6mm)
 ABD6079B Qty: 100 Head diameter: 10mm
 Stem length: 10mm

Apps: Honda/Acura, Chrysler
 Interchange no.: H91520-SM4-C010



Hood Trunk Moulding Acura/Honda 94-on

ABD6080 Qty: 10 Hole size: 15/64" (6mm)
 ABD6080B Qty: 100 Head diameter: 12mm
 Stem length: 9mm

Apps: Acura/Honda
 Interchange no.: H91518-SM4-003

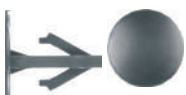

Cowl Top Ret. Clip Honda Accord 90-on

ABD6081 Qty: 10 Hole size: 15/64" (6mm)
 ABD6081B Qty: 100 Head diameter: 14mm
 Stem length: 16mm

Apps: Honda
 Interchange no.: H91501-SM4-003



Nissan Ret. Clip

ABD6082 Qty: 10 Hole size: 10mm
 ABD6082RX Qty: 2 Head diameter: 20mm
 ABD6082B Qty: 100 Stem length: 16mm

Apps: Nissan
 Interchange no.: N01553-00051



Chrysler Panel Fastener

ABD6093 Qty: 10 Hole size: 5/16"
 ABD6093RX Qty: 2 Head diameter:
 ABD6093B Qty: 100 Stem length:

Apps: Chrysler
 Interchange no.: C4114785

RETAINERS - DOOR RETAINERS



Door Trim Panel Ret. GM 78-on

ABD6001 Qty: 10 Hole size: 1/4"
 ABD6001RX Qty: 5 Head diameter: 7/8"
 ABD6001B Qty: 100 Stem length: 3/4"

Apps: GM
 Interchange no: GM3065575



Door Trim Panel Ret. GM 83-on

ABD6003 Qty: 10 Hole size: 1/4"
 ABD6003RX Qty: 5 Head diameter: 3/4" x 7/8"
 ABD6003B Qty: 100 Stem length: 3/4"

Apps: GM
 Interchange nos.: GM20421800,
 GM15600382



Door Trim Panel Ret. Ford 81-on

ABD6019 Qty: 10 Hole size: 1/4"
 ABD6019RX Qty: 4 Head diameter: 25/32"
 ABD6019B Qty: 100 Stem length: 5/8"

Apps: Ford
 Interchange no: F-N8109925S















Door Trim Panel Ret. Ford/Chrysler 75-on

ABD6023 Qty: 10 Hole size: 1/4"
 ABD6023RX Qty: 4 Head diameter: 15/16"
 ABD6023B Qty: 100 Stem length: 11/16"

Apps: Ford/Chrysler
 Interchange nos.: F-385661S,
 C6032363

RETAINERS - DOOR RETAINERS

	Trim Panel Ret. Ford/Chrysler 76-on	ABD6024 ABD6024RX ABD6024B	Qty: 10 Qty: 3 Qty: 100	Hole size: 1/4" Head diameter: 15/16" Stem length: 15/16"	Apps: Ford Interchange no.: F-387496S
	Door Trim Panel Ret. Chrysler Vans 98-on	ABD6031 ABD6031RX ABD6031B	Qty: 10 Qty: 2 Qty: 100	Hole size: 8.5mm Head diameter: 20mm Stem length: 8mm	Apps: Chrysler Interchange no.: C6505292AA
	Door Panel Ret. GM/Chrysler 76-on	ABD6035 ABD6035RX ABD6035B	Qty: 10 Qty: 4 Qty: 100	Hole size: 1/4" Head diameter: 15/16" Stem length: 11/16"	Apps: GM/Chrysler Interchange nos.: GM-9685057, C-6003349
	Door Panel Ret. GM 81-88/Jeep 91-on	ABD6037 ABD6037RX ABD6037B	Qty: 10 Qty: 2 Qty: 100	Hole size: 1/4" Head diameter: 3/4" Stem length: 1/2"	Apps: GM, Chrysler Interchange nos.: GM796255, C6033862
	Door Panel Ret. Camaro/Firebird 89-on	ABD6038 ABD6038RX ABD6038B	Qty: 10 Qty: 5 Qty: 100	Hole size: 1/4" Head diameter: 3/4" Stem length: 3/4"	Apps: GM Interchange nos.: GM20374473, GM12337920
	Door Panel Ret. Saturn 91-on	ABD6042 ABD6042RX ABD6042B	Qty: 10 Qty: 2 Qty: 100	Hole size: 7.5mm Head diameter: 20mm Stem length: 18mm	Apps: GM Saturn Interchange nos.: GM21012058, GM21042045, GM21041053
	Trim Panel Ret. Ford 85-on	ABD6045 ABD6045RX ABD6045B	Qty: 10 Qty: 2 Qty: 100	Hole size: 9/32" Head diameter: 3/4" Stem length: 3/4"	Apps: Ford Interchange no.: F-N805155S
	Trim Panel Ret. Ford/GM/Jeep 88-on	ABD6046 ABD6046RX ABD6046B	Qty: 10 Qty: 3 Qty: 100	Hole size: 1/4" Head diameter: 3/4" Stem length: 1"	Apps: Ford/GM Interchange nos.: F-N805612-S100, GM-10143422
	Int. Door Trim Ret. Ford 77-on	ABD6047 ABD6047RX ABD6047B	Qty: 10 Qty: 3 Qty: 100	Hole size: 9/32" Head diameter: 3/4" Stem length: 9/16"	Apps: Ford Interchange no.: F-387477S
	Seat Back Panel Ret. Ford 77-on	ABD6048 ABD6048RX ABD6048B	Qty: 10 Qty: 3 Qty: 100	Hole size: 9/32" Head diameter: 5/8" Stem length: 5/8"	Apps: Ford Interchange no.: F-387182S
	Trim Panel Ret. Ford 81-on	ABD6049 ABD6049RX ABD6049B	Qty: 10 Qty: 4 Qty: 100	Hole size: 1/4" Head diameter: 3/4" Stem length: 13/16"	Apps: Ford Interchange no.: F-389144S
	Door Trim Panel Ret. Chrysler 95-on	ABD6053 ABD6053RX ABD6053B	Qty: 10 Qty: 5 Qty: 100	Hole size: 1/4" Head diameter: 25/32" Stem length: 9/16"	Apps: Chrysler Interchange no.: C-6504014

RX indicates packaging suited for retail and merchandisers.

RETAINERS - DOOR RETAINERS



Door Trim Panel Ret. Ford 81-on

ABD6083 Qty: 10 Hole size: 1/4"
 ABD6083RX Qty: 3 Head diameter: 3/4"
 ABD6083B Qty: 100 Stem length: 5/8"

Apps: Ford
 Interchange no.: F-N802900



Trim Panel Ret. GMC Truck

ABD6084 Qty: 10 Hole size: 1/4"
 ABD6084RX Qty: 5 Head diameter: 3/4"
 ABD6084B Qty: 100 Stem length: 1"

Apps: GM
 Interchange no.: GM-363137



Conduit to Sheet Metal Door GM

ABD6085 Qty: 10 Hole size: 1/4"
 ABD6085B Qty: 100 Head diameter: 15/16"
 Stem length: 1-1/18"

Apps: GM
 Interchange nos.: GM20451401



Trim Panel Ret. GM 87-on

ABD6086 Qty: 10 Hole size: 1/4"
 ABD6086RX Qty: 3 Head diameter: 15/16"
 ABD6086B Qty: 100 Stem length: 1-1/4"

Apps: GM
 Interchange no.: GM-10126901



Door Panel Ret. Toyota

ABD6087 Qty: 10 Hole size: 9mm
 ABD6087RX Qty: 4 Head diameter: 18mm
 ABD6087B Qty: 100 Stem length: 14mm

Apps: Toyota
 Interchange no.: T67771-01010



Trim Panel Ret. Honda 90-on

ABD6088 Qty: 10 Hole size: 9mm
 ABD6088RX Qty: 2 Head diameter: 18mm
 ABD6088B Qty: 100 Stem length: 14mm

Apps: Honda
 Interchange no.: 91556-SP0-003



Door Trim Panel Ret. GM 82-on

ABD6089 Qty: 10 Hole size: 7.5mm
 ABD6089RX Qty: 4 Head diameter: 20mm
 ABD6089B Qty: 100 Stem length: 23mm

Apps: GM
 Interchange no.: GM-10153057



Trim Panel Ret. GM 97-on

ABD6090 Qty: 10 Hole size: 1/4"
 ABD6090RX Qty: 4 Head diameter: 20mm
 ABD6090B Qty: 100 Stem length: 24mm

Apps: GM
 Interchange no.: GM-10285935



Door Trim/Headliner Ret. GM 71-on

ABD6091 Qty: 10 Hole size: 1/4"
 ABD6091RX Qty: 8 Head diameter: 3/4"
 ABD6091B Qty: 100 Stem length: 1/2"

Apps: GM
 Interchange nos.: GM-2064891,
 GM-9883583, GM-9818648



Trim Panel Ret. GM Truck 76-on

ABD6092 Qty: 10 Hole size: 1/4"
 ABD6092RX Qty: 3 Head diameter: 9/16" x 11/16"
 ABD6092B Qty: 100 Stem length: 3/4"

Apps: GM
 Interchange nos.: GM-15612948,
 GM-15545202, GM-15607165



Door Trim Retainer (Nissan)

ABD6096 Qty: 10 Hole size: 5/16" (8mm)
 ABD6096B Qty: 100 Head diameter: (13mm)
 Stem length: 17.5mm

Apps: Nissan
 Interchange nos.: 01553-S3500



Door Trim Retainer (GM / Toyota)

ABD6171 Qty: 10 Hole size: 9mm
 ABD6171B Qty: 100 Stem length: 14mm

Apps: GM / Toyota
 Interchange nos.: GM-9500564,
 T-67771-01010















Door Trim Retainer (Toyota)

ABD6174 Qty: 10 Hole size: 13mm
 ABD6174B Qty: 100 Stem length: 11mm

Apps: Toyota
 Interchange nos.: 67771-30070

RX indicates packaging suited for retail and merchandisers.

RETAINERS - PUSH TYPE

	Mud Skirt and Fender Liner GM/Chrysler 81-on	ABD6101 ABD6101RX ABD6101B	Qty: 10 Qty: 5 Qty: 100	Hole size: 1/4" Head diameter: 11/16" Stem length: 9/16"	Apps: GM/Chrysler Interchange nos.: GM-140499205, GM-14019206, C-34201621
	Splash Shield, Fascia Ret. GM/Ford 76-on	ABD6102 ABD6102RX ABD6102B	Qty: 10 Qty: 4 Qty: 100	Hole size: 1/4" Head diameter: 1" Stem length: 7/8"	Apps: GM/Ford Interchange nos.: GM-14093088, F-N802781-S
	Air Baffle Ret. Saturn 91-on	ABD6103 ABD6103RX ABD6103B	Qty: 10 Qty: 3 Qty: 100	Hole size: 8mm Head diameter: 20mm Stem length: 20mm	Apps: GM Saturn Interchange nos.: GM-21030249, C-6503598, F-807389S
	Front Bumper Cover Ford Truck F-150, 250 99-on	ABD6104 ABD6104RX ABD6104B	Qty: 10 Qty: 2 Qty: 100	Hole size: 10mm Head diameter: 16mm Stem length: 12mm	Apps: Ford Interchange no.: F-XL3Z-17E971-AA
	Fascia Ret. GM 79-on	ABD6105 ABD6105RX ABD6105B	Qty: 10 Qty: 2 Qty: 100	Hole size: 1/2" Head diameter: 1/8" Stem length: 3/4"	Apps: GM Interchange no.: GM-5973400
	Rad. Shroud Trim Ret. GM/Ford 82-on	ABD6106 ABD6106RX ABD6106B	Qty: 10 Qty: 4 Qty: 100	Hole size: 1/4" Head diameter: 11/16" Stem length: 7/8"	Apps: GM/Ford Interchange nos.: GM-20664092, F-N804570S
	Door Trim Panel GM Truck C, K, 1, 2, 3 95-on	ABD6107 ABD6107RX ABD6107B	Qty: 10 Qty: 3 Qty: 100	Hole size: 1/4" Head diameter: 9/16" Stem length: 41/64"	Apps: GM Interchange no.: GM-15960325
	Coolant Recovery Tank GM/Chrysler 92-on	ABD6108 ABD6108RX ABD6108B	Qty: 10 Qty: 3 Qty: 100	Hole size: 1/4" Head diameter: 11/16" Stem length: 13/16"	Apps: GM/Chrysler Interchange nos.: GM-101344707, C6501925
	Fascia Ret., Splash Shield Ford/Chrysler	ABD6109 ABD6109B	Qty: 10 Qty: 100	Hole size: 5/16" Head diameter: 1" Stem length: 7/8"	Apps: Ford/Chrysler Interchange nos.: N8034231-S, C6501590
	Fascia Ret., Trim, Grille Ford Aerostar/Escort/Lynx 85-on	ABD6110 ABD6110B	Qty: 10 Qty: 100	Hole size: 1/4" Head diameter: 15/32" Stem length: 21/32"	Apps: Ford Interchange no.: N803494S
	Trim Ret. Jeep Grand Cherokee Laredo 94-on	ABD6111 ABD6111RX ABD6111B	Qty: 10 Qty: 1 Qty: 100	Hole size: 1/4" Head diameter: 1" Stem length: 1"	Apps: Chrysler Jeep Interchange no.: C-6503106
	Trim Ret. Chrysler Concorde/Dodge Intrepid 93-on	ABD6112 ABD6112RX ABD6112B	Qty: 10 Qty: 1 Qty: 100	Hole size: 1/2" Head diameter: 7/8" Stem length: 1-1/16"	Apps: Chrysler Interchange no.: C-4630253

RX indicates packaging suited for retail and merchandisers.

RETAINERS - PUSH TYPE



Trim Ret. Honda

ABD6113	Qty: 10	Hole size: 6mm
ABD6113RX	Qty: 4	Head diameter: 18mm
ABD6113B	Qty: 100	Stem length: 11mm

Apps: Honda
Interchange no.: 90688-SB0-003



Bumper Ret. Acura/Honda 94-on

ABD6114	Qty: 10	Hole size: 8mm
ABD6114RX	Qty: 2	Head diameter: 20mm
ABD6114B	Qty: 100	Stem length: 11mm

Apps: Acura/Honda
Interchange no.: 91512-SX0-003



Screw-type Retainer Honda Accord 90-on

ABD6115	Qty: 10	Hole size: 8mm
ABD6115RX	Qty: 2	Head diameter: 18mm
ABD6115B	Qty: 100	Stem length: 21mm

Apps: Honda
Interchange no.: 90505-SM4-003



Washer/Overflow Bottle Ret. GM 81-on

ABD6116	Qty: 10	Hole size: 5/16"
ABD6116RX	Qty: 3	Head diameter: 21/32"
ABD6116B	Qty: 100	Stem length: 9/16"

Apps: GM
Interchange no.: GM14019226



Bumper Push Ret. Nissan 240X/Maxima

ABD6117	Qty: 10	Hole size: 10mm
ABD6117B	Qty: 100	Head diameter: 18mm Stem length: 15mm

Apps: Nissan
Interchange nos.: 01553-09241, FB01-56-964



Screw-type Toyota/Mazda

ABD6118	Qty: 10	Hole size: 7mm
ABD6118RX	Qty: 4	Head diameter: 15mm
ABD6118B	Qty: 100	Stem length: 12mm

Apps: Toyota/Mazda
Interchange no.: 90467-06017



Bumper Cover Ret. Mazda LS400

ABD6119	Qty: 10	Hole size: 9mm
ABD6119RX	Qty: 2	Head diameter: 15mm
ABD6119B	Qty: 100	Stem length: 27mm

Apps: Mazda
Interchange no.: 90467-09093



Rocker Panel/Wheel Liner Ret. Saturn 91-on

ABD6120	Qty: 10	Hole size: 8mm
ABD6120RX	Qty: 3	Head diameter: 15mm
ABD6120B	Qty: 100	Stem length: 20mm

Apps: GM Saturn
Interchange no.: GM-21075686



Screw-type Ret. Honda/Mazda/Nissan

ABD6121	Qty: 10	Hole size: 8mm
ABD6121RX	Qty: 4	Head diameter: 20mm
ABD6121B	Qty: 100	Stem length: 9mm

Apps: Honda/Mazda/Nissan
Interchange no.: 90675-SB3-003



Screw-type Ret. Honda Accord 91-on

ABD6122	Qty: 10	Hole size: 8mm
ABD6122RX	Qty: 2	Head diameter: 20mm
ABD6122B	Qty: 100	Stem length: 9mm

Apps: Honda
Interchange no.: 91512-SM4-003



Fascia Ret. GM 92-on

ABD6123	Qty: 10	Hole size: 3/8"
ABD6123RX	Qty: 2	Head diameter: 1"
ABD6123B	Qty: 100	Stem length: 23/32"

Apps: GM
Interchange nos.: GM-14045480,
GM-8942981190















Bumper Fascia Ret. Honda Accord 90-on

ABD6124	Qty: 10	Hole size: 10mm
ABD6124B	Qty: 100	Head diameter: 20mm Stem length: 27mm

Apps: Honda
Interchange no.: 91502-SM4-0000

RETAINERS - PUSH TYPE

	Screw-type Ret. GM/Honda/Mazda			Apps: GM/Honda/Mazda Interchange nos.: GM-94198687, 90657-SA6-0030, N304-13356A
	ABD6125	Qty: 10	Hole size: 7mm	
	ABD6125RX	Qty: 3	Head diameter: 14mm	
	ABD6125B	Qty: 100	Stem length: 11mm	
	Cowl Panel Ret. Nissan 80-on/Geo Storm 90-on			Apps: Nissan Interchange nos.: GM-94051993, 66860-01W01
	ABD6126	Qty: 10	Hole size: 6mm	
	ABD6126RX	Qty: 2	Head diameter: 14mm	
	ABD6126B	Qty: 100	Stem length: 16mm	
	Screw-type Ret. Honda/Nissan/Isuzu			Apps: Interchange no.: 90684-SA5-0030
	ABD6127	Qty: 10	Hole size: 6mm	
	ABD6127RX	Qty: 5	Head diameter: 15mm	
	ABD6127B	Qty: 100	Stem length: 11mm	
	Bumper Cover Ret. Toyota Camry 92-on			Apps: Toyota Interchange no.: 90467-09145
	ABD6128	Qty: 10	Hole size: 9mm	
	ABD6128RX	Qty: 2	Head diameter: 15mm	
	ABD6128B	Qty: 100	Stem length: 12mm	
	Push-type Ret. Mazda/Ford Aspire			Apps: Mazda/Ford Interchange nos.: F-B092-51-833, MB-455-56143
	ABD6129	Qty: 10	Hole size: 8mm	
	ABD6129B	Qty: 100	Head diameter: 18mm	
			Stem length: 12mm	
	Bumper Cover Ret. Mazda ES300 93-on			Apps: Mazda Interchange no.: 90467-09101
	ABD6130	Qty: 10	Hole size: 9mm	
	ABD6130RX	Qty: 2	Head diameter: 18mm	
	ABD6130B	Qty: 100	Stem length: 23mm	
	Front/Rear Bumper Ret. Acura Legacy 91-on			Apps: Acura Interchange no.: 91503-SPO-003
	ABD6131	Qty: 10	Hole size: 10mm	
	ABD6131B	Qty: 100	Head diameter: 20mm	
			Stem length: 15mm	
	Inner Fender Ret. Nissan 80-on			Apps: Nissan Interchange no.: 63844-01A00
	ABD6132	Qty: 10	Hole size: 8mm	
	ABD6132RX	Qty: 4	Head diameter: 20mm	
	ABD6132B	Qty: 100	Stem length: 18mm	
	Front/Rear Bumper Ret. Honda 90-on			Apps: Honda Interchange no.: 91502-SPO-003
	ABD6133	Qty: 10	Hole size: 10mm	
	ABD6133RX	Qty: 2	Head diameter: 20mm	
	ABD6133B	Qty: 100	Stem length: 25mm	
	Bumper Fascia Ret. Honda Accord 90-on			Apps: Honda Interchange no.: 91504-SM4-000
	ABD6134	Qty: 10	Hole size: 10mm	
	ABD6134RX	Qty: 2	Head diameter: 20mm	
	ABD6134B	Qty: 100	Stem length: 24mm	
	Screw type Ret. Ford 87-on			Apps: Ford Interchange no.: N804837-S
	ABD6136	Qty: 10	Hole size: 1/4"	
	ABD6136B	Qty: 100	Head diameter: 1"	
			Stem length: 29/32"	
	Bumper Cover Ret. Nissan			Apps: Nissan Interchange no.: 01553-01393
	ABD6137	Qty: 10	Hole size: 10mm	
	ABD6137B	Qty: 100	Head diameter: 20 x 30mm	
			Stem length: 18mm	

RX indicates packaging suited for retail and merchandisers.

RETAINERS - PUSH TYPE



Tail Light Ret. GM/Chrysler

ABD6138 Qty: 10 Hole size: 3/16"
 ABD6138RX Qty: 3 Head diameter: 3/8"
 ABD6138B Qty: 100 Stem length: 7/16"

Apps: GM/Chrysler
 Interchange nos.: GM-16500308,
 C-6500787



Truck Grille to Metal Ret. Ford 1978-on

ABD6139 Qty: 10 Hole size: 1/4"
 ABD6139B Qty: 100 Head diameter: 1/4"
 Stem length: 11/16"

Apps: Ford
 Interchange no.: 387944-S



GM Weatherstrip Ret./Chrysler Fender Ret. 68-on

ABD6140 Qty: 10 Hole size: 1/4"
 ABD6140B Qty: 100 Head diameter: 11/16"
 Stem length: 5/8"

Apps: GM/Chrysler
 Interchange nos.: GM472434,
 G-6031390



Push-in Type Ret. Toyota/Nissan

ABD6141 Qty: 10 Hole size: 7mm
 ABD6141RX Qty: 2 Head diameter: 18mm
 ABD6141B Qty: 100 Stem length: 11mm

Apps: Toyota/Nissan
 Interchange nos.: 90467-07043,
 80999-05N-07



Trim Ret. Honda/Nissan

ABD6142 Qty: 10 Hole size: 8mm
 ABD6142RX Qty: 2 Head diameter: 20mm
 ABD6142B Qty: 100 Stem length: 14mm

Apps: Honda/Nissan
 Interchange nos.: 91545SE0-0030,
 63848-01G00



Front/Rear Bumper Ret. Nissan/Infiniti

ABD6143 Qty: 10 Hole size: 8mm
 ABD6143RX Qty: 2 Head diameter: 20mm
 ABD6143B Qty: 100 Stem length: 15mm

Apps: Nissan/Infiniti
 Interchange nos.: 0153-06721



Wheel Opening Moulding Ret. GM/Saturn 91-on

ABD6144 Qty: 10 Hole size: 1/4"
 ABD6144B Qty: 100 Head diameter: 19/32"
 Stem length: 3/4"

Apps: GM Saturn
 Interchange no.: 21077123



Rad. Bumper Fender Ret. GM/Jeep Trucks 99-on

ABD6145 Qty: 10 Hole size: 6mm
 ABD6145B Qty: 100 Head diameter: 17mm
 Stem length: 16mm

Apps: GM
 Interchange nos.: GM15149708,
 C-6506008AA



Body Ret. GM/Chrysler 84-on

ABD6146 Qty: 10 Hole size: 1/4"
 ABD6146B Qty: 100 Head diameter: 11/16"
 Stem length: 7/8"

Apps: GM/Chrysler
 Interchange nos.: GM20510029,
 C-34202672



Exterior Body Ret. GM 94-on

ABD6147 Qty: 10 Hole size: 9/32"
 ABD6147RX Qty: 2 Head diameter: 11/16"
 ABD6147B Qty: 100 Stem length: 7/8"

Apps: GM
 Interchange no.: GM-20590899



Fascia Bumper Ret. GM Light Truck/Olds 90-on

ABD6148 Qty: 10 Hole size: 3/8" (9.5mm)
 ABD6148B Qty: 100 Head diameter: 18mm
 Stem length: 23mm

Apps: GM
 Interchange nos.: 10157900,
 11517803, 15993201















Front Bumper Ret. GM Light Truck/Olds 90-on

ABD6149 Qty: 10 Hole size: 3/8" (9.5mm)
 ABD6149RX Qty: 2 Head diameter: 18mm
 ABD6149B Qty: 100 Stem length: 23mm

Apps: GM
 Interchange no.: 11517803

RETAINERS - PUSH TYPE

	Rear Bumper Cover Ret. Toyota Tercel 88-on	ABD6150 ABD6150RX ABD6150B	Qty: 10 Qty: 1 Qty: 100	Hole size: 9mm Head diameter: 18mm Stem length: 28mm	Apps: Toyota Interchange nos.: 52161-02020, 52161-16010
	Rear Air Baffle Cadillac Eldorado, Seville 93-on	ABD6151 ABD6151B	Qty: 10 Qty: 100	Hole size: 1/4" Head diameter: 3/4" Stem length: 1-1/8"	Apps: GM Interchange no.: 3540858
	Front Fender Liner Toyota Tercel 94-on	ABD6152 ABD6152RX ABD6152B	Qty: 10 Qty: 2 Qty: 100	Hole size: 7mm Head diameter: 20mm Stem length: 8mm	Apps: Toyota Interchange no.: 90467-07166
	Push-in Type Ret. Nissan Maxima/300ZX	ABD6153 ABD6153RX ABD6153B	Qty: 10 Qty: 2 Qty: 100	Hole size: 8mm Head diameter: 20mm Stem length: 9mm	Apps: Nissan Interchange no.: 01553-09321
	Bumper Support Ret. Honda Civic 93-on	ABD6154 ABD6154RX ABD6154B	Qty: 10 Qty: 2 Qty: 100	Hole size: 8mm Head diameter: 20mm Stem length: 10mm	Apps: Honda Interchange no.: 91501-S04-003
	Front Bumper Ret. Acura/Honda 96-on	ABD6155 ABD6155RX ABD6155B	Qty: 10 Qty: 2 Qty: 100	Hole size: 10mm Head diameter: 20mm Stem length: 13mm	Apps: Acura/Honda Interchange no.: 91503-SZ5-003, 91503-SZ3-003
	Bumper Ret. Honda Accord/Odyssey 96-on	ABD6156 ABD6156RX ABD6156B	Qty: 10 Qty: 2 Qty: 100	Hole size: 10mm Head diameter: 20mm Stem length: 18mm	Apps: Honda Interchange no.: 91503-SZ5-003
	Fascia Ret. Chrysler/Dodge 98-on	ABD6157 ABD6157B	Qty: 10 Qty: 100	Hole size: 5/16" Head diameter: 23/32" Stem length: 29/32"	Apps: Chrysler Interchange nos.: 6504521
	Splash/Shield Spare Tire Ret. GM/Ford 84-on	ABD6158 ABD6158RX ABD6158B	Qty: 10 Qty: 3 Qty: 100	Hole size: 5/16" Head diameter: 1" Stem length: 7/8"	Apps: GM/Ford Interchange nos.: GM-20570245, F-N804614S
	Bumper Fascia Ret. GM 87-on	ABD6159 ABD6159RX ABD6159B	Qty: 10 Qty: 3 Qty: 100	Hole size: 1/2" Head diameter: 1" Stem length: 1"	Apps: GM Interchange no.: GM-22535007
	Fender Apron Ret. GM Cobalt 05-06	ABD6160	Qty: 10	Hole size: 8.5mm Head diameter: 19mm Stem length: 14mm	Apps: GM Interchange no.: 11609417
	Ergo Tuflock Ret. GM/Ford 03-on	ABD6161	Qty: 10	Hole size: 6.5mm Head diameter: 18mm Stem length: 22mm	Apps: GM/Ford Interchange no.: GM-11589291, F-W713331S300

RX indicates packaging suited for retail and merchandisers.

RETAINERS - PUSH TYPE



Ergo Tuflock Ret. GM/Chrysler 02-on

ABD6162

Qty: 10

Hole size: 6.5mm
Head diameter: 18mm
Stem length: 17.5mm

Apps: GM/Chrysler
Interchange nos.: GM-11589289,
C-6508863AA



Bumper Fascia Ret. GM 02-on

ABD6163

Qty: 10

Hole size: 6.5mm
Head diameter: 18mm
Stem length: 20mm

Apps: GM
Interchange no.: 11589290



Ergo Tuflock Ret. GM/Chrysler 07-on

ABD6164

Qty: 10

Hole size: 8mm
Head diameter: 19mm
Stem length: 16mm

Apps: GM/Chrysler
Interchange no.: GM-15296830,
C-0516530AA



Ergo Tuflock Ret. GM 07-on

ABD6165

Qty: 10

Hole size: 8.5mm
Head diameter: 20mm
Stem length: 20mm

Apps: GM
Interchange no.: 11589292



Panel Ret. GM Hummer 06-on

ABD6166

Qty: 10

Hole size: 9mm
Head diameter: 19mm
Stem length:

Apps: GM
Interchange no.: 11589294



Ergo Tuflock Cowl & Fender Ret. GM 05-on

ABD6167

Qty: 10

Hole size: 8.5mm
Head diameter: 20mm
Stem length: 22mm

Apps: GM/Ford
Interchange no.: GM-11589293,
F-W712196S300



Ergo Tuflock Ret. GM Impala/Solstice 06-07

ABD6168

Qty: 10

Hole size: 9.5mm
Head diameter: 18mm
Stem length: 20mm

Apps: GM/Chrysler
Interchange no.: GM-11561368,
C-065008712AA



Ergo Tuflock Ret. GM/Ford 05-on

ABD6169

Qty: 10

Hole size: 10.5mm
Head diameter: 25mm
Stem length: 20mm

Apps: GM/Chrysler
Interchange nos.: GM-11589295,
C-5GUU9K11BA



Ergo Tuflock Ret. GM 07-on

ABD6170

Qty: 10

Hole size: 10.5mm
Head diameter: 25mm
Stem length: 23mm

Apps: GM
Interchange nos.: 11589296

Push Type Retainer - Nissan

ABD6173

Qty: 10

Hole size: 5/16" (8mm)

Apps: Nissan

ABD6173B

Qty: 100

Stem length: 20mm

Interchange nos.: 76882-57A00

FASCIA RETAINERS



ABD6175

Qty: 10

Hole size: 7/16" (11mm)

Apps: Toyota

ABD6175B

Qty: 100

Stem: 14mm

Interchange nos.: 01553-03101

GRILL RETAINERS



ABD6172

Qty: 10

Hole size: 15/64" (6mm)

Apps: Nissan

ABD6172B

Qty: 100

Stem: 8mm

Interchange nos.: 66814-01G00

PANEL RETAINERS



ABD6094

Qty: 10

Hole size: 15/64" (6mm)

Apps: Honda/Isuzu/Mazda/Nissan/Toyota

ABD6094B

Qty: 100

Stem: 16mm

Interchange nos.: H-90467-11005, I-89421-76980,
M-9926-40-658, N-76906-T3000, T-90467-09069-06-20

RX indicates packaging suited for retail and merchandisers.



Phillips Oval HD Sheet Metal Screw Undersize HD Chrome

ABD6317	Qty: 10	Screw size: 8 x 3/4"	Apps: Undersize HD chrome
ABD6317RX	Qty: 10	Head size: #6	
ABD6317B	Qty: 100		



Phillips Oval HD Sheet Metal Screw Undersize HD Chrome

ABD6318	Qty: 10	Screw size: 8 x 1"	Apps: Undersize HD chrome
ABD6318RX	Qty: 10	Head size: #6	
ABD6318B	Qty: 100		



Phillips Oval HD Sheet Metal Screw Undersize HD Chrome

ABD6319	Qty: 10	Screw size: 8 x 1-1/4"	Apps: Undersize HD chrome
ABD6319RX	Qty: 10	Head size: #6	
ABD6319B	Qty: 100		



Phillips Oval HD Sheet Metal Screw Undersize HD Chrome

ABD6320	Qty: 10	Screw size: 10 x 1"	Apps: Undersize HD chrome
ABD6320RX	Qty: 10	Head size: #8	
ABD6320B	Qty: 100		



Phillips Oval HD Sheet Metal Screw Undersize HD Chrome

ABD6380	Qty: 10	Screw size: 8 x 1-1/2"	Apps: Undersize HD chrome
ABD6380RX	Qty: 10	Head size: #6	
ABD6380B	Qty: 100		



Phillips Oval HD Sheet Metal Screw Undersize HD Chrome

ABD6382	Qty: 10	Screw size: 10 x 3/4"	Apps: Undersize HD chrome
ABD6382RX	Qty: 10	Head size: #6	
ABD6382B	Qty: 100		



Phillips Oval HD Sheet Metal Screw Chrome

ABD6284	Qty: 10	Screw size: 8 x 3/4"	Apps: Chrome
ABD6284RX	Qty: 10	Head size: #8	
ABD6284B	Qty: 100		



Phillips Oval HD Sheet Metal Screw Chrome

ABD6379	Qty: 10	Screw size: 8 x 1-1/4"	Apps: Chrome
ABD6379B	Qty: 100	Head size: #8	



Phillips Oval HD Sheet Metal Screw Undersize HD Black

ABD6321	Qty: 10	Screw size: 8 x 3/4"	Apps: Undersize HD black
ABD6321RX	Qty: 10	Head size: #6	
ABD6321B	Qty: 100		



Phillips Oval HD Sheet Metal Screw Undersize HD Black

ABD6322	Qty: 10	Screw size: 8 x 1"	Apps: Undersize HD black
ABD6322RX	Qty: 10	Head size: #6	
ABD6322B	Qty: 100		



Phillips Oval HD Sheet Metal Screw Undersize HD Black

ABD6381	Qty: 10	Screw size: 8 x 1-1/2"	Apps: Undersize HD black
ABD6381B	Qty: 100	Head size: #6	



Phillips Oval HD Sheet Metal Screw Undersize HD Black

ABD6383	Qty: 10	Screw size: 10 x 3/4"	Apps: Undersize HD black
ABD6383RX	Qty: 10	Head size: #6	
ABD6383B	Qty: 100		

TRIM SCREWS



Phillips Oval Head Black Finish Sheet Metal Screw

ABD6377 Qty: 10 Screw size: 8 x 3/4" Apps: Black finish
ABD6377B Qty: 100 Head size: #8



Phillips Oval Head Black Finish Sheet Metal Screw

ABD6378 Qty: 10 Screw size: 8 x 1" Apps: Black finish
ABD6378B Qty: 100 Head size: #8



Phillips Pan Head Sheet Metal Screw Bright Zinc

ABD6385 Qty: 10 Screw size: 8 x 1" Apps: Bright zinc
ABD6385B Qty: 100 Head size: #8



Phillips Pan Head Sheet Metal Screw Bright Zinc

ABD6386 Qty: 10 Screw size: 10 x 3/4" Apps: Bright zinc
ABD6386B Qty: 100 Head size:



Phillips Pan Head Sheet Metal Screw Bright Zinc

ABD6389 Qty: 10 Screw size: 12 x 3/4" Apps: Bright zinc
ABD6389B Qty: 100 Head size:



Phillips Pan Head Sheet Metal Screw Bright Zinc

ABD6390 Qty: 10 Screw size: 14 x 3/4" Apps: Bright zinc
ABD6390B Qty: 100 Head size:



Phillips Pan Head Sheet Metal Screw Black Finish

ABD6323 Qty: 10 Screw size: 8 x 3/4" Apps: Black finish
ABD6323RX Qty: 10 Head size:
ABD6323B Qty: 100



Phillips Pan Head Sheet Metal Screw Black Finish

ABD6324 Qty: 10 Screw size: 8 x 1" Apps: Black finish
ABD6324RX Qty: 10 Head size:
ABD6324B Qty: 100



Phillips Pan Head Sheet Metal Screw Black Finish

ABD6384 Qty: 10 Screw size: 8 x 1/2" Apps: Black finish
ABD6384RX Qty: 10 Head size:
ABD6384B Qty: 100



Phillips Pan Head Sheet Metal Screw Black Finish

ABD6387 Qty: 10 Screw size: 10 x 3/4" Apps: Black finish
ABD6387RX Qty: 10 Head size:
ABD6387B Qty: 100



Phillips Pan Head Sheet Metal Screw Black Finish

ABD6388 Qty: 10 Screw size: 10 x 1" Apps: Black finish
ABD6388RX Qty: 10 Head size:
ABD6388B Qty: 100





Phillips Oval Head Trim Screw SEMS Chrome

ABD6304 Qty: 10 Screw size: 8 x 1-1/4" Apps: SEMS chrome
ABD6304B Qty: 100 Head size: #6

	Phillips Oval Head Trim Screw SEMS Chrome			
	ABD6306	Qty: 10	Screw size: 10 x 3/4"	Apps: SEMS chrome
	ABD6306RX	Qty: 3	Head size: #8	
	ABD6306B	Qty: 100		

	Phillips Oval Head Trim Screw SEMS Chrome			
	ABD6307	Qty: 10	Screw size: 10 x 1"	Apps: SEMS chrome
	ABD6307RX	Qty: 3	Head size: #8	
	ABD6307B	Qty: 100		

	Phillips Oval Head Trim Screw SEMS Chrome			
	ABD6311	Qty: 10	Screw size: 8 x 3/4"	Apps: SEMS chrome
	ABD6311RX	Qty: 3	Head size: #6	
	ABD6311B	Qty: 100		

	Phillips Oval Head Trim Screw SEMS Chrome			
	ABD6312	Qty: 10	Screw size: 8 x 1"	Apps: SEMS chrome
	ABD6312RX	Qty: 6	Head size: #6	
	ABD6312B	Qty: 100		

	Phillips Oval Head Trim Screw SEMS Black			
	ABD6301	Qty: 10	Screw size: 10 x 3/4"	Apps: SEMS black
	ABD6301RX	Qty: 5	Head size: #8	
	ABD6301B	Qty: 100		

	Phillips Oval Head Trim Screw SEMS Black			
	ABD6302	Qty: 10	Screw size: 10 x 1"	Apps: SEMS black
	ABD6302RX	Qty: 4	Head size: #8	
	ABD6302B	Qty: 100		

	Phillips Oval Head Trim Screw SEMS Black			
	ABD6308	Qty: 10	Screw size: 8 x 5/8"	Apps: SEMS black
	ABD6308B	Qty: 100	Head size: #6	

	Phillips Oval Head Trim Screw SEMS Black			
	ABD6309	Qty: 10	Screw size: 8 x 3/4"	Apps: SEMS black
	ABD6309RX	Qty: 4	Head size: #6	
	ABD6309B	Qty: 100		

	Phillips Oval Head Trim Screw SEMS Black			
	ABD6310	Qty: 10	Screw size: 8 x 1"	Apps: SEMS black
	ABD6310RX	Qty: 8	Head size: #6	
	ABD6310B	Qty: 100		

	Indented Hex Head Tek Screw Bright Zinc			
	ABD6316	Qty: 10	Screw size: 8 x 1/2"	Apps: Bright zinc
	ABD6316RX	Qty: 6	1/4" hex	
	ABD6316B	Qty: 100		

	Indented Hex Head Tek Screw Bright Zinc			
	ABD6335	Qty: 10	Screw size: 8 x 3/4"	Apps: Bright zinc
	ABD6335RX	Qty: 10	3/4" hex	
	ABD6335B	Qty: 100		

	Indented Hex Head Tek Screw Bright Zinc			
	ABD6208	Qty: 10	Screw size: 10 x 3/4"	Apps: Bright zinc
	ABD6208RX	Qty: 10	5/16" hex	
	ABD6208B	Qty: 100		

RX indicates packaging suited for retail and merchandisers.

TRIM SCREWS



Phillips Flat Top Washer Head Black Trim Screw

ABD6393 Qty: 10 Screw size: 8 x 5/8" Apps: Black
 ABD6393B Qty: 100 13/32 O.D. washer



Phillips Flat Top Washer Head Black Trim Screw

ABD6394 Qty: 10 Screw size: 8 x 1" Apps: Black
 ABD6394RX Qty: 10 13/32 O.D. washer
 ABD6394B Qty: 100



Phillips Flat Top Washer Head Black Trim Screw

ABD6395 Qty: 10 Screw size: 8 x 1-1/4" Apps: Black
 ABD6395B Qty: 100 13/32 O.D. washer



Phillips Flat Top Washer Head Black Trim Screw

ABD6332 Qty: 10 Screw size: 8 x 3/4" Apps: Black
 ABD6332RX Qty: 10 13/32 O.D. washer
 ABD6332B Qty: 100



Phillips Flat Top Washer Head Black Trim Screw

ABD6333 Qty: 10 Screw size: 8 x 3/4" Apps: Black
 ABD6333B Qty: 100 1/2 O.D. washer



Phillips Flat Top Washer Head Black Trim Screw

ABD6334 Qty: 10 Screw size: 10 x 3/4" Apps: Black
 ABD6334RX Qty: 10 1/2 O.D. washer
 ABD6334B Qty: 100



Tek Screw 12mm O.D. Loose Washer Black

ABD6329 Qty: 10 Screw size: 4.2-1.41 x 20mm Apps: Black
 ABD6329B Qty: 100 7mm IND hex washer HD



Tek Screw 12mm O.D. Loose Washer Black

ABD6330 Qty: 10 Screw size: 4.2-1.41 x 20mm Apps: Black
 ABD6330RX Qty: 4 7mm IND hex washer HD
 ABD6330B Qty: 100



Phillips Flat Top Washer Head Black Trim Screw Chrysler

ABD6398 Qty: 10 Screw size: 8 x 1.2" Apps: Chrysler
 ABD6398RX Qty: 10 Interchange no.: CHRY9422202
 ABD6398B Qty: 100



Phillips Flat Top Washer Head Black Trim Screw Ford

ABD6203 Qty: 10 Screw size: 8 x 3/4" Apps: Ford
 ABD6203B Qty: 100 1/2 O.D. washer Interchange no.: F56912-S2















Phillips Flat Top Washer Head Black Trim Screw GM

ABD6331 Qty: 10 Screw size: 8 x 1/2" Apps: GM
 ABD6331RX Qty: 6 13/32 O.D. washer Interchange no.: GM11505104
 ABD6331B Qty: 100



Phillips Oval Head Loose Washer Tek Screw Black

ABD6305 Qty: 10 Screw size: 8 x 3/4" Apps: Black
 ABD6305B Qty: 100 #6

	Phillips Oval Washer Head Wheel Opening Tek Screw Black GM ABD6314 ABD6314B	Qty: 10 Qty: 100	Screw size: 8 x 1/2" 13/32" O.D. washer	Apps: GM Interchange no.: 2043550
	Phillips Oval HD Wheel Opening Tek Screw Chrome ABD6313 ABD6313B	Qty: 10 Qty: 100	Screw size: 8 x 1/2" 13/32" O.D. washer	Apps: Chrome
	Phillips Oval HD Wheel Opening Tek Screw Bright Zinc GM ABD6399 ABD6399B	Qty: 10 Qty: 100	Screw size: 8 x 1/2" 3/8" IND hex	Apps: GM Interchange no.: 1689827
	Phillips Oval Washer Head Mounting Tex Screw Black ABD6315 ABD6315B	Qty: 10 Qty: 100	Screw size: 8 x 3/4" 13/32" O.D. washer	Apps: Black
	Phillips Oval Washer Head Chrome GM ABD6201 ABD6201B	Qty: 10 Qty: 100	Screw size: 8 x 1/2" 1/4" hex head slot	Apps: GM
	Phillips Oval Washer Head Black Phosphate GM ABD6204 ABD6204B	Qty: 10 Qty: 100	Screw size: 8 x 3/4" 13/32" O.D. washer	Apps: GM Interchange no.: 11501884
	Phillips Oval Wheel Opening Moulding Bright Zinc Ford ABD6396 ABD6396B	Qty: 10 Qty: 100	Screw size: 8 x 3/8" Head size: #6	Apps: Ford Interchange no.: 381671S
	Metric Torx Trim Screws GM ABD6326 ABD6326B	Qty: 10 Qty: 100	Screw size: 4.2-1.41 x 30mm 7mm oval head	Apps: GM Interchange no.: 11504656
	Metric Torx Trim Screws Black GM ABD6328 ABD6328B	Qty: 10 Qty: 100	Screw size: 4.2-1.41 x 25mm 8mm pan head	Apps: GM Interchange no.: 11504662
	Metric Torx Trim Screws SS Chrome GM ABD6325 ABD6325B	Qty: 10 Qty: 100	Screw size: 4.2-1.41 x 30mm 7mm oval head	Apps: GM Interchange no.: 11504522
	Metric Torx Trim Screws SS Chrome GM ABD6327 ABD6327B	Qty: 10 Qty: 100	Screw size: 4.2-1.41 x 25mm 8mm pan head	Apps: GM Interchange no.: 11504661
	Sheet Metal Screws Black 11/16" Loose Washer GM ABD6352 ABD6352RX ABD6352B	Qty: 10 Qty: 4 Qty: 100	Screw size: 6.3-1.81 x 25mm 10mm IND hex wash HD	Apps: GM Interchange no.: 11500996

TRIM SCREWS



Sheet Metal Screws Black 12mm Loose Washer GM

ABD6202	Qty: 10	Screw size: 4.2-1.41 x 16mm	Apps: GM
ABD6202B	Qty: 100	7mm IND hex head	Interchange no.: 11503395



Sheet Metal Screws Black 12mm Loose Washer GM

ABD6205	Qty: 10	Screw size: 4.2-1.41 x 20mm	Apps: GM
ABD6205RX	Qty: 8	7mm IND hex head	Interchange no.: 11503396
ABD6205B	Qty: 100		



Sheet Metal Screws Black 12mm Loose Washer GM

ABD6206	Qty: 10	Screw size: 4.2-1.41 x 20mm	Apps: GM
ABD6206B	Qty: 100	7mm IND hex wash head HD	Interchange no.: 11504056



Sheet Metal Screws Black 17mm Loose Washer Black GM

ABD6351	Qty: 10	Screw size: 6.3-1.81 x 20mm	Apps: GM
ABD6351RX	Qty: 4	10mm IND hex HD	Interchange no.: 11505022
ABD6351B	Qty: 100		



Sheet Metal Screws Black 17mm Loose Washer Black GM

ABD6207	Qty: 10	Screw size: 4.2-1.41 x 20mm	Apps: GM
ABD6207RX	Qty: 4	7mm IND hex HD	Interchange no.: 11503892
ABD6207B	Qty: 100		



Sheet Metal Screws Black 17mm Loose Washer GM

ABD6303	Qty: 10	Screw size: 4.2-1.41 x 20mm	Apps: GM
ABD6303B	Qty: 100	7mm IND hex HD	Interchange no.: 11503892



Phillips Pozidrive Chrome GM

ABD6397	Qty: 10	Screw size: 4.2-1.41 x 12mm	Apps: GM
ABD6397B	Qty: 100	13/32 O.D. washer	Interchange no.: 11501794



License Plate Screw Black O.D. Washer Head Slotted

ABD6218	Qty: 10	Screw size: 1/4" (#14) x 3/4"	Apps: Black
ABD6218B	Qty: 100	3/8" IND hex	



License Plate Screw Black O.D. Washer Head Slotted

ABD6215	Qty: 10	Screw size: 1/4" (#14) x 5/8"	Apps: Black
ABD6215RX	Qty: 5	5/16" IND hex	
ABD6215B	Qty: 100		



License Plate Screw Zinc 1/2" Washer Head Slotted

ABD6336	Qty: 10	Screw size: 1/4" (#14) x 3/4"	Apps: Zinc
ABD6336RX	Qty: 5	3/8" IND hex	
ABD6336B	Qty: 100		



License Plate Screw Kit Black Nylon with Hex Nut

ABD6213	Qty: 10	Screw size: 6-1.00 x 20mm	Apps: Black nylon
ABD6213B	Qty: 100		



License Plate Screw Phillips Pan Wash Head Ford Contour 95-on

ABD6210	Qty: 10	Screw size: M5-0.8 x 12mm	Apps: Ford Contour
ABD6210RX	Qty: 5	1/2" (12.7mm)	
ABD6210B	Qty: 100		

TRIM SCREWS



License Plate Screw Phillips Zinc Head Washer 19mm Honda 90-on

ABD6212	Qty: 10	Screw size: M6-1.81 x 20mm	Apps: Honda
ABD6212B	Qty: 100	12mm (1/2") head	Interchange no.: 93904-46320



License Plate Screw Slotted Truss HD Bright Zinc

ABD6216	Qty: 10	Screw size: 1/4" (#14) x 3/4"	Apps: Bright zinc
ABD6216RX	Qty: 8	9/16 head	
ABD6216B	Qty: 100		



License Plate Screw Slotted Truss HD Bright Zinc GM

ABD6209	Qty: 10	Screw size: 10 x 5/8"	Apps: GM
ABD6209RX	Qty: 5	1/2" O.D. washer	Interchange nos.: 3783002
ABD6209B	Qty: 100		



License Plate Screw Slotted Truss Head Black

ABD6217	Qty: 10	Screw size: 1/4" (#14) x 3/4"	Apps: Black
ABD6217B	Qty: 100	9/16 head	



License Plate Screw Slotted Truss HD Black GM S&T Truck 98-on

ABD6211	Qty: 10	Screw size: #14 x 1-3/16"	Apps: GM S&T Truck
ABD6211RX	Qty: 2	9/16" head	Interchange no.: 16502342
ABD6211B	Qty: 100		



License Plate Screw Duo Drive Truss Head Dacromet 360 GM

ABD6214	Qty: 10	Screw size: M6.3 3-1.81 x	Apps: GM
ABD6214B	Qty: 100	16mm, 14mm head	



Dealer License Plate Thumb Screw

ABD6219	Qty: 10	Screw size: 1/4" (#14) x 1/2"	Apps:
ABD6219B	Qty: 100	1/2" length	Interchange no.:

BODY BOLTS



CA-type Bolts O.D. Loose Washer Black

ABD6372	Qty: 10	Screw size: 7/8"	Apps: Black
ABD6372B	Qty: 100	5/16-18 x 1"	
		1/2" IND hex head	



CA-type Bolts O.D. Loose Washer Black

ABD6373	Qty: 10	Screw size: 1"	Apps: Black
ABD6373B	Qty: 100	3/8" 16 x 1	
		9/16" IND hex head	



CA Body Bolt O.D. Loose Washer Black

ABD6374	Qty: 10	Screw size: 1-1/8"	Apps:
ABD6374RX	Qty: 1	3/8-16 x 1-1/2"	Interchange nos.:
ABD6374B	Qty: 100	9/16" IND hex head	



Metric-type CA Flange Bolt 13mm O.D. Washer Black GM

ABD6342	Qty: 10	Flange bolt: 13mm	Apps: GM
ABD6342RX	Qty: 5	Screw size: 6-1.00 x 20mm	Interchange no.: 11503800
ABD6342B	Qty: 100	10mm IND hex head	

RX indicates packaging suited for retail and merchandisers.

BODY BOLTS



Metric-type CA Body Bolt 16mm O.D. Washer Black GM

ABD6360	Qty: 10	Body bolt: 16mm	Apps: GM
ABD6360RX	Qty: 3	Screw size: 8-1.25 x 25mm	Interchange no.: 11500970
ABD6360B	Qty: 100	13mm IND hex head	



Metric-type CA Flange Bolt 17mm O.D. Washer Black GM

ABD6350	Qty: 10	Body bolt: 17mm	Apps: GM
ABD6350RX	Qty: 3	Screw size: 8-1.25 x 30mm	Interchange no.: 11500971
ABD6350B	Qty: 100	13mm IND hex head	



Metric-type CA Body Bolt 17mm O.D. Loose Washer Black GM

ABD6341	Qty: 10	Screw size:	Apps: GM
ABD6341RX	Qty: 3	6-1.00 x 20mm	Interchange no.: 11502941
ABD6341B	Qty: 100	10mm IND hex head	



Metric-type CA Body Bolt 17mm O.D. Loose Washer Black GM

ABD6345	Qty: 10	Screw size:	Apps: GM
ABD6345RX	Qty: 4	6-1.00 x 25mm	Interchange no.: 11503834
ABD6345B	Qty: 100	10mm IND hex head	



Metric-type CA Body Bolt 17mm O.D. Loose Washer Black GM

ABD6344	Qty: 10	Screw size:	Apps: GM
ABD6344RX	Qty: 3	6-1.00 x 35mm	Interchange no.: 11505044
ABD6344B	Qty: 100	10mm IND hex head	



Metric-type CA Body Bolt 24mm O.D. Loose Washer Black GM

ABD6343	Qty: 10	Screw size:	Apps: GM
ABD6343RX	Qty: 3	6-1.00 x 25mm	Interchange no.: 11503982
ABD6343B	Qty: 100	10mm IND hex head	



Metric-type CA Body Bolt 24mm O.D. Loose Washer Black GM

ABD6349	Qty: 10	Screw size:	Apps: GM
ABD6349RX	Qty: 2	8-1.25 x 25mm	Interchange no.: 11503619
ABD6349B	Qty: 100	13mm IND hex head	



Metric-type CA Body Bolt 24mm O.D. Loose Washer Black GM

ABD6353	Qty: 10	Screw size:	Apps: GM
ABD6353RX	Qty: 2	8-1.25 x 30mm	Interchange no.: 11501188
ABD6353B	Qty: 100	13mm IND hex head	



Metric-type CA Body Bolt 28mm O.D. Loose Washer Black GM

ABD6357	Qty: 10	Screw size:	Apps: GM
ABD6357RX	Qty: 1	10-1.50 x 40mm	Interchange nos: 11501193
ABD6357B	Qty: 100	15mm IND hex head	



Metric Dog Point Body Bolt 19mm O.D. Loose Washer Black Ford

ABD6337	Qty: 10	Screw size:	Apps: Ford
ABD6337RX	Qty: 4	6-1.00 x 22mm	Interchange no.: N606676-S2
ABD6337B	Qty: 100	8mm IND hex head	



Metric Dog Point Body Bolt 19mm O.D. Loose Washer Black Ford

ABD6338	Qty: 10	Screw size:	Apps: Ford
ABD6338RX	Qty: 4	6-1.00 x 28mm	Interchange no.: N606677-S
ABD6338B	Qty: 100	8mm IND hex head	



Metric Dog Point Body Bolt 19mm O.D. Loose Washer Zinc Finish Ford

ABD6375	Qty: 10	Screw size:	Apps: Ford
ABD6375RX	Qty: 3	6-1.00 x 28mm	Interchange nos.: N606677-S36
ABD6375B	Qty: 100	8mm IND hex head	

	Metric Body Bolt 13mm O.D. Washer Black GM	ABD6376 ABD6376B	Qty: 10 Qty: 100	Screw size: 6-1.00 x 20mm 10mm IND hex head	Apps: GM Interchange no.: 11504570
	Metric Dog Point Body Bolt 3/4" O.D. Loose Washer Ford	ABD6339 ABD6339RX ABD6339B	Qty: 10 Qty: 3 Qty: 100	Screw size: 1/4"-20 x 15/16" 7/16" IND hex head	Apps: Ford Interchange no.: 57030-S2
	Mirror Mounting Screw and Jack Nut Assembly GM	ABD6371 ABD6371B	Qty: 10 Qty: 100	Screw size: 1/4"-20 x 1"	Apps: GM Interchange no.: 367292
	Outside Mirror Mt. Bolt Chrome GM	ABD6370 ABD6370RX ABD6370B	Qty: 10 Qty: 1 Qty: 100	Screw size: 1/4"-20 x 1"	Apps: GM Interchange no.: 367291
	Bumper Bolt Round-style Head SS Capped	ABD6361 ABD6361RX ABD6361B	Qty: 10 Qty: 1 Qty: 100	Screw size: 5/16"-18 x 1" Head diameter: 3/4"	Apps: SS
	Bumper Bolt Round-style Head SS Capped	ABD6363 ABD6363RX ABD6363B	Qty: 10 Qty: 1 Qty: 100	Screw size: 3/8"-16 x 1-1/4" Head diameter: 7/8"	Apps: SS
	Bumper Bolt Round-style Head SS Capped	ABD6364 ABD6364RX ABD6364B	Qty: 10 Qty: 1 Qty: 100	Screw size: 7/16"-14 x 1-1/4" Head diameter: 29/32"	Apps: SS
	Bumper Bolt Round-style Head SS Capped	ABD6365 ABD6365RX ABD6365B	Qty: 10 Qty: 1 Qty: 100	Screw size: 1/2"-13 x 1-1/2" Head diameter: 1-3/32"	Apps: SS
	Bumper Bolt Pan-style Head SS Capped Chrysler	ABD6362 ABD6362RX ABD6362B	Qty: 10 Qty: 1 Qty: 100	Screw size: 3/8"-16 x 1" Head diameter: 7/8"	Apps: Chrysler Interchange no.: 6026723
	Bumper Bolt Pan-style Head SS Capped GM	ABD6366 ABD6366RX ABD6366B	Qty: 10 Qty: 1 Qty: 100	Screw size: 8-1.25 x 25mm Head diameter: 19mm	Apps: GM Interchange no.: 14003784

SPECIALTY NUTS & GROMMETS



Extruded Nut Bright Zinc Center of Hole to Edge 15/32"

ABD6259	Qty: 10	Screw size: 10-24	Apps: Bright zinc
ABD6259B	Qty: 100	Range: .025"/.125"	



Extruded U-nut Black Center of Hole to Edge 17/32" GM

ABD6367	Qty: 10	Screw size: 1/4"-20	Apps: GM
ABD6367RX	Qty: 3	Range: .010"-.165"	Interchange no.: 1494252
ABD6367B	Qty: 100		



Extruded U-nut Black Center of Hole to Edge 25/32" Ford

ABD6260	Qty: 10	Screw size: 1/4"-20	Apps: Ford
ABD6260RX	Qty: 3	Range: .010"-.165"	Interchange no.: 45267
ABD6260B	Qty: 100		



Extruded U-nut Black Center of Hole to Edge 27/32" GM

ABD6368	Qty: 10	Screw size: 5/16"-18	Apps: GM
ABD6368RX	Qty: 2	Range: .010"-.170"	Interchange no.: 1494258
ABD6368B	Qty: 100		



Extruded U-nut Black Center of Hole to Edge 3/4" Ford

ABD6369	Qty: 10	Screw size: 3/8"-16	Apps: Ford
ABD6369RX	Qty: 1	Range: .035"/.205"	Interchange no.: 1494254
ABD6369B	Qty: 100		



Extruded U-nut Black Center of Hole to Edge 1-1/8" Ford

ABD6261	Qty: 10	Screw size: 3/8"-16	Apps: Ford
ABD6261RX	Qty: 1	Range: .035"/.220"	Interchange no.: 45269
ABD6261B	Qty: 100		



Extruded U-nut Black Center of Hole to Edge 17/32" GM

ABD6346	Qty: 10	Screw size: 6-1.00mm	Apps: GM
ABD6346RX	Qty: 3	Range: .010"-.165"	Interchange no.: 11503957
ABD6346B	Qty: 100		



Extruded U-nut Black Center of Hole to Edge 25/32" GM

ABD6347	Qty: 10	Screw size: 6-1.00mm	Apps: GM
ABD6347RX	Qty: 3	Range: .010"-.165"	Interchange no.: 11503715
ABD6347B	Qty: 100		



Thread Cutting Nuts Zinc Finish 5/8" Flange

ABD6262	Qty: 10	Screw size: 6-3.10mm	Apps: GM
ABD6262B	Qty: 100	Range: .010"-.165"	Interchange no.: 11500658



Extruded U-nut Black Center of Hole to Edge 9/16" GM

ABD6354	Qty: 10	Screw size: 8-1.25mm	Apps: GM
ABD6354RX	Qty: 2	Range: .010"-.165"	Interchange no.: 11500660
ABD6354B	Qty: 100		



Extruded U-nut Black Center of Hole to Edge 13/16" GM

ABD6355	Qty: 10	Screw size: 8-1.25mm	Apps: GM
ABD6355RX	Qty: 2	Range: .010"-.175"	Interchange no.: 11500661
ABD6355B	Qty: 100		



Extruded U-nut Black Center of Hole to Edge 3/4" GM

ABD6358	Qty: 10	Screw size: 10-1.50mm	Apps: GM
ABD6358RX	Qty: 1	Range: .035"/.232"	Interchange no.: 11500662
ABD6358B	Qty: 100		

SPECIALTY NUTS & GROMMETS

	Wide Range U-nut Center of Hole to Edge Black 3/8"			
	ABD6245	Qty: 10	Screw size: 6	Apps: Black
	ABD6245B	Qty: 100	Range: .025"/.125"	Interchange no.:

	Wide Range U-nut Center of Hole to Edge Black 3/8" GM			
	ABD6254	Qty: 10	Screw size: 8	Apps: GM
	ABD6254RX	Qty: 7	Range: .020"/.150"	Interchange no.: 9424837
	ABD6254B	Qty: 100		

	Wide Range U-nut Center of Hole to Edge Black 5/8" GM			
	ABD6255	Qty: 10	Screw size: 8	Apps: GM
	ABD6255RX	Qty: 6	Range: .025"/.150"	Interchange no.: 9431535
	ABD6255B	Qty: 100		

	Wide Range U-nut Center of Hole to Edge Black 3/8" GM			
	ABD6256	Qty: 10	Screw size: 14	Apps: GM
	ABD6256RX	Qty: 6	Range: .025"/.150"	Interchange no.: 9431532
	ABD6256B	Qty: 100		

	U-type Speed Nut Ret. Center of Hole to Edge Black 9/16" GM			
	ABD6257	Qty: 10	Screw size: 1/4-20"	Apps: GM
	ABD6257B	Qty: 100	Range: .064"/.125"	Interchange no.: 9431647

	U-type Ret. Center of Hole to Edge 11mm Black Toyota			
	ABD6258	Qty: 10	Screw size: 10	Apps: Toyota
	ABD6258RX	Qty: 2	Range: Up to 11mm	Interchange nos.: 53879-14010A
	ABD6258B	Qty: 100		

	Metric Hex Flange Nut Black 11.8mm O.D. Washer GM			
	ABD6340	Qty: 10	Screw size:	Apps: GM
	ABD6340RX	Qty: 6	5-.80mm	Interchange no.: 11502722
	ABD6340B	Qty: 100	8mm hex size	

	Metric Hex Flange Nut Black 16mm O.D. Serrated Washer GM			
	ABD6247	Qty: 10	Screw size:	Apps: GM
	ABD6247RX	Qty: 6	1-1.00mm	Interchange no.:
	ABD6247B	Qty: 100	10mm hex size	

	Metric Hex Flange Nut Black 19mm O.D. Serrated Washer			
	ABD6246	Qty: 10	Screw size:	Apps:
	ABD6246RX	Qty: 5	8-1.25mm	Interchange nos:
	ABD6246B	Qty: 100	13mm hex size	

	Metric Hex Flange Nut Black 21mm O.D. Washer GM			
	ABD6359	Qty: 10	Screw size: 10-1.50mm	Apps: GM
	ABD6359RX	Qty: 4	15mm hex size	Interchange no.: 11501850
	ABD6359B	Qty: 100		

	Metric Hex Nut Black 16mm O.D. Loose Barbed Washer GM			
	ABD6348	Qty: 10	Screw size:	Apps: GM
	ABD6348RX	Qty: 4	6-1.00mm	Interchange no.: 11505329
	ABD6348B	Qty: 100	10mm hex size	

	Metric Hex Nut Black 19mm O.D. Loose Barbed Washer Chrysler			
	ABD6244	Qty: 10	Screw size:	Apps: Chrysler
	ABD6244RX	Qty: 3	6-1.00 mm	Interchange no.: 6100049
	ABD6244B	Qty: 100	10mm hex size	

RX indicates packaging suited for retail and merchandisers.

SPECIALTY NUTS & GROMMETS



Metric Hex Nut Black 24mm O.D. Loose Barbed Washer GM

ABD6356	Qty: 10	Screw size:	Apps: GM
ABD6356RX	Qty: 2	8-1.25mm	Interchange no.: 11503695
ABD6356B	Qty: 100	13mm hex size	



Hex Flange Nuts Bright Zinc 1/2" O.D. Serrated Washer

ABD6273	Qty: 10	Screw size:	Apps:
ABD6273B	Qty: 100	10-24	Interchange no.:



Thread Cutting Nuts Zinc Finish 17/32" Flange

ABD6263	Qty: 10	Screw size:	Apps: Zinc finish
ABD6263B	Qty: 100	1/8" stud 5/16" hex	Interchange no.:



Thread Cutting Nuts Zinc Finish 11/32" Flange

ABD6264	Qty: 10	Screw size:	Apps: Zinc finish
ABD6264B	Qty: 100	5/32" stud 11/32" hex	Interchange no.:



Thread Cutting Nuts Zinc Finish 1/2" Flange

ABD6265	Qty: 10	Screw size:	Apps: Zinc finish
ABD6265B	Qty: 100	3/16" stud 3/8" hex	Interchange no.:



Thread Cutting Nuts Zinc Finish 5/8" Flange

ABD6266	Qty: 10	Screw size:	Apps: Zinc finish
ABD6266RX	Qty: 7	3/16" stud	Interchange no.:
ABD6266B	Qty: 100	3/8" hex	



Thread Cutting Nuts Zinc Finish 19/32" Flange

ABD6267	Qty: 10	Screw size:	Apps: Zinc finish
ABD6267RX	Qty: 7	1/4" stud	Interchange no.:
ABD6267B	Qty: 100	7/16" hex	



Thread Cutting Nuts Zinc Finish 11/16" Flange

ABD6272	Qty: 10	Screw size:	Apps: Zinc finish
ABD6272RX	Qty: 8	1/4" stud	Interchange no.:
ABD6272B	Qty: 100	7/16" hex	



Thread Cutting Nuts Zinc Finish 7/8" Flange

ABD6268	Qty: 10	Screw size:	Apps: Zinc finish
ABD6268RX	Qty: 4	5/16" stud	Interchange no.:
ABD6268B	Qty: 100	1/2" hex	



Thread Cutting Nuts Black Finish 15mm Flange

ABD6269	Qty: 10	Screw size:	Apps: Zinc finish
ABD6269RX	Qty: 6	5mm stud	Interchange no.:
ABD6269B	Qty: 100	10mm hex	



Thread Cutting Nuts Zinc Finish 18mm Flange GM

ABD6271	Qty: 10	Screw size:	Apps: Zinc finish
ABD6271B	Qty: 100	8mm stud 13mm hex	Interchange no.: GM11502507















Thread Cutting Nuts Zinc Finish 20mm Flange GM

ABD6270	Qty: 10	Screw size:	Apps: Zinc finish
ABD6270RX	Qty: 6	6.3mm stud	Interchange no.: GM11501836
ABD6270B	Qty: 100	11mm hex	

RX indicates packaging suited for retail and merchandisers.

SPECIALTY NUTS & GROMMETS

	Push-on Type Ret. Zinc Finish ABD6274 ABD6274B	Qty: 10 Qty: 100	Screw size: 1/8" stud 3/8" flange O.D.	Apps: Zinc finish Interchange no.:
	Push-on Type Ret. Zinc Finish ABD6275 ABD6275B	Qty: 10 Qty: 100	Screw size: 5/32" stud 7/16" flange O.D.	Apps: Zinc finish Interchange no.:
	Push-on Type Ret. Zinc Finish ABD6276 ABD6276B	Qty: 10 Qty: 100	Screw size: 3/16" stud 7/16" flange O.D.	Apps: Zinc finish Interchange no.:
	Push-on Type Ret. Zinc Finish ABD6277 ABD6277B	Qty: 10 Qty: 100	Screw size: 1/4" stud 1/2" flange O.D.	Apps: Zinc finish Interchange no.:
	Push-on Type Ret. Zinc Finish ABD6278 ABD6278RX ABD6278B	Qty: 10 Qty: 10 Qty: 100	Screw size: 5/16" bolt 5/8" flange O.D.	Apps: Zinc finish Interchange no.:
	Push-on Type Ret. Black Finish GM ABD6279 ABD6279B	Qty: 10 Qty: 100	Screw size: 4mm stud 11mm flange O.D.	Apps: GM Interchange no.: 11501937
	Push-on Type Ret. Black Finish ABD6280 ABD6280RX ABD6280B	Qty: 10 Qty: 10 Qty: 100	Screw size: 1/2" stud 15/16" flange O.D.	Apps: Black finish Interchange no.:
	Push-on Type Ret. Zinc Finish GM ABD6281 ABD6281B	Qty: 10 Qty: 100	Screw size: 8-1.25mm bolt 16mm flange O.D.	Apps: GM Interchange no.: 11502504
	Push-on Type Bumper Strip Ret. Dacromet Finish GM ABD6282 ABD6282RX ABD6282B	Qty: 10 Qty: 10 Qty: 100	Screw size: 8-1.25mm bolt 24mm flange O.D.	Apps: GM Interchange no.: 10009923
	Push-on Type Bumper Ret. Dacromet Finish GM ABD6283 ABD6283RX ABD6283B	Qty: 10 Qty: 6 Qty: 100	Screw size: 10-1.50mm bolt 24mm flange O.D.	Apps: GM Interchange no.: 11501849
	Light Nuts Side Marker Natural Nylon Nissan ABD6221 ABD6221B	Qty: 10 Qty: 100	Screw size: #8 screw	Apps: Nissan Interchange no.: 96706-B0700
	Headlight Bezel Nuts Natural Nylon GM ABD6223 ABD6223RX ABD6223B	Qty: 10 Qty: 8 Qty: 100	Screw size: #6 to #8	Apps: GM Interchange no.: 380382

RX indicates packaging suited for retail and merchandisers.

SPECIALTY NUTS & GROMMETS



Headlight Bezel Nuts Natural Nylon GM

ABD6224 Qty: 10 Screw size: #6 Apps: GM
 ABD6224B Qty: 100 Interchange no.: 1370853



Headlight Bezel Nuts Natural Nylon GM/Universal

ABD6227 Qty: 10 Screw size: #8 or #10 Apps: GM/Universal
 ABD6227RX Qty: 8 Interchange no.: 14013246
 ABD6227B Qty: 100



Headlight Bezel and Grille Nuts Natural Nylon Toyota

ABD6230 Qty: 10 Screw size: #10 Apps: Toyota
 ABD6230B Qty: 100 8mm x 9mm head Interchange no.: 90189-05013



Grille Screw Nuts Natural Nylon Ford/Universal

ABD6220 Qty: 10 Screw size: #8 or #10 Apps: Ford/Universal
 ABD6220RX Qty: 10 Interchange no.: 379830S
 ABD6220B Qty: 100



Grille Screw Nuts Natural Nylon GM

ABD6225 Qty: 10 Screw size: #8 or #10 Apps: GM
 ABD6225B Qty: 100 Interchange no.: 3919773



Grille Screw Nuts Natural Nylon GM/Universal

ABD6226 Qty: 10 Screw size: #8 or #10 Apps: GM/Universal
 ABD6226RX Qty: 10 Interchange no.: 3893980
 ABD6226B Qty: 100



Grille and Side Marker Light Grommets Black Nylon Ford

ABD6234 Qty: 10 Screw size: Apps: Ford
 ABD6234B Qty: 100 10mm hole size Interchange no.: N807994-S



Screw Grommet Grille Attachment Natural Nylon GM

ABD6235 Qty: 10 Screw size: Apps: GM
 ABD6235B Qty: 100 #6 or #8 screw Interchange no.: 14032291



License Plate Nuts White Plastic GM

ABD6232 Qty: 10 Screw size: 1/4" or #14 Apps: GM
 ABD6232RX Qty: 8 Interchange no.: 4755299
 ABD6232B Qty: 100



Nylon License Plate Nuts GM

ABD6233 Qty: 10 Screw size: 1/4" or #14 Apps: GM
 ABD6233B Qty: 100 Interchange no.: 380370



Screw Grommets Natural Nylon Fits 8.5mm Square Hole Toyota

ABD6228 Qty: 10 Screw size: #10 Apps: Toyota
 ABD6228RX Qty: 3 Interchange no.: 90189-06010
 ABD6228B Qty: 100



Screw Grommets Black Nylon Fits 9mm Square Hole Toyota

ABD6229 Qty: 10 Screw size: #10 Apps: Toyota
 ABD6229B Qty: 100 Interchange no.: 90189-06018

SPECIALTY NUTS & GROMMETS



Screw Grommets Natural Nylon Fits 8.5mm x 8mm Hole Honda

ABD6231	Qty: 10	Screw size: #10	Apps: Honda
ABD6231B	Qty: 100		Interchange no.: 90662-671-0030



Screw Grommets Natural Nylon Fits 7mm Square Hole Honda

ABD6236	Qty: 10	Screw size:	Apps: Honda
ABD6236RX	Qty: 2	#6 screw/14mm head	Interchange no.: 90662-693-0030
ABD6236B	Qty: 100	10mm length	



Screw Grommets Natural Nylon Fits 7mm Square Hole Honda

ABD6237	Qty: 10	Screw size: #6 screw	Apps: Honda
ABD6237B	Qty: 100		Interchange no.: 90662-671-8110M1



Screw Grommets Natural Nylon Honda

ABD6238	Qty: 10	Screw size:	Apps: Honda
ABD6238RX	Qty: 5	#8 screw/16mm head	Interchange no.: 90661-SC7-0030
ABD6238B	Qty: 100	17mm length	



Screw Grommets Natural Nylon Toyota

ABD6239	Qty: 10	Screw size: #10 screw	Apps: Toyota
ABD6239RX	Qty: 4	18mm head	Interchange no.: 90189-06001
ABD6239B	Qty: 100	17mm length	

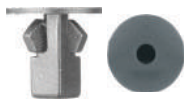

Screw Grommets Black Nylon Toyota

ABD6242	Qty: 10	Screw size: 1/4" (#14) screw	Apps: Toyota
ABD6242RX	Qty: 5	20mm head	Interchange no.: 90189-06013
ABD6242B	Qty: 100	17mm stem	



Screw Grommets Fender Liner Black Nylon Toyota

ABD6240	Qty: 10	Screw size:	Apps: Toyota
ABD6240B	Qty: 100	#12 screw 10mm square hole	Interchange no.: 90189-06028



Screw Grommets Fender Liner Black Nylon Toyota

ABD6241	Qty: 10	Screw size:	Apps: Toyota
ABD6241B	Qty: 100	#12 screw 8mm square hole	Interchange no.: 90189-06157



Barrel Nuts Black Ford

ABD6250	Qty: 10	Screw size:	Apps: Ford
ABD6250B	Qty: 100	1/8" stud 1/4" hole	Interchange no.: 375480-S100



Barrel Nuts Black Chrysler

ABD6251	Qty: 10	Screw size:	Apps: Chrysler
ABD6251B	Qty: 100	3/16" stud 7/32" hole	Interchange no.: 6000558



Barrel Nuts Black Ford

ABD6252	Qty: 10	Screw size:	Apps: Ford
ABD6252B	Qty: 100	1/4" stud 9/32" hole	Interchange no.: 354341-S



Rubber Well Nut for 1/2" Hole GM

ABD6249	Qty: 10	Screw size:	Apps: GM
ABD6249RX	Qty: 2	1/4"-20 thread	Interchange nos.: 528846
ABD6249B	Qty: 100	9/16" long	

DOOR HINGE PINS (APPLICATION BUSHINGS)



Door Hinge Pin Bushings GM Cars 80-98 in Kit ABDHP-1004

ABDHP0500	Qty: 10	MM: 38402	I.D.: 0.345	Apps: GM
ABDHP0500B	Qty: 100	AUV: 14553	O.D.: 0.489	Interchange no.: 20429500
			HT: 0.362	



Door Hinge Pin Bushings GM Cars 80-98 in Kit ABDHP-1006

ABDHP0501	Qty: 10	MM: 38404	I.D.: 0.345	Apps: GM
ABDHP0501B	Qty: 100	AUV: 14550	O.D.: 0.419	Interchange no.: 9721917
			HT: 0.295	



Door Hinge Pin Bushings Chrysler

ABDHP0502	Qty: 10	MM: 38406	I.D.: 0.269	Apps: Chrysler
ABDHP0502B	Qty: 100	AUV:	O.D.: 0.316	Interchange no.: 4033711
			HT: 0.356	



Door Hinge Pin Bushings GM C&K Series P/Us 99-05

ABDHP0503	Qty: 10	MM:	I.D.:	Apps: GM
ABDHP0503B	Qty: 100	AUV:	O.D.:	Interchange no.:
			HT:	



Door Hinge Pin Bushings GM Cars 75-80

ABDHP0504	Qty: 10	MM:	I.D.: 0.384	Apps: GM
ABDHP0504B	Qty: 100	AUV: 14548	O.D.: 0.501	Interchange no.: 9822198
			HT: 0.46	



Door Hinge Pin Bushings GM C&K Series Trucks 98-03

ABDHP0505	Qty: 10	MM: 38417	I.D.: 0.385	Apps: GM
ABDHP0505B	Qty: 100	AUV: 16937	O.D.: 0.53	Interchange no.: 15562609 (9164)
			HT: 0.365	



Door Hinge Pin Bushings Ford Mustang/Capri 79-98

ABDHP0506	Qty: 10	MM: 38396	I.D.: 0.348	Apps: Ford
ABDHP0506B	Qty: 100	AUV:	O.D.: 0.479	Interchange no.: D90Z-6522841A
			HT: 0.296	



Door Hinge Pin Bushings GM Cars 72-on

ABDHP0507	Qty: 10	MM:	I.D.: 0.346	Apps: GM
ABDHP0507B	Qty: 100	AUV: 14549	O.D.: 0.490	Interchange no.: 9716926
			HT: 0.375	



Door Hinge Pin Bushings GM C&K Series Trucks 98-03

ABDHP0508	Qty: 10	MM: 38418	I.D.: 0.345	Apps: GM
ABDHP0508B	Qty: 100	AUV: 16936	O.D.: 0.495	Interchange no.: 12338074
			HT: 0.365	



Door Hinge Pin Bushings GM C&K Series Trucks 98-03

ABDHP0509	Qty: 10	MM:	I.D.: 21/64	Apps: GM
ABDHP0509B	Qty: 100	AUV: 17976	O.D.: 9/16	Interchange no.: 15562610
			HT: 1/64	

DOOR HINGE PINS (APPLICATION KITS)

	Door Hinge Pin Bushings Kit GM C&K Series Truck 88-03 One-door	ABDHP1000 Qty: 10 MM: 38416	Apps:
		ABDHP1000B Qty: 100	Interchange no.:
	Door Hinge Pin Bushings Kit S-10 Blazer/Jimmy 82-94 One-door	ABDHP1001 Qty: 10 MM: 38407	Apps:
		ABDHP1001B Qty: 100	Interchange no.:
	Door Hinge Pin Bushings Kit GM Cars/Trucks 60-98 One-door	ABDHP1002 Qty: 10 MM: 38400	Apps:
		ABDHP1002B Qty: 100	Interchange no.:
	Door Hinge Pin Bushings Kit Ford F Series Trucks 80-98 One-door	ABDHP1003 Qty: 10 MM: 38410	Apps:
		ABDHP1003B Qty: 100	Interchange no.:
	Door Hinge Pin Bushings Kit GM Cars/Trucks 60-98 One-door	ABDHP1004 Qty: 10 MM: 38402	Apps:
		ABDHP1004B Qty: 100	Interchange no.:
	Door Hinge Pin Bushings Kit Ford Mustang/Capri 79-98 One-door	ABDHP1005 Qty: 10 MM: 38395	Apps:
		ABDHP1005B Qty: 100	Interchange no.:
	Door Hinge Pin Bushing Kit Dodge Vans 69-94 Side/Rear Door	ABDHP1006 Qty: 10 MM: 38404	Apps:
		ABDHP1006B Qty: 100	Interchange no.:
	Door Hinge Pin Bushing Kit Dodge D/W P/U/Ramcharger 84-97 One-door	ABDHP1007 Qty: 10 MM: 38386	Apps:
		ABDHP1007B Qty: 100	Interchange no.:
	Door Hinge Pin Bushing Kit Chrysler Cars/Minivans 84-92 One-door	ABDHP1008 Qty: 10 MM: 38388	Apps:
		ABDHP1008B Qty: 100	Interchange no.:
	Door Hinge Pin Bushing Kit GMC/C&K Series P/Us 99-05 One-door	ABDHP1009 Qty: 10 MM: 38437	Apps:
		ABDHP1009B Qty: 100 AUV: 20485	Interchange no.:
	Door Hinge Pin Bushing Kit GM S10/Jimmy Blazer 94-04 One-door	ABDHP1010 Qty: 10 MM: 38419	Apps:
		ABDHP1010B Qty: 100	Interchange no.:
	Door Hinge Pin Bushing Kit Jeep Grand Cherokee 94-98 One-door	ABDHP1011 Qty: 10 MM: 38422	Apps:
		ABDHP1011B Qty: 100	Interchange no.:
	Door Hinge Pin Bushing Kit Dodge Ram Trucks 94-03	ABDHP1012 Qty: 10 MM: 38423	Apps:
		ABDHP1012B Qty: 100	Interchange no.:

RX indicates packaging suited for retail and merchandisers.

RX indicates packaging suited for retail and merchandisers.

DOOR HINGE PINS (APPLICATION PINS)



Door Hinge Pin Long GM in Kit ABDHP-1009

ABDHP0600 Qty: 10
ABDHP0600B Qty: 100

Apps: GM
Interchange no.:



Door Hinge Pin Short GM in Kit ABDHP-1009

ABDHP0601 Qty: 10
ABDHP0601B Qty: 100

Apps: GM
Interchange no.:



Door Hinge Pins GM Compact Cars 78-95

ABDHP0602 Qty: 10 MM: 38407 Length: 4" Apps: GM
ABDHP0602B Qty: 100 AUV: 18193 HD O.D.: 7/16" Interchange no.: 20043351
Dia.: 11/32"



Door Hinge Pins GM Full-size Cars 72-93

ABDHP0603 Qty: 10 MM: 38401 Length: 4-1/16" Apps: GM
ABDHP0603B Qty: 100 AUV: 14559 HD O.D.: 9/16" Interchange no.: 6271989
Dia.: 11/32"



Door Hinge Pins GM S/T Trucks 94-on

ABDHP0604 Qty: 10 MM: Length: 4-1/8" Apps: GM
ABDHP0604B Qty: 100 AUV: 19781 HD O.D.: 1/2" Interchange no.: 15653790
Dia.: 11/32"



Door Hinge Pins Compact GM Trucks C&K 88-on

ABDHP0605 Qty: 10 MM: 38416 Length: 5-1/4" Apps: GM
ABDHP0605B Qty: 100 AUV: 19424 HD O.D.: 9/16" Interchange no.: 15591860
Dia.: 11/32"



Door Hinge Pins GM/Roller GM Light Trucks C&K 88-00

ABDHP0606 Qty: 10 MM: Length: 5-1/2" Apps: GM
ABDHP0606B Qty: 100 AUV: 19725 HD O.D.: 19/32" Interchange no.: 12540326
Dia.: 9/16"



Door Hinge Pins Ford Mustang/Tempo/Capri 79-93

ABDHP0607 Qty: 10 MM: 38395 Length: 3-3/18" Apps: Ford
ABDHP0607B Qty: 100 AUV: 19594 HD O.D.: 9/16" Interchange no.: D9ZZ-6643030-AA
Dia.: 11/32"



Door Hinge Pins Ford Trucks Ranger F-150, 250, 350 80-98

ABDHP0608 Qty: 10 MM: Length: 3-1/2" Apps: Ford
ABDHP0608B Qty: 100 AUV: 20346 HD O.D.: 9/16" Interchange no.: E8UZ1522840
Dia.: 11/32"



Door Hinge Pins Chrysler Dodge Van, Ramcharger, Trailduster 70-on

ABDHP0609 Qty: 10 MM: 38405 Length: 2-3/4" Apps:
ABDHP0609B Qty: 100 AUV: 14562 HD O.D.: 9/16" Interchange no.: 6028993
Dia.: 17/64"

DOOR LOCKS & HOOD PROP CLIPS



Hood Prop Clip GM Venture Van 97-on

ABDH1201 Qty: 10 Rod dia.: M8
 ABDH1201RX Qty: 1 Hole sq.: 5 x 14mm
 Car: 97-7639

Apps: GM
 Interchange no.: 10271128



Hood Prop Clip Toyota Camry 96-on

ABDH1202 Qty: 10 Rod dia.: 9mm
 ABDH1202RX Qty: 1 Hole sq.: 10mm
 AUV: 19529

Apps: Toyota
 Interchange no.: 53455-33010



Hood Prop Clip Saturn 97-on

ABDH1203 Qty: 10 Rod dia.: 5/16"
 ABDH1203RX Qty: 2 AUV: 19902

Apps: GM Saturn
 Interchange no.: 21097292



Hood Prop Clip Chrysler PT Cruiser 00-on/GM Cars/Trucks 90-on

ABDH1204 Qty: 10 Rod dia.: 7mm Car: 99-8115
 ABDH1204RX Qty: 1 Hole sq.: M10
 AUV: 23031

Apps: Chrysler/GM
 Interchange nos.: 50227550AB,
 15021761



Hood Prop Clip Ford Cars 75-83/E Vans 80-81

ABDH1205 Qty: 10 AUV: 17338
 ABDH1205RX Qty: 2 Car: 80-5163

Apps: Ford
 Interchange no.: D5ZZ-16828B



Hood Prop Clip Ford/Mercury Cars 75-on/E Vans 80-91/Escape 01-on

ABDH1206 Qty: 10 Rod dia.: 5/16"
 ABDH1206RX Qty: 2 AUV: 16954
 Car: 78-4740

Apps: Ford/Mercury
 Interchange no.: 386299S



Hood Prop Clip Ford 98-on

ABDH1207 Qty: 10 Rod dia.: 5/16"
 ABDH1207RX Qty: 2 AUV: 16992
 Car: 99-8072

Apps: Ford
 Interchange no.: E83Z-16828A



Hood Prop Clip Ford Contour, Mercury Mystique 95-on

ABDH1208 Qty: 10 Rod dia.: 6mm Car: 95-7371
 ABDH1208RX Qty: 1 Hole sq.: 7mm
 AUV: 18504

Apps: Ford/Mercury
 Interchange no.: W702380-S300



Hood Prop Clip Honda Accord 86-on

ABDH1209 Qty: 10 AUV: 16950

Apps: Honda
 Interchange no.: 90677-SE0-003



Hood Prop Clip Chrysler 81-on

ABDH1210 Qty: 10 Car: 80-5258
 ABDH1210RX Qty: 2

Apps: Chrysler
 Interchange no.: 4103276



Hood Prop Clip Ford Econoline 92-on

ABDH1211 Qty: 10 Car: 91-6984
 ABDH1211RX Qty: 1

Apps: Ford
 Interchange no.: F2UZ-16828A



Hood Prop Clip Ford Topaz/Tempo/Escort/Lynx 84-on

ABDH1212 Qty: 10 Rod dia.: 1/4"
 ABDH1212RX Qty: 2 Car: 84-5757

Apps: Ford
 Interchange no.: E1FZ-16828C

DOOR LOCKS & HOOD PROP CLIPS

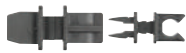

Hood Prop Clip Chrysler Minivans 97-on

ABDH1213RX

Qty: 1

Rod dia.: 5/16"
AUV: 20419

Apps: Chrysler

Interchange no.: J4007456



Door Lock Rod Clip Ford Products Left-hand Side

ABDH1214RX

Qty: 2

Rod size: 5/32"

Apps: Ford

Interchange no.: E6AZ-5421952A



Door and Tailgate Clip GM/Ford

ABDH1215RX

Qty: 2

Rod size: 10-24"

Apps: GM/Ford

Interchange no.:



Door Lock Rod Clip Ford Products

ABDH1216RX

Qty: 2

Apps: Ford

Interchange no.: F85Z-152195BB



Door Lock Rod Clip Ford Products

ABDH1217RX

Qty: 1

Apps: Ford

Interchange no.: E6DZ-5421952A



Door Lock Rod Clip GM/Ford Right-hand Side

ABDH1218RX

Qty: 2

Apps: GM

Interchange no.:



Door Lock Rod Clip Ford Right-hand Side

ABDH1219RX

Qty: 2

Rod size: 5/32"

Apps: Ford

Interchange no.:



Door Lock Rod Clip GM/Ford 72-on

ABDH1220RX

Qty: 2

Rod size: 5/32"
AUV: 14967

Apps: GM/Ford

Interchange nos.: D2VZ-6521952A,
9815325



Door Lock Rod Clip Chry Neon/Cirrus/Stratus/Jeep Cherokee Left-hand Side 95-on

ABDH1221RX

Qty: 2

Rod size: 1/8"
AUV: 19190

Apps: Chrysler

Interchange no.: 4658445



Door Lock Rod Clip GM/Chrysler Left-hand Side

ABDH1222RX

Qty: 2

Rod size: 5/32"

Apps: GM/Chrysler

Interchange no.:



Door Lock Rod Clip GM Cars Right-hand Side 92-on

ABDH1223RX

Qty: 2

Rod size: 5/32"
AUV: 18393

Apps: GM

Interchange no.: 20582533



Door Lock Clip GM Cars Right-hand Side

ABDH1224RX

Qty: 2

Apps: GM

Interchange no.:

DOOR LOCKS & HOOD PROP CLIPS



Door Lock Rod Clip GM Left/Right-hand Side

ABDH1225RX Qty: 2 Rod size: Oblong hole Apps: GM
Interchange no.:



Door Lock Rod Clip GM/Chrysler Right-hand Side

ABDH1226RX Qty: 2 Rod size: 5/32" Apps: GM/Chrysler
Interchange no.:



Door Lock Rod Clip GM Cars 92-on Left-hand Side

ABDH1227RX Qty: 2 Rod size: 5/32" Apps: GM
AUV: 18392 Interchange no.: 20582532



Door Handle Rod Clip GM Cars 91-on 6mm Hole Size

ABDH1228RX Qty: 2 Rod size: 5/32" Apps: GM
AUV: 19339 Interchange no.: 16609280



Door Handle Rod Clip Chrysler Products 72-on Left-hand Side

ABDH1229RX Qty: 2 Rod size: 5/32" Apps: Chrysler
AUV: 15674 Interchange no.: 4658677



Sliding Door Lock Rod Clip Chrysler Van 77-on Left-hand Side

ABDH1230RX Qty: 2 Rod size: 5/32" Apps: Chrysler
AUV: 20307 Interchange no.:



Door Lock Rod Clip Chrysler Products Left-hand Side

ABDH1231RX Qty: 2 Rod size: 5/32" Apps: Chrysler
Interchange no.:



Door Lock Rod Chrysler Neon/Cirrus/Stratus/Jeep Cherokee 95-on Right-hand Side

ABDH1232RX Qty: 2 Rod size: 1/8" Apps: Chrysler
AUV: 19191 Interchange no.: 4658444



Door Lock Rod Clip Chrysler Right-hand Side

ABDH1233RX Qty: 2 Rod size: 5/32" Apps: Chrysler
Interchange no.:



Door Lock Rod Clip Chrysler Right-hand Side

ABDH1234RX Qty: 2 Rod size: 5/32" Apps: Chrysler
Interchange no.:



Door Lock Rod Clip Chrysler 72-on Right-hand Side

ABDH1235RX Qty: 2 Rod size: 5/32" Apps: Chrysler
AUV: 15673 Interchange no.: 4658676



Blind Rivets Black Nylon GM

ABD6501	Qty: 10	Hole: 13/64" (5mm)	Apps: GM
ABD6501RX	Qty: 3	Panel/grip range: 1/16"-11/64"	Interchange no.: 20423647
ABD6501B	Qty: 100	Flange size: 15/32"	



Blind Rivets Black Nylon Chrysler

ABD6502	Qty: 10	Hole: 3/16" (5mm)	Apps: Chrysler
ABD6502B	Qty: 100	Panel/grip range: 5/32"-1/4"	Interchange no.: 6502689
		Flange size: 11/32"	



Blind Rivets Black Nylon GM

ABD6503	Qty: 10	Hole: 3/16" (5mm)	Apps: GM
ABD6503RX	Qty: 4	Panel/grip range: 1/8"-15/64"	Interchange no.: 20432975
ABD6503B	Qty: 100	Flange size: 15/32"	



Blind Rivets Black Nylon Chrysler

ABD6504	Qty: 10	Hole: 3/16" (5mm)	Apps: Chrysler
ABD6504RX	Qty: 4	Panel/grip range: 15/64"-25/64"	Interchange no.: 6500898
ABD6504B	Qty: 100	Flange size: 15/32"	



Blind Rivets Black Nylon GM

ABD6505	Qty: 10	Hole: 15/64"	Apps: GM
ABD6505B	Qty: 100	Panel/grip range: 5/32"-15/16"	Interchange no.: 10036503
		Flange size: 5/8"	



Blind Rivets Black Nylon GM

ABD6506	Qty: 10	Hole: 15/64"	Apps: GM
ABD6506B	Qty: 100	Panel/grip range: 11/64"-11/32"	Interchange no.: 25524005
		Flange size: 1/2"	



Blind Rivets Black Nylon GM

ABD6507	Qty: 10	Hole: 1/4" (6.3mm)	Apps: GM
ABD6507RX	Qty: 3	Panel/grip range: 3/32"-3/16"	Interchange no.: 20421672
ABD6507B	Qty: 100	Flange size: 1/2"	



Blind Rivets Black Nylon GM

ABD6508	Qty: 10	Hole: 1/4" (6.3mm)	Apps: GM
ABD6508RX	Qty: 3	Panel/grip range: 5/32"-13/32"	Interchange no.: 20452072
ABD6508B	Qty: 100	Flange size: 1/2"	



Blind Rivets Black Nylon GM

ABD6509	Qty: 10	Hole: 17/64" (6.6mm)	Apps: GM
ABD6509RX	Qty: 3	Panel/grip range: 3/32"-3/16"	Interchange no.: 20433026
ABD6509B	Qty: 100	Flange size: 45/64"	



Blind Rivets Black Nylon GM

ABD6510	Qty: 10	Hole: 1/4" (6.3mm)	Apps: GM
ABD6510RX	Qty: 5	Panel/grip range: 5/32"-13/32"	Interchange no.: 14063981
ABD6510B	Qty: 100	Flange size: 43/64"	















Blind Rivets Black Nylon Ford

ABD6511	Qty: 10	Hole: 1/4" (6.3mm)	Apps: Ford
ABD6511RX	Qty: 2	Panel/grip range: 5/16"-15/32"	Interchange no.: N8044675S
ABD6511B	Qty: 100	Flange size: 43/64"	



Blind Rivets Black Nylon Ford

ABD6512	Qty: 10	Hole: 5/32" (4mm)	Apps: Ford
ABD6512B	Qty: 100	Panel/grip range: 1/4"-13/32"	Interchange no.: N8045835
		Flange size: Square hole	

	All Aluminum Rivets ABD6513 ABD6513RX ABD6513B	Qty: 10 Qty: 10 Qty: 100	Hole: 1/8" Panel/grip range: 3/16"-1/4" Flange size: 1/4"	Apps: Interchange no.: IND. #44
	All Aluminum Rivets ABD6514 ABD6514RX ABD6514B	Qty: 10 Qty: 7 Qty: 100	Hole: 3/16" Panel/grip range: 1/4"-3/8" Flange size: 3/8"	Apps: Interchange no.: IND. #66
	All Aluminum Rivets ABD6515 ABD6515RX ABD6515B	Qty: 10 Qty: 6 Qty: 100	Hole: 3/16" Panel/grip range: 1/4"-3/8" Flange size: 5/8"	Apps: Interchange no.: IND. #66L
	SS Rivet Mandrel Moulding Ford ABD6516 ABD6516B	Qty: 10 Qty: 100	Hole: 1/8" Panel/grip range: 3/16"-1/4" Flange size: 3/16"	Apps: Ford Interchange no.: 38229S
	All Aluminum Black Closed End Pop Rivet Luggage Rack Ford ABD6517 ABD6517B	Qty: 10 Qty: 100	Hole: 1/8" Panel/grip range: 3/16"-1/4" Flange size: 7/32"	Apps: Ford Interchange no.: N803933-S101
	Aluminum Rivet Steel Mandrel Windshield Rail Black Ford ABD6518 ABD6518B	Qty: 10 Qty: 100	Hole: 15/64" Panel/grip range: 1/16"-1/8" Flange size: 3/8"	Apps: Ford Interchange no.: N805759-S100
	Aluminum Rivet Steel Mandrel Wheel Opening VW ABD6519 ABD6519B	Qty: 10 Qty: 100	Hole: 5/32" Panel/grip range: 1/4"-3/8" Flange size: 15/32"	Apps: VW Interchange no.: N900-845-01
	All Steel GM Outside Door Handle Black GM ABD6520 ABD6520B	Qty: 10 Qty: 100	Hole: 3/16" Panel/grip range: 1/16"-17/64" Flange size: 3/8"	Apps: GM Interchange no.: 22641917
	Aluminum Split-type Rivet Black Ford ABD6521 ABD6521RX ABD6521B	Qty: 10 Qty: 2 Qty: 100	Hole: 3/16" Panel/grip range: 5/64"-15/64" Flange size: 7/16"	Apps: Ford Interchange no.: N805592-S100
	Aluminum Split-type Rivet Moulding Attachment Black GM ABD6522 ABD6522B	Qty: 10 Qty: 100	Hole: 3/16" Panel/grip range: 3/64"-11/32" Flange size: 3/8"	Apps: GM Interchange no.: 10125439
	Aluminum Closed End Pop Rivet Black Ford ABD6523 ABD6523B	Qty: 10 Qty: 100	Hole: 3/16" Panel/grip range: 3/8"-1/2" Flange size: 3/8"	Apps: Ford Interchange no.: 390428-S100
	Aluminum Grille/Fascia Rivet Black Ford ABD6524 ABD6524RX ABD6524B	Qty: 10 Qty: 4 Qty: 100	Hole: 3/16" Panel/grip range: 3/8"-1/2" Flange size: 9/16"	Apps: Ford Interchange no.: 388664-S100

RX indicates packaging suited for retail and merchandisers.



Aluminum Pop Rivet Grille and Bumper Ford

ABD6525	Qty: 10	Hole: 3/16"	Apps: Ford
ABD6525B	Qty: 100	Panel/grip range: 11/16"-13/16"	Interchange no.: N807168-S
		Flange size: 3/4"	



All Steel Bright Zinc Headlight Ret. Rivet GM

ABD6526	Qty: 10	Hole: 1/4"	Apps: GM
ABD6526B	Qty: 100	Panel/grip range: 3/64"-5/64"	Interchange no.: 15022087
		Flange size: 19/32"	



Aluminum Rivet Steel Mandrel Window Reg. Peel Rivet GM

ABD6527	Qty: 10	Hole: 1/4"	Apps: GM
ABD6527RX	Qty: 2	Panel/grip range: 9/64"-3/16"	Interchange no.: 9437486
ABD6527B	Qty: 100	Flange size: 1/2"	



All Steel Zinc and Gold Chrome Front Bumper Assembly Rivet Ford

ABD6528	Qty: 10	Hole size: 1/4"	Apps: Ford
ABD6528B	Qty: 100	Head diameter: 1/8"-1/4"	Interchange no.: 372820-S36
		Stem length: 1/2"	



Aluminum Rivet Mandrel Outside Door Handle Black Ford

ABD6529	Qty: 10	Hole: 1/4"	Apps: Ford
ABD6529RX	Qty: 3	Panel/grip range: 3/32"-1/8"	Interchange no.: 388047-S102
ABD6529B	Qty: 100	Flange size: 1/2"	



Aluminum Rivet Steel Mandrel Outside Door Handle Black Ford

ABD6530	Qty: 10	Hole: 1/4"	Apps: Ford
ABD6530RX	Qty: 2	Panel/grip range: 1/32"-7/32"	Interchange no.: 388047-S100
ABD6530B	Qty: 100	Flange size: 1/2"	



Aluminum Steel Door Handle Rivet Black Ford

ABD6531	Qty: 10	Hole: 1/4"	Apps: Ford
ABD6531B	Qty: 100	Panel/grip range: 1/32"-7/32"	Interchange no.: W525172-S417
		Flange size: 1/2"	



All Steel Bumper Assembly Rivet Black Ford

ABD6532	Qty: 10	Hole: 1/4"	Apps: Ford
ABD6532RX	Qty: 2	Panel/grip range: 1/8"-1/4"	Interchange no.: 388442-S100
ABD6532B	Qty: 100	Flange size: 3/4"	



Aluminum Rivet Steel Mandrel Window Reg. Peel Rivet GM

ABD6533	Qty: 10	Hole: 1/4"	Apps: GM
ABD6533RX	Qty: 4	Panel/grip range: 1/32"-9/64"	Interchange no.: 9436175
ABD6533B	Qty: 100	Flange size: 1/2"	



Aluminum Split-type Rivet Bumper Cover and UNV Black Ford

ABD6534	Qty: 10	Hole: 1/4"	Apps: Ford
ABD6534RX	Qty: 2	Panel/grip range: 3/16"-3/8"	Interchange no.: N806860-S100
ABD6534B	Qty: 100	Flange size: 11/16"	















Aluminum Rivet Steel Mandrel Glass Stop Peel Rivet GM

ABD6535	Qty: 10	Hole: 1/4"	Apps: GM
ABD6535RX	Qty: 3	Panel/grip range: 33/64"-19/32"	Interchange no.: 9437938
ABD6535B	Qty: 100	Flange size: 1/2"	



Aluminum Steel Door Glass Peel Rivet Ford

ABD6536	Qty: 10	Hole: 1/4"	Apps: Ford
ABD6536B	Qty: 100	Panel/grip range: 25/64"-21/32"	Interchange no.: W525175S
		Flange size: 5/8"	

	Reveal Moulding Clip Rear Window GM ABD6601 Qty: 10 ABD6601B Qty: 100	Apps: GM Interchange no.: 4523699
	Reveal Moulding Clip Rear Window GM ABD6602 Qty: 10 ABD6602RX Qty: 2 ABD6602B Qty: 100	Apps: GM Interchange no.: 9808241
	Reveal Moulding Clip Rear Window GM ABD6603 Qty: 10 ABD6603RX Qty: 3 ABD6603B Qty: 100	Apps: GM Interchange no.: 8717859
	Reveal Moulding Clip Windshield and Rear Window GM ABD6604 Qty: 10 ABD6604RX Qty: 3 ABD6604B Qty: 100	Apps: GM Interchange no.: 20603072
	Reveal Moulding Clip Windshield Upper/Lower GM ABD6605 Qty: 10 ABD6605B Qty: 100	Apps: GM Interchange no.: 7698976
	Reveal Moulding Clip Windshield GM ABD6606 Qty: 10 ABD6606B Qty: 100	Apps: GM Interchange no.: 9895598
	Reveal Moulding Clip Windshield, Skylight Quart and Rear Windshield GM ABD6607 Qty: 10 ABD6607B Qty: 100	Apps: GM Interchange no.: 7730788
	Reveal Moulding Clip Rear Window GM ABD6608 Qty: 10 ABD6608B Qty: 100	Apps: GM Interchange no.: 1654047
	Reveal Moulding Clip Windshield and Backlite Ford ABD6609 Qty: 10 ABD6609RX Qty: 2 ABD6609B Qty: 100	Apps: GM Interchange no.: E3SB6342413AB
	Reveal Moulding Clip Windshield and Rear Window GM ABD6610 Qty: 10 ABD6610B Qty: 100	Apps: GM Interchange no.: 7693140
	Reveal Moulding Windshield to Panel GM ABD6611 Qty: 10 ABD6611B Qty: 100	Apps: GM Interchange no.: 9731301
	Reveal Moulding Clip Rear Window Ford ABD6612 Qty: 10 ABD6612B Qty: 100	Apps: Ford Interchange no.: C6AB-6242413-A

WINDSHIELD PARTS



Reveal Moulding Clip Windshield and Rear Window Ford

ABD6613 Qty: 10
 ABD6613RX Qty: 3
 ABD6613B Qty: 100

Apps: Ford
 Interchange no.: C5ZZ-6543413-B



Windshield Washer Hose Retainer Honda

ABD6614 Qty: 10 Hole size: 9/32" (7mm)
 ABD6614RX Qty: 3 Hose I.D.: 7/64" (3mm)
 ABD6614B Qty: 100 Hose O.D.: 13/64" (5mm)

Apps: Honda
 Interchange no.: 90652-SB2-023



Reveal Moulding Clip Windshield and Backlite Chrysler

ABD6615 Qty: 10
 ABD6615RX Qty: 1
 ABD6615B Qty: 100

Apps: Chrysler
 Interchange no.: 6003752



Hose Clips Windshield Washer Honda

ABD6616 Qty: 10
 ABD6616RX Qty: 1
 ABD6616B Qty: 100

Apps: Honda
 Interchange no.: 91512-SE0-003

HEADLIGHT PARTS



Headlight Adjusting Screw GM 73-96

ABD6701 Qty: 10 Size: 1/4-28 x 2"
 ABD6701RX Qty: 2 Dorman/MM: #42161
 ABD6701B Qty: 100

Apps: GM
 Interchange no.: 343543



Headlight Adjusting Screw GM Blue Nylon Nut

ABD6702 Qty: 10 Size: 1/4-28 x 2"
 ABD6702RX Qty: 2
 ABD6702B Qty: 100

Apps: GM
 Interchange no.: 556196



Headlight Adjusting Screw GM Green Nylon Nut

ABD6703 Qty: 10 Size: 1/4-28 x 2"
 ABD6703RX Qty: 2
 ABD6703B Qty: 100

Apps: GM
 Interchange no.: 365270

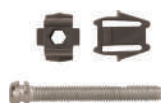

Headlight Adjusting Screw Chrysler White Nylon Nut

ABD6704 Qty: 10 Size: 1/4-28 x 2"
 ABD6704RX Qty: 6
 ABD6704B Qty: 100

Apps: Chrysler
 Interchange no.: 3574085



Headlight Adjusting Screw GM Pink Nylon Nut

ABD6705 Qty: 10 Size: 1/4-28 x 2"
 ABD6705RX Qty: 2
 ABD6705B Qty: 100

Apps: GM
 Interchange no.: 1606642



Headlight Panel Retainers GM

ABD6706 Qty: 10 Size: #8 screw
 ABD6706RX Qty: 4
 ABD6706B Qty: 100

Apps: GM
 Interchange no.: 25501771









Headlight Component Retaining Clips Ford

ABD6707 Qty: 10
 ABD6707RX Qty: 2
 ABD6707 Qty: 100

Apps: Ford
 Interchange no.: E9DB-13N0200AA

RX indicates packaging suited for retail and merchandisers.

HEADLIGHT PARTS

	Rear Light Assembly Retainers Ford	ABD6708 ABD6708RX ABD6708B	Qty: 10 Qty: 2 Qty: 100	Size: #8 screw	Apps: Ford Interchange no.: N806624-S191
	Headlight Adjusting Screw GM Trucks 75-05	ABD6709 ABD6709RX ABD6709B	Qty: 10 Qty: 2 Qty: 100	Size: 1/4-28 x 2" Dorman/MM: #42119	Apps: GM Interchange no.:
	Headlight Adjusting Screw Chrysler Products 78-94	ABD6710 ABD6710RX ABD6710B	Qty: 10 Qty: 2 Qty: 100	Size: 1/4-28 x 2" Dorman/MM: #42188	Apps: Chrysler Interchange no.:
	Headlight Bulb Ret. 9004 Bulb Ford 85-on	ABD6711 ABD6711B	Qty: 10 Qty: 100	Dorman/MM: #42412	Apps: Ford Interchange no.:
	Headlight Bulb Ret. 9004 Bulb Ford/Toyota 86-on	ABD6712 ABD6712RX ABD6712B	Qty: 10 Qty: 1 Qty: 100	Dorman/MM: #42413	Apps: Ford/Toyota Interchange no.:
	Headlight Bulb Ret. 9004/9007 Bulb GM 86-05	ABD6713 ABD6713RX ABD6713B	Qty: 10 Qty: 1 Qty: 100	Dorman/MM: #42415	Apps: GM Interchange no.:
	Headlight Bulb Ret. 9004 Bulb Chrysler 87-on/Ford 82-on	ABD6714 ABD6714B	Qty: 10 Qty: 100	Dorman/MM: #42420	Apps: Chrysler/Ford Interchange no.:

MISCELLANEOUS PARTS

	Vinyl Top Moulding Clip White GM	ABD6903 ABD6903RX ABD6903B	Qty: 10 Qty: 2 Qty: 100		Apps: GM Interchange no.: 1688094
	Quarter Panel and Reveal Moulding Clip GM	ABD6904 ABD6904RX ABD6904B	Qty: 10 Qty: 4 Qty: 100		Apps: GM Interchange no.: 7731589
	Door, Quarter Panel and Rear End Moulding Clip White GM	ABD6905 ABD6905RX ABD6905B	Qty: 10 Qty: 4 Qty: 100		Apps: GM Interchange no.: 8799350
	Quarter Belt Reveal Moulding Clip GM	ABD6906 ABD6906RX ABD6906B	Qty: 10 Qty: 4 Qty: 100	Size: 7/16" wide Size: 31/32" long	Apps: GM Interchange no.: 20199675
	Body Side Moulding Clip Gray GM	ABD6907 ABD6907RX ABD6907B	Qty: 10 Qty: 4 Qty: 100		Apps: GM Interchange no.: 9838109

RX indicates packaging suited for retail and merchandisers.

MISCELLANEOUS PARTS



Quarter Belt Reveal Moulding Clip White GM

ABD6908 Qty: 10
 ABD6908RX Qty: 4
 ABD6908B Qty: 100

Apps: GM
 Interchange no.: 20175051



Rocker Panel Moulding Clip White GM

ABD6909 Qty: 10 Hole size: 7/16"
 ABD6909RX Qty: 2 Stem size: 9/16"
 ABD6909B Qty: 100

Apps: GM
 Interchange no.: 10443956



Rocker Panel Ground Effects Moulding Black Ford

ABD6910 Qty: 10
 ABD6910RX Qty: 2
 ABD6910B Qty: 100

Apps: Ford
 Interchange no.: F1TZ-7810182A

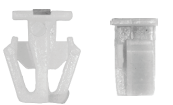

Body Side Moulding Clip White Honda

ABD6911 Qty: 10
 ABD6911RX Qty: 2
 ABD6911B Qty: 100

Apps: Honda
 Interchange no.: 91534-SE0-000



Rocker Panel Moulding Clip Green GM

ABD6912 Qty: 10 Hole size: 3/4"
 ABD6912RX Qty: 2 Stem size: 9/16"
 ABD6912B Qty: 100

Apps: GM
 Interchange no.: 10423553



Rocker Panel Moulding Clip Green Acura

ABD6913 Qty: 10
 ABD6913B Qty: 100

Apps: Acura
 Interchange no.: 91501-SG0-003



Belt Moulding Clip White Honda

ABD6914 Qty: 10
 ABD6914RX Qty: 1
 ABD6914B Qty: 100

Apps: Honda
 Interchange no.: 91510-SR3-003



Belt Moulding Clip White Honda

ABD6915 Qty: 10
 ABD6915RX Qty: 1
 ABD6915B Qty: 100

Apps: Honda
 Interchange no.: 91527-SM4-003



Universal Wire-type Moulding Fastener

ABD6916 Qty: 10 Size: 5/16" to 1/2"
 ABD6916B Qty: 100

Apps:
 Interchange no.:



Fender Moulding Clip Red Toyota

ABD6917 Qty: 10 Head size: 17mm
 ABD6917RX Qty: 2 Stem size: 13mm
 ABD6917B Qty: 100

Apps: Toyota
 Interchange no.: 90904-67037



Front/Rear Door Universal Moulding Clip GM

ABD6918 Qty: 10
 ABD6918B Qty: 100

Apps: GM
 Interchange no.: 4759145



Plate Size Universal Moulding Clip Chrysler

ABD6919 Qty: 10 Size: 10-24 x 3/4"
 ABD6919RX Qty: 1 Size: 11/32" x 23/32"
 ABD6919B Qty: 100

Apps: Chrysler
 Interchange no.: 1624705

MISCELLANEOUS PARTS

	Plate Size Universal Moulding Clip Chrysler	ABD6920 ABD6920RX ABD6920B	Qty: 10 Qty: 1 Qty: 100	Size: 10-24 x 3/4" Size: 1/2" x 1-25/64"	Apps: Chrysler Interchange no.: 6000705
	Plate Size Universal Moulding Clip Ford	ABD6921 ABD6921B	Qty: 10 Qty: 100	Size: 10-24 x 3/4" Size: 1/2" x 1-1/16"	Apps: Ford Interchange no.: 6358560
	Moulding Clip GM	ABD6922 ABD6922RX ABD6922B	Qty: 10 Qty: 2 Qty: 100	Size: 10-24 x 1/2" Size: 9/16" x 1-13/16"	Apps: GM Interchange no.: 3744999
	Flush-type Nylon Locking Hole Plugs Black	ABD6923 ABD6923B	Qty: 10 Qty: 100	Hole size: 3/16" Head size: 1/4"	Apps: Interchange no.:
	Flush-type Nylon Locking Hole Plugs Black	ABD6924 ABD6924B	Qty: 10 Qty: 100	Hole size: 1/4" Head size: 5/16"	Apps: Interchange no.:
	Flush-type Nylon Locking Hole Plugs Black	ABD6925 ABD6925B	Qty: 10 Qty: 100	Hole size: 3/8" Head size: 15/32"	Apps: Interchange no.:
	Flush-type Nylon Locking Hole Plugs Black	ABD6926 ABD6926B	Qty: 10 Qty: 100	Hole size: 1/4" Head diameter: 37/64"	Apps: Interchange no.:
	Flush-type Nylon Locking Hole Plugs Black	ABD6927 ABD6927B	Qty: 10 Qty: 100	Hole size: 3/4" Head diameter: 59/64"	Apps: Interchange no.:
	Flush-type Plastic Hole Plugs Black	ABD6928 ABD6528B	Qty: 10 Qty: 100	Hole size: 1/4" Head size: 1/2"	Apps: Interchange no.:
	Flush-type Plastic Hole Plugs Black	ABD6929 ABD6929RX ABD6929B	Qty: 10 Qty: 8 Qty: 100	Hole size: 3/8" Head size: 3/4"	Apps: Interchange no.:
	Flush-type Plastic Locking Hole Plugs Black	ABD6930 ABD6930RX ABD6930B	Qty: 10 Qty: 8 Qty: 100	Hole size: 1/2" Head size: 7/8"	Apps: Interchange no.:
	Flush-type Plastic Hole Plugs Black	ABD6931 ABD6931RX ABD6931B	Qty: 10 Qty: 8 Qty: 100	Hole size: 3/4" Head size: 1"	Apps: Interchange no.:

RX indicates packaging suited for retail and merchandisers.

MISCELLANEOUS PARTS



Flush-type Plastic Hole Plugs Black

ABD6932 Qty: 10 Hole size: 1/4"
 ABD6932B Qty: 100 Head size: 1/2"

Apps:
 Interchange no.:



Flush-type Plastic Hole Plugs Black

ABD6933 Qty: 10 Hole size: 3/8"
 ABD6933B Qty: 100 Head size: 3/4"

Apps:
 Interchange no.:



Flush-type Plastic Hole Plugs Black

ABD6934 Qty: 10 Hole size: 1/2"
 ABD6934B Qty: 100 Head size: 7/8"

Apps:
 Interchange no.:



Flush-type Plastic Hole Plugs Black

ABD6935 Qty: 10 Hole size: 3/4"
 ABD6935B Qty: 100 Head size: 1"

Apps:
 Interchange no.:



Steel Body Shims Bright Zinc 1-1/4" x 1-1/8"

ABD6936 Qty: 10 Size: 1/16" thick
 ABD6936B Qty: 100 Size: 3/8" slot

Apps:
 Interchange no.:



Steel Body Shims Bright Zinc 1-1/4" x 1-3/4"

ABD6937 Qty: 10 Size: 1/16" thick
 ABD6937RX Qty: 4 Size: 1/2" slot
 ABD6937B Qty: 100

Apps:
 Interchange no.:



Steel Body Shims Bright Zinc 1-1/4" x 1-1/8"

ABD6938 Qty: 10 Size: 1/8" thick
 ABD6938RX Qty: 4 Size: 3/8" slot
 ABD6938B Qty: 100

Apps:
 Interchange no.:



Steel Body Shims Bright Zinc 1-1/4" x 1-3/4"

ABD6939 Qty: 10 Size: 1/8" thick
 ABD6939RX Qty: 4 Size: 1/2" slot
 ABD6939B Qty: 100

Apps:
 Interchange no.:



Steel Body Shims Bright Zinc 2" x 1-1/2"

ABD6940 Qty: 10 Size: 1/18" thick
 ABD6940RX Qty: 2 Size: 3/4" slot
 ABD6940B Qty: 100

Apps:
 Interchange no.:



Chrome Plug Button

ABD6941 Qty: 10 Size: 3/8"
 ABD6941B Qty: 100

Apps:
 Interchange no.:



Chrome Plug Button

ABD6942 Qty: 10 Size: 1/2"
 ABD6942B Qty: 100

Apps:
 Interchange no.:



Chrome Plug Button

ABD6943 Qty: 10 Size: 5/8"
 ABD6943B Qty: 100

Apps:
 Interchange no.:

MISCELLANEOUS PARTS

	Chrome Plug Button ABD6944 Qty: 10 ABD6944B Qty: 100	Size: 3/4"	Apps: Interchange no.:
	Chrome Plug Button ABD6945 Qty: 10 ABD6945B Qty: 100	Size: 1" MM/Dorman: #700-234	Apps: Interchange no.:
	Rubber Bumpers GM ABD6946 Qty: 10 ABD6946RX Qty: 2 ABD6946B Qty: 100	Length: 5/8" Diam.: 1/2"	Apps: GM Interchange no.: 4081765
	Rubber Bumpers GM ABD6947 Qty: 10 ABD6947RX Qty: 2 ABD6947B Qty: 100	Length: 1/2" Diam.: 3/4"	Apps: GM Interchange no.: 4137121
	Rubber Bumpers GM ABD6948 Qty: 10 ABD6948RX Qty: 1 ABD6948B Qty: 100		Apps: Interchange no.:
	Hood Bumpers Ford ABD6949 Qty: 10 ABD6949B Qty: 100		Apps: Interchange no.:
	Hood Bumpers Chrysler 81-on ABD6950 Qty: 10 ABD6950RX Qty: 1 ABD6950B Qty: 100	Length: 2-3/16" Diam.: 23/32"	Apps: Chrysler Interchange no.: 4103165
	Hood Bumpers Chrysler Minivans 02-on ABD6951 Qty: 10 ABD6951B Qty: 100	Length: 2-3/16" Diam.: 23/32"	Apps: Chrysler Interchange no.:
	Hood Bumpers GM SM 79-on ABD6952 Qty: 10 ABD6952RX Qty: 1 ABD6952B Qty: 100	Length: 1-1/4" Diam.: 11/16"	Apps: GM Interchange no.: 1717924
	Hood Bumpers GM Large 80-on ABD6953 Qty: 10 ABD6953RX Qty: 1 ABD6953B Qty: 100	Length: 1-29/32" Diam.: 15/16"	Apps: GM Interchange no.: 472450
	Hood Insulation Clips ABD6095 Qty: 10 ABD6095B Qty: 100	Size: 3/16" (5mm) Stem: 9mm	Apps: Nissan Interchange no.: 65846-30F00, 65832-F5000

RX indicates packaging suited for retail and merchandisers.

Discover other shop supplies on our website.