



RPHA ST

PERFORMANCE REINVENTED
MANUAL

⚠ WARNING

For your safety, it is important that you completely read the owner's manual and all warning labels.





RPHA ST

- Innovative Fiberglass Composite: New Light-Weight FRP Shell Construction
- Integrated Sunshield: Smoke tinted Sunshield deploys quickly and easily.
- Max Air-flow Top Vent: Variable air flow is adjusted by glove-friendly intake vent.
- Superior automatic shield locking system with spring controlled lever.
- 5mm Initial shield position by releasing shield locking system.
- RapidFire™ Shield Replacement System: Simple and secure shield ratchet system provides ultra-quick, tool-less removal and installation for efficient operation.
- Eye glasses and sun glasses friendly EPS shape.
- Pinlock®-prepared shield and Includes Pinlock®100% Max vision Anti-fog insert
- For the perfect and compact dimensions, RPHA ST comes in 3 different shells: 1st shell for XS-S sizing, 2nd for M-L sizing and 3rd for XL-2XL sizing.
- SilverCool Plus™ Interior: Premium soft feel with Ginkgo Extract, moisture-wicking and odor-free interior with advanced silver anti-bacterial fabric. Crown and cheek pads are fully removable and washable.

DOT Approved
SIZES: XS-2XL

Important Safety Information	3
Selecting the Right Helmet	3-4
Specifications	4
Using Your Helmet Correctly	5-6
Inspect Your Helmet	5
Fasten the Retention System	5-6
Maintaining Your Helmet Correctly.....	6-13
Shell Cleaning.....	6
Interior Cleaning	6
Vent Cleaning	6
Shield Cleaning	6
Shield Removal.....	7
Shield Installation.....	7
Cheek Pad Removal.....	8
Cheek Pad Installation	8
Chin Strap Cover Removal.....	9
Chin Strap Cover Installation.....	9
Crown Pad Removal.....	9
Crown Pad Installation.....	10
Sunshield Operation.....	10
Sunshield Removal.....	11
Sunshield Installation.....	11
Breath Deflector Removal.....	11
Breath Deflector Installation.....	12
Chin Curtain Removal.....	12
Chin Curtain Installation	12
Replacement Parts	13
Helmet Modifications.....	13
Storing Your Helmet Correctly	13
Helmet Replacement	13
Warranty	14

Important Safety Information

WARNING

The instructions in this manual are designed to help you select the right helmet, wear it properly, take care of it, and know when to replace it. Failure to follow these instructions may increase your risk of serious injury or death in an accident.

In order to get the most protection possible from your helmet, you should always do the following:

- Wear your helmet when you ride;
- Handle your helmet carefully to avoid accidental damage; and
- Ride safely – do not take risks because you are wearing a helmet.

Although your HJC helmet is designed to reduce or prevent some injuries when worn, no helmet can protect you from all possible or foreseeable impacts. For example, your helmet cannot protect you from spinal or neck injuries. In addition, there is no guarantee that your helmet will prevent injuries to the area of your head that is covered.

Selecting the Right Helmet

WARNING Never buy a used helmet or borrow someone else's helmet. Over time the protective foam in helmets will adjust to the contours of a user's head. A used or borrowed helmet may not offer as much protection as a new helmet.

WARNING Wearing the wrong size helmet can increase your risk of serious injury or death in an accident. A helmet that is too large for your head may be dislodged or knocked off in an accident. To select the right size helmet for your head, follow these instructions:

1. **Measure your head.** Wrap a tape measure around your head about one inch (2.5 cm) above your eyebrows.
2. **Use the sizing chart** to select the helmet size that corresponds most closely to your head measurement. If your head size falls between two helmet sizes, try on the larger helmet first and then the smaller size.

Sizing Chart

	XS	S	M	L	XL	2XL
Hat Size	6 3/4 - 6 7/8	6 7/8 - 7	7 1/8 - 7 1/4	7 1/4 - 7 3/8	7 1/2 - 7 5/8	7 3/4 - 7 7/8
Centimeter	54-55	55-56	57-58	58-59	60-61	62-63
Inch	21 1/4 - 21 5/8	21 5/8 - 22	22 1/2 - 22 7/8	22 7/8 - 23 1/4	23 5/8 - 24	24 3/8 - 24 3/4

3. **Try on the helmet** by grasping both chin straps to pull the helmet completely onto your head, ensuring that the top of your head is in contact with the top of the helmet interior.
4. **Check for a proper fit.** To make sure your helmet is the right size, check that:
 - The helmet inner lining fits snugly around your head.
 - The top pad presses firmly on your head.
 - The cheek pads contact your cheeks.
 - There is no space around your brow under the inner lining. Test this by trying to insert your fingers.

If the helmet does not fit snugly, try on a smaller size.

5. **Check your field of vision when trying on a helmet.** Some helmets may obstruct or block your vision when looking left, right, up, or down.

WARNING Always make sure you can see well enough to safely operate your motorcycle.

6. **Test the helmet fit** by placing your hands on each side of the helmet. While holding your head as motionless as possible, try rotating your helmet from left to right then up and down. If you can feel the helmet padding sliding on your head, it is too big, try a size smaller. You should feel the helmet move the skin on your head and face as you try to move the helmet.

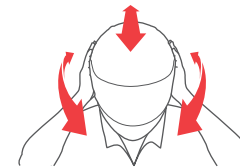

7. **Fasten the retention system (chin strap)** as tight as possible under your jaw without causing pain. There must be no slack in the strap, and the strap must be tight up against your jaw. See page 5-6.

8. **Test the retention system (chin strap)**

- Put your hands on the back of the helmet and try to push the helmet off by rotating it forward.
- Put your hands on the front of the helmet above your forehead (or on the chin guard) and try to push the helmet off by rotating backward.

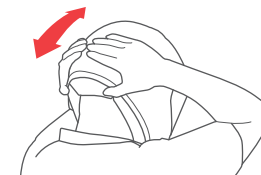

WARNING If helmet comes off, try another size or another model or brand.

Repeat steps 3 through 8 until you find a helmet that fits your head snugly and securely.

Specifications

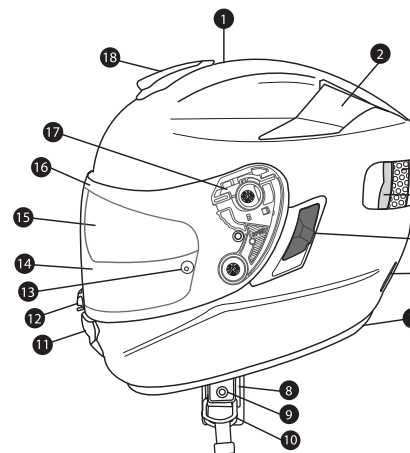

1. Outer Shell
2. Rear Venturi Exhausts
3. Impact Absorbent Liner
4. Comfort Liner
5. Sunshield Lever
6. Lower Rear Exhaust Venturi Vents
7. Rubber Edge Trim
8. Chin Strap
9. Chin Strap Snap
10. Double "D" Ring
11. Front Chin Vent
12. Shield Locking System
13. Pinlock® Pins
14. Tool-less Shield
15. Sunshield
16. Eyepoint Gasket
17. Shield Ratchet
18. Top Front Vent

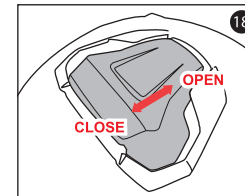
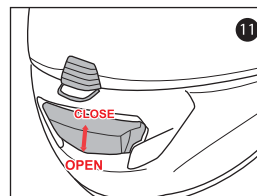

Using Your Helmet Correctly

WARNING To reduce the risk of serious injury or death and to help prevent damage to your helmet:

- **Never adjust your helmet accessories while riding** – Only make helmet adjustments when stopped.
- **Never drop your helmet** – Dropping your helmet may crack the shell or damage the protective foam. The damage may not be visible. Your helmet is only designed for ONE impact. Refer to "Helmet Replacement (p. 13) for more information on what to do after helmet has been dropped.
- **Never wear anything between your head and your helmet** – This may reduce the effectiveness of your helmet.
- **Never hang or hook your helmet on anything including mirror stalks or sissy bars** – Doing so may cause damage to the helmet protective foam or liner.
- **Never use insect repellent on or around your helmet** – Insect repellent may damage your helmet's shield, shell, protective foam, or other components.
- **Never expose helmet to gasoline or gasoline fumes** – Gasoline may damage your helmet's shield, shell, protective foam, or other components.
- **Never use a dark or tinted face shield at night or in low visibility conditions.**

- If you have any questions on what other substances may damage your helmet, please contact us.

- **Always wear eye protection** – If you are not using a helmet with a face shield, always wear eye protection when riding. Always lock your face shield in place when you are riding.
- **Always be alert for sounds** – Your helmet may impair your hearing. However, your helmet is not a form of hearing protection.
- **Always store your helmet in its helmet bag** when not in use to help reduce accidental surface damage.

WARNING To reduce the risk of serious injury or death, always use your helmet correctly.

Inspect your helmet

To ensure that your helmet is in the best condition to maximize your protection, always inspect your helmet for damage before riding:

- **Check the shield and shield ratchet** – re-tighten shield ratchet screws if necessary. Be sure not to over-tighten any screws. Plastic base plate screws can break and plastic screws can strip the screw sleeves if over-tightened.
- **Check for helmet damage.** If your helmet is damaged or cracked, stop using it immediately. See "Helmet Replacement" (p.13) section for further information. If your helmet has been dropped, you may not be able to see the damage.
- **Check for worn or damaged parts.** Plastic components may wear out over time. If you find worn or damaged parts, replace them or purchase a new helmet. See "Replacement Parts" (p. 13) for information on parts replacement.

WARNING If parts fall off while riding, your vision may be blocked which could cause an accident.

- **Check the retention system (chin strap) for damage.** If it is frayed or ripped, replace the helmet.
- **Check that all pads are in place.** Both of the cheek pads and the crown pads must be in place.

Check Your Face Shield

If your face shield is scratched or damaged it may reduce the visibility-replace if necessary. Always make sure you can see well enough to safely operate your motorcycle.

Fasten the Retention System

Fasten the retention system (chin strap) as tight as possible under your jaw without causing pain. There must be no slack in the strap, and the strap must be snug up against your jaw. If the retention system is not tight, your helmet may become dislodged or knocked off in an accident.

WARNING Do not rely on the snap to secure the helmet. The snap is provided only to prevent the strap from flapping in the air. Fasten the retention system only in the following manner:

Double "D" Ring

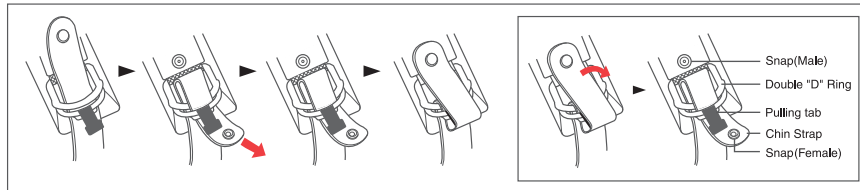

Maintaining Your Helmet Correctly

Shell Cleaning

WARNING Only use the approved methods listed below to clean the helmet. Using other unapproved chemicals or methods may damage the helmet shell or lining. A damaged helmet may increase your risk of serious injury or death in an accident.

Glossy Finish. HJC recommends cleaning your helmet with products designed for automotive cleaning and polishing. All HJC helmets are finished with an automotive type base coat/clear coat finish. Rubbing compounds can be used for deep cleaning to remove many scratches and scuffs. Follow the product's instructions diligently. Over polishing with rubbing compounds can cause light abrasions which may dull the finish of your helmet. Stickers and decals will leave adhesive residue when removed. To remove the adhesive residue, use alcohol swabs. Be certain to immediately wipe away the excess liquid and clean the area with soap and water once the adhesive residue is removed. Do not use excessive pressure while rubbing when attempting to remove the adhesive residue, instead use multiple light treatments.

Non-Glossy Finish. For our flat finish (non-glossy) helmets, we recommend using warm water and mild soap. Use multiple treatments for heavier dirt. Do not use excessive pressure or rubbing compounds while cleaning the surface as a "glossy" effect could be created, ruining the flat finish appearance.

Interior Cleaning

Although we recommend changing a helmet every 3 to 5 years, the accumulation of sweat, humidity, and dirt can deteriorate the fabric and stitching and this may cause odor. To wash HJC removable pads, HJC recommends regular machine washing and air drying. For non-removable interiors, HJC recommends using bacteria and mildew eliminating products such as "Helmet Fresh".

Vent Cleaning

Dirt and debris can find its way into the venting of your HJC helmet. Compressed air cans used for cleaning computer keyboards may be used to blow the debris from the ventilation system. It is recommended that you remove any removable pads before doing this process.

Shield Cleaning

The helmet shield is made of polycarbonate materials with a polyurethane abrasion resistance coating. It should be cleaned using a weak solution of mild soap and warm water. Never use hot water, salt water, benzene, thinner, gasoline or any other harsh agents. Treat carefully when cleaning to preserve the abrasion resistant coating. When deep scratches are visible, it is highly recommended that the helmet shield be replaced. Tinted shields are for "Day time use only" and are not suitable for use at night or in conditions of poor visibility.

Shield Removal

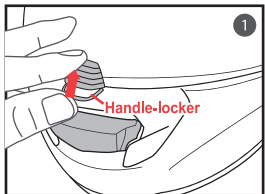

1. Lift up the handle-locker.

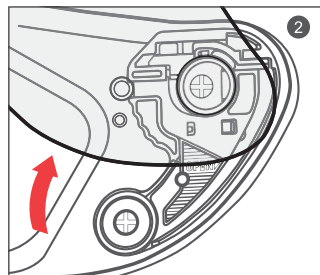

2. Open shield to the maximum open position.

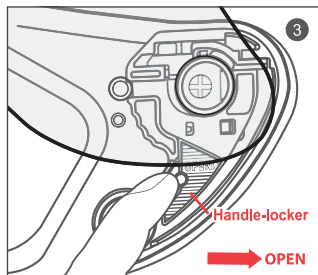

3. Push the handle-locker to the open position. The shield will be automatically released out of base ratchet mechanism.

Shield Installation

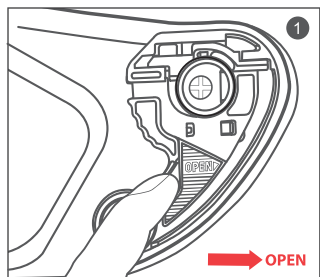

1. Ensure that the handle-locker is in the open position.

2. Align and insert the top of the shield guide into the plate-gear guide.

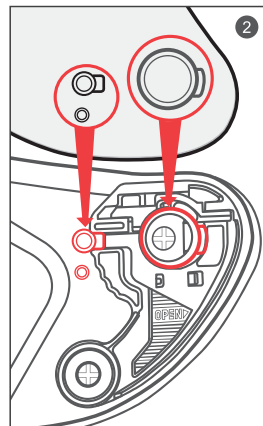

3. With the guides properly aligned, press the lower section of the shield into the plate-gear mechanism. The locking tab should pop into position, locking the shield into place.

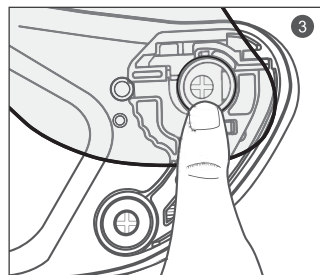

WARNING Always check to make sure helmet pads are installed before using the helmet. A helmet with missing or improperly installed pads may increase your risk of serious injury or death in an accident.

Cheek Pad Removal

There are 3 snaps holding the cheek pad in place.

1. Gently pry the cheek pad away from the interior, releasing the snaps.
2. Grasp the cheek pad near its center and gently pull it free from the chin strap.

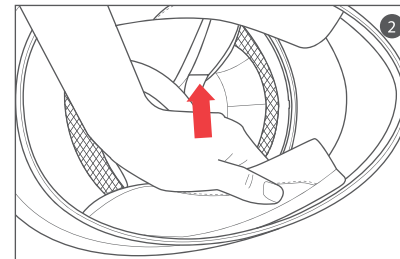
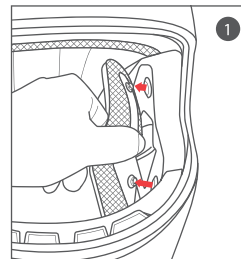

Cheek Pad Installation

1. Feed the chin strap through the opening in the cheek pad.
2. Align and fully slide the cheek pad plastic plate between shell and EPS.
3. Clip the cheek pad's 3 small male snaps to the 3 female snaps fixed on the shell interior.

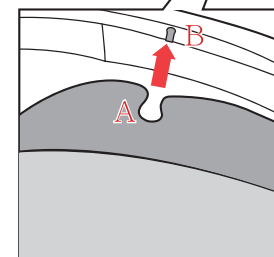
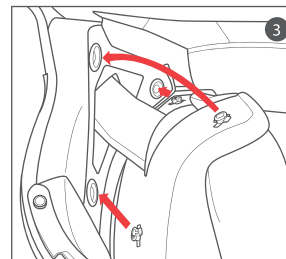
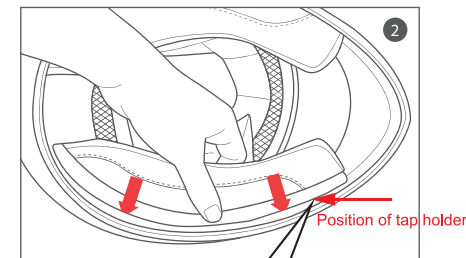
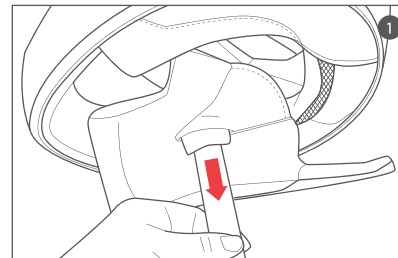

※ Slide tab 'A' from the cheek pad into the holder 'B'. (Repeat same on opposite side)

Chin Strap Cover Removal

1. Grasp the end of the chin strap cover and pull/pry away from the helmet.

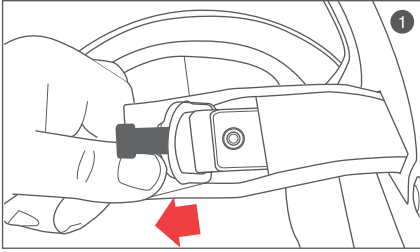

Chin Strap Cover Installation

1. Insert the chin strap into the chin strap cover and push the chin strap cover all the way in.

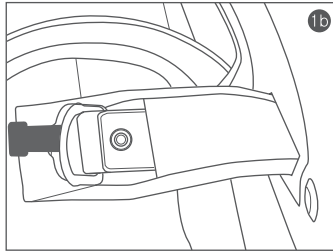
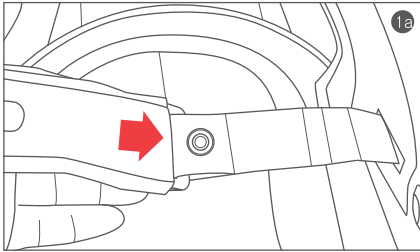

Crown Pad Removal

There are 3 snaps / plastic sleeves that hold the front of the crown pad in place and 2 snaps at the rear.

1. Grasp the crown pad fabric as close as possible to its plastic base and pull/pry away from the helmet. Notice how the crown pad plastic section aligns with the shell plastic sleeve. This will help orient you with the reinstallation.
2. Repeat same at rear.

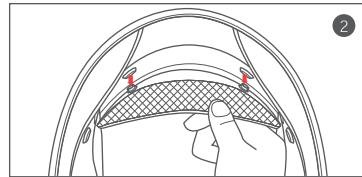
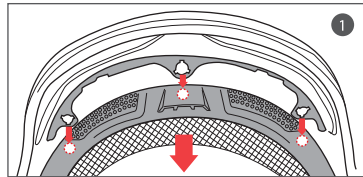

Crown Pad Installation

1. Align and push the crown pad plastic sleeves into the slot located on the crown pad's plastic base followed by pressing the snap into place, repeat for each snap.
2. Align and snap the two rear snaps into place.

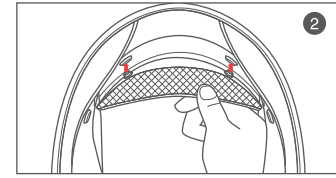
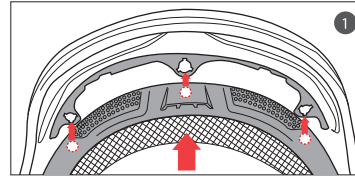

⚠️WARNING

Try not to operate the sunshield mechanism while riding as this may impair your vision and may lead to an accident unless it is necessary and may be done safely.

DO NOT pull on the sunshield when it is already down. The sunshield may be ejected and this will increase the risk of serious injury or death in the event of an accident.

DO NOT attempt to adjust the sunshield with your hands. Always use the sunshield lever and the sunshield release button located at the top of the helmet.

DO NOT use sunshield at night time.

Sunshield Operation

Above illustration shows raised sunshield position.

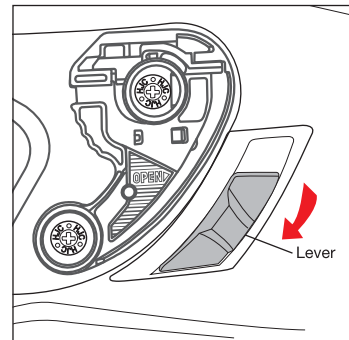

Above illustration shows lowered sunshield position.

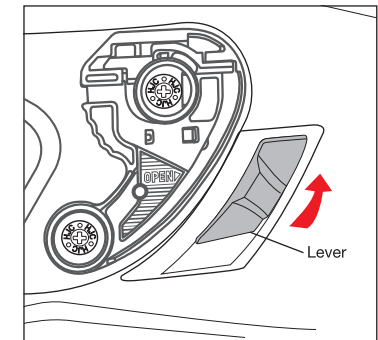

Sunshield Removal

1. While sunshield is in lower position, gently pull it until you see the top of the sunshield.
2. Gently pull one side of the sunshield as arrow indicates (repeat same for other side).

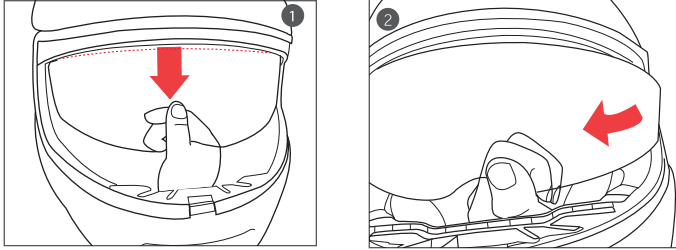

Sunshield Installation

1. Insert sunshield tab 'A' into 'B' position. (Repeat same on opposite side)

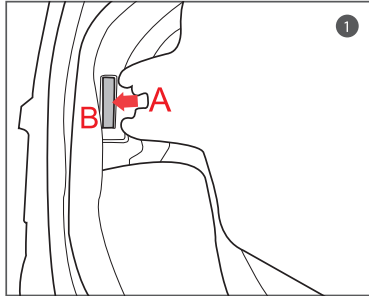

※ When installing the sunshield, be sure to have it slid behind the top 'B' holder.

Breath Deflector Removal

1. Push breath deflector flat and pull away from the helmet as arrows indicate.

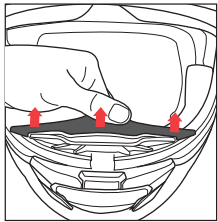

Breath Deflector Installation

1. Push breath deflector into specified slot as arrows indicate.

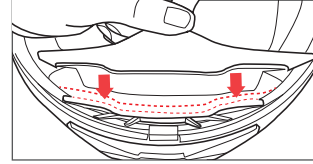

Chin Curtain Removal

1. As illustrated, pull below the snaps for removable.

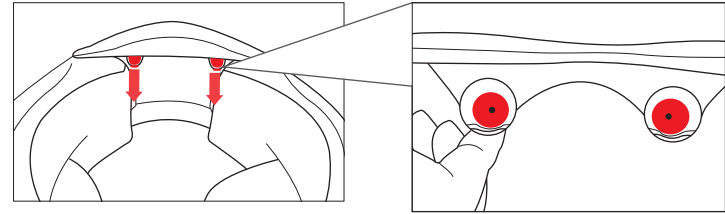

Chin Curtain Installation

1. Align the chin curtain snaps with the two female snaps on the chin bar. Push into place.

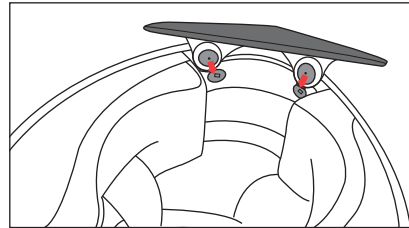

Replacement Parts

⚠WARNING Use of replacement parts not manufactured by HJC may increase your risk of serious injury or death in an accident. Only use HJC parts that are specifically designed to work with this helmet.

Do Not Modify Your Helmet

Your HJC helmet is designed to meet DOT standard.

Contact HJC America for more information about the DOT standard.

Modifying your helmet may increase your risk of serious injury or death in an accident.

Do not modify your HJC helmet. Modifications include the following:

- drilling holes;
- cutting shell, liner, or strap;
- modifying the retention system, including adding a chin cup;
- removing parts;
- painting; and
- attaching accessories that are not manufactured by HJC for this helmet.

If you have questions about modifications, please contact HJC America. See back cover for contact information.

🔪 Storing Your Helmet Correctly

⚠WARNING An improperly stored helmet can become damaged and may increase your risk of serious injury or death in an accident. You should:

- Store helmet in a cool and dry place,
- Keep helmet away from pets and other animals,
- Keep helmet away from heat in excess of 122°F and do not set on or near hot surfaces,
- When helmets left out in the sun for extended periods of time, it may fade overtime.

🔪 Helmet Replacement

⚠WARNING Although your HJC Helmet is constructed with the best materials available to offer a long-lasting product, it will eventually need to be replaced. Immediately replace your helmet if:

- It has suffered an impact. Your helmet is only designed for ONE impact. An impact may fracture the outer shell or compress the impact absorbing liner. You may not be able to detect this damage. Any impact in a crash or a drop from as low as 4 feet is enough to damage your helmet.
- The shell, lining, or retention system is damaged. The helmet shell, the impact absorbing lining, and the retention system must be in good condition to provide you with the most protection.

Even if your helmet has not been damaged, it needs to be replaced every 3 to 5 years depending on how much you use it. Over time, UV rays and adhesive and component aging will damage your helmet. Wearing a damaged helmet may increase your risk of serious injury or death in an accident.

If you are unsure if you need to replace your helmet, contact HJC America before using your helmet again.

Helmet Disposal

⚠WARNING If you buy a new helmet, destroy the old one to ensure it cannot be reused. Do not sell or give away your old helmet, even if it has not been damaged. Over time the protective foam in the helmet will adjust to the contours of your head. If someone else uses this helmet it will not provide them with as much protection.