

Mounting Instructions
Reverse light



Comet 450/550



Kit includes

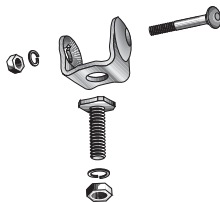

2

Accessories

(not included with kit)

12V H3: Best.-Nr.:
8GH 002 090 133

24V H3: Best.-Nr.:
8GH 002 090 251

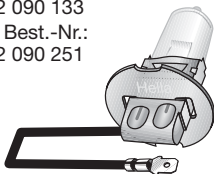

12V
Best.-Nr.:
4RA 003 510-361

24V
Best.-Nr.:
4RA 003 510-651

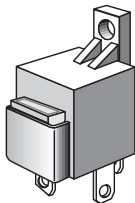

6,3 x 0,8 mm
Best.-Nr.: 8KW 708 373-812



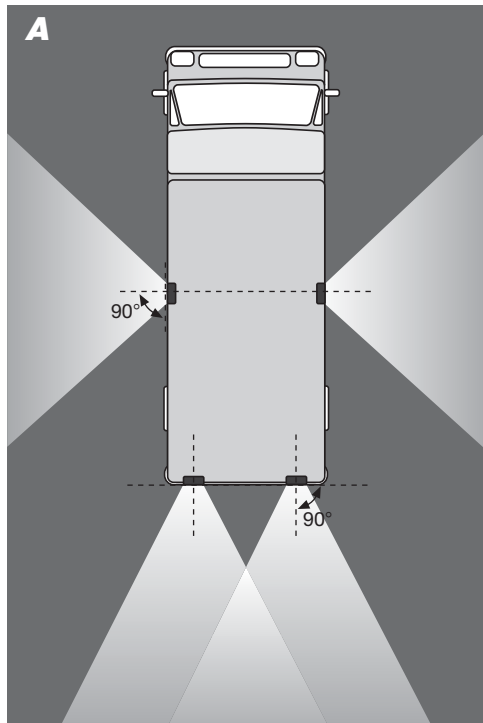
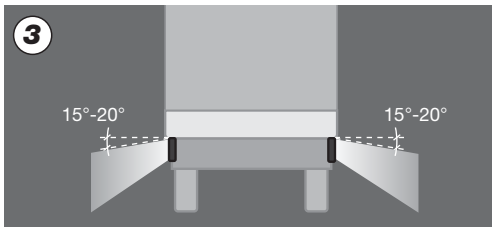
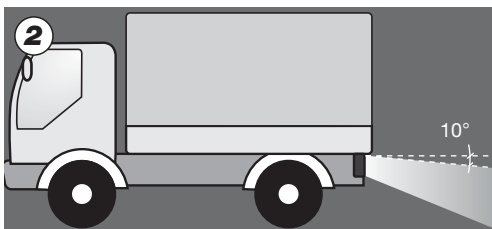
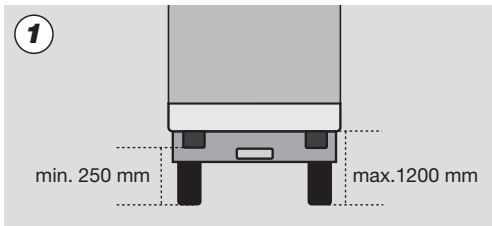

B

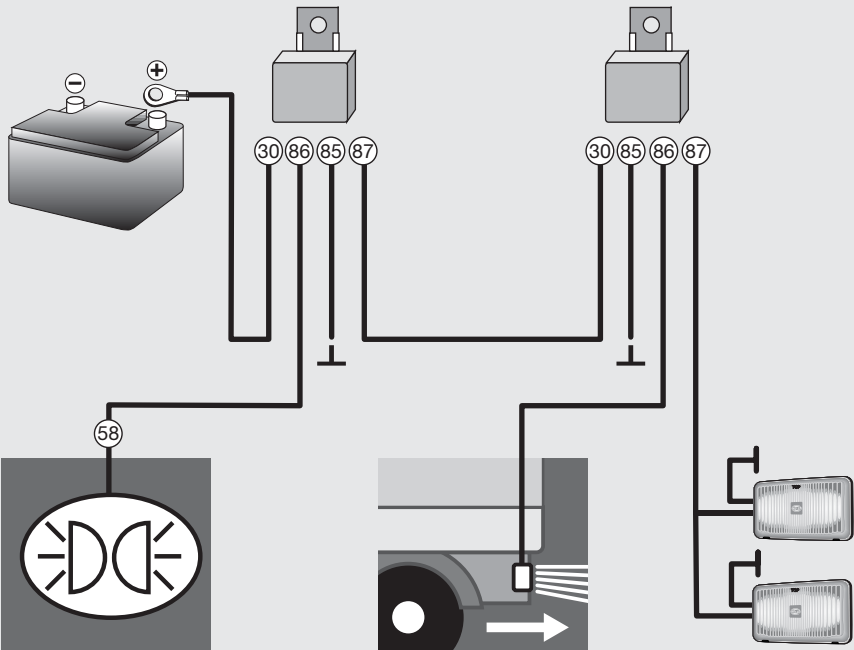

Tools:

- Folding rule
 - Pliers for crimp connectors
 - Chisel
 - Crosshead screwdriver
 - Screwdriver
 - Open-end/Ring spanner 13, 17, 19
 - Drill bits Ø 3, 11 mm
-

Page 3 and 4: Installation

Pendant or upright installation is possible. The light must not protrude beyond the edge of the vehicle. (see page 4, Fig.: **A**)

1. Determine the installation position (Fig.: **1**) and mark the fastening points.
2. Pilot-drill using a 3 mm drill bit, and drill out to 11 mm. Seal drilled metal parts with rust protection.

3. Remove the light insert. Push blade terminals onto the cables and crimp together. Insert the bulb and the sealing grommet in accordance with the instructions. Assemble the housing according to the chosen position.
 4. Align and tighten the light according to the chosen mounting location (Fig.: **2** and **3**).
-

Page 5: Electrics

Caution! – Ignition in zero position. Install the Hella relays (available from accessory dealers) in a splash-proof position, with the connection terminals pointing

downwards. Lay the cables and connect them in accordance with circuit diagram **B**. Connect terminal 86 of the second relay to the existing reverse light.