

Hawk Performance
Products Catalog



What's stopping you?



Automotive • Race • Motorcycle • Off-Road





What's **Stopping** You?

When you **DEMAND** Performance!

4	Welcome to Hawk
5	Hawk Performance & Motorsports
6	HPS 5.0 - High Performance Street Compound
7	HP Plus - Autocross & Track Day Compound
8	PC - Luxury & Touring Compound
9	Street/Race - Street Race Compound
10	LTS - Light Truck & SUV Compound
11	SD - Super Duty Truck Compound
12	Sector 27 - Street Rotors
13	Sector 27 - Rotor and Brake Pad Kit
14	Motorsport Compounds
16	DTC-50 - High Torque Race Compound
17	DTC-80 - Professional Race Compound
18	DTC-30/60/70 - Dynamic Torque Compounds
19	HT-10/Black/Blue 42 - Race Compounds
20	DTC - Race Rotors
21	Motorcycle Compounds
22	Motorsport Compound Guide
24	Street FAQ's and Warranty
26	Motorsport FAQ's
28	Compound Code and Breakdown
29	Brake Pad Diagrams
122	Brake Pad Compound Applications
342	Rotor Applications
420	Brake and Rotor Kit Applications
476	Motorcycle Compound Applications
501	Specialty Caliper Guide
507	FMSI Cross Reference Guide



HAWK Performance... ...Makes Brakes

We Are Hawk Performance.

We make brakes that control speed on the racetrack and instill confidence on the drive home.

For more than 25 years, Hawk has been finding fractions of seconds on the racetrack and we have channeled that knowledge into every product we make. After all, powerful and reliable braking for your daily drive is about much more than bringing home a trophy.

Hawk is the Official Brake Product for motorsports organizations like the National Auto Sport Association, Ron Fellows Performance Driving School, Allen Berg Racing School, and the SCCA, and we are the Official Brake Choice for some of the world's most exciting drivers and teams in motorsports today.

Whether your ride is an Indycar or Muscle Car, Motorcycle, Import Tuner or SUV, our superior brake and friction products enable you to control, command, and conquer the road and racetrack in virtually any vehicle.

What's stopping you?



| American Muscle

| European Touring

| Tuners

| Motorcycle

| Off-Road

| SUV

| Truck





AUTOCROSS/CLUB RACING

This diverse group of motorsports enthusiasts requires a brake pad product that is street worthy, yet maintains many of the high temperature and elevated coefficient of friction attributes of a pure race pad. Hawk Performance is proud to offer true intermediate brake products like HP Plus and Street/Race that can transition between street and track environments.

ROAD RACING/TOURING

Hawk Performance, the Official Brake Product of SCCA, NASA and, most recently, the Official Brake Pad of the WRL, has long been an industry leader in friction material development for sports car/GT racing and open wheel road racing. Hawk Performance offers a wide variety of brake compounds that are application specific and offer superior performance for all types and classes of road race cars.

PAVEMENT CIRCLE TRACK

This is where Hawk Performance first entered the motorsports market back in 1990. Our history of short track, intermediate and superspeedway wins is undeniable. The fact is, our products truly outperform the competition in this high-temperature, brutal braking environment. From local short tracks to NASCAR feeder series, Hawk Performance is a proven champion.

FORMULA

Hawk Performance offers a wide variety of brake compounds with features designed to exceed the demanding environments found in open-wheel Formula racing.

DRAG

Hawk's products provide the high cold-static coefficient of friction to hold a car on the line, and the high-dynamic characteristics to stop the car at the finish line. More importantly, our products can withstand sudden bursts of energy without glazing.

OFF-ROAD RACING

Hawk Performance has been the brand of choice for top teams in TORC, SCORE and LOORRS off-road racing. The combination of exceptional stopping power, elevated fade resistance, extended pad life and superior bond strength make our products ideal for this abusive environment.

DIRT CIRCLE TRACK

From LOORS to World of Outlaws Craftsman Series, Hawk Performance has been the brake pad supplier of championship teams for over a decade. Our products provide superior performance for both open-wheel and late model stock cars so you'll never sacrifice stopping power when you're kicking up the dirt.

RALLY RACING

The varied terrain and conditions in rally racing create a unique and harsh environment for brake products. Transitions from steep downhill trails in the dirt to forging water, and from meeting the pavement to ascending through switchbacks all require a versatile and progressive brake pad. That's why championship teams know Hawk Performance is the first and best rally pad solution.

HPS 5.0 HIGH PERFORMANCE STREET COMPOUND



“

The premium replacement for American muscle cars,
European touring sedans & tuners

”

HPS 5.0

Hit the Rev Limiter.

For years, engine builders have been pushing motors to the limits of their ability, and at Hawk Performance, we're closer than ever to pushing the ABS Rev Limiter to its limits. High Performance Street 5.0 pads give your vehicle the greatest stopping power and pedal feel without compromising ABS.

HPS 5.0 is a Ferro-Carbon compound that provides advanced braking characteristics to enhance the driving experience. This compound combines the safety and quality of aerospace design with the braking technology of motorsports. The results are shorter stopping distances, improved performance under heavy braking conditions, and street car friendly characteristics.

HPS 5.0 BRAKE PAD KEY FEATURES:

- Aggressive torque
- Great rotor & pad wear life
- 100°-750°F operating temperatures
- Smooth and predictable control
- Designed to deliver high deceleration rates
- Smooth braking feel
- Consistent brake release characteristic



IDEAL FOR HIGH PERFORMANCE STREET CARS



For Autocross, Solo II and Track Day Events



HP Plus

From the Track to the Garage.

Hawk Performance's HP Plus brake pad is ideal for Autocross and Track Day drivers looking for a high performance race compound that can take the heat of the track and still get them home safely.

HP Plus utilizes a unique Ferro-Carbon, high-tech friction material that was developed and manufactured specifically for Autocross, Solo and Track Day applications. This formulation offers lower wear rates and higher torque values than other friction materials. Wide and linear torque makes HP Plus the perfect upgrade over stock for high performance street cars used in Autocross competition, or that are subjected to racing-style heavy braking.

HP PLUS BRAKE PAD KEY FEATURES:

- Low to mid temperature range
- Fade resistant
- Smooth and predictable torque
- Ideal for autocross & club racing events



IDEAL FOR IMPORT & DOMESTIC AUTOMOBILES

Performance Ceramic LUXURY & TOURING STREET COMPOUND



“

Clean, quiet and quick stopping power with uncompromising performance

”

PC Performance Ceramic

Low Dust. Low Noise.

Hawk understands the needs of today's ceramic brake pad users and has specifically formulated our composite material to meet – and beat - the stringent low noise, ultra-low dust performance standards they have set. Engineered to reduce brake NVH (Noise, Vibration and Harshness), Performance Ceramic is a premium disc brake pad that delivers excellent performance mile after mile.

Providing a linear friction profile that allows your vehicle's ABS system to operate most effectively, our unique compound has the advantage of never sacrificing power to achieve traditional ceramic pad attributes. With Hawk's PC, you can expect reduced brake pad wear, longer rotor life and our quietest ride ever.

PC BRAKE PAD KEY FEATURES:

- Extremely quiet
- Ultra-low dust
- Improved stopping power
- Extended pad life
- Gentle on rotors
- Stable friction output



IDEAL FOR ALL LUXURY IMPORT & DOMESTIC STREET VEHICLES



Providing the edge over the competition



Street/Race

The Master of Faster.

Using decades of engineering data from our racing programs, the Hawk Performance team cross-engineered the Street/Race compound as the ultimate high-performance street brake pad.

Perfect for performance drivers who use their street cars for Autocross, HPDE, open track and time-trial racing, High Performance Street/Race pads feature a unique Ferro-Carbon compound that improves vehicle handling, driver confidence, and overall safety. Street/Race performs flawlessly at operating temperatures between 100° and 1200° F, offering superior torque while providing consistent braking characteristics and great pedal feel.

STREET/RACE BRAKE PAD KEY FEATURES:

- Controllable torque
- Great rotor & pad wear life
- 100°-1200°F operating temperatures
- Smooth feel and bite
- Excellent brake rotor wear
- Consistent brake release characteristics



IDEAL FOR AUTOCROSS, OPEN TRACK



**A better way to stop your light and full-size trucks,
vans and SUVs**



LTS

Bigger Wheels. Bigger Brakes.

We understand that traditional car brake pad technology just doesn't cut it on today's trucks. This is especially true for heavily loaded trucks and vehicles used in moderate towing. Our LTS/Light Truck & SUV disc brake compound dramatically improves your vehicle's stopping power and fade resistance and outlasts the competition in terms of rotor and pad wear.

Ideal for a broad range of import and domestic vehicles, LTS provides superior stopping power and longer pad life without excessive noise and dust. Engineered by truck brake pad experts, the Ferro-Carbon friction material of LTS is the optimal pad choice for light duty trucks, all classes of SUVs and vans up to 1 ton, and provides 20-40% more stopping power over stock replacement pads

LTS BRAKE PAD KEY FEATURES:

- Strong and balanced initial bite, hot or cold
- Ferro-Carbon friction
- Low torque
- Greater fade resistance
- Low dust output
- Excellent pad and rotor life



**IDEAL FOR LIGHT AND FULL-SIZE TRUCKS,
VANS AND SUVs**



High fade resistance, with superior high temperature, high inertia capabilities



SD Super Duty

For Extreme Payloads.

For over 25 years, Hawk Performance has developed friction solutions for some of the largest trucks on the planet. Our products are used by both OE and aftermarket companies servicing the mining, construction, military and commercial truck markets and Hawk's SuperDuty compound features that same high performance, severe-duty friction technology.

The unique Ferro-Carbon material in SD disc brake pads delivers extremely high fade resistance, with superior high-temperature rotor and brake pad wear. This compound has been engineered for Class 2 and higher, on-highway, commercial grade vehicles.

This product is not recommended for personal or recreational trucks and SUVs.

SD BRAKE PAD KEY FEATURES:

- Engineered from technology used in heavy-duty on/off highway and military applications
- Extremely high coefficient of friction and fade resistance
- Recommended for professional fleets (greater than 1 ton) and light trucks towing excessive payloads



**IDEAL FOR PROFESSIONAL FLEETS
AND COMMERCIAL PAYLOADS**



Stopping heritage and packaged performance drive your vehicle into the fast lane



Sector 27 Rotors

Drilled & Slotted.

Legendary in motorsports performance, many of the world's most famous race drivers and teams run under the number 27. Like that number, Hawk Performance brake solutions that dominate on the track and rule the street are legendary, too. Our Sector 27 rotors continue that tradition by raising the bar in friction performance.

Sector 27 rotors are a unique drilled and slotted design: Beveled drilled holes provide superior cooling under the most extreme conditions, while rounded slots provide consistent contact between the rotor and pad to sweep away gas and dust. The result is a high performance rotor that enables harder, more precise braking, with temperatures lowered by as much as 180 degrees. To ensure long life and to reduce rust, Sector 27 products are plated with silver zinc elements and precisely manufactured so every rotor is balanced to stringent specifications and fits perfectly.

SECTOR 27 ROTOR KEY FEATURES:

- Premium quality castings
- Drill and slot patterns engineered to extend pad and rotor life
- Dissipates heat faster
- Reduced brake fade and rotor warpage
- Improved stopping ability
- Aggressive rotor looks great behind custom wheels



IDEAL FOR ALL IMPORT & DOMESTIC STREET VEHICLES



Our best street rotors and pads make this kit a winning combination



Sector 27 Kits

The Team to Beat.

Hawk Performance has simplified the process of dramatically improving any vehicle's stopping distance without upgrading to expensive specialty calipers. Our Sector 27 Rotor and Brake Pad Kits offer vehicle-specific matched pad and rotor bundles, all delivered in one box to save you time and money.

Available as complete front or rear axle packages in a number of customizable options, these combo kits include a pair of Hawk's unbeatable Sector 27 rotors and a set of our popular HPS, HPS 5.0, LTS or PC compound brake pads. Take your car or truck's performance and stopping power to a whole new level with the winning team of race proven, street legal rotors and pads.

SECTOR 27 KIT FEATURES:

- Increased stopping power
- Reduced brake fade
- Improved brake system effectiveness
- Lowered temperatures
- Silver Zinc Plating prevents the rotor from rusting prematurely
- Aggressive look behind custom wheels
- Extended pad and rotor life



IDEAL FOR ALL IMPORT & DOMESTIC STREET VEHICLES



DTC-80

For all asphalt circle track and road racing venues that need a high torque, high temperature-resilient friction material. Intended for the hardest braking circuits where the most demanding brake products are required.

DTC-70

Extremely high torque with aggressive controllable initial bite. Superior release and torque control characteristics. Brake pads designed for cars with high deceleration rates, with or without down force.

DTC-60

High torque compound with less initial bite than DTC-70. Superior release and torque control characteristics. Designed for cars with high deceleration rates, with or without down force. Recommended for use with DTC-70 when split friction between front and rear axle is desired.

DTC-50

Very high torque with aggressive initial bite. Excellent modulation and release characteristics. Brake pads designed for cars with extremely high deceleration rates and downforce.

DTC-30

Uniquely controllable torque with smooth consistent feel and bite. Superior release and medium torque control characteristics.

DTC-15

Developed specifically to meet the demands of dirt circle track applications. Medium torque compound (less torque than DTC-30, more than DTC-05) with superior release characteristics and excellent cold effectiveness.

DTC-05

Friction formula developed specifically to meet the demands of lower torque dirt track racing. Provides very controllable, higher temperature performance as compared to stock pads.



HT-10

Intermediate to high torque with a smooth initial bite. Very consistent pedal feel. Excellent modulation and release characteristics.

Black

Medium torque and temperature. Good all-purpose racing brake pad. Great in multiple race environments from Dirt Modified to IMCA style pavement racing.

MT-4

Medium to high torque and temperature compound with medium to high initial bite. Designed for circle track cars under 2800 lbs without high deceleration rates.

DR-97

Excellent static and dynamic coefficient of friction. Smooth linear torque. Low pad and rotor wear. Specifically designed for use in drag racing applications.

Blue-42

Medium to high torque and temperature compound with excellent brake modulation. #1 selling compound for SCCA.

HP Plus

Utilizes unique Ferro-Carbon, high tech friction material developed for sport driving. This compound formulation offers lower wear rates, higher torque values than competitive materials.

NEW



“

The only solution when racers demand tremendous stopping power with industry leading bite

”

DTC-50

Get Into the Winners' Circle.

Hawk's DTC-50 is what racers have been asking for: a pad that can be used as a split compound for tuning, and an endurance compound that can be used at the highest levels of racing. DTC-50 was developed through extensive testing, giving racers a pad that enhances our line of Dynamic Torque Control products and bridges the temperature and brake torque range from our current DTC-30 to DTC-60 race pads.

This new compound offers consistent performance across a wide range of temperatures while providing very high torque and aggressive initial bite.

DTC-50 BRAKE PAD KEY FEATURES:

- Very high torque with aggressive initial bite
- Excellent modulation and release characteristics
- High temperature fade resistance
- Designed for high deceleration rates
- Open Wheel/Formula, Sports Car/GT, Trophy Truck, Class 1/Class 10 Off Road



**IDEAL FOR OPEN WHEEL/FORMULA, SPORTS CAR/GT,
AND CLASS 1/CLASS 10 OFF ROAD**

NEW



“

Specifically designed to meet the highest demands of sports car and circle track racing

”

DTC-80

Faster Lap Times. Higher Finishes.

Our products have dominated motorsports for more than 25 years, and this revolutionary compound is taking that domination to a new level. Intended for the hardest braking circuits where the most demanding brake products are required, DTC-80 is a compound engineered for use on all circle track and road racing venues where a high torque, high temperature-resilient friction material is a must. With a formulated flat coefficient of friction at high temperature levels, DTC-80 provides consistent performance corner after corner.

Track tested and proven effective, this formulation offers lower wear rates and higher torque values than other competitive materials on the market today. The end results are better car control, more confident brake zone feel, and stunningly predictable performance.

DTC-80 BRAKE PAD KEY FEATURES:

- High initial bite
- High torque level
- Consistent brake torque level over temperature range
- Consistent with pressure at high temperatures over 1200° F
- 500°F to 1700° operating temperature range
- Superior pad and rotor wear



IDEAL FOR FULL PROFESSIONAL SPORT CAR RACING



Unbeatable race friction products that disperse and dispel energy in any race



DTC-30

Dirt Circle Superiority.

DTC-30 is a controllable torque, multi-purpose compound, proven effective in a range of series. It delivers superior release characteristics and smooth pedal feel and initial bite for dirt and circle tracks, NASCAR modified, drag racing, trophy trucks, pro buggies and more.

DTC-30 BRAKE PAD KEY FEATURES:

- Consistent, smooth braking
- 100°-800° F optimal temp range
- Medium torque
- Good cold effectiveness

DTC-60

Tame Downforce and Deceleration.

Running with extremely high deceleration rates and increased downforce poses different challenges, so we designed DTC-60. Recommended with DTC-70 when split friction between axles is desired, it has excellent modulation and release characteristics.

DTC-60 BRAKE PAD KEY FEATURES:

- Superior release and torque control
- 700°-1100° F optimal temp range
- Very low abrasive rotor wear
- Ideal for all club levels

DTC-70

Low Abrasion. High Performance.

DTC-70 was engineered with extremely high torque and highly aggressive initial bite for cars with high deceleration rates, with or without downforce. With superior release and control characteristics it's a winning race solution on its own or as split friction with DTC-60.

DTC-70 BRAKE PAD KEY FEATURES:

- High performance high torque compound
- 800°-1200° F optimal temp range
- Superior rotor and pad wear



Knocking out the competition to win more championships for over 25 years



HT-10

Road Racing Will Never Be The Same.

For linear in-braking in a medium temperature range, look no further than HT-10. It delivers smooth, controllable initial bite and consistent pedal feel. It's no wonder Hawk's legacy friction products have become the choice of champions.

HT-10 BRAKE PAD KEY FEATURES:

- Good static and dynamic coefficient of friction
- High torque
- 500°-1100° F optimal temp range
- Excellent modulation characteristics

Black

Proven by the Test of Time.

Working with racers at all levels, we know the challenges of getting your car to the track. Black was designed as an all purpose, low cost race pad. It's good cold effectiveness is up to the task on a wide range of tracks from Dirt Modified to IMCA style pavement racing.

BLACK BRAKE PAD KEY FEATURES:

- Medium torque
- All purpose race compound
- 200° - 700° optimal temp range

Blue 42

Dominate the Competition.

Designed as an entry level endurance compound, there's nothing second-string about Hawk's Blue 42 race compound. Easier to bed in and delivering excellent pad and rotor life, Blue 42 is a medium torque pad developed specifically for Road, Rally and Circle Track racing.

BLUE 42 BRAKE PAD KEY FEATURES:

- Increased mid-Mu characteristics
- Intermediate initial bite
- 350°-800° F optimal temp range
- Medium torque



“

Optimal brake performance and durability for on- and off-road racing

”

DTC Rotors

More stopping power. Longer life.

Hawk Performance has developed the ideal rotor that optimizes brake performance and durability for a wide range of sports cars and racing environments. DTC directional rotors seamlessly mesh advanced design and metallurgy to create the perfect “matched set” system when run with our DTC series brake pads.

Cast from a proprietary formulation of premium alloys and long grain carbon iron for maximum thermal stability and resistance to distortion, DTC rotors feature an exclusive multi-pass progressive slot design. The combination of copper and molybdenum for high-temperature strength and thermal crack resistance and our unique interior vane and mounting lug design provides superior structural integrity. Every DTC rotor is meticulously checked for proper balance, thickness, flatness and runout.

DTC ROTOR KEY FEATURES:

- Superior initial bite, release characteristics and wear debris removal
- Specific RMS finish enhances creation of proper transfer film
- Efficient cooling, exceptional wear
- Hard and intermediate braking on asphalt and dirt track
- Ideal for use with Tube Works, Pro Am, Wilwood, Brembo, Coleman, Camburg, and many other Off Road racing applications



IDEAL FOR WIDE RANGE OF CIRCLE TRACK
AND OFF-ROAD RACING



Engineered to provide optimal braking power and control for your American-made Bike



Sintered Metallic

Hawk Performance Sintered Metallic disc brake pads offer world-class braking performance for heavy motorcycles. This product line combines the quality and compatibility of Original Equipment with unsurpassed stopping power and quiet braking performance. In wet or dry braking conditions, nothing beats Hawk's Sintered Metallic brake pads.

SINTERED METALLIC MOTORCYCLE PAD KEY FEATURES

- Superior stopping power
- HH+ rated friction material, highest in the industry
- Smooth, progressive engagement
- Fade-free performance
- Virtually dust free
- Lowest pad wear in the market

Non-Asbestos Organic

Hawk Performance Non-Asbestos Organic (NAO) disc brake pads offer best-in-class performance when compared to other leading aftermarket organic pads. Progressive brake modulation characteristics maximize rider comfort and control. NAO is ideal for bikes with polished or chrome rotors.

NAO MOTORCYCLE PAD KEY FEATURES

- Excellent stopping power
- GG rated friction material
- Smooth, linear engagement
- Exceptional thermal stability
- Extremely gentle on rotors
- Extended pad life characteristics
- Low dust

Motorsport Compound Guide

COMPOUND	COMMENTS/REMARKS	OPERATING TEMP.	OPTIMAL TEMP.	TORQUE LEVEL	APPLICATIONS
DTC-80	<ul style="list-style-type: none"> - High initial bite & high friction level - Consistant brake torque over its temperature range (over 1200° F) - Superior pad and rotor wear - All circle track and road racing venues demanding high torque & high temp 	500-1700	600-1500	HIGH	<ul style="list-style-type: none"> - NASCAR/NASCAR Modified - ARCA - Super Late Models - Demanding Tarmac - Pavement Circle Track - Sports Car/GT/GS - All club levels - Open Wheel/Formula
DTC-70	<ul style="list-style-type: none"> - High temp & high torque - Superior pad and rotor wear - Excellent torque controll - Excellent modulation and release characteristics - Designed for high deceleration rates 	400-1600	800-1200	HIGH	<ul style="list-style-type: none"> - NASCAR/NASCAR Modified - ARCA - Super Late Models - Pavement Circle Track - Demanding Tarmac - Pro Lite - Sports Car/GT/GS - All club levels - Open Wheel/Formula - Monster Trucks - Pro 2/Pro 4 Off Road Trucks
DTC-60	<ul style="list-style-type: none"> - High temp & high torque - Provide superior pad and rotor wear - Excellent torque controll - Excellent modulation and release characteristics - Heavier gravel rally - Lighter tarmac rally 	400-1600	700-1100	HIGH	<ul style="list-style-type: none"> - NASCAR/NASCAR Modified - ARCA - Super Late Models - Pavement Circle Track - Pro 2/Pro 4 Off Road Trucks - Pro Lite - Sports Car/GT/GS - All club levels - Open Wheel/Formula - Popular choice on lightweight front axle apps w/ or w/o ABS
DTC-50	<ul style="list-style-type: none"> - Designed for high deceleration rates - High temperature fade resistance - Very high torque with aggressive initial bite 	300-1400	500-1100	HIGH	<ul style="list-style-type: none"> - Open Wheel/Formula - Sports Car/GT - Trophy Truck - F2000 - F3000 - Class 1/Class 10 Off Road
DTC-30	<ul style="list-style-type: none"> - Wide temp range - Controllable torque - Smooth feel and bite - Excellent release characteristics - Multi-purpose gravel rally - Excellent brake rotor wear 	100-1200	100-800	MEDIUM	<ul style="list-style-type: none"> - NASCAR/NASCAR Modified - Circle Track - Dirt Track - Trophy Truck - Pro Lite - Drag Racing - Sprint Cars - Pro Buggy - Pro 2/Pro 4 Off Road Trucks - Class 1/Class 10 Off Road
DTC-15	<ul style="list-style-type: none"> - Low to mid temp range - Medium torque - Torque level just below DTC-30 	100-800	300-600	MEDIUM	<ul style="list-style-type: none"> - Circle Track - Dirt Track Late Model - Dirt Modified

COMPOUND	COMMENTS/REMARKS	OPERATING TEMP.	OPTIMAL TEMP. RANGE	TORQUE LEVEL	APPLICATIONS
DTC-05	<ul style="list-style-type: none"> - Low to mid temp range - Smooth and predictable torque - Designed to provide lower torque 	100-700	100-500	LOW	<ul style="list-style-type: none"> - Autocross/Track Day Events - Dirt Modified - Specialty Caliper and brake kit
HT-10	<ul style="list-style-type: none"> - Linear in-braking characteristics across temp. ranges - Intermediate to high torque 	300-1300	500-1100	HIGH	<ul style="list-style-type: none"> - Road Racing for higher torque than Blue 42 - Increased track day performance
MT-4	<ul style="list-style-type: none"> - Mid to high initial bite - Intermediate to high torque - Immediate brake torque at lower brake temp 	200-1300	400-1200	HIGH	<ul style="list-style-type: none"> - Pavement Circle Track (under 2000 lbs.) - Pavement Street Stock (under 2800 lbs.) - NASCAR Modified - Pavement Limited - Late Model - Pavement Modified
Blue 42	<ul style="list-style-type: none"> - Low to mid temp range - Low to intermediate torque - Excellent modulation - Multi-purpose compound 	250-1000	350-800	MEDIUM	<ul style="list-style-type: none"> - Road and Rally Racing - Entry level race compound - Trophy Truck - Class 1/Class 10 Off-Road
Black	<ul style="list-style-type: none"> - Lower temp - Low to intermediate torque 	100-900	200-700	MEDIUM	<ul style="list-style-type: none"> - Dirt Circle Track - All-purpose compound - For lower temp and torque applications - Dirt modified - Pavement (MCA Style)
DR-97	<ul style="list-style-type: none"> - Designed for use on aluminum rotors - Good static and dynamic coefficient of friction 	100-900	100-700	MEDIUM	<ul style="list-style-type: none"> - Specialty calipers used in low-to-medium deceleration drag racing
Street/Race	<ul style="list-style-type: none"> - A race pad designed for street use - Wide temp range - Controllable torque - Smooth feel and bite 	100-1200	100-800	MEDIUM	<ul style="list-style-type: none"> - Autocross - Club track day events - Popular choice for rear axle use on GT, GS and club level applications with ABS
HP Plus	<ul style="list-style-type: none"> - Designed to get you to and from the track without requiring a brake change - Low to mid temp range - Smooth and predictable torque 	100-800	300-600	LOW	<ul style="list-style-type: none"> - Autocross Club track day events - Popular choice for rear axle use on GT, GS and club level applications with ABS

MOTORSPORTS COMPOUNDS

BRAKE PADS	COMPOUNDS	BRAKE PADS	COMPOUNDS	BRAKE PADS	COMPOUNDS
Blue 42	EE	DTC-30	W	HP PLUS	N
Black	M	DTC-50	V	HT-10	S
DR-97	J	DTC-60	G	MT-4	L
DTC-05	H	DTC-70	U	STREET/RACE	R
DTC-15	A	DTC-80	Q		

Frequently Asked Street Pad Questions

Q: What compound is best for my application?

A: This is highly dependent on the vehicle and expectations of the customer.

Q: What causes brake noise?

A: There are literally hundreds of reasons why brake noise occurs and most have nothing to do with brake pads. Improper installation, brake system maintenance, rotor quality and debris tend to be the most common causes.

Sometimes brake squeal can be an indicator that there is a problem. Maintenance is required if you experience brake squeal for any of the following reasons:

- Lack of friction material (brakes need to be replaced)
- Loose fitting brake in the caliper
- Loose fitting or missing brake hardware (i.e. shims, anti-rattle clips)
- Loose lug nuts or caliper hardware
- Debris caught between the rotor and the surface of the brake pad
- Heat-cracked or worn rotors
- Uneven finish on resurfaced rotors

In some cases, a user may experience brake noise when no maintenance is required. We call these NVH (Noise, Vibration and Harshness) issues. Brake squeal is typically caused by vibration between the brake pads, rotors and brake calipers. Some brands of semi-metallic brakes are more likely to experience brake squeal due to the metallic ingredients in the brake pads.

Hawk Performance has a great reputation for manufacturing low-noise, high-performance brake pads. All Hawk Performance products have an OE quality shim, severe duty powder coat surface treatment and "GearHead Grease Paks" to virtually eliminate the risk of brake noise. Below are the instructions for proper use of our "GearHead Grease Paks."

1. To silence brake noise – Apply 1-2 grams on the backside of the brake pad and evenly spread across the surface making sure to cover any areas where the pad contacts the caliper or piston.
2. To lubricate calipers – Clean and inspect all brake caliper parts making sure to inspect for damage or excessive corrosion. Apply to pins, slides, bushings, pistons, rubber sleeves and seals.

DO NOT APPLY TO THE ROTOR FACE OR THE BRAKING SURFACE OF THE PAD!

Caution: For eye and skin contact, flush with water for 15 minutes. Wash skin with soap and water; call a physician if irritation persists. If swallowed do NOT induce vomiting; call a physician. KEEP OUT OF REACH OF CHILDREN.

Q: How do I break-in my new pads?

A: Brake Pad Burnishing/Bedding-In Instructions

1. After installing new brake pads, make 6 to 10 stops from approximately 30-35 MPH applying moderate pressure.
 2. Make an additional 2 to 3 hard stops from approximately 40-45 MPH.
 3. DO NOT DRAG BRAKES!
 4. Allow at least 15 minutes for the brake system to cool down.
 5. After step 4 is completed, your new Hawk Performance brake pads are ready for use.
-

Q: Why should I follow a break-in procedure on new brake pads?

A: Correct brake pad break-in (bedding) is important to ensure quality braking performance over the life of the pad. This procedure allows the rubbing surface of the brake pad to be brought to temperature, creating a transfer-film layer of friction material to be applied to the rotor surface. This allows the brake pad material to rub against itself rather than the bare rotor. This increases the stopping performance of the brake pad and can reduce pad and rotor wear.

Q: Can I run cross-drilled or slotted rotors with Hawk Performance brake pads?

A: Yes you can. We do suggest a slotted or solid faced rotor for performance applications. Cross drilled rotors are primarily for looks, so some trade-offs - such as increased brake pad wear and increased dust - may occur.

Q: Where can I find an authorized distributor of Hawk Performance brake pads?

A: You can find authorized dealers of Hawk Performance products by entering your zip code or the dealer's name in the box on the Dealer Locator page of our website. If you are looking for a distributor outside the U.S., simply use the International Dealer Locator page.

Q: Does Hawk Performance have a part for my vehicle application?

A: We are constantly developing new applications, please search for it on our website. To search for a part for your vehicle application, choose the year, make and model on the "Part Search and Order Online" page of our website and hit "Search." All Hawk Performance part numbers for your specified application will be displayed, if available.

Q: What can I do during installation to ensure my brakes won't squeal?

A: First, choose Hawk Performance high performance disc brake pads as your upgrade over other aftermarket brake suppliers. The next best steps you can take to avoid having noisy brakes are:

- Turn / machine the rotors (machining off a small layer of the brake rotor to make it smooth again)
- Wash and dry the rotor to rid of debris
- Install the pads securely and according to instruction
- Properly bed-in the pads according to instruction
- Apply a thin layer of a silicone compound called anti-squeal brake lube on the back of the brake pads

Our standard installation procedures are outlined below. This information is printed on the box of every brake pad set we manufacture, and should be followed in accordance with the application-specific brake pad installation instructions provided by the vehicle manufacturer.

Brake Pad Installation Procedure

- Install brake pads properly. Be sure pads are securely positioned in the caliper.
- Flush brake system with fresh brake fluid.
- Check all hydraulic parts for excess wear and tear.
- Check disc for proper thickness, parallelism, and lateral runout.
- Check disc for scoring or grooves over .012" depth. If either applies, resurfacing is required.
- If discs do not need resurfacing, then contamination from the previous brake pads must be removed. Sand discs with 130-grit sandpaper using moderate pressure. Use soap and water to clean disc surface after sanding. Discs should be free and clear of oil, grease and brake fluid.
- Inspect calipers for freedom of movement. Lubricate where necessary.

Limited Lifetime Warranty

Hawk Performance warrants products to be free of defects from workmanship and materials. This warranty does not apply to normal wear or damage caused by negligence, lack of maintenance, accident, abnormal operations, or improper installation or service. Hawk Performance does not make any other warranty claims, either expressed or implied, including the implied warranties of merchantability or fitness for a particular purpose. In no event will Hawk Performance be liable for incident or consequential damages of any kind, whether such damages are claimed on account of breach of warranty, breach of contract, negligence, or strict product liability. This includes without limitation, damage to property, or other economic losses that may be incurred. Any, and all, warranty claims must be processed through Hawk Performance. All valid warranty claims will be replaced/reimbursed with Hawk Performance products of equal or greater value.

Frequently Asked Street Pad Questions

Q: What are racing brake pads made from?

A: Racing brake pads are made from a variety of ingredients like metals, resins and fillers. The combination of ingredients and the size and weight of the ingredients used in the friction formula can create very different performance levels and characteristics.

Q: With all the different brake compounds available today, how do I make the proper choice of what to use on my racecar?

A: Choosing the proper brake pad compound that will provide the best performance for your Motorsports application can be made easier by following the guidelines outlined below:

- Determine what compounds and styles of brake pads are available for your calipers and type of racing.
 - Determine the operating temperature of your car's brake system. Heat sensitive paint can be applied to the brake pads and rotors to help you gauge temperature. Tire pyrometers can be used, but due to the cool down time the temperature numbers may not be accurate.
 - Upon learning your system's temperatures, or if you do not know your temperatures, contact Hawk Performance for recommendations regarding proper brake material for your application.
 - Other drivers that share your driving style will sometimes provide valuable information that may allow you to learn what brake pads other drivers have used and liked or disliked.
 - Contact your local racing products dealer and inquire as to what brake pads they offer and recommend for your application.
 - It's important to understand different types of racecars, racing surfaces and driving styles may require different levels of braking performance, and many drivers expect the brake system to have a certain feel that suits their individual needs. Because of this, it should not be assumed that what works for one driver would work for all. In some cases the best way to learn what is best for you is to experiment with a variety of friction compounds to determine how a particular pad differs from another regarding issues such as pedal feel, consistency and rotor and brake pad wear.
-

Q: What are some noticeable signs that I have made the wrong pad choice for my Motorsports racing application?

A: When a friction compound is used in a substantially higher temperature range than intended, the material can quickly lose its ability to perform correctly. Generally, an overheated brake pad will continue to provide a hard pedal feel but require more foot and pedal effort to achieve even marginal performance. Continued use during this type of circumstance can result in complete brake pad failure.

Q: What happens if I choose a brake pad compound that does not have a high enough temperature range for my application?

A: It's important to understand the chain of events that take place when a brake pad becomes too hot to work correctly. As the pad begins to lose performance effectiveness the driver may try to compensate by pushing harder and longer on the pedal. This may cause friction surface temperature to increase thereby increasing the brake problem. When this occurs, great stress is put on the friction material and the material can begin to crystallize. In extreme cases delaminating between the friction material and the pad's backing plate can sometimes occur. This type of situation may be corrected by choosing a friction compound designed to withstand higher temperature.

Q: Why should I perform a break-in procedure on new brake pads?

A: Correct brake pad break-in (bedding) is important to assure optimal braking performance over the life of the pad. This procedure allows the rubbing surface of the brake pad to slowly be brought up to racing temperatures. Proper bedding creates a transfer layer film of friction material to be applied to the rotor surface. This allows the brake pad material to rub against itself rather than the bare rotor. This increases the stopping performance of the brake pad and can reduce pad and rotor wear.

Q: What is the proper procedure for breaking in new brake pads?

A: Brake Pad Burnishing/Bedding-In Instructions

1. After reaching medium speed engage brake pedal to slow car without coming to a complete stop. Release pedal quickly and do not drag brakes. Repeat four or five times.
2. At higher speeds engage brake pedal to slow car without coming to a complete stop. Release pedal quickly and do not drag brakes. Repeat five times.
3. At or near race speed engage brake pedal to slow car without coming to a complete stop. Release pedal quickly and do not drag brakes. Repeat three times. Allow a few seconds between brake engagements while car is in motion.
4. Do not hold brake pedal. Park car for approximately 20 minutes or until brake rotors are completely cool to the touch.
5. If during the above steps the brake pedal becomes soft or brake fade is noticed, park the car immediately for approximately 20 minutes. Do not hold brake pedal.

IMPORTANT REMINDERS WHEN BURNISHING/BEDDING BRAKE PADS

- Do not attempt to use badly worn or damaged rotors with new brake pads.
- Do not drag brakes while car is moving during break-in procedure.
- Do not engage pedal while car is stopped at any time following the break-in procedure.
- Upon completing the procedure, allow the brake system to completely cool before racing.
- Applying the pedal a few times before the start of the race will allow the brake pads to heat up before attempting to reach race speeds.
- Clean a used rotor surface with fine sand paper or steel wool, rinse with water, dry and install before bedding new pads.
- Some forms of racing don't allow time for the proper break-in procedure to be performed. However, it is still very important to attempt to perform at least the core of the procedure: Build up heat slowly and allow the system to completely cool down before racing if possible.

Q: What can happen to my brake pads if not bedded properly?

A: Proper break-in will assure that small amounts of heat are introduced to the brake pad. Brake pads that are brought up to temperature too fast and not properly allowed to cool down may quickly become glazed and not perform as originally intended. The pad's rubbing surface reaches extreme heat levels during racing use. The surface needs slow temperature increases to help prepare the pad. Large amounts of heat all at one time can cause the brake pad rubbing surface to become somewhat liquified and coat the pad surface with a glaze. This will dramatically reduce stopping performance as certain ingredients in the friction compound breakdown and cause glazing of the rubbing surface of the brake pad.

Q: How can I tell by looking at the brake pad if my pads have been glazed over?

A: When a brake pad glazes over, the friction surface develops a cloudy or glassy looking coating. It is possible to remove the glazed surface by using sand paper to grind away the damaged layer and expose a new layer that will require the proper bedding procedure.

Q: What is a pre-bedded brake pad?

A: Some brake pad manufacturers offer a pre-bedded pad and/or a pre-bedding service. Pre-bedding involves placing pads in a caliper and running them against a mechanically driven rotor in a controlled environment. The rotor and pads are slowly brought up to temperature and allowed to cool down over several cycles. This process simulates on track situations while allowing the two surfaces to mate correctly in an optimum environment. While this process can be very expensive, it greatly reduces the break-in time prior to pad purchase. In most cases the rotor and the pad are, and should be, sold as a matched set.

Q: What is a pre-burnished brake pad?

A: Some brake pads are pre-burnished during the manufacturing process. Pads that are pre-burnished have had high temperature applied to the rubbing surface to simulate the first few engagements on an actual race car. The process will allow the pad to break-in quickly and to begin working more effectively in a shorter time. Pre-burnished pads still need to be properly bedded to help assure that the pad and the rotor have an opportunity to mate correctly.

Hawk Performance - BRAKE PAD DIAGRAM BREAKDOWN AND COMPOUND CODES

Pad thickness in inches (and millimeters) to include core and friction material

Carry-over column for industry reference numbers and pad thickness

Hawk Performance part number

Hawk Performance compound codes

Industry reference numbers (FMSI)

Length in inches (and millimeters)

Original equipment and/or aftermarket caliper manufacturer

Width in inches (and millimeters)

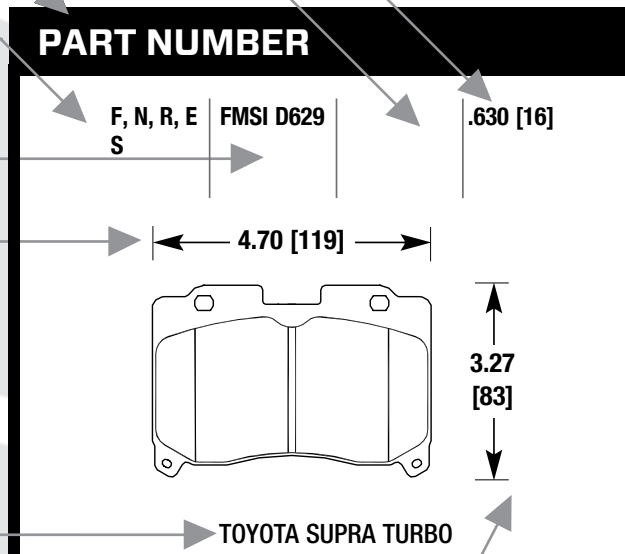

PAD/ROTOR KIT CODE BREAKDOWN

HK 4218 .448 X
 HAWK KIT ROTOR PAD SHAPE INSERT COMPOUND CODE

BRAKE PAD CODE BREAKDOWN

HB 245 X .631
 HAWK BRAKE PAD SHAPE INSERT COMPOUND CODE PAD THICKNESS

STREET COMPOUNDS

BRAKE PAD	COMPOUNDS
HPS 5.0	B
HPS Performance Street	F
Performance Ceramic	Z
LTS Light Truck & SUV	Y
Super Duty	P

MOTORSPORTS COMPOUNDS

BRAKE PAD	COMPOUNDS
Black	M
Blue 42	EE
DR-97	J
DTC-05	H
DTC-15	A
DTC-30	W
DTC-50	V
DTC-60	G
DTC-70	U
DTC-80	Q
HP PLUS	N
HT-10	S
MT-4	L
STREET/RACE	R



BRAKE PAD DIAGRAMS



Hawk Performance - BRAKE PAD DIAGRAMS

HB100

B, F, N, R, E	.480 [12]
EE, G, H, J, L	.625 [16]
M, S, U, V, W	

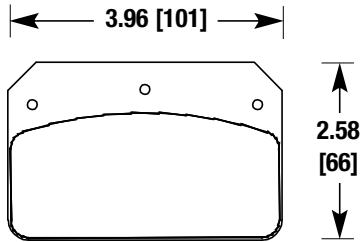

OUTLAW, SIERRA,
WILWOOD, RED DEVIL

HB103

B, F, N, P, Y	FMSI D52	.590 [15]
Z, A, E, EE, G	FMSI D122	
H, L, M, S, U	FMSI D313	
V, W		

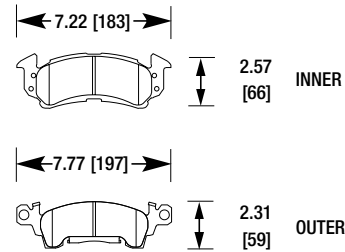

GM INTERMEDIATE

HB101

E, EE, G, H, L	.775 [20]
M, S, U, V, W	.800 [20]
F, N	

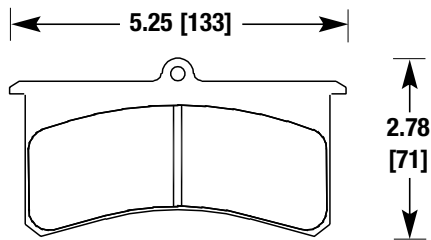

AP RACING, OUTLAW, SIERRA,
WILWOOD 7320, RED DEVIL

HB104

E, G, H, J, L	.485 [12]
M, S, U, W	
B, F, N	

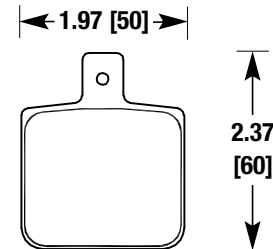

OUTLAW, SIERRA,
WILWOOD 7012, RED DEVIL

HB102

F, N, E, G	.600 [15]
M, S, U, V	.625 [16]
W	.800 [20]

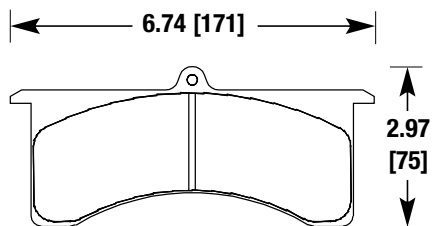

AP RACING, SIERRA,
WILWOOD 7520

HB105

F, N, Z, E	.620 [16]	.980 [25]
G, S, U, V	.708 [18]	
W	.775 [20]	

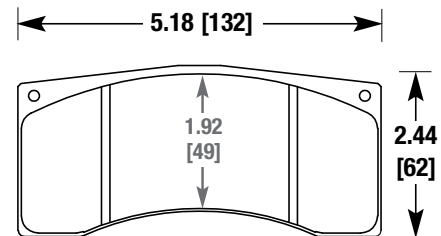

ALCON, BREMBO,
PORSCHE

HB107

F, E, EE		.620 [16]
G, S, U, V		

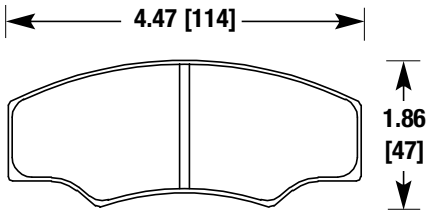

ALCON, AP RACING,
FORMULA ATLANTIC

HB110

F, B, N, R		.654 [17]
Z, E, G, S		.775 [20]
U, W		

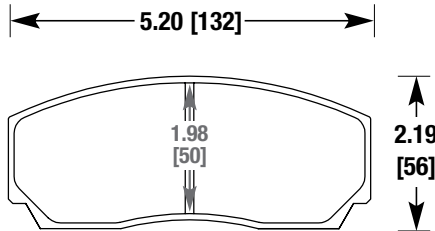

ALCON, AP RACING

HB108

E, EE, G	FMSI D5	.560 [14]
M, S, V		

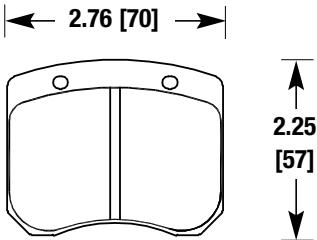

AP RACING,
FORMULA FORD 2000, LUCAS GIRLING

HB111

B, F, N, R	FMSI D412	.610 [15]
Z, E, EE, G		
M, S, U		

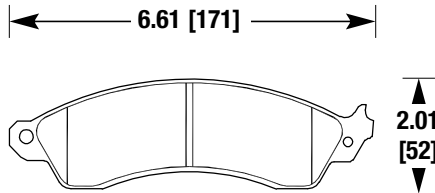

CAMARO, CORVETTE,
FIREBIRD, MUSTANG

HB109

B, F, N, R	.650 [16]	1.120 [28]
Z, E, G, U	.710 [18]	.800 [20]
	.980 [25]	

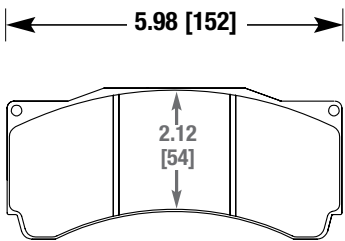

ALCON, AP RACING

HB112

B, F, N, R	FMSI D213	.540 [14]
Z, E, G, M	FMSI D295	
S, U	FMSI D413	

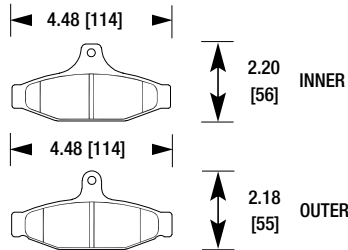

CAMARO, CORVETTE,
FIREBIRD (REAR)

Hawk Performance - BRAKE PAD DIAGRAMS

HB113

F, N, E, G | FMSI D373 | .590 [15]
U

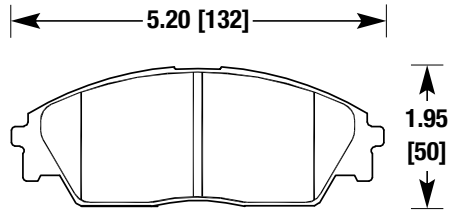

HONDA

HB117

E, EE, M | | .380 [10]

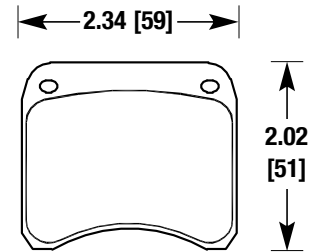

ALCON, AP RACING,
FORMULA FORD 1600

HB114

E, G | | .980 [25]

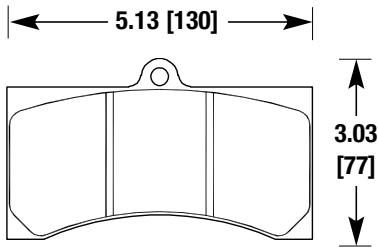

ALCON, AP RACING,
WILWOOD

HB118

E, EE, M, S | FMSI D44 | .560 [14]
U, V

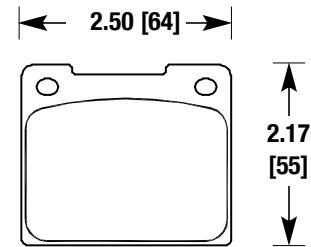

FORMULA MAZDA, LUCAS GIRLING

HB116

E, EE, M, S | | .580 [15]

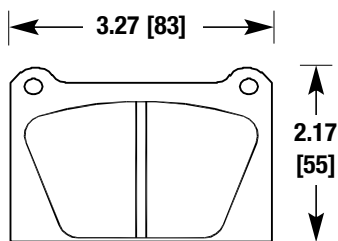

ALCON, LUCAS GIRLING

HB119

A, E, EE, G, H | FMSI D138 | .594 [15]
L, M, S, U, V | FMSI D154
W, B, F, N, P | FMSI D202
R, Y, Z

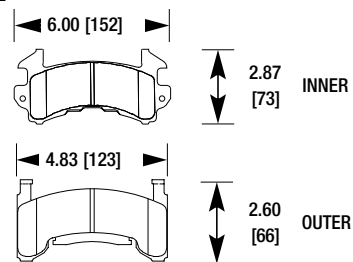

GM METRIC

HB120

E, F, N, R Z	FMSI D531	.560 [14]
-----------------	-----------	-----------

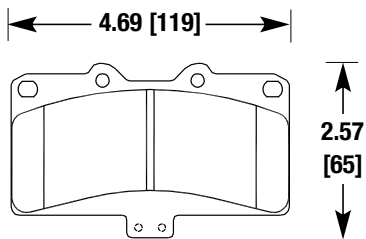

DODGE STEALTH, MITSUBISHI 3000GT

HB123

E, L, M, N	FMSI D61	.535 [14]
------------	----------	-----------

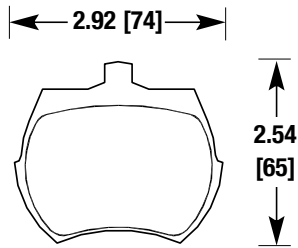

AUSTIN, MG,
MORRIS, TRIUMPH, WOLSELEY

HB121

E, S, U		.710 [18] .980 [25]
---------	--	------------------------

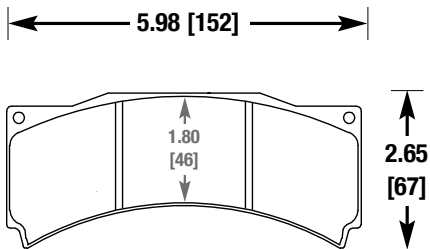

ALCON, AP RACING

HB125

F, Z, E	FMSI D199 FMSI D200 FMSI D499	.650 [17]
---------	-------------------------------------	-----------

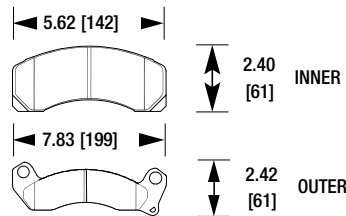

FORD, LINCOLN, MERCURY

HB122

F, N, R, Z E, G, U, W		.710 [18] .980 [25]
--------------------------	--	------------------------

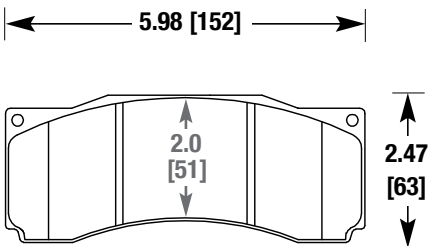

ALCON, AP RACING, STOP TECH, ROUSH

HB126

B, F, N, R Z, E, G, S U	FMSI D8	.505 [13]
-------------------------------	---------	-----------

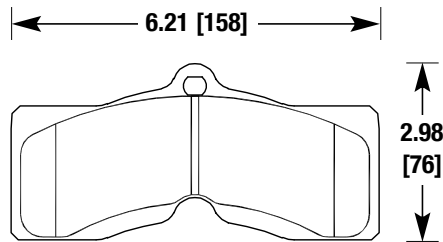

CHEVY, PONTIAC

HB128

F, N, E, G		.505 [13]
S, U		

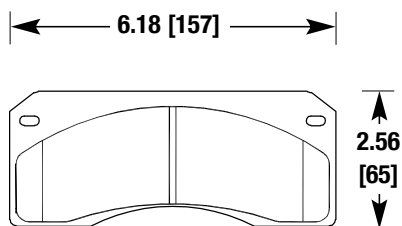

CORVETTE TWIN PIN

HB132

E, M, F, N	FMSI D27	.580 [15]
------------	----------	-----------

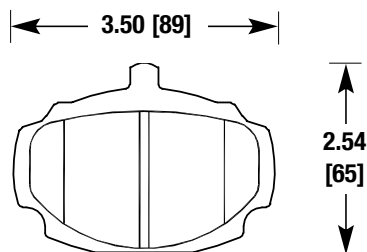

HUMBER, MG, SAAB, SINGER, VAUXHALL

HB130

G, U, V, W	.620 [16]	.980 [25]
	.684 [17]	1.018 [26]
	.775 [20]	1.097 [28]

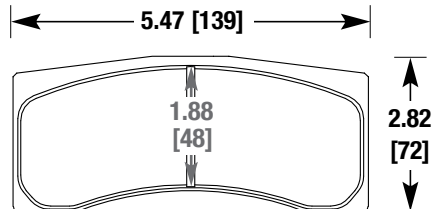

BREMBO, WILWOOD

HB135

E, EE, G, S	FMSI D394	.642 [16]
U, V, B, F	FMSI D725	.770 [20]
N, R, Z		

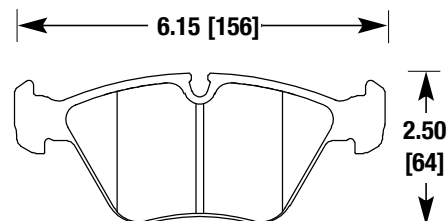

AUDI, BMW, JAGUAR

HB131

F, P, E, G	FMSI D153	.595 [15]
L, M, U, W	FMSI D392	
	FMSI D614	

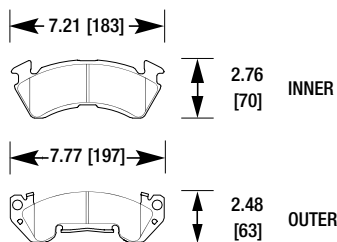

CHEVROLET IMPALA, CAPRICE, POLICE & HD

HB136

B, F, N, Z	FMSI D558	.690 [18]
E, EE, G, S		
U		

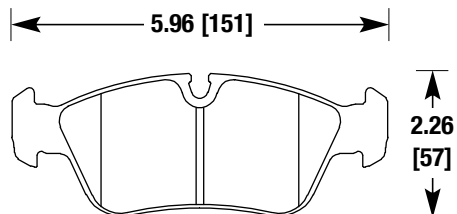

BMW

HB137

F, N, R, E	FMSI D253	.690 [18]
G, S, U	FMSI D395	

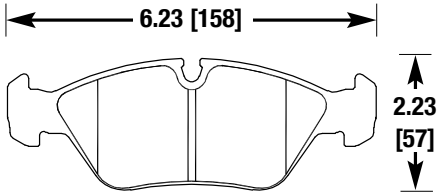

BMW, FERRARI, PORSCHE

HB143

B, F, N, R	FMSI D503	.680 [17]
Z, E, EE, G		
S, U, W		

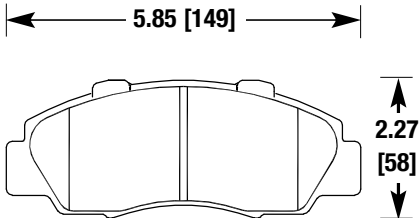

ACURA, HONDA, ISUZU

HB138

N, E, S		.690 [18]
---------	--	-----------

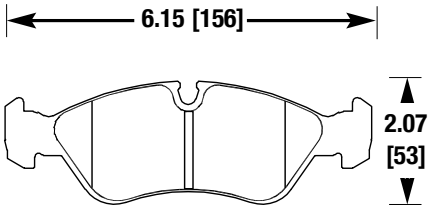

OPEL ASTRA

HB144

E, U, W, F	FMSI D568	.690 [18]
		.719

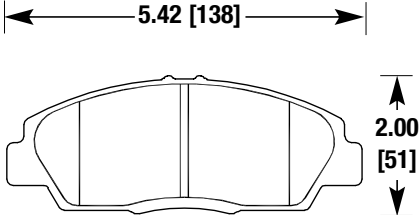

HONDA PRELUDE

HB141

B, F, N, R	FMSI D372	.650 [17]
Z, E, EE, G	FMSI D447	.709
S, U, V, W	FMSI D609	

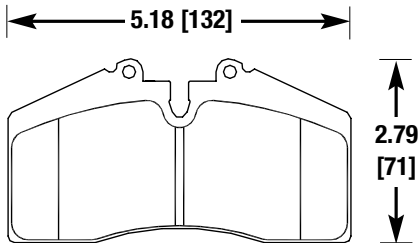

AUDI, FERRARI, PORSCHE

HB145

B, F, N, R	FMSI D537	.570 [14]
Y, Z, E, EE		
G, M, S, U		
W		

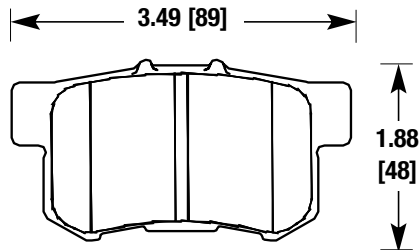

ACURA, HONDA, ISUZU (REAR)

HB148

F, N, R, Z	FMSI D457	.560 [14]
E, EE, G, M	FMSI D468	
S, V, W,	FMSI D525	

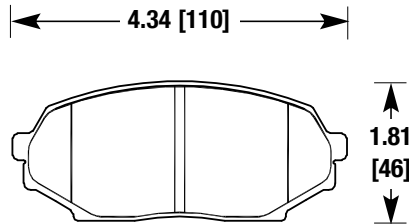

GEO, ISUZU, MAZDA, PONTIAC

HB151

F, N, E, EE	FMSI D235	.505 [13]
M		

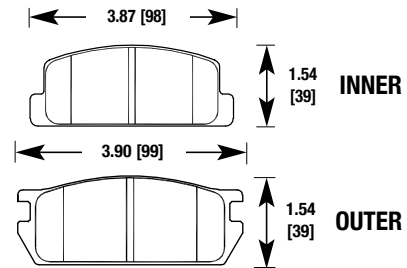

MAZDA RX-7 (REAR)

HB149

E, EE, G, M	FMSI D635	.505 [13]
S, V, W, B		
F, N, R, Z		

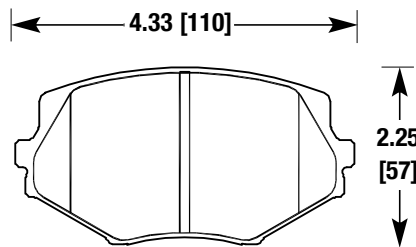

MAZDA MIATA

HB152

E, EE, G, M	FMSI D131	.540 [14]
S, F, N		

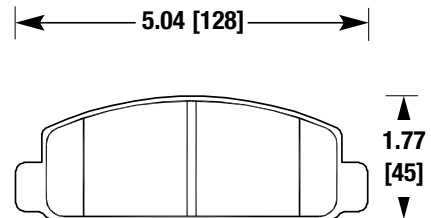

MAZDA RX-7

HB150

E, EE, F, N	FMSI D76	.555 [14]
-------------	----------	-----------

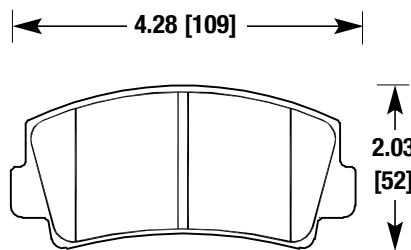

FORD, MAZDA

HB155

E, EE, G	FMSI D331	.580 [15]
M, S, B, F	FMSI D463	
N, R	FMSI D585	

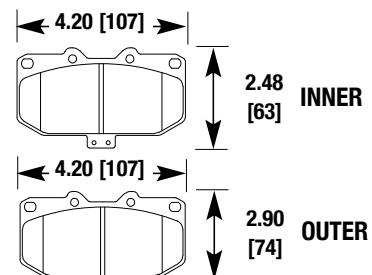

MAZDA RX-7

HB156

E, F	FMSI D94 FMSI D169 FMSI D172	.562 [14]
------	------------------------------------	-----------

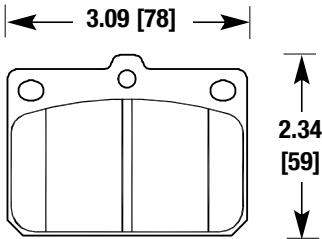

HYUNDAI, MAZDA, MITSUBISHI, TOYOTA

HB159

E, EE, G, M S, V, W, B F, N, R, Z	FMSI D636 FMSI D663	.492 [12]
---	------------------------	-----------

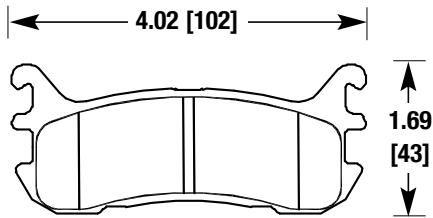

FORD, MAZDA, MERCURY (REAR)

HB157

F, N, R, E EE, G, M W	FMSI D458	.484 [12]
-----------------------------	-----------	-----------

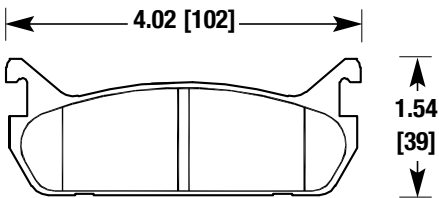

FORD, MAZDA, MERCURY (REAR)

HB167

E, G, S, U V, W		.620 [16] .778 [20] .854 [22]
--------------------	--	-------------------------------------

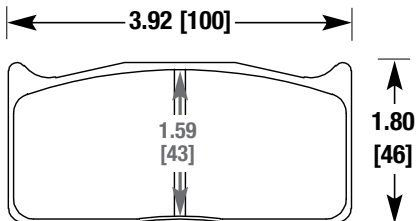

AP RACING, BREMBO, FORMULA ATLANTIC

HB158

B, F, N, R Z, E, EE, G M, S, W	FMSI D283 FMSI D332 FMSI D482	.515 [13]
--------------------------------------	-------------------------------------	-----------

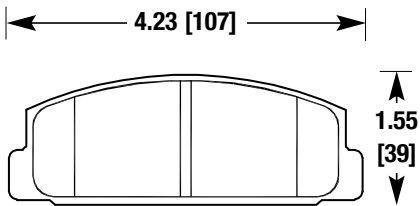

MAZDA RX-7 (REAR)

HB169

F, N, E, EE M, S, U, W	FMSI D57 FMSI D114 FMSI D161	.560 [14]
---------------------------	------------------------------------	-----------

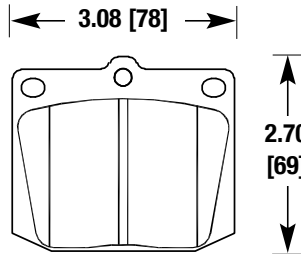

NISSAN

Hawk Performance - BRAKE PAD DIAGRAMS

HB170

B, F, N, R	FMSI D345	.650 [17]
Z, E, EE, G	FMSI D446	.710 [18]
M, S, U	FMSI D608	

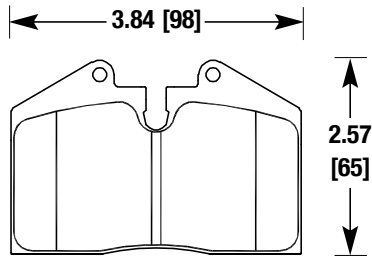

AUDI, FERRARI, PORSCHE

HB173

F, N, E	FMSI D294	.570 [14]
		.595 [15]

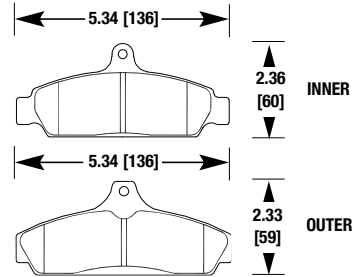

CORVETTE

HB171

E, EE, S, U	FMSI D45	.590 [15]
W, F, N, Z	FMSI D287	.720

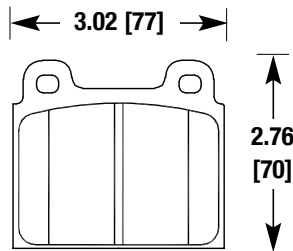

ALFA ROMEO, FERRARI, MERCEDES, OPEL, PORSCHE

HB176

E, M, B, F	FMSI D415	FMSI D658	.614 [16]
N, Z	FMSI D512	FMSI D759	.680 [17]
	FMSI D559	FMSI D782	
	FMSI D641		

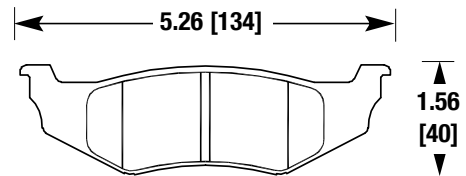

CHRYSLER, DODGE, EAGLE, PLYMOUTH (REAR)

HB172

F, N, R, Z	FMSI D31	.500 [13]
E, EE, G, M	FMSI D58	.595 [15]
S, U, W	FMSI D861	

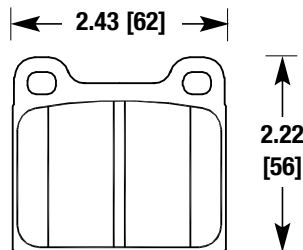

ALFA ROMEO, BMW, MERCEDES, PORSCHE, VOLVO

HB177

F, N, E, G	FMSI D642	.630 [16]
S		.710 [18]

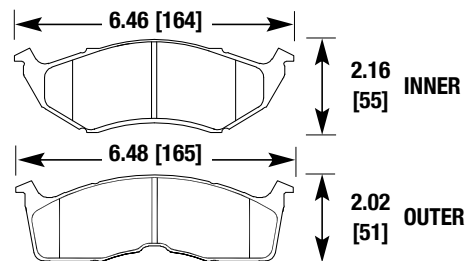

CHRYSLER, DODGE, EAGLE, PLYMOUTH

HB178

B, F, N, R	FMSI D460	.564 [14]
Z, E, G, S	FMSI D647	
W		

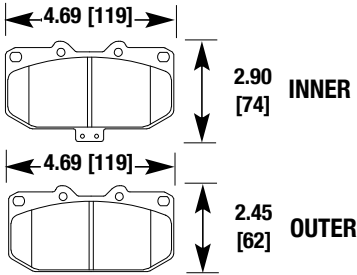

NISSAN 300ZX

HB181

F, N, Z, E	FMSI D639	.590 [15]
G, S, U	FMSI D960	.660 [17]

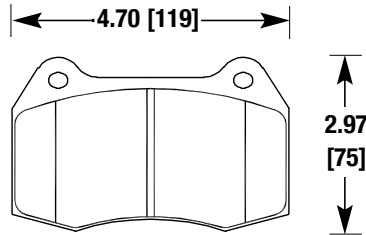

BMW, NISSAN

HB179

E, S, W, B	FMSI D461	.630 [16]
F, N, R, Z		

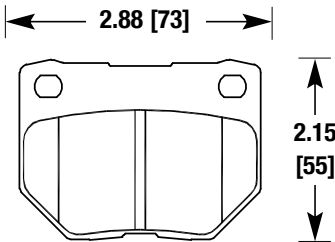

NISSAN 300ZX (REAR)

HB182

F, N, Z, E	FMSI D600	.660 [17]
------------	-----------	-----------

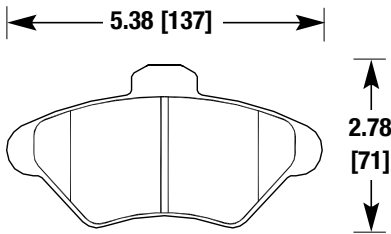

FORD, MERCURY

HB180

B, F, N, R	FMSI D109	.560 [14]
Z, E, EE, G	FMSI D961	.591 [15]
S, U, W		.640 [16]

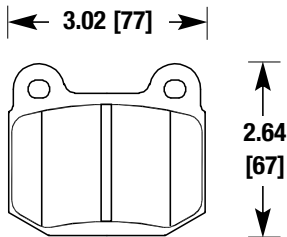

ALFA ROMEO, BMW, LOTUS,
NISSAN, OPEL

HB183

E, G, M, U	FMSI D627	.585 [15]
B, F, N, R		.660 [17]
Z		

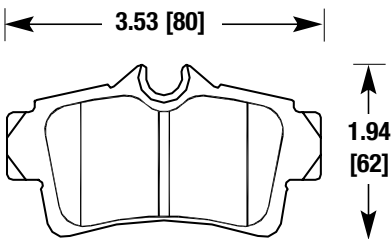

MUSTANG (REAR)

HB184

F, E, G, S	FMSI D594	.650 [17]
U		.710 [18]
		.787 [20]

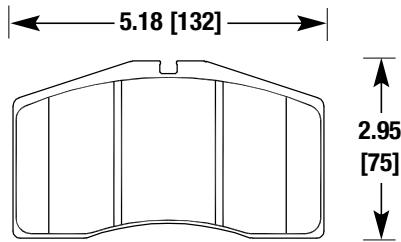

AUDI, BREMBO, PORSCHE

HB190

E, EE, G, S	FMSI D227	.600 [15]
W, F, N, Z	FMSI D684	.730 [19]
	FMSI D696	

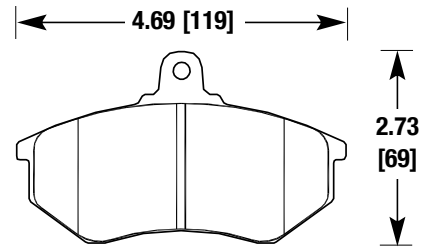

AUDI, VOLKSWAGEN

HB185

F, N, R, E	FMSI D504	.590 [15]
------------	-----------	-----------

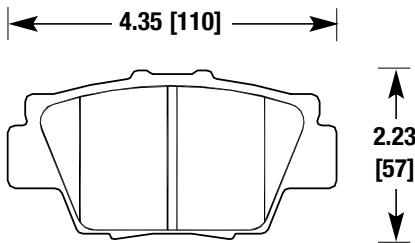

ACURA NSX (REAR)

HB191

E, EE, S, F	FMSI D241	FMSI D539	.590 [15]
N	FMSI D242	FMSI D570	
	FMSI D302		

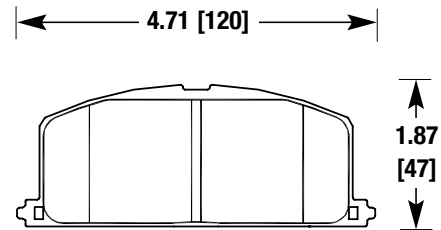

CHEVY, GEO, LEXUS, TOYOTA

HB189

F, N, Z, E	FMSI D280	.550 [14]
EE, G, S	FMSI D307	.595 [15]
W	FMSI D569	

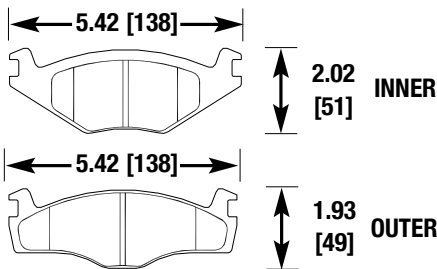

VOLKSWAGEN

HB192

B, G, S, U		.620 [16]
W		

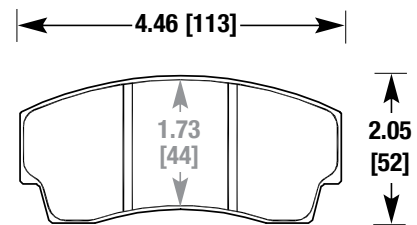

ALCON, AP RACING, FORMULA ATLANTIC

HB193

B, F, N, R	FMSI D810	.610 [15]
Z, E, G, S	FMSI D968	.670 [17]
U, V, W		.715 [18]

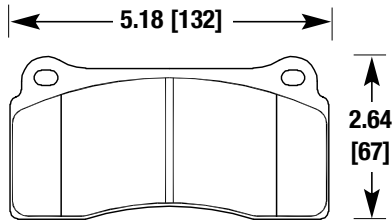

BREMBO F-40, DODGE, FERRARI,
JAGUAR, NISSAN

HB198

F, N, E, EE	FMSI D252	.565 [14]
G, S	FMSI D254	.685 [17]
	FMSI D445	

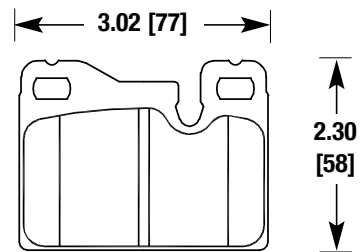

PORSCHE

HB194

E, G, S, U	FMSI D592	.570 [14]
V, W, B, F	FMSI D1053	.665 [17]
N, R, Y, Z		

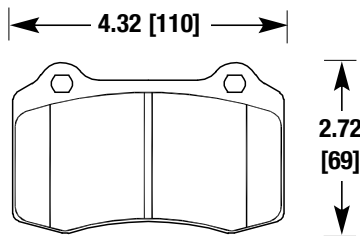

ESPIRIT, JAGUAR, MUSTANG, VIPER

HB199

F, N, E, EE	FMSI D141	FMSI D443	.660 [17]
G, S, U	FMSI D251	FMSI D455	.702 [18]
	FMSI D424		

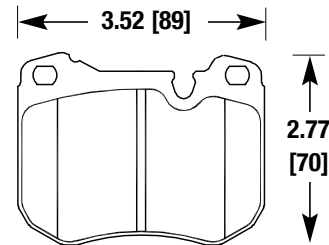

LAMBORGHINI, MERCEDES,
PEUGEOT, PORSCHE

HB195

E, EE, G, S	FMSI D278	FMSI D487	.640 [16]
V, F, N, R	FMSI D439	FMSI D493	
Z	FMSI D454		

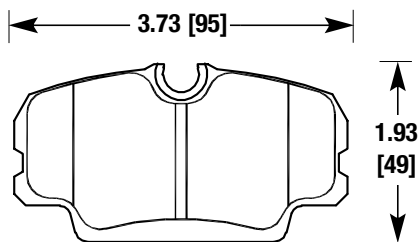

ALFA ROMEO, BMW, MERCEDES,
PEUGEOT, SAAB

HB201

E, F, N, R	FMSI D631	.620 [16]
Z		

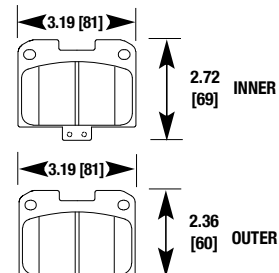

DODGE STEALTH, MITSUBISHI 3000GT (REAR)

Hawk Performance - BRAKE PAD DIAGRAMS

HB202

F, N, E | FMSI D189 | .580 [15]
 FMSI D282

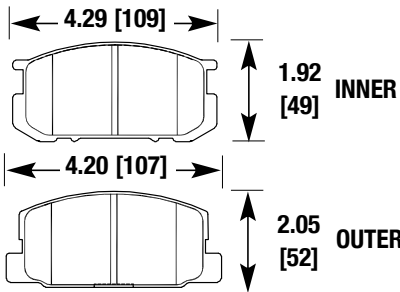

SUBARU, TOYOTA

HB206

E | FMSI D163 | .565 [14]

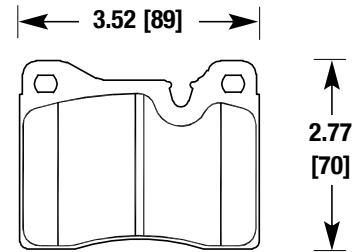

BMW, FERRARI, LAMBORGHINI, MASERATI

HB203

F, N, M | FMSI D305 | .550 [14]

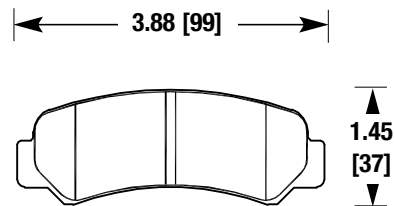

TOYOTA COROLLA (REAR)

HB208

G, S, U, V | .620 [16]
 .708 [18]
 .787 [20]
 .866 [22]

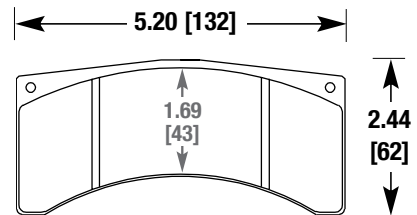

BREMBO F3000, WILWOOD

HB204

F, N, R, E | FMSI D43 | .615 [16]
 EE, M, S, W

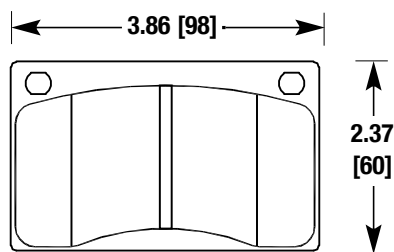

VOLVO

HB210

B, F, P, Y | FMSI D477 | .677 [17]
 Z | FMSI D712

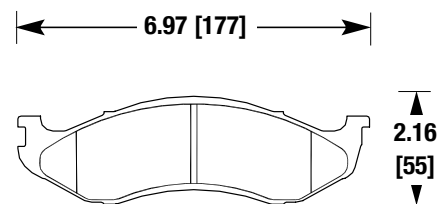

JEEP

HB211

F, N, Z, E	FMSI D583	.606 [15]
S	FMSI D637	
	FMSI D893	

← 5.18 [132] →

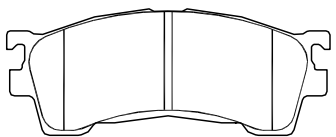

↑ 2.02 [51]
↓

FORD, MAZDA

HB214

B, F, N, Z	FMSI D530	.618 [16]
E, G, S	FMSI D723	

← 5.90 [150] →

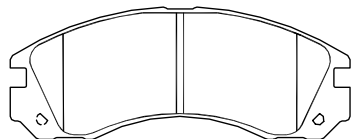

↑ 2.27 [58]
↓

DODGE, EAGLE,
MITSUBISHI, PLYMOUTH

HB212

F, N, Z, E	FMSI D584	.535 [14]
M		

← 3.94 [100] →

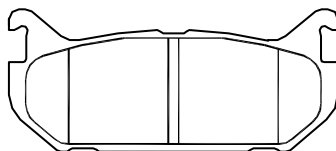

↑ 1.71 [43]
↓

FORD, MAZDA (REAR)

HB215

F, N, R, E	FMSI D629	.630 [16]
S		

← 4.70 [119] →

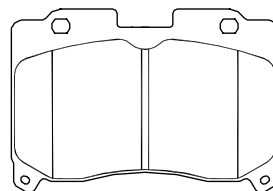

↑ 3.27 [83]
↓

TOYOTA SUPRA TURBO

HB213

F, N, Z, E	FMSI D484	.626 [16]
------------	-----------	-----------

← 5.03 [128] →

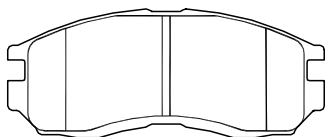

↑ 2.06 [52]
↓

CHRYSLER, DODGE, EAGLE,
MITSUBISHI, PLYMOUTH

HB216

E, F, N, R	FMSI D630	.590 [15]
------------	-----------	-----------

← 3.18 [81] →

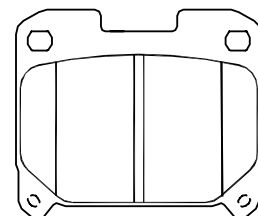

↑ 2.70 [69]
↓

TOYOTA SUPRA TURBO (REAR)

Hawk Performance - BRAKE PAD DIAGRAMS

HB217

F, Z, E | FMSI D623 | .681 [17]

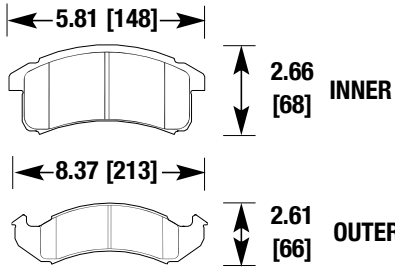

BUICK, CADILLAC, CHEVY, OLDS, PONTIAC

HB224

U | | 1.120 [28]

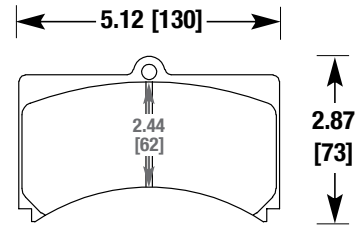

ALCON, WILWOOD

HB218

B, F, N, R | FMSI D273 | .583 [15]
 Z, E, EE, G | FMSI D474 |
 S, U, W | FMSI D560 |

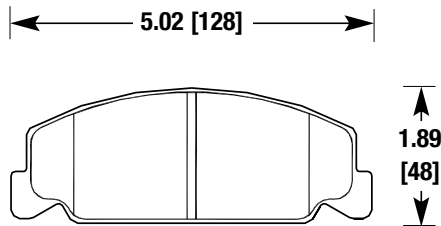

HONDA

HB227

B, F, N, R | FMSI D396 | .630 [16]
 Z, E, EE, G | FMSI D692 |
 S, U, V | FMSI D763 |

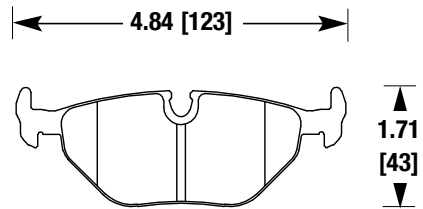

BMW, SAAB (REAR)

HB221

G, U, V, W | | .684 [17]
 1.100 [28]
 1.180 [30]

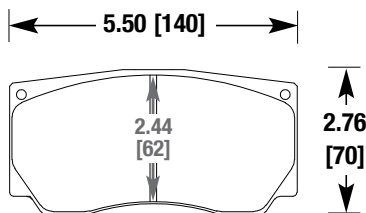

AP RACING, BREMBO, WILWOOD

HB229

E, S | FMSI D81 | .580 [15]

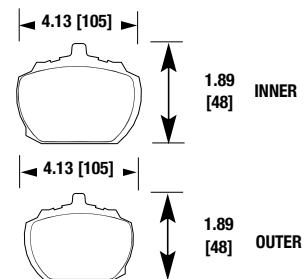

TRIUMPH

HB231

F, N, E	FMSI D422	.575 [15] .625 [16]
---------	-----------	------------------------

4.77 [121]

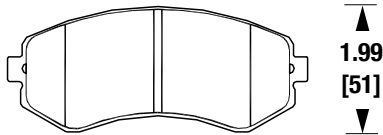

NISSAN 240SX

HB236

E, W, N, R	FMSI D668	.622 [16]
------------	-----------	-----------

4.27 [108]

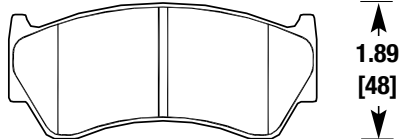

NISSAN

HB232

F, N	FMSI D376	.681 [17]
------	-----------	-----------

5.52 [140]

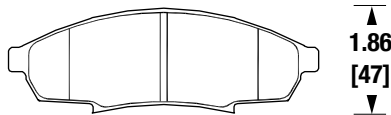

BUICK, CHEVY, OLDS, PONTIAC

HB237

F, N, E, G H, J, L, M S, U, V, W		.480 [12] .625 [16]
--	--	------------------------

3.95 [100]

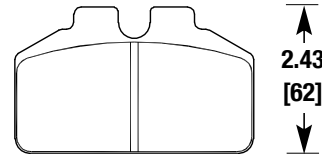

OUTLAW, SIERRA, WILWOOD

HB235

F, N, Z, E	FMSI D462 FMSI D485	.665 [17]
------------	------------------------	-----------

5.40 [137]

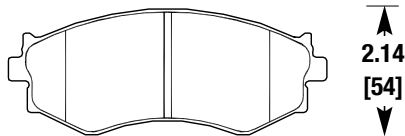

INFINITI, NISSAN

HB238

U		1.180 [30]
---	--	------------

5.98 [152]

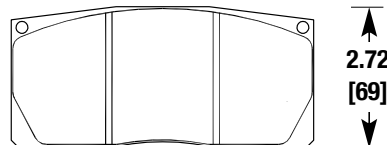

ALCON, WILWOOD

HB240

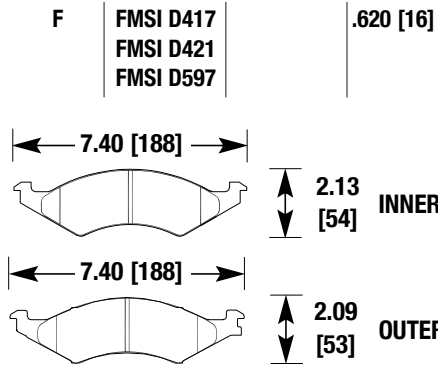

FORD, LINCOLN, MERCURY

HB245

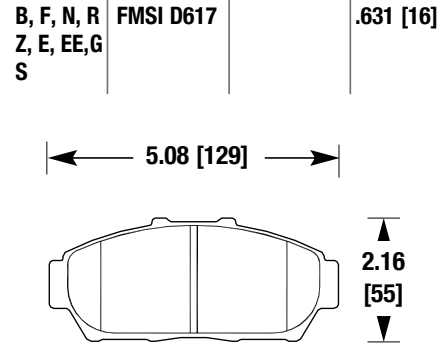

ACURA, HONDA

HB242

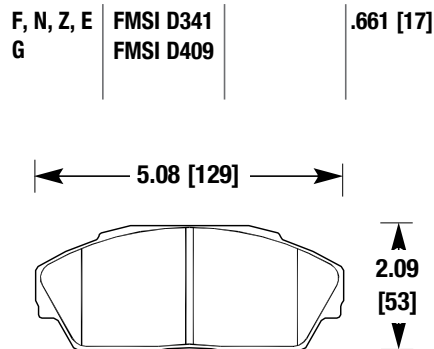

ACURA, HONDA

HB246

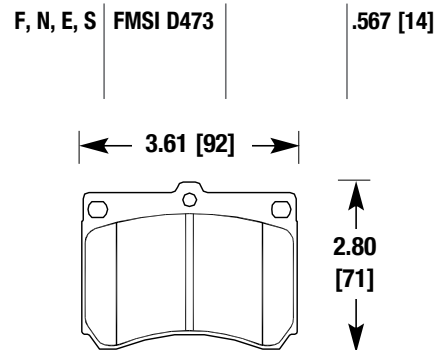

FORD, MAZDA, MERCURY

HB244

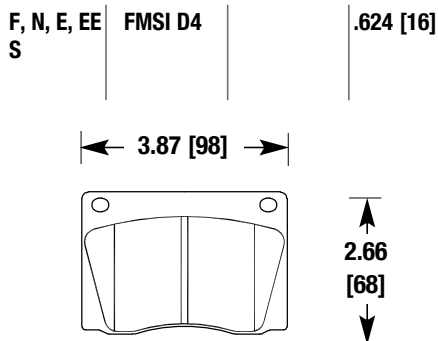

ALFA ROMEO, ASTON MARTIN,
JAGUAR, LOTUS, VOLVO

HB247

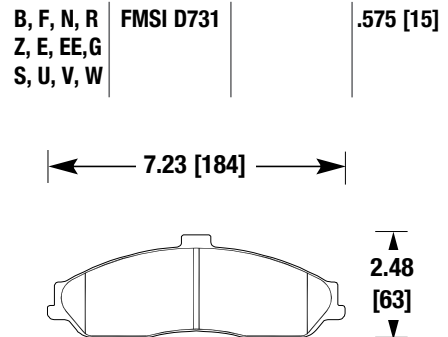

C-5 CORVETTE

HB248

B, F, N, R	FMSI D732	.650 [17]
Z, E, EE, G		
S, U, V, W		

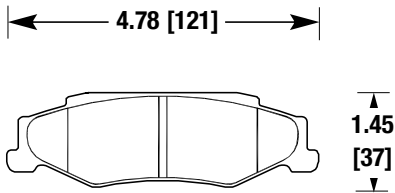

C-5 CORVETTE, CADILLAC XLR (REAR)

HB252

P	FMSI D184 FMSI D380 FMSI D717	.860 [22]
---	-------------------------------------	-----------

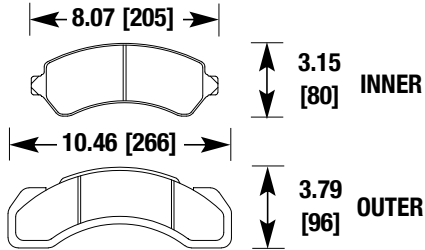

CHEVY/GMC TRUCK,
FREIGHTLINER, INTERNATIONAL

HB249

E, G, S, U	FMSI D749	.575 [15]
V, W, B, F		
N, Z		

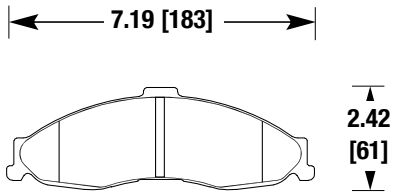

CAMARO, FIREBIRD

HB253

P	FMSI D224	.750 [19]
---	-----------	-----------

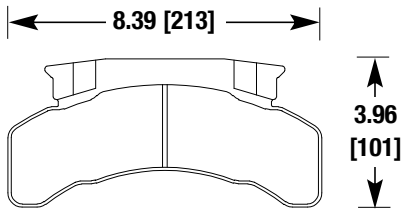

CHEVY/GMC TRUCK, FORD TRUCK

HB250

E, G, S, U	FMSI D750	.653 [17]
B, F, N, Z		

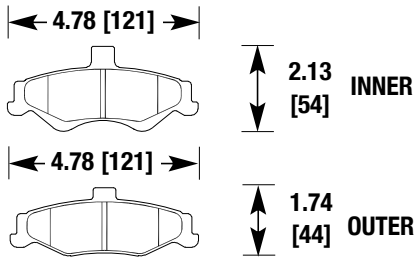

CAMARO, FIREBIRD (REAR)

HB254

P	FMSI D236	1.000 [25]
---	-----------	------------

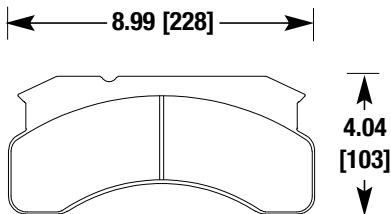

FORD MEDIUM DUTY

Hawk Performance - BRAKE PAD DIAGRAMS

HB255

P	FMSI D120	.655 [17]
---	-----------	-----------

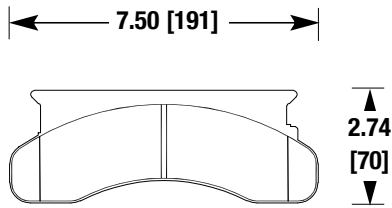

FORD TRUCK

HB263

B, F, N, R Z, E, G, U W	FMSI D431	.650 [17]
-------------------------------	-----------	-----------

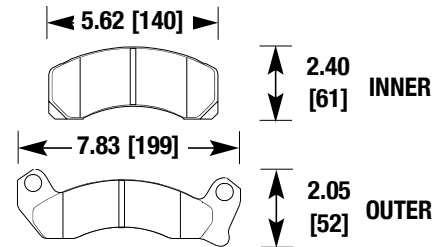

FORD

HB260

F, Z	FMSI D730	.670 [17]
------	-----------	-----------

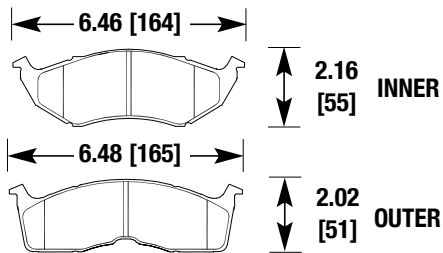

CHRYSLER, DODGE

HB266

F, N, P, Y Z	FMSI D679	.650 [17]
-----------------	-----------	-----------

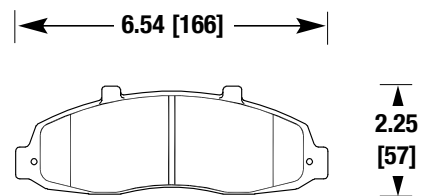

FORD F-150, LINCOLN BLACKWOOD

HB262

B, F, N, Z E, EE, S	FMSI D272	FMSI D230	.540 [14]
	FMSI D323	FMSI D231	
	FMSI D429	FMSI D232	
	FMSI D464		

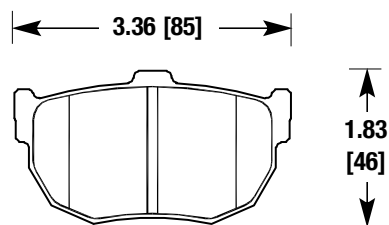

HYUNDAI, NISSAN (REAR)

HB267

J, V, W	RACE	.480 [12]
---------	------	-----------

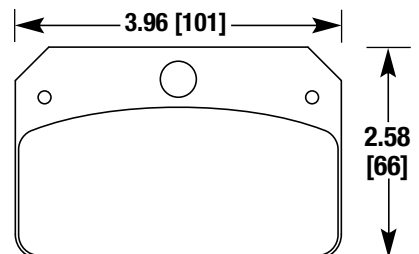

STRANGE W/ .438 CENTER HOLE

HB268

G, B, F, N	FMSI D430	.606 [15]
Z	FMSI D815	.665 [17]
	FMSI D526	

5.40 [137]

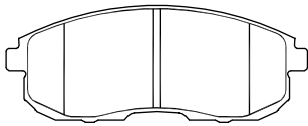

2.09 [53]

INFINITI, NISSAN

HB271

E, G, F, N	FMSI D228	.605 [15]
Z	FMSI D306	.635 [16]
	FMSI D851	

3.42 [87]

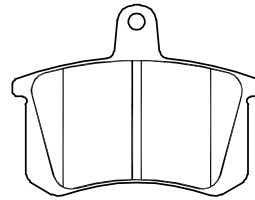

2.63 [67]

ALFA ROMEO, AUDI, VOLKSWAGEN (REAR)

HB269

F, Z, E, S	FMSI D555	.763 [19]
------------	-----------	-----------

6.15 [156]

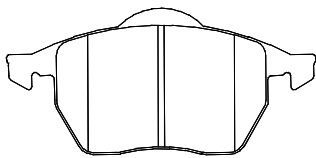

2.92 [74]

AUDI, VOLKSWAGEN

HB272

B, F, N, Z	FMSI D687	.763 [19]
E		

6.15 [156]

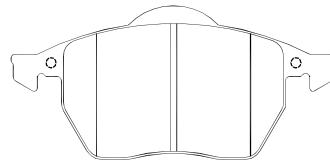

2.92 [74]

AUDI, VOLKSWAGEN

HB270

F, E	FMSI D362	.724 [18]
	FMSI D419	

5.70 [145]

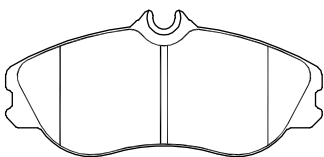

2.65 [67]

AUDI

HB274

E, S, B, F	FMSI D804	.610 [15]
N, Z		

6.88 [175]

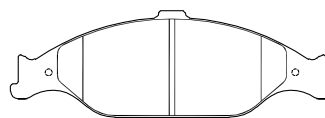

2.38 [60]

FORD MUSTANG

Hawk Performance - BRAKE PAD DIAGRAMS

HB275

E, G, S, U	FMSI D465	.594 [15]	.620 [16]
W, B, F, N	FMSI D764		.660 [17]
R, Z			

← 5.43 [138] →

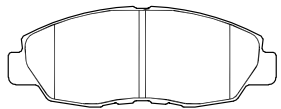

↑ 2.05 [52] ↓

ACURA, HONDA, POLARIS SLINGSHOT

HB283

F, P, Y, Z	FMSI D652	.650 [17]
------------	-----------	-----------

← 6.06 [154] →

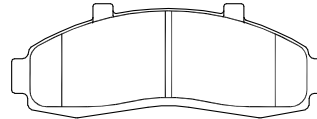

↑ 2.21 [58] ↓

FORD TRUCK, MAZDA, MERCURY

HB278

S, W, F, N	FMSI D491	.465 [12]
R, E		.583 [15]

← 4.96 [126] →

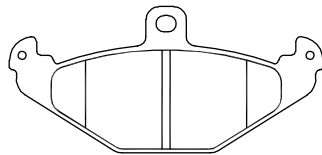

↑ 2.32 [59] ↓

LOTUS ELISE, DODGE VIPER (REAR)

HB284

F, Z	FMSI D664	.575 [15]
------	-----------	-----------

← 5.52 [140] →

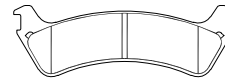

↑ 1.78 [45] ↓

INNER

← 5.52 [140] →

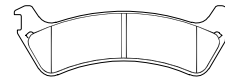

↑ 1.78 [45] ↓

OUTER

FORD WINDSTAR (REAR)

HB279

F, P, Y	FMSI D205	FMSI D607	.594 [15]
	FMSI D249	FMSI D654	
	FMSI D387		

← 6.29 [160] →

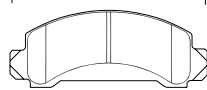

↑ 2.46 [62] ↓

INNER

← 6.77 [172] →

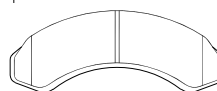

↑ 2.47 [63] ↓

OUTER

FORD RANGER

HB285

F, P	FMSI D625	.595 [18]
------	-----------	-----------

← 5.52 [140] →

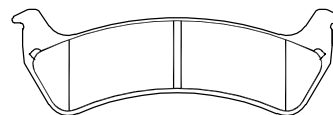

↑ 1.78 [45] ↓

JEEP GRAND CHEROKEE

HB286

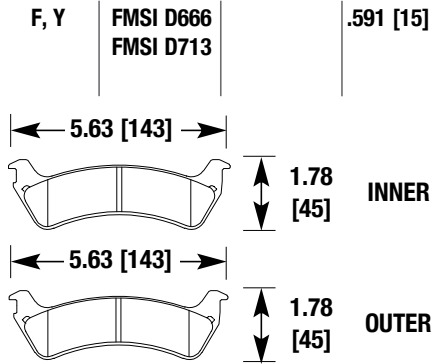

JEEP GRAND CHEROKEE (REAR)

HB290

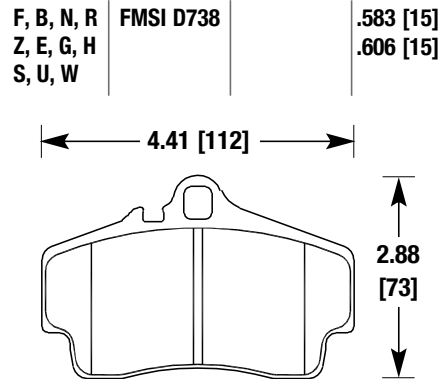

PORSCHE (REAR)

HB287

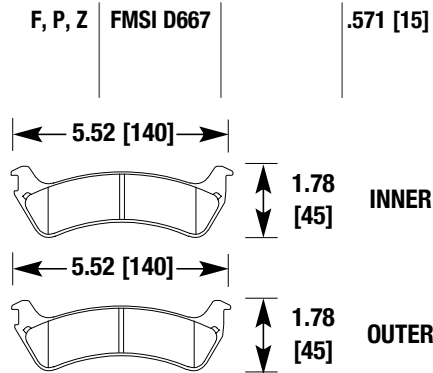

FORD EXPLORER, MERCURY MOUNTAINEER

HB291

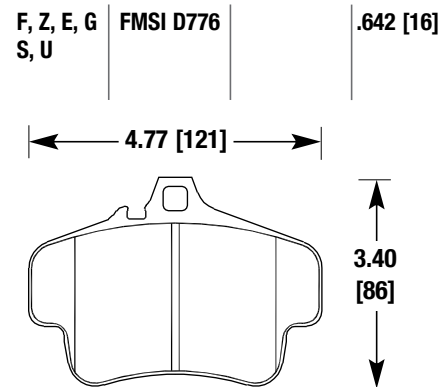

PORSCHE

HB289

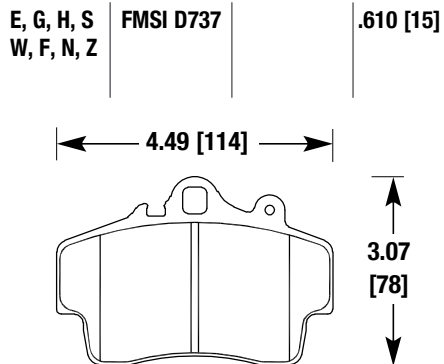

PORSCHE BOXSTER

HB292

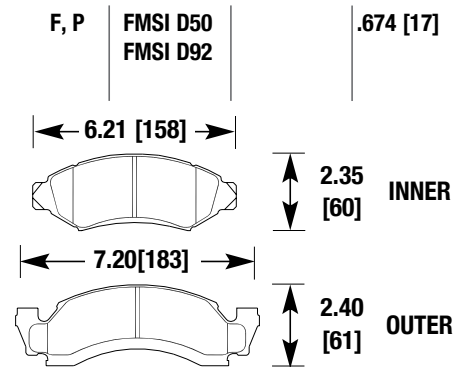

FORD, LINCOLN, MERCURY

Hawk Performance - BRAKE PAD DIAGRAMS

HB293

F	FMSI D360 FMSI D375	.668 [17]
---	------------------------	-----------

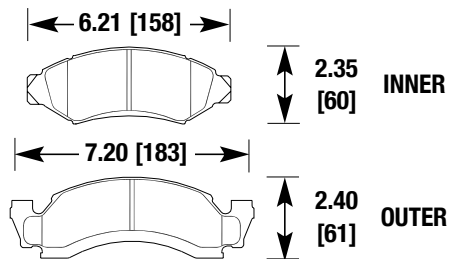

FORD TRUCK

HB296

F, P, Y, Z	FMSI D370 FMSI D845	.670 [17]
------------	------------------------	-----------

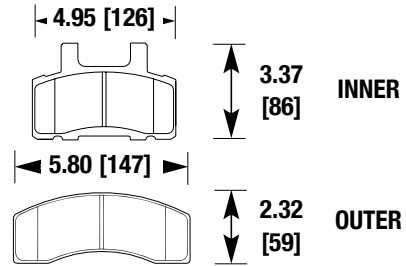

CHEVY/GMC TRUCK, DODGE TRUCK

HB294

F, P, Z	FMSI D748	.646 [16]
---------	-----------	-----------

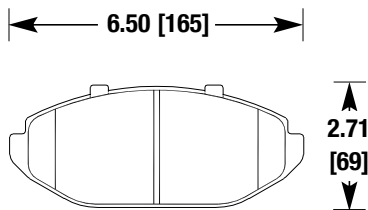

FORD, LINCOLN, MERCURY

HB298

F, P, Y	FMSI D459	.787 [20]
---------	-----------	-----------

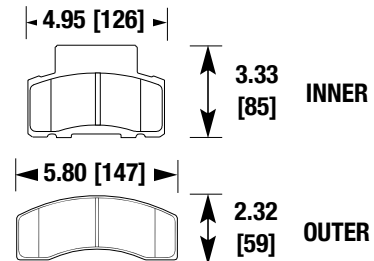

CHEVY/GMC TRUCK, DODGE TRUCK

HB295

F, P, Y	FMSI D626 FMSI D632	.630 [16]
---------	------------------------	-----------

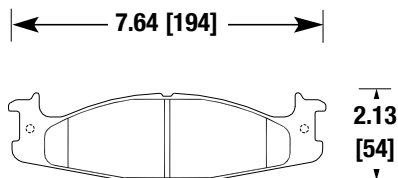

FORD TRUCK

HB299

F, P, Y, Z	FMSI D702	.650 [17]
------------	-----------	-----------

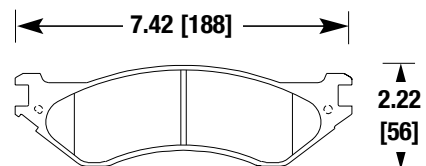

DODGE TRUCK, FORD TRUCK, LINCOLN

HB301

F, P, Y, Z	FMSI D711 FMSI D879	.630 [16]
------------	------------------------	-----------

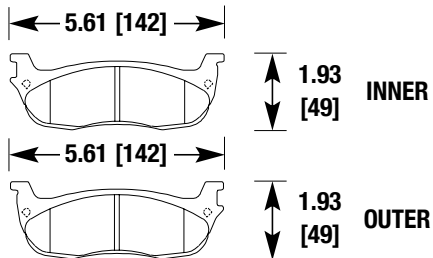

FORD TRUCK, LINCOLN (REAR)

HB304

F, P, Y, Z	FMSI D726	.598 [15]
------------	-----------	-----------

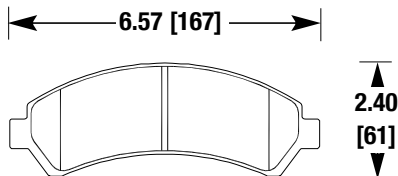

CHEVY/GMC TRUCK, ISUZU, OLDS

HB302

F, P, Y, Z	FMSI D756 FMSI D824	.700 [18]
------------	------------------------	-----------

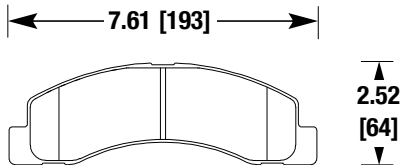

FORD TRUCK

HB305

F, P, Y, Z	FMSI D729	.610 [15]
------------	-----------	-----------

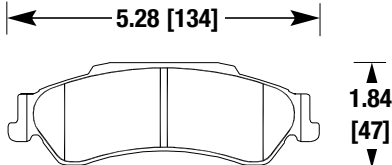

CHEVY/GMC TRUCK, ISUZU, OLDS (REAR)

HB303

F, P, Y, Z	FMSI D757	.685 [17]
------------	-----------	-----------

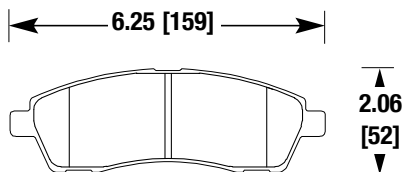

FORD TRUCK (REAR)

HB306

F, P	FMSI D746	.795 [20]
------	-----------	-----------

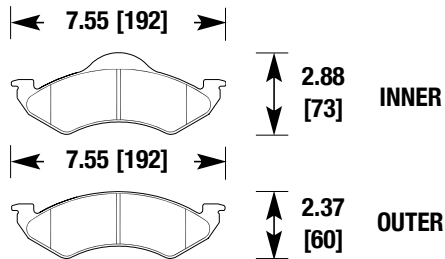

DODGE DAKOTA/DURANGO

HB307

F, P, Y, Z | FMSI D820 | .795 [20]

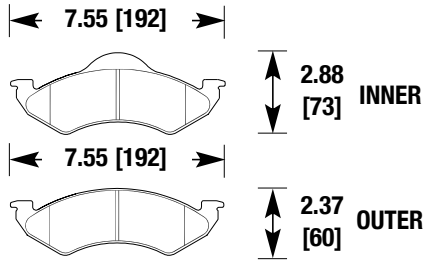

DODGE DAKOTA/DURANGO

HB312

F, P, R, Y | FMSI D502 | .600 [15]

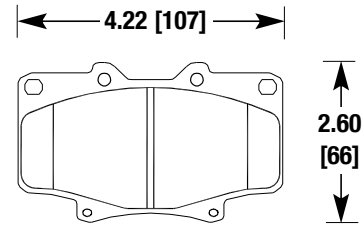

LEXUS LX450, TOYOTA LANDCRUISER

HB310

F, Z | FMSI D562
FMSI D695 | .689 [18]

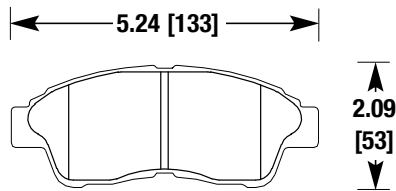

GEO, TOYOTA

HB313

F, P, R, Y | FMSI D772 | .685 [17]

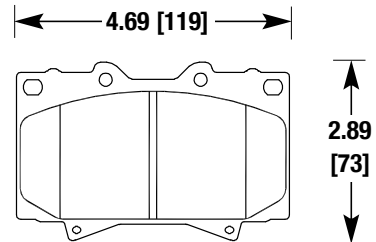

LEXUS LX470, TOYOTA LANDCRUISER

HB311

E, F, P, Y | FMSI D611 | .591 [15]

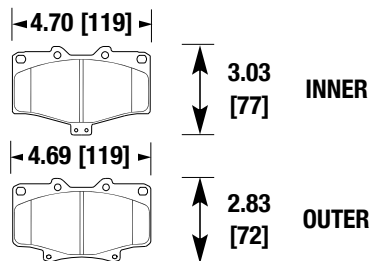

TOYOTA

HB314

F, P, Y | FMSI D812 | .665 [17]

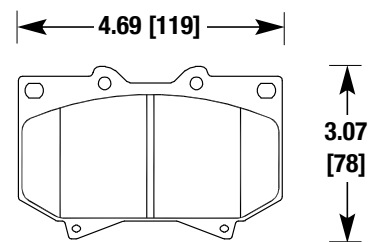

TOYOTA SEQUOIA/TUNDRA

HB315

F, P, Y, Z | FMSI D436 | .669 [17]

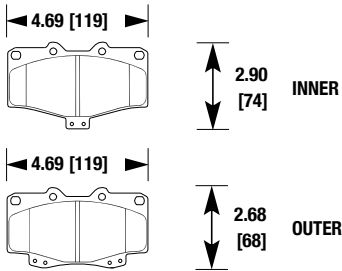

TOYOTA

HB320

F, N, Z | FMSI D707 | .669 [17]

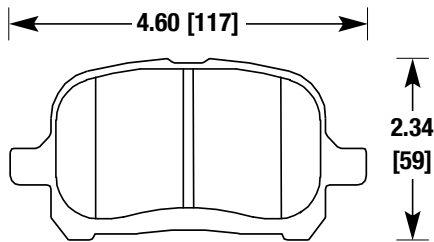

LEXUS, TOYOTA

HB316

F, P, Y, Z | FMSI D799 | .670 [17]

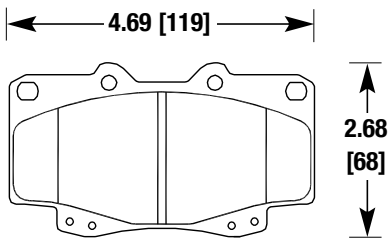

TOYOTA TACOMA

HB321

F | FMSI D741 | .650 [17]

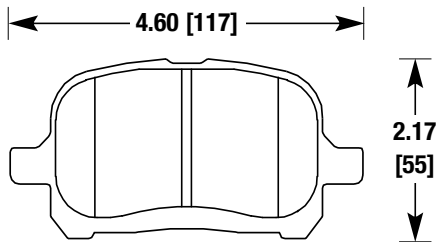

CHEVY, TOYOTA

HB318

E, F, N, Z | FMSI D697 | .669 [17]
 FMSI D718
 FMSI D744

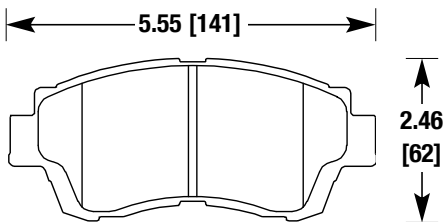

LEXUS, TOYOTA

HB322

F, P, Y, Z | FMSI D784 | .717 [18]

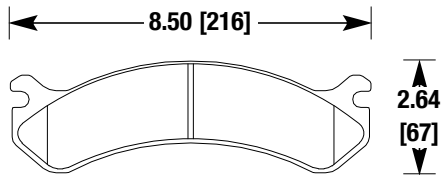

CADILLAC, CHEVY/GMC TRUCK,
 HUMMER H2

Hawk Performance - BRAKE PAD DIAGRAMS

HB323

B, F, P, Y Z	FMSI D785	.724 [18]
-----------------	-----------	-----------

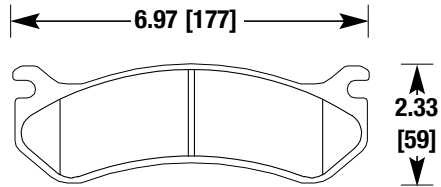

CADILLAC, CHEVY/GMC TRUCK,
HUMMER H2

HB326

F, N, Y, Z	FMSI D691 FMSI D855	.646 [16]
------------	------------------------	-----------

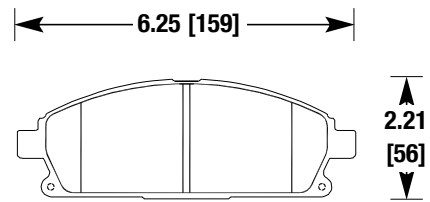

INFINITI, NISSAN

HB324

F, P, Y, Z	FMSI D792	.673 [17]
------------	-----------	-----------

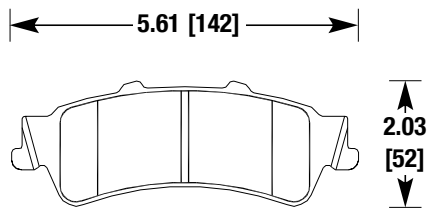

CADILLAC,
CHEVY/GMC TRUCK (REAR)

HB327

P	FMSI D786	.799 [20] 1.050 [27]
---	-----------	-------------------------

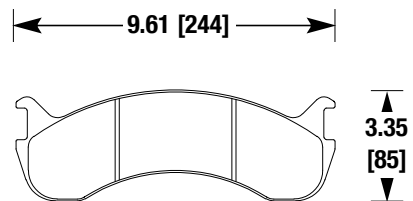

INTERNATIONAL

HB325

E, S, F, N R, Y, Z	FMSI D547 FMSI D681	.720 [18]
-----------------------	------------------------	-----------

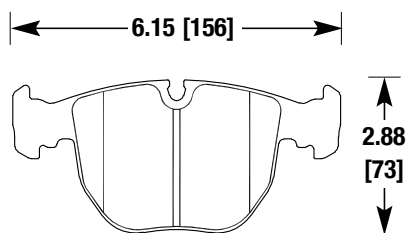

BMW

HB328

S, B, F, N R, Z	FMSI D817	.685 [17]
--------------------	-----------	-----------

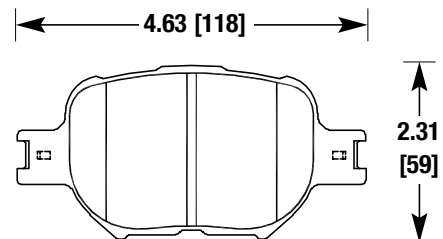

TOYOTA CELICA

HB329

S, F, N | FMSI D823 | .543 [14]

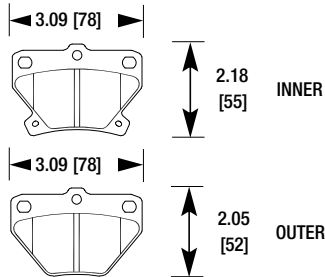

TOYOTA CELICA (REAR)

HB334

P, Y | FMSI D655 | .705 [18]
.736 [19]

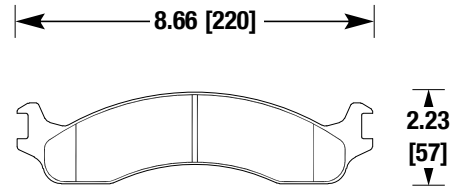

DODGE TRUCK, FORD TRUCK

HB331

G, U | | 1.170 [30]

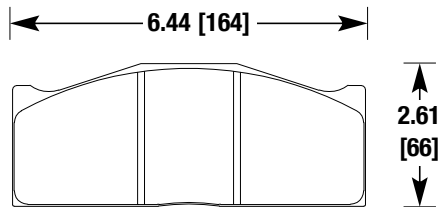

AP RACING, BREMBO
TRANS AM

HB335

F, P | FMSI D777 | .815 [21]

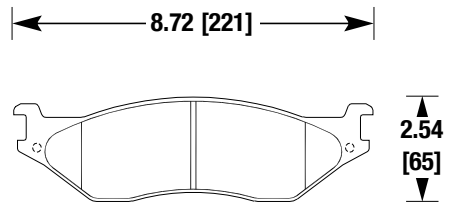

FORD TRUCK

HB332

B, F, P, Y | FMSI D369 | .654 [17]
Z | FMSI D789

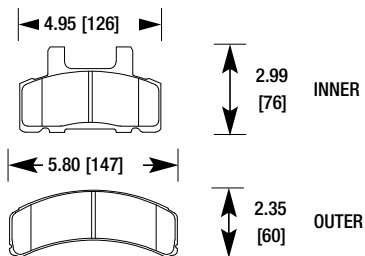

CADILLAC, CHEVY/GMC TRUCK,
DODGE TRUCK

HB336

Y | FMSI D450 | .655 [17]

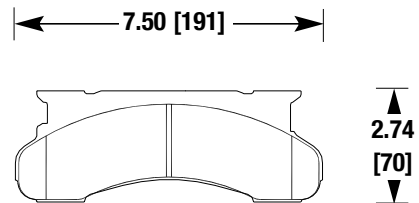

FORD TRUCK

HB340

F, S | .710 [18]

5.51 [140]

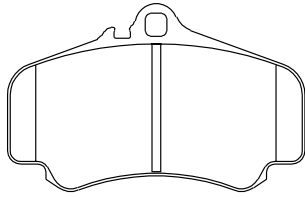

3.49
[89]

PORSCHE 996 GTR

HB347

F, Z | FMSI D601 | .689 [18]
FMSI D656

4.87 [124]

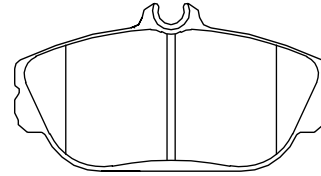

2.62
[67]

FORD, LINCOLN, MERCURY

HB341

F, P, Z | FMSI D674 | .618 [16]

5.53 [140]

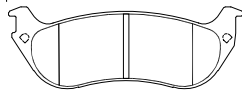

1.94
[49] INNER

5.53 [140]

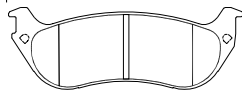

1.94
[49] OUTER

FORD, LINCOLN, MERCURY
(REAR WITH STEEL PISTON)

HB348

G, U, V | 1.140 [29] | .980 [25]
.866 [22]
.775 [20]

6.44 [164]

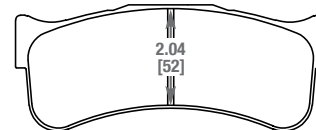

3.02
[77]

BREMBO

HB346

F, E | FMSI D816 | .713 [18]

7.00 [178]

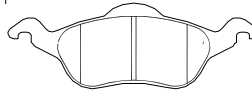

2.39
[61] INNER

7.00 [178]

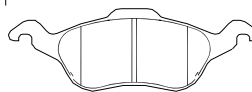

2.30
[58] OUTER

FORD FOCUS

HB349

G, U, B, F | .980 [25]
N, R

6.41 [163]

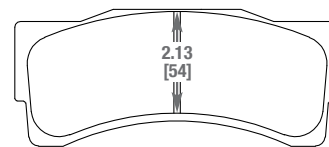

3.17
[81]

ALCON, AP RACING

HB350

E, EE, G, M, W, B	FMSI D339 FMSI D374	.496 [13]
F, N, R, Z	FMSI D564	

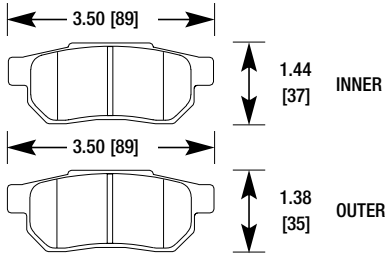

ACURA, HONDA (REAR)

HB353

F, Y, Z	FMSI D690	.618 [16]
---------	-----------	-----------

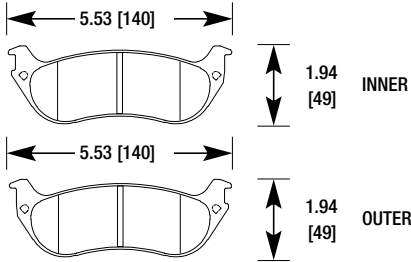

FORD, LINCOLN, MERCURY
(REAR WITH PHENOLIC PISTON)

HB351

E, G, U, V S		.620 [16] .778 [20]
-----------------	--	------------------------

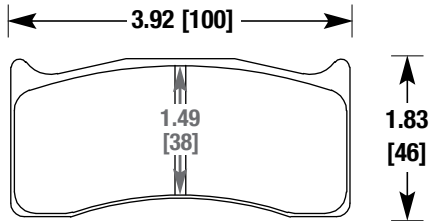

BREMBO, TOYOTA ATLANTIC,
WILWOOD

HB354

F, Z	FMSI D836 FMSI D840	.756 [19]
------	------------------------	-----------

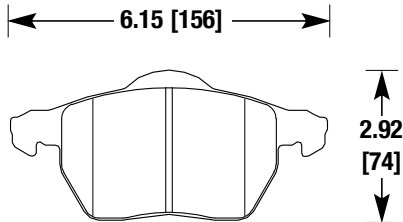

AUDI, VOLKSWAGEN

HB352

E, S, B, F N, Z	FMSI D721	.665 [17]
--------------------	-----------	-----------

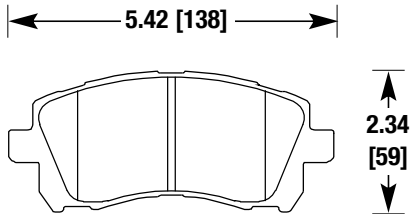

SUBARU

HB359

G, F, N, Z	FMSI D508 FMSI D698 FMSI D714	FMSI D814	.543 [14]
------------	-------------------------------------	-----------	-----------

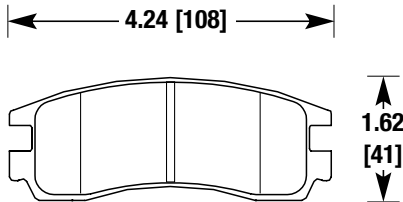

BUICK, CADILLAC, CHEVY,
OLDS, PONTIAC (REAR)

HB360

B, F, N, Z	FMSI D699	FMSI D1075	.670 [17]
	FMSI D818	FMSI D1224	
	FMSI D850		

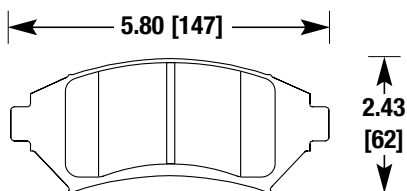

BUICK, CADILLAC, CHEVY,
OLDS, PONTIAC

HB363

E, F	FMSI D839	.689 [18]
	FMSI D912	

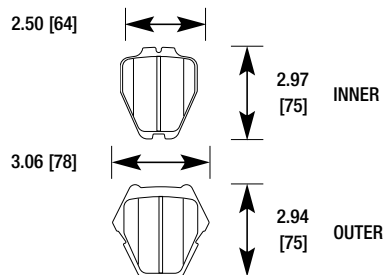

AUDI, VOLKSWAGEN

HB361

B, F, N, R Z, E, EE, G S, U, W	FMSI D829	.622 [16]

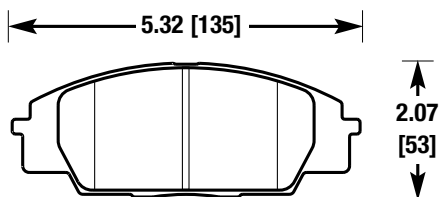

ACURA RSX, HONDA S2000

HB364

B, F, N, R Z, E	FMSI D1017	FMSI D340	.587 [15]
	FMSI D1023	FMSI D894	
	FMSI D1112		

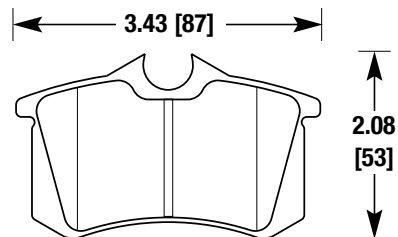

AUDI, PEUGEOT, VOLKSWAGEN,
WILWOOD (REAR)

HB362

E, S, F, N Y	FMSI D548	.642 [16]

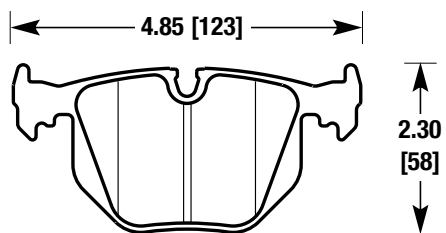

BMW (REAR)

HB365

F, N, Z	FMSI D768	.728 [18]
---------	-----------	-----------

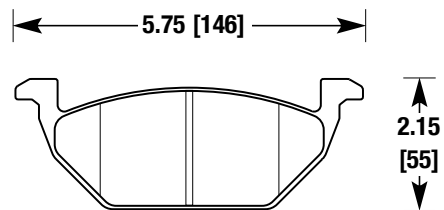

VOLKSWAGEN

HB366

B, F, N, Z FMSI D787 .681 [17]
 E, G, S, U
 W

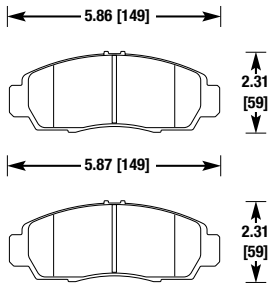

ACURA, HONDA

HB369

S, U .775 [20]
 .980 [25]

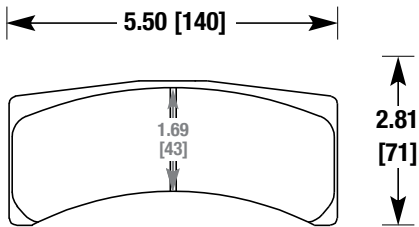

WILWOOD

HB367

F, N, Z, E FMSI D383 .585 [15]
 M FMSI D471

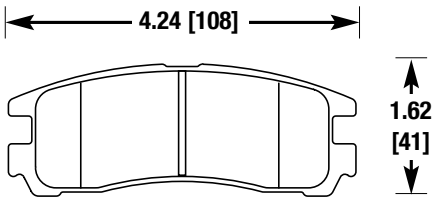

CHRYSLER, DODGE, EAGLE,
 MITSUBISHI, SUBARU (REAR)

HB370

B, F, N, Z FMSI D905 .559 [14]
 E, G

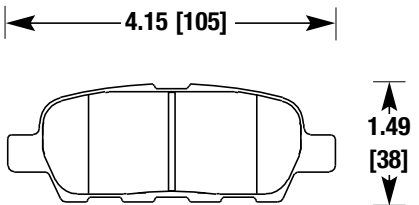

NISSAN (REAR)

HB368

E, F, N, Z FMSI D924 .665 [17]

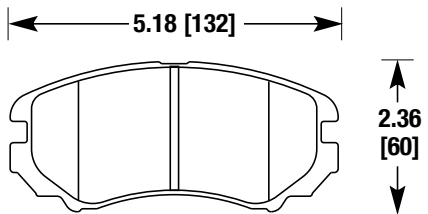

HYUNDAI, KIA

HB371

F FMSI D603 .600 [15]

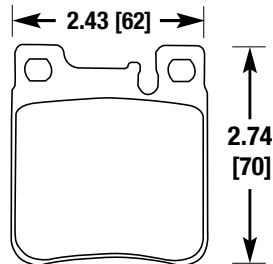

CHRYSLER, MERCEDES (REAR)

Hawk Performance - BRAKE PAD DIAGRAMS

HB372

F, Y	FMSI D858	.626 [16]
------	-----------	-----------

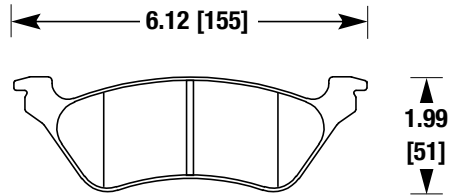

CHRYSLER, DODGE TRUCK (REAR)

HB375

F	FMSI D619	.669 [17]
---	-----------	-----------

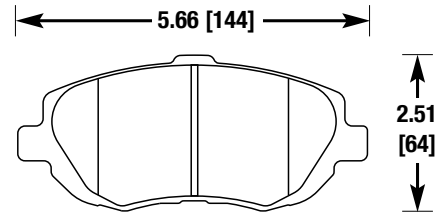

LEXUS, TOYOTA

HB373

F, Y	FMSI D844 FMSI D856	.689 [18]
------	------------------------	-----------

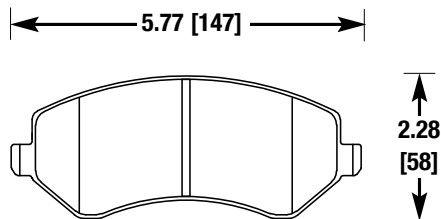

BUICK, CHRYSLER, DODGE TRUCK, JEEP

HB376

F	FMSI D805 FMSI D849	.665 [17]
---	------------------------	-----------

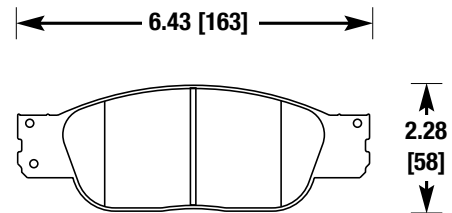

FORD, LINCOLN, JAGUAR

HB374

F	FMSI D857	.700 [18]
---	-----------	-----------

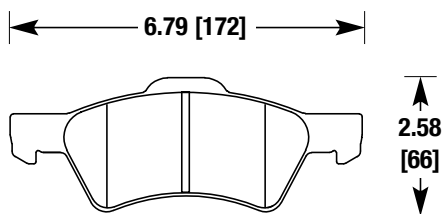

CHRYSLER, DODGE TRUCK

HB377

B, F, N, Z E, S, V	FMSI D841	.760 [19]
-----------------------	-----------	-----------

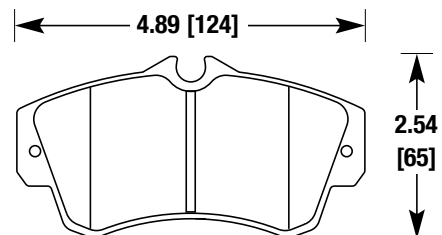

DODGE

HB378

B, F, N, R	FMSI D900	.565 [14]
Z, E, G, S	FMSI D1008	.626 [16]
W		

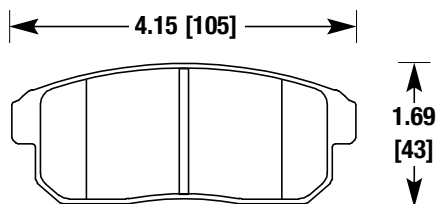

MAZDA RX-8, NISSAN (REAR)

HB383

F, Y	FMSI D883	.685 [17]
------	-----------	-----------

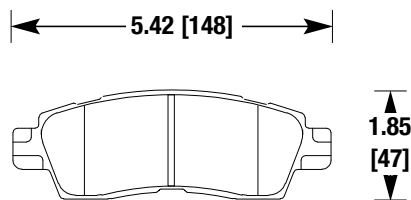

BUICK, CHEVYTRUCK, GMC, ISUZU, OLDS (REAR)

HB381

F, Y	FMSI D791	.661 [17]
------	-----------	-----------

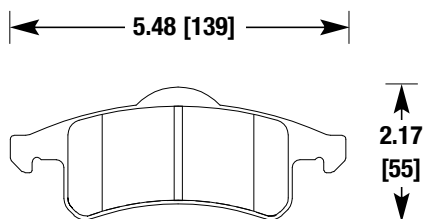

JEEP GRAND CHEROKEE (REAR)

HB384

F	FMSI D556 FMSI D807	.587 [15]
---	------------------------	-----------

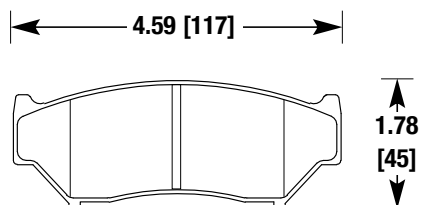

CHEVYTRUCK, GEO, SUZUKI

HB382

F, Y	FMSI D882	.657 [17]
------	-----------	-----------

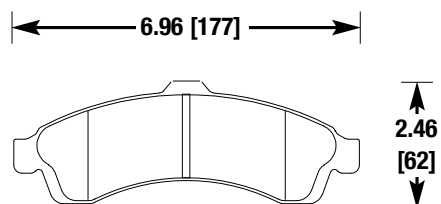

BUICK, CHEVYTRUCK, GMC, ISUZU, OLDS

HB385

F, Y	FMSI D834	.640 [16]
------	-----------	-----------

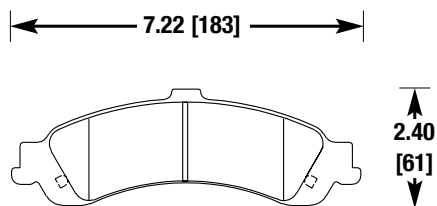

CADILLAC, CHEVY/GMC TRUCK (REAR)

Hawk Performance - BRAKE PAD DIAGRAMS

HB387

F, Z | FMSI D888 | .547 [14]

6.18 [157]

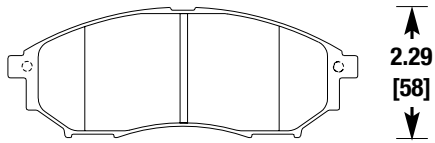

INFINITI

HB393

F, R, Y, G | FMSI D914 | .665 [17]
U, W | FMSI D943
FMSI D958

5.58 [142]

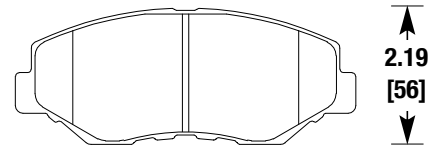

HONDA

HB388

F | FMSI D819 | .756 [19]
FMSI D936

6.11 [155]

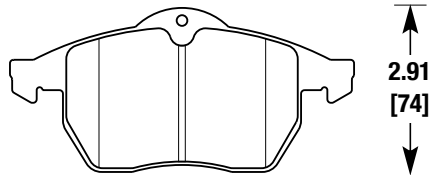

SAAB, SATURN

HB396

F | FMSI D215 | .630 [16]

4.95 [126]

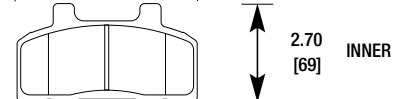

2.70 [69] INNER

5.83 [148]



2.23 [57] OUTER

BUICK, CADILLAC, CHEVY, CHEVY TRUCK
OLDS, PONTIAC

HB390

F | FMSI D506 | .602 [15]
FMSI D673

5.81 [148]

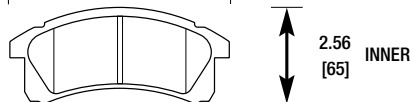

2.56 [65] INNER

7.50 [191]



2.62 [67] OUTER

BUICK, CHEVROLET, OLDS, PONTIAC

HB397

F | FMSI D256 | .585 [15]

4.55 [116]

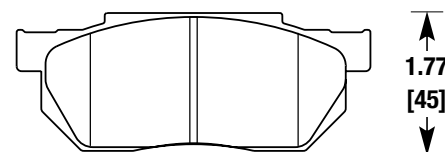

1.77 [45]

HONDA

HB398

F	FMSI D269	.680 [17]
---	-----------	-----------

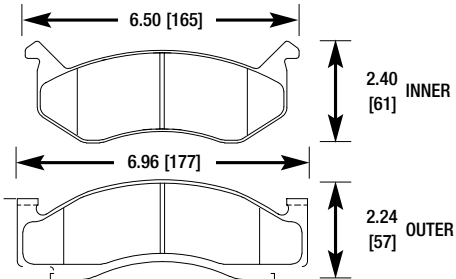

DODGE TRUCK

HB401

F	FMSI D325 FMSI D352 FMSI D685	.587 [15]
---	-------------------------------------	-----------

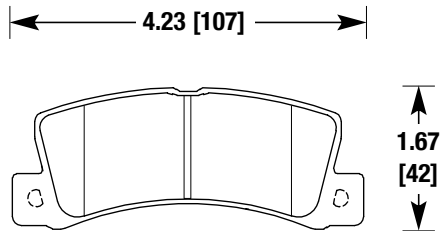

GEO, LEXUS, TOYOTA (REAR)

HB399

E, EE, S, U V, F, N, R Z	FMSI D279	.630 [16]
--------------------------------	-----------	-----------

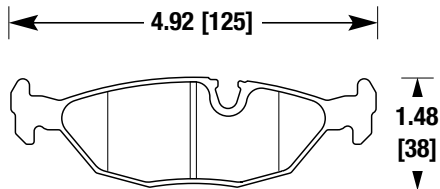

BMW (REAR)

HB402

F, Y	FMSI D333	.669 [17]
------	-----------	-----------

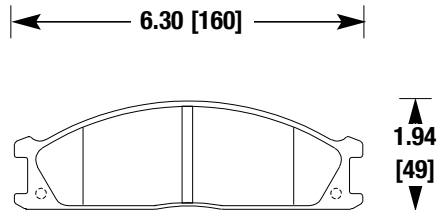

NISSAN TRUCK, SUBARU

HB400

F	FMSI D159 FMSI D183 FMSI D190	FMSI D289	.630 [16]
---	-------------------------------------	-----------	-----------

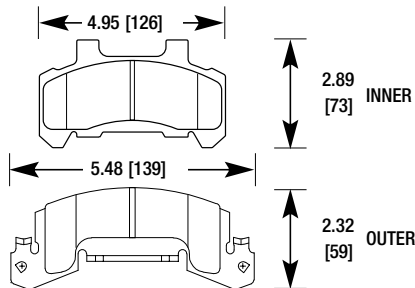

BUICK, CADILLAC, CHEVY, OLDS, PONTIAC

HB403

F	FMSI D334	.587 [15]
---	-----------	-----------

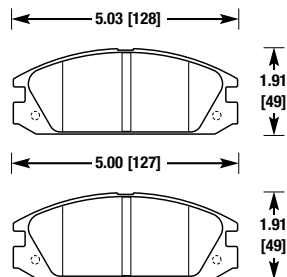

ACURA, HONDA

Hawk Performance - BRAKE PAD DIAGRAMS

HB404

F, Y	FMSI D349	.642 [16]
------	-----------	-----------

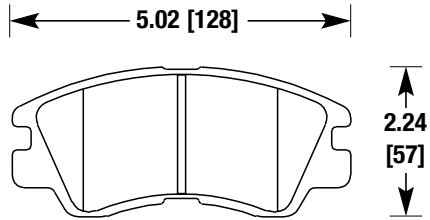

DODGE TRUCK, MITSUBISHI

HB413

F	FMSI D542	.690 [18]
---	-----------	-----------

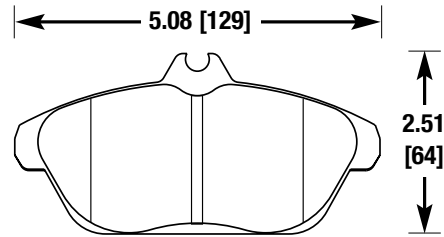

VOLVO

HB407

F, Y	FMSI D389 FMSI D433 FMSI D589	.602 [15]
------	-------------------------------------	-----------

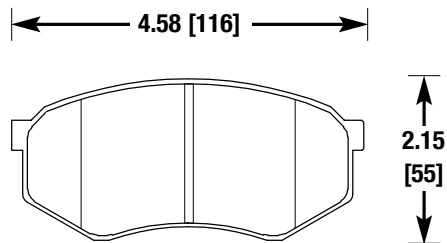

MAZDA, TOYOTA, TOYOTA TRUCK

HB414

F	FMSI D576	.622 [16]
---	-----------	-----------

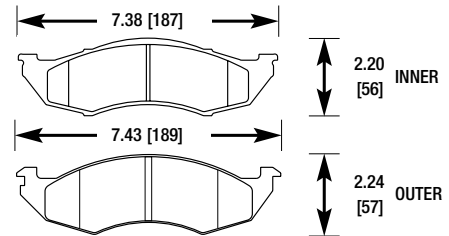

MERCURY, NISSAN TRUCK

HB409

F	FMSI D507 FMSI D728 FMSI D549	.661 [17]
---	-------------------------------------	-----------

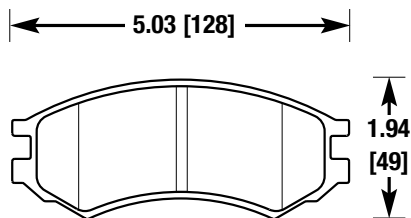

SATURN "S" SERIES

HB415

F	FMSI D587	.583 [15]
---	-----------	-----------

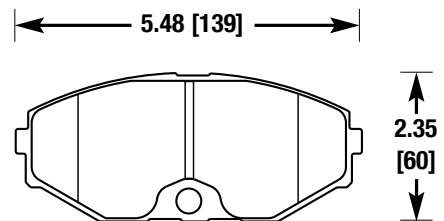

INFINITI

HB416

F	FMSI D598 FMSI D765	.689 [18]
---	------------------------	-----------

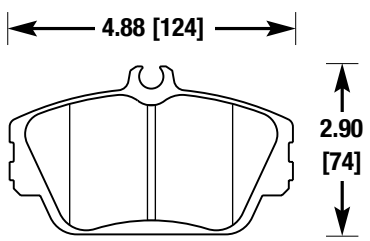

FORD, LINCOLN, MERCURY

HB420

F	FMSI D648 FMSI D745 FMSI D801	.724 [18]
---	-------------------------------------	-----------

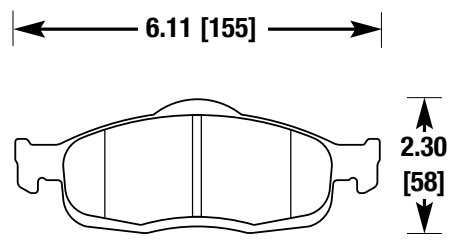

FORD, MERCURY

HB417

F	FMSI D610	.659 [17]
---	-----------	-----------

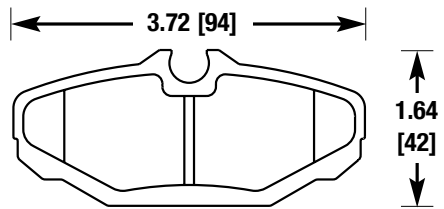

FORD, LINCOLN, MERCURY (REAR)

HB421

F	FMSI D540 FMSI D595	.622 [16]
---	------------------------	-----------

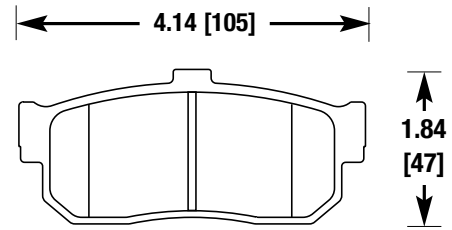

INFINITI, NISSAN (REAR)

HB418

E, G, S, U	FMSI D621	.646 [16]
B, F, N, R	FMSI D948	
Z		

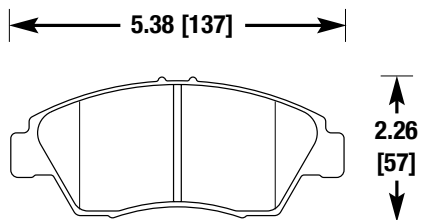

HONDA

HB422

F	FMSI D579	.610 [15]
---	-----------	-----------

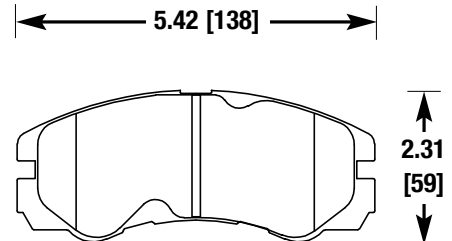

ACURA, HONDA, ISUZU

Hawk Performance - BRAKE PAD DIAGRAMS

HB424

F	FMSI D722	.665 [17]
---	-----------	-----------

← 5.42 [138] →

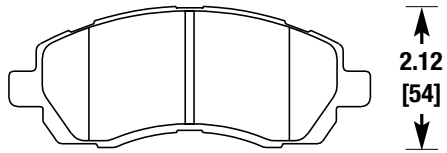

SUBARU

HB428

F	FMSI D806 FMSI D944	.650 [17]
---	------------------------	-----------

← 4.40 [112] →

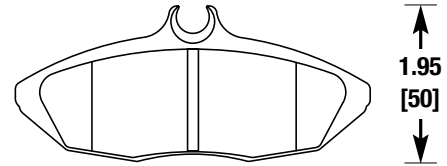

DODGE, FORD, JAGUAR
LINCOLN (REAR)

HB425

F	FMSI D727 FMSI D752	.661 [17]
---	------------------------	-----------

← 6.35 [161] →

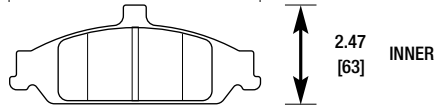

2.47
[63] INNER

← 6.35 [161] →

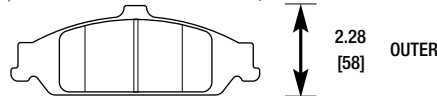

2.28
[58] OUTER

CHEVROLET, OLDS, PONTIAC

HB429

F	FMSI D862	.681 [17]
---	-----------	-----------

← 4.85 [123] →

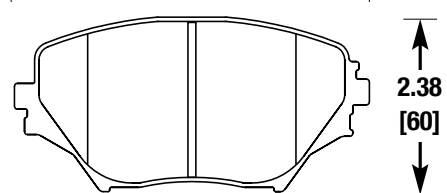

TOYOTA RAV-4

HB427

F, Y	FMSI D773	.685 [17]
------	-----------	-----------

← 4.84 [123] →

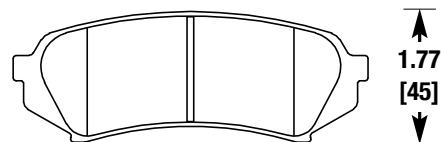

LEXUS, TOYOTA TRUCK (REAR)

HB430

B, F, N, Z E, S, W	FMSI D886	.547 [14]
-----------------------	-----------	-----------

← 3.43 [87] →

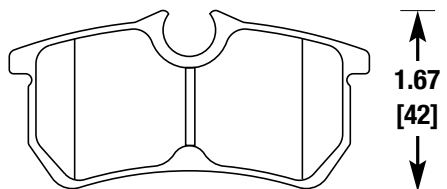

FORD FOCUS (REAR)

HB431

F, N, E, S V, W	FMSI D890	.606 [15]
--------------------	-----------	-----------

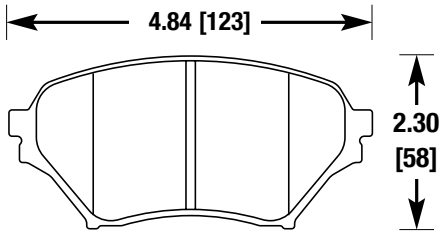

MAZDA MIATA

HB434

B, F, N, R Z, E, G, S U	FMSI D770	.543 [14]
-------------------------------	-----------	-----------

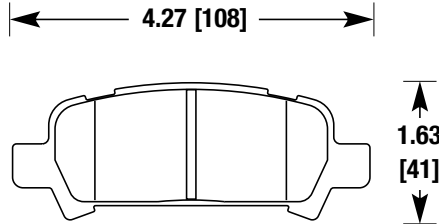

SUBARU (REAR)

HB432

E, G, S, W B, F, N, R Z	FMSI D929	.661 [17]
-------------------------------	-----------	-----------

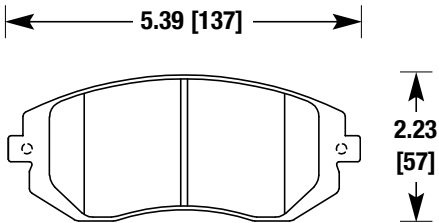

SUBARU

HB435

F, Y	FMSI D866	.622 [16]
------	-----------	-----------

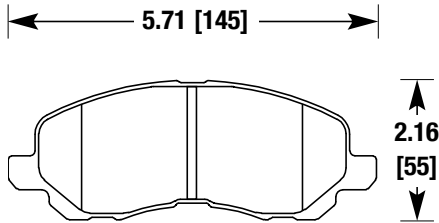

CHRYSLER, DODGE, MITSUBISHI

HB433

F	FMSI D931 FMSI D997	.654 [17]
---	------------------------	-----------

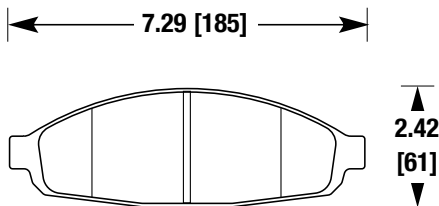

CHRYSLER, FORD, LINCOLN, MERCURY

HB436

F, N, Z, E	FMSI D892	.535 [14]
------------	-----------	-----------

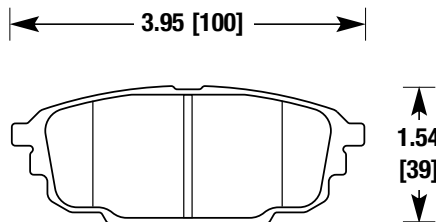

MAZDA PROTEGE (REAR)

Hawk Performance - BRAKE PAD DIAGRAMS

HB437

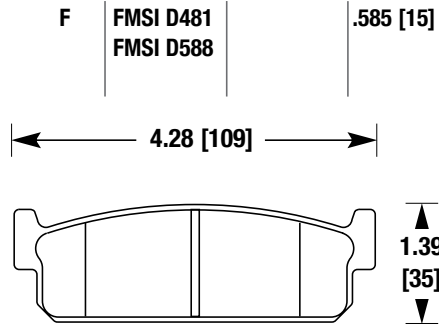

INFINITI (REAR)

HB440

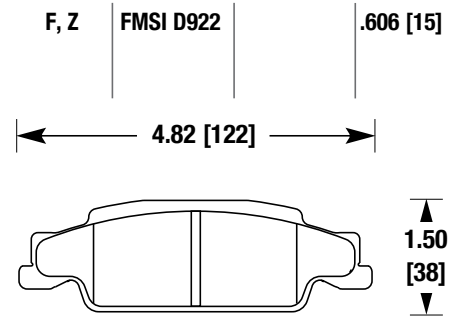

CADILLAC CTS, STS (REAR)

HB438

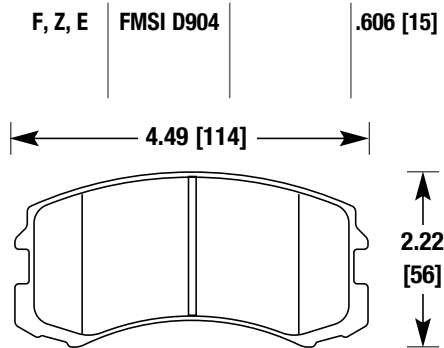

MITSUBISHI LANCER

HB441

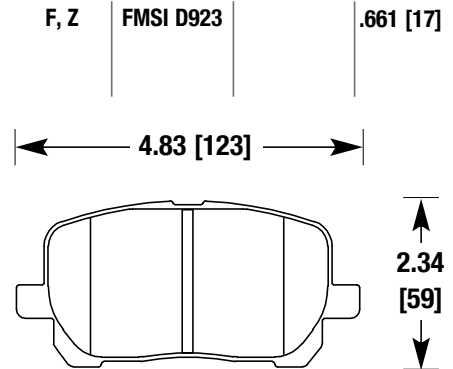

PONTIAC, TOYOTA

HB439

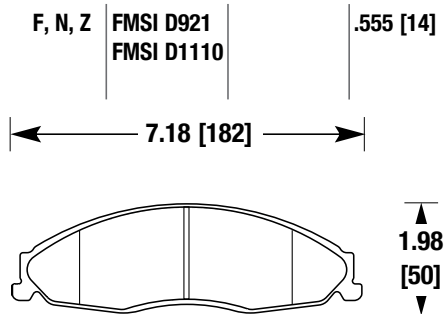

CADILLAC CTS, STS

HB442

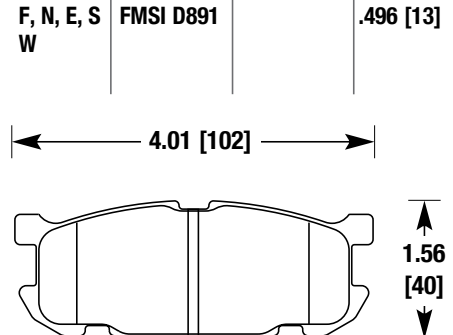

MAZDA MIATA (REAR)

HB443

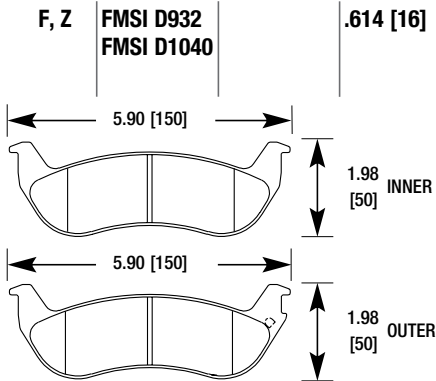

FORD, LINCOLN, MERCURY (REAR)

HB446

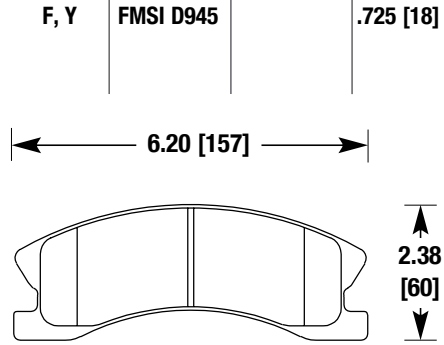

JEEP GRAND CHEROKEE

HB444

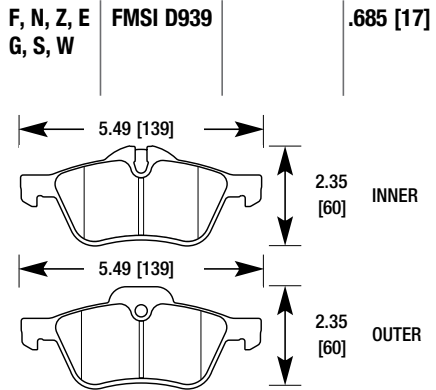

MINI COOPER

HB447

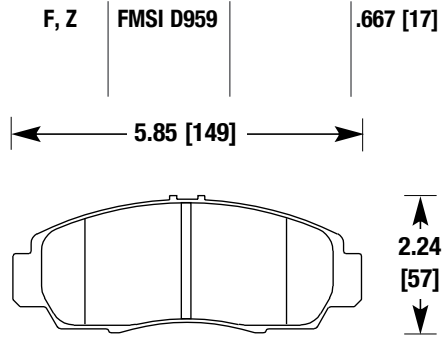

HONDA ACCORD

HB445

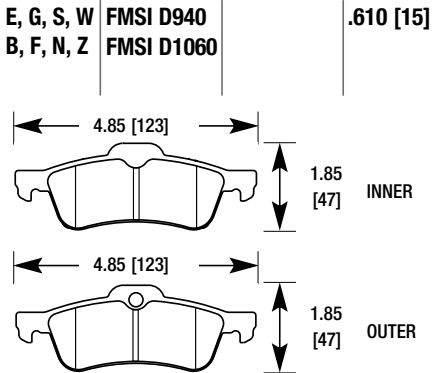

MINI COOPER (REAR)

HB448

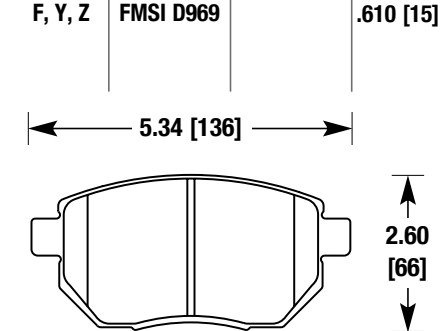

INFINITI, NISSAN, NISSAN TRUCK

HB449

F, N, Z, E | FMSI D970 | .679 [17]

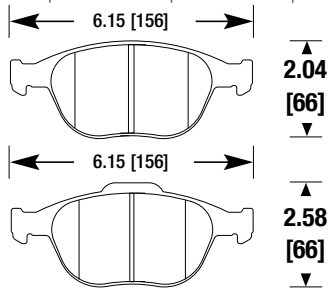

MAZDA

HB452

E, S, W, B | FMSI D1004 | .545 [14]
F, N, R, Z

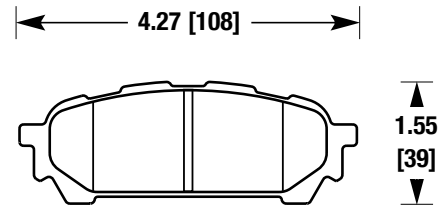

SUBARU (REAR)

HB450

F, Z | FMSI D999 | .555 [14]

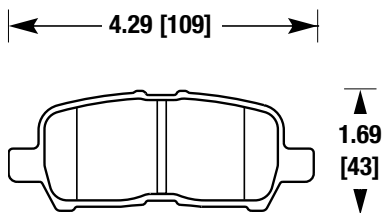

PONTIAC GRAND PRIX (REAR)

HB453

B, F, N, R | FMSI D1001 | .585 [15]
Z, E, EE, G | FMSI D1016
S, U, V, W | FMSI D1050

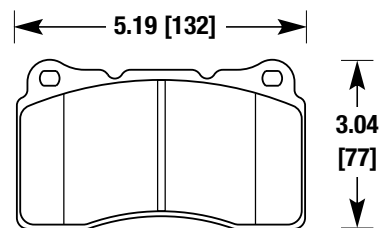

MITSUBISHI EVO, SUBARU IMPREZA

HB451

F, Z | FMSI D1000 | .668 [17]

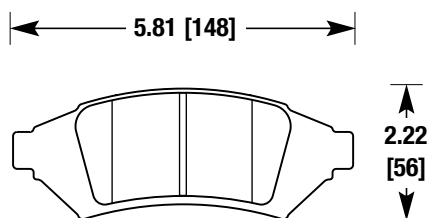

PONTIAC GRAND PRIX

HB454

F | FMSI D992 | .715 [18]

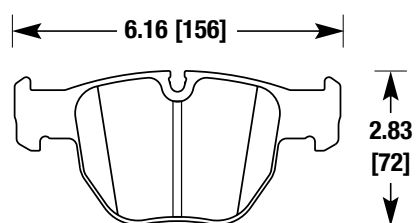

RANGE ROVER

HB455

F, Y, Z	FMSI D1011 FMSI D1083	.785 [20]
---------	--------------------------	-----------

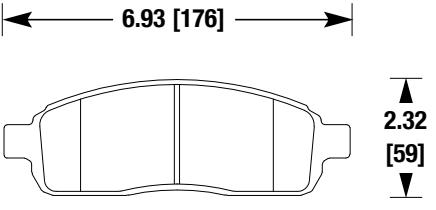

FORD TRUCK

HB458

F, Z	FMSI D1042	.642 [16]
------	------------	-----------

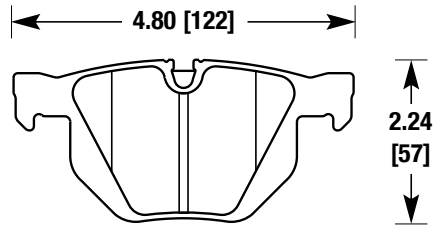

BMW 525i

HB456

F, Y, Z	FMSI D1012	.705 [18]
---------	------------	-----------

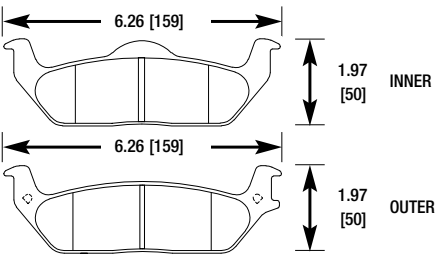

FORD F-150 (REAR)

HB459

F, N, Z, S	FMSI D957	.700 [18]
------------	-----------	-----------

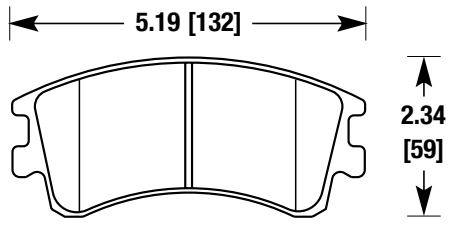

MAZDA 6

HB457

F, N, Z	FMSI D1037	.605 [15]
---------	------------	-----------

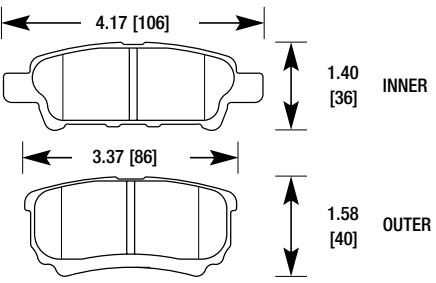

MITSUBISHI LANCER (REAR)

HB460

F, Z	FMSI D1043	.580 [15]
------	------------	-----------

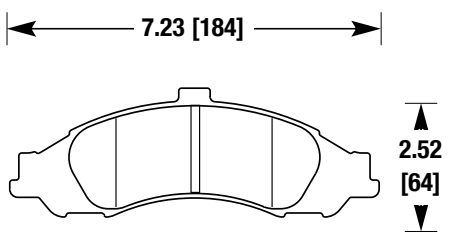

PONTIAC GTO

Hawk Performance - BRAKE PAD DIAGRAMS

HB461

F, Y, E, W	FMSI D864	FMSI D1013	.646 [16]
	FMSI D903		
	FMSI D955		

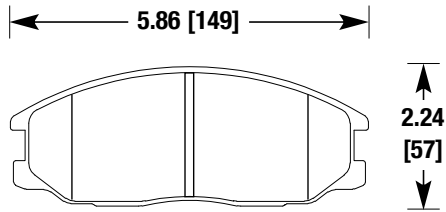

HYUNDAI, KIA

HB464

E, G, S, U	FMSI D946	.764 [19]
V, B, F, N		
R, Y, Z		

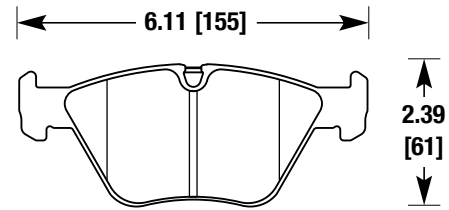

BMW

HB462

F, Y, Z	FMSI D934	.827 [21]
---------	-----------	-----------

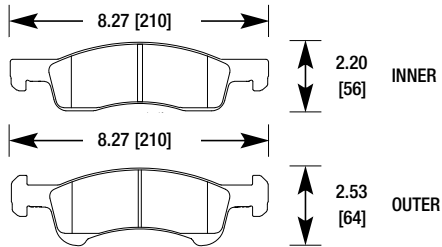

FORD TRUCK, LINCOLN

HB467

F, Z	FMSI D1019	.540 [14]
------	------------	-----------

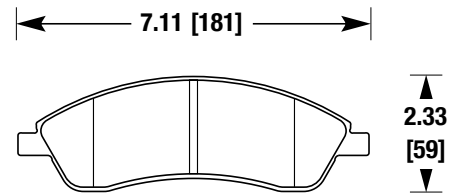

CADILLAC SRX

HB463

F, Y, Z	FMSI D935	.787 [20]
---------	-----------	-----------

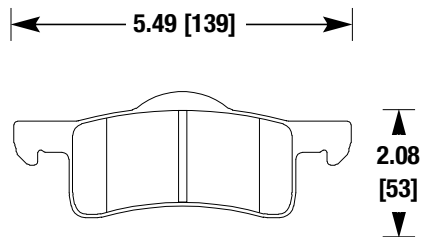

FORD TRUCK, LINCOLN (REAR)

HB468

F, N, E, S	FMSI D1002	.492 [12]
------------	------------	-----------

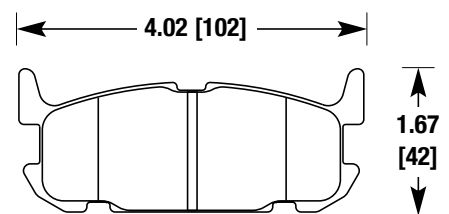

MAZDA MIATA

HB469

F	FMSI D676	.705 [18]
---	-----------	-----------

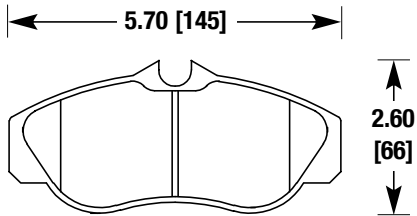

LAND ROVER DISCOVERY

HB472

F, Y, Z	FMSI D913 FMSI D833	.650 [17]
---------	------------------------	-----------

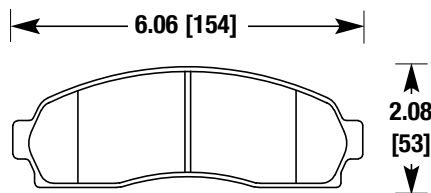

CHEVY TRUCK, FORD TRUCK, MAZDA TRUCK,
MERCURY, SATURN

HB470

E, G, S, V B, F, N, R Z	FMSI D1009	.643 [16]
-------------------------------	------------	-----------

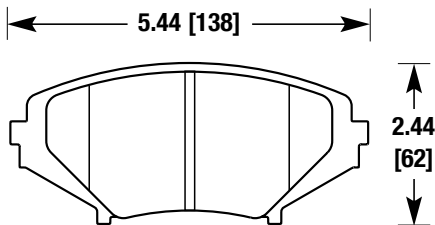

MAZDA RX-8

HB474

F, Z	FMSI D908	.681 [17]
------	-----------	-----------

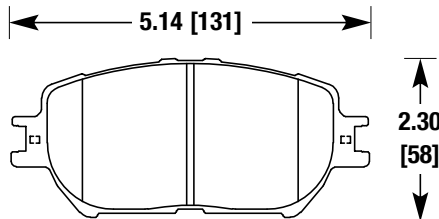

TOYOTA CAMRY

HB471

F, N, S, U	FMSI D11	.510 [13]
------------	----------	-----------

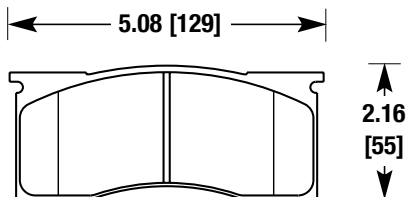

DODGE, PLYMOUTH

HB475

F, N, E, S	FMSI D266 FMSI D441	.642 [16]
------------	------------------------	-----------

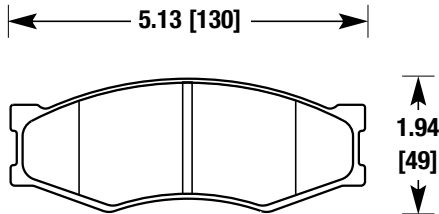

NISSAN

Hawk Performance - BRAKE PAD DIAGRAMS

HB476

F, Y	FMSI D962	.707 [18]
------	-----------	-----------

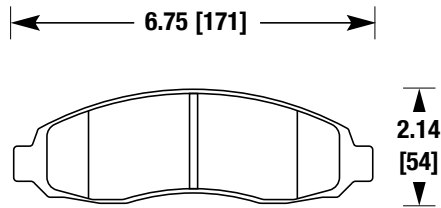

DODGE DAKOTA

HB479

P	FMSI D928	.700 [18]
---	-----------	-----------

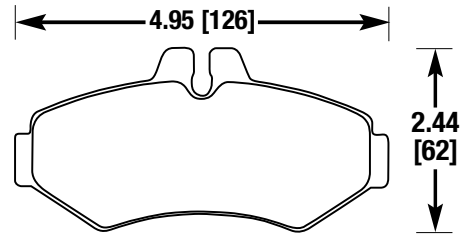

DODGE TRUCK, FREIGHTLINER (REAR)

HB477

F, Y	FMSI D606	.610 [15]
------	-----------	-----------

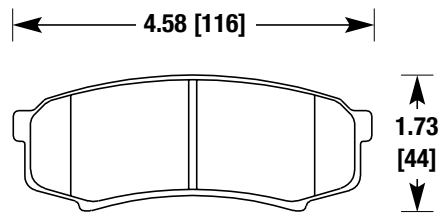

LEXUS, TOYOTA (REAR)

HB483

F, Z, G, S U, V	FMSI D991	.635 [16]
--------------------	-----------	-----------

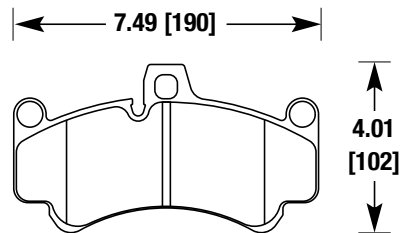

PORSCHE

HB478

E, G, S, U W, B, F, N R, Z	FMSI D1095	.605 [15]
----------------------------------	------------	-----------

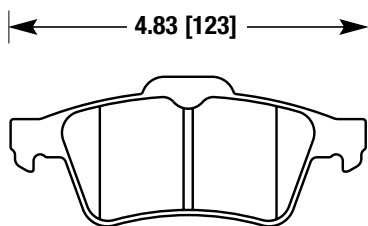

MAZDA 3, SOLSTICE (REAR)

HB484

E, G, S, U V, B, F, N R, Z	FMSI D1081	.670 [17]
----------------------------------	------------	-----------

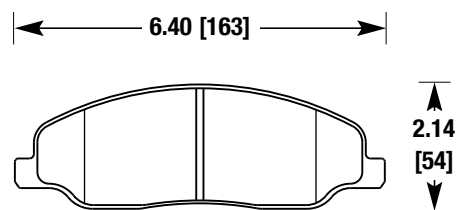

MUSTANG

HB485

F, N, R, Z	FMSI D1082	.656 [17]
E, EE, G, S		
V, W, B		

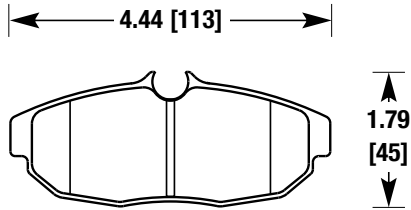

MUSTANG (REAR)

HB488

F, Y, Z	FMSI D830	.629 [16]
---------	-----------	-----------

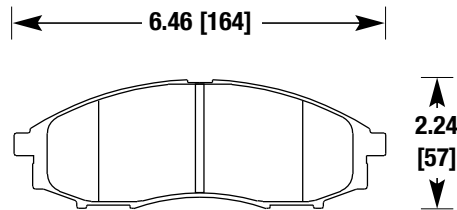

NISSAN TRUCK

HB486

G, U, W, P		.708 [18]
		1.094 [28]

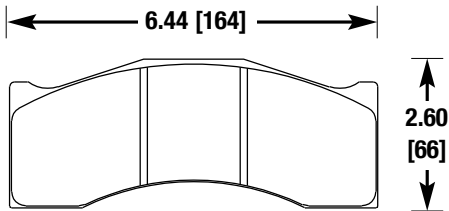

BREMBO

HB489

F	FMSI D755	.630 [16]
---	-----------	-----------

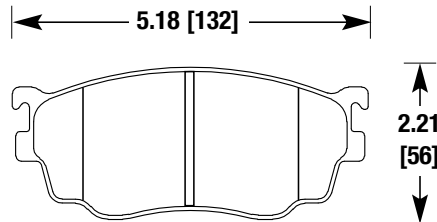

MAZDA 626

HB487

F, Y	FMSI D859	.733 [19]
	FMSI D821	

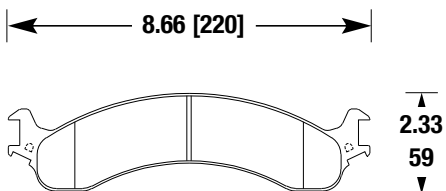

DODGE TRUCK

HB490

B, F, P, R	FMSI D976	.665 [17]
Y, Z		

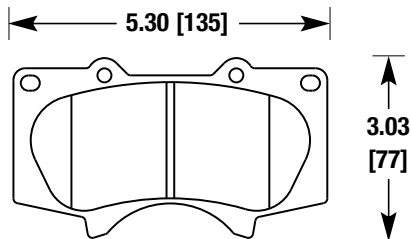

LEXUS, TOYOTA

Hawk Performance - BRAKE PAD DIAGRAMS

HB491

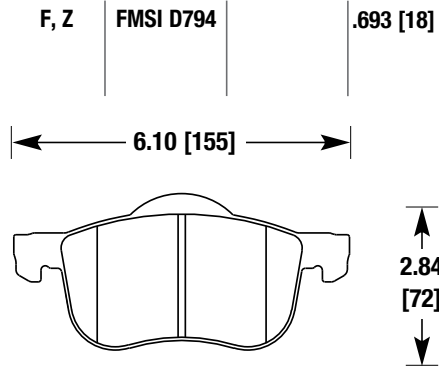

VOLVO

HB494

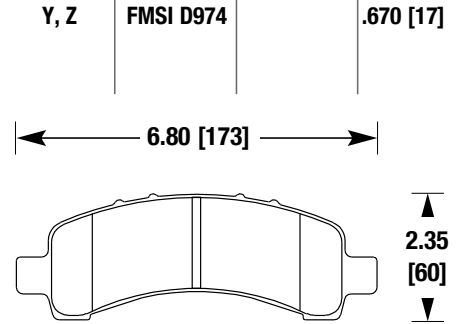

CADILLAC, CHEVY TRUCK, GMC TRUCK (REAR)

HB492

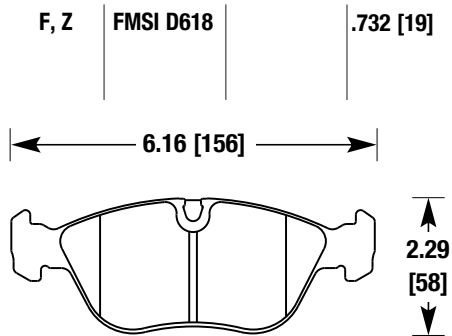

VOLVO

HB495

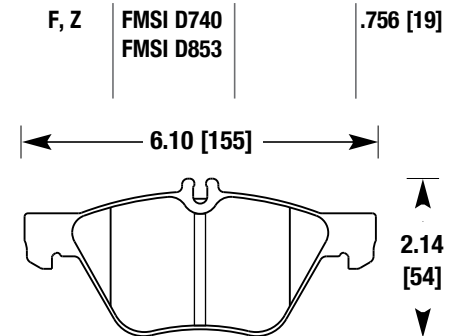

MERCEDES BENZ

HB493

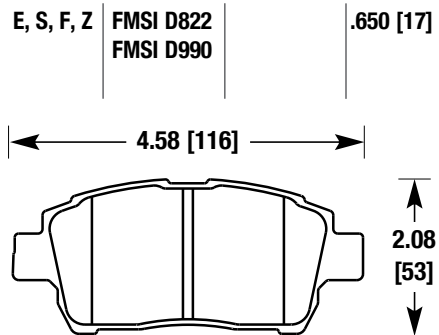

SCION, TOYOTA

HB496

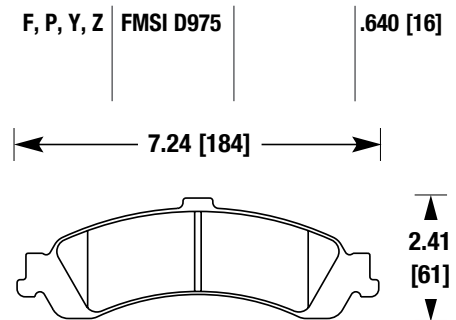

CADILLAC, CHEVY TRUCK, GMC TRUCK (REAR)

HB497

F, Z, S, U | FMSI D682 | .776 [20]

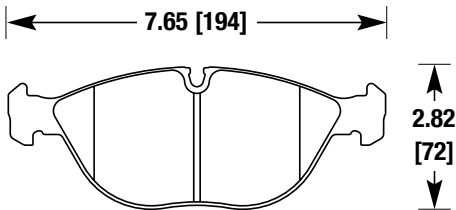

BMW

HB501

E, G, B, F | FMSI D977 | .625 [16]
N, Y, Z | FMSI D1014

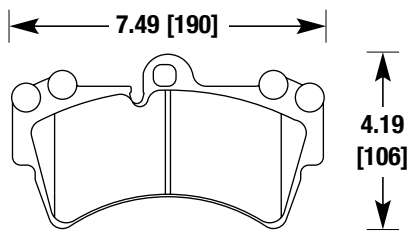

PORSCHE

HB498

F | FMSI D869 | .772 [20]

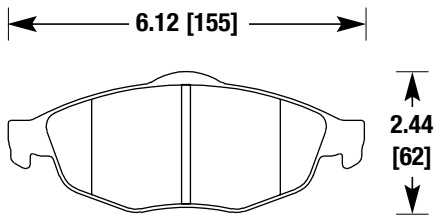

CHRYSLER, DODGE

HB502

B, F, Y, Z | FMSI D978 | .606 [15]

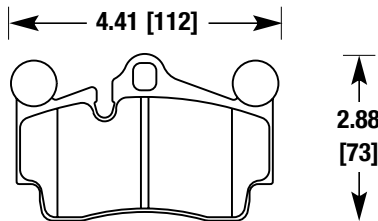

PORSCHE, VOLKSWAGEN

HB499

F, Z | FMSI D771 | .610 [15]

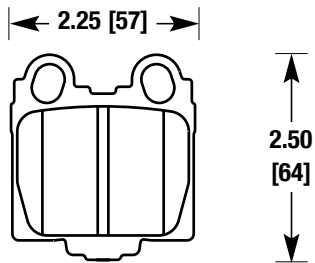

LEXUS (REAR)

HB503

P, Y, Z | FMSI D963 | .790 [20]

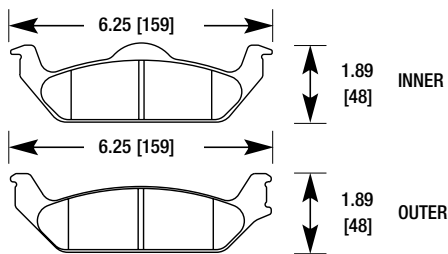

DODGE DAKOTA (REAR)

HB504

F, Z	FMSI D872	.740 [19]
------	-----------	-----------

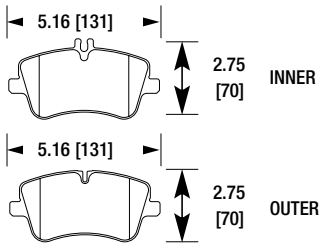

MERCEDES BENZ

HB507

F, Z	FMSI D1056	.711 [18]
------	------------	-----------

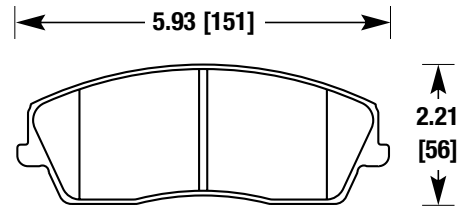

CHRYSLER, DODGE

HB505

Z	FMSI D760	.654 [17]
---	-----------	-----------

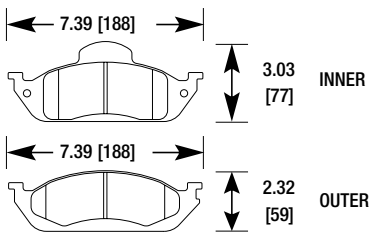

MERCEDES BENZ

HB508

F, Z	FMSI D1057	.586 [15] .675 [17]
------	------------	------------------------

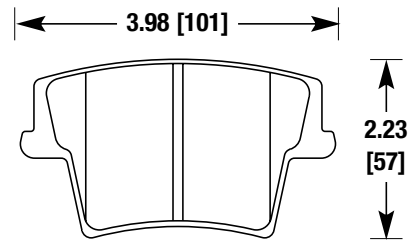

CHRYSLER, DODGE (REAR)

HB506

F, Z	FMSI D865	.610 [15]
------	-----------	-----------

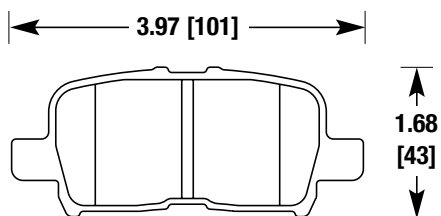

ACURA, HONDA (REAR)

HB509

B, F, N, R Z	FMSI D1058	.678 [17]
-----------------	------------	-----------

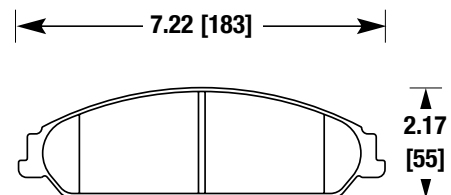

CHRYSLER, DODGE

HB510

F, Z	FMSI D661	.580 [15]
------	-----------	-----------

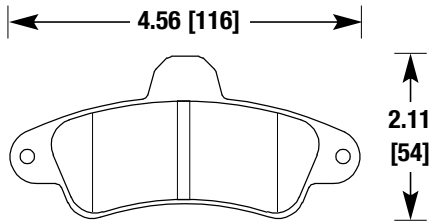

FORD MERCURY (REAR)

HB514

F, P, Y	FMSI D898	.610 [15]
---------	-----------	-----------

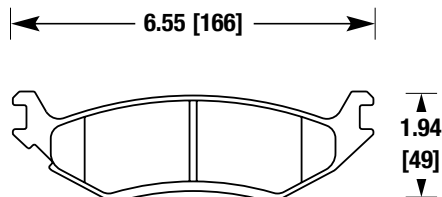

DODGE VAN (REAR)

HB512

W, B, F, R Y, Z	FMSI D1007	.605 [15]
--------------------	------------	-----------

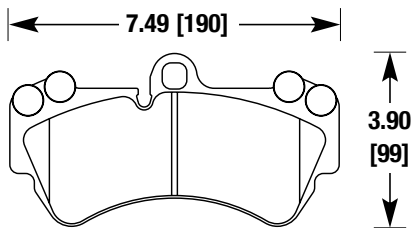

VOLKSWAGEN TOUAREG

HB515

F, N, Z	FMSI D915	.760 [19]
---------	-----------	-----------

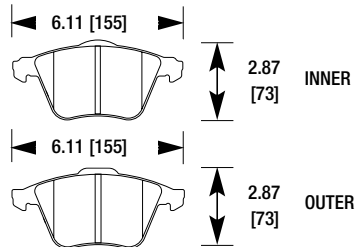

AUDI, VOLVO

HB513

F, Y	FMSI D967	.610 [15]
------	-----------	-----------

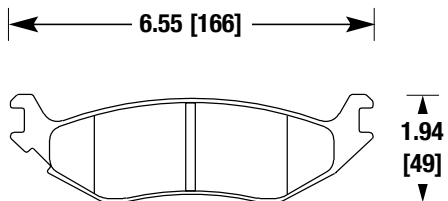

DODGE TRUCK (REAR)

HB517

F, Z	FMSI D956	.690 [18]
------	-----------	-----------

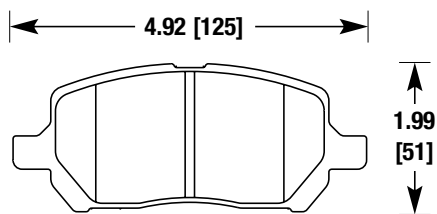

CHEVY, PONTIAC, SATURN

HB518

B, F, N, R	FMSI D683	.642 [16]
Y, Z, E, G		
S, U		

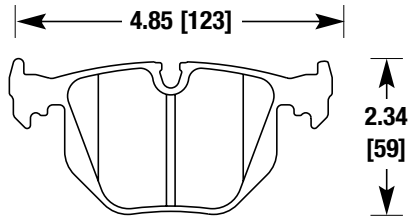

BMW (REAR)

HB521

F, N, G, H		.650 [17]
L, M, S, U		.800 [20]
V, W		

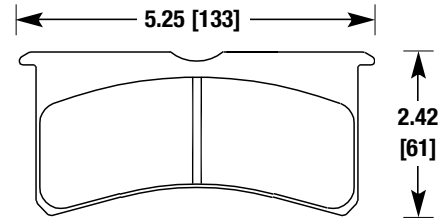

WILWOOD BRIDGE-BOLT SUPERLITE
7420, 7416

HB519

E, G, S, V	FMSI D1044	.682 [17]
B, F, N		

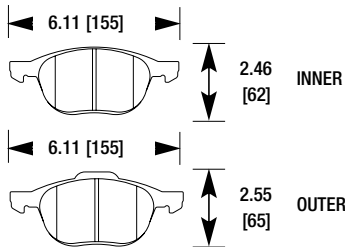

MAZDA 3

HB522

B, F, N, R	FMSI D1179	.565 [14]
E, EE, G,		
S, U		

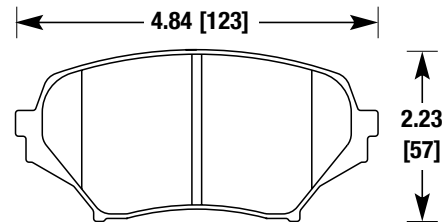

MAZDA MIATA MX-5

HB520

F, Y, Z	FMSI D881	.575 [15]
---------	-----------	-----------

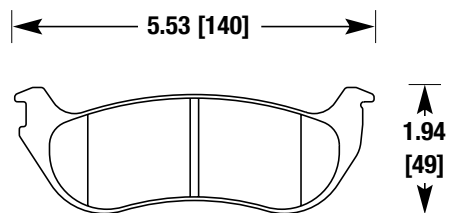

FORD EXPLORER (REAR)

HB523

B, F, N, R	FMSI D1180	.539 [14]
E, G, S, W		

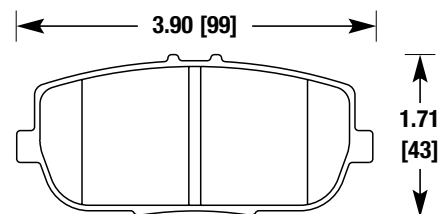

MAZDA MIATA MX-5 (REAR)

HB524

B, F, N, Z	FMSI D1028	.740 [19]
E, G, S, U	FMSI D1160	

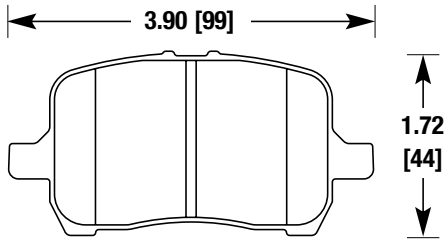

COBALT, SOLSTICE

HB527

Y, Z	FMSI D1120	.604 [15]
------	------------	-----------

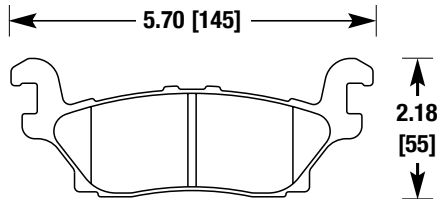

HUMMER H3 (REAR)

HB525

F, N, Z, G	FMSI D1033	.540 [14]
------------	------------	-----------

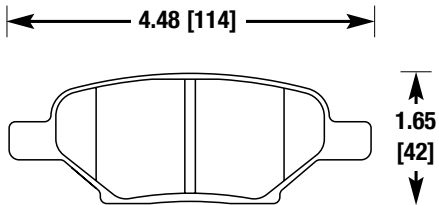

COBALT

HB528

P, Y	FMSI D1069	.811 [21]
------	------------	-----------

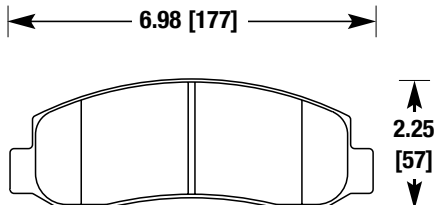

FORD F250/F350 SUPER DUTY

HB526

Y, Z	FMSI D1119	.665 [17]
------	------------	-----------

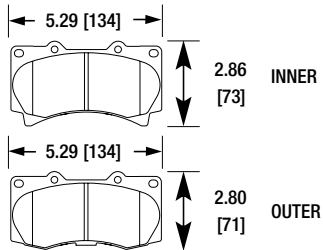

HUMMER H3

HB529

P, Y	FMSI D1068	.710 [18]
------	------------	-----------

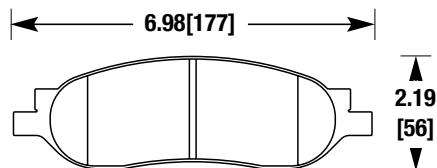

FORD TRUCK (REAR)

Hawk Performance - BRAKE PAD DIAGRAMS

HB530

F, N, Z, G | FMSI D1049 | .570 [14]
U, W

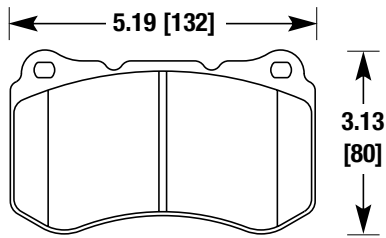

ACURA

HB533

B, F, N, R | FMSI D1078 | .668 [17]
Z, G, U

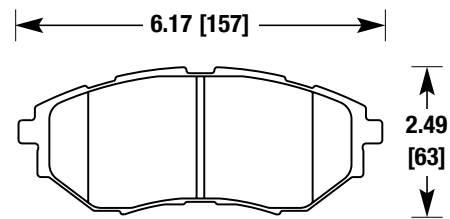

SUBARU

HB531

G, U, W, B | FMSI D1185 | .570 [14]
F, N, R, Z

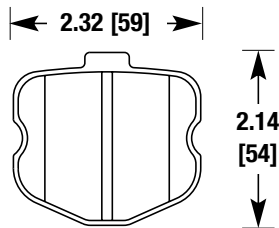

CORVETTE Z06 (FRONT)

HB534

B, F, N, Z | FMSI D1061 | .750 [19]
S, U

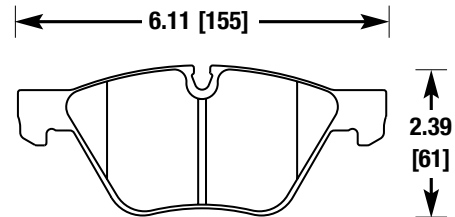

BMW

HB532

G, U, V, W | FMSI D1185 | .570 [14]
B, F, N, R
Z

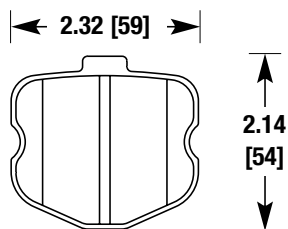

CORVETTE Z06 (REAR)

HB535

F | FMSI D1159 | .638 [16]

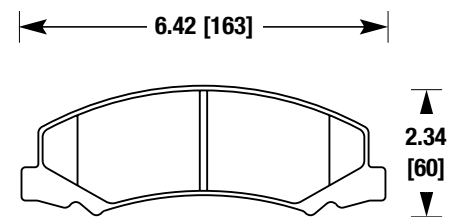

BUICK

HB536

F | FMSI D1076 | .704 [18]

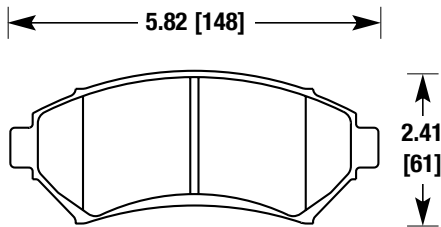

CADILLAC, CHEVY

HB540

F, E, G, H, J, M, S, U, W, V | .490 [12]

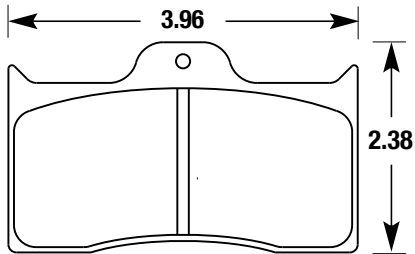

WILWOOD 7112

HB538

B, F, N, Z | FMSI D1111 | .760 [19]

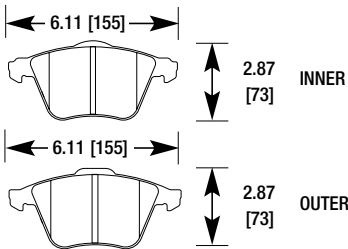

AUDI

HB541

F, E, G, H S, U, W | .630 [16]

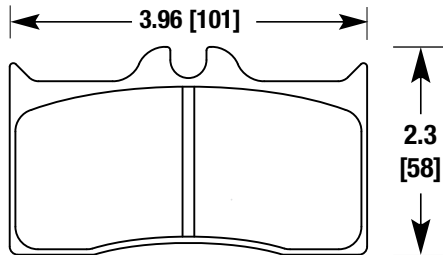

WILWOOD 7216

HB539

F, Y | FMSI D0802 | .650 [17]

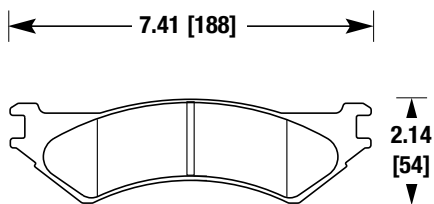

CHEVY IMPALA

HB542

F, E, G, J S, U, V, W | .600 [15] .490 [12]

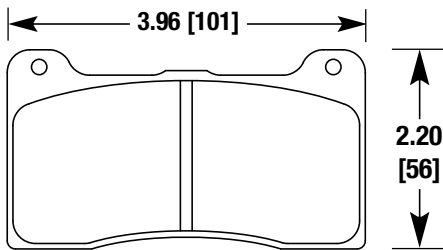

WILWOOD 7812, 7816

HB543

B, F, N, R FMSI D1107 .760 [19]
Z, G

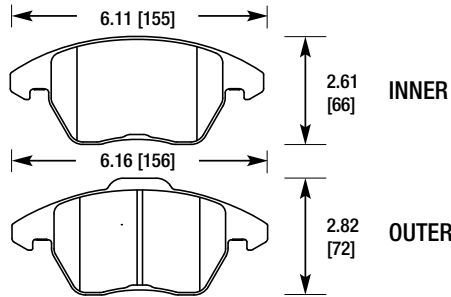

AUDI, VOLKSWAGEN

HB546

F, N, Z, S FMSI D781 .654 [17]
U

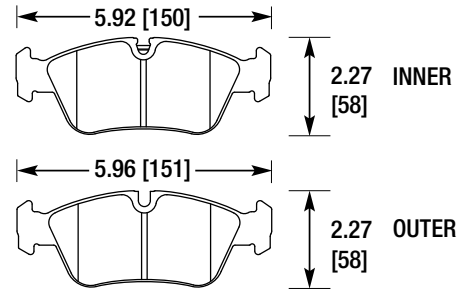

BMW Z4 ROADSTER, BMW 3 SERIES

HB544

S, B, F, N FMSI D1108 .628 [16]
R, Z

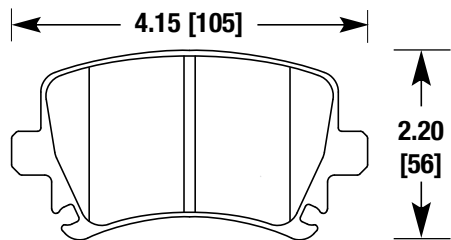

AUDI, VOLKSWAGEN (REAR)

HB547

P, Y, W FMSI D1066 .798 [20]

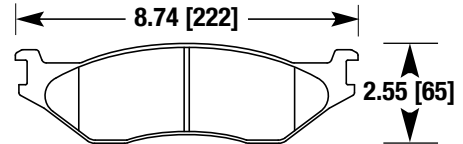

FORD F-450

HB545

E, G, U, W FMSI D960 .564 [14]
B, F, N, Z .610 [15]

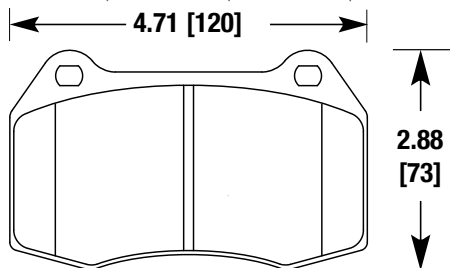

NISSAN 350Z W/BREMBO,
INFINITI G35 COUPE W/BREMBO

HB548

F, N, G, U FMSI D1379 .590 [15]
W

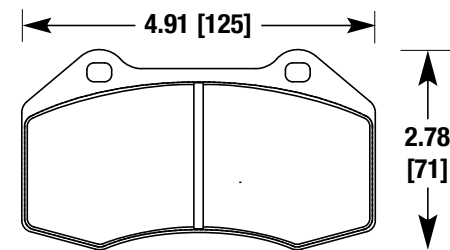

CHEVY COBALT SS
MX-5 MIATA

HB549

B, F, N, Z | FMSI D1186 | .702 [18]
G

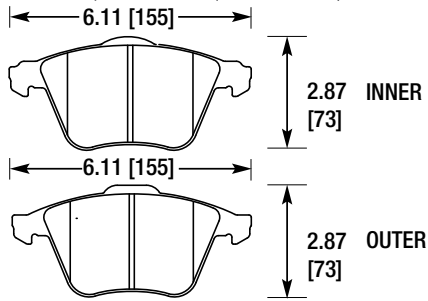

MAZDASPEED 3 AND 6

HB552

F, P, Y | FMSI D965 | .722 [18]

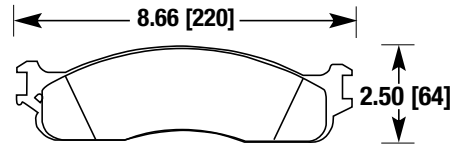

DODGE RAM PICKUP

HB550

E, G, S, U | FMSI D917 | .634 [16]
F, B, N, R
Z

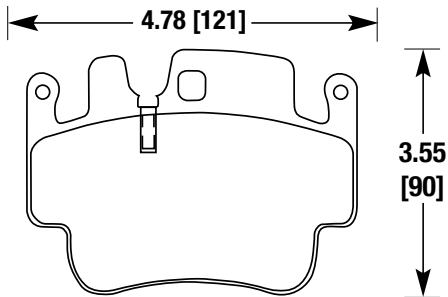

PORSCHE 911/BOXSTER/CAYMAN

HB553

F, N, Z | FMSI D1108 | .652 [17]

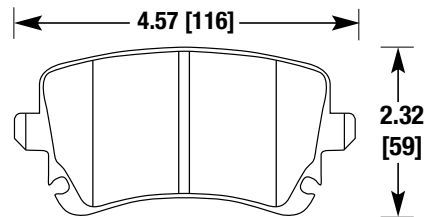

AUDI, VOLKSWAGEN

HB551

E, G, S, U | FMSI D918 | .748 [19]
W, B, F, N
R, Z

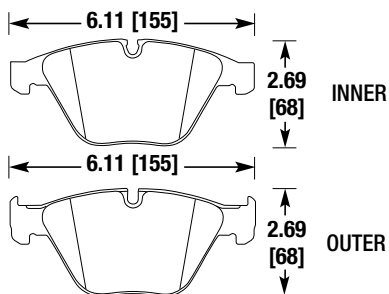

BMW

HB554

F, P, Y, Z | FMSI D1039 | .643 [16]
G, U, W

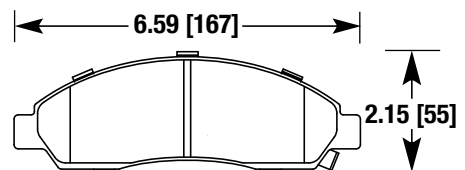

CHEVY COLORADO

Hawk Performance - BRAKE PAD DIAGRAMS

HB555

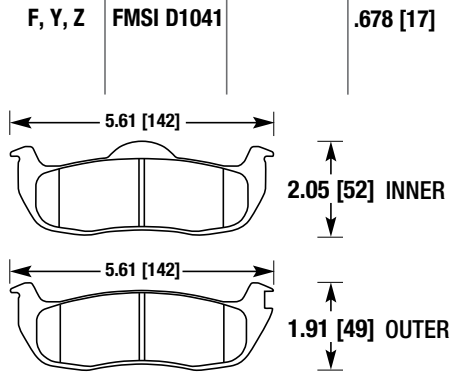

JEEP GRAND CHEROKEE (REAR)

HB558

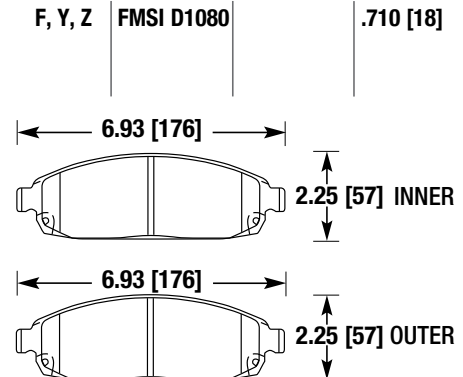

JEEP GRAND CHEROKEE

HB556

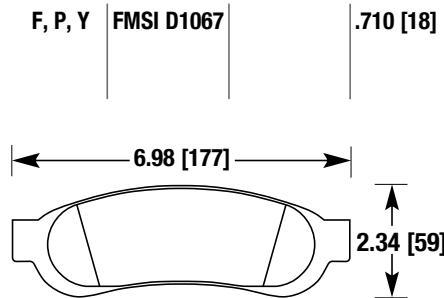

FORD F-350 SUPER DUTY PICKUP (REAR)

HB559

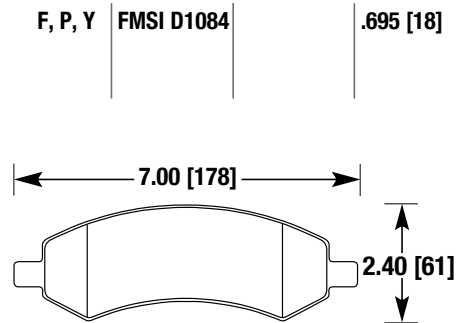

DODGE DAKOTA

HB557

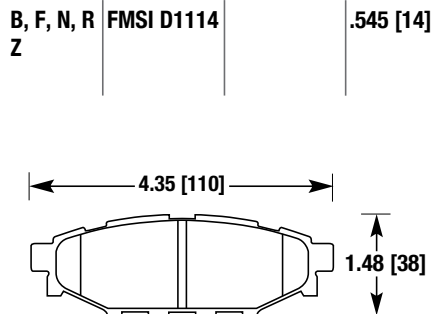

SUBARU LEGACY (REAR)

HB560

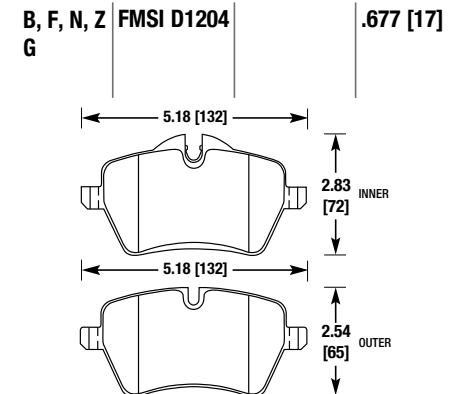

MINI COOPER (FRONT)

HB561

F, P, Y, Z | FMSI D1092 | .710 [18]

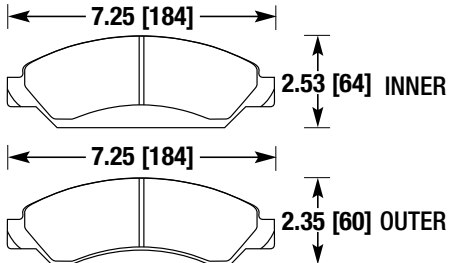

CHEVY SILVERADO

HB564

B, F, Z | FMSI D1161 | .567 [14]

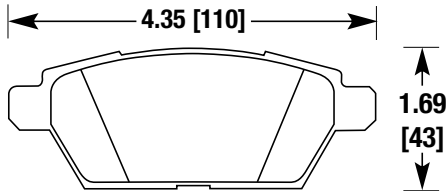

FORD FUSION (REAR)

HB562

B, F, N, Z | FMSI D1113 | .612 [16]

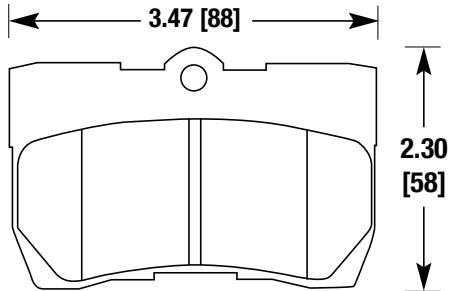

LEXUS IS250 (REAR)

HB565

F, Z | FMSI D1164 | .688 [17]

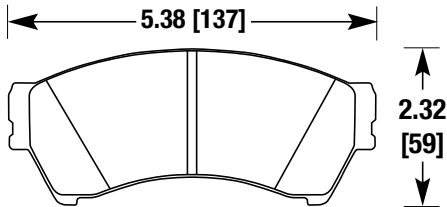

FORD FUSION

HB563

B, F, N, Y
Z | FMSI D1149 | .656 [17]

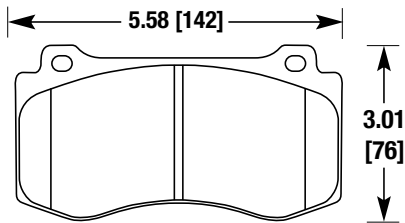

CHRYSLER, DODGE, JEEP

HB566

F, N, Z | FMSI D1178 | .688 [17]

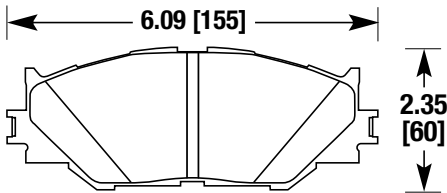

LEXUS IS250

HB567

F, Y, Z | FMSI D1183 | .694 [18]
 FMSI D1063

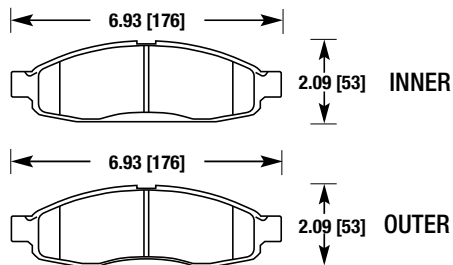

NISSAN TITAN

HB570

B, F, Z, G | FMSI D1308 | .666 [17]
 W, U

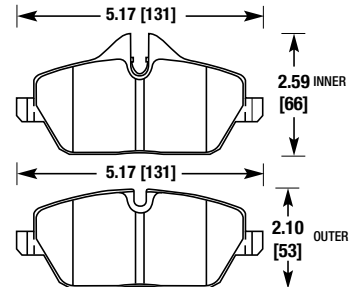

MINI COOPER STANDARD BRAKES

HB568

F, P, Y, Z | FMSI D1194 | .666 [17]

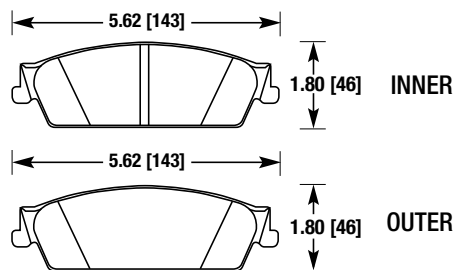

CADILLAC ESCALADE

HB571

F, N, Z, E | FMSI D973 | .605 [15]

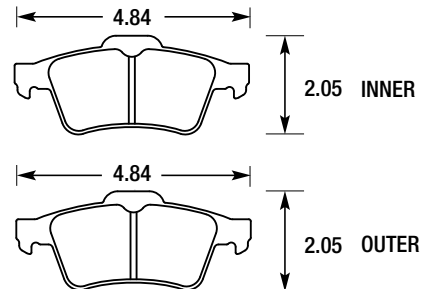

MAZDA 3 (REAR)

HB569

B, F, Y, Z | FMSI D1273 | .650 [17]

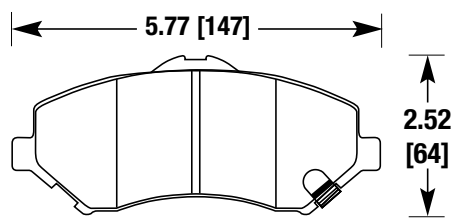

JEEP WRANGLER RUBICON

HB572

B, F, Y, Z | FMSI D536 | .570 [14]
 E, G, W | FMSI D1086

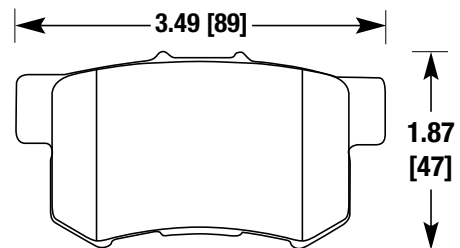

HONDA (REAR)

HB573

F, N, R, Z | FMSI D1048 | .615 [16]

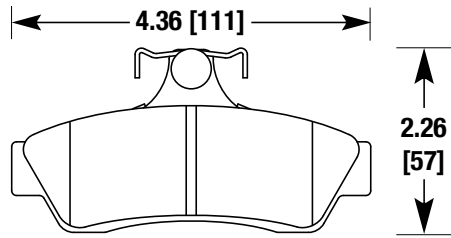

GTO (REAR)

HB579

Y | FMSI D1279 | .785 [20]

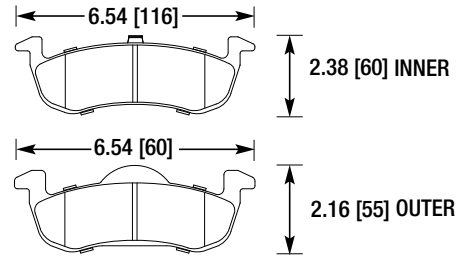

FORD EXPEDITION (REAR)

HB574

E, G, S, B | FMSI D1309 | .636 [16]
F, N, Z

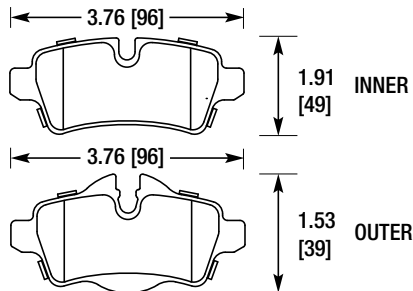

MINI COOPER (REAR)

HB580

F, E, G | FMSI D545 | .627 [16]
FMSI D347

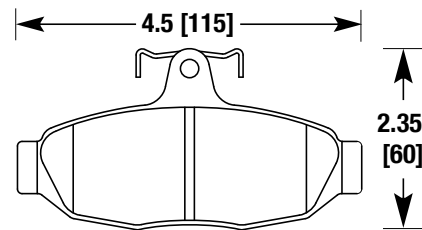

FORD, FACTORY 5 (REAR)

HB578

Y | FMSI D1278 | .735 [19]

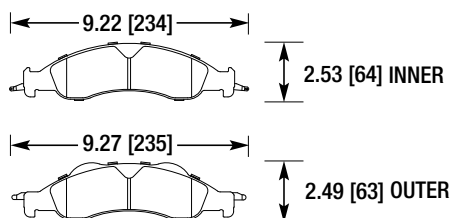

FORD EXPEDITION

HB581

B, F, N, R | .660 [17]
Y, E, G, S
U, V, W

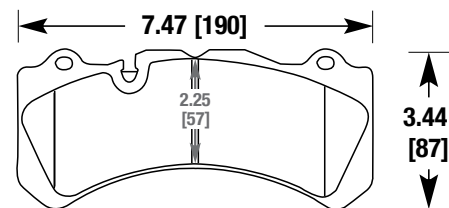

BREMBO SPORT BIG BRAKE KIT

Hawk Performance - BRAKE PAD DIAGRAMS

HB582

B, F, N, R
E, G, U, W

.660 [17]

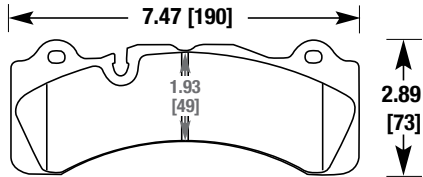

BREMBO SPORT BIG BRAKE KIT SCALLOPED

HB585

B, R, Z, U

.660 [17]

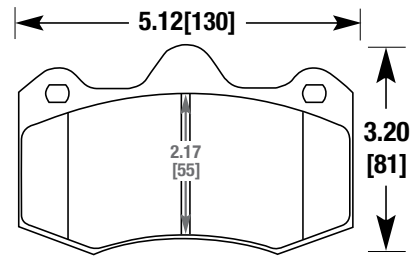

AP RACING CP6600D55

HB583

N, H, J, V
W

.480 [12]

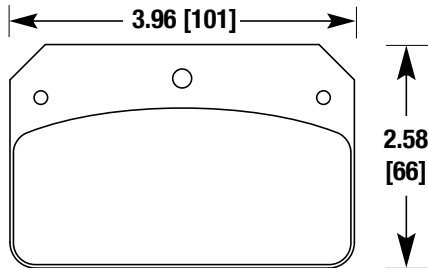

AEROSPACE DYNALITE

HB586

U, B, F, N
R, Z

.660 [17]

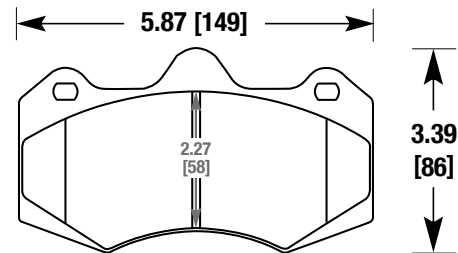

AP RACING CP7040D61

HB584

H, J, W

.485 [12]

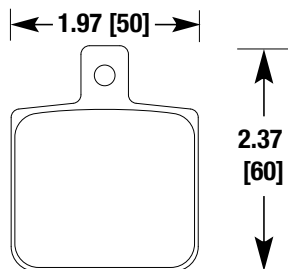

AEROSPACE SINGLE DYNALITE

HB587

S, U, B, F
R, Z

.630 [16]

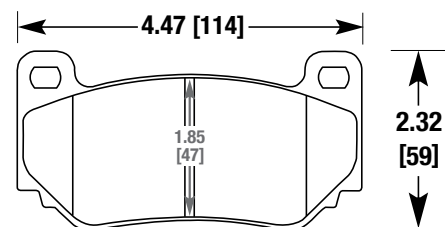

AP RACING CP7600D46

HB589

P, R, Y, Z | FMSI D1303 | .704 [18]

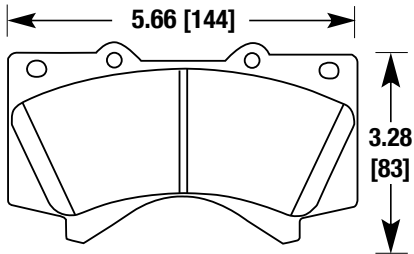

TOYOTA TUNDRA

HB594

F | FMSI D1215 | .657 [17]

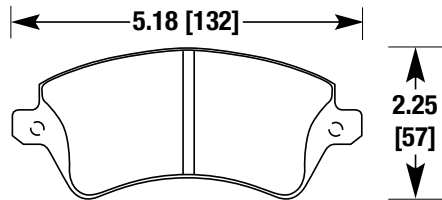

TOYOTA COROLLA

HB590

P, R, Y, Z | FMSI D1304 | .682 [17]

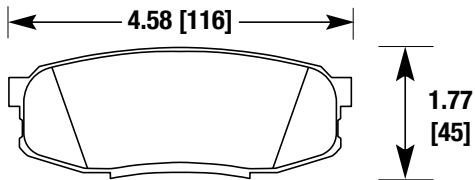

TOYOTA TUNDRA (REAR)

HB596

F | FMSI D1184 | .690 [18]

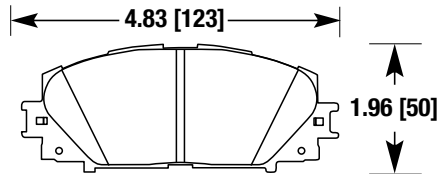

TOYOTA YARIS

HB592

F | FMSI D1035 | .665 [17]

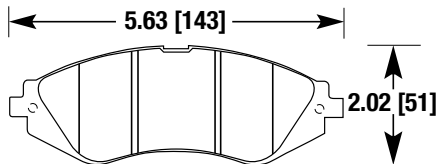

CHEVY OPTRA, AVEO

HB597

F | FMSI D766 | .681 [17]

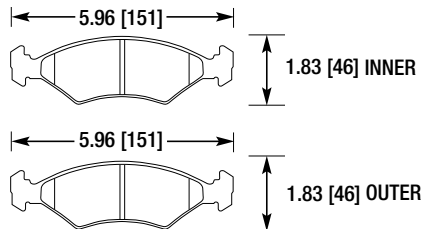

FORD FIESTA, KIA SEPHIA

Hawk Performance - BRAKE PAD DIAGRAMS

HB599

F, Z | FMSI D1287 | .616 [16]

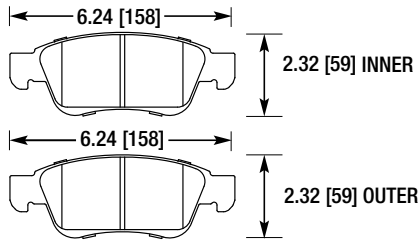

INFINITI G37

HB602

E, G, U, W | FMSI D1347 | .545 [14]
B, F, N, R
Z

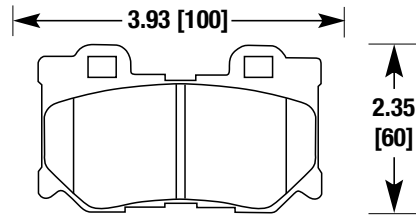

INFINITI G37 SPORT (REAR)

HB600

B, F, N, Z | FMSI D1288 | .539 [14]

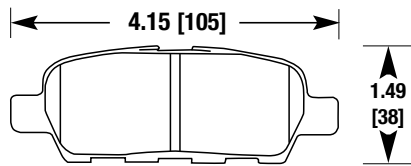

INFINITI G37 (REAR)

HB603

F, N, Z, G | FMSI D1371 | .616 [16]
S, U, W

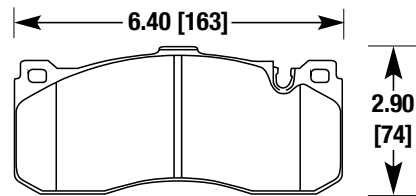

BMW 135i

HB601

E, G, U, W | FMSI D1346 | .626 [16]
B, F, N, R
Z

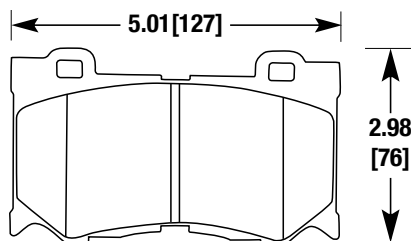

INFINITI G37 SPORT

HB604

F, N, G, S | FMSI D1372 | .598 [15]
W

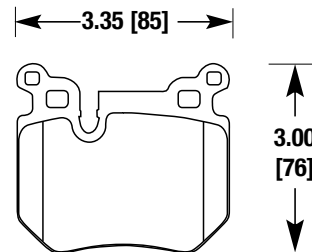

BMW 135i (REAR)

HB605

U, V, W | .625 [16]

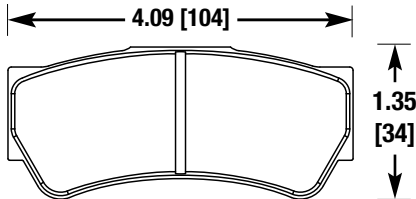

BREMBO

HB608

B, F, Y | FMSI D1274 | .630 [16]

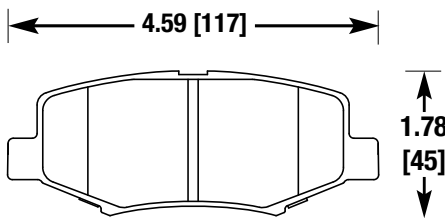

JEEP (REAR)

HB606

B, F, N, Z | FMSI D1351 | .650 [17]

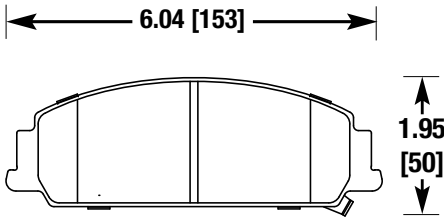

PONTIAC G8

HB609

B, F, N, R | FMSI D1029 | .572 [15]
Z, E, G, S
U, W

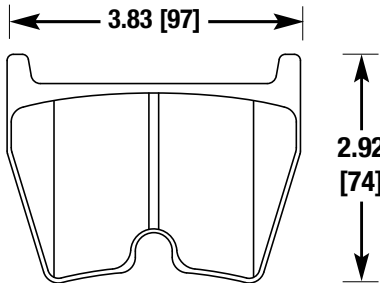

AUDI

HB607

F, N, R, Z | FMSI D1352 | .616 [16]

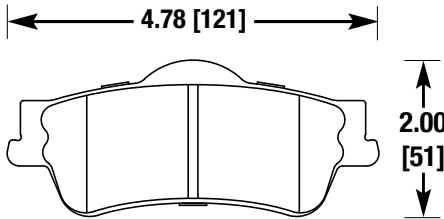

PONTIAC G8 (REAR)

HB610

F, Z | FMSI D835 | .587 [15]

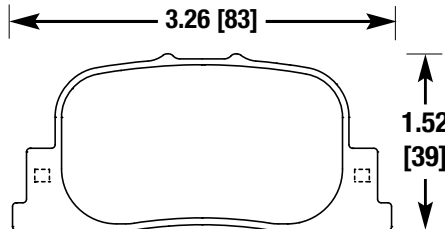

SCION, TOYOTA

HB611

G, H, M, U V, W	RACE	.490 [12]
--------------------	------	-----------

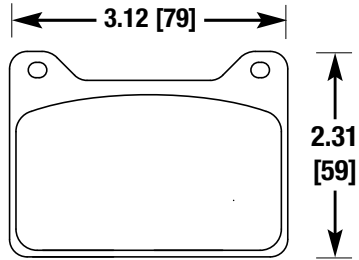

WILWOOD 7912

HB614

U, W, F	FMSI D195	.600 [15]
---------	-----------	-----------

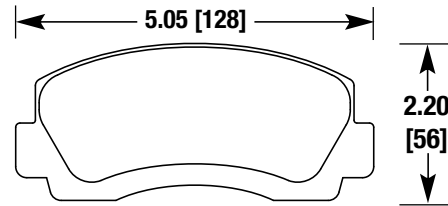

SWIFT

HB612

Y, Z	FMSI D1158	.690 [18]
------	------------	-----------

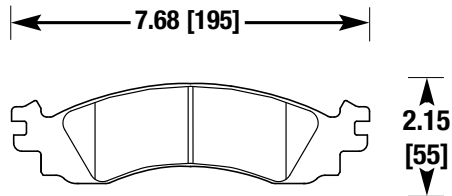

FORD EXPLORER

HB615

B, F, N, R Z, G, S, U W	FMSI D1368	.535 [15]
-------------------------------	------------	-----------

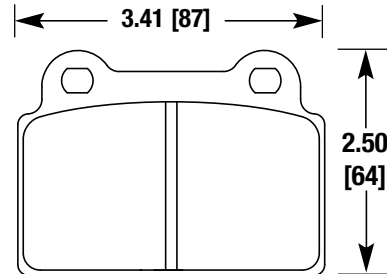

MINI (REAR)

HB613

Y, Z	FMSI D1109	.589 [15]
------	------------	-----------

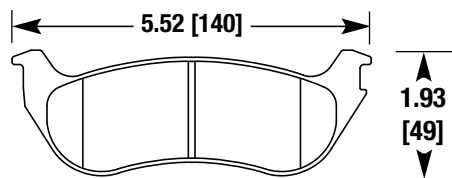

FORD EXPLORER (REAR)

HB616

B, F, N, R Z, G	FMSI D1116 FMSI D1365	.607 [15]
--------------------	--------------------------	-----------

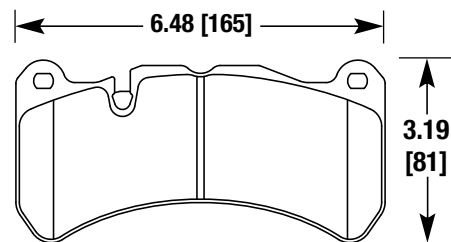

LEXUS, MERCEDES

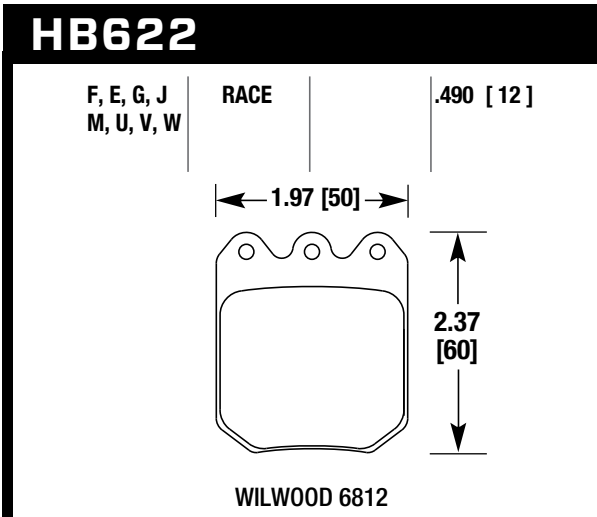
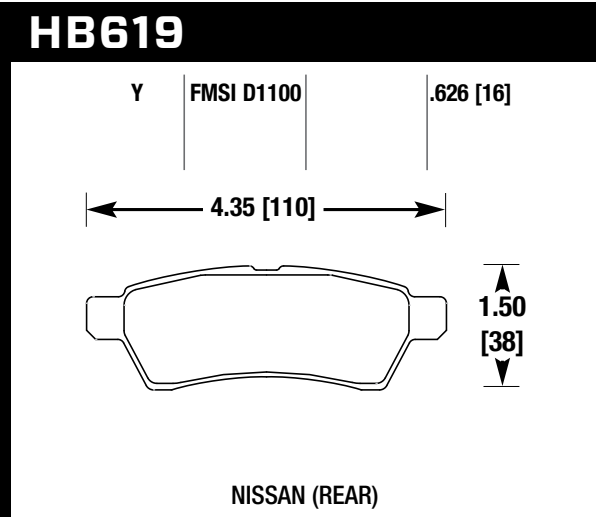
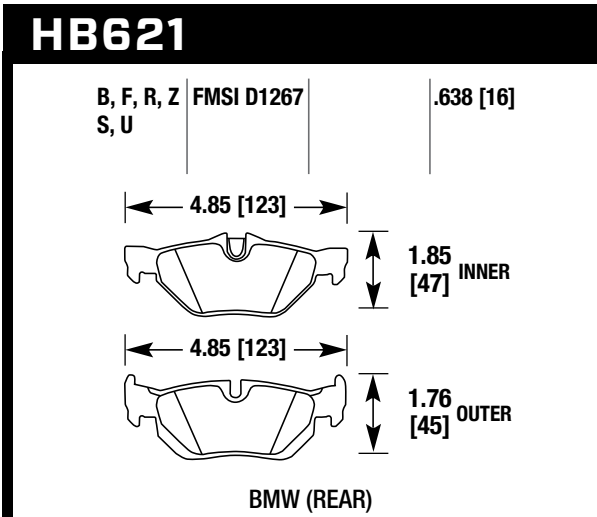
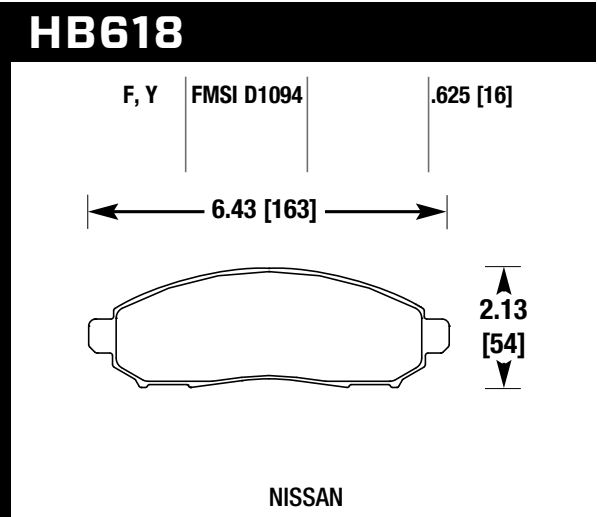
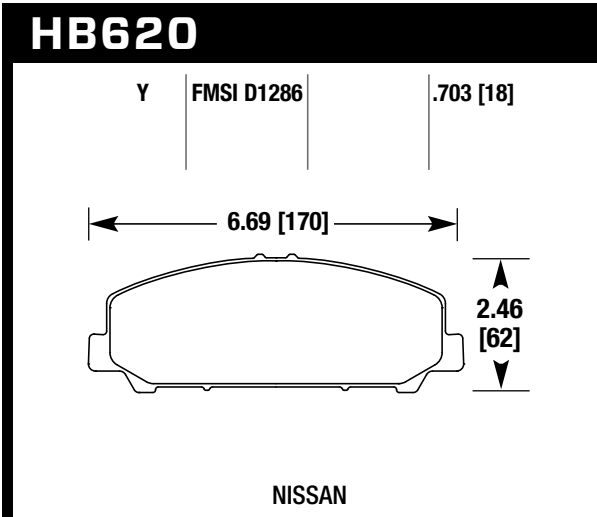
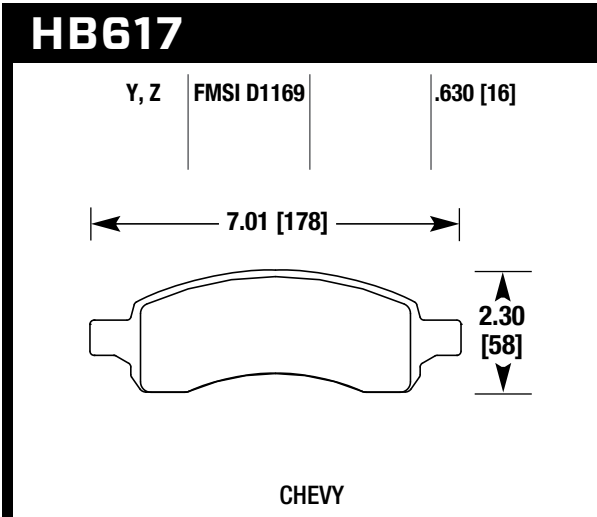

HB624

B, F, N, R Z	FMSI D1170	.642 [16]
-----------------	------------	-----------

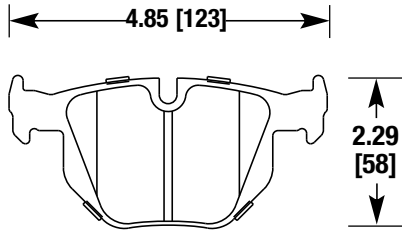

BMW (REAR)

HB627

F, Z	FMSI D1210	.690 [18]
------	------------	-----------

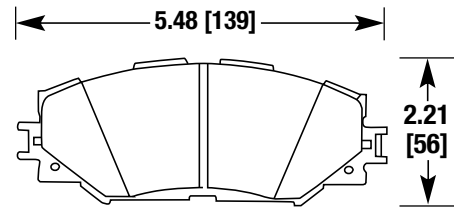

SCION

HB625

B, F, R, Z	FMSI D1359	.760 [19]
------------	------------	-----------

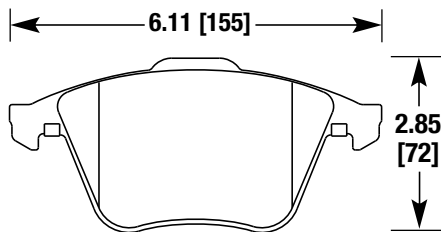

AUDI

HB628

F, Z	FMSI D1249	.651 [17]
------	------------	-----------

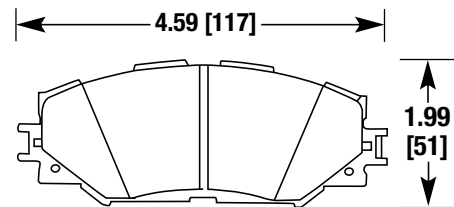

SCION

HB626

F, Z, E, G W	FMSI D1336	.577 [15]
-----------------	------------	-----------

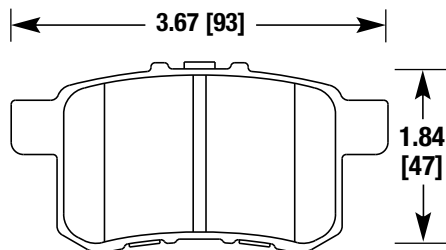

ACURA/HONDA (REAR)

HB629

F	FMSI D1354	.565 [14]
---	------------	-----------

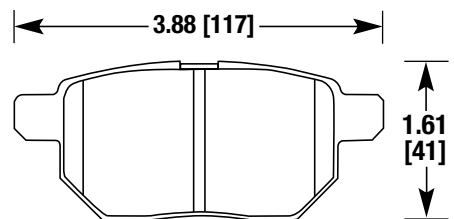

SCION (REAR)

HB630

B, F, N, R	FMSI D919	.626 [16]
Z, G, U, W		

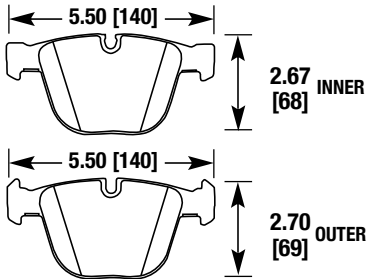

BMW (REAR)

HB633

P, Y	FMSI D1399	.790 [19]
------	------------	-----------

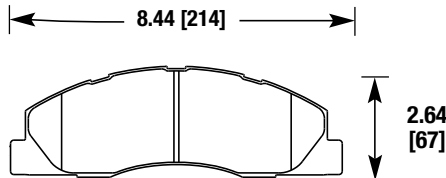

DODGE TRUCK

HB631

F, N, Z, U	FMSI D1395	.622 [17]
------------	------------	-----------

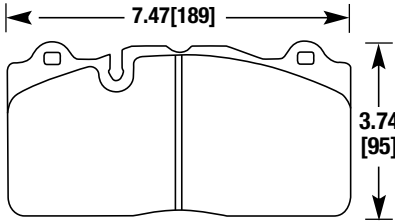

CORVETTE

HB634

P, Y	FMSI D1400	.750 [19]
------	------------	-----------

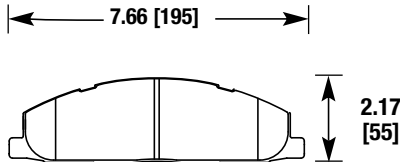

DODGE TRUCK (REAR)

HB632

U, B, F, N	FMSI D1129	.586 [15]
Y, Z		

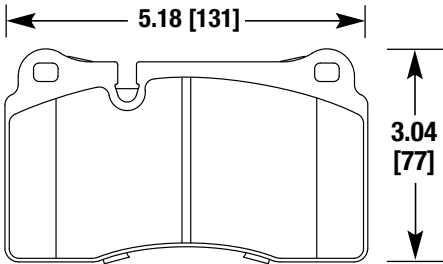

CORVETTE (REAR)

HB636

F, N, Z	FMSI D1396	.644 [16]
---------	------------	-----------

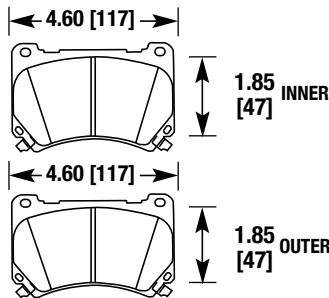

HYUNDAI

Hawk Performance - BRAKE PAD DIAGRAMS

HB637

F, N, Z | FMSI D1387 | .583 [15]

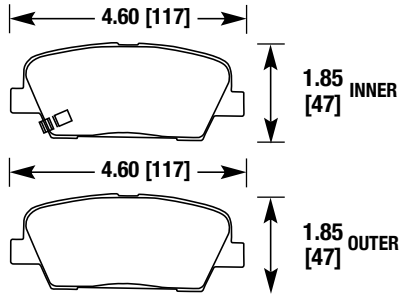

HYUNDAI (REAR)

HB640

G, S, F, N | FMSI D1403 | .550 [14]
Z

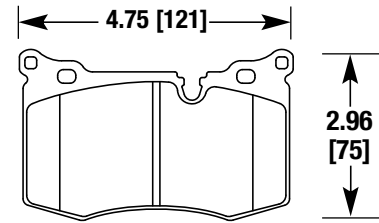

MINI COOPER JCW

HB638

F, N, Z | FMSI D1404 | .702 [18]

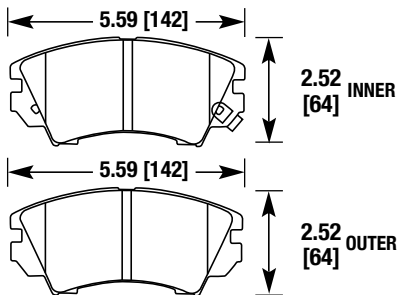

CAMARO

HB641

B, F, R, Z | FMSI D1322 | .696 [18]

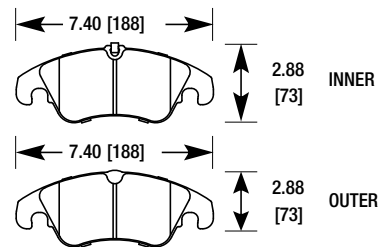

AUDI

HB639

G, F, N, Y | FMSI D1337 | .645 [16]
Z

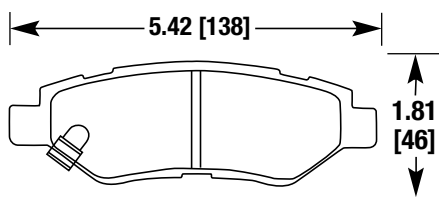

CAMARO (REAR)

HB642

B, F, N, R | FMSI D1386 | .658 [17]
Z, W

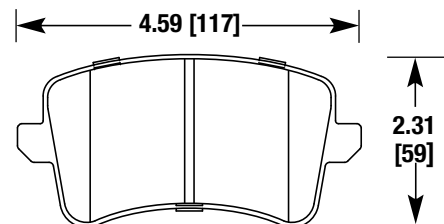

AUDI (REAR)

HB643

F	FMSI D39	.595 [15]
---	----------	-----------

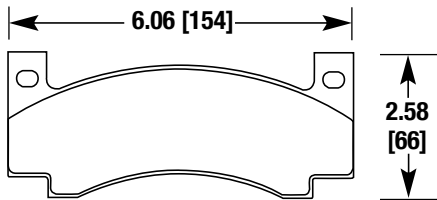

MOPAR

HB646

F	FMSI D34	.526 [13]
---	----------	-----------

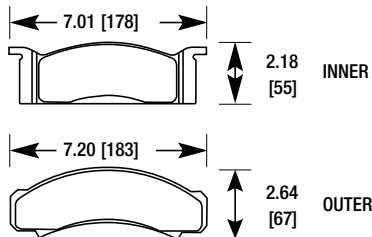

FORD, MERCURY

HB644

Y, Z	FMSI D1392	.785 [20]
------	------------	-----------

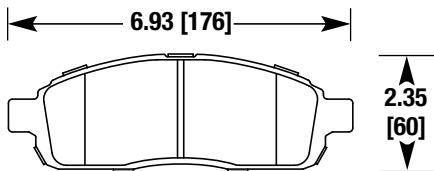

FORD TRUCK

HB647

B, F, Z	FMSI D1222 FMSI D1293	.692 [43]
---------	--------------------------	-----------

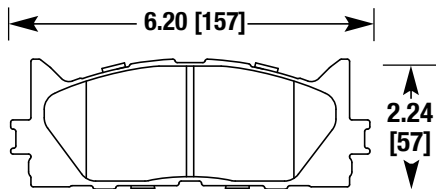

TOYOTA CAMRY

HB645

G, U, V, W		.490 [12]
------------	--	-----------

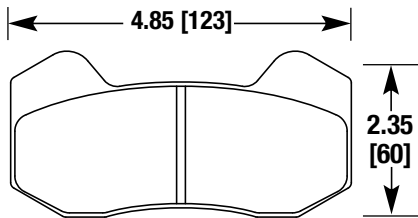

WILLWOOD 6712

HB648

B, F, Z	FMSI D1212	.607 [15]
---------	------------	-----------

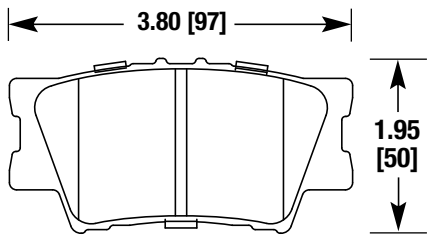

TOYOTA CAMRY (REAR)

Hawk Performance - BRAKE PAD DIAGRAMS

HB649

B, F, R, Z G, U, W	FSMI D1405	.605 [15]
-----------------------	------------	-----------

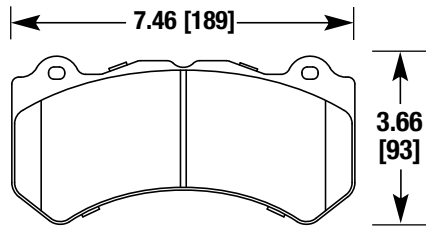

CADILLAC, CHEVY CAMARO

HB652

F, Z	FMSI D795	.634 [16]
------	-----------	-----------

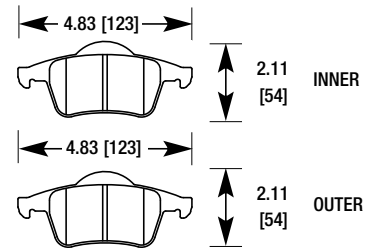

VOLVO (REAR)

HB650

F, N, R, Z G, U, V, W	FSMI D1382	.730 [19]
--------------------------	------------	-----------

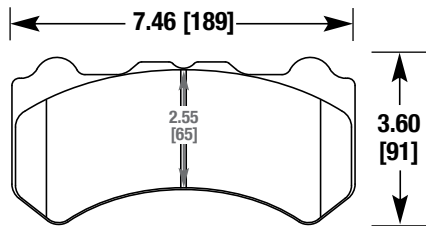

NISSAN

HB653

U		.606 [15]
---	--	-----------

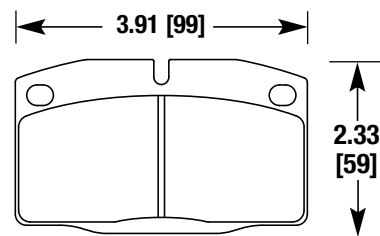

CARBONE LORRAINE 4012

HB651

F, Z, G, U	FSMI D1299 FSMI D1300	.624 [16]
------------	--------------------------	-----------

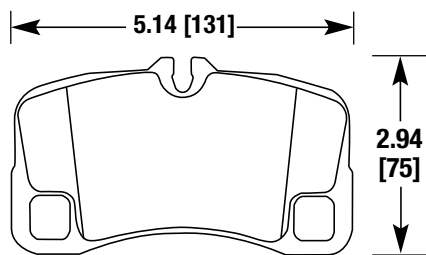

PORSCHE (REAR)

HB654

U		.748 [16]
---	--	-----------

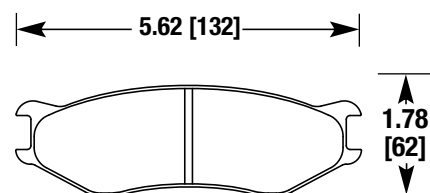

PFC ZR34

HB655

F, N, U | .620 [16]

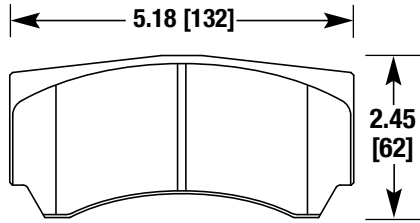

ALCON

HB658

G, U, W, B | FMSI D1185 | .570 [14]
F, N, R, Z

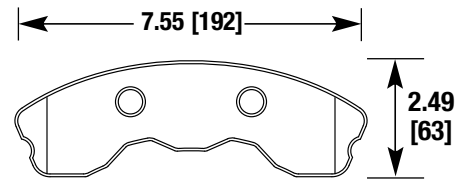

CORVETTE ONE-PIECE

HB656

F, Y | FMSI D1258 | .684 [17]

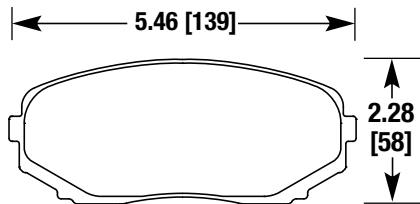

FORD

HB659

B, F, N, R | FMSI D1185 | .570 [14]
Z, G, U, W

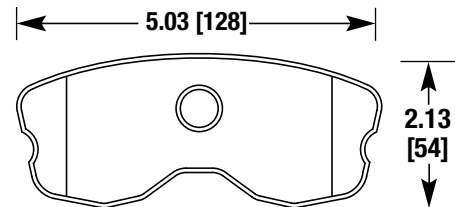

CORVETTE ONE-PIECE (REAR)

HB657

F | FMSI D1259 | .667 [17]

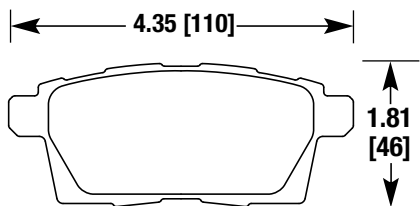

FORD (REAR)

HB660

F, N, Z, G | FMSI D1338 | .661 [17]
W | FMSI D1374

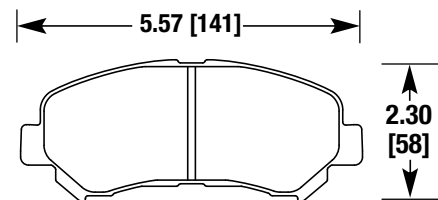

NISSAN SENTRA

HB661

B, F, N, Z | FMSI D1413 | .667 [17]

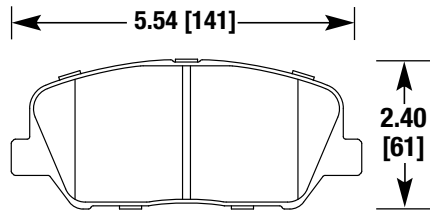

HYUNDAI

HB664

B, F, Z, G | FMSI D1135 | .634 [16]
U, W

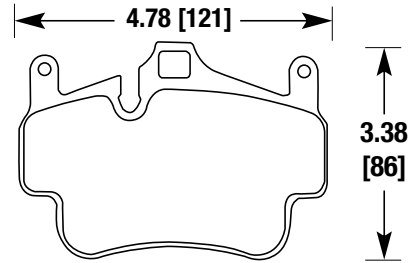

PORSCHE

HB662

B, F, N, Z | FMSI D1284 | .587 [15]

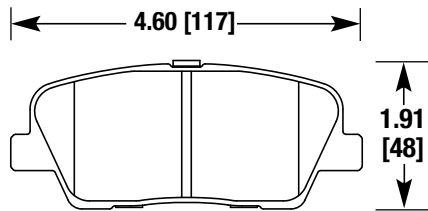

HYUNDAI (REAR)

HB665

B, F, Z, G | FMSI D1134 | .577 [15]
U, W

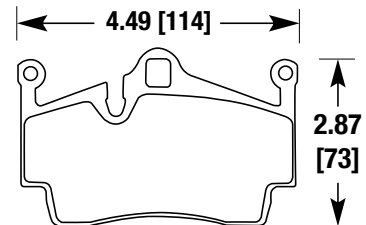

PORSCHE (REAR)

HB663

G, F, N, R | FMSI D1428 | .557 [14]
Z

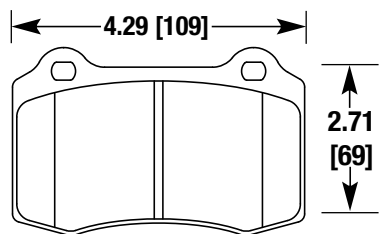

HYUNDAI (REAR)

HB667

F, Z, G, U | FMSI D916 | .622 [16]
W

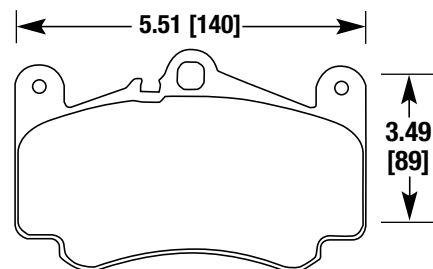

PORSCHE

HB668

B, F, N, Z	FMSI D1454	.567 [14]
E, G, W		

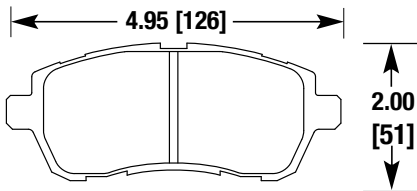

FORD FIESTA, MAZDA 2

HB671

G, U, W, B	FMSI D1124	.628 [16]
F, N, R, Z		

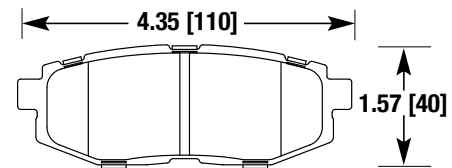

SUBARU / SCION (REAR)

HB669

F, N, Z	FMSI D1433	.671 [17]
---------	------------	-----------

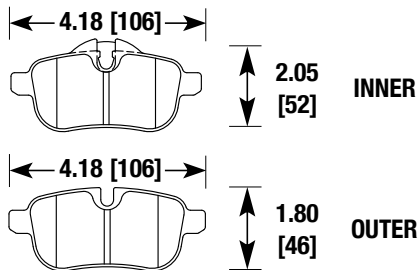

BMW (REAR)

HB672

P, Y, Z	FMSI D1414	.714 [18]
---------	------------	-----------

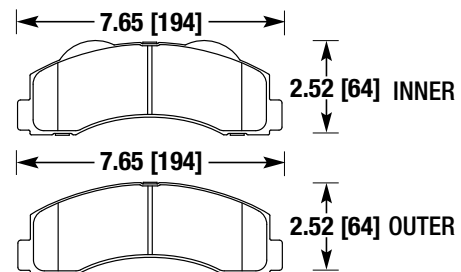

FORD TRUCK

HB670

F	FMSI D572	.610 [15]
---	-----------	-----------

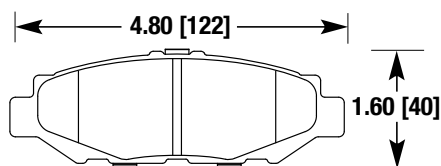

LEXUS, TOYOTA (REAR)

HB673

F	FMSI D532	.602 [15]
---	-----------	-----------

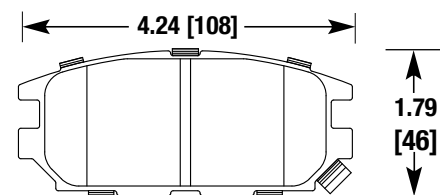

MITSUBISHI (REAR)

Hawk Performance - BRAKE PAD DIAGRAMS

HB674

F, Y, Z | FMSI D1377 | .664 [17]

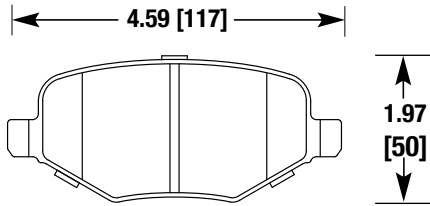

FORD, LINCOLN (REAR)

HB677

Y, Z | FMSI D906 | .685 [17]

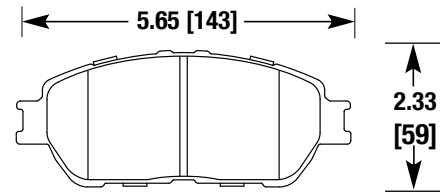

TOYOTA

HB675

F, Y | FMSI D868 | .602 [15]

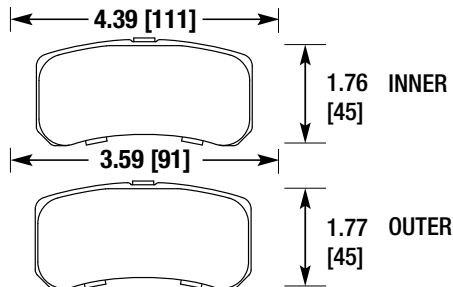

MINISUBISHI (REAR)

HB678

Y, Z | FMSI D1102 | .709 [18]

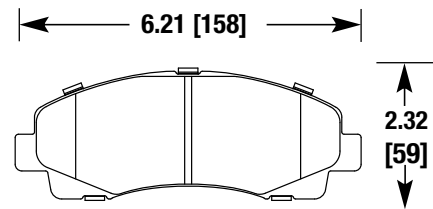

ACURA, HONDA

HB676

F, Z, G | FMSI D1151 | .780 [20]

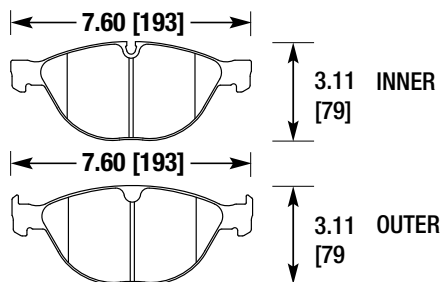

BMW M5, M6

HB679

Y, Z | FMSI D1103 | .600 [15]

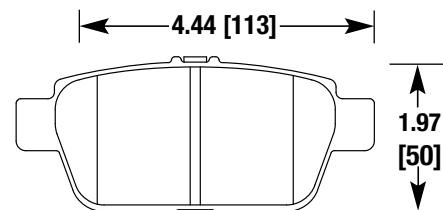

ACURA, HONDA (REAR)

HB680

F, N	FMSI D669	.583 [15]
------	-----------	-----------

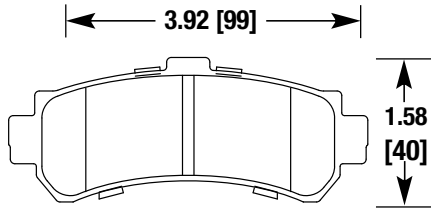

NISSAN (REAR)

HB683

B, Y, Z	FMSI D1165	.651 [16]
---------	------------	-----------

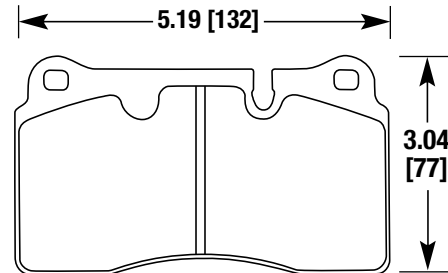

RANGE ROVER

HB681

Y, Z	FMSI D1098	.686 [17]
------	------------	-----------

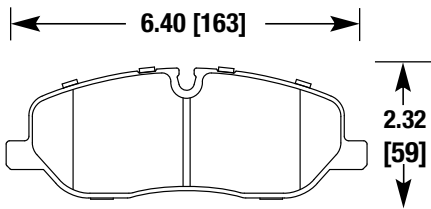

RANGE ROVER

HB684

Y, Z	FMSI D1425	.694 [18]
------	------------	-----------

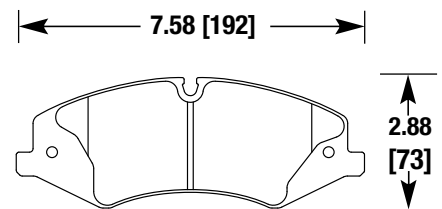

RANGE ROVER

HB682

B, Y, Z	FMSI D1099	.657 [16]
---------	------------	-----------

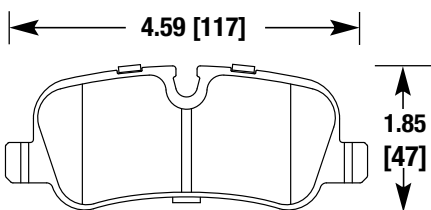

RANGE ROVER (REAR)

HB685

Y, Z	FMSI D1426	.610 [15]
------	------------	-----------

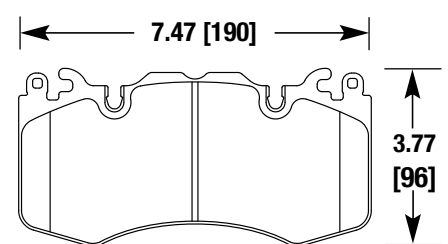

RANGE ROVER

Hawk Performance - BRAKE PAD DIAGRAMS

HB686

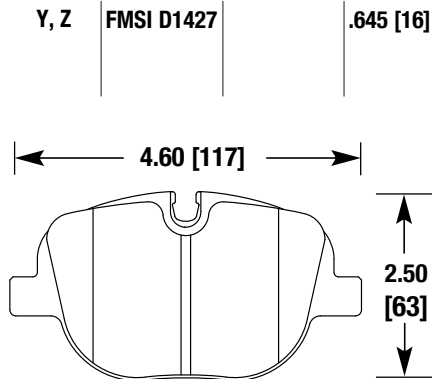

RANGE ROVER (REAR)

HB689

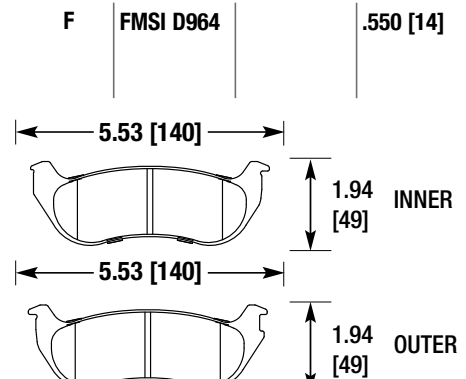

JEEP WRANGLER / LIBERTY (REAR)

HB687

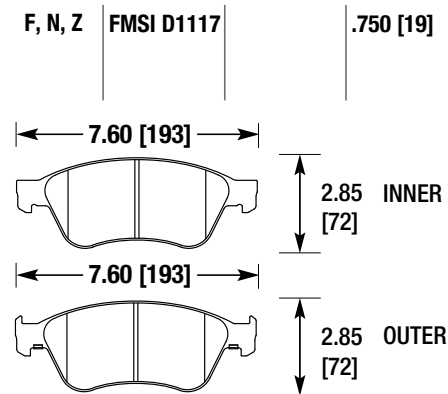

AUDI

HB690

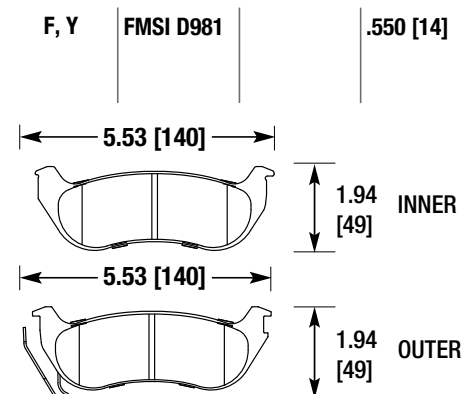

JEEP WRANGLER / LIBERTY (REAR)

HB688

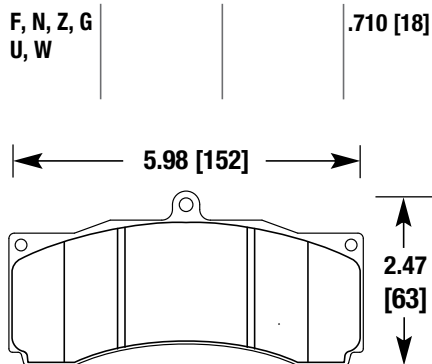

ALCON, AP RACING

HB691

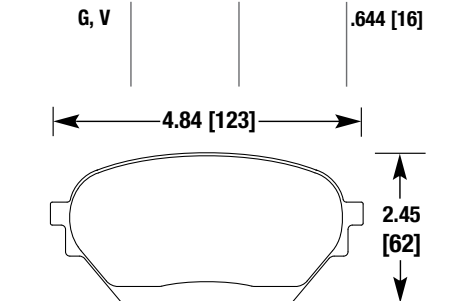

MAZDA MIATA MX5
(OPTIMIZED PAD RADIAL DEPTH AND THICKNESS)

HB693

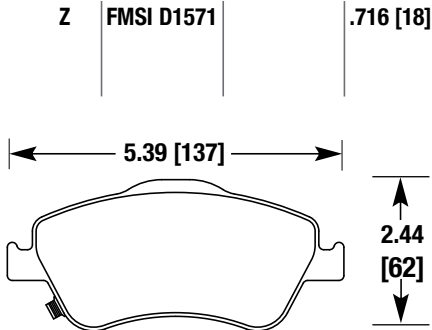

TOYOTA COROLLA (LATIN AMERICA)

HB699

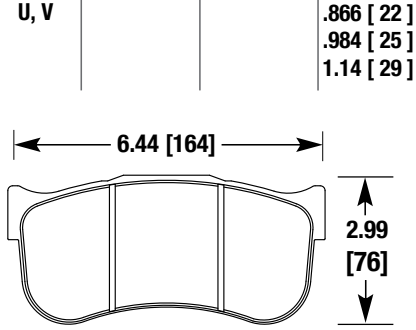

BREMBO

HB694

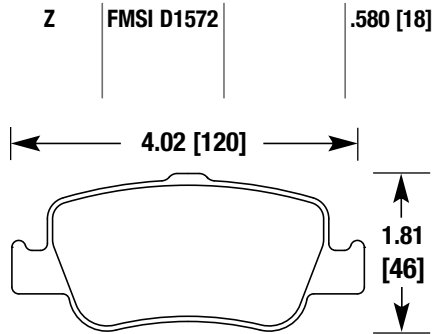

TOYOTA COROLLA (LATIN AMERICA, REAR)

HB700

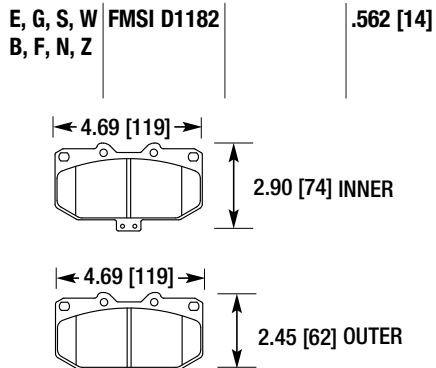

SUBARU WRX

HB695

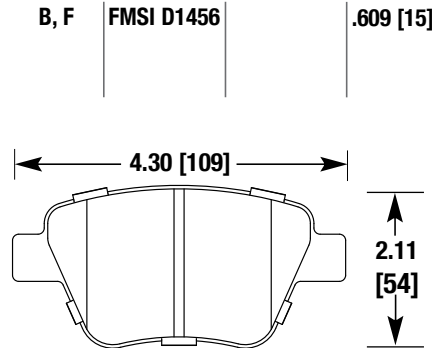

VOLKSWAGEN, AUDI (REAR)

HB701

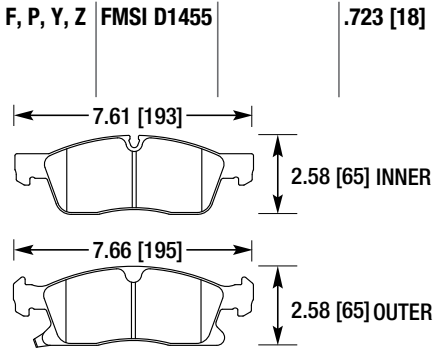

JEEP GRAND CHEROKEE

Hawk Performance - BRAKE PAD DIAGRAMS

HB702

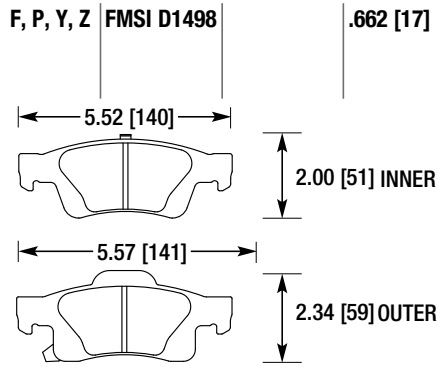

JEEP GRAND CHEROKEE (REAR)

HB705

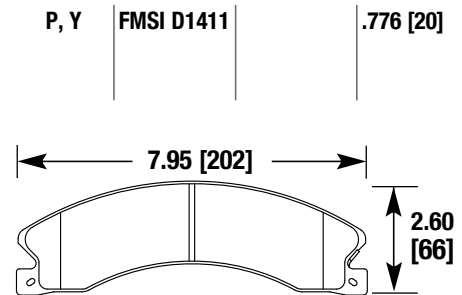

CHEVY/GMC TRUCK

HB703

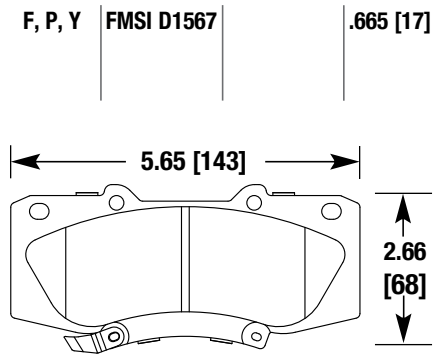

TOYOTA HILUX

HB706

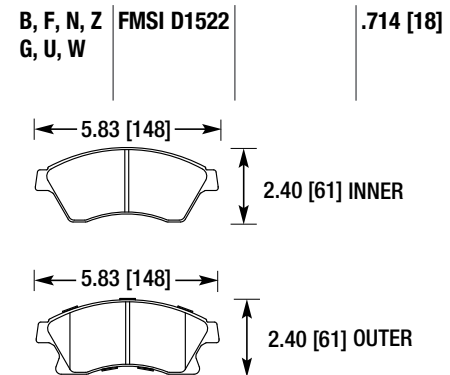

CHEVY CRUZE/SONIC

HB704

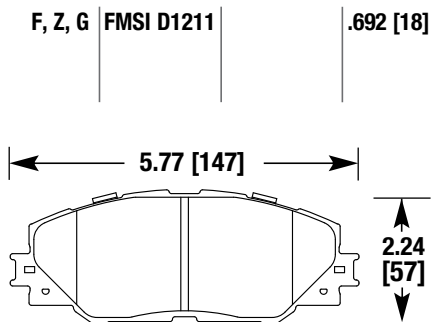

SCION

HB707

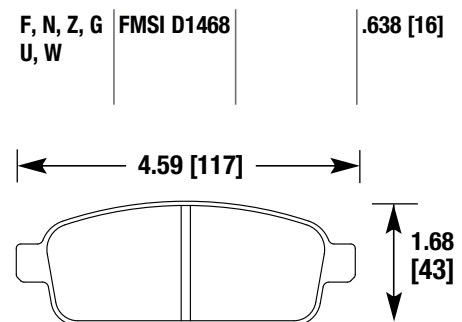

CHEVY CRUZE (REAR)

HB708

F, Y, Z | FMSI D1294 | .738 [19]

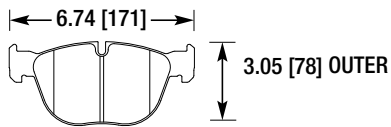
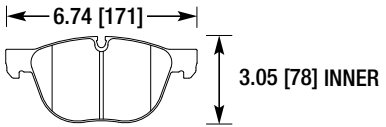

BMW X5/X6

HB711

B, F, N, R | FMSI D1539 | .661 [17]
Z, G, U, W

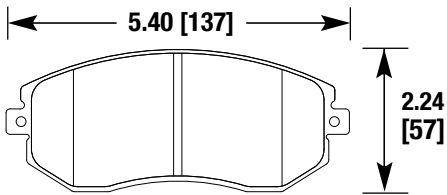

SUBARU, SCION

HB709

F, N, Z, G | .630 [16]
U, W

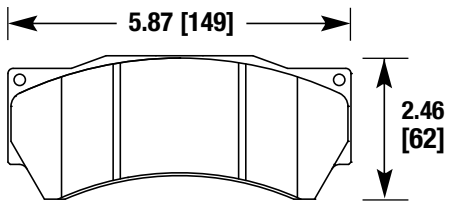

ALCON

HB712

B, F, N, R | FMSI D1668 | .680 [17]
Z, G, W

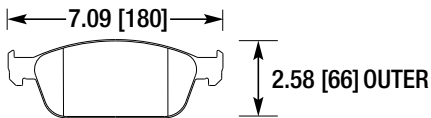
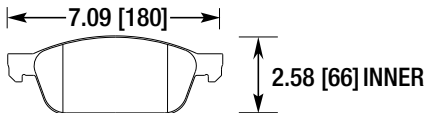

FORD, FOCUS ST (FRONT)

HB710

F, P, Y, Z | FMSI D1508 | .706 [18]

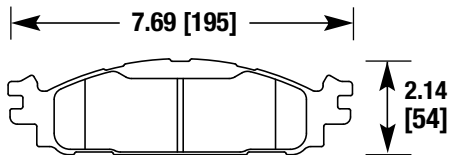

FORD EXPLORER

HB713

B, W, Z | FMSI D30 | .585 [15]

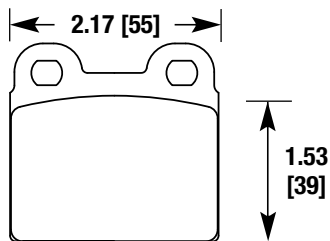

PORSCHE (REAR)

HB714

P	D1680	.715 [18]
---	-------	-----------

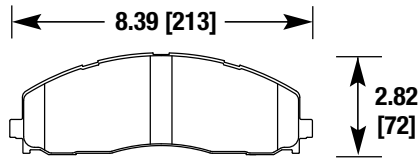

FORD F-250/350/450 SUPER DUTY (FRONT)

HB717

B, F, N, R Z		.660 [17]
-----------------	--	-----------

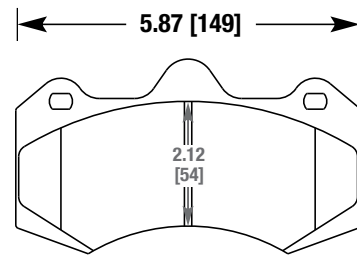

AP RACING CP7040D54

HB715

P	D1691	.713 [18]
---	-------	-----------

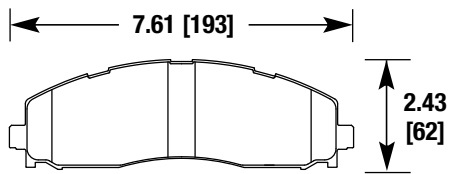

FORD F-250/350/450 SUPER DUTY (REAR)

HB718

F, G, U		.654 [17]
---------	--	-----------

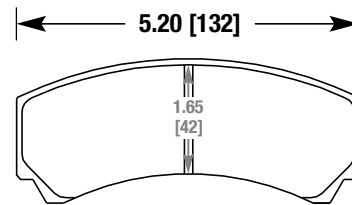

AP/ALCON RACE CALIPER

HB716

B, F, N, R Z		.710 [18]
-----------------	--	-----------

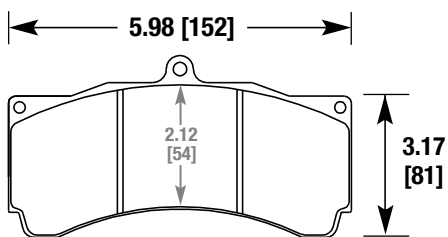

AP / ALCON RACE CALIPER

HB719

B, G, U, W, Z	FMSI D1389	.668 [17]
------------------	------------	-----------

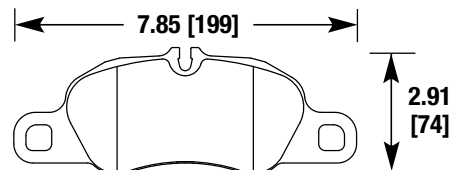

PORSCHE CAYMAN (FRONT)

HB720

B, Y, Z | FMSI D1349 | .575 [15]

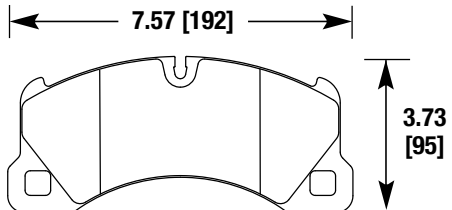

PORSCHE CAYMAN (REAR)

HB724

B, R, Z | FMSI D1071 | .637 [16]

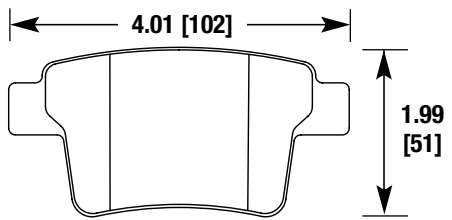

FORD TAURUS / FIVE HUNDRED
JAGUAR X-TYPE (REAR)

HB722

B, R, W, Z | FMSI D1366 | .652 [17]

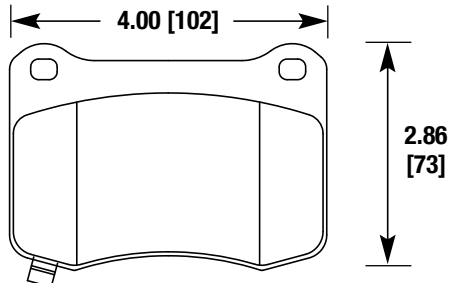

LEXUS IS F (REAR)

HB725

B, G, R | FMSI D1730 | .650 [16]
W, Z

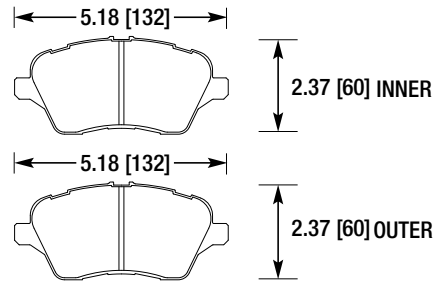

FORD FIESTA ST (FRONT)

HB723

B, R, Z | FMSI D1070 | .665 [17]

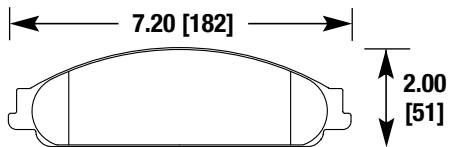

FORD TAURUS / FIVE HUNDRED (FRONT)

HB726

B, F, G, R | FMSI D1474 | .582 [15]
U, Z

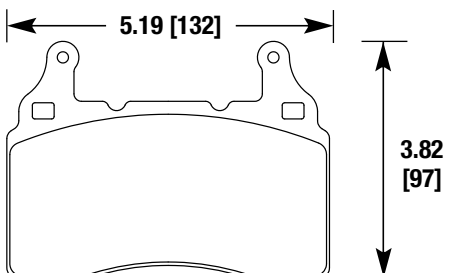

CADILLAC CTS/XTS, COVETTE (FRONT)

Hawk Performance - BRAKE PAD DIAGRAMS

HB727

B, F, G, N | FMSI D1718 | .592 [15]
R, U, Z

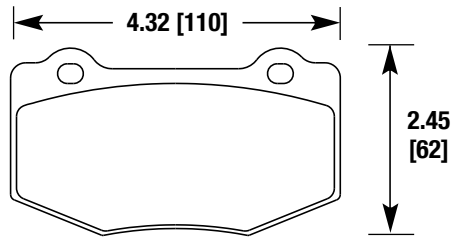

2014 CORVETTE (REAR)

HB734

B, W, Z | FMSI D1594 | .584 [15]

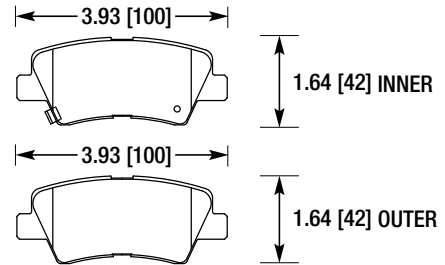

VELOSTER TURBO/KIA (REAR)

HB731

B, Z | FMSI D1291 | .620 [16]

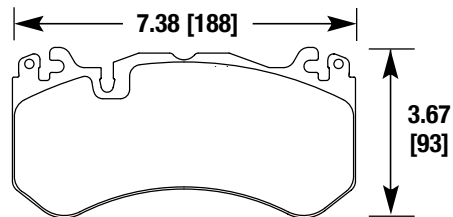

AUDI RS7 / MERCEDES (FRONT)

HB735

B, W, Z | FMSI D1595 | .666 [17]

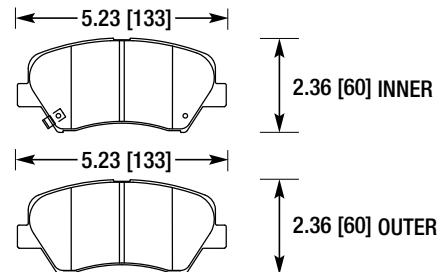

HYUNDAI VELOSTER (FRONT)

HB733

B, F, N, R | FMSI D918 | .748 [19]
Z, EE, G, | FMSI D1260
S, U, W

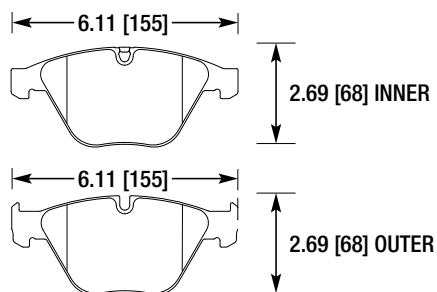

BMW (FRONT)

HB736

B, Z | FMSI D1568 | .629 [16]

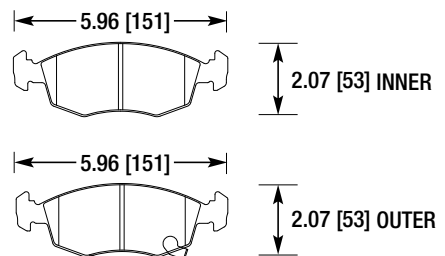

FIAT 500 '12 -'15 (FRONT)

HB737

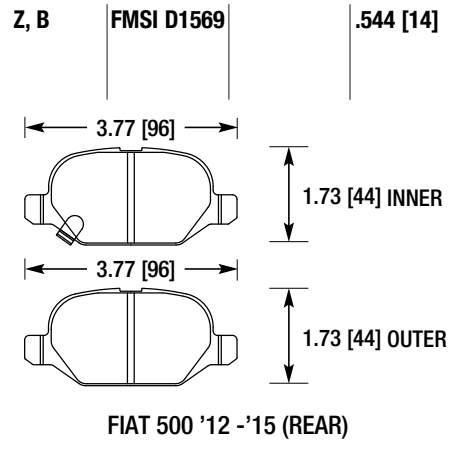

HB740

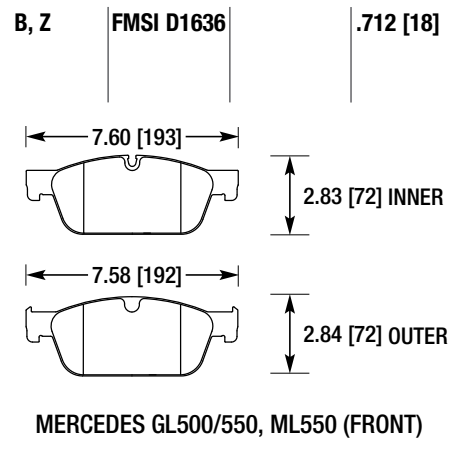

HB738

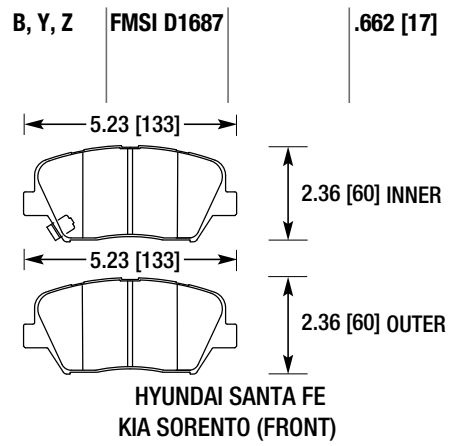

HB741

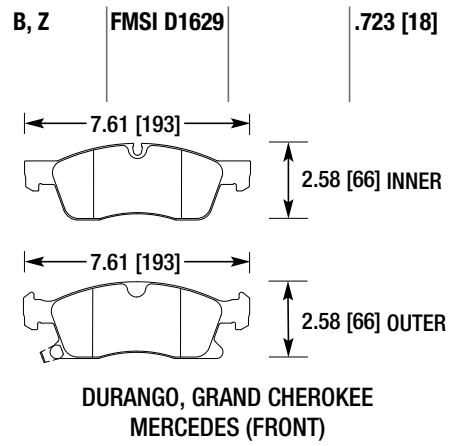

HB739

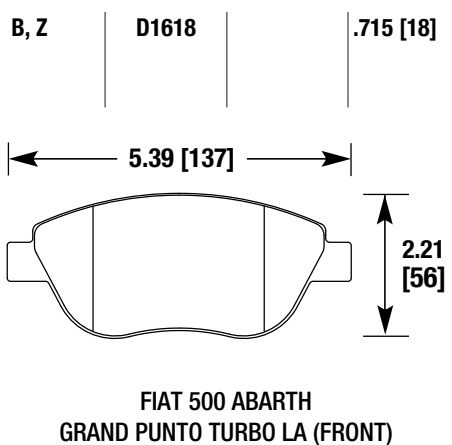

HB742

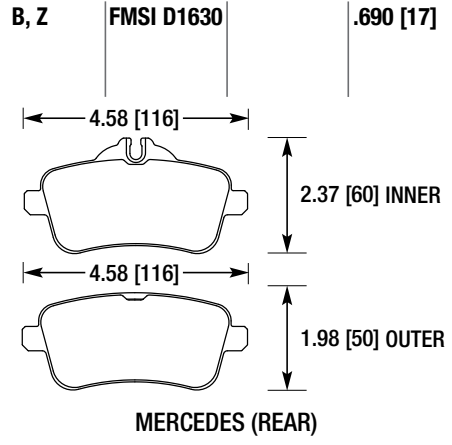

Hawk Performance - BRAKE PAD DIAGRAMS

HB743

B, Z | FMSI D1123 | .795 [20]

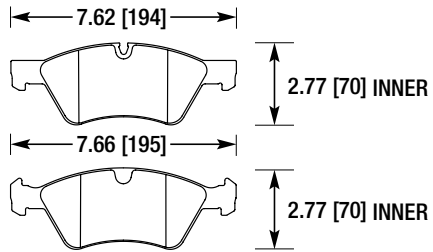

MERCEDES (FRONT)

HB746

B, F, Z | FMSI D1659 | .645 [16]

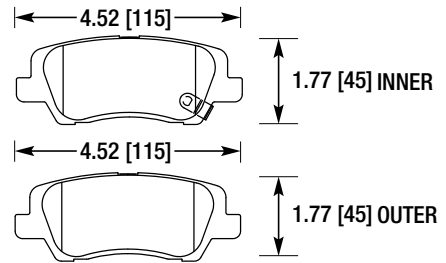

CADILLAC ATS/CTS (REAR)

HB744

B, Z | FMSI D1122 | .660 [17]

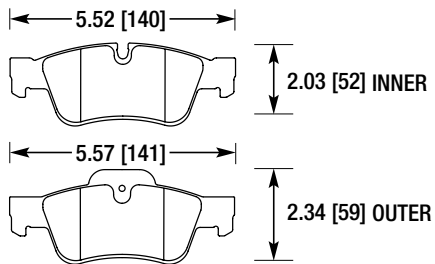

MERCEDES (REAR)

HB747

B, R | FMSI D1650 | .626 [16]

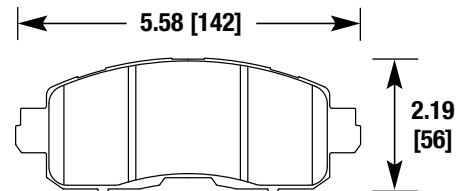

NISSAN ALTIMA (FRONT)

HB745

B, Z | FMSI D1272 | .777 [20]

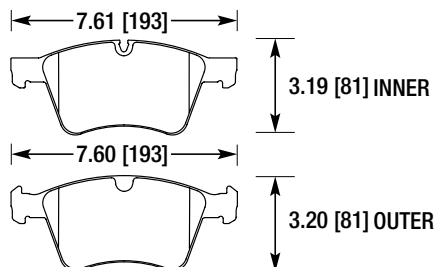

MERCEDES GL320 (FRONT)

HB748

B, F, N, R | FMSI D1561 | .723 [18]
Z, U

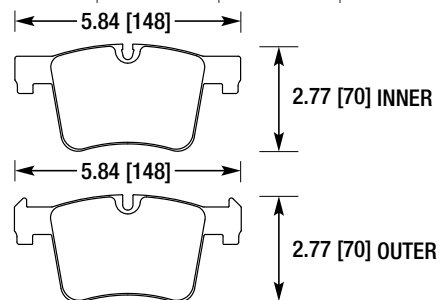

BMW (FRONT)

HB749

B, F, N | FMSI D1613 | .648 [16]
R, Z

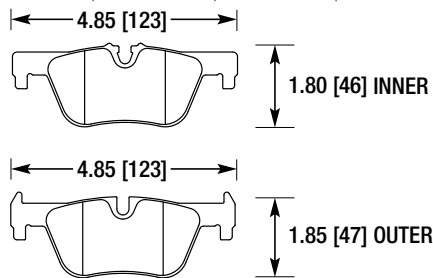

BMW (REAR)

HB752

B, F, R | FMSI D1340 | .769 [20]

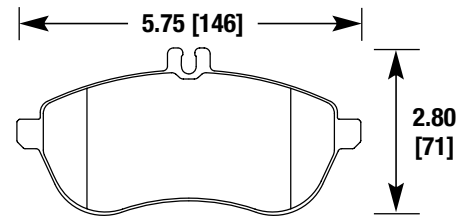

MERCEDES (FRONT)

HB750

B, F, N | FMSI D1504 | .720 [18]
R, Z

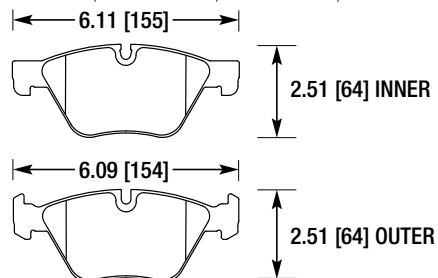

BMW 528i,528i XDRIVE (FRONT)

HB753

B, F, R | FMSI D1341 | .666 [17]

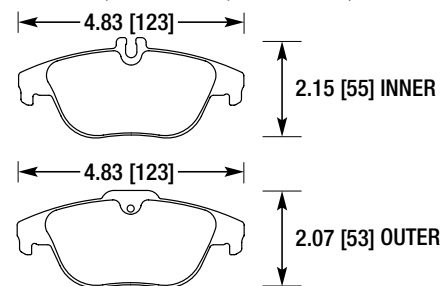

MERCEDES (REAR)

HB751

B, F, N | FMSI D1473 | .675 [17]
R, Z

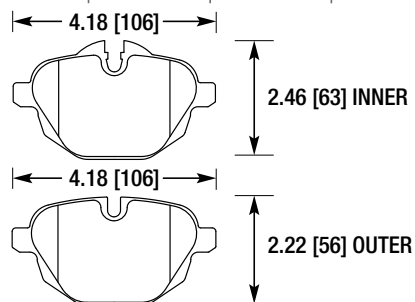

BMW (REAR)

HB754

B, F, R | FMSI D1342 | .726 [18]

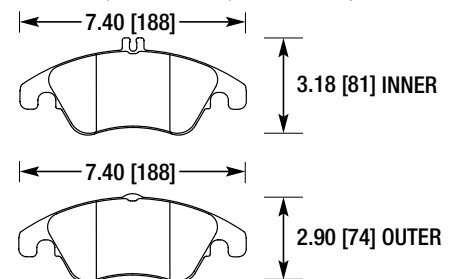

MERCEDES (FRONT)

Hawk Performance - BRAKE PAD DIAGRAMS

HB755

B, F, R | FMSI D986 | .620 [16]

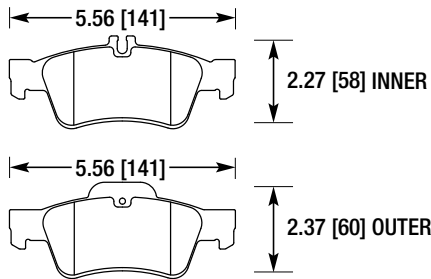

MERCEDES (REAR)

HB758

B, F, N, Z | FMSI D1537 | .652 [17]

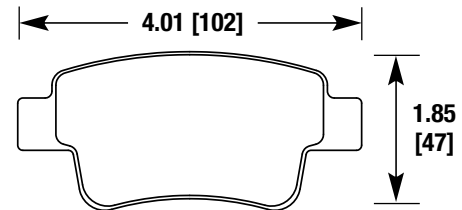

FIAT GRAND PUNTO LATIN AM (REAR)

HB756

B, F, R | FMSI D1406 | .770 [19]

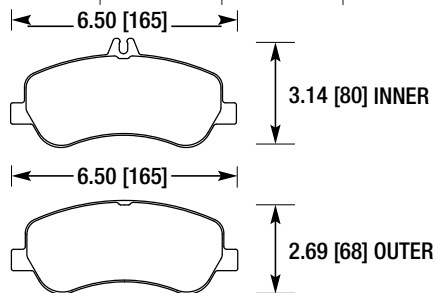

MERCEDES GLK250, GLK350 (FRONT)

HB759

B, F, N, Z | FMSI D1306 | .750 [19]

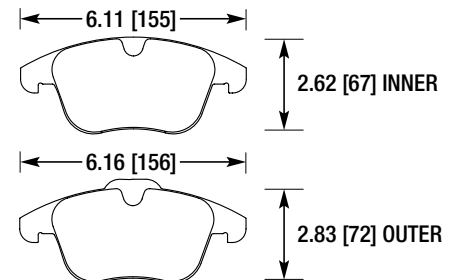

LAND ROVER / VOLVO (FRONT)

HB757

B, F, N, R, Z | FMSI D1549 | .758 [19]

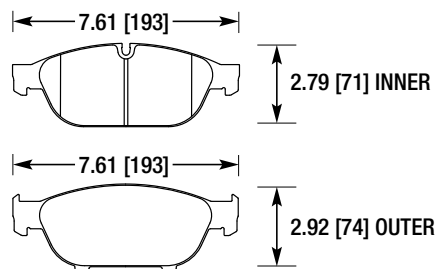

AUDI (FRONT)

HB760

B, F, N, Z | FMSI D1355 | .620 [16]

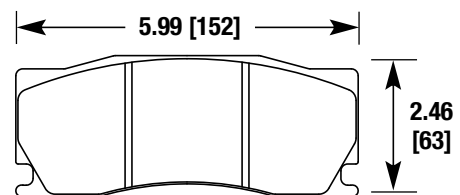

JAGUAR W/ALCON BRAKES (FRONT)

HB761

B, R, Z	FMSI D1577	.593 [15]
---------	------------	-----------

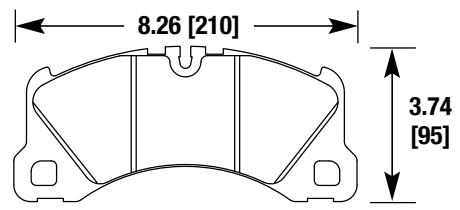

PORSCHE CAYENNE, PANAMERA (FRONT)

HB765

B, R	FMSI D1609	.664 [17]
------	------------	-----------

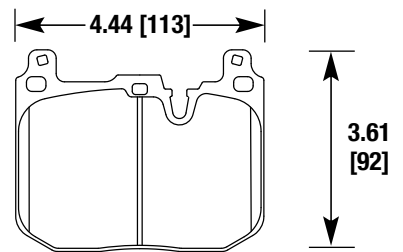

BMW (FRONT)

HB762

B, R, Z	FMSI D1453	.634 [16]
---------	------------	-----------

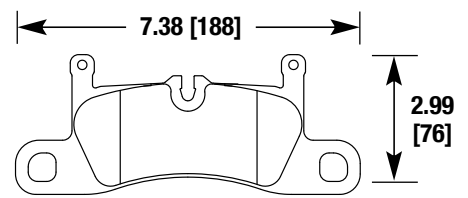

PORSCHE / VW (REAR)

HB766

B, G, R, U	FMSI D1656	.624 [16]
------------	------------	-----------

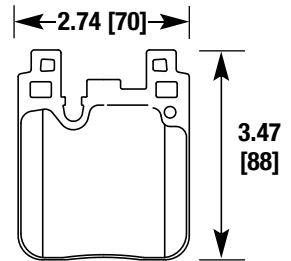

BMW (REAR)

HB764

B, G, U, Z		.628 [16]
------------	--	-----------

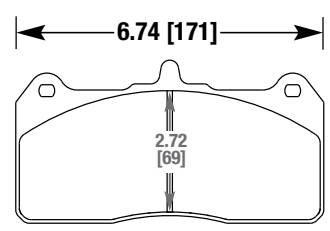

AP RACING CP7555D70

HB768

B, R	FMSI D1597	.714 [18]
------	------------	-----------

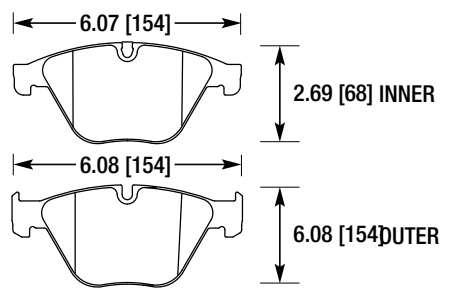

BMW (FRONT)

Hawk Performance - BRAKE PAD DIAGRAMS

HB770

B | FMSI D1654 | .624 [16]

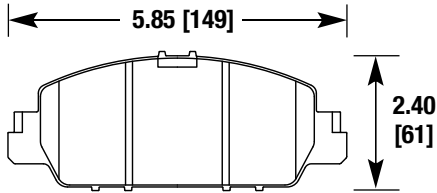

HONDA ACCORD / HR-V (FRONT)

HB773

B, F, G, N | FMSI D1791 | .664 [17]
R, W, Z

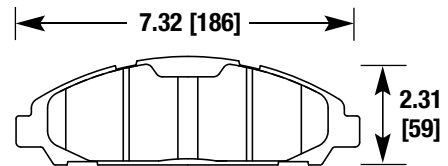

FORD MUSTANG (FRONT)

HB771

B | FMSI D1451 | .577 [15]

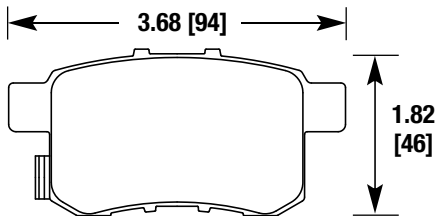

HONDA / ACURA (REAR)

HB774

B, F, N, R | FMSI D1793 | .650 [17]
W, Z

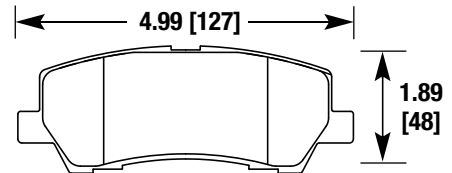

FORD MUSTANG (REAR)

HB772

Y, Z | FMSI D1602 | .654 [17]

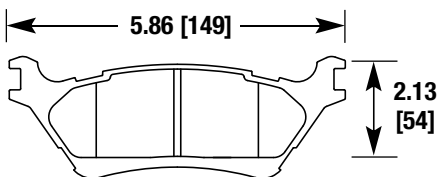

FORD TRUCK (REAR)

HB775

P, Y | FMSI D1328 | .735 [19]

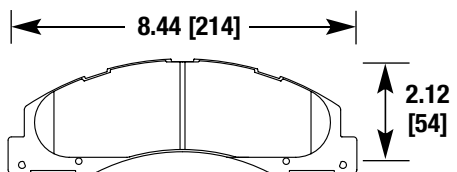

FORD TRUCK (FRONT)

HB776

P, Y	FMSI D1329	.671 [17]
------	------------	-----------

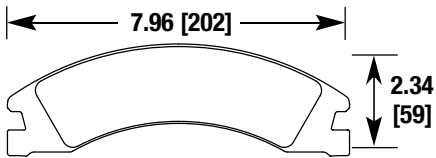

FORD TRUCK (REAR)

HB780

B, F, R	FMSI D1575	.625 [16]
---------	------------	-----------

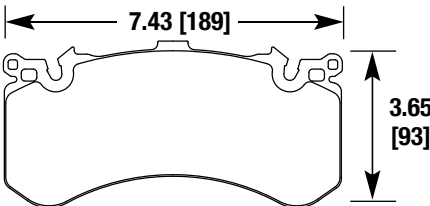

AUDI (FRONT)

HB777

B, F, Y	FMSI D1412	.750 [19]
---------	------------	-----------

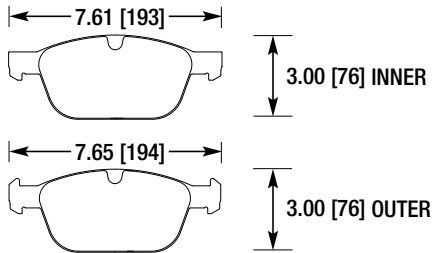

VOLVO (FRONT)

HB787

B, F, G, R U, Z	FMSI D1474	.582 [15]
--------------------	------------	-----------

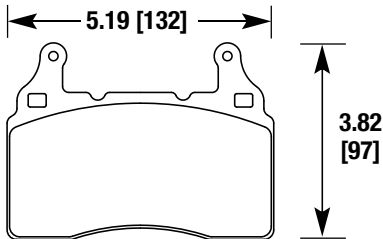

CORVETTE HEAVY DUTY, CHEVROLET SS
TELSA S (FRONT)

HB779

B, F, R	FMSI D1633	.740 [19]
---------	------------	-----------

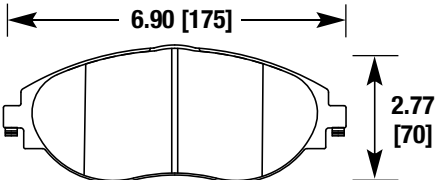

VW / AUDI (FRONT)



BRAKE PAD APPLICATIONS

BRAKE PAD APPLICATIONS



MAKE/ MODEL	SUBMODEL	YEARS	ENGINE (LITER)	NOTE	FRONT		REAR	
					OES	HB SERIES	OES	HB SERIES
ACURA								
CL		1997	2.2L		770465	HB275X.620	770537	HB145X.570
CL		1997	3.0L			HB143X.680		HB145X.570
CL		1997-1998	3.0L				770537	
CL		1997		43022SV4G00, 4 Cylinder				HB572X.570
CL		1998		45022S87A01, 6 Cylinder		HB143X.680		HB145X.570
CL		1999	2.3L		770465	HB275X.620	770537	HB145X.570
CL		1999	3.0L			HB143X.680		
CL		2001	All			HB366X.681	770537	HB145X.570
CL	Type-S	2001	All			HB366X.681	770537	HB145X.570
CL		2002-2003		45022S0KA11		HB366X.681		HB572X.570
ILX		2013	All		770914	HB393X.665	770537	HB145X.570
ILX		2013-2014	All	Hybrid		HB418X.646	770537	HB145X.570
ILX		2014	All				770537	HB145X.570
ILX		2014		45022T2FA00		HB393X.665		
ILX		2015		45022T2FA01		HB393X.665		HB145X.570
ILX		2016		43022TR0A01				HB145X.570
Integra	LS	1986-1989	All			HB403X.587		HB350X.496
Integra	RS	1986-1989	All			HB403X.587		HB350X.496
Integra	Special Edition Ls	1987	All			HB403X.587		
Integra	SE	1988	All			HB403X.587		
Integra	GS	1990-1993	All		770409	HB242X.661		HB350X.496
Integra	GSR	1990-1993	All		770409	HB242X.661		HB350X.496
Integra	LS	1990-1993	All		770409	HB242X.661		HB350X.496
Integra	RS	1990-1993	All		770409	HB242X.661		HB350X.496
Integra	LS	1994	All			HB245X.631		HB350X.496
Integra	RS	1994-1998	All			HB245X.631		HB350X.496
Integra	GSR	1994-2001	All			HB245X.631		HB350X.496
Integra	Special Edition	1995-1996	All			HB245X.631		HB350X.496
Integra	LS	1995-2001	All			HB245X.631		
Integra	Type-R	1997-1998	All			HB143X.680	770537	HB145X.570
Integra	GS	1997-2001	All			HB245X.631		HB350X.496
Integra		1998		43022ST7A02				HB350X.496
Integra	Type-R	2000-2001	All			HB143X.680	770537	HB145X.570
Integra		2000-2001		43022ST7A02				HB350X.496
Legend		1986-1990	All	Sedan		HB242X.661		
Legend	L	1986-1990	All	Sedan	770409	HB242X.661		
Legend	LS	1986-1990	All	Coupe	770409	HB242X.661		
Legend		1987-1990	All	Coupe	770409	HB242X.661	770537	HB145X.570
Legend	L	1987-1990	All	Coupe	770409	HB242X.661	770537	HB145X.570
Legend	LS	1987-1990	All	Coupe	770409	HB242X.661	770537	HB145X.570
Legend		1987		45022SD4A13, Sedan		HB242X.661		
Legend		1987-1988		43022SG0020, Coupe				HB145X.570
Legend		1987-1988		45022SG0517, Coupe		HB242X.661		
Legend		1988-1990	All	Sedan	770409			
Legend		1988		45022SG0517, Sedan		HB242X.661		
Legend		1991	All	Coupe		HB143X.680		HB572X.570
Legend		1991	All	Sedan		HB143X.680		HB572X.570
Legend		1991-1993	All	Coupe			770536	
Legend		1991-1993	All	Sedan			770536	
Legend	L	1991-1995	All	Coupe		HB143X.680	770536	HB572X.570
Legend	L	1991-1995	All	Sedan		HB143X.680	770536	HB572X.570
Legend	LS	1991-1995	All	Coupe		HB143X.680	770536	HB572X.570
Legend		1992	All	Coupe		HB143X.680		HB572X.570
Legend		1992	All	Sedan		HB143X.680		HB572X.570
Legend		1993	All	Coupe		HB143X.680		HB572X.570

BRAKE PAD APPLICATIONS

Hawk Performance - BRAKE PAD APPLICATIONS

HB
HAWK BRAKE

245
PAD SHAPE

x
INSERT COMPOUND CODE

.631
PAD THICKNESS

MAKE/ MODEL	SUBMODEL	YEARS	ENGINE (LITER)	NOTE	FRONT		REAR	
					OES	HB SERIES	OES	HB SERIES
ACURA (CONTINUED)								
Legend		1993	All	Sedan		HB143X.680		HB572X.570
Legend	GS	1994-1995	All	Coupe		HB143X.680	770536	HB572X.570
Legend	GS	1994-1995	All	Sedan		HB143X.680	770536	HB572X.570
Legend	SE	1995	All	Coupe		HB143X.680	770536	HB572X.570
Legend	SE	1995	All	Sedan		HB143X.680	770536	HB572X.570
MDX		2001-2002	All					HB506X.610
MDX	Touring	2001-2002	All					HB506X.610
MDX		2003-2006	All		770691	HB326X.646		HB506X.610
MDX	Touring	2003-2006	All		770691	HB326X.646		HB506X.610
NSX		1991-2005	All			HB143X.680		HB185X.590
NSX	T	1995-1999	All			HB143X.680		HB185X.590
RDX		2007-2009		Front	771089		770536	HB572X.570
RDX		2010	All	AWD				HB572X.570
RDX		2010-2012	All	AWD	771089		770536	
RDX		2010-2012	All	FWD	771089			
RDX		2010-2012		43022SXS000, FWD				HB145X.570
RDX		2011-2012	All	AWD				HB572X.570
RDX		2013-2015		43022TOGA00				HB145X.570
RDX		2016		43022TOGA01				HB145X.570
RL		1996-1998	All			HB143X.680		HB572X.570
RL		1996-2004	All				770536	
RL		1999-2004	All			HB366X.681		HB572X.570
RL		1999				HB366X.681		HB145X.570
RL		1999-2004					770537	
RL		2000-2004				HB366X.681		HB145X.570
RSX	Type-R	2002-2004	All	Japan Spec		HB181X.660		
RSX	Base	2002-2006	All			HB418X.646	770537	HB145X.570
RSX	Type-S	2002-2006	All			HB361X.622	770537	HB145X.570
SLX		1996-1999	All			HB422X.610		
TL		1995-1998	2.5L		770503	HB143X.680	770537	HB145X.570
TL		1995-1997	3.2L			HB143X.680		HB145X.570
TL		1995-1998	3.2L				770537	
TL		1998	3.2L			HB143X.680		HB145X.570
TL		1999-2003	All			HB366X.681	770536	HB572X.570
TL	Type-S	2002-2003	All			HB366X.681	770536	HB572X.570
TL		2004-2005	All	w/Brembo Front Calipers		HB530X.570		HB572X.570
TL		2004-2008	All	w/Brembo Front Calipers			770536	
TL		2004-2008	All	w/o Brembo Front Calipers		HB366X.681	770536	HB572X.570
TL		2006	All	w/Brembo Front Calipers		HB530X.570		HB572X.570
TL		2007-2008	All	w/Brembo Front Calipers		HB530X.570		HB572X.570
TL	Type-S	2007-2008	All			HB530X.570		HB572X.570
TL		2009-2014	All			HB678X.709		HB679X.600
TLX		2015		45022SJPA01		HB678X.709		
TSX		2004-2008	All			HB366X.681	770537	HB145X.570
TSX		2004-2008				HB366X.681		HB626X.577
TSX		2009-2010	All			HB366X.681		HB626X.577
TSX		2011-2014	All			HB366X.681		HB626X.577
Vigor	GS	1992-1994	All			HB143X.680	770537	HB145X.570
Vigor	LS	1992-1994	All			HB143X.680	770537	HB145X.570
ALFA ROMEO								
164		1990						HB271X.635
164		1991-1995		60760120				HB271X.635
4C		2015				HB548X.590		
Alfetta		1972-1977				HB172X.500		
Alfetta	GT	1975-1977	All			HB172X.595		

BRAKE PAD APPLICATIONS



MAKE/ MODEL	SUBMODEL	YEARS	ENGINE (LITER)	NOTE	FRONT		REAR	
					OES	HB SERIES	OES	HB SERIES
ALFA ROMEO CONTINUED								
Alfetta	Sport	1975-1977	All			HB172X.595		
Berlina	Veloce	1968-1971	All			HB171X.590		
Berlina		1968-1971		Veloce				HB713X.585
Berlina		1972-1975	All			HB171X.590		
GT Veloce		1968-1971						HB713X.585
GT Veloce	GT series 1750	1969-1971	All			HB171X.590		
GT Veloce		1972-1975	All			HB171X.590		
GTV-6		1981-1983						HB713X.585
GTV-6	2.5	1982	All			HB171X.590		
GTV-6	2.5	1984-1986	All			HB180X.560		
GTV-6		1984-1986				HB180X.591		
Milano	Silver	1987	All			HB180X.560		
Milano	Platinum	1987-1988	All			HB180X.560		
Milano	Gold	1987-1989	All			HB180X.560		
Milano		1987-1989				HB180X.591		
Milano	Verde	1988-1989	All			HB180X.560		
Spider		1968-1975	All			HB171X.590		
Spider		1968-1971						HB713X.585
Spider	Veloce	1970-1982	All			HB171X.590		
Spider		1975-1982		Veloce				HB713X.585
Spider		1982-1994				HB180X.591		HB713X.585
Spider	Veloce	1983-1990	All			HB180X.560		
Spider	Graduate	1986-1990	All			HB180X.560		
Spider	Quadrifoglio	1986-1990	All			HB180X.560		
Sprint	Veloce	1977-1979	All			HB172X.595		
Sprint		1977-1980				HB172X.500		
AMERICAN MOTORS								
Ambassador		1971-1973	All			HB643X.595		
Concord		1982-1983				HB103X.590		
Concord	Station Wagon	1982-1983				HB103X.590		
Eagle		1982-1984				HB103X.590		
Eagle		1985-1988		J8133853		HB103X.590		
Gremlin		1973-1975	All	w/Bendix Caliper		HB292X.674		
Gremlin		1973-1975	All	w/KH Caliper		HB643X.595		
Gremlin	6 Cylinder	1975-1976				HB292X.674		
Gremlin	8 Cylinder	1975-1976				HB292X.674		
Gremlin	Custom	1976	All	w/Bendix Caliper		HB292X.674		
Gremlin	Custom	1976	All	w/KH Caliper		HB643X.595		
Hornet		1971-1972	All			HB643X.595		
Hornet		1973	All	w/Bendix Caliper		HB292X.674		
Hornet		1973	All	w/KH Caliper		HB643X.595		
Hornet	Sportabout	1973	All	w/Bendix Caliper		HB292X.674		
Hornet	Sportabout	1973	All	w/KH Caliper		HB643X.595		
Hornet		1974-1976	All			HB292X.674		
Hornet		1974-1976	All			HB643X.595		
Hornet	Sportabout	1974-1976	All			HB292X.674		
Hornet	Sportabout	1974-1976	All			HB643X.595		
Hornet	6 Cylinder	1975-1976				HB292X.674		
Hornet	8 Cylinder	1975-1976				HB292X.674		
Javelin		1971-1974	All			HB643X.595		
Matador		1971-1974	All			HB643X.595		
Matador		1975-1978	All			HB292X.674		
Matador	Taxi	1975				HB292X.674		
Matador	Station Wagon	1975-1976				HB292X.674		
Matador		1975-1978				HB292X.674		

BRAKE PAD APPLICATIONS



Hawk Performance - BRAKE PAD APPLICATIONS

HB **245** **x** **.631**
 HAWK BRAKE PAD SHAPE INSERT COMPOUND CODE PAD THICKNESS

MAKE/ MODEL	SUBMODEL	YEARS	ENGINE (LITER)	NOTE	FRONT		REAR	
					OES	HB SERIES	OES	HB SERIES
AMERICAN MOTORS CONTINUED								
Matador	Police	1977-1978				HB292X.674		
Pacer		1975-1976	All			HB292X.674		
Spirit		1982-1983				HB103X.590		
Spirit	GT	1982-1983				HB103X.590		
Taxi & Fleet		1975				HB292X.674		
ASTON MARTIN								
DB9		2005	All			HB632X.586		
DB9		2005				HB632X.586		
AUDI								
80		1988-1992	All			HB190X.730		HB271X.635
80		1988-1992	All	w/Wear Sensor				HB271X.635
90		1988-1991	All					HB271X.635
90		1988-1991	All	w/Wear Sensor				HB271X.635
90		1988-1989		8A0698151B		HB190X.730		
90		1990-1991		443698151K		HB190X.730		
90	CS	1993	All	w/Wear Sensor		HB270X.724A		
90	S	1993-1994	All					HB271X.635
90	S	1993-1994	All	w/Wear Sensor		HB270X.724A		HB271X.635
90	CS	1994	All					HB271X.635
90	CS	1994	All	w/Wear Sensor		HB270X.724A		HB271X.635
90	Sport	1995	All					HB271X.635
90	Sport	1995	All	w/Wear Sensor		HB270X.724A		HB271X.635
100		1989-1991		443698151F		HB190X.730		
100		1989-1991		443698451B				HB271X.635
100		1992-1993	All			HB269X.763		HB271X.635
100		1992-1993	All	w/Large Round Wear Sensor		HB269X.763B		HB271X.635
100		1992-1993	All	w/Oval Wear Sensor		HB269X.763A		HB271X.635
100	CS	1992-1994	All			HB269X.763		HB271X.635
100	CS	1992-1994	All	w/Large Round Wear Sensor		HB269X.763B		HB271X.635
100	CS	1992-1994	All	w/Oval Wear Sensor		HB269X.763A		HB271X.635
100	S	1992-1994	All			HB269X.763		
100	S	1992-1994	All	w/Large Round Wear Sensor		HB269X.763B		HB271X.635
100	S	1992-1994	All	w/Oval Wear Sensor		HB269X.763A		HB271X.635
200		1989-1991	All	w/ATE Front Caliper		HB135X.642		HB271X.635
200		1989-1991	All	w/Girling Front Caliper				HB271X.635
200		1989-1991	All	w/Girling Front Caliper, w/Wear Sensor		HB270X.724A		HB271X.635
4000		1983-1984				HB190X.730		HB271X.635
4000		1985-1987				HB190X.600		
5000		1980-1983	All			HB190X.730		HB271X.635
5000		1980-1983	All	w/Wear Sensor				HB271X.635
5000	S	1980-1987	All			HB190X.730		HB271X.635
5000	S	1980-1987	All	w/Wear Sensor				HB271X.635
5000	Turbo	1981-1983	All			HB190X.730		HB271X.635
5000	Turbo	1981-1983	All	w/Wear Sensor				HB271X.635
5000	S Turbo	1984-1985	All			HB190X.600		HB271X.635
5000	S Turbo	1984-1985	All	w/Wear Sensor		HB190X.600A		HB271X.635
5000	S Turbo	1985		443698151F		HB190X.730		
5000	S	1985-1988		443698151F		HB190X.730		
5000	CS	1986-1987	All					HB271X.635
5000	CS	1986-1987	All	w/Wear Sensor		HB270X.724A		HB271X.635
5000	CS	1986-1988		443698151F		HB190X.730		
5000	S	1988	All					HB271X.635
5000	S	1988	All	w/Wear Sensor		HB270X.724A		HB271X.635
100 Quattro		1989		4D0698451A				HB271X.635
100 Quattro		1989-1991		443698151J		HB190X.730		

BRAKE PAD APPLICATIONS



MAKE/ MODEL	SUBMODEL	YEARS	ENGINE (LITER)	NOTE	FRONT		REAR	
					OES	HB SERIES	OES	HB SERIES
AUDI CONTINUED								
100 Quattro		1990-1991		447698451A				HB271X.635
100 Quattro	CS	1992-1994	All			HB269X.763		HB271X.635
100 Quattro	CS	1992-1994	All	w/Large Round Wear Sensor		HB269X.763B		HB271X.635
100 Quattro	CS	1992-1994	All	w/Oval Wear Sensor		HB269X.763A		HB271X.635
100 Series	Auto Trans	1970-1972				HB206X.565		
200 Quattro		1989	All	w/ATE Front Caliper		HB135X.642		HB271X.635
200 Quattro		1989	All	w/Girling Front Caliper				HB271X.635
200 Quattro		1989	All	w/Girling Front Caliper, w/Wear Sensor		HB270X.724A		HB271X.635
200 Quattro		1990	All			HB135X.642		HB271X.635
200 Quattro		1990	All			HB270X.724A		HB271X.635
200 Quattro	10V	1991	All	w/ATE Front Caliper		HB135X.642		HB271X.635
200 Quattro	10V	1991	All	w/Girling Front Caliper				HB271X.635
200 Quattro	10V	1991	All	w/Girling Front Caliper, w/Wear Sensor		HB270X.724A		HB271X.635
200 Quattro	20V	1991	All	w/ATE Front Caliper		HB135X.642		HB271X.635
200 Quattro	20V	1991	All	w/Girling Front Caliper				HB271X.635
200 Quattro	20V	1991	All	w/Girling Front Caliper, w/Wear Sensor		HB270X.724A		HB271X.635
4000 Quattro	S	1984-1985	All			HB190X.600		HB271X.635
4000 Quattro	S	1984-1985	All	w/Wear Sensor		HB190X.600A		HB271X.635
4000 Quattro	CS	1986	All			HB190X.600		HB271X.635
4000 Quattro	CS	1986-1987	All	w/Wear Sensor		HB190X.600A		HB271X.635
4000 Quattro	CS	1987	All			HB190X.600		
5000 Quattro	CS	1986	All			HB190X.730		
5000 Quattro	Front & Rear from Vin 44-G-07	1986		4D0698451A				HB271X.635
5000 Quattro	Front & Rear: to Vin 44-G-07	1986		443698151F		HB190X.730		
5000 Quattro	Front & Rear: to Vin 44-G-07	1986		443698451B				HB271X.635
5000 Quattro	CS	1987-1988	All					HB271X.635
5000 Quattro	CS	1987-1988	All	w/Wear Sensor		HB270X.724A		HB271X.635
80 Quattro		1988-1992	All			HB190X.730		HB271X.635
80 Quattro		1988-1992	All	w/Wear Sensor				HB271X.635
90 Quattro		1988-1989	All			HB190X.730		HB271X.635
90 Quattro		1988-1989	All	w/Wear Sensor				HB271X.635
90 Quattro	20V	1990-1991	All			HB190X.730		HB271X.635
90 Quattro	20V	1990-1991	All	w/Wear Sensor		HB270X.724A		HB271X.635
90 Quattro	Front: SOHC Engine	1990-1991		8A0698151B		HB190X.730		
90 Quattro		1992		4A0698451				HB271X.635
90 Quattro	CS	1993-1994	All					HB271X.635
90 Quattro	CS	1993-1994	All	w/Wear Sensor		HB270X.724A		HB271X.635
90 Quattro		1995	All					HB271X.635
90 Quattro		1995	All	w/Wear Sensor		HB270X.724A		HB271X.635
90 Quattro	Sport	1995	All					HB271X.635
90 Quattro	Sport	1995	All	w/Wear Sensor		HB270X.724A		HB271X.635
A3	Sportback TDI 16V Quattro	2006-2009	2.0L			HB543X.760		HB544X.628
A3	Sportback TDI 16V	2006-2009	2.0L			HB543X.760		HB544X.628
A3	TDI 16v	2006-2009	2.0L			HB543X.760		HB544X.628
A3	TDI Quattro	2006-2009	2.0L			HB543X.760		HB544X.628
A3	TFSII Quattro	2006-2009	2.0L			HB543X.760		HB544X.628
A3	V6 Quattro	2006-2009	3.2L			HB543X.760		HB544X.628
A3		2006-2007		2WD		HB543X.760		HB544X.628
A3		2006-2009		Quattro		HB543X.760		HB544X.628
A3		2008		2WD From VIN 8P-8-057779		HB543X.760		HB544X.628
A3		2008		2WD To VIN 8P-8-057778		HB543X.760		HB544X.628
A3	Except TDI	2009	All			HB543X.760		HB544X.628
A3		2009		2WD		HB543X.760		HB544X.628
A3	TDI	2010-2012	All	TDI (non-Quattro)		HB543X.760		HB364X.642
A3		2010		Except TDI (non-Quattro)		HB543X.760		HB544X.628

BRAKE PAD APPLICATIONS



Hawk Performance - BRAKE PAD APPLICATIONS

HB
HAWK BRAKE

245
PAD SHAPE

x
INSERT COMPOUND CODE

.631
PAD THICKNESS

MAKE/ MODEL	SUBMODEL	YEARS	ENGINE (LITER)	NOTE	FRONT		REAR	
					OES	HB SERIES	OES	HB SERIES
AUDI CONTINUED								
A3		2010		Quattro Models; Bosch rear brakes; 272mm Rear Disc		HB543X.760		HB544X.628
A3		2010		Quattro Models; TRW/Lucas Rear Brakes; 282mm Rear Disc		HB543X.760		HB544X.628
A3	TDI	2010-2013		1K0698451J				HB364X.642
A3	Except TDI	2011-2013	All	Except TDI (non-Quattro)		HB543X.760		HB695X.609
A3		2011		3C0698151D		HB543X.760		
A3		2011-2012		Quattro Models		HB543X.760		HB695X.609
A3	2.0L Not TDI	2012		3C0698151D		HB543X.760		
A3		2013	All	TDI (non-Quattro)				HB364X.642
A3	TDI	2013	All	TDI (non-Quattro)		HB543X.760		
A3		2013				HB543X.760		HB544X.628
A3		2013		3C0698151D		HB543X.760		
A3 Quattro		2006-2007	All			HB543X.760		HB543X.760
A3 Quattro		2008-2013	All			HB543X.760		HB695X.609
A3 Quattro		2009	2.0L	1K0698451G				HB544X.628
A3 Quattro		2009	2.0L	3C0698151C		HB543X.760		
A3 Quattro	3.2 Liter	2009		1K0698451G				HB544X.628
A3 Quattro		2010	All	Bosch Rear Brakes; 272mm Rotor		HB543X.760		HB695X.609
A3 Quattro		2010	All	TRW/Lucas Rear Brakes; 282mm Rotor		HB543X.760		HB695X.609
A4	Except Quattro	1996-2001		Except Quattro				HB271X.635
A4	Quattro	1996-2001		Quattro				HB271X.635
A4		1997-2001	All			HB269X.763		HB364X.642
A4		1997-2001	All	w/Large Round Wear Sensor		HB269X.763B		HB364X.642
A4		1997-2001	All	w/Oval Wear Sensor		HB269X.763A		HB364X.642
A4	Except Quattro	1997		Except Quattro from VIN 8DV168351 (after 2/97)				HB271X.635
A4	Except Quattro	1997		Except Quattro to VIN 8DV168350 (before 2/97)				HB364X.587
A4		1997-1999				HB272X.763		
A4	Avant	1998	All			HB269X.763		HB364X.642
A4	Avant	1998	All	w/Large Round Wear Sensor		HB269X.763B		HB364X.642
A4	Avant	1998	All	w/Oval Wear Sensor		HB269X.763A		HB364X.642
A4		2002-2003	3.0L	6 Cyl. 3.0L				HB364X.587
A4		2002-2004	All	w/Wear Sensor		HB354X.756A		HB364X.642
A4	Turbo	2002-2003		4 Cyl. 1.8L Turbo				HB364X.587
A4	Cabriolet	2003-2004	All	w/Wear Sensor		HB354X.756A		HB364X.642
A4	Turbo	2004	1.8L	4 Cyl. 1.8L Turbo to VIN 8E-5-060 000		HB354X.756A		HB364X.587
A4		2004	3.0L	6 Cyl. 3.0L to VIN 8E-5-060 000		HB354X.756A		HB364X.587
A4		2004-2006		8E0698451D				HB364X.587
A4		2005	1.8L	4 Cyl. 1.8L Turbo - Cabriolet		HB354X.756A		HB364X.587
A4	2.0L Turbo or 3.2L Sedan	2005	2.0L / 3.2L	2.0L Turbo or 3.2L Sedan from VIN 8E-5-400-001		HB538X.760		HB544X.628
A4		2005	3.0L	6 Cyl. 3.0L - Cabriolet		HB354X.756A		HB364X.587
A4		2005-2008	All					HB544X.628
A4		2005-2006		8E0698151G		HB538X.760		
A4	4 Cyl. 1.8L Turbo-Cabriolet	2006	1.8L	4 Cyl. 1.8L Turbo - Cabriolet		HB354X.756A		HB364X.587
A4	6 Cyl. 3.0L - Cabriolet	2006	3.0L	6 Cyl. 3.0L - Cabriolet		HB354X.756A		HB364X.587
A4	Sedan or Wagon	2006				HB538X.760		HB544X.628
A4		2007-2008				HB538X.760		HB544X.628
A4	Cabriolet	2009	All			HB538X.760		HB544X.628
A4		2009-2014	All			HB641X.696		HB642X.658
A4		2009						HB642X.658
A4	Cabriolet	2009				HB538X.760		HB544X.628
A4	Cabriolet	2009		8E0698151G		HB538X.760		
A4	Sedan/Wagon	2009				HB641X.696		HB642X.658
A4		2010				HB641X.696		HB642X.658
A4		2011						HB642X.658
A4	Except Quattro	2011				HB641X.696		HB642X.658

MAKE/ MODEL	SUBMODEL	YEARS	ENGINE (LITER)	NOTE	FRONT		REAR	
					OES	HB SERIES	OES	HB SERIES
AUDI CONTINUED								
A4	Quattro; From 6/20/11	2011		Quattro; From 6/20/11		HB641X.696		HB642X.658
A4	Quattro; To 6/9/11	2011		Quattro; To 6/9/11		HB641X.696		HB642X.658
A4		2012-2013				HB641X.696		HB642X.658
A4		2014-2015						HB642X.658
A4		2015		8K0698151K		HB641X.696		
A4		2015		8K0698451B				HB642X.658
A4		2016				HB641X.696		HB642X.658
A4 Quattro		1996-2002	All			HB269X.763		
A4 Quattro		1996-2002	All	w/Large Round Wear Sensor		HB269X.763B		
A4 Quattro		1996-2002	All	w/Oval Wear Sensor		HB269X.763A		
A4 Quattro		1996-1997		4A0698451				HB271X.635
A4 Quattro	Avant	1998-1999	All			HB269X.763		HB271X.635
A4 Quattro	Avant	1998-1999	All	w/Large Round Wear Sensor		HB269X.763B		HB271X.635
A4 Quattro	Avant	1998-1999	All	w/Oval Wear Sensor		HB269X.763A		HB271X.635
A4 Quattro		1998				HB272X.763		
A4 Quattro	Avant	1998						HB271X.605
A4 Quattro	Front: 321 mm Rotors	1999						HB271X.605
A4 Quattro	Front: 321 mm Rotors	1999		4B3698151		HB363X.689		
A4 Quattro	Avant	2000-2002	All			HB269X.763		
A4 Quattro	Avant	2000-2002	All	w/Large Round Wear Sensor		HB269X.763B		
A4 Quattro	Avant	2000-2002	All	w/Oval Wear Sensor		HB269X.763A		
A4 Quattro		2000-2002						HB271X.605
A4 Quattro		2003-2004	All	w/Wear Sensor		HB354X.756A		
A4 Quattro	Avant	2003-2004	All	w/Wear Sensor		HB354X.756A		
A4 Quattro		2003		8E0698451E				HB364X.587
A4 Quattro	Cabriolet	2004	All	w/Wear Sensor		HB354X.756A		
A4 Quattro		2004-2005		8E0698451D				HB364X.587
A4 Quattro		2005-2008	All					HB544X.628
A4 Quattro	Avant	2005-2008	All					HB544X.628
A4 Quattro		2005-2009		8E0698151G		HB538X.760		
A4 Quattro		2006		8E0698451E				HB364X.587
A4 Quattro	Cabriolet	2007-2009	All					HB544X.628
A4 Quattro		2009-2014	All			HB641X.696		HB642X.658
A4 Quattro		2009-2015						HB642X.658
A4 Quattro		2015		8K0698151K		HB641X.696		
A4 Quattro		2015		8K0698451B				HB642X.658
A4 Quattro		2016				HB641X.696		HB642X.658
A5		2010-2014	All			HB641X.696		HB642X.658
A5		2010-2013		Models with 314mm (12.36") Front Rotors				HB642X.658
A5		2010-2013		Models with 320mm (12.6") Front Rotors		HB641X.696		HB642X.658
A5		2010-2014						HB642X.658
A5 Quattro		2008-2014	All	Except Premium		HB641X.696		HB642X.658
A5 Quattro		2008-2015						HB642X.658
A5 Quattro		2013	All	Premium		HB757X.758		
A5 Quattro		2013		Premium		HB757X.758		
A5 Quattro	Premium	2013		4G0698151B		HB641X.696		
A5 Quattro		2015		8K0698151K		HB641X.696		
A5 Quattro		2015		8K0698451B				HB642X.658
A5 Quattro		2016				HB641X.696		HB642X.658
A6		1995-1998	All			HB269X.763		HB271X.635
A6		1995-1998	All	w/Large Round Wear Sensor		HB269X.763B		HB271X.635
A6		1995-1998	All	w/Oval Wear Sensor		HB269X.763A		HB271X.635
A6	RWD	1995-1997				HB269X.763		HB271X.635
A6		1998		4B0698451E				HB364X.642
A6	Avant	1998		4B0698451E				HB364X.642

BRAKE PAD APPLICATIONS

Hawk Performance - BRAKE PAD APPLICATIONS

HB **245** **x** **.631**
 HAWK BRAKE PAD SHAPE INSERT COMPOUND CODE PAD THICKNESS

MAKE/ MODEL	SUBMODEL	YEARS	ENGINE (LITER)	NOTE	FRONT		REAR	
					OES	HB SERIES	OES	HB SERIES
AUDI CONTINUED								
A6	RWD	1998		with 15" Wheels except AFC engine		HB354X.756A		HB364X.642
A6	RWD	1998		with 16" Wheels except AFC engine		HB354X.756A		HB364X.642
A6		1999	All			HB269X.763		
A6		1999	All	w/Large Round Wear Sensor		HB269X.763B		
A6		1999	All	w/Oval Wear Sensor		HB269X.763A		
A6	RWD	1999-2001		2.8L with 15" Wheels		HB354X.756A		HB364X.642
A6	RWD	1999-2001		2.8L with 16" Wheels		HB354X.756A		HB364X.642
A6		2000-2001	All			HB269X.763		HB364X.642
A6		2000-2001	All	w/Large Round Wear Sensor		HB269X.763B		HB364X.642
A6		2000-2001	All	w/Oval Wear Sensor		HB269X.763A		HB364X.642
A6		2002-2004	All	Front Rotors 312mm				HB364X.587
A6		2002-2004	All	Front Rotors 320mm				HB364X.587
A6	RWD	2002-2004				HB515X.760		HB364X.587
A6	RWD	2002-2004				HB354X.756A		HB364X.642
A6	Front: 312 mm Rotors	2003-2004		8E0698451L				HB364X.587
A6		2005-2009	All	Rear Rotors 302mm				HB544X.628
A6		2005-2009	All	Rear Rotors 330mm				HB553X.652
A6	Rear: 302 mm Rotors	2005		4F0698151D		HB538X.760		
A6	RWD	2005-2011				HB538X.760		HB544X.628
A6	Rear: 302 mm Rotors	2006-2008		8E0698151G		HB538X.760		
A6		2010-2011	All					HB544X.628
A6		2010-2011		3C0698451D				HB544X.628
A6		2010-2011		4F0698151K				
A6		2010-2011				HB538X.760		
A6		2012-2014	All			HB641X.696		
A6	RWD	2012-2013				HB641X.696		
A6		2015		4G0698151D		HB641X.696		
A6		2016	All			HB757X.758		
A6		2016				HB757X.758		
A6 Quattro		1995-1997	All			HB269X.763		HB271X.635
A6 Quattro		1995-1997	All	w/Large Round Wear Sensor		HB269X.763B		HB271X.635
A6 Quattro		1995-1997	All	w/Oval Wear Sensor		HB269X.763A		HB271X.635
A6 Quattro		1995-1997				HB269X.763		
A6 Quattro		1998-2001	All			HB269X.763		HB364X.642
A6 Quattro		1998-2001	All	w/Large Round Wear Sensor		HB269X.763B		HB364X.642
A6 Quattro		1998-2001	All	w/Oval Wear Sensor		HB269X.763A		HB364X.642
A6 Quattro		1998		With AFC Engine (12 Valve Engine)		HB269X.763		HB271X.635
A6 Quattro		1998		w/AHA Engine (30 Valve Engine) and 15" Wheels		HB354X.756A		HB364X.642
A6 Quattro		1998		w/AHA Engine (30 Valve Engine) and 16" Wheels Exc. 215/55/R16 Tires - Avant Wagon		HB354X.756A		HB364X.642
A6 Quattro		1998		w/AHA Engine (30 Valve Engine) and 16" Wheels Exc. 215/55/R16 Tires - Sedan		HB354X.756A		HB364X.642
A6 Quattro		1998		w/AHA Engine (30 valve engine) & 215/55/R16 Tires		HB354X.756A		HB364X.642
A6 Quattro	Avant	1999	All			HB269X.763		
A6 Quattro	Avant	1999	All	w/Large Round Wear Sensor		HB269X.763B		
A6 Quattro	Avant	1999	All	w/Oval Wear Sensor		HB269X.763A		
A6 Quattro		1999-2001		2.8L and 16" Wheels Exc. 215/55/R16 Tires - Avant Wagon		HB354X.756A		HB364X.642
A6 Quattro		1999-2001		2.8L & 16" Wheels Exc. 215/55/R16 Tires-Sedan		HB354X.756A		HB364X.642
A6 Quattro		1999-2001		2.8L and 215/55/R16 Tires		HB354X.756A		HB364X.642
A6 Quattro		1999-2001		2.8L with 15" Wheels		HB354X.756A		HB364X.642
A6 Quattro	Avant	2000-2001	2.7L	Turbo		HB363X.689		HB364X.642
A6 Quattro	Avant	2000-2001	2.7L	w/Large Round Wear Sensor, Turbo				HB364X.642
A6 Quattro	Avant	2000-2001	2.7L	w/Oval Wear Sensor, Turbo		HB363X.689A		HB364X.642
A6 Quattro	Avant	2000-2001	2.8L	288mm Front Disc, Sedan, Except 215/55R16 Tires		HB363X.689		HB364X.642
A6 Quattro	Avant	2000-2001	2.8L	288mm Front Disc, Wagon, Except 215/55R16 Tires		HB363X.689		HB364X.642

BRAKE PAD APPLICATIONS

MAKE/ MODEL	SUBMODEL	YEARS	ENGINE (LITER)	NOTE	FRONT		REAR	
					OES	HB SERIES	OES	HB SERIES
AUDI CONTINUED								
A6 Quattro	Avant	2000-2001	2.8L	312mm Front Disc, , w/215/55R16 Tires		HB363X.689		HB364X.642
A6 Quattro	Avant	2000-2001	2.8L	312mm Front Disc, Sedan, Except 215/55R16 Tires		HB363X.689		HB364X.642
A6 Quattro	Avant	2000-2001	2.8L	312mm Front Disc, Wagon, Except 215/55R16 Tires		HB363X.689		HB364X.642
A6 Quattro	Avant	2000-2001	2.8L	w/Large round wear sensor, 288mm front disc, Sedan, Except 215/55R16 Tires				HB364X.642
A6 Quattro	Avant	2000-2001	2.8L	w/Large round wear sensor, 288mm front disc, Wagon, Except 215/55R16 Tires				HB364X.642
A6 Quattro	Avant	2000-2001	2.8L	w/Large round wear sensor, 312mm front disc, With 215/55R16 Tires				HB364X.642
A6 Quattro	Avant	2000-2001	2.8L	w/Large round wear sensor, 312mm front disc, Sedan, Except 215/55R16 Tires				HB364X.642
A6 Quattro	Avant	2000-2001	2.8L	w/Large round wear sensor, 312mm front disc, Wagon, Except 215/55R16 Tires				HB364X.642
A6 Quattro	Avant	2000-2001	2.8L	w/Oval wear sensor, 288mm front disc, Sedan, Except 215/55R16 Tires		HB363X.689A		HB364X.642
A6 Quattro	Avant	2000-2001	2.8L	w/Oval wear sensor, 288mm front disc, Wagon, Except 215/55R16 Tires		HB363X.689A		HB364X.642
A6 Quattro	Avant	2000-2001	2.8L	w/Oval Wear Sensor, 312mm Front Disc, With 215/55R16 Tires		HB363X.689A		HB364X.642
A6 Quattro	Avant	2000-2001	2.8L	w/Oval Wear Sensor, 312mm Front Disc, Sedan, Except 215/55R16 Tires		HB363X.689A		HB364X.642
A6 Quattro	Avant	2000-2001	2.8L	w/Oval Wear Sensor, 312mm Front Disc, Wagon, Except 215/55R16 Tires		HB363X.689A		HB364X.642
A6 Quattro	321mm Rotors	2000		4B3698151		HB363X.689		
A6 Quattro		2000-2001		2.7L Turbo		HB363X.689		HB364X.642
A6 Quattro	321mm Rotors	2000-2001		4B0698451E				HB364X.642
A6 Quattro		2000-2004		V8		HB363X.689		HB364X.642
A6 Quattro		2001		2.8L with 16" Wheels		HB354X.756A		HB364X.642
A6 Quattro		2002	All	w/Dual Piston		HB363X.689		HB364X.642
A6 Quattro		2002	All	w/Dual Piston, w/Large Round Wear Sensor				HB364X.642
A6 Quattro		2002	All	w/Dual Piston, w/Oval Wear Sensor		HB363X.689A		HB364X.642
A6 Quattro		2002	All	w/Single Piston		HB515X.760		HB364X.642
A6 Quattro	Avant	2002-2003	All			HB515X.760		HB364X.642
A6 Quattro		2002-2004		2.7L turbo with 2 pad front caliper		HB515X.760		HB364X.642
A6 Quattro		2002-2004		2.7L turbo with 4 pad front caliper		HB363X.689		HB364X.642
A6 Quattro		2002-2004		3.0L Sedan		HB354X.756A		HB364X.642
A6 Quattro		2002-2004		3.0L Wagon		HB354X.756A		HB364X.642
A6 Quattro	312mm Rotors	2002-2004		8E0698451L				HB364X.587
A6 Quattro	320mm Rotors	2002-2004		8E0698451L				HB364X.587
A6 Quattro		2003	All			HB363X.689		HB364X.642
A6 Quattro		2003	All	w/Large Round Wear Sensor				HB364X.642
A6 Quattro		2003	All	w/Oval Wear Sensor		HB363X.689A		HB364X.642
A6 Quattro		2004	All	w/Dual Piston		HB363X.689		HB364X.642
A6 Quattro		2004	All	w/Dual Piston, w/Large Round Wear Sensor				HB364X.642
A6 Quattro		2004	All	w/Dual Piston, w/Oval Wear Sensor		HB363X.689A		HB364X.642
A6 Quattro		2004	All	w/Single Piston		HB515X.760		HB364X.642
A6 Quattro	Avant	2004	All	w/Dual Piston		HB363X.689		HB364X.642
A6 Quattro	Avant	2004	All	w/Dual Piston, w/Large Round Wear Sensor				HB364X.642
A6 Quattro	Avant	2004	All	w/Dual Piston, w/Oval Wear Sensor		HB363X.689A		HB364X.642
A6 Quattro	Avant	2004	All	w/Single Piston		HB515X.760		HB364X.642
A6 Quattro		2005		8E0698151C		HB515X.760		
A6 Quattro		2005-2008		3.2L		HB538X.760		HB544X.628
A6 Quattro		2005-2008		4.2L V8		HB538X.760		HB553X.652
A6 Quattro	Avant	2006	All					HB544X.628
A6 Quattro		2006-2009	All	302mm Rotors				HB544X.628
A6 Quattro		2006-2011	All	330mm Rotors				HB553X.652

BRAKE PAD APPLICATIONS



Hawk Performance - BRAKE PAD APPLICATIONS

HB
HAWK BRAKE

245
PAD SHAPE

x
INSERT COMPOUND CODE

.631
PAD THICKNESS

MAKE/ MODEL	SUBMODEL	YEARS	ENGINE (LITER)	NOTE	FRONT		REAR	
					OES	HB SERIES	OES	HB SERIES
AUDI CONTINUED								
A6 Quattro	Front: 321mm Rotors Rear: 302mm Rotors	2006		4F0698151A		HB515X.760		
A6 Quattro	Front: 347mm Rotors Rear: 330mm Rotors	2006		4F0698151D		HB538X.760		
A6 Quattro	Rear: 302mm Rotors	2007-2008		8E0698151G		HB538X.760		
A6 Quattro		2009		8E0698151G		HB538X.760		
A6 Quattro		2009-2011		3.0T - Not Armored; 347mm Front Rotor		HB538X.760		HB553X.652
A6 Quattro		2009-2011		3.0T Not Armored; 321mm Front Rotor		HB538X.760		HB553X.652
A6 Quattro		2009-2011		4.2 V8 - Not Armored; 321mm Front Rotor		HB538X.760		HB553X.652
A6 Quattro		2009-2011		4.2 V8 - Not Armored; 347mm Front Rotor		HB538X.760		HB553X.652
A6 Quattro		2009-2011		Armored Vehicle		HB687X.750		HB553X.652
A6 Quattro		2012		Models with 345mm (13.6") Front Rotors		HB641X.696		
A6 Quattro		2012-2015		V6		HB757X.758		
A6 Quattro		2013-2014	All	4 cyl Engine		HB641X.696		
A6 Quattro	V6	2013		4G0698151B		HB641X.696		
A6 Quattro		2014	All	TDI		HB641X.696		
A6 Quattro	V6	2014-2015		4G0698151G		HB641X.696		
A6 Quattro	L4	2015		4G0698151D		HB641X.696		
A6 Quattro	TDI	2015		4G0698151D		HB641X.696		
A6 Quattro		2016				HB757X.758		
A7 Quattro		2012-2013		320mm Front; 300mm Rear		HB641X.696		
A7 Quattro		2012-2013		345mm Front; 330mm Rear		HB641X.696		
A7 Quattro		2012-2016				HB757X.758		
A7 Quattro		2014	All	TDI		HB641X.696		
A7 Quattro		2014-2016		4G0698151G		HB641X.696		
A7 Quattro	TDI	2015		4G0698151D		HB641X.696		
A8		1997-1999	All	w/Large Round Wear Sensor		HB269X.763B		HB271X.635
A8		1997-1999	All	w/Oval Wear Sensor		HB269X.763A		HB271X.635
A8		1997-1998				HB269X.763		HB271X.635
A8		1999		from VIN Number 4DW004500		HB363X.689A		HB364X.642
A8		1999		to VIN Number 4DW004500		HB269X.763		HB271X.635
A8 Quattro		1997-1999	All	w/Large Round Wear Sensor		HB269X.763B		HB271X.635
A8 Quattro		1997-1999	All	w/Oval Wear Sensor		HB269X.763A		HB271X.635
A8 Quattro		1997-1998				HB269X.763		HB271X.635
A8 Quattro		1999		from VINNUMBER 4DW004500		HB363X.689A		HB364X.642
A8 Quattro		1999		to VINNUMBER 4DW004500		HB269X.763		HB271X.635
A8 Quattro		2000-2003	All	w/Large Round Wear Sensor				HB364X.642
A8 Quattro		2000-2003	All	w/Oval Wear Sensor		HB363X.689A		HB364X.642
A8 Quattro		2000				HB363X.689A		HB364X.642
A8 Quattro	Front 323mm Rotors Rear 245mm Rotors	2000						HB271X.605
A8 Quattro	Front 323mm Rotors Rear 245mm Rotors	2000		4D0698151S		HB363X.689		
A8 Quattro	Front 345mm Rotors	2000-2003		4D0698151L		HB184X.650		
A8 Quattro	L	2001-2002	All			HB363X.689		HB364X.642
A8 Quattro	L	2001-2003	All	w/Large Round Wear Sensor				HB364X.642
A8 Quattro	L	2001-2003	All	w/Oval Wear Sensor		HB363X.689A		HB364X.642
A8 Quattro		2001-2002		269mm Rear Rotor		HB363X.689A		HB364X.642
A8 Quattro		2001-2002		280mm Rear Rotor		HB363X.689A		HB364X.642
A8 Quattro	Front 323mm Rotors	2001-2003		4D0698151S		HB363X.689		
A8 Quattro	L	2003	All			HB363X.689		
A8 Quattro	L	2003	All					HB364X.642
A8 Quattro		2003		to VIN Number 4D 3 004 999; 269mm Rear Rotor		HB363X.689A		HB364X.642
A8 Quattro		2003		to VIN Number 4D 3 004 999; 280mm Rear Rotor		HB363X.689A		HB364X.642
A8 Quattro		2003-2004		From VIN Number 4E 3 000 001		HB687X.750		HB553X.652
A8 Quattro	Front 385mm Rotors	2005		4E0698151E		HB687X.750		

MAKE/ MODEL	SUBMODEL	YEARS	ENGINE (LITER)	NOTE	FRONT		REAR	
					OES	HB SERIES	OES	HB SERIES
AUDI CONTINUED								
A8 Quattro		2005-2009		6.0L v12		HB687X.750		HB553X.652
A8 Quattro		2005-2010		4.2L V8		HB687X.750		HB553X.652
A8 Quattro		2011				HB757X.758		
A8 Quattro		2011		4H0698151G		HB641X.696		
A8 Quattro		2012-2015		W12		HB780X.625		
A8 Quattro		2013-2014				HB757X.758		
A8 Quattro		2013-2014		4H0698151G		HB641X.696		
A8 Quattro		2016				HB757X.758		
A8 Quattro	L	2016		A8 Quattro L, W12		HB780X.625		
Allroad		2013		314mm Front Rotors				HB642X.658
Allroad		2013		320mm Front Rotors; MFG From 6/20/2011		HB641X.696		HB642X.658
Allroad		2013		320mm Front Rotors; MFG Up to 6/19/2011		HB641X.696		HB642X.658
Allroad		2013-2016						HB642X.658
Allroad		2014-2016		8K0698151H		HB641X.696		
Allroad		2014-2016		8K0698451A				HB642X.658
Allroad Quattro		2001-2003	All	w/Large Round Wear Sensor				HB364X.642
Allroad Quattro		2001-2003	All	w/Oval Wear Sensor		HB363X.689A		HB364X.642
Allroad Quattro		2001-2003		4 pad front caliper only		HB363X.689		HB364X.587
Allroad Quattro		2001-2005		2 pad front caliper only		HB515X.760		HB364X.587
Allroad Quattro		2003-2005	All	w/Dual Piston		HB363X.689		HB364X.642
Allroad Quattro		2003-2005	All	w/Dual Piston, w/Large Round Wear Sensor				HB364X.642
Allroad Quattro		2003-2005	All	w/Dual Piston, w/Oval Wear Sensor		HB363X.689A		HB364X.642
Allroad Quattro		2003-2005	All	w/Single Piston		HB515X.760		HB364X.642
Allroad Quattro		2003		4B0698451E				HB364X.642
Allroad Quattro		2003		4B3698151		HB363X.689		
Allroad Quattro	Front: 2 piston caliper	2004		4B0698451E				HB364X.642
Allroad Quattro		2004-2005		4 pad front caliper 2.7L V6		HB363X.689		HB364X.587
Allroad Quattro		2004-2005		4 pad front caliper 4.2L V8		HB363X.689		HB364X.587
Allroad Quattro	Front: 2 piston caliper	2004-2005		4B3698151		HB363X.689		
Allroad Quattro	Front: 2 piston caliper	2005		3B0698451				HB364X.642
Cabriolet		1994-1997	All	w/Wear Sensor		HB270X.724A		HB271X.635
Cabriolet		1994-1998						HB271X.635
Coupe	GT	1985-1987	All			HB190X.600		
Coupe	GT	1985-1987	All	w/Wear Sensor		HB190X.600A		
Coupe		1987		443698451B				HB271X.635
Coupe Quattro		1990		4D0698451A				HB271X.635
Coupe Quattro		1991		447698451A				HB271X.635
Q3		2015		3AA698451				HB544X.628
Q3		2015-2016		5N0698151B		HB543X.760		
Q3 Quattro		2015		3AA698451				HB544X.628
Q3 Quattro		2015-2016		5N0698151B		HB543X.760		
Q5		2009-2010				HB641X.696		HB642X.658
Q5		2011						HB642X.658
Q5		2011		From 6/20/11		HB641X.696		HB642X.658
Q5		2011		To 6/19/11		HB641X.696		HB642X.658
Q5		2012				HB641X.696		HB642X.658
Q5		2013-2014	All					HB642X.658
Q5	Hybrid	2013-2014	All			HB641X.696		HB642X.658
Q5		2013-2016		2.0 Liter				HB642X.658
Q5		2013-2016		3.0 Liter				HB642X.658
Q5		2013-2016		Hybrid				HB642X.658
Q5		2015	2.0L	8K0698451B				HB642X.658
Q5	3.0 Liter	2015		8K0698451E				HB642X.658
Q5	Hybrid	2015-2016		8K0698451D				HB642X.658
Q5	Hybrid	2015-2016		8R0698151A		HB641X.696		

BRAKE PAD APPLICATIONS



Hawk Performance - BRAKE PAD APPLICATIONS

HB
HAWK BRAKE

245
PAD SHAPE

x
INSERT COMPOUND CODE

.631
PAD THICKNESS

MAKE/ MODEL	SUBMODEL	YEARS	ENGINE (LITER)	NOTE	FRONT		REAR	
					OES	HB SERIES	OES	HB SERIES
AUDI CONTINUED								
Q7	Premium	2007-2014	All			HB501X.625		HB502X.606
Q7		2007-2012				HB501X.625		HB502X.606
Q7		2015		7L0698151R		HB501X.625		
Q7		2015		7L0698451H				HB502X.606
Quattro		1983-1984						HB271X.635
Quattro		1985		443698151J		HB190X.730		
Quattro		1985		443698451B				HB271X.635
Quattro		1985		4D0698451A				HB271X.635
R8		2008-2010				HB609X.572		
R8		2008-2011		Rear pad w/o wear sensor notch				HB193X.670
R8		2010		420698151C		HB609X.572		
R8		2010-2011		1K0698451B				HB544X.628
R8		2011		8J0698151C		HB543X.760		
R8		2011-2012				HB543X.760		
R8		2011-2012		420698151D		HB609X.572		
R8		2014-2015		420698151E		HB609X.572		
RS4		2007-2008				HB609X.572		HB553X.652
RS5		2013		8T0698151B		HB609X.572		
RS5		2014-2015		8T0698151C		HB609X.572		
RS6		2003-2004				HB609X.572		HB553X.652
RS7		2014-2016		4G0698151J		HB731X.620		
S3		2015-2016				HB779X.740		
S4		1992-1994				HB270X.724A		HB271X.635
S4		1993-1994	All					HB271X.635
S4		1993-1994	All	w/Wear Sensor		HB270X.724A		HB271X.635
S4		2000-2002	All			HB363X.689		HB364X.642
S4		2000-2002	All	w/Large Round Wear Sensor				HB364X.642
S4		2000-2002	All	w/Oval Wear Sensor		HB363X.689A		HB364X.642
S4		2000-2002				HB363X.689		HB364X.642
S4	Avant	2001-2002	All			HB363X.689		HB364X.642
S4	Avant	2001-2002	All	w/Large Round Wear Sensor				HB364X.642
S4	Avant	2001-2002	All	w/Oval Wear Sensor		HB363X.689A		HB364X.642
S4	Cabriolet	2004-2008	All					HB553X.652
S4	Base	2004-2009	All					HB553X.652
S4		2004-2009				HB538X.760		HB553X.652
S4	Avant	2008	All					HB553X.652
S4		2010-2014	All			HB641X.696		HB642X.658
S4		2010				HB641X.696		HB642X.658
S4		2011						HB642X.658
S4		2011		MFG From 11/08/2010		HB641X.696		HB642X.658
S4		2011		MFG To 11/08/2010		HB641X.696		HB642X.658
S4		2012-2013				HB641X.696		HB642X.658
S4		2014-2015						HB642X.658
S4		2015		8K0698451D				HB642X.658
S4		2015		8R0698151		HB641X.696		
S5		2008-2010				HB641X.696		HB642X.658
S5		2011		Coupe		HB641X.696		HB642X.658
S5		2011-2012		Convertible		HB641X.696		HB642X.658
S5		2011-2016						HB642X.658
S5		2013-2015		8K0698451D				HB642X.658
S5		2013-2015		8R0698151		HB641X.696		
S6		1995-1997						HB271X.635
S6		1995-1997		w/Wear Sensor		HB270X.724A		
S6	Avant	2002-2004	All			HB363X.689		HB364X.642
S6	Avant	2002-2004	All	w/Large Round Wear Sensor				HB364X.642

BRAKE PAD APPLICATIONS



MAKE/ MODEL	SUBMODEL	YEARS	ENGINE (LITER)	NOTE	FRONT		REAR	
					OES	HB SERIES	OES	HB SERIES
AUDI CONTINUED								
S6	Avant	2002-2004	All	w/Oval Wear Sensor		HB363X.689A		HB364X.642
S6		2002-2004				HB363X.689		HB364X.587
S6		2004		4B0698151R		HB515X.760		
S6		2004		4B0698451E				HB364X.642
S6		2004		4B3698151		HB363X.689		
S6		2007-2011				HB687X.750		HB553X.652
S6		2013-2016				HB780X.625		
S7		2013-2016				HB780X.625		
S8		2001-2003	All	w/Female oval wear sensor. 16.5 in. long lead				HB364X.642
S8		2001-2003	All	w/Female oval wear sensor. 8 in. long lead				HB364X.642
S8		2001-2003				HB184X.650		HB364X.587
S8		2007-2009				HB687X.750		HB553X.652
S8		2013-2016				HB780X.625		
S8		2016				HB757X.758		
SQ5		2014-2015		8K0698451D				HB642X.658
SQ5		2014-2016						HB642X.658
Super 90		1969-1972				HB172X.500		
Super 90		1970-1972	All			HB172X.595		
TT		2000-2006	All			HB272X.763		HB364X.642
TT		2000-2006						HB364X.642
TT		2000-2006		w/Wear Sensor		HB272X.763A		
TT	Rear: From Vin 8N-5-010 001	2005		1J0698451E				HB364X.642
TT	Rear: From Vin 8N-5-011 001	2005		1J0698451N				HB364X.587
TT		2008-2009				HB543X.760		HB544X.628
TT	S	2009	All			HB625X.760		HB544X.628
TT		2010-2011	All			HB625X.760		HB544X.628
TT		2010		8J0698151C		HB543X.760		
TT Quattro		2000-2006	1.8L			HB272X.763		HB364X.642
TT Quattro		2000-2006	1.8L	w/Wear Sensor		HB272X.763A		HB364X.642
TT Quattro		2000-2006		1.8L 180HP solid rear rotor		HB272X.763A		HB364X.587
TT Quattro		2000-2006		1.8L 225HP vented rear rotor		HB272X.763A		HB364X.587
TT Quattro		2004-2006	3.2L			HB497X.776		HB364X.642
TT Quattro		2004-2006		3.2L V6		HB497X.776		HB364X.587
TT Quattro		2005-2006		1J0698451N				HB364X.587
TT Quattro		2008-2009	3.2L			HB625X.760		HB544X.628
TT Quattro		2008		3.2L V6		HB538X.760		HB544X.628
TT Quattro	S	2009-2014	3.2L			HB625X.760		HB544X.628
TT Quattro		2009		2.0T (Exc. TTS)		HB543X.760		HB544X.628
TT Quattro		2009		3.2L V6 or TTS 2.0T		HB538X.760		HB544X.628
TT Quattro		2009-2015		8J0698151C		HB543X.760		
TT Quattro		2010-2014	All			HB543X.760		HB544X.628
TT Quattro		2010-2011		Base Model		HB543X.760		HB544X.628
TT Quattro		2010-2011		S Model		HB538X.760		HB544X.628
TT Quattro	RS	2012-2014	All					HB544X.628
TT Quattro		2012-2013		Base, Prestige, Premium Plus; 312mm Front Rotor		HB543X.760		HB544X.628
TT Quattro		2012-2014		RS; 370mm Front Rotor; Vented Rear Rotor				HB544X.628
TT Quattro		2012-2014		S; 340mm Front Rotor; Vented Rear Rotor		HB538X.760		HB544X.628
TT Quattro		2014		Base, Premium Plus; 312mm Front Rotor		HB543X.760		HB544X.628
TT Quattro		2015		1K0698451G				HB544X.628
TT Quattro	S	2015		1K0698451K				HB544X.628
TT Quattro	S	2015		8J0698151F		HB625X.760		
V8 Quattro	32V	1990-1991	All	w/Wear Sensor		HB270X.724A		
V8 Quattro	Front: 2 Piston Caliper	1990-1994		4A0698451				HB271X.635

BRAKE PAD APPLICATIONS



Hawk Performance - BRAKE PAD APPLICATIONS

HB
HAWK BRAKE

245
PAD SHAPE

x
INSERT COMPOUND CODE

.631
PAD THICKNESS

MAKE/ MODEL	SUBMODEL	YEARS	ENGINE (LITER)	NOTE	FRONT		REAR	
					OES	HB SERIES	OES	HB SERIES
AUSTIN HEALEY								
Healey Sprite		1964-1970				HB123X.535		
3000		1964-1968				HB169X.560		
Sprite		1964-1970				HB123X.535		
BMW								
325		1984-1987		Models with ATE Front Calipers		HB195X.640		HB399X.630
325		1984-1987		Models with Girling Front Calipers		HB195X.640		HB399X.630
325		1986-1988	All			HB195X.640		HB399X.630
325		1988		AWD Models with ATE Front Calipers		HB195X.640		HB399X.630
325		1988		AWD Models with Girling Front Calipers		HB195X.640		HB399X.630
325		1988		RWD Models with ATE Front Calipers		HB195X.640		HB399X.630
325		1988		RWD Models with Girling Front Calipers		HB195X.640		HB399X.630
1600		1970-1971				HB206X.565		
1602		1970-1971				HB206X.565		
1800		1970-1971				HB206X.565		
1802		1970-1971				HB206X.565		
2000		1969-1971	All			HB206X.565		
2000		1969-1971				HB206X.565		HB713X.585
2000	Touring	1971	All			HB206X.565		
2000		1972				HB206X.565		
2002		1968				HB206X.565		
2002		1969-1971	All			HB206X.565		
2002		1972-1976				HB206X.565		
2500		1969-1971	All			HB206X.565		
2500		1969-1971				HB206X.565		HB713X.585
2800		1969-1971	All			HB206X.565		
2800		1969-1974				HB206X.565		HB713X.585
1 Series M		2011	All			HB551X.748		HB630X.626
1 Series M		2011				HB551X.748		HB630X.626
125i		2011	All			HB534X.750		HB621X.638
128i		2008-2009				HB534X.750		HB621X.638
128i		2010		MFG From 3/2010		HB534X.750		HB621X.638
128i		2010		MFG Up to 2/2010		HB534X.750		HB621X.638
128i		2011-2013				HB534X.750		HB621X.638
135i		2008-2013	All			HB603X.616		HB604X.598
135i		2008-2011				HB603X.616		HB604X.598
135i		2012				HB603X.616		HB748X.723
135is		2013	All			HB603X.616		HB604X.598
1600-2		1970-1971				HB206X.565		
2000c		1970	All			HB206X.565		
2000c		1970						HB713X.585
2000cs		1970	All			HB206X.565		
2000cs		1970						HB713X.585
2000ti		1970-1971	All			HB206X.565		
2000ti		1970						HB713X.585
2000tii		1970-1971	All			HB206X.565		
2000tii	Lux	1970-1971	All			HB206X.565		
2000tii		1970						HB713X.585
2000tii	Touring	1971	All			HB206X.565		
2000tii		1972				HB206X.565		
2002ti		1970-1971	All			HB206X.565		
2002ti		1974				HB206X.565		
2002tii		1971-1974	All			HB206X.565		
2002tii		1971-1973				HB206X.565		
228i		2014-2015				HB748X.723		
228i		2014-2015		34206799809				HB749X.648

BRAKE PAD APPLICATIONS

MAKE/ MODEL	SUBMODEL	YEARS	ENGINE (LITER)	NOTE	FRONT		REAR	
					OES	HB SERIES	OES	HB SERIES
BMW CONTINUED								
228i	M Sport	2014-2015				HB748X.723		
228i	M Sport	2014-2015		34216850569				HB749X.648
228i		2014-2016		Blue Caliper				HB766X.624
228i xDrive		2015-2016		Blue Caliper				HB766X.624
2800CS		1970-1971				HB206X.565		HB713X.585
3.0CS		1971				HB206X.565		HB713X.585
3.0CS		1972-1974	All			HB206X.565		
3.0CS		1972-1974						HB713X.585
3.0CSi		1971-1974	All			HB206X.565		
3.0CSi		1971-1974						HB713X.585
3.0CSL		1971	All			HB206X.565		
3.0CSL		1971						HB713X.585
3.0S		1971-1974	All			HB206X.565		
3.0S		1971-1974						HB713X.585
3.0Si		1971	All			HB206X.565		
3.0Si		1971						HB713X.585
3.0Si		1975-1976	All			HB206X.565		
3.0Si		1975-1976						HB713X.585
318i	E30	1984-1985	All			HB195X.640		
318i		1984-1985				HB195X.640		
318i	E30	1991	All	To 4/91		HB195X.640		HB399X.630
318i		1991-1992		E30 (4 Lug) Models with ATE Front Calipers		HB195X.640		HB399X.630
318i		1991-1992		E30 (4 Lug) Models with Girling Front Calipers		HB195X.640		HB399X.630
318i		1992-1998	All			HB136X.690		HB227X.630
318i		1992		E36 (5 Lug)		HB136X.690		HB227X.630
318i		1993-1998		E36 318i, 318iS		HB136X.690		HB227X.630
318i	Rear from 05/1993	1994		34211161455				HB227X.630
318is	E30	1991	All	To 4/91		HB195X.640		HB399X.630
318is		1991-1992		E30 (4 Lug) Models with ATE Front Calipers		HB195X.640		HB399X.630
318is		1991-1992		E30 (4 Lug) Models with Girling Front Calipers		HB195X.640		HB399X.630
318is		1992-1997	All			HB136X.690		HB227X.630
318is		1992		E36 (5 Lug)		HB136X.690		HB227X.630
318is		1993-1997		E36 318i, 318iS		HB136X.690		HB227X.630
318is	Rear from 05/1993	1994		34211161455				HB227X.630
318ti		1995-1998	All			HB136X.690		HB227X.630
318ti		1995-1999		318Ti		HB136X.690		HB227X.630
318ti		1999	All			HB136X.690		HB136X.690
320i		1977-1982	All			HB180X.560		
320i		1977-1979				HB180X.591		
320i		1979				HB180X.640		
320i		1983				HB180X.640		
320i		2013-2014				HB748X.723		HB749X.648
320i		2015				HB748X.723		
320i		2015		34206799809				HB749X.648
320i		2016		Blue Caliper				HB766X.624
320i xDrive		2013-2014				HB748X.723		HB749X.648
320i xDrive		2015				HB748X.723		
320i xDrive		2015		34206799809				HB749X.648
320i xDrive		2016		Blue Caliper				HB766X.624
323Ci		2000	All			HB546X.654		HB227X.630
323Ci		2000		323i, 323Ci - E46 Sedan, Coupe, Convertible		HB136X.690		HB227X.630
323i		1998		323i E36 Convertible - Vented Rear Rotors		HB136X.690		HB227X.630
323i		1999-2000	All			HB546X.654		HB227X.630
323i		1999		323i - E36 Convertible		HB136X.690		HB227X.630
323i		1999		323i - E46 Sedan, Coupe		HB136X.690		HB227X.630

BRAKE PAD APPLICATIONS



Hawk Performance - BRAKE PAD APPLICATIONS

HB **245** **x** **.631**
 HAWK BRAKE PAD SHAPE INSERT COMPOUND CODE PAD THICKNESS

MAKE/ MODEL	SUBMODEL	YEARS	ENGINE (LITER)	NOTE	FRONT		REAR	
					OES	HB SERIES	OES	HB SERIES
BMW CONTINUED								
323i		1999		323i, 323is - E36 Sedan, Coupe		HB136X.690		HB227X.630
323i		1999		34211164499				HB227X.630
323i	Convertible	1999		34216761239				HB227X.630
323i		1999-2000		34216750190				HB227X.630
323i	Sport Wagon	2000	All			HB546X.654		HB227X.630
323i		2000		323i - E46 Wagon		HB136X.690		HB227X.630
323i		2000		323i, 323Ci - E46 Sedan, Coupe, Convertible		HB136X.690		HB227X.630
323i	Sport Wagon	2000		34216761241				HB227X.630
323i		2010-2011	All	Wear sensor, front pads, F & Z only		HB551X.748		HB621X.638
323is		1998-1999	All			HB546X.654		HB227X.630
323is		1998		323is E36 Coupe - Solid Rear Rotors		HB136X.690		HB227X.630
323is		1999		323i, 323is - E36 Sedan, Coupe		HB136X.690		HB227X.630
325Ci		2001-2006	All			HB136X.690		HB227X.630
325Ci		2001-2005		325i; 325Ci RWD (E46)		HB136X.690		HB227X.630
325Ci		2006		Ci Coupe & Convertible (E46)		HB136X.690		HB227X.630
325e	E30	1984-1987	All			HB195X.640		HB399X.630
325e		1984-1987		Models with ATE Front Calipers		HB195X.640		HB399X.630
325e		1984-1987		Models with Girling Front Calipers		HB195X.640		HB399X.630
325es	E30	1986-1987	All			HB195X.640		HB399X.630
325es		1986-1987		Models with ATE Front Calipers		HB195X.640		HB399X.630
325es		1986-1987		Models with Girling Front Calipers		HB195X.640		HB399X.630
325i	E30	1987-1991	All			HB195X.640		HB399X.630
325i		1987		Models with ATE Front Calipers		HB195X.640		HB399X.630
325i		1987		Models with Girling Front Calipers		HB195X.640		HB399X.630
325i		1988-1991		AWD MODELS with ATE Front Calipers		HB195X.640		HB399X.630
325i		1988-1991		AWD MODELS with Girling Front Calipers		HB195X.640		HB399X.630
325i		1988-1991		RWD MODELS with ATE Front Calipers		HB195X.640		HB399X.630
325i		1988-1991		RWD MODELS with Girling Front Calipers		HB195X.640		HB399X.630
325i	E36	1992-1995	All			HB136X.690		HB227X.630
325i		1992		E30 MODELS with ATE Front Calipers		HB195X.640		HB399X.630
325i		1992		E30 MODELS with Girling Front Calipers		HB195X.640		HB399X.630
325i		1992		E36 Models		HB136X.690		HB227X.630
325i		1993		34111160522		HB195X.640		
325i		1993		34211158323				HB399X.630
325i		1993-1995				HB136X.690		HB227X.630
325i	Rear from 05/1993	1994		34211161455				HB227X.630
325i	Sport Wagon	2001-2003	All			HB136X.690		HB227X.630
325i		2001-2005	All			HB546X.654		HB227X.630
325i		2001-2005		325i; 325Ci RWD (E46)		HB136X.690		HB227X.630
325i		2004		34216761241				HB227X.630
325i	E90	2006	All	RWD		HB534X.750		
325i		2006		325i RWD (E90)		HB534X.750		HB621X.638
325is		1987		Models with ATE Front Calipers		HB195X.640		HB399X.630
325is		1987		Models with Girling Front Calipers		HB195X.640		HB399X.630
325is		1988-1991		AWD MODELS with ATE Front Calipers		HB195X.640		HB399X.630
325is		1988-1991		AWD MODELS with Girling Front Calipers		HB195X.640		HB399X.630
325is		1988-1991		RWD MODELS with ATE Front Calipers		HB195X.640		HB399X.630
325is		1988-1991		RWD MODELS with Girling Front Calipers		HB195X.640		HB399X.630
325is		1992-1995	All			HB136X.690		HB227X.630
325is		1992		E30 MODELS with ATE Front Calipers		HB195X.640		HB399X.630
325is		1992		E30 MODELS with Girling Front Calipers		HB195X.640		HB399X.630
325is		1992		E36 Models		HB136X.690		HB227X.630
325is		1993-1995				HB136X.690		HB227X.630
325is	Rear from 05/1993	1994		34211161455				HB227X.630
325iX	E30	1988-1991	All			HB195X.640		HB399X.630

BRAKE PAD APPLICATIONS

MAKE/ MODEL	SUBMODEL	YEARS	ENGINE (LITER)	NOTE	FRONT		REAR	
					OES	HB SERIES	OES	HB SERIES
BMW CONTINUED								
325iX		1988-1991		AWD Models with ATE Front Calipers		HB195X.640		HB399X.630
325iX		1988-1991		AWD Models with Girling Front Calipers		HB195X.640		HB399X.630
325iX		1988-1991		RWD Models with ATE Front Calipers		HB195X.640		HB399X.630
325iX		1988-1991		RWD Models with Girling Front Calipers		HB195X.640		HB399X.630
325xi	Sport Wagon	2001-2003	All			HB136X.690		HB227X.630
325xi		2001-2005	All			HB136X.690		HB227X.630
325xi		2001-2005		325xi AWD only (E46)		HB136X.690		HB227X.630
325xi		2006	All			HB534X.750		
325xi		2006		325xi AWD Sedan & Sport Wagon (E90/E91)		HB534X.750		
325xi		2006		34216767150				HB621X.638
328Ci		2000	2.8L			HB136X.690		HB227X.630
328Ci		2000		34211164499				HB227X.630
328Ci		2000		34216750190				HB227X.630
328Ci		2000		E46 Sedan		HB136X.690		HB227X.630
328d		2014				HB748X.723		HB749X.648
328d		2015				HB748X.723		
328d		2015		34206873094				HB749X.648
328d xDrive		2014				HB748X.723		HB749X.648
328d xDrive		2014		Blue Caliper				HB766X.624
328d xDrive		2015				HB748X.723		
328d xDrive		2015		34206873094				HB749X.648
328i		1996		Convertible - Vented Rear Disc		HB136X.690		HB227X.630
328i		1996		Sedan/Coupe - Solid Rear Disc		HB136X.690		HB227X.630
328i		1997-1998		Sedan & Coupe E36		HB136X.690		HB227X.630
328i		1998-2000	All			HB546X.654		HB227X.630
328i		1999		34116756128		HB546X.654		
328i		1999		34216750190				HB227X.630
328i		1999		E36 328i Coupe/Sedan		HB136X.690		HB227X.630
328i	Convertible	1999		34116756128		HB546X.654		
328i	Convertible	1999		34216761239				HB227X.630
328i		1999-2000		E46 Sedan		HB136X.690		HB227X.630
328i		2007	All	AWD models & RWD Convertible & Wagon		HB534X.750		HB621X.638
328i		2007	All	RWD Coupe & Sedan		HB534X.750		HB621X.638
328i		2007		328i RWD Convertible or Wagon		HB534X.750		HB621X.638
328i		2007		328i RWD Coupe or Sedan		HB534X.750		HB621X.638
328i	Front from 09/2007	2007		34116780711		HB551X.748		
328i		2008-2012	All	AWD models & RWD Convertible & Wagon		HB551X.748		HB621X.638
328i		2008-2012	All	RWD Coupe & Sedan		HB551X.748		HB621X.638
328i		2008		328i RWD Convertible or Wagon		HB551X.748		HB621X.638
328i		2008		328i RWD Coupe or Sedan		HB551X.748		HB621X.638
328i	Xdrive	2009-2012	All	AWD; E90, E91, E92 Wear sensor, front pads, F & Z		HB551X.748		HB621X.638
328i		2009		AWD Coupe or Sports Wagon		HB551X.748		HB621X.638
328i		2009		AWD Sedan		HB551X.748		HB621X.638
328i		2009-2010		RWD Convertible or Sports Wagon		HB551X.748		HB621X.638
328i		2009-2010		RWD Coupe or Sedan		HB551X.748		HB621X.638
328i		2010		AWD Convertible or Sports Wagon		HB551X.748		HB621X.638
328i		2011		2WD; Convertible, Wagon		HB551X.748		HB621X.638
328i		2011		2WD; Coupe, Sedan		HB551X.748		HB621X.638
328i	Xdrive	2012-2013	All	L6		HB551X.748		HB621X.638
328i		2012						HB766X.624
328i		2012		2WD; E92 Coupe		HB551X.748		HB621X.638
328i		2012		2WD; E93 Convertible, E91 Wagon		HB551X.748		HB621X.638
328i		2012		E91 Wagon xDrive AWD		HB551X.748		HB621X.638
328i		2012		E92 Coupe xDrive AWD		HB551X.748		HB621X.638

BRAKE PAD APPLICATIONS

Hawk Performance - BRAKE PAD APPLICATIONS

HB **245** **x** **.631**
 HAWK BRAKE PAD SHAPE INSERT COMPOUND CODE PAD THICKNESS

MAKE/ MODEL	SUBMODEL	YEARS	ENGINE (LITER)	NOTE	FRONT		REAR	
					OES	HB SERIES	OES	HB SERIES
BMW CONTINUED								
328i		2012		F30 Sedan Exc. M Package		HB748X.723		HB749X.648
328i		2012		F30 Sedan With M Package		HB748X.723		HB749X.648
328i	F30 Chassis	2012				HB748X.723		HB749X.648
328i	L6	2013	All			HB551X.748		HB621X.638
328i	L6	2013	All	Convertible; Except Performance Brakes		HB551X.748		HB621X.638
328i	L6	2013	All	Convertible; Performance Brakes		HB551X.748		HB621X.638
328i	L6	2013	All	Coupe; Except Performance Brakes		HB551X.748		HB621X.638
328i	L6	2013	All	Coupe; Performance Brakes		HB551X.748		HB621X.638
328i	L4	2013				HB748X.723		HB749X.648
328i	L6 Convertible	2013		34116790759		HB551X.748		
328i	L6	2013		34116790759		HB551X.748		
328i		2013-2016		Blue Caliper				HB766X.624
328i		2014				HB748X.723		HB749X.648
328i		2015				HB748X.723		
328i		2015		34206799809				HB749X.648
328i	M Sport	2015				HB748X.723		
328i	M Sport	2015		34216850569				HB749X.648
328i GT xDrive		2014				HB748X.723		HB749X.648
328i GT xDrive		2014-2015		Blue Caliper				HB766X.624
328i GT xDrive		2015				HB748X.723		
328i GT xDrive		2015		34206799809				HB749X.648
328i xDrive		2009		AWD Coupe or Sports Wagon		HB551X.748		HB621X.638
328i xDrive		2009		AWD Sedan		HB551X.748		HB621X.638
328i xDrive		2009-2010		RWD Convertible or Sports Wagon		HB551X.748		HB621X.638
328i xDrive		2009-2010		RWD Coupe or Sedan		HB551X.748		HB621X.638
328i xDrive		2010		AWD Convertible or Sports Wagon		HB551X.748		HB621X.638
328i xDrive		2011		2WD; Convertible, Wagon		HB551X.748		HB621X.638
328i xDrive		2011		2WD; Coupe, Sedan		HB551X.748		HB621X.638
328i xDrive		2012		2WD; E92 Coupe		HB551X.748		HB621X.638
328i xDrive		2012		2WD; E93 Convertible, E91 Wagon		HB551X.748		HB621X.638
328i xDrive		2012		E91 Wagon xDrive AWD		HB551X.748		HB621X.638
328i xDrive		2012		E92 Coupe xDrive AWD		HB551X.748		HB621X.638
328i xDrive		2012		F30 Sedan Exc. M Package		HB748X.723		HB749X.648
328i xDrive		2012		F30 Sedan With M Package		HB748X.723		HB749X.648
328i xDrive	L4	2013				HB748X.723		HB749X.648
328i xDrive	L6	2013		34116790759		HB551X.748		
328i xDrive	L6	2013		34216790761				HB621X.638
328i xDrive		2013-2016		Blue Caliper				HB766X.624
328i xDrive		2014				HB748X.723		HB749X.648
328i xDrive		2015				HB748X.723		
328i xDrive		2015		34206799809				HB749X.648
328i xDrive	M Sport	2015				HB748X.723		
328i xDrive	M Sport	2015		34216850569				HB749X.648
328is		1996		Convertible - Vented Rear Disc		HB136X.690		HB227X.630
328is		1996		Sedan/Coupe - Solid Rear Disc		HB136X.690		HB227X.630
328is		1997-1998		Sedan & Coupe E36		HB136X.690		HB227X.630
328is		1998-1999	All			HB136X.690		HB227X.630
328is		1999		E46 Sedan		HB136X.690		HB227X.630
328xi		2007	All			HB534X.750		HB621X.638
328xi		2007		328xi AWD Coupe		HB534X.750		HB621X.638
328xi		2007		328xi AWD Sedan/Wagon		HB534X.750		HB621X.638
328xi	Front from 09/2007	2007		34116780711		HB551X.748		
328xi		2008	All	Wear sensor, front pads, F & Z only		HB551X.748		HB621X.638
328xi		2008		328xi AWD Coupe or Wagon		HB551X.748		HB621X.638
328xi		2008		328xi AWD Sedan		HB551X.748		HB621X.638

BRAKE PAD APPLICATIONS

MAKE/ MODEL	SUBMODEL	YEARS	ENGINE (LITER)	NOTE	FRONT		REAR	
					OES	HB SERIES	OES	HB SERIES
BMW CONTINUED								
330Ci		2001-2006	All			HB464X.764		HB518X.642
330Ci		2001-2005				HB464X.764		HB518X.642
330Ci		2006		E46 Coupe & Convertible		HB464X.764		HB518X.642
330Ci		2006		E90 Sedan exc. Xi AWD		HB534X.750		HB624X.642
330i		2001-2005	All			HB464X.764		HB518X.642
330i		2001-2005				HB464X.764		HB518X.642
330i		2006	All			HB534X.750		HB624X.642
330i		2006		E46 Coupe & Convertible		HB464X.764		HB518X.642
330i		2006		E90 Sedan exc. Xi AWD		HB534X.750		HB624X.642
330xi		2001-2005	All			HB464X.764		HB518X.642
330xi		2001-2005				HB464X.764		HB518X.642
330xi		2006	All			HB534X.750		HB624X.642
330xi		2006		E46 Coupe & Convertible		HB464X.764		HB518X.642
330xi		2006		E90 Xi AWD Sedan		HB534X.750		HB624X.642
335d		2009-2011	All	Wear sensor, front pads, F & Z only		HB551X.748		HB624X.642
335d		2009		335d, 335i exc. xDrive		HB551X.748		HB624X.642
335d		2010-2011		335d		HB551X.748		HB624X.642
335i		2007-2011	All	E90, E92, E93 Wear sensor, front pads, F & Z		HB551X.748		HB624X.642
335i		2007		MFG After 2/2007		HB551X.748		HB624X.642
335i		2007		MFG Up To 1/2007		HB551X.748		HB624X.642
335i		2008		335i Coupe & Sedan		HB551X.748		HB624X.642
335i		2009		335d, 335i exc. xDrive		HB551X.748		HB624X.642
335i	Xdrive	2010-2012	All	E90, E92, E93 Wear sensor, front pads, F & Z		HB551X.748		HB624X.642
335i		2010-2011		335i		HB551X.748		HB624X.642
335i		2012-2013	All	Coupe		HB551X.748		HB624X.642
335i	Sedan	2012						HB766X.624
335i		2012-2013		335i (E90, E92, E93)		HB551X.748		HB624X.642
335i	Xdrive	2013	All	Coupe		HB551X.748		HB624X.642
335i		2013-2015		Blue Caliper				HB766X.624
335i GT xDrive		2014-2016		Blue Caliper				HB766X.624
335i xDrive		2009-2011		335i xDrive		HB551X.748		HB624X.642
335i xDrive		2012-2013		335i xDrive (E90, E92, E93)		HB551X.748		HB624X.642
335i xDrive		2013-2015		Blue Caliper				HB766X.624
335is		2011-2013	All	Wear sensor, front pads, F & Z only		HB551X.748		HB624X.642
335is		2011-2013		335is		HB551X.748		HB624X.642
335xi		2007-2008	All	Wear sensor, front pads, F & Z only		HB551X.748		HB624X.642
335xi		2007		MFG After 2/2007		HB551X.748		HB624X.642
335xi		2007		MFG Up To 1/2007		HB551X.748		HB624X.642
335xi		2008		335xi AWD Coupe & Sedan		HB551X.748		HB624X.642
340i		2016		Blue Caliper				HB766X.624
340i xDrive		2016		Blue Caliper				HB766X.624
428i		2014				HB748X.723		HB749X.648
428i		2014-2016		Blue Caliper				HB766X.624
428i		2015				HB748X.723		
428i	M Sport	2015		34206799809				HB749X.648
428i	M Sport	2015		34216850569		HB748X.723		
428i Gran Coupe		2015				HB748X.723		
428i Gran Coupe		2015		34206799809				HB749X.648
428i Gran Coupe	M Sport	2015				HB748X.723		
428i Gran Coupe		2015-2016		Blue Caliper				HB766X.624
428i xDrive		2014				HB748X.723		HB749X.648
428i xDrive		2014-2016		Blue Caliper				HB766X.624
428i xDrive		2015				HB748X.723		
428i xDrive		2015		34206799809				HB749X.648

BRAKE PAD APPLICATIONS



Hawk Performance - BRAKE PAD APPLICATIONS

HB
HAWK BRAKE

245
PAD SHAPE

x
INSERT COMPOUND CODE

.631
PAD THICKNESS

MAKE/ MODEL	SUBMODEL	YEARS	ENGINE (LITER)	NOTE	FRONT		REAR	
					OES	HB SERIES	OES	HB SERIES
BMW CONTINUED								
428i xDrive	M Sport	2015				HB748X.723		
428i xDrive	M Sport	2015		34216850569				HB749X.648
428i xDrive Gran Coupe		2015				HB748X.723		
428i xDrive Gran Coupe		2015		34206799809				HB749X.648
428i xDrive Gran Coupe	M Sport	2015				HB748X.723		
428i xDrive Gran Coupe		2015-2016		Blue Caliper				HB766X.624
435i		2014-2016		Blue Caliper				HB766X.624
435i Gran Coupe		2015-2016		Blue Caliper				HB766X.624
435i xDrive		2014-2016		Blue Caliper				HB766X.624
524td		1985-1986	All			HB137X.690		HB399X.630
525i		1989-1995	All			HB135X.770		HB227X.630
525i		1989-1995		E34		HB135X.642		HB227X.630
525i		2001-2003	All					HB227X.630
525i	Sport Wagon	2001-2003	All					HB227X.630
525i		2001-2003		Sedan		HB135X.770		
525i		2001-2003		Touring		HB135X.770		
525i		2004-2005	All	Automatic Trans Wear sensor, front pads, F & Z only		HB551X.748		HB458X.642
525i		2004-2005	All	Manual Transmission		HB534X.750		HB458X.642
525i		2004-2005		Automatic Transmission		HB551X.748		HB518X.642
525i		2004-2005		Manual Transmission		HB135X.770		HB518X.642
525i		2006	All	Wear sensor, front pads, F & Z only		HB551X.748		HB458X.642
525i		2006		525i from 9/29/06		HB551X.748		HB518X.642
525i		2006		525i to 9/29/06		HB551X.748		HB518X.642
525i		2007	All			HB534X.750		HB518X.642
525i		2007		525i		HB551X.748		HB518X.642
525iT		1993-1995	All					HB227X.630
525iT		1993-1995	All					HB572X.570
525iT		1993-1995		E34		HB135X.642		HB227X.630
525xi		2006-2007	All	Wear sensor, front pads, F & Z only		HB551X.748		HB458X.642
525xi		2006-2007		525xi AWD		HB551X.748		HB518X.642
528e		1982-1988	All			HB137X.690		HB399X.630
528i		1979-1981	All			HB206X.565		
528i		1979						HB713X.585
528i		1997-1998	All			HB135X.770		HB227X.630
528i		1997-2000		E39; Sedan		HB135X.770		
528i		1998-2000		E39; Touring		HB135X.770		
528i		1999-2000		34211163395				HB227X.630
528i		2008-2010	All	Wear sensor, front pads, F & Z only		HB551X.748		HB458X.642
528i		2008-2010		528i E60		HB551X.748		HB518X.642
528i	Xdrive	2009-2010	All	Wear sensor, front pads, F & Z only		HB551X.748		HB458X.642
528i		2009-2010		528i xDrive E60		HB551X.748		HB518X.642
528i		2011-2014		528i		HB750X.720		
528i		2011-2015						HB751X.675
528i	Performance Brakes	2012-2013		34116851269		HB551X.748		
528i		2012-2014		528i xDrive		HB750X.720		
528i	Performance Brakes	2012-2016						HB751X.675
528i		2015		34116796844		HB750X.720		
528i		2016				HB750X.720		HB751X.675
528i		2014-2016		Performance Brakes		HB768X.714		
528i xDrive		2009-2010		34116784129		HB551X.748		
528i xDrive		2009-2010		34216784135				HB458X.642
528i xDrive		2012-2015						HB751X.675
528i xDrive		2012-2015		34116796844		HB750X.720		
528xi		2008	All	Wear sensor, front pads, F & Z only		HB551X.748		HB458X.642

MAKE/ MODEL	SUBMODEL	YEARS	ENGINE (LITER)	NOTE	FRONT		REAR	
					OES	HB SERIES	OES	HB SERIES
BMW CONTINUED								
528xi		2008		528xi AWD E60		HB551X.748		HB518X.642
530i		1975-1978	All			HB206X.565		HB206X.565
530i		1975-1978						HB713X.585
530i		1994-1995		E34		HB135X.642		HB227X.630
530i		2001-2003				HB325X.720		
530i		2001-2003		34211163395				HB227X.630
530i		2001-2003		E39		HB325X.720		
530i		2004-2005		E60		HB551X.748		HB518X.642
530i		2006-2007		Sedan except xi AWD		HB551X.748		HB518X.642
530xi		2006-2007		530xi- AWD Sedan		HB551X.748		HB518X.642
530xi		2006-2007		530xi- AWD Sports Wagon		HB551X.748		HB518X.642
533i		1983-1988				HB137X.690		HB399X.630
535d		2014-2015						HB751X.675
535d		2014-2016				HB768X.714		
535d xDrive		2014-2015						HB751X.675
535d xDrive		2014-2016				HB768X.714		
535i		1985-1987	All			HB137X.690		HB399X.630
535i		1988		34211157814				HB227X.630
535i		1989-1993		E34		HB135X.642		HB227X.630
535i		2008-2009		535i Sedan except xi AWD		HB551X.748		HB630X.626
535i		2010		535i Sedan except xDrive AWD		HB551X.748		HB630X.626
535i		2011-2016						HB751X.675
535i		2011-2016				HB768X.714		
535i GT		2010		535i GT				HB630X.626
535i GT		2010-2015		34116793021		HB551X.748		
535i GT		2011-2012		535i GT, GT xDrive				HB630X.626
535i GT		2013-2015		34216793025				HB630X.626
535i GT xDrive		2011-2012		535i GT, GT xDrive				HB630X.626
535i GT xDrive		2011-2015		34116793021		HB551X.748		
535i GT xDrive		2013-2015		34216793025				HB630X.626
535i xDrive		2009		34116764540		HB551X.748		
535i xDrive		2009		34216763044				HB458X.642
535i xDrive		2010		535i xDrive - AWD Sedan		HB551X.748		HB518X.642
535i xDrive		2011-2015						HB751X.675
535i xDrive		2011-2016				HB768X.714		
535is		1988		34211162536				HB227X.630
535xi		2008		535xi- AWD Sedan		HB551X.748		HB518X.642
535xi		2008		535xi- AWD Sport Wagon		HB551X.748		HB518X.642
540i		1994-1995				HB135X.642		HB227X.630
540i		1997-2003				HB325X.720		
540i		1997-2003		34211163395				HB227X.630
540i		1998-1999		Sedan E39		HB325X.720		
540i		1998-1999		Wagon E39		HB325X.720		
540i		2000		Sedan from 3/00 E39		HB325X.720		
540i		2000		Sedan to 3/00 E39		HB325X.720		
540i		2000		Wagon from 3/00 E39		HB325X.720		
540i		2000		Wagon to 3/00 E39		HB325X.720		
540i		2001-2003		Sedan E39		HB325X.720		
540i		2001-2003		Wagon E39		HB325X.720		
545i		2004-2005		E60		HB551X.748		HB630X.626
550i		2006-2009		E60		HB551X.748		HB630X.626
550i		2010		Except GT		HB551X.748		HB630X.626
550i		2011-2015		34116793021		HB551X.748		
550i GT		2010		GT				HB630X.626
550i GT		2010-2015		34116793021		HB551X.748		

BRAKE PAD APPLICATIONS



Hawk Performance - BRAKE PAD APPLICATIONS

HB **245** **x** **.631**
 HAWK BRAKE PAD SHAPE INSERT COMPOUND CODE PAD THICKNESS

MAKE/ MODEL	SUBMODEL	YEARS	ENGINE (LITER)	NOTE	FRONT		REAR	
					OES	HB SERIES	OES	HB SERIES
BMW CONTINUED								
550i GT		2011-2015		34216793025				HB630X.626
550i GT xDrive		2010-2015		34116793021		HB551X.748		
550i GT xDrive		2010-2015		34216793025				HB630X.626
550i xDrive		2011-2015		34116793021		HB551X.748		
635CSi		1985-1989		34111157510		HB137X.690		
635CSi		1985-1989		34211157514				HB399X.630
640i		2012-2016				HB768X.714		
640i Gran Coupe		2013-2016				HB768X.714		
640i xDrive		2014-2016				HB768X.714		
640i xDrive Gran Coupe		2014-2016				HB768X.714		
645Ci		2004-2005	All	Wear sensor, front pads, F & Z only		HB551X.748		HB630X.626
645Ci		2004-2005		E63, E64		HB551X.748		HB630X.626
650i		2006-2010	All	Wear sensor, front pads, F & Z only		HB551X.748		HB630X.626
650i		2006-2010		E63, E64		HB551X.748		HB630X.626
650i		2012-2016		34116793021		HB551X.748		
650i Gran Coupe		2013-2016		34116793021		HB551X.748		
650i xDrive		2012-2016		34116793021		HB551X.748		
650i xDrive Gran Coupe		2013-2016		34116793021		HB551X.748		
733i		1978-1982	All			HB206X.565		
735i		1985		34211156746				HB399X.630
735i		1986	All			HB206X.565		HB399X.630
735i		1987-1991	All			HB135X.770		HB227X.630
735i		1988-1992				HB135X.642		HB227X.630
735iL		1988-1992	All			HB135X.770		HB227X.630
735iL		1988-1992				HB135X.642		HB227X.630
740i		1993-1994	All			HB135X.770		HB227X.630
740i		1993-1994		E32 model		HB135X.642		HB227X.630
740i		1995	All			HB325X.720		HB518X.642
740i		1995				HB325X.720		
740i		1995		E38 model		HB325X.720		HB518X.642
740i		1997-2001	All			HB325X.720		HB518X.642
740i		1997				HB325X.720		
740i		1997		E38 model		HB325X.720		HB518X.642
740i		1998-2001				HB325X.720		HB518X.642
740i		2011-2013	All					HB630X.626
740i		2011-2013						HB630X.626
740i		2011-2015		34116793021		HB551X.748		
740i		2014-2015		34216793025				HB630X.626
740iL		1993-1994	All			HB135X.642		HB227X.630
740iL		1993-1994		E32 model		HB135X.642		HB227X.630
740iL		1995-1998	All			HB325X.720		HB518X.642
740iL		1995-1997				HB325X.720		
740iL		1995-1997		E38 model		HB325X.720		HB518X.642
740iL		1998-2001				HB325X.720		HB518X.642
740Ld xDrive		2015		34116793021		HB551X.748		
740Ld xDrive		2015		34216793025				HB630X.626
740Li		2011-2013						HB630X.626
740Li		2011-2015		34116793021		HB551X.748		
740Li		2014-2015		34216793025				HB630X.626
740Li xDrive		2013						HB630X.626
740Li xDrive		2013-2015		34116793021		HB551X.748		
740Li xDrive		2014-2015		34216793025				HB630X.626
745i		2002-2005	All	Wear sensor, front pads, F & Z only		HB551X.748		HB630X.626
745i		2002-2005		E65		HB551X.748		HB630X.626
745Li		2002-2005	All	Wear sensor, front pads, F & Z only		HB551X.748		HB630X.626

BRAKE PAD APPLICATIONS



MAKE/ MODEL	SUBMODEL	YEARS	ENGINE (LITER)	NOTE	FRONT		REAR	
					OES	HB SERIES	OES	HB SERIES
BMW CONTINUED								
745Li		2002-2005		E65		HB551X.748		HB630X.626
750i		2006-2008	All	Wear sensor, front pads, F & Z only		HB551X.748		HB630X.626
750i		2006-2008				HB551X.748		HB630X.626
750i		2009		34216790966				HB630X.626
750i		2009-2010		34116775322		HB551X.748		
750i		2010-2014	All					HB630X.626
750i	Xdrive	2010-2014	All					HB630X.626
750i		2011-2015		34116793021		HB551X.748		
750i		2015		34216793025				HB630X.626
750i xDrive		2010-2015		34116793021		HB551X.748		
750i xDrive		2010-2015		34216793025				HB630X.626
750iL		1988-1994	All			HB135X.770		HB227X.630
750iL		1988-1990				HB135X.642		HB227X.630
750iL		1991-1994		E32 model		HB135X.642		HB227X.630
750iL		1995-1997		E38 model		HB497X.776		HB518X.642
750iL		1996-2001	All			HB497X.776		HB518X.642
750iL		1998-2001				HB497X.776		HB518X.642
750Li		2006-2009	All	Wear sensor, front pads, F & Z only		HB551X.748		HB630X.626
750Li		2006-2008				HB551X.748		HB630X.626
750Li		2010-2014	All					HB630X.626
750Li	Xdrive	2010-2014	All					HB630X.626
750Li		2010		34116775322		HB551X.748		
750Li		2011-2015		34116793021		HB551X.748		
750Li		2015		34216793025				HB630X.626
750Li xDrive		2010-2015		34116793021		HB551X.748		
750Li xDrive		2010-2015		34216793025				HB630X.626
760i		2004-2006	All	Wear sensor, front pads, F & Z only		HB551X.748		HB630X.626
760i		2004				HB551X.748		HB630X.626
760i		2005		From 3/05		HB551X.748		HB630X.626
760i		2005		To 3/05		HB551X.748		HB630X.626
760i		2006				HB551X.748		HB630X.626
760Li		2003-2007	All	Wear sensor, front pads, F & Z only		HB551X.748		HB630X.626
760Li		2003-2004				HB551X.748		HB630X.626
760Li		2005		From 3/05		HB551X.748		HB630X.626
760Li		2005		To 3/05		HB551X.748		HB630X.626
760Li		2006-2008				HB551X.748		HB630X.626
760Li		2010-2014	All					HB630X.626
760Li		2010-2012						HB630X.626
760Li		2015		34216790966				HB630X.626
840Ci		1994-1997	All			HB181X.660		HB362X.642
840Ci		1994-1997				HB181X.590		
840Ci		1994-1997		840Ci, 850Ci		HB181X.660		HB362X.642
850Ci		1993	All			HB325X.720		HB362X.642
850Ci		1993				HB325X.720		
850Ci		1993		850i, 850Ci		HB325X.720		HB362X.642
850Ci		1994-1997	All			HB181X.660		HB362X.642
850Ci	1 Piston Caliper Front	1994		34111160296		HB325X.720		
850Ci		1994		1 Piston Caliper Front		HB325X.720		
850Ci		1994-1997				HB181X.590		
850Ci		1994-1997		840Ci, 850Ci		HB181X.660		HB362X.642
850CSi		1994-1995	All			HB325X.720		HB362X.642
850CSi		1994-1995				HB325X.720		
850CSi		1994-1995		850CSi		HB325X.720		HB362X.642
850i		1991-1992	All			HB325X.720		HB362X.642
850i		1991-1992				HB325X.720		

BRAKE PAD APPLICATIONS



Hawk Performance - BRAKE PAD APPLICATIONS

HB **245** **x** **.631**
 HAWK BRAKE PAD SHAPE INSERT COMPOUND CODE PAD THICKNESS

MAKE/ MODEL	SUBMODEL	YEARS	ENGINE (LITER)	NOTE	FRONT		REAR	
					OES	HB SERIES	OES	HB SERIES
BMW CONTINUED								
850i		1991-1992		850i, 850Ci		HB325X.720		HB362X.642
ActiveHybrid 3		2013-2015		Blue Caliper				HB766X.624
ActiveHybrid 5		2012-2015						HB751X.675
ActiveHybrid 5		2012-2016				HB768X.714		
ActiveHybrid 7		2013-2015		34116793021		HB551X.748		
ActiveHybrid 7		2013-2015		34216793025				HB630X.626
Alpina B7		2007-2008	All			HB676X.780		HB630X.626
Alpina B7		2007-2008				HB676X.780		HB630X.626
Alpina B7		2011-2013						HB630X.626
Alpina B7		2014-2015		34216793025				HB630X.626
Alpina B7 xDrive		2011-2015		34216793025				HB630X.626
Alpina B7L		2011-2015		34216793025				HB630X.626
Alpina B7L xDrive		2011-2015		34216793025				HB630X.626
Bavaria		1972-1974				HB206X.565		HB713X.585
i3		2014				HB570X.666		
i3		2014		34116862309		HB570X.666		
L6		1987		34111157510		HB137X.690		
L6		1987		34211157925				HB399X.630
L7		1986-1987		34211157925				HB399X.630
M235i		2014-2016						HB766X.624
M235i xDrive		2015-2016						HB766X.624
M3		1988-1991	All			HB137X.690		HB227X.630
M3		1988-1990				HB137X.690		HB227X.630
M3		1995-1999	All			HB135X.770		HB227X.630
M3		1995-1999				HB135X.642		HB227X.630
M3		2001-2002	All			HB135X.770		HB518X.642
M3		2001-2005				HB135X.642		HB518X.642
M3		2003-2005	All			HB464X.764		HB518X.642
M3		2006	All			HB464X.764		
M3		2006	All					HB518X.642
M3		2006		Excluding Euro Spec or Competition Models		HB135X.642		HB518X.642
M3		2006		With Competition Package				HB518X.642
M3		2008-2013	All	Wear sensor, front pads, F & Z only		HB551X.748		HB630X.626
M3		2008-2012				HB551X.748		HB630X.626
M3		2015-2016						HB766X.624
M4		2015-2016						HB766X.624
M5		1988	All			HB206X.565		
M5		1988				HB206X.565		HB399X.630
M5		1991-1993	All			HB135X.770		HB227X.630
M5		1991-1993				HB135X.642		HB227X.630
M5		2000-2003	All			HB325X.720		HB518X.642
M5		2000-2003				HB325X.720		
M5		2000-2003		E39		HB325X.720		HB518X.642
M5		2006-2010	All			HB676X.780		HB630X.626
M5		2006-2009		E60		HB676X.780		HB630X.626
M5		2010				HB676X.780		HB630X.626
M6		1987-1988	All			HB206X.565		
M6		1987-1988		34212226013				HB399X.630
M6		2006-2010	All			HB676X.780		HB630X.626
M6		2006-2009		E63, E64		HB676X.780		HB630X.626
M6		2010				HB676X.780		HB630X.626
X1	S Drive 28i	2012	All			HB534X.750		HB621X.638
X1	XDrive 28i	2012-2014	All			HB551X.748		HB621X.638
X1	XDrive 35i	2012-2014	All			HB551X.748		HB624X.642
X1	xDrive28i	2012-2015		34116790759		HB551X.748		

BRAKE PAD APPLICATIONS



MAKE/ MODEL	SUBMODEL	YEARS	ENGINE (LITER)	NOTE	FRONT		REAR	
					OES	HB SERIES	OES	HB SERIES
BMW CONTINUED								
X1	xDrive35i	2012-2015		34116794920		HB551X.748		
X1	S Drive 28i	2013-2014	All			HB551X.748		HB621X.638
X1		2013		AWD		HB464X.764		HB518X.642
X1		2013		RWD		HB464X.764		HB518X.642
X1	sDrive28i	2013-2015		34116790759		HB551X.748		
X1	sDrive28i	2015		34216790761				HB621X.638
X1	xDrive28i	2015		34216790761				HB621X.638
X1	xDrive35i	2015		34216790762				HB624X.642
X3		2004-2010	All			HB464X.764		HB518X.642
X3		2004-2010				HB464X.764		HB518X.642
X3		2011		E83 Chassis		HB464X.764		HB518X.642
X3		2011		F25 Chassis		HB748X.723		
X3		2011-2016				HB748X.723		HB751X.675
X4		2015-2016				HB748X.723		HB751X.675
X5	4.4i	2000-2006	All	Will not fit 4.6iS.		HB325X.720		HB518X.642
X5		2000-2001				HB325X.720		HB518X.642
X5	3.0i	2001-2006	All	Will not fit 4.6iS.		HB325X.720		HB518X.642
X5		2002-2003		3.0L or 4.4L		HB325X.720		HB518X.642
X5		2002-2003		4.6is				HB518X.642
X5		2002-2006				HB325X.720		
X5		2004		3.0L or 4.4L with solid rear disc		HB325X.720		HB518X.642
X5		2004-2006		4.4L with vented rear disc		HB325X.720		HB518X.642
X5		2005-2006		3.0L with solid rear disc		HB325X.720		HB518X.642
X5		2005-2006		4.8iS				HB518X.642
X5	3.0si	2007-2008	All			HB708X.738		HB458X.642
X5	4.8i	2007-2008	All			HB708X.738		HB630X.626
X5		2007-2008		3.0Si		HB708X.738		HB458X.642
X5		2007-2008		4.8i		HB708X.738		
X5	Xdrive30i	2009-2010	All			HB708X.738		HB458X.642
X5	Xdrive48i	2009-2010	All			HB708X.738		HB630X.626
X5	Xdrive35d	2009-2014	All			HB708X.738		HB458X.642
X5		2009		xDrive30i; xDrive35d		HB708X.738		HB458X.642
X5		2009		xDrive48i		HB708X.738		
X5	xDrive48i	2009-2010		34216768471				HB630X.626
X5		2010		xDrive 30i		HB708X.738		HB458X.642
X5		2010		xDrive 48i		HB708X.738		
X5	M	2010		34216794879				HB630X.626
X5		2010-2012		xDrive 35d		HB708X.738		HB458X.642
X5	Xdrive35i	2011-2014	All			HB708X.738		HB458X.642
X5	Xdrive50i	2011-2014	All					HB630X.626
X5		2011-2012		xDrive 35i		HB708X.738		HB458X.642
X5	M	2015		34216794879				HB630X.626
X5	sDrive35i	2015		34116857096		HB708X.738		
X5	sDrive35i	2015		34216868497				HB458X.642
X5	xDrive35d	2015		34116857096		HB708X.738		
X5	xDrive35d	2015		34216868497				HB458X.642
X5	xDrive35i	2015		34116857096		HB708X.738		
X5	xDrive35i	2015		34216868497				HB458X.642
X5	xDrive50i	2015		34216857117				HB630X.626
X5	M	2016						HB630X.626
X5	sDrive35i	2016				HB708X.738		HB458X.642
X5	xDrive35d	2016				HB708X.738		HB458X.642
X5	xDrive35i	2016				HB708X.738		HB458X.642
X5	xDrive50i	2016						HB630X.626
X6	Xdrive35i	2008-2009	All			HB708X.738		HB630X.626

BRAKE PAD APPLICATIONS



Hawk Performance - BRAKE PAD APPLICATIONS

HB
HAWK BRAKE

245
PAD SHAPE

x
INSERT COMPOUND CODE

.631
PAD THICKNESS

MAKE/ MODEL	SUBMODEL	YEARS	ENGINE (LITER)	NOTE	FRONT		REAR	
					OES	HB SERIES	OES	HB SERIES
BMW CONTINUED								
X6	Xdrive50i	2008-2012	All					HB630X.626
X6		2008-2009		XDrive35i		HB708X.738		
X6	xDrive35i, Rear from 10/2008	2009		34216776937				HB458X.642
X6	Xdrive35i	2010-2014	All			HB708X.738		HB458X.642
X6		2010-2012		XDrive35i		HB708X.738		HB458X.642
X6	xDrive50i	2013-2014		34216768471				HB630X.626
X6	M	2013-2015		34216794879				HB630X.626
X6	sDrive35i	2015		34116857096		HB708X.738		
X6	sDrive35i	2015		34216868497				HB458X.642
X6	xDrive35i	2015		34116857096		HB708X.738		
X6	xDrive35i	2015		34216868497				HB458X.642
X6	xDrive50i	2015		34216857117				HB630X.626
X6	M	2016						HB630X.626
X6	sDrive35i	2016				HB708X.738		HB458X.642
X6	xDrive35i	2016				HB708X.738		HB458X.642
X6	xDrive50i	2016						HB630X.626
Z3	Roadster	1996-1999	All			HB136X.690		HB227X.630
Z3		1996-1997		6 Cylinder		HB136X.690		HB227X.630
Z3		1996-1998		4 Cylinder		HB136X.690		HB227X.630
Z3		1998	1.9L	34211162446				HB227X.630
Z3	M Roadster	1998-2002	All			HB135X.770		HB227X.630
Z3		1998		6 Cylinder exc. M series		HB136X.690		HB227X.630
Z3	2.8L	1998		34116761244		HB546X.654		
Z3	2.8L	1998		34216761238				HB227X.630
Z3		1998-2002		M series		HB135X.642		HB227X.630
Z3	Coupe	1999-2000	All			HB546X.654		HB227X.630
Z3	M Coupe	1999-2002	All			HB135X.770		HB227X.630
Z3		1999-2000		Except M series		HB136X.690		HB227X.630
Z3		1999-2002		34211165233				HB227X.630
Z3	Roadster	2000	All			HB546X.654		HB227X.630
Z3	Coupe	2001-2002	2.5L			HB546X.654		HB227X.630
Z3	Roadster	2001-2002	2.5L			HB546X.654		HB227X.630
Z3	Coupe	2001-2002	3.0L					HB227X.630
Z3	Roadster	2001-2002	3.0L					HB227X.630
Z3		2001-2002		2.5L		HB136X.690		HB227X.630
Z3		2001-2002		3.0L		HB136X.690		HB227X.630
Z4	Roadster	2003	2.5L			HB546X.654		HB227X.630
Z4		2003		2.5i		HB136X.690		
Z4		2003		2.5i				HB227X.630
Z4		2003-2008		3.0i		HB136X.690		HB227X.630
Z4	2.5i	2004-2005	2.5L			HB546X.654		HB227X.630
Z4	3.0i	2004-2005	3.0L			HB546X.654		HB227X.630
Z4		2004-2005		2.5i		HB136X.690		HB227X.630
Z4	2.5L	2004-2005		34216761239				HB227X.630
Z4	Coupe 3.0si	2006-2008	3.0L			HB464X.764		HB227X.630
Z4	Roadster 3.0i	2006-2008	3.0L			HB546X.654		HB227X.630
Z4	Roadster 3.0si	2006-2008	3.0L			HB464X.764		
Z4	M Coupe	2006-2008	All			HB464X.764		HB518X.642
Z4	M Roadster	2006-2008	All			HB464X.764		HB518X.642
Z4	3.0Si	2006-2007		34216761241				HB227X.630
Z4	Roadster 3.0i	2006-2007		34216761241				HB227X.630
Z4		2006-2008		3.0Si		HB464X.764		HB227X.630
Z4		2006-2008		M3.2				HB518X.642
Z4		2009-2010	All			HB534X.750		HB669X.671
Z4		2009-2010		SDrive30i		HB534X.750		HB669X.671

BRAKE PAD APPLICATIONS

MAKE/ MODEL	SUBMODEL	YEARS	ENGINE (LITER)	NOTE	FRONT		REAR	
					OES	HB SERIES	OES	HB SERIES
BMW CONTINUED								
Z4		2009-2010		SDrive35i		HB534X.750		HB669X.671
Z4	Sdrive30i	2011-2012	All			HB534X.750		HB669X.671
Z4	Sdrive35is	2011-2012	All	Wear sensor, front pads, F & Z only		HB551X.748		
Z4	Sdrive35i	2011-2014	All			HB534X.750		HB669X.671
Z4		2011		SDrive30i; SDrive 35i		HB534X.750		HB669X.671
Z4	sDrive35is	2011		34116783542		HB551X.748		
Z4		2011-2013		SDrive35is		HB551X.748		
Z4		2011-2013		SDrive35is		HB733X.748		
Z4	sDrive35is	2011-2016						HB751X.675
Z4		2012-2013		SDrive28i; 30i; 35i		HB534X.750		HB669X.671
Z4	sDrive35is	2012-2016		34116794917		HB551X.748		
Z4	sDrive28i	2015-2016		34116797858		HB534X.750		
Z4	sDrive28i	2015-2016		34216797861				HB669X.671
Z4	sDrive35i	2015-2016		34116797858		HB534X.750		
Z4	sDrive35i	2015-2016		34216797861				HB669X.671
Z8		2000-2003				HB497X.776		HB518X.642
Z8	Alpina Roadster	2003	All			HB497X.776		
BUICK								
Allure		2005-2007				HB360X.670		HB450X.555
Allure		2008-2009		V6 Models		HB360X.670		HB450X.555
Allure		2008-2009		V8 Models		HB535X.638		HB359X.543
Allure		2009	All			HB535X.638		HB359X.543
Apollo		1973-1975	All		770052	HB103X.590		
Apollo	SR	1975	All		770052	HB103X.590		
Apollo		1975						HB119X.594
Centurion		1971				HB103X.590		
Centurion		1972-1973	All		770052	HB103X.590		
Century		1972				HB103X.590		
Century	Station Wagon	1972				HB103X.590		HB119X.594
Century	Luxus	1973-1974	All		770052	HB103X.590		
Century		1973-1977	All		770052	HB103X.590		
Century		1973-1975						HB119X.594
Century	Custom	1975-1977	All		770052	HB103X.590		
Century	Special	1975-1977	All		770052	HB103X.590		
Century		1977						HB235X.665
Century	Custom	1978-1979	All		770154	HB119X.594		
Century	Special	1978-1979	All		770154	HB119X.594		
Century	Sport	1978-1979	All		770154	HB119X.594		
Century	Limited	1978-1981	All		770154	HB119X.594		
Century		1978-1981				HB119X.594		
Century		1980-1981	All		770154	HB119X.594		
Century	Sport	1980			770154	HB119X.594		
Century	Estate Wagon	1981	All		770154	HB119X.594		
Century	Custom	1982	All	10-1/4 inch Front Disc	770289	HB400X.630		
Century	Custom	1982	All	9-3/4 inch Front Disc	770289	HB400X.630		
Century	Custom	1982-1986	All			HB396X.630		
Century	T-Type	1983-1986	All	w/Heavy Duty Brakes		HB396X.630		
Century	T-Type	1983-1986	All	w/Standard Brakes		HB400X.630		
Century	Limited	1983-1993	All	w/ 100mm Bolt Circle		HB396X.630		
Century	Limited	1983-1993	All	w/ 115mm Bolt Circle		HB396X.630		
Century		1983-1984				HB400X.630		
Century	Estate Wagon	1984-1985	All	w/ 100mm Bolt Circle		HB396X.630		
Century	Estate Wagon	1984-1985	All	w/ 115mm Bolt Circle		HB396X.630		
Century	Estate Wagon	1984-1986	All	w/ 100mm Bolt Circle	770289	HB400X.630		
Century	Estate Wagon	1984-1986	All	w/ 115mm Bolt Circle	770289	HB400X.630		

BRAKE PAD APPLICATIONS



Hawk Performance - BRAKE PAD APPLICATIONS

HB **245** **x** **.631**
 HAWK BRAKE PAD SHAPE INSERT COMPOUND CODE PAD THICKNESS

MAKE/ MODEL	SUBMODEL	YEARS	ENGINE (LITER)	NOTE	FRONT		REAR	
					OES	HB SERIES	OES	HB SERIES
BUICK CONTINUED								
Century	Light Duty	1985-1989		18024902		HB400X.630		
Century	Custom	1987-1989	All	w/Heavy Duty Brakes, w/ 100mm Bolt Circle		HB396X.630		
Century	Custom	1987-1989	All	w/Heavy Duty Brakes, w/ 115mm Bolt Circle		HB396X.630		
Century	Custom	1987-1989	All	w/Standard Brakes		HB400X.630		
Century	Estate Wagon	1987-1989	All	w/Heavy Duty Brakes, w/ 100mm Bolt Circle		HB396X.630		
Century	Estate Wagon	1987-1989	All	w/Heavy Duty Brakes, w/ 115mm Bolt Circle		HB396X.630		
Century	Custom	1987-1989	All	w/Standard Brakes, w/ 100mm Bolt Circle	770289	HB400X.630		
Century	Custom	1987-1989	All	w/Standard Brakes, w/ 115mm Bolt Circle	770289	HB400X.630		
Century	Estate Wagon	1987-1989	All	w/Standard Brakes, w/ 100mm Bolt Circle	770289	HB400X.630		
Century	Estate Wagon	1987-1989	All	w/Standard Brakes, w/ 115mm Bolt Circle	770289	HB400X.630		
Century		1987-1989		18024919		HB396X.630		
Century	Custom	1990-1996	All			HB396X.630		
Century	Special	1990-1996	All			HB396X.630		
Century		1990-1996				HB396X.630		
Century		1993		18019347				HB359X.543
Century		1994-1996		18048649				HB359X.543
Century	Custom	1997-2000	All		770699	HB360X.670		
Century	Limited	1997-2005	All			HB360X.670		
Century		1997-2000		18048650				HB359X.543
Century		1997-2003				HB360X.670		
Century	Custom	2001-2005	All		770699	HB360X.670	770508	HB359X.543
Century		2003	All		770699	HB360X.670	770508	HB359X.543
Century		2004-2005				HB360X.670		HB359X.543
Century	Special Edition	2005	All		770699	HB360X.670	770508	HB359X.543
Electra		1970-1971				HB103X.590		
Electra	225 Custom	1972-1975	All		770052	HB103X.590		HB235X.665
Electra	225	1972-1978	All			HB103X.590		HB235X.665
Electra	225	1972-1979	All		770052			
Electra		1973	All		770052	HB103X.590		HB235X.665
Electra	225 Limited	1974-1977	All		770052	HB103X.590		HB235X.665
Electra	Limited	1976	All			HB103X.590		HB235X.665
Electra	Limited	1976-1984	All		770052			
Electra	Limited	1977-1984	All			HB103X.590		
Electra	Park Avenue	1978	All			HB103X.590		HB235X.665
Electra	Park Avenue	1978-1984	All		770052			
Electra		1978						HB103X.590
Electra	Wagon	1978						HB235X.665
Electra		1978-1984						HB235X.665
Electra	225	1979	All			HB103X.590		
Electra	Park Avenue	1979-1984	All			HB103X.590		
Electra	Estate Wagon	1980-1989	All		770052	HB103X.590		
Electra	300	1985	All	FWD		HB396X.630		
Electra	Park Avenue	1985-1990	All			HB396X.630		
Electra	T-Type	1985-1990	All			HB396X.630		
Electra		1986	All	FWD		HB396X.630		
Electra	Limited	1987-1990	All	FWD		HB396X.630		
Electra	Ultra	1989	All	FWD		HB396X.630		
Electra	Park Avenue Ultra	1990	All	FWD		HB396X.630		
Enclave		2008-2014	All			HB617X.630		HB383X.685
Enclave		2008-2014				HB617X.630		HB383X.685
Enclave		2015		15911562		HB617X.630		
Enclave		2015		22866196				HB383X.685
Encore		2013						HB707X.638
Encore		2014-2015		13408579				HB707X.638
Estate Wagon		1970-1971				HB103X.590		

BRAKE PAD APPLICATIONS



MAKE/ MODEL	SUBMODEL	YEARS	ENGINE (LITER)	NOTE	FRONT		REAR	
					OES	HB SERIES	OES	HB SERIES
BUICK CONTINUED								
Estate Wagon		1972-1979	All		770052	HB103X.590		
Estate Wagon		1977-1979						HB235X.665
GS		1970-1971				HB103X.590		
GS		1972	All		770052	HB103X.590		
GS 455		1970-1971				HB103X.590		
GS 455		1972	All		770052	HB103X.590		
LaCrosse		2005-2007				HB360X.670		HB450X.555
LaCrosse		2008-2009		CX, CXL; 3.8L		HB360X.670		HB450X.555
LaCrosse		2008-2009		Super; 5.3L		HB535X.638		HB359X.543
LaCrosse	Super	2008-2009		88967229				HB359X.543
LeSabre		1970-1971				HB103X.590		
LeSabre		1972-1981	All		770052	HB103X.590		
LeSabre	Custom	1972-1990	All		770052	HB103X.590		
LeSabre	Luxus	1974	All		770052	HB103X.590		
LeSabre		1977-1984						HB119X.594
LeSabre	Sport	1978-1980	All		770052	HB103X.590		
LeSabre		1978						HB103X.590
LeSabre	Limited	1979-1985	All		770052	HB103X.590		
LeSabre	Estate Wagon	1980-1990	All		770052	HB103X.590		
LeSabre	Estate Wagon	1980-1984						HB235X.665
LeSabre		1985		18029594				HB119X.594
LeSabre	Limited	1986-1991	All			HB396X.630		
LeSabre		1987-1991	All			HB396X.630		
LeSabre		1990		Exc. Wagon		HB396X.630		
LeSabre		1991				HB396X.630		
LeSabre		1991		18019286				HB359X.543
LeSabre		1992-1993		18024915		HB103X.590		
LeSabre		1992-1994		18048649				HB359X.543
LeSabre	Custom	1994-1998	All			HB217X.681		
LeSabre	Limited	1994-1998	All			HB217X.681		
LeSabre		1994-1999				HB217X.681		
LeSabre		1995		18023301				HB359X.543
LeSabre		1996-1999		19152686				HB359X.543
LeSabre		1999	All			HB217X.681		
LeSabre	Custom	2000-2005	All	w/12 in. Front Discs	770699	HB360X.670	770508	HB359X.543
LeSabre	Limited	2000-2005	All	w/12 in. Front Discs	770699	HB360X.670	770508	HB359X.543
LeSabre	16" Wheels	2000-2003		18045380		HB360X.670		
LeSabre		2000-2004		16" Wheels with 12" Front Rotors		HB360X.670		HB359X.543
LeSabre	16" Wheels	2000-2004		18043999				HB359X.543
LeSabre		2000-2005		15" Wheels with 11" Front Rotors		HB360X.670		HB359X.543
LeSabre	15" Wheels	2000-2005		18043999				HB359X.543
LeSabre	16" Wheels	2004		88964119		HB536X.704		
LeSabre	16" Wheels, Front: From Vin 129026	2005		18043999				HB359X.543
LeSabre	16" Wheels, Front: To Vin 129025	2005		18045380		HB360X.670		
LeSabre		2005		16" Wheels with 12" Front Rotors		HB536X.704		HB359X.543
Lucerne		2006-2011		V6 Models		HB535X.638		
Lucerne		2006-2011		V8 Models		HB535X.638		
Park Avenue		1991-1993		18024915		HB103X.590		
Park Avenue		1991-1995		18048649				HB359X.543
Park Avenue		1994-1996				HB217X.681		
Park Avenue		1996		18023301				HB359X.543
Park Avenue		1997		Rear Disc Brakes		HB360X.670		HB359X.543
Park Avenue		1997		Rear Drum Brakes		HB360X.670		
Park Avenue		1998-2002				HB360X.670		HB359X.543

BRAKE PAD APPLICATIONS



Hawk Performance - BRAKE PAD APPLICATIONS

HB **245** **x** **.631**
 HAWK BRAKE PAD SHAPE INSERT COMPOUND CODE PAD THICKNESS

MAKE/ MODEL	SUBMODEL	YEARS	ENGINE (LITER)	NOTE	FRONT		REAR	
					OES	HB SERIES	OES	HB SERIES
BUICK CONTINUED								
Park Avenue		2003-2005		Except Ultra		HB360X.670		HB359X.543
Park Avenue		2003-2005		Ultra		HB360X.670		HB359X.543
Rainier		2004-2005		with 6 Cyl. Engine		HB382X.657		HB383X.685
Rainier		2004-2005		with V8 Engine		HB382X.657		HB383X.685
Rainier		2006-2007		with 6 Cyl. Engine		HB617X.630		HB383X.685
Rainier		2006-2007		with V8 Engine		HB617X.630		HB383X.685
Regal		1973-1976				HB103X.590		
Regal		1973-1977			770052			
Regal		1977				HB103X.590		HB235X.665
Regal	Base, Limited, Sport	1978-1981				HB119X.594		
Regal		1978-1984				HB119X.594		
Regal	Sport, Estate Wagon, Limited, Type-T, Base	1982				HB119X.594		
Regal	Sport, Estate Wagon, Limited, Type-T, Base	1983				HB119X.594		
Regal	Sport, Estate Wagon, Limited Type-T, Base, Grand National	1984-1987				HB119X.594		
Regal	Custom	1988-1993	All			HB232X.681		
Regal	Limited	1988-1996	All			HB232X.681		
Regal		1988-1993				HB232X.681		
Regal	Gran Sport	1992-1996	All			HB232X.681		
Regal	Custom	1994-1996	All			HB232X.681		HB359X.543
Regal		1994				HB232X.681		HB359X.543
Regal		1995		267mm diameter front rotor		HB232X.681		HB359X.543
Regal		1995		286mm diameter front rotor		HB232X.681		HB359X.543
Regal		1996				HB232X.681		HB359X.543
Regal	GS	1997-2004	All		770699	HB360X.670	770508	HB359X.543
Regal	LS	1997-2004	All		770699	HB360X.670	770508	HB359X.543
Regal		1997-2004				HB360X.670		HB359X.543
Regal		1999-2004	All			HB360X.670		HB359X.543
Regal	Turbo GS	2012-2013	All		771001	HB453X.585		
Regal		2012-2013		Brembo Front Caliper; Vented Rear Rotor	771001	HB453X.585		
Regal	GS	2014-2015		13329562		HB453X.585		
Rendezvous		2002-2005	All			HB373X.689		HB359X.543
Rendezvous		2002-2007		2WD		HB373X.689		HB359X.543
Rendezvous		2002-2007		AWD		HB373X.689		HB359X.543
Rendezvous	Ultra	2004-2005	All			HB373X.689		HB359X.543
Rendezvous	CXL Plus	2005	All			HB373X.689		HB359X.543
Rendezvous	CX	2006-2007	All			HB373X.689		HB359X.543
Rendezvous	CXL	2006-2007	All			HB373X.689		HB359X.543
Riviera		1969-1971				HB103X.590		
Riviera		1972-1978	All		770052	HB103X.590		HB103X.590
Riviera		1977-1978						HB235X.665
Riviera	S	1979	All			HB119X.594		HB119X.594
Riviera		1979-1985	All			HB119X.594		HB119X.594
Riviera	S	1980				HB119X.594		HB119X.594
Riviera	T-Type	1981-1985	All			HB119X.594		HB119X.594
Riviera		1992-1993						HB359X.543
Riviera		1992-1993		18024915		HB103X.590		
Riviera		1995-1996				HB217X.681		HB359X.543
Riviera		1997-1999				HB360X.670		HB359X.543
Roadmaster	Base, Estate	1991			770052	HB103X.590		
Roadmaster	Limited	1992-1995				HB103X.590		
Roadmaster	Limited, Limited Wagon	1996				HB103X.590		
Skyhawk		1975	All		770052	HB103X.590		

BRAKE PAD APPLICATIONS



MAKE/ MODEL	SUBMODEL	YEARS	ENGINE (LITER)	NOTE	FRONT		REAR	
					OES	HB SERIES	OES	HB SERIES
BUICK CONTINUED								
Skyhawk		1976-1980						HB119X.594
Skyhawk	Custom	1982-1987	All			HB400X.630		
Skyhawk	Limited	1982-1987	All			HB400X.630		
Skyhawk	Sport	1986-1987	All			HB400X.630		
Skyhawk		1988-1989	All			HB400X.630		
Skylark		1968						HB119X.594
Skylark		1969-1971				HB103X.590		
Skylark	Sports Wagon	1971				HB103X.590		HB119X.594
Skylark		1972	All		770052	HB103X.590		
Skylark	Custom	1972	All		770052	HB103X.590		
Skylark	Sports Wagon	1972						HB119X.594
Skylark	SR	1975-1977	All		770052	HB103X.590		
Skylark		1975-1979	All		770052	HB103X.590		
Skylark	Custom	1975-1979	All		770052	HB103X.590		
Skylark	S	1976-1979	All		770052	HB103X.590		
Skylark		1976-1979						HB119X.594
Skylark		1980-1982	All			HB400X.630		
Skylark	Sport	1980-1982	All			HB400X.630		
Skylark	Limited	1980-1989	All			HB400X.630		
Skylark		1981				HB400X.630		
Skylark	T-Type	1983-1984	All			HB400X.630		
Skylark	Custom	1983-1989	All			HB400X.630		
Skylark		1986-1989				HB400X.630		
Skylark		1990	All	w/o Performance Package		HB400X.630		
Skylark		1990	All	w/Performance Package		HB390X.602		
Skylark	Custom	1990	All	w/o Performance Package		HB400X.630		
Skylark	Custom	1990	All	w/Performance Package		HB390X.602		
Skylark	Gran Sport	1990	All	w/o Performance Package		HB400X.630		
Skylark	Gran Sport	1990	All	w/Performance Package		HB390X.602		
Skylark	Luxury Edition	1990	All	w/o Performance Package		HB400X.630		
Skylark	Luxury Edition	1990	All	w/Performance Package		HB390X.602		
Skylark		1990		Exc. Performance Package		HB400X.630		
Skylark		1990		Performance Package		HB390X.602		
Skylark	Luxury Edition	1991	All			HB390X.602		
Skylark		1991-1992	All			HB390X.602		
Skylark	Custom	1991-1997	All			HB390X.602		
Skylark	Gran Sport	1991-1997	All			HB390X.602		
Skylark		1991-1998				HB390X.602		
Skylark	Limited	1993-1997	All			HB390X.602		
Skylark		1998	All			HB390X.602		
Somersset	T-Type	1986	All			HB400X.630		
Somersset		1986-1987	All			HB400X.630		
Somersset	Limited	1986-1987	All			HB400X.630		
Somersset Regal		1985		18024902		HB400X.630		
Sportwagon		1969-1970				HB103X.590		
Sportwagon		1971				HB103X.590		HB119X.594
Sportwagon		1972	All		770052	HB103X.590		
Sportwagon		1972						HB119X.594
Terraza	CX, CXL	2005-2006		AWD or FWD Special Suspension		HB360X.670		
Terraza	CX, CXL	2005-2006		FWD; Except Special Suspension		HB360X.670		
Terraza	CX, CXL	2007				HB360X.670		
Verano		2012-2013						HB383X.685
Verano		2014-2015		13319293				HB707X.638
Wildcat		1970				HB103X.590		

Hawk Performance - BRAKE PAD APPLICATIONS

HB **245** **x** **.631**
 HAWK BRAKE PAD SHAPE INSERT COMPOUND CODE PAD THICKNESS

MAKE/ MODEL	SUBMODEL	YEARS	ENGINE (LITER)	NOTE	FRONT		REAR	
					OES	HB SERIES	OES	HB SERIES
CADILLAC								
60 Special		1993		18024915		HB103X.590		
60 Special		1993		18048649				HB359X.543
60 Special	HD Brakes	1993		89026844		HB332X.654		
Allante		1993						HB359X.543
Allante		1993		18024915		HB103X.590		
ATS		2013	All			HB453X.585		
ATS		2013	All	w/ Brembo Front Caliper		HB453X.585		
ATS		2013		J55 HD Brake Package		HB453X.585		HB746X.645
ATS		2013		JE5 Standard Brake Package				HB746X.645
ATS	Brembo Front Brake	2013		22866931		HB453X.585		
ATS		2013-2015		Brembo Front Brake				HB746X.645
ATS		2013-2015		Performance				HB746X.645
ATS	Performance	2013-2015		22791925		HB453X.585		
ATS		2013-2016						HB746X.645
ATS		2014-2015		22857904				HB746X.645
ATS	Brembo Front Brake	2014-2015		22857904				HB746X.645
ATS	Brembo Front Brake	2014-2015		23145627		HB453X.585		
ATS	Performance	2014-2015		22857909				HB746X.645
ATS	JE5 & JE2	2016		23316762				HB746X.645
Brougham		1987-1992		18024914		HB103X.590		
Calais		1970-1976				HB103X.590		
Catera		1997-2001				HB423X.709		
Cimarron		1982-1988	All			HB400X.630		
Cimarron		1985-1988	All		770289			
Commercial Chassis		1970-1974				HB103X.590		
Commercial Chassis		1975-1984	All		770052	HB103X.590		
Commercial Chassis		1991				HB332X.654		HB235X.665
Commercial Chassis		1992-1993				HB332X.654		
CTS		2003-2005		Sport Suspension; Except CTS-V		HB439X.555		HB440X.606
CTS		2003-2007		Standard Suspension; Except CTS-V		HB439X.555		HB440X.606
CTS		2004-2007		CTS-V; Brembo Calipers		HB453X.585		HB194X.570
CTS	V	2004-2007		89047725		HB453X.585		
CTS		2006-2007		Sport Suspension; Except CTS-V		HB467X.540		
CTS		2008		J55 Brake Package -339mm (13.3") Rear Rotor				HB639X.645
CTS		2008		JE5 Brake Package -315mm (12.4") Rear Rotor				HB639X.645
CTS		2008-2014						HB639X.645
CTS		2008-2014		Heavy Duty				HB639X.645
CTS		2009-2012		CTS-V		HB649X.605		HB194X.570
CTS		2009-2013		V6 -J55 Brake Package 339mm (13.3") Rear Rotor				HB639X.645
CTS		2009-2013		V6 - JE5 Brake Package 315mm (12.4") Rear Rotor				HB639X.645
CTS		2013		CTS-V with 2-Piece Front Rotors		HB649X.605		HB194X.570
CTS		2013		CTS-V with Co-Cast Front Rotors		HB649X.605		HB194X.570
CTS		2014		20962994				HB639X.645
CTS		2014		Vsport Performance				HB746X.645
CTS	Heavy Duty	2014		20876917				HB639X.645
CTS	Vsport Performance, Front OE to 03/2014 23441307 from 03/2014	2014		22857909				HB746X.645
CTS	Vsport Performance, Front OE to 03/2014 23441307 from 03/2014	2014		22976409		HB453X.585		
CTS		2014-2015		Sedan				HB746X.645
CTS	Sedan	2014-2015		22857904				HB746X.645
CTS	Sedan	2014-2015		23145627		HB453X.585		
CTS	V	2014-2015		25940447		HB649X.605		
CTS	V	2014-2015		89047744				HB194X.570

MAKE/ MODEL	SUBMODEL	YEARS	ENGINE (LITER)	NOTE	FRONT		REAR	
					OES	HB SERIES	OES	HB SERIES
CADILLAC CONTINUED								
CTS		2015						HB746X.645
CTS		2015		22857909				HB746X.645
CTS		2015		23441307				
DeVille		1970						
DeVille		1971-1984	All		770052			
DeVille		1977-1984						
DeVille		1985-1990	All					HB235X.665
DeVille	HD Brakes	1990		12321448				
DeVille		1991-1993		12510001				
DeVille		1991-1993		Heavy duty chassis				
DeVille		1992		18018757				HB359X.543
DeVille		1993		12510024				HB359X.543
DeVille		1994-1996	All					HB359X.543
DeVille	Concours	1994-1996	All					HB359X.543
DeVille		1994-1996						HB359X.543
DeVille	D-Elegance	1997	All		770699		770508	HB359X.543
DeVille		1997-1999	All					HB359X.543
DeVille	Concours	1997-1999	All					HB359X.543
DeVille		1997						HB359X.543
DeVille		1997		18029826				HB359X.543
DeVille	Rear Drum	1997		89026844				
DeVille		1997-2005		18045380				
DeVille		1998		Rear Drum				
DeVille		1998-1999		Rear Disc				HB359X.543
DeVille		1998-2001		18043999				HB359X.543
DeVille	Rear Drum	1999		89026844				
DeVille		2000-2005	All	w/Heavy Duty Brakes				HB359X.543
DeVille		2000-2005	All	w/Standard Brakes	770699		770508	HB359X.543
DeVille		2000-2004		Heavy duty brakes - 8 Lug				HB324X.673
DeVille		2000-2005		except heavy duty brakes				HB359X.543
DeVille	DHS	2001-2005	All	w/Heavy Duty Brakes				HB359X.543
DeVille	DHS	2001-2005	All	w/Standard Brakes				HB359X.543
DeVille	DTS	2001-2005	All	w/Heavy Duty Brakes				HB359X.543
DeVille	DTS	2001-2005	All	w/Standard Brakes				HB359X.543
DeVille		2002-2005		18043995				HB359X.543
DeVille		2005		Heavy duty brakes				HB324X.673
DTS		2006-2011		Hearse or Limo, w/ Heavy Duty Brakes				HB324X.673
DTS		2006-2011		Sedan w/ Standard Brakes				
Eldorado		1967-1970						
Eldorado		1971-1978	All		770052			
Eldorado		1976-1978						HB103X.590
Eldorado		1979-1985	All					HB119X.594
Eldorado	Biarritz	1984-1985	All					HB119X.594
Eldorado		1992-1993		12510001				HB103X.590
Eldorado	Base, Sport, Touring	1992-1993						HB359X.543
Eldorado	Base, Touring	1994-1996						HB359X.543
Eldorado	Base, Touring	1997						HB359X.543
Eldorado	ETC, Base	1998-2002						HB359X.543
ELR		2014-2015		13319293				HB707X.638
ELR	Performance	2015		13417473				HB707X.638
ELR	Performance	2015		23441307				
ELR		2016		13417473				HB707X.638
Escalade		1999-2000						HB332X.654
Escalade		2002						HB385X.640
Escalade	RWD	2002		89027010				HB494X.670

BRAKE PAD APPLICATIONS



Hawk Performance - BRAKE PAD APPLICATIONS

HB **245** **x** **.631**
 HAWK BRAKE PAD SHAPE INSERT COMPOUND CODE PAD THICKNESS

MAKE/ MODEL	SUBMODEL	YEARS	ENGINE (LITER)	NOTE	FRONT		REAR	
					OES	HB SERIES	OES	HB SERIES
CADILLAC CONTINUED								
Escalade	AWD	2002-2004		18045936				HB496X.640
Escalade		2003-2006		2WD/RWD		HB323X.724		HB494X.670
Escalade		2003-2006		4WD		HB323X.724		HB385X.640
Escalade	AWD	2005-2006		88964192				HB496X.640
Escalade	ESV, EXT	2007				HB561X.710		HB568X.666
Escalade	ESV, EXT	2008		Front caliper bracket cast number 285/286C		HB561X.710		HB568X.666
Escalade	ESV, EXT	2008		Front caliper bracket cast number 351/352C		HB561X.710		HB568X.666
Escalade	ESV, EXT	2009-2013				HB561X.710		HB568X.666
Escalade		2014		22742382		HB561X.710		
Escalade		2014		25949454				HB568X.666
Escalade		2015		23135915		HB561X.710		
Escalade		2015		23164777				HB568X.666
Escalade		2016		23487649		HB561X.710		
Escalade ESV	AWD	2003		18045936				HB496X.640
Escalade ESV	AWD	2003		18048101		HB323X.724		
Escalade ESV	RWD	2003		18048101		HB323X.724		
Escalade ESV	RWD	2003		88982614				HB494X.670
Escalade ESV		2004		18045936				HB496X.640
Escalade ESV		2004-2006		18048101		HB323X.724		
Escalade ESV		2005-2006		88964192				HB496X.640
Escalade ESV		2007		15792633				HB568X.666
Escalade ESV		2007		89059119		HB561X.710		
Escalade ESV		2008-2009		15945636				HB568X.666
Escalade ESV		2008-2011		25918342		HB561X.710		
Escalade ESV		2010-2014		25949454				HB568X.666
Escalade ESV		2012-2014		22742382		HB561X.710		
Escalade ESV		2015		23135915		HB561X.710		
Escalade ESV		2015		23164777				HB568X.666
Escalade EXT	RWD	2002		89027010				HB494X.670
Escalade EXT	AWD	2002-2003		18045936				HB496X.640
Escalade EXT	AWD	2002-2003		18048101		HB323X.724		
Escalade EXT	RWD	2002-2003		18048101		HB323X.724		
Escalade EXT	RWD	2003		88982614				HB494X.670
Escalade EXT		2004		18045936				HB496X.640
Escalade EXT		2004-2006		18048101		HB323X.724		
Escalade EXT		2005-2006		88964192				HB496X.640
Escalade EXT		2007		15792633				HB568X.666
Escalade EXT		2007		89059119		HB561X.710		
Escalade EXT		2008-2009		15945636				HB568X.666
Escalade EXT		2008-2011		25918342		HB561X.710		
Escalade EXT		2010-2013		25949454				HB568X.666
Escalade EXT		2012-2013		22742382		HB561X.710		
Fleetwood		1970				HB103X.590		
Fleetwood	60 Special	1971-1976	All		770052	HB103X.590		
Fleetwood	75	1971-1976	All		770052	HB103X.590		
Fleetwood		1971-1985	All		770052	HB103X.590		
Fleetwood	60 Special Brougham	1974	All		770052	HB103X.590		
Fleetwood	Brougham	1977	7.0L		770052	HB103X.590		
Fleetwood	Formal	1977-1984	All		770052	HB103X.590		
Fleetwood		1977						HB103X.590
Fleetwood	Brougham	1978	All		770052	HB103X.590		HB235X.665
Fleetwood		1979						HB119X.594
Fleetwood		1980-1984						HB235X.665
Fleetwood	Brougham	1981-1996	All		770052	HB103X.590		
Fleetwood	FWD	1985		18024918		HB396X.630		

BRAKE PAD APPLICATIONS



MAKE/ MODEL	SUBMODEL	YEARS	ENGINE (LITER)	NOTE	FRONT		REAR	
					OES	HB SERIES	OES	HB SERIES
CADILLAC CONTINUED								
Fleetwood	75	1986	All			HB396X.630		
Fleetwood		1986-1990	All			HB396X.630		
Fleetwood	D-Elegance	1987-1988	All			HB396X.630		
Fleetwood	60 Special	1987-1990	All			HB396X.630		
Fleetwood	HD Brakes	1990		18029805		HB332X.654		
Fleetwood		1991-1993	All		770369	HB332X.654		
Fleetwood		1991-1992		18024915		HB103X.590		
Fleetwood		1992		18019989				HB359X.543
Fleetwood		1992		Front wheel drive - heavy duty chassis		HB332X.654		
Fleetwood		1992		Rear wheel drive with ABS		HB103X.590		
Fleetwood		1992		Rear wheel drive without ABS		HB103X.590		
Fleetwood		1993-1996		with ABS 2" Wide Rear Shoe		HB103X.590		
Fleetwood		1993-1996		without ABS 2 3/4" Wide Rear Shoe		HB103X.590		
Seville		1976-1979	All		770052	HB103X.590		HB103X.590
Seville		1980-1985	All			HB119X.594		HB119X.594
Seville		1992-1993						HB359X.543
Seville		1992-1993		12510001		HB103X.590		
Seville	SLS, STS	1994-1996				HB217X.681		HB359X.543
Seville	SLS, STS	1997-2004				HB360X.670		HB359X.543
SRX		2004-2009				HB467X.540		
SRX		2010-2013						HB639X.645
SRX		2010-2015		Performance Brakes				HB639X.645
SRX		2014	All					HB639X.645
SRX		2014-2015						HB639X.645
SRX		2015		20962994				HB639X.645
SRX	Performance Brakes	2015		20962994				HB639X.645
STS		2005	All	Performance Brakes		HB467X.540		
STS		2005	All	Standard Brakes		HB439X.555		HB440X.606
STS	Heavy Duty	2005		89047744				HB194X.570
STS	Heavy Duty	2005-2011		89047725		HB453X.585		
STS	V	2006-2007	All	Standard Brakes; JL9		HB439X.555		HB440X.606
STS	V	2006-2008	All	HD Brakes; J56		HB453X.585		HB194X.570
STS	V	2006-2008	All	Performance Brakes; JE5		HB467X.540		
STS	V	2006-2008	All	STS-V Supercharged; Brembo Brakes		HB453X.585		HB194X.570
STS	V, Platinum	2008	All	Standard Brakes; JL9		HB439X.555		HB440X.606
STS	V	2009	All	Standard Brakes; 5 Lug; JL9 pkg.				HB440X.606
STS	V	2009	All	STS-V Supercharged; 6 Lug		HB453X.585		HB194X.570
STS		2010-2011	All	Standard Brakes; 5 Lug; JL9 pkg.				HB440X.606
STS	Platinum	2010-2011	All	STS-V Supercharged; 6 Lug		HB453X.585		HB194X.570
XLR	Base	2004-2005				HB247X.575		HB248X.650
XLR	V	2006-2008	All			HB247X.575		HB248X.650
XLR	Base, V	2006-2007		Except XLR-V		HB247X.575		HB248X.650
XLR	Base, V	2006-2007		XLR-V Supercharged		HB247X.575		HB248X.650
XLR	Platinum	2008-2009	All			HB247X.575		HB248X.650
XLR	Base, V, Platinum	2008		Except XLR-V				HB248X.650
XLR	Base, V, Platinum	2008		XLR-V Supercharged				HB248X.650
XLR	Base, V	2008		Except XLR-V		HB247X.575		
XLR	Base, V	2008		XLR-V Supercharged		HB247X.575		
XLR	Base, V, Platinum	2009		Except XLR-V		HB247X.575		HB248X.650
XLR	Base, V, Platinum	2009		XLR-V Supercharged		HB247X.575		HB248X.650
XTS		2013		22976409		HB453X.585		
XTS		2013		5 Lug, Heavy Duty Brakes		HB453X.585		
XTS		2013		6 Lug		HB561X.710		HB383X.685
XTS	Performance	2013		22866931		HB453X.585		
XTS	Heavy Duty, J55 Brake	2014		22742382		HB561X.710		

BRAKE PAD APPLICATIONS

Hawk Performance - BRAKE PAD APPLICATIONS

HB
HAWK BRAKE

245
PAD SHAPE

x
INSERT COMPOUND CODE

.631
PAD THICKNESS

MAKE/ MODEL	SUBMODEL	YEARS	ENGINE (LITER)	NOTE	FRONT		REAR	
					OES	HB SERIES	OES	HB SERIES
CADILLAC CONTINUED								
XTS	Heavy Duty, J55 Brake	2014		22892950				HB383X.685
XTS	J64 Brake 18" Wheels	2014		23145627		HB453X.585		
XTS		2015		23145627		HB453X.585		
XTS	Heavy Duty	2015		22742382		HB561X.710		
XTS	Heavy Duty	2015		22892950				HB383X.685
CHECKER								
A11		1970-1974				HB103X.590		
A11E		1970-1974				HB103X.590		
Marathon	A-12	1971-1974				HB103X.590		
Marathon		1975-1976				HB103X.590		
Marathon		1977-1982				HB103X.590		HB235X.665
Taxicab	A12	1971-1974				HB103X.590		
Taxicab		1975-1976				HB103X.590		
Taxicab		1977-1982				HB103X.590		HB235X.665
CHEVROLET								
Astro		1985-1989	All		770052	HB103X.590		
Astro		1989						HB119X.594
Astro		1990-1995		2WD with 4 wheel ABS	770052	HB103X.590		
Astro		1990-1995		2WD with Rear wheel ABS	770052	HB103X.590		
Astro		1990-2002		4WD	770369	HB332X.654		
Astro		1996-2002		2WD	770052	HB103X.590		
Astro		2003-2005				HB323X.724		HB324X.673
Avalanche	LS, LT, LTZ	2007				HB561X.710		HB568X.666
Avalanche	LS, LT, LTZ	2008		Models w/front caliper bracket cast number 285/286C		HB561X.710		HB568X.666
Avalanche	LS, LT, LTZ	2008		Models w/front caliper bracket cast number 351/352C		HB561X.710		HB568X.666
Avalanche	LS, LT, LTZ	2009				HB561X.710		HB568X.666
Avalanche	LS, LT, LTZ, Police	2010-2013				HB561X.710		HB568X.666
Avalanche 1500		2002	All	w/ Limited Slip and Dual Piston Rear Caliper		HB323X.724		HB385X.640
Avalanche 1500		2002	All	w/Single piston rear caliper 18.5 min thick rear rotor		HB323X.724		HB324X.673
Avalanche 1500		2002	All	w/ Single piston rear caliper 28.5 min Thick rear rotor		HB323X.724		HB324X.673
Avalanche 1500		2002		Dual piston rear caliper with limited slip axle		HB323X.724		HB385X.640
Avalanche 1500		2002		Single piston rear caliper w/o limited slip axle		HB323X.724		HB324X.673
Avalanche 1500	RWD	2002		89027010				HB494X.670
Avalanche 1500	4WD	2002-2004		18045936				HB496X.640
Avalanche 1500		2003-2006		2WD		HB323X.724		HB494X.670
Avalanche 1500		2003-2006		4WD		HB323X.724		HB385X.640
Avalanche 1500	4WD	2005		88964192				HB496X.640
Avalanche 1500	4WD	2006		88967105				HB496X.640
Avalanche 2500	LS, LT	2002-2004	All	Exc. Models With 2" Body Lift		HB322X.717		HB323X.724
Avalanche 2500	LS, LT	2002-2004	All	Models With 2" Body Lift		HB322X.717		HB323X.724
Avalanche 2500	LS, LT	2005-2006	All			HB322X.717		HB323X.724
Aveo		2004-2011			771035	HB592X.665		
Aveo	(Mexico)	2014				HB592X.665		
Aveo5		2007-2011	All		771035	HB592X.665		
B60	B6P042	1983-1990	All			HB253X.750		HB253X.750
B60	B6P042	1983-1991				HB251X1.14		HB251X1.14
B60	B6P042	1991				HB253X.750		HB253X.750
B7	B7T042	1992				HB251X1.14		HB251X1.14
B7	B7T042	1992				HB253X.750		HB253X.750
B7	B7T042	1995-1997				HB253X.750		HB251X1.14
B7	B7T042	1997				HB251X1.14		HB251X1.14
Bel Air		1970-1975	All		770052	HB103X.590		
Beretta		1987-1988	All			HB400X.630		
Beretta	GT	1989	All			HB400X.630		
Beretta	GT, GTZ	1990-1991	All			HB400X.630		

MAKE/ MODEL	SUBMODEL	YEARS	ENGINE (LITER)	NOTE	FRONT		REAR	
					OES	HB SERIES	OES	HB SERIES
CHEVROLET CONTINUED								
Beretta	GT, GTZ	1992-1993	All			HB390X.602		
Beretta	Z26	1994-1996	All			HB390X.602		
Biscayne		1970-1972				HB103X.590		
Blazer		1987-1989		18043837		HB103X.590		
Blazer		1990-1991		12321435		HB103X.590		
Blazer		1992-1994		12321448		HB332X.654		
Blazer		1995-1996		18026296		HB119X.594		
Blazer		1997		18026926		HB119X.594		
Blazer		1997-2005		18026156				HB305X.610
Blazer		1997-2005		18029863		HB304X.598		
Brookwood		1970-1972				HB103X.590		
C10		1975-1984				HB103X.590		
C10		1985-1986		18024904		HB103X.590		
C10 Pickup		1971-1974				HB103X.590		
C10 Suburban		1971-1984	All		770052	HB103X.590		
C10 Suburban		1985-1986		18024904		HB103X.590		
C1500	Pickup	1988-1989		Std. cab heavy duty chassis, extended cab		HB332X.654		
C1500	Pickup	1990-1991		Std. cab heavy duty chassis, extended cab perf. pkg SS454		HB332X.654		
C1500	Pickup	1992-1999				HB332X.654		
C1500 Suburban		1992-1993	All		770369	HB332X.654		
C1500 Suburban		1992-1993				HB332X.654		
C1500 Suburban		1994-1999	All	w/13 in. Rear Drums		HB296X.670		
C1500 Suburban		1994-1999	All	w/11 in. Rear Drums	770369	HB332X.654		
C1500 Suburban		1994-1999		5 Lug		HB332X.654		
C1500 Suburban		1994-1999		8 lug		HB296X.670		
C20		1975-1984				HB103X.590		
C20		1979-1984				HB131X.595		
C20		1985-1986		18043837		HB103X.590		
C20 Pickup	Leaf Spring	1971-1972				HB103X.590		
C20 Pickup		1971-1974				HB103X.590		
C20 Suburban		1971-1978	All		770052	HB103X.590		
C20 Suburban		1979-1986	All	w/13 in. Rear Drums		HB131X.595		
C20 Suburban		1979-1986	All	w/11 in. Rear Drums	770052	HB103X.590		
C2500	GVW 7,200 Lbs	1988		89026844		HB332X.654		
C2500	GVW 8,600 Lbs	1988		19152634		HB296X.670		
C2500		1989	All			HB131X.595		
C2500	Pickup	1989-1991		8 LUG, 8600 lbs. GVWR		HB296X.670		
C2500	Pickup	1989-1993		6 LUG, 7200 lbs. GVWR		HB332X.654		
C2500	Pickup	1992-1996		8 LUG with 4 wheel ABS		HB296X.670		
C2500	Pickup	1992-1996		8 LUG with rear wheel ABS		HB296X.670		
C2500	Pickup	1994-1996		6 LUG with 4 wheel ABS		HB332X.654		
C2500	Pickup	1994-1996		6 LUG with rear wheel ABS		HB332X.654		
C2500	Pickup	1997-2000		6 LUG, 7200 lbs. GVWR		HB332X.654		
C2500	Pickup	1997-2000		8 LUG, 8600 lbs. GVWR		HB296X.670		
C2500	Pickup	2011	All			HB705X.776		HB705X.776
C2500		2011		19210707				HB323X.724
C2500 Suburban		1992-1999	All		770369	HB332X.654		
C2500 Suburban	2WD	1992-1999				HB296X.670		
C30		1975-1978				HB103X.590		
C30		1979-1984				HB131X.595		
C30 Pickup		1971-1974				HB103X.590		
C3500		1988-1989		Dual rear wheel		HB296X.670		
C3500		1988-1989		Single rear wheel		HB296X.670		
C3500		1989-1991	All	w/13 x 2.5 in. Drums		HB131X.595		

BRAKE PAD APPLICATIONS



Hawk Performance - BRAKE PAD APPLICATIONS

HB **245** **x** **.631**
 HAWK BRAKE PAD SHAPE INSERT COMPOUND CODE PAD THICKNESS

MAKE/ MODEL	SUBMODEL	YEARS	ENGINE (LITER)	NOTE	FRONT		REAR	
					OES	HB SERIES	OES	HB SERIES
CHEVROLET CONTINUED								
C3500		1990-1991		Dual rear wheel with rear drum		HB298X.787		
C3500		1990-1991		Single rear wheel except utility chassis option 8S9		HB296X.670		
C3500		1990-1991		Single rear wheel with utility chassis option 8S9		HB296X.670		
C3500		1992-1993		Dual rear wheel with rear drum brakes		HB298X.787		
C3500		1992-1996		Single rear wheel with ABS		HB296X.670		
C3500		1992-1996		Single rear wheel without ABS		HB296X.670		
C3500	Rear Disc	1994				HB252X.860		HB252X.860
C3500		1994-1996		Dual rear wheel with rear drum		HB298X.787		
C3500	Rear Disc	1995-2000				HB252X.860		
C3500		1997-2000		Dual rear wheel with rear drum brakes		HB298X.787		
C3500		1997-2000		Single rear wheel with ABS except extended cab		HB296X.670		
C3500		1997-2000		Single rear wheel with extended cab		HB298X.787		
C3500		2001-2002				HB252X.860		HB252X.860
C3500		2011	All			HB705X.776		HB705X.776
C4500 Kodiak		2003-2006				HB511X.790		HB511X.790
C4500 Kodiak	DIH PB	2003-2006				HB511X.790		
C4500 Kodiak		2007-2009						HB511X.790
C50	C5D042	1988-1990				HB252X.860		HB253X.750
C5500 Kodiak		1990-1991		12475227		HB253X.750		HB253X.750
C5500 Kodiak		2003-2005				HB511X.790		HB511X.790
C5500 Kodiak		2006				HB511X.790		
C5500 Kodiak		2008-2009						HB511X.790
C60	C6D042	1983-1984	All			HB253X.750		HB251X1.14
C60	C6D042	1985-1990	All			HB253X.750		HB253X.750
C60	C6D042	1985-1990				HB251X1.14		HB251X1.14
C60 Kodiak		1990-1991				HB251X1.14		HB251X1.14
C60 Kodiak		1990-1991		12475227		HB253X.750		HB253X.750
C60 Kodiak	C6H042	1992-1994	All			HB253X.750		HB253X.750
C60 Kodiak		1992						HB251X1.14
C60 Kodiak		1992				HB251X1.14		
C60 Kodiak	C6H042	1992-1993				HB251X1.14		HB251X1.14
C60 Kodiak		1993-1996				HB251X1.14		HB251X1.14
C60 Kodiak	C6H042	1995-1996	All	Front Dayton Calipers. Rear 2 Piston Calipers		HB253X.750		HB253X.750
C60 Kodiak	C6H042	1995-1996	All	Front Dayton Calipers. Rear 4 Piston Calipers		HB253X.750		
C60 Kodiak	C6H042	1996				HB251X1.14		HB251X1.14
C6500 Kodiak	C6H042	1997	All	Front Dayton Calipers. Rear 2 Piston Calipers		HB253X.750		HB253X.750
C6500 Kodiak	C6H042	1997	All	Front Dayton Calipers. Rear 4 Piston Calipers		HB253X.750		
C6500 Kodiak	C6H042	1997				HB251X1.14		HB251X1.14
C6500 Kodiak	Front Axle 11000 Lbs Rear Axle 16900-21000 Lbs	1997-2002				HB251X1.14		HB251X1.14
C6500 Kodiak	Front Axle 8100 Lbs Rear Axle 15000-16900 Lbs	1998		15619100		HB253X.750		HB253X.750
C6500 Kodiak	Front Axle 8100 Lbs Rear Axle 15000-16900 Lbs	1999-2002		12475227		HB253X.750		HB253X.750
C6500 Kodiak		2003-2004				HB511X.790		
C6500 Kodiak		2009						HB511X.790
C70	C7D042	1983-1990	All			HB253X.750		
C70		1983-1990				HB251X1.14		HB251X1.14
C70		1985-1987		15559756				HB253X.750
C70	C7D042	1988-1990				HB251X1.14		HB251X1.14
C70		1989		15611046				HB253X.750
C70	Front Axle 7000 Lbs Rear Axle 15000 Lbs	1990		15619100				HB253X.750
C70 Kodiak	Front Axle 8100 Lbs Rear Axle 15000 Lbs	1990-1991		12475227		HB253X.750		HB253X.750

BRAKE PAD APPLICATIONS



MAKE/ MODEL	SUBMODEL	YEARS	ENGINE (LITER)	NOTE	FRONT		REAR	
					OES	HB SERIES	OES	HB SERIES
CHEVROLET CONTINUED								
C70 Kodiak	Front Axle 11000 Lbs Rear Axle 16900-21000 Lbs	1990-1996				HB251X1.14		HB251X1.14
C70 Kodiak	C7H042	1992-1994	All			HB253X.750		
C70 Kodiak	Front Axle 8100 Lbs Rear Axle 15000 Lbs	1992-1994		12475227				HB253X.750
C70 Kodiak	C7H042	1992-1996				HB251X1.14		HB251X1.14
C70 Kodiak	C7H064	1994-1996				HB251X1.14		HB251X1.14
C70 Kodiak		1994-1997				HB251X1.14		HB251X1.14
C70 Kodiak	C7H042	1995	All	Front Dayton Calipers. Rear 2 Piston Calipers		HB253X.750		
C70 Kodiak	C7H042	1995	All	Front Dayton Calipers. Rear 4 Piston Calipers		HB253X.750		HB253X.750
C70 Kodiak	C7H042	1996-1997	All	Front Dayton Calipers. Rear 2 Piston Calipers		HB253X.750		HB253X.750
C70 Kodiak	C7H042	1996-1997	All	Front Dayton Calipers. Rear 4 Piston Calipers		HB253X.750		
C7500 Kodiak	C7H042	1997	All	Front Dayton Calipers. Rear 2 Piston Calipers		HB253X.750		HB253X.750
C7500 Kodiak	C7H042	1997	All	Front Dayton Calipers. Rear 4 Piston Calipers		HB253X.750		
C7500 Kodiak	C7H042	1997				HB251X1.14		HB251X1.14
C7500 Kodiak	Front Axle 11000 Lbs Rear Axle 16900-21000 Lbs	1997-2002				HB251X1.14		HB251X1.14
C7500 Kodiak	Front Axle 8100 Lbs Rear Axle 15000-16900 Lbs	1998		15619100		HB253X.750		HB253X.750
C7500 Kodiak	Front Axle 8100 Lbs Rear Axle 15000-16900 Lbs	1999-2002		12475227		HB253X.750		HB253X.750
Camaro	Z28	1967-1968	All	w/4 Wheel Disc Brakes		HB126X.505		HB126X.505
Camaro		1968-1969		Z28, Rear Disc Brakes		HB126X.505		HB126X.505
Camaro		1969-1981	All		770052	HB103X.590		
Camaro		1969		Front Disc, Rear Drum		HB103X.590		
Camaro		1970				HB103X.590		
Camaro		1971				HB103X.590		HB119X.594
Camaro	Z28	1972	All		770052	HB103X.590		
Camaro		1972-1975				HB103X.590		
Camaro	LT	1976	All		770052	HB103X.590		
Camaro		1976-1981				HB103X.590		HB119X.594
Camaro	LT	1977				HB103X.590		
Camaro		1982-1987	All			HB119X.594		HB119X.594
Camaro		1982-1984		Rear Disc Brakes		HB119X.594		HB119X.594
Camaro		1982-1992		Rear Drum Brakes		HB119X.594		
Camaro		1985-1988		Rear Disc - except Performance Pkg.		HB119X.594		HB119X.594
Camaro		1985-1988		Rear Disc - with Performance Pkg.		HB111X.610		HB112X.540
Camaro		1988	All	w/Standard Brakes		HB119X.594		HB119X.594
Camaro		1988-1989	All	w/Heavy Duty Brakes		HB111X.610		HB112X.540
Camaro		1989	All	w/Standard Brakes		HB119X.594		
Camaro		1989-1992		Rear Disc with 1LE Performance Pkg.		HB111X.610		HB112X.540
Camaro		1989-1992		Rear Disc, except 1LE Performance Pkg.		HB119X.594		HB112X.540
Camaro	Iroc-Z	1990	All	w/Heavy Duty Brakes		HB111X.610		HB112X.540
Camaro	Iroc-Z	1990	All	w/Standard Brakes		HB119X.594		HB112X.540
Camaro	RS	1990-1992	All	w/Heavy Duty Brakes		HB111X.610		HB112X.540
Camaro	RS	1990-1992	All	w/Standard Brakes		HB119X.594		HB112X.540
Camaro	Z28	1991-1992	All	w/Heavy Duty Brakes		HB111X.610		HB112X.540
Camaro	Z28	1991-1992	All	w/Standard Brakes		HB119X.594		HB112X.540
Camaro		1993		12510027		HB103X.590		
Camaro		1993		Rear Disc Brakes				HB112X.540
Camaro		1994-1997	All			HB217X.681		
Camaro	Z28	1994-1997	All			HB217X.681		HB112X.540
Camaro		1994-1997		Rear Disc Brakes		HB217X.681		HB112X.540
Camaro		1994-1997		Rear Drum Brakes		HB217X.681		
Camaro	RS	1996-1997	All			HB217X.681		HB112X.540
Camaro	SS	1998-2002	5.7L		770749	HB249X.575	770750	HB250X.653

BRAKE PAD APPLICATIONS



Hawk Performance - BRAKE PAD APPLICATIONS

HB
HAWK BRAKE

245
PAD SHAPE

x
INSERT COMPOUND CODE

.631
PAD THICKNESS

MAKE/ MODEL	SUBMODEL	YEARS	ENGINE (LITER)	NOTE	FRONT		REAR	
					OES	HB SERIES	OES	HB SERIES
CHEVROLET CONTINUED								
Camaro		1998-2002	All		770749	HB249X.575	770750	HB250X.653
Camaro	Z28	1998-2002	All		770749	HB249X.575	770750	HB250X.653
Camaro		1998-2002				HB249X.575		HB250X.653
Camaro	LS	2010-2014	3.6L			HB638X.702		HB639X.645
Camaro	LT	2010-2014	3.6L			HB638X.702		HB639X.645
Camaro	SS	2010	6.2L					HB194X.570
Camaro		2010-2014	6.2L			HB726X.582		HB194X.570
Camaro		2010-2011		6.2L SS Model		HB726X.582		HB194X.570
Camaro		2010-2014		3.6L LS or LT Models		HB638X.702		HB639X.645
Camaro		2010-2015		3.6 Liter				HB639X.645
Camaro	SS	2011-2014	6.2L			HB726X.582		HB194X.570
Camaro	ZL1	2012-2014	6.2L			HB649X.605		HB194X.570
Camaro		2012-2014		6.2L SS		HB726X.582		HB194X.570
Camaro		2012-2014		ZL1		HB649X.605		HB194X.570
Camaro	Z/28	2014		22990624		HB631X.622		
Camaro	Z/28	2014		22990625				HB632X.586
Camaro	3.6 Liter	2015		92230269		HB638X.702		
Camaro	3.6 Liter	2015		92230273				HB639X.645
Camaro	6.2 Liter Supercharged	2015		25940447		HB649X.605		
Camaro	6.2 Liter Supercharged	2015		89047744				HB194X.570
Camaro	6.2 Liter	2015		22907156		HB453X.585		
Camaro	6.2 Liter	2015		89047744				HB194X.570
Camaro	7.0 Liter	2015		22990624		HB631X.622		
Camaro	7.0 Liter	2015		22990625				HB632X.586
Camaro	LS	2015		22990624		HB631X.622		
Camaro	LS	2015		22990625				HB632X.586
Camaro	SS	2016				HB726X.582		HB194X.570
Caprice		1970-1993	All		770052	HB103X.590		
Caprice		1971				HB103X.590		
Caprice	Station Wagon	1971				HB103X.590		
Caprice	Estate	1973-1977	All		770052	HB103X.590		
Caprice	Classic	1973-1993	All		770052	HB103X.590		
Caprice		1977-1984						HB119X.594
Caprice	Station Wagon	1977-1984						HB235X.665
Caprice		1985-1989		18029594				HB119X.594
Caprice	Classic Brougham	1987-1990	All		770052	HB103X.590		
Caprice	Classic LTZ	1991-1993	All		770052	HB103X.590		
Caprice		1991-1993		11" or 9 1/2" Rear Drum - except Police/HD		HB103X.590		
Caprice		1991-1993		11" Rear Drum Models - Police/Heavy Duty		HB131X.595		
Caprice	Classic LS	1993-1994	All		770052	HB103X.590		
Caprice		1994	All	Police		HB131X.595		
Caprice		1994	All	Except Police	770052	HB103X.590		
Caprice	LS	1994	All		770052	HB103X.590		
Caprice	Classic	1994-1996	All	Police		HB131X.595		
Caprice	Classic	1994-1996	All	Except Police	770052	HB103X.590		
Caprice		1994-1996		9 1/2" Rear Drum - except Police/HD		HB103X.590		
Caprice	Police	1994-1996		12510047		HB131X.595		
Caprice	(Latin America)	2006-2007		92193446		HB606X.650		
Caprice	(Latin America)	2006-2007		92193454				HB607X.616
Caprice		2011	All	Police		HB638X.702		HB607X.616
Caprice		2011-2013				HB638X.702		HB607X.616
Caprice		2012	3.6L			HB606X.650		HB607X.616
Caprice		2012	6.0L			HB638X.702		HB607X.616
Caprice		2013	All			HB638X.702		
Caprice		2014		92250968				HB607X.616

BRAKE PAD APPLICATIONS



MAKE/ MODEL	SUBMODEL	YEARS	ENGINE (LITER)	NOTE	FRONT		REAR	
					OES	HB SERIES	OES	HB SERIES
CHEVROLET CONTINUED								
Caprice		2014-2015		92257988		HB638X.702		
Caprice		2015		92265457				HB607X.616
Captiva Sport		2012-2015			771264			
Cavalier		1982-1991				HB400X.630		
Cavalier		1992-2005				HB390X.602		
Cavalier	225mm Drum	1995-2001		18048649				HB359X.543
Cavalier	225mm Drum	2002		18048648				HB359X.543
Celebrity		1982-1983				HB400X.630		
Celebrity		1983				HB396X.630		
Celebrity	Station Wagon	1984				HB396X.630		
Celebrity	Except Sta. Wagon	1984				HB396X.630		
Celebrity	Except Sta. Wagon	1984				HB400X.630		
Celebrity		1985-1989		18024902		HB400X.630		
Celebrity		1985-1989		18024919		HB396X.630		
Celebrity		1990		12510008		HB396X.630		
Chevelle		1967-1972				HB103X.590		
Chevelle		1967-1973			770052			
Chevelle		1973-1975				HB103X.590		HB119X.594
Chevelle	Station Wagon	1974-1975				HB103X.590		
Chevelle		1976				HB103X.590		
Chevelle		1977				HB103X.590		HB235X.665
Chevy II		1969-1970				HB103X.590		
Cheyenne		2013	All			HB561X.710		
Citation		1980-1983	All			HB400X.630		
Citation	Front: Late	1981				HB400X.630		
Citation II		1980-1984				HB400X.630		
Citation II		1985		12300242		HB119X.594		
Citation II		1985		18024902		HB400X.630		
City Express		2015		19317044		HB618X.625		
Classic		2004-2005				HB425X.661		
Cobalt		2005-2007		SS		HB524X.740		HB525X.540
Cobalt		2005-2010		Base LS & LT w/rear drum brakes; 4 lug wheels		HB517X.690		
Cobalt		2007		22705327		HB524X.740		
Cobalt		2007-2010		LT & LTZ w/Rear Drum Brakes; 5 Lug Wheels		HB517X.690		
Cobalt		2008		Sport; w/Rear Disc Brakes; 5 Lug Wheels		HB524X.740		HB525X.540
Cobalt	Sport	2008		25809846		HB524X.740		
Cobalt		2008-2010		SS w/Brembo Brakes		HB548X.590		HB478X.605
Cobalt		2009-2010		25960262				HB525X.540
Colorado		2004			771039	HB554X.643		
Colorado	Sport, Sport LS, Z71, Z71 LS	Z85, Z85 LS	2005			771039	HB554X.643	
Colorado	LS, LT, WT	2006-2008			771039	HB554X.643		
Colorado		2009-2012				HB617X.630		
Corsica	Base	1987-1988				HB400X.630		
Corsica	LTZ	1989				HB400X.630		
Corsica	LT, LTZ	1990				HB400X.630		
Corsica	LT	1991				HB400X.630		
Corsica	LT	1992-1993				HB390X.602		
Corsica	Base	1994-1996				HB390X.602		
Corvette		1965-1982				HB126X.505		HB126X.505
Corvette		1965-1982				HB126X.505		HB128X.505
Corvette		1965-1982				HB128X.505		HB126X.505
Corvette		1965-1982				HB128X.505		HB128X.505
Corvette		1984-1987				HB173X.570		HB112X.540
Corvette		1988-1995		Except heavy duty suspension		HB111X.610		HB112X.540
Corvette		1988-1995		Heavy duty suspension		HB111X.610		HB112X.540

BRAKE PAD APPLICATIONS



Hawk Performance - BRAKE PAD APPLICATIONS

HB **245** **x** **.631**
 HAWK BRAKE PAD SHAPE INSERT COMPOUND CODE PAD THICKNESS

MAKE/ MODEL	SUBMODEL	YEARS	ENGINE (LITER)	NOTE	FRONT		REAR	
					OES	HB SERIES	OES	HB SERIES
CHEVROLET CONTINUED								
Corvette		1996				HB111X.610		HB112X.540
Corvette		1997-2004				HB247X.575		HB248X.650
Corvette		2005-2007		except Z51 Package		HB247X.575		HB248X.650
Corvette		2005-2009		Z51 Package		HB247X.575		HB248X.650
Corvette		2006		Z06		HB531X.570		HB532X.570
Corvette		2006		Z06		HB658X.570		HB532X.570
Corvette	Z06	2006-2013				HB531X.570		HB532X.570
Corvette	Z06	2006-2013				HB531X.570		HB659X.570
Corvette	Z06	2006-2013				HB658X.570		HB532X.570
Corvette	Z06	2006-2013				HB658X.570		HB659X.570
Corvette		2007-2008		Z06 Package		HB531X.570		HB659X.570
Corvette		2007-2009		Z06 Package		HB658X.570		HB532X.570
Corvette		2008-2009		Standard Brakes		HB247X.575		HB248X.650
Corvette		2009		Z06 Package		HB531X.570		HB532X.570
Corvette	Z06	2009				HB532X.570		HB532X.570
Corvette	Z06	2009				HB532X.570		HB659X.570
Corvette		2009-2013		ZR1 Package		HB631X.622		HB632X.586
Corvette	ZR1	2009-2013		19206975				HB632X.586
Corvette		2010-2011		Base Model; Except Magnetic Ride Control		HB247X.575		HB248X.650
Corvette		2010-2011		Base Model; Magnetic Ride Control		HB247X.575		HB248X.650
Corvette		2010-2011		Z06 / Grand Sport Package		HB531X.570		HB532X.570
Corvette		2010-2011		Z06 / Grand Sport Package		HB658X.570		HB532X.570
Corvette	Grand Sport	2010-2013				HB531X.570		HB532X.570
Corvette	Grand Sport	2010-2013				HB531X.570		HB659X.570
Corvette	Grand Sport	2010-2013				HB658X.570		HB532X.570
Corvette	Grand Sport	2010-2013				HB658X.570		HB659X.570
Corvette	Z06, Ceramic Composite Brake		2011		19206975			
Corvette	HB632X.586							
Corvette	Grand Sport	2011				HB532X.570		HB532X.570
Corvette	Grand Sport	2011				HB532X.570		HB659X.570
Corvette		2012-2013		Base model with heavy duty J55 or F55 brake package-340mm (13.3") front rotor		HB247X.575		HB248X.650
Corvette		2012-2013		Base model with standard JL9 brake package -25mm (12.8") Front Rotor		HB247X.575		HB248X.650
Corvette		2012-2013		Z06 w/Carbon Ceramic Brake Package option code Z07		HB631X.622		HB632X.586
Corvette		2012-2013		Z06 / Grand Sport Package with Iron Brake Rotors		HB531X.570		HB532X.570
Corvette		2012-2013		Z06 / Grand Sport Package with Iron Brake Rotors		HB658X.570		HB532X.570
Corvette	Heavy Duty	2014	All			HB726X.582		
Corvette		2014		Sting Ray with Standard JL9 Brake Package		HB453X.585		HB727X.592
Corvette		2014-2015		23145627		HB453X.585		
Corvette		2014-2015		Sting Ray Z51 - J55 Brake Package OE Designed Co-Cast Brake Rotors		HB726X.582		HB727X.592
Corvette		2014-2015		Sting Ray Z51 - J55 Brake Package Re-designed full cast brake rotors - improved cooling		HB726X.582		HB727X.592
Corvette		2015		Heavy Duty		HB787X.582		
Corvette	Heavy Duty	2015		23441307		HB726X.582		
Corvette	Z06 Ceramic	2015		23198733		HB631X.622		
Corvette	Z06 Ceramic	2015		23198750				HB632X.586
Corvette	Z06	2015		25940447		HB649X.605		
Corvette	J57	2016		23198733		HB631X.622		
Corvette	J57	2016		23198750				HB632X.586
Cruze	1LT, 2LT, Eco, LS, LTZ	2011-2013		Rear Disc Models		HB706X.714		HB707X.638
Cruze	1LT, 2LT, Eco, LS, LTZ	2011-2014		Rear Drum Models		HB706X.714		
Cruze	1LT, 2LT, Eco, LS, LTZ	2014		Diesel Engine				HB707X.638
Cruze	1LT, 2LT, Eco, LS, LTZ	2014		Rear Disc Models - Gas Engine		HB706X.714		HB707X.638

BRAKE PAD APPLICATIONS



MAKE/ MODEL	SUBMODEL	YEARS	ENGINE (LITER)	NOTE	FRONT		REAR	
					OES	HB SERIES	OES	HB SERIES
CHEVROLET CONTINUED								
Cruze	Diesel	2015		13319293				HB707X.638
Cruze	LTZ	2015		13356286		HB706X.714		
Cruze	LTZ	2015		13408579				HB707X.638
El Camino	Base, Custom	1972-1974			770052	HB103X.590		
El Camino		1972-1975						HB119X.594
El Camino	Base	1975-1976			770052	HB103X.590		
El Camino		1977						HB235X.665
El Camino	Base, Classic	1977			770052	HB103X.590		
El Camino		1978-1984				HB119X.594		
El Camino	Base	1978-1987				HB119X.594		
Equinox	LS, LT	2005-2006			770833	HB472X.650		
Equinox		2007-2009			771264		771275	
Estate		1970				HB103X.590		
Express 1500		1996-2002				HB332X.654		
Express 1500		1999-2002	All		770369	HB332X.654		
Express 1500		2003-2008	All			HB323X.724		HB494X.670
Express 1500	LS	2003-2008	All			HB323X.724		HB494X.670
Express 1500	LT	2003-2008	All			HB323X.724		HB494X.670
Express 1500		2003-2008				HB323X.724		
Express 1500		2009-2014	All			HB561X.710		HB494X.670
Express 1500		2009-2014				HB561X.710		
Express 2500		1996-2000	All	8 lug		HB296X.670		
Express 2500		1996-2002	All	6 Lug Wheels Only.	770369	HB332X.654		
Express 2500		1996-1998		8 Lug 7700 - 8600 lb GVW		HB296X.670		
Express 2500		1996-2002		6 Lug 7300 lb. GVW		HB332X.654		
Express 2500		1999-2000		8 Lug 8500 lb. GVW		HB296X.670		
Express 2500		2001-2002	6.5L	8 Lug, Diesel		HB298X.787		
Express 2500		2001-2002	All	8 Lug, except Diesel		HB296X.670		
Express 2500		2001-2002		8 Lug 7700 - 8600 lb. GVW with diesel		HB298X.787		
Express 2500		2001-2002		8 Lug 7700 - 8600 lb. GVW with gas engine		HB296X.670		
Express 2500		2003-2005	All	6 Lug Wheels Only.		HB323X.724		HB494X.670
Express 2500		2003-2005	All	8 lug		HB322X.717		HB494X.670
Express 2500		2003-2005		6 Lug 7300 lb. GVW		HB323X.724		HB494X.670
Express 2500		2003-2005		8 Lug with Diesel Engine		HB322X.717		HB494X.670
Express 2500		2003-2005		8 Lug with Gasoline Engine		HB322X.717		HB494X.670
Express 2500	LT	2006-2010	All			HB322X.717		HB494X.670
Express 2500	LS	2006-2011	All			HB322X.717		HB494X.670
Express 2500		2006-2014	All			HB322X.717		HB494X.670
Express 2500		2006-2014		Diesel Engine		HB322X.717		HB494X.670
Express 2500		2006-2014		Gas Engine		HB322X.717		HB494X.670
Express 2500	LT	2011	All			HB322X.717		
Express 2500		2015		19210706		HB322X.717		
Express 2500		2015		88983902				HB494X.670
Express 3500		1996-1998		Dual Rear Wheels		HB298X.787		
Express 3500		1996-1998		Single Rear Wheels		HB296X.670		
Express 3500		1999-2002	All			HB298X.787		
Express 3500		1999-2000		Single rear wheel except heavy duty		HB296X.670		
Express 3500		1999-2002		Dual rear wheels except heavy duty		HB298X.787		
Express 3500		2001		Single Rr Whl with G315 Cab & Chassis except heavy duty		HB296X.670		
Express 3500		2002		19152634		HB296X.670		
Express 3500		2002		Single rear wheel except heavy duty		HB298X.787		
Express 3500		2003-2007	All	Dual Rear Wheels		HB322X.717		
Express 3500		2003-2008	All	Single Rear Wheels. 330 x 76mm Rear Rotor		HB322X.717		HB494X.670
Express 3500		2003-2008	All	Single Rear Wheels. 330 x 90mm Rear Rotor		HB322X.717		HB494X.670

BRAKE PAD APPLICATIONS

Hawk Performance - BRAKE PAD APPLICATIONS

HB **245** **x** **.631**
 HAWK BRAKE PAD SHAPE INSERT COMPOUND CODE PAD THICKNESS

MAKE/ MODEL	SUBMODEL	YEARS	ENGINE (LITER)	NOTE	FRONT		REAR	
					OES	HB SERIES	OES	HB SERIES
CHEVROLET CONTINUED								
Express 3500	LS	2003-2010	All	Single Rear Wheels. 330 x 76mm Rear Rotor		HB322X.717		HB494X.670
Express 3500	LS	2003-2010	All	Single Rear Wheels. 330 x 90mm Rear Rotor		HB322X.717		HB494X.670
Express 3500	LT	2003-2010	All	Single Rear Wheels. 330 x 76mm Rear Rotor		HB322X.717		HB494X.670
Express 3500	LT	2003-2010	All	Single Rear Wheels. 330 x 90mm Rear Rotor		HB322X.717		HB494X.670
Express 3500		2003-2006		Dual Rear Wheels		HB322X.717		
Express 3500		2003-2014		Single Rear Wheels with 4.63" Diameter Rear Hub Hole		HB322X.717		HB494X.670
Express 3500		2003-2014		Single Rear Wheels with 4.83" Diameter Rear Hub Hole		HB322X.717		HB494X.670
Express 3500		2007-2008		DRW		HB322X.717		
Express 3500		2008-2014	All	Dual Rear Wheels		HB322X.717		HB705X.776
Express 3500		2009-2014		DRW		HB322X.717		HB705X.776
Express 3500		2011-2014	All	Single rear wheel		HB322X.717		HB494X.670
Express 3500		2015		19210706		HB322X.717		
Express 3500		2015		22960231				HB705X.776
Express 3500		2015		88983902				HB494X.670
Express 3500	GVW 14,040 Lbs., Dual Rear Wheel	2015		19210708		HB322X.717		
Express 3500	GVW 14,040 Lbs., Dual Rear Wheel	2015		20850250				HB705X.776
Express 3500	GVW 14,040 Lbs.	2015		88983902				HB494X.670
Express 4500		2009-2013	All			HB322X.717		HB705X.776
Express 4500		2009-2014		DRW		HB322X.717		HB705X.776
Express 4500		2009-2014		Single rear wheels w/ 4.63" diameter rear hub hole		HB322X.717		HB494X.670
Express 4500		2009-2014		Single rear wheels w/ 4.83" diameter rear hub hole		HB322X.717		HB494X.670
F6B042		1997	All			HB253X.750		HB253X.750
F6B042		1997				HB251X1.14		HB251X1.14
G10		1975-1984				HB103X.590		
G10		1985-1991		18043837		HB103X.590		
G10		1992		12321435		HB103X.590		
G10		1993		12510032		HB103X.590		
G10		1994-1995		18043837		HB103X.590		
G10 Van		1971-1974	All		770052	HB103X.590		
G10 Van	Sportvan	1971-1974	All		770052	HB103X.590		
G10 Van		1972						HB119X.594
G20		1975-1984				HB103X.590		
G20		1985-1991		18043837		HB103X.590		
G20		1992		12321435		HB103X.590		
G20		1993		12510032		HB103X.590		
G20		1994-1995		18043837		HB103X.590		
G20 Van		1971-1974	All		770052	HB103X.590		
G20 Van	Sportvan	1971-1974	All		770052	HB103X.590		
G30		1975-1984				HB103X.590		
G30		1979-1984				HB131X.595		
G30 Van		1971-1974	All		770052	HB103X.590		
G30 Van	Sportvan	1971-1974	All		770052	HB103X.590		
HHR	LS, LS Panel, LT, LT Panel	2006-2007				HB524X.740		
HHR		2008		15243704		HB524X.740		
HHR	LS, LS Panel, LT, LT Panel	2008		Rear Disc Brakes		HB524X.740		
HHR	LS, LS Panel, LT, LT Panel	2008		Rear Drum Brakes		HB524X.740		
HHR	SS	2008				HB548X.590		
HHR	SS	2008		Rear Disc Brakes				HB525X.540
HHR		2009		25809846		HB524X.740		
HHR	SS, SS Panel	2009-2010		Rear Disc Brakes, Brembo Front Caliper		HB548X.590		HB525X.540
HHR	SS, SS Panel	2009-2010		Rear Disc Brakes, except Brembo front caliper		HB524X.740		HB525X.540
HHR	SS, SS Panel	2009-2011		Rear Drum Brakes		HB524X.740		

MAKE/ MODEL	SUBMODEL	YEARS	ENGINE (LITER)	NOTE	FRONT		REAR	
					OES	HB SERIES	OES	HB SERIES
CHEVROLET CONTINUED								
HHR		2010		20881786		HB524X.740		
HHR		2010-2011		25960262				HB525X.540
Impala		1970-1985	All		770052	HB103X.590		
Impala		1971				HB103X.590		
Impala	Station Wagon	1971				HB103X.590		
Impala	Custom	1976	All		770052	HB103X.590		
Impala	Custom	1977				HB103X.590		
Impala		1977-1978						HB119X.594
Impala	Station Wagon	1977-1984						HB235X.665
Impala		1979-1984						HB235X.665
Impala	SS	1994-1996				HB131X.595		
Impala		2000		18042417				HB359X.543
Impala	Base, LS	2000				HB360X.670		HB359X.543
Impala		2000-2004		18045380		HB360X.670		
Impala	Police	2000-2004		18042417				HB359X.543
Impala	Base, LS, Police	2001				HB360X.670		HB359X.543
Impala	Base, LS	2002				HB360X.670		HB359X.543
Impala	Base, LS, Police	2003				HB360X.670		HB359X.543
Impala	Base, LS, SS	2004				HB360X.670		HB359X.543
Impala		2005	All			HB536X.704		
Impala	LS	2005	All			HB536X.704		HB359X.543
Impala	SS	2005	All			HB536X.704		
Impala	Front: To Vin 59143075 Rear: Police	2005		18042417				HB359X.543
Impala	Front: To Vin 59143075 Rear: Police	2005		18045380		HB360X.670		
Impala	LS, SS	2005		From VIN 59143076		HB536X.704		HB359X.543
Impala	LS, SS	2005		To VIN 59143075		HB360X.670		HB359X.543
Impala	Base, Police	2006				HB535X.638		HB359X.543
Impala		2007-2010				HB535X.638		HB359X.543
Impala	Base, Police	2011				HB535X.638		HB450X.555
Impala	Base	2012-2013		Except Police/Taxi		HB535X.638		HB450X.555
Impala	Base	2012-2013		Police/Taxi		HB535X.638		HB450X.555
Impala Limited		2014		Except Police/Taxi		HB535X.638		HB450X.555
Impala Limited		2014		Police/Taxi		HB535X.638		HB450X.555
Impala Limited		2015		18048690				HB450X.555
Impala Limited		2015		19260481		HB535X.638		
Impala Limited	Police	2015		18048690				HB450X.555
Impala Limited	Police	2015		19207421		HB535X.638		
K10		1975-1984				HB103X.590		
K10		1985-1986		18043837		HB103X.590		
K10 Pickup		1971-1974				HB103X.590		
K10 Suburban		1971-1986	All		770052	HB103X.590		
K1500		1988-1991	All	Extended Cab		HB332X.654		
K1500		1992-1999				HB332X.654		
K1500 Suburban	4WD	1992-1993				HB332X.654		
K1500 Suburban	4WD	1994-1999		6 Lug -11" rear drum		HB332X.654		
K1500 Suburban	4WD	1994-1999		8 lug - 13" rear drum		HB296X.670		
K20		1975-1984				HB103X.590		
K20		1979-1984				HB131X.595		
K20		1985-1986		18043837		HB103X.590		
K20 Pickup		1971-1974				HB103X.590		
K20 Suburban		1971-1978				HB103X.590		
K20 Suburban		1979-1984	All	w/13 in. Rear Drums		HB131X.595		
K20 Suburban		1979-1984	All	w/11 in. Rear Drums	770052	HB103X.590		
K20 Suburban		1985-1986	All			HB131X.595		

BRAKE PAD APPLICATIONS



Hawk Performance - BRAKE PAD APPLICATIONS

HB
HAWK BRAKE

245
PAD SHAPE

x
INSERT COMPOUND CODE

.631
PAD THICKNESS

MAKE/ MODEL	SUBMODEL	YEARS	ENGINE (LITER)	NOTE	FRONT		REAR	
					OES	HB SERIES	OES	HB SERIES
CHEVROLET CONTINUED								
K20 Suburban		1985-1986		18043837		HB103X.590		
K2500		1988-1998		6 Lug, w/11 in. Rear Drums		HB332X.654		
K2500		1988-1998		8 Lug, w/13 in. Rear Drums		HB296X.670		
K2500		1999-2000				HB296X.670		
K2500		2011	All			HB705X.776		HB705X.776
K2500		2011		19210707				HB323X.724
K2500 Suburban		1992-1999	All			HB296X.670		
K2500 Suburban	4WD	1992-1999				HB296X.670		
K30		1977-1978				HB103X.590		
K3500		1988-1989				HB296X.670		
K3500		1990-1996		Single Rear Wheels		HB296X.670		
K3500		1990-2000		Dual Rear Wheels		HB298X.787		
K3500		1997		Single rear wheel extended cab		HB298X.787		
K3500		1997-2000		Single rear wheel except extended cab		HB296X.670		
K3500		1998-2000		Single Rear Wheels		HB298X.787		
K3500		2011	All			HB705X.776		HB705X.776
K5 Blazer		1984-1986				HB103X.590		
Kingswood		1970-1973				HB103X.590		
Kingswood	Station Wagon	1971-1972				HB103X.590		
Lacetti	(Latin America)	2005-2007		96405129		HB592X.665		
Laguna	Estate	1973	All		770052	HB103X.590		
Laguna		1973-1976	All		770052	HB103X.590		
LLV	Postal Van	1987-1995	All			HB119X.594		
Lumina	Euro	1990				HB232X.681		
Lumina	Euro, Z34	1991-1994				HB232X.681		
Lumina		1995		18043995				HB359X.543
Lumina	LS	1995		267mm Dia. Front Rotor		HB232X.681		HB359X.543
Lumina	LS	1995		286mm Dia. Front Rotor		HB232X.681		HB359X.543
Lumina		1995-1996		18048649				HB359X.543
Lumina		1996		18024530				HB359X.543
Lumina	LS	1996				HB232X.681		HB359X.543
Lumina	LTZ	1997				HB232X.681		HB359X.543
Lumina		1997-1999		18043995				HB359X.543
Lumina		1997-2001		18023301				HB359X.543
Lumina	Base, LTZ	1998				HB232X.681		HB359X.543
Lumina	Base	1999				HB232X.681		HB359X.543
Lumina		2000-2001				HB232X.681		
Lumina APV		1990-1991	All			HB396X.630		
Lumina APV		1992		18019286				HB359X.543
Lumina APV		1992-1993		12510001		HB103X.590		
Lumina APV		1993		18019347				HB359X.543
Lumina APV		1994-1996	All			HB217X.681		
Lumina APV		1994-1996		18048649				HB359X.543
Malibu	Estate	1973-1976	All		770052	HB103X.590		
Malibu		1973-1977	All		770052	HB103X.590		
Malibu	Classic	1974-1977	All		770052	HB103X.590		
Malibu	Classic	1978-1982	All			HB119X.594		
Malibu		1978-1983	All			HB119X.594		
Malibu		1978-1983				HB119X.594		
Malibu		1997-2003				HB425X.661		
Malibu		2004-2005		Maxx		HB524X.740		HB525X.540
Malibu		2004-2005		New body style with rear disc		HB524X.740		HB525X.540
Malibu		2004-2005		Old body style with rear drum		HB425X.661		
Malibu	2.2L	2004-2006		25864605				HB525X.540
Malibu		2005		New body style with rear drum		HB524X.740		

BRAKE PAD APPLICATIONS

MAKE/ MODEL	SUBMODEL	YEARS	ENGINE (LITER)	NOTE	FRONT		REAR	
					OES	HB SERIES	OES	HB SERIES
CHEVROLET CONTINUED								
Malibu		2006-2007		Rear disc models w/76mm (10.9") front rotors		HB524X.740		HB525X.540
Malibu		2006-2007		Rear disc models w/296mm (11.65") front rotors		HB524X.740		HB525X.540
Malibu		2006-2007		with rear drums		HB524X.740		
Malibu		2007		15808204		HB524X.740		
Malibu	Maxx, SS also	2007		15808204		HB524X.740		
Malibu		2008		Models with 276mm (10.9") Front Rotors		HB524X.740		HB525X.540
Malibu		2008		Models with 296mm (11.65") Front Rotors		HB524X.740		HB525X.540
Malibu		2009-2012				HB524X.740		HB525X.540
Malibu	(Latin America)	2011		22731037		HB524X.740		
Malibu	(Latin America)	2011		25864605				HB525X.540
Malibu		2011		25864605				HB525X.540
Monte Carlo		1970-1973	All			HB103X.590		
Monte Carlo		1970-1977	All		770052			
Monte Carlo		1970						HB119X.594
Monte Carlo		1973						HB119X.594
Monte Carlo		1974	All			HB103X.590		HB119X.594
Monte Carlo		1975-1977	All			HB103X.590		
Monte Carlo		1975						HB119X.594
Monte Carlo		1977						HB235X.665
Monte Carlo		1978-1981	All			HB119X.594		
Monte Carlo		1978-1984				HB119X.594		
Monte Carlo	SS	1985-1988				HB119X.594		
Monte Carlo		1995		267mm Dia. Front Rotor				HB359X.543
Monte Carlo		1995		286mm Dia. Front Rotor				HB359X.543
Monte Carlo	LS, Z34	1995		267mm Dia. Front Rotor		HB232X.681		
Monte Carlo	LS, Z34	1995		286mm Dia. Front Rotor		HB232X.681		
Monte Carlo	Police	1995		18043995				HB359X.543
Monte Carlo		1995-1996		18048649				HB359X.543
Monte Carlo		1995-1999		18043995				HB359X.543
Monte Carlo	Police	1996		18024530				HB359X.543
Monte Carlo	LS, Z34	1996-1998				HB232X.681		
Monte Carlo		1996-1999						HB359X.543
Monte Carlo		1997-1999		18023301				HB359X.543
Monte Carlo	Police	1997-1999		18043995				HB359X.543
Monte Carlo	Base	1999				HB232X.681		
Monte Carlo	LS, SS	2000-2004				HB360X.670		HB359X.543
Monte Carlo	LS, LT, SS	2005		From Vin 59148924		HB536X.704		HB359X.543
Monte Carlo	LS, LT, SS	2005		To Vin 59148923		HB360X.670		HB359X.543
Monte Carlo		2006-2007				HB535X.638		HB359X.543
Monza		1975				HB103X.590		
Monza		1976-1980						HB119X.594
Nova		1969-1974		Models with Front Disc Brakes	770052	HB103X.590		
Nova	Custom	1973	5.0L		770052	HB103X.590		
Nova	Custom	1973-1979	All		770052	HB103X.590		
Nova		1975-1979			770052	HB103X.590		HB119X.594
Nova	Concours	1976	All		770052	HB103X.590		
Nova	Concours	1977				HB103X.590		
Nova		1985		94855748		HB191X.590		
Nova		1986-1988	All		770242	HB191X.590		
Optra		2004	All		771035	HB592X.665		
Optra		2004						HB593X.548
Orlando		2012		13319293				HB707X.638
P10		1975-1982				HB103X.590		
P10 Van		1971-1974				HB103X.590		
P20		1975-1984				HB103X.590		

BRAKE PAD APPLICATIONS



Hawk Performance - BRAKE PAD APPLICATIONS

HB
HAWK BRAKE

245
PAD SHAPE

x
INSERT COMPOUND CODE

.631
PAD THICKNESS

MAKE/ MODEL	SUBMODEL	YEARS	ENGINE (LITER)	NOTE	FRONT		REAR	
					OES	HB SERIES	OES	HB SERIES
CHEVROLET CONTINUED								
P20		1979-1984				HB131X.595		
P20		1985-1989		18043837		HB103X.590		
P20 Van		1971				HB103X.590		
P20 Van		1972-1974	All		770052	HB103X.590		
P30		1975-1978				HB103X.590		
P30	12-14000 GVW	1977				HB103X.590		HB103X.590
P30	12-14.5K GVW	1978				HB103X.590		HB103X.590
P30		1979-1984				HB131X.595		
P30		1997-1999		with Rear Discs		HB252X.860		HB252X.860
P30 Van		1971-1974				HB103X.590		
P60	P6T042	1988-1990				HB252X.860		
P6000	P6S042	1992				HB253X.750		HB251X1.14
P6000	P6S042	1993-1996	All			HB253X.750		HB251X1.14
P6T042		1984-1990	All			HB253X.750		
P6T042		1988-1990						HB253X.750
Prizm		1998-2002				HB321X.650		
R10		1987		2 3/4" Rear Shoes JB5 & JD5		HB103X.590		
R10		1987		2" Rear Shoe JB1 & JB3		HB103X.590		
R10 Suburban		1987-1988		18043837		HB103X.590		
R1500 Suburban		1989-1991	All			HB131X.595		
R1500 Suburban		1990-1991		12321435		HB103X.590		
R20		1987-1988	All			HB131X.595		
R20		1987		11" Rear Drum		HB103X.590		
R20		1988		18043837		HB103X.590		
R20 Suburban		1987-1988	All			HB131X.595		
R20 Suburban		1987-1988		18043837		HB103X.590		
R2500		1989	All			HB131X.595		
R2500		1989		18043837		HB103X.590		
R2500 Suburban		1989-1991	All			HB131X.595		
R2500 Suburban		1989		18043837		HB103X.590		
R2500 Suburban		1990-1991		12321435		HB103X.590		
R30		1987-1988	All			HB131X.595		
R3500		1989-1991	All	w/13 x 2.5 in. Drums		HB131X.595		
S10		1982-1984				HB119X.594		
S10		1985		18026926		HB119X.594		
S10		1986-1990		2WD		HB119X.594		
S10		1987-1996		4WD		HB119X.594		
S10		1991-1995		2WD with 4 wheel ABS		HB119X.594		
S10		1991-1995		2WD with Rear wheel ABS		HB119X.594		
S10		1996-1997		18026296		HB119X.594		
S10		1996-1997		2WD Electric Pickup		HB119X.594		
S10		1996-1997		2WD except Electric Pickup		HB119X.594		
S10		1997		4WD with Rear Disc		HB304X.598		HB305X.610
S10		1997		4WD with Rear Drum		HB119X.594		
S10	RWD	1998-2002		18026296		HB119X.594		
S10		1998-2003		2WD		HB119X.594		
S10		1998-2003		4WD		HB304X.598		HB305X.610
S10		2004		4WD with 2.2 L Eng.		HB304X.598		HB305X.610
S10		2004		4WD with 4.3 L Eng.		HB304X.598		HB305X.610
S10 Blazer		1983-1984				HB119X.594		
S10 Blazer		1983-1990		2WD		HB119X.594		
S10 Blazer		1986-1994		4WD		HB119X.594		
S10 Blazer		1991-1994		2WD with 4 wheel ABS		HB119X.594		
S10 Blazer		1991-1994		2WD with Rear wheel ABS		HB119X.594		
S7T042		1988-1990				HB251X1.14		HB251X1.14

BRAKE PAD APPLICATIONS

MAKE/ MODEL	SUBMODEL	YEARS	ENGINE (LITER)	NOTE	FRONT		REAR	
					OES	HB SERIES	OES	HB SERIES
CHEVROLET CONTINUED								
S7T042		1992				HB251X1.14		HB251X1.14
School Bus Chassis		1983-1984				HB253X.750		HB251X1.14
School Bus Chassis		1983-1990				HB251X1.14		HB251X1.14
School Bus Chassis	Front Axle 7500 Lbs Rear Axle 15000 Lbs	1985-1986		15559755		HB253X.750		HB253X.750
School Bus Chassis	Front Axle 7500 Lbs Rear Axle 15000 Lbs	1987		15559755				HB253X.750
School Bus Chassis	Front Axle 7500 Lbs Rear Axle 15000 Lbs	1987		15559756		HB253X.750		
School Bus Chassis		1988-1990				HB251X1.14		HB253X.750
School Bus Chassis		1988-1990				HB253X.750		HB251X1.14
School Bus Chassis		1988-1990				HB253X.750		HB253X.750
School Bus Chassis		1992				HB251X1.14		HB251X1.14
School Bus Chassis		1992				HB251X1.14		HB253X.750
School Bus Chassis		1992				HB253X.750		HB251X1.14
School Bus Chassis		1992				HB253X.750		HB253X.750
School Bus Chassis	Front Axle 8100 Lbs Rear Axle 15000 Lbs	1993-1994		12475227		HB253X.750		HB253X.750
School Bus Chassis	Front Axle 9000 Lbs Rear Axle 16900-21000 Lbs	1993-1996				HB251X1.14		HB251X1.14
School Bus Chassis	Front Axle 8100 Lbs Rear Axle 15000 Lbs	1995-1998		15619100		HB253X.750		HB253X.750
School Bus Chassis	Front Axle 9000 Lbs Rear Axle 16900 Lbs	1997-2002				HB251X1.14		HB251X1.14
School Bus Chassis	Front Axle 8100 Lbs Rear Axle 15000 Lbs	1999-2002		12475227		HB253X.750		HB253X.750
Silverado	SS	2003-2006		18048083				HB324X.673
Silverado	SS	2003-2006		18048101		HB323X.724		
Silverado		2007		89059119		HB561X.710		
Silverado 1500		1999-2000	All	Must have 17" wheel or larger		HB323X.724		HB324X.673
Silverado 1500	2WD	1999-2000				HB323X.724		HB324X.673
Silverado 1500	4WD	1999-2000				HB323X.724		HB324X.673
Silverado 1500		2001	All	"2 Door Ext. Cab Must have 17" wheel or larger		HB323X.724		HB324X.673
Silverado 1500		2001	All	"2 Door. Reg Cab. Must have 17" wheel or larger		HB323X.724		HB324X.673
Silverado 1500		2001-2002	All	4 Door		HB322X.717		HB323X.724
Silverado 1500	2WD	2001		6 Lug		HB323X.724		HB324X.673
Silverado 1500	4WD	2001-2002		6 lug with single piston rear calipers		HB323X.724		HB324X.673
Silverado 1500	4WD	2001-2003		6 lug with dual piston rear calipers		HB323X.724		HB385X.640
Silverado 1500		2002	All	Extended Cab. 4 Wheel Steering Must have 17" wheel or larger for rear kit		HB323X.724		HB385X.640
Silverado 1500		2002	All	"Regular Cab. 2 Wheel Steering. Must have 17" wheel or larger for rear kit		HB323X.724		HB324X.673
Silverado 1500	2WD	2002		6 lug with single piston rear calipers		HB323X.724		HB324X.673
Silverado 1500	2WD	2002-2003		6 lug with dual piston rear calipers		HB323X.724		HB385X.640
Silverado 1500		2003	All	4 Door Heavy Duty. 2 Wheel Steering		HB322X.717		HB323X.724
Silverado 1500		2003	All	4 Door Heavy Duty. 4 Wheel Steering Must have 17" or larger wheel		HB323X.724		HB324X.673
Silverado 1500		2003	All	Extended Cab. 2 Wheel Steering Must have 17" or larger wheel		HB323X.724		HB324X.673
Silverado 1500		2003	All	Extended cab 4 wheel steering. 325mm rear disc Must have 17" or larger wheel		HB323X.724		HB323X.724
Silverado 1500		2003	All	Extended cab 4 wheel steering. 330mm rear disc Must have 17" or larger wheel		HB323X.724		HB385X.640
Silverado 1500		2003-2004	All	Regular Cab Must have 17" or larger wheel		HB323X.724		HB324X.673
Silverado 1500	SS	2003-2006	All	Must have 17" wheel or larger for rear kit		HB323X.724		HB385X.640

BRAKE PAD APPLICATIONS



Hawk Performance - BRAKE PAD APPLICATIONS

HB **245** **x** **.631**
 HAWK BRAKE PAD SHAPE INSERT COMPOUND CODE PAD THICKNESS

MAKE/ MODEL	SUBMODEL	YEARS	ENGINE (LITER)	NOTE	FRONT		REAR	
					OES	HB SERIES	OES	HB SERIES
CHEVROLET CONTINUED								
Silverado 1500	2 Wheel Steering	2003		88982614				HB494X.670
Silverado 1500	2WD	2003		6 lug Quadrasteer Models w/single piston rear calipers		HB323X.724		HB324X.673
Silverado 1500	2WD	2003		6 lug with single piston rear calipers Exc. Quadrasteer		HB323X.724		HB324X.673
Silverado 1500	4 Wheel Steering	2003		18045936				HB496X.640
Silverado 1500	4WD	2003		6 lug Quadrasteer Models with single piston rear calipers		HB323X.724		HB324X.673
Silverado 1500	4WD	2003		6 lug with single piston rear calipers Exc. Quadrasteer		HB323X.724		HB324X.673
Silverado 1500	SS	2003-2007				HB323X.724		HB385X.640
Silverado 1500		2004	All	Crew Cab Must have 17" wheel or larger		HB323X.724		HB385X.640
Silverado 1500		2004	All	Extended Cab. 2 Wheel Steering. Except Hybrid Must have 17" wheel or larger		HB323X.724		HB324X.673
Silverado 1500		2004	All	Extended Cab. 4 Wheel Steering. Except Hybrid Must have 17" wheel or larger		HB323X.724		HB385X.640
Silverado 1500		2004	All	Hybrid, Must have 17" wheel or larger		HB323X.724		HB324X.673
Silverado 1500		2004		18045936				HB496X.640
Silverado 1500	4WD	2004		6 lug Quadrasteer models w/dual piston rear calipers		HB323X.724		HB385X.640
Silverado 1500	4WD	2004		6 lug with dual piston rear calipers Except Quadrasteer		HB323X.724		HB385X.640
Silverado 1500	2WD	2004-2005		6 lug Quadrasteer models w/dual piston rear calipers		HB323X.724		HB385X.640
Silverado 1500	2WD	2004-2005		6 lug with dual piston rear calipers Except Quadrasteer		HB323X.724		HB385X.640
Silverado 1500	2WD	2004-2006		6 lug with single piston rear calipers		HB323X.724		HB324X.673
Silverado 1500	4WD	2004-2006		6 lug with single piston rear calipers		HB323X.724		HB324X.673
Silverado 1500		2005	All	w/Rear Disc Brakes. Ext Cab. Hybrid Must have 17" wheel or larger		HB323X.724		HB324X.673
Silverado 1500		2005	All	w/Rear Disc Brakes Must have 17" wheel or larger		HB323X.724		HB324X.673
Silverado 1500		2005	All	w/Rear Drum Brakes		HB561X.710		
Silverado 1500	Crew Cab	2005		18045936				HB496X.640
Silverado 1500	2WD	2005-2006		With Rear Drum Brakes		HB561X.710		
Silverado 1500	4WD	2005-2006		6 lug with dual piston rear calipers		HB323X.724		HB385X.640
Silverado 1500	4WD	2005-2006		With Rear Drum Brakes		HB561X.710		
Silverado 1500		2006	6.0L			HB323X.724		HB385X.640
Silverado 1500		2006	All	6400 lb. GVW, Rear Disc Must have 17" wheel or larger		HB323X.724		HB324X.673
Silverado 1500		2006	All	6400 lb. GVW, Rear Drum		HB561X.710		
Silverado 1500		2006	All	7000 lb. GVW, Rear Drum		HB561X.710		
Silverado 1500		2006	All	7200 lb. GVW, Rear Disc Must have 17" wheel or larger		HB323X.724		HB324X.673
Silverado 1500	2WD	2006		6 lug with dual piston rear calipers		HB323X.724		HB385X.640
Silverado 1500	Crew Cab	2006		88967105				HB496X.640
Silverado 1500		2007	All	w/Rear Disc Brakes		HB561X.710		HB568X.666
Silverado 1500		2007	All	w/Rear Drum Brakes		HB561X.710		
Silverado 1500	Classic LS	2007	All	w/Rear Disc Brakes		HB561X.710		HB568X.666
Silverado 1500	Classic LS	2007	All	w/Rear Drum Brakes		HB561X.710		
Silverado 1500	Classic LT	2007	All	w/Rear Disc Brakes		HB561X.710		HB568X.666
Silverado 1500	Classic LT	2007	All	w/Rear Drum Brakes		HB561X.710		
Silverado 1500	Classic WT	2007	All	w/Rear Disc Brakes		HB561X.710		HB568X.666
Silverado 1500	Classic WT	2007	All	w/Rear Drum Brakes		HB561X.710		
Silverado 1500	2WD	2007		6 lug classic models w/single piston rear calipers		HB323X.724		HB324X.673
Silverado 1500	2WD	2007		6 lug classic SS w/dual piston rear calipers		HB323X.724		HB385X.640
Silverado 1500	2WD	2007		6 lug new body style models w/rear disc brakes Front caliper bracket Cast Number 351C/352C		HB561X.710		HB568X.666

BRAKE PAD APPLICATIONS

MAKE/ MODEL	SUBMODEL	YEARS	ENGINE (LITER)	NOTE	FRONT		REAR	
					OES	HB SERIES	OES	HB SERIES
CHEVROLET CONTINUED								
Silverado 1500	2WD	2007		With rear drum brakes Front Caliper Bracket Cast Number 285C/286C		HB561X.710		
Silverado 1500	2WD	2007		With rear drum brakes Front Caliper Bracket Cast Number 351C/352C		HB561X.710		
Silverado 1500	4WD	2007		New Body Style 6 lug models w/rear disc brakes		HB561X.710		HB568X.666
Silverado 1500	4WD	2007		New Body Style with rear drum brakes Front Caliper Bracket Cast Number 351C/352C		HB561X.710		
Silverado 1500	4WD	2007		Old Body Style 6 lug w/dual piston rear calipers		HB323X.724		HB385X.640
Silverado 1500	4WD	2007		Old Body Style 6 lug w/single piston rear calipers		HB323X.724		HB324X.673
Silverado 1500	4WD	2007		Old Body Style with rear drum brakes Front Caliper Bracket Cast Number 285C/286C		HB561X.710		
Silverado 1500	Police	2008	All			HB561X.710		HB568X.666
Silverado 1500		2008-2014	All	w/Rear Drum Brakes. Except Hybrid		HB561X.710		
Silverado 1500		2008-2014	All	With Rear Disc Brakes		HB561X.710		HB568X.666
Silverado 1500	2WD	2008-2013		With Rear Disc Brakes		HB561X.710		HB568X.666
Silverado 1500	2WD	2008-2013		With Rear Drum Brakes		HB561X.710		
Silverado 1500	4WD	2008-2013		With Rear Disc Brakes		HB561X.710		HB568X.666
Silverado 1500	4WD	2008-2013		With Rear Drum Brakes		HB561X.710		
Silverado 1500	Police	2010	All			HB561X.710		HB568X.666
Silverado 1500		2015		23135915		HB561X.710		
Silverado 1500		2015		23164777				HB568X.666
Silverado 1500 HD	2WD	2001-2002		8 lug		HB322X.717		HB323X.724
Silverado 1500 HD	4WD	2001-2002		8 lug		HB322X.717		HB323X.724
Silverado 1500 HD	2WD	2003		8 lug - Exc. QuadraSteer		HB322X.717		HB323X.724
Silverado 1500 HD	2WD	2003		8 lug QuadraSteer		HB322X.717		HB324X.673
Silverado 1500 HD	4WD	2003		8 lug - Exc. QuadraSteer		HB322X.717		HB323X.724
Silverado 1500 HD	4WD	2003		8 lug with QuadraSteer		HB322X.717		HB385X.640
Silverado 1500 HD	2WD	2005		8 lug with QuadraSteer		HB322X.717		HB385X.640
Silverado 1500 HD	2WD	2005		8 lug without QuadraSteer		HB322X.717		HB323X.724
Silverado 1500 HD	4WD	2005		8 lug with QuadraSteer		HB322X.717		HB385X.640
Silverado 1500 HD	4WD	2005		8 lug without QuadraSteer		HB322X.717		HB323X.724
Silverado 1500 HD	2WD	2006-2007		8 lug		HB322X.717		HB323X.724
Silverado 1500 HD	4WD	2006-2007		8 lug		HB322X.717		HB323X.724
Silverado 2500		1999-2000	6.0L	Automatic		HB322X.717		HB323X.724
Silverado 2500		1999-2000	6.0L	Manual		HB322X.717		HB323X.724
Silverado 2500		1999-2000	All	Except 6.0L		HB322X.717		HB323X.724
Silverado 2500		1999-2000		Except 6.0L with 5 speed		HB322X.717		HB323X.724
Silverado 2500		1999-2000		with 6.0L 5 speed		HB322X.717		HB323X.724
Silverado 2500		2001-2004	All	Automatic		HB322X.717		HB323X.724
Silverado 2500		2001-2004	All	Manual		HB322X.717		HB323X.724
Silverado 2500		2001-2004		Automatic transmission except Heavy Duty		HB322X.717		HB323X.724
Silverado 2500		2001-2004		Manual transmission except Heavy Duty		HB322X.717		HB323X.724
Silverado 2500 HD		2001-2003	All			HB322X.717		HB323X.724
Silverado 2500 HD		2001-2003				HB322X.717		HB323X.724
Silverado 2500 HD		2004	All	2 Wheel Steering		HB322X.717		HB323X.724
Silverado 2500 HD		2004	All	4 Wheel Steering		HB322X.717		HB323X.724
Silverado 2500 HD		2004		Models with 2 wheel steering		HB322X.717		HB323X.724
Silverado 2500 HD		2004		Models with 4 wheel steering		HB322X.717		HB323X.724
Silverado 2500 HD		2005	All			HB322X.717		HB323X.724
Silverado 2500 HD		2005-2006				HB322X.717		HB323X.724
Silverado 2500 HD	LS	2006	All			HB322X.717		HB323X.724
Silverado 2500 HD	LT	2006-2010	All			HB322X.717		HB323X.724
Silverado 2500 HD	WT	2006-2010	All			HB322X.717		HB323X.724
Silverado 2500 HD	Classic LS	2007	All			HB322X.717		HB323X.724
Silverado 2500 HD	Classic LT	2007	All			HB322X.717		HB323X.724
Silverado 2500 HD	Classic WT	2007	All			HB322X.717		HB323X.724

BRAKE PAD APPLICATIONS

Hawk Performance - BRAKE PAD APPLICATIONS

HB **245** **x** **.631**
 HAWK BRAKE PAD SHAPE INSERT COMPOUND CODE PAD THICKNESS

MAKE/ MODEL	SUBMODEL	YEARS	ENGINE (LITER)	NOTE	FRONT		REAR	
					OES	HB SERIES	OES	HB SERIES
CHEVROLET CONTINUED								
Silverado 2500 HD	LTZ	2007-2010	All			HB322X.717		HB323X.724
Silverado 2500 HD		2008-2010				HB322X.717		HB323X.724
Silverado 2500 HD		2011-2013	All			HB705X.776		HB705X.776
Silverado 2500 HD		2011-2013				HB705X.776		HB705X.776
Silverado 2500 HD		2014-2015		20829195				HB705X.776
Silverado 2500 HD		2014-2015		22770745		HB705X.776		
Silverado 2500 HD		2015		22960231				HB705X.776
Silverado 3500		2001-2003	All	2WD/4WD		HB322X.717		HB322X.717
Silverado 3500		2001-2003				HB322X.717		HB322X.717
Silverado 3500		2004-2005	All	4WD. Single Rear Wheels		HB322X.717		HB323X.724
Silverado 3500		2004-2007	All	DRW		HB322X.717		HB322X.717
Silverado 3500		2004-2005		2WD		HB322X.717		HB322X.717
Silverado 3500		2004-2005		4WD Dual Rear Wheels		HB322X.717		HB322X.717
Silverado 3500		2004-2005		4WD Single Rear Wheels		HB322X.717		HB323X.724
Silverado 3500	LS	2006	All	Single Rear Wheels		HB322X.717		HB323X.724
Silverado 3500	LT	2006	All	Single Rear Wheels		HB322X.717		HB323X.724
Silverado 3500	WT	2006	All	Single Rear Wheels		HB322X.717		HB323X.724
Silverado 3500		2006-2007		DRW		HB322X.717		HB322X.717
Silverado 3500		2006-2007		SRW		HB322X.717		HB323X.724
Silverado 3500	Classic LS	2007	All	Single Rear Wheels		HB322X.717		HB323X.724
Silverado 3500	Classic WT	2007	All	Single Rear Wheels		HB322X.717		HB323X.724
Silverado 3500 HD		2007-2010	All	12,000 lbs. GVW		HB322X.717		HB322X.717
Silverado 3500 HD		2007-2010	All	9,900 lbs. GVW		HB322X.717		HB323X.724
Silverado 3500 HD		2007-2010		DRW		HB322X.717		HB322X.717
Silverado 3500 HD		2007-2010		SRW		HB322X.717		HB323X.724
Silverado 3500 HD		2011-2014	All			HB705X.776		HB705X.776
Silverado 3500 HD		2011-2013		DRW		HB705X.776		HB705X.776
Silverado 3500 HD		2011-2013		SRW		HB705X.776		HB705X.776
Silverado 3500 HD		2015		20829195				HB705X.776
Silverado 3500 HD		2015		22770745		HB705X.776		
Silverado 3500 HD		2015		22960231				HB705X.776
Sonic		2012				HB706X.714		
Sonic		2013		Rear Disc		HB706X.714		HB707X.638
Sonic		2013		Rear Drum		HB706X.714		
Sonic		2014		13356286		HB706X.714		
Sonic	RS	2014-2015		13356286		HB706X.714		
Sonic	RS	2014-2015		13408579				HB707X.638
Spark		2011-2013	All	(Latin America)	771590			
Spark		2013-2014			771035	HB592X.665		
Spark		2015		95194917		HB592X.665		
Spark EV		2014-2015		95194917		HB592X.665		
SS		2014				HB726X.582		HB607X.616
SS		2015		89047744				HB194X.570
SSR		2003-2005	All			HB382X.657		HB383X.685
SSR		2003-2005				HB382X.657		HB383X.685
SSR		2006	All			HB617X.630		HB383X.685
SSR		2006				HB617X.630		HB383X.685
Suburban		2015		23135915		HB561X.710		
Suburban		2015		23164777				HB568X.666
Suburban 1500		2000	All	w/13 in. Rear Drums. 6 Lug.		HB296X.670		
Suburban 1500		2000	All	w/13 in. Rear Drums. 8 Lug		HB296X.670		
Suburban 1500		2000	All	w/11 in. Rear Drums	770369	HB332X.654		
Suburban 1500		2000-2002	All	w/Limited Slip Must have 17" wheel or larger		HB323X.724		HB385X.640
Suburban 1500		2000-2002	All	w/o Limited Slip Must have 17" wheel or larger		HB323X.724		HB324X.673

BRAKE PAD APPLICATIONS



MAKE/ MODEL	SUBMODEL	YEARS	ENGINE (LITER)	NOTE	FRONT		REAR	
					OES	HB SERIES	OES	HB SERIES
CHEVROLET CONTINUED								
Suburban 1500	2WD	2000		5 Lug -11" rear drum old body style		HB332X.654		
Suburban 1500	2WD	2000		8 lug - 13" rear drum old body style		HB296X.670		
Suburban 1500	4WD	2000		6 Lug -11" rear drum old body style		HB332X.654		
Suburban 1500	4WD	2000		8 lug - 13" rear drum old body style		HB296X.670		
Suburban 1500		2000-2001		18045936				HB496X.640
Suburban 1500	2WD	2000-2002		6 lug with dual piston rear calipers		HB323X.724		HB385X.640
Suburban 1500	2WD	2000-2002		6 lug with single piston rear calipers		HB323X.724		HB324X.673
Suburban 1500	4WD	2000-2002		6 lug with dual piston rear calipers		HB323X.724		HB385X.640
Suburban 1500	4WD	2000-2002		6 lug with single piston rear calipers		HB323X.724		HB324X.673
Suburban 1500	4WD	2002		18045936				HB496X.640
Suburban 1500	RWD	2002		89027010				HB494X.670
Suburban 1500		2003-2006	All	2WD - Must have 17" wheel or larger		HB323X.724		HB494X.670
Suburban 1500		2003-2006	All	4WD - Must have 17" wheel or larger		HB323X.724		HB496X.640
Suburban 1500	2WD	2003-2006				HB323X.724		
Suburban 1500	4WD	2003-2006				HB323X.724		HB385X.640
Suburban 1500		2007-2014	All			HB561X.710		HB568X.666
Suburban 1500	2WD	2007-2013				HB561X.710		HB568X.666
Suburban 1500	4WD	2007-2013				HB561X.710		HB568X.666
Suburban 1500	Police	2010	All			HB561X.710		HB568X.666
Suburban 2500		2000	All	w/Rear Drum Brakes.		HB296X.670		
Suburban 2500		2000-2002	All	w/Rear disc brakes w/4.63" Rear disc hub hole		HB322X.717		HB323X.724
Suburban 2500		2000-2002	All	w/Rear disc brakes w/4.84" Rear disc hub hole		HB322X.717		HB323X.724
Suburban 2500	2WD	2000		w/Rear disc brakes and 4.63" rear disc center hole		HB322X.717		HB323X.724
Suburban 2500	2WD	2000		w/Rear disc brakes and 4.8" rear disc center hole		HB322X.717		HB323X.724
Suburban 2500	4WD	2000		w/Rear disc brakes and 4.63" rear disc center hole		HB322X.717		HB323X.724
Suburban 2500	4WD	2000		w/Rear disc brakes and 4.8" rear disc center hole		HB322X.717		HB323X.724
Suburban 2500	2WD	2001-2002		with 4.63" rear disc center hole		HB322X.717		HB323X.724
Suburban 2500	2WD	2001-2002		with 4.8" rear disc center hole		HB322X.717		HB323X.724
Suburban 2500	4WD	2001-2002		with 4.63" rear disc center hole		HB322X.717		HB323X.724
Suburban 2500	4WD	2001-2002		with 4.8" rear disc center hole		HB322X.717		HB323X.724
Suburban 2500		2003-2005	All	2 Wheel Steering. w/4.63" rear disc hub hole		HB322X.717		HB323X.724
Suburban 2500		2003-2005	All	2 Wheel Steering. w/4.84" rear disc hub hole		HB322X.717		HB323X.724
Suburban 2500		2003-2005	All	4 Wheel Steering		HB322X.717		HB324X.673
Suburban 2500	2WD	2003		w/2 wheel steering & 4.63" rear disc center hole		HB322X.717		HB323X.724
Suburban 2500	2WD	2003		w/2 wheel steering & 4.8" rear disc center hole		HB322X.717		HB323X.724
Suburban 2500	2WD	2003-2005		with 4 wheel steering		HB322X.717		HB323X.724
Suburban 2500	4WD	2003-2005		w/2 wheel steering and 4.63" rear disc center hole		HB322X.717		HB323X.724
Suburban 2500	4WD	2003-2005		w/2 wheel steering and 4.8" rear disc center hole		HB322X.717		HB323X.724
Suburban 2500	4WD	2003-2005		with 4 wheel steering		HB322X.717		HB323X.724
Suburban 2500	4WD	2003-2005		with 4 wheel steering		HB322X.717		HB323X.724
Suburban 2500	2WD	2004-2005		w/2 wheel steering and 4.63" rear disc center hole		HB322X.717		HB323X.724
Suburban 2500	2WD	2004-2005		w/2 wheel steering and 4.8" rear disc center hole		HB322X.717		HB323X.724
Suburban 2500		2006	All	w/Rear disc brakes. w/4.63" rear disc center hole		HB322X.717		HB323X.724
Suburban 2500		2006	All	w/Rear disc brakes. w/4.84" rear disc center hole		HB322X.717		HB323X.724
Suburban 2500	2WD	2006		with 4.63" rear disc center hole		HB322X.717		HB323X.724
Suburban 2500	2WD	2006		with 4.8" rear disc center hole		HB322X.717		HB323X.724
Suburban 2500	4WD	2006		with 4.63" rear disc center hole		HB322X.717		HB323X.724
Suburban 2500	4WD	2006		with 4.8" rear disc center hole		HB322X.717		HB323X.724
Suburban 2500		2007-2013	All			HB322X.717		HB323X.724
Suburban 2500	2WD	2007-2013				HB322X.717		HB323X.724
Suburban 2500	4WD	2007-2013				HB322X.717		HB323X.724
T10	BLAZER & PICKUP	2002				HB304X.598		HB305X.610
T10	Blazer	2003		with automatic transmission		HB304X.598		HB305X.610
T10	Blazer	2003		with manual transmission		HB304X.598		HB305X.610
T10	Pickup	2003				HB304X.598		HB305X.610
T10	Blazer	2004		2 Door with automatic transmission		HB304X.598		HB305X.610

BRAKE PAD APPLICATIONS



Hawk Performance - BRAKE PAD APPLICATIONS

HB **245** **x** **.631**
 HAWK BRAKE PAD SHAPE INSERT COMPOUND CODE PAD THICKNESS

MAKE/ MODEL	SUBMODEL	YEARS	ENGINE (LITER)	NOTE	FRONT		REAR	
					OES	HB SERIES	OES	HB SERIES
CHEVROLET CONTINUED								
T10	Blazer	2004		2 Door with manual transmission		HB304X.598		HB305X.610
T10	Blazer	2004		4 Door		HB304X.598		HB305X.610
T10	Pickup	2004		with 2.2L engine		HB304X.598		HB305X.610
T10	Pickup	2004		with 4.3L engine		HB304X.598		HB305X.610
T6500	T-Series, Front Axle 8100 Lbs Rear Axle 15000-16900 Lbs	1997-1998		15619100		HB253X.750		HB253X.750
T6500	T-Series, Front Axle 11000 Lbs Rear Axle 16900-21000 Lbs	1997-2002				HB251X1.14		HB251X1.14
T6500	T-Series, Front Axle 8100 Lbs Rear Axle 15000 - 16900 Lbs	1999-2002		12475227		HB253X.750		HB253X.750
T7500	F7B042	1997				HB251X1.14		
T7500	T-Series, Front Axle 8100 Lbs Rear Axle 15000-16900 Lbs	1997-1998		15619100		HB253X.750		HB253X.750
T7500	T-Series, Front Axle 11000 Lbs Rear Axle 16900-21000 Lbs	1997-2002				HB251X1.14		HB251X1.14
T7500	T-Series, Front Axle 8100 Lbs Rear Axle 15000-16900 Lbs	1999-2002		12475227		HB253X.750		HB253X.750
Tahoe		1995-1997	All		770369	HB332X.654		
Tahoe	2WD	1995-1997				HB332X.654		
Tahoe	4WD	1995-1999				HB332X.654		
Tahoe		1997		18025354		HB296X.670		
Tahoe		1998-1999	All	Police		HB296X.670		
Tahoe		1998-1999	All	Except Police	770369	HB332X.654		
Tahoe	2WD	1998-2000		Rear 10" Drum except Police & Diesel Eng.		HB332X.654		
Tahoe	2WD	1998-2000		Rear 11" Drum Police & Diesel Eng.		HB296X.670		
Tahoe		2000	All	2WD. Police. w/Rear Drum Brakes		HB296X.670		
Tahoe		2000	All	2WD. w/Rear Disc Brakes Must have 17" wheel or larger		HB323X.724		HB385X.640
Tahoe		2000	All	4WD. w/Rear Disc Brakes. w/Limited Slip Must have 17" wheel or larger		HB323X.724		HB385X.640
Tahoe		2000	All	4WD. w/Rear Disc Brakes. w/o Limited Slip Must have 17" wheel or larger		HB323X.724		HB324X.673
Tahoe		2000	All	2WD. Except Police. w/Rear Drum Brakes	770369	HB332X.654	770834	
Tahoe		2000	All	4WD. w/Rear Drum Brakes	770369	HB332X.654	770834	
Tahoe	2WD	2000		Rear Disc		HB323X.724		HB385X.640
Tahoe	4WD	2000		Rear Disc with Dual Piston Rear Calipers		HB323X.724		HB385X.640
Tahoe	4WD	2000		Rear Disc With Single Piston Rear Calipers		HB323X.724		HB324X.673
Tahoe	4WD	2000		With Rear Drum Brakes		HB332X.654		
Tahoe		2000-2001		18045936				HB496X.640
Tahoe		2001	All	2WD- Must have 17" wheel or larger		HB323X.724		HB385X.640
Tahoe		2001-2002	All	4WD. w/Limited Slip Must have 17" wheel or larger		HB323X.724		HB385X.640
Tahoe		2001-2002	All	4WD. w/o Limited Slip Must have 17" wheel or larger		HB323X.724		HB324X.673
Tahoe	2WD	2001				HB323X.724		HB385X.640
Tahoe	4WD	2001-2002		With Dual Piston Rear Calipers		HB323X.724		HB385X.640
Tahoe	4WD	2001-2002		With Single Piston Rear Calipers		HB323X.724		HB324X.673
Tahoe		2002	All	2WD. Classic Style Must have 17" wheel or larger		HB323X.724		HB385X.640
Tahoe		2002	All	2WD. New Style Must have 17" wheel or larger		HB323X.724		HB494X.670
Tahoe	2WD	2002		Akebono Rear Calipers		HB323X.724		
Tahoe	2WD	2002		PBR Rear Calipers		HB323X.724		HB385X.640
Tahoe	4WD	2002-2004		18045936				HB496X.640
Tahoe		2003-2006	All	2WD, Must have 17" wheel or larger		HB323X.724		HB494X.670
Tahoe		2003-2006	All	4WD, Must have 17" wheel or larger		HB323X.724		HB385X.640
Tahoe	2WD	2003-2006				HB323X.724		
Tahoe	4WD	2003-2006				HB323X.724		HB385X.640

MAKE/ MODEL	SUBMODEL	YEARS	ENGINE (LITER)	NOTE	FRONT		REAR	
					OES	HB SERIES	OES	HB SERIES
CHEVROLET CONTINUED								
Tahoe	4WD	2005-2006		88964192				HB496X.640
Tahoe	Police	2007-2013	All			HB561X.710		HB568X.666
Tahoe	LS	2007-2014	All			HB561X.710		HB568X.666
Tahoe	LT	2007-2014	All			HB561X.710		HB568X.666
Tahoe	LTZ	2007-2014	All			HB561X.710		HB568X.666
Tahoe	2WD	2007				HB561X.710		HB568X.666
Tahoe	4WD	2007				HB561X.710		HB568X.666
Tahoe	Hybrid	2008	All			HB561X.710		HB568X.666
Tahoe	2WD	2008-2015		Except Police		HB561X.710		HB568X.666
Tahoe	2WD	2008-2015		Police		HB561X.710		HB568X.666
Tahoe	4WD	2008-2015		Except Police		HB561X.710		HB568X.666
Tahoe	4WD	2008-2015		Police		HB561X.710		HB568X.666
Tahoe	PPV	2014						HB568X.666
Tahoe		2015		23164777				HB568X.666
Tahoe	Police	2015		23453018				HB568X.666
Tahoe		2016		23487649		HB561X.710		
Townsmen		1970-1972				HB103X.590		
Tracker		1998		4 Door		HB384X.587		
Tracker		1999-2004				HB384X.587		
Trailblazer		2002-2004		5 Passenger with 113" WB		HB382X.657		HB383X.685
Trailblazer		2002-2004		7 Passenger with 129" WB		HB382X.657		HB383X.685
Trailblazer		2005		4.2L Eng 5 Passenger		HB382X.657		HB383X.685
Trailblazer		2005		4.2L Eng 7 Passenger		HB382X.657		HB383X.685
Trailblazer		2005		5.3L Eng		HB382X.657		HB383X.685
Trailblazer		2006		4.2L Eng.; Base		HB617X.630		HB383X.685
Trailblazer		2006		4.2L Eng.; EXT		HB617X.630		HB383X.685
Trailblazer		2006		5.3L Eng.		HB617X.630		HB383X.685
Trailblazer		2006		SS Model		HB617X.630		HB383X.685
Trailblazer		2007-2009		4.2L Eng		HB617X.630		HB383X.685
Trailblazer		2007-2009		5.3L Eng		HB617X.630		HB383X.685
Trailblazer		2007-2009		6.0L; SS Model		HB617X.630		HB383X.685
Trailblazer EXT		2002		12497782		HB382X.657		
Trailblazer EXT		2002		88935809				HB383X.685
Trailblazer EXT		2003-2004		88982932		HB382X.657		
Trailblazer EXT		2003-2005		88983915				HB383X.685
Trailblazer EXT		2005		88964424		HB382X.657		
Trailblazer EXT		2006		19149111				HB383X.685
Trailblazer EXT		2006		88965681		HB617X.630		
Traverse		2009-2014				HB617X.630		HB383X.685
Traverse		2015		15911562		HB617X.630		
Traverse		2015		22866196				HB383X.685
Trax		2014		13408579				HB707X.638
Trax	(Latin America)	2015		13408579				HB707X.638
Uplander		2005		FWD with special suspension or AWD		HB360X.670		
Uplander		2005		FWD without special suspension		HB360X.670		
Uplander		2006		AWD		HB360X.670		
Uplander		2006		FWD except Special Suspension		HB360X.670		
Uplander		2006		FWD with Special Suspension		HB360X.670		
Uplander		2007-2008				HB360X.670		
V10		1987				HB103X.590		
V10 Suburban		1987-1988		18043837		HB103X.590		
V1500 Suburban		1989-1991	All			HB131X.595		
V1500 Suburban		1990-1991		12321435		HB103X.590		
V20		1987	All			HB131X.595		
V20		1987		11" Rear Drum		HB103X.590		

BRAKE PAD APPLICATIONS



Hawk Performance - BRAKE PAD APPLICATIONS

HB **245** **x** **.631**
 HAWK BRAKE PAD SHAPE INSERT COMPOUND CODE PAD THICKNESS

MAKE/ MODEL	SUBMODEL	YEARS	ENGINE (LITER)	NOTE	FRONT		REAR	
					OES	HB SERIES	OES	HB SERIES
CHEVROLET CONTINUED								
V20 Suburban		1987-1988	All			HB131X.595		
V20 Suburban		1987-1988		18043837		HB103X.590		
V2500 Suburban		1989-1991	All			HB131X.595		
V2500 Suburban		1989		18043837		HB103X.590		
V2500 Suburban		1990-1991		12321435		HB103X.590		
Vega	Late	1971				HB103X.590		
Vega		1972-1975				HB103X.590		
Vega		1976-1977				HB103X.590		HB119X.594
Venture		1997-2001		18048650				HB359X.543
Venture		1997-2005		Two Wheel Drive		HB360X.670		
Venture	FWD	2002-2003		18045380		HB360X.670		
Venture		2002-2005		All Wheel Drive		HB373X.689		HB359X.543
Venture	AWD	2002-2005		18045984				HB359X.543
Venture	FWD	2002-2005		18048650				HB359X.543
Venture	FWD	2004-2005		18048030		HB360X.670		
Volt		2011-2014						HB707X.638
Volt		2015		13319293				HB707X.638
W3500 Tiltmaster		1998-2007				HB537X.783		
W4500 Tiltmaster		1998-2007				HB537X.783		
W5500 Tiltmaster		2000-2007				HB537X.783		
CHRYSLER								
200		2011-2014	All	w/BRF Brakes		HB435X.622		HB457X.605
200		2011-2014	All	w/BRG Brakes		HB435X.622		HB675X.602
200		2011-2012		Models With 262mm (10.3") Rear Rotors (BRF RPO Code)		HB435X.622		HB457X.605
200		2011-2012		Models w/302mm (11.9") Rear Rotors (BRG RPO Code)		HB435X.622		HB675X.602
200	BRF	2011-2013		68020494AB		HB435X.622		
200	BRG	2011-2013		68020494AB		HB435X.622		
200		2013	All	w/BR3 Brakes		HB435X.622		HB675X.602
200		2013-2014	All	w/BR1 Brakes	771058	HB509X.678		HB675X.602
200		2013		Models w/295mm (11.6") Front Rotors and 262mm (10.3") Rear Rotors		HB435X.622		HB457X.605
200		2013		Models with 295mm (11.6") Front Rotors and 302mm (11.9") Rear Rotors		HB435X.622		HB675X.602
200		2013		Models with 340mm (13.3") Front Rotors and 302mm (11.9") Rear Rotors		HB509X.678		HB675X.602
200	BR3	2013		68035576AB		HB435X.622		
200	BRF, Sedan	2014		68020494AB		HB435X.622		
200	BRG, Convertible	2014		68020494AB		HB435X.622		
300		1969-1971	All			HB643X.595		
300		2005-2007	2.7L			HB507X.711		HB508X.675
300	C	2005-2010	5.7L	V8 2WD & 4WD	771058	HB509X.678	771057	HB508X.586
300	C	2005-2010	5.7L	V8 NON SRT-8	771058	HB509X.678	771057	HB508X.586
300	C SRT8	2005-2014	6.1L			HB563X.656		HB194X.570
300		2005-2010	All	all except SRT 8. With Vented rear rotor	771058		771057	
300		2005-2010	All	all except SRT 8. With Solid rear rotor		HB507X.711		HB508X.586
300		2005-2010	All	all except SRT 8. With Vented rear rotor		HB509X.678		HB508X.586
300		2005		V8, 5.7L - (Vented Rear Rotors)		HB509X.678		HB508X.586
300		2005-2007		HEMI 6.1L SRT-8		HB563X.656		HB194X.570
300		2005-2013		V6 - (Solid Rear Rotors)		HB507X.711		HB508X.586
300		2006-2013		V8, 5.7L or AWD V6 - (Vented Rear Rotors)		HB509X.678		HB508X.586
300		2008-2010		SRT-8		HB563X.656		HB194X.570
300		2011-2014	3.6L	RWD - with Solid rear rotor		HB507X.711		HB508X.675
300		2011		V8, 5.7L or AWD V6 - (Vented Rear Rotors)	771058		771057	
300		2012-2014	All	AWD w/vented rear rotors. Excl SRT-8	771058	HB509X.678	771057	HB508X.586

BRAKE PAD APPLICATIONS



MAKE/ MODEL	SUBMODEL	YEARS	ENGINE (LITER)	NOTE	FRONT		REAR	
					OES	HB SERIES	OES	HB SERIES
CHRYSLER CONTINUED								
300		2012-2013		SRT-8		HB563X.656		HB194X.570
300	SRT8	2014		68144223AA				HB194X.570
300	AWD	2015						HB508X.675
300	AWD	2015		05142558AB		HB509X.678		
300	RWD	2015						HB508X.675
300	RWD	2015		05174001AC		HB507X.711		
300M	Front: 15" wheels Rear: Non ABS	1999		05010034AA		HB260X.670		
300M	Front: 15" Wheels Rear: Non ABS	1999		05011762AA				HB176X.614
300M	Front:16" Wheels Rear: ABS	1999		05011631AA				HB176X.614
300M	Front:16" Wheels Rear: ABS	1999		05011743AA		HB260X.670		
300M		1999-2002		with Performance Package				HB176X.614
300M		1999-2004		without Performance Package				HB176X.614
300M		2000		05010034AA		HB260X.670		
300M	Rear: 16" Steel Wheels	2001		05011631AA				HB176X.614
300M	Rear: Not 16" Steel Wheels	2001		05010034AB		HB260X.670		
300M	Rear: Not 16" Steel Wheels	2001		05011762AA				HB176X.614
300M	Performance Package, Rear: Perf.Suspension & HD Brakes	2002		05011631AA				HB176X.614
300M	Performance Package, Rear Perf.Suspension & HD Brakes	2002		05018595AA		HB260X.670		
300M	Rear: Touring Suspension	2002		05010034AB		HB260X.670		
300M	Rear: Touring Suspension	2002		05080896AA				HB176X.614
300M	Special	2002		05010034AB		HB260X.670		
300M	Special	2002		05011631AA				HB176X.614
300M		2003		05018595AA		HB260X.670		
300M	Performance Package	2003		05010034AB		HB260X.670		
300M	Performance Package	2003		05011631AA				HB176X.614
300M	Special	2003		05086167AA		HB260X.670		
300M	Special	2003		05086170AA				HB176X.614
300M		2003-2004		05080896AA				HB176X.614
300M		2004		05010034AB		HB260X.670		
300M	Performance Package	2004		05086167AA		HB260X.670		
300M	Performance Package	2004		05086170AA				HB176X.614
300M	Special	2004		05011631AA				HB176X.614
300M	Special	2004		05018595AA		HB260X.670		
Aspen		2007-2009				HB559X.695		HB514X.610
Cirrus		1995		4720644				HB176X.614
Cirrus		1995-2000		with 14" Wheel				HB176X.614
Cirrus		1995-2000		with 15" Wheel				HB176X.614
Concorde		1993-1994				HB241X.710		HB176X.614
Concorde		1995	All			HB177X.710		HB176X.614
Concorde		1995-1997						HB176X.614
Concorde	LX	1996-1997	All			HB177X.710		HB176X.614
Concorde	LXI	1996-1997	All			HB177X.710		HB176X.614
Concorde		1998-2001	All					HB176X.614
Concorde		1998-1999		Models with 297mm (11.7") Front Rotors		HB260X.670		HB176X.614
Concorde	Front:15" Wheels Rear: ABS	1998-1999		05011631AA				HB176X.614
Concorde	Front:16" Wheels Rear: Non ABS	1998-1999		05011762AA				HB176X.614
Concorde		1998-2000		Models with 282mm (11.1") Front Rotors		HB260X.670		HB176X.614
Concorde		2000		Models with 297mm (11.7") Front Rotors - Exc Performance Package		HB260X.670		HB176X.614
Concorde		2000		Models with 297mm (11.7") Front Rotors With Performance Package		HB260X.670		HB176X.614
Concorde	Rear: 16" Steel Wheels	2001		05011631AA				HB176X.614

BRAKE PAD APPLICATIONS



Hawk Performance - BRAKE PAD APPLICATIONS

HB
HAWK BRAKE

245
PAD SHAPE

x
INSERT COMPOUND CODE

.631
PAD THICKNESS

MAKE/ MODEL	SUBMODEL	YEARS	ENGINE (LITER)	NOTE	FRONT		REAR	
					OES	HB SERIES	OES	HB SERIES
CHRYSLER CONTINUED								
Concorde	Rear: Not 16" Steel Wheels	2001		05011762AA				HB176X.614
Concorde		2001-2004		Exc Performance Package		HB260X.670		HB176X.614
Concorde		2001-2004		with Performance Package		HB260X.670		HB176X.614
Concorde	Rear: Performance Suspension	2002		05011631AA				HB176X.614
Concorde	Rear: Touring Suspension	2002		05080896AA				HB176X.614
Concorde	Rear: Except HD Brakes	2003-2004		05080896AA				HB176X.614
Concorde	Rear: HD Brakes	2003-2004		05086170AA				HB176X.614
Cordoba		1975				HB643X.595		
Cordoba		1976	All			HB103X.590		
Cordoba		1977				HB103X.590		
Crossfire		2004				HB495X.756		
Crossfire		2005-2006		05139218AA		HB495X.756		
Crossfire		2005-2006		Except SRT-6		HB495X.756		
Crossfire		2005-2006		SRT-6		HB497X.776		HB371X.600
Crossfire		2007-2008				HB495X.756		
Grand Voyager		2000		04883833AA				HB372X.626
Imperial		1970-1973	All			HB643X.595		
Imperial	Crown	1970-1973	All			HB643X.595		
Imperial	Early	1971				HB643X.595		
Imperial		1974-1975				HB398X.680		
Imperial		1991-1992				HB411X.717		HB176X.614
Imperial		1993						HB176X.614
Imperial		1993		4509374				HB176X.614
Imperial	Sport	1993				HB411X.717		
Imperial	Sport	1993		4509374				HB176X.614
Intrepid		1993-1994				HB241X.710		
Intrepid		1993-1994		4728146				HB176X.614
Intrepid		1995-1997		4773265				HB176X.614
Intrepid		1998-1999		05011631AA				HB176X.614
Intrepid		1998-1999		05011743AA		HB260X.670		
Intrepid		1998-2000		05010034AA		HB260X.670		
Intrepid		1998-2001		05011762AA				HB176X.614
Intrepid		2001		05011631AA				HB176X.614
Intrepid		2001-2004		05010034AB		HB260X.670		
Intrepid	Heavy Duty	2002		05011631AA				HB176X.614
Intrepid	Heavy Duty	2002		05018595AA		HB260X.670		
Intrepid		2002-2004		05080896AA				HB176X.614
Intrepid	Heavy Duty	2003-2004		05086167AA		HB260X.670		
Intrepid	Heavy Duty	2003-2004		05086170AA				HB176X.614
LeBaron		1983						HB176X.614
LeBaron	2 Dr.	1985-1987		04238827				HB176X.614
LeBaron	4 Dr.	1987		04238827				HB176X.614
LeBaron		1988-1989		04238827				HB176X.614
LeBaron		1989		Coupe & Convertible with 14" or 15" Wheels				HB176X.614
LeBaron		1989		Coupe & Convertible with 16" Wheels				HB176X.614
LeBaron		1990		Coupe & Convertible, GTC, GTS w/14" or 15" W/hs				HB176X.614
LeBaron		1990		Coupe & Convertible, GTC, GTS w/16" Wheels				HB176X.614
LeBaron		1990		Sedan & Wagon				HB176X.614
LeBaron		1991		GTC, GTS, Sedan & Wagon with Rear disc				HB176X.614
LeBaron		1991-1992		Rear Disc Coupe & Convertible w/14" Wheel				HB176X.614
LeBaron		1991-1992		Rear Disc Coupe & Convertible w/15" Wheel				HB176X.614
LeBaron		1992		Rear Disc Sedan and Wagon w/14" Wheel				HB176X.614
LeBaron		1992		Rear Disc Sedan and Wagon w/15" Wheel				HB176X.614
LeBaron		1992-1993		4509374				HB176X.614
LeBaron		1992-1995				HB411X.717		

BRAKE PAD APPLICATIONS

MAKE/ MODEL	SUBMODEL	YEARS	ENGINE (LITER)	NOTE	FRONT		REAR	
					OES	HB SERIES	OES	HB SERIES
CHRYSLER CONTINUED								
LeBaron		1993-1995		Rear Disc with 14" Wheel				HB176X.614
LeBaron		1993-1995		Rear Disc with 15" Wheel				HB176X.614
LeBaron		1994		4720644				HB176X.614
LHS		1994	All					HB176X.614
LHS		1994				HB241X.710		HB176X.614
LHS		1995-1997	All			HB177X.710		HB176X.614
LHS		1995-1997						HB176X.614
LHS		1999-2001	All			HB260X.670		HB176X.614
LHS	Front: 15" Wheels Rear: ABS	1999		05011631AA				HB176X.614
LHS	Front: 16" Wheels Rear: Non ABS	1999		05011762AA				HB176X.614
LHS		1999-2000		15" Wheels				HB176X.614
LHS		1999-2000		16" Wheels				HB176X.614
LHS		2001		with ABS				HB176X.614
LHS		2001		without ABS				HB176X.614
LHS	Rear: 16" Steel Wheels	2001		05011631AA				HB176X.614
LHS	Rear: Not 16" Steel Wheels	2001		05011762AA				HB176X.614
New Yorker		1969-1973	All			HB643X.595		
New Yorker		1971				HB643X.595		
New Yorker		1974-1978				HB398X.680		
New Yorker	Fifth Avenue	1991-1993	All					HB176X.614
New Yorker	Salon	1991-1993	All					HB176X.614
New Yorker		1991		4423667				HB176X.614
New Yorker		1991-1993				HB411X.717		
New Yorker		1992		4509374				HB176X.614
New Yorker	Front: Non Sport Package	1993		4509374				HB176X.614
New Yorker		1994	All					HB176X.614
New Yorker		1994				HB241X.710		
New Yorker		1995-1996	All			HB177X.710		HB176X.614
Newport		1969				HB643X.595		
Newport		1970-1973	All			HB643X.595		
Newport		1971				HB643X.595		
Newport		1974-1978				HB398X.680		
Pacifica		2004-2008				HB433X.654		
Prowler		2001-2002	All			HB260X.670		HB260X.670
PT Cruiser		2001-2002		With Rear Disc Brakes		HB377X.760		HB176X.614
PT Cruiser		2001-2002		With Rear Drum Brakes		HB377X.760		
PT Cruiser		2003		With Rear Disc Brakes - Non-Turbo		HB377X.760		HB176X.614
PT Cruiser		2003		With Rear Drum Brakes - Non-Turbo		HB377X.760		
PT Cruiser		2003		with Turbo		HB377X.760		HB176X.614
PT Cruiser	Turbo	2003-2004		05086567AA				HB176X.614
PT Cruiser		2003-2008		05018208AA				HB176X.614
PT Cruiser		2004		HO Turbo		HB377X.760		HB176X.614
PT Cruiser		2004-2005		Rear disc with Turbo - Not HO		HB377X.760		HB176X.614
PT Cruiser		2004-2005		Rear drum except Turbo		HB377X.760		
PT Cruiser		2004-2005		Rear drum with Turbo		HB377X.760		
PT Cruiser		2005		05086567AA				HB176X.614
PT Cruiser		2005		HO Turbo; GT		HB377X.760		HB176X.614
PT Cruiser		2006-2007		With Rear Discs; HO Turbo; GT		HB377X.760		HB176X.614
PT Cruiser		2006-2007		With Rear Discs; Turbo; Limited		HB377X.760		HB176X.614
PT Cruiser	GT	2006-2007		05086567AA				HB176X.614
PT Cruiser		2006-2009		With Rear Drums		HB377X.760		
PT Cruiser		2008		05086567AA				HB176X.614
PT Cruiser		2008-2009		With Rear Disc		HB377X.760		HB176X.614
PT Cruiser		2010				HB377X.760		HB176X.614
Sebring	Coupe	1995-2000	All			HB213X.626		HB367X.585

BRAKE PAD APPLICATIONS



Hawk Performance - BRAKE PAD APPLICATIONS

HB
HAWK BRAKE

245
PAD SHAPE

x
INSERT COMPOUND CODE

.631
PAD THICKNESS

MAKE/ MODEL	SUBMODEL	YEARS	ENGINE (LITER)	NOTE	FRONT		REAR	
					OES	HB SERIES	OES	HB SERIES
CHRYSLER CONTINUED								
Sebring		1995-2000		Coupe		HB213X.626		HB367X.585
Sebring	Convertible	1996-2000	All					HB176X.614
Sebring		1996-2000		Convertible & Sedan				HB176X.614
Sebring	Sedan	2001-2002	All			HB498X.772		HB176X.614
Sebring	Convertible	2001-2006	All			HB498X.772		HB176X.614
Sebring		2001-2005		4 Cyl.Coupe		HB213X.626		HB367X.585
Sebring		2001-2005		6 Cyl.Coupe		HB435X.622		HB367X.585
Sebring	Coupe	2001-2005		4 Cyl., w/Rear Drum Brakes.		HB213X.626		
Sebring	Coupe	2001-2005		6 Cyl., w/Rear Disc Brakes.	770866	HB435X.622		HB367X.585
Sebring		2001-2006		Convertible & Sedan		HB498X.772		HB176X.614
Sebring		2003-2004		05083071AA				HB176X.614
Sebring	Sedan	2003-2006		4 Cyl., w/Rear Drum Brakes.		HB498X.772		
Sebring	Sedan	2003-2006		6 Cyl., w/Rear Disc Brakes.		HB498X.772		HB176X.614
Sebring	Sedan	2007-2008	2.4L		770866	HB435X.622		
Sebring	Sedan	2007-2008	2.7L		770866	HB435X.622		HB457X.605
Sebring	Sedan	2007-2008	3.5L		770866	HB435X.622		
Sebring		2007		05191231AA		HB435X.622		
Sebring		2007-2010		With 262mm (10.3") Rear Discs		HB435X.622		HB457X.605
Sebring		2007-2010		With 302mm (11.9") Rear Discs		HB435X.622		HB675X.602
Sebring		2007-2010		With Rear Drums		HB435X.622		
Sebring	Convertible	2008	2.4L		770866	HB435X.622		
Sebring	Convertible	2008	2.7L		770866	HB435X.622		HB457X.605
Sebring	Convertible	2008	3.5L		770866	HB435X.622		HB176X.614
Sebring	Front: Convertible	2008		68020494AA		HB435X.622		
Sebring		2009		68035576AA		HB435X.622		
Sebring	Convertible	2010	2.7L	68035576AA		HB435X.622		
Sebring	Sedan	2010	2.7L	68035576AA		HB435X.622		
Sebring	Convertible	2010	All		770866	HB435X.622		HB176X.614
Town & Country		1969-1973	All			HB643X.595		
Town & Country	Wagon	1971				HB643X.595		
Town & Country	Wagon	1974-1978				HB398X.680		
Town & Country	Front: 14" Wheels	1990		4313080				HB286X.591
Town & Country	Front: 14" Wheels	1991-1993		4423606				HB286X.591
Town & Country		1991-1994				HB411X.717		
Town & Country	Front: 14" Wheels Rear: FWD	1994		4723367				HB286X.591
Town & Country	AWD	1995				HB411X.717		
Town & Country	FWD	1995				HB411X.717		
Town & Country	FWD	1995		4723367				HB286X.591
Town & Country		1997-2000		04883833AA				HB372X.626
Town & Country		2001-2006		With Rear Disc		HB374X.700		HB372X.626
Town & Country		2001-2006		With Rear Drum		HB373X.689		
Town & Country	Rear Drum	2005		04883833AA				HB372X.626
Town & Country		2007		with Rear Discs		HB374X.700		HB372X.626
Town & Country		2007		With Rear Drums		HB373X.689		
Town & Country		2008-2011				HB569X.650		
Town & Country		2010		68053152AB		HB569X.650		
Town & Country	HD Brakes	2010-2011		68029263AA		HB569X.650		
Town & Country		2011		68093323AB		HB569X.650		
Town & Country		2012		Models w/single piston front caliper MFG After 3/24/2012		HB569X.650		
Town & Country		2012		Models w/single piston front caliper MFG Before 3/23/2012		HB569X.650		
Town & Country	Rear to 3/23/2012	2012		68093323AB		HB569X.650		
Town & Country		2013		Models with Single Piston front caliper		HB569X.650		
Town & Country		2013-2014		68093323AB		HB569X.650		

BRAKE PAD APPLICATIONS

MAKE/ MODEL	SUBMODEL	YEARS	ENGINE (LITER)	NOTE	FRONT		REAR	
					OES	HB SERIES	OES	HB SERIES
CHRYSLER CONTINUED								
Town & Country	BRE	2015		68093323AB		HB569X.650		
Voyager		2000		10" diameter front rotor		HB177X.630		
Voyager		2000		11" diameter front rotor		HB177X.630		
Voyager		2000-2002		04883833AA				HB372X.626
Voyager		2001-2003				HB373X.689		
Voyager	ABS	2003		04883833AA				HB372X.626
Voyager	Non ABS	2003		04883833AA				HB372X.626
Voyager	Non ABS	2003		05019804AA		HB374X.700		
DAEWOO								
Nubira	(Latin America)	2005-2007		96405129		HB592X.665		
DODGE								
400		1983						HB176X.614
A100	D, W	1976-1980				HB398X.680		
AD150		1981-1992				HB398X.680		
AD150	S	1991-1992				HB398X.680		
Aries	400	1983						HB176X.614
Aries		1983-1984						HB176X.614
Aries		1985-1989		04238827				HB176X.614
Avenger		1995-2000				HB213X.626		HB367X.585
Avenger	R/T	2008	All	FWD				HB675X.602
Avenger		2008		68020494AA		HB435X.622		
Avenger	BRF	2008		68020494AA		HB435X.622		
Avenger	BRG	2008-2009		68020494AA		HB435X.622		
Avenger		2008-2010		w/Rear Discs; R/T; 3.5L; w/302mm Rear Discs		HB435X.622		HB675X.602
Avenger		2008-2010		w/Rear Discs; SXT; 2.7L; w/262mm Rear Discs		HB435X.622		HB457X.605
Avenger		2008-2010		With Rear Drums		HB435X.622		
Avenger		2009		68035576AA		HB435X.622		
Avenger	BRF	2009		68035576AA		HB435X.622		
Avenger		2010	All	Convertible				HB457X.605
Avenger		2010-2014	All	w/BRF Brakes				HB457X.605
Avenger		2010-2014	All	w/BRG Brakes				HB675X.602
Avenger	BRG	2010		68035576AA		HB435X.622		
Avenger	BRF	2010-2014		68020494AB		HB435X.622		
Avenger		2011-2012		With 262mm (10.3") Rear Rotors		HB435X.622		HB457X.605
Avenger		2011-2012		With 302mm (11.9") Rear Rotors		HB435X.622		HB675X.602
Avenger	BRG	2011-2014		68020494AB		HB435X.622		
Avenger		2013	All	w/BR3 Brakes				HB675X.602
Avenger		2013-2014	All	w/BR1 Brakes				HB675X.602
Avenger		2013		Models with 295mm (11.6") Front Rotors and 262mm (10.3") Rear Rotors		HB435X.622		HB457X.605
Avenger		2013		Models with 295mm (11.6") Front Rotors and 302mm (11.9") Rear Rotors		HB435X.622		HB675X.602
Avenger		2013		Models with 340mm (13.3") Front Rotors and 302mm (11.9") Rear Rotors		HB509X.678		HB675X.602
Avenger	BR3	2013		68035576AB		HB435X.622		
Avenger	BR1	2014		68147681AA		HB509X.678		
AW150		1981-1992				HB398X.680		
AW150	S	1991-1992				HB398X.680		
B100		1975-1980				HB398X.680		
B100 Van		1971-1972	All			HB643X.595		
B100 Van		1973-1974				HB398X.680		
B150		1981-1983				HB398X.680		
B150		1984-1987	All			HB398X.680		
B150	Sportsman	1984-1987	All			HB398X.680		
B150		1988-1993		4318728		HB398X.680		
B150		1994		4728777		HB398X.680		

BRAKE PAD APPLICATIONS

Hawk Performance - BRAKE PAD APPLICATIONS

HB
HAWK BRAKE

245
PAD SHAPE

x
INSERT COMPOUND CODE

.631
PAD THICKNESS

MAKE/ MODEL	SUBMODEL	YEARS	ENGINE (LITER)	NOTE	FRONT		REAR	
					OES	HB SERIES	OES	HB SERIES
DODGE CONTINUED								
B1500		1995-1997	All			HB398X.680		
B1500	Sportsman	1995-1997	All			HB398X.680		
B1500		1998	All		770702	HB299X.650		
B1500		1998		05003999AA				HB299X.650
B200		1975-1980				HB398X.680		
B200 Van		1971-1972				HB643X.595		
B200 Van		1973-1974				HB398X.680		
B250		1981-1983				HB398X.680		
B250		1984-1994	All			HB398X.680		
B250	Sportsman	1984-1994	All			HB398X.680		
B2500		1995-1997	All			HB398X.680		
B2500	Sportsman	1995-1997	All			HB398X.680		
B2500		1998	All			HB334X.736		
B2500		1998		05003999AA				HB299X.650
B300 Van		1972				HB643X.595		
B350	Sportsman	1984-1993	All			HB398X.680		
B350		1994		4728777		HB398X.680		
B3500		1995-1997	All			HB398X.680		
B3500	Sportsman	1995-1997	All			HB398X.680		
B3500		1998	All			HB334X.736		
B3500		1998		05003999AA				HB299X.650
Caliber	R/T	2007-2012	All					HB457X.605
Caliber		2007-2009		R/T, SXT with Rear Discs		HB435X.622		HB457X.605
Caliber		2007-2009		SE; SXT, with Rear Drums		HB435X.622		
Caliber	SRT-4	2008	All		771058	HB509X.678		HB675X.602
Caliber	SXT	2008-2012	All					HB457X.605
Caliber		2008-2009		68020494AA		HB435X.622		
Caliber		2008-2009		SRT-4; 2.4L Turbo		HB509X.678		HB675X.602
Caliber		2010-2011		2.0L; with Rear Discs		HB435X.622		HB457X.605
Caliber		2010-2011		2.4L; with Rear Discs		HB435X.622		HB675X.602
Caliber		2010-2012		With Rear Drums		HB435X.622		
Caliber		2012		68020494AB		HB435X.622		
Caliber		2012		with Rear Discs		HB435X.622		HB457X.605
Caliber	SXT	2012		68020494AB		HB435X.622		
Caravan		1984						HB286X.591
Caravan		1985-1988		4313080				HB286X.591
Caravan	Front: 14" Wheels	1989-1990		4313080				HB286X.591
Caravan	FWD, Front: 14" Wheels	1991		4318080				HB286X.591
Caravan	AWD	1991-1995				HB411X.717		
Caravan	FWD, Front: 14" Wheels	1992-1993		4423606				HB286X.591
Caravan	FWD, Front: 14" Wheels	1994		4723367				HB286X.591
Caravan	FWD	1995		4723367				HB286X.591
Caravan	ES	1996-1997	All			HB177X.710		
Caravan	LE	1996-1997	All			HB177X.710		
Caravan	SE	1996-1997	All			HB177X.710		
Caravan		1996-2000	All			HB177X.710		
Caravan		1997-2001		04883833AA				HB372X.626
Caravan	SE	1999	All			HB177X.710		
Caravan	SE	2001	All	w/Rear Disc Brakes		HB374X.700		HB372X.626
Caravan	Sport	2001	All	w/Rear Drum Brakes		HB373X.689		
Caravan		2001-2004	All	w/Rear Disc Brakes		HB374X.700		HB372X.626
Caravan		2001-2004	All	w/Rear Drum Brakes		HB373X.689		
Caravan	SE	2001-2004	All	w/Rear Drum Brakes		HB373X.689		
Caravan		2001-2002		Rear Drum		HB373X.689		
Caravan		2001-2006		Rear Disc		HB374X.700		HB372X.626

BRAKE PAD APPLICATIONS

MAKE/ MODEL	SUBMODEL	YEARS	ENGINE (LITER)	NOTE	FRONT		REAR	
					OES	HB SERIES	OES	HB SERIES
DODGE CONTINUED								
Caravan		2003-2004		04883833AA				HB372X.626
Caravan		2003-2004		Rear Drum with caliper casting Number 134731		HB373X.689		
Caravan		2003-2004		Rear Drum with caliper casting Number 6623.9		HB374X.700		
Caravan	SE	2004	All	w/Rear Disc Brakes		HB374X.700		
Caravan	SE	2005	All			HB374X.700		HB372X.626
Caravan		2005-2007	All			HB374X.700		HB372X.626
Caravan		2005-2006		Rear Drum		HB373X.689		
Caravan	Rear Drum	2005-2007		04883833AA				HB372X.626
Caravan	SE	2006	All	w/Rear Disc Brakes		HB374X.700		HB372X.626
Caravan	SE	2006-2007	All	w/Rear Drum Brakes		HB373X.689		
Caravan	SXT	2006-2007	All	w/Rear Disc Brakes		HB374X.700		HB372X.626
Caravan	SXT	2006-2007	All	w/Rear Drum Brakes		HB373X.689		
Caravan	SE	2007	All	w/Rear Disc Brakes				HB372X.626
Caravan		2007		with Rear Discs		HB374X.700		HB372X.626
Caravan		2007		With Rear Drums		HB373X.689		
CB300		1973				HB398X.680		
Challenger		1970		6 cylinder		HB643X.595		
Challenger		1970		8 Cylinder		HB643X.595		
Challenger	6 Cyl	1970				HB643X.595		
Challenger	8 Cyl	1970				HB643X.595		
Challenger	R/T	1970				HB643X.595		
Challenger		1971-1974				HB643X.595		
Challenger	SRT8	2008-2014	6.1L					HB194X.570
Challenger		2008	All			HB509X.678		HB508X.675
Challenger		2008-2013		SRT8		HB563X.656		HB194X.570
Challenger	SE	2009-2013	3.5L	Solid Rear Disc				HB508X.675
Challenger	R/T	2009-2013	All	Vented rear disc		HB509X.678		HB508X.586
Challenger		2009-2011		R/T		HB509X.678		HB508X.586
Challenger		2009-2011		SE		HB507X.711		HB508X.586
Challenger	SE Rallye Pkg	2011-2013	3.6L	Solid Rear Disc				HB508X.675
Challenger	SXT	2012-2013	All			HB507X.711		HB508X.675
Challenger	SXT	2012-2013	All	Excl. SRT8, Performance brakes		HB509X.678		HB508X.675
Challenger	V6	2012-2013	All	Solid Rear Disc				HB508X.675
Challenger	V6	2012-2013	All	Touring Brakes				HB508X.675
Challenger		2012-2013		Models with solid rear rotors		HB507X.711		HB508X.586
Challenger		2012-2013		Models with vented rear rotors		HB509X.678		HB508X.586
Challenger	SRT8	2012-2013		68144213AA		HB563X.656		
Challenger	R/T	2014		05142558AA		HB509X.678		
Challenger	SRT8	2014		68144223AA		HB563X.656		HB194X.570
Challenger	SXT Performance	2014		05142558AB		HB509X.678		
Challenger	SXT	2014-2015		05174001AC		HB507X.711		
Challenger		2015						HB508X.675
Challenger		2015		05142558AB		HB509X.678		
Challenger	R/T Performance	2015		68147681AA		HB509X.678		
Challenger	SRT	2015		68144213AA		HB563X.656		
Challenger	SRT	2015		68144223AA				HB194X.570
Challenger	SXT	2015						HB508X.675
Charger		1969-1970				HB643X.595		
Charger	Super Bee 8 Cylinder	1969-1970				HB643X.595		
Charger	Super Bee	1969-1971				HB643X.595		
Charger	Station Wagon	1969-1972				HB643X.595		
Charger	Super Bee	1971-1977	All	w/Pin Type Calipers		HB643X.595		
Charger	8 Cylinder	1971-1972				HB643X.595		
Charger		1983-1984						HB176X.614
Charger	Shelby	1983-1984						HB176X.614

BRAKE PAD APPLICATIONS



Hawk Performance - BRAKE PAD APPLICATIONS

HB **245** **x** **.631**
 HAWK BRAKE PAD SHAPE INSERT COMPOUND CODE PAD THICKNESS

MAKE/ MODEL	SUBMODEL	YEARS	ENGINE (LITER)	NOTE	FRONT		REAR	
					OES	HB SERIES	OES	HB SERIES
DODGE CONTINUED								
Charger		1985-1987		04238827				HB176X.614
Charger	Daytona R/T	2006-2013	All	w/Vented Rear Rotor				HB508X.586
Charger	Police	2006-2013	All					HB508X.586
Charger	R/T	2006-2013	All	w/Vented Rear Rotor		HB509X.678		HB508X.586
Charger	SXT RWD	2006-2013	All	RWD w/ Solid Rear Rotor				HB508X.586
Charger		2006-2014	All	RWD w/ Solid Rear Rotor				HB508X.586
Charger		2006-2014	All	RWD w/Vented Rear Rotor				HB508X.586
Charger		2006-2014	All	w/HD Brakes. W/Solid Rear Rotor				HB508X.675
Charger	SE	2006-2014	All	RWD w/ Solid Rear Rotor				HB508X.586
Charger	SRT8	2006-2014	All					HB194X.570
Charger		2006		Police or Daytona R/T Models with 13.7" Vented Rear Rotors		HB509X.678		
Charger		2006		V6 Models with Solid Rear Rotors		HB507X.711		HB508X.586
Charger	SRT8	2006		05174311AA		HB563X.656		
Charger		2006-2010		SRT-8		HB563X.656		HB194X.570
Charger		2006-2013		Models with 12.6" Vented Rear Rotors		HB509X.678		HB508X.586
Charger		2007-2013		Models with solid rear rotors		HB507X.711		HB508X.586
Charger		2007-2013		Police or Heavy Duty Models with 13.7" Vented Rear Rotors		HB509X.678		
Charger		2008-2014	All	AWD w/Solid Rear Rotor				HB508X.675
Charger		2012-2013		SRT-8		HB563X.656		HB194X.570
Charger	SRT8	2012-2013		68144213AA		HB563X.656		
Charger	R/T	2014	All	RWD		HB509X.678		
Charger	RWD	2014		05174001AC		HB507X.711		
Charger	SRT8	2014		68144223AA		HB563X.656		HB194X.570
Charger	AWD	2015						HB508X.675
Charger	AWD	2015		05142558AB		HB509X.678		
Charger	BR7	2015		68248384AB		HB649X.605		
Charger	R/T Road & Track	2015						HB508X.675
Charger	R/T Road & Track	2015		68147681AA		HB509X.678		
Charger	R/T	2015		68144213AA		HB563X.656		
Charger	R/T	2015		68144223AA				HB194X.570
Charger	RWD, BR8 System	2015		05174001AC		HB507X.711		
Charger	RWD	2015						HB508X.675
Colt		1993		MB928641		HB213X.626		
Colt		1993-1994		MB699336				HB367X.585
Colt		1993-1994		MB928463		HB213X.626		
Colt		1994		MB928461		HB213X.626		
Coronet	Super Bee	1970	All	w/Pin Type Calipers		HB643X.595		
Coronet		1970-1976	All	w/Pin Type Calipers		HB643X.595		
Coronet	Crestwood	1970-1976	All	w/Pin Type Calipers		HB643X.595		
Coronet		1970-1971				HB643X.595		
Coronet	Station Wagon	1970-1972				HB643X.595		
D100		1975-1980				HB398X.680		
D100		1984-1989		4318728		HB398X.680		
D100 Pickup		1972				HB643X.595		
D100 Pickup		1973-1974				HB398X.680		
D150		1977-1983				HB398X.680		
D150		1984-1993	All			HB398X.680		
D150	S	1990-1991	All			HB398X.680		
D200		1975				HB398X.680		
D200 Pickup		1972	All			HB643X.595		
D200 Pickup		1972				HB643X.595		
D200 Pickup		1973-1974				HB398X.680		
D250		1984-1993	All			HB398X.680		
D300 Pickup		1972	All	Single Rear Wheels		HB643X.595		

BRAKE PAD APPLICATIONS

MAKE/ MODEL	SUBMODEL	YEARS	ENGINE (LITER)	NOTE	FRONT		REAR	
					OES	HB SERIES	OES	HB SERIES
DODGE CONTINUED								
D350		1984-1993	All			HB398X.680		
D400		1978-1981				HB103X.590		
Dakota		1987-1993		4313080				HB286X.591
Dakota		1991-1992		2WD		HB308X.689		
Dakota		1991-1996		4WD		HB308X.689		
Dakota		1993-1996		2WD with 4 Whl. ABS		HB308X.689		
Dakota		1993-1996		2WD with Rear Whl. ABS		HB308X.689		
Dakota		1994-2002		4723367				HB286X.591
Dakota		1997-1998				HB308X.689		
Dakota		1999				HB306X.795		
Dakota		2000-2002				HB307X.795		
Dakota		2003	All					HB503X.790
Dakota		2003	All	w/Wear Sensor	770962	HB476X.707		
Dakota		2003-2004				HB476X.707		HB503X.790
Dakota		2004	All		770962	HB476X.707		HB503X.790
Dakota		2005-2011				HB559X.695		
Dart		1966	All			HB471X.510		
Dart	6 Cyl	1967				HB471X.510		
Dart	8 Cyl	1967				HB471X.510		
Dart	270	1968	All			HB471X.510		
Dart	GT	1968-1969	All			HB471X.510		
Dart	GTS	1968-1969	All			HB471X.510		
Dart		1968-1972	All			HB471X.510		
Dart	Custom	1969-1972	All			HB471X.510		
Dart	Swinger	1969-1972	All			HB471X.510		
Dart	Demon 340	1971-1972	All			HB471X.510		
Dart	Demon	1971-1972	All			HB471X.510		
Dart	Special	1971-1972	All			HB471X.510		
Daytona		1989		04238827				HB176X.614
Daytona	Rear Drum	1990		04238827				HB176X.614
Daytona	Rear Disc	1991		4423667				HB176X.614
Daytona	Rear Drum	1991-1993				HB411X.717		
Daytona	Rear Disc	1992-1993		4509374				HB176X.614
Durango		1998-1999	All			HB306X.795		
Durango		1998-1999				HB306X.795		
Durango		2000-2002				HB307X.795		
Durango		2003	All		770702	HB299X.650	770967	HB513X.610
Durango		2003-2006				HB299X.650		HB514X.610
Durango		2004-2009	All					HB513X.610
Durango		2007-2009				HB559X.695		HB514X.610
Durango	Citadel	2011-2014	3.6L					HB702X.662
Durango	Citadel	2011-2014	3.6L	330mm Front Rotors				HB702X.662
Durango	Citadel	2011-2014	3.6L	350mm Front Rotors				HB702X.662
Durango	Crew	2011-2014	3.6L					HB702X.662
Durango	Crew	2011-2014	3.6L	330mm Front Rotors				HB702X.662
Durango	Crew	2011-2014	3.6L	350mm Front Rotors				HB702X.662
Durango	Crewlux	2011-2014	3.6L					HB702X.662
Durango	Crewlux	2011-2014	3.6L	330mm Front Rotors				HB702X.662
Durango	Crewlux	2011-2014	3.6L	350mm Front Rotors				HB702X.662
Durango	Express	2011-2014	3.6L					HB702X.662
Durango	Express	2011-2014	3.6L	330mm Front Rotors				HB702X.662
Durango	Express	2011-2014	3.6L	350mm Front Rotors				HB702X.662
Durango	Heat	2011-2014	3.6L					HB702X.662
Durango	Heat	2011-2014	3.6L	330mm Front Rotors				HB702X.662
Durango	Heat	2011-2014	3.6L	350mm Front Rotors				HB702X.662

BRAKE PAD APPLICATIONS



Hawk Performance - BRAKE PAD APPLICATIONS

HB
HAWK BRAKE

245
PAD SHAPE

x
INSERT COMPOUND CODE

.631
PAD THICKNESS

MAKE/ MODEL	SUBMODEL	YEARS	ENGINE (LITER)	NOTE	FRONT		REAR	
					OES	HB SERIES	OES	HB SERIES
DODGE CONTINUED								
Durango	R/T	2011-2014	5.7L			HB701X.723		HB702X.662
Durango		2011-2013		330mm Front Disc; Solid Rear Disc		HB701X.723		HB702X.662
Durango		2011-2013		350mm Front Disc; Vented Rear Disc		HB701X.723		HB702X.662
Durango		2012-2015		HD Brake		HB741X.723		
Durango		2015		68052369AA		HB701X.723		
Durango		2015		68052386AA				HB702X.662
Durango	HD Brakes	2015		68052386AA				HB702X.662
Dynasty		1991-1993	All					HB176X.614
Dynasty	LE	1991-1993	All					HB176X.614
Dynasty		1991		4423667				HB176X.614
Dynasty		1991-1993				HB411X.717		
Dynasty		1992-1993		4509374				HB176X.614
Grand Caravan		1987-1990		4313080				HB286X.591
Grand Caravan	FWD, Front: 14" Wheels	1991		4423606				HB286X.591
Grand Caravan	AWD	1991-1995				HB411X.717		
Grand Caravan	FWD	1991-1995				HB411X.717		
Grand Caravan	FWD, Front: 14" Wheels	1992		4318080				HB286X.591
Grand Caravan	FWD, Front: 14" Wheels	1993		4423606				HB286X.591
Grand Caravan	FWD, Front: 14" Wheels	1994		4723367				HB286X.591
Grand Caravan	FWD	1995		4723367				HB286X.591
Grand Caravan		1997-2000		04883833AA				HB372X.626
Grand Caravan		2000		Rear disc with 10" front disc		HB177X.630		
Grand Caravan		2000		Rear disc with 11" front disc		HB177X.630		
Grand Caravan	ES	2001	All	w/Rear Disc Brakes.				HB372X.626
Grand Caravan	Sport	2001-2003	All	w/Rear Disc Brakes.				HB372X.626
Grand Caravan		2001-2005	All	w/Rear Disc Brakes.				HB372X.626
Grand Caravan	Rear Drum	2001-2005		04883833AA				HB372X.626
Grand Caravan		2001-2006		Rear Disc		HB374X.700		HB372X.626
Grand Caravan		2001-2006		Rear Drum		HB373X.689		
Grand Caravan		2006-2007	All					HB372X.626
Grand Caravan	SE	2006-2007	All					HB372X.626
Grand Caravan	SXT	2006-2007	All					HB372X.626
Grand Caravan		2007				HB374X.700		HB372X.626
Grand Caravan		2008-2011				HB569X.650		
Grand Caravan	Performance Package	2010		68053152AB		HB569X.650		
Grand Caravan	Performance	2010-2011		68029263AA		HB569X.650		
Grand Caravan		2011		68093323AB		HB569X.650		
Grand Caravan		2012		Models with Single Piston front caliper MFG After 3/24/2012		HB569X.650		
Grand Caravan		2012		Models with Single Piston front caliper MFG Before 3/23/2012		HB569X.650		
Grand Caravan	Rear to 3/23/2012	2012		68093323AB		HB569X.650		
Grand Caravan		2013		Models with Single Piston front caliper		HB569X.650		
Grand Caravan	BRE	2013-2015		68093323AB		HB569X.650		
Intrepid		1993-1994	All					HB176X.614
Intrepid	ES	1993-1994	All					HB176X.614
Intrepid		1993-1994				HB241X.710		
Intrepid		1993-1994		4728146				HB176X.614
Intrepid		1993-1994		With Rear Disc Brakes				HB176X.614
Intrepid		1995-1997	All			HB177X.710		HB176X.614
Intrepid	ES	1995-1997	All			HB177X.710		HB176X.614
Intrepid		1995-1996						HB176X.614
Intrepid		1995-1997		4773265				HB176X.614
Intrepid		1997		With Rear Disc Brakes				HB176X.614
Intrepid		1998-2001	All					HB176X.614
Intrepid		1998-1999		with 16" or 17" Wheels		HB260X.670		HB176X.614

MAKE/ MODEL	SUBMODEL	YEARS	ENGINE (LITER)	NOTE	FRONT		REAR	
					OES	HB SERIES	OES	HB SERIES
DODGE CONTINUED								
Intrepid	Front: 15" Wheels Rear: ABS	1998-1999		05011631AA				HB176X.614
Intrepid	Front: 16" Wheels Rear: Non ABS	1998-1999		05011762AA				HB176X.614
Intrepid		1998-2000		with 15" Wheels		HB260X.670		HB176X.614
Intrepid	R/T	2000	All					HB176X.614
Intrepid	ES	2000-2004	All					HB176X.614
Intrepid		2000		w/16" or 17" Wheels - Excluding Perf. Pkg.		HB260X.670		HB176X.614
Intrepid		2000		w/16" or 17" Wheels - With Perf.Pkg.		HB260X.670		HB176X.614
Intrepid	Rear: 16" Steel Wheels	2001		05011631AA				HB176X.614
Intrepid	Rear: Not 16" Steel Wheels	2001		05011762AA				HB176X.614
Intrepid		2001-2004		Excluding Performance Pkg.		HB260X.670		HB176X.614
Intrepid		2001-2004		With Performance Pkg.		HB260X.670		HB176X.614
Intrepid	SE	2002-2004	All					HB176X.614
Intrepid	Rear: Perf. Suspension	2002		05011631AA				HB176X.614
Intrepid	Rear: Touring Suspension	2002		05080896AA				HB176X.614
Intrepid	SXT	2003-2004	All					HB176X.614
Intrepid		2003-2004		05080896AA				HB176X.614
Intrepid	HD Brakes	2003-2004		05086170AA				HB176X.614
Intrepid	Police	2004	All					HB176X.614
Journey		2009-2011				HB569X.650		
Journey		2012-2013		Models with Single Piston front caliper		HB569X.650		
Journey	BRF Brake Code	2012-2013		68093323AB		HB569X.650		
Lancer		1985-1989		04238827				HB176X.614
Magnum	SE	2005-2008	2.7L	w/Vented Rear Rotor	771056	HB507X.711	771057	HB508X.586
Magnum	SXT	2005-2008	2.7L	w/Vented Rear Rotor - AWD	771058	HB509X.678	771057	HB508X.586
Magnum	SXT	2005-2008	2.7L	w/Vented Rear Rotor - RWD	771056	HB507X.711	771057	HB508X.586
Magnum	SXT	2005-2008	3.5L	w/Vented Rear Rotor - AWD	771058	HB509X.678	771057	HB508X.586
Magnum	SXT	2005-2008	3.5L	w/Vented Rear Rotor - RWD	771056	HB507X.711	771057	HB508X.586
Magnum	R/T	2005-2008	5.7L	w/Vented Rear Rotor		HB509X.678		HB508X.586
Magnum		2005		Models w/Vented Rear Rotors; Except SRT-8		HB509X.678		HB508X.586
Magnum		2005-2008		Models w/Solid Rear Rotors		HB507X.711		HB508X.586
Magnum		2005-2008		SRT-8		HB563X.656		HB194X.570
Magnum	SRT8	2006-2007	6.1L					HB194X.570
Magnum	SRT8	2006		05174311AA		HB563X.656		
Magnum		2006-2008		Models w/vented rear rotors; Except Police/SRT-8		HB509X.678		HB508X.586
Magnum		2006-2008		Police package with 13.7" Vented rear rotors		HB509X.678		
MB250		1981				HB398X.680		
Mini Ram		1984						HB286X.591
Mini Ram		1985-1988		4313080				HB286X.591
Mini Ram	Long Wheel Base	1987-1988		4313080				HB286X.591
Monaco	Station Wagon	1967				HB643X.595		
Monaco		1969	All			HB643X.595		
Monaco		1969-1971				HB643X.595		
Monaco	Station Wagon	1969-1971				HB643X.595		
Monaco	Includes Station Wagon	1970	All			HB643X.595		
Monaco		1971-1973	All			HB643X.595		
Monaco	8 Cyl. Intermediate	1971				HB643X.595		
Monaco	Intermediate	1974				HB643X.595		
Monaco	Station Wagon	1974-1975				HB398X.680		
Monaco		1974-1976				HB398X.680		
Monaco	Crestwood	1977	All	w/Pin Type Calipers		HB643X.595		
Monaco		1977-1978	All			HB643X.595		
Neon	Highline	1995-1997	All			HB177X.630		HB176X.614
Neon	Sport	1995-1997	All			HB177X.630		HB176X.614
Neon		1995-1999	All			HB177X.630		HB176X.614

BRAKE PAD APPLICATIONS



Hawk Performance - BRAKE PAD APPLICATIONS

HB
HAWK BRAKE

245
PAD SHAPE

x
INSERT COMPOUND CODE

.631
PAD THICKNESS

MAKE/ MODEL	SUBMODEL	YEARS	ENGINE (LITER)	NOTE	FRONT		REAR	
					OES	HB SERIES	OES	HB SERIES
DODGE CONTINUED								
Neon		1995-1996		5 lug rear drum		HB177X.630		
Neon		1995-2002		With Rear Disc		HB177X.630		HB176X.614
Neon		1997-2002		with rear drum		HB177X.630		
Neon		1998-2004		05011630AA				HB176X.614
Neon		2000-2001	All			HB260X.670		HB176X.614
Neon	R/T	2001-2004	All			HB260X.670		HB176X.614
Neon	ACR	2002	All			HB260X.670		HB176X.614
Neon	ES	2002	All			HB260X.670		HB176X.614
Neon	SE	2002-2004	All			HB260X.670		HB176X.614
Neon	SXT	2003-2004	All			HB260X.670		HB176X.614
Neon	SRT-4	2003-2005	All			HB377X.760		HB176X.614
Neon		2003-2005		except SRT-4, with Rear Disc		HB177X.630		HB176X.614
Neon		2003-2005		except SRT-4, with Rear Drum		HB177X.630		
Neon		2003-2005		SRT-4		HB377X.760		HB176X.614
Neon	SRT-4	2003-2005		05086567AA				HB176X.614
Neon		2005		05014438AA		HB260X.670		
Nitro	R/T	2007-2011	All			HB569X.650		HB608X.630
Nitro	SLT	2007-2011	All			HB569X.650		HB608X.630
Nitro	SXT	2007-2011	All			HB569X.650		HB608X.630
Nitro		2007-2011				HB569X.650		HB608X.630
Nitro	HD Brakes	2009		68044866AA		HB569X.650		
Nitro	HD Brakes	2010-2011		68044866AC		HB569X.650		
Omni		1983-1984						HB176X.614
Omni		1985-1990		04238827				HB176X.614
Polara		1969	All			HB643X.595		
Polara		1969-1970				HB643X.595		
Polara	Station Wagon	1969-1970				HB643X.595		
Polara	Includes Station Wagon	1970	All			HB643X.595		
Polara		1971-1973	All			HB643X.595		
Polara		1974-1975				HB398X.680		
Polara	Station Wagon	1974-1975				HB398X.680		
Power Ram 50		1985-1986		MB193298		HB614X.600		
Raider		1987		MB193298		HB614X.600		
Raider		1988	All			HB404X.642		
Raider		1989		MB500812		HB404X.642		
Ram	Mini Van	1984						HB286X.591
Ram 1500		1994-1999		2WD		HB332X.654		
Ram 1500		1994-1999		4WD		HB332X.654		
Ram 1500		2000		05003899AA		HB299X.650		
Ram 1500		2000		05018240AA		HB299X.650		
Ram 1500		2000-2001		2WD		HB299X.650		
Ram 1500		2000-2001		4WD		HB299X.650		
Ram 1500		2002-2005	All	2/4WD				HB513X.610
Ram 1500		2002-2003				HB299X.650		HB514X.610
Ram 1500		2004-2005		05139733AA		HB299X.650		
Ram 1500		2004-2005		except SRT-10		HB299X.650		HB514X.610
Ram 1500		2004-2006		SRT-10				HB299X.650
Ram 1500	SRT10	2004-2006		05139917AA				HB299X.650
Ram 1500		2006-2008	All	Mega Cab				HB299X.650
Ram 1500		2006-2008	All	Quad Cab				HB513X.610
Ram 1500		2006-2008	All	Quad Cab 4WD 5.7 liter V8				HB514X.610
Ram 1500		2006-2008		Mega Cab		HB552X.722		HB299X.650
Ram 1500		2006-2008		Regular & Quad Cab		HB559X.695		HB514X.610
Ram 1500	Extended Crew Cab	2006-2008		05093257AA				HB299X.650
Ram 1500		2009-2010	All					HB513X.610

BRAKE PAD APPLICATIONS

MAKE/ MODEL	SUBMODEL	YEARS	ENGINE (LITER)	NOTE	FRONT		REAR	
					OES	HB SERIES	OES	HB SERIES
DODGE CONTINUED								
Ram 1500		2009-2010				HB559X.695		HB514X.610
Ram 1500 Van		1999-2002				HB299X.650		
Ram 1500 Van		2003	All		770702	HB299X.650		HB514X.610
Ram 1500 Van		2003						HB514X.610
Ram 2500		1994-1996		4WD 3500 lb. front axle		HB296X.670		
Ram 2500		1994-1996		4WD 4500 lb. front axle		HB298X.787		
Ram 2500		1994-1999		2WD		HB296X.670		
Ram 2500		1997-1999		4WD 7500 lb. GVW		HB296X.670		
Ram 2500		1997-1999		4WD 8800 lb. GVW		HB298X.787		
Ram 2500		2000-2008	All	2/4WD				HB299X.650
Ram 2500		2000		2WD		HB487X.733		
Ram 2500		2001-2002				HB487X.733		HB299X.650
Ram 2500		2003-2008				HB552X.722		HB299X.650
Ram 2500		2009-2010	All					HB634X.750
Ram 2500		2009-2010				HB633X.790		HB634X.750
Ram 2500 Van		1999-2003				HB334X.705		
Ram 2500 Van		2003		05003999AA				HB299X.650
Ram 3500		1994-1999		2WD with Independent Front Susp.		HB298X.787		
Ram 3500		1994-1999		2WD with Solid Front Axle		HB298X.787		
Ram 3500		1994-1999		4WD		HB298X.787		
Ram 3500		2000-2002	All	2/4WD				HB299X.650
Ram 3500		2000		Rear Disc		HB487X.733		HB299X.650
Ram 3500		2000		Rear Drum		HB487X.733		
Ram 3500		2001		05015337AA				HB299X.650
Ram 3500		2001		05018563AA				HB299X.650
Ram 3500		2001-2002				HB487X.733		HB299X.650
Ram 3500		2003-2008	All	2/4WD. SRW/DRW				HB299X.650
Ram 3500		2003-2008				HB552X.722		HB299X.650
Ram 3500		2009	All	2/4WD				HB634X.750
Ram 3500		2009-2010				HB633X.790		HB634X.750
Ram 3500		2010	All					HB634X.750
Ram 3500 Van		1999-2003				HB334X.705		
Ram 3500 Van		1999-2003		05003999AA				HB299X.650
Ram 50		1985-1986		MB193298		HB614X.600		
Ram 50	Custom	1987-1989	All			HB404X.642		
Ram 50	Sport	1987-1989	All			HB404X.642		
Ram 50		1987-1993	All			HB404X.642		
Ram 50	SE	1990-1993	All			HB404X.642		
Ramcharger		1985-1993		4318728		HB398X.680		
Rampage		1983-1984						HB176X.614
Royal Mini Ram		1984-1987		4313080				HB286X.591
Royal Monaco		1975-1977				HB398X.680		
Shadow		1987-1994		04238827				HB176X.614
Shadow		1991-1994				HB411X.717		
Shadow		1993-1994		4509374				HB176X.614
Spirit	14" Wheels Rear Disc	1991		4423667				HB176X.614
Spirit	15" Wheels	1991		4423667				HB176X.614
Spirit	14" Wheels Rear Disc	1991-1994				HB411X.717		
Spirit	14" Wheels Rear Drum	1991-1994				HB411X.717		
Spirit	14" Wheels Rear Disc	1992-1993		4509374				HB176X.614
Spirit	15" Wheels	1992-1993		4509374				HB176X.614
Spirit	14" Wheels Rear Disc	1994		4720644				HB176X.614
Spirit	15" Wheels	1994		4720644				HB176X.614
Spirit		1995				HB411X.717		
Spirit		1995		4720644				HB176X.614

BRAKE PAD APPLICATIONS



Hawk Performance - BRAKE PAD APPLICATIONS

HB **245** **x** **.631**
 HAWK BRAKE PAD SHAPE INSERT COMPOUND CODE PAD THICKNESS

MAKE/ MODEL	SUBMODEL	YEARS	ENGINE (LITER)	NOTE	FRONT		REAR	
					OES	HB SERIES	OES	HB SERIES
DODGE CONTINUED								
Sprinter 2500	2500	2003-2006	All					HB479X.700
Sprinter 2500		2003-2006		w/Bosch Calipers and 276mm (10.86") Front Rotors; Rear Axle From L874989 or X34861				HB479X.700
Sprinter 2500		2003-2006		With Bosch Calipers and 276mm (10.86") Front Rotors; Rear Axle Up To L874988 or X34860				HB479X.700
Sprinter 2500		2003-2006		w/Bosch Calipers and 285mm (11.2") Front Rotors				HB479X.700
Sprinter 3500		2003-2005		w/Bosch Calipers and 276mm (10.86") Front Rotors; Rear Axle From L874989 or X34861				HB479X.700
Sprinter 3500		2003-2005		With Bosch Calipers and 276mm (10.86") Front Rotors; Rear Axle Up To L874988 or X34860				HB479X.700
Sprinter 3500		2003-2005		With Bosch Calipers and 285mm (11.2") Front Rotors; 272mm (10.7") Rear Rotors				HB479X.700
Sprinter 3500	3500	2005-2006	All					HB479X.700
St. Regis	Station Wagon	1969-1972				HB643X.595		
St. Regis		1971-1972				HB643X.595		
St. Regis		1974-1975				HB398X.680		
St. Regis	Station Wagon	1974-1975				HB398X.680		
Stealth		1991-1993	All	AWD		HB120X.560		
Stealth		1991-1996	All	2WD				HB367X.585
Stealth		1991-1993		4WD		HB120X.560		HB673X.602
Stealth		1991-1996		2WD		HB214X.618		HB367X.585
Stealth		1994		AWD		HB120X.560		HB673X.602
Stealth	AWD	1994		MR128100				HB201X.620
Stealth		1995-1996	All	AWD				HB201X.620
Stealth	R/T Turbo	1995-1996	All	AWD				HB201X.620
Stealth		1995-1996		AWD		HB120X.560		HB201X.620
Stratus	Sedan	1995-2006	All					HB176X.614
Stratus		1995-2000		with 14" Wheels				HB176X.614
Stratus		1995-2000		with 15" Wheels				HB176X.614
Stratus		2001-2005		4 Cyl. Coupe		HB213X.626		
Stratus		2001-2005		6 Cyl. Coupe		HB435X.622		HB367X.585
Stratus		2001-2006		Sedan		HB498X.772		HB176X.614
Stratus		2003-2004		05083071AA				HB176X.614
Viper		1992-2000	All					HB278X.583
Viper		1992-2000				HB194X.570		HB278X.465
Viper	GTS	1996	All					HB278X.583
Viper	GTS	2000	All					HB278X.583
Viper	RT10	2000	All					HB278X.583
Viper		2001-2002	All					HB428X.650
Viper		2001-2002				HB194X.570		
Viper	SRT-10	2003-2006	All			HB193X.670		HB193X.670
Viper	SRT-10	2008-2009	All			HB193X.670		HB193X.670
Viper		2010		05093291AA		HB193X.670		HB193X.670
Viper		2015		05093291AB		HB193X.670		HB193X.670
Viper	Black Caliper	2015		68232820AA		HB453X.585		HB453X.585
W100		1975-1977				HB398X.680		
W100		1986-1989				HB398X.680		
W150		1977-1984				HB398X.680		
W150		1985		4318728		HB398X.680		
W150		1986-1993				HB398X.680		
W200		1977				HB103X.590		
W200		1980				HB103X.590		
W250		1981				HB103X.590		
W250		1984-1993	All	w/3800 lb. Front Axle		HB398X.680		
W250		1986-1993		3500 lb. front axle		HB398X.680		
W300		1978-1980				HB103X.590		

BRAKE PAD APPLICATIONS



MAKE/ MODEL	SUBMODEL	YEARS	ENGINE (LITER)	NOTE	FRONT		REAR	
					OES	HB SERIES	OES	HB SERIES
DODGE CONTINUED								
W350		1981				HB103X.590		
W350		1984				HB398X.680		
W350	Front: 3,500 Lbs. Axle	1985-1987		4318727		HB398X.680		
W350	Front: 4,000 Lbs. Axle	1988-1989		4318728		HB398X.680		
W400		1977-1980				HB103X.590		
W450		1981				HB103X.590		
DONGNAN								
Lancer EX		2012		SE001211				HB457X.605
EAGLE								
Summit	Station Wagon AWD	1992		MB857336				HB367X.585
Summit	Station Wagon	1992		MB857336				HB367X.585
Summit	Station Wagon	1992-1994		MB699334				HB367X.585
Summit	Coupe	1993		MB928641		HB213X.626		
Summit	Sedan	1993-1994		MB928463		HB213X.626		
Summit		1993-1996		Wagon; w/Rear Discs		HB213X.626		HB367X.585
Summit	Sedan	1993-1996		MB699334				HB367X.585
Summit	Coupe	1994		MB928461		HB213X.626		
Summit	Coupe	1995-1996		MB699334				HB367X.585
Summit	Coupe	1995-1996		MB950554		HB213X.626		
Summit	Sedan	1995-1996		MB950555		HB213X.626		
Talon	Front from 04/01/1989	1990		MB699174		HB213X.626		
Talon	AWD	1991-1992		with ABS		HB213X.626		
Talon	AWD	1991-1992		without ABS		HB213X.626		
Talon	2WD	1991-1994		with ABS		HB213X.626		
Talon	2WD	1991-1994		without ABS		HB213X.626		
Talon	AWD	1993				HB214X.618		
Talon	AWD	1994		to 11/1994		HB214X.618		HB673X.602
Talon	4WD, Rear to 11/1994	1995		MR129434				HB673X.602
Talon	AWD	1995		from 12/1994		HB214X.618		HB367X.585
Talon	2WD	1995-1996				HB213X.626		HB367X.585
Talon	AWD	1996-1998				HB214X.618		HB367X.585
Talon	2WD	1997-1998		With Rear Disc		HB213X.626		HB367X.585
Talon	2WD	1997-1998		with rear drum		HB213X.626		
Talon	TSI	1998	All	AWD				HB367X.585
Vision	ESI	1993-1994	All					HB176X.614
Vision	TSI	1993-1994	All					HB176X.614
Vision		1993-1994				HB241X.710		
Vision		1993-1997		w/Rear Discs				HB176X.614
Vision	ESI	1995-1997	All			HB177X.710		HB176X.614
Vision	TSI	1995-1997	All			HB177X.710		HB176X.614
FERRARI								
360		2000-2005	3.6L			HB194X.665		HB194X.665
360	Modena	2000	All			HB193X.670		
550 Maranello		1996		70000912		HB181X.660		
550 Maranello		1997-2002	5.5L			HB181X.660		
612 Scaglietti		2004-2006	All			HB632X.586		
F355		1999	All			HB170X.650		HB170X.650
F40		1988-1992	All			HB193X.670		HB193X.670
F50		1993-1994				HB193X.670		
F50		1995	All			HB193X.670		HB193X.670
FIAT								
500		2012		Excluding Abarth				HB737X.544
500	Abarth	2012		68190118AA		HB739X.715		
500		2012-2013		Abarth Models				HB737X.544
500		2012-2015				HB736X.629		

BRAKE PAD APPLICATIONS



Hawk Performance - BRAKE PAD APPLICATIONS

HB
HAWK BRAKE

245
PAD SHAPE

x
INSERT COMPOUND CODE

.631
PAD THICKNESS

MAKE/ MODEL	SUBMODEL	YEARS	ENGINE (LITER)	NOTE	FRONT		REAR	
					OES	HB SERIES	OES	HB SERIES
FIAT CONTINUED								
500		2013		Electric Models				HB737X.544
500		2013		Excluding Abarth; Gas Engine				HB737X.544
500	Abarth	2013				HB739X.715		
500		2014		68088919AA				HB737X.544
500	Abarth Cabrio	2014		68088919AA				HB737X.544
500	c	2014		68088919AB				HB737X.544
500		2015		68088919AB				HB737X.544
500	Abarth, Turbo Also	2015		68088919AB				HB737X.544
Grande Punto		2007-2010				HB739X.715		
Grande Punto		2007-2010		(Latin America)				HB758X.652
FORD								
Aerostar		1986		E79Z2001A		HB279X.594		
Aerostar	Front from 03/1987	1987		F09Z2001A		HB279X.594		
Aerostar	Front to 03/1987	1987		E79Z2001A		HB279X.594		
Aerostar		1988-1989		F09Z2001A		HB279X.594		
Aerostar		1990-1997		2WD		HB279X.594		
Aerostar		1990-1997		AWD		HB279X.594		
Aerostar	Front & Rear from 11/1992	1993		F29Z2001A		HB279X.594		
Aerostar	Front & Rear to 11/1992	1993		F09Z2001A		HB279X.594		
Aspire		1994-1997		F4BZ2001A		HB246X.567		
B600		1984-1989	All	6000-7000 Front Axle		HB253X.750		
B600		1984-1989	All	8000-12000 Front Axle		HB254X1.00		
B700		1984-1989	All			HB254X1.00		
B7000		1984-1987	All			HB254X1.00		
Bronco		1976				HB292X.674		
Bronco		1977-1986	All			HB292X.674		
Bronco		1986-1987				HB293X.668		
Bronco		1988-1993	All			HB293X.668		
Bronco		1994-1996	All			HB295X.630		
Bronco		1994-1996				HB295X.630		
Bronco II		1984-1990	All			HB279X.594		
Bronco II	Front from 10/1986	1987		F09Z2001A		HB279X.594		
Bronco II	Front to 10/1986	1987		E79Z2001A		HB279X.594		
C600		1984-1986	All			HB253X.750		
C700		1984-1986	All	6000-7000 Front Axle		HB253X.750		
C700		1984-1986	All	8000-12000 Front Axle		HB254X1.00		
C7000		1984-1986	All	6000-7000 Front Axle		HB253X.750		
C7000		1984-1986	All	8000-12000 Front Axle		HB254X1.00		
C800		1984-1987	All			HB254X1.00		
C8000		1984	All			HB254X1.00		
CF7000		1995-1997				HB254X1.00		
CF7000		1995-1997		E6HZ2001C		HB253X.750		
CF8000		1995-1997				HB254X1.00		
CF8000		1995-1997		E6HZ2001C		HB253X.750		
C-Max		2013				HB519X.682		HB478X.605
C-Max		2014-2015		BV6Z2001B		HB519X.682		
C-Max		2014-2015		BV6Z2200C				HB478X.605
C-Max		2016				HB519X.682		
Contour	GL	1995-1998	All					HB510X.580
Contour	LX	1995-1998	All					HB510X.580
Contour	SE	1995-1998	All					HB510X.580
Contour		1995-1997		with ABS		HB420X.724		HB510X.580
Contour		1995-1997		without ABS		HB420X.724		
Contour	Sport	1996-1997	All					HB510X.580
Contour		1997-2000	All					HB510X.580

MAKE/ MODEL	SUBMODEL	YEARS	ENGINE (LITER)	NOTE	FRONT		REAR	
					OES	HB SERIES	OES	HB SERIES
FORD CONTINUED								
Contour		1997		F5RZ2001C		HB420X.724		
Contour		1998		XS8Z2001CA		HB420X.724		
Contour		1998-2000		Rear Disc; Except SVT model w/Sensor in front pads		HB420X.724		HB510X.580
Contour		1998-2000		Rear Disc; Except SVT model Without Sensor in front pads		HB420X.724		HB510X.580
Contour		1998-2000		Rear Drum Brakes - w/Sensor in front pads		HB420X.724		
Contour		1998-2000		Rear Drum Brakes - w/o Sensor in front pads		HB420X.724		
Contour		1998-2000		SVT - With Sensor in front pads				HB510X.580
Contour		1998-2000		SVT - Without Sensor in front pads				HB510X.580
Contour	Rear Drum 4 Cylinder	1999-2000		XS8Z2001CA		HB420X.724		
Country Sedan		1971-1974				HB292X.674		
Country Squire		1971-1972				HB292X.674		
Country Squire		1973-1974	All			HB292X.674		
Country Squire		1987-1991	All			HB125X.650		
Country Squire	LX	1987-1991	All			HB125X.650		
Courier		1977-1982				HB150X.555		
Crown Victoria	Touring Sedan	1992	All			HB125X.650		
Crown Victoria		1992-1994	All			HB125X.650		
Crown Victoria	LX	1992-1994	All			HB125X.650		
Crown Victoria	S	1992-1994	All			HB125X.650		
Crown Victoria	Police	1992		F4AZ2001D		HB125X.650		
Crown Victoria	Police Interceptor	1993-1994	All			HB125X.650		
Crown Victoria	Police, Front to 06/10/1993	1993		F4AZ2001D		HB125X.650		
Crown Victoria		1996-1997		with Phenolic (Plastic) Piston Rear Caliper				HB520X.575
Crown Victoria		1996-1997		with Steel Piston Rear Caliper				HB341X.618
Crown Victoria	LX	1998	All					HB353X.618
Crown Victoria	Police Interceptor	1998	All					HB353X.618
Crown Victoria	S	1998	All					HB353X.618
Crown Victoria		1998-2002	All					HB341X.618
Crown Victoria		1998-2002		with Phenolic (Plastic) Piston Rear Caliper		HB294X.646		HB520X.575
Crown Victoria		1998-2002		with Steel Piston Rear Caliper		HB294X.646		HB341X.618
Crown Victoria		2003-2011	All		770931	HB433X.654	770932	HB443X.614
Crown Victoria	Police Interceptor	2003-2011	All		770931	HB433X.654	770932	HB443X.614
Crown Victoria		2003-2011				HB433X.654		HB443X.614
Crown Victoria	LX Sport	2006-2011	All					HB443X.614
Crown Victoria	LX	2006-2011	All					HB443X.614
Custom	6 Cylinder, Early	1971				HB292X.674		
Custom	6 Cylinder, Late	1971				HB292X.674		
Custom	8 Cylinder, Early	1971				HB292X.674		
Custom	8 Cylinder, Late	1971				HB292X.674		
Custom	Station Wagon,Convertible, Early	1971				HB292X.674		
Custom	Station Wagon,Convertible, Late	1971				HB292X.674		
Custom	Taxi, Early	1971				HB292X.674		
Custom	Taxi, Late	1971				HB292X.674		
Custom	Police	1971-1972				HB292X.674		
Custom	6 Cylinder	1972				HB292X.674		
Custom	8 Cylinder	1972				HB292X.674		
Custom	Station Wagon,Convertible	1972				HB292X.674		
Custom	Taxi	1972				HB292X.674		
Custom 500	Early	1973				HB292X.674		
Custom 500	Late	1973				HB292X.674		
Custom 500	Station Wagon, Early	1973				HB292X.674		
Custom 500	Station Wagon, Late	1973				HB292X.674		
Custom 500	Police & Taxi	1973-1974				HB292X.674		

BRAKE PAD APPLICATIONS

Hawk Performance - BRAKE PAD APPLICATIONS

HB
HAWK BRAKE

245
PAD SHAPE

x
INSERT COMPOUND CODE

.631
PAD THICKNESS

MAKE/ MODEL	SUBMODEL	YEARS	ENGINE (LITER)	NOTE	FRONT		REAR	
					OES	HB SERIES	OES	HB SERIES
FORD CONTINUED								
Custom 500		1974				HB292X.674		
Custom 500	Station Wagon	1974				HB292X.674		
Custom 500		1975	All			HB292X.674		
Custom 500		1976-1978				HB292X.674		
Custom 500		1979-1980				HB125X.650		
Custom 500	Sta. Wag.,Police,Taxi	1979-1980				HB125X.650		
Custom 500	Early	1981				HB125X.650		
Custom 500	Late	1981				HB125X.650		
Custom 500	Police, Late	1981				HB125X.650		
Custom 500	Sta. Wag.,Police,Taxi, Early	1981				HB125X.650		
Custom 500	Station Wagon, Late	1981				HB125X.650		
Custom 500		1982-1984				HB125X.650		
Custom 500	Police	1982-1984				HB125X.650		
Custom 500	Station Wagon	1982-1984				HB125X.650		
Custom 500	Taxi	1982-1984				HB125X.650		
E-100 Econoline		1975-1976	All			HB292X.674		
E-100 Econoline	Club Wagon	1975-1977	All			HB292X.674		
E-100 Econoline		1978-1983				HB292X.674		
E-100 Econoline Club Wagon			1975-1983				HB292X.674	
E-150		2003		with 4 Whl. ABS		HB295X.630		
E-150		2003		with Rear Whl. ABS		HB295X.630		
E-150		2007				HB334X.705		HB539X.650
E-150		2008-2014				HB775X.735		HB776X.671
E-150 Econoline		1975-1976	All			HB292X.674		
E-150 Econoline	Club Wagon	1975-1986	All			HB292X.674		
E-150 Econoline	Super	1985-1986	All			HB292X.674		
E-150 Econoline		1986				HB292X.674		
E-150 Econoline		1987-1993				HB293X.668		
E-150 Econoline	Club Wagon	1994-1998	All			HB295X.630		
E-150 Econoline		1994-2001	All			HB295X.630		
E-150 Econoline		1994-2002		with 4 Whl. ABS		HB295X.630		
E-150 Econoline		1994-2002		with Rear Whl. ABS		HB295X.630		
E-150 Econoline		2008		(Latin America)		HB775X.735		HB776X.671
E-150 Econoline Club Wagon		1975-1984				HB292X.674		
E-150 Econoline Club Wagon		1985		D6TZ2001D		HB292X.674		
E-150 Econoline Club Wagon		1986		E6TZ2001A		HB292X.674		
E-150 Econoline Club Wagon		1990-1993				HB293X.668		
E-150 Econoline Club Wagon		1994-2002		F5TZ2001BC		HB295X.630		
E-250		2003-2007				HB334X.705		HB539X.650
E-250		2006-2007	All					HB539X.650
E-250		2008-2014				HB775X.735		HB776X.671
E-250 Econoline		1975-1982						HB539X.650
E-250 Econoline	Club Wagon	1976-1988	All			HB255X.655		
E-250 Econoline	Super	1977-1988	All			HB255X.655		
E-250 Econoline	Super Wagon	1978-1984	All			HB255X.655		
E-250 Econoline		1985-1994		E5TZ2200B				HB539X.650
E-250 Econoline		1986-1991				HB255X.655		
E-250 Econoline		1989-1991	All			HB336X.655		
E-250 Econoline	Club Wagon	1989-1991	All			HB336X.655		
E-250 Econoline	Super	1989-1991	All			HB336X.655		
E-250 Econoline	HD	1991	All			HB336X.655		
E-250 Econoline		1995-2001		with 4 Whl. ABS		HB334X.705		HB539X.650
E-250 Econoline		1995-2001		with Rear Whl. ABS		HB334X.705		HB539X.650
E-250 Econoline		1997-2002	All					HB539X.650
E-250 Econoline		2002				HB334X.705		HB539X.650

BRAKE PAD APPLICATIONS

MAKE/ MODEL	SUBMODEL	YEARS	ENGINE (LITER)	NOTE	FRONT		REAR	
					OES	HB SERIES	OES	HB SERIES
FORD CONTINUED								
E-250 Econoline Club Wagon		1975						HB539X.650
E-250 Econoline Club Wagon		1976-1982				HB255X.655		HB539X.650
E-250 Econoline Club Wagon		1983-1984				HB255X.655		
E-250 Econoline Club Wagon		1985-1989		F1TZ2001A		HB336X.655		
E-250 Econoline Club Wagon		1985-1991		E5TZ2200B				HB539X.650
E-250 Econoline Club Wagon		1990		F7TZ2001BA		HB336X.655		
E-250 Econoline Club Wagon		1991		F1TZ2001A		HB336X.655		
E-250 Super Duty		2004-2005				HB334X.736		
E-250 Super Duty		2004-2005		XC2Z2200AB				HB539X.650
E-350 Club Wagon		2003-2005				HB334X.736		
E-350 Club Wagon		2003-2005		XC2Z2200AB				HB539X.650
E-350 Econoline		1976-1977				HB255X.655		
E-350 Econoline	Super Wagon	1978-1988	All			HB255X.655		
E-350 Econoline	Super	1978-1988	All			HB255X.655		
E-350 Econoline		1986-1991		Dual Rr Whl		HB255X.655		
E-350 Econoline		1986-1991		Single Rr Whl		HB255X.655		
E-350 Econoline		1987-1988		F1TZ2001A		HB336X.655		
E-350 Econoline	DRW	1987-1988		F1TZ2001A		HB336X.655		
E-350 Econoline		1989-1991	All			HB336X.655		
E-350 Econoline	Super Wagon	1989-1991	All			HB336X.655		
E-350 Econoline	Super	1989-1991	All			HB336X.655		
E-350 Econoline	DRW	1994-1998		F4TZ2200A				HB299X.650
E-350 Econoline		1995-2000		Dual Rr Whl with 4 Whl. ABS		HB334X.705		HB539X.650
E-350 Econoline		1995-2000		Dual Rr Whl with Rear Whl. ABS		HB334X.705		HB539X.650
E-350 Econoline		1995-2000		Single Rr Whl with 4 Whl. ABS		HB334X.705		HB539X.650
E-350 Econoline	Super Duty	1996		F4TZ2200A				HB299X.650
E-350 Econoline		1998		F81Z2001AB		HB302X.700		
E-350 Econoline	DRW	1998		F81Z2001AB		HB302X.700		
E-350 Econoline	Super Wagon	1999	All					HB539X.650
E-350 Econoline	Super	1999	All					HB539X.650
E-350 Econoline		1999-2002	All			HB334X.736		HB539X.650
E-350 Econoline		1999-2000		Single Rr Whl with Rear Whl. ABS		HB334X.705		HB539X.650
E-350 Econoline		2001-2002		DRW		HB334X.705		HB539X.650
E-350 Econoline		2001-2002		SRW		HB334X.705		HB539X.650
E-350 Econoline		2007				HB334X.736		
E-350 Econoline		2007		6C2Z2200C				HB539X.650
E-350 Econoline		2008				HB775X.735		HB776X.671
E-350 Econoline Club Wagon		1977-1984				HB255X.655		
E-350 Econoline Club Wagon		1985-1989		F1TZ2001A		HB336X.655		
E-350 Econoline Club Wagon		1990		F7TZ2001BA		HB336X.655		
E-350 Econoline Club Wagon		1991		F1TZ2001A		HB336X.655		
E-350 Econoline Club Wagon		1995-1998				HB334X.736		
E-350 Econoline Club Wagon	Front Super Duty	1996		F4TZ2200A				HB299X.650
E-350 Econoline Club Wagon		1998		F4TZ2200A				HB299X.650
E-350 Econoline Club Wagon		1998		F81Z2001AB		HB302X.700		
E-350 Econoline Club Wagon		1999		2C2Z2200AA				HB539X.650
E-350 Econoline Club Wagon		2000-2002		XC2Z2200AB				HB539X.650
E-350 Super Duty		2003-2007		DRW		HB334X.705		HB539X.650
E-350 Super Duty		2003-2007		SRW		HB334X.705		HB539X.650
E-350 Super Duty		2006-2007	All					HB539X.650
E-350 Super Duty	XL	2006-2007	All					HB539X.650
E-350 Super Duty	XLT	2006-2007	All					HB539X.650
E-350 Super Duty		2008-2016				HB775X.735		HB776X.671
E-450 Super Duty		2003-2007				HB334X.705		
E-450 Super Duty		2008				HB775X.735		

BRAKE PAD APPLICATIONS

Hawk Performance - BRAKE PAD APPLICATIONS

HB **245** **x** **.631**
 HAWK BRAKE PAD SHAPE INSERT COMPOUND CODE PAD THICKNESS

MAKE/ MODEL	SUBMODEL	YEARS	ENGINE (LITER)	NOTE	FRONT		REAR	
					OES	HB SERIES	OES	HB SERIES
FORD CONTINUED								
E-450 Super Duty		2009-2010				HB775X.735		HB776X.671
E-450 Super Duty		2011-2016				HB775X.735		
E-550 Econoline Super Duty		2002-2006		F81Z2001CA		HB335X.815		HB335X.815
E-550 Super Duty		2003				HB335X.815		HB335X.815
EcoSport	(Latin America)	2003	All	(Latin America)	771175			
EcoSport	(Latin America)	2012		M7N152K021AA		HB519X.682		
EcoSport	(Latin America)	2013		MCN152K021AA		HB519X.682		
Edge		2007-2010	All					HB657X.667
Edge		2007-2009		296mm (11.65") Front Rotors		HB656X.684		HB657X.667
Edge		2007-2009		320mm (12.6") Front Rotors		HB656X.684		HB657X.667
Edge		2010				HB656X.684		HB657X.667
Edge		2011-2014	All					HB674X.664
Edge		2011-2013				HB656X.684		HB674X.664
Edge		2014-2015		BT4Z2001B		HB656X.684		
Edge		2015		CT4Z2200A				HB674X.664
Elite		1975	All			HB292X.674		
Elite		1976				HB292X.674		
Escape		2001-2005	All	w/Rear Drum Brakes		HB473X.752		
Escape		2001-2004				HB473X.752		
Escape		2005-2007		w/Rear Drums		HB473X.752		
Escape	Limited	2006-2007	All	w/Rear Drum Brakes		HB473X.752		
Escape	XLS	2006-2007	All	w/Rear Drum Brakes		HB473X.752		
Escape	XLT	2006-2007	All	w/Rear Drum Brakes		HB473X.752		
Escape	Hybrid	2007	All	w/Rear Drum Brakes		HB473X.752		
Escape		2008-2012	All		771047			
Escape	Hybrid	2010-2012	All		771047			
Escape		2013-2014	1.6L	FWD Only		HB519X.682		
Escape		2013-2014	2.0L	FWD Only		HB519X.682		
Escape		2013-2014	2.5L	FWD Only		HB519X.682		
Escape		2013-2014		1.6L Engine AWD				HB478X.605
Escape		2013-2014		1.6L Engine FWD		HB519X.682		HB478X.605
Escape		2013-2014		2.0L Engine				HB478X.605
Escape		2013-2014		2.5L Engine		HB519X.682		HB478X.605
Escape	4WD	2013-2015		CV6Z2001B		HB519X.682		
Escape	4WD	2013-2015		CV6Z2200A				HB478X.605
Escape	FWD	2013-2015				HB519X.682		
Escape	FWD	2013-2015		CV6Z2001C		HB519X.682		
Escape	FWD	2013-2015		CV6Z2200A				HB478X.605
Escape	Front: 2.0 Liter Gas & 1.6L Ecoboost	2016		CV6Z2001F		HB519X.682		
Escort	GT	1991-1996	All					HB157X.484
Escort		1991-1993		F1CZ2001A		HB246X.567		
Escort		1991-1996		DOHC 1.8L		HB246X.567		HB157X.484
Escort	LX	1997-1998	All					HB159X.492
Escort	Sport	1997-1998	All					HB159X.492
Escort		1997-2002	All					HB159X.492
Escort		1997-2002				HB246X.567		HB159X.492
Escort		1998-2003		F7CZ2200BA				HB159X.492
Escort		1998-2003		F7CZ2200CA				HB159X.492
Escort		2003		ZX2		HB246X.567		HB159X.492
Excursion		2000-2005	All	2WD				HB303X.685
Excursion		2000		2WD - Manufactured after 1/2000		HB302X.700		HB303X.685
Excursion		2000		2WD - Manufactured up to 12/1999		HB302X.700		HB303X.685
Excursion		2000		4WD - Manufactured after 1/2000		HB302X.700		HB303X.685
Excursion		2000		4WD - Manufactured up to 12/1999		HB302X.700		HB303X.685

BRAKE PAD APPLICATIONS



MAKE/ MODEL	SUBMODEL	YEARS	ENGINE (LITER)	NOTE	FRONT		REAR	
					OES	HB SERIES	OES	HB SERIES
FORD CONTINUED								
Excursion		2001-2005		2WD		HB302X.700		HB303X.685
Excursion		2001-2005		4WD		HB302X.700		HB303X.685
Expedition		1997-2002	All					HB301X.630
Expedition		1997-1999		2WD		HB299X.650		HB301X.630
Expedition		1997-1999		4WD		HB299X.650		HB301X.630
Expedition		1999		XL3Z2200AA				HB301X.630
Expedition		2000		2WD From 12/99 - 14mm Studs		HB299X.650		HB301X.630
Expedition		2000		2WD To 11/99 - 12mm Studs		HB299X.650		HB301X.630
Expedition		2000		4WD; From 12/99		HB299X.650		HB301X.630
Expedition		2000		4WD; To 11/99		HB299X.650		HB301X.630
Expedition		2001		2WD		HB299X.650		HB301X.630
Expedition		2001		4WD		HB299X.650		HB301X.630
Expedition		2002		2WD; From 3/18/02		HB299X.650		HB301X.630
Expedition		2002		2WD; To 3/18/02		HB299X.650		HB301X.630
Expedition		2002		4WD; From 3/18/02		HB299X.650		HB301X.630
Expedition		2002		4WD; To 3/18/02		HB299X.650		HB301X.630
Expedition		2003-2005	All					HB463X.787
Expedition		2003-2006				HB462X.827		HB463X.787
Expedition	Eddie Bauer	2004	All					HB463X.787
Expedition	King Ranch	2005	All					HB463X.787
Expedition	Limited	2006	All					HB463X.787
Expedition	XLS	2006	All					HB463X.787
Expedition	XLT Sport	2006	All					HB463X.787
Expedition	XLT	2006	All					HB463X.787
Expedition	Eddie Bauer	2007-2009	All					HB579X.785
Expedition	EL Eddie Bauer	2007-2009	All					HB579X.785
Expedition	EL King Ranch	2007-2009	All					HB579X.785
Expedition	EL Limited	2007-2009	All					HB579X.785
Expedition	EL Xlt	2007-2009	All					HB579X.785
Expedition	Funkmaster Flex Edition	2007-2009	All					HB579X.785
Expedition	King Ranch	2007-2009	All					HB579X.785
Expedition	Limited	2007-2009	All					HB579X.785
Expedition	XLT	2007-2009	All					HB579X.785
Expedition		2007-2009				HB578X.735		HB579X.785
Expedition		2010-2014	All					HB579X.785
Expedition		2010-2014				HB672X.714		HB579X.785
Expedition		2015-2016		CL1Z2200A				HB579X.785
Explorer		1991-1992		2WD with ABS		HB279X.594		
Explorer		1991-1992		2WD without ABS		HB279X.594		
Explorer		1991-1992		4WD 2.2" Tall Rotor Hat		HB279X.594		
Explorer		1991-1992		4WD 2.5" Tall Rotor Hat		HB279X.594		
Explorer		1993-1994		2WD		HB279X.594		
Explorer		1993-1994		4WD		HB279X.594		
Explorer		1995-2001	All					HB287X.571
Explorer		1995-2000		2WD		HB283X.650		HB287X.571
Explorer		1995-2000		4WD		HB283X.650		HB287X.571
Explorer	Sport	2001	All	AWD/4WD	770833	HB472X.650		
Explorer	Sport	2001	All	RWD	770833	HB472X.650		
Explorer		2001		2WD except Sport		HB283X.650		HB287X.571
Explorer		2001		4WD except Sport		HB283X.650		HB287X.571
Explorer	Sport	2001-2002		2WD with Phenolic Piston Rear Calipers		HB472X.650		HB287X.571
Explorer	Sport	2001-2002		2WD with Steel Piston Rear Calipers		HB472X.650		HB287X.571
Explorer	Sport	2001-2002		4WD with Phenolic Piston Rear Calipers		HB472X.650		HB287X.571
Explorer	Sport	2001-2002		4WD with Steel Piston Rear Calipers		HB472X.650		HB287X.571
Explorer	Sport	2002-2003	All		770833	HB472X.650	770667	HB287X.571

BRAKE PAD APPLICATIONS



Hawk Performance - BRAKE PAD APPLICATIONS

HB **245** **x** **.631**
 HAWK BRAKE PAD SHAPE INSERT COMPOUND CODE PAD THICKNESS

MAKE/ MODEL	SUBMODEL	YEARS	ENGINE (LITER)	NOTE	FRONT		REAR	
					OES	HB SERIES	OES	HB SERIES
FORD CONTINUED								
Explorer		2002-2004	All					HB520X.575
Explorer		2002		Except Sport		HB472X.650		HB520X.575
Explorer	Sport	2003		2L2Z2200BA				HB287X.571
Explorer		2003-2005				HB472X.650		HB520X.575
Explorer		2005-2010	All					HB613X.589
Explorer		2006-2010				HB612X.690		HB613X.589
Explorer		2011-2014	All	Standard Brakes				HB674X.664
Explorer		2011-2012				HB710X.706		HB674X.664
Explorer		2013		DG1Z2200E				HB674X.664
Explorer		2013-2014		Standard Brakes; 325mm (12.8") Front Rotors		HB710X.706		HB674X.664
Explorer	HD Brakes	2013-2016		DG1Z22001D		HB710X.706		
Explorer		2014-2016		EG1Z2200A				HB674X.664
Explorer		2015-2016		EB5Z22001A		HB710X.706		
Explorer	HD Brakes	2015-2016		EG1Z2200B				HB674X.664
Explorer Sport Trac		2001-2002		2WD		HB472X.650		
Explorer Sport Trac		2001-2002		4WD		HB472X.650		
Explorer Sport Trac		2003-2005	All					HB287X.571
Explorer Sport Trac		2003-2005		2WD		HB472X.650		HB287X.571
Explorer Sport Trac		2003-2005		4WD		HB472X.650		HB287X.571
Explorer Sport Trac		2007-2010	All					HB613X.589
Explorer Sport Trac		2007-2010				HB612X.690		HB613X.589
F-100	4 x 2	1975-1983				HB292X.674		
F-100	4 x 4	1976				HB292X.674		
F-100 Pickup		1973-1974	All			HB292X.674		
F-150		1975-1985	All			HB292X.674		
F-150		1986-1993	All			HB293X.668		
F-150	2WD	1986				HB292X.674		
F-150	4WD	1986-1993				HB293X.668		
F-150	2WD	1987-1993				HB293X.668		
F-150		1994-1996	All			HB295X.630		
F-150	2WD	1994-1996		with 4 Whl. ABS		HB295X.630		
F-150	2WD	1994-1996		with Rear Whl. ABS		HB295X.630		
F-150	4WD	1994-1996				HB295X.630		
F-150	Lightning/Harley Davidson	1997-1998	5.4L		770702	HB299X.650		HB301X.630
F-150		1997	All			HB266X.650		
F-150		1997-1998	All		770679			
F-150	2WD	1997-1998		with 4 Whl. ABS		HB266X.650		
F-150	2WD	1997-1998		with Rear Whl. ABS		HB266X.650		
F-150	4WD	1997-1998				HB266X.650		
F-150		1998	All			HB266X.650		HB301X.630
F-150		1999	All	5 Lug, Rear Disc, Exc Lightning, From 12/99	770679	HB266X.650		HB301X.630
F-150		1999	All	5 Lug, Rear Drum, From 12/99	770679	HB266X.650		
F-150		1999	All	7 Lug, Rear Disc	770702	HB299X.650		HB301X.630
F-150		1999	All	7 Lug, Rear Drum	770702	HB299X.650		
F-150		1999	All	8 lug	770702	HB299X.650		HB539X.650
F-150	Lightning/Harley Davidson	1999-2003	All	Lightning, 5 Lug, Rear Disc, From 12/99	770702	HB299X.650		HB301X.630
F-150	2WD	1999		Rear Disc - except Lightning & NASCAR		HB266X.650		HB301X.630
F-150	2WD	1999		Rear Disc - Lightning/NASCAR Models		HB299X.650		HB301X.630
F-150	2WD	1999		Rear Drum with 4 Whl. ABS		HB266X.650		
F-150	2WD	1999		Rear Drum with Rear Whl. ABS		HB266X.650		
F-150	4WD	1999		Models with Rear Disc Brakes		HB266X.650		HB301X.630
F-150	4WD	1999		Models with Rear Drum Brakes		HB266X.650		
F-150		2000-2003	All	5 Lug, Rear Disc, Exc Lightning, From 12/99	770679	HB266X.650		HB301X.630
F-150		2000-2003	All	5 Lug, Rear Drum, From 12/99	770679	HB266X.650		
F-150		2000-2003	All	7 Lug, Rear Disc	770702	HB299X.650		HB301X.630

BRAKE PAD APPLICATIONS



MAKE/ MODEL	SUBMODEL	YEARS	ENGINE (LITER)	NOTE	FRONT		REAR	
					OES	HB SERIES	OES	HB SERIES
FORD CONTINUED								
F-150		2000-2003	All	7 Lug, Rear Drum	770702	HB299X.650		
F-150		2000-2003	All	8 lug	770702	HB299X.650		HB539X.650
F-150	2WD	2000		From 12/99 - 7 Lug Models with 4 Wheel ABS - Rear Disc		HB299X.650		HB301X.630
F-150	2WD	2000		From 12/99 - 7 Lug Models with 4 Wheel ABS - Rear Drum		HB299X.650		
F-150	2WD	2000		From 12/99 - 7 Lug Models with Rear Wheel ABS - Rear Disc		HB299X.650		HB301X.630
F-150	2WD	2000		From 12/99 - 7 Lug Models with Rear Wheel ABS - Rear Drum		HB299X.650		
F-150	2WD	2000		From 12/99 - Lightning & NASCAR 5 lugs, 14mm Studs		HB299X.650		HB301X.630
F-150	2WD	2000		From 12/99 - Rear Disc except Lightning 5 lugs, 14mm Studs		HB266X.650		HB301X.630
F-150	2WD	2000		From 12/99 - Rear Drum 5 Lug		HB266X.650		
F-150	2WD	2000		To 11/99 - 12mm Lugs except Lightning & NASCAR		HB266X.650		HB301X.630
F-150	2WD	2000		To 11/99 - 12mm Lugs Lightning & NASCAR		HB299X.650		HB301X.630
F-150	2WD	2000		To 11/99 - Rear Drum with 4 Whl. ABS		HB266X.650		
F-150	2WD	2000		To 11/99 - Rear Drum with Rear Whl. ABS		HB266X.650		
F-150	4WD	2000		Mfg After 12/99, 5 lugs, Rear Disc Brakes		HB266X.650		HB301X.630
F-150	4WD	2000		Mfg After 12/99, 5 lugs, Rear Drum Brakes		HB266X.650		
F-150	4WD	2000		Mfg After 12/99, 7 Lugs, Rear Disc Brakes		HB299X.650		HB301X.630
F-150	4WD	2000		Mfg After 12/99, 7 Lugs, Rear Drum Brakes		HB299X.650		
F-150	4WD	2000		Mfg Before 11/99, 5 lug, Rear Disc Brakes		HB266X.650		HB301X.630
F-150	4WD	2000		Mfg Before 11/99, 5 lug, Rear Drum Brakes		HB266X.650		
F-150	Lightning	2000		XL3Z2200AA				HB301X.630
F-150		2000-2003		XL3Z2200AA				HB301X.630
F-150	2WD	2000-2004		8 Lug Models		HB299X.650		HB539X.650
F-150	2WD	2001		7 Lug Models with 4 Wheel ABS - Rear Disc		HB299X.650		HB301X.630
F-150	2WD	2001		7 Lug Models with 4 Wheel ABS - Rear Drum		HB299X.650		
F-150	2WD	2001		7 Lug Models with Rear Wheel ABS - Rear Disc		HB299X.650		HB301X.630
F-150	2WD	2001		7 Lug Models with Rear Wheel ABS - Rear Drum		HB299X.650		
F-150	2WD	2001-2003		5 Lug Models With Rear Disc except Lightning & NASCAR		HB266X.650		HB301X.630
F-150	2WD	2001-2003		5 Lug Models With Rear Drum		HB266X.650		
F-150	2WD	2001-2003		Lightning & NASCAR Models		HB299X.650		HB301X.630
F-150	4WD	2001-2003		5 Lugs - Rear Disc Brakes		HB266X.650		HB301X.630
F-150	4WD	2001-2003		5 Lugs - Rear Drum Brakes		HB266X.650		
F-150	4WD	2001-2003		7 Lugs - Rear Disc Brakes		HB299X.650		HB301X.630
F-150	4WD	2001-2003		7 Lugs - Rear Drum Brakes		HB299X.650		
F-150	Lightning, GVW 7,700 Lbs.	2001-2003		XL3Z2200AA				HB301X.630
F-150	2WD	2002-2003		7 Lugs - Rear Disc		HB299X.650		HB301X.630
F-150	2WD	2002-2003		7 Lugs - Rear Drum		HB299X.650		
F-150	Heritage	2004	All	5 Lug Wheels	770679	HB266X.650		HB301X.630
F-150	Heritage	2004	All	7 Lug Wheels	770702	HB299X.650		HB301X.630
F-150		2004	All	6 Lug Wheels - 2WD	771011		771012	
F-150		2004-2008	All	6 Lug Wheels - 2WD		HB455X.785		HB456X.705
F-150		2004-2008	All	6 Lug Wheels - 4WD	771011	HB455X.785	771012	HB456X.705
F-150		2004-2008	All	7 Lug Wheels	771011	HB455X.785	771012	HB456X.705
F-150	2WD	2004		6 Lug New Model		HB455X.785		HB456X.705
F-150	2WD	2004		7 Lug New Model		HB455X.785		HB456X.705
F-150	2WD	2004		Heritage, 5 Lug Rear Disc		HB266X.650		HB301X.630
F-150	2WD	2004		Heritage, 5 Lug Rear Drum		HB266X.650		
F-150	2WD	2004		Heritage, 7 Lug - Rear Disc		HB299X.650		HB301X.630
F-150	2WD	2004		Heritage, 7 Lug - Rear Drum		HB299X.650		
F-150	2WD	2004		Lightning		HB299X.650		HB301X.630

BRAKE PAD APPLICATIONS



Hawk Performance - BRAKE PAD APPLICATIONS

HB **245** **x** **.631**
 HAWK BRAKE PAD SHAPE INSERT COMPOUND CODE PAD THICKNESS

MAKE/ MODEL	SUBMODEL	YEARS	ENGINE (LITER)	NOTE	FRONT		REAR	
					OES	HB SERIES	OES	HB SERIES
FORD CONTINUED								
F-150	4WD	2004		Heritage Model - 5 Lugs - Rear Disc Brakes		HB266X.650		HB301X.630
F-150	4WD	2004		Heritage Model - 5 Lugs - Rear Drum Brakes		HB266X.650		
F-150	4WD	2004		Heritage Model - 7 Lugs - Rear Disc Brakes		HB299X.650		HB301X.630
F-150	4WD	2004		Heritage Model - 7 Lugs - Rear Drum Brakes		HB299X.650		
F-150	4WD	2004		New Model - 6 lug		HB455X.785		HB456X.705
F-150	4WD	2004		New Model - 7 Lug		HB455X.785		HB456X.705
F-150	Lightning	2004		XL3Z2200AA				HB301X.630
F-150	2WD	2005-2006		Heavy Duty Pkg 7 Lug		HB455X.785		HB456X.705
F-150	2WD	2005-2008		Base Payload Pkg 6 Lug		HB455X.785		HB456X.705
F-150	4WD	2005-2008		6 Lug		HB455X.785		HB456X.705
F-150	4WD	2005-2008		7 Lug		HB455X.785		HB456X.705
F-150	2WD	2007-2008		HD Payload Pkg 7 Lug		HB455X.785		HB456X.705
F-150		2008-2009	All	2008 is for Lariat model		HB644X.785		HB456X.705
F-150		2008		6L3Z2001A		HB455X.785		
F-150	2WD	2009		Base Payload Pkg 6 Lug		HB644X.785		HB456X.705
F-150	2WD	2009		HD Payload Pkg 7 Lug		HB644X.785		HB456X.705
F-150	4WD	2009		6 Lug		HB644X.785		HB456X.705
F-150	4WD	2009		7 Lug		HB644X.785		HB456X.705
F-150	SVT Raptor	2010-2011	All			HB672X.714		HB456X.705
F-150		2010-2012	All	Base, 2WD & 4WD 6 lug		HB672X.714		HB456X.705
F-150	2WD	2010		Base Payload Pkg 6 Lug		HB672X.714		HB456X.705
F-150	2WD	2010		HD Payload Pkg 7 Lug		HB672X.714		HB456X.705
F-150	4WD	2010-2011		6 Lug		HB672X.714		HB456X.705
F-150	4WD	2010-2011		7 Lug		HB672X.714		HB456X.705
F-150	RAPTOR 4WD	2010-2011				HB672X.714		HB456X.705
F-150	2WD	2011		6 Lug		HB672X.714		HB456X.705
F-150	2WD	2011		7 Lug		HB672X.714		HB456X.705
F-150		2012	All	Production date to 10/23/2011 Base, 2WD & 4WD 6 lug		HB672X.714		
F-150		2012-2014						HB772X.654
F-150	2WD	2012-2014		6 Lug		HB672X.714		
F-150	2WD	2012-2014		7 Lug		HB672X.714		
F-150	4WD	2012-2014		6 Lug		HB672X.714		
F-150	4WD	2012-2014		7 Lug		HB672X.714		
F-150	RAPTOR 4WD	2012-2014				HB672X.714		
F-150		2014	All			HB672X.714		
F-150		2015-2016		Mechanical PB				HB772X.654
F-150 Heritage		2004		F85Z2001AA		HB266X.650		
F-150 Heritage		2004		XL3Z2200AA				HB301X.630
F-150 Heritage	GVW 7,700 Lbs.	2004		F75Z2001AA		HB299X.650		
F-250	(6200-6900#)	1975				HB292X.674		HB539X.650
F-250	(Over 6900#)	1975						HB539X.650
F-250	(6200-6800#)	1976				HB255X.655		HB539X.650
F-250	(6200-6800#)	1976-1978				HB292X.674		HB539X.650
F-250	(Over 6800#)	1976-1978				HB255X.655		HB539X.650
F-250	4 x 4	1976-1984				HB255X.655		HB539X.650
F-250	(6200-6800#)	1977				HB255X.655		HB301X.630
F-250	(6200-6800#)	1978				HB255X.655		HB539X.650
F-250	(6200-6900#)	1979				HB255X.655		HB539X.650
F-250	(6200-6900#)	1979				HB292X.674		HB539X.650
F-250	(Over 6900#)	1979-1980				HB255X.655		HB539X.650
F-250	(6350-6900#)	1980-1984				HB255X.655		HB539X.650
F-250	(6350-6900#)	1980-1984				HB292X.674		HB539X.650
F-250	(Over 6900#)	1981-1984				HB255X.655		
F-250		1985		D6TZ2001D		HB292X.674		

BRAKE PAD APPLICATIONS



MAKE/ MODEL	SUBMODEL	YEARS	ENGINE (LITER)	NOTE	FRONT		REAR	
					OES	HB SERIES	OES	HB SERIES
FORD CONTINUED								
F-250		1985		F1TZ2001A		HB336X.655		
F-250		1985-1996		E5TZ2200B				HB539X.650
F-250	2WD	1986-1994				HB255X.655		
F-250	4WD	1986-1994				HB255X.655		
F-250	2WD	1995				HB334X.705		
F-250	4WD	1995-1996				HB334X.705		
F-250	2WD	1996		Rear Drum 12x3" Rear Brake		HB334X.705		
F-250	2WD	1996		Standard Duty 12x2 1/2" Rear Brake		HB334X.705		
F-250	Over GVW 8500	1997		E5TZ2200B				HB539X.650
F-250	Under GVW 8500	1997		F75Z2200AA				HB539X.650
F-250	Under GVW 8500	1997		XL3Z2200AA				HB301X.630
F-250	2WD	1997-1998		Rear Disc 7 Lug with 4 Whl. ABS		HB299X.650		HB301X.630
F-250	2WD	1997-1998		Rear Disc 7 Lug with Rear Whl. ABS		HB299X.650		HB301X.630
F-250	2WD	1997-1998		Rear Drum 7 Lug with 4 Whl. ABS		HB299X.650		
F-250	2WD	1997-1998		Rear Drum 7 Lug with Rear Whl. ABS		HB299X.650		
F-250	2WD	1997-1998		Rear Drum 8 Lug		HB334X.705		
F-250	4WD	1997-1998		7 Lug - Rear Disc		HB299X.650		HB301X.630
F-250	4WD	1997-1998		7 Lug - Rear Drum		HB299X.650		
F-250	4WD	1997-1998		8 Lug - Rear Drum		HB334X.705		
F-250	2WD	1999		Exc. Super Duty Models Rear Disc 7 Lug with 4 Whl. ABS		HB299X.650		HB301X.630
F-250	2WD	1999		Exc. Super Duty Models Rear Disc 7 Lug with Rear Whl. ABS		HB299X.650		HB301X.630
F-250	2WD	1999		Exc. Super Duty Models Rear Drum 7 Lug with 4 Whl. ABS		HB299X.650		
F-250	2WD	1999		Exc. Super Duty Models Rear Drum 7 Lug with Rear Whl. ABS		HB299X.650		
F-250	2WD	1999		Exc. Super Duty Models - Rear Drum 8 Lug		HB334X.705		
F-250	4WD	1999		7 Lug - Rear Disc - Exc. Super Duty		HB299X.650		HB301X.630
F-250	4WD	1999		7 Lug - Rear Drum - Exc. Super Duty		HB299X.650		
F-250	4WD	1999		8 Lug - Rear Drum - Exc. Super Duty		HB334X.705		
F-250 Pickup	4 x 4	1972						HB539X.650
F-250 Pickup		1973-1974	All			HB292X.674		
F-250 Pickup	(Over 6200#)	1973-1974						HB539X.650
F-250 Super Duty		1999-2004	All			HB302X.700		HB303X.685
F-250 Super Duty	4WD	1999		From 3/22/99 (101mm tall Front rotor)		HB302X.700		HB303X.685
F-250 Super Duty	4WD	1999		To 3/22/99 (95mm tall Front rotor)		HB302X.700		HB303X.685
F-250 Super Duty	2WD	1999-2001		with 4 Whl. ABS		HB302X.700		HB303X.685
F-250 Super Duty	2WD	1999-2001		with Rear Whl. ABS		HB302X.700		HB303X.685
F-250 Super Duty	4WD	2000-2004				HB302X.700		HB303X.685
F-250 Super Duty	2WD	2002-2004				HB302X.700		HB303X.685
F-250 Super Duty		2005-2007	All			HB528X.811		HB529X.710
F-250 Super Duty	2WD	2005-2006				HB528X.811		HB529X.710
F-250 Super Duty	4WD	2005-2006				HB528X.811		HB529X.710
F-250 Super Duty	2WD	2007		Manufactured After 12/18/2006		HB528X.811		HB556X.710
F-250 Super Duty	2WD	2007		Manufactured Before 12/17/2006		HB528X.811		HB529X.710
F-250 Super Duty	4WD	2007		Mfg. After 12/17/2006		HB528X.811		HB529X.710
F-250 Super Duty	4WD	2007		Mfg. Before 12/17/2006		HB528X.811		HB529X.710
F-250 Super Duty		2008-2012	All			HB528X.811		HB556X.710
F-250 Super Duty	2WD	2008-2011				HB528X.811		HB556X.710
F-250 Super Duty	4WD	2008-2011				HB528X.811		HB556X.710
F-250 Super Duty		2012		BC3Z2001A		HB528X.811		
F-250 Super Duty	2WD	2012						HB556X.710
F-250 Super Duty	4WD	2012						HB556X.710
F-350		1976-1981				HB255X.655		
F-350	4 x 4	1979				HB255X.655		HB539X.650

BRAKE PAD APPLICATIONS



Hawk Performance - BRAKE PAD APPLICATIONS

HB **245** **x** **.631**
 HAWK BRAKE PAD SHAPE INSERT COMPOUND CODE PAD THICKNESS

MAKE/ MODEL	SUBMODEL	YEARS	ENGINE (LITER)	NOTE	FRONT		REAR	
					OES	HB SERIES	OES	HB SERIES
FORD CONTINUED								
F-350	4 x 4	1980-1981				HB255X.655		
F-350	2WD	1982-1994		Dual Rr Whl		HB255X.655		
F-350	2WD	1986-1994		Single Rr Whl		HB255X.655		
F-350	4WD	1986-1994				HB255X.655		
F-350		1987-1989		F1TZ2001A		HB336X.655		
F-350	DRW	1987-1989		F1TZ2001A		HB336X.655		
F-350		1990		F7TZ2001BA		HB336X.655		
F-350	DRW	1990		F7TZ2001BA		HB336X.655		
F-350		1991-1994		F1TZ2001A		HB336X.655		
F-350	DRW	1991-1994		F1TZ2001A		HB336X.655		
F-350	DRW	1994-1997		F4TZ2200A				HB299X.650
F-350	2WD	1995-1997		Dual Rr Whl		HB334X.705		
F-350	2WD	1995-1997		Single Rr Whl		HB334X.705		
F-350	4WD	1995-1997				HB334X.705		
F-350 Super Duty		1998		F81Z2001AB		HB302X.700		
F-350 Super Duty		1998		F81Z2200AA				HB303X.685
F-350 Super Duty		1999-2004	All	2WD		HB302X.700		HB303X.685
F-350 Super Duty		1999-2004	All	4WD. Dual Rear Wheels From 3/22/1999 with 3.92" tall front disc		HB302X.700		HB303X.685
F-350 Super Duty	4WD	1999		Dual Rr Whl; 101mm tall rotor; MFG From 3/22/99		HB302X.700		HB303X.685
F-350 Super Duty	4WD	1999		Dual Rr Whl; 95mm tall front rotor; MFG Up To 3/21/1999		HB302X.700		HB303X.685
F-350 Super Duty	4WD	1999		Single Rr Whl; 101mm tall rotor; MFG From 3/22/99		HB302X.700		HB303X.685
F-350 Super Duty	4WD	1999		Single Rr Whl; 95mm tall front rotor; MFG Up To 3/21/1999		HB302X.700		HB303X.685
F-350 Super Duty	2WD	1999-2002		Single Rr Whl with 4 Whl. ABS		HB302X.700		HB303X.685
F-350 Super Duty	2WD	1999-2002		Single Rr Whl with Rear Whl. ABS		HB302X.700		HB303X.685
F-350 Super Duty	2WD	1999-2004		Dual Rear Wheels		HB302X.700		HB303X.685
F-350 Super Duty	4WD	2000-2004		Dual Rear Wheels		HB302X.700		HB303X.685
F-350 Super Duty	4WD	2000-2004		Single Rear Wheels		HB302X.700		HB303X.685
F-350 Super Duty	2WD	2003-2004		Single Rear Wheels		HB302X.700		HB303X.685
F-350 Super Duty		2005	All	Dual Rear Wheels		HB528X.811		HB556X.710
F-350 Super Duty		2005	All	Single Rear Wheels		HB528X.811		HB529X.710
F-350 Super Duty	2WD	2005-2006		Dual Rear Wheels		HB528X.811		HB556X.710
F-350 Super Duty	2WD	2005-2006		Single Rear Wheels		HB528X.811		HB529X.710
F-350 Super Duty	4WD	2005-2006		Single Rear Wheels		HB528X.811		HB529X.710
F-350 Super Duty	4WD	2005-2009		Dual Rear Wheels		HB528X.811		HB556X.710
F-350 Super Duty		2006-2007	All	Dual Rear Wheels		HB528X.811		
F-350 Super Duty		2006-2007	All	Single Rear Wheels		HB528X.811		
F-350 Super Duty	2WD	2007		Dual Rr Whl - MFG After 1/2007		HB528X.811		HB556X.710
F-350 Super Duty	2WD	2007		Dual Rr Whl - MFG Before 12/2006		HB528X.811		HB556X.710
F-350 Super Duty	2WD	2007		Single Rr Whl - MFG After 1/2007		HB528X.811		HB556X.710
F-350 Super Duty	2WD	2007		Single Rr Whl - MFG Before 12/2006		HB528X.811		HB529X.710
F-350 Super Duty	4WD	2007		Single Rr Whl - Manufactured After 1/2007		HB528X.811		HB556X.710
F-350 Super Duty	4WD	2007		Single Rr Whl - Manufactured Before 12/2006		HB528X.811		HB529X.710
F-350 Super Duty		2008-2012	All			HB528X.811		HB556X.710
F-350 Super Duty	2WD	2008-2009		DRW		HB528X.811		HB556X.710
F-350 Super Duty	2WD	2008-2009		SRW		HB528X.811		HB556X.710
F-350 Super Duty	4WD	2008-2009		Single Rr Whl		HB528X.811		HB556X.710
F-350 Super Duty	2WD	2010		DRW - MFG After 2/22/2010		HB528X.811		HB556X.710
F-350 Super Duty	2WD	2010		DRW - MFG Before 2/12/2010		HB528X.811		HB556X.710
F-350 Super Duty	2WD	2010		SRW - MFG After 9/16/2010		HB528X.811		HB556X.710
F-350 Super Duty	2WD	2010		SRW - MFG Before 2/12/2010		HB528X.811		HB556X.710
F-350 Super Duty	2WD	2010		SRW - MFG From 2/22/2010 to 9/15/2010		HB528X.811		HB556X.710

BRAKE PAD APPLICATIONS



MAKE/ MODEL	SUBMODEL	YEARS	ENGINE (LITER)	NOTE	FRONT		REAR	
					OES	HB SERIES	OES	HB SERIES
FORD CONTINUED								
F-350 Super Duty	4WD	2010		Dual Rr Whl - MFG After 2/22/2010		HB528X.811		HB556X.710
F-350 Super Duty	4WD	2010		Dual Rr Whl - MFG Before 2/12/2010		HB528X.811		HB556X.710
F-350 Super Duty	4WD	2010		Single Rr Whl - MFG After 9/16/2010		HB528X.811		HB556X.710
F-350 Super Duty	4WD	2010		Single Rr Whl - MFG Before 2/12/2010		HB528X.811		HB556X.710
F-350 Super Duty	4WD	2010		Single Rr Whl MFG From 2/22/2010 to 9/15/2010		HB528X.811		HB556X.710
F-350 Super Duty	2WD	2011		DRW		HB528X.811		HB556X.710
F-350 Super Duty	2WD	2011		SRW		HB528X.811		HB556X.710
F-350 Super Duty	4WD	2011		Dual Rr Whl - MFG After 11/1/2010		HB528X.811		HB556X.710
F-350 Super Duty	4WD	2011		Dual Rr Whl - MFG Before 11/1/2010		HB528X.811		HB556X.710
F-350 Super Duty	4WD	2011		Single Rr Whl		HB528X.811		HB556X.710
F-350 Super Duty		2012		BC3Z2001A		HB528X.811		
F-350 Super Duty	2WD	2012		DRW				HB556X.710
F-350 Super Duty	2WD	2012		SRW				HB556X.710
F-350 Super Duty	4WD	2012		Dual Rr Whl				HB556X.710
F-350 Super Duty	4WD	2012		Single Rr Whl				HB556X.710
F-350 Super Duty	DRW	2012		BC3Z2001B		HB528X.811		
F-450 Super Duty		1999-2004	All			HB335X.815		HB335X.815
F-450 Super Duty		1999		MFG After 3/23/1999		HB335X.815		HB335X.815
F-450 Super Duty		2000-2001				HB335X.815		HB335X.815
F-450 Super Duty		2002-2004		With ABS Ring on Rear Rotors		HB335X.815		HB335X.815
F-450 Super Duty		2002-2004		Without ABS Ring on Rear Rotors		HB335X.815		HB335X.815
F-450 Super Duty	Lariat	2005-2011	All			HB547X.798		HB547X.798
F-450 Super Duty	XL	2005-2011	All			HB547X.798		HB547X.798
F-450 Super Duty	XLT	2005-2011	All			HB547X.798		HB547X.798
F-450 Super Duty		2005-2009				HB547X.798		HB547X.798
F-450 Super Duty	Front & Rear: To 12/01/2008	2009		5C3Z2001BB				HB547X.798
F-450 Super Duty	Front & Rear: To 12/01/2008	2009		8C3Z2001A		HB528X.811		
F-450 Super Duty		2010-2012		Pickup		HB528X.811		HB556X.710
F-450 Super Duty		2010-2014		Cab & Chassis		HB547X.798		HB547X.798
F-450 Super Duty	Cab and Chassis	2011-2014	All			HB547X.798		HB547X.798
F-450 Super Duty		2011		8C3Z2001C		HB528X.811		
F-450 Super Duty	Cab & Chassis	2015				HB547X.798		HB547X.798
F-450 Super Duty	Cab & Chassis	2015		9C3Z2001A		HB547X.798		HB547X.798
F53	Stripped Chassis	1998-2004	All			HB335X.815		HB335X.815
F53		2005-2007		F81Z2001CA		HB335X.815		HB335X.815
F53	16K - 22K GVW	2008-2009		8U9Z2001BB				HB547X.798
F53	16K - 22K GVW	2008-2009		8U9Z2001C		HB547X.798		
F53	Stripped Chassis	2010-2011	All			HB547X.798		HB547X.798
F53	Stripped Chassis	2010-2014	All	GVW 24,000 - 26,000		HB327X.799		HB327X.799
F53	Stripped Chassis	2012-2014	All	GVW 16,000 - 22,000		HB547X.798		HB547X.798
F-550 Super Duty		1999		MFG After 3/23/1999		HB335X.815		HB335X.815
F-550 Super Duty		2000-2004	All			HB335X.815		HB335X.815
F-550 Super Duty		2000-2001				HB335X.815		HB335X.815
F-550 Super Duty		2002-2004		With ABS Ring on Rear Rotors		HB335X.815		HB335X.815
F-550 Super Duty		2002-2004		Without ABS Ring on Rear Rotors		HB335X.815		HB335X.815
F-550 Super Duty	Lariat	2005-2014	All			HB547X.798		HB547X.798
F-550 Super Duty	XL	2005-2014	All			HB547X.798		HB547X.798
F-550 Super Duty	XLT	2005-2014	All			HB547X.798		HB547X.798
F-550 Super Duty		2005-2015				HB547X.798		HB547X.798
F-550 Super Duty	Front & Rear: To 12/01/2008	2009		5C3Z2001BB		HB547X.798		HB547X.798
F-550 Super Duty		2011-2013	All	Dual Rear Wheels		HB528X.811		HB556X.710
F-550 Super Duty		2015		9C3Z2001A		HB547X.798		HB547X.798
F59	Stripped Chassis	1998-2004	All			HB335X.815		HB335X.815
F59	Stripped Chassis	2008-2011	All	GVW 16,000 - 22,000		HB547X.798		HB547X.798

BRAKE PAD APPLICATIONS

Hawk Performance - BRAKE PAD APPLICATIONS

HB
HAWK BRAKE

245
PAD SHAPE

x
INSERT COMPOUND CODE

.631
PAD THICKNESS

MAKE/ MODEL	SUBMODEL	YEARS	ENGINE (LITER)	NOTE	FRONT		REAR	
					OES	HB SERIES	OES	HB SERIES
FORD CONTINUED								
F59	Stripped Chassis	2008-2011	All	GVW 24,000 - 26,000		HB327X.799		HB327X.799
F600		1984-1989	All			HB253X.750		
F650	Air actuated PB	2000-2002		1C4Z2001AA		HB253X.750		
F650		2003	All			HB253X.750		
F650	Super Duty	2007-2008	All			HB327X1.05		
F700		1984-1996	All	6000-7000 Front Axle		HB253X.750		
F700		1984-1996	All	8000-12000 Front Axle		HB254X1.00		
F700		1997-1998				HB254X1.00		
F700		1997-1998		E6HZ2001C		HB253X.750		
F7000		1984-1987	All	6000-7000 Front Axle		HB253X.750		
F7000		1984-1987	All	8000-12000 Front Axle		HB254X1.00		
F750		2001-2003	All			HB253X.750		
F800		1983	All			HB254X1.00		
F800		1984-1989	All	6000-7000 Front Axle		HB253X.750		
F800		1984-1989	All	8000-12000 Front Axle		HB254X1.00		
F800		1995-1999				HB254X1.00		
F800		1995-1999		E6HZ2001C		HB253X.750		
F8000		1983	All			HB254X1.00		
F8000		1984-1986	All	6000-7000 Front Axle		HB253X.750		
F8000		1984-1986	All	8000-12000 Front Axle		HB254X1.00		
F8000		1987				HB253X.750		
F8000		1987				HB254X1.00		
Fairlane	8 Cylinder	1966				HB646X.526		
Fairlane		1967				HB471X.510		
Fairlane		1968-1970	All			HB646X.526		
Fairlane		1968				HB646X.526		
Fairlane		1970				HB646X.526		
Falcon		1968-1970	All			HB646X.526		
Fiesta		2011-2014	All			HB668X.567		
Fiesta	S Sedan	2011-2014	All			HB668X.567		
Fiesta	SE Sedan/Hatchback	2011-2014	All			HB668X.567		
Fiesta		2011-2013				HB668X.567		
Fiesta	ST	2014	All			HB725X.650		HB430X.547
Fiesta		2014		Except ST		HB668X.567		
Fiesta		2014		ST Models				HB430X.547
Fiesta	ST	2014		ST Models		HB725X.650		
Fiesta		2014-2016		ST				HB430X.547
Fiesta		2015		AE8Z2001B		HB668X.567		
Fiesta	ST	2015		AY1Z2001B		HB725X.650		
Fiesta	ST	2015-2016		C1BZ2200A				HB430X.547
Fiesta		2016		AE8Z2001C		HB668X.567		
Fiesta	ST	2016				HB725X.650		
Five Hundred		2005-2007				HB723X.665		HB724X.637
Flex		2009-2014	All			HB710X.706		HB674X.664
Flex		2009-2012				HB710X.706		HB674X.664
Flex		2012-2014	All	Standard Brakes		HB710X.706		HB674X.664
Flex		2013		DG1Z2200E				HB674X.664
Flex		2013-2014		Standard Brakes; 325mm (12.8") Front Rotors		HB710X.706		HB674X.664
Flex	HD Brakes	2013-2015		DG1Z2001D		HB710X.706		
Flex		2014-2015		EG1Z2200A				HB674X.664
Flex		2015		EB5Z2001A		HB710X.706		
Flex	HD Brakes	2015		EG1Z2200B				HB674X.664
Focus	LE	2000	All			HB346X.713		
Focus	LX	2000	All			HB346X.713		
Focus	SE	2000	All			HB346X.713		

BRAKE PAD APPLICATIONS

MAKE/ MODEL	SUBMODEL	YEARS	ENGINE (LITER)	NOTE	FRONT		REAR	
					OES	HB SERIES	OES	HB SERIES
FORD CONTINUED								
Focus	ZTS	2000	All			HB346X.713		
Focus	ZX3	2000-2004	All			HB346X.713		HB430X.547
Focus		2000-2001				HB346X.713		HB430X.547
Focus	S2	2001-2002	All			HB346X.713		HB430X.547
Focus	Street	2001-2002	All			HB346X.713		HB430X.547
Focus	LX	2001-2004	All			HB346X.713		HB430X.547
Focus	SE	2001-2004	All			HB346X.713		HB430X.547
Focus	ZTS	2001-2004	All			HB346X.713		HB430X.547
Focus	SVT	2002-2004	All			HB449X.679		HB430X.547
Focus	ZTW	2002-2004	All		770816	HB346X.713		HB430X.547
Focus	ZX5	2002-2004	All		770816	HB346X.713		HB430X.547
Focus		2002-2004						HB430X.547
Focus		2002-2004		except SVT		HB346X.713		HB430X.547
Focus		2002-2004		SVT		HB449X.679		HB430X.547
Focus	ZX3	2005-2006	All		771044	HB519X.682		HB430X.547
Focus	ZX4 ST	2005-2006	All		771044	HB519X.682		HB430X.547
Focus	ZX4	2005-2006	All		771044	HB519X.682		HB430X.547
Focus	ZX5	2005-2006	All		771044	HB519X.682		HB430X.547
Focus	ZXW	2005-2006	All		771044	HB519X.682		HB430X.547
Focus		2005-2007				HB519X.682		HB430X.547
Focus	S	2007	All		771044	HB519X.682		HB430X.547
Focus	SE	2007	All		771044	HB519X.682		HB430X.547
Focus	SES	2007	All		771044	HB519X.682		HB430X.547
Focus	ST	2007	All		771044	HB519X.682		HB430X.547
Focus	Base	2012-2014	All		771044	HB519X.682		
Focus	Electric	2012-2014	All		771044	HB519X.682		
Focus		2012		with Rear Discs		HB519X.682		HB478X.605
Focus		2012-2014		CV6Z2001A		HB519X.682		HB478X.605
Focus		2012-2014		With Rear Drums - S Model		HB519X.682		
Focus	Electric	2012-2015		BV6Z2001B		HB519X.682		
Focus	Electric	2012-2015		BV6Z2200C				HB478X.605
Focus	ST	2013-2014	All			HB712X.680		HB478X.605
Focus		2013-2014		ST		HB712X.680		HB478X.605
Focus		2013-2014		w/Rear discs - SE, SEL, Electric or Titanium models		HB519X.682		HB478X.605
Focus	Front OE # to 12/15/2014	2015		CV6Z2001A		HB519X.682		
Focus	Front OE # to 12/15/2014	2015		CV6Z2200A				HB478X.605
Focus	ST	2015		CV6Z2200A				HB478X.605
Focus	Electric	2016				HB519X.682		
Freestyle		2005-2007				HB723X.665		HB724X.637
FT800		1984-1986	All			HB254X1.00		
FT800		1985	All	Air		HB254X1.00		
FT8000		1984	All			HB254X1.00		
FT-900		1985-1986	All			HB254X1.00		
Fusion	S	2006-2012	All		771164	HB565X.688		HB564X.567
Fusion	SE	2006-2012	All		771164	HB565X.688		HB564X.567
Fusion	SEL	2006-2012	All		771164	HB565X.688		HB564X.567
Fusion		2006-2012				HB565X.688		HB564X.567
Fusion	Hybrid	2008-2012	All		771164	HB565X.688		HB564X.567
Galaxie 500		1971-1974				HB292X.674		
Gran Torino		1972-1973				HB292X.674		
Gran Torino	Elite	1974	All			HB292X.674		
Gran Torino	Sport	1974	All			HB292X.674		
Gran Torino		1974-1976	All			HB292X.674		
Gran Torino	Brougham	1974-1976	All			HB292X.674		
Gran Torino	Squire	1974-1976	All			HB292X.674		

BRAKE PAD APPLICATIONS



Hawk Performance - BRAKE PAD APPLICATIONS

HB
HAWK BRAKE

245
PAD SHAPE

x
INSERT COMPOUND CODE

.631
PAD THICKNESS

MAKE/ MODEL	SUBMODEL	YEARS	ENGINE (LITER)	NOTE	FRONT		REAR	
					OES	HB SERIES	OES	HB SERIES
FORD CONTINUED								
GT		2005-2006	All			HB453X.585		HB453X.585
GT		2005-2006				HB453X.585		HB453X.585
L800		1984	All	6000-7000 Front Axle		HB253X.750		
L800		1984	All	8000-12000 Front Axle		HB254X1.00		
L800		1985				HB253X.750		
L800		1985				HB254X1.00		
L8000		1984-1989	All	6000-7000 Front Axle		HB253X.750		
L8000		1984-1989	All	8000-12000 Front Axle		HB254X1.00		
LCF	C450	2006-2007		5C3Z2001BA		HB547X.798		HB547X.798
LCF	C550	2006-2007		5C3Z2001BA		HB547X.798		HB547X.798
LN		1995-1997				HB254X1.00		
LN		1995-1997		E6HZ2001C		HB253X.750		
LN600		1984	All			HB253X.750		
LN600		1985				HB253X.750		
LN700		1984-1986	All	6000-7000 Front Axle		HB253X.750		
LN700		1984-1986	All	8000-12000 Front Axle		HB254X1.00		
LN7000		1984-1989	All	6000-7000 Front Axle		HB253X.750		
LN7000		1984-1989	All	8000-12000 Front Axle		HB254X1.00		
LN7000		1990				HB253X.750		
LN7000		1990				HB254X1.00		
LN800		1984	All	6000-7000 Front Axle		HB253X.750		
LN800		1984	All	8000-12000 Front Axle		HB254X1.00		
LN800		1985				HB253X.750		
LN800		1985				HB254X1.00		
LN8000		1984-1989	All	6000-7000 Front Axle		HB253X.750		
LN8000		1984-1989	All	8000-12000 Front Axle		HB254X1.00		
LNT-800		1984	All			HB254X1.00		
LNT8000		1984	All			HB254X1.00		
Lobo		2014						HB772X.654
LT-800		1984	All			HB254X1.00		
LT8000		1984	All			HB254X1.00		
LTD		1970-1971				HB292X.674		
LTD	Brougham	1972-1976	All			HB292X.674		
LTD		1972-1978	All			HB292X.674		
LTD	Landau	1975-1978	All			HB292X.674		
LTD		1979-1980				HB125X.650		
LTD	S	1981-1982	All			HB125X.650		
LTD		1981-1985	All			HB125X.650		
LTD	Country Squire	1981-1986	All			HB125X.650		
LTD	Crown Victoria	1981-1986	All			HB125X.650		
LTD	Brougham	1983-1986	All			HB125X.650		
LTD	LX	1985	All			HB125X.650		
LTD		1985-1986		E2AZ2001E		HB125X.650		
LTD Crown Victoria	LX	1987-1991	All			HB125X.650		
LTD Crown Victoria	S	1987-1991	All			HB125X.650		
LTD Crown Victoria		1988-1991	All			HB125X.650		
LTD Crown Victoria		1990-1991		F4AZ2001D		HB125X.650		
LTD II	Brougham	1977	All			HB292X.674		
LTD II	Squire	1977	All			HB292X.674		
LTD II		1977-1979	All			HB292X.674		
LTD II	S	1977-1979	All			HB292X.674		
Mustang		1967	All	w/Front Disc Brakes		HB471X.510		
Mustang		1967				HB471X.510		
Mustang		1968-1973	All			HB646X.526		
Mustang		1968		with 427 Eng		HB646X.526		

BRAKE PAD APPLICATIONS



MAKE/ MODEL	SUBMODEL	YEARS	ENGINE (LITER)	NOTE	FRONT		REAR	
					OES	HB SERIES	OES	HB SERIES
FORD CONTINUED								
Mustang		1969		except 427 Eng.		HB646X.526		
Mustang		1969		Except 428 or 429 Eng.		HB646X.526		
Mustang		1969		with 428 or 429 Eng.		HB646X.526		
Mustang		1970-1973				HB646X.526		
Mustang	SVO	1984-1986	2.3L			HB125X.650		
Mustang		1984-1986		SVO		HB125X.650		
Mustang	GT	1987-1993	5.0L		770431	HB263X.650		
Mustang	LX	1987-1993	5.0L		770431	HB263X.650		
Mustang		1987-1992		8 Cyl.		HB125X.650		
Mustang		1993		Cobra		HB125X.650		HB580X.627
Mustang		1993		Except Cobra		HB125X.650		HB580X.627
Mustang	Cobra	1994	5.0L			HB111X.610		
Mustang	GT	1994-1998	All			HB182X.660		
Mustang	All, Except Cobra	1994-2004	All					HB183X.660
Mustang		1994-1998		Cobra		HB111X.610		
Mustang		1994-1998		Except Cobra		HB182X.660		
Mustang	COBRA	1994-2004						HB183X.585
Mustang	Cobra SVT	1995	5.0L			HB111X.610		
Mustang	GTS	1995	5.0L			HB182X.660		
Mustang	Cobra R	1995	5.8L			HB111X.610		
Mustang	Cobra	1996-1999	4.6L			HB111X.610		
Mustang	Base	1999-2004	3.8L			HB274X.610		HB183X.660
Mustang	GT	1999-2004	4.6L			HB274X.610		
Mustang		1999-2001		Cobra & Bullitt		HB111X.610		
Mustang		1999-2001		except Cobra & Bullitt		HB274X.610		
Mustang	SVT Cobra R	2000	5.4L			HB194X.665		HB183X.585
Mustang	Bullitt	2001	4.6L			HB111X.610		
Mustang	Cobra	2001	4.6L			HB111X.610		
Mustang	Cobra	2002		F5ZZ2001A		HB111X.610		
Mustang		2002-2004		Base & GT		HB274X.610		
Mustang	Cobra	2003-2004	4.6L			HB111X.610		
Mustang	Mach 1	2003-2004	4.6L			HB111X.610		
Mustang		2003-2004		Cobra & SVT, MACH 1		HB111X.610		
Mustang		2005-2007		V6 - 4.0L		HB484X.670		HB485X.656
Mustang		2005-2007		V8 4.6L		HB484X.670		HB485X.656
Mustang		2005-2010						HB485X.656
Mustang	V6	2005-2010						HB485X.656
Mustang	Saleen S281 Extreme	2007	4.6L	Alcon/AP Racing caliper		HB122X.710		
Mustang	Shelby GT500	2007-2009	5.4L			HB453X.585		HB485X.656
Mustang		2007-2008		Shelby GT		HB484X.670		HB485X.656
Mustang		2007-2008		Shelby GT500		HB453X.585		HB485X.656
Mustang	Shelby GT500	2007-2011		7R3Z2001A		HB453X.585		
Mustang	Shelby GT500	2008-2011	All			HB453X.585		HB485X.656
Mustang		2008-2009		Bullitt				HB485X.656
Mustang		2008-2009		V6		HB484X.670		HB485X.656
Mustang		2008-2009		V8; GT		HB484X.670		HB485X.656
Mustang		2009-2011		Shelby		HB453X.585		HB485X.656
Mustang		2009-2011		Shelby GT500				HB485X.656
Mustang		2010		V6 MFG after 3/21/2010 Except models with Brembo Front Calipers		HB484X.670		HB485X.656
Mustang		2010		V6 MFG up to 3/20/2010		HB484X.670		HB485X.656
Mustang		2010		V8; GT MFG after 3/21/2010 Except models with Brembo Front Calipers		HB484X.670		HB485X.656
Mustang		2010		V8; GT MFG up to 3/20/2010		HB484X.670		HB485X.656
Mustang		2010-2011		Base or GT With Brembo Front Calipers		HB453X.585		HB485X.656

Hawk Performance - BRAKE PAD APPLICATIONS

HB **245** **x** **.631**
 HAWK BRAKE PAD SHAPE INSERT COMPOUND CODE PAD THICKNESS

MAKE/ MODEL	SUBMODEL	YEARS	ENGINE (LITER)	NOTE	FRONT		REAR	
					OES	HB SERIES	OES	HB SERIES
FORD CONTINUED								
Mustang	V6	2011-2014	3.7L	Front rotor fits models w/o performance brake pkg				HB485X.656
Mustang	5.0L Performance	2011-2012	5.0L	w/Brembo Brakes		HB453X.585		HB485X.656
Mustang	5.0L Performance, Brembo Package	2011		7R3Z2001A		HB453X.585		
Mustang		2011-2012		V6 Models without Brembo Front Calipers		HB484X.670		HB485X.656
Mustang		2011-2012		V8; GT Models without Brembo Front Calipers		HB484X.670		HB485X.656
Mustang	Boss 302	2012-2013	5.0L			HB453X.585		HB485X.656
Mustang	GT	2012-2014	5.0L	Standard Brakes		HB484X.670		HB485X.656
Mustang	GT Brembo	2012	All			HB453X.585		HB485X.656
Mustang	Shelby GT500	2012	All			HB453X.585		
Mustang		2012		SHELBY		HB453X.585		
Mustang	GT Brembo	2012		7R3Z2001A		HB453X.585		
Mustang	Shelby GT500, Brembo Pkg	2012		7R3Z2001A		HB453X.585		
Mustang	Boss 302	2012-2013		7R3Z2001A		HB453X.585		
Mustang		2012-2014		Base, GT, or Boss 302 w/Brembo Front Calipers		HB453X.585		HB485X.656
Mustang	Boss 302	2013	5.0L		771001			
Mustang	Shelby GT500	2013	All	w/Brembo Brakes		HB453X.585		
Mustang	GT	2013-2014	All	Performance Brakes	771001	HB453X.585		HB485X.656
Mustang	Shelby GT500, Front to 04/30/2012	2013		7R3Z2001A		HB453X.585		
Mustang		2013-2014		Base, GT, or Boss 302 w/Brembo Front Calipers	771001			
Mustang		2013-2014		Models with Standard Front Calipers and 316mm (12.45") Front Rotors		HB484X.670		HB485X.656
Mustang		2013-2014		Models with Standard Front Calipers and 336mm (13.23") Front Rotors		HB484X.670		HB485X.656
Mustang		2013-2014		Shelby GT500				HB485X.656
Mustang	Shelby GT500	2014	All					HB485X.656
Mustang	GT Brembo Track	2014	All		771001	HB453X.585		HB485X.656
Mustang	GT Brembo	2014	All	w/Auto Trans	771001	HB453X.585		HB485X.656
Mustang	GT Brembo	2014	All	w/Manual Trans	771001	HB453X.585		
Mustang	GT Brembo Track	2014		7R3Z2001A		HB453X.585		
Mustang		2015		50th Anniversary Edition				HB774X.650
Mustang		2015		Brembo Package				HB774X.650
Mustang		2015-2016				HB773X.664		HB774X.650
Mustang		2016		Performance				HB774X.650
Police Interceptor Sedan		2013-2016		DG1Z2001D		HB710X.706		
Police Interceptor Utility		2013-2016		DG1Z2001D		HB710X.706		
Police Interceptor Utility		2013-2016		EG1Z2200B				HB674X.664
Police Interceptor Utility		2016						HB674X.664
Probe	GT	1993-1997	All	race material .634 thick	770583	HB211X.606		HB212X.535
Probe		1993-1997			770583	HB211X.606		HB212X.535
Ranch Wagon		1971-1974				HB292X.674		
Ranchero	500	1976-1979	All			HB292X.674		
Ranchero	GT	1976-1979	All			HB292X.674		
Ranchero	Squire	1977-1979	All			HB292X.674		
Ranger		1982-1983				HB279X.594		
Ranger		1983-1994	All			HB279X.594		
Ranger	Super	1987-1994	All			HB279X.594		
Ranger	Front: From 10/1986	1987		F09Z2001A		HB279X.594		
Ranger	Front: To 10/1986	1987		E79Z2001A		HB279X.594		
Ranger		1995	All		770652	HB283X.650		
Ranger	Super	1995-1998	All		770652	HB283X.650		
Ranger		1998-2002		2WD with 4 Whl. ABS & Coil Spring Fr. Susp.		HB283X.650		
Ranger		1998-2002		2WD with Rear Whl. ABS & Coil Spring Fr. Susp.		HB283X.650		
Ranger		1998-2002		2WD With Torsion Bar Front Suspension		HB283X.650		
Ranger		1998-2002		4WD		HB283X.650		
Ranger		1998-2002		Electric Eng		HB283X.650		

BRAKE PAD APPLICATIONS



MAKE/ MODEL	SUBMODEL	YEARS	ENGINE (LITER)	NOTE	FRONT		REAR	
					OES	HB SERIES	OES	HB SERIES
FORD CONTINUED								
Ranger		1998-2002		XL2Z2200AA				HB287X.571
Ranger	Edge	2001-2002	All		770652	HB283X.650		
Ranger		2003-2004	All		770833	HB472X.650		
Ranger	Edge	2003-2005	All		770833	HB472X.650		
Ranger		2003-2006		2WD with 4 wheel ABS		HB472X.650		
Ranger		2003-2009		4WD		HB472X.650		
Ranger	FX4	2005-2009	All			HB472X.650		
Ranger	XL	2005-2009	All			HB472X.650		
Ranger	XLT	2005-2009	All			HB472X.650		
Ranger	FX4	2005-2011	All		770833			
Ranger	XL	2005-2011	All		770833			
Ranger	XLT	2005-2011	All		770833			
Ranger	Sport	2006-2009	All			HB472X.650		
Ranger	STX	2006-2009	All			HB472X.650		
Ranger	Sport	2006-2011	All		770833			
Ranger	STX	2006-2011	All		770833			
Ranger		2007-2009		2WD		HB472X.650		
Ranger	STX	2010	All			HB472X.650		HB443X.614
Ranger	FX4	2010-2011	All			HB472X.650		HB443X.614
Ranger	Sport	2010-2011	All			HB472X.650		HB443X.614
Ranger	XL	2010-2011	All			HB472X.650		HB443X.614
Ranger	XLT	2010-2011	All			HB472X.650		HB443X.614
Ranger		2010-2011		2WD		HB472X.650		HB443X.614
Ranger		2010-2011		4WD		HB472X.650		HB443X.614
Ranger	STX	2011	All			HB472X.650		
Ranger		2011		BL5Z2200A				HB443X.614
Ranger	4WD	2011		BL5Z2200A				HB443X.614
Ranger	(Latin America)	2012		M8L552001AA		HB472X.650		
Special Service Police Sedan		2015		DG1Z2001D		HB710X.706		
Taurus		1986-1988		SHO; with Rear Disc, w/Metal Caliper Piston				HB580X.627
Taurus		1986-1990		2U2Z2V001GA		HB240X.620		
Taurus	Station Wagon	1986-1990		2U2Z2V001GA		HB240X.620		
Taurus	L	1989-1992	All			HB240X.620		
Taurus	SHO	1989-1992	All			HB240X.620		HB580X.627
Taurus	GL	1989-1993	All			HB240X.620		
Taurus	LX	1989-1993	All			HB240X.620		
Taurus		1989-1990		SHO; with Rear Disc				HB580X.627
Taurus	SHO	1989-1990		2U2Z2V001RA		HB240X.620		
Taurus	SHO	1989-1992		F20Y2200B				HB580X.627
Taurus		1991		Rear Disc Brakes; w/Steel Piston Front Caliper MFG From 2/1991		HB240X.620		
Taurus		1991		Rear Disc Brakes; w/Steel Piston Front Caliper MFG Up To 1/1991		HB240X.620		
Taurus		1991		Rear Drum; with Steel Piston Caliper MFG From 2/1991		HB240X.620		
Taurus		1991		Rear Drum; with Steel Piston Caliper MFG Up To 1/1991		HB240X.620		
Taurus		1992		except SHO; w/Rear Disc; w/Steel Piston Caliper		HB240X.620		
Taurus		1992		except SHO; w/Rear Drum; w/Steel Piston Caliper		HB240X.620		
Taurus		1992		SHO; with Phenolic Piston Front Caliper				HB580X.627
Taurus		1992		SHO; with Steel Piston Caliper		HB240X.620		HB580X.627
Taurus		1993		except SHO; With Rear Disc		HB240X.620		HB417X.659
Taurus		1993		except SHO; With Rear Drum		HB240X.620		
Taurus		1993		SHO		HB240X.620		HB417X.659
Taurus		1993-1999		F2DZ2200B				HB417X.659
Taurus	SHO	1994	All			HB347X.689		HB417X.659

BRAKE PAD APPLICATIONS



Hawk Performance - BRAKE PAD APPLICATIONS

HB
HAWK BRAKE

245
PAD SHAPE

x
INSERT COMPOUND CODE

.631
PAD THICKNESS

MAKE/ MODEL	SUBMODEL	YEARS	ENGINE (LITER)	NOTE	FRONT		REAR	
					OES	HB SERIES	OES	HB SERIES
FORD CONTINUED								
Taurus	GL	1994-1998	All			HB347X.689		
Taurus	LX	1994-1998	All			HB347X.689		
Taurus		1994		SHO		HB347X.689		HB417X.659
Taurus		1994-1995		with rear drums		HB347X.689		
Taurus		1994-2000		except SHO; With Rear Disc		HB347X.689		HB417X.659
Taurus	SE	1995	All		770601	HB347X.689		
Taurus		1995-1998		SHO		HB275X.660		HB417X.659
Taurus		1995-1998		SHO		HB416X.689		HB417X.659
Taurus	SHO	1995-1999		F80Z2001BA		HB416X.689		
Taurus	G	1996-1997	All			HB347X.689		
Taurus		1996-2000		except SHO; With Rear Drums		HB347X.689		
Taurus	SHO	1998-1999	All			HB416X.689		HB417X.659
Taurus		1999-2000	All			HB347X.689		HB417X.659
Taurus		1999		SHO		HB275X.660		
Taurus		1999-2000		SHO; with Rear Disc		HB416X.689		HB417X.659
Taurus		2001-2002	All	Except Police		HB416X.689		HB417X.659
Taurus		2001-2002	All	Police		HB347X.689		HB417X.659
Taurus		2001-2002		1F1Z2001AA		HB416X.689		
Taurus	Station Wagon	2001-2002		1F1Z2001AA		HB416X.689		
Taurus		2001-2003		Station Wagon		HB275X.660		
Taurus		2001-2005		with Rear Discs		HB416X.689		HB417X.659
Taurus		2001-2007				HB275X.660		
Taurus		2001-2007		with rear drums		HB416X.689		
Taurus		2003-2007	All			HB416X.689		HB417X.659
Taurus		2003		3F1Z2001BA		HB416X.689		
Taurus	Station Wagon	2003		3F1Z2001BA		HB416X.689		
Taurus	SE	2006	All			HB416X.689		
Taurus	SEL	2006	All			HB416X.689		
Taurus		2008-2009	All			HB723X.665		HB724X.637
Taurus	X	2008-2009	All			HB723X.665		HB724X.637
Taurus		2008-2009				HB723X.665		HB724X.637
Taurus	SHO	2010-2012	All		771158	HB612X.690		HB674X.664
Taurus	SHO	2010				HB612X.690		HB674X.664
Taurus		2010-2012				HB710X.706		HB674X.664
Taurus	SHO	2011-2012		Excluding Performance Package		HB710X.706		HB674X.664
Taurus	SHO	2011-2012		Performance Package		HB612X.690		HB674X.664
Taurus	SHO	2012-2013	All	Excl Perf Pkg		HB710X.706		HB674X.664
Taurus		2012-2014	All			HB710X.706		HB674X.664
Taurus		2013		Excluding Police; 325mm (12.8") Front Rotors				HB674X.664
Taurus		2013-2014		BB5Z2001B		HB710X.706		
Taurus		2013-2014		DG1Z2200E				HB674X.664
Taurus	SHO Performance	2013-2014		DG1Z2001E		HB710X.706		
Taurus	SHO	2013-2015		DG1Z2001D		HB710X.706		
Taurus		2015		EB5Z2001A		HB710X.706		
Taurus		2015		EG1Z2200A				HB674X.664
Taurus	SHO Performance	2015		DG1Z2001F		HB710X.706		
Taurus	SHO	2015		EG1Z2200B				HB674X.664
Taurus X		2008-2009				HB723X.665		HB724X.637
Thunderbird		1965-1967				HB103X.590		
Thunderbird		1970-1971				HB292X.674		
Thunderbird		1972-1978	All			HB292X.674		
Thunderbird		1979				HB292X.674		
Thunderbird	MT5	1987-1988	All		770431	HB263X.650		
Thunderbird		1987-1988		With Rear Disc		HB125X.650		HB580X.627
Thunderbird		1989-1992	All			HB240X.620		

BRAKE PAD APPLICATIONS



MAKE/ MODEL	SUBMODEL	YEARS	ENGINE (LITER)	NOTE	FRONT		REAR	
					OES	HB SERIES	OES	HB SERIES
FORD CONTINUED								
Thunderbird	LX	1989-1992	All			HB240X.620		
Thunderbird	SC	1989-1992	All			HB240X.620		HB580X.627
Thunderbird	Super Coupe	1989-1992		E9S2Z200B				HB580X.627
Thunderbird	SC	1993-1995	All			HB182X.660		
Thunderbird	LX	1993-1997	All			HB182X.660		
Thunderbird		1993-1995		Rear Disc Brakes		HB182X.660		
Thunderbird		1993-1995		Rear Drum Brakes		HB182X.660		
Thunderbird		1996		except Sport Package, Rear Drum		HB182X.660		
Thunderbird		1996-1997		except Sport Package, Rear Disc		HB182X.660		
Thunderbird		1996-1997		Sport Package, Rear Disc		HB416X.689		
Thunderbird		2002-2005	All			HB376X.665		HB428X.650
Thunderbird		2002-2005				HB376X.665		
Torino		1970-1971	All			HB646X.526		
Torino		1970-1971				HB646X.526		
Torino		1972		Except Police		HB292X.674		
Torino		1973		except Police/Wagon		HB292X.674		
Torino		1973		Police/Wagon		HB292X.674		
Torino		1974-1976		Police Taxi		HB292X.674		
Torino		1975-1976	All			HB292X.674		
Transit		2006-2012	All	(Latin America)	771528			
Transit		2013		(Latin America)	771555			
Transit Connect		2010-2013	All			HB449X.679		
Transit Connect		2010-2013				HB449X.679		
Transit Connect		2014	All	104.8 in. Wheelbase		HB519X.682		
Transit Connect		2014-2016		CV6Z2200A				HB478X.605
Transit Connect		2015-2016		CV6Z2001B		HB519X.682		
Windstar		1995-1998	All			HB347X.689		
Windstar		1995-1998		with Rear Discs		HB347X.689		HB284X.575
Windstar		1995-1998		with rear drums		HB347X.689		
Windstar		1999-2003	All					HB284X.575
Windstar		1999				HB342X.701		
Windstar		1999		with Rear Discs				HB284X.575
Windstar		2000				HB342X.701		HB284X.575
Windstar		2001-2003				HB342X.701		
Windstar		2001-2003		with Rear Discs				HB284X.575
ZX2		1998-2003	All			HB246X.567		HB159X.492
ZX2	S/R	1999-2000	All			HB246X.567		HB159X.492
F-250 Super Duty		2013-2015				HB714X.715		HB715X.713
F-350 Super Duty		2013		DRW		HB714X.715		HB715X.713
F-350 Super Duty		2013-2015				HB714X.715		HB715X.713
F-450 Super Duty		2013-2015				HB714X.715		HB715X.713
FREIGHTLINER								
Sprinter 2500		2002-2006		w/Bosch Calipers and 276mm (10.86") Front Rotors; Rear Axle From L874989 or X34861				HB479X.700
Sprinter 2500		2002-2006		w/Bosch Calipers and 276mm (10.86") Front Rotors; Rear Axle Up To L874988 or X34860				HB479X.700
Sprinter 2500		2002-2006		w/Bosch Calipers and 285mm (11.2") Front Rotors				HB479X.700
Sprinter 2500	16" Wheels	2003		05103550BB				HB479X.700
Sprinter 2500	2500	2006	All					HB479X.700
Sprinter 2500	16" Wheels	2006		05103550BB				HB479X.700
Sprinter 3500		2002-2005		w/Bosch Calipers and 276mm (10.86") Front Rotors; Rear Axle From L874989 or X34861				HB479X.700
Sprinter 3500		2002-2005		w/Bosch Calipers and 276mm (10.86") Front Rotors; Rear Axle Up To L874988 or X34860				HB479X.700
Sprinter 3500		2002-2005		With Bosch Calipers and 285mm (11.2") Front Rotors; 272mm (10.7") Rear Rotors				HB479X.700

Hawk Performance - BRAKE PAD APPLICATIONS

H B **2 4 5** **x** **.6 3 1**
 HAWK BRAKE PAD SHAPE INSERT COMPOUND CODE PAD THICKNESS

MAKE/ MODEL	SUBMODEL	YEARS	ENGINE (LITER)	NOTE	FRONT		REAR	
					OES	HB SERIES	OES	HB SERIES
FREIGHTLINER CONTINUED								
Sprinter 3500	16" Wheels	2002-2006		05103550BB				HB479X.700
Sprinter 3500	3500	2006	All					HB479X
GEO								
Prizm		1989		94851930		HB191X.590		
Prizm	GSI	1990-1992	All		770242	HB191X.590		HB401X.587
Prizm	LSI	1990-1992	All		770242	HB191X.590		
Prizm		1990-1992		With Rear Disc		HB191X.590		HB401X.587
Prizm		1990-1992		With Rear Drum		HB191X.590		
Prizm		1993-1997	All			HB310X.689		
Prizm	LSI	1993-1997	All			HB310X.689		
Prizm		1993-1997				HB310X.689		
Storm	2+2	1990-1993	All			HB148X.560		
Storm		1990-1993	All			HB148X.560		
Storm	GSI	1990-1993	All			HB148X.560		
Storm		1990-1993				HB148X.560		
Tracker		1996-1997	All	4 Door		HB384X.587		
Tracker		1996-1997		4 Door		HB384X.587		
GMC								
Acadia		2007-2014	All			HB617X.630		HB383X.685
Acadia		2007-2013						HB383X.685
Acadia		2015						HB383X.685
Acadia		2015		15911562		HB617X.630		
Acadia		2015		22866196				HB383X.685
B6000	B6P042	1983-1990	All			HB253X.750		HB253X.750
B6000	B6P042	1983-1991				HB251X1.14		HB251X1.14
B6000	B6P042	1991				HB251X1.14		HB253X.750
B6000	B6P042	1991				HB253X.750		HB251X1.14
B6000	B6P042	1991				HB253X.750		HB253X.750
B7	B700	1993-1994				HB251X1.14		HB251X1.14
B7	B7T042	1995-1997	All			HB253X.750		
B7	B7T042	1995-1996						HB251X1.14
B7	B7T042	1997				HB251X1.14		HB251X1.14
C15		1975-1978				HB103X.590		
C15 Suburban		1975-1978	All		770052	HB103X.590		
C15/C1500 Pickup		1971-1974	All		770052	HB103X.590		
C15/C1500 Suburban		1971-1974	All		770052	HB103X.590		
C1500		1979-1980				HB103X.590		
C1500		1981-1986		JB1, JB3 Brake System (1" Thick Rotor)		HB103X.590		
C1500		1981-1986		JB5, JD3, or JD5 brake system (1.25" thick rotor)		HB103X.590		
C1500		1988	All	Extended Cab	770369	HB332X.654		
C1500		1988-1991		Std. cab heavy duty chassis, Extended cab		HB332X.654		
C1500	Sierra XC	1989-1991	All	Extended Cab	770369	HB332X.654		
C1500	Sierra	1989-1991	All	Extended Cab	770369	HB332X.654		
C1500		1990-1991		SS 454 Models		HB332X.654		
C1500	Sierra XC	1992-1997	All		770369	HB332X.654		
C1500	Sierra	1992-1997	All		770369	HB332X.654		
C1500		1992-1998				HB332X.654		
C1500		1998-1999	All		770369	HB332X.654		
C1500		1999		Rear Drum Models		HB332X.654		
C1500 Suburban		1979-1984	All		770052	HB103X.590		
C1500 Suburban		1985-1986		18024904		HB103X.590		
C1500 Suburban		1992-1993	All		770369	HB332X.654		
C1500 Suburban		1992-1993				HB332X.654		
C1500 Suburban		1994-1999	All	w/13 in. Rear Drums		HB296X.670		
C1500 Suburban		1994-1999	All	w/11 in. Rear Drums	770369	HB332X.654		

BRAKE PAD APPLICATIONS



MAKE/ MODEL	SUBMODEL	YEARS	ENGINE (LITER)	NOTE	FRONT		REAR	
					OES	HB SERIES	OES	HB SERIES
GMC CONTINUED								
C1500 Suburban		1994-1999		5 Lug		HB332X.654		
C1500 Suburban		1994-1999		8 lug		HB296X.670		
C25		1975-1978				HB103X.590		
C25 Suburban		1975-1978	All		770052	HB103X.590		
C25/C2500 Pickup		1971-1974	All		770052	HB103X.590		
C25/C2500 Suburban		1971-1974	All		770052	HB103X.590		
C25/C2500 Suburban		1971				HB103X.590		
C25/C2500 Suburban	Leaf Spring	1971				HB103X.590		
C2500		1979-1984				HB103X.590		
C2500		1979-1984				HB131X.595		
C2500		1985-1986		STD Cab Pickup; 11" Rear Drum	770052	HB103X.590		
C2500		1988-1989	All			HB131X.595		
C2500		1988-1998	All	8600 lbs. GVWR		HB296X.670		
C2500		1988-1998	All	7200 lbs. GVWR	770369	HB332X.654		
C2500		1988				HB332X.654		
C2500	Sierra XC	1989-1998	All	8600 lbs. GVWR		HB296X.670		
C2500	Sierra	1989-1998	All	8600 lbs. GVWR		HB296X.670		
C2500	Sierra XC	1989-1998	All	7200 lbs. GVWR	770369	HB332X.654		
C2500	Sierra	1989-1998	All	7200 lbs. GVWR	770369	HB332X.654		
C2500		1989-1991		8 Lug		HB296X.670		
C2500		1989-1993		6 Lug		HB332X.654		
C2500		1992-1996		8 LUG with 4 wheel ABS		HB296X.670		
C2500		1992-1996		8 LUG with rear wheel ABS		HB296X.670		
C2500		1994-1996		6 LUG with 4 wheel ABS		HB332X.654		
C2500		1994-1996		6 LUG with rear wheel ABS		HB332X.654		
C2500		1997-1998		6 Lug Models		HB332X.654		
C2500		1997-1998		8 Lug Models		HB296X.670		
C2500		1999-2000	All			HB296X.670		
C2500		1999-2000		6 Lug Models - Rear Drum Brakes		HB332X.654		
C2500		1999-2000		8 Lug Models - Rear Drum Brakes		HB296X.670		
C2500		2011	All			HB705X.776		HB705X.776
C2500		2011		19210707				HB323X.724
C2500 Suburban		1979-1986	All	w/13 in. Rear Drums		HB131X.595		
C2500 Suburban		1979-1986	All	w/11 in. Rear Drums	770052	HB103X.590		
C2500 Suburban		1992-1999	All		770369	HB332X.654		
C2500 Suburban		1992-1999				HB296X.670		
C35		1975-1978				HB103X.590		
C35/C3500 Pickup		1971-1974	All		770052	HB103X.590		
C3500		1979-1984				HB131X.595		
C3500		1988	All	w/13 x 2.5 in. Drums		HB131X.595		
C3500		1988-1989	All			HB296X.670		
C3500		1988-1989		Single Rr Whl		HB296X.670		
C3500		1990-1993	All	w/Rear Drum Brakes.		HB296X.670		
C3500		1990-2000	All	Drum Rear. Dual Rear Wheel		HB298X.787		
C3500		1990-1991		Dual Rr Whl with Rear Drum		HB296X.670		
C3500		1990-1991		Single Rr Whl 9000 - 9200 GVW		HB296X.670		
C3500		1990-1991		Single Rr Whl except 9000-9200 GVW		HB296X.670		
C3500		1992-1996		Single Rr Whl with ABS		HB296X.670		
C3500		1992-1996		Single Rr Whl without ABS		HB296X.670		
C3500		1992-2000		Dual Rr Whl with Rear Drum		HB298X.787		
C3500	GVW 15,000 Lbs.	1994				HB252X.860		HB252X.860
C3500	GVW 15,000 Lbs.	1995-1999						HB252X.860
C3500		1997-2000		Single Rr Whl except Extended Cab Pickup		HB296X.670		
C3500		1997-2000		Single Rr Whl Extended Cab Pickup		HB298X.787		
C3500		1998-2000	All	Drum Rear. Single Rear Wheel		HB296X.670		

BRAKE PAD APPLICATIONS



Hawk Performance - BRAKE PAD APPLICATIONS

HB **245** **x** **.631**
 HAWK BRAKE PAD SHAPE INSERT COMPOUND CODE PAD THICKNESS

MAKE/ MODEL	SUBMODEL	YEARS	ENGINE (LITER)	NOTE	FRONT		REAR	
					OES	HB SERIES	OES	HB SERIES
GMC CONTINUED								
C3500		2011	All			HB705X.776		HB705X.776
C4500 Topkick	DIH PB	2003-2006				HB511X.790		
C4500 Topkick		2003-2009						HB511X.790
C5000		1988-1990				HB252X.860		HB253X.750
C5000 Topkick		1990-1991		12475227		HB253X.750		HB253X.750
C5500 Topkick		2003-2005				HB511X.790		HB511X.790
C5500 Topkick	DIH PB	2003-2006				HB511X.790		
C5500 Topkick		2008-2009						HB511X.790
C6000	C6D042	1983-1985	All			HB253X.750		HB253X.750
C6000		1983-1984						HB251X1.14
C6000		1985-1990				HB251X1.14		HB251X1.14
C6000	C6D042	1986	All			HB253X.750		
C6000	C6D042	1987-1990	All			HB253X.750		HB253X.750
C6000		1988-1990				HB252X.860		HB251X1.14
C6000 Topkick	Front Axle 8100 Lbs Rear Axle 15000 Lbs.	1990-1991		12475227		HB253X.750		HB253X.750
C6000 Topkick	Front Axle 11000 Lbs Rear Axle 16900-21000 Lbs	1990-1996				HB251X1.14		HB251X1.14
C6000 Topkick	C6H042	1992-1994	All			HB253X.750		HB253X.750
C6000 Topkick	C6H042	1995-1996	All	Front Dayton Calipers. Rear 2 Piston Calipers		HB253X.750		HB253X.750
C6000 Topkick	C6H042	1995-1996	All	Front Dayton Calipers. Rear 4 Piston Calipers		HB253X.750		
C6000 Topkick		1997				HB251X1.14		HB251X1.14
C6000 Topkick		1997				HB251X1.14		HB253X.750
C6000 Topkick		1997				HB253X.750		HB251X1.14
C6000 Topkick		1997				HB253X.750		HB253X.750
C6500 Topkick	C6H042	1992-1993				HB251X1.14		HB251X1.14
C7000	C7D042	1983-1990	All			HB253X.750		
C7000		1983-1990				HB251X1.14		HB251X1.14
C7000	Front Axle 7000 Lbs Rear Axle 15000 Lbs.	1985		15559755				HB253X.750
C7000	Front Axle 7000 Lbs Rear Axle 15000 Lbs.	1986		15559756				HB253X.750
C7000	Front Axle 7000 Lbs Rear Axle 15000 Lbs.	1987		15611046				HB253X.750
C7000	Front Axle 7000 Lbs Rear Axle 15000 Lbs.	1988-1989		15559755				HB253X.750
C7000		1990		15619100				HB253X.750
C7000 Topkick	Front Axle 8100 Lbs Rear Axle 15000 Lbs.	1990-1991		12475227		HB253X.750		HB253X.750
C7000 Topkick	Front Axle 11000 Lbs Rear Axle 16900 - 21000 Lbs.	1990-1996				HB251X1.14		HB251X1.14
C7000 Topkick	C7H042	1992-1994	All			HB253X.750		
C7000 Topkick	Front Axle 8100 Lbs Rear Axle 15000 Lbs.	1992-1994		12475227				HB253X.750
C7000 Topkick		1994-1996				HB251X1.14		HB251X1.14
C7000 Topkick	C7H042	1995-1996	All	Front Dayton Calipers. Rear 2 Piston Calipers		HB253X.750		HB253X.750
C7000 Topkick	C7H042	1995-1996	All	Front Dayton Calipers. Rear 4 Piston Calipers		HB253X.750		
C7500 Topkick	C7H042	1992-1996				HB251X1.14		HB251X1.14
C7500 Topkick	C7H064	1994-1996				HB251X1.14		HB251X1.14
C7500 Topkick	C7H042	1997	All	Front Dayton Calipers. Rear 2 Piston Calipers		HB253X.750		HB253X.750
C7500 Topkick	C7H042	1997	All	Front Dayton Calipers. Rear 4 Piston Calipers		HB253X.750		
C7500 Topkick	Front Axle 11000 Lbs Rear Axle 16900 - 21000 Lbs.	1997-2002				HB251X1.14		HB251X1.14
C7500 Topkick	Front Axle 8100 Lbs Rear Axle 15000 - 16900 Lbs	1998-1999		15619100		HB253X.750		HB253X.750
C7500 Topkick	Front Axle 8100 Lbs Rear Axle 15000-16900 Lbs	2000-2002		12475227		HB253X.750		HB253X.750

BRAKE PAD APPLICATIONS



MAKE/ MODEL	SUBMODEL	YEARS	ENGINE (LITER)	NOTE	FRONT		REAR	
					OES	HB SERIES	OES	HB SERIES
GMC CONTINUED								
Caballero		1978-1981	All			HB119X.594		
Caballero		1978-1987				HB119X.594		
Canyon		2004	All		771039	HB554X.643		
Canyon		2004-2008				HB554X.643		
Canyon	Z71 Fleet	2005	All		771039	HB554X.643		
Canyon	Z71 SL	2005	All		771039	HB554X.643		
Canyon	Z71 SLE	2005	All		771039	HB554X.643		
Canyon	Z85 SL	2005	All		771039	HB554X.643		
Canyon	Z85 SLE	2005	All		771039	HB554X.643		
Canyon	SL	2006-2008	All		771039	HB554X.643		
Canyon	SLE	2006-2008	All		771039	HB554X.643		
Canyon	SLT	2006-2008	All		771039	HB554X.643		
Canyon	WT	2006-2008	All		771039	HB554X.643		
Canyon		2009-2012	All			HB617X.630		
Canyon		2009-2012				HB617X.630		
Envoy	XL	2002-2004	All			HB382X.657		HB383X.685
Envoy		2002-2003		5 Passenger with 113" WB		HB382X.657		HB383X.685
Envoy		2002-2003		7 Passenger with 129" WB		HB382X.657		HB383X.685
Envoy	XUV	2004	All			HB382X.657		HB383X.685
Envoy		2004		Base with 113" wheelbase		HB382X.657		HB383X.685
Envoy		2004		XL, XUV models with 129" WB		HB382X.657		HB383X.685
Envoy	Denali	2005	All			HB382X.657		HB383X.685
Envoy	SLE	2005	All			HB382X.657		HB383X.685
Envoy	SLT	2005	All			HB382X.657		HB383X.685
Envoy	XL Denali	2005	All			HB382X.657		HB383X.685
Envoy	XL SLE	2005	All			HB382X.657		HB383X.685
Envoy	XL SLT	2005	All			HB382X.657		HB383X.685
Envoy	XUV SLE	2005	All			HB382X.657		HB383X.685
Envoy	XUV SLT	2005	All			HB382X.657		HB383X.685
Envoy		2005		4.2L 6 Cylinder Engine Base Models (113" Wheelbase)		HB382X.657		HB383X.685
Envoy		2005		4.2L 6 Cylinder Engine - XL, XUV Models (129" Wheelbase)		HB382X.657		HB383X.685
Envoy		2005		Models with 5.3L V8		HB382X.657		HB383X.685
Envoy	Sport	2006-2007	All			HB617X.630		HB383X.685
Envoy		2006-2009	All			HB617X.630		HB383X.685
Envoy		2006		4.2L Base 5 Passenger		HB617X.630		HB383X.685
Envoy		2006		4.2L XL 7 Passenger		HB617X.630		HB383X.685
Envoy		2006		5.3L Eng.		HB617X.630		HB383X.685
Envoy		2007-2009		4.2L Engine		HB617X.630		HB383X.685
Envoy		2007-2009		5.3L Engine		HB617X.630		HB383X.685
Envoy XL		2002		12497782		HB382X.657		
Envoy XL		2002		88935809				HB383X.685
Envoy XL		2003-2005		88982932		HB382X.657		
Envoy XL		2003-2005		88983915				HB383X.685
Envoy XL		2006		19149111				HB383X.685
Envoy XL		2006		88965681		HB617X.630		
Envoy XUV		2004-2005		88982932		HB382X.657		
Envoy XUV		2004-2005		88983915				HB383X.685
G15		1975-1978				HB103X.590		
G15/G1500 Van		1971-1972				HB103X.590		HB119X.594
G15/G1500 Van		1973-1974				HB103X.590		
G1500		1979-1992				HB103X.590		
G1500		1981-1992			770052			
G1500		1993-1995		with 4 Whl. ABS & Vac Booster	770052	HB103X.590		

BRAKE PAD APPLICATIONS



Hawk Performance - BRAKE PAD APPLICATIONS

HB
HAWK BRAKE

245
PAD SHAPE

x
INSERT COMPOUND CODE

.631
PAD THICKNESS

MAKE/ MODEL	SUBMODEL	YEARS	ENGINE (LITER)	NOTE	FRONT		REAR	
					OES	HB SERIES	OES	HB SERIES
GMC CONTINUED								
G1500		1993-1995		with Rear Whl. ABS	770052	HB103X.590		
G25		1975-1978				HB103X.590		
G25/G2500 Van		1971-1974				HB103X.590		
G2500		1979-1984				HB103X.590		
G2500		1985		18043837		HB103X.590		
G2500		1986-1992			770052	HB103X.590		
G2500		1993-1995		with 4 Whl. ABS & Vac Booster	770052	HB103X.590		
G2500		1993-1995		with Rear Whl. ABS	770052	HB103X.590		
G35		1975-1978				HB103X.590		
G35/G3500 Van		1971-1974				HB103X.590		
G3500		1979-1984				HB103X.590		
G3500		1979-1984				HB131X.595		
G3500		1996		Dual Rr Whl		HB298X.787		
G3500		1996		Single Rr Whl		HB296X.670		
Jimmy		1985-1987	All			HB305X.610		
Jimmy		1985-1990	All		770052			
Jimmy		1985-1990		Mid-Size Jimmy 2WD		HB119X.594		
Jimmy		1985-1991		Mid-Size Jimmy 4WD		HB119X.594		
Jimmy		1989-1990	All			HB305X.610		
Jimmy		1991	All			HB119X.594		
Jimmy		1991		Mid-Size Jimmy 2WD 4 Whl. ABS		HB119X.594		
Jimmy		1991		Mid-Size Jimmy 2WD without 4 Whl. ABS		HB119X.594		
Jimmy		1992-1994		Full Size Jimmy 4WD		HB332X.654		
Jimmy		1992-1995		2WD 4 Whl. ABS		HB119X.594		
Jimmy		1992-1995		2WD without 4 Whl. ABS		HB119X.594		
Jimmy		1992-1996		4WD		HB119X.594		
Jimmy		1995-1997	All			HB119X.594		
Jimmy		1996-1997		2WD		HB119X.594		
Jimmy		1997		4WD with Rear Disc		HB304X.598		HB305X.610
Jimmy		1997		4WD with Rear Drum		HB119X.594		
Jimmy		1998-2001	All			HB304X.598		HB305X.610
Jimmy	Envoy	1998-2001	All			HB304X.598		HB305X.610
Jimmy		1998-2002		2WD		HB304X.598		HB305X.610
Jimmy		1998-2002		4WD		HB304X.598		HB305X.610
Jimmy		2003-2005		18026156				HB305X.610
Jimmy		2003-2005		18029863		HB304X.598		
K15		1975-1978				HB103X.590		
K15 Suburban		1975-1978	All		770052	HB103X.590		
K15/K1500 Pickup		1971-1974	All		770052	HB103X.590		
K15/K1500 Suburban		1971-1974	All		770052	HB103X.590		
K1500		1979-1986				HB103X.590		
K1500		1988-1991	All	Extended Cab	770369	HB332X.654		
K1500		1988-1991		Models with HD Brakes (Front rotors are 1.25" thick at the friction surface)		HB332X.654		
K1500		1992-1998	All		770369	HB332X.654		
K1500		1992-1998				HB332X.654		
K1500		1999		Models with Rear Drum Brakes		HB332X.654		
K1500 Suburban		1979-1986	All		770052	HB103X.590		
K1500 Suburban		1992-1993				HB332X.654		
K1500 Suburban		1994-1999	All	6 Lug	770369	HB332X.654		
K1500 Suburban		1994-1999		6 Lug -11" Rear Drum		HB332X.654		
K1500 Suburban		1994-1999		8 lug - 13" Rear Drum		HB296X.670		
K25		1975-1978				HB103X.590		
K25 Suburban		1975-1978				HB103X.590		
K25/K2500 Pickup		1971-1974	All		770052	HB103X.590		

BRAKE PAD APPLICATIONS

MAKE/ MODEL	SUBMODEL	YEARS	ENGINE (LITER)	NOTE	FRONT		REAR	
					OES	HB SERIES	OES	HB SERIES
GMC CONTINUED								
K25/K2500 Suburban	Leaf Spring	1971-1972				HB103X.590		
K25/K2500 Suburban		1971-1974				HB103X.590		
K2500		1979-1984				HB103X.590		
K2500		1979-1984				HB131X.595		
K2500		1985		18043837		HB103X.590		
K2500		1986		JB6 & JD6		HB103X.590		
K2500		1988-2000	All	w/11 in. Rear Drums	770369	HB332X.654		
K2500		1988-1998		6 Lug		HB332X.654		
K2500		1988-1998		8 lug		HB296X.670		
K2500		1999-2000				HB296X.670		
K2500		2011	All			HB705X.776		HB705X.776
K2500		2011		19210707				HB323X.724
K2500 Suburban		1979-1984	All	w/13 in. Rear Drums		HB131X.595		
K2500 Suburban		1979-1984	All	w/11 in. Rear Drums	770052	HB103X.590		
K2500 Suburban		1985-1986	All			HB131X.595		
K2500 Suburban		1985-1986		18043837		HB103X.590		
K2500 Suburban		1992-1993				HB296X.670		
K2500 Suburban		1994-1996		11" Rear Drum		HB332X.654		
K2500 Suburban		1994-1996		13" Rear Drum		HB296X.670		
K2500 Suburban		1997-1999		11" Rear Drum 7200 lb. GVW		HB332X.654		
K2500 Suburban		1997-1999		13" Rear Drum 8600 lb. GVW		HB296X.670		
K35		1977-1978	All		770052	HB103X.590		
K3500		1988-1989		Dual Rr Whl		HB296X.670		
K3500		1988-1996		Single Rr Whl		HB296X.670		
K3500		1990-2000		Dual Rr Whl		HB298X.787		
K3500		1997-2000		18025354		HB296X.670		
K3500		1997-2000		Single Rr Whl		HB298X.787		
K3500		2011	All			HB705X.776		HB705X.776
P15		1975-1978				HB103X.590		
P15/P1500 Van		1971-1974	All		770052	HB103X.590		
P1500		1979-1982				HB103X.590		
P25		1975-1978				HB103X.590		
P25/P2500 Van		1971-1974	All			HB103X.590		
P25/P2500 Van		1985	All	w/13 in. Rear Drums		HB131X.595		
P25/P2500 Van		1985	All		770052	HB103X.590		
P25/P2500 Van		1986-1989	All			HB131X.595		
P25/P2500 Van		1986-1989		18043837		HB103X.590		
P2500		1979-1987				HB103X.590		
P2500		1979-1987				HB131X.595		
P2500	11.15 x 2.75" Brakes	1988				HB103X.590		
P2500	11.15 x 2.75" Brakes	1989		18043837		HB103X.590		
P35	Motor Home Chassis	1972				HB103X.590		
P35	Motor Home Chassis	1975-1976				HB103X.590		
P35		1975-1978				HB103X.590		
P35	12-14K	1977				HB103X.590		HB103X.590
P35	Motor Home Chassis	1977-1978				HB103X.590		HB235X.665
P35	12-14.5K	1978				HB103X.590		HB103X.590
P35/P3500 Van		1971-1974	All		770052	HB103X.590		
P35/P3500 Van	Motor Home	1974	All		770052	HB103X.590		
P3500		1979-1988				HB131X.595		
P3500	DRW	1997				HB252X.860		HB252X.860
P3500	Rear Disc	1997-1999				HB252X.860		HB252X.860
P60	P6T042	1988-1990				HB252X.860		
P6500	P6S042	1992-1996				HB253X.750		HB251X.14
P6T042		1984-1987				HB253X.750		

BRAKE PAD APPLICATIONS



Hawk Performance - BRAKE PAD APPLICATIONS

HB
HAWK BRAKE

245
PAD SHAPE

x
INSERT COMPOUND CODE

.631
PAD THICKNESS

MAKE/ MODEL	SUBMODEL	YEARS	ENGINE (LITER)	NOTE	FRONT		REAR	
					OES	HB SERIES	OES	HB SERIES
GMC CONTINUED								
P6T042		1988-1990				HB253X.750		HB253X.750
R1500		1987		2 3/4" Rear Shoes JB5 & JD5		HB103X.590		
R1500		1987		2" Rear Shoe JB1 & JB3		HB103X.590		
R1500 Suburban		1987-1988		18043837		HB103X.590		
R1500 Suburban		1989-1991	All			HB131X.595		
R1500 Suburban		1990-1991		12321435		HB103X.590		
R2500		1987-1989	All			HB131X.595		
R2500		1987		11" Rear Drum		HB103X.590		
R2500		1988-1989		18043837		HB103X.590		
R2500 Suburban		1987-1991	All			HB131X.595		
R2500 Suburban		1987-1989		18043837		HB103X.590		
R2500 Suburban		1990-1991		12321435		HB103X.590		
R3500		1988	All	w/13 x 2.5 in. Drums		HB131X.595		
S15	2WD	1982-1989				HB119X.594		
S15	4WD	1982-1989				HB119X.594		
S15		1983-1988	All			HB119X.594		
S15		1990	All			HB119X.594		
S15 Jimmy		1983-1994	All			HB119X.594		
S7T042		1988-1990				HB251X1.14		HB251X1.14
Safari		1985		2WD with 4 wheel ABS		HB103X.590		
Safari		1986		2WD with Rear wheel ABS		HB103X.590		
Safari		1987		4WD		HB332X.654		
Safari	M Power	1987		18043837		HB103X.590		
Safari		1988		2WD with 4 wheel ABS		HB103X.590		
Safari		1989-2002	All	AWD	770369	HB332X.654		
Safari		1989		2WD with Rear wheel ABS		HB103X.590		
Safari	XT	1990-1997	All	AWD	770369	HB332X.654		
Safari		1990		4WD		HB332X.654		
Safari	RWD	1990		18043837		HB103X.590		
Safari	XT	1991-1992	All	RWD	770052	HB103X.590		
Safari		1991-2001	All	RWD	770052	HB103X.590		
Safari		1991		2WD with 4 wheel ABS		HB103X.590		
Safari		1992-1995		2WD with Rear wheel ABS		HB103X.590		
Safari		1993-2002		4WD		HB332X.654		
Safari		1994-1995		2WD with 4 wheel ABS		HB103X.590		
Safari		1996-2002		2WD		HB103X.590		
Safari		2003-2005	All			HB323X.724		
Safari		2003-2005				HB323X.724		HB324X.673
Savana 1500		1996-2002				HB332X.654		
Savana 1500		1999-2002	All		770369	HB332X.654		
Savana 1500		2003-2008	All			HB323X.724		
Savana 1500	LS	2003-2008	All			HB323X.724		
Savana 1500	LT	2003-2008	All			HB323X.724		
Savana 1500		2003-2005		88965714				HB494X.670
Savana 1500		2003-2008				HB323X.724		
Savana 1500		2006-2008		89027019				HB494X.670
Savana 1500		2009-2013	All			HB561X.710		HB494X.670
Savana 1500		2009-2014				HB561X.710		
Savana 1500		2014		89027019				HB494X.670
Savana 2500		1996-2000	All	8 lug		HB296X.670		
Savana 2500		1996-2002	All	6 Lug Wheels Only.	770369	HB332X.654		
Savana 2500		1996-2000		8 lug		HB296X.670		
Savana 2500		1996-2002		6 Lug		HB332X.654		
Savana 2500		2001-2002	6.5L	8 Lug, Diesel		HB298X.787		
Savana 2500		2001-2002	All	8 Lug, except Diesel		HB296X.670		

BRAKE PAD APPLICATIONS

MAKE/ MODEL	SUBMODEL	YEARS	ENGINE (LITER)	NOTE	FRONT		REAR	
					OES	HB SERIES	OES	HB SERIES
GMC CONTINUED								
Savana 2500		2001-2002		8 Lug with Diesel Engine		HB298X.787		
Savana 2500		2001-2002		8 Lug with Gas Engine		HB296X.670		
Savana 2500		2003-2005	All	6 Lug Wheels Only.		HB323X.724		HB494X.670
Savana 2500		2003-2005	All	8 lug				HB494X.670
Savana 2500		2003-2005		6 Lug		HB323X.724		HB494X.670
Savana 2500		2003-2005		8 lug		HB322X.717		HB494X.670
Savana 2500		2006-2013	All					HB494X.670
Savana 2500	LS	2006-2013	All					HB494X.670
Savana 2500	LT	2006-2013	All					HB494X.670
Savana 2500		2006-2014		Diesel Engine		HB322X.717		HB494X.670
Savana 2500		2006-2014		Gas Engine		HB322X.717		HB494X.670
Savana 2500		2015		19210706		HB322X.717		
Savana 2500		2015		88983902				HB494X.670
Savana 3500		1996-1998	All	8 lug		HB296X.670		
Savana 3500		1996-2000		Single Rr Whl		HB296X.670		
Savana 3500		1996-2002		Dual Rr Whl		HB298X.787		
Savana 3500		1999-2002	All			HB298X.787		
Savana 3500		2001		Single Rr Whl G315 Cab & Chassis		HB296X.670		
Savana 3500		2001-2002		Single Rr Whl except G315 Cab & Chassis		HB298X.787		
Savana 3500		2002		19152634		HB296X.670		
Savana 3500		2003-2013	All	SRW				HB494X.670
Savana 3500		2003-2006		Dual Rr Whl		HB322X.717		
Savana 3500		2003-2006		Single Rr Whl		HB322X.717		HB494X.670
Savana 3500		2004-2013	All	SRW W/ 86mm tall rear rotor				HB494X.670
Savana 3500		2004-2013	All	SRW W/ 91mm tall rear rotor				HB494X.670
Savana 3500		2007-2014		DRW		HB322X.717		
Savana 3500		2007-2014		SRW; 86mm Tall Rear Disc		HB322X.717		HB494X.670
Savana 3500		2007-2014		SRW; 91mm Tall Rear Disc		HB322X.717		HB494X.670
Savana 3500	DRW	2008		20850250				HB705X.776
Savana 3500		2009-2010	All	DRW				HB705X.776
Savana 3500	GVW 10000 Cutaway	2011-2012		20850250				HB705X.776
Savana 3500	GVW 8600 Cutaway	2011-2012		20850250				HB705X.776
Savana 3500		2013	All	DRW				HB705X.776
Savana 3500	GVW 14,040 Lbs., Parking Brake-Stability Control	2014		20850250				HB705X.776
Savana 3500		2015		19210706		HB322X.717		
Savana 3500		2015		22960231				HB705X.776
Savana 3500		2015		88983902				HB494X.670
Savana 3500	Chassis cab, Dual rear wheel	2015		19210708		HB322X.717		
Savana 3500	Chassis cab, Dual rear wheel	2015		20850250				HB705X.776
Savana 3500	Chassis Cab	2015		88983902				HB494X.670
Savana 4500		2009-2014		DRW		HB322X.717		
Savana 4500		2009-2014		SRW; 86mm Tall Rear Disc		HB322X.717		HB494X.670
Savana 4500		2009-2014		SRW; 91mm Tall Rear Disc		HB322X.717		HB494X.670
School Bus Chassis		1983-1984				HB253X.750		HB251X1.14
School Bus Chassis		1983-1990				HB251X1.14		HB251X1.14
School Bus Chassis	Front Axle 7000 Lbs Rear Axle 15000 Lbs	1985-1986		15559755		HB253X.750		
School Bus Chassis	Front Axle 7000 Lbs Rear Axle 15000 Lbs	1985-1986		15611046				HB253X.750
School Bus Chassis	Front Axle 7000 Lbs Rear Axle 15000 Lbs	1987		15611046		HB253X.750		HB253X.750
School Bus Chassis		1988-1990				HB251X1.14		HB253X.750
School Bus Chassis		1988-1990				HB253X.750		HB251X1.14
School Bus Chassis		1988-1990				HB253X.750		HB253X.750

BRAKE PAD APPLICATIONS



Hawk Performance - BRAKE PAD APPLICATIONS

HB **245** **x** **.631**
 HAWK BRAKE PAD SHAPE INSERT COMPOUND CODE PAD THICKNESS

MAKE/ MODEL	SUBMODEL	YEARS	ENGINE (LITER)	NOTE	FRONT		REAR	
					OES	HB SERIES	OES	HB SERIES
GMC CONTINUED								
School Bus Chassis	Front Axle 8100 Lbs Rear Axle 15000 Lbs	1993-1994		12475227		HB253X.750		HB253X.750
School Bus Chassis	Front Axle 9000 Lbs Rear Axle 16900 - 21000 Lbs.	1993-1998				HB251X1.14		HB251X1.14
School Bus Chassis	Front Axle 8100 Lbs Rear Axle 15000 Lbs	1995-1998		15619100		HB253X.750		HB253X.750
School Bus Chassis	Front Axle 8100 Lbs Rear Axle 15000 Lbs	1999-2002		12475227		HB253X.750		HB253X.750
School Bus Chassis	Front Axle 9000 Lbs Rear Axle 16900 Lbs.	1999-2002				HB251X1.14		HB251X1.14
Sierra 1500	2WD	1999-2000				HB323X.724		HB324X.673
Sierra 1500	4WD	1999-2000				HB323X.724		HB324X.673
Sierra 1500		2001-2002	All	4 Door				HB323X.724
Sierra 1500	2WD	2001		6 Lug		HB323X.724		HB324X.673
Sierra 1500	4DR Crew Cab	2001		18026219		HB322X.717		
Sierra 1500	4WD	2001-2002		6 lug with single piston rear calipers		HB323X.724		HB324X.673
Sierra 1500	4WD	2001-2003		6 lug with dual piston rear calipers		HB323X.724		HB385X.640
Sierra 1500	2WD	2002		6 lug with single piston rear calipers		HB323X.724		HB324X.673
Sierra 1500	4 Wheel Steering	2002		88964201		HB322X.717		
Sierra 1500	2WD	2002-2003		6 lug with dual piston rear calipers		HB323X.724		HB385X.640
Sierra 1500		2003	All	4 Door Heavy Duty. 2 Wheel Steering Must have 17" wheels or bigger				HB323X.724
Sierra 1500		2003	All	4 Door Heavy Duty. 4 Wheel Steering Must have 17" wheels or bigger				HB324X.673
Sierra 1500	2WD	2003		6 lug Quadrasteer models w/single piston rear calipers		HB323X.724		HB324X.673
Sierra 1500	2WD	2003		6 lug w/single piston rear calipers,Exc. Quadrasteer		HB323X.724		HB324X.673
Sierra 1500	4WD	2003		6 lug Quadrasteer Models w/single piston rear calipers		HB323X.724		HB324X.673
Sierra 1500	4WD	2003		6 lug w/single piston rear calipers,Exc. Quadrasteer		HB323X.724		HB324X.673
Sierra 1500	4 Wheel Steering	2003-2004		18045936				HB496X.640
Sierra 1500	4 Wheel Steering	2004		88964201		HB322X.717		
Sierra 1500	4WD	2004		6 lug Quadrasteer models w/dual piston rear calipers		HB323X.724		HB385X.640
Sierra 1500	4WD	2004		6 lug with dual piston rear calipers Except Quadrasteer		HB323X.724		HB385X.640
Sierra 1500	2WD	2004-2005		6 lug Quadrasteer models w/dual piston rear calipers		HB323X.724		HB385X.640
Sierra 1500	2WD	2004-2005		6 lug with dual piston rear calipers - Except Quadrasteer		HB323X.724		HB385X.640
Sierra 1500	2WD	2004-2006		6 lug with single piston rear calipers		HB323X.724		HB324X.673
Sierra 1500	4WD	2004-2006		6 lug with single piston rear calipers		HB323X.724		HB324X.673
Sierra 1500		2005	All	w/Rear Disc Brakes Must have 17" wheels or bigger				HB324X.673
Sierra 1500	Crew Cab	2005		18045936				HB496X.640
Sierra 1500	2WD	2005-2006		With Rear Drum Brakes		HB561X.710		
Sierra 1500	4WD	2005-2006		6 lug with dual piston rear calipers		HB323X.724		HB385X.640
Sierra 1500	4WD	2005-2006		With Rear Drum Brakes		HB561X.710		
Sierra 1500	2WD	2006		6 lug with dual piston rear calipers		HB323X.724		HB385X.640
Sierra 1500	Crew Cab	2006		88967105				HB496X.640
Sierra 1500		2007	All	w/Rear Disc Brakes. 6 Lugs				HB568X.666
Sierra 1500		2007	All	w/Rear Disc Brakes. 8 Lugs				HB568X.666
Sierra 1500	Classic LS	2007	All	w/Rear Disc Brakes. 6 Lugs				HB568X.666
Sierra 1500	Classic LS	2007	All	w/Rear Disc Brakes. 8 Lugs				HB568X.666
Sierra 1500	Classic LT	2007	All	w/Rear Disc Brakes. 6 Lugs				HB568X.666
Sierra 1500	Classic LT	2007	All	w/Rear Disc Brakes. 8 Lugs				HB568X.666
Sierra 1500	Classic WT	2007	All	w/Rear Disc Brakes. 6 Lugs				HB568X.666
Sierra 1500	Classic WT	2007	All	w/Rear Disc Brakes. 8 Lugs				HB568X.666

BRAKE PAD APPLICATIONS



MAKE/ MODEL	SUBMODEL	YEARS	ENGINE (LITER)	NOTE	FRONT		REAR	
					OES	HB SERIES	OES	HB SERIES
GMC CONTINUED								
Sierra 1500		2007		88967105				HB496X.640
Sierra 1500	2WD	2007		6 lug classic models w/single piston rear calipers			HB323X.724	HB324X.673
Sierra 1500	2WD	2007		6 lug new body style models with rear disc brakes Front Caliper Bracket Cast Number 351C/352C			HB561X.710	HB568X.666
Sierra 1500	2WD	2007		With rear drum brakes Front caliper bracket cast number 285C/286C			HB561X.710	
Sierra 1500	2WD	2007		With rear drum brakes Front Caliper Bracket Cast Number 351C/352C			HB561X.710	
Sierra 1500	4WD	2007		New Body Style 6 lug models w/rear disc brakes			HB561X.710	HB568X.666
Sierra 1500	4WD	2007		New Body Style with rear drum brakes Front Caliper Bracket Cast Number 351C/352C			HB561X.710	
Sierra 1500	4WD	2007		Old Body Style 6 lug w/dual piston rear calipers			HB323X.724	HB385X.640
Sierra 1500	4WD	2007		Old Body Style 6 lug w/single piston rear calipers			HB323X.724	HB324X.673
Sierra 1500	4WD	2007		Old Body Style with rear drum brakes Front Caliper Bracket Cast Number 285C/286C			HB561X.710	
Sierra 1500	Police	2008	All					HB568X.666
Sierra 1500		2008-2014	All					HB568X.666
Sierra 1500	2WD	2008-2013		With Rear Disc Brakes			HB561X.710	HB568X.666
Sierra 1500	2WD	2008-2013		With Rear Drum Brakes			HB561X.710	
Sierra 1500	4WD	2008-2013		With Rear Disc Brakes			HB561X.710	HB568X.666
Sierra 1500	4WD	2008-2013		With Rear Drum Brakes			HB561X.710	
Sierra 1500	Police	2010	All					HB568X.666
Sierra 1500		2014-2015		23135915			HB561X.710	
Sierra 1500		2015		23164777				HB568X.666
Sierra 1500 HD		2001-2003	All	Except 4 Wheel Steering.				HB323X.724
Sierra 1500 HD	2WD	2001-2002		8 lug			HB322X.717	HB323X.724
Sierra 1500 HD	4WD	2001-2002		8 lug			HB322X.717	HB323X.724
Sierra 1500 HD	2WD	2003		8 lug - Exc. Quadrasteer			HB322X.717	HB323X.724
Sierra 1500 HD	2WD	2003		8 lug Quadrasteer			HB322X.717	HB324X.673
Sierra 1500 HD	4WD	2003		8 lug - Exc. Quadrasteer			HB322X.717	HB323X.724
Sierra 1500 HD	4WD	2003		8 lug with Quadrasteer			HB322X.717	HB385X.640
Sierra 1500 HD		2005-2006	All	Except 4 Wheel Steering.				HB323X.724
Sierra 1500 HD	2WD	2005		8 lug with Quadrasteer			HB322X.717	HB385X.640
Sierra 1500 HD	2WD	2005		8 lug without Quadrasteer			HB322X.717	HB323X.724
Sierra 1500 HD	4WD	2005		8 lug with Quadrasteer			HB322X.717	HB385X.640
Sierra 1500 HD	4WD	2005		8 lug without Quadrasteer			HB322X.717	HB323X.724
Sierra 1500 HD	2WD	2006-2007		8 lug			HB322X.717	HB323X.724
Sierra 1500 HD	4WD	2006-2007		8 lug			HB322X.717	HB323X.724
Sierra 1500 HD	Classic LT	2007	All	Except 4 Wheel Steering.				HB323X.724
Sierra 2500		1999-2000	6.0L	Automatic				HB323X.724
Sierra 2500		1999-2000	6.0L	Manual				HB323X.724
Sierra 2500		1999-2000	All	Except 6.0L				HB323X.724
Sierra 2500		1999-2000		Except 6.0L with 5 speed			HB322X.717	HB323X.724
Sierra 2500		1999-2000		with 6.0L 5 speed			HB322X.717	HB323X.724
Sierra 2500		2001-2004	All	Automatic				HB323X.724
Sierra 2500		2001-2004	All	Manual				HB323X.724
Sierra 2500		2001-2004		Automatic transmission except Heavy Duty			HB322X.717	HB323X.724
Sierra 2500		2001-2004		Manual transmission except Heavy Duty			HB322X.717	HB323X.724
Sierra 2500		2004		18041762			HB323X.724	
Sierra 2500	4 Wheel Steering	2004		18041762			HB323X.724	
Sierra 2500 HD		2001-2003	All					HB323X.724
Sierra 2500 HD		2001-2003					HB322X.717	HB323X.724
Sierra 2500 HD		2004	All	2 Wheel Steering				HB323X.724
Sierra 2500 HD		2004	All	4 Wheel Steering				HB323X.724
Sierra 2500 HD		2004		Models with 2 wheel steering			HB322X.717	HB323X.724

BRAKE PAD APPLICATIONS

Hawk Performance - BRAKE PAD APPLICATIONS

HB **245** **x** **.631**
 HAWK BRAKE PAD SHAPE INSERT COMPOUND CODE PAD THICKNESS

MAKE/ MODEL	SUBMODEL	YEARS	ENGINE (LITER)	NOTE	FRONT		REAR	
					OES	HB SERIES	OES	HB SERIES
GMC CONTINUED								
Sierra 2500 HD		2004		Models with 4 wheel steering		HB322X.717		HB323X.724
Sierra 2500 HD		2005	All					HB323X.724
Sierra 2500 HD		2005-2010				HB322X.717		HB323X.724
Sierra 2500 HD	LS	2006	All					HB323X.724
Sierra 2500 HD	LT	2006-2010	All					HB323X.724
Sierra 2500 HD	WT	2006-2010	All					HB323X.724
Sierra 2500 HD	Classic LS	2007	All					HB323X.724
Sierra 2500 HD	Classic LT	2007	All					HB323X.724
Sierra 2500 HD	Classic WT	2007	All					HB323X.724
Sierra 2500 HD	LTZ	2007-2010	All					HB323X.724
Sierra 2500 HD		2011-2013	All					HB705X.776
Sierra 2500 HD		2011-2013				HB705X.776		HB705X.776
Sierra 2500 HD		2014-2015		20829195				HB705X.776
Sierra 2500 HD		2014-2015		22770745		HB705X.776		
Sierra 2500 HD		2015		22960231				HB705X.776
Sierra 3500		2001-2003				HB322X.717		HB322X.717
Sierra 3500		2004-2005		2WD		HB322X.717		HB322X.717
Sierra 3500		2004-2005		4WD Dual rear wheels		HB322X.717		HB322X.717
Sierra 3500		2004-2005		4WD Single rear wheels		HB322X.717		HB323X.724
Sierra 3500		2006-2007		DRW		HB322X.717		HB322X.717
Sierra 3500		2006-2007		SRW		HB322X.717		HB323X.724
Sierra 3500 HD		2007-2010	All	12,000 lbs. GVW				HB322X.717
Sierra 3500 HD		2007-2010	All	9,900 lbs. GVW				HB323X.724
Sierra 3500 HD		2007-2010		DRW		HB322X.717		HB322X.717
Sierra 3500 HD		2007-2010		SRW		HB322X.717		HB323X.724
Sierra 3500 HD		2011-2013		DRW		HB705X.776		HB705X.776
Sierra 3500 HD		2011-2013		SRW		HB705X.776		HB705X.776
Sierra 3500 HD		2014		20828610				HB705X.776
Sierra 3500 HD		2014-2015		22770745		HB705X.776		
Sierra 3500 HD		2015		20829195				HB705X.776
Sierra 3500 HD		2015		22960231				HB705X.776
Sierra C3		2001				HB323X.724		HB385X.640
Sierra Denali		2002-2006				HB323X.724		HB385X.640
Sierra Denali		2007		Classic		HB323X.724		HB385X.640
Sierra Denali		2007		New Body Style		HB561X.710		HB568X.666
Sierra Denali	6.0L	2007		25852957		HB561X.710		
Sierra Denali	6.0L	2007		88967105				HB496X.640
Sierra Denali	6.2L	2007		89059119		HB561X.710		
Sierra Denali		2008-2010				HB561X.710		HB568X.666
Sonoma	2WD	1991-1995		4 Whl. ABS		HB119X.594		
Sonoma	2WD	1991-1995		without 4 Whl. ABS		HB119X.594		
Sonoma	4WD	1991-1997				HB119X.594		
Sonoma		1996		18026296		HB119X.594		
Sonoma	2WD	1996-2003				HB119X.594		
Sonoma		1997		18026926		HB119X.594		
Sonoma		1998-2003	All	2WD				HB305X.610
Sonoma	Front: RWD	1998-2002		18026296		HB119X.594		
Sonoma	4WD	1998-2003				HB304X.598		HB305X.610
Sonoma		2004	All					HB305X.610
Sonoma	2WD	2004				HB304X.598		HB305X.610
Sonoma	4WD	2004		2.2 L Eng.		HB304X.598		HB305X.610
Sonoma	4WD	2004		4.3 L Eng.		HB304X.598		HB305X.610
Sprint		1972-1977	All		770052	HB103X.590		
Sprint	Custom	1972-1977	All		770052	HB103X.590		
Sprint		1972-1975						HB119X.594

BRAKE PAD APPLICATIONS



MAKE/ MODEL	SUBMODEL	YEARS	ENGINE (LITER)	NOTE	FRONT		REAR	
					OES	HB SERIES	OES	HB SERIES
GMC CONTINUED								
Sprint		1977						HB235X.665
Syclone	4WD	1991				HB119X.594		
T15		1983-1993				HB119X.594		
T-Series	Front Axle 11000 Lbs Rear Axle 16900-21000 Lbs.	1997-1998				HB251X1.14		HB251X1.14
T-Series	Front Axle 8100 Lbs Rear Axle 15000- 6900 Lbs.	1997-1999		15619100		HB253X.750		HB253X.750
T-Series	Front 11K Lbs Rear 16.9K-21K Lbs PB: Man Trans	1999-2002				HB251X1.14		HB251X1.14
T-Series	Front Axle 8100 Lbs Rear Axle 15000-16900 Lbs.	2000-2002		12475227		HB253X.750		HB253X.750
Typhoon		1992-1993				HB119X.594		
V1500		1987				HB103X.590		
V1500 Suburban		1987-1988		18043837		HB103X.590		
V1500 Suburban		1989-1991	All			HB131X.595		
V1500 Suburban		1990-1991		12321435		HB103X.590		
V2500		1987	All			HB131X.595		
V2500		1987		18043837		HB103X.590		
V2500 Suburban		1987-1991	All			HB131X.595		
V2500 Suburban		1987-1989		18043837		HB103X.590		
V2500 Suburban		1990-1991		12321435		HB103X.590		
W3500 Forward		1998-2007				HB537X.783		
W4500 Forward		1998-2007				HB537X.783		
W5500 Forward		2000-2007				HB537X.783		
Yukon	2WD	1992-1997				HB332X.654		
Yukon	Denali, 2WD	1992-1997				HB332X.654		
Yukon		1992-1999				HB332X.654		
Yukon	Denali, 4WD	1992-1999				HB332X.654		
Yukon		1995-1997	All		770369	HB332X.654		
Yukon		1997		18025354		HB296X.670		
Yukon		1998-1999	All	Police		HB296X.670		
Yukon		1998-1999	All	Except Police	770369	HB332X.654		
Yukon	2WD	1998-2000		w/11.9" Rear Drums, except Performance Pkg		HB332X.654		
Yukon	2WD	1998-2000		w/13.6" Rear Drums, Performance Pkg		HB296X.670		
Yukon	Denali, 2WD	1998-2000		w/11.9" Rear Drums, except Performance Pkg		HB332X.654		
Yukon	Denali, 2WD	1998-2000		w/13.6" Rear Drums, Performance Pkg		HB296X.670		
Yukon		2000	All	2WD. Police. w/Rear Drum Brakes		HB296X.670		
Yukon		2000	All	2WD. w/Rear Disc Brakes Must have 17" wheel or larger		HB323X.724		HB385X.640
Yukon		2000	All	4WD. w/Rear Disc Brakes. w/Limited Slip Must have 17" wheel or larger		HB323X.724		HB385X.640
Yukon		2000	All	4WD. w/Rear Disc Brakes. w/o Limited Slip Must have 17" wheel or larger		HB323X.724		HB324X.673
Yukon		2000	All	2WD. Except Police. w/Rear Drum Brakes	770369	HB332X.654		
Yukon		2000	All	4WD. w/Rear Drum Brakes	770369	HB332X.654		
Yukon		2000		with Rear Drums		HB332X.654		
Yukon	2WD	2000		with Rear Discs		HB323X.724		HB385X.640
Yukon	Denali, 2WD	2000		with Rear Discs		HB323X.724		HB385X.640
Yukon	Denali, 4WD	2000		with Rear Drums		HB332X.654		
Yukon		2000-2001		18045936				HB496X.640
Yukon		2000-2002		With Dual Piston Rear Calipers		HB323X.724		HB385X.640
Yukon		2000-2002		With Single Piston Rear Calipers		HB323X.724		HB324X.673
Yukon	Denali, 4WD	2000-2002		With Dual Piston Rear Calipers		HB323X.724		HB385X.640
Yukon	Denali, 4WD	2000-2002		With Single Piston Rear Calipers		HB323X.724		HB324X.673
Yukon		2001	All	2WD Must have 17" wheel or larger		HB323X.724		HB385X.640

BRAKE PAD APPLICATIONS

Hawk Performance - BRAKE PAD APPLICATIONS

HB **245** **x** **.631**
 HAWK BRAKE PAD SHAPE INSERT COMPOUND CODE PAD THICKNESS

MAKE/ MODEL	SUBMODEL	YEARS	ENGINE (LITER)	NOTE	FRONT		REAR	
					OES	HB SERIES	OES	HB SERIES
GMC CONTINUED								
Yukon		2001-2002	All	4WD. w/Limited Slip Must have 17" wheels or larger		HB323X.724		HB385X.640
Yukon		2001-2002	All	4WD. w/o Limited Slip Must have 17" wheels or larger		HB323X.724		HB324X.673
Yukon	2WD	2001				HB323X.724		HB385X.640
Yukon	Denali, 2WD	2001				HB323X.724		HB385X.640
Yukon		2002	All	2WD. Classic Style Must have 17" wheels or larger		HB323X.724		HB385X.640
Yukon		2002	All	2WD. New Style Must have 17" wheels or larger		HB323X.724		HB494X.670
Yukon	2WD	2002		With Akebono Rear Calipers		HB323X.724		
Yukon	2WD	2002		With PBR Rear Calipers		HB323X.724		HB385X.640
Yukon	Denali, 2WD	2002		With Akebono Rear Calipers		HB323X.724		
Yukon	Denali, 2WD	2002		With PBR Rear Calipers		HB323X.724		HB385X.640
Yukon	4WD	2002-2004		18045936				HB496X.640
Yukon		2003-2006	All	2WD- Must have 17" wheels or larger		HB323X.724		HB494X.670
Yukon		2003-2006	All	4WD-Must have 17" wheels or larger		HB323X.724		HB385X.640
Yukon		2003-2006				HB323X.724		HB385X.640
Yukon	2WD	2003-2006				HB323X.724		
Yukon	Denali, 2WD	2003-2006				HB323X.724		
Yukon	Denali, 4WD	2003-2006				HB323X.724		HB385X.640
Yukon	4WD	2005-2006		88964192				HB496X.640
Yukon	Police	2007-2010	All			HB561X.710		HB568X.666
Yukon	LS	2007-2013	All			HB561X.710		HB568X.666
Yukon	LT	2007-2013	All			HB561X.710		HB568X.666
Yukon	LTZ	2007-2013	All			HB561X.710		HB568X.666
Yukon		2007-2014				HB561X.710		HB568X.666
Yukon	2WD	2007-2014				HB561X.710		HB568X.666
Yukon	Denali, 2WD	2007-2014				HB561X.710		HB568X.666
Yukon	Denali, 4WD	2007-2014				HB561X.710		HB568X.666
Yukon	Hybrid	2008	All			HB561X.710		HB568X.666
Yukon		2015				HB561X.710		
Yukon		2015		23164777				HB568X.666
Yukon	Denali	2015				HB561X.710		
Yukon	Police	2015		23164777				HB568X.666
Yukon	Police	2015		25910430		HB561X.710		
Yukon		2016		23487649		HB561X.710		
Yukon XL		2015				HB561X.710		
Yukon XL		2015		23164777				HB568X.666
Yukon XL 1500		2000	All	w/13 in. Rear Drums. 6 Lug.		HB296X.670		
Yukon XL 1500		2000	All	w/11 in. Rear Drums	770369	HB332X.654		
Yukon XL 1500		2000-2002	All	w/Limited Slip		HB323X.724		HB385X.640
Yukon XL 1500		2000-2002	All	w/o Limited Slip		HB323X.724		HB324X.673
Yukon XL 1500		2000-2001		18045936				HB496X.640
Yukon XL 1500	2WD	2000-2001		With Dual Piston Rear Calipers		HB323X.724		HB385X.640
Yukon XL 1500	2WD	2000-2001		With Single Piston Rear Calipers		HB323X.724		HB324X.673
Yukon XL 1500	4WD	2000-2002		with Limited Slip Axle		HB323X.724		HB385X.640
Yukon XL 1500	4WD	2000-2002		without Limited Slip Axle		HB323X.724		HB324X.673
Yukon XL 1500	2WD	2002		Rear Disc with Limited Slip Axle		HB323X.724		HB385X.640
Yukon XL 1500	2WD	2002		Rear Disc without Limited Slip Axle		HB323X.724		HB324X.673
Yukon XL 1500	RWD	2002		89027010				HB494X.670
Yukon XL 1500	4WD	2002-2004		18045936				HB496X.640
Yukon XL 1500		2003-2006	All			HB323X.724		HB494X.670
Yukon XL 1500	2WD	2003-2006				HB323X.724		
Yukon XL 1500	4WD	2003-2006				HB323X.724		HB385X.640
Yukon XL 1500	4WD	2005-2006		88964192				HB496X.640

BRAKE PAD APPLICATIONS



MAKE/ MODEL	SUBMODEL	YEARS	ENGINE (LITER)	NOTE	FRONT		REAR	
					OES	HB SERIES	OES	HB SERIES
GMC CONTINUED								
Yukon XL 1500		2007-2013	All			HB561X.710		HB568X.666
Yukon XL 1500	2WD	2007-2014				HB561X.710		HB568X.666
Yukon XL 1500	4WD	2007-2014				HB561X.710		HB568X.666
Yukon XL 1500	Police	2010	All			HB561X.710		HB568X.666
Yukon XL 2500		2000-2002		with 4.63" Rear Hub Hole		HB322X.717		HB323X.724
Yukon XL 2500		2000-2002		with 4.83" Rear Hub Hole		HB322X.717		HB323X.724
Yukon XL 2500		2003-2005		w/2 Wheel Steering with 4.63" Rear Hub Hole		HB322X.717		HB323X.724
Yukon XL 2500		2003-2005		w/2 Wheel Steering with 4.83" Rear Hub Hole		HB322X.717		HB323X.724
Yukon XL 2500		2003-2005		w/4 Wheel Steering		HB322X.717		HB323X.724
Yukon XL 2500		2006		w/4.63" Rear Hub Hole		HB322X.717		HB323X.724
Yukon XL 2500		2006		w/4.83" Rear Hub Hole		HB322X.717		HB323X.724
Yukon XL 2500		2007-2013				HB322X.717		HB323X.724
HOLDEN								
Caprice	Australia	2006-2012	All			HB606X.650		
Commodore	Australia	2006-2012	All			HB606X.650		HB607X.616
Statesman	Australia	2006-2012	All			HB606X.650		
HONDA								
Accord	1800 LX, Coupe	1984-1985	1.8L			HB218X.583		
Accord	1800 LX, Sedan	1984-1985	1.8L			HB218X.583		
Accord	1800 Std, Coupe	1984-1985	1.8L			HB218X.583		
Accord	1800 Std, Sedan	1984-1985	1.8L			HB218X.583		
Accord	S, Coupe	1985	1.8L			HB218X.583		
Accord	S, Sedan	1985	1.8L			HB218X.583		
Accord	DX, Coupe	1986-1988	2.0L			HB403X.587		
Accord	DX, Sedan	1986-1988	2.0L			HB403X.587		
Accord	LX, Coupe	1986-1988	2.0L			HB403X.587		
Accord	LX, Sedan	1986-1988	2.0L			HB403X.587		
Accord	LXI, Coupe	1988-1989	2.0L			HB242X.661		
Accord	LXI, Sedan	1988-1989	2.0L			HB242X.661		
Accord	Coupe	1988-1989		DX		HB403X.587		
Accord	Coupe	1988-1989		LXi		HB242X.661		
Accord	Lxi	1988-1989		45022SD4A13		HB242X.661		
Accord	SEI, Coupe	1989	2.0L			HB242X.661		HB350X.496
Accord	SEI, Sedan	1989	2.0L			HB242X.661		HB350X.496
Accord	Coupe	1989		SEI		HB393X.665		HB350X.496
Accord	Sei	1989		43022SD2505				HB350X.496
Accord	Sei	1989		45022SD4A13		HB242X.661		
Accord	EX, Station Wagon	1991-1997	2.2L			HB143X.680		
Accord	LX, Station Wagon	1991-1997	2.2L			HB143X.680		
Accord	Sedan	1991		43022SM4G00				HB145X.570
Accord	Coupe	1992		EX				HB145X.570
Accord	Coupe	1993		DX and LX		HB275X.620		
Accord	Coupe	1993		EX and SE		HB275X.620		HB145X.570
Accord	Coupe	1994		DX and LX with Rear Drum brakes		HB275X.620		
Accord	Sedan	1994				HB275X.620		HB145X.570
Accord	Coupe	1994-1995		43022SV4G00				HB572X.570
Accord	Coupe	1994-1997		EX, SE, or LX with Rear Disc brakes		HB275X.620		HB145X.570
Accord	Wagon	1994-1997				HB143X.680		HB145X.570
Accord	EX, Sedan	1995-1997	2.7L			HB143X.680		
Accord	EX, Station Wagon	1995-1997	2.7L			HB143X.680		
Accord	LX, Sedan	1995-1997	2.7L			HB143X.680		
Accord	LX, Station Wagon	1995-1997	2.7L			HB143X.680		
Accord	Sedan	1995-1996		43022SV4G00				HB572X.570
Accord	Coupe	1995-1997		DX or LX with Rear Drum brakes		HB275X.620		
Accord	Sedan	1995-1997		4 Cyl.		HB275X.620		HB145X.570

BRAKE PAD APPLICATIONS



Hawk Performance - BRAKE PAD APPLICATIONS

HB
HAWK BRAKE

245
PAD SHAPE

x
INSERT COMPOUND CODE

.631
PAD THICKNESS

MAKE/ MODEL	SUBMODEL	YEARS	ENGINE (LITER)	NOTE	FRONT		REAR	
					OES	HB SERIES	OES	HB SERIES
HONDA CONTINUED								
Accord	Sedan	1995-1997		V6		HB143X.680		HB145X.570
Accord		1998-1999		Coupe		HB275X.594		
Accord		1998-2002		Sedan		HB275X.594		
Accord	Coupe	1998-2002		4 Cylinder Models with Rear Disc brakes		HB275X.620		HB145X.570
Accord	Coupe	1998-2002		4 Cylinder Models with Rear Drum brakes		HB275X.620		
Accord	Coupe	1998-2002		V6 Models		HB143X.680		HB145X.570
Accord	Sedan	1998-2002		4 Cyl. with Rear Discs		HB275X.620		HB145X.570
Accord	Sedan	1998-2002		4 Cyl. with Rear Drums		HB275X.620		
Accord	Sedan	1998-2002		6 Cyl.		HB143X.680		HB145X.570
Accord	LX, Sedan	2003-2007	3.0L	Except Hybrid		HB447X.667		
Accord	Sedan	2003-2004		6 cylinder		HB366X.681		HB145X.570
Accord	Sedan	2003-2006		4 Cylinder with Rear Disc		HB393X.665		HB145X.570
Accord	Sedan	2003-2006		4 Cylinder with Rear Drums		HB393X.665		
Accord	Coupe	2003-2007		4 Cylinder Models with Rear Disc brakes		HB393X.665		HB145X.570
Accord	Coupe	2003-2007		4 Cylinder Models with Rear Drum brakes		HB393X.665		
Accord	Coupe	2003-2007		V6 Models With Automatic Trans		HB366X.681		HB145X.570
Accord	Coupe	2003-2007		V6 Models With Manual Trans		HB366X.681		HB145X.570
Accord	Hybrid	2005		V6 Hybrid		HB393X.665		HB145X.570
Accord	Sedan	2005-2006		6 Cylinder; Except Hybrid		HB366X.681		HB145X.570
Accord	Hybrid, Coupe	2006-2007	3.0L			HB447X.667		
Accord	Hybrid, Sedan	2006-2007	3.0L			HB366X.681		
Accord	Hybrid	2006-2007		V6 Hybrid		HB366X.681		HB145X.570
Accord	Sedan	2007		4 Cyl. with Rear Discs		HB393X.665		HB145X.570
Accord	Sedan	2007		4 Cyl. with Rear Drums		HB393X.665		
Accord	Sedan	2007		6 Cyl; Except Hybrid		HB366X.681		HB145X.570
Accord	EX, Coupe	2008-2012	2.4L			HB366X.681		
Accord	EX, Sedan	2008-2012	2.4L			HB366X.681		
Accord	EX, Coupe	2008-2012	3.5L			HB366X.681		
Accord	EX, Sedan	2008-2012	3.5L			HB366X.681		
Accord	LX-P	2008						HB771X.597
Accord	LX-P	2008		43022TA0A70				HB626X.577
Accord	Sedan	2008-2010		LX, LX-P		HB393X.665		HB626X.577
Accord	Coupe	2008-2012		EX, EX-L 4 Cylinder or EX-L V6		HB366X.681		HB626X.577
Accord	Sedan	2008-2012		EX, EX-L		HB366X.681		HB626X.577
Accord	Coupe	2008-2014		LX-S 4 Cylinder		HB393X.665		HB626X.577
Accord	Crosstour	2010-2011	3.5L			771089		
Accord	EX	2010		43022TA0A70				HB626X.577
Accord	LX	2010		43022TA0A70				HB626X.577
Accord	EX	2010-2012						HB771X.597
Accord	LX	2010-2012						HB771X.597
Accord	SE	2011-2012						HB771X.597
Accord	Sedan	2011-2012		LX, LX-P, SE		HB393X.665		HB626X.577
Accord	Coupe	2013-2014		EX, EX-L 4 Cylinder				HB626X.577
Accord	Coupe	2013-2014		EX-L V6				HB626X.577
Accord	Sedan	2013-2014		EX, EX-L, Sport - 4 Cylinder				HB626X.577
Accord	Sedan	2013-2014		EX-L, Touring - V6				HB626X.577
Accord	Sedan	2013-2014		LX - 282mm (11.1") front rotors		HB393X.665		HB626X.577
Accord		2013-2015				HB770X.624		HB771X.597
Accord		2014		45022T2GA00		HB393X.665		
Accord	Hybrid	2014						HB626X.577
Accord	Sedan	2014		Plug-In		HB393X.665		HB626X.577
Accord	LX	2014-2016						HB771X.597
Accord		2015		43022TA0A81				HB626X.577
Accord		2015		45022T2GA01		HB393X.665		
Accord	Hybrid	2015				HB770X.624		HB771X.597

BRAKE PAD APPLICATIONS

MAKE/ MODEL	SUBMODEL	YEARS	ENGINE (LITER)	NOTE	FRONT		REAR	
					OES	HB SERIES	OES	HB SERIES
HONDA CONTINUED								
Accord	Hybrid	2015		43022TA0A81				HB626X.577
Accord	Hybrid	2015		45022T3ZA01		HB393X.665		
Accord	LX	2015		43022TA0A81				HB626X.577
Accord	LX	2015		45022T2FA01		HB393X.665		
Accord	EX	2016				HB770X.624		HB771X.597
Accord	LX-S	2016						HB771X.597
Accord	Sport Touring	2016						HB771X.597
Accord Crosstour		2010		43022TP6A00				HB145X.570
Accord Crosstour	AWD	2011		43022TP6A00				HB145X.570
Accord Crosstour	FWD	2011		43022TP6A00				HB145X.570
Accord Crosstour	FWD	2011			771089			
Civic	1500 GL	1984	1.5L			HB397X.585		
Civic	1500 DX	1984-1987	1.5L			HB397X.585		
Civic	1500 S	1984-1985	1.8L			HB397X.585		
Civic		1985-1987	1.3L			HB397X.585		
Civic	1500	1985	1.5L			HB397X.585		
Civic	1300	1987	1.3L			HB397X.585		
Civic	1500	1987	1.5L			HB397X.585		
Civic	1500 DX	1988	1.5L			HB218X.583		
Civic		1988-1991	1.5L			HB218X.583		
Civic	4wd	1988-1991	1.6L			HB113X.590		
Civic	EX 1600, Sedan	1990-1991	All			HB242X.661		
Civic		1990-1991		45022SK7010		HB242X.661		
Civic	Hatchback	1990-1991				HB218X.583		
Civic	Sedan	1990-1991		DX LX 1500 cc		HB218X.583		
Civic	Sedan	1990-1991		EX 1600 cc		HB242X.661		
Civic	Wagon	1990-1991		Wagon 2WD		HB218X.583		
Civic	Wagon	1990-1991		Wagon 4WD		HB113X.590		
Civic	EX, Sedan	1992-1993	All			HB242X.661		
Civic	EX	1992		43022SR3000				HB350X.496
Civic	EX	1992		45022SR3N31		HB242X.661		
Civic	Hatchback	1992		DX CX VX 1500 cc		HB218X.583		
Civic	Hatchback	1992-1993		Si 1.6L		HB218X.583		HB350X.496
Civic	Sedan	1992-1993		DX LX		HB218X.583		
Civic	Sedan	1992-1993		EX		HB242X.661		HB350X.496
Civic	Si	1992-1993		43022SR3000				HB350X.496
Civic	EX 1600, Coupe	1993-1995	All	w/ABS		HB245X.631		
Civic	EX 1600, Coupe	1993-1995	All	w/o ABS		HB418X.646		
Civic	EX 4 Dr	1993		43022SR3000				HB350X.496
Civic	EX 4 Dr	1993		45022SR3N31		HB242X.661		
Civic	Coupe	1993-1995		DX		HB218X.583		
Civic	Coupe	1993-1995		EX with rear disc with ABS		HB245X.631		HB350X.496
Civic	Coupe	1993-1995		EX with rear drum & no ABS		HB418X.646		
Civic	Hatchback	1993-1995		DX CX VX 1.5L		HB218X.583		
Civic	EX, Sedan	1994-1995	All	w/ABS		HB245X.631		
Civic	LX, Sedan	1994-1995	All	w/ABS. w/Rear Disc Brakes		HB245X.631		
Civic	Si 1600, Hatchback	1994-1995	All	w/ABS		HB245X.631		
Civic		1994-1995		43022SR3010				HB350X.496
Civic	Hatchback	1994-1995		Si 1.6L with ABS		HB245X.631		HB350X.496
Civic	Hatchback	1994-1995		Si 1.6L without ABS		HB218X.583		HB350X.496
Civic	Sedan	1994-1995		DX LX with rear drum		HB218X.583		
Civic	Sedan	1994-1995		EX LX with rear disc with ABS		HB245X.631		HB350X.496
Civic	LX, Sedan	1996	All	w/ABS & A/T	770465	HB275X.620		
Civic	EX, Coupe	1996-2005	All			HB275X.620		
Civic	Sedan	1996		DX LX w/o ABS or LX w/ABS and Manual Trans		HB218X.583		

BRAKE PAD APPLICATIONS



Hawk Performance - BRAKE PAD APPLICATIONS

HB
HAWK BRAKE

245
PAD SHAPE

x
INSERT COMPOUND CODE

.631
PAD THICKNESS

MAKE/ MODEL	SUBMODEL	YEARS	ENGINE (LITER)	NOTE	FRONT		REAR	
					OES	HB SERIES	OES	HB SERIES
HONDA CONTINUED								
Civic	Sedan	1996		EX LX with ABS and automatic trans.		HB275X.620		
Civic	Coupe	1996-2000		DX HX		HB218X.583		
Civic	Hatchback	1996-2000				HB218X.583		
Civic	Coupe	1996-2003		EX		HB275X.620		
Civic		1996-2005				HB275X.620		
Civic	Sedan	1997-2000		DX LX GX		HB218X.583		
Civic	Sedan	1997-2000		EX		HB275X.620		
Civic	Si, Coupe	1999-2000	All			HB275X.620		HB350X.496
Civic	2 Door Si	1999		43022S04020				HB350X.496
Civic	Coupe	1999-2000		Si		HB275X.620		HB350X.496
Civic	Si	1999-2003				HB275X.620		
Civic	Si	2000		43022S04030				HB350X.496
Civic	DX, Coupe	2001-2005	All	Rear Drum		HB275X.620		
Civic	DX, Sedan	2001-2005	All	Rear Drum		HB275X.620		
Civic	GX, Sedan	2001-2005	All			HB275X.620		
Civic	HX, Coupe	2001-2005	All			HB275X.620		
Civic	LX, Coupe	2001-2005	All			HB275X.620		
Civic	LX, Sedan	2001-2005	All			HB275X.620		
Civic	GX	2001				HB275X.620		
Civic	Coupe	2001-2003		DX, HX, LX		HB275X.620		
Civic	Sedan	2001-2003		DX, LX		HB275X.620		
Civic	Sedan	2001-2003		EX, GX		HB275X.620		
Civic	Si, Hatchback	2002-2003	All			HB275X.620		
Civic	Hatchback	2002-2003				HB275X.620		HB145X.570
Civic	Si	2002-2004		43022S6D000				HB572X.570
Civic	Hybrid, Sedan	2003-2008	All			HB418X.646		
Civic	Sedan	2003-2008		Hybrid		HB418X.646		
Civic	Coupe	2004-2005		DX, HX		HB275X.620		
Civic	Coupe	2004-2005		EX, LX		HB275X.620		
Civic	Hatchback	2004-2005				HB418X.646		HB145X.570
Civic	Sedan	2004-2005		DX		HB275X.620		
Civic	Sedan	2004-2005		EX, GX, LX		HB275X.620		
Civic	Si, Coupe	2006-2011	All			HB361X.622		
Civic	Si, Sedan	2006-2011	All			HB361X.622		
Civic	Coupe	2006		DX LX with rear drum		HB275X.620		
Civic	Coupe	2006		EX with rear disc		HB275X.620		HB145X.570
Civic	Coupe	2006		Si Coupe		HB361X.622		HB145X.570
Civic	Sedan	2006		EX with rear disc		HB275X.620		HB145X.570
Civic	Sedan	2006-2008		DX LX with rear drum		HB275X.620		
Civic		2006-2011				HB275X.594		
Civic		2006-2011		EX		HB275X.594		
Civic	Sedan	2006-2011		GX; w/Rear Drums		HB366X.681		
Civic	Coupe	2007-2008		DX, LX; 1.8L; w/Rear Drums		HB275X.620		
Civic	Coupe	2007-2008		EX; 1.8L; w/Rear Discs		HB275X.620		HB145X.570
Civic	Coupe	2007-2008		Si; 2.0L; w/Rear Discs		HB361X.622		HB145X.570
Civic	Sedan	2007-2010		EX; w/Rear Discs		HB275X.620		HB145X.570
Civic	Sedan	2007-2011		Si; w/Rear Discs		HB361X.622		HB145X.570
Civic	Coupe	2009-2010		EX; w/Rear Discs		HB275X.620		HB145X.570
Civic	Coupe	2009-2011		Si; w/Rear Discs		HB361X.622		HB145X.570
Civic	Sedan	2009-2011		DX, LX with rear drum		HB275X.620		
Civic	Sedan	2009-2011		Hybrid		HB418X.646		HB145X.570
Civic	Coupe	2009-2012		DX, LX; w/Rear Drums		HB275X.620		
Civic	Coupe	2011-2012		EX, EX-L; w/Rear Discs		HB275X.620		HB145X.570
Civic	Sedan	2011-2012		EX, EX-L; w/Rear Discs		HB275X.620		HB145X.570
Civic	Si, Coupe	2012-2013	All		770914	HB393X.665		

BRAKE PAD APPLICATIONS

MAKE/ MODEL	SUBMODEL	YEARS	ENGINE (LITER)	NOTE	FRONT		REAR	
					OES	HB SERIES	OES	HB SERIES
HONDA CONTINUED								
Civic	Sedan	2012		DX, LX, HF with rear drum		HB275X.620		
Civic	Coupe	2012-2013		Si; w/Rear Discs		HB393X.665		HB145X.570
Civic	Sedan	2012-2013		Hybrid		HB418X.646		
Civic	Sedan	2012-2013		Si; w/Rear Discs		HB393X.665		HB145X.570
Civic	Si, Sedan	2012-2013			770914	HB393X.665		
Civic	Coupe	2013		LX; w/Rear Drums		HB275X.620		
Civic	SEDAN	2013		LX, HF with rear drum		HB275X.620		
Civic	Coupe	2013-2014		EX, EX-L; w/Rear Discs		HB393X.665		HB145X.570
Civic	Sedan	2013-2014		EX, EX-L; w/Rear Discs		HB393X.665		HB145X.570
Civic	Hybrid	2014		45022TR2A00		HB418X.646		
Civic	Manual Transmission	2014		45022TR3A01		HB275X.620		
Civic	CVT Trans	2015		45022T2FA01		HB393X.665		
Civic	EX	2015		43022TR0A01				HB145X.570
Civic	EX	2015		45022T2FA01		HB393X.665		
Civic	Hybrid	2015		45022TR2A01		HB418X.646		
Civic	Manual Trans	2015		45022TR3A02		HB275X.620		
Civic	Si	2015		43022TR0A01				HB145X.570
Civic	Si	2015		45022TR7A02		HB393X.665		
Civic del Sol	Si	1993-1997	All					HB350X.496
Civic del Sol	Vtec	1993-1997	All			HB418X.646		HB350X.496
Civic del Sol	Si	1993-1994		43022SR2000				HB350X.496
Civic del Sol		1993-1997		S		HB218X.583		
Civic del Sol		1993-1997		Si		HB218X.583		HB350X.496
Civic del Sol		1993-1997		VTEC		HB418X.646		HB350X.496
Civic del Sol	Vtec	1994		43022SR2000				HB350X.496
Civic del Sol	Si	1995		43022SR3010				HB350X.496
Civic del Sol	Vtec	1995		43022SR3010				HB350X.496
Civic del Sol	Si	1995-1997		45022S04V00		HB245X.631		
Civic del Sol	Si	1996		43022S04000				HB350X.496
Civic del Sol	Si	1997		43022S04010				HB350X.496
Crosstour	AWD	2012		43022TP6A00				HB145X.570
Crosstour	FWD	2012		43022TP6A00				HB145X.570
Crosstour	AWD	2012			771089			
Crosstour		2013-2014		43022TP6A00				HB145X.570
Crosstour		2015			771089			
Crosstour		2015		43022TP6A01				HB145X.570
CR-V		1997-2001		Rear Drum		HB143X.680		
CR-V	LX	2002-2004	All	w/Drum Style Parking Brake		HB393X.665		HB145X.570
CR-V	LX	2002-2004	All	w/Integrate Parking Brake	770914	HB393X.665	770536	HB572X.570
CR-V		2002-2004				HB393X.665		HB572X.570
CR-V	LX	2005-2006	All			HB393X.665		HB145X.570
CR-V	SE	2005-2006	All			HB393X.665		
CR-V	EX	2005-2006	All		770914	HB393X.665		
CR-V		2005-2006				HB393X.665		
CR-V	SE	2007-2011	2.4L		771089			
CR-V		2007-2008		43022S9A010				HB145X.570
CR-V		2009-2011		43022SXS000				HB145X.570
CR-V	EX-L	2012	All		770914	HB393X.665		
CR-V	LX	2012	All		771089			
CR-V	AWD	2012-2014	All		771089			
CR-V	FWD	2012-2014	All		770914	HB393X.665		
CR-V	AWD	2012		43022TP6A00				HB145X.570
CR-V	FWD	2012		43022TP6A00				HB145X.570
CR-V		2012-2014		FWD Models		HB393X.665		
CR-V	AWD	2013-2014		43022TOGA00				HB145X.570

BRAKE PAD APPLICATIONS



Hawk Performance - BRAKE PAD APPLICATIONS

HB
HAWK BRAKE

245
PAD SHAPE

x
INSERT COMPOUND CODE

.631
PAD THICKNESS

MAKE/ MODEL	SUBMODEL	YEARS	ENGINE (LITER)	NOTE	FRONT		REAR	
					OES	HB SERIES	OES	HB SERIES
HONDA CONTINUED								
CR-V	FWD	2013-2014		43022T0GA00				HB145X.570
CR-V	AWD	2015			771089			
CR-V	AWD	2015		43022T0GA01				HB145X.570
CR-V	FWD	2015		43022T0GA01				HB145X.570
CR-V	FWD	2015		45022SCVA01			HB393X.665	
CRX	1.5	1984					HB397X.585	
CRX	1.5	1985		45022SB2671			HB397X.585	
CRX	Si	1986-1987	All				HB397X.585	
CRX	1500 HF	1988-1989	All				HB397X.585	
CRX	DX	1988-1989	All				HB218X.583	
CRX	Si	1988-1989	All				HB218X.583	
CRX		1988		Si			HB218X.583	
CRX		1988-1989		DX			HB218X.583	
CRX		1988-1991		HF			HB397X.585	
CRX		1989		Si			HB218X.583	HB350X.496
CRX	HF	1990-1991	All				HB397X.585	
CRX	Si	1990-1991	All				HB113X.590	HB350X.496
CRX		1990-1991		Base			HB218X.583	
CRX		1990-1991		Si			HB113X.590	HB350X.496
CR-Z		2011-2014	All				HB418X.646	
CR-Z		2011-2014					HB418X.646	HB145X.570
CR-Z		2015		43022SV4A23				HB145X.570
CR-Z		2015		45022TK6A01			HB418X.646	
Element		2003-2011					HB393X.665	HB572X.570
Element	LX	2004-2011	All					HB572X.570
Element	SC	2007-2011	All					HB572X.570
Fit		2007-2013	All				HB418X.646	
Fit	Sport	2007-2013	All				HB418X.646	
Fit		2007-2012					HB418X.646	
Fit	EV	2013-2014	All		770914		HB393X.665	
Fit		2013		With Gas Engine			HB418X.646	
HR-V		2016					HB770X.624	
HR-V		2016		45022T2GA01			HB393X.665	
Insight		2000-2006		with automatic transmission			HB397X.585	
Insight	Electric	2001-2004	All	Automatic Transmission Only			HB397X.585	
Insight		2001-2006	All	Automatic Transmission Only			HB397X.585	
Insight	Manual Trans	2001		45022S3YA01			HB397X.585	
Insight	Manual Trans	2002-2006		45022S3YA02			HB397X.585	
Insight		2010-2014	All				HB275X.620	
Insight		2010-2013					HB275X.620	
Insight		2010-2014					HB275X.594	
Odyssey	EX	1995-1998	All	w/Drum Style Parking Brake				HB145X.570
Odyssey	EX	1995-1998	All	w/Integrate Parking Brake				HB572X.570
Odyssey	LX	1995-1998	All	w/Drum Style Parking Brake				HB145X.570
Odyssey	LX	1995-1998	All	w/Integrate Parking Brake				HB572X.570
Odyssey		1995-1998					HB143X.680	HB145X.570
Odyssey		2002-2004						HB506X.610
Odyssey		2011-2014	All		771089			
Odyssey		2015			771089			
Passport	EX	1994	All				HB422X.610	
Passport	LX	1994	All				HB422X.610	
Passport	DX	1994-1996	All				HB422X.610	
Passport	4 Cyl	1994-1996		8970796380			HB422X.610	
Passport		1997		8971317480			HB422X.610	
Passport		1998-2001		2WD; With Rear Discs			HB422X.610	

BRAKE PAD APPLICATIONS

MAKE/ MODEL	SUBMODEL	YEARS	ENGINE (LITER)	NOTE	FRONT		REAR	
					OES	HB SERIES	OES	HB SERIES
HONDA CONTINUED								
Passport		1998-2001		2WD; With Rear Drums		HB422X.610		
Passport		1998-2001		4WD		HB422X.610		
Pilot		2003-2008				HB393X.665		HB506X.610
Prelude		1983-1987	All			HB397X.585		
Prelude	2.0 Si	1985-1987	All			HB403X.587		
Prelude	2.0 Si	1985-1987		43022SF0505				HB350X.496
Prelude	2.0 Si 4WS	1988-1989	All			HB242X.661		
Prelude	2.0 Si	1988-1991	All			HB242X.661		
Prelude	2.0 Si	1988		45022SD4020		HB242X.661		
Prelude	2.0 S	1988-1989		43022SR3010				HB350X.496
Prelude	2.0 Si	1988-1989		43022SR3010				HB350X.496
Prelude		1988-1989		Si, SE		HB242X.661		HB350X.496
Prelude		1988-1990		S		HB113X.590		HB350X.496
Prelude	2.0 Si	1989		45022SD4A13		HB242X.661		
Prelude	Si 4WS	1990-1991	All			HB242X.661		
Prelude	Si ALB	1990-1991	All			HB242X.661		
Prelude	Si	1990-1991	All			HB242X.661		HB350X.496
Prelude		1990		Si		HB242X.661		HB350X.496
Prelude	2.0 S	1990		43022SR3030				HB350X.496
Prelude	2.0 Si	1990		43022SR3030				HB350X.496
Prelude	2.0 Si	1990		45022SE0G10		HB242X.661		
Prelude		1991				HB242X.661		HB350X.496
Prelude	S	1992-1996	All					HB145X.570
Prelude	Si	1992-1996	All					HB145X.570
Prelude		1992-1996		except V-Tec		HB144X.719		HB145X.570
Prelude		1992-1996		V-TEC		HB143X.680		HB145X.570
Prelude	Vtec	1993-1996	All			HB143X.680		
Prelude	SH	1997-2001	All					HB145X.570
Prelude		1997-2001				HB143X.680		HB145X.570
Ridgeline		2006-2014	All			HB678X.709		
Ridgeline		2006-2013				HB678X.709		HB679X.600
Ridgeline		2014		43022TK4A00				HB679X.600
S2000		2000-2009	All			HB361X.622		HB145X.570
S2000		2000-2009				HB361X.622		HB145X.570
S2000	CR	2008-2009	All			HB361X.622		
Wagovan		1984				HB397X.585		
Wagovan		1986-1987	All			HB397X.585		
HUMMER								
H1		2003		GVW 12100 Lbs		HB264X.575		HB264X.575
H1		2004				HB264X.575		HB264X.575
H1		2006				HB264X.575		HB264X.575
H2		2003-2009	All					HB323X.724
H2		2003-2009				HB322X.717		HB323X.724
H3		2006-2010	All			HB526X.665		HB527X.604
H3		2006-2010				HB526X.665		HB527X.604
H3	Alpha	2008-2010	All			HB526X.665		
H3	X	2008-2010	All			HB526X.665		
H3T		2009-2010	All			HB526X.665		HB527X.604
H3T		2009-2010				HB526X.665		HB527X.604
HYUNDAI								
Accent		2012-2014		583021RA30				HB734X.584
Azera		2006-2011	All			HB368X.665		
Azera		2006-2008				HB368X.665		
Azera		2009		From 7/09		HB368X.665		
Azera		2009		To 6/09		HB368X.665		



Hawk Performance - BRAKE PAD APPLICATIONS

HB
HAWK BRAKE

245
PAD SHAPE

x
INSERT COMPOUND CODE

.631
PAD THICKNESS

MAKE/ MODEL	SUBMODEL	YEARS	ENGINE (LITER)	NOTE	FRONT		REAR	
					OES	HB SERIES	OES	HB SERIES
HYUNDAI CONTINUED								
Azera		2010-2011				HB368X.665		
Elantra		1992-1994				HB261X.665		
Elantra		1994-1995		5830228A01				HB262X.540
Elantra		1996		5830229A00				HB262X.540
Elantra		1996-1997				HB261X.665		
Elantra		1997-2001		5830229A10				HB262X.540
Elantra		1998				HB261X.665		HB262X.540
Elantra		1999-2000						HB262X.540
Elantra		1999-2000		5810129A70		HB368X.665		
Elantra		2001				HB261X.665		HB262X.540
Elantra		2002-2006	All		770941			
Elantra		2002-2005						HB262X.540
Elantra	Front from 02/2005	2005-2006		581012DA70		HB368X.665		
Elantra	Front to 02/2005	2005-2006		583022DA00				HB262X.540
Elantra		2006		with Rear Discs				HB262X.540
Elantra	Limited	2007	All			HB368X.665		
Elantra	GLS	2007-2010	All			HB368X.665		
Elantra	SE	2007-2010	All			HB368X.665		
Elantra		2007-2008				HB368X.665		
Elantra		2009-2010		Sedan Model		HB368X.665		
Elantra	Blue	2010	All			HB636X.644		HB637X.583
Elantra		2011-2012		583023XA30				HB734X.584
Elantra		2013-2014	All			HB735X.666		HB734X.584
Elantra	GT	2013-2014	All					HB734X.584
Elantra		2013-2015				HB735X.666		
Elantra	Coupe	2014	All			HB735X.666		HB734X.584
Elantra		2015		581013XA20		HB735X.666		
Elantra		2015		583023XA30				HB734X.584
Elantra Coupe		2013-2015		583023XA30				HB734X.584
Elantra Coupe		2014-2015				HB735X.666		
Elantra Coupe		2014-2015		581013XA20		HB735X.666		
Elantra GT		2013-2014						HB734X.584
Elantra GT		2013-2014		58302A5B30				HB734X.584
Entourage		2007		From 4/28/07				HB662X.587
Entourage		2008						HB662X.587
Entourage		2009		583024DU02				HB662X.587
Equus		2011	All			HB636X.644		
Equus		2011				HB636X.644		HB662X.587
Equus		2012-2013						HB662X.587
Equus		2014-2015		583023NA00				HB662X.587
Genesis	Sedan	2009-2011	3.8L	V6 Only				HB637X.583
Genesis	Sedan	2009-2010	5.0L	V8 Only		HB636X.644		HB637X.583
Genesis	Sedan	2009		V6				HB662X.587
Genesis	Sedan	2009		V8		HB636X.644		HB662X.587
Genesis		2009-2011		V6		HB635X.645		
Genesis	Sedan	2010-2014		V8		HB636X.644		
Genesis	Sedan	2011	4.6L	V8 Only		HB636X.644		
Genesis	Sedan	2012-2013	All			HB636X.644		
Genesis	Sedan	2012-2014		V6		HB636X.644		
Genesis Coupe		2010-2013	All	w/o Brembo Brakes		HB661X.667		HB662X.587
Genesis Coupe	Track	2010-2013	All	w/Brembo Brakes		HB453X.585		HB663X.557
Genesis Coupe	Track	2010-2012		581012MA10		HB453X.585		HB663X.557
Genesis Coupe		2010-2013		w/Brembo Brakes-340MM (13.4") Front Rotor		HB453X.585		
Genesis Coupe		2010-2013		w/Standard Brakes-320MM (12.6") Front Rotor		HB661X.667		HB662X.587
Genesis Coupe	Track	2013-2015		581012MA10		HB453X.585		

BRAKE PAD APPLICATIONS



MAKE/ MODEL	SUBMODEL	YEARS	ENGINE (LITER)	NOTE	FRONT		REAR	
					OES	HB SERIES	OES	HB SERIES
HYUNDAI CONTINUED								
Genesis Coupe	Track	2013-2015		583022MA10				HB663X.557
Genesis Coupe		2014-2015		581012MA00		HB661X.667		
Genesis Coupe		2014-2015		583022MA00				HB662X.587
Santa Fe		2001-2005	All			HB461X.646		
Santa Fe		2001-2002		2WD		HB461X.646		
Santa Fe		2001-2002		4WD		HB461X.646		
Santa Fe		2003-2004		5810126A40		HB461X.646		
Santa Fe		2003-2005		275mm Front Discs		HB461X.646		
Santa Fe		2003-2005		293mm Front Discs		HB461X.646		
Santa Fe	GLS	2006	All			HB461X.646		
Santa Fe	Limited	2006	All			HB461X.646		
Santa Fe		2006				HB461X.646		
Santa Fe		2010-2013						HB662X.587
Santa Fe	Sport	2013-2014	All			HB738X.662		
Santa Fe	Sport	2013-2014		583022WA00				HB662X.587
Santa Fe		2013-2015		583022WA00				HB662X.587
Sonata		1989-1998				HB261X.665		
Sonata		1991		5830533B00				HB417X.659
Sonata		2002-2004	2.4L			HB368X.665		
Sonata		2003		Non-ABS; From 4/03		HB368X.665		
Sonata		2004				HB261X.665		
Sonata		2004				HB368X.665		
Sonata	GL	2005-2006	All			HB368X.665		
Sonata		2005		2.4L 4 Cyl. - MFG After 4/2005		HB368X.665		
Sonata		2005		3.3L 6 Cyl. - MFG After 4/2005		HB368X.665		
Sonata		2005		MFG Up To 3/2005		HB368X.665		
Sonata	GLS	2006-2010	2.4L			HB368X.665		
Sonata	LX	2006-2010	2.4L			HB368X.665		
Sonata	GLS	2006-2010	3.3L			HB368X.665		
Sonata	LX	2006-2010	3.3L			HB368X.665		
Sonata		2006-2007		2.4L 4 Cyl.		HB368X.665		
Sonata		2006-2007		3.3L 6 Cyl.		HB368X.665		
Sonata	Limited	2007-2010	All			HB368X.665		
Sonata	SE	2007-2010	All			HB368X.665		
Sonata		2008		2.4L 4 Cyl. - MFG After 1/21/2008		HB368X.665		
Sonata		2008		2.4L 4 Cyl. - MFG Up To 1/20/2008		HB368X.665		
Sonata		2008		3.3L 6 Cyl. - MFG After 1/21/2008		HB368X.665		
Sonata		2008		3.3L 6 Cyl. - MFG Up To 1/20/2008		HB368X.665		
Sonata		2009		2.4L 4 Cyl.		HB368X.665		
Sonata		2009		3.3L 6 Cyl.		HB368X.665		
Sonata		2010		MFG Before 11/2009 - 2.4L 4 Cyl.		HB368X.665		
Sonata		2010		MFG Before 11/2009 - 3.3L 6 Cyl.		HB368X.665		
Sonata		2015		Power Parking Brake				HB734X.584
Sonata	Power Parking Brake	2015		58302C1A50				HB734X.584
Tiburon	FX	1997-1998	All					HB262X.540
Tiburon		1997-1998				HB261X.665		
Tiburon		1997-1998		5830229A10				HB262X.540
Tiburon		1999				HB261X.665		HB262X.540
Tiburon		1999		583022DA00				HB262X.540
Tiburon		2000-2001						HB262X.540
Tiburon		2000-2001		5810129A70		HB368X.665		
Tiburon		2003-2004	All			HB368X.665		
Tiburon	GT	2003-2007	All			HB368X.665		
Tiburon		2003				HB368X.665		HB262X.540
Tiburon		2004-2006		with 6 Speed				HB262X.540

BRAKE PAD APPLICATIONS



Hawk Performance - BRAKE PAD APPLICATIONS

HB
HAWK BRAKE

245
PAD SHAPE

x
INSERT COMPOUND CODE

.631
PAD THICKNESS

MAKE/ MODEL	SUBMODEL	YEARS	ENGINE (LITER)	NOTE	FRONT		REAR	
					OES	HB SERIES	OES	HB SERIES
HYUNDAI CONTINUED								
Tiburon		2004-2008		except 6 Speed		HB368X.665		HB262X.540
Tiburon	GS	2005-2006	All			HB368X.665		
Tiburon		2005		583022CA00				HB262X.540
Tiburon	SE	2005-2008		583022CA00				HB262X.540
Tiburon		2006		583022DA10				HB262X.540
Tiburon	GT Limited	2007	All			HB368X.665		
Tiburon		2007-2008		583022CA00				HB262X.540
Tiburon		2007-2008		6 Speed				HB262X.540
Tiburon	GS	2008	All			HB368X.665		
Tiburon	GT	2008		583022CA00				HB262X.540
Tucson	LX	2005	All			HB368X.665		
Tucson	GL	2005-2006	All			HB368X.665		
Tucson	GLS	2005-2006	All			HB368X.665		
Tucson	AWD	2005-2009	All			HB368X.665		
Tucson	FWD	2005-2009	All			HB368X.665		
Tucson		2005-2008		2WD		HB368X.665		
Tucson		2005-2009		4WD		HB368X.665		
Tucson	Limited	2006	All			HB368X.665		
Tucson	GLS	2008-2009	All			HB368X.665		
Tucson	Limited	2008-2009	All			HB368X.665		
Tucson	SE	2008-2009	All			HB368X.665		
Tucson		2009		FWD		HB368X.665		
Veloster		2012-2014	All			HB735X.666		
Veloster		2012				HB735X.666		HB734X.584
Veloster	Turbo	2013-2014	All			HB661X.667		
Veloster		2013		Non-Turbo		HB735X.666		HB734X.584
Veloster		2013		Turbo		HB735X.666		HB734X.584
Veloster		2013-2015				HB735X.666		HB734X.584
Veloster		2014-2015		583022VA30				HB734X.584
Veloster		2014-2015		Turbo				HB734X.584
Veloster	Turbo	2014-2015		583022VA30				HB734X.584
Veloster		2015		581012VA10		HB735X.666		
Veloster	Turbo	2015		581012VA20		HB661X.667		
XG300		2001	All			HB461X.646		
XG300		2001				HB461X.646		
XG350	L	2002-2004	All			HB461X.646		
XG350		2002-2005	All			HB461X.646		
XG350		2002				HB461X.646		
XG350		2003		From 2/1/03		HB461X.646		
XG350		2003		To 2/1/03		HB461X.646		
XG350		2004-2005				HB461X.646		
INFINITI								
EX35	Journey	2008-2009	All		770888	HB387X.547		
EX35		2008-2012	All		770888	HB387X.547		
EX35		2008-2009				HB387X.547		HB600X.539
EX35	Rear from 08/2009	2010		D40601MB0A				HB370X.559
EX35	Rear to 08/2009	2010		D4060EG50C				HB600X.539
EX35		2010-2012				HB387X.547		HB370X.559
EX37		2013	All		770888	HB387X.547		HB370X.559
EX37		2013				HB387X.547		HB370X.559
FX35		2003-2004				HB448X.610		HB370X.559
FX35		2005		From 11/05		HB387X.547		HB370X.559
FX35		2005		To 11/05		HB448X.610		HB370X.559
FX35		2006	All	Made On or After 11-1-05		HB387X.547		
FX35	Front to 11/2005	2006		41060CG00J		HB448X.610		

MAKE/ MODEL	SUBMODEL	YEARS	ENGINE (LITER)	NOTE	FRONT		REAR	
					OES	HB SERIES	OES	HB SERIES
INFINITI CONTINUED								
FX35		2006-2008				HB387X.547		HB370X.559
FX35		2007-2012	All			HB387X.547		
FX35		2009-2012	All		770888			
FX35		2009				HB387X.547		HB600X.539
FX35		2010-2012				HB387X.547		HB370X.559
FX37		2013	All		770888	HB387X.547		HB370X.559
FX37		2013				HB387X.547		HB370X.559
FX45		2003-2004				HB448X.610		HB370X.559
FX45		2005		From 11/05		HB387X.547		HB370X.559
FX45		2005		To 11/05		HB448X.610		HB370X.559
FX45		2006	All	Made On or After 11-1-05		HB387X.547		
FX45	Front to 11/2005	2006		41060CG00J		HB448X.610		
FX45		2006-2008				HB387X.547		HB370X.559
FX45		2007-2008	All			HB387X.547		
FX50		2009-2013	All					HB602X.545
FX50	Sport	2009-2013	All					HB602X.545
FX50		2009-2013				HB601X.626		HB602X.545
G20		1991-1996	All		770462	HB235X.665		HB421X.622
G20		1991-1992						HB421X.622
G20		1993		From 11/93				HB421X.622
G20		1993		To 10/93				HB421X.622
G20		1994		4106078J90		HB235X.665		
G20		1994		440606E390				HB421X.622
G20		1994-1996						HB421X.622
G20		1999				HB268X.606		HB421X.622
G20		1999				HB268X.665		HB421X.622
G20		2000		To 11/00		HB268X.665		HB421X.622
G20		2000-2002				HB268X.606		
G20		2001-2002		From 12/00		HB268X.665		HB378X.626
G25		2011-2012		RWD		HB387X.547		HB370X.559
G25	X	2011-2012		AWD		HB387X.547		HB370X.559
G35		2003		Brembo Brakes		HB545X.564		HB180X.560
G35		2003		Standard Brakes		HB268X.665		HB370X.559
G35		2003-2004				HB268X.606		
G35		2003-2004		w/ Brembo Brakes		HB545X.564		
G35		2004		Brembo Brakes		HB545X.610		
G35		2004		RWD - Brembo Brakes		HB545X.564		HB180X.560
G35		2004		RWD - Standard Brakes		HB268X.665		HB370X.559
G35	X	2004-2005		AWD		HB268X.665		HB370X.559
G35		2005		AWD		HB268X.606		
G35		2005-2006		RWD		HB387X.547		HB370X.559
G35	X	2006-2008		AWD		HB387X.547		HB370X.559
G35		2007		RWD Coupe		HB387X.547		HB370X.559
G35		2007-2008		RWD; Sport Sedan		HB599X.616		HB370X.559
G35	Sport	2007-2008		D4060EG50C				HB600X.539
G35		2008		D4060EG50C				HB600X.539
G35		2008		RWD; Sedan; Except Sport Sedan		HB387X.547		HB370X.559
G37		2008		Coupe; Except Sport Coupe		HB599X.616		HB370X.559
G37		2008		Sport Coupe		HB601X.626		HB602X.545
G37		2008-2010		D4060EG50C				HB600X.539
G37		2009		RWD Coupe, Convertible; Except Sport Coupe; 330mm (13") Front Rotors		HB599X.616		HB370X.559
G37		2009-2010		Sport Package (Coupe, Sedan, Convertible) 355mm (14") Front Rotors		HB601X.626		HB602X.545
G37	Journey Sedan	2009-2010		D4060EG50C				HB600X.539

BRAKE PAD APPLICATIONS



Hawk Performance - BRAKE PAD APPLICATIONS

HB **245** **x** **.631**
 HAWK BRAKE PAD SHAPE INSERT COMPOUND CODE PAD THICKNESS

MAKE/ MODEL	SUBMODEL	YEARS	ENGINE (LITER)	NOTE	FRONT		REAR	
					OES	HB SERIES	OES	HB SERIES
INFINITI CONTINUED								
G37	Journey	2009-2010		D4060EG50C				HB600X.539
G37	Sedan	2009-2010		D4060EG50C				HB600X.539
G37	X	2009-2010		AWD; 320mm (12.6") Front Rotors		HB387X.547		HB370X.559
G37	X	2009-2010		D4060EG50C				HB600X.539
G37		2009-2013		RWD Sedan; 320mm (12.6") Front Rotors		HB387X.547		HB370X.559
G37		2010-2013		RWD Coupe, Convertible; Except Sport Package 330mm (13") Front Rotors		HB599X.616		HB370X.559
G37	Coupe, Convertible also	2011		D4M60EG50C				HB600X.539
G37		2011-2013		Sport Package or IPL Models (Coupe, Sedan, Convertible) 355mm (14") Front Rotors		HB601X.626		HB602X.545
G37	Sedan	2011-2013		D40601MB0A				HB370X.559
G37	X	2011-2013		AWD Coupe; Except Sport Package 330mm (13") Front Rotors	HB599X.616		HB370X.559	
G37	X	2011-2013		AWD Sedan; Exc Brembo Brakes 320mm (12.6") Front Rotors		HB387X.547		HB370X.559
G37	X	2011-2013		Sport Package or IPL Models (Coupe, Sedan, Convertible) 355mm (14") Front Rotors		HB601X.626		HB602X.545
G37		2012-2013		D4M60EG50C				HB600X.539
I30		1996-1999				HB268X.665		HB421X.622
I30		2000		To 10/00		HB268X.665		HB421X.622
I30	Front from 06/2000	2000		410602Y990		HB268X.665		
I30	Front to 06/2000	2000		410602Y091		HB268X.665		
I30		2000-2001				HB268X.606		
I30		2001		From 11/00		HB268X.665		HB378X.626
I30	Rear from 10/2000	2001		410602Y091		HB268X.665		
I30	Rear to 10/2000	2001		440604U090				HB421X.622
I35		2002-2004				HB268X.606		HB378X.626
I35		2002-2004				HB268X.665		HB378X.626
J30		1993-1997				HB415X.583		HB437X.585
JX35		2013						HB370X.559
M30		1990-1991	All			HB475X.642		
M30		1992		D1060F6494		HB475X.642		
M35		2006-2009				HB387X.547		HB370X.559
M35		2010				HB387X.547		HB600X.539
M35h		2012				HB387X.547		HB370X.559
M35h		2013		Models with 4 Piston Front Calipers - 355mm (13.98") Front Rotors		HB601X.626		HB602X.545
M35h		2013		Models with Single Piston Front Caliper - 319mm (12.58") Front Rotors		HB387X.547		HB370X.559
M37		2011-2012		RWD Base		HB387X.547		HB370X.559
M37		2011-2012		RWD Sport Model		HB601X.626		HB602X.545
M37	X	2011-2012				HB387X.547		HB370X.559
M37		2011-2013		D40601MB0A				HB370X.559
M37		2013		Models with 4 Piston Front Calipers 355mm (13.98") Front Rotors		HB601X.626		HB602X.545
M37		2013		Models with Single Piston Front Caliper 319mm (12.58") Front Rotors		HB387X.547		HB370X.559
M37	X	2013		Models with 4 Piston Front Calipers - 355mm (13.98") Front Rotors		HB601X.626		HB602X.545
M37	X	2013		Models with Single Piston Front Caliper 319mm (12.58") Front Rotors		HB387X.547		HB370X.559
M45		2003-2004				HB387X.547		HB437X.585
M45	Sport	2006-2009	All			HB387X.547		HB370X.559
M45		2006-2010				HB387X.547		HB370X.559
M45		2010	All		770888	HB387X.547		HB600X.539
M56	Sport	2011-2013	All			HB601X.626		HB602X.545
M56		2011-2012		RWD Base		HB387X.547		HB370X.559

BRAKE PAD APPLICATIONS

MAKE/ MODEL	SUBMODEL	YEARS	ENGINE (LITER)	NOTE	FRONT		REAR	
					OES	HB SERIES	OES	HB SERIES
INFINITI CONTINUED								
M56		2011-2012		RWD Sport Model		HB601X.626		HB602X.545
M56	X	2011-2012				HB387X.547		HB370X.559
M56		2011-2013		D40601MB0A				HB370X.559
M56		2013		Models w/4 Piston Front Calipers 355mm (13.98") Front Rotors		HB601X.626		HB602X.545
M56		2013		Models w/Single Piston Front Caliper 319mm (12.58") Front Rotors		HB387X.547		HB370X.559
M56	X	2013		Models with 4 Piston Front Calipers 355mm (13.98") Front Rotors		HB601X.626		HB602X.545
M56	X	2013		Models with Single Piston Front Caliper 319mm (12.58") Front Rotors		HB387X.547		HB370X.559
Q40		2015		D10601NC0B		HB387X.547		
Q40		2015		D40601MB0A				HB370X.559
Q45		1990-1993						HB437X.585
Q45		1990-1993		4106060U90		HB415X.583		
Q45		1994		From 3/94		HB415X.583		HB437X.585
Q45		1994		To 2/94				HB437X.585
Q45	Rear to 03/1994	1994		4106060U90		HB415X.583		
Q45		1995-1996				HB415X.583		HB437X.585
Q45		1997-2001			770691	HB326X.646		HB437X.585
Q45		2002-2006				HB387X.547		HB437X.585
Q50		2014-2015		D40601MB0A				HB370X.559
Q50	Sport	2014-2015		D10601TG1C		HB601X.626		
Q50	Sport	2014-2015		D40604GH0A				HB602X.545
Q60		2014-2015		D1060JK00B		HB599X.616		
Q60		2014-2015		D4M60EG50C				HB600X.539
Q60	Sport	2014-2015		D1060JL00J		HB601X.626		
Q60	Sport	2014-2015		D4060JL00J				HB602X.545
Q70		2014		D10601NC0C		HB387X.547		
Q70		2014-2015		D40601MB0A				HB370X.559
Q70	Sport	2014-2015		D10601TG1C		HB601X.626		
Q70	Sport	2014-2015		D4060JL00J				HB602X.545
Q70		2015		D10601NC0B		HB387X.547		
Q70L		2015		D10601NC0C		HB387X.547		
Q70L		2015		D40601MB0A				HB370X.559
Q70L	Sport	2015		D10601TG1C		HB601X.626		
Q70L	Sport	2015		D4060JL00J				HB602X.545
QX4		1997		410600W785		HB326X.646		
QX4		1998-2003			770691	HB326X.646		
QX50		2014		D10601NC0C		HB387X.547		
QX50		2014-2015		D40601MB0A				HB370X.559
QX50		2015		D10601NC0B		HB387X.547		
QX56		2004-2006	All	w/Bosch front caliper and 320mm front disc		HB567X.694		HB555X.678
QX56		2004						HB555X.678
QX56		2005		From 3/05		HB567X.694		HB555X.678
QX56		2005		To 3/05				HB555X.678
QX56		2006-2010	All	w/Akebono front caliper and 350mm front disc		HB620X.703		HB555X.678
QX56		2006-2007		Models With 320mm Front Rotors		HB567X.694		HB555X.678
QX56		2006-2007		Models With 350mm Front Rotors		HB620X.703		HB555X.678
QX56		2008-2010				HB620X.703		HB555X.678
QX56		2011		D10601LA1A		HB620X.703		
QX56		2012-2013		D10609FE0A		HB620X.703		
QX60		2014-2015		D4M609N00A				HB370X.559
QX70	3.7 Liter	2014		41060EG090		HB387X.547		
QX70	3.7 Liter	2014		D40601MB0A				HB370X.559
QX70	5.0 Liter	2014		D1060JL00J		HB601X.626		

BRAKE PAD APPLICATIONS



Hawk Performance - BRAKE PAD APPLICATIONS

HB **245** **x** **.631**
 HAWK BRAKE PAD SHAPE INSERT COMPOUND CODE PAD THICKNESS

MAKE/ MODEL	SUBMODEL	YEARS	ENGINE (LITER)	NOTE	FRONT		REAR	
					OES	HB SERIES	OES	HB SERIES
INFINITI CONTINUED								
QX70	5.0 Liter	2014		D4060JL00J				HB602X.545
QX70		2015		D10601NC0B		HB387X.547		
QX70		2015		D40601MB0A				HB370X.559
QX80		2014-2015		D10609FE0A		HB620X.703		
INTERNATIONAL								
100		1974	All			HB292X.674		
150		1975	All			HB292X.674		
150		1976				HB292X.674		
3000		1996-1997				HB252X.860		HB252X.860
1600 Series	1650	1984-1989				HB251X1.14		HB251X1.14
1700 Series	1750	1984-1989				HB251X1.14		HB251X1.14
1700 Series	1753 School Bus	1984-1989				HB251X1.14		HB251X1.14
1800 Series	1850	1984-1987				HB251X1.14		HB251X1.14
1800 Series	1853 School Bus	1984-1989				HB251X1.14		HB251X1.14
1900 Series	1950	1985-1989				HB251X1.14		HB251X1.14
Scout II		1974-1980	All			HB292X.674		
Scout II	Terra	1976-1980	All			HB292X.674		
Scout II	Traveler	1976-1980	All			HB292X.674		
Scout II	SS2	1978-1979	All			HB292X.674		
TerraStar		2012	All			HB547X.798		HB547X.798
ISUZU								
Amigo		1989-1991		8943357871		HB422X.610		
Amigo		1992		8943881980		HB422X.610		
Amigo		1993		8970494290		HB422X.610		
Amigo		1993		From 8/93		HB422X.610		
Amigo		1994				HB422X.610		
Amigo		1998-2000		2WD		HB422X.610		
Amigo		1998-2000		4WD		HB422X.610		
Ascender		2003				HB382X.657		HB383X.685
Ascender		2004-2006		5 Passenger		HB382X.657		HB383X.685
Ascender		2004-2006		7 Passenger		HB382X.657		HB383X.685
Ascender	Limited	2005	All			HB382X.657		HB383X.685
Ascender	S	2005	All			HB382X.657		HB383X.685
Ascender	LS	2005-2006	All			HB382X.657		HB383X.685
Ascender		2007-2008				HB617X.630		HB383X.685
Axiom		2002-2004				HB422X.610		
FSR		1997		8124752270		HB253X.750		
FSR		1997-1998		8156191000				HB253X.750
FSR	PB: Manual Transmission	1998		8156191000				HB253X.750
FSR	PB: Manual Transmission	1999-2001		8124752270				HB253X.750
FSR	Rear: 4 Piston Caliper	1999-2001		8124752270		HB253X.750		
FSR		2002		8124752270				HB253X.750
FSR	Rear 4 piston caliper 1st design	2002		8124752270		HB253X.750		
FTR		1997		8156191000		HB253X.750		HB253X.750
FTR		1998		8124752270		HB253X.750		
FTR	PB: Manual Transmission	1998		8156191000				HB253X.750
FTR	PB: Manual Transmission	1999-2001		8124752270				HB253X.750
FTR	Rear: 4 Piston Caliper	1999-2001		8124752270		HB253X.750		
FTR		2002		8124752270				HB253X.750
FTR	Rear 4 piston caliper 1st design	2002		8124752270		HB253X.750		
FVR		1997		8156191000		HB253X.750		HB253X.750
FVR		1998		8156191000		HB253X.750		
FVR	PB: Manual Transmission	1998-1999		8156191000				HB253X.750
FVR	Rear: 4 Piston Caliper	1999		8156191000		HB253X.750		

BRAKE PAD APPLICATIONS

MAKE/ MODEL	SUBMODEL	YEARS	ENGINE (LITER)	NOTE	FRONT		REAR	
					OES	HB SERIES	OES	HB SERIES
ISUZU CONTINUED								
FVR	PB: Manual Transmission	2000-2001		8124752270				HB253X.750
FVR	Rear: 4 Piston Caliper	2000-2001		8124752270			HB253X.750	
FVR		2002		8124752270				HB253X.750
FVR	Rear 4 piston caliper 1st design	2002		8124752270			HB253X.750	
Hombre		1996-1997					HB119X.594	
Hombre	2WD	1998-2000		8180262960			HB119X.594	
Hombre		1998-2000		2WD			HB119X.594	
Hombre		1998-2000		4WD			HB304X.598	HB305X.610
i-280		2006			771039	HB554X.643		
i-290	LS	2007	All		771039	HB554X.643		
i-290	S	2007-2008	All		771039	HB554X.643		
i-290		2007-2008				HB554X.643		
i-350		2006	All		771039	HB554X.643		
i-350		2006				HB554X.643		
i-370		2007-2008				HB554X.643		
I-Mark		1985		8970128800		HB422X.610		
Impulse		1990	All			HB148X.560		
Impulse	RS	1991-1992	All			HB148X.560		
Impulse	XS	1991-1992	All			HB148X.560		
NPR		1998-2003				HB537X.783		
NPR	Class 4 Gas V8	2008-2009				HB537X.783		
NPR-HD		2008-2009				HB537X.783		
Oasis		1996		5862030430		HB143X.680		
Oasis		1996-1997		5862029840				HB572X.570
Oasis		1997		5862056370		HB143X.680		
Oasis		1998-1999				HB143X.680		HB145X.570
Pickup		1988		8943357870		HB422X.610		
Pickup	Rear Disc: From 01/1990	1989		8943357870		HB422X.610		
Pickup		1990-1991		8943357871		HB422X.610		
Pickup		1992		8944611551		HB422X.610		
Pickup		1993-1995		8970494291		HB422X.610		
Reach		2012				HB537X.783		
Rodeo		1991		8943881980		HB422X.610		
Rodeo		1992		3.2L V6 Eng.; From 11/92		HB422X.610		
Rodeo		1993-1995		8970796380		HB422X.610		
Rodeo		1993-1996		3.2L V6 Eng		HB422X.610		
Rodeo		1996		2.6L 4 Cyl.; From 12/95		HB422X.610		
Rodeo		1997-2000		Rear Disc Brakes		HB422X.610		
Rodeo		1997-2000		Rear Drum Brakes		HB422X.610		
Rodeo		2001		Rear Disc Brakes - Mfg Before 6/2001		HB422X.610		
Rodeo		2001		Rear Drum Brakes - Mfg Before 6/2001		HB422X.610		
Rodeo Sport		2001		Rear Disc Brakes		HB422X.610		
Rodeo Sport		2001		Rear Drum Brakes		HB422X.610		
Stylus	XS	1991		8970118921		HB148X.560		
Stylus		1991-1993		8970118921		HB148X.560		
Stylus	RS	1992		8970118921		HB148X.560		
Trooper		1987-1988		8944611550		HB422X.610		
Trooper		1989-1990		8943357871		HB422X.610		
Trooper		1991		From 10/91 - with ABS		HB422X.610		
Trooper		1991		From 10/91 - without ABS		HB422X.610		
Trooper		1992-1997		with ABS		HB422X.610		
Trooper		1992-1997		without ABS		HB422X.610		
Trooper		1998-2002				HB422X.610		
VehiCROSS		1999-2001				HB422X.610		

BRAKE PAD APPLICATIONS

Hawk Performance - BRAKE PAD APPLICATIONS

HB **245** **x** **.631**
 HAWK BRAKE PAD SHAPE INSERT COMPOUND CODE PAD THICKNESS

MAKE/ MODEL	SUBMODEL	YEARS	ENGINE (LITER)	NOTE	FRONT		REAR	
					OES	HB SERIES	OES	HB SERIES
JAGUAR								
S-Type		2000-2004	All			HB376X.665		HB428X.650
S-Type		2000-2002				HB376X.665		
S-Type		2003-2005		Sport suspension 320mm front disc, except Type R				HB428X.650
S-Type		2003-2005		Std suspension 300mm front disc, except Type R				HB428X.650
S-Type		2003-2005		Type R		HB444X.685		HB194X.570
S-Type		2005		C2C22316				HB428X.650
S-Type		2005		C2C27271				HB478X.605
S-Type	R	2005		C2C27271				HB478X.605
S-Type		2006		R Model		HB444X.685		HB428X.650
S-Type		2006-2008		Except R Model - 305mm Front Rotor				HB478X.605
S-Type		2006-2008		Except R Model - 326mm Front Rotor				HB478X.605
S-Type		2007-2008		R Model				HB478X.605
Super V8		2005		C2C24018		HB444X.685		
Super V8		2005		C2C27271				HB478X.605
Super V8		2006-2009						HB478X.605
Vanden Plas		1990-1994				HB135X.642		
Vanden Plas		1995-1997		JLM11903				HB194X.570
Vanden Plas		1998-2003				HB135X.642		
Vanden Plas		1998-2003		JLM21220				HB194X.570
Vanden Plas	Brembo Brakes	2002-2003		MXD1550AB		HB193X.670		
Vanden Plas		2004-2005						HB428X.650
Vanden Plas		2005		C2C27271				HB478X.605
Vanden Plas		2006-2009						HB478X.605
XF		2009		Luxury, Premium Luxury				HB478X.605
XF		2009		Supercharged				HB478X.605
XF		2010		4.2L Models				HB478X.605
XF		2010-2012		5.0L Non-Supercharged Models				HB478X.605
XF		2013		2.0L Turbo Models				HB478X.605
XF		2013		3.0L Supercharged Models				HB478X.605
XF		2014		C2P17595				HB478X.605
XF	3.0L	2014		C2P17595				HB478X.605
XF	AWD	2014-2015		C2P17595				HB478X.605
XF	Premium	2015		C2P17595				HB478X.605
XF	RWD	2015		C2P17595				HB478X.605
XJ		2010		C2P17595				HB478X.605
XJ		2011-2012		Non-Supercharged Models				HB478X.605
XJ		2013		3.0L Supercharged or 5.0L Non-Supercharged Models				HB478X.605
XJ	AWD	2014-2015		C2P17595				HB478X.605
XJ	RWD	2014-2015		C2P17595				HB478X.605
XJ12		1972-1974				HB244X.624		
XJ12		1995-1996				HB135X.642		
XJ12		1995-1996		JLM11903				HB194X.570
XJ6		1972-1975				HB244X.624		
XJ6		1990-1997				HB135X.642		
XJ6		1995-1997		JLM11903				HB194X.570
XJ8		1998-2003				HB135X.642		
XJ8		1998-2003		JLM21220				HB194X.570
XJ8		2004-2005						HB428X.650
XJ8		2005		C2C27271				HB478X.605
XJ8		2006-2009						HB478X.605
XJR		1995-1997				HB135X.642		
XJR		1995-1997		JLM11903				HB194X.570
XJR	Performance Package	1997		JLM11903				HB194X.570
XJR	Performance Package	1997		MXD1550AA		HB193X.670		

BRAKE PAD APPLICATIONS



MAKE/ MODEL	SUBMODEL	YEARS	ENGINE (LITER)	NOTE	FRONT		REAR	
					OES	HB SERIES	OES	HB SERIES
JAGUAR CONTINUED								
XJR		1998-1999		JLM21220				HB194X.570
XJR		1998-2001		w/305mm Front Disc		HB135X.642		
XJR		1998-2001		w/325mm Front Disc		HB135X.642		
XJR		2000-2002		JLM20257				HB194X.570
XJR		2002-2003				HB135X.642		HB194X.570
XJR		2002-2003				HB193X.670		HB194X.570
XJR		2003		JLM21220				HB194X.570
XJR		2004-2005				HB444X.685		HB194X.570
XJR		2005		C2C27271				HB478X.605
XJR		2006-2009						HB478X.605
XJRS	Late	1993		JLM21344				HB194X.570
XJS		1995-1996		JLM11903				HB194X.570
XK		2007-2013						HB478X.605
XK		2010-2011		Alcon Brakes		HB760X.620		
XK		2014-2015		C2P17595				HB478X.605
XK8		1997-1998				HB135X.642		
XK8		1997-2002		JLM21220				HB194X.570
XK8		1999		From CHNUMBER 037347		HB135X.642		
XK8		1999		To CHNUMBER 037347		HB135X.642		
XK8		2000-2002				HB135X.642		
XK8		2003-2006				HB135X.642		HB194X.570
XKR		2000-2006				HB193X.670		HB194X.570
XKR		2007						HB478X.605
XKR		2008		Portfolio		HB760X.620		
XKR		2008-2009		Models with Standard Brakes				HB478X.605
XKR		2009-2012		Alcon Brakes		HB760X.620		
XKR-S		2012		Alcon Brakes		HB760X.620		
X-Type		2005		Models From Vin NUMBER E24054				HB724X.637
X-Type		2006-2008						HB724X.637
JEEP								
Cherokee	SJ	1974-1976	All		770052	HB103X.590		
Cherokee		1977-1983				HB103X.590		HB235X.665
Cherokee		1984-1991		Full Size		HB103X.590		
Cherokee	XJ	1990-1998	All	4WD		HB210X.677		
Cherokee	XJ	1990-2001	All	2WD		HB210X.677		
Cherokee		1990-1991		2WD; Mid Size XJ Series		HB210X.677		
Cherokee		1990-1992		4WD; Mid Size XJ Series		HB210X.677		
Cherokee	4 x 2	1990-1993		4423606				HB286X.591
Cherokee	4 x 2	1990-1993		5252613		HB103X.590		
Cherokee	4 x 4	1990-1993		4423606				HB286X.591
Cherokee		1992		2WD; Mid Size XJ Series; From 2/92		HB210X.677		
Cherokee		1992		2WD; Mid Size XJ Series; To 1/92		HB210X.677		
Cherokee		1993-1998		Mid Size XJ Series		HB210X.677		
Cherokee		1994-2000		4723367				HB286X.591
Cherokee	XJ	1999	All	4WD. w/78mm Hat Height.		HB210X.677		
Cherokee	XJ	1999	All	4WD. w/82mm Hat Height.		HB210X.677		
Cherokee		1999		3 1/4" Tall Composite front rotor		HB210X.677		
Cherokee		1999		3" Tall Full Cast front rotor		HB210X.677		
Cherokee	XJ	2000-2001	All	4WD		HB210X.677		
Cherokee		2000-2001		Mid Size XJ Series		HB210X.677		
CJ5		1977-1978	All			HB292X.674		
CJ5		1982-1983				HB103X.590		
CJ7		1977-1978	All			HB292X.674		
CJ7		1982-1984				HB103X.590		
CJ7		1985-1986		J8133853		HB103X.590		

BRAKE PAD APPLICATIONS



Hawk Performance - BRAKE PAD APPLICATIONS

HB **245** **x** **.631**
 HAWK BRAKE PAD SHAPE INSERT COMPOUND CODE PAD THICKNESS

MAKE/ MODEL	SUBMODEL	YEARS	ENGINE (LITER)	NOTE	FRONT		REAR	
					OES	HB SERIES	OES	HB SERIES
JEEP CONTINUED								
Comanche		1986-1989		83501167		HB103X.590		
Comanche		1990	All	4WD		HB210X.677		
Comanche		1990-1992	All	2WD		HB210X.677		
Comanche	4 x 2	1990-1992		4423606				HB286X.591
Comanche	4 x 2	1990-1992		5252613		HB103X.590		
Comanche	4 x 4	1990-1992		4423606				HB286X.591
Comanche		1990-1992		4WD		HB210X.677		
Comanche		1991-1992	All			HB210X.677		
Commander		2006-2010	All		771080	HB558X.710		HB555X.678
Commander	Limited	2006-2010	All		771080	HB558X.710		HB555X.678
Commander		2006-2010				HB558X.710		HB555X.678
Commander	Overland	2007-2010	All					HB555X.678
Commander	Sport	2008-2010	All					HB555X.678
Compass		2007-2008				HB435X.622		HB457X.605
Compass		2007-2008		68028671AA				HB675X.602
Compass		2007-2013		68020494AB		HB435X.622		
Compass	Sport Drum	2008-2014		68020494AB		HB435X.622		
Compass		2009-2014		Models with 262mm Rear Rotors		HB435X.622		HB457X.605
Compass		2009-2014		Models with 302mm Rear Rotors		HB435X.622		HB675X.602
Compass		2009-2014		Rear Drum Models		HB435X.622		
Compass	Rear BRF	2014-2015		68020494AB		HB435X.622		
Compass	Rear BR1, BRG	2015		68028671AA				HB675X.602
Compass	Rear BRF	2015		05191271AC				HB457X.605
Compass	Sport Drum	2015		68035576AB		HB435X.622		
Compass		2016						HB457X.605
Compass		2016						HB675X.602
Grand Cherokee		1993-1994		Fr. VIN Number 358322		HB210X.677		HB286X.591
Grand Cherokee		1993-1994		To VIN Number 358321		HB210X.677		HB287X.571
Grand Cherokee	Laredo, ZJ	1994	All					HB285X.595
Grand Cherokee	Limited, ZJ	1994	All					HB285X.595
Grand Cherokee	SE, ZJ	1994	All					HB285X.595
Grand Cherokee	Orvis, ZJ	1995	All					HB286X.591
Grand Cherokee	SE, ZJ	1995	All					HB286X.591
Grand Cherokee	Laredo, ZJ	1995-1998	All					HB286X.591
Grand Cherokee	Limited, ZJ	1995-1998	All					HB286X.591
Grand Cherokee		1995-1998				HB210X.677		HB286X.591
Grand Cherokee	Orvis, ZJ	1997	All					HB286X.591
Grand Cherokee	TSI, ZJ	1997-1998	All					HB286X.591
Grand Cherokee		1997-1998		04883344		HB210X.677		
Grand Cherokee	5.9 Limited, ZJ	1998	5.9L					HB286X.591
Grand Cherokee	Laredo, WJ	1999-2002	All	w/Akebono Front Caliper		HB446X.725		HB381X.661
Grand Cherokee	Limited, WJ	1999-2002	All	w/Akebono Front Caliper		HB446X.725		HB381X.661
Grand Cherokee		1999-2002		Original Style Teves Caliper casting 4835				HB381X.661
Grand Cherokee		1999-2002		Retro-Fit Style Akebono Caliper casting 4802		HB446X.725		HB381X.661
Grand Cherokee	Overland, WJ	2002	All	w/Akebono Front Caliper		HB446X.725		HB381X.661
Grand Cherokee	WJ	2002	All	w/Akebono Front Caliper		HB446X.725		HB381X.661
Grand Cherokee	Laredo, WJ	2003-2004	All			HB446X.725		HB381X.661
Grand Cherokee	Limited, WJ	2003-2004	All			HB446X.725		HB381X.661
Grand Cherokee	Overland, WJ	2003-2004	All			HB446X.725		HB381X.661
Grand Cherokee		2003-2004				HB446X.725		HB381X.661
Grand Cherokee	Special Edition, WJ	2004	All			HB446X.725		HB381X.661
Grand Cherokee	Laredo, WK	2005-2010	All		771080	HB558X.710		HB555X.678
Grand Cherokee	Limited, WK	2005-2010	All		771080	HB558X.710		HB555X.678
Grand Cherokee		2005				HB558X.710		HB555X.678
Grand Cherokee	65th Anniversary Edition, WK	2006	All		771080	HB558X.710		HB555X.678

BRAKE PAD APPLICATIONS



MAKE/ MODEL	SUBMODEL	YEARS	ENGINE (LITER)	NOTE	FRONT		REAR	
					OES	HB SERIES	OES	HB SERIES
JEEP CONTINUED								
Grand Cherokee	Srt8, WK	2006-2010	All			HB563X.656		HB194X.570
Grand Cherokee	Overland, WK	2006-2010	All		771080	HB558X.710		HB555X.678
Grand Cherokee		2006-2010		05080868AC		HB558X.710		
Grand Cherokee		2006-2010		Except SRT-8		HB558X.710		HB555X.678
Grand Cherokee		2006-2010		SRT-8		HB563X.656		HB194X.570
Grand Cherokee	WK2	2011-2014	All			HB701X.723		HB702X.662
Grand Cherokee	WK2	2011-2014	All	330mm Front Rotors		HB701X.723		HB702X.662
Grand Cherokee	WK2	2011-2014	All	350mm Front Rotors		HB701X.723		HB702X.662
Grand Cherokee		2011		Models with vented rear rotors		HB701X.723		HB702X.662
Grand Cherokee		2011-2014		Models with solid rear rotors		HB701X.723		HB702X.662
Grand Cherokee	SRT8, WK2	2012-2014	All			HB649X.605		HB194X.570
Grand Cherokee		2012-2013		Models with Vented Rear Rotors Excluding SRT-8		HB701X.723		HB702X.662
Grand Cherokee		2012-2013		SRT-8		HB649X.605		HB194X.570
Grand Cherokee	BR1	2013				HB741X.723		
Grand Cherokee		2014		Models with Vented Rear Rotors Excluding SRT		HB701X.723		HB702X.662
Grand Cherokee		2014		SRT		HB649X.605		HB194X.570
Grand Cherokee	BR2	2014				HB741X.723		
Grand Cherokee	BR1, BR3 also	2015		68052386AA				HB702X.662
Grand Cherokee	BR3	2015				HB741X.723		
Grand Cherokee	BRY	2015		68052369AA		HB701X.723		
Grand Cherokee	BRY	2015		68052386AA				HB702X.662
Grand Cherokee	SRT	2015		68144427AB		HB649X.605		
Grand Wagoneer		1984						HB235X.665
Grand Wagoneer		1984-1991		Full Size	770052	HB103X.590		
Grand Wagoneer		1985-1991		J8127782				HB235X.665
Grand Wagoneer		1993		83504371		HB103X.590		
Grand Wagoneer		1993		J8127782				HB235X.665
J10		1974-1988	All		770052	HB103X.590		
J10		1978-1984						HB235X.665
J10		1985-1988		J8127782				HB235X.665
J20		1974-1988	All		770052	HB103X.590		
Liberty	KJ	2002	All	Rear Drum Brakes		HB373X.689		
Liberty	Limited, KJ	2002-2007	All			HB373X.689		
Liberty	Sport, KJ	2002-2007	All			HB373X.689		
Liberty		2002-2007				HB373X.689		
Liberty	Renegade, KJ	2003-2006	All			HB373X.689		
Liberty	KJ	2003-2007	All			HB373X.689		
Liberty	KJ	2003-2007						HB690X.550
Liberty	Rocky Mountain Edition, KJ	2005	All			HB373X.689		
Liberty	65th Anniversary Edition, KJ	2006	All			HB373X.689		
Liberty	Limited, KJ	2008-2012	All	w/Standard Brakes		HB569X.650		
Liberty	Sport, KJ	2008-2012	All	w/Standard Brakes		HB569X.650		
Liberty	HD Brakes	2008-2010		68044866AA		HB569X.650		
Liberty		2008-2011				HB569X.650		
Liberty	KJ	2008-2011						HB608X.630
Liberty	HD Brakes	2011-2012		68044866AC		HB569X.650		
Liberty		2012		HD Brakes - 332mm (13") Front Rotors		HB569X.650		
Liberty		2012		Standard Brakes - 302mm (11.9") Front Rotors		HB569X.650		
Liberty	KJ	2012		HD Brakes - 332mm (13") Front Rotors				HB608X.630
Liberty	KJ	2012		Standard Brakes - 302mm (11.9") Front Rotors				HB608X.630
Patriot		2007-2014	All	w/10.313 in. Rear Rotor	770866	HB435X.622		
Patriot		2007-2014	All	w/11.89 in. Rear Rotor	770866	HB435X.622		
Patriot	Limited	2007-2014	All	w/10.313 in. Rear Rotor	770866	HB435X.622		

BRAKE PAD APPLICATIONS



Hawk Performance - BRAKE PAD APPLICATIONS

HB **245** **x** **.631**
 HAWK BRAKE PAD SHAPE INSERT COMPOUND CODE PAD THICKNESS

MAKE/ MODEL	SUBMODEL	YEARS	ENGINE (LITER)	NOTE	FRONT		REAR	
					OES	HB SERIES	OES	HB SERIES
JEEP CONTINUED								
Patriot	Limited	2007-2014	All	w/11.89 in. Rear Rotor	770866	HB435X.622		
Patriot		2007-2008				HB435X.622		HB457X.605
Patriot		2007-2008		68028671AA				HB675X.602
Patriot	Sport	2008-2014	All	w/10.313 in. Rear Rotor	770866	HB435X.622		
Patriot	Sport	2008-2014	All	w/11.89 in. Rear Rotor	770866	HB435X.622		
Patriot		2008-2013		68020494AB		HB435X.622		
Patriot	Sport Drum	2008-2014		68020494AB		HB435X.622		
Patriot		2009-2014		Rear Disc Models w/262mm (10.3") Rear Rotors		HB435X.622		HB457X.605
Patriot		2009-2014		Rear Disc Models w/302mm (11.9") Rear Rotors		HB435X.622		HB675X.602
Patriot		2009-2014		Rear Drum Models		HB435X.622		
Patriot	Rear BRF	2014-2015		68020494AB		HB435X.622		
Patriot	Rear BR1, BRG	2015		68028671AA				HB675X.602
Patriot	Rear BRF	2015		05191271AC				HB457X.605
Patriot	Sport Drum	2015		68035576AB		HB435X.622		
Patriot		2016						HB457X.605
Patriot		2016						HB675X.602
Scrambler		1982-1984				HB103X.590		
Scrambler	Dana Axle	1985		J8133853		HB103X.590		
Wagoneer	Custom	1974-1976	All		770052	HB103X.590		
Wagoneer		1974-1985	All		770052	HB103X.590		
Wagoneer		1977-1983						HB235X.665
Wagoneer		1986-1989		83501167		HB103X.590		
Wagoneer	Limited	1990	All			HB210X.677		
Wagoneer		1990		4423606				HB286X.591
Wrangler		1987-1989		83501167		HB103X.590		
Wrangler		1990-1993		4423606				HB286X.591
Wrangler	87-95YJ	1990-1995				HB210X.677		
Wrangler		1994-1995		4723367				HB286X.591
Wrangler	Sport, 97-06TJ	1997	All					HB286X.591
Wrangler		1997		04883344		HB210X.677		
Wrangler		1997		4723367				HB286X.591
Wrangler	97-06TJ	1997-1998				HB210X.677		
Wrangler	97-06TJ	1998	All					HB286X.591
Wrangler	97-06TJ	1999		3 1/4" Tall Composite front rotor		HB210X.677		
Wrangler	97-06TJ	1999		3" Tall Full Cast front rotor		HB210X.677		
Wrangler		1999-2000		4723367				HB286X.591
Wrangler	97-06TJ	2000-2002				HB210X.677		
Wrangler	Rubicon, 97-06TJ	2003-2006	All					HB689X.550
Wrangler		2003-2006		04883344AD		HB210X.677		
Wrangler		2003-2006		Rear Disc Models				HB690X.550
Wrangler	97-06TJ	2003-2006		Rear Disc Models		HB210X.677		
Wrangler	97-06TJ	2003-2006		Rear Drum Models		HB210X.677		
Wrangler	Rear Drum	2003-2006		04883344AD		HB210X.677		
Wrangler	Unlimited, 97-06TJ	2004-2006	All					HB690X.550
Wrangler	Unlimited	2004		04883344AD		HB210X.677		
Wrangler	Unlimited Rubicon, 97-06TJ	2005-2006	All					HB689X.550
Wrangler	Rubicon, 07-14JK	2007-2014	All					HB608X.630
Wrangler	Sahara, 07-14JK	2007-2014	All					HB608X.630
Wrangler	Unlimited Rubicon, 07-14JK	2007-2014	All					HB608X.630
Wrangler	Unlimited X, 07-14JK	2007-2014	All					HB608X.630
Wrangler	X, 07-14JK	2007-2014	All					HB608X.630
Wrangler		2007-2014						HB608X.630
Wrangler	07-14JK	2007-2014				HB569X.650		
Wrangler		2015		68003701AB		HB569X.650		

BRAKE PAD APPLICATIONS



MAKE/ MODEL	SUBMODEL	YEARS	ENGINE (LITER)	NOTE	FRONT		REAR	
					OES	HB SERIES	OES	HB SERIES
JEEP CONTINUED								
Wrangler		2015		68003776AA				HB608X.630
Wrangler		2016						HB608X.630
KIA								
Amanti		2004-2006	All			HB461X.646		
Amanti		2004-2006				HB461X.646		
Amanti		2007-2009				HB368X.665		
Borrego		2009						HB637X.583
Borrego		2010-2011		583022JA00				HB637X.583
Cadenza		2014	All		771295			
Cadenza	Limited	2014	All	No Parking Brake on Limited	771295			HB734X.584
Cadenza		2014		Limited				HB734X.584
Cadenza		2014-2015		Power Parking Brake				HB734X.584
Cadenza	Power Parking Brake	2015		583023RA70				HB734X.584
Forte		2014	All					HB734X.584
Forte	SX	2014	All					HB734X.584
Forte		2014						HB734X.584
Forte		2014-2015		SX				HB734X.584
Forte		2015						HB734X.584
Forte	SX	2015						HB734X.584
Forte Koup		2014	All					HB734X.584
Forte Koup	EX	2014	All					HB734X.584
Forte Koup		2014						HB734X.584
Forte Koup		2014-2015		EX				HB734X.584
Forte Koup		2015						HB734X.584
Forte Koup	EX	2015						HB734X.584
K900	5000 CC	2015						HB662X.587
Magentis		2007		581012GA01		HB368X.665		
Optima		2001		5810138A70		HB368X.665		
Optima		2002		From 7/2002		HB368X.665		
Optima		2003-2004	All			HB368X.665		
Optima		2003-2010				HB368X.665		
Optima	EX	2005-2010	All			HB368X.665		
Optima	LX	2005-2010	All			HB368X.665		
Optima		2011-2013	2.0L	2.0 L Engine		HB661X.667		
Optima		2011		EX, SX Turbo Models		HB661X.667		
Optima		2012-2013		2.0L Turbo Models		HB661X.667		
Optima	Hybrid EX, No Parking Brake on Hybrid EX	2014		583023ZA00				HB734X.584
Optima	Limited, No Parking Brake on Limited	2014		581014CA10		HB661X.667		
Optima	Limited, No Parking Brake on Limited	2014		583024CA00				HB734X.584
Optima	SX Turbo	2014		581014CA10		HB661X.667		
Optima	Manual Parking Brake	2015				HB661X.667		
Optima	Power Parking Brake	2015				HB661X.667		
Optima	Power Parking Brake	2015		583023ZA00				HB734X.584
Rio		2001-2002		K0BA23328Z		HB246X.567		
Rio		2012-2014		583021WA30				HB734X.584
Rio		2015						HB734X.584
Rondo	w/o Parking Brake	2014		58101A4A01		HB738X.662		
Rondo	w/Parking Brake	2014		58101A4A01		HB738X.662		
Rondo		2015				HB738X.662		
Rondo	w/Electric Parking Brake	2015				HB738X.662		
Sedona		2002-2004	All			HB461X.646		
Sedona		2002-2003				HB461X.646		

BRAKE PAD APPLICATIONS

Hawk Performance - BRAKE PAD APPLICATIONS

H B **2 4 5** **x** **.6 3 1**
 HAWK BRAKE PAD SHAPE INSERT COMPOUND CODE PAD THICKNESS

MAKE/ MODEL	SUBMODEL	YEARS	ENGINE (LITER)	NOTE	FRONT		REAR	
					OES	HB SERIES	OES	HB SERIES
KIA CONTINUED								
Sedona		2004		Manufactured after 12/2003		HB461X.646		
Sedona		2004		Manufactured up to 12/2003		HB461X.646		
Sedona	Front & rear from 12/01/2003	2004		4K52Y3323Z		HB461X.646		
Sedona	Front & rear to 12/01/2003	2004		0K52Y3323Z		HB461X.646		
Sedona		2005				HB461X.646		
Sedona		2007-2012						HB662X.587
Sedona		2014		583024DU02				HB662X.587
Sephia		1995-1997	All			HB597X.681		
Sephia		2000	All			HB597X.681		
Sorento		2003-2004	All			HB461X.646		
Sorento		2003		581013EU00		HB461X.646		
Sorento		2003-2009				HB461X.646		
Sorento	EX	2005-2009	All			HB461X.646		
Sorento	LX	2005-2009	All			HB461X.646		
Sorento		2011-2013						HB662X.587
Sorento		2014	All			HB738X.662		
Sorento		2014		583022WA00				HB662X.587
Sorento		2015				HB738X.662		
Soul		2010-2013	All			HB368X.665		
Soul		2010		1.6L Rear Disc Models		HB368X.665		
Soul		2010		1.6L Rear Drum Models		HB368X.665		
Soul		2010-2011		2.0L		HB368X.665		
Soul		2011		1.6L		HB368X.665		
Soul		2012-2013				HB368X.665		
Soul		2014	All					HB734X.584
Soul		2014-2015						HB734X.584
Soul		2015		583022B2A00				HB734X.584
Soul EV		2015						HB734X.584
Soul EV		2015		58302E4A00				HB734X.584
Spectra	2.0Liter	2004		583022FA00				HB262X.540
Spectra		2004-2009						HB262X.540
Spectra		2007-2009		583022FA00				HB262X.540
Spectra5		2005-2009						HB262X.540
Sportage	EX	2005-2010	All			HB368X.665		
Sportage	EX	2005-2010	All	AWD		HB368X.665		
Sportage	EX	2005-2010	All	FWD		HB368X.665		
Sportage	LX	2005-2010	All			HB368X.665		
Sportage	LX	2005-2010	All	AWD		HB368X.665		
Sportage	LX	2005-2010	All	FWD		HB368X.665		
Sportage		2005-2010		2WD		HB368X.665		
Sportage		2005-2010		4WD		HB368X.665		
Sportage	AWD	2011-2013	All		771295			
Sportage	FWD	2012-2013	All		771295			
LAMBORGHINI								
Diablo		1995-1996	5.7L			HB181X.660		HB170X.650
Diablo		1997-2000	5.7L			HB193X.670		HB193X.670
Diablo		1999-2001	6.0L			HB193X.670		HB193X.670
Gallardo		2003-2005	5.0L			HB609X.572		HB193X.670
Murcielago		2001-2005	6.2L			HB193X.670		HB193X.670
LAND ROVER								
Discovery		1994		STC8572		HB469X.705		
Discovery		1995	All			HB469X.705		
Discovery		1996-1999		STC8572		HB469X.705		
Discovery	Series li	1999	All			HB469X.705		

BRAKE PAD APPLICATIONS



MAKE/ MODEL	SUBMODEL	YEARS	ENGINE (LITER)	NOTE	FRONT		REAR	
					OES	HB SERIES	OES	HB SERIES
LAND ROVER CONTINUED								
Discovery		1999		SERIES II		HB469X.705		HB195X.640
Discovery		2000-2004	All			HB469X.705		
Discovery		2000-2004				HB469X.705		HB195X.640
LR2		2008-2015				HB759X.750		
LR3		2005-2009	All			HB681X.686		
LR3		2005-2007						HB682X.657
LR3		2005-2007		4.0L V6		HB681X.686		HB682X.657
LR3		2005-2007		4.4L V8		HB681X.686		HB682X.657
LR3		2008-2009				HB681X.686		HB682X.657
LR4		2010-2014	All			HB684X.694		
LR4	Late models.	2010		LR021253		HB684X.694		
LR4		2010-2013				HB684X.694		HB682X.657
LR4		2014-2015						HB682X.657
LR4		2014-2015		LR055455				HB682X.657
LR4		2015		LR051626		HB684X.694		
Range Rover		1990-1992		RTC6781		HB469X.705		
Range Rover		1993-1994		STC8571		HB469X.705		
Range Rover		1995	All			HB469X.705		HB195X.640
Range Rover	Classic Lwb	1995	All			HB469X.705		
Range Rover	Classic	1995	All			HB469X.705		
Range Rover	SE	1995-1998	All			HB469X.705		
Range Rover		1995-2002		4.0 SE & 4.6 HSE		HB469X.705		
Range Rover	HSE	1996-1998	All			HB469X.705		
Range Rover		1996-2002	All					HB195X.640
Range Rover		2003-2004	All			HB454X.715		
Range Rover		2003-2005				HB325X.720		HB518X.642
Range Rover	HSE	2005	All			HB454X.715		
Range Rover	HSE	2006-2009	All	With 344mm Front Discs		HB681X.686		HB682X.657
Range Rover	HSE	2006-2009	All	With 360mm Front Discs		HB681X.686		HB682X.657
Range Rover	Sport Supercharged	2006-2009	All	With 344mm Front Discs		HB681X.686		HB682X.657
Range Rover	Sport Supercharged	2006-2009	All	With 360mm Front Discs		HB681X.686		HB682X.657
Range Rover	Supercharged	2006-2009	All	With 344mm Front Discs		HB681X.686		HB682X.657
Range Rover	Supercharged	2006-2009	All	With 360mm Front Discs		HB681X.686		HB682X.657
Range Rover		2006-2009		HSE; Except Sport; 4.4L V8; 344mm Front Rotor		HB681X.686		HB682X.657
Range Rover		2006-2009		Supercharged		HB683X.651		HB682X.657
Range Rover		2006-2009		Supercharged; Except Sport; 360mm Front Rotor		HB683X.651		HB682X.657
Range Rover		2006-2012						HB682X.657
Range Rover	Sport LE	2008	All			HB683X.651		
Range Rover	Sport Supercharged	2010	All			HB685X.610		
Range Rover	Supercharged	2010-2012	All			HB685X.610		HB686X.645
Range Rover	Sport	2010-2013	All			HB684X.694		
Range Rover	Standard	2010-2013	All			HB684X.694		
Range Rover		2010-2012		Non-Supercharged		HB684X.694		HB682X.657
Range Rover		2010-2012		Supercharged		HB685X.610		HB686X.645
Range Rover	Sport Supercharged	2012-2014	All			HB685X.610		
Range Rover	Evoque	2012-2015				HB759X.750		
Range Rover		2013				HB685X.610		
Range Rover	Supercharged	2014	All			HB685X.610		
Range Rover		2014-2015		LR051626		HB684X.694		
Range Rover	Supercharged	2015		LR020362		HB685X.610		
Range Rover Evoque		2012-2015				HB759X.750		
Range Rover Sport		2006-2009		HSE; 337mm Front Rotor		HB681X.686		HB682X.657
Range Rover Sport		2006-2009		Supercharged		HB683X.651		HB682X.657
Range Rover Sport		2006-2009		Supercharged; 360mm Front Rotor		HB683X.651		HB682X.657
Range Rover Sport		2006-2013						HB682X.657

BRAKE PAD APPLICATIONS



Hawk Performance - BRAKE PAD APPLICATIONS

HB
HAWK BRAKE

245
PAD SHAPE

x
INSERT COMPOUND CODE

.631
PAD THICKNESS

MAKE/ MODEL	SUBMODEL	YEARS	ENGINE (LITER)	NOTE	FRONT		REAR	
					OES	HB SERIES	OES	HB SERIES
LAND ROVER CONTINUED								
Range Rover Sport		2008		LE		HB683X.651		HB682X.657
Range Rover Sport		2010		LR016962		HB684X.694		
Range Rover Sport		2010-2013		Non-Supercharged		HB684X.694		HB682X.657
Range Rover Sport		2010-2013		Supercharged		HB685X.610		HB686X.645
Range Rover Sport	Supercharged, 5 Liter	2014		LR020362		HB685X.610		
Range Rover Sport		2014-2015		LR051626		HB684X.694		
Range Rover Sport	Supercharged	2015		LR020362		HB685X.610		
LEXUS								
CT200h		2011-2013	All	w/259mm Rear Rotors		HB596X.690		HB629X.565
CT200h		2011-2013	All	w/279mm Rear Rotors		HB596X.690		HB629X.565
CT200h		2011-2013		Models w/259mm (10.2") Rear Brake Rotors				HB629X.565
CT200h		2011-2013		Models w/79mm (11") Rear Brake Rotors				HB629X.565
CT200h		2014-2015		0446547070		HB596X.690		
CT200h		2014-2015		0446676012				HB629X.565
CT200h		2016						HB629X.565
ES250		1990-1991				HB191X.590		HB401X.587
ES300		1992-1996	All			HB318X.669		
ES300		1992-1996				HB318X.669		HB401X.587
ES300		1997-2001	All			HB320X.669		
ES300		1997-1999				HB320X.669		HB401X.587
ES300		2000-2001				HB320X.669		HB610X.587
ES300		2002-2003	All			HB677X.685		
ES300		2002-2003				HB677X.685		
ES300h		2013-2014	All			HB647X.692		
ES300h		2013				HB647X.692		HB648X.607
ES300h		2014						HB648X.607
ES300h		2015		0446533471		HB647X.692		
ES300h		2015		0446633200				HB648X.607
ES300h		2016				HB647X.692		HB648X.607
ES330		2004-2006	All			HB677X.685		
ES330		2004-2006				HB677X.685		
ES350		2007-2014	All			HB647X.692		
ES350		2007-2013				HB647X.692		HB648X.607
ES350		2014						HB648X.607
ES350		2015		0446533471		HB647X.692		
ES350		2015		0446633200				HB648X.607
ES350		2016				HB647X.692		HB648X.607
GS300		1993-2005	All			HB375X.669		
GS300		1993-1997				HB375X.669		HB670X.610
GS300		1998-2005				HB375X.669		HB499X.610
GS300		2006	All		770908	HB474X.681		HB562X.612
GS300		2006				HB474X.681		HB562X.612
GS350		2007-2008		AWD Models				HB562X.612
GS350		2007-2008		RWD Models				HB562X.612
GS350		2009-2010		US Models				HB562X.612
GS350		2009-2011		Canada Models - 2WD				HB562X.612
GS350		2009-2011		Canada Models - AWD				HB562X.612
GS350		2011		US Models MFG After 1/2011				HB562X.612
GS350		2011		US Models MFG Up To 1/2011				HB562X.612
GS400		1998-2000	All		770619	HB375X.669		HB499X.610
GS400		1998-2000				HB375X.669		HB499X.610
GS430		2001-2005	All		770619	HB375X.669		HB499X.610
GS430		2001-2005				HB375X.669		HB499X.610
GS430		2006-2007						HB562X.612
GS450h		2007-2008						HB562X.612

BRAKE PAD APPLICATIONS

MAKE/ MODEL	SUBMODEL	YEARS	ENGINE (LITER)	NOTE	FRONT		REAR	
					OES	HB SERIES	OES	HB SERIES
LEXUS CONTINUED								
GS450h		2009-2010		US Models				HB562X.612
GS450h		2009-2011		Canada Models				HB562X.612
GS450h		2011		US Models MFG After 1/2011				HB562X.612
GS450h		2011		US Models MFG Up To 1/2011				HB562X.612
GS460		2008						HB562X.612
GS460		2009-2010		US Models				HB562X.612
GS460		2009-2011		Canada Models				HB562X.612
GS460		2011		US Models MFG After 1/2011				HB562X.612
GS460		2011		US Models MFG Up To 1/2011				HB562X.612
GX460		2010-2014	All		770976	HB490X.665		
GX460		2010-2013				HB490X.665		HB477X.610
GX460		2014-2015		0446660140				HB477X.610
GX460		2015		0446560320		HB490X.665		
GX460		2016				HB477X.610		
GX470		2003-2009	All		770976	HB490X.665		HB477X.610
GX470		2003-2009				HB490X.665		HB477X.610
HS250h		2010-2012	All			HB627X.690		
HS250h		2010-2012				HB627X.690		HB648X.607
IS F		2008-2014	All			HB616X.607		
IS F		2008-2013				HB616X.607		HB722X.652
IS F		2014				HB616X.607		
IS F		2014		044660W031				HB722X.652
IS250		2006-2008	All			HB566X.688		
IS250		2006-2008				HB566X.688		HB562X.612
IS250		2009-2013	All			HB474X.681		
IS250		2009		Canada Models		HB566X.688		HB562X.612
IS250		2009		USA Models		HB474X.681		HB562X.612
IS250		2010		Sedan - Canada Models		HB566X.688		HB562X.612
IS250		2010		Sedan - USA Models		HB474X.681		HB562X.612
IS250	C	2010-2013		Convertible - Canada Models		HB566X.688		HB562X.612
IS250	C	2010-2013		Convertible - USA Models		HB474X.681		HB562X.612
IS250		2011-2013		Sedan, Exc. Sport Suspension - Canada Models		HB566X.688		HB562X.612
IS250		2011-2013		Sedan, Exc. Sport Suspension - USA Models		HB474X.681		HB562X.612
IS250		2011-2013		Sedan, Sport Suspension - Canada Models		HB566X.688		HB562X.612
IS250		2011-2013		Sedan, Sport Suspension - USA Models		HB474X.681		HB562X.612
IS250	C	2014-2015		0446530340		HB474X.681		
IS250	RWD	2014-2015		0446553040		HB566X.688		
IS300		2001-2005	All		770619	HB375X.669		HB499X.610
IS300		2001-2005				HB375X.669		HB499X.610
IS300	Sportcross	2002-2005	All			HB375X.669		
IS350		2006-2008						HB562X.612
IS350		2009-2010		US Models				HB562X.612
IS350		2009-2012		Canada Models				HB562X.612
IS350	C	2010		US Models				HB562X.612
IS350	C	2010-2012		Canada Models				HB562X.612
IS350		2011		US Models MFG After 1/2011				HB562X.612
IS350		2011		US Models MFG Up To 1/2011				HB562X.612
IS350	C	2011		US Models MFG After 1/2011				HB562X.612
IS350	C	2011		US Models MFG Up To 1/2011				HB562X.612
IS350		2012-2013		US Models				HB562X.612
IS350	C	2012-2013		US Models				HB562X.612
LS400		1990-1992				HB318X.669		
LX450		1996-1997	All		770502	HB312X.591	770606	HB477X.610
LX450		1996-1997				HB312X.591		HB477X.610
LX470		1998-2007	All			HB313X.685		HB427X.685

BRAKE PAD APPLICATIONS



Hawk Performance - BRAKE PAD APPLICATIONS

HB
HAWK BRAKE

245
PAD SHAPE

x
INSERT COMPOUND CODE

.631
PAD THICKNESS

MAKE/ MODEL	SUBMODEL	YEARS	ENGINE (LITER)	NOTE	FRONT		REAR	
					OES	HB SERIES	OES	HB SERIES
LEXUS CONTINUED								
LX470		1998-2007				HB313X.685		HB427X.685
LX570		2008-2011	All		771303	HB589X.704		
LX570		2008-2011				HB589X.704		HB590X.682
LX570		2013-2014	All		771303	HB589X.704		
LX570		2013				HB589X.704		HB590X.682
LX570		2014-2015		0446660160				HB590X.682
LX570		2015		0446560280		HB589X.704		
RX300		1999-2001	All			HB320X.669		
RX300		1999-2001		AWD		HB320X.669		HB401X.587
RX300		1999-2001		FWD		HB320X.669		HB401X.587
RX300		2002-2003		AWD				HB401X.587
RX300		2002-2003		FWD				HB401X.587
SC300		1992-1998				HB318X.669		HB670X.610
SC300	Front from 03/1995	1995		0449124080		HB318X.669		
SC300		1996-1998	All			HB318X.669		
SC300		1999-2000						HB670X.610
SC400		1992-2000						HB670X.610
SC430		2002-2006	All			HB375X.669		
SC430		2002-2010				HB375X.669		HB499X.610
SC430		2008-2010	All			HB375X.669		
LINCOLN								
Blackwood		2002	All		770679	HB266X.650	770711	HB301X.630
Blackwood		2002-2003				HB266X.650		HB301X.630
Continental		1965-1967				HB103X.590		
Continental	Early	1971				HB292X.674		
Continental	Late	1971				HB292X.674		
Continental		1972				HB292X.674		
Continental		1973-1979	All			HB292X.674		
Continental	302	1980				HB125X.650		
Continental	351	1980				HB125X.650		
Continental		1982-1987	All			HB125X.650		
Continental	Givenchy	1987-1988	All			HB125X.650		
Continental		1988-1990	All			HB240X.620		HB580X.627
Continental	Signature	1988-1992	All			HB240X.620		HB580X.627
Continental	Executive	1991-1992	All			HB240X.620		HB580X.627
Continental		1993-1994				HB347X.689		HB417X.659
Continental		1995	All			HB416X.689		HB417X.659
Continental		1995-2002				HB416X.689		HB417X.659
Continental		1997-2002	All			HB416X.689		HB417X.659
Continental		1997-1998				HB275X.660		HB417X.659
LS		2000-2005	All			HB376X.665		
LS		2000-2002				HB376X.665		HB428X.650
LS		2003		V6 Engine		HB376X.665		HB428X.650
LS		2003		V8 Engine		HB376X.665		HB428X.650
LS		2004-2006				HB376X.665		HB428X.650
LS	Sport	2006	All			HB376X.665		
Mark III	Early	1971				HB292X.674		
Mark III	Late	1971				HB292X.674		
Mark IV		1971-1972				HB292X.674		
Mark IV		1973-1976	All			HB292X.674		
Mark LT		2006-2008	All	4WD; 6 Lugs	771011	HB455X.785	771012	HB456X.705
Mark LT		2006-2008	All	4WD; 7 Lugs	771011	HB455X.785	771012	HB456X.705
Mark LT		2006-2008	All	RWD; 6 Lugs	771011	HB455X.785	771012	HB456X.705
Mark LT		2006-2008	All	RWD; 7 Lugs	771011	HB455X.785	771012	HB456X.705
Mark LT		2006-2008		2WD; 6 Lug		HB455X.785		HB456X.705

BRAKE PAD APPLICATIONS



MAKE/ MODEL	SUBMODEL	YEARS	ENGINE (LITER)	NOTE	FRONT		REAR	
					OES	HB SERIES	OES	HB SERIES
LINCOLN CONTINUED								
Mark LT		2006-2008		2WD; 7 Lug		HB455X.785		HB456X.705
Mark LT		2006-2008		4WD; 6 Lug		HB455X.785		HB456X.705
Mark LT		2006-2008		4WD; 7 Lug		HB455X.785		HB456X.705
Mark V		1977-1979	All			HB292X.674		
Mark VI	351	1980				HB125X.650		
Mark VI	302	1980-1981				HB125X.650		
Mark VI		1982-1983	All			HB125X.650		
Mark VII		1984-1987	All			HB125X.650		
Mark VII		1988-1989		E4LY2001E		HB125X.650		
Mark VII		1990		F0LY2001A		HB125X.650		
Mark VII	Bill Blass	1991-1992	All			HB125X.650		HB580X.627
Mark VII	LSC	1991-1992	All			HB125X.650		HB580X.627
Mark VIII		1993-1998				HB416X.689		
MKS		2009	All		771158	HB612X.690		
MKS		2009-2012				HB710X.706		HB674X.664
MKS		2010-2013	All	Standard Brakes		HB710X.706		
MKS		2014-2015		DG1Z2001D		HB710X.706		
MKS		2015		EG1Z2200B				HB674X.664
MKT		2010-2011	All		771158	HB612X.690		
MKT		2010-2012				HB710X.706		HB674X.664
MKT		2012-2014	All	Standard Brakes		HB710X.706		
MKT		2013-2014		Performance Brakes				HB579X.785
MKT		2013-2014		Standard Duty Calipers		HB710X.706		HB674X.664
MKT	Performance Brake	2013-2014		DG1Z2001E		HB710X.706		
MKT		2013-2015		EG1Z2200A				HB674X.664
MKT	HD Brakes	2013-2015		DG1Z2001D		HB710X.706		
MKT		2015		EB5Z2001A		HB710X.706		
MKT	HD Brakes	2015		EG1Z2200B				HB674X.664
MKT	Performance Brake	2015		CL1Z2200A				HB579X.785
MKT	Performance Brake	2015		DG1Z2001F		HB710X.706		
MKX		2007-2014	All			HB656X.684		
MKX		2007-2008		296mm Front Rotors		HB656X.684		HB657X.667
MKX		2007-2008		320mm Front Rotors		HB656X.684		HB657X.667
MKX		2009-2010				HB656X.684		HB657X.667
MKX		2011-2013				HB656X.684		HB674X.664
MKX		2014-2015		CT4Z2200A				HB674X.664
MKX		2015		BT4Z2001B		HB656X.684		
MKZ		2007-2012	All		771164	HB565X.688		HB564X.567
MKZ		2007-2012				HB565X.688		HB564X.567
Navigator		1998-2002	All		770702	HB299X.650		
Navigator		1998-1999		2WD		HB299X.650		HB301X.630
Navigator		1998-1999		4WD		HB299X.650		HB301X.630
Navigator		2000		2WD; From 12/99; 14mm Studs		HB299X.650		HB301X.630
Navigator		2000		2WD; To 11/99; 12mm Studs		HB299X.650		HB301X.630
Navigator		2000		4WD; From 12/99; 14mm Studs		HB299X.650		HB301X.630
Navigator		2000		4WD; To 11/99; 12mm Studs		HB299X.650		HB301X.630
Navigator		2001-2002		2WD		HB299X.650		HB301X.630
Navigator		2001-2002		4WD		HB299X.650		HB301X.630
Navigator		2003-2005	All			HB462X.827		
Navigator		2003-2006				HB462X.827		HB463X.787
Navigator	Luxury	2006	All			HB462X.827		
Navigator	Ultimate	2006	All			HB462X.827		
Navigator	L Luxury	2007	All			HB578X.735		
Navigator	L Ultimate	2007	All			HB578X.735		
Navigator	Luxury	2007	All			HB578X.735		

BRAKE PAD APPLICATIONS



Hawk Performance - BRAKE PAD APPLICATIONS

HB
HAWK BRAKE

245
PAD SHAPE

x
INSERT COMPOUND CODE

.631
PAD THICKNESS

MAKE/ MODEL	SUBMODEL	YEARS	ENGINE (LITER)	NOTE	FRONT		REAR	
					OES	HB SERIES	OES	HB SERIES
LEXUS CONTINUED								
Navigator	Ultimate	2007	All			HB578X.735		
Navigator		2007-2009				HB578X.735		HB579X.785
Navigator		2008-2010	All			HB578X.735		
Navigator	L	2008-2010	All			HB578X.735		
Navigator		2010-2014	All			HB672X.714		
Navigator		2010-2014				HB672X.714		HB579X.785
Navigator		2015-2016		CL1Z2200A				HB579X.785
Town Car		1973-1979				HB292X.674		
Town Car		1981				HB125X.650		
Town Car		1982-1990	All			HB125X.650		
Town Car	Cartier	1987-1994	All			HB125X.650		
Town Car	Signature	1987-1994	All			HB125X.650		
Town Car	Signature Se	1989	All			HB125X.650		
Town Car	Executive	1991-1994	All			HB125X.650		
Town Car	Jack Nicklaus	1993	All			HB125X.650		
Town Car	Front: From 06/10/1993 From 06/10/1993	1993		F4AZ2001B		HB125X.650		
Town Car	Limousine, Front	1993		F4AZ2001C		HB125X.650		
Town Car	Tournament Edition	1994	All			HB125X.650		
Town Car	Front: Steel Piston Caliper	1994		F4AZ2001B		HB125X.650		
Town Car	Limousine	1994		F4AZ2001C		HB125X.650		
Town Car		1996		with Phenolic (Plastic) Piston Rear Caliper				HB520X.575
Town Car		1996		with Steel Piston Rear Caliper				HB341X.618
Town Car		1997						HB341X.618
Town Car		1998-2002	All	w/Phenolic Piston	770748	HB294X.646	770690	HB353X.618
Town Car		1998-2002	All	w/Steel Piston	770748	HB294X.646	770674	HB341X.618
Town Car		1998-2002		with Phenolic (Plastic) Piston Rear Caliper		HB294X.646		HB520X.575
Town Car		1998-2002		with Steel Piston Rear Caliper		HB294X.646		HB341X.618
Town Car	Cartier	2003	All			HB433X.654		
Town Car	Executive	2003-2007	All			HB433X.654		
Town Car	Signature	2003-2007	All			HB433X.654		
Town Car	Limousine	2003-2010		3W1Z2200BA				HB301X.630
Town Car		2003-2011		Limo		HB433X.654		HB301X.630
Town Car		2003-2011		Sedan		HB433X.654		HB443X.614
Town Car	Ultimate	2004	All			HB433X.654		
Town Car	Rear: From 12/01/1993	2004		4W1Z2200AA				HB443X.614
Town Car	Executive L	2005-2007	All			HB433X.654		
Town Car	Signature L	2005-2007	All			HB433X.654		
Town Car	Signature Limited	2005-2007	All			HB433X.654		
Town Car		2005-2006		4W1Z2200AA				HB443X.614
Town Car	Designer Series	2006-2007	All			HB433X.654		
Town Car		2007-2011		6W1Z2200AA				HB443X.614
Town Car		2008-2011	All			HB433X.654		
Town Car	Limousine	2008-2011	All			HB433X.654		
Town Car	Limousine	2011		6W1Z2200BA				HB301X.630
Zephyr		2006	All		771164	HB565X.688		HB564X.567
Zephyr		2006				HB565X.688		HB564X.567
LOTUS								
Elise		2001-2005	All			HB180X.560		HB278X.465
Elise		2001-2005				HB180X.591		
Elise		2010-2011	All			HB180X.560		HB278X.465
Elise		2010-2011				HB180X.591		
Exige		2010-2011	All			HB180X.560		HB278X.465

MAKE/ MODEL	SUBMODEL	YEARS	ENGINE (LITER)	NOTE	FRONT		REAR	
					OES	HB SERIES	OES	HB SERIES
MASERATI								
Exige		2010-2011				HB180X.591		
MAZDA								
2	Sport	2011-2014	All			HB668X.567		
2	Touring	2011-2014	All			HB668X.567		
2		2011-2013				HB668X.567		
3	I	2004-2005	All		771044			
3	S	2004-2005	All		771044			
3	SP23	2004-2005	All		771044	HB519X.682		
3	S	2004-2011	All			HB519X.682		
3	I	2004-2013	All			HB519X.682		
3		2004-2005		2.0L Eng		HB519X.682		HB571X.605
3		2004-2006		2.3L Engine		HB519X.682		HB478X.605
3		2006		2.0L Eng		HB519X.682		HB478X.605
3	Front from 09/2005 Rear from 11/2005	2006		C2Y33323ZA		HB519X.682		
3	Mazdaspeed	2007-2013	All			HB549X.702		HB478X.605
3		2007-2008		3s; 2.3L Eng		HB519X.682		HB478X.605
3		2007-2013		3i; 2.0L Eng		HB519X.682		HB478X.605
3		2007-2013		C2Y33323ZA		HB519X.682		
3		2007-2013		MazdaSpeed; Turbo 2.3L				HB478X.605
3	Mazdaspeed	2007-2013		B3YF3323Z		HB515X.760		
3		2010-2013		3s; 2.5L Eng		HB519X.682		HB478X.605
3	(Mexico Built)	2014		BJY72648Z				HB675X.602
5	Grand Touring	2006-2007	All		771044			
5	Sport	2006-2007	All		771044			
5	Touring	2006-2007	All		771044			
5	Grand Touring	2006-2010	All			HB519X.682		
5	Sport	2006-2010	All			HB519X.682		
5	Touring	2006-2010	All			HB519X.682		
5	Rear from 02/2006	2006		C2Y32648ZA				HB478X.605
5		2006-2007				HB519X.682		HB571X.605
5		2008-2010				HB519X.682		HB478X.605
5	Grand Touring	2012-2014	All			HB519X.682		
5	Sport	2012-2014	All			HB519X.682		
5	Touring	2012-2014	All			HB519X.682		
5		2012-2013				HB519X.682		HB478X.605
5		2014		C2Y32648ZA				HB478X.605
6	I	2003-2005	All			HB459X.700		HB158X.515
6	S	2003-2005	All			HB459X.700		HB158X.515
6		2003		GKYA2643Z				HB158X.515
6		2003-2005				HB459X.700		HB158X.515
6	Mazdaspeed	2006-2010	All			HB549X.702		HB564X.567
6	S	2006-2013	All		771164	HB565X.688		
6		2006		except MazdaSpeed 6		HB565X.688		HB564X.567
6		2006		MazdaSpeed 6		HB549X.702		HB564X.567
6		2007		Except MazdaSpeed		HB565X.688		HB564X.567
6		2007		MazdaSpeed		HB549X.702		HB564X.567
6	I	2008-2013	All		771164	HB565X.688		HB564X.567
6		2008-2013				HB565X.688		HB564X.567
323		1990-1991	All			HB246X.567		
323		1992-1995		B5Y63328Z		HB246X.567		
626	ES	1993-1997	All	race material .634 thick				HB212X.535
626	LX	1993-1997	All	race material .634 thick				HB212X.535
626		1993-1997			770583	HB211X.634		HB212X.535

BRAKE PAD APPLICATIONS



Hawk Performance - BRAKE PAD APPLICATIONS

HB
HAWK BRAKE

245
PAD SHAPE

x
INSERT COMPOUND CODE

.631
PAD THICKNESS

MAKE/ MODEL	SUBMODEL	YEARS	ENGINE (LITER)	NOTE	FRONT		REAR	
					OES	HB SERIES	OES	HB SERIES
MAZDA CONTINUED								
626		1998-2000		2.5L Engine		HB489X.630		HB212X.535
626		1998-2002		2.0L Engine	770583	HB211X.634		
626		2001		2.5L Engine		HB489X.630		
626	ES	2001		G5Y62643ZC				HB212X.535
626		2002		2.5L Engine				HB212X.535
808		1971-1977				HB156X.562		
929		1988-1991	All			HB407X.602		
929	S	1990-1991	All			HB407X.602		
929		1990-1991		Except ABS		HB407X.602		
929		1990-1991		with ABS		HB407X.602		
1500		1967-1970				HB150X.555		
1800		1968-1972				HB150X.555		
B1800		1977				HB150X.555		
B1800		1978	All			HB150X.555		
B2000		1979-1984	All			HB150X.555		
B2000		1985				HB150X.555		
B2300		1994	All			HB279X.594		
B2300	2WD	1994				HB279X.594		
B2300	4WD	1994				HB279X.594		
B2300		1995-1997	All		770652	HB283X.650		
B2300	2WD	1995-1997		4 Wheel ABS		HB283X.650		
B2300	2WD	1995-1997		Rear Wheel ABS		HB283X.650		
B2300	4WD	1995-1997				HB283X.650		
B2300	2WD	2001-2002				HB283X.650		
B2300	4WD	2001-2002				HB283X.650		
B2300		2003-2008	All		770833	HB472X.650		
B2300	Front to 08/05/2002	2003		ZZR049280A		HB283X.650		
B2300	2WD	2003-2009				HB472X.650		
B2300	4WD	2003-2009				HB472X.650		
B2500		1998-2001	All		770652	HB283X.650		
B2500	2WD	1998-2000		Coil Spring Front Suspension; 4 Wheel ABS		HB283X.650		
B2500	2WD	1998-2000		Coil Spring Front Suspension; Rear Wheel ABS		HB283X.650		
B2500	2WD	1998-2000		Torsion Bar Front Suspension		HB283X.650		
B2500	4WD	1998-2001				HB283X.650		
B2500	2WD	2001				HB283X.650		
B2500	2WD	2004-2006				HB472X.650		
B2500	4WD	2004-2006				HB472X.650		
B3000		1994	All			HB279X.594		
B3000	2WD	1994				HB279X.594		
B3000	4WD	1994				HB279X.594		
B3000		1995-1996	All		770652	HB283X.650		
B3000	2WD	1995-1996		4 Wheel ABS		HB283X.650		
B3000	2WD	1995-1996		Rear Wheel ABS		HB283X.650		
B3000	4WD	1995-1996				HB283X.650		
B3000		1998-2002	All		770652	HB283X.650		
B3000	2WD	1998-2000		Coil Spring Front Suspension; 4 Wheel ABS		HB283X.650		
B3000	2WD	1998-2000		Coil Spring Front Suspension; Rear Wheel ABS		HB283X.650		
B3000	2WD	1998-2000		Torsion Bar Front Suspension		HB283X.650		
B3000	4WD	1998-2002				HB283X.650		
B3000	2WD	2001-2002				HB283X.650		
B3000		2003-2007	All		770833	HB472X.650		
B3000	Front to 08/05/2002	2003		ZZR049280A		HB283X.650		
B3000	2WD	2003-2007				HB472X.650		
B3000	4WD	2003-2007				HB472X.650		
B3000	DS	2006-2007	All		770833	HB472X.650		

BRAKE PAD APPLICATIONS



MAKE/ MODEL	SUBMODEL	YEARS	ENGINE (LITER)	NOTE	FRONT		REAR	
					OES	HB SERIES	OES	HB SERIES
MAZDA CONTINUED								
B4000		1994	All			HB279X.594		
B4000	2WD	1994				HB279X.594		
B4000	4WD	1994				HB279X.594		
B4000		1995-2002	All		770652	HB283X.650		
B4000	2WD	1995-1997		4 Wheel ABS		HB283X.650		
B4000	2WD	1995-1997		Rear Wheel ABS		HB283X.650		
B4000	4WD	1995-2002				HB283X.650		
B4000	2WD	1998-2000		Coil Spring Front Suspension; 4 Wheel ABS		HB283X.650		
B4000	2WD	1998-2000		Coil Spring Front Suspension; Rear Wheel ABS		HB283X.650		
B4000	2WD	1998-2000		Torsion Bar Front Suspension		HB283X.650		
B4000	2WD	2001-2002				HB283X.650		
B4000		2003-2008	All		770833	HB472X.650		
B4000	Front to 08/05/2002	2003		ZZR049280A		HB283X.650		
B4000	2WD	2003-2009				HB472X.650		
B4000	4WD	2003-2009				HB472X.650		
B4000	SE	2006-2008	All		770833	HB472X.650		
Cosmo		1976	All			HB152X.540		
Cosmo		1977-1978				HB152X.540		
CX-7		2007-2012	All			HB656X.684		HB657X.667
CX-7		2007-2012				HB656X.684		HB657X.667
CX-9		2007-2014	All			HB656X.684		
CX-9		2007-2013				HB656X.684		HB657X.667
CX-9		2014		L2Y82643ZA				HB657X.667
Miata		1990-1993	All			HB148X.560		HB157X.484
Miata		1990-1993				HB148X.560		HB157X.484
Miata		1994-1997	All					HB159X.492
Miata		1994-1997				HB149X.505		HB159X.492
Miata		1999-2000	All					HB159X.492
Miata		1999-2000				HB149X.505		HB159X.492
Miata		2001-2005	All	w/ Sport Suspension		HB431X.606		
Miata		2001-2002		with Hard or Sport Suspension		HB431X.606		
Miata		2001-2003		with Sport Suspension				HB442X.496
Miata		2001-2005		with Normal Suspension		HB149X.505		HB159X.492
Miata		2003		N0Y82643Z				HB159X.492
Miata		2003-2005		N0Y33323Z		HB149X.505		
Miata	Mazdaspeed	2004-2005	All			HB431X.606		HB468X.492
Miata		2004-2005		N0Y82643ZA				HB159X.492
Millenia	S	1995-1998	All			HB419X.634		
Millenia		1995-2002	All			HB419X.634		
Millenia		1995-2002				HB419X.634		
Millenia	L	1996-1997	All			HB419X.634		
Millenia	S	2002	All			HB419X.634		
MPV	4WD	1992-1993				HB379X.626		
MPV		1994-1998				HB379X.626		
MX-3	GS	1992-1994	All			HB246X.567		
MX-3		1992-1995	All			HB246X.567		
MX-3		1992-1995				HB246X.567		
MX-3		1996		BRY43323Z		HB246X.567		
MX-5 Miata		2006-2013				HB522X.565		HB523X.539
MX-5 Miata		2014		NFY72648Z				HB523X.539
MX-5 Miata		2014		NFY73328ZC		HB522X.565		
MX-5 Miata		2016				HB548X.590		HB523X.539
MX-6	LS	1993-1997	All	race material .634 thick				HB212X.535
MX-6		1993-1997				HB211X.634		HB212X.535
Navajo	LX	1991-1994	All			HB279X.594		

BRAKE PAD APPLICATIONS



Hawk Performance - BRAKE PAD APPLICATIONS

HB
HAWK BRAKE

245
PAD SHAPE

x
INSERT COMPOUND CODE

.631
PAD THICKNESS

MAKE/ MODEL	SUBMODEL	YEARS	ENGINE (LITER)	NOTE	FRONT		REAR	
					OES	HB SERIES	OES	HB SERIES
MAZDA CONTINUED								
Navajo	2WD	1991-1994				HB279X.594		
Navajo	4WD	1991-1994				HB279X.594		
Navajo	DX	1992-1994	All			HB279X.594		
Protege	SE	1990	All			HB246X.567		
Protege	4wd	1990-1991	All			HB246X.567		
Protege	LX	1990-1994	All			HB246X.567		
Protege		1990-1991		B5Y63323Z		HB246X.567		
Protege		1990-1991		DOHC Eng.; w/Rear Discs		HB246X.567		HB157X.484
Protege		1990-1991		DOHC Eng.; w/Rear Drums		HB246X.567		
Protege	DX	1991-1994	All			HB246X.567		
Protege		1992-1994		Rear Discs Brakes		HB246X.567		HB157X.484
Protege	Front SOHC Motor	1992-1994		B5Y63328Z		HB246X.567		
Protege		1994-1995	All			HB246X.567		
Protege	ES	1995-1998	All			HB246X.567		
Protege		1995		B5Y63323Z		HB246X.567		
Protege		1995-1996		Rear Discs Brakes		HB246X.567		HB159X.492
Protege	ES	1995-1996		BCYF2643Z				HB159X.492
Protege	DX	1996-1998	All			HB246X.567		
Protege	LX	1996-1998	All			HB246X.567		
Protege		1996		BCYW3323ZA		HB246X.567		
Protege		1997-1998		1.8L Eng.		HB246X.567		HB159X.492
Protege		1997-1998		BCYW3323ZC		HB246X.567		
Protege		1997-1998		BCYW3328ZA		HB246X.567		
Protege	ES	1997-1998		BCYF2643ZA				HB159X.492
Protege		1999-2001	1.8L	Race Material .634 thick	770583	HB211X.606		
Protege		1999-2000		1.8L Eng.		HB211X.606		
Protege		2001		2.0L; ES, MP3		HB211X.606		
Protege		2001		2.0L; ES, MP3, Race Material .634 thick				HB436X.535
Protege		2001		2.0L; LX with Rear Drum		HB211X.606		
Protege	ProtTgT 5	2002-2003	All	Race Material .634 thick		HB211X.606		
Protege	ProtOgθ 5	2002-2003	All	Race Material .634 thick	770583			
Protege	DX	2002-2003	All	Race Material .634 thick	770583	HB211X.606		
Protege	LX	2002-2003	All	Race Material .634 thick	770583	HB211X.606		
Protege		2002-2003		DX, LX, MP3 Rear Drum		HB211X.606		
Protege		2002-2003		ES; w/Rear Discs		HB211X.606		HB436X.535
Protege	Mazdaspeed	2003	All			HB489X.630		HB158X.515
Protege		2003		MazdaSpeed		HB489X.630		HB158X.515
Protege	Mazdaspeed	2003		GGYB2648Z				HB158X.515
Protege5		2002-2003				HB211X.634		HB436X.535
Rotary Pickup		1976	All			HB150X.555		
Rotary Pickup		1977				HB150X.555		
RX-2		1970-1974	All			HB150X.555		
RX-3		1971-1978	All			HB156X.562		
RX-4		1974-1978	All			HB150X.555		
RX-7		1979	All			HB150X.555		
RX-7	4 Wheel Disc	1979-1980						HB151X.505
RX-7		1980				HB150X.555		
RX-7		1981-1985	All			HB150X.555		
RX-7		1981-1983				HB150X.555		HB151X.505
RX-7		1984-1985	All	Fuel Injected Models		HB152X.540		
RX-7		1984						HB151X.505
RX-7		1984-1985		GSL-SE		HB152X.540		HB158X.515
RX-7		1985	1.1L	FA1849280A				HB151X.505
RX-7	Base	1986-1991	All	4-lug, Excluding Turbo		HB152X.540		
RX-7	Base	1986-1991	All	5-lug, Excluding Turbo		HB155X.580		

BRAKE PAD APPLICATIONS

MAKE/ MODEL	SUBMODEL	YEARS	ENGINE (LITER)	NOTE	FRONT		REAR	
					OES	HB SERIES	OES	HB SERIES
MAZDA CONTINUED								
RX-7	Turbo	1986-1991	All	Turbo		HB155X.580		
RX-7		1986-1988		5 Lug		HB155X.580		HB158X.515
RX-7		1989-1991		with Solid Rear Disc		HB152X.540		HB158X.515
RX-7		1989-1991		with Vented Rear Disc		HB155X.580		HB158X.515
RX-7	GXL	1990	All	w/Electronic Adjustable Suspension		HB155X.580		
RX-7	GXL	1990	All	w/Standard Suspension		HB152X.540		
RX-7	U	1990	All	w/Electronic Adjustable Suspension		HB155X.580		
RX-7	U	1990	All	w/Standard Suspension		HB152X.540		
RX-7	Hard Suspension	1991		FB0649280A				HB158X.515
RX-7	Std. Suspension	1991		FB0649280A				HB158X.515
RX-7		1993-1995	All	w/Electronic Adjustable Suspension		HB155X.580		HB158X.515
RX-7		1993-1995				HB155X.580		HB158X.515
RX-8		2004-2008		with Sport Suspension		HB470X.643		HB378X.565
RX-8		2004-2008		without Sport Suspension		HB470X.643		HB378X.565
RX-8		2009-2011				HB470X.643		HB378X.565
Tribute		2001	All			HB473X.752		
Tribute		2001-2004				HB473X.752		
Tribute	DX	2002-2004	All			HB473X.752		
Tribute	ES	2002-2004	All			HB473X.752		
Tribute	LX	2002-2004	All			HB473X.752		
Tribute	S	2005	All			HB473X.752		
Tribute	I	2005-2006	All	W/Rear Discs;		HB473X.752		
Tribute	I	2005-2006	All	W/Rear Drums;		HB473X.752		
Tribute		2005-2006		2.3L		HB473X.752		
Tribute		2008-2011			771047			
MCLAREN								
MP4-12C		2012-2014		Base		HB585X.660		HB586X.660
MERCEDES-BENZ								
200		1968				HB244X.624		HB172X.500
220		1963-1966				HB244X.624		
220		1968-1973						HB172X.500
230		1966-1967				HB244X.624		
230		1968-1969				HB244X.624		HB172X.500
230		1974-1978						HB172X.500
230		1977-1978	All					HB172X.595
250		1972-1973						HB172X.500
280		1973-1975	All					HB172X.595
280		1973-1976						HB172X.500
300		1962				HB172X.595		HB172X.595
190D	2.2	1984-1985	2.2L			HB195X.640		
190D	2.5	1986-1989	2.5L			HB195X.640		
190D	T	1987	All			HB195X.640		
190E	2.3	1984-1988	2.3L			HB195X.640		
190E	2.3-16	1986-1987	2.3L			HB195X.640		
190E		1986-1987		0024200220		HB195X.640		
190E	2.6	1987-1993	2.6L			HB195X.640		
190E		1987-1993		Models with ASR		HB195X.640		
190E		1987-1993		Models without ASR		HB195X.640		
190E	2.3	1991-1993	2.3L			HB195X.640		
200D		1968-1969				HB244X.624		HB172X.500
200D		1970-1973						HB172X.500
220b		1964-1965				HB244X.624		
220D		1968-1973						HB172X.500

Hawk Performance - BRAKE PAD APPLICATIONS

HB
HAWK BRAKE

245
PAD SHAPE

x
INSERT COMPOUND CODE

.631
PAD THICKNESS

MAKE/ MODEL	SUBMODEL	YEARS	ENGINE (LITER)	NOTE	FRONT		REAR	
					OES	HB SERIES	OES	HB SERIES
MERCEDES-BENZ CONTINUED								
220S		1964-1966				HB244X.624		
220Sb		1964-1965				HB244X.624		
220SE		1964-1966				HB244X.624		
230S		1966-1967				HB244X.624		
230S		1968-1969				HB244X.624		HB172X.500
230SL		1963-1966				HB244X.624		
230SL		1967				HB244X.624		HB172X.500
240D		1974-1982	All					HB172X.595
240D		1974-1983						HB172X.500
250C		1969-1973						HB172X.500
250S		1966-1968						HB172X.500
250S		1971						HB172X.500
250SE		1966-1968						HB172X.500
250SE		1971-1972						HB172X.500
250SEC		1966-1968						HB172X.500
250SL		1966-1968						HB172X.500
280C		1973-1974	All					HB172X.595
280C		1973-1976						HB172X.500
280CE		1978-1979	All					HB172X.595
280CE		1978-1981						HB172X.500
280E		1977-1981						HB172X.500
280S		1975-1976						HB172X.500
280S		1976	All					HB172X.595
280SE		1972-1973						HB172X.500
280SE	4.5	1973	4.5L					HB172X.595
280SE		1977-1980						HB172X.500
280SE		1978-1979	All					HB172X.595
280SEL		1973						HB172X.500
300CD		1978-1981	All					HB172X.595
300CD		1978-1984						HB172X.500
300CD		1990-1992		0014209520				HB371X.600
300CD	Front: Early	1993		0014209520				HB371X.600
300D		1962				HB172X.595		HB172X.595
300D		1966	All			HB171X.590		
300D		1966						HB172X.500
300D		1967	All			HB171X.590		HB172X.500
300D		1968-1972	All			HB171X.590		
300D		1968-1972						HB172X.500
300D		1975-1984						HB172X.500
300D		1982-1985	All					HB172X.595
300E	2.8, Front: Early	1993		0014209520				HB371X.600
300E	4Matic, Front: Early	1993		0014209520				HB371X.600
300E	Front: Early	1993		0014209520				HB371X.600
300SD		1978-1980	All					HB172X.595
300SD		1978-1984						HB172X.500
300SD		1982-1985	All					HB172X.595
300SD		1991						HB371X.600
300SD		1992-1993		With ATE Front Caliper				HB371X.600
300SD		1992-1993		With Girling Front Caliper				HB371X.600
300SDL	Rear: Standard	1986-1987		0014209320				HB172X.595
300SE		1961-1962				HB172X.595		HB172X.595
300SE		1963-1965						HB172X.595
300SE		1966	All			HB171X.590		HB172X.595
300SE		1988-1990						HB172X.595
300SE	Rear: Standard	1988-1991		0014209320				HB172X.595

BRAKE PAD APPLICATIONS

MAKE/ MODEL	SUBMODEL	YEARS	ENGINE (LITER)	NOTE	FRONT		REAR	
					OES	HB SERIES	OES	HB SERIES
MERCEDES-BENZ CONTINUED								
300SE		1990	All					HB172X.595
300SE		1991		MFG after 4/1991 With ATE Front Caliper				HB371X.600
300SE		1991		MFG after 4/1991 With Girling Front Caliper				HB371X.600
300SE		1991		MFG UP TO 3/1991				HB172X.595
300SE		1992-1993		With ATE Front Caliper				HB371X.600
300SE		1992-1993		With Girling Front Caliper				HB371X.600
300SEL		1963				HB172X.595		HB172X.595
300SEL		1964-1965						HB172X.595
300SEL		1966-1973						HB172X.500
300SEL		1968-1972	All			HB171X.590		HB172X.595
300SEL		1988-1991						HB172X.595
300SEL	Rear: Standard	1988-1991		0014209320				HB172X.595
300SL		1961-1963				HB172X.595		HB172X.595
300SL		1990-1993		0014209520				HB371X.600
300TD		1979-1984						HB172X.500
300TD		1985		0004206220				HB172X.595
300TD		1987		0014209520				HB371X.600
300TE		1988-1993		0014209520				HB371X.600
350SD		1991	All					HB172X.595
350SD		1991						HB172X.595
350SD	Rear: Standard	1991		0014209320				HB172X.595
350SDL		1990-1991	All					HB172X.595
350SDL		1990-1991						HB172X.595
350SDL	Rear: Standard	1990-1991		0014209320				HB172X.595
350SL		1972-1974						HB172X.500
380SE		1984						HB172X.500
380SEC		1982-1983						HB172X.500
380SEL		1981-1983						HB172X.500
380SEL		1982	All					HB172X.595
380SL		1981-1984						HB172X.500
380SLC		1981						HB172X.500
400E		1992-1993		0014209520				HB371X.600
400SE		1992						HB371X.600
400SEL		1986-1988						HB172X.500
400SEL		1993						HB371X.600
420SEL		1986-1991						HB172X.595
420SEL	Rear: Standard	1986-1991		0014209320				HB172X.595
420SEL		1989-1990	All					HB172X.595
450SE		1973-1976	All					HB172X.595
450SE		1973-1976						HB172X.500
450SEL		1973-1980	All					HB172X.595
450SEL		1973-1980						HB172X.500
450SEL	6.9	1977-1979	6.9L					HB172X.595
450SL		1973-1980	All					HB172X.595
450SL		1973-1980						HB172X.500
450SLC		1973-1980	All					HB172X.595
450SLC		1973-1980						HB172X.500
500E		1992-1993		0014209520				HB371X.600
500SEC		1984						HB172X.500
500SEC		1985	All					HB172X.595
500SEC		1993						HB371X.600
500SEL		1984						HB172X.500
500SEL		1985	All					HB172X.595
500SEL		1992-1993						HB371X.600
500SL		1990-1993		0014209520				HB371X.600

BRAKE PAD APPLICATIONS



Hawk Performance - BRAKE PAD APPLICATIONS

HB
HAWK BRAKE

245
PAD SHAPE

x
INSERT COMPOUND CODE

.631
PAD THICKNESS

MAKE/ MODEL	SUBMODEL	YEARS	ENGINE (LITER)	NOTE	FRONT		REAR	
					OES	HB SERIES	OES	HB SERIES
MERCEDES-BENZ CONTINUED								
560SEC		1986-1991	All					HB172X.595
560SEC		1986-1991						HB172X.595
560SEC	Rear: Optional	1986-1991		0014209320				HB172X.595
560SEL		1986-1991	All					HB172X.595
560SEL		1986-1991						HB172X.595
560SEL	Rear: Standard	1986-1991		0014209320				HB172X.595
560SL		1986-1989	All			HB199X.702		HB172X.595
560SL		1986-1989				HB199X.660		
600SEC		1993						HB371X.600
600SEL		1992-1993						HB371X.600
600SL		1993						HB371X.600
C230	Rear: USA Built Vehicle	1999-2000		0014209520				HB371X.600
C230		2002-2003	All	w/o Sport Package		HB211X.606		
C230		2002				HB504X.740		
C230		2003		With Sport Package		HB504X.740		
C230		2003		Without Sport Package		HB504X.740		
C230	Sport, Front: Early	2003		0044200520		HB497X.776		
C230	Sport	2004		0044200520		HB497X.776		
C230		2004-2005		Except Sport Sedan; With 1 Piston Front Caliper		HB504X.740		
C230	Kompressor	2005	All			HB504X.740		
C230		2006		0034206020		HB504X.740		
C230		2013	All			HB504X.740		
C240		2001-2002	All	RWD		HB504X.740		
C240		2001-2002				HB504X.740		
C240	Sport	2002-2004		0044200520		HB497X.776		
C240	4Matic	2003	All	AWD		HB504X.740		
C240	4Matic	2003-2005	All			HB504X.740		
C240		2003		RWD; Sedan		HB504X.740		
C240		2003		RWD; Wagon		HB504X.740		
C240		2003-2005		Sedan; 4Matic AWD		HB504X.740		
C240		2003-2005		Sedan; Except 4Matic AWD		HB504X.740		
C240		2003-2005		Wagon; 4Matic AWD		HB504X.740		
C240		2003-2005		Wagon; RWD		HB504X.740		
C240	Except Sport	2004				HB504X.740		
C240	4Matic	2004-2005		AWD		HB504X.740		
C240		2005		RWD; Sedan		HB504X.740		
C240		2005		RWD; Wagon		HB504X.740		
C250		2012-2013		Coupe; Sport Edition (13.5 inch Front Rotors)		HB754X.726		HB753X.666
C250		2012-2013		Sedan; Coupe Excluding Special Edition (11.6 inch Front Rotors)		HB752X.769		HB753X.666
C250		2014		0054201220		HB752X.769		
C250		2014		0054204220				HB753X.666
C250	Sport	2014		0054201320		HB754X.726		
C250	Sport	2014		0054204220				HB753X.666
C250		2015		0074205720		HB752X.769		
C250		2015		0074206020				HB753X.666
C250	Sport	2015		0074207520		HB754X.726		
C250	Sport	2015		0074208520				HB753X.666
C280	Rear: Traction Control	1996-1997		0014209520				HB371X.600
C280		1998-2000		0014209520				HB371X.600
C280	Luxury	2006-2007	All			HB504X.740		
C280		2006-2007		4Matic AWD		HB504X.740		
C280		2006-2007		Except 4Matic AWD; w/1 Piston Front Caliper		HB504X.740		
C300		2008				HB752X.769		HB753X.666
C300		2009				HB752X.769		

BRAKE PAD APPLICATIONS



MAKE/ MODEL	SUBMODEL	YEARS	ENGINE (LITER)	NOTE	FRONT		REAR	
					OES	HB SERIES	OES	HB SERIES
MERCEDES-BENZ CONTINUED								
C300		2009-2014		0054204220				HB753X.666
C300		2010-2012		0054201220		HB752X.769		
C300		2013-2014		0054201320		HB754X.726		
C32 AMG		2002-2004						HB371X.600
C32 AMG		2002-2004		0044200520		HB497X.776		
C32 AMG	Sport	2002-2004		0044200520		HB497X.776		
C320		2001-2005	All			HB504X.740		
C320		2001-2002				HB504X.740		
C320	Sport	2001-2004		0044200520		HB497X.776		
C320	4Matic	2003-2005	All			HB504X.740		
C320		2003-2004		Except 4Matic AWD; Except Sport Sedan		HB504X.740		
C320		2003-2005		4Matic AWD		HB504X.740		
C320		2005		Except 4Matic AWD; Except Sport Sedan; With 1 Piston Front Caliper		HB504X.740		
C350	Luxury	2006-2007	All	AWD		HB504X.740		
C350	Luxury	2006-2007	All	RWD		HB504X.740		
C350	Sport	2006-2007	All	AWD		HB504X.740		
C350	Sport	2006-2007	All	RWD		HB504X.740		
C350		2006-2007		4Matic AWD		HB504X.740		
C350		2006-2007		Except Sport Sedan; Except 4Matic AWD; With 1 Piston Front Caliper		HB504X.740		
C350	Sport	2006-2007		0044209020		HB497X.776		
C350		2008		0054200720				HB753X.666
C350		2008-2014		0054201320		HB754X.726		
C350		2009-2014		0054204220				HB753X.666
C350		2015		0074205820		HB754X.726		
C350		2015		0074206020				HB753X.666
C36 AMG		1995		0014209520				HB371X.600
C36 AMG		1996-1997		0044201620				HB371X.600
C43 AMG		1998-2000				HB497X.776		HB371X.600
C43 AMG		1999-2000	All			HB497X.776		HB371X.600
C55 AMG		2005-2006						HB371X.600
C55 AMG		2005-2006		0044200520		HB497X.776		
C63 AMG		2008-2011		Models with 1-Piece Front Rotors		HB731X.620		
C63 AMG		2008-2011		Models with 2-Piece Front Rotors		HB731X.620		
C63 AMG		2012		Black Series Coupe		HB731X.620		
C63 AMG		2012		Models with 1-Piece Front Rotors Excluding Black Series Coupe		HB731X.620		
C63 AMG		2012		Models with 2-Piece Front Rotors Excluding Black Series Coupe		HB731X.620		
C63 AMG		2013		Models with 1-Piece Front Rotors		HB731X.620		
C63 AMG		2013		Models with 2-Piece Front Rotors		HB731X.620		
C63 AMG		2014		0054203320		HB731X.620		
C63 AMG		2015		0074205920		HB731X.620		
CL500		1998						HB371X.600
CL500		1999		W140 Model				HB371X.600
CL500		2000-2002		0034204220		HB497X.776		
CL500		2003		From Chassis Number A028700				HB755X.620
CL500	Rear: To Vin A 028699	2003		0034208920		HB497X.776		
CL500		2004-2006						HB755X.620
CL500		2004-2006		0034208920		HB497X.776		
CL55 AMG		2001-2003	All			HB497X.776		
CL55 AMG		2004-2006		0034207120		HB497X.776		
CL550		2007-2013						HB755X.620
CL550		2014		0064200120				HB755X.620
CL600		1998-1999						HB371X.600

BRAKE PAD APPLICATIONS



Hawk Performance - BRAKE PAD APPLICATIONS

HB **245** **x** **.631**
 HAWK BRAKE PAD SHAPE INSERT COMPOUND CODE PAD THICKNESS

MAKE/ MODEL	SUBMODEL	YEARS	ENGINE (LITER)	NOTE	FRONT		REAR	
					OES	HB SERIES	OES	HB SERIES
MERCEDES-BENZ CONTINUED								
CL600		2001-2002		0044200420		HB497X.776		
CL600		2003-2006		0044200820		HB497X.776		
CL600		2007-2013						HB755X.620
CL600		2014		0064200120				HB755X.620
CLA45 AMG		2014		0074209020				HB742X.690
CLA45 AMG	Both Red & Silver Calipers have same FMSI #s	2015		0074209020				HB742X.690
CLK320		1998-2002	All			HB495X.756		
CLK320		1998-1999		With 2 Pin Pad Rear Calipers		HB495X.756		HB371X.600
CLK320		2000-2002		With 1 Pin Pad Rear Calipers		HB495X.756		
CLK320		2003-2005	All			HB504X.740		
CLK320		2003		0044200320		HB495X.756		
CLK320		2003-2005		W209 Model		HB504X.740		
CLK350	except sport model	2006-2009	All			HB504X.740		
CLK350		2006-2007				HB504X.740		
CLK350		2008-2009		Except Sport; With 1 Piston Front Caliper		HB504X.740		
CLK430		1999-2003	All			HB495X.756		
CLK430		1999				HB495X.756		HB371X.600
CLK430		2000-2003				HB495X.756		
CLK500		2003-2006						HB371X.600
CLK500		2003-2006		0044200520		HB497X.776		
CLK55 AMG		2001-2002				HB497X.776		HB371X.600
CLK55 AMG		2003-2004						HB371X.600
CLK55 AMG		2003-2004		0044200520		HB497X.776		
CLK55 AMG		2005-2006	All			HB616X.607		
CLK55 AMG		2005-2006				HB616X.607		
CLK550		2007-2009						HB371X.600
CLK550		2007-2009		0044209020		HB497X.776		
CLK63 AMG		2007-2008	All			HB616X.607		
CLK63 AMG		2007				HB616X.607		
CLK63 AMG		2008		Cabriolet		HB616X.607		
CLK63 AMG		2008		Coupe		HB731X.620		
CLK63 AMG		2008-2009				HB616X.607		
CLK63 AMG		2009		0054203920		HB616X.607		
CLS400		2015		0074205820		HB754X.726		
CLS400		2015		0074206820				HB755X.620
CLS500		2005		0044204420				HB755X.620
CLS500		2005-2006		0044200520		HB497X.776		
CLS500		2006						HB755X.620
CLS55 AMG		2006		0034207120		HB497X.776		
CLS550		2007-2011		0044209020		HB497X.776		
CLS550		2007-2014						HB755X.620
CLS550		2015		0074206820				HB755X.620
CLS63 AMG		2007-2010		Except Sport; w/60mm (14.17") Front Rotors		HB731X.620		
CLS63 AMG		2007-2010		Sport; With 390mm (15.35") Front Rotors		HB731X.620		
CLS63 AMG	Performance Package	2007-2011		0044208420		HB731X.620		
CLS63 AMG		2011-2014		Iron Brake Rotors		HB731X.620		
CLS63 AMG S		2014		Iron Brake Rotors		HB731X.620		
CLS63 AMG S		2015		0074207620		HB731X.620		
E250		2014		0054201320		HB754X.726		
E250		2014		0054209420				HB755X.620
E250		2015		0074205820		HB754X.726		
E250		2015		0074206820				HB755X.620
E300		1996-1997		0014209520				HB371X.600
E300		1998-1999	All			HB495X.756		HB371X.600

BRAKE PAD APPLICATIONS



MAKE/ MODEL	SUBMODEL	YEARS	ENGINE (LITER)	NOTE	FRONT		REAR	
					OES	HB SERIES	OES	HB SERIES
MERCEDES-BENZ CONTINUED								
E300		1998-1999		Models with 1 Pin Rear Calipers		HB495X.756		
E300		1998-1999		Models with 2 Pin Rear Calipers		HB495X.756		HB371X.600
E300		2013		0074205820		HB754X.726		
E320	Front: Early	1994-1995		0014209520				HB371X.600
E320	Wagon	1994-1995						HB371X.600
E320		1996-1999	All			HB495X.756		
E320	Sedan	1996-2000		With 1 Pin Pad Rear Calipers		HB495X.756		
E320	Sedan	1996-2000		With 2 Pin Pad Rear Calipers		HB495X.756		HB371X.600
E320	4Matic	1998		0034202920		HB495X.756		
E320	Wagon	1998-2003				HB495X.756		HB371X.600
E320	4Matic, Rear:One retaining pin	1999		0034202920		HB495X.756		
E320		2000-2002		0034202920		HB495X.756		
E320	Wagon	2000-2002		0034202920		HB495X.756		
E320	Sedan	2001-2002				HB495X.756		
E320	4Matic	2003		0044200320		HB495X.756		
E320	Sedan	2003		W211 Model				HB755X.620
E320		2003-2005		0044208720		HB495X.756		
E320	Wagon	2004		4Matic AWD Models		HB495X.756		HB755X.620
E320	Wagon	2004		RWD Models				HB755X.620
E320	4Matic	2004-2005		0044200720		HB495X.756		
E320	Sedan	2004-2005		4Matic AWD		HB495X.756		HB755X.620
E320	Sedan	2004-2005		Except 4Matic AWD				HB755X.620
E320	Wagon	2005		W211 4Matic		HB495X.756		HB755X.620
E320	Wagon	2005		W211 Except 4Matic				HB755X.620
E320	CDI	2005-2006		0044207920		HB495X.756		
E320	Sedan	2006						HB755X.620
E320	Sedan	2007-2009		4Matic		HB495X.756		HB755X.620
E320	Sedan	2007-2009		Except Sport Sedan; Except 4Matic				HB755X.620
E320	Sedan	2007-2009		Sport Sedan; Except 4Matic				HB755X.620
E350	4Matic	2006-2009	All			HB495X.756		
E350	4Matic Sport, Front: From Vin X 196565	2006		1644200820		HB745X.777		
E350	4Matic Sport, Front: To Vin 196564	2006	2006		0034209120		HB497X.776	
E350	Sedan	2006		4Matic AWD		HB495X.756		HB755X.620
E350	Sedan	2006		Except 4Matic AWD; From CHNUMBER A870951; w/vented rear discs				HB755X.620
E350	Sedan	2006		Except 4Matic AWD; To CHNUMBER A870950 With Solid Rear Discs				HB755X.620
E350	Wagon	2006		4Matic		HB495X.756		HB755X.620
E350	Wagon	2006		Except 4Matic; From CHNUMBER A870951				HB755X.620
E350	Wagon	2006		Except 4Matic; To CHNUMBER A870950				HB755X.620
E350		2006-2009		0044207920		HB495X.756		
E350	4Matic	2006-2009		0044200720		HB495X.756		
E350	Sport	2006-2009		0044200520		HB497X.776		
E350	Sedan	2007-2008		Except Sport Sedan; Except 4Matic				HB755X.620
E350	Sedan	2007-2008		Sport Sedan; Except 4Matic				HB755X.620
E350	4Matic Sport	2007-2009		1644200820		HB745X.777		
E350	Sedan	2007-2009		4Matic Base		HB495X.756		HB755X.620
E350	Sedan	2007-2009		4Matic Sport Sedan		HB743X.795		HB755X.620
E350	Wagon	2007-2009				HB495X.756		HB755X.620
E350	Sedan	2009		RWD; Base				HB755X.620
E350	Sedan	2009		RWD; Sport Sedan				HB755X.620
E350		2010-2013		0054201320		HB754X.726		
E350		2010-2013		0054209420				HB755X.620
E350	4Matic	2010-2013		0054201320		HB754X.726		

BRAKE PAD APPLICATIONS

Hawk Performance - BRAKE PAD APPLICATIONS

HB
HAWK BRAKE

245
PAD SHAPE

x
INSERT COMPOUND CODE

.631
PAD THICKNESS

MAKE/ MODEL	SUBMODEL	YEARS	ENGINE (LITER)	NOTE	FRONT		REAR	
					OES	HB SERIES	OES	HB SERIES
MERCEDES-BENZ CONTINUED								
E350	4Matic	2010-2013		0054209420				HB755X.620
E350	Coupe	2010-2014		0054201320		HB754X.726		
E350	Coupe	2010-2014		0054204220				HB753X.666
E350	4Matic	2013-2014		0074206020				HB753X.666
E350	4Matic	2014		0074205820		HB754X.726		
E350	4Matic	2014		0074206820				HB755X.620
E350		2014-2015		0074205820		HB754X.726		
E350		2014-2015		0074206820				HB755X.620
E400		2013						HB755X.620
E400		2013-2014		0054201320		HB754X.726		
E400		2014		0054209420				HB755X.620
E400		2015		0074205820		HB754X.726		
E400		2015		0074206020				HB753X.666
E400	Sedan	2015		0074205820		HB754X.726		
E400	Sedan	2015		0074206820				HB755X.620
E420		1994-1995		0014209520				HB371X.600
E420		1997	All			HB495X.756		
E420		1997		With 1 Pin Pad Rear Caliper; (W210)		HB495X.756		
E420		1997		With 2 Pin Pad Rear Caliper; (W210)		HB495X.756		HB371X.600
E430		1998-1999		With 2 Pin Pad Rear Caliper		HB495X.756		HB371X.600
E430	Rear: One retaining pin	1998-1999		0034202920		HB495X.756		
E430		1998-2000		With 1 Pin Pad Rear Caliper		HB495X.756		
E430		2000-2002	All			HB495X.756		
E430	4Matic	2000-2002	All			HB497X.776		
E430		2000		With 2 Pin Pad Rear Caliper; Except 4Matic AWD		HB495X.756		HB371X.600
E430		2000-2002		0034202920		HB495X.756		
E430		2000-2002		4Matic AWD		HB497X.776		HB371X.600
E430		2001-2002		Except 4Matic AWD		HB495X.756		
E500		1994		0014209520				HB371X.600
E500		1995						HB371X.600
E500		2003						HB755X.620
E500		2003-2006		0044200520		HB497X.776		
E500		2004-2005		4Matic AWD		HB497X.776		HB755X.620
E500		2004-2006		Except 4Matic AWD; With Solid Rear Discs				HB755X.620
E500		2004-2006		Except 4Matic AWD; With Vented Rear Discs				HB755X.620
E500	4Matic, Front: From Vin X 196565	2005-2006		1644200820		HB745X.777		
E500		2006		4Matic AWD		HB743X.795		HB755X.620
E500	4Matic, Front: From Vin X 196564	2006		0034209120		HB497X.776		
E55 AMG		1999-2002	All			HB497X.776		HB371X.600
E55 AMG		1999-2002				HB497X.776		HB371X.600
E55 AMG		2003-2006		0034207120		HB497X.776		
E550		2007-2009		0044209020		HB497X.776		
E550		2007-2009		4Matic AWD		HB743X.795		HB755X.620
E550		2007-2009		RWD, w/Factory Cross-Drilled Rotors (Sport Pkg)				HB755X.620
E550		2007-2009		RWD - With Factory Plain Rotors (Base)				HB755X.620
E550	4Matic	2007-2009		1644200820		HB745X.777		
E550		2010-2011		0054209420				HB755X.620
E550	Coupe	2010-2011		0054201320		HB754X.726		
E550	Coupe	2010-2011		0054204220				HB753X.666
E550		2010-2012		Sedan				HB755X.620
E550	4Matic	2010-2014		0054209420				HB755X.620
E550		2012-2014		0054204220				HB753X.666
E550		2013-2014		4Matic Sedan				HB755X.620
E550		2015		0074205820		HB754X.726		

BRAKE PAD APPLICATIONS

MAKE/ MODEL	SUBMODEL	YEARS	ENGINE (LITER)	NOTE	FRONT		REAR	
					OES	HB SERIES	OES	HB SERIES
MERCEDES-BENZ CONTINUED								
E550		2015		0074206020				HB753X.666
E63 AMG		2007-2009				HB731X.620		
E63 AMG		2010-2013		With Iron Brake Rotors		HB731X.620		
E63 AMG		2014		0074207620		HB731X.620		
E63 AMG S		2014-2015		0074207620		HB731X.620		
E63 AMG S		2016				HB731X.620		
G500		2002-2008	All					HB479X.700
G500		2002-2007		Front axle stamped from R163869; Rear axle stamped from R119849				HB479X.700
G500		2002-2007		Front axle stamped from R163869; Rear axle stamped up to R119848				HB479X.700
G500		2002-2007		Front axle stamped up to R163868; Rear axle stamped from R119849				HB479X.700
G500		2002-2007		Front axle stamped up to R163868; Rear axle stamped up to R119848				HB479X.700
G500		2008						HB479X.700
G55 AMG		2003-2004	All					HB479X.700
G55 AMG		2003-2004						HB479X.700
G55 AMG		2005-2006				HB743X.795		HB744X.660
G55 AMG		2005-2011		0044204020		HB745X.777		
G55 AMG		2007-2011						HB744X.660
G550		2009-2014	All					HB479X.700
G550		2009-2014						HB479X.700
G550		2015		0004209720				HB479X.700
G63 AMG		2013-2014				HB731X.620		HB744X.660
G63 AMG		2015						HB744X.660
G63 AMG		2015		0064207720		HB731X.620		
GL320	19" Wheels	2007		1644201320		HB745X.777		
GL320		2007-2008		330mm (13") Front Rotors		HB743X.795		HB744X.660
GL320	18" Wheels	2007-2008		1644201820		HB745X.777		
GL320		2007-2009		350mm (13.78") Front Rotors		HB743X.795		HB744X.660
GL320		2008-2009		373mm (14.68") Front Rotors		HB745X.777		HB744X.660
GL350		2010-2012		350mm (13.78") Front Rotors		HB743X.795		HB744X.660
GL350		2010-2012		373mm (14.68") Front Rotors		HB745X.777		HB744X.660
GL350		2013		AMG Performance Pkg		HB701X.723		HB742X.690
GL350		2013		Except AMG Performance Pkg		HB701X.723		HB742X.690
GL350		2013-2015				HB741X.723		
GL350		2014		0064203420				HB742X.690
GL350	Blue Tec 4Matic	2015		0074207720				HB742X.690
GL450		2007		1644200820		HB745X.777		
GL450		2007-2008		330mm (13") Front Rotors		HB743X.795		HB744X.660
GL450		2007-2012		350mm (13.78") Front Rotors		HB743X.795		HB744X.660
GL450		2008-2012		373mm (14.68") Front Rotors		HB745X.777		HB744X.660
GL450		2013				HB701X.723		
GL450		2013				HB741X.723		HB742X.690
GL450		2014		0064203420				HB742X.690
GL450		2014-2015				HB741X.723		
GL450		2015		0074207820				HB742X.690
GL450		2016				HB701X.723		HB742X.690
GL500	4Matic	2015		0074207720				HB742X.690
GL500	4Matic	2015		0074207920		HB740X.712		
GL550		2008		330mm (13") Front Rotors		HB743X.795		HB744X.660
GL550		2008-2012		350mm (13.78") Front Rotors		HB743X.795		HB744X.660
GL550		2008-2012		373mm (14.68") Front Rotors		HB745X.777		HB744X.660
GL550		2013		USA - Spec Models		HB740X.712		HB742X.690

BRAKE PAD APPLICATIONS

Hawk Performance - BRAKE PAD APPLICATIONS

HB
HAWK BRAKE

245
PAD SHAPE

x
INSERT COMPOUND CODE

.631
PAD THICKNESS

MAKE/ MODEL	SUBMODEL	YEARS	ENGINE (LITER)	NOTE	FRONT		REAR	
					OES	HB SERIES	OES	HB SERIES
MERCEDES-BENZ CONTINUED								
GL550		2014		0064203420				HB742X.690
GL550		2014		0074200920		HB740X.712		
GL550		2015		0074207820				HB742X.690
GL63 AMG		2013-2014				HB731X.620		HB742X.690
GL63 AMG		2015		0074208620				HB742X.690
GLA45 AMG		2015		0074209020				HB742X.690
GLK250		2013-2014				HB756X.770		
GLK250		2013-2014		0054205120				HB753X.666
GLK250	Rear: Blue Tec 4Matic Front: 4Matic	2015		0074206220				HB753X.666
GLK250	Rear: Blue Tec 4Matic Front: 4Matic	2015		0074207420		HB756X.770		
GLK350		2010		0054205120				HB753X.666
GLK350		2010-2014				HB756X.770		
GLK350		2011-2012		0054204920				HB753X.666
GLK350		2013-2014		0054205120				HB753X.666
GLK350	2WD	2015		0074206220				HB753X.666
GLK350	2WD	2015		0074207420		HB756X.770		
GLK450	4Matic	2014		0074200920		HB740X.712		
ML250		2015				HB741X.723		
ML250		2015		0074208320				HB742X.690
ML320		1998-2002	All			HB505X.654		
ML320		1998-2003		(W163)		HB505X.654		
ML320		2007		(W164)		HB743X.795		HB744X.660
ML320		2007		1644200820		HB745X.777		
ML320		2008-2009		1644201820		HB745X.777		
ML320		2008-2009		With 330mm Front Discs; w/Solid Rear Discs		HB743X.795		HB744X.660
ML320		2008-2009		With 350mm Front Discs; w/Vented Rear Discs		HB743X.795		HB744X.660
ML350		2003-2005	All			HB505X.654		
ML350		2003-2005		(W163)		HB505X.654		
ML350		2006-2007		(W164)		HB743X.795		HB744X.660
ML350		2006-2011		1644200820		HB745X.777		
ML350		2008-2011		w/330mm Front Discs;w/Solid Rear Discs		HB743X.795		HB744X.660
ML350		2008-2011		w/350mm Front Discs; w/Vented Rear Discs		HB743X.795		HB744X.660
ML350	4Matic Sport	2012				HB741X.723		
ML350	Bluetec 4Matic	2012				HB741X.723		
ML350		2012-2013		AMG Sport Pkg		HB701X.723		HB742X.690
ML350		2012-2013		Base		HB701X.723		HB742X.690
ML350		2012-2015				HB741X.723		
ML350	4Matic	2012-2015				HB741X.723		
ML350	Sport	2013-2015				HB741X.723		
ML350		2014		0064204120				HB742X.690
ML350	4Matic	2014		0074208320				HB742X.690
ML350	Sport	2014		0064203420				HB742X.690
ML350		2015		0074208320				HB742X.690
ML350	Sport	2015		0074207820				HB742X.690
ML400		2015		0074207820				HB742X.690
ML430		1999				HB505X.654		
ML430		2000-2001		1634200620		HB497X.776		
ML450		2010-2011		1644200820		HB745X.777		
ML450		2010-2011		Models w/330mm (13") Front Rotors and Solid Rear Rotors		HB743X.795		HB744X.660
ML450		2010-2011		Models with 330mm (13") Front Rotors and Vented Rear Rotors		HB743X.795		HB744X.660
ML450		2010-2011		Models with 350mm (13.78") Front Rotors		HB743X.795		HB744X.660
ML500		2002-2005		1634200820		HB497X.776		

BRAKE PAD APPLICATIONS



MAKE/ MODEL	SUBMODEL	YEARS	ENGINE (LITER)	NOTE	FRONT		REAR	
					OES	HB SERIES	OES	HB SERIES
MERCEDES-BENZ CONTINUED								
ML500		2006-2007		1644200820		HB745X.777		
ML500		2006-2007		W164; Except Sport; With Solid Rear Discs		HB743X.795		HB744X.660
ML500		2006-2007		W164; Except Sport; With Vented Rear Discs		HB743X.795		HB744X.660
ML500		2006-2007		W164; Sport		HB743X.795		HB744X.660
ML55 AMG		2000-2003		1634200820		HB497X.776		
ML550		2008-2011		1644201820		HB745X.777		
ML550		2008-2011		Models with 330mm (13") Front Rotors and Solid Rear Rotors		HB743X.795		HB744X.660
ML550		2008-2011		Models with 330mm (13") Front Rotors and Vented Rear Rotors		HB743X.795		HB744X.660
ML550		2008-2011		Models with 350mm (13.78") Front Rotors		HB743X.795		HB744X.660
ML550		2012-2014				HB740X.712		HB742X.690
ML63 AMG		2012-2014				HB731X.620		HB742X.690
ML63 AMG		2015		0074208620				HB742X.690
R320		2007		1644200820		HB745X.777		
R320		2007-2009		Models with 330mm (13") Front Rotors and Solid Rear Rotors		HB743X.795		HB744X.660
R320		2007-2009		Models with 330mm (13") Front Rotors and Vented Rear Rotors		HB743X.795		HB744X.660
R320		2007-2009		Models with 350mm (13.78") Front Rotors		HB743X.795		HB744X.660
R320		2008		1644201820		HB745X.777		
R320		2009		1644200820		HB745X.777		
R350		2006-2012		1644200820		HB745X.777		
R350		2006-2012		Models with 330mm (13") Front Rotors and Solid Rear Rotors		HB743X.795		HB744X.660
R350		2006-2012		Models with 330mm (13") Front Rotors and Vented Rear Rotors	HB743X.795			HB744X.660
R350		2006-2012		Models with 350mm (13.78") Front Rotors		HB743X.795		HB744X.660
R500		2006-2007		1644200820		HB745X.777		
R500		2006-2007		Models with 330mm (13") Front Rotors and Solid Rear Rotors		HB743X.795		HB744X.660
R500		2006-2007		Models with 330mm (13") Front Rotors and Vented Rear Rotors	HB743X.795			HB744X.660
R500		2006-2007		Models with 350mm (13.78") Front Rotors		HB743X.795		HB744X.660
S320		1994-1999		ATE Front Calipers				HB371X.600
S320		1994-1999		Girling Front Calipers				HB371X.600
S350		1994-1995		ATE Front Calipers				HB371X.600
S350		1994-1995		Girling Front Calipers				HB371X.600
S350		2006		0044200520		HB497X.776		
S350		2006		W220				HB755X.620
S350	Sport	2012		0064200120				HB755X.620
S350		2012-2013		Sport Package				HB755X.620
S350		2012-2013		Without Sport Package				HB755X.620
S400		2010-2013		Sport Package				HB755X.620
S400		2010-2013		Without Sport Package				HB755X.620
S420		1994-1999						HB371X.600
S430		2000-2002		0044200420		HB497X.776		
S430		2003-2004	All			HB497X.776		
S430		2003		RWD; Solid Rear Rotors				HB755X.620
S430		2003-2006		0034208920		HB497X.776		
S430		2003-2006		4Matic AWD		HB497X.776		HB755X.620
S430		2004-2006		RWD				HB755X.620
S430	4Matic	2005-2006	All			HB497X.776		
S500		1994-1999						HB371X.600
S500		2000-2002		0044200420		HB497X.776		
S500	Armored	2000-2006		0034203020				HB371X.600

BRAKE PAD APPLICATIONS

Hawk Performance - BRAKE PAD APPLICATIONS

HB
HAWK BRAKE

245
PAD SHAPE

x
INSERT COMPOUND CODE

.631
PAD THICKNESS

MAKE/ MODEL	SUBMODEL	YEARS	ENGINE (LITER)	NOTE	FRONT		REAR	
					OES	HB SERIES	OES	HB SERIES
MERCEDES-BENZ CONTINUED								
S500		2002-2003		From 9/02; 4Matic AWD		HB497X.776		HB755X.620
S500		2003-2004	All			HB497X.776		
S500		2003-2006		0034208920		HB497X.776		
S500	Sport Package	2003-2006		0044200420		HB497X.776		
S500		2004-2006		4Matic AWD		HB497X.776		HB755X.620
S500		2004-2006		RWD				HB755X.620
S500	4Matic	2005-2006	All			HB497X.776		
S55 AMG		2001-2002		0034204220		HB497X.776		
S55 AMG	Rear: From Vin A 315856	2003		0034207120		HB497X.776		
S55 AMG		2004-2006		0034207120		HB497X.776		
S550		2007-2008		RWD				HB755X.620
S550		2007-2011		4Matic AWD				HB755X.620
S550		2009-2011		RWD - Sport Package				HB755X.620
S550		2009-2013		RWD - Base				HB755X.620
S550		2012-2013		4Matic AWD - AMG Sport Package				HB755X.620
S550		2012-2013		4Matic AWD - Base				HB755X.620
S550		2012-2013		RWD - AMG Sport Package				HB755X.620
S600		1994-1999						HB371X.600
S600		2001-2002		0044200420		HB497X.776		
S600		2003-2006		0044200820		HB497X.776		
S600	Armored	2003-2006		0044200820		HB497X.776		
S600		2007-2013		Exc. Armored Vehicle				HB755X.620
S600		2014		0064200120				HB755X.620
S600		2015		0084201020		HB731X.620		
S65 AMG		2015		0004204400		HB731X.620		
SL320		1994		0014209520				HB371X.600
SL320		1995-1996		From CHNUMBER F125157 (290mm Rear Rotor)				HB371X.600
SL320		1997						HB371X.600
SL500		1994-1995		0014209520				HB371X.600
SL500		1996-1998		Solid Rear Rotors				HB371X.600
SL500		1996-1998		Vented Rear Rotors				HB371X.600
SL500		1999-2002						HB371X.600
SL500		1999-2002		0034200820		HB497X.776		
SL500		2003		0044200520		HB497X.776		
SL500		2003		From Chassis Number F063165				HB755X.620
SL500		2003		Up to Chassis Number F063164				HB755X.620
SL500		2004-2006						HB755X.620
SL500		2004-2006		0034208920		HB497X.776		
SL55 AMG		2003-2006		0034207120		HB497X.776		
SL55 AMG		2007-2008		6 Piston Front Calipers		HB731X.620		
SL55 AMG	Performance Package	2007-2008		0044208420		HB731X.620		
SL550		2007-2008						HB755X.620
SL550		2007-2009		0044209020		HB497X.776		
SL550		2009		Exc. Sport Package				HB755X.620
SL550		2009		Sport Package				HB755X.620
SL550		2011-2012		0044209020		HB497X.776		
SL550		2011-2012		0064200120				HB755X.620
SL550		2011-2012		Exc. Sport Package				HB755X.620
SL550		2011-2012		Sport Package				HB755X.620
SL550	Sport	2011-2012		0064200120				HB755X.620
SL600		1994-2002						HB371X.600
SL600		2000-2002		0034200820		HB497X.776		
SL600		2004-2007		0034207120		HB497X.776		
SL600		2008-2009				HB731X.620		

BRAKE PAD APPLICATIONS

MAKE/ MODEL	SUBMODEL	YEARS	ENGINE (LITER)	NOTE	FRONT		REAR	
					OES	HB SERIES	OES	HB SERIES
MERCEDES-BENZ CONTINUED								
SL63 AMG		2009				HB731X.620		
SL63 AMG		2011-2012		Except Performance Package (360mm Front Rotors)		HB731X.620		
SL63 AMG		2011-2012		Performance Package (390mm Front Rotors)		HB731X.620		
SL63 AMG		2013-2014		Iron Brake Rotors		HB731X.620		
SL63 AMG		2015		0084203020		HB731X.620		
SL65 AMG		2007-2008				HB731X.620		
SL65 AMG		2009		0044208420		HB731X.620		
SL65 AMG		2009		Base		HB731X.620		
SL65 AMG		2009		Black Series		HB731X.620		
SL65 AMG		2011		0044208420		HB731X.620		
SL65 AMG		2011		Base		HB731X.620		
SL65 AMG		2011		Performance Package		HB731X.620		
SL65 AMG		2013-2014		Iron Brake Rotors		HB731X.620		
SL65 AMG		2015		0084203020		HB731X.620		
SLK250		2012-2014		0064207120		HB752X.769		
SLK250	Sport	2012-2014		0064202820		HB754X.726		
SLK250		2015		0074209220		HB752X.769		
SLK250	Sport	2015		0074207520		HB754X.726		
SLK280		2006-2008	All			HB504X.740		
SLK280		2006-2008		Except Sport		HB504X.740		
SLK300		2009-2011	All	With Sport Package		HB504X.740		
SLK300		2009-2011	All	Without Sport Package		HB504X.740		
SLK300		2009-2011		0034206020		HB504X.740		
SLK32 AMG		2002-2004	All			HB497X.776		HB371X.600
SLK32 AMG		2002-2004				HB497X.776		HB371X.600
SLK320		2001-2004				HB495X.756		
SLK350		2005		0044200520		HB497X.776		
SLK350	Front: To 01/03/2006	2006		0044200520		HB497X.776		
SLK350		2012-2014		0064202820		HB754X.726		
SLK350		2015		0074207520		HB754X.726		
SLK55 AMG		2005-2006	All	w/o Performance Package		HB616X.607		
SLK55 AMG		2005-2010				HB616X.607		
SLK55 AMG		2005-2010		0044209020		HB497X.776		
SLK55 AMG		2005-2010		Performance Package		HB616X.607		
SLK55 AMG		2007	All	w/Performance Package		HB616X.607		
SLK55 AMG		2007-2010		0034203020				HB371X.600
SLK55 AMG		2008-2010	All			HB616X.607		
SLK55 AMG		2012-2013		1 Piece Brake Rotors				HB742X.690
SLK55 AMG		2012-2013		2 Piece Brake Rotors				HB742X.690
SLK55 AMG		2014		0064206820				HB742X.690
SLK55 AMG		2015		0074209020				HB742X.690
SLR McLaren		2005-2008		0044204620		HB497X.776		
SLS AMG		2011-2014		Cast Iron Brake Rotors		HB731X.620		
SLS AMG		2015		0074206520		HB731X.620		
Sprinter 2500		2002	All					HB479X.700
Sprinter 2500	Teves Calipers 16" Wheels	2002-2003		0044202720				HB479X.700
Sprinter 2500		2004	All					HB479X.700
Sprinter 2500	16" Wheels	2004-2005		0044202720				HB479X.700
Sprinter 3500	16" Wheels	2002		0044202720				HB479X.700
Sprinter 3500		2003		0044202720				HB479X.700
MERCURY								
Colony Park		1971-1974				HB292X.674		
Colony Park		1987-1991	All			HB125X.650		

BRAKE PAD APPLICATIONS



Hawk Performance - BRAKE PAD APPLICATIONS

HB
HAWK BRAKE

245
PAD SHAPE

x
INSERT COMPOUND CODE

.631
PAD THICKNESS

MAKE/ MODEL	SUBMODEL	YEARS	ENGINE (LITER)	NOTE	FRONT		REAR	
					OES	HB SERIES	OES	HB SERIES
MERCURY CONTINUED								
Comet	6 Cyl	1968				HB646X.526		
Cougar		1967				HB471X.510		
Cougar		1968-1973	All			HB646X.526		
Cougar	XR-7	1974-1979	All			HB292X.674		
Cougar		1975-1979	All			HB292X.674		
Cougar	Brougham Villager	1977	All			HB292X.674		
Cougar	Brougham	1977	All			HB292X.674		
Cougar	XR-7	1987-1988	All		770431	HB263X.650		
Cougar		1987-1988		Rear Disc		HB125X.650		HB580X.627
Cougar	LS	1989-1992	All			HB240X.620		
Cougar	XR-7	1989-1992	All			HB240X.620		HB580X.627
Cougar	XR7	1989-1992		E9SZ2200B				HB580X.627
Cougar	XR-7	1993-1997	All			HB182X.660		
Cougar		1993-1995		With Rear Disc Brakes		HB182X.660		
Cougar		1993-1997		with Rear Drums		HB182X.660		
Cougar		1996-1997	All	With Sport Package		HB416X.689		
Cougar		1996-1997		Sport Package		HB416X.689		
Cougar		1996-1997		w/Rear Disc Brakes - except Sport Package		HB182X.660		
Cougar		1999-2002	All	w/Rear Discs, With 260mm Front Discs		HB420X.724		
Cougar		1999-2002	All	w/Rear Discs, With 278mm Front Discs		HB420X.724		
Cougar		1999-2002		w/Rear Disc Brakes - 260mm Front Rotors w/oPad Wear Sensors		HB420X.724		HB510X.580
Cougar		1999-2002		w/Rear Disc Brakes - 278mm Front Rotors without Pad Wear Sensors		HB420X.724		HB510X.580
Cougar		1999-2002		w/Rear Drums - No pad wear sensor in front pads		HB420X.724		
Cougar		2000-2002		XS8Z2001CA		HB420X.724		
Cougar	S	2001	All			HB420X.724		
Cyclone		1971				HB292X.674		
Grand Marquis		1975-1978	All			HB292X.674		
Grand Marquis		1979-1981				HB125X.650		
Grand Marquis	Sta.Wagon,Police,Taxi	1979-1981				HB125X.650		
Grand Marquis		1981-1994	All			HB125X.650		
Grand Marquis	Police	1981-1984				HB125X.650		
Grand Marquis	Police & Taxi	1982-1984				HB125X.650		
Grand Marquis	Colony Park	1983	All			HB125X.650		
Grand Marquis	Front: Police & Station Wagon	1985-1986		E2AZ2001E		HB125X.650		
Grand Marquis	Front: Police	1987-1989		E2AZ2001E		HB125X.650		
Grand Marquis	Front: Police	1990-1991		F4AZ2001D		HB125X.650		
Grand Marquis	Police	1992		F4AZ2001D		HB125X.650		
Grand Marquis	Police, Front: From 06/10/1993	1993		F4AZ2001C		HB125X.650		
Grand Marquis	Police, Front: To 06/10/1993	1993		F4AZ2001D		HB125X.650		
Grand Marquis	Front: Steel piston	1994		F4AZ2001B		HB125X.650		
Grand Marquis	Police	1994		F4AZ2001C		HB125X.650		
Grand Marquis	Police	1996		F6AZ2200BA				HB341X.618
Grand Marquis		1997		F6AZ2200CA				HB341X.618
Grand Marquis		1998-2002	All			HB294X.646		
Grand Marquis		1998-2001		with Phenolic (Plastic) Piston Rear Caliper		HB294X.646		HB520X.575
Grand Marquis		1998-2002		with Steel Piston Rear Caliper		HB294X.646		HB341X.618
Grand Marquis		2002		with Phenolic (Plastic) Piston Rear Caliper		HB294X.646		
Grand Marquis		2002		with Phenolic (Plastic) Piston Rear Caliper				HB520X.575
Grand Marquis		2003-2011	All			HB433X.654		
Grand Marquis		2003-2011				HB433X.654		HB443X.614
Grand Marquis	GS	2006-2011	All			HB433X.654		
Grand Marquis	LS	2006-2011	All			HB433X.654		
Marauder		2003-2004	All		770931	HB433X.654	770932	HB443X.614

BRAKE PAD APPLICATIONS



MAKE/ MODEL	SUBMODEL	YEARS	ENGINE (LITER)	NOTE	FRONT		REAR	
					OES	HB SERIES	OES	HB SERIES
MERCURY CONTINUED								
Marauder		2003-2004				HB433X.654		HB443X.614
Mariner		2005	All			HB473X.752		
Mariner		2005-2006		Rear Drum Brakes		HB473X.752		
Mariner	Convenience	2006-2007	All			HB473X.752		
Mariner	Hybrid	2007	All			HB473X.752		
Mariner		2007		w/Rear Drums		HB473X.752		
Mariner		2008-2011			771047			
Marquis	Interceptor	1971				HB292X.674		
Marquis	Police	1971				HB292X.674		
Marquis		1971-1972				HB292X.674		
Marquis		1973-1975	All			HB292X.674		
Marquis		1976-1978				HB292X.674		
Marquis	Sta.Wagon,Police,Taxi	1979-1981				HB125X.650		
Marquis		1979-1982				HB125X.650		
Marquis	Police	1981-1982				HB125X.650		
Marquis	Station Wagon	1981-1982				HB125X.650		
Marquis	Police & Taxi	1982				HB125X.650		
Meteor	(Canada)	1966-1967				HB103X.590		
Meteor	(Canada) 6 Cylinder	1971-1972				HB292X.674		
Meteor	(Canada) 8 Cylinder	1971-1972				HB292X.674		
Meteor	(Canada) Station Wagon	1971-1973				HB292X.674		
Meteor	(Canada)	1973				HB292X.674		
Milan		2006-2011	All		771164	HB565X.688		
Milan	Premier	2006-2011	All		771164	HB565X.688		
Milan		2006-2011				HB565X.688		HB564X.567
Montego		1968-1969	All			HB646X.526		
Montego	Includes Station Wagon	1970		6 cylinder		HB646X.526		
Montego	Includes Station Wagon	1970		8 Cylinder		HB646X.526		
Montego		1971	All			HB646X.526		
Montego	GT	1972-1973	All			HB292X.674		
Montego		1972-1976	All			HB292X.674		
Montego	MX Brougham	1972-1976	All			HB292X.674		
Montego	MX	1972-1976	All			HB292X.674		
Montego	Villager	1972-1976	All			HB292X.674		
Montego		2005				HB723X.665		
Montego		2006-2007				HB723X.665		HB724X.637
Monterey	Car	1971-1974				HB292X.674		
Mountaineer		1997-2001	All	AWD/4WD	770652	HB283X.650	770667	HB287X.571
Mountaineer		1997-2001	All	RWD	770652	HB283X.650	770667	HB287X.571
Mountaineer		1997-2001		2WD		HB283X.650		HB287X.571
Mountaineer		1997-2001		4WD		HB283X.650		HB287X.571
Mountaineer		2002	All		770833		770881	
Mountaineer		2002-2005	All			HB472X.650		
Mountaineer		2002-2005				HB472X.650		HB520X.575
Mountaineer		2003-2005	All		770833			
Mountaineer	Premier	2004	All		770833	HB472X.650		
Mountaineer		2006-2010	All		771158	HB612X.690		
Mountaineer		2006				HB612X.690		HB520X.575
Mountaineer		2007-2010				HB612X.690		HB613X.589
Mystique	Young America	1995	All			HB420X.724		
Mystique	GS	1995-1998	All			HB420X.724		
Mystique	LS	1995-1998	All			HB420X.724		
Mystique		1995-1997		with Rear Discs		HB420X.724		HB510X.580
Mystique		1995-1997		with Rear Drums		HB420X.724		
Mystique		1998		XS8Z2001BA		HB420X.724		

BRAKE PAD APPLICATIONS



Hawk Performance - BRAKE PAD APPLICATIONS

HB **245** **x** **.631**
 HAWK BRAKE PAD SHAPE INSERT COMPOUND CODE PAD THICKNESS

MAKE/ MODEL	SUBMODEL	YEARS	ENGINE (LITER)	NOTE	FRONT		REAR	
					OES	HB SERIES	OES	HB SERIES
MERCURY CONTINUED								
Mystique		1998-2000		With Rear Discs; w/o Sensor on Front Pads		HB420X.724		HB510X.580
Mystique		1998-2000		With Rear Discs; w/Sensor on Front Pads				HB510X.580
Mystique		1998-2000		With Rear Drums; w/o Sensor on Front Pads		HB420X.724		
Mystique		1999-2000	All			HB420X.724		
Mystique	Rear: Drum 2.0 Ltr	1999-2000		XS8Z2001BA		HB420X.724		
Sable		1986-1991		2U2Z2V001GA		HB240X.620		
Sable	Station Wagon	1986-1991		2U2Z2V001GA		HB240X.620		
Sable		1989-1993	All			HB240X.620		
Sable		1990-1992		F20Y2200B				HB580X.627
Sable	Station Wagon	1991-1992		F20Y2200B				HB580X.627
Sable	Rear Drum: To 03/15/1992	1992		F2DZ2001A		HB240X.620		
Sable	Station Wagon, Rear Drum: To 03/15/1992	1992		F2DZ2001A		HB240X.620		
Sable		1993						HB417X.659
Sable		1993		F3DZ2001A		HB240X.620		
Sable	Station Wagon	1993		F3DZ2001A		HB240X.620		
Sable		1993-1998		F2DZ2200B				HB417X.659
Sable		1994-2000	All			HB347X.689		
Sable		1994-2000				HB347X.689		HB417X.659
Sable		1999-2005		YF1Z2200AA				HB417X.659
Sable	Police	2001		F4DZ2001B		HB347X.689		
Sable		2001-2002		1F1Z2001AA		HB416X.689		
Sable	Station Wagon	2001-2002		1F1Z2001AA		HB416X.689		
Sable		2001-2003		Station Wagon		HB275X.660		
Sable		2001-2005				HB275X.660		HB417X.659
Sable		2001-2005				HB416X.689		HB417X.659
Sable		2002-2005	All			HB416X.689		
Sable	Station Wagon	2003		3F1Z2001BA		HB416X.689		
Sable		2003-2005		3F1Z2001BA		HB416X.689		
Sable		2008-2009				HB723X.665		HB724X.637
Tracer		1991-1993	All			HB246X.567		HB157X.484
Tracer	LTS	1991-1996	All			HB246X.567		HB157X.484
Tracer	Front: 1.9 Ltr Rear Drum: 1.9 Ltr Only	1991-1993		F1CZ2001A		HB246X.567		
Tracer	Trio	1994-1996	All			HB246X.567		
Tracer	LS	1997-1998	All			HB246X.567		HB159X.492
Tracer	Trio	1997-1998	All			HB246X.567		HB159X.492
Tracer		1997-1999		F7CZ2200BA				HB159X.492
Tracer		1997-1999		F7CZ2200CA				HB159X.492
Tracer		1999		XS4Z2001AA		HB246X.567		
Villager		1993-2002	All			HB414X.622		
Villager		1993-2002				HB414X.622		
MG								
1100		1962-1966				HB123X.535		
MGA		1958				HB172X.595		HB172X.595
MGA		1959				HB172X.595		HB172X.595
MGB		1962-1966				HB132X.580		
MGB	GT	1967-1974	All			HB132X.580		
MGB		1967-1980	All			HB132X.580		
MGB		1981				HB132X.580		
Midget	1098cc	1962-1965				HB123X.535		
Midget		1966-1979	All			HB123X.535		
MINI								
Cooper		2002-2005				HB444X.685		HB445X.610
Cooper	JC Works Brakes	2002-2005		34116770251		HB560X.677		
Cooper		2006	All	John Cooper Works		HB560X.677		



MAKE/ MODEL	SUBMODEL	YEARS	ENGINE (LITER)	NOTE	FRONT		REAR	
					OES	HB SERIES	OES	HB SERIES
MINI CONTINUED								
Cooper	S	2006-2008	All	John Cooper Works		HB560X.677		
Cooper		2006		w/o John Cooper Sport Brakes		HB444X.685		
Cooper		2006		With or Without John Cooper Sport Brakes				HB445X.610
Cooper	Convertible	2007-2008	All	John Cooper Works		HB560X.677		
Cooper	S Convertible	2007-2008	All	John Cooper Works		HB560X.677		
Cooper	Convertible	2007-2009	All			HB570X.666		
Cooper	S Convertible	2007-2009	All			HB444X.685		
Cooper		2007-2014	All			HB570X.666		
Cooper	S	2007-2014	All			HB560X.677		
Cooper		2007		Convertible; w/John Cooper Works Kit; 2 94mm Front Rotor		HB560X.677		HB445X.610
Cooper		2007		Convertible; w/o John Cooper Works Kit; 276mm Front Rotor		HB444X.685		HB445X.610
Cooper		2007		Coupe; Except S; 280mm Front Rotor		HB570X.666		HB574X.636
Cooper		2007		Coupe; S; 294mm Front Rotor		HB560X.677		HB574X.636
Cooper		2007		Coupe; w/John Cooper Works Kit; 294mm Front Rotor		HB560X.677		HB574X.636
Cooper		2007-2015				HB570X.666		
Cooper	S Clubman	2008-2010	All			HB560X.677		
Cooper	Clubman	2008-2014	All			HB570X.666		
Cooper		2008		Convertible; w/John Cooper Works Brake Kit; 294mm Front Rotor		HB560X.677		HB445X.610
Cooper		2008		Convertible; w/o John Cooper Works Brake Kit; 276mm Front Rotor		HB444X.685		HB445X.610
Cooper		2008		Coupe and Clubman; Except S Model; 280mm Front Rotor		HB570X.666		HB574X.636
Cooper		2008		Coupe and Clubman; S Model; 294mm Front Rotor		HB560X.677		HB574X.636
Cooper		2008		Coupe and Clubman; w/John Cooper Works Brake Kit; 294mm Front Rotor		HB560X.677		HB574X.636
Cooper	Base	2009-2014	All	John Cooper Works		HB640X.550		
Cooper		2009-2011		Base Model; 280mm Front Rotor		HB570X.666		HB574X.636
Cooper		2009-2011		Cooper S; Exc. JCW Brakes; 294mm Front Rotor		HB560X.677		HB574X.636
Cooper		2009-2011		Models w/John Cooper Works Big Brake Kit; 316mm Front Rotor		HB640X.550		HB574X.636
Cooper		2009-2011		Models w/John Cooper Works Brakes; 294mm Front Rotor		HB560X.677		HB574X.636
Cooper	Countryman	2011-2014	All			HB560X.677		
Cooper		2012-2013		Base Model; 280mm Front Rotor - MFG After 12/2011		HB570X.666		HB574X.636
Cooper		2012-2013		Base Model; 280mm Front Rotor - MFG Before 12/2011		HB570X.666		HB574X.636
Cooper		2012-2013		Cooper S; Exc. JCW Brakes; 294mm Front Rotor - MFG Before 12/2011		HB560X.677		HB574X.636
Cooper		2012-2013		Models w/John Cooper Works Big Brake Kit; 316mm Front Rotor - MFG After 12/2011		HB560X.677		HB574X.636
Cooper		2012-2013		Models w/John Cooper Works Big Brake Kit; 316mm Front Rotor - MFG Before 12/2011		HB640X.550		HB574X.636
Cooper		2012-2013		Models w/John Cooper Works Brakes; 294mm Front Rotor - MFG Before 12/2011		HB560X.677		HB574X.636
Cooper	JC Works Brakes GP	2013		34106860642		HB603X.616		
Cooper		2014-2015		34216794059				HB574X.636
Cooper	JC Works Brakes	2014-2015		34216778327				HB574X.636
Cooper	S	2014-2015		34216794059				HB574X.636
Cooper		2015	1.5L	34106863292		HB570X.666		
Cooper		2015	1.5 Liter			HB570X.666		
Cooper		2015		34116794056		HB570X.666		
Cooper	JC Works Brakes	2015		34116789157		HB640X.550		
Cooper	S	2015		34116798469		HB560X.677		

BRAKE PAD APPLICATIONS

Hawk Performance - BRAKE PAD APPLICATIONS

HB
HAWK BRAKE

245
PAD SHAPE

x
INSERT COMPOUND CODE

.631
PAD THICKNESS

MAKE/ MODEL	SUBMODEL	YEARS	ENGINE (LITER)	NOTE	FRONT		REAR	
					OES	HB SERIES	OES	HB SERIES
MINI CONTINUED								
Cooper Countryman		2011-2013		294mm Front Rotor		HB560X.677		
Cooper Countryman		2011-2013		307mm Front Rotor		HB560X.677		
Cooper Countryman		2011-2013		John Cooper Works Brake Package		HB560X.677		
Cooper Countryman		2014-2015		34119808705		HB560X.677		
Cooper Paceman		2013		294mm Front Rotor		HB560X.677		
Cooper Paceman		2013		307mm Front Rotor		HB560X.677		
Cooper Paceman		2013		John Cooper Works Brake Package		HB560X.677		
Cooper Paceman		2014-2015		34119808705		HB560X.677		
MITSUBISHI								
3000GT	VR-4	1991-1998	All			HB120X.560		
3000GT		1991-1992		VR-4		HB120X.560		HB673X.602
3000GT		1991-1998		except VR4		HB214X.618		HB367X.585
3000GT		1993		VR-4; From 6/93		HB120X.560		HB201X.620
3000GT		1993		VR-4; To 5/93		HB120X.560		HB673X.602
3000GT		1994-1999		VR-4		HB120X.560		HB201X.620
3000GT		1999		Except VR-4		HB214X.618		HB367X.585
Diamante		1992-1996		Sedan		HB214X.618		HB367X.585
Diamante		1992-1996		Wagon		HB214X.618		HB673X.602
Diamante		1997-2004				HB214X.618		
Eclipse		1990-1991		AWD Turbo		HB213X.626		
Eclipse		1990-1993		2WD Turbo		HB213X.626		
Eclipse		1990-1993		Non Turbo		HB213X.626		
Eclipse		1992		AWD Turbo, From 6/92		HB214X.618		
Eclipse		1992		AWD Turbo, To 5/92		HB213X.626		
Eclipse		1993		AWD Turbo		HB214X.618		
Eclipse		1994		2WD Turbo from 1/94		HB213X.626		HB367X.585
Eclipse		1994		2WD Turbo to 12/93		HB213X.626		
Eclipse		1994		AWD Turbo to 12/93		HB214X.618		
Eclipse		1994		Non Turbo from 1/94		HB213X.626		HB367X.585
Eclipse		1994		Non Turbo to 12/93		HB213X.626		
Eclipse		1994-1995		AWD Turbo, from 1/94 to 10/94		HB214X.618		HB673X.602
Eclipse		1995		AWD Turbo, from 11/94		HB214X.618		HB367X.585
Eclipse		1995-1999		2WD Turbo		HB213X.626		HB367X.585
Eclipse		1995-1999		Non Turbo		HB213X.626		HB367X.585
Eclipse		1996-1999		AWD Turbo		HB214X.618		HB367X.585
Eclipse		2000		V6		HB214X.618		HB367X.585
Eclipse	Front from 06/2000	2000		MR527674		HB435X.622		
Eclipse	Front to 05/2000	2000		MR569592		HB214X.618		
Eclipse		2000-2001		4 Cylinder		HB213X.626		
Eclipse		2001-2005		V6		HB435X.622		HB367X.585
Eclipse		2002-2005		4 Cylinder		HB435X.622		
Eclipse	GS	2006-2012	All	4 Cyl				HB367X.585
Eclipse	Non-Turbo GS	2006-2008		4 Cyl. Only				HB367X.585
Eclipse		2006-2012		4 Cylinder		HB435X.622		HB367X.585
Eclipse		2006-2012		V6		HB435X.622		HB673X.602
Eclipse	Non-Turbo GT	2006-2012		6 Cyl. Only				HB673X.602
Eclipse	4 Cyl.	2010-2012		4605A684		HB435X.622		
Eclipse	6 Cyl.	2010-2012		4605A684		HB435X.622		
Endeavor		2004-2008						HB675X.602
Endeavor		2010-2011						HB675X.602
Expo	SP	1992-1993	All			HB213X.626		HB367X.585
Expo		1992-1995	All			HB213X.626		
Expo		1994-1995		MR129433				HB367X.585
Expo LRV		1992-1994	All			HB213X.626		
Expo LRV	Sport	1992-1994	All			HB213X.626		HB367X.585

BRAKE PAD APPLICATIONS

MAKE/ MODEL	SUBMODEL	YEARS	ENGINE (LITER)	NOTE	FRONT		REAR	
					OES	HB SERIES	OES	HB SERIES
MITSUBISHI CONTINUED								
Expo LRV		1992-1994		MB699334				HB367X.585
Galant		1988		MB699056				HB367X.585
Galant	Non-Turbo	1989-1993	All				HB213X.626	
Galant	Turbo	1990-1993	All				HB214X.618	
Galant		1990		Rear Disc Models			HB213X.626	
Galant		1990		Rear Drum Models			HB213X.626	
Galant		1991		FWD models - Rear Disc			HB213X.626	
Galant		1991		FWD models - Rear Drum			HB213X.626	
Galant		1991		GSX Models			HB213X.626	
Galant		1991-1992		VR-4 Models			HB214X.618	
Galant		1992		MB699334				HB367X.585
Galant		1992		Rear Disc Models - Exc VR-4			HB213X.626	
Galant		1992-1997		Rear Drum Models			HB213X.626	
Galant		1993		Rear Disc Models MFG After 2/1993			HB213X.626	HB367X.585
Galant		1993		Rear Disc Models MFG Before 1/1993			HB213X.626	
Galant		1994-1998	All	To 1/1998			HB213X.626	
Galant		1994		Rear Disc Models			HB213X.626	HB367X.585
Galant		1998		Rear Drum Models - MFG After 1/1998			HB213X.626	
Galant		1998		Rear Drum Models - MFG Before 1/1998			HB213X.626	
Galant		1999		Rear Disc Models			HB214X.618	HB367X.585
Galant		1999-2001		Rear Drum Models			HB213X.626	
Galant		2000		Rear Disc Models - MFG After 6/2000			HB435X.622	HB367X.585
Galant		2000		Rear Disc Models - MFG Before 5/2000			HB214X.618	HB367X.585
Galant	6 Cyl, Front to 05/2000	2000		MR569592			HB214X.618	
Galant		2001-2003		Rear Disc Models			HB435X.622	HB367X.585
Galant		2002-2003		Rear Drum Models			HB435X.622	
Galant		2004-2007	3.8L	6 Cyl. Only	770866		HB435X.622	
Galant		2004-2006		4 Cyl.			HB435X.622	HB367X.585
Galant		2004-2006		6 Cyl.			HB435X.622	HB367X.585
Galant	Ralliart	2007-2010	3.8L		770866		HB435X.622	HB673X.602
Galant		2007		DE; ES; SE Models			HB435X.622	HB367X.585
Galant		2007		GTS			HB435X.622	HB367X.585
Galant		2007-2008		Ralliart			HB435X.622	HB673X.602
Galant		2008		DE; ES; Models			HB435X.622	HB367X.585
Galant		2009		2.4L 4 Cyl.			HB435X.622	HB367X.585
Galant		2009		3.8L V6			HB435X.622	HB673X.602
Galant		2010-2012					HB435X.622	HB367X.585
Galant		2010-2012		4 Cyl. Only				HB367X.585
Galant		2010-2012		6 Cyl. Only	770866		HB435X.622	770383
Galant	3.8 Liter	2012		4605A684			HB435X.622	
L200		2005-2008	All	(Latin America)	771519			
Lancer	LS	2002-2004	All		770904		HB438X.606	
Lancer		2002-2003		LS, OZ Rally; w/Rear Drums			HB438X.606	
Lancer		2002-2004		ES; w/Rear Drums			HB438X.606	
Lancer		2002-2006		Evolution			HB453X.585	HB180X.560
Lancer	Evolution	2003-2006	All		771001		HB453X.585	HB180X.560
Lancer		2003-2004		MR485499				HB180X.560
Lancer		2003-2006		Evolution	771001			
Lancer	Sportback	2004	All	4 Lugs				HB457X.605
Lancer	Sportback	2004	All	5 Lugs				HB457X.605
Lancer	Ralliart	2004-2006	All	5 Lug	770866		HB435X.622	HB457X.605
Lancer		2004		LS; w/Rear Drums			HB438X.606	
Lancer		2004		OZ Rally; w/Rear Drums			HB438X.606	
Lancer		2004		Sportback, LS, Ralliart; w/Rear Discs; 5 Bolt Wheel			HB435X.622	HB457X.605

BRAKE PAD APPLICATIONS

Hawk Performance - BRAKE PAD APPLICATIONS

HB
HAWK BRAKE

245
PAD SHAPE

x
INSERT COMPOUND CODE

.631
PAD THICKNESS

MAKE/ MODEL	SUBMODEL	YEARS	ENGINE (LITER)	NOTE	FRONT		REAR	
					OES	HB SERIES	OES	HB SERIES
MINI CONTINUED								
Mini		2004		Sportback, LS; Ralliart; w/Rear Discs; 4 Bolt Wheel		HB435X.622		HB457X.605
Mini	Evolution MR	2005-2006	All			HB453X.585		HB180X.560
Mini	Evolution RS	2005-2006	All		771001	HB453X.585		HB180X.560
Mini	Oz Rally	2005-2006	All		770904	HB438X.606		HB457X.605
Mini	ES	2005-2007	All		770904	HB438X.606		
Mini		2005		MR449086				HB180X.560
Mini		2005		With Rear Drums; ES		HB438X.606		
Mini		2005		With Rear Drums; O-Z Rally		HB438X.606		
Mini		2005-2006		Ralliart; w/Rear Discs		HB435X.622		HB457X.605
Mini	Evolution SE	2006	All		771001	HB453X.585		HB180X.560
Mini		2006-2007		MR485499				HB180X.560
Mini		2006-2007		With Rear Drums; w/ABS		HB438X.606		
Mini		2006-2007		With Rear Drums; w/o ABS		HB438X.606		
Mini	DE	2008-2011	All		770866	HB435X.622		HB457X.605
Mini	Evolution	2008-2014	All	1-piece front rotor				HB615X.535
Mini	GTS	2008-2014	All					HB675X.602
Mini	ES	2008-2014	All		770866	HB435X.622		HB457X.605
Mini		2008-2009		DE; w/Rear Drums		HB435X.622		
Mini		2008-2009		ES; w/Rear Discs		HB435X.622		HB457X.605
Mini		2008-2010		GTS; w/Rear Discs		HB435X.622		HB675X.602
Mini		2008-2011		Evolution; 2 Piece Front Rotor	771001	HB453X.585		HB615X.535
Mini		2008-2011		Evolution; Standard Front Rotor	771001	HB453X.585		HB615X.535
Mini	Ralliart	2009-2011	All			HB214X.618		HB675X.602
Mini	Ralliart	2009-2011		4605A717		HB214X.618		
Mini		2009-2012		Ralliart 2.0L Turbo AWD		HB214X.618		HB675X.602
Mini		2010		DE, ES; w/Rear Discs		HB435X.622		HB457X.605
Mini		2011		GTS		HB435X.622		HB675X.602
Mini		2011-2012		DE, ES; w/Rear Drums		HB435X.622		
Mini		2011-2012		ES; w/Rear Discs		HB435X.622		HB457X.605
Mini		2012		GT		HB435X.622		HB675X.602
Mini		2012		SE		HB435X.622		HB457X.605
Mini		2012-2013		Evolution GSR; Standard Front Rotor		HB453X.585		HB615X.535
Mini		2012-2013		Evolution MR; 2 Piece Front Rotor		HB453X.585		HB615X.535
Mini		2013		GT Sportback		HB435X.622		HB675X.602
Mini		2013		ES Sportback		HB435X.622		
Mini		2013		ES Sportback				HB457X.605
Mini		2013		Evolution GSR; Standard Front Rotor	771001			
Mini		2013		Evolution MR; 2 Piece Front Rotor	771001			
Mini	Ralliart	2014	All			HB214X.618		HB675X.602
Mini	SE	2014	All		770866	HB435X.622		HB675X.602
Mini	Evolution	2014		4605A572		HB453X.585		
Mini	Ralliart	2014		4605A717		HB214X.618		
Mighty Max		1983-1984				HB614X.600		
Mighty Max		1985-1986	All			HB614X.600		
Mighty Max	SPX	1987-1989	All			HB404X.642		
Mighty Max		1987-1994	All			HB404X.642		
Mighty Max	LWB	1989	All			HB404X.642		
Mighty Max	SWB	1989	All			HB404X.642		
Mighty Max	LWB	1992	All			HB404X.642		
Mighty Max	SWB	1992	All			HB404X.642		
Mighty Max	SWB	1995	All			HB404X.642		
Mighty Max		1996		MR128799		HB404X.642		
Mirage		1990-1991		Sedan; 1.6L DOHC		HB213X.626		
Mirage		1992		1.6L; w/Rear Discs; From 6/92		HB213X.626		HB213X.626
Mirage		1992		1.6L; w/Rear Discs; To 5/92		HB213X.626		HB213X.626

BRAKE PAD APPLICATIONS

MAKE/ MODEL	SUBMODEL	YEARS	ENGINE (LITER)	NOTE	FRONT		REAR	
					OES	HB SERIES	OES	HB SERIES
MINI CONTINUED								
Mini	2 DR	1993		MB950554		HB213X.626		
Mini	4 DR w/ABS	1993		MB950555		HB213X.626		
Mini	4 DR	1993		MB699334				HB367X.585
Mini	4 DR	1993		MB950555		HB213X.626		
Mini		1994-1996		MB699334				HB367X.585
Mini		1994-1996		MB950554		HB213X.626		
Mini		1994-1996		MB950555		HB213X.626		
Mini		1997		MR389511		HB213X.626		
Mini		1997-1999		MR344164				HB367X.585
Mini		1998-1999		SEDAN; From 6/98 with 14" Wheels		HB213X.626		
Mini		1999		MR389511		HB213X.626		
Mini	2 Door 1.8 Liter	1999		MR344164				HB367X.585
Mini		2000-2002	All			HB213X.626		
Mini	4 Door 1.8 Liter	2000		MR334024				HB367X.585
Mini	4 Door 1.8 Liter	2000		MR389511		HB213X.626		
Mini		2000-2002		MR334023				HB367X.585
Mini		2000-2002		SEDAN; with 14" Wheels		HB213X.626		
Mini		1985-1987		MB193298		HB614X.600		
Mini	Sport	1988-1990	All			HB404X.642		
Mini	LS	1989-1995	All			HB404X.642		
Mini		1989		4 Cyl. Eng.		HB404X.642		
Mini	RS	1991	All			HB404X.642		
Mini		1991-1992		6 Cyl. Eng.		HB214X.618		
Mini		1993		6 Cyl. Eng. - 3.0L SOHC From 3/93		HB214X.618		
Mini		1993		6 Cyl. Eng. - 3.5L DOHC From 3/93		HB214X.618		
Mini		1993		6 Cyl. Eng. To 2/93		HB214X.618		
Mini		1994-1997		6 Cyl. Eng. - 3.0L SOHC		HB214X.618		
Mini		1994-1997		6 Cyl. Eng. - 3.5L DOHC		HB214X.618		
Mini		1998-2000		6 Cyl. Eng. 3.0L SOHC		HB214X.618		
Mini		1998-2000		6 Cyl. Eng. 3.5L DOHC		HB214X.618		
Mini		1999	All			HB214X.618		
Mini		2001-2004		6 Cyl. Eng.				HB675X.602
Mini		2005-2006						HB675X.602
Mini	(Latin America)	2009		4605A481		HB490X.665		
Mini		2010-2011	All	(Latin America)	770976	HB490X.665		
Mini	Sport	1997-1999				HB214X.618		
Mini	Sport	1999-2004	All			HB214X.618		
Mini	Sport	2000-2004		with 15" Wheels		HB214X.618		
Mini	Sport	2000-2004		with 16" Wheels		HB214X.618		HB409X.661
Mini		2003-2004				HB435X.622		
Mini	XLS	2005	All			HB214X.618		
Mini	Limited	2005-2006	All			HB214X.618		HB457X.605
Mini	LS	2005-2006	All			HB214X.618		HB457X.605
Mini		2005-2006				HB214X.618		HB457X.605
Mini	SE	2006	All			HB214X.618		
Mini	ES	2007-2008	All		770866	HB435X.622		
Mini	LS	2007-2008	All		770866	HB435X.622		
Mini	XLS	2007-2008	All		770866	HB435X.622		
Mini		2007				HB435X.622		HB675X.602
Mini		2008-2011		4 Cylinder 5 Passenger Models		HB435X.622		HB675X.602
Mini		2008-2011		4 Cylinder 7 Passenger Models		HB435X.622		HB675X.602
Mini		2008-2011		V6 Models		HB435X.622		HB675X.602
Mini		2009-2014	All		770866	HB435X.622		
Mini		2012				HB435X.622		HB675X.602
Mini		2013		2.0L Models		HB435X.622		HB675X.602

BRAKE PAD APPLICATIONS

Hawk Performance - BRAKE PAD APPLICATIONS

H B **2 4 5** **x** **.6 3 1**
 HAWK BRAKE PAD SHAPE INSERT COMPOUND CODE PAD THICKNESS

MAKE/ MODEL	SUBMODEL	YEARS	ENGINE (LITER)	NOTE	FRONT		REAR	
					OES	HB SERIES	OES	HB SERIES
mitsubishi continued								
Outlander		2013		2.4L AWD Models		HB435X.622		HB675X.602
Outlander		2013		2.4L FWD Models		HB435X.622		HB675X.602
Outlander		2013		3.0L Models		HB435X.622		HB675X.602
Outlander		2014		4605A802				HB675X.602
Outlander Sport		2011	All		770866	HB435X.622		
Outlander Sport		2011				HB435X.622		HB675X.602
Outlander Sport		2013	All		770866	HB435X.622		
Outlander Sport		2013				HB435X.622		
Outlander Sport		2013-2014		4605B070				HB675X.602
Outlander Sport		2014		4605B163		HB435X.622		
Pick-up	2WD, 4WD	1987-1993				HB404X.642		
Pick-up		1994-1995				HB404X.642		
Precis		1987		5810321330		HB169X.560		
Raider	XLS	2006	All			HB559X.695		
Raider	Durocross	2006-2010	All			HB559X.695		
Raider	LS	2006-2010	All			HB559X.695		
Raider		2006-2010				HB559X.695		
Raider	SE	2007-2010	All			HB559X.695		
Sigma		1989-1990		MB699056				HB367X.585
Van		1987-1990	All			HB404X.642		
mitsubishi fuso								
FE	FE434	1989		MC869779		HB407X.602		
FE	FE444	1989		MC869779		HB407X.602		
FE		1990-1992		MC869779		HB407X.602		
FE		1993-1995		MC869778		HB407X.602		
NISSAN								
620		1975-1979				HB169X.560		
720	2WD	1985-1986		4 Cyl. Eng.; except Heavy Duty & Cab & Chassis -From 11/85		HB475X.642		
720	2WD	1985-1986		4 Cyl. Eng. Diesel; exc. Heavy Duty & Cab & Chassis From 11/85		HB402X.669		
720	2WD	1985-1986		V6 Eng.; except Heavy Duty & Cab & Chassis From 11/85		HB402X.669		
720	2WD	1985-1986		with Dual Rr Whl - From 11/85		HB402X.669		
720	2WD	1985-1986		with Single Rr Whl - From 11/85		HB402X.669		
720	4WD	1985-1986		From 11/85		HB402X.669		
810		1977-1980	All			HB169X.560		
810		1981						HB262X.540
200SX		1980-1983						HB262X.540
200SX		1981	All					HB112X.540
200SX	Turbo	1984						HB262X.540
200SX	Turbo	1985		4406001P93				HB262X.540
200SX		1986	1.8L	4106032F86		HB475X.642		
200SX		1986	1.8L	4406001P93				HB262X.540
200SX	2.0L	1986-1987		4406001P93				HB262X.540
200SX		1986-1988				HB475X.642		HB262X.540
200SX		1987-1988	All			HB475X.642		
200SX	2.0L	1987		4106032F86		HB475X.642		
200SX	3.0L	1987		4406001P93				HB262X.540
200SX	3.0L	1987-1988		D106011P26		HB475X.642		
200SX	2.0L	1988		4106032F85		HB475X.642		
200SX		1995-1998	1.6L	w/Rear Drum	770668	HB236X.622		
200SX	SE	1995-1998	1.6L	w/Rear Drum	770668	HB236X.622		HB680X.583
200SX		1995-1998	2.0L	w/Rear Disc	770668	HB236X.622		
200SX	SE	1995-1998	2.0L	w/Rear Disc	770668	HB236X.622		HB680X.583

BRAKE PAD APPLICATIONS



MAKE/ MODEL	SUBMODEL	YEARS	ENGINE (LITER)	NOTE	FRONT		REAR	
					OES	HB SERIES	OES	HB SERIES
NISSAN CONTINUED								
200SX		1995-1996				HB236X.622		HB680X.583
200SX	SE-R	1996-1998	All			HB236X.622		
200SX		1997		1.6 Liter From 8/97; E, XE without ABS		HB236X.622		
200SX		1997-1998		1.6L except E, XE		HB236X.622		HB680X.583
200SX		1997-1998		w 2.0L		HB236X.622		HB680X.583
200SX		1998		1.6 Liter E, XE without ABS		HB236X.622		
240SX	SE	1989-1993	All	Non-ABS		HB231X.625		HB262X.540
240SX	SE	1989-1993	All	4-Wheel ABS	770462	HB235X.665		HB262X.540
240SX		1989-1990		4406035F92				HB262X.540
240SX	With ABS	1989-1990		4406035F92				HB262X.540
240SX		1989-1993		with ABS				HB262X.540
240SX		1989-1993		without ABS		HB231X.625		HB262X.540
240SX	With ABS	1989-1994		41060G8191		HB235X.665		
240SX		1989-1996				HB231X.575		
240SX	LE	1991-1992	All	4-Wheel ABS		HB235X.665		
240SX	LE	1991-1992	All	Non-ABS		HB231X.625		
240SX		1991-1993	All			HB231X.625		
240SX		1991-1994		4406053F92				HB262X.540
240SX	With ABS	1991-1994		4406053F92				HB262X.540
240SX	SE	1994-1996	All			HB231X.625		
240SX		1994		From 2/94 - with ABS		HB231X.625		HB262X.540
240SX		1994		From 2/94 - without ABS 4 Lug		HB231X.625		HB262X.540
240SX		1994		From 2/94 - without ABS 5 Lug		HB231X.625		HB262X.540
240SX		1994		To 1/94 - with ABS				HB262X.540
240SX		1994		To 1/94 - without ABS		HB231X.625		HB262X.540
240SX		1995-1996	All			HB231X.625		
240SX		1995		with ABS		HB231X.625		HB262X.540
240SX		1995		without ABS 4 Lug		HB231X.625		HB262X.540
240SX		1995		without ABS 5 Lug		HB231X.625		HB262X.540
240SX		1996		From 7/96 - with ABS				HB262X.540
240SX		1996		From 7/96 - without ABS 4 Lug				HB262X.540
240SX		1996		From 7/96 - without ABS, 5 Lug				HB262X.540
240SX		1996		To 6/96 - with ABS		HB231X.625		HB262X.540
240SX		1996		To 6/96 - without ABS 4 Lug		HB231X.625		HB262X.540
240SX		1996		To 6/96 - without ABS 5 Lug		HB231X.625		HB262X.540
240SX	LE	1997	All			HB235X.665		
240SX	SE	1997	All			HB235X.665		
240SX		1997-1998	All			HB235X.665		
240SX		1997-1998		with ABS				HB262X.540
240SX		1997-1998		without ABS 4 Lug				HB262X.540
240SX		1997-1998		without ABS 5 Lug				HB262X.540
240Z		1970-1973	All			HB169X.560		
260Z	2+2	1974-1975	All			HB169X.560		
260Z		1974-1975	All			HB169X.560		
280Z	2+2	1975-1978	All			HB169X.560		
280Z		1975-1978	All			HB169X.560		
280ZX		1979-1980						HB262X.540
280ZX		1981		From 9/81				HB262X.540
280ZX		1982-1983						HB262X.540
300ZX	Base	1984-1986	All			HB475X.642		
300ZX		1984		except Turbo		HB475X.642		HB262X.540
300ZX		1984		Turbo		HB475X.642		HB262X.540
300ZX		1985		To 8/85 except SF. Canada; except Turbo		HB475X.642		HB262X.540
300ZX		1985-1986		From 9/85; except Turbo		HB475X.642		HB262X.540
300ZX		1985-1986		To 8/86; Turbo		HB475X.642		HB262X.540

BRAKE PAD APPLICATIONS



Hawk Performance - BRAKE PAD APPLICATIONS

HB **245** **x** **.631**
 HAWK BRAKE PAD SHAPE INSERT COMPOUND CODE PAD THICKNESS

MAKE/ MODEL	SUBMODEL	YEARS	ENGINE (LITER)	NOTE	FRONT		REAR	
					OES	HB SERIES	OES	HB SERIES
NISSAN CONTINUED								
300ZX		1986		From 9/86; except Turbo		HB475X.642		HB262X.540
300ZX		1986		From 9/86; Turbo				HB262X.540
300ZX	Base	1987-1989	All	To 1/89, Excl. Turbo		HB475X.642		
300ZX		1987-1988		4406035F92				HB262X.540
300ZX		1987-1988		except Turbo		HB475X.642		HB262X.540
300ZX		1987-1988		Turbo				HB262X.540
300ZX	Turbo	1987-1988		4406035F92				HB262X.540
300ZX	Base	1989-1996	All	From 2/89, Excl. Turbo		HB178X.564		
300ZX	Turbo	1989-1996	All	From 7/89		HB178X.564		
300ZX		1989		To 1/89; except Turbo		HB475X.642		HB262X.540
300ZX		1989		To 1/89; Turbo				HB262X.540
300ZX	Rear to 12/1988	1989		4406035F92				HB262X.540
300ZX	Turbo, Rear to 12/1988	1989		4406035F92				HB262X.540
300ZX		1989-1990		From 2/89 To 6/90; except Turbo		HB178X.564		HB179X.630
300ZX		1989-1990		From 6/89; Turbo		HB178X.564		HB179X.630
300ZX		1990		From 7/90; except Turbo		HB178X.564		HB179X.630
300ZX		1991-1992		except Turbo		HB178X.564		HB179X.630
300ZX		1991-1996		Turbo		HB178X.564		HB179X.630
300ZX		1993		From 9/93; except Turbo		HB178X.564		HB179X.630
300ZX		1993		to 8/93; except Turbo		HB178X.564		HB179X.630
300ZX		1994-1996		except Turbo		HB178X.564		HB179X.630
350Z		2003	All	w/o Brembo Brakes. w/o 18 in. Wheels		HB268X.665		
350Z		2003	All	w/o Brembo Brakes. w/o 18 in. Wheels				HB370X.559
350Z	Enthusiast	2003-2009	All	w/Brembo Brakes and 18 in. Wheels		HB545X.564		HB180X.560
350Z	Grand Touring	2003-2009	All	w/Brembo Brakes and 18 in. Wheels		HB545X.564		HB180X.560
350Z	Touring	2003-2009	All	w/Brembo Brakes and 18 in. Wheels		HB545X.564		HB180X.560
350Z	Track	2003-2009	All	w/Brembo Brakes and 18 in. Wheels		HB545X.564		HB180X.560
350Z		2003-2005				HB268X.606		
350Z		2003-2005		Track		HB545X.610		
350Z		2003-2005		with Standard Brakes		HB268X.665		HB370X.559
350Z		2003-2008		with Brembo Brakes		HB545X.564		HB180X.560
350Z	Grand Touring	2003-2009		w/ Brembo Brakes		HB545X.564		
350Z	Track	2003-2009		w/ Brembo Brakes		HB545X.564		
350Z		2004-2005	All	w/o Brembo Brakes. w/o 18 in. Wheels		HB268X.665		HB370X.559
350Z	Enthusiast	2006-2009	All	w/o Brembo Brakes. w/o 18 in. Wheels				HB370X.559
350Z	Grand Touring	2006-2009	All	w/o Brembo Brakes. w/o 18 in. Wheels				HB370X.559
350Z	Touring	2006-2009	All	w/o Brembo Brakes. w/o 18 in. Wheels				HB370X.559
350Z	Track	2006-2009	All	w/o Brembo Brakes. w/o 18 in. Wheels				HB370X.559
350Z		2006-2008		with Standard Brakes		HB387X.547		HB370X.559
350Z		2006-2009		Grand Touring		HB545X.610		
350Z		2009		Base/Touring Models; Except Sport Package (Iron Calipers)		HB387X.547		HB370X.559
350Z		2009		Nismo Sport Package (Aluminum Calipers)		HB601X.626		HB602X.545
350Z	Grand Touring	2009		D1060CD00C		HB545X.564		
350Z	Grand Touring	2009		D4060CD01B				HB180X.560
370Z	Base	2009-2014	All	w/o Sport Brakes		HB387X.547		HB600X.539
370Z	Touring	2009-2014	All	w/o Sport Brakes		HB387X.547		HB600X.539
370Z		2009-2013		Base/Touring Models; Except Sport Package (Iron Calipers)		HB387X.547		HB370X.559
370Z		2009-2013		Nismo Sport Package (Aluminum Calipers)		HB601X.626		HB602X.545
370Z		2010-2016		D40601MB0A				HB370X.559
370Z	Sport	2014-2016		D10601TG1C		HB601X.626		
370Z	Sport	2014-2016		D4060JL00J				HB602X.545
370Z		2015		D10601NC0B		HB387X.547		
370Z		2016		D10601NC0C		HB387X.547		

BRAKE PAD APPLICATIONS



MAKE/ MODEL	SUBMODEL	YEARS	ENGINE (LITER)	NOTE	FRONT		REAR	
					OES	HB SERIES	OES	HB SERIES
NISSAN CONTINUED								
620 Pickup		1977				HB169X.560		
620 Pickup		1978-1979	All			HB169X.560		
Altima	GLE	1993-1997	2.4L		770815			
Altima	GXE	1993-1997	2.4L		770815			
Altima	SE	1993-1997	2.4L		770815			
Altima	XE	1993-1997	2.4L		770815			
Altima		1993-1997	All					HB421X.622
Altima		1993-2001				HB268X.606		HB421X.622
Altima		1993-2001				HB268X.665		HB421X.622
Altima	Front Automatic Trans	1996-1997		440606E390				HB421X.622
Altima		1998-2001	2.4L		770815			
Altima		1998-2000	All			HB320X.669		HB421X.622
Altima		2001	All			HB320X.669		
Altima		2002-2004				HB268X.606		HB370X.559
Altima		2002-2005		410608J090		HB268X.665		
Altima		2005-2006				HB268X.606		
Altima		2005-2006		except SE-R				HB370X.559
Altima		2005-2006		SE-R		HB448X.610		HB370X.559
Altima		2006		41060ZB590		HB268X.665		
Altima		2007-2012	All			HB268X.665		HB600X.539
Altima		2007-2012				HB268X.606		HB370X.559
Altima		2007-2012				HB268X.665		HB370X.559
Altima		2010		D40609N00B				HB370X.559
Altima	Coupe	2013	All			HB268X.665		
Altima	Sedan	2013-2014	All					HB370X.559
Altima		2013		D40609N00C				HB370X.559
Altima		2013		Sedan		HB747X.626		HB370X.559
Altima	Coupe	2013		D40609N00C				HB370X.559
Altima		2013		Coupe		HB268X.606		HB370X.559
Altima		2013		Coupe		HB268X.665		HB370X.559
Altima		2013		Coupe		HB747X.626		HB370X.559
Altima		2013-2015				HB747X.626		
Altima	(Mexico)	2014				HB268X.665		
Altima		2014		(Mexico)		HB268X.606		
Altima		2014-2015		All		HB747X.626		
Altima		2015		Aluminum Wheels		HB747X.626		
Altima		2015		D40609HM0A				HB370X.559
Altima	Aluminum Wheels	2015		D40609HM0B				HB370X.559
Armada	LE	2005-2006	All			HB567X.694		
Armada	SE Off-Road	2005-2006	All			HB567X.694		
Armada	SE	2005-2006	All			HB567X.694		
Armada		2005		From 3/05		HB567X.694		HB555X.678
Armada		2005		To 3/05				HB555X.678
Armada		2006		w/Akebono Front Calipers and 350mm front Rotors		HB620X.703		HB555X.678
Armada		2006		w/Bosch Front Calipers and 320mm front Rotors		HB567X.694		HB555X.678
Armada		2007-2011	All			HB620X.703		
Armada		2007		With Akebono Front Calipers and 350mm front Rotors; From 4/07		HB620X.703		HB555X.678
Armada		2007		With Akebono Front Calipers and 350mm front Rotors; To 4/07		HB620X.703		HB555X.678
Armada		2008-2013				HB620X.703		HB555X.678
Armada		2014-2015		D10609FE0A		HB620X.703		
Armada		2014-2015		D40609FE0A				HB555X.678
Axxess		1990	All			HB235X.665		
Axxess		1990		4106032R90		HB235X.665		

BRAKE PAD APPLICATIONS



Hawk Performance - BRAKE PAD APPLICATIONS

H B **2 4 5** **x** **.6 3 1**
 HAWK BRAKE PAD SHAPE INSERT COMPOUND CODE PAD THICKNESS

MAKE/ MODEL	SUBMODEL	YEARS	ENGINE (LITER)	NOTE	FRONT		REAR	
					OES	HB SERIES	OES	HB SERIES
NISSAN CONTINUED								
Axxess		1991-1993		4106065E90		HB235X.665		
Cabstar		2008-2011	All	(Latin America)	771622			
Cube		2009-2014	All			HB268X.665		
Cube		2009-2014				HB268X.606		
D21	Hard Body	1986-1993	All	4WD	770333	HB402X.669		
D21	2WD	1986-1987		4 Cyl. Eng. Diesel; exc. Heavy Duty & Cab & Chassis - From 11/85 to 8/87		HB402X.669		
D21	2WD	1986-1987		4 Cyl. Eng.; exc. Heavy Duty & Cab & Chassis - From 11/85 to 8/87		HB475X.642		
D21	2WD	1986-1988		with Dual Rr Whl - From 11/85 To 8/88		HB402X.669		
D21	2WD 4 Cyl.	1986-1989		D106011P26		HB475X.642		
D21	2WD	1986-1989		V6 Eng.; except Heavy Duty & Cab & Chassis From 11/85 to 5/89		HB402X.669		
D21	2WD	1986-1989		with Single Rr Whl - From 11/85 To 7/89		HB402X.669		
D21	4WD	1986-1994				HB402X.669		
D21	2WD	1987-1989		4 Cyl. Eng.; exc. Heavy Duty & Cab & Chassis From 9/87 to 7/89		HB475X.642		
D21	2WD	1987-1989		9/87-7/89, except Heavy Duty & Cab and Chassis Diesel		HB402X.669		
D21	2WD	1988-1989		with Dual Rr Whl - From 9/88 To 5/89		HB402X.669		
D21	2WD	1989-1991		From 8/89 to 12/91; except Heavy Duty & Cab & Chassis		HB475X.642		
D21	2WD	1989-1991		V6 Eng.; From 8/89 to 12/91; except Heavy Duty & Cab & Chassis		HB402X.669		
D21	2WD	1989-1991		with Single Rr Whl - From 8/89 To 12/91		HB402X.669		
D21	4WD 6 Cyl.	1990-1993		4106032G94		HB402X.669		
D21	2WD 6 Cyl.	1990-1994		4106032G94		HB402X.669		
D21	SE, Hard Body	1991-1994	All		770333	HB402X.669		
D21	2WD	1992-1993		except Heavy Duty & Cab & Chassis - From 1/92		HB475X.642		
D21	2WD	1992-1993		V6 Eng.; except Heavy Duty & Cab & Chassis From 1/92		HB402X.669		
D21	2WD	1992-1993		with Single Rr Whl - From 1/92		HB402X.669		
D21	XE, Hard Body	1994	All	4WD	770333	HB402X.669		
D21	2WD	1994		Except Heavy Duty & Cab & Chassis		HB475X.642		
D21	2WD	1994		Heavy Duty & Cab & Chassis		HB402X.669		
D21	4WD	1994		4106032G94		HB402X.669		
Frontier	2WD	1998-2002		6 Cyl.		HB402X.669		
Frontier	4WD	1998-2002				HB402X.669		
Frontier	2WD	1999-2004		4 Cyl.		HB402X.669		
Frontier		2000-2002	All		770333	HB402X.669		
Frontier		2003-2004	All	4WD / V6		HB488X.629		
Frontier		2003-2004	All	4 Cylinder	770333	HB402X.669		
Frontier	2WD	2003-2004		6 Cyl.		HB488X.629		
Frontier	4WD	2003-2004				HB488X.629		
Frontier		2005-2014	All		771094	HB618X.625	771100	HB619X.626
Frontier	2WD	2005-2013		4 Cyl.		HB618X.625		HB619X.626
Frontier	2WD	2005-2013		6 Cyl.		HB618X.625		HB619X.626
Frontier	4WD	2005-2013				HB618X.625		HB619X.626
Frontier	(Mexico)	2014				HB402X.669		
Frontier		2015		41060ZP025		HB618X.625		
Frontier		2015		44060EA085				HB619X.626
GT-R		2009-2014	All			HB650X.730		
GT-R		2009-2013				HB650X.730		HB193X.670
GT-R		2014-2016		D4060JF20C				HB193X.670
GT-R		2015-2016		D106080B0A		HB650X.730		
Juke		2011-2014	All			HB268X.665		

BRAKE PAD APPLICATIONS



MAKE/ MODEL	SUBMODEL	YEARS	ENGINE (LITER)	NOTE	FRONT		REAR	
					OES	HB SERIES	OES	HB SERIES
NISSAN CONTINUED								
Juke		2011-2013				HB268X.606		HB370X.559
Juke		2014-2015				HB268X.606		
Juke		2014-2015		D10609AJ0A		HB268X.665		
Juke		2014-2015		D4M609N00B				HB370X.559
Juke	Nismo RS	2014-2015		D1M609N00A		HB660X.661		
Juke	Nismo RS	2014-2015		D4060JA00J				HB600X.539
Leaf		2011-2013				HB618X.625		HB370X.559
Leaf	Front: Japan Built Vehicle	2014		D1M60CY70B		HB618X.625		
Leaf	Front: Japan Built Vehicle	2014		D40603NF0B				HB370X.559
Leaf		2014-2015				HB747X.626		
Leaf		2014-2015		All		HB747X.626		
Leaf		2015		D40603NF0B				HB370X.559
Maxima		1981-1984						HB262X.540
Maxima		1985-1988	All			HB475X.642		HB262X.540
Maxima		1989-1990	All		770815	HB268X.665		HB262X.540
Maxima		1989-1998				HB268X.665		HB421X.622
Maxima		1990		4406065E90				HB262X.540
Maxima		1990-1994				HB268X.606		HB421X.622
Maxima	SE	1991-1999	All		770815	HB268X.665		
Maxima	Rear To 09/1990	1991		4406065E90				HB262X.540
Maxima	GXE	1992-1999	All		770815	HB268X.665		
Maxima		1992		4406061J92				HB421X.622
Maxima	Front: Auto Trans w/o ABS	1993-1994		4406061J92				HB421X.622
Maxima	GLE	1995-1999	All		770815	HB268X.665		
Maxima		1999		From 4/1999		HB268X.665		HB421X.622
Maxima		1999		To 3/1999		HB268X.665		HB421X.622
Maxima		2000-2001	All		770815	HB268X.665		
Maxima		2000				HB268X.606		HB421X.622
Maxima		2000				HB268X.665		HB421X.622
Maxima		2001				HB268X.606		
Maxima		2001		From 10/2000		HB268X.665		HB378X.626
Maxima		2001		To 10/2000		HB268X.665		HB421X.622
Maxima		2002		41060AU091		HB268X.665		
Maxima		2002-2003				HB268X.606		HB378X.626
Maxima		2003		410605Y790		HB268X.665		
Maxima		2004-2005	All		770969	HB448X.610		
Maxima		2004-2008				HB448X.610		HB370X.559
Maxima		2009-2013				HB660X.661		HB370X.559
Maxima		2014		D10609N00A		HB660X.661		
Maxima		2014		D40609N00B				HB370X.559
Maxima		2016		D10609DFOA		HB660X.661		
Maxima		2016		D40609HM0C				HB370X.559
Murano		2003-2004	All		770969	HB448X.610		
Murano		2003-2007				HB448X.610		HB370X.559
Murano	S	2005-2007	All		770969	HB448X.610		
Murano	SE	2005-2007	All		770969	HB448X.610		
Murano	SL	2005-2007	All		770969	HB448X.610		
Murano		2009-2010				HB448X.610		HB370X.559
Murano	Crosscabriolet	2011-2012	All		770888	HB387X.547		
Murano		2011-2012		CrossCabriolet		HB387X.547		HB370X.559
Murano		2011-2012		D4M609N00A				HB370X.559
Murano		2011-2012		Excluding CrossCabriolet		HB448X.610		HB370X.559
Murano	Crosscabriolet	2011-2012		D4M609N00A				HB370X.559
Murano		2013				HB387X.547		HB370X.559
Murano		2014		D1060EJ20A		HB387X.547		

BRAKE PAD APPLICATIONS



Hawk Performance - BRAKE PAD APPLICATIONS

HB
HAWK BRAKE

245
PAD SHAPE

x
INSERT COMPOUND CODE

.631
PAD THICKNESS

MAKE/ MODEL	SUBMODEL	YEARS	ENGINE (LITER)	NOTE	FRONT		REAR	
					OES	HB SERIES	OES	HB SERIES
NISSAN CONTINUED								
Murano		2014-2015		D4M609N00A				HB370X.559
NP300		2012	All	(Latin America)	770554			
NV1500		2012-2014	All			HB705X.776		
NV1500		2012-2013				HB705X.776		HB705X.776
NV1500		2014-2015		D40601PA0A				HB705X.776
NV1500		2015		D10601PA0A		HB705X.776		
NV200		2013-2014				HB618X.625		
NV200		2015		D10603LM0A		HB618X.625		
NV2500		2012-2014	All			HB705X.776		
NV2500		2012-2013				HB705X.776		HB705X.776
NV2500		2014-2015		D40601PA0A				HB705X.776
NV2500		2015		D10601PA0A		HB705X.776		
NV3500		2012-2014	All			HB705X.776		
NV3500		2012-2013				HB705X.776		HB705X.776
NV3500		2014-2015		D40601PA0A				HB705X.776
NV3500		2015		D10601PA0A		HB705X.776		
Pathfinder		1987-1989	All		770333	HB402X.669		
Pathfinder		1987-1995				HB402X.669		
Pathfinder	SE	1990-1995	All		770333	HB402X.669		
Pathfinder	XE	1990-1995	All		770333	HB402X.669		
Pathfinder	LE	1994-1995	All		770333	HB402X.669		
Pathfinder		1995		4106032G94		HB402X.669		
Pathfinder	LE	1996-1997	All		770691	HB326X.646		
Pathfinder	SE	1996-1997	All		770691	HB326X.646		
Pathfinder	XE	1996-1997	All		770691	HB326X.646		
Pathfinder		1996-2004			770691	HB326X.646		
Pathfinder		1998-2004	All		770691	HB326X.646		
Pathfinder	Front From 07/2001	2001		410605W585		HB326X.646		
Pathfinder	Armada	2004	All			HB567X.694		HB555X.678
Pathfinder		2004		410605W585		HB326X.646		
Pathfinder		2005-2007	All		771094	HB618X.625		
Pathfinder		2005-2007				HB618X.625		HB619X.626
Pathfinder		2008-2012	4.0L		771094	HB618X.625		
Pathfinder		2008-2012	5.6L		770888	HB387X.547		
Pathfinder		2008-2012		4.0L V6		HB618X.625		HB619X.626
Pathfinder		2008-2012		5.6L V8		HB387X.547		HB619X.626
Pathfinder		2013						HB370X.559
Pathfinder		2014-2015		D4M609N00A				HB370X.559
Pickup	2WD 4 Cyl.	1995		4106011P86		HB475X.642		
Pickup	2WD 6 Cyl.	1995		4106032G91		HB402X.669		
Pickup	4WD 4 Cyl.	1995		4106032G91		HB402X.669		
Pickup	4WD 6 Cyl.	1995		4106032G94		HB402X.669		
Pickup	2WD, Front from 01/1996	1996		D106011P26		HB475X.642		
Pickup	2WD, Front to 01/1996	1996		4106011P86		HB475X.642		
Pickup	4WD	1996-1997		4106057G90		HB402X.669		
Pickup	2WD	1997		D106011P26		HB475X.642		
Pulsar		1983				HB475X.642		
Pulsar	Option	1983-1984				HB475X.642		
Pulsar	Gasoline	1984				HB475X.642		
Pulsar NX		1983-1986	All			HB475X.642		
Pulsar NX		1987		4106076A87		HB475X.642		
Pulsar NX		1988	1.6L	4106076A87		HB475X.642		
Pulsar NX		1989	1.6L	4106077A90		HB475X.642		
Pulsar NX		1990	1.6L	4106075A92		HB475X.642		
Quest	GXE	1993-1998	All			HB414X.622		

BRAKE PAD APPLICATIONS

MAKE/ MODEL	SUBMODEL	YEARS	ENGINE (LITER)	NOTE	FRONT		REAR	
					OES	HB SERIES	OES	HB SERIES
NISSAN CONTINUED								
Quest	XE	1993-1998	All			HB414X.622		
Quest		1993-2002				HB414X.622		
Quest		1999-2002	All			HB414X.622		
Quest		2004-2009	All		770691	HB326X.646		
Quest		2004-2009			770691	HB326X.646		HB370X.559
Quest	S	2005-2008	All		770691	HB326X.646		
Quest	SE	2005-2008	All		770691	HB326X.646		
Quest	SL	2005-2008	All		770691	HB326X.646		
Quest		2011-2013						HB370X.559
Quest		2014-2015		D4M609N00A				HB370X.559
Rogue		2008-2013	All			HB660X.661		HB600X.539
Rogue		2008-2013				HB660X.661		HB370X.559
Rogue	(Mexico)	2014				HB660X.661		HB600X.539
Rogue		2014		S, SL Models With 3 Rows of Seats				HB370X.559
Rogue		2014		S, SL, SV Models With 2 Rows of Seats				HB370X.559
Rogue	2 Row Seating	2015		D40604CU2A				HB370X.559
Rogue	3 Row Seating	2015		D40604CU2A				HB370X.559
Rogue Select		2014-2015		D1M60JE00A		HB660X.661		
Rogue Select		2014-2015		D4060JA00J				HB600X.539
Sentra		1982				HB475X.642		
Sentra	Gasoline	1983				HB475X.642		
Sentra	Diesel	1984				HB475X.642		
Sentra	Diesel	1985		41060D1787		HB475X.642		
Sentra	Gasoline	1985		4106011A93		HB475X.642		
Sentra		1986		4106011A93		HB475X.642		
Sentra		1987		4106061A90		HB475X.642		
Sentra		1988		4106075A90		HB475X.642		
Sentra		1989-1990		4106075A92		HB475X.642		
Sentra		1995	All			HB236X.622		
Sentra	XE	1995-1997	All			HB236X.622		
Sentra	GLE	1995-1999	All			HB236X.622		
Sentra	GXE	1995-1999	All			HB236X.622		
Sentra		1995-1997		2.0L; except Wagon		HB236X.622		HB680X.583
Sentra	E	1996	All			HB236X.622		
Sentra		1998-1999	All			HB236X.622		
Sentra		1998-1999		E, XE Models with Rear Drum Brakes		HB236X.622		
Sentra		1998-1999		GLE, GXE Models with Rear Drum Brakes		HB236X.622		
Sentra		1998-1999		Models with Rear Disc Brakes		HB236X.622		HB680X.583
Sentra	B15 (Latin America)	1999-2000		Sunny		HB598X.606		
Sentra		2000-2001	1.8L	410608M190		HB235X.665		
Sentra		2000	All	W/Rear Discs; From 1/00	770462	HB235X.665		
Sentra		2000	All	W/Rear Discs; To 12/99	770462	HB235X.665		
Sentra		2000	All	W/Rear Drums; From 1/00	770462	HB235X.665		
Sentra		2000	All	W/Rear Drums; To 12/99	770462	HB235X.665		
Sentra		2000		E, XE Models with Rear Drum Brakes MFG up to 12/1999		HB236X.622		
Sentra		2000		GLE, GXE Models with Rear Drum Brakes MFG up to 12/1999		HB236X.622		
Sentra		2000		Models with Rear Disc Brakes MFG after 1/2000		HB268X.665		HB421X.622
Sentra		2000		Models with Rear Disc Brakes MFG up to 12/1999		HB236X.622		HB680X.583
Sentra		2000-2001		2.0L		HB268X.606		
Sentra		2001	2.0L	Disc	770815			
Sentra		2001-2006	All	w/Rear Drum Brakes.		HB235X.665		

BRAKE PAD APPLICATIONS



Hawk Performance - BRAKE PAD APPLICATIONS

HB **245** **x** **.631**
 HAWK BRAKE PAD SHAPE INSERT COMPOUND CODE PAD THICKNESS

MAKE/ MODEL	SUBMODEL	YEARS	ENGINE (LITER)	NOTE	FRONT		REAR	
					OES	HB SERIES	OES	HB SERIES
NISSAN CONTINUED								
Sentra		2001		Models with Rear Disc Brakes MFG after 6/2001		HB268X.665		HB378X.626
Sentra		2001		Models with Rear Disc Brakes MFG up to 6/2001		HB268X.665		HB421X.622
Sentra		2002		Models with Rear Disc Brakes		HB268X.665		HB378X.626
Sentra		2002-2006		2.5L		HB268X.606		
Sentra	SE-R Spec V	2003-2006	All	w/Brembo Front Calipers		HB545X.564		
Sentra		2003-2006		Models with Rear Disc Brakes Exc. SE-R Spec V		HB268X.665		HB378X.626
Sentra		2003-2006		SE-R Spec V				HB378X.626
Sentra	SE-R Spec V	2003-2006		w/ Brembo Brakes		HB545X.564		
Sentra		2004	1.8L	Disc	770815			
Sentra		2004	2.5L	Disc	770815			
Sentra		2004-2006		SER Spec V, With Brembo Calipers		HB545X.610		
Sentra		2007-2009	All			HB268X.665		HB600X.539
Sentra	SE-R	2007-2009	All			HB268X.665		HB600X.539
Sentra	SE-R Spec V	2007-2012	All					HB600X.539
Sentra		2007-2012		SE-R		HB268X.606		
Sentra		2007-2013		2.0L; w/Rear Drums		HB268X.665		
Sentra		2007-2013		2.5L; Except SE-R Spec V		HB268X.665		HB370X.559
Sentra		2007-2013		2.5L; SE-R Spec V		HB660X.661		HB370X.559
Sentra		2007-2015				HB268X.606		
Sentra	SE-R	2010-2012	All	w/CVT Trans		HB268X.665		HB600X.539
Sentra	SE-R	2010-2012	All	w/Manual Trans				HB600X.539
Sentra		2011		SL		HB268X.606		
Sentra		2012	All	w/Rear Drum Brakes.		HB268X.665		
Sentra		2013	All	w/Rear Disc	770815	HB268X.665		
Sentra		2014		D40609N00B				HB370X.559
Sentra		2014-2015		D1060EM30C		HB268X.665		
Sentra		2015		D40609HM0B				HB370X.559
Stanza	GL	1984-1985	All			HB475X.642		
Stanza	XE	1984-1985	All			HB475X.642		
Stanza		1986-1989	All			HB475X.642		
Stanza		1988		D106032E25		HB475X.642		
Stanza		1990-1992	All			HB235X.665		HB262X.540
Stanza		1990-1992		4406065E90				HB262X.540
Stanza		1991		4106032R90		HB235X.665		
Stanza		1992		4106078E91		HB235X.665		
Tiida		2014		(Mexico)		HB268X.606		
Titan		2004	All			HB567X.694		
Titan		2004						HB555X.678
Titan	LE	2005-2007	All			HB567X.694		
Titan	SE	2005-2007	All			HB567X.694		
Titan	XE	2005-2007	All			HB567X.694		
Titan		2005		From 3/05		HB567X.694		HB555X.678
Titan		2005		To 3/05				HB555X.678
Titan		2006-2007				HB567X.694		HB555X.678
Titan		2008-2010	All			HB620X.703		
Titan		2008-2010				HB620X.703		HB555X.678
Titan		2011-2012		D10601LA1A		HB620X.703		
Titan		2011-2013						HB555X.678
Titan		2013-2015		D10609FE0A		HB620X.703		
Titan		2014-2015		D40609FE0A				HB555X.678
Van		1987-1988		4106023C90		HB402X.669		
Versa	S	2007	All		770815	HB268X.665		

BRAKE PAD APPLICATIONS

MAKE/ MODEL	SUBMODEL	YEARS	ENGINE (LITER)	NOTE	FRONT		REAR	
					OES	HB SERIES	OES	HB SERIES
NISSAN CONTINUED								
Versa	SL	2007	All		770815	HB268X.665		
Versa		2007-2008				HB268X.606		
Versa	S	2008	All	Non-ABS	770815	HB268X.665		
Versa	SL	2008	All	Non-ABS	770815	HB268X.665		
Versa		2008		D1060EM30A		HB268X.665		
Versa		2009-2012	1.8L	D1060EM30A		HB268X.665		
Versa	S	2009-2012	1.8L		770815	HB268X.665		
Versa	SL	2009-2012	1.8L		770815	HB268X.665		
Versa		2009-2012		1.8 Liter		HB268X.606		
Xterra		2000-2004	All			HB488X.629		
Xterra		2000-2004				HB488X.629		
Xterra		2005-2014	All		771094	HB618X.625		
Xterra		2005-2013				HB618X.625		HB619X.626
Xterra		2014-2015		44060EA085				HB619X.626
Xterra		2015		41060ZP025		HB618X.625		
X-Trail	(Latin America)	2001-2004		410608H386		HB326X.646		
X-Trail	(Mexico)	2014						HB600X.539
OLDSMOBILE								
88		1992-1995		12510024				HB359X.543
88		1993		12510001		HB103X.590		
88		1994-1999				HB217X.681		
88		1996-1999		18023301				HB359X.543
98		1968-1981	All		770052	HB103X.590		
98		1971-1976				HB103X.590		
98	Regency	1973-1983	All		770052	HB103X.590		
98		1977				HB103X.590		HB235X.665
98		1978-1979						HB235X.665
98		1978-1979		Except HD (10.98" Rotors)		HB103X.590		
98		1978-1979		HD (11.9" Rotors)		HB103X.590		
98		1980-1984				HB103X.590		HB235X.665
98	Regency Brougham	1982-1984	All		770052	HB103X.590		
98	Regency Brougham	1985-1990	All			HB396X.630		
98	Regency	1985-1990	All			HB396X.630		
98		1985-1990				HB396X.630		
98	Regency Touring	1988-1990	All			HB396X.630		
98		1991-1993		12510001		HB103X.590		
98		1992-1993		18048649				HB359X.543
98	Regency	1994	All			HB217X.681		
98	Regency Elite	1994-1996	All			HB217X.681		
98		1994-1995		12510024				HB359X.543
98		1994-1996				HB217X.681		
98		1996		18023301				HB359X.543
442		1970-1971	6.6L		770052	HB103X.590		
Achieva	S	1992-1995	All			HB390X.602		
Achieva	SL	1992-1997	All			HB390X.602		
Achieva		1992-1998				HB390X.602		
Achieva	SC	1994	All			HB390X.602		
Achieva		1996	All			HB390X.602		
Achieva	SC	1996-1997	All			HB390X.602		
Alero		1999-2004	All			HB425X.661		
Alero		1999-2004				HB425X.661		HB359X.543
Aurora		1995-1996	All			HB217X.681		
Aurora		1995-1996				HB217X.681		HB359X.543
Aurora		1997-1999	All			HB360X.670		

BRAKE PAD APPLICATIONS



Hawk Performance - BRAKE PAD APPLICATIONS

HB
HAWK BRAKE

245
PAD SHAPE

x
INSERT COMPOUND CODE

.631
PAD THICKNESS

MAKE/ MODEL	SUBMODEL	YEARS	ENGINE (LITER)	NOTE	FRONT		REAR	
					OES	HB SERIES	OES	HB SERIES
OLDSMOBILE CONTINUED								
Aurora		1997-1999				HB360X.670		HB359X.543
Aurora		2001-2002	All			HB360X.670		
Aurora		2001-2003				HB360X.670		HB359X.543
Bravada		1991-1994	All			HB119X.594		
Bravada		1991-1994				HB119X.594		
Bravada		1996	All			HB119X.594		
Bravada		1996				HB119X.594		
Bravada		1996		18026296		HB119X.594		
Bravada		1997-2001	All		770726	HB304X.598		
Bravada		1997-2000		18026156				HB305X.610
Bravada		2001				HB304X.598		HB305X.610
Bravada		2002-2004	All		770882	HB382X.657		
Bravada		2002-2004				HB382X.657		HB383X.685
Calais		1985-1987	All			HB400X.630		
Calais		1985-1987				HB400X.630		
Calais	Supreme	1986-1987	All			HB400X.630		
Custom Cruiser		1970-1976				HB103X.590		
Custom Cruiser		1977-1984				HB103X.590		HB235X.665
Custom Cruiser		1985-1992		18024914		HB103X.590		
Cutlass		1970-1977	All		770052	HB103X.590		
Cutlass	S	1971-1977	All		770052	HB103X.590		
Cutlass		1972-1975						HB119X.594
Cutlass	Salon	1975-1977	All		770052	HB103X.590		
Cutlass		1977						HB235X.665
Cutlass	Salon Brougham	1978-1980	All			HB119X.594		
Cutlass	Salon	1978-1987	All			HB119X.594		
Cutlass		1978-1984				HB119X.594		
Cutlass		1979-1986	All			HB119X.594		
Cutlass	Brougham	1980-1981	All			HB119X.594		
Cutlass	LS	1980-1981	All			HB119X.594		
Cutlass	GLS	1997	All			HB425X.661		
Cutlass		1997-1999	All			HB425X.661		
Cutlass		1997		with rear drums		HB425X.661		
Cutlass		1998-1999				HB425X.661		
Cutlass Calais		1978-1984				HB119X.594		
Cutlass Calais		1982-1984	All			HB119X.594		
Cutlass Calais		1988-1989	All			HB400X.630		
Cutlass Calais	International	1988-1989	All			HB400X.630		
Cutlass Calais	SL	1988-1989	All			HB400X.630		
Cutlass Calais		1988-1989				HB400X.630		
Cutlass Calais	S	1989	All			HB400X.630		
Cutlass Calais		1990	All	w/o Performance Package		HB400X.630		
Cutlass Calais		1990	All	w/Performance Package		HB390X.602		
Cutlass Calais	International	1990	All	w/o Performance Package		HB400X.630		
Cutlass Calais	International	1990	All	w/Performance Package		HB390X.602		
Cutlass Calais	S	1990	All	w/o Performance Package		HB400X.630		
Cutlass Calais	S	1990	All	w/Performance Package		HB390X.602		
Cutlass Calais	SL	1990-1991	All			HB390X.602		
Cutlass Calais		1990		except Performance Package		HB400X.630		
Cutlass Calais		1990		Performance Package		HB390X.602		
Cutlass Calais		1991	All			HB390X.602		
Cutlass Calais	International	1991	All			HB390X.602		
Cutlass Calais	S	1991	All			HB390X.602		
Cutlass Calais		1991				HB390X.602		
Cutlass Ciera		1982	All			HB400X.630		

BRAKE PAD APPLICATIONS

MAKE/ MODEL	SUBMODEL	YEARS	ENGINE (LITER)	NOTE	FRONT		REAR	
					OES	HB SERIES	OES	HB SERIES
OLDSMOBILE CONTINUED								
Cutlass Ciera	Brougham	1982	All			HB400X.630		
Cutlass Ciera	LS	1983-1985	All	w/Heavy Duty Brakes		HB396X.630		
Cutlass Ciera	LS	1983-1985	All	w/Standard Brakes		HB400X.630		
Cutlass Ciera	Brougham	1983-1988	All	w/Heavy Duty Brakes		HB396X.630		
Cutlass Ciera	Brougham	1983-1988	All	w/Standard Brakes		HB400X.630		
Cutlass Ciera		1983-1989	All	w/Heavy Duty Brakes		HB396X.630		
Cutlass Ciera		1983-1989	All	w/Standard Brakes		HB400X.630		
Cutlass Ciera		1983-1984				HB400X.630		
Cutlass Ciera	Cruiser	1984-1989	All	w/Heavy Duty Brakes		HB396X.630		
Cutlass Ciera	Cruiser	1984-1989	All	w/Standard Brakes		HB400X.630		
Cutlass Ciera	Light Duty	1985-1986		18024902		HB400X.630		
Cutlass Ciera	S	1987	All	w/Heavy Duty Brakes		HB396X.630		
Cutlass Ciera	S	1987	All	w/Standard Brakes		HB400X.630		
Cutlass Ciera	Cruiser Brougham	1987-1988	All	w/Heavy Duty Brakes		HB396X.630		
Cutlass Ciera	Cruiser Brougham	1987-1988	All	w/Standard Brakes		HB400X.630		
Cutlass Ciera	SL	1987-1988	All	w/Heavy Duty Brakes		HB396X.630		
Cutlass Ciera	SL	1987-1988	All	w/Standard Brakes		HB400X.630		
Cutlass Ciera	Light Duty	1987-1989		12321438		HB400X.630		
Cutlass Ciera	Cruiser SL	1989	All	w/Heavy Duty Brakes		HB396X.630		
Cutlass Ciera	Cruiser SL	1989	All	w/Standard Brakes		HB400X.630		
Cutlass Ciera	International	1989	All	w/Heavy Duty Brakes		HB396X.630		
Cutlass Ciera	International	1989	All	w/Standard Brakes		HB400X.630		
Cutlass Ciera	Cruiser	1990	All			HB396X.630		
Cutlass Ciera	International	1990	All			HB396X.630		
Cutlass Ciera		1990-1992	All			HB396X.630		
Cutlass Ciera	Cruiser SL	1990-1993	All			HB396X.630		
Cutlass Ciera	S	1990-1994	All			HB396X.630		
Cutlass Ciera	SL	1990-1994	All			HB396X.630		
Cutlass Ciera	Cruiser S	1991-1994	All			HB396X.630		
Cutlass Ciera		1993		12510018				HB359X.543
Cutlass Ciera	Special Edition	1994	All			HB396X.630		
Cutlass Ciera		1994-1996		18048649				HB359X.543
Cutlass Ciera		1995-1996		12510008				
Cutlass Cruiser		1980-1983				HB396X.630		
Cutlass Cruiser		1987-1989		12321422		HB396X.630		
Cutlass Cruiser	Light Duty	1987-1989		12321438		HB400X.630		
Cutlass Cruiser		1990		12510008		HB396X.630		
Cutlass Salon		1975				HB103X.590		HB119X.594
Cutlass Salon		1976				HB103X.590		
Cutlass Salon		1977				HB103X.590		HB235X.665
Cutlass Salon		1978-1981				HB119X.594		
Cutlass Salon		1985-1987		18026296		HB119X.594		
Cutlass Supreme		1970-1976				HB103X.590		
Cutlass Supreme	Station Wagon	1971				HB103X.590		
Cutlass Supreme	Cruiser	1974-1975	All		770052	HB103X.590		
Cutlass Supreme	Brougham	1976	All		770052	HB103X.590		
Cutlass Supreme		1977				HB103X.590		HB235X.665
Cutlass Supreme	Brougham	1977				HB103X.590		
Cutlass Supreme		1978-1987	All			HB119X.594		
Cutlass Supreme	Brougham	1978-1987	All			HB119X.594		
Cutlass Supreme		1978-1987				HB119X.594		
Cutlass Supreme	Classic Brougham	1988	All			HB119X.594		
Cutlass Supreme	Classic	1988	All			HB119X.594		
Cutlass Supreme	International	1988-1992	All			HB232X.681		
Cutlass Supreme		1988-1993	All			HB232X.681		

BRAKE PAD APPLICATIONS



Hawk Performance - BRAKE PAD APPLICATIONS

HB
HAWK BRAKE

245
PAD SHAPE

x
INSERT COMPOUND CODE

.631
PAD THICKNESS

MAKE/ MODEL	SUBMODEL	YEARS	ENGINE (LITER)	NOTE	FRONT		REAR	
					OES	HB SERIES	OES	HB SERIES
OLDSMOBILE CONTINUED								
Cutlass Supreme		1988		FWD		HB232X.681		
Cutlass Supreme		1988		RWD		HB119X.594		
Cutlass Supreme	5.0L	1988		18026296		HB119X.594		
Cutlass Supreme	SL	1989-1991	All			HB232X.681		
Cutlass Supreme		1989-1993				HB232X.681		
Cutlass Supreme	S	1992-1994	All			HB232X.681		
Cutlass Supreme		1994-1997	All	4WD		HB232X.681		
Cutlass Supreme		1994		Fwd, except 286mm Front		HB232X.681		HB359X.543
Cutlass Supreme		1994-1996		except 267mm Front Rotor		HB232X.681		HB359X.543
Cutlass Supreme	SL	1995-1997	All			HB232X.681		
Cutlass Supreme		1995		with Fwd, except 286mm Front		HB232X.681		HB359X.543
Cutlass Supreme		1997		With Rear Disc		HB232X.681		HB359X.543
Cutlass Tiara		1976				HB103X.590		
Delmont 88		1968	All		770052	HB103X.590		
Delta 88		1969-1976				HB103X.590		
Delta 88		1977-1978						HB235X.665
Delta 88		1977-1978		Except HD or Wagon (11.1" Rotors)		HB103X.590		
Delta 88		1977-1985		HD or Wagon (11.9" Rotors)		HB103X.590		
Delta 88		1979-1984						HB119X.594
Delta 88		1979-1985		Except HD or Wagon (10.98" Rotors)		HB103X.590		
Delta 88	Royale Brougham	1986-1991	All			HB396X.630		
Delta 88	Royale	1986-1991	All			HB396X.630		
Delta 88		1986-1991		Front Wheel Drive		HB396X.630		
Delta 88		1986-1991		Rear Wheel Drive (Wagon)		HB103X.590		
Delta 88		1991		12510017				HB359X.543
F85		1968-1972	All		770052	HB103X.590		
F85		1969-1972				HB103X.590		
Firenza	SX	1982-1985	All			HB400X.630		
Firenza		1982-1986	All			HB400X.630		
Firenza	LX	1982-1987	All			HB400X.630		
Firenza	S	1982-1987	All			HB400X.630		
Firenza	GT	1986-1987	All			HB400X.630		
Firenza	LC	1986-1987	All			HB400X.630		
Firenza		1988		18024902		HB400X.630		
Intrigue		1998-2002	All	JA9 Heavy Duty Brakes		HB360X.670		
Intrigue		1998-2002	All	JB9 Standard Brakes		HB360X.670		
Intrigue		1998-1999		JA9 Brake Package - Heavy Duty Brakes; 12" Front Rotors		HB360X.670		HB359X.543
Intrigue		1998-1999		JB9 Brake Package - Standard Brakes; 11" Front Rotors		HB360X.670		HB359X.543
Intrigue		2000-2002				HB360X.670		HB359X.543
LSS		1996-1999				HB217X.681		
LSS		1996-1999		18023301				HB359X.543
LSS		1997-1999	All			HB217X.681		
Omega		1973-1979	All		770052	HB103X.590		
Omega	Salon	1975	All		770052	HB103X.590		
Omega		1975-1979						HB119X.594
Omega	F85	1976	All		770052	HB103X.590		
Omega	Brougham	1976-1979	All		770052	HB103X.590		
Omega	F85	1977				HB103X.590		
Omega		1980-1984	All			HB400X.630		
Omega	Brougham	1980-1984	All			HB400X.630		
Omega		1981				HB400X.630		
Regency		1997-1998	All			HB217X.681		
Regency		1997-1998		18023301				HB359X.543

BRAKE PAD APPLICATIONS

MAKE/ MODEL	SUBMODEL	YEARS	ENGINE (LITER)	NOTE	FRONT		REAR	
					OES	HB SERIES	OES	HB SERIES
OLDSMOBILE CONTINUED								
Silhouette		1990-1991	All			HB396X.630		
Silhouette		1992		18019347				HB359X.543
Silhouette		1992-1993		18024915		HB103X.590		
Silhouette		1993		18019286				HB359X.543
Silhouette		1994-1996	All			HB217X.681		
Silhouette		1994-1996				HB217X.681		
Silhouette		1994-1996		18048649				HB359X.543
Silhouette		1997-2001	All			HB360X.670		
Silhouette		1997-2001		18023301				HB359X.543
Silhouette		1997-2002				HB360X.670		
Silhouette		2002-2003	All	w/Rear Drum Brakes.		HB360X.670		
Silhouette	AWD	2002		89047824		HB373X.689		
Silhouette	FWD	2002		18045380		HB360X.670		
Silhouette	AWD	2002-2004		18045984				HB359X.543
Silhouette	FWD	2002-2004		18023301				HB359X.543
Silhouette		2003-2004		AWD		HB373X.689		HB359X.543
Silhouette		2003-2004		FWD; with Rear Discs		HB360X.670		HB359X.543
Silhouette		2003-2004		FWD; with Rear Drums		HB360X.670		
Silhouette	FWD	2003-2004		18048030		HB360X.670		
Silhouette		2004	All			HB360X.670		
Starfire		1975				HB103X.590		
Starfire		1976-1980						HB119X.594
Toronado		1967				HB103X.590		
Toronado		1968-1976	All		770052	HB103X.590		
Toronado		1969-1978				HB103X.590		
Toronado	Brougham	1975-1978	All		770052	HB103X.590		
Toronado	XSR	1977	All		770052	HB103X.590		
Toronado		1978	All		770052	HB103X.590		
Toronado		1979-1981	All			HB119X.594		
Toronado	Brougham	1979-1985	All			HB119X.594		
Toronado		1979-1985				HB119X.594		HB119X.594
Toronado		1984-1985	All			HB119X.594		
Toronado		1992						HB359X.543
Toronado		1992		12510001		HB103X.590		
Vista Cruiser		1968-1975	All		770052	HB103X.590		
OPEL								
1900	Rallye	1971-1972	All			HB172X.595		
1900		1971-1974				HB172X.500		
1900		1973-1974	All			HB172X.595		
1900		1975				HB180X.591		
Kadett		1965-1966				HB713X.585		
Kadett		1967				HB172X.500		
Kadett		1971-1972				HB172X.500		
Kadett 1100		1968-1970				HB172X.500		
Kadett 1500		1968-1970				HB172X.500		
Manta		1971-1974	All			HB172X.595		
Manta		1971-1974				HB172X.500		
Manta		1975	All			HB180X.560		
Manta		1975				HB180X.591		
PEUGEOT								
308	(Latin America)	2009		425260		HB543X.760		
308		2010		(Latin America)	771107	HB543X.760		
405	DL	1989	All			HB195X.640		HB364X.642
405	Mi16	1989	All			HB195X.640		HB364X.642

BRAKE PAD APPLICATIONS

Hawk Performance - BRAKE PAD APPLICATIONS

HB
HAWK BRAKE

245
PAD SHAPE

x
INSERT COMPOUND CODE

.631
PAD THICKNESS

MAKE/ MODEL	SUBMODEL	YEARS	ENGINE (LITER)	NOTE	FRONT		REAR	
					OES	HB SERIES	OES	HB SERIES
PEUGEOT CONTINUED								
405	S	1989	All			HB195X.640		HB364X.642
504		1979-1982	All			HB199X.702		
504		1979-1983				HB199X.660		
504		1979-1983		Station Wagon		HB199X.660		
504		1983				HB199X.702		
504		1983		Station Wagon		HB199X.702		
505		1980-1987	All			HB199X.702		
505		1980-1989				HB199X.660		
505	GL	1984-1987	All			HB199X.702		
505	STI	1986-1988	All			HB199X.702		
505	S	1986-1989	All			HB199X.702		
505	Liberte	1987	All			HB199X.702		
505	GLS	1987-1988	All			HB199X.702		
505	STX	1987-1989	All			HB199X.702		
505	GLX	1988	All			HB199X.702		
505	DL	1988-1989	All			HB199X.702		
505	SW8	1989	All			HB199X.702		
505	Turbo	1989	All			HB199X.702		
604		1977-1982	All			HB199X.702		
604		1977-1984				HB199X.660		
604		1983-1984				HB199X.702		
PLYMOUTH								
Acclaim	14" Wheels Rear Disc	1991		4423667				HB176X.614
Acclaim	15" Wheels	1991		4423667				HB176X.614
Acclaim	14" Wheels Rear Disc	1991-1994				HB411X.717		
Acclaim	14" Wheels Rear Drum	1991-1994				HB411X.717		
Acclaim	14" Wheels Rear Disc	1992-1993		4509374				HB176X.614
Acclaim	15" Wheels	1992-1993		4509374				HB176X.614
Acclaim	14" Wheels Rear Disc	1994		4720644				HB176X.614
Acclaim	15" Wheels	1994		4720644				HB176X.614
Acclaim		1995				HB411X.717		
Acclaim		1995		4720644				HB176X.614
Barracuda	6 Cyl.	1966-1968				HB471X.510		
Barracuda	8 Cyl.	1966-1968				HB471X.510		
Barracuda		1969				HB471X.510		
Barracuda		1970		6 cylinder		HB643X.595		
Barracuda		1970		8 Cylinder		HB643X.595		
Barracuda	6 Cyl.	1970				HB643X.595		
Barracuda	8 Cyl.	1970				HB643X.595		
Barracuda		1971-1974	All			HB643X.595		
Barracuda	Gran Coupe	1971-1974	All			HB643X.595		
Barracuda		1971-1974				HB643X.595		
Belvedere	Station Wagon	1969-1971				HB643X.595		
Belvedere	Includes Station Wagon	1970	All			HB643X.595		
Belvedere		1970-1971				HB643X.595		
Breeze		1996-1998		4762669				HB176X.614
Breeze		1996-2000		with 14" Wheels				HB176X.614
Breeze		1996-2000		with 15" Wheels				HB176X.614
Breeze		1999-2000		05012651AA				HB176X.614
Colt	Vista SE	1992	All			HB213X.626		
Colt	Vista	1992-1994	All			HB213X.626		
Colt	Vista 4 x 4	1992-1994		MB857336				HB367X.585
Colt	Vista	1992-1994		MB699334				HB367X.585
Colt	Vista	1992-1994		MB857336				HB367X.585
Colt	4 DR w/ABS	1993		MB928463		HB213X.626		

BRAKE PAD APPLICATIONS



MAKE/ MODEL	SUBMODEL	YEARS	ENGINE (LITER)	NOTE	FRONT		REAR	
					OES	HB SERIES	OES	HB SERIES
PLYMOUTH CONTINUED								
Colt	2 DR	1993-1994		MB928461		HB213X.626		
Colt	4 DR	1993-1994		MB699334				HB367X.585
Colt	4 DR	1993-1994		MB928463		HB213X.626		
Cricket		1971-1972				HB118X.560		
Duster		1970-1972				HB471X.510		
Fury		1969-1970		8 Cylinder		HB643X.595		
Fury	8 Cylinder	1969-1970				HB643X.595		
Fury	Station Wagon	1969-1971				HB643X.595		
Fury		1970		6 cylinder		HB643X.595		
Fury	6 Cylinder	1970				HB643X.595		
Fury		1971-1973	All			HB643X.595		
Fury	Sport	1971-1973	All			HB643X.595		
Fury	Gran Coupe	1971-1974	All			HB643X.595		
Fury	6 Cylinder, Early	1971				HB643X.595		
Fury	8 Cylinder, Early	1971				HB643X.595		
Fury		1971-1973				HB643X.595		
Fury		1974				HB398X.680		
Fury		1975-1978	All			HB643X.595		
Fury	Sport	1975-1978	All			HB643X.595		
Fury		1975-1976				HB643X.595		
Fury		1978				HB643X.595		
Gran Fury	Early	1971				HB643X.595		
Gran Fury	Late	1971				HB643X.595		
Gran Fury	Sport GT, Early	1971				HB643X.595		
Gran Fury	Sport GT, Late	1971				HB643X.595		
Gran Fury	Station Wagon, Early	1971				HB643X.595		
Gran Fury	Station Wagon, Late	1971				HB643X.595		
Gran Fury		1972-1973				HB643X.595		
Gran Fury	Station Wagon	1972-1973				HB643X.595		
Gran Fury	Station Wagon	1974-1975				HB398X.680		
Gran Fury		1974-1977				HB398X.680		
Grand Voyager		1987						HB286X.591
Grand Voyager		1988-1990		4313080				HB286X.591
Grand Voyager		1991-1993		4423606				HB286X.591
Grand Voyager		1991-1995				HB411X.717		
Grand Voyager		1994-1995		4723367				HB286X.591
Grand Voyager	AWD	1995				HB411X.717		
Grand Voyager	SE	1996-1997	All			HB177X.710		
Grand Voyager		1996-2000	All			HB177X.710		
Grand Voyager		1997-2000		04883833AA				HB372X.626
Horizon	Turismo	1983-1984						HB176X.614
Horizon		1985-1990		04238827				HB176X.614
Laser		1990-1992	All			HB213X.626		
Laser	RS	1990-1992	All			HB213X.626		
Laser		1990-1994		2WD Turbo		HB213X.626		
Laser		1990-1994		Non Turbo		HB213X.626		
Laser		1992		AWD Turbo		HB213X.626		
Laser		1993-1994	All			HB214X.618		
Laser	RS	1993-1994	All			HB214X.618		
Laser		1993-1994		AWD Turbo		HB214X.618		
Neon	Sport	1995-1996	All			HB177X.630		
Neon	Highline	1995-1997	All			HB177X.630		
Neon		1995-1999	All			HB177X.630		
Neon		1995-1996		5 lug rear drum		HB177X.630		
Neon		1995-1996		Rear Disc Models		HB177X.630		HB176X.614

BRAKE PAD APPLICATIONS



Hawk Performance - BRAKE PAD APPLICATIONS

HB **245** **x** **.631**
 HAWK BRAKE PAD SHAPE INSERT COMPOUND CODE PAD THICKNESS

MAKE/ MODEL	SUBMODEL	YEARS	ENGINE (LITER)	NOTE	FRONT		REAR	
					OES	HB SERIES	OES	HB SERIES
PLYMOUTH CONTINUED								
Neon		1997-2001				HB177X.630		HB176X.614
Neon		1998-2001		05011630AA				HB176X.614
Neon		2000-2001		05014438AA		HB260X.670		
PB100		1975-1980				HB398X.680		
PB100 Van		1974				HB398X.680		
PB150		1981-1983				HB398X.680		
PB200		1975-1980				HB398X.680		
PB200 Van		1974				HB398X.680		
PB250		1981-1983				HB398X.680		
Prowler		1997	All			HB260X.670		HB260X.670
Prowler		1999-2001	All			HB260X.670		HB260X.670
Reliant		1983-1984						HB176X.614
Reliant		1985-1989		04238827				HB176X.614
Satellite		1970		6 Cylinder, w/Pin Type Calipers		HB643X.595		
Satellite		1970		8 Cylinder, w/Pin Type Calipers		HB643X.595		
Satellite	6 Cylinder	1970				HB643X.595		
Satellite	8 Cylinder	1970				HB643X.595		
Satellite	Station Wagon	1970				HB643X.595		
Satellite	Station Wagon	1970		w/Pin Type Calipers		HB643X.595		
Satellite		1971-1974	All	w/Pin Type Calipers		HB643X.595		
Satellite		1971-1972				HB643X.595		
Satellite		1973-1974		Slider Type Caliper		HB643X.595		
Sundance		1987-1990		04238827				HB176X.614
Sundance		1989-1990		With Rear Disc				HB176X.614
Sundance		1991-1994				HB411X.717		HB176X.614
Sundance		1993-1994		04238827				HB176X.614
Sundance		1993-1994		4509374				HB176X.614
Turismo		1983-1985						HB176X.614
Valiant	6 Cylinder	1966-1968				HB471X.510		
Valiant	8 Cylinder	1966-1968				HB471X.510		
Valiant		1969				HB471X.510		
Valiant	8 Cylinder	1970				HB471X.510		
Valiant		1971-1972	All			HB471X.510		
Voyager	100 Series	1974-1982				HB398X.680		
Voyager	200 Series	1974-1982				HB398X.680		
Voyager	PB-150,PB-250	1983				HB398X.680		
Voyager		1984						HB286X.591
Voyager		1985-1990		4313080				HB286X.591
Voyager	Front: 14" Wheels Rear: FWD	1991-1993		4318080				HB286X.591
Voyager		1991-1995				HB411X.717		
Voyager	Front: 14" Wheels Rear: FWD	1994		4723367				HB286X.591
Voyager	Rear: FWD	1995		4723367				HB286X.591
Voyager	SE	1996-1997	All			HB177X.710		
Voyager		1996-2000	All			HB177X.710		
Voyager		1997-2000		04883833AA				HB372X.626
PONTIAC								
6000		1982	All			HB400X.630		
6000	LE	1982	All			HB400X.630		
6000		1983-1989	All	w/Heavy Duty Brakes		HB396X.630		
6000	LE	1983-1989	All	w/Heavy Duty Brakes		HB396X.630		
6000	LE	1983-1989	All	w/Standard Brakes		HB400X.630		
6000	STE	1983-1989	All			HB396X.630		
6000		1983-1984				HB400X.630		
6000	Light Duty Brakes	1985-1989		18024902		HB400X.630		
6000	STE	1985-1989		18024902		HB400X.630		

BRAKE PAD APPLICATIONS



MAKE/ MODEL	SUBMODEL	YEARS	ENGINE (LITER)	NOTE	FRONT		REAR	
					OES	HB SERIES	OES	HB SERIES
PONTIAC CONTINUED								
6000	SE	1986-1989	All	w/Heavy Duty Brakes		HB396X.630		
6000	SE	1986-1989	All	w/Standard Brakes		HB400X.630		
6000	LE	1990-1991	All			HB396X.630		
6000	SE	1990-1991	All			HB396X.630		
Acadian		1969-1971				HB103X.590		
Astre		1975				HB103X.590		
Astre		1976-1977				HB103X.590		HB119X.594
Aztek	GT	2001	All			HB373X.689		HB359X.543
Aztek		2001-2005	All			HB373X.689		HB359X.543
Aztek	2WD	2001-2005				HB373X.689		
Aztek	4WD	2001-2005				HB373X.689		HB359X.543
Aztek	Rally	2004	All			HB373X.689		HB359X.543
Bonneville		1969-1972				HB103X.590		
Bonneville		1973-1981	All		770052	HB103X.590		
Bonneville		1978-1981				HB119X.594		HB119X.594
Bonneville	Safari	1979-1981	All		770052	HB103X.590		
Bonneville		1982-1986	All			HB119X.594		
Bonneville	Brougham	1982-1986	All			HB119X.594		
Bonneville		1982-1984				HB119X.594		
Bonneville	LE	1984-1986	All			HB119X.594		
Bonneville		1987	All			HB396X.630		
Bonneville	LE	1987-1991	All			HB396X.630		
Bonneville	SE	1988-1991	All			HB396X.630		
Bonneville	SSE	1988-1991	All			HB396X.630		
Bonneville		1991		18019286				HB359X.543
Bonneville		1992-1993		18024915		HB103X.590		
Bonneville		1992-1995		18048649				HB359X.543
Bonneville	SE	1994-1998	All			HB217X.681		
Bonneville	SSE	1994-1998	All			HB217X.681		
Bonneville		1994-1999				HB217X.681		
Bonneville		1996-1999		19152686				HB359X.543
Bonneville		1999	All			HB217X.681		
Bonneville		2000-2003	All			HB360X.670		HB359X.543
Bonneville	SSEi	2000-2003	All		770699	HB360X.670	770508	HB359X.543
Bonneville	SE	2000-2005	All		770699	HB360X.670	770508	HB359X.543
Bonneville	SLE	2000-2005	All		770699	HB360X.670	770508	HB359X.543
Bonneville		2000-2003		18043999				HB359X.543
Bonneville		2000-2003		18045380		HB360X.670		
Bonneville		2000-2004		SLE, SSEi		HB360X.670		HB359X.543
Bonneville		2000-2005		SE		HB360X.670		HB359X.543
Bonneville	SE	2000-2005		18043999				HB359X.543
Bonneville	GXP	2004-2005	All			HB467X.540		HB359X.543
Bonneville	SLE	2004		18043999				HB359X.543
Bonneville	SLE	2004		88964119		HB536X.704		
Bonneville		2004-2005		GXP		HB467X.540		HB359X.543
Bonneville	GXP	2004-2005		18043995				HB359X.543
Bonneville		2005		SLE, SSEi		HB536X.704		HB359X.543
Bonneville	SLE, Front: From Vin 129028	2005		18043999				HB359X.543
Bonneville	SLE, Front: To Vin 129027	2005		18045380		HB360X.670		
Catalina		1969-1972				HB103X.590		
Catalina	Station Wagon	1971-1972				HB103X.590		
Catalina		1973-1981	All		770052	HB103X.590		
Catalina	Safari	1973-1981	All		770052	HB103X.590		
Catalina		1977-1981						HB119X.594
Catalina	Station Wagon	1977-1981						HB235X.665

BRAKE PAD APPLICATIONS

Hawk Performance - BRAKE PAD APPLICATIONS

HB **245** **x** **.631**
 HAWK BRAKE PAD SHAPE INSERT COMPOUND CODE PAD THICKNESS

MAKE/ MODEL	SUBMODEL	YEARS	ENGINE (LITER)	NOTE	FRONT		REAR	
					OES	HB SERIES	OES	HB SERIES
PONTIAC CONTINUED								
Executive		1969-1970				HB103X.590		
Firebird		1969-1975				HB103X.590		
Firebird		1973-1981	All		770052	HB103X.590		
Firebird	Esprit	1973-1981	All		770052	HB103X.590		
Firebird	Formula	1973-1981	All		770052	HB103X.590		
Firebird	Trans Am	1973-1981	All		770052	HB103X.590		
Firebird		1976-1977				HB103X.590		HB119X.594
Firebird		1978		Rear Disc Brakes		HB103X.590		HB119X.594
Firebird		1978		Rear Drum Brakes		HB103X.590		
Firebird		1979-1981				HB103X.590		HB119X.594
Firebird		1982-1987				HB119X.594		HB119X.594
Firebird		1988-1992	All	w/Performance Package		HB111X.610		
Firebird		1988		except Performance Pkg.		HB119X.594		HB119X.594
Firebird		1988-1992		Performance Pkg.		HB111X.610		HB112X.540
Firebird	Trans Am GTA SE	1989	All	w/Performance Package		HB111X.610		
Firebird	Trans Am GTA	1989	All	w/Performance Package		HB111X.610		HB112X.540
Firebird	Formula	1989-1992	All	w/Performance Package		HB111X.610		HB112X.540
Firebird		1989-1992	All	w/o Performance Package	770154	HB119X.594		
Firebird	Formula	1989-1992	All	w/o Performance Package	770154	HB119X.594	770413	HB112X.540
Firebird		1989-1992		except Performance Pkg.		HB119X.594		HB112X.540
Firebird	Trans Am GTA	1990	All	w/Performance Package		HB111X.610		
Firebird	Trans Am GTA	1990	All	w/Performance Package				HB112X.540
Firebird	Trans Am GTA	1991-1992	All	w/Performance Package		HB111X.610		HB112X.540
Firebird		1993		18024917		HB103X.590		
Firebird		1993		Rear Disc Brakes				HB112X.540
Firebird	Trans Am GT	1994	All			HB217X.681		
Firebird		1994-1997	All			HB217X.681		
Firebird	Formula	1994-1997	All			HB217X.681		HB112X.540
Firebird	Trans Am	1994-1997	All			HB217X.681		
Firebird		1994-1997		Rear Disc Brakes		HB217X.681		HB112X.540
Firebird		1994-1997		Rear Drum Brakes		HB217X.681		
Firebird	Firehawk	1998	All		770749	HB249X.575		
Firebird		1998-2002	All		770749	HB249X.575	770750	HB250X.653
Firebird	Formula	1998-2002	All		770749	HB249X.575	770750	HB250X.653
Firebird	Trans Am	1998-2002	All		770749	HB249X.575	770750	HB250X.653
Firebird		1998-2002				HB249X.575		HB250X.653
G3		2009-2010	All		771035	HB592X.665		
G5	GT	2007-2009	All	w/Rear Drum Brakes.		HB517X.690		
G5		2007-2010	All	w/Rear Disc Brakes.		HB524X.740		
G5		2007-2010	All	w/Rear Drum Brakes.		HB517X.690		
G5	GT	2007-2010	All	w/Rear Disc Brakes.		HB524X.740		
G5		2007-2008		5 Lugs; w/Rear Discs		HB524X.740		HB525X.540
G5		2007-2010		4 Lugs; w/Rear Drums		HB517X.690		
G5		2007-2010		5 Lugs; w/Rear Drums		HB517X.690		
G5		2009		25960262				HB525X.540
G5	GT	2009		25809846		HB524X.740		
G5		2009-2010		5 Lugs; w/Rear Discs		HB517X.690		HB525X.540
G6	GT	2005	All		771039	HB554X.643		
G6	Base	2005-2010	All			HB524X.740		
G6		2005				HB524X.740		HB525X.540
G6	GT	2006-2010	All			HB524X.740		
G6	GTP	2006-2010	All			HB524X.740		
G6		2006-2007		4 Cyl.		HB524X.740		HB525X.540
G6		2006-2007		V6		HB524X.740		HB525X.540
G6		2006-2008		15808204		HB524X.740		

BRAKE PAD APPLICATIONS



MAKE/ MODEL	SUBMODEL	YEARS	ENGINE (LITER)	NOTE	FRONT		REAR	
					OES	HB SERIES	OES	HB SERIES
PONTIAC CONTINUED								
G6	(Latin America)	2008-2009		25864605				HB525X.540
G6		2008-2010				HB524X.740		HB525X.540
G6		2008-2010		25864605				HB525X.540
G8	Base	2008-2009	All	w/298 mm Front Rotor		HB606X.650		HB607X.616
G8	GT	2008-2009	All	w/321mm Front rotor, w/324mm Rear Rotor		HB606X.650		HB607X.616
G8	GXP	2008-2009	All			HB453X.585		
G8		2008		GT		HB606X.650		HB607X.616
G8		2008		V6		HB606X.650		HB607X.616
G8		2009		GT, With 321mm Diameter Front Rotors		HB606X.650		HB607X.616
G8		2009		GXP With 355mm Diameter Front Rotors		HB453X.585		HB607X.616
G8		2009		V6 Models		HB606X.650		HB607X.616
G8	GXP	2009		89047725		HB453X.585		
Grand Am		1973-1975	All		770052	HB103X.590		
Grand Am		1985-1988	All			HB400X.630		
Grand Am	LE	1985-1989	All			HB400X.630		
Grand Am	SE	1986-1989	All			HB400X.630		
Grand Am		1986-1989				HB400X.630		
Grand Am	LE	1990	All	w/o Performance Package		HB400X.630		
Grand Am	LE	1990	All	w/Performance Package		HB390X.602		
Grand Am	SE	1990	All	w/o Performance Package		HB400X.630		
Grand Am	SE	1990	All	w/Performance Package		HB390X.602		
Grand Am		1990		except Performance Pkg. WS6		HB400X.630		
Grand Am		1990		with Performance Pkg. WS6		HB390X.602		
Grand Am		1991	All			HB390X.602		
Grand Am	LE	1991	All			HB390X.602		
Grand Am	SE	1991-1997	All			HB390X.602		
Grand Am		1991-1998				HB390X.602		
Grand Am	GT	1992-1997	All			HB390X.602		
Grand Am		1999-2004	All			HB425X.661		
Grand Am		1999-2005				HB425X.661		HB359X.543
Grand Am	GT1	2005	All			HB425X.661		
Grand Am	GT	2005	All			HB425X.661		
Grand Am	SE	2005	All			HB425X.661		
Grand Prix		1969-1972				HB103X.590		
Grand Prix		1973-1977	All		770052	HB103X.590		
Grand Prix	LJ	1977	All		770052	HB103X.590		
Grand Prix	SJ	1977-1980	All		770052	HB103X.590		
Grand Prix		1978-1981	All			HB119X.594		
Grand Prix	LJ	1978-1983	All			HB119X.594		
Grand Prix		1978-1981				HB119X.594		HB119X.594
Grand Prix	Brougham	1981	All			HB119X.594		
Grand Prix		1982-1987				HB119X.594		
Grand Prix		1988-1989	All			HB232X.681		
Grand Prix	LE	1988-1993	All			HB232X.681		
Grand Prix	SE	1988-1993	All			HB232X.681		
Grand Prix		1988-1993				HB232X.681		
Grand Prix	McLaren	1990	All			HB232X.681		
Grand Prix	STE	1990-1993	All			HB232X.681		
Grand Prix	GT	1991-1993	All			HB232X.681		
Grand Prix		1992-1993	All			HB232X.681		
Grand Prix	SE	1994	All	w/Rear Disc Brakes.		HB232X.681		
Grand Prix		1994				HB232X.681		HB359X.543
Grand Prix	GT	1995-1996	All			HB232X.681		
Grand Prix	GTP	1995-1996	All			HB232X.681		
Grand Prix	SE	1995-1996	All			HB232X.681		

BRAKE PAD APPLICATIONS



Hawk Performance - BRAKE PAD APPLICATIONS

HB
HAWK BRAKE

245
PAD SHAPE

x
INSERT COMPOUND CODE

.631
PAD THICKNESS

MAKE/ MODEL	SUBMODEL	YEARS	ENGINE (LITER)	NOTE	FRONT		REAR	
					OES	HB SERIES	OES	HB SERIES
PONTIAC CONTINUED								
Grand Prix		1995-1996		267mm Dia. Front Rotor		HB232X.681		HB359X.543
Grand Prix		1995-1996		286mm Dia. Front Rotor		HB232X.681		HB359X.543
Grand Prix		1996	All			HB232X.681		
Grand Prix	SE	1997-1998	All			HB360X.670		
Grand Prix	GTP	1997-2003	All			HB360X.670		
Grand Prix	GT	1997-2003	All			HB360X.670		HB359X.543
Grand Prix	GT	1997-2003	All		770699		770508	
Grand Prix		1997-2003				HB360X.670		HB359X.543
Grand Prix		1998-2003	All		770699	HB360X.670	770508	HB359X.543
Grand Prix		2004	All			HB451X.668		HB450X.555
Grand Prix	GTP	2004	All			HB451X.668		
Grand Prix		2004		Base & GT; 3.8L		HB451X.668		HB450X.555
Grand Prix		2004		GTP		HB451X.668		HB450X.555
Grand Prix		2005	All					HB440X.606
Grand Prix	GTP	2005	All					HB450X.555
Grand Prix	GXP	2005-2008	All			HB439X.555		HB440X.606
Grand Prix		2005-2006		Base & GT; 3.8L		HB360X.670		HB450X.555
Grand Prix		2005-2008		GXP; 5.3L		HB439X.555		HB440X.606
Grand Prix		2007-2008		Base, GT, GTP; 3.8L		HB360X.670		HB450X.555
Grand Prix		2008	All					HB450X.555
GTO		1969-1973				HB103X.590		
GTO		1973	All		770052	HB103X.590		
GTO		2004	All			HB460X.580		HB573X.615
GTO		2004				HB460X.580		HB573X.615
GTO		2005-2006	All			HB247X.575		HB573X.615
GTO		2005-2006				HB247X.575		HB573X.615
J2000		1982-1983	All			HB400X.630		
J2000	Early	1982				HB400X.630		
J2000	Late	1982				HB400X.630		
J2000 Sunbird		1984				HB400X.630		
J2000 Sunbird	Early	1985				HB400X.630		
J2000 Sunbird	Late	1985		18024902		HB400X.630		
LeMans		1969-1971				HB103X.590		
LeMans		1973-1977	All		770052	HB103X.590		
LeMans	Safari	1973-1977	All		770052	HB103X.590		
LeMans	Sport	1973-1977	All		770052	HB103X.590		
LeMans		1978-1981				HB119X.594		HB119X.594
Montana		1999-2001	All			HB360X.670		
Montana		1999-2001				HB360X.670		
Montana		1999-2001		18023301				HB359X.543
Montana		2002-2004	All	AWD	770856	HB373X.689	770508	HB359X.543
Montana		2002-2004	All	FWD, w/Rear Disc	770699	HB360X.670	770508	HB359X.543
Montana		2002-2004	All	FWD, w/Rear Drum	770699	HB360X.670		
Montana	FWD	2002		18045380		HB360X.670		
Montana	2WD	2002-2004				HB360X.670		
Montana	4WD	2002-2004				HB373X.689		HB359X.543
Montana	AWD	2002-2004		18045984				HB359X.543
Montana	FWD	2002-2005		18048650				HB359X.543
Montana	FWD	2003-2005		18048030		HB360X.670		
Montana		2005	All		770699	HB360X.670		
Montana	SV6	2005	All	AWD	770856	HB373X.689	770508	HB359X.543
Montana	SV6	2005	All	FWD, Except Performance Suspensions	770699	HB360X.670	770508	HB359X.543
Montana	SV6	2005	All	FWD, w/Performance Suspension	770699	HB360X.670	770508	HB359X.543
Montana	2WD	2005		With Rear Disc Brakes and Independent Rear Suspension		HB360X.670		

BRAKE PAD APPLICATIONS

MAKE/ MODEL	SUBMODEL	YEARS	ENGINE (LITER)	NOTE	FRONT		REAR	
					OES	HB SERIES	OES	HB SERIES
PONTIAC CONTINUED								
Montana	2WD	2005		With Rear Disc Brakes, I-Beam Rear Axle		HB360X.670		
Montana	2WD	2005		With Rear Drum Brakes		HB360X.670		
Montana	4WD	2005-2006				HB360X.670		
Montana	SV6	2006	All			HB360X.670		
Montana	2WD	2006		Models with I-Beam Rear Axle		HB360X.670		
Montana	2WD	2006		Models with Independent Rear Suspension		HB360X.670		
Parisienne		1970-1976				HB103X.590		
Parisienne	Station Wagon	1971				HB103X.590		
Parisienne	Sta.Wagon,Police,Taxi	1972-1975				HB103X.590		
Parisienne	Station Wagon	1976				HB103X.590		
Parisienne		1977-1981				HB103X.590		HB119X.594
Parisienne	Station Wagon	1977-1982				HB103X.590		HB235X.665
Parisienne		1982				HB103X.590		
Parisienne		1983-1986	All		770052	HB103X.590		
Parisienne	Brougham	1983-1986	All		770052	HB103X.590		
Parisienne	Station Wagon	1983-1984						HB235X.665
Parisienne		1984						HB119X.594
Phoenix		1977-1979				HB103X.590		HB119X.594
Phoenix		1980-1981				HB400X.630		
Phoenix	LJ	1981-1983	All			HB400X.630		
Phoenix		1981-1984	All			HB400X.630		
Phoenix	SJ	1982-1983	All			HB400X.630		
Pursuit		2005-2006		10365723				HB525X.540
Pursuit		2005-2006		22705327		HB524X.740		
Pursuit	With Rear Drums	2005-2006		10366667		HB517X.690		
Safari		1969-1970				HB103X.590		
Safari		1976				HB103X.590		
Safari		1987-1989	All		770052	HB103X.590		
Solstice		2006-2009	All			HB524X.740		
Solstice		2006-2009				HB524X.740		HB478X.605
Solstice	GXP	2007	All			HB524X.740		
Sunbird		1976-1980						HB119X.594
Sunbird		1986-1988	All			HB400X.630		
Sunbird	GT	1986-1991	All			HB400X.630		
Sunbird	SE	1986-1991	All			HB400X.630		
Sunbird		1986-1991				HB400X.630		
Sunbird	LE	1989-1991	All			HB400X.630		
Sunbird		1991	All			HB400X.630		
Sunbird	GT	1992-1993	All			HB390X.602		
Sunbird	SE	1992-1994	All			HB390X.602		
Sunbird		1992-1994				HB390X.602		
Sunbird	LE	1993-1994	All			HB390X.602		
Sunfire		1995-2005				HB390X.602		
Sunfire	GT	1996-1997	All		770914	HB393X.665		
Sunfire	SE	1996-1997	All		770914	HB393X.665		
Sunfire		1998-2005	All			HB390X.602		
Tempest		1969-1970				HB103X.590		
Torrent		2006	All		770833	HB472X.650		
Torrent		2006				HB472X.650		
Trans Sport		1990-1991	All			HB396X.630		
Trans Sport		1992-1993		12510001		HB103X.590		
Trans Sport		1992-1993		18019347				HB359X.543
Trans Sport		1994-1996	All			HB217X.681		
Trans Sport		1994-1996				HB217X.681		
Trans Sport		1994-1996		12510024				HB359X.543

BRAKE PAD APPLICATIONS



Hawk Performance - BRAKE PAD APPLICATIONS

HB **245** **x** **.631**
 HAWK BRAKE PAD SHAPE INSERT COMPOUND CODE PAD THICKNESS

MAKE/ MODEL	SUBMODEL	YEARS	ENGINE (LITER)	NOTE	FRONT		REAR	
					OES	HB SERIES	OES	HB SERIES
PONTIAC CONTINUED								
Trans Sport		1997-1998	All			HB360X.670		
Trans Sport		1997-1998				HB360X.670		HB359X.543
Trans Sport		1999		18023301				HB359X.543
Trans Sport		1999		18045380		HB360X.670		
Ventura		1971-1972				HB103X.590		
Ventura	Custom	1973-1975	All		770052	HB103X.590		
Ventura		1973-1977	All		770052	HB103X.590		
Ventura	S	1975	All		770052	HB103X.590		
Ventura	SJ	1975-1977	All		770052	HB103X.590		
Ventura		1976-1977						HB119X.594
Vibe	GT	2003-2006	All		770923	HB441X.661		
Vibe		2003-2008	All		770833	HB472X.650		
Vibe		2003-2006		with Rear Discs		HB441X.661		HB329X.543
Vibe		2003-2006		with rear drums		HB441X.661		
Vibe		2007-2008				HB441X.661		
Vibe		2009-2010	1.8L			HB627X.690		HB629X.565
Vibe		2009-2010	1.8L	Except GT and AWD		HB627X.690		HB629X.565
Vibe		2009-2010	2.4L	Except GT and AWD		HB627X.690		HB629X.565
Vibe		2009-2010	2.4L	GT and AWD		HB704X.692		HB648X.607
Vibe		2009-2010		1.8L 2WD		HB627X.690		HB629X.565
Vibe		2009-2010		2.4L 2WD		HB704X.692		HB629X.565
Vibe		2009-2010		AWD or GT Models		HB704X.692		HB648X.607
Wave	(Canada)	2005		96534655		HB592X.665		
Wave		2006	All	(Canada)	771035	HB592X.665		
Wave	(Canada)	2007-2008		96534655		HB592X.665		
Wave5	(Canada)	2005-2007		96475176		HB592X.665		
PORSCHE								
911	Carrera 2	1965-1968	All			HB172X.595		
911		1965-1968				HB172X.500		HB713X.585
911		1969	All	With "M" series calipers		HB172X.595		
911	Carrera 2	1969	All	With "M" series calipers		HB172X.595		HB172X.595
911	Carrera 2	1969	All	With "S" series calipers		HB171X.590		
911		1969						HB713X.585
911		1970-1972	All			HB172X.595		HB172X.595
911	E	1970-1972	All	With "S" series calipers		HB171X.590		HB172X.595
911	Carrera 2	1970-1973	All			HB172X.595		HB172X.595
911		1970-1974						HB172X.500
911	E	1973	All					HB172X.595
911	E	1973	All	With "S" series calipers		HB171X.590		
911		1973	All					HB172X.595
911		1973	All			HB172X.595		
911		1974	All	With "M" series calipers		HB172X.595		HB172X.595
911		1974	All	With "S" series calipers		HB171X.590		HB172X.595
911	Carrera	1974	All	With "S" series calipers		HB171X.590		HB172X.595
911		1974-1977	All			HB172X.595		HB172X.595
911		1975-1977	All			HB171X.590		HB172X.595
911	Carrera	1975-1977	All			HB171X.590		HB172X.595
911	Carrera	1975-1977	All	With "M" series calipers		HB171X.590		HB171X.590
911	S	1975-1977	All	With "S" series calipers		HB171X.590		HB171X.590
911	SC	1978-1983	All	exc Turbo Look		HB171X.590		HB172X.595
911	Turbo	1978-1979						HB172X.595
911	SC	1979-1983	All	Turbo Look		HB170X.650		HB170X.650
911	Carrera	1984-1989	All			HB171X.590		
911	Turbo	1984				HB170X.650		HB170X.650
911	Turbo Carrera	1985-1986				HB170X.650		HB170X.650

BRAKE PAD APPLICATIONS



MAKE/ MODEL	SUBMODEL	YEARS	ENGINE (LITER)	NOTE	FRONT		REAR	
					OES	HB SERIES	OES	HB SERIES
PORSCHE CONTINUED								
911		1987-1989	All			HB170X.650		
911	Turbo	1987						HB170X.650
911		1988						HB170X.650
911	Carrera 4	1989-1994	All			HB170X.650		HB170X.650
911	Carrera	1990		99335193901		HB141X.650		
911	Carrera, 964	1991	All			HB170X.650		
911	Turbo, 964	1991-1992	All			HB141X.650		HB170X.650
911	Carrera 2 Turbo Look	1991-1994	All			HB184X.650		HB141X.650
911	Carrera 2S	1991-1994	All			HB184X.650		HB141X.650
911	Carrera 4 Turbo Look	1991-1994	All			HB170X.650		HB170X.650
911	Carrera 4S	1991-1994	All			HB170X.650		HB170X.650
911		1991		96535193902		HB141X.650		
911	Turbo	1991-1993		99335193901		HB141X.650		
911	Carrera 2, 964	1992-1994	All			HB170X.650		HB170X.650
911	4WD	1992				HB170X.650		HB170X.650
911	Turbo 3.6, 993	1993-1994	All			HB184X.650		HB170X.650
911	Turbo, 993	1993-1994	All			HB184X.650		HB170X.650
911		1993		96435193902		HB170X.650		
911	Carrera 2, 993	1994-1998	All			HB141X.650		HB170X.650
911		1994		964 Body; Carrera 2		HB170X.650		HB170X.650
911		1994		993 Body; Carrera 2		HB141X.650		HB170X.650
911		1994		993 Body; Carrera 4		HB170X.650		HB170X.650
911		1994		993 Body; Turbo 3.6		HB184X.650		HB170X.650
911	Carrera 4	1994						HB141X.650
911	Carrera 4	1994		99335193901		HB141X.650		
911	Carrera 4, 993	1995-1997	All			HB141X.650		HB170X.650
911	Turbo, 993	1995-1998	All			HB184X.650		HB141X.650
911		1995		993 Body		HB141X.650		HB170X.650
911	Carrera 2	1995		99335193901		HB141X.650		
911	Carrera 2 Turbo Look, 993	1996-1998	All			HB184X.650		HB141X.650
911	Carrera 2s, 993	1996-1998	All			HB184X.650		HB141X.650
911	Carrera 4 Turbo Look, 993	1996-1998	All			HB184X.650		HB141X.650
911	Carrera 4S, 993	1996-1998	All			HB184X.650		HB141X.650
911	Carrera Targa	1996-1997		99335193901		HB141X.650		
911	Turbo	1996-1997		99335193901				HB141X.650
911		1996-1998		993 Body; Carrera 4S		HB141X.650		HB170X.650
911		1996-1998		993 Body; Except Turbo and Carrera 4S		HB141X.650		HB170X.650
911		1996-1998		993 Body; Turbo		HB184X.650		HB141X.650
911	Carrera 2	1997		99335193901		HB141X.650		
911	Carrera 4	1997		99335193901		HB141X.650		
911	Carrera 4, 993	1998	All					HB170X.650
911	Targa	1998	All			HB291X.642		HB290X.606
911	Carrera 2, 996	1998-2000	All			HB291X.642		HB290X.583
911	Carrera 4S	1998		99335193901				HB141X.650
911	Targa	1998		99335193901		HB141X.650		
911	Carrera 4, 996	1999-2000	All			HB291X.642		HB290X.606
911	GT3 Cup, 996	1999-2000	All			HB667X.622		HB290X.583
911	GT3 Cup, 996	2001	All			HB667X.622		HB291X.642
911	Turbo, 996	2001-2002	All			HB667X.622		HB550X.634
911	Carrera 2, 996	2001-2005	All			HB550X.634		HB290X.583
911	Carrera 4, 996	2001-2005	All			HB550X.634		HB290X.606
911		2001		99635194701		HB483X.635		
911		2001-2002				HB483X.635		
911	Carrera 4 Turbo Look, 996	2002	All			HB667X.622		HB550X.634
911	Carrera 4S, 996	2002	All			HB667X.622		HB550X.634

BRAKE PAD APPLICATIONS



Hawk Performance - BRAKE PAD APPLICATIONS

HB **245** **x** **.631**
 HAWK BRAKE PAD SHAPE INSERT COMPOUND CODE PAD THICKNESS

MAKE/ MODEL	SUBMODEL	YEARS	ENGINE (LITER)	NOTE	FRONT		REAR	
					OES	HB SERIES	OES	HB SERIES
PORSCHE CONTINUED								
911	Gt3 Cup, 996	2002-2005	All			HB483X.635		HB291X.642
911		2002				HB291X.642		
911	Carrera 4 Turbo Look, 996	2003-2005	All	w/Iron Discs		HB667X.622		HB550X.634
911	Carrera 4S, 996	2003-2005	All	w/Iron Discs		HB667X.622		HB550X.634
911	Gt2, 996	2003-2005	All			HB483X.635		HB291X.642
911	Turbo, 996	2003-2005	All	w/Iron Discs		HB667X.622		HB550X.634
911		2003		Carrera 4S		HB483X.635		
911		2003-2004		Turbo		HB483X.635		
911	Gt3, 996	2004-2005	All	w/Iron Discs		HB483X.635		HB291X.642
911		2004		Carrera 4		HB483X.635		
911		2004		GT2		HB483X.635		
911		2004		GT3		HB483X.635		
911	Carrera 2 Turbo Look, 997	2005	All	w/Iron Discs		HB667X.622		HB550X.634
911	Carrera 2, 997	2005	All	Sport		HB664X.634		HB665X.577
911	Carrera 2, 997	2005	All	Standard Brakes		HB550X.634		HB290X.583
911	Carrera 2S, 997	2005	All	w/Iron Discs		HB667X.622		HB550X.634
911		2005				HB483X.635		
911	Carrera 4, 996	2006-2008	All			HB664X.634		HB290X.606
911	Carrera 2, 997	2006-2010	All			HB664X.634		HB290X.583
911	Carrera 2 Turbo Look, 997	2006-2012	All	W/ Ceramic disc		HB483X.635		HB664X.634
911	Carrera 2 Turbo Look, 997	2006-2012	All	w/Iron Discs		HB667X.622		HB664X.634
911	Carrera 2S, 997	2006-2012	All	W/ Ceramic disc		HB483X.635		HB664X.634
911	Carrera 2S, 997	2006-2012	All	w/Iron Discs		HB667X.622		HB664X.634
911	Carrera 4 Turbo Look, 997	2006-2012	All	W/ Ceramic disc		HB483X.635		HB664X.634
911	Carrera 4 Turbo Look, 997	2006-2012	All	w/Iron Discs		HB667X.622		HB664X.634
911	Carrera 4S, 997	2006-2012	All	W/ Ceramic disc		HB483X.635		HB664X.634
911	Carrera 4S, 997	2006-2012	All	w/Iron Discs		HB667X.622		HB664X.634
911		2006		Carrera		HB483X.635		
911		2006		Carrera 4		HB483X.635		
911		2006		GT2		HB483X.635		
911	Turbo	2006		99635294903				HB550X.634
911		2006-2007		Turbo		HB483X.635		
911	GT3, 997	2007	All			HB483X.635		HB651X.624
911	GT3 Cup, 997	2007-2008	All			HB483X.635		HB651X.624
911	Gt3, 996	2007-2008	All			HB483X.635		HB651X.624
911	Turbo, 997	2007-2012	All			HB483X.635		HB651X.624
911		2007		GT3		HB483X.635		
911	GT3 RSR, 997	2008	All			HB483X.635		
911	Targa 4	2008	All			HB483X.635		
911	GT2	2008-2012	All			HB483X.635		HB651X.624
911	Targa 4S	2008-2012	All	W/ Ceramic disc		HB483X.635		
911	Targa 4S	2008-2012	All	w/Iron Discs		HB667X.622		HB664X.634
911		2008				HB483X.635		
911	Targa	2009-2012	All			HB483X.635		HB664X.634
911		2009		GT2		HB483X.635		
911	Carrera	2009				HB719X.668		HB719X.668
911		2009-2010		Carrera		HB483X.635		
911		2009-2010		Targa		HB483X.635		
911	Targa	2009-2010				HB719X.668		
911		2009-2013		Turbo		HB483X.635		
911	GT3, 997	2010-2011	All			HB483X.635		HB651X.624
911		2010-2011		GT3		HB483X.635		
911	Carrera	2010-2011				HB719X.668		
911		2011		GT2		HB483X.635		
911		2012		Ceramic		HB483X.635		

BRAKE PAD APPLICATIONS



MAKE/ MODEL	SUBMODEL	YEARS	ENGINE (LITER)	NOTE	FRONT		REAR	
					OES	HB SERIES	OES	HB SERIES
PORSCHE CONTINUED								
911		2012-2013		Turbo Ceramic		HB483X.635		
911		2012-2014				HB719X.668		
911	Turbo, 991	2013	All			HB483X.635		HB651X.624
911		2015		99135193900		HB719X.668		
912		1965-1969	All			HB172X.595		HB172X.595
912	E	1965-1969	All			HB172X.595		HB172X.595
912		1965-1969				HB172X.500		HB713X.585
914	4	1970-1972	All	To 7/72		HB172X.595		
914	6	1970-1972	All			HB172X.595		HB172X.595
914		1970-1972		4, 6		HB172X.500		
914		1972-1975	All			HB172X.595		
924	Sport	1977-1979	All			HB199X.702		HB198X.685
924	Turbo	1977-1979	All			HB199X.702		HB198X.685
924		1977-1982	All			HB198X.685		
924		1977-1978				HB198X.685		
924		1979-1980				HB198X.685		HB198X.656
924		1979-1980				HB198X.685		HB198X.685
924		1979-1980				HB199X.660		HB198X.685
924		1979-1980				HB199X.702		HB198X.656
924		1979-1980				HB199X.702		HB198X.685
924		1979-1982				HB199X.660		HB198X.656
924	Sport	1980	All	w/Rear Disc Brakes.		HB199X.702		HB198X.685
924	Turbo Sport	1980	All	w/Rear Disc Brakes.		HB199X.702		HB198X.685
924	Turbo	1980	All	w/Rear Drum Brakes.		HB198X.685		
924	Sport	1981-1982	All			HB199X.702		HB198X.685
924	Turbo	1981-1982	All			HB199X.702		
924		1981-1982				HB199X.660		HB198X.685
924	S	1987-1988	All			HB199X.702		HB198X.685
924		1987-1988				HB199X.660		HB198X.685
928	GTS	1978	All			HB199X.702		
928	CS	1978-1981	All			HB199X.702		HB198X.685
928	GT	1978-1981	All			HB199X.702		HB198X.685
928	S4	1978-1981	All			HB199X.702		HB198X.685
928	S	1978-1981	All			HB199X.702		HB198X.685
928		1978-1980				HB199X.660		HB198X.656
928		1978-1980				HB199X.660		HB198X.685
928	GTS	1979-1981	All			HB199X.702		HB198X.685
928		1981						HB198X.656
928		1981						HB198X.685
928	CS	1982-1985	All			HB137X.690		
928	GT	1982-1985	All			HB137X.690		
928	GTS	1982-1985	All			HB137X.690		
928	S4	1982-1985	All			HB137X.690		
928	S	1982-1985	All			HB137X.690		HB198X.685
928		1982-1985				HB137X.690		HB198X.656
928		1982-1985				HB137X.690		HB198X.685
928	CS	1986-1991	All			HB141X.650		
928	GT	1986-1991	All			HB141X.650		
928	GTS	1986-1991	All			HB141X.650		
928	S4	1986-1991	All			HB141X.650		
928	S	1986-1991	All			HB141X.650		HB170X.650
928		1989-1991				HB141X.650		HB170X.650
928	CS	1993-1995	All			HB184X.650		
928	GT	1993-1995	All			HB184X.650		
928	GTS	1993-1995	All			HB184X.650		

BRAKE PAD APPLICATIONS



Hawk Performance - BRAKE PAD APPLICATIONS

HB
HAWK BRAKE

245
PAD SHAPE

x
INSERT COMPOUND CODE

.631
PAD THICKNESS

MAKE/ MODEL	SUBMODEL	YEARS	ENGINE (LITER)	NOTE	FRONT		REAR	
					OES	HB SERIES	OES	HB SERIES
PORSCHE CONTINUED								
928	S4	1993-1995	All			HB184X.650		
928	S	1993-1995	All			HB184X.650		HB198X.685
928		1993-1995				HB141X.650		HB170X.650
944		1983-1989	All			HB199X.702		HB198X.685
944		1983-1984				HB199X.660		HB198X.656
944		1983-1984				HB199X.660		HB198X.685
944		1985-1989				HB199X.660		HB198X.685
944	Turbo	1986-1988	All			HB170X.650		HB170X.650
944		1986-1989		94435195102		HB199X.702		
944		1986-1989		94435295102				HB198X.685
944	S	1987-1988	All	16 Valve		HB199X.702		HB198X.685
944	S2 Cabriolet	1989	All			HB170X.650		HB170X.650
944	S2	1989	All			HB170X.650		HB170X.650
944	Turbo	1989-1991	All	w/Koni Sport Suspension		HB141X.650		HB170X.650
944		1990-1991	All	Sport Suspension		HB141X.650		HB198X.685
944	Base	1990-1991	All			HB170X.650		HB170X.650
944		1990		92835193904		HB141X.650		
968		1992	All	w/o Sport Suspension		HB170X.650		
968		1992-1995	All	w/Sport Suspension		HB141X.650		
968		1992						HB170X.650
968	Sport	1992						HB170X.650
968	Sport	1992-1995		96535193903		HB141X.650		
968		1993	All	w/o Sport Suspension		HB170X.650		HB170X.650
968		1994	All	w/o Sport Suspension		HB170X.650		
968		1994						HB170X.650
968	Sport	1994						HB170X.650
968		1995	All	w/o Sport Suspension		HB170X.650		HB170X.650
356C		1964-1965				HB172X.500		HB713X.585
356SC		1964-1965				HB172X.500		HB713X.585
Boxster		1997-2004	All			HB289X.610		HB290X.606
Boxster		1997-2004				HB289X.610		HB290X.583
Boxster	S	2000-2004	All	w/Iron Discs		HB550X.634		HB290X.606
Boxster	S	2000-2004						HB290X.583
Boxster	S	2005-2007	All	w/Iron Discs				HB290X.606
Boxster		2005-2008	All			HB289X.610		
Boxster		2005-2006		3.2 Liter		HB483X.635		
Boxster	3.2 Liter	2005-2006		99635194701		HB483X.635		
Boxster	S	2005-2007		w/Iron Discs				HB290X.583
Boxster		2005-2008				HB289X.610		HB665X.577
Boxster	S	2007-2012	3.4L	w/Ceramic Discs		HB483X.635		
Boxster	3.4 Liter	2007		99735193905		HB664X.634		
Boxster		2007-2011		3.4 Liter		HB483X.635		
Boxster	S	2008-2012	All	w/Iron Discs		HB664X.634		HB290X.583
Boxster		2009-2012	All			HB664X.634		HB665X.577
Boxster		2009-2010		Base		HB664X.634		HB665X.577
Boxster	S	2009-2012		w/Iron Discs		HB664X.634		HB665X.577
Boxster		2011-2012		Base, Spyder - Iron Discs		HB664X.634		HB665X.577
Boxster		2012		3.4 Liter Ceramic		HB483X.635		
Boxster	S	2013				HB719X.668		
Boxster		2013-2014				HB719X.668		
Boxster		2013-2014		Base - Iron Discs				HB665X.577
Boxster	S	2013-2014		w/Iron Discs				HB665X.577
Boxster		2015		98735293901				HB665X.577
Boxster		2015		99735193809		HB719X.668		
Carrera		1964				HB172X.500		HB713X.585

BRAKE PAD APPLICATIONS

MAKE/ MODEL	SUBMODEL	YEARS	ENGINE (LITER)	NOTE	FRONT		REAR	
					OES	HB SERIES	OES	HB SERIES
PORSCHE CONTINUED								
Carrera GT		2004-2005				HB483X.635		HB483X.635
Carrera GT		2004-2005		98035193900		HB483X.635		HB483X.635
Cayenne		2003-2006	All	17 in. Wheel		HB512X.605		HB502X.606
Cayenne		2003-2006	All	18 in. Wheel		HB501X.625		HB502X.606
Cayenne	S	2003-2006	All	18 in. Wheel		HB501X.625		HB502X.606
Cayenne		2003		95535193914		HB501X.625		
Cayenne	Turbo	2003		95535193914		HB501X.625		
Cayenne		2003				HB501X.625		HB502X.606
Cayenne		2003				HB512X.605		HB502X.606
Cayenne		2004		95535193912		HB501X.625		
Cayenne	Turbo	2004		95535193913		HB501X.625		
Cayenne		2004-2006				HB512X.605		
Cayenne		2004-2006		330mm Front Disc		HB512X.605		HB502X.606
Cayenne		2004-2006		350mm Front Disc		HB501X.625		HB502X.606
Cayenne		2005-2006		380mm Front Disc				HB502X.606
Cayenne		2005-2006		95535193914		HB501X.625		
Cayenne	Turbo	2005-2006		95535193914		HB501X.625		
Cayenne	GTS	2008	All	17 in. Wheel, 368mm Front Disc		HB512X.605		HB502X.606
Cayenne	S	2008	All	18 in. Wheel		HB501X.625		HB502X.606
Cayenne	Turbo	2008	All	17 in. Wheel, 368mm Front Disc		HB512X.605		HB502X.606
Cayenne	Turbo	2008	All	18 in. Wheel, 368mm Front Disc		HB501X.625		HB502X.606
Cayenne		2008-2010	All	17 in. Wheel		HB512X.605		HB502X.606
Cayenne		2008-2010	All	18 in. Wheel		HB501X.625		HB502X.606
Cayenne		2008		Turbo		HB720X.575		
Cayenne	GTS	2008-2009		95535193914		HB501X.625		
Cayenne		2008-2010				HB512X.605		
Cayenne		2008-2010		330mm Front Disc		HB512X.605		HB502X.606
Cayenne		2008-2010		350mm Front Disc		HB501X.625		HB502X.606
Cayenne		2008-2010		380mm Front Disc				HB502X.606
Cayenne	GTS	2009-2010	All	18 in. Wheel		HB501X.625		HB502X.606
Cayenne		2009-2010		Turbo S		HB720X.575		
Cayenne	GTS	2010		95535193915		HB501X.625		
Cayenne		2011		S		HB720X.575		HB762X.634
Cayenne		2011-2012				HB720X.575		HB762X.634
Cayenne		2011-2012		Turbo				HB762X.634
Cayenne		2012-2015		Ceramic		HB720X.575		
Cayenne		2013						HB762X.634
Cayenne		2013		S		HB761X.593		HB762X.634
Cayenne	S	2013				HB761X.593		
Cayenne		2014				HB761X.593		HB762X.634
Cayenne		2014		Turbo		HB761X.593		HB762X.634
Cayenne		2014		Turbo Ceramic		HB720X.575		
Cayenne	Turbo	2014				HB761X.593		
Cayenne		2015				HB761X.593		HB762X.634
Cayman		2006	All	w/Iron Discs		HB550X.634		HB290X.583
Cayman	S	2006	All	w/Iron Discs		HB550X.634		HB290X.583
Cayman	3.4 Liter Ceramic	2006		99635194701		HB483X.635		
Cayman		2006-2007		S; w/Iron Discs				HB290X.583
Cayman	3.4 Liter	2006-2007		99635294903		HB550X.634		
Cayman		2006-2012		3.4 Liter Ceramic		HB483X.635		
Cayman		2006-2012		S; w/Ceramic Discs				HB664X.634
Cayman		2007-2008	All	w/Iron Discs		HB289X.610		
Cayman	S	2007-2008	All	w/Iron Discs		HB289X.610		HB290X.583
Cayman	3.4 Liter Ceramic	2007		99735194801		HB483X.635		
Cayman		2007-2008		Base Model		HB289X.610		HB665X.577

BRAKE PAD APPLICATIONS



Hawk Performance - BRAKE PAD APPLICATIONS

HB
HAWK BRAKE

245
PAD SHAPE

x
INSERT COMPOUND CODE

.631
PAD THICKNESS

MAKE/ MODEL	SUBMODEL	YEARS	ENGINE (LITER)	NOTE	FRONT		REAR	
					OES	HB SERIES	OES	HB SERIES
PORSCHE CONTINUED								
Cayman		2008-2012	All	w/Iron Discs		HB664X.634		
Cayman		2008		S; w/Iron Discs		HB664X.634		HB290X.583
Cayman	3.4 Liter Ceramic	2008		99635194701		HB483X.635		
Cayman	S	2009	All	w/Iron Discs		HB664X.634		HB665X.577
Cayman		2009		S; w/Iron Discs		HB664X.634		HB665X.577
Cayman		2009-2012		Base Model		HB664X.634		HB665X.577
Cayman	3.4 Liter Ceramic	2009-2012		99735194801		HB483X.635		
Cayman	S	2010-2012	All	w/Iron Discs		HB664X.634		HB290X.583
Cayman		2010-2012		S; w/Iron Discs		HB664X.634		HB290X.583
Cayman	R	2011-2012	All	w/Iron Discs		HB664X.634		HB290X.583
Cayman		2012		R; w/Ceramic Discs				HB664X.634
Cayman		2012		R; w/Iron Discs		HB664X.634		HB290X.583
Cayman		2014				HB719X.668		
Cayman		2014		Base Model				HB665X.577
Cayman		2014		S; w/Ceramic Discs				HB664X.634
Cayman		2014		S; w/Iron Discs				HB665X.577
Cayman		2015		98735293901				HB665X.577
Cayman		2015		99735193809		HB719X.668		
Macan	Turbo	2015				HB761X.593		
Macan		2015-2016		Ceramic		HB720X.575		
Macan		2015-2016		Turbo		HB761X.593		
Panamera		2010				HB720X.575		
Panamera		2010-2013				HB761X.593		
Panamera		2010-2016		Ceramic		HB720X.575		
Panamera		2014-2016				HB720X.575		
RAM								
1500		2011				HB559X.695		HB514X.610
1500		2012		68071076AA				HB513X.610
1500		2012		Exc. Tradesman HD Models		HB559X.695		HB514X.610
1500		2012		Tradesman HD Models		HB633X.790		HB634X.750
1500		2013-2014				HB559X.695		HB514X.610
1500		2015		05143350AC		HB559X.695		
1500		2015		68071076AB				HB513X.610
2500		2011-2014				HB633X.790		HB634X.750
2500		2015		68049148AA		HB633X.790		
2500		2015		68049158AA				HB634X.750
3500		2011-2013				HB633X.790		HB634X.750
3500		2014-2015		68049148AA		HB633X.790		
3500		2014-2015		68049158AA				HB634X.750
C/V		2012		Models with Single Piston front caliper MFG After 3/24/2012		HB569X.650		
C/V		2012		Models with Single Piston front caliper MFG Before 3/23/2012		HB569X.650		
C/V	Rear to 3/23/2012	2012		68093323AB		HB569X.650		
C/V		2013		68093323AB		HB569X.650		
C/V		2013		Models with Single Piston front caliper		HB569X.650		
C/V	BRE	2014-2015		68093323AB		HB569X.650		
Dakota		2011				HB559X.695		
RENAULT								
Fluence	(Latin America)	2011-2012		440602070R				HB364X.587
Koleos	(Latin America)	2009-2010		D4060JA00JR				HB600X.539
Koleos		2011-2012	All	(Latin America)		HB387X.547		HB600X.539
Safrane		2011-2012	All	(Latin America)		HB268X.665		
Safrane	(Latin America)	2011		4811152110K1		HB268X.665		
Safrane		2011-2012		(Latin America)		HB268X.606		

BRAKE PAD APPLICATIONS

MAKE/ MODEL	SUBMODEL	YEARS	ENGINE (LITER)	NOTE	FRONT		REAR	
					OES	HB SERIES	OES	HB SERIES
RENAULT CONTINUED								
Scala	(Latin America)	2011-2012				HB598X.606		
Scenic	(Latin America)	2007		440607960R				HB364X.587
ROLLS ROYCE								
Phantom		2003-2005				HB676X.780		
ROVER								
2000		1964-1965				HB172X.595		HB172X.595
2000		1966-1970				HB169X.560		
3500S		1969-1970				HB244X.624		
SAAB								
99		1968-1972				HB172X.500		HB713X.585
99		1969-1974	All			HB172X.595		
99		1973				HB172X.500		
99		1973						HB713X.585
99		1974				HB172X.500		HB713X.585
99		1975-1980				HB169X.560		
900		1979-1982				HB169X.560		
900		1983-1984				HB169X.560		HB713X.585
900		1985-1986		8993263		HB169X.560		
900		1985-1987						HB713X.585
900		1987		9102708		HB169X.560		
900		1988	All			HB195X.640		
900	S	1988	All			HB195X.640		
900		1988-1993				HB195X.640		HB399X.630
9000		1986		8961856				HB399X.630
9000		1987		8968018		HB195X.640		
9000		1987		8968026				HB399X.630
9000		1988		8993974		HB195X.640		
9000		1988-1998						HB399X.630
9000		1989	All			HB195X.640		
42616	SE	1999	All			HB388X.756		
42616		1999-2001	All			HB388X.756		
42616	Viggen	1999-2002	All			HB388X.756		
42616		1999-2002		Except Viggen- Models W/288mm (11.3") Diameter Front Rotors		HB388X.756		
42616		1999-2002		Viggen Models- Models W/308mm (12.1") Diameter Front Rotors		HB388X.756		
42616	SE	2001-2002	All			HB388X.756		
42616	SE	2003	All	w/288mm Front Rotors		HB388X.756		HB478X.605
42616		2003		Arc & Vector Models; 302mm (11.89") Front Disc				HB571X.605
42616		2003		Convertible Models; 288mm (11.3") Front Disc		HB388X.756		
42616		2003-2004		Linear Models; 285mm (11.22") Front Disc				HB571X.605
42616	16" Wheels	2004		93166942				HB478X.605
42616	17" Wheels	2004		93183140				HB478X.605
42616		2004		Arc & Aero Models; 302mm (11.89") Front Disc				HB571X.605
42616		2005		Arc & Aero Models; 302mm (11.89") Front Disc				HB478X.605
42616		2005		Linear Models; 285mm (11.22") Front Disc				HB478X.605
42616		2006-2007		2.0T; 285mm (11.22") Front disc w/vented rear rotors				HB478X.605
42616		2006-2008		2.0T; 285mm (11.22") Front disc w/solid rear rotors				HB478X.605
42616		2006-2008		Aero; 2.8L; With 302mm (11.89") Front Disc				HB478X.605
42616		2006-2011		Aero; 2.8L; With 314mm (12.36") Front Disc				HB478X.605
42616	Front 345mm Rotor	2008		93195754		HB515X.760		
42616	Aero Xwd	2009-2010	All			HB515X.760		
42616		2009-2011		2.0T (Except XWD); 302mm (11.89") Front Disc With Vented Rear Rotors				HB478X.605
42616		2009-2011		2.0T Touring & Comfort; 285mm (11.22") Front Disc With SOLID Rear Rotors				HB478X.605

BRAKE PAD APPLICATIONS

Hawk Performance - BRAKE PAD APPLICATIONS

HB **245** **x** **.631**
 HAWK BRAKE PAD SHAPE INSERT COMPOUND CODE PAD THICKNESS

MAKE/ MODEL	SUBMODEL	YEARS	ENGINE (LITER)	NOTE	FRONT		REAR	
					OES	HB SERIES	OES	HB SERIES
SAAB CONTINUED								
42616		2009-2011		2.0T XWD; 302mm (11.89") Front Disc With VENTED Rear Rotors				HB478X.605
42616		2009-2011		Aero XWD; 2.8L; With 345mm (13.58") Front Disc				HB478X.605
42616		2009-2011		Aero; 2.8L; 302mm (11.89") Front Disc With VENTED Rear Rotors				HB478X.605
42616	Front 345mm Rotor	2011		93195754		HB515X.760		
42618		1999	All	To Serial Number X3025751		HB388X.756		
42618		1999	All	From Serial Number X3025752				HB227X.630
42618		1999	All	From Serial Number X3025752		HB388X.756		
42618	Front from Vin X3020001 Rear from Vin X3025752	1999		5058110				HB227X.630
42618		1999-2001		Aero Models with 308mm (12.1") Front Disc		HB388X.756		
42618		1999-2001		Except Aero; with 288mm (11.3") Front Disc		HB388X.756		
42618		2000	All			HB388X.756		
42618	Aero	2000-2005	All			HB388X.756		HB227X.630
42618		2001	All			HB388X.756		HB227X.630
42618	Arc	2002-2005	All			HB388X.756		HB227X.630
42618	Linear	2002-2005	All			HB388X.756		HB227X.630
42618		2002-2004		2.3L Turbo Models with 288mm (11.3") Front Disc		HB388X.756		
42618		2002-2004		Arc/Aero Models with 308mm (12.1") Front Disc		HB388X.756		
42618		2004		Models with 299mm (11.77") Rear Rotors		HB354X.756A		
42618		2005		Models with 286mm (11.26") Rear Rotors		HB354X.756A		
42618		2005-2006		Aero Models with 308mm (12.1") Front Disc		HB354X.756A		
42618		2005-2006		Linear/Arc Models with 288mm (11.3") Front Disc		HB388X.756		
42618	2.3t	2006-2009	All	w/Wear Sensor		HB354X.756A		HB227X.630
42618	Aero	2006-2009	All	w/Wear Sensor		HB354X.756A		HB227X.630
42618	288mm Rotor	2006-2009		5058110				HB227X.630
42618	308mm Rotor	2006-2009		5058110				HB227X.630
42618	288mm Rotor	2007-2009		5533518		HB388X.756		
42618		2008-2010		308mm Front Disc; 286mm Solid Rear Disc		HB354X.756A		
42618		2008-2010		308mm Front Disc; 299mm Vented Rear Disc		HB354X.756A		
42618		2011		321mm Front Disc; Except Performance Package		HB638X.702		
42618		2011		Brembo Front Caliper; 355mm Front Rotors		HB453X.585		
9-2X	Aero	2005-2006	All			HB432X.661		
9-2X		2005-2006		Aero; 2.0L Turbo		HB432X.661		HB452X.545
9-2X		2005-2006		Linear; 2.5L		HB432X.661		HB452X.545
9-2X	2.5i	2006	All			HB432X.661		
9-3X		2010-2011	All			HB515X.760		
9-3X		2010-2011		2.0T XWD; 302mm (11.89") Front Disc With VENTED Rear Rotors				HB478X.605
9-4X		2011						HB639X.645
9-7x	Arc	2005	All			HB382X.657		
9-7x	Linear	2005	All			HB382X.657		
9-7x		2005				HB382X.657		HB383X.685
9-7x		2006-2009	All			HB617X.630		
9-7x		2006-2007				HB617X.630		HB383X.685
9-7x		2008-2009		4.2i; 5.3i		HB617X.630		HB383X.685
9-7x		2008-2009		Aero; 6.0L		HB617X.630		HB383X.685
SATURN								
Aura		2007-2009	All			HB524X.740		
Aura		2007-2009				HB524X.740		HB525X.540
Ion		2003-2004	All			HB517X.690		
Ion		2003				HB517X.690		
Ion	Red Line	2004-2007	All		771028	HB524X.740	771033	HB525X.540
Ion		2004-2007		except Redline		HB517X.690		

BRAKE PAD APPLICATIONS



MAKE/ MODEL	SUBMODEL	YEARS	ENGINE (LITER)	NOTE	FRONT		REAR	
					OES	HB SERIES	OES	HB SERIES
SATURN CONTINUED								
Ion		2004-2007		Redline		HB524X.740		HB525X.540
Ion-1		2003-2004		22688646		HB517X.690		
Ion-1		2005	All			HB517X.690		
Ion-2		2003-2004		22688646		HB517X.690		
Ion-2		2005-2007	All			HB517X.690		
Ion-3		2003-2004		22688646		HB517X.690		
Ion-3		2005-2007	All			HB517X.690		
L100		2001-2002				HB388X.756		
L100		2002	All			HB388X.756		
L200		2001-2003				HB388X.756		
L200		2002-2003	All			HB388X.756		
L300		2001-2005				HB388X.756		
L300		2002-2005	All			HB388X.756		
LS		2000		21019628		HB388X.756		
LS1		2000		21019628		HB388X.756		
LS2		2000		21019628		HB388X.756		
LW1		2000		21019628		HB388X.756		
LW2		2000		21019628		HB388X.756		
LW200		2001-2003	All			HB388X.756		
LW300		2001-2003	All			HB388X.756		
Outlook		2007-2008	All		771169	HB617X.630	770883	HB383X.685
Outlook		2007-2010						HB383X.685
Outlook		2009	All		771169	HB617X.630		
Outlook		2010	All		771169	HB617X.630	770883	HB383X.685
Relay		2005		FWD		HB360X.670		
Relay		2005-2006		AWD		HB360X.670		
Relay		2006		FWD; w/o Special Suspension		HB360X.670		
Relay		2006		FWD; w/Special Suspension		HB360X.670		
Relay		2007		FWD		HB360X.670		
Relay-1		2007	All			HB360X.670		
Relay-2		2005-2007	All			HB360X.670		
Relay-3		2005-2007	All			HB360X.670		
SC		1991-1992				HB409X.661		HB359X.543
SC1		1993-2002				HB409X.661		HB359X.543
SC2		1993-2002				HB409X.661		HB359X.543
Sky		2007-2010	All			HB524X.740		HB478X.605
Sky	Red Line	2007-2010	All			HB524X.740		HB478X.605
Sky		2007-2010				HB524X.740		HB478X.605
SL		1991-2002				HB409X.661		HB359X.543
SL1		1991-1998	All			HB409X.661		HB359X.543
SL1		1991-2002				HB409X.661		HB359X.543
SL1		1999-2002	All			HB409X.661		
SL2		1991-1998	All			HB409X.661		HB359X.543
SL2		1991-2002				HB409X.661		HB359X.543
SL2		1999-2002	All			HB409X.661		
SW1		1993-1998	All			HB409X.661		HB359X.543
SW1		1993-1999				HB409X.661		HB359X.543
SW1		1999	All			HB409X.661		
SW2		1993-1998	All			HB409X.661		HB359X.543
SW2		1993-2001				HB409X.661		HB359X.543
SW2		1999-2001	All			HB409X.661		
Vue		2002-2007	All		770833	HB472X.650		
Vue		2002-2007				HB472X.650		
Vue	Red Line	2004	All		770833	HB472X.650		
Vue	Red Line	2006	All		770833	HB472X.650		

BRAKE PAD APPLICATIONS



Hawk Performance - BRAKE PAD APPLICATIONS

H B **2 4 5** **x** **.6 3 1**
 HAWK BRAKE PAD SHAPE INSERT COMPOUND CODE PAD THICKNESS

MAKE/ MODEL	SUBMODEL	YEARS	ENGINE (LITER)	NOTE	FRONT		REAR	
					OES	HB SERIES	OES	HB SERIES
SATURN CONTINUED								
Vue	Green Line	2007	All		770833	HB472X.650		
Vue		2008-2010	All		771264			
SCION								
FR-S	Base 2dr Coupe	2013-2014	All			HB711X.661		HB671X.628
FR-S		2013				HB711X.661		
FR-S		2015		SU00304089		HB711X.661		
FR-S		2015		SU00304097				HB671X.628
FR-S		2016						HB671X.628
iM		2016				HB704X.692		HB629X.565
iQ		2012-2014	All			HB493X.650		
iQ		2012				HB493X.650		
iQ		2013		0446574020		HB493X.650		
iQ	EV	2013		0446552320		HB596X.690		
iQ		2015		0446574020		HB493X.650		
TC		2005-2010	All			HB328X.685		HB610X.587
TC		2005-2010				HB328X.685		HB610X.587
TC	Spec	2007-2008	All			HB328X.685		
TC		2011-2014	All			HB704X.692		
TC		2011-2013				HB704X.692		HB629X.565
TC		2014-2015		0446621020				HB629X.565
TC		2015		0446542180		HB704X.692		
TC		2016				HB704X.692		HB629X.565
xA		2004	All			HB493X.650		
xA		2004-2006				HB493X.650		
xA		2005-2006	All			HB628X.651		
xB		2004	All			HB493X.650		
xB		2004-2006				HB493X.650		
xB		2005-2006	All			HB628X.651		
xB		2008-2013	All			HB627X.690		HB629X.565
xB		2008-2013				HB627X.690		HB629X.565
xB		2014-2015		0446542200		HB627X.690		
xB		2014-2015		0446612150				HB629X.565
xD		2008-2014	All			HB627X.690		
xD		2008-2013				HB627X.690		
SEAT								
Alhambra	(Latin America)	2002						HB364X.642
SRT								
Viper		2013-2014		05093291AB		HB193X.670		HB193X.670
Viper	Black Caliper	2014		68232820AA		HB453X.585		HB453X.585
STUDEBAKER								
Avanti		1962-1964				HB172X.595		
Challenger	8 Cylinder	1964				HB172X.595		
Commander	8 Cylinder	1964				HB172X.595		
Daytona		1963-1964				HB172X.595		
Hawk		1964				HB172X.595		
Lark	6 Cylinder	1963				HB172X.595		
SUBARU								
B9 Tribeca		2006-2007	All		771078	HB533X.668		HB671X.628
B9 Tribeca	Limited	2006-2007	All		771078	HB533X.668		HB671X.628
Baja		2003	All			HB432X.661		
Baja		2003				HB432X.661		HB434X.543
Baja	Turbo	2004-2006	All			HB432X.661		
Baja	Sport	2004				HB432X.661		
Baja		2004-2006		except Turbo		HB432X.661		HB434X.543
Baja		2004-2006		Turbo		HB432X.661		HB434X.543

BRAKE PAD APPLICATIONS



MAKE/ MODEL	SUBMODEL	YEARS	ENGINE (LITER)	NOTE	FRONT		REAR	
					OES	HB SERIES	OES	HB SERIES
SUBARU CONTINUED								
Baja	Turbo	2004-2006				HB432X.661		
Brat	DL	1982	All			HB202X.580		
Brat		1983				HB202X.580		
BRZ	Limited	2013-2014	All	277mm Front Disc; Solid Rear Disc				HB557X.545
BRZ	Premium	2013-2014	All	292mm Front Disc; Vented Rear Disc		HB711X.661		HB671X.628
BRZ		2013		With Solid Rear Rotors		HB711X.661		HB557X.545
BRZ		2013		With Vented Rear Rotors		HB711X.661		HB671X.628
BRZ	Rear: Solid Rotors	2014		26696AG051				HB557X.545
BRZ		2014-2015		26296SC011		HB711X.661		
BRZ		2014-2015		26696CA000				HB671X.628
BRZ		2015		26696AG051				HB557X.545
DL		1981-1983	All			HB202X.580		
DL		1984				HB202X.580		
DL	Station Wagon	1984				HB202X.580		
Forester		1998-2002				HB352X.665		HB434X.543
Forester	XS	2002-2003	All	From 02/2002 to 02/2003		HB432X.661		
Forester	XS	2003-2005	All	From 03/2003		HB432X.661		
Forester	XT	2003-2005	All	From 03/2003		HB432X.661		
Forester		2003				HB432X.661		HB434X.543
Forester		2004-2008				HB432X.661		HB452X.545
Forester	X	2006-2008	All	w/Rear Drum Brakes.		HB432X.661		
Forester	X L.L. Bean Edition	2006-2010	All			HB432X.661		
Forester	XT Limited	2006-2010	All			HB432X.661		
Forester	Sports 2.5 X	2008	All	w/Rear Drum Brakes.		HB432X.661		
Forester	Sports 2.5 Xt	2008-2010	All			HB432X.661		
Forester	Sports 2.5 X	2009-2010	All			HB432X.661		HB557X.545
Forester	X	2009-2010	All			HB432X.661		
Forester		2009				HB432X.661		HB557X.545
Forester		2010		Manufactured after 4/15/2010		HB711X.661		HB557X.545
Forester		2010		Manufactured before 4/14/2010		HB432X.661		HB557X.545
Forester		2011-2013	All			HB711X.661		HB557X.545
Forester		2011-2013				HB711X.661		HB557X.545
Forester		2014	2.0L	2.0xt		HB533X.668		
Forester		2014	2.5i			HB711X.661		HB557X.545
Forester		2014		2.0L Models		HB533X.668		HB671X.628
Forester		2014		2.5L Models		HB711X.661		HB557X.545
Forester	2.0XT	2015		26296AJ010		HB533X.668		
Forester	2.0XT	2015		26696SG000				HB671X.628
Forester	2.5i	2015		26296SC011		HB711X.661		
Forester	2.5i	2015		26696FJ000				HB557X.545
GL		1981-1983	All			HB202X.580		
GL		1984				HB202X.580		
GL	Station Wagon	1984				HB202X.580		
Impreza		1993-1996		Rear Disc Models				HB367X.585
Impreza	Wagon	1993-1996		Rear Disc Models				HB367X.585
Impreza	Outback	1995-1996		Rear Disc				HB367X.585
Impreza		1997				HB424X.665		
Impreza	Outback	1997-2001				HB424X.665		
Impreza	Wagon	1997-2001				HB424X.665		
Impreza		1998		RS - MFG before 6/1998		HB352X.665		HB367X.585
Impreza		1998-2001		Rear Drum Models		HB424X.665		
Impreza		1999		RS - MFG after 7/1998		HB352X.665		HB434X.543
Impreza		2000-2001		RS		HB352X.665		HB434X.543
Impreza	WRX	2002	All			HB352X.665		
Impreza		2002				HB432X.661		HB434X.543

BRAKE PAD APPLICATIONS



Hawk Performance - BRAKE PAD APPLICATIONS

HB **245** **x** **.631**
 HAWK BRAKE PAD SHAPE INSERT COMPOUND CODE PAD THICKNESS

MAKE/ MODEL	SUBMODEL	YEARS	ENGINE (LITER)	NOTE	FRONT		REAR	
					OES	HB SERIES	OES	HB SERIES
SUBARU CONTINUED								
Impreza	OUTBACK	2002				HB432X.661		
Impreza	Wagon	2002				HB432X.661		
Impreza	WRX	2002				HB352X.665		HB434X.543
Impreza	WRX	2003	All	From 1/03		HB432X.661		
Impreza	WRX	2003	All	To 12/02		HB432X.661		
Impreza		2003		Models MFG after 1/2003		HB432X.661		HB452X.545
Impreza		2003		Models MFG up to 12/2002		HB432X.661		HB434X.543
Impreza	OUTBACK	2003		Rear Disc		HB432X.661		HB452X.545
Impreza	Wagon	2003		Models MFG after 1/2003		HB432X.661		HB452X.545
Impreza	Wagon	2003		Models MFG up to 12/2002		HB432X.661		
Impreza	WRX	2003		Mfg. Date from 9/2002		HB432X.661		HB452X.545
Impreza	WRX	2003		Mfg. Date up to 8/2002		HB352X.665		HB434X.543
Impreza	WRX STi	2004	All			HB453X.585		HB180X.560
Impreza	WRX	2004	All			HB432X.661		
Impreza	OUTBACK	2004				HB432X.661		HB452X.545
Impreza	WRX	2004				HB432X.661		HB452X.545
Impreza		2004-2007				HB432X.661		HB452X.545
Impreza	Wagon	2004-2007				HB432X.661		HB452X.545
Impreza	WRX STi	2004-2014			771001	HB453X.585		HB180X.560
Impreza	WRX	2005	All			HB432X.661		HB452X.545
Impreza	WRX STi	2005-2007	All			HB453X.585		
Impreza	WRX STi	2005-2014	All		771001			
Impreza	WRX	2005				HB432X.661		
Impreza	OUTBACK SPORT	2005-2007				HB432X.661		HB452X.545
Impreza	WRX	2006-2007	All			HB700X.562		
Impreza	WRX	2006-2007	All	Limited		HB700X.562		
Impreza	WRX	2006-2007	All	TR		HB700X.562		
Impreza	WRX	2006-2007				HB700X.562		HB179X.630
Impreza	WRZ STi Limited	2007	All			HB453X.585		HB180X.560
Impreza	2.5i	2008-2010	All	Sedan				HB557X.545
Impreza	2.5i	2008-2010	All	Wagon				HB557X.545
Impreza	WRX	2008-2012	All			HB432X.661		HB557X.545
Impreza	WRX STi	2008-2014	All			HB453X.585		HB180X.560
Impreza		2008				HB432X.661		HB557X.545
Impreza	Wagon	2008		Rear Disc Models		HB432X.661		HB557X.545
Impreza	Wagon	2008		Rear Drum Models		HB432X.661		
Impreza	OUTBACK SPORT	2008-2010				HB432X.661		HB557X.545
Impreza	WRX	2008-2010				HB432X.661		HB557X.545
Impreza		2009-2010		2.5 GT Models		HB432X.661		HB557X.545
Impreza		2009-2010		Excluding 2.5 GT Models		HB432X.661		HB557X.545
Impreza	Wagon	2009-2010		2.5 GT Models		HB432X.661		HB557X.545
Impreza	Wagon	2009-2010		Excluding 2.5 GT Models		HB432X.661		HB557X.545
Impreza		2011-2013	All					HB557X.545
Impreza	OUTBACK SPORT	2011				HB711X.661		HB557X.545
Impreza		2011-2014				HB711X.661		HB557X.545
Impreza	Wagon	2011-2014				HB711X.661		HB557X.545
Impreza	WRX	2011-2014				HB711X.661		HB557X.545
Impreza	WRX	2015	All			HB533X.668		HB557X.545
Justy		1987-1988		725191631		HB475X.642		
Justy	13" Wheels	1989		725193010		HB475X.642		
Legacy	Non-Turbo	1990-1994	All					HB367X.585
Legacy		1990-1996	All					HB367X.585
Legacy		1990-1994		Except 4WD Turbo				HB367X.585
Legacy		1991-1994	All	W/Rear Discs; AWD; Sedan; Turbocharged;				HB367X.585
Legacy		1991-1994	All	W/Rear Discs; Sedan; Naturally Aspirated;				HB367X.585

BRAKE PAD APPLICATIONS



MAKE/ MODEL	SUBMODEL	YEARS	ENGINE (LITER)	NOTE	FRONT		REAR	
					OES	HB SERIES	OES	HB SERIES
SUBARU CONTINUED								
Legacy		1991-1994	All	W/Rear Discs; Wagon;				HB367X.585
Legacy	Outback	1995-1996	All					HB367X.585
Legacy		1995		w/Rear Discs				HB367X.585
Legacy	GT	1996	All					HB367X.585
Legacy		1996		GT, LSI, Outback; w/Rear Discs				HB367X.585
Legacy		1996		L, LS; w/Rear Discs				HB367X.585
Legacy	LSI	1997	All	14 in. Wheel		HB424X.665		HB367X.585
Legacy	LSI	1997	All	15 or 16 in. Wheels		HB352X.665		HB367X.585
Legacy	GT	1997-1998	All			HB352X.665		HB367X.585
Legacy	L	1997-1998	All	14 in. Wheel		HB424X.665		HB367X.585
Legacy	L	1997-1998	All	15 or 16 in. Wheels		HB352X.665		HB367X.585
Legacy	Limited	1997-1998	All			HB352X.665		HB367X.585
Legacy	Outback	1997-1998	All	14 in. Wheel		HB424X.665		HB367X.585
Legacy	Outback	1997-1998	All	15 or 16 in. Wheels		HB352X.665		HB367X.585
Legacy	Postal	1997-1998	All	14 in. Wheel		HB424X.665		
Legacy	Postal	1997-1998	All	15 or 16 in. Wheels		HB352X.665		
Legacy		1997		GT, LS, LSI, Outback; w/Rear Discs		HB352X.665		HB367X.585
Legacy		1997-1999		L; w/Rear Discs		HB424X.665		HB367X.585
Legacy		1997-2000		w/Rear Drums		HB424X.665		
Legacy		1998-1999		GT, LTD, Outback; w/Rear Discs		HB352X.665		HB367X.585
Legacy		1999	All					HB367X.585
Legacy		1999	All			HB424X.665		
Legacy		2000		w/Rear Discs		HB352X.665		HB434X.543
Legacy	GT Limited	2001	All			HB352X.665		
Legacy		2001		GT LTD; w/Rear Discs		HB352X.665		HB434X.543
Legacy		2001		L, GT; w/Rear Discs		HB352X.665		HB434X.543
Legacy		2001		w/Rear Drums; From 5/01		HB352X.665		
Legacy		2001		w/Rear Drums; To 4/01		HB424X.665		
Legacy	GT Limited	2002	All	To 4/2002		HB432X.661		
Legacy	GT	2002	All	To 4/2002		HB432X.661		
Legacy	GT	2002-2004	All	From 5/2002		HB432X.661		
Legacy		2002		L, LS; w/Rear Discs; From 5/02		HB432X.661		HB434X.543
Legacy		2002		L, LS; w/Rear Discs; To 4/02		HB352X.665		HB434X.543
Legacy		2002-2004		GT; LTD Models		HB432X.661		HB434X.543
Legacy		2002-2004		w/Rear Drums		HB352X.665		
Legacy		2003-2004		L, LS; w/Rear Discs		HB432X.661		HB434X.543
Legacy		2005-2006		2.5GT		HB533X.668		HB434X.543
Legacy		2005-2006		2.5i		HB432X.661		HB557X.545
Legacy		2007-2008		2.5GT, Spec B, 3.0R		HB533X.668		HB434X.543
Legacy		2007-2009		2.5i, 2.5i Limited		HB432X.661		HB557X.545
Legacy		2009		2.5GT, Spec B, 3.0R Limited		HB533X.668		HB434X.543
Legacy		2009		3.0R, Excluding Limited		HB432X.661		HB557X.545
Legacy	2.5 GT	2010-2012	2.5L					HB671X.628
Legacy	2.5i	2010-2012	2.5L					HB557X.545
Legacy	3.6 R	2010-2014	3.6L					HB671X.628
Legacy		2010-2012		2.5GT, 3.6R		HB533X.668		HB671X.628
Legacy		2010-2012		2.5i		HB432X.661		HB557X.545
Legacy	2.5i	2013-2014	2.5L			HB711X.661		HB557X.545
Legacy		2013-2014		2.5i		HB711X.661		HB557X.545
Legacy		2013-2014		3.6R		HB533X.668		HB671X.628
Legacy	2.5i	2015		26296AL000		HB533X.668		
Legacy	3.6R	2015		26296VA000		HB533X.668		
Outback		2000-2001				HB352X.665		HB434X.543
Outback		2001	All			HB424X.665		
Outback		2002-2004	All			HB432X.661		

BRAKE PAD APPLICATIONS



Hawk Performance - BRAKE PAD APPLICATIONS

HB
HAWK BRAKE

245
PAD SHAPE

x
INSERT COMPOUND CODE

.631
PAD THICKNESS

MAKE/ MODEL	SUBMODEL	YEARS	ENGINE (LITER)	NOTE	FRONT		REAR	
					OES	HB SERIES	OES	HB SERIES
SUBARU CONTINUED								
Outback		2002		From 10/2001		HB432X.661		HB434X.543
Outback		2002		To 9/2001		HB352X.665		HB434X.543
Outback		2003-2004				HB432X.661		HB434X.543
Outback	2.5 XT	2005	2.5L			HB432X.661		HB557X.545
Outback	2.5i	2005	2.5L			HB432X.661		
Outback	3.0 R	2005	3.0L			HB432X.661		
Outback		2005		2.5 XT Turbo		HB432X.661		HB557X.545
Outback		2005		2.5i, 3.0R		HB432X.661		HB557X.545
Outback	R VDC Limited	2006	All			HB432X.661		HB557X.545
Outback	R	2006	All			HB432X.661		HB557X.545
Outback	XT	2006	All			HB432X.661		HB557X.545
Outback	R L.L. Bean Edition	2006-2009	All			HB432X.661		HB557X.545
Outback	2.5i	2006-2011	All			HB432X.661		HB557X.545
Outback		2006-2009				HB432X.661		HB557X.545
Outback	2.5i Basic	2007	All			HB432X.661		HB557X.545
Outback	2.5i Limited	2007	All			HB432X.661		HB557X.545
Outback	XT Limited	2007-2010	All			HB432X.661		HB557X.545
Outback	2.5i L.L. Bean Edition	2008-2010	All			HB432X.661		HB557X.545
Outback		2008-2012	All			HB432X.661		HB557X.545
Outback	3.6 R	2010-2014	All			HB533X.668		HB671X.628
Outback		2010-2012		2.5i		HB432X.661		HB557X.545
Outback		2010-2014		3.6R Model		HB533X.668		HB671X.628
Outback	2.5i	2013-2014	2.5L			HB711X.661		HB557X.545
Outback		2013-2014	All			HB711X.661		HB557X.545
Outback		2013-2014		2.5i		HB711X.661		HB557X.545
Outback		2015		26296VA000		HB533X.668		
SVX	Alcyone	1992-1997	All		770333	HB402X.669		HB367X.585
SVX		1993-1997				HB402X.669		HB367X.585
Tribeca		2008-2014	All		771078	HB533X.668		HB671X.628
Tribeca	Limited	2008-2014	All		771078	HB533X.668		
Tribeca	Premiere	2008-2014	All		771078	HB533X.668		HB671X.628
Tribeca		2008-2014				HB533X.668		HB671X.628
WRX		2015				HB533X.668		
WRX		2015		26696AG051				HB557X.545
WRX STI		2015		26296FE100		HB453X.585		
WRX STI		2015		26696FG000				HB180X.560
XV Crosstrek		2013-2014	All			HB711X.661		HB557X.545
XV Crosstrek	Base	2013-2014	All			HB711X.661		HB557X.545
XV Crosstrek		2013-2014				HB711X.661		HB557X.545
XV Crosstrek		2015		26296FJ020		HB711X.661		
XV Crosstrek		2015		26696FJ000				HB557X.545
Equator		2009-2011	All		771094	HB618X.625	771100	HB619X.626
Equator		2009-2012		2.5L		HB618X.625		HB619X.626
Equator		2009-2012		4.0L V6		HB618X.625		HB619X.626
Equator	2.5 Liter	2011		5521082Z30		HB620X.703		
Equator		2012	4.0L		771094	HB618X.625	771100	HB619X.626
Equator	2.5 Liter	2012		5521082Z32		HB620X.703		
Ertiga	(China)	2012		55810B58M50N000		HB668X.567		
Forenza		2004-2008	All		771035	HB592X.665		
Forenza		2004-2006						HB593X.548
Grand Vitara		2009-2011						HB370X.559
Grand Vitara		2012		5580077K00				HB370X.559
Grand Vitara		2013		5580077K02				HB370X.559
Kizashi		2010-2013	All			HB660X.661		HB145X.570
Kizashi		2010-2011				HB660X.661		

MAKE/ MODEL	SUBMODEL	YEARS	ENGINE (LITER)	NOTE	FRONT		REAR	
					OES	HB SERIES	OES	HB SERIES
SUBARU CONTINUED								
Reno		2005-2008	All		771035	HB592X.665		
Reno		2005-2006						HB593X.548
Sidekick	Hardtop	1991		5520056830		HB384X.587		
Sidekick	JLX	1992-1995	All			HB384X.587		
Sidekick	JS	1992-1998	All			HB384X.587		
Sidekick	JX	1992-1998	All			HB384X.587		
Sidekick	Sport	1996-1998	All		770680			
Sidekick		1996-1998		4 Door		HB384X.587		
SX4		2007						HB145X.570
SX4	(Canadian)	2007-2008		5581080J00		HB268X.665		
SX4		2007-2008		5581080J00		HB268X.665		
SX4		2008-2012		w/Rear Discs				HB145X.570
SX4		2009-2013	All			HB268X.665		
SX4	AWD	2009-2013	All			HB268X.665		HB145X.570
SX4		2009-2013				HB268X.606		
SX4		2009-2013		5581080J01		HB268X.665		
SX4		2009-2013		AWD		HB268X.606		
SX4	AWD	2009-2013		5581080J01		HB268X.665		
Vitara		1999-2004				HB384X.587		
Vitara		2000-2004	All			HB384X.587		
XL-7		2007			771264			
TESLA								
S		2012-2014	All			HB787X.582		HB663X.557
S		2012-2014				HB787X.582		HB194X.570
S		2015		105506600B		HB453X.585		
S		2015		105506800B				HB663X.557
TOYOTA								
2000GT		1967-1968				HB172X.595		HB172X.595
4Runner		1984				HB312X.591		
4Runner		1985-1987		0446535170		HB312X.591		
4Runner	4 Cyl.	1988-1989		0446535170		HB312X.591		
4Runner	6 Cyl.	1988-1989				HB317X.591		
4Runner	SR5	1990-1991	All			HB189X.595		
4Runner	SR5	1990-1991	All			HB315X.669		
4Runner	SR5	1990-1991	All		770436			
4Runner		1991		Models MFG After 6/1991		HB311X.591		
4Runner	SR5	1992-1995	All			HB311X.591		
4Runner		1992-1994				HB311X.591		
4Runner		1995-2002		Models with 297mm (11.69") Front Rotors		HB315X.669		
4Runner		1995-2002		Models with 319mm (12.56") Front Rotors		HB315X.669		
4Runner	Limited	1996-1997	All		770436	HB315X.669		
4Runner	SR5	1996-1997	All		770436	HB315X.669		
4Runner		1996-2002	All		770436	HB315X.669		
4Runner	Limited	2003	All	With 17 inch Wheels; 338mm Front Discs	770976			
4Runner	Limited	2003-2009	All	With 17 inch Wheels; 338mm Front Discs		HB490X.665		HB477X.610
4Runner		2003-2009	All	With 16 inch Wheels; 319mm Front Discs	770976	HB490X.665	770606	HB477X.610
4Runner		2003-2009	All	With 17 inch Wheels; 338mm Front Discs	770976	HB490X.665	770606	HB477X.610
4Runner	Limited	2003-2009	All	With 16 inch Wheels; 319mm Front Discs	770976	HB490X.665		HB477X.610
4Runner	Sport	2003-2009	All	With 16 inch Wheels; 319mm Front Discs	770976	HB490X.665	770606	HB477X.610
4Runner	Sport	2003-2009	All	With 17 inch Wheels; 338mm Front Discs	770976	HB490X.665	770606	HB477X.610
4Runner		2003-2011	All		770976	HB490X.665	770606	HB477X.610
4Runner	SR5	2003-2011	All		770976	HB490X.665	770606	HB477X.610
4Runner		2003-2009		Models with 319mm (12.56") Front Rotors		HB490X.665		HB477X.610
4Runner		2003-2009		Models with 338mm (13.30") Front Rotors		HB490X.665		HB477X.610
4Runner	Limited	2004-2009	All	With 17 inch Wheels; 338mm Front Discs	770976		770606	

BRAKE PAD APPLICATIONS



Hawk Performance - BRAKE PAD APPLICATIONS

H B **2 4 5** **x** **.6 3 1**
 HAWK BRAKE PAD SHAPE INSERT COMPOUND CODE PAD THICKNESS

MAKE/ MODEL	SUBMODEL	YEARS	ENGINE (LITER)	NOTE	FRONT		REAR	
					OES	HB SERIES	OES	HB SERIES
TOYOTA CONTINUED								
4Runner	Limited	2010-2014	All		770976	HB490X.665	770606	HB477X.610
4Runner	Sport	2010-2014	All		770976	HB490X.665	770606	HB477X.610
4Runner		2010-2014				HB490X.665		HB477X.610
4Runner		2014	All		770976	HB490X.665	770606	HB477X.610
4Runner	SR5	2014	All		770976	HB490X.665	770606	HB477X.610
4Runner		2015		0446560320		HB490X.665		
4Runner		2015		0446660140				HB477X.610
Avalon	XLS	1995	All			HB318X.669		
Avalon	XL	1995-1997	All			HB318X.669		
Avalon		1995-1997				HB318X.669		
Avalon	XLS	1997	All			HB318X.669		
Avalon		1998-2004				HB320X.669		
Avalon	XL	2002-2003	All			HB320X.669		
Avalon	XLS	2002-2003	All			HB320X.669		
Avalon		2005-2007	All			HB677X.685		
Avalon		2005-2007				HB677X.685		
Avalon		2008-2013	All			HB647X.692		HB648X.607
Avalon		2008-2014				HB647X.692		HB648X.607
Avalon		2015		0446507010		HB647X.692		
Avalon		2015		0446606200				HB648X.607
Camry		1983				HB191X.590		
Camry	DLX	1984-1986	All		770242	HB191X.590		
Camry	LE	1984-1986	All		770242	HB191X.590		
Camry		1987-1991		4 Cyl.		HB191X.590		
Camry		1988-1991		V6		HB191X.590		HB401X.587
Camry		1990-1991		All-Trac		HB191X.590		HB401X.587
Camry	4 Cyl ABS	1991		0449133010		HB310X.689		
Camry	4 Cyl Non-ABS	1991		0449133010		HB310X.689		
Camry	4 Cyl	1991		0449133010		HB310X.689		
Camry	6 Cyl ABS	1991		0449133020		HB318X.669		
Camry	6 Cyl Non-ABS	1991		0449133020		HB318X.669		
Camry	6 Cyl	1991		0449133020		HB318X.669		
Camry		1992-1996	2.2L	4 Cyl. Only. w/Rear Disc Brakes.		HB310X.689		HB401X.587
Camry		1992-1996	2.2L	4 Cyl. Only. w/Rear Drum Brakes.		HB310X.689		
Camry		1992-1996	3.0L	6 Cyl. Only		HB318X.669		HB401X.587
Camry		1992-1996		4 Cyl.		HB310X.689		HB401X.587
Camry		1992-1996		V6 Sedan		HB318X.669		HB401X.587
Camry		1992-1996		V6 Wagon		HB318X.669		HB401X.587
Camry	6 Cyl	1996		0449133060		HB318X.669		
Camry		1997-1999	2.2L	w/Rear Disc Brakes.		HB310X.689		
Camry		1997-1999	3.0L			HB320X.669		HB401X.587
Camry		1997-1999		4 Cyl.		HB310X.689		
Camry		1997-1999		V6		HB320X.669		HB401X.587
Camry		2000-2001	2.2L	14 in. Wheel		HB310X.689		
Camry		2000-2001	2.2L	15 in. Wheel		HB318X.669		
Camry		2000-2001	3.0L			HB320X.669		
Camry	4 Cyl	2000		0446533170		HB318X.669		
Camry		2000-2001		4 cyl; 14" Wheels Made in Japan		HB310X.689		
Camry		2000-2001		4 cyl; 15" Wheels Made in U.S.A.		HB318X.669		
Camry		2000-2001		V6; Made in Japan		HB320X.669		HB610X.587
Camry		2000-2001		V6; Made in USA		HB320X.669		
Camry	4 Cyl	2001		0446533220		HB318X.669		
Camry	LE	2002-2006	2.4L	4 Cyl. Only	770908	HB474X.681		
Camry	SE	2002-2006	2.4L	4 Cyl. Only	770908	HB474X.681		
Camry	XLE	2002-2006	2.4L	4 Cyl. Only	770908	HB474X.681		

BRAKE PAD APPLICATIONS



MAKE/ MODEL	SUBMODEL	YEARS	ENGINE (LITER)	NOTE	FRONT		REAR	
					OES	HB SERIES	OES	HB SERIES
TOYOTA CONTINUED								
Camry	SE	2002-2004	3.0L	6 Cyl. Only		HB474X.681		
Camry	XLE	2002-2004	3.0L	6 Cyl. Only		HB474X.681		
Camry	LE	2002-2006	3.0L	6 Cyl. Only	770908	HB474X.681		
Camry		2002		4 Cyl., Rear Disc Made in Japan		HB474X.681		
Camry		2002		4 Cyl., Rear Disc Made in USA		HB474X.681		
Camry		2002		4 Cyl., Rear Drum		HB474X.681		
Camry		2002		6 Cyl., SE, XLE with Stepped Hub; Made in Japan		HB474X.681		
Camry		2002		6 Cyl., SE, XLE with Stepped Hub; Made in USA		HB474X.681		
Camry		2002		6 Cyl., SE, XLE with Straight Hub; Made in Japan		HB474X.681		
Camry		2002		6 Cyl., SE, XLE with Straight Hub; Made in USA		HB474X.681		
Camry		2002-2004		6 Cyl., LE; Made in Japan		HB474X.681		
Camry		2002-2004		6 Cyl., LE; Made in USA		HB474X.681		
Camry		2003-2004		6 Cyl., SE, XLE Made in Japan		HB474X.681		
Camry		2003-2004		6 Cyl., SE, XLE Made in USA		HB474X.681		
Camry		2003-2006		4 Cyl., SE, XLE Made in USA		HB474X.681		
Camry		2005		6 Cyl., SE 3.3L, XLE 3.0L; Made in USA		HB677X.685		
Camry		2005-2006		4 Cyl., SE, XLE Made in Japan		HB474X.681		
Camry		2005-2006		6 Cyl., LE Made in USA		HB474X.681		
Camry		2005-2006		6 Cyl., LE, Made in Japan		HB474X.681		
Camry		2005-2006		6 Cyl., SE 3.3L, XLE 3.0L; Made in Japan		HB677X.685		
Camry		2006		6 Cyl., SE, XLE; Made in USA		HB677X.685		
Camry	Hybrid	2007	All			HB647X.692		HB648X.607
Camry	LE	2007-2014	All			HB647X.692		HB648X.607
Camry	SE	2007-2014	All			HB647X.692		HB648X.607
Camry	XLE	2007-2014	All			HB647X.692		HB648X.607
Camry		2007-2014				HB647X.692		HB648X.607
Camry	Hybrid	2009	All			HB647X.692		HB648X.607
Camry		2015		0446507010		HB647X.692		
Camry		2015		0446606200				HB648X.607
Camry		2016				HB647X.692		HB648X.607
Celica		1971-1975				HB169X.560		
Celica		1981	All			HB614X.600		
Celica	Supra	1981	All			HB614X.600		
Celica	ST Sport	1986	All		770242	HB191X.590		
Celica	GTS Sport	1986-1987	All		770242	HB191X.590		
Celica	GT	1986-1989	All		770242	HB191X.590		
Celica	Front from 10/1985	1986		0449120320		HB191X.590		
Celica	Front to 10/1985	1986		0449120181		HB191X.590		
Celica	GTS Sport	1986		0449120180		HB191X.590		
Celica	Supra	1986		04465YZZA2		HB191X.590		
Celica	Supra	1986		0446633010				HB401X.587
Celica	GTS Sport	1986-1987		0449220011				HB401X.587
Celica	ST	1987-1989	All		770242	HB191X.590		
Celica	GTS Sport	1987				HB191X.590		
Celica		1987-1988		0449120271		HB191X.590		
Celica	GTS Sport ABS	1988		0449220011				HB401X.587
Celica	GTS Sport Non ABS	1988		0449220060				HB401X.587
Celica	4WD ABS	1988-1989		0446633010				HB401X.587
Celica	4WD Non ABS	1988-1989		0446633010				HB401X.587
Celica	GTS Sport ABS	1988-1989		0449132201		HB191X.590		
Celica	GTS Sport ABS	1989		0446633010				HB401X.587
Celica	GTS Sport Non ABS	1989		0446633010				HB401X.587
Celica		1990		GT		HB191X.590		
Celica		1990-1991		GT-S		HB191X.590		HB401X.587
Celica		1990-1992		All-Trac Turbo Models		HB191X.590		HB401X.587

BRAKE PAD APPLICATIONS



Hawk Performance - BRAKE PAD APPLICATIONS

HB
HAWK BRAKE

245
PAD SHAPE

x
INSERT COMPOUND CODE

.631
PAD THICKNESS

MAKE/ MODEL	SUBMODEL	YEARS	ENGINE (LITER)	NOTE	FRONT		REAR	
					OES	HB SERIES	OES	HB SERIES
TOYOTA CONTINUED								
Celica		1990-1993		ST		HB191X.590		
Celica		1991		Convertible or GT Models		HB191X.590		
Celica		1992		Convertible		HB191X.590		HB401X.587
Celica		1992-1993		GT, GT-S		HB191X.590		HB401X.587
Celica	GT	1993	All		770242	HB191X.590		
Celica	ST	1993	All		770242	HB191X.590		
Celica		1993				HB191X.590		HB401X.587
Celica		1993		All-Trac Turbo		HB191X.590		HB401X.587
Celica	ST	1994-1997	All			HB310X.689		
Celica	GT	1994-1998	All			HB318X.669		HB401X.587
Celica		1994		GT		HB318X.669		HB401X.587
Celica		1994-1997		ST		HB310X.689		
Celica		1995-1997		Convertible & GT		HB318X.669		HB401X.587
Celica	GT, Rear from 10/1995	1996		0446620020				HB401X.587
Celica	GT, Rear from 10/1995	1996		0449133060		HB318X.669		
Celica	GT	1997		0446533060		HB318X.669		HB401X.587
Celica		1998-1999				HB318X.669		HB401X.587
Celica		2000	All			HB493X.650		
Celica		2000		Rear Drum Models		HB493X.650		
Celica		2000-2005		Rear Disc Models		HB328X.685		HB329X.543
Celica	GTS	2001-2005	All			HB328X.685		HB329X.543
Celica		2001-2005		Rear Drum Models		HB328X.685		
Celica	GT	2002-2005	All			HB328X.685		HB329X.543
Corolla	1600	1970-1973				HB169X.560		
Corolla	SR5	1975				HB169X.560		
Corolla	LE	1984	All		770242	HB191X.590		
Corolla	Sport Dlx	1984	All		770242	HB191X.590		
Corolla	DLX	1984-1985	All		770242	HB191X.590		
Corolla	Sedan, Liftback	1984				HB191X.590		
Corolla	GTS	1985	All			HB202X.580		HB203X.550
Corolla	LE LTD	1985	All		770242	HB191X.590		
Corolla	Sport GTS	1985		0449112241		HB191X.590		
Corolla		1985-1987		0449112241		HB191X.590		
Corolla	Couple Only, Including Sport GTS Coupe	1986	All			HB202X.580		
Corolla	GTS	1986	All					HB203X.550
Corolla	GTS Sport	1986	All		770242	HB191X.590		
Corolla	Sport GTS	1986		0449132050		HB191X.590		
Corolla		1986			770242	HB191X.590		
Corolla	GTS	1987	All			HB202X.580		HB203X.550
Corolla	FX16	1987	All		770242	HB191X.590		HB203X.550
Corolla	FX	1987-1988	All		770242	HB191X.590		
Corolla	DLX	1987-1992	All		770242	HB191X.590		
Corolla		1987		0449132050		HB191X.590		
Corolla	FX16	1987		0449102010		HB191X.590		
Corolla	Sport GTS	1987		0449112241		HB191X.590		
Corolla	FX16 GTS	1988	All		770242	HB191X.590		HB401X.587
Corolla	SR5 All Trac	1988-1990	All		770242	HB191X.590		
Corolla	GTS	1988-1991	All		770242	HB191X.590		HB401X.587
Corolla	SR5	1988-1991	All		770242	HB191X.590		
Corolla	DLX All Trac	1988-1992	All		770242	HB191X.590		
Corolla		1988		0449112300		HB191X.590		
Corolla	DLX	1988		0449112300		HB191X.590		
Corolla	FX16	1988		0449112300		HB191X.590		
Corolla	FX	1988		0449112300		HB191X.590		

BRAKE PAD APPLICATIONS

MAKE/ MODEL	SUBMODEL	YEARS	ENGINE (LITER)	NOTE	FRONT		REAR	
					OES	HB SERIES	OES	HB SERIES
TOYOTA CONTINUED								
Corolla	GTS	1988-1989		0449112300		HB191X.590		
Corolla	AWD	1989		0449112300		HB191X.590		
Corolla	FWD	1989		0449112300		HB191X.590		
Corolla		1990-1992	All		770242	HB191X.590		
Corolla		1990-1991		Except GT-S		HB191X.590		
Corolla		1990-1991		GT-S		HB191X.590		HB401X.587
Corolla		1992				HB191X.590		
Corolla	LE	1993-1995	All			HB310X.689		
Corolla		1993-1997	All			HB310X.689		
Corolla	DX	1993-1997	All			HB310X.689		
Corolla		1993-1997				HB310X.689		
Corolla		1998-2002	All			HB321X.650		
Corolla		1998-2002				HB321X.650		
Corolla	(Latin America)	2002						HB595X.589
Corolla	(Latin America)	2002		Fielder		HB594X.657		HB595X.589
Corolla		2003-2004	All		770923	HB441X.661		
Corolla		2003-2004				HB441X.661		
Corolla	XRS	2005-2006	All		770923	HB441X.661		HB329X.543
Corolla		2005-2006				HB441X.661		HB329X.543
Corolla	CE	2006-2008	All		770923	HB441X.661		
Corolla	LE	2006-2008	All		770923	HB441X.661		
Corolla	S	2006-2008	All		770923	HB441X.661		
Corolla	Latin America	2007-2011	All			HB693X.716		HB694X.580
Corolla		2007-2008				HB441X.661		
Corolla	Sport	2008	All		770923	HB441X.661		
Corolla	XRS	2009	All	Rear Disc		HB704X.692		HB629X.565
Corolla		2009-2014	All	Rear Drum		HB627X.690		
Corolla		2009-2010		w/Rear Discs		HB627X.690		HB629X.565
Corolla		2009-2010		w/Rear Drums		HB627X.690		
Corolla	XRS	2010	All	Rear Disc		HB627X.690		HB629X.565
Corolla		2011-2013				HB627X.690		
Corolla	Latin America	2013	All			HB627X.690		HB629X.565
Corolla		2014		w/Rear Discs		HB627X.690		HB629X.565
Corolla		2014		w/Rear Drums		HB627X.690		
Corolla		2015		0446502410		HB627X.690		
Corolla	S	2015		0446502410		HB627X.690		
Corolla	S	2015		0446602310				HB629X.565
Corolla	S	2016						HB629X.565
Corona		1967				HB172X.595		
Corona		1970-1972				HB169X.560		
Corona		1973-1974	All			HB169X.560		
Corona	SR5	1975-1976	2.2L			HB169X.560		
Corona	DLX	1975-1978	All			HB169X.560		
Corona	SR5	1975				HB169X.560		
Corona	Custom	1977-1978	All			HB169X.560		
Corona		1979	All			HB169X.560		
Corona		1980-1982				HB169X.560		
Cressida		1978-1980	All			HB169X.560		
Cressida	Luxury	1989-1992	All			HB407X.602		
Crown		1968-1970	All			HB169X.560		
Crown	2000, 2300	1971				HB169X.560		
Crown	MS-60, MS-70	1971-1972				HB169X.560		
Crown	Station Wagon	1971-1972				HB169X.560		
Echo		2001-2005	All			HB493X.650		
Echo		2001-2005				HB493X.650		

BRAKE PAD APPLICATIONS



Hawk Performance - BRAKE PAD APPLICATIONS

HB **245** **x** **.631**
 HAWK BRAKE PAD SHAPE INSERT COMPOUND CODE PAD THICKNESS

MAKE/ MODEL	SUBMODEL	YEARS	ENGINE (LITER)	NOTE	FRONT		REAR	
					OES	HB SERIES	OES	HB SERIES
TOYOTA CONTINUED								
FJ Cruiser	TRD Special Edition	2007	All		770976	HB490X.665	770606	HB477X.610
FJ Cruiser		2007-2014	All		770976	HB490X.665	770606	HB477X.610
FJ Cruiser		2007-2014				HB490X.665		HB477X.610
FJ Cruiser	Trail Teams Special Edition	2008-2010	All		770976	HB490X.665	770606	HB477X.610
Hi-Lux		2005-2013	All	(Latin America)	771567	HB703X.665		
Hi-Lux	(Latin America)	2006		044650K230		HB316X.670		
Hi-Lux	(Latin America)	2013		044650K280		HB490X.665		
Land Cruiser		1976-1984				HB312X.591		
Land Cruiser		1985-1987		0446535170		HB312X.591		
Land Cruiser		1988-1989		0449160010		HB312X.591		
Land Cruiser		1990-1992				HB312X.591		
Land Cruiser		1991-1994	All		770502	HB312X.591		
Land Cruiser		1993-1997				HB312X.591		HB477X.610
Land Cruiser		1996-1997			770502			
Land Cruiser		1998			770502	HB312X.591	770773	HB427X.685
Land Cruiser		1998-2007				HB313X.685		HB427X.685
Land Cruiser		2008-2011			771303	HB589X.704		HB590X.682
Land Cruiser		2013			771303			
Land Cruiser		2013-2014				HB589X.704		HB590X.682
Land Cruiser		2015		0446560280		HB589X.704		
Land Cruiser		2015		0446660160				HB590X.682
Land Cruiser		2016				HB589X.704		
Mark II		1972-1976				HB169X.560		
Matrix		2003-2005	All			HB441X.661		HB329X.543
Matrix	XR	2003-2005	All			HB441X.661		HB329X.543
Matrix	XRS	2003-2006	All		770923	HB441X.661		HB329X.543
Matrix		2003-2008	All		770923			
Matrix	XR	2003-2008	All		770923			
Matrix		2003-2006				HB441X.661		HB329X.543
Matrix		2006-2008	All			HB441X.661		
Matrix	XR	2006-2008	All			HB441X.661		
Matrix		2007-2008				HB441X.661		
Matrix	XR	2007-2008		0446620090				HB329X.543
Matrix		2009-2013	1.8L			HB627X.690		HB629X.565
Matrix		2009-2013	1.8L	AWD		HB627X.690		HB629X.565
Matrix		2009-2013	1.8L	FWD		HB627X.690		HB629X.565
Matrix		2009	2.4L	2WD		HB704X.692		HB629X.565
Matrix		2009	2.4L	AWD		HB704X.692		HB648X.607
Matrix	S	2009-2013	2.4L	AWD		HB704X.692		HB648X.607
Matrix	S	2009-2013	2.4L	FWD		HB704X.692		HB629X.565
Matrix	XRS	2009-2013	2.4L			HB627X.690		HB648X.607
Matrix		2009-2013		XRS		HB704X.692		HB648X.607
Matrix		2010-2013		1.8L		HB627X.690		HB629X.565
Matrix		2010-2013		2.4L; 2WD		HB704X.692		HB629X.565
Matrix		2010-2013		2.4L; AWD		HB704X.692		HB648X.607
MR2		1985-1989	All		770242	HB191X.590		
MR2		1987-1989				HB191X.590		
MR2		1991-1995	All	Non-Turbo	770242	HB191X.590		
MR2		1991-1995		except Turbo		HB191X.590		
MR2 Spyder		2000-2005	All			HB493X.650		
MR2 Spyder		2000-2005				HB493X.650		
Paseo		1992-1998	All		770242	HB191X.590		
Paseo		1992-1998				HB191X.590		
Paseo	Convertible	1997	All		770242	HB191X.590		
Paseo		1999		0446512090		HB191X.590		

BRAKE PAD APPLICATIONS

MAKE/ MODEL	SUBMODEL	YEARS	ENGINE (LITER)	NOTE	FRONT		REAR	
					OES	HB SERIES	OES	HB SERIES
TOYOTA CONTINUED								
Pickup	SR-5	1975				HB169X.560		
Pickup		1976-1983	All			HB169X.560		
Pickup		1978				HB169X.560		
Pickup	4WD	1979-1984				HB312X.591		
Pickup		1980-1983				HB169X.560		
Pickup	Diesel	1981-1982				HB169X.560		
Pickup	4WD	1985		0449135080		HB312X.591		
Pickup	4WD	1986		0449160010		HB312X.591		
Pickup	4WD	1987-1988		0449135100		HB312X.591		
Pickup	6 Cyl	1988				HB317X.591		
Pickup	SR5	1989-1991	All	2WD		HB407X.602		
Pickup	SR5	1989-1991	All	4WD	770436	HB315X.669		
Pickup		1989-1992	All	2WD		HB407X.602		
Pickup	DLX	1989-1992	All	2WD		HB407X.602		
Pickup	DLX	1989-1992	All	4WD	770436	HB315X.669		
Pickup	2WD SRW	1989-1991		0449122280		HB407X.602		
Pickup	Sht Bd Dix Exc	1991-1992	All	2WD		HB407X.602		
Pickup	Sht Bd Dix Exc	1991-1992	All	4WD	770436	HB315X.669		
Pickup	DLX	1993-1995	All		770436	HB315X.669		
Pickup	SR5	1994-1995	All	4WD	770436	HB315X.669		
Prius		2001-2009	All			HB493X.650		
Prius		2001-2009				HB493X.650		
Prius	Touring	2007-2009	All			HB493X.650		
Prius		2010-2013	All			HB596X.690		HB629X.565
Prius		2010-2014						HB629X.565
Prius	C	2012-2013	All			HB596X.690		
Prius	V	2012-2014	All			HB627X.690		
Prius		2015		0446547070		HB596X.690		
Prius		2015		0446647100				HB629X.565
Prius C		2012-2014				HB596X.690		
Prius C		2015		0446552320		HB596X.690		
Prius V		2012-2014				HB627X.690		
Prius V		2015		0446542200		HB627X.690		
RAV4		1996-2000	All			HB310X.689		
RAV4		1996-2000				HB310X.689		
RAV4		1998-2000		0446542060		HB310X.689		
RAV4		2001-2005	All			HB429X.681		
RAV4		2001		0446542041		HB310X.689		
RAV4		2001-2003				HB429X.681		
RAV4		2002-2003		0446542090		HB310X.689		
RAV4		2004-2005		w/Rear Discs		HB429X.681		
RAV4		2004-2005		w/Rear Drums		HB429X.681		
RAV4		2006-2013	2.4L	w/o 3rd Row Seat		HB627X.690		HB648X.607
RAV4		2006-2013	2.4L	with 3rd Row Seat		HB704X.692		HB648X.607
RAV4		2006-2012		2.4L; w/3rd Row Seat		HB704X.692		HB648X.607
RAV4		2006-2012		2.4L; w/o 3rd Row Seat		HB627X.690		HB648X.607
RAV4		2006-2012		3.5L		HB704X.692		HB648X.607
RAV4	EV	2013-2014	All			HB704X.692		HB648X.607
RAV4		2013-2014		EV Electric Model		HB704X.692		HB648X.607
RAV4		2013-2014		Models with 275mm (10.8") Front Rotors		HB627X.690		HB648X.607
RAV4		2013-2014		Models with 296mm (11.65") Front Rotors		HB704X.692		HB648X.607
RAV4		2014	All			HB704X.692		HB648X.607
RAV4	LE	2014	All			HB627X.690		HB648X.607
RAV4		2015		0446502230		HB704X.692		
RAV4		2015		0446642060				HB648X.607

BRAKE PAD APPLICATIONS



Hawk Performance - BRAKE PAD APPLICATIONS

HB
HAWK BRAKE

245
PAD SHAPE

x
INSERT COMPOUND CODE

.631
PAD THICKNESS

MAKE/ MODEL	SUBMODEL	YEARS	ENGINE (LITER)	NOTE	FRONT		REAR	
					OES	HB SERIES	OES	HB SERIES
TOYOTA CONTINUED								
Rush	(Latin America)	2009		04465B4030		HB213X.626		
Sequoia		2001-2002	All			HB314X.665		HB477X.610
Sequoia		2001-2002		with Frt. Caliper Casting Number 13WL		HB490X.665		HB477X.610
Sequoia		2001-2002		with Frt. Caliper Casting Number S13WE		HB314X.665		HB477X.610
Sequoia		2003-2004	All		770976	HB490X.665	770606	HB477X.610
Sequoia		2003-2007				HB490X.665		HB477X.610
Sequoia	Limited	2005-2007	All		770976	HB490X.665	770606	HB477X.610
Sequoia	SR5	2005-2007	All		770976	HB490X.665	770606	HB477X.610
Sequoia	Limited	2008-2014	All		771303	HB589X.704	771304	HB590X.682
Sequoia	Platinum	2008-2014	All		771303	HB589X.704	771304	HB590X.682
Sequoia	Platinum	2008-2014	All					
Sequoia	SR5	2008-2014	All		771303	HB589X.704	771304	HB590X.682
Sequoia		2008-2014				HB589X.704		HB590X.682
Sequoia		2015		044650C020		HB589X.704		
Sequoia		2015		044660C010				HB590X.682
Sequoia		2016				HB589X.704		HB590X.682
Sienna		1998-2003	All			HB318X.669		
Sienna		1998-2003				HB318X.669		
Sienna		2004-2010	All			HB677X.685		
Sienna		2004-2010		w/Rear Discs		HB677X.685		
Sienna		2004-2010		w/Rear Drums		HB677X.685		
Solara		1999-2000	2.2L			HB320X.669		HB401X.587
Solara		1999-2000	3.0L			HB320X.669		
Solara		1999		From 8/99		HB320X.669		
Solara		1999		To 8/99		HB320X.669		HB401X.587
Solara		2000-2003				HB320X.669		
Solara		2004-2008	All			HB677X.685		
Solara		2004-2008				HB677X.685		
Supra		1993-1998	All	Non-Turbo		HB375X.669		HB670X.610
Supra	Twin Turbo	1993-1998	All			HB215X.630		HB216X.590
Supra	Twin Turbo	1993-1998	All	From 5/93		HB215X.630		HB216X.590
Supra		1993-1998	All	Non-Turbo, From 5/96	770619	HB375X.669		HB670X.610
Supra		1993-1998		except Turbo		HB375X.669		HB670X.610
Supra		1993-1998		Turbo		HB215X.630		HB216X.590
Supra		1998	All	From 5/93				HB216X.590
T100	SR5	1993-1995	All	4WD		HB311X.591		
T100		1993-1998	All	4WD		HB311X.591		
T100		1993-1998	All	RWD; 1/2 Ton		HB311X.591		
T100	4WD	1993-1998				HB311X.591		
T100	SR5	1996-1997	All			HB311X.591		
Tacoma	Regular Cab	1995	All	4WD	770436	HB315X.669		
Tacoma	SR5	1995	All	4WD	770436	HB315X.669		
Tacoma		1995-1997	All	2WD		HB407X.602		
Tacoma	Regular Cab	1995-1997	All	2WD		HB407X.602		
Tacoma	2WD	1995-1997				HB407X.602		
Tacoma	2WD	1995-1997		0446535070		HB407X.602		
Tacoma	4WD	1995-2003				HB315X.669		
Tacoma	Regular Cab	1996-1997	All		770436	HB315X.669		
Tacoma	SR5	1996-1997	All		770436	HB315X.669		
Tacoma		1998-2004	All	5 Lug, From 2/98		HB407X.602		
Tacoma	2WD, 1 Piston Caliper	1998		0446535070		HB407X.602		
Tacoma	4WD	1998				HB317X.591		
Tacoma	2WD	1998-2003		6 Lug Models		HB315X.669		
Tacoma	2WD	1998-2004		5 Lug Models		HB407X.602		
Tacoma	Pre Runner	1999-2001	All	2WD		HB316X.670		

BRAKE PAD APPLICATIONS

MAKE/ MODEL	SUBMODEL	YEARS	ENGINE (LITER)	NOTE	FRONT		REAR	
					OES	HB SERIES	OES	HB SERIES
TOYOTA CONTINUED								
Tacoma	2WD, 1 Piston Caliper	1999-2000		0446504020		HB407X.602		
Tacoma	2WD	2001		0446504020		HB407X.602		
Tacoma	2WD, 4 Piston Caliper	2002		0446504030		HB316X.670		
Tacoma	4WD, 4 Piston Caliper	2002		0446504030		HB316X.670		
Tacoma	2WD	2002-2004		0446504040		HB407X.602		
Tacoma	2WD	2004		6 Lug Models with VDC (318.5mm Front Rotors)		HB315X.669		
Tacoma	2WD	2004		6 Lug Models without VDC (296.8mm Front Rotors)		HB315X.669		
Tacoma	4WD	2004		6 Lug Models with VDC (318.5mm Front Rotors)		HB315X.669		
Tacoma	4WD	2004		6 Lug Models without VDC (296.8mm Front Rotors)		HB315X.669		
Tacoma		2005-2014	All	5 Lug RWD, With Single piston		HB677X.685		
Tacoma	X-Runner	2005-2014	All	2WD, 5 Lug wheels, single piston caliper		HB677X.685		
Tacoma		2005-2014	All	6 Lug RWD and 4WD with 4 piston caliper	770976	HB490X.665		
Tacoma	Pre Runner	2005-2014	All	6 Lug Wheels Only	770976	HB490X.665		
Tacoma		2005-2014		5 Lug Wheels		HB677X.685		
Tacoma		2005-2014		6 Lug Wheels		HB490X.665		
Tacoma	4WD	2015		0446504070		HB490X.665		
Tacoma	RWD	2015		0446504080		HB677X.685		
Tercel	Std	1983	All		770242	HB191X.590		
Tercel	DLX	1983-1988	All		770242	HB191X.590		
Tercel	SR5	1983-1988	All		770242	HB191X.590		
Tercel		1984-1985	All		770242	HB191X.590		
Tercel	Std	1986-1988	All		770242	HB191X.590		
Tercel	Front from 09/1985	1986		0449116110		HB191X.590		
Tercel	Station Wagon 4WD, Front from 09/1985	1986			0449116110		HB191X.590	
Tercel	Station Wagon, Front from 09/1985	1986			0449116110		HB191X.590	
Tercel	Station Wagon 4WD	1987		0449116110		HB191X.590		
Tercel		1987-1988		0449116081		HB191X.590		
Tercel	Station Wagon	1987-1988		0449116110		HB191X.590		
Tercel	EZ	1988	All		770242	HB191X.590		
Tercel		1989-1996	All		770242	HB191X.590		
Tercel	EZ	1990	All		770242	HB191X.590		
Tercel	DLX	1990-1994	All		770242	HB191X.590		
Tercel		1990-1998				HB191X.590		
Tercel	LE	1991-1993	All		770242	HB191X.590		
Tercel	DX	1995-1996	All		770242	HB191X.590		
Tercel	CE	1997-1998	All		770242	HB191X.590		
Tercel		1999		0446512090		HB191X.590		
Tundra		2000-2003	All	w/ 4.7 in. Brake Pad		HB314X.665		
Tundra		2000-2002		with Frt. Caliper Casting Number 13WL		HB490X.665		
Tundra		2000-2002		with Frt. Caliper Casting Number S13WE		HB314X.665		
Tundra		2003	All	w/ 5.3 in. Brake Pad	770976	HB490X.665		
Tundra		2003		Mfg. Before 8/2002		HB490X.665		
Tundra		2003		Mfg. From 8/2002		HB490X.665		
Tundra		2004-2006	All		770976	HB490X.665		
Tundra		2004-2006				HB490X.665		
Tundra	SR5	2005	All		770976	HB490X.665		
Tundra	Limited	2005-2006	All		770976	HB490X.665		
Tundra		2007-2014	All		771303	HB589X.704	771304	HB590X.682
Tundra	Limited	2007-2014	All		771303	HB589X.704	771304	HB590X.682
Tundra	SR5	2007-2014	All		771303	HB589X.704	771304	HB590X.682
Tundra		2007-2014				HB589X.704		HB590X.682
Tundra		2015		044650C020		HB589X.704		
Tundra		2015		044660C010				HB590X.682

BRAKE PAD APPLICATIONS



Hawk Performance - BRAKE PAD APPLICATIONS

HB
HAWK BRAKE

245
PAD SHAPE

x
INSERT COMPOUND CODE

.631
PAD THICKNESS

MAKE/ MODEL	SUBMODEL	YEARS	ENGINE (LITER)	NOTE	FRONT		REAR	
					OES	HB SERIES	OES	HB SERIES
TOYOTA CONTINUED								
Yaris		2007-2011	All			HB596X.690		
Yaris	S	2007-2011	All			HB596X.690		
Yaris		2007-2011				HB596X.690		
Yaris		2012-2014	All	excluding SE		HB596X.690		
Yaris	SE	2012-2014	All					HB629X.565
Yaris		2012-2014		with Rear Discs				HB629X.565
Yaris		2012-2014		with rear drums		HB596X.690		
Yaris		2015		0446552260		HB596X.690		
Yaris	SE	2015		0446652170				HB629X.565
TRIUMPH								
GT6		1966-1971				HB169X.560		
Herald	13/60	1968				HB118X.560		
Spitfire	Mark III	1965-1966				HB118X.560		
Spitfire		1967-1979				HB118X.560		
Spitfire	MK IV	1967-1980				HB118X.560		
Spitfire	MKIII	1967-1980				HB118X.560		
Stag		1970-1973				HB229X.580		
TR4		1963-1965				HB169X.560		
TR6		1968-1972				HB169X.560		
TR7		1975-1980	All			HB123X.535		
TR7		1981-1982				HB123X.535		
TR8		1980-1981	All			HB229X.580		
TR8		1982				HB229X.580		
VOLKSWAGEN								
411		1968-1970				HB172X.595		
411		1971-1972	All			HB172X.595		
411		1973		0004205720		HB172X.595		
412		1973-1974	All			HB172X.595		
Amarok		2010-2011	All	(Latin America)	771555			
Beetle		1998-2004	1.9L			HB365X.728		HB364X.642
Beetle		1998-2004	1.9L	w/Electronic Wear Sensor		HB365X.728A		HB364X.642
Beetle		1998				HB365X.728		HB364X.587
Beetle		1999-2000	1.8L			HB365X.728		HB364X.642
Beetle		1999-2000	1.8L	w/Electronic Wear Sensor		HB365X.728A		HB364X.642
Beetle		1999-2005	2.0L			HB272X.763		HB364X.642
Beetle		1999-2005	2.0L	w/Wear Sensor		HB272X.763A		HB364X.642
Beetle		1999-2005		1.8L Turbo		HB272X.763A		HB364X.587
Beetle		1999-2005		except 1.8L Gas Turbo		HB365X.728		HB364X.587
Beetle		2001-2002	1.8L			HB272X.763		HB364X.642
Beetle		2001-2002	1.8L	w/Wear Sensor		HB272X.763A		HB364X.642
Beetle		2001		1J0698451R				HB364X.642
Beetle	GLS TDI	2005	1.9L			HB365X.728		HB364X.642
Beetle	GLS TDI	2005	1.9L	w/Electronic Wear Sensor		HB365X.728A		HB364X.642
Beetle	280mm Brake Rotors	2005		1J0698451E				HB364X.642
Beetle	288mm Brake Rotors	2005		1J0698451E				HB364X.642
Beetle	TDI	2006	1.9L			HB365X.728		HB364X.642
Beetle	TDI	2006	1.9L	w/Electronic Wear Sensor		HB365X.728A		HB364X.642
Beetle	2.5	2006	2.5L			HB272X.763		HB364X.642
Beetle	2.5	2006	2.5L	w/Wear Sensor		HB272X.763A		HB364X.642
Beetle		2006-2007		1.8L Turbo, Turbo S		HB272X.763A		HB364X.587
Beetle		2006-2007		2.0L Gas, 1.9L TDI		HB365X.728		HB364X.587
Beetle		2006-2007		2.5L 5 Cyl.		HB272X.763A		HB364X.587
Beetle	280mm Brake Rotors	2006-2010		1J0698451R				HB364X.642
Beetle	288mm Brake Rotors	2006-2010		1J0698451R				HB364X.642
Beetle	280mm Brake Rotors	2007		1J0698151F		HB365X.728		

MAKE/ MODEL	SUBMODEL	YEARS	ENGINE (LITER)	NOTE	FRONT		REAR	
					OES	HB SERIES	OES	HB SERIES
VOLKSWAGEN CONTINUED								
Beetle	S	2008-2010	2.5L	w/280mm Rotors		HB365X.728		HB364X.642
Beetle	S	2008-2010	2.5L	w/280mm Rotors, w/Electronic Wear Sensor		HB365X.728A		HB364X.642
Beetle	S	2008-2010	2.5L	w/288mm Rotors		HB272X.763		HB364X.642
Beetle	S	2008-2010	2.5L	w/288mm Rotors, w/Wear Sensor		HB272X.763A		HB364X.642
Beetle	SE	2008-2010	2.5L	w/280mm Rotors		HB365X.728		HB364X.642
Beetle	SE	2008-2010	2.5L	w/280mm Rotors, w/Electronic Wear Sensor		HB365X.728A		HB364X.642
Beetle	SE	2008-2010	2.5L	w/288mm Rotors		HB272X.763		HB364X.642
Beetle	SE	2008-2010	2.5L	w/288mm Rotors, w/Wear Sensor		HB272X.763A		HB364X.642
Beetle		2008				HB272X.763A		HB364X.587
Beetle		2009-2010		Convertible		HB272X.763A		HB364X.587
Beetle		2009-2010		Coupe		HB365X.728		HB364X.587
Beetle		2012-2014	All			HB543X.760		HB695X.609
Beetle		2012		2.0T		HB543X.760		HB695X.609
Beetle		2012		2.5L		HB543X.760		HB695X.609
Beetle		2012-2013		5C0698451A				HB364X.642
Beetle	(Mexico)	2014				HB365X.728		
Beetle		2015		5C0698151A		HB543X.760		
Beetle		2015		5Q0698451E				HB364X.642
Cabrio		1995-1998				HB190X.600		
Cabrio		1995-2002			770696			
Cabrio		1996-1997		357698151E		HB190X.600		
Cabrio		1999-2002				HB190X.600		HB364X.587
Cabriole		1985-1990	All			HB189X.595		
Cabriole		1985-1993				HB189X.550		
Cabriole	Front: From Vin 013001	1990		191698151H		HB189X.595		
Cabriole	Front: From Vin 011291	1991		191698151G		HB189X.595		
Cabriole	Front: To Vin 011290	1991		191698151H		HB189X.595		
CC		2009-2014	2.0L	Turbo FWD		HB543X.760		HB544X.628
CC	VR6	2009-2011	All			HB515X.760		
CC	Front: From Vin 3C-9-538 152	2009		3C0698151C		HB543X.760		
CC	Front: To Vin 3C-9-538 151	2009		3C0698451D				HB544X.628
CC	VR6 4Motion	2009-2011		3C0698451C				HB544X.628
CC		2009-2012		2.0L		HB543X.760		HB544X.628
CC		2009-2012		3.6L				HB544X.628
CC	VR6 Sport	2010		3C0698451F				HB544X.628
CC		2010-2011		3C0698451E				HB544X.628
CC		2010-2012		3C0698151C		HB543X.760		
CC	V6	2012		1K0698151B		HB515X.760		HB544X.628
CC		2012-2014		3C0698451F				HB544X.628
CC		2013-2015		3C0698151D		HB543X.760		
CC	4 Motion	2013-2015		3C0698451C				HB544X.628
CC		2013-2017		4 Motion		HB779X.740		
CC		2015		3AA698451				HB544X.628
Clasico	(Mexico)	2014				HB543X.760		HB695X.609
Corrado		1990-1992	All			HB190X.730		HB364X.587
Corrado		1990-1992	All	w/Wear Sensor				HB364X.587
Corrado		1990-1991		1.8L Eng.				HB364X.642
Corrado	SLC	1992-1993	All			HB190X.730		HB364X.587
Corrado	SLC	1992-1993	All	w/Wear Sensor				HB364X.587
Corrado		1992-1995		2.8L Eng.				HB364X.642
Corrado	Rear: From Vin 50P009001	1993		357698151B		HB190X.730		
Corrado		1994-1995		357698151B		HB190X.730		
Eos	Komfort	2007-2010	All			HB543X.760		HB544X.628
Eos	Lux	2007-2010	All			HB543X.760		HB544X.628
Eos	Turbo	2007-2010	All			HB543X.760		HB544X.628

BRAKE PAD APPLICATIONS



Hawk Performance - BRAKE PAD APPLICATIONS

HB **245** **x** **.631**
 HAWK BRAKE PAD SHAPE INSERT COMPOUND CODE PAD THICKNESS

MAKE/ MODEL	SUBMODEL	YEARS	ENGINE (LITER)	NOTE	FRONT		REAR	
					OES	HB SERIES	OES	HB SERIES
VOLKSWAGEN CONTINUED								
Eos		2007-2009				HB543X.760		HB544X.628
Eos	VR6	2008	All			HB543X.760		HB544X.628
Eos		2010		MFG Date From 11/2009		HB543X.760		HB695X.609
Eos		2010		MFG Date Up to 10/2009		HB543X.760		HB544X.628
Eos		2011-2014	All		771107	HB543X.760		HB695X.609
Eos		2011-2012				HB543X.760		HB695X.609
Eos		2015		3C0698151D		HB543X.760		
Eos		2015		5K0698451A				HB695X.609
Fastback		1972-1973				HB172X.500		
Golf		1985-1986		Base; With Rear Drums		HB189X.550		
Golf		1985-1989		GTI				HB364X.587
Golf	GTI	1985-1992		191698151G		HB189X.595		
Golf		1987-1992		Base, GL; With Rear Drums		HB189X.550		
Golf		1990-1992		GTI - Rear Disc				HB364X.587
Golf	GTI	1993	2.0L			HB190X.600		
Golf	GTI	1993	2.0L	w/Wear Sensor		HB190X.600A		
Golf	III GL	1993-1994	2.0L			HB190X.600		
Golf	III GL	1993-1994	2.0L	w/Wear Sensor		HB190X.600A		
Golf	GL	1993-1994	2.0L		770696	HB190X.730		
Golf		1993		Base, GL; With Rear Drums	770696	HB190X.600		
Golf		1993-1994		Base, GL	770696	HB190X.600		HB364X.587
Golf	GTI	1994	2.0L			HB190X.730		HB364X.587
Golf	GTI	1994	2.0L	w/Wear Sensor				HB364X.587
Golf		1994		GTI (5 Lug)				HB364X.587
Golf	III Celebration Edition	1995	2.0L	w/Wear Sensor		HB190X.600A		
Golf	III City	1995	2.0L	w/Wear Sensor		HB190X.600A		
Golf	III Sport	1995	2.0L	w/Wear Sensor		HB190X.600A		
Golf	III Celebration Edition	1995	2.0L		770696	HB190X.600		
Golf	III City	1995	2.0L		770696	HB190X.600		
Golf	III Sport	1995	2.0L		770696	HB190X.600		
Golf	LE	1995-1997	2.0L			HB190X.600		
Golf	LE	1995-1997	2.0L	w/Wear Sensor		HB190X.600A		
Golf	GTI VR6	1995	2.8L			HB190X.600		HB364X.587
Golf	GTI VR6	1995	2.8L	w/Wear Sensor		HB190X.600A		HB364X.587
Golf	GL	1995-1997	All			HB190X.600		
Golf	GL	1995-1997	All	w/Wear Sensor		HB190X.600A		
Golf		1995		GTI VR6				HB364X.587
Golf	GTI 2.8 Liter	1995		357698151C		HB190X.730		
Golf		1995		GL, City, Celebration Edition - Rear Disc	770696	HB190X.600		HB364X.587
Golf		1995		GL, City, Celebration Edition - Rear Drum	770696	HB190X.600		
Golf	GTI	1996-1999	2.0L			HB190X.600		HB364X.587
Golf	GTI	1996-1999	2.0L	w/Wear Sensor		HB190X.600A		HB364X.587
Golf	GTI VR6	1996-1998	2.8L			HB272X.763		HB364X.587
Golf	GTI VR6	1996-1998	2.8L	w/Wear Sensor		HB272X.763A		HB364X.587
Golf		1996		GL - Rear Disc	770696	HB190X.600		HB364X.587
Golf		1996		GL - Rear Drum	770696	HB190X.600		
Golf		1996-1998		GTI VR6		HB272X.763		HB364X.587
Golf		1996-1998		GTI 2.0L	770696	HB190X.600		HB364X.587
Golf	Jazz	1997	2.0L			HB190X.600		
Golf	Jazz	1997	2.0L	w/Wear Sensor		HB190X.600A		
Golf	K2	1997-1998	2.0L			HB190X.600		
Golf	K2	1997-1998	2.0L	w/Wear Sensor		HB190X.600A		
Golf	GTI	1997		357698151E		HB190X.600		
Golf		1997		US Model - GL, Jazz, K2, Trek - Rear Disc	770696	HB190X.600		HB364X.587
Golf		1997		US Model - GL, Jazz, K2, Trek - Rear Drum	770696	HB190X.600		

BRAKE PAD APPLICATIONS

MAKE/ MODEL	SUBMODEL	YEARS	ENGINE (LITER)	NOTE	FRONT		REAR	
					OES	HB SERIES	OES	HB SERIES
VOLKSWAGEN CONTINUED								
Golf		1998	2.0L			HB190X.600		
Golf		1998	2.0L	w/Wear Sensor		HB190X.600A		
Golf		1998		US Model - GL, K2 - Rear Disc	770696	HB190X.600		HB364X.587
Golf		1998		US Model - GL, K2 - Rear Drum	770696	HB190X.600		
Golf	GL	1999	1.9L	From 12/98		HB190X.600		HB364X.587
Golf	GL	1999	1.9L	w/Wear Sensor, From 12/98		HB190X.600A		HB364X.587
Golf	GL	1999	1.9L	To 11/98	770696	HB190X.600	770340	HB364X.587
Golf	GL	1999	1.9L	w/Wear Sensor, To 11/98	770696	HB190X.600A	770340	HB364X.587
Golf	GL	1999	2.0L	From 12/98		HB190X.600		HB364X.587
Golf	GL	1999	2.0L	w/Wear Sensor, From 12/98		HB190X.600A		HB364X.587
Golf	LE	1999	2.0L	w/Wear Sensor From 12/98		HB190X.600A		HB364X.587
Golf	LE	1999	2.0L	w/Wear Sensor To 11/98		HB190X.600A		HB364X.587
Golf	GL	1999	2.0L	To 11/98	770696	HB190X.600	770340	HB364X.587
Golf	GL	1999	2.0L	w/Wear Sensor, To 11/98	770696	HB190X.600A	770340	HB364X.587
Golf	LE	1999	2.0L	From 12/98	770696	HB190X.600	770340	HB364X.587
Golf	LE	1999	2.0L	To 11/98	770696	HB190X.600	770340	HB364X.587
Golf	GL	1999	2.8L	From 12/98		HB190X.600		HB364X.587
Golf	GL	1999	2.8L	w/Wear Sensor, From 12/98		HB190X.600A		HB364X.587
Golf	GL	1999	2.8L	To 11/98	770696	HB190X.600	770340	HB364X.587
Golf	GL	1999	2.8L	w/Wear Sensor, To 11/98	770696	HB190X.600A	770340	HB364X.587
Golf	GTI	1999-2000	2.8L			HB272X.763		HB364X.642
Golf	GTI	1999-2000	2.8L	w/Wear Sensor		HB272X.763A		HB364X.642
Golf		1999		GL, GLS, TDI - Rear Disc - MFG After 12/1998 and Before 5/1999		HB365X.728		HB364X.587
Golf		1999		GL, GLS, TDI - Rear Disc - MFG After 6/1999		HB365X.728		HB364X.587
Golf		1999		GL, Wolfsburg Edition - Rear Drum MFG After 12/1998 and Before 5/1999		HB365X.728		
Golf		1999		GL, Wolfsburg Edition - Rear Drum MFG After 6/1999		HB365X.728		
Golf		1999		GTI - MFG After 12/1998 and Before 4/1999 (Without Sensor in front pads)		HB272X.763		HB364X.587
Golf		1999		GTI - MFG After 5/1999 (With Sensor in front pads)		HB272X.763A		HB364X.587
Golf		1999		GTI VR6 - MFG Before 11/1998		HB272X.763		HB364X.587
Golf		1999		GL, GLS, TDI - Rear Disc MFG Before 12/1998	770696	HB190X.600		HB364X.587
Golf		1999		GL, Wolfsburg Edition - Rear Drum MFG Before 12/1998	770696	HB190X.600		
Golf		1999		GTI 2.0L - MFG Before 11/1998	770696	HB190X.600		HB364X.587
Golf		2000-2001	1.8L			HB365X.728		HB364X.642
Golf		2000-2001	1.8L	w/Electronic Wear Sensor		HB365X.728A		HB364X.642
Golf		2000-2006	1.9L			HB365X.728		HB364X.642
Golf		2000-2006	1.9L	w/Electronic Wear Sensor		HB365X.728A		HB364X.642
Golf	LE	2000	2.0L	w/Electronic Wear Sensor		HB365X.728A		
Golf	LE	2000	2.0L	w/Electronic Wear Sensor		HB365X.728A		HB544X.628
Golf		2000-2007	2.0L			HB365X.728		HB364X.642
Golf		2000-2007	2.0L	w/Electronic Wear Sensor		HB365X.728A		HB364X.642
Golf	LE	2000-2007	2.0L			HB365X.728		HB544X.628
Golf	GL	2000-2005	All	w/Electronic Wear Sensor		HB365X.728A		HB544X.628
Golf	GL	2000-2007	All			HB365X.728		HB544X.628
Golf	GLS	2000-2007	All			HB365X.728		HB544X.628
Golf	GLS	2000-2007	All	w/Electronic Wear Sensor		HB365X.728A		HB544X.628
Golf		2000		Base, GL, GLS		HB365X.728		HB364X.587
Golf		2000		GTI		HB272X.763A		HB364X.587
Golf	LE	2001-2007	2.0L	w/Electronic Wear Sensor		HB365X.728A		HB544X.628
Golf	GTI	2001	2.8L			HB272X.763		HB364X.587

BRAKE PAD APPLICATIONS



Hawk Performance - BRAKE PAD APPLICATIONS

HB **245** **x** **.631**
 HAWK BRAKE PAD SHAPE INSERT COMPOUND CODE PAD THICKNESS

MAKE/ MODEL	SUBMODEL	YEARS	ENGINE (LITER)	NOTE	FRONT		REAR	
					OES	HB SERIES	OES	HB SERIES
VOLKSWAGEN CONTINUED								
Golf	GTI	2001	2.8L	w/Wear Sensor		HB272X.763A		HB364X.587
Golf		2001		GTI, GLS Turbo		HB272X.763A		HB364X.587
Golf		2001-2002		1J0698451E				HB364X.642
Golf		2001-2002		Base, GL, GLS non-turbo		HB365X.728		HB364X.587
Golf	GTI 1.8t	2002-2005	1.8L			HB272X.763		HB364X.587
Golf	GTI 1.8t	2002-2005	1.8L	w/Wear Sensor		HB272X.763A		HB364X.587
Golf	GTI	2002	2.8L			HB272X.763		HB364X.642
Golf	GTI	2002	2.8L	w/Wear Sensor		HB272X.763A		HB364X.642
Golf	GLS TDI	2002-2006	All	w/Electronic Wear Sensor. w/Solid Rear Disc		HB365X.728A		HB544X.628
Golf	GLS TDI	2002-2006	All	w/Solid Rear Disc		HB365X.728		HB544X.628
Golf		2002		GTI w/Vented rear rotors - Excluding GTI 337		HB272X.763A		HB364X.587
Golf		2002		GTI, GLS Turbo with Solid Rear Rotors		HB272X.763A		HB364X.587
Golf	GTI	2003-2004	2.8L	w/Wear Sensor. w/Solid Rear Disc		HB272X.763A		
Golf		2003		Base, GL, GLS		HB365X.728		HB364X.587
Golf		2003-2005		GTI With Solid Rear Rotors		HB272X.763A		HB364X.587
Golf		2003-2005		GTI With Vented Rear Rotors		HB272X.763A		HB364X.587
Golf	GTI	2004	1.8L	w/Wear Sensor. w/Solid Rear Disc		HB272X.763A		
Golf	R32	2004-2005	3.2L			HB497X.776		HB364X.642
Golf		2004		1J0698451E				HB364X.642
Golf		2004		R32		HB497X.776		HB364X.587
Golf		2004-2006		Base, GL, GLS, TDI		HB365X.728		HB364X.587
Golf	GTI 1.8t	2006	1.8L			HB543X.760		HB544X.628
Golf	GTI	2006-2007	2.0L			HB543X.760		
Golf	GL	2006	All	w/Electronic Wear Sensor		HB365X.728A		
Golf	GL	2006	All	w/Electronic Wear Sensor				HB544X.628
Golf		2006		1J0698451E				HB364X.642
Golf	GL	2007	All	w/Electronic Wear Sensor		HB365X.728A		HB544X.628
Golf		2010	2.0L			HB365X.728		HB364X.642
Golf		2010	2.0L	w/Electronic Wear Sensor		HB365X.728A		HB364X.642
Golf	GTI	2010	2.0L			HB543X.760		HB544X.628
Golf	LE	2010	2.0L			HB365X.728		HB544X.628
Golf	LE	2010	2.0L	w/Electronic Wear Sensor		HB365X.728A		HB544X.628
Golf		2010	All	(Latin America)		HB365X.728A		HB364X.642
Golf	GL	2010	All			HB365X.728		HB544X.628
Golf	GL	2010	All	w/Electronic Wear Sensor		HB365X.728A		HB544X.628
Golf	GLS	2010	All			HB365X.728		HB544X.628
Golf	GLS	2010	All	w/Electronic Wear Sensor		HB365X.728A		HB544X.628
Golf	(Latin America)	2010		1J0698451R				HB364X.642
Golf	TDI	2010-2011		3C0698151D		HB543X.760		
Golf		2010-2012		2.0L TDI with 260mm Rear Brake Rotors		HB543X.760		HB544X.628
Golf		2010-2012		2.0L TDI with 272mm Rear Brake Rotors		HB543X.760		HB695X.609
Golf		2010-2012		2.5L Gas		HB543X.760		HB695X.609
Golf	GTI	2011-2014	2.0L			HB543X.760		HB695X.609
Golf		2011		1K0698451J				HB364X.642
Golf	R	2012-2013	2.0L			HB625X.760		HB544X.628
Golf		2012-2014	All			HB543X.760		HB695X.609
Golf		2012		Golf R		HB538X.760		HB544X.628
Golf		2012-2013		3C0698151D		HB543X.760		
Golf	TDI	2015		5Q0698451E				HB364X.642
Golf		2015-2016		R		HB779X.740		
GTI		2006-2014	All			HB543X.760		
GTI		2006-2010				HB543X.760		HB544X.628
GTI		2011-2012				HB543X.760		HB695X.609
GTI		2013		5K0698451				HB695X.609
GTI		2014		5K0698451A				HB695X.609

BRAKE PAD APPLICATIONS

MAKE/ MODEL	SUBMODEL	YEARS	ENGINE (LITER)	NOTE	FRONT		REAR	
					OES	HB SERIES	OES	HB SERIES
VOLKSWAGEN CONTINUED								
GTI		2015-2016		Performance		HB779X.740		
GTI	Performance	2015-2016		1K0698451K				HB544X.628
Jetta		1980				HB189X.595		
Jetta	Deluxe	1981-1985	All			HB189X.595		
Jetta	GLI	1985	1.8L			HB189X.595		
Jetta	GLI	1985-1986						HB364X.587
Jetta	Includes GLI	1986	All			HB189X.595		
Jetta		1987	1.6L			HB189X.595		
Jetta	GLI	1987	1.8L			HB189X.595		
Jetta		1987-1989	1.8L			HB189X.595		
Jetta	GLI 16-Valve	1987-1989	1.8L			HB189X.595		
Jetta	GLI 16 Valve	1987-1989						HB364X.587
Jetta	GLI 16 Valve	1987-1989		191698151G		HB189X.595		
Jetta	Carat	1988	All			HB189X.595		
Jetta		1989	1.6L			HB189X.595		
Jetta	Carat, Front:From Vin 520001 Rear: Not ABS	1990		191698151G		HB189X.595		
Jetta	GLI 16 Valve, Front: From Vin 520001	1990		191698151G		HB189X.595		
Jetta		1990-1992		Rear Drum		HB189X.550		
Jetta		1990-1993		Rear Disc	770696	HB190X.600		HB364X.587
Jetta	GL	1991-1992	1.8L			HB189X.595		
Jetta	Carat	1991-1992		191698151H		HB189X.595		
Jetta	GLI 16 Valve	1991-1992		191698151G		HB189X.595		
Jetta	III GL	1993-1995	2.0L			HB190X.600		
Jetta	III GL	1993-1995	2.0L	w/Wear Sensor		HB190X.600A		
Jetta	III GLS	1993-1995	2.0L			HB190X.600		
Jetta	III GLS	1993-1995	2.0L	w/Wear Sensor		HB190X.600A		
Jetta		1993		Rear Drum	770696	HB190X.600		
Jetta	III GLX	1994				HB272X.763		
Jetta		1994-1995		GLX - 2.8L				HB364X.587
Jetta	III GLX	1994-1995		357698151C		HB190X.730		
Jetta		1994-1997		2.0L Gas - Rear Disc	770696	HB190X.600		HB364X.587
Jetta		1994-1997		2.0L Gas - Rear Drum	770696	HB190X.600		
Jetta	GL	1996-1998	2.0L			HB190X.600		
Jetta	GL	1996-1998	2.0L	w/Wear Sensor		HB190X.600A		
Jetta	GLS	1996-1998	2.0L			HB190X.600		HB364X.587
Jetta	GLS	1996-1998	2.0L	w/Wear Sensor		HB190X.600A		HB364X.587
Jetta	GLX	1996-1999	2.8L			HB272X.763		HB364X.587
Jetta	GLX	1996-1999	2.8L	w/Wear Sensor		HB272X.763A		HB364X.587
Jetta		1996-1997		GLX - 2.8L		HB272X.763		HB364X.587
Jetta		1997		1.9L TDI Diesel - US Models only	770696	HB190X.600		
Jetta		1998	2.0L	w/Wear Sensor, From 10/98		HB190X.600A		
Jetta		1998	2.0L	w/Wear Sensor, To 9/98		HB190X.600A		
Jetta		1998	2.0L	From 10/98	770696	HB190X.600		
Jetta		1998	2.0L	To 9/98	770696	HB190X.600		
Jetta		1998		5 Lug - 2.0L Gas or 1.9L TDI - Rear Disc - MFG Date From 10/98		HB365X.728		HB364X.587
Jetta		1998		5 Lug - GLX - 2.8L - MFG Date From 10/98		HB272X.763		HB364X.587
Jetta		1998		5 Lug - GLX - 2.8L - MFG Date Up To 9/98		HB272X.763		HB364X.587
Jetta		1998		4 Lug 1.9L TDI Diesel - US Models only MFG Date Up To 9/98	770696	HB190X.600		
Jetta		1998		4 Lug 2.0L Gas - Rear Disc MFG Date Up To 9/98	770696	HB190X.600		HB364X.587
Jetta		1998		4 Lug 2.0L Gas - Rear Drum MFG Date Up To 9/98	770696	HB190X.600		

BRAKE PAD APPLICATIONS

Hawk Performance - BRAKE PAD APPLICATIONS

HB **245** **x** **.631**
 HAWK BRAKE PAD SHAPE INSERT COMPOUND CODE PAD THICKNESS

MAKE/ MODEL	SUBMODEL	YEARS	ENGINE (LITER)	NOTE	FRONT		REAR	
					OES	HB SERIES	OES	HB SERIES
VOLKSWAGEN CONTINUED								
Jetta		1998		4 Lug Wolfsburg Edition	770696	HB190X.600		
Jetta	Front: To Vin 1H-W-001 300	1998-1999		1HM698151		HB190X.600		
Jetta	VR6	1999-2004	All			HB272X.763		HB364X.587
Jetta	VR6	1999-2004	All	w/Wear Sensor		HB272X.763A		HB364X.587
Jetta		1999		5 Lug - 2.0L Gas or 1.9L TDI MFG Date From 10/98 to 5/99		HB365X.728		HB364X.587
Jetta		1999		5 Lug - 2.0L Gas or 1.9L TDI MFG Date From 6/99		HB365X.728		HB364X.587
Jetta		1999		5 Lug - 2.8L or 1.8T - MFG Date From 6/99		HB272X.763A		HB364X.587
Jetta		1999		5 Lug Models - GLX / GLS - 2.8L MFG Date From 10/98 to 5/99		HB272X.763		HB364X.587
Jetta		1999		4 Lug Models - Wolfsburg Edition, GL, GLS, TDI	770696	HB190X.600		HB364X.587
Jetta	GLS	2000-2001	1.8L			HB365X.728		HB364X.587
Jetta	GLS	2000-2001	1.8L	w/Electronic Wear Sensor		HB365X.728A		HB364X.587
Jetta	TDI	2000-2001	1.9L			HB365X.728		HB364X.587
Jetta	TDI	2000-2001	1.9L	w/Electronic Wear Sensor		HB365X.728A		HB364X.587
Jetta	GL	2000-2001	2.0L	w/Electronic Wear Sensor		HB365X.728A		HB364X.587
Jetta	GLS	2000-2001	2.0L			HB365X.728		HB364X.587
Jetta	GLS	2000-2001	2.0L	w/Electronic Wear Sensor		HB365X.728A		HB364X.587
Jetta	GL	2000-2001	2.0L		770768	HB365X.728		
Jetta		2000		2.0L Gas or 1.9L TDI		HB365X.728		HB364X.587
Jetta		2000		2.8L or 1.8T		HB272X.763A		HB364X.587
Jetta	Front: 288mm Rotors	2001		1J0698451E				HB364X.642
Jetta	Sedan	2001-2003		2.8L or 1.8T		HB272X.763A		HB364X.587
Jetta	Sedan	2001-2004		2.0L Gas or 1.9L TDI		HB365X.728		HB364X.587
Jetta	Wagon	2001-2004		2.0L Gas or 1.9L TDI		HB365X.728		HB364X.587
Jetta	Wagon	2001-2004		2.8L or 1.8T		HB272X.763A		HB364X.587
Jetta	GLS	2002-2004	1.8L			HB365X.728		HB364X.642
Jetta	GLS	2002-2004	1.8L	w/Electronic Wear Sensor		HB365X.728A		HB364X.642
Jetta	TDI	2002-2004	1.9L			HB365X.728		HB364X.642
Jetta	TDI	2002-2004	1.9L	w/Electronic Wear Sensor		HB365X.728A		HB364X.642
Jetta	GL	2002-2003	2.0L			HB365X.728		HB364X.642
Jetta	GL	2002-2003	2.0L	w/Electronic Wear Sensor		HB365X.728A		HB364X.642
Jetta	GLS	2002-2004	2.0L			HB365X.728		HB364X.642
Jetta	GLS	2002-2004	2.0L	w/Electronic Wear Sensor		HB365X.728A		HB364X.642
Jetta		2002-2003		1J0698451E				HB364X.642
Jetta	GL	2003	1.8L			HB365X.728		HB364X.642
Jetta	GL	2003	1.8L	w/Electronic Wear Sensor		HB365X.728A		HB364X.642
Jetta	GLI	2004	1.8L	Turbo		HB272X.763		HB364X.587
Jetta	Front: 288mm & 312mm Rotors	2004		1J0698451E				HB364X.642
Jetta	SEDAN	2004		2.8L or 1.8T Models with Solid Rear Rotors		HB272X.763A		HB364X.587
Jetta	SEDAN	2004		GLI 1.8T or 2.8L with Vented Rear Rotors		HB272X.763A		HB364X.587
Jetta	TDI	2005	1.9L	From 1/05		HB365X.728		HB544X.628
Jetta	TDI	2005	1.9L	To 12/04		HB365X.728		HB544X.628
Jetta	TDI	2005	1.9L	w/Electronic Wear Sensor, From 1/05		HB365X.728A		HB544X.628
Jetta	TDI	2005	1.9L	w/Electronic Wear Sensor, To 12/04		HB365X.728A		HB544X.628
Jetta	GLI	2005-2010	2.0L	2.0L, Turbo, Gas; exc Wagon		HB543X.760		
Jetta		2005		1J0698151F		HB365X.728		
Jetta	Sedan	2005		2.0L Gas or 1.9L TDI - MFG Date up to 12/04		HB365X.728		HB364X.587
Jetta	Sedan	2005		2.8L or 1.8T Models with Solid Rear Rotors MFG Date up to 12/04		HB272X.763A		HB364X.587
Jetta	Sedan	2005		GLI 1.8T or 2.8L with Vented Rear Rotors MFG Date up to 12/04		HB272X.763A		HB364X.587
Jetta	Sedan	2005		GLI or 2.0T - MFG Date from 1/05		HB543X.760		HB544X.628
Jetta	Sedan	2005		TDI or 2.5L Gas - MFG Date from 1/05		HB543X.760		HB544X.628
Jetta	Wagon	2005		1.8T		HB272X.763A		HB364X.587

BRAKE PAD APPLICATIONS



MAKE/ MODEL	SUBMODEL	YEARS	ENGINE (LITER)	NOTE	FRONT		REAR	
					OES	HB SERIES	OES	HB SERIES
VOLKSWAGEN CONTINUED								
Jetta	Wagon	2005		2.0L Gas, 2.5L Gas, or 1.9L TDI		HB365X.728		HB364X.587
Jetta	2.0T	2006-2010	2.0L	2.0L, Turbo, Gas; exc Wagon		HB543X.760		
Jetta	Sedan	2006-2010		GLI or 2.0T		HB543X.760		HB544X.628
Jetta	Sedan	2006-2010		TDI or 2.5L Gas		HB543X.760		HB544X.628
Jetta	Sedan	2008-2009		Jetta City (Canada)		HB365X.728		HB364X.587
Jetta	Wagon	2009-2010		Gas Engine		HB543X.760		HB544X.628
Jetta	Wagon	2009-2010		TDI		HB543X.760		HB544X.628
Jetta	TDI	2010-2013	1.9L		771107	HB543X.760		HB695X.609
Jetta	2.0T	2011-2012	2.0L	2.0L, Turbo, Gas		HB543X.760		HB695X.609
Jetta	2.0T	2011-2012	2.0L	2.0L; Gas, exc Turbo		HB365X.728		
Jetta	GLI	2011-2012	2.0L	2.0L; Gas, exc Turbo		HB365X.728		
Jetta	GLI	2011-2013	2.0L	2.0L, Turbo, Gas		HB543X.760		HB695X.609
Jetta	S	2011-2012	2.5L					HB695X.609
Jetta	SE	2011-2012	2.5L					HB695X.609
Jetta	SEL	2011-2012	2.5L					HB695X.609
Jetta	Sedan	2011-2012		2.0L Non-Turbo Rear Drum		HB365X.728		
Jetta	Sedan	2011-2012		2.0T		HB543X.760		HB695X.609
Jetta	Sedan	2011-2012		2.5L Gas Rear Drum		HB543X.760		
Jetta	Sedan	2011-2012		TDI or 2.5L Gas Rear Disc		HB543X.760		HB695X.609
Jetta	Wagon	2011-2012		Rear Disc Brakes - Gas Engine		HB543X.760		HB695X.609
Jetta	Wagon	2011-2012		Rear Disc Brakes - TDI		HB543X.760		HB695X.609
Jetta	Wagon	2011-2012		Rear Drum Brakes		HB543X.760		
Jetta	Sedan 5 Cyl.	2012		5C0698451				HB364X.642
Jetta	S 2 Liter	2013		5C0698451				HB364X.642
Jetta	TDI	2013		5C0698451				HB364X.642
Jetta	Hybrid SE	2013-2014		5C0698451A				HB364X.642
Jetta	S 2 Liter	2013-2014		5C0698151		HB365X.728		
Jetta	WAGON	2013-2014		Gas Engine		HB543X.760		HB364X.587
Jetta	WAGON	2013-2014		TDI		HB543X.760		HB695X.609
Jetta	GLI	2014		5C0698151A		HB543X.760		
Jetta	GLI	2014		5C0698451A				HB364X.642
Jetta	Hybrid SE	2014		5C0698151A		HB543X.760		
Jetta	S 2 Liter	2014		5C0698451A				HB364X.642
Jetta		2015		5C0698151A		HB543X.760		
Jetta		2015		5Q0698451E				HB364X.642
Jetta	S	2015		5C0698151		HB365X.728		
Jetta	S	2015		5Q0698451E				HB364X.642
Karmann Ghia		1967-1976						HB198X.685
Passat	GL	1990-1991	2.0L			HB190X.600		
Passat	GL	1990-1991	2.0L	w/Wear Sensor		HB190X.600A		
Passat		1990-1991						HB364X.587
Passat	GL	1992-1993	2.0L			HB190X.730		HB364X.587
Passat	GL	1992-1993	2.0L	w/Wear Sensor				HB364X.587
Passat	GL	1992-1993	2.0L	w/Wear Sensor, w/Syncro Ring		HB190X.600A		HB364X.587
Passat	GL	1992-1993	2.0L	w/Syncro Ring		HB190X.600		
Passat	GL	1992-1993	2.0L	w/Syncro Ring		HB190X.730		HB364X.587
Passat		1992-1993		2.0L; Rear Disc	770696	HB190X.600		HB364X.587
Passat		1992-1993		2.0L; Rear Drum	770696	HB190X.600		
Passat		1992-1994		2.8L				HB364X.587
Passat	GLX	1993	2.8L	w/Syncro Ring		HB190X.600		
Passat	GLX	1993	2.8L	w/Syncro Ring				HB364X.587
Passat	GLX	1993-1995	2.8L	w/Wear Sensor, w/Syncro Ring		HB190X.600A		HB364X.587
Passat	2.8 L, Rear: To Vin 31PE080000	1993		357698151B		HB190X.730		
Passat	GLX	1994-1995	2.8L	w/Syncro Ring		HB190X.600		HB364X.587
Passat		1994		2.0L		HB190X.600		HB364X.587

BRAKE PAD APPLICATIONS



Hawk Performance - BRAKE PAD APPLICATIONS

HB **245** **x** **.631**
 HAWK BRAKE PAD SHAPE INSERT COMPOUND CODE PAD THICKNESS

MAKE/ MODEL	SUBMODEL	YEARS	ENGINE (LITER)	NOTE	FRONT		REAR	
					OES	HB SERIES	OES	HB SERIES
VOLKSWAGEN CONTINUED								
Passat		1994-1995		2.0L	770696			
Passat	GLS	1995	2.0L	w/Syncro Ring		HB190X.730		
Passat	GLS	1995-1996	2.0L			HB190X.730		HB364X.587
Passat	GLS	1995-1996	2.0L	w/Syncro Ring		HB190X.600		
Passat	GLS	1995-1996	2.0L	w/Wear Sensor				HB364X.587
Passat	GLS	1995-1996	2.0L	w/Wear Sensor, w/Syncro Ring		HB190X.600A		
Passat		1995		1.9L Diesel Canada				HB364X.642
Passat		1995		2.0L		HB190X.600		HB364X.642
Passat		1995		2.8L				HB364X.642
Passat	2.8 L	1995		357698151B		HB190X.730		
Passat	TDI	1996-1997	1.9L	w/Wear Sensor, w/Syncro Ring		HB190X.600A		
Passat	TDI	1996-1997	1.9L	w/Syncro Ring	770696	HB190X.600		
Passat		1996-1997		2.8L		HB272X.763		HB364X.642
Passat		1996-1997		TDI - USA Model	770696	HB190X.600		HB364X.642
Passat	GLX	1997	2.8L	w/Wear Sensor		HB354X.756A		HB364X.587
Passat	GLS	1998	1.8L	From 7/98; From CHNUMBER 3B-X-124-108		HB269X.763		
Passat	GLS	1998	1.8L	To 7/98; To CHNUMBER 3B-X-124-107		HB269X.763		
Passat	GLS	1998	1.8L	w/Large Round Wear Sensor, From 7/98; From CHNUMBER 3B-X-124-108		HB269X.763B		
Passat	GLS	1998	1.8L	w/Large Round Wear Sensor, To 7/98; To CHNUMBER 3B-X-124-107		HB269X.763B		
Passat	GLS	1998	1.8L	w/Oval Wear Sensor, From 7/98; From CHNUMBER 3B-X-124-108		HB269X.763A		
Passat	GLS	1998	1.8L	w/Oval Wear Sensor, To 7/98; To CHNUMBER 3B-X-124-107		HB269X.763A		
Passat	GLS	1998	2.8L	From 7/98; From CHNUMBER 3B-X-124-108		HB272X.763		HB364X.642
Passat	GLS	1998	2.8L	To 7/98; To CHNUMBER 3B-X-124-107		HB272X.763		HB364X.642
Passat	GLS	1998	2.8L	w/Wear Sensor, From 7/98; From CHNUMBER 3B-X-124-108		HB272X.763A		HB364X.642
Passat	GLS	1998	2.8L	w/Wear Sensor, To 7/98; To CHNUMBER 3B-X-124-107		HB272X.763A		HB364X.642
Passat		1998		Diesel				HB364X.642
Passat		1998		Gas				HB364X.642
Passat	2.8 L	1998		8E0698451E				HB364X.587
Passat		1999	1.8L			HB269X.763		HB364X.642
Passat		1999	1.8L	w/Large Round Wear Sensor		HB269X.763B		HB364X.642
Passat		1999	1.8L	w/Oval Wear Sensor		HB269X.763A		HB364X.642
Passat		1999	2.8L			HB272X.763		HB364X.642
Passat		1999	2.8L	w/Wear Sensor		HB272X.763A		HB364X.642
Passat		1999		AWD		HB354X.756A		HB364X.642
Passat		1999-2005		FWD		HB354X.756A		HB364X.642
Passat		2000-2001	1.8L	w/Wear Sensor		HB354X.756A		HB364X.642
Passat		2000-2001	2.8L	w/Wear Sensor		HB354X.756A		HB364X.642
Passat		2000-2001		AWD				HB364X.642
Passat		2001		4B0698451E				HB364X.642
Passat	GLS 4 Motion	2002	2.8L	w/Wear Sensor		HB354X.756A		HB364X.642
Passat	GLX 4 Motion	2002	2.8L	w/Wear Sensor		HB354X.756A		HB364X.642
Passat	Front: 321mm Rotors	2002		4B0698451E				HB364X.642
Passat		2002-2004		AWD Except W8				HB364X.642
Passat		2002-2004		W8		HB363X.689		HB364X.587
Passat	Front: 321mm Rotors	2002-2005		4B3698151		HB363X.689		
Passat	4 Motion	2003-2004	2.8L	w/Wear Sensor		HB354X.756A		HB364X.642
Passat	4 Motion	2003-2005	4.0L	w/Wear Sensor		HB354X.756A		HB364X.642
Passat	W8 4 Motion	2003-2005	4.0L	4 pad front caliper (available with wear sensor)		HB363X.689		HB364X.642
Passat	4 Motion	2004	1.8L	w/Wear Sensor		HB354X.756A		HB364X.642
Passat	4.0 L	2004		3B0698451				HB364X.642

BRAKE PAD APPLICATIONS



MAKE/ MODEL	SUBMODEL	YEARS	ENGINE (LITER)	NOTE	FRONT		REAR	
					OES	HB SERIES	OES	HB SERIES
VOLKSWAGEN CONTINUED								
Passat	Front: 288mm Rotors	2004-2005		3B0698451				HB364X.642
Passat	4 Motion	2005	1.8L	w/Wear Sensor		HB354X.756A		HB544X.628
Passat	4 Motion	2005	2.8L	w/Wear Sensor		HB354X.756A		HB544X.628
Passat		2005		AWD				HB364X.642
Passat		2006-2007	2.0L	Except 4-Motion		HB543X.760		HB544X.628
Passat	Turbo	2006-2010	2.0L			HB543X.760		HB544X.628
Passat		2006-2007	3.6L	Except 4-Motion		HB543X.760		HB544X.628
Passat		2006	All	Except 4-Motion		HB543X.760		HB544X.628
Passat	4 Motion	2006-2009	All			HB538X.760		HB544X.628
Passat		2006-2007		2.0L Turbo, 3.6L; Except 4-Motion		HB543X.760		HB544X.628
Passat		2006-2007		3.6L 4-Motion				HB544X.628
Passat	3.6 L	2006-2007		1K0698151B		HB515X.760		
Passat		2007	All	Except 4-Motion		HB543X.760		HB544X.628
Passat	Komfort	2008-2010	2.0L			HB543X.760		HB544X.628
Passat	Lux	2008-2010	2.0L			HB543X.760		HB544X.628
Passat	4 Motion	2008	3.6L			HB515X.760		
Passat		2008-2009	3.6L	3.6L FWD		HB538X.760		HB544X.628
Passat	VR6	2008-2010	3.6L	Except 4-Motion		HB543X.760		HB544X.628
Passat		2008		2.0L Turbo		HB543X.760		HB544X.628
Passat		2008		3.6L				HB544X.628
Passat	3.6 L	2008		3C0698451C				HB544X.628
Passat		2009		2.0L Turbo - Mfg After 12/2008		HB543X.760		HB544X.628
Passat		2009		2.0L Turbo - Mfg Before 12/2008		HB543X.760		HB544X.628
Passat		2009		3.6L V6; Canadian Models				HB544X.628
Passat	Base	2010	All			HB543X.760		HB544X.628
Passat		2010				HB543X.760		HB544X.628
Passat		2012-2013		5N0698151A		HB543X.760		
Passat		2012-2014						HB695X.609
Passat		2014-2015		5N0698151B		HB543X.760		
Passat	TDI	2015		5K0698451A				HB695X.609
Passat	TDI	2015		5N0698151B		HB543X.760		
Passat CC		2010		1K0698151B		HB515X.760		
Passat CC		2010		3C0698151A		HB543X.760		
Passat CC		2010		3C0698151C		HB543X.760		
Passat CC		2010		3C0698451C				HB544X.628
Passat CC		2012				HB779X.740		
Phaeton		2004-2006	All					HB544X.628
Phaeton		2004-2006				HB687X.750		HB553X.652
Polo	(Mexico)	2014				HB543X.760		
Quantum	Custom	1982-1983	All			HB189X.595		
Quantum	DLX	1982-1983	All			HB189X.595		
Quantum	GL Deluxe	1984	All			HB189X.595		
Quantum	Wolfsburg Edition	1984	All			HB189X.595		
Quantum	GL Custom	1984-1986	All			HB189X.595		
Quantum		1985	All			HB189X.595		
Quantum	Syncro	1986-1988	All	w/Wear Sensor				HB364X.587
Quantum	Syncro	1988				HB190X.600		
R32		2008						HB544X.628
R32		2008		1K0698151B		HB515X.760		
Rabbit		1979-1984	All			HB189X.595		
Rabbit	L Custom	1981-1982	All			HB189X.595		
Rabbit	LS Deluxe	1981-1982	All			HB189X.595		
Rabbit	GL DLX	1983	All			HB189X.595		
Rabbit	GTI Sport	1983	All			HB189X.595		
Rabbit	LS Custom	1983	All			HB189X.595		

Hawk Performance - BRAKE PAD APPLICATIONS

HB
HAWK BRAKE

245
PAD SHAPE

x
INSERT COMPOUND CODE

.631
PAD THICKNESS

MAKE/ MODEL	SUBMODEL	YEARS	ENGINE (LITER)	NOTE	FRONT		REAR	
					OES	HB SERIES	OES	HB SERIES
VOLKSWAGEN CONTINUED								
Rabbit	L	1983-1984	All			HB189X.595		
Rabbit		2006		1K0698451F				HB544X.628
Rabbit		2006		3C0698151A		HB543X.760		
Rabbit		2007-2009				HB543X.760		HB544X.628
Rabbit Convertible		1980-1984	All			HB189X.595		
Rabbit Pickup		1980-1983				HB189X.595		
Routan		2009-2011				HB569X.650		
Routan	S	2012		7B0698151D		HB569X.650		
Routan		2012-2013		Models with Single Piston front caliper		HB569X.650		
Routan	S	2013-2014		7B0698151F		HB569X.650		
Saveiro		2010-2011	All	(Latin America)	771555			
Saveiro		2012-2013	All	(Latin America)	771641			
Scirocco		1979	All			HB189X.595		
Scirocco		1980-1984				HB189X.595		
Scirocco		1985-1987		191698151G		HB189X.595		
Scirocco	16 Valve	1986				HB190X.600		HB364X.587
Scirocco	16-Valve	1987	All			HB189X.595		
Scirocco	16-Valve	1987-1988	All	w/Wear Sensor				HB364X.587
Scirocco	16 Valve	1987				HB190X.600		
Scirocco	16 Valve	1989				HB190X.600		HB364X.587
Tiguan	S	2009-2010	2.0L			HB543X.760		HB544X.628
Tiguan	SE	2009-2010	2.0L			HB543X.760		HB544X.628
Tiguan	SEL	2009-2010	2.0L			HB543X.760		HB544X.628
Tiguan		2009-2014						HB544X.628
Tiguan		2011-2012		5N0698151A		HB543X.760		
Tiguan		2013		5N0698151		HB543X.760		
Tiguan		2014-2015		5N0698151B		HB543X.760		
Tiguan		2015		3AA698451				HB544X.628
Touareg		2004-2005	3.2L	17 in. Wheels, w/330mm Rotors		HB512X.605		HB502X.606
Touareg		2004-2005	3.2L	18 in. Wheel, w/350mm Rotors		HB501X.625		
Touareg		2004-2005	4.2L	17 in. Wheels, w/330mm Rotors		HB512X.605		HB502X.606
Touareg		2004-2005	4.2L	18 in. Wheel, w/350mm Rotors		HB501X.625		HB502X.606
Touareg	TDI	2004	4.9L	17 in. Wheels, w/330mm Rotors		HB512X.605		HB502X.606
Touareg	TDI	2004	4.9L	18 in. Wheel, w/350mm Rotors		HB501X.625		HB502X.606
Touareg	Front: 350mm Rotors	2004		7L0698151G		HB501X.625		
Touareg	TDI	2004		7L0698151J		HB501X.625		
Touareg		2004		18 in. Wheel, w/350mm Rotors		HB501X.625		
Touareg		2004		18 in. Wheel, w/350mm Rotors				HB502X.606
Touareg		2004-2005		17 in. Wheels, w/330mm Rotors		HB512X.605		HB502X.606
Touareg		2004-2006				HB512X.605		
Touareg		2005		18 in. Wheel, w/350mm Rotors		HB501X.625		HB502X.606
Touareg		2006-2014	3.6L	4 Piston Front Caliper; 330mm Front Disc		HB632X.586		
Touareg		2006-2007	4.2L	w/350mm Rotors		HB501X.625		HB502X.606
Touareg	TDI	2006-2009	5.0L	w/350mm Rotors		HB501X.625		HB502X.606
Touareg		2006		Models with 350mm Front Discs		HB501X.625		
Touareg		2006		w/350mm Rotors				HB502X.606
Touareg	Front: 350mm Rotors Rear: 2 piston caliper	2006		7L0698151G		HB501X.625		
Touareg		2006-2007		Models with 4 Piston Front Calipers and 330mm Front Discs		HB632X.586		
Touareg		2006-2007		Models with 6 Piston Front Calipers and 330mm Front Discs		HB512X.605		HB502X.606
Touareg	TDI	2006-2008		7L0698151J		HB501X.625		
Touareg		2007-2010		w/350mm Rotors		HB501X.625		HB502X.606
Touareg		2008-2014	4.2L	4 Piston Front Caliper; 330mm Front Disc		HB632X.586		

BRAKE PAD APPLICATIONS

MAKE/ MODEL	SUBMODEL	YEARS	ENGINE (LITER)	NOTE	FRONT		REAR	
					OES	HB SERIES	OES	HB SERIES
VOLKSWAGEN CONTINUED								
Touareg		2008-2009		330mm Front Discs - 2 Piston Rear Caliper		HB632X.586		
Touareg		2008-2009		330mm Front Discs - 4 Piston Rear Caliper		HB632X.586		HB502X.606
Touareg		2010-2011		330mm Front Discs		HB632X.586		
Touareg		2011						HB762X.634
Touareg		2011-2015		Hybrid		HB720X.575		HB762X.634
Touareg		2012		330mm Front Discs - MFG from 10/24/2011		HB512X.605		
Touareg		2012		330mm Front Discs - MFG up to 10/23/2011		HB632X.586		
Touareg		2012-2014				HB512X.605		HB762X.634
Touareg		2013-2014		330mm Front Discs		HB512X.605		
Touareg		2015						HB762X.634
Touareg		2015		7P6698151C		HB632X.586		
Transporter	211	1971-1972	All			HB171X.590		
Transporter	215	1971-1972	All			HB171X.590		
Transporter	261	1971-1972	All			HB171X.590		
Transporter	265	1971-1972	All			HB171X.590		
Transporter		1971-1972	All			HB171X.590		
Transporter	211	1973-1979	All			HB171X.720		
Transporter	215	1973-1979	All			HB171X.720		
Transporter	261	1973-1979	All			HB171X.720		
Transporter	265	1973-1979	All			HB171X.720		
Transporter		1973-1979	All			HB171X.720		
Vanagon	Kombi	1980-1981	All			HB171X.720		
Vanagon	Campmobile	1980-1985	All			HB171X.720		
Vanagon	Transport	1981	All			HB171X.720		
Vanagon		1982-1985	All			HB171X.720		
Vento	(Mexico)	2014				HB365X.728		
Vento	(Mexico)	2014				HB543X.760		
VOLVO								
122		1961-1968				HB244X.624		
142	S	1969	All			HB204X.615		
142		1969-1972				HB204X.615		HB118X.560
142		1970-1974	All			HB204X.615		
142	E	1971-1972	All			HB204X.615		
142		1973						HB118X.560
142		1973				HB204X.615		
142	GL	1974	All			HB204X.615		
142		1974				HB204X.615		HB118X.560
144		1969-1970				HB204X.615		
144	Deluxe	1969-1971				HB204X.615		HB118X.560
144	Gr. Luxe	1971				HB204X.615		HB118X.560
144		1971-1974				HB204X.615		HB118X.560
145		1968-1971				HB204X.615		HB118X.560
145	S	1969	All			HB204X.615		
145		1971-1974	All			HB204X.615		HB172X.595
145	Deluxe	1971-1972						HB118X.560
145		1972-1974				HB204X.615		
164		1969-1975				HB204X.615		HB118X.560
164		1972	All			HB204X.615		HB172X.595
164		1972-1975				HB204X.615		HB172X.500
164	E	1973-1974	All			HB204X.615		HB172X.595
164		1975	All			HB204X.615		HB172X.595
182		1971-1973				HB204X.615		HB118X.560
183		1971-1973				HB204X.615		HB118X.560
240		1979				HB204X.615		HB118X.560
240		1979				HB204X.615		HB172X.500

BRAKE PAD APPLICATIONS



Hawk Performance - BRAKE PAD APPLICATIONS

HB
HAWK BRAKE

245
PAD SHAPE

x
INSERT COMPOUND CODE

.631
PAD THICKNESS

MAKE/ MODEL	SUBMODEL	YEARS	ENGINE (LITER)	NOTE	FRONT		REAR	
					OES	HB SERIES	OES	HB SERIES
VOLVO CONTINUED								
240	DL	1990	All			HB204X.615		HB172X.595
240		1990-1993	All			HB204X.615		HB172X.595
240		1990-1993				HB204X.615		
240	SE	1991	All			HB204X.615		HB172X.595
240	GL	1992	All			HB204X.615		HB172X.595
242	GL	1975	All			HB204X.615		HB172X.595
242		1975-1978				HB204X.615		HB118X.560
242		1975-1978				HB204X.615		HB172X.500
242		1976	All			HB204X.615		HB172X.595
242	GL	1980-1983		Coupe		HB204X.615		
242	GLT	1983				HB204X.615		
244	GL	1975	All			HB204X.615		HB172X.595
244		1975-1978				HB204X.615		HB118X.560
244		1975-1978				HB204X.615		HB172X.500
244		1976	All			HB204X.615		HB172X.595
244	GL	1980-1983		Coupe		HB204X.615		
244	GLT	1983				HB204X.615		
244		1985-1989				HB204X.615		
244		1985-1989		2717395		HB204X.615		
245		1975-1978	All			HB204X.615		HB172X.595
245		1975-1978				HB204X.615		HB118X.560
245		1975-1978				HB204X.615		HB172X.500
245	GL	1980-1983		Coupe		HB204X.615		
245	GLT	1983				HB204X.615		
245		1985-1989				HB204X.615		
245		1985-1989		2717395		HB204X.615		
260		1979				HB204X.615		HB118X.560
260		1979				HB204X.615		HB172X.500
262	C	1979	All			HB204X.615		HB172X.595
262		1979				HB204X.615		HB118X.560
262		1979				HB204X.615		HB172X.500
262	GL	1980-1983		Coupe		HB204X.615		
264		1975-1978				HB204X.615		HB118X.560
264		1975-1978				HB204X.615		HB172X.500
264	GL	1980-1983		Coupe		HB204X.615		
265		1975-1978				HB204X.615		HB118X.560
265		1975-1978				HB204X.615		HB172X.500
265		1976	All			HB204X.615		HB172X.595
265	GL	1977-1978	All			HB204X.615		HB172X.595
740	SE	1991	All			HB413X.690		
740		1991-1992	All			HB413X.690		
760		1983-1984		GLE				HB172X.500
850		1993-1997	All		770618	HB492X.732		HB172X.595
850		1994		2717585				HB172X.595
850		1994		94855930		HB492X.732		
850	2.3 Liter	1994		2715878		HB492X.732		
850	2.3 Liter	1994		271758				HB172X.595
850	T-5R	1995	All			HB492X.732		
850	Turbo	1995-1996	All			HB492X.732		
850	GLT	1995-1997	All			HB492X.732		
850	R	1997	All			HB492X.732		
850	T-5	1997	All			HB492X.732		
940	GLE	1991	All			HB413X.690		
940	SE	1991	All			HB413X.690		
940		1991-1995	All			HB413X.690		

BRAKE PAD APPLICATIONS

MAKE/ MODEL	SUBMODEL	YEARS	ENGINE (LITER)	NOTE	FRONT		REAR	
					OES	HB SERIES	OES	HB SERIES
VOLVO CONTINUED								
940	Rear: 2 Piston Caliper	1995		2717379		HB413X.690		
960		1992-1993	All	w/o ABS		HB413X.690		
960	Sedan	1994		2719797		HB413X.690		
960	Wagon	1994		2719790		HB413X.690		
960		1994-1997				HB413X.690		
1800		1961-1968				HB244X.624		
1800	S	1968				HB244X.624		
1800	S	1969				HB204X.615		
1800	E	1969-1970				HB204X.615		
1800	ES	1969-1973				HB204X.615		
1800	E	1970-1972	All			HB204X.615		
1800	S	1970-1971				HB204X.615		HB118X.560
1800	E	1971-1973				HB204X.615		HB118X.560
1800	ES	1972-1973	All			HB204X.615		
1800	S	1972-1973				HB204X.615		
145 Deluxe		1971-1972						HB172X.500
C30		2008-2012				HB519X.682		HB478X.605
C30		2013		307420310				HB478X.605
C30		2013		307936180		HB519X.682		
C70	16" Wheels	1998		271758				HB172X.595
C70	16" Wheels	1998		2723435		HB492X.732		
C70	17" Wheels	1998		2724631				HB172X.595
C70		1998				HB492X.732		HB172X.595
C70	16" Wheels	1999		2724630				HB172X.595
C70	17" Wheels	1999		271758				HB172X.595
C70		1999-2004		Models with 280mm (11.02") Front Rotors		HB492X.732		HB172X.595
C70		1999-2004		Models with 302mm (11.89") Front Rotors		HB354X.756A		HB172X.595
C70	16" Wheels	1999-2005		94852670		HB492X.732		
C70	17" Wheels	2000		2724630				HB172X.595
C70	16" Wheels	2000-2003		2717585				HB172X.595
C70	17" Wheels	2001-2003		2717585				HB172X.595
C70	16" Wheels	2004		2724631				HB172X.595
C70	17" Wheels	2004-2005		2724630				HB172X.595
C70	16" Wheels	2005		2724630				HB172X.595
C70	320mm Brake Rotors	2006-2008		307420290		HB515X.760		
C70		2006-2012		Models with 300mm (11.81") Front Rotors		HB519X.682		HB478X.605
C70		2006-2012		Models with 320mm (12.6") Front Rotors				HB478X.605
C70	320mm Brake Rotors	2009-2013		31212184		HB515X.760		
C70	300mm Brake Rotors	2013		307420310				HB478X.605
C70	300mm Brake Rotors	2013		307936180		HB519X.682		
C70	320mm Brake Rotors	2013		307420310				HB478X.605
DL		1980-1984				HB204X.615		HB118X.560
DL		1980-1984				HB204X.615		HB172X.500
GL	Coupe	1980-1982				HB204X.615		HB118X.560
GL Coupe		1980-1982						HB172X.500
GLE		1984						HB172X.500
GLT		1983				HB204X.615		HB118X.560
GLT		1983				HB204X.615		HB172X.500
S40		2000-2003				HB500X.645		HB516X.626
S40		2004		1.9 Liter		HB500X.645		HB516X.626
S40		2004		2004.5 model - 2.4i; 300mm Front Disc		HB519X.682		HB571X.605
S40		2004		2004.5 model - T5; 320mm Front Disc				HB571X.605
S40	278mm Brake Rotors	2004-2005		307420310				HB478X.605
S40	300mm Brake Rotors	2004-2005		307420310				HB478X.605
S40	320mm Brake Rotors	2004-2005		307420310				HB478X.605

BRAKE PAD APPLICATIONS



Hawk Performance - BRAKE PAD APPLICATIONS

HB **245** **x** **.631**
 HAWK BRAKE PAD SHAPE INSERT COMPOUND CODE PAD THICKNESS

MAKE/ MODEL	SUBMODEL	YEARS	ENGINE (LITER)	NOTE	FRONT		REAR	
					OES	HB SERIES	OES	HB SERIES
VOLVO CONTINUED								
S40	320mm Brake Rotors	2004-2008		307420290		HB515X.760		
S40		2005		2.4i; 300mm Front Disc		HB519X.682		HB571X.605
S40		2005		T5; 320mm Front Disc				HB571X.605
S40		2006-2010		2.4i; 300mm Front Disc		HB519X.682		HB478X.605
S40		2006-2010		T5; 320mm Front Disc				HB478X.605
S40	320mm Brake Rotors	2009-2011		31212184		HB515X.760		
S40		2011		Models with 300mm (11.81") Front Rotors		HB519X.682		HB478X.605
S40		2011		Models with 320mm (12.6") Front Rotors				HB478X.605
S60		2001-2003		Except T5		HB491X.693		HB652X.634
S60		2001-2003		T5		HB491X.693		HB652X.634
S60		2004-2007		Except T5 & R; 286mm Front Disc		HB491X.693		HB652X.634
S60		2004-2007		R Model		HB453X.585		HB194X.570
S60		2004-2007		T5; 305mm Front Disc		HB491X.693		HB652X.634
S60		2008-2009		Except T5; 305mm Front Disc		HB491X.693		HB652X.634
S60		2008-2009		T5; 316mm Front Disc				HB652X.634
S60		2011-2015				HB759X.750		
S60		2011-2016		300mm Brake Rotors		HB759X.750		
S70		1998				HB492X.732		HB172X.595
S70	Front: 16" & 17" Wheels	1998		271758				HB172X.595
S70	15" Wheels	1998-1999		271758				HB172X.595
S70	Front: 16" & 17" Wheels	1998-2000		2723435		HB492X.732		
S70		1999-2000		2WD		HB492X.732		HB172X.595
S70		1999-2000		AWD; From CHNUMBER 596636		HB492X.732		HB652X.634
S70		1999-2000		AWD; To CHNUMBER 596635		HB492X.732		
S70	Front: 16" & 17" Wheels	1999-2000		2717585				HB172X.595
S70	15" Wheels	2000		2717585				HB172X.595
S80		1999-2006		286mm Front Discs		HB491X.693		HB652X.634
S80		1999-2006		305mm Front Discs		HB491X.693		HB652X.634
S80		2007-2009		3.2 w/300mm Brake Rotors		HB759X.750		
S80		2007-2009		3.2 w/300mm Front Discs		HB759X.750		
S80		2007-2009		300mm Front Discs		HB759X.750		
S80		2007-2016		300mm Brake Rotors		HB759X.750		
S80	300mm Brake Rotors	2010-2015				HB759X.750		
S90		1997-1998				HB413X.690		
V40		2000-2004				HB500X.645		HB516X.626
V50		2005		2.4i; 300mm Front Discs		HB519X.682		HB571X.605
V50		2005		T5; 320mm Front Discs				HB571X.605
V50	278mm Brake Rotors	2005		307420310				HB478X.605
V50	300mm Brake Rotors	2005		307420310				HB478X.605
V50	320mm Brake Rotors	2005		307420310				HB478X.605
V50	320mm Brake Rotors	2005-2008		307420290		HB515X.760		
V50		2006-2010		2.4i; 300mm Front Discs		HB519X.682		HB478X.605
V50		2006-2010		T5; 320mm Front Discs				HB478X.605
V50	320mm Brake Rotors	2009-2011		31212184		HB515X.760		
V50		2011		300mm Front Discs		HB519X.682		HB478X.605
V50		2011		320mm Front Discs				HB478X.605
V60		2015		300mm Front Discs		HB759X.750		
V60		2015-2016		300mm Brake Rotor		HB759X.750		
V70		1998		2WD; 302mm Front Discs		HB492X.732		HB172X.595
V70		1998		AWD & R; 280mm Front Discs		HB492X.732		
V70		1998		AWD & R; 302mm Front Discs		HB492X.732		
V70	AWD, Front: OE # 16" Wheels	1998		2723435		HB492X.732		
V70	FWD, Front: OE # 15" Wheels	1998		271758				HB172X.595
V70		1998-2000		2WD; 280mm Front Discs		HB492X.732		HB172X.595
V70	FWD, Front: OE # 15" Wheels	1998-2000		94855930		HB492X.732		

BRAKE PAD APPLICATIONS

MAKE/ MODEL	SUBMODEL	YEARS	ENGINE (LITER)	NOTE	FRONT		REAR	
					OES	HB SERIES	OES	HB SERIES
VOLVO CONTINUED								
V70		1999		AWD From CHNUMBER 588640; R From CHNUMBER 587597; 302mm Front Discs		HB492X.732		HB652X.634
V70		1999		AWD To CHNUMBER 588639; R To CHNUMBER 587596; 302mm Front Discs		HB492X.732		
V70		1999		AWD; To CHNUMBER 588639; 280mm Front Discs		HB492X.732		
V70	AWD, Front: OE # 16" or 17" Wheels	1999-2000		94852670		HB492X.732		
V70	FWD, Front: OE # 15" Wheels	1999-2000		2717585				HB172X.595
V70		2000		AWD; 280mm Front Discs		HB492X.732		HB652X.634
V70		2000		R Model		HB492X.732		HB652X.634
V70		2001-2003		Except T5; 286mm Front Discs		HB491X.693		HB652X.634
V70		2001-2003		T5; 305mm Front Discs		HB491X.693		HB652X.634
V70		2004-2007		Except T5 & R; 286mm Front Discs		HB491X.693		HB652X.634
V70		2004-2007		R Model; 330mm Front Discs		HB453X.585		HB194X.570
V70		2004-2007		T; 305mm Front Discs		HB491X.693		HB652X.634
V70		2008-2010		300mm Brake Rotors		HB759X.750		
V70		2008-2010		300mm Front Discs		HB759X.750		
V90		1997-1998				HB413X.690		
XC70		2003-2007				HB491X.693		HB652X.634
XC70		2008-2015		300mm Front Discs		HB759X.750		
XC70		2008-2016		300mm Brake Rotors		HB759X.750		
VPG								
MV-1		2011-2012				HB360X.670		

BRAKE PAD APPLICATIONS

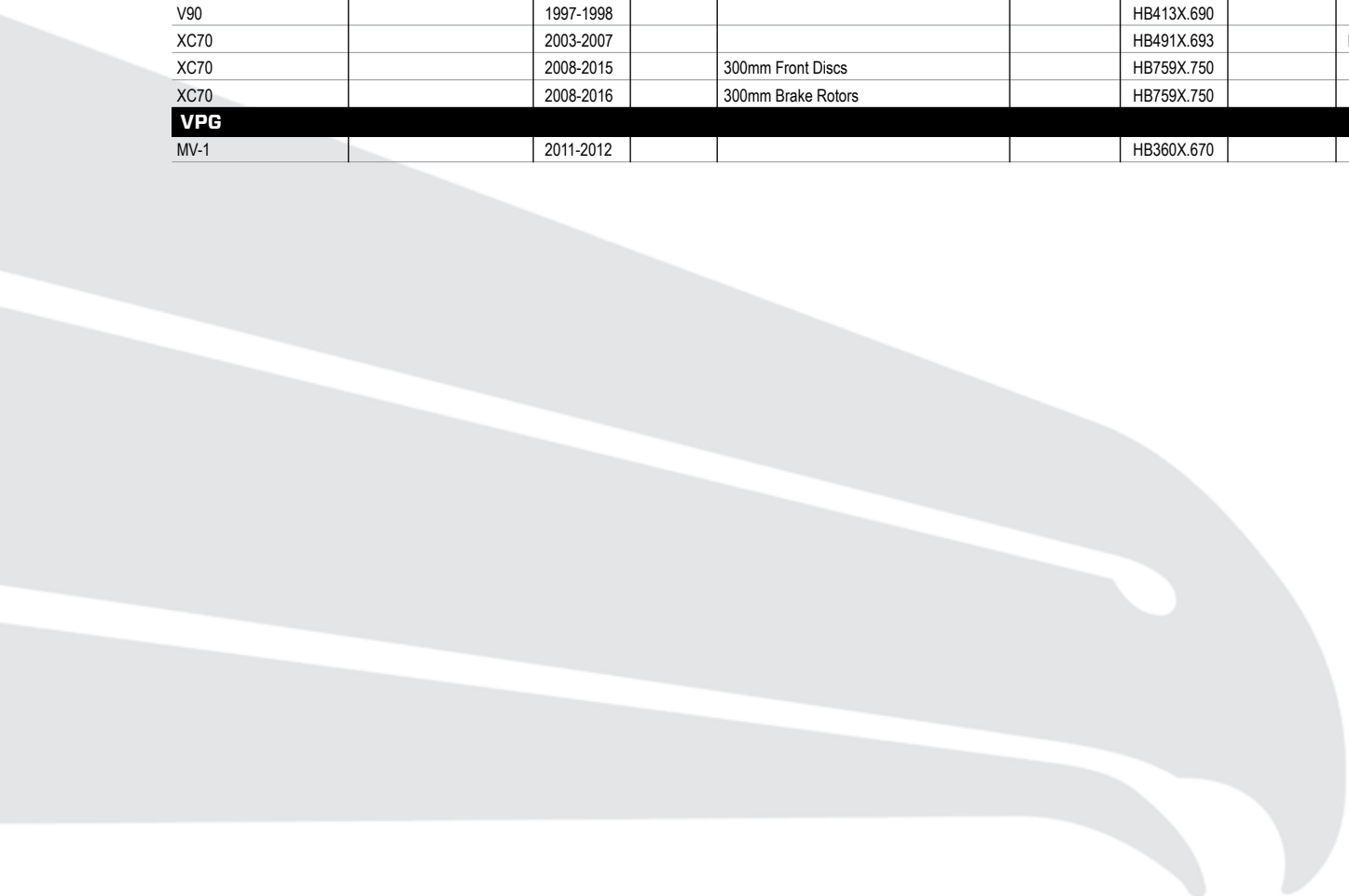

What's stopping you?





ROTOR APPLICATIONS

ROTOR APPLICATIONS

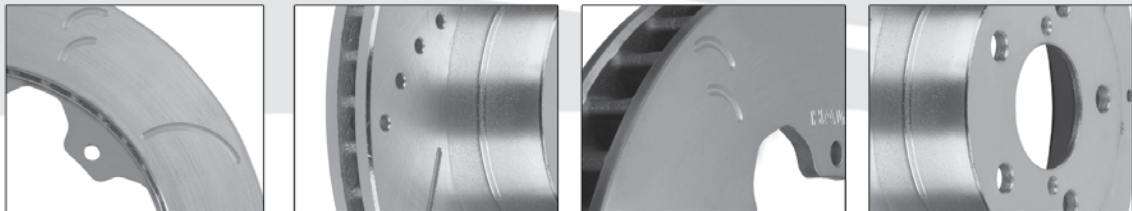

Hawk Performance - ROTOR APPLICATIONS

HK 4218 .448 X
 HAWK KIT ROTOR PAD SHAPE INSERT COMPOUND CODE

MAKE/ MODEL	SUBMODEL	YEARS	ENGINE (LITER)	NOTE	FRONT	REAR
					ROTOR	ROTOR
ACURA						
CL		1997	2.2L	2156cc L4	HR5175	
CL		1997				HR5177
CL		1998-1999	2.3L	2254cc L4	HR5302	
CL		1998-1999	3.0L	2997cc V6	HR5301	
CL		1998-1999				HR5304
CL		2001-2003			HR5317	HR5343
ILX	Base	2013-2015	2.4L	300mm Front Rotor, 2354cc L4	HR5363	
ILX	Hybrid	2013-2014			HR5098	
ILX		2013-2015				HR5303
ILX	Base	2014-2015	2.0L	280mm Front Rotor, 1997cc 122cid L4	HR5233	
Integra		1990-1996			HR5174	HR5132
Integra	RS	1997-1998			HR5174	HR5132
Integra	Type R	1997-1998			HR5179	HR5308
Integra	GS	1997-2001			HR5174	HR5132
Integra	GS-R	1997-2001			HR5174	HR5132
Integra	LS	1997-2001			HR5174	HR5132
Integra	Type R	2000-2001			HR5179	HR5308
Legend		1991-1992			HR5179	HR5180
Legend		1993		Coupe	HR5230	
Legend		1993		Sedan	HR5179	
Legend		1993-1995				HR5180
Legend	GS	1994-1995		Sedan	HR5230	
Legend	L	1994-1995		Sedan	HR5179	
Legend	LS	1994-1995		Sedan	HR5179	
Legend	SE	1995		Sedan	HR5179	
MDX		2001-2006			HR5317	HR5342
MDX		2007-2013			HR4958	HR4997
RDX		2007-2012			HR4960	HR4949
RDX		2013-2016				HR4949
RL		1996-1998			HR5179	HR5180
RL		1999-2001			HR5320	HR5322
RL		2002-2004			HR5320	
RL		2005-2012			HR4934	HR4935
RSX	Base	2002-2006			HR5344	
RSX		2002-2006				HR5308
RSX	Type-S	2002-2006			HR5363	
SLX		1996-1999				HR5206
TL		1996-1998	3.2L	3206cc V6	HR5179	
TL		1999-2003			HR5317	HR5319
TL		2004-2008		Brembo Front Caliper	HR4936	
TL		2004-2008				HR5359
TL		2004-2008		Standard Front Caliper	HR5317	
TL		2009-2014			HR5034	HR5033
TSX		2004-2008			HR5317	HR5346
TSX		2009-2014			HR5317	HR4957
ZDX		2010-2013			HR4958	HR4997
AUDI						
A3		2006-2007			HR4897	HR4898
A3		2008		From CH# 8P-8-057779		HR4538
A3		2008			HR4897	
A3		2009			HR4897	HR4538
A3	Base	2010-2013			HR4897	HR4567
A3	TDI	2010-2013			HR4845	HR4570
A3		2015-2016		288mm Front Rotor	HR4845	
A3		2015-2016		312mm Front Rotor	HR4897	

ROTOR APPLICATIONS



MAKE/ MODEL	SUBMODEL	YEARS	ENGINE (LITER)	NOTE	FRONT	REAR
					ROTORS	ROTORS
AUDI CONTINUED						
A3		2015-2016		272mm Rear Rotor		HR4567
A3 Quattro		2006-2007			HR4897	HR4898
A3 Quattro		2008-2010			HR4897	
A3 Quattro		2010		Bosch Rear Brakes; 272mm Rotor		HR4567
A3 Quattro		2011-2013			HR4897	HR4567
A3 Quattro		2015-2016		288mm Front Rotor	HR4845	
A3 Quattro		2015-2016		312mm Front Rotor	HR4897	
A3 Quattro		2015-2016		272mm Rear Rotor		HR4567
A4		1996-2001			HR4695	HR4724
A4		2002-2003	1.8L	1781cc L4, Sedan; Turbocharged; To CH# 8E-5-060-000	HR4695	
A4		2002-2005	1.8L	1781cc L4, Turbocharged		HR4784
A4		2002-2005	3.0L	2976cc V6, Sedan	HR4743	HR4785
A4		2003	1.8L	1781cc L4, Convertible; Turbocharged; To CH# 8E-5-006-000	HR4695	
A4		2003-2004	3.0L	2976cc V6, Convertible	HR4743	HR4785
A4		2004	1.8L	1781cc L4, Convertible; Turbocharged; To 7/04; To CH# 8E-5-006-000	HR4695	
A4		2004	1.8L	1781cc L4, Sedan; Turbocharged; To 7/04; To CH# 8E-5-060-000	HR4695	
A4		2005	3.0L	2976cc V6, Convertible; From 1/05	HR4743	HR4489
A4		2005	3.0L	2976cc V6, Convertible; To 12/04	HR4743	HR4785
A4		2006		Sedan	HR4766	HR4489
A4		2006		Convertible		HR4784
A4		2007-2008			HR4766	HR4489
A4		2009		Sedan	HR4852	HR4490
A4		2009		Convertible	HR4766	HR4489
A4		2010-2011			HR4852	HR4490
A4		2012-2016				HR4490
A4 Quattro		1996-2001			HR4695	HR4723
A4 Quattro		2002-2003	1.8L	1781cc L4, Turbocharged	HR4695	HR4784
A4 Quattro		2002-2004	3.0L	2976cc V6, Sedan	HR4743	HR4785
A4 Quattro		2004	1.8L	1781cc L4, Turbocharged; To 7/04; To CH# 8E-5-060-000	HR4695	HR4784
A4 Quattro		2004	1.8L	1781cc L4, Sedan; Turbocharged; From 7/04; From CH# 8E-5-060-001		HR4784
A4 Quattro		2004	3.0L	2976cc V6, Convertible	HR4743	HR4785
A4 Quattro		2005	1.8L	1781cc L4, Sedan; Turbocharged; To 12/04		HR4784
A4 Quattro		2005	2.0L	1984cc 121cid L4, Sedan; Turbocharged		HR4489
A4 Quattro		2005	2.0L	1984cc 121cid L4, Sedan; Turbocharged; From 1/05; From CH# 8E-5-400-001	HR4766	
A4 Quattro		2005	3.0L	2976cc V6, Sedan	HR4743	
A4 Quattro		2005	3.0L	2976cc V6, Sedan		HR4785
A4 Quattro		2005-2006	3.0L	2976cc V6, Convertible	HR4743	
A4 Quattro		2005	3.2L	3123cc V6, Sedan		HR4489
A4 Quattro		2005	3.2L	3123cc V6, Sedan; From 1/05; From CH# 8E-5-400-001	HR4766	
A4 Quattro		2005-2006		Convertible		HR4785
A4 Quattro		2006	2.0L	1984cc 121cid L4, Sedan; Turbocharged	HR4766	HR4489
A4 Quattro		2006	3.2L	3123cc V6, Sedan	HR4766	HR4489
A4 Quattro		2007-2008			HR4766	HR4489
A4 Quattro		2009		Sedan	HR4852	HR4490
A4 Quattro		2009		Convertible	HR4766	HR4489
A4 Quattro		2009		Wagon	HR4852	HR4490
A4 Quattro		2010			HR4852	HR4490
A4 Quattro		2011		To 6/19/11	HR4852	
A4 Quattro		2011-2016				HR4490
A5		2008-2009			HR4852	HR4490
A5		2010-2011		TRW/Girling Front Brakes; 320mm Front Disc	HR4852	

Hawk Performance - ROTOR APPLICATIONS

HK 4218 .448 X
 HAWK KIT ROTOR PAD SHAPE INSERT COMPOUND CODE

MAKE/ MODEL	SUBMODEL	YEARS	ENGINE (LITER)	NOTE	FRONT	REAR
					ROTOR	ROTOR
AUDI CONTINUED						
A5		2010-2016				HR4490
A5 Quattro		2008-2009			HR4852	HR4490
A5 Quattro		2010-2011		TRW/Girling Front Brakes; 320mm Front Disc	HR4852	
A5 Quattro		2010-2016				HR4490
A6		1995-1997			HR4695	HR4694
A6		1998-2001		288mm Front Disc	HR4695	
A6		1998-2001		312mm Front Disc	HR4743	
A6		1998-2001				HR4694
A6		2002-2004			HR4743	HR4694
A6		2005-2011			HR4846	HR4491
A6		2012-2013				HR4490
A6 Quattro		1995-1997			HR4695	HR4694
A6 Quattro		1998-1999		Sedan; Except 215/55R16 Tires		HR4752
A6 Quattro		1998-1999		w/15 inch Wheels	HR4695	
A6 Quattro		1998-1999		w/16 inch Wheels	HR4743	
A6 Quattro		1998-1999		Wagon; Except 215/55R16 Tires		HR4492
A6 Quattro		1998-1999		With 215/55R16 Tires		HR4787
A6 Quattro		2000-2001	2.7L	2671cc V6, Turbocharged	HR4766	HR4787
A6 Quattro		2000-2001	2.8L	2771cc V6, 288mm Front Disc	HR4695	
A6 Quattro		2000-2001	2.8L	2771cc V6, 312mm Front Disc	HR4743	
A6 Quattro		2000-2001	2.8L	2771cc V6, Sedan; Except 215/55R16 Tires		HR4752
A6 Quattro		2000-2001	2.8L	2771cc V6, Wagon; Except 215/55R16 Tires		HR4492
A6 Quattro		2000-2001	2.8L	2771cc V6, With 215/55R16 Tires		HR4787
A6 Quattro		2000-2004	4.2L	4172cc V8	HR4791	
A6 Quattro		2002-2004	2.7L	2671cc V6, Turbocharged		HR4787
A6 Quattro		2002-2004	2.7L	2671cc V6, Turbocharged; 2 Pad Front Caliper	HR4766	
A6 Quattro		2002-2004	2.7L	2671cc V6, Turbocharged; 4 Pad Front Caliper	HR4791	
A6 Quattro		2002-2004	3.0L	2976cc V6, Sedan		HR4787
A6 Quattro		2002-2004	3.0L	2976cc V6, Wagon		HR4492
A6 Quattro		2002-2004	3.0L	2976cc V6	HR4743	
A6 Quattro		2005-2008	3.2L	3123cc V6	HR4846	HR4491
A6 Quattro		2005-2008	4.2L	4163cc V8	HR4843	HR4844
A6 Quattro		2009-2010	4.2L	4163cc V8, Armoured Vehicle	HR4840	
A6 Quattro		2009-2011		302mm		HR4491
A6 Quattro		2009-2011		321mm; Except Armoured	HR4846	
A6 Quattro		2009-2011		330mm		HR4844
A6 Quattro		2009-2011		347mm; Except Armoured	HR4843	
A7 Quattro		2012-2013		320mm Front; 300mm Rear		HR4490
A8		1997-1998			HR4743	
A8		1999		To 8/99; To CH# 4D-Y-005-000	HR4743	
A8		1999		From 8/99; From CH# 4D-Y-005-001	HR4777	HR4778
A8		2000			HR4777	HR4778
A8 Quattro		1997-1998			HR4743	
A8 Quattro		1999		To 8/99; To CH# 4D-Y-005-000	HR4743	
A8 Quattro		1999		From 8/99; From CH# 4D-Y-005-001	HR4777	HR4778
A8 Quattro		2000-2002			HR4777	HR4778
A8 Quattro		2003		To CH# 4D-3-004-999		HR4778
A8 Quattro		2003			HR4777	
A8 Quattro		2004-2006	4.2L	4172cc V8	HR4840	
A8 Quattro		2007-2010	4.2L	4163cc V8	HR4840	
allroad		2013-2014				HR4490
Allroad Quattro		2001-2003			HR4766	HR4787
Allroad Quattro		2004-2005	2.7L	2671cc V6		HR4787
Allroad Quattro		2004-2005			HR4766	
Q3		2015-2016			HR4897	

ROTOR APPLICATIONS



MAKE/ MODEL	SUBMODEL	YEARS	ENGINE (LITER)	NOTE	FRONT	REAR
					ROTORS	ROTORS
AUDI CONTINUED						
Q3 Quattro		2015			HR4897	
Q5		2009-2010			HR4852	HR4490
Q5		2011		To 6/19/11	HR4852	
Q5		2011-2012				HR4490
Q5		2013-2016	2.0L	1984cc 121cid L4, FLEX; Brembo Brakes		HR4490
Q7		2007-2015		Iron Disc	HR4839	HR4496
S3		2015-2016				HR4539
S4		2000-2002			HR4766	HR4767
S4		2004-2009			HR4838	HR4497
S6		2002-2004			HR4791	
TT		1999		From 3/99		HR4751
TT		2000-2006			HR4775	HR4751
TT		2008-2009			HR4897	
TT Quattro		2000-2006	1.8L	1781cc L4, Vented Rear Rotor		HR4776
TT Quattro		2000-2006	1.8L	1781cc L4, Solid Rear Rotor		HR4786
TT Quattro		2000-2003			HR4775	
TT Quattro		2004-2006	1.8L	1781cc L4, 180hp	HR4775	
TT Quattro		2004-2006	1.8L	1781cc L4, 225hp	HR4775	
TT Quattro		2004-2006	3.2L	3189cc 195cid V6		HR4776
TT Quattro	Base	2009-2011			HR4897	
TT Quattro	Premium Plus	2012-2013		312mm	HR4897	
TT Quattro	Prestige	2012-2013		312mm	HR4897	
TT Quattro	Base	2014-2015		312mm	HR4897	
BMW						
128i		2008-2013			HR4856	
228i		2014-2015		Except M Sport Package; 312mm Front Rotor	HR4869	
318i		1991		E30 Body Code; To 4/91	HR4656	HR4657
318i		1992-1998		E36 Body Code	HR4688	HR4689
318is		1991		E30 Body Code; To 4/91	HR4656	HR4657
318is		1992-1998		E36 Body Code	HR4688	HR4689
318ti		1995-1999			HR4725	HR4726
320i		2013-2015			HR4869	
320i xDrive		2013-2015			HR4869	
323Ci		2000		E46 Body Code	HR4688	HR4736
323i		1998-1999		E36 Body Code; Convertible; Vented Rear Disc	HR4688	HR4736
323i		1999		E46 Body Code; Sedan	HR4688	
323i		1999		E36 Body Code; Sedan; Solid Rear Disc		HR4689
323i		1999		E46 Body Code; Sedan; Vented Rear Disc		HR4736
323i		1999-2000		E36 Body Code; Sedan	HR4688	
323i		2000		E46 Body Code; Sedan	HR4688	HR4736
323i		2000		E46 Body Code; Wagon	HR4760	HR4761
323is		1998-1999		E36 Body Code	HR4688	
323is		1998-1999		E36 Body Code; Solid Rear Disc		HR4689
325Ci		2001-2006		E46 Body Code	HR4760	HR4761
325i		1989-1990		From 9/90; E30		HR4657
325i		1989-1991		E30 Body Code	HR4656	
325i		1991		From 9/90 to 4/91; E30		HR4657
325i		1991		From 5/91		HR4689
325i		1992-1995		E36 Body Code	HR4688	
325i		1992-1995				HR4689
325i		2001-2006		E46 Body Code	HR4760	HR4761
325i		2006		E90 Body Code	HR4856	HR4503
325is		1989-1990		E30 Body Code	HR4656	HR4657
325is		1991		E30 Body Code	HR4656	
325is		1991		From 9/90 to 4/91; E30		HR4657

ROTOR APPLICATIONS

Hawk Performance - ROTOR APPLICATIONS

HK 4218 .448 X
 HAWK KIT ROTOR PAD SHAPE INSERT COMPOUND CODE

MAKE/ MODEL	SUBMODEL	YEARS	ENGINE (LITER)	NOTE	FRONT	REAR
					ROTOR	ROTOR
BMW CONTINUED						
325is		1991		From 5/91		HR4689
325is		1992-1995		E36 Body Code	HR4688	
325is		1992-1995				HR4689
325iX		1989-1991		E30 Body Code	HR4656	
325iX		1991		From 9/90 to 4/91; E30		HR4657
325iX		1991		From 5/91		HR4689
325xi		2001-2005		E46 Body Code	HR4760	HR4842
325xi		2006		E91 Body Code	HR4856	HR4502
325xi		2006		E90 Body Code	HR4856	HR4502
328Ci		2000			HR4760	HR4761
328d		2014-2015		312mm Front Rotor	HR4869	
328d xDrive		2014-2015		312mm Front Rotor	HR4869	
328i		1996-1999		E36 Body Code	HR4688	
328i		1996-1999		E36 Body Code; Sedan		HR4689
328i		1996-1999		E36 Body Code; Convertible		HR4736
328i		1999-2000		E46 Body Code	HR4760	HR4761
328i		2007			HR4856	
328i		2007-2011		Sedan		HR4503
328i		2007-2011		Convertible		HR4502
328i		2007-2011		Wagon		HR4502
328i		2007-2011		Coupe		HR4503
328i		2008-2011			HR4869	
328i		2012		E93 Body Code; Sedan	HR4869	HR4503
328i		2012		Convertible	HR4869	HR4502
328i		2012		Wagon	HR4869	HR4502
328i		2012		Coupe	HR4869	HR4503
328i		2012-2013		F30 Body Code; Sedan; Except With M Package	HR4869	
328i		2013		Convertible; Except Performance Brakes	HR4869	HR4502
328i		2013		Coupe; Except Performance Brakes	HR4869	
328i		2013		Coupe		HR4503
328i GT xDrive		2014-2015		312mm Front Rotors	HR4869	
328i xDrive		2009-2012			HR4869	HR4502
328i xDrive		2013		F30 Body Code; Sedan; Except M Sport and Performance Brakes	HR4869	
328i xDrive		2013		Coupe	HR4869	HR4502
328is		1996-1999		E36 Body Code	HR4688	
328is		1996-1999		Rear Disc; Solid Rear Disc		HR4689
328xi		2007			HR4856	HR4502
328xi		2008			HR4869	HR4502
330Ci		2001-2006		E46 Body Code	HR4782	HR4783
330i		2001-2005		E46 Body Code	HR4782	HR4783
330i		2006		E90 Body Code	HR4857	HR4504
330xi		2001-2005		E46 Body Code	HR4782	HR4783
330xi		2006		E90 Body Code	HR4857	HR4504
335d		2009-2010		E90 Body Code	HR4862	HR4504
335d		2011			HR4862	HR4504
335i		2007-2010		E92 Body Code	HR4862	HR4504
335i		2007-2010		E93 Body Code	HR4862	HR4504
335i		2007-2010		E90 Body Code	HR4862	HR4504
335i		2011			HR4862	HR4504
335i		2012-2013		Convertible	HR4862	HR4504
335i		2012-2013		Coupe	HR4862	HR4504
335i xDrive		2009-2010		E92 Body Code	HR4862	HR4504
335i xDrive		2009-2010		E90 Body Code	HR4862	HR4504
335i xDrive		2011-2012			HR4862	HR4504
335i xDrive		2013		Coupe	HR4862	HR4504

ROTOR APPLICATIONS

MAKE/ MODEL	SUBMODEL	YEARS	ENGINE (LITER)	NOTE	FRONT	REAR
					ROTORS	ROTORS
BMW CONTINUED						
335is		2011-2013			HR4862	HR4504
335xi		2007-2008		E90 Body Code	HR4862	HR4504
335xi		2008		E92 Body Code	HR4862	HR4504
428i		2014-2015		Except M Sport Package	HR4869	
428i xDrive		2014-2015		Except M Sport Package	HR4869	
525i		1989-1995			HR4675	HR4676
525i		2001-2003			HR4740	HR4741
525i		2004-2005		Automatic Trans.	HR4880	
525i		2004-2005		Standard Trans.	HR4855	
525i		2004-2006				HR4882
525i		2006		From 10/06	HR4855	
525i		2006		To 9/06	HR4880	
525i		2007			HR4855	HR4882
525iT		1993			HR4675	HR4676
525xi		2006-2007			HR4880	HR4505
528i		1997-1998		E39 Body Code	HR4740	HR4741
528i		1999		E39 Body Code	HR4740	
528i		1999		E39 Body Code		HR4741
528i		2000		E39 Body Code	HR4740	HR4741
528i		2008-2010		E60 Body Code	HR4880	HR4882
528i xDrive		2009-2010		E60 Body Code	HR4880	HR4882
528xi		2008			HR4880	HR4505
530i		1994-1995			HR4675	HR4676
530i		2001-2003			HR4790	HR4741
530i		2004-2007			HR4880	HR4882
530xi		2006-2007			HR4880	HR4505
535i		1989-1993			HR4675	HR4676
535i		2008-2010			HR4854	HR4506
535i xDrive		2009-2010		E61 Body Code	HR4880	HR4505
535i xDrive		2009-2010		E60 Body Code	HR4880	HR4505
535xi		2008			HR4880	HR4505
540i		1994-1995		E34 Body Code	HR4668	
540i		1994-1995				HR4712
540i		1997-1999		E39 Body Code	HR4690	
540i		1997-2000				HR4741
540i		2000		To 3/00	HR4690	
540i		2000		From 3/00	HR4790	
540i		2001-2003			HR4790	HR4741
540i		2002				
545i		2004-2006		E60 Body Code	HR4854	HR4506
550i		2006-2010		E60 Body Code	HR4854	HR4506
645Ci		2004-2005		E63 Body Code	HR4854	HR4506
645Ci		2004-2005		E64 Body Code	HR4854	HR4506
650i		2006-2007		E63 Body Code	HR4854	HR4506
650i		2006-2007		E64 Body Code	HR4854	HR4506
650i		2008-2010			HR4854	HR4506
735i		1988		From 3/88	HR4668	
735i		1989-1992			HR4668	
735iL		1988		From 3/88	HR4668	
735iL		1989-1992			HR4668	
740i		1993-1994		E32 Body Code	HR4668	
740i		1995		E38 Body Code	HR4690	HR4691
740i		1997-2001		E38 Body Code	HR4690	HR4691
740iL		1993-1994		E32 Body Code	HR4668	
740iL		1995-2001		E38 Body Code	HR4690	HR4691

Hawk Performance - ROTOR APPLICATIONS

HK 4218 .448 X
 HAWK KIT ROTOR PAD SHAPE INSERT COMPOUND CODE

MAKE/ MODEL	SUBMODEL	YEARS	ENGINE (LITER)	NOTE	FRONT	REAR
					ROTOR	ROTOR
BMW CONTINUED						
745i		2002		E65 Body Code	HR4874	
745i		2003-2005		E65 Body Code	HR4874	HR4875
745Li		2002-2005		E66 Body Code	HR4874	HR4875
750i		2006-2008		E65 Body Code	HR4874	HR4507
750i		2009		E65 Body Code	HR4874	
750iL		1988-1994		E32 Body Code	HR4668	
750iL		1995-2001		E38 Body Code	HR4727	
750Li		2006-2008		E66 Body Code	HR4874	HR4507
750Li		2009		E66 Body Code	HR4874	
760i		2004		E65 Body Code	HR4874	HR4875
760i		2005		E65 Body Code; From 3/05		HR4507
760i		2005		E65 Body Code; To 3/05		HR4875
760i		2005		E65 Body Code	HR4874	
760i		2006		E65 Body Code	HR4874	HR4507
760Li		2003-2004		E66 Body Code	HR4874	HR4875
760Li		2005		E66 Body Code; From 3/05		HR4507
760Li		2005		E66 Body Code; To 3/05		HR4875
760Li		2005		E66 Body Code	HR4874	
760Li		2006-2008		E66 Body Code	HR4874	HR4507
M3		1995-1999		E36 Body Code	HR4722	HR4721
M3		2001-2005		E46 Body Code	HR4792	HR4793
M3		2006		E46 Body Code; w/o Competition Package	HR4792	HR4793
M5		1991-1993		E34 Body Code		HR4712
M5		2000-2003		E39 Body Code		HR4793
X1	sDrive28i	2013-2015			HR4869	HR4502
X1	xDrive28i	2013-2015			HR4869	HR4502
X1	xDrive35i	2013-2015			HR4862	HR4504
X3		2004-2011			HR4813	HR4814
X5		2000-2001			HR4762	HR4763
X5	3.0i	2002-2003			HR4762	HR4763
X5	4.4i	2002-2003			HR4762	HR4763
X5	4.6is	2002-2003			HR4794	HR4795
X5	4.4i	2004		Rear Disc; w/Solid Rear Disc		HR4763
X5	3.0i	2004-2006		Rear Disc; w/Solid Rear Disc		HR4763
X5	3.0i	2004-2006			HR4762	
X5	4.4i	2004-2006		Rear Disc; w/Vented Rear Disc		HR4795
X5	4.4i	2004-2006			HR4762	
X5	4.8is	2005-2006			HR4794	HR4795
X5	3.0si	2007-2008			HR4864	HR4511
X5	4.8i	2007-2008			HR4863	HR4512
X5	xDrive30i	2009-2010			HR4864	HR4511
X5	xDrive48i	2009-2010			HR4863	HR4512
X5	xDrive35d	2009-2012			HR4863	HR4511
X5	xDrive50i	2011-2013			HR4581	HR4512
X5	xDrive35i	2011-2015			HR4864	HR4511
X5	xDrive35d	2013-2015			HR4864	HR4511
X5	sDrive35i	2014-2015			HR4864	HR4511
X5	xDrive50i	2014-2015		Except M Performance Brakes	HR4581	HR4512
X6		2008-2009				HR4512
X6	xDrive35i	2008-2009		E71 Body Code	HR4863	HR4512
X6	xDrive50i	2008-2014		E71 Body Code	HR4581	HR4512
X6	xDrive35i	2010		E71 Body Code	HR4863	HR4511
X6	ActiveHybrid	2010-2011		E72 Body Code		HR4512
X6	xDrive35i	2011-2014		E71 Body Code	HR4864	HR4511
X6	xDrive35i	2015			HR4864	HR4511

ROTOR APPLICATIONS



MAKE/ MODEL	SUBMODEL	YEARS	ENGINE (LITER)	NOTE	FRONT	REAR
					ROTORS	ROTORS
BMW CONTINUED						
X6	xDrive50i	2015			HR4581	HR4512
Z3		1996-1997	1.9L	1895cc L4	HR4725	
Z3		1996-1997				HR4742
Z3		1997	2.8L	2793cc L6	HR4688	
Z3	Roadster	1998	1.9L	1895cc L4	HR4725	HR4742
Z3	Roadster	1998	2.8L	2793cc L6	HR4688	HR4742
Z3	M Roadster	1998-2002			HR4722	HR4721
Z3	Coupe	1999-2000			HR4688	HR4742
Z3	Roadster	1999-2000			HR4688	HR4742
Z3	M Coupe	1999-2002			HR4722	HR4721
Z3	Roadster	2001-2002	2.5L	2494cc 152cid L6	HR4688	HR4742
Z3	Coupe	2001-2002	3.0L	2979cc L6	HR4760	HR4742
Z3	Roadster	2001-2002	3.0L	2979cc L6	HR4760	HR4742
Z4	2.5i	2003-2005			HR4688	HR4796
Z4	3.0i	2003-2005			HR4760	HR4797
Z4	Coupe 3.0si	2006		From 1/06	HR4782	HR4797
Z4	Roadster 3.0si	2006		From 1/06	HR4782	HR4797
Z4	Roadster 3.0i	2006-2008			HR4760	HR4797
Z4	Coupe 3.0si	2007-2008			HR4782	HR4797
Z4	Roadster 3.0si	2007-2008			HR4782	HR4797
Z4	sDrive30i	2009-2011		E89 Body Code		HR4589
Z4	sDrive35i	2009-2015		E89 Body Code		HR4589
Z4	sDrive28i	2012-2015		E89 Body Code		HR4589
BUICK						
Apollo		1973-1974			HR4065	
Apollo		1975			HR4066	
Century		1973-1977			HR4066	
Century		1979-1981			HR4132	
Century		1983-1989		115mm Bolt Circle	HR4140	
Century		1990-1996			HR4140	
Century		1997-2003			HR4160	
Century		2004-2005			HR4160	HR4166
Electra		1977		Rear Disc	HR4066	
Electra		1977-1978		With 9-1/2 inch Rear Drums	HR4066	
Electra		1985-1990		FWD	HR4140	
Enclave		2008-2015			HR4417	HR4413
Encore		2013-2015				HR4115
Estate Wagon		1977		Rear Disc	HR4066	
Estate Wagon		1977-1978		With 9-1/2 inch Rear Drums	HR4066	
GS		1970-1972			HR4065	
GS 350		1968-1969			HR4065	
GS 400		1968-1969			HR4065	
GS 455		1970-1972			HR4065	
LaCrosse		2005-2007			HR4176	HR4182
LaCrosse	CX	2008			HR4176	HR4182
LaCrosse	CXL	2008			HR4176	HR4182
LaCrosse	CXS	2008			HR4176	HR4182
LaCrosse	Super	2008-2009			HR4092	HR4082
LaCrosse	CX	2009				HR4182
LaCrosse	CXL	2009				HR4182
LaCrosse		2010			HR4095	HR4117
LaCrosse		2011-2012		321mm Front Rotor; Vented Rear Rotor	HR4095	
LaCrosse		2011-2012				HR4117
LaCrosse		2013-2015		321mm Front Rotor; Vented Rear Rotor	HR4095	HR4117
LeSabre		1977-1978		With 9 inch Rear Drums	HR4066	

ROTOR APPLICATIONS



Hawk Performance - ROTOR APPLICATIONS

HK 4218 .448 X
 HAWK KIT ROTOR PAD SHAPE INSERT COMPOUND CODE

MAKE/ MODEL	SUBMODEL	YEARS	ENGINE (LITER)	NOTE	FRONT	REAR
					ROTOR	ROTOR
BUICK CONTINUED						
LeSabre		1986-1991		FWD	HR4140	
LeSabre		1992-1999			HR4160	
LeSabre		2000-2004		w/16 inch Wheels	HR4164	
LeSabre		2000-2005		w/15 inch Wheels	HR4160	
LeSabre		2000-2005				HR4156
LeSabre		2005		w/16 inch Wheels	HR4191	
Lucerne	CX	2006-2008	3.8L	3800cc 231cid V6	HR4081	
Lucerne	CXL	2006-2008	3.8L	3800cc 231cid V6	HR4081	
Lucerne	CXL	2006-2007	4.6L	281cid V8	HR4092	
Lucerne	CXS	2006-2008	4.6L	281cid V8	HR4092	
Lucerne		2006-2011				HR4411
Lucerne	CX	2009-2011			HR4081	
Lucerne	CXL	2009-2011			HR4081	
Lucerne	Super	2009-2011			HR4092	
Lucerne	CXL Special Edition	2010			HR4081	
Park Avenue		1991-1996			HR4160	
Park Avenue		1997-2002			HR4164	HR4156
Park Avenue	Base	2003-2005				HR4156
Park Avenue		2003-2005			HR4164	
Park Avenue	Ultra	2003-2005				HR4170
Rainier	CXL	2004-2005	4.2L	256cid L6	HR4399	
Rainier		2004-2007	5.3L	5328cc 325cid V8	HR4400	
Rainier		2004-2007				HR4397
Rainier		2006-2007	4.2L	256cid L6	HR4407	
Reatta		1988-1991			HR4140	
Regal		1973-1977			HR4066	
Regal		1979-1981			HR4132	
Regal		1988-1993			HR4146	HR4147
Regal		1994			HR4146	
Regal		1995		267mm Front Disc	HR4146	
Regal		1995		286mm Front Disc	HR4163	
Regal		1996			HR4163	
Regal		1997-2004			HR4160	HR4166
Regal		2011-2015		321mm Front Rotor; Except Brembo Calipers	HR4095	
Regal		2011-2015		Vented Rear Rotor		HR4117
Regal		2012-2013		Brembo Calipers	HR4415	
Rendezvous		2002-2006		AWD	HR4173	
Rendezvous		2002-2007		FWD	HR4172	
Rendezvous		2002-2007				HR4174
Riviera		1986-1991			HR4140	
Riviera		1992-1993			HR4160	HR4156
Riviera		1995-1996			HR4160	HR4156
Riviera		1997-1999			HR4164	HR4156
Roadmaster		1991-1996			HR4150	
Skylark		1967-1972			HR4065	
Skylark		1975-1978			HR4066	
Skylark		1990		Performance Package	HR4149	
Skylark		1991-1998			HR4149	
Special		1967-1969			HR4065	
Sportwagon		1969-1972			HR4065	
Terraza		2005			HR4176	
Terraza		2006-2007			HR4408	
CADILLAC						
Allante		1987-1992			HR4140	
Allante		1993			HR4160	HR4156

ROTOR APPLICATIONS

MAKE/ MODEL	SUBMODEL	YEARS	ENGINE (LITER)	NOTE	FRONT	REAR
					ROTORS	ROTORS
CADILLAC CONTINUED						
Brougham		1991-1992		RWD; With 2 inch Wide Rear Shoes	HR4150	
CTS	Base	2003-2005		Sport Suspension	HR4073	HR4074
CTS	Base	2003-2007		Standard Suspension	HR4072	HR4074
CTS	V	2004-2007		Brembo Caliper	HR4075	HR4076
CTS	Base	2006-2007		Sport Suspension	HR4077	HR4090
CTS		2008		315mm; Except Sport and Performance Package	HR4093	HR4096
CTS		2008		339mm; Sport and Performance Package		HR4128
CTS		2008		345mm; Sport and Performance Package	HR4094	
CTS	Base	2008-2014		Except Sport and Performance Pkg; 315mm Front Rotor; 315mm Rear Rotor	HR4093	HR4096
CTS	Base	2008-2014		Sport and Performance Pkg (FE3); 345mm Front Rotor; 339mm Rear Rotor	HR4094	HR4128
CTS	V	2009-2015		Brembo Caliper		HR4416
CTS	Luxury	2010-2014		Except Sport and Performance Pkg; 315mm Front Rotor; 315mm Rear Rotor	HR4093	HR4096
CTS	Luxury	2010-2014		Sport and Performance Pkg (FE3); 345mm Front Rotor; 339mm Rear Rotor	HR4094	HR4128
CTS	Performance	2010-2014		Except Sport and Performance Pkg; 315mm Front Rotor; 315mm Rear Rotor	HR4093	HR4096
CTS	Performance	2010-2014		Sport and Performance Pkg (FE3); 345mm Front Rotor; 339mm Rear Rotor	HR4094	HR4128
CTS	Premium	2010-2014		Except Sport and Performance Pkg; 315mm Front Rotor; 315mm Rear Rotor	HR4093	HR4096
CTS	Premium	2010-2014		Sport and Performance Pkg (FE3); 345mm Front Rotor; 339mm Rear Rotor	HR4094	HR4128
CTS	Base	2015		Heavy Duty Brakes (J55)		HR4096
CTS	Luxury	2015		Heavy Duty Brakes (J55)		HR4096
CTS	Performance	2015		Heavy Duty Brakes (J55)		HR4096
CTS	Premium	2015		Heavy Duty Brakes (J55)		HR4096
DeVille		1985-1989			HR4140	
DeVille		1990		Standard Brakes	HR4140	
DeVille		1990		Heavy Duty Brakes	HR4160	
DeVille		1991-1996			HR4160	
DeVille		1997			HR4164	HR4156
DeVille		1998-1999		Rear Disc	HR4164	HR4156
DeVille		2000-2005		Standard Brakes	HR4164	HR4170
DeVille		2000-2005		Heavy Duty Brakes	HR4392	
DTS		2006-2011		Standard Duty	HR4092	HR4411
Eldorado		1986-1991			HR4140	
Eldorado		1992-1996			HR4160	HR4156
Eldorado		1997-2002			HR4164	HR4156
Escalade		1999-2000			HR4367	
Escalade		2002-2006			HR4390	HR4395
Escalade		2007-2016			HR4403	HR4406
Escalade ESV		2003-2006			HR4390	HR4395
Escalade ESV		2007-2016			HR4403	HR4406
Escalade ESV		2016				
Escalade EXT		2002-2006			HR4390	HR4395
Escalade EXT		2007-2013			HR4403	HR4406
Fleetwood		1985-1989		FWD	HR4140	
Fleetwood		1990		FWD; Standard Brakes	HR4140	
Fleetwood		1990		FWD; Heavy Duty Brakes	HR4160	
Fleetwood		1991-1992		FWD	HR4160	
Fleetwood		1993-1996		RWD; 4-Wheel ABS	HR4150	
Seville		1976			HR4066	
Seville		1986-1991			HR4140	

ROTOR APPLICATIONS

Hawk Performance - ROTOR APPLICATIONS

HK 4218 .448 X
 HAWK KIT ROTOR PAD SHAPE INSERT COMPOUND CODE

MAKE/ MODEL	SUBMODEL	YEARS	ENGINE (LITER)	NOTE	FRONT	REAR
					ROTOR	ROTOR
CADILLAC CONTINUED						
Seville		1992-1996			HR4160	HR4156
Seville		1997			HR4164	HR4156
Seville		1998-2002			HR4164	HR4170
Seville		2003-2004			HR4073	HR4170
SRX		2004-2009			HR4088	HR4089
STS		2005		Standard Brakes (JL9)	HR4073	HR4074
STS		2005		Performance Brakes (JE5)	HR4077	HR4090
STS	Base	2006-2008		Standard Brakes (JL9)	HR4073	HR4074
STS	Base	2006-2008		Performance Brakes (JE5)	HR4077	
STS	V	2006-2008		Supercharged; Brembo Brakes	HR4075	HR4076
STS	Base	2006-2009		Heavy Duty Brakes (J56)	HR4075	
STS	Base	2006-2011		Heavy Duty Brakes (J56); 6 Lugs		HR4076
STS	Base	2006-2011		Performance Brakes (JE5); 5 Lugs		HR4090
STS	Platinum	2008		Performance Brakes (JE5); 5 Lugs	HR4077	HR4090
STS	Platinum	2008		Standard Brakes (JL9); 5 Lugs	HR4073	HR4074
STS	Platinum	2008-2009		Heavy Duty Brakes (J56); 6 Lugs	HR4075	HR4076
STS	Platinum	2009		Performance Brakes (JE5); 5 Lugs		HR4090
STS	Platinum	2009		Standard Brakes (JL9); 5 Lugs		HR4074
STS	V	2009		Supercharged; Brembo Brakes		HR4076
STS	V	2009		Brembo Brakes	HR4075	
STS	Base	2009-2010		Standard Brakes (JL9)		HR4074
XLR		2004			HR4167	HR4168
XLR		2005			HR4071	HR4168
XLR	Base	2006-2007			HR4071	HR4168
XLR	V	2006-2009		Supercharged	HR4070	HR4086
XLR	Base	2008			HR4167	HR4168
XLR	Platinum	2008-2009			HR4167	HR4168
XTS		2013-2016		Hearse; 6 Lug; Also fits Armored and Commercial Chassis	HR4403	
XTS		2013-2016		Limousine; 6 Lug; Also fits Armored and Commercial Chassis	HR4403	
XTS		2013-2016		Sedan; 5 Lugs; Except Armored and Commercial Chassis		HR4117
CHEVROLET						
Astro		2003-2005			HR4390	HR4391
Avalanche		2007-2013			HR4403	HR4406
Avalanche 1500		2002		Without Limited Slip Axle; Single Piston Rear Caliper		HR4391
Avalanche 1500		2002		With Limited Slip Axle; Dual Piston Rear Caliper		HR4395
Avalanche 1500		2002			HR4390	
Avalanche 1500		2003-2006			HR4390	HR4395
Avalanche 2500		2002				HR4393
Avalanche 2500		2002-2004		Except 2 inch Body Raise	HR4392	
Avalanche 2500		2002-2004		With 2 inch Body Raise	HR4404	
Avalanche 2500		2003-2004				HR4394
Avalanche 2500		2005-2006			HR4392	HR4394
Beretta		1992-1996			HR4149	
Blazer		1992-1994		4WD	HR4367	
Blazer		1995-1996		4WD	HR4366	
Blazer		1995		RWD; 4-Wheel ABS	HR4374	
Blazer		1996-1997		RWD	HR4374	
Blazer		1997-2001		4WD		HR4387
Blazer		1997		4WD; Rear Disc	HR4388	
Blazer		1997		4WD; Rear Drum	HR4366	
Blazer	Base	1998-1999		2 Door; 4WD; Standard Trans.	HR4388	
Blazer		1998-2003		RWD	HR4388	HR4389
Blazer	LS	1998-2003		2 Door; 4WD; Standard Trans.	HR4388	
Blazer		2002-2003		2 Door; 4WD; Standard Trans.		HR4387
Blazer		2002-2003		2 Door; 4WD; Automatic Trans.		HR4389

ROTOR APPLICATIONS



MAKE/ MODEL	SUBMODEL	YEARS	ENGINE (LITER)	NOTE	FRONT	REAR
					ROTORS	ROTORS
CHEVROLET CONTINUED						
Blazer		2002-2004		4 Door; 4WD; Automatic Trans.		HR4389
Blazer	LS	2004		2 Door; 4WD; Standard Trans.	HR4388	HR4387
Blazer	LS	2004		2 Door; 4WD; Automatic Trans.		HR4389
Blazer	Xtreme	2004		RWD		HR4389
Blazer		2004-2005		RWD	HR4388	
Blazer	ZR2	2004-2005		RWD		HR4387
Blazer	ZR2	2004-2005		2 Door; 4WD		HR4387
Blazer	Base	2005		RWD		HR4389
Blazer	Base	2005		2 Door; 4WD; Standard Trans.	HR4388	HR4387
Blazer	Base	2005		2 Door; 4WD; Automatic Trans.		HR4389
C1500		1995-1999			HR4379	
C1500 Suburban		1992-1993			HR4379	
C1500 Suburban		1994-1999		Rear Drum; With 11 inch Rear Drums	HR4379	
C1500 Suburban		1994-1999		Rear Drum; With 13 inch Rear Drums	HR4381	
C2500		1997-2000		With 13 inch Rear Drums; 8600 Lb GVW	HR4381	
C2500 Suburban		1992-1999			HR4381	
C3500		1992-1996		2-Wheel ABS; SRW	HR4381	
C3500		1997-2000		Standard Cab Pickup; SRW	HR4381	
C3500		1997-2000		Cab & Chassis; SRW	HR4381	
C3500		1997-2000		Crew Cab Pickup; SRW	HR4381	
Camaro		1968-1969		Rear Disc	HR4068	HR4068
Camaro		1968-1969		Rear Drum	HR4065	
Camaro		1970-1978			HR4066	
Camaro		1989-1992		Rear Disc; Except 1LE Performance Package	HR4110	
Camaro		1989-1992		Rear Drum	HR4110	
Camaro		1993-1997			HR4160	HR4159
Camaro		1998-2002			HR4164	HR4171
Camaro	LS	2010-2015			HR4095	HR4096
Camaro	LT	2010-2015			HR4095	HR4096
Camaro	SS	2010-2015			HR4415	HR4416
Camaro	ZL1	2012-2015				HR4416
Caprice		1977-1978		With 9-1/2 inch Rear Drums	HR4066	
Caprice		1991-1996		Rear Drum; With 9.5 inch Rear Drums	HR4150	
Caprice		1994-1996		Rear Disc		HR4162
Caprice		2011-2015			HR4094	HR4107
Caprice		2016			HR4094	
Captiva Sport		2012-2015			HR4409	HR4410
Cavalier		1992-2005			HR4149	
Celebrity		1983-1989		115mm Bolt Circle	HR4140	
Celebrity		1990			HR4140	
Chevelle		1967-1972			HR4065	
Chevelle		1973			HR4066	
Chevy II		1967-1968			HR4065	
Classic		2004-2005			HR4165	
Cobalt	Base	2005		Rear Drum; 4 Lugs	HR4184	
Cobalt	LS	2005-2006		Rear Drum; 4 Lugs	HR4184	
Cobalt	LT	2005-2006		Rear Drum; 4 Lugs	HR4184	
Cobalt	SS	2005-2006		Supercharged; Rear Disc; 5 Lugs	HR4187	
Cobalt		2005-2008		Rear Disc		HR4188
Cobalt	LTZ	2007		Rear Drum; 5 Lugs; 16 inch Wheels	HR4064	
Cobalt	SS	2007		Rear Disc; 5 Lugs; Except Brembo Caliper	HR4187	
Cobalt	LS	2007-2010		Rear Drum; 4 Lugs; 15 inch Wheels	HR4184	
Cobalt	LT	2007-2010		Rear Drum; 4 Lugs; 15 inch Wheels	HR4184	
Cobalt	LT	2007-2010		Rear Drum; 5 Lugs; 16 inch Wheels	HR4064	
Cobalt	Sport	2008		Rear Disc; 5 Lugs	HR4187	

Hawk Performance - ROTOR APPLICATIONS

HK 4218

HAWK KIT

ROTOR

.448

PAD SHAPE

X

INSERT COMPOUND CODE

MAKE/ MODEL	SUBMODEL	YEARS	ENGINE (LITER)	NOTE	FRONT	REAR
					ROTOR	ROTOR
CHEVROLET CONTINUED						
Cobalt	SS	2008-2010		Rear Disc	HR4111	
Cobalt		2009-2010		Rear Disc		HR4112
Cobalt	Base	2010		Rear Drum; 4 Lugs; 15 inch Wheels	HR4184	
Cobalt	Base	2010		Rear Drum; 5 Lugs; 16 inch Wheels	HR4064	
Colorado		2004-2008			HR4402	
Colorado		2009-2012			HR4101	
Corsica		1992-1996			HR4149	
Corvette		1963-1982			HR4080	HR4068
Corvette		1984-1987			HR4141	HR4142
Corvette		1988-1995		Standard Suspension	HR4153	
Corvette		1988-1995		Heavy Duty Suspension	HR4157	
Corvette		1988-1995				HR4154
Corvette		1996			HR4157	HR4154
Corvette		1997-2004			HR4167	HR4168
Corvette		2005		Z51 Package	HR4070	
Corvette		2005		Except Z51 Package	HR4071	
Corvette		2005				HR4168
Corvette	Base	2006-2008		Z51 Package	HR4070	HR4086
Corvette	Base	2006-2009		Standard Brakes	HR4071	HR4168
Corvette	Z06	2006-2013			HR4084	HR4085
Corvette	Base	2010-2013		Standard Brakes (JL9)	HR4071	HR4168
Corvette	Base	2010-2013		Magnetic Ride Control (F55) or Upgraded Brakes (J55)	HR4070	HR4086
Corvette	Grand Sport	2010-2013			HR4084	HR4085
Corvette	Z06 Carbon	2011			HR4084	HR4085
Corvette	427	2013			HR4084	HR4085
Cruze		2011-2013			HR4119	HR4115
Cruze		2014-2016		GAS	HR4119	HR4115
El Camino		1969-1972			HR4065	
El Camino		1973-1977			HR4066	
El Camino		1979-1981			HR4132	
Equinox		2005-2006			HR4175	
Equinox		2007-2009			HR4409	HR4410
Equinox		2010-2016			HR4095	HR4124
Express 1500		1996-2002			HR4379	
Express 1500		2003-2008			HR4390	HR4395
Express 1500		2009-2014			HR4403	HR4395
Express 2500		1996-2000		8 Lug	HR4381	
Express 2500		2001-2002		GAS; 8 Lug	HR4381	
Express 2500		2003		8 Lug	HR4392	HR4393
Express 2500		2003-2005		6 Lug	HR4390	HR4401
Express 2500		2004-2008		8 Lug	HR4392	
Express 2500		2004-2009		GAS; 8 Lug		HR4393
Express 2500		2006-2008		6 Lug	HR4390	
Express 2500		2006-2010		DIESEL; 8 Lug		HR4394
Express 2500		2009-2016			HR4392	
Express 2500		2010		FLEX; 8 Lug		HR4393
Express 2500		2011-2016		86mm Tall		HR4393
Express 2500		2011-2016		91mm Tall		HR4394
Express 3500		1996-2000		SRW	HR4381	
Express 3500		2001		Cutaway Van; 139.0" Wheelbase; SRW	HR4381	
Express 3500		2003		SRW		HR4394
Express 3500		2003-2008		DRW		HR4396
Express 3500		2003-2016			HR4404	
Express 3500		2004-2016		Rear Disc; SRW; 86mm Tall Rear Discs		HR4393
Express 3500		2004-2016		Rear Disc; SRW; 91mm Tall Rear Discs		HR4394

ROTOR APPLICATIONS

MAKE/ MODEL	SUBMODEL	YEARS	ENGINE (LITER)	NOTE	FRONT	REAR
					ROTORS	ROTORS
CHEVROLET CONTINUED						
Express 4500		2009-2016		Rear Disc; SRW; 86mm Tall Rear Discs		HR4393
Express 4500		2009-2016		Rear Disc; SRW; 91mm Tall Rear Discs		HR4394
Express 4500		2009-2016			HR4404	
G10 Van		1971-1973			HR4066	
HHR		2006-2007			HR4087	
HHR		2008-2010		Rear Disc	HR4187	HR4188
HHR		2008-2010		Rear Drum	HR4087	
HHR		2011			HR4087	
Impala		1977-1978		With 9-1/2 inch Rear Drums	HR4066	
Impala		1994-1996			HR4150	HR4162
Impala		2000-2004			HR4164	HR4166
Impala	Base	2005			HR4191	
Impala		2005				HR4166
Impala	LS	2005			HR4191	
Impala	SS	2005			HR4164	
Impala		2006-2010			HR4081	HR4082
Impala		2011			HR4081	HR4182
Impala		2012-2013		Except Police, Taxi	HR4081	
Impala		2012-2013		Police, Taxi	HR4092	
Impala		2012-2013				HR4182
Impala		2014-2016			HR4095	HR4117
Impala Limited		2014-2016		Except Police, Taxi	HR4081	
Impala Limited		2014-2016		Police, Taxi	HR4092	
Impala Limited		2014-2016				HR4182
K1500		1988-1999			HR4367	
K1500 Suburban		1992-1993			HR4367	
K1500 Suburban		1994-1999		8 Lugs	HR4155	
K1500 Suburban		1994-1999		6 Lugs	HR4367	
K2500		1990-1998		With 13 inch Rear Drums; With 8600 Lb GVW	HR4155	
K2500		1990-1998		With 11 inch Rear Drums; With 7200 Lb GVW	HR4367	
K2500		1999-2000			HR4155	
K2500 Suburban		1992-1999			HR4155	
K3500		1990-1996		SRW	HR4155	
K3500		1992-2000		DRW; With 317mm Front Discs	HR4380	
K3500		1997-2000		Standard Cab Pickup; SRW	HR4155	
Laguna		1973-1976			HR4066	
Lumina		1990-1994			HR4146	HR4147
Lumina		1995		267mm Front Disc	HR4146	
Lumina		1995		286mm Front Disc	HR4163	
Lumina		1996-2001			HR4163	
Lumina APV		1990-1991			HR4140	
Malibu		1967			HR4065	
Malibu		1973			HR4066	
Malibu		1979-1981			HR4132	
Malibu		1997-2003			HR4165	
Malibu		2004-2005		Rear Disc		HR4188
Malibu		2004-2005		Hatchback; Rear Disc	HR4187	
Malibu		2004-2005		Sedan; Rear Disc	HR4189	
Malibu		2004-2005		Sedan; Rear Drum	HR4189	
Malibu		2006-2007		Rear Disc	HR4187	HR4188
Malibu		2006-2007		Rear Drum	HR4189	
Malibu		2008	2.2L	2198cc 134cid L4	HR4189	
Malibu		2008	2.4L	145cid L4	HR4189	
Malibu		2008	3.5L	3490cc 213cid V6	HR4187	
Malibu		2008	3.6L	217cid V6	HR4187	

ROTOR APPLICATIONS



Hawk Performance - ROTOR APPLICATIONS

HK 4218 .448 X
 HAWK KIT ROTOR PAD SHAPE INSERT COMPOUND CODE

MAKE/ MODEL	SUBMODEL	YEARS	ENGINE (LITER)	NOTE	FRONT	REAR
					ROTOR	ROTOR
CHEVROLET CONTINUED						
Malibu		2008		Rear Disc		HR4188
Malibu		2009		Rear Disc		
Malibu		2009			HR4187	HR4188
Malibu		2010-2012		Rear Disc		HR4188
Malibu		2010-2012			HR4187	
Malibu		2013-2016		312mm Front Discs and Vented Rear Discs	HR4095	
Malibu		2013-2016		Vented Rear Discs		HR4117
Monte Carlo		1970-1972			HR4065	
Monte Carlo		1973-1977			HR4066	
Monte Carlo		1979-1981			HR4132	
Monte Carlo		1995		267mm Front Discs	HR4146	
Monte Carlo		1995		286mm Front Discs	HR4163	
Monte Carlo		1996-1999			HR4163	
Monte Carlo		2000-2004			HR4164	HR4166
Monte Carlo		2005				HR4166
Monte Carlo	LS	2005			HR4191	
Monte Carlo	SS	2005			HR4164	
Monte Carlo		2006-2007			HR4081	HR4082
Nova		1969-1974			HR4065	
Nova		1975-1978			HR4066	
Prizm		1998-2002			HR5261	
S10		1989-1991		RWD	HR4110	
S10		1989-1997		4WD	HR4366	
S10		1992-1995		RWD; 2-Wheel ABS	HR4110	
S10		1994-1995		RWD; 4-Wheel ABS	HR4374	
S10		1996-1997		RWD; GAS	HR4374	
S10		1997		RWD; ELECTRIC	HR4366	
S10		1998-2003		RWD	HR4374	HR4387
S10		1998-2004		4WD	HR4388	HR4387
S10 Blazer		1989-1990		RWD	HR4110	
S10 Blazer		1989-1994		4WD	HR4366	
S10 Blazer		1991-1994		RWD; 4-Wheel ABS	HR4374	
S10 Blazer		1991-1994		RWD; 2-Wheel ABS	HR4110	
Silverado 1500		1999-2000			HR4390	HR4391
Silverado 1500		2001		2 Door; RWD		HR4391
Silverado 1500		2001		4 Door; 4WD; HD		HR4393
Silverado 1500		2001		4 Door; RWD; HD		HR4393
Silverado 1500		2001		Extended Cab Pickup; 4WD		HR4395
Silverado 1500		2001		Standard Cab Pickup; 4WD		HR4391
Silverado 1500		2001-2002		4 Door; Extended Cab Pickup; HD		HR4393
Silverado 1500		2001-2002		Extended Cab Pickup; Standard Duty; 4 Wheel Steering		HR4395
Silverado 1500		2001-2002		Standard Cab Pickup	HR4390	
Silverado 1500		2001-2002		Standard Cab Pickup; Standard Duty; 2 Wheel Steering		HR4391
Silverado 1500		2001-2003		Extended Cab Pickup	HR4390	
Silverado 1500		2003		Standard Cab Pickup	HR4390	HR4391
Silverado 1500		2003		Extended Cab Pickup; 2 Wheel Steering		HR4391
Silverado 1500		2003		Extended Cab Pickup; 4 Wheel Steering; 325mm Rear Discs		HR4391
Silverado 1500		2003		Extended Cab Pickup; 4 Wheel Steering; 330mm Rear Discs		HR4395
Silverado 1500		2004		Standard Cab Pickup		HR4391
Silverado 1500		2004		Standard Cab Pickup; Rear Disc	HR4390	
Silverado 1500		2004		Crew Cab Pickup		HR4395
Silverado 1500		2004		Extended Cab Pickup; 4WD; HD; With 4.63 inch Rear Hub Hole		HR4393
Silverado 1500		2004		Extended Cab Pickup; 4WD; HD; With 4.83 inch Rear Hub Hole		HR4394
Silverado 1500		2004		Extended Cab Pickup; 4WD; Standard Duty; 2 Wheel Steering		HR4391
Silverado 1500		2004		Extended Cab Pickup; 4WD; Standard Duty; 4 Wheel Steering		HR4395

ROTOR APPLICATIONS

MAKE/ MODEL	SUBMODEL	YEARS	ENGINE (LITER)	NOTE	FRONT	REAR
					ROTORS	ROTORS
CHEVROLET CONTINUED						
Silverado 1500		2004		Extended Cab Pickup; AWD		HR4395
Silverado 1500		2004		Extended Cab Pickup; RWD; HD; With 4.63 inch Rear Hub Hole		HR4393
Silverado 1500		2004		Extended Cab Pickup; RWD; HD; With 4.83 inch Rear Hub Hole		HR4394
Silverado 1500		2004		Extended Cab Pickup; RWD; Standard Duty; 2 Wheel Steering		HR4391
Silverado 1500		2004		Extended Cab Pickup; RWD; Standard Duty; 4 Wheel Steering		HR4395
Silverado 1500		2004-2005		Crew Cab Pickup; Rear Disc	HR4392	
Silverado 1500		2004-2006		Extended Cab Pickup; Rear Disc	HR4390	
Silverado 1500		2005		Crew Cab Pickup; Rear Disc; With 2 Wheel Steering		HR4393
Silverado 1500		2005		Crew Cab Pickup; Rear Disc; With 4 Wheel Steering		HR4405
Silverado 1500	Base	2005		Extended Cab Pickup; Rear Disc		HR4391
Silverado 1500	SS	2005		Extended Cab Pickup; Rear Disc; Per Aces 2006 SS had rear drums		HR4395
Silverado 1500		2005-2006		Rear Drum	HR4403	
Silverado 1500		2005-2006		Standard Cab Pickup; Rear Disc	HR4390	HR4391
Silverado 1500	Hybrid	2005-2006		Extended Cab Pickup; Rear Disc		HR4391
Silverado 1500	LS	2005-2006		Extended Cab Pickup; Rear Disc		HR4391
Silverado 1500	LT	2005-2006		Extended Cab Pickup; Rear Disc		HR4391
Silverado 1500		2006		Crew Cab Pickup; Rear Disc	HR4392	HR4393
Silverado 1500	WT	2006		Extended Cab Pickup; Rear Disc		HR4391
Silverado 1500		2007-2016		Rear Disc		HR4406
Silverado 1500		2007-2016			HR4403	
Silverado 1500 Classic		2007		Rear Disc		
Silverado 1500 Classic		2007			HR4403	
Silverado 1500 HD		2001-2002			HR4392	HR4393
Silverado 1500 HD		2003		4WD; With 2 Wheel Steering		HR4393
Silverado 1500 HD		2003		4WD; With 4 Wheel Steering		HR4405
Silverado 1500 HD		2003		RWD; With 2 Wheel Steering		HR4393
Silverado 1500 HD		2003		RWD; With 4 Wheel Steering		HR4391
Silverado 1500 HD		2003			HR4392	
Silverado 1500 HD		2005		With 2 Wheel Steering		HR4393
Silverado 1500 HD		2005		With 4 Wheel Steering		HR4405
Silverado 1500 HD		2005			HR4392	HR4393
Silverado 1500 HD		2006			HR4392	HR4393
Silverado 1500 HD Classic		2007			HR4392	HR4393
Silverado 2500		1999-2000	5.3L	5328cc 325cid V8		HR4393
Silverado 2500		1999-2000	6.0L	5967cc 364cid V8, Automatic Trans.		HR4393
Silverado 2500		1999-2000	6.0L	5967cc 364cid V8, Standard Trans.		HR4394
Silverado 2500		1999-2004			HR4392	
Silverado 2500		2001-2004		Automatic Trans.		HR4393
Silverado 2500		2001-2004		Standard Trans.		HR4394
Silverado 2500 HD		2001-2003			HR4404	HR4394
Silverado 2500 HD		2004		With 2 Wheel Steering		HR4394
Silverado 2500 HD		2004		With 4 Wheel Steering		HR4405
Silverado 2500 HD		2004			HR4404	
Silverado 2500 HD		2005-2007			HR4404	HR4394
Silverado 2500 HD		2009-2010			HR4404	HR4394
Silverado 2500 HD		2011-2016			HR4125	HR4127
Silverado 2500 HD Classic		2007			HR4404	HR4394
Silverado 3500		2001-2003			HR4404	HR4396
Silverado 3500		2004-2006		SRW		HR4394
Silverado 3500		2004-2006		DRW		HR4396
Silverado 3500		2004-2006			HR4404	
Silverado 3500 Classic		2007		SRW		HR4394
Silverado 3500 Classic		2007		DRW		HR4396
Silverado 3500 Classic		2007			HR4404	

ROTOR APPLICATIONS



Hawk Performance - ROTOR APPLICATIONS

HK 4218 .448 X
 HAWK KIT ROTOR PAD SHAPE INSERT COMPOUND CODE

MAKE/ MODEL	SUBMODEL	YEARS	ENGINE (LITER)	NOTE	FRONT	REAR
					ROTOR	ROTOR
CHEVROLET CONTINUED						
Silverado 3500 HD		2007-2010		SRW		HR4394
Silverado 3500 HD		2007-2010		DRW		HR4396
Silverado 3500 HD		2007-2010			HR4404	
Silverado 3500 HD		2011-2016		SRW		HR4127
Silverado 3500 HD		2011-2016		DRW		HR4126
Silverado 3500 HD		2011-2016			HR4125	
Sonic		2012			HR4119	
Sonic		2013-2016			HR4119	HR4115
SS		2014			HR4415	HR4107
SS		2015			HR4415	
SSR		2003-2005			HR4400	HR4397
SSR		2006			HR4407	HR4397
Suburban		2015-2016			HR4403	HR4406
Suburban 1500		2000-2002		4WD	HR4390	
Suburban 1500		2000-2002		RWD	HR4390	
Suburban 1500		2000-2002		4WD; With Limited Slip Axle		HR4395
Suburban 1500		2000-2002		4WD; Without Limited Slip Axle		HR4391
Suburban 1500		2000-2002		RWD; With Limited Slip Axle		HR4395
Suburban 1500		2000-2002		RWD; Without Limited Slip Axle		HR4391
Suburban 1500		2003-2006		4WD	HR4390	HR4395
Suburban 1500		2003-2006		RWD	HR4390	HR4395
Suburban 1500		2007-2014			HR4403	HR4406
Suburban 2500		2000-2002		4WD; With 4.63 inch Hub Hole		HR4393
Suburban 2500		2000-2002		RWD; With 4.63 inch Rear Hub Hole		HR4393
Suburban 2500		2000-2002		4WD; With 4.83 inch Hub Hole		HR4394
Suburban 2500		2000-2002		RWD; With 4.83 inch Rear Hub Hole		HR4394
Suburban 2500		2000-2006		4WD	HR4392	
Suburban 2500		2000-2006		RWD	HR4392	
Suburban 2500		2003-2005		4WD; With 4 Wheel Steering		HR4391
Suburban 2500		2003-2005		RWD; With 4 Wheel Steering		HR4391
Suburban 2500		2003-2005		4WD; With 2 Wheel Steering; With 4.63 inch Hub Hole		HR4393
Suburban 2500		2003-2005		4WD; With 2 Wheel Steering; With 4.83 inch Hub Hole		HR4394
Suburban 2500		2003-2005		RWD; With 2 Wheel Steering; With 4.63 inch Hub Hole		HR4393
Suburban 2500		2003-2005		RWD; With 2 Wheel Steering; With 4.83 inch Hub Hole		HR4394
Suburban 2500		2006		RWD; With 4.63 inch Rear Hub Hole		HR4393
Suburban 2500		2006		RWD; With 4.83 inch Rear Hub Hole		HR4394
Suburban 2500		2006		4WD; With 4.63 inch Rear Hub Hole		HR4393
Suburban 2500		2006		4WD; With 4.83 inch Rear Hub Hole		HR4394
Suburban 2500		2007		4WD	HR4392	HR4393
Suburban 2500		2007		RWD	HR4392	HR4393
Suburban 2500		2008-2013		4WD	HR4392	HR4394
Suburban 2500		2008-2013		RWD	HR4392	HR4394
Tahoe		1995-1999		4WD	HR4367	
Tahoe		1995-1999		RWD	HR4379	
Tahoe		2000		Rear Drum	HR4379	
Tahoe		2000		4WD; Rear Disc	HR4390	
Tahoe		2000		RWD; Rear Disc	HR4390	
Tahoe		2000-2002		RWD		HR4395
Tahoe		2000-2002		4WD; With Dual Piston Rear Calipers		HR4395
Tahoe		2000-2002		4WD; With Single Piston Rear Calipers		HR4391
Tahoe		2001-2002			HR4390	
Tahoe		2003-2006			HR4390	HR4395
Tahoe		2007-2011		Except Police	HR4403	
Tahoe		2007-2012				HR4406
Tahoe		2008-2016		Police	HR4102	

ROTOR APPLICATIONS

MAKE/ MODEL	SUBMODEL	YEARS	ENGINE (LITER)	NOTE	FRONT	REAR
					ROTORS	ROTORS
CHEVROLET CONTINUED						
Tahoe		2012			HR4403	
Tahoe		2013-2016			HR4403	HR4406
Trailblazer		2002-2004		Regular; 5 Passenger	HR4399	
Trailblazer		2002-2004		Extended; 7 Passenger	HR4400	
Trailblazer		2002-2009				HR4397
Trailblazer		2005	4.2L	256cid L6	HR4399	
Trailblazer		2006	4.2L	256cid L6, Extended Length	HR4400	
Trailblazer		2006	4.2L	256cid L6, Regular Length	HR4407	
Trailblazer		2006-2008	5.3L	5328cc 325cid V8	HR4400	
Trailblazer		2006-2008	6.0L	5967cc 364cid V8	HR4091	
Trailblazer		2007-2008	4.2L	256cid L6	HR4407	
Trailblazer	LT	2009			HR4407	
Trailblazer	SS	2009			HR4091	
Trailblazer EXT		2002-2006			HR4400	HR4397
Traverse		2009-2016			HR4417	HR4413
Trax		2013-2014		Canada		HR4115
Trax		2014-2016				HR4115
Uplander		2005			HR4176	
Uplander		2006-2008			HR4408	
Venture		1997-2001			HR4160	
Venture		2002-2004		AWD	HR4173	HR4174
Venture		2002-2005		FWD	HR4160	
CHRYSLER						
200		2011-2012			HR4236	
200		2011-2014		302mm Rear Disc		HR4193
200		2011-2014		262mm Rear Disc		HR4237
200		2013-2014		295mm Front Disc	HR4236	
200		2013-2014		340mm Front Disc	HR4196	
200		2015-2016		305mm Front Disc	HR4208	
300		2005-2009	2.7L	2700cc 167cid V6	HR4231	HR4234
300		2005-2008	3.5L	3497cc 215cid V6	HR4231	HR4234
300		2005-2009	5.7L	345cid V8	HR4232	HR4235
300		2005-2009	6.1L	6059cc 370cid V8	HR4468	HR4469
300		2009	3.5L	3497cc 215cid V6		HR4234
300	C SRT8	2010		RWD	HR4468	HR4469
300	S	2010		RWD; w/Vented Rear Discs	HR4232	HR4235
300		2010-2013		AWD; w/Vented Rear Discs	HR4232	HR4235
300	C	2010-2013		RWD; w/Vented Rear Discs	HR4232	HR4235
300		2010-2015		RWD; w/Solid Rear Discs	HR4231	HR4234
300	S	2012-2013		RWD; w/Vented Rear Discs	HR4232	HR4235
300	SRT8	2012-2013		RWD	HR4468	HR4469
300	C Luxury	2013		RWD; w/Vented Rear Discs	HR4232	HR4235
300	C Luxury	2014		RWD; w/Vented Rear Discs	HR4232	
300	C Luxury	2014		RWD; w/Vented Rear Discs; Except Police		HR4235
300	C Luxury	2014		RWD; w/Vented Rear Discs; Police		HR4238
300	SRT8	2014		RWD	HR4468	
300		2014-2015		AWD; w/Vented Rear Discs	HR4232	
300		2014-2015		AWD; w/Vented Rear Discs; Except Police		HR4235
300		2014-2015		AWD; w/Vented Rear Discs; Police		HR4238
300	C	2014-2015		RWD; w/Vented Rear Discs	HR4232	
300	C	2014-2015		RWD; w/Vented Rear Discs; Except Police		HR4235
300	C	2014-2015		RWD; w/Vented Rear Discs; Police		HR4238
300	S	2014-2015		RWD; w/Vented Rear Discs	HR4232	
300	S	2014-2015		RWD; w/Vented Rear Discs; Except Police		HR4235
300	S	2014-2015		RWD; w/Vented Rear Discs; Police		HR4238

Hawk Performance - ROTOR APPLICATIONS

HK 4218 .448 X
 HAWK KIT ROTOR PAD SHAPE INSERT COMPOUND CODE

MAKE/ MODEL	SUBMODEL	YEARS	ENGINE (LITER)	NOTE	FRONT	REAR
					ROTOR	ROTOR
CHRYSLER CONTINUED						
300	C Platinum	2015		RWD; w/Vented Rear Discs	HR4232	
300	C Platinum	2015		RWD; w/Vented Rear Discs; Except Police		HR4235
300	C Platinum	2015		RWD; w/Vented Rear Discs; Police		HR4238
300	Limited	2015		RWD; w/Vented Rear Discs	HR4232	
300	Limited	2015		RWD; w/Vented Rear Discs; Except Police		HR4235
300	Limited	2015		RWD; w/Vented Rear Discs; Police		HR4238
300M		1999-2004			HR4226	HR4216
Aspen		2007-2009			HR4448	HR4450
Cirrus		1995-2000		With 14 inch Wheels	HR4221	
Cirrus		1995-2000		With 15 inch Wheels	HR4222	
Cirrus		1995-2000				HR4223
Concorde		1993-2004				HR4216
Concorde		1998-1999		16 or 17 inch Wheels	HR4225	
Concorde		2000		16 or 17 inch Wheels; Without Performance Package	HR4225	
Concorde		2000		16 or 17 inch Wheels; W/Performance Package	HR4226	
Concorde		2001-2004		4-Wheel ABS	HR4226	
Concorde		2004		Non-ABS	HR4225	
Cordoba		1975			HR4211	
Cordoba		1976		From 12/75	HR4210	
Cordoba		1976		To 11/75	HR4211	
Cordoba		1977-1979			HR4210	
Cordoba		1980-1983			HR4211	
Crossfire		2004			HR4757	HR4662
Crossfire	Base	2005-2006			HR4757	HR4662
Crossfire	Limited	2005-2006			HR4757	HR4662
Crossfire		2007-2008			HR4757	HR4662
Fifth Avenue		1983-1989			HR4211	
Grand Voyager		2000		With 282mm Front Disc	HR4438	
Imperial		1981-1983			HR4211	
LeBaron		1977-1981			HR4211	
LHS		1994-1997				HR4216
LHS		1999-2000		With 297mm Front Discs	HR4225	
LHS		1999-2000				HR4216
LHS		2001			HR4225	HR4216
Neon		2000-2001			HR4227	HR4223
New Yorker		1979-1981			HR4210	
New Yorker		1982			HR4211	
Newport		1979-1981			HR4210	
Pacifica		2004-2008			HR4455	HR4456
Prowler		2001-2002			HR4438	
PT Cruiser		2001-2002			HR4228	HR4223
PT Cruiser		2003		Turbocharged; Rear Disc		HR4230
PT Cruiser		2003-2005		Turbocharged	HR4229	
PT Cruiser		2003-2008		Naturally Aspirated; Rear Disc		HR4223
PT Cruiser		2003-2009		Naturally Aspirated	HR4228	
PT Cruiser	GT	2004-2007		Turbocharged; Rear Disc		HR4230
PT Cruiser	Limited	2004-2008		Turbocharged; Rear Disc		HR4223
PT Cruiser	GT	2006-2007		Turbocharged	HR4229	
PT Cruiser	Limited	2006-2007		Turbocharged	HR4228	
PT Cruiser		2008-2009		Turbocharged	HR4229	
PT Cruiser		2009-2010		Rear Disc		HR4230
PT Cruiser		2010			HR4228	
Sebring		1995-2000		Coupe; Rear Disc		HR5281
Sebring		1995-2000		Coupe	HR5170	
Sebring		1996-2000		Convertible	HR4221	HR4223

ROTOR APPLICATIONS

MAKE/ MODEL	SUBMODEL	YEARS	ENGINE (LITER)	NOTE	FRONT	REAR
					ROTORS	ROTORS
CHRYSLER CONTINUED						
Sebring		2001-2005		Sedan; Rear Disc		HR4223
Sebring		2001-2005		Coupe; Rear Disc	HR5348	HR5281
Sebring		2001-2005		Coupe; Rear Drum	HR5170	
Sebring		2001-2005		Sedan	HR4222	
Sebring		2001-2006		Convertible	HR4222	HR4223
Sebring		2006		Sedan	HR4222	HR4223
Sebring		2007-2008	2.7L	2700cc 167cid V6, Sedan; Rear Disc; 262mm Rear Discs		HR4237
Sebring		2007-2008	3.5L	3497cc 215cid V6, Sedan; Rear Disc; 302mm Rear Discs		HR4193
Sebring		2007-2008		Sedan	HR4236	
Sebring		2008	2.7L	2700cc 167cid V6, Convertible; Rear Disc; 262mm Rear Discs		HR4237
Sebring		2008	3.5L	3497cc 215cid V6, Convertible; Rear Disc; 302mm Rear Discs		HR4193
Sebring		2008		Convertible	HR4236	
Sebring		2009-2010		Rear Disc; 302mm Rear Discs		HR4193
Sebring		2009-2010		Rear Disc; 262mm Rear Discs		HR4237
Sebring		2009-2010			HR4236	
Town & Country		1977-1978		With 10 inch Rear Drums	HR4211	
Town & Country		1979-1981			HR4211	
Town & Country		1997-2000		Rear Disc		HR4436
Town & Country		1997-2000		AWD	HR4438	
Town & Country		1997-2000		FWD; 282mm Front Discs	HR4438	
Town & Country		2001-2007		Rear Disc	HR4452	HR4436
Town & Country		2003-2007		Rear Drum	HR4449	
Town & Country		2008-2011			HR4477	HR4241
Town & Country		2012-2015		302mm Front Disc; Single Piston Front Caliper	HR4477	
Town & Country		2012-2015		305mm Rear Disc; Single Piston Front Caliper		HR4241
Voyager		2000		With 282mm Front Discs	HR4438	
Voyager		2001-2003		Rear Drum	HR4449	
DODGE						
Aspen		1976-1980			HR4211	
Avenger		1995-2000			HR5170	HR5281
Avenger		2008-2012			HR4236	
Avenger		2008-2014		Rear Disc; With 302mm Rear Disc		HR4193
Avenger		2008-2014		Rear Disc; With 262mm Rear Disc		HR4237
Avenger		2013-2014		295mm Front Disc	HR4236	
Avenger		2013-2014		340mm Front Disc	HR4196	
Caliber	SE	2007-2009	1.8L	1798cc 110cid L4	HR4192	
Caliber	SXT	2007-2009	1.8L	1798cc 110cid L4	HR4192	
Caliber	SE	2007-2009	2.0L	1998cc 122cid L4	HR4236	
Caliber	SXT	2007-2009	2.0L	1998cc 122cid L4	HR4236	
Caliber	R/T	2007-2009			HR4236	
Caliber	R/T	2007-2010		Rear Disc		HR4237
Caliber	SXT	2007-2010		Rear Disc		HR4237
Caliber	SRT-4	2008-2009			HR4196	HR4193
Caliber		2010		Rear Disc	HR4236	
Caliber	Heat	2010		Rear Drum	HR4192	
Caliber	Rush	2010		Rear Disc		HR4237
Caliber	SE	2010		Rear Drum	HR4192	
Caliber	SXT	2010		Rear Drum	HR4192	
Caliber	Express	2010-2011		Rear Drum	HR4192	
Caliber	Mainstreet	2010-2011		Rear Drum	HR4192	
Caliber		2011-2012		Rear Disc	HR4236	HR4237
Caravan		1997-2000		15 inch Wheels; With 282mm Front Discs	HR4438	
Caravan		2000		Rear Disc		HR4436
Caravan		2001-2007		Rear Disc	HR4452	HR4436
Caravan		2001-2007		Rear Drum	HR4449	

Hawk Performance - ROTOR APPLICATIONS

HK 4218 .448 X
 HAWK KIT ROTOR PAD SHAPE INSERT COMPOUND CODE

MAKE/ MODEL	SUBMODEL	YEARS	ENGINE (LITER)	NOTE	FRONT	REAR
					ROTOR	ROTOR
DODGE CONTINUED						
Challenger		1973-1974			HR4211	
Challenger		2008			HR4468	HR4469
Challenger	SE	2009-2011			HR4231	HR4234
Challenger	R/T	2009-2014			HR4232	HR4235
Challenger	SRT8	2009-2014			HR4468	HR4469
Challenger	R/T Classic	2012			HR4232	HR4235
Challenger	SXT Plus	2012		Performance Brakes	HR4232	HR4235
Challenger	SXT Plus	2012		Touring Brakes	HR4231	HR4234
Challenger	SXT	2012-2014		Performance Brakes	HR4232	HR4235
Challenger	SXT	2012-2014		Touring Brakes	HR4231	HR4234
Challenger	Rallye Redline	2014		Performance Brakes	HR4232	
Challenger	Rallye Redline	2014		Touring Brakes	HR4231	
Challenger	SRT Hellcat	2015				HR4469
Charger		1973-1974			HR4211	
Charger		1975		With 10 inch Rear Drums	HR4211	
Charger		1976		From 12/75	HR4210	
Charger		1977			HR4210	
Charger		2006-2010	2.7L	2700cc 167cid V6	HR4231	
Charger		2006-2010	2.7L	2700cc 167cid V6, Solid Rotor; Except Police and Heavy Duty		HR4234
Charger		2006-2010	2.7L	2700cc 167cid V6, Vented Rotor; Police and Heavy Duty		HR4238
Charger		2006-2010	3.5L	3497cc 215cid V6, 12.60 inch Diameter; Vented Rotor; Except Police and Heavy Duty		HR4235
Charger		2006-2010	3.5L	3497cc 215cid V6, 13.78 inch Diameter; Vented Rotor; Except Police and Heavy Duty		HR4193
Charger		2006-2010	3.5L	3497cc 215cid V6, Except Police or HD	HR4231	
Charger		2006-2010	3.5L	3497cc 215cid V6, Police or HD	HR4232	
Charger		2006-2010	3.5L	3497cc 215cid V6, Solid Rotor; Except Police and Heavy Duty		HR4234
Charger		2006-2010	3.5L	3497cc 215cid V6, Vented Rotor; Police and Heavy Duty		HR4238
Charger		2006	5.7L	345cid V8, Vented Rotor; Police and Heavy Duty; Optional Pads		HR4238
Charger		2006-2010	5.7L	345cid V8	HR4232	
Charger		2006-2010	5.7L	345cid V8, Except Police and Heavy Duty		HR4235
Charger		2006-2010	5.7L	345cid V8, Vented Rotor; Police and Heavy Duty		HR4238
Charger		2006-2010	6.1L	6059cc 370cid V8	HR4468	HR4469
Charger	SE	2011		RWD; Except Police	HR4231	
Charger	SE	2011		Solid Rear Disc		HR4234
Charger	R/T	2011-2014		Except Police; 320mm Vented Rear Disc		HR4235
Charger	R/T	2011-2014		Police; 350mm Vented Rear Disc		HR4238
Charger	R/T	2011-2014			HR4232	
Charger	SXT Plus	2012		Except Police; Solid Rear Disc		HR4234
Charger	SXT Plus	2012		Except Police; Solid Rear Rotor	HR4231	
Charger	SXT Plus	2012		Except Police; Vented Rear Disc		HR4235
Charger	SXT Plus	2012		Except Police; Vented Rear Rotor	HR4232	
Charger	SXT Plus	2012		Police; Vented Rear Disc		HR4238
Charger	SXT Plus	2012		Police; Vented Rear Rotor	HR4232	
Charger	SE	2012-2014		Except Police; Solid Rear Disc		HR4234
Charger	SE	2012-2014		Except Police; Solid Rear Rotor	HR4231	
Charger	SE	2012-2014		Except Police; Vented Rear Disc		HR4235
Charger	SE	2012-2014		Except Police; Vented Rear Rotor	HR4232	
Charger	SE	2012-2014		Police; Vented Rear Disc		HR4238
Charger	SE	2012-2014		Police; Vented Rear Rotor	HR4232	
Charger	SRT8	2012-2014			HR4468	HR4469
Charger	SXT	2012-2014		Except Police; Solid Rear Disc		HR4234
Charger	SXT	2012-2014		Except Police; Solid Rear Rotor	HR4231	
Charger	SXT	2012-2014		Except Police; Vented Rear Disc		HR4235
Charger	SXT	2012-2014		Except Police; Vented Rear Rotor	HR4232	

ROTOR APPLICATIONS



MAKE/ MODEL	SUBMODEL	YEARS	ENGINE (LITER)	NOTE	FRONT	REAR
					ROTORS	ROTORS
DODGE CONTINUED						
Charger	SXT	2012-2014		Police; Vented Rear Disc		HR4238
Charger	SXT	2012-2014		Police; Vented Rear Rotor	HR4232	
Charger	Pursuit	2014		345mm front disc	HR4232	
Charger	Pursuit	2014-2015		Vented Rear Disc		HR4238
Charger	R/T Road & Track	2015			HR4232	HR4235
Charger	R/T Scat Pack	2015			HR4468	HR4469
Charger	R/T	2015			HR4232	HR4235
Charger	SE	2015		AWD	HR4232	HR4235
Charger	SE	2015		RWD	HR4231	HR4234
Charger	SRT 392	2015			HR4468	HR4469
Charger	SRT Hellcat	2015				HR4469
Charger	SXT	2015		AWD	HR4232	HR4235
Charger	SXT	2015		RWD	HR4231	HR4234
Coronet		1973-1975			HR4211	
Coronet		1976		From 12/75	HR4210	
Dakota		1997-2002			HR4437	
Dakota		2003-2004		Rear Disc		HR4459
Dakota		2003-2004			HR4457	
Dakota		2005-2010			HR4460	
Dart		1973-1976			HR4211	
Dart		2013-2015			HR4208	HR4206
Diplomat		1977-1989			HR4211	
Durango		1998-2002			HR4437	
Durango		2003			HR4453	HR4454
Durango		2004-2009			HR4448	HR4450
Durango		2011-2015		330mm Front Disc; Solid Rear Disc	HR4199	
Durango		2011-2015		350mm Front Disc; Vented Rear Disc	HR4201	
Durango		2011-2015		Solid Rear Axle		HR4198
Durango		2011-2015		Vented Rear Axle		HR4200
Grand Caravan		1997-2000		AWD	HR4438	
Grand Caravan		1997-2000		FWD; 15 inch Wheels; With 282mm Front Discs	HR4438	
Grand Caravan		1997-2007				HR4436
Grand Caravan		2001-2006		Rear Drum	HR4449	
Grand Caravan		2001-2007		Rear Disc	HR4452	
Grand Caravan		2008-2011			HR4477	HR4241
Grand Caravan		2012-2016		302mm Front Disc; Single Piston Front Caliper	HR4477	
Grand Caravan		2012-2016		305mm Rear Disc; Single Piston Front Caliper		HR4241
Intrepid		1993-2004				HR4216
Intrepid		1998-1999		With 297mm Front Discs	HR4225	
Intrepid		2000		Non-ABS; With 297mm Front Discs	HR4225	
Intrepid		2000		4-Wheel ABS; With 297mm Front Discs	HR4226	
Intrepid		2001-2004		4-Wheel ABS	HR4226	
Intrepid		2001-2004		Non-ABS	HR4225	
Journey		2009-2011			HR4477	HR4241
Journey		2012		302mm Front Disc	HR4477	
Journey		2012-2013		305mm Rear Disc		HR4241
Magnum		1978-1979			HR4210	
Magnum		2005-2008	2.7L	2700cc 167cid V6	HR4231	
Magnum		2005-2008	2.7L	2700cc 167cid V6, Except Police and Heavy Duty		HR4234
Magnum		2005-2008	2.7L	2700cc 167cid V6, Police and Heavy Duty		HR4235
Magnum		2005-2008	3.5L	3497cc 215cid V6	HR4231	
Magnum		2005-2008	3.5L	3497cc 215cid V6, Except Police and Heavy Duty		HR4234
Magnum		2005-2008	3.5L	3497cc 215cid V6, Police and Heavy Duty		HR4235
Magnum		2005-2008	5.7L	345cid V8	HR4232	
Magnum		2005-2008	5.7L	345cid V8, Except Police and Heavy Duty		HR4235



Hawk Performance - ROTOR APPLICATIONS

HK 4218 .448 X
 HAWK KIT ROTOR PAD SHAPE INSERT COMPOUND CODE

MAKE/ MODEL	SUBMODEL	YEARS	ENGINE (LITER)	NOTE	FRONT	REAR
					ROTOR	ROTOR
DODGE CONTINUED						
Magnum		2005-2008	5.7L	345cid V8, Police and Heavy Duty		HR4235
Magnum		2006-2008	6.1L	6059cc 370cid V8	HR4468	HR4469
Mirada		1980-1983			HR4211	
Monaco		1977-1978		With 10 inch Rear Drums	HR4210	
Neon		1997-1999				HR4223
Neon		2000-2003			HR4227	HR4223
Neon	SE	2004		Rear Disc		HR4223
Neon	SXT	2004			HR4227	HR4223
Neon	SE	2004-2005			HR4227	
Neon	SRT-4	2004-2005			HR4229	HR4230
Neon	SXT	2005			HR4227	
Nitro		2007-2011			HR4194	HR4195
Ram 1500		1994-1999		4WD	HR4429	
Ram 1500		2000-2001		4WD	HR4446	
Ram 1500		2000-2001		RWD	HR4445	
Ram 1500		2002-2003			HR4448	HR4450
Ram 1500	SLT	2004-2006		Standard Cab Pickup	HR4448	HR4450
Ram 1500	SLT	2004-2006		Crew Cab Pickup	HR4448	HR4450
Ram 1500	SRT-10	2004-2006		Standard Cab Pickup	HR4461	HR4462
Ram 1500	ST	2004-2006		Standard Cab Pickup	HR4448	HR4450
Ram 1500	ST	2004-2006		Crew Cab Pickup	HR4448	HR4450
Ram 1500	Hemi Sport	2005		Standard Cab Pickup	HR4448	HR4450
Ram 1500	Hemi Sport	2005		Crew Cab Pickup	HR4448	HR4450
Ram 1500	Rumble Bee	2005		Standard Cab Pickup	HR4448	HR4450
Ram 1500	Laramie	2005-2006		Standard Cab Pickup	HR4448	HR4450
Ram 1500	Laramie	2005-2006		Crew Cab Pickup	HR4448	HR4450
Ram 1500	SRT-10	2005-2006		Crew Cab Pickup	HR4461	HR4462
Ram 1500	Sport	2006		Standard Cab Pickup	HR4448	HR4450
Ram 1500	Sport	2006		Crew Cab Pickup	HR4448	HR4450
Ram 1500	TRX4	2006		Standard Cab Pickup	HR4448	HR4450
Ram 1500	TRX4	2006		Crew Cab Pickup	HR4448	HR4450
Ram 1500		2006-2008		Extended Crew Cab Pickup; Also called Mega Cab	HR4466	HR4467
Ram 1500		2007-2008		Standard Cab Pickup	HR4448	HR4450
Ram 1500		2007-2008		Crew Cab Pickup	HR4448	HR4450
Ram 1500		2009-2010		Standard Cab Pickup	HR4448	
Ram 1500		2009-2010		Crew Cab Pickup	HR4448	
Ram 1500		2009-2010				HR4450
Ram 2500		1994-1996		4WD; With 3500 Lb Front Axle	HR4155	
Ram 2500		1994-1996		4WD; With 4500 Lb Front Axle	HR4380	
Ram 2500		1997		4WD; With 7500 Lb GVW	HR4155	
Ram 2500		1997		4WD; With 8800 Lb GVW	HR4380	
Ram 2500		1998-1999		4WD	HR4380	
Ram 2500		2000-2002		4WD	HR4444	HR4451
Ram 2500		2000-2002		RWD	HR4444	HR4451
Ram 2500		2003-2008		4WD	HR4466	HR4467
Ram 2500		2003-2008		RWD	HR4466	HR4467
Ram 2500		2009-2010			HR4239	HR4240
Ram 3500		1994-1999		4WD	HR4380	
Ram 3500		1994-1999		RWD; With Solid Front Axle	HR4380	
Ram 3500		2000-2002		4WD	HR4444	HR4451
Ram 3500		2000-2002		RWD	HR4444	HR4451
Ram 3500		2003-2008		4WD	HR4466	HR4467
Ram 3500		2003-2008		RWD	HR4466	HR4467
Ram 3500		2009-2010			HR4239	HR4240
Ram 4500		2008-2010				HR4258

ROTOR APPLICATIONS

MAKE/ MODEL	SUBMODEL	YEARS	ENGINE (LITER)	NOTE	FRONT	REAR
					ROTORS	ROTORS
DODGE CONTINUED						
Ram 5500		2008-2010				HR4258
Royal Monaco		1977		With 10 inch Rear Drums	HR4210	
St. Regis		1979-1981			HR4210	
Stealth		1991-1993		AWD	HR5214	HR5217
Stealth		1991-1996		FWD	HR5215	HR5216
Stealth		1994-1996		AWD	HR5291	HR5292
Stratus		1995-2000		Sedan; With 14 inch Wheels	HR4221	
Stratus		1995-2000		Sedan; With 15 inch Wheels	HR4222	
Stratus		1995-2006		Sedan; Rear Disc		HR4223
Stratus		2001-2005		Coupe; Rear Disc	HR5348	HR5281
Stratus		2001-2005		Coupe; Rear Drum	HR5170	
Stratus		2001-2006		Sedan	HR4222	
EAGLE						
Talon		1990-1992		Turbocharged	HR5170	
Talon		1990-1992		FWD; Turbocharged		HR5171
Talon		1990-1994		Naturally Aspirated	HR5170	HR5171
Talon		1993-1994		FWD; Turbocharged	HR5170	HR5171
Talon		1993-1997		AWD; Turbocharged	HR5215	
Talon		1995		Naturally Aspirated	HR5170	HR5281
Talon		1995		FWD; Turbocharged	HR5170	HR5281
Talon		1995		AWD; Turbocharged; Rear Disc; With Solid Rear Discs		HR5281
Talon		1996		Naturally Aspirated		HR5281
Talon		1996-1998		Naturally Aspirated	HR5170	
Talon		1996-1998		Turbocharged		HR5281
Talon		1996-1998		FWD; Turbocharged	HR5170	
FORD						
Bronco		1994-1996			HR4304	
C-Max		2013			HR4281	
C-Max	Energi SEL	2014-2016			HR4895	
C-Max	Hybrid SE	2014-2016			HR4281	
C-Max	Hybrid SEL	2014-2016			HR4281	
Crown Victoria		1996-1997				HR4032
Crown Victoria		1998-2002			HR4035	HR4032
Crown Victoria		2003-2011			HR4042	HR4043
E-150		2003			HR4303	
E-150		2004-2007			HR4255	
E-150		2008-2014			HR4098	
E-150 Club Wagon		2003			HR4303	
E-150 Club Wagon		2004-2005			HR4255	
E-150 Econoline		1990-1993			HR4246	
E-150 Econoline		1994-2002		2-Wheel ABS	HR4302	
E-150 Econoline		2002		4-Wheel ABS	HR4303	
E-150 Econoline Club Wagon			1990-1993			HR4246
E-150 Econoline Club Wagon			1994-2001		4-Wheel ABS	HR4303
E-150 Econoline Club Wagon			2002			HR4303
E-250		2003-2007			HR4309	HR4340
E-250		2008-2014			HR4098	
E-250 Econoline		1995-1999		4-Wheel ABS	HR4309	
E-250 Econoline		1999-2000				HR4340
E-250 Econoline		2000		4-Wheel ABS; To 1/10/00	HR4309	
E-250 Econoline		2000		From 1/10/00	HR4309	
E-250 Econoline		2001-2002			HR4309	HR4340
E-250 Super Duty		2004-2005			HR4309	HR4340
E-350 Club Wagon		2003-2005		SRW	HR4309	HR4340
E-350 Club Wagon		2003-2005		DRW	HR4305	HR4341

ROTOR APPLICATIONS



Hawk Performance - ROTOR APPLICATIONS

HK 4218 .448 X
 HAWK KIT ROTOR PAD SHAPE INSERT COMPOUND CODE

MAKE/ MODEL	SUBMODEL	YEARS	ENGINE (LITER)	NOTE	FRONT	REAR
					ROTOR	ROTOR
FORD CONTINUED						
E-350 Econoline		1995-1998		4-Wheel ABS; DRW	HR4305	
E-350 Econoline		1995-1998		4-Wheel ABS; SRW	HR4309	
E-350 Econoline Club Wagon		1995-2000		4-Wheel ABS; DRW	HR4305	
E-350 Econoline Club Wagon		1995-2000		4-Wheel ABS; SRW	HR4309	
E-350 Econoline Club Wagon		1999-2000		SRW		HR4340
E-350 Econoline Club Wagon		1999-2000		DRW		HR4341
E-350 Econoline Club Wagon		2001-2002		SRW	HR4309	HR4340
E-350 Econoline Club Wagon		2001-2002		DRW	HR4305	HR4341
E-350 Super Duty		1999-2000		DRW		HR4341
E-350 Super Duty		1999-2000		4-Wheel ABS; DRW	HR4305	
E-350 Super Duty		1999-2000		4-Wheel ABS; SRW	HR4309	
E-350 Super Duty		1999-2003		Cutaway Van; SRW		HR4341
E-350 Super Duty		1999-2003		Extended Cargo Van; SRW		HR4340
E-350 Super Duty		1999-2003		Standard Cargo Van; SRW		HR4340
E-350 Super Duty		1999-2003		Stripped Chassis; SRW		HR4341
E-350 Super Duty		2001-2003		SRW	HR4309	
E-350 Super Duty		2001-2007		DRW	HR4305	HR4341
E-350 Super Duty		2004-2007		SRW	HR4309	HR4340
E-350 Super Duty		2008-2016		SRW	HR4098	
E-450 Econoline Super Duty		2000-2002			HR4305	HR4327
E-450 Super Duty		2003-2007			HR4305	HR4327
E-550 Econoline Super Duty		2002			HR4343	HR4332
E-550 Super Duty		2003			HR4343	HR4332
Edge		2007-2008		320mm diameter	HR4059	
Edge		2007-2008		296mm diameter	HR4061	
Edge		2007-2008				HR4060
Edge		2009-2010			HR4059	HR4060
Edge		2011-2015			HR4059	HR4055
Escape		2001-2004			HR4350	
Escape		2005-2007		Rear Disc	HR4251	HR4252
Escape		2005-2007		Rear Drum	HR4350	
Escape		2008		Rear Disc		HR4252
Escape		2008-2012			HR4251	
Escape		2013-2016	1.6L	1601cc 98cid L4, 4WD	HR4896	
Escape		2013-2016	1.6L	1601cc 98cid L4, FWD	HR4895	
Escape		2013-2016	2.0L	1999cc 122cid L4	HR4896	
Escape		2013-2016	2.5L	2488cc 152cid L4	HR4895	
Escort		1991-2003		Rear Disc		HR5207
Excursion		2000-2002		RWD	HR4336	
Excursion		2000-2005		4WD	HR4342	
Excursion		2000-2005				HR4334
Excursion		2003-2005		RWD	HR4056	
Expedition		1997-1998		RWD	HR4326	
Expedition		1997-1999		4WD	HR4321	
Expedition		1997-1999				HR4322
Expedition		1999-2000		RWD; With 12mm Studs	HR4326	
Expedition		1999-2000		RWD; With 14mm Studs	HR4346	
Expedition		2000		4WD; From 12/99	HR4321	
Expedition		2000		4WD; To 11/99	HR4321	
Expedition		2000		From 11/99; With 14mm Studs		HR4344
Expedition		2000		To 11/99; With 12mm Studs		HR4322
Expedition		2001		4WD	HR4321	
Expedition		2001		RWD	HR4346	
Expedition		2001				HR4344
Expedition		2002		4WD; To 3/18/02	HR4321	

ROTOR APPLICATIONS

MAKE/ MODEL	SUBMODEL	YEARS	ENGINE (LITER)	NOTE	FRONT	REAR
					ROTORS	ROTORS
FORD CONTINUED						
Expedition		2002		From 3/18/02	HR4352	HR4353
Expedition		2002		RWD; To 3/18/02	HR4346	
Expedition		2002		To 3/18/02		HR4344
Expedition		2003-2006			HR4352	HR4353
Expedition		2007-2016			HR4254	HR4264
Explorer		1995-2000		4WD	HR4317	
Explorer		1995-2000		RWD	HR4314	
Explorer		1995-2000				HR4315
Explorer		1996-2000		AWD	HR4317	
Explorer		2001		4 Door		HR4315
Explorer		2001		4 Door; 4WD	HR4317	
Explorer		2001		4 Door; AWD	HR4317	
Explorer		2001		4 Door; RWD	HR4314	
Explorer		2001-2002		2 Door		HR4315
Explorer		2001-2003		2 Door; 4WD	HR4348	
Explorer		2001-2003		2 Door; RWD	HR4347	
Explorer		2002-2003		4 Door	HR4351	HR4349
Explorer		2003		2 Door		HR4248
Explorer		2004-2005			HR4351	HR4349
Explorer		2006-2010			HR4083	HR4349
Explorer		2011-2012			HR4272	HR4055
Explorer		2013-2016		Heavy Duty Brakes; includes Police Interceptor Pkg.	HR4277	HR4278
Explorer		2013-2016		Standard Duty Brakes	HR4272	HR4055
Explorer Sport Trac		2001-2005		4WD	HR4348	
Explorer Sport Trac		2001-2005		RWD	HR4347	
Explorer Sport Trac		2003-2005				HR4248
Explorer Sport Trac		2007-2010			HR4083	HR4349
F-150		1990-1993		RWD	HR4246	
F-150		1994-1996		4WD	HR4304	
F-150		1994-1996		RWD; 2-Wheel ABS	HR4302	
F-150		1997-1998		RWD; Rear Drum; 4-Wheel ABS	HR4318	
F-150		1997-1999		4WD	HR4320	
F-150		1997-1999		RWD; Rear Drum; 2-Wheel ABS	HR4319	
F-150		1999		RWD; Rear Disc		HR4322
F-150		1999		4WD; Rear Disc; From 12/98		HR4322
F-150	Base	1999		RWD; Rear Disc	HR4318	
F-150	Lariat	1999		RWD; Rear Disc	HR4318	
F-150	Lightning	1999		RWD; Rear Disc	HR4326	
F-150	XL	1999		RWD; Rear Disc	HR4318	
F-150	XLT	1999		RWD; Rear Disc	HR4318	
F-150		2000		RWD; Rear Disc; To 11/99		HR4322
F-150		2000		4WD; Rear Disc; From 12/99; 5 Lugs		HR4344
F-150		2000		4WD; Rear Disc; To 11/99		HR4322
F-150		2000		RWD; Rear Disc; From 12/99; 5 Lugs		HR4344
F-150		2000		RWD; Rear Disc; From 12/99; 8 Lugs		HR4341
F-150		2000		RWD; Rear Drum; 2-Wheel ABS; To 11/99	HR4319	
F-150	Base	2000		RWD; From 12/99; 5 Lugs	HR4345	
F-150	Harley-Davidson Edition	2000		RWD; From 12/99; 5 Lugs	HR4345	
F-150	Harley-Davidson Edition	2000		RWD; Rear Disc; To 11/99	HR4318	
F-150	Lariat	2000		RWD; From 12/99; 5 Lugs	HR4345	
F-150	Lariat	2000		RWD; Rear Disc; To 11/99	HR4318	
F-150	Lightning	2000		RWD; From 12/99; 5 Lugs	HR4346	
F-150	Lightning	2000		RWD; Rear Disc; To 11/99	HR4326	
F-150	XL	2000		RWD; From 12/99; 5 Lugs	HR4345	
F-150	XLT	2000		RWD; From 12/99; 5 Lugs	HR4345	

Hawk Performance - ROTOR APPLICATIONS

HK 4218

HAWK KIT

ROTOR

.448

PAD SHAPE

X

INSERT COMPOUND CODE

MAKE/ MODEL	SUBMODEL	YEARS	ENGINE (LITER)	NOTE	FRONT	REAR
					ROTOR	ROTOR
FORD CONTINUED						
F-150	XLT	2000		RWD; Rear Disc; To 11/99	HR4318	
F-150		2000-2003		4WD; 5 Lugs	HR4320	
F-150		2001-2003		4WD; Rear Disc; 5 Lugs		HR4344
F-150		2001-2003		RWD; Rear Disc; 5 Lugs		HR4344
F-150		2001-2003		RWD; Rear Disc; 8 Lugs		HR4341
F-150	Harley-Davidson Edition	2001-2003		RWD; 5 Lugs	HR4345	
F-150	Lariat	2001-2003		RWD; 5 Lugs	HR4345	
F-150	Lightning	2001-2003		RWD; 5 Lugs	HR4346	
F-150	XL	2001-2003		RWD; 5 Lugs	HR4345	
F-150	XLT	2001-2003		RWD; 5 Lugs	HR4345	
F-150		2004		4WD; New Model; 6 Lugs; Base Payload Package	HR4358	HR4360
F-150		2004		4WD; New Model; 7 Lugs; HD Payload Package	HR4359	
F-150		2004		RWD; New Model; 6 Lugs; Base Payload Package	HR4356	HR4360
F-150		2004		RWD; New Model; 7 Lugs; HD Payload Package	HR4357	
F-150		2005-2007		4WD; With 6 Lugs	HR4358	HR4360
F-150		2005-2008		4WD; With 7 Lugs	HR4359	
F-150		2005-2008		RWD; Base Payload Package; 6 Lugs	HR4356	HR4360
F-150		2005-2008		RWD; HD Payload Package; 7 Lugs	HR4357	
F-150		2008		4WD; With 6 Lugs	HR4358	
F-150		2009		4WD; 6 Lugs	HR4267	
F-150		2009		RWD; 6 Lugs	HR4267	HR4360
F-150		2009-2011		4WD; With 6 Lugs		HR4360
F-150		2010		RWD; 6 Lugs	HR4254	
F-150		2010		RWD; 6 Lugs		HR4360
F-150		2010-2014		4WD; 6 Lugs	HR4254	
F-150		2011		RWD; 6 Lugs	HR4254	HR4360
F-150		2012-2014		6 Lugs		HR4283
F-150		2012-2014		RWD; 6 Lugs	HR4254	
F-150		2015-2016		With Manual Parking Brake		HR4283
F-150		2015-2016			HR4254	
F-150 Heritage		2004		4WD; 5 Lugs	HR4320	
F-150 Heritage		2004		4WD; Rear Disc; 5 Lugs		HR4344
F-150 Heritage		2004		RWD; 5 Lugs	HR4345	
F-150 Heritage		2004		RWD; Rear Disc; 5 Lugs		HR4344
F-150 Heritage		2004		RWD; Rear Disc; 8 Lugs		HR4341
F-250		1995-1996		4WD	HR4316	
F-250		1997-1999		4WD; Rear Drum; 8 Lugs	HR4316	
F-250 Super Duty		1999		4WD		HR4334
F-250 Super Duty		1999		4WD; From 3/22/99	HR4342	
F-250 Super Duty		1999		4WD; To 3/22/99	HR4330	
F-250 Super Duty		1999-2000		RWD; 4-Wheel ABS	HR4336	
F-250 Super Duty		1999-2000		RWD		HR4334
F-250 Super Duty		1999-2000		RWD; 2-Wheel ABS	HR4335	
F-250 Super Duty		2000-2004		4WD	HR4342	HR4334
F-250 Super Duty		2001-2002		RWD	HR4336	HR4334
F-250 Super Duty		2003-2004		RWD	HR4056	HR4334
F-250 Super Duty		2005		RWD	HR4259	HR4260
F-250 Super Duty		2005-2012		4WD	HR4253	HR4260
F-250 Super Duty		2006-2007		RWD		HR4260
F-250 Super Duty		2006-2007		RWD; From 12/18/06	HR4273	
F-250 Super Duty		2006-2007		RWD; To 12/17/06	HR4259	
F-250 Super Duty		2008-2012		RWD	HR4273	HR4260
F-350		1995-1997		4WD	HR4316	
F-350 Super Duty		1999		4WD; From 3/22/99; 101mm tall front rotor	HR4342	
F-350 Super Duty		1999		4WD; To 3/22/99; 95mm tall front rotor	HR4330	

ROTOR APPLICATIONS

MAKE/ MODEL	SUBMODEL	YEARS	ENGINE (LITER)	NOTE	FRONT	REAR
					ROTORS	ROTORS
FORD CONTINUED						
F-350 Super Duty		1999-2002		RWD; SRW		HR4334
F-350 Super Duty		1999-2002		RWD; 2-Wheel ABS; SRW	HR4335	
F-350 Super Duty		1999-2002		RWD; 4-Wheel ABS; SRW	HR4336	
F-350 Super Duty		1999-2002		RWD; DRW; With 14x2.0mm Studs	HR4337	
F-350 Super Duty		1999-2004		4WD; DRW		HR4333
F-350 Super Duty		1999-2004		4WD; SRW		HR4334
F-350 Super Duty		1999-2004		RWD; DRW		HR4333
F-350 Super Duty		2000-2004		4WD	HR4342	
F-350 Super Duty		2003-2004		RWD; SRW	HR4056	HR4334
F-350 Super Duty		2005-2007		RWD; SRW	HR4259	HR4260
F-350 Super Duty		2005-2012		4WD; DRW	HR4253	HR4262
F-350 Super Duty		2005-2012		4WD; SRW	HR4253	HR4260
F-350 Super Duty		2005-2012		RWD; DRW		HR4262
F-350 Super Duty		2008-2012		RWD; SRW	HR4273	HR4260
F-450 Super Duty		1999		4 X 4; From 3/22/99	HR4343	
F-450 Super Duty		1999				HR4332
F-450 Super Duty		1999-2004		4 X 2	HR4343	
F-450 Super Duty		2000			HR4343	HR4332
F-450 Super Duty		2001				HR4332
F-450 Super Duty		2001-2003		4 X 4	HR4343	
F-450 Super Duty		2002-2004		Without ABS Ring		HR4332
F-450 Super Duty		2004		4 X 4; 13.03 inch Diameter	HR4342	
F-450 Super Duty		2005-2010			HR4257	HR4258
F-450 Super Duty		2011-2012		Crew Cab Pickup	HR4253	HR4262
F-450 Super Duty		2011-2012		Cab & Chassis - Crew Cab	HR4257	HR4258
F-450 Super Duty		2011-2012		Cab & Chassis - Long Conventional	HR4257	HR4258
F-450 Super Duty		2013-2016		Cab & Chassis - Crew Cab; 10 Lugs	HR4257	HR4258
F-450 Super Duty		2013-2016		Cab & Chassis - Long Conventional; 10 Lugs	HR4257	HR4258
F53		1999			HR4332	HR4332
F53		2000		To 10/03/00		HR4332
F53		2000-2006			HR4332	
F53		2007		From 11/07; Under 23k lb GVW; Dana 80, 110, & 130 Rear Axles	HR4332	
F53		2007		To 10/07	HR4332	
F53		2008-2016		Under 23k lb GVW; Dana 80, 110, and 130 Rear Axles	HR4332	
F-550 Super Duty		1999		RWD; To 3/22/99	HR4343	
F-550 Super Duty		1999		From 3/23/99	HR4343	
F-550 Super Duty		1999				HR4332
F-550 Super Duty		2000-2001			HR4343	HR4332
F-550 Super Duty		2002-2004		No ABS Ring		HR4332
F-550 Super Duty		2002-2004			HR4343	
F-550 Super Duty		2005-2012			HR4257	HR4258
F-550 Super Duty		2013-2016				HR4258
Fairlane		1967			HR4033	
Falcon		1967			HR4033	
Fiesta		2011-2013			HR4271	
Fiesta		2014		Rear Drum	HR4271	
Fiesta		2014				HR4041
Fiesta		2015		Rear Drum	HR4271	HR4041
Fiesta		2016		Rear Drum	HR4271	
Fiesta		2016				HR4041
Five Hundred		2005-2007			HR4054	HR4055
Flex		2009-2011			HR4063	HR4055
Flex		2012			HR4272	HR4055
Flex		2013-2016		Standard Brakes	HR4272	HR4055
Flex		2013-2016		Heavy Duty Brakes	HR4277	HR4278

ROTOR APPLICATIONS



MAKE/ MODEL	SUBMODEL	YEARS	ENGINE (LITER)	NOTE	FRONT	REAR
					ROTOR	ROTOR
FORD CONTINUED						
Focus		2000			HR4039	
Focus		2001			HR4039	HR4041
Focus	LX	2002-2004		Rear Disc		HR4041
Focus	LX	2002-2004			HR4039	
Focus	SE	2002-2004		Rear Disc		HR4041
Focus	SE	2002-2004			HR4039	
Focus	SVT	2002-2004			HR4046	HR4047
Focus	ZTS	2002-2004		Rear Disc		HR4041
Focus	ZTS	2002-2004			HR4039	
Focus	ZTW	2002-2004		Rear Disc		HR4041
Focus	ZTW	2002-2004			HR4039	
Focus	ZX3	2002-2004		Rear Disc		HR4041
Focus	ZX3	2002-2004			HR4039	
Focus	ZX5	2002-2004		Rear Disc		HR4041
Focus	ZX5	2002-2004			HR4039	
Focus		2005-2007			HR4048	HR4041
Focus		2008-2011			HR4062	
Focus		2012			HR4281	HR4280
Focus	ST	2013-2014		Rear Disc	HR4896	
Focus		2013-2016		Rear Drum	HR4281	
Focus	Electric	2013-2016		Rear Disc	HR4281	
Focus		2013-2016				HR4280
Focus	SE	2013-2016		Rear Disc	HR4281	
Focus	Titanium	2013-2016		Rear Disc	HR4281	
Focus	ST	2015-2016		Rear Disc; With 320mm front rotor	HR4896	
Freestar		2004-2007			HR4249	HR4250
Freestyle		2005-2007			HR4054	HR4055
Fusion		2006-2009			HR4945	HR5368
Fusion		2010		From 12/09		HR5368
Fusion		2010		To 11/09		HR5368
Fusion		2010			HR4945	
Fusion		2011-2012			HR4945	HR5368
Mustang		1965-1966			HR4033	
Mustang		1967	4.7L	4727cc 289cid V8	HR4033	
Mustang		1990-1992	5.0L	302cid V8	HR4011	
Mustang	GT	1993	5.0L	302cid V8	HR4011	
Mustang	LX	1993	5.0L	302cid V8	HR4011	
Mustang		1993		Rear Disc		HR4010
Mustang	SVT Cobra	1994-1999			HR4025	HR4026
Mustang	Base	1994-2004			HR4023	HR4024
Mustang	GT	1994-2004			HR4023	HR4024
Mustang	SVT Cobra R	2000			HR4025	HR4026
Mustang	GT Bullitt	2001			HR4025	HR4026
Mustang	SVT Cobra	2001			HR4025	HR4026
Mustang	SVT Cobra 10th Anniversary	2003			HR4025	HR4026
Mustang	Mach I	2003-2004			HR4025	HR4026
Mustang	SVT Cobra	2003-2004			HR4025	HR4026
Mustang	SVT Cobra	2004				HR4026
Mustang	Base	2005-2010			HR4050	
Mustang	GT	2005-2010			HR4049	
Mustang		2005-2012				HR4051
Mustang	Shelby GT	2007-2008			HR4049	
Mustang	Shelby GT500	2007-2012		With Brembo Brakes	HR4058	
Mustang	Bullitt	2008-2009			HR4049	
Mustang	Shelby GT500KR	2009		With Brembo Brakes	HR4058	

ROTOR APPLICATIONS

MAKE/ MODEL	SUBMODEL	YEARS	ENGINE (LITER)	NOTE	FRONT	REAR
					ROTORS	ROTORS
FORD CONTINUED						
Mustang	Base	2011-2012			HR4049	
Mustang	GT	2011-2014		With Brembo Brakes	HR4058	
Mustang	GT	2011-2014		With Standard Brakes	HR4279	
Mustang	Base	2013			HR4049	HR4051
Mustang	Boss 302	2013		With Brembo Brakes	HR4058	
Mustang	Boss 302	2013				HR4051
Mustang	GT	2013-2014				HR4051
Mustang	Base	2014				
Police Interceptor Sedan		2013-2014			HR4277	HR4278
Police Interceptor Utility		2013-2014			HR4277	HR4278
Probe		1993-1997			HR5210	HR5211
Ranchero		1967			HR4033	
Ranger		1998-2000		RWD; Rear Disc	HR4314	HR4315
Ranger		1998-2000		RWD; Rear Drum; Front Torsion Bar Spring	HR4314	
Ranger		1998-2002		4WD	HR4317	
Ranger		2001-2002		RWD; Rear Disc		HR4315
Ranger		2001-2009		RWD	HR4314	
Ranger		2003-2011		4WD	HR4348	
Taurus	GL	1993-1997		Rear Disc		HR4021
Taurus	LX	1993-1999		Rear Disc		HR4021
Taurus	SHO	1993				HR4021
Taurus	SHO	1994-1995			HR4031	HR4021
Taurus	GL	1994-1997			HR4031	
Taurus	LX	1994-1999			HR4031	
Taurus	SE	1995		Rear Disc		HR4021
Taurus	SE	1995			HR4031	
Taurus	G	1996-1997			HR4031	
Taurus	SHO	1996-1999			HR4029	HR4021
Taurus	SE Comfort	1998		Rear Disc		HR4021
Taurus	SE Comfort	1998			HR4031	
Taurus	SE	1998-1999		Rear Disc		HR4021
Taurus	SE	1998-1999			HR4031	
Taurus		2000			HR4031	
Taurus		2000-2005		Rear Disc		HR4021
Taurus		2001-2007			HR4029	
Taurus		2008-2009			HR4054	HR4055
Taurus		2010			HR4063	HR4055
Taurus		2011-2012			HR4272	HR4055
Taurus	Limited	2013		Except Police Vehicles	HR4272	HR4055
Taurus	Limited	2013		Police Vehicles	HR4277	HR4278
Taurus	SE	2013		Except Police Vehicles	HR4272	HR4055
Taurus	SE	2013		Police Vehicles	HR4277	HR4278
Taurus	SEL	2013		Except Police Vehicles	HR4272	HR4055
Taurus	SEL	2013		Police Vehicles	HR4277	HR4278
Taurus	SHO	2013-2016			HR4277	HR4278
Taurus	Limited	2014-2016			HR4272	HR4055
Taurus	SE	2014-2016			HR4272	HR4055
Taurus	SEL	2014-2016			HR4272	HR4055
Taurus X		2008-2009			HR4054	HR4055
Thunderbird		1991-1995			HR4031	
Thunderbird		1993-1997		Rear Disc		HR4019
Thunderbird		1996-1997		Rear Drum	HR4031	
Thunderbird		1996-1997		Rear Disc; Sport Package; 294mm Front Discs	HR4029	
Thunderbird		1996-1997		Rear Disc; Except Sport Package; 276mm Front Discs	HR4031	
Thunderbird		2002-2005			HR4038	HR4040

Hawk Performance - ROTOR APPLICATIONS

HK 4218 .448 X
 HAWK KIT ROTOR PAD SHAPE INSERT COMPOUND CODE

MAKE/ MODEL	SUBMODEL	YEARS	ENGINE (LITER)	NOTE	FRONT	REAR
					ROTOR	ROTOR
FORD CONTINUED						
Transit Connect		2010-2013			HR4269	
Transit Connect		2014-2016			HR4896	
Windstar		1995-1998			HR4031	
GMC						
Acadia		2007-2016			HR4417	HR4413
C1500		1995-1999			HR4379	
C1500 Suburban		1992-1993		RWD	HR4379	
C1500 Suburban		1994-1999		RWD; Rear Drum; With 11 inch Rear Drums	HR4379	
C1500 Suburban		1994-1999		RWD; Rear Drum; With 13 inch Rear Drums	HR4381	
C2500		1997-2000		With 13 inch Rear Drums; 8600 Lb GVW	HR4381	
C2500 Suburban		1992-1999			HR4381	
C3500		1992-1996		2-Wheel ABS; SRW	HR4381	
C3500		1997-2000		Standard Cab Pickup; SRW	HR4381	
C3500		1997-2000		Cab & Chassis; SRW	HR4381	
C3500		1997-2000		Crew Cab Pickup; SRW	HR4381	
Caballero		1979-1981			HR4132	
Canyon		2004-2008			HR4402	
Canyon		2009-2012			HR4101	
Envoy		2002-2004			HR4399	HR4397
Envoy		2005-2009	4.2L	256cid L6	HR4407	
Envoy		2005-2009	5.3L	5328cc 325cid V8	HR4400	
Envoy		2005-2009				HR4397
Envoy XL		2002-2006			HR4400	HR4397
Envoy XUV		2004-2005			HR4400	HR4397
G15/G1500 Van		1971-1973			HR4066	
Jimmy		1992-1994		RWD; 2-Wheel ABS	HR4110	
Jimmy		1992-1995		RWD; 4-Wheel ABS	HR4374	
Jimmy		1992-1996		4WD	HR4366	
Jimmy		1996-1997		RWD	HR4374	
Jimmy		1997		4WD; Rear Disc	HR4388	HR4387
Jimmy		1997		4WD; Rear Drum	HR4366	
Jimmy		1998-2002		4WD	HR4388	
Jimmy		1998-2002		RWD	HR4388	
Jimmy		1998-2002		4WD; Rear Disc		HR4387
Jimmy		1998-2002		RWD; Rear Disc		HR4389
K1500		1988-1999			HR4367	
K1500 Suburban		1992-1993		4WD	HR4367	
K1500 Suburban		1994-1999		4WD; 6 Lugs	HR4367	
K1500 Suburban		1994-1999		4WD; 8 Lugs	HR4155	
K2500		1990-1998		With 13 inch Rear Drums; With 8600 Lb GVW	HR4155	
K2500		1990-1998		With 11 inch Rear Drums; With 7200 Lb GVW	HR4367	
K2500		1999-2000			HR4155	
K2500 Suburban		1992-1999			HR4155	
K3500		1990-1996		SRW	HR4155	
K3500		1992-2000		DRW; With 317mm Front Discs	HR4380	
K3500		1997-2000		Standard Cab Pickup; SRW	HR4155	
S15 Jimmy		1989-1990		RWD	HR4110	
S15 Jimmy		1989-1991		4WD	HR4366	
S15 Jimmy		1991		RWD; 4-Wheel ABS	HR4374	
Safari		2003-2005			HR4390	HR4391
Savana 1500		1996-2002			HR4379	
Savana 1500		2003-2008			HR4390	HR4395
Savana 1500		2009-2013			HR4403	HR4395
Savana 2500		1996-2000		8 Lug	HR4381	
Savana 2500		2001-2002		GAS; 8 Lug	HR4381	

ROTOR APPLICATIONS



MAKE/ MODEL	SUBMODEL	YEARS	ENGINE (LITER)	NOTE	FRONT	REAR
					ROTORS	ROTORS
GMC CONTINUED						
Savana 2500		2003-2005		6 Lug	HR4390	HR4401
Savana 2500		2003-2008		8 Lug	HR4392	
Savana 2500		2003-2009		GAS; 8 Lug		HR4393
Savana 2500		2006-2008		6 Lug	HR4390	
Savana 2500		2006-2010		DIESEL; 8 Lug		HR4394
Savana 2500		2009-2016			HR4392	
Savana 2500		2010		FLEX; 8 Lug		HR4393
Savana 2500		2011-2016		86mm Tall		HR4393
Savana 2500		2011-2016		91mm Tall		HR4394
Savana 3500		1996-2000		SRW	HR4381	
Savana 3500		2001		Cutaway Van; 139.0" Wheelbase; SRW	HR4381	
Savana 3500		2003		SRW		HR4394
Savana 3500		2003-2008		DRW		HR4396
Savana 3500		2003-2016			HR4404	
Savana 3500		2004-2016		Rear Disc; SRW; 86mm Tall Rear Discs		HR4393
Savana 3500		2004-2016		Rear Disc; SRW; 91mm Tall Rear Discs		HR4394
Savana 4500		2009-2016		Rear Disc; SRW; 86mm Tall Rear Discs		HR4393
Savana 4500		2009-2016		Rear Disc; SRW; 91mm Tall Rear Discs		HR4394
Savana 4500		2009-2016			HR4404	
Sierra 1500		1999-2000			HR4390	HR4391
Sierra 1500		2001		2 Door; RWD		HR4391
Sierra 1500		2001		4 Door; 4WD; HD		HR4393
Sierra 1500		2001		4 Door; RWD; HD		HR4393
Sierra 1500		2001		Extended Cab Pickup; 4WD		HR4395
Sierra 1500		2001		Standard Cab Pickup; 4WD		HR4391
Sierra 1500		2001-2002		4 Door; Extended Cab Pickup; HD		HR4393
Sierra 1500		2001-2002		Extended Cab Pickup; Standard Duty; 4 Wheel Steering		HR4395
Sierra 1500		2001-2002		Standard Cab Pickup	HR4390	
Sierra 1500		2001-2002		Standard Cab Pickup; Standard Duty; 2 Wheel Steering		HR4391
Sierra 1500		2001-2003		Extended Cab Pickup	HR4390	
Sierra 1500		2003		Standard Cab Pickup	HR4390	HR4391
Sierra 1500		2003		Extended Cab Pickup; 2 Wheel Steering		HR4391
Sierra 1500		2003		Extended Cab Pickup; 4 Wheel Steering; 325mm Rear Discs		HR4391
Sierra 1500		2003		Extended Cab Pickup; 4 Wheel Steering; 330mm Rear Discs		HR4395
Sierra 1500		2004		Standard Cab Pickup		HR4391
Sierra 1500		2004		Extended Cab Pickup; Rear Disc	HR4390	
Sierra 1500		2004		Standard Cab Pickup; Rear Disc	HR4390	
Sierra 1500		2004		Crew Cab Pickup		HR4395
Sierra 1500		2004		Extended Cab Pickup; 4WD; HD; With 4.63 inch Rear Hub Hole		HR4393
Sierra 1500		2004		Extended Cab Pickup; 4WD; HD; With 4.83 inch Rear Hub Hole		HR4394
Sierra 1500		2004		Extended Cab Pickup; 4WD; Standard Duty; 2 Wheel Steering		HR4391
Sierra 1500		2004		Extended Cab Pickup; 4WD; Standard Duty; 4 Wheel Steering		HR4395
Sierra 1500		2004		Extended Cab Pickup; RWD; HD; With 4.63 inch Rear Hub Hole		HR4393
Sierra 1500		2004		Extended Cab Pickup; RWD; HD; With 4.83 inch Rear Hub Hole		HR4394
Sierra 1500		2004		Extended Cab Pickup; RWD; Standard Duty; 2 Wheel Steering		HR4391
Sierra 1500		2004		Extended Cab Pickup; RWD; Standard Duty; 4 Wheel Steering		HR4395
Sierra 1500		2004-2005		Crew Cab Pickup; Rear Disc	HR4392	
Sierra 1500		2005		Extended Cab Pickup; Rear Disc	HR4390	HR4391
Sierra 1500		2005		Crew Cab Pickup; Rear Disc; With 2 Wheel Steering		HR4393
Sierra 1500		2005		Crew Cab Pickup; Rear Disc; With 4 Wheel Steering		HR4405
Sierra 1500		2005-2006		Rear Drum	HR4403	
Sierra 1500		2005-2006		Standard Cab Pickup; Rear Disc	HR4390	HR4391
Sierra 1500		2006	4.3L	262cid V6, Extended Cab Pickup; Rear Disc		HR4391
Sierra 1500		2006	4.8L	294cid V8, Extended Cab Pickup; Rear Disc		HR4391
Sierra 1500		2006	5.3L	5328cc 325cid V8, Extended Cab Pickup; Rear Disc		HR4391

ROTOR APPLICATIONS



Hawk Performance - ROTOR APPLICATIONS

HK 4218 .448 X
 HAWK KIT ROTOR PAD SHAPE INSERT COMPOUND CODE

MAKE/ MODEL	SUBMODEL	YEARS	ENGINE (LITER)	NOTE	FRONT	REAR
					ROTOR	ROTOR
GMC CONTINUED						
Sierra 1500		2006	6.0L	5967cc 364cid V8, Extended Cab Pickup; Rear Disc		HR4395
Sierra 1500		2006		Extended Cab Pickup; Rear Disc	HR4390	
Sierra 1500		2006		Crew Cab Pickup; Rear Disc	HR4392	HR4393
Sierra 1500		2007		8 Lug	HR4392	
Sierra 1500		2007		6 Lug	HR4403	
Sierra 1500		2007		Rear Disc; 8 Lug		HR4393
Sierra 1500		2007		Rear Disc; 6 Lug		HR4406
Sierra 1500		2008-2016		Rear Disc		HR4406
Sierra 1500		2008-2016			HR4403	
Sierra 1500 Classic		2007		8 Lug	HR4392	
Sierra 1500 Classic		2007		6 Lug	HR4403	
Sierra 1500 Classic		2007		Rear Disc; 8 Lug		HR4393
Sierra 1500 Classic		2007		Rear Disc; 6 Lug		HR4406
Sierra 1500 HD		2001-2002			HR4392	HR4393
Sierra 1500 HD		2003		4WD; With 2 Wheel Steering		HR4393
Sierra 1500 HD		2003		4WD; With 4 Wheel Steering		HR4405
Sierra 1500 HD		2003		RWD; With 2 Wheel Steering		HR4393
Sierra 1500 HD		2003		RWD; With 4 Wheel Steering		HR4391
Sierra 1500 HD		2003			HR4392	
Sierra 1500 HD		2005		With 2 Wheel Steering		HR4393
Sierra 1500 HD		2005		With 4 Wheel Steering		HR4405
Sierra 1500 HD		2005			HR4392	
Sierra 1500 HD		2006			HR4392	HR4393
Sierra 1500 HD Classic		2007			HR4392	HR4393
Sierra 2500		1999-2000	5.3L	5328cc 325cid V8		HR4393
Sierra 2500		1999-2000	6.0L	5967cc 364cid V8, Automatic Trans.		HR4393
Sierra 2500		1999-2000	6.0L	5967cc 364cid V8, Standard Trans.		HR4394
Sierra 2500		1999-2004			HR4392	
Sierra 2500		2001-2004		Automatic Trans.		HR4393
Sierra 2500		2001-2004		Standard Trans.		HR4394
Sierra 2500 HD		2001-2003			HR4404	HR4394
Sierra 2500 HD		2004		With 2 Wheel Steering		HR4394
Sierra 2500 HD		2004		With 4 Wheel Steering		HR4405
Sierra 2500 HD		2004			HR4404	
Sierra 2500 HD		2005-2008			HR4404	HR4394
Sierra 2500 HD		2009			HR4404	
Sierra 2500 HD		2010			HR4404	HR4394
Sierra 2500 HD		2011-2016			HR4125	HR4127
Sierra 2500 HD Classic		2007			HR4404	HR4394
Sierra 3500		2001-2003			HR4404	HR4396
Sierra 3500		2004-2006		SRW		HR4394
Sierra 3500		2004-2006		DRW		HR4396
Sierra 3500		2004-2006			HR4404	
Sierra 3500 Classic		2007		SRW		HR4394
Sierra 3500 Classic		2007		DRW		HR4396
Sierra 3500 Classic		2007			HR4404	
Sierra 3500 HD		2007-2010		SRW		HR4394
Sierra 3500 HD		2007-2010		DRW		HR4396
Sierra 3500 HD		2007-2010			HR4404	
Sierra 3500 HD		2011-2016		SRW		HR4127
Sierra 3500 HD		2011-2016		DRW		HR4126
Sierra 3500 HD		2011-2016			HR4125	
Sonoma		1991-1995		RWD; 2-Wheel ABS	HR4110	
Sonoma		1991-1997		4WD	HR4366	
Sonoma		1994-1995		RWD; 4-Wheel ABS	HR4374	

ROTOR APPLICATIONS



MAKE/ MODEL	SUBMODEL	YEARS	ENGINE (LITER)	NOTE	FRONT	REAR
					ROTORS	ROTORS
GMC CONTINUED						
Sonoma		1996-2003		RWD	HR4374	HR4387
Sonoma		1998-2004		4WD	HR4388	HR4387
Sprint		1971-1972			HR4065	
Sprint		1973-1977			HR4066	
Terrain		2010-2015			HR4095	HR4124
Yukon		1992-1999		4WD	HR4367	
Yukon		1995-1999		RWD	HR4379	
Yukon		2000-2002		4WD; With Limited Slip Axle		HR4395
Yukon		2000-2002		4WD; Without Limited Slip Axle		HR4391
Yukon		2000-2002			HR4390	
Yukon		2003-2006			HR4390	HR4395
Yukon		2007-2016			HR4403	HR4406
Yukon XL		2015-2016			HR4403	HR4406
Yukon XL 1500		2000-2002		Without Limited Slip Axle		HR4391
Yukon XL 1500		2000-2002		With Limited Slip Axle		HR4395
Yukon XL 1500		2000-2002			HR4390	
Yukon XL 1500		2003-2006			HR4390	HR4395
Yukon XL 1500		2007-2014			HR4403	HR4406
Yukon XL 2500		2000-2002		With 4.63 inch Rear Hub Hole		HR4393
Yukon XL 2500		2000-2002		With 4.83 inch Rear Hub Hole		HR4394
Yukon XL 2500		2000-2006			HR4392	
Yukon XL 2500		2003-2005		With 4 Wheel Steering		HR4405
Yukon XL 2500		2003-2005		With 2 Wheel Steering; With 4.63 inch Hub Hole		HR4393
Yukon XL 2500		2003-2005		With 2 Wheel Steering; With 4.83 inch Hub Hole		HR4394
Yukon XL 2500		2006		With 4.63 inch Rear Hub Hole		HR4393
Yukon XL 2500		2006		With 4.83 inch Rear Hub Hole		HR4394
Yukon XL 2500		2007			HR4392	HR4393
Yukon XL 2500		2008-2013			HR4392	HR4394
HONDA						
Accord		1990-1994		Sedan	HR5175	
Accord		1990-1997		Coupe	HR5175	
Accord		1991-1997		Sedan; Rear Disc		HR5177
Accord		1991-1997		Wagon		HR5177
Accord		1992-1997		Coupe; Rear Disc		HR5177
Accord		1995-1997	2.2L	2156cc L4, Sedan	HR5175	
Accord		1998-2002	2.3L	2254cc L4, Coupe	HR5302	
Accord		1998-2002	2.3L	2254cc L4, Coupe; Rear Disc		HR5304
Accord		1998-2002	2.3L	2254cc L4, Sedan	HR5302	HR5304
Accord		1998-2002	3.0L	2997cc V6, Coupe	HR5233	
Accord		1998-2002	3.0L	2997cc V6, Coupe; Rear Disc		HR5308
Accord		1998-2002	3.0L	2997cc V6, Sedan	HR5233	HR5308
Accord		2003-2007	2.4L	2354cc L4, Coupe	HR5233	
Accord		2003-2007	2.4L	2354cc L4, Sedan	HR5233	
Accord		2003-2004	3.0L	2977cc V6, Sedan	HR5233	
Accord		2003-2005	3.0L	2977cc V6, Coupe; Automatic Trans.	HR5233	
Accord		2003-2005	3.0L	2977cc V6, Coupe; Standard Trans.	HR5317	
Accord		2003-2004		Sedan; Rear Disc		HR5346
Accord		2003-2007		Coupe; Rear Disc		HR5346
Accord		2005	3.0L	2977cc V6, Sedan; GAS	HR5233	
Accord		2005-2007	3.0L	2997cc V6, Sedan; ELECTRIC/GAS	HR5317	
Accord		2005-2007		Sedan; ELECTRIC/GAS; Rear Disc		HR4957
Accord		2005-2007		Sedan; GAS; Rear Disc		HR5346
Accord		2006-2007	3.0L	2997cc V6, Coupe; Automatic Trans.	HR5233	
Accord		2006-2007	3.0L	2997cc V6, Coupe; Standard Trans.	HR5317	
Accord		2006-2007	3.0L	2997cc V6, Sedan; GAS	HR5233	

ROTOR APPLICATIONS

Hawk Performance - ROTOR APPLICATIONS

HK 4218 .448 X
 HAWK KIT ROTOR PAD SHAPE INSERT COMPOUND CODE

MAKE/ MODEL	SUBMODEL	YEARS	ENGINE (LITER)	NOTE	FRONT	REAR
					ROTOR	ROTOR
HONDA CONTINUED						
Accord	EX	2008-2012	2.4L	2354cc L4, Sedan	HR5317	
Accord	EX-L	2008-2012	2.4L	2354cc L4, Sedan	HR5317	
Accord	LX	2008-2012	2.4L	2354cc L4, Sedan	HR5233	
Accord	EX	2008-2012	3.5L	3471cc V6, Coupe	HR5317	
Accord	EX-L	2008-2012	3.5L	3471cc V6, Coupe	HR5317	
Accord		2008-2016				HR4957
Accord	LX-P	2009-2012	2.4L	2354cc L4, Sedan	HR5233	
Accord	LX-S	2009-2012	2.4L	2354cc L4, Coupe	HR5233	
Accord	SE	2011-2012	2.4L	2354cc L4	HR5233	
Accord Crosstour		2010-2011			HR4960	
Civic		1990-1991		Wagon; 4WD	HR5130	
Civic		1990-1991		Hatchback	HR5176	
Civic		1990-1991		Wagon; FWD	HR5176	
Civic	DX	1990-1993		Sedan	HR5176	
Civic	EX	1990-1993		Sedan	HR5174	
Civic	LX	1990-1993		Sedan	HR5176	
Civic		1992-1993		Sedan; Rear Disc		HR5132
Civic	Si	1992-1993		Hatchback	HR5176	HR5132
Civic	CX	1992-1995		Hatchback	HR5176	
Civic	DX	1992-1995		Hatchback	HR5176	
Civic	VX	1992-1995		Hatchback	HR5176	
Civic		1993-1995		Coupe; Rear Disc		HR5132
Civic	DX	1993-2000		Coupe	HR5176	
Civic	EX	1993-2005		Coupe	HR5174	
Civic		1994-1995		Sedan; Rear Disc	HR5174	HR5132
Civic		1994-1995		Sedan; Rear Drum	HR5176	
Civic	Si	1994-1995		Hatchback		HR5132
Civic	Si	1994-1995		Hatchback; 4-Wheel ABS	HR5174	
Civic	Si	1994-1995		Hatchback; Non-ABS	HR5176	
Civic	DX	1996		Sedan; Non-ABS	HR5176	
Civic	LX	1996		Sedan; Non-ABS	HR5176	
Civic	LX	1996		Sedan; Automatic Trans.; 4-Wheel ABS	HR5174	
Civic	LX	1996		Sedan; Standard Trans.; 4-Wheel ABS	HR5176	
Civic		1996-2000		Hatchback	HR5176	
Civic	EX	1996-2000		Sedan	HR5174	
Civic	HX	1996-2000		Coupe	HR5176	
Civic	DX	1997-2000		Sedan	HR5176	
Civic	LX	1997-2000		Sedan	HR5176	
Civic	GX	1998-2000		Sedan	HR5176	
Civic		1999-2000		Coupe; Rear Disc		HR5132
Civic	Si	1999-2000		Coupe	HR5174	
Civic	DX	2001-2004		Coupe	HR5174	
Civic		2001-2005		Sedan	HR5174	
Civic	HX	2001-2005		Coupe	HR5174	
Civic	LX	2001-2005		Coupe	HR5174	
Civic	Si	2002-2003		Hatchback	HR5174	
Civic	Si	2004-2005		Hatchback	HR5344	HR5308
Civic	DX	2006-2011		Sedan	HR5344	
Civic	DX	2006-2011		Coupe	HR5344	
Civic	EX	2006-2011		Sedan	HR5344	
Civic	EX	2006-2011		Coupe	HR5344	
Civic	Hybrid	2006-2011		Sedan	HR5344	
Civic	LX	2006-2011		Sedan	HR5344	
Civic	LX	2006-2011		Coupe	HR5344	
Civic	GX	2006-2012		Sedan	HR5233	

ROTOR APPLICATIONS

MAKE/ MODEL	SUBMODEL	YEARS	ENGINE (LITER)	NOTE	FRONT	REAR
					ROTORS	ROTORS
GMC CONTINUED						
Civic		2006-2014		Sedan; Rear Disc		HR5303
Civic		2006-2015		Coupe; Rear Disc		HR5303
Civic	Si	2006-2015		Coupe	HR5363	
Civic	Si	2007-2015		Sedan	HR5363	
Civic	MUGEN Si	2008		Sedan	HR5363	
Civic	Hybrid-L	2009-2011		Sedan	HR5344	
Civic	EX	2012			HR5098	
Civic	EX-L	2012			HR5098	
Civic	DX	2012-2013			HR5098	
Civic	LX	2012-2013			HR5098	
Civic	Hybrid	2012-2015			HR5098	
Civic	Hybrid-L	2012-2015			HR5098	
Civic	EX	2013-2015			HR5233	
Civic	EX-L	2013-2015			HR5233	
Civic	HF	2013-2015			HR5098	
Civic	LX	2014-2015		Automatic CVT Trans.	HR5098	
Civic	LX	2014-2015		Standard Trans.	HR5233	
Civic	SE	2015			HR5098	
Civic del Sol		1993-1997		Rear Disc		HR5132
Civic del Sol	S	1993-1997			HR5176	
Civic del Sol	Si	1993-1997		Non-ABS	HR5176	
Civic del Sol	VTEC	1994-1997		4-Wheel ABS	HR5174	
Crosstour		2012-2015			HR4960	
CR-V		1997-2001			HR5179	
CR-V		2002-2004			HR5233	HR5345
CR-V		2005-2006			HR5363	HR4949
CR-V		2007-2011			HR4960	HR4949
CR-V		2012-2016		AWD	HR4960	
CR-V		2012-2016				HR4949
CRX	Base	1990-1991			HR5176	
CRX	Si	1990-1991			HR5130	HR5132
CR-Z		2011-2015			HR5344	
Element		2003-2011			HR5233	HR5359
Fit		2007-2012			HR5174	
Fit		2013-2014		GAS	HR5174	
Insight		2010-2014			HR5174	
Odyssey		1995-1998			HR5179	HR5180
Odyssey		1999-2001			HR5317	
Odyssey		2002-2004			HR5317	HR5360
Odyssey		2005-2010			HR5361	HR5362
Odyssey		2011-2014			HR5034	HR4997
Odyssey		2015-2016				HR4997
Passport		1994-2002		Rear Disc		HR5206
Passport		2002			HR5347	
Pilot		2003-2008			HR5317	HR5342
Pilot		2009-2015			HR4958	HR4997
Prelude		1988-1991				HR5132
Prelude	Si 4WS	1992-1994			HR5302	
Prelude		1992-1996				HR5131
Prelude	S	1992-1996			HR5302	
Prelude	Si	1992-1996			HR5302	
Prelude	VTEC	1993-1996			HR5231	
Prelude	SE	1995			HR5302	
Prelude		1997-2001			HR5179	HR5303
Ridgeline		2006-2014			HR5357	HR5358
S2000		2000-2009			HR5312	HR5321

ROTOR APPLICATIONS



Hawk Performance - ROTOR APPLICATIONS

HK 4218 .448 X
 HAWK KIT ROTOR PAD SHAPE INSERT COMPOUND CODE

MAKE/ MODEL	SUBMODEL	YEARS	ENGINE (LITER)	NOTE	FRONT	REAR
					ROTOR	ROTOR
HUMMER						
H2		2003-2009			HR4392	HR4393
H3		2006-2010			HR4464	HR4465
H3T		2009-2010			HR4464	HR4465
HYUNDAI						
Azera		2009		From 7/09		HR5002
Azera		2010-2016				HR5002
Elantra		1992-1996			HR5242	
Elantra		1997			HR5242	HR5283
Elantra		1998		To 8/16/98	HR5242	
Elantra		1998		From 8/16/08	HR5244	
Elantra		1998				HR5283
Elantra		1999-2006			HR5244	HR5283
Elantra		2007-2010				HR5001
Elantra		2009-2011		Hatchback	HR4932	
Entourage		2007-2008			HR4990	
Genesis		2009-2011	4.6L	4627cc V8	HR5028	
Genesis		2009-2015				HR5029
Genesis		2012-2014	3.8L	3778cc V6	HR5028	
Genesis Coupe		2010-2015		With Brembo Brakes	HR5077	HR5076
Genesis Coupe		2010-2015		With Standard Brakes	HR5079	HR5078
Santa Fe		2001	2.4L	2351cc L4, From 11/00	HR5334	
Santa Fe		2001	2.7L	2656cc V6, 4WD; To 11/00	HR5333	
Santa Fe		2001	2.7L	2656cc V6, FWD; From 11/00	HR5334	
Santa Fe		2001		To 10/00	HR5334	
Santa Fe		2001-2005				HR5340
Santa Fe		2002	2.4L	2351cc L4	HR5334	
Santa Fe		2002	2.7L	2656cc V6, 4WD	HR5333	
Santa Fe		2002	2.7L	2656cc V6, FWD	HR5334	
Santa Fe		2003-2005		With 293mm Front Discs	HR5333	
Santa Fe		2003-2005		With 275mm Front Discs	HR5334	
Santa Fe		2006			HR5333	HR5340
Santa Fe		2007-2009			HR4994	HR5004
Sonata		1999-2001			HR5244	
Sonata		2006-2010	2.4L	2359cc L4	HR4932	HR5341
Sonata		2006-2010	3.3L	3342cc V6	HR4992	HR5002
Sonata		2011-2014			HR4992	HR5002
Sonata	Hybrid Limited	2015			HR4992	HR5002
Sonata	Hybrid	2015			HR4992	HR5002
Sonata	Eco	2015-2016		Without Electronic Parking Brake		HR5002
Sonata	Limited 2.0T	2015-2016		Without Electronic Parking Brake		HR5002
Sonata	Limited	2015-2016		Without Electronic Parking Brake		HR5002
Sonata	SE	2015-2016		Without Electronic Parking Brake		HR5002
Sonata	Sport 2.0T	2015-2016		Without Electronic Parking Brake		HR5002
Sonata	Sport	2015-2016		Without Electronic Parking Brake		HR5002
Sonata	Hybrid Limited	2016		With Manual Parking Brake		HR5002
Sonata	Hybrid	2016		With Manual Parking Brake		HR5002
Tiburon		1997-1998			HR5242	HR5283
Tiburon		1999-2001			HR5244	HR5283
Tiburon		2003-2006			HR4932	HR4933
Tiburon		2007-2008		4 Speed Trans.	HR4932	HR4933
Tiburon		2007-2008		5 Speed Trans.	HR4932	HR4933
Tucson		2005-2009		FWD		HR5341
Tucson		2005-2009		4WD		HR5340
Tucson		2005-2009			HR4932	
Tucson		2010-2011		FWD	HR4932	

ROTOR APPLICATIONS

MAKE/ MODEL	SUBMODEL	YEARS	ENGINE (LITER)	NOTE	FRONT	REAR
					ROTORS	ROTORS
HYUNDAI CONTINUED						
Tucson		2010-2011		AWD	HR4992	HR5340
Tucson		2012-2014		AWD		HR5340
Tucson		2012-2014			HR4992	
Tucson	GLS	2015		AWD		HR5340
Tucson	Limited	2015		AWD		HR5340
Tucson	SE	2015		AWD		HR5340
Tucson	Fuel Cell	2015-2016				HR5002
Veloster	Turbo	2013-2016			HR4992	
Veloster	Turbo R-Spec	2014-2016			HR4992	
XG300		2001				HR5341
XG350		2002-2005				HR5341
INFINITI						
EX35		2008-2012			HR4909	HR4937
EX37		2013			HR4909	HR4937
FX35		2003-2004			HR4900	HR5356
FX35		2005		To 11/05	HR4900	
FX35		2005		From 11/05	HR4964	
FX35		2005				HR5356
FX35		2006-2012			HR4964	HR5356
FX37		2013			HR4964	HR5356
FX45		2003-2004			HR4900	HR5356
FX45		2005		To 11/05	HR4900	
FX45		2005		From 11/05	HR4964	
FX45		2005				HR5356
FX45		2006-2008			HR4964	HR5356
FX50		2009-2013			HR4971	HR5037
G20		1991-1996			HR5161	HR5198
G20		1999-2002			HR5202	HR5198
G25		2011-2012		w/o Sports Brake Package; 320mm Front, 203mm Rear Rotor	HR4909	HR4937
G35		2003		With Brembo Brakes	HR4905	HR4906
G35		2003		With Standard Brakes	HR4903	HR4904
G35		2004		RWD; With Brembo Brakes	HR4905	HR4906
G35		2004		RWD; With Standard Brakes	HR4903	HR4904
G35		2004-2005		AWD	HR4903	HR4904
G35		2005-2006		RWD	HR4909	HR4937
G35		2006		AWD	HR4909	HR4937
G35		2007		Coupe; RWD	HR4909	
G35	Base	2007		Coupe; RWD	HR4909	
G35	Base	2007		Coupe		HR4937
G35		2007-2008		AWD	HR4909	
G35	Base	2007-2008		Sedan		HR4937
G35	Base	2007-2008		Sedan; RWD	HR4909	
G35	Journey	2007-2008		Sedan		HR4937
G35	Journey	2007-2008		Sedan; RWD	HR4909	
G35	Sport	2007-2008		Sedan		HR5005
G35	Sport	2007-2008		Sedan; RWD	HR4966	
G35	X	2007-2008		Sedan		HR4937
G37	Base	2008			HR4966	HR5005
G37	Journey	2008			HR4966	HR5005
G37	Sport	2008			HR4971	HR5006
G37	Base	2009-2010		With Sport Package		HR5006
G37	Base	2009-2010		Without Sport Package		HR4937
G37	Base	2009-2010		Sedan; Without Sport Package	HR4900	
G37	Journey	2009-2010		Sedan; Without Sport Package	HR4900	HR4937
G37	Journey	2009-2010		Coupe; Without Sport Package		HR5005

Hawk Performance - ROTOR APPLICATIONS

HK 4218 .448 X
 HAWK KIT ROTOR PAD SHAPE INSERT COMPOUND CODE

MAKE/ MODEL	SUBMODEL	YEARS	ENGINE (LITER)	NOTE	FRONT	REAR
					ROTOR	ROTOR
INFINITI CONTINUED						
G37	Journey	2009-2010		Sedan; With Sport Package		HR5006
G37	Sport	2009-2010		With Sport Package		HR5006
G37	Sport	2009-2010		Without Sport Package		HR4937
G37	Sport	2009-2010		Sedan; With Sport Package	HR4971	
G37	X	2009-2010		Sedan; Without Sport Package	HR4900	
G37	Journey	2010		Convertible; Without Sport Package		HR5005
G37	Sport	2011		With Sport Brake Package; 350mm Rear Disc		HR5006
G37	Base	2011-2013		Without Sport Brake Package; 330mm Front Disc	HR4966	
G37	Base	2011-2013		Without Sport Brake Package; 330mm Rear Disc		HR5005
G37	IPL	2011-2013		Without Sport Brake Package; 330mm Front Disc	HR4966	
G37	IPL	2011-2013		Without Sport Brake Package; 330mm Rear Disc		HR5005
G37	IPL	2011-2013		With Sport Brake Package; 350mm Rear Disc		HR5006
G37	IPL	2011-2013		With Sport Brake Package; 355mm Front Disc	HR4971	
G37	Journey	2011-2013		Coupe; Without Sport Brake Package; 330mm Front Disc	HR4966	
G37	Journey	2011-2013		Coupe; Without Sport Brake Package; 330mm Rear Disc		HR5005
G37	Journey	2011-2013		Sedan; Without Sport Brake Package; 307mm Rear Disc		HR4937
G37	Journey	2011-2013		Sedan; Without Sport Brake Package; 320mm Front Disc	HR4909	
G37	Sport	2011-2013		With Sport Brake Package; 355mm Front Disc	HR4971	
G37	Sport	2011-2013		Coupe; Without Sport Brake Package; 330mm Front Disc	HR4966	
G37	Sport	2011-2013		Coupe; Without Sport Brake Package; 330mm Rear Disc		HR5005
G37	Sport	2011-2013		Sedan; Without Sport Brake Package; 307mm Rear Disc		HR4937
G37	Sport	2011-2013		Sedan; Without Sport Brake Package; 320mm Front Disc	HR4909	
G37	sport	2012		With Sport Brake Package; 350mm Rear Disc		HR5006
G37	Sport	2013		With Sport Brake Package; 350mm Rear Disc		HR5006
I30		1996-1999			HR5163	HR5269
I30		2000-2001			HR5315	HR5269
I35		2002-2004			HR5316	HR5269
J30		1993-1997			HR5195	HR5268
JX35		2013				HR5356
M35		2006-2010			HR4909	HR4937
M35h		2012-2013		With Sport Package	HR4971	HR5037
M35h		2012-2013		Without Sport Package	HR4909	HR5356
M37		2011-2013		With Sport Package	HR4971	HR5037
M37		2011-2013		Without Sport Package	HR4909	HR5356
M45		2003-2004			HR4926	HR5007
M45		2006-2010			HR4909	HR4937
M56		2011-2013		With Sport Package	HR4971	HR5037
M56		2011-2013		Without Sport Package	HR4909	HR5356
Q40		2015			HR4909	HR4937
Q45		1990-1996			HR5195	HR5196
Q45		1997-2001			HR5275	HR5268
Q45		2002-2006			HR4926	HR5007
Q50	Base	2014-2015				HR5356
Q50	Hybrid Premium	2014-2015				HR5356
Q50	Hybrid Sport	2014-2015			HR4971	HR5037
Q50	Premium	2014-2015				HR5356
Q50	Sport	2014-2015			HR4971	HR5037
Q60		2014-2015		330mm Front Rotor	HR4966	
Q60		2014-2015		330mm Rear Rotor		HR5005
Q60		2014-2015		350mm Rear Rotor		HR5006
Q60		2014-2015		355mm Front Rotor	HR4971	
Q70	3.7	2014-2015		Except Sport Brakes	HR4909	HR5356
Q70	3.7	2014-2015		Sport Brakes	HR4971	HR5037
Q70	5.6	2014-2015		Except Sport Brakes	HR4909	HR5356
Q70	5.6	2014-2015		Sport Brakes	HR4971	HR5037

ROTOR APPLICATIONS

MAKE/ MODEL	SUBMODEL	YEARS	ENGINE (LITER)	NOTE	FRONT	REAR
					ROTORS	ROTORS
INFINITI CONTINUED						
Q70	Hybrid	2014-2015			HR4909	HR5356
QX4		1997			HR5273	
QX4		1998-2003			HR5314	
QX50		2014-2015			HR4909	HR4937
QX56		2004			HR5364	HR5365
QX56		2005		Akebono Front Caliper; 350mm Rotor; From 10/05	HR4965	
QX56		2005		Bosch Front Caliper; 320mm Rotor; From 3/05	HR4952	
QX56		2005		To 3/05	HR5364	
QX56		2005-2007				HR5365
QX56		2006		Bosch Front Caliper; 320mm Rotor; To 9/06	HR4952	
QX56		2006-2007		Akebono Front Caliper; 350mm Rotor	HR4965	
QX56		2008-2010			HR4970	HR5365
QX56		2011-2013			HR5099	HR5100
QX60		2014-2015				HR5356
QX70		2014	3.7L	3696cc V6, From 9/13	HR4909	
QX70		2014	3.7L	3696cc V6, To 9/13	HR4964	
QX70		2014	3.7L	3696cc V6		HR5356
QX70		2014	5.0L	5026cc V8	HR4971	HR5037
QX70		2015	3.7L	3696cc V6	HR4909	HR5356
QX80		2014-2015			HR5099	HR5100
ISUZU						
Amigo		1994				HR5206
Amigo		1998-2000				HR5206
Ascender		2003			HR4400	HR4397
Ascender		2004-2006		5 Passenger	HR4399	
Ascender		2004-2006		7 Passenger	HR4400	
Ascender		2004-2006				HR4397
Ascender		2007-2008			HR4399	HR4397
Axiom		2002		From 11/01	HR5347	
Axiom		2002				HR5206
Axiom		2003-2004			HR5347	HR5206
Hombre		1996			HR4374	
Hombre		1997-2000		RWD	HR4374	
Hombre		1997-2000				HR4387
Hombre		1998-2000		4WD	HR4388	
i-280		2006			HR4402	
i-290		2007-2008			HR4402	
i-350		2006			HR4402	
i-370		2007-2008			HR4402	
Rodeo		1994-2001				HR5206
Rodeo		2001		From 7/01	HR5347	
Rodeo		2002-2004			HR5347	HR5206
Rodeo Sport		2001		From 7/01	HR5347	
Rodeo Sport		2001				HR5206
Rodeo Sport		2002-2003			HR5347	HR5206
Trooper		1992-2002				HR5206
VehiCROSS		1999-2001				HR5206
JAGUAR						
S-Type		2000-2002			HR4038	
S-Type	Base	2000-2005				HR4040
S-Type	Base	2003-2005		Standard Suspension; 300mm Front Discs	HR4038	
S-Type	Sport	2005		Standard Suspension; 300mm Front Discs	HR4038	
S-Type	Sport	2005				HR4040
S-Type	VDP Edition	2006		326mm Front Rotor	HR4549	HR4516
S-Type	Base	2006-2008		326mm Front Rotor	HR4549	HR4516

MAKE/ MODEL	SUBMODEL	YEARS	ENGINE (LITER)	NOTE	FRONT	REAR
					ROTOR	ROTOR
JAGUAR CONTINUED						
S-Type	R	2006-2008				HR4516
Super V8		2006-2009				HR4516
Vanden Plas		1990-1997			HR4702	
Vanden Plas		2004-2005				HR4040
Vanden Plas		2006-2009			HR4549	HR4516
XF		2009				HR4516
XF	Luxury	2009			HR4549	
XF	Premium Luxury	2009			HR4549	
XF	Base	2010			HR4549	HR4516
XF	Luxury	2010			HR4549	HR4516
XF	Premium Luxury	2010			HR4549	HR4516
XF	Premium	2010			HR4549	HR4516
XF	Premium	2011				HR4516
XF	Base	2011-2013				HR4516
XF	3.0L AWD	2013				HR4516
XF	3.0L	2013				HR4516
XF		2014-2015	2.0L	1999cc 122cid L4	HR4549	HR4516
XF		2014-2015	3.0L	2995cc 183cid V6		HR4516
XJ		2011-2013	5.0L	5000cc V8, Naturally Aspirated		HR4516
XJ		2013-2015	3.0L	2995cc 183cid V6		HR4516
XJ6		1990-1997			HR4702	
XJ8		2004-2005				HR4040
XJ8		2006-2009			HR4549	HR4516
XJR		2006-2009				HR4516
XK		2007-2009			HR4549	HR4516
XK		2010-2014				HR4516
XKR		2007				HR4516
XKR		2008-2009		Except Alcon Package		HR4516
X-Type		2002-2008			HR4834	HR4835
JEEP						
Cherokee		1990-1991		4WD	HR4424	
Cherokee		1992		4WD; To 1/92	HR4424	
Cherokee		1992		From 2/92	HR4424	
Cherokee		1993-1998			HR4424	
Cherokee		1999		With 82mm Tall Front Discs	HR4424	
Cherokee		1999		With 78mm Tall Front Discs	HR4443	
Cherokee		2000-2001			HR4443	
Comanche		1990-1992		4WD	HR4424	
Commander		2006-2010			HR4473	HR4474
Compass		2007-2008			HR4236	HR4237
Compass		2009-2016		302mm Rear Rotor		HR4193
Compass		2009-2016		262mm Rear Rotor		HR4237
Compass		2009-2016			HR4236	
Grand Cherokee		1993-1998			HR4424	HR4432
Grand Cherokee		1999-2004			HR4441	HR4442
Grand Cherokee		2005			HR4473	HR4474
Grand Cherokee	65th Anniversary Edition	2006			HR4473	HR4474
Grand Cherokee	Overland	2006-2009			HR4473	HR4474
Grand Cherokee	Laredo	2006-2010			HR4473	HR4474
Grand Cherokee	Limited	2006-2010			HR4473	HR4474
Grand Cherokee	SRT8	2006-2010			HR4475	HR4476
Grand Cherokee		2011		330mm Front Rotor; Solid Rear Rotor	HR4199	HR4198
Grand Cherokee		2011		350mm Front Rotor; Vented Rear Rotor	HR4201	HR4200
Grand Cherokee	Overland Summit	2012		330mm Front Rotor; Solid Rear Rotor	HR4199	HR4198
Grand Cherokee	Overland Summit	2012		350mm Front Rotor; Vented Rear Rotor	HR4201	HR4200

ROTOR APPLICATIONS

MAKE/ MODEL	SUBMODEL	YEARS	ENGINE (LITER)	NOTE	FRONT	REAR
					ROTORS	ROTORS
JEEP CONTINUED						
Grand Cherokee	Laredo E	2012-2013		Canada; 330mm Front Rotor; Solid Rear Rotor	HR4199	HR4198
Grand Cherokee	Laredo E	2012-2013		Canada; 350mm Front Rotor; Vented Rear Rotor	HR4201	HR4200
Grand Cherokee	Laredo X	2012-2013		Canada; 330mm Front Rotor; Solid Rear Rotor	HR4199	HR4198
Grand Cherokee	Laredo X	2012-2013		Canada; 350mm Front Rotor; Vented Rear Rotor	HR4201	HR4200
Grand Cherokee	SRT8	2012-2013			HR4203	HR4202
Grand Cherokee	Laredo	2012-2015		330mm Front Rotor; Solid Rear Rotor	HR4199	HR4198
Grand Cherokee	Laredo	2012-2015		350mm Front Rotor; Vented Rear Rotor	HR4201	HR4200
Grand Cherokee	Limited	2012-2015		330mm Front Rotor; Solid Rear Rotor	HR4199	HR4198
Grand Cherokee	Limited	2012-2015		350mm Front Rotor; Vented Rear Rotor	HR4201	HR4200
Grand Cherokee	Overland	2012-2015		330mm Front Rotor; Solid Rear Rotor	HR4199	HR4198
Grand Cherokee	Overland	2012-2015		350mm Front Rotor; Vented Rear Rotor	HR4201	HR4200
Grand Cherokee	SRT	2014-2015			HR4203	HR4202
Grand Cherokee	Summit	2014-2015		330mm Front Rotor; Solid Rear Rotor	HR4199	HR4198
Grand Cherokee	Summit	2014-2015		350mm Front Rotor; Vented Rear Rotor	HR4201	HR4200
Liberty		2002			HR4447	
Liberty		2003-2007			HR4447	HR4463
Liberty		2008-2011			HR4194	HR4195
Liberty		2012		Standard Brakes	HR4194	
Liberty		2012				HR4195
Patriot		2007-2008			HR4236	HR4237
Patriot		2009-2016		302mm Rear Rotor		HR4193
Patriot		2009-2016		262mm Rear Rotor		HR4237
Patriot		2009-2016			HR4236	
Renegade		2015-2016			HR4208	
Wagoneer		1990			HR4424	
Wrangler		1990-1995			HR4424	
Wrangler		1997-1998			HR4424	
Wrangler		1999		With 82mm Tall Front Discs	HR4424	
Wrangler		1999		With 78mm Tall Front Discs	HR4443	
Wrangler		2000-2002			HR4443	
Wrangler		2003-2006			HR4443	HR4463
Wrangler		2007-2012			HR4470	HR4242
Wrangler		2013-2016		Standard Brakes; BRW	HR4470	
Wrangler		2013-2016				HR4242
KIA						
Cadenza		2014-2016		Manual Parking Brakes		HR5002
Forte		2010-2013	2.4L	2359cc L4	HR4992	
Forte	SX	2014			HR4992	
Forte Koup		2010-2013	2.4L	2359cc L4	HR4992	
Forte Koup	SX	2014-2015			HR4992	
Forte5		2012-2013	2.4L	2359cc L4	HR4992	
Optima		2007-2010			HR4932	HR5341
Optima		2011-2012	2.4L	2359cc L4	HR4992	
Optima		2011-2012				HR5002
Optima		2013	2.4L	2359cc L4	HR4992	
Optima		2013		Except Electric Parking Brake		HR5002
Optima		2014-2015	2.4L	2359cc L4	HR4992	
Optima		2014				HR5002
Optima		2015		Except Electric Parking Brake		HR5002
Sedona		2006-2012			HR4990	
Sedona		2014			HR4990	
Sorento		2003-2006			HR5060	HR5061
Soul		2012-2013			HR4932	
Sportage		2005-2010		FWD		HR5341
Sportage		2005-2010		AWD		HR5340

ROTOR APPLICATIONS

MAKE/ MODEL	SUBMODEL	YEARS	ENGINE (LITER)	NOTE	FRONT	REAR
					ROTOR	ROTOR
KIA CONTINUED						
Sportage		2005-2010			HR4932	
Sportage		2011		FWD	HR4932	
Sportage		2011		AWD	HR4992	HR5340
Sportage		2012-2016	2.4L	2359cc L4	HR4992	
Sportage		2012-2016		AWD		HR5340
LAND ROVER						
Discovery	Series II	1999			HR4822	HR4734
Discovery		2000-2004			HR4822	HR4734
Freelander		2002-2005			HR4830	
LR3		2005			HR4827	HR4519
LR3		2006-2007	4.4L	4394cc V8	HR4827	HR4519
LR3		2008-2009			HR4827	HR4519
LR4		2010-2011			HR4831	HR4519
LR4		2012-2015		ABS exciter teeth in casting		HR4519
LR4		2012-2015			HR4831	
Range Rover	SE	1995				HR4734
Range Rover		1996-2002				HR4734
Range Rover		2014-2015	3.0L	2995cc 183cid V6	HR4831	
Range Rover		2014-2015	5.0L	5000cc 305cid V8, Without Brembo Caliper	HR4831	
Range Rover Sport		2006-2009				HR4519
Range Rover Sport	HSE	2006-2009			HR4827	
Range Rover Sport	Supercharged	2006-2009			HR4831	
Range Rover Sport	HSE	2010-2013			HR4831	HR4519
Range Rover Sport	HSE	2014-2015			HR4831	
Range Rover Sport	SE	2014-2015			HR4831	
LEXUS						
CT200h		2011-2015		259mm Rotors		HR5015
ES300		1992-1996			HR5235	HR5236
ES300		1997-2001			HR5235	HR5241
ES300		2002			HR5352	HR5353
ES300		2003			HR5257	HR5353
ES300h		2013-2014			HR4924	HR5122
ES330		2004-2006			HR5257	HR5353
ES350		2007-2012			HR4924	HR4938
ES350		2013-2015			HR4924	HR5122
GS300		1993-1997			HR5239	HR5240
GS300		1998-2005			HR5239	HR5259
GS300		2006			HR4939	HR4940
GS350		2007-2008		AWD	HR4976	
GS350		2007-2008		RWD	HR4941	
GS350		2007-2011				HR4940
GS350		2009-2010		USA Equipped	HR5043	
GS350		2009-2011		RWD; Canada Equipped	HR4941	
GS350		2009-2011		AWD; Canada Equipped	HR4976	
GS350		2013-2015		AWD	HR5116	
GS350	Base	2013-2015		RWD	HR5116	
GS400		1998-2000			HR5239	HR5259
GS430		2001-2005			HR5239	HR5259
GS430		2006-2007			HR4941	HR4940
GS450h		2007-2008			HR4941	HR4940
GS450h		2009-2011		Canada	HR4941	
GS450h		2009-2011		United States	HR5043	
GS450h		2009-2011				HR4940
GS450h		2013-2015			HR5116	
GS460		2008			HR4941	HR4940

ROTOR APPLICATIONS

MAKE/ MODEL	SUBMODEL	YEARS	ENGINE (LITER)	NOTE	FRONT	REAR
					ROTORS	ROTORS
LEXUS CONTINUED						
GS460		2009-2011		Canada	HR4941	
GS460		2009-2011		United States	HR5043	
GS460		2009-2011				HR4940
GX460		2010-2015			HR5045	HR5046
GX470		2003-2009			HR5355	HR5351
HS250h		2010-2012			HR4973	HR5023
IS250		2006-2008			HR5352	HR4942
IS250		2009				HR4942
IS250		2009-2013		USA Equipped	HR4939	
IS250		2009-2013		Canada Equipped	HR5352	
IS250		2010		Sedan		HR4942
IS250		2010-2015		Convertible		HR4940
IS250		2011-2013		Sedan; With Sport Suspension		HR4940
IS250		2011-2013		Sedan; Without Sport Suspension		HR4942
IS250		2014-2015		Sedan	HR5352	HR4942
IS250		2014-2015		Convertible; Canada	HR5352	
IS250		2014-2015		Convertible; United States	HR4939	
IS300		2001-2005			HR5239	HR5259
IS350		2006-2008			HR4941	HR4940
IS350		2009-2010		USA Equipped	HR5043	
IS350		2009-2013		Canada Equipped	HR4941	
IS350		2009-2013				HR4940
IS350		2011		USA Equipped; To 12/10	HR5043	
IS350		2012		USA Equipped; From 1/11	HR5116	
IS350		2013		USA Equipped	HR5116	
IS350		2014-2015		Convertible		HR4940
IS350		2014-2015		Convertible; Canada	HR4941	
IS350		2014-2015		Convertible; United States	HR5116	
IS350	Base	2014-2015		Sedan	HR5116	
IS350	F Sport	2014-2015		Sedan	HR4941	
LS400		1993-1994			HR5239	HR5240
LS400		1995-2000			HR5295	HR5240
LS430		2001-2006			HR5329	HR5330
LS460		2007-2009		RWD; Without Touring Package	HR4974	HR5009
LS460	L	2007-2009		RWD; With Touring Package	HR4975	HR5010
LS460		2009-2012		AWD	HR4975	HR5010
LS460		2010-2012		RWD; With Sport Package; With Brembo Brakes	HR5030	HR5010
LS460		2010-2012		RWD; Without Sport Package	HR4974	HR5009
LS460	Base	2013-2015		AWD	HR4975	HR5010
LS460	Base	2013-2015		RWD	HR4974	HR5009
LS460	F Sport	2013-2015			HR5030	HR5010
LS460	L	2013-2015		AWD	HR4975	HR5010
LS460	L	2013-2015		RWD	HR4974	HR5009
LS600h		2008-2015			HR4975	HR5010
LX450		1996-1997			HR5262	HR5263
LX470		1998-2007			HR5255	HR5256
LX570		2008-2011			HR4980	HR5011
LX570		2013-2015			HR4980	HR5011
NX200t		2015			HR4978	
NX300h		2015			HR4978	
RX300		1999-2003		FWD		HR5236
RX300		1999-2003		AWD		HR5258
RX300		1999-2003			HR5257	
RX330		2004-2006			HR4943	HR4944
RX350		2007-2009			HR4943	HR4944

ROTOR APPLICATIONS

Hawk Performance - ROTOR APPLICATIONS

HK 4218 .448 X
 HAWK KIT ROTOR PAD SHAPE INSERT COMPOUND CODE

MAKE/ MODEL	SUBMODEL	YEARS	ENGINE (LITER)	NOTE	FRONT	REAR
					ROTOR	ROTOR
LEXUS CONTINUED						
RX350		2010-2015			HR4978	HR5040
RX400h		2006-2008			HR4943	HR4944
RX450h		2010-2014			HR4978	HR5040
SC300		1992-1998			HR5237	HR5238
SC300		1999-2000			HR5239	HR5240
SC400		1992-2000			HR5239	HR5240
SC430		2002-2010			HR5239	HR5259
LINCOLN						
Aviator		2003-2005			HR4354	HR4355
Blackwood		2002			HR4345	HR4344
Continental		1993-1994			HR4031	HR4021
Continental		1995-2002			HR4029	HR4021
LS		2000-2006			HR4038	HR4040
Mark LT		2006-2008		6 Lugs		HR4360
Mark LT		2006-2008		4WD; 6 Lugs	HR4358	
Mark LT		2006-2008		RWD; 6 Lugs	HR4356	
Mark LT		2006-2008		4WD; 7 Lugs	HR4359	
Mark LT		2006-2008		RWD; 7 Lugs	HR4357	
Mark VIII		1993-1995				HR4019
Mark VIII		1996-1998			HR4029	HR4019
MKS		2009-2010			HR4063	HR4055
MKS		2011-2012			HR4272	HR4055
MKS		2013-2016			HR4277	HR4278
MKT		2010			HR4063	HR4055
MKT		2011-2012			HR4272	HR4055
MKT		2013-2016		HD Caliper; 14mm Front Caliper Mounting	HR4277	HR4278
MKT		2013-2016		Performance Caliper; 16mm Front Caliper Mounting	HR4277	
MKT		2013-2016		Standard Duty Caliper	HR4272	HR4055
MKX		2007-2008		320mm diameter	HR4059	
MKX		2007-2008		296mm diameter	HR4061	
MKX		2007-2008				HR4060
MKX		2009-2010			HR4059	HR4060
MKX		2011-2015			HR4059	HR4055
MKZ		2007-2012			HR4945	HR5368
Navigator		1998-1999		RWD	HR4326	
Navigator		1998-1999				HR4322
Navigator		1998-2000		4WD	HR4321	
Navigator		2000		To 11/99; With 12mm Studs		HR4322
Navigator		2000		From 12/99; With 14mm Studs		HR4344
Navigator		2000		RWD; From 12/99; With 14mm Studs	HR4346	
Navigator		2000		RWD; To 11/99; With 12mm Studs	HR4326	
Navigator		2001		RWD	HR4346	
Navigator		2001		4WD; From 5/24/01	HR4321	
Navigator		2001		4WD; To 5/24/01	HR4321	
Navigator		2001				HR4344
Navigator		2002		4WD; To 3/18/02	HR4321	
Navigator		2002		From 3/18/02	HR4352	HR4353
Navigator		2002		RWD; To 3/18/02	HR4346	
Navigator		2002		To 3/18/02		HR4344
Navigator		2003-2006			HR4352	HR4353
Navigator		2007-2016			HR4254	HR4264
Town Car		1998-1999		Sedan		HR4032
Town Car		1998-1999			HR4035	
Town Car		2000			HR4035	HR4032
Town Car		2001		Sedan		HR4032

ROTOR APPLICATIONS

MAKE/ MODEL	SUBMODEL	YEARS	ENGINE (LITER)	NOTE	FRONT	REAR
					ROTORS	ROTORS
LINCOLN CONTINUED						
Town Car		2001			HR4035	
Town Car		2002			HR4035	HR4032
Town Car		2003-2011			HR4042	
Zephyr		2006			HR4945	HR5368
MAZDA						
2		2011-2014			HR5109	
3		2004-2006	2.0L	2000cc 122cid L4	HR4910	HR4911
3		2004-2006	2.3L	2260cc L4	HR4912	HR4913
3	i	2007-2013			HR4910	HR4911
3	Mazdaspeed	2007-2013			HR4983	HR4913
3	S	2007-2013			HR4912	HR4913
5		2006-2010			HR4912	HR5012
5		2012-2015			HR4912	HR5012
6		2003-2005			HR5367	HR5368
6	i	2006-2007			HR4945	HR5368
6	Mazdaspeed	2006-2007			HR4946	HR4947
6	S	2006-2007			HR4945	HR5368
6		2008-2013			HR4945	HR5368
626		1993-1997		Rear Disc		HR5211
626		1993-1997			HR5210	
626		1998-2002	2.0L	1991cc L4	HR5210	
626		1998-2002		Rear Disc		HR5368
B2300		2001-2009			HR4314	
B2500		1999		Front Torsion Bar Spring	HR4314	
B2500		2001			HR4314	
B3000		1998-2000		RWD; Front Torsion Bar Spring	HR4314	
B3000		1998-2002		4WD	HR4317	
B3000		2001-2002		RWD	HR4314	
B3000		2003-2007			HR4314	
B4000		1998-2000		RWD; Front Torsion Bar Spring	HR4314	
B4000		1998-2002		4WD	HR4317	
B4000		2001-2004		RWD	HR4314	
B4000		2003-2009		4WD	HR4348	
CX-7		2007-2012			HR4982	HR5047
CX-9		2007-2015			HR5049	HR5048
Miata		1990-1993			HR5189	HR5190
Miata		1994-1997			HR5212	HR5207
Miata		1999-2000			HR5212	HR5207
Miata		2001-2003		Sport Suspension	HR5335	HR5336
Miata		2001-2003		Normal Suspension	HR5212	HR5207
Miata	Base	2004-2005		Sport Suspension	HR5335	HR5336
Miata	Base	2004-2005		Normal Suspension	HR5212	HR5207
Miata	LS	2004-2005		Sport Suspension	HR5335	HR5336
Miata	LS	2004-2005		Normal Suspension	HR5212	HR5207
Miata	Mazdaspeed	2004-2005			HR5335	HR5336
Millenia		1995-2000			HR5278	
MPV		2000-2006			HR5278	
MX-3		1992-1993	1.8L	1845cc V6		HR5207
MX-3		1994-1995	1.6L	1597cc L4, 4-Wheel ABS		HR5207
MX-5 Miata		2006-2015			HR4948	HR5368
MX-6		1993-1997			HR5210	HR5211
Protege		1990-1998		Rear Disc		HR5207
Protege	MP3	2001		Rear Disc	HR5210	HR5211
Protege	ES	2001-2003		Rear Disc	HR5210	HR5211
Protege	Mazdaspeed	2003		Rear Disc		HR5368



Hawk Performance - ROTOR APPLICATIONS

HK 4218 .448 X
 HAWK KIT ROTOR PAD SHAPE INSERT COMPOUND CODE

MAKE/ MODEL	SUBMODEL	YEARS	ENGINE (LITER)	NOTE	FRONT	REAR
					ROTOR	ROTOR
MAZDA CONTINUED						
Protege5		2002-2003			HR5210	HR5211
RX-7		1989-1991		With Solid Rear Disc		HR5191
RX-7		1989-1991		With Vented Rear Disc		HR5151
RX-7		1989-1991			HR5150	
RX-7		1993-1995			HR5276	HR5277
RX-8		2004-2008		With Normal Suspension	HR5349	
RX-8		2004-2008		With Sport Suspension	HR5350	
RX-8		2004-2008				HR5366
RX-8		2009-2011			HR5350	HR5366
Tribute		2001-2004			HR4350	
Tribute		2005-2006		Rear Disc	HR4251	HR4252
Tribute		2005-2006		Rear Drum	HR4350	
Tribute		2008-2010			HR4251	HR4252
Tribute		2011			HR4251	
MERCEDES-BENZ						
C220		1994-1996		202.022 Body Code	HR4713	
C230		1997		202.023 Body Code; With Vented Front Discs	HR4713	
C230		1999-2000		202.024 Body Code	HR4870	HR4662
C230		2002		203.747 Body Code	HR4870	HR4662
C230		2003		203.040 Body Code; With Sport Package	HR4757	HR4737
C230		2003		203.040 Body Code; Without Sport Package	HR4870	HR4662
C230		2003		203.740 Body Code; With Sport Package	HR4757	HR4737
C230		2003		203.740 Body Code; Without Sport Package	HR4870	HR4662
C230		2004		203.040 Body Code; Coupe; With 1 Piston Front Caliper		HR4662
C230		2004		203.040 Body Code; Sedan; With 1 Piston Front Caliper	HR4870	HR4662
C230		2004		203.040 Body Code; Sedan; With 4 Piston Front Caliper	HR4808	HR4737
C230		2004		203.740 Body Code; Coupe; With 1 Piston Front Caliper		HR4662
C230		2004		203.740 Body Code; Sedan; With 1 Piston Front Caliper	HR4870	HR4662
C230		2004		203.740 Body Code; Sedan; With 4 Piston Front Caliper	HR4808	HR4737
C230		2005		203.040 Body Code; Sedan; With 2 Piston Front Caliper	HR4808	HR4737
C230		2005		203.740 Body Code; Sedan; With 2 Piston Front Caliper	HR4808	HR4737
C230	Sport	2006-2007		203.052 Body Code; Sedan; With 2 Piston Front Caliper	HR4808	HR4737
C240		2001-2002		203.061 Body Code	HR4870	HR4662
C240		2003-2005		203.061 Body Code; AWD	HR4757	HR4737
C240		2003-2005		203.061 Body Code; RWD	HR4870	
C240		2003-2005		203.061 Body Code; Sedan; RWD		HR4662
C240		2003-2005		203.061 Body Code; Wagon; RWD		HR4737
C240		2003-2005		203.081 Body Code; AWD	HR4757	HR4737
C240		2003-2005		203.081 Body Code; RWD	HR4870	
C240		2003-2005		203.081 Body Code; Sedan; RWD		HR4662
C240		2003-2005		203.081 Body Code; Wagon; RWD		HR4737
C240		2003-2005		203.281 Body Code; AWD	HR4757	HR4737
C240		2003-2005		203.281 Body Code; RWD	HR4870	
C240		2003-2005		203.281 Body Code; Sedan; RWD		HR4662
C240		2003-2005		203.281 Body Code; Wagon; RWD		HR4737
C280		1994-1995		202.028 Body Code	HR4713	
C280		1996-1997		202.028 Body Code	HR4870	HR4662
C280		1998-2000		202.029 Body Code	HR4870	HR4662
C280		2006-2007		203.054 Body Code	HR4757	HR4737
C280		2006-2007		203.092 Body Code	HR4757	HR4737
C320		2001		203.064 Body Code		
C320		2001-2002		203.064 Body Code	HR4757	HR4737
C320		2002		203.264 Body Code	HR4757	HR4737
C320		2003		203.764 Body Code; Sedan; AWD	HR4757	
C320		2003		203.764 Body Code		HR4737

ROTOR APPLICATIONS



MAKE/ MODEL	SUBMODEL	YEARS	ENGINE (LITER)	NOTE	FRONT	REAR
					ROTORS	ROTORS
MERCEDES-BENZ CONTINUED						
C320		2003		203.764 Body Code; Sedan; RWD; Except 4 Piston Caliper	HR4757	
C320		2003		203.764 Body Code; Sedan; RWD; With 4 Piston Front Caliper	HR4808	
C320		2003		203.764 Body Code; Wagon; AWD	HR4757	
C320		2003-2004		203.064 Body Code		HR4737
C320		2003-2004		203.064 Body Code; Sedan; RWD; Except 4 Piston Caliper	HR4757	
C320		2003-2004		203.064 Body Code; Sedan; RWD; With 4 Piston Front Caliper	HR4808	
C320		2003-2004		203.064 Body Code; Wagon; AWD	HR4757	
C320		2003-2004		203.084 Body Code		HR4737
C320		2003-2004		203.084 Body Code; Sedan; RWD; Except 4 Piston Caliper	HR4757	
C320		2003-2004		203.084 Body Code; Sedan; RWD; With 4 Piston Front Caliper	HR4808	
C320		2003-2004		203.084 Body Code; Wagon; AWD	HR4757	
C320		2003-2004		203.284 Body Code		HR4737
C320		2003-2004		203.284 Body Code; Sedan; AWD	HR4757	
C320		2003-2004		203.284 Body Code; Sedan; RWD; Except 4 Piston Caliper	HR4757	
C320		2003-2004		203.284 Body Code; Sedan; RWD; With 4 Piston Front Caliper	HR4808	
C320		2003-2004		203.284 Body Code; Wagon; AWD	HR4757	
C320		2003-2005		203.064 Body Code; Sedan; AWD	HR4757	
C320		2003-2005		203.084 Body Code; Sedan; AWD	HR4757	
C320		2005		203.064 Body Code; AWD		HR4737
C320		2005		203.064 Body Code; RWD		HR4737
C320		2005		203.064 Body Code; Sedan; RWD; With 1 Piston Front Caliper	HR4757	
C320		2005		203.064 Body Code; Sedan; RWD; With 2 Piston Front Caliper	HR4808	
C320		2005		203.084 Body Code; AWD		HR4737
C320		2005		203.084 Body Code; RWD		HR4737
C320		2005		203.084 Body Code; Sedan; RWD; With 1 Piston Front Caliper	HR4757	
C320		2005		203.084 Body Code; Sedan; RWD; With 2 Piston Front Caliper	HR4808	
C320		2005		203.764 Body Code; AWD		HR4737
C320		2005		203.764 Body Code; RWD		HR4737
C320		2005		203.764 Body Code; Sedan; AWD	HR4757	
C320		2005		203.764 Body Code; Sedan; RWD; With 1 Piston Front Caliper	HR4757	
C320		2005		203.764 Body Code; Sedan; RWD; With 2 Piston Front Caliper	HR4808	
C350		2006-2007		203.056 Body Code		HR4737
C350		2006-2007		203.056 Body Code; AWD	HR4757	
C350		2006-2007		203.087 Body Code		HR4737
C350		2006-2007		203.087 Body Code; AWD	HR4757	
C350	Luxury	2006-2007		203.056 Body Code; Sedan; RWD; With 1 Piston Front Caliper	HR4757	
CL500		2000			HR4779	HR4524
CL500		2001			HR4779	
CL500		2002			HR4779	HR4524
CL500		2003		From CH# A032100	HR4871	HR4523
CL500		2003		To CH# A032099	HR4779	HR4524
CL500		2004-2006			HR4871	HR4523
CLK320		1998-2002		208.365 Body Code	HR4757	HR4737
CLK320		1999-2003		208.465 Body Code	HR4757	HR4737
CLK320		2003-2005		209.365 Body Code	HR4757	HR4737
CLK320		2004-2005		209.465 Body Code	HR4757	HR4737
CLK350		2006-2007		209.356 Body Code	HR4757	HR4737
CLK350		2006-2007		209.456 Body Code	HR4757	HR4737
CLK350		2008-2009		209.356 Body Code		HR4737
CLK350		2008-2009		209.456 Body Code		HR4737
CLK350		2008-2009		209.356 Body Code; With 1 Piston Front Caliper	HR4757	
CLK350		2008-2009		209.356 Body Code; With 2 Piston Front Caliper	HR4808	
CLK350		2008-2009		209.456 Body Code; With 1 Piston Front Caliper	HR4757	
CLK350		2008-2009		209.456 Body Code; With 2 Piston Front Caliper	HR4808	
CLK430		2000-2003		1 Pin Caliper		HR4737

ROTOR APPLICATIONS



Hawk Performance - ROTOR APPLICATIONS

HK 4218 .448 X
 HAWK KIT ROTOR PAD SHAPE INSERT COMPOUND CODE

MAKE/ MODEL	SUBMODEL	YEARS	ENGINE (LITER)	NOTE	FRONT	REAR
					ROTOR	ROTOR
MERCEDES-BENZ CONTINUED						
CLK430		2000-2003			HR4757	
CLS400		2015				HR4811
CLS500		2006				HR4811
CLS550		2007				HR4811
CLS550		2008-2011		219.372 Body Code		HR4811
E250		2014-2016		Except Load Stage Design		HR4810
E250		2014-2016		With Load Stage Design		HR4811
E300		1996-1997		210.020 Body Code	HR4870	HR4662
E300		1998-1999		210.025 Body Code	HR4757	HR4737
E320		1994-1995		124.032 Body Code; Convertible		HR4662
E320		1994-1995		124.032 Body Code; Coupe		HR4662
E320		1994-1995		124.032 Body Code; Sedan		HR4662
E320		1994-1995		124.032 Body Code; Wagon		HR4737
E320		1994-1995		124.052 Body Code; Convertible		HR4662
E320		1994-1995		124.052 Body Code; Coupe		HR4662
E320		1994-1995		124.052 Body Code; Sedan		HR4662
E320		1994-1995		124.052 Body Code; Wagon		HR4737
E320		1994-1995		124.066 Body Code; Convertible		HR4662
E320		1994-1995		124.066 Body Code; Coupe		HR4662
E320		1994-1995		124.066 Body Code; Sedan		HR4662
E320		1994-1995		124.066 Body Code; Wagon		HR4737
E320		1994-1995		124.092 Body Code; Convertible		HR4662
E320		1994-1995		124.092 Body Code; Coupe		HR4662
E320		1994-1995		124.092 Body Code; Sedan		HR4662
E320		1994-1995		124.092 Body Code; Wagon		HR4737
E320		1996-1997		210.055 Body Code; Sedan	HR4757	HR4737
E320		1998-2002		210.065 Body Code; Sedan	HR4757	HR4737
E320		1998-2002		210.065 Body Code; Wagon	HR4757	HR4737
E320		1998-2002		210.082 Body Code; Sedan	HR4757	HR4737
E320		1998-2002		210.082 Body Code; Wagon	HR4757	HR4737
E320		1998-2002		210.265 Body Code; Sedan	HR4757	HR4737
E320		1998-2002		210.282 Body Code; Sedan	HR4757	HR4737
E320		1998-2003		210.265 Body Code; Wagon	HR4757	HR4737
E320		1998-2003		210.282 Body Code; Wagon	HR4757	HR4737
E320		2003-2005		211.065 Body Code; Sedan		HR4810
E320		2004-2005		211.065 Body Code; Wagon		HR4811
E320		2004-2005		211.082 Body Code; Sedan		HR4810
E320		2004-2005		211.082 Body Code; Wagon		HR4811
E320		2004-2005		211.265 Body Code; Sedan		HR4810
E320		2004-2005		211.265 Body Code; Wagon		HR4811
E320		2004-2005		211.282 Body Code; Sedan		HR4810
E320		2004-2005		211.282 Body Code; Wagon		HR4811
E320		2005-2006		211.026 Body Code; Sedan		HR4810
E320		2007-2009		211.022 Body Code; Sedan		HR4810
E350		2006		211.056 Body Code; Sedan; AWD		HR4811
E350		2006		211.056 Body Code; Sedan; RWD; From CH# A870951; With Vented Rear Discs		HR4811
E350		2006		211.056 Body Code; Sedan; RWD; To CH# A870950; With Solid Rear Discs	HR4873	HR4810
E350		2006		211.056 Body Code; Wagon		HR4811
E350		2006		211.056 Body Code; Wagon; RWD; To CH# A870950	HR4873	
E350		2006		211.087 Body Code; Sedan; AWD		HR4811
E350		2006		211.087 Body Code; Sedan; RWD; From CH# A870951; With Vented Rear Discs		HR4811
E350		2006		211.087 Body Code; Sedan; RWD; To CH# A870950; With Solid Rear Discs	HR4873	HR4810

ROTOR APPLICATIONS



MAKE/ MODEL	SUBMODEL	YEARS	ENGINE (LITER)	NOTE	FRONT	REAR
					ROTORS	ROTORS
MERCEDES-BENZ CONTINUED						
E350		2006		211.087 Body Code; Wagon		HR4811
E350		2006		211.087 Body Code; Wagon; RWD; To CH# A870950	HR4873	
E350		2006		211.256 Body Code; Sedan; AWD		HR4811
E350		2006		211.256 Body Code; Sedan; RWD; From CH# A870951; With Vented Rear Discs		HR4811
E350		2006		211.256 Body Code; Sedan; RWD; To CH# A870950; With Solid Rear Discs	HR4873	HR4810
E350		2006		211.256 Body Code; Wagon		HR4811
E350		2006		211.256 Body Code; Wagon; RWD; To CH# A870950	HR4873	
E350		2006		211.287 Body Code; Sedan; AWD		HR4811
E350		2006		211.287 Body Code; Sedan; RWD; From CH# A870951; With Vented Rear Discs		HR4811
E350		2006		211.287 Body Code; Sedan; RWD; To CH# A870950; With Solid Rear Discs	HR4873	HR4810
E350		2006		211.287 Body Code; Wagon		HR4811
E350		2006		211.287 Body Code; Wagon; RWD; To CH# A870950	HR4873	
E350		2007-2009		211.056 Body Code; Sedan		HR4811
E350		2007-2009		211.087 Body Code; Sedan		HR4811
E350		2007-2009		211.087 Body Code; Wagon; AWD		HR4811
E350		2007-2009		211.287 Body Code; Sedan		HR4811
E350		2007-2009		211.287 Body Code; Wagon; AWD		HR4811
E350		2010		212.087 Body Code; Sedan		HR4811
E350		2011-2014		Sedan		HR4811
E350		2011-2014		Wagon		HR4811
E350		2015-2016				HR4811
E400		2013-2014				HR4811
E400		2015		Coupe; AWD		HR4811
E400		2015-2016		Sedan		HR4811
E420		1997		210.072 Body Code	HR4757	HR4737
E430		1998-1999		210.070 Body Code	HR4757	HR4737
E430		2000-2002		210.070 Body Code; RWD	HR4757	HR4737
E430		2000-2002		210.083 Body Code; RWD	HR4757	HR4737
E500		2003		211.070 Body Code	HR4873	HR4811
E500		2004-2006		211.070 Body Code; AWD	HR4872	HR4811
E500		2004-2006		211.070 Body Code; RWD	HR4873	
E500		2004-2006		211.083 Body Code; AWD	HR4872	HR4811
E500		2004-2006		211.083 Body Code; RWD	HR4873	
E500		2004-2006		211.283 Body Code; AWD	HR4872	HR4811
E500		2004-2006		211.283 Body Code; RWD	HR4873	
E500		2004-2006		RWD; With Solid Rear Discs		HR4810
E500		2004-2006		RWD; With Vented Rear Discs		HR4811
E550		2007-2009		211.072 Body Code		HR4811
E550		2007-2009		211.072 Body Code; AWD	HR4872	
E550		2007-2009		211.090 Body Code		HR4811
E550		2007-2009		211.090 Body Code; AWD	HR4872	
G55 AMG		2005-2006		463.271 Body Code	HR4800	HR4801
GL320		2007-2008		330mm Front Rotor	HR4802	
GL320		2007-2008		Solid Rear Rotor		HR4803
GL320		2007-2009		Vented Rear Rotor		HR4801
GL320		2007-2009		350mm Front Rotor	HR4800	
GL350		2010-2012		350mm Front Rotor	HR4800	
GL350		2010-2012				HR4801
GL450		2007		164.871 Body Code	HR4800	HR4801
GL450		2008-2012		164.871 Body Code		HR4801
GL450		2008-2012		164.871 Body Code; 350mm Front Rotor	HR4800	
GL550		2008-2012		164.886 Body Code		HR4801

Hawk Performance - ROTOR APPLICATIONS

HK 4218 .448 X
 HAWK KIT ROTOR PAD SHAPE INSERT COMPOUND CODE

MAKE/ MODEL	SUBMODEL	YEARS	ENGINE (LITER)	NOTE	FRONT	REAR
					ROTOR	ROTOR
MERCEDES-BENZ CONTINUED						
GL550		2009-2012		164.886 Body Code; 350mm Front Rotor	HR4800	
GL550		2013		Canada		HR4801
GL550		2013		Canada; 350mm Front Rotor	HR4800	
GLK250		2013-2015				HR4811
GLK350	4Matic	2010		204.987 Body Code		HR4811
GLK350	Base	2010		204.956 Body Code		HR4811
GLK350		2011-2015				HR4811
ML320		1998-2003		163.154 Body Code	HR4758	HR4759
ML320		2007		164.122 Body Code	HR4802	HR4803
ML320		2008		164.122 Body Code; With 330mm Front Discs	HR4802	
ML320		2008		164.122 Body Code; With 350mm Front Discs	HR4800	
ML320		2008		164.122 Body Code; With Solid Rear Discs		HR4803
ML320		2008		164.122 Body Code; With Vented Rear Discs		HR4801
ML320		2009		164.125 Body Code; With 330mm Front Discs	HR4802	
ML320		2009		164.125 Body Code; With 350mm Front Discs	HR4800	
ML320		2009		164.125 Body Code; With Solid Rear Discs		HR4803
ML320		2009		164.125 Body Code; With Vented Rear Discs		HR4801
ML350		2003-2005		163.157 Body Code	HR4758	HR4759
ML350		2006-2007		164.186 Body Code	HR4802	HR4803
ML350		2008-2010		164.186 Body Code; With 330mm Front Discs	HR4802	
ML350		2008-2010		164.186 Body Code; With 350mm Front Discs	HR4800	
ML350		2008-2010		164.186 Body Code; With Solid Rear Discs		HR4803
ML350		2008-2010		164.186 Body Code; With Vented Rear Discs		HR4801
ML350		2011		With 330mm Front Discs	HR4802	
ML350		2011		With 350mm Front Discs	HR4800	
ML350		2011		With Solid Rear Rotor		HR4803
ML350		2011		With Vented Rear Rotor		HR4801
ML430		1999		163.172 Body Code	HR4758	HR4759
ML450		2010-2011		164.195 Body Code; 330mm Front Rotors	HR4802	
ML450		2010-2011		164.195 Body Code; 350mm Front Rotors	HR4800	
ML450		2010-2011		164.195 Body Code; With Solid Rear Rotors		HR4803
ML450		2010-2011		164.195 Body Code; With Vented Rear Rotors		HR4801
ML500		2006-2007		164.175 Body Code; Except Sport Package	HR4802	
ML500		2006-2007		164.175 Body Code; Except Sport Package; With Solid Rear Discs		HR4803
ML500		2006-2007		164.175 Body Code; Except Sport Package; With Vented Rear Discs	HR4801	
ML500		2006-2007		164.175 Body Code; Sport Package	HR4800	HR4801
ML550		2008-2011		164.172 Body Code; 330mm Front Rotor	HR4802	
ML550		2008-2011		164.172 Body Code; 350mm Front Rotor	HR4800	
ML550		2008-2011		164.172 Body Code; Solid Rear Rotor		HR4803
ML550		2008-2011		164.172 Body Code; Vented Rear Rotor		HR4801
R320		2007-2009		Vented Rear Rotor		HR4801
R320		2007-2009		330mm Front Rotor	HR4802	
R320		2007-2009		350mm Front Rotor	HR4800	
R320		2007-2009		Solid Rear Rotor		HR4803
R350		2006-2007		251.165 Body Code; 330mm Front Rotor	HR4802	
R350		2006-2007		251.165 Body Code; Solid Rear Rotor		HR4803
R350		2008		251.165 Body Code; 330mm Front Rotor	HR4802	HR4803
R350		2008		251.156 Body Code; 330mm Front Rotor	HR4802	HR4803
R350		2009		251.156 Body Code; 330mm Front Rotor	HR4802	
R350		2009		251.156 Body Code; 350mm Front Rotor	HR4800	
R350		2009		251.156 Body Code; Solid Rear Rotor		HR4803
R350		2009		251.156 Body Code; Vented Rear Rotor		HR4801
R350		2009-2010		251.165 Body Code; 330mm Front Rotor	HR4802	
R350		2009-2010		251.165 Body Code; Solid Rear Rotor		HR4803

ROTOR APPLICATIONS

MAKE/ MODEL	SUBMODEL	YEARS	ENGINE (LITER)	NOTE	FRONT	REAR
					ROTORS	ROTORS
MERCEDES-BENZ CONTINUED						
R350		2009-2010		251.165 Body Code; 350mm Front Rotor	HR4800	
R350		2009-2010		251.165 Body Code; Vented Rear Rotor		HR4801
R350		2010		251.124 Body Code; 330mm Front Rotor	HR4802	
R350		2010		251.124 Body Code; 350mm Front Rotor	HR4800	
R350		2010		251.124 Body Code; Solid Rear Rotor		HR4803
R350		2010		251.124 Body Code; Vented Rear Rotor		HR4801
R350		2011-2012		Vented Rear Rotor		HR4801
R350		2011-2012		330mm Front Rotor	HR4802	
R350		2011-2012		350mm Front Rotor	HR4800	
R350		2011-2012		Solid Rear Rotor		HR4803
R500		2006-2007		Vented Rear Rotor		HR4801
R500		2006-2007		330mm Front Rotor	HR4802	
R500		2006-2007		350mm Front Rotor	HR4800	
R500		2006-2007		Solid Rear Rotor		HR4803
S350		2006		220.067 Body Code	HR4871	HR4523
S430		2000-2001		220.170 Body Code	HR4779	HR4524
S430		2002-2003		220.170 Body Code		HR4524
S430		2002-2003		220.170 Body Code; To 8/02	HR4779	
S430		2002-2003		220.170 Body Code; RWD; From 9/02	HR4871	
S430		2003		220.170 Body Code; AWD; From 9/02	HR4872	
S430		2003		220.183 Body Code		HR4524
S430		2003		220.183 Body Code; AWD; From 9/02	HR4872	
S430		2003		220.183 Body Code; RWD; From 9/02	HR4871	
S430		2003		220.183 Body Code; To 8/02	HR4779	
S430		2004-2006		220.170 Body Code; AWD	HR4872	HR4524
S430		2004-2006		220.170 Body Code; RWD	HR4871	HR4523
S430		2004-2006		220.183 Body Code; AWD	HR4872	HR4524
S430		2004-2006		220.183 Body Code; RWD	HR4871	HR4523
S500		2000-2001		220.175 Body Code	HR4779	HR4524
S500		2002-2003		220.175 Body Code		HR4524
S500		2002-2003		220.175 Body Code; To 8/02	HR4779	
S500		2002-2003		220.175 Body Code; RWD; From 9/02	HR4871	
S500		2003		220.175 Body Code; AWD; From 9/02	HR4872	
S500		2003		220.184 Body Code		HR4524
S500		2003		220.184 Body Code; AWD; From 9/02	HR4872	
S500		2003		220.184 Body Code; RWD; From 9/02	HR4871	
S500		2003		220.184 Body Code; To 8/02	HR4779	
S500		2004-2006		220.175 Body Code; AWD	HR4872	HR4524
S500		2004-2006		220.175 Body Code; RWD	HR4871	HR4523
S500		2004-2006		220.184 Body Code; AWD	HR4872	HR4524
S500		2004-2006		220.184 Body Code; RWD	HR4871	HR4523
SL320		1994-1995		129.063 Body Code; To CH# F125157		HR4686
SL320		1994-1997		129.063 Body Code	HR4687	
SL500		1994-1995		129.067 Body Code	HR4687	HR4686
SL500		1996-1998		129.067 Body Code; With Solid Discs	HR4687	
SL500		2005-2006		230.475 Body Code; From CH# F063165	HR4873	
SLK230		1998-2000		170.447 Body Code	HR4870	HR4662
SLK230		2001-2004		170.449 Body Code	HR4870	HR4662
SLK280		2006		Except Sport Pkg.	HR4757	HR4662
SLK280		2006		Sport Pkg.	HR4808	HR4737
SLK280		2007-2008		171.454 Body Code; Except Sport Package	HR4757	HR4662
SLK280		2007-2008		171.454 Body Code; Sport Package	HR4808	HR4737
SLK300		2009-2011		171.454 Body Code; With Sport Package	HR4757	HR4737
SLK300		2009-2011		171.454 Body Code; Without Sport Package	HR4808	HR4662
SLK320		2001		170.449 Body Code	HR4870	HR4662

Hawk Performance - ROTOR APPLICATIONS

HK 4218 .448 X
 HAWK KIT ROTOR PAD SHAPE INSERT COMPOUND CODE

MAKE/ MODEL	SUBMODEL	YEARS	ENGINE (LITER)	NOTE	FRONT	REAR
					ROTOR	ROTOR
MERCEDES-BENZ CONTINUED						
SLK320		2002-2004		170.449 Body Code	HR4757	HR4662
SLK350		2005-2008		171.456 Body Code	HR4808	HR4737
SLK350		2009-2011		171.458 Body Code; Sport Package	HR4808	HR4737
MERCURY						
Caliente		1967			HR4033	
Comet		1967			HR4033	
Cougar		1967			HR4033	
Cougar		1991-1995			HR4031	
Cougar		1993-1997		Rear Disc		HR4019
Cougar		1996		Rear Drum	HR4031	
Cougar		1996-1997		Rear Disc; With Sport Package	HR4029	
Cougar		1996-1997		Rear Disc; Except Sport Package	HR4031	
Cyclone		1967			HR4033	
Grand Marquis		1996-1997				HR4032
Grand Marquis		1998-2002			HR4035	HR4032
Grand Marquis		2003-2011			HR4042	HR4043
Marauder		2003-2004			HR4042	HR4043
Mariner		2005-2008		Rear Disc	HR4251	HR4252
Mariner		2005-2008		Rear Drum	HR4350	
Mariner		2009-2011		Rear Drum	HR4251	
Milan		2006-2011			HR4945	HR5368
Montego		2005-2007			HR4054	HR4055
Monterey		2004-2007			HR4249	HR4250
Mountaineer		1997-2001		AWD	HR4317	
Mountaineer		1997-2001		4WD	HR4317	
Mountaineer		1997-2001		RWD	HR4314	
Mountaineer		1997-2001				HR4315
Mountaineer		2002-2005			HR4351	HR4349
Mountaineer		2006-2010			HR4083	HR4349
Sable		1993				HR4021
Sable		1994-2000			HR4031	HR4021
Sable		2001-2005			HR4029	HR4021
Sable		2008-2009			HR4054	HR4055
Villager		1993-2002			HR4297	
Voyager		1967			HR4033	
MINI						
Cooper		2002-2005			HR4780	HR4781
Cooper		2006		Without John Cooper Works Brakes Kit; w/276mm Front Discs	HR4780	
Cooper		2006				HR4781
Cooper	Base	2007		Convertible; Without John Cooper Works Brakes Kit; With 276mm Front Discs	HR4780	
Cooper		2007-2008				HR4529
Cooper	Base	2007-2009		Hatchback; With 280mm Front Discs	HR4866	
Cooper	Base	2008-2009		Convertible; Without John Cooper Works Brakes Kit; With 276mm Front Discs	HR4865	
Cooper	Clubman	2008-2009		Except JCW Brake Package	HR4866	
Cooper	S	2008-2009		Convertible; Without John Cooper Works Brakes Kit; With 276mm Front Discs	HR4865	
Cooper		2009		Except JCW Brakes		HR4529
Cooper	Base	2010-2013		Except JCW Brakes	HR4866	
Cooper	Clubman	2010-2013		Except JCW Brakes	HR4866	
Cooper	S Clubman	2010-2013		Except JCW Brakes	HR4866	
Cooper	S	2010-2013		Except JCW Brakes	HR4866	
Cooper	Coupe S	2012-2013		Except JCW Brakes	HR4866	
Cooper	Coupe	2012-2013		Except JCW Brakes	HR4866	
Cooper	Roadster S	2012-2013		Except JCW Brakes	HR4866	

ROTOR APPLICATIONS



MAKE/ MODEL	SUBMODEL	YEARS	ENGINE (LITER)	NOTE	FRONT	REAR
					ROTORS	ROTORS
MINI CONTINUED						
Cooper	Roadster	2012-2013		Except JCW Brakes	HR4866	
Cooper	Base	2014		Except Sport Brake Update	HR4866	HR4529
Cooper	Base	2014		With Sport Brake Update		HR4529
Cooper	Clubman	2014		Except Sport Brake Upgrade	HR4866	
Cooper	Clubman	2014				HR4529
Cooper	Coupe	2014			HR4866	HR4529
Cooper	Roadster S	2014				HR4529
Cooper	S Clubman	2014				HR4529
Cooper	Coupe S	2014-2015				HR4529
Cooper	John Cooper Works	2014-2015		Convertible		HR4529
Cooper	Roadster John Cooper Works	2014-2015				HR4529
Cooper	Roadster	2014-2015		Except Sport Brake Upgrade	HR4866	
Cooper	Roadster	2014-2015				HR4529
Cooper	Base	2015		Convertible	HR4866	HR4529
Cooper	S	2015		Convertible		HR4529
MITSUBISHI						
3000GT		1991-1992		AWD	HR5214	
3000GT		1991-1995		FWD	HR5215	HR5216
3000GT		1993		AWD; From 6/93	HR5291	HR5292
3000GT		1993		AWD; To 5/93	HR5214	
3000GT		1994-1999		AWD	HR5291	HR5292
3000GT		1996		FWD	HR5215	
3000GT		1996		FWD		HR5216
3000GT		1997-1999		FWD	HR5215	HR5216
Diamante		1992-1996		Sedan		HR5216
Diamante		1992-2004			HR5215	
Eclipse		1990-1991		AWD	HR5170	HR5171
Eclipse		1990-1993		FWD	HR5170	HR5171
Eclipse		1992		AWD		HR5171
Eclipse		1992		AWD; From 6/92	HR5215	
Eclipse		1992		AWD; To 5/92	HR5170	
Eclipse		1993		AWD	HR5215	HR5171
Eclipse		1994		D21A Body Code; FWD		HR5171
Eclipse		1994		D22A Body Code; FWD		HR5171
Eclipse		1994		D27A Body Code; AWD		HR5171
Eclipse		1994-1995		AWD	HR5215	
Eclipse		1994-1999		FWD	HR5170	
Eclipse		1995-1999		D32A Body Code; FWD		HR5281
Eclipse		1995		AWD; From 11/94		HR5281
Eclipse		1996-1999		AWD	HR5215	HR5281
Eclipse		1996-1999		D38A Body Code; FWD		HR5281
Eclipse		2000-2001	2.4L	2351cc L4	HR5170	
Eclipse		2000	3.0L	2972cc 181cid V6	HR5215	HR5281
Eclipse		2001	3.0L	2972cc 181cid V6	HR5348	HR5281
Eclipse		2002-2005	3.0L	2972cc 181cid V6		HR5281
Eclipse		2002-2005			HR5348	
Eclipse		2006-2012	2.4L	2378cc L4		HR4927
Eclipse		2006-2012	3.8L	3828cc 230cid V6		HR4959
Eclipse		2006-2012			HR4901	
Endeavor		2004-2007			HR4919	HR4920
Endeavor		2010-2011			HR4919	HR4920
Galant		1989		From 11/89	HR5244	
Galant		1990			HR5244	
Galant		1991-1992		FWD	HR5244	
Galant	GSX	1991-1992		AWD	HR5244	

Hawk Performance - ROTOR APPLICATIONS

HK 4218 .448 X
 HAWK KIT ROTOR PAD SHAPE INSERT COMPOUND CODE

MAKE/ MODEL	SUBMODEL	YEARS	ENGINE (LITER)	NOTE	FRONT	REAR
					ROTOR	ROTOR
MINI CONTINUED						
Mini		1993-1997			HR5244	
Mini		1998-2001	2.4L	2351cc L4	HR5170	
Mini		1998		From 2/98	HR5170	
Mini		1998		To 1/98	HR5244	
Mini		1999	3.0L	2972cc 181cid V6	HR5215	
Mini		1999-2003		Rear Disc		HR5281
Mini		2000	3.0L	2972cc 181cid V6, From 6/00	HR5348	
Mini		2000	3.0L	2972cc 181cid V6, To 5/00	HR5215	
Mini		2001-2003	3.0L	2972cc 181cid V6	HR5348	
Mini		2002-2004	2.4L	2351cc L4	HR5348	
Mini		2004	3.8L	3800cc V6	HR4901	
Mini		2004-2006				HR4927
Mini		2005-2009	2.4L	2378cc L4	HR5348	
Mini		2005-2009	3.8L	3828cc 230cid V6	HR4901	
Mini	DE	2007	2.4L	2378cc L4		HR4927
Mini	ES	2007	2.4L	2378cc L4		HR4927
Mini	GTS	2007	3.8L	3828cc 230cid V6		HR4927
Mini	Ralliart	2007-2009				HR4959
Mini	DE	2008				HR4927
Mini	ES	2008-2009				HR4927
Mini	Sport Edition	2009				HR4927
Mini	Sport V6	2009				HR4959
Mini		2010-2012			HR5348	HR4927
Lancer	LS	2002-2004		FWD	HR5244	
Lancer	ES	2002-2005		FWD	HR5287	
Lancer	OZ Rally	2002-2005		FWD	HR5244	
Lancer		2003-2004		AWD	HR4907	HR4928
Lancer	Ralliart	2004		FWD	HR5348	
Lancer	Ralliart	2004		FWD; 5 Lugs	HR5348	HR5281
Lancer	Ralliart	2004		Sedan; FWD		HR5281
Lancer	Sportback	2004		FWD; 5 Lugs	HR5348	HR5281
Lancer		2005-2006		AWD		HR4928
Lancer	Evolution MR	2005-2006		AWD	HR4907	
Lancer	Evolution RS	2005-2006		AWD	HR4907	
Lancer	Evolution	2005-2006		AWD	HR4907	
Lancer	Ralliart	2005-2006		FWD; Rear Disc	HR5348	HR5281
Lancer	Evolution SE	2006		AWD	HR4907	
Lancer	OZ Rally	2006		FWD; Rear Drum; 4-Wheel ABS	HR5244	
Lancer	OZ Rally	2006		FWD; Rear Drum; Non-ABS	HR5287	
Lancer	SE	2006		FWD	HR5287	
Lancer	ES	2006-2007		FWD; Rear Drum; 4-Wheel ABS	HR5244	
Lancer	ES	2006-2007		FWD; Rear Drum; Non-ABS	HR5287	
Lancer		2008		AWD		HR5013
Lancer	Evolution GSR	2008		AWD; With Standard Discs	HR4985	
Lancer	Evolution MR	2008		AWD; With Standard Discs	HR4985	
Lancer	DE	2008-2009		FWD; Rear Disc		HR4237
Lancer	GTS	2008-2011		FWD	HR4236	
Lancer	GTS	2008-2011		FWD; Rear Disc		HR4193
Lancer	DE	2008-2015		FWD	HR4192	
Lancer	ES	2008-2015		FWD	HR4192	
Lancer	ES	2008-2015		FWD; Rear Disc		HR4237
Lancer	Ralliart	2009-2015		Rear Disc		HR5027
Lancer	Evolution MR Touring	2010-2011		AWD		HR5013
Lancer	Evolution MR Touring	2010-2011		AWD; With Standard Discs	HR4985	
Lancer	GTS Sportback	2010-2011		FWD	HR4236	

ROTOR APPLICATIONS



MAKE/ MODEL	SUBMODEL	YEARS	ENGINE (LITER)	NOTE	FRONT	REAR
					ROTORS	ROTORS
MINI CONTINUED						
Lancer	GTS Sportback	2010-2011		FWD; Rear Disc		HR4193
Lancer	Evolution GSR	2010-2015		AWD		HR5013
Lancer	Evolution GSR	2010-2015		AWD; With 1 Piece Disc	HR4985	
Lancer	Evolution MR	2010-2015		AWD		HR5013
Lancer	Evolution MR	2010-2015		AWD; With 1 Piece Disc	HR4985	
Lancer	ES Sportback	2011-2012		FWD	HR4192	
Lancer	ES Sportback	2011-2012		FWD; Rear Disc		HR4237
Lancer	GT Sportback	2012		FWD	HR4236	HR4193
Lancer	SE	2012		AWD	HR4236	
Lancer	GT	2012-2015		FWD	HR4236	HR4193
Lancer	SE	2012-2015		AWD; Rear Disc		HR4237
Lancer	SE	2013-2015		AWD	HR4192	
Mirage		1998		From 6/98; With 256mm Front Discs	HR5287	
Mirage		1999-2000		With 256mm Front Discs	HR5287	
Mirage		2001-2002			HR5287	
Montero		2000		From 2/00	HR4923	HR4930
Montero		2001-2006			HR4923	HR4930
Outlander		2003-2004			HR5348	
Outlander		2005-2006				HR5281
Outlander		2007			HR4236	HR5027
Outlander	ES	2008-2009				HR4193
Outlander	LS	2008-2009				HR5027
Outlander	SE	2008-2009				HR4193
Outlander	XLS	2008-2009				HR5027
Outlander		2008-2016			HR4236	
Outlander		2010-2011	2.4L	2360cc 144cid L4, 5 Passenger		HR4193
Outlander		2010-2011	2.4L	2360cc 144cid L4, 7 Passenger		HR5027
Outlander		2010-2013	3.0L	2998cc 182cid V6		HR5027
Outlander		2012-2015	2.4L	2360cc 144cid L4, AWD		HR5027
Outlander		2012-2015	2.4L	2360cc 144cid L4, FWD		HR4193
Outlander Sport		2011-2012			HR4236	HR4193
Outlander Sport		2013-2016			HR4236	
Raider		2006-2009			HR4460	
Sigma		1989-1990			HR5244	
NISSAN						
200SX		1995-1997	1.6L	1597cc 97cid L4, Rear Disc	HR5270	
200SX		1995-1998	1.6L	1597cc 97cid L4, Rear Drum	HR5270	
200SX		1995-1998	2.0L	1998cc L4, Rear Disc	HR5271	
200SX		1998	1.6L	1597cc 97cid L4, Rear Disc	HR5271	
240SX		1989-1993		4-Wheel ABS	HR5161	
240SX		1989-1993		Non-ABS	HR5160	
240SX		1989-1993				HR5162
240SX		1994		4-Wheel ABS; To 1/94; 4 Lugs	HR5161	
240SX		1994		From 2/94; 4 Lugs		HR5162
240SX		1994		From 2/94; 5 Lugs	HR5204	HR5272
240SX		1994		Non-ABS; 4 Lugs	HR5160	
240SX		1994		To 1/94		HR5162
240SX		1995		4 Lugs	HR5160	HR5162
240SX		1995		5 Lugs	HR5204	HR5272
240SX		1996		From 7/96; 4 Lugs	HR5161	
240SX		1996		To 6/96; 4 Lugs	HR5160	
240SX		1996		To 6/96; 5 Lugs	HR5204	
240SX		1996		4 Lugs		HR5162
240SX		1996-1998		5 Lugs		HR5272
240SX		1997-1998		4 Lugs	HR5161	HR5162

ROTOR APPLICATIONS



Hawk Performance - ROTOR APPLICATIONS

HK 4218 .448 X
 HAWK KIT ROTOR PAD SHAPE INSERT COMPOUND CODE

MAKE/ MODEL	SUBMODEL	YEARS	ENGINE (LITER)	NOTE	FRONT	REAR
					ROTOR	ROTOR
NISSAN CONTINUED						
280ZX		1979-1983			HR4899	
300ZX		1989		Turbocharged	HR5197	
300ZX		1989		From 2/89		HR5166
300ZX		1989		Naturally Aspirated; From 2/89	HR5165	
300ZX		1990		To 6/90	HR5165	
300ZX		1990		From 7/90	HR5197	
300ZX		1990				HR5166
300ZX		1991-1996			HR5197	HR5166
350Z		2003-2005		With Standard Brakes	HR4903	HR4904
350Z		2003-2009		With Brembo Brakes	HR4905	HR4906
350Z		2006-2009		With Standard Brakes	HR4909	HR4937
370Z		2009-2016		Aluminum Calipers; Sport Performance Brakes	HR4971	HR5006
370Z		2009-2016		Iron Calipers; Standard Brakes	HR4909	HR4937
Altima		1993-2001			HR5202	HR5198
Altima		2002-2004			HR5316	HR4902
Altima		2005-2006				HR4902
Altima	SE-R	2005-2006			HR4900	
Altima	S	2005-2006			HR5316	
Altima	Base	2006			HR5316	
Altima		2007-2012			HR4967	HR4902
Altima		2013		Coupe	HR4967	
Altima		2013-2015				HR4902
Armada		2005		From 3/05; With Bosch Front Calipers	HR4952	
Armada		2005		From 3/05; With Akebono Front Calipers	HR4965	
Armada		2005		To 3/05	HR5364	
Armada		2005-2007				HR5365
Armada		2006		With Bosch Front Calipers	HR4952	
Armada		2006		With Akebono Front Calipers	HR4965	
Armada		2007		To 4/07	HR4965	
Armada		2007		From 4/07	HR4970	
Armada		2008-2015			HR4970	HR5365
Cube		2009-2014			HR4963	
Frontier		1998		RWD	HR5313	
Frontier		1999	2.4L	2389cc L4, RWD; From 4/99	HR5313	
Frontier		1999		RWD; To 4/99	HR5313	
Frontier		2000-2004	2.4L	2389cc L4, RWD	HR5313	
Frontier		2003-2004	3.3L	3275cc V6, RWD	HR5273	
Frontier		2003-2004		4WD	HR5273	
Frontier		2005-2015	2.5L	2500cc L4, RWD	HR4956	
Frontier		2005-2015	4.0L	3954cc V6, RWD	HR4921	
Frontier		2005-2012		RWD		HR4954
Frontier		2005-2015		4WD	HR4921	HR4954
Frontier		2013		RWD		HR4051
Frontier		2014-2015		RWD		HR4954
Juke		2011-2013			HR5085	HR4902
Juke	Nismo RS	2014-2015				HR4904
Juke	Nismo	2014-2015			HR5085	HR4902
Juke	S	2014-2015			HR5085	HR4902
Juke	SL	2014-2015			HR5085	HR4902
Juke	SV	2014-2015			HR5085	HR4902
Leaf		2011-2015				HR4904
Maxima		1990-1994			HR5163	
Maxima		1994		From 2/94		HR5269
Maxima		1995-1998			HR5163	HR5269
Maxima		1999		To 3/99	HR5163	

ROTOR APPLICATIONS

MAKE/ MODEL	SUBMODEL	YEARS	ENGINE (LITER)	NOTE	FRONT	REAR
					ROTORS	ROTORS
NISSAN CONTINUED						
Maxima		1999		From 4/99	HR5315	
Maxima		1999				HR5269
Maxima		2000-2001			HR5315	HR5269
Maxima		2002-2003			HR5316	HR5269
Maxima		2004-2005			HR4900	HR4902
Maxima		2006-2008			HR4909	HR4902
Maxima		2009-2014			HR4909	HR4937
Murano		2003-2005			HR4900	HR5356
Murano		2006-2007			HR4909	HR5356
Murano		2009-2011			HR4900	HR5356
Murano		2012-2014			HR4909	HR5356
Murano		2015				HR5356
Pathfinder		1996-1998			HR5273	
Pathfinder		1999		To 12/98	HR5273	
Pathfinder		1999		From 12/98	HR5314	
Pathfinder		2000-2003			HR5314	
Pathfinder	Armada LE	2004			HR5364	HR5365
Pathfinder	Armada SE	2004			HR5364	HR5365
Pathfinder	LE	2004			HR5314	
Pathfinder	SE	2004			HR5314	
Pathfinder		2005-2007			HR4921	HR4922
Pathfinder		2008-2009	4.0L	3954cc V6	HR4921	
Pathfinder		2008-2009				HR4922
Pathfinder		2010	4.0L	3954cc V6	HR4921	HR4922
Pathfinder		2011-2012	4.0L	3954cc V6	HR4921	
Pathfinder		2011-2012				HR4922
Pathfinder		2015				HR5356
Quest		1993-2002			HR4297	
Quest		2004-2009			HR4926	HR5356
Quest		2011-2015			HR4926	HR5356
Rogue		2008-2013			HR4968	HR4904
Rogue		2014-2015				HR4904
Sentra		1995-1997			HR5270	
Sentra		1998-1999		Rear Disc	HR5271	
Sentra		1998-1999		Rear Drum	HR5270	
Sentra		2000		Rear Disc; From 1/00	HR5202	HR5198
Sentra		2000		Rear Disc; To 12/99	HR5271	
Sentra		2000		Rear Drum; From 1/00	HR5161	
Sentra		2000		Rear Drum; To 12/99	HR5270	
Sentra		2001-2002		Rear Disc	HR5202	HR5198
Sentra		2001-2006		Rear Drum	HR5161	
Sentra		2003		Rear Disc; With Standard Front Calipers	HR5202	
Sentra		2003		Rear Disc; To 4/03		HR5198
Sentra	Limited Edition	2003		Rear Disc; From 4/03		HR5198
Sentra	SE-R	2003		Rear Disc; From 4/03		HR5198
Sentra	S	2004		Rear Disc	HR5202	HR5198
Sentra	SE-R	2004-2006		Rear Disc	HR5202	HR5198
Sentra	Base	2007-2012			HR4963	
Sentra	SE-R Spec V	2007-2012				HR4902
Sentra	SE-R	2007-2012			HR4968	HR4902
Sentra	S	2007-2012			HR4963	
Sentra	SL	2007-2012			HR4963	
Sentra	SR	2009-2012			HR4963	
Sentra		2013-2015				HR4902
Titan		2004			HR5364	HR5365

ROTOR APPLICATIONS



Hawk Performance - ROTOR APPLICATIONS

HK 4218 .448 X
 HAWK KIT ROTOR PAD SHAPE INSERT COMPOUND CODE

MAKE/ MODEL	SUBMODEL	YEARS	ENGINE (LITER)	NOTE	FRONT	REAR
					ROTOR	ROTOR
NISSAN CONTINUED						
Titan		2005		To 3/05	HR5364	
Titan		2005		From 3/05	HR4952	
Titan		2005				HR5365
Titan		2006-2007			HR4952	HR5365
Titan		2008-2015			HR4970	HR5365
Versa		2007-2008			HR4963	
Versa	S	2009-2010			HR4963	
Versa	SL	2009-2010			HR4963	
Versa		2011-2012	1.8L	1798cc L4	HR4963	
Xterra		2000-2004			HR5273	
Xterra		2005-2015			HR4921	HR4954
OLDSMOBILE						
98		1985-1990			HR4140	
442		1969-1971			HR4065	
Alero		1999-2004			HR4165	HR4166
Aurora		1995-1996			HR4160	HR4156
Aurora		1997-1999			HR4164	HR4156
Aurora		2001-2003			HR4164	HR4156
Bravada		1991-1994			HR4366	
Bravada		1996			HR4366	
Bravada		1997-2001			HR4388	HR4387
Bravada		2002-2004			HR4399	HR4397
Custom Cruiser		1991-1992			HR4150	
Cutlass		1969-1972			HR4065	
Cutlass		1973-1977			HR4066	
Cutlass		1979-1981			HR4132	
Cutlass		1997-1999			HR4165	
Cutlass Ciera		1983-1989		115mm Bolt Circle	HR4140	
Cutlass Ciera		1990-1996			HR4140	
Cutlass Cruiser		1987-1994			HR4140	
Cutlass Supreme		1969-1972			HR4065	
Cutlass Supreme		1973-1977			HR4066	
Cutlass Supreme		1979-1981			HR4132	
Cutlass Supreme		1989-1993			HR4146	HR4147
Cutlass Supreme		1994-1995		267mm Front Discs	HR4146	
Cutlass Supreme		1994-1995		286mm Front Discs	HR4163	
Cutlass Supreme		1996-1997			HR4163	
Delta 88		1977-1978		Except Heavy Duty	HR4066	
Delta 88		1986-1991			HR4140	
F85		1969-1972			HR4065	
Intrigue		1998-1999		Standard Brakes - JB9	HR4160	
Intrigue		1998-1999		HD Brakes - JA9	HR4164	
Intrigue		1998-1999				HR4166
Intrigue		2000-2002			HR4160	HR4166
LSS		1997-1999			HR4160	
Omega		1973-1974			HR4065	
Omega		1975-1979			HR4066	
Silhouette		1990-1991			HR4140	
Silhouette		1992-2001			HR4160	
Silhouette		2002-2004		FWD	HR4160	
Silhouette		2002-2004		AWD	HR4173	
Silhouette		2002-2004				HR4174
Tornado		1986-1991			HR4140	
Tornado		1992			HR4160	HR4156
Vista Cruiser		1969-1972			HR4065	

ROTOR APPLICATIONS



MAKE/ MODEL	SUBMODEL	YEARS	ENGINE (LITER)	NOTE	FRONT	REAR
					ROTORS	ROTORS
OLDSMOBILE CONTINUED						
Vista Cruiser		1973-1975			HR4066	
Barracuda		1973-1974			HR4211	
PLYMOUTH						
Breeze		1996-2000		Rear Disc; 260mm Front Disc	HR4221	
Breeze		1996-2000		Rear Disc; 282mm Front Disc	HR4222	
Breeze		1996-2000		Rear Disc		HR4223
Breeze		1996-2000		Rear Drum	HR4221	
Cuda		1973-1974			HR4211	
Duster		1973-1976			HR4211	
Fury		1975			HR4211	
Fury		1976		From 1/76	HR4210	
Fury		1976		To 1/76	HR4211	
Fury		1977-1978			HR4210	
Gran Fury		1980-1981			HR4210	
Gran Fury		1982-1989			HR4211	
Grand Voyager		1997		FWD; With 15 inch Wheels	HR4438	
Grand Voyager		1997		Rear Disc; Canada		HR4436
Grand Voyager		1997		AWD	HR4438	
Grand Voyager		1998-2000		With 15 inch Wheels	HR4438	
Laser		1990		From 4/89	HR5170	
Laser		1991-1992			HR5170	
Laser		1993-1994		FWD	HR5170	
Laser		1993-1994		AWD; Turbocharged	HR5215	
Neon		1995-2001		Rear Disc		HR4223
Neon		2000-2001			HR4227	
Prowler		1997			HR4438	
Prowler		1999-2001			HR4438	
Roadrunner		1973-1975			HR4211	
Satellite		1973-1974			HR4211	
Scamp		1973-1976			HR4211	
Valiant		1973-1976			HR4211	
Volare		1976-1980			HR4211	
Voyager		1997-2000		With 15 inch Wheels	HR4438	
Voyager		1998-2000		Rear Disc		HR4436
PONTIAC						
6000		1983-1989		4-1/2 inch Bolt Circle	HR4140	
6000		1990-1991			HR4140	
Aztek		2001-2005		FWD	HR4172	
Aztek		2001-2005		AWD	HR4173	
Aztek		2001-2005				HR4174
Bonneville		1977-1981		With 9-1/2 inch Rear Drums	HR4066	
Bonneville		1987-1991			HR4140	
Bonneville		1992-1999			HR4160	
Bonneville		2000-2003				HR4156
Bonneville	SE	2000-2003			HR4160	
Bonneville	SLE	2000-2003			HR4164	
Bonneville	SSEi	2000-2003			HR4164	
Bonneville	SLE	2004			HR4164	HR4156
Bonneville	GXP	2004-2005			HR4077	HR4170
Bonneville	SE	2004-2005			HR4160	HR4156
Bonneville	SLE	2005			HR4191	HR4156
Catalina		1977-1981		With 9-1/2 inch Rear Drums	HR4066	
Firebird		1969			HR4065	
Firebird		1970-1977			HR4066	
Firebird		1978		Rear Drum	HR4066	

Hawk Performance - ROTOR APPLICATIONS

HK 4218 .448 X
 HAWK KIT ROTOR PAD SHAPE INSERT COMPOUND CODE

MAKE/ MODEL	SUBMODEL	YEARS	ENGINE (LITER)	NOTE	FRONT	REAR
					ROTOR	ROTOR
PONTIAC CONTINUED						
Firebird		1989-1992		Rear Disc; Except Performance Pkg	HR4110	
Firebird		1989-1992		Rear Drum	HR4110	
Firebird		1993-1997			HR4160	HR4159
Firebird		1998-2002			HR4164	HR4171
G5		2007		Rear Disc; 5 Lugs	HR4187	HR4188
G5		2007-2009		Rear Drum; 5 Lugs	HR4064	
G5		2007-2009		Rear Drum; 4 Lugs	HR4184	
G5		2008-2009		Rear Disc; 5 Lugs	HR4064	HR4188
G6		2005			HR4187	HR4188
G6		2006-2008	2.4L	2384cc 145cid L4	HR4189	
G6		2006	3.5L	214cid V6	HR4187	
G6		2006-2009	3.9L	3880cc 237cid V6	HR4187	
G6		2006-2010				HR4188
G6		2007-2010	3.5L	3490cc 213cid V6	HR4187	
G6		2007-2009	3.6L	217cid V6	HR4187	
G8	GT	2008-2009		324mm		HR4107
G8	GXP	2009		324mm		HR4107
G8	GXP	2009		365mm	HR4415	
Grand Am		1973-1975			HR4066	
Grand Am		1990		With WS6 Performance Package	HR4149	
Grand Am		1991-1998			HR4149	
Grand Am		1999-2005			HR4165	HR4166
Grand Prix		1969-1972			HR4065	
Grand Prix		1973-1977			HR4066	
Grand Prix		1979-1981			HR4132	
Grand Prix		1989-1993			HR4146	HR4147
Grand Prix		1994			HR4146	
Grand Prix		1995-1996		With 267mm Front Discs	HR4146	
Grand Prix		1995-1996		With 286mm Front Discs	HR4163	
Grand Prix		1997-2003			HR4160	HR4166
Grand Prix		2004			HR4176	HR4182
Grand Prix	GTP	2005			HR4176	HR4182
Grand Prix	GT	2005-2007			HR4176	HR4182
Grand Prix	Base	2005-2008			HR4176	HR4182
Grand Prix	GXP	2005-2008			HR4177	HR4183
GTO		1969-1972			HR4065	
GTO		1973			HR4066	
GTO		2004			HR4178	HR4180
GTO		2005-2006			HR4179	HR4181
LeMans		1969-1972			HR4065	
LeMans		1973-1977			HR4066	
LeMans		1979-1981			HR4132	
Montana		1999-2001			HR4160	
Montana		2002		AWD; Rear Disc	HR4173	
Montana		2002		AWD; Rear Disc		HR4174
Montana		2002-2004		FWD; Rear Drum	HR4160	
Montana		2002-2004		FWD; Rear Disc		HR4166
Montana		2003-2004		AWD; Rear Disc	HR4173	HR4174
Montana	Base	2005		FWD; Rear Drum	HR4160	
Montana	Base	2005		FWD		HR4166
Montana	SV6	2005		FWD	HR4176	
Montana	SV6	2005		AWD	HR4176	
Montana		2006-2008			HR4408	
Phoenix		1977-1978			HR4066	
Pursuit		2005-2006		Rear Drum; 4 Lugs	HR4184	

ROTOR APPLICATIONS



MAKE/ MODEL	SUBMODEL	YEARS	ENGINE (LITER)	NOTE	FRONT	REAR
					ROTORS	ROTORS
PONTIAC CONTINUED						
Pursuit		2006		Rear Disc; 5 Lugs	HR4187	HR4188
Solstice		2006-2009			HR4078	HR4079
Sunbird		1992-1994			HR4149	
Sunfire		1998-2005			HR4149	
Tempest		1967-1970			HR4065	
Torrent		2006			HR4175	
Torrent		2007-2009			HR4409	HR4410
Trans Sport		1990-1991			HR4140	
Ventura		1971-1974			HR4065	
Ventura		1975-1977			HR4066	
Vibe		2003-2006		Rear Disc		HR5325
Vibe		2003-2008			HR5324	
Vibe		2009-2010	1.8L	1798cc L4	HR4979	
Vibe	Base	2009-2010	1.8L	1798cc L4		HR5015
Vibe		2009-2010	2.4L	2362cc L4	HR4924	
Vibe	AWD	2009-2010	2.4L	2362cc L4		HR5016
Vibe	Base	2009-2010	2.4L	2362cc L4		HR5017
Vibe	GT	2009-2010	2.4L	2362cc L4		HR5016
PORSCHE						
911	Carrera 4	1999-2002			HR4849	
911	Carrera	1999-2004			HR4849	
911	Carrera 4	2003		996 Body Code	HR4849	
911	Carrera	2005		996 Body Code	HR4849	
911	Carrera	2005-2008		997 Body Code	HR4849	
911	Carrera 4	2006-2008		997 Body Code	HR4849	
911	Targa 4	2007-2008		997 Body Code	HR4849	
Boxster	Base	1997-1999			HR4753	HR4754
Boxster	Roadster S	2000-2003			HR4849	
Boxster	Roadster	2000-2003			HR4753	HR4754
Boxster	Base	2004			HR4753	HR4754
Boxster	S Special Edition	2004			HR4849	
Boxster	S	2004			HR4849	
Boxster	S	2005-2012		With Iron Discs	HR4849	
Boxster	S Limited Edition	2008		With Iron Discs	HR4849	
Boxster	Base	2009-2012		With Iron Rotors	HR4849	
Boxster	Spyder	2011-2012		With Iron Rotors	HR4849	
Boxster	S Black Edition	2012		With Iron Rotors	HR4849	
Cayenne		2003			HR4839	HR4496
Cayenne		2004-2006		With 330mm Front Discs	HR4837	HR4496
Cayenne		2004-2006		With 350mm Front Discs	HR4839	HR4496
Cayenne		2008-2010		With 330mm Front Discs	HR4837	HR4496
Cayenne		2008-2010		With 350mm Front Discs	HR4839	HR4496
Cayenne	Base	2011-2012		Iron Rotor; With 350mm Front Rotors	HR4839	
Cayenne		2011-2016		350 or 360mm Front; Iron Rotor		HR4496
Cayenne		2013-2016		350mm Front; Iron Rotor	HR4839	
Cayman		2006		With Iron Discs	HR4849	
Cayman	S	2007-2008		Hatchback; With Iron Discs	HR4849	
Cayman		2009-2012		With Iron Discs	HR4849	
RAM						
1500		2011-2015			HR4448	HR4450
2500		2011-2016			HR4239	HR4240
3500		2011-2013			HR4239	HR4240
3500		2014-2016			HR4239	
4500		2011-2012				HR4258
5500		2011-2012				HR4258



Hawk Performance - ROTOR APPLICATIONS

HK 4218 .448 X
 HAWK KIT ROTOR PAD SHAPE INSERT COMPOUND CODE

MAKE/ MODEL	SUBMODEL	YEARS	ENGINE (LITER)	NOTE	FRONT	REAR
					ROTOR	ROTOR
RAM CONTINUED						
CV		2012-2014		302mm Front Disc; Single Piston Front Caliper	HR4477	
CV		2012-2014		305mm Rear Disc; Single Piston Front Caliper		HR4241
Dakota		2011			HR4460	
SAAB						
900		1987		From 8/87		HR4660
900		1988-1993				HR4660
900		1994-1996			HR4719	HR4720
900		1997-1998			HR4746	HR4745
9000		1988-1998				HR4660
9-3		1999		To CH# X2020000 or X7020000	HR4746	
9-3	Base	1999		From CH# X2020001 or X7020001	HR4746	
9-3	SE	1999		From CH# X2020001 or X7020001	HR4746	
9-3		1999-2002				HR4745
9-3	Base	2000-2001			HR4746	
9-3	SE	2000-2002			HR4746	
9-3		2003		Convertible; With 288mm Discs	HR4746	
9-3		2003		Convertible; With 288mm Front Discs		HR4745
9-3	Vector	2003		With 302mm Discs	HR4807	
9-3	Arc	2003-2005		With 302mm Discs	HR4807	
9-3	Arc	2003-2005		With 302mm Front Discs		HR4806
9-3	Linear	2003-2005		With 285mm Discs	HR4804	
9-3	Linear	2003-2005		With 285mm Front Discs		HR4805
9-3	Aero	2004-2010		With 302mm Discs	HR4807	
9-3	Aero	2004-2010		With 302mm Front Discs		HR4806
9-3	2.0T	2006-2010		With 285mm Discs	HR4804	
9-3	2.0T	2006-2010		With 285mm Front Discs		HR4805
9-3	Aero	2006-2011		With 314mm Discs	HR4812	
9-3	Aero	2006-2011		With 314mm Front Discs		HR4806
9-3	Turbo4	2011		FWD; Except Performance Package; 285mm Front Disc	HR4804	
9-3	Turbo4	2011		FWD; Performance Package; 302mm Front Disc	HR4807	
9-3	Turbo4	2011		FWD; Except Performance Package; 278mm Rear Disc		HR4805
9-3	Turbo4	2011		FWD; Performance Package; 292mm Rear Disc		HR4806
9-5		1999		From CH# X3020001 To CH# X30225751		HR4745
9-5		1999		TO CH# X3020000		HR4745
9-5		1999		From CH# X3025752		HR4817
9-5		1999			HR4746	
9-5	Gary Fisher	2000			HR4746	
9-5	2.3t	2000-2001			HR4746	
9-5		2000-2001				HR4817
9-5	SE	2000-2001			HR4746	
9-5		2002-2004		185hp; With 288mm Discs	HR4746	HR4817
9-5	Linear	2005		185hp; With 288mm Discs	HR4746	
9-5	Linear	2005		220hp; With 288mm Discs	HR4746	
9-5	Arc	2005-2006		185hp; With 288mm Discs	HR4746	
9-5	Arc	2005-2006		220hp; With 288mm Discs	HR4746	
9-5		2005-2006				HR4817
9-5		2007-2009		286mm Discs		HR4817
9-5		2010		With 286mm Rear Discs		HR4817
9-5		2011		With 321mm Front Discs	HR4095	
9-5		2011		With 321mm Front Discs		HR4117
9-5		2011		With 337mm Front Discs		HR4117
9-5		2011		With 355mm Front Discs		HR4117
9-2X	Linear	2005			HR5250	
9-2X	Aero	2005-2006			HR5339	
9-2X		2005-2006				HR5139

ROTOR APPLICATIONS

MAKE/ MODEL	SUBMODEL	YEARS	ENGINE (LITER)	NOTE	FRONT	REAR
					ROTORS	ROTORS
SAAB CONTINUED						
9-2X	2.5i	2006			HR5250	
9-3X		2010		With 302mm Discs	HR4807	
9-3X		2010		With 302mm Front Discs		HR4806
9-3X		2010-2011		With 285mm Discs	HR4804	
9-3X		2010-2011		With 285mm Front Discs		HR4805
9-7x		2005-2007			HR4400	HR4397
9-7x	Aero	2008			HR4091	
9-7x	4.2i	2008-2009			HR4407	
9-7x	5.3i	2008-2009			HR4400	
9-7x		2008-2009				HR4397
SATURN						
Aura		2007-2009			HR4187	HR4188
Ion	1	2003-2005			HR4184	
Ion	2	2003-2007			HR4184	
Ion	3	2003-2007			HR4184	
Ion	Red Line	2004-2007			HR4187	HR4188
L100		2001-2002			HR4746	HR4745
L200		2001-2003			HR4746	HR4745
L300		2001-2005			HR4746	HR4745
LS		2000			HR4746	HR4745
LS1		2000			HR4746	HR4745
LS2		2000			HR4746	HR4745
LW1		2000			HR4746	HR4745
LW2		2000			HR4746	HR4745
LW200		2001-2003			HR4746	HR4745
LW300		2001-2003			HR4746	HR4745
Outlook		2007-2010			HR4417	HR4413
Relay		2005			HR4176	
Relay		2006-2007			HR4408	
SC		1991-1992			HR4152	
SC1		1993-2002			HR4152	
SC2		1993-2002			HR4152	
Sky		2007-2010			HR4078	HR4079
SL		1991-2002			HR4152	
SL1		1991-2002			HR4152	
SL2		1991-2002			HR4152	
SW1		1993-1999			HR4152	
SW2		1993-2001			HR4152	
Vue		2002-2007			HR4175	
Vue		2008-2010			HR4409	HR4410
SCION						
FR-S		2013-2016			HR4955	HR5051
TC		2005-2010			HR5324	HR5325
TC		2011-2016			HR4924	HR5087
xA		2004-2006			HR4908	
xB		2004-2006			HR4908	
xB		2008-2015			HR4973	HR5017
xD		2008-2014			HR4979	
SUBARU						
Baja		2003			HR5339	HR5332
Baja		2004-2006				HR5332
Baja	Sport	2004-2006			HR5339	
Baja	Turbo	2004-2006			HR4955	
BRZ		2013-2015		With Solid Rear Rotors	HR5250	HR5018

Hawk Performance - ROTOR APPLICATIONS

HK 4218 .448 X
 HAWK KIT ROTOR PAD SHAPE INSERT COMPOUND CODE

MAKE/ MODEL	SUBMODEL	YEARS	ENGINE (LITER)	NOTE	FRONT	REAR
					ROTOR	ROTOR
SUBARU CONTINUED						
BRZ		2013-2015		With Vented Rear Rotors	HR4955	HR5051
Forester		1998-2002			HR5250	
Forester		1999-2002		Rear Disc		HR5139
Forester		2003		Rear Disc		
Forester		2003			HR5339	HR5139
Forester		2004-2008		Rear Disc		HR5139
Forester		2004-2008			HR5339	
Forester		2009-2010			HR4914	HR5018
Forester		2011-2013			HR4955	HR5018
Forester		2014-2015	2.0L	1998cc 122cid H4	HR4986	
Forester		2014-2015	2.5L	2498cc 152cid H4	HR4955	
Impreza	LS	1993-1994		Wagon; Rear Disc		HR5139
Impreza	LS	1993-1994		Sedan; AWD	HR5138	
Impreza	LS	1993-1994		Wagon; Rear Disc; 4-Wheel ABS	HR5138	
Impreza	LS	1993-1994		Sedan; Rear Disc		HR5139
Impreza	Base	1993-1995		Sedan; FWD; With 14 inch Wheels	HR5138	
Impreza	Base	1993-1995		Sedan; FWD; With 13 inch Wheels	HR5254	
Impreza	L	1993-1995		Sedan; FWD; With 14 inch Wheels	HR5138	
Impreza	L	1993-1995		Sedan; FWD; With 13 inch Wheels	HR5254	
Impreza	L	1993-1995		Wagon; FWD; Rear Drum; Non-ABS; With 260mm Front Discs	HR5138	
Impreza	L	1993-1995		Wagon; FWD; Rear Drum; Non-ABS; With 243mm Front Discs	HR5254	
Impreza	L	1993-1996		Sedan; AWD	HR5138	
Impreza	L	1993-1996		Wagon; AWD; Rear Drum; Non-ABS	HR5138	
Impreza	L	1993		Wagon; FWD; Rear Drum; Non-ABS	HR5254	
Impreza	LS	1993		Sedan; FWD; With 14 inch Wheels	HR5138	
Impreza	LS	1993		Sedan; FWD; With 13 inch Wheels	HR5254	
Impreza	LS	1993		Wagon; FWD; With 14 inch wheels	HR5138	
Impreza	LS	1993		Wagon; FWD; With 13 inch wheels	HR5254	
Impreza	L	1995-1996		Wagon; Rear Disc		HR5139
Impreza	L	1995-1996		Sedan; Rear Disc		HR5139
Impreza	L	1995-1996		Coupe; AWD	HR5138	
Impreza	LX	1995-1996		Wagon; Rear Disc		HR5139
Impreza	LX	1995-1996		Sedan; AWD	HR5138	
Impreza	LX	1995-1996		Wagon; AWD	HR5138	
Impreza	LX	1995-1996		Sedan; Rear Disc		HR5139
Impreza	LX	1995-1996		Coupe; Rear Disc		HR5139
Impreza	LX	1995-1996		Coupe; AWD	HR5138	
Impreza	Outback	1995-1996		4-Wheel ABS		HR5139
Impreza	Outback	1995-2001			HR5138	
Impreza	Base	1995		Sedan; AWD	HR5138	
Impreza	Base	1995		Coupe; FWD; With 13 inch Wheels	HR5254	
Impreza	Base	1995		Coupe; FWD; With 14 inch Wheels	HR5138	
Impreza	Base	1995		Coupe; AWD	HR5138	
Impreza	L	1995		Coupe; FWD; With 13 inch Wheels	HR5254	
Impreza	L	1995		Coupe; FWD; With 14 inch Wheels	HR5138	
Impreza	L	1995		Wagon; FWD; Rear Disc; 4-Wheel ABS	HR5138	
Impreza	LX	1995		Sedan; FWD; With 14 inch Wheels	HR5138	
Impreza	LX	1995		Sedan; FWD; With 13 inch Wheels	HR5254	
Impreza	LX	1995		Wagon; FWD; With 14 inch wheels	HR5138	
Impreza	LX	1995		Wagon; FWD; With 13 inch wheels	HR5254	
Impreza	LX	1995		Coupe; FWD; With 13 inch Wheels	HR5254	
Impreza	LX	1995		Coupe; FWD; With 14 inch Wheels	HR5138	
Impreza	Brighton	1996-1997		Coupe	HR5138	
Impreza	L	1997-2001		Sedan	HR5138	
Impreza	L	1997-2001		Wagon	HR5138	

ROTOR APPLICATIONS

MAKE/ MODEL	SUBMODEL	YEARS	ENGINE (LITER)	NOTE	FRONT	REAR
					ROTORS	ROTORS
SUBARU CONTINUED						
Impreza	L	1997-2001		Coupe	HR5138	
Impreza	RS	1998-2001		Coupe	HR5250	HR5139
Impreza	RS	2001-2005		Sedan	HR5250	HR5139
Impreza	Outback	2002			HR5250	
Impreza	WRX	2002			HR5339	HR5139
Impreza	TS	2002-2003		Wagon	HR5250	
Impreza	TS	2003		Wagon; From 1/03		HR5139
Impreza	WRX	2003		From 1/03	HR5339	HR5139
Impreza	WRX	2003		To 12/02	HR5339	HR5139
Impreza	Outback	2003-2004			HR5250	HR5139
Impreza	TS	2004		Wagon	HR5250	HR5139
Impreza	WRX	2004-2005			HR5339	HR5139
Impreza	RS	2005		Wagon	HR5250	HR5139
Impreza	Outback Sport	2005-2007			HR5250	HR5139
Impreza	WRX STI	2005-2007			HR4914	HR4915
Impreza	2.5i	2006-2007		Sedan	HR5250	
Impreza	2.5i	2006-2007		Wagon	HR5250	
Impreza	2.5i	2006-2007				HR5139
Impreza	WRX Limited	2006-2007			HR5339	HR4953
Impreza	WRX TR	2006-2007			HR5339	HR4953
Impreza	WRX	2006-2007			HR5339	HR4953
Impreza	WRX STI Limited	2007			HR4914	HR4915
Impreza	2.5i	2008-2010		Sedan	HR5250	HR5018
Impreza	2.5i	2008-2010		Wagon	HR5250	HR5018
Impreza	Outback Sport	2008-2010			HR5250	HR5018
Impreza	WRX	2008-2010			HR5339	HR5018
Impreza	WRX STI	2008-2014			HR4914	HR5019
Impreza	2.5 GT	2009-2010			HR5339	HR5018
Impreza	2.5i Premium	2010			HR5250	HR5018
Impreza	WRX Limited	2010			HR5339	HR5018
Impreza	WRX Premium	2010			HR4914	HR5019
Impreza	WRX STI Special Edition	2010			HR4914	HR5019
Impreza	2.5i Premium	2011			HR4955	HR5018
Impreza	2.5i	2011			HR4955	HR5018
Impreza	Outback Sport	2011			HR4955	HR5018
Impreza	WRX Limited	2011-2014			HR4955	HR5018
Impreza	WRX Premium	2011-2014			HR4955	HR5018
Impreza	WRX STI Limited	2011-2014			HR4914	HR5019
Impreza	WRX	2011-2014			HR4955	HR5018
Impreza	Base	2012-2015			HR5250	
Impreza	Limited	2012-2015			HR5250	
Impreza	Premium	2012-2015			HR5250	
Impreza	Sport Limited	2012-2015			HR5250	
Impreza	Sport Premium	2012-2015			HR5250	
Legacy		1990-1994		FWD	HR5138	
Legacy		1991-1994		Sedan; Naturally Aspirated; Rear Disc		HR5139
Legacy		1991-1994		Wagon; Rear Disc		HR5139
Legacy		1991-1994		AWD; Turbocharged	HR5250	
Legacy		1995-1999		Rear Disc		HR5139
Legacy		1995		Sedan	HR5138	
Legacy		1995		Wagon	HR5138	
Legacy	LS	1996			HR5138	
Legacy	LSi	1996-1997			HR5250	
Legacy	Brighton	1996-1999		Wagon	HR5138	
Legacy	L	1996-1999			HR5138	

Hawk Performance - ROTOR APPLICATIONS

HK 4218 .448 X
 HAWK KIT ROTOR PAD SHAPE INSERT COMPOUND CODE

MAKE/ MODEL	SUBMODEL	YEARS	ENGINE (LITER)	NOTE	FRONT	REAR
					ROTOR	ROTOR
SUBARU CONTINUED						
Legacy	Outback	1996-1999			HR5250	
Legacy	GT	1996-2001			HR5250	
Legacy	L 30th Anniversary	1999			HR5138	
Legacy	Limited 30th Anniversary	1999		Sedan; Rear Disc	HR5250	
Legacy	Brighton	2000		Sedan	HR5250	
Legacy	GT Limited	2000			HR5250	
Legacy		2000-2004		Rear Disc		HR5332
Legacy	L	2000-2004			HR5250	
Legacy	GT Limited	2001-2002			HR5339	
Legacy	GT	2002-2004			HR5339	
Legacy	L SE	2003		Sedan	HR5250	
Legacy	L 35th Anniversary	2004			HR5250	
Legacy	GT	2005-2006			HR4986	HR4953
Legacy	2.5i	2006			HR4955	HR5020
Legacy	GT spec.B	2006-2009			HR4986	HR4953
Legacy	2.5i Limited	2007-2009			HR4955	HR5020
Legacy	2.5i Special Edition	2007-2009			HR4955	HR5020
Legacy	GT Limited	2007-2009			HR4986	HR4953
Legacy	GT	2008			HR4986	HR4953
Legacy	2.5i	2008-2009			HR4955	HR5020
Legacy	3.0 R Limited	2008-2009			HR4986	HR4953
Legacy	3.0 R	2009			HR4955	HR5020
Legacy	2.5GT	2010-2012			HR4986	HR5051
Legacy	3.6R Premium	2010-2012			HR4986	HR5051
Legacy	3.6R	2010-2013			HR4986	HR5051
Legacy	2.5i Limited	2010-2014			HR4955	HR5018
Legacy	2.5i Premium	2010-2014			HR4955	HR5018
Legacy	2.5i	2010-2014			HR4955	HR5018
Legacy	3.6R Limited	2010-2014			HR4986	HR5051
Outback		2000			HR5250	HR5332
Outback		2001-2004			HR5339	HR5332
Outback		2005				HR5020
Outback	i	2005			HR5339	
Outback	R L.L. Bean Edition	2005			HR5339	
Outback	R	2005			HR5339	
Outback	XT Limited	2005			HR4955	
Outback	XT	2005			HR4955	
Outback		2006-2009			HR4955	HR5020
Outback	3.6R Premium	2010-2012			HR4986	HR5051
Outback	3.6R	2010-2013			HR4986	HR5051
Outback	2.5i Limited	2010-2014			HR4955	HR5018
Outback	2.5i Premium	2010-2014			HR4955	HR5018
Outback	2.5i	2010-2014			HR4955	HR5018
Outback	3.6R Limited	2010-2014			HR4986	HR5051
WRX STI		2015			HR4914	HR5019
XV Crosstrek		2013-2015			HR4955	
SUZUKI						
Equator		2009-2012	2.5L	2500cc L4	HR4956	
Equator		2009-2012	4.0L	3954cc V6	HR4921	
Equator		2009-2012				HR4954
Grand Vitara		2000-2005			HR5305	
XL-7		2002-2006			HR5305	
XL-7		2007-2009			HR4409	HR4410

ROTOR APPLICATIONS

MAKE/ MODEL	SUBMODEL	YEARS	ENGINE (LITER)	NOTE	FRONT	REAR
					ROTORS	ROTORS
TOYOTA						
4Runner		1991		From 6/91	HR5260	
4Runner		1992-1995			HR5260	
4Runner		1996		To 10/95	HR5260	
4Runner		1996		From 11/95; 297mm Front Discs	HR5297	
4Runner		1996		From 11/95; 319mm Front Discs	HR5300	
4Runner		1997-2000		297mm Front Discs	HR5297	
4Runner		1997-2000		319mm Front Discs	HR5300	
4Runner		2001-2002		Except 16 inch Wheels; With 297mm Front Discs	HR5297	
4Runner		2001-2002		With 16 inch Wheels; 319mm Front Discs	HR5300	
4Runner		2003-2009		With 16 inch Wheels; 319mm Front Discs	HR4918	
4Runner		2003-2009		With 17 inch Wheels; 338mm Front Discs	HR5355	
4Runner		2003-2009				HR5351
4Runner		2010-2016			HR5045	HR5046
Avalon		1995-1999			HR5235	HR5294
Avalon		2000-2004			HR5235	HR5326
Avalon		2005-2007			HR5352	HR5353
Avalon		2008-2012			HR4924	HR4938
Avalon		2013-2015			HR4924	HR5122
Camry		1992-1999	2.2L	2164cc L4	HR5234	
Camry		1992-1993	3.0L	2959cc V6	HR5235	
Camry		1992-1996		Wagon; Rear Disc		HR5236
Camry		1992-1996		Sedan; Rear Disc		HR5241
Camry		1994-2001	3.0L	2995cc V6	HR5235	
Camry		1994-1996		Coupe; Rear Disc		HR5241
Camry		1997-2001		Rear Disc		HR5241
Camry		2000-2001	2.2L	2164cc L4, 225mm Front Disc	HR5234	
Camry		2000-2001	2.2L	2164cc L4, 275mm front Disc	HR5235	
Camry		2002-2006	2.4L	2362cc L4	HR5235	
Camry	SE	2002-2003	3.0L	2995cc V6, Plain Hat	HR5352	
Camry	SE	2002-2003	3.0L	2995cc V6, Stepped Hat	HR5257	
Camry	XLE	2002-2004	3.0L	2995cc V6, Plain Hat	HR5352	
Camry	XLE	2002-2004	3.0L	2995cc V6, Stepped Hat	HR5257	
Camry	LE	2002-2006	3.0L	2995cc V6	HR5235	
Camry		2002-2006		Rear Disc		HR5353
Camry	SE	2004	3.3L	3300cc V6, Plain Hat	HR5352	
Camry	SE	2004	3.3L	3300cc V6, Stepped Hat	HR5257	
Camry	XLE	2005-2006	3.0L	2995cc V6	HR5352	
Camry	SE	2005-2006	3.3L	3300cc 202cid V6, Plain Hat	HR5352	
Camry		2007-2011			HR4924	HR4938
Camry		2012-2016			HR4924	HR5122
Celica	GT	1994			HR5267	
Celica	GT	1995-1998		Convertible; To 12/97	HR5267	
Celica		1998-1999		From 12/97	HR5267	
Celica		1998-1999				HR5298
Celica	GTS	2000-2005			HR5324	HR5325
Celica	GT	2001-2005			HR5324	
Corolla		1993-1996		Wagon	HR5261	
Corolla		1993-1997		Sedan	HR5261	
Corolla		1998-2002			HR5261	
Corolla	CE	2003-2008			HR5324	
Corolla	LE	2003-2008			HR5324	
Corolla	S	2003-2008			HR5324	
Corolla		2005-2006		Rear Disc		HR5325
Corolla	XRS	2005-2006			HR5324	
Corolla		2009-2011		Rear Disc		HR5015



MAKE/ MODEL	SUBMODEL	YEARS	ENGINE (LITER)	NOTE	FRONT	REAR
					ROTOR	ROTOR
TOYOTA CONTINUED						
Corolla		2009-2015			HR4979	
Corolla		2014-2015		Rear Disc		HR5015
Echo		2001-2005			HR5224	
FJ Cruiser		2007-2009			HR4918	HR5351
FJ Cruiser		2010-2014			HR4918	HR5046
Highlander		2001-2003		FWD		HR5236
Highlander		2001-2003		AWD		HR5258
Highlander		2001-2003			HR5257	
Highlander		2004-2005			HR5257	HR4944
Highlander		2006-2007		ELECTRIC/GAS	HR4943	
Highlander		2006-2007		GAS	HR5257	
Highlander		2006-2007				HR4944
Highlander		2008-2013			HR4978	HR5022
Highlander		2014-2015			HR4978	HR5040
Land Cruiser		1993-1994			HR5262	
Land Cruiser		1995		From 1/95	HR5262	
Land Cruiser		1995		To 12/94	HR5262	
Land Cruiser		1995				HR5263
Land Cruiser		1996-1997			HR5262	HR5263
Land Cruiser		1998-2007			HR5255	HR5256
Land Cruiser		2008-2011			HR4980	HR5011
Land Cruiser		2013-2015			HR4980	HR5011
Land Cruiser		2016			HR4977	HR5011
Matrix	XRS	2003-2007				HR5325
Matrix		2003-2008			HR5324	
Matrix	Base	2009-2013			HR4979	HR5015
Matrix	S	2009-2013		FWD		HR5017
Matrix	S	2009-2013		AWD		HR5016
Matrix	S	2009-2013			HR4924	
Matrix	XRS	2009-2013			HR4924	HR5016
Mirai		2016			HR4924	
MR2	Base	1991		From 1/90	HR5221	
MR2	Base	1991				HR5222
MR2	Turbo	1991		From 1/90	HR5221	
MR2	Turbo	1991				HR5222
MR2	Turbo	1992		To 12/91	HR5221	HR5222
MR2	Base	1992-1995			HR5221	HR5222
MR2	Turbo	1992-1995		From 1/92	HR5264	HR5265
MR2 Spyder		2000-2005			HR5224	HR5328
Prius		2001-2003			HR5261	
Prius		2004-2009			HR4916	
Prius		2010-2015				HR5015
Prius V		2012-2016			HR4973	
RAV4		1996-2000			HR5299	
RAV4		2001-2005			HR5354	
RAV4		2004-2005		Rear Disc		HR5024
RAV4		2006-2008	2.4L	2362cc L4, W/3rd Row Seat	HR4924	
RAV4		2006-2008	2.4L	2362cc L4, W/O 3rd Row Seat	HR4973	
RAV4		2006-2012	3.5L	3456cc V6	HR4924	
RAV4		2006-2015		Rear Disc		HR5023
RAV4		2009-2012	2.5L	2494cc 152cid L4, W/3rd Row Seat	HR4924	
RAV4		2009-2012	2.5L	2494cc 152cid L4, W/O 3rd Row Seat	HR4973	
RAV4	EV	2012-2014			HR4924	
RAV4	LE	2013-2015		296mm Front Disc	HR4924	
RAV4	LE	2013-2015		275mm Front Disc	HR4973	

ROTOR APPLICATIONS

MAKE/ MODEL	SUBMODEL	YEARS	ENGINE (LITER)	NOTE	FRONT	REAR
					ROTORS	ROTORS
TOYOTA CONTINUED						
RAV4	Limited	2013-2015		296mm Front Disc	HR4924	
RAV4	Limited	2013-2015		275mm Front Disc	HR4973	
RAV4	XLE	2013-2015		296mm Front Disc	HR4924	
RAV4	XLE	2013-2015		275mm Front Disc	HR4973	
Sequoia		2001-2007			HR5327	HR5351
Sequoia		2008-2016			HR4977	HR5011
Sienna		1998-2003			HR5235	
Sienna		2004-2010			HR5352	HR5025
Sienna		2011-2015			HR4978	HR5040
Solara		1999-2003			HR5235	HR5241
Solara		2004-2008			HR5352	HR5353
Supra		1993-1998		Naturally Aspirated		HR5240
T100		1993-1998		4WD	HR5260	
Tacoma		1995-2003		6 Lugs	HR5297	
Tacoma		1995-2004		5 Lugs	HR5296	
Tacoma		2004		W/O VSC; 6 Lugs	HR5297	
Tacoma		2004		W/VSC; 6 Lugs	HR5300	
Tacoma		2005-2015		6 Lugs	HR4918	
Tacoma		2005-2015		5 Lugs	HR4917	
Tundra		2000-2006			HR5327	
Tundra		2007-2016			HR4977	HR5011
Venza		2009-2015			HR5041	HR5042
VOLKSWAGEN						
Beetle		1998			HR4748	HR4751
Beetle		1999-2005	1.8L	1781cc L4	HR4770	
Beetle		1999-2006	1.9L	1896cc 116cid L4	HR4748	
Beetle		1999-2005	2.0L	1984cc 121cid L4	HR4748	
Beetle		1999-2006				HR4751
Beetle		2006	2.5L	2480cc 151cid L5	HR4770	
Beetle		2007-2008			HR4770	HR4751
Beetle		2009-2010		Hatchback; 280mm Front Rotor	HR4748	
Beetle		2009-2010		Convertible; 288mm Front Rotor	HR4770	
Beetle		2009-2010				HR4751
Beetle		2012-2014	2.0L	1984cc 121cid L4, GAS	HR4897	
Beetle		2012-2014	2.5L	2480cc 151cid L5	HR4845	
Beetle		2012-2014				HR4567
Beetle		2013-2014	2.0L	1968cc 120cid L4, DIESEL	HR4845	
Beetle		2015		288mm Front Rotor	HR4845	
Beetle		2015		312mm Front Rotor	HR4897	
Beetle		2015				HR4570
Beetle	R-Line S	2016		312mm Front Rotor	HR4897	
Beetle	R-Line SE	2016		312mm Front Rotor	HR4897	
Beetle	R-Line SE	2016				HR4570
Beetle	R-Line SEL	2016		312mm Front Rotor	HR4897	
Beetle	R-Line SEL	2016				HR4570
Beetle	R-Line S	2016				HR4570
Beetle	S	2016		288mm Front Rotor	HR4845	
Beetle	SE	2016		288mm Front Rotor	HR4845	
Beetle	SE	2016				HR4570
Beetle	SEL	2016		288mm Front Rotor	HR4845	
Beetle	SEL	2016				HR4570
Beetle	S	2016				HR4570
Beetle	Wolfsburg Edition	2016		288mm Front Rotor	HR4845	
Beetle	Wolfsburg Edition	2016				HR4570
Cabrio		1995-1998			HR4666	

Hawk Performance - ROTOR APPLICATIONS

HK 4218 .448 X
 HAWK KIT ROTOR PAD SHAPE INSERT COMPOUND CODE

MAKE/ MODEL	SUBMODEL	YEARS	ENGINE (LITER)	NOTE	FRONT	REAR
					ROTOR	ROTOR
VOLKSWAGEN CONTINUED						
Cabrio		1999-2002			HR4666	HR4665
Cabrio		2002				
CC		2009-2010	2.0L	1984cc 121cid L4	HR4897	HR4898
CC		2009-2011	3.6L	3597cc 219cid V6	HR4847	HR4539
CC		2011-2016	2.0L	1984cc 121cid L4	HR4897	
CC		2012-2015	3.6L	3597cc 219cid V6		HR4539
Corrado		1990-1991				HR4665
Corrado		1992-1995			HR4692	HR4693
e-Golf		2015-2016			HR4845	HR4567
Eos		2007-2009			HR4897	
Eos		2009		From 11/09		HR4567
Eos		2010-2014			HR4897	HR4567
Eos		2015-2016		312mm Front Rotor	HR4897	
Eos		2015-2016		272mm Rear Rotor		HR4567
Eos		2016		288mm Front Rotor	HR4845	
Golf		1990-1994		Rear Disc		HR4665
Golf		1993-1994			HR4666	
Golf		1995	2.0L	1984cc 121cid L4	HR4666	
Golf		1995	2.8L	2792cc V6	HR4692	
Golf		1995		Rear Disc		HR4693
Golf		1996-1998	2.0L	1984cc 121cid L4	HR4666	HR4665
Golf		1996-1998	2.8L	2792cc V6	HR4731	HR4693
Golf		1999	1.9L	1896cc 116cid L4, From 12/98	HR4748	
Golf		1999	1.9L	1896cc 116cid L4, To 11/98	HR4666	HR4665
Golf		1999	2.0L	1984cc 121cid L4, From 12/98	HR4748	
Golf		1999	2.0L	1984cc 121cid L4, To 11/98	HR4666	HR4665
Golf		1999	2.8L	2792cc V6, From 11/98	HR4770	
Golf		1999	2.8L	2792cc V6, To 11/98	HR4731	HR4693
Golf		1999		From 12/98		HR4751
Golf		2000-2002	1.8L	1781cc L4	HR4770	
Golf		2000-2001	1.9L	1896cc 116cid L4	HR4748	
Golf		2000-2001	2.0L	1984cc 121cid L4	HR4748	
Golf		2000-2002	2.8L	2792cc V6	HR4770	
Golf		2000-2002				HR4751
Golf		2003		With Solid Discs	HR4770	
Golf		2003		With Vented Discs	HR4775	
Golf		2003-2004		With Solid Rear Discs		HR4751
Golf		2003-2004		With Vented Rear Discs		HR4776
Golf		2004	1.8L	1781cc L4, With Solid Discs	HR4770	
Golf		2004	1.8L	1781cc L4, With Vented Discs	HR4775	
Golf		2004	1.9L	1896cc 116cid L4, With Solid Discs	HR4770	
Golf		2004	1.9L	1896cc 116cid L4, With Vented Discs	HR4775	
Golf		2004	2.0L	1984cc 121cid L4, With Solid Discs	HR4770	
Golf		2004	2.0L	1984cc 121cid L4, With Vented Discs	HR4775	
Golf		2004	2.8L	2792cc V6, With Solid Discs	HR4770	
Golf		2004	2.8L	2792cc V6, With Vented Discs	HR4775	
Golf		2005		With Solid Discs	HR4770	HR4751
Golf		2005		With Vented Discs	HR4775	HR4776
Golf		2006	1.9L	1896cc 116cid L4	HR4748	
Golf		2006	2.0L	1984cc 121cid L4	HR4748	
Golf		2006		Solid Rear Disc		HR4751
Golf	TDI	2010	2.0L	1968cc 120cid L4, Bosch Rear Brakes; 272mm Rear Discs		HR4567
Golf	TDI	2010	2.0L	1968cc 120cid L4, Lucas Rear Brakes; 260mm Rear Discs		HR4538
Golf	Base	2010	2.5L	2480cc 151cid L5		HR4567
Golf		2010		Solid Rear Disc		HR4751

ROTOR APPLICATIONS



MAKE/ MODEL	SUBMODEL	YEARS	ENGINE (LITER)	NOTE	FRONT	REAR
					ROTORS	ROTORS
TOYOTA CONTINUED						
Golf		2010			HR4845	
Golf	Base	2011-2013		Lucas 260mm Rear Rotor		HR4538
Golf	Base	2011-2013		Bosch 272mm Rear Rotor		HR4567
Golf	Base	2011-2013			HR4845	
Golf	TDI	2011-2013		Lucas 260mm Rear Rotor		HR4538
Golf	TDI	2011-2013		Bosch 272mm Rear Rotor		HR4567
Golf	TDI	2011-2013			HR4845	
Golf	R	2012-2013			HR4847	HR4539
Golf		2014		288mm Front Rotor	HR4845	
Golf		2014		312mm Front Rotor	HR4897	
Golf		2014		272mm Rear Rotor		HR4567
Golf		2014-2015		253mm Rear Rotor		HR4570
Golf		2015		310mm Rear Rotor		HR4539
Golf	Launch Edition	2015		253mm Rear Rotor		HR4570
Golf	Launch Edition	2015		288mm Front Rotor	HR4845	
Golf	Launch Edition	2015		272mm Rear Rotor		HR4567
Golf	R	2015-2016				HR4539
Golf	S	2015-2016		288mm Front Rotor	HR4845	
Golf	S	2015-2016		272mm Rear Rotor		HR4567
Golf	SE	2015-2016		288mm Front Rotor	HR4845	
Golf	SE	2015-2016		272mm Rear Rotor		HR4567
Golf	SEL	2015-2016		288mm Front Rotor	HR4845	
Golf	SEL	2015-2016		272mm Rear Rotor		HR4567
Golf	TDI S	2015-2016		253mm Rear Rotor		HR4570
Golf	TDI S	2015-2016		288mm Front Rotor	HR4845	
Golf	TDI SE	2015-2016		253mm Rear Rotor		HR4570
Golf	TDI SE	2015-2016		288mm Front Rotor	HR4845	
Golf	TDI SEL	2015-2016		253mm Rear Rotor		HR4570
Golf	TDI SEL	2015-2016		288mm Front Rotor	HR4845	
Golf	Base	2016		253mm Rear Rotor		HR4570
Golf	Base	2016		288mm Front Rotor	HR4845	
Golf	Base	2016		272mm Rear Rotor		HR4567
GTI		2006-2009			HR4897	HR4898
GTI		2010			HR4897	
GTI		2011-2014			HR4897	HR4567
GTI		2015-2016		Except Performance Package; 272mm Rear Rotor		HR4567
GTI		2015-2016		Except Performance Package; 312mm Front Rotor	HR4897	
GTI		2015-2016		Performance Package; 310mm Rear Rotor		HR4539
Jetta		1990-1992		Rear Disc	HR4666	HR4665
Jetta		1993-1994			HR4666	HR4665
Jetta		1995-1997	2.0L	1984cc 121cid L4	HR4666	HR4665
Jetta		1995	2.8L	2792cc V6	HR4692	HR4693
Jetta		1996	1.9L	1896cc 116cid L4		HR4665
Jetta		1996	2.8L	2792cc V6	HR4731	HR4693
Jetta		1997	1.9L	1896cc 116cid L4	HR4748	HR4665
Jetta		1997	2.8L	2792cc V6	HR4770	HR4693
Jetta		1998	1.9L	1896cc 116cid L4, To 9/98		HR4665
Jetta		1998-2003	1.9L	1896cc 116cid L4	HR4748	
Jetta		1998	2.0L	1984cc 121cid L4, From 10/98	HR4748	
Jetta		1998	2.0L	1984cc 121cid L4, To 9/98	HR4666	HR4665
Jetta		1998	2.8L	2792cc V6, To 9/98		HR4693
Jetta		1998-2003	2.8L	2792cc V6	HR4770	
Jetta		1998		From 10/98		HR4751
Jetta		1999-2003	2.0L	1984cc 121cid L4	HR4748	
Jetta		1999-2003				HR4751

Hawk Performance - ROTOR APPLICATIONS

HK 4218 .448 X
 HAWK KIT ROTOR PAD SHAPE INSERT COMPOUND CODE

MAKE/ MODEL	SUBMODEL	YEARS	ENGINE (LITER)	NOTE	FRONT	REAR
					ROTOR	ROTOR
VOLKSWAGEN CONTINUED						
Jetta		2000-2003	1.8L	1781cc L4	HR4770	
Jetta		2004-2005	1.8L	1781cc L4	HR4770	HR4751
Jetta		2004	1.9L	1896cc 116cid L4	HR4748	HR4751
Jetta		2004	2.0L	1984cc 121cid L4	HR4748	HR4751
Jetta		2004	2.8L	2792cc V6, From 3/04	HR4775	
Jetta		2004	2.8L	2792cc V6, Rear Disc; From 3/04; With Vented Rear Discs		HR4776
Jetta		2004	2.8L	2792cc V6, Rear Disc; To 3/04; With Solid Rear Discs		HR4751
Jetta		2004	2.8L	2792cc V6, To 3/04	HR4770	
Jetta		2005	1.9L	1896cc 116cid L4, From 1/05		HR4538
Jetta		2005	1.9L	1896cc 116cid L4, To 12/04		HR4751
Jetta		2005	1.9L	1896cc 116cid L4	HR4748	
Jetta		2005	2.0L	1984cc 121cid L4, From 1/05		HR4898
Jetta		2005	2.0L	1984cc 121cid L4, To 12/04		HR4751
Jetta		2005	2.0L	1984cc 121cid L4	HR4897	
Jetta		2005	2.5L	2480cc 151cid L5	HR4845	HR4538
Jetta		2006	1.9L	1896cc 116cid L4		HR4538
Jetta		2006-2009	2.0L	1984cc 121cid L4		HR4898
Jetta		2006-2009	2.5L	2480cc 151cid L5		HR4538
Jetta		2006-2010		288mm Front Rotor	HR4845	
Jetta		2006-2010		312mm Front Rotor	HR4897	
Jetta		2009	2.0L	1968cc 120cid L4		HR4898
Jetta	TDI	2010	2.0L	1968cc 120cid L4, Sedan; Turbocharged; DIESEL		HR4538
Jetta	Wolfsburg Edition	2010	2.0L	1984cc 121cid L4, Sedan; Turbocharged; GAS		HR4898
Jetta		2010	2.5L	2480cc 151cid L5, Sedan		HR4538
Jetta		2010		Wagon		HR4538
Jetta		2010-2011		260mm Rotor		HR4538
Jetta		2011-2014	2.0L	1968cc 120cid L4, Sedan; DIESEL	HR4845	HR4567
Jetta		2011-2014	2.0L	1968cc 120cid L4, Wagon; DIESEL	HR4897	
Jetta		2011-2014	2.5L	2480cc 151cid L5, Sedan		HR4567
Jetta		2011-2014	2.5L	2480cc 151cid L5, Wagon		HR4570
Jetta		2011-2014	2.5L	2480cc 151cid L5	HR4845	
Jetta		2012-2014	2.0L	1984cc 121cid L4, Sedan; Turbocharged; GAS		HR4567
Jetta		2012-2014	2.0L	1984cc 121cid L4, Turbocharged; GAS	HR4897	
Jetta		2013-2014	1.4L	1395cc 85cid L4, ELECTRIC/GAS	HR4845	HR4567
Jetta		2014	1.8L	1798cc 110cid L4	HR4845	HR4567
Jetta		2014	2.0L	1984cc 121cid L4, Naturally Aspirated; GAS	HR4845	
Jetta		2014	2.0L	1984cc 121cid L4, Sedan; GAS		HR4567
Jetta		2015		Sedan; 280mm Front Rotor; 253mm Rear Rotor		HR4567
Jetta		2015		Sedan; 288mm Front Rotor	HR4845	
Jetta		2015		Sedan; 288mm Front Rotor; 253mm Rear Rotor		HR4570
Jetta		2015		Sedan; 312mm Front Rotor	HR4897	
Jetta		2015		Sedan; 312mm Front Rotor; 253mm Rear Rotor		HR4567
Jetta	GLI SE	2016		Sedan; 312mm Front Rotor	HR4897	
Jetta	GLI SE	2016		Sedan; 253mm Rear Rotor		HR4570
Jetta	GLI SEL	2016		Sedan; 312mm Front Rotor	HR4897	
Jetta	GLI SEL	2016		Sedan; 253mm Rear Rotor		HR4570
Jetta	Hybrid SEL Premium	2016		Sedan; 288mm Front Rotor	HR4845	
Jetta	Hybrid SEL Premium	2016		Sedan; 253mm Rear Rotor		HR4570
Jetta	Hybrid SEL Premium	2016		Sedan; 272mm Rear Rotor		HR4567
Jetta	S	2016		Sedan; 272mm Rear Rotor		HR4570
Jetta	SE	2016		Sedan; 288mm Front Rotor	HR4845	
Jetta	SE	2016		Sedan; 253mm Rear Rotor		HR4570
Jetta	SE	2016		Sedan; 272mm Rear Rotor		HR4567
Jetta	SEL Premium	2016		Sedan; 288mm Front Rotor	HR4845	
Jetta	SEL Premium	2016		Sedan; 253mm Rear Rotor		HR4570

ROTOR APPLICATIONS



MAKE/ MODEL	SUBMODEL	YEARS	ENGINE (LITER)	NOTE	FRONT	REAR
					ROTORS	ROTORS
TOYOTA CONTINUED						
Jetta	SEL Premium	2016		Sedan; 272mm Rear Rotor		HR4567
Jetta	SEL	2016		Sedan; 288mm Front Rotor	HR4845	
Jetta	SEL	2016		Sedan; 253mm Rear Rotor		HR4570
Jetta	SEL	2016		Sedan; 272mm Rear Rotor		HR4567
Jetta	Sport	2016		Sedan; 288mm Front Rotor	HR4845	
Jetta	Sport	2016		Sedan; 253mm Rear Rotor		HR4570
Jetta	Sport	2016		Sedan; 272mm Rear Rotor		HR4567
Passat		1990-1992			HR4666	
Passat		1993	1.8L	1780cc L4	HR4666	HR4665
Passat		1993-1997	1.9L	1896cc 116cid L4	HR4666	HR4665
Passat		1993	2.0L	1984cc 121cid L4	HR4666	HR4665
Passat		1993-1995	2.8L	2792cc V6	HR4692	HR4693
Passat		1994	2.0L	1984cc L4	HR4666	HR4665
Passat		1995-1996	2.0L	1984cc 121cid L4	HR4666	HR4665
Passat		1996-1997	2.8L	2792cc V6	HR4731	HR4693
Passat		1998		From 7/98; From CH# 3B-X-124-108	HR4695	
Passat		1998				HR4694
Passat		1999-2001		FWD	HR4695	HR4694
Passat		2000-2001		AWD	HR4695	HR4723
Passat		2002-2004	1.8L	1781cc L4, FWD	HR4695	HR4694
Passat		2002-2004	2.8L	2771cc V6, AWD		HR4723
Passat		2002-2004	2.8L	2771cc V6, FWD	HR4695	HR4694
Passat		2002-2004		AWD	HR4695	
Passat		2004	1.8L	1781cc L4, AWD		HR4723
Passat		2004	2.0L	1967cc 120cid L4, FWD	HR4695	HR4694
Passat		2005		FWD	HR4695	HR4694
Passat		2005		AWD	HR4695	HR4723
Passat		2006-2007	2.0L	1984cc 121cid L4, FWD	HR4897	HR4898
Passat		2006-2007	3.6L	3597cc 219cid V6, AWD	HR4847	HR4539
Passat		2006-2007	3.6L	3597cc 219cid V6, FWD	HR4897	HR4898
Passat		2008-2009	2.0L	1984cc 121cid L4	HR4897	HR4898
Passat		2008	3.6L	3597cc 219cid V6	HR4847	HR4539
Passat		2009	3.6L	3597cc 219cid V6, Canada	HR4847	HR4539
Passat		2010			HR4897	
Passat		2012-2015			HR4897	HR4567
Phaeton		2004-2006			HR4840	
R32		2008			HR4847	HR4539
Rabbit		2006-2009			HR4845	HR4538
Routan		2009-2011			HR4477	HR4241
Routan		2012-2013		302mm Front Rotor	HR4477	
Routan		2012-2013		305mm Rear Rotor		HR4241
Tiguan		2009-2010			HR4897	HR4898
Tiguan		2011-2016			HR4897	
Touareg		2004-2007				HR4496
Touareg		2004-2010		With 350mm Front Discs	HR4839	
Touareg		2004-2016		With 330mm Front Discs	HR4837	
Touareg		2008-2010		330mm or 350mm Front Rotors		HR4496
Touareg		2011-2016				HR4496
VOLVO						
850		1994-1997			HR4717	HR4718
960		1995-1997			HR4717	
C30		2008-2011			HR4895	HR4535
C30		2012-2013		278mm Front Disc	HR4281	
C30		2012-2013		300mm Front Disc	HR4895	
C30		2012-2013				HR4535

Hawk Performance - ROTOR APPLICATIONS

HK 4218

HAWK KIT

ROTOR

.448

PAD SHAPE

X

INSERT COMPOUND CODE

MAKE/ MODEL	SUBMODEL	YEARS	ENGINE (LITER)	NOTE	FRONT	REAR
					ROTOR	ROTOR
VOLVO CONTINUED						
C70		1998-2001				HR4718
C70		1998-2002		With 280mm Front Discs	HR4717	
C70		2003-2004				HR4718
C70		2006-2008			HR4895	HR4535
C70		2009-2013		300mm Front Rotors	HR4895	
C70		2009-2013		320mm Front Rotors	HR4896	
C70		2009-2013				HR4535
S40		2000-2004			HR4773	HR4774
S40	i	2005		With 300mm Front Discs	HR4895	
S40	T5	2005-2010		With 320mm Front Discs	HR4896	
S40		2005-2012				HR4535
S40	2.4i	2006-2010		With 300mm Front Discs	HR4895	
S40	T5 R-Design	2010		With 320mm Front Discs	HR4896	
S40		2011-2012		With 300mm Front Discs	HR4895	
S40		2011-2012		With 320mm Front Discs	HR4896	
S40		2012		With 278mm Front Discs	HR4281	
S60	2.4T	2001-2003			HR4771	
S60		2001-2003				HR4764
S60	T5	2001-2003			HR4772	
S60	2.5T	2004-2007		With 286mm Front Discs	HR4771	
S60	2.5T	2004-2007				HR4764
S60	T5	2004-2007		With 305mm Front Discs	HR4772	
S60	T5	2004-2007				HR4764
S60	2.5T	2008-2009		With 305mm Front Discs	HR4772	
S60		2008-2009				HR4764
S60	T5	2008-2009		With 316mm Front Discs	HR4892	
S70		1998			HR4717	HR4718
S70		1999-2000		AWD; TO CH# 506635		HR4756
S70		1999-2000		FWD		HR4718
S80		1999-2006		With 286mm Front Discs	HR4771	
S80		1999-2006		With 305mm Front Discs	HR4772	
S80		1999-2006				HR4764
S90		1997-1998			HR4717	
V40		2000-2004			HR4773	HR4774
V50	i	2005		With 300mm Front Discs	HR4895	
V50	T5	2005-2009		With 320mm Front Discs	HR4896	
V50		2005-2011				HR4535
V50	2.4i	2006-2010		With 300mm Front Discs	HR4895	
V50	T5 R-Design	2010		With 320mm Front Discs	HR4896	
V50		2011		With 300mm Front Discs	HR4895	
V50		2011		With 320mm Front Discs	HR4896	
V70		1998		AWD		HR4756
V70		1998-2000		AWD; With 280mm Front Discs	HR4717	
V70		1998-2000		FWD; With 280mm Front Discs	HR4717	
V70		1998-2000		FWD		HR4718
V70		1999		AWD; To CH# 588639		HR4756
V70		2000		AWD; To CH# 587441; With Girling Rear Calipers		HR4756
V70		2001-2003		AWD	HR4771	HR4764
V70	2.4T	2001-2003		FWD; With 286mm Front Discs	HR4771	
V70	Base	2001-2003		FWD; With 286mm Front Discs	HR4771	
V70	T5	2001-2005		FWD; With 305mm Front Discs	HR4772	
V70	T5	2001-2005		FWD		HR4764
V70	2.5T AWD	2004		AWD; With 286mm Front Discs	HR4771	
V70		2004-2006		AWD; With 286mm Front Disc	HR4771	
V70	2.4	2004-2007		FWD; With 286mm Front Discs	HR4771	

ROTOR APPLICATIONS



MAKE/ MODEL	SUBMODEL	YEARS	ENGINE (LITER)	NOTE	FRONT	REAR
					ROTORs	ROTORs
VOLVO CONTINUED						
V70	2.5T	2004-2007		FWD; With 286mm Front Discs	HR4771	
V90		1997-1998			HR4717	
XC70		2003-2006		With 286mm Front Discs	HR4771	
XC70		2003-2007				HR4764
XC70		2007		With 305mm Front Discs	HR4771	
XC90		2003-2014		With 316mm Front Discs	HR4892	
XC90		2003-2014		With 336mm Front Discs	HR4893	
XC90		2003-2014				HR4546

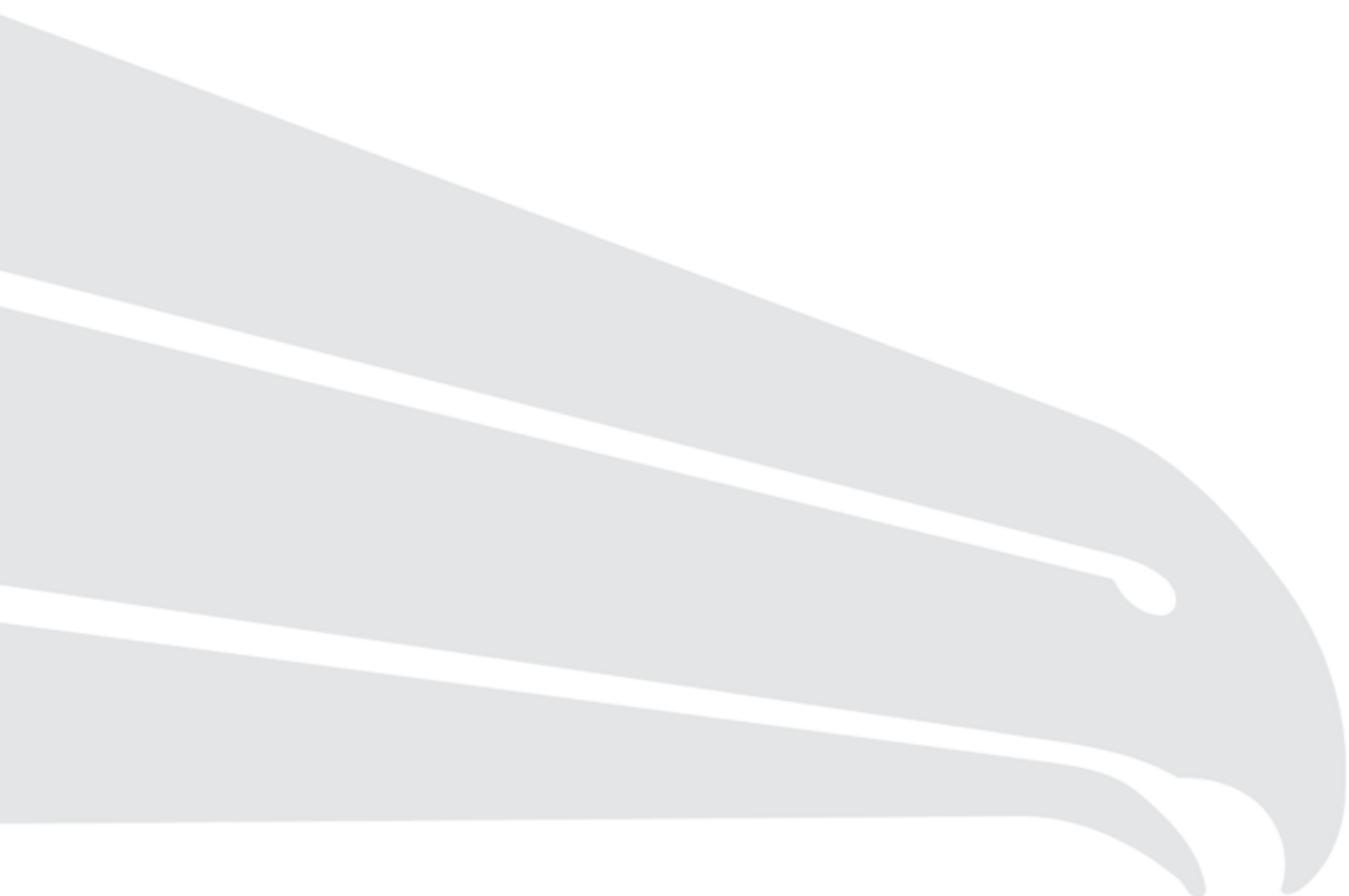

ROTOR APPLICATIONS

When you **DEMAND** Performance!





KIT APPLICATIONS

BRAKE PAD AND ROTOR KIT APPLICATIONS



Hawk Performance - KIT APPLICATIONS

HK 4218 .448 X
 HAWK KIT ROTOR PAD SHAPE INSERT COMPOUND CODE

MAKE/ MODEL	SUBMODEL	YEARS	ENGINE (LITER)	NOTE	FRONT	REAR
					KIT	KIT
ACURA						
CL		1997	2.2L	4 Cylinder	HK5175.275X	HK5177.145X
CL		1997	3.0L	6 Cylinder		HK5177.145X
CL		1998	2.3L	4 Cylinder		HK5304.145X
CL		1998-1999	3.0L	6 Cylinder	HK5301.143X	HK5304.145X
CL		1999	2.3L	4 Cylinder	HK5302.275X	HK5304.145X
CL		2001	3.2L	6 Cylinder	HK5317.366X	HK5343.145X
CL		2002-2003	3.2L	6 Cylinder	HK5317.366X	
CL		2002-2003				HK5343.572X
ILX		2013	2.0L			HK5303.145X
ILX		2013-2015	2.4L		HK5363.393X	HK5303.145X
ILX		2013-2014		Hybrid Model	HK5098.418X	HK5303.145X
ILX		2014-2015	2.0L		HK5233.393X	HK5303.145X
ILX		2015		Hybrid Model		HK5303.145X
Integra		1986-1989			HK5130.403X	
Integra		1990-1993			HK5174.242X	HK5132.350X
Integra		1994-1995			HK5174.245X	HK5132.350X
Integra		1996			HK5174.245X	HK5132.350X
Integra		1997		except Type R Models		HK5132.350X
Integra		1997		Type R Models	HK5179.143X	HK5308.145X
Integra		1998-2001		except Type R Models	HK5174.245X	HK5132.350X
Integra		1998		Type R Models	HK5179.143X	HK5308.145X
Integra		2000-2001		Type R Models	HK5179.143X	HK5308.145X
Legend	L	1986-1990	All	Sedan	HK5179.242F	
Legend	LS	1986-1990	All	Sedan	HK5179.242F	
Legend		1991-1992				HK5180.572X
Legend		1993		Coupe	HK5230.143X	HK5180.572X
Legend	GS	1994-1995		Sedan	HK5230.143X	
Legend		1994-1995				HK5180.572X
MDX		2001-2002				HK5342.506X
MDX		2003-2006			HK5317.326X	HK5342.506X
RDX		2007-2009				HK4949.572X
RL		1996-1998			HK5179.143X	HK5180.572X
RL		1999-2001			HK5320.366X	HK5322.145X
RL		2002-2004			HK5320.366X	
RSX		2002-2003		Base; L	HK5344.418X	HK5308.145X
RSX		2002-2006		Type-S	HK5363.361X	HK5308.145X
RSX		2004-2006		Base	HK5344.418X	HK5308.145X
TL		1995-1998	3.2L		HK5179.143X	
TL		1999-2003			HK5317.366X	HK5319.572X
TL		2004-2008	All	w/Brembo Front Calipers	HK4936.530F	
TL		2004-2008		Brembo front calipers	HK4936.530X	HK5359.572X
TL		2004-2008		Standard front calipers	HK5317.366X	HK5359.572X
TL		2009-2014			HK5034.678X	HK5033.679X
TSX		2004-2008			HK5317.366X	HK5346.145X
TSX		2009-2014			HK5317.366X	HK4957.626X
AUDI						
A3		2006-2007		2WD	HK4897.543X	HK4898.544X
A3		2006-2008		Quattro	HK4897.543X	HK4898.544X
A3		2008		2WD From VIN 8P-8-057779	HK4897.543X	HK4898.544X
A3		2008		2WD To VIN 8P-8-057778	HK4897.543X	HK4898.544X
A3		2009		2WD	HK4897.543X	HK4538.544X
A3		2009		Quattro	HK4897.543X	
A3		2010		Quattro Models; TRW/Lucas Rear Brakes; 282mm Rear Disc	HK4897.543X	
A3		2010		Except TDI (non-Quattro)	HK4897.543X	HK4567.544X
A3		2010		Quattro Models; Bosch Rear Brakes; 272mm Rear Disc	HK4897.543X	HK4567.544X

BRAKE PAD AND ROTOR KIT APPLICATIONS

MAKE/ MODEL	SUBMODEL	YEARS	ENGINE (LITER)	NOTE	FRONT	REAR
					KIT	KIT
AUDI CONTINUED						
A3		2010		TDI (non-Quattro)	HK4845.543X	HK4570.544X
A3	TDI	2010-2013				HK4570.364X
A3		2011-2012		Except TDI (non-Quattro)	HK4897.543X	HK4567.695X
A3		2011-2012		Quattro Models	HK4897.543X	HK4567.695X
A3		2011-2012		TDI (non-Quattro)	HK4845.543X	
A3		2013			HK4897.543X	
A4		1996		Except Quattro		HK4724.271X
A4		1996-1998		Quattro		HK4723.271X
A4		1997		Except Quattro to VIN 8DV168350 (before 2/97)		HK4724.271X
A4		1997		Except Quattro from VIN 8DV168351 (after 2/97)		HK4724.364X
A4		1998		Except Quattro		HK4724.364X
A4		1999-2000		Except Quattro	HK4695.269X	
A4		1999-2001		Quattro	HK4695.269X	HK4723.271X
A4		1999-2001		With Wear Sensor, Quattro	HK4695.269X	
A4		1999-2001		With Wear Sensor, Except Quattro	HK4695.269X	
A4		1999-2001		With Large Round Wear Sensor, Quattro	HK4695.269X	
A4		1999-2001		With Large Round Wear Sensor, Except Quattro	HK4695.269X	
A4		2001		Except Quattro	HK4695.269X	HK4724.271X
A4		2002-2003		4 Cyl. 1.8L Turbo		HK4784.364X
A4		2002-2003		6 Cyl. 3.0L	HK4743.354X	HK4785.364X
A4		2002-2003		With Wear Sensor, 6 Cyl. 3.0L	HK4743.354X	
A4		2004		4 Cyl. 1.8L Turbo to VIN 8E-5-060 000		HK4784.364X
A4		2004		6 Cyl. 3.0L to VIN 8E-5-060 000	HK4743.354X	HK4785.364X
A4		2004		With Wear Sensor, 6 Cyl. 3.0L to VIN 8E-5-060 000	HK4743.354X	
A4		2005		4 Cyl. 1.8L Turbo - Cabriolet		HK4784.364X
A4		2005		6 Cyl. 3.0L - Cabriolet	HK4743.354X	HK4785.364X
A4		2005		2.0L Turbo or 3.2L Sedan from VIN 8E-5-400-001		HK4489.544X
A4		2005-2006		With Wear Sensor, 6 Cyl. 3.0L - Cabriolet	HK4743.354X	
A4		2006		6 Cyl. 3.0L - Cabriolet	HK4743.354X	
A4		2006		Sedan or Wagon		HK4489.544X
A4		2007-2008			HK4766.538X	HK4489.544X
A4		2009		Convertible	HK4766.538X	
A4		2009		Cabriolet		HK4489.544X
A4		2009		Sedan/Wagon	HK4852.641X	HK4490.642X
A4		2010			HK4852.641X	HK4490.642X
A4		2011		Quattro; To 6/9/11	HK4852.641X	HK4490.642X
A4		2011		Quattro; From 6/20/11		HK4490.642X
A4		2011		Except Quattro	HK4852.641X	HK4490.642X
A4		2012-2015				HK4490.642X
A4 Quattro		2005	2.0L	1984cc 121cid L4, Sedan; Turbocharged; From 1/05; From CH# 8E-5-400-001	HK4766.538X	
A4 Quattro		2005	3.2L	3123cc V6, Sedan; From 1/05; From CH# 8E-5-400-001	HK4766.538X	
A4 Quattro		2006	2.0L	1984cc 121cid L4, Sedan; Turbocharged	HK4766.538X	
A4 Quattro		2006	3.2L	3123cc V6, Sedan	HK4766.538X	
A4 Quattro		2007-2008			HK4766.538X	
A4 Quattro		2009		Convertible	HK4766.538X	
A5		2008-2009			HK4852.641X	HK4490.642X
A5		2010-2011		Models with 320mm (12.6") Front Rotors	HK4852.641X	HK4490.642X
A5		2010-2013		Models with 314mm (12.36") Front Rotors		HK4490.642X
A5		2012-2013		Models with 320mm (12.6") Front Rotors		HK4490.642X
A5		2014-2015				HK4490.642X
A6		1995-1997		With Wear Sensor	HK4695.269X	
A6		1995-1997		With Large Round Wear Sensor	HK4695.269X	
A6		1995-1997			HK4695.269X	HK4694.271X
A6		1998		with 16" Wheels except AFC engine	HK4743.354X	

Hawk Performance - KIT APPLICATIONS

HK 4218 .448 X
 HAWK KIT ROTOR PAD SHAPE INSERT COMPOUND CODE

MAKE/ MODEL	SUBMODEL	YEARS	ENGINE (LITER)	NOTE	FRONT	REAR
					KIT	KIT
AUDI CONTINUED						
A6		1998		With Wear Sensor, with 16" Wheels except AFC engine	HK4743.354X	
A6		1999-2000		2.8L with 15" Wheels	HK4695.269X	HK4694.364X
A6		1999-2000		2.8L with 16" Wheels	HK4743.269X	HK4694.364X
A6		1999-2001		With Wear Sensor, 2.8L with 15" Wheels	HK4695.269X	
A6		1999-2001		With Large Round Wear Sensor, 2.8L with 15" Wheels	HK4695.269X	
A6		2001		2.8L with 15" Wheels	HK4695.269X	
A6		2001		2.8L with 16" Wheels	HK4743.269X	
A6		2002			HK4743.354X	HK4694.364X
A6		2002-2004		With Wear Sensor	HK4743.354X	
A6		2003-2004			HK4743.354X	
A6		2005-2011				HK4491.544X
A6 Quattro		1995-1997		With Wear Sensor	HK4695.269X	
A6 Quattro		1995-1997		With Large Round Wear Sensor	HK4695.269X	
A6 Quattro		1995-1997			HK4695.269X	HK4694.271X
A6 Quattro		1998		With AHA Engine (30 Valve Engine) and 16" Wheels Exc. 215/55/R16 Tires - Avant Wagon	HK4743.269X	HK4492.364X
A6 Quattro		1998		With AFC Engine (12 Valve Engine)	HK4695.269X	HK4694.271X
A6 Quattro		1998		With AHA Engine (30 Valve Engine) and 15" Wheels	HK4695.269X	HK4752.364X
A6 Quattro		1998		With AHA Engine (30 Valve Engine) and 16" Wheels Exc. 215/55/R16 Tires - Sedan	HK4743.269X	HK4752.364X
A6 Quattro		1998		With Wear Sensor, With AHA Engine (30 Valve Engine) and 15" Wheels	HK4695.269X	
A6 Quattro		1998		With Wear Sensor, With AFC Engine (12 Valve Engine)	HK4695.269X	
A6 Quattro		1998		With Large Round Wear Sensor, With AHA Engine (30 Valve Engine) and 15" Wheels	HK4695.269X	
A6 Quattro		1998		With Large Round Wear Sensor, With AFC Engine (12 Valve Engine)	HK4695.269X	
A6 Quattro		1998		With AHA Engine (30 Valve Engine) and 215/55/R16 Tires	HK4743.269X	
A6 Quattro		1999		2.8L and 16" Wheels Exc. 215/55/R16 Tires - Avant Wagon	HK4743.269X	HK4492.364X
A6 Quattro		1999		2.8L with 15" Wheels	HK4695.269X	HK4752.364X
A6 Quattro		1999		2.8L and 16" Wheels Exc. 215/55/R16 Tires - Sedan	HK4743.269X	HK4752.364X
A6 Quattro		1999		2.8L and 215/55/R16 Tires	HK4743.269X	
A6 Quattro		1999		With Wear Sensor, 2.8L with 15" Wheels	HK4695.269X	
A6 Quattro		1999		With Large Round Wear Sensor, 2.8L with 15" Wheels	HK4695.269X	
A6 Quattro	Avant	2000	2.8L	w/Oval Wear Sensor, 312mm Front Disc, Wagon, Except 215/55R16 Tires	HK4743.363X	
A6 Quattro	Avant	2000-2001	2.8L	288mm Front Disc, Sedan, Except 215/55R16 Tires	HK4695.363X	
A6 Quattro	Avant	2000-2001	2.8L	288mm Front Disc, Wagon, Except 215/55R16 Tires	HK4695.363X	
A6 Quattro	Avant	2000-2001	2.8L	w/Oval Wear Sensor, 288mm Front Disc, Sedan, Except 215/55R16 Tires	HK4695.363XA	
A6 Quattro	Avant	2000-2001	2.8L	w/Oval Wear Sensor, 288mm Front Disc, Wagon, Except 215/55R16 Tires	HK4695.363XA	
A6 Quattro	Avant	2000-2001	2.8L	312mm Front Disc, , With 215/55R16 Tires	HK4743.363X	
A6 Quattro	Avant	2000-2001	2.8L	312mm Front Disc, Sedan, Except 215/55R16 Tires	HK4743.363X	
A6 Quattro	Avant	2000-2001	2.8L	312mm Front Disc, Wagon, Except 215/55R16 Tires	HK4743.363X	
A6 Quattro	Avant	2000-2001	2.8L	w/Oval Wear Sensor, 312mm Front Disc, , w/215/55R16 Tires	HK4743.363XA	
A6 Quattro	Avant	2000-2001	2.8L	w/Oval Wear Sensor, 312mm Front Disc, Sedan, Except 215/55R16 Tires	HK4743.363XA	
A6 Quattro		2000-2001		With Wear Sensor, 2.7L Turbo	HK4766.363X	
A6 Quattro		2000-2001		2.8L and 16" Wheels Exc. 215/55/R16 Tires - Avant Wagon	HK4743.354X	HK4492.364X
A6 Quattro		2000-2001		2.8L with 15" Wheels		HK4752.364X
A6 Quattro		2000-2001		2.8L and 16" Wheels Exc. 215/55/R16 Tires - Sedan	HK4743.354X	HK4752.364X
A6 Quattro		2000-2001		2.8L and 215/55/R16 Tires	HK4743.354X	HK4787.364X
A6 Quattro		2000-2001		2.7L Turbo	HK4766.363X	HK4787.364X
A6 Quattro		2000-2001		With Wear Sensor, 2.8L and 215/55/R16 Tires	HK4743.354X	
A6 Quattro		2000-2001		With Wear Sensor, 2.8L and 16" Wheels Exc. 215/55/R16 Tires - Sedan	HK4743.354X	

BRAKE PAD AND ROTOR KIT APPLICATIONS

MAKE/ MODEL	SUBMODEL	YEARS	ENGINE (LITER)	NOTE	FRONT	REAR
					KIT	KIT
AUDI CONTINUED						
A6 Quattro		2000-2001		With Wear Sensor, 2.8L and 16" Wheels Exc. 215/55/R16 Tires - Avant Wagon	HK4743.354X	
A6 Quattro		2000-2004		V8	HK4791.363X	
A6 Quattro	Avant	2001	2.8L	w/Oval Wear Sensor, 312mm Front Disc, Wagon, Except 215/55R16 Tires	HK4743.363XA	
A6 Quattro		2001		2.8L with 16" Wheels	HK4743.354X	HK4787.364X
A6 Quattro		2001		With Wear Sensor, 2.8L with 16" Wheels	HK4743.354X	
A6 Quattro		2002-2004		2.7L turbo with 2 pad front caliper	HK4766.515X	
A6 Quattro		2002-2004		2.7L turbo with 4 pad front caliper	HK4791.363X	
A6 Quattro		2002-2004		3.0L Wagon	HK4743.354X	HK4492.364X
A6 Quattro		2002-2004		3.0L Sedan	HK4743.354X	
A6 Quattro		2002-2004		With Wear Sensor, 3.0L Wagon	HK4743.354X	
A6 Quattro		2002-2004		With Wear Sensor, 3.0L Sedan	HK4743.354X	
A6 Quattro		2005-2008		3.2L		HK4491.544X
A6 Quattro		2005-2008		4.2L V8		HK4844.553X
A6 Quattro		2009-2011		Armored Vehicle	HK4840.687X	HK4844.553X
A6 Quattro		2009-2011		3.0T Not Armored; 321mm Front Rotor		HK4844.553X
A6 Quattro		2009-2011		3.0T - Not Armored; 347mm Front Rotor		HK4844.553X
A6 Quattro		2009-2011		4.2 V8 - Not Armored; 321mm Front Rotor		HK4844.553X
A6 Quattro		2009-2011		4.2 V8 - Not Armored; 347mm Front Rotor		HK4844.553X
A8		1997-1998			HK4743.269X	
A8		1999		to VIN# 4DW004500	HK4743.269X	
A8 Quattro		1997-1998			HK4743.269X	
A8 Quattro		1999		to VIN# 4DW004500	HK4743.269X	
A8 Quattro		2003-2004		From VIN # 4E 3 000 001	HK4840.687X	
A8 Quattro		2005-2010		4.2L V8	HK4840.687X	
allroad		2013		320mm Front Rotors; MFG Up to 6/19/2011	HK4852.641X	HK4490.642X
allroad		2013		314mm Front Rotors		HK4490.642X
allroad		2013		320mm Front Rotors; MFG From 6/20/2011		HK4490.642X
Allroad Quattro		2001-2002		2 pad front caliper only		HK4787.364X
Allroad Quattro		2001-2003		4 pad front caliper only	HK4766.363X	HK4787.364X
Allroad Quattro		2001-2003		With Wear Sensor, 4 pad front caliper only	HK4766.363X	
Allroad Quattro		2003		2 pad front caliper only	HK4766.515X	HK4787.364X
Allroad Quattro		2004-2005		2 pad front caliper only	HK4766.515X	
Allroad Quattro		2004-2005		4 pad front caliper 2.7L V6	HK4766.363X	
Allroad Quattro		2004-2005		4 pad front caliper 4.2L V8	HK4766.363X	
Allroad Quattro		2004-2005		With Wear Sensor, 4 pad front caliper 4.2L V8	HK4766.363X	
Allroad Quattro		2004-2005		With Wear Sensor, 4 pad front caliper 2.7L V6	HK4766.363X	
Q5		2009-2010			HK4852.641X	HK4490.642X
Q5		2011		To 6/19/11	HK4852.641X	HK4490.642X
Q5		2011		From 6/20/11		HK4490.642X
Q5		2012				HK4490.642X
Q5		2013-2015		2.0L 4 Cylinder Non-Hybrid		HK4490.642X
Q7		2007-2015				HK4496.502X
S4		2000-2002		With Wear Sensor	HK4766.363X	
S4		2000-2002			HK4766.363X	HK4767.364X
S4		2004-2009			HK4838.538X	HK4497.553X
S6		2002-2004			HK4791.363X	
TT		2000-2005		With Wear Sensor		HK4751.364X
TT		2000-2005			HK4775.272X	HK4751.364X
TT		2006			HK4775.272X	
TT		2008-2009			HK4897.543X	
TT Quattro		2000-2005		1.8L 225HP vented rear rotor	HK4775.272X	HK4776.364X
TT Quattro		2000-2005		1.8L 180HP solid rear rotor	HK4775.272X	HK4786.364X
TT Quattro		2004-2005		3.2L V6		HK4776.364X

BRAKE PAD AND ROTOR KIT APPLICATIONS

Hawk Performance - KIT APPLICATIONS

HK 4218 .448 X
 HAWK KIT ROTOR PAD SHAPE INSERT COMPOUND CODE

MAKE/ MODEL	SUBMODEL	YEARS	ENGINE (LITER)	NOTE	FRONT	REAR
					KIT	KIT
AUDI CONTINUED						
TT Quattro		2006		1.8L 225HP vented rear rotor	HK4775.272X	
TT Quattro		2006		1.8L 180HP solid rear rotor	HK4775.272X	
TT Quattro		2009		2.0T (Exc. TTS)	HK4897.543X	
TT Quattro		2010-2011		Base Model	HK4897.543X	
TT Quattro		2012-2013		Base, Prestige, Premium Plus; 312mm Front Rotor	HK4897.543X	
TT Quattro		2014		Base, Premium Plus; 312mm Front Rotor	HK4897.543X	
BMW						
128i		2008-2013			HK4856.534X	
318i		1991		E30 Body Code; To 4/91	HK4656.195X	HK4657.399X
318i		1992-1998		E36 Body Code		HK4689.227X
318is		1991		E30 Body Code; To 4/91	HK4656.195X	HK4657.399X
318is		1992-1997		E36 Body Code		HK4689.227X
318ti		1995-1998				HK4726.227X
318ti		1999				HK4726.136X
323Ci		2000	All		HK4688.546X	HK4691.362X
323Ci		2000		E46 Body Code		HK4736.227X
323i		1998-1999		E36 Body Code; Convertible; Vented Rear Disc		HK4736.227X
323i		1999		E36 Body Code; Sedan; Solid Rear Disc		HK4689.227X
323i		1999		E46 Body Code; Sedan; Vented Rear Disc		HK4736.227X
323i	Sport Wagon	2000	All		HK4760.546X	
323i		2000		E46 Body Code; Sedan		HK4736.227X
323is		1998-1999	All		HK4688.546X	HK4691.362X
323is		1998-1999		E36 Body Code; Solid Rear Disc		HK4689.227X
325 Series		2006		325i RWD (E90)		HK4503.621X
325 Series		2006		Ci Coupe & Convertible (E46)		HK4761.227X
325i		1989-1991		E30 Body Code	HK4656.195X	HK4657.399X
325i		1992-1995				HK4689.227X
325i		2006		E90 Body Code	HK4856.534X	
325is		1989-1991		E30 Body Code	HK4656.195X	HK4657.399X
325is		1992-1995				HK4689.227X
325iX		1989-1990		E30 Body Code	HK4656.195X	
325iX		1991		E30 Body Code	HK4656.195X	HK4657.399X
325xi		2001-2005		E46 Body Code		HK4842.227X
325xi		2006		E90 Body Code	HK4856.534X	
325xi		2006		E91 Body Code	HK4856.534X	
328 Series		2007		328i RWD Convertible or Wagon		HK4502.621X
328 Series		2007		328xi AWD Coupe		HK4502.621X
328 Series		2007		328xi AWD Sedan/Wagon		HK4502.621X
328 Series		2007		328i RWD Coupe or Sedan		HK4503.621X
328 Series		2008		328i RWD Convertible or Wagon	HK4869.551X	HK4502.621X
328 Series		2008		328xi AWD Coupe or Wagon	HK4869.551X	HK4502.621X
328 Series		2008		328xi AWD Sedan	HK4869.551X	HK4502.621X
328 Series		2008		328i RWD Coupe or Sedan	HK4869.551X	HK4503.621X
328 Series		2009		AWD Coupe or Sports Wagon	HK4869.551X	HK4502.621X
328 Series		2009		AWD Sedan	HK4869.551X	HK4502.621X
328 Series		2009-2010		RWD Convertible or Sports Wagon	HK4869.551X	HK4502.621X
328 Series		2009-2010		RWD Coupe or Sedan	HK4869.551X	HK4503.621X
328 Series		2010		AWD Convertible or Sports Wagon	HK4869.551X	HK4502.621X
328 Series		2011		2WD; Convertible, Wagon	HK4869.551X	HK4502.621X
328 Series		2011		xDrive	HK4869.551X	HK4502.621X
328 Series		2011		2WD; Coupe, Sedan	HK4869.551X	HK4503.621X
328 Series		2012		2WD; E93 Convertible, E91 Wagon	HK4869.551X	HK4502.621X
328 Series		2012		E91 Wagon xDrive AWD	HK4869.551X	HK4502.621X
328 Series		2012-2013		E92 Coupe xDrive AWD	HK4869.551X	HK4502.621X
328 Series		2012-2013		2WD; E92 Coupe	HK4869.551X	HK4503.621X

BRAKE PAD AND ROTOR KIT APPLICATIONS

MAKE/ MODEL	SUBMODEL	YEARS	ENGINE (LITER)	NOTE	FRONT	REAR
					KIT	KIT
BMW CONTINUED						
328 Series		2013		2WD; E93 Convertible	HK4869.551X	HK4502.621X
328i		1996-1999		E36 Body Code; Sedan		HK4689.227X
328i		1996-1999		E36 Body Code; Convertible		HK4736.227X
328i		1999-2000	All		HK4760.546X	
328i		2007			HK4856.534X	
328is		1996-1999		Rear Disc; Solid Rear Disc		HK4689.227X
328xi		2007			HK4856.534X	
330Ci		2001-2006		E46 Body Code		HK4783.518X
330Ci		2006			HK4857.534X	
330i		2001-2005		E46 Body Code		HK4783.518X
330i		2006	All		HK4857.534X	
330i		2006		E90 Body Code		HK4504.518X
330i		2006			HK4857.534X	
330xi		2001-2005		E46 Body Code		HK4783.518X
330xi		2006	All		HK4857.534X	
330xi		2006		E90 Body Code		HK4504.518X
330xi		2006			HK4857.534X	
335 Series		2010-2011		335d	HK4862.551X	
335 Series		2010-2011		335i	HK4862.551X	
335 Series		2010-2011		335i xDrive	HK4862.551X	
335 Series		2011-2013		335is	HK4862.551X	
335 Series		2012-2013		335i (E92, E93)	HK4862.551X	
335 Series		2012-2013		335i xDrive (E92, E93)	HK4862.551X	
525i		1989-1995			HK4675.135X	HK4676.227X
525i		2001-2003		Sedan	HK4740.135X2	
525i		2001-2003		Touring	HK4740.135X2	
525i		2001-2003				HK4741.227X
525i		2004-2005		manual transmission	HK4855.135X2	
525i		2004-2006				HK4882.458X
525i		2006		From 10/06	HK4855.551X	
525i		2006		To 9/06	HK4880.551X	
525i		2007				HK4882.518X
525iT		1993			HK4675.135X	HK4676.227X
525xi		2006-2007			HK4880.551X	HK4505.458X
528i		1997-1998	All		HK4740.135X2	
528i		1997-2000		E39 Body Code		HK4741.227X
528i		1997-2000		E39; Sedan	HK4740.135X2	
528i		1998-2000		E39; Touring	HK4740.135X2	
528i		2008-2010		E60 Body Code	HK4880.551X	HK4882.458X
528i xDrive		2009-2010		E60 Body Code	HK4880.551X	HK4882.458X
528xi		2008			HK4880.551X	HK4505.458X
530i		1994-1995			HK4675.135X	HK4676.227X
530i		2001-2003			HK4790.325X	HK4741.227X
530i		2004-2007			HK4880.551X	HK4882.518X
530xi		2006-2007			HK4880.551X	HK4505.518X
535i		1989-1993			HK4675.135X	HK4676.227X
535i		2008-2010			HK4854.551X	HK4506.630X
535i xDrive		2009		E60 Body Code	HK4880.551X	HK4505.458X
535i xDrive		2009		E61 Body Code	HK4880.551X	HK4505.458X
535i xDrive		2010		E60 Body Code	HK4880.551X	HK4505.518X
535i xDrive		2010		E61 Body Code	HK4880.551X	HK4505.518X
535xi		2008			HK4880.551X	HK4505.518X
540i		1994-1995		E34 Body Code	HK4668.135X	
540i		1997-1999		E39 Body Code	HK4690.325X	HK4741.227X
540i		2000		To 3/00	HK4690.325X	

BRAKE PAD AND ROTOR KIT APPLICATIONS

Hawk Performance - KIT APPLICATIONS

HK 4218 .448 X
 HAWK KIT ROTOR PAD SHAPE INSERT COMPOUND CODE

MAKE/ MODEL	SUBMODEL	YEARS	ENGINE (LITER)	NOTE	FRONT	REAR
					KIT	KIT
BMW CONTINUED						
540i		2000		From 3/00	HK4790.325X	
540i		2000				HK4741.227X
540i		2001-2003			HK4790.325X	HK4741.227X
545i		2004-2005		E60 Body Code	HK4854.551X	HK4506.630X
550i		2006-2010		E60 Body Code	HK4854.551X	HK4506.630X
645Ci		2004-2005		E63 Body Code	HK4854.551X	HK4506.630X
645Ci		2004-2005		E64 Body Code	HK4854.551X	HK4506.630X
650i		2006-2007		E63 Body Code	HK4854.551X	HK4506.630X
650i		2006-2007		E64 Body Code	HK4854.551X	HK4506.630X
650i		2008-2010			HK4854.551X	HK4506.630X
735i		1988		From 3/88	HK4668.135X	
735i		1989-1992			HK4668.135X	
735iL		1988		From 3/88	HK4668.135X	
735iL		1989-1992			HK4668.135X	
740i		1993-1994		E32 Body Code	HK4668.135X	
740i		1995		E38 Body Code	HK4690.325X	HK4691.518X
740i		1997-2001		E38 Body Code	HK4690.325X	HK4691.518X
740iL		1993-1994		E32 Body Code	HK4668.135X	
740iL		1995-2001		E38 Body Code	HK4690.325X	HK4691.518X
745i		2002-2005	All	Wear sensor, front pads, F & Z only		HK4875.630X
745i		2002-2005		E65 Body Code	HK4874.551X	HK4875.630X
745i		2002-2005		E65		HK4875.630X
745Li		2002-2005	All	Wear sensor, front pads, F & Z only		HK4875.630X
745Li		2002-2005		E66 Body Code	HK4874.551X	HK4875.630X
745Li		2002-2005		E65		HK4875.630X
750i		2006-2008		E65 Body Code	HK4874.551X	HK4507.630X
750i		2009		E65 Body Code	HK4874.551X	
750iL		1988-1994		E32 Body Code	HK4668.135X	
750iL		1995-2001		E38 Body Code	HK4727.497X	
750Li		2006-2009	All	Wear sensor, front pads, F & Z only		HK4507.630X
750Li		2006-2008		E66 Body Code	HK4874.551X	HK4507.630X
750Li		2009		E66 Body Code	HK4874.551X	
760i		2004		E65 Body Code	HK4874.551X	HK4875.630X
760i		2004-2005		To 3/05		HK4875.630X
760i		2005		E65 Body Code	HK4874.551X	
760i		2005		E65 Body Code; From 3/05		HK4507.630X
760i		2005		E65 Body Code; To 3/05		HK4875.630X
760i		2005-2006				HK4507.630X
760i		2006		E65 Body Code	HK4874.551X	HK4507.630X
760Li		2003-2004		E66 Body Code	HK4874.551X	HK4875.630X
760Li		2003-2005		To 3/05		HK4875.630X
760Li		2005		E66 Body Code	HK4874.551X	
760Li		2005		E66 Body Code; From 3/05		HK4507.630X
760Li		2005		E66 Body Code; To 3/05		HK4875.630X
760Li		2005-2008				HK4507.630X
760Li		2006-2008		E66 Body Code	HK4874.551X	HK4507.630X
M3		1995-1999			HK4722.135X	HK4721.227X
M3		2001-2005				HK4793.518X
M3		2006		Excluding Euro Spec or Competition Models		HK4793.518X
M5		1991-1993				HK4712.227X
M5		2000-2003		E39		HK4793.518X
X1	xDrive35i	2013				HK4504.518X
X1		2013-2015		sDrive 28i	HK4869.551X	HK4502.621X
X1		2013-2015		xDrive 28i	HK4869.551X	HK4502.621X
X1		2013-2015		xDrive 35i	HK4862.551X	HK4504.624X

BRAKE PAD AND ROTOR KIT APPLICATIONS

MAKE/ MODEL	SUBMODEL	YEARS	ENGINE (LITER)	NOTE	FRONT	REAR
					KIT	KIT
BMW CONTINUED						
X3		2004-2010				HK4814.518X
X3		2011		E83 Chassis		HK4814.518X
X5		2000-2001			HK4762.325X	HK4763.518X
X5		2002-2003		3.0L or 4.4L	HK4762.325X	HK4763.518X
X5		2002-2003		4.6is		HK4795.518X
X5		2004		3.0L or 4.4L with solid rear disc	HK4762.325X	HK4763.518X
X5		2004-2006		4.4L with vented rear disc	HK4762.325X	HK4795.518X
X5		2005-2006		3.0L with solid rear disc	HK4762.325X	HK4763.518X
X5		2005-2006		4.8iS		HK4795.518X
X5		2007-2008		3.0si	HK4864.708X	HK4511.458X
X5		2007-2008		4.8i	HK4863.708X	HK4512.630X
X5		2009		xDrive30i; xDrive35d	HK4864.708X	HK4511.458X
X5		2009		xDrive48i	HK4863.708X	HK4512.630X
X5		2010		xDrive 30i	HK4864.708X	HK4511.458X
X5		2010		xDrive 48i	HK4863.708X	HK4512.630X
X5		2010-2013		xDrive 35d	HK4863.708X	HK4511.458X
X5		2011-2013		xDrive 35i	HK4864.708X	HK4511.458X
X5		2011-2015		xDrive 50i		HK4512.630X
X5		2014-2015		sDrive 35i, xDrive 35i, xDrive 35d	HK4864.708X	HK4511.458X
X6		2008		XDrive35i	HK4863.708X	HK4512.630X
X6		2008-2014		XDrive50i		HK4512.630X
X6		2009		XDrive35i Mfg from 10/2008	HK4863.708X	HK4511.458X
X6		2009		XDrive35i Mfg up to 10/2008	HK4863.708X	HK4512.630X
X6		2010		XDrive35i	HK4863.708X	HK4511.458X
X6		2010		ACTIVEHYBRID Mfg after 4/2010		HK4512.630X
X6		2010		ACTIVEHYBRID Mfg up to 3/2010		HK4512.630X
X6		2011		ActiveHybrid		HK4512.630X
X6		2011-2014		XDrive35i	HK4864.708X	HK4511.458X
Z3		1996-1997		6 cylinder	HK4688.136X	HK4742.227X
Z3		1996-1998		4 Cylinder	HK4725.136X	HK4742.227X
Z3		1998		6 cylinder exc. M series	HK4688.136X	HK4742.227X
Z3		1998-2002		M series	HK4722.135X	HK4721.227X
Z3	Coupe	1999-2000	All		HK4688.546X	HK4691.362X
Z3		1999-2000		Except M series	HK4688.136X	HK4742.227X
Z3	Roadster	2001-2002	2.5L			HK4691.362X
Z3		2001-2002		2.5L	HK4688.136X	HK4742.227X
Z3		2001-2002		3.0L	HK4760.136X	HK4742.227X
Z4		2003-2005		2.5i	HK4688.136X	HK4796.227X
Z4		2003-2008		3.0i	HK4760.136X	HK4797.227X
Z4		2006-2008		3.0si	HK4782.464X	HK4797.227X
Z4		2009-2010		SDrive30i		HK4589.669X
Z4		2009-2010		SDrive35i		HK4589.669X
Z4		2011		SDrive30i; SDrive 35i		HK4589.669X
Z4		2012-2013		SDrive28i; 30i; 35i		HK4589.669X
BUICK						
Allure		2005-2007			HK4176.360X	HK4182.450X
Allure		2008		V8 Models	HK4092.535X	HK4082.359X
Allure		2008-2009		V6 Models	HK4176.360X	HK4182.450X
Allure		2009		V8 Models		HK4082.359X
Century	Estate Wagon	1984-1989	All	w/ 115mm Bolt Circle	HK4140.400X	
Century	Custom	1987-1989	All	w/ 115mm Bolt Circle	HK4140.400X	
Century		1990-1996			HK4140.396X	
Century		1997-2003			HK4160.360X	
Century		2004-2005			HK4160.360X	HK4166.359X
Enclave		2008-2015			HK4417.617X	HK4413.383X

BRAKE PAD AND ROTOR KIT APPLICATIONS



Hawk Performance - KIT APPLICATIONS

HK 4218 .448 X
 HAWK KIT ROTOR PAD SHAPE INSERT COMPOUND CODE

MAKE/ MODEL	SUBMODEL	YEARS	ENGINE (LITER)	NOTE	FRONT	REAR
					KIT	KIT
BUICK CONTINUED						
Encore		2013-2015				HK4115.707X
LaCrosse		2005-2007			HK4176.360X	HK4182.450X
LaCrosse		2008-2009		Super; 5.3L	HK4092.535X	HK4082.359X
LaCrosse		2008-2009		CX, CXL; 3.8L	HK4176.360X	HK4182.450X
LeSabre		1990		Exc. Wagon	HK4140.396X	
LeSabre		1991			HK4140.396X	
LeSabre		1994-1999			HK4160.217X	
LeSabre		2000-2004		16" Wheels with 12" Front Rotors	HK4164.360X	HK4156.359X
LeSabre		2000-2005		15" Wheels with 11" Front Rotors	HK4160.360X	HK4156.359X
LeSabre		2005		16" Wheels with 12" Front Rotors	HK4191.536X	HK4156.359X
Lucerne		2006-2011		V8 Models	HK4092.535X	
Lucerne		2006-2011		V6 Models	HK4081.535X	
Park Avenue		1994-1996			HK4160.217X	
Park Avenue		1997		Rear Disc Brakes	HK4164.360X	HK4156.359X
Park Avenue		1997		Rear Drum Brakes	HK4164.360X	
Park Avenue		1998-2002			HK4164.360X	HK4156.359X
Park Avenue		2003-2005		Except Ultra	HK4164.360X	HK4156.359X
Park Avenue		2003-2005		Ultra	HK4164.360X	HK4170.359X
Rainier		2004-2005		with 6 Cyl. Engine	HK4399.382X	HK4397.383X
Rainier		2004-2005		with V8 Engine	HK4400.382X	HK4397.383X
Rainier		2006-2007		with 6 Cyl. Engine		HK4397.383X
Rainier		2006-2007		with V8 Engine	HK4400.617X	HK4397.383X
Regal		1973-1977			HK4066.103X	
Regal		1979-1981			HK4132.119X	
Regal		1988-1994			HK4146.232X	
Regal		1995		267mm diameter front rotor	HK4146.232X	
Regal		1995		286mm diameter front rotor	HK4163.232X	
Regal		1996			HK4163.232X	
Regal		1997-2004			HK4160.360X	HK4166.359X
Regal		2012-2013		Brembo Front Caliper; Vented Rear Rotor	HK4415.453X	
Rendezvous		2002-2007		AWD	HK4173.373X	HK4174.359X
Rendezvous		2002-2007		2WD	HK4172.373X	HK4174.359X
Riviera		1992-1993				HK4156.359X
Riviera		1995-1996			HK4160.217X	HK4156.359X
Riviera		1997-1999			HK4164.360X	HK4156.359X
Skylark		1990		Performance Package	HK4149.390X	
Skylark		1991-1998			HK4149.390X	
Terraza		2005		AWD or FWD Special Suspension	HK4176.360X	
Terraza		2005		FWD; Except Special Suspension	HK4176.360X	
Terraza		2006		AWD or FWD Special Suspension	HK4408.360X	
Terraza		2006		FWD; Except Special Suspension	HK4408.360X	
Terraza		2007			HK4408.360X	
CADILLAC						
Allante		1993				HK4156.359X
CTS		2003-2005		Sport Suspension; Except CTS-V	HK4073.439X	HK4074.440X
CTS		2003-2007		Standard Suspension; Except CTS-V	HK4072.439X	HK4074.440X
CTS		2004-2007		CTS-V; Brembo Calipers	HK4075.453X	HK4076.194X
CTS		2006-2007		Sport Suspension; Except CTS-V	HK4077.467X	
CTS		2008		JE5 Brake Package - 315mm (12.4") Rear Rotor		HK4096.639X
CTS		2008		J55 Brake Package - 339mm (13.3") Rear Rotor		HK4128.639X
CTS		2009-2012		CTS-V		HK4416.194X
CTS		2009-2013		V6 - JE5 Brake Package - 315mm (12.4") Rear Rotor		HK4096.639X
CTS		2009-2013		V6 - J55 Brake Package - 339mm (13.3") Rear Rotor		HK4128.639X
CTS		2013-2015		CTS-V with 2-Piece Front Rotors		HK4416.194X
CTS		2013-2015		CTS-V with Co-Cast Front Rotors		HK4416.194X

BRAKE PAD AND ROTOR KIT APPLICATIONS



MAKE/ MODEL	SUBMODEL	YEARS	ENGINE (LITER)	NOTE	FRONT	REAR
					KIT	KIT
CADILLAC CONTINUED						
CTS		2014		Coupe&Wagon with JE5 Brake Package - 315mm (12.4") Rear Rotor		HK4096.639X
CTS		2014		Coupe&Wagon with J55 Brake Package - 339mm (13.3") Rear Rotor		HK4128.639X
DeVille		1991-1993		Heavy duty chassis	HK4160.332X	
DeVille		1994-1996			HK4160.217X	HK4156.359X
DeVille		1997			HK4164.360X	HK4156.359X
DeVille		1998-1999		Rear Disc	HK4164.360X	HK4156.359X
DeVille		2000-2004		Heavy duty brakes - 8 Lug	HK4392.322X	
DeVille		2000-2005		except heavy duty brakes	HK4164.360X	HK4170.359X
DeVille		2005		Heavy duty brakes	HK4392.322X	
DTS		2006-2011		Sedan	HK4092.535X	
Eldorado		1992-1993				HK4156.359X
Eldorado		1994-1996			HK4160.217X	HK4156.359X
Eldorado		1997-2002			HK4164.360X	HK4156.359X
Escalade		1999-2000			HK4367.332X	
Escalade		2002			HK4390.323X	HK4395.385X
Escalade		2003-2006		2WD	HK4390.323X	
Escalade		2003-2006		4WD	HK4390.323X	
Escalade		2003-2006				HK4395.385X
Escalade		2007			HK4403.561X	HK4406.568X
Escalade	ESV, EXT	2007-2013			HK4403.561X	
Escalade		2008		Front Caliper Bracket Cast #351/352C	HK4403.561X	HK4406.568X
Escalade		2008		Front Caliper Bracket Cast #285/286C		HK4406.568X
Escalade		2009-2015			HK4403.561X	HK4406.568X
Escalade		2016			HK4403.561X	
Fleetwood		1992		Front wheel drive - heavy duty chassis	HK4160.332X	
Seville		1992-1993				HK4156.359X
Seville		1994-1996			HK4160.217X	HK4156.359X
Seville		1997			HK4164.360X	HK4156.359X
Seville		1998-2003				HK4170.359X
Seville		2004			HK4073.360X	HK4170.359X
SRX		2004-2009			HK4088.467X	
STS		2005		Standard Brakes	HK4073.439X	HK4074.440X
STS		2005		Performance Brakes	HK4077.467X	
STS		2006-2008		Standard Brakes; JL9	HK4073.439X	HK4074.440X
STS		2006-2008		HD Brakes; J56	HK4075.453X	HK4076.194X
STS		2006-2008		STS-V Supercharged; Brembo Brakes	HK4075.453X	HK4076.194X
STS		2006-2008		Performance Brakes; JE5	HK4077.467X	
STS		2009-2011		Standard Brakes; 5 Lug; JL9 pkg.		HK4074.440X
STS		2009-2011		STS-V Supercharged; 6 Lug	HK4075.453X	HK4076.194X
XLR		2004			HK4167.247X	HK4168.248X
XLR		2005			HK4071.247X	HK4168.248X
XLR		2006-2007		Except XLR-V	HK4071.247X	HK4168.248X
XLR		2006-2009		XLR-V Supercharged	HK4070.247X	HK4086.248X
XLR		2008-2009		Except XLR-V	HK4167.247X	HK4168.248X
XTS		2013		6 Lug	HK4403.561X	
XTS		2014-2015		6 Lug	HK4403.561X	
CHEVROLET						
Astro		2003-2005			HK4390.323X	HK4391.324X
Avalanche		2007			HK4403.561X	HK4406.568X
Avalanche	LS, LT, LTZ	2007-2009			HK4403.561X	
Avalanche		2008		Models with front caliper bracket cast # 351/352C	HK4403.561X	HK4406.568X
Avalanche		2008		Models with front caliper bracket cast # 285/286C		HK4406.568X
Avalanche		2009-2013			HK4403.561X	HK4406.568X

BRAKE PAD AND ROTOR KIT APPLICATIONS



Hawk Performance - KIT APPLICATIONS

HK 4218

HAWK KIT

ROTOR

.448

PAD SHAPE

X

INSERT COMPOUND CODE

MAKE/ MODEL	SUBMODEL	YEARS	ENGINE (LITER)	NOTE	FRONT	REAR
					KIT	KIT
CHEVROLET CONTINUED						
Avalanche	LS, LT, LTZ, Police	2010-2013			HK4403.561X	
Avalanche 1500		2002		Single piston rear caliper without limited slip axle	HK4390.323X	HK4391.324X
Avalanche 1500		2002		Dual piston rear caliper with limited slip axle	HK4390.323X	
Avalanche 1500		2003-2006		2WD	HK4390.323X	
Avalanche 1500		2003-2006		4WD	HK4390.323X	
Avalanche 1500		2003-2006				HK4395.385X
Avalanche 2500		2002		Exc. Models With 2" Body Lift	HK4392.322X	HK4393.323X
Avalanche 2500		2002		Models With 2" Body Lift	HK4404.322X	HK4393.323X
Avalanche 2500		2003-2004		Exc. Models With 2" Body Lift	HK4392.322X	HK4394.323X
Avalanche 2500		2003-2004		Models With 2" Body Lift	HK4404.322X	HK4394.323X
Avalanche 2500		2005-2006			HK4392.322X	HK4394.323X
Beretta		1992-1996			HK4149.390X	
C1500 Suburban		1992-1993			HK4379.332X	
C1500 Suburban		1994		5 Lug	HK4379.296X	
C1500 Suburban		1995-1999		5 Lug	HK4379.332X	
C1500 Suburban		1995-1999		8 Lug	HK4381.296X	
Camaro		1969		Front Disc, Rear Drum	HK4065.103X	
Camaro		1970-1978			HK4066.103X	
Camaro		1993		Rear Disc Brakes		HK4159.112X
Camaro		1994-1997		Rear Disc Brakes	HK4160.217X	HK4159.112X
Camaro		1994-1997		Rear Drum Brakes	HK4160.217X	
Camaro		1998-2002			HK4164.249X	HK4171.250X
Camaro		2010-2011		6.2L SS Model		HK4416.194X
Camaro		2010-2015		3.6L LS or LT Models	HK4095.638X	HK4096.639X
Camaro		2012-2014		6.2L SS		HK4416.194X
Camaro		2012-2015		ZL1		HK4416.194X
Camaro		2015		6.2L SS	HK4415.453X	HK4416.194X
Caprice		1991-1993		11" Rear Drum Models - Police/Heavy Duty	HK4150.131X	
Caprice		2011-2013			HK4094.638X	HK4107.607X
Cavalier		1992-2005			HK4149.390X	
Chevelle		1969-1972			HK4065.103X	
Chevelle		1973			HK4066.103X	
Classic		2004-2005			HK4165.425X	
Cobalt		2005-2007		SS	HK4187.524X	HK4188.525X
Cobalt		2005-2010		Base LS & LT w/Rear Drum Brakes; 4 Lug Wheels	HK4184.517X	
Cobalt		2007-2010		LT & LTZ w/Rear Drum Brakes; 5 Lug Wheels	HK4064.517X	
Cobalt		2008		Sport; w/Rear Disc Brakes; 5 Lug Wheels	HK4187.524X	HK4188.525X
Cobalt		2008-2010		SS With Brembo Brakes		HK4112.478X
Colorado		2004-2008			HK4402.554X	
Corsica		1992-1996			HK4149.390X	
Corvette		1984-1987	All		HK4141.173X	HK4142.112X
Corvette		1988-1995		except heavy duty suspension	HK4153.111X	HK4154.112X
Corvette		1988-1995		Heavy Duty Suspension		HK4154.112X
Corvette		1996				HK4154.112X
Corvette		1997-2004			HK4167.247X	HK4168.248X
Corvette		2005-2007		except Z51 Package	HK4071.247X	HK4168.248X
Corvette		2005-2009		Z51 Package	HK4070.247X	HK4086.248X
Corvette		2006		Z06 Package		HK4085.659X
Corvette		2006		Z06	HK4084.658X	
Corvette		2006-2013		Z06	HK4084.531X	HK4085.532X
Corvette		2007-2008		Z06 Package	HK4084.658X	HK4085.659X
Corvette		2008-2009		Standard Brakes	HK4071.247X	HK4168.248X
Corvette		2009		Z06 Package		HK4085.659X
Corvette		2010-2011		Z06 / Grand Sport Package		HK4085.659X
Corvette		2010-2011		Base Model; Magnetic Ride Control	HK4070.247X	HK4086.248X

BRAKE PAD AND ROTOR KIT APPLICATIONS

MAKE/ MODEL	SUBMODEL	YEARS	ENGINE (LITER)	NOTE	FRONT	REAR
					KIT	KIT
CHEVROLET CONTINUED						
Corvette		2010-2011		Base Model; Except Magnetic Ride Control	HK4071.247X	HK4168.248X
Corvette		2010-2013		Grand Sport	HK4084.531X	HK4085.532X
Corvette		2012-2013		Z06 / Grand Sport Package with Iron Brake Rotors		HK4085.659X
Corvette		2012-2013		Base Model with Heavy Duty J55 or F55 Brake Package (340mm (13.3") Front Rotor)	HK4070.247X	HK4086.248X
Corvette		2012-2013		Base Model with Standard JL9 Brake Package (325mm (12.8") Front Rotor)	HK4071.247X	HK4168.248X
Cruze		2011-2013		Rear Disc Models	HK4119.706X	HK4115.707X
Cruze		2011-2016		Rear Drum Models	HK4119.706X	
Cruze		2014-2015		Rear Disc Models - Gas Engine	HK4119.706X	HK4115.707X
Cruze		2016		Rear Disc Models - Gas Engine	HK4119.706X	
El Camino		1972		Models with Front Disc Brakes	HK4065.103X	
El Camino		1973-1977			HK4066.103X	
El Camino		1979-1981			HK4132.119X	
Equinox		2005-2006			HK4175.472X	
Express 1500		2009-2014			HK4403.561X	
HHR		2006-2007			HK4087.524X	
HHR		2008		Rear Disc Brakes	HK4187.524X	HK4188.525X
HHR		2008-2011		Rear Drum Brakes	HK4087.524X	
HHR		2009-2010		Rear Disc Brakes, Except Brembo Front Caliper	HK4187.524X	HK4188.525X
HHR		2009-2010		Rear Disc Brakes, Brembo Front Caliper		HK4188.525X
Impala		2000-2004			HK4164.360X	HK4166.359X
Impala		2005		To VIN 59143075	HK4164.360X	HK4166.359X
Impala		2005		From VIN 59143076	HK4191.536X	HK4166.359X
Impala		2006-2010			HK4081.535X	HK4082.359X
Impala		2011			HK4081.535X	HK4182.450X
Impala		2012-2013		Except Police/Taxi	HK4081.535X	HK4182.450X
Impala		2012-2013		Police/Taxi	HK4092.535X	HK4182.450X
Impala Limited		2014-2015		(Old Body Style) Except Police/Taxi	HK4081.535X	HK4182.450X
Impala Limited		2014-2015		(Old Body Style) Police/Taxi	HK4092.535X	HK4182.450X
Impala Limited		2016		(Old Body Style) Except Police/Taxi		HK4182.450X
Impala Limited		2016		(Old Body Style) Police/Taxi		HK4182.450X
Impala SS		1994-1996			HK4150.131X	
Lumina		1990-1994			HK4146.232X	
Lumina		1995		Models with rear Disc Brakes and 267mm Dia. Front Rotor	HK4146.232X	
Lumina		1995		Models with Rear Drum Brakes and 267mm Dia. Front Rotor	HK4146.232X	
Lumina		1995		Models with rear Disc Brakes and 286mm Dia. Front Rotor	HK4163.232X	
Lumina		1995		Models with Rear Drum Brakes and 286mm Dia. Front Rotor	HK4163.232X	
Lumina		1996-1999		Models with rear Disc Brakes	HK4163.232X	
Lumina		1996-1999		Models with rear Drum Brakes	HK4163.232X	
Lumina		2000-2001			HK4163.232X	
Malibu		1980-1981			HK4132.119X	
Malibu		1997-2003			HK4165.425X	
Malibu		2004-2005		Maxx	HK4187.524X	HK4188.525X
Malibu		2004-2005		New body style with rear disc	HK4189.524X	HK4188.525X
Malibu		2004-2005		Old body style with rear drum	HK4165.425X	
Malibu		2005		New body style with rear drum	HK4189.524X	
Malibu		2006-2007		Rear Disc Models with 296mm (11.65") Front Rotors	HK4187.524X	HK4188.525X
Malibu		2006-2007		Rear Disc Models with 276mm (10.9") Front Rotors	HK4189.524X	HK4188.525X
Malibu		2006-2007		with rear drums	HK4189.524X	
Malibu		2008		Models with 296mm (11.65") Front Rotors	HK4187.524X	HK4188.525X
Malibu		2008		Models with 276mm (10.9") Front Rotors	HK4189.524X	HK4188.525X
Malibu		2009-2012			HK4187.524X	HK4188.525X
Monte Carlo		1995		With Rear Disc Brakes and 267mm Dia. front rotor	HK4146.232X	
Monte Carlo		1995		With Rear Drum Brakes and 267mm Dia. front rotor	HK4146.232X	

BRAKE PAD AND ROTOR KIT APPLICATIONS

Hawk Performance - KIT APPLICATIONS

HK 4218 .448 X
 HAWK KIT ROTOR PAD SHAPE INSERT COMPOUND CODE

MAKE/ MODEL	SUBMODEL	YEARS	ENGINE (LITER)	NOTE	FRONT	REAR
					KIT	KIT
CHEVROLET CONTINUED						
Monte Carlo		1995		With Rear Disc Brakes and 286mm Dia. front rotor	HK4163.232X	
Monte Carlo		1995		With Rear Drum Brakes and 286mm Dia. front rotor	HK4163.232X	
Monte Carlo		1996-1999		With Rear Disc Brakes	HK4163.232X	
Monte Carlo		1996-1999		With Rear Drum Brakes	HK4163.232X	
Monte Carlo		2000-2004			HK4164.360X	HK4166.359X
Monte Carlo		2005		To Vin 59148923	HK4164.360X	HK4166.359X
Monte Carlo		2005		From Vin 59148924		HK4166.359X
Monte Carlo		2006-2007			HK4081.535X	HK4082.359X
Nova		1969-1974		Models with Front Disc Brakes	HK4065.103X	
Nova		1975-1978			HK4066.103X	
Prizm		1998-2002			HK5261.321X	
S10		1989-1991		RWD	HK4110.119X	
S10		1992-1995		RWD; 2-Wheel ABS	HK4110.119X	
S10 Blazer		1989-1990		RWD	HK4110.119X	
S10 Blazer		1991-1994		RWD; 2-Wheel ABS	HK4110.119X	
Silverado 1500		2005	All	w/Rear Drum Brakes.	HK4392.561X	
Silverado 1500		2005		Crew Cab Pickup; Rear Disc; With 4 Wheel Steering		HK4405.324X
Silverado 1500	2WD	2005-2006		With Rear Drum Brakes	HK4392.561X	
Silverado 1500	4WD	2005-2006		With Rear Drum Brakes	HK4392.561X	
Silverado 1500		2005-2013		2WD, with rear drum brakes	HK4403.561X	
Silverado 1500		2005-2013		4WD, with rear drum brakes	HK4403.561X	
Silverado 1500		2006	All	6400 lb. GVW, Rear Drum	HK4392.561X	
Silverado 1500		2006	All	7000 lb. GVW, Rear Drum	HK4392.561X	
Silverado 1500		2007-2013		2WD, with rear disc brakes	HK4403.561X	
Silverado 1500		2007-2013		4WD, with rear disc brakes	HK4403.561X	
Silverado 1500 HD		2003		4WD, 8 lug with QuadraSteer		HK4405.385X
Silverado 1500 HD		2005		4WD, 8 lug with QuadraSteer		HK4405.385X
Silverado 1500 HD		2005		2WD, 8 lug with QuadraSteer		HK4405.385X
Silverado 2500		1999-2000		except 6.0L with 5 speed	HK4392.322X	HK4393.323X
Silverado 2500		1999-2000		with 6.0L 5 speed	HK4392.322X	HK4394.323X
Silverado 2500		2001-2004		Automatic transmission except Heavy Duty	HK4392.322X	HK4393.323X
Silverado 2500		2001-2004		Manual transmission except Heavy Duty	HK4392.322X	HK4394.323X
Silverado 2500 HD		2001-2003			HK4404.322X	HK4394.323X
Silverado 2500 HD		2004		Models with 2 wheel steering	HK4404.322X	HK4394.323X
Silverado 2500 HD		2004		Models with 4 wheel steering	HK4404.322X	HK4405.323X
Silverado 2500 HD		2005-2010			HK4404.322X	HK4394.323X
Silverado 3500		2001-2003			HK4404.322X	HK4396.322X
Silverado 3500		2004-2005		2WD	HK4404.322X	HK4396.322X
Silverado 3500		2004-2005		4WD Single rear wheels	HK4404.322X	HK4394.323X
Silverado 3500		2004-2005		4WD Dual rear wheels	HK4404.322X	HK4396.322X
Silverado 3500		2006-2007		SRW	HK4404.322X	HK4394.323X
Silverado 3500		2006-2007		DRW	HK4404.322X	HK4396.322X
Silverado 3500 HD		2007-2010		SRW	HK4404.322X	HK4394.323X
Silverado 3500 HD		2007-2010		DRW	HK4404.322X	HK4396.322X
Sonic		2012			HK4119.706X	
Sonic		2013-2015		Rear Disc	HK4119.706X	HK4115.707X
Sonic		2013-2015		Rear Drum	HK4119.706X	
SS		2014				HK4107.607X
SS		2015			HK4415.453X	
SSR		2003-2005			HK4400.382X	HK4397.383X
SSR		2006				HK4397.383X
Suburban		2015			HK4403.561X	HK4406.568X
Suburban 1500		2003-2006		4WD		HK4395.385X
Suburban 1500		2003-2006		RWD		HK4395.385X
Suburban 1500		2007-2013		2WD	HK4403.561X	

BRAKE PAD AND ROTOR KIT APPLICATIONS

MAKE/ MODEL	SUBMODEL	YEARS	ENGINE (LITER)	NOTE	FRONT	REAR
					KIT	KIT
CHEVROLET CONTINUED						
Suburban 1500		2007-2013		4WD	HK4403.561X	
Tahoe		2003-2006				HK4395.385X
Tahoe		2007-2013		2WD, Except Police	HK4403.561X	
Tahoe		2007-2013		4WD, Except Police	HK4403.561X	
Tahoe		2008-2015		2WD, Police	HK4102.561X	
Tahoe		2008-2015		4WD, Police	HK4102.561X	
Tahoe		2008-2016		Police	HK4102.561X	
Trailblazer		2002-2004		5 Passenger with 113" WB	HK4399.382X	HK4397.383X
Trailblazer		2002-2004		7 Passenger with 129" WB	HK4400.382X	HK4397.383X
Trailblazer		2005		4.2L Eng 5 Passenger	HK4399.382X	HK4397.383X
Trailblazer		2005		4.2L Eng 7 Passenger	HK4400.382X	HK4397.383X
Trailblazer		2005		5.3L Eng	HK4400.382X	HK4397.383X
Trailblazer		2006		4.2L Eng.; EXT	HK4400.617X	HK4397.383X
Trailblazer		2006		5.3L Eng.	HK4400.617X	HK4397.383X
Trailblazer		2006		4.2L Eng.; Base		HK4397.383X
Trailblazer		2006		SS Model		HK4397.383X
Trailblazer		2007-2009		5.3L Eng	HK4400.617X	HK4397.383X
Trailblazer		2007-2009		4.2L Eng		HK4397.383X
Trailblazer		2007-2009		6.0L; SS Model		HK4397.383X
Traverse		2009-2015			HK4417.617X	HK4413.383X
Trax		2015		Rear Disc		HK4115.707X
Uplander		2005		FWD with special suspension or AWD	HK4176.360X	
Uplander		2005		FWD without special suspension	HK4176.360X	
Uplander		2006		AWD	HK4408.360X	
Uplander		2006		FWD except Special Suspension	HK4408.360X	
Uplander		2006		FWD with Special Suspension	HK4408.360X	
Uplander		2007-2009			HK4408.360X	
Venture		1997-2005		Two Wheel Drive	HK4160.360X	
Venture		2002-2004		AWD	HK4173.360X	
Venture		2002-2005		All Wheel Drive	HK4173.373X	HK4174.359X
CHRYSLER						
200		2011-2012		Models With 302mm (11.9") Rear Rotors (BRG RPO Code)	HK4236.435X	HK4193.675X
200		2011-2012		Models With 262mm (10.3") Rear Rotors (BRF RPO Code)	HK4236.435X	HK4237.457X
200		2013-2014		Models with 340mm (13.3") Front Rotors and 302mm (11.9") Rear Rotors	HK4196.509X	HK4193.675X
200		2013-2014		Models with 295mm (11.6") Front Rotors and 302mm (11.9") Rear Rotors	HK4236.435X	HK4193.675X
200		2013-2014		Models with 295mm (11.6") Front Rotors and 262mm (10.3") Rear Rotors	HK4236.435X	HK4237.457X
300		2005-2007	2.7L			HK4234.508XA
300	C	2005-2010	5.7L	V8 NON SRT-8		HK4234.508XA
300	C	2005-2010	5.7L	V8 2WD & 4WD		HK4234.508XA
300		2005-2010	All	all except SRT 8. With Solid rear rotor		HK4234.508XA
300		2005-2010	All	all except SRT 8. With Vented rear rotor		HK4234.508XA
300		2005		V8, 5.7L - (Vented Rear Rotors)	HK4232.509X	HK4234.508XA
300		2005		V8, 5.7L - (Vented Rear Rotors)	HK4232.509X	HK4235.508X
300		2005		V8, 5.7L or AWD V6 - (Vented Rear Rotors)		HK4235.508X
300		2005		With Wear Sensor, V8, 5.7L - (Vented Rear Rotors)		HK4235.508X
300		2005-2007		HEMI 6.1L SRT-8	HK4468.563X	HK4469.194X
300		2005-2013		V6 - (Solid Rear Rotors)	HK4231.507X	HK4234.508XA
300		2005-2013		V6 - (Solid Rear Rotors)	HK4231.507X	HK4234.508X
300		2005-2013		With Wear Sensor, V8, 5.7L or AWD V6 - (Vented Rear Rotors)		HK4235.508X
300		2006-2013		V8, 5.7L or AWD V6 - (Vented Rear Rotors)	HK4232.509X	HK4234.508XA
300		2006-2013		V8, 5.7L or AWD V6 - (Vented Rear Rotors)	HK4232.509X	HK4235.508X
300		2008-2010		SRT-8	HK4468.563X	HK4469.194X

BRAKE PAD AND ROTOR KIT APPLICATIONS



Hawk Performance - KIT APPLICATIONS

HK 4218 .448 X
 HAWK KIT ROTOR PAD SHAPE INSERT COMPOUND CODE

MAKE/ MODEL	SUBMODEL	YEARS	ENGINE (LITER)	NOTE	FRONT	REAR
					KIT	KIT
CHRYSLER CONTINUED						
300		2011-2014	3.6L	RWD - with Solid rear rotor		HK4234.508XA
300		2012-2014	All	AWD w/vented rear rotors. Excl SRT-8		HK4234.508XA
300		2012-2014		SRT-8	HK4468.563X	HK4469.194X
300		2014-2015		V6 - (Solid Rear Rotors)	HK4231.507X	HK4234.508X
300		2014-2015		V8, 5.7L or AWD V6 - (Vented Rear Rotors)	HK4232.509X	HK4235.508X
300		2014-2015		w/Wear Sensor, V8, 5.7L or AWD V6 - (Vented Rear Rotors)		HK4235.508X
300	AWD	2015				HK4234.508XA
300	RWD	2015				HK4234.508XA
300M		1999-2002		With Performance Package		HK4216.176X
300M		1999-2004		without Performance Package		HK4216.176X
Aspen		2007-2009			HK4448.559X	HK4450.514X
Cirrus		1995-2000		with 14" Wheel		HK4223.176X
Cirrus		1995-2000		with 15" Wheel		HK4223.176X
Concorde		1995-1997				HK4216.176X
Concorde		1998-1999		Models with 297mm (11.7") Front Rotors	HK4225.260X	HK4216.176X
Concorde		1998-2000		Models with 282mm (11.1") Front Rotors		HK4216.176X
Concorde		2000		Models with 297mm (11.7") Front Rotors - Exc Performance Package	HK4225.260X	HK4216.176X
Concorde		2000		Models with 297mm (11.7") Front Rotors - With Performance Package	HK4226.260X	HK4216.176X
Concorde		2001-2004		Exc Performance Package	HK4225.260X	HK4216.176X
Concorde		2001-2004		With Performance Package	HK4226.260X	HK4216.176X
Crossfire		2004			HK4757.495X	
Crossfire		2005-2006		Except SRT-6	HK4757.495X	
Crossfire		2007-2008			HK4757.495X	
LHS		1995-1997				HK4216.176X
LHS		1999-2000		15" Wheels		HK4216.176X
LHS		1999-2000		16" Wheels		HK4216.176X
LHS		2001		with ABS		HK4216.176X
LHS		2001		without ABS		HK4216.176X
Pacifica		2004-2008			HK4455.433X	
Prowler		2001-2002			HK4438.260X	
PT Cruiser		2001-2002		With Rear Disc Brakes	HK4228.377X	HK4223.176X
PT Cruiser		2001-2002		With Rear Drum Brakes	HK4228.377X	
PT Cruiser		2003		With Rear Disc Brakes - Non-Turbo	HK4228.377X	HK4223.176X
PT Cruiser		2003		with Turbo	HK4229.377X	HK4230.176X
PT Cruiser		2003		With Rear Drum Brakes - Non-Turbo	HK4228.377X	
PT Cruiser		2004		HO Turbo	HK4229.377X	HK4230.176X
PT Cruiser		2004-2005		Rear disc with Turbo - Not HO	HK4229.377X	HK4223.176X
PT Cruiser		2004-2005		Rear drum except Turbo	HK4228.377X	
PT Cruiser		2004-2005		Rear drum with Turbo	HK4229.377X	
PT Cruiser		2005		HO Turbo; GT	HK4229.377X	HK4230.176X
PT Cruiser		2006-2007		With Rear Discs; Turbo; Limited	HK4228.377X	HK4223.176X
PT Cruiser		2006-2007		With Rear Discs; HO Turbo; GT	HK4229.377X	HK4230.176X
PT Cruiser		2006-2009		with rear drums	HK4228.377X	
PT Cruiser		2008-2009		With Rear Disc	HK4229.377X	HK4230.176X
PT Cruiser		2010			HK4228.377X	HK4230.176X
Sebring		1995-2000		Coupe	HK5170.213X	HK5281.367X
Sebring		1996-2000		Convertible & Sedan		HK4223.176X
Sebring		2001-2005		4 Cyl.Coupe	HK5170.213X	HK5281.367X
Sebring		2001-2005		6 Cyl.Coupe	HK5348.435X	HK5281.367X
Sebring		2001-2006		Convertible & Sedan	HK4222.498X	HK4223.176X
Sebring		2007-2010		with rear drums	HK4236.435X	
Sebring		2007-2010		With 302mm (11.9") Rear Discs	HK4236.435X	HK4193.675X
Sebring		2007-2010		With 262mm (10.3") Rear Discs	HK4236.435X	HK4237.457X

BRAKE PAD AND ROTOR KIT APPLICATIONS

MAKE/ MODEL	SUBMODEL	YEARS	ENGINE (LITER)	NOTE	FRONT	REAR
					KIT	KIT
CHEVROLET CONTINUED						
Town & Country		2001-2004		With Rear Disc		HK4436.372X
Town & Country		2001-2006		with Rear Drum	HK4449.373X	
Town & Country		2005		With Rear Disc	HK4452.374X	HK4436.372X
Town & Country		2006		With Rear Disc		HK4436.372X
Town & Country		2007		with rear drums	HK4449.373X	
Town & Country		2007		with Rear Discs		HK4436.372X
Town & Country		2008-2011			HK4477.569X	
Town & Country		2012		Models with Single Piston front caliper MFG After 3/24/2012	HK4477.569X	
Town & Country		2012		Models with Single Piston front caliper MFG Before 3/23/2012	HK4477.569X	
Town & Country		2013-2015		Models with Single Piston front caliper	HK4477.569X	
Voyager		2000		11" diameter front rotor	HK4438.177X	
Voyager		2001-2003			HK4449.373X	
DODGE						
Avenger		1995-2000			HK5170.213X	HK5281.367X
Avenger		2008-2010		with rear drums	HK4236.435X	
Avenger		2008-2010		With Rear Discs; R/T; 3.5L; w/302mm Rear Discs	HK4236.435X	HK4193.675X
Avenger		2008-2010		With Rear Discs; SXT; 2.7L; w/262mm Rear Discs	HK4236.435X	HK4237.457X
Avenger		2011-2012		With 302mm (11.9") Rear Rotors	HK4236.435X	HK4193.675X
Avenger		2011-2012		With 262mm (10.3") Rear Rotors	HK4236.435X	HK4237.457X
Avenger		2013-2014		Models with 340mm (13.3") Front Rotors and 302mm (11.9") Rear Rotors	HK4196.509X	HK4193.675X
Avenger		2013-2014		Models with 295mm (11.6") Front Rotors and 302mm (11.9") Rear Rotors	HK4236.435X	HK4193.675X
Avenger		2013-2014		Models with 295mm (11.6") Front Rotors and 262mm (10.3") Rear Rotors	HK4236.435X	HK4237.457X
C/V		2012-2014		Models with Single Piston front caliper	HK4477.569X	
Caliber		2007-2009		R/T, SXT with Rear Discs	HK4236.435X	HK4237.457X
Caliber		2007-2009		SE; SXT, with Rear Drums	HK4192.435X	
Caliber		2008-2009		SRT-4; 2.4L Turbo	HK4196.509X	HK4193.675X
Caliber		2010-2011		2.4L; with Rear Discs	HK4236.435X	HK4193.675X
Caliber		2010-2011		2.0L; with Rear Discs	HK4192.435X	HK4237.457X
Caliber		2010-2012		with rear drums	HK4192.435X	
Caliber		2012		with Rear Discs	HK4192.435X	HK4237.457X
Caravan		2001		Rear Disc	HK4452.374X	HK4436.372X
Caravan		2001-2002		Rear Drum	HK4449.373X	
Caravan		2002		Rear Disc		HK4436.372X
Caravan		2003-2004		Rear Drum with caliper casting # 134731	HK4449.373X	
Caravan		2003-2004		Rear Drum with caliper casting # 6623.9	HK4449.374X	
Caravan		2003-2006		Rear Disc	HK4452.374X	HK4436.372X
Caravan		2005-2006		Rear Drum	HK4449.373X	
Caravan		2007		with rear drums	HK4449.373X	
Caravan		2007		with Rear Discs	HK4452.374X	HK4436.372X
Challenger		2008	All			HK4469.508X
Challenger		2008			HK4468.509X	
Challenger		2008-2014		SRT8	HK4468.563X	HK4469.194X
Challenger	SE	2009-2013	3.5L	Solid Rear Disc		HK4234.508XA
Challenger	R/T	2009-2012	All	Vented rear disc		HK4234.508XA
Challenger	R/T	2009-2013	All	Vented rear disc		HK4235.508X
Challenger	R/T	2009-2013	All	With Wear Sensor, Vented rear disc		HK4235.508X
Challenger		2009-2011		SE	HK4231.507X	HK4234.508XA
Challenger		2009-2011		SE	HK4231.507X	HK4234.508X
Challenger		2009-2011		R/T	HK4232.509X	HK4234.508XA
Challenger		2009-2011		R/T	HK4232.509X	HK4235.508X
Challenger		2009-2011		With Wear Sensor, R/T		HK4235.508X
Challenger	SE Rallye Pkg	2011-2013	3.6L	Solid Rear Disc		HK4234.508XA

BRAKE PAD AND ROTOR KIT APPLICATIONS

Hawk Performance - KIT APPLICATIONS

HK 4218 .448 X
 HAWK KIT ROTOR PAD SHAPE INSERT COMPOUND CODE

MAKE/ MODEL	SUBMODEL	YEARS	ENGINE (LITER)	NOTE	FRONT	REAR
					KIT	KIT
DODGE CONTINUED						
Challenger	SXT	2012-2013	All	Excl. SRT8, Performance brakes	HK4231.509X	HK4234.508XA
Challenger	SXT	2012-2013	All			HK4234.508XA
Challenger	V6	2012-2013	All	Solid Rear Disc		HK4234.508XA
Challenger	V6	2012-2013	All	Touring Brakes		HK4234.508XA
Challenger		2012-2013		Models with solid rear rotors	HK4231.507X	HK4234.508XA
Challenger		2012-2013		Models with solid rear rotors	HK4231.507X	HK4234.508XA
Challenger		2012-2013		Models with vented rear rotors		HK4234.508XA
Challenger		2012-2013		Models with vented rear rotors (Exc. SRT8)	HK4232.509X	HK4235.508X
Challenger		2012-2013		With Wear Sensor, Models with vented rear rotors (Exc. SRT8)		HK4235.508X
Challenger		2014		Models with solid rear rotors	HK4231.507X	
Challenger		2014		Models with vented rear rotors (Exc. SRT8)	HK4232.509X	
Challenger		2015		Models with solid rear rotors	HK4231.507X	HK4234.508X
Challenger		2015		SRT 392 with Standard Brakes (4 piston front caliper)		HK4234.508XA
Challenger		2015		SRT 392 with Standard Brakes (4 piston front caliper)	HK4468.563X	HK4469.194X
Challenger		2015		Models with vented rear rotors (Exc. SRT)	HK4232.509X	HK4235.508X
Challenger		2015		With Wear Sensor, Models with vented rear rotors (Exc. SRT)		HK4235.508X
Challenger		2015		SRT 392 with Performance Brakes (6 piston front caliper)		HK4469.194X
Challenger		2015		SRT Hellcat		HK4469.194X
Challenger		2016		Models with vented rear rotors (Exc. SRT)	HK4232.509X	
Charger	Daytona R/T	2006-2013	All	w/Vented Rear Rotor		HK4234.508XA
Charger	Police	2006-2013	All			HK4234.508XA
Charger	R/T	2006-2013	All	w/Vented Rear Rotor		HK4234.508XA
Charger	SXT RWD	2006-2013	All	RWD w/ Solid Rear Rotor		HK4234.508XA
Charger		2006-2014	All	RWD w/ Solid Rear Rotor		HK4234.508XA
Charger		2006-2014	All	RWD w/Vented Rear Rotor		HK4234.508XA
Charger		2006-2014	All	w/HD Brakes. W/Solid Rear Rotor		HK4234.508XA
Charger	SE	2006-2014	All	RWD w/ Solid Rear Rotor		HK4234.508XA
Charger		2006		V6 Models with Solid Rear Rotors	HK4231.507X	HK4234.508XA
Charger		2006		V6 Models with Solid Rear Rotors	HK4231.507X	HK4234.508X
Charger		2006		Police or Daytona R/T Models with 13.7" Vented Rear Rotors	HK4232.509X	
Charger		2006-2010		SRT-8	HK4468.563X	HK4469.194X
Charger		2006-2013		Models with 12.6" Vented Rear Rotors	HK4232.509X	HK4234.508XA
Charger		2006-2013		Models with 12.6" Vented Rear Rotors	HK4232.509X	HK4235.508X
Charger		2006-2013		With Wear Sensor, Models with 12.6" Vented Rear Rotors		HK4235.508X
Charger		2007-2013		Models with solid rear rotors	HK4231.507X	HK4234.508XA
Charger		2007-2013		Models with solid rear rotors	HK4231.507X	HK4234.508X
Charger		2007-2013		Police or Heavy Duty Models with 13.7" Vented Rear Rotors	HK4232.509X	
Charger		2008-2014	All	AWD w/Solid Rear Rotor		HK4234.508XA
Charger		2012-2014		SRT-8	HK4468.563X	HK4469.194X
Charger		2014		Pursuit Models with 13.6" Front Rotors and 13.7" Vented Rear Rotors	HK4232.509X	
Charger		2014-2015		Models with solid rear rotors	HK4231.507X	HK4234.508X
Charger		2014-2015		Models with 12.6" Vented Rear Rotors	HK4232.509X	HK4235.508X
Charger		2014-2015		With Wear Sensor, Models with 12.6" Vented Rear Rotors		HK4235.508X
Charger		2015		SRT 392 with Standard Brakes (4 piston front caliper)	HK4468.563X	HK4469.194X
Charger		2015		SRT 392 with Performance Brakes (6 piston front caliper)		HK4469.194X
Charger		2015		SRT Hellcat		HK4469.194X
Charger	AWD	2015				HK4234.508XA
Charger	R/T Road & Track	2015				HK4234.508XA
Charger	RWD	2015				HK4234.508XA
Charger		2016		Models with 12.6" Vented Rear Rotors	HK4232.509X	
Dakota		1997-1998			HK4437.308X	
Dakota		1999			HK4437.306X	
Dakota		2000-2002			HK4437.307X	
Dakota		2003-2004			HK4457.476X	HK4459.503X

BRAKE PAD AND ROTOR KIT APPLICATIONS



MAKE/ MODEL	SUBMODEL	YEARS	ENGINE (LITER)	NOTE	FRONT	REAR
					KIT	KIT
DODGE CONTINUED						
Dakota		2005-2011			HK4460.559X	
Durango		1998-1999			HK4437.306X	
Durango		2000-2002			HK4437.307X	
Durango		2003			HK4453.299X	HK4454.513X
Durango		2003			HK4453.299X	HK4454.514X
Durango		2004-2006			HK4448.299X	HK4450.513X
Durango		2007-2009			HK4448.559X	HK4450.513X
Durango		2011-2012		350mm Front Disc; Vented Rear Disc	HK4201.701X	HK4200.702X
Durango		2011-2015		330mm Front Disc; Solid Rear Disc	HK4199.701X	HK4198.702X
Durango		2013-2015		350mm Front Disc; Vented Rear Disc BR6 RPO Code	HK4201.701X	HK4200.702X
Durango		2013-2015		350mm Front Disc; Vented Rear Disc BR8 RPO Code		HK4200.702X
Grand Caravan		2001-2005		Rear Disc	HK4452.374X	HK4436.372X
Grand Caravan		2001-2006		Rear Drum	HK4449.373X	
Grand Caravan		2006		Rear Disc		HK4436.372X
Grand Caravan		2007			HK4452.374X	HK4436.372X
Grand Caravan		2008-2011			HK4477.569X	
Grand Caravan		2012		Models with Single Piston front caliper MFG After 3/24/2012	HK4477.569X	
Grand Caravan		2012		Models with Single Piston front caliper MFG Before 3/23/2012	HK4477.569X	
Grand Caravan		2013-2015		Models with Single Piston front caliper	HK4477.569X	
Intrepid		1995-1996				HK4216.176X
Intrepid		1997		With Rear Disc Brakes		HK4216.176X
Intrepid		1998-1999		with 16" or 17" Wheels	HK4225.260X	HK4216.176X
Intrepid		1998-2000		with 15" Wheels		HK4216.176X
Intrepid		2000		with 16" or 17" Wheels - Excluding Performance Pkg.	HK4225.260X	HK4216.176X
Intrepid		2000		with 16" or 17" Wheels - With Performance Pkg.	HK4226.260X	HK4216.176X
Intrepid		2001-2004		Excluding Performance Pkg.	HK4225.260X	HK4216.176X
Intrepid		2001-2004		With Performance Pkg.	HK4226.260X	HK4216.176X
Journey		2009-2011			HK4477.569X	
Journey		2012-2013		Models with Single Piston front caliper	HK4477.569X	
Magnum	SE	2005-2008	2.7L	w/Vented Rear Rotor		HK4234.508XA
Magnum	SE	2005-2008	2.7L	w/Vented Rear Rotor		HK4234.508X
Magnum	SXT	2005-2008	2.7L	w/Vented Rear Rotor - AWD	HK4231.509X	HK4234.508XA
Magnum	SXT	2005-2008	2.7L	w/Vented Rear Rotor - AWD	HK4231.509X	HK4234.508X
Magnum	SXT	2005-2008	2.7L	w/Vented Rear Rotor - RWD		HK4234.508XA
Magnum	SXT	2005-2008	2.7L	w/Vented Rear Rotor - RWD		HK4234.508X
Magnum	SXT	2005-2008	3.5L	w/Vented Rear Rotor - AWD	HK4231.509X	HK4234.508XA
Magnum	SXT	2005-2008	3.5L	w/Vented Rear Rotor - AWD	HK4231.509X	HK4234.508X
Magnum	SXT	2005-2008	3.5L	w/Vented Rear Rotor - RWD		HK4234.508XA
Magnum	SXT	2005-2008	3.5L	w/Vented Rear Rotor - RWD		HK4234.508X
Magnum	R/T	2005-2008	5.7L	w/Vented Rear Rotor		HK4234.508XA
Magnum	R/T	2005-2008	5.7L	w/Vented Rear Rotor		HK4235.508X
Magnum	R/T	2005-2008	5.7L	With Wear Sensor, w/Vented Rear Rotor		HK4235.508X
Magnum		2005		Models w/Vented Rear Rotors; Except SRT-8	HK4232.509X	HK4234.508XA
Magnum		2005		Models w/Vented Rear Rotors; Except SRT-8	HK4232.509X	HK4235.508X
Magnum		2005		With Wear Sensor, Models w/Vented Rear Rotors; Except SRT-8		HK4235.508X
Magnum		2005-2008		SRT-8	HK4468.563X	HK4469.194X
Magnum		2005-2008		Models w/Solid Rear Rotors	HK4231.507X	HK4234.508XA
Magnum		2005-2008		Models w/Solid Rear Rotors	HK4231.507X	HK4234.508X
Magnum		2006-2008		Models w/Vented Rear Rotors; Except Police/SRT-8	HK4232.509X	HK4234.508XA
Magnum		2006-2008		Models w/Vented Rear Rotors; Except Police/SRT-8	HK4232.509X	HK4235.508X
Magnum		2006-2008		With Wear Sensor, Models w/Vented Rear Rotors; Except Police/SRT-8		HK4235.508X
Magnum		2006-2008		Police Package with 13.7" Vented Rear Rotors	HK4232.509X	
Neon		1995-1999		With Rear Disc		HK4223.176X

Hawk Performance - KIT APPLICATIONS

HK 4218 .448 X
 HAWK KIT ROTOR PAD SHAPE INSERT COMPOUND CODE

MAKE/ MODEL	SUBMODEL	YEARS	ENGINE (LITER)	NOTE	FRONT	REAR
					KIT	KIT
DODGE CONTINUED						
Neon		2000-2002		With Rear Disc	HK4227.177X	HK4223.176X
Neon		2000-2002		with Rear Drum	HK4227.177X	
Neon		2003-2005		except SRT-4, with Rear Disc	HK4227.177X	HK4223.176X
Neon		2003-2005		SRT-4	HK4229.377X	HK4230.176X
Neon		2003-2005		except SRT-4, with Rear Drum	HK4227.177X	
Nitro		2007-2011			HK4194.569X	HK4195.608X
Ram 1500		1994-1999		4WD	HK4429.332X	
Ram 1500		2000-2001		4WD	HK4446.299X	
Ram 1500		2000-2001		RWD	HK4445.299X	
Ram 1500		2002-2003			HK4448.299X	HK4450.513X
Ram 1500	SLT	2004-2005		Standard Cab Pickup	HK4448.299X	
Ram 1500	SLT	2004-2005		Crew Cab Pickup	HK4448.299X	
Ram 1500	ST	2004-2005		Standard Cab Pickup	HK4448.299X	
Ram 1500	ST	2004-2005		Crew Cab Pickup	HK4448.299X	
Ram 1500	SRT-10	2004-2006		Standard Cab Pickup		HK4462.299X
Ram 1500	Hemi Sport	2005		Standard Cab Pickup	HK4448.299X	
Ram 1500	Hemi Sport	2005		Crew Cab Pickup	HK4448.299X	
Ram 1500	Laramie	2005		Standard Cab Pickup	HK4448.299X	
Ram 1500	Laramie	2005		Crew Cab Pickup	HK4448.299X	
Ram 1500	Rumble Bee	2005		Standard Cab Pickup	HK4448.299X	
Ram 1500	SRT-10	2005-2006		Crew Cab Pickup		HK4462.299X
Ram 1500		2006-2008		Extended Crew Cab Pickup; Also called Mega Cab	HK4466.552X	
Ram 1500		2009-2010				HK4450.513X
Ram 2500		2000-2002		4WD	HK4444.487X	HK4451.299X
Ram 2500		2000-2002		RWD	HK4444.487X	HK4451.299X
Ram 2500		2003-2008		4WD	HK4466.552X	
Ram 2500		2003-2008		RWD	HK4466.552X	
Ram 3500		1994-1999		4WD	HK4380.298X	
Ram 3500		1994-1999		RWD; With Solid Front Axle	HK4380.298X	
Ram 3500		2000-2002		4WD	HK4444.487X	HK4451.299X
Ram 3500		2000-2002		RWD	HK4444.487X	HK4451.299X
Ram 3500		2003-2008		4WD	HK4466.552X	
Ram 3500		2003-2008		RWD	HK4466.552X	
Stealth		1991-1993		4WD	HK5214.120X	HK5217.673X
Stealth		1991-1996		2WD	HK5215.214X	HK5216.367X
Stealth		1994		AWD	HK5291.120X	HK5292.673X
Stealth		1995-1996		AWD	HK5291.120X	HK5292.201X
Stratus		1995-2000		with 15" Wheels		HK4223.176X
Stratus		1995-2000		with 14" Wheels		HK4223.176X
Stratus		2001-2005		6 Cyl. Coupe	HK5348.435X	HK5281.367X
Stratus		2001-2005		4 Cyl. Coupe	HK5170.213X	
Stratus		2001-2006		Sedan	HK4222.498X	HK4223.176X
EAGLE						
Summit		1993-1996		Wagon; w/Rear Discs	HK5244.213X	
FORD						
Bronco		1994-1996			HK4304.295X	
C-Max		2013-2016		Hybrid Models	HK4281.519X	
C-Max		2013-2016		Energi	HK4895.519X	
Crown Victoria		1996-1997		with Steel Piston Rear Caliper		HK4032.341X
Crown Victoria		1996-1997		with Phenolic (Plastic) Piston Rear Caliper		HK4032.520X
Crown Victoria		1998-2002		with Steel Piston Rear Caliper	HK4035.294X	HK4032.341X
Crown Victoria		1998-2002		with Phenolic (Plastic) Piston Rear Caliper	HK4035.294X	HK4032.520X
Crown Victoria		2003-2011			HK4042.433X	HK4043.443X
E-150		2003		with 4 Whl. ABS	HK4303.295X	
E-150		2003		with Rear Whl. ABS	HK4302.295X	

BRAKE PAD AND ROTOR KIT APPLICATIONS

MAKE/ MODEL	SUBMODEL	YEARS	ENGINE (LITER)	NOTE	FRONT	REAR
					KIT	KIT
FORD CONTINUED						
E-150		2007				HK4340.539X
E-150 Econoline		1987-1993			HK4246.293X	
E-150 Econoline		1994-2002		with 4 Whl. ABS	HK4303.295X	
E-150 Econoline		1994-2002		with Rear Whl. ABS	HK4302.295X	
E-250		2003-2007				HK4340.539X
E-250 Econoline		1995-2001		with 4 Whl. ABS		HK4340.539X
E-250 Econoline		1995-2001		with Rear Whl. ABS		HK4340.539X
E-250 Econoline		2002				HK4340.539X
E-350		2003		SRW		HK4340.539X
E-350		2003		DRW		HK4341.539X
E-350 Econoline		1995-1998		Single Rr Whl with 4 Whl. ABS		HK4341.539X
E-350 Econoline		1995-2000		Dual Rr Whl with 4 Whl. ABS		HK4341.539X
E-350 Econoline		1995-2000		Dual Rr Whl with Rear Whl. ABS		HK4341.539X
E-350 Econoline		1999-2000		Single Rr Whl with 4 Whl. ABS		HK4340.539X
E-350 Econoline		1999-2000		Single Rr Whl with Rear Whl. ABS		HK4341.539X
E-350 Econoline		2001-2002		SRW		HK4340.539X
E-350 Econoline		2001-2002		DRW		HK4341.539X
E-350 Super Duty		2004-2007		SRW		HK4340.539X
E-350 Super Duty		2004-2007		DRW		HK4341.539X
Edge		2007-2009		320mm (12.6") Front Rotors	HK4059.656X	HK4060.657X
Edge		2007-2009		296mm (11.65") Front Rotors	HK4061.656X	HK4060.657X
Edge		2010			HK4059.656X	HK4060.657X
Edge		2011-2015			HK4059.656X	HK4055.674X
Escape		2001-2004			HK4350.473X	
Escape		2005-2007		With Rear Disc Brakes	HK4251.473X	
Escape		2005-2007		with rear drums	HK4350.473X	
Escape		2013-2015		1.6L ENGINE FWD	HK4895.519X	
Escape		2013-2015		2.5L ENGINE	HK4895.519X	
Escape		2013-2015		1.6L ENGINE AWD	HK4896.519X	
Escape		2013-2015		2.0L ENGINE	HK4896.519X	
Escort		1991-1996		DOHC 1.8L		HK5207.157X
Escort		1997-2002				HK5207.159X
Escort		2003		ZX2		HK5207.159X
Excursion		2000		2WD - Manufactured after 1/2000	HK4336.302X	HK4334.303X
Excursion		2000		2WD - Manufactured up to 12/1999	HK4336.302X	HK4334.303X
Excursion		2000		4WD - Manufactured after 1/2000	HK4342.302X	HK4334.303X
Excursion		2000		4WD - Manufactured up to 12/1999	HK4342.302X	HK4334.303X
Excursion		2001-2002		2WD	HK4336.302X	HK4334.303X
Excursion		2001-2005		4WD	HK4342.302X	HK4334.303X
Excursion		2003-2005		2WD	HK4056.302X	HK4334.303X
Expedition		1997-1999		2WD	HK4326.299X	HK4322.301X
Expedition		1997-1999		4WD	HK4321.299X	HK4322.301X
Expedition		2000		4WD; To 11/99	HK4321.299X	HK4322.301X
Expedition		2000		2WD To 11/99 - 12mm Studs	HK4326.299X	HK4322.301X
Expedition		2000		4WD; From 12/99	HK4321.299X	HK4344.301X
Expedition		2000		2WD From 12/99 - 14mm Studs	HK4346.299X	HK4344.301X
Expedition		2001		2WD	HK4346.299X	HK4344.301X
Expedition		2001		4WD	HK4321.299X	HK4344.301X
Expedition		2002		4WD; To 3/18/02	HK4321.299X	HK4344.301X
Expedition		2002		2WD; To 3/18/02	HK4346.299X	HK4344.301X
Expedition		2002		From 3/18/02	HK4352.299X	HK4353.301X
Expedition		2003-2006			HK4352.462X	HK4353.463X
Explorer		1995-2000		2WD	HK4314.283X	HK4315.287X
Explorer		1995-2000		4WD	HK4317.283X	HK4315.287X
Explorer	Sport	2001	All	AWD/4WD	HK4317.472X	

BRAKE PAD AND ROTOR KIT APPLICATIONS

Hawk Performance - KIT APPLICATIONS

HK 4218 .448 X
 HAWK KIT ROTOR PAD SHAPE INSERT COMPOUND CODE

MAKE/ MODEL	SUBMODEL	YEARS	ENGINE (LITER)	NOTE	FRONT	REAR
					KIT	KIT
FORD CONTINUED						
Explorer		2001		2WD except Sport	HK4314.283X	HK4315.287X
Explorer		2001		4WD except Sport	HK4317.283X	HK4315.287X
Explorer		2002		except Sport	HK4351.472X	HK4349.520X
Explorer		2002-2003		4 Door		HK4349.287X
Explorer		2003-2005			HK4351.472X	HK4349.520X
Explorer		2006-2010				HK4349.613X
Explorer		2011-2012			HK4272.710X	HK4055.674X
Explorer		2013-2016		Standard Brakes; 325mm (12.8") Front Rotors	HK4272.710X	HK4055.674X
Explorer Sport Trac		2001-2005		2WD	HK4347.472X	
Explorer Sport Trac		2001-2005		4WD	HK4348.472X	
Explorer Sport Trac		2007-2010				HK4349.613X
F-150		1997-1998		RWD; Rear Drum; 4-Wheel ABS	HK4318.266X	
F-150		1997-1999		4WD	HK4320.266X	
F-150		1997-1999		RWD; Rear Drum; 2-Wheel ABS	HK4319.266X	
F-150	Base	1999		RWD; Rear Disc	HK4318.266X	
F-150	Lariat	1999		RWD; Rear Disc	HK4318.266X	
F-150	XL	1999		RWD; Rear Disc	HK4318.266X	
F-150	XLT	1999		RWD; Rear Disc	HK4318.266X	
F-150		2000		RWD; Rear Drum; 2-Wheel ABS; To 11/99	HK4319.266X	
F-150	Harley-Davidson Edition	2000		RWD; Rear Disc; To 11/99	HK4318.266X	
F-150	Lariat	2000		RWD; Rear Disc; To 11/99	HK4318.266X	
F-150	XLT	2000		RWD; Rear Disc; To 11/99	HK4318.266X	
F-150		2000-2003		4WD; 5 Lugs	HK4320.266X	
F-150 Heritage		2004		4WD; 5 Lugs	HK4320.266X	
F-150 Pickup 2WD		2000-2004		8 Lug Models		HK4341.539X
F-250 Super Duty		1999		4WD; To 3/22/99	HK4330.302X	
F-250 Super Duty		1999-2000		RWD; 2-Wheel ABS	HK4335.302X	
F-250 Super Duty		2005-2007		4WD		HK4260.529X
F-250 Super Duty		2005-2007		RWD		HK4260.529X
F-250 Super Duty		2008-2012		4WD		HK4260.556X
F-250 Super Duty		2008-2012		RWD		HK4260.556X
F-350 Super Duty		1999		4WD; To 3/22/99; 95mm tall front rotor	HK4330.302X	
F-350 Super Duty		1999-2002		RWD; 2-Wheel ABS; SRW	HK4335.302X	
F-350 Super Duty		1999-2002		RWD; DRW; With 14x2.0mm Studs	HK4337.302X	
F-350 Super Duty		1999-2004		4WD; DRW		HK4333.303X
F-350 Super Duty		1999-2004		RWD; DRW		HK4333.303X
F-350 Super Duty		2005-2007		4WD; SRW		HK4260.529X
F-350 Super Duty		2005-2007		RWD; SRW		HK4260.529X
F-350 Super Duty		2008-2012		4WD; SRW		HK4260.556X
F-350 Super Duty		2008-2012		RWD; SRW		HK4260.556X
F-350 Super Duty Pickup 2WD		2005-2006		Dual Rear Wheel		HK4262.556X
F-350 Super Duty Pickup 2WD		2007		Dual Rr Whl - MFG After 1/2007		HK4262.556X
F-350 Super Duty Pickup 2WD		2007		Dual Rr Whl - MFG Before 12/2006		HK4262.556X
F-350 Super Duty Pickup 2WD		2008-2009		DRW		HK4262.556X
F-350 Super Duty Pickup 2WD		2010		DRW - MFG After 2/22/2010		HK4262.556X
F-350 Super Duty Pickup 2WD		2010		DRW - MFG Before 2/12/2010		HK4262.556X
F-350 Super Duty Pickup 2WD		2011-2012		DRW		HK4262.556X
F-350 Super Duty Pickup 4WD		2005-2009		Dual Rr Whl		HK4262.556X
F-350 Super Duty Pickup 4WD		2010		Dual Rr Whl - MFG After 2/22/2010		HK4262.556X
F-350 Super Duty Pickup 4WD		2010		Dual Rr Whl - MFG Before 2/12/2010		HK4262.556X
F-350 Super Duty Pickup 4WD		2011		Dual Rr Whl - MFG After 11/1/2010		HK4262.556X
F-350 Super Duty Pickup 4WD		2011		Dual Rr Whl - MFG Before 11/1/2010		HK4262.556X
F-350 Super Duty Pickup 4WD		2012		Dual Rr Whl		HK4262.556X
F-450 Super Duty		2010-2012		Pickup		HK4262.556X
Fiesta		2011-2013			HK4271.668X	

BRAKE PAD AND ROTOR KIT APPLICATIONS

MAKE/ MODEL	SUBMODEL	YEARS	ENGINE (LITER)	NOTE	FRONT	REAR
					KIT	KIT
FORD CONTINUED						
Fiesta		2014-2015		Rear Drum Models	HK4271.668X	
Fiesta		2014-2015		ST Models		HK4041.430X
Five Hundred		2005-2007			HK4054.723X	HK4055.724X
Flex		2009-2011			HK4063.710X	HK4055.674X
Flex		2012			HK4272.710X	HK4055.674X
Flex		2013-2015		Standard Brakes; 325mm (12.8") Front Rotors	HK4272.710X	HK4055.674X
Focus		2000			HK4039.346X	
Focus		2001			HK4039.346X	HK4041.430X
Focus		2002-2004		except SVT	HK4039.346X	HK4041.430X
Focus		2002-2004		SVT	HK4046.449X	HK4047.430X
Focus		2005-2007			HK4048.519X	HK4041.430X
Focus		2012		with Rear Discs	HK4281.519X	HK4280.478X
Focus		2012-2014		With Rear Drums - S Model	HK4281.519X	
Focus		2013-2014		With Rear Discs - SE, SEL, Electric or Titanium Models	HK4281.519X	HK4280.478X
Focus		2013-2014		ST	HK4896.712X	HK4280.478X
Freestyle		2005-2007			HK4054.723X	HK4055.724X
Fusion		2006-2012			HK4945.565X	HK5368.564X
Mustang		1990-1992	5.0L	302cid V8	HK4011.125X	
Mustang	GT	1993	5.0L	302cid V8	HK4011.125X	
Mustang	LX	1993	5.0L	302cid V8	HK4011.125X	
Mustang		1994-1998		except COBRA	HK4023.182X	HK4024.183X
Mustang		1994-1998		COBRA	HK4025.111X	HK4026.183X
Mustang		1999-2000		COBRA - No Logo on front caliper	HK4025.111X	HK4026.183X
Mustang		1999-2000		COBRA - With COBRA on front caliper	HK4025.111X	HK4026.183X
Mustang		1999-2004		Base & GT	HK4023.274X	HK4024.183X
Mustang	SVT Cobra R	2000	5.4L		HK4025.194X	
Mustang		2001		COBRA & Bullitt - No Logo on front caliper	HK4025.111X	HK4026.183X
Mustang		2001		COBRA & Bullitt - With COBRA on front caliper	HK4025.111X	HK4026.183X
Mustang		2003-2004		COBRA & SVT, MACH 1	HK4025.111X	HK4026.183X
Mustang		2005-2007		V8 4.6L	HK4049.484X	HK4051.485X
Mustang		2005-2007		V6 - 4.0L	HK4050.484X	HK4051.485X
Mustang		2007-2008		SHELBY GT	HK4049.484X	HK4051.485X
Mustang		2007-2008		SHELBY GT500	HK4058.453X	HK4051.485X
Mustang		2008-2009		V8; GT	HK4049.484X	HK4051.485X
Mustang		2008-2009		V6	HK4050.484X	HK4051.485X
Mustang		2009-2011		SHELBY	HK4058.453X	HK4051.485X
Mustang		2010		V6 MFG after 3/21/2010 Except models with Brembo Front Calipers	HK4049.484X	HK4051.485X
Mustang		2010		V8; GT MFG up to 3/20/2010	HK4049.484X	HK4051.485X
Mustang		2010		V6 MFG up to 3/20/2010	HK4050.484X	HK4051.485X
Mustang		2010		V8; GT MFG after 3/21/2010 Except models with Brembo Front Calipers	HK4279.484X	HK4051.485X
Mustang		2010-2011		Base or GT With Brembo Front Calipers	HK4058.453X	HK4051.485X
Mustang		2011-2012		V6 Models without Brembo Front Calipers	HK4049.484X	HK4051.485X
Mustang		2011-2012		V8; GT Models without Brembo Front Calipers	HK4279.484X	HK4051.485X
Mustang		2012		SHELBY	HK4058.453X	
Mustang		2012-2014		Base, GT, or Boss 302 With Brembo Front Calipers	HK4058.453X	HK4051.485X
Mustang		2013-2014		Models with Standard Front Calipers and 316mm (12.45") Front Rotors	HK4049.484X	HK4051.485X
Mustang		2013-2014		Models with Standard Front Calipers and 336mm (13.23") Front Rotors	HK4279.484X	HK4051.485X
Probe		1993-1997			HK5210.211X	HK5211.212X
Ranger		1998-2002		4WD	HK4317.283X	
Ranger		1998-2002		2WD With Torsion Bar Front Suspension	HK4314.283X	
Ranger		1998-2002		Electric Eng	HK4314.283X	
Ranger		2003-2006		2WD with 4 wheel ABS	HK4314.472X	

BRAKE PAD AND ROTOR KIT APPLICATIONS

Hawk Performance - KIT APPLICATIONS

HK 4218

.448

X

HAWK KIT

ROTOR

PAD SHAPE

INSERT COMPOUND CODE

MAKE/ MODEL	SUBMODEL	YEARS	ENGINE (LITER)	NOTE	FRONT	REAR
					KIT	KIT
FORD CONTINUED						
Ranger		2003-2011		4WD	HK4348.472X	
Ranger		2007-2009		2WD	HK4314.472X	
Taurus		1993		SHO		HK4021.417X
Taurus		1993		except SHO; With Rear Disc		HK4021.417X
Taurus		1994		SHO	HK4031.347X	HK4021.417X
Taurus		1994-1995		with rear drums	HK4031.347X	
Taurus		1994-2000		except SHO; With Rear Disc	HK4031.347X	HK4021.417X
Taurus		1995		SHO	HK4031.416X	HK4021.417X
Taurus		1996-1998		SHO	HK4029.416X	HK4021.417X
Taurus		1996-2000		except SHO; With Rear Drums	HK4031.347X	
Taurus		1999-2000		SHO; with Rear Disc	HK4029.416X	HK4021.417X
Taurus		2001-2005		with Rear Discs	HK4029.416X	HK4021.417X
Taurus		2001-2007		with rear drums	HK4029.416X	
Taurus		2008-2009			HK4054.723X	HK4055.724X
Taurus		2010			HK4063.710X	HK4055.674X
Taurus		2011-2012			HK4272.612X	HK4055.674X
Taurus		2011-2012			HK4272.710X	HK4055.674X
Taurus		2013-2015		Excluding Police; 325mm (12.8") Front Rotors	HK4272.710X	HK4055.674X
Taurus X		2008-2009			HK4054.723X	HK4055.724X
Thunderbird		1993-1995		Rear Disc Brakes	HK4031.182X	
Thunderbird		1993-1995		Rear Drum Brakes	HK4031.182X	
Thunderbird		1996		except Sport Package, Rear Drum	HK4031.182X	
Thunderbird		1996-1997		Sport Package, Rear Disc	HK4029.416X	
Thunderbird		1996-1997		except Sport Package, Rear Disc	HK4031.182X	
Thunderbird		2002-2005			HK4038.376X	HK4040.428X
Transit Connect		2010-2013			HK4269.449X	
Windstar		1995-1998		with rear drums	HK4031.347X	
Windstar		1995-1998		with Rear Discs	HK4031.347X	
GEO						
Prizm		1993-1997			HK5261.310X	
GMC						
Acadia		2007-2015			HK4417.617X	HK4413.383X
C1500 Suburban		1992-1993			HK4379.332X	
C1500 Suburban		1994		5 Lug	HK4379.296X	
C1500 Suburban		1995-1999		5 Lug	HK4379.332X	
C1500 Suburban		1995-1999		8 Lug	HK4381.296X	
C2500 Suburban		1992-1999			HK4381.296X	
Canyon		2004-2008			HK4402.554X	
Envoy		2002-2003		5 Passenger with 113" WB	HK4399.382X	HK4397.383X
Envoy		2002-2003		7 Passenger with 129" WB	HK4400.382X	HK4397.383X
Envoy		2004		Base with 113" wheelbase	HK4399.382X	HK4397.383X
Envoy		2004		XL, XUV models with 129" WB	HK4400.382X	HK4397.383X
Envoy		2005		4.2L 6 Cylinder Engine - Base Models (113" Wheelbase)	HK4399.382X	HK4397.383X
Envoy		2005		4.2L 6 Cylinder Engine - XL, XUV Models (129" Wheelbase)	HK4400.382X	HK4397.383X
Envoy		2005		Models with 5.3L V8	HK4400.382X	HK4397.383X
Envoy		2006		5.3L Eng.	HK4400.617X	HK4397.383X
Envoy		2006		4.2L XL 7 Passenger	HK4400.617X	HK4397.383X
Envoy		2006		4.2L Base 5 Passenger		HK4397.383X
Envoy		2007-2009		5.3L Engine	HK4400.617X	HK4397.383X
Envoy		2007-2009		4.2L Engine		HK4397.383X
Jimmy		1992-1994		RWD; 2-Wheel ABS	HK4110.119X	
Jimmy		1997		4WD with rear disc	HK4388.304X	HK4387.305X
Jimmy		1998-2002		2WD	HK4388.304X	HK4389.305X
Jimmy		1998-2002		4WD	HK4388.304X	HK4387.305X
K1500 Suburban		1992-1993			HK4367.332X	

BRAKE PAD AND ROTOR KIT APPLICATIONS

MAKE/ MODEL	SUBMODEL	YEARS	ENGINE (LITER)	NOTE	FRONT	REAR
					KIT	KIT
GMC CONTINUED						
K1500 Suburban		1995-1999		8 lug - 13" rear drum	HK4155.296X	
K1500 Suburban		1995-1999		6 Lug -11" rear drum	HK4367.332X	
K2500 Suburban		1992-1993			HK4155.296X	
K2500 Suburban		1994-1996		13" Rear Drum	HK4155.296X	
K2500 Suburban		1997-1999		13" Rear Drum 8600 lb. GVW	HK4155.296X	
S15 Jimmy		1989-1990		RWD	HK4110.119X	
Safari		2003-2005			HK4390.323X	HK4391.324X
Savana 1500		1996-2002			HK4379.332X	
Savana 1500		2003-2008			HK4390.323X	
Savana 1500		2009-2014			HK4403.561X	
Savana 2500		1996-2000		8 Lug	HK4381.296X	
Savana 2500		2001-2002		8 Lug with Gas Engine	HK4381.296X	
Savana 2500		2003-2005		6 Lug	HK4390.323X	
Savana 2500		2003-2005		8 Lug	HK4392.322X	HK4393.494X
Savana 2500		2006-2014		Gas Engine	HK4392.322X	HK4393.494X
Savana 2500		2006-2014		Diesel Engine	HK4392.322X	HK4394.494X
Savana 3500		1996-2000		Single Rr Whl	HK4381.296X	
Savana 3500		2001		Single Rr Whl G315 Cab & Chassis	HK4381.296X	
Savana 3500		2003-2006		Dual Rr Whl	HK4404.322X	
Savana 3500		2003-2006		Single Rr Whl	HK4404.322X	HK4394.494X
Savana 3500		2007-2014		DRW	HK4404.322X	
Savana 3500		2007-2014		SRW; 86mm Tall Rear Disc	HK4404.322X	HK4393.494X
Savana 3500		2007-2014		SRW; 91mm Tall Rear Disc	HK4404.322X	HK4394.494X
Savana 4500		2009-2014		DRW	HK4404.322X	
Savana 4500		2009-2014		SRW; 86mm Tall Rear Disc	HK4404.322X	
Savana 4500		2009-2014		SRW; 91mm Tall Rear Disc	HK4404.322X	
Sierra	Denali	2007-2010			HK4403.561X	
Sierra 1500		2005		Crew Cab Pickup; Rear Disc; With 4 Wheel Steering		HK4405.324X
Sierra 1500	2WD	2005-2006		With Rear Drum Brakes	HK4392.561X	
Sierra 1500	4WD	2005-2006		With Rear Drum Brakes	HK4392.561X	
Sierra 1500		2005-2013		2WD, with rear drum brakes	HK4403.561X	
Sierra 1500		2005-2013		4WD, with rear drum brakes	HK4403.561X	
Sierra 1500		2007	All	w/Rear Disc Brakes. 8 Lugs		HK4393.568X
Sierra 1500	Classic LS	2007	All	w/Rear Disc Brakes. 8 Lugs		HK4393.568X
Sierra 1500	Classic LT	2007	All	w/Rear Disc Brakes. 8 Lugs		HK4393.568X
Sierra 1500	Classic WT	2007	All	w/Rear Disc Brakes. 8 Lugs		HK4393.568X
Sierra 1500	2WD	2007		With rear drum brakes Front Caliper Bracket Cast Number 285C/286C	HK4392.561X	
Sierra 1500	2WD	2007		6 lug new body style models with rear disc brakes Front Caliper Bracket Cast NUMBER 351C/352C	HK4392.561X	
Sierra 1500	2WD	2007		With rear drum brakes Front Caliper Bracket Cast Number 351C/352C	HK4392.561X	
Sierra 1500	4WD	2007		Old Body Style with rear drum brakes Front Caliper Bracket Cast NUMBER 285C/286C	HK4392.561X	
Sierra 1500	4WD	2007		New Body Style 6 lug models with rear disc brakes	HK4392.561X	
Sierra 1500	4WD	2007		New Body Style with rear drum brakes Front Caliper Bracket Cast NUMBER 351C/352C	HK4392.561X	
Sierra 1500	Denali	2007-2010			HK4403.561X	
Sierra 1500		2007-2013		2WD, with rear disc brakes	HK4403.561X	
Sierra 1500		2007-2013		4WD, with rear disc brakes	HK4403.561X	
Sierra 1500 Classic	Denali	2007			HK4403.561X	
Sierra 1500 HD		2003		4WD, 8 lug with Quadrasteer		HK4405.385X
Sierra 1500 HD		2005		4WD, 8 lug with Quadrasteer		HK4405.385X
Sierra 1500 HD		2005		2WD, 8 lug with Quadrasteer		HK4405.385X
Sierra 2500		1999-2000		except 6.0L with 5 speed	HK4392.322X	HK4393.323X
Sierra 2500		1999-2000		with 6.0L 5 speed	HK4392.322X	HK4394.323X

Hawk Performance - KIT APPLICATIONS

HK 4218

HAWK KIT

ROTOR

.448

PAD SHAPE

X

INSERT COMPOUND CODE

MAKE/ MODEL	SUBMODEL	YEARS	ENGINE (LITER)	NOTE	FRONT	REAR
					KIT	KIT
FORD CONTINUED						
Sierra 2500		2001-2003		Automatic transmission except Heavy Duty	HK4392.322X	HK4393.323X
Sierra 2500		2001-2003		Manual transmission except Heavy Duty	HK4392.322X	HK4394.323X
Sierra 2500		2004		Automatic transmission except Heavy Duty		HK4393.323X
Sierra 2500		2004		Manual transmission except Heavy Duty		HK4394.323X
Sierra 2500 HD		2001-2003			HK4404.322X	HK4394.323X
Sierra 2500 HD		2004		Models with 2 wheel steering	HK4404.322X	HK4394.323X
Sierra 2500 HD		2004		Models with 4 wheel steering	HK4404.322X	HK4405.323X
Sierra 2500 HD		2005-2010			HK4404.322X	HK4394.323X
Sierra 3500		2001-2003			HK4404.322X	HK4396.322X
Sierra 3500		2004-2005		2WD	HK4404.322X	HK4396.322X
Sierra 3500		2004-2005		4WD Single rear wheels	HK4404.322X	HK4394.323X
Sierra 3500		2004-2005		4WD Dual rear wheels	HK4404.322X	HK4396.322X
Sierra 3500		2006-2007		SRW	HK4404.322X	HK4394.323X
Sierra 3500		2006-2007		DRW	HK4404.322X	HK4396.322X
Sierra 3500 HD		2007-2010		SRW	HK4404.322X	HK4394.323X
Sierra 3500 HD		2007-2010		DRW	HK4404.322X	HK4396.322X
Sierra C3		2001			HK4390.323X	
Sierra Denali		2002-2006			HK4390.323X	
Sierra Denali		2007		New Body Style	HK4403.561X	HK4406.568X
Sierra Denali		2007		Classic	HK4390.323X	
Sierra Denali		2008-2010			HK4403.561X	HK4406.568X
Sonoma		1991-1995		RWD; 2-Wheel ABS	HK4110.119X	
Yukon		2003-2006				HK4395.385X
Yukon		2007-2014		2WD	HK4403.561X	
Yukon		2007-2014		4WD	HK4403.561X	
Yukon	Denali	2007-2014		2WD	HK4403.561X	
Yukon	Denali	2007-2014		4WD	HK4403.561X	
Yukon	Denali	2015			HK4403.561X	
Yukon		2015			HK4403.561X	
Yukon XL	Denali	2015			HK4403.561X	
Yukon XL		2015			HK4403.561X	HK4406.568X
Yukon XL 1500		2003-2006				HK4395.385X
Yukon XL 1500		2007-2013	All		HK4403.561X	
Yukon XL 1500		2007-2014		2WD	HK4403.561X	
Yukon XL 1500		2007-2014		4WD	HK4403.561X	
Yukon XL 2500		2000-2002		with 4.63" Rear Hub Hole	HK4392.322X	HK4393.323X
Yukon XL 2500		2000-2002		with 4.83" Rear Hub Hole	HK4392.322X	HK4394.323X
Yukon XL 2500		2003-2005		with 2 Wheel Steering with 4.63" Rear Hub Hole	HK4392.322X	HK4393.323X
Yukon XL 2500		2003-2005		with 2 Wheel Steering with 4.83" Rear Hub Hole	HK4392.322X	HK4394.323X
Yukon XL 2500		2003-2005		with 4 Wheel Steering	HK4392.322X	HK4405.323X
Yukon XL 2500		2006		with 4.63" Rear Hub Hole	HK4392.322X	HK4393.323X
Yukon XL 2500		2006		with 4.83" Rear Hub Hole	HK4392.322X	HK4394.323X
Yukon XL 2500		2007			HK4392.322X	HK4393.323X
Yukon XL 2500		2008-2013			HK4392.322X	HK4394.323X
HONDA						
Accord		1998-2002	3.0L	2997cc V6, Coupe	HK5233.143X	
Accord		1998-2002	3.0L	2997cc V6, Sedan	HK5233.143X	
Accord		2003-2007	2.4L	2354cc L4, Coupe	HK5233.366X	
Accord		2003-2007	2.4L	2354cc L4, Sedan	HK5233.366X	
Accord		2003-2004	3.0L	2977cc V6, Sedan	HK5233.366X	
Accord		2003-2005	3.0L	2977cc V6, Coupe; Automatic Trans.	HK5233.366X	
Accord		2005	3.0L	2977cc V6, Sedan; GAS	HK5233.366X	
Accord		2005-2007		Sedan; ELECTRIC/GAS; Rear Disc		HK4957.145X
Accord		2006-2007	3.0L	2997cc V6, Coupe; Automatic Trans.	HK5233.366X	
Accord		2006-2007	3.0L	2997cc V6, Sedan; GAS	HK5233.366X	

BRAKE PAD AND ROTOR KIT APPLICATIONS

MAKE/ MODEL	SUBMODEL	YEARS	ENGINE (LITER)	NOTE	FRONT	REAR
					KIT	KIT
HONDA CONTINUED						
Accord	LX	2008-2012	2.4L	2354cc L4, Sedan	HK5233.366X	
Accord	LX-P	2009-2012	2.4L	2354cc L4, Sedan	HK5233.366X	
Accord	LX-S	2009-2012	2.4L	2354cc L4, Coupe	HK5233.366X	
Accord	SE	2011-2012	2.4L	2354cc L4	HK5233.366X	
Civic	DX	1992-1993		Sedan	HK5176.218X	
Civic	LX	1992-1993		Sedan	HK5176.218X	
Civic	Si	1992-1993		Hatchback	HK5176.218X	
Civic	CX	1992-1995		Hatchback	HK5176.218X	
Civic	DX	1992-1995		Hatchback	HK5176.218X	
Civic	VX	1992-1995		Hatchback	HK5176.218X	
Civic	DX	1993-2000		Coupe	HK5176.218X	
Civic		1994-1995		Sedan; Rear Drum	HK5176.218X	
Civic	Si	1994-1995		Hatchback; Non-ABS	HK5176.218X	
Civic	DX	1996		Sedan; Non-ABS	HK5176.218X	
Civic	LX	1996		Sedan; Non-ABS	HK5176.218X	
Civic	LX	1996		Sedan; Standard Trans.; 4-Wheel ABS	HK5176.218X	
Civic		1996-2000		Hatchback	HK5176.218X	
Civic	HX	1996-2000		Coupe	HK5176.218X	
Civic	DX	1997-2000		Sedan	HK5176.218X	
Civic	LX	1997-2000		Sedan	HK5176.218X	
Civic	GX	1998-2000		Sedan	HK5176.218X	
Civic	Si	2004-2005		Hatchback	HK5344.275X	
Civic	DX	2006-2011		Sedan	HK5344.275X	
Civic	DX	2006-2011		Coupe	HK5344.275X	
Civic	EX	2006-2011		Sedan	HK5344.275X	
Civic	EX	2006-2011		Coupe	HK5344.275X	
Civic	Hybrid	2006-2011		Sedan	HK5344.275X	
Civic	LX	2006-2011		Sedan	HK5344.275X	
Civic	LX	2006-2011		Coupe	HK5344.275X	
Civic	Hybrid-L	2009-2011		Sedan	HK5344.275X	
Civic	EX	2012			HK5098.275X	
Civic	EX-L	2012			HK5098.275X	
Civic	DX	2012-2013			HK5098.275X	
Civic	LX	2012-2013			HK5098.275X	
Civic	Hybrid	2012-2015			HK5098.275X	
Civic	Hybrid-L	2012-2015			HK5098.275X	
Civic	HF	2013-2015			HK5098.275X	
Civic	LX	2014-2015		Automatic CVT Trans.	HK5098.275X	
Civic	SE	2015			HK5098.275X	
Civic del Sol		1993-1997		Si		HK5132.350X
Civic del Sol		1993-1997		VTEC	HK5174.418X	HK5132.350X
Civic del Sol	S	1993-1997			HK5176.218X	
Civic del Sol	Si	1993-1997		Non-ABS	HK5176.218X	
CR-V		1997-2001		Rear Drum	HK5179.143X	
CR-V	LX	2002-2004	All			HK5345.572X
CR-V		2002-2004			HK5233.393X	HK5345.145X
CR-V		2002-2004			HK5233.393X	HK5345.572X
CR-V		2005-2006			HK5363.393X	
CRX		1988		Si	HK5130.218X	
CRX		1988		DX	HK5130.218X	
CRX		1989		DX	HK5130.218X	HK5132.350X
CRX		1990-1991		Si	HK5130.113X	HK5132.350X
CR-Z		2011-2014			HK5344.418X	
Element		2003-2011			HK5233.393X	HK5359.572X
Fit		2007-2012			HK5174.418X	

BRAKE PAD AND ROTOR KIT APPLICATIONS

MAKE/ MODEL	SUBMODEL	YEARS	ENGINE (LITER)	NOTE	FRONT	REAR
					KIT	KIT
HONDA CONTINUED						
Fit		2013		Gas Engine	HK5174.418X	
Insight		2010-2013			HK5174.275X	
Odyssey		1995-1998			HK5179.143X	HK5180.145X
Odyssey		2002-2004				HK5360.506X
Pilot		2003-2008			HK5317.393X	HK5342.506X
Prelude		1988-1989		Si, SE		HK5132.350X
Prelude		1988-1990		S		HK5132.350X
Prelude		1990		Si		HK5132.350X
Prelude		1991				HK5132.350X
Prelude		1992		except V-Tec		HK5131.145X
Prelude		1992-1996		V-TEC	HK5231.143X	HK5131.145X
Prelude		1993-1996		except V-Tec	HK5302.144X	HK5131.145X
Prelude		1997-2001			HK5179.143X	HK5303.145X
S2000		2000-2009			HK5312.361X	HK5321.145X
HUMMER						
H2		2003-2009			HK4392.322X	HK4393.323X
H3		2006-2010			HK4464.526X	HK4465.527X
H3T		2009-2010			HK4464.526X	HK4465.527X
HYUNDAI						
Elantra		1997-2006				HK5283.262X
Genesis		2009-2011	4.6L	4627cc V8	HK5028.636X	
Genesis		2009		Sedan, V6		HK5029.662X
Genesis		2009		Sedan, V8		HK5029.662X
Genesis		2012-2014	3.8L	3778cc V6	HK5028.636X	
Genesis Coupe	Track	2010-2013	All	w/Brembo Brakes		HK5076.663X
Genesis Coupe		2010-2013		With Brembo Brakes (340MM (13.4") Front Rotor)	HK5077.453X	HK5076.194X
Genesis Coupe		2010-2013		With Standard Brakes (320MM (12.6") Front Rotor)	HK5079.661X	
Genesis Coupe		2010-2015		With Standard Brakes		HK5078.662X
Santa Fe		2001-2002		2WD	HK5334.461X	
Santa Fe		2001-2002		4WD	HK5333.461X	
Santa Fe		2003-2005		293mm Front Discs	HK5333.461X	
Santa Fe		2003-2005		275mm Front Discs	HK5334.461X	
Santa Fe		2006			HK5333.461X	
Sonata		2005		2.4L 4 Cyl. - MFG After 4/2005	HK4932.368X	
Sonata		2005		3.3L 6 Cyl. - MFG After 4/2005	HK4992.368X	
Sonata		2006-2007		2.4L 4 Cyl.	HK4932.368X	
Sonata		2006-2007		3.3L 6 Cyl.	HK4992.368X	
Sonata		2008		2.4L 4 Cyl. - MFG After 1/21/2008	HK4932.368X	
Sonata		2008		2.4L 4 Cyl. - MFG Up To 1/20/2008	HK4932.368X	
Sonata		2008		3.3L 6 Cyl. - MFG After 1/21/2008	HK4992.368X	
Sonata		2008		3.3L 6 Cyl. - MFG Up To 1/20/2008	HK4992.368X	
Sonata		2009		2.4L 4 Cyl.	HK4932.368X	
Sonata		2009		3.3L 6 Cyl.	HK4992.368X	
Sonata		2010		MFG Before 11/2009 - 2.4L 4 Cyl.	HK4932.368X	
Sonata		2010		MFG Before 11/2009 - 3.3L 6 Cyl.	HK4992.368X	
Tiburon		1997-2001				HK5283.262X
Tiburon		2003			HK4932.368X	HK4933.262X
Tiburon		2004-2006				HK4933.262X
Tiburon		2004-2008		except 6 Speed	HK4932.368X	
Tiburon		2007-2008		4 Speed Trans.		HK4933.262X
Tiburon		2007-2008		5 Speed Trans.		HK4933.262X
Tucson		2005-2008		2WD	HK4932.368X	
Tucson		2005-2009		4WD	HK4932.368X	
Tucson		2009		FWD	HK4932.368X	

BRAKE PAD AND ROTOR KIT APPLICATIONS

MAKE/ MODEL	SUBMODEL	YEARS	ENGINE (LITER)	NOTE	FRONT	REAR
					KIT	KIT
INFINITI						
EX35		2008-2009			HK4909.387X	
EX35		2010-2012			HK4909.387X	HK4937.370X
EX37		2013			HK4909.387X	HK4937.370X
FX35		2003-2004			HK4900.448X	HK5356.370X
FX35		2005		To 11/05	HK4900.387X	HK5356.370X
FX35		2005		From 11/05	HK4964.387X	HK5356.370X
FX35		2006-2008			HK4964.387X	HK5356.370X
FX35		2009			HK4964.387X	
FX35		2010-2012			HK4964.387X	HK5356.370X
FX37		2013			HK4964.387X	HK5356.370X
FX45		2003-2004			HK4900.448X	HK5356.370X
FX45		2005		To 11/05	HK4900.387X	HK5356.370X
FX45		2005		From 11/05	HK4964.387X	HK5356.370X
FX45		2006-2008			HK4964.387X	HK5356.370X
FX50		2009-2013			HK4971.601X	HK5037.602X
G20		1991-1992			HK5161.235X	HK5198.421X
G20		1993		From 11/93	HK5161.235X	HK5198.421X
G20		1993		To 10/93	HK5161.235X	HK5198.421X
G20		1994-1996			HK5161.235X	HK5198.421X
G20		1999			HK5202.268X	HK5198.421X
G20		2000		To 11/00	HK5202.268X	HK5198.421X
G20		2001-2002		From 12/00	HK5202.268X	
G25		2011-2012		RWD	HK4909.387X	HK4937.370X
G35		2003		Standard Brakes	HK4903.268X	
G35		2003		Brembo Brakes	HK4905.545X	HK4906.180X
G35		2004		RWD - Standard Brakes	HK4903.268X	HK4904.370X
G35		2004		RWD - Brembo Brakes	HK4905.545X	HK4906.180X
G35		2005		RWD	HK4909.268X	HK4937.370X
G35		2005-2006		RWD	HK4909.387X	HK4937.370X
G35		2007		RWD Coupe	HK4909.387X	HK4937.370X
G35		2007		RWD; Sport Sedan	HK4966.599X	HK5005.370X
G35		2008		RWD; Sedan; Except Sport Sedan	HK4909.387X	HK4937.370X
G35		2008		RWD; Sport Sedan	HK4966.599X	
G37		2008		Sport Coupe	HK4971.601X	HK5006.602X
G37		2008		Coupe; Except Sport Coupe	HK4966.599X	
G37		2009		RWD Coupe, Convertible; Except Sport Coupe; 330mm (13") Front Rotors	HK4966.599X	
G37		2009-2010		Sport Package (Coupe, Sedan, Convertible) 355mm (14") Front Rotors	HK4971.601X	HK5006.602X
G37	Sport	2009-2010		Sedan; With Sport Package	HK4971.387X	
G37		2009-2013		RWD Sedan; 320mm (12.6") Front Rotors	HK4909.387X	HK4937.370X
G37		2010-2013		RWD Coupe, Convertible; Except Sport Package; 330mm (13") Front Rotors	HK4966.599X	
G37		2011-2013		Sport Package or IPL Models (Coupe, Sedan, Convertible) 355mm (14") Front Rotors	HK4971.601X	HK5006.602X
G37	IPL	2011-2013		With Sport Brake Package; 355mm Front Disc	HK4971.387X	
G37	Sport	2011-2013		With Sport Brake Package; 355mm Front Disc	HK4971.387X	
G37 X		2011-2013		Sport Package or IPL Models (Coupe, Sedan, Convertible) 355mm (14") Front Rotors		HK5006.602X
G37 X		2011-2013		AWD Coupe; Except Sport Package; 330mm (13") Front Rotors	HK4966.599X	
I30		1996-1999			HK5163.268X	HK5269.421X
I30		2000		To 10/00	HK5315.268X	HK5269.421X
I30		2001		From 11/00	HK5315.268X	HK5269.378X
I35		2002-2004			HK5316.268X	HK5269.378X
J30		1993-1997			HK5195.415X	HK5268.437X

BRAKE PAD AND ROTOR KIT APPLICATIONS

Hawk Performance - KIT APPLICATIONS

HK 4218 .448 X
 HAWK KIT ROTOR PAD SHAPE INSERT COMPOUND CODE

MAKE/ MODEL	SUBMODEL	YEARS	ENGINE (LITER)	NOTE	FRONT	REAR
					KIT	KIT
INFINITI CONTINUED						
JX35		2013				HK5356.370X
M35		2006-2009			HK4909.387X	HK4937.370X
M35		2010			HK4909.387X	
M35h		2012			HK4909.387X	HK5356.370X
M35h		2012-2013		With Sport Package	HK4971.387X	HK5037.370X
M35h		2013		Models with 4 Piston Front Calipers 355mm (13.98") Front Rotors	HK4971.601X	HK5037.602X
M35h		2013		Models with Single Piston Front Caliper 319mm (12.58") Front Rotors	HK4909.387X	HK5356.370X
M37		2011-2012		RWD Sport Model	HK4971.601X	HK5037.602X
M37		2011-2012		RWD Base	HK4909.387X	HK5356.370X
M37		2011-2013		With Sport Package	HK4971.387X	HK5037.370X
M37		2013		Models with 4 Piston Front Calipers 355mm (13.98") Front Rotors	HK4971.601X	HK5037.602X
M37		2013		Models with Single Piston Front Caliper 319mm (12.58") Front Rotors	HK4909.387X	HK5356.370X
M45		2003-2004			HK4926.387X	HK5007.437X
M45		2006-2010			HK4909.387X	HK4937.370X
M56		2011-2012		RWD Sport Model	HK4971.601X	HK5037.602X
M56		2011-2012		RWD Base	HK4909.387X	HK5356.370X
M56		2011-2013		With Sport Package	HK4971.387X	HK5037.370X
M56		2013		Models with 4 Piston Front Calipers 355mm (13.98") Front Rotors	HK4971.601X	HK5037.602X
M56		2013		Models with Single Piston Front Caliper 319mm (12.58") Front Rotors	HK4909.387X	HK5356.370X
Q40		2015			HK4909.387X	HK4937.370X
Q45		1990-1993			HK5195.415X	
Q45		1994		From 3/94	HK5195.415X	HK5196.437X
Q45		1994		To 2/94	HK5195.415X	
Q45		1995-1996			HK5195.415X	HK5196.437X
Q45		1997-2001			HK5275.326X	HK5268.437X
Q45		2002-2006			HK4926.387X	HK5007.437X
Q50		2014-2015		Sport, Hybrid Sport	HK4971.601X	HK5037.602X
Q50		2014-2015		Base, Premium, Hybrid		HK5356.370X
Q50	Hybrid Sport	2014-2015				HK5037.370X
Q50	Sport	2014-2015				HK5037.370X
Q60		2014-2015		330mm Rear Rotor		HK5005.600X
Q60		2014-2015		355mm Front Rotors	HK4971.601X	HK5006.602X
Q60		2014-2015		330mm Front Rotors	HK4966.599X	
Q70	3.7	2014-2015		Sport Brakes	HK4971.387X	HK5037.370X
Q70	5.6	2014-2015		Sport Brakes	HK4971.387X	HK5037.370X
Q70		2014-2015		355mm Front Rotors - Sport Brakes	HK4971.601X	HK5037.602X
Q70		2014-2015		320mm Front Rotors - Exc Sport Brakes	HK4909.387X	HK5356.370X
Q70L		2015		355mm Front Rotors - Sport Brakes	HK4971.601X	HK5037.602X
Q70L		2015		320mm Front Rotors - Exc Sport Brakes	HK4909.387X	HK5356.370X
QX4		1997-2003			HK5314.326X	
QX50		2014-2015			HK4909.387X	HK4937.370X
QX56		2004			HK5364.567X	HK5365.555X
QX56		2005		To 3/05	HK5364.567X	HK5365.555X
QX56		2005		From 3/05	HK4952.567X	HK5365.555X
QX56		2006-2007		Models With 320mm Front Rotors	HK4952.567X	HK5365.555X
QX56		2006-2007		Models With 350mm Front Rotors		HK5365.555X
QX56		2008-2010				HK5365.555X
QX60		2014-2015				HK5356.370X
QX70		2014	5.0L	5026cc V8	HK4971.387X	HK5037.370X
QX70		2014		V8	HK4971.601X	HK5037.602X

BRAKE PAD AND ROTOR KIT APPLICATIONS

MAKE/ MODEL	SUBMODEL	YEARS	ENGINE (LITER)	NOTE	FRONT	REAR
					KIT	KIT
INFINITI CONTINUED						
QX70		2014		V6 Mfg From 9/2013	HK4909.387X	HK5356.370X
QX70		2014		V6 Mfg Up To 9/2013	HK4964.387X	HK5356.370X
QX70		2015		V6	HK4909.387X	HK5356.370X
ISUZU						
Ascender		2003			HK4400.382X	HK4397.383X
Ascender		2004-2005		7 Passenger	HK4400.382X	HK4397.383X
Ascender		2004-2006		5 Passenger	HK4399.382X	HK4397.383X
Ascender		2006		7 Passenger		HK4397.383X
Ascender		2007-2008				HK4397.383X
Hombre		1998-2000		4WD	HK4388.304X	HK4387.305X
i-280		2006			HK4402.554X	
i-290		2007-2008			HK4402.554X	
i-350		2006			HK4402.554X	
i-370		2007-2008			HK4402.554X	
Oasis		1996-1997			HK5179.143X	
Oasis		1998-1999			HK5179.143X	HK5180.145X
JAGUAR						
S-Type		2000-2002			HK4038.376X	HK4040.428X
S-Type		2003-2004		Std suspension 300mm front disc, except Type R	HK4038.376X	HK4040.428X
S-Type		2003-2005		Sport suspension 320mm front disc, except Type R		HK4040.428X
S-Type		2005		Std suspension 300mm front disc, except Type R		HK4040.428X
S-Type		2006		R Model		HK4516.428X
S-Type		2006-2008		Except R Model - 326mm Front Rotor		HK4516.478X
S-Type		2007-2008		R Model		HK4516.478X
Super V8		2006-2008				HK4516.478X
Vanden Plas		2004-2005				HK4040.428X
Vanden Plas		2006-2008				HK4516.478X
XF		2009		Luxury, Premium Luxury		HK4516.478X
XF		2009		Supercharged		HK4516.478X
XF		2010		4.2L Models		HK4516.478X
XF		2010-2012		5.0L Non-Supercharged Models		HK4516.478X
XF		2013		2.0L Turbo Models		HK4516.478X
XF		2013		3.0L Supercharged Models		HK4516.478X
XJ		2011-2012		Non-Supercharged Models		HK4516.478X
XJ		2013		3.0L Supercharged or 5.0L Non-Supercharged Models		HK4516.478X
XJ8		2004-2005				HK4040.428X
XJ8		2006-2009				HK4516.478X
XJR		2006-2009				HK4516.478X
XK		2007-2013				HK4516.478X
XKR		2007				HK4516.478X
XKR		2008-2009		Models with Standard Brakes		HK4516.478X
X-Type		2005		Models From Vin # E24054		HK4835.724X
X-Type		2006-2008				HK4835.724X
JEEP						
Cherokee		1990-1992		4WD; Mid Size XJ Series	HK4424.210X	
Cherokee		1992		2WD; Mid Size XJ Series; From 2/92	HK4424.210X	
Cherokee		1993-1998		Mid Size XJ Series	HK4424.210X	
Cherokee		1999		3 1/4" Tall Composite front rotor	HK4424.210X	
Cherokee		1999		3" Tall Full Cast front rotor	HK4443.210X	
Cherokee		2000-2001		Mid Size XJ Series	HK4443.210X	
Comanche		1990-1992		4WD	HK4424.210X	
Commander		2006-2010			HK4473.558X	HK4474.555X
Compass		2007-2008			HK4236.435X	HK4237.457X
Compass		2009-2014		Rear Drum Models	HK4236.435X	
Compass		2009-2014		Models with 302mm Rear Rotors	HK4236.435X	HK4193.675X

BRAKE PAD AND ROTOR KIT APPLICATIONS

Hawk Performance - KIT APPLICATIONS

HK 4218 .448 X
 HAWK KIT ROTOR PAD SHAPE INSERT COMPOUND CODE

MAKE/ MODEL	SUBMODEL	YEARS	ENGINE (LITER)	NOTE	FRONT	REAR
					KIT	KIT
JEEP CONTINUED						
Compass		2009-2014		Models with 262mm Rear Rotors	HK4236.435X	HK4237.457X
Grand Cherokee		1993-1994		Fr. VIN # 358322	HK4424.210X	HK4432.286X
Grand Cherokee		1993-1994		To VIN # 358321	HK4424.210X	
Grand Cherokee		1995-1998			HK4424.210X	HK4432.286X
Grand Cherokee		1999-2002		Original Style Teves Caliper casting 4835		HK4442.381X
Grand Cherokee		1999-2002		Retro-Fit Style Akebono Caliper casting 4802		HK4442.381X
Grand Cherokee		2003-2004				HK4442.381X
Grand Cherokee		2005			HK4473.558X	HK4474.555X
Grand Cherokee		2006-2010		SRT-8	HK4475.563X	HK4476.194X
Grand Cherokee		2006-2010		Except SRT-8	HK4473.558X	HK4474.555X
Grand Cherokee		2011		Models with vented rear rotors	HK4201.701X	HK4200.702X
Grand Cherokee		2011-2015		Models with solid rear rotors	HK4199.701X	HK4198.702X
Grand Cherokee		2012-2013		SRT-8	HK4203.649X	HK4202.194X
Grand Cherokee		2012-2013		Models with Vented Rear Rotors - Excluding SRT-8	HK4201.701X	HK4200.702X
Grand Cherokee		2014		Models with Vented Rear Rotors - Excluding SRT	HK4201.701X	HK4200.702X
Grand Cherokee		2014		SRT	HK4203.649X	HK4202.194X
Grand Cherokee		2015		Models with Vented Rear Rotors - Excluding SRT		HK4200.702X
Grand Cherokee		2015		SRT	HK4203.649X	
Liberty		2002			HK4447.373X	
Liberty		2003-2007			HK4447.373X	HK4463.690X
Liberty		2008-2011			HK4194.569X	HK4195.608X
Liberty		2012		Standard Brakes - 302mm (11.9") Front Rotors	HK4194.569X	HK4195.608X
Liberty		2012		HD Brakes - 332mm (13") Front Rotors		HK4195.608X
Patriot		2007-2008			HK4236.435X	HK4237.457X
Patriot		2009-2014		Rear Drum Models	HK4236.435X	
Patriot		2009-2014		Rear Disc Models with 302mm (11.9") Rear Rotors	HK4236.435X	HK4193.675X
Patriot		2009-2014		Rear Disc Models with 262mm (10.3") Rear Rotors	HK4236.435X	HK4237.457X
Wrangler		1990-1995			HK4424.210X	
Wrangler		1997-1998			HK4424.210X	
Wrangler		1999		3 1/4" Tall Composite front rotor	HK4424.210X	
Wrangler		1999		3" Tall Full Cast front rotor	HK4443.210X	
Wrangler		2000-2002			HK4443.210X	
Wrangler		2003-2006		Rear Disc Models	HK4443.210X	HK4463.690X
Wrangler		2003-2006		Rear Drum Models	HK4443.210X	
Wrangler		2007-2015			HK4470.569X	HK4242.608X
KIA						
Optima		2007-2010			HK4932.368X	
Sorento		2003-2006			HK5060.461X	
Soul		2012-2013			HK4932.368X	
Sportage		2005-2010		2WD	HK4932.368X	
Sportage		2005-2010		4WD	HK4932.368X	
LAND ROVER						
Discovery		1999		SERIES II	HK4822.469X	HK4734.195X
Discovery		2000-2004			HK4822.469X	HK4734.195X
LEXUS						
CT200h		2011-2013		Models with 259mm (10.2") Rear Brake Rotors		HK5015.629X
ES300		1992-1996			HK5235.318X	HK5236.401X
ES300		1997-1999			HK5235.320X	HK5241.401X
ES300		2000-2001			HK5235.320X	HK5241.610X
ES300		2002-2003			HK5352.677X	
ES300h		2013-2015			HK4924.647X	HK4938.648X
ES330		2004-2006			HK5257.677X	
ES350		2007-2012			HK4924.647X	HK4938.648X
ES350		2013			HK4924.647X	HK5122.648X
ES350		2014			HK4924.647X	HK4938.648X

BRAKE PAD AND ROTOR KIT APPLICATIONS



MAKE/ MODEL	SUBMODEL	YEARS	ENGINE (LITER)	NOTE	FRONT	REAR
					KIT	KIT
LEXUS CONTINUED						
ES350		2015			HK4924.647X	HK5122.648X
GS300		1993-1997			HK5239.375X	HK5240.670X
GS300		1998-2005			HK5239.375X	HK5259.499X
GS300		2006			HK4939.474X	HK4940.562X
GS350		2007-2008		AWD Models		HK4940.562X
GS350		2007-2008		RWD Models		HK4940.562X
GS350		2009-2010		US Models		HK4940.562X
GS350		2009-2011		Canada Models - 2WD		HK4940.562X
GS350		2009-2011		Canada Models - AWD		HK4940.562X
GS350		2011		US Models MFG After 1/2011		HK4940.562X
GS350		2011		US Models MFG Up To 1/2011		HK4940.562X
GS400		1998-2000			HK5239.375X	HK5259.499X
GS430		2001-2005			HK5239.375X	HK5259.499X
GS430		2006-2007				HK4940.562X
GS450h		2007-2008				HK4940.562X
GS450h		2009-2010		US Models		HK4940.562X
GS450h		2009-2011		Canada Models		HK4940.562X
GS450h		2011		US Models MFG After 1/2011		HK4940.562X
GS450h		2011		US Models MFG Up To 1/2011		HK4940.562X
GS460		2008				HK4940.562X
GS460		2009-2010		US Models		HK4940.562X
GS460		2009-2011		Canada Models		HK4940.562X
GS460		2011		US Models MFG After 1/2011		HK4940.562X
GS460		2011		US Models MFG Up To 1/2011		HK4940.562X
GX460		2010-2015			HK5045.490X	HK5046.477X
GX470		2003-2009			HK5355.490X	HK5351.477X
HS250h		2010-2012			HK4973.627X	HK5023.648X
IS250		2006-2008			HK5352.566X	HK4942.562X
IS250		2009		Canada Models	HK5352.566X	HK4942.562X
IS250		2009		USA Models	HK4939.474X	HK4942.562X
IS250		2010		Sedan - USA Models	HK4939.474X	HK4942.562X
IS250		2010		Sedan - Canada Models	HK5352.566X	HK4942.562X
IS250		2011-2013		Sedan, Sport Suspension - USA Models	HK4939.474X	HK4940.562X
IS250		2011-2013		Sedan, Sport Suspension - Canada Models	HK5352.566X	HK4940.562X
IS250		2011-2013		Sedan, Exc. Sport Suspension - USA Models	HK4939.474X	HK4942.562X
IS250		2011-2013		Sedan, Exc. Sport Suspension - Canada Models	HK5352.566X	HK4942.562X
IS250		2014-2015		F Sport Sedan	HK5352.566X	
IS250C		2010-2013		Convertible - USA Models	HK4939.474X	HK4940.562X
IS250C		2010-2013		Convertible - Canada Models		HK4940.562X
IS250C		2014-2015		Convertible - USA Models	HK4939.474X	
IS300		2001-2005			HK5239.375X	HK5259.499X
IS350		2006-2008				HK4940.562X
IS350		2009-2010		US Models		HK4940.562X
IS350		2009-2012		Canada Models		HK4940.562X
IS350		2011		US Models MFG After 1/2011		HK4940.562X
IS350		2011		US Models MFG Up To 1/2011		HK4940.562X
IS350		2012-2013		US Models		HK4940.562X
IS350C		2010		US Models		HK4940.562X
IS350C		2010-2012		Canada Models		HK4940.562X
IS350C		2011		US Models MFG After 1/2011		HK4940.562X
IS350C		2011		US Models MFG Up To 1/2011		HK4940.562X
IS350C		2012-2013		US Models		HK4940.562X
LX450		1996-1997			HK5262.312X	HK5263.477X
LX470		1998-2007			HK5255.313X	HK5256.427X
RX300		1998		AWD		HK5258.401X

Hawk Performance - KIT APPLICATIONS

HK 4218 .448 X
 HAWK KIT ROTOR PAD SHAPE INSERT COMPOUND CODE

MAKE/ MODEL	SUBMODEL	YEARS	ENGINE (LITER)	NOTE	FRONT	REAR
					KIT	KIT
LEXUS CONTINUED						
RX300		1998		FWD		HK5236.401X
RX300		1999-2001		AWD	HK5257.320X	HK5258.401X
RX300		1999-2001		FWD	HK5257.320X	HK5236.401X
RX300		2002-2003		AWD		HK5258.401X
RX300		2002-2003		FWD		HK5236.401X
SC300		1992-1998			HK5237.318X	
SC300		1999-2000				HK5240.670X
SC400		1992-2000				HK5240.670X
SC430		2002-2010			HK5239.375X	HK5259.499X
LINCOLN						
Blackwood		2002-2003			HK4345.266X	HK4344.301X
Continental		1993-1994			HK4031.347X	HK4021.417X
Continental		1995-2002			HK4029.416X	HK4021.417X
LS		2000-2002			HK4038.376X	HK4040.428X
LS		2003		V6 Engine	HK4038.376X	HK4040.428X
LS		2003		V8 Engine	HK4038.376X	HK4040.428X
LS		2004-2006			HK4038.376X	HK4040.428X
Mark LT		2006-2008		2WD; 6 Lug	HK4356.455X	HK4360.456X
Mark LT		2006-2008		4WD; 6 Lug	HK4358.455X	HK4360.456X
Mark LT		2006-2008		2WD; 7 Lug	HK4357.455X	
Mark LT		2006-2008		4WD; 7 Lug	HK4359.455X	
Mark VIII		1993-1998			HK4029.416X	
MKS		2009			HK4063.612X	HK4055.674X
MKS		2010			HK4063.710X	HK4055.674X
MKS		2011-2012			HK4272.710X	HK4055.674X
MKT		2010			HK4063.612X	HK4055.674X
MKT		2011			HK4272.612X	HK4055.674X
MKT		2011-2012			HK4272.710X	HK4055.674X
MKT		2013-2014		Standard Duty Calipers	HK4272.710X	HK4055.674X
MKX		2007-2008		320mm Front Rotors	HK4059.656X	HK4060.657X
MKX		2007-2008		296mm Front Rotors	HK4061.656X	HK4060.657X
MKX		2009-2010			HK4059.656X	HK4060.657X
MKX		2011-2015			HK4059.656X	HK4055.674X
MKZ		2007-2012			HK4945.565X	HK5368.564X
Navigator		1998-1999		2WD	HK4326.299X	HK4322.301X
Navigator		1998-1999		4WD	HK4321.299X	HK4322.301X
Navigator		2000		4WD; To 11/99; 12mm Studs	HK4321.299X	HK4322.301X
Navigator		2000		2WD; To 11/99; 12mm Studs	HK4326.299X	HK4322.301X
Navigator		2000		4WD; From 12/99; 14mm Studs	HK4321.299X	HK4344.301X
Navigator		2000		2WD; From 12/99; 14mm Studs	HK4346.299X	HK4344.301X
Navigator		2001-2002		2WD	HK4346.299X	HK4344.301X
Navigator		2001-2002		4WD	HK4321.299X	HK4344.301X
Navigator		2002		From 3/18/02	HK4352.299X	HK4353.301X
Navigator		2003-2006			HK4352.462X	HK4353.463X
Town Car		1996		with Steel Piston Rear Caliper		HK4032.341X
Town Car		1996		with Phenolic (Plastic) Piston Rear Caliper		HK4032.520X
Town Car		1997				HK4032.341X
Town Car		1998-2002	All	w/Phenolic Piston		HK4032.353X
Town Car		1998-2002		with Steel Piston Rear Caliper	HK4035.294X	HK4032.341X
Town Car		1998-2002		with Phenolic (Plastic) Piston Rear Caliper	HK4035.294X	HK4032.520X
Town Car		2003-2011		Sedan	HK4042.433X	
Town Car		2003-2011		Limo	HK4042.433X	
Zephyr		2006			HK4945.565X	HK5368.564X
MAZDA						
3		2004-2005		2.0L Eng	HK4910.519X	HK4911.571X

BRAKE PAD AND ROTOR KIT APPLICATIONS



MAKE/ MODEL	SUBMODEL	YEARS	ENGINE (LITER)	NOTE	FRONT	REAR
					KIT	KIT
MAZDA CONTINUED						
3		2004-2006		2.3L Engine	HK4912.519X	HK4913.478X
3		2006		2.0L Eng	HK4910.519X	HK4911.478X
3	Mazdaspeed	2007-2013	All		HK4983.549X	
3		2007-2008		3s; 2.3L Eng	HK4912.519X	HK4913.478X
3		2007-2013		3i; 2.0L Eng	HK4910.519X	HK4911.478X
3		2007-2013		MazdaSpeed; Turbo 2.3L		HK4913.478X
3		2010-2013		3s; 2.5L Eng	HK4912.519X	HK4913.478X
5		2006-2007			HK4912.519X	HK5012.571X
5		2008-2010			HK4912.519X	HK5012.478X
5		2011			HK4912.519X	
5		2012-2013			HK4912.519X	HK5012.478X
6		2003-2005			HK5367.459X	HK5368.158X
6		2006		MAZDASPEED 6	HK4946.549X	HK4947.564X
6		2006		except MAZDASPEED 6		HK5368.564X
6		2007		MazdaSpeed	HK4946.549X	HK4947.564X
6		2007		Except MazdaSpeed		HK5368.564X
6		2008			HK4945.565X	HK5368.564X
6		2009-2010				HK5368.564X
6		2011-2013			HK4945.565X	HK5368.564X
626		1993-1997			HK5210.211X	HK5211.212X
626		1998-2000		2.0L ENGINE	HK5210.211X	HK5368.212X
626		2001-2002		2.5L ENGINE		HK5368.212X
626		2001-2002		2.0L ENGINE	HK5210.211X	
CX-7		2007-2012			HK4982.656X	HK5047.657X
CX-9		2007-2015			HK5049.656X	HK5048.657X
Miata		1990-1993			HK5189.148X	HK5190.157X
Miata		1994-1997			HK5212.149X	HK5207.159X
Miata		1999-2000			HK5212.149X	HK5207.159X
Miata		2001-2002		with Normal Suspension	HK5212.149X	HK5207.159X
Miata		2001-2002		with Hard or Sport Suspension	HK5335.431X	HK5336.442X
Miata		2003			HK5335.431X	HK5336.442X
Miata		2004-2005	All	w/ Sport Suspension		HK5336.468X
Miata	Mazdaspeed	2004-2005	All			HK5336.468X
Miata		2004-2005			HK5335.431X	
MX-5 Miata		2006-2014			HK4948.522X	HK5368.523X
MX-5 Miata		2015			HK4948.522X	
MX-6		1993-1997			HK5210.211X	HK5211.212X
Protege		1990-1991		DOHC Eng.; w/Rear Discs		HK5207.157X
Protege		1992-1994		Rear Discs Brakes		HK5207.157X
Protege		1995-1996		Rear Discs Brakes		HK5207.159X
Protege		1997-1998		1.8L Eng.		HK5207.159X
Protege		2001		2.0L; ES, MP3	HK5210.211X	HK5211.436X
Protege		2002-2003		ES; w/Rear Discs	HK5210.211X	HK5211.436X
Protege		2003		MazdaSpeed		HK5368.158X
Protege5		2002-2003			HK5210.211X	HK5211.436X
RX-7		1986-1988		5 Lug	HK5150.155X	HK5151.158X
RX-7		1989-1991		with Vented Rear Disc	HK5150.155X	HK5151.158X
RX-7		1989-1991		with Solid Rear Disc		HK5191.158X
RX-7		1993-1995			HK5276.155X	HK5277.158X
RX-8		2004-2008		without Sport Suspension	HK5349.470X	HK5366.378X
RX-8		2004-2008		with Sport Suspension	HK5350.470X	HK5366.378X
RX-8		2009-2011			HK5350.470X	HK5366.378X
Tribute		2001-2004			HK4350.473X	
Tribute		2005-2006		3.0L	HK4251.473X	

BRAKE PAD AND ROTOR KIT APPLICATIONS



Hawk Performance - KIT APPLICATIONS

HK 4218 .448 X
 HAWK KIT ROTOR PAD SHAPE INSERT COMPOUND CODE

MAKE/ MODEL	SUBMODEL	YEARS	ENGINE (LITER)	NOTE	FRONT	REAR
					KIT	KIT
MERCEDES-BENZ						
Tribute		2005-2006		2.3L	HK4350.473X	
C230		2003		With Sport Package	HK4757.504X	
C230		2003		Without Sport Package	HK4870.504X	
C230		2004-2005		Except Sport Sedan; With 1 Piston Front Caliper	HK4870.504X	
C230		2005		Sport Sedan; With 4 Piston Front Caliper	HK4808.504X	
C230		2006		Sport Sedan; With 2 Piston Front Caliper	HK4808.504X	
C240		2001-2002			HK4870.504X	
C240		2003-2004		203.061 Body Code; AWD	HK4757.497X	
C240		2003-2004		203.081 Body Code; AWD	HK4757.497X	
C240		2003-2004		203.281 Body Code; AWD	HK4757.497X	
C240		2003-2005		Sedan; 4Matic AWD	HK4757.504X	
C240		2003-2005		Wagon; 4Matic AWD	HK4757.504X	
C240		2003-2005		Sedan; Except 4Matic AWD	HK4870.504X	
C240		2003-2005		Wagon; RWD	HK4870.504X	
C280		2006-2007		4Matic AWD	HK4757.504X	
C280		2006-2007		Except 4Matic AWD; With 1 Piston Front Caliper	HK4757.504X	
C320		2001-2002		203.064 Body Code	HK4757.497X	
C320		2001-2002			HK4757.504X	
C320		2002		203.264 Body Code	HK4757.497X	
C320		2003		203.764 Body Code; Sedan; RWD; Except 4 Piston Caliper	HK4757.497X	
C320		2003		203.764 Body Code; Sedan; AWD	HK4757.497X	
C320		2003		203.764 Body Code; Wagon; AWD	HK4757.497X	
C320		2003-2004		203.064 Body Code; Sedan; RWD; Except 4 Piston Caliper	HK4757.497X	
C320		2003-2004		203.084 Body Code; Sedan; RWD; Except 4 Piston Caliper	HK4757.497X	
C320		2003-2004		203.284 Body Code; Sedan; RWD; Except 4 Piston Caliper	HK4757.497X	
C320		2003-2004		203.064 Body Code; Sedan; AWD	HK4757.497X	
C320		2003-2004		203.064 Body Code; Wagon; AWD	HK4757.497X	
C320		2003-2004		203.084 Body Code; Sedan; AWD	HK4757.497X	
C320		2003-2004		203.084 Body Code; Wagon; AWD	HK4757.497X	
C320		2003-2004		203.284 Body Code; Sedan; AWD	HK4757.497X	
C320		2003-2004		203.284 Body Code; Wagon; AWD	HK4757.497X	
C320		2003-2004		Except 4Matic AWD; Except Sport Sedan	HK4757.504X	
C320		2003-2005		4Matic AWD	HK4757.504X	
C320		2005		Except 4Matic AWD; Except Sport Sedan; w/1 Piston Front Caliper	HK4757.504X	
C320		2005		Sport Sedan; With 2 Piston Front Caliper	HK4808.504X	
C350		2006-2007		203.056 Body Code; AWD	HK4757.497X	
C350		2006-2007		203.087 Body Code; AWD	HK4757.497X	
C350		2006-2007		4Matic AWD	HK4757.504X	
C350		2006-2007		Except Sport Sedan; Except 4Matic AWD; w/1 Piston Front Caliper	HK4757.504X	
C350	Luxury	2006-2007		203.056 Body Code; Sedan; RWD; w/1 Piston Front Caliper	HK4757.497X	
C36 AMG		1996-1997				HK4737.371X
CLK320		1998-1999		With 2 Pin Pad Rear Calipers	HK4757.495X	HK4737.371X
CLK320		2000-2002		With 1 Pin Pad Rear Calipers	HK4757.495X	
CLK320		2003-2005		W209 Model	HK4757.504X	
CLK350		2006-2007			HK4757.504X	
CLK350		2008-2009		Except Sport; With 1 Piston Front Caliper	HK4757.504X	
CLK350		2008-2009		Sport; With 2 Piston Front Caliper	HK4808.504X	
CLK430		1999			HK4757.495X	HK4737.371X
CLK430		2000-2003			HK4757.495X	
E300		1998-1999		Models with 1 Pin Rear Calipers	HK4757.495X	HK4737.371X
E300		1998-1999		Models with 2 Pin Rear Calipers	HK4757.495X	HK4737.371X
E320 Sedan		1996-2000		With 2 Pin Pad Rear Calipers		HK4737.371X
E320 Wagon		1994-1995				HK4737.371X
E420		1997		With 1 Pin Pad Rear Caliper; (W210)	HK4757.495X	HK4737.371X
E420		1997		With 2 Pin Pad Rear Caliper; (W210)	HK4757.495X	HK4737.371X

BRAKE PAD AND ROTOR KIT APPLICATIONS

MAKE/ MODEL	SUBMODEL	YEARS	ENGINE (LITER)	NOTE	FRONT	REAR
					KIT	KIT
MERCEDES-BENZ CONTINUED						
E430		1998-1999		With 2 Pin Pad Rear Caliper	HK4757.495X	HK4737.371X
E430		1998-2000		With 1 Pin Pad Rear Caliper	HK4757.495X	HK4737.371X
E430		2000		With 2 Pin Pad Rear Caliper; Except 4Matic AWD	HK4757.495X	HK4737.371X
E430		2001-2002		Except 4Matic AWD	HK4757.495X	HK4737.371X
E500		2004-2005		4Matic AWD	HK4872.497X	
S430		2003-2006		4Matic AWD	HK4872.497X	
S500		2002-2003		From 9/02; 4Matic AWD	HK4872.497X	
S500		2004-2006		4Matic AWD	HK4872.497X	
SLK280		2006-2008		except Sport	HK4757.504X	
SLK280		2006-2008		Sport	HK4808.504X	
SLK300		2009-2011			HK4808.504X	
MERCURY						
Cougar		1993-1995		With Rear Disc Brakes	HK4031.182X	
Cougar		1993-1997		with rear drums	HK4031.182X	
Cougar		1996-1997		Sport Package	HK4029.416X	
Cougar		1996-1997		With Rear Disc Brakes - except Sport Package	HK4031.182X	
Grand Marquis		1998-2002		with Steel Piston Rear Caliper	HK4035.294X	HK4032.341X
Grand Marquis		1998-2002		with Phenolic (Plastic) Piston Rear Caliper	HK4035.294X	HK4032.520X
Grand Marquis		2003-2011			HK4042.433X	HK4043.443X
Marauder		2003-2004			HK4042.433X	HK4043.443X
Mariner		2005-2006		Rear Drum Brakes	HK4350.473X	
Mariner		2005-2006		with 4 Wheel Disc Brakes	HK4251.473X	
Mariner		2007		w/Rear Discs	HK4251.473X	
Mariner		2007		w/Rear Drums	HK4350.473X	
Milan		2006-2011			HK4945.565X	HK5368.564X
Montego		2005-2007			HK4054.723X	HK4055.724X
Mountaineer		1997-2001		2WD	HK4314.283X	HK4315.287X
Mountaineer		1997-2001		4WD	HK4317.283X	HK4315.287X
Mountaineer		2002-2005			HK4351.472X	HK4349.520X
Mountaineer		2006				HK4349.520X
Mountaineer		2007-2010				HK4349.613X
Sable		1993				HK4021.417X
Sable		1994-2000			HK4031.347X	HK4021.417X
Sable		2001-2005			HK4029.416X	HK4021.417X
Sable		2008-2009			HK4054.723X	HK4055.724X
MINI						
Cooper		2002-2005			HK4780.444X	HK4781.445X
Cooper		2006		w/o John Cooper Sport Brakes	HK4780.444X	HK4781.445X
Cooper		2006		with John Cooper Sport Brakes		HK4781.445X
Cooper		2007		Convertible; w/John Cooper Works Kit; 294mm Front Rotor		HK4529.445X
Cooper		2007		Convertible; w/o John Cooper Works Kit; 276mm Front Rotor		HK4529.445X
Cooper		2007		Coupe; Except S; 280mm Front Rotor	HK4866.570X	HK4529.574X
Cooper		2007		Coupe; S; 294mm Front Rotor		HK4529.574X
Cooper		2007		Coupe; w/John Cooper Works Kit; 294mm Front Rotor		HK4529.574X
Cooper		2008		Convertible; w/John Cooper Works Brake Kit; 294mm Front Rotor		HK4529.445X
Cooper		2008		Convertible; w/o John Cooper Works Brake Kit; 276mm Front Rotor		HK4529.445X
Cooper		2008		Coupe and Clubman; Except S Model; 280mm Front Rotor	HK4866.570X	HK4529.574X
Cooper		2008		Coupe and Clubman; S Model; 294mm Front Rotor		HK4529.574X
Cooper		2008		Coupe and Clubman; w/John Cooper Works Brake Kit; 294mm Front Rotor		HK4529.574X
Cooper		2009-2013		Base Model; 280mm Front Rotor	HK4866.570X	HK4529.574X
Cooper		2009-2013		Cooper S; Exc. JCW Brakes; 294mm Front Rotor		HK4529.574X
Cooper		2014-2015		Base Model; 1.6L; 280mm Front Rotor	HK4866.570X	HK4529.574X
Cooper		2014-2015		Cooper S; 1.6L; Exc. JCW Brakes; 294mm Front Rotor		HK4529.574X

BRAKE PAD AND ROTOR KIT APPLICATIONS

Hawk Performance - KIT APPLICATIONS

HK 4218 .448 X
 HAWK KIT ROTOR PAD SHAPE INSERT COMPOUND CODE

MAKE/ MODEL	SUBMODEL	YEARS	ENGINE (LITER)	NOTE	FRONT	REAR
					KIT	KIT
MITSUBISHI						
3000GT		1991-1992		VR-4	HK5214.120X	HK5217.673X
3000GT		1991-1998		except VR4	HK5215.214X	HK5216.367X
3000GT		1993		VR-4; To 5/93	HK5214.120X	HK5217.673X
3000GT		1993		VR-4; From 6/93	HK5291.120X	HK5292.201X
3000GT		1994-1998		VR-4	HK5291.120X	HK5292.201X
3000GT		1999		VR-4	HK5215.120X	HK5216.201X
3000GT		1999		Except VR-4	HK5215.214X	HK5216.367X
Diamante		1992-1996		Sedan	HK5215.214X	HK5216.367X
Diamante		1992-1996		Wagon	HK5215.214X	
Diamante		1997-2004			HK5215.214X	
Eclipse		1990		AWD Turbo - MFG After 5/1990	HK5170.213X	
Eclipse		1990		AWD Turbo - MFG up to 4/1990	HK5170.213X	
Eclipse		1990-1992		2WD Turbo	HK5170.213X	
Eclipse		1990-1993		Non Turbo	HK5170.213X	
Eclipse		1991		AWD Turbo	HK5170.213X	
Eclipse		1992		AWD Turbo, To 5/92	HK5170.213X	
Eclipse		1992		AWD Turbo, From 6/92	HK5215.214X	
Eclipse		1993		AWD Turbo	HK5215.214X	
Eclipse		1993		2WD Turbo - Mfg. After 6/1992	HK5170.213X	
Eclipse		1993		2WD Turbo - Mfg. Up To 5/1992	HK5170.213X	
Eclipse		1994		2WD Turbo from 1/94	HK5170.213X	HK5281.367X
Eclipse		1994		Non Turbo from 1/94	HK5170.213X	HK5281.367X
Eclipse		1994		2WD Turbo to 12/93	HK5170.213X	
Eclipse		1994		Non Turbo to 12/93	HK5170.213X	
Eclipse		1994		AWD Turbo to 12/93	HK5215.214X	
Eclipse		1994-1995		AWD Turbo, from 1/94 to 10/94	HK5215.214X	
Eclipse		1995-1999		2WD Turbo	HK5170.213X	HK5281.367X
Eclipse		1995-1999		Non Turbo	HK5170.213X	HK5281.367X
Eclipse		1995		AWD Turbo, from 11/94	HK5215.214X	HK5281.367X
Eclipse		1996-1999		AWD Turbo	HK5215.214X	HK5281.367X
Eclipse		2000		V6	HK5215.214X	HK5281.367X
Eclipse		2000-2001		4 Cylinder	HK5170.213X	
Eclipse		2001-2005		V6	HK5348.435X	HK5281.367X
Eclipse		2002-2005		4 Cylinder	HK5348.435X	
Eclipse		2006-2012		4 Cylinder	HK4901.435X	HK4927.367X
Eclipse		2006-2012		V6	HK4901.435X	HK4959.673X
Endeavor		2004-2012				HK4920.675X
Galant		1998		Rear Drum Models - MFG After 1/1998	HK5170.213X	
Galant		1999		Rear Disc Models	HK5215.214X	HK5281.367X
Galant		1999-2001		Rear Drum Models	HK5170.213X	
Galant		2000		Rear Disc Models - MFG Before 5/2000	HK5215.214X	HK5281.367X
Galant		2000		Rear Disc Models - MFG After 6/2000	HK5348.435X	HK5281.367X
Galant		2001-2003		Rear Disc Models	HK5348.435X	HK5281.367X
Galant		2002-2003		Rear Drum Models	HK5348.435X	
Galant		2004-2006		6 Cyl.	HK4901.435X	HK4927.367X
Galant		2004-2006		4 Cyl.	HK5348.435X	HK4927.367X
Galant		2007		GTS	HK4901.435X	HK4927.367X
Galant		2007		DE; ES; SE Models	HK5348.435X	HK4927.367X
Galant		2007-2008		Ralliart	HK4901.435X	HK4959.673X
Galant		2008		DE; ES; Models	HK5348.435X	HK4927.367X
Galant		2009		2.4L 4 Cyl.	HK5348.435X	HK4927.367X
Galant		2009		3.8L V6	HK4901.435X	HK4959.673X
Galant		2010-2012			HK5348.435X	HK4927.367X
Lancer		2002-2003		LS, OZ Rally; w/Rear Drums	HK5244.438X	
Lancer		2002-2004		ES; w/Rear Drums	HK5287.438X	

BRAKE PAD AND ROTOR KIT APPLICATIONS

MAKE/ MODEL	SUBMODEL	YEARS	ENGINE (LITER)	NOTE	FRONT	REAR
					KIT	KIT
MITSUBISHI CONTINUED						
Lancer		2002-2006		Evolution	HK4907.453X	HK4928.180X
Lancer		2004		Sportback, LS, Ralliart; w/Rear Discs; 5 Bolt Wheel	HK5348.435X	HK5281.457X
Lancer		2004		LS; w/Rear Drums	HK5244.438X	
Lancer		2004		OZ Rally; w/Rear Drums	HK5244.438X	
Lancer	Oz Rally	2005	All		HK5348.438X	
Lancer		2005		With Rear Drums; O-Z Rally	HK5244.438X	
Lancer		2005		With Rear Drums; ES	HK5287.438X	
Lancer		2005-2006		Ralliart; w/Rear Discs	HK5348.435X	HK5281.457X
Lancer		2006-2007		With Rear Drums; w/ABS	HK5244.438X	
Lancer		2006-2007		With Rear Drums; w/o ABS	HK5287.438X	
Lancer		2008-2009		ES; w/Rear Discs	HK4192.435X	HK4237.457X
Lancer		2008-2009		DE; w/Rear Drums	HK4192.435X	
Lancer		2008-2010		GTS; w/Rear Discs	HK4236.435X	HK4193.675X
Lancer		2008-2011		Evolution; Standard Front Rotor	HK4985.453X	HK5013.615X
Lancer		2008-2011		Evolution; 2 Piece Front Rotor		HK5013.615X
Lancer		2009-2014		Ralliart 2.0L Turbo AWD		HK5027.675X
Lancer		2010		DE, ES; w/Rear Discs	HK4192.435X	HK4237.457X
Lancer		2011		GTS	HK4236.435X	HK4193.675X
Lancer		2011-2012		ES; w/Rear Discs	HK4192.435X	HK4237.457X
Lancer		2011-2014		DE, ES; w/Rear Drums	HK4192.435X	
Lancer		2012		SE	HK4236.435X	HK4237.457X
Lancer		2012		GT	HK4236.435X	HK4193.675X
Lancer		2012-2014		Evolution GSR; Standard Front Rotor	HK4985.453X	HK5013.615X
Lancer		2012-2014		Evolution MR; 2 Piece Front Rotor		HK5013.615X
Lancer		2013-2014		GT Sportback	HK4236.435X	HK4193.675X
Lancer		2013-2014		ES Sportback, SE	HK4192.435X	HK4237.457X
Mirage		1998-1999		SEDAN; From 6/98 with 14" Wheels	HK5287.213X	
Mirage		2000-2002		SEDAN; with 14" Wheels	HK5287.213X	
Montero		2001-2004		6 Cyl. Eng.		HK4930.675X
Montero		2005-2006				HK4930.675X
Outlander		2003-2004			HK5348.435X	
Outlander		2005-2006				HK5281.457X
Outlander		2007			HK4236.435X	HK5027.675X
Outlander		2008-2011		V6 Models	HK4236.435X	HK5027.675X
Outlander		2008-2011		4 Cylinder 5 Passenger Models	HK4236.435X	HK4193.675X
Outlander		2008-2011		4 Cylinder 7 Passenger Models	HK4236.435X	HK5027.675X
Outlander		2012			HK4236.435X	HK5027.675X
Outlander		2013-2014		2.4L AWD Models	HK4236.435X	HK4193.675X
Outlander		2013-2014		2.0L Models	HK4236.435X	HK5027.675X
Outlander		2013-2014		2.4L FWD Models	HK4236.435X	HK5027.675X
Outlander		2013-2014		3.0L Models	HK4236.435X	HK5027.675X
Outlander Sport		2011-2012			HK4236.435X	HK4193.675X
Outlander Sport		2013-2014			HK4236.435X	
Raider		2006-2010			HK4460.559X	
NISSAN						
240SX		1989-1993		with ABS	HK5161.235X	
240SX		1989-1993		without ABS	HK5160.231X	
240SX		1989-1993				HK5162.262X
240SX		1994		From 2/94; 5 Lugs		HK5272.262X
240SX		1994		From 2/94 - without ABS 4 Lug	HK5160.231X	
240SX		1994		To 1/94 - without ABS	HK5160.231X	
240SX		1994		To 1/94 - with ABS	HK5161.235X	
240SX		1994		From 2/94 - with ABS	HK5204.231X	
240SX		1994		From 2/94 - without ABS 5 Lug	HK5204.231X	
240SX		1994		From 2/94; 4 Lugs		HK5162.262X

BRAKE PAD AND ROTOR KIT APPLICATIONS



Hawk Performance - KIT APPLICATIONS

HK 4218 .448 X
 HAWK KIT ROTOR PAD SHAPE INSERT COMPOUND CODE

MAKE/ MODEL	SUBMODEL	YEARS	ENGINE (LITER)	NOTE	FRONT	REAR
					KIT	KIT
NISSAN CONTINUED						
240SX		1994		To 1/94		HK5162.262X
240SX		1995-1998		4 Lugs		HK5162.262X
240SX		1995-1998		5 Lugs		HK5272.262X
240SX		1995		without ABS 4 Lug	HK5160.231X	
240SX		1995		without ABS 5 Lug	HK5204.231X	
240SX		1995		with ABS	HK5204.231X	
240SX		1996		To 6/96 - without ABS 4 Lug	HK5160.231X	
240SX		1996		To 6/96 - with ABS	HK5204.231X	
240SX		1996		To 6/96 - without ABS 5 Lug	HK5204.231X	
240SX		1997-1998		without ABS 4 Lug	HK5161.235X	
300ZX		1989-1990		From 2/89 To 6/90; except Turbo	HK5165.178X	HK5166.179X
300ZX		1989-1990		From 6/89; Turbo	HK5197.178X	HK5166.179X
300ZX		1990		From 7/90; except Turbo	HK5197.178X	HK5166.179X
300ZX		1991-1992		except Turbo	HK5197.178X	HK5166.179X
300ZX		1991-1996		Turbo	HK5197.178X	HK5166.179X
300ZX		1993		From 9/93; except Turbo	HK5197.178X	HK5166.179X
300ZX		1993		to 8/93; except Turbo	HK5197.178X	HK5166.179X
300ZX		1994-1996		except Turbo	HK5197.178X	HK5166.179X
350Z		2003-2005		With Standard Brakes	HK4903.268X	HK4904.370X
350Z		2003-2008		with Brembo Brakes	HK4905.545X	HK4906.180X
350Z		2006-2008		With Standard Brakes	HK4909.387X	HK4937.370X
350Z		2009		Base/Touring Models; Except Sport Package (Iron Calipers)	HK4909.387X	HK4937.370X
350Z		2009		Nismo Sport Package (Aluminum Calipers)	HK4971.601X	HK5006.602X
370Z		2009-2015		Base/Touring Models; Except Sport Package (Iron Calipers)	HK4909.387X	HK4937.370X
370Z		2009-2015		Nismo Sport Package (Aluminum Calipers)	HK4971.601X	HK5006.602X
370Z		2009-2016		Aluminum Calipers; Sport Performance Brakes	HK4971.387X	
Altima		1993-2001			HK5202.268X	HK5198.421X
Altima		2002-2004			HK5316.268X	HK4902.370X
Altima		2005-2006		SE-R	HK4900.448X	HK4902.370X
Altima		2005-2006		except SE-R	HK5316.268X	HK4902.370X
Altima		2007-2012			HK4967.268X	
Altima		2013		Coupe	HK4967.268X	
Armada		2005		To 3/05	HK5364.567X	HK5365.555X
Armada		2005		From 3/05	HK4952.567X	HK5365.555X
Armada		2006		With Bosch Front Calipers and 320mm front Rotors	HK4952.567X	HK5365.555X
Armada		2006		With Akebono Front Calipers and 350mm front Rotors		HK5365.555X
Armada		2007		With Akebono Front Calipers and 350mm front Rotors; From 4/07		HK5365.555X
Armada		2007		With Akebono Front Calipers and 350mm front Rotors; To 4/07		HK5365.555X
Armada		2008-2014				HK5365.555X
Cube		2009-2014			HK4963.268X	
Frontier		1998		RWD	HK5313.402X	
Frontier		1999	2.4L	2389cc L4, RWD; From 4/99	HK5313.402X	
Frontier		1999		RWD; To 4/99	HK5313.402X	
Frontier		2000-2004	2.4L	2389cc L4, RWD	HK5313.402X	
Frontier 2WD		2005-2015		6 Cyl.	HK4921.618X	
Frontier 2WD		2005-2015		4 Cyl.	HK4956.618X	
Frontier 4WD		2005-2015			HK4921.618X	
Juke		2014-2015		Nismo RS Models		HK4904.370X
Leaf		2011-2013				HK4904.370X
Leaf		2014		MFG Before 11/13		HK4904.370X
Leaf		2014		MFG From 12/13		HK4904.370X
Leaf		2015				HK4904.370X
Maxima		1989-1994			HK5163.268X	HK5272.421X
Maxima		1995-1998			HK5163.268X	HK5269.421X
Maxima		1999		To 3/1999	HK5163.268X	HK5269.421X

BRAKE PAD AND ROTOR KIT APPLICATIONS



MAKE/ MODEL	SUBMODEL	YEARS	ENGINE (LITER)	NOTE	FRONT	REAR
					KIT	KIT
NISSAN CONTINUED						
Maxima		1999		From 4/1999		HK5269.421X
Maxima		2000			HK5315.268X	HK5269.421X
Maxima		2001		From 10/2000	HK5315.268X	HK5269.378X
Maxima		2001		To 10/2000	HK5315.268X	HK5269.421X
Maxima		2002-2003			HK5316.268X	HK5269.378X
Maxima		2004-2006			HK4900.448X	HK4902.370X
Maxima		2007-2008			HK4909.448X	HK4902.370X
Maxima		2009-2014			HK4909.660X	HK4937.370X
Murano		2003-2005			HK4900.448X	HK5356.370X
Murano		2006-2007			HK4909.448X	HK5356.370X
Murano		2009-2010			HK4900.448X	HK5356.370X
Murano		2011-2012		CrossCabriolet	HK4900.387X	HK5356.370X
Murano		2011-2012		Excluding CrossCabriolet	HK4900.448X	HK5356.370X
Murano		2013-2014			HK4900.387X	HK5356.370X
Murano		2015				HK5356.370X
Pathfinder		1996-1998			HK5273.326X	
Pathfinder		1999-2004			HK5314.326X	
Pathfinder		2005-2007			HK4921.618X	
Pathfinder		2008-2012		4.0L V6	HK4921.618X	
Pathfinder		2013-2015				HK5356.370X
Quest		1993-2002			HK4297.414X	
Quest		2004-2009			HK4926.326X	HK5356.370X
Quest		2011-2013				HK5356.370X
Rogue		2008-2013			HK4968.660X	HK4904.370X
Rogue		2014-2015		S, SL Models With 3 Rows of Seats		HK4904.370X
Rogue		2014-2015		S, SL, SV Models With 2 Rows of Seats		HK4904.370X
Rogue Select		2014-2015				HK4904.370X
Sentra		2000		Rear Drum Models - MFG After 1/2000	HK5161.235X	
Sentra		2000		Rear Disc; From 1/00	HK5202.235X	
Sentra		2000		Rear Drum; To 12/99	HK5270.235X	
Sentra		2000		Rear Disc; To 12/99	HK5271.235X	
Sentra		2000		Models with Rear Disc Brakes - MFG after 1/2000	HK5202.268X	HK5198.421X
Sentra		2001		Models with Rear Disc Brakes - MFG after 6/2001	HK5202.268X	
Sentra		2001		Models with Rear Disc Brakes - MFG up to 6/2001	HK5202.268X	HK5198.421X
Sentra		2001-2002		Rear Disc	HK5202.235X	
Sentra		2001-2006		Rear Drum Models	HK5161.235X	
Sentra		2002		Models with rear Disc Brakes	HK5202.268X	
Sentra		2003		Rear Disc; With Standard Front Calipers	HK5202.235X	
Sentra		2003-2006		Models with Rear Disc Brakes - Exc. SE-R Spec V	HK5202.268X	
Sentra	S	2004		Rear Disc	HK5202.235X	
Sentra	SE-R	2004-2006		Rear Disc	HK5202.235X	
Sentra	SE-R Spec V	2007-2012	All			HK4902.600X
Sentra		2007-2013		2.0L; w/Rear Drums	HK4963.268X	
Sentra		2007-2013		2.5L; Except SE-R Spec V	HK4968.268X	
Sentra	SE-R	2010-2012	All	w/Manual Trans		HK4902.600X
Titan		2004			HK5364.567X	HK5365.555X
Titan		2005		To 3/05	HK5364.567X	HK5365.555X
Titan		2005		From 3/05	HK4952.567X	HK5365.555X
Titan		2006-2007			HK4952.567X	HK5365.555X
Titan		2008-2015				HK5365.555X
Versa		2007-2008			HK4963.268X	
Versa		2009-2012		1.8L	HK4963.268X	
Xterra		2000-2004			HK5273.488X	
Xterra		2005-2015			HK4921.618X	

BRAKE PAD AND ROTOR KIT APPLICATIONS



Hawk Performance - KIT APPLICATIONS

HK 4218 .448 X
 HAWK KIT ROTOR PAD SHAPE INSERT COMPOUND CODE

MAKE/ MODEL	SUBMODEL	YEARS	ENGINE (LITER)	NOTE	FRONT	REAR
					KIT	KIT
OLDSMOBILE						
Achieva		1992-1998			HK4149.390X	
Alero		1999-2004			HK4165.425X	HK4166.359X
Aurora		1995-1996			HK4160.217X	HK4156.359X
Aurora		1997-1999			HK4164.360X	HK4156.359X
Aurora		2001-2003			HK4164.360X	HK4156.359X
Bravada		1997-2001			HK4388.304X	HK4387.305X
Bravada		2002-2004			HK4399.382X	HK4397.383X
Cutlass		1997		with rear drums	HK4165.425X	
Cutlass		1998-1999			HK4165.425X	
Cutlass Calais		1990		Performance Pkg	HK4149.390X	
Cutlass Calais		1991			HK4149.390X	
Cutlass Supreme		1971-1972			HK4065.103X	
Cutlass Supreme		1979-1981			HK4132.119X	
Cutlass Supreme		1988		FWD	HK4146.232X	
Cutlass Supreme		1989-1993			HK4146.232X	
Cutlass Supreme		1994		Fwd, except 286mm Front	HK4146.232X	
Cutlass Supreme		1994-1996		except 267mm Front Rotor	HK4163.232X	
Cutlass Supreme		1995		with Fwd, except 286mm Front	HK4146.232X	
Cutlass Supreme		1997		With Rear Disc	HK4163.232X	
Delta 88		1977-1978		Except HD or Wagon (11.1" Rotors)	HK4066.103X	
F85		1969-1972			HK4065.103X	
Intrigue		1998-1999		JB9 Brake Package - Standard Brakes; 11" Front Rotors	HK4160.360X	HK4166.359X
Intrigue		1998-1999		JA9 Brake Package - Heavy Duty Brakes; 12" Front Rotors	HK4164.360X	HK4166.359X
Intrigue		2000-2002			HK4160.360X	HK4166.359X
LSS		1996-1999			HK4160.217X	
Silhouette		1994-1996			HK4160.217X	
Silhouette		1997-2002			HK4160.360X	
Silhouette		2002		AWD	HK4173.360X	
Silhouette		2003-2004		FWD; with Rear Discs	HK4160.360X	HK4166.359X
Silhouette		2003-2004		FWD; with Rear Drums	HK4160.360X	
Silhouette		2003-2004		AWD	HK4173.360X	HK4174.359X
Silhouette		2003-2004		AWD	HK4173.373X	HK4174.359X
Tornado		1992				HK4156.359X
PLYMOUTH						
Laser		1990-1994		2WD Turbo	HK5170.213X	
Laser		1990-1994		Non Turbo	HK5170.213X	
Laser		1992		AWD Turbo	HK5170.213X	
Laser		1993-1994		AWD Turbo	HK5215.214X	
Neon		1995-1996		Rear Disc Models		HK4223.176X
Neon		1997-1999				HK4223.176X
Neon		2000-2001			HK4227.177X	HK4223.176X
Prowler		1997			HK4438.260X	
Prowler		1999-2001			HK4438.260X	
PONTIAC						
Aztek 2WD		2001-2005			HK4172.373X	
Bonneville		1994-1999			HK4160.217X	
Bonneville		2000-2004		SLE, SSEi	HK4164.360X	HK4156.359X
Bonneville		2000-2005		SE	HK4160.360X	HK4156.359X
Bonneville		2004-2005		GXP	HK4077.467X	HK4170.359X
Bonneville		2005		SLE, SSEi	HK4191.536X	HK4156.359X
Firebird		1969			HK4065.103X	
Firebird		1970-1977			HK4066.103X	
Firebird		1978		Rear Drum Brakes	HK4066.103X	
Firebird		1993		Rear Disc Brakes		HK4159.112X
Firebird		1994-1997		Rear Disc Brakes	HK4160.217X	HK4159.112X

BRAKE PAD AND ROTOR KIT APPLICATIONS

MAKE/ MODEL	SUBMODEL	YEARS	ENGINE (LITER)	NOTE	FRONT	REAR
					KIT	KIT
PONTIAC CONTINUED						
Firebird		1994-1997		Rear Drum Brakes	HK4160.217X	
Firebird		1998-2002			HK4164.249X	HK4171.250X
G5		2007		5 Lugs; w/Rear Discs	HK4187.524X	HK4188.525X
G5		2007-2010		5 Lugs; w/Rear Drums	HK4064.517X	
G5		2007-2010		4 Lugs; w/Rear Drums	HK4184.517X	
G5		2008		5 Lugs; w/Rear Discs	HK4064.524X	HK4188.525X
G5		2009-2010		5 Lugs; w/Rear Discs	HK4064.517X	HK4188.525X
G6		2005			HK4187.524X	HK4188.525X
G6		2006-2007		V6	HK4187.524X	HK4188.525X
G6		2006-2007		4 Cyl.	HK4189.524X	HK4188.525X
G6		2008-2010			HK4187.524X	HK4188.525X
G8		2008		GT		HK4107.607X
G8		2009		GXP With 355mm Diameter Front Rotors	HK4415.453X	HK4107.607X
G8		2009		GT, With 321mm Diameter Front Rotors		HK4107.607X
Grand Am		1990		with Performance Pkg. WS6	HK4149.390X	
Grand Am		1991-1998			HK4149.390X	
Grand Am		1999-2005			HK4165.425X	HK4166.359X
Grand Prix		1988-1994			HK4146.232X	
Grand Prix		1995-1996		267mm Dia. Front rotor	HK4146.232X	
Grand Prix		1995-1996		286mm Dia. Front rotor	HK4163.232X	
Grand Prix		1997-2003			HK4160.360X	HK4166.359X
Grand Prix		2004		Base & GT; 3.8L	HK4176.451X	HK4182.450X
Grand Prix		2004		GTP	HK4176.451X	HK4182.450X
Grand Prix		2005-2006		Base & GT; 3.8L	HK4176.360X	HK4182.450X
Grand Prix		2005-2006		Base & GT; 3.8L	HK4176.360X	HK4183.450X
Grand Prix		2005-2008		GXP; 5.3L	HK4177.439X	HK4183.440X
Grand Prix		2007-2008		Base, GT, GTP; 3.8L	HK4176.360X	HK4182.450X
Grand Prix		2007-2008		Base, GT, GTP; 3.8L	HK4176.360X	HK4183.450X
GTO		1969-1972			HK4065.103X	
GTO		1973			HK4066.103X	
GTO		2004			HK4178.460X	HK4180.573X
GTO		2005-2006			HK4179.247X	HK4181.573X
Montana		1999-2001			HK4160.360X	
Montana		2002-2004		AWD; Rear Disc	HK4173.360X	
Montana	SV6	2005	All	AWD	HK4176.373X	
Montana		2007-2008			HK4408.360X	
Montana 2WD		2006		Models with I-Beam Rear Axle	HK4408.360X	
Montana 2WD		2006		Models with Independent Rear Suspension	HK4408.360X	
Montana 4WD		2006			HK4408.360X	
Solstice		2006-2009			HK4078.524X	HK4079.478X
Sunbird		1992-1994			HK4149.390X	
Sunfire		1995-2005			HK4149.390X	
Torrent		2006			HK4175.472X	
Trans Sport		1994-1996			HK4160.217X	
Trans Sport		1997-1998			HK4160.360X	HK4166.359X
Vibe		2003-2006		with rear drums	HK5324.441X	
Vibe		2003-2006		with Rear Discs	HK5324.441X	HK5325.329X
Vibe		2007-2008			HK5324.441X	
Vibe		2009-2010	2.4L	2362cc L4	HK4924.627X	
Vibe	AWD	2009-2010	2.4L	2362cc L4		HK5016.629X
Vibe	GT	2009-2010	2.4L	2362cc L4		HK5016.629X
Vibe		2009-2010		1.8L 2WD	HK4979.627X	HK5015.629X
Vibe		2009-2010		AWD or GT Models	HK4924.704X	HK5016.648X
Vibe		2009-2010		2.4L 2WD	HK4924.704X	HK5017.629X

BRAKE PAD AND ROTOR KIT APPLICATIONS



MAKE/ MODEL	SUBMODEL	YEARS	ENGINE (LITER)	NOTE	FRONT	REAR
					KIT	KIT
PORSCHE						
Boxster		1997-2004			HK4753.289X	HK4754.290X
Boxster		2009-2010		Base	HK4849.664X	
Boxster		2011-2012		Base, Spyder - Iron Discs	HK4849.664X	
Cayenne		2003				HK4496.502X
Cayenne		2004-2006		330mm Front Disc		HK4496.502X
Cayenne		2004-2006		350mm Front Disc		HK4496.502X
Cayenne		2008-2010		330mm Front Disc		HK4496.502X
Cayenne		2008-2010		350mm Front Disc		HK4496.502X
Cayman		2006-2007		S; w/Iron Discs	HK4849.550X	
Cayman		2008-2012		S; w/Iron Discs	HK4849.664X	
Cayman		2009-2012		Base Model	HK4849.664X	
Cayman		2012		R; w/Iron Discs	HK4849.664X	
RAM						
1500		2011			HK4448.559X	HK4450.514X
1500		2012		Exc. Tradesman HD Models	HK4448.559X	
1500		2012				HK4450.513X
1500		2013-2014			HK4448.559X	HK4450.514X
1500		2015			HK4448.559X	HK4450.513X
C/V		2012		Models with Single Piston front caliper MFG After 3/24/2012	HK4477.569X	
C/V		2012		Models with Single Piston front caliper MFG Before 3/23/2012	HK4477.569X	
C/V		2013		Models with Single Piston front Caliper	HK4477.569X	
C/V		2014		Models with Single Piston front caliper	HK4477.569X	
SAAB						
Dakota		2011			HK4460.559X	
900		1988-1993				HK4660.399X
9000		1988-1998				HK4660.399X
9-3		1999-2002		Except Viggen (Models W/288mm (11.3") Diameter Front Rotors)	HK4746.388X	
9-3		2003		Convertible Models; 288mm (11.3") Front Disc	HK4746.388X	HK4745.478X
9-3		2003		Arc & Vector Models; 302mm (11.89") Front Disc		HK4806.571X
9-3		2003-2004		Linear Models; 285mm (11.22") Front Disc		HK4805.571X
9-3		2004		Arc & Aero Models; 302mm (11.89") Front Disc		HK4806.571X
9-3		2005		Linear Models; 285mm (11.22") Front Disc		HK4805.478X
9-3		2005		Arc & Aero Models; 302mm (11.89") Front Disc		HK4806.478X
9-3		2006-2007		2.0T; 285mm (11.22") Front Disc With VENTED Rear Rotors		HK4806.478X
9-3		2006-2008		2.0T; 285mm (11.22") Front Disc With SOLID Rear Rotors		HK4805.478X
9-3		2006-2008		Aero; 2.8L; With 302mm (11.89") Front Disc		HK4806.478X
9-3		2006-2011		Aero; 2.8L; With 314mm (12.36") Front Disc		HK4806.478X
9-3		2009-2011		2.0T Touring & Comfort; 285mm (11.22") Front Disc With Solid Rear Rotors		HK4805.478X
9-3		2009-2011		2.0T (Except XWD); 302mm (11.89") Front Disc With Vented Rear Rotors		HK4806.478X
9-3		2009-2011		Aero; 2.8L; 302mm (11.89") Front Disc With Vented Rear Rotors		HK4806.478X
9-5		1999-2001		Except Aero; with 288mm (11.3") Front Disc	HK4746.388X	HK4817.227X
9-5		1999-2001		Aero Models with 308mm (12.1") Front Disc		HK4817.227X
9-5		2002-2004		2.3L Turbo Models with 288mm (11.3") Front Disc	HK4746.388X	HK4817.227X
9-5		2005		Models with 286mm (11.26") Rear Rotors		HK4817.227X
9-5		2005-2006		Linear/Arc Models with 288mm (11.3") Front Disc	HK4746.388X	HK4817.227X
9-5		2005-2006		Aero Models with 308mm (12.1") Front Disc		HK4817.227X
9-5		2007-2009		308mm Front Disc; 286mm Solid Rear Disc		HK4817.227X
9-5		2011		321mm Front Disc; Except Performance Package	HK4095.638X	
9-2X		2005-2006		Linear; 2.5L	HK5250.432X	HK5139.452X
9-2X		2005-2006		Aero; 2.0L Turbo	HK5339.432X	HK5139.452X
9-7x		2005			HK4400.382X	HK4397.383X
9-7x		2006-2007			HK4400.617X	HK4397.383X
9-7x		2008-2009		4.2i; 5.3i	HK4400.617X	HK4397.383X

BRAKE PAD AND ROTOR KIT APPLICATIONS

MAKE/ MODEL	SUBMODEL	YEARS	ENGINE (LITER)	NOTE	FRONT	REAR
					KIT	KIT
SAAB CONTINUED						
9-7x		2008-2009		Aero; 6.0L		HK4397.383X
SATURN						
Aura		2007-2010			HK4187.524X	HK4188.525X
Ion		2003			HK4184.517X	
Ion		2004-2007		Redline	HK4187.524X	HK4188.525X
Ion		2004-2007		except Redline	HK4184.517X	
L Series		2000-2005			HK4746.388X	
Outlook		2007-2010			HK4417.617X	HK4413.383X
Relay		2005		AWD	HK4176.360X	
Relay		2005		FWD	HK4176.360X	
Relay		2006		FWD; w/o Special Suspension	HK4408.360X	
Relay		2006		FWD; w/Special Suspension	HK4408.360X	
Relay		2006		AWD	HK4408.360X	
Relay		2007		FWD	HK4408.360X	
S Series		1991-1998		Rear Disc Models	HK4152.409X	
S Series		1991-1998		Rear Drum Models	HK4152.409X	
S Series		1999-2002			HK4152.409X	
Sky		2007-2010			HK4078.524X	HK4079.478X
Vue		2002-2007			HK4175.472X	
SCION						
FR-S		2013-2015			HK4955.711X	HK5051.671X
FR-S		2016				HK5051.671X
TC		2005-2010			HK5324.328X	HK5325.610X
TC		2011-2016			HK4924.704X	HK5087.629X
xA		2004-2006			HK4908.493X	
xB		2004-2006			HK4908.493X	
xB		2008-2013			HK4973.627X	HK5017.629X
xB		2014			HK4973.627X	HK5017.629X
xB		2015			HK4973.627X	HK5017.629X
xD		2008-2013			HK4979.627X	
SUBARU						
Baja		2003			HK5339.432X	HK5332.434X
Baja		2004-2006		except Turbo	HK5339.432X	HK5332.434X
Baja		2004-2006		Turbo	HK4955.432X	HK5332.434X
BRZ		2013-2015		With Solid Rear Rotors	HK5250.711X	HK5018.557X
BRZ		2013-2015		With Vented Rear Rotors	HK4955.711X	HK5051.671X
BRZ		2016		With Solid Rear Rotors		HK5018.557X
BRZ		2016		With Vented Rear Rotors		HK5051.671X
Forester		1998-2002			HK5250.352X	HK5139.434X
Forester		2003			HK5339.432X	HK5139.434X
Forester		2004-2008			HK5339.432X	HK5139.452X
Forester		2009			HK4955.432X	HK5018.557X
Forester		2010		Manufactured before 4/14/2010	HK4955.432X	HK5018.557X
Forester		2010		Manufactured after 4/15/2010		HK5018.557X
Forester		2011-2013			HK4955.711X	HK5018.557X
Forester		2014-2015		2.5L Models	HK4955.711X	
Forester		2014-2015		2.0L Models	HK4986.533X	
Impreza		1993-1996		Rear Disc Models		HK5139.367X
Impreza		1997-2001		Rear Drum Models	HK5138.424X	
Impreza		1997-2001		Wagon	HK5138.424X	
Impreza	Outback	1997-2001			HK5138.424X	
Impreza		1997			HK5138.424X	
Impreza		1998		RS - MFG before 6/1998	HK5250.352X	HK5139.367X
Impreza	L	1998-2001		Sedan	HK5138.352X	
Impreza	L	1998-2001		Coupe	HK5138.352X	

BRAKE PAD AND ROTOR KIT APPLICATIONS



Hawk Performance - KIT APPLICATIONS

HK 4218 .448 X
 HAWK KIT ROTOR PAD SHAPE INSERT COMPOUND CODE

MAKE/ MODEL	SUBMODEL	YEARS	ENGINE (LITER)	NOTE	FRONT	REAR
					KIT	KIT
SUBARU CONTINUED						
Impreza	L	1998-2001		Wagon	HK5138.352X	
Impreza	Outback	1998-2001			HK5138.352X	
Impreza		1999		RS - MFG after 7/1998	HK5250.352X	HK5139.434X
Impreza		2000-2001		RS	HK5250.352X	HK5139.434X
Impreza		2002			HK5250.432X	HK5139.434X
Impreza		2003		Models MFG up to 12/2002	HK5250.432X	HK5139.434X
Impreza		2003		Models MFG after 1/2003	HK5250.432X	HK5139.452X
Impreza		2004-2007			HK5250.432X	HK5139.452X
Impreza	WRX	2006-2007	All	Limited	HK5339.700X	
Impreza	WRX	2006-2007	All	TR	HK5339.700X	
Impreza	WRX	2006-2007	All		HK5339.700X	
Impreza	WRX Limited	2006-2007				HK4953.179X
Impreza	WRX TR	2006-2007				HK4953.179X
Impreza	WRX	2006-2007				HK4953.179X
Impreza		2008			HK5250.432X	HK5018.557X
Impreza		2009-2010		2.5 GT Models	HK4955.432X	HK5018.557X
Impreza		2009-2010		Excluding 2.5 GT Models	HK5250.432X	HK5018.557X
Impreza		2011			HK5250.711X	HK5018.557X
Impreza		2012-2014			HK5250.711X	
Impreza Outback Sport		2008-2011				HK5018.557X
Impreza Wagon		2008		Rear Disc Models		HK5018.557X
Impreza Wagon		2009-2010		2.5 GT Models		HK5018.557X
Impreza Wagon		2009-2010		Excluding 2.5 GT Models		HK5018.557X
Impreza Wagon		2011				HK5018.557X
Impreza WRX		2008-2014				HK5018.557X
Impreza WRX STI		2005			HK4914.453X	
Impreza WRX STI		2006-2007			HK4914.453X	HK4915.180X
Impreza WRX STI		2008-2014			HK4914.453X	HK5019.180X
Legacy		1990-1994		Except 4WD Turbo		HK5139.367X
Legacy		1995		w/Rear Discs		HK5139.367X
Legacy		1996		GT, LSi, Outback; w/Rear Discs		HK5139.367X
Legacy		1996		L, LS; w/Rear Discs		HK5139.367X
Legacy	L	1997-1998	All	14 in. Wheel	HK5138.424X	
Legacy	LSi	1997-1998	All	14 in. Wheel	HK5138.424X	
Legacy	Outback	1997-1998	All	14 in. Wheel	HK5138.424X	
Legacy	Postal	1997-1998	All	14 in. Wheel	HK5138.424X	
Legacy		1997-1999		L; w/Rear Discs	HK5138.424X	HK5139.367X
Legacy	Brighton	1997-1999		Wagon	HK5138.352X	
Legacy	L	1997-1999			HK5138.352X	
Legacy		1997-2001		w/Rear Drums	HK5138.424X	
Legacy		1997		GT, LS, LSi, Outback; w/Rear Discs	HK5250.352X	HK5139.367X
Legacy		1998-1999		GT, LTD, Outback; w/Rear Discs	HK5250.352X	HK5139.367X
Legacy	L 30th Anniversary	1999			HK5138.352X	
Legacy		2000		w/Rear Discs	HK5250.352X	HK5332.434X
Legacy		2001		L, GT; w/Rear Discs	HK5250.352X	HK5332.434X
Legacy		2001		GT LTD; w/Rear Discs	HK5339.352X	HK5332.434X
Legacy		2001		w/Rear Drums; To 4/01	HK5138.424X	
Legacy		2001		w/Rear Drums; From 5/01	HK5250.352X	
Legacy		2002		L, LS; w/Rear Discs; To 4/02	HK5250.352X	HK5332.434X
Legacy		2002		L, LS; w/Rear Discs; From 5/02	HK5250.432X	HK5332.434X
Legacy		2002		GT; LTD Models	HK5339.432X	HK5332.434X
Legacy		2002-2004		w/Rear Drums	HK5250.352X	
Legacy		2003-2004		L, LS; w/Rear Discs	HK5250.352X	HK5332.434X
Legacy		2003-2004		GT; LTD Models	HK5339.352X	HK5332.434X
Legacy		2005		2.5i	HK5250.432X	HK5020.557X

BRAKE PAD AND ROTOR KIT APPLICATIONS

MAKE/ MODEL	SUBMODEL	YEARS	ENGINE (LITER)	NOTE	FRONT	REAR
					KIT	KIT
SUBARU CONTINUED						
Legacy		2005-2006		2.5GT	HK4986.533X	HK4953.434X
Legacy		2006		2.5i	HK4955.432X	HK5020.557X
Legacy		2007-2008		2.5GT, Spec B, 3.0R	HK4986.533X	HK4953.434X
Legacy		2007-2009		2.5i, 2.5i Limited	HK4955.432X	HK5020.557X
Legacy		2009		2.5GT, Spec B, 3.0R Limited	HK4986.533X	HK4953.434X
Legacy		2009		3.0R, Excluding Limited	HK4955.432X	HK5020.557X
Legacy		2010-2012		2.5GT, 3.6R	HK4986.533X	HK5051.671X
Legacy		2010-2012		2.5i	HK4955.432X	HK5018.557X
Legacy		2013-2014		3.6R	HK4986.533X	HK5051.671X
Legacy		2013-2014		2.5i	HK4955.711X	HK5018.557X
Outback		2000			HK5250.352X	HK5332.434X
Outback		2001	All		HK5138.424X	
Outback		2001			HK5339.352X	HK5332.434X
Outback		2002		From 10/2001	HK5339.352X	HK5332.434X
Outback		2002		To 9/2001	HK5339.352X	HK5332.434X
Outback		2003-2004			HK5339.432X	HK5332.434X
Outback		2005		2.5 XT Turbo	HK4955.432X	HK5020.557X
Outback		2005		2.5i, 3.0R	HK5339.432X	HK5020.557X
Outback		2006-2009			HK4955.432X	HK5020.557X
Outback		2010-2012		2.5i	HK4955.432X	HK5018.557X
Outback		2010-2014		3.6R Model	HK4986.533X	HK5051.671X
Outback		2013-2014		2.5i	HK4955.711X	HK5018.557X
WRX STI		2015			HK4914.453X	HK5019.180X
XV Crosstrek		2013-2015			HK4955.711X	
SUZUKI						
Equator		2009-2012		4.0L V6	HK4921.618X	
Equator		2009-2012		2.5L	HK4956.618X	
TOYOTA						
4Runner		1991		Models MFG After 6/1991	HK5260.311X	
4Runner		1992-1994			HK5260.311X	
4Runner		1995		Models mfg up to 7/1995 with 290mm (11.42") Front Rotors	HK5260.311X	
4Runner		2001-2002		Models with 319mm (12.56") Front Rotors	HK5300.315X	
4Runner		2001-2002		Models with 297mm (11.69") Front Rotors	HK5297.315X	
4Runner		2003-2009		Models with 319mm (12.56") Front Rotors	HK4918.490X	HK5351.477X
4Runner		2003-2009		Models with 338mm (13.30") Front Rotors	HK5355.490X	HK5351.477X
4Runner		2010-2015			HK5045.490X	HK5046.477X
Avalon		1995-1997			HK5235.318X	
Avalon		1998-2004			HK5235.320X	
Avalon		2005-2007			HK5352.677X	
Avalon		2008-2014			HK4924.647X	HK4938.648X
Camry		1992-1996		V6 Wagon	HK5235.318X	HK5236.401X
Camry		1992-1996		V6 Sedan	HK5235.318X	HK5241.401X
Camry		1992-1996		4 Cyl.	HK5234.310X	HK5241.401X
Camry		1997-1999		V6	HK5235.320X	HK5241.401X
Camry		1997-1999		4 Cyl.	HK5234.310X	
Camry		2000-2001		V6; Made in Japan	HK5235.320X	HK5241.610X
Camry		2000-2001		4 cyl; 14" Wheels Made in Japan	HK5234.310X	
Camry		2000-2001		4 cyl; 15" Wheels Made in U.S.A.	HK5235.318X	
Camry		2000-2001		V6; Made in USA	HK5235.320X	
Camry		2002		4 Cyl., Rear Disc Made in Japan	HK5235.474X	
Camry		2002		4 Cyl., Rear Disc Made in USA	HK5235.474X	
Camry		2002		4 Cyl., Rear Drum	HK5235.474X	
Camry		2002		6 Cyl., SE, XLE with Stepped Hub; Made in Japan	HK5257.474X	
Camry		2002		6 Cyl., SE, XLE with Stepped Hub; Made in USA	HK5257.474X	
Camry		2002		6 Cyl., SE, XLE with Straight Hub; Made in Japan	HK5352.474X	

BRAKE PAD AND ROTOR KIT APPLICATIONS



Hawk Performance - KIT APPLICATIONS

HK 4218 .448 X
 HAWK KIT ROTOR PAD SHAPE INSERT COMPOUND CODE

MAKE/ MODEL	SUBMODEL	YEARS	ENGINE (LITER)	NOTE	FRONT	REAR
					KIT	KIT
TOYOTA CONTINUED						
Camry		2002		6 Cyl., SE, XLE with Straight Hub; Made in USA	HK5352.474X	
Camry		2002-2004		6 Cyl., LE; Made in Japan	HK5235.474X	
Camry		2002-2004		6 Cyl., LE; Made in USA	HK5235.474X	
Camry		2003-2004		6 Cyl., SE, XLE Made in Japan	HK5257.474X	
Camry		2003-2004		6 Cyl., SE, XLE Made in USA	HK5257.474X	
Camry		2003-2006		4 Cyl. LE	HK5235.474X	
Camry		2003-2006		4 Cyl., SE, XLE Made in USA	HK5235.474X	
Camry		2004-2006		4 Cyl., SE, XLE Made in Japan	HK5235.474X	
Camry		2005		6 Cyl., SE 3.3L, XLE 3.0L; Made in USA	HK5352.677X	
Camry		2005-2006		6 Cyl., LE Made in USA	HK5235.474X	
Camry		2005-2006		6 Cyl., LE, Made in Japan	HK5235.474X	
Camry		2005-2006		6 Cyl., SE 3.3L, XLE 3.0L; Made in Japan	HK5352.677X	
Camry		2006		6 Cyl., SE, XLE; Made in USA	HK5352.677X	
Camry		2007-2011			HK4924.647X	HK4938.648X
Camry		2012-2015			HK4924.647X	HK5122.648X
Celica		1994		GT	HK5267.318X	
Celica		1995-1997		Convertible & GT	HK5267.318X	HK5298.401X
Celica		1998-1999			HK5267.318X	HK5298.401X
Celica		2000-2005		Rear Disc Models	HK5324.328X	HK5325.329X
Celica		2001-2005		Rear Drum Models	HK5324.328X	
Corolla		1993-1997			HK5261.310X	
Corolla		1998-2002			HK5261.321X	
Corolla		2003-2004			HK5324.441X	
Corolla		2005-2006			HK5324.441X	HK5325.329X
Corolla		2007-2008			HK5324.441X	
Corolla		2009-2010		w/Rear Discs	HK4979.627X	HK5015.629X
Corolla		2009-2010		w/Rear Drums	HK4979.627X	
Corolla		2011-2013			HK4979.627X	
Corolla		2014-2015		w/Rear Discs	HK4979.627X	HK5015.629X
Corolla		2014-2015		w/Rear Drums	HK4979.627X	
Echo		2001-2005			HK5224.493X	
FJ Cruiser		2007-2009			HK4918.490X	HK5351.477X
FJ Cruiser		2010-2014			HK4918.490X	HK5046.477X
Land Cruiser		1993-1997			HK5262.312X	HK5263.477X
Land Cruiser		1998				HK5256.427X
Land Cruiser		1999-2007			HK5255.313X	HK5256.427X
Matrix		2003-2008			HK5324.441X	HK5325.329X
Matrix		2009-2013		1.8L	HK4979.627X	HK5015.629X
Matrix		2009-2013		2.4L; AWD	HK4924.704X	HK5016.648X
Matrix		2009-2013		XRS	HK4924.704X	HK5016.648X
Matrix		2009-2013		2.4L; 2WD	HK4924.704X	HK5017.629X
Matrix	S	2009-2013		AWD		HK5016.629X
Matrix	S	2009-2013			HK4924.627X	
Matrix	XRS	2009-2013			HK4924.627X	HK5016.629X
MR2		1991-1995		except Turbo	HK5221.191X	
MR2 Spyder		2000-2005			HK5224.493X	
Prius		2001-2003			HK5261.493X	
Prius		2004-2009			HK4916.493X	
Prius		2010-2015				HK5015.629X
Prius Plug-in		2012-2015				HK5015.629X
Prius V		2012-2016			HK4973.627X	
RAV4		1996-2000			HK5299.310X	
RAV4		2001-2003			HK5354.429X	
RAV4		2004-2005		w/Rear Discs	HK5354.429X	
RAV4		2004-2005		w/Rear Drums	HK5354.429X	

BRAKE PAD AND ROTOR KIT APPLICATIONS

MAKE/ MODEL	SUBMODEL	YEARS	ENGINE (LITER)	NOTE	FRONT	REAR
					KIT	KIT
TOYOTA CONTINUED						
RAV4		2006-2008	2.4L	2362cc L4, W/3rd Row Seat	HK4924.627X	
RAV4		2006-2012	3.5L	3456cc V6	HK4924.627X	
RAV4		2006-2010		2.4L; w/3rd Row Seat	HK4924.704X	HK5023.648X
RAV4		2006-2010		3.5L	HK4924.704X	HK5023.648X
RAV4		2006-2010		2.4L; w/o 3rd Row Seat	HK4973.627X	HK5023.648X
RAV4		2009-2012	2.5L	2494cc 152cid L4, W/3rd Row Seat	HK4924.627X	
RAV4		2011		2.4L; w/3rd Row Seat or V6 Made in USA up to 8/2011	HK4924.704X	HK5023.648X
RAV4		2011		2.4L; w/o 3rd Row Seat Made in Japan Between 2/2011 and 5/2011	HK4973.627X	HK5023.648X
RAV4		2011		2.4L; w/o 3rd Row Seat Made in Japan From 6/2011	HK4973.627X	HK5023.648X
RAV4		2011		2.4L; w/o 3rd Row Seat Made in Japan up to 1/2011	HK4973.627X	HK5023.648X
RAV4		2011		2.4L; w/o 3rd Row Seat Made in USA up to 8/2011	HK4973.627X	HK5023.648X
RAV4		2011-2012		2.4L; w/3rd Row Seat or V6 Made in Japan	HK4924.704X	HK5023.648X
RAV4		2011-2012		2.4L; w/3rd Row Seat or V6 Made in USA from 9/2011	HK4924.704X	HK5023.648X
RAV4		2011-2012		2.4L; w/o 3rd Row Seat Made in USA from 9/2011	HK4973.627X	HK5023.648X
RAV4		2012		2.4L; w/o 3rd Row Seat Made in Japan	HK4973.627X	HK5023.648X
RAV4	EV	2012-2014			HK4924.627X	
RAV4	LE	2013-2014		296mm Front Disc	HK4924.627X	
RAV4	Limited	2013-2014		296mm Front Disc	HK4924.627X	
RAV4	XLE	2013-2014		296mm Front Disc	HK4924.627X	
RAV4		2013-2015		EV Electric Model	HK4924.704X	HK5023.648X
RAV4		2013-2015		Models with 275mm (10.8") Front Rotors made in Japan	HK4973.627X	HK5023.648X
RAV4		2013-2015		Models with 275mm (10.8") Front Rotors made in USA	HK4973.627X	HK5023.648X
RAV4		2013-2015		Models with 296mm (11.65") Front Rotors	HK4924.704X	HK5023.648X
Sequoia		2001-2002		with Frt. Caliper Casting # S13WE	HK5327.314X	HK5351.477X
Sequoia		2001-2002		with Frt. Caliper Casting # 13WL	HK5327.490X	HK5351.477X
Sequoia		2003-2007			HK5327.490X	HK5351.477X
Sienna		1998-2003			HK5235.318X	
Sienna		2004-2010		w/Rear Discs	HK5352.677X	
Sienna		2004-2010		w/Rear Drums	HK5352.677X	
Solara		1999		To 8/99	HK5235.320X	HK5241.401X
Solara		1999		From 8/99	HK5235.320X	
Solara		2000-2003			HK5235.320X	
Solara		2004-2008			HK5352.677X	
Supra		1993-1998		except Turbo		HK5240.670X
Tacoma		1995-1997		2WD	HK5296.407X	
Tacoma		1998		2WD, 5 Lug Models	HK5296.407X	
Tacoma		2005-2015		6 Lug Wheels	HK4918.490X	
Tundra		2000-2002		with Frt. Caliper Casting # S13WE	HK5327.314X	
Tundra		2000-2002		with Frt. Caliper Casting # 13WL	HK5327.490X	
Tundra		2003		Mfg. Before 8/2002	HK5327.490X	
Tundra		2003		Mfg. From 8/2002	HK5327.490X	
Tundra		2004-2006			HK5327.490X	
VOLKSWAGEN						
Beetle		1998		With Wear Sensor		HK4751.364X
Beetle		1998			HK4748.365X	HK4751.364X
Beetle		1999-2005		except 1.8L Gas Turbo	HK4748.365X	HK4751.364X
Beetle		1999-2005		1.8L Turbo	HK4770.272X	HK4751.364X
Beetle		1999-2005		With Wear Sensor, except 1.8L Gas Turbo		HK4751.364X
Beetle		1999-2005		With Wear Sensor, 1.8L Turbo		HK4751.364X
Beetle		2006		1.8L Turbo, Turbo S	HK4770.272X	
Beetle		2006		2.5L 5 Cyl.	HK4770.272X	
Beetle		2006-2007		2.0L Gas, 1.9L TDI	HK4748.365X	
Beetle		2008			HK4770.272X	
Beetle		2009-2010		Convertible	HK4770.272X	
Beetle		2009-2010		Coupe	HK4748.365X	

BRAKE PAD AND ROTOR KIT APPLICATIONS

Hawk Performance - KIT APPLICATIONS

HK 4218 .448 X
 HAWK KIT ROTOR PAD SHAPE INSERT COMPOUND CODE

MAKE/ MODEL	SUBMODEL	YEARS	ENGINE (LITER)	NOTE	FRONT	REAR
					KIT	KIT
VOLKSWAGEN CONTINUED						
Beetle		2012		2.0T	HK4897.543X	HK4567.695X
Beetle		2012		2.5L	HK4845.543X	HK4567.695X
Beetle		2013		2.0 TDI or 2.5L Gas	HK4845.543X	HK4567.695X
Beetle		2013-2014		2.0T Gas Engine	HK4897.543X	HK4567.695X
Beetle		2014		1.8T, 2.0 TDI, or 2.5L Gas	HK4845.543X	HK4567.695X
Beetle		2015		1.8T, 2.0 TDI, or 2.5L Gas	HK4845.543X	
Beetle		2015		2.0T Gas Engine	HK4897.543X	
Beetle		2015				HK4570.364X
Cabrio		1995-1998		With Wear Sensor	HK4666.190X	
Cabrio		1995-1998			HK4666.190X	
Cabrio		1999-2002		With Wear Sensor	HK4666.190X	HK4665.364X
Cabrio		1999-2002			HK4666.190X	HK4665.364X
CC		2009-2014		3.6L		HK4539.544X
CC		2009-2014		2.0L	HK4897.543X	
Corrado		1990-1991	All	w/Wear Sensor		HK4665.364X
Corrado		1990-1991	All	With Wear Sensor, w/Wear Sensor		HK4665.364X
Corrado		1990-1991		With Wear Sensor, 1.8L Eng.		HK4665.364X
Corrado		1990-1991		1.8L Eng.		HK4665.364X
Corrado		1992-1995		2.8L Eng.	HK4692.190X	HK4693.364X
Corrado		1992-1995		With Wear Sensor, 2.8L Eng.		HK4693.364X
Eos		2007-2009			HK4897.543X	
Eos		2010		MFG Date From 11/2009	HK4897.543X	HK4567.695X
Eos		2010		MFG Date Up to 10/2009	HK4897.543X	
Eos		2011-2012			HK4897.543X	HK4567.695X
Golf		1985-1989		GTI		HK4665.364X
Golf		1985-1989		With Wear Sensor, GTI		HK4665.364X
Golf		1990-1992		GTI - Rear Disc		HK4665.364X
Golf		1990-1992		With Wear Sensor, GTI - Rear Disc		HK4665.364X
Golf	GL	1993-1994	2.0L	Base, GL; With Rear Drums	HK4666.190X	
Golf	GL	1993-1994	2.0L	With Wear Sensor, Base, GL; With Rear Drums	HK4666.190X	
Golf		1993-1994		Base, GL	HK4666.190X	HK4665.364X
Golf		1993-1994		With Wear Sensor, Base, GL	HK4666.190X	HK4665.364X
Golf		1993		Base, GL; With Rear Drums	HK4666.190X	
Golf		1993		With Wear Sensor, Base, GL; With Rear Drums	HK4666.190X	
Golf		1994		GTI VR6		HK4665.364X
Golf		1994		GTI (5 Lug)	HK4692.190X	HK4693.364X
Golf		1994		With Wear Sensor, GTI (5 Lug)		HK4693.364X
Golf		1994-1997		With Wear Sensor, GTI VR6		HK4665.364X
Golf	III Celebration Edition	1995	2.0L	w/Wear Sensor	HK4692.190XA	
Golf	III Celebration Edition	1995	2.0L	With Wear Sensor	HK4666.190X	
Golf	III Celebration Edition	1995	2.0L		HK4666.190X	
Golf	III City	1995	2.0L	w/Wear Sensor	HK4692.190XA	
Golf	III City	1995	2.0L	With Wear Sensor	HK4666.190X	
Golf	III City	1995	2.0L		HK4666.190X	
Golf	III Sport	1995	2.0L	w/Wear Sensor	HK4692.190XA	
Golf	III Sport	1995	2.0L	With Wear Sensor	HK4666.190X	
Golf	III Sport	1995	2.0L		HK4666.190X	
Golf		1995-1998		With Wear Sensor, GTI VR6		HK4693.364X
Golf		1995		GL, City, Celebration Edition - Rear Disc	HK4666.190X	HK4665.364X
Golf		1995		With Wear Sensor, GL, City, Celebration Edition - Rear Disc	HK4666.190X	HK4665.364X
Golf		1995		GTI VR6	HK4692.190X	HK4665.364X
Golf		1995		GTI VR6	HK4692.190X	HK4693.364X
Golf		1995		GL, City, Celebration Edition - Rear Drum	HK4666.190X	
Golf		1995		With Wear Sensor, GL, City, Celebration Edition - Rear Drum	HK4666.190X	
Golf		1996-1998	2.8L	2792cc V6, With Wear Sensor	HK4731.190X	

BRAKE PAD AND ROTOR KIT APPLICATIONS

MAKE/ MODEL	SUBMODEL	YEARS	ENGINE (LITER)	NOTE	FRONT	REAR
					KIT	KIT
TOYOTA CONTINUED						
Golf		1996-1998	2.8L	2792cc V6	HK4731.190X	
Golf		1996		GL - Rear Disc	HK4666.190X	HK4665.364X
Golf		1996		With Wear Sensor, GL - Rear Disc	HK4666.190X	HK4665.364X
Golf		1996		GL - Rear Drum	HK4666.190X	
Golf		1996		With Wear Sensor, GL - Rear Drum	HK4666.190X	
Golf		1996-1997		GTI VR6	HK4731.272X	HK4665.364X
Golf		1996-1997		GTI VR6	HK4731.272X	HK4693.364X
Golf		1996-1998		GTI 2.0L	HK4666.190X	HK4665.364X
Golf		1996-1998		With Wear Sensor, GTI 2.0L	HK4666.190X	HK4665.364X
Golf		1997		US Model - GL, Jazz, K2, Trek - Rear Disc	HK4666.190X	HK4665.364X
Golf		1997		With Wear Sensor, US Model - GL, Jazz, K2, Trek - Rear Disc	HK4666.190X	HK4665.364X
Golf		1997		US Model - GL, Jazz, K2, Trek - Rear Drum	HK4666.190X	
Golf		1997		With Wear Sensor, US Model - GL, Jazz, K2, Trek - Rear Drum	HK4666.190X	
Golf		1998		US Model - GL, K2 - Rear Disc	HK4666.190X	HK4665.364X
Golf		1998		With Wear Sensor, US Model - GL, K2 - Rear Disc	HK4666.190X	HK4665.364X
Golf		1998		GTI VR6	HK4731.272X	HK4693.364X
Golf		1998		US Model - GL, K2 - Rear Drum	HK4666.190X	
Golf		1998		With Wear Sensor, US Model - GL, K2 - Rear Drum	HK4666.190X	
Golf		1999	1.9L	1896cc 116cid L4, From 12/98	HK4748.190X	
Golf		1999	1.9L	1896cc 116cid L4, With Wear Sensor, From 12/98	HK4748.190X	
Golf	GL	1999	1.9L	w/Wear Sensor, From 12/98		HK4665.364X
Golf	GL	1999	1.9L	With Wear Sensor, w/Wear Sensor, From 12/98		HK4665.364X
Golf		1999	2.0L	1984cc 121cid L4, From 12/98	HK4748.190X	
Golf		1999	2.0L	1984cc 121cid L4, With Wear Sensor, From 12/98	HK4748.190X	
Golf	LE	1999	2.0L	From 12/98		HK4665.364X
Golf	LE	1999	2.0L	To 11/98		HK4665.364X
Golf	LE	1999	2.0L	With Wear Sensor, To 11/98		HK4665.364X
Golf	LE	1999	2.0L	With Wear Sensor, From 12/98		HK4665.364X
Golf		1999	2.8L	2792cc V6, From 11/98	HK4770.190X	
Golf		1999	2.8L	2792cc V6, To 11/98	HK4731.190X	
Golf		1999	2.8L	2792cc V6, With Wear Sensor, From 11/98	HK4770.190X	
Golf		1999	2.8L	2792cc V6, With Wear Sensor, To 11/98	HK4731.190X	
Golf		1999		GL, GLS, TDI - Rear Disc - MFG Before 12/1998	HK4666.190X	HK4665.364X
Golf		1999		GTI 2.0L - MFG Before 11/1998	HK4666.190X	HK4665.364X
Golf		1999		With Wear Sensor, GL, GLS, TDI - Rear Disc - MFG Before 12/1998	HK4666.190X	HK4665.364X
Golf		1999		With Wear Sensor, GTI 2.0L - MFG Before 11/1998	HK4666.190X	HK4665.364X
Golf		1999		GTI - MFG After 5/1999 (With Sensor in front pads)	HK4770.272X	HK4665.364X
Golf		1999		GTI - MFG After 5/1999 (With Sensor in front pads)	HK4770.272X	HK4751.364X
Golf		1999		With Wear Sensor, GTI - MFG After 5/1999 (With Sensor in front pads)		HK4665.364X
Golf		1999		With Wear Sensor, GTI - MFG After 5/1999 (With Sensor in front pads)		HK4751.364X
Golf		1999		GTI VR6 - MFG Before 11/1998	HK4731.272X	HK4693.364X
Golf		1999		With Wear Sensor, GTI VR6 - MFG Before 11/1998		HK4693.364X
Golf		1999		GL, GLS, TDI - Rear Disc - MFG After 12/1998 and Before 5/1999	HK4748.365X	HK4751.364X
Golf		1999		GL, GLS, TDI - Rear Disc - MFG After 6/1999	HK4748.365X	HK4751.364X
Golf		1999		GTI - MFG After 12/1998 and Before 4/1999 (w/o sensor in front pads)	HK4770.272X	HK4751.364X
Golf		1999		With Wear Sensor, GTI - MFG After 12/1998 and Before 4/1999 (Without Sensor in front pads)		HK4751.364X
Golf		1999		With Wear Sensor, GL, GLS, TDI - Rear Disc - MFG After 6/1999		HK4751.364X
Golf		1999		With Wear Sensor, GL, GLS, TDI - Rear Disc MFG After 12/1998 and Before 5/1999		HK4751.364X
Golf		1999		GL, Wolfsburg Edition - Rear Drum - MFG Before 12/1998	HK4666.190X	
Golf		1999		With Wear Sensor, GL, Wolfsburg Edition - Rear Drum MFG Before 12/1998	HK4666.190X	

BRAKE PAD AND ROTOR KIT APPLICATIONS



Hawk Performance - KIT APPLICATIONS

HK 4218 .448 X
 HAWK KIT ROTOR PAD SHAPE INSERT COMPOUND CODE

MAKE/ MODEL	SUBMODEL	YEARS	ENGINE (LITER)	NOTE	FRONT	REAR
					KIT	KIT
VOLKSWAGEN CONTINUED						
Golf		1999		GL, Wolfsburg Edition - Rear Drum MFG After 12/1998 and Before 5/1999	HK4748.365X	
Golf		1999		GL, Wolfsburg Edition - Rear Drum - MFG After 6/1999	HK4748.365X	
Golf		2000		GTI	HK4770.272X	HK4751.364X
Golf		2000		With Wear Sensor, GTI		HK4751.364X
Golf		2000		Base, GL, GLS	HK4748.365X	HK4751.364X
Golf		2000		With Wear Sensor, Base, GL, GLS		HK4751.364X
Golf		2001		GTI, GLS Turbo	HK4770.272X	HK4751.364X
Golf		2001		With Wear Sensor, GTI, GLS Turbo		HK4751.364X
Golf		2001-2002		Base, GL, GLS non-turbo	HK4748.365X	HK4751.364X
Golf		2001-2002		With Wear Sensor, Base, GL, GLS non-turbo		HK4751.364X
Golf		2002		GTI, GLS Turbo with Solid Rear Rotors	HK4770.272X	HK4751.364X
Golf		2002		With Wear Sensor, GTI, GLS Turbo with Solid Rear Rotors		HK4751.364X
Golf		2002		GTI With Vented Rear Rotors - Excluding GTI 337	HK4775.272X	HK4776.364X
Golf		2003		Base, GL, GLS	HK4748.365X	HK4751.364X
Golf		2003		With Wear Sensor, Base, GL, GLS		HK4751.364X
Golf		2003-2005		GTI With Solid Rear Rotors	HK4770.272X	HK4751.364X
Golf		2003-2005		With Wear Sensor, GTI With Solid Rear Rotors		HK4751.364X
Golf		2003-2005		GTI With Vented Rear Rotors	HK4775.272X	HK4776.364X
Golf		2004		R32		HK4776.364X
Golf		2004-2005		Base, GL, GLS, TDI	HK4748.365X	HK4751.364X
Golf		2004-2005		With Wear Sensor, Base, GL, GLS, TDI		HK4751.364X
Golf		2006		Base, GL, GLS, TDI	HK4748.365X	
Golf		2010-2013		2.0L TDI with 260mm Rear Brake Rotors	HK4845.543X	HK4538.544X
Golf		2010-2013		2.0L TDI with 272mm Rear Brake Rotors	HK4845.543X	HK4567.695X
Golf		2010-2013		2.5L Gas	HK4845.543X	HK4567.695X
Golf		2012-2013		Golf R		HK4539.544X
Golf		2014		Models with 288mm Front Brake Rotors and 272mm Rear Brake Rotors	HK4845.543X	HK4567.695X
Golf		2014		Models with 312mm Front Brake Rotors and 272mm Rear Brake Rotors	HK4897.543X	HK4567.695X
Golf		2014		253mm Rear Rotor		HK4570.695X
Golf		2015		253mm Rear Rotor		HK4570.364X
Golf	Launch Edition	2015		253mm Rear Rotor		HK4570.364X
Golf	TDI S	2015		253mm Rear Rotor		HK4570.364X
Golf	TDI SE	2015		253mm Rear Rotor		HK4570.364X
Golf	TDI SEL	2015		253mm Rear Rotor		HK4570.364X
GTI		2006-2009			HK4897.543X	HK4898.544X
GTI		2010			HK4897.543X	
GTI		2011-2014			HK4897.543X	HK4567.695X
GTI		2015-2016		With Performance Brakes		HK4539.544X
Jetta		1990-1993		With Wear Sensor, Rear Disc	HK4666.190X	HK4665.364X
Jetta		1990-1993		Rear Disc	HK4666.190X	HK4665.364X
Jetta		1993		With Wear Sensor, Rear Drum	HK4666.190X	
Jetta		1993		Rear Drum	HK4666.190X	
Jetta		1994-1995		GLX - 2.8L	HK4692.190X	HK4665.364X
Jetta		1994-1995		GLX - 2.8L	HK4692.190X	HK4693.364X
Jetta		1994-1995		With Wear Sensor, GLX - 2.8L		HK4665.364X
Jetta		1994-1997		2.0L Gas - Rear Disc	HK4666.190X	HK4665.364X
Jetta		1994-1997		With Wear Sensor, 2.0L Gas - Rear Disc	HK4666.190X	HK4665.364X
Jetta		1994-1997		With Wear Sensor, GLX - 2.8L		HK4693.364X
Jetta		1994-1997		2.0L Gas - Rear Drum	HK4666.190X	
Jetta		1994-1997		With Wear Sensor, 2.0L Gas - Rear Drum	HK4666.190X	
Jetta		1996	2.8L	2792cc V6, With Wear Sensor	HK4731.190X	
Jetta		1996	2.8L	2792cc V6	HK4731.190X	

BRAKE PAD AND ROTOR KIT APPLICATIONS

MAKE/ MODEL	SUBMODEL	YEARS	ENGINE (LITER)	NOTE	FRONT	REAR
					KIT	KIT
VOLKSWAGEN CONTINUED						
Jetta	GLX	1996	2.8L	w/Wear Sensor		HK4665.364X
Jetta	GLX	1996	2.8L	With Wear Sensor, w/Wear Sensor		HK4665.364X
Jetta		1996-1997		GLX - 2.8L	HK4731.272X	HK4693.364X
Jetta		1997-1999	1.9L	1896cc 116cid L4, With Wear Sensor	HK4748.190X	
Jetta		1997-1999	1.9L	1896cc 116cid L4	HK4748.190X	
Jetta		1997-1999	2.8L	2792cc V6, With Wear Sensor	HK4770.190X	
Jetta		1997-1999	2.8L	2792cc V6	HK4770.190X	
Jetta		1997		1.9L TDI Diesel - US Models only	HK4666.190X	
Jetta		1997		With Wear Sensor, 1.9L TDI Diesel - US Models only	HK4666.190X	
Jetta		1998	2.0L	1984cc 121cid L4, From 10/98	HK4748.190X	
Jetta		1998	2.0L	1984cc 121cid L4, With Wear Sensor, From 10/98	HK4748.190X	
Jetta		1998		4 Lug 2.0L Gas - Rear Disc - MFG Date Up To 9/98	HK4666.190X	HK4665.364X
Jetta		1998		With Wear Sensor, 4 Lug 2.0L Gas - Rear Disc MFG Date Up To 9/98	HK4666.190X	HK4665.364X
Jetta		1998		5 Lug - GLX - 2.8L - MFG Date Up To 9/98	HK4731.272X	HK4693.364X
Jetta		1998		With Wear Sensor, 5 Lug - GLX - 2.8L - MFG Date Up To 9/98		HK4693.364X
Jetta		1998		5 Lug - GLX - 2.8L - MFG Date From 10/98	HK4770.272X	HK4751.364X
Jetta		1998		5 Lug - 2.0L Gas or 1.9L TDI - Rear Disc - MFG Date From 10/98		HK4751.364X
Jetta		1998		With Wear Sensor, 5 Lug - GLX - 2.8L - MFG Date From 10/98		HK4751.364X
Jetta		1998		With Wear Sensor, 5 Lug - 2.0L Gas or 1.9L TDI - Rear Disc MFG Date From 10/98		HK4751.364X
Jetta		1998		4 Lug 1.9L TDI Diesel - US Models only - MFG Date Up To 9/98	HK4666.190X	
Jetta		1998		4 Lug 2.0L Gas - Rear Drum - MFG Date Up To 9/98	HK4666.190X	
Jetta		1998		4 Lug Wolfsburg Edition	HK4666.190X	
Jetta		1998		With Wear Sensor, 4 Lug Wolfsburg Edition	HK4666.190X	
Jetta		1998		With Wear Sensor, 4 Lug 2.0L Gas - Rear Drum MFG Date Up To 9/98	HK4666.190X	
Jetta		1998		With Wear Sensor, 4 Lug 1.9L TDI Diesel US Models only - MFG Date Up To 9/98	HK4666.190X	
Jetta		1999	2.0L	1984cc 121cid L4, With Wear Sensor	HK4748.190X	
Jetta		1999	2.0L	1984cc 121cid L4	HK4748.190X	
Jetta		1999		4 Lug Models - Wolfsburg Edition, GL, GLS, TDI	HK4666.190X	HK4665.364X
Jetta		1999		With Wear Sensor, 4 Lug Models - Wolfsburg Edition, GL, GLS, TDI	HK4666.190X	HK4665.364X
Jetta		1999		5 Lug - 2.8L or 1.8T - MFG Date From 6/99	HK4770.272X	HK4665.364X
Jetta		1999		5 Lug - 2.8L or 1.8T - MFG Date From 6/99	HK4770.272X	HK4751.364X
Jetta		1999		With Wear Sensor, 5 Lug - 2.8L or 1.8T - MFG Date From 6/99		HK4665.364X
Jetta		1999		With Wear Sensor, 5 Lug - 2.8L or 1.8T - MFG Date From 6/99		HK4751.364X
Jetta		1999		5 Lug - 2.0L Gas or 1.9L TDI - MFG Date From 10/98 to 5/99	HK4748.365X	HK4751.364X
Jetta		1999		5 Lug - 2.0L Gas or 1.9L TDI - MFG Date From 6/99	HK4748.365X	HK4751.364X
Jetta		1999		5 Lug Models - GLX / GLS - 2.8L - MFG Date From 10/98 to 5/99	HK4770.272X	HK4751.364X
Jetta		1999		With Wear Sensor, 5 Lug Models - GLX / GLS - 2.8L MFG Date From 10/98 to 5/99		HK4751.364X
Jetta		1999		With Wear Sensor, 5 Lug - 2.0L Gas or 1.9L TDI MFG Date From 6/99		HK4751.364X
Jetta		1999		With Wear Sensor, 5 Lug - 2.0L Gas or 1.9L TDI MFG Date From 10/98 to 5/99		HK4751.364X
Jetta		2000		2.0L Gas or 1.9L TDI	HK4748.365X	HK4751.364X
Jetta		2000		2.8L or 1.8T	HK4770.272X	HK4751.364X
Jetta		2000		With Wear Sensor, 2.8L or 1.8T		HK4751.364X
Jetta		2000		With Wear Sensor, 2.0L Gas or 1.9L TDI		HK4751.364X
Jetta	TDI	2005	1.9L	From 1/05		HK4751.544X
Jetta		2005		Sedan, TDI or 2.5L Gas - MFG Date from 1/05		HK4751.544X
Jetta		2008-2009		Sedan, TDI or 2.5L Gas		HK4751.544X
Jetta		2011	2.5L	2480cc 151cid L5, Wagon		HK4570.695X
Jetta		2012-2014	2.5L	2480cc 151cid L5, Wagon		HK4570.364X
Jetta		2015		Sedan; 288mm Front Rotor; 253mm Rear Rotor		HK4570.364X

BRAKE PAD AND ROTOR KIT APPLICATIONS

Hawk Performance - KIT APPLICATIONS

HK 4218 .448 X
 HAWK KIT ROTOR PAD SHAPE INSERT COMPOUND CODE

MAKE/ MODEL	SUBMODEL	YEARS	ENGINE (LITER)	NOTE	FRONT	REAR
					KIT	KIT
VOLKSWAGEN CONTINUED						
Passat		1992-1993		2.0L; Rear Disc	HK4666.190X	HK4665.364X
Passat		1992-1993		With Wear Sensor, 2.0L; Rear Disc	HK4666.190X	HK4665.364X
Passat		1992-1993		2.0L; Rear Drum	HK4666.190X	
Passat		1992-1993		With Wear Sensor, 2.0L; Rear Drum	HK4666.190X	
Passat		1992-1995		2.8L	HK4692.190X	HK4665.364X
Passat		1992-1995		2.8L	HK4692.190X	HK4693.364X
Passat		1992-1997		With Wear Sensor, 2.8L		HK4665.364X
Passat		1992-1997		With Wear Sensor, 2.8L		HK4693.364X
Passat		1994-1995		2.0L	HK4666.190X	HK4665.364X
Passat		1994-1995		With Wear Sensor, 2.0L	HK4666.190X	HK4665.364X
Passat		1996-1997	2.8L	2792cc V6, With Wear Sensor	HK4731.190X	
Passat		1996-1997	2.8L	2792cc V6	HK4731.190X	
Passat		1996-1997		TDI - USA Model	HK4666.190X	HK4665.364X
Passat		1996-1997		With Wear Sensor, TDI - USA Model	HK4666.190X	HK4665.364X
Passat		1996-1997		2.8L	HK4731.272X	HK4665.364X
Passat		1996-1997		2.8L	HK4731.272X	HK4693.364X
Passat	GLS	1998	2.8L	From 7/98; From CH# 3B-X-124-108	HK4695.272X	
Passat	GLS	1998	2.8L	w/Wear Sensor, From 7/98; From CH# 3B-X-124-108	HK4695.272X	
Passat		1999-2001		AWD		HK4723.364X
Passat		1999-2003		FWD		HK4694.364X
Passat		2002-2003		AWD Except W8		HK4723.364X
Passat		2006-2007		3.6L 4-Motion		HK4539.544X
Passat		2006-2007		2.0L Turbo, 3.6L; Except 4-Motion	HK4897.543X	HK4898.544X
Passat		2008		3.6L		HK4539.544X
Passat		2008		2.0L Turbo	HK4897.543X	HK4898.544X
Passat		2009		3.6L V6; Canadian Models		HK4539.544X
Passat		2009		2.0L Turbo - Mfg After 12/2008		HK4898.544X
Passat		2009		2.0L Turbo - Mfg Before 12/2008		HK4898.544X
Passat		2010			HK4897.543X	
Passat		2012-2015			HK4897.543X	HK4567.695X
Phaeton		2004-2006			HK4840.687X	
R32		2008				HK4539.544X
Rabbit		2007-2009			HK4845.543X	HK4538.544X
Routan		2009-2011			HK4477.569X	
Routan		2012-2013		Models with Single Piston front Caliper	HK4477.569X	
Tiguan		2009-2010			HK4897.543X	HK4898.544X
Tiguan		2011-2014			HK4897.543X	
Touareg		2004-2005		350mm Front Rotors		HK4496.502X
Touareg		2004-2005		330mm Front Rotors		HK4496.502X
Touareg		2006-2007		Models with 350mm Front Discs		HK4496.502X
Touareg		2006-2007		Models with 6 Piston Front Calipers and 330mm Front Discs		HK4496.502X
Touareg		2008-2009		330mm Front Discs - 4 Piston Rear Caliper		HK4496.502X
Touareg		2008-2010		350mm Front Discs		HK4496.502X
VOLVO						
850		1994-1997			HK4717.492X	HK4718.172X
960		1995-1997			HK4717.413X	
C30		2008-2012			HK4895.519X	HK4535.478X
C70		1998			HK4717.492X	HK4718.172X
C70		1999-2004		Models with 280mm (11.02") Front Rotors	HK4717.492X	HK4718.172X
C70		1999-2004		Models with 302mm (11.89") Front Rotors		HK4718.172X
C70		2006-2012		Models with 320mm (12.6") Front Rotors		HK4535.478X
C70		2006-2012		Models with 300mm (11.81") Front Rotors	HK4895.519X	HK4535.478X
S40		2004		2004.5 model - 2.4i; 300mm Front Disc	HK4895.519X	HK4535.571X
S40		2004		2004.5 model - T5; 320mm Front Disc		HK4535.571X
S40		2005		2.4i; 300mm Front Disc	HK4895.519X	HK4535.571X

BRAKE PAD AND ROTOR KIT APPLICATIONS



MAKE/ MODEL	SUBMODEL	YEARS	ENGINE (LITER)	NOTE	FRONT	REAR
					KIT	KIT
VOLVO CONTINUED						
S40		2005		T5; 320mm Front Disc		HK4535.571X
S40		2006-2010		2.4i; 300mm Front Disc	HK4895.519X	HK4535.478X
S40		2006-2010		T5; 320mm Front Disc		HK4535.478X
S40		2011		Models with 320mm (12.6") Front Rotors		HK4535.478X
S40		2011		Models with 300mm (11.81") Front Rotors	HK4895.519X	HK4535.478X
S40		2012		Models with 300mm (11.81") Front Rotors	HK4895.519X	
S60		2001-2003		Except T5	HK4771.491X	HK4764.652X
S60		2001-2003		T5	HK4772.491X	HK4764.652X
S60		2004-2007		Except T5 & R; 286mm Front Disc	HK4771.491X	HK4764.652X
S60		2004-2007		T5; 305mm Front Disc	HK4772.491X	HK4764.652X
S60		2008-2009		Except T5; 305mm Front Disc	HK4772.491X	HK4764.652X
S60		2008-2009		T5; 316mm Front Disc		HK4764.652X
S70		1998			HK4717.492X	HK4718.172X
S70		1999-2000		AWD; To CH# 596635		HK4756.172X
S70		1999-2000		2WD	HK4717.492X	HK4718.172X
S80		1999-2006		286mm Front Discs	HK4771.491X	HK4764.652X
S80		1999-2006		305mm Front Discs	HK4772.491X	HK4764.652X
S90		1997-1998			HK4717.413X	
V50		2005		2.4i; 300mm Front Discs	HK4895.519X	HK4535.571X
V50		2005		T5; 320mm Front Discs		HK4535.571X
V50		2006-2010		2.4i; 300mm Front Discs	HK4895.519X	HK4535.478X
V50		2006-2010		T5; 320mm Front Discs		HK4535.478X
V50		2011		300mm Front Discs	HK4895.519X	HK4535.478X
V50		2011		320mm Front Discs		HK4535.478X
V50		2012		300mm Front Discs	HK4895.519X	
V70		1998		2WD; 302mm Front Discs		HK4718.172X
V70		1998		AWD & R; 280mm Front Discs	HK4717.492X	HK4756.172X
V70		1998		AWD & R; 302mm Front Discs		HK4756.172X
V70		1998-2000		2WD; 280mm Front Discs	HK4717.492X	HK4718.172X
V70		1999		AWD; To CH# 588639; 280mm Front Discs	HK4717.492X	HK4756.172X
V70		1999		AWD To CH# 588639; R To CH# 587596; 302mm Front Discs		HK4756.172X
V70		2000		AWD; 280mm Front Discs	HK4717.492X	
V70		2001-2003		Except T5; 286mm Front Discs	HK4771.491X	HK4764.652X
V70		2001-2003		T5; 305mm Front Discs	HK4772.491X	HK4764.652X
V70		2004-2007		Except T5 & R; 286mm Front Discs	HK4771.491X	HK4764.652X
V70		2004-2007		T; 305mm Front Discs	HK4772.491X	HK4764.652X
V90		1997-1998			HK4717.413X	
XC70		2003-2007			HK4771.491X	HK4764.652X

BRAKE PAD AND ROTOR KIT APPLICATIONS



MOTORCYCLE APPLICATIONS



MOTORCYCLE APPLICATION GUIDE

Hawk Performance - MOTORCYCLE APPLICATION GUIDE

CLASS	MODEL	YEARS	FRONT		REAR	
			ORGANIC	METALLIC	ORGANIC	METALLIC
HARLEY DAVIDSON						
FL	Hydra Glide Police	1975-1979	HMC1035	--	HMC1035	--
FLD	Switchback	2012-2013, 2015-2016	HMC1019	HMC5019	--	--
FLD	Switchback	2012-2016	--	--	HMC1020	HMC5020
FLH	Electra Glide	1980	HMC1035	--	HMC1033	--
FLH	Electra Glide	1974-1976	HMC1035	--	HMC1035	--
FLH	Electra Glide	1977-1978	HMC1035	--	HMC1035	--
FLH	Electra Glide	1982-1983	HMC1036	--	HMC1035	--
FLH	Electra Glide 80	1981	HMC1035	--	HMC1033	--
FLH	Electra Glide 80	1978-1980	HMC1035	--	HMC1035	--
FLH	Electra Glide Anniversary	1978	HMC1035	--	HMC1035	--
FLH	Electra Glide Classic	1982-1983	HMC1036	--	HMC1033	--
FLH	Electra Glide Special	1984	HMC1035	--	HMC1033	--
FLH	Heritage Softail	1981	HMC1036	--	HMC1033	--
FLHP	Road King Police	2012-2016	HMC1016	HMC5016	HMC1016	HMC5016
FLHPEI	Electra Glide Police EFI	2006	HMC1015	HMC5015	HMC1015	HMC5015
FLHPEI	Road King Police CA EFI	2005	HMC1015	HMC5015	HMC1015	HMC5015
FLHPI	Road King Police EFI	2005-2006	HMC1015	HMC5015	--	--
FLHR	Project Rushmore Road King	2016	HMC1016	HMC5016	HMC1016	HMC5016
FLHR	Road King	1994-1999	HMC1002	HMC5002	HMC1006	HMC5006
FLHR	Road King	2000-2007	HMC1015	HMC5015	HMC1015	HMC5015
FLHR	Road King	2008, 2010-2016	HMC1016	HMC5016	HMC1016	HMC5016
FLHR	Road King Anniversary	2013	HMC1016	HMC5016	HMC1016	HMC5016
FLHR	Road King Classic	1994-1999	HMC1002	HMC5002	HMC1006	HMC5006
FLHRC	Road King Classic	2007	HMC1015	HMC5015	HMC1015	HMC5015
FLHRC	Road King Classic	2011	HMC1019	HMC5019	HMC1020	HMC5020
FLHRC	Road King Classic	2008-2015	HMC1016	HMC5016	HMC1016	HMC5016
FLHRCi	Road King	1994-1999	HMC1002	HMC5002	HMC1006	HMC5006
FLHRCi	Road King Classic	1994-1999	HMC1002	HMC5002	HMC1006	HMC5006
FLHRCi	Road King Classic	2000-2007	HMC1015	HMC5015	HMC1015	HMC5015
FLHRi	Road King	2000-2007	HMC1015	HMC5015	HMC1015	HMC5015
FLHRS	Road King Custom	2004-2007	HMC1015	HMC5015	HMC1015	HMC5015
FLHRSE3	CVO Road King	2007	--	--	HMC1015	HMC5015
FLHRSE4	CVO Road King	2008	HMC1016	HMC5016	HMC1016	HMC5016
FLHRSE5	CVO Road King	2013-2014	HMC1016	HMC5016	HMC1016	HMC5016
FLHRSE5	CVO Road King Anniversary	2013	HMC1016	HMC5016	HMC1016	HMC5016
FLHRSE6	CVO Road King	2014	HMC1016	HMC5016	HMC1016	HMC5016
FLHRSEI	CVO Road King EFI	2002	HMC1015	HMC5015	HMC1015	HMC5015
FLHRSEI2	CVO Road King EFI	2003	HMC1015	HMC5015	HMC1015	HMC5015
FLHRSi	Road King Custom	2004-2006	HMC1015	HMC5015	HMC1015	HMC5015

Hawk Performance - MOTORCYCLE APPLICATION GUIDE

CLASS	MODEL	YEARS	FRONT		REAR	
			ORGANIC	METALLIC	ORGANIC	METALLIC
HARLEY DAVIDSON						
FLHS	Electra Glide	1977-1980	HMC1035	--	HMC1035	--
FLHS	Electra Glide Sport	1990	HMC1002	HMC5002	HMC1006	HMC5006
FLHT	Electra Glide	1984-1999	HMC1002	HMC5002	--	--
FLHT	Electra Glide	1985-1986	--	--	HMC1001	HMC5001
FLHT	Electra Glide	1986-1999	--	--	HMC1006	HMC5006
FLHT	Electra Glide Classic	1984-1999	HMC1002	HMC5002	--	--
FLHT	Electra Glide Classic	1986-1999	--	--	HMC1006	HMC5006
FLHT	Electra Glide Standard	2000-2007	HMC1015	HMC5015	HMC1015	HMC5015
FLHT	Electra Glide Standard	2008-2009	HMC1016	HMC5016	HMC1016	HMC5016
FLHT	Electra Glide Ultra Classic	1984-1999	HMC1002	HMC5002	--	--
FLHT	Electra Glide Ultra Classic	1986-1999	--	--	HMC1006	HMC5006
FLHT	Tour Glide	1984	HMC1002	HMC5002	--	--
FLHT	Tour Glide	1984	--	--	HMC1033	--
FLHT	Ultra Glide	1984-1999	HMC1002	HMC5002	--	--
FLHT	Ultra Glide	1986-1999	--	--	HMC1006	HMC5006
FLHTC	Electra Glide Classic	1993	--	--	HMC1005	HMC5005
FLHTC	Electra Glide Classic	2011	HMC1019	HMC5019	HMC1020	HMC5020
FLHTC	Electra Glide Classic	1985-1986	HMC1002	HMC5002	HMC1001	HMC5001
FLHTC	Electra Glide Classic	1990-1999	HMC1002	HMC5002	--	--
FLHTC	Electra Glide Classic	2000-2005, 2007	HMC1015	HMC5015	HMC1015	HMC5015
FLHTC	Electra Glide Classic	2008-2013	HMC1016	HMC5016	HMC1016	HMC5016
FLHTC	Electra Glide Ultra Classic	1990-1999	HMC1002	HMC5002	HMC1006	HMC5006
FLHTCi	Electra Glide	1984-1999	HMC1002	HMC5002	--	--
FLHTCi	Electra Glide	1986-1999	--	--	HMC1006	HMC5006
FLHTCi	Electra Glide Classic	1984-1999	HMC1002	HMC5002	--	--
FLHTCi	Electra Glide Classic	1986-1999	--	--	HMC1006	HMC5006
FLHTCi	Electra Glide Classic	2000-2007	HMC1015	HMC5015	HMC1015	HMC5015
FLHTCi	Electra Glide Ultra Classic	1984-1999	HMC1002	HMC5002	--	--
FLHTCi	Electra Glide Ultra Classic	1986-1999	--	--	HMC1006	HMC5006
FLHTCi	Electra Glide Ultra Classic	2008-2010	HMC1016	HMC5016	HMC1016	HMC5016
FLHTCi	Ultra Glide	1984-1999	HMC1002	HMC5002	--	--
FLHTCi	Ultra Glide	1986-1999	--	--	HMC1006	HMC5006
FLHTCSE	CVO Electra Glide Classic	2004	HMC1015	HMC5015	HMC1015	HMC5015
FLHTCSE2	CVO Electra Glide Classic	2005	HMC1015	HMC5015	HMC1015	HMC5015
FLHTCU	Electra Glide Classic	2014	--	--	HMC1020	HMC5020
FLHTCU	Electra Glide Ultra Classic	2011	HMC1016	HMC5016	HMC1016	HMC5016
FLHTCU	Electra Glide Ultra Classic	2014	--	--	HMC1020	HMC5020
FLHTCU	Electra Glide Ultra Classic	2007-2010	HMC1015	HMC5015	HMC1015	HMC5015
FLHTCU	Project Rushmore Electra Glide Ultra Classic	2015-2016	HMC1016	HMC5016	HMC1016	HMC5016

Hawk Performance - MOTORCYCLE APPLICATION GUIDE

CLASS	MODEL	YEARS	FRONT		REAR	
			ORGANIC	METALLIC	ORGANIC	METALLIC
HARLEY DAVIDSON						
FLHTCUi	Electra Glide Ultra Classic	2000-2006	HMC1015	HMC5015	HMC1015	HMC5015
FLHTCUL	Electra Glide Ultra Classic Low	2015-2016	HMC1016	HMC5016	HMC1016	HMC5016
FLHTCUL	Project Rushmore Electra Glide Ultra Classic Low	2015-2016	HMC1016	HMC5016	HMC1016	HMC5016
FLHTCUSE	CVO Electra Glide Ultra Classic	2006	HMC1015	HMC5015	HMC1015	HMC5015
FLHTCUSE2	CVO Electra Glide Ultra Classic	2007	HMC1015	HMC5015	HMC1015	HMC5015
FLHTCUSE5	CVO Electra Glide Ultra Classic	2010	HMC1016	HMC5016	HMC1016	HMC5016
FLHTCUSE6	CVO Electra Glide Ultra Classic	2011	HMC1016	HMC5016	HMC1016	HMC5016
FLHTCUSE7	CVO Electra Glide Ultra Classic	2012	HMC1016	HMC5016	HMC1016	HMC5016
FLHTCUSE8	CVO Electra Glide Ultra Classic	2013	HMC1016	HMC5016	--	--
FLHTCUTG	Project Rusmore Tri Glide Ultra	2015-2016	HMC1027	HMC5027F	HMC1027	HMC5027R
FLHTCUTG	Tri Glide Ultra Classic Trike	2009-2013	HMC1016	HMC5016	--	--
FLHTCUTG	Tri Glide Ultra Classic Trike	2009-2013	--	--	HMC1045	HMC5045
FLHTCUTG	Tri Glide Ultra Trike	2014-2016	HMC1027	HMC5027F	HMC1027	HMC5027R
FLHTi	Electra Glide Standard	2000-2007	HMC1015	HMC5015	HMC1015	HMC5015
FLHTK	Electra Glide Standard Ultra LTD	2010	HMC1016	HMC5016	HMC1016	HMC5016
FLHTK	Electra Glide Ultra Classic	2010	HMC1016	HMC5016	HMC1016	HMC5016
FLHTK	Electra Glide Ultra Limited	2011	HMC1019	HMC5019	HMC1020	HMC5020
FLHTK	Electra Glide Ultra LTD	2010	HMC1016	HMC5016	HMC1016	HMC5016
FLHTK	Project Rushmore Ultra Limited	2015-2016	HMC1016	HMC5016	HMC1016	HMC5016
FLHTK	Ultra Limited	2010-2016	HMC1016	HMC5016	HMC1016	HMC5016
FLHTK	Ultra Limited Anniversary	2013	HMC1016	HMC5016	HMC1016	HMC5016
FLHTKL	Project Rushmore Ultra Limited Low	2015-2016	HMC1016	HMC5016	HMC1016	HMC5016
FLHTKL	Ultra Limited Low	2015-2016	HMC1016	HMC5016	HMC1016	HMC5016
FLHTKSE	CVO Limited	2014-2016	HMC1016	HMC5016	HMC1016	HMC5016
FLHTKSE	Project Rushmore CVO Limited	2015-2016	HMC1016	HMC5016	HMC1016	HMC5016
FLHTP	Electra Glide Police	2000-2007	HMC1015	HMC5015	HMC1015	HMC5015
FLHTP	Electra Glide Police	2008, 2012-2106	HMC1016	HMC5016	HMC1016	HMC5016
FLHTPI	Electra Glide Police EFI	2005-2006	HMC1015	HMC5015	HMC1015	HMC5015
FLHX	Project Rushmore Street Glide	2015-2016	HMC1016	HMC5016	HMC1016	HMC5016
FLHX	Street Glide	2006-2007	HMC1015	HMC5015	HMC1015	HMC5015
FLHX	Street Glide	2008-2016	HMC1016	HMC5016	HMC1016	HMC5016
FLHXi	Street Glide	2006-2007	HMC1015	HMC5015	HMC1015	HMC5015
FLHXS	Project Rushmore Street Glide Special	2015-2016	HMC1016	HMC5016	HMC1016	HMC5016
FLHXS	Street Glide Special	2014-2016	HMC1016	HMC5016	HMC1016	HMC5016
FLHXSE	CVO Street Glide	2010, 2015-2016	HMC1016	HMC5016	HMC1016	HMC5016
FLHXSE	Project Rushmore CVO Street Glide	2015-2016	HMC1016	HMC5016	HMC1016	HMC5016
FLHXSE2	CVO Street Glide	2011	HMC1016	HMC5016	HMC1016	HMC5016
FLHXSE3	CVO Street Glide	2012	HMC1016	HMC5016	HMC1016	HMC5016
FLHXXX	Street Glide Trike	2010	--	--	HMC1045	HMC5045

Hawk Performance - MOTORCYCLE APPLICATION GUIDE

CLASS	MODEL	YEARS	FRONT		REAR	
			ORGANIC	METALLIC	ORGANIC	METALLIC
HARLEY DAVIDSON						
FLHXXX	Street Glide Trike	2010-2011	HMC1016	HMC5016	--	--
FLRT	Freewheeler	2015	HMC1027	HMC5027F	--	--
FLRT	Freewheeler	2015-2016	--	--	HMC1028	HMC5028
FLRT	Project Rushmore Freewheeler	2015-2016	HMC1027	HMC5027F	HMC1027	HMC5027R
FLS	Slim	2012-2016	HMC1019	HMC5019	HMC1020	HMC5020
FLSS	Slim S	2016	HMC1019	HMC5019	HMC1020	HMC5020
FLST	Fat Boy	1984-1987	--	--	HMC1001	HMC5001
FLST	Fat Boy	1984-1999	HMC1002	HMC5002	--	--
FLST	Fat Boy	1987-1999	--	--	HMC1005	HMC5005
FLST	Heritage Softail	2006	HMC1015	HMC5015	HMC1015	HMC5015
FLST	Heritage Softail	1984-1987	--	--	HMC1001	HMC5001
FLST	Heritage Softail	1984-1999	HMC1002	HMC5002	--	--
FLST	Heritage Softail	1987-1999	--	--	HMC1005	HMC5005
FLST	Heritage Softail	2008-2010	--	--	HMC1020	HMC5020
FLST	Heritage Softail Custom	1984-1987	--	--	HMC1001	HMC5001
FLST	Heritage Softail Custom	1984-1999	HMC1002	HMC5002	--	--
FLST	Heritage Softail Custom	1987-1999	--	--	HMC1005	HMC5005
FLST	Heritage Springer	1984-1987	--	--	HMC1001	HMC5001
FLST	Heritage Springer	1984-1999	HMC1002	HMC5002	--	--
FLST	Heritage Springer	1987-1999	--	--	HMC1005	HMC5005
FLST	Night Train	1984-1987	--	--	HMC1001	HMC5001
FLST	Night Train	1984-1999	HMC1002	HMC5002	--	--
FLST	Night Train	1987-1999	--	--	HMC1005	HMC5005
FLST	Softail	1984-1987	--	--	HMC1001	HMC5001
FLST	Softail	1984-1999	HMC1002	HMC5002	--	--
FLST	Softail	1987-1999	--	--	HMC1005	HMC5005
FLST	Softail Custom	1984-1987	--	--	HMC1001	HMC5001
FLST	Softail Custom	1984-1999	HMC1002	HMC5002	--	--
FLST	Softail Custom	1987-1999	--	--	HMC1005	HMC5005
FLST	Springer	1984-1987	--	--	HMC1001	HMC5001
FLST	Springer	1984-1999	HMC1002	HMC5002	--	--
FLST	Springer	1987-1999	--	--	HMC1005	HMC5005
FLSTC	Fat Boy	1984-1987	--	--	HMC1001	HMC5001
FLSTC	Fat Boy	1984-1999	HMC1002	HMC5002	--	--
FLSTC	Fat Boy	1987-1999	--	--	HMC1005	HMC5005
FLSTC	Heritage Softail	1984-1987	--	--	HMC1001	HMC5001
FLSTC	Heritage Softail	1984-1999	HMC1002	HMC5002	--	--
FLSTC	Heritage Softail	1987-1999	--	--	HMC1005	HMC5005
FLSTC	Heritage Softail Classic	2007	--	--	HMC1018	HMC5018

Hawk Performance - MOTORCYCLE APPLICATION GUIDE

CLASS	MODEL	YEARS	FRONT		REAR	
			ORGANIC	METALLIC	ORGANIC	METALLIC
HARLEY DAVIDSON						
FLSTC	Heritage Softail Classic	2016	--	--	HMC1020	HMC5020
FLSTC	Heritage Softail Classic	1984-1987	--	--	HMC1001	HMC5001
FLSTC	Heritage Softail Classic	1987-1999	HMC1002	HMC5002	HMC1005	HMC5005
FLSTC	Heritage Softail Classic	2000-2007	HMC1015	HMC5015	HMC1015	HMC5015
FLSTC	Heritage Softail Classic	2008-2015	HMC1019	HMC5019	HMC1020	HMC5020
FLSTC	Heritage Softail Classic Anniversary	2013	--	--	HMC1020	HMC5020
FLSTC	Heritage Softail Custom	1984-1987	--	--	HMC1001	HMC5001
FLSTC	Heritage Softail Custom	1984-1999	HMC1002	HMC5002	--	--
FLSTC	Heritage Softail Custom	1987-1999	--	--	HMC1005	HMC5005
FLSTC	Heritage Springer	1984-1987	--	--	HMC1001	HMC5001
FLSTC	Heritage Springer	1984-1999	HMC1002	HMC5002	--	--
FLSTC	Heritage Springer	1987-1999	--	--	HMC1005	HMC5005
FLSTC	Night Train	1984-1987	--	--	HMC1001	HMC5001
FLSTC	Night Train	1984-1999	HMC1002	HMC5002	--	--
FLSTC	Night Train	1987-1999	--	--	HMC1005	HMC5005
FLSTC	Softail	1984-1987	--	--	HMC1001	HMC5001
FLSTC	Softail	1984-1999	HMC1002	HMC5002	--	--
FLSTC	Softail	1987-1999	--	--	HMC1005	HMC5005
FLSTC	Softail	2006-2007	HMC1015	HMC5015	HMC1015	HMC5015
FLSTC	Softail Custom	1984-1987	--	--	HMC1001	HMC5001
FLSTC	Softail Custom	1984-1999	HMC1002	HMC5002	--	--
FLSTC	Softail Custom	1987-1999	--	--	HMC1005	HMC5005
FLSTC	Springer	1984-1987	--	--	HMC1001	HMC5001
FLSTC	Springer	1984-1999	HMC1002	HMC5002	--	--
FLSTC	Springer	1987-1999	--	--	HMC1005	HMC5005
FLSTCi	Heritage Softail Classic	2000-2004	HMC1015	HMC5015	HMC1015	HMC5015
FLSTCI	Softail	2006	HMC1015	HMC5015	HMC1015	HMC5015
FLSTF	Fat Boy	1984-1987	--	--	HMC1001	HMC5001
FLSTF	Fat Boy	1984-1999	HMC1002	HMC5002	--	--
FLSTF	Fat Boy	1987-1999	--	--	HMC1005	HMC5005
FLSTF	Fat Boy	2000-2007	HMC1015	HMC5015	HMC1015	HMC5015
FLSTF	Fat Boy	2008-2015	HMC1019	HMC5019	--	--
FLSTF	Fat Boy	2008-2016	--	--	HMC1020	HMC5020
FLSTF	Fat Boy Special	2012-2014	HMC1019	HMC5019	HMC1020	HMC5020
FLSTF	Heritage Softail	1984-1987	--	--	HMC1001	HMC5001
FLSTF	Heritage Softail	1984-1999	HMC1002	HMC5002	--	--
FLSTF	Heritage Softail	1987-1999	--	--	HMC1005	HMC5005
FLSTF	Heritage Softail Custom	1984-1987	--	--	HMC1001	HMC5001
FLSTF	Heritage Softail Custom	1984-1999	HMC1002	HMC5002	--	--

Hawk Performance - MOTORCYCLE APPLICATION GUIDE

CLASS	MODEL	YEARS	FRONT		REAR	
			ORGANIC	METALLIC	ORGANIC	METALLIC
HARLEY DAVIDSON						
FLSTF	Heritage Softail Custom	1987-1999	--	--	HMC1005	HMC5005
FLSTF	Heritage Springer	1984-1987	--	--	HMC1001	HMC5001
FLSTF	Heritage Springer	1984-1999	HMC1002	HMC5002	--	--
FLSTF	Heritage Springer	1987-1999	--	--	HMC1005	HMC5005
FLSTF	Night Train	1984-1987	--	--	HMC1001	HMC5001
FLSTF	Night Train	1984-1999	HMC1002	HMC5002	--	--
FLSTF	Night Train	1987-1999	--	--	HMC1005	HMC5005
FLSTF	Softail	1984-1987	--	--	HMC1001	HMC5001
FLSTF	Softail	1984-1999	HMC1002	HMC5002	--	--
FLSTF	Softail	1987-1999	--	--	HMC1005	HMC5005
FLSTF	Softail Custom	1984-1987	--	--	HMC1001	HMC5001
FLSTF	Softail Custom	1984-1999	HMC1002	HMC5002	--	--
FLSTF	Softail Custom	1987-1999	--	--	HMC1005	HMC5005
FLSTF	Springer	1984-1987	--	--	HMC1001	HMC5001
FLSTF	Springer	1984-1999	HMC1002	HMC5002	--	--
FLSTF	Springer	1987-1999	--	--	HMC1005	HMC5005
FLSTFB	Fat Boy	2012-2014	HMC1019	HMC5019	--	--
FLSTFB	Fat Boy	2015-2016	--	--	HMC1020	HMC5020
FLSTFB	Fat Boy Lo	2010-2016	--	--	HMC1020	HMC5020
FLSTFB	Fat Boy Lo Anniversary	2013	--	--	HMC1020	HMC5020
FLSTFB	Fat Boy Special	2010-2014	HMC1019	HMC5019	HMC1020	HMC5020
FLSTFBS	Fat Boy S	2016	HMC1019	HMC5019	HMC1020	HMC5020
FLSTFi	Fat Boy	2000-2006	HMC1015	HMC5015	HMC1015	HMC5015
FLSTFi	Fat Boy 15th Anniversary Edition	2005-2007	HMC1015	HMC5015	HMC1015	HMC5015
FLSTFSE	CVO Fat Boy	2005	HMC1015	HMC5015	HMC1015	HMC5015
FLSTFSE2	CVO Fat Boy	2006	HMC1015	HMC5015	HMC1015	HMC5015
FLSTi	Heritage Softail	2006	HMC1015	HMC5015	HMC1015	HMC5015
FLSTN	Fat Boy	1984-1987	--	--	HMC1001	HMC5001
FLSTN	Fat Boy	1984-1999	HMC1002	HMC5002	--	--
FLSTN	Fat Boy	1987-1999	--	--	HMC1005	HMC5005
FLSTN	Heritage Softail	1984-1987	--	--	HMC1001	HMC5001
FLSTN	Heritage Softail	1984-1999	HMC1002	HMC5002	--	--
FLSTN	Heritage Softail	1987-1999	--	--	HMC1005	HMC5005
FLSTN	Heritage Softail Custom	1984-1987	--	--	HMC1001	HMC5001
FLSTN	Heritage Softail Custom	1984-1999	HMC1002	HMC5002	--	--
FLSTN	Heritage Softail Custom	1987-1999	--	--	HMC1005	HMC5005
FLSTN	Heritage Softail Nostalgia	1993-1999	HMC1002	HMC5002	--	--
FLSTN	Heritage Softail Nostalgia	1993-1999	--	--	HMC1005	HMC5005
FLSTN	Heritage Springer	1984-1987	--	--	HMC1001	HMC5001

Hawk Performance - MOTORCYCLE APPLICATION GUIDE

CLASS	MODEL	YEARS	FRONT		REAR	
			ORGANIC	METALLIC	ORGANIC	METALLIC
HARLEY DAVIDSON						
FLSTN	Heritage Springer	1984-1999	HMC1002	HMC5002	--	--
FLSTN	Heritage Springer	1987-1999	--	--	HMC1005	HMC5005
FLSTN	Night Train	1984-1987	--	--	HMC1001	HMC5001
FLSTN	Night Train	1984-1999	HMC1002	HMC5002	--	--
FLSTN	Night Train	1987-1999	--	--	HMC1005	HMC5005
FLSTN	Nostalgia	1993-1996	--	--	HMC1005	HMC5005
FLSTN	Softail	1984-1987	--	--	HMC1001	HMC5001
FLSTN	Softail	1984-1999	HMC1002	HMC5002	--	--
FLSTN	Softail	1987-1999	--	--	HMC1005	HMC5005
FLSTN	Softail Custom	1984-1987	--	--	HMC1001	HMC5001
FLSTN	Softail Custom	1984-1999	HMC1002	HMC5002	--	--
FLSTN	Softail Custom	1987-1999	--	--	HMC1005	HMC5005
FLSTN	Softail Deluxe	2016	--	--	HMC1020	HMC5020
FLSTN	Softail Deluxe	2006-2007	HMC1015	HMC5015	HMC1015	HMC5015
FLSTN	Softail Deluxe	2008-2015	HMC1019	HMC5019	HMC1020	HMC5020
FLSTN	Springer	1984-1987	--	--	HMC1001	HMC5001
FLSTN	Springer	1984-1999	HMC1002	HMC5002	--	--
FLSTN	Springer	1987-1999	--	--	HMC1005	HMC5005
FLSTNi	Softail Deluxe	2005-2006	HMC1015	HMC5015	HMC1015	HMC5015
FLSTNSE	CVO Softail Deluxe	2014-2015	HMC1019	HMC5019	HMC1020	HMC5020
FLSTS	Fat Boy	1984-1987	--	--	HMC1001	HMC5001
FLSTS	Fat Boy	1984-1999	HMC1002	HMC5002	--	--
FLSTS	Fat Boy	1987-1999	--	--	HMC1005	HMC5005
FLSTS	Heritage Softail	1984-1987	--	--	HMC1001	HMC5001
FLSTS	Heritage Softail	1984-1999	HMC1002	HMC5002	--	--
FLSTS	Heritage Softail	1987-1999	--	--	HMC1005	HMC5005
FLSTS	Heritage Softail Custom	1984-1987	--	--	HMC1001	HMC5001
FLSTS	Heritage Softail Custom	1984-1999	HMC1002	HMC5002	--	--
FLSTS	Heritage Softail Custom	1987-1999	--	--	HMC1005	HMC5005
FLSTS	Heritage Springer	1984-1987	--	--	HMC1001	HMC5001
FLSTS	Heritage Springer	1984-2003	HMC1002	HMC5002	--	--
FLSTS	Heritage Springer	1987-1999	--	--	HMC1005	HMC5005
FLSTS	Heritage Springer	1997-2003	--	--	HMC1015	HMC5015
FLSTS	Night Train	1984-1987	--	--	HMC1001	HMC5001
FLSTS	Night Train	1984-1999	HMC1002	HMC5002	--	--
FLSTS	Night Train	1987-1999	--	--	HMC1005	HMC5005
FLSTS	Softail	1984-1987	--	--	HMC1001	HMC5001
FLSTS	Softail	1984-1999	HMC1002	HMC5002	--	--
FLSTS	Softail	1987-1999	--	--	HMC1005	HMC5005

Hawk Performance - MOTORCYCLE APPLICATION GUIDE

CLASS	MODEL	YEARS	FRONT		REAR	
			ORGANIC	METALLIC	ORGANIC	METALLIC
HARLEY DAVIDSON						
FLSTS	Softail Custom	1984-1987	--	--	HMC1001	HMC5001
FLSTS	Softail Custom	1984-1999	HMC1002	HMC5002	--	--
FLSTS	Softail Custom	1987-1999	--	--	HMC1005	HMC5005
FLSTSB	Cross Bones	2008-2011	HMC1002	HMC5002	HMC1020	HMC5020
FLSTSC	Springer Classic	2005-2007	HMC1002	HMC5002	HMC1015	HMC5015
FLSTSC	Springer Classic	2005-2007	--	--	HMC1018	HMC5018
FLSTSCi	Softail	2007	HMC1002	HMC5002	HMC1015	HMC5015
FLSTSCi	Springer Classic	2007	HMC1002	HMC5002	--	--
FLSTSCi	Springer Classic	2005-2006	HMC1002	HMC5002	HMC1015	HMC5015
FLSTSCi	Springer Classic	2006-2007	--	--	HMC1018	HMC5018
FLSTSE	CVO Softail Convertible	2010	--	--	HMC1020	HMC5020
FLSTSE2	CVO Softail Convertible	2011	--	--	HMC1020	HMC5020
FLSTSE3	CVO Softail Convertible	2012	--	--	HMC1020	HMC5020
FLSTSi	Heritage Springer	2000-2003	HMC1002	HMC5002	HMC1015	HMC5015
FLT	Electra Glide	1984-1999	HMC1002	HMC5002	--	--
FLT	Electra Glide	1986-1999	--	--	HMC1006	HMC5006
FLT	Electra Glide Classic	1984-1999	HMC1002	HMC5002	--	--
FLT	Electra Glide Classic	1986-1999	--	--	HMC1006	HMC5006
FLT	Electra Glide Ultra Classic	1984-1999	HMC1002	HMC5002	--	--
FLT	Electra Glide Ultra Classic	1986-1999	--	--	HMC1006	HMC5006
FLT	Tour Glide	1982	HMC1036	--	HMC1033	--
FLT	Tour Glide 80	1980-1981	HMC1036	--	HMC1033	--
FLT	Tour Glide 80	1984-1985	HMC1002	HMC5002	--	--
FLT	Tour Glide 80	1984-1985	--	--	HMC1033	--
FLT	Tour Glide 80 Classic	1981	HMC1036	--	HMC1033	--
FLT	Tour Glide Classic	1982-1983	HMC1036	--	HMC1033	--
FLT	Ultra Glide	1984-1999	HMC1002	HMC5002	--	--
FLT	Ultra Glide	1986-1999	--	--	HMC1006	HMC5006
FLT/H	Electra Glide	1986-1987	HMC1002	HMC5002	HMC1006	HMC5006
FLTC	Tour Glide Classic	1990	HMC1002	HMC5002	HMC1006	HMC5006
FLTC	Tour Glide Classic	1985-1986	HMC1002	HMC5002	HMC1001	HMC5001
FLTR	Road Glide	2000-2007	HMC1015	HMC5015	HMC1015	HMC5015
FLTR	Road Glide	2008-2009	HMC1016	HMC5016	HMC1016	HMC5016
FLTRi	Road Glide	2000-2006	HMC1015	HMC5015	HMC1015	HMC5015
FLTRi	Road Glide Classic	2000-2006	HMC1015	HMC5015	HMC1015	HMC5015
FLTRSEI	CVO Road Glide EFI	2000	HMC1015	HMC5015	HMC1015	HMC5015
FLTRSEI2	CVO Road Glide EFI	2001	HMC1015	HMC5015	HMC1015	HMC5015
FLTRU	Road Glide Ultra	2011-2013, 2016	HMC1016	HMC5016	HMC1016	HMC5016
FLTRUSE	CVO Road Glide Ultra	2011, 2015-2016	HMC1016	HMC5016	HMC1016	HMC5016

Hawk Performance - MOTORCYCLE APPLICATION GUIDE

CLASS	MODEL	YEARS	FRONT		REAR	
			ORGANIC	METALLIC	ORGANIC	METALLIC
HARLEY DAVIDSON						
FLTRUSE	Project Rushmore CVO Road Glide Ultra	2015-2016	HMC1016	HMC5016	HMC1016	HMC5016
FLTRX	Project Rushmore Road Glide	2015-2016	HMC1016	HMC5016	HMC1016	HMC5016
FLTRX	Road Glide	2015-2016	HMC1016	HMC5016	HMC1016	HMC5016
FLTRX	Road Glide Custom	2010-2013	HMC1016	HMC5016	HMC1016	HMC5016
FLTRXS	Project Rushmore Road Glide Special	2015-2016	HMC1016	HMC5016	HMC1016	HMC5016
FLTRXS	Road Glide Special	2015-2016	HMC1016	HMC5016	HMC1016	HMC5016
FLTRXSE	CVO Road Glide Custom	2012	HMC1016	HMC5016	HMC1016	HMC5016
FLTRXSE2	CVO Road Glide Custom	2013	HMC1016	HMC5016	HMC1016	HMC5016
FLTRXSE2	CVO Road Glide Custom Anniversary	2013	HMC1016	HMC5016	HMC1016	HMC5016
FX	Super Glide	1974-1980	HMC1002	HMC5002	--	--
FX	Super Glide	1974-1980	--	--	HMC1035	--
FX	Super Glide	1984-1986	HMC1002	HMC5002	HMC1001	HMC5001
FXB	Sturgis	1982	HMC1002	HMC5002	--	--
FXB	Sturgis	1982	--	--	HMC1035	--
FXB	Sturgis	1974-1977	HMC1039	--	--	--
FXB	Sturgis 80	1980-1981	HMC1002	HMC5002	--	--
FXB	Sturgis 80	1980-1981	--	--	HMC1035	--
FXCW	Rocker	2008-2009	HMC1019	HMC5019	HMC1020	HMC5020
FXCWC	Rocker C	2008-2011	HMC1019	HMC5019	HMC1020	HMC5020
FXD	Convertible	1984-1987	--	--	HMC1001	HMC5001
FXD	Convertible	1984-1999	HMC1002	HMC5002	--	--
FXD	Convertible	1987-1999	--	--	HMC1005	HMC5005
FXD	Low Rider	1984-1987	--	--	HMC1001	HMC5001
FXD	Low Rider	1984-1999	HMC1002	HMC5002	--	--
FXD	Low Rider	1987-1999	--	--	HMC1005	HMC5005
FXD	Sport Glide	1984-1987	--	--	HMC1001	HMC5001
FXD	Sport Glide	1984-1999	HMC1002	HMC5002	--	--
FXD	Sport Glide	1987-1999	--	--	HMC1005	HMC5005
FXD	Super Glide	1984-1987	--	--	HMC1001	HMC5001
FXD	Super Glide	1984-1999	HMC1002	HMC5002	--	--
FXD	Super Glide	1987-1999	--	--	HMC1005	HMC5005
FXD	Super Glide	2000-2005, 2007	HMC1015	HMC5015	HMC1015	HMC5015
FXD	Super Glide	2008-2010	HMC1019	HMC5019	HMC1020	HMC5020
FXD	Wide Glide	1984-1987	--	--	HMC1001	HMC5001
FXD	Wide Glide	1984-1999	HMC1002	HMC5002	--	--
FXD	Wide Glide	1987-1999	--	--	HMC1005	HMC5005
FXDB	Street Bob	2007	--	--	HMC1015	HMC5015
FXDB	Street Bob	2014	HMC1019	HMC5019	HMC1020	HMC5020
FXDB	Street Bob	2008-2016	HMC1015	HMC5015	HMC1020	HMC5020

Hawk Performance - MOTORCYCLE APPLICATION GUIDE

CLASS	MODEL	YEARS	FRONT		REAR	
			ORGANIC	METALLIC	ORGANIC	METALLIC
HARLEY DAVIDSON						
FXDB	Street Bob Daytona	1991-1999	HMC1002	HMC5002	HMC1005	HMC5005
FXDB	Street Bob Sturgis	1991-1999	HMC1002	HMC5002	HMC1005	HMC5005
FXDB	Sturgis	1991-1999	HMC1002	HMC5002	HMC1005	HMC5005
FXDBA	Street Bob	2013	HMC1019	HMC5019	HMC1020	HMC5020
FXDBB	Street Bob	2014	HMC1019	HMC5019	HMC1020	HMC5020
FXDBB	Street Bob	2015-2016	--	--	HMC1020	HMC5020
FXDBi	Street Bob	2006-2007	HMC1015	HMC5015	HMC1015	HMC5015
FXDBi	Street Bob EFI	2006	HMC1015	HMC5015	HMC1015	HMC5015
FXDBP	Street Bob	2013-2016	HMC1019	HMC5019	HMC1020	HMC5020
FXDBS	Super Glide Sturgis	1991	HMC1002	HMC5002	HMC1005	HMC5005
FXDBS	Super Glide Sturgis EFI	1991	--	--	HMC1005	HMC5005
FXDC	Super Glide Custom	1992	--	--	HMC1005	HMC5005
FXDC	Super Glide Custom	2007	HMC1015	HMC5015	HMC1015	HMC5015
FXDC	Super Glide Custom	2006-2007	--	--	HMC1015	HMC5015
FXDC	Super Glide Custom	2008-2014	HMC1019	HMC5019	HMC1020	HMC5020
FXDC	Super Glide 35th Anniversary EFI	2005-2007	HMC1015	HMC5015	--	--
FXDC	Super Glide Custom	1992	HMC1002	HMC5002	--	--
FXDC	Super Glide Custom Anniversary	2013	--	--	HMC1020	HMC5020
FXDCi	Super Glide Custom	2005-2007	HMC1015	HMC5015	HMC1015	HMC5015
FXDCi	Super Glide Custom EFI	2005-2006	HMC1015	HMC5015	HMC1015	HMC5015
FXDF	Fat Bob	2008-2014, 2016	HMC1019	HMC5019	--	--
FXDF	Fat Bob	2008-2016	--	--	HMC1020	HMC5020
FXDF	Wide Glide	2012	HMC1019	HMC5019	HMC1020	HMC5020
FXDFSE	CVO Fat Bob	2009-2010	--	--	HMC1020	HMC5020
FXDi	35th Anniversary Super Glide	2006	HMC1015	HMC5015	HMC1015	HMC5015
FXDi	Super Glide	2004-2007	HMC1015	HMC5015	HMC1015	HMC5015
FXDI	Super Glide EFI	2005-2006	HMC1015	HMC5015	HMC1015	HMC5015
FXDI35	Super Glide 35th Anniversary EFI	2006	HMC1015	HMC5015	HMC1015	HMC5015
FXDL	Convertible	1984-1987	--	--	HMC1001	HMC5001
FXDL	Convertible	1984-1999	HMC1002	HMC5002	--	--
FXDL	Convertible	1987-1999	--	--	HMC1005	HMC5005
FXDL	Low Rider	1984-1987	--	--	HMC1001	HMC5001
FXDL	Low Rider	1984-1999	HMC1002	HMC5002	--	--
FXDL	Low Rider	1987-1999	--	--	HMC1005	HMC5005
FXDL	Low Rider	2000-2005, 2007	HMC1015	HMC5015	HMC1015	HMC5015
FXDL	Low Rider	2008-2009	HMC1019	HMC5019	--	--
FXDL	Low Rider	2008-2016	--	--	HMC1020	HMC5020
FXDL	Sport Glide	1984-1987	--	--	HMC1001	HMC5001
FXDL	Sport Glide	1984-1999	HMC1002	HMC5002	--	--

Hawk Performance - MOTORCYCLE APPLICATION GUIDE

CLASS	MODEL	YEARS	FRONT		REAR	
			ORGANIC	METALLIC	ORGANIC	METALLIC
HARLEY DAVIDSON						
FXDL	Sport Glide	1987-1999	--	--	HMC1005	HMC5005
FXDL	Super Glide	1984-1987	--	--	HMC1001	HMC5001
FXDL	Super Glide	1984-1999	HMC1002	HMC5002	--	--
FXDL	Super Glide	1987-1999	--	--	HMC1005	HMC5005
FXDL	Wide Glide	1984-1986	--	--	HMC1001	HMC5001
FXDL	Wide Glide	1984-1999	HMC1002	HMC5002	--	--
FXDL	Wide Glide	1987-1999	--	--	HMC1005	HMC5005
FXDLi	Dyna	2006-2007	HMC1015	HMC5015	HMC1015	HMC5015
FXDLi	Low Rider	2004-2005	HMC1015	HMC5015	HMC1015	HMC5015
FXDLS	Low Rider S	2016	--	--	HMC1020	HMC5020
FXDP	Super Glide Police	2001-2004	HMC1015	HMC5015	HMC1015	HMC5015
FXDS-CON	Dyna Convertible	2000-2002	HMC1015	HMC5015	HMC1015	HMC5015
FXDS-CONV	Low Rider Convertible	1994-1998	--	--	HMC1005	HMC5005
FXDSE	CVO Super Glide	2007	HMC1015	HMC5015	HMC1015	HMC5015
FXDSE2	CVO Super Glide	2008	--	--	HMC1020	HMC5020
FXDSE2	Super Glide	2008	--	--	HMC1020	HMC5020
FXDWG	Convertible	1984-1987	--	--	HMC1001	HMC5001
FXDWG	Convertible	1984-1999	HMC1002	HMC5002	--	--
FXDWG	Convertible	1987-1999	--	--	HMC1005	HMC5005
FXDWG	Low Rider	1984-1987	--	--	HMC1001	HMC5001
FXDWG	Low Rider	1984-1999	HMC1002	HMC5002	--	--
FXDWG	Low Rider	1987-1999	--	--	HMC1005	HMC5005
FXDWG	Sport Glide	1984-1987	--	--	HMC1001	HMC5001
FXDWG	Sport Glide	1984-1999	HMC1002	HMC5002	--	--
FXDWG	Sport Glide	1987-1999	--	--	HMC1005	HMC5005
FXDWG	Super Glide	1984-1987	--	--	HMC1001	HMC5001
FXDWG	Super Glide	1984-1999	HMC1002	HMC5002	--	--
FXDWG	Super Glide	1987-1999	--	--	HMC1005	HMC5005
FXDWG	Wide Glide	1984-1986	--	--	HMC1001	HMC5001
FXDWG	Wide Glide	1984-1999	HMC1002	HMC5002	--	--
FXDWG	Wide Glide	1987-1999	--	--	HMC1005	HMC5005
FXDWG	Wide Glide	2000-2005, 2007	HMC1015	HMC5015	HMC1015	HMC5015
FXDWG	Wide Glide	2008, 2010-2016	HMC1019	HMC5019	HMC1020	HMC5020
FXDWG2	CVO Wide Glide	2001	HMC1015	HMC5015	HMC1015	HMC5015
FXDWG3	CVO Wide Glide	2002	HMC1015	HMC5015	HMC1015	HMC5015
FXDWGi	Wide Glide	2004-2007	HMC1015	HMC5015	HMC1015	HMC5015
FXDX	Super Glide Sport	2000-2005	HMC1015	HMC5015	HMC1015	HMC5015
FXDXi	Super Glide Sport	2004-2006	HMC1015	HMC5015	HMC1015	HMC5015
FXDXT	Super Glide T-Sport	2000-2003	HMC1015	HMC5015	HMC1015	HMC5015

Hawk Performance - MOTORCYCLE APPLICATION GUIDE

CLASS	MODEL	YEARS	FRONT		REAR	
			ORGANIC	METALLIC	ORGANIC	METALLIC
HARLEY DAVIDSON						
FXE	Super Glide	1982	HMC1002	HMC5002	HMC1005	HMC5005
FXE	Super Glide	1974-1980	--	--	HMC1035	--
FXE	Super Glide	1974-1986	HMC1002	HMC5002	--	--
FXE	Super Glide	1978-1981	--	--	HMC1035	--
FXE	Super Glide	1983-1984	--	--	HMC1035	--
FXE	Super Glide	1984-1986	--	--	HMC1001	HMC5001
FXE	Super Glide	1974-1977	HMC1039	--	--	--
FXEF	80 Fat Bob	1979-1981	HMC1002	HMC5002	--	--
FXEF	80 Fat Bob	1979-1981	--	--	HMC1035	--
FXEF	Fat Bob	1984-1986	HMC1002	HMC5002	--	--
FXEF	Fat Bob	1984-1986	--	--	HMC1001	HMC5001
FXLR	Convertible	1984-1987	--	--	HMC1001	HMC5001
FXLR	Convertible	1984-1999	HMC1002	HMC5002	--	--
FXLR	Convertible	1987-1999	--	--	HMC1005	HMC5005
FXLR	Dyna	1984-1987	--	--	HMC1001	HMC5001
FXLR	Dyna	1984-1999	HMC1002	HMC5002	--	--
FXLR	Dyna	1987-1999	--	--	HMC1005	HMC5005
FXLR	Low Rider	1984-1987	--	--	HMC1001	HMC5001
FXLR	Low Rider	1984-1999	HMC1002	HMC5002	--	--
FXLR	Low Rider	1987-1999	--	--	HMC1005	HMC5005
FXLR	Low Rider Custom	1987-1994	HMC1002	HMC5002	--	--
FXLR	Low Rider Custom	1987-1999	--	--	HMC1005	HMC5005
FXLR	Sport Glide	1984-1987	--	--	HMC1001	HMC5001
FXLR	Sport Glide	1984-1999	HMC1002	HMC5002	--	--
FXLR	Sport Glide	1987-1999	--	--	HMC1005	HMC5005
FXLR	Super Glide	1984-1987	--	--	HMC1001	HMC5001
FXLR	Super Glide	1984-1999	HMC1002	HMC5002	--	--
FXLR	Super Glide	1987-1999	--	--	HMC1005	HMC5005
FXLR	Super Glide Low Rider Custom	1987	--	--	HMC1001	HMC5001
FXLR	Super Glide Low Rider Custom	1987-1994	--	--	HMC1005	HMC5005
FXLR	Super Glide Low Rider Custom Anniversary	1987	HMC1001	HMC5001	HMC1005	HMC5005
FXLR	Wide Glide	1984-1986	--	--	HMC1001	HMC5001
FXLR	Wide Glide	1984-1999	HMC1002	HMC5002	--	--
FXLR	Wide Glide	1987-1999	--	--	HMC1005	HMC5005
FXR	Convertible	1984-1987	--	--	HMC1001	HMC5001
FXR	Convertible	1984-1999	HMC1002	HMC5002	--	--
FXR	Convertible	1987-1999	--	--	HMC1005	HMC5005
FXR	Low Rider	1984-1987	--	--	HMC1001	HMC5001
FXR	Low Rider	1984-1999	HMC1002	HMC5002	--	--

Hawk Performance - MOTORCYCLE APPLICATION GUIDE

CLASS	MODEL	YEARS	FRONT		REAR	
			ORGANIC	METALLIC	ORGANIC	METALLIC
HARLEY DAVIDSON						
FXR	Low Rider	1987-1999	--	--	HMC1005	HMC5005
FXR	Sport Glide	1984-1987	--	--	HMC1001	HMC5001
FXR	Sport Glide	1984-1999	HMC1002	HMC5002	--	--
FXR	Sport Glide	1987-1999	--	--	HMC1005	HMC5005
FXR	Super Glide	1978-1981	--	--	HMC1035	--
FXR	Super Glide	1984-1987	--	--	HMC1001	HMC5001
FXR	Super Glide	1984-1999	HMC1002	HMC5002	--	--
FXR	Super Glide	1986-1994	HMC1002	HMC5002	--	--
FXR	Super Glide	1987-1999	--	--	HMC1005	HMC5005
FXR	Super Glide II	1982-1985	--	--	HMC1001	HMC5001
FXR	Super Glide II	1984-1985	HMC1002	HMC5002	--	--
FXR	Wide Glide	1984-1986	--	--	HMC1001	HMC5001
FXR	Wide Glide	1984-1999	HMC1002	HMC5002	--	--
FXR	Wide Glide	1987-1999	--	--	HMC1005	HMC5005
FXR2	Super Glide	1999	HMC1002	HMC5002	HMC1005	HMC5005
FXR3	Super Glide	1999	HMC1002	HMC5002	HMC1005	HMC5005
FXR4	Super Glide	2000	HMC1015	HMC5015	HMC1015	HMC5015
FXRC	Super Glide Custom	1985	HMC1002	HMC5002	HMC1001	HMC5001
FXRD	Convertible	1984-1987	--	--	HMC1001	HMC5001
FXRD	Convertible	1984-1999	HMC1002	HMC5002	--	--
FXRD	Convertible	1987-1999	--	--	HMC1005	HMC5005
FXRD	Dyna	1984-1987	--	--	HMC1001	HMC5001
FXRD	Dyna	1984-1999	HMC1002	HMC5002	--	--
FXRD	Dyna	1987-1999	--	--	HMC1005	HMC5005
FXRD	Low Rider	1984-1987	--	--	HMC1001	HMC5001
FXRD	Low Rider	1984-1999	HMC1002	HMC5002	--	--
FXRD	Low Rider	1987-1999	--	--	HMC1005	HMC5005
FXRD	Sport Glide	1984-1987	--	--	HMC1001	HMC5001
FXRD	Sport Glide	1984-1999	HMC1002	HMC5002	--	--
FXRD	Sport Glide	1987-1999	--	--	HMC1005	HMC5005
FXRD	Sport Glide GTE	1985-1986	HMC1002	HMC5002	--	--
FXRD	Sport Glide GTE	1985-1986	--	--	HMC1001	HMC5001
FXRD	Super Glide	1984-1987	--	--	HMC1001	HMC5001
FXRD	Super Glide	1984-1999	HMC1002	HMC5002	--	--
FXRD	Super Glide	1987-1999	--	--	HMC1005	HMC5005
FXRD	Super Glide Grand Touring	1986	HMC1002	HMC5002	HMC1001	HMC5001
FXRD	Wide Glide	1984-1986	--	--	HMC1001	HMC5001
FXRD	Wide Glide	1984-1999	HMC1002	HMC5002	--	--
FXRD	Wide Glide	1987-1999	--	--	HMC1005	HMC5005

Hawk Performance - MOTORCYCLE APPLICATION GUIDE

CLASS	MODEL	YEARS	FRONT		REAR	
			ORGANIC	METALLIC	ORGANIC	METALLIC
HARLEY DAVIDSON						
FXRDG	Super Glide Disc Glide	1984	HMC1002	HMC5002	HMC1001	HMC5001
FXRP	Super Glide Police	1984-1987	--	--	HMC1001	HMC5001
FXRP	Super Glide Police	1987-1994	--	--	HMC1005	HMC5005
FXRS	Convertible	1984-1987	--	--	HMC1001	HMC5001
FXRS	Convertible	1984-1999	HMC1002	HMC5002	--	--
FXRS	Convertible	1987-1999	--	--	HMC1005	HMC5005
FXRS	Low Glide	1982-1984	HMC1002	HMC5002	HMC1001	HMC5001
FXRS	Low Rider	1984-1987	--	--	HMC1001	HMC5001
FXRS	Low Rider	1984-1999	HMC1002	HMC5002	--	--
FXRS	Low Rider	1987-1999	--	--	HMC1005	HMC5005
FXRS	Low Rider Sport	1987-1999	HMC1002	HMC5002	HMC1005	HMC5005
FXRS	Sport Glide	1984-1987	--	--	HMC1001	HMC5001
FXRS	Sport Glide	1984-1999	HMC1002	HMC5002	--	--
FXRS	Sport Glide	1987-1999	--	--	HMC1005	HMC5005
FXRS	Super Glide	1984-1987	--	--	HMC1001	HMC5001
FXRS	Super Glide	1984-1999	HMC1002	HMC5002	--	--
FXRS	Super Glide	1987-1999	--	--	HMC1005	HMC5005
FXRS	Super Glide II	1982-1983	--	--	HMC1001	HMC5001
FXRS	Super Glide II	1982-1999	HMC1002	HMC5002	--	--
FXRS	Super Glide II	1987-1999	--	--	HMC1005	HMC5005
FXRS	Super Glide Low Rider	1982-1987	--	--	HMC1001	HMC5001
FXRS	Super Glide Low Rider	1987-1991	--	--	HMC1005	HMC5005
FXRS	Super Glide Low Rider Anniversary	1988	HMC1002	HMC5002	HMC1005	HMC5005
FXRS	Super Glide Low Rider Anniversary	1999	--	--	HMC1005	HMC5005
FXRS	Wide Glide	1984-1987	--	--	HMC1001	HMC5001
FXRS	Wide Glide	1984-1999	HMC1002	HMC5002	--	--
FXRS	Wide Glide	1987-1999	--	--	HMC1005	HMC5005
FXRS-CONV	Super Glide Low Rider Convertible	1988	--	--	HMC1005	HMC5005
FXRS-CONV	Super Glide Low Rider Convertible	1989-1993	--	--	HMC1005	HMC5005
FXRSSP	Super Glide Low Rider Sport	1987	--	--	HMC1001	HMC5001
FXRSSP	Super Glide Low Rider Sport	1987-1993	--	--	HMC1005	HMC5005
FXRT	Convertible	1984-1987	--	--	HMC1001	HMC5001
FXRT	Convertible	1984-1999	HMC1002	HMC5002	--	--
FXRT	Convertible	1987-1999	--	--	HMC1005	HMC5005
FXRT	Low Rider	1984-1987	--	--	HMC1001	HMC5001
FXRT	Low Rider	1984-1999	HMC1002	HMC5002	--	--
FXRT	Low Rider	1987-1999	--	--	HMC1005	HMC5005
FXRT	Sport Glide	1984-1987	--	--	HMC1001	HMC5001
FXRT	Sport Glide	1984-1999	HMC1002	HMC5002	--	--

Hawk Performance - MOTORCYCLE APPLICATION GUIDE

CLASS	MODEL	YEARS	FRONT		REAR	
			ORGANIC	METALLIC	ORGANIC	METALLIC
HARLEY DAVIDSON						
FXRT	Sport Glide	1987-1999	--	--	HMC1005	HMC5005
FXRT	Super Glide	1984-1987	--	--	HMC1001	HMC5001
FXRT	Super Glide	1984-1999	HMC1002	HMC5002	--	--
FXRT	Super Glide	1987-1999	--	--	HMC1005	HMC5005
FXRT	Super Glide II	1983	HMC1002	HMC5002	HMC1001	HMC5001
FXRT	Super Glide Sport Glide	1984-1987	--	--	HMC1001	HMC5001
FXRT	Super Glide Sport Glide	1987-1992	--	--	HMC1005	HMC5005
FXRT	Wide Glide	1984-1987	--	--	HMC1001	HMC5001
FXRT	Wide Glide	1984-1999	HMC1002	HMC5002	--	--
FXRT	Wide Glide	1987-1999	--	--	HMC1005	HMC5005
FXS	Blackline	2011-2013	--	--	HMC1020	HMC5020
FXS	Blackline	2012-2013	HMC1019	HMC5019	HMC1020	HMC5020
FXS	Low Rider	1982	--	--	HMC1035	--
FXS	Low Rider	1978-1979	--	--	HMC1035	--
FXS	Low Rider	1978-1986	HMC1002	HMC5002	--	--
FXS	Low Rider	1984-1986	HMC1002	HMC5002	HMC1001	HMC5001
FXS	Low Rider 80	1979-1981	HMC1002	HMC5002	--	--
FXS	Low Rider 80	1979-1981	--	--	HMC1035	--
FXSB	Breakout	2013-2016	--	--	HMC1020	HMC5020
FXSB	Breakout	2014-2016	HMC1019	HMC5019	HMC1020	HMC5020
FXSB	Low Rider	1983-1985	HMC1002	HMC5002	HMC1001	HMC5001
FXSBSE	CVO Breakout	2013-2014	HMC1019	HMC5019	HMC1020	HMC5020
FXSE	CVO Pro Street Breakout	2016	HMC1019	HMC5019	HMC1020	HMC5020
FXST	Fat Boy	1984-1987	--	--	HMC1001	HMC5001
FXST	Fat Boy	1984-1999	HMC1002	HMC5002	--	--
FXST	Fat Boy	1987-1999	--	--	HMC1005	HMC5005
FXST	Heritage Softail	1984-1987	--	--	HMC1001	HMC5001
FXST	Heritage Softail	1984-1999	HMC1002	HMC5002	--	--
FXST	Heritage Softail	1987-1999	--	--	HMC1005	HMC5005
FXST	Heritage Softail Custom	1984-1987	--	--	HMC1001	HMC5001
FXST	Heritage Softail Custom	1984-1999	HMC1002	HMC5002	--	--
FXST	Heritage Softail Custom	1987-1999	--	--	HMC1005	HMC5005
FXST	Heritage Springer	1984-1987	--	--	HMC1001	HMC5001
FXST	Heritage Springer	1984-1999	HMC1002	HMC5002	--	--
FXST	Heritage Springer	1987-1999	--	--	HMC1005	HMC5005
FXST	Night Train	1984-1987	--	--	HMC1001	HMC5001
FXST	Night Train	1984-1999	HMC1002	HMC5002	--	--
FXST	Night Train	1987-1999	--	--	HMC1005	HMC5005
FXST	Softail	1984-1987	--	--	HMC1001	HMC5001

Hawk Performance - MOTORCYCLE APPLICATION GUIDE

CLASS	MODEL	YEARS	FRONT		REAR	
			ORGANIC	METALLIC	ORGANIC	METALLIC
HARLEY DAVIDSON						
FXST	Softail	1984-1999	HMC1002	HMC5002	--	--
FXST	Softail	1987-1999	--	--	HMC1005	HMC5005
FXST	Softail Custom	1984-1987	--	--	HMC1001	HMC5001
FXST	Softail Custom	1984-1999	HMC1002	HMC5002	--	--
FXST	Softail Custom	1987-1999	--	--	HMC1005	HMC5005
FXST	Softail Standard	1984-1990,1999	HMC1002	HMC5002	--	--
FXST	Softail Standard	1987-1990, 1999	--	--	HMC1005	HMC5005
FXST	Softail Standard	2000-2005	HMC1015	HMC5015	--	--
FXST	Softail Standard	2000-2005, 2007	--	--	HMC1015	HMC5015
FXST	Softail Standard	2006-2007	--	--	HMC1018	HMC5018
FXST	Softail Standard	2008-2009, 2014-2015	HMC1019	HMC5019	--	--
FXST	Softail Standard	2008-2015	--	--	HMC1020	HMC5020
FXST	Springer	1984-1987	--	--	HMC1001	HMC5001
FXST	Springer	1984-1999	HMC1002	HMC5002	--	--
FXST	Springer	1987-1999	--	--	HMC1005	HMC5005
FXSTB	Fat Boy	1984-1987	--	--	HMC1001	HMC5001
FXSTB	Fat Boy	1984-1999	HMC1002	HMC5002	--	--
FXSTB	Fat Boy	1987-1999	--	--	HMC1005	HMC5005
FXSTB	Heritage Softail	1984-1987	--	--	HMC1001	HMC5001
FXSTB	Heritage Softail	1984-1999	HMC1002	HMC5002	--	--
FXSTB	Heritage Softail	1987-1999	--	--	HMC1005	HMC5005
FXSTB	Heritage Softail Custom	1984-1987	--	--	HMC1001	HMC5001
FXSTB	Heritage Softail Custom	1984-1999	HMC1002	HMC5002	--	--
FXSTB	Heritage Softail Custom	1987-1999	--	--	HMC1005	HMC5005
FXSTB	Heritage Springer	1984-1987	--	--	HMC1001	HMC5001
FXSTB	Heritage Springer	1984-1999	HMC1002	HMC5002	--	--
FXSTB	Heritage Springer	1987-1999	--	--	HMC1005	HMC5005
FXSTB	Night Train	2007	HMC1015	HMC5015	--	--
FXSTB	Night Train	1984-1987	--	--	HMC1001	HMC5001
FXSTB	Night Train	1984-1999	HMC1002	HMC5002	--	--
FXSTB	Night Train	1987-1999	--	--	HMC1005	HMC5005
FXSTB	Night Train	2000-2007	--	--	HMC1015	HMC5015
FXSTB	Night Train	2008-2009	HMC1019	HMC5019	HMC1020	HMC5020
FXSTB	Night Train Softail	2006-2007	HMC1015	HMC5015	HMC1018	HMC5018
FXSTB	Softail	1984-1987	--	--	HMC1001	HMC5001
FXSTB	Softail	1984-1999	HMC1002	HMC5002	--	--
FXSTB	Softail	1987-1999	--	--	HMC1005	HMC5005
FXSTB	Softail Custom	1984-1987	--	--	HMC1001	HMC5001
FXSTB	Softail Custom	1984-1999	HMC1002	HMC5002	--	--

Hawk Performance - MOTORCYCLE APPLICATION GUIDE

CLASS	MODEL	YEARS	FRONT		REAR	
			ORGANIC	METALLIC	ORGANIC	METALLIC
HARLEY DAVIDSON						
FXSTB	Softail Custom	1987-1999	--	--	HMC1005	HMC5005
FXSTB	Springer	1984-1987	--	--	HMC1001	HMC5001
FXSTB	Springer	1984-1999	HMC1002	HMC5002	--	--
FXSTB	Springer	1987-1999	--	--	HMC1005	HMC5005
FXSTBi	Night Train	2000-2006	HMC1015	HMC5015	HMC1015	HMC5015
FXSTBI	Night Train EFI	2001-2005	HMC1015	HMC5015	HMC1015	HMC5015
FXSTBi	Night Train Softail	2006-2007	HMC1015	HMC5015	HMC1018	HMC5018
FXSTC	Fat Boy	1984-1987	--	--	HMC1001	HMC5001
FXSTC	Fat Boy	1984-1999	HMC1002	HMC5002	--	--
FXSTC	Fat Boy	1987-1999	--	--	HMC1005	HMC5005
FXSTC	Heritage Softail	1984-1987	--	--	HMC1001	HMC5001
FXSTC	Heritage Softail	1984-1999	HMC1002	HMC5002	--	--
FXSTC	Heritage Softail	1987-1999	--	--	HMC1005	HMC5005
FXSTC	Heritage Softail Custom	1984-1987	--	--	HMC1001	HMC5001
FXSTC	Heritage Softail Custom	1984-1999	HMC1002	HMC5002	--	--
FXSTC	Heritage Softail Custom	1987-1999	--	--	HMC1005	HMC5005
FXSTC	Heritage Springer	1984-1987	--	--	HMC1001	HMC5001
FXSTC	Heritage Springer	1984-1999	HMC1002	HMC5002	--	--
FXSTC	Heritage Springer	1987-1999	--	--	HMC1005	HMC5005
FXSTC	Night Train	1984-1987	--	--	HMC1001	HMC5001
FXSTC	Night Train	1984-1999	HMC1002	HMC5002	--	--
FXSTC	Night Train	1987-1999	--	--	HMC1005	HMC5005
FXSTC	Softail	1984-1987	--	--	HMC1001	HMC5001
FXSTC	Softail	1984-1999	HMC1002	HMC5002	--	--
FXSTC	Softail	1987-1999	--	--	HMC1005	HMC5005
FXSTC	Softail Custom	2007	HMC1015	HMC5015	HMC1015	HMC5015
FXSTC	Softail Custom	1984-1987	--	--	HMC1001	HMC5001
FXSTC	Softail Custom	1984-1999	HMC1002	HMC5002	--	--
FXSTC	Softail Custom	1987-1999	--	--	HMC1005	HMC5005
FXSTC	Softail Custom	2007-2010	HMC1019	HMC5019	--	--
FXSTC	Softail Custom	2008-2010	--	--	HMC1020	HMC5020
FXSTC	Springer	1984-1987	--	--	HMC1001	HMC5001
FXSTC	Springer	1984-1999	HMC1002	HMC5002	--	--
FXSTC	Springer	1987-1999	--	--	HMC1005	HMC5005
FXSTD	Deuce	2000-2007	HMC1015	HMC5015	HMC1015	HMC5015
FXSTDi	Deuce	2000-2007	HMC1015	HMC5015	HMC1015	HMC5015
FXSTDI	Deuce EFI	2005-2006	HMC1015	HMC5015	HMC1015	HMC5015
FXSTDSE	CVO Deuce	2003	HMC1015	HMC5015	HMC1015	HMC5015
FXSTDSE2	CVO Deuce	2004	HMC1015	HMC5015	HMC1015	HMC5015

Hawk Performance - MOTORCYCLE APPLICATION GUIDE

CLASS	MODEL	YEARS	FRONT		REAR	
			ORGANIC	METALLIC	ORGANIC	METALLIC
HARLEY DAVIDSON						
FXSTi	Softail Standard	2000-2006	--	--	HMC1015	HMC5015
FXSTi	Softail Standard	2000-2007	HMC1015	HMC5015	HMC1018	HMC5018
FXSTi	Softail Standard EFI	2001-2005	HMC1015	HMC5015	HMC1015	HMC5015
FXSTS	Fat Boy	1984-1987	--	--	HMC1001	HMC5001
FXSTS	Fat Boy	1984-1999	HMC1002	HMC5002	--	--
FXSTS	Fat Boy	1987-1999	--	--	HMC1005	HMC5005
FXSTS	Heritage Softail	1984-1987	--	--	HMC1001	HMC5001
FXSTS	Heritage Softail	1984-1999	HMC1002	HMC5002	--	--
FXSTS	Heritage Softail	1987-1999	--	--	HMC1005	HMC5005
FXSTS	Heritage Softail Custom	1984-1987	--	--	HMC1001	HMC5001
FXSTS	Heritage Softail Custom	1984-1999	HMC1002	HMC5002	--	--
FXSTS	Heritage Softail Custom	1987-1999	--	--	HMC1005	HMC5005
FXSTS	Heritage Springer	1984-1987	--	--	HMC1001	HMC5001
FXSTS	Heritage Springer	1984-1999	HMC1002	HMC5002	--	--
FXSTS	Heritage Springer	1987-1999	--	--	HMC1005	HMC5005
FXSTS	Night Train	1984-1987	--	--	HMC1001	HMC5001
FXSTS	Night Train	1984-1999	HMC1002	HMC5002	--	--
FXSTS	Night Train	1987-1999	--	--	HMC1005	HMC5005
FXSTS	Softail	1984-1987	--	--	HMC1001	HMC5001
FXSTS	Softail	1984-1999	HMC1002	HMC5002	--	--
FXSTS	Softail	1987-1999	--	--	HMC1005	HMC5005
FXSTS	Softail Custom	1984-1987	--	--	HMC1001	HMC5001
FXSTS	Softail Custom	1984-1999	HMC1002	HMC5002	--	--
FXSTS	Softail Custom	1987-1999	--	--	HMC1005	HMC5005
FXSTS	Springer	1984-1987	--	--	HMC1001	HMC5001
FXSTS	Springer	1984-2006	HMC1002	HMC5002	--	--
FXSTS	Springer	1988-2006	--	--	HMC1005	HMC5005
FXSTSB	Bad Boy	1995-1997	--	--	HMC1005	HMC5005
FXSTSi	Softail	2005	HMC1002	HMC5002	HMC1015	HMC5015
FXSTSi	Springer	2000-2005	HMC1002	HMC5002	HMC1015	HMC5015
FXSTSi	Springer EFI	2001-2002, 2004-2006	HMC1002	HMC5002	--	--
FXSTSSE	CVO Springer Classic	2007	HMC1002	HMC5002	--	--
FXSTSSE2	CVO Springer	2008	--	--	HMC1020	HMC5020
FXSTSSE3	CVO Springer	2009	--	--	HMC1020	HMC5020
FXWG	Wide Glide	1980-1982	--	--	HMC1002	HMC5002
FXWG	Wide Glide	1980-1988	HMC1002	HMC5002	--	--
FXWG	Wide Glide	1987-1988	--	--	HMC1005	HMC5005
FXWG	Wide Glide	1983-1986	--	--	HMC1001	HMC5001
VLHTCUSE3	CVO Electra Glide Ultra Classic	2008	HMC1016	HMC5016	HMC1016	HMC5016

Hawk Performance - MOTORCYCLE APPLICATION GUIDE

CLASS	MODEL	YEARS	FRONT		REAR	
			ORGANIC	METALLIC	ORGANIC	METALLIC
HARLEY DAVIDSON						
VLHTCUSE4	CVO Electra Glide Ultra Classic	2009	HMC1016	HMC5016	HMC1016	HMC5016
VRSCA	V-Rod	2006	HMC1016	HMC5016	HMC1016	HMC5016
VRSCA	V-Rod	2002-2005	HMC1015	HMC5015	HMC1015	HMC5015
VRSCAW	V-Rod	2007-2010	HMC1016	HMC5016	HMC1016	HMC5016
VRSCAWA	V-Rod ABS	2008	HMC1016	HMC5016	HMC1016	HMC5016
VRSCB	V-Rod	2004-2005	HMC1015	HMC5015	HMC1015	HMC5015
VRSCD	Night Rod	2006-2008	HMC1016	HMC5016	HMC1016	HMC5016
VRSCDA	V-Rod Special Night Rod ABS	2008	HMC1016	HMC5016	HMC1016	HMC5016
VRSCDX	Night Rod Special	2007-2016	HMC1016	HMC5016	HMC1016	HMC5016
VRSCDX	V-Rod 10th Anniversary Edition	2012	HMC1016	HMC5016	HMC1016	HMC5016
VRSCDXA	V-Rod Special Night Rod ABS	2008	HMC1016	HMC5016	HMC1016	HMC5016
VRSCF	V-Rod Muscle	2009-2016	HMC1016	HMC5016	HMC1016	HMC5016
VRSCR	Street Rod	2006-2007	HMC1016	HMC5016	HMC1016	HMC5016
VRSCSE	CVO V-Rod	2006	HMC1016	HMC5016	HMC1016	HMC5016
VRSCSE2	V-Rod	2005	HMC1015	HMC5015	HMC1015	HMC5015
VRSCX	V-Rod	2006-2008	HMC1016	HMC5016	HMC1016	HMC5016
VRSCX	V-Rod NHRA Commemorative Edition	2007	HMC1016	HMC5016	HMC1016	HMC5016
XG	Street 500	2016	HMC1007	HMC5007	--	--
XG	Street 500	2016	--	--	HMC1038	HMC5038
XG	Street 500	2014-2015	HMC1029	HMC5029F	HMC1029	HMC5029R
XG	Street 750	2016	HMC1007	HMC5007	--	--
XG	Street 750	2016	--	--	HMC1038	HMC5038
XG	Street 750	2014-2015	HMC1029	HMC5029F	HMC1029	HMC5029R
XL	883L Super Low	2014	HMC1032	HMC5032	HMC1041	HMC5041
XL	883L Super Low	2011-2013	HMC1013	HMC5013	HMC1014	HMC5014
XL	CP Sportster 1200 Custom	2014-2016	HMC1032	HMC5032	HMC1041	HMC5041
XL	Iron 883	2009	HMC1013	HMC5013	HMC1014	HMC5014
XL	L Sportster 1200 Low	2004-2010	HMC1013	HMC5013	HMC1014	HMC5014
XL	L Sportster 883 Low	2006-2013	HMC1013	HMC5013	HMC1014	HMC5014
XL	N Iron 883	2013	HMC1013	HMC5013	HMC1014	HMC5014
XL	N Iron 883	2014-2016	HMC1032	HMC5032	HMC1041	HMC5041
XL	N Nightster	2007-2010	HMC1013	HMC5013	HMC1014	HMC5014
XL	R Roadster 883	2010-2013	HMC1013	HMC5013	HMC1014	HMC5014
XL	R Roadster 883	2014-2016	HMC1032	HMC5032	HMC1041	HMC5041
XL	R Sportster 883	2010	HMC1013	HMC5013	HMC1014	HMC5014
XL	R Sportster 883	2000-2003	HMC1015	HMC5015	HMC1015	HMC5015
XL	R Sportster R 883	2005-2009	HMC1013	HMC5013	HMC1014	HMC5014
XL	R Sportster Roadster 1200	2004-2008	HMC1013	HMC5013	HMC1014	HMC5014
XL	Sportster	1974-1977	HMC1039	--	--	--

Hawk Performance - MOTORCYCLE APPLICATION GUIDE

CLASS	MODEL	YEARS	FRONT		REAR	
			ORGANIC	METALLIC	ORGANIC	METALLIC
HARLEY DAVIDSON						
XL	Sportster	1984-1987	--	--	HMC1001	HMC5001
XL	Sportster	1984-1999	HMC1002	HMC5002	--	--
XL	Sportster	1987-1999	--	--	HMC1005	HMC5005
XL	Sportster 1000	1978	HMC1002	HMC5002	--	--
XL	Sportster 1000	1978	--	--	HMC1036	--
XL	Sportster 1200 C Custom	2004-2014	HMC1013	HMC5013	HMC1014	HMC5014
XL	Sportster 1200 CB Custom	2014	HMC1032	HMC5032	HMC1041	HMC5041
XL	Sportster 1200 Custom	2014	HMC1032	HMC5032	HMC1041	HMC5041
XL	Sportster 1200 Custom	2000-2003	HMC1015	HMC5015	HMC1015	HMC5015
XL	Sportster 1200 Sport	2000-2003	HMC1015	HMC5015	HMC1015	HMC5015
XL	Sportster 50th Anniversary	2007	HMC1013	HMC5013	HMC1014	HMC5014
XL	Sportster 53c Custom	1984-1999	HMC1002	HMC5002	--	--
XL	Sportster 883	2004-2013	HMC1013	HMC5013	HMC1014	HMC5014
XL	Sportster 883 53c Custom	2000-2003	HMC1015	HMC5015	HMC1015	HMC5015
XL	Sportster 883 C Custom	2004-2013	HMC1013	HMC5013	HMC1014	HMC5014
XL	Sportster 883 Custom	2000-2003	HMC1015	HMC5015	HMC1015	HMC5015
XL	Sportster 883 Hugger	2000-2003	HMC1015	HMC5015	HMC1015	HMC5015
XL	Sportster 883 R	2005-2013	HMC1013	HMC5013	HMC1014	HMC5014
XL	Sportster 883 Standard	2004-2008	HMC1013	HMC5013	HMC1014	HMC5014
XL	T Super Low 1200	2015-2016	HMC1032	HMC5032	HMC1041	HMC5041
XL	V Seventy-Two	2011-2013	HMC1013	HMC5013	HMC1014	HMC5014
XL	V Seventy-Two 1200	2014-2016	HMC1032	HMC5032	HMC1041	HMC5041
XL	X Forty-Eight	2011-2013	HMC1013	HMC5013	HMC1014	HMC5014
XL	X Forty-Eight 1200	2014-2016	HMC1032	HMC5032	HMC1041	HMC5041
XLCH	Sportster	1984-1987	--	--	HMC1001	HMC5001
XLCH	Sportster	1984-1999	HMC1002	HMC5002	--	--
XLCH	Sportster	1987-1999	--	--	HMC1005	HMC5005
XLCH	Sportster 1000	1973	HMC1035	--	--	--
XLCH	Sportster 1000	1978-1980	HMC1002	HMC5002	--	--
XLCH	Sportster 1000	1978-1980	--	--	HMC1036	--
XLCH	Sportster 53c Custom	1984-1999	HMC1002	HMC5002	--	--
XLH	Sportster	1984-1987	--	--	HMC1001	HMC5001
XLH	Sportster	1984-1999	HMC1002	HMC5002	--	--
XLH	Sportster	1987-1999	--	--	HMC1005	HMC5005
XLH	Sportster 1000	1983	--	--	HMC1001	HMC5001
XLH	Sportster 1000	1979-1982	HMC1002	HMC5002	--	--
XLH	Sportster 1000	1979-1982	--	--	HMC1036	--
XLH	Sportster 1000	1987-1988	HMC1002	HMC5002	HMC1005	HMC5005
XLH	Sportster 1100	1985-1986	HMC1002	HMC5002	HMC1001	HMC5001

Hawk Performance - MOTORCYCLE APPLICATION GUIDE

CLASS	MODEL	YEARS	FRONT		REAR	
			ORGANIC	METALLIC	ORGANIC	METALLIC
HARLEY DAVIDSON						
XLH	Sportster 1100 Electric Start	1987	--	--	HMC1005	HMC5005
XLH	Sportster 1100 Electric Start	1984-1985	HMC1002	HMC5002	--	--
XLH	Sportster 1100 Electric Start	1986-1987	--	--	HMC1001	HMC5001
XLH	Sportster 1100 Electric Start Anniversary	1986-1987	HMC1002	HMC5002	--	--
XLH	Sportster 1100 Electric Start Anniversary	1987	--	--	HMC1001	HMC5001
XLH	Sportster 1100 Electric Start Anniversary	1987	--	--	HMC1005	HMC5005
XLH	Sportster 1200	1990-1999	HMC1002	HMC5002	HMC1005	HMC5005
XLH	Sportster 1200	2000-2003	HMC1015	HMC5015	HMC1015	HMC5015
XLH	Sportster 1200 Custom	1996-1999	HMC1002	HMC5002	HMC1005	HMC5005
XLH	Sportster 1200 Custom	2000-2003	--	--	HMC1015	HMC5015
XLH	Sportster 1200 Sport	1996-1999	HMC1002	HMC5002	HMC1005	HMC5005
XLH	Sportster 1200 Sport	2000-2003	--	--	HMC1015	HMC5015
XLH	Sportster 1200 Standard	1988-1999	HMC1002	HMC5002	HMC1005	HMC5005
XLH	Sportster 53c Custom	1984-1999	HMC1002	HMC5002	--	--
XLH	Sportster 883	1970-1983	HMC1002	HMC5002	--	--
XLH	Sportster 883	1985-1986	--	--	HMC1001	HMC5001
XLH	Sportster 883	1987-1999	--	--	HMC1005	HMC5005
XLH	Sportster 883	2000-2003	HMC1015	HMC5015	--	--
XLH	Sportster 883 Custom	1999	HMC1002	HMC5002	HMC1005	HMC5005
XLH	Sportster 883 Custom	1988-1995	--	--	HMC1005	HMC5005
XLH	Sportster 883 Custom	2000-2003	HMC1015	HMC5015	HMC1015	HMC5015
XLH	Sportster 883 Deluxe	1988-1995	HMC1002	HMC5002	HMC1005	HMC5005
XLH	Sportster 883 Hugger	1987	--	--	HMC1001	HMC5001
XLH	Sportster 883 Hugger	1988-1999	--	--	HMC1005	HMC5005
XLH	Sportster 883 Hugger	2000-2003	HMC1015	HMC5015	HMC1015	HMC5015
XLH	Sportster 883 R Flat Track	2000-2003	HMC1015	HMC5015	HMC1015	HMC5015
XLH	Sportster 883 Roadster	2002-2003	HMC1015	HMC5015	HMC1015	HMC5015
XLH	Sportster 883 Standard	1986-1991, 1993-1999	HMC1002	HMC5002	HMC1005	HMC5005
XLS	Anniversary 1000	1982	HMC1002	HMC5002	HMC1001	HMC5001
XLS	Roadster 1000	1979-1982	HMC1002	HMC5002	--	--
XLS	Roadster 1000	1979-1982	--	--	HMC1036	--
XLS	Sportster	1984-1987	--	--	HMC1001	HMC5001
XLS	Sportster	1984-1999	HMC1002	HMC5002	--	--
XLS	Sportster	1987-1999	--	--	HMC1005	HMC5005
XLS	Sportster 1000	1983-1985	HMC1002	HMC5002	HMC1001	HMC5001
XLS	Sportster 1000 Roadster	1983-1985	--	--	HMC1001	HMC5001
XLS	Sportster 1000 Roadster	1984-1985	HMC1002	HMC5002	HMC1001	HMC5001
XLS	Sportster 53c Custom	1984-1999	HMC1002	HMC5002	--	--
XLX	Sportster	1984-1987	--	--	HMC1001	HMC5001

Hawk Performance - MOTORCYCLE APPLICATION GUIDE

CLASS	MODEL	YEARS	FRONT		REAR	
			ORGANIC	METALLIC	ORGANIC	METALLIC
HARLEY DAVIDSON						
XLX	Sportster	1984-1999	HMC1002	HMC5002	--	--
XLX	Sportster	1987-1999	--	--	HMC1005	HMC5005
XLX	Sportster 1000	1984-1985	--	--	HMC1001	HMC5001
XLX	Sportster 1000 61	1983-1984	HMC1002	HMC5002	HMC1001	HMC5001
XLX	Sportster 1100	1986	HMC1002	HMC5002	HMC1001	HMC5001
XLX	Sportster 53c Custom	1984-1999	HMC1002	HMC5002	--	--
XR	Sportster 1000	1983-1985	HMC1002	HMC5002	HMC1001	HMC5001
XR	Sportster 1200	2008	HMC1019	HMC5019	HMC1014	HMC5014
XR	Sportster 1200 X	2010	HMC1019	HMC5019	HMC1014	HMC5014

MODEL	YEARS	FRONT		REAR	
		ORGANIC	METALLIC	ORGANIC	METALLIC
BUELL					
All	1994-1997	HMC1037	--	HMC1040	HMC5040
Blast	2001-2009	HMC1004	HMC5004	HMC1003	HMC5003
CR	2009-2010	HMC1043	HMC5043	HMC1044	HMC5044
M2 Cyclone (counterbored screws fixing disc)	2000-2005	HMC1017	HMC5017	HMC1003	HMC5003
M2 Cyclone (countersunk screws fixing disc)	1998-2001	HMC1017	HMC5017	HMC1003	HMC5003
R	2008-2010	HMC1043	HMC5043	HMC1044	HMC5044
RS	-	HMC1037	--	HMC1040	HMC5040
S1 Lightning (countersunk screws fixing disc)	1998-2002	HMC1017	HMC5017	HMC1003	HMC5003
S1 White Lightning (countersunk screws fixing disc)	1998-2002	HMC1017	HMC5017	HMC1003	HMC5003
S3 Thunderbolt (countersunk screws fixing disc)	1998-2002	HMC1017	HMC5017	HMC1003	HMC5003
S3T Thunderbolt (countersunk screws fixing disc)	1998-2001	HMC1017	HMC5017	HMC1003	HMC5003
X1 Lightning (countersunk screws fixing disc)	1998-2001	HMC1017	HMC5017	HMC1003	HMC5003
X1 Lightning (counterbored screws fixing disc)	2000-2005	HMC1017	HMC5017	HMC1003	HMC5003
X1 Lightning	2001-2002	HMC1017	HMC5017	HMC1003	HMC5003
XB 12 R Firebolt	2004-2008	--	HMC5011	HMC1003	HMC5003
XB 12 R Firebolt	2009-2010	--	--	HMC1003	HMC5003
XB 12 R Firebolt	2009-2010	HMC1043	HMC5043	--	--
XB 12 S Lightning	2004-2008	--	HMC5011	HMC1003	HMC5003
XB 12 SCG Lightning	2006-2010	--	HMC5011	HMC1003	HMC5003
XB 12 SS Lightning Long	2006-2008	--	HMC5011	HMC1003	HMC5003
XB 12 STT Super TT	2007-2010	--	HMC5011	HMC1003	HMC5003
XB 12 X Ulysses	2006-2010	--	HMC5011	HMC1003	HMC5003
XB 12 XT Ulysses	2008-2010	--	HMC5011	HMC1003	HMC5003
XB12 SS Lightning Long	2009-2010	--	--	HMC1003	HMC5003
XB12 SS Lightning Long	2009-2010	HMC1043	HMC5043	--	--

Hawk Performance - MOTORCYCLE APPLICATION GUIDE

MODEL	YEARS	FRONT		REAR	
		ORGANIC	METALLIC	ORGANIC	METALLIC
BUELL					
XB12STT Lightning	2008	--	HMC5011	HMC1003	HMC5003
XB9R Firebolt	2002-2010	--	HMC5011	HMC1003	HMC5003
XB9S Lightning	2003-2010	--	HMC5011	HMC1003	HMC5003
XB9SX CityX	2005-2010	--	HMC5011	HMC1003	HMC5003
XB9SX Lightning	2008-2010	--	HMC5011	--	HMC5011
XB9SX Lightning CityX	2005-2009	--	HMC5011	HMC1003	HMC5003

MODEL	YEARS	FRONT		REAR	
		ORGANIC	METALLIC	ORGANIC	METALLIC
INDIAN					
Chief	2002-2008	HMC1008	HMC5008	HMC1008	HMC5008
Chief Blackhawk	2011-2013	HMC1023	HMC5023	HMC1034	HMC5034
Chief Bomber	2010-2013	HMC1023	HMC5023	HMC1034	HMC5034
Chief Classic	2014	--	HMC5012	HMC1004	HMC5004
Chief Classic	2010-2013	HMC1023	HMC5023	HMC1034	HMC5034
Chief Dark Horse	2010-2013	HMC1023	HMC5023	HMC1034	HMC5034
Chief Deluxe	2009-2013	HMC1023	HMC5023	HMC1034	HMC5034
Chief Deluxe	2002-2008	HMC1008	HMC5008	HMC1008	HMC5008
Chief Roadmaster	2002-2008	HMC1008	HMC5008	HMC1008	HMC5008
Chief Roadmaster	2009-2013	HMC1023	HMC5023	HMC1034	HMC5034
Chief Springfield	2002-2008	HMC1008	HMC5008	HMC1008	HMC5008
Chief Standard	2009-2013	HMC1023	HMC5023	HMC1034	HMC5034
Chief Vintage	2014	--	HMC5012	HMC1004	HMC5004
Chief Vintage	2002-2008	HMC1008	HMC5008	HMC1008	HMC5008
Chief Vintage	2009-2013	HMC1023	HMC5023	HMC1034	HMC5034
Chieftain	2014	--	HMC5012	HMC1004	HMC5004
Dark Horse	2016	--	HMC5012	HMC1004	HMC5004
Roadmaster	2015	--	HMC5012	HMC1004	HMC5004
Scout	2015	HMC1030	HMC5030	HMC1031	HMC5031
Scout	2001-2008	HMC1008	HMC5008	HMC1008	HMC5008
Scout Deluxe	2001-2008	HMC1008	HMC5008	HMC1008	HMC5008
Scout Sixty	2016	HMC1030	HMC5030	HMC1031	HMC5031
Scout Springfield	2001-2008	HMC1008	HMC5008	HMC1008	HMC5008
Spirit	2002-2008	HMC1008	HMC5008	HMC1008	HMC5008
Spirit Deluxe	2002-2008	HMC1008	HMC5008	HMC1008	HMC5008
Spirit Roadmaster	2002-2008	HMC1008	HMC5008	HMC1008	HMC5008
Spirit Springfield	2002-2008	HMC1008	HMC5008	HMC1008	HMC5008

Hawk Performance - MOTORCYCLE APPLICATION GUIDE

MODEL	YEARS	FRONT		REAR	
		ORGANIC	METALLIC	ORGANIC	METALLIC
VICTORY					
Arlen Ness Victory Vision	2010	--	HMC5010	HMC1004	HMC5004
Boardwalk	2013	--	HMC5012	HMC1004	HMC5004
Cory Ness Jackpot	2008-2010	--	HMC5012	HMC1004	HMC5004
Cross Country	2010	--	HMC5012	HMC1004	HMC5004
Cross Country 8-Ball	2014	--	HMC5012	HMC1004	HMC5004
Cross Country Tour	2012	--	HMC5012	HMC1004	HMC5004
Cross Roads	2010	--	HMC5012	HMC1004	HMC5004
Cross Roads 8-Ball	2014	--	HMC5012	HMC1004	HMC5004
Cross Roads Classic	2014	--	HMC5012	HMC1004	HMC5004
Empulse TT	2016	HMC1009	HMC5009	HMC5042	HMC1042
Gunner	2015	--	HMC5012	HMC1004	HMC5004
Hammer	2005-2007	HMC1009	HMC5009	HMC1007	HMC5007
Hammer	2008-2010	--	HMC5012	HMC1004	HMC5004
Hammer 8-Ball	2010	--	HMC5012	HMC1004	HMC5004
Hammer S	2006-2008	HMC1009	HMC5009	HMC1007	HMC5007
Hammer S	2008-2010	--	HMC5012	HMC1004	HMC5004
Hard-Ball	2012	--	HMC5012	HMC1004	HMC5004
Jackpot	2010	--	HMC5012	HMC1004	HMC5004
Judge	2013	--	HMC5012	HMC1004	HMC5004
Kingpin	2010	--	HMC5012	HMC1004	HMC5004
Kingpin	2004-2007	HMC1009	HMC5009	HMC1007	HMC5007
Kingpin	2008-2010	--	HMC5012	HMC1004	HMC5004
Kingpin 8-Ball	2008-2010	--	HMC5012	HMC1004	HMC5004
Kingpin All	2008	--	HMC5012	HMC1004	HMC5004
Kingpin Tour	2004-2007	HMC1009	HMC5009	HMC1007	HMC5007
Kingpin Tour	2008-2009	--	HMC5012	HMC1004	HMC5004
Kingpin-Low	2009	--	HMC5012	HMC1004	HMC5004
Magnum	2015	--	HMC5012	HMC1004	HMC5004
Ness Signature Series	2005-2007	HMC1009	HMC5009	HMC1007	HMC5007
Touring Cruiser	2003-2006	HMC1009	HMC5009	HMC1007	HMC5007
V92C Cruiser	1998-2002	HMC1009	HMC5009	HMC1007	HMC5007
V92C Deluxe	2001-2002	HMC1009	HMC5009	HMC1007	HMC5007
V92SC Sport Cruiser	2000-2002	HMC1009	HMC5009	HMC1007	HMC5007
Vegas	2003-2007	HMC1009	HMC5009	HMC1007	HMC5007
Vegas	2008-2010	--	HMC5012	HMC1004	HMC5004
Vegas 8-Ball	2005-2007	HMC1009	HMC5009	HMC1007	HMC5007
Vegas 8-Ball	2008-2010	--	HMC5012	HMC1004	HMC5004
Vegas Jackpot	2006-2007	HMC1009	HMC5009	HMC1007	HMC5007
Vegas Jackpot	2008-2009	--	HMC5012	HMC1004	HMC5004
Vegas Low	2008-2009	--	HMC5012	HMC1004	HMC5004
Victory V92C (All single front rotor)	1998-2003	HMC1009	HMC5009	HMC1007	HMC5007
Victory V92SC	2000-2003	HMC1009	HMC5009	HMC1007	HMC5007
Vision 8-Ball	2010	--	HMC5010	HMC1004	HMC5004
Vision All	2008	--	HMC5010	HMC1004	HMC5004
Vision Street	2008-2009	--	HMC5010	HMC1004	HMC5004
Vision Tour	2008-2010	--	HMC5010	HMC1004	HMC5004



SPECIALTY CALIPER GUIDE

SPECIALTY CALIPER GUIDE



Hawk Performance - SPECIALTY CALIPER GUIDE

MFG	CALIPER	PAD
Aerospace Components	4 Piston	HB100x.480
Aerospace Components	GT	HB101x.800
Aerospace Components	2 Piston	HB104x.485
Aerospace Components	Single Floater	HB104x.485
Aerospace Components	Single Dynalite	HB584x.485
Alcon	B-Type	HB105x.775
Alcon	CAR71i110	HB105x.775
Alcon	MB4	HB105x.775
Alcon	DP83	HB105x.980
Alcon	4 Piston H-Type	HB107x.620
Alcon	TA-6	HB109x.650
Alcon	Advantage 6	HB109x.710
Alcon	TA6	HB109x.710
Alcon	Advantage 6 GT	HB109x.980
Alcon	CAR89	HB109x.980
Alcon	XR-6	HB109x1.12
Alcon	Advantage R-Type	HB118x.560
Alcon	Advantage R-Type Monoblock	HB118x.560
Alcon	R-Type	HB118x.560
Alcon	CAR89 51mm Radial Depth	HB122x.710
Alcon	CAR32	HB130x.775
Alcon	L-Type	HB167x.778
Alcon	P-Type	HB170x.650
Alcon	TA-4	HB184x.650
Alcon	TA-4	HB184x.710
Alcon	K-Type	HB184x.787
Alcon	H-Type	HB192x.620
Alcon	4 Piston TPC	HB221x1.18
Alcon	CAR20	HB221x1.18
Alcon	XF-Type (Scalloped)	HB224x1.12
Alcon	XT	HB238x1.18
Alcon	XT-4	HB238x1.18
Alcon	XT-6	HB238x1.18
Alcon	CAR94	HB331x1.17
Alcon	CAR95	HB349x1.18
Alcon	DP88	HB349x1.18
Alcon	TA-6+	HB349x1.18
Alcon	CAR22 48mm Radial Depth	HB351x.620
Alcon	Mono4	HB655x.620
Alcon	RC4498X600	HB655x.620
Alcon	CAR89 51mm Radial Depth	HB688x.710
Alcon	Mono6	HB709x.630
AP Racing	CP5846	HB105x.980
AP Racing	CP5847	HB105x.980
AP Racing	CP6070	HB105x.980
AP Racing	CP6270	HB105x.980
AP Racing	CP6271	HB105x.980
AP Racing	CP6470	HB105x.980
AP Racing	CP6480	HB105x.980
AP Racing	CP2361	HB107x.620
AP Racing	CP3228	HB107x.620
AP Racing	CP5104	HB107x.620
AP Racing	CP5144	HB107x.620
AP Racing	CP2485	HB108x.560
AP Racing	CP2561	HB108x.560

MFG	CALIPER	PAD
AP Racing	CP2576	HB108x.560
AP Racing	CP2577	HB108x.560
AP Racing	CP3176	HB108x.560
AP Racing	CP3177	HB108x.560
AP Racing	CP3178	HB108x.560
AP Racing	CP3215	HB718x.654
AP Racing	CP3676	HB108x.560
AP Racing	CP3677	HB108x.560
AP Racing	CP4586	HB108x.560
AP Racing	CP4596	HB108x.560
AP Racing	CP5020	HB108x.560
AP Racing	CP5211	HB108x.560
AP Racing	CP5311	HB108x.560
AP Racing	CP5060-2/3/4/5ST	HB109x.650
AP Racing	CP5060-2/3/4/5ST	HB109x.710
AP Racing	CP5810	HB109x.980
AP Racing	CP5890	HB109x.980
AP Racing	CP5895	HB109x.980
AP Racing	CP6078	HB109x.980
AP Racing	CP3307	HB110x.654
AP Racing	CP4219	HB110x.654
AP Racing	CP5040-5S4	HB110x.654
AP Racing	CP5219	HB110x.654
AP Racing	CP2279	HB110x.775
AP Racing	CP3788	HB110x.775
AP Racing	CP3789	HB110x.775
AP Racing	CP3799	HB110x.775
AP Racing	CP5835	HB110x.775
AP Racing	CP5880	HB110x.775
AP Racing	CP5040-20/21/22/23S4	HB114x.980
AP Racing	CP5040-30/31/32/33S4	HB114x.980
AP Racing	CP2505	HB117x.380
AP Racing	CP3696	HB117x.380
AP Racing	CP3696-6EO	HB117x.380
AP Racing	CP5060-10/11/12/13ST	HB122x.710
AP Racing	CP5570	HB122x.710
AP Racing	CP5779	HB130x.775
AP Racing	CP5780	HB130x.775
AP Racing	CP5788	HB130x.775
AP Racing	CP5789	HB130x.775
AP Racing	CP5836	HB130x.775
AP Racing	CP5420	HB167x.778
AP Racing	CP5421	HB167x.778
AP Racing	CP5510	HB167x.778
AP Racing	CP5515	HB167x.778
AP Racing	CP5610	HB167x.778
AP Racing	CP6120	HB171x.590
AP Racing	CP6121	HB171x.590
AP Racing	CP5119	HB180x.560
AP Racing	CP5316	HB180x.560
AP Racing	CP5317	HB180x.560
AP Racing	CP6126	HB180x.560
AP Racing	CP5045	HB184x.787
AP Racing	CP3345	HB192x.620
AP Racing	CP3714	HB114x.980

Hawk Performance - SPECIALTY CALIPER GUIDE

MFG	CALIPER	PAD
AP Racing	CP4567	HB192x.620
AP Racing	CP5040-10/11/12/13S4	HB192x.620
AP Racing	CP5100	HB192x.620
AP Racing	CP5108	HB192x.620
AP Racing	CP5788	HB105x.775
AP Racing	CP6760	HB192x.620
AP Racing	CP5842	HB331x1.17
AP Racing	CP5845	HB331x1.17
AP Racing	Radi-CAL	HB331x1.17
AP Racing	CP6070	HB105x.980
AP Racing	CP6600	HB585x.660
AP Racing	CP6820	HB105x.620
AP Racing	CP7040	HB586x.660
AP Racing	CP9040	HB586x.660
AP Racing	CP7600	HB587x.630
AP Racing	CP7606	HB587x.630
AP Racing	CP7613	HB587x.630
AP Racing	CP5060-10/11/12/13ST	HB688x.710
AP Racing	CP5070	HB688x.710
AP Racing	CP5095	HB688x.710
AP Racing	CP5260-8/9/10/11	HB688x.710
AP Racing	CP5270-2/3/4/5	HB688x.710
AP Racing	CP5570	HB688x.710
AP Racing	CP6056	HB688x.710
AP Racing	CP5555	HB716x.710
AP Racing	CP5090	HB718x.654
AP Racing	CP8250	HB521x.800
AP Racing (Essex)	CP4751 (SC200)	HB101x.800
AP Racing (Essex)	CP4761 (SC200)	HB101x.800
AP Racing (Essex)	CP5751 (SC300)	HB101x.800
AP Racing (Essex)	CP6751 (SC275)	HB101x.800
AP Racing (Essex)	CP6761 (SC275)	HB101x.800
AP Racing (Essex)	CP7751 (SC400)	HB101x.800
AP Racing (Essex)	CP5805 (SC360/560)	HB102x.800
AP Racing (Essex)	CP5060-22S4L	HB109x.980
AP Racing (Essex)	CP5060-23S4L	HB109x.980
AP Racing (Essex)	CP5060-24S4L	HB109x.980
AP Racing (Essex)	CP5060-25S4L	HB109x.980
AP Racing (Essex)	CP5060-28S4L	HB109x.980
AP Racing (Essex)	CP5060-29S4L	HB109x.980
AP Racing (Essex)	CP5060-30S4L	HB109x.980
AP Racing (Essex)	CP5060-31S4L	HB109x.980
AP Racing (Essex)	CP5260 (SC660)	HB109x.980
AP Racing (Essex)	CP5270 (SC670)	HB109x.980
AP Racing (Essex)	CP9660-2S4L	HB109x.980
AP Racing (Essex)	CP9660-3S4L	HB109x.980
AP Racing (Essex)	CP9668-2S7L	HB109x.980
AP Racing (Essex)	CP9668-3S7L	HB109x.980
AP Racing (Essex)	CP5810 (SC660)	HB109x1.12
AP Racing (Essex)	CP5890 (SC670)	HB109x1.12
AP Racing (Essex)	CP5200 (SC250)	HB110x.654
AP Racing (Essex)	CP9441-2S4L	HB110x.654
AP Racing (Essex)	CP9441-3S4L	HB110x.654
AP Racing (Essex)	CP5830 (SC430)	HB110x.775
AP Racing (Essex)	CP5410 (SC240)	HB167x.778

MFG	CALIPER	PAD
AP Racing (Essex)	CP5850 (SC675)	HB221x1.10
AP Racing (Essex)	CP5755 (SC100)	HB237x.625
AP Racing (Essex)	CP5756 (SC100)	HB237x.625
AP Racing (Essex)	CP5757 (SC100)	HB237x.625
AP Racing (Essex)	CP5820 (SC680)	HB331x1.17
AP Racing (Essex)	CP8350-24S4L	HB521x.800
AP Racing (Essex)	CP8350-25S4L	HB521x.800
AP Racing (Essex)	CP8350-26S4L	HB521x.800
AP Racing (Essex)	CP8350-27S4L	HB521x.800
AP Racing (Essex)	CP8350-32S4L	HB521x.800
AP Racing (Essex)	CP8350-33S4L	HB521x.800
AP Racing (Essex)	CP5040-24S4L	HB718x.654
AP Racing (Essex)	CP5040-25S4L	HB718x.654
AP Racing (Essex)	CP5040-26S4L	HB718x.654
AP Racing (Essex)	CP5040-27S4L	HB718x.654
AP Racing (Essex)	CP9440-2S4L	HB718x.654
AP Racing (Essex)	CP9440-3S4L	HB718x.654
Baer	S4	HB100x.480
Baer	Sport (Front)	HB111x.610
Baer	SS (Front)	HB111x.610
Baer	Track (Front)	HB111x.610
Baer	Sport (Rear)	HB112x.540
Baer	SS (Rear)	HB112x.540
Baer	Track (Rear)	HB112x.540
Baer	6S	HB122x.710
Baer	6R	HB122x.710
Baer	IronSport	HB183x.585
Baer	6P	HB247x.575
Baer	GT	HB247x.575
Baer	GT Plus	HB247x.575
Baer	T4	HB249x.575
Baer	Alumisport	HB509x.678
Baer	6S	HB688x.710
Baer	6R	HB688x.710
Brakeman	F3 Tornado	HB100x.480
Brakeman	F3 Tornado	HB100x.625
Brakeman	F4 Tornado	HB101x.800
Brakeman	F5 Tornado	HB114x.980
Brakeman	F2 Tornado	HB108x.560
Brakeman	F1 Tornado	HB117x.380
Brakeman	Replacement Metric Style Caliper	HB119x.594
Brembo	X97.60.41/44	HB105x.620
Brembo	X97.60.81/84	HB105x.620
Brembo	X98.A8.41/44	HB105x.620
Brembo	XA2.E6.11/14	HB105x.620
Brembo	XA2.E6.31/34	HB105x.620
Brembo	XA2.E6.51/54	HB105x.620
Brembo	XA0.80.51/54	HB105x.708
Brembo	XA2.E5.01/04	HB105x.775
Brembo	XA2.E5.11/14	HB105x.775
Brembo	XA5.90.01/04	HB105x.775
Brembo	XA6.H7.11/14	HB105x.775
Brembo	XB0.77.03-04	HB105X.775
Brembo	XA2.E7.01/04	HB105x.980
Brembo	XA2.E7.03/04	HB105x.980

Hawk Performance - SPECIALTY CALIPER GUIDE

MFG	CALIPER	PAD
Brembo	XA2.E7.11/14	HB105x.980
Brembo	XA2.E7.13/14	HB105x.980
Brembo	XA8.30.11/14	HB105x.980
Brembo	XA8.30.51/52/53/54	HB105x.980
Brembo	XB0.L2.11/14	HB105X.980
Brembo	XA5.TO.01/04	HB130X.684
Brembo	XA5.TO.03/04	HB130X.684
Brembo	XA9.Y6.53/54	HB130x.684
Brembo	X2.023.21/24	HB130x.775
Brembo	X2.028.01/04	HB130x.775
Brembo	X9.060.71/74	HB130x.980
Brembo	XA4.D3.01/04	HB130x.980
Brembo	20.8271.10/40	HB130x1.018
Brembo	20.8330.10/20	HB130x1.018
Brembo	X9.060.51/54	HB130x1.018
Brembo	20.8330.30/40	HB130x1.097
Brembo	S4	HB141x.650
Brembo	XA2.30.11/14	HB167x.620
Brembo	XA2.30.21/24	HB167x.620
Brembo	XA2.86.31/34	HB167x.620
Brembo	NASCAR Rear	HB167x.778
Brembo	X2.029.21/24	HB167x.778
Brembo	X2.029.71/74	HB167x.778
Brembo	X6.059.41/44	HB167x.778
Brembo	X9.011.01/04	HB167x.778
Brembo	X9.011.31/34	HB167x.778
Brembo	X96.14.01/04	HB167x.778
Brembo	XA3.A4.01/04	HB167x.778
Brembo	XA3.A4.41/44	HB167x.778
Brembo	XA3.G2.11/12	HB167x.778
Brembo	XA3.G2.11/14	HB167x.778
Brembo	XA7.GO.11/12	HB167x.778
Brembo	XA7.G1.53/54	HB167x.778
Brembo	X97.24.01	HB172x.595
Brembo	X97.24.10	HB172x.595
Brembo	X97.24.21	HB172x.595
Brembo	X97.24.31	HB172x.595
Brembo	X97.24.51	HB172x.595
Brembo	X97.24.61	HB172x.595
Brembo	XA8.U2.01	HB172x.595
Brembo	XA6.L6.11/14	HB180X.560
Brembo	Big Red	HB184x.650
Brembo	GT3R 4 Piston	HB184x.710
Brembo	20.8643.23/28/29	HB193x.670
Brembo	20.8644.10/22/23	HB193x.670
Brembo	F-40	HB193x.670
Brembo	Caliper Family B	HB193x.670
Brembo	Caliper Family H	HB193x.670
Brembo	Caliper Family P	HB193x.670
Brembo	20.5272.12/22	HB194x.570
Brembo	Caliper Family A	HB194x.570
Brembo	Caliper Family C	HB194x.570
Brembo	Caliper Family E	HB194x.570
Brembo	Caliper Family F	HB194x.570
Brembo	X98.A8.41/44	HB208x.620

MFG	CALIPER	PAD
Brembo	XA2.E6.11/14	HB208x.620
Brembo	XA2.E6.31/34	HB208x.620
Brembo	XA0.80.51/54	HB208x.708
Brembo	XA1.37.11/14	HB208x.708
Brembo	XA5.09.01/04	HB208x.708
Brembo	XA5.TO.01/04	HB221X.684
Brembo	XA5.TO.03/04	HB221X.684
Brembo	XA9.Y6.53/54	HB221x.684
Brembo	NASCAR Front	HB221x1.18
Brembo	X93.45.11/14	HB221x1.18
Brembo	NASCAR Front	HB331x1.17
Brembo	X6.L4.01/04	HB331x1.17
Brembo	XA6.61.21/24	HB348X.980
Brembo	XA2.86.83/84	HB348x1.14
Brembo	XA3.02.11/12	HB348x1.14
Brembo	XA3.02.21/22	HB348x1.14
Brembo	XA3.02.31/32	HB348x1.14
Brembo	XA3.02.41/42	HB348x1.14
Brembo	XA3.B7.51/54	HB348x1.14
Brembo	XA4.F1.01/02	HB348x1.14
Brembo	XA4.F1.11/12	HB348x1.14
Brembo	XA4.F1.21/22	HB348x1.14
Brembo	XA4.F1.31/32	HB348x1.14
Brembo	XA5.C2.01/02	HB348x1.14
Brembo	XA6.61.01/04	HB348x1.14
Brembo	XA6.H7.01/02	HB348x1.14
Brembo	XA8.31.11/12	HB348x1.14
Brembo	X2.040.01/04	HB351x.620
Brembo	X9.066.91/94	HB351x.620
Brembo	X94.75.11/14	HB351x.620
Brembo	XA4.10.01/04	HB351x.620
Brembo	NASCAR Front	HB486x.708
Brembo	X6.L4.01/04	HB486x.708
Brembo	NASCAR Front	HB486x1.094
Brembo	X6.L4.01/04	HB486x1.094
Brembo	XA8.Z4.01/04	HB486x1.094
Brembo	Caliper Family J	HB581x.660
Brembo	Caliper Family N	HB581x.660
Brembo	Caliper Family M	HB582x.660
Brembo	XA6.S0.01/04	HB605x.625
Brembo	XA6.S0.01/02/03/04	HB605x.625
Brembo	XA6.S0.21/24	HB605x.625
Brembo	XA6.S0.21/22/23/24	HB605x.625
Brembo	B10	HB605x.625
Brembo	Caliper Family G	HB609x.572
Brembo	GT3 Wide Annulus	HB699x.984
Brembo	GT3 Wide Annulus	HB699x1.14
Brembo	XA8.31.21/22	HB699x1.14
Brembo	XA8.31.31/32	HB699x1.14
Carbone Lorraine	4012	HB653x.606
CNC	624	HB100x.480
CNC	625	HB100x.480
CNC	626	HB100x.480
CNC	642	HB100x.480
CNC	643	HB100x.480

SPECIALTY CALIPER GUIDE

Hawk Performance - SPECIALTY CALIPER GUIDE

MFG	CALIPER	PAD
CNC	648	HB100x.480
CNC	664	HB100x.480
CNC	674	HB100x.480
CNC	627	HB101x.800
CNC	636	HB101x.800
CNC	654	HB101x.800
CNC	630	HB102x.800
CNC	631	HB102x.800
CNC	633	HB102x.800
CNC	623	HB104x.485
CNC	644	HB104x.485
CNC	645	HB104x.485
CNC	651	HB104x.485
CNC	652	HB104x.485
CNC	672	HB104x.485
Coleman	Series I	HB101x.800
Coleman	Series II	HB101x.800
Coleman	Series III	HB105x.708
Coleman	Series III	HB105x.775
Coleman	Series III	HB105x.980
Coleman	Series IV	HB109x.650
Coleman	Series IV	HB109x.710
Coleman	Series IV	HB109x.980
Coleman	Series IV	HB109x1.12
Coleman	GM Metric	HB119x.594
CompBrake	Pro Race Three	HB100x.480
CompBrake	Pro Race Five	HB110x.654
CompBrake	Pro Race Six	HB110x.654
CompBrake	Pro Race Four	HB180x.560
CompBrake	Pro Race Seven	HB184x.650
CompBrake	Pro Race Two	HB237x.480
CompBrake	Comp-B16	HB237x.480
CompBrake	Pro Race Two	HB237x.625
CompBrake	Comp-B16	HB237x.625
CompBrake	Pro Race One	HB521x.800
Hawk	HCAS101	HB119x.594
Hawk	HCAS300	HB247x.575
Hawk	HCAS301	HB247x.575
Hawk	HCAS302	HB247x.575
Hawk	HCAS304	HB247x.575
Hawk	HCAS305	HB247x.575
Hawk	HCAS306	HB247x.575
Hawk	HCAS307	HB247x.575
Hawk	HCAS303	HB385x.640
JAMAR	DB300CAL	HB100x.480
JAMAR	DBBCAL	HB104x.485
JAMAR	JAM-300	HB100x.480
JAMAR	JAM4000	HB100x.480
JAMAR	JAM-6000	HB102x.600
JAMAR	JAM-6000	HB102x.800
Lucas Girling		HB116x.580
Mark Williams	83100	HB104x.485
Mark Williams	82100	HB237x.480
Mark Williams	81100	HB237x.625
Opel Astra		HB138x.690

MFG	CALIPER	PAD
Outlaw	2000	HB100x.480
Outlaw	3000	HB101x.800
Outlaw	4000	HB101x.800
Outlaw	4000XD	HB101x.800
Outlaw	GM	HB103x.590
Outlaw	1000	HB104x.485
Outlaw	2800	HB237x.625
Outlaw	Inboard Sprint Car Caliper	HB237x.625
Outlaw	M-16	HB237x.625
PFC	ZR34	HB654x.748
Red Devil	300 Series	HB101x.800
Red Devil	Single Piston Floater	HB104x.485
Red Devil	600 Series - Short Track	HB238x1.18
Rotora	FF4	HB105x.620
Rotora	RF401	HB105x.708
Rotora	RF402	HB105x.708
Rotora	FC6	HB109x.710
Rotora	RF403	HB110x.654
Rotora	RF404	HB110x.654
Rotora	RF201	HB180x.560
Rotora	RF202	HB180x.560
Rotora	FC2	HB180x.560
Rotora	FC4	HB193x.610
Rotora	RF801	HB609x.572
Rotora	FC8	HB609x.572
Sierra / JFZ	MGN Dual	HB100x.480
Sierra / JFZ	XL Series	HB101x.800
Sierra / JFZ	GN Series	HB102x.800
Sierra / JFZ	GM Series	HB103x.590
Sierra / JFZ	MGN Single	HB104x.485
Sparta Evolution	2P-A	HB180x.560
Sparta Evolution	4P-B (Small/Rear)	HB194x.570
Sparta Evolution	6P-B	HB581x.660
Sparta Evolution	6P-A	HB582x.660
Sparta Evolution	4P-A (Large/Front)	HB632x.586
Stop Tech	ST-60	HB122x.710
Stop Tech	ST-40 / STR-40	HB141x.650
Stop Tech	ST-43	HB521x.800
Stop Tech	ST-45	HB141x.650
Stop Tech	ST-50	HB141x.650
Stop Tech	ST-41	HB170x.650
Stop Tech	ST-21	HB172x.595
Stop Tech	ST-22	HB180x.560
Stop Tech	STR-40GT	HB221x1.10
Stop Tech	ST-20	HB266x.650
Stop Tech	ST-43	HB521x.650
Stop Tech	ST-42	HB542x.600
Stop Tech	ST-60	HB688x.710
Stop Tech	STR-60	HB688x.710
Strange	2 Piston	HB104x.485
Strange	4 Piston - Cotter Pin	HB267x.480
Strange	S-Series Caliper	HB583x.480
US Brake	F33i	HB100x.480
US Brake	F88i	HB101x.800
US Brake	Standard GM	HB103x.590

Hawk Performance - SPECIALTY CALIPER GUIDE

MFG	CALIPER	PAD
US Brake	DL Single	HB104x.485
US Brake	Oversize Metric GM	HB119x.594
US Brake	Stock Metric GM	HB119x.594
US Brake	F22i	HB237x.480
US Brake	F22i	HB237x.625
Wilwood	Dynalite	HB100x.480
Wilwood	LC-GT	HB101x.800
Wilwood	Superlite II, III	HB101x.800
Wilwood	GN III (7520)	HB102x.800
Wilwood	GM II, GM III	HB103x.590
Wilwood	Dynalite Single Floater	HB104x.485
Wilwood	Dynalite Single	HB104x.485
Wilwood	GT4000	HB105x.708
Wilwood	GM Metric	HB119x.594
Wilwood	GM Metric Aluminum Racing Calipers	HB119x.594
Wilwood	Forged Billet Aluminum D8-4 Corvette (D8)	HB126x.505
Wilwood	Forged Billet Aluminum D8-6 Corvette (D8)	HB126x.505
Wilwood	Integra IP	HB130x.980
Wilwood	Integra HP	HB221x1.10
Wilwood	GT 6000 - Radius	HB224x1.12
Wilwood	GT III - Radius	HB224x1.12
Wilwood	Dynalite w/ Bridgebolt	HB237x.480
Wilwood	Dynalite w/ Bridgebolt	HB237x.625
Wilwood	Prolite (9930)	HB238x1.18
Wilwood	IR-GT	HB351x.620
Wilwood	IR-GT (7620)	HB351x.778
Wilwood	IR-GTR4 (7620)	HB351x.778
Wilwood	Combination Parking Brake Calipers (D340)	HB364x.642
Wilwood	Integra LP (9725)	HB369x.980
Wilwood	Billet Narrow Superlite 4	HB521x.650
Wilwood	Billet Narrow Superlite 6 Lug Mount	HB521x.650
Wilwood	Billet Narrow Superlite 6 Radial Mount	HB521x.650
Wilwood	Superlite-4/6, Forged, Narrow (7416)	HB521x.650
Wilwood	Forged Superlite Internal	HB521x.800

MFG	CALIPER	PAD
Wilwood	Superlite 4R (7420)	HB521x.800
Wilwood	Superlite 6R (7420)	HB521x.800
Wilwood	Superlite SL4R (7420)	HB521x.800
Wilwood	Superlite ST (7420)	HB521x.800
Wilwood	Superlite-4/6, Forged (7420)	HB521x.800
Wilwood	Billet Dynalite w/ Cotter Pin (7112)	HB540x.490
Wilwood	Forged Dynalite (7112)	HB540x.490
Wilwood	Forged Dynalite-M (7112)	HB540x.490
Wilwood	Dynalite - Forged w/cotter pin (7112)	HB540x.490
Wilwood	Dynalite - Billet Narrow (7216)	HB541x.630
Wilwood	Dynalite - Billet Radial Narrow (7216)	HB541x.630
Wilwood	NDL (7216)	HB541x.630
Wilwood	Billet Dynalite - Side Inlet	HB542x.490
Wilwood	DPC56 CALIPER	HB542x.490
Wilwood	Dynapro Dust-Boot	HB542x.490
Wilwood	DynaPro Lug Mount (7812)	HB542x.490
Wilwood	Dynapro Lug Mount Forged Billet (7812)	HB542x.490
Wilwood	Forged DPHA	HB542x.490
Wilwood	Forged Dynapro Lug Mount Low-Profile	HB542x.490
Wilwood	Billet Narrow Dynalite Radial Mount	HB542x.600
Wilwood	Dynapro Narrow Mount (7816)	HB542x.600
Wilwood	DynaPro NDL (7816)	HB542x.600
Wilwood	Dynalite - Forged Narrow Mount w/ Bridgebolt (7816)	HB542x.600
Wilwood	Dynapro Radial Mount (7816)	HB542x.600
Wilwood	Dynapro Radial Mount Billet (7816)	HB542x.600
Wilwood	Dynapro-13 Radial Mount Billet (7816)	HB542x.600
Wilwood	7912	HB611x.490
Wilwood	Powerlite Radial Mount	HB611x.490
Wilwood	Billet Dynalite Single	HB622x.490
Wilwood	Dynalite Single Floating (6812)	HB622x.490
Wilwood	DynaPro Single (6812)	HB622x.490
Wilwood	Dynalite Single (6812)	HB622x.490
Wilwood	Dynalite Single LW (6812)	HB622x.490
Wilwood	DynaPro 6A Lug Mount (Type 6712)	HB645x.490



FMSI CROSS REFERENCE

SPECIALTY CALIPER GUIDE



Hawk Performance - FMSI CROSS REFERENCE

FMSI NUMBER	HAWK NUMBER
D4	HB244x.624
D5	HB108x.560
D8	HB126x.505
D11	HB471x.510
D27	HB132x.580
D30	HB713x.585
D31	HB172x.500
D31	HB172x.595
D34	HB646x.526
D39	HB643x.595
D43	HB204x.615
D44	HB118x.560
D45	HB171x.590
D45	HB171x.720
D50	HB292x.674
D52	HB103x.590
D57	HB169x.560
D58	HB172x.595
D61	HB123x.535
D76	HB150x.555
D81	HB229x.580
D92	HB292x.674
D94	HB156x.562
D100	HB207x.580
D109	HB180x.560
D109	HB180x.591
D109	HB180x.640
D114	HB169x.560
D120	HB255x.655
D122	HB103x.590
D126	HB733x.748
D131	HB152x.540
D138	HB119x.594
D141	HB199x.702
D145	HB207x.580
D153	HB131x.595
D154	HB119x.594
D158	HB189x.595
D159	HB400x.630
D161	HB169x.560
D163	HB206x.565
D169	HB156x.562
D172	HB156x.562
D174	HB180x.640
D183	HB400x.630
D184	HB252x.860
D189	HB202x.580
D190	HB400x.630
D195	HB614x.600
D199	HB125x.650
D200	HB125x.650
D202	HB119x.594
D205	HB279x.594
D206	HB189x.595
D213	HB112x.540

FMSI NUMBER	HAWK NUMBER
D215	HB396x.630
D224	HB253x.750
D225	HB251x1.14
D227	HB190x.600
D227	HB190x.730
D228	HB271x.635
D230	HB262x.540
D231	HB262x.540
D232	HB262x.540
D235	HB151x.505
D236	HB254x1.00
D241	HB191x.590
D242	HB191x.590
D249	HB279x.594
D251	HB199x.702
D252	HB198x.685
D253	HB137x.690
D254	HB198x.685
D256	HB397x.585
D266	HB475x.642
D269	HB398x.680
D272	HB262x.540
D273	HB218x.583
D278	HB195x.640
D279	HB399x.630
D280	HB189x.550
D280	HB189x.595
D282	HB202x.580
D283	HB158x.515
D287	HB171x.590
D289	HB400x.630
D290	HB190x.730
D292	HB134x.665
D294	HB173x.570
D295	HB112x.540
D302	HB191x.590
D305	HB203x.550
D306	HB271x.605
D307	HB189x.595
D313	HB103x.590
D321	HB195x.640
D323	HB262x.540
D325	HB401x.587
D331	HB155x.580
D332	HB158x.515
D333	HB402x.669
D334	HB403x.587
D339	HB350x.496
D340	HB364x.587
D340	HB364x.642
D341	HB242x.661
D345	HB170x.650
D347	HB580x.627
D349	HB404x.642
D352	HB401x.587

Hawk Performance - FMSI CROSS REFERENCE

FMSI NUMBER	HAWK NUMBER
D356	HB191x.590
D360	HB293x.668
D362	HB270x.724
D364	HB350x.496
D369	HB332x.654
D370	HB296x.670
D372	HB141x.650
D373	HB113x.590
D374	HB350x.496
D375	HB293x.668
D376	HB232x.681
D380	HB252x.860
D383	HB367x.585
D387	HB279x.594
D389	HB407x.602
D392	HB131x.595
D394	HB135x.642
D394	HB135x.770
D395	HB137x.690
D396	HB227x.630
D409	HB242x.661
D410	HB317x.591
D412	HB111x.610
D413	HB112x.540
D415	HB176x.614
D417	HB240x.620
D419	HB270x.724
D421	HB240x.620
D422	HB231x.625
D424	HB199x.660
D429	HB262x.540
D430	HB268x.665
D431	HB263x.650
D433	HB407x.602
D436	HB315x.669
D439	HB195x.640
D441	HB475x.642
D443	HB199x.702
D445	HB198x.685
D446	HB170x.650
D446	HB170x.710
D447	HB141x.650
D450	HB336x.655
D454	HB195x.640
D455	HB199x.702
D457	HB148x.560
D458	HB157x.484
D459	HB298x.787
D460	HB178x.564
D461	HB179x.630
D462	HB235x.665
D463	HB155x.580
D464	HB262x.540
D465	HB275x.620
D468	HB148x.560

FMSI NUMBER	HAWK NUMBER
D469	HB235x.665
D470	HB408x.665
D471	HB367x.585
D473	HB246x.567
D474	HB218x.583
D476	HB318x.669
D477	HB210x.677
D481	HB437x.585
D482	HB158x.515
D484	HB213x.626
D485	HB235x.665
D487	HB195x.640
D491	HB278x.465
D491	HB278x.583
D493	HB195x.640
D499	HB125x.650
D502	HB312x.591
D503	HB143x.680
D504	HB185x.590
D506	HB390x.602
D507	HB409x.661
D508	HB359x.543
D512	HB176x.614
D521	HB411x.717
D522	HB410x.721
D524	HB411x.717
D525	HB148x.560
D526	HB268x.665
D529	HB308x.689
D530	HB214x.618
D531	HB120x.560
D532	HB673x.602
D536	HB572x.570
D537	HB145x.570
D539	HB191x.590
D540	HB421x.622
D542	HB413x.690
D545	HB580x.627
D547	HB325x.720
D548	HB362x.642
D549	HB409x.661
D551	HB379x.626
D551	HB379x.626
D555	HB269x.763
D555	HB269x.763A
D555	HB269x.763B
D556	HB384x.587
D558	HB136x.690
D559	HB176x.614
D560	HB218x.583
D562	HB310x.689
D564	HB350x.496
D568	HB144x.719
D569	HB189x.595
D570	HB191x.590

FMSI CROSS REFERENCE

Hawk Performance - FMSI CROSS REFERENCE

FMSI NUMBER	HAWK NUMBER
D572	HB670x.610
D576	HB414x.622
D579	HB422x.610
D583	HB211x.634
D584	HB212x.535
D585	HB155x.580
D587	HB415x.583
D588	HB437x.585
D589	HB407x.602
D591	HB241x.710
D592	HB194x.570
D592	HB194x.665
D593	HB308x.689
D594	HB184x.650
D594	HB184x.650B
D594	HB184x.650C
D595	HB421x.622
D597	HB240x.620
D598	HB416x.689
D600	HB182x.660
D601	HB347x.689
D603	HB371x.600
D606	HB477x.610
D607	HB279x.594
D608	HB170x.650
D609	HB141x.650
D610	HB417x.659
D611	HB311x.591
D614	HB131x.595
D617	HB245x.631
D618	HB492x.732
D619	HB375x.669
D621	HB418x.646
D623	HB217x.681
D625	HB285x.595
D626	HB295x.630
D627	HB183x.585
D627	HB183x.660
D629	HB215x.630
D630	HB216x.590
D631	HB201x.620
D632	HB295x.630
D634	HB413x.690
D635	HB149x.505
D636	HB159x.492
D637	HB211x.634
D639	HB181x.660
D641	HB176x.614
D642	HB177x.630
D642	HB177x.710
D643	HB419x.634
D647	HB178x.564
D648	HB420x.724
D650	HB233x.635
D652	HB283x.650

FMSI NUMBER	HAWK NUMBER
D654	HB279x.594
D655	HB334x.705
D655	HB334x.736
D656	HB347x.689
D658	HB176x.614
D661	HB510x.580
D663	HB159x.492
D664	HB284x.575
D666	HB286x.591
D667	HB287x.571
D668	HB236x.622
D669	HB680x.583
D673	HB390x.602
D674	HB341x.618
D676	HB469x.705
D679	HB266x.650
D681	HB325x.720
D682	HB497x.776
D683	HB518x.642
D684	HB190x.730
D685	HB401x.587
D687	HB272x.763
D687	HB272x.763A
D690	HB353x.618
D691	HB326x.646
D692	HB227x.630
D695	HB310x.689
D696	HB190x.600
D697	HB318x.669
D698	HB359x.543
D699	HB360x.670
D702	HB299x.650
D707	HB320x.669
D711	HB301x.630
D712	HB210x.677
D713	HB286x.591
D714	HB359x.543
D717	HB252x.860
D718	HB318x.669
D720	HB423x.709
D721	HB352x.665
D722	HB424x.665
D723	HB214x.618
D725	HB135x.770
D726	HB304x.598
D727	HB425x.661
D728	HB409x.661
D729	HB305x.610
D730	HB260x.670
D731	HB247x.575
D732	HB248x.650
D737	HB289x.610
D738	HB290x.583
D738	HB290x.606
D740	HB495x.756

Hawk Performance - FMSI CROSS REFERENCE

FMSI NUMBER	HAWK NUMBER
D741	HB321x.650
D744	HB318x.669
D745	HB420x.724
D746	HB306x.795
D748	HB294x.646
D749	HB249x.575
D750	HB250x.653
D752	HB425x.661
D754	HB359x.543
D755	HB489x.630
D756	HB302x.700
D757	HB303x.685
D758	HB299x.650
D759	HB176x.614
D760	HB505x.654
D763	HB227x.630
D764	HB275x.620
D764	HB275x.660
D765	HB416x.689
D766	HB597x.681
D768	HB365x.728
D769	HB344x.992
D770	HB434x.543
D771	HB499x.610
D772	HB313x.685
D773	HB427x.685
D776	HB291x.642
D777	HB335x.815
D781	HB546x.654
D782	HB176x.614
D784	HB322x.717
D785	HB323x.724
D786	HB327x.799
D786	HB327x1.105
D787	HB366x.681
D789	HB332x.654
D791	HB381x.661
D792	HB324x.673
D794	HB491x.693
D795	HB652x.634
D799	HB316x.670
D801	HB420x.724
D802	HB539x.650
D803	HB342x.701
D804	HB274x.610
D805	HB376x.665
D806	HB428x.650
D807	HB384x.587
D810	HB193x.670
D812	HB314x.665
D814	HB359x.543
D815	HB268x.665
D816	HB346x.713
D817	HB328x.685
D818	HB360x.670

FMSI NUMBER	HAWK NUMBER
D819	HB388x.756
D820	HB307x.795
D821	HB487x.733
D822	HB493x.650
D823	HB329x.543
D824	HB302x.700
D825	HB537x.783
D829	HB361x.622
D830	HB488x.629
D833	HB472x.650
D834	HB385x.640
D835	HB610x.587
D836	HB354x.756A
D837	HB500x.645
D838	HB516x.626
D839	HB363x.689
D840	HB354x.756A
D841	HB377x.760
D842	HB299x.650
D843	HB473x.752
D844	HB373x.689
D845	HB296x.670
D849	HB376x.665
D850	HB360x.670
D851	HB271x.605
D853	HB495x.756
D855	HB326x.646
D856	HB373x.689
D857	HB374x.700
D858	HB372x.626
D859	HB487x.733
D861	HB172x.595
D862	HB429x.681
D864	HB461x.646
D865	HB506x.610
D866	HB435x.622
D868	HB675x.602
D869	HB498x.772
D872	HB504x.740
D879	HB301x.630
D881	HB520x.575
D882	HB382x.657
D883	HB383x.685
D886	HB430x.547
D888	HB387x.547
D890	HB431x.606
D891	HB442x.496
D892	HB436x.535
D893	HB211x.634
D894	HB364x.642
D897	HB299x.650
D898	HB514x.610
D900	HB378x.626
D903	HB461x.646
D904	HB438x.606

FMSI CROSS REFERENCE

Hawk Performance - FMSI CROSS REFERENCE

FMSI NUMBER	HAWK NUMBER
D905	HB370x.559
D906	HB677x.685
D908	HB474x.681
D909	HB322x.717
D912	HB363x.689
D913	HB472x.650
D914	HB393x.665
D915	HB515x.760
D916	HB667x.622
D917	HB550x.634
D918	HB551x.748
D918	HB733x.748
D919	HB630x.626
D921	HB439x.555
D922	HB440x.606
D923	HB441x.661
D924	HB368x.665
D928	HB479x.700
D929	HB432x.661
D931	HB433x.654
D932	HB443x.614
D934	HB462x.827
D935	HB463x.787
D936	HB388x.756
D939	HB444x.685
D940	HB445x.610
D943	HB393x.665
D944	HB428x.650
D945	HB446x.725
D946	HB464x.764
D947	HB465x.764
D948	HB418x.646
D955	HB461x.646
D956	HB517x.690
D957	HB459x.700
D958	HB393x.665
D959	HB447x.667
D960	HB545x.564
D961	HB180x.560
D962	HB476x.707
D963	HB503x.790
D964	HB689x.550
D965	HB552x.722
D966	HB299x.650
D967	HB513x.610
D968	HB193x.670
D969	HB448x.610
D970	HB449x.679
D973	HB571x.605
D974	HB494x.670
D975	HB496x.640
D976	HB490x.665
D977	HB501x.625
D978	HB502x.606
D979	HB466x.780
D981	HB690x.550

FMSI NUMBER	HAWK NUMBER
D986	HB755x.620
D989	HB591x.760
D990	HB493x.650
D991	HB483x.635
D992	HB454x.715
D997	HB433x.654
D999	HB450x.555
D1000	HB451x.668
D1001	HB453x.585
D1002	HB468x.492
D1003	HB466x.780
D1004	HB452x.545
D1007	HB512x.605
D1008	HB378x.565
D1009	HB470x.643
D1010	HB511x.790
D1011	HB455x.785
D1012	HB456x.705
D1013	HB461x.646
D1014	HB501x.625
D1016	HB453x.585
D1017	HB364x.642
D1018	HB553x.652
D1019	HB467x.540
D1023	HB364x.642
D1024	HB687x.750
D1027	HB588x.875
D1028	HB524x.740
D1029	HB609x.572
D1033	HB525x.540
D1035	HB592x.665
D1036	HB593x.548
D1037	HB457x.605
D1039	HB554x.643
D1040	HB443x.614
D1041	HB555x.678
D1042	HB458x.642
D1043	HB460x.580
D1044	HB519x.682
D1048	HB573x.615
D1049	HB530x.570
D1050	HB453x.585
D1053	HB194x.570
D1056	HB507x.711
D1057	HB508x.586
D1057	HB508x.675
D1058	HB509x.678
D1060	HB445x.610
D1061	HB534x.750
D1063	HB567x.694
D1066	HB547x.798
D1067	HB556x.710
D1068	HB529x.710
D1069	HB528x.811
D1070	HB723x.665
D1071	HB724x.637

Hawk Performance - FMSI CROSS REFERENCE

FMSI NUMBER	HAWK NUMBER
D1075	HB360x.670
D1076	HB536x.704
D1077	HB299x.650
D1078	HB533x.668
D1079	HB299x.650
D1080	HB558x.710
D1081	HB484x.670
D1082	HB485x.656
D1083	HB455x.785
D1084	HB559x.695
D1087	HB555x.678
D1092	HB561x.710
D1094	HB618x.625
D1095	HB478x.605
D1096	HB299x.650
D1098	HB681x.686
D1099	HB682x.657
D1100	HB619x.626
D1101	HB619x.626
D1102	HB678x.709
D1103	HB679x.600
D1107	HB543x.760
D1108	HB544x.628
D1109	HB613x.589
D1110	HB439x.555
D1111	HB538x.760
D1112	HB364x.587
D1113	HB562x.612
D1114	HB557x.545
D1116	HB616x.607
D1117	HB687x.750
D1119	HB526x.665
D1120	HB527x.604
D1122	HB744x.660
D1123	HB743x.795
D1124	HB671x.628
D1125	HB368x.665
D1129	HB632x.586
D1134	HB665x.577
D1135	HB664x.634
D1149	HB563x.656
D1151	HB676x.780
D1158	HB612x.690
D1159	HB535x.638
D1160	HB524x.740
D1161	HB564x.567
D1164	HB565x.688
D1169	HB617x.630
D1170	HB624x.642
D1178	HB566x.688
D1179	HB522x.565
D1180	HB523x.539
D1181	HB558x.710
D1182	HB700x.562
D1183	HB567x.694

FMSI NUMBER	HAWK NUMBER
D1184	HB596x.690
D1185	HB531x.570
D1185	HB532x.570
D1185	HB658x.570
D1185	HB659x.570
D1186	HB549x.702
D1192	HB565x.688
D1193	HB598x.606
D1194	HB568x.666
D1204	HB560x.677
D1210	HB627x.690
D1211	HB704x.692
D1212	HB648x.607
D1215	HB594x.657
D1216	HB595x.589
D1222	HB647x.692
D1224	HB360x.670
D1230	HB519x.682
D1244	HB128x.505
D1249	HB628x.651
D1258	HB656x.684
D1259	HB657x.667
D1260	HB551x.748
D1263	HB683x.651
D1267	HB621x.638
D1270	HB194x.570
D1272	HB745x.777
D1273	HB569x.650
D1274	HB608x.630
D1276	HB447x.667
D1278	HB578x.735
D1279	HB579x.785
D1284	HB662x.587
D1285	HB435x.622
D1286	HB620x.703
D1287	HB599x.616
D1288	HB600x.539
D1291	HB731x.620
D1293	HB647x.692
D1294	HB708x.738
D1298	HB563x.656
D1299	HB651x.624
D1300	HB651x.624
D1303	HB589x.704
D1304	HB590x.682
D1306	HB759x.750
D1307	HB778x.630
D1308	HB570x.666
D1309	HB574x.636
D1319	HB543x.760
D1322	HB641x.696
D1327	HB435x.622
D1333	HB528x.811
D1334	HB556x.710
D1336	HB626x.577

FMSI CROSS REFERENCE

Hawk Performance - FMSI CROSS REFERENCE

FMSI NUMBER	HAWK NUMBER
D1337	HB639x.645
D1338	HB660x.661
D1340	HB752x.769
D1341	HB753x.666
D1342	HB754x.726
D1346	HB601x.626
D1347	HB602x.545
D1349	HB720x.575
D1351	HB606x.650
D1352	HB607x.616
D1353	HB547x.798
D1354	HB629x.565
D1355	HB760x.620
D1359	HB625x.760
D1363	HB561x.710
D1364	HB525x.540
D1365	HB616x.607
D1366	HB722z.652
D1367	HB561x.710
D1368	HB615x.535
D1371	HB603x.616
D1372	HB604x.598
D1374	HB660x.661
D1376	HB710x.706
D1377	HB674x.664
D1379	HB548x.590
D1380	HB561x.710
D1382	HB650x.730
D1383	HB193x.670
D1384	HB635x.645
D1386	HB642x.658
D1387	HB637x.583
D1389	HB719x.668
D1392	HB644x.785
D1393	HB370x.559
D1394	HB418x.646
D1395	HB631x.622
D1396	HB636x.644
D1399	HB633x.790
D1400	HB634x.750
D1403	HB640x.550
D1404	HB638x.702
D1405	HB649x.605
D1406	HB756x.770
D1411	HB705x.776
D1413	HB661x.667
D1414	HB672x.714
D1415	HB370x.559
D1419	HB531x.570
D1419	HB532x.570
D1419	HB658x.570
D1419	HB659x.570
D1423	HB629x.565
D1425	HB684x.694
D1426	HB685x.610
D1427	HB686x.645

FMSI NUMBER	HAWK NUMBER
D1428	HB663x.557
D1433	HB669x.671
D1451	HB626x.577
D1453	HB762x.634
D1454	HB668x.567
D1455	HB701x.723
D1456	HB695x.609
D1463	HB484x.670
D1464	HB484x.670
D1465	HB485x.656
D1468	HB707x.638
D1473	HB751x.675
D1474	HB726x.582
D1474-RA	HB787x.582
D1479	HB684x.694
D1498	HB702x.662
D1504	HB750x.760
D1506	HB366x.681
D1507	HB383x.685
D1508	HB710x.706
D1522	HB706x.714
D1537	HB758x.652
D1539	HB711x.661
D1549	HB757x.758
D1561	HB748x.723
D1563	HB519x.682
D1565	HB705x.776
D1567	HB703x.665
D1568	HB736x.629
D1569	HB737x.544
D1571	HB693x.716
D1572	HB694x.580
D1575	HB780x.625
D1577	HB761x.593
D1578	HB275x.620
D1584	HB678x.709
D1594	HB794x.584
D1595	HB735x.666
D1609	HB765x.664
D1613	HB749x.648
D1618	HB739x.715
D1629	HB741x.723
D1630	HB742x.690
D1636	HB740x.712
D1650	HB747x.626
D1659	HB746x.645
D1666	HB616x.607
D1668	HB712x.680
D1680	HB714x.715
D1687	HB738x.662
D1687	HB738x.662
D1691	HB715x.713
D1718	HB727x.592
D1730	HB725x.650
D1791	HB773x.664
D1793	HB774x.650

FMSI CROSS REFERENCE



What's stopping you?



Hawk Performance is passionately devoted to promoting racing at every level,
and proud to sponsor these fine industry partners:

