



GARAGE HANDBOOK Nº 505

Hurry! Get Ready for Fall!



ORBITALS
p. 24-27



TIRES
p. 17



TOWELS
p. 11



CAR COVERS
p. 50



In My Garage

AUTUMN REQUIRES SPECIAL PREPARATION

THE COVER CAR

1963 Lincoln Continental

Our 2017 SEMA Show entry was executed by J-Rod & Custom of Black Diamond, Wash. With the theme "Built for burnouts and disturbing the peace," its '60s-era V8 was swapped for a Ford Motorsports 427-cubic-inch V8 for well over 500 horses. It's often on display in our Tacoma, WA, showroom.

"Strive for perfection in everything. Take the best that exists and make it better. If it doesn't exist, create it. Accept nothing nearly right or good enough."

This quote by Sir Henry Royce, co-founder of Rolls-Royce, has appeared in every one of our handbooks. At Griot's Garage, we are driven to provide our customers with exceptional products and customer service... all backed by a world-class guarantee. We strive for perfection by holding ourselves to the highest standards at every turn.

We make it, teach it, and guarantee it.

Autumn is coming, and winter is right on its bumper. It's time to formulate a plan...or maybe two, if you have a car you'll be tucking away.

Daily Driver: Make sure your surface protection is up to date on the car you drive every day. Whether you choose wax, ceramics, or other synthetics (p. 30), each will bring you a smile as rain beads beautifully and rolls off your protected paint. Our Glass Sealant (p.36) is another must. It works so well, you often don't need to turn on your wipers. For safe visibility, protecting glass, and prolonging wiper life, it's unbeatable.

Maintaining correct tire pressure as the temperature changes is also essential for safer driving, better gas mileage, and extending the life of your tread. See page 43 for excellent gauges and inflating tools.

Other suggestions as fall approaches: Keep one of our 2000A 12V Lithium-Ion Jump Starters (p. 52) in every car. If your battery loses its charge in the cold, it's a savior. Our Air Dryer Desiccant Bags help behind the scenes, quietly preventing moisture, odors, and mildew from gaining traction in your car interior or trunk.

Car Storage: We can help prepare your vehicle for a long nap. See pages 52-53 for battery managers and chargers, and fluid extractors. Use a custom-made or disposable car cover (p. 50) to protect your exterior from months of settling dust.

Whether you're preparing your car for the changing weather or for a seasonal nap, we're here to lend a hand.

Richard - Richard Griot



STAY CLEAN
DISPOSABLE CAR COVER
92511



STAY FRESH
STINKY-BE-GONE™
92020



STAY DRY
AIR DRYER DESICCANT BAGS
92015



**FLAT-FREE
TIRE RAMPS**

Our ramps prevent flat spots and help tires hold their shape.

BATTERY MANAGER V

State-of-the-art technology to improve battery performance and longevity.

ANALOG TIRE INFLATING GUN

Maintain proper tire pressure especially during changing temperatures.

DISPOSABLE CAR COVER

Prevent settling dust, especially when woodworking or using aerosols.

A Long Winter's Nap

Every good mammal knows that the change in weather means it's time to store your summer treasures and prepare for winter. For Homo Sapiens Automoticus, winter storage means taking care of tires and fluids, keeping your battery healthy, and making sure the scourge of moisture doesn't damage or corrode any part of your prized vehicle.

Here's a glimpse of the tools you need for storage and maintenance.



STAY CHARGED
BATTERY MANAGER V
92232



STAY INFLATED
ANALOG TIRE INFLATING GUN
92553

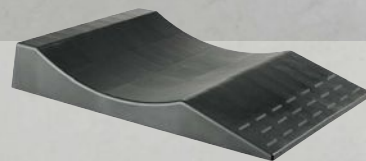

STAY IN SHAPE
FLAT-FREE TIRE RAMPS
36883

ROUTINE MAINTENANCE

They don't call it "Fall" for nothing. There's lots of debris falling and it can really affect the finish on your car. Keep it clean, and keep it protected. We'll provide the products to deep clean your car, decontaminate your paint, and add a protective finish that will give you a highly reflective shine.

| 2018 BMW M2



▶ **ULTIMATE WASH,
WHEEL & TIRE KIT
11365**





HOSE & BUCKET • ½ oz : 1 gal
▶ SUPER CONCENTRATED CAR WASH pH balanced and safe for wax and all finishes. Lifts dirt while preventing swirls and scratches.
11102 16 oz.
11103 Gallon



HOSE & BUCKET 1 oz : 1 gal
▶ BEST OF SHOW® WASH & WAX A deep clean and a stunning shine in one step. Removes dirt, and leave a layer of carnauba wax protection.
10974 16 oz.
10887 48 oz.
11396 Gallon



HOSE & BUCKET • 2 oz : 1 gal
NEW ▶ CERAMIC WASH & COAT Add SiO₂ ceramic protection as you wash. Low-sudsing and lubricant-rich. Use in conjunction with our other ceramic products.
10885 48 oz.



HOSE & BUCKET • 1 oz : 1 gal
▶ BRILLIANT FINISH™ CAR WASH Special brighteners provide a lasting high-gloss and streak-free finish. Premium concentrated formula yields rich, cleansing suds.
10866 64 oz.



REDUCED WATER • 1 oz : 2½ gal
▶ RINSELESS WASH & WAX Wash indoors or out, no rinsing required. Hydrophobic polymers and carnauba wax formula is ideal for in-garage washing, apartment dwellers, and rust-prone classic cars.
10493 16 oz.
10497 Gallon



REDUCED WATER • 1 oz : 1 gal
▶ BRILLIANT FINISH RINSELESS WASH Wash your car from a single bucket; no hose needed. Advanced polymer technology gently traps dirt in your towel for a streak-free finish.
10939 64 oz.



WATERLESS
▶ SPRAY-ON CAR WASH Get a quality spray-and-wipe car wash in minutes. Spray-On Car Wash soaks in and breaks up light dirt and road grime, then wipes away to reveal clean, shiny paint. Great for in-garage car cleaning. **10984 22 oz.**
11065 35 oz. • 11066 Gallon
SPRAY-ON CAR WASH KIT 11353 (35 oz Spray-On Car Wash, 2 PFM® Terry Weave Towels)
REFILL KIT ADD-ON OPTION Adds a refill gallon and Bottle-Top Funnel



The Best of the Basics

1. **▶ ULTIMATE CAR WASH BUCKET**

6-gal. capacity with a lower grille that keeps your mitt away from dirt. Upper grille holds wash tools.

67255

2. **NEW MICROFIBER PLUSH EDGELESS WASH CLOTHS**

This plush microfiber glides across body panels to lift dirt and grime without scratching.

10295, Set of 2

3. **▶ MICROFIBER WASH PADS & MITTS**

Designed to hold suds, clean thoroughly and easily rinse clean.

11290 Pads

10268 Mitts

4. **BOARS' HAIR DETAILING BRUSH**

9½" polypropylene handle with gentle 2½" boars' hair for precise interior/exterior detailing. **15517**



5. **BOARS' HAIR WASH BRUSH AND TELESCOPING POLE**

Loosens dirt and easily rinses clean. Split-end bristles are gentle on paint. Telescoping pole has 73" reach.

10274

6. **STARTER CAR WASH KIT**

Protect paint with the finest Car Wash, two ultra-soft Microfiber Wash Mitts, and the Ultimate Wash Bucket.

11327



7. **▶ COLLAPSIBLE SILICONE BUCKET**

Adjusts to two sizes; holds up to 2.5 gallon. Collapses to 2" high.

66004

8. **WASH MOP STICK KIT**

Holds tons of suds. Pole extends from 44" to 73". Two mop heads included.

78306

WASH MOP HEADS

78306C Set of 2

The Basis of Efficient Maintenance

THE BEST CLEANING TOOLS ARE KEY TO PROTECTING YOUR INVESTMENT

PROFESSIONAL WATER HOSE Our zero-memory, no-frustration design allows this hose to lay flat so it won't work against you. Kink-defiant, abrasion-resistant outer shell, and crush-resistant, anodized aluminum ends. Extreme-weather flexibility makes it easy to coil in temperatures as low as -40°. Inside diameter is 3/8". Uses 3/4" GHT fittings. **94759** 60 ft. 100 ft.



THE FINEST WATER HOSE NOZZLE Delivers even spray patterns and won't leak or break like the knock-offs. Based on firefighter gear, ours has a soft rubber surround to protect paint from accidental hits. Tough solid anodized aluminum body and stainless steel internals. **92548**

BEST IN FLOW VALVE & FINEST NOZZLE KIT By combining the Finest Nozzle with our all-new Best in Flow Valve, there's no need to reset your nozzle every time you start water flow. Just press the valve and spray. **11512** **50044** Best in Flow Water Valve **84024** Quick Disconnect Set

Kit Includes:

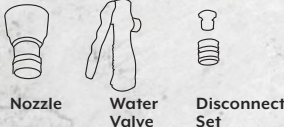

MANUAL PRO WATER HOSE REEL This high-quality reel holds up to 125 ft. of 3/4" hose and can lock in place or rotate 360 degrees. It's made with powder-coated 18-gauge steel and has brass and galvanized fittings. Keep hose accessories close at hand in the storage basket. Easily detach the reel for winter storage. **92529**

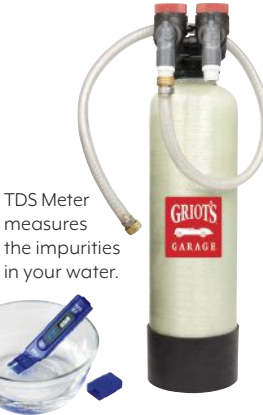

PORTABLE WATER DEIONIZER Hard water leaves a ring of corrosive sediment that can etch paint. Our deionizer dissolves most water impurities to eliminate spots. To prolong resin life, you can bypass the filter when you're not washing your car. Water is considered "hard" above 170 ppm total dissolved solids (TDS). Use our TDS Meter to test your water. **37201A** **37299** Replacement Deionizer Resin **33480** TDS Water Meter



IN-LINE WATER SOFTENER AND DEIONIZER Hard water leaves water spots when it dries. Wash and rinse with truly clean water. Filled with green deionizing crystals that turn purple when it's time to replace the filter. 14" long, 4 1/4" in diameter. **37244** **37244A** Replacement Filter

Protect Paint With Touch-Free Cleaning

BOSS™ FOAMING SYSTEM



We designed our innovative BOSS Foam Cannon to help you avoid wash-induced scratches and deliver superior gloss and protection. In addition to long-lasting performance, the system is a fun way to keep your car spotless. Powered by a pressure washer, the cannon's nozzle adjusts from a 0-degree stream for long-range use on trucks and RVs to a wide spray up to 40 degrees. Our exclusive Auto-Mix feature saves time: no hand mixing or math required. Just screw in a bottle of concentrate and use one of the included Sure-Flow Metering Tips for the proper ratio. Made with a stainless steel manifold that resists corrosion common with standard brass designs. Included: a Stainless Steel Quick Disconnect Coupler and a 1.1 Primary Jet for lower output pressure washers.

BOSS™ FOAM CANNON BF302



SURE-FLOW METERING TIPS B3006 Set of 6



▶ **BOSS™ FOAMING SYSTEM STARTER KIT** The perfect complement to your pressure washer, this kit helps you avoid wash-induced scratches while you add gloss and protection. Includes our amazing, extra-large PFM® Drying towel. **B4001**



▶ **BOSS™ FOAMING SYSTEM COMPLETE KIT** This kit works with your pressure washer to deliver more touch-free cleaning from scratch. Includes a secondary bottle for Foaming Surface Prep. **B4003**

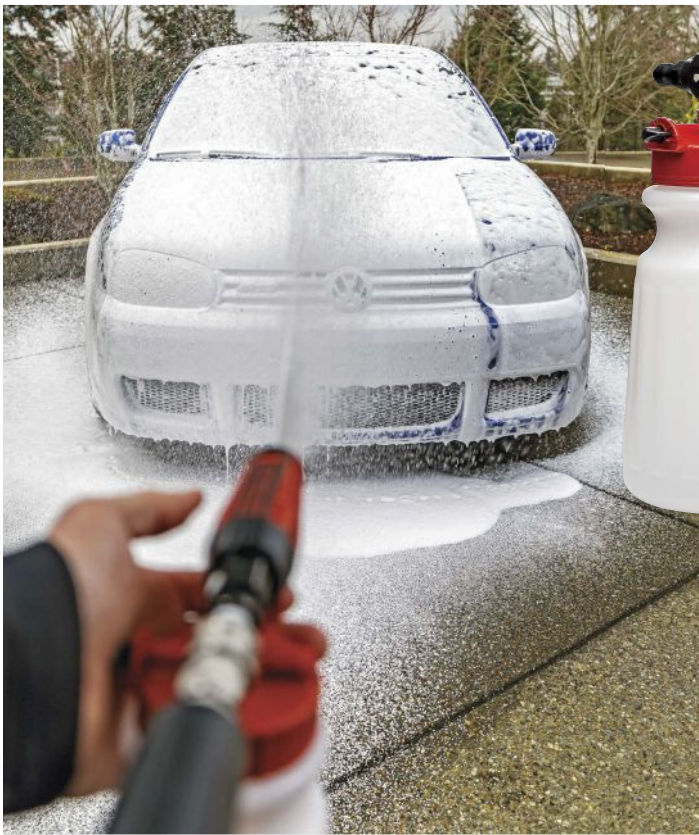

Introducing Our Newest Weapon

NEW BRILLIANT FINISH™ FOAM CANNON We've designed a new foam cannon to assist in your ongoing campaign against dirt and grime. Our Brilliant Finish Foam cannon is precision machined and lightweight with an electroplated, rifled aluminum manifold for ultra-dry foam. Its wide-based jar resists tipping and the cannon is easier to grip. Adjustable foam output dial delivers exactly the consistency of foam that's right for you. **51185**



NEW BRILLIANT FINISH™ FOAM CANNON ENTHUSIAST KIT With this kit and your pressure washer, you can begin basic maintenance with touch-free cleaning and minimal-touch drying. **55739**

Formulated For Foam-Cleaning Efficiency

CLEAN AND PROTECT YOUR VEHICLE WITH THE INDUSTRY'S BEST FOAMING SOLUTIONS

▶ **FOAMING SURFACE PREP** Our Surface Prep deep cleans with a high pH formulation to break down waxes and sealants, providing a clean surface for paint correction or to add a new wax basecoat. Dilute in a secondary bottle for a spray-on cleaner.

B3103 35 oz. • B3101 Gallon
B3110 10:1 Secondary Bottle + Sprayer

▶ **FOAMING SURFACE WASH** Our pH-neutral formula deep cleans and prolongs the life of waxes and sealants. Dual-layer foam formula features a layer that clings to the paint to loosen and encapsulate dirt, and a second layer that releases and carries it away.

B3203 35 oz. • B3201 Gallon

▶ **FOAMING POLY GLOSS** Seal your flawless finish. Foaming Poly Gloss delivers water-repelling protection, intense gloss and a slick touch. Dense, clinging suds contain hydrophobic polymers that enhance and protect exterior paint, glass, wheels, and trim while enhancing waxes and sealants.

B3303 35 oz. • B3301 Gallon





A. ▶ NEW 3000 PSI HD ELECTRIC PRESSURE WASHER Our newest pressure washer has a 15-amp, 1800-watt induction motor that's more powerful, longer-lasting, and super quiet. It generates water pressure up to 3000 psi, delivering 1.3 gallons of water flow per minute. Includes easy-squeeze gun, 25' hose, 4 nozzles, a rotary turbo nozzle, and a 23" lance extension. See complete details online. **81267**

81305 25' High Pressure Extension Hose

B. ▶ 2300 PSI ELECTRIC PRESSURE WASHER The ideal companion for applying our BOSS Foaming system. Also great for cleaning driveways, decks and fences. The 13-amp motor generates up to 2,300 psi with 1.5 gal./minute flow. Includes couplers, turbo tip, 4 nozzles, detergent tank, 35' power cord, and 25' pressure hose. Equipped with disconnects. See full details online. **81253**



- Washer detaches from cart for added portability.
- Industrial-strength induction motor runs quieter, lasts longer.

81305 25' Extension Hose

81333 Pressure Washer Wall Mount and Hose Kit

Foam-Cleaning Alternatives

NO PRESSURE WASHER? NO PROBLEM



▶ BRILLIANT FINISH™ FOAMING SPRAYER Protect your car's finish and get the benefits of foam cleaning for a safe, thorough wash without a power washer. After applying the foam wash, detach the jet and reservoir with the quick-release to free the included pistol-grip nozzle and speed up the rinsing process. **51140**



▶ PUMP-UP FOAMER Deep clean and supercharge cleaners and degreasers by creating a clingy foam for extended dwell time and deep-cleaning. Our Pump-Up Foamer holds 60 oz. and produces up to 43 psi. Ideal for paint, trim, engines, wheels, undercarriage, carpet, upholstery, leather, convertible tops, and more. Save time and effort and maximize cleaning power. **77584**



▶ AIR FOAMER SUDSING GUN This pro-grade, pneumatic tool produces amazing foam for interior and exterior cleaning. Includes a 33.8 oz. reservoir. Fill with any ready-to-use foaming cleaner, carpet and upholstery cleaners, non-acidic wheel cleaners, Engine Cleaner, and more! Our 22 oz. and 35 oz. bottles can be directly attached. **51183**



Griot's Microfiber

THE BEST IN CLASS
FOR ANY TASK

A. MICROFIBER EDGELESS TOWELS
Paint Safe Multi-Use • 320 GSM
16" x 16", Set of 6 **14902**

B. DUAL WEAVE INTERIOR TOWELS
Interior/Leather • 400 GSM
16" x 16", Set of 3 **10282** See pg. 34

C. PFM® TERRY WEAVE TOWELS
Paint Safe Multi-Use • 1,120 GSM 16"
x 16". **55586** Set of 2

D. NEW PFM® CRINKLE GLASS TOWELS
Glass/Windows • 570 GSM
16" x 16", Set of 3 **55583** See pg. 37

E. PFM® DUAL WEAVE GLASS TOWELS
Glass/Windows • 870 GSM
9" x 9", Set of 4 **55582** See pg. 37

F. PFM® DUAL WEAVE WAX REMOVAL TOWELS
Wax/Polish Removal • 450 GSM
9" x 9", Set of 4 **55525** See pg. 30

**J. NEW PFM® EDGELESS DETAILING
TOWELS** Exterior Detailing • 1,120 GSM
16" x 9", Set of 3 **55527** See pg. 21

GSM (grams per square meter) is the standard measurement for weight and quality of fabrics. Higher GSM means better absorbency and lift capabilities.



MICROFIBER & FOAM PAD CLEANER

Release and remove residues to revitalize your microfiber towels and cloths when you launder them. Wash separately from other fabrics. Use 2-4 oz. per load.
11078 35 oz.
11067 Gallon



ULTIMATE MICROFIBER TOWEL KIT

Our broadest selection of microfiber products saves you a bundle. You'll be ready for any drying, detailing, waxing, interior cleaning, or workshop job. Includes a 35 oz. Microfiber & Foam Pad Cleaner to keep towels working like new. **11338**

WHEEL CLEANING

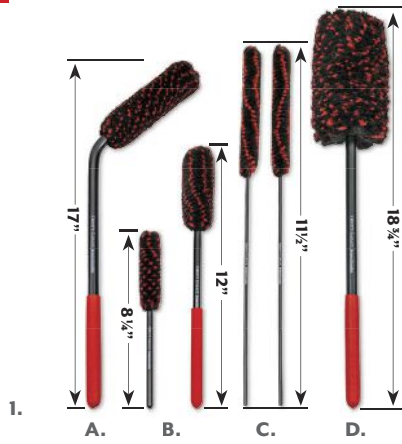

1.



4.



7.



2.



5.



8.



3.



6.



9.

1. **MICROFIBER WHEEL WANDS** Reach the deepest crevices in wheels, grilles, under rocker panels, and in engine bays.

- A. **15568 Large 45° Wand**
- B. **15704 Two Wand Set**
- C. **15712 MicrofiberVentandG rille Brush, Set of 2**
- D. **15541 Extra-Large Wand**

4. **THREE-FINGER DETAIL MITTS** Highly maneuverable and sewn inside to ensure safe cleaning. **11838 Set of 2**

7. **LUG NUT CLEANING BRUSH** The perfect tool for removing brake dust and grime around inset lug nuts. **15597**

2. **LONG-REACH BRUSHES** Soft, porous synthetic material. Wedge shape allows you to get into small areas. 12¼" long. Great for wheels (including wide wheels). **15736 Set of 3**

5. **WHEEL WASHING KIT** Bucket holds up to 2½ gallons, collapses to 2". Kit includes 35 oz. of Heavy-Duty Wheel Cleaner, two Three-Finger Detail Mitts, and Extra-Large Microfiber Wheel Wand. **11399**

8. **WHEEL CLEANING KIT** This money-saving kit includes all the scrub tools to remove stubborn dirt and brake dust from your wheels. Safe for all wheels, including painted wheels. Environmentally safe. **11224**

3. **BENDABLE WHEEL BRUSHES** Large is 18" long with a 9" x 4¼" brush (1⅞" long bristles); compact is 13" long with a 5½" x 2½" brush (1" long bristles). Sold individually. **15524 Large**
15690 Compact

6. **HEAVY DUTY WHEEL CLEANING KIT** Make quick, easy work of removing road grime and brake dust from your wheels. **11318**

9. **NEW MICROFIBER WHEEL WASH MITTS** These four-fingered mitts are designed for cleaning delicate wheel faces. We've blended a non-abrasive scrubbing fiber with microfiber to safely release brake dust and road grime. **11820 Set of 2**

The Worst Job Made Easy

Loosening and cleaning brake dust and road grime from wheels is difficult and time-consuming, especially when wheels have recessed edges and grooves where dirt builds up. Our superior wheel cleaning products safely loosen and remove even the most stubborn grime.



SINCE 1990

▶ **WHEEL CLEANER** Premium biodegradable ingredients and safe for all types of wheels. Its high concentrate allows the cleaner to hang on the wheel longer to soften brake dust, road oils, and other deposits. Approved by BBS,[®] Dayton Wire Wheel Company,[™] and The Tire Rack.[®] Available in a 35 oz. kit with a Long-Reach Brush and a pair of Three-Finger Detail mitts. **10970 22 oz.** • **11106 35 oz.** • **11107 Gallon**
11224 Kit

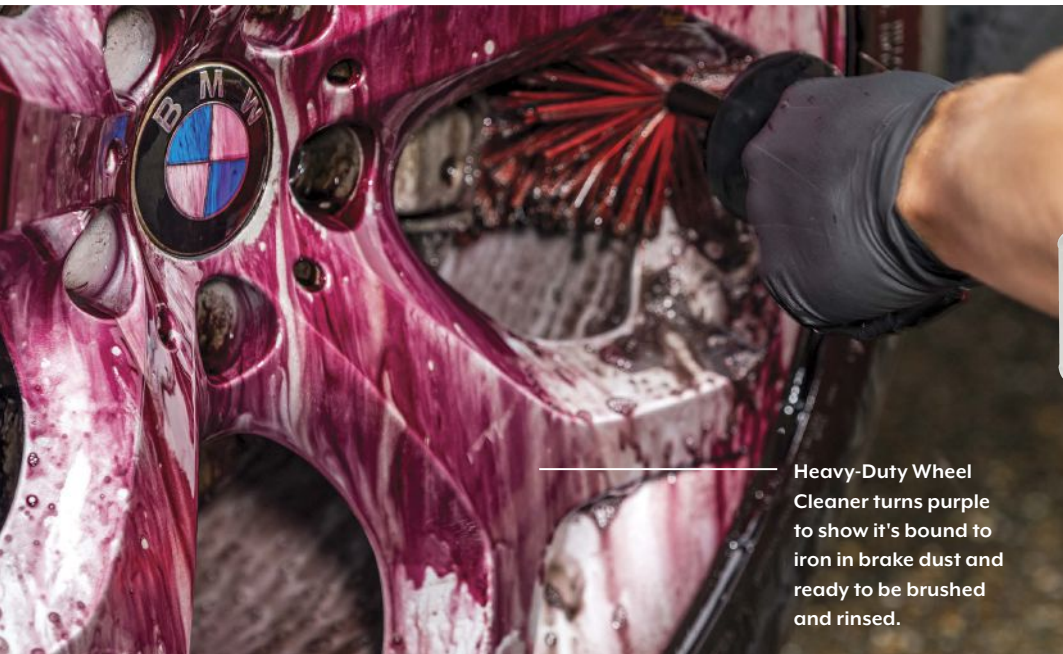

Heavy-Duty Wheel Cleaner turns purple to show it's bound to iron in brake dust and ready to be brushed and rinsed.



▶ HEAVY-DUTY WHEEL CLEANER

Our updated cleaner turns purple to show it's binding with iron-based brake dust, then releases the dust and other road grime from the surface of your wheels. Though it's our toughest wheel cleaner, the formula is non-acidic and non-caustic so it's safe on any wheel type. Kit: 35 oz. bottle, 3 Long-Reach Wheel Scrubber Brushes and 2 Three-Finger Detail Mitts. **10973 22 oz.**
11026 35 oz.
11027 Gallon
11318 Kit



SPRAY ON THOROUGHLY



LET SIT & GENTLY AGITATE



RINSE CLEAN

Drying Techniques to Protect Your Vehicle's Paint

Drying is where many scratches, swirl marks, and other blemishes can be introduced to your car's finish. That's why we've developed a number of paint-safe drying options. From our Airstream Drying Gun to our reliance on microfiber technology, our thoughtful drying products are designed to ensure paint perfection.



GRIOT'S GARAGE TIP
ENHANCE YOUR DRYING... AND ADD PROTECTION.

These products make drying your vehicle easier while adding some additional protection after each wash.



A. 8-PEAK HP AIR BLOWER Cut drying time by up to 80% with super-safe no-touch, swirl-free drying. Features two 4-hp motors, each controlled by a separate switch. Includes a flexible, 30' hose and five handy attachments. **15133**

C. LONG-REACH WATER BLADE Remove 90% of the water on your car in a single swipe. The Y-blade design hugs the contours of curved car bodies without catching. Rigid, plastic handle with a 14" long Y-blade. Double up with a blade in one hand and a drying towel in the other for fast car drying. **82165**

B. AIRSTREAM DRYING GUN Cuts drying time up to 75%. Thorough drying also deters oxidation and rust. Includes a powerful 1.3 peak hp motor, hard plastic air flare and soft rubber nozzle. 9½" tall; ¾ lbs. Made in the U.S.A. **15035**

AIRSTREAM DRYING GUN UPGRADE KIT 15035K



D. MICROFIBER WIPE DOWN TOWEL Dry and clean those hidden, dirty areas of your vehicles, such as wheels, doorsills, gutters, trunk and hood channels, and doorjamb. This super-absorbent 18" x 24" towel has a classic, waffle-weave pattern that holds a ton of water. Machine wash. **11239**

REMARKABLE TOWELS THAT MAKE A REMARKABLE DIFFERENCE

Does someone really need a special towel to dry a car? One pass of a Griot's microfiber towel results in a true eureka moment and a dry surface. Yes, it's truly worth it.

E. ▶ THE EXTRA-LARGE PFM® EDGELESS DRYING TOWEL Unleashes 1,044 square inches of thirsty ultra-premium microfiber. You'll love how its massive 29" x 36" size, double-ply construction, and 1,120 GSM (grams per square meter) weight can dry even large vehicles like SUVs, trucks, and RVs quickly and with minimal wringing. Edgeless design for maximum safety. **55596**

F. ▶ PFM® TERRY WEAVE DRYING TOWEL This towel combines 1,120 GSM material, a 25" x 35" size, and our innovative long-loop PFM weave to give you the speed and convenience of one-pass, streak-free "matador style" drying. Curved satin edges for scratch prevention. **55590**

G. ▶ MICROFIBER TERRY WEAVE DRYING TOWEL This 25" x 35" drying towel has a tight, terry loop weave. The premium-quality 550 GSM weight microfiber is soft, super absorbent and delivers streak-free drying. The single-ply design is easy to wring out. Curved satin edges increase durability and prevent scratches. **55517**

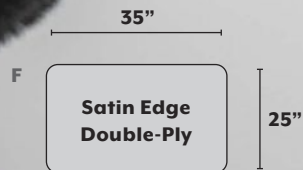
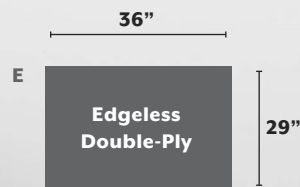

GRIOT'S GARAGE TIP

OLÉ!

To protect your paint, we've created microfiber drying towels with such a high degree of absorbency, they dry with just one pass. We recommend drying "matador style" for best results. Drape the towel over the wet surface and simply pull it toward you. That one pass is all that's needed to dry the surface of your roof, hood, and trunk.

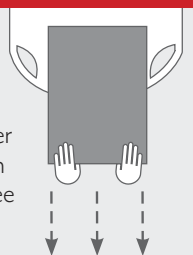

Rubber & Trim: Prep, Clean, Protect

Tires are often the most neglected part of exterior car care. Once you've cleaned your paint and then polished and sealed your glass, it's time to give your rubber and trim surfaces some needed attention. Whether you prefer a clean natural appearance, a satin finish or a high-gloss shine, we can help you clean, prep, and dress for success.

Many of these products can also be used on rubber trim, wheel wells, and more.

▶ To see the process, or to get help deciding what's right for your vehicle, see our videos online under the "How-To" section, "Wheels & Tires."

For a tire dressing to work well, the rubber must first be cleaned and stripped of silicones, sealants, waxes, oils, greases, and dressing residue. These three liquid products prep your tires and set the stage for success.

Curved bristle pattern deep cleans along a tire's contours.



Contours to clean vinyl, plastic, leather, rubber, paint and more.

1. TIRE SCRUBBING BRUSH This brush's ergonomically correct handle and robust nylon bristles help power away stubborn road grime deposits. **15540**

2. ▶ FOAMING TIRE CLEANER Powerful foam cuts through stubborn brake dust and road grime. Safe for use on nearly any type of tires. **10952**

3. ▶ RUBBER CLEANER With a quick mist and gentle scrub, this surfactant-based cleaner releases silicone and wax residues from tires. **11136 35 oz.**
11137 Gallon

4. ▶ RUBBER PREP This solvent-based produces a deep clean for neglected, dirty tires. Also use when changing the tire dressing you use. **11071 16 oz.**

5. ERGO WAVE FOAM SCRUBBER Rugged open-cell construction resists tears and contours to surfaces. Use for prepping tires for dressing. **10520**



NEW TRIM & DETAIL COATING Restores, and protects trim, plastic grilles, rubber engine bays, door jambs and more. Just spray on and walk-away. Non-greasy, UV protection. **10946 12 oz.**



▶ UNDERCARRIAGE SPRAY Easily detail wheel wells, frame, springs, and other black items beneath your vehicle. **10987 22 oz.**
11139 Gallon



NEW ▶ CERAMIC TRIM WIPES These wipes restore and protect damaged and faded trim. ASTM-tested up to 200 washes or two years, they offer extreme UV and stain resistance. **11524 4-count**



▶ BLACK SHINE™ TRIM RESTORER & APPLICATOR Restore and protect weathered hard plastic, rubber, vinyl bumpers, and trim. Applicator included. **10858 8 oz.**

Natural, Satin or High Gloss

PROTECT YOUR TIRE SURFACES AND GET THE LEVEL OF VISUAL SHINE YOU PREFER



VINYL & RUBBER DRESSING NATURAL. Gives your tires a natural look. Also great for interior and exterior trim. **10981 22 oz.**
11175 Gallon



LONG-LASTING TIRE DRESSING SATIN GLOSS. Durability and shine increase with each coating. Our most durable option. **11044 16 oz.**



BLACK SATIN TIRE COATING SATIN. Quickly dries to a non-greasy finish. Provides great durability against rain. Resists slinging. **10951 15 oz.**



BLACK SHINE HIGH GLOSS TIRE GEL HIGH GLOSS. Goes on smooth for high gloss with minimal sling and no overspray. **10995 16 oz.**



BLACK SHINE HIGH GLOSS TIRE SPRAY HIGH GLOSS. Spray on; the longer it sits, the glossier the result. Use applicator for more subdued look. **10957 22oz.**
10958 Gal.



BLACK SHINE TIRE AND TRIM COATING HIGH GLOSS. Our premium, highest gloss dressing. Aerosol delivery. **10938 15 oz.**
10850 21.5 oz.



BLUE DETAIL SPONGES
These popular applicators are sliced in the middle, so they're easier to hold. Rinse clean, wring out, and reuse. **11205 Set of 2**



3" BLUE APPLICATOR PADS
Great for applying liquid, gel and cream dressings. Hook-and-loop back for use with our Contour Grip 3" Pad Holder. **11249 Set of 3**



CONTOUR GRIP 3" PAD HOLDER
Hook-and-loop base holds any 3" pads for waxing, defect corrections or application of dressings. Made of firm, dense foam. **10621**



TARGET TIRE DRESSING KIT
Target-patterned recesses and large-cell foam conform to the tire's sidewall to apply thin, even coats to your tires. **50524**

Save a Bundle!

We've removed the guesswork by assembling the products you need to get started and save money.



A. STARTER CAR CARE KIT Here are the finest, most-used car care products in one money-saving kit. Perfect to get any first-timer started, or an easy way for long-time customers to stock up on their favorite essentials. **11131**



B. MOBILE WASH KIT Everything you need for a full wash and dry on the road with our collapsible bucket. Perfect for car shows. **11366**

Collapses to an ultra-compact, easy-to-store size.



C. YOUR FAVORITES GALLON COLLECTION Save money and reduce waste when you purchase by the gallon and refill your spray bottles. Stock up so you always have the products you need in reserve. **11356**

D. RINSELESS WASH & WAX KIT Get a great wash in a fraction of the time of a traditional wash. With its perfect blend of hydrophobic polymers and carnauba wax, you get jaw-dropping paint while also enhancing gloss and protection. Use 1 ounce in 2½ gallons of water when you wash or dilute at 15:1 for use as a pre-spray on stubborn road grime. **11381**



BRILLIANT FINISH™ RINSELESS WASH KIT Everything you need for a safe, effective cleaning from a single bucket, no hose required. **11405**



MASTER CAR CARE KIT After years of listening to our customers' needs, we've assembled a hand-picked collection of our finest car care products. Our Master Car Care Collection includes everything you need to detail your vehicle from start to finish. From washing and waxing to window and wheel cleaning. Even tire dressing and leather care. You get it all! Start enjoying car care perfection today at a huge savings.

11391

CONCOURS LAWN KIT The essentials you'll need to prep before, during, and after car shows and road trips. Products fit nicely in our nifty Concours Bag. Built tough and water-resistant, with mesh pockets outside and elastic straps inside. Measures 13½" x 7½" x 10½".

11389



WEEKEND THERAPY KIT This kit makes it easy to wash and dress the key surfaces of your car for glistening results. You get perfectly matched car care products for every exterior surface of your car and save time and money.

11398



G9 ORBITAL MASTER KIT Polishing and waxing your paint has never been easier, safer and more fun. Here's everything you need to clean and detail from start to finish, inside and out. This popular kit takes the guesswork out of selecting the proper products AND saves you tons of money! We've upgraded this kit with our new, feature-rich G9 Random Orbital Polisher.

G1105





PAIN T CARE

ELEVATE YOUR SHINE STANDARDS

The bright, reflective, glossy shine you've given your paint is your badge of honor. It's dazzling visual proof of the work you've put into caring for your vehicle. To get and maintain it requires more than occasional washing. We offer the prep cleansers, the paint decontaminating products, the polishing tools, and the natural or synthetic waxes to help you achieve brilliance.



★★★★★ “I’ve been using this product on my daily driver Mustang (even in the winter) to clean it. I have won several trophies and recently won where I was judged on how clean the vehicle was – received perfect score and could not have without Griot’s Help!” – **MIKESADLER67**



SINCE 1990

▶ **SPEED SHINE®** It's the must-have, go-to, daily dust and dirt cleaner that extends the time between major washings. Thanks to its superior lubricity, Speed Shine is also an excellent lubricant for use with our surface prep products on pages 22-23. Speed Shine® will detail your car in five minutes. Safe for all finishes; use in shaded areas. Works best with our blue PFM® Detailing Towels. **10950 22 oz.**

11146 35 oz. • 11148 Gallon

PFM® SPEED SHINE® KIT 35 oz. Speed Shine and a set of 3 PFM Edgeless Detailing Towels **11369**

PFM® SPEED SHINE® KIT + REFILL Adds Speed Shine® gallon + Threaded Bottle-Top Funnel **11293**

▶ **BEST OF SHOW® DETAILER** Our premium detailer is a quick, easy way to add pop to paint. Advanced polymers add incredible color, depth, and clarity to paint, chrome, or trim while eliminating dust, fingerprints, and light dirt between washes. We've formulated it to be used in direct sunlight, so it's great for using at car shows.

10980 22 oz. • 11042 Gal.



NEW ▶ **CERAMIC SPEED SHINE®** The best spray detailer now offers ceramic protection. Our exclusive blend of advanced silane polymer technology delivers an ultra-slick, high-gloss finish that's safe on all exterior surfaces. **10945 22 oz. • 10986 Gallon**

| 1963 Lincoln Continental



NEW PFM® EDGELESS DETAILING TOWELS 1,120 GSM. 16" x 9", Set of 3 **55527**



▶ **MICROFIBER PLUS EDGELESS TOWELS** Our softest microfiber, these 16" x 16" 470 GSM towels are great on delicate finishes. Use them with our Spray-On Car Wash, Speed Shine®, Best of Show® Spray Wax, and Best of Show® Detailer. **14901 Set of 6**

Paint Contaminant Removal Techniques

Decontaminating paint is the easiest, most dramatic and most satisfying step in paint care. It quickly takes your surfaces from feeling rough and dull to super slick and smooth. The difference is astounding.



1 SURFACE PREP

Use Foaming Surface Prep to strip organic contaminants and old wax. Apply with any of our foaming tools.



2 LUBRICATE & GLIDE

Apply a lubricating wash and glide Paint Cleaning Clay or our synthetic clays in a crosshatch pattern over all exterior surfaces. Wipe away contaminants.



3 PROTECT

Apply a protective finish to protect paint. Waxes, synthetics or ceramic

NOTE: On heavily contaminated surfaces, use Iron and Fallout Remover.

B
Up to 70 cars

A
Up to 7 cars

G
Up to 60 cars

F
Up to 21 cars

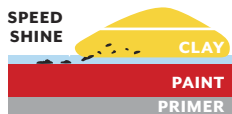

Paint Cleaning Clay safely lifts away contaminants that washing alone can't.

A. PAINT CLEANING CLAY Our clay bar picks up and holds bonded contaminants such as iron, sap, tar, severe water spots, and grime. Use Speed Shine® as a lubricant. **11153 8 oz.**

PAINT CLEANING CLAY KIT
8 oz. (226 g) clay bar and a 35 oz. Speed Shine®. **11145**

COMPLETE PAINT CLEANING CLAY KIT
8 oz. (226 g) clay bar, a 22 oz. Speed Shine®, and three PFM® Detailing Towels. **11255**

POLYMER/CLAY MATRIX These products are the fastest, most effective way to remove stubborn above-surface contaminants like iron fallout, tree sap, bugs, and grime. Use it on exterior paint, glass, chrome, and plastic. Our patented diamond-patterned matrix lasts up to 10 times longer than a traditional clay bar. Choose from these options:

B. FINE SURFACE PREP MITT Measures 5½" x 7½" for quickly working the whole car. **10678**

C. FAST SURFACE PREP MITT For ultra-fast contamination removal and more stubborn embedded debris. Measures 5½" x 7½". **10679** (Includes Free 22 oz. Speed Shine®)

D. NEW 3" SURFACE PREP PAD Efficiently decontaminate your paint with your random orbital. Removes fine to severe contaminants like industrial fallout, tree sap, water spots and more. **10669**

E. 6" SURFACE PREP PAD For our random orbitals. **10680**

F. NEW SURFACE PREP TOWEL This flexible edgeless microfiber prep towel follows contours to remove contaminants on paint, glass, chrome and wheels. **55592**

G. BRILLIANT FINISH™ SYNTHETIC CLAY Includes foam palm pad for easy use. **10691** (Includes Free 22 oz. Speed Shine®)

C
Up to 70 cars



D
Up to 40 cars



E
Up to 25 cars



H



I



J



H. ▶ IRON & FALLOUT REMOVER

Chemically dissolves embedded iron brake dust and fallout from paint, wheels, glass, stainless steel, and chrome. Its acid-free, pH-balanced gel clings to work longer, and changes color as it works. Can also be dispensed via THE BOSS™ Foam Cannon. **10948 35 oz.** • **10949 Gal.**

I. ▶ FOAMING SURFACE PREP Part of our popular BOSS™ Foaming System, Foaming Surface Prep strips away dirt and wax to prepare paint for decontamination. Apply with any of our foaming tools (p. 8-9). It can also be mixed in our Secondary Spray Bottle. **B3103 35 oz.** • **B3101 Gallon B3110 10:1 Secondary Bottle, 35 oz.**

J. ▶ SURFACE PREP MITT KIT All you'll need to remove above-surface micro contaminants— the clay, the lubricant, and the towels for the final wipe down. **11387**

▶ SPEED SHINE® An ideal lubricant to use with our decontaminating clays and pads. Mist, rub, and wipe contaminants away. **11146 35 oz.**



GRIOT'S GARAGE TIP

LUBRICATION DILUTION

It's important to use a lubricant during the decontaminating process. Use any of these products, diluted as shown here.

- **Speed Shine®** Spray on undiluted
- **Super Concentrated Car Wash** 1:256, ½ oz./Gal. (typical wash dilution)
- **Brilliant Finish™ Car Wash** 1:128, 1 oz./Gal. (typical wash dilution)
- **Brilliant Finish™ Rinseless Wash** 1:6, 6 oz./35 oz. bottle
- **Rinseless Wash and Wax** 1:15, mix in dilution bottle

Paint Correction 101: The Introduction

THE SAFE WAY TO ENHANCE AND BEAUTIFY YOUR PAINT

Are you ready to take the next step toward creating a brilliant, glossy finish? Welcome to paint correction, the process that smooths and levels the paint to optimize its reflective properties. To start, we recommend our G9 orbital (sold on p. 26). With it, any beginner can correct and polish paint without causing damage. Your paint's condition will determine the pads and creams you choose.

📷 Erik Johnson, Image Detailing



ALWAYS place pad with polish or compounds against the paint before starting the orbital. Otherwise, you'll Jackson Pollock your garage.



HEAVIER DEFECTS



LIGHT/MODERATE DEFECTS



MINOR DEFECTS

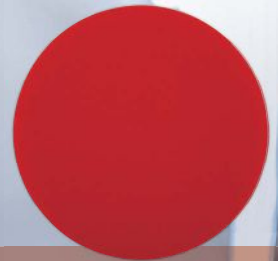

WAXING/SEALING

Choose the Right Pad For Your Vehicle's Paint Needs

MICROFIBER FAST FINISHING PAD

Speed, versatility, and precision are what gives these pads superior defect removal and finishing capabilities.

Tough on scuffs and faster than foam.

10426W 6.5" Pad

ORANGE FOAM CORRECTING PADS

The dense, firm foam of these pads removes light to moderate defects using correcting liquids, BOSS™ Creams, or One-Step Sealant.

10617 6.5" Pads, Set of 2

10516 5.5" Pads, Set of 2

11241 3" Pads, Set of 3

BLACK FOAM FINISHING PADS

Multi-purpose foam for fine polishes and sealants. Ideal for removal of fine swirls, scratches and light defects on the most delicate paint finishes.

10619 6.5" Pad, Set of 2

10518 5.5" Pads, Set of 2

11274 3" Pads, Set of 3

RED FOAM WAXING PADS

Ultra-soft foam for precise, even application of waxes and sealants. Ensures easy product removal with uniform color.

10624 6.5" Pads, Set of 2

10525 5.5" Pads, Set of 2

11263 3" Pads, Set of 3

Correct, Refine, and Polish Your Paint



PAINT REFINEMENT BEFORE PROTECTION

▶ COMPLETE COMPOUND™

Complete Compound™ is our front-line polish. Its cutting-edge formula smooths out moderate to severe scratches, swirl marks, and blemishes, restoring depth and vitality to paint. Apply with a Random Orbital or by hand. **10862 16 oz.**

▶ COMPLETE POLISH

Complete Polish provides fine correction for delicate paints or finishes presenting minor blemishes. A perfect follow-up to Complete Compound, its advanced sub-micron abrasives are gentle and effective, creating an ideal finish that's ready for sealant or wax. **10876 16 oz.**

ALL-IN-ONES: REFINEMENT PLUS PROTECTION

▶ LIQUID WAX 3-IN-1

Formulated with micro abrasives, Liquid Wax 3-in-1 is a bit more aggressive for light swirl removal, adding richness and depth to your paint, then seals it with long-lasting, carnauba-based protection. It's designed to achieve amazing results by hand, but also works great with machine application. **11013 16 oz.**

▶ ONE-STEP SEALANT

Produce spectacular results when time is of the essence and outstanding results are key. An incredible milder all-in-one, it is effective at removing fine scratches and swirl marks while imparting long-lasting synthetic polymer protection on all types of paint. **11075 16 oz.**

LET'S GET STARTED WITH PAINT CORRECTION



**G9 STARTER ORBITAL KIT
G1107**



**▶ G9 ORBITAL CORRECT
& PROTECT KIT
G1103**



▶ THE BOSS™ LED SWIRL-FINDER LIGHT This amazing light reveals paint defects. Its larger adjustable array generates up to 320 lumens and is temp-rated at 5000K to illuminate a wider spectrum. The adjustable 120 lumen, 6000K LED tip shows the finest imperfections. **B8000**



NEW PRECISION MASKING TAPES Protect your delicate trim and emblems when polishing. Our flexible, water-resistant washable masking tape easily follows curves. 3/4" or 1 1/2" widths. 54.7 yards.
82018 3/4"
82036 1 1/2"



▶ PAD CONDITIONING BRUSH A dirty pad can cause swirl marks or hazing. This uniquely shaped brush clears product buildup from your pads. Brushing also balances pad weight to reduce pad wobble. **15548**



NEW DETAILING APRON Protect your car and your clothing as you work. Stain and shrink resistant. Two pockets. Embroidered with the Griot's Garage logo. One size fits all.
777639

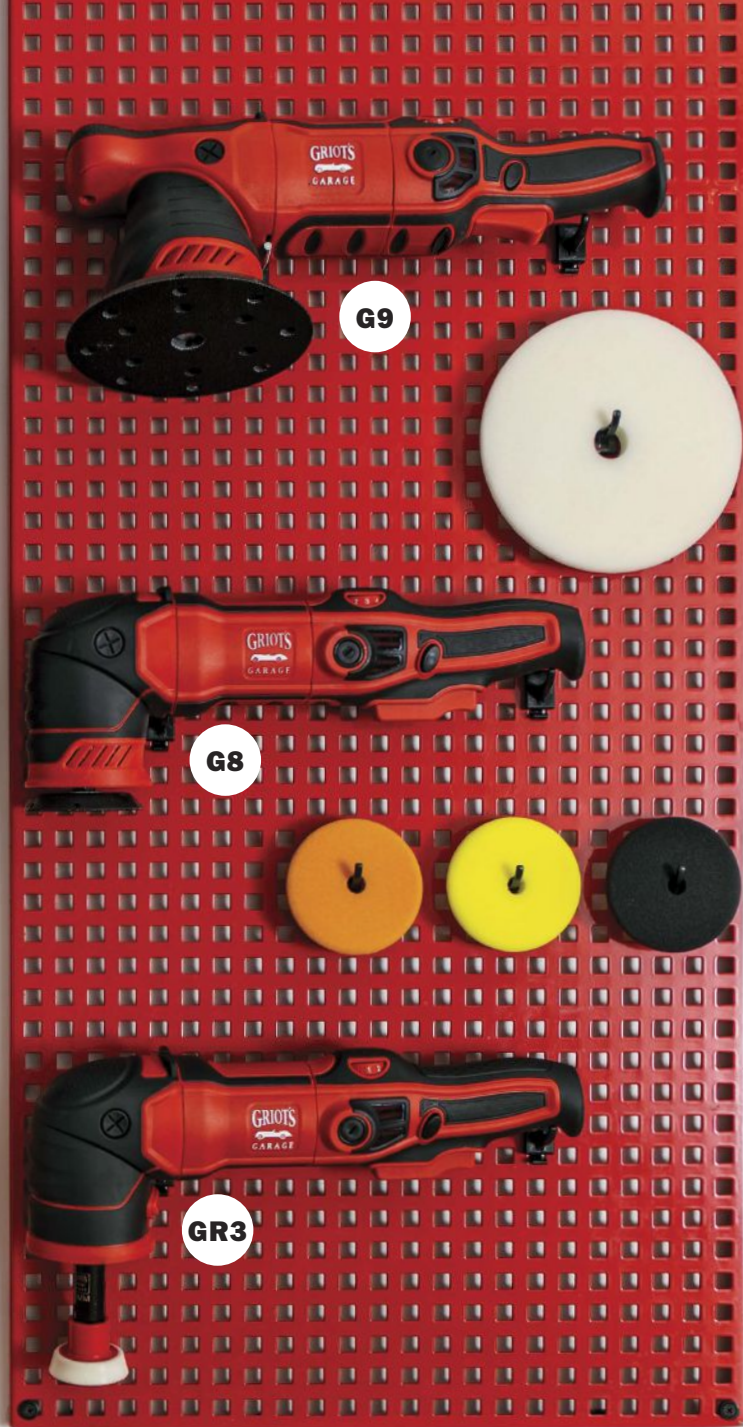

The World-Leader in Orbital Polishers

We've continually refined our orbitals to make paint perfection a fun and rewarding task. Our newest tools represent 28 years of improvement with better ergonomics, increased power, and better cooling systems. There's a model for every enthusiast level, from beginner to pro-shop specialist.

(See detailed specifications online.)

G9

▶ RANDOM ORBITAL POLISHER



The Everyman • For beginners to pros • Low speed waxing to moderate correction • 9mm orbit • 1,000-watt motor • 6" backing plate (5" compatible) **10901**



VENTED ORBITAL BACKING PLATES

10555 5"

(Optional G9 Upgrade)

10660 6"

(Included with G9 Orbital)

5" ORBITAL CONVERSION KIT 10515

(Shown above; for use with our G9 Orbital)

G8

▶ MINI RANDOM ORBITAL POLISHER



The Scalpel • Ideal for tight spaces • Waxing to heavy correction • 8mm orbit • 700-watt motor • 3" and 2" backing plates included. **10908**



G9 STARTER ORBITAL KIT
G1107



**G8 ORBITAL CORRECT
& PROTECT KIT**
11635



**G8 ORBITAL 3-STEP BEST
OF SHOW KIT**
11638



▶ **G9 ORBITAL CORRECT
& PROTECT KIT**
G1103

Our Newest Generation of Long-Throw Orbitals

These all-new G15 and G21 machines retain their 15mm and 21mm throws but we've upgraded their performance. The body is 20% longer to accommodate our 1,100-watt motor (a 22% power increase).

We also integrated cooling fans into the backing plate. Both models have a refined gearset, and a precision CNC-machined counterbalance. For specifications, visit our website.

25' QUICK-CONNECT CORD 10905 (Optional upgrade for any of our orbitals)



G15

▶ **LONG-THROW ORBITAL POLISHER**

The Pro-thusiast

- Experienced machine users
- Fast, light to heavy paint correction
- 15mm orbit
- 1,100-watt motor
- 5" backing plate (6" compatible) **10915**



G21

▶ **LONG-THROW ORBITAL POLISHER**

The Veteran

- A pro-shop favorite
- Fast, heavy correction capability
- 21mm orbit
- 1,100-watt motor
- 6" backing plate (5" compatible) **10921**



GR3

NEW ▶ **MINI ROTARY POLISHER**

The Professional Touch • A pro-shop favorite • Fast, heavy correction capability • 700-watt motor • Includes 1", 2", 3" Mini Rotary Backing Plates and 2" and 3" Shaft Extensions. **10918**
10580 Backing Plate Set (1", 2", 3")



G9 ORBITAL 2-STEP BOSS KIT
G1111



▶ **G8 PAD ACCESSORY KIT**
11640



▶ **G8 & G9 ORBITAL 2-STEP CERAMIC KIT** 11565 **\$299.99**

BOSS™: Best Of Show System®

We've updated our Best of Show System from the machines (see page 26) to more aggressive pads and new 1" sizes. The system allows you to change and customize the aggressiveness of your paint correction with variable-speed orbitals, carefully formulated and defined creams, and a range of aggressive (dense) to mild (soft, flexible) pads.



▶ **LONG-THROW ORBITAL 2-STEP CERAMIC KIT** Remove swirls and scratches and then protect your paint with our amazing Ceramic 3-in-1 Wax. Choose G21 or G15. See details online. **B1125**



▶ **LONG-THROW ORBITAL BOSS™ PRO GRADE KIT** Includes the creams and pads for any paint correction, from aggressive repair to fine polishing. Choose G21 or G15. See details online, including a full list of products included in this money-saving pro kit. **B1141**



NEW MATERIAL • NEW 1" SIZE
▶ **BOSS™ KNITTED WOOL PADS** Our most aggressive pad yet. Sliver-knit natural wool with Innerflex™ foam for contouring and heat management. Low lint.
BKW6 6" Pads, Set of 2
BKW5 5" Pads, Set of 2
BKW3 3" Pads, Set of 3
BKW2 2" Pads, Set of 4
BKW1 1" Pads, Set of 6



NEW & IMPROVED • NEW 1" SIZE
▶ **BOSS™ MICROFIBER FAST CUTTING PADS** Our new plush-nap microfiber quickly removes the deepest scratches and most stubborn oxidation.
BMFC6 6" Pads, Set of 2
BMFC5 5" Pads, Set of 2
BMFC3 3" Pads, Set of 3
BMFC2 2" Pads, Set of 4
BMFC1 1" Pads, Set of 6



NEW & IMPROVED • NEW 1" SIZE
▶ **BOSS™ MICROFIBER PADS** Amplifies the effectiveness of BOSS creams for rapid removal of severe defects. Foam interface conforms to contours.
BMF6 6.5" Pads, Set of 2
BMF5 5.5" Pads, Set of 2
BMF3 3" Pads, Set of 3
BMF2 2" Pads, Set of 4
BMF1 1" Pads, Set of 6



NEW & IMPROVED • NEW 3" SIZE INNERFLEX PAD
Reduces the aggressiveness of 3", 5.5" and 6.5" BOSS foam pads while helping pads conform to body panels. Reduces temperature buildup and extends pad life.
BIP6 6" Pad
BIP5 5" Pad
BIP3 3" Pad

FOR SEVERE DEFECTS



▶ FAST CORRECTING CREAM

Our most-aggressive BOSS cream with our most-aggressive foam pad to correct deep scratches, serious swirls, and oxidation. Pads are made with ultra-firm, open-cell euro foam to provide consistent correction, and long-lasting durability. Use a softer pad to reduce the aggressiveness of Fast Correcting Cream.

B110P Pint • **B110G** Gallon

FAST CORRECTING FOAM PADS:

B110F6 6.5" Pads, Set of 2 • **B110F5** 5.5" Pads, Set of 2

B110F3 3" Pads, Set of 3 • **B110F2** 2" Pads, Set of 4

NEW B110F1 1" Pads, Set of 6

FOR MODERATE DEFECTS



▶ CORRECTING CREAM

BOSS Correcting Cream levels paint surfaces to eliminate moderate defects. We recommend using an open-cell euro foam BOSS Correcting Foam Pad, but you can increase or reduce the aggressiveness of the cream with a firmer or softer pad.

B120P Pint • **B120G** Gallon

CORRECTING FOAM PADS:

B120F6 6.5" Pads, Set of 2 • **B120F5** 5.5" Pads, Set of 2

B120F3 3" Pads, Set of 3 • **B120F2** 2" Pads, Set of 4

NEW B120F1 1" Pads, Set of 6

FOR FINE POLISHING



▶ PERFECTING CREAM

This balanced blend of sub-micron abrasives and polishing oils removes the most minute scratches, swirl marks, and hazing holograms. It's our most gentle BOSS correction cream, but its intensity can be increased with a firmer, more aggressive pad in place of the suggested BOSS Perfecting Foam Pad.

B130P Pint • **B130G** Gallon

PERFECTING FOAM PADS:

B130F6 6.5" Pads, Set of 2 • **B130F5** 5.5" Pads, Set of 2

B130F3 3" Pads, Set of 3 • **B130F2** 2" Pads, Set of 4

NEW B130F1 1" Pads, Set of 6

POLISH AND PROTECT



▶ FINISHING SEALANT

Protect your freshly perfected paint from the elements. BOSS Finishing Sealant is formulated with sub-micron abrasives, polishing oils, polymers, and waxes to remove any light hazing or residue from previous steps. Use the ultra-soft BOSS Finishing Foam Pad for polishing. Increase aggressiveness with other pads.

B140P Pint

FINISHING FOAM PADS:

B140F6 6.5" Pads, Set of 2 • **B140F5** 5.5" Pads, Set of 2

B140F3 3" Pads, Set of 3 • **B140F2** 2" Pads, Set of 4

NEW B140F1 1" Pads, Set of 6

Prepare for Fall

What wax will prepare your vehicle for fall and winter? That depends on your goals.

- For amazing show-car depth requiring more frequent application: **Naturals.**
- To save time with fast application: **Spray-ons.**
- For super durability and beading: **Synthetics & Ceramics.**



▶ PREMIUM CARNAUBA PASTE WAX

- Highest grade natural carnauba available. Great color "pop".
- Absolute highest visual depth and clarity. The show-car choice.
- Less durable in extreme weather conditions. Apply by hand 3-4x/year.

11029 12 oz.

PREMIUM CARNAUBA PASTE WAX KIT

11430

Kit: Wax, 3" Red Wax Pad & Holder, 2 Dual Weave PFM Wax Removal Towels.



▶ BEST OF SHOW® SPRAY WAX

- Natural wax shine with little application time required.
- Natural carnauba plus polymer protection; great visual depth.
- Use to boost other wax basecoats between full applications.
- Not as long lasting, but easy to apply with each washing.

10968 22 oz.

10969 Gallon



#1 SYNTHETIC WAX

▶ LIQUID GLOSS POLY WAX

- Super durable finish; application necessary only 1-2 times per year.
- Synthetic polymer technology.
- Goes on quickly, by hand or with an orbital.
- Great gloss, less depth than natural waxes but lasts far longer.
- Can be supplemented with spray-ons.

10920 16 oz.

NATURALS

- + Unmatched visual depth and color
- Less durable than synthetic; requires more frequent application

SPRAY-ONS

- + Super fast application saves time
- + Ideal basecoat boosters
- Great shine but less durable

SYNTHETICS

- + Amazing long-lasting durability
- Good gloss but less depth than natural carnauba



#1 CARNAUBA WAX

▶ BEST OF SHOW® WAX

- Amazing color, depth & clarity.
- Highest quality carnauba and a unique blend of oils.
- Apply paste by hand; liquid by hand or machine.
- Apply 3-4 times per year.

11171 16 oz.



▶ SPRAY-ON WAX

- Use to quickly and easily boost a natural carnauba basecoat.
- For use primarily as a drying agent, not as a wax basecoat.
- Apply after each washing.

10962 22 oz. • 11097 Gal.



PFM® DUAL WEAVE WAX REMOVAL

TOWELS Use the heavy 450 GSM side to clear away wax; flip to lightly buff with the ultra-soft, 280 GSM classic microfi ber side. 9"x9". **55525 Set of 4**



3" HAND WAXING & CORRECTING KIT

Remove light defects and then add gloss and protection in tight spaces. Dense compact grip holder for comfort during the application process. **11423**



HAND WAX APPLICATORS

Ultra-soft, open-cell foam ensures safe, and consistent application of waxes and sealants. **10627 Set of 3**

A New Family of Ceramics Products

ALL DEVELOPED AND MANUFACTURED IN-HOUSE

Our existing Ceramic 3-in-1 Wax is super simple to use and offers incredible protection. But it needed some helpers, so we spent an entire year developing complementary products. Each one has its own spectacular qualities that also enhance the characteristics of the Ceramic 3-in-1 Wax you love. Intense water beading, self-cleaning capability, easier maintenance, and jaw dropping gloss.

Ultimate Base Coat

CERAMIC 3-IN-1 WAX Our Ceramic 3-in-1 Wax bonds with your paint to guard against surface oxidation, UV rays, stains, acid rain etching, and more. Use in place of conventional waxes or sealants. Lasts up to a year!

10978 22 oz. • 10983 Gallon



Ceramic Touch Ups

NEW ▶ CERAMIC SPEED SHINE® The world's best spray detailer now offers ceramic protection. Our exclusive blend of advanced silane polymer technology delivers an ultra-slick, high-gloss finish that's safe on all exterior surfaces. **10945 22 oz. • 10986 Gallon**



Bolster Protection

NEW ▶ CERAMIC WASH & COAT Add SiO₂ ceramic protection each time you wash. Our low-sudsing, lubricant-rich formula cleans and protects all exterior surfaces. Use with our other ceramic products for ultimate protection. **10885 48 oz.**



NEW CERAMIC FAMILY KIT 11604



▶ CERAMIC 3-IN-1 WAX KIT + REFILL 11508



G9 ORBITAL 2-STEP CERAMIC KIT 11558

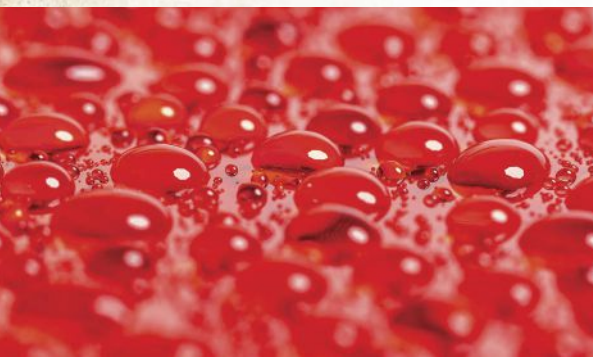

THE MOST DURABLE PROTECTION SiO₂ (or silicon dioxide), is a derivative of silica delivered in liquid form for automotive protection.

Our Ceramic 3-in-1 formula features a proprietary, water-based blend of special ultra-hydrophobic polymers, nanoparticles of SiO₂, and carnauba wax. The result is a highly-durable layer for paint, glass and trim that lasts up to a year.



INTERIOR CARE

INTERIOR DETAILING MAKES ALL THE DIFFERENCE Attention to detail elevates the ordinary vehicle interior to one that's visually stunning. To keep surfaces free of summer dust, pollen and other outdoor particles, we've formulated cleaners, leather restoring products, brushes and tools to get your interior clean, fresh, and looking new.

| 2005 Porsche Carrera GT

CLEAN



▶ **INTERIOR CLEANER** This cleaner has more intense cleaning power but is safe for all interior surfaces. Contains no dyes or other chemicals that could alter the color of the surface you are cleaning. Removes oil, dirt, and contaminants from carpets, floor mats, seats, fabrics, headliner, door panels, and your dash. Just spray on and wipe off. **10956 22 oz. • 11104 35 oz. • 11105 Gallon**

PROTECT



▶ **VINYL & RUBBER DRESSING** Enhance and protect vinyl, rubber and plastic parts. This product cleans and protects in one step, leaving a non-greasy, UV-resistant satin finish without that goopy gloss left behind by other dressings. Contains no harmful additives, waxes or other solvents that can dull the surface of vinyl and rubber over time. **10981 22 oz. • 11175 Gallon**

MAINTAIN



▶ **INTERIOR DETAILER** This gentle cleanser maintains a natural look on all interior surfaces while adding strong UV and anti-static protection. Safe for all interior surfaces: vinyl, leather, wood, painted trim, metal, carbon fiber, plastic, and even NAV screens. Won't smudge or fog glass. **10975 22 oz. • 10976 Gallon**



NEW FOAMING CARPET & UPHOLSTERY CLEANER This fast-drying, foaming formula removes oil- and water-based stains on fabric seats, carpets and even plastics. Upside-down fan nozzle evenly distributes cleaner into fibers. Citrus fragrance. **11298 19 oz.**



NEW ODOR NEUTRALIZING CARPET & UPHOLSTERY CLEANER Our hydrogen peroxide formula removes tough stains and odors. Prevents resoiling. For carpets, microfiber seats, and at home. **10990 22 oz. • 10996 Gal.**

NEW ▶ **SURFACE DISINFECTANT** Our disinfectant is safe for vehicle interiors and throughout your home. Kills Covid-19, Influenza A, Rhinovirus, E-coli, Salmonella, MRSA and more. Cleans, deodorizes and disinfects in one simple process with no dyes or fragrances. **10966 22 oz.**



BOARS' HAIR DETAIL BRUSHES For interior and exterior detailing, nothing beats these brushes for quick, safe, scratch-free cleaning. The boars' hair is epoxy-set in wooden handles. Safe for the most delicate interior surfaces. **15516 2 included**

SILICONE INTERIOR BRUSH 100% silicone bristles have a natural electrostatic charge to attract and remove pet fur, hair, lint, and dust from interior materials such as cloth seats, carpet, and fabric upholstery. **15564**



Revitalize Your Leather

NOURISH AND PROTECT YOUR INTERIOR

Natural leather can age, fade, crack, and retain odors, especially after it's been baked all summer long. We offer gels and sprays to clean, revitalize, and protect leather. Some are best for new leather, others are meant for badly damaged interiors. If you're not sure what's right for your vehicle, watch our videos online or give us a call.



LEATHER CARE SPRAY KIT

Clean, eliminate odors and revitalize your leather seats with this all-in-one kit. Includes three Dual Weave Interior Towels.

11259



THE ULTIMATE INTERIOR KIT

This kit includes everything to detail all surfaces of your car's interior, including the appropriate applicators and microfibre towels.

11491



DUAL WEAVE INTERIOR TOWELS

You get two towels in one. The thick side's unique diamond-patterned waffle weave works with our interior cleaners and detailers to lift and trap dirt. Flip the 16" x 16", 400 GSM towel for a low-nap weave that excels at light dusting and buffing. **10282 Set of 3**



BEFORE

AFTER



▶ LEATHER REJUVENATOR

Contains natural penetrating oils that nourish aged and neglected leather far better than lanolin-based products. See our video online for detailed use instructions.

11141 8 oz.



▶ ODOR NEUTRALIZING LEATHER CLEANER

Leather tends to absorb odors from food, smoke and more. This pH-balanced formula effectively removes stains and denim transfer while eliminating unpleasant odors. Safe for both aniline and pigmented leather.

10971 22 oz.



▶ LEATHER CARE

Our leather care products clean soiled leather, replace vital nutrients, dry clear on perforated leather, leave a non-greasy, supple finish after the final buff, and actually smell like new leather. We have creams for those who want to work the product into the leather, or spray for perforated leather or for quicker application.

11142 16 oz. Cream

10994 22 oz. Spray

11055 Gallon



▶ LEATHER 3-IN-1

The best choice for newer leather and even leatherette. Rich conditioners penetrate into the grain to moisturize, soften, and keep leather healthy while advanced polymers create a water and stain-resistant barrier that protect against UV damage, premature aging, and cracking. Original gel or convenient spray.

11019 16 oz. Cream

10963 22 oz. Spray

10964 Gallon



BLUE DETAIL SPONGES

These multi-use applicators are ideal for our leather care products. Sliced in the middle, so they're easier to hold. Rinse clean, wring out, and reuse.

11205 Set of 2



3" BLUE APPLICATOR PADS

Great for applying leather care products, even in tight seams and spaces. Hook-and-loop back for use with our Contour Grip 3" Pad Holder.

11249 Set of 3



CONTOUR GRIP 3" PAD HOLDER

Hook-and-loop base holds any 3" pads for easy application on interior leather. Made of firm, dense foam.

10621



MICROFIBER CLEANING PADS

Soft microfiber towels with polypropylene fiber wrapped over a foam core. Great for use with any of our interior cleaning products. 1" x 4½" x 5¾". Machine washable.

11242 Set of 3

USE THESE PRODUCTS TOGETHER FOR GREAT RESULTS



NEW ODOR NEUTRALIZING CARPET & UPHOLSTERY CLEANER Our hydrogen peroxide formula removes tough stains and odors, and prevents resoiling. For carpets, microfiber seats, and around the home.

10990 22 oz.
10996 Gallon



NEW FOAMING CARPET & UPHOLSTERY CLEANER This fast-drying, foaming formula removes oil- and water-based stains on fabric seats, carpets and even plastics. Upside-down fan nozzle evenly distributes cleaner into fibers. Citrus fragrance. **11298 19 oz.**

▶ PORTABLE STEAM CLEANER This portable, steam cleaner does the work of larger commercial models. Its stainless steel 1.6-liter boiler with a 1,500-watt heating element produces steam temperatures up to 220°F at 58 psi for intense cleaning and sanitizing power. Includes steam gun, 6' hose, and a wide variety of extension tubes, cleaning heads, and brushes. A Griot's Garage eight-piece bonus set included.

90541

- Easy deep cleaning and sanitization.
- Great for fabric, carpet, & plastic.
- Includes extensions, cleaning heads.



A Clear Vision of What's Ahead

AUTUMN RAINS CAN MAKE EVEN ROUTINE DRIVING DANGEROUS

Clean glass is essential to safe driving, especially during steady autumn rainfall. Put some fun back into beautifying your car and making it safer to drive. We've made it easy to clean, decontaminate, polish and seal glass to ensure crystal clarity and a create super slick, hydrophobic surface that scares away water.



▶ WINDOW CLEANER
Wipe away accumulated residue, fingerprints, your pet's "nose art" and more to leave your windows crystal clear, inside and out. Our cleaner is free of dyes, perfumes, and chemicals that cause hazing. Ammonia-free so it's safe on tinted windows. **11108 35 oz.**
11110 Gallon



▶ ULTRA-PREMIUM GLASS CLEANER Just a light mist of our aerosol glass cleaner creates foam that stays on glass surfaces longer to loosen dirt, oil, and grime. Creates crystal clear, haze-free glass, and mirrors. It's ammonia-free, and safe for tinted windows. Unlike many aerosols, it contains no ozone-depleting CFCs. **10998 19 oz.**



ULTIMATE WINDOW CLEANING KIT
Get crystal-clear glass quickly and easily. The Kit contains Window Cleaner and our lint-free, disposable polypropylene towels (a thermo-plastic polymer) for a streak-free shine. Convenient dispenser box. **11510**
14910 Lint-Free Towels, 150



▶ PFM® DUAL WEAVE WINDOW KIT Pristine windows are a wipe away now that we've bundled a 35 oz. bottle of our Window Cleaner with our PFM® Dual Weave Glass Towels (see above). **11292**



TREATED

UNTREATED

▶ GLASS SEALANT Living in the Northwest, I experience lots of wet weather driving. This sealant dramatically increases your wet weather visibility making for a safer and much less stressful motoring experience. Simply wipe on and buff off. It creates a hydrophobic surface that repels water instantly. It also helps you remove ice, salt, frost, and bug jerky more easily. Great for sleet and snow, and it helps your wipers work better too. For best results, use our Lint-Free Towels to clean your windows and apply Glass Sealant. **11033 8 oz.**

Richard - Richard Griot



NEW PFM® CRINKLE GLASS TOWELS Specially designed with a dual-weave fabric for lint-free, streak-free, crystal-clear glass. The "crinkle" side provides great cleaning and absorption. The densely woven side quickly buffs the surface. 570 GSM. 16" x 16". **55583 Set of 3**

▶ PFM® DUAL WEAVE GLASS TOWELS

Two-sided for streak-free, crystal-clear glass. The thick terry-style weave works with our glass cleaners to lift away dirt. Then flip it to the smooth tight weave side for a fast, lint-free buffing. It's the best glass-cleaning towel you can buy. 9" x 9". **55582 Set of 4**



WINDOW CLEANER SET The detachable, wedge-shaped, flexible head of our Window Cleaner easily reaches the base of your windshield and other tough spots. Includes a 14" handle, two washable, reversible microfiber window bonnets, a multi-purpose bonnet and a storage bag. **90248**

90263 Microfiber Bonnets, set of 3

90245 Multi-Purpose Bonnets, set of 3

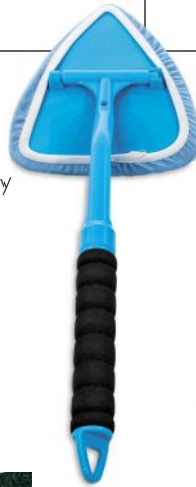

Microfiber Bonnets



Multi-Purpose Bonnet



▶ GLASS CLEANING CLAY Like paint, glass can also become embedded with contaminants. A first step in glass cleaning, our Glass Cleaning Clay strips away road film, tar, and water spots to make windows as slick as ice. Use Glass Cleaning Clay after cleaning and before polishing. Lubricate with Speed Shine®, work the clay back and forth and buff with our PFM® Detailing Towels. Also removes film on the inside of windshields! **11049 3.5 oz.**

GRIOT'S GARAGE TIP

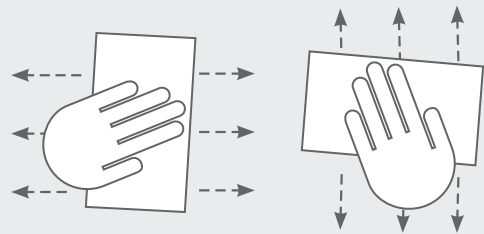

Outside windshield

Inside windshield

FIND THE STREAK INSTANTLY

When cleaning the outside of your windows, wipe with your towel in a side-to-side motion. When you move inside, wipe top to bottom.

Why? When you see a streak, you'll know by its direction which side needs a touch-up.

An Illuminating Innovation

NEW CERAMIC HEADLIGHT

RESTORATION KIT In partnership with Cerakote®, we've created the easiest to use, most durable headlight coating on the market. Guaranteed to last for life, these kits restore optical clarity with moderate or severe damage without tools. Includes two oxidation removal wipes, two ceramic headlight wipes and nitrile gloves.

MODERATE 11377
SEVERE 11422



1. **STINKY-BE-GONE™** Bamboo-activated charcoal provides a non-toxic, odorless way to control cabin odors. Reusable. Just leave the convenient canvas bag in the sun a few hours every few months. 500g. **92020, 3 or more**

2. **AIR DRYER STORAGE DESICCANT BAG** Silica gel absorbs moisture to prevent corrosion, mold and fogging. Dry in an oven to reuse. 500g. **92015, 3 or more**

3. **FINE LEATHER INTERIOR CAR SCENT** A couple spritzes under each seat, and you'll bring back the scent of fine leather. Saturate a small sponge and place it under a seat near an air vent to circulate the scent. Lasts about a week. **11150 4 oz.**

4. **ODOR EXTERMINATOR®** Odor Exterminator® eradicates odors caused by bacteria, molds, mildew, chemicals and petroleum. **11008**

5. **MICROFIBER MINI DUSTER** 13½" long with a 7½" long brush head, making it ideal for hard-to-reach interior spaces. Mist with Interior Detailer and wipe away dust. Machine washable. **11412**

6. **PLASTIC CLEANER/POLISH** Remove blemishes with Plastic Polish and clean dashes, headlight covers, taillights, trim and more with Plastic Cleaner. 8 oz. ea. **11185 Cleaner • 11186 Polish**



Have One for the Road



WATER RESISTANT TRUNK BAG Keep your trunk necessities in one compact case. Built with strong, water-resistant polyester with a dual zipper across the top. Measures 16½" x 10½"

x 8" with two zippered pockets on one side (2½" x 5½" x 8"). Large zippered pocket on the other side is 13" across. Holds jumper cables, car care supplies, tools, and more. **77843**



CONCOURS BAG We've created this smaller car care organizing bag to hold the essentials you'll need for travel or car shows. At 13½" x 7½" x 10½", it's big enough to hold multiple 22 oz., 16 oz., 8 oz. bottles, aerosol glass cleaner and tire dressing, towels, and detailing brushes. Yet it's small enough to fit easily in even the most space-constrained trunks. Built with tough, water-resistant 600 denier nylon with a rigid structure and mesh pockets on the outside for 8 oz. bottles. **92121**



DETAILER'S BAG Carry your entire paint correction system in one comfortable bag. It's designed to secure a Random Orbital machine and stow paint care essentials from liquids to pads to cloths and towels. Great for mobile detailers or car shows. This big bag (20" x 10½" x 10") features tough, water-resistant, 600 denier nylon. The shoulder strap has durable composite clasps. Padded handle straps with hook-and-loop closure. **92221**



NEW CAR CARE ORGANIZER BAG III Our upgraded organizer has larger, rigid, waterproof panels inside to maintain shape. Larger mesh pockets inside and out now hold 22 oz. bottles. The main compartment holds all our orbitals, new and old. Elastic straps inside secure brushes, detailing swabs and tools. Made of tough, water-resistant nylon with shoulder strap and foam-gripped handle. 18¼" x 9¼" x 19¼". **92206**

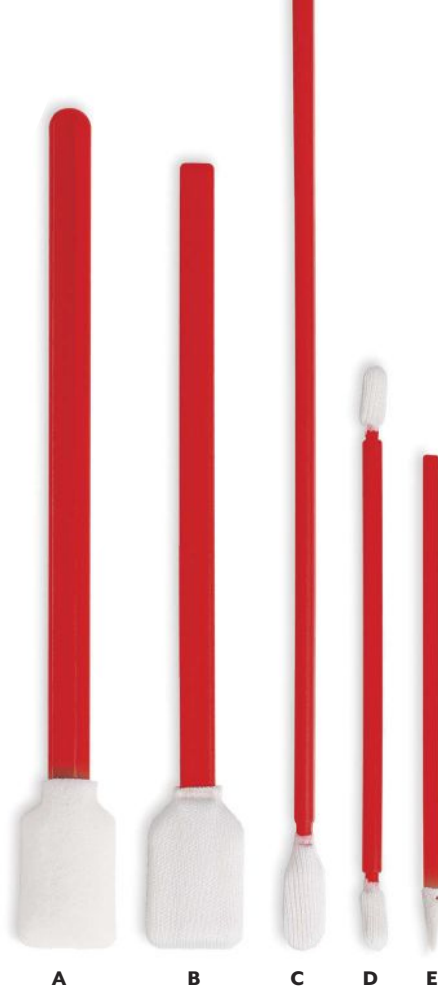

▶ DETAILING SWABS, 50 COUNT

We've hijacked these high-tech swabs from the clean rooms of the semiconductor industry when we realized their tight-quarters detailing potential. Pick from five different designs featuring foam or microfiber, different handle lengths, and head shapes.

15707 (Save 15% when you buy 5 or more of any one type.)

- A. Large Square Foam
- B. Large Square Microfiber
- C. Long-Reach Microfiber

- D. Dual-Head Microfiber
- E. Fine-Point Foam

15708 Variety Pack (50 ea. of all five types.)



HEAVY-DUTY METAL POLISH Return the shine to tarnished metal. Silicone-free and water-soluble, it's safe and effective on non-clearcoated aluminum, steel, stainless steel, magnesium, and even plastic and acrylic surfaces. Apply by hand or orbital. Easy to rinse off. Meets commercial aviation requirements. **11155 6 oz.**



NEW MICROFIBER EDGELESS UTILITY TOWELS These multipurpose towels are ultrasonically cut to create soft edges for delicate surfaces. Densely woven 265 GSM microfiber is absorbent, so it will lift and hold waxes and polishes. For dirty or delicate jobs. 12" x 12". **14331 Set of 50**



DETAILING STICK SYSTEM The tempered aluminum shafts are coated with a chemical-resistant clear vinyl so they won't scratch or mar a fine finish as your detail in tight spaces. Add Microfiber Detailing Socks for quick, safe, and easy cleaning.

- 10219**
- 10221 Microfiber Detailing Socks, set of 4**

Assorted tips are chemical- and petroleum-resistant, so they can be soaked in a cleaner if needed.

The Best on Your Block

For some of us, detailing an engine compartment is just as important as making the exterior shine. If you're the type who displays your vehicle with the hood up, this page is for you.



▶ FOAMING METAL DETAILER This fast-acting, foam-and-wipe detailer removes smudges and grime while enhancing the shine of metal parts. It removes water spots, fingerprints, grease, and more while leaving behind a protective film that resists re-soiling. Use on bare, painted, or powder-coated metal or stainless steel. **10927 17 oz.**



ENGINE BAY DRESSING Specially formulated to enhance and protect engine bay parts. Make your engine bay shine as black parts appear blacker and wires more vibrant. Won't attract dust, making it easier to detail your motor next time. **20244 12.5 oz.**



OIL & GREASE CLEANER For filthy engines in need of more deep-cleaning power. Quickly cuts through oil and grease, stains, and residue. Use on any water-safe surface. Contains no harmful VOCs, is pH balanced and has no petroleum-based ingredients so there's no risk of bleaching, fading, or damaging surfaces. Great for engines, under car areas, and rear end housings. **10965 22 oz. • 11047 Gallon**



ENGINE CLEANER When your pride extends to what's under your hood, here's the product to loosen and break up grease, grime, and gunk, in preparation for dressing. Just spray-on, agitate with a detail brush, and wipe clean with a shop towel. **10959 22 oz. 11158 Gallon**



MICROFIBER SHOP TOWELS These are not your father's red shop towels. Ours are lint-free microfiber, highly absorbent, washable and reusable. At a buck apiece, they're a great value. 13" x 15". **14875 Set of 20**

Turbo-Powered Cleaning

Sometimes routine washing just isn't enough. Not only is it tough to remove bugs splattered and dried at high speeds, rubber track streaks, sap, and road tar, those are exactly the cling-ons that will permanently damage your paint. We have what you need to leave them in the dust.



2019 McLaren Senna



NEW TAR, BUG & SAP REMOVER The fastest and safest way to remove stubborn substances from exterior surfaces, including wheel wells, rocker panels, fenders and trim, and more. Safe for clear coat, chrome and most plastic surfaces. **10897 13 oz.**



▶ TRACK SPRAY Formulated specifically for track-event maintenance, Track Spray helps remove stubborn rubber beads, cone marks and skid marks. It goes on thick and clings for longer dwell time. Test spot on vinyl graphics or clear bras before using. Search this product online to see a video focused on track-related cleaning. **10979 22 oz.**



FOUR-FINGER MESH MITTENS The soft, unique microfiber weave traps bugs and grime in the mitt and keeps it away from your paint. Rinse these mittens often during use. Works great with Bug & Smudge Remover. **11842 Set of 2**



▶ BUG BARRICADE™ Before heading off on a road trip, spray Bug Barricade right over your wax and spread with a microfiber cloth. The invisible, water-soluble barrier prevents bugs from sticking and makes clean up easy. **10953 22 oz.**

▶ BUG & SMUDGE REMOVER Insects are tenacious, even after they've exploded. They're difficult to remove and their exoskeletons scratch paint and trim surfaces during cleaning. Use Bug & Smudge Remover to soften and remove dried bug putty as well as heavy oils, road grime and rubber track marks. **10982 22 oz.**
11015 Gallon



Bug Barricade made washing off these bug guts a breeze.

Strategies for Controlling Inflation

Follow the law (Boyle's Law, that is) and maintain proper tire pressure during changing temperatures to preserve tread life, drive safely and save money with better gas mileage.



ANALOG TIRE INFLATING GUN Easy-to-read and is built to last, our inflating gun has a soft rubber surround to protect the gauge and your car. Fully depress the handle to fill, or halfway to bleed off excess pressure. Gauge reads 0-85 psi (0-5.8 Bar). The long, 40-inch inflating hose clips on to the tire valve allowing one-handed use. Made in Italy.

92553



ANALOG TIRE PRESSURE GAUGE

This gauge features a classic analog long-sweep needle readout with high-quality, accurate internals. The 2½" dial is laid out with half pound increments for precise readings. Measures 0 to 60 psi with accuracy within 2% of the reading. Gauge holds pressure reading until released via bleeder valve. An angled chuck swivels for easy measuring regardless of valve stem position. Flexible 17" hose. Internal gauge damper. **44494**

AIR PULSE

BLOW GUN Great as a dryer or to clean Orbital pads, this professional-grade, pneumatic-powered specialty tool's unique tip spins up to 8,000 rpm to create a high-velocity vortex of air that powers away dirt and grime from interior fabrics, engine parts, and trim. Detachable brush helps loosen embedded dirt.

90655



AIR PULSE FIRM BRUSH 90554

(One included with Air Pulse Blow Gun.)



COUPLER SETS

A. 84060 Increased Airflow Anti-Jam Coupler Set

B. 84065 Coupler Set For Compressor

(Individual couplers sold on website or by phone.)

PORTABLE 3 GALLON AIR COMPRESSOR

This low-speed, oil-free, direct drive air compressor provides quiet, trouble-free operation. It has a two-cylinder pump powered by a two-horsepower, 1,700-rpm motor that is capable of delivering 4.5 cfm at 90 psi. The compressor's three-gallon tank offers a maximum working pressure of 150 psi. Includes a heavy-duty roll-cage, integrated cord wrap, upward-facing gauges, and automatic internal overload protection. **94414**



GARAGE & TOOLS

Your garage is your personal space. It's where you do your thing. We understand. We can help you customize it with the tools, lighting, covers, and racks to make your garage time effective, efficient, and fun.

| 1972 Porsche 911S





NEW USAG CANTILEVER TOOL BOXES

Sturdy, electoplated, corrosion-resistant steel. See details online.

T1755 5 Compartment (17 $\frac{1}{2}$ x 8 $\frac{1}{2}$ x 8 $\frac{1}{2}$)

T1733 3 Compartment (17 $\frac{1}{2}$ x 8 $\frac{1}{2}$ x 6 $\frac{1}{2}$)

T1701 Single Compartment (17 $\frac{1}{2}$ x 8 $\frac{1}{2}$ x 4 $\frac{1}{4}$)

ROLLING TIRE CART

With our tire cart, you can roll the resting snow tires or other stock out of the way. 30" in diameter, 17 lbs. and can hold 1,000 lbs. Includes a 12' tie-down strap for stability and safety. Has 5 commercial-grade casters: 3 swivel and lock; 2 are fixed for easy straight-line maneuvering.

79923



Two locking casters for convenience.



Cart is easy to move when not in use.



PROTECTIVE LUG NUT SOCKET SET

Designed for safe lug nut torquing, the malleable nylon outer sleeve on these deep, thin-wall lug, 1/2" drive sockets reduce the chance of damaging wheels with tight, recessed mounting points. Made from rugged chromoly to withstand the stress of impact wrenches. Standard set includes 3/4", 7/8", 13/16", 1", and 1 1/16". Metric set features 17, 19, and 21 mm.

77187 5-pc. standard set

77145 3-piece metric set



▶ SWISSTRAX MODULAR GARAGE FLOORING

These easy-to-install, 15¾" x 15¾" modular tiles will instantly improve the look and functionality of your garage. A typical garage can be completed in a matter of hours without professional assistance.

SWISSTRAX PRO TILES 50824

Ribbed or Smooth, Set of 6

EDGES PRO 50623

Pegged or Looped, Set of 10

CORNERS PRO 50623 Set of 4



TILES

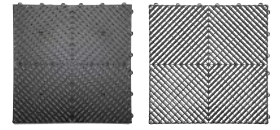

Smooth

Ribbed

EDGES



Pegged

Looped

CORNERS



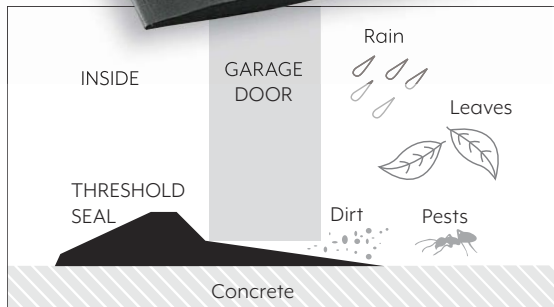

THRESHOLD SEAL Help keep leaves, rain, dust, bugs, rodents and cold air from sneaking under your garage door. This seal installs in minutes with a strong adhesive so it stays put. May be driven over and remains flexible down to -40°F! Adhesive requires a caulking gun. 3" x ½". **92299 16' • 20'**



GRIOT'S LED DOUBLE-SIDED SIGN Our bright, two-sided LED backlit sign has a powder-coated aluminum frame and acrylic faces that are silk screened with our logo. Includes a 12V power supply and a 110V, 39" power cord. Indoor use only. Both sizes are 3.15" wide. **10798 12" x 12" (5.7 lbs.)**
24" x 24" (9.3 lbs.)



COINTOP



GROOVED

GARAGE FLOOR MATS Keeping the garage floor clean is easy with these heavy-duty, industrial-grade mats. These extra-thick mats are impervious to oil and grease and provide cushioned, slip-resistant surface. Trim to fit and cover your entire floor or use it as a parking pad to protect your painted or tiled floor. These mats will give your garage a clean look and form a nice moisture barrier. Available in three different styles and colors, and a variety of sizes. Proudly made in the U.S.A.

- COIN TOP 77903**
7½' x 17' • 8½' x 22' • 10' x 24'
- GROOVED 77911**
7½' x 17' • 8½' x 22' • 10' x 24'
- DIAMOND PLATE 77932**
7½' x 17' • 8½' x 22' • 10' x 24'

	COIN TOP	GROOVED	DIAMOND PLATE
Sandstone			
Gray			
Black			



Illuminating Solutions

BRIGHT IDEAS FOR ENHANCING YOUR WORK SPACE

The days are getting shorter, but the light's getting brighter. With our brilliant lighting solutions, you can see every speck and smudge and ensure that your detailing is meticulous.



NEW PRO LED HEADLAMP This low-profile high-performance light has an adjustable 350 lumens CREE spotlight and side-mounted COB-flood LEDs that deliver 240-degree halo lighting to illuminate your peripheral vision in all directions. Weights only 5.8 oz. With red night vision and hazard lighting. USB charging for up to 55 hours of use.

13097



Screws into a light bulb socket for 3.8x the light of a 60-watt bulb.



MOTION ACTIVATED LED CEILING LIGHT Upgrading your garage lighting is as simple as screwing in a light bulb, because that's exactly how you install this ceiling light. It features a motion-sensing array surrounded by three adjustable cast aluminum LED light panels with a natural white 5,400K color temperature. Customize its functionality with its motion sensor sensitivity dial. Rated to last 50,000 hours, the light will shut off after two minutes of inactivity. Provides a super bright 4,000 lumens of light from 25 watts of power, 5 times more light than a typical 60-watt, 800-lumen bulb. **13725**



▶ THE BOSS™ LED SWIRL-FINDER LIGHT

Paint evaluation is a critical, yet often overlooked, step in paint care. It tells you how much correction you need at the start and allows you to track your progress. This light features two light sources; the larger, COB (Chip On Board) array generates up to 320 lumens via an adjustable dial and is temperature rated at 5000K to illuminate a wider spectrum of the body panel. The 120 lumen, 6000K adjustable focus LED tip light can concentrate the beam to reveal finer surface defects. **B8000**



Dual Magnet Belt Clip



LED Tip Light extends from 60° to 10° viewing angle.



▶ SLIM LED WORK LIGHT This wand-style 15-watt LED features a 1" wide and 3/8" wide lighting element that gets right into cramped, tight spaces. Use the rheostatic thumbwheel to bring intensity up to a super bright 410 lumens. Position via its magnetic swivel, ball joint base, or hanging hook. Run time is 2.5 hours at full brightness and up to 10 hours on low settings. Recharge the Lithium-Ion battery using the included micro USB charger, cord, and wall adapter. **13023**





BEFORE

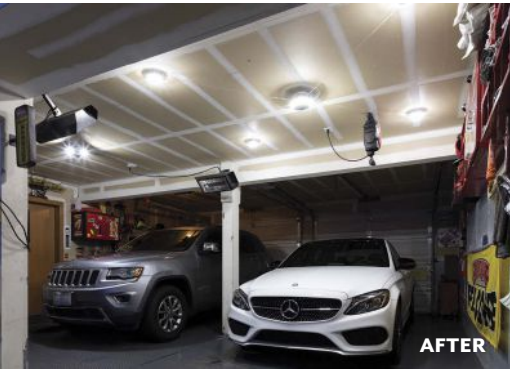

AFTER

5-POD LED CEILING LIGHT Our 5-panel, motion-activated 7,500-lumen, LED lighting system will fully illuminate your garage. It consists of a central hub that screws into an existing conventional light bulb socket and four satellite pods that can be placed up to 9.5' from the hub. The power cords that run from the hub are held taut by a cable management system that wraps the pod base. Motion sensor sensitivity can be adjusted to a 20-foot radius; the light shuts off after two minutes of inactivity. Turn off motion sensing to activate from a wall switch. The main hub has an integrated USB port for powering a security camera (not included). **13706**

Includes main hub/light, four satellites, and hardware.



Base screws into light bulb sockets.



Satellite pods can be placed 9.5' from base.



Cable management system holds cables taut.

CORDLESS PRO LED SHOP LIGHT A unique Fresnel-like lens generates an ultra-wide floodlight beam. Available in two intensities: 4,100 lumens and 1,800 lumens. Each light features a nylon handle that rotates 180 degrees to act as a self support or mounting point, has a run time of up to 8 hours, and features multiple output settings. Lights can also be used with an optional neodymium magnetic base mounts or a tripod. The optional, telescoping tripod holds three lights and extends from 2'6" to 5'8". Each light sold individually and includes a wall charger.

- 47854** 4100 Lumens • 1800 Lumens
- 47925** LED Shop Light Tripod
- 47941** Magnetic Base



4,100 lumen

1,800 lumen

Optional magnetic base.



WALL MOUNTED DOOR GUARDS Dense 1½" foam with pre-installed adhesive backed tape. 17¾" x 3" wide. **36113** Set of 2



Reinforced, holds 5 tons each. Non-slip feet.

FLAT-FREE TIRE RAMPS Our ramp's contoured shape prevents flat-spots during long-term storage. **36883** Set of 4



PERFECT PARKING MAT Park in the same spot. 11" x 21". In black, red, or high visibility yellow. With mounting tape. **77057** (Sold individually.)



PARKING STOP Strong adhesive strips keep the stop in place. 16" x 3½" x ¼". Made in the U.S.A. **36808**

Individually Made for Your Car

CUSTOM-MADE COVERS FIT THE CONTOURS OF YOUR MAKE AND MODEL, PROTECTING IT FROM AUTUMN RAIN, POLLUTION, AND UV DAMAGE



Tight weave beads water off.



WEATHERSHIELD HP® NON-BULKY CAR COVER GREAT OUTDOOR PROTECTION

▶ "This is my favorite outdoor cover. The Weathershield HP® cover is made with special dyes and sealants to keep your cover looking new, longer. This cover's water-shedding technology is the same breathable fabric used in waterproof hiking outerwear; water just sheets off. Take it off after a rain-storm, give it a quick shake, and the remaining moisture will dry within minutes. It's more compact than other water-resistant covers and fits easily into any washer and dryer for cleaning. Five colors available, shown below. Custom-made to fit like a glove."

Richard - Richard Griot

92487 (Allow 7-8 weeks for cover to be custom-made and delivered.)



FORM-FIT™ FORM-FITTED INDOOR PROTECTION

Spandex® threads in the polyester weave create the perfect balance of elasticity, breathability, and protection. The inside is soft, sheared 100% cotton terry loop. Designed for special cars that reside mostly in the garage so it has no waterproofing. Choose from six colors. Storage bag included. **92490** (Allow 7-8 weeks to have your cover custom-made and delivered.)



▶ **FABRIC PROTECTANT** Repel oil- and water-based stains, and fade-inducing UV rays with durable Fabric Protectant. It's micro-bonding fluoropolymer formula is safe for all fabrics, including convertible tops and carpet. **10960 22 oz. 10961 Gallon**



DISPOSABLE CAR COVER Short-term protection during on outdoor or garage projects like painting and woodworking. Elastic band keeps cover snug and secured. 14' x 20'. **92511**



ACCORDION WINDSHIELD SUNSHADE Our sunshades are custom-made to fit your vehicle. Over 500 patterns available. Sun-reflective on one side, soft felt on the other. Optional storage bag available. **10240 10275 Storage Bag** (Allow 5-6 weeks to have your sunshade custom-made and delivered.)

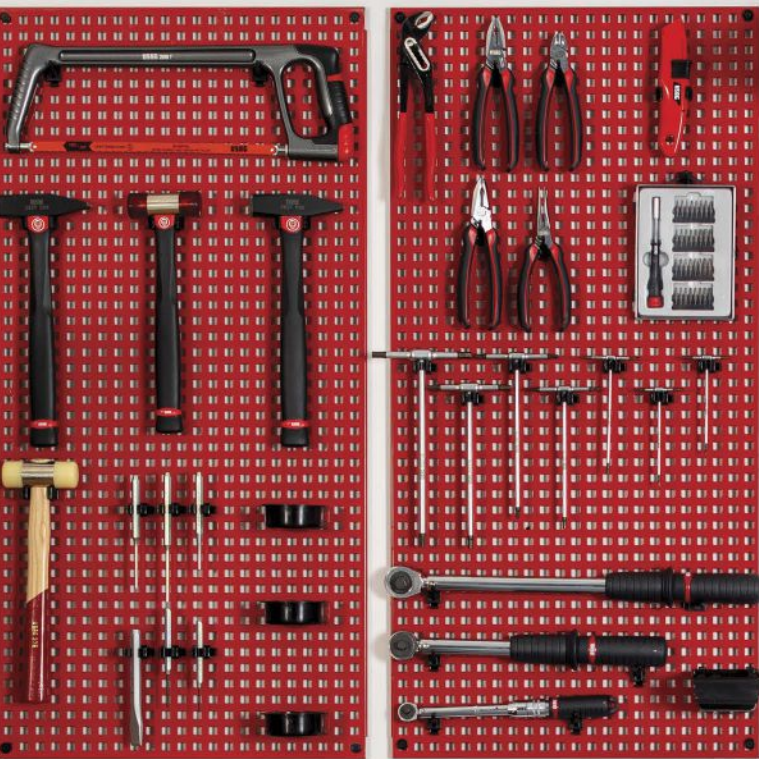

1



2



3



4



5

1. STEEL TOOL PANEL SYSTEM

Our pro-quality Steel Tool Panel System has “pull-out proof” snap-in pegs, making it easy to reorganize tools. Simple to install and to take along if you move, the system is a lifetime purchase in tool organization. With 10 tool-holding clips, 15 tool hanging hooks and a hammer holder. Includes mounting hardware. 19”t x 37”w. Upgrade with our accessory kit. It includes 2 short steel tool hooks, 2 long steel tool hooks, 5 small tool clips, 5 large tool clips, 5 socket holders, 2 round storage boxes, 2 pencil holding boxes, 2 hammer holders, 5 tool hanging hooks, and 2 rectangular storage boxes. **92392**

92382 Accessory Kit (Shown below)

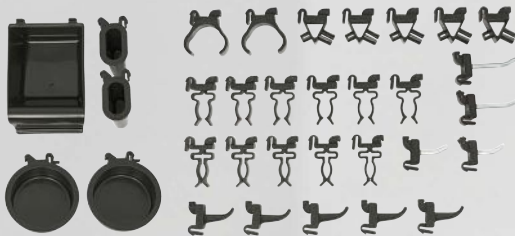

The Keys to the Efficient Garage

2. GARAGE UTILITY SHELF Laser-cut from 16-gauge steel and powder-coated Griot's Red. Organize your detailing bottles, towels, tools, and pads. Mounting hardware included. 12" deep, 33¼" wide. **77857**

3-4. BOTTLE RACKS Great for organizing your Griot's bottles. Made from 18-gauge steel, finished with a durable powder coating. Mounting hardware is included.

3. **77852** 35 oz. (21½" wide) Bottle Rack

4. **77874** 16 & 22 oz. (21½" wide) Bottle Rack

5. MAGNETIC PAPER TOWEL HOLDER Super-strong magnets lock this paper towel holder to steel toolboxes and workbenches. Supports any typical, 5" diameter roll of paper or shop towel. Easy to move where needed. **55581**





BATTERY MANAGER V Rather than a static trickle charger, this tool is a smarter, safer, active management device with state-of-the-art technology to improve battery performance, longevity, and overall condition. It services a wide range of 6- and 12-volt battery types, including Conventional, Maintenance Free, AGM, Spiral Wound, Deep Cycle, and LiFePO4 Lithium. Other high-tech benefits include reverse polarity protection, temperature compensation, short-circuit protection, over-voltage protection, and a recovery mode to resume charging after power outages. Safer. Smarter. Better. This is the finest battery manager we've ever sold. Components shown below are included. **92232**



Cable Clamps



Hard-Wire Mount



Cigarette Lighter



Cable Adapter

RETRACTABLE EXTENSION CORD REEL

Our cord reel delivers 45 feet of power via 14-gauge cord on a swivel mounted reel with a 180-degree radius. The cord features three grounded plugs, a 3' long inlet cable, and a 16-amp circuit breaker with a manual reset button. The reel's auto-latching mechanism sets the desired length of cord in 18-inch intervals, has a manual lock option for added safety, and cord leveler for care-free retraction.

13083



Conveniently store clamp on the back.



MICROPROCESSOR-CONTROLLED BATTERY CHARGER/MAINTAINER

Save money and time while maintaining your batteries. This proprietary microprocessor-based, multi-phase charger features reverse polarity protection to prevent shorting a battery, the charger, or even an explosion if the wires accidentally get crossed. With a selectable charging rate of 20A/10A/2A, the unit quickly recharges even a large, dead battery then switches into a maintain mode. Charges and maintains all sizes of 12-volt and 6-volt, lead-acid batteries, including: Conventional, Maintenance-Free, AGM, Gel Cell, Spiral Wound, Deep Cycle, and Marine types. **92256**

USB & 12V charging ports.

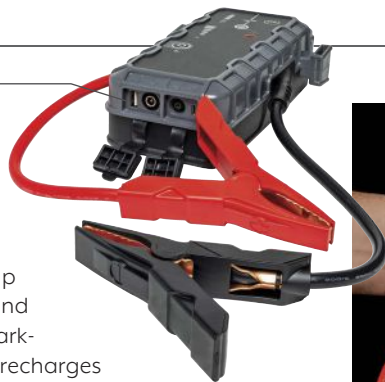

2000A 12V LITHIUM-ION JUMP STARTER

Make sure no one in your family gets stranded. At only 4lbs., our jump starter packs a wallop, delivering 2,000 amps or 15,700 Joules to jump start fully drained batteries, gas engines up to 8 liters and diesel engines up to 6 liters. It will jump to 40 vehicles on a single charge and features a patented safety technology that provides spark-proof connections and reverse polarity protection. Also recharges cell phones, tablets, and more and can power 12-volt devices, like a tire inflator or power inverter. Built-in rechargeable, 400 lumen LED flashlight. Measures 8 1/2" x 5 7/8" x 2 5/8" (width with clamps). See list of included components online. **94616**





SINCE 1990

SIPHON PUMP Autopart store siphons are embarrassingly cheap. We've been selling this awesome one for 30 years. Now with 2 more feet of tubing! This 13" long PVC pump is safe for gasoline, oil, kerosene, or diesel fuel. Great for farm tools, power equipment, mowers, generators, sinks, toilet bowls or pumping gas from one car to another. With 10' of clear tubing. **44406**

MULTI-FLUID

EXTRACTOR Fast, easy, mess-free fluid removal. Oil changes can be exasperating. I especially hate it when I'm loosening the oil pan plug and it comes off unexpectedly, sending slimy oil running over my hand and down my arm. Here's the help we all need. Simply slide the extractor's suction tube down your dipstick tube, pump the handle to create a vacuum inside the lightweight, 6.8 qt. chamber, and in a matter of minutes the oil will be sucked out of the sump. It also sucks out transmission, brake, power steering and differential fluid, gear oil, and antifreeze. Chamber measures 24"t x 6½"w. The captured liquid dispenses easily for recycling. Includes two dipstick tubes measuring 4' x ¼" OD and 4' x ⅜" OD, one main suction tube, and one brake bleeding tube with bleeder valve adapter.

10115

Measure the inside diameter (ID) of dipstick tube to confirm fit for your vehicle.

Richard



Time to Stash Your Treasure

EVERYTHING YOU NEED TO STORE YOUR PRIZED VEHICLE FOR FALL AND WINTER

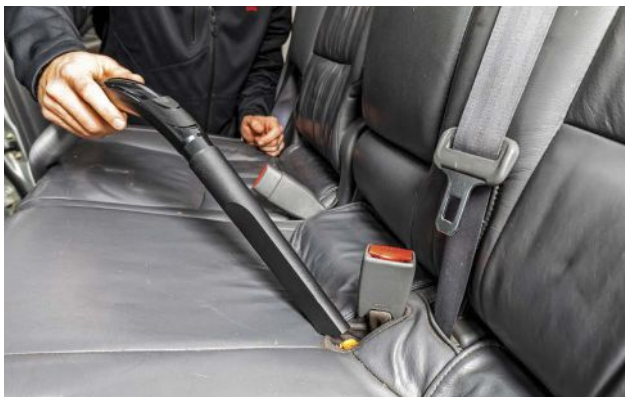

WALL-MOUNT WET/DRY GARAGE VACUUM A powerful 12-amp motor makes this vacuum one of the most powerful on the market. Wet/dry functionality, 32' hose and a 4-gallon, semi-translucent catch tank. Also great for blowing debris. Includes a 5-foot power cord, 6 attachments and two extensions. See website for details and a full list of accessories. **90502**



LITHIUM-ION HANDHELD AUTO VACUUM Powerful and compact, this vacuum performs without the hassle of a cord. Its 22-volt lithium-ion battery creates a powerful suction and powers a motorized turbo brush that helps lift pet hair, pine needles, and debris, and stores it in a .4 liter dirt cup. The 2 ft. long extension hose, dusting brush and crevice tool reach into tight spots to reach dirt. Dual LED headlights illuminate dark floorboards and crevices. **91008**



We're Here to Support Your Organization

You work far more efficiently when everything you need is organized and right at your fingertips.

And with our detailing carts, you can bring it all with you as you move around your vehicle.

The Ultimate Detailing Cart

NEW ▶ Focus on your detailing by keeping every tool, towel, and chemical right where you can reach it. This durable, lightweight cart features a custom-designed top shelf to hold our orbitals, brushes, your phone, and all sizes of our bottles. Two deep tub shelves hold towels, pads, and other tools. High quality 4" casters with locks and ball bearings. **92528**

Lightweight Detailing Cart

▶ This new lightweight cart has superior locking casters, extruded aluminum uprights, improved storage, and includes shelf dividers. Ideal for tools, and detailing accessories. 36" T x 26 1/4" W x 19 1/4" D. Weighs 17 1/2 pounds with dividers. **92505**



Custom top tray



Optional bin for trash or towels



Tool holes for screwdrivers



Power cord storage

Get in at the Ground Level

MOVE ALL AROUND YOUR CAR WHILE DETAILING

Smart tools aren't always those you access with a phone. Sometimes they're the ones that are carefully thought-out, well-designed and constructed to solve a problem, make your life easier and get things done more efficiently. And save your back.

▶ KING'S PNEUMATIC CREEPER II

This new generation King's Pneumatic Creeper helps you focus on lowdown projects without stressing your back or knees. With a 19½" wide, contoured cushion and a pneumatic seat that easily raises and lowers from 18¼" to 22¼", this throne provides comfort during wheel cleaning, waxing, bleeding brakes, and a multitude of other tasks. Has 4" swivel casters (two are locking), and a four-sector lower tray for tools, parts, and fasteners. **38942**

Bottle Holders, Set of 2

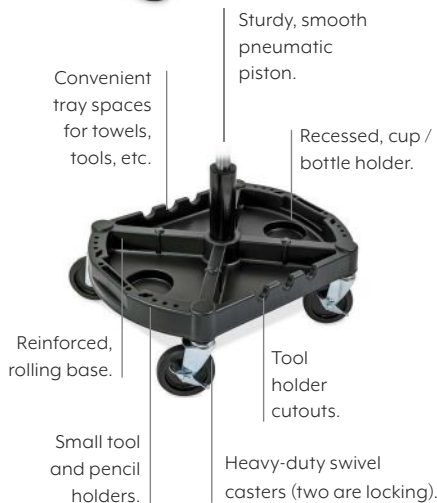

Sturdy, smooth pneumatic piston.

Convenient tray spaces for towels, tools, etc.

Recessed, cup / bottle holder.

Reinforced, rolling base.

Tool holder cutouts.

Small tool and pencil holders.

Heavy-duty swivel casters (two are locking).

SINCE 1990

▶ **CADILLAC OF CREEPERS** Our ninth generation of this creeper clearly lives up to its name. Features a low-profile steel frame, smooth-rolling polyurethane casters and a three-position adjustable headrest. Measures 40" x 19" x 3¾". **38912**



Make headrest adjustments while lying on the creeper.



Six polyurethane casters let you glide over the roughest driveways.



KNEE PLEASER Protect your knees. Great for garage or garden, its outer cover is a water-resistant nylon/neoprene cloth. Inside is a soft gel that disperses pressure when compressed. Measures 9" x 20". 1½" thick. **51400**

Nit-Picky Tools

FOR THE PRECISION-MINDED CAR ENTHUSIAST



Actual Size • 9 3/4"



Actual Size • 5 5/16"



8-PIECE LONG-REACH HOOK & PICK SET

Ideal for positioning, adjusting, and retrieving small parts, pulling stubborn hoses, removing small fuses and O-rings, and other intricate engine bay work. High-carbon, heat-treated steel construction, and textured, cushioned, slip-resistant grips.

46608

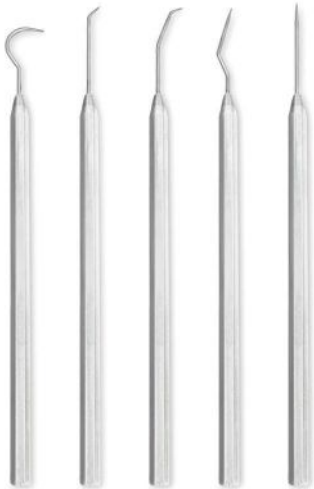

5-PIECE MICRO PICK SET

This stainless steel set is ideal for positioning, adjusting, and retrieving small parts, separating wires, removing small fuses and O-rings, as well as cleaning out gummed-up grooves, channels, or conduits. No job is too small.

46601



PLIERS RACK This rack holds up to 14 sets of pliers of varying sizes and can be mounted on a pegboard, in a drawer, or standing on your workbench. Made from tough powder-coated steel plate. The wire holder is triple dipped in vinyl. 12"x 2 1/2"x 7". **55612**



113-PIECE TAMPER-PROOF BIT SET

Get all the tamper-resistant and regular bits you'll ever need. A clever plastic cover insert holds everything in place so the set stays organized. The most complete, high quality set you can find. **49140**



ULTRA-SOFT FENDER COVER Prevent nicks, scratches and smudges. This ultra-plush, quality fender cover combines fleece and microfiber and has three sewn pockets to hold tools and hardware. Strong corner magnets secure the cover and are hidden in padded pockets for removal when washing. 41" x 20". **77675**

Corner magnets hold the cover in place, and are removable for washing



7-in-1, and Then Some

The most versatile and efficient all-around tool you'll ever own.



Inset hardware tray and handle.

Holds 440 lbs.

Wheels for dolly or creeper mode when legs are folded.

Adjustable legs.

Workbench mode

1990 Jeep Grand Wagoneer



7-IN-1 MULTI-PURPOSE WORKBENCH

Our 7-in-1 Multi-Purpose Workbench will allow you to set up shop nearly anywhere. With its legs fully extended, you get a workbench/sawhorse that stands 30 $\frac{3}{4}$ " tall and features a 21 $\frac{3}{8}$ "x 42 $\frac{1}{2}$ " surface. The unit has two grounded 120V outlets with a 15-amp surge protector for power tools. It also has 2 USB ports to recharge mobile devices. Shorten the legs and the workbench becomes a platform that's 20 $\frac{3}{8}$ " high and can support up to 440 lbs. In this mode it's great for painting or detailing tall trucks and SUVs. Tuck the legs and you have a mobile cart, hand truck, creeper, or dolly that can move up to 220 lbs. around your garage or storage area. See all its many features and modes online. **91582**



Scaffold



Sawhorse



Platform



Dolly



Creeper



Hand Truck



The Professional Tool Choice

These days, you can easily find tools that are dirt cheap (both meanings apply). But then the chrome flakes off and the tolerances are so squishy, you can round off any machine bolt as you flay your knuckles. But some of us look at tools the way other people look at art, furniture or jewelry — as investments or heirlooms that should be of such astounding quality, you'll mention them in your last will and testament. If you have more than one child, they'll eventually discover who was the favorite.

The tool of choice at the Ferrari factory in Italy, USAG is a leading manufacturer of innovative, high-quality professional tools. With nearly 100 years of experience in motorsports, USAG tools are crafted to the highest quality standards and built with superior materials for dependable performance.

Nick Griot
- Nick Griot

NEW USAG CANTILEVER TOOL BOXES

Sturdy, electroplated, corrosion-resistant steel. See details online.

T1755 5 Compartment
(17½ x 8½ x 8½)

T1733 3 Compartment
(17½ x 8½ x 6½)

T1701 Single Compartment
(17½ x 8½ x 4¼)

A. USAG SELF-RETRACTING SAFETY KNIFE T1420

B. NEW USAG MULTI-PURPOSE SCISSORS WITH INCLINED BLADES T1437

C. SCREWDRIVER SETS

T1233 12-piece

T1231 8-piece

D. NEW USAG 5-PIECE FILE SET

T1306 Bastard Cut

T1312 Second Cut

E. USAG 17-PIECE METRIC COMBINATION WRENCH SET T1020

F. USAG 13 PIECE STANDARD COMBINATION WRENCH SET T1023



NEW USAG ROLL-UP BAG FOR CAR MAINTENANCE Convenient nylon tool roll keeps tools organized for roadside repairs. See included tool list online.
T1610



NEW USAG PIN PUNCHES An essential set of chrome vanadium steel pin punches, ideal for driving fasteners, rivets and hole alignment. Metal holder. See sizes online. **T1479 Set of 7**



NEW USAG MAGNETIC PICK-UP TOOL WITH LED LIGHT Strong, flexible stainless 4-arm claw actuated with thumb push-button. Includes magnetic tip, LED light. 26½". **T1433**



Extension can convert tool into a T-Handle.

1/4"
Head flexes 180° to allow positioning in tight spaces.

MINI 31-PIECE BIT & RATCHET SET Teaming many of the bits you use most, you'll find this kit especially effective for tight quarter projects. The kit features a 1/4" drive ratchet with an adjustable head that can be angled to engage hard-to-access fasteners. **T1133 1/4" Drive**



1/4"



Head stays locked until release button is pressed.

4 1/2"

USAG MINI 11-PIECE METRIC SOCKET & RATCHET SET This compact set can fit in your pocket and has sockets that are 50% shorter for working in tight spaces. An unlocking button allows the head to hinge 90 degrees in either direction. **T1140 1/4" Drive**



1/2"
STANDARD

SOCKET & RATCHET SET These 1/2-inch drive set ratchets are 10 1/4" long for exceptional leverage. Forged-steel body with USAG's patented pawl for higher resistance and smoother operation. Standard or metric. 1/4" drive sets available online. **T1154 15-Piece Standard, 1/2" Drive**
T1143 15-Piece Metric Set, 1/2" Drive



1/4"
METRIC

USAG 34-PIECE METRIC SOCKET, BIT & RATCHET SET
T1127 1/4" Drive



A.



Wire stripper for 15-, 13-, and 11-gauge wires.



Snip cables up to 50mm² diameter.

Included hard cover/belt clip.

B.



Notched for easy wire cutting.



Tube-holding jaws.

USAG SCISSORS Begin enjoying precision, comfort, and quality with the world's best scissors. Buy them and smile.

A. T1411 Pro Electricians Scissors
B. T1428 Compact Utility Scissors

USAG METRIC AND STANDARD TOOL SETS

The right tool for any job. You get fully outfitted 1/4" and 1/2" drives, socket sets with extensions, u-joints, adapters, combination wrenches, screwdrivers, pliers, and all the bits you could possibly need. The metric set can be ordered in the suitcase or a trolley case with wheels and a telescopic handle. See the website for a detailed inclusion list for each set.

T1600 181-Piece Metric Set
T1600 181-Piece Metric Tool Set, Trolley
(Pictured)

T1602 174-Piece Standard Tool Set



1/4"
METRIC

A superior mix of tools needed for many projects... just grab this case and hit the ground running!

Cases are built tough with reinforced aluminum. Trolley case adds wheels and a handle.





1

2



3



5



6



7



8



9



11

1/4"



1/2"



12



13



14



15



4



10



16

17

18



19

1. USAG MAGNESIUM IMPACT WRENCH, ½" DRIVE This race-proven impact gun is 1 ½ pounds lighter than USAG's standard aluminum-bodied versions due to its magnesium construction. Features a reversible, double-hammer mechanism with three torque settings and a progressive trigger that ramps up to its max torque of 1,180 lb-ft. 90 psi. See details online. **T1052**

2. USAG HAMMER & PUNCH SETS USAG hammers sold individually or as a kit. The kit contains the wood-handled deadblow mallet, a graphite-handled mechanics hammer, four pin punches, a center punch, and a cold chisel, all in a convenient tray.

A. T1308 Hammer & Punch Set

B. T1311 Mechanics Hammer

C. T1300 Mallet with Graphite Handle

3. NEW USAG NEEDLE FILES An agile set of needle files for precision filing projects. See details online. **T1325 Set of 6**

4. NEW USAG 5-PIECE FILE SET Shape, sharpen, debur and smooth out a variety of surfaces. See list of files online.

T1306 Bastard Cut

T1312 Second Cut

5. USAG TORQUE WRENCHES These precision wrenches have earned the highest form of international certification, ISO 6789. USAG's best for precision tightening from valve covers to suspension components to heavy-duty wheel lug nuts.

T1080 ¼" Drive

⅜" Drive

½" Drive

6. REVERSIBLE RATCHET These superior reversible ratchets feature a forged-steel body and USAG's new patented pawl that provides higher resistance and smoother operation.

T1170 ¼" Drive, 4¾" long

⅜" Drive, 7" long

½" Drive, 10¼" long

7. USAG 3-PIECE PLIERS SET 7 ⅝" combination pliers with knurled inner surfaces; 7¼" half-round extra-long nose pliers with straight jaws; 7" diagonal cutting nippers with induction hardening on cutting edges. **T1506**

8. NEW USAG PLIERS FOR CIRCLIPS Remove circlips and snap rings with confidence with these precision pliers. **T1544 Set of 4**

9. USAG COMBIDRIVE SCREWDRIVER & BITS Primarily a ratcheting bit holder, but by placing the hex shaft into the body of the grip, you get a high-torque T-Handle driver. Six bits are stored in the tool end, which doubles as a bit driver.

T1206

Converts to a stubby or T-handle



10. SCREWDRIVER SETS Slot-tip & Phillips. 12-piece includes Pozidriv. Details online.

T1233 12-piece

T1231 8-piece

11. USAG REVOLVING GRIP RATCHET

This ratchet is absolutely the best execution of dual mode we've ever seen. Excellent grip, 60-tooth mechanism, and button release to swap sockets.

T1190 ¼" Drive

½" Drive

• Handle twists for tight spaces.

• Traditional ratcheting action increases leverage.



12. USAG COMBINATION & BOX JOINT PLIERS The ones you reach for most. 9½" box joint pliers. 7⅝" combination pliers. Details online. **T1510**

13. USAG SELF-RETRACTING SAFETY KNIFE Ergonomic alloy handle with automatic blade recall. **T1420**

14. USAG MULTI-PURPOSE SCRAPER Stainless steel body with plastic handle. 6¼" long. 1½" wide blades. **T1405**

15. NEW USAG MULTI-PURPOSE KNIFE Retractable, locking, folding pocket knife with a sharp serrated 3" steel blade. Thumb stud for one-handed opening. **T1455**

16. USAG Multi-Purpose Scissors **T1415**

17. USAG Multi-Purpose Scissors, inclined Blades **T1437**

18. USAG Professional Electricians Scissors **T1411**

19. USAG Compact Utility Scissors **T1428**

Mason Customer Experience **A-N**

Sam Product Development **A-B**

Todd Creative **C**

Evan Customer Experience **D**



Nick Product Development **L-M**

Stevie Product Development **N**



If You Can't Avoid Problems, Anticipate Them

PREPARATION IS KEY TO ENJOYING THE JOURNEY



Optional Flexible Spout

WORLD'S FINEST JERRY CAN Our Jerry Can holds 5.3 gallons (20 liters) and is made from pressed steel whose extrusions increase strength. Includes easy pour spout, shown on can. **92181 92179 Flexible High-Flow Spout**



ROADSIDE SAFETY KIT Be prepared! Kit includes a water-resistant trunk bag with room for more gear, compressor, fire extinguisher, and a Pro LED headlamp that doubles as a hazard warning. **11880**



STAINLESS STEEL LICENSE PLATE FRAME

American-made, stainless steel frames. In polished stainless, matte black, and black pearl powder-coated in three styles. Matching fasteners, and removable, UV-resistant shield. **10362**

LICENSE PLATE SECURITY CAPS

Includes standard and metric locking stainless steel star pin fasteners, key, and rattle-stop hardware. Brushed or black. **10374 Set of 2**



Get in Gear

BRANDED GRIOT'S APPAREL

Our apparel is made with quality materials and features high-end embroidery. Note: Polo Shirts and T-Shirts available in men's sizes M - XXL.



Connor Customer Experience O-P



A. NEW GRIOT'S GARAGE® SNAPBACK HAT 78151
(Select Gray or Black)

B. GRIOT'S 1/4 ZIP NORTH FACE® PULLOVER 77762

C. GRIOT'S HOODIE 77783

D. HAVE FUN IN YOUR GARAGE T-SHIRT 78134

E. STAY OUT OF MY GARAGE!®™ PERFORMANCE T-SHIRT 78121

F. CARBON FIBER COASTERS 3.7" x 3.7". Includes stand. 71129

G. CARBON FIBER BI-FOLD WALLET 3.4" x 3.4" 71143

H. CARBON FIBER SLIM MINIMALIST WALLET 2.6" x 4.1". 71145

I. CARBON FIBER WRENCH BOTTLE OPENER 71131

J. CARBON FIBER MONEY CLIP 71140

K. CARBON FIBER NO-TOUCH KEYPCHAIN 3.6" x 1.6". 7114

L. GRIOT'S CAFFEINE & GASOLINE® T-SHIRT 7810

M. NEW GRIOT'S GARAGE® STRAW HAT 78173

N. GRIOT'S POLO SHIRT BLACK 78143 RED 78143

O. GRIOT'S PUFFY VEST 77963

P. GRIOT'S CARHARTT® BEANIE 78507

Q. CAFFEINE & GASOLINE® COFFEE MUG 77554

R. GRIOT'S VACUUM INSULATED TUMBLER 77150



▶ ULTRA-COMPACT FIRE EXTINGUISHER Smothers flames with a gaseous cloud that bonds to the oxygen molecules and prohibits them from combusting. Lasts 50 seconds and can be aimed and held with one hand, away from danger. 10½" long. **26679**



12-VOLT AIR COMPRESSOR This quite compressor fills an average flat in less than 2 minutes. With the 10' power cord (plugs into your cigarette lighter) and the 3' long air hose, it reaches every tire. Max working pressure is 60 psi. Requires a power port rated for 15 amps. **10285**



12V TIRE INFLATOR AND REPAIR SYSTEM This system pumps in sealant while the tire inflates and works for 125 miles. The sealant wipes out during tire repair. Repairs punctures up to ¼" in size. **36859**
36875 Replacement Sealant Canister



HELLA HORNS Give 'em the business! Super loud at 118 dB with a high/low tone (500Hz/300Hz). Swap out current horns with existing wiring or add to existing horns with included "Y" wires. 5" diameter, 2½" deep. **77573 Pair**