

SPECIFIC ENGINE GUARD

BMW F650/800GS 2008

MOUNTING INSTRUCTIONS

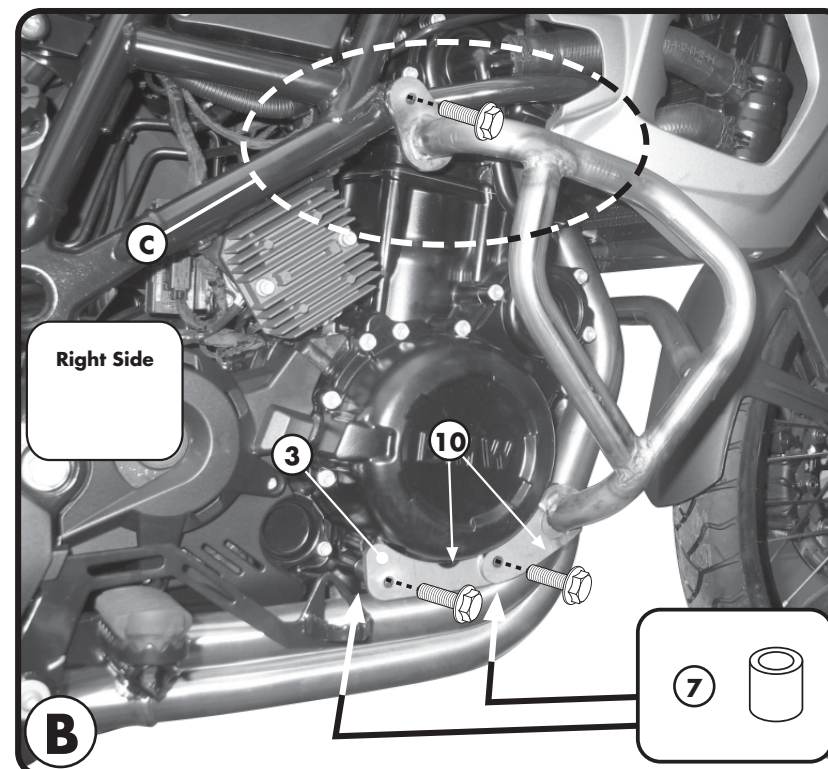
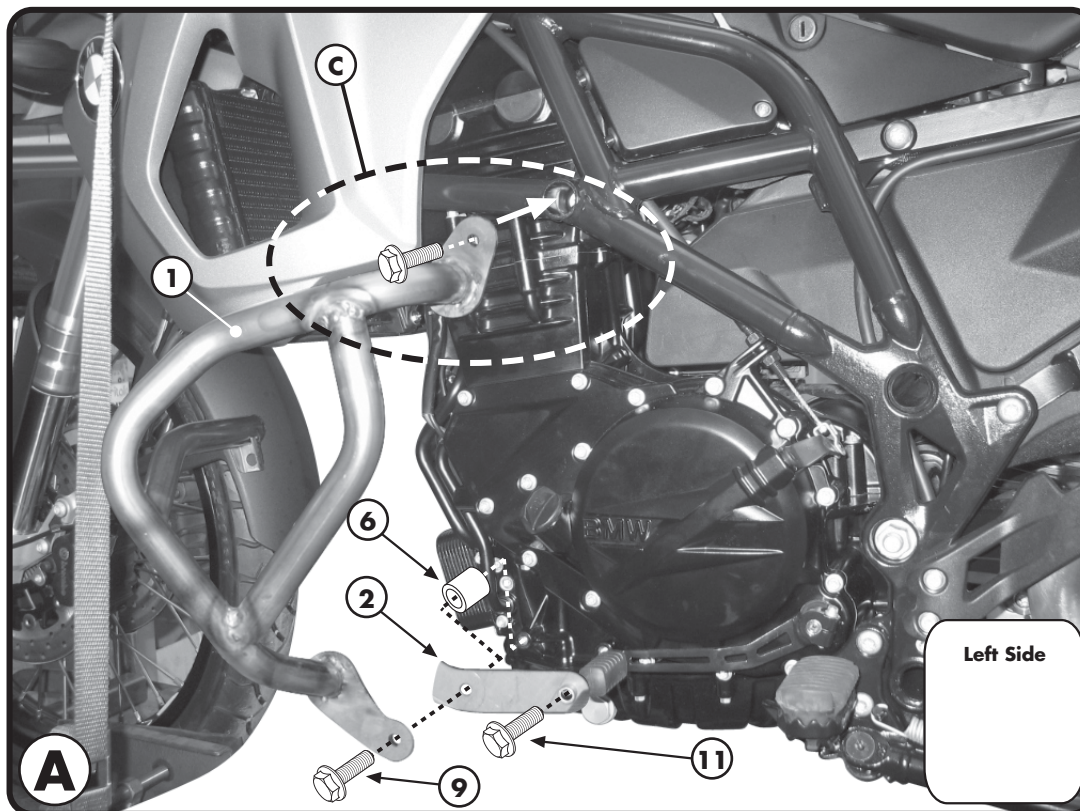
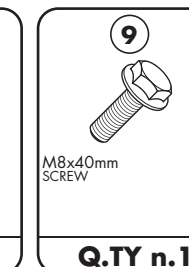
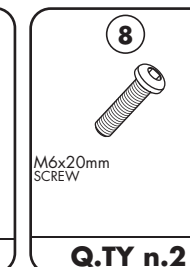
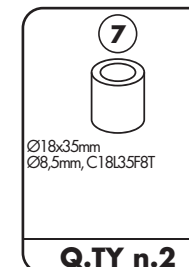
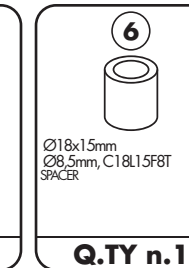
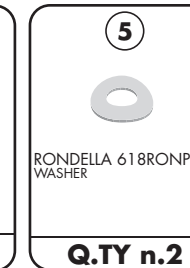
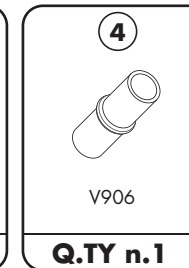
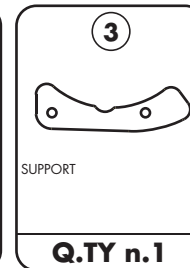
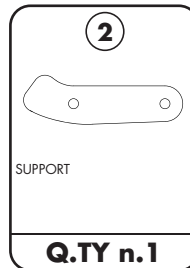

SPECIFIC ENGINE GUARD

BMW F650/800GS 2008

MOUNTING INSTRUCTIONS

10



M8x60mm
SCREW

Q.TY n.2

11



M8x25mm
SCREW

Q.TY n.3

12

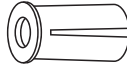

FISHER
V695
EXPANDING TUBE INSERT

Q.TY n.2

13



Ø17X10mm M8
V697
THREADED CONE

Q.TY n.2

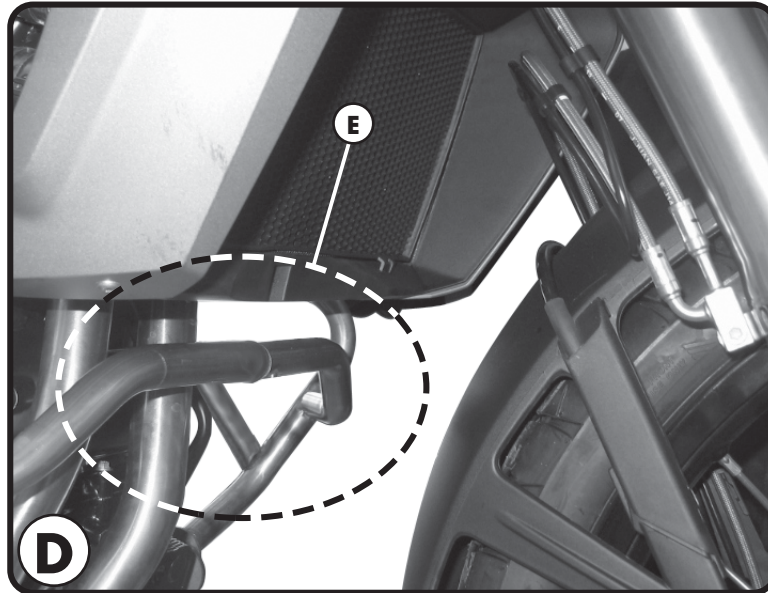

WE RECOMMEND THAT THE MOUNTING IS CARRIED OUT BY A QUALIFIED MOTORCYCLE MECHANIC

