





TN5108 - KN5108

SPECIFIC ENGINE GUARD

BMW

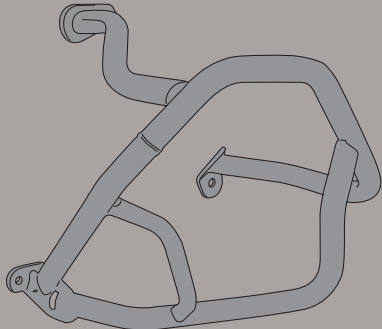
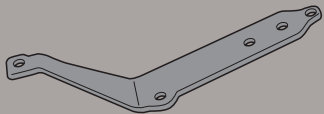
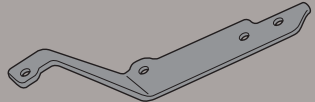
R1200GS

(2013)

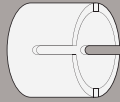
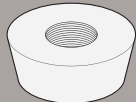
N°	Description	Features	Code	Quantity	
1	Engine Guard	-	-	2 (Dx;Sx)	
2	Support	Sp. 5mm (Dx)	GL2413	1	
3	Support	Sp. 5mm (Sx)	GL2414	1	
4	Screw	TCEI M10x50	1050TCEI	4	
5	Screw	TECEI M10x30	1030TCEI	2	
6	Screw	TCEI M8x25	825TCEI	6	
7	Screw	TCEI M8x20	820TCEI	2	
8	Expanding Tube Insert	Ø33x22 Foro 28mm	LT0979	2	
9	Spacer	Ø29.5/Ø26.5 Foro M10 passo 1,5	V866	2	

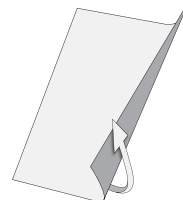

TN5108 - KN5108

SPECIFIC ENGINE GUARD

BMW

R1200GS

(2013)

N°	Description	Features	Code	Quantity	
10	Washer	Ø10	10RON	6	
11	Washer	Ø8	8RON	8	
12	Bolt	Dado Auto Bloccante Flangiato M8	8DADIAFLN	6	

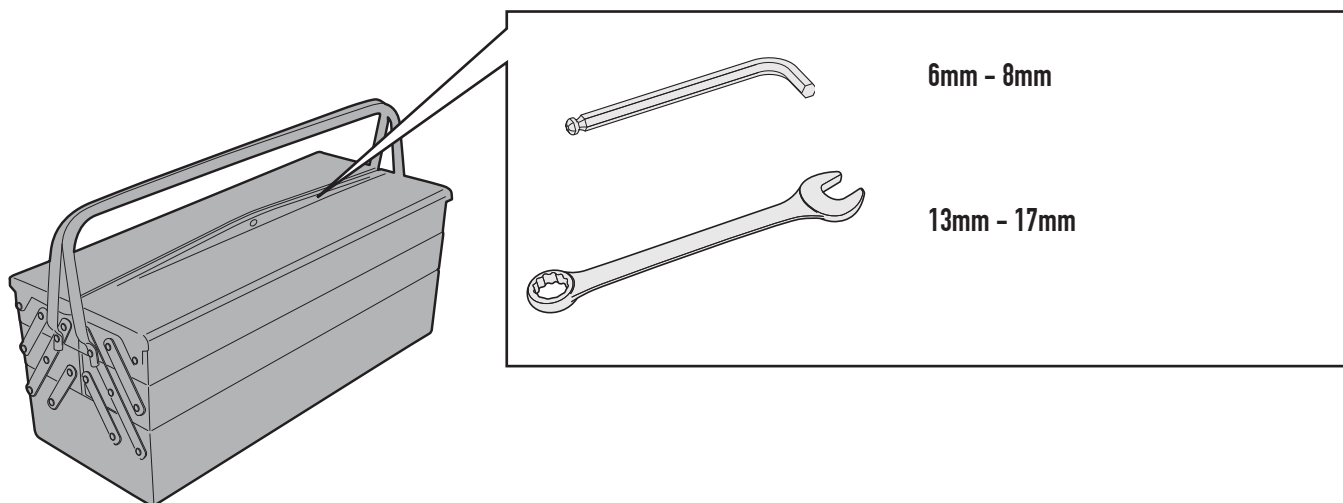

TN5108 - KN5108

SPECIFIC ENGINE GUARD

BMW

R1200GS

(2013)

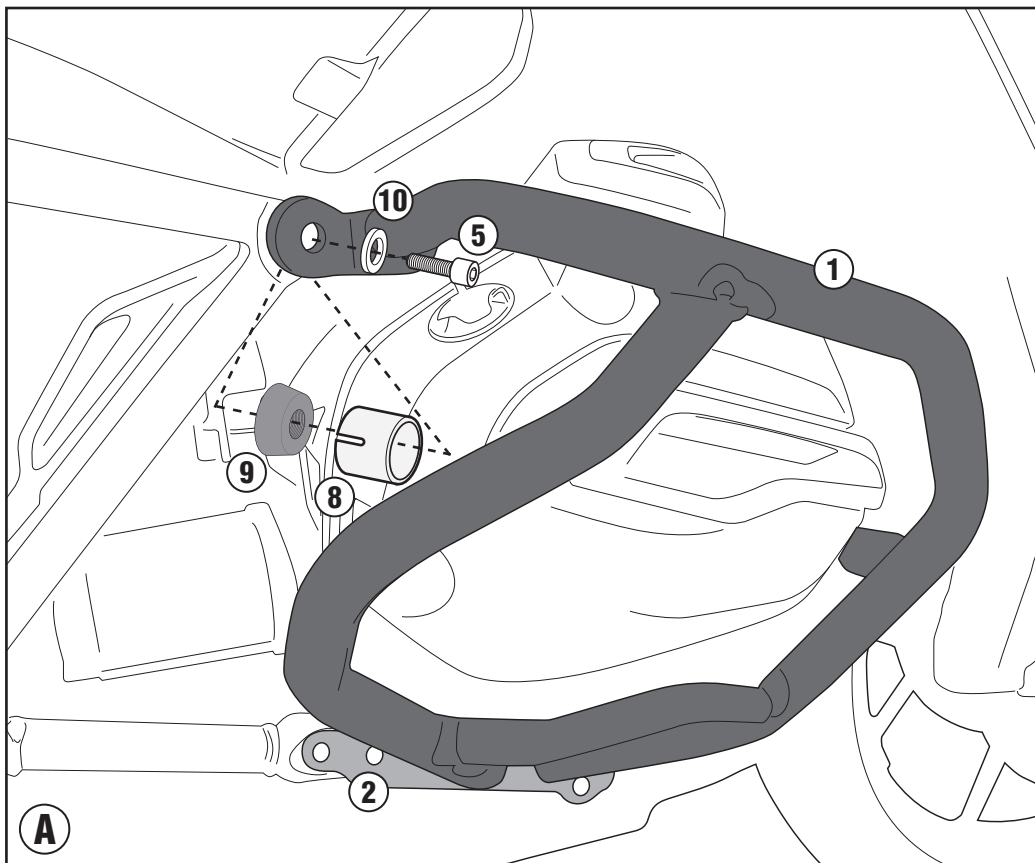
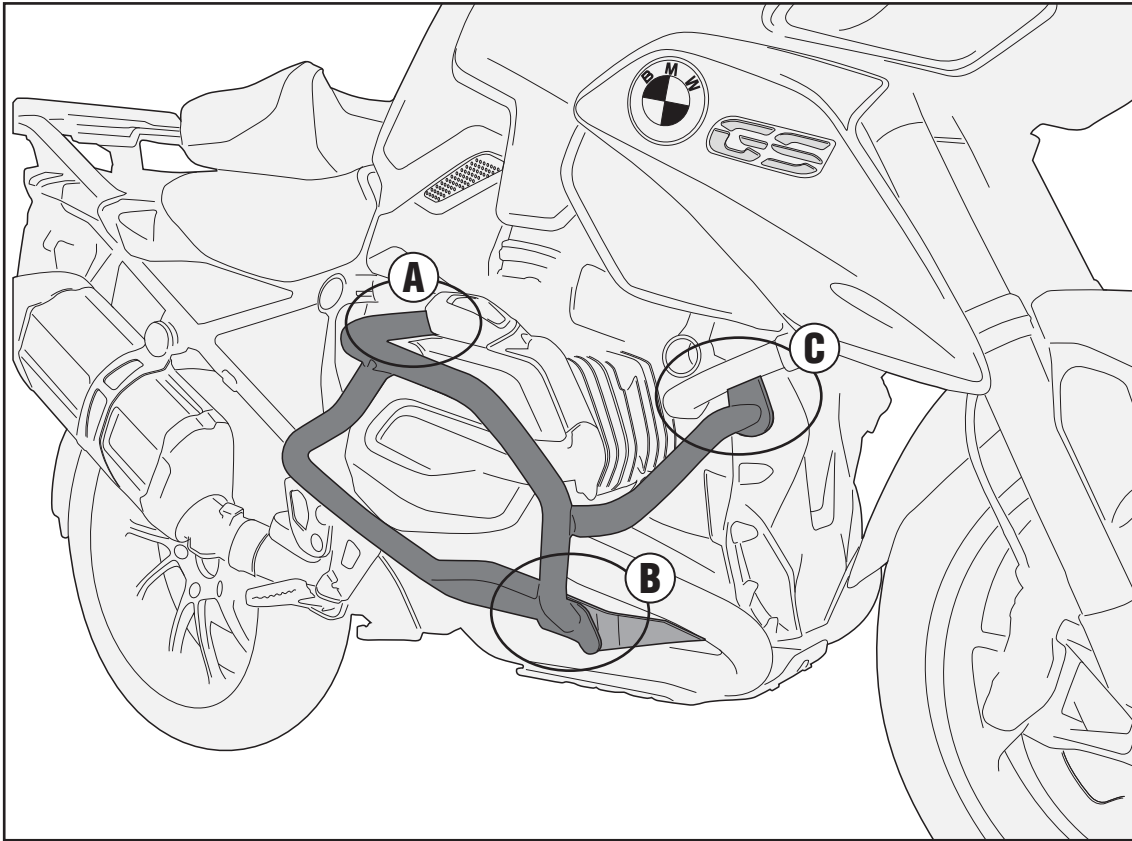

TN5108 - KN5108

SPECIFIC ENGINE GUARD

BMW

R1200GS

(2013)

