



Hydraulics 101

# Introduction to Hydraulics



GATES

*Professional Development*

SERIES

## The Tools You Need to Succeed

Gates Corporation is proud to offer you this hydraulic training series. We understand that the more knowledgeable you are about the products you sell, the more effective you'll be in solving your customer's problems.

In this manual, we will discuss:

- Principles of fluid power
- Components of a typical fluid power system
- Hydraulic applications
- Basics of hose and couplings
- Sales opportunities

## Principles of Hydraulics

In general, the word “hydraulics” refers to power produced by moving liquids. Modern hydraulics is defined as the use of a confined liquid to transmit power, multiply force or produce motion.

Though hydraulic power in the form of water wheels and other simple devices have been in use for centuries, the principles of hydraulics weren't formulated into scientific law until the 17th century. It was then that French philosopher Blaise Pascal discovered that liquids cannot be compressed. Pascal's Law states, “Pressure applied on a confined fluid is transmitted in all directions with equal force on all surfaces.”

To better understand Pascal's Law, let's use a bottle filled with liquid as an example. Let's say the bottle has a one-square-inch opening. If we were to apply 10 pounds of force on the cork at the opening, 10 pounds of force would be applied equally to all sides of the bottle. This is expressed as 10 psi, or 10 pounds of force per square inch. 10 psi represents the fluid pressure of the system.



Generally speaking, the word “hydraulics” refers to power produced by the moving of confined liquids.



## The Industrial Revolution

While well-understood in theory, Pascal's Law wasn't put into practical application until the Industrial Revolution. A British mechanic named Joseph Bramah built a hydraulic press using pressure, force and a confined fluid in a lever-like system. A closed system, such as the one diagrammed here, provides a mechanical advantage similar to that of a simple lever.

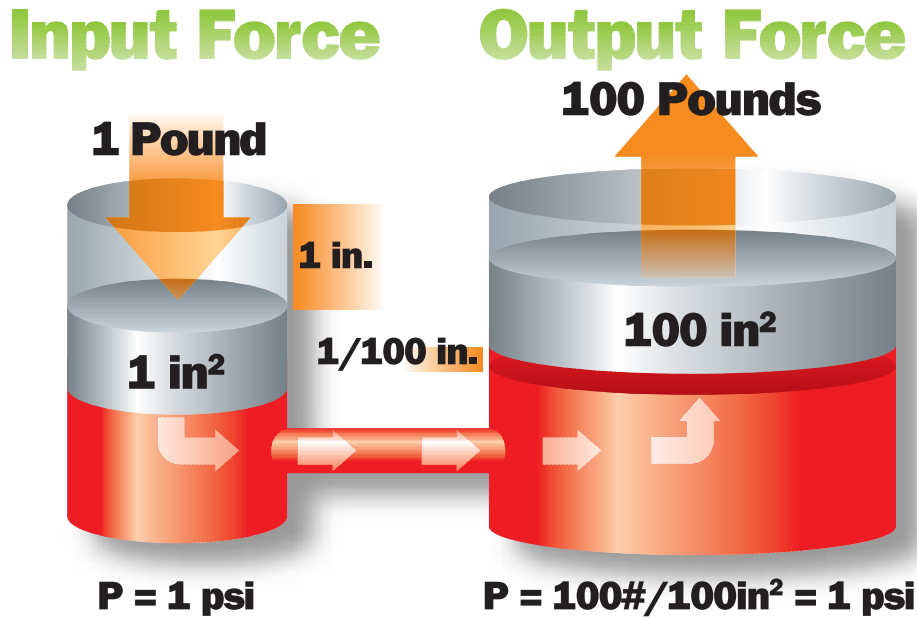

One pound of force applied to a one-square-inch cylinder can balance 100 pounds of force on a 100-square-inch cylinder.

Bramah discovered that, in a closed fluid system, a small force exerted on a small cylinder could balance a large force on a large cylinder. One pound of force applied to a one-square-inch cylinder can balance 100 pounds of force on a 100-square-inch cylinder. In this way, we can move a 100-pound weight using only one pound of force.

The distance the 100 pounds will travel is inversely proportional to the distance the applied force travels. So if we move a one-square-inch cylinder a distance of one inch, the 100-square-inch cylinder will move only 1/100th of an inch.



Hydraulic hose has the advantage of transferring fluid using lightweight components and adds flexibility when routing transfer lines.

A pump's function is to convert mechanical energy into hydraulic energy by forcing fluid under pressure into the system.

## Key Components of Hydraulic Systems

**Fluid** - can be almost any liquid. The most common hydraulic fluids contain specially compounded petroleum oils that lubricate and protect the system from corrosion.

**Reservoir** - acts as a storehouse for the fluid and a heat dissipater.

**Hydraulic Pump** - converts the mechanical energy into hydraulic energy by forcing hydraulic fluid, under pressure, from the reservoir into the system.

**Hydraulic Valves** - control pressure, direction and flow rate of the hydraulic fluid.

**Actuator** - converts hydraulic energy into mechanical energy to do work. An actuator can be a rotary hydraulic motor or a hydraulic cylinder. Hydraulic motors and cylinders are used on agricultural, construction and industrial equipment.

**Filter** - removes unwanted contaminants from the fluid.

**Hose or Tubing Fluid Lines** - transport hydraulic fluid from the pump through the hydraulic system.

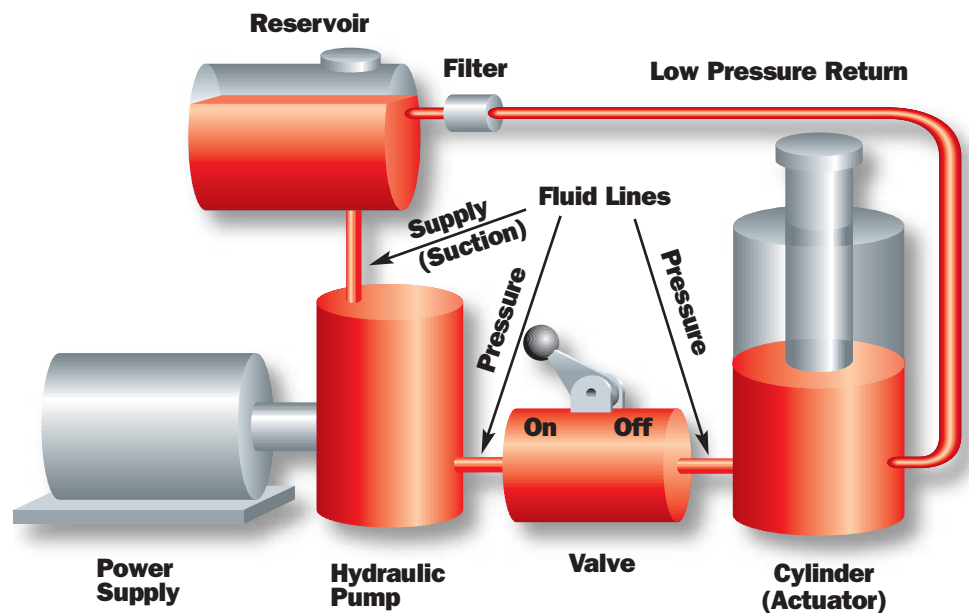

While there are different kinds of pumps, actuators, valves, etc., the basic design of a hydraulic system is essentially the same for all machinery.

## Hydraulic Systems

To understand how hydraulic systems work, it's important to understand

- The characteristics of fluids
- The two types of hydraulic systems
- Hydrodynamics

There are two types of hydraulic systems, hydrostatic systems and hydrodynamic systems.

**Hydrostatic systems** use static confined liquids to perform work. Force is multiplied proportionately from one confined container to another. A hydraulic jack is an example of a hydrostatic system.

**Hydrodynamic systems** use fluids in motion to perform work, using a pump to transfer energy. The pump sets the fluid in motion which transfers energy to a driven element. An example of a hydrodynamic systems is a back hoe.



In hydrodynamic systems, fluids flow. In the process, they create friction, which causes heat and a drop in pressure. These reduce system efficiency.



Fluids assume the shape of their container. They flow freely through components and around corners.

## Hydraulic Principles

### Characteristics of Fluids

Both gases and liquids are fluids with one important difference between them: Gases are highly compressible (as we find in A/C systems). Liquids are **not** compressible.

A fluid can be divided within a hydraulic system to perform multiple tasks at different speeds, all at the same time. For example, different diameter lines often branch off a simple manifold. Smaller diameter lines restrict the flow of the fluid, thus speeding it up. Larger diameter lines slow the flow down. By controlling the rate of flow, we can provide the precise force needed to perform different tasks within the various parts of a hydraulic system.

Hydraulic systems use liquids to transmit force. The word “hydraulics” comes from Greek, *hydro*, meaning “water,” and *autos*, meaning “pipe”. Familiar examples of where you’d find hydraulics in use are in elevators, grease guns, airplane controls, construction equipment and automobile brakes.

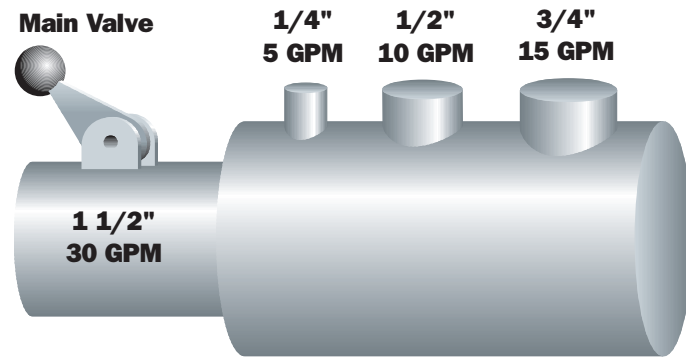

**A restriction in the line, such as a smaller ID hose, causes the fluid to flow more quickly. Larger ID hoses slow the flow down.**

## Fluid Characteristics

**Hydraulic fluids can be almost any liquid.** However, to maximize system performance, the following characteristics are important:

**Quality** - The fluid should enhance system performance, provide long service life and reduce maintenance.

**Viscosity** - The viscosity of a fluid is its resistance to flow at a given temperature. If it flows easily, its viscosity is low. If it flows with difficulty, its viscosity is high. **Temperature affects viscosity.** Fluids at high temperatures have lower viscosity and higher flow ability. Fluids at low temperatures have higher viscosity and lower flow ability. Choosing the proper viscosity assures the right flow for optimum system performance.

**Anti-foam** - Aeration or foaming (that is, air in the system) can create severe safety hazards and pump damage. Anti-foaming agents help prevent foaming and retention of air in the reservoir.

**Oxidation stability** - This quality resists chemical breakdown and the resulting sludge buildup. Sludge, insoluble gums and varnish greatly reduce fluid service life.

**Pour point** - This is the lowest temperature at which a fluid will flow. It should be 20° F below the lowest expected temperature.

**Rust and corrosion prevention** - Acids formed by the interaction of water in hydraulic fluid can corrode metal components. Corrosion inhibitors either form a protective coating on surfaces or they neutralize acids as they form.

**Demulsifiers** - These are additives that help the fluid reject the accumulation of water. Water in the bottom of a reservoir could freeze in cold weather and cause cavitation of the pump.

**Fire resistance** - Fire-resistant fluids will not sustain combustion when an ignition source is removed. Resistant fluids will not allow flame to flash back to the ignition source.



Hydraulic fluids have four functions:

1. Power transmission
2. System lubrication
3. Heat dissipation
4. Aeration prevention (not allowing outside air to penetrate the system)



## Component Characteristics

### Reservoir

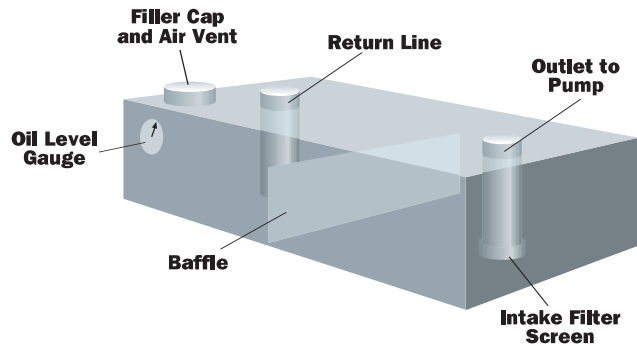

The reservoir has four fluid-related functions. It

1. Provides storage
2. Maintains cleanliness
3. Maintains temperature
4. Removes air

For optimum system performance, reservoirs used in industrial applications usually hold three times the fluid output of the pump. This allows the oil to cool before it re-enters the pump to once again be used in the system.

### Pump

Most pumps used in hydraulic systems are **positive displacement** pumps. There are two types, fixed and variable. Fixed displacement pumps deliver a constant rate of flow which cannot be adjusted. Variable displacement pumps have an adjustable rate of flow.

**Rotary pumps** are either gear or vane pumps.

### Gear Pump Characteristics

Gear pumps develop flow by carrying fluid between the tooth spaces of two meshed gears. They are:

- Strong, durable
- Fixed displacement
- Usually louder than vane pumps
- Handle contamination better
- Lower cost

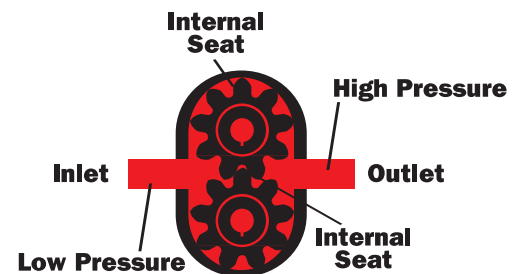

Positive displacement pumps are either rotary or reciprocating pumps.

### Vane Pump Characteristics

Vane pumps use a slotted rotor, vanes and cam ring as pumping elements. They are:

- Either variable or fixed in delivery
- Relatively quiet
- Easy to rebuild
- Self-adjusting to wear
- Not as durable as gear pumps

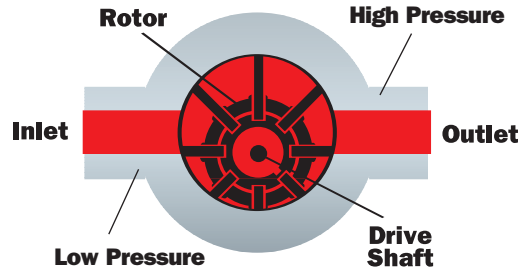

### Reciprocating Pump Characteristics

Reciprocating pumps draw fluid as the piston is retracted and then expel it as the piston moves forward. There are four types of reciprocating pumps:

1. Radial piston
2. Axial piston
3. In-line
4. Bent axis axial piston.

All four pumps share the following characteristics. They:

- Are long lasting
- Are volumetrically efficient
- Are expensive
- Handle higher pressures
- Handle variable volume

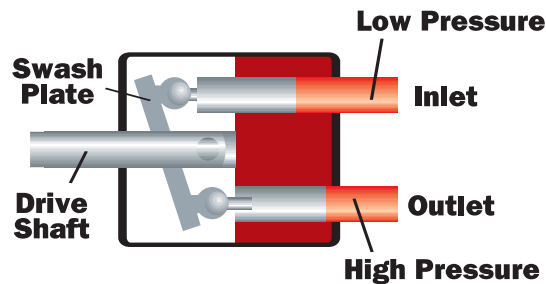



Valves control

- Flow speed
- Flow direction
- Flow pressure



The output of a cylinder actuator is a straight line motion and/or force.

## Valves

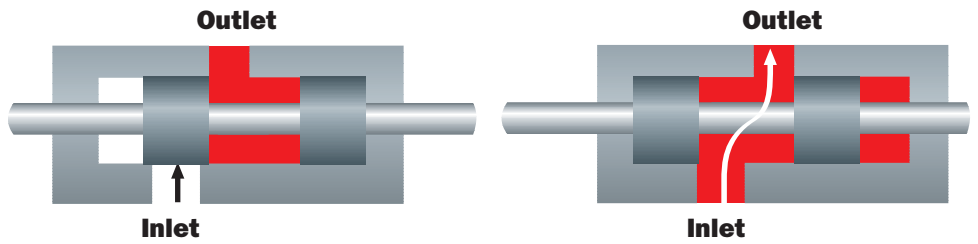

**Directional control valves**, including spool and rotary valves, can be two-way, three-way or four-way.

**Speed control valves** include needle, globe, compensating and non-compensating valves.

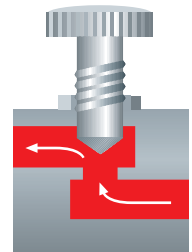

**Pressure control valves** include relief, regulator, sequence, counterbalance, holding and unloading valves.

**System Pressure**

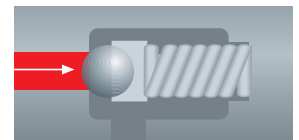

**Tank**

### Actuator

The actuator converts hydraulic energy into mechanical energy to do work.

### Types of Actuators

**Cylinder (linear) actuators** - The output of a cylinder is a straight line motion and/or force. Cylinder actuators are used to lift weight, exert force, clamp, etc.

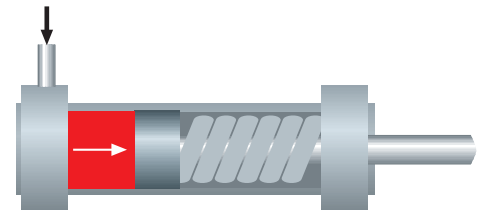

**Rotary (motor) actuators** - The output of a rotary actuator is a rotating force. Rotary actuators are used to power pulleys, gears, rack-and-pinions, conveyors, drive axles, etc.

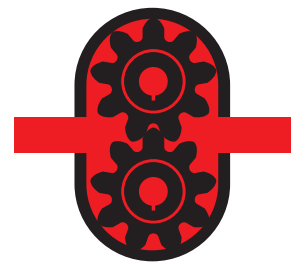

## Filters

The most popular filters in hydraulic systems are **surface filters**.

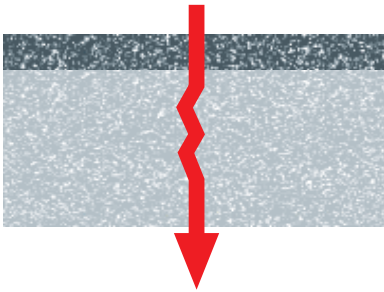

**Surface Filter**

### Filter Ratings

Filters remove particles which are rated in microns. For example, a filter rated at 10 microns would trap at least one particle 10 microns or larger. Filters commonly range from 3 - 35 microns and are installed on:

- Suction lines
- Pressure lines
- Return lines

### Lines

Hydraulic fluids were transferred in steel lines on early hydraulic applications. But steel lines have definite disadvantages compared to hose, which has become the most widely used means of power transmission in the world. Hose offers distinct advantages over metal pipe or tubes because hose:

- Is highly resistant to rust
- Supports high-pressure fluids and pressure impulses
- Is easy to route and install
- Adds flexibility to moving parts
- Is shock resistant
- Is sturdy
- Is lightweight

Each hose is designed to meet the demands of its specific working environment.

The Gates Hydraulic **system** is a highly-engineered hose-and-connector interface that utilizes all components (hose, couplings, ferrules and crimpers), designed to exceed industry standards.



*Photo courtesy of Bobcat Company*



Filters remove unwanted particles from the fluid.



Lines transport the fluid from the pump through the hydraulic system. The lines can be rigid metal pipe, tubes or flexible hose assemblies.

The use of hydraulic machinery gained acceptance in the early 1940s. Engineers discovered that lightweight hydraulic systems needed only minimal space to produce high-powered output. Further, these self-lubricating systems protected the metal pipe and tube conductors from rusting.

Eventually, hydraulic hose replaced the metal pipe and tube conductors of those early systems. Rust-resistant hoses were easier to route and install, and they added flexibility to moving parts. Hoses also absorbed the shock and vibration that typically broke the metal tube conductors. In addition, hose withstood the constant impulse (many times per second) of the hydraulic pumps that were pushing fluid throughout the system.

Today, hydraulic hose is the most widely used means of power transmission in the world. Farm machinery, trucks, busses and all types of earth moving equipment use hydraulic hoses.

## Why Hydraulic Hose?

### Oil & Gas Drilling



Oil & Gas Drilling Rigs

### Agricultural Equipment



Combines/Harvesters



Midsize to Large Tractors



Lawn & Garden Tractors

### Construction Equipment



Loaders



Hauler Trucks



Cement Trucks



Dozers/Crawlers



Rollers

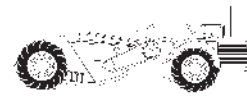

Scrapers



Excavators



Backhoes

### Mining Equipment



Dozers/Crawlers



Hauler Trucks



Excavators

### Manufacturing Maintenance, Repair, Operations



Fork Lifts

- Machine Tools
- Injection Molders
- Presses
- Roof Supports

## Basics of Hose

The wide range of hydraulic applications calls for hydraulic hose of different sizes, capabilities and constructions. Most hydraulic hoses are built to standards, such as Society of Automotive Engineers (SAE), European Norm (EN), and International Standards Organization (ISO), which set general guidelines regarding construction, tolerances and minimum performance ratings, among others. **However, these ratings do not guarantee that all products meeting one standard are exactly the same.**

Manufacturing tolerances vary from manufacturer to manufacturer but stay within international standards. For that reason, Gates recommends never mixing and matching manufacturing products from different manufacturers when making a hydraulic assembly.

There are additional standards set by such government agencies as the:

- Mine Safety and Health Administration (MSHA), which sets specifications for flame resistance
- Coast Guard (USCG), which determines suitability for marine vessel usage
- Department of Transportation Federal Motor Vehicle Safety Standards (DOT/FMVSS), which sets requirements for hydraulic, air and vacuum brake hose, hose assemblies and hose end fittings for use on passenger cars, trucks, busses, trailers and motorcycles



SAE, EN and ISO specifications set specific requirements concerning size, tolerances and minimum performance characteristics for each major hose type.



The inside diameter (ID) of the tube is the key measurement of hose size.

The reinforcement is the muscle of all hydraulic hoses and it determines working pressure.

Gates has a line of abrasion-resistant hoses that lasts longer than standard rubber cover hoses.

## Hydraulic Hose Construction

There are three major components within all hydraulic hoses. Each hose consists of a **tube, reinforcement** and **cover**.

### **Tube:**

The tube must be specially compounded to chemically resist any adverse effects of the fluid flowing through it. It must also be resistant to corrosion, deterioration and the effects of temperature extremes.

**The inside diameter (ID) of the tube is the key measurement of hose size.** It must provide the proper volume of fluid for the specific application. For an SAE specification hose, the smaller the ID of the tube, the higher the pressure it can handle.

### **Reinforcement:**

The reinforcement is the muscle of all hydraulic hoses; it determines the working pressure of the hose. It is either a braid or a spiral wrap and is made from natural fibers, synthetic materials or wire. Some hoses have a reinforcement that is a combination of fiber and wire, or multiple layers of wire braids or spiral layers.

### **Cover:**

The cover protects the tube and reinforcement from heat, abrasion, corrosion and environmental deterioration. It can be made from synthetic rubber, fiber braids or a combination of both.

**Synthetic rubber covers** are more resistant to abrasion than textile-braid covers. Gates MegaTuff® and XtraTuff™ hoses are extremely abrasion resistant and last longer than standard hoses with rubber covers.

**Textile-braid covers** are preferred when gases are present because gases migrating through the hose will not cause a textile-braid cover to blister or separate from the tube. However, textile-braid covers can trap oil, dirt and other contaminants which shorten hose life.

**NOTE:** The types of materials used in the tube, reinforcement and cover will be discussed in a later training module.

## Types of Hose by Operating Pressure

Hydraulic hose can be grouped by their **operating pressure at a given ID** from “extremely high” to “low”. For example, the very-high-pressure hose, 32C12, a hose with a 2” ID, has an operating pressure of 2500 psi. In contrast, a 3/8” ID hose, such as G1, has a operating pressure of 2600 psi, yet is considered a medium pressure hose. In general, the larger the hose ID, the lower the operating pressure.

This grouping of hose by pressure rating is confusing. For now, it is enough for you to know only that such a rating system exists. We’ll discuss hose selection and pressure ratings in a later training module.

### Extremely High and Very High Pressure Hose

Very-high and extremely-high pressure hoses perform best on applications that are subject to extreme high impulse (or pressure surges) such as off-highway equipment and heavy-duty machinery, for example. These hoses are reinforced with four or six layers of spiraled, high-tensile steel wire over a layer of yarn braid. Again, we’ll discuss the specifics of hose materials in a later training module.



The rated working pressure of a hydraulic hose is the maximum pressure at which the hose is to be used. It is not to be exceeded in any application.



**High-Pressure Hose**

Reinforced with two steel wire braids, these are often called “two-wire” braid hoses. You’ll find them in high-pressure applications, such as on construction equipment. They range in operating pressures from 6000 psi (3/16” ID) to 1825 psi (2” ID).

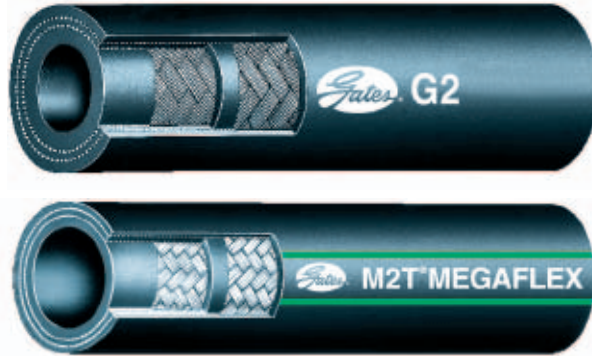

**Medium-Pressure Hose**

Operating at pressures from 3000 psi to 300 psi, these hoses can have one-wire, multiple-wire and/or textile-braid construction.



Burst pressure is not a working pressure rating. It is a safety value to cover pressure surges.

# I N T R O D U C T I O N T O H Y D R A U L I C S

Medium-pressure hoses often find application on heavy-duty truck and fleet vehicles. In the 1940s, there were no flexible hoses designed especially for the fleet user. However, truck mechanics found an aircraft hose that met the demands of fleet applications. Soon, this aircraft hose replaced the rigid copper tubing originally used on trucks. This truck hose is often called, "flexline," or "TWT" (textile-wire-textile). The Gates name is C5 (SAE 100R5).





Suction return hoses must be rated for vacuum. Look for the In. Hg (Inches of Mercury) value.

**Specialty Hose**

**Fleet and Air Brake System Hoses**



**Low-Pressure Hose**

You'll find these hoses in applications with operating pressures under 300 psi. Typically, they're used to transmit petroleum-based fluids, lubricating oil, air, glycol anti-freeze and water. Gates GMV hose is also rated for suction applications.



### Specialty Hose

Many hoses don't fit easily into a particular pressure category. These special application hoses are used to convey such things as refrigerant or LP gas. They are capable of operating at temperature extremes and in those applications requiring non-conductivity of electricity.

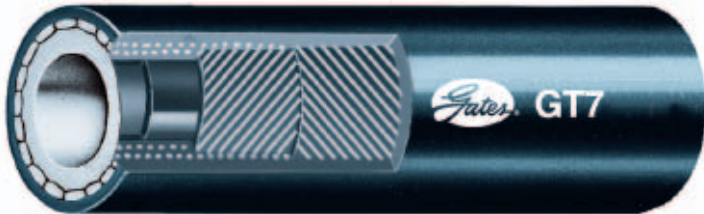

GT7NC and GT8NC thermoplastic hoses have the same pressure rating as SAE 100R1 and SAE 100R2 hoses, respectively. However, they are quite different in construction to meet special application needs (lighter weight, very long lengths and non-conductivity).

## **Automotive Hoses**

### **Power Steering Hose**

In addition to a complete line of power steering assemblies, Gates manufactures hoses for power steering pressure and return lines.



Using PS188 hose and couplings, you can custom fabricate power steering assemblies using your Gates crimping equipment.

### **Air Conditioning and Refrigeration Systems Hose**

#### **PolarSeal® Barrier Refrigerant Hose**

Used in automobile A/C systems, as well as industrial A/C systems (such as tractors, trucks and both mobile and stationary refrigeration units), PolarSeal hose minimizes the permeation of R134A and R12 refrigerants.



**Hose Nomenclature**



**12 EF G 5K**

- 5000 psi rating
- Global
- Environmentally Friendly
- Dash size (3/4" I.D.)



**8 M 2 T**

- Thin cover
- 2 Wire
- MegaSys® (1/2 SAE bend radius)
- Dash size (1/2" I.D.)



**Dash Sizes**

The inside diameter (ID) of a hydraulic hose determines its size. This ID size is expressed as a Dash Number, which is the number of 1/16" segments to equal the hose ID. For example, a 1/4" ID hose has 4 1/16" segments for a dash size of -4. A 1/2" ID hose (8/16") has a dash size of -8. A hose with a 2" ID has a dash size of -32.

NOTE: The dash size always precedes the Gates nomenclature, as you see in the illustration above (8 = dash size + M2T = the Gates name).

**However, there are exceptions.**



**8 C 5 C**

- "Cotton" cover
- SAE 100R5 Specs
- Dash size (13/32" I.D.)

**Hoses designed to replace tubing are the exceptions to this dash size classification.** Tubing is measured by its **outside diameter (OD)**. For example, a 1/2" OD tube has an inside diameter (ID) of 13/32". The -8 hose replacement for this tubing has a 13/32" ID, but it is still called -8, the equivalent of 1/2" tube OD.

**Dash size exceptions in the Gates line are C5, PolarSeal' and C14 (PTFE).**

Dash No.	Hose I.D. (Inches)			
	All Except, C5 Series, C14 and AC134a		C5 Series, C14 and AC134a	
	In.	mm	In.	mm
-2	1/8	3.2	--	--
-3	3/16	4.8	--	--
-4	1/4	6.4	3/16	4.8
-5	5/16	7.9	1/4	6.4
-6	3/8	9.5	5/16	7.9
-8	1/2	12.7	13/32	10.3
-10	5/8	15.9	1/2	12.7
-12	3/4	19.0	5/8	15.9
-14	7/8	22.2	--	--
-16	1	25.4	7/8	22.2
-20	1-1/4	31.8	1-1/8	28.6
-24	1-1/2	38.1	1-3/8	34.9
-32	2	50.8	1-13/16	46.0
-36	2-1/4	57.6	--	--
-40	2-1/2	63.5	2-3/8	60.3
-48	3	76.2	--	--
-56	3-1/2	88.9	--	--
-64	4	101.6	--	--



Couplings, or “fittings,” are the metal components that are teamed with hose to make hydraulic hose assemblies.

## Basics of Couplings

Couplings attach the hose to the equipment. They’re also the metal components of any hydraulic hose assembly. The **stem end** of the coupling connects to the hose, while the **thread end** (or coupling termination) of the coupling attaches to the equipment. All Gates **descriptions of couplings** put the **hose end first**, followed by the thread end.

### Field-Attachable Couplings

Higher pressure hoses can use field-attachable (also called “reusable”) couplings, as well as permanent couplings. You can fit field-attachable couplings right on the hose using only a wrench and a vise. No special equipment is required. While handy, they do cost more than permanent couplings and take more time to attach.

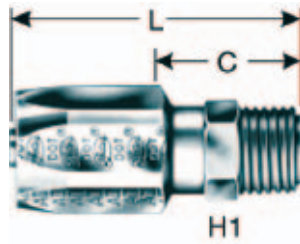
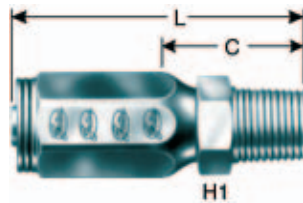

### Permanent Couplings

You need crimping or swaging equipment (sometimes both) to put a permanent coupling on a hose. Permanent couplings can be pre-assembled (“one piece”), such as our MegaCrimp® couplings. One-piece couplings have the ferrule permanently attached to the stem.

Gates also offers two-piece couplings, which consist of a ferrule and separate stem. Gates GlobalSpiral™ GS spiral wire couplings are a good example.

#### MegaCrimp® Coupling

Wire Reinforcement



Serration “biting” the wire

#### Global Spiral™ Coupling

Ferrule

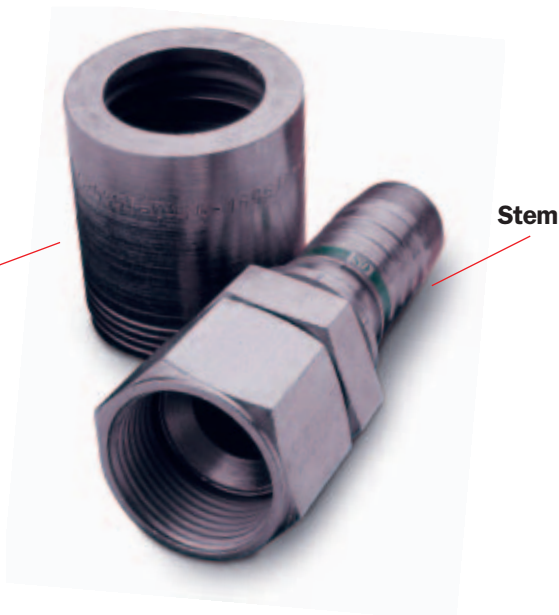

Stem



Permanent couplings are generally more reliable, easier and quicker to attach than field-attachable couplings, which makes them the most popular couplings in use.



Gates descriptions always list stem end first. For example, 8G-8MP  
Stem End = (8G) -  
Thread End = (8MP)



**Coupling Thread Types and Seals**

There are three types of coupling interfaces used in hydraulics today: Thread Interface, Mated Angle, and O-Ring.

**Interference Seal**

Threaded couplings have two types of threads: Male (outside threads) and Female (inside threads).

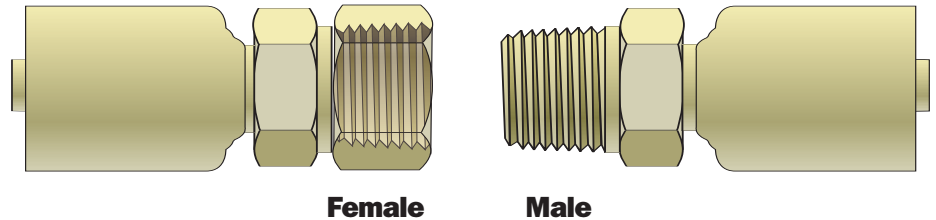

**National Pipe Tapered Fuel**

There are two types of threads. The first, the National Pipe Tapered for Fuel (NPTF) has, as the name implies, **a tapered thread**. When the male and female components are threaded together, the tapered threads deform, applying pressure on one another, and thus making a tight seal.

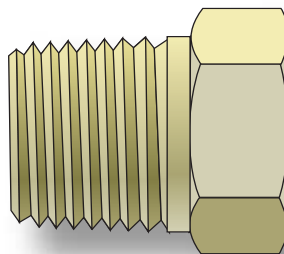

**NPTF**



Threads and sealing surfaces conform to one of many industry standards. A few of the more common North American thread end types are introduced here. In a later training module, we'll study international threads.

**Mated Angle Seals**

Here, the seal is made when the male and female threads are screwed together. Two types of mated angle seals are SAE 45° and JIC 37°, but there are others. The NPSM seal is a mated angle.

**National Pipe Straight Mechanical**

National Pipe Straight Thread Mechanical Joint (NPSM) brings two 30° tapered seats together to make the seal.

SAE 45° flare couplings are used on lower pressure applications, such as fuel lines, hot oil lines or refrigerant lines. A “rule of thumb” states that they are also used in “under the hood” and in marine applications.

JIC 37° angle seats are used on medium-pressure and high-pressure lines on heavy equipment to join hydraulic hose assemblies to hydraulic system components.

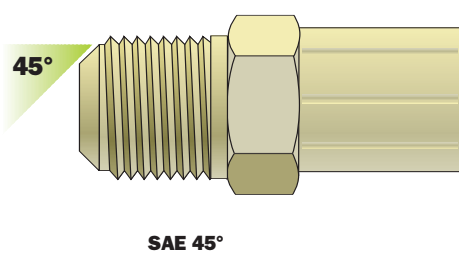
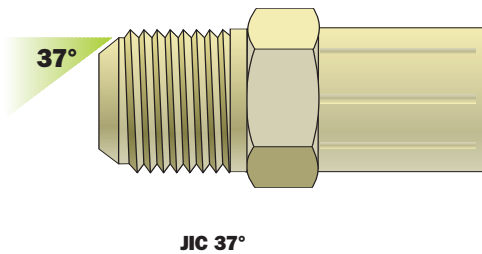
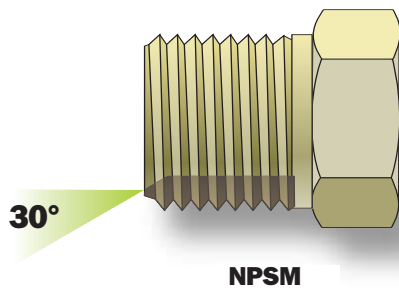

Couplings with angle seats for sealing have straight or parallel threads. The threads themselves do not seal fluids as with tapered threads. Instead, the threads function to mechanically bring the two mating angle seats together.



Gates provides tools for measuring and identifying the many different types of thread ends on the market. These tools come in a handy Pocket Kit (Part No. 86583/Product No. 7369-4318) that includes a thread specification booklet with the various shapes and measurements necessary for proper identification.

### O-Ring Seals

There are three types of O-Ring seal designs:

#### O-Ring Boss

#### Flat-Face O-Ring Seal

#### O-Ring Flange

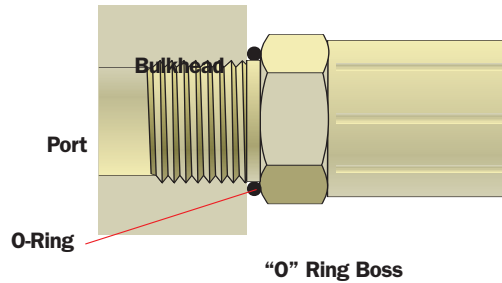

In the **Boss** design, straight threads make the connection while a rubber "O" makes the seal. Threads pull the O-ring against the port, which has a machined groove for the O-ring, flattening the O-ring and making a seal that is excellent for high-pressure applications.

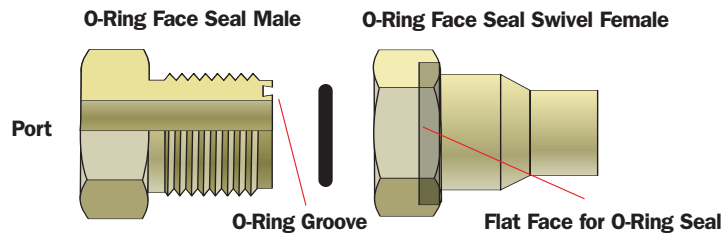

In the **Flat-Face O-Ring Seal (FFOR)**, the O-ring sits in a groove on the male's face. The seal is made when the O-ring of the male meets and flat face of the female. The solid male O-ring face seal fitting will mate **only** with a swivel female O-ring face seal fitting.

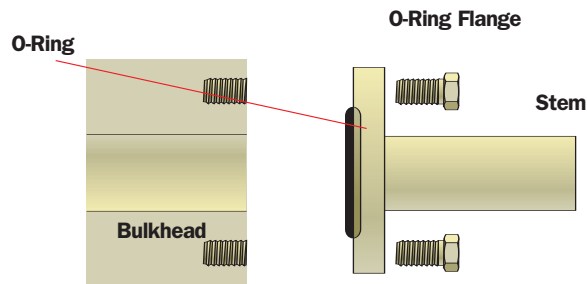

**O-Ring Flanges** make high-pressure, large-diameter connections. A port is bored with a center outlet, surrounded by a smooth flat face which has four tapped holes and four mounting bolts that tighten down onto flange clamps. There are no threads on this coupling. The flange itself has the groove for the O-ring.

## Hydraulic Crimping Equipment

Gates offers five crimpers you can use to make factory-quality assemblies in the field.

### Power Crimp® 707

Our most popular and versatile crimper, the PC 707 crimps four-wire hoses from 3/16" to 1-1/4" I.D. For stationary applications and operating on either 115v or 220v, it can be modified to act as a swager. The bottom load PC707 and digital readout allows the operation to make factory-quality assemblies quickly and easily.



### MobileCrimp® 4-20

This lightweight (58 lbs) portable crimper can handle 1-1/4" I.D. four-wire hose. It's perfect for use on service trucks or where electrical power is not readily available. Highly adaptable, the MC 4-20 operates on air pressure, AC or DC – even a hand pump. Available in either Positive Stop or Digital Dial models.



### GC32-XD Crimper

The first global crimper, the GC32-XD automatically converts any electrical input voltage greater than 208 volts to 220 volts (single phase). Quickly and easily makes hydraulic assemblies from Gates entire hose and coupling product line. Adjustable to operator height and reach. Includes color-coded die sets stored in see-through polypropylene tubs, a Quick Change Tool to make loading dies easy, and optional depth-stop, plus other features to make crimp assembly production fast and easy.



Different die sets are required, depending on the type and size of the hose and the couplings to be attached. Always refer to the crimp data manual (428-7365).



Selection of Gates crimpers depends on such factors as hose size, production rates, portability and cost.

### **OmniCrimp® 21**

No need for plumbing lines, air bleeding or special hookups. The OmniCrimp 21 is self contained. Everything you need to crimp all Gates six-wire hydraulic hose from 3/16" to 2" I.D. is under the hood. A speed-loading die system and front-end feed makes crimping easy.



### **Power Crimp® 3000B**

Rugged, powerful and economical, the PC 3000B crimps all Gates six-wire hydraulic hoses from 3/16" to 2" I.D. An automatic limit switch allows you to make accurate crimps with the push of a button. The PC 3000B makes a good companion to the PC 707.



**Model 2-24 Hose Cutter**

With a reversible 8-inch scalloped-edge high-speed steel blade, the Model 2-24 cuts up to 1-1/2" ID two-wire braid reinforced hose. It is designed to operate on standard 20 amp service and is also available with a DC motor for mobile service applications. Weight: 65 pounds.



**Power Cutter 207 Cut-Off Saw**

Interchangeable blades make cutting braided or spiral-wire hose easy. Powered by a 4.2 hp motor, it accommodates hoses of all sizes and makes straight, accurate cuts.



**Model 6-32 Hose Cutter**

Powered by a 3 HP (5.2 HP peak) single or three-phase 230V, 60Hz., 15 amp motor, the Model 6-32 cuts from two- to six-wire braid reinforced hose in IDs up to two inches. Includes a Coolant Spray Kit to reduce blade heat in high-capacity cutting applications. Weight: 215 pounds.



**Vertical Coupling Cabinet**

Four heavy-gauge steel drawers slide out for easy access. Each shelf holds a combination of ten 3 1/2"-wide bin boxes or five 7"-wide bin boxes.



## Where Hydraulic Hose is Sold

Gates Corporation is the world leader in the manufacture of hydraulic hose and couplings. Our products include hose, couplings, adapters, quick disconnects, crimpers and accessories to these products.

### The Distribution Channel

Replacement hose and fittings are available from Gates through several distribution channels, including:

- Automotive Warehouse Distributors
- Fleet and Heavy-Duty Distributors
- Industrial Hydraulic Specialists
- Original Equipment Dealers

The Automotive Sales Division serves the Automotive Warehouse Distributor as well as the Fleet and Heavy-Duty distribution channels for hydraulic hose and couplings.

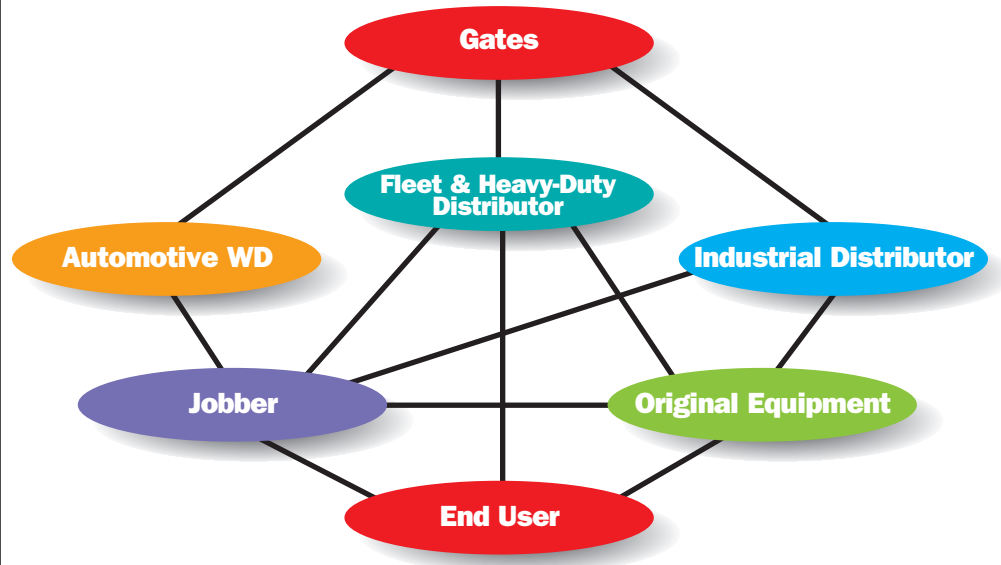

**Distributors** may fabricate hydraulic assemblies by attaching couplings to hose, or they may resell hydraulic hose and couplings for assembly by dealers or end-users.

A **dealer** sells and/or services equipment using hydraulic hose assemblies.

**End-users** may also fabricate assemblies, but they usually install a pre-made assembly on their equipment.

## Where Hydraulic Hose is Used

### Fleets

Hydraulic hoses are not restricted to use on hydraulic systems. Because of their superior resistance to heat, oil and abrasion, hydraulic hoses are also used on trucks, buses and large diesel-powered vehicles. Such non-hydraulic applications include connections to turbo chargers, engine and transmission oil coolant lines, diesel fuel, gasoline, air and water lines, and those under-the-hood applications where hoses are subjected to severe heat, weathering and abrasion.

- Glad Hands
- Truck Valves
- Liquid Drain Cocks
- Air Drain Cocks
- Air Tank Valves
- Shut-Off Cocks
- Brass Adapters
- Check Valves

