



# Gardner-Westcott Company

Quality Chrome Plated and Stainless Steel Fasteners

## AUTOMOTIVE FASTENER CATALOG



**AMERICAN  
AND  
METRIC  
THREADS**

**SERVING THE AUTO ENTHUSIAST FOR OVER 4 DECADES**

# Table of Contents



1

<b>Index</b>	<b>2</b>
<b>Technical Information</b>	<b>3-7</b>
<i>Specifications and Sizes</i> .....	4
<i>Style Chart and How to Measure</i> .....	5
<i>Thread Identification Fittings</i> .....	6
<i>Conversion, Reference and Equivalent Charts</i> .....	7
<b>Engine Dress Up Kits</b>	<b>8-14</b>
<i>Product Emblem Stamped Identification Part Number Chart</i> .....	8
<i>Chevrolet and Emblem Stamped Chevy Bowtie, SS, RS, 350 and 454</i> .....	10
<i>Pontiac and Oldsmobile Emblem Stamped Arrow, GTO, GT and Olds Rocket</i> .....	11
<i>Mopar and Emblem Stamped Chrysler Pentastar, Mopar, Dodge Ram and Hemi</i> ....	12
<i>Ford, Flathead and Emblem Stamped Ford Oval, Vintage, V8 and Ford Mustang</i> ....	13
<i>6-71 Series Blower Dress Up &amp; Nissan Z Engine Dress Up Kits</i> .....	14
<b>Individual Sets</b>	<b>15-22</b>
<i>Chevrolet</i> .....	16
<i>Emblem Stamped Chevy Bowtie, SS, RS, 350 and 454</i> .....	17
<i>Emblem Stamped Pontiac, GTO, GT and Oldsmobile Rocket</i> .....	17
<i>Ford</i> .....	18
<i>Emblem Stamped Ford Oval, V8 and Mustang</i> .....	19
<i>Emblem Stamped Flame and Skull</i> .....	19
<i>Mopar</i> .....	20
<i>Emblem Stamped Mopar, Chrysler Pentastar, Dodge Ram and Hemi</i> .....	20
<i>Buick and VW</i> .....	20
<i>Interior Screw Sets</i> .....	21
<b>Bulk Fasteners- (Chrome, Stainless and Zinc)* Also see Alphabetical Index on Pg. 2</b>	<b>23-56</b>
<i>American Thread</i> .....	24
<i>Metric Thread</i> .....	49
<b>Assortments/Trays</b>	<b>57-68</b>
<b>Fittings- (Brass and Hand Polished Chrome Plated)</b>	<b>69-74</b>
<b>Product Display Units- (Floor and Counter Displays)</b>	<b>75-90</b>

**TERMS**.....Cash or COD company check acceptable unless otherwise specified.

**CREDIT**..... Applications for open account warrants at least three references of reputable firms that you have dealt with in the past year. Terms are net 30 days from date of invoice. If a customer is in arrears on an open account, future shipments will be processed on a COD basis until credit is restored.

**PRICING**..... All retail prices shown are suggested only and in no way dictate a set price. Prices are subject to change without notice.

**SHIPPING**..... We ship UPS and by truck, always collect, with any service charges to be paid by customer.

**CLAIMS**.....We are not responsible for goods damaged in transit and all claims must be filed with the carrier involved.

**RETURNS**.....Returns for credit require prior notification and authorization. No returns will be accepted after 30 days from date of invoice.

**GUARANTEE**.....If any part is found to be defective in workmanship or unsatisfactory in any way, we will replace it or give credit where applicable.





# Alphabetical Index by Part

## Bolts

	American			Metric		
	Chr.	SS	Zinc	Chr.	SS	Zinc
Body Bolts.....	28	---	---	---	---	---
Bumper Bolts.....	---	36	---	---	---	---
Carriage Bolts.....	28	36	---	---	53	---
Flange Bolts.....	---	---	---	---	---	---
Hex Caps.....	26	40	45	51	53	55
Hex Head Sems.....	28	---	---	---	---	---
Spinlock Bolts.....	28	---	---	---	---	---
Step Bolts.....	28	---	---	---	---	---

## Washers

	American			Metric		
	Chr.	SS	Zinc	Chr.	SS	Zinc
Cup Washers.....	32	---	---	---	---	---
External Lock Washers.....	31	41	46	---	---	---
External Countersunk.....	31	41	---	---	---	---
Internal Lock Washers.....	31	41	46	---	---	---
Finishing.....	32	41	---	---	---	---
Flush.....	32	---	---	---	---	---
Flat Washers.....	31	41	46	52	54	56
Flat Washers AN.....	31	41	---	---	---	---
Flat Washers USS.....	32	---	---	---	---	---
GW Hardened Washers.....	31	41	---	---	---	---
High Collar Lock Washers.....	31	41	---	---	---	---
Lock Washers.....	31	41	46	52	54	56
Neoprene Backed Washers.....	---	42	---	---	---	---
White Nylon Washers.....	---	42	---	---	---	---
Super Flat Washers.....	32	41	46	52	---	---
Wave Washers.....	---	---	---	52	54	---

## Nuts

	American			Metric		
	Chr.	SS	Zinc	Chr.	SS	Zinc
Acorn Nuts.....	34	42	---	52	---	---
Acorn Nuts Low Crown.....	34	---	---	---	---	---
Acorn Push on Covers.....	34	---	---	---	---	---
Allen Nuts.....	33	---	---	---	---	---
Castle Nuts.....	---	42	---	---	---	---
Flange Nuts.....	35	---	---	52	---	---
Flexloc Nuts.....	33	---	---	---	---	---
Hex Nuts.....	33	42	46	52	54	56
Jam Flexloc Nuts.....	33	---	---	---	---	---
Jam Nuts Thin.....	33	43	46	52	54	---
Jam Nylon Insert Lock Nuts.....	33	43	46	54	56	---
Left Hand Thread.....	35	---	---	---	---	---
Nylon Insert Lock Nuts.....	33	42	46	52	54	56
Slotted Nuts.....	33	---	---	---	---	---
Spike Nuts.....	34	---	---	---	---	---
Spin Locks.....	---	43	---	---	---	---
Wing Nuts.....	35	---	---	---	---	---
Wing Nuts Wide Base.....	35	---	---	---	---	---

## Other Items

	American			Metric		
	Chr.	SS	Zinc	Chr.	SS	Zinc
Assortments.....	57	62	63	65	68	---
Axle Kits, VW.....	---	---	---	20	---	---
Blower Kit for 6-71 & 8-71.....	14	14	---	---	---	---
Bulk.....	23	36	45	49	53	56
Chevrolet Engine Kits.....	10	10	---	10	10	---
Chevy Bow Tie Product Line.....	27	37	---	---	---	---
Cotter Pins.....	35	35	35	---	---	---
Fittings Brass.....	69	---	---	---	---	---
Fittings Chrome.....	69	---	---	---	---	---
Ford Engine Kits.....	13	13	---	---	---	---
Ford Flathead Acorn Kit.....	13	---	---	---	---	---
Ford Oval Product Line.....	29	38	---	---	---	---
Grease Fittings.....	35	---	---	---	---	---
Hinge Pins.....	21	20	---	---	---	---
Hole Plugs.....	35	42	---	---	---	---
Hose Clamps.....	---	36	---	---	---	---
Interior Kits.....	21	22	---	---	---	---
License Plate Kits.....	16	---	---	---	---	---
Line Clamps.....	---	36	---	---	---	---
Metal Trays & Cabinets.....	58	---	---	---	---	---
Mopar Engine Kits.....	12	12	---	---	---	---
Mopar Emblem Product Line.....	20	20	---	---	---	---
Muffler Clamps.....	---	36	---	---	---	---
Mustang Front End Kits.....	18	---	---	---	---	---
Nissan 3.0 V-6 Engine Kits.....	---	---	---	14	14	---
Oldsmobile Engine Kits.....	11	11	---	---	---	---
Pipe Plugs Allen Style.....	35	42	---	---	---	---
Pontiac Engine Kits.....	11	11	---	---	---	---
Product Display Units.....	73	77	---	---	---	---
Spacers.....	34	---	---	---	---	---
Threaded Rod.....	---	42	---	---	---	---
Throttle Return Springs.....	28	28	---	---	---	---
Zinc L-9 Bolts.....	---	---	45	---	---	---
Zinc L-9 Washers.....	---	---	46	---	---	---
Zinc L-9 Nuts.....	---	---	46	---	---	---

## Screws

	American			Metric		
	Chr.	SS	Zinc	Chr.	SS	Zinc
Allen Screws.....	24	39	45	50	53	---
Button Head Allen Screws.....	24	39	---	50	53	---
Button Head Torx Screws.....	26	---	---	---	---	---
Flat Head Allen Screws.....	25	39	---	50	53	---
12 Point Screws.....	25	---	---	51	---	---
Ford Hinge Screws.....	22	---	---	---	---	---
Machine Screws.....	30	44	47	---	54	48
Sheet Metal Screws.....	30	44	47	---	54	48
Set Screws.....	---	40	---	---	---	---
Wood Screws.....	30	44	47	---	---	48



## Inside This Section

<b>Specifications and Sizes</b>	
<i>American Thread</i> .....	4
<i>Metric Thread</i> .....	4
<i>Washer Specifications</i> .....	4
<i>Wrench Sizes</i> .....	4
<i>Tensile Requirements</i> .....	4
<i>Torx and Bit Sizes</i> .....	4
<b>Style Chart</b>	
<i>Bolt and Screws Head Styles</i> .....	5
<b>How to Measure</b>	
<i>Bolt Length</i> .....	5
<i>Screw Shank</i> .....	5
<i>Bolt Gage</i> .....	5
<b>Thread Identification</b>	
<i>SAE 45° Flare</i> .....	6
<i>Inverted Flare</i> .....	6
<i>Pipe</i> .....	6
<i>Compression</i> .....	6
<i>Double Compression</i> .....	6
<b>Conversion and Reference Charts</b>	
<i>Wrench Size</i> .....	7
<i>Threads per Inch</i> .....	7
<i>Thread Pitch</i> .....	7
<i>Metric Conversion</i> .....	7
<i>Equivalents</i> .....	7







# Specifications and Sizes

## American Thread

Size	Decimal Equivalent	Threads Per Inch		Allen Screw Maximum		Button Heads Maximum		Flat Heads Maximum	
		Coarse	Fine	Key Size	Head O.D.	Key Size	Head O.D.	Key Size	Head O.D.
#4	.112	40	40	0/02	.100	1/16	.212	1/16	.255
#5	.125	40	44	3/32	.205	5/64	.238	5/64	.281
#6	.138	32	40	7/64	.226	5/64	.262	5/64	.307
#8	.164	32	36	9/64	.270	3/32	.312	3/32	.359
#10 (3/16)	.190	24	32	5/32	.312	1/8	.361	1/8	.411
1/4	.250	20	28	3/16	.375	5/32	.437	5/32	.531
5/16	.3125	18	24	1/4	.469	3/16	.547	3/16	.656
3/8	.375	16	24	5/16	.562	7/32	.656	7/32	.781
7/16	.4375	14	20	3/8	.656	---	---	1/4	.844
1/2	.500	13	20	3/8	.750	5/16	.875	5/16	.938
5/8	.625	11	18	1/2	.938	3/8	1.00	3/8	1.188
3/4	.750	10	16	5/8	1.125	---	---	---	---

## Torx Size and Bit Sizes

Torx Size	Bit Size
6/32	T-10
8/32	T-15
10/24	T-25
10/32	T-25
1/4	T-27
5/16	T-40
3/8	T-45
1/2	T-55
5/8	T-60

## Flat Washer Specifications

Size	Flat Washers			AN Washers			GW Washers		
	O.D.	I.D.	Thickness	O.D.	I.D.	Thickness	O.D.	I.D.	Thickness
#6	3/8	5/32	3/64	---	---	---	---	---	---
#8	7/16	3/16	3/64	---	---	---	---	---	---
#10	1/2	7/32	3/64	.437	.203	1/32	---	---	---
#12	9/16	1/4	1/16	---	---	---	---	---	---
1/4	5/8	9/32	1/16	.500	.265	1/16	5/8	.260	.08
5/16	11/16	11/32	1/16	.562	.328	1/16	11/16	.323	.09
3/8	13/16	13/32	1/16	.625	.390	1/16	13/16	.385	.09
7/16	59/64	15/32	1/16	.750	.453	1/16	59/64	.448	.10
1/2	1-1/16	17/32	3/32	.875	.516	1/16	1-1/16	.510	.11
9/16	1-3/16	19/32	3/32	1.062	.578	1/16	---	---	---
5/8	1-5/16	21/32	3/32	1.187	.641	1/16	1-5/16	.635	.12
3/4	1-1/2	13/16	9/64	---	---	---	---	---	---

## Metric Flat Washer Specifications

Size	Flat Washers		
	O.D.	I.D.	Thickness
4mm	9	4.3	0.8
5mm	10	5.3	1
6mm	12	6.4	11.6
7mm	14	7.4	1.6
8mm	16	8.4	1.6
10mm	20	10.5	2
12mm	24	13	2.5
14mm	28	15	2.5
16mm	30	17	3
18mm	34	19	3

## American Wrench Sizes (Width across flats) - Hex Bolts

Wrench Size	Bolt Diameter
7/16	1/4
1/2	5/16
9/16	3/8
5/8	7/16
3/4	1/2
13/16	9/16
15/16	5/8
1 1/8	3/4

## Metric Wrench Sizes (Width across flats) - Hex Bolts

Wrench Size	Bolt Diameter
5.5mm	3mm
7mm	4mm
8mm	5mm
10mm	6mm
11mm	7mm
13mm	8mm
17mm	10mm
19mm	12mm

## Metric Thread

Size	Threads Per Inch		Allen Screw Maximum		Button Heads Maximum		Flat Heads Maximum	
	Coarse	Fine	Key Size	Head O.D.	Key Size	Head O.D.	Key Size	Head O.D.
3mm	0.5	---	2.5mm	5.5mm	2mm	5.70mm	2mm	6.40mm
4mm	0.7	---	3mm	7.0mm	2.5mm	7.60mm	2.5mm	8.60mm
5mm	0.8	---	4mm	8.5mm	3mm	9.50mm	3mm	10.60mm
6mm	1.0	---	5mm	10.00mm	4mm	10.50mm	4mm	12.60mm
8mm	1.25	1.00	6mm	13.00mm	5mm	14.00mm	5mm	16.80mm
10mm	1.50	1.25	8mm	16.00mm	6mm	17.50mm	6mm	21.00mm
12mm	1.75	1.50	10mm	18.00mm	8mm	21.00mm	8mm	25.00mm

## Tensile Strengths of Material Requirements

Material	LBS.
Stainless Steel	85,000
Grade 2	85,000
Grade 5	120,000
Grade 8	150,000

# Style Chart and Measuring



## Styles in Chrome



**H= Hex Caps**  
Chrome Plated



**S= Allen Screws**  
Chrome Plated



**B= Button Head**  
Chrome Plated



**N= 12 Point**  
Chrome Plated



**P= Allen Screws**  
Polished Chrome Plated

## Styles in Stainless Steel



**HS= Hex Bolts**  
Stainless Steel



**SS= Allen Screws**  
Stainless Steel



**SB= Button Head**  
Stainless Steel



**HSP= Hex Bolts**  
Stainless Steel  
Polished



**SSP= Allen Screws**  
Stainless Steel  
Polished

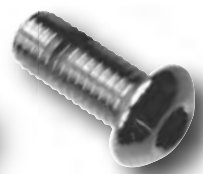

**SBP= Button Head**  
Stainless Steel  
Polished

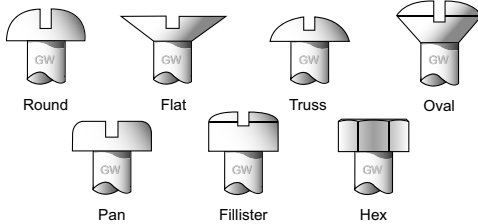

Acorn Nut  
and Slotted Stud  
Kits



Sheet Metal  
Screw

Wood Screw

Machine Screw

## How to Measure

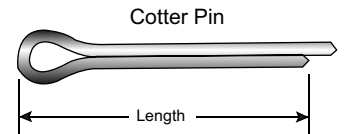
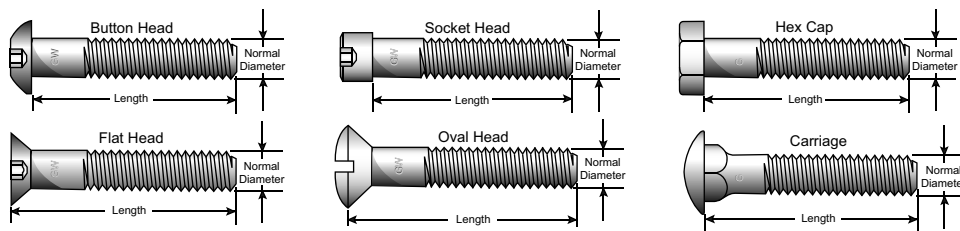

## Actual Shank Sizes

To Determine Sizes  
of Screws. Lay screw  
flat within parallel  
lines shown in border

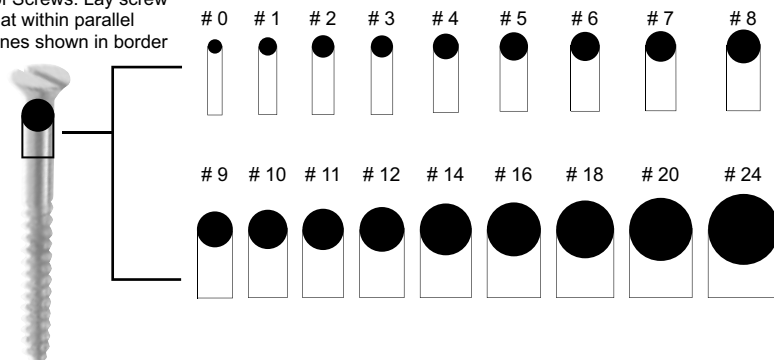

## Bolt Gage

Combined American and Metric gage to measure bolts, nuts and screws is an every day necessity to the dealer. These gages are available and can be ordered by **Part # gage**

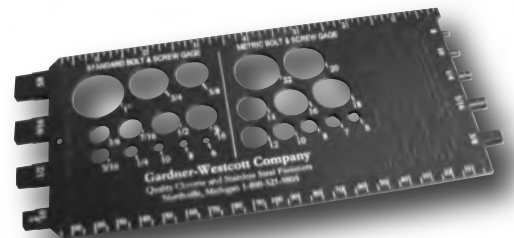





# Thread Identification Fittings

## Standard Thread Identification

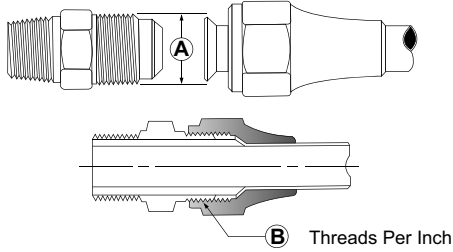

### S.A.E 45° Flare

<b>Tube O.D.</b>	1/8	3/16	1/4	5/16	3/8	7/16	1/2	5/8	3/4
<b>Diameter A</b>	5/16	3/8	7/16	1/2	5/8	11/16	3/4	7/8	1 1/16
<b>Thread Size B</b>	24	24	20	20	18	16	16	14	14

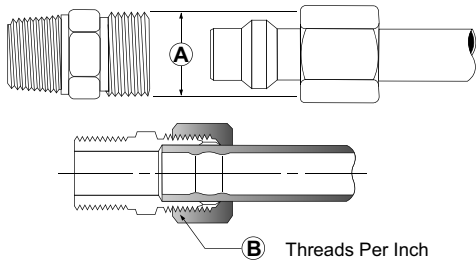

### Compression

<b>Tube O.D.</b>	1/8	3/16	1/4	5/16	3/8	7/16	1/2	5/8	3/4	1
<b>Diameter A</b>	5/16	3/8	7/16	1/2	9/16	5/8	11/16	13/16	1	1 1/4
<b>Thread Size B</b>	24	24	24	24	24	24	20	18	18	18

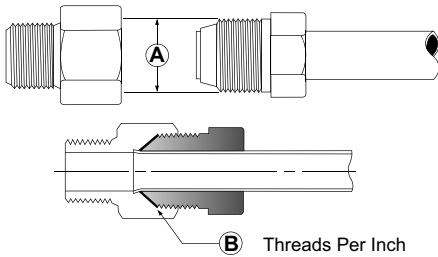

### Double Compression

<b>Tube O.D.</b>	1/8	3/16	1/4	5/16	3/8	7/16	1/2
<b>Diameter A</b>	5/16	3/8	7/16	1/2	9/16	5/8	11/16
<b>Thread Size B</b>	24	24	24	20	20	18	16

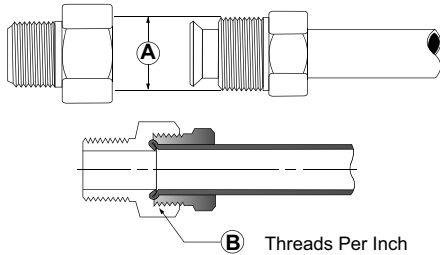

### Inverted Flare

<b>Tube O.D.</b>	1/8	3/16	1/4	5/16	3/8	7/16	1/2	5/8	3/4	7/8	1
<b>Diameter A</b>	5/16	3/8	7/16	1/2	5/8	11/16	3/4	7/8	1 1/16	1 3/16	1 5/16
<b>Thread Size B</b>	28	24	24	20	18	18	18	18	16	16	16

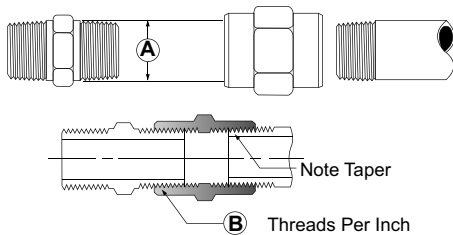

### Pipe

<b>Pipe Size A</b>	1/16	1/8	1/4	3/8	1/2	3/4	1
<b>Thread Size B</b>	1/16-27	1/8-27	1/4-18	3/8-18	1/2-14	3/4-14	1-11 1/2
<b>Working Pressure</b>	1200	1200	1200	1200	1200	1000	1000
<b>Thread OD</b>	1/4	3/8	1/2	5/8	3/4	1	1 1/4

# Conversion and Reference Charts



## American Equivalents

Fraction	Decimal	Millimeter
1/64	.0156	0.397
1/32	.0312	0.794
3/64	.0468	1.191
1/16	.0625	1.588
5/64	.0781	1.984
3/32	.0937	2.381
7/64	.1093	2.778
<b>1/8</b>	<b>.1250</b>	<b>3.175</b>
9/64	.1406	3.572
5/32	.1562	3.969
11/64	.1718	4.366
3/16	.1875	4.763
13/64	.2031	5.159
7/32	.2187	5.556
15/64	.2343	5.953
<b>1/4</b>	<b>.2500</b>	<b>6.350</b>
17/64	.2656	6.747
9/32	.2812	7.144
19/64	.2968	7.541
5/16	.3125	7.938
21/64	.3281	8.334
11/32	.34375	8.731
23/64	.3593	9.128
<b>3/8</b>	<b>.3750</b>	<b>9.525</b>
25/64	.3906	9.922
13/32	.4062	10.319
27/64	.4218	10.716
7/16	.4375	11.113
29/64	.4531	11.509
15/32	.4687	11.906
31/64	.4843	12.303
<b>1/2</b>	<b>.5000</b>	<b>12.700</b>
33/64	.5156	13.097
17/32	.5312	13.494
35/64	.5468	13.891
9/16	.5625	14.288
37/64	.5781	14.684
19/32	.5937	15.081
39/64	.6093	15.478
<b>5/8</b>	<b>.6250</b>	<b>15.875</b>
41/64	.6406	16.272
21/32	.6562	16.669
43/64	.6718	17.066
11/16	.6875	17.463
45/64	.7031	17.859
23/32	.7187	18.256
47/64	.7343	18.653
<b>3/4</b>	<b>.7500</b>	<b>19.050</b>
49/64	.7656	19.447
25/32	.7812	19.844
51/64	.7968	20.241
13/16	.8125	20.638
53/64	.8281	21.034
27/32	.8437	21.431
55/64	.8593	21.828
<b>7/8</b>	<b>.8750</b>	<b>22.225</b>
57/64	.8906	22.622
29/32	.9062	23.019
59/64	.9218	23.416
15/16	.9275	23.813
61/64	.9531	24.209
31/32	.9687	24.606
63/64	.9843	25.003
<b>1"</b>	<b>1.0000</b>	<b>25.400</b>

## Metric Conversion Chart

Inches	Millimeters
1/4	6mm
5/16	8mm
3/8	10mm
1/2	12mm
5/8	16mm
3/4	20mm
1	25mm
1-3/16	30mm
1-3/8	35mm
1-9/16	40mm
1-3/4	45mm
2	50mm
2-3/16	55mm
2-3/8	60mm
2-9/16	65mm
2-3/4	70mm
3	75mm
3-3/16	80mm
3-3/8	85mm
3-1/2	90mm
4	100mm
4-3/8	110mm
4-3/4	120mm

Technical  
Info

## Threads Per Inch American

Coarse	Fine
10/24	10/32
1/4-20	1/4-28
5/16-18	5/16-24
3/8-16	3/8-24
7/16-14	7/16-20
1/2-13	1/2-20
9/16-12	9/16-18
5/8-11	5/8-18
3/4-10	3/4-16

## Threads Pitches Metric

Diameter	Pitch
6mm	1.0
8mm	1.25
8mm Fine	1.0
10mm	1.50
10mm Fine	1.25
12mm	1.75
12mm Fine	1.50
14mm	2.0
14mm Fine	1.50





# Awesome

**Product Emblem Stamped Hex Caps Chrome Plated and Polished Stainless Steel**



Ford Oval use Part Prefix  
11-56250 to order



Chevy Bowtie use Part Prefix  
10-56490 to order

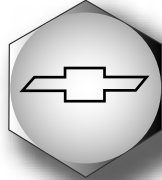

Mopar use Part Prefix  
23-56330 to order

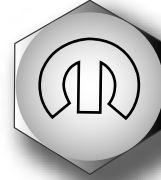

Pontiac Arrow use Part Prefix  
12-56490 to order

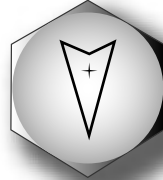

Ford V8 use Part Prefix  
24-xxxxx to order



Chevy SS use Part Prefix  
13-xxxxx to order



Pontiac GTO use Part Prefix  
20-xxxxx to order



Chrysler Pentastar use Part Prefix  
21-xxxxx to order



Ford Mustang use Part Prefix  
25-xxxxx to order



Chevy RS use Part Prefix  
16-xxxxx to order



Pontiac GT use Part Prefix  
15-xxxxx to order



Hemi Mopar use Part Prefix  
27-xxxxx to order



Flames use Part Prefix  
17-xxxxx to order



350 use Part Prefix  
18-xxxxx to order



454 use Part Prefix  
19-xxxxx to order



Dodge Ram use Part Prefix  
22-xxxxx to order



Skulls use Part Prefix  
14-xxxxx to order



Olds Rocket use Part Prefix  
26-xxxxx to order

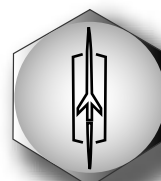

**What better way to make a statement!**

**Select style when ordering:**

**H = Chrome Plated or HSP = Stainless Steel Polished.**

**Example:** Engine Dress Up Kit Part # XX - XXXXX - **H** or **HSP**

└─ Emblem Prefix Number  
└─ Engine Kit Number



## Inside This Section

<b>Chevrolet Engine Sets</b>	
<i>Small Block, Big Block, LT1, Vortec and LS1-LS6.....</i>	<i>10</i>
<b>Emblem Stamped Chevy Bowtie, SS, RS, 350 &amp; 454</b>	
<i>Small Block, Big Block, LT1, Vortec and LS1-LS6.....</i>	<i>10</i>
<b>Pontiac Engine Sets</b>	
<i>Engine 326-455 Displacements.....</i>	<i>11</i>
<b>Emblem Stamped Pontiac Arrow, GTO and GT</b>	
<i>Engine 326-455 Displacements.....</i>	<i>11</i>
<b>Oldsmobile Engine Sets</b>	
<i>Engine 260-455 Displacements.....</i>	<i>11</i>
<b>Emblem Stamped Oldsmobile Rocket</b>	
<i>Engine 260-455 Displacements.....</i>	<i>11</i>
<b>Chrysler Mopar Engine Sets</b>	
<i>Small Block.....</i>	<i>12</i>
<i>Big Block.....</i>	<i>12</i>
<b>Emblem Stamped Mopar, Chrysler Pentastar, Dodge Ram and Hemi</b>	
<i>Small Block.....</i>	<i>12</i>
<i>Big Block.....</i>	<i>12</i>
<b>Ford Engine Sets</b>	
<i>Small Block.....</i>	<i>13</i>
<i>Big Block.....</i>	<i>13</i>
<i>Flathead.....</i>	<i>13</i>
<b>Emblem Stamped Ford Oval, Ford Vintage V8 &amp; Ford Mustang Pony</b>	
<i>Small Block.....</i>	<i>13</i>
<i>Big Block.....</i>	<i>13</i>
<b>6-71 and 8-71 Mooneyham Blower Dress Up Kits</b>	
<i>Big Block.....</i>	<i>14</i>
<b>Nissan Z Engine Dress Up Kits</b>	
<i>3.0 V-6.....</i>	<i>14</i>

All automobile manufacturers brand names listed are registered trademarks ®





# Chevrolet Engine Dress Up Kits

\* For other bolt head styles see the Pick Your Style chart at the top of page 14 in the Individual Applications Section



## Chevy Small and Big Block Kits Contain:

Intake Manifold, Valve Cover, Water Neck, Water Pump, Timing Cover, Fuel Pump, Oil Pan, Distributor Hold Down and either Headers or Standard Exhaust Bolts. Washers are supplied where applicable.

**Note:** Small Block Kit contains the Short Water Pump & Big Block contains the Extended Water Pump.

**Also: LS1-LS6 Engine's Kits will Contain:** Oil Pan, Header Bolts, Front Cover, Water Crossover, Crank Sender, Water Pump, Valve Cover, Thermostat Housing, Throttle Body, Manifold Hold Down, Kick Down & Fuel Rail Fasteners. **Please specify aluminum or steel valve covers when ordering.**

Engine Dress Up Kit  
Part # 56490

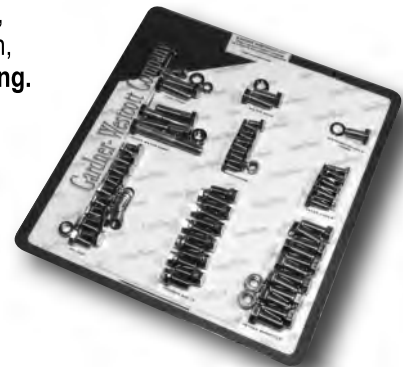

## Description

Description	Part #
Small Block Chevy with Headers.....	56490
Small Block Chevy with Standard Exhaust Bolts.....	56492
Big Block Chevy with Headers.....	56491
LT1 Chevy Engine with Headers.....	56495
Vortec 350 Chevy Small Block with Headers.....	56494
LS1-LS6 Engine with Headers (4 bolt valve covers in this kit).....	56404
LS1-LS6 Engine with Standard Exhaust Bolts (same as above kit).....	56405

## Chevy Bowtie Stamped Dress Up Kits

Gardner-Westcott is now offering a new and different look for engine dress up bolts, The Chevy Bowtie emblem stamped directly onto the head of the bolts. They are available in decorative Polished Chrome Plated or Stainless Steel versions, in all the sizes needed to give your car that special look. What better way to make a statement than with these unique bolts.

**Gardner-Westcott** is exclusively licensed by **GM** to produce this product. Same as above engine kits. **Please specify steel or aluminum valve covers when ordering.**

Chevy Bow Tie  
Engine Dress Up Kit  
# 10-56492H

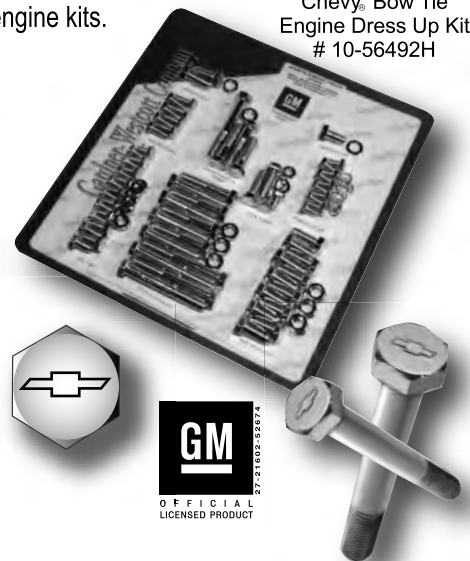

Select style when ordering: **H** = Chrome Plated or **HSP** = Stainless Steel Polished.

**Example:** Engine Dress Up Kit Part # 10-56490- **H** or **HSP**

## Description

Description	Part #
Small Block Chevy with Headers.....	10-56490
Small Block Chevy with Standard Exhaust Bolts.....	10-56492
Big Block Chevy with Headers.....	10-56491
LT1 Chevy Engine with Headers.....	10-56495
Vortec 350 Chevy Small Block with Headers.....	10-56494
LS1-LS6 Engine with Headers (4 bolt valve covers in this kit).....	10-56404
LS1-LS6 Engine with Standard Exhaust Bolts (same as above kit).....	10-56405

## Emblem Engine Dress Up Sets Available For

Chevy SS  
Part #

13-56490  
13-56492  
13-56491  
13-56495  
13-56494



Chevy RS  
Part #

16-56490  
16-56492  
16-56491  
16-56495  
16-56494



Chevy 350  
Part #

18-56490  
18-56492  
18-56491  
18-56494



Chevy 454  
Part #

19-56491  
19-56495



## 6-71 Blower Engine Dress Up Kit

Part #

Chevy Big Block 6-71 Blower Engine Dress Up Kit..... 56671-P

(This kit will cover the entire top end of a Mooneyham or similar blower unit, Also you can add the finishing touch to your 6-71 Blower by adding (36) - 5/16 chrome hole covers Part # 43570 and (26) - 1/4 chrome hole covers Part # 43569)

# Pontiac & Olds Engine Dress Up Kits



**Engine Dress Up Kits**

\* For other bolt head styles see the Pick Your Style chart at the top of page 16 in the Individual Applications Section



## Pontiac Engine Kits Contain:

Intake Manifold, Valve Cover, Thermostat Housing, Water Pump, Timing Cover, Timing Cover to Intake Manifold, Fuel Pump, Oil Pan, Distributor Hold Down and Oil Filter Adapter. Washers are supplied where applicable. **Please specify steel or aluminum valve covers.**



### Description

### Part #

Engine Dress Up Kit for 326 - 455 (with no exhaust).....	56500
Engine Dress Up Kit for 350, 389, 400, 421 - 455 (with no exhaust).....	56505

## Pontiac ▼

### Pontiac Arrow, GTO and GT Engine Dress Up Kits

Dress up your Pontiac Gardner-Westcott is now offering a new and different look for engine dress up bolts, The Pontiac Arrow, GTO and GT emblem stamped directly onto the head of the bolts. They are available in decorative Polished Chrome Plated or Stainless Steel versions, in all the sizes needed to give your car that special look. What better why to make a statement than with these unique bolts. Gardner-Westcott is exclusively licensed by GM to produce this product.

**Select style when ordering:**

**H** = Chrome Plated or **HSP** = Stainless Steel Polished.

**Example:**

Engine Dress Up Kit Part # 12-56500- **H** or **HSP**

### Description

### Part #

Engine Dress Up Kit for 326 - 455 (with no exhaust).....	12-56500
Engine Dress Up Kit for 350, 389, 400, 421 - 455 (with no exhaust).....	12-56505



**Pontiac GTO**  
Part #



20-56500  
20-56505

**Pontiac GT**  
Part #



15-56500  
15-56505

## Oldsmobile



### Oldsmobile Engine Kits Contain:

Intake Manifold, Valve Cover, Water Neck, Water Pump, Timing Cover, Fuel Pump, Oil Pan, Distributor Hold Down and Oil Filter Housing. Washers are supplied where applicable.

**Please specify steel or aluminum valve covers.**

### Description

### Part #

Engine Dress Up Kit for 260 - 455 (with no exhaust).....	56501
--	-------

### Olds Rocket Engine Dress Up Kit

### Part #

Engine Dress Up Kit for 260 - 455 (with no exhaust).....	26-56501
--	----------



Oldsmobile Rocket use Part Prefix 26-xxxxx to order





# Chrysler Engine Dress Up Kits

\* For other bolt head styles see the Pick Your Style chart at the top of page 18 in the Individual Applications Section



**Gardner-Westcott's** Engine Dress Up Kits are available Chrome Plated, Stainless Steel and Polished Stainless Steel. Bolt Styles available include Hex Caps, Allen Screws, Button Head, 12 Point also Mopar, Chrysler Pentastar and Dodge Ram Stamped Hex Cap Bolts.

## Chrysler Mopar Small and Big Block Kits Contain:

Please specify steel or aluminum valve covers.

Intake Manifold, Valve Cover, Water Pump, Timing Cover, Fuel Pump, Oil Pan, and either Headers or Standard Exhaust Bolts. Washers are supplied where applicable.

Description	Part #
Small Block Mopar with Headers.....	56330
Small Block Mopar with Standard Exhaust.....	56331
Big Block Mopar with Headers.....	56332



Engine Dress Up Kit Part # 56331-H

## Mopar Stamped Dress Up Kits

Dress up your Mopar! Gardner-Westcott Company is now offering a new and different look for engine dress up bolts, The Mopar emblem stamped directly onto the head of the bolts. They are available in decorative Polished Chrome Plated or Stainless Steel versions in all the sizes needed to give your car that special look. What better way to make a Mopar statement than with these unique bolts! **Gardner-Westcott Company** is licensed by Mopar to produce this product



MOPAR, JEEP, DODGE, HEMI, PLYMOUTH, RAM, SRT, CHRYSLER and related logos, vehicle model names and trade dress are trademarks of Chrysler Group LLC and used under license by (licensee name). ©2015 Chrysler Group LLC.

## Mopar, Chrysler Pentastar, Dodge Ram and Hemi Kits Contain:

Please specify steel or aluminum valve covers.

Intake Manifold, Valve Cover, Water Pump, Timing Cover, Fuel Pump, Oil Pan, and either Headers or Standard Exhaust Bolts. Washers are supplied where applicable.

Select style when ordering: **H** = Chrome Plated or **HSP** = Stainless Steel Polished.



**Example:** Engine Dress Up Kit Part # 23-56331- **H** or **HSP**

Description	Part #
Small Block Mopar with Headers.....	23-56330
Small Block Mopar with Standard Exhaust.....	23-56331
Big Block Mopar with Headers.....	23-56332

## Emblem Engine Dress Up Sets Available in:

Chrysler Pentastar Part #

21-56330  
21-56331  
21-56332



Dodge Ram Part #

22-56330  
22-56331  
22-56332



Hemi Mopar Part #

27-56330  
27-56331  
27-56332



Engine Dress Up Kit Part # 23-56331-HSP

# Ford Engine Dress Up Kits



\* For other bolt head styles see the Pick Your Style chart at the top of page 16 in the Individual Applications Section



**Gardner Westcott's** Engine Dress Up Kits are available Chrome Plated, Stainless Steel and Polished Stainless Steel. Bolt Styles available include Hex Caps, Allen Screws, Button Head, 12 Point, Ford Oval, Ford V8 & Ford Mustang Stamped Hex Cap Bolts.

## Ford 289, 302 only Kits Contain:

Intake Manifold, Valve Cover, Filler Neck, Timing Cover, Fuel Pump, Oil Pan, and either Headers or Standard Exhaust Bolts. Washers are supplied where applicable. **Note: Water Pump Bolts are not included.**

### Description

	Part #
289, 302 Ford with Headers.....	56250
289, 302 Ford with Standard Exhaust.....	56251
390, 428 Ford with Headers.....	56253
429, 460 Ford with Headers.....	56254
351 Cleveland.....	56255
400 Modified.....	56256

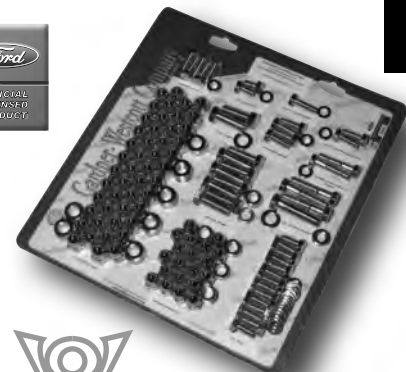

### Description

	Part #
8BA 49-53 Chrome acorn covers for both Cylinder Heads and Intake Manifold.....	56263-AC
8BA 49-53 Chrome acorn nuts for both Cylinder Heads and Intake Manifold along with Stamped V8 Hex Caps for Timing Cover, Coil Bracket, Fan Shaft, Distributor Hold Down, Coolant Neck, Water Pump, Fuel Pump Stand Off, Stand Off to Fuel Pump, Oil Filter Mount and Oil Pan.....	24-56264-AC



Flathead Engine Dress Up Kit Part # 24-56264-AC

## Ford Stamped Engine Dress Up Kits

**Dress up your Ford!** We now offer a new and different look for engine dress up bolts, The Ford Oval emblem stamped directly onto the head of the bolts. They are available in decorative Polished Chrome Plated or Stainless Steel versions in all the sizes needed to give your car that special look. What better way to make a Ford statement than with these unique bolts.

## Ford Oval, V8 & Mustang Emblem Stamped Dress Up Kits

Ford Oval Engine Dress Up Kit Part # 11-56256-HSP

### Description

	Part #
289, 302 Ford with Headers.....	11-56250
289, 302 Ford with Standard Exhaust.....	11-56251
390, 428 Ford with Headers.....	11-56253
429, 460 Ford with Headers.....	11-56254
351 Cleveland.....	11-56255
400 Modified with Standard Exhaust.....	11-56256



## Emblem Engine Dress Up Sets Available in:

**Ford V8**  
Part #

**Ford Mustang**  
Part #

- 24-56250
- 24-56251
- 24-56253
- 24-56254
- 24-56255
- 24-56256



- 25-56250
- 25-56251
- 25-56253
- 25-56254
- 25-56255
- 25-56256



**Select style when ordering:**

**H** = Chrome Plated or **HSP** = Stainless Steel Polished.

**Example:**

Engine Dress Up Kit Part # 11-56250- **H** or **HSP**

**Engine Dress Up Kits**





# 6-71 Blower Dress Up Kit

**Gardner-Westcott Company** has created a dress-up kit especially for the very popular 6-71 and 8-71 supercharger blower. Now you can dress up your show blower with either chrome or polished chrome allen fasteners. We also have an accessory kit of chrome hole plugs, that will add that clean definitive touch and really set off your supercharger. The kit contains fasteners for the top end of a 6-71 or 8-71 series blower, which includes; the Upper Pulley, Bearing Support Front Cover Plate, Front Cover, Bearing Rear Cover Plate, Bearing Plate, Upper Plenum to Intake, Thermostat Housing and Burp Valve.



S= Allen Screws  
Chrome Plated

P= Allen Screws  
Polished Chrome  
Plated  
Knurles Removed

SS= Allen Screws  
Stainless Steel

SSP= Allen Screws  
Stainless Steel  
Polished  
Knurles Removed

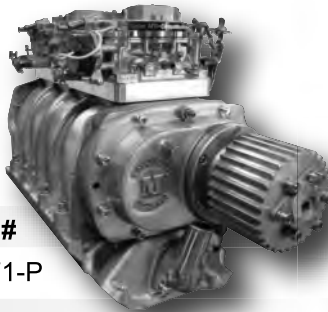

Blower Dress Up Kit  
Part # 56671-P

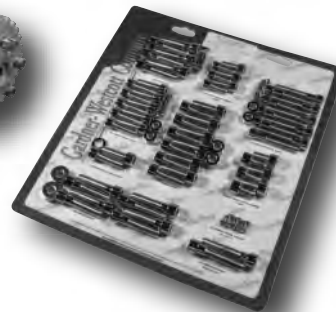

## Blower Dress Up Kit

Part #

Big Block Chevy 6-71 thru 8-71 - (Mooneyham Blower)..... 56671-P

## Optional Hole Plugs to detail Allen Screws

Part #

5/16 Size for 3/8 Allens - (36 required)..... 43570

1/4 Size for 5/16 Allens - (26 required)..... 43569

**NOTE:** Some blower configurations may differ, in which case we can offer complete american and metric bulk assortments to detail any engine build or custom project.

# Nissan Dress Up Kits

## Nissan Z 3.0 V-6 Engine Dress Up Kits

Fits 1984 - 89

### Style Description

- HSPA** = Hex Cap Polished Stainless Steel with Polished Stainless Steel Rubber Backed Washers
- HA** = Hex Cap Chrome with Polished Stainless Steel Rubber Backed Washers
- HSP** = Hex Cap Polished Stainless Steel
- H** = Hex Cap Chrome Plated
- P** = Polished Chrome Allens Screws
- SSP** = Stainless Steel Polished Allen Screws
- C** = Chrome Plated Flat Head Allen Screws
- B** = Button Head Chrome Plated Allen Screws
- BSP** = Button Head Stainless Steel Polished Allen Screws



Valve Covers  
56102-H



Manifold Cover  
56103-C

### Valve Cover Part #

### Fender Bolts Part #

Valve Cover..... 56102-H  
Valve Cover..... 56102-HA  
Valve Cover..... 56102-HSP  
Valve Cover..... 56102-HSPA  
Valve Cover..... 56102-P  
Valve Cover..... 56102-SSP

Fender Bolts..... 56104-B  
Fender Bolts..... 56104-BSP  
Fender Bolts..... 56104-H  
Fender Bolts..... 56104-HA  
Fender Bolts..... 56104-HSP  
Fender Bolts..... 56104-HSPA

### Manifold Cover Part #

### Hood Hinge Part #

Manifold Cover..... 56103-C  
Manifold Cover..... 56103-FASP

Hood Hidge & Latch..... 56105-H  
Hood Hidge & Latch..... 56105-HA  
Hood Hidge & Latch..... 56105-HSP  
Hood Hidge & Latch..... 56105-HSPA



Fender Bolts  
56104-H



Hood Hinge & Latch  
56105-H



## Inside This Section

<i>Chevrolet.....</i>	<i>16</i>
<i>Emblem Stamped Chevy Bow Tie, SS, RS, 350 and 454.....</i>	<i>17</i>
<i>Emblem Stamped Pontiac, GTO and GT.....</i>	<i>17</i>
<i>Ford.....</i>	<i>18</i>
<i>Emblem Stamped Ford Oval, Ford V8 and Ford Mustang.....</i>	<i>19</i>
<i>Emblem Stamped Flame and Skull.....</i>	<i>19</i>
<i>Mopar.....</i>	<i>20</i>
<i>Emblem Stamped Mopar, Chrysler Pentastar, Dodge Ram and Hemi.....</i>	<i>20</i>
<i>Buick.....</i>	<i>20</i>
<i>VW.....</i>	<i>20</i>
<i>Interior Screw Sets.....</i>	<i>21</i>

**Individual Sets**



Intake Manifold Kit  
for 429 Engine  
Part # 11-56246-H

Mustang Front End Kit  
Part # 56260-H



## Pick your style of fastener

Style



H= Hex Caps Chrome Plated    S= Allen Screws Chrome Plated    B= Button Head Chrome Plated    N= 12 Point Chrome Plated    P= Allen Screws Polished Chrome Plated    HS= Hex Bolts Stainless Steel    SS= Allen Screws Stainless Steel    SB= Button Head Stainless Steel    HSP= Hex Bolts Stainless Steel Polished    SSP= Allen Screws Stainless Steel Polished    SBP= Button Head Stainless Steel Polished

Description	Part #
Alternator Jam Nut Chrome.....	15574
Axle Truck 10 Bolt, 2 & 4 Wheel Drive.....	56458
Axle Truck 12 Bolt, 2 & 4 Wheel Drive.....	56459
Bell Housing.....	56484
Bumper Bolt Kit 67 - 69 Camaro Frt.....	56850
Bumper Bolt Kit 67 - 69 Camaro Rr.....	56851
Bumper Bolt Kit 67 - 69 Camaro Frt, (w/washers & nuts)..	56852
Bumper Bolt Kit 67 - 69 Camaro Rr, (w/washers & nuts)...	56853
Carburetor Stud Kits with 4 Studs, (w/washers & nuts)	
1 3/8" overall length Stainless Steel.....	4086
1 1/2" overall length Stainless Steel.....	4087
2" overall length Stainless Steel.....	4088
1 3/8" overall length Chrome Plated.....	4083
1 1/2" overall length Chrome Plated.....	4084
2" overall length Chrome Plated.....	4085
Coil Mount to Block.....	56478
Exhaust Manifold.....	56477
Exhaust Manifold Studs Standard in Stainless Steel	
3/8-16 x 2 1/4" sold each.....	88347
3/8-16 x 2 3/4" sold each.....	88349
3/8-16 x 3" sold each.....	88348
Fan Spacer Bolts Extended.....	56457
Fan Spacer Bolts Short.....	56456
Front Cover Bolts.....	56464
Fuel Pump.....	56460
Head Bolt Washers.....	56473W
Head Bolts Outside Small Block.....	56472
Head Bolts Outside Big Block.....	56493
Head Bolts Outside Aluminum Small Block.....	56480
Header Bolts LT-1 Engine.....	56498
Header Bolts 350 Vortec Engine 1".....	56702
Header Bolts Big Block.....	56488
Header Bolts, (small 3/8" Hex 3/4" long).....	56415-H
Header Bolts Small Block, (small 3/8" Hex 1" long).....	56416-H
Header Bolts Small Block 1" Long.....	56418
Header Bolts Small Block.....	56461
Header Bolts LS1 - LS6.....	56406
Hood Hinge Bolts.....	56481
Injection Mount LT-1 Engine.....	56499
Intake Manifold V6 1977 to 1981.....	56421

Description	Part #
Intake Manifold LT-1 Engine.....	56402
Intake Manifold 350 Vortec Engine.....	56700
Intake Manifold Big Block.....	56479
Intake Manifold Small Block.....	56469
Intake Manifold Small Block (except undersized 3/8" Hex Chrome).....	56469-UH
Intake Manifold Small Block (except undersized 3/8" Hex Stainless Polished).....	56469-UHSP
License Plate Screw Kit Chrome Plated.....	56220
License Plate Kit for Plastic inserts.....	56401
Mag Wheel Washers Chrome (Sold Each).....	23578
Mag Wheel Washers Stainless (Sold Each).....	75578
Oil Pan LT-1 Engine.....	56497
Oil Pan Small Block.....	56465
Oil Pan Big Block.....	56487
Rear Cover 10 Bolt.....	56475
Rear Cover 12 Bolt.....	56476
Timing Cover LT-1 Engine.....	56400
Timing Cover 502 Big Block.....	56455
Transmission Pan Cover 700R4.....	56236
Transmission Pan Small Block.....	56474
Tune Port Injection System.....	56417
Valve Cover Flange Small Block.....	56410
Valve Cover Acorns and Studs.....	56462A
Valve Cover LT-1 Engine.....	56403
Valve Cover 350 Vortec Engine.....	56701
Valve Cover Aluminum Big Block.....	56486
Valve Cover Aluminum Small Block.....	56466
Valve Cover Steel Big Block.....	56485
Valve Cover Steel Small Block.....	56463
Valve Cover Long Big Block.....	56489
Valve Cover LS1 - LS6 (with coil packs).....	56407
Valve Cover Spike Nut & Studs (Steel).....	56462-X1
Valve Cover Spike Nut & Studs (Aluminum).....	56462-X2
Water Neck 45°.....	56471
Water Neck 90°.....	56470
Water Pump LT-1 Engine.....	56496
Water Pump Extended.....	56467
Water Pump Short Small Block.....	56468

# Individual Sets for Chevy®



You can also order the listed Individual sets with the Emblems Stamped on the Hex Caps as shown below by using the Part Prefix associated with that emblem.



*Chevy Bowtie*  
use Part Prefix  
10-xxxxx to order



*Chevy SS*  
use Part Prefix  
13-xxxxx to order



*Chevy RS*  
use Part Prefix  
16-xxxxx to order



*350*  
use Part Prefix  
18-xxxxx to order



*454*  
use Part Prefix  
19-xxxxx to order

**Select style when ordering: H = Chrome Plated or HSP = Stainless Steel Polished.**  
**Example:** Engine Dress Up Kit Part # 10-56458- *H* or *HSP*

**Individual Sets**

Description	Part #
Axle Truck 10 Bolt, 2 & 4 Wheel Drive.....	10-56458
Axle Truck 12 Bolt, 2 & 4 Wheel Drive.....	10-56459
Bell Housing.....	10-56484
Coil Mount to Block.....	10-56478
Exhaust Manifold.....	10-56477
Fan Spacer Bolts Extended.....	10-56457
Fan Spacer Bolts Short.....	10-56456
Fuel Pump.....	10-56460
Head Bolts- Outside Sm. Block.....	10-56472
Head Bolts- Outside Big Block.....	10-56493
Header Bolts LT-1 Engine.....	10-56498
Header Bolts 350 Vortec Engine.....	10-56702
Header Bolts Big Block.....	10-56488
Header Bolts Sm. Block 1" Long.....	10-56418
Header Bolts Sm. Block.....	10-56461
Header Bolts LS1-LS6.....	10-56406
Hood Hinge Bolts.....	10-56481
Hood Hinge Bolts 1955 to 1957.....	10-56482
Hood Hinge Bushing Kits GM (late model)....	10-56419
Injection Mount LT-1 Engine.....	10-56499
Intake Manifold LT-1 Engine.....	10-56402
Intake Manifold 350 Vortec Engine.....	10-56700
Intake Manifold Big Block.....	10-56479
Intake Manifold Sm. Block.....	10-56469

Description	Part #
License Plate Kit.....	10-56401
Oil Pan LT-1 Engine.....	10-56497
Oil Pan Sm. Block.....	10-56465
Oil Pan Big Block.....	10-56487
Rear Cover 10 Bolt.....	10-56475
Rear Cover 12 Bolt.....	10-56476
Timing Cover Bolts.....	10-56464
Timing Cover LT-1 Engine.....	10-56400
Transmission Pan Cover 700R4.....	10-56236
Transmission Pan Sm. Block.....	10-56474
Valve Cover Flange Bolts Sm. Block.....	10-56412
Valve Cover LT-1 Engine.....	10-56403
Valve Cover 350 Vortec Engine.....	10-56701
Valve Cover Aluminum Big Block.....	10-56486
Valve Cover Aluminum Sm. Block.....	10-56466
Valve Cover Steel Big Block.....	10-56485
Valve Cover Steel Sm. Block.....	10-56463
Valve Cover LS1-LS6 (with coil packs).....	10-56407
Water Neck 45°.....	10-56471
Water Neck 90°.....	10-56470
Water Pump LT-1 Engine.....	10-56496
Water Pump Extended.....	10-56467
Water Pump Short Sm. Block.....	10-56468

# Pontiac ▼

**Example:** Engine Dress Up Kit Part # 12-56500- *H* or *HSP*



*Pontiac Arrow*  
use Part Prefix  
12-xxxxx to order



*Pontiac GTO*  
use Part Prefix  
20-xxxxx to order



*Pontiac GT*  
use Part Prefix  
15-xxxxx to order

Description	Part #
326-455 Engine Dress Up Kit.....	56500
350,389,400 & 455 H.O. Exhaust Kit.....	56517
326-455 Intake Manifold.....	56522
326-455 Intake Manifold.....	56522-HS
350-455 Intake Manifold.....	56521
Water Pump.....	56533
350-455 Timing Cover.....	56515
350, 389 Oil Pan.....	56531

Part Numbers Listed here are Individual Kits w/o Emblem Stamped Prefix Numbers.

Description	Part #
326, 455 Oil Pan.....	56532
350 Aluminum Value Cover.....	56529
326 Valve Cover.....	56528
326 Steel Valve Cover.....	56258-H
326 Timing Cover.....	56516
Fuel Pump.....	56519
350-455 Engine Dress Up Kit.....	56505



## Pick your style of fastener



H= Hex Caps Chrome Plated    S= Allen Screws Chrome Plated    B= Button Head Chrome Plated    N= 12 Point Chrome Plated    P= Allen Screws Polished Chrome Plated    HS= Hex Bolts Stainless Steel    SS= Allen Screws Stainless Steel    SB= Button Head Stainless Steel    HSP= Hex Bolts Stainless Steel Polished    SSP= Allen Screws Stainless Steel Polished    SBP= Button Head Stainless Steel Polished

### Description

### Part #

Alternator Jam Nut Chrome (Sold Each).....	15574
Bed Bolt Set - 1953 to 1956 (F-100).....	56252
Cylinder Head Flathead (Chrome Acorn Covers).....	56259-AC
Exhaust Manifold 289 and 302.....	56248
Fuel Pump 289 and 302.....	56240
Fuel Pump 351 Cleveland and 400.....	56243
Header Bolts (3/8-16 x 1 with 7/16 wrench).....	56223
Header Bolts (3/8-16 x 1 with 3/8 wrench).....	56200
Intake Manifold 429.....	56246
Intake Manifold FE Engine.....	56245
Intake Manifold 289.....	56221
Intake Manifold 351 Cleveland.....	56222
Intake Manifold Flathead (Chrome Acorn Covers).....	56257-AC
Mustang Front End Kit.....	56260
Rack Bolts 5/8 x 4" (Grade 8 Chrome Plated).....	56261
Oil Pan 289 and 302.....	56231
Oil Pan 351 Cleveland and 400.....	56232
Oil Pan 390 and 428.....	56233
Tie Rod Nuts 11/16-18 (Stainless Left Hand Thread, sold each).....	67561-L
Tie Rod Nuts 11/16-18 (Stainless Right Hand Thread, sold each).....	67561-R
Timing Cover 289 and 302.....	56242
Timing Cover 390.....	56244
Transmission Pan Cover C4.....	56235
Transmission Pan Cover C6.....	56234
Valve Cover Aluminum 289 and 302.....	56227
Valve Cover Aluminum 351 Cleveland.....	56228
Valve Cover Steel 289.....	56224
Valve Cover Steel 351 Cleveland.....	56225
Valve Cover Steel 428.....	56226
Water Neck.....	56230

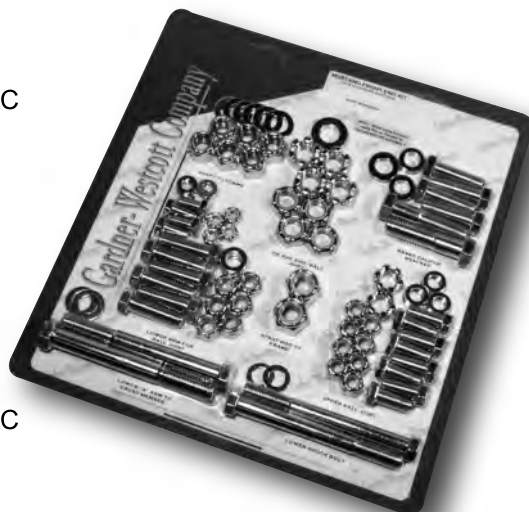

Mustang Front End Kit  
Part # 56260-H



Cylinder Head  
8BA 49-53 Ford Flathead  
Part # 56250-AC

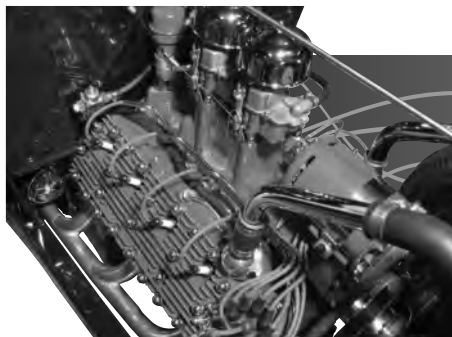

# Flatheads



# Individual Sets for Ford



You can also order the listed Individual Applications sets with the Emblems Stamped on the Hex Caps as shown below by using the Part Prefix associated with that emblem.

**Select style when ordering:**

**H** = Chrome Plated or **HSP** = Stainless Steel Polished.

**Example:** Engine Dress Up Sets Part #  $\boxed{XX}$  -  $\boxed{XXXXX}$  - **H** or **HSP**  
Emblem Prefix Number  
Individual Kit Number

**Individual Sets**

Ford Oval use  
Part Prefix  
11-56xxx-H to order



Flames use  
Part Prefix  
17-56xxx to order



Ford V8 use  
Part Prefix  
24-56xxx to order



Skulls use  
Part Prefix  
14-56xxx to order



Ford Mustang use  
Part Prefix  
25-56xxx to order



**We also carry these other selected Custom Emblems to choose from**

**Description**

**Part #**

Bed Bolt Set 1953 to 1956 F-100.....	11-56252
Exhaust Manifold 289 and 302.....	11-56248
Fuel Pump 289 and 302.....	11-56240
Fuel Pump 351 Cleveland and 400.....	11-56243
Header Bolts.....	11-56223
Intake Manifold 429.....	11-56246
Intake Manifold FE Engine.....	11-56245
Intake Manifold 289.....	11-56221
Intake Manifold 351 Cleveland.....	11-56222
Mustang Front End Kit.....	11-56260
Rack Bolts 5/8 x 4" Grade 8 Chrome Plated.....	11-56261
Oil Pan 289 and 302.....	11-56231
Oil Pan 351 Cleveland and 400.....	11-56232
Oil Pan 390 and 428.....	11-56233
Timing Cover 289 and 302.....	11-56242
Timing Cover 390.....	11-56244
Transmission Pan Cover C4.....	11-56235
Transmission Pan Cover C6.....	11-56234
Valve Cover Aluminum 289 and 302.....	11-56227
Valve Cover Aluminum 351 Cleveland.....	11-56228
Valve Cover Steel 289.....	11-56224
Valve Cover Steel 351 Cleveland.....	11-56225
Valve Cover Steel 428.....	11-56226
Water Neck.....	11-56230



Intake Manifold Kit for 429 Engine Part # 11-56246-H







# Individual Sets for Mopar

## Pick your style of fastener



H= Hex Caps Chrome Plated    S= Allen Screws Chrome Plated    B= Button Head Chrome Plated    N= 12 Point Chrome Plated    P= Allen Screws Polished Chrome Plated    HS= Hex Bolts Stainless Steel    SS= Allen Screws Stainless Steel    SB= Button Head Stainless Steel    HSP= Hex Bolts Stainless Steel Polished    SSP= Allen Screws Stainless Steel Polished    SBP= Button Head Stainless Steel Polished

Description	Part #
Oil Pan Small Block.....	56301
Intake Manifold Small Block.....	56302
Header Bolts Small Block.....	56303
Valve Cover Small Block.....	56304
Water Pump Small Block.....	56305
Fuel Pump Small Block.....	56306

Description	Part #
Oil Pan Big Block.....	56307
Intake Manifold Big Block.....	56308
Header Bolts Big Block.....	56309
Valve Cover Big Block.....	56310
Water Pump Big Block.....	56311
Fuel Pump Big Block.....	56312

You can also order the listed Individual Sets with the Emblems Stamped on the Hex Caps as shown below by using the Part Prefix associated with that emblem.

## Mopar

Chrysler Pentastar use Part Prefix  
21-56xxx to order



Dodge Ram use Part Prefix  
22-56xxx to order



Mopar use Part Prefix  
23-56xxx to order



Hemi Mopar use Part Prefix  
27-56xxx to order



OFFICIAL  
LICENSED  
PRODUCT

MOPAR, JEEP, DODGE, HEMI, PLYMOUTH, RAM, SRT, CHRYSLER and related logos, vehicle model names and trade dress are trademarks of Chrysler Group LLC and used under license by (licensee name). ©2015 Chrysler Group LLC

Select style when ordering:

H = Chrome Plated or HSP = Stainless Steel Polished.

**Example:**

Engine Dress Up Kit Part # 21-56301- **H** or **HSP**

Description	Part #
Oil Pan Small Block.....	21-56301
Intake Manifold Small Block.....	21-56302
Header Bolts Small Block.....	21-56303
Valve Cover Small Block.....	21-56304
Water Pump Small Block.....	21-56305
Fuel Pump Small Block.....	21-56306

Description	Part #
Oil Pan Big Block.....	21-56307
Intake Manifold Big Block.....	21-56308
Header Bolts Big Block.....	21-56309
Valve Cover Big Block.....	21-56310
Water Pump Big Block.....	21-56311
Fuel Pump Big Block.....	21-56312

## Buick

Description	Part #
Intake Manifold V6, 1977 - 1981.....	56420
Water Pump V6, 1977 - 1981.....	56422
Crank Pulley V6, 1977 - 1981.....	56423
Valve Cover V6.....	56424

## VW

Description	Part #
Transmission Axle Swing Acorn Kit, (Metric Thread).....	56800-A
Transmission Axle IRS Acorn Kit, (Metric Thread).....	56801-A

# Interior Screw Kits

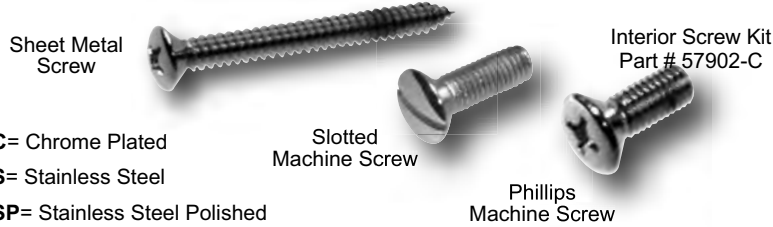

**Individual Sets**

**C=** Chrome Plated  
**S=** Stainless Steel  
**SP=** Stainless Steel Polished

Interior Screw Kit  
 Part # 57902-C

**Kits include sheet metal screws and/or machine screws. Washers are supplied where applicable.**

Make	Model	Styles Available	Part #
<b>Chevrolet</b>			
1937 - 1941	Four Door	C S SP	57900
1937 - 1941	Coupe	C S SP	57901
1937 - 1941	Two Door Sedan	C S SP	57902
1956 - 1957	Two Door Sedan	C S SP	57939
	Latch Striker Dovetail Kit Two Doors	C S SP	57001
	Latch Striker Dovetail Kits thru 1958	-- S SP	56904
<b>Buick</b>			
1940	Limited Four Door with Side Mounts	C S SP	57400
<b>Oldsmobile</b>			
1947	Four Door 78 Series	C S SP	57501
<b>Plymouth</b>			
1941	Four Door	C S SP	57605
1946	Two Door Sedan	C S SP	57602
<b>Dodge</b>			
1933	Coupe with Rumble Seat	C S SP	57500
1939	Two Door Sedan	C S SP	57603
1939	Two Door Coupe	C S SP	57604
<b>Door Screws</b>			
	Latch and Dovetail 1/4-20 x 1/2 #12 Head Stainless Steel	-- S SP	89206-12
	Latch and Dovetail 1/4-20 x 1/2 #12 Head Chrome Plated	C -- ----	40206-12
	Striker Mounting Screws 1/4-20 x 1 #10 Head Stainless Steel	-- S SP	94214-10
	Striker Mounting Screws 1/4-20 x 1 #10 Head Chrome Plated	C -- ----	39214-10
<b>Hinge Screws</b>			
5/16-24	x 3/4 Hex Head 9/16 across the flats Stainless Steel	-- S SP	88275
5/16-24	x 1 Flat Phillips Hinge Screw Stainless Steel	-- S SP	94281
5/16-24	x 1 Flat Phillips Hinge Chrome Plated	C -- ----	39281
5/16-24	x 1 Oval Phillips Hinge Screw Stainless Steel	-- S SP	89281
5/16-24	x 1 Oval Phillips Hinge Screw Chrome Plated	C -- ----	40281
5/16	External Countersunk Washers Stainless Steel	-- S ----	89570
5/16	External Countersunk Washers Chrome Plated	C -- ----	35570



# Interior Screw Kits

**Kits include sheet metal screws and/or machine screws.  
Washers are supplied where applicable.**

<b>Ford (Stainless Steel Only)</b>	<b>Part #</b>
1928 - 1929 Coupe.....	J-286
1928 - 1929 Two Door.....	J-287
1930 - 1931 Coupe.....	J-308
1930 - 1931 Two Door.....	J-309
1932 Phaeton.....	J-321
1932 Coupe 3 Window.....	J-322
1932 Coupe 5 Window.....	J-323
1932 Coupe Two Door.....	J-324
1933 - 1934 Roadster.....	J-330
1933 - 1934 Coupe.....	J-332
1935 - 1936 Coupe.....	J-352
1936 Two Door.....	J-353
1937 Coupe.....	J-371
1937 Two Door.....	J-372
1938 - 1939 Coupe.....	J-380
1938 - 1939 Two Door.....	J-381
1938 - 1939 Convertible.....	J-383
1940 Coupe.....	J-400
1940 Two Door.....	J-401
1941 Coupe.....	J-410
1941 Two Door.....	J-411
1941 Convertible.....	J-413
1942 - 1948 Two Door and Coupe.....	J-420
1942 - 1948 Convertible.....	J-422

Interior Screw Kit  
Part # J-401



<b>Hinge Screws (Chrome Plated Only)</b>	<b>Part #</b>
1928 - 1934 5/16-24 x 1 sold each.....	59281
1928 - 1934 5/16-24 x 3 sold each.....	59299
5/16 Recessed Washers.....	23549

<b>Hinge Pins (Chrome Plated Only)</b>	<b>Part #</b>
1928 - 1931 Closed Car.....	59028
1931 Slant Windshield.....	59029
1928 - 1931 Roadster/Phaeton.....	59030
1932 - 1948 V-8.....	59031

<b>Hinge Pins (Stainless Steel Polished Only)</b>	<b>Part #</b>
10/32 x 1/2 Screw no slot.....	59034
5/16 - 24 Cage Nuts.....	59035

<b>Assortments</b>	<b>Part #</b>
Interior & Door Screws in Stainless Steel.....	56900
Interior & Door Screws in Stainless Steel Polished.....	56901
Interior & Door Screws in Chrome Plated.....	56902



Cage Nuts  
Part # 59035



Hinge Screws  
Chrome Plated  
Part # 59281

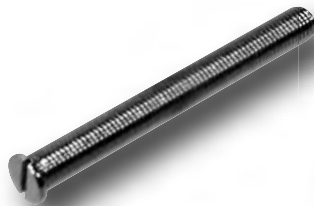

Hinge Screws  
Chrome Plated  
Part # 59299



Hinge Pins  
Chrome Plated  
Part # 59031



Hinge Pins  
Chrome Plated  
Part # 59030



## Inside This Section

### American Thread Chrome Plated

Allen Screws.....	24
Button Head Screws.....	24
Flat Head Allen Screws.....	25
12 Point Screws.....	25
Hex Cap Screws.....	26
Torx Button Head Screws.....	26
Chevy Bowtie Hex Caps.....	27
Carriage, Body, Sems, Spinloc & Step.....	28
Ford Oval Hex Caps.....	29
Machine Screws.....	30
Washers.....	31-32
Nuts.....	33
Acorn Nuts, Covers & 12 Pt. Nuts.....	34
Spacers.....	34
Cotter Pins, Hole Plugs, Pipe Plugs, Flange, Wing Nuts.....	35

### American Stainless Steel

Clamps.....	36
Chevy Bowtie Hex Caps.....	37
Ford Oval Hex Caps.....	38
Allen Screws.....	39
Button Head Screws.....	39
Flat Head Allen Screws.....	39
Hex Caps Screws.....	40
Set Screws.....	40
Washers.....	41-42
Nuts.....	42-43
Machine Screws.....	44

### American Zinc Plated

Hex Caps (Grade 5, 8 and L-9 Products).....	45
Allen Screws (Grade 8).....	45
Washers and L-9 Products.....	46
Nuts and L-9 Products.....	46
Machine Screws.....	47

**Bulk Fasteners  
Chrome Plated  
Stainless and Zinc**





# Bulk Chrome Fasteners American

## Allen Screws Chrome Plated and Polished Chrome



**12xxx**  
for Chrome Allen  
with Knurls



**10xxx**  
for Polished Chrome Allen  
with Knurls Removed

	4/40	6/32	8/32	10/24	10/32	1/4 -20	1/4 -28	5/16 -18	5/16 -24	3/8 -16	3/8 -24	7/16 -14	7/16 -20	1/2 -13	1/2 -20	5/8 -11	5/8 -18
3/8	12088	12104	12128	12152	12153	12204	12205	12268	12269								
1/2	12089	12106	12130	12154	12155	12206	12207	12270	12271	12322	12323						
5/8	12090	12108	12132	12156	12157	12208	12209	12272	12273	12324	12325						
3/4	12091	12110	12134	12158	12159	12210	12211	12274	12275	12326	12327	12374	12375	12414	12415		
7/8		12112	12136	12160	12161	12212	12213	12278	12279	12328	12329						
1		12114	12138	12162	12163	12214	12215	12280	12281	12330	12331	12376	12377	12416	12417	12488	12489
1 1/4			12140	12166	12167	12218	12219	12284	12285	12334	12335	12378	12379	12418	12419	12490	
1 1/2			12142	12168	12169	12220	12221	12286	12287	12336	12337	12380	12381	12420	12421	12492	12493
1 3/4				12170	12171	12222	12223	12288	12289	12338	12339	12382	12383	12422	12423	12494	12495
2				12172	12173	12224	12225	12290	12291	12340	12341	12384	12385	12424	12425	12496	12497
2 1/4				12174	12175	12226	12227	12292	12293	12342	12343	12386	12387	12426	12427	12498	12499
2 1/2				12176	12177	12228	12229	12294	12295	12344	12345	12388	12389	12428	12429	12500	12501
2 3/4					12179	12230	12231	12296	12297	12346	12347	12390	12391	12430	12431	12502	
3						12232	12233	12298	12299	12348	12349	12392	12393	12432	12433	12504	12505
3 1/4						12234	12235	12300	12301	12350	12351	12394	12395	12434	12435	12506	
3 1/2						12236	12237	12302	12303	12352	12353	12396	12397	12436	12437	12508	12509
4						12240	12241	12306	12307	12356	12357	12400		12440	12441	12512	12513
4 1/2						12244		12310	12311	12360	12361	12404		12442	12443	12514	
5						12246		12312	12313	12362	12363	12406		12444	12445	12516	12517
5 1/2								12316	12317	12366	12367	12410		12446	12447	12518	12519
6						12248			12319	12368		12412		12448		12520	

## Button Head Allen Screws Chrome Plated

Button Head Allen



	4/40	6/32	8/32	10/24	10/32	12/24	1/4 -20	1/4 -28	5/16 -18	5/16 -24	3/8 -16	3/8 -24	7/16 -14	7/16 -20	1/2 -13	1/2 -20	5/8 -11
1/4	13087	13102	13126	13150	13151												
3/8	13088	13104	13128	13152	13153		13204	13205	13268	13269							13415
1/2	13089	13106	13130	13154	13155	13186	13206	13207	13270	13271	13322	13323					
5/8	13090	13108	13132	13156	13157		13208	13209	13272	13273	13324						
3/4	13091	13110	13134	13158	13159		13210	13211	13274	13275	13326	13327			13414		
7/8			13136	13160	13161		13212	13213	13278	13279	13328						
1		13114	13138	13162	13163	13194	13214	13215	13280	13281	13330	13331	13376		13416	13417	13488
1 1/4			13140	13166	13167		13218	13219	13284	13285	13334	13335	13378	13379	13418	13419	13490
1 1/2				13168	13169		13220	13221	13286	13287	13336	13337	13380	13381	13420	13421	13492
1 3/4							13222	13223	13288	13289	13338	13339	13382		13422		
2							13224	13225	13290	13291	13340	13341	13384	13385	13424	13425	13496
2 1/4							13226		13292		13342	13343					
2 1/2							13228		13294		13344	13345		13389	13428	13429	13500
2 3/4									13296		13346						
3							13232		13298		13348	13349			13432	13433	13504
3 1/2							13236				13352						13508
4							13240				13356		13400		13440	13441	

# Bulk Chrome Fasteners American



## Flat Head Allen Screws Chrome Plated

Flat Head Allen



**American  
Bulk Chrome**

	6/32	8/32	10/24	10/32	12/24	1/4 -20	1/4 -28	5/16 -18	5/16 -24	3/8 -16	3/8 -24	7/16 -14	1/2 -13	1/2 -20
1/4	14102													
3/8	14104	14128	14152	14153		14204	14205							
1/2	14106	14130	14154	14155	14186	14206	14207	14270	14271	14322				
5/8	14108	14132	14156	14157		14208	14209	14272	14273	14324	14325			
3/4	14110	14134	14158	14159	14190	14210	14211	14274	14275	14326	14327	14374	14414	14527
7/8		14136	14160	14161		14212	14213	14278	14279	14328				
1	14114	14138	14162	14163	14194	14214	14215	14280	14281	14330	14331	14376	14416	14417
1 1/4		14140	14166	14167		14218	14219	14284	14285	14334	14335	14378	14418	14419
1 1/2		14142	14168	14169		14220	14221	14286	14287	14336	14337	14380	14420	14421
1 3/4			14170			14222		14288		14338		14382	14422	14423
2						14224		14290		14340		14384	14424	14425
2 1/4								14292		14342		14386	14426	
2 1/2						14228		14294		14344		14388	14428	
2 3/4						14230				14346				
3						14232		14302		14348		14392	14432	
3 1/2						14236				14352		14396	14436	
4						14240		14306					14440	
4 1/2										14360				

## 12 Point Screws Chrome Plated

12 Point Screw



	1/4 -20	1/4 -28	5/16 -18	5/16 -24	3/8 -16	3/8 -24	7/16 -14	7/16 -20	1/2 -13	1/2 -20	5/8 -11	5/8 -18
3/8												
1/2	29206	29207	29270	29271	29322	29323						
5/8	29208	29209	29272	29273								
3/4	29210	29211	29274	29275	29326	29327	29374		29414	29527		
7/8	29212	29213										
1	29214	29215	29280	29281	29330	29331	29376	29377	29416	29417	29488	29489
1 1/4	29218	29219	29284	29285	29334	29335	29378	29379	29418	29419	29490	29491
1 1/2	29220	29221	29286	29287	29336	29337	29380	29381	29420	29421	29492	29493
1 3/4	29222	29223	29288	29289	29338	29339	29382	29383	29422	29423	29494	29495
2	29224	29225	29290	29291	29340	29341	29384	29385	29424	29425	29496	29497
2 1/4	29226	29227	29292	29293	29342	29343	29386	29387	29426	29427	29498	
2 1/2	29228	29229	29294	29295	29344	29345	29388	29389	29428	29429	29500	29501
2 3/4	29230	29231	29296	29297	29346	29347	29390	29391	29430		29502	
3	29232	29233	29298	29299	29348	29349	29392	29393	29432	29433	29504	29505
3 1/4			29300	29301	29350	29351	29394		29434			
3 1/2			29302	29303	29352	29353	29396	29397	29436	29437	29508	29509
4					29356	29357	29400		29440		29512	
4 1/2					29360				29442		29514	
5					29362				29444		29516	





# Bulk Chrome Fasteners American

## Hex Caps Screws Chrome Plated Grade 5 & Grade 8

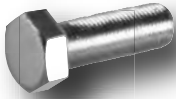

**11xxx**  
for Grade 5  
Chrome Hex Caps

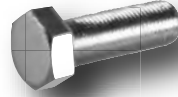

**31xxx**  
for Grade 8  
Chrome Hex Caps

	1/4 -20	1/4 -28	5/16 -18	5/16 -24	3/8 -16	3/8 -24	7/16 -14	7/16 -20	1/2 -13	1/2 -20	9/16 -12	9/16 -18	5/8 -11	5/8 -18
1/2	11206	11207	11270	11271	11322	11323								
5/8	11208	11209	11272	11273	11324	11325								
3/4	11210	11211	11274	11275	11326	11327	11374	11375	11414	11527				
7/8	11212	11213	11278	11279	11328	11329								
1	11214	11215	11280	11281	11330	11331	11376	11377	11416	11417	11452	11453	11488	11489
1 1/4	11218	11219	11284	11285	11334	11335	11378	11379	11418	11419	11454	11455	11490	11491
1 1/2	11220	11221	11286	11287	11336	11337	11380	11381	11420	11421	11456	11457	11492	11493
1 3/4	11222	11223	11288	11289	11338	11339	11382	11383	11422	11423	11458	11459	11494	11495
2	11224	11225	11290	11291	11340	11341	11384	11385	11424	11425	11460	11461	11496	11497
2 1/4	11226	11227	11292	11293	11342	11343	11386	11387	11426	11427	11462	11463	11498	11499
2 1/2	11228	11229	11294	11295	11344	11345	11388	11389	11428	11429	11464	11465	11500	11501
2 3/4	11230	11231	11296	11297	11346	11347	11390	11391	11430	11431	11466	11467	11502	11503
3	11232	11233	11298	11299	11348	11349	11392	11393	11432	11433	11468	11469	11504	11505
3 1/4	11234	11235	11300	11301	11350	11351	11394	11395	11434	11435	11470	11471	11506	11507
3 1/2	11236	11237	11302	11303	11352	11353	11396	11397	11436	11437	11472	11473	11508	11509
4	11240	11241	11306	11307	11356	11357	11400	11401	11440	11441	11476	11477	11512	11513
4 1/2	11244		11310	11311	11360	11361	11404	11405	11442	11443	11478	11479	11514	11515
5	11246		11312	11313	11362	11363	11406	11407	11444	11445	11480	11481	11516	11517
5 1/2	11246-B	11247-C	11316	11317	11366	11367	11410	11411	11446	11447	11482	11483	11518	11519
6	11246-A	11247-A	11318	11319	11368	11369	11412		11448	11449	11484	11485	11520	11521

## Torx Button Head Screws Chrome Plated

Torx Button Head



	8/32	10/24	10/32	1/4 -20	1/4 -28	5/16 -18	5/16 -24	3/8 -16	3/8 -24	1/2 -13
1/4	46126	46150	46151							
3/8	46128	46152	46153	46204	46205	46268	46269			
1/2	46130	46154	46155	46206	46207	46270	46271	46322	46323	
5/8	46132	46156	46157	46208	46209	46272	46273	46324		
3/4	46134	46158	46159	46210	46211	46274	46275	46326		
7/8		46160	46160	46212		46278		46328		
1		46162	46163	46214	46215	46280	46281	46330	46331	46416
1 1/4				46218				46334		46418
1 1/2				46220				46336		46420
1 3/4				46222				46338		
2				46224				46340		
2 1/4				46226				46342		
2 1/2				46228				46344		
2 3/4								46346		
3				46232				46348		

# Bulk Chrome Fasteners American



27

## Screws

Bowtie Hex Cap



### Bowtie Hex Caps

	1/4 -20	1/4 -28	5/16 -18	5/16 -24	3/8 -16	3/8 -24	7/16 -14	7/16 -20	1/2 -13	1/2 -20	9/16 -12	9/16 -18	5/8 -11	5/8 -18
1/2	10-11206	10-11207	10-11270	10-11271	10-11322	10-11323								
5/8	10-11208	10-11209	10-11272	10-11273	10-11324	10-11325								
3/4	10-11210	10-11211	10-11274	10-11275	10-11326	10-11327	10-11374	10-11375	10-11414	10-11527				
7/8	10-11212	10-11213	10-11278	10-11279	10-11328	10-11329								
1	10-11214	10-11215	10-11280	10-11281	10-11330	10-11331	10-11376	10-11377	10-11416	10-11417	10-11452	10-11453	10-11488	10-11489
1 1/4	10-11218	10-11219	10-11284	10-11285	10-11334	10-11335	10-11378	10-11379	10-11418	10-11419	10-11454	10-11455	10-11490	10-11491
1 1/2	10-11220	10-11221	10-11286	10-11287	10-11336	10-11337	10-11380	10-11381	10-11420	10-11421	10-11456	10-11457	10-11492	10-11493
1 3/4	10-11222	10-11223	10-11288	10-11289	10-11338	10-11339	10-11382	10-11383	10-11422	10-11423	10-11458	10-11459	10-11494	10-11495
2	10-11224	10-11225	10-11290	10-11291	10-11340	10-11341	10-11384	10-11385	10-11424	10-11425	10-11460	10-11461	10-11496	10-11497
2 1/4	10-11226	10-11227	10-11292	10-11293	10-11342	10-11343	10-11386	10-11387	10-11426	10-11427	10-11462	10-11463	10-11498	10-11499
2 1/2	10-11228	10-11229	10-11294	10-11295	10-11344	10-11345	10-11388	10-11389	10-11428	10-11429	10-11464	10-11465	10-11500	10-11501
2 3/4	10-11230	10-11231	10-11296	10-11297	10-11346	10-11347	10-11390	10-11391	10-11430	10-11431	10-11466	10-11467	10-11502	10-11503
3	10-11232	10-11233	10-11298	10-11299	10-11348	10-11349	10-11392	10-11393	10-11432	10-11433	10-11468	10-11469	10-11504	10-11505
3 1/4	10-11234	10-11235	10-11300	10-11301	10-11350	10-11351	10-11394	10-11395	10-11434	10-11435	10-11470	10-11471	10-11506	10-11507
3 1/2	10-11236	10-11237	10-11302	10-11303	10-11352	10-11353	10-11396	10-11397	10-11436	10-11437	10-11472	10-11473	10-11508	10-11509
4	10-11240	10-11241	10-11306	10-11307	10-11356	10-11357	10-11400	10-11401	10-11440	10-11441	10-11476	10-11477	10-11512	10-11513
4 1/2	10-11244		10-11310	10-11311	10-11360	10-11361	10-11404	10-11405	10-11442	10-11443	10-11478	10-11479	10-11514	10-11515
5	10-11246		10-11312	10-11313	10-11362	10-11363	10-11406	10-11407	10-11445	10-11446	10-11480	10-11481	10-11516	10-11517
5 1/2	10-11246-B	10-11247-C	10-11316	10-11317	10-11366	10-11367	10-11410	10-11411	10-11447	10-11448	10-11482	10-11483	10-11518	10-11519
6	10-11246-A	10-11247-A	10-11318	10-11319	10-11368	10-11369	10-11412	10-11413	10-11449	10-11450	10-11484	10-11485	10-11520	10-11521

### Bowtie Body Bolts

Size	Part #
14 x 3/4 - 3/8 Hex	10-55669-P3
14 x 3/4 - 7/16 Hex	10-55669-P7
5/16 x 13/16	10-22276
5/16 x 1 1/4	10-22284
<b>Stainless Steel Only</b>	
5/16 x 13/16	10-88276



Body Bolt

### Bowtie Spinloc Bolts

Size	Part #
1/4-20 x 5/8	10-43208
5/16-18 x 3/4	10-43274
5/16-18 x 1	10-43280
5/16-18 x 1 1/4	10-43284
5/16-24 x 1	10-43281
3/8-16 x 1	10-43330



Spinloc Bolt

### Bowtie Hex Washer Sems Polished & Chrome Plated

With Washer Loose From Head		
Size	Washer O.D.	Part #
1/4-20 x 7/8	3/4"	10-25212
5/16-18 x 1	1"	10-25280
3/8-16 x 3/4	1"	10-25326
3/8-16 x 1	1"	10-25330
3/8-16 x 1 1/2	1"	10-25336



Hex Washer Sem



OFFICIAL LICENSED PRODUCT

### Bolts Also Available In These Selected Emblem Stamped Hex Cap Styles

<b>Chevy SS</b> Use Part Prefix 13-xxxxx to order	<b>Chevy RS</b> Use Part Prefix 16-xxxxx to order	<b>Chevy 350</b> Use Part Prefix 18-xxxxx to order	<b>Chevy 454</b> Use Part Prefix 19-xxxxx to order	<b>Flame</b> Use Part Prefix 17-xxxxx to order
<b>Pontiac</b> Use Part Prefix 12-xxxxx to order	<b>GTO</b> Use Part Prefix 20-xxxxx to order	<b>GT</b> Use Part Prefix 15-xxxxx to order	<b>Olds Rocket</b> Use Part Prefix 26-xxxxx to order	<b>Skull</b> Use Part Prefix 14-xxxxx to order



# Bulk Chrome Fasteners American

## Screws

### Carriage Bolts

Carriage Bolt

	3/16	1/4	5/16	3/8	7/16	1/2
1/2	27154	27206				
3/4		27210	27274	27326		
1	27162	27214	27280	27330	27376	27416
1 1/2	27168	27220	27286	27336	27380	27420
1 3/4		27222			27382	27422
2		27224	27290	27340	27384	27424
2 1/4		27226	27292			
2 1/2		27228	27294	27344	27388	27428
2 3/4			27296			
3		27232	27298	27348	27392	27432
3 1/2		27236	27302	27352	27396	27436
4		27240	27306	27356	27400	27440
4 1/2			27310	27360	27404	27442
5		27246	27312	27362	27406	27444
5 1/2					27410	27446
6			27318	27368		27448



### Spinloc Bolts

Spinloc Bolt

Size	Part #
1/4-20 x 5/8	43208
5/16-18 x 3/4	43274
5/16-18 x 1	43280
5/16-18 x 1 1/4	43284
5/16-24 x 1	43281
3/8-16 x 1	43330



### Step Bolts

Step Bolt

Size	Part #
1/4 x 1	28214
1/4 x 1 1/2	28220
1/4 x 2	28224
5/16 x 1	28280
5/16 x 1 1/2	28286
5/16 x 2 1/2	28294
3/8 x 1	28330
3/8 x 1 1/2	28336



### Body Bolts

Body Bolt

Size	Part #
14 x 3/4-3/8 Hex	55669-3
14 x 3/4-7/16 Hex	55669-7
14 x 3/4-3/8 Hex w/ loose washer	55669-W3
14 x 3/4-7/16 Hex w/ loose washer	55669-W7
<b>Body Bolts with Polished Heads</b>	
14 x 3/4-3/8 Hex	55669-P3
14 x 3/4-7/16 Hex	55669-P7
5/16 x 13/16	22276
5/16 x 1 1/4	22284
<b>Body Bolts in Stainless Steel</b>	
5/16 x 13/16	88276
<b>Body Bolts Unpolished</b>	
5/16 x 13/16	09276
5/16 x 1 1/4	09284



**Body & Spinloc Bolt Assortment**  
20 Sizes with 200 pieces Part # A-201

### Mag Wheel Washers

Size	O.D. is 1 1/8"	Part #
11/16	Chrome	23578
	Stainless	75578
	Stainless Polished	SP-75578

### Throttle Return Springs

Size	Part #
Chrome Plated Inner & Outer	09012
Chrome Outer & Gold Plated Inner	09013
Gold Plated Inner & Outer	09015
Gold Plated Outer & Chrome Inner	09014
Black	09012-black
Red	09012-red
White	09012-white
Blue	09012-blue

### Hex Washer Sems Polished and Chrome Plated

With washer loose from head

Hex Washer Sem

Size	Washer O.D.	Part #
1/4-20 x 7/8	3/4"	25212
5/16-18 x 1	1"	25280
3/8-16 x 3/4	1"	25326
3/8-16 x 1	1"	25330
3/8-16 x 1 1/2	1 1/8"	25336



Throttle Return Springs

# Bulk Chrome Fasteners American



## Screws

Ford Oval Hex Cap

### Ford Oval Hex Caps

	1/4 -20	1/4 -28	5/16 -18	5/16 -24	3/8 -16	3/8 -24	7/16 -14	7/16 -20	1/2 -13	1/2 -20	9/16 -12	9/16 -18	5/8 -11	5/8 -18
1/2	11-11206	11-11207	11-11270	11-11271	11-11322	11-11323								
5/8	11-11208	11-11209	11-11272	11-11273	11-11324	11-11325								
3/4	11-11210	11-11211	11-11274	11-11275	11-11326	11-11327	11-11374	11-11375	11-11414	11-11527				
7/8	11-11212	11-11213	11-11278	11-11279	11-11328	11-11329								
1	11-11214	11-11215	11-11280	11-11281	11-11330	11-11331	11-11376	11-11377	11-11416	11-11417	11-11452	11-11453	11-11488	11-11489
1 1/4	11-11218	11-11219	11-11284	11-11285	11-11334	11-11335	11-11378	11-11379	11-11418	11-11419	11-11454	11-11455	11-11490	11-11491
1 1/2	11-11220	11-11221	11-11286	11-11287	11-11336	11-11337	11-11380	11-11381	11-11420	11-11421	11-11456	11-11457	11-11492	11-11493
1 3/4	11-11222	11-11223	11-11288	11-11289	11-11338	11-11339	11-11382	11-11383	11-11422	11-11423	11-11458	11-11459	11-11494	11-11495
2	11-11224	11-11225	11-11290	11-11291	11-11340	11-11341	11-11384	11-11385	11-11424	11-11425	11-11460	11-11461	11-11496	11-11497
2 1/4	11-11226	11-11227	11-11292	11-11293	11-11342	11-11343	11-11386	11-11387	11-11426	11-11427	11-11462	11-11463	11-11498	11-11499
2 1/2	11-11228	11-11229	11-11294	11-11295	11-11344	11-11345	11-11388	11-11389	11-11428	11-11429	11-11464	11-11465	11-11500	11-11501
2 3/4	11-11230	11-11231	11-11296	11-11297	11-11346	11-11347	11-11390	11-11391	11-11430	11-11431	11-11466	11-11467	11-11502	11-11503
3	11-11232	11-11233	11-11298	11-11299	11-11348	11-11349	11-11392	11-11393	11-11432	11-11433	11-11468	11-11469	11-11504	11-11505
3 1/4	11-11234	11-11235	11-11300	11-11301	11-11350	11-11351	11-11394	11-11395	11-11434	11-11435	11-11470	11-11471	11-11506	11-11507
3 1/2	11-11236	11-11237	11-11302	11-11303	11-11352	11-11353	11-11396	11-11397	11-11436	11-11437	11-11472	11-11473	11-11508	11-11509
4	11-11240	11-11241	11-11306	11-11307	11-11356	11-11357	11-11400	11-11401	11-11440	11-11441	11-11476	11-11477	11-11512	11-11513
4 1/2	11-11244		11-11310	11-11311	11-11360	11-11361	11-11404	11-11405	11-11442	11-11443	11-11478	11-11479	11-11514	11-11515
5	11-11246		11-11312	11-11313	11-11362	11-11363	11-11406	11-11407	11-11445	11-11446	11-11480	11-11481	11-11516	11-11517
5 1/2	11-11246-B	11-11247-C	11-11316	11-11317	11-11366	11-11367	11-11410	11-11411	11-11447	11-11448	11-11482	11-11483	11-11518	11-11519
6	11-11246-A	11-11247-A	11-11318	11-11319	11-11368	11-11369	11-11412	11-11413	11-11449	11-11450	11-11484	11-11485	11-11520	11-11521

### Ford Oval Body Bolts

### Ford Oval Spinloc Bolts

### Ford Oval Hex Washer Sems Polished & Chrome Plated

Size	Part #
1/4 x 3/4 - 3/8 Hex	11-55669-P3
1/4 x 3/4 - 7/16 Hex	11-55669-P7
5/16 x 13/16	11-22276
5/16 x 1 1/4	11-22284
<b>Stainless Steel Only</b>	
5/16 x 13/16	11-88276

Size	Part #
1/4-20 x 5/8	11-43208
5/16-18 x 3/4	11-43274
5/16-18 x 1	11-43280
5/16-18 x 1 1/4	11-43284
5/16-24 x 1	11-43281
3/8-16 x 1	11-43330

Size	Washer O.D.	Part #
1/4-20 x 7/8	3/4"	11-25212
5/16-18 x 1	1"	11-25280
3/8-16 x 3/4	1"	11-25326
3/8-16 x 1	1"	11-25330
3/8-16 x 1 1/2	1"	11-25336



Body Bolt



Spinloc Bolt



Hex Washer Sem

**Example:** Part # 24-11210 to Purchase: 1/4-20 x 3/4 Ford V-8 Stamped Hex Cap in Chrome



**Ford Oval**  
Use Part Prefix  
11-xxxxx to order



**Ford V8**  
Use Part Prefix  
24-xxxxx to order



**Ford Mustang**  
Use Part Prefix  
25-xxxxx to order



# Bulk Chrome Fasteners American

## Machine and Sheet Metal Screws Chrome Plated

**Example:** To order a **8/32 x 5/8 Oval Phillips Machine Screw**: Use **Chart #1** for the type of head style required, take those first two digits for the beginning part number which would be **"40"**. Now look up the diameter and length from **Chart #2 or #3** for last three digits for **8/32 x 5/8** is **"132"**. Put the two together for a part number of **40132**, or simply order by style and size.

**Chart #1: Select Styles**

Style	Chrome Slotted	Phillips
Round Head	33xxx	38xxx
Flat Head	36xxx	39xxx
Truss Head	51xxx	53xxx
Oval Head	34xxx	40 / 57*
Pan Head	35xxx	41xxx
Fillister	37xxx	n/a
Hex	55xxx	n/a
Round Wood	33xxx	n/a
Flat Wood	47xxx	49xxx
Oval Wood	48xxx	50xxx

**\*NOTE: Not all styles available in all sizes**

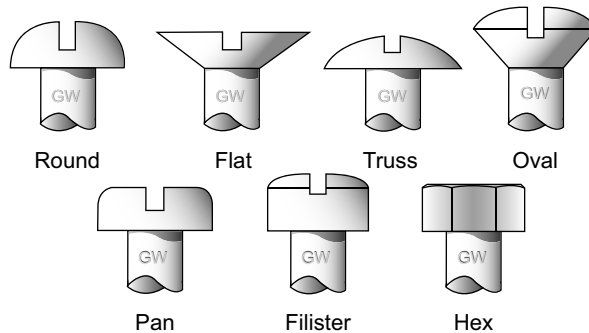

**\*NOTE: Oval Phillips Sheet Metal Screws use Prefix 57 not 40**

**Chart #2: Machine Screw Sizes**

	6/32	8/32	10/24	10/32	12/24	1/4 -20	1/4 -28	5/16 -18	5/16 -24	3/8 -16
3/8	104	128	152	153	184	204				
1/2	106	130	154	155	186	206		270		
5/8		132	156	157	188	208	209			
3/4	110	134	158	159	190	210	211	274	275	
7/8		136	160	161	192	212				
1	114	138	162	163	194	214	215	280	281	330
1 1/4	116	140	166	167	196	218	219	284	285	334
1 1/2	118	142	168	169	198	220	221	286	287	336
1 3/4			170	171		222		288	289	338
2	122		172	173		224		290	291	340

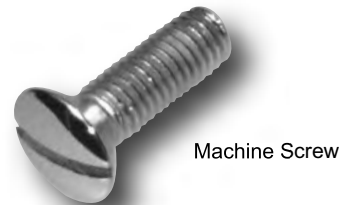

Machine Screw

**Chart #3: Sheet Metal & Wood Screw Sizes**

	#6	#8	#10	#12	#14
1/2	616	628	641	654	667
5/8	617	629	642	655	668
3/4	618	630	643	656	669
1	620	632	645	658	671
1 1/4	621	633	646	659	672
1 1/2	622	634	647	660	673
1 3/4	623	680	648	661	674
2	624	635	649	662	675
2 1/4				663	676
2 1/2				664	677



Sheet Metal Screw



Woodscrew



**American Bulk Chrome**

## Washers Chrome Plated

### Flat Washers Standard SAE

Size	Part #
4	23564
6	23565
8	23566
10	23567
12	23568
1/4	23569
5/16	23570
3/8	23571
7/16	23572
1/2	23573
9/16	23574
5/8	23575
3/4	23576

Flat Washer



### Hardened Flat Washer "G-W" Washers

Size	Part #
1/4	33569
5/16	33570
3/8	33571
7/16	33572
1/2	33573
5/8	33575

Hardened Flat Washer



### AN Flat Washers Small OD Chrome

Size	Part #
10	26567
1/4	26569
5/16	26570
3/8	26571
7/16	26572
1/2	26573
9/16	26574
5/8	26575
3/4	26576
1	26577

AN Flat Washer



### Lock Washers

Size	Part #
4	24564
6	24565
8	24566
10	24567
12	24568
1/4	24569
5/16	24570
3/8	24571
7/16	24572
1/2	24573
9/16	24574
5/8	24575
3/4	24576

Lock Washer



## Also Available in Assortments

All Items shown on this page can be purchased individually

### High Collar Lock Washers

Size	Part #
8	25566
10	25567
1/4	25569
5/16	25570
3/8	25571
7/16	25572
1/2	25573
5/8	25575



### Internal Lock Washers

Size	Part #
6	29565
8	29566
10	29567
12	29568
1/4	29569
5/16	29570
3/8	29571
7/16	29572
1/2	29573
5/8	29575



### External Countersunk Washers

Size	Part #
6	35565
8	35566
10	35567
12	35568
1/4	35569
5/16	35570



### External Lock Washers

Size	Part #
6	32565
8	32566
10	32567
12	32568
1/4	32569
5/16	32570
3/8	32571
7/16	32572
1/2	32573



**Note:** O.D. of Washer is the same as the Head of the Allen Screw

**Having difficulties locating a particular item please call**





## Washers Chrome Plated

### Cup Washers

Size	Part #
3/8 x 1 1/4	22334
1/2 x 1 1/4	22418
1/2 x 1 7/16	22420
5/8 x 1 1/4	22490

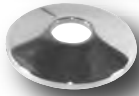

22334  
Cup Washer



22418  
Cup Washer



22420  
Cup Washer



22490  
Cup Washer

Cup Washers Sold Each.

### Finishing Washer

Size	Part #
6	34565
8	34566
10	34567
12	34568
14	34569



Finishing Washer

### Flush Washer

Size	Part #
6	41565
8	41566
10	41567



Flush Washer

### Flat Washer USS Standard

Size	I.D.	O.D.	Part #
1/4	5/16	3/4	23274
5/16	3/8	7/8	23328
3/8	7/16	1	23376
7/16	1/2	1 1/4	23418
1/2	9/16	1 3/8	23456
9/16	5/8	1 1/2	23492



Flat Washer

For  
Stainless Steel  
Super Flat  
Fender Washers  
See page 41

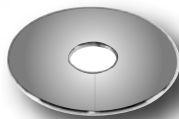

Super  
Flat Washers  
Sold Each.

### Super Flat Fender Washers

Size	O.D.	Thickness	Part #
#8	3/4		23134
#10	3/4		23158
#10	1		23162
5/16	5/32	3/64	23128
3/16	1		23162
1/4	7/8		23212
1/4	1		23214
1/4	1 1/4		23218
5/16	1		23280
5/16	3/4		23274
5/16	13/16	3/32	23278
5/16	1 1/8		23282
5/16	1 1/4		23284
5/16	1 1/2		23286
5/16	1 1/2	1/8	23286H
11/32	1 1/32		23283
13/32	11/16	1/16	23326
3/8	3/4	.060	23326A
3/8	7/8		23328
3/8		Heat Treat	23329
3/8	1 1/4		23334
3/8	1 1/2		23336
3/8	1 1/2	1/8	23336H
3/8	2	1/16	23340
7/16	29/32	.190	23374
7/16	15/16		23375
7/16	1	1/8	23376
7/16	1 1/8	5/32	23377
7/16	1 1/8		23379
1/2	13/16		23415
1/2	1 1/8		23416
1/2	1 1/4		23418
1/2	2		23424
9/16	1 3/8		23456
5/8	1 1/2		23492
5/8	1 3/4		23495
21/32	1 1/16		23488
11/16	1 3/8	3/16	23496
11/16	1 3/8	Pivot Shaft	23579
7/16	2		23594



## Nuts Chrome Plated

### Hex Nuts

Size	Part #
4/40	15536
5/40	15537
6/32	15538
8/32	15540
10/24	15542
10/32	15543
12/24	15544
1/4-20	15546
1/4-28	15547
5/16-18	15548
5/16-24	15549
3/8-16	15550
3/8-24	15551
7/16-14	15552
7/16-20	15553
1/2-13	15554
1/2-20	15555
9/16-12	15556
9/16-18	15557
5/8-11	15558
5/8-18	15559
3/4-10	15560
3/4-16	15561



Hex Nuts  
1/4, 5/16 and 3/8  
Sold  
100 per bag.



### Nylon Insert Lock Nuts

Size	Part #
4/40	17536
5/40	17537
6/32	17538
8/32	17540
10/24	17542
10/32	17543
12/24	17544
1/4-20	17546
1/4-28	17547
5/16-18	17548
5/16-24	17549
3/8-16	17550
3/8-24	17551
7/16-14	17552
7/16-20	17553
1/2-13	17554
1/2-20	17555
9/16-12	17556
9/16-18	17557
5/8-11	17558
5/8-18	17559
3/4-10	17560
3/4-16	17561

### Thin Jam Lock Nuts

Size	Part #
1/4-20	27546
1/4-28	27547
5/16-18	27548
5/16-24	27549
3/8-16	27550
3/8-24	27551
7/16-14	27552
7/16-20	27553
1/2-13	27554
1/2-20	27555
9/16-12	27556
9/16-18	27557
5/8-11	27558
5/8-18	27559
3/4-10	27560
3/4-16	27561



### Flexloc® Nuts (All Metal)

Size	Part #
10/24	18542
10/32	18543
1/4-20	18546
1/4-28	18547
5/16-18	18548
5/16-24	18549
3/8-16	18550
3/8-24	18551
7/16-14	18552
7/16-20	18553
1/2-13	18554
1/2-20	18555
9/16-12	18556
9/16-18	18557
5/8-11	18558
5/8-18	18559
3/4-10	18560
3/4-16	18561

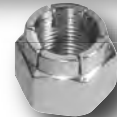

All items shown on this page can be purchased individually

American Bulk Chrome

### Slotted Nuts

Size	Part #
1/4-20	22546
1/4-28	22547
5/16-18	22548
5/16-24	22549
3/8-16	22550
3/8-24	22551
7/16-14	22552
7/16-20	22553
1/2-13	22554
1/2-20	22555
9/16-12	22556
9/16-18	22557
5/8-11	22558
5/8-18	22559
3/4-10	22560
3/4-16	22561



### Allen Nuts

Size	Part #
10/24	19542
10/32	19543
1/4-20	19546
1/4-28	19547
5/16-18	19548
5/16-24	19549
3/8-16	19550
3/8-24	19551
7/16-14	19552
7/16-20	19553
1/2-13	19554
1/2-20	19555
5/8-11	19558
5/8-18	19559



### Thin Jam Hex Nuts

Size	Part #
1/4-20	16546
1/4-28	16547
5/16-18	16548
5/16-24	16549
3/8-16	16550
3/8-24	16551
7/16-14	16552
7/16-20	16553
1/2-13	16554
1/2-20	16555
9/16-12	16556
9/16-18	16557
5/8-11	16558
5/8-18	16559
3/4-10	16560
3/4-16	16561

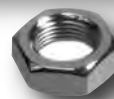

### Thin Jam Flexloc Nuts (All Metal)

Size	Part #
1/4-20	28546
1/4-28	28547
5/16-18	28548
5/16-24	28549
3/8-16	28550
3/8-24	28551
7/16-14	28552
7/16-20	28553
1/2-13	28554
1/2-20	28555
9/16-12	28556
9/16-18	28557
5/8-11	28558
5/8-18	28559
3/4-10	28560
3/4-16	28561





# Bulk Chrome Fasteners American

## Nuts Chrome Plated

### Acorn Nuts

Coarse and Fine Thread

Size	Part #
4/40	21536
6/32	21538
8/32	21540
10/24	21542
10/32	21543
12/24	21544
1/4-20	21546
1/4-28	21547
5/16-18	21548
5/16-24	21549
3/8-16	21550
3/8-24	21551
7/16-14	21552
7/16-20	21553
1/2-13	21554
1/2-20	21555
9/16-12	21556
9/16-18	21557
5/8-11	21558
5/8-18	21559
3/4-10	21560
3/4-16	21561
1-14	21565



### Low Crown Acorn Nuts

Coarse and Fine Thread

Size	Part #
8/32	33540
10/24	33542
10/32	33543
1/4-20	33546
1/4-28	33547
5/16-18	33548
5/16-24	33549
3/8-16	33550
3/8-24	33551
7/16-14	33552
7/16-20	33553
1/2-13	33554
1/2-20	33555
5/8-11	33558
5/8-18	33559



### Acorn Push On Covers

Wrench Size	Part #	Bolt/Nut Diameter
7/16	45552	1/4
1/2	45554	5/16
9/16	45556	3/8
5/8	45558	7/16
11/16	45559	
7/8	45562	
3/4	45560	

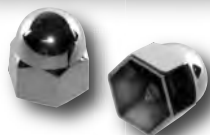

## Spacers Chrome Plated

ID	OD	Length	Part #
1/4	7/16	3/16	20080
1/4	7/16	1/4	20081
1/4	7/16	3/8	20082
1/4	7/16	1/2	20082-A
1/4	7/16	5/8	20083
1/4	7/16	3/4	20084
1/4	7/16	7/8	20094
1/4	7/16	1 1/16	20085
1/4	5/8	1/8	20040
1/4	5/8	1/4	20036
1/4	5/8	3/8	20037
1/4	5/8	1/2	20038
1/4	5/8	3/4	20039
1/4	5/8	1	20041
5/16	7/16	5/8	20045
5/16	1/2	3/16	20049
5/16	1/2	1/4	20050
5/16	1/2	3/8	20050-A
5/16	1/2	1/2	20051
5/16	1/2	17/32	20093
5/16	1/2	3/4	20052
5/16	1/2	1	20053
5/16	1/2	1 1/4	20054
5/16	5/8	1/8	20055
5/16	5/8	3/16	20056
5/16	5/8	1/4	20057
5/16	5/8	3/8	20058
5/16	5/8	1/2	20059
5/16	5/8	3/4	20060
5/16	5/8	1	20061
3/8	9/16	1/8	20087

ID	OD	Length	Part #
3/8	9/16	3/8	20086
3/8	13/16	5/32	20091
3/8	5/8	1/4	20067
3/8	5/8	3/8	20068
3/8	1	5/16	C-31-32
3/8	5/8	1/2	20069
3/8	13/16	1/2	20092
3/8	5/8	3/4	20070
3/8	13/16	29/32	20092-A
3/8	5/8	1	20072
3/8	5/8	1 1/2	20075
3/8	3/4	1/8 Tapered	20021
3/8	3/4	1/4	20022
3/8	3/4	3/8	20023
3/8	3/4	1/2	20024
3/8	3/4	3/4	20025
3/8	3/4	1	20026
3/8	7/8	5/8	20089
7/16	3/4	3/32	23580
7/16	11/16	5/16	20088
1/2	5/16	15/16	20095
1/2	3/4	1/8	20030
1/2	3/4	1/4	20031
1/2	3/4	1/2	20032
1/2	3/4	3/4	20033
1/2	3/4	1	20034
1/2	7/8	3/8	20097
1/2	15/16	21/32	20096
1/2	1 1/16	5/16	23200
9/16	7/8	3/4	20100
5/8	1 1/2	3/8	C-31-100
13/32	1	.322	23327



All Items shown on this page can be purchased individually

### Spike Nuts

Coarse and Fine Thread

Size	Part #
1/4-20	26546
1/4-28	26547
5/16-18	26548
5/16-24	26549
3/8-16	26550
3/8-24	26551
7/16-14	26552
7/16-20	26553
1/2-13	26554
1/2-20	26555
5/8-18	26559

Non-Alcoholic but may be habit forming



Spike Nuts

# Bulk Chrome Fasteners American



35

## Cotter Pins Chrome, Stainless or Zinc

Size	Chrome Part #	Stainless Part #	Zinc Part #
1/16 x 1/2		78580	01587
1/16 x 3/4		78587	01588
1/16 x 1 1/4		78588A	01588A
5/64 x 3/4		78581	01589
3/32 x 3/4	29589	78589	01590
3/32 x 1	29590	78590	01591
3/32 x 1 1/4	29591A	78591	
3/32 x 1 1/2		78591A	
3/32 x 1 3/4	29587		01592
1/8 x 3/4	29592	78592	
1/8 x 1		78584	01593
1/8 x 1 1/4	29593	78593	
1/8 x 1 1/2	29585	78585	
1/8 x 1 3/4		78585A	
1/8 x 2		78595	
5/32 x 1		78585B	01599
5/32 x 1 1/2	29588	78588	
5/32 x 1 3/4	29586	78586	01594
3/16 x 1	29594	78594	
3/16 x 1 3/4		78597	



Cotter Pin Assortments A-34 Zinc or A-34C Chrome Plated

American Bulk Chrome

## Flange & Locking Flange Nuts

Size	Part #	Locking #
1/4-20	44546	44546-L
5/16-18	44548	44548-L
5/16-24	44549	44549-L
3/8-16	44550	44550-L
3/8-24	44551	44551-L
7/16-14	44552	----
1/2-13	44554	----
1/2-20	44555	----



### Wide Base Wing Nut

Size	Part #
1/4-20	23546-W



## Grease Fittings Chrome Plated

Size	Part #
1/4-28 Straight	57547
1/4-28 90°	57548
1/4-28 45°	57546
1/8 Pipe Straight	57550
1/8 Pipe 45°	57549



### Wing Nuts

Size	Part #
1/4-20	23546
5/16-18	23548
3/8-16	23550



## Allen Pipe Plugs

Size	Part #
1/16	31587
1/8	31588
1/4	31569
3/8	31571
1/2	31573
3/4	31576

Note: See Fitting Section for more Pipe Plugs



## Hole Plugs

Size	Part #	Use with Allen Screw
3/16	43567	1/4
1/4	43569	5/16
5/16	43570	3/8
3/8	43571	7/16
7/16	43572	
1/2	43573	
5/8	43575	
3/4	43576	
7/8	43577	
1	43578	
1 1/4	43579	
1 1/2	43580	

Note: Hole Plugs available in Flat or Gloss black finish add - FB (flat black) or - GB (gloss black) to the end of part #

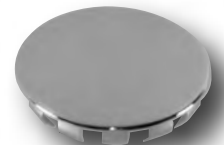



## American Thread Stainless Steel

### Clamps

#### Muffler Clamps O.D. Pipe Size Polished Stainless Steel



Size	Part #
1 3/4	SP-67338
1 7/8	SP-67339
2 1/4	SP-67342

#### Line Clamps in Stainless Steel

\*14 x 3/4 Drill Point Sheet Metal Screw, Stainless Steel

Size	Part #
*14 x 3/4	67002
3/16	67003
1/4	67004
5/16	67005
3/8	67006



### Hose Clamps in Stainless Steel

Entire clamp is Stainless Steel including the screw. This product is manufactured in Sweden with rolled up band edges and smooth inside surface of the clamp this spares the hose and insures a high and uniform tightening force. With the flexible screwdriver you can tighten and slacken the clamp from an angle of 90° without slipping.

Size	Min. Dia.	Max. Dia.	Part #
3	5/16	5/8	67014
4	7/16	3/4	67017
6	1/2	7/8	67020
8	5/8	1 1/16	67024
10	3/4	1 3/16	67028
12	7/8	1 7/16	67032
1	1 1/16	1 5/8	67038
20	1 1/4	1 7/8	67044
24	1 1/2	2 1/16	67050
28	1 3/4	2 3/8	67056
32	2	2 11/16	67065
36	2 5/16	3 1/8	67075
44	2 11/16	3 1/2	67085
48	3	3 7/8	67095



### Screws

#### Carriage Bolts

	3/16	1/4	5/16	3/8	1/2
1/2	79154	79206			
3/4	79158	79210	79274	79326	
1	79162	79214	79280	79330	79416
1 1/2	79168	79220	79286	79336	79420
1 3/4		79222		79338	79422
2	79172	79224	79290	79340	79424
2 1/4		79226	79292		
2 1/2		79228	79294	79334	79428
2 3/4			79296		
3		79232	79298	79348	79432
3 1/2		79236	79302	79352	79436
4		79240	79306	79356	79440
4 1/2				79360	79442
5				79362	79444
6				79368	79448



Carriage Bolt

*Note: Some larger size carriage bolt part numbers may not be listed, please call for various sizes and prices.*

#### Bumper Bolts Stainless Steel Capped

Size	Part #
5/16 x 3/4	18274
3/8 x 1	18330
3/8 x 1 1/2	18336
7/16 x 1	18376
7/16 x 1 1/4	18378
7/16 x 1 1/2	18380
7/16 x 1 3/4	18382
1/2 x 1 3/8	18420

*Bumper bolt is made from Steel, Zinc Plated with a Stainless Steel cap.*

*Note: See carriage bolts for entire bolt made of Stainless Steel*

**NOTE: Add the prefix SP when ordering Polished Stainless Steel Example: SP-18420**

# Bulk Stainless Fasteners American



## Screws

Bowtie Hex Cap



### Bowtie Hex Caps

	1/4 -20	1/4 -28	5/16 -18	5/16 -24	3/8 -16	3/8 -24	7/16 -14	7/16 -20	1/2 -13	1/2 -20	9/16 -12	9/16 -18	5/8 -11	5/8 -18
1/2	10-77206	10-77207	10-77270	10-77271	10-77322	10-77323								
5/8	10-77208	10-77209	10-77272	10-77273	10-77324	10-77325					NOTE: Some 9/16 and 5/8 sizes are not listed on chart but certain sizes may be available upon request. Also add the prefix SP when ordering Polished Stainless Steel.			
3/4	10-77210	10-77211	10-77274	10-77275	10-77326	10-77327	10-77374							
7/8	10-77212	10-77213	10-77278	10-77279	10-77328	10-77329								
1	10-77214	10-77215	10-77280	10-77281	10-77330	10-77331	10-77376	10-77377	10-77416	10-77417				
1 1/4	10-77218	10-77219	10-77284	10-77285	10-77334	10-77335	10-77378	10-77379	10-77418	10-77419	10-77454			
1 1/2	10-77220	10-77221	10-77286	10-77287	10-77336	10-77337	10-77380	10-77381	10-77420	10-77421				10-77493
1 3/4	10-77222	10-77223	10-77288	10-77289	10-77338	10-77339	10-77382	10-77383	10-77422	10-77423				
2	10-77224	10-77225	10-77290	10-77291	10-77340	10-77341	10-77384	10-77385	10-77424	10-77425	10-77460			10-77497
2 1/4	10-77226	10-77227	10-77292	10-77293	10-77342	10-77343	10-77386	10-77387	10-77426	10-77427				10-77499
2 1/2	10-77228	10-77229	10-77294	10-77295	10-77344	10-77345	10-77388	10-77389	10-77428	10-77429				10-77501
2 3/4	10-77230	10-77231	10-77296	10-77297	10-77346	10-77347	10-77390	10-77391	10-77430	10-77431				10-77503
3	10-77232	10-77233	10-77298	10-77299	10-77348	10-77349	10-77392	10-77393	10-77432	10-77433	10-77468			10-77505
3 1/4	10-77234	10-77235	10-77300	10-77301	10-77350	10-77351	10-77394		10-77434	10-77435				
3 1/2	10-77236	10-77237	10-77302	10-77303	10-77352	10-77353	10-77396		10-77436	10-77437	10-77472	10-77473		10-77509
4	10-77240	10-77241	10-77306	10-77307	10-77356	10-77357	10-77400		10-77440	10-77441	10-77476			
4 1/2	10-77244		10-77310	10-77311	10-77360	10-77361	10-77404		10-77442	10-77443	10-77478		10-77514	10-77515
5	10-77246		10-77312	10-77313	10-77362	10-77363	10-77406		10-77444		10-77480		10-77516	
5 1/2			10-77316	10-77317	10-77366	10-77367	10-77410		10-77446		10-77482		10-77518	
6	10-77246-A		10-77318	10-77319	10-77368	10-77369	10-77412		10-77448		10-77484		10-77520	

You can also order the above listed Stainless Steel Part Numbers with the Emblems Stamped on the Hex Cap Bolts as shown below by using the Part Prefix associated with that emblem.

**Example:** Dress Up Bolt Part # 10-77210 to Purchase: 1/4-20 x 3/4 Chevy Bowtie Stamped Hex Cap in Polished Stainless Steel

Bolts are hand polished stainless steel then stamped with your choice of emblem



Chevy Bowtie  
use Part Prefix  
10-77xxx to order

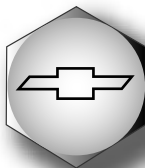

Chevy SS  
use Part Prefix  
13-77xxx to order



Chevy RS  
use Part Prefix  
16-77xxx to order



350  
use Part Prefix  
18-77xxx to order



454  
use Part Prefix  
19-77xxx to order



We also carry these other selected General Motors Emblems to choose from

Pontiac Arrow  
use Part Prefix  
12-77xxx to order



Pontiac GTO  
use Part Prefix  
20-77xxx to order



Pontiac GT  
use Part Prefix  
15-77xxx to order



Olds Rocket  
use Part Prefix  
26-77xxx to order

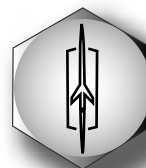



# Bulk Stainless Steel American

## Screws

Ford Oval Hex Cap



### Ford Oval Hex Caps

	1/4 -20	1/4 -28	5/16 -18	5/16 -24	3/8 -16	3/8 -24	7/16 -14	7/16 -20	1/2 -13	1/2 -20	9/16 -12	9/16 -18	5/8 -11	5/8 -18
1/2	11-77206	11-77207	11-77270	11-77271	11-77322	11-77323								
5/8	11-77208	11-77209	11-77272	11-77273	11-77324	11-77325								
3/4	11-77210	11-77211	11-77274	11-77275	11-77326	11-77327	11-77374							
7/8	11-77212	11-77213	11-77278	11-77279	11-77328	11-77329								
1	11-77214	11-77215	11-77280	11-77281	11-77330	11-77331	11-77376	11-77377	11-77416	11-77417				
1 1/4	11-77218	11-77219	11-77284	11-77285	11-77334	11-77335	11-77378	11-77379	11-77418	11-77419	11-77454			
1 1/2	11-77220	11-77221	11-77286	11-77287	11-77336	11-77337	11-77380	11-77381	11-77420	11-77421				11-77493
1 3/4	11-77222	11-77223	11-77288	11-77289	11-77338	11-77339	11-77382	11-77383	11-77422	11-77423				
2	11-77224	11-77225	11-77290	11-77291	11-77340	11-77341	11-77384	11-77385	11-77424	11-77425	11-77460			11-77497
2 1/4	11-77226	11-77227	11-77292	11-77293	11-77342	11-77343	11-77386	11-77387	11-77426	11-77427				11-77499
2 1/2	11-77228	11-77229	11-77294	11-77295	11-77344	11-77345	11-77388	11-77389	11-77428	11-77429				11-77501
2 3/4	11-77230	11-77231	11-77296	11-77297	11-77346	11-77347	11-77390	11-77391	11-77430	11-77431				11-77503
3	11-77232	11-77233	11-77298	11-77299	11-77348	11-77349	11-77392	11-77393	11-77432	11-77433	11-77468			11-77505
3 1/4	11-77234	11-77235	11-77300	11-77301	11-77350	11-77351	11-77394		11-77434	11-77435				
3 1/2	11-77236	11-77237	11-77302	11-77303	11-77352	11-77353	11-77396		11-77436	11-77437	11-77472	11-77473		11-77509
4	11-77240	11-77241	11-77306	11-77307	11-77356	11-77357	11-77400		11-77440	11-77441	11-77476			
4 1/2	11-77244		11-77310	11-77311	11-77360	11-77361	11-77404		11-77442	11-77443	11-77478		11-77514	11-77515
5	11-77246		11-77312	11-77313	11-77362	11-77363	11-77406		11-77444		11-77480		11-77516	
5 1/2			11-77316	11-77317	11-77366	11-77367	11-77410		11-77446		11-77482		11-77518	
6			11-77318	11-77319	11-77368	11-77369	11-77412		11-77448		11-77484		11-77520	

NOTE: Some 9/16 and 5/8 sizes are not listed on chart but certain sizes may be available upon request. Also add the prefix SP when ordering Polished Stainless Steel.



You can also order the above listed Stainless Steel Part Numbers with the Emblems Stamped on the Hex Cap Bolts as shown below by using the Part Prefix associated with that emblem.

Ford Oval  
use Part Prefix  
11-77xxx to order



Ford V8  
use Part Prefix  
24-77xxx to order



Ford Mustang  
use Part Prefix  
25-77xxx to order



Flames  
use Part Prefix  
17-77xxx to order



Skulls  
use Part Prefix  
14-77xxx to order



**Example:** Dress Up Bolt Part # 11-77210 to Purchase: 1/4-20 x 3/4 Ford Oval Stamped Hex Cap in Polished Stainless Steel



Mopar  
use Part Prefix  
23-xxxxx to order



Chrysler Pentastar  
use Part Prefix  
21-xxxxx to order



Hemi Mopar  
use Part Prefix  
27-xxxxx to order



Dodge Ram  
use Part Prefix  
22-xxxxx to order



We also carry these other selected Chrysler Emblems to choose from

# Bulk Stainless Fasteners American



## Allen Screws Stainless Steel

	6/32	8/32	10/24	10/32	1/4 -20	1/4 -28	5/16 -18	5/16 -24	3/8 -16	3/8 -24	7/16 -14	1/2 -13	5/8 -11
3/8	73104	73128	73152	73153	73204						Allen		
1/2	73106	73130	73154	73155	73206	73207	73270		73322				
5/8		73132	73156	73157	73208	73209	73272	73273	73324				
3/4	73110	73134	73158	73159	73210	73211	73274	73275	73326	73327	73374	73414	
7/8		73136	73160	73161	73212		73278		73328				
1	73114	73138	73162	73163	73214	73215	73280	73281	73330	73331	73376	73416	
1 1/4		73140	73166	73167	73218	73219	73284	73285	73334	73335	73378	73418	
1 1/2		73142	73168	73169	73220	73221	73286	73287	73336	73337	73380	73420	73492
1 3/4			73170	73171	73222	73223	73288	73289	73338	73339	73382	73422	73494
2	73122		73172	73173	73224	73225	73290	73291	73340	73341	73384	73424	73496
2 1/4			73174		73226	73227	73292		73342		73386	73426	73498
2 1/2			73176		73228		73294	73295	73344	73345	73388	73428	73500
2 3/4					73230		73296		73346			73430	
3					73232		73298	73299	73348		73392	73432	73504
3 1/2					73236		73302		73352	73353	73396	73436	73508
4					73240		73306		73356	73347	73400	73440	73512



73xxx for  
Stainless  
Steel  
Allen with  
Knurls

**American  
Bulk Stainless**



SP - 73xxx for  
Polished Stainless Steel  
Allen with Knurls  
Removed

## Button Head Allen Screws

	6/32	8/32	10/24	10/32	1/4 -20	1/4 -28	5/16 -18	5/16 -24	3/8 -16	3/8 -24	1/2 -13
1/4	72102	72126	72150	72151							
3/8	72104	72128	72152	72153	72204						
1/2	72106	72130	72154	72155	72206		72270		72322		
5/8		72132	72156	72157	72208		72272				
3/4	72110	72134	72158	72159	72210	72211	72274	72275	72326	72327	
1	72114	72138	72162	72163	72214	72215	72280	72281	72330	72331	72416
1 1/4			72166	72167	72218		72284	72285	72334	72335	72418
1 1/2			72168	72169	72220		72286	72287	72336	72337	72420
1 3/4					72222						
2			72172	72173	72224		72290	72291	72340		72424
2 1/2							72294		72344		72428
3					72232		72298		72348		72432
3 1/2					72236						
4					72240		72306				

72xxx for  
Stainless Steel  
Button Head Allen



SP - 72xxx for  
Polished Stainless Steel  
Button Head Allen

## Flat Head Allen Screws

	6/32	8/32	10/24	10/32	1/4 -20	1/4 -28	5/16 -18	5/16 -24	3/8 -16	1/2 -13	5/8 -11
3/8	71104		71152	71153	71204						
1/2	71106	71130	71154	71155	71206		71270				
5/8		71132	71156	71157	71208		71272				
3/4		71134	71158	71159	71210	71211	71274		71326		
1	71114	71138	71162	71163	71214	71215	71280	71281	71330	71416	71488
1 1/4		71140	71166	71167	71218	71219	71284		71334	71418	71490
1 1/2		71142	71168	71169	71220	71221	71286		71336	71420	71492
1 3/4					71222		71288		71338	71422	71494
2					71224		71290		71340	71424	71496
2 1/2									71344		
3							71298		71348	71432	

71xxx for  
Stainless Steel  
Flat Head Allen



SP - 71xxx for  
Polished Stainless Steel  
Flat Head Allen





# Bulk Stainless Steel American

## Hex Caps Screws Stainless Steel

**77xxx**  
for Stainless Steel  
Hex Cap Screws

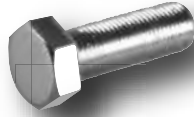

**SP - 77xxx**  
for Polished Stainless Steel  
Hex Cap Screws

NOTE: 9/16 & 5/8 sizes are not listed on chart but certain sizes may be available upon request.

	4/40	6/32	8/32	10/24	10/32	12/24	1/4 -20	1/4 -28	5/16 -18	5/16 -24	3/8 -16	3/8 -24	7/16 -14	7/16 -20	1/2 -13	1/2 -20
3/8	77088		77128	77152	77153		77204	77205	77268							
1/2		77106	77130	77154	77155	77186	77206	77207	77270	77271	77322	77323				
5/8			77132	77156	77157		77208	77209	77272	77273	77324	77325				
3/4			77134	77158	77159		77210	77211	77274	77275	77326	77327			77414	
7/8			77136				77212	77213	77278	77279	77328	77329				
1		77114	77138	77162	77163	77194	77214	77215	77280	77281	77330	77331	77376	77377	77416	77417
1 1/4				77166	77167		77218	77219	77284	77285	77334	77335	77378	77379	77418	77419
1 1/2			77142	77168	77169		77220	77221	77286	77287	77336	77337	77380	77381	77420	77421
1 3/4							77222	77223	77288	77289	77338	77339	77382	77383	77422	77423
2							77224	77225	77290	77291	77340	77341	77384	77385	77424	77425
2 1/4							77226	77227	77292	77293	77342	77343	77386	77387	77426	77427
2 1/2							77228	77229	77294	77295	77344	77345	77388	77389	77428	77429
2 3/4							77230	77231	77296		77346			77391	77430	
3							77232	77233	77298	77299	77348	77349	77392	77393	77432	77433
3 1/4							77234		77300	77301	77350		77394		77434	77435
3 1/2							77236	77237	77302		77352	77353	77396		77436	77437
3 3/4							77238		77304		77354				77438	
4							77240		77306		77356	77357	77400		77440	77441
4 1/2							77244		77310	77311	77360	77361	77404		77442	77443
5							77246		77312	77313	77362		77406		77444	
5 1/2									77316		77366				77446	
6							77246-A		77318		77368		77412		77448	

## Set Screws Plain Steel

	6/32	8/32	10/24	10/32	1/4 -20	1/4 -28	5/16 -18	5/16 -24	3/8 -16	3/8 -24
1/4	47102	47126	47150	47151						
3/8	47104	47128	47152	47153	47204	47205	47268			
1/2	47106	47130	47154	47155	47206	47207	47270	47271	47322	47323
5/8	47108	47132	47156	47157	47208	47209	47272	47273	47324	47325
3/4	47110	47134	47158	47159	47210	47211	47274	47275	47326	47327
1	47114	47138	47162	47163	47214	47215	47280	47281	47330	47331
1 1/4			47166	47167	47218	47219	47284	47285	47334	47335
1 1/2			47168	47169	47220	47221	47286	47289	47336	47337
1 3/4					47222		47288			
2					47224	47225	47290	47291	47340	47341
2 1/2					47228		47294		47344	

Set Screws  
Sold Each



**Stainless Steel Available**



**American Bulk Stainless**

## Washers Stainless Steel

### Flat Washers

Size	Part #
4	75564
6	75565
8	75566
10	75567
1/4	75569
5/16	75570
3/8	75571
7/16	75572
1/2	75573
5/8	75575
3/4	75576



### AN Washers Small OD

Size	Part #
6	84565
8	84566
10	84567
1/4	84569
5/16	84570
3/8	84571
7/16	84572
1/2	84573
5/8	84575
3/4	84576



### Lock Washers

Size	Part #
4	76564
6	76565
8	76566
10	76567
1/4	76569
5/16	76570
3/8	76571
7/16	76572
1/2	76573
5/8	76575
3/4	76576



### Finishing Washers

Size	Part #
6	78565
8	78566
10	78567
1/4	78569
5/16	78570



### High Collar Lock Washers

Size	Part #
1/4	80569
5/16	80570
3/8	80571
1/2	80573



All Items shown on this page can be purchased individually

## GW Stainless Steel Flat Washers



Size	Part #
1/4	70569
5/16	70570
3/8	70571
7/16	70572
1/2	70573
5/8	70575

Our Stainless Steel washer is thicker than standard flat washers and has a close tolerance ID for a snug fit. It has a standard OD so it can be used anywhere a regular washer was.

## Super Flat Washers

Size	Part #
#6 x 5/8	66108
#8 x 3/4	66134
3/16 x 11/16	66157
3/16 x 3/4	66158
3/16 x 1	66162
3/8 x 1	66330
3/8 x 1 1/4	66334
1/4 x 1	66214
1/4 x 1 1/4	66218
5/16 x 3/4	SP- 66274
5/16 x 1 1/2	66286
3/8 x 7/8	SP- 66328
3/8 x 1 1/2	66336
7/16 x 1	66376
7/16 x 1 1/8	SP- 66377
1/2 x 1 1/4	SP- 66418
1/2 x 1 1/2	66420
1/2 x 2	66424
5/8 x 1 1/2	SP- 66492
5/8 x 1 3/4	66494
3/4 x 1 3/4	66528

(SP-) Super Flat Washers Polished Stainless Steel in that size only

### Internal Lock Washers

Size	Part #
4	82564
6	82565
8	82566
10	82567
1/4	82569
5/16	82570
3/8	82571
7/16	82572
1/2	82573
5/8	82575



### External Lock Washers

Size	Part #
4	83564
6	83565
8	83566
10	83567
1/4	83569
5/16	83570
3/8	83571
7/16	83572
1/2	83573
5/8	83575



### External Countersunk Washers

Size	Part #
6	89565
8	89566
10	89567
1/4	89569
5/16	89570

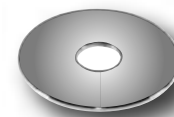



# Bulk Stainless Steel American

## Washers Stainless Steel

### White Nylon Flat Washers

Size	Part #
8	87566
10	87567
1/4	87569
5/16	87570
3/8	87571
7/16	87572
1/2	87573
5/8	87575



### Neoprene Backed Flat Washers

Size	Part #
10	81567
1/4	81569
5/16	81570
3/8	81571
1/2	81573



Available in  
Stainless Steel Polished  
Add SP-81xxx

### Pipe Plugs Allen Style

Size	Part #
1/8	86588
1/4	86569
3/8	86571
1/2	86573
3/4	86576



### Threaded Rod Stainless Steel

Size	Part #
6/32	63122
8/32	63148
10/24	63180
10/32	63181
1/4-20	63232
1/4-28	63233
5/16-18	63298
5/16-24	63299
3/8-16	63348
3/8-24	63349
7/16-14	63392
7/16-20	63393
1/2-13	63432
1/2-20	63433
5/8-11	63504

Threaded Rod  
Sold in Three Foot Lengths

All Items shown on this page can  
be purchased individually

## Nuts Stainless Steel

### Acorn Nuts

Size	Part #
6/32	68538
8/32	68540
10/24	68542
10/32	68543
1/4-20	68546
1/4-28	68547
5/16-18	68548
5/16-24	68549
3/8-16	68550
3/8-24	68551
7/16-14	68552
7/16-20	68553
1/2-13	68554
1/2-20	68555
5/8-11	68558
5/8-18	68559



### Castle Nuts

Size	Part #
3/8-24	81551
1/2-13	81554
1/2-20	81555
5/8-11	81558



For Stainless Steel Polished  
Order with the SP-Prefix than the  
five digit Part # SP-xxxxx

### Hex Nuts

Size	Part #
6/32	70538
8/32	70540
10/24	70542
10/32	70543
1/4-20	70546
1/4-28	70547
5/16-18	70548
5/16-24	70549
3/8-16	70550
3/8-24	70551
7/16-14	70552
7/16-20	70553
1/2-13	70554
1/2-20	70555
9/16-12	70556
9/16-18	70557
5/8-11	70558
5/8-18	70559
3/4-10	70560
3/4-16	70561



### Nylon Lock Nuts

Size	Part #
4/40	69536
6/32	69538
8/32	69540
10/24	69542
10/32	69543
1/4-20	69546
1/4-28	69547
5/16-18	69548
5/16-24	69549
3/8-16	69550
3/8-24	69551
7/16-14	69552
7/16-20	69553
1/2-13	69554
1/2-20	69555
9/16-12	69556
9/16-18	69557
5/8-11	69558
5/8-18	69559
3/4-10	69560
3/4-16	69561





## Nuts Stainless Steel

### Jam Nuts

Size	Part #
1/4-20	67546
1/4-28	67547
5/16-18	67548
5/16-24	67549
3/8-16	67550
3/8-24	67551
7/16-14	67552
7/16-20	67553
1/2-13	67554
1/2-20	67555
9/16-18	67557
5/8-11	67558
5/8-18	67559
3/4-16	67561
3/4-10	67560



### Jam Lock Nuts

Size	Part #
1/4-20	66546
1/4-28	66547
5/16-18	66548
5/16-24	66549
3/8-16	66550
3/8-24	66551
7/16-14	66552
7/16-20	66553
1/2-13	66554
1/2-20	66555
5/8-11	66558
5/8-18	66559
3/4-16	66561



### Spin Locks

Size	Part #
1/4-20	65546
5/16-18	65548
5/16-24	65549
3/8-16	65550
3/8-24	65551



All Items shown on this page can be purchased individually





# Bulk Stainless Steel American

## Machine and Sheet Metal Screws Stainless Steel

**Example:** To order a **8/32 x 5/8 Oval Phillips Machine Screw**: Use **Chart #1** for head style required, take those first two digits for the beginning part number which would be "40" Now look up the diameter and length from **Chart #2 or #3** for last three digits for **8/32 x 5/8** is "132" Put the two together for a part number of **89132**, or simply order by style and size.

### Chart #1: Select Styles

Style	Stainless Steel Slotted	Stainless Steel Phillips
Round Head	99	95
Flat Head	98	94
Truss Head	93	80
Oval Head	97	89
Pan Head	96	92
Fillister	78	n/a
Hex	77	n/a
Round Wood	83	n/a
Flat Wood	85	n/a
Oval Wood	84	81

Include the prefix **SP-89132** for **Stainless Steel Polished**

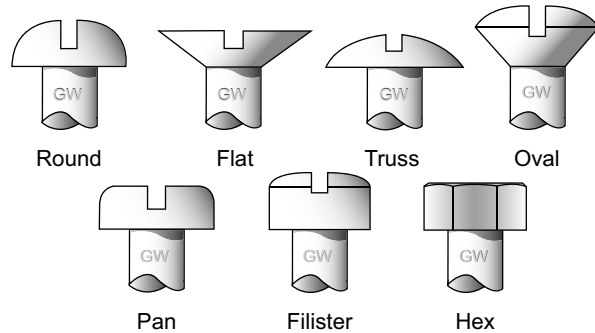

### Chart #2: Machine Screw Sizes

	6/32	8/32	10/24	10/32	12/24	1/4 -20	1/4 -28	5/16 -18	5/16 -24	3/8 -16
3/8	104	128	152	153	184	204				
1/2	106	130	154	155	186	206		270		
5/8		132	156	157	188	208	209			
3/4	110	134	158	159	190	210	211	274	275	
7/8		136	160	161	192	212			279	
1	114	138	162	163	194	214	215	280	281	330
1 1/4	116	140	166	167	196	218	219	284	285	334
1 1/2	118	142	168	169	198	220	221	286	287	336
1 3/4			170	171		222		288	289	338
2	122		172	173		224		290	291	340



Machine Screw

Head Styles: Oval, Flat or Pan  
Note: Not all styles available in all sizes

### Chart #3: Sheet Metal & Wood Screw Sizes

	#6	#8	#10	#12	#14
1/2	616	628	641	654	667
5/8	617	629	642	655	668
3/4	618	630	643	656	669
1	620	632	645	658	671
1 1/4	621	633	646	659	672
1 1/2	622	634	647	660	673
1 3/4	623	680	648	661	674
2	624	635	649	662	675
2 1/4	625	636	650	663	676
2 1/2	626	637	651	664	677



Sheet Metal Screw



Woodscrew

# Bulk Zinc Fasteners American



45

## Hex Cap Screws Zinc Plated and L-9 Products

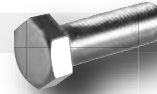

07xxx  
for Grade 5  
Hex Cap Screws

	1/4 -20	1/4 -28	5/16 -18	5/16 -24	3/8 -16	3/8 -24	7/16 -14	7/16 -20	1/2 -13	1/2 -20	5/8 -11	5/8 -18
1/2	07206	07207	07270	07271	07322	07323						
5/8	07208	07209	07272	07273	07324	07325						
3/4	07210	07211	07274	07275	07326	07327	07374	07375	07414			
7/8	07212	07213	07278	07279	07328	07329						
1	07214	07215	07280	07281	07330	07331	07376	07377	07416	07417	07488	07489
1 1/4	07218	07219	07284	07285	07334	07335	07378	07379	07418	07419	07490	07491
1 1/2	07220	07221	07286	07287	07336	07337	07380	07381	07420	07421	07492	07493
1 3/4	07222	07223	07288	07289	07338	07339	07382	07383	07422	07423	07494	07495
2	07224	07225	07290	07291	07340	07341	07384	07385	07424	07425	07496	07497
2 1/4	07226	07227	07292	07293	07342	07343	07386	07387	07426	07427	07498	07499
2 1/2	07228	07229	07294	07295	07344	07345	07388	07389	07428	07429	07500	07501
2 3/4	07230	07231	07296	07297	07346	07347	07390	07391	07430	07431	07502	07503
3	07232	07233	07298	07299	07348	07349	07392	07393	07432	07433	07504	07505
3 1/4	07234	07235	07300	07301	07350	07351	07394	07395	07434	07435	07506	07507
3 1/2	07236	07237	07302	07303	07352	07353	07396	07397	07436	07437	07508	07509
4	07240	07241	07306	07307	07356	07357	07400	07401	07440	07441	07512	07513
4 1/2	07244		07310	07311	07360	07361	07404	07405	07442	07443	07514	07515
5	07246		07312	07313	07362	07363	07406	07407	07444	07445	07516	07517
5 1/2			07316	07317	07366	07367	07410	07411	07446	07447	07518	07519
6				07319	07368		07412		07448	07449	07520	07521

48xxx  
for Grade 8  
Hex Cap Screws  
(Yellow)



When Ordering  
L-9 Zinc Plated  
Hex Caps  
use: 52xxx  
for the first two  
numers in Part #

## Allen Screws Zinc Plated Grade 8



08xxx  
for Grade 8  
Allen Screws

NOTE: Some sizes  
shown may not be  
available.

	6/32	8/32	10/24	10/32	1/4 -20	1/4 -28	5/16 -18	5/16 -24	3/8 -16	3/8 -24	7/16 -14	7/16 -20	1/2 -13	1/2 -20	5/8 -11	5/8 -18
3/8	08104	08128	08152	08153												
1/2	08106	08130	08154	08155	08206	08207	08270	08271	08322	08323						
5/8	08108	08132	08156	08157	08208	08209	08272	08273	08324	08325						
3/4	08110	08134	08158	08159	08210	08211	08274	08275	08326	08327	08374	08375	08414	08415		
7/8	08112	08136	08160	08161	08212	08213	08278	08279	08328	08329						
1	08114	08138	08162	08163	08214	08215	08280	08281	08330	08331	08376	08377	08416	08417	08488	08489
1 1/4		08140	08166	08167	08218	08219	08284	08285	08334	08335	08378	08379	08418	08419	08490	
1 1/2		08142	08168	08169	08220	08221	08286	08287	08336	08337	08380	08381	08420	08421	08492	08493
1 3/4			08170	08171	08222	08223	08288	08289	08338	08339	08382	08383	08422	08423	08494	08495
2			08172	08173	08224	08225	08290	08291	08340	08341	08384	08385	08424	08425	08496	08497
2 1/4			08174	08175	08226	08227	08292	08293	08342	08343	08386	08387	08426	08427	08498	
2 1/2			08176	08177	08228	08229	08294	08295	08344	08345	08388	08389	08428	08429	08500	
2 3/4					08230	08231	08296	08297	08346	08347	08390	08391	08430	08431	08502	
3					08232	08233	08298	08299	08348	08349	08392	08393	08432	08433	08504	
3 1/4					08234		08300	08301	08350	08351	08394	08395	08434	08435	08506	
3 1/2					08236		08302	08303	08352	08353	08396	08397	08436	08437	08508	
4							08306	08307	08356				08440	08441	08512	
4 1/2							08310	08311	08360				08442		08514	
5							08312	08313	08362				08444		08516	
5 1/2							08316	08317	08366				08446		08518	
6								08319	08368				08448		08520	

American  
Bulk Stainless



# Bulk Zinc Fasteners American

## Washers Zinc Plated and L-9 Products

### Flat Washers and L-9

Size	Part #	L-9 #
4	04564	--
6	04565	--
8	04566	--
10	04567	--
12	04568	--
1/4	04569	55569
5/16	04570	55570
3/8	04571	55571
7/16	04572	55572
1/2	04573	55573
9/16	04574	55574
5/8	04575	55575
3/4	04576	--
7/8	04577	--



### Fender Washers

Size	Part #
10 x 1	01567
1/4 x 1	01569
1/4 x 1 1/4	01218
1/4 x 1 1/2	09569
5/16 x 1 1/4	01284
5/16 x 1 1/2	01570
3/8 x 1 1/2	01571



### External Lock Washers

Size	Part #
4	02564
6	02565
8	02566
10	02567
12	02568
1/4	02569
5/16	02570
3/8	02571
7/16	02572
1/2	02573



### Internal Lock Washers

Size	Part #
4	03564
6	03565
8	03566
10	03567
12	03568
1/4	03569
5/16	03570
3/8	03571
7/16	03572
1/2	03573
5/8	03575
3/4	03576



### Lock Washers and L-9

Size	Part #	L-9 #
4	05564	--
6	05565	--
8	05566	--
10	05567	--
12	05568	--
1/4	05569	52569
5/16	05570	52570
3/8	05571	52571
7/16	05572	52572
1/2	05573	52573
9/16	05574	52574
5/8	05575	52575
3/4	05576	--
7/8	05577	--
1	05578	--



## Nuts Zinc Plated and L-9 Products

### Hex Nuts & L-9

Size	Part #	L-9 #
4/40	06536	--
5/40	06537	--
6/32	06538	--
8/32	06540	--
10/24	06542	--
10/32	06543	--
1/4-20	06546	52546
1/4-28	06547	52547
5/16-18	06548	52548
5/16-24	06549	52549
3/8-16	06550	52550
3/8-24	06551	52551
7/16-14	06552	52552
7/16-20	06553	52553
1/2-13	06554	52554
1/2-20	06555	52555
9/16-12	06556	06556
9/16-18	06557	--
5/8-11	06558	52558
5/8-18	06559	52559
3/4-10	06560	--
3/4-16	06561	--



### Nylon Lock Nuts

Size	Part #
4/40	03536
5/40	03537
6/32	03538
8/32	03540
10/24	03542
10/32	03543
1/4-20	03546
1/4-28	03547
5/16-18	03548
5/16-24	03549
3/8-16	03550
3/8-24	03551
7/16-14	03552
7/16-20	03553
1/2-13	03554
1/2-20	03555
9/16-12	03556
9/16-18	03557
5/8-11	03558
5/8-18	03559
3/4-10	03560
3/4-16	03561



### Jam Hex Nuts

Size	Part #
1/4-20	04546
1/4-28	04547
5/16-18	04548
5/16-24	04549
3/8-16	04550
3/8-24	04551
7/16-14	04552
1/2-20	04555
9/16-18	04557
5/8-18	04559
3/4-16	04561



### Jam Lock Nuts

Size	Part #
1/4-20	02546
1/4-28	02547
5/16-18	02548
5/16-24	02549
3/8-16	02550
3/8-24	02551
7/16-14	02552
7/16-20	02553
1/2-13	02554
1/2-20	02555
9/16-12	02556
9/16-18	02557
5/8-11	02558
5/8-18	02559



All Items shown on this page can be purchased individually



## Machine and Sheet Metal Screws Zinc Plated

**Example:** To order a **8/32 x 5/8 Oval Phillips Machine Screw**: Use **Chart #1** for the type of head style required, take those first two digits for the beginning part number which would be **"40"**. Now look up the diameter and length from **Chart #2 or #3** for last three digits for **8/32 x 5/8** is **"132"** Put the two together for a part number of **40132**, or simply order by style and size.

**Note;** When placing your order please ask for Zinc Plated Screws.

### Chart #1: Select Styles

*Note; Not all Sizes and Styles Available*

Style	Slotted	Phillips
Round Head	04	05
Flat Head	02	03
Truss Head	01	n/a
Pan Head	04	n/a
Fillister	06	n/a



Round



Flat



Truss

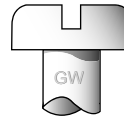

Pan



Fillister

### Chart #2: Machine Screw Sizes

	6/32	8/32	10/24	10/32	12/24	1/4 -20	1/4 -28	5/16 -18	5/16 -24	3/8 -16
3/8	104	128	152	153	184	204				
1/2	106	130	154	155	186	206		270		
5/8		132	156	157	188	208	209			
3/4	110	134	158	159	190	210	211	274	275	
7/8		136	160	161	192	212			279	
1	114	138	162	163	194	214	215	280	281	330
1 1/4	116	140	166	167	196	218	219	284	285	334
1 1/2	118	142	168	169	198	220	221	286	287	336
1 3/4			170	171		222		288	289	338
2	122		172	173		224		290	291	340

Machine Screws are sold each



Machine Screw

### Chart #3: Sheet Metal Sizes

	#6	#8	#10	#12	#14
1/2	616	628	641	654	667
5/8	617	629	642	655	668
3/4	618	630	643	656	669
1	620	632	645	658	671
1 1/4	621	633	646	659	672
1 1/2	622	634	647	660	673
1 3/4	623	680	648	661	674
2	624	635	649	662	675
2 1/4	625	636	650	663	676
2 1/2	626	637	651	664	677

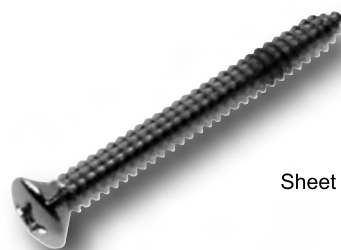

Sheet Metal Screw





# We have the fasteners for any project

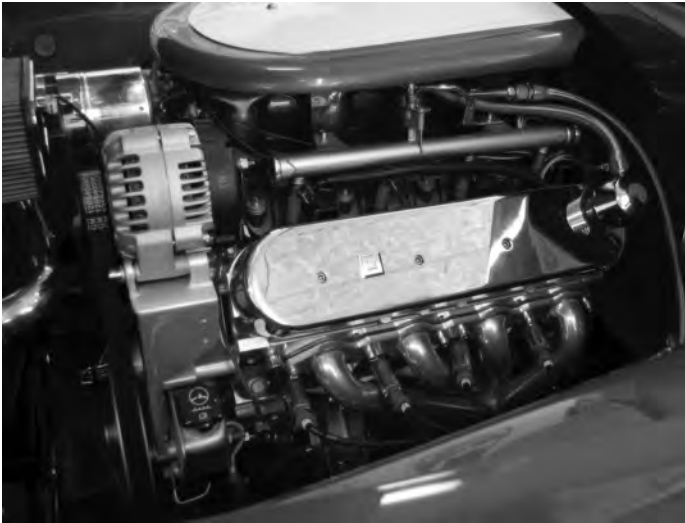



## Inside This Section

### *Metric Thread Chrome Plated*

<i>Allen Screws.....</i>	<i>50</i>
<i>Button Head Screws.....</i>	<i>50</i>
<i>Flat Head Allen Screws.....</i>	<i>50</i>
<i>Hex Cap Screws.....</i>	<i>51</i>
<i>12 Point Screws.....</i>	<i>51</i>
<i>Nuts.....</i>	<i>52</i>
<i>Washers.....</i>	<i>52</i>

### *Metric Stainless Steel*

<i>Allen Screws.....</i>	<i>53</i>
<i>Button Head Screws.....</i>	<i>53</i>
<i>Flat Head Allen Screws.....</i>	<i>53</i>
<i>Hex Caps Screws.....</i>	<i>53</i>
<i>Carriage Bolts.....</i>	<i>53</i>
<i>Washers.....</i>	<i>54</i>
<i>Nuts.....</i>	<i>54</i>
<i>Machine Screws.....</i>	<i>54</i>

### *Metric Zinc Plated*

<i>Allen Screws.....</i>	<i>55</i>
<i>Hex Caps.....</i>	<i>55</i>
<i>Washers.....</i>	<i>56</i>
<i>Nuts.....</i>	<i>56</i>

**Bulk Fasteners  
Chrome Plated  
Stainless and Zinc**





# Bulk Chrome Fasteners Metric

## Allen Screws Chrome Plated and Polished



For Metric Chrome Allen  
with Knurls  
use 12xxx



For Polished Chrome Allen  
with Knurls Removed  
use 10xxx

	4mm/ 0.7	5mm/ 0.8	6mm/ 1.0	8mm/ 1.25	Fine Thread 8mm/ 1.0	10mm/ 1.50	Fine Thread 10mm/ 1.25	12mm/ 1.75
8		12721	12734					
10	12711	12722	12735	12770				
12	12712	12723	12736	12771				
16	12714	12725	12738	12772				
20	12715	12726	12739	12773	12773F	12794	12816	
25	12716	12727	12740	12774	12774F	12795	12817	12836
27			12740A		12775F			
30	12717	12728	12741	12775	12776F	12796	12818	12837
35		12729	12742	12776	12777F	12797	12819	12838
40		12730	12743	12777	12778F	12798	12820	12839
45		12731	12744	12778	12779F	12799	12821	12840
50		12732	12745	12779		12800	12822	12841
55			12746	12780		12801	12823	12842
60		12733	12747	12781		12802	12824	12843
65			12748	12782		12803	12825	12844
70			12749	12783		12804	12826	12845
75			12750	12784		12805	12827	12846
80			12751	12785		12806	12828	12847
85				12786		12807	12829	12848
90			12753	12787		12808	12830	12849
95			12754					
100			12755	12788		12809	12831	12850
110			12756	12789		12810		
115			12756A					
120			12757	12790		12811		

**Key: Read Across For Diameter  
Read Down For Length**

---

*Call if you do not see  
the sizes you need !*

## Button Head Allen Screws

## Flat Head Allen Screws



	4mm/ 0.7	5mm/ 0.8	6mm/ 1.0	8mm/ 1.25	10mm/ 1.50	12mm/ 1.75
6	13709					
8	13710	13721	13734			
10	13711	13722	13735	13770		
12	13712	13723	13736	13771		
16	13714	13725	13738	13772	13793	
20	13715	13726	13739	13773	13794	13835
25	13716	13727	13740	13774	13795	
30		13728	13741	13775	13796	13837
35			13742	13776	13797	13838
40	13719		13743	13777	13798	13839
45				13778	13799	
50				13779	13800	13841
60				13781	13802	13843
70				13783	13804	13845
80				13785	13806	
90				13787	13808	13849
100						13850

	4mm/ 0.7	5mm/ 0.8	6mm/ 1.0	8mm/ 1.25	10mm/ 1.50
6	14709				
8	14710	14721	14734		
10	14711	14722	14735		
12	14712	14723	14736	14771	
16	14714	14725	14738	14772	14793
20	14715	14726	14739	14773	14794
25	14716	14727	14740	14774	14795
30	14717	14728	14741	14775	14796
35	14718	14729	14742	14776	14797
40	14719	14730	14743	14777	14798
45	14720A	17731	17744	14778	14799

# Bulk Chrome Fasteners Metric



## Hex Cap Screws Chrome Plated

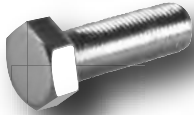

	4mm/ 0.7	5mm/ 0.8	6mm/ 1.0	7mm/ 1.0	8mm/ 1.25	10mm/ 1.50	Fine Thread 10mm/ 1.25	12mm/ 1.75	Fine Thread 12mm/ 1.50	14mm/ 2.00	Fine Thread 14mm/ 1.50
10	11711	11722	11735	11760	11770						
16	11712	11725	11738	11762	11772	11793					
20	11714	11726	11739	11763	11773	11794	11816	11835	11856	11873	
25	11715	11727	11740	11764	11774	11795	11817	11836	11857	11874	11895
30	11716	11728	11741	11765	11775	11796	11818	11837	11858	11875	
35	11717	11729	11742	11766	11776	11797	11819	11838	11859	11876	
40		11730	11743	11767	11777	11798	11820	11839	11860	11877	
45		11731	11744		11778	11799	11821	11840	11861		11899
50		11732	11745	11769	11779	11800	11822	11841	11862	11879	
55			11746		11780	11801	11823	11842	11863		11901
60			11747		11781	11802	11824	11843	11864	11881	
65			11748		11782	11803	11825	11844	11865		
70			11749		11783	11804	11826	11845	11866	11883	
75			11750		11784	11805		11846	11867		
80			11751		11785	11806	11828	11847	11868	11885	
90			11753		11787	11808	11830	11849	11870	11887	
100			11755		11788	11809	11831	11850	11871	11888	
110			11756		11789	11810		11851			
120			11757		11790	11811		11852			
130								11853		11891	
140					11792	11813				11892	

## 12 Point Flange



**Key: Read Across For Diameter  
Read Down For Length**

*Call if you do not see  
the sizes you need !*

	6mm/ 1.0	8mm/ 1.25	10mm/ 1.50	12mm/ 1.75
16	29738	29772		
20	29739	29773		
25	29740	29774	29795	29836
30	29741	29775	29796	29837
35	29742	29776	29797	29838
40	29743	29777	29798	29839
45	29744	29778	29799	29840
50	29745	29779	29800	29841
55		29780	29801	29842
60		29781	29802	29843
65		29782	29803	
70		29783	29804	
75		29784		
80		29785	29806	
90			29807	29849
100			29808	29850
110				
120				



**Demand only the finest Quality Fasteners**



# Bulk Chrome Fasteners Metric

## Nuts Chrome Plated

### Acorn Nuts

Size	Part #
4mm x .70	21950
5mm x .80	21952
6mm x 1.0	21954
7mm x 1.0	21956
8mm x 1.0	
8mm x 1.25	21958
10mm x 1.25	21961
10mm x 1.50	21962
12mm x 1.25	21963
12mm x 1.50	21965
12mm x 1.75	21966



### Hex Nuts

Size	Part #
4mm x .70	15950
5mm x .80	15952
6mm x 1.0	15954
7mm x 1.0	15956
8mm x 1.0	15957
8mm x 1.25	15958
10mm x 1.25	15961
10mm x 1.50	15962
12mm x 1.25	15963
12mm x 1.50	15965
12mm x 1.75	15966
14mm x 1.50	15967
14mm x 2.00	15968
16mm x 1.50	15969
16mm x 2.00	15970



### Jam Nuts

Size	Part #
8mm x 1.0	16957
8mm x 1.25	16958
10mm x 1.25	16961
10mm x 1.50	16962
12mm x 1.25	16963
12mm x 1.50	16965
12mm x 1.75	16966
14mm x 1.50	16967
14mm x 2.00	16968
16mm x 1.50	16969
16mm x 2.00	16970



### Nylon Lock Nuts

Size	Part #
4mm x .70	17950
5mm x .80	17952
6mm x 1.0	17954
7mm x 1.0	17956
8mm x 1.0	17957
8mm x 1.25	17958
10mm x 1.25	17961
10mm x 1.50	17962
12mm x 1.25	17963
12mm x 1.50	17965
12mm x 1.75	17966
14mm x 1.50	17967
14mm x 2.00	17968
16mm x 1.50	17969
16mm x 2.00	17970



All Items shown on this page can be purchased individually

### Flange Nuts

Size	Part #
6mm x 1.0	44954
8mm x 1.25	44958
10mm x 1.50	44962
12mm x 1.75	44966
16mm x 2.0	44970



### Flange Lock Nuts

Size	Part #
8mm x 1.25	44958-L
10mm x 1.50	44962-L
12mm x 1.75	44966-L
16mm x 2.0	44970-L



## Washers Chrome Plated

### Flat Washers

Size	Part #
4mm	23985
5mm	23986
6mm	23987
7mm	23988
8mm	23989
10mm	23990
12mm	23991
14mm	23992
16mm	23993



### Lock Washers

Size	Part #
4mm	24985
5mm	24986
6mm	24987
7mm	24988
8mm	24989
10mm	24990
12mm	24991
14mm	24992
16mm	24993



### Wave Washers

Size	Part #
8mm	23989W
12mm	24991W



### Super Flat Washers

Size	Part #
6mm x 10	23735
6mm x 18	23278A
8mm x 24	23773A

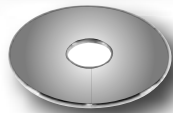

Note: See specification for dimensions  
Page 4



## Allen Screws Stainless Steel



*73xxx for Stainless Steel Allens with Knurls or for Polished add SP-73xxx*

	4mm/ 0.7	5mm/ 0.8	6mm/ 1.0	8mm/ 1.25	10mm/ 1.50	12mm/ 1.75
8		73721	73734			
10	73711	73722	73735	73770		
12	73712	73723	73736	73771		
16	73714	73725	73738	73772		
20	73715	73726	73739	73773	73794	73835
25	73716	73727	73740	73774	73795	73836
30	73717	73728	73741	73775	73796	73837
35		73729	73742	73776	73797	73838
40		73730	73743	73777	73798	73839
45		73731	73744	73778	73799	73840
50		73732	73745	73779	73800	73841
55			73746	73780	73801	73842
60			73747	73781	73802	73843
65			73748	73782	73803	73844
70			73749	73783	73804	73845
75			73750	73784	73805	73846
80			73751	73785	73806	73847
90			73753	73787	73808	73849
100				73788	73809	73850

## Hex Caps Screws

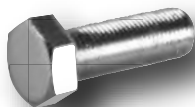

*77xxx for Stainless Steel Hex Caps or for Polished add SP-77xxx*

	4mm/ 0.7	5mm/ 0.8	6mm/ 1.0	8mm/ 1.25	10mm/ 1.50	12mm/ 1.75
10	77711	77722	77735	77770		
16	77714	77725	77738	77772	77793	
20	77715	77726	77739	77773	77794	77835
25	77716	77727	77740	77774	77795	77836
30	77717	77728	77741	77775	77796	77837
35		77729	77742	77776	77797	77838
40		77730	77743	77777	77798	77839
45		77731	77744	77778	77799	77840
50		77732	77745	77779	77800	77841
55			77746	77780	77801	77842
60			77747	77781	77802	77843
65			77748	77782	77803	77844
70			77749	77783	77804	77845
75			77750	77784	77805	77846
80			77751	77785	77806	77847
90			77753	77787	77808	77849
100			77755	77788	77809	77850
110			77756	77789	77810	77851

## Button Head Allen Screws



*72xxx for Stainless Steel Allen Button Heads or for Polished add SP-72xxx*

	4mm/ 0.7	5mm/ 0.8	6mm/ 1.0	8mm/ 1.25	10mm/ 1.50
8	72710	72721	72734		
10	72711	72722	72235	72770	
12	72712	72723	72736	72771	
16	72714	72725	72738	72772	72793
20		72726	72739	72773	72794
25		72727	72740	72774	72795
30		72728	72741	72775	72796

## Flat Head Allen Screws



*71xxx for Stainless Steel Flat Head Allens or for Polished add SP-71xxx*

	4mm/ 0.7	5mm/ 0.8	6mm/ 1.0	8mm/ 1.25	10mm/ 1.50
6	71709				
8	71710	71721	71734		
10	71711	71722	71235		
12	71712	71723	71736	71771	
16	71714	71725	71738	71772	71793
20	71715	71726	71739	71173	71794
25	71716	71727	71740	71774	71795
30	71717	71728	71741	71775	71796

## Carriage Bolts



*79xxx for Stainless Steel Flat Head Allens or for Polished add SP-79xxx*

	10mm/ 1.50
25	79795
50	79800
60	79802

**Key: Read Across For Diameter  
Read Down For Length**

*Call if you do not see  
the sizes you need !*

**Metric  
Bulk Stainless**



# Bulk Stainless Fasteners Metric

## Washers Stainless Steel

### Flat Washers

Size	Part #
4mm	75985
5mm	75986
6mm	75987
8mm	75989
10mm	75990
12mm	75991
14mm	75992
16mm	75993



### Lock Washers

Size	Part #
4mm	76985
5mm	76986
6mm	76987
8mm	76989
10mm	76990
12mm	76991
14mm	76992
16mm	76993



### Wave Washers

Size	Part #
5mm	76986W
6mm	76987W
8mm	76989W
10mm	76990W



**Example:** To order a 6 x 10 Oval Phillips Machine Screw: Use **Chart #1** for head style part number which would be "89". Look up diameter and length from **Chart #2** for last three digits 6 x 10 is 735. Put the two together for a part number of 89735, or simply order by style and size. **Include the Prefix SP-89735 for Stainless Steel Polished**



Cheesehead

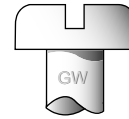

Pan



Oval

## Nuts Stainless Steel

### Hex Nuts

Size	Part #
4mm x .70	70950
5mm x .80	70952
6mm x 1.0	70954
7mm x 1.0	70956
8mm x 1.25	70958
10mm x 1.0	70959
10mm x 1.25	70961
10mm x 1.50	70962
12mm x 1.50	70965
12mm x 1.75	70966



### Jam Nuts

Size	Part #
8mm x 1.25	67958
10mm x 1.50	67962
12mm x 1.75	67966

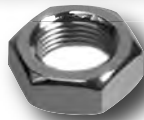

*For Stainless Steel Polished Order with the SP-Prefix than the five digit Part # SP-xxxxx*

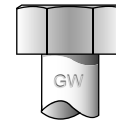

Hex



Flat

### Chart #1: Select Styles

Style	Slotted	Phillips
Round Head	99	N/A
Flat Head	98	94
Truss Head	93	N/A
Oval Head	97	89
Pan Head	96	92
Cheesehead	78	N/A
Hex	77	N/A

## Nylon Lock Nuts

Size	Part #
4mm x .70	69950
5mm x .80	69952
6mm x 1.0	69954
8mm x 1.25	69958
10mm x 1.50	69962
12mm x 1.75	69966



All Items shown on this page can be purchased individually

### Chart #2: Metric Machine Screws

	m3	m4	m5	m6	m8
8mm	701	710	721	734	770
10mm	702	711	722	735	771
12mm	703	712	723	736	772
16mm	705	714	725	738	773
29mm	706	715	726	739	774
25mm	707	716	727	740	775
30mm	708	717	728	741	776
35mm				742	777



## Hex Cap Screws Zinc Plated

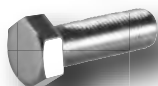

07xxx for Zinc  
Hex Caps

	4mm/ 0.7	5mm/ 0.8	6mm/ 1.0	7mm/ 1.0	8mm/ 1.25	10mm/ 1.50	Fine Thread		
							10mm/ 1.25	12mm/ 1.75	12mm/ 1.50
10	07711	07722	07735	07760	07770				
16	07714	07725	07738	07762	07772	07793			
20	07715	07726	07739	07763	07773	07794	07816	07835	07856
25	07716	07727	07740	07764	07774	07795	07817	07836	07857
30	07717	07728	07741	07765	07775	07796	07818	07837	07858
35		07729	07742	07766	07776	07797	07819	07838	07859
40		07730	07743	07767	07777	07798	07820	07839	07860
45		07731	07744		07778	07799	07821	07840	07861
50		07732	07745	07769	07779	07800	07822	07841	07862
55			07746		07780	07801	07823	07842	07863
60			07747		07781	07802	07824	07843	07864
65			07748		07782	07803	07825	07844	07865
70			07749		07783	07804	07826	07845	07866
75			07750		07784	07805		07846	07867
80			07751		07785	07806	07828	07847	07868
90			07753		07787	07808	07830	07849	07870
100			07755		07788	07809	07831	07850	07871
110			07756		07789	07810		07851	07872
120			07757		07790	07811	07833	07852	

Metric  
Bulk Zinc

## Allen Screws Zinc Plated



For Metric Zinc Allen  
with Knurls use 08xxx

Key: Read Across For Diameter  
Read Down For Length

Call if you do not see  
the sizes you need !

	4mm/ 0.7	5mm/ 0.8	6mm/ 1.0	8mm/ 1.25	8mm/ 1.0	10mm/ 1.50	10mm/ 1.25	12mm/ 1.75
8		08721	08734					
10	08711	08722	08735	08770				
12	08712	08723	08736	08771				
16	08714	08725	08738	08772				
20	08715	08726	08739	08773		08794		
25	08716	08727	08740	08774	08774F	08795		08836
27			08740A					
30	08717	08728	08741	08775	08776F	08796	08818	08837
35	08718	08729	08742	08776		08797	08819	08838
40	08719	08730	08743	08777	08778F	08798		08839
45	08720	08731	08744	08778		08799	08821	08840
50	08720A	08732	08745	08779		08800	08822	08841
55			08746	08780		08801		08842
60			08747	08781		08802	08824	08843
65			08748	08782		08803	08825	08844
70			08749	08783		08804		08845
75			08750	08784		08805		08846
80				08785		08806		08847
85							08829	
90						08808	08830	08849
95								
100						08809	08831	
110								
115								
120						08811		





# Bulk Zinc Fasteners Metric

## Washers Zinc Plated

### Flat Washers

Size	Part #
4mm	04985
5mm	04986
6mm	04987
8mm	04989
10mm	04990
12mm	04991
14mm	04992
16mm	04993



### Lock Washers

Size	Part #
4mm	05985
5mm	05986
6mm	05987
8mm	05989
10mm	05990
12mm	05991
14mm	05992
16mm	05993



## Nuts Zinc Plated

### Hex Nuts

Size	Part #
4mm x .70	06950
5mm x .80	06952
6mm x 1.0	06954
7mm x 1.0	06956
8mm x 1.0	06957
8mm x 1.25	06958
10mm x 1.25	06961
10mm x 1.50	06962
12mm x 1.25	06963
12mm x 1.50	06965
12mm x 1.75	06966
14mm x 1.50	06967
14mm x 2.00	06968
16mm x 1.50	06969
16mm x 2.00	06970

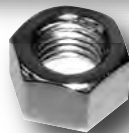

### Nylon Insert Lock Nuts

Size	Part #
4mm x .70	03950
5mm x .80	03952
6mm x 1.0	03954
7mm x 1.0	03956
8mm x 1.0	03957
8mm x 1.25	03958
10mm x 1.25	03961
10mm x 1.50	03962
12mm x 1.25	03963
12mm x 1.50	03965
12mm x 1.75	03966
14mm x 1.50	03967
14mm x 2.00	03968
16mm x 1.50	03969
16mm x 2.00	03970



*Gardner-Westcott*

**SECOND TO NONE**



## Inside This Section

### American Thread Chrome Plated

Tray Assortments.....	58-59
Speciality Assortments.....	60
Shop Master Assortments.....	61

### American Thread Stainless Steel

Tray Assortments.....	62
Allen Screws.....	62
Hex caps.....	62
Hex Nuts and Lock Nuts.....	62
Washers.....	62

### Zinc Plated

Tray Assortments.....	63
Allen Screw.....	63
Hex Caps.....	63
Hex Nuts.....	63
Washers and Lock Nuts.....	63
The Shop Master.....	63

### Brass Fittings Chrome Plated

Tray Assortment.....	64
----------------------	----

**Assortments in  
Chrome Plated,  
Stainless Steel & Zinc**



**Custom  
and  
Speciality  
Assortments  
Available**





# Assortments in American Thread

## Tray Assortments (Chrome Plated)

### Acorn Nuts

Acorn Nuts #8 thru 5/8 Coarse & Fine - (14 Sizes & 109 Pieces).....	A-7	----
Acorn Nuts 1/4 thru 1/2 Coarse & Fine - (12 Sizes & 120 pieces).....	A-5	----
Acorn Nuts Low Crown 8/32-5/8-18 - (15 Sizes & 108 Pieces).....	A-148	----



Acorn Nut

Low  
Crown  
Acorn

### Allen Head Screws

4-40, 6/32, 8/32, 12/24 - (24 Sizes & 240 Pieces).....	A-39	A-39-P
10/24 & 10/32 - (23 Sizes & 230 Pieces).....	A-38	A-38-P
8/32, 10/24, 10/32, 1/4-28 - (24 Sizes & 205 Pieces).....	A-41	A-41-P
1/4-20 - (16 Sizes & 150 Pieces).....	A-40	A-40-P
1/4-28 - (12 Sizes & 120 Pieces).....	A-37	A-37-P
5/16-18 - (12 Sizes & 110 Pieces).....	A-42	A-42-P
5/16-24 - (12 Sizes & 115 Pieces).....	A-43	A-43-P
3/8-16 - (12 Sizes & 90 Pieces).....	A-44	A-44-P
3/8-24 - (12 Sizes & 85 Pieces).....	A-45	A-45-P
7/16 -14 - (11 Sizes & 72 Pieces).....	A-46	A-46-P
7/16-20 - (10 Sizes & 59 Pieces).....	A-47	A-47-P
1/2-13 - (11 Sizes & 72 Pieces).....	A-48	A-48-P
1/2-20 - (10 Sizes & 57 Pieces).....	A-49	A-49-P
1/4, 5/16, 3/8 Coarse - (24 Sizes & 220 Pieces).....	24-CA	24-CAP
1/4, 5/16, 3/8 Fine - (23 Sizes & 210 Pieces).....	24-FA	24-FAP



Chrome Allen



Polished Allen

### Body & Spinloc Bolts

1/16, 3/32, 1/8, 3/16 - (20 Sizes & 200 Pieces).....	A-201	----
--	-------	------

Body Bolt



### Button Head Allen Screws

8/32, 10/24, 10/32, 1/4-28 - (20 Sizes & 101 Pieces).....	A-25	----
1/4-20, 5/16-18, 3/8-16 - (24 Sizes & 112 Pieces).....	A-26	----
1/4-28, 5/16-18, 3/8-16 - (24 Sizes & 112 Pieces).....	A-26F	----
5/16-24, 3/8-24, 1/2-13 - (14 Sizes & 67 Pieces).....	A-27	----

Button Head Allen



### Cotter Pins

1/16, 3/32, 1/8, 3/16 - (9 Sizes & 425 Pieces).....	A-34C	----
---	-------	------

### Flat Head Allen Screws

8/32, 10/24, 10/32, 1/4-28 - (24 Sizes & 240 Pieces).....	A-10	----
8/32, 10/32, 1/4-28, 5/16-24, 3/8-24 - (16 Sizes & 160 Pieces).....	A-9	----
1/4, 5/16, 3/8 Coarse - (24 Sizes 112 Pieces).....	A-28	----
1/4, 5-16, 3/8 Fine - (24 Sizes 112 Pieces).....	A-28F	----

Flat Head Allen



### Flexloc® Nuts

#10 thru 1/2 Coarse & Fine - (12 Sizes & 110 Pieces).....	A-11	----
---	------	------

Flexloc®  
Nut

### Flexloc® Jam Nuts

#10 thru 1/2 Coarse & Fine - (12 Sizes & 110 Pieces).....	A-12	----
Nuts & Jam Flexloc Nuts 1/4 thru 5/8 - (24 Sizes & 240 Pieces).....	A-19	----

Flexloc®  
Jam Nut

### Hex Cap Screws

1/4, 5/16, 3/8 Coarse - (24 Sizes & 220 Pieces).....	24-C	----
1/4, 5/16, 3/8 Fine - (24 Sizes & 220 Pieces).....	24-F	----
7/16 & 1/2 Coarse - (11 Sizes & 80 Pieces).....	23-C	----
7/16 & 1/2 Fine - (12 Sizes & 90 Pieces).....	23-F	----
7/16 & 1/2 Coarse - (2 Diameters at various length with 90 Pieces).....	31-C	----
7/16 & 1/2 Fine - (2 Diameters at various length with 90 Pieces).....	31-F	----

Hex Cap



### Hex Nuts

6/32 thru 5/8 Coarse & Fine - (16 Sizes & 534 Pieces).....	A-30	----
1/4 thru 3/8 Hex Nuts, Flat & Lock Washers - (12 Sizes & 1200 Pieces).....	12-W	----
7/16 thru 5/8 Hex Nuts, Flat & Lock Washers - (12 Sizes & 540 Pieces).....	23-W	----

Hex Nut









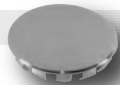
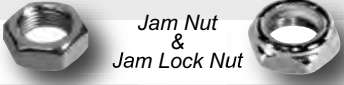

# Assortments in American Thread



**Assortments  
Chrome**

## Tray Assortments (Chrome Plated)

	Chrome Part #	
<b>Fillister Head Slotted</b> ( <i>Machine Screws</i> )		
6/32 thru 1/4-20 Coarse & Fine - (24 Sizes & 240 Pieces).....	A-179	Slotted Fillister
<b>Flat Head Slotted</b> ( <i>Machine Screws</i> )		
6/32 thru 1/4-20 Coarse & Fine - (24 Sizes & 240 Pieces).....	A-73-C	
<b>Flat Head Slotted</b> ( <i>Sheet Metal Screws</i> )		
#4 thru #14 - (23 Sizes & 230 Pieces).....	A-75-C	
<b>Hole Plugs</b>		
Brass & Chrome 3/16 thru 1 1/2 - (16 Sizes & 219 Pieces).....	A-76	Hole Plug
Chrome 3/16 thru 3/4 - (7 Sizes & 130 Pieces).....	A-77	
Flat Black 3/16 thru 1 1/2 - (16 Sizes & 219 Pieces).....	A-76-FB	
Gloss Black 3/16 thru 3/4 - (7 Sizes & 130 Pieces).....	A-77-GB	
<b>Jam Nuts &amp; Jam Lock Nuts</b>		
1/4 thru 5/8 Coarse & Fine - (24 Sizes & 220 Pieces).....	A-14	Jam Nut & Jam Lock Nut
1/4 thru 1/2 Coarse & Fine - (20 Sizes & 160 Pieces).....	A-55	
<b>Lock Nuts Nylon Insert</b>		
#10 thru 5/8 Coarse & Fine - (11 Sizes & 190 Pieces).....	A-8	Nylon Insert Lock Nut
4/40 thru 3/4 Coarse & Fine - (20 Sizes & 274 Pieces).....	A-18	
<b>Oil Line Fitting</b> ( <i>Chrome Plated Brass</i> )		
Special selected fittings - (12 Sizes & 75 Pieces).....	A-52	(See Upper Portion of Pg. 64 For more Details)
<b>Oval Head</b> ( <i>Machine Screws</i> )		
4/40 thru 3/8 Phillips Coarse & Fine - (24 Sizes & 240 Pieces).....	A-175	Oval Phillips Machine Screw
4/40 thru 3/8 Slotted Coarse & Fine - (24 Sizes & 240 Pieces).....	A-176	
<b>Oval Head</b> ( <i>Sheet Metal Screws</i> )		
#4 thru #14 Phillips - (24 Sizes & 240 Pieces).....	A-202	Oval Slotted Machine Screw
#4 thru #14 Slotted - (24 Sizes & 240 Pieces).....	A-203	
<b>Pan Head Slotted</b> ( <i>Sheet Metal Screws</i> )		
#8, #10, #12 & #14 - (24 Sizes & 240 Pieces).....	A-74-C	Oval Phillips Sheet Metal Screw
<b>Round Head Slotted</b> ( <i>Sheet Metal Screws</i> )		
4/40, 5/40, 6/32 & 8/32 - (23 Sizes & 230 Pieces).....	A-71-C	
10/24, 10/32 & 12/24 - (21 Sizes & 210 Pieces).....	A-72-C	
<b>Spacers</b>		(See Pg. 60 For more Details)
<b>Torx Button Head</b>		
8/32, 10/24, 10/32, 1/4-28 - (24 Sizes & 240 Pieces).....	A-180	Torx Button Head
1/4-20, 5/16, 3/8, 1/2 - (24 Sizes & 235 Pieces).....	A-181	
<b>Washers</b>		
#8 thru 5/8 Flat & Lock Washers - (16 Sizes & 960 Pieces).....	A-31	Flat Washer
#6 thru 5/8 Internal, External & AN - (22 Sizes & 435 Pieces).....	A-33	Lock Washer
<b>Washers G-W Heat Treated</b>		
#8 thru 5/8 Flat & Lock Washers - (16 Sizes & 960 Pieces).....	A-29	(See Lower Portion of Pg. 60 For more Details)
AN #8 thru 3/4 & Std. 1/4 thru 5/8 - (21 Sizes & 435 Pieces).....	A-160	
<b>12 Point Screws</b>		
1/4-20 Coarse - (16 Sizes & 155 Pieces).....	A-240	12 Point Screw
1/4-28 Fine - (20 Sizes & 141 Pieces).....	A-241	
5/16-18 Coarse - (12 Sizes & 102 Pieces).....	A-242	
5/16-24 Fine - (12 Sizes & 97 Pieces).....	A-243	
3/8-16 Coarse - (12 Sizes & 105 Pieces).....	A-244	
3/8-24 Fine - (12 Sizes & 105 Pieces).....	A-245	
7/16-14 & 7/16-20 - (6 Sizes & 75 Pieces).....	A-247	
1/2-13 & 1/2-20 - (16 Sizes & 80 Pieces).....	A-248	
1/4, 5/16, 3/8 Coarse - (24 Sizes & 220 Pieces).....	A-24-C	
1/4, 5/16, 3/8 Fine - (24 Sizes & 220 Pieces).....	A-24-F	



# Assortments in American Thread

## Speciality Assortments (Chrome Plated)

Chrome Part # Polished Part #

### Allen Head Assortment Groups (Includes; 6 Metal Trays & 1 Cabinet with items listed below)

A-40 - (1/4-20 Sizes), A-41 - (8/32, 10/24, 10/32, 1/4-28 Sizes), A-42 - (5/16-18 Sizes),  
 A-43 - (5/16-24 Sizes), A-44 - (3/8-16 Sizes), A-45 - (3/8-24 Sizes)..... A-50 A-50-P

### 12 Point Screw Assortment Groups (Includes; 6 Metal Trays & 1 Cabinet with items listed below)

A-240 - (1/4-20 Sizes), A-241 - (1/4-28 Sizes), A-242 - (5/16-18 Sizes),  
 A-243 - (5/16-24 Sizes), A-244 - (3/8-16 Sizes), A-245 - (3/8-24 Sizes)..... A-250 ---

### Chrome Plated Brass Fitting Assortment (Includes; 1 Metal Tray with items listed below)

Chrome Plated Brass Fittings - (Straight Hose Barb Male Pipe Rigid, Straight  
 Street Elbow, 45° Street Elbow, Hose Tee, Socket Pipe Plug, Hex Head Pipe Plug,  
 Sleeve Nut & Washer Seals)..... A-52 ---

### Spacer Assortments (Includes; 1 Metal Tray with a 12 or 16 size compartment either with items listed below)

Featuring 12 Sizes - (I.D.'s 3/8, 7/16 & 5/8)..... A-16 ---  
 Featuring 16 Sizes - (I.D.'s 1/4 & 5/16 with Lengths from 1/4 to 1 1/4)..... A-15 ---

### Spike Nuts

Featuring 11 Sizes - (11 Sizes & 78 Pieces)..... A-97 ---

Non-Alcoholic but may be habit forming



Sizes	1/4 -20	1/4 -28	5/16 -18	5/16 -24	3/8 -16	3/8 -24
Part #	26546	26547	26548	26549	26550	26551
	7/16 -14	7/16 -20	1/2 -13	1/2 -20	5/8 -18	
	26552	26553	26554	26555	26559	

Can be purchased individually

## The G-W Hardened Flat Washer

**GARDNER-WESTCOTT COMPANY** is proud to supply the first flat washer strong enough to use on motor mounts or belt sprockets and with the exceptional cosmetic quality to be used on a show bike. This hardened steel washer is thicker than standard flat washers and has a close tolerance ID for a snug fit. It has a standard OD so it can be used anywhere a regular washer was. Now available in bulk from 1/4" thru 5/8" or in Assortment # A-29 which includes; #8, #10, 1/4, 5/16, 3/8, 7/16, 1/2 and 5/8 diameter G-W Hardened Flat Washers including Lock Washers -- all show chromed, labeled and in a metal tray.



Also Available in Stainless Steel Sold Individually

### G-W Heat Treated Washer & Lock Washer (Includes; 1 Metal Tray with Items Listed Below)

Chrome Part # Polished Part #

Flat Washers - (#8, #10, 1/4, 5/16, 3/8, 7/16, 1/2, 5/8)  
 Lock Washers - (#8, #10, 1/4, 5/16, 3/8, 7/16, 1/2, 5/8)..... A-29 ---



**Assortments  
Chrome**

## MASTER ASSORTMENT

Part # A-98 consists of 6 trays (2,221 individual pieces) and includes the sliding drawer cabinet. Each tray is clearly labeled for ease in identification and re-ordering. This assortment contains 2 trays of Hex Caps 1/4, 5/16 and 3/8 inch diameter both coarse and fine thread; (Note Allen Screws or Bow Tie Hex Caps may be substituted for the Hex Caps) 1 Tray with Washers and Hex Nuts 1/4, 5/16 & 3/8 and 1 Tray each of Button Head Allens, Flat Head Allens and Oval Phillips Machine Screws.

Trays can be purchased separately also. To organize your current stock you can purchase empty trays and bins. We offer hundreds of assortments - call us to customize trays for your shop.

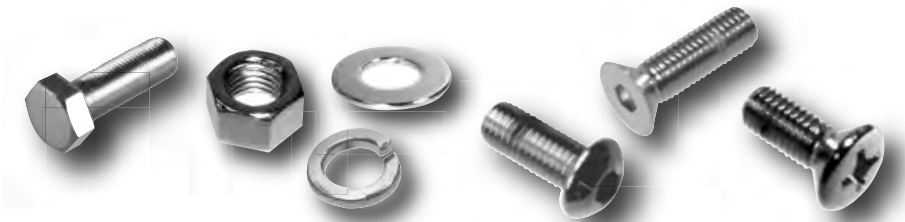

Hex Caps		Part #
Coarse Thread 1/4 thru 3/8.....	24 Sizes.....	# 24-C
Fine Thread 1/4 thru 3/8.....	24 Sizes.....	# 24-F
<b>Hex Nuts, Flat and Lock Washers</b>		
1/4 thru 3/8.....	12 Sizes.....	#12-W
<b>Button Head Allen Screws</b>		
8/32 thru 1/4-28.....	20 Sizes.....	# A-25
<b>Flat Head Allen Screws</b>		
8/32 thru 3/8-16.....	24 Sizes.....	# A-10
<b>Machine Screws Oval Head Phillips</b>		
4/40 thru 3/8-24.....	24 Sizes.....	# A-175



*When You Demand The Best  
Why Settle For Less...*





# Assortments in American Thread

## Tray Assortments (Stainless Steel)

### Acorn Nuts

Acorn Nuts #8 thru 5/8 Coarse & Fine - (14 Sizes & 113 Pieces)..... A-7-S A-7-SP



Low Crown  
Acorn Nut

### Allen Head Screws

4-40, 6/32, 8/32, 12/24 - (24 Sizes & 240 Pieces)..... A-39-S A-39-SP

1/4-20 - (12 Sizes & 120 Pieces)..... A-40-S A-40-SP

8/32, 10/24, 10/32, 1/4-28 - (21 Sizes & 190 Pieces)..... A-41-S A-41-SP

5/16-18 - (12 Sizes & 120 Pieces)..... A-42-S A-42-SP

5/16-24 - (10 Sizes & 100 Pieces)..... A-43-S A-43-SP

3/8-16 - (12 Sizes & 90 Pieces)..... A-44-S A-44-SP

3/8-24 - (9 Sizes & 75 Pieces)..... A-45-S A-45-SP

7/16 -14 Coarse & Fine - (12 Sizes & 82 Pieces)..... A-46-S ----

1/4-28, 5/16-24, 3/8-24 Fine - (24 Sizes & 210 Pieces)..... ---- 24-FASP



Stainless Steel  
Knurled Allen



Stainless Steel  
Polished Allen

### Allen Head Screw Assortment Group

Contains; 1 Metal Cabinet with 6 Trays & the following 6 sets

A-40-S, A-41-S, A-42-S, A-43-S, A-44-S, A-45-S - (83 Sizes & 621 Pieces)..... A-50-S A-50-SP

### Button Head Allen Screws

8/32, 10/24, 10/32, 1/4-28 - (20 Sizes & 102 Pieces)..... A-25-S ----

1/4-20, 5/16-18, 3/8-16 - (24 Sizes & 114 Pieces)..... A-26-S ----

5/16-24, 3/8-24, 1/2-13 - (14 Sizes & 64 Pieces)..... A-27-S A-27-SSP



Button Head Allen

### Flat Head Allen Screws

8/32, 10/24, 10/32, 1/4-28 - (20 Sizes & 200 Pieces)..... A-10-S A-10-SSP



Flat Head Allen

### Hex Caps

1/4, 5/16, 3/8 Coarse - (24 Sizes & 227 Pieces)..... A-24-CS A-24-CSP

1/4, 5/16, 3/8 Fine - (24 Sizes & 227 Pieces)..... A-24-FS A-24-FSP

7/16, 1/2 Coarse & Fine - (20 Sizes & 155 Pieces)..... A-23-CS A-23-CSSP

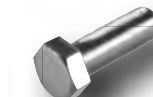

Hex Cap

### Hex Nuts

6/32 thru 5/8 Coarse & Fine - (16 Sizes & 534 Pieces)..... A-30-S A-30-SP

1/4 thru 3/8 Hex Nuts, Flat & Lock Washers - (12 Sizes & 1200 Pieces)... 12-W-S 12-W-SP

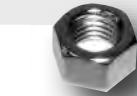

Hex Nut

### Lock Nuts Nylon Insert

6/32 thru 5/8-18 Coarse & Fine - (16 Sizes & 279 Pieces)..... A-32-S A-32-SP



Nylon Insert Lock Nut

### Slotted Fillister Head (Machine Screw)

6/32, 8/32, 10/24, 10/32, 12/24, 1/4 - (24 Sizes & 240 Pieces)..... A-178 ----



Slotted  
Fillister

### Washers

#8 thru 5/8 Flat & Lock Washers - (16 Sizes & 960 Pieces)..... A-31-S A-31-SP

#6 thru 5/8 Internal, External & AN - (22 Sizes & 880 Pieces)..... A-33-S ----



Flat & Lock Washer



## Zinc Plated Fastener Assortments THE SHOP MASTER

Offering a full line of fastener assortments is important. Custom Vehicles need custom fasteners and that's why we make fastener assortments with the custom builder in mind. The organization of your stock is important, why waste time looking for a nut or bolt. **Gardner-Westcott's** assortments organize styles and sizes for fast access and easy stock control. All assortments come in metal tray and are labeled inside and outside for your convenience.....

**Assortments  
Zinc**

**A-70**  
6 Trays  
in Cabinet

**A-90**  
4 Trays  
in Cabinet

**A-80**  
4 Trays  
in Cabinet

**A-81**  
2 Trays  
in Cabinet

Part #

A-34

A-71

A-72

A-73

A-74

A-75

A-76

A-91

A-92

A-93

A-94

A-82

A-83

A-84

A-85

A-86

A-87



Contents of each Tray

Cotter Pins

Round Slotted Screws 4/40, 5/40, 6/32, 8/32

Round Slotted Screws 10/24, 10/32, 12/24

Flat Head Slotted Screws 4/40, 6/32, 8/32, 10/24, 10/32

Pan Slotted Sheet Metal Screws #4, 6, 8, 10, 12

Flat Head Slotted Sheet Metal Screws #4, 6, 8, 10, 12, 1/4"

Hole Plugs 3/16" thru 1"

Hex Nuts American Thread #4/40 thru 3/4-16

Nylon Lock Nuts American Thread #4/40 thru 3/4-16

Flat Washers & Lock Washers #4 thru 3/4"

External, Internal Star, AN sm. OD & Fender lg. OD Washers

Hex Cap American Thread 1/4-20 & 1/4-28 Diameter

Hex Cap American Thread 5/16-18 & 5/16-24 Diameter

Hex Cap American Thread 3/8-16 Diameter

Hex Cap American Thread 3/8-24 Diameter

Hex Cap American Thread 7/16-14 & 7/16-20 Diameter

Hex Cap American Thread 1/2-13 & 1/2-20 Diameter

Part # A-100





# Assortments in American Thread

## Hand Polished Brass Chrome Plated

Part #

**Brass Fittings Chrome Plated** ..... 12 Sizes..... # A-52

includes select sizes of the following fittings: Straight Hose Barb Male Pipe Rigid, Straight Hose Barb Male Pipe Rigid, Street Elbow, 45° Street Elbow, Hose Tee, Socket Pipe Plug, Hex Head Pipe Plug, Sleeve Nut and Washer Seal.



Chrome Plated Brass Tray Assortment #A-52

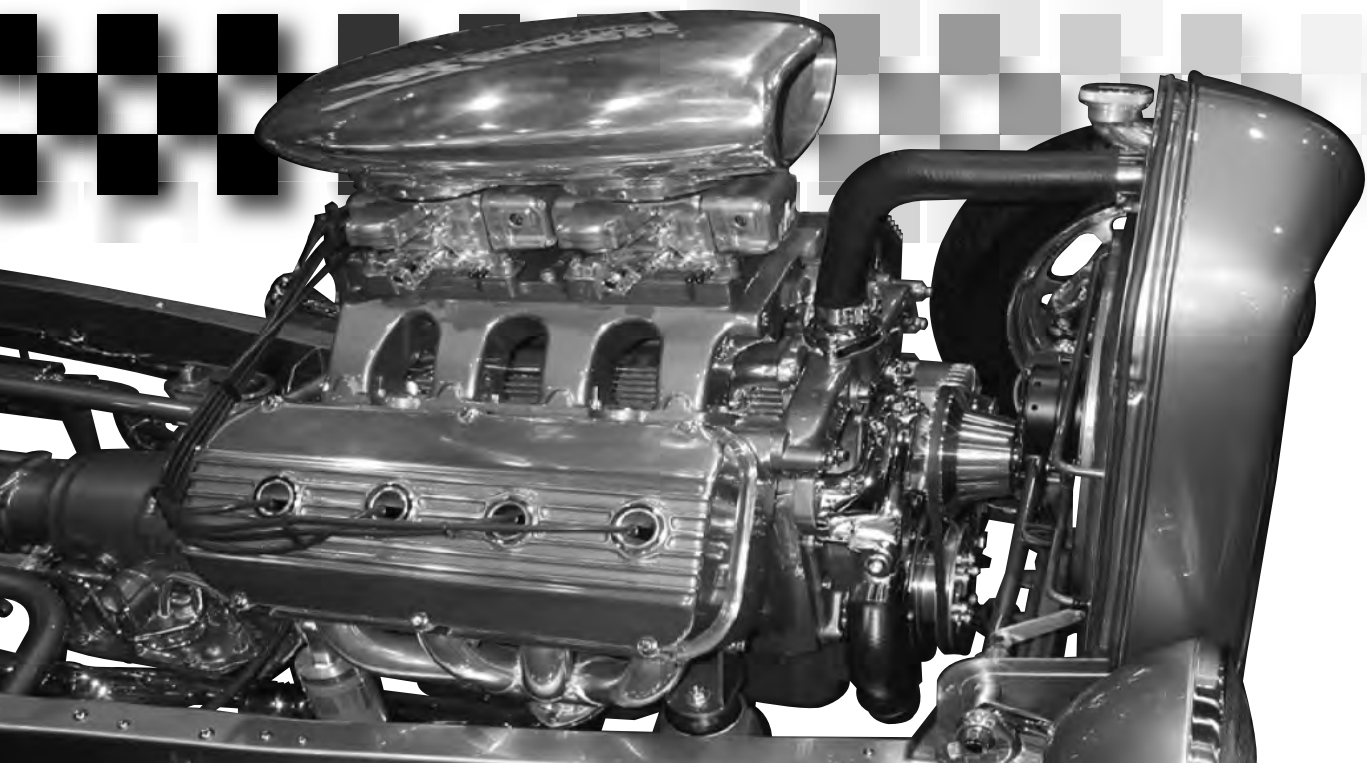



## Inside This Section

### Metric Thread Chrome Plated

- Tray Assortments..... 66
- Acorn Nuts & Spacers..... 66
- Allen Head Screws..... 66
- Hex Caps..... 66
- Nylon Insert Lock Nuts..... 66
- Flat & Lock Washers..... 66
- Speciality Dealer Assortments..... 67

### Metric Thread Stainless Steel

- Tray Assortments..... 68
- Allen Head Screws..... 68
- Hex Caps..... 68
- Hex Nuts & Lock Nuts..... 68
- Flat & Lock Washers..... 68

### Metric Thread Zinc Plated

- Tray Assortments..... 68
- Allen Head Screws..... 68
- Hex Caps..... 68
- Hex Nuts & Lock Nuts..... 68
- Flat & Lock Washers..... 68

**Assortments in  
Chrome Plated and  
Stainless Steel**

**Detailed Custom Assortments with Speciality Lengths and Diameters Available**





# Assortments in Metric Thread

## Tray Assortments (Chrome Plated)

### Acorn Nuts and Spacers Combination

Acorn Nuts 4mm thru 12mm

Spacers 1/4 x 1/4 thru 3/8 x 1 - (15 Sizes & 140 Pieces)..... A-62

Chrome  
Part #

Polished  
Part #



Acorn Nut

### Allen Head Screws

4mm & 5mm - (24 Sizes & 210 Pieces)..... A-301-C

A-301-P

5mm & 6mm - (16 Sizes & 240 Pieces)..... A-21

A-21-P

6mm with (special 6m x 27m & 8m - 70m) - (16 Sizes & 160 Pieces)..... A-325-C

A-325-P

6mm (8m - 75m) - (24 Sizes & 120 Pieces)..... A-302-C

A-302-P

8mm x 1.25 (10m - 80m) - (16 Sizes & 130 Pieces)..... A-326-C

A-326-P

8mm x 1.25 (10m - 60m)

also 8mm x 1.0 (25m - 50m) - (16 Sizes & 124 Pieces)..... A-303-C

A-303-P

8mm (10m - 50m) & 10mm x 1.50 (25m - 65m)..... -----

A-328-P

10mm x 1.50 (20m - 75m) - (12 Sizes & 95 Pieces)..... A-327-C

A-327-P

10mm x 1.50 (20m - 65m)

also 10mm x 1.25 (25m - 50m) - (16 Sizes & 120 Pieces)..... A-304-C

A-304-P

10mm x 1.50 (70m - 100m)

also 10mm x 1.25 (55m - 90m) - (12 Sizes & 60 Pieces)..... A-308-C

A-308-P

12mm x 1.75 (25m - 90m) - (12 Sizes & 60 Pieces)..... A-305-C

A-305-P



Chrome Allen



Polished Allen

### Allen Screw Combination

Allens - 5mm x 12 - 10mm x 1.5 x 55

Flat Head - 4mm x 12 - 6mm x 16, 6mm x 35

Button Head - 6mm x 16 - 6mm x 30 - (25 Sizes & 205 Pieces)..... A-25-C

A-25-P



Flat  
Head Allen

### Button Head Allen Screws

4mm x 6m - 4m x 25, 5mm x 5 - 5m x 30

also 6mm x 8m - 6m x 35m - (23 Sizes & 230 Pieces)..... A-315

-----



Button Head

### Hex Caps

6mm x 12 - 6m x 50, 8mm x 12 - 8m x 55

also 10mm x 1.25 x 20 - 10m x 1.25 x 50 - (24 Sizes & 205 Pieces)..... 24-M

-----

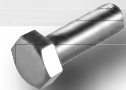

Hex Cap

### Hex Nut and Nylon Insert Lock Nut Combination

Hex Nuts 4mm thru 12mm

Lock Nuts 4mm thru 12mm - (24 Sizes & 365 Pieces)..... A-61-C

-----



Hex Nut

### Flat & Lock Washer Combination

Flat Washers 3mm thru 14mm

Lock Washers 3mm thru 14mm - (16 Sizes & 430 Pieces)..... A-60-C

-----



Flat & Lock Washers



A-326-P



A-60



A-61

# Assortments in Metric Thread



**Metric  
Chrome**

## Metric Master Assortment

This Chrome Fastener set up will make it easy to customize your vehicle. Featuring **Metric Allen Screws**, including the following items. Flat Washers, Lock Washers, Hex Nuts and Lock Nuts all in **Show Chrome**. Contains all six metal tray assortments housed in a metal drawer cabinet.

A-301-P		<b>Allen Screws 4mm and 5mm</b>
A-325-P		<b>Allen Screws 6mm</b>
A-326-P		<b>Allen Screws 8mm</b>
A-327-P		<b>Allen Screws 10mm</b>
A-60		<b>Flat Washers and Lock Washers</b>
A-61		<b>Hex Nuts and Lock Nuts</b>

All above is in Cabinet **Part # A-330-P** with Polished Chrome Allens, it is also available with Knurled Chrome Allens in Cabinet **Part # A-330-C**.

## Metric Assortments

**Part # A-300-P** is specially designed for the builder in mind. This assortment offers a wide range of sizes starting at 4mm up to 12mm. Includes special fine thread 8 & 10mm and also with longer lengths. The six metal trays are clearly labeled for ease in identification and the assortment includes the cabinet.

<p>Not included order separately</p>	A-301-P		<b>Allen Screws 4mm and 5mm</b>	<p>Not included order separately</p>
	A-302-P		<b>Allen Screws 6mm</b>	
	A-303-P		<b>Allen Screws 8mm Coarse &amp; Fine</b>	
	A-304-P		<b>Allen Screws 10mm Coarse &amp; Fine</b>	
	A-308-P		<b>Allen Screws 10mm Long Coarse &amp; Fine</b>	
	A-305-P		<b>Allen Screws 12mm</b>	

**Part #A-60-C includes  
Chrome Flat Washers and  
Lock Washers  
3mm to 14mm**

**Part #A-61-C includes  
Hex Nuts and Lock Nuts  
in coarse and fine thread  
4mm to 12mm**



# Assortments in Metric Thread

## Tray Assortments (Stainless Steel)

### Allen Head Screws

	Stainless Part #	Polished Part #
5mm & 6mm - (16 Sizes & 200 Pieces).....	A-64	A-64-SP
4mm & 5mm - (24 Sizes & 205 Pieces).....	A-301-S	A-301-SP
6mm x 1.0 x 8 thru 6mm x 1.0 x 75 - (16 Sizes & 140 Pieces).....	A-302-S	A-302-SP
8mm x 1.25 x 12 thru 8mm x 1.25 x 80 - (15 Sizes & 120 Pieces).....	A-326-S	A-326-SP
8mm x 1.25 x 10 thru 8mm x 1.25 x 80 - (16 Sizes & 124 Pieces).....	A-303-S	A-303-SP
10mm x 20 thru 10mm x 75 - (12 Sizes & 95 Pieces).....	A-327-S	A-327-SP
10mm x 1.50 x 20 thru 10mm x 1.50 x 75 - (12 Sizes & 90 Pieces).....	A-304-S	A-304-SP
12mm x 1.75 x 25 thru 12mm x 1.75 x 90 - (12 Sizes & 60 Pieces).....	A-305-S	A-305-SP



Stainless Steel  
Knurled Allen



Stainless Steel  
Polished Allen

### Hex Caps

6mm x 12 thru 8mm x 1.25 x 50 - (16 Sizes & 160 Pieces).....	A-63	A-63-SP
6mm x 12 - 6m x 50, 8mm x 12 - 8m x 55 also 10mm x 1.25 x 20 - 10m x 1.25 x 50 - (24 Sizes & 205 Pieces).....	24-MS	-----

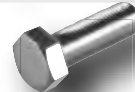

Hex Cap

### Hex Nut and Nylon Insert Lock Nut Combination

Hex Nuts 4mm thru 12mm Lock Nuts 4mm thru 12mm - (24 Sizes & 365 Pieces).....	A-65-S	A-65-SP
--	--------	---------

### Flat & Lock Washer Combination

Flat Washers 3mm thru 14mm Lock Washers 3mm thru 14mm - (16 Sizes & 430 Pieces).....	A-60-S	A-60-SP
---	--------	---------

## Tray Assortments (Zinc)

### Allen Head Screws

	Zinc Part #
4mm & 5mm - (24 Sizes & 205 Pieces).....	A-301-Z
6mm x 1.0 x 8 thru 6mm x 1.0 x 75 - (16 Sizes & 140 Pieces).....	A-325-Z
8mm x 1.25 x 10 thru 8mm x 1.25 x 80 - (16 Sizes & 124 Pieces).....	A-326-Z
10mm x 1.50 x 20 thru 10mm x 1.50 x 75 - (12 Sizes & 90 Pieces).....	A-327-Z
12mm x 1.75 x 25 thru 12mm x 1.75 x 90 - (12 Sizes & 60 Pieces).....	A-305-Z
8mm x 1.25 x 10 thru 8mm x 1.25 x 80 - (16 Sizes & 124 Pieces).....	A-303-Z
10mm x 1.50 x 20 thru 10mm x 1.50 x 75 - (12 Sizes & 90 Pieces).....	A-304-Z
10mm x 1.50 x 20 thru 10mm x 1.50 x 75 - Long - (12 Sizes & 90 Pieces).....	A-308-Z

Stainless Steel  
Knurled Allen



### Master Metric Zinc Allen Assortment

4mm & 5mm, 8mm x 1.25, 8mm x 1.0, 10mm x 1.25, 10mm x 1.50, 12mm x 1.75 x 90, 4mm thru 12mm Hex Nuts, Lock Nuts, Flat Washers & Lock Washers all in a (6) trayed cabinet.....	A-300-Z
--	---------

### Hex Caps

6mm x 1.0 x 8 thru 6mm x 1.0 x 75 - (16 Sizes & 140 Pieces).....	A-302-HZ
6mm x 1.0 x 8 thru 6mm x 1.0 x 75 - (16 Sizes & 140 Pieces).....	A-325-HZ
10mm x 20 thru 10mm x 75 - (12 Sizes & 95 Pieces).....	A-327-HZ
12mm x 1.75 x 25 thru 12mm x 1.75 x 90 - (12 Sizes & 60 Pieces).....	A-305-HZ
6mm, 8mm & 10mm - Long - (24 Sizes & 205 Pieces).....	A-24M-HZ



Nylon Insert  
Lock Nut

### Hex Nut and Nylon Insert Lock Nut Combination

Hex Nuts & Nylon Insert Lock Nuts 4mm thru 12mm - (24 Sizes & 365 Pieces).....	A-61-Z
--	--------



Hex Nut

### Flat & Lock Washer Combination

Flat Washers & Lock Washers 3mm thru 14mm - (16 Sizes & 430 Pieces).....	A-60-Z
--	--------

Flat & Lock  
Washers

### Flat & Lock Washer Hex Nuts Combination

Flat Washers, Lock Washers & Hex Nuts 6mm, 8mm & 10mm.....	A-12-WMZ
--	----------





## Inside This Section

### Fittings

<i>Pipe Fittings</i> .....	70-71
<i>Inverted Flare Fittings</i> .....	71-72
<i>Compression Fittings</i> .....	72-73
<i>Special Fittings</i> .....	73
<i>Vacuum Connectors</i> .....	74

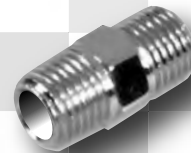

**Chrome and Brass  
Fittings**



# Pipe Fittings

## Pipe Fittings

### Straight Hose Barb Male Pipe

Hose Size	Pipe Size	Brass Part #	Chrome Part #
3/8	1/8	90TD-6 x 2	7-90TD-6 x 2
1/4	1/8	90TD-4 x 2	7-90TD-4 x 2
3/8	1/4	90TD-6 x 4	7-90TD-6 x 4
1/2	1/4	90TD-8 x 4	7-90TD-8 x 4



### Straight Hose Barb Male Pipe

Hose Size	Pipe Size	Brass Part #	Chrome Part #
3/16	1/8	90HB-3 x 2	7-90HB-3 x 2
1/4	1/8	90HB-4 x 2	7-90HB-4 x 2
1/4	1/4	90HB-4 x 4	7-90HB-4 x 4
5/16	1/8	90HB-5 x 2	7-90HB-5 x 2
5/16	1/4	90HB-5 x 4	7-90HB-5 x 4
3/8	1/8	90HB-6 x 2	7-90HB-6 x 2
3/8	1/4	90HB-6 x 4	7-90HB-6 x 4



### 90° Hose Barb Male Pipe

Hose Size	Pipe Size	Brass Part #	Chrome Part #
1/4	1/8	91HB-4 x 2	7-91HB-4 x 2
1/4	1/4	91HB-4 x 4	7-91HB-4 x 4
5/16	1/8	91HB-5 x 2	7-91HB-5 x 2
5/16	1/4	91HB-5 x 4	7-91HB-5 x 4
3/8	1/8	91HB-6 x 2	7-91HB-6 x 2
3/8	1/4	91HB-6 x 4	7-91HB-6 x 4
3/8	3/8	91HB-6 x 6	7-91HB-6 x 6



### Street Elbows

Pipe Size	Brass Part #	Chrome Part #
1/8	116PSE-2	7-116PSE-2
1/4	116PSE-4	7-116PSE-4
3/8	116PSE-6	7-116PSE-6



### Street Elbows 45°

Pipe Size	Brass Part #	Chrome Part #
1/8	124PSE-2	7-124PSE-2
1/4	124PSE-4	7-124PSE-4
3/8	124PSE-6	7-124PSE-6



### Socket Pipe Plug

Pipe Size	Brass Part #	Chrome Part #
1/8	107CSP-2	7-107CSP-2
1/4	107CSP-4	7-107CSP-4
3/8	107CSP-6	7-107CSP-6

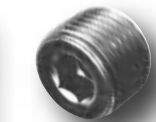

### Slotted Pipe Plug

Pipe Size	Brass Part #	Chrome Part #
1/8	117SPP-2	7-117SPP-2
1/4	117SPP-4	7-117SPP-4
3/8	117SPP-6	7-117SPP-6



### Hex Head Pipe Plug

Pipe Size	Brass Part #	Chrome Part #
1/8	121PP-2	7-121PP-2
1/4	121PP-4	7-121PP-4
3/8	121PP-6	7-121PP-6
1/2	121PP-8	7-121PP-8

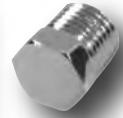

### Square Head Pipe Plug

Pipe Size	Brass Part #	Chrome Part #
1/8	109PP-2	7-109PP-2
1/4	109PP-4	7-109PP-4
3/8	109PP-6	7-109PP-6
1/2	109PP-8	7-109PP-8

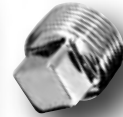

### Close Nipple

Pipe Size	Brass Part #	Chrome Part #
1/8	112PCN-2	7-112PCN-2
1/4	112PCN-4	7-112PCN-4
3/8	112PCN-6	7-112PCN-6



### Long Nipple

Pipe Size	Brass Part #	Chrome Part #
1/8 x 1 1/2	113PLN-2 x 1.5	7-113PLN-2 x 1.5
1/8 x 2	113PLN-2 x 2	7-113PLN-2 x 2
1/8 x 2 1/2	113PLN-2 x 2.5	7-113PLN-2 x 2.5
1/8 x 3	113PLN-2 x 3	7-113PLN-2 x 3
1/4 x 1 1/2	113PLN-4 x 1.5	7-113PLN-4 x 1.5
1/4 x 2	113PLN-4 x 2	7-113PLN-4 x 2
1/4 x 2 1/2	113PLN-4 x 2.5	7-113PLN-4 x 2.5
1/4 x 3	113PLN-4 x 3	7-113PLN-4 x 3
3/8 x 1 1/2	113PLN-6 x 1.5	7-113PLN-6 x 1.5
3/8 x 2	113PLN-6 x 2	7-113PLN-6 x 2



### Hex Nipple

Pipe Size	Brass Part #	Chrome Part #
1/8	122PHN-2	7-122PHN-2
1/4	122PHN-4	7-122PHN-4
3/8	122PHN-6	7-122PHN-6



### Hex Reducing Nipple

Pipe Size	Brass Part #	Chrome Part #
1/4 x 1/8	123PRN-4 x 2	7-123PRN-4 x 2
3/8 x 1/4	123PRN-6 x 4	7-123PRN-6 x 4



### Adapter

Pipe Size	Brass Part #	Chrome Part #
1/8 x 1/8	120PA-2 x 2	7-120PA-2 x 2
1/4 x 1/8	120PA-4 x 2	7-120PA-4 x 2
1/4 x 1/4	120PA-4 x 4	7-120PA-4 x 4
3/8 x 1/4	120PA-6 x 4	7-120PA-6 x 4





Fittings

## Pipe Bushing

Pipe Size	Brass Part #	Chrome Part #
1/4 x 1/8	110PB-4 x 2	7-110PB-4 x 2
3/8 x 1/8	110PB-6 x 2	7-110PB-6 x 2
3/8 x 1/4	110PB-6 x 4	7-110PB-6 x 4
1/2 x 1/4	110PB-8 x 4	7-110PB-8 x 4
1/2 x 3/8	110PB-8 x 6	7-110PB-8 x 6



## Inverted Flare Fittings

### Brass Inverted Flare Tube Nut

O.D. Tube	Brass Part #	Chrome Part #
3/16	411NB-3	7-411NB-3
1/4	411NB-4	7-411NB-4
5/16	411NB-5	7-411NB-5
3/8	411NB-6	7-411NB-6



## Pipe Thread Lock Nut

Pipe Size	Brass Part #	Chrome Part #
1/8	111PLN-2	7-111PLN-2
1/4	111PLN-4	7-111PLN-4
3/8	111PLN-6	7-111PLN-6



### Steel Inverted Flare Long Tube Nut

O.D. Tube	Brass Part #	Chrome Part #
3/16	411NL-3	7-411NL-3
1/4	411NL-4	7-411NL-4



## Pipe Tee

Pipe Size	Brass Part #	Chrome Part #
1/8	101PT-2	7-101PT-2
1/4	101PT-4	7-101PT-4
3/8	101PT-6	7-101PT-6



### Inverted Flare Male Connectors

O.D. Tube	O.D. Pipe	Brass Part #	Chrome Part #
3/16	1/8	48IC-3 x 2	7-48IC-3 x 2
1/4	1/8	48IC-4 x 2	7-48IC-4 x 2
5/16	1/8	48IC-5 x 2	7-48IC-5 x 2
5/16	1/4	48IC-5 x 4	7-48IC-5 x 4
3/8	1/8	48IC-6 x 2	7-48IC-6 x 2
3/8	1/4	48IC-6 x 4	7-48IC-6 x 4



## Pipe Street Tee

Pipe Size	Brass Part #	Chrome Part #
1/8	127PT-2	7-127PT-2
1/4	127PT-4	7-127PT-4
3/8	127PT-6	7-127PT-6



### Inverted Flare Male Elbow

O.D. Tube	O.D. Pipe	Brass Part #	Chrome Part #
3/16	1/8	49IE-3 x 2	7-49IE-3 x 2
1/4	1/8	49IE-4 x 2	7-49IE-4 x 2
5/16	1/8	49IE-5 x 2	7-49IE-5 x 2
5/16	1/4	49IE-5 x 4	7-49IE-5 x 4
3/8	1/8	49IE-6 x 2	7-49IE-6 x 2
3/8	1/4	49IE-6 x 4	7-49IE-6 x 4



## Straight Heater Hose Barb

Hose Size	Pipe Size	Brass Part #	Chrome Part #
5/8	3/8	68HHB-10 x 6	7-68HHB-10 x 6
5/8	1/2	68HHB-10 x 8	7-68HHB-10 x 8
3/4	1/2	68HHB-12 x 8	7-68HHB-12 x 8
3/8	3/8	68HHB-6 x 6	7-68HHB-6 x 6
1/2	3/8	68HHB-8 x 6	7-68HHB-8 x 6



### Inverted Male Rigid Hose Barb

Hose Size	O.D. Tube	Brass Part #	Chrome Part #
1/4	1/4	93HB-4 x 4	7-93HB-4 x 4
1/4	5/16	93HB-4 x 5	7-93HB-4 x 5
5/16	1/4	93HB-5 x 4	7-93HB-5 x 4
5/16	5/16	93HB-5 x 5	7-93HB-5 x 5
5/16	3/8	93HB-5 x 6	7-93HB-5 x 6
3/8	5/16	93HB-6 x 5	7-93HB-6 x 5



## Extended Straight Heater Hose Barb

Hose Size	Pipe Size	Chrome Part #
5/8	1/2	7-68HHBL-10 x 8



## 90° Heater Hose Barb

Hose Size	Pipe Size	Brass Part #	Chrome Part #
5/8	3/8	69HHB-10 x 6	7-69HHB-10 x 6
5/8	1/2	69HHB-10 x 8	7-69HHB-10 x 8
3/4	1/2	69HHB-12 x 8	7-69HHB-12 x 8
3/8	3/8	69HHB-6 x 6	7-69HHB-6 x 6
1/2	3/8	69HHB-8 x 6	7-69HHB-8 x 6



### Inverted Flare Reducing Nut

O.D. Tube	Inv. Nut	Brass Part #	Chrome Part #
3/16	1/4	411NR-3 x 4	7-411NR-3 x 4
3/16	5/16	411NR-3 x 5	7-411NR-3 x 5
3/16	9/16	411NR-3 x 9/16	7-411NR-3 x 9/16
1/4	9/16	411NR-4 x 9/16	7-411NR-4 x 9/16







# Inverted and Special Fittings

## Steel Inverted Flare Nut

O.D. Tube	Brass Part #	Chrome Part #
3/16	41INS-3	7-41INS-3
1/4	41INS-4	7-41INS-4
5/16	41INS-5	7-41INS-5
3/8	41INS-6	7-41INS-6



## Inverted Flare Steel Plug

O.D. Tube	Brass Part #	Chrome Part #
3/16	W131-3	7-W131-3
1/4	W131-4	7-W131-4
5/16	W131-5	7-W131-5
3/8	W131-6	7-W131-6



## Inverted Flare Union Tee

O.D. Tube	Brass Part #	Chrome Part #
3/16	W702-3	7-W702-3
1/4	W702-4	7-W702-4
5/16	W702-5	7-W702-5

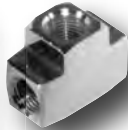

## Inverted Flare Brake Line Union

O.D. Tube	Brass Part #	Chrome Part #
3/16	42IU-3	7-42IU-3
1/4	42IU-4	7-42IU-4
5/16	42IU-5	7-42IU-5
3/8	42IU-6	7-42IU-6



## Brake Line Tee Mount Inverted Flare

O.D. Tube	Brass Part #	Chrome Part #
3/16	W7812	7-W7812
1/4	W7765	7-W7765

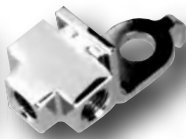

## Metric Brake Line Adapter

Inverted Female x Male Thread	Brass Part #	Chrome Part #
3/16 std 10mm x 1.0	202M-10	7-202M-10
10mm x 1.0 x 11mm x 1.5	202M-11	7-202M-11
10mm x 1.0 x 12mm x 1.0	202M-12	7-202M-12
10mm x 1.0 x 13mm x 1.5	202M-13	7-202M-13

## Inverted Flare Male Branch Tee

Size	Brass Part #	Chrome Part #
3/16	W600-3 x 2	7-W600-3 x 2
1/4	W600-4 x 2	7-W600-4 x 2
5/16	W600-5 x 2	7-W600-5 x 2
3/8	W600-6 x 4	7-W600-6 x 4



## Compression Fittings Brass

### Compression Sleeve

O.D. Tube	Part #
1/8	6460CS-2
3/16	6460CS-3
1/4	6460CS-4
5/16	6460CS-5
3/8	6460CS-6



### Compression Nut

O.D. Tube	Brass Part #	Chrome Part #
1/8	61CN-2	7-61CN-2
3/16	61CN-3	7-61CN-3
1/4	61CN-4	7-61CN-4
5/16	61CN-5	7-61CN-5
3/8	61CN-6	7-61CN-6

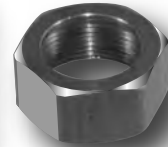

### Compression Tube Inserts

O.D. Tube	Part #
1/8	60TI-2
3/16	60TI-3
1/4	60TI-4
5/16	60TI-5
3/8	60TI-6



### Compression Full Union

O.D. Tube	Brass Part #	Chrome Part #
1/8	62CU-2	7-62CU-2
3/16	62CU-3	7-62CU-3
1/4	62CU-4	7-62CU-4
5/16	62CU-5	7-62CU-5
3/8	62CU-6	7-62CU-6



### Compression 3 Way Tee

O.D. Tube	Brass Part #	Chrome Part #
1/8	64CT-2	7-64CT-2
3/16	64CT-3	7-64CT-3
1/4	64CT-4	7-64CT-4
5/16	64CT-5	7-64CT-5
3/8	64CT-6	7-64CT-6





## Compression Male Connector

O.D. Tube	Brass Part #	Chrome Part #
1/8 x 1/8	68CC-2 x 2	7-68CC-2 x 2
3/16 x 1/8	68CC-3 x 2	7-68CC-3 x 2
1/4 x 1/8	68CC-4 x 2	7-68CC-4 x 2
1/4 x 1/4	68CC-4 x 4	7-68CC-4 x 4
5/16 x 1/8	68CC-5 x 2	7-68CC-5 x 2
5/16 x 1/4	68CC-5 x 4	7-68CC-5 x 4
3/8 x 1/8	68CC-6 x 2	7-68CC-6 x 2
3/8 x 1/4	68CC-6 x 4	7-68CC-6 x 4
3/8 x 3/8	68CC-6 x 6	7-68CC-6 x 6
1/2 x 1/4	68CC-8 x 4	7-68CC-8 x 4



## Hose Tee

Hose	Brass Part #	Chrome Part #
1/4	94HBT-4	7-94HBT-4
5/16	94HBT-5	7-94HBT-5
3/8	94HBT-6	7-94HBT-6



Fittings

## Compression Male Elbow

O.D. Tube	Brass Part #	Chrome Part #
1/8 x 1/8	69CE-2 x 2	7-69CE-2 x 2
3/16 x 1/8	69CE-3 x 2	7-69CE-3 x 2
1/4 x 1/8	69CE-4 x 2	7-69CE-4 x 2
1/4 x 1/4	69CE-4 x 4	7-69CE-4 x 4
5/16 x 1/8	69CE-5 x 2	7-69CE-5 x 2
5/16 x 1/4	69CE-5 x 4	7-69CE-5 x 4
3/8 x 1/8	69CE-6 x 2	7-69CE-6 x 2
3/8 x 1/4	69CE-6 x 4	7-69CE-6 x 4
3/8 x 3/8	69CE-6 x 6	7-69CE-6 x 6



## Transmission Adapter

Inv. Flare Str. Pipe	Brass Part #	Chrome Part #
5/16 x 1/8		



## Special Fittings

### Dual Brake Reducing Adapter

Hose/Hose	Brass Part #	Chrome Part #
3/16 x 1/4	203-3 x 4	7-203-3 x 4
3/16 x 5/16	203-3 x 5	7-203-3 x 5
1/4 x 3/16	203-4 x 3	7-203-4 x 3
1/4 x 5/16	203-4 x 5	7-203-4 x 5
5/16 x 1/4	203-5 x 4	7-203-5 x 4
5/16 x 3/8	203-5 x 6	7-203-5 x 6
3/8 x 5/16	203-6 x 5	7-203-6 x 5
1/4 x 1/4 (9/16-18)	203-7908	7-203-7908
3/16 x 3/16 (9/16-20)	203-7910	7-203-7910
3/16 x 3/16 (9/16-18)	203-7911	7-203-7911
3/16 (9/16-18) x 5/16	203-7912	7-203-7912
3/16 (1/2-20) x 3/16 (9/16-18)	203-7913	7-203-7913
5/16 x 5/16 w/seal	203F-1074	7-203F-1074
1/4 x 5/16 w/seal	203F-7727	7-203F-7727
1/4 x 7/16-20 w/seal	203F-7732	7-203F-7732
3/16 x 5/16 w/seal	203F-7817	7-203F-7817

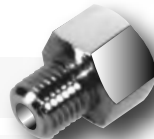

## Metric Brake Union

Thread/Flare	Brass Part #	Chrome Part #
3/16 Std/Bubble 3	300B-3	7-300B-3
10mm x 1.0 Standard	300M-3	7-300M-3
10mm x 1.0 Bubble 2	300MB-3	7-300MB-3



## Hose Splicer

Hose/Hose	Brass Part #	Chrome Part #
3/16 x 3/16	92HB-3 x 3	7-92HB-3 x 3
1/4 x 1/4	92HB-4 x 4	7-92HB-4 x 4
5/16 x 5/16	92HB-5 x 5	7-92HB-5 x 5
3/8 x 3/8	92HB-6 x 6	7-92HB-6 x 6





# Chrome and Brass Fittings

## Drain Cocks

Size	Brass #	Chrome #
1/4	326DC-4	7-326DC-4



## Brake Bleeder Screws Chrome

Size	Part #
3/8-24 x 1 1/2	45-9400
3/8-24 x 1 1/8	45-9402
5/16-24 x 1	45-9403
1/4-28 x 1	45-9404
8mm x 1.25 x 23.8	45-9405
10mm x 1.5 x 27.5	45-9406



## Grease Fittings

Size	Part #
1/4-28 45° (Chrome)	57546
1/4-28 Straight	57547
1/4-28 Straight-Long	57547-L
1/4-28 90°	57548
1/8 45°	57549
1/8 Straight	57550
1/8 90°	57551
1/4-28 90° (Stainless)	88546
1/4-28 Straight	88547
1/8 Straight	88610
1/8 90°	88613
1/8 45°	88688



## Steel Brake Line Coil

Size	Part #
3/16	64542
1/4	64546
5/16	64548
3/8	64550



## Vacuum Connectors

### Vacuum Hose Splicer Plastic

Hose/Hose	Part #
1/8 x 1/8	62NU-2
3/16 x 3/16	62NU-3
1/4 x 1/4	62NU-4
5/16 x 5/16	62NU-5
3/8 x 3/8	62NU-6
3/16 x 1/8	62NUR-3 x 2
3/16 x 1/4	62NUR-3 x 4
1/4 x 1/8	62NUR-4 x 2
1/4 x 3/8	62NUR-4 x 6



### Vacuum Hose Elbow Plastic

Hose/Hose	Part #
3/16 x 3/16	64NE-3
3/16 x 1/8	64NE-3 x 2
3/16 x 1/4	64NE-3 x 4
1/4 x 1/4	64NE-4



### Vacuum Hose Tee Plastic

Hose/Hose	Part #
1/8	64NT-2
3/32	64NT-2.5
1/8 x 3/16 x 1/8	64NT-2 x 3 x 2
3/16	64NT-3
3/16 x 1/8 x 3/16	64NT-3 x 2 x 3
3/16 x 3/16 x 1/8	64NT-3 x 3 x 2
3/16 x 1/4 x 3/16	64NT-3 x 4 x 3
1/4	64NT-4
1/4 x 1/4 x 3/16	64NT-4 x 4 x 3
5/16	64NT-5
3/8	64NT-6
3/8 x 3/8 x 1/4	64NT-6 x 6 x 4



### Vacuum Rubber Caps

I.D.Hose	Part #
1/8	64CAP-2
5/32	64CAP-2.5
3/16	64CAP-3
1/4	64CAP-4
5/16	64CAP-5
3/8	64CAP-6





## Inside This Section

Detail Listing on each Unit

<b>J1POP-1</b> Hex Caps and Hex Nuts (Chrome Plated).....	76
<b>J1POP-2</b> Washers, Body Bolts and Pipe Plugs (Chrome Plated).....	76
<b>J1POP-3</b> Oval Phillips, Slotted Machine and Sheet Metal Screws (Chrome Plated).....	77
<b>J1POP-4</b> Button Head, Carriage Bolts and Lock Nuts (Chromed Plated).....	77
<b>J1POP-5</b> Brass Fittings Hand Polished (Chrome Plated).....	78
<b>LOGO DISPLAYERS</b> Counter Top Unit with Stamped Hex Caps.....	78
<b>J1POP-6</b> Ford and Chrysler Mopar Bolt Kits (Chrome & Polished Stainless).....	79
<b>J1POP-7</b> Chevy Kits and Bowtie Stamped Bolts.....	80
<b>J1POP-8</b> Chevy Bowtie and Ford Oval Stamped Bolts Kits.....	81
<b>J1POP-9</b> Chevy, Ford and Mopar Kits.....	82
<b>J1POP-10</b> Metric Screw Kits (Chrome Plated).....	83
<b>J1POP-11</b> Ford Oval Stamped Bolt Kits (Chrome Plated & Polished Stainless).....	84
<b>J1POP-12</b> Metric Screw Kits (Stainless Steel).....	85
<b>J1POP-14</b> Ford & Ford Oval Stamped Bolt Kits (Chrome Plated).....	86
<b>J1POP-15</b> Ford Oval Stamped Bolt Kits (Chrome Plated).....	86
<b>J1POP-16</b> Pontiac Arrow Stamped Bolt Kits (Chrome Plated).....	87
<b>J2POP-1</b> Combination of J1POP-1 & J1POP-2 Units (Chrome Plated).....	88
<b>J2POP-2</b> Combination of J1POP-3 & J1POP-4 Units (Chrome Plated).....	89
<b>J2POP-3</b> Nuts, Washers, Button Heads, Hex Caps, Lock Nuts & Sheet Metal Screws (Polished Stainless).....	90

## Product Display Units



Hex Caps and Hex Nuts  
Chrome Plated  
#J1POP-1 Full Floor Unit



Logo Stamped  
Counter Top Display Unit



Brass Fittings Chrome Plated  
#J1POP-5 Counter Top Unit

What a simple way to organized and showcase your chrome plated and stainless steel fastener products.

- **Increases product visibility.**
- **Contains the most popular sizes sought after by auto enthusiasts.**
- **Allows wider range of product in least amount of space.**
- **Simple to stock and reorder.**
- **Customizing available to fit your needs.**



# P.O.P. Unit Descriptions

## COUNTER TOP UNITS



**J1POP-1 Hex Caps & Hex Nuts - contains (48) items in chrome and (2) ea. carded kits of the following fasteners:**

Kit Part #	Description	Qty. per card	Kit Part #	Description	Qty. per card	Kit Part #	Description	Qty. per card
J0012	1/4-20 x 1/2 Hex Caps	(4)	J0108	3/8-16 x 1 1/2 Hex Caps	(4)	J0765	10/24 Hex Nuts	(12)
J0016	1/4-20 x 3/4 Hex Caps	(4)	J0110	3/8-16 x 1 3/4 Hex Caps	(4)	J0766	10/32 Hex Nuts	(12)
J0020	1/4-20 x 1 Hex Caps	(4)	J0112	3/8-16 x 2 Hex Caps	(4)	J0768	1/4-20 Hex Nuts	(15)
J0050	5/16-18 x 5/8 Hex Caps	(4)	J0114	3/8-16 x 2 1/4 Hex Caps	(4)	J0769	1/4-28 Hex Nuts	(15)
J0052	5/16-18 x 3/4 Hex Caps	(4)	J0116	3/8-16 x 2 1/2 Hex Caps	(4)	J0770	5/16-18 Hex Nuts	(13)
J0053	5/16-24 x 3/4 Hex Caps	(4)	J0118	3/8-16 x 2 3/4 Hex Caps	(3)	J0771	5/24-24 Hex Nuts	(13)
J0056	5/16-18 x 1 Hex Caps	(4)	J0120	3/8-16 x 3 Hex Caps	(3)	J0772	3/8-16 Hex Nuts	(11)
J0059	5/16-18 x 1 1/4 Hex Caps	(4)	J0148	7/16-14 x 1 Hex Caps	(3)	J0773	3/8-24 Hex Nuts	(11)
J0065	5/16-18 x 2 Hex Caps	(4)	J0150	7/16-14 x 1 1/4 Hex Caps	(3)	J0774	7/16-14 Hex Nuts	(7)
J0068	5/16-24 x 2 1/4 Hex Caps	(4)	J0156	7/16-14 x 2 Hex Caps	(3)	J0775	7/16-20 Hex Nuts	(7)
J0069	5/16-18 x 2 1/2 Hex Caps	(4)	J0184	1/2-13 x 1 Hex Caps	(3)	J0776	1/2-13 Hex Nuts	(6)
J0098	3/8-16 x 3/4 Hex Caps	(4)	J0188	1/2-13 x 1 1/2 Hex Caps	(3)	J0777	1/2-20 Hex Nuts	(6)
J0099	3/8-24 x 3/4 Hex Caps	(4)	J0189	1/2-20 x 1 1/2 Hex Caps	(3)	J0778	9/16-12 Hex Nuts	(5)
J0102	3/8-16 x 1 Hex Caps	(4)	J0192	1/2-13 x 2 Hex Caps	(3)	J0779	9/16-18 Hex Nuts	(5)
J0103	3/8-24 x 1 Hex Caps	(4)	J0196	1/2-13 x 2 1/2 Hex Caps	(3)	J0780	5/8-11 Hex Nuts	(5)
J0106	3/8-16 x 1 1/4 Hex Caps	(4)	J0197	1/2-20 x 2 1/2 Hex Caps	(3)	J0781	5/8-18 Hex Nuts	(5)

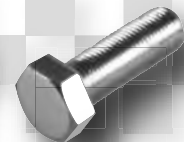

**J1POP-2 Washers, Body Bolts & Pipe Plugs - contains (48) Items in chrome and (2) ea. carded kits of the following:**

Kit Part #	Description	Qty. per card	Kit Part #	Description	Qty. per card	Kit Part #	Description	Qty. per card
J0852	#10 Flat Washers	(14)	J0876	5/16 AN Washers	(11)	J2229	5/16 x 13/16 Pol. Body Bolts	(4)
J0854	1/4 Flat Washers	(15)	J0877	3/8 AN Washers	(10)	J2230	5/16 x 1 1/4 Pol. Body Bolts	(3)
J0855	5/16 Flat Washers	(13)	J0878	7/16 AN Washers	(8)	J2255	1/4-20 x 7/8 Hex Sems	(4)
J0856	3/8 Flat Washers	(11)	J0879	1/2 AN Washers	(7)	J2256	5/16-18 x 1 Hex Sems	(4)
J0857	7/16 Flat Washers	(10)	J0880	9/16 AN Washers	(6)	J2257	3/8-16 x 3/4 Hex Sems	(3)
J0858	1/2 Flat Washers	(9)	J0881	5/8 AN Washers	(6)	J2258	3/8-16 x 1 Hex Sems	(3)
J0859	9/16 Flat Washers	(8)	J2250	3/8 x 1 1/4 Shock Washers	(4)	J2259	3/8-16 1 1/2 Hex Sems	(3)
J0860	5/8 Flat Washers	(8)	J2251	1/2 x 1 1/4 Shock Washers	(4)	J2261	1/4-20 x 5/8 Spin Locks	(6)
J0865	1/4 Lock Washers	(15)	J2252	1/2 x 1 7/16 Shock Washers	(4)	J2262	5/16-18 x 3/4 Spinlocks	(4)
J0866	5/16 Lock Washers	(13)	J2253	5/8 x 1 1/4 Shock Washers	(4)	J2263	5/16-18 x 1 Spinlocks	(4)
J0867	3/8 Lock Washers	(11)	J2223	5/16-18 x1 SS Body Bolts	(1)	J2264	5/16-18 X 1 1/4 Spinlocks	(4)
J0868	7/16 Lock Washers	(10)	J2224	14 x 3/4 Body Bolts 3/8 AF	(10)	J2265	3/8-16 x 1 Spinlocks	(3)
J0869	1/2 Lock Washers	(9)	J2225	14 x 3/4 Pol. Body Bolts 3/8 AF	(9)	J2266	5/16-24 x 1 Spinlocks	(5)
J0870	9/16 Lock Washers	(8)	J2226	14 x 3/4 Body Bolts 7/16 AF	(9)	J2267	3/8 Pipe Plugs	(3)
J0871	5/8 Lock Washers	(8)	J2227	5/16 x 13/16 Body Bolts	(7)	J2268	1/2 Pipe Plugs	(2)
J0875	1/4 AN Washers	(12)	J2228	5/16 x 1 1/4 Body Bolts	(4)	J2269	3/4 Pipe Plugs	(2)



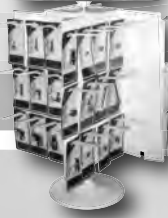

# P.O.P Unit Descriptions



## COUNTER TOP UNITS

**J1POP-3 Oval Slotted & Phillips Machine Screws - contains (48) items in chrome and (2) ea. carded kits of the following fasteners:**

Kit Part #	Description	Qty. per card	Kit Part #	Description	Qty. per card	Kit Part #	Description	Qty. per card
J0982	- 6/32 x 3/8 Oval Slot MS	(5)	J1020	- 12/24 x 1 Oval Slot MS	(4)	J1298	- 8 x 3/4 Oval Phillips SMS	(6)
J0983	- 6/32 x 1/2 Oval. Sl. MS	(5)	J1025	- 1/4-20 x 1 Oval. Sl. MS	(6)	J1299	- 8 x 3/4 Oval. Ph. # 6 Hds. SMS	(6)
J0985	- 6/32 x 3/4 Oval. Sl. MS	(5)	J1036	- 5/16-24 x 1 Oval. Sl. MS	(5)	J1300	- 8 x 7/8 Oval. Ph. SMS	(6)
J0986	- 6/32 x 1 Oval. Sl. MS	(5)	J1157	- 10/32 x 3/8 Oval. Ph. MS	(6)	J1301	- 8 x 7/8 Oval. Ph. # 6 Hds. SMS	(6)
J0992	- 8/32 x 1/2 Oval. Sl. MS	(7)	J1159	- 10/32 x 1/2 Oval. Ph. MS	(6)	J1302	- 8 x 1 Oval. Ph. SMS	(6)
J1001	- 10/24 x 1/2 Oval. Sl. MS	(6)	J1162	- 10/24 x 3/4 Oval. Ph. MS	(6)	J1303	- 8 x 1 Oval. Ph. # 6 Hds. SMS	(6)
J1002	- 10/32 x 1/2 Oval. Sl. MS	(6)	J1163	- 10/32 x 3/4 Oval. Ph. MS	(6)	J1304	- 8 x 1 1/4 Oval. Ph. SMS	(6)
J1005	- 10/24 x 3/4 Oval. Sl. MS	(6)	J1166	- 10/24 x 1 Oval. Ph. MS	(6)	J1305	- 8 x 1 1/4 Oval. Ph. # 6 Hds. SMS	(5)
J1006	- 10/32 x 3/4 Oval. Sl. MS	(6)	J1167	- 10/32 x 1 Oval. Ph. MS	(6)	J1306	- 8 x 1 1/2 Oval. Ph. SMS	(5)
J1008	- 10/32 x 1 Oval. Sl. MS	(6)	J1182	- 1/4-20 x 3/4 Oval. Ph. MS	(6)	J1307	- 8 x 1 1/2 Oval. Ph. # 6 Hds. SMS	(5)
J1010	- 10/32 x 1 1/4 Oval. Sl. MS	(4)	J1183	- 1/4-20 x 1 Oval. Ph. MS	(6)	J1308	- 8 x 3/4 Oval. Ph. # 6 Hds. SMS	(4)
J1012	- 10/32 x 1 1/2 Oval. Sl. MS	(4)	J1186	- 1/4-20 x 1 1/2 Oval. Ph. MS	(6)	J1309	- 8 x 3/4 Oval. Ph. SMS	(6)
J1013	- 10/32 x 1 3/4 Oval. Sl. MS	(4)	J1294	- 8 x 1/2 Oval. Ph. SMS	(6)	J1310	- 8 x 2 Oval. Ph. SMS	(5)
J1014	- 10/32 x 2 Oval. Sl. MS	(4)	J1295	- 8 x 1/2 Oval. Ph. HD SMS	(6)	J1311	- 8 x 2 Oval. Ph. # 6 Hds. SMS	(4)
J1017	- 12/24 x 1/2 Oval. Sl. MS	(4)	J1296	- 8 x 5/8 Oval. Ph. SMS	(6)	J1315	- 10 x 3/4 Oval. Ph. SMS	(7)
J1019	- 12/24 x 3/4 Oval Sl. MS	(4)	J1297	- 8 x 5/8 Oval. Ph. #6 Hds.	(6)	J1317	- 12 x 1 Oval. Ph. SMS	(4)

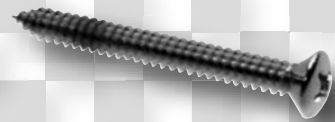

**J1POP-4 Button Heads, Carriage Bolts & Super Washers - contains (48) items in chrome and (2) ea. carded kits of the following:**

Kit Part #	Description	Qty. per card	Kit Part #	Description	Qty. per card	Kit Part #	Description	Qty. per card
J0535	- 8/32 x 1/2 Button Heads	(4)	J0618	- 3/8-16 x 1 1/2 Btn. Hds.	(2)	J0891	- 1/4 x 1 1/2 Carriage Bolts w/HN	(4)
J0546	- 10/24 x 1/2 Btn. Hds.	(4)	J0793	- 1/4-20 Lock Nuts	(8)	J0901	- 5/16 x 1 Carriage Bolts w/HN	(4)
J0547	- 10/32 x 1/2 Btn. Hds.	(4)	J0794	- 1/4-28 Lock Nuts	(8)	J0903	- 5/16 x 1 1/2 Carriage Bolts w/HN	(4)
J0550	- 10/24 x 3/4 Btn. Hds.	(4)	J0795	- 5/16-18 Lock Nuts	(8)	J0914	- 3/8-16 x 1 Carriage Bolts w/HN	(4)
J0551	- 10/32 x 3/4 Btn. Hds.	(4)	J0796	- 5/16-24 Lock Nuts	(8)	J0917	- 3/8-16 x 2 Carriage Bolts w/HN	(4)
J0564	- 1/4-20 x 1/2 Btn. Hds.	(4)	J0797	- 3/8-16 Lock Nuts	(6)	J0918	- 3/8 x 2 1/2 Carriage Bolts w/HN	(3)
J0568	- 1/4-20 x 3/4 Btn. Hds.	(4)	J0798	- 3/8-24 Lock Nuts	(6)	J0926	- 7/16-14 x 1 1/4 Cge. Bolts w/HN	(3)
J0572	- 1/4-20 x 1 Btn. Hds.	(4)	J0799	- 7/16-14 Lock Nuts	(5)	J0928	- 7/16-14 x 1 3/4 Cge. Bolts w/HN	(3)
J0574	- 1/4-20 x 1 1/4 Btn. Hds.	(4)	J0800	- 7/16-20 Lock Nuts	(5)	J0938	- 1/2-13 x 1 3/4 Cge. Bolts w/HN	(3)
J0588	- 5/16-18 x 3/4 Btn. Hds.	(4)	J0801	- 1/2-13 Lock Nuts	(5)	J2271	- 3/16 x 1 Super Washers	(5)
J0589	- 5/16-24 x 3/4 Btn. Hds.	(4)	J0802	- 1/2-20 Lock Nuts	(5)	J2272	- 1/4 x 1 Super Washers	(5)
J0592	- 5/16-18 x 1 Btn. Hds.	(4)	J0803	- 9/16-12 Lock Nuts	(4)	J2273	- 5/16 x 1 1/8 Super Washers	(5)
J0593	- 5/16-24 x 1 Btn. Hds.	(4)	J0804	- 9/16-18 Lock Nuts	(4)	J2274	- 5/16 x 1 1/2 Super Washers	(4)
J0596	- 5/16-18 x 1 1/2 Btn. Hds.	(3)	J0805	- 5/8-11 Lock Nuts	(4)	J2275	- 3/8 x 1 1/2 Super Washers	(4)
J0610	- 3/8-16 x 3/4 Btn. Hds.	(4)	J0806	- 5/16-16 Lock Nuts	(4)	J2276	- 7/16 x 1 Super Washers	(6)
J0614	- 3/8-16 x 1 Btn. Hds.	(4)	J0888	- 1/4 x 3/4 Carriage w/HN	(4)	J2277	- 1/2 x 1 1/4 Super Washers	(6)

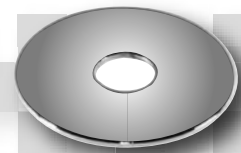



# P.O.P. Unit Descriptions

## COUNTER TOP UNITS



### J1POP-5 Polished Brass Fittings Show Chrome Plated -

*contains (47) items in chrome and (3) ea. carded kits of the following fasteners:*

*Gardner-Westcott took the standard brass fitting and hand polished it to a smooth mirror finish, than we Show Chrome Plated it. We then carded our hottest selling parts to create this counter top display unit. This turnable display unit contains 3 each of 47 different carded skin packed items.*

#### Heater Hose Barb 90°

- J9001 5/8" Hose 1/2" Pipe (3)
- J9002 5/8" Hose 3/8" Pipe (3)

#### Heater Hose Barb Straight

- J9003 5/8" Hose 1/2" Pipe (3)
- J9004 5/8" Hose 3/8" Pipe (3)
- J9005 3/4" Hose 1/2" Pipe (3)

#### Hex Head Pipe Plugs

- J9006 1/2" (3)
- J9007 3/8" (3)
- J9008 1/4" (3)
- J9009 1/8" (3)

#### Inverted Flare Fittings

- J9010 3/16" Tube 1/8" Pipe 45° Male Elbow (3)
- J9011 3/16" x 1/4" Reducing Nut (3)
- J9023 1/8" Tube Nut Steel (3)
- J9024 Brake Line Union 3/16" (3) □
- J9040 3/16" Flare 1/8" Pipe Male Connector (3)
- J9041 3/16" x 1/8" Inv. Flare Female Branch Tee (3)

#### Transmission Adapter

- J9012 5/16" x 5/16" Inv. Flare Trans. Adapter (3)
- J9013 3/8" x 3/8" Inv. Nut Trans. Adapter (3)

#### Socket Pipe Plugs

- J9014 1/8" Socket Pipe Plugs (3)
- J9015 1/4" Socket Pipe Plugs (3)
- J9016 3/8" Socket Pipe Plugs (3)
- J9017 1/2" Socket Pipe Plugs (3)

#### Pipe Bushing

- J9018 1/4" x 1/8" (3)
- J9019 3/8" x 1/8" (3)
- J9020 3/8" x 1/4" (3)

#### Street Elbow Fittings

- J9021 1/8" (3)
- J9022 1/4" (3)



Counter Top  
Display Unit



Part # J1POP-5  
Hand Polished Brass Fittings  
Show Chrome Plated  
Contains (3) each carded of 47 Items

#### Adapter

- J9025 1/8" x 1/8" Adapter (3)

#### Straight Hose Barb - Male Pipe

- J9026 3/16" Hose 1/8" Pipe M.H.B.P. (3)
- J9027 1/4" Hose 1/8" Pipe M.H.B.P. (3)
- J9028 5/16" Hose 1/8" Pipe M.H.B.P. (3)
- J9029 3/8" Hose 1/8" Pipe M.H.B.P. (3)
- J9030 3/8" Hose 1/4" Pipe M.H.B.P. (3)

#### 90° Hose Barb - Male Pipe

- J9031 5/16" Hose 1/8" Pipe 90° (3)
- J9032 3/8" Hose 1/8" Pipe 90° (3)
- J9033 3/8" Hose 1/4" Pipe 90° (3)

#### Brake Line Tee and Union

- J9034 3/16" Brake Line Tee w/Mount (3)
- J9035 3/16" Inv. Flare Union Tee (3)

#### Nipple

- J9036 1/8" Close Nipple (3)
- J9037 1/8" x 1 1/2" Long Nipple (3)

#### Drain Cock

- J9038 1/4" Drain Cocks (3)

#### Male Pipe Rigid Straight Hose Barb

- J9043 1/8" Hose 1/8" Pipe (3)
- J9044 1/4" Hose 1/8" Pipe (3)
- J9045 3/8" Hose 1/4" Pipe (3)

#### Brake Bleeder Screws

- J9046 3/8"-24 x 1 1/2" (3)
- J9047 3/8"-24 x 1 1/4" (3)
- J9048 5/16"-24 x 1" (3)
- J9049 1/4"-28 x 1" (3)

## Logo Displayer Counter Top Unit

*Gardner-Westcott also has a great way to showcase our very popular line of emblem stamped hex caps. Now your customers can see first hand the exceptional quality of each hand stamped emblem displayed on a green plastic stand that measures 7" high x 7" wide with a 3" base and can be placed in a highly visible area on your counter top. Each logo hex cap is identified with white letters clearly showing the Chevy Bowtie, Chevy SS, Chevy RS, Pontiac, Pontiac GT, Pontiac GTO, 350, 454, Oldsmobile Rocket, Chrysler Pentastar, Chrysler Mopar, Hemi Mopar, Dodge Ram, Ford Oval, Ford Vintage V-8, Mustang Pony, Flame and Skull. And we have added a few head styles to round out the display like Hex Caps Chrome Plated, Hex Caps Polished Stainless Steel, Allen Head Chrome Plated, Allen Head Stainless Steel Polished, 12 Point Chrome Plated, Button Head Allen Chrome Plated, Torx Button Head Chrome Plated and Flat Head Allen Chrome Plated.*



Logo Display Counter Top Unit  
Chrome Plated and Polished  
Stainless Steel Fasteners  
Part # Logo Display

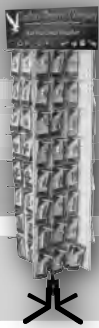

# P.O.P Unit Descriptions



## FULL FLOOR UNITS

**J1POP-6 Ford and Mopar Engine Dress up kits - contains (80) items in chrome and polished stainless steel (1) & (2) ea. carded kits of the following kits:**



### Ford Chrome Hex Cap Kits

Kit Part #	Description	Qty. of cards
56255-H	- 351 Cleveland Engine Dress Up Kit	(1)
56250-H	- S/B Engine Dress Up Kit	(1)
56248-H	- 302 Exhaust Manifold Kit	(2)
56246-H	- 429 Intake Manifold Kit	(2)
56244-H	- 390 Timing Cover Kit	(2)
56242-H	- 289 Timing Cover Kit	(2)
56243-H	- 351 Cleveland Fuel Pump Kit	(2)
56240-H	- 289, 302 Fuel Pump Kit	(2)
56236-H	- 700-R4 Trans Pan (1986) Kit	(2)
56235-H	- C-4 Transmission Kit	(2)
56234-H	- C-6 Trans Pan Kit	(2)
56232-H	- 351 Cleveland & 400 Oil Pan Kit	(2)
56231-H	- 289, 302 Oil Pan Kit	(2)
56230-H	- Water Neck Kit	(2)
56227-H	- 289 Aluminum Valve Cover Kit	(2)
56226-H	- 428 Steel Valve Cover Kit	(2)
56225-H	- 400 Steel Valve Cover Kit	(2)
56224-H	- 289 Steel Valve Cover Kit	(2)
56223-H	- 7/16 Header Bolts Kit	(2)
56222-H	- 351 Cleveland Intake Manifold Kit	(2)
56221-H	- 289 Intake Manifold Kit	(2)

### Ford Stainless Steel Hex Cap Kits

Kit Part #	Description	Qty. of cards
56255-HSP	- 351 Cleveland Engine Dress Up Kit	(1)
56250-HSP	- S/B Engine Dress Up Kit	(1)
56248-HSP	- 302 Exhaust Manifold Kit	(2)
56246-HSP	- 429 Intake Manifold Kit	(2)
56244-HSP	- 390 Timing Cover Kit	(2)
56242-HSP	- 289 Timing Cover Kit	(2)
56243-HSP	- 351 Cleveland Fuel Pump Kit	(2)
56240-HSP	- 289, 302 Fuel Pump Kit	(2)
56236-HSP	- 700-R4 Trans Pan (1986) Kit	(2)
56235-HSP	- C-4 Transmission Kit	(2)
56234-HSP	- C-6 Trans Pan Kit	(2)
56232-HSP	- 351 Cleveland & 400 Oil Pan Kit	(2)
56231-HSP	- 289, 302 Oil Pan Kit	(2)
56230-HSP	- Water Neck Kit	(2)
56227-HSP	- 289 Aluminum Valve Cover Kit	(2)
56226-HSP	- 428 Steel Valve Cover Kit	(2)
56225-HSP	- 400 Steel Valve Cover Kit	(2)
56224-HSP	- 289 Steel Valve Cover Kit	(2)
56223-HSP	- 7/16 Header Bolts Kit	(2)
56222-HSP	- 351 Cleveland Intake Manifold Kit	(2)
56221-HSP	- 289 Intake Manifold Kit	(2)



**OFFICIAL LICENSED PRODUCT**

MOPAR, JEEP, DODGE, HEMI, PLYMOUTH, RAM, SRT, CHRYSLER and related logos, vehicle model names and trade dress are trademarks of Chrysler Group LLC and used under license by (licensee name). ©2015 Chrysler Group LLC

### Mopar Chrome Hex Cap Kits

Kit Part #	Description	Qty. of cards
56332-H	- B/B Engine Dress Up Kit	(1)
56330-H	- S/B Engine Dress Up Kit	(1)
56306-H	- B/B Fuel Pump Kit	(2)
56305-H	- S/B Water Pump Kit	(2)
56304-H	- S/B Valve Cover Kit	(2)
56303-H	- S/B Header Bolt Kit	(2)
56302-H	- S/B Intake Manifold Kit	(2)
56301-H	- S/B Oil Pan Kit	(2)
09012	- Chrome Throttle Return Spring	(2)
09012 - Blu	- Blue Throttle Return Spring	(2)
09015	- Gold Throttle Return Spring	(2)
P-31-100	- Ch. Valve Stem Covers	(2)
56220-B	- Ch. Bullet License Plate Kit	(2)
4083	- Ch. 5/16 x 1 3/8 Carb Stud Kit	(2)
4084	- Ch. 5/16 x 1 1/2 Carb Stud Kit	(2)
57605-C	- Interior Trim 4 Dr. Screw Kit	(2)
57602-C	- Interior Trim 2 Dr. Screw Kit	(2)
J9001	- 90° Heater Hose 5/8 x 1/2	(2)
J9002	- 90° Heater Hose 5/8 x 3/8	(2)

### Mopar Stainless Steel Hex Cap Kits

Kit Part #	Description	Qty. of cards
56332-HSP	- B/B Engine Dress Up Kit	(1)
56330-HSP	- S/B Engine Dress Up Kit	(1)
56306-HSP	- B/B Fuel Pump Kit	(2)
56305-HSP	- S/B Water Pump Kit	(2)
56304-HSP	- S/B Valve Cover Kit	(2)
56303-HSP	- S/B Header Bolt Kit	(2)
56302-HSP	- S/B Intake Manifold Kit	(2)
56301-HSP	- S/B Oil Pan Kit	(2)
09012-Re	- Red Throttle Return Spring	(2)
09012-BLK	- Black Throttle Return Spring	(2)
67561-L	- 11/16-18 Left Hand Jam Nuts	(2)
67561-R	- 11/16-18 Right Hand Jam Nuts	(2)
4086	- SS. 5/16 x 1 3/8 Carb Stud Kit	(2)
4087	- SS. 5/16 x 1 1/2 Carb Stud Kit	(2)
J9003	- 5/8 x 1/2 Straight Heater Hose	(2)
J9004	- 5/8 x 3/8 Straight Heater Hose	(2)
J9005	- 3/4 x 1/2 Straight Heater Hose	(2)
J9038	- 1/4 Drain Cocks	(2)





# P.O.P. Unit Descriptions

## FULL FLOOR UNITS



**J1POP-7 Chevy Engine Dress Up Application - contains (98) items in chrome and polished stainless steel (1) & (2) ea. carded kits of the following:**



**Exclusively From Gardner-Westcott**

**Make a Chevy Statement with Gardner-Westcott's very popular Chevy Bow Tie Bolts, The emblem is stamped directly onto the head of the bolts. Available in our Show Chrome Plated version or Polished Stainless Steel.**



### Chrome Plated Hex Cap Kits

Kit Part #	Description	Qty. of cards
56490-H	- S/B Chevy Engine Dress Up Kit	(1)
56465-H	- Oil Pan Bolts S/B & LT-1 Kit	(1)
56485-H	- Steel Valve Covers B/B Kit	(1)
56468-H	- Water Pump S/B Short Kit	(1)
56464-H	- Timing Cover Kit	(1)
56484-H	- Bell Housing Kit	(1)
4083	- 5/16 x 1 3/8 Carb Stud Kit	(1)
4084	- 5/16 x 1 1/2 Carb Stud Kit	(1)
09112	- Chrome Throttle Return Springs	(3)
56220	- License Plate Kit	(1)
56461-H	- Header Bolts Kit	(1)
56418-H	- S/B Header Bolts 1" Long Kit	(1)
56477-H	- Exhaust Manifold w/ Flat Washers Kit	(1)
56469-H	- Intake Manifold S/B Kit	(1)

H= Hex Caps  
Chrome Plated

### Polished Chrome Allen Head Screw Kits

Kit Part #	Description	Qty. of cards
56490-P	- S/B Chevy Engine Dress Up Kit	(1)
56465-P	- Oil Pan Bolts S/B & LT-1 Kit	(1)
56485-P	- Valve Covers B/B Kit	(1)
56468-P	- Water Pump S/B Short Kit	(1)
56464-P	- Timing Cover Kit	(1)
56484-P	- Bell Housing Kit	(1)
56220-B	- Bullet License Plate Kit	(1)
56477-P	- Exhaust Manifold w/ Flat Washers Kit	(1)
56469-P	- Intake Manifold S/B Kit	(1)

P= Allen Screws  
Polished Chrome  
Plated

### Polished Stainless Steel Hex Cap Kits

Kit Part #	Description	Qty. of cards
56490-HSP	- S/B Chevy Engine Dress Up Kit	(1)
56465-HSP	- S/B & LT-1 Oil Pan Bolts Kit	(1)
56485-HSP	- B/B Steel Valve Covers Kit	(1)
56468-HSP	- S/B Water Pump Short Kit	(1)
56464-HSP	- Timing Cover Kit	(1)
56484-HSP	- Bell Housing Kit	(1)
56461-HSP	- S/B Header Bolt 3/4" Kit	(1)
56477-HSP	- Exhaust Manifold Kit	(1)
56469-HSP	- S/B Intake Manifold Kit	(1)
4086	- 1 3/8 Stainless Steel Carb Kit	(1)
4084	- 1 1/2 Stainless Steel Carb Kit	(1)
09113	- Stainless Steel Throttle Return Spring	(3)

HSP= Hex Caps  
Stainless Steel  
Polished

### Polished Stainless Steel Allen Head Screw Kits

Kit Part #	Description	Qty. of cards
56490-SSP	- S/B Chevy Engine Dress Up Kit	(1)
56465-SSP	- S/B & LT-1 Oil Pan Bolts Kit	(1)
56485-SSP	- B/B Valve Covers Kit	(1)
56468-SSP	- S/B Water Pump Short Kit	(1)
56464-SSP	- Timing Cover Kit	(1)
56484-SSP	- Bell Housing Kit	(1)
56461-SSP	- S/B Header Bolt Kit	(1)
56477-SSP	- Exhaust Manifold Kit	(1)
56469-SSP	- S/B Intake Manifold Kit	(1)
56220-SSP	- License Plate Kit	(2)

SSP= Allen Screws  
Stainless Steel  
Polished

### Chrome Chevy Bow Tie Hex Cap Kits

Kit Part #	Description	Qty. of cards
10-56490-H	- S/B Chevy Engine Dress Up Kit	(1)
10-56495-H	- LT-1 Engine Dress Up Kit	(1)
10-56465-H	- S/B Oil Pan Bolts Kit	(2)
10-56463-H	- S/B Valve Cover Steel Kit	(2)
10-56468-H	- S/B Short Water Pump Kit	(2)
10-56467-H	- S/B Extended Water Pump Kit	(2)
10-56464-H	- Timing Cover Kit	(2)
10-56400-H	- Timing Cover LT-1 Kit	(2)
10-56466-H	- S/B Valve Cover Aluminum Kit	(2)
10-56478-H	- Coil Mt. to Blk. & Flat Washer Kit	(2)
10-56461-H	- S/B Header Bolt Kit	(1)
10-56418-H	- S/B Header Bolt 1" Long Kit	(1)
10-56477-H	- Exhaust Manifold Kit	(2)
10-56469-H	- S/B Intake Manifold Kit	(2)

### Polished Stainless Bow Tie Hex Caps Kits

Kit Part #	Description	Qty. of cards
10-56490-HSP	- S/B Chevy Engine Dress Up Kit	(1)
10-56491-HSP	- B/B Engine Dress Up Kit	(1)
10-56465-HSP	- S/B Oil Pan Bolts Kit	(2)
10-56463-HSP	- S/B Valve Cover Steel Kit	(2)
10-56468-HSP	- S/B Short Water Pump Kit	(2)
10-56467-HSP	- S/B Extended Water Pump Kit	(2)
10-56464-HSP	- Timing Cover Kit	(2)
10-56484-HSP	- Bell Housing Kit	(2)
10-56466-HSP	- S/B Valve Cover Aluminum Kit	(2)
10-56401-HSP	- License Plate Bolt Kit	(2)
10-56461-HSP	- S/B Header Bolt Kit	(1)
10-56418-HSP	- S/B Header Bolt 1" Long Kit	(1)
10-56477-HSP	- Exhaust Manifold Kit	(2)
10-56469-HSP	- S/B Intake Manifold Kit	(2)

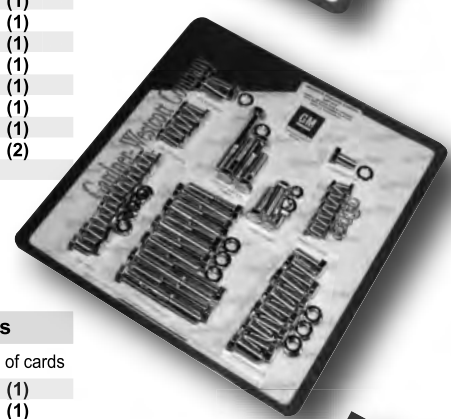

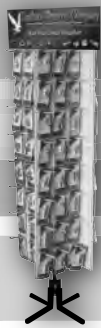

# P.O.P Unit Descriptions



## FULL FLOOR UNITS

**J1POP-8 Chevy Bow Tie & Ford Oval Stamped Fastener Kits - contains (89) items in chrome and stainless steel (2 & 3) ea. carded kits of the following:**

### Chevy Bow Tie Hex Cap Chrome Plated and Stainless Steel Kits

Engine Dress-Up Chrome Kits			Bow Tie Chrome Kits			Bow Tie Stainless Kits		
Kit Part #	Description	Qty. of cards	Kit Part #	Description	Qty. of cards	Kit Part #	Description	Qty. of cards
10-56490-H	S/B Engine Set	(2)	X-10-11206	1/4-20 x 1/2	(3)	X-10-77206	1/4-20 X 1/2	(3)
10-56464-H	Front Cover	(3)	X-10-11210	1/4-20 x 3/4	(3)	X-10-77210	1/4-20 x 3/4	(3)
10-56456-H	Short Fan Spacer Bolts	(3)	X-10-11214	1/4-20 x 1	(3)	X-10-77214	1/4-20 x 1	(3)
10-56460-H	S/B Fuel Pump	(2)	X-10-11218	1/4-20 x 1 1/4	(3)	X-10-77218	1/4-20 x 1 1/4	(3)
10-56461-H	Header Bolts	(2)	X-10-11220	1/4-20 x 1 1/2	(3)	X-10-77220	1/4-20 x 1 1/2	(3)
10-56469-H	Intake Manifold	(2)	X-10-11224	1/4-20 x 2	(3)	X-10-77224	1/4-20 x 2	(3)
10-56465-H	S/B & LT-1 Oil Pan	(3)	X-10-11274	5/16-18 x 3/4	(3)	X-10-77274	5/16-18 x 3/4	(3)
10-56474-H	Trans Pan with Washers	(2)	X-10-11280	5/16-18 x 1	(3)	X-10-77280	5/16-18 x 1	(3)
10-56463-H	Steel Valve Cover	(3)	X-10-11284	5/16-18 x 1 1/4	(3)	X-10-77284	5/16-18 x 1 1/4	(3)
10-56471-H	Water Neck 45 W/F/W	(3)	X-10-11286	5/16-18 x 1 1/2	(3)	X-10-77286	5/16-18 x 1 1/2	(3)
10-56468-H	Water Pump Short	(3)	X-10-11290	5/16-18 x 2	(3)	X-10-77290	5/16-18 x 2	(3)
10-56401-H	License Plate Kit	(2)	X-10-11326	3/8-16 x 3/4	(3)	X-10-77326	3/8-16 x 3/4	(3)
			X-10-11330	3/8-16 x 1	(3)	X-10-77330	3/8-16 x 1	(3)
			X-10-11334	3/8-16 x 1 1/4	(3)	X-10-77334	3/8-16 x 1 1/4	(3)
			X-10-11336	3/8-16 x 1 1/2	(3)	X-10-77336	3/8-16 x 1 1/2	(3)
			X-10-11340	3/8-16 x 2	(3)	X-10-77340	3/8-16 x 2	(3)



### Ford Oval Hex Cap Chrome Plated and Stainless Steel Kits

Engine Dress-Up Chrome Kits			Ford Oval Chrome Kits			Ford Oval Stainless Kits		
Kit Part #	Description	Qty. of cards	Kit Part #	Description	Qty. of cards	Kit Part #	Description	Qty. of cards
11-56250-H	S/B Engine Set	(2)	X-11-11206	1/4-20 x 1/2	(3)	X-11-77206	1/4-20 X 1/2	(3)
11-56240-H	282, 302 Fuel Pump	(3)	X-11-11210	1/4-20 x 3/4	(3)	X-11-77210	1/4-20 x 3/4	(3)
11-56223-H	7/16 Header Bolts	(2)	X-11-11214	1/4-20 x 1	(3)	X-11-77214	1/4-20 x 1	(3)
11-56231-H	289, 302 Oil Pan	(3)	X-11-11218	1/4-20 x 1 1/4	(3)	X-11-77218	1/4-20 x 1 1/4	(3)
11-56242-H	289 Timing Cover	(3)	X-11-11220	1/4-20 x 1 1/2	(3)	X-11-77220	1/4-20 x 1 1/2	(3)
11-56235-H	C-4 Transmission	(3)	X-11-11224	1/4-20 x 2	(3)	X-11-77224	1/4-20 x 2	(3)
11-56224-H	289 Steel Valve Cover	(3)	X-11-11274	5/16-18 x 3/4	(3)	X-11-77274	5/16-18 x 3/4	(3)
11-56226-H	428 Steel Valve Cover	(3)	X-11-11280	5/16-18 x 1	(3)	X-11-77280	5/16-18 x 1	(3)
11-56230-H	Water Neck	(3)	X-11-11284	5/16-18 x 1 1/4	(3)	X-11-77284	5/16-18 x 1 1/4	(3)
11-56260-H	74 to 78 Mustang Front End	(3)	X-11-11286	5/16-18 x 1 1/2	(3)	X-11-77286	5/16-18 x 1 1/2	(3)
11-56227-H	289 Aluminum Valve Cover	(3)	X-11-11290	5/16-18 x 2	(3)	X-11-77290	5/16-18 x 2	(3)
11-56233-H	390, 428 Oil Pan	(3)	X-11-11326	3/8-16 x 3/4	(3)	X-11-77326	3/8-16 x 3/4	(3)
11-56248-H	302 Exhaust Manifold	(3)	X-11-11330	3/8-16 x 1	(3)	X-11-77330	3/8-16 x 1	(3)
			X-11-11334	3/8-16 x 1 1/4	(3)	X-11-77334	3/8-16 x 1 1/4	(3)
			X-11-11336	3/8-16 x 1 1/2	(3)	X-11-77336	3/8-16 x 1 1/2	(3)
			X-11-11340	3/8-16 x 2	(3)	X-11-77340	3/8-16 x 2	(3)



When limited space is a commodity and you want your products to be organized, easy to maintain and reordering to be a snap. Than our Point of Purchase Product Display Floor Units will meet your requirements and more.



# P.O.P. Unit Descriptions

## FULL FLOOR UNITS



**J1POP-9 Chevy, Ford and Chrysler Stamped Fastener Kits with various Chrome Plated Brass Fittings - this unit contains (77) items (1-3) ea. carded kits of the following:**



### Chevy Bow Tie Chrome Kits

Kit Part #	Description	Qty. of cards
10-56490-H	- S/B w/Headers Engine Dress Up Kit	(2)
10-56491-H	- B/B w/headers Engine Dress Up Kit	(2)
10-56488-H	- B/B Header Bolt Kit	(3)
10-56487-H	- B/B Oil Pan Kit	(3)
10-56486-H	- B/B Aluminum Valve Cover Kit	(3)
10-56467-H	- S/B Extended Water Pump Kit	(3)
10-56479-H	- B/B Intake Manifold Kit	(3)
10-56477-H	- Exhaust Manifold Kit	(3)
10-56489-H	- B/B Long Valve Cover Kit	(3) □
10-56464-H	- S/B Timing Cover Kit	(3)
10-56456-H	- Fan Spacer Bolt Short Kit	(3)
10-56460-H	- S/B Fuel Pump Kit	(3)
10-56461-H	- S/B Header Bolt Kit	(3)
10-56469-H	- S/B Intake Manifold Kit	(3)
10-56465-H	- S/B Oil Pan Kit	(3)
10-56466-H	- S/B Aluminum Valve Cover Kit	(3)
10-56471-H	- S/B 45° Water Neck Kit	(3)
10-56468-H	- S/B Short Water Pump Kit	(3)

### Ford Oval Chrome Kits

Kit Part #	Description	Qty. of cards
11-56250-H	- S/B w/Headers Engine Dress Up Kit	(2)
11-56240-H	- 282, 302 Fuel Pump Kit	(3)
11-56223-H	- 7/16 Header Bolt Kit	(3)
11-56231-H	- 289, 302 Oil Pan Kit	(3)
11-56242-H	- 289 Timing Cover Kit	(3)
11-56235-H	- C-4 Transmission Pan Cover Kit	(3)
11-56224-H	- 289 Steel Valve Cover Kit	(3)
11-56226-H	- 428 Steel Valve Cover Kit	(3)
11-56230-H	- Water Neck Kit	(3) □
11-56227-H	- 289 Aluminum Valve Cover Kit	(3)
11-56233-H	- 390, 428 Oil Pan Kit	(3)
11-56248-H	- 289, 302 Exhaust Manifold Kit	(3)
11-56260-H	- 74-78 Mustang Front End Kit	(1)
09012	- Chrome Plated Throttle Return Spring	(2)
09015	- Gold Plated Throttle Return Spring	(2)



### Mopar Chrome Kits

Kit Part #	Description	Qty. of cards
23-56330-H	- S/B w/Headers Engine Dress Up Kit	(2)
23-56332-H	- B/B w/Headers Engine Dress Up Kit	(2)
23-56301-H	- S/B Oil Pan Kit	(3)
23-56303-H	- S/B Header Bolt Kit	(3)
23-56304-H	- S/B Valve Cover Kit	(3)
23-56305-H	- S/B Water Pump Kit	(3)
23-56306-H	- S/B Fuel Pump Kit	(3)
23-56302-H	- S/B Intake Manifold Kit	(3)
23-56307-H	- B/B Oil Pan Kit	(3) □
23-56308-H	- B/B Intake Manifold Kit	(3)
23-56309-H	- B/B Header Bolt Kit	(3)
23-56310-H	- B/B Valve Cover Kit	(3)
23-56311-H	- B/B Water Pump Kit	(3)
23-56312-H	- B/B Fuel Pump Kit	(3)

### Chrome Plated Brass Fittings

Kit Part #	Description	Qty. of cards
J9015	- 1/4 Socket Pipe Plug	(2)
J9016	- 3/8 Socket Pipe Plug	(2)
J9017	- 1/2 Socket Pipe Plug	(2)
J9019	- 3/8 x 1/8 Pipe Bushing	(2)
J9020	- 3/8 x 1/4 Pipe Bushing	(2)
J9021	- 1/8 Street Elbow	(2)
J9025	- Adapter 1/8 x 1/8	(2)
J9026	- Straight Hose Barb Male Pipe 3/16 x 1/8	(2)
J9030	- Straight Hose Barb Male Pipe 3/8 x 1/4	(2) □
J9031	- 90° Hose Barb Male Pipe 5/16 x 1/8	(2)
J9032	- 90° Hose Barb Male Pipe 3/8 x 1/8	(2)
J9033	- 90° Hose Barb Male Pipe 3/8 x 1/4	(2)
J9034	- 3/16 Brake Line Tee with Mount	(2)
J9035	- Inverted Flare Union Tee 3/16	(2)

### Chrome Plated Brass Fittings

Kit Part #	Description	Qty. of cards
J9001	- 90° Heater Hose Barb 5/8 x 1/2	(2)
J9002	- 90° Heater Hose Barb 5/8 x 3/8	(2)
J9003	- Straight Heater Hose Barb 3/8 x 1/2	(2)
J9004	- Straight Heater Hose Barb 5/8 x 3/8	(2)
J9005	- Straight Heater Hose Barb 3/4 x 1/2	(2)
J9006	- 1/2 Hex Head Pipe Plug	(2)
J9007	- 3/8 Hex Head Pipe Plug	(2)
J9010	- Inverted Flare 45° Male Elbow 3/16 x 1/8	(2)
J9014	- 1/8 Socket Pipe Plug	(2)

### Chrome Plated Brass Fittings

Kit Part #	Description	Qty. of cards
J9038	- 1/4 Drain Cocks	(2)
J9040	- Inverted Flare Male Pipe 3/16 x 1/8	(2)
J9041	- Inverted Flare Female Branch Tee	(2)
J9044	- Male Pipe Rigid Hose Barb 1/4 x 1/8	(2)
J9045	- Male Pipe Rigid Hose Barb 3/8 x 1/4	(2)
J9047	- Brake Bleeder Screws 3/8-24 x 1 1/2	(2)
J9048	- Brake Bleeder Screws 5/16-24 x 1	(2)
J9049	- Brake Bleeder Screws 1/4-28 x 1	(2)





# P.O.P Unit Descriptions



## COUNTER TOP UNITS

**J1POP-10 Metric Hex Cap Screws, Hex Nuts and Flat Washers in Chrome - contains (48) items and (3) ea. carded kits of the following:**

### Chrome Metric Hex Cap Screw Kits (Side 1)

Kit Part #	Description	Qty. of cards	Qty. per card
X-11725	- 5mm x 0.8 x 16	(3)	(4)
X-11726	- 5mm x 0.8 x 20	(3)	(4)
X-11727	- 5mm x 0.8 x 25	(3)	(4)
X-11728	- 5mm x 0.8 x 30	(3)	(4)
X-11729	- 5mm x 0.8 x 35	(3)	(4)
X-11730	- 5mm x 0.8 x 40	(3)	(4)
X-11731	- 5mm x 0.8 x 45	(3)	(4)
X-11732	- 5mm x 0.8 x 50	(3)	(4)
X-11738	- 6mm x 1.0 x 16	(3)	(4)
X-11739	- 6mm x 1.0 x 20	(3)	(4)
X-11740	- 6mm x 1.0 x 25	(3)	(4)
X-11741	- 6mm x 1.0 x 30	(3)	(4)

### Chrome Metric Hex Cap Screw Kits (Side 3)

Kit Part #	Description	Qty. of cards	Qty. per card
X-11794	- 10mm x 1.5 x 20	(3)	(3)
X-11795	- 10mm x 1.5 x 25	(3)	(3)
X-11796	- 10mm x 1.5 x 30	(3)	(3)
X-11797	- 10mm x 1.5 x 35	(3)	(3)
X-11798	- 10mm x 1.5 x 40	(3)	(3)
X-11799	- 10mm x 1.5 x 45	(3)	(3)
X-11800	- 10mm x 1.5 x 50	(3)	(3)
X-11835	- 12mm x 1.75 x 20	(3)	(3)
X-11836	- 12mm x 1.75 x 25	(3)	(3)
X-11837	- 12mm x 1.75 x 30	(3)	(3)
X-11838	- 12mm x 1.75 x 35	(3)	(3)
X-11839	- 12mm x 1.75 x 40	(3)	(3)

### Chrome Metric Hex Cap Screw Kits (Side 2)

Kit Part #	Description	Qty. of cards	Qty. per card
X-11742	- 6mm x 1.0 x 35	(3)	(4)
X-11743	- 6mm x 1.0 x 40	(3)	(4)
X-11744	- 6mm x 1.0 x 45	(3)	(4)
X-11745	- 6mm x 1.0 x 50	(3)	(4)
X-11773	- 8mm x 1.25 x 20	(3)	(4)
X-11774	- 8mm x 1.25 x 25	(3)	(4)
X-11775	- 8mm x 1.25 x 30	(3)	(4)
X-11776	- 8mm x 1.25 x 35	(3)	(4)
X-11777	- 8mm x 1.25 x 40	(3)	(4)
X-11778	- 8mm x 1.25 x 45	(3)	(4)
X-11779	- 8mm x 1.25 x 50	(3)	(4)
X-11781	- 8mm x 1.25 x 60	(3)	(4)

### Chrome Metric Hex Cap Screw Kits (Side 4)

Kit Part #	Description	Qty. of cards	Qty. per card
X-11840	- 12mm x 1.75 x 45	(3)	(3)
X-11841	- 12mm x 1.75 x 50	(3)	(3)

### Chrome Metric Hex Nut Kits

Kit Part #	Description	Qty. of cards	Qty. per card
X-15952	- 5mm x .80	(3)	(6)
X-15954	- 6mm x 1.0	(3)	(6)
X-15958	- 8mm x 1.25	(3)	(6)
X-15962	- 10mm x 1.50	(3)	(6)
X-15966	- 12mm x 1.75	(3)	(4)

### Chrome Metric Flat Washer Kits

Kit Part #	Description	Qty. of cards	Qty. per card
X-23986	- 5mm	(3)	(10)
X-23987	- 6mm	(3)	(10)
X-23989	- 8mm	(3)	(10)
X-23990	- 10mm	(3)	(8)
X-23991	- 12mm	(3)	(8)

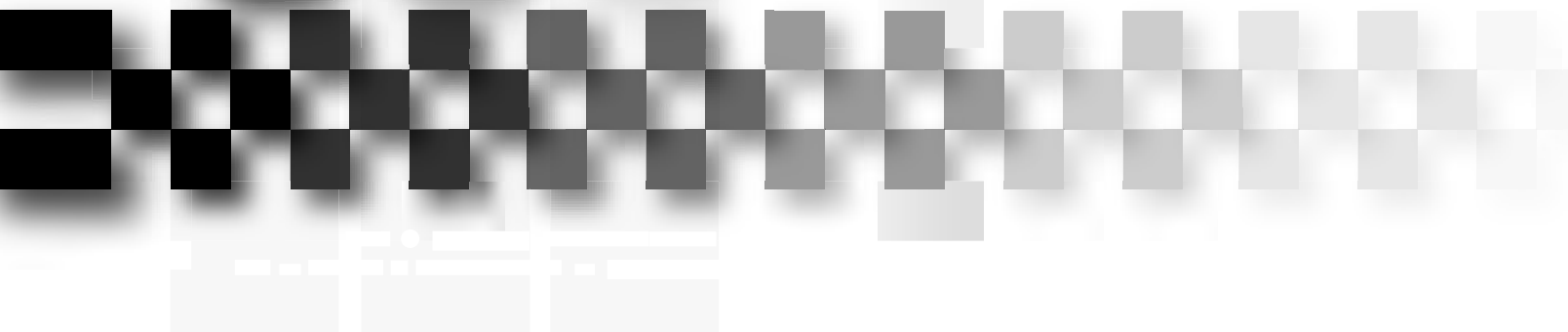
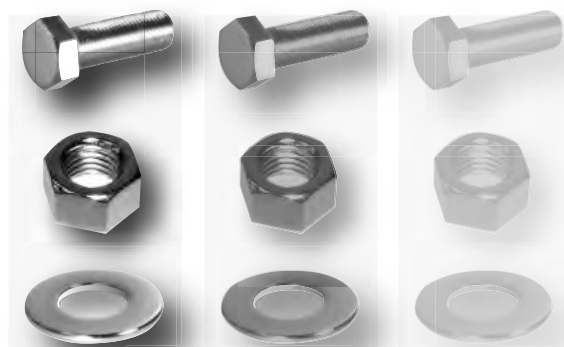



# P.O.P. Unit Descriptions

## FULL FLOOR UNITS



**J1POP-11 Ford Oval Stamped and Non-Stamped Hex Cap Engine Dress Up Kits - contains (50) items in chrome and polished stainless steel (2 & 3) ea. carded kits of the following:**



### Ford Oval Chrome Kits

Kit Part #	Description	Qty. of cards
11-56250-H	S/B Engine Set Hex Caps	(2)
11-56240-H	282, 302 Fuel Pump	(3)
11-56223-H	7/16 Header Bolts	(3)
11-56231-H	289, 302 Oil Pan	(3)
11-56242-H	289 Timing Cover	(3)
11-56235-H	C-4 Transmission	(3)
11-56224-H	289 Steel Valve Cover	(3)
11-56226-H	428 Steel Valve Cover	(3)
11-56230-H	Water Neck	(3)
11-56260-H	74 thru 78 Mustang Front End	(3)
11-56227-H	289 Aluminum Valve Cover	(3)
11-56233-H	390, 428 Oil Pan	(3)
11-56248-H	302 Exhaust Manifold	(3)

### Ford Oval Stainless Steel Kits

Kit Part #	Description	Qty. of cards
11-56250-HSP	S/B Engine Set Hex Caps	(2)
11-56240-HSP	282, 302 Fuel Pump	(3)
11-56223-HSP	7/16 Header Bolts	(3)
11-56231-HSP	289, 302 Oil Pan	(3)
11-56242-HSP	289 Timing Cover	(3)
11-56235-HSP	C-4 Transmission	(3)
11-56224-HSP	289 Steel Valve Cover	(3)
11-56226-HSP	428 Steel Valve Cover	(3)
11-56230-HSP	Water Neck	(3)
11-56227-HSP	289 Aluminum Valve Cover	(3)
11-56233-HSP	390, 428 Oil Pan	(3)
11-56248-HSP	302 Exhaust Manifold	(3)

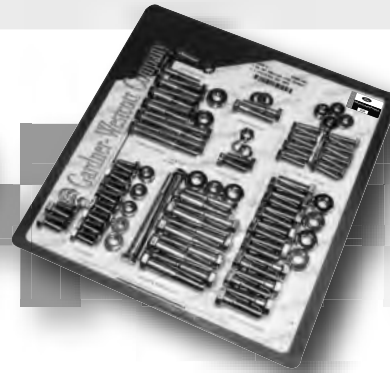
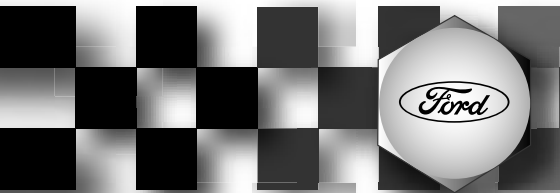

Engine Dress Up Kit  
Part # 56250-HSP

### Ford Standard Chrome Kits

Kit Part #	Description	Qty. of cards
56250-H	S/B Engine Set Hex Caps	(2)
56240-H	282, 302 Fuel Pump	(3)
56223-H	7/16 Header Bolts	(3)
56231-H	289, 302 Oil Pan	(3)
56242-H	289 Timing Cover	(3)
56235-H	C-4 Transmission	(3)
56224-H	289 Steel Valve Cover	(3)
56226-H	428 Steel Valve Cover	(3)
56230-H	Water Neck	(3)
56260-H	74 thru 78 Mustang Front End	(3)
56227-H	289 Aluminum Valve Cover	(3)
56233-H	390, 428 Oil Pan	(3)
56248-H	302 Exhaust Manifold	(3)

### Ford Standard Stainless Steel Kits

Kit Part #	Description	Qty. of cards
56250-HSP	S/B Engine Set Hex Caps	(2)
56240-HSP	282, 302 Fuel Pump	(3)
56223-HSP	7/16 Header Bolts	(3)
56231-HSP	289, 302 Oil Pan	(3)
56242-HSP	289 Timing Cover	(3)
56235-HSP	C-4 Transmission	(3)
56224-HSP	289 Steel Valve Cover	(3)
56226-HSP	428 Steel Valve Cover	(3)
56230-HSP	Water Neck	(3)
56227-HSP	289 Aluminum Valve Cover	(3)
56233-HSP	390, 428 Oil Pan	(3)
56248-HSP	302 Exhaust Manifold	(3)



# P.O.P Unit Descriptions



## COUNTER TOP UNITS

**J1POP-10 Metric Hex Cap Screws, Hex Nuts and Flat Washers in Stainless Steel - contains (48) items and (3) ea. carded kits of the following:**

### Stainless Steel Metric Hex Cap Screw Kits (Side 1)

Kit Part #	Description	Qty. of cards	Qty. per card
X-77725	- 5mm x 0.8 x 16	(3)	(4)
X-77726	- 5mm x 0.8 x 20	(3)	(4)
X-77727	- 5mm x 0.8 x 25	(3)	(4)
X-77728	- 5mm x 0.8 x 30	(3)	(4)
X-77729	- 5mm x 0.8 x 35	(3)	(4)
X-77730	- 5mm x 0.8 x 40	(3)	(4)
X-77731	- 5mm x 0.8 x 45	(3)	(4)
X-77732	- 5mm x 0.8 x 50	(3)	(4)
X-77738	- 6mm x 1.0 x 16	(3)	(4)
X-77739	- 6mm x 1.0 x 20	(3)	(4)
X-77740	- 6mm x 1.0 x 25	(3)	(4)
X-77741	- 6mm x 1.0 x 30	(3)	(4)

### Stainless Steel Metric Hex Cap Screw Kits (Side 2)

Kit Part #	Description	Qty. of cards	Qty. per card
X-77742	- 6mm x 1.0 x 35	(3)	(4)
X-77743	- 6mm x 1.0 x 40	(3)	(4)
X-77744	- 6mm x 1.0 x 45	(3)	(4)
X-77745	- 6mm x 1.0 x 50	(3)	(4)
X-77773	- 8mm x 1.25 x 20	(3)	(4)
X-77774	- 8mm x 1.25 x 25	(3)	(4)
X-77775	- 8mm x 1.25 x 30	(3)	(4)
X-77776	- 8mm x 1.25 x 35	(3)	(4)
X-77777	- 8mm x 1.25 x 40	(3)	(4)
X-77778	- 8mm x 1.25 x 45	(3)	(4)
X-77779	- 8mm x 1.25 x 50	(3)	(4)
X-77781	- 8mm x 1.25 x 60	(3)	(4)

### Stainless Steel Metric Hex Cap Screw Kits (Side 3)

Kit Part #	Description	Qty. of cards	Qty. per card
X-77794	- 10mm x 1.5 x 20	(3)	(3)
X-77795	- 10mm x 1.5 x 25	(3)	(3)
X-77796	- 10mm x 1.5 x 30	(3)	(3)
X-77797	- 10mm x 1.5 x 35	(3)	(3)
X-77798	- 10mm x 1.5 x 40	(3)	(3)
X-77799	- 10mm x 1.5 x 45	(3)	(3)
X-77800	- 10mm x 1.5 x 50	(3)	(3)
X-77835	- 12mm x 1.75 x 20	(3)	(3)
X-77836	- 12mm x 1.75 x 25	(3)	(3)
X-77837	- 12mm x 1.75 x 30	(3)	(3)
X-77838	- 12mm x 1.75 x 35	(3)	(3)
X-77839	- 12mm x 1.75 x 40	(3)	(3)

### Stainless Steel Metric Hex Cap Screw Kits (Side 4)

Kit Part #	Description	Qty. of cards	Qty. per card
X-77840	- 12mm x 1.75 x 45	(3)	(3)
X-77841	- 12mm x 1.75 x 50	(3)	(3)

### Stainless Steel Metric Hex Nut Kits

Kit Part #	Description	Qty. of cards	Qty. per card
X-70952	- 5mm x .80	(3)	(6)
X-70954	- 6mm x 1.0	(3)	(6)
X-70958	- 8mm x 1.25	(3)	(6)
X-70962	- 10mm x 1.50	(3)	(6)
X-70966	- 12mm x 1.75	(3)	(4)

### Stainless Steel Metric Flat Washer Kits

Kit Part #	Description	Qty. of cards	Qty. per card
X-75986	- 5mm	(3)	(10)
X-75987	- 6mm	(3)	(10)
X-75989	- 8mm	(3)	(10)
X-75990	- 10mm	(3)	(8)
X-75991	- 12mm	(3)	(8)

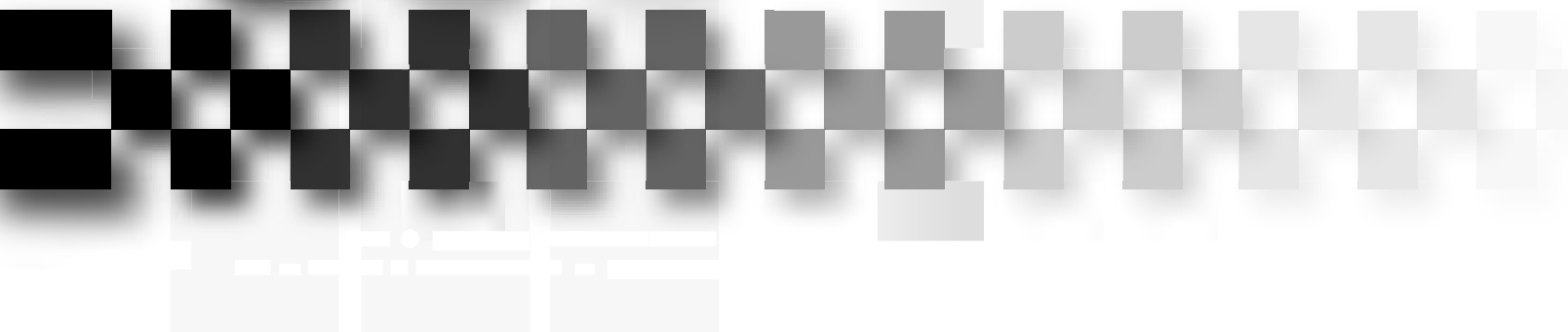
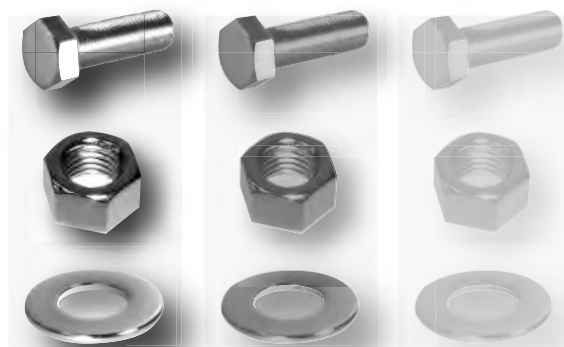



# P.O.P. Unit Descriptions

## COUNTER TOP UNITS



**J1POP-14 Ford and Ford Oval Stamped Hex Cap Engine Dress Up Kits**  
*Contains (24) items in chrome (2 & 3) ea. carded kits of the following:*

### Ford Chrome Kits

Kit Part #	Description	Qty. of cards
56250-H	- S/B Engine Dress Up Set	(2)
56221-H	- 289, 302 Intake Manifold Kit	(3)
56240-H	- 282, 302 Fuel Pump Kit	(3)
56223-H	- 7/16 Header Bolts Kit	(3)
56231-H	- 289, 302 Oil Pan Kit	(3)
56242-H	- 289 Timing Cover Kit	(3)
56224-H	- 289 Steel Valve Cover Kit	(3)
56230-H	- Water Neck Kit	(3)
56220-H	- License Plate Kit	(3)
56401-H	- License Plate Bolt Kit	(3)
11-56250-H	- S/B Engine Set Hex Caps	(2)

### Ford Oval Chrome Kits

Kit Part #	Description	Qty. of cards
11-56221-H	- 289, 302 Intake Manifold	(3)
11-56240-H	- 282, 302 Fuel Pump	(3)
11-56223-H	- 7/16 Header Bolts	(3)
11-56231-H	- 289, 302 Oil Pan	(3)
11-56242-H	- 289 Timing Cover	(3)
11-56224-H	- 289 Steel Valve Cover	(3)
11-56230-H	- Water Neck	(3)
09012-blk	- Black Throttle Return Spring	(3)
09012-re	- Red Throttle Return Spring	(3)
09012-wht	- White Throttle Return Spring	(3)
09012-blu	- Blue Throttle Return Spring	(3)
09012	- Chrome Throttle Return Spring	(3)



## FULL FLOOR UNITS

**J1POP-15 Ford Oval Stamped Hex Cap Engine Dress Up Kits**  
*Contains (63) items in chrome (2 & 3) ea. carded kits of the following:*

### Ford Oval Chrome Kits

Kit Part #	Description	Qty. of cards	Kit Part #	Description	Qty. of cards
11-56256-H	- 400 w/St'rd Exhaust Eng. Dress Up Kit	(2)	X-11-11206	- 1/4-20 x 1/2	(3)
11-56255-H	- 351 Cleveland Engine Dress Up Kit	(2)	X-11-11208	- 1/4-20 x 5/8	(3)
11-56254-H	- 429, 460 w/Headers Eng. Dress Up Kit	(2)	X-11-11210	- 1/4-20 x 3/4	(3)
11-56253-H	- 390, 428 w/Headers Eng. Dress Up Kit	(2)	X-11-11212	- 1/4-20 x 7/8	(3)
11-56251-H	- 289, 302 w/St'rd Exhaust Eng. Dress Up Kit	(2)	X-11-11214	- 1/4-20 x 1	(3)
11-56250-H	- 289, 302 w/Headers Eng. Dress Up Kit	(2)	X-11-11218	- 1/4-20 x 1 1/4	(3)
11-56248-H	- 302 Exhaust Manifold Kit	(3)	X-11-11222	- 1/4-20 x 1 3/4	(3)
11-56247-H	- 390, 428 Intake Manifold Kit	(3)	X-11-11220	- 1/4-20 x 1 1/2	(3)
11-56246-H	- 429 Intake Manifold Kit	(3)	X-11-11224	- 1/4-20 x 2	(3)
11-56242-H	- 289 Timing Cover Kit	(3)	X-11-11270	- 5/16-18 x 1/2	(3)
11-56240-H	- 289, 302 Fuel Pump Kit	(3)	X-11-11272	- 5/16-18 x 5/8	(3)
11-56238-H	- 390, 429 Fuel Pump Kit	(3)	X-11-11274	- 5/16-18 x 3/4	(3)
11-56237-H	- 429, 460 Oil Pan Kit	(3)	X-11-11278	- 5/16-18 x 7/8	(3)
11-56235-H	- C-4 Transmission Kit	(3)	X-11-11280	- 5/16-18 x 1	(3)
11-56234-H	- C-6 Trans Pan Kit	(3)	X-11-11284	- 5/16-18 x 1 1/4	(3)
11-56233-H	- 390, 428 Oil Pan Kit	(3)	X-11-11286	- 5/16-18 x 1 1/2	(3)
11-56231-H	- 289, 302 Oil Pan Kit	(3)	X-11-11288	- 5/16-18 x 1 3/4	(3)
11-56230-H	- Water Neck Kit	(3)	X-11-11290	- 5/16-18 x 2	(3)
11-56229-H	- 429, 460 Valve Cover Kit	(3)	X-11-11326	- 3/8-16 x 3/4	(3)
11-56227-H	- 289 Aluminum Valve Cover Kit	(3)	X-11-11330	- 3/8-16 x 1	(3)
11-56226-H	- 428 Steel Valve Cover Kit	(3)	X-11-11334	- 3/8-16 x 1 1/4	(3)
11-56224-H	- 289 Steel Valve Cover Kit	(3)	X-11-11336	- 3/8-16 x 1 1/2	(3)
11-56223-H	- 7/16 Header Bolts Kit	(3)	X-11-11338	- 3/8-16 x 1 3/4	(3)
11-56222-H	- 351 Cleveland Intake Manifold Kit	(3)	X-11-11340	- 3/8-16 x 2	(3)
11-56221-H	- 289 Intake Manifold Kit	(3)	X-11-55669-P3	- 14 x 3/4 3/8 Hex	(3)
11-56260-H	- 74-78 Mustang Front End Kit	(2)	X-11-56669-P7	- 14 x 3/4 7/16 Hex	(3)
11-56261-H	- Rack Bolts 5/8 x 4" Grade 8	(3)	X-11-22276	- 5/16 X 13/16 Body Bolts	(3)
11-56220-H	- License Plate Stamped Ford Oval Kit	(3)	X-11-22284	- 5/16 X 1 1/4 Body Bolts	(3)
11-56401-H	- License Plate for Plastic Ford Oval Kit	(3)	X-11-25212	- 1/4-20 x 7/8	(3)
J1784	- License Plate Truss Slot Kit	(3)	X-11-25280	- 5/16-18 x 1	(3)
X-11-25330	- 3/8-16 x 1 Sems	(3)	X-11-25336	- 3/8-16 x 1 1/2 Sems	(3)





# P.O.P Unit Descriptions



## FULL FLOOR UNITS

**J1POP-16 Pontiac Engine Dress Up Kits with Pontiac and GT Stamped Hex Caps - contains (68) items in chrome (2 & 3) ea. carded kits of the following:**

### Engine Dress-Up Chrome Kits

Kit Part #	Description	Qty. of cards	Kit Part #	Description	Qty. of cards
56500-H	- S/B Engine Dress Up Kit	(2)	12-56500-H	- S/B Engine Dress Up Kit	(2)
56522-H	- 326 S/B Intake Manifold Kit	(3)	12-56522-H	- 326 S/B Intake Manifold Kit	(3)
56521-H	- 350 B/B Intake Manifold Kit	(3)	12-56521-H	- 350 B/B Intake Manifold Kit	(3)
56533-H	- Water Pump Kit	(3)	12-56533-H	- Water Pump Kit	(3)
56515-H	- 350 B/B Timing Cover Kit	(3)	12-56515-H	- 350 B/B Timing Cover Kit	(3)
56531-H	- 350, 389 Oil Pan Kit	(3)	12-56531-H	- 350, 389 Oil Pan Kit	(3)
56532-H	- 326, 453 Oil Pan Kit	(3)	12-56532-H	- 326, 453 Oil Pan Kit	(3)
56529-H	- 350 Aluminum Valve Cover Kit	(3)	12-56529-H	- 350 Aluminum Valve Cover Kit	(3)
56528-H	- 326 S/B Valve Cover Kit	(3)	12-56528-H	- 326 S/B Valve Cover Kit	(3)
56516-H	- 326 S/B Timing Cover Kit	(3)	12-56516-H	- 326 S/B Timing Cover Kit	(3)
56519-H	- Fuel Pump Kit	(3)	12-56519-H	- Fuel Pump Kit	(3)
56505-H	- B/B Engine Dress Up Kit	(2)	12-56505-H	- B/B Engine Dress Up Kit	(2)
56220-H	- License Plate Kit	(3)	12-56220-H	- Pontiac Logo License Plate Kit	(3)
56220-B	- Bullet License Plate Kit	(3)	15-56500-H	- S/B Engine Dress Up Kit	(2)
09012	- Chrome Throttle Return Spring	(3)	15-56522-H	- 326 S/B Intake Manifold Kit	(3)
09015	- Gold Throttle Return Spring	(3)	15-56521-H	- 350 B/B Intake Manifold Kit	(3)
09012-black	- Black Throttle Return Spring	(3)	15-56533-H	- Water Pump Kit	(3)
09012-red	- Red Throttle Return Spring	(3)	15-56515-H	- 350 B/B Timing Cover Kit	(3)
09012-white	- White Throttle Return Spring	(3)	15-56531-H	- 350, 389 Oil Pan Kit	(3)
09012-blue	- Blue Throttle Return Spring	(3)	15-56532-H	- 326, 453 Oil Pan Kit	(3)
X-29591	- 3/32 x 1 1/4 Cotter Pin	(3)	15-56529-H	- 350 Aluminum Valve Cover Kit	(3)
X-29587	- 3/32 x 1 3/4 Cotter Pin	(3)	15-56528-H	- 326 S/B Valve Cover Kit	(3)
X-29593	- 1/8 x 1 1/4 Cotter Pin	(3)	15-56516-H	- 326 S/B Timing Cover Kit	(3)
X-29585	- 1/8 x 1 1/2 Cotter Pin	(3)	15-56519-H	- Fuel Pump Kit	(3)
X-29588	- 5/32 x 1 1/2 Cotter Pin	(3)	15-56505-H	- B/B Engine Dress Up Kit	(2)
X-25212	- 1/4-20 X 7/8 Sems	(3)	15-56220-H	- GT Logo License Plate Kit	(3)
X-25280	- 5/16-18 x 1 Sems	(3)	X-43567	- 3/16 Hole Plug	(3)
X-25326	- 3/8-16 x 3/4 Sems	(3)	X-43569	- 1/4 Hole Plug	(3)
X-25330	- 3/8-16 x 1 Sems	(3)	X-43570	- 5/16 Hole Plug	(3)
X-25336	- 3/8-16 x 1 1/2 Sems	(3)	X-43571	- 3/8 Hole Plug	(3)
4083	- 5/16 x 1 3/8 Carb Studs	(3)	X-43572	- 7/16 Hole Plug	(3)
4084	- 5/16 x 1 1/2 Carb Studs	(3)	X-43573	- 1/2 Hole Plug	(3)
4085	- 5/16 x 2 Carb Studs	(3) □	X-43575	- 5/8 Hole Plug	(3)
			X-43576	- 3/4 Hole Plug	(3)







# P.O.P. Unit Descriptions

## FULL FLOOR UNITS

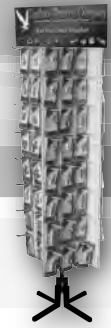

**J2POP-1 is a combination of J1POP-1 and J1POP-2 Units**

**Contains (96) items all in chrome (2) ea. carded kits of the following fasteners:**

### Chrome Hex Nuts and Hex Cap Screws

Kit Part #	Description	Qty. per card	Kit Part #	Description	Qty. per card	Kit Part #	Description	Qty. per card
J0765	10/24 Hex Nuts	(12)	J0012	1/4-20 x 1/2 Hex Caps	(4)	J0108	3/8-16 x 1 1/2 Hex Caps	(4)
J0766	10/32 Hex Nuts	(12)	J0016	1/4-20 x 3/4 Hex Caps	(4)	J0110	3/8-16 x 1 3/4 Hex Caps	(4)
J0768	1/4-20 Hex Nuts	(15)	J0020	1/4-20 x 1 Hex Caps	(4)	J0112	3/8-16 x 2 Hex Caps	(4)
J0769	1/4-28 Hex Nuts	(15)	J0050	5/16-18 x 5/8 Hex Caps	(4)	J0114	3/8-16 x 2 1/4 Hex Caps	(4)
J0770	5/16-18 Hex Nuts	(13)	J0052	5/16-18 x 3/4 Hex Caps	(4)	J0116	3/8-16 x 2 1/2 Hex Caps	(4)
J0771	5/24-24 Hex Nuts	(13)	J0053	5/16-24 x 3/4 Hex Caps	(4)	J0118	3/8-16 x 2 3/4 Hex Caps	(3)
J0772	3/8-16 Hex Nuts	(11)	J0056	5/16-18 x 1 Hex Caps	(4)	J0120	3/8-16 x 3 Hex Caps	(3)
J0773	3/8-24 Hex Nuts	(11)	J0059	5/16-18 x 1 1/4 Hex Caps	(4)	J0148	7/16-14 x 1 Hex Caps	(3)
J0774	7/16-14 Hex Nuts	(7)	J0065	5/16-18 x 2 Hex Caps	(4)	J0150	7/16-14 x 1 1/4 Hex Caps	(3)
J0775	7/16-20 Hex Nuts	(7)	J0068	5/16-24 x 2 1/4 Hex Caps	(4)	J0156	7/16-14 x 2 Hex Caps	(3)
J0776	1/2-13 Hex Nuts	(6)	J0069	5/16-18 x 2 1/2 Hex Caps	(4)	J0184	1/2-13 x 1 Hex Caps	(3)
J0777	1/2-20 Hex Nuts	(6)	J0098	3/8-16 x 3/4 Hex Caps	(4)	J0188	1/2-13 x 1 1/2 Hex Caps	(3)
J0778	9/16-12 Hex Nuts	(5)	J0099	3/8-24 x 3/4 Hex Caps	(4)	J0189	1/2-20 x 1 1/2 Hex Caps	(3)
J0779	9/16-18 Hex Nuts	(5)	J0102	3/8-16 x 1 Hex Caps	(4)	J0192	1/2-13 x 2 Hex Caps	(3)
J0780	5/8-11 Hex Nuts	(5)	J0103	3/8-24 x 1 Hex Caps	(4)	J0196	1/2-13 x 2 1/2 Hex Caps	(3)
J0781	5/8-18 Hex Nuts	(5)	J0106	3/8-16 x 1 1/4 Hex Caps	(4)	J0197	1/2-20 x 2 1/2 Hex Caps	(3)

### Chrome Washers, Body, Hex Sems, Spin Lock Bolts and Pipe Plugs

Kit Part #	Description	Qty. per card	Kit Part #	Description	Qty. per card	Kit Part #	Description	Qty. per card
J0852	#10 Flat Washers	(14)	J0876	5/16 AN Washers	(11)	J2229	5/16 x 13/16 Pol. Body Bolts	(4)
J0854	1/4 Flat Washers	(15)	J0877	3/8 AN Washers	(10)	J2230	5/16 x 1 1/4 Pol. Body Bolts	(3)
J0855	5/16 Flat Washers	(13)	J0878	7/16 AN Washers	(8)	J2255	1/4-20 x 7/8 Hex Sems	(4)
J0856	3/8 Flat Washers	(11)	J0879	1/2 AN Washers	(7)	J2256	5/16-18 x 1 Hex Sems	(4)
J0857	7/16 Flat Washers	(10)	J0880	9/16 AN Washers	(6)	J2257	3/8-16 x 3/4 Hex Sems	(3)
J0858	1/2 Flat Washers	(9)	J0881	5/8 AN Washers	(6)	J2258	3/8-16 x 1 Hex Sems	(3)
J0859	9/16 Flat Washers	(8)	J2250	3/8 x 1 1/4 Shock Washers	(4)	J2259	3/8-16 1 1/2 Hex Sems	(3)
J0860	5/8 Flat Washers	(8)	J2251	1/2 x 1 1/4 Shock Washers	(4)	J2261	1/4-20 x 5/8 Spin Locks	(6)
J0865	1/4 Lock Washers	(15)	J2252	1/2 x 1 7/16 Shock Washers	(4)	J2262	5/16-18 x 3/4 Spin Locks	(4)
J0866	5/16 Lock Washers	(13)	J2253	5/8 x 1 1/4 Shock Washers	(4)	J2263	5/16-18 x 1 Spin Locks	(4)
J0867	3/8 Lock Washers	(11)	J2223	5/16-18 x1 SS Body Bolts	(1)	J2264	5/16-18 X 1 1/4 Spin Locks	(4)
J0868	7/16 Lock Washers	(10)	J2224	14 x 3/4 Body Bolts 3/8 AF	(10)	J2265	3/8-16 x 1 Spin Locks	(3)
J0869	1/2 Lock Washers	(9)	J2225	14 x 3/4 Body Bolts 3/8 AF	(9)	J2266	5/16-24 x 1 Spin Locks	(5)
J0870	9/16 Lock Washers	(8)	J2226	14 x 3/4 Body Bolts 7/16 AF	(9)	J2267	3/8 Pipe Plugs	(3)
J0871	5/8 Lock Washers	(8)	J2227	5/16 x 13/16 Body Bolts	(7)	J2268	1/2 Pipe Plugs	(2)
J0875	1/4 AN Washers	(12)	J2228	5/16 x 1 1/4 Body Bolts	(4)	J2269	3/4 Pipe Plugs	(2)

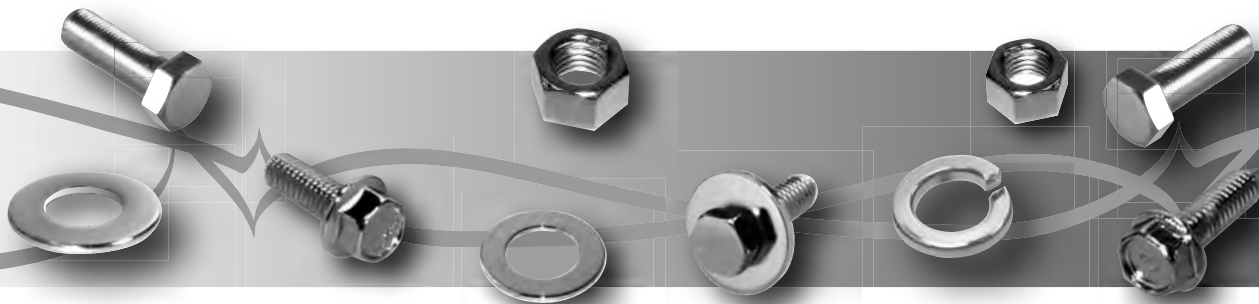



# P.O.P Unit Descriptions



## FULL FLOOR UNITS

**J2POP-2 is a combination of J1POP-3 and J1POP-4 Units**

**Contains (96) items all in chrome (2)ea. carded kits of the following fasteners:**

### Chrome Oval Slotted, Phillips Machine and Sheet Metal Screws

Kit Part #	Description	Qty. per card	Kit Part #	Description	Qty. per card	Kit Part #	Description	Qty. per card
J0982	- 6/32 x 3/8 Oval Slot MS	(5)	J1020	- 12/24 x 1 Oval Sl. MS	(4)	J1298	- 8 x 3/4 Oval Phillips SMS	(6)
J0983	- 6/32 x 1/2 Oval Sl. MS	(5)	J1025	- 1/4-20 x 1 Oval Sl. MS	(6)	J1299	- 8 x 3/4 Oval Ph. # 6 SMS	(6)
J0985	- 6/32 x 3/4 Oval Sl. MS	(5)	J1036	- 5/16-24 x 1 Oval Sl. MS	(5)	J1300	- 8 x 7/8 Oval Ph. SMS	(6)
J0986	- 6/32 x 1 Oval Sl. MS	(5)	J1157	- 10/32 x 3/8 Oval Ph. MS	(6)	J1301	- 8 x 7/8 Oval Ph. # 6 SMS	(6)
J0992	- 8/32 x 1/2 Oval Sl. MS	(7)	J1159	- 10/32 x 1/2 Oval Ph. MS	(6)	J1302	- 8 x 1 Oval Ph. SMS	(6)
J1001	- 10/24 x 1/2 Oval Sl. MS	(6)	J1162	- 10/24 x 3/4 Oval Ph. MS	(6)	J1303	- 8 x 1 Oval Ph. # 6 SMS	(6)
J1002	- 10/32 x 1/2 Oval Sl. MS	(6)	J1163	- 10/32 x 3/4 Oval Ph. MS	(6)	J1304	- 8 x 1 1/4 Oval Ph. SMS	(6)
J1005	- 10/24 x 3/4 Oval Sl. MS	(6)	J1166	- 10/24 x 1 Oval Ph. MS	(6)	J1305	- 8 x 1 1/4 Oval Ph. # 6 SMS	(5)
J1006	- 10/32 x 3/4 Oval Sl. MS	(6)	J1167	- 10/32 x 1 Oval Ph. MS	(6)	J1306	- 8 x 1 1/2 Oval Ph. SMS	(5)
J1008	- 10/32 x 1 Oval Sl. MS	(6)	J1182	- 1/4-20 x 3/4 Oval Ph. MS	(6)	J1307	- 8 x 1 1/2 Oval Ph. # 6 SMS	(5)
J1010	- 10/32 x 1 1/4 Oval Sl. MS	(4)	J1183	- 1/4-20 x 1 Oval Ph. MS	(6)	J1308	- 8 x 3/4 Oval Ph. # 6 SMS	(4)
J1012	- 10/32 x 1 1/2 Oval Sl. MS	(4)	J1186	- 1/4-20 x 1 1/2 Oval Ph. MS	(6)	J1309	- 8 x 3/4 Oval Ph. SMS	(6)
J1013	- 10/32 x 1 3/4 Oval Sl. MS	(4)	J1294	- 8 x 1/2 Oval Ph. SMS	(6)	J1310	- 8 x 2 Oval Ph. SMS	(5)
J1014	- 10/32 x 2 Oval Sl. MS	(4)	J1295	- 8 x 1/2 Oval Ph. SMS	(6)	J1311	- 8 x 2 Oval Ph. # 6 SMS	(4)
J1017	- 12/24 x 1/2 Oval Sl. MS	(4)	J1296	- 8 x 5/8 Oval Ph. SMS	(6)	J1315	- 10 x 3/4 Oval Ph. SMS	(7)
J1019	- 12/24 x 3/4 Oval Sl. MS	(4)	J1297	- 8 x 5/8 Oval Ph. #6 SMS	(6)	J1317	- 12 x 1 Oval Ph. SMS	(4)

### Chrome Button Heads, Lock Nuts, Carriage Bolts and Super Washers

Kit Part #	Description	Qty. per card	Kit Part #	Description	Qty. per card	Kit Part #	Description	Qty. per card
J0535	- 8/32 x 1/2 Button Heads	(4)	J0618	- 3/8-16 x 1 1/2 Btn. Hds.	(2)	J0891	- 1/4 x 1 1/2 Carriage	(4)
J0546	- 10/24 x 1/2 Btn. Hds.	(4)	J0793	- 1/4-20 Lock Nuts	(8)	J0901	- 5/16 x 1 Carriage	(4)
J0547	- 10/32 x 1/2 Btn. Hds.	(4)	J0794	- 1/4-28 Lock Nuts	(8)	J0903	- 5/16 x 1 1/2 Carriage	(4)
J0550	- 10/24 x 3/4 Btn. Hds.	(4)	J0795	- 5/16-18 Lock Nuts	(8)	J0914	- 3/8-16 x 1 Carriage	(4)
J0551	- 10/32 x 3/4 Btn. Hds.	(4)	J0796	- 5/16-24 Lock Nuts	(8)	J0917	- 3/8-16 x 2 Carriage	(4)
J0564	- 1/4-20 x 1/2 Btn. Hds.	(4)	J0797	- 3/8-16 Lock Nuts	(6)	J0918	- 3/8 x 2 1/2 Carriage	(3)
J0568	- 1/4-20 x 3/4 Btn. Hds.	(4)	J0798	- 3/8-24 Lock Nuts	(6)	J0926	- 7/16-14 x 1 1/4 Carriage	(3)
J0572	- 1/4-20 x 1 Btn. Hds.	(4)	J0799	- 7/16-14 Lock Nuts	(5)	J0928	- 7/16-14 x 1 3/4 Carriage	(3)
J0574	- 1/4-20 x 1 1/4 Btn. Hds.	(4)	J0800	- 7/16-20 Lock Nuts	(5)	J0938	- 1/2-13 x 1 3/4 Carriage	(3)
J0588	- 5/16-18 x 3/4 Btn. Hds.	(4)	J0801	- 1/2-13 Lock Nuts	(5)	J2271	- 3/16 x 1 Super Washers	(5)
J0589	- 5/16-24 x 3/4 Btn. Hds.	(4)	J0802	- 1/2-20 Lock Nuts	(5)	J2272	- 1/4 x 1 Super Washers	(5)
J0592	- 5/16-18 x 1 Btn. Hds.	(4)	J0803	- 9/16-12 Lock Nuts	(4)	J2273	- 5/16 x 1 1/8 Super Washers	(5)
J0593	- 5/16-24 x 1 Btn. Hds.	(4)	J0804	- 9/16-18 Lock Nuts	(4)	J2274	- 5/16 x 1 1/2 Super Washers	(4)
J0596	- 5/16-18 x 1 1/2 Btn. Hds.	(3)	J0805	- 5/8-11 Lock Nuts	(4)	J2275	- 3/8 x 1 1/2 Super Washers	(4)
J0610	- 3/8-16 x 3/4 Btn. Hds.	(4)	J0806	- 5/16-16 Lock Nuts	(4)	J2276	- 7/16 x 1 Super Washers	(6)
J0614	- 3/8-16 x 1 Btn. Hds.	(4)	J0888	- 1/4 x 3/4 Carriage w/HN	(4)	J2277	- 1/2 x 1 1/4 Super Washers	(6)

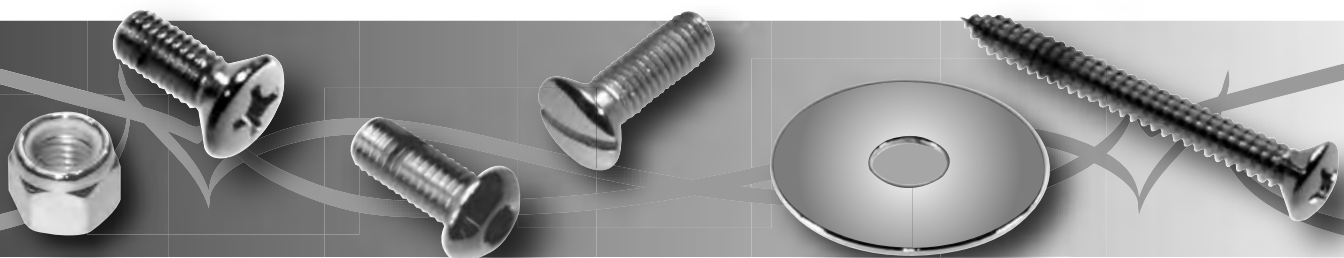



# P.O.P. Unit Descriptions

## FULL FLOOR UNITS

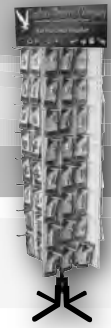

**J2POP-3 is a Product Display Unit of Polished Stainless Steel**  
**Contains (96) items of (1) ea. carded kits of the following fasteners:**

**Polished Stainless Steel Hex Caps, Hex Nuts, Button Head Allen Screws, Flat Washers, Nylon Lock Nuts and Oval Phillips Sheet Metal Screws**

Kit Part #	Description	Qty. per card	Kit Part #	Description	Qty. per card
J7000	- 1/4-20 x 1/2 Hex Caps	(7)	J7048	- 10/32 x 1/2 Button Head Allens	(8)
J7001	- 1/4-20 x 3/4 Hex Caps	(7)	J7049	- 10/24 x 3/4 Button Head Allens	(7)
J7002	- 1/4-20 x 1 Hex Caps	(7)	J7050	- 10/32 x 3/4 Button Head Allens	(7)
J7003	- 5/16-18 x 5/8 Hex Caps	(6)	J7051	- 1/4-20 x 1/2 Button Head Allens	(6)
J7004	- 5/16-18 x 3/4 Hex Caps	(6)	J7052	- 1/4-20 x 3/4 Button Head Allens	(6)
J7005	- 5/16-18 x 1 Hex Caps	(6)	J7053	- 1/4-20 x 1 Button Head Allens	(6)
J7006	- 5/16-18 x 1 1/4 Hex Caps	(6)	J7054	- 1/4-20 x 1 1/4 Button Head Allens	(5)
J7007	- 5/16-18 x 2 Hex Caps	(5)	J7055	- 5/16-18 x 3/4 Button Head Allens	(5)
J7008	- 5/16-18 x 2 1/2 Hex Caps	(4)	J7056	- 5/16-24 x 3/4 Button Head Allens	(2)
J7009	- 3/8-16 x 3/4 Hex Caps	(6)	J7057	- 5/16-18 x 1 Button Head Allens	(4)
J7010	- 3/8-16 x 1 Hex Caps	(6)	J7058	- 5/16-24 x 1 Button Head Allens	(2)
J7011	- 3/8-16 x 1 1/4 Hex Caps	(5)	J7059	- 5/16-18 x 1 1/2 Button Head Allens	(4)
J7012	- 3/8-16 x 1 1/2 Hex Caps	(4)	J7060	- 3/8-16 x 3/4 Button Head Allens	(4)
J7013	- 3/8-16 x 1 3/4 Hex Caps	(4)	J7061	- 3/8-16 x 1 Button Head Allens	(3)
J7014	- 3/8-16 x 2 Hex Caps	(4)	J7062	- 3/8-16 x 1 1/2 Button Head Allens	(3)
J7015	- 3/8-16 x 2 1/4 Hex Caps	(4)	J7063	- 3/16 Flat Washers	(10)
J7016	- 3/8-16 x 2 1/2 Hex Caps	(3)	J7064	- 1/4 Flat Washers	(10)
J7017	- 3/8-16 x 2 3/4 Hex Caps	(3)	J7065	- 5/16 Flat Washers	(9)
J7018	- 3/8-16 x 3 Hex Caps	(3)	J7066	- 3/8 Flat Washers	(8)
J7019	- 7/16-14 x 1 Hex Caps	(4)	J7067	- 7/16 Flat Washers	(7)
J7020	- 7/16-14 x 1 1/4 Hex Caps	(4)	J7068	- 1/2 Flat Washers	(6)
J7021	- 7/16-14 x 2 Hex Caps	(3)	J7069	- 5/8 Flat Washers	(5)
J7022	- 1/2-13 x 1 Hex Caps	(3)	J7070	- 1/4-20 Nylon Lock Nuts	(4)
J7023	- 1/2-13 x 1 1/2 Hex Caps	(3)	J7071	- 1/4-28 Nylon Lock Nuts	(4)
J7024	- 1/2-13 x 2 Hex Caps	(3)	J7072	- 5/16-18 Nylon Lock Nuts	(4)
J7025	- 1/2-13 x 2 1/2 Hex Caps	(2)	J7073	- 5/16-24 Nylon Lock Nuts	(4)
J7026	- 5/16-24 x 3/4 Hex Caps	(6)	J7074	- 3/8-16 Nylon Lock Nuts	(3)
J7027	- 5/16-24 x 2 1/4 Hex Caps	(4)	J7075	- 3/8-24 Nylon Lock Nuts	(3)
J7028	- 3/8-24 x 3/4 Hex Caps	(6)	J7076	- 7/16-14 Nylon Lock Nuts	(3)
J7029	- 3/8-24 x 1 Hex Caps	(5)	J7077	- 7/16-20 Nylon Lock Nuts	(5)
J7030	- 1/2-20 x 1 1/2 Hex Caps	(2)	J7078	- 1/2-13 Nylon Lock Nuts	(3)
J7031	- 1/2-20 x 2 1/2 Hex Caps	(2)	J7079	- 1/2-20 Nylon Lock Nuts	(2)
J7032	- 10/24 Hex Nuts	(4)	J7080	- 5/8-11 Nylon Lock Nuts	(2)
J7033	- 1/4-20 Hex Nuts	(4)	J7081	- 5/8-18 Nylon Lock Nuts	(2)
J7034	- 5/16-18 Hex Nuts	(4)	J7082	- #8 x 1/2 Oval Phillips Sheet Metal Screws	(8)
J7035	- 3/8-16 Hex Nuts	(4)	J7083	- #8 x 3/4 Oval Phillips Sheet Metal Screws	(8)
J7036	- 7/16-14 Hex Nuts	(3)	J7084	- #8 x 1 Oval Phillips Sheet Metal Screws	(8)
J7037	- 1/2-13 Hex Nuts	(3)	J7085	- #8 x 1 1/4 Oval Phillips Sheet Metal Screws	(8)
J7038	- 5/8-11 Hex Nuts	(2)	J7086	- 8 x 3/4 #6 Oval Phillips Sheet Metal Screws	(6)
J7039	- 10/32 Hex Nuts	(4)	J7087	- 8 x 1 #6 Oval Phillips Sheet Metal Screws	(6)
J7040	- 1/4-28 Hex Nuts	(4)	J7088	- 8 x 1 1/4 #6 Oval Phillips Sheet Metal Screws	(6)
J7041	- 5/16-24 Hex Nuts	(4)	J7089	- 8 x 1 1/2 #6 Oval Phillips Sheet Metal Screws	(6)
J7042	- 3/8-24 Hex Nuts	(4)	J7090	- 8/32 x 3/4 Oval Phillips Sheet Metal Screws	(8)
J7043	- 7/16-20 Hex Nuts	(3)	J7091	- 10/32 x 1/2 Oval Phillips Sheet Metal Screws	(8)
J7044	- 1/2-20 Hex Nuts	(3)	J7092	- 10/32 x 3/4 Oval Phillips Sheet Metal Screws	(8)
J7045	- 5/8-18 Hex Nuts	(2)	J7093	- 10/32 x 1 Oval Phillips Sheet Metal Screws	(8)
J7046	- 8/32 x 1/2 Button Head Allens	(8)	J7094	- 10/24 x 3/4 Oval Phillips Sheet Metal Screws	(8)
J7047	- 10/24 x 1/2 Button Head Allens	(8)	J7095	- 12/24 x 1 Oval Phillips Sheet Metal Screws	(6)

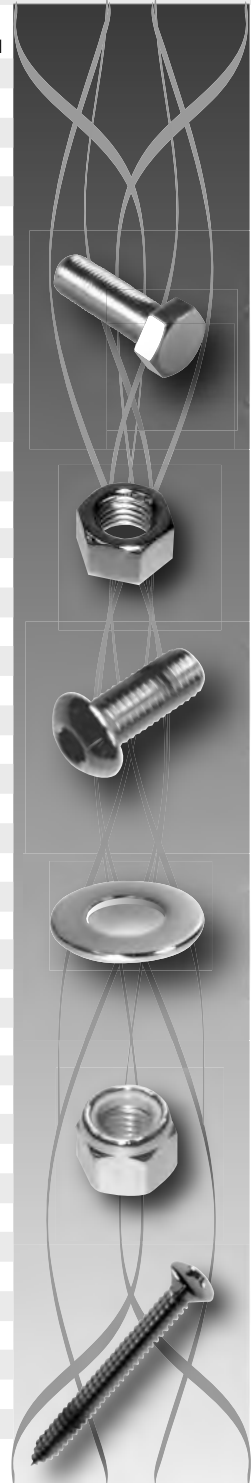





# Gardner-Westcott Company

Quality Chrome Plated and Stainless Steel Fasteners

## MOTORCYCLE FASTENER CATALOG

AMERICAN, METRIC AND BRITISH THREADS

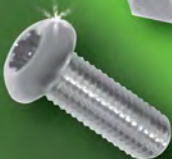

SERVING THE MOTORCYCLE INDUSTRY FOR OVER 40 YEARS

# Table of Contents



1

<b>Index</b>	<b>2</b>
<b>Harley-Davidson</b>	<b>3-56</b>
<i>Big Twin</i> .....	3
<i>Sportster</i> .....	19
<i>45cu Flathead</i> .....	31
<i>V-Rod</i> .....	33
<i>Specialty</i> .....	37
<i>Stock Style</i> .....	49
<b>British Motorcycles</b>	<b>55-58</b>
<i>BSA, Norton, Royal Enfield</i> .....	56
<i>Triumph</i> .....	57
<i>Acorn Sets</i> .....	58
<b>Motorcycles Brands and Motors</b>	<b>59-64</b>
	<i>S&amp;S Motors (Call for information)</i>
<i>Indian</i> .....	60
<i>Victory</i> .....	61
<i>Honda</i> .....	62
<i>Kawasaki</i> .....	63
<i>Suzuki</i> .....	64
<i>Yamaha</i> .....	64
<i>Ultima 100cu Motor</i> .....	64
<b>Assortments (Chrome, Stainless Steel &amp; Zinc)</b>	<b>65-78</b>
<i>American Thread Chrome Plated</i> .....	66
<i>American Thread Stainless Steel</i> .....	72
<i>American Thread Zinc Plated</i> .....	73
<i>Metric Thread Chrome Plated</i> .....	75
<i>Metric Thread Stainless Steel and Zinc</i> .....	78
<b>Bulk Fasteners (Chrome, Stainless &amp; Zinc)</b>	<b>79-106</b>
<i>American Thread</i> .....	80
<i>Metric Thread</i> .....	99
<b>Electrical and Fittings</b>	<b>107-116</b>
<i>Electrical</i> .....	108
<i>Fittings, Brass and Chrome</i> .....	111
<b>Technical Info</b>	<b>Appendix</b>
<b>TERMS</b> .....Cash or COD company check acceptable unless otherwise specified.	
<b>CREDIT</b> .....Applications for open account warrants at least three references of reputable firms that you have dealt with in the past year. Terms are net 30 days from date of invoice.If a customer is in arrears on an open account, future shipments will be processed on a COD basis until credit is restored.	
<b>PRICING</b> ..... All retail prices shown are suggested only and in no way dictate a set price. Prices are subject to change without notice.	
<b>SHIPPING</b> ..... We ship UPS and by truck, always collect, with any service charges to be paid by customer.	
<b>CLAIMS</b> .....We are not responsible for goods damaged in transit and all claims must be filed with the carrier involved.	
<b>RETURNS</b> .....Returns for credit require prior notification and authorization. No returns will be accepted after 30 days from date of invoice.	
<b>GUARANTEE</b> .....If any part is found to be defective in workmanship or unsatisfactory in any way, we will replace it or give credit where applicable.	





## Sets

### Harley-Davidson

Acorn Nut Sets, Big Twin .....	15
Acorn Nut Sets, Sportsters .....	23
Allen Plugs .....	38
Allen Screw Sets, 45CU Flathead .....	31
Other Applications, Big Twin .....	7
Other Applications, Sportsters .....	23
Axles.....	39
Axle Nuts Sets .....	39
Banjo Bolts .....	40
Bleeder Screw Cover Acorns .....	40
Builder Set, Big Twin .....	4
Builder Set, Sportsters .....	20
Brake Fasteners .....	40
Custom Applications.....	42
Cylinder Base Fasteners.....	43
Front End Fasteners .....	43
Front End Detail Set .....	43
Head Bolts .....	44
ISO Mount Studs .....	45
Motor Sets, Big Twin .....	5
Motor Sets, Sportsters .....	21
Oil Pump Fasteners .....	47
Primary Cover Allen Plugs .....	38
Rocker Box Fasteners .....	46
Rocker Shaft Fasteners .....	46
Side Cover Sets, Big Twin .....	6
Side Cover Sets, Sportsters .....	22
Specialty Fasteners .....	37
Stock Style Replacement Fasteners .....	49
Stock Style Replacement Sets .....	53
Studs .....	54
Trans Oil Allen Plug .....	14
Trans Top Cover .....	14
VRSCA V-Rod.....	33

### British Motorcycles

Side Cover Sets.....	56
BSA, Norton & Royal Enfield.....	56
Triumph.....	57
Acorn Motor Sets.....	58
Acorn Individual Sets.....	58

### Select Motorcycle Sets

Indian .....	60
Victory Motor Sets .....	61
Victory Side Cover Sets .....	61
Victory Individual Applications Sets .....	61
Victory Nut Sets .....	61
Victory Washer Sets .....	61
Honda Motor Sets .....	62
Honda Side Cover Sets .....	62
Kawasaki Motor Sets .....	63
Kawasaki Side Cover Sets .....	63
Suzuki Side Cover Sets .....	64
Yamaha Motor Sets .....	64
Yamaha Side Cover Sets .....	64
Ultima Motor Set .....	64

## Assortments

### American Thread

<b>Chrome Plated</b>	
Tray Assortments.....	66
Allen Head Screws.....	67
Hex Cap Screws.....	68
12 Point Screws.....	69
Specialty Dealer Assortments.....	69
Shop Master.....	70
Point of Purchase Display.....	71

### Stainless Steel

Tray Assortments.....	72
Allen Head Screws.....	72
Hex Cap Screws.....	72
Nylon Insert Lock Nuts.....	72
Washers.....	72

### Zinc Plated

Tray Assortments.....	73
Shop Master.....	73
Hex Cap Screws.....	73
Hex Nuts.....	73
Nylon Insert Lock Nuts.....	73
Washers.....	73
Shop Master.....	73

### Metric Thread

#### Chrome Plated

Tray Assortments.....	75
Acorn Nuts & Spacers.....	76
Allen Head Screws.....	76
Hex Caps.....	76
Nuts.....	76
Washers.....	76
Cruiser Assortment.....	77
Dealer Assortment.....	77

#### Stainless Steel

Allen Head Screws.....	78
Hex Caps.....	78
Nuts.....	78
Washers.....	78

#### Zinc Plated

Allen Head Screws.....	78
Master Allen Assortment.....	78
Hex Caps.....	78
Nuts.....	78
Washers.....	78

## Bulk Fasteners

### American Thread

#### Chrome Plated

Allen Screws.....	80
Button Head Allens.....	80
Button Head Torx.....	80
Cotter Pins.....	89
Flat Head Allen.....	81
12 Point Screws.....	81
Flame Stamped Hex Caps.....	83
Hex Caps.....	82
Machine Screws.....	84
Nuts.....	87
Polished Allens.....	80
Sheet Metal Screws.....	84
Skull Stamped Hex Caps.....	83
Spacers.....	88
Spike Nuts.....	83
G-W Hardened Washers.....	85
Washers.....	85
Valve Cover Stems.....	38

#### Stainless Steel

Allen Screws.....	90
Button Head Allen.....	90
Flat Head Allen.....	90
Hex Caps.....	91
Nuts.....	93
Machine Screws.....	95
Washers.....	92

#### Zinc Plated and L-9 Products

Allen Screws.....	96
Hex Caps & L-9.....	96
Nuts & L-9.....	97
Washers & L-9.....	97
Machine Screws.....	98

### Metric Thread

#### Chrome Plated

Allen Screws.....	100
Hex Caps.....	101
Nuts.....	102
Washers.....	102

#### Stainless Steel

Allen Screws.....	103
Hex Caps.....	103
Nuts.....	104
Washers.....	104

#### Zinc Plated

Allen Screws.....	105
Hex Caps.....	105
Nuts.....	106
Washers.....	106

## Electrical and Fittings

Electrical Wire.....	108
Heat Shrink Tubing.....	108
Clamps.....	108
Clutch Removal Washers.....	108
Nutserts.....	109
Fittings.....	112
Technical Information.....	117



## Inside This Section

### Allen Style

<i>Builders Fastener Sets.....</i>	<i>4</i>
<i>Motor Sets.....</i>	<i>5</i>
<i>Side Cover Sets.....</i>	<i>6</i>
<i>Individual Application Sets.....</i>	<i>7-14</i>

### Acorn Style

<i>Show Bike Kits.....</i>	<i>15</i>
<i>Individual Application Sets .....</i>	<i>16 -19</i>





# Big Twin Builder Fastener Sets

**Evolution Shovelhead Panhead Knucklehead Twin Cam 88cu., 96cu., 103cu. & 110cu.**

"Where there is a bolt, you get a Allen Screw,



Where there is a nut, you get a Acorn Nut"



The perfect combination of **Allen Screws, Acorn Nuts** and Washers for Motor and Transmission of Big Twins. Contains: Timing Plug, Oil Pump, Side Covers, Clutch and Chain Covers, Top Front & Rear Motor Mount (w/all Stabilizing Link Fasteners, Regulator and Bracket Mount on FXR and FLT Models), Lifter Base, Point Cover, Header Mount, Inner Primary to Casing, Rocker Box, Cylinder Base, Motor Case, Transmission Cover.

## Our Builders Fastener Sets Are For Motor and Transmission



C= Chrome Plated



P= Polished Chrome Plated Knurled



S= Stainless Steel



SP= Stainless Steel Polished Knurled



A= 12 Point Chrome Plated

(Please order Head Bolts separately)

## Builders Fastener Sets

### Styles Available

### Part #

2009 & Up Twin Cam FLT Models .....	C P S SP A	GW-72-A
2008 - 2012 Softail Rocker FXCW & FXCWC Models.....	C P S SP A	GW-73-A
2007 & Up Twin Cam Dyna Glide Models .....	C P S SP A	GW-75-A
2007 & Up Twin Cam Softail (Except FXCW & FXCWC Models).....	C P S SP A	GW-76-A
2007 - 2008 Twin Cam FLT Models 96cu.....	C P S SP A	GW-77-A
2006 - Twin Cam Dyna Glide Models 88cu.....	C P S SP A	GW-78-A
2000 - 2006 Twin Cam Softail Models 88B.....	C P S SP A	GW-79-A
1999 - 2005 Twin Cam Dyna Glide Models 88cu.....	C P S SP A	GW-99-A
1999 - 2006 Twin Cam FLT Models 88cu.....	C P S SP A	GW-98-A
1996 - 1999 Evolution FXST & FLST Softail Models.....	C P -- -- A	GW-95-A
1996 - 1998 Evolution Dyna Glide Models.....	C P -- -- --	GW-96-A
1996 - 1998 Evolution FLT Models.....	C P -- -- A	GW-97-A
1992 - 1995 Evolution Dyna Glide Models.....	C P -- -- --	GW-81-A
1991 - 1995 Evolution FXR & FLT Models.....	C P -- -- --	GW-80-A
1987 - 1990 Evolution FXR & FLT Models.....	C P -- -- A	GW-86-A
1987 - 1995 Evolution FXST & FLST Softail Models.....	C P -- -- --	GW-87-A
1986 - Evolution FXST & FLST Softail Models.....	C P -- -- --	GW-85-A
1984 - 1986 Evolution FXR & FLT Models.....	C P -- -- --	GW-84-A
1985 - 1986 Evolution (4 Speed ) Models 1984 & 85 FXST.....	C P -- -- A	GW-83-A
1982 - 1983 Shovelhead (5 Speed) FXR, FXRS & FXRT.....	C P -- -- --	GW-82-A
1979 - 1984 Shovelhead (4 Speed) Models.....	C P -- -- A	GW-88-A
1977 - 1978 Shovelhead.....	C P -- -- --	GW-89-A
1970 - 1976 Shovelhead.....	C P -- -- --	GW-90-A
1966 - 1969 Shovelhead.....	C P -- -- --	GW-91-A
1965 - Panhead.....	C P -- -- --	GW-92-A
1958 - 1964 Panhead.....	C P -- -- --	GW-93-A
1948 - 1957 Panhead.....	C P -- -- --	GW-94-A



Builders Set P-GW-77-A

**Most Sets Available in Polished Stainless Steel**



# Big Twin Motor Sets



Motor Sets include all Side Covers, Lifter Base Timing Plug, Inner Primary Mount, Top, Front and Rear Motor Mounts (with Stabilizing Link Fasteners on FXR and FLT Models), Rocker Box Covers on Pan, Evolution and Twin Cams. Header Mount, Point Cover or Generator Mount. Washers and Nuts supplied where applicable.



Motor Set P-96-76



C= Chrome Plated

P= Polished Chrome Plated  
Knurls Removed

S= Stainless Steel

SP= Stainless Steel Polished  
Knurls Removed

A= 12 Point Chrome Plated

Big Twin

	Styles Available					Part #
2009 & Up Twin Cam FLT Models .....	C	P	S	SP	A	96-72
2008 - 2012 Softail Rocker FXCW & FXCWC Models.....	C	P	S	SP	A	96-73
2007 & 2008 Twin Cam FLT Models .....	C	P	S	SP	A	96-77
2007 & Up Twin Cam Softail (except these models FXCW & FXCWC).....	C	P	S	SP	A	96-76
2007 & Up Twin Cam Dyna Glide Models .....	C	P	S	SP	A	96-75
2000 - 2006 Twin Cam Softail 88B.....	C	P	S	SP	A	88-79
2006 - Twin Cam Dyna Glide Models 88cu.....	C	P	S	SP	A	88-77
1999 - 2005 Twin Cam Dyna Glide Models 88cu.....	C	P	S	SP	A	88-99
1999 - 2006 Twin Cam FLT Models 88cu.....	C	P	S	SP	A	88-98
1991 - 1998 Evolution Dyna Glide Models.....	C	P	S	SP	A	80-81
1991 - 1998 Evolution FLT & FXR Models.....	C	P	S	SP	A	80-88
1987 - 1991 Evolution FLT & FXR Models.....	C	P	S	SP	A	80-86
1987 - 1999 Evolution FXST & FLST Softail Models.....	C	P	S	SP	A	80-87
1986 - Evolution FXST & FLST Softail Models.....	C	P	S	SP	A	80-85
1984 - 1986 Evolution (5 Speed) FXR & FLT Models.....	C	P	S	SP	A	80-84
1985 - Evolution (4 Speeds) & 1984 - 1985 Softails.....	C	P	S	SP	A	80-83
1982 - 1983 Shovelhead (all) FXR Models.....	C	P	S	SP	A	80-82
1977 - 1984 Shovelhead FX & FLH (all 4 Speeds).....	C	P	S	SP	A	74-89
1970 - 1976 Shovelhead FX & FLH (all) Models.....	C	P	--	--	A	74-90
1966 - 1969 Shovelhead (all) 74cu. Models.....	C	P	--	--	--	74-91
1965 - Panhead (with Short Pan Cover Screws).....	C	P	--	--	--	74-92
1965 - Panhead (with Long Pan Cover Screws).....	C	P	--	--	--	74-92D
1958 - 1964 Panhead (with Short Pan Cover Screws).....	C	P	--	--	--	74-93
1958 - 1964 Panhead (with Long Pan Cover Screws).....	C	P	--	--	--	74-93D
1948 - 1957 Panhead (with Short Pan Cover Screws).....	C	P	--	--	--	74-94
1948 - 1957 Panhead (with Long Pan Cover Screws).....	C	P	--	--	--	74-94D
1936 - 1947 Knucklehead .....	C	P	--	--	--	74-95

## Big Twin Full Motorcycle Sets

Full Motorcycle Sets for 2000 & Up Softail Models contains fasteners for the Motor including Head Bolts, Transmission, Chassie, Wheels and Brake Components. Sets contain one each of every applicable set listed in individual applications. Sets for the full motorcycle are done in **Polished Show Chrome**.

2000 - 2006 FXST & FXSTB Softails.....	P-99-100
2000 - 2006 FXSTS Springer Softails.....	P-99-101
2000 - 2006 FLSTC & FLSTF Softails.....	P-99-102
2000 - 2006 FLSTS Springer Softails.....	P-99-103



# Big Twin Side Cover Sets

**Cam & Primary Cover Sets Includes:** Transmission, Chain Clutch or Derby provided where applicable.

	Styles Available	Part #
2007 & Up Twin Cam Softtail Models .....	C P S SP A	10-12-01
2007 & Up Twin Cam FLT Models .....	C P S SP A	10-14-01
2006 & Up Twin Cam Dyna Glide Models .....	C P S SP A	10-15-01
2008 - 2012 Softtail Rocker Models.....	C P S SP A	10-11-01
2000 - 2006 Twin Cam Softtail Models 88B.....	C P S SP A	10-16-01
1999 - 2005 Twin Cam Dyna Glide Models 88cu.....	C P S SP A	10-18-01
1999 - 2006 Twin Cam FLT Models 88cu.....	C P S SP A	10-17-01
1991 - 1998 Dyna Glide Models.....	C P S SP A	10-19-01
1987 - 1999 Softtail Models.....	C P S SP A	10-24-01
1987 - 1998 FXR & FLT (5 Speed Models).....	C P S SP A	10-20-01
1985 - 1986 FXR & FLT (5 Speed Models).....	C P S SP A	10-21-01
1982 - 1984 & 1980 - 1984 FXR 1982 - 1984, 1980 - 1984 FLT.....	C P S SP A	10-22-01
1970 - 1984 FLH & FX (All 4 Speed Models).....	C P -- --- --	10-25-01
1965 - 1969 (Cam, Primary & Chain Inspection Cover Set).....	C P -- --- --	10-23-01
1936 - 1964 (Cam, Primary, Derby & Inspection Cover Set).....	C P -- --- A	10-27-01



Side Cover Set  
P-10-12-01

## Cam Cover Set Only

1999 & Up Twin Cam 88cu. & 96cu. Dyna & FLT Models; 2000 & Up Softtail Models.....	C P S SP A	10-18-06
1991 - 1998 FXR & Dyna Glide Models.....	C P S SP A	10-20-06
1987 - 1999 Softtail Models.....	C P S SP A	10-24-06
1970 - 1986 FLH & FX Models (All 4 Speeds).....	C P S SP A	10-25-06
1936 - 1969 Big Twins 74cu.....	C P -- --- A	10-27-06

## Primary, Clutch and Chain Covers Only

2007 & Up Twin Cam FLT Models 96cu.....	C P S SP A	10-14-08
2006 & Up Twin Cam Dyna Glide & 2007 Softails.....	C P S SP A	10-15-08
Same as above with Spike Nuts & Studs.....	C -- -- --- --	50-179x
1999 - 2006 Twin Cam FLT Models 88cu. (Primary cover only).....	C P S SP A	10-17-08
1999 - 2006 Dyna Glide Models 88cu. (Primary cover only) & 2000 - 2006 Softails.....	C P S SP A	10-18-08
1989 - 1998 FXST, FLST Models & 1991 - 1998 Dyna Glide 80cu. Models.....	C P S SP A	10-24-08N
1987 - 1988 Softtail Models & 1984 - 1986 FXST.....	C P S SP A	10-24-08
1970 - 1984 FX & FLH Models (4 Speeds).....	C P S SP A	10-25-08
1985 - 1998 FXR & FLT Models (5 Speeds).....	C P S SP A	10-21-08
1980 - 1984 FXR & FLT Models (5 Speeds).....	C P S SP A	10-22-08
1965 - 1969 Big Twins.....	C -- -- --- --	10-23-08
1936 - 1964 (Derby & Inspection Covers).....	C P S SP --	10-27-09
1936 - 1964 Big Twins (Primary cover only).....	C P S SP A	10-27-05

## Transmission Side Covers

2007 & Up Twin Cam Softtail Models 96cu.....	C P S SP A	10-12-07
2007 & Up Twin Cam FLT Models 96cu.....	C P S SP A	10-14-07
2006 & Up Twin Cam Dyna Glide Models 88cu.....	C P S SP A	10-15-07
1987 - 2006 (Transmission Side Covers only 5 Speeds).....	C P S SP A	10-20-07
1980 - 1986 (Transmission Side Covers only 5 Speeds).....	C P S SP A	10-22-07
1936 - 1984 Big Twins (4 Speeds with removal of studs).....	C P S SP A	74-12

# Big Twin Individual Sets



- Where required, sets are supplied with Flat Washers, Lock Washers, Special Washers, Hex Nuts and/or Locknuts.
- Some sets are only available in Polished Chrome.
- All sets are available in 24K Gold Plated.
- Some sets are available in other styles.



**Big Twin**

## Air Cleaner Cover

**Styles Available**     **Part #**

1984 & Up Big Twin ( <i>Stock 1 Screw Round</i> ).....	C	P	S	SP	--	--	--	80-54
1979 - 1985 ( <i>Stock 3 Screw</i> ).....	C	P	S	SP	--	A	--	20-54
1967 - 1978 XL & FL & 1988 XLH ( <i>Stock Oval</i> ).....	C	P	--	--	--	--	--	20-33

## Bendix

Bendix Carburetor Set.....	C	P	--	--	--	--	--	31-37
----------------------------	---	---	----	----	----	----	----	-------

## Belt Sprocket to Hub Mount with special washers

2007 & Up Softail & Dyna Glide Models & 2007 FLT Modles.....	C	P	--	--	H	A	--	96-58
2000 - 2006 Dyna Glide & Softail also 2004 - 2006 FLT Models.....	C	P	--	--	H	A	--	88-59
2000 - 2003 FLT Models.....	C	P	--	--	H	A	--	88-49
1980 - 1983 FLTS ( <i>1987-1999 FXR, FLT, FXST &amp; FLST, 1991-1999 FXD Cast Wheel</i> ).....	C	P	--	--	H	A	--	74-59
1980 - 1984 FX & ( <i>1984-1986 FLT, 1983-1985 FLH, 1982-1986 FXR Cast Wheel</i> ).....	C	P	S	SP	H	A	--	74-49
1987 - 1990 FXR, FLT, FXST, FLST Models ( <i>Laced Wheel</i> ).....	C	P	--	--	H	A	--	74-58
1984 - 1985 FXWG & ( <i>1986 FXST &amp; FXR, 1992 &amp; Up Big Twins, 1991 &amp; Up XL Laced Wheel</i> )...	C	P	--	--	H	A	--	80-51

## Belt Guard Mount

2000 & Up Softail Models.....	C	P	S	SP	H	A	--	88-25
-------------------------------	---	---	---	----	---	---	----	-------

## Brake Line Banjo Bolts

2008 & Up FLT Models also 2006 & Up V-Rods, ( <i>replaces 41750-06A</i> ).....	--	P	--	--	--	A	--	80-119
1984 & Up ( <i>Front includes aluminum washers, replaces 41739-84A</i> ).....	--	P	--	--	--	A	--	80-111
1982 & Up ( <i>Front and or Rear includes aluminum washers, replaces 41747-82A</i> ).....	--	P	--	--	--	A	--	80-110
1958 - 1972 ( <i>Rear Brake Wheel Cylinder includes washers</i> ).....	--	P	--	--	--	--	--	80-112

## Brake Caliper Bolts

(See Disc Brake Caliper Mount)

## Cam Cover

1999 & Up Twin Cam 88cu. also 2000 & Up Softail Models.....	C	P	S	SP	H	A	--	10-18-06
1987 - 1998 FXR, FLT; also 1991 - 1998 Dyna Glide.....	C	P	S	SP	H	A	--	10-20-06
1970 - 1985 FLH & FX Models ( <i>All 4 Speeds</i> ).....	C	P	S	SP	H	A	--	10-25-06
1936 - 1969 Big Twins 74cu.....	C	P	--	--	--	--	--	10-27-06

## Carburetor Sets

Bendix Carburetor Set.....	C	P	S	SP	--	A	--	31-37
Keihin Carburetor ( <i>Butterfly Throttle HD</i> ).....	C	P	S	--	--	--	--	80-36
Keihin Carburetor ( <i>Constant Velocity HD</i> ).....	C	P	S	SP	--	--	--	61-36
Keihin Carburetor ( <i>Constant Velocity Top Cover Only</i> ).....	C	P	S	SP	--	--	--	61-37
Dellorto Pumper Carb; 38mm & 40mm ( <i>with Allen Wrench</i> ).....	C	P	--	--	--	--	--	31-36
S&S Super E&G ( <i>shorty Full Carb Set</i> ).....	C	P	S	--	--	--	--	31-38
S&S Super ( <i>with Air Cleaner &amp; Intake Set</i> ).....	C	P	S	SP	--	--	--	31-33



# Big Twin Individual Sets

## Chain Sprocket To Hub

	Styles Available	Part #
1973 - 1984 FX, FLH also 1984 - early & 1985 FXST Softail ( <i>Laced Wheel</i> ).....	C P S SP H A --	74-48
1973 - 1985 Big Twins ( <i>Cast Wheels</i> ).....	C P S SP H A --	74-49

## Coil

2004 & Up Dyna Glide Models ( <i>Coil Cover Mount</i> ).....	C P S SP H A --	88-45
1999 - 2003 Dyna Glide Models ( <i>Coil Cover Mount</i> ).....	C P S SP H A --	88-46

## Circuit Breaker

1936 - 1969 Circuit Breaker Mount.....	C P -- ---- -- A --	74-41
--	---------------------	-------

## Cylinder

Cylinder Base Allen Screws ( <i>requires removal of studs on Pan &amp; Shovelheads</i> ).....	C P -- ---- -- A --	74-08
---	---------------------	-------

## Derby

1999 & Up Twin Cam Derby ( <i>available in Bottonhead Torx &amp; Buttonhead Allens</i> ).....	C P S SP -- A T	10-18-09
1970 - 1998 Big Twins ( <i>Only Derby Cover</i> ).....	C P S SP -- A --	10-20-09
1936 - 1964 Big Twins ( <i>Derby &amp; Inspection Covers</i> ).....	C P -- ---- -- --	10-27-09

## Disc Brake Caliper Mount - Front

2008 & Up Dyna & Softail ( <i>except Springers</i> ) ( <i>Also Part # 96-146 I has no pins</i> ).....	-- P -- ---- -- A --	96-146
2008 & Up FLT Models ( <i>Also Part # 96-147 I has no pins</i> ).....	-- P -- ---- -- A --	96-147
2000 - 2007 ( <i>except Springers</i> ).....	-- P -- ---- -- A --	80-147
1993 - 1999 ( <i>except Springers</i> ).....	-- P -- ---- -- --	80-143
1984 - 1992 ( <i>except Springers</i> ).....	-- P -- ---- -- --	80-144
1988 & Up FXSTS Springer Softails.....	-- P -- ---- -- --	80-145
1997 & Up FLSTS Springer Softails.....	-- P -- ---- -- --	80-146
1977 - 1983 Dual XL & FX.....	C P -- ---- -- --	80-43
1974 - 1977 Single XL & FX.....	C P -- ---- -- A --	20-49

## Disc Brake Caliper Mount - Rear

2008 & Up FLT & V-Rod Models ( <i>Also Part # 96-148 I has no pins</i> ).....	-- P -- ---- -- A --	96-148
2008 & Up Dyna Glide & Softail Models ( <i>Also Part # 96-143 I has no pins</i> ).....	-- P -- ---- -- A --	96-143
2006 - 2007 Softail FX Models ( <i>Also Part # 96-147 I has no pins</i> ).....	-- P -- ---- -- A --	80-149
2000 - 2007 ( <i>except 2006 &amp; 2007 Softail FX Models</i> ).....	-- P -- ---- -- A --	80-148
1987 - 1999 Rear Brake Caliper.....	C -- -- ---- -- --	80-142
1982 - 1986 FXR Rear.....	C P S SP -- A --	61-08
1973 - 1984 Rear FX, FLH & Front FLH ( <i>with special washers</i> ).....	C P S SP H A --	74-43

## Disc Brake Rotor to Hub - Front

1984 & Up Single - ( <i>Fits All Cast Wheel, dual disc will require 2 sets</i> ).....	C -- -- ---- -- -- T	80-42
1984 & Up Single - ( <i>Fits All Laced Wheel</i> ).....	C -- -- ---- -- -- T	80-41
2014 FLT Models - FLHX, FLHTCU, FLHXS & FLHTK.....	-- P -- ---- -- -- T	96-42
2006 & Up Dyna Glide, FXD, FXGL Models Brake Rotor to Hub.....	-- P -- ---- -- --	69-42
1974 - 1978 Single - XL & FX.....	C P S SP -- --	20-55
1977 - 1983 Dual - Fits FX & XL, 1982 - 1983 FXR Models ( <i>Cast Wheel</i> ).....	C -- -- ---- -- --	20-04
1977 - 1983 Dual - Fits FX & XL, 1982 - 1983 FXR Models ( <i>Laced Wheel</i> ).....	C -- -- ---- -- --	20-04N

## Disc Brake Rotor to Hub - Rear

1992 & Up Big Twins ( <i>Cast Wheel</i> ).....	C -- -- ---- -- -- T	61-32
1992 & Up Big Twins ( <i>Laced Wheel</i> ).....	C -- -- ---- -- -- T	61-31
1981 - 1991 FXR Models, 1984 - 1991 FXST, FLST Models.....	C P S SP -- --	74-52
1977 - 1991 Big Twins ( <i>Cast Wheel</i> ).....	C P S SP -- --	74-01
1973 - 1984 FX & FLH ( <i>with Lock Nuts</i> ).....	C P -- ---- H --	74-51
1981 - 1984 FLH ( <i>Laced Wheel</i> ).....	C -- -- ---- -- --	20-69
1980 - 1981 FLT ( <i>Cast Wheel</i> ).....	C -- -- ---- -- --	80-76
1982 - 1985 FLT; 1980 - 1981 Right Side Front FLT ( <i>Cast Wheel</i> ).....	C -- -- ---- -- --	80-75

## Disc Brake Support Bracket and Mount - Rear

1973 - 1982 Big Twins, ( <i>Hex Caps Chrome includes washers &amp; cotter pins</i> ).....	-- -- -- ---- H --	31-07
1981 - 1984 FLH also 1981 - 1982 FX & 1983 FXE Models ( <i>Hex Cap and clevis pin and cotter pins</i> ).....	-- -- -- ---- H --	31-08

# Big Twin Individual Sets



Electrical Panel	Styles Available	Part #
2000 & Up Dyna Glide.....	C P S SP -- A --	88-48
1991 - 2003 Dyna Glide ( <i>Electrical Panel Frame Cover</i> ).....	C P S SP -- A --	80-48
<b>Fender Mount - Front</b>		
1972 XL & FX.....	C P S SP -- -- --	20-22
1974 - 1983 XL & FX ( <i>includes Bracket Mount</i> ).....	C P S SP -- -- --	20-03
1984 & Up XL, FX, Dyna's ( <i>except</i> ) FXDWG.....	C P S SP -- -- --	61-04
Softail & Dyna Wide Glide ( <i>with Lock Nuts</i> ).....	C P S SP -- -- --	88-04
FXDWG, FXST & FXSTB ( <i>only with Acorn Nuts</i> ).....	C P S SP H A --	88-04A
<b>Fender Rail-Rear</b>		
2000 & Up FXST Models ( <i>call for set</i> ).....	C P S SP H -- --	88-21
1986 - 1999 FXST Models.....	C P -- -- -- --	80-46
2003 & Up FLST Models ( <i>no bags</i> ).....	C P S SP H A --	88-23
1958 - 1978 FLH ( <i>no bags or rack</i> ).....	C P -- -- -- --	80-05
1980 & Earlier FX ( <i>with CTSK holes</i> ).....	C P S SP -- -- --	74-21
1980 - 1985 FXWG.....	C P -- -- -- A --	80-21
1984 & Earlier FX ( <i>with Sissy Bar</i> ).....	C P S SP H -- --	74-23
1984 & Earlier FX ( <i>with STD head no bars</i> ).....	C P S SP H -- --	80-11
1984 & Earlier FX ( <i>with Sissy Bar CTSK holes</i> ).....	C P -- -- -- --	74-30
<b>Floorboard Mount</b>		
1982 & Up Floorboard Hinge Bolt Mount Set ( <i>Hex Caps with nuts and washers</i> ).....	-- -- -- -- H -- --	80-104
<b>Foot Peg Mount</b>		
2006 & Earlier XL, Dyan Glide & Softail ( <i>Pin Style 1 Set</i> ).....	C P S SP H A --	88-35
1985 & Earlier XL, FX & FLH ( <i>Front &amp; Rear special shoulder bolts</i> ).....	C -- -- -- -- --	20-35
1982 - 1994 Foot Pegs Mount - FXRS ( <i>All 3 Set</i> ).....	C P S SP H A --	80-35
<b>Foot Peg &amp; Bracket Mount</b>		
2000 & Up Softail Models Bracket Mount, ( <i>both sides with Brake Pedal Mount and Master Cylinder Cover Screws, Shifter Arm and Kickstand Mount</i> ).....	C P S SP H A T	88-01
2000 & Up FXST Softail Models ( <i>same as above</i> ).....	C P S SP H A T	88-03
1991 & Up Dyna Glide.....	C P -- -- -- --	80-105
1974 - 1984 FX Rear.....	C P S SP H A --	74-36
<b>Front Fork Leg Damper Tube</b>		
1975 & Up XL, FX, FXR & FXD ( <i>both with washers</i> ).....	C -- -- -- -- --	61-58
<b>Front Fork Leg Drain-Front</b>		
1977 & Up FLH, FLT, FXWG & FXDWG Softail also all 41mm Models.....	C P -- -- -- --	74-45
1973 - XL, FX, FXR & FXD thru 2005 Dyna's ( <i>with washers &amp; Allen wrench</i> ).....	C P -- -- -- --	20-58
1957 - 1972 XL & FX Models.....	C P -- -- -- --	20-57
1947 - 1977 FLH & 45cu. Flatheads.....	C P S -- -- -- --	74-47
<b>Fork Tube Allen Caps</b>		
1988 - 2005 Sportsters & FXR Model, 1987 - 2005 Dyna's 39mm.....	C -- -- -- -- --	99-23
1977 & Up FLH and FXWG.....	C -- -- -- -- --	99-21
<b>Frame Side Cover</b>		
2004 & Up Dyna Glide Models.....	C P S SP -- -- --	88-48
1991 - 2003 FXD Dyna Glide Models ( <i>Electrical Panel Cover</i> ).....	C P S SP -- -- --	80-48
1982 - 1994 FXR Models.....	C P S SP -- -- --	80-47
<b>Front End Detail Set</b>		
1988 - 2007 XL, FXR and FXD 39mm. ( <i>includes fasteners for Fork Tube Caps, Top Triple Tree Bolt, Drain Screw, Axle Cap, Nuts and Triple Tree Pinch Bolts</i> ).....	C P -- -- -- --	80-49



# Big Twin Individual Sets

Gas Tank Mount	Styles Available	Part #
Fatbob - FLH and FXEF ( <i>Early Style 4 Speeds</i> ).....	C P S SP H A --	74-34
Fatbob - Big Twin ( <i>4 Speed, Late Style includes: spacers, shims and rear bolts</i> ).....	C P -- ---- -- A --	80-134
Fatbob - Big Twins 1985 and 1986.....	C P S SP H A --	80-34
1982 - 1994 FXR & FXRSP, 1982-87 FXRS Models ( <i>includes Top Panel Mount</i> ).....	C P S SP -- -- --	80-39
1988 - 1994 FXRS Models.....	C P S SP -- -- --	80-70
1984 - 1989 FXST Models.....	C P S ---- -- -- --	80-72
1990 - 1999 FXST and FLST Models.....	C P S ---- -- -- --	80-98
2000 & Up Softail Models ( <i>with Speedo Cover and Tank Cover</i> ).....	C P S SP H A --	88-34
1991 & Up Dyna Glide Models <i>except</i> FXDWG.....	C P S ---- -- -- --	80-73
2008 & Up FLT.....	C P S SP H A --	96-34
<b>Generator Screws</b>		
1958 - 1969 Big Twin.....	C P -- ---- -- A --	74-14
1936 - 1957 Big Twin.....	C P -- ---- -- -- --	74-13
<b>Handlebar Clamp Mount</b>		
1984 & Up XL and FXR ( <i>Speedo Bracket</i> ).....	C P S SP -- -- --	80-55
1981 & Up XL and FX.....	C P S SP -- -- --	80-52
1974 - 1981 XL and FX.....	C P S SP -- -- --	20-52
<b>Handlebar Lever Switch Boxes</b>		
2008 & Up with Brake and Master Cylinder Covers, <i>except</i> FLT.....	C P S SP -- -- --	96-50
2009 & Up SE Models.....	C -- S SP -- -- --	96-50B
1996 & Up with Master Cylinder Screws, <i>except</i> 2008 & Up FLT.....	C P S SP -- -- T	74-150
1996 & Up with Master Cylinder Screws, <i>except</i> 2008 & Up FLT ( <i>in Buttonhead</i> ).....	C P S SP -- -- --	74-150B
1996 & Up with Master Cylinder Screws, <i>except</i> 2008 & Up FLT ( <i>in Stock Style</i> ).....	C P S SP -- -- --	74-150Y
2008 & Up FLT <i>except</i> SE Models with Master Cylinder Screws.....	C P S SP -- -- --	88-150B
2008 & Up SE Models with Master Cylinder Screws.....	C P S SP -- -- --	96-150B
1982 - 1995 HD with Master Cylinder Screws.....	C P S SP -- -- --	74-50
1982 - 1995 HD with Master Cylinder Screws - HD ( <i>in Buttonhead</i> ).....	C P S SP -- -- --	74-50B
1973 - 1981 HD with Master Cylinder and Twist Grip Screws.....	C P S SP -- -- --	20-40
1971 Harley's with Switch Mount.....	C P S SP -- -- --	20-39
<b>Handlebar Rizer Mount</b>		
1986 - 1996 FXST, FXSTC, 1993 - 2000 FLT, 1995 & Up FLST( <i>with cup washers</i> ).....	C P -- ---- H A --	80-123
1991 & Up Dyna Glides and 1997 & Up FXST ( <i>with lockwashers and cup washers</i> ).....	C P S SP H A --	80-120W
1974 - 1984 FX Models ( <i>with lock and cup washers and nuts</i> ).....	-- -- -- ---- H -- --	80-122H
<b>Head Bolts</b>		
1992 & Up Sportsters and Big Twins.....	-- -- -- ---- -- A --	61-110
1986 - 1991 Big Twins; 1987 - 1991 XL.....	-- -- -- ---- -- A --	61-100
1984 - 1985 Evolution.....	C P -- ---- -- A --	80-10
1948 - 1985 Panhead and Shovelhead ( <i>with Special Washers</i> ).....	C P -- ---- -- A --	74-10
1948 - 1985 Panhead and Shovelhead ( <i>with Special Washers Stock Style Hex</i> ).....	C -- -- ---- -- -- --	31-09
Knucklehead 74cu. ( <i>with Special Washers</i> ).....	C P -- ---- -- -- --	74-09
<b>Header Mount</b>		
Shovelhead, ( <i>includes gaskets and washers</i> ).....	C P S SP H A --	74-20
Evolution Motors ( <i>with removal of stud</i> ).....	C P S SP -- A --	80-03
Evolution & Big Twin Cam Stock Style Flange Nuts.....	-- P -- ---- -- -- --	50-03Y
<b>Headlight Bracket</b>		
Headlight Bracket Mount - XL, FX and FXR.....	C P S SP H A --	20-23
<b>Inner Primary to Motor Case</b>		
1999 - 2006 Dyna Glide 88cu; 2000 - 2007 FLT and Softails.....	C P S SP H A --	88-53
1970 - 1985 Big Twin ( <i>4 Speed</i> ).....	C P S SP H A --	74-53
1991 - 1998 Big Twin FXR, FLT, FXD and 1999 FXST Softails.....	C P S SP H A --	80-53
<b>Intake Manifold</b>		
1991 - 2001 big Twins ( <i>Injected Models</i> ).....	C P S SP H A --	61-04
1990 - 1994 Big Twins ( <i>with Carburetors</i> ).....	C P S SP H A --	61-38
1995 & Up Big Twins ( <i>with Carburetors</i> ).....	C P S SP H A --	61-39

# Big Twin Individual Sets



	Styles Available							Part #
<b>Keihin Carburetor</b>								
Harleys Set ( <i>butterfly throttle</i> ).....	C	P	--	----	--	--	80-36	
Harleys Set ( <i>constant velocity</i> ).....	C	P	--	----	--	--	61-36	
Constant Velocity Top Cover Only.....	C	P	--	----	--	--	61-37	
<b>Kickstand</b>								
1985 - FLH and FX.....	C	P	S	SP	H	A	--	74-25
<b>Kick Starter</b>								
HD Kick Starter Arm Mount Top and Bottom.....	C	P	S	SP	H	A	--	20-26
<b>License Plate Mount</b>								
Fits All ( <i>includes Flat Washers &amp; Hex Nuts</i> ).....	C	P	S	SP	H	A	--	20-34
Fits All ( <i>includes Flat Washers &amp; Acorn Nuts</i> ).....	C	P	S	SP	H	A	--	20-34A
Fits All ( <i>includes Flat Washers &amp; Lock Nuts</i> ).....	C	P	S	SP	H	A	--	20-34N
Fits All ( <i>includes Flat Washers &amp; Spike Nuts</i> ).....	C	P	--	----	--	--	--	20-34x
Bracket to Fender ( <i>All with large washers &amp; Hex Nuts</i> ).....	C	P	S	SP	H	A	--	20-41
<b>Lifter Base</b>								
1999 & Up Twin Cam 88cu. & 96cu. FLT, Dyna Glide & 2000 & Up Softails.....	C	P	S	SP	--	A	--	88-26
1977 - 1999 Big Twin 80cu.....	C	P	S	SP	--	A	--	74-26
1936 - 1976 Big Twin.....	C	P	--	----	--	A	--	74-16
1977 - 1999 Custom Big Twin Old Blocks.....	C	P	--	----	--	A	--	31-35
1977 & Earlier Custom Big Twin New Blocks.....	C	P	--	----	--	A	--	31-16
<b>Magneto Cover</b>								
All Models, ( <i>with Allen wrench</i> ).....	C	P	S	SP	--	--	--	20-46
<b>Master Cylinder Rear</b>								
Brake Pedal Mnt. with Top Cover, Bracket Mnt. ( <i>footpeg brackets both sides</i> ).....	C	P	S	SP	H	A	--	88-01
2005 & Up FXST & 2006 & Up Dyna Glides ( <i>Rear Master Cylinder Cover</i> ).....	C	--	S	SP	--	--	--	96-01
1982 - 1994 FXR ( <i>with Reservoir &amp; Cover Mount</i> ).....	C	P	S	SP	--	--	--	80-38
1984 - 1985 Fx Cover Mount.....	C	P	S	SP	--	--	--	80-04
1979 - 1983 FX Cover Mount.....	C	P	S	SP	--	--	--	80-01
<b>Motor Case Set</b>								
Big Twin 88B Twin Cam 2000 & Up Softail Models .....	C	P	--	----	H	A	--	88-31
Big Twin 88cu. Twin Cam Models; 1999 & Up FLT and Dyna Models .....	C	P	--	----	H	--	--	88-29
1996 - 1999 Big Twin 80cu.....	C	P	--	----	H	--	--	80-157
1983 - 1995 Big Twin 80cu.....	C	P	--	----	H	--	--	80-57
1979 - 1982 Big Twin 80cu.....	C	P	--	----	H	--	--	74-31
Big Twin 74cu.....	C	P	--	----	H	--	--	74-29
Big Twin 74cu. thru 1978 ( <i>incl. Tapered studs, Allen Screws, Acorn Nuts, Washers</i> ).....	C	P	--	----	--	--	--	74-29YA
Big Twin 74cu. thru 1978 ( <i>Same as Above with Hex Cap &amp; Hex Nuts Stock Style</i> ).....	C	P	--	----	--	--	--	74-29YH
<b>Motor Mount - Top, Front &amp; Rear</b>								
2009 & Up FLT Models ( <i>Top, Front and Rear</i> ).....	C	P	S	SP	H	--	--	96-16
2007 - 2008 FLT Models ( <i>Top, Front and Rear</i> ).....	C	P	S	SP	H	--	--	96-17
2007 & Up Dyna Glides ( <i>Top, Front and Rear and Trans</i> ).....	C	P	S	SP	H	--	--	96-18
2007 & Up Softails ( <i>Top, Front and Rear Post with Spacers</i> ).....	C	P	S	SP	H	--	--	96-19
2007 & Up Softails ( <i>Top, Rear and Post</i> ).....	C	P	S	SP	H	A	--	96-11
2000 - 2006 Softails ( <i>Top, Bottom, Front and Rear with Front Spacers</i> ).....	C	P	S	SP	H	--	--	88-19
2000 & Up Softail Models, Big Twin 88B ( <i>Lower Front Set with Spacers</i> ).....	C	P	--	----	H	--	--	88-11
2000 - 2006 Softails ( <i>Top, Bottom and Rear only</i> ).....	C	P	--	----	H	--	--	88-14
1999 - 2006 Dyna Glide Models.....	C	P	S	SP	H	A	--	88-18
1999 - 2006 FLT Models.....	C	P	S	SP	H	A	--	88-17
1991 - 1998 Dyna Glides.....	C	P	--	----	--	--	--	80-77
1948 - 1984 Big Twin ( <i>4 Speeds with Special Washers</i> ).....	C	P	S	SP	H	A	--	74-19
1948 - 1985 Big Twin ( <i>4 Speeds Top Strap</i> ).....	C	P	S	SP	H	A	--	74-11
1982 - 1983 FXRS.....	C	P	--	----	H	A	--	80-19
1984 - 1986 FLT & FXR.....	C	P	S	SP	H	A	--	80-17
1987 - 1990 FLT & FXR.....	C	P	S	SP	H	A	--	80-56
1991 - 1998 FLT & FXR.....	C	P	--	----	--	--	--	80-96
1984 - 1999 Softail & 1985 FX.....	C	P	S	SP	H	A	--	80-18



# Big Twin Individual Sets

## Oil Filter Mount

	Styles Available	Part #
1999 - 2000 Twin Cam 88cu Models.....	C P S SP -- A --	88-28
1992 - 1999 Big Twins 80cu.....	C P S SP -- A --	80-116

## Oil Pump Mount

1992 - 1999 Big Twins 80cu.....	C P -- ---- -- A --	80-97
1979 - 1991 Big Twins.....	C P -- ---- H A --	74-32
1968 - 1978 Big Twins.....	C P -- ---- -- --	74-28
1936 - 1967 Big Twins.....	C P -- ---- -- --	80-13

## Oil Pump Top Plug Set

1981 - 1999 80cu. (o-rings & plugs for case oil screen, ck. valve & relief valve).....	C -- -- ---- -- --	80-32
1970 - 1980 74cu. & 80cu. (o-rings, plugs for case oil screen, ck. valve & relief valve).....	C -- -- ---- -- --	80-28
1968 - 1969 74cu. (includes o-ring, plugs for case oil screen, ck. valve & relief valve).....	C -- -- ---- -- --	80-29
1966 - 1967 74cu. (replaces plugs for motor case oil screen, ck. valve & relief valve).....	C -- -- ---- -- --	80-30
1952 - 1965 74cu. (replaces plugs for motor case oil screen, ck. valve & relief valve).....	C -- -- ---- -- --	80-31

## Oil Tank Drain Screw

H-D 1981 & Up (with special washer).....	C P -- ---- -- A --	80-20
H-D thru 1980.....	C P -- ---- -- A --	20-20

## Pan Covers

1948 - 1965 Panhead (with thick "D" ring).....	C P S SP -- -- --	10-27-03
1948 - 1965 Panhead (with thin "D" ring).....	C P S ---- -- --	10-27-02

## Points Cover Mount

1999 & Up Twin Cam 88 Models, Dyna, FLT and 2000 & Up Softails.....	-- P S SP -- -- T	88-12
1979 - 1999 (Buttonhead Allens with gasket and wrench 80cu).....	C P S SP -- -- T	20-37
1970 - 1978 (Buttonhead Allens with gasket and wrench).....	C P S SP -- -- T	20-12
1970 - 1978 (includes Condenser Mount and Point Mount).....	C P -- ---- -- -- T	74-44

## Primary Cover, includes clutch and chain covers

2007 & Up FLT Models (Primary & Derby Covers).....	C P S SP -- A --	10-14-08
2006 & Up Dyna Glide and 2007 & Up Softail Models.....	C P S SP -- A --	10-15-08
1999 - 2005 Dyna Glide & 2006 Softail Models.....	C P S SP -- A --	10-18-08
1999 - 2006 FLT Models.....	C P S SP -- A --	10-17-08
1989 - 1998 FXST, FLST; 1991 - 1998 Dyna Glide Models.....	C -- -- ---- -- A --	10-24-08N
1987 - 1988 Softail Models.....	C P S SP -- A --	10-24-08
1970 - 1984 FX & FLH Models (4 Speeds).....	C P S SP -- A --	10-25-08
1985 - 1998 FLT Models (5 Speeds).....	C P S SP -- A --	10-21-08
1980 - 1984 Softail (5 Speed).....	C P S SP -- A --	10-22-08
1965 - 1969 (Primary and Chain Inspection Cover).....	C P -- ---- -- --	10-23-08

## Rear Fork

1984 - 1999 Softail Models (Rear Fork Assembly Mount).....	C -- -- ---- H -- --	80-09
2000 & Up Softail Models (Rear Fork Assembly Mount).....	C -- -- ---- H -- --	88-09H

## Regulator Mount

2001 & Up Softail Models.....	C P S SP -- A --	88-07
2004 & Up Dyna Glide Models.....	C P S SP -- A --	88-08
2000 & Up 88B Softails (includes Bracket Mount).....	C P S SP -- A --	88-02
1996 - 2003 Dyna Glide Models.....	C P S SP -- A --	80-132
1976 - 1984 Big Twins, FL and FX, 1984 -1986 Softail; 1991 - 1995 Dyna Glide.....	C P S SP -- A --	74-24
1980 & Up FXR & FLT Models (Includes Bracket Mount).....	C P S SP -- A --	80-02
Big Twins 1970 - 1974.....	C P S SP -- -- --	74-27

## Rocker Arm Shaft End-Right

1971 - 1984 XL & Shovelhead.....	C P S SP -- A --	74-55
1971 - 1984 Shovelhead (in Buttonheads).....	C P S SP -- A --	74-55B
1966 - 1970 Shovelhead & 1957 - 1970 Sportster.....	C P S SP -- A --	74-56



# Big Twin Individual Sets



**Big Twin**

	Styles Available							Part #
<b>Rocker Boxes</b>								
1999 & Up 88cu. Twin Cam FLT & Dyna Models & 2000 Softails.....	C	P	S	SP	H	A	--	88-15
1984 - 1999 Evolution 80cu. (with copper and steel washers).....	C	P	S	SP	H	A	--	80-15
1984 - 1999 Evolution 80cu. (with taper cup washers).....	C	P	S	SP	H	A	--	80-15W
1981 - 1984 Shovelhead (requires drilling to 3/8 diameter hole).....	C	P	S	SP	H	A	--	80-08
1966 - 1981 Shovelhead (requires drilling to 3/8 diameter hole).....	C	P	S	SP	H	A	--	74-15
Full Rocker Box Mount Set (fits Evolutions with inside & top mounting hardware).....	C	P	--	--	--	--	--	80-115Y
<b>Saddle Bag</b>								
1986 & Up FHLT (Saddle Bag, Racks, Fender Rails & Crash Bars Mount Set).....	C	P	S	SP	--	--	--	80-66
<b>Seat Mount</b>								
1996 & Earlier FX & FXR Models (Fender, Rear with special washers and wrench).....	C	P	S	SP	H	A	--	74-67
1997 & Up FX Models (Rear).....	C	P	S	SP	H	A	T	61-67
Forward FLSTC, FLSTF Softails.....	C	P	S	SP	--	A	--	80-167
<b>Shifter Lever Mount</b>								
1974 - FLH and XL.....	C	P	S	SP	H	A	--	20-30
1974 - 1985 FX.....	C	P	S	SP	H	A	--	74-22
<b>Shock Absorber Mount</b>								
2008 & Up Dyna Glides.....	C	P	S	SP	H	A	--	96-07
2006 - 2007 Dyna Glides.....	C	P	S	SP	H	A	--	96-06
2002 - 2005 Dyna Glide FADX & FXDXI Models.....	C	P	S	SP	H	A	--	88-128
2002 - 2005 Dyna Glide (except FXDX Models).....	C	P	S	SP	H	A	--	88-126
1991 - 2001 Dyna Glide (except FXDS).....	C	P	--	--	H	A	--	80-128
2000 & Up Softail Models (Hex Caps only).....	--	--	--	--	H	--	--	88-06
1984 - 1999 Softail Models (with washers and Hex Caps only).....	--	--	--	--	H	--	--	80-127H
1984 - FXR & 1986 - 1987 XL.....	C	P	--	--	H	A	--	80-07
1973 - 1985 FX & FLH.....	C	P	--	--	H	A	--	80-06
1989 - 1994 FXR.....	C	P	--	--	H	A	--	80-126
<b>Speedo &amp; Track</b>								
1977 - 1985 FXS (Housing Mount on gas tank).....	C	P	S	SP	--	A	--	74-42
1989 - 1994 FXR & XL (Mount and Handlebar Clamp).....	C	P	S	SP	--	--	--	80-55
<b>Star Wheel</b>								
1966 & Earlier FLH (Star Wheel Bearing Cover).....	C	P	--	--	H	A	--	74-35
<b>Swing Arm</b>								
1989 & Up FXR & FLT (Bracket to Frame).....	C	P	S	SP	H	A	--	80-79
1982 - 1988 FXR & FLT (Bracket to Frame).....	C	P	S	SP	H	A	--	80-40
2009 & Up Softail Models (Frame to Swing Arm Frame Pivot Mount).....	--	P	--	--	H	--	--	96-09
2000 - 2008 Softail Models (Frame to Swing Arm Frame Pivot Mount).....	C	P	--	--	H	--	--	88-09
1984 - 1999 Softail Models (Frame to Swing Arm Frame Pivot Mount).....	C	P	--	--	H	--	--	80-09
<b>Tail Light</b>								
1999 & Up Harley's (sold each Tail Light Lens Mount Screws).....	--	P	S	--	--	--	--	80-136
1973 - 1998 Harley's (sold each Tail Light Lens Mount Screws).....	C	--	--	--	--	--	--	80-135
<b>Timing</b>								
1999 & Up Twin Cam Models (Timing Cover Cam Position Sensor Cover).....	C	P	S	SP	H	A	T	88-12
1979 - 1999 80cu. (Buttonhead Allens with gasket and wrench).....	C	P	S	SP	--	--	T	20-37
1970 - 1978 (Buttonhead Allens with gasket and wrench).....	C	P	S	SP	--	--	--	20-12
All H-D (Timing Plug).....	C	P	--	--	--	A	--	20-20
<b>Transmission Mount</b>								
2000 & Up Softail Models (Trans Bracket Mount).....	C	P	S	SP	H	A	--	88-36
1989 - 1999 Softail Models.....	C	P	S	SP	H	A	--	80-158
1941 - 1977 Big Twin (4 Speeds, includes Trans Plate Mount).....	C	P	S	SP	--	--	--	80-59



# Big Twin Individual Sets

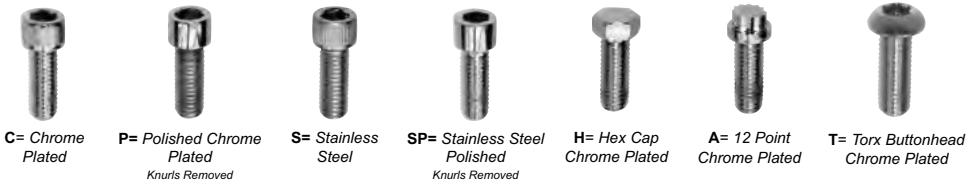

## Transmission Oil Fill Plug

	Styles Available							Part #
2007 & Up Softail Models.....	C	P	--	----	--	--	--	96-12
1987 & 2006 Big Twin (with O'Ring & Dip Stick).....	C	--	--	----	--	--	--	80-14
1936 - 1986 Big Twin (4 Speeds - Includes special washer).....	C	--	--	----	--	--	--	80-12

## Transmission Bottom Cover

1999 - 2014 Dyna Glide Models.....	C	P	S	SP	H	A	T	88-78
1993 - 2014 FLT Models.....	C	P	S	SP	H	A	T	80-107

## Transmission Side Cover

2007 & Up FLT Models (Trans Outer Back Cover - 6 Speeds).....	C	P	S	SP	--	A	--	10-14-07
2007 & Up Softail Models (Outer & Back Trans Cover - 6 Speeds).....	C	P	S	SP	--	A	--	10-12-07
2006 & Up Dyna Glide (Outer Back Trans Cover - 6 Speeds).....	C	P	S	SP	--	A	--	10-15-07
1987 -2005 (5 Speeds).....	C	P	S	SP	--	A	--	10-20-07
1980 - 1986 Big Twins (5 Speeds).....	C	P	S	SP	--	A	--	10-22-07
1936 - 1984 (4 Speeds - requires removal of studs).....	C	P	S	SP	H	A	T	74-12

## Transmission Top and Bottom Cover

1993 - 1998 FLT Models (Includes Oil Fill Cover and Speed Sensor Mount).....	C	P	S	SP	--	A	--	80-106
1991 - 1998 Dyna Glide (Includes Oil Fill Cover and Speed Sensor Mount).....	C	P	S	SP	--	A	--	80-78

## Transmission Top Cover

2006 & Up Dyna Glides and 2007 & Up FLT and Softail.....	C	P	S	SP	--	A	--	88-39
1999 - 2005 Dyna Glide Models.....	C	P	S	SP	--	A	--	88-38
1999 - 2005 FLT Models.....	C	P	S	SP	--	A	--	88-37
1998 - 2006 Softail Models.....	C	P	S	SP	--	A	--	80-169
1991 - 1998 Dyna Glide (Includes Oil Fill Cover and Speed Sensor Mount).....	C	P	S	SP	H	A	T	80-108
1988 - 1997 Big Twins (5 Speeds- except FXD Models Fits Softails).....	C	P	S	SP	H	A	T	80-69
1980 - 1987 Big Twins (5 Speeds).....	C	P	S	SP	H	A	T	80-37
1979 - 1985 FL & FX also Big Twins (4 Speeds).....	C	P	S	SP	--	A	T	74-37
1965 - 1978 Big Twins (4 Speeds).....	C	P	--	----	--	--	--	74-38
1936 - 1964 Big Twins (4 Speeds).....	C	P	--	----	--	--	--	74-68

## Tripple Tree

1988 & Up FXR, XL also 1991 & Up FXD, FXDL 39mm (Top Bolt & Flat Washer).....	C	P	--	----	H	--	--	80-58
1988 & Up FXR & XL 39mm (Fork, Drain, Axle Caps and Nuts - Full Set).....	C	P	--	----	--	--	--	80-49
1987 & Earlier XL & FX (Pinch Bolts).....	C	P	S	SP	--	--	--	20-45
FXWG & FXST (Pinch Bolts and Headlights Mount).....	C	P	--	----	--	--	--	80-45
XL & FX (sides) also FXR (4 screws on sides).....	C	P	--	----	--	--	T	20-21

## Turn Signals

1986 & Up H-D (Turn Signals Cover Mount includes - O'Rings).....	C	P	S	SP	--	--	--	61-13
--	---	---	---	----	----	----	----	-------

## Wheel Adjustment Bolts

2007 & Up Dyna Glide Models (Rear).....	C	P	--	----	H	--	--	96-151
2008 & Up All Softail Models (Rear).....	C	P	--	----	H	--	--	96-150
1992 - 2006 Dyna Glide Models (Rear).....	C	P	--	----	H	--	--	80-151
1993 - 2007 All Softail Models (Rear).....	C	P	--	----	H	--	--	80-150
1987 - 1992 All Softail Models (Rear).....	C	P	--	----	H	--	--	80-50
1972 & Earlier Big Twins (Rear).....	C	P	--	----	--	--	--	74-40

## Windshield

1984 - 1994 FXRT (with Headlight Cover Mount).....	C	P	S	SP	--	--	--	80-68
1986 & Up FLHT & FLHTC 80cu. (with Spotlight, Dash, Radio Cover and Side of Triple Trees).....	C	P	--	----	--	--	--	80-67

# Big Twin Acorn Style Sets



Gardner-Westcott's **Acorn Style Sets** include slotted studs for easy removal. Show Kit Sets contain; Primary, Transmission and Cam Side Covers, Oil Pump, Motor Mounts, Transmission Top, Inner Primary, Header Acorns, Point Cover, Rocker Box, Lifter Base, Timing Plug and Motor Case. Our Show Bike Kits now include more sets than ever and use the proper height or shank Acorn for the application. Flat Washers, Lock Washers or special Washers are included, and are in **Show Chrome Plated**.

Big Twin

## Show Bike Kits

### Part #

2007 & Up Softail Models.....	50-310A
2007 & Up Dyna Glide Models.....	50-311A
2009 & Up FLT Models.....	50-113A
2008 - 2007 FLT Models.....	50-312A
2000 - 2006 Softail Models.....	50-180A
1999 - 2005 Dyna Glide Models.....	50-119A
1999 - 2006 FLT Models.....	50-120A
1996 - 1999 FXST & FLST Softail Models.....	50-118A
1996 - 1998 Dyna Glide.....	50-117A
1996 - 1998 FXR & FLT Models.....	50-116A
1991 - 1995 Dyan Glide FXDB.....	50-114A
1991 - 1995 FXR & FLT Models.....	50-115A
1987 - 1995 FXST & FLST Softail Models.....	50-112A
1987 - 1990 FXR & FLT Models.....	50-113A
1986 - FXST & FLST Softail Models.....	50-111A
1985 - Evolution (4 Speed) & 1984 - 1985 FXST.....	50-101A
1984 - 1986 Evolution (5 Speed) Models.....	50-102A
1982 - 1983 Shovelhead FXR Models.....	50-103A
1979 - 1984 Shovelhead (4 Speed) Models.....	50-104A
1977 - 1978 Shovelhead 74cu.....	50-105A
1970 - 1976 Shovelhead 74cu.....	50-106A
1966 - 1969 Shovelhead 74cu.....	50-107A
1965 - Panhead (with Long D-Ring Screws).....	50-110A
1948 - 1964 Panhead (with Short or Long D-Ring Screws).....	50-108A

Slotted Studs  
for easy removal  
washers included  
in Sets



Show Bike Kit  
50-104A



Most Sets  
Available with  
Spike Nuts



# Big Twin Individual Acorn Nut Sets

Axle	Part #
1975 & Earlier FLH Models ( <i>Axle Cap; Front Nut, Washers and Studs Front</i> ).....	50-157A
1977 & Up FLH, FLT, FXDWG & 1973 - 1987 FX, XL ( <i>Axle Cap Nut Set</i> ).....	50-159A
1980 - 2007 FLT, 1988 & Up FXR, 1984 & Up Softails ( <i>Axle Nut Set Front</i> ).....	C-31-44A
1973 - 1988 All Models ( <i>Axle Nut Set Rear</i> ).....	C-31-41A
<b>Belt Sprocket to Hub</b>	
1999 & Earlier ( <i>4 and 5 Speeds</i> ).....	50-67A
2000 & Up Dyna and Softail Models also 2004 & Up FLT.....	50-168A
<b>Cam Cover</b>	
1999 & Up Twin Cam 88, 88B & 96cu.....	50-170A
1970 & Up Big Twins 80cu.....	50-24A
1936 - 1969 Big Twins.....	50-72A
<b>Circuit Breaker Base</b>	
1936 - 1957.....	50-73A
<b>Cylinder Base</b>	
1936 - 1984 Shovelhead, Panhead and Knucklehead ( <i>special 9/16" Hex Cap</i> ).....	C-31-80A
<b>Frame</b>	
1991 & Up Dyna Glide ( <i>Side Cover</i> ).....	50-148A
<b>Gas Tank Mount</b>	
1993 & Up Dyna Glide FXDWG Models only ( <i>includes Dash Mount</i> ).....	50-84A
1991 & Up Dyna Glides .....	50-85A
<b>Generator Screw</b>	
1958 - 1969 .....	50-75A
1936 - 1957 .....	50-76A
<b>Handle Bar Clamp</b>	
1974 - 1981 .....	50-152A
1982 & Up .....	50-153A
<b>Handle Bar Lever and Switch Box</b>	
1982 - 1995 .....	50-150A
<b>Head Bolt Set</b>	
Panhead & Shovelhead ( <i>9/16" Hex Cap for easy use</i> ).....	50-68A
<b>Header Mount Set</b>	
Twin Cam Models ( <i>Studs &amp; Flange Nuts</i> ).....	50-203Y
Twin Cam Models ( <i>Studs &amp; Acorn Nuts</i> ).....	50-203A
1984 & Up Evolution and Twin Cam 88, 96 & 103cu.....	50-03A
Shovelheads ( <i>includes Gaskets, Studs &amp; Washers</i> ).....	31-50A
Evolution & Twin Cam ( <i>Stock Style</i> ).....	50-03Y
<b>License Plate Set</b>	
Fits all Motorcycles.....	50-36A
<b>Lifter Base Set</b>	
1999 & Up Twin Cam 88 & 88B.....	50-171A
1977 - 1999 Big Twins 74cu. & 80cu.....	50-18A
1936 - 1976 Big Twins.....	50-17A
1977 & Up Blocks on pre 1976 Motors.....	50-65A
<b>Motor Case</b>	
2000 & Up Twin Cam 88B & 96cu. Softail ( <i>Stud &amp; Acorn Set</i> ).....	50-165A
1999 & Up Twin Cam 88 Dyna, 96cu. & FLT ( <i>Stud &amp; Acorn Set</i> ).....	50-172A
1996 - 1999 Big Twins 80cu. ( <i>Stud &amp; Acorn Set</i> ).....	50-164A
1983 - 1995 80cu. ( <i>Stud &amp; Acorn Set</i> ).....	50-163A
1979 - 1982 80cu. ( <i>Stud &amp; Acorn Set</i> ).....	31-31A
1978 & Earlier 74cu. ( <i>Stud &amp; Acorn Set</i> ).....	31-29A

Slotted Studs  
for easy removal  
washers included  
in Sets



Most Sets  
Available with  
Spike Nuts



# Big Twin Individual Acorn Nut Sets



<b>Motor Mount Set</b>	<b>Part #</b>
2007 & Up Softail Models.....	50-319A
2007 & Up Dyna Glides.....	50-318A
2009 & Up FLT Models.....	50-316A
2007 - 2008 FLT Models.....	50-317A
2000 - 2006 Softail Models (Top, Front & Rear).....	50-175A
1999 - 2006 Dyna Glides (Top, Front & Rear).....	50-173A
1999 - 2006 FLT Models (Top, Front & Rear).....	50-174A
1991 - 1998 Dyna Glides (Top, Front & Rear).....	50-86A
1991 - 1998 FXR & FLT (Top, Front & Rear).....	50-82A
1987 - 1990 FXR & FLT (Top, Front & Rear).....	50-81A
1987 - 1999 FXST & FLST (Top, Front & Rear).....	50-05A
1985 - 1986 (4 Speed) & 1984 - 1986 FXST (Top, Front & Rear).....	50-39A
1984 - 1986 (5 Speed) FXR & FLT (Top, Front & Rear).....	50-38A
1982 - 1983 FXR & FLT (Top, Front & Rear).....	50-37A
1948 - 1984 (4 Speeds).....	50-19A

<b>Oil Pump</b>	
1992 - 1999 & Up Big Twins 80cu.....	50-197A
1979 - 1991 Big Twins.....	50-35A
1968 - 1978 Shovelheads.....	50-34A
1936 - 1967 Big Twins.....	31-40A

<b>Oil Tank</b>	
1981 & Up (Drain Bolts).....	50-46A
1980 & Earlier (Drain Bolts).....	C-20-20

<b>Points Cover Mount</b>	
1999 & Up Timer Cover Twin Cam 88 & 2000 & Up 88B Softail .....	50-144A
1979 - 1999, 80cu. (Includes Gasket).....	50-96A
1970 - 1978 (Includes Gasket).....	50-97A

<b>Primary Cover</b>	
2007 & Up FLT Models.....	50-186A
2006 & Up Dyna & 2007 & Up Softail Models.....	50-185A
1999 - 2006 FLT Models.....	50-183A
1999 - 2005 Dyna & Softail Models.....	50-179A
1986 - 1988 Softail Models.....	50-98A
1989 - 1998 Softail Models & 1991 - 1998 Dyna Glide Models.....	50-99A
1985 - 1998 FLH & FXR Models.....	50-31A
1980 - 1984 5 Speeds FXR & FLT Models.....	50-23A
1970 - 1985 (4 Speeds) & 1984 - 1985 FXST.....	50-25A
1965 - 1969 Big Twins.....	50-77A
1936 - 1964 Big Twins.....	50-78A
1965 & Up (Custom using Accessory Stamped Cover).....	50-79A

<b>Regulator Mount and Bracket Mount</b>	
2000 & Up Softail Models.....	50-162A
1997 & Up FLT.....	50-161A
1980 - 1996 FLT & FXR.....	50-04A

<b>Rocker Arm Shaft</b>	
1971 - 1984 Shovelhead (End Plugs).....	50-71A
Shovelheads (End Nuts - Left Side with Special Washers).....	50-40A

<b>Rocker Box</b>	
1999 & Up Twin Cam 88 also 2000 & Up 88B & 96cu.....	50-176A
1984 - 1999 Evolution 80cu. (Includes Special Washers).....	50-20A
1966 - 1984 Shovelhead (Low Crown Includes Special Washers).....	50-15A
Panhead - (Pan Covers Short D Ring length).....	50-91A
Panhead - (Pan Covers Long D Ring length).....	50-92A



Acorn Kit 50-82A



Most Sets Available with Spike Nuts



# Big Twin Individual Acorn Nut Sets

## Star Wheel

### Part #

1966 & Earlier..... 50-93A

## Timing Plug

Fits All Harley's..... C-20-20

## Transmission Side Cover

2007 & Up Softail Models..... 50-322A  
 2006 & Up Dyna Glides..... 50-325A  
 2007 & Up FLT Models..... 50-324A  
 1987 - 2006 Big Twins also 2005 & Earlier Dyna Glides..... 50-42A  
 1980 - 1986 Big Twins (5 Speed)..... 50-22A  
 1936 - 1985 Big Twins (4 Speed)..... 50-12A

## Transmission Top Cover

2006 & Up Dyna Glides, 2007 & Up FLT & Softail Models..... 50-187A  
 1999 - 2005 Dyna Glides (Includes Bottom Cover)..... 50-177A  
 1999 - 2006 FLT Models (Includes Bottom Cover)..... 50-178A  
 1993 - 1998 FLT Models (Includes Bottom Cover)..... 50-149A  
 1991 - 1998 Dyna Glides (Includes Bottom Cover)..... 50-87A  
 1998 - 2006 Softail Models..... 50-182A  
 1988 - 1997 also 1999 & Up FLT Models (5 Speeds except - Dyna Glide Models)..... 50-122A  
 1980 - 1987 (5 Speeds)..... 50-06A  
 1975 - 1985 (4 Speeds)..... 50-11A  
 1965 - 1978 Big Twins..... 50-146A  
 1936 - 1964..... 50-147A

## Triple Trees

XL, FX & FXR (Both Sides)..... 50-21A  
 1949 & Up FL, FLH, FXWG & FXDWG (Top Nut with Washer)..... 50-195A



Acorn Kit 50-195A



## Inside This Section

### Allen Style

<i>Builders Fastener Sets.....</i>	<i>20</i>
<i>Full Allen Motorcycle Sets.....</i>	<i>20</i>
<i>Motor Sets.....</i>	<i>21</i>
<i>Side Cover Sets.....</i>	<i>22</i>
<i>Individual Sets.....</i>	<i>23-28</i>

### Acorn Style

<i>Show Bike Kits.....</i>	<i>28</i>
<i>Individual Sets .....</i>	<i>29-30</i>

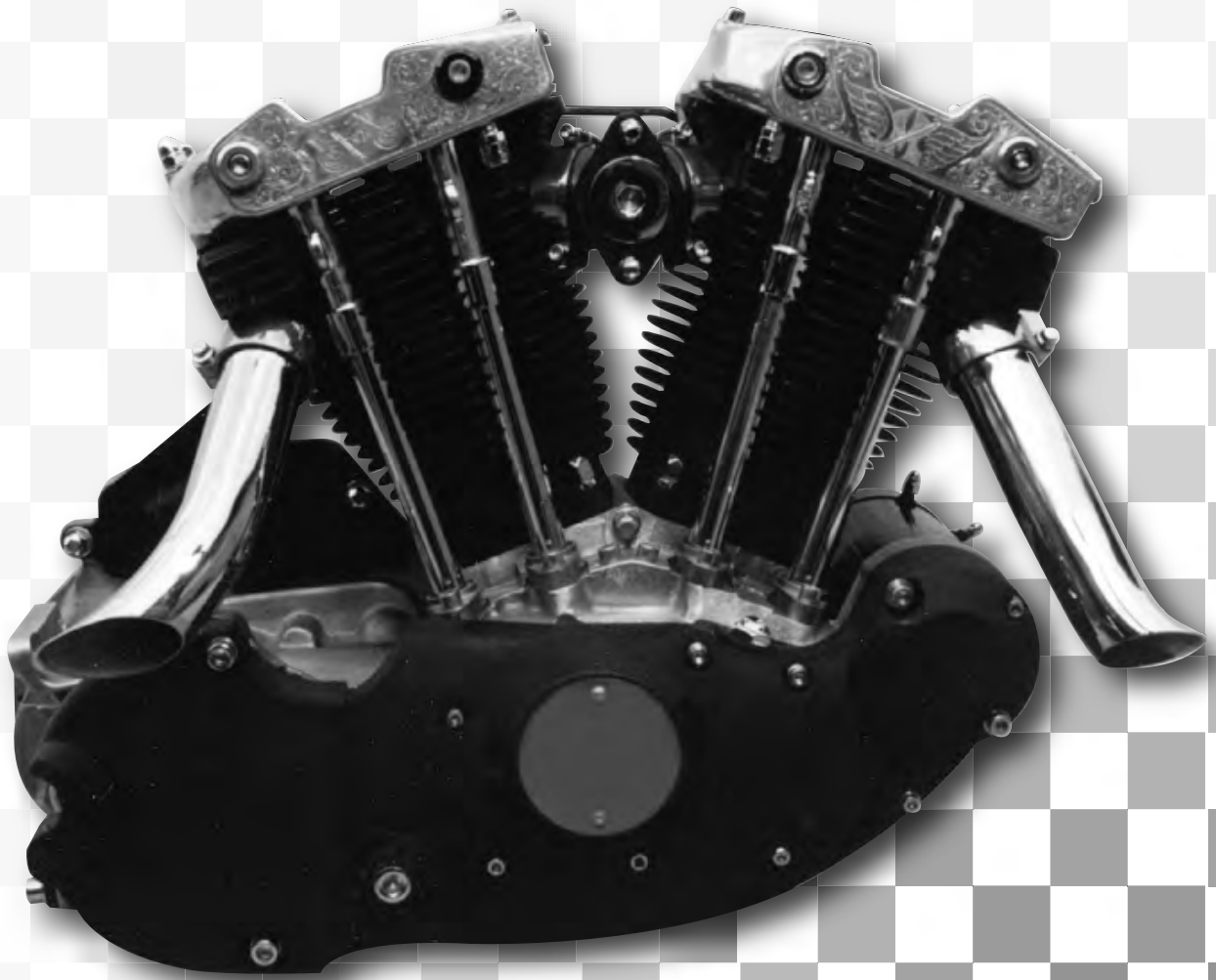



# Sportster Builder Sets

"Where there is a bolt, you get a Allen Screw,



Where there is a nut, you get a Acorn Nut"



Gardner-Westcott's combination set of **Chrome Allen Screws** and **Acorn nuts** with Chrome Washers for Sportster Motors.



C= Chrome Plated



P= Polished Chrome Plated  
Knurls Removed

## Builders Fastener Sets

	Styles Available	Part #
2004 & Up.....	C P	GW-04-A
1992 - 2003 ( <i>Evolution</i> ).....	C P	GW-61-A
1986 - 1990 ( <i>Evolution</i> ).....	C P	GW-60-A
1984 1/2 & 1985 ( <i>Iron Head Alternator</i> ).....	C P	GW-59-A
1979 - 1984 1/2.....	C P	GW-58-A
1977 - 1978.....	C P	GW-57-A
Late 1973 - 1976.....	C P	GW-56-A
1971 - Early 1973.....	C P	GW-55-A
1957 - 1969 XLCH.....	C P	GW-54-A
1967 - 1970 XLH & 1970 XLCH.....	C P	GW-53-A



Builders Set GW-61-A

## Full Allen Motorcycle Sets

The Full Allen Set for your Sportster includes; Allens for Motor, Transmission, Chassie and Head Bolts. Where required, Sets supplied with Flat Washers, Lock Washers, Hex Nuts or Lock Nuts.

	Styles Available	Part #
2004 - 2008 ( <i>for Dual Disc Models</i> ).....	C P	20-66
2004 - 2008 ( <i>for Single Disc Models</i> ).....	C P	20-67
1991 - 2003 ( <i>V2 - 5 Speeds</i> ).....	C P	20-81
1988 - 1990.....	C P	20-76
1986 - 1987 ( <i>V2</i> ).....	C P	20-78
1985 - 1984 1/2 ( <i>Alternator</i> ).....	C P	20-84
1983 - 1984.....	C P	20-83
1982 - Only.....	C P	20-82
1979 - 1981.....	C P	20-79
1977 - 1978.....	C P	20-77
1967 - 1970 XLH & Up 1990 XLCH.....	C P	20-74
1975 - 1976.....	C P	20-75
1973 - 1974.....	C P	20-73
1972 - Only.....	C P	20-72
1971 - Only.....	C P	20-71
1957 - 1969 XLCH.....	C P	20-70





## Motor Sets

All Sportster Motor Sets contain **Allen Screws** for Cam and Primary, Generator or Oil Filter Mount, Sprocket, Rocker Box, Top Motor Mount, Lifter Base, Point or Magneto Cover, Flat Washers, Lock Washers, Special Washers, Hex Nuts and Lock Nuts supplied where needed.

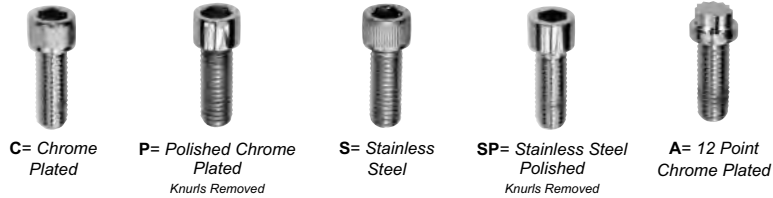

	Styles Available	Part #
2004 & Up.....	C P S SP A	20-85
1991 - 2003 (Evolution).....	C P S SP A	20-86
1986 - 1990 (Evolution).....	C P S SP A	20-87
1984 1/2 & 1985 (Iron Head Alternator).....	C P S SP A	20-88
1977 - 1984 1/2.....	C P S SP A	20-89
1971 - 1976.....	C P S SP A	20-90
1957 - 1969 XLCH.....	C P -- -- --	20-91
1967 - 1970 XLH & 1970 XLCH.....	C P -- -- --	20-92
1957 - 1966 XLH.....	C P -- -- --	20-93
1952 - 1956 K Models.....	C P -- -- --	20-94



Motor Set P-20-89



# Sportster Side Cover Sets

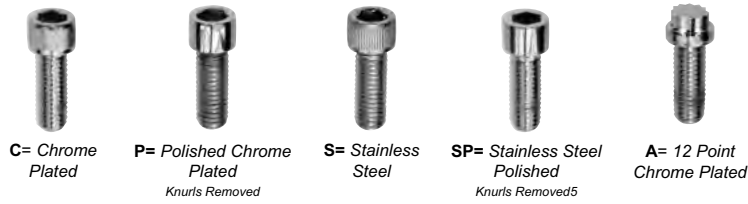

## Cam and Primary with Inspection, Sprocket and Oil Fill Check Screws where applicable

	Part #	Styles Available
2004 & Up.....	10-31-01	C P S SP A
1991 - 2003.....	10-30-01	C P S SP A
1986 - 1990.....	10-29-01	C P S SP A
1977 - 1985.....	10-28-01	C P S SP A
1971 - 1976.....	10-26-01	C P S SP A
1957 - 1969 XLCH.....	10-33-01	C P -- ---- --
1967 - 1970 XLH & 1970 XLCH.....	10-34-01	C P -- ---- --
1957 - 1966 XLH & 1952 - 1956 K & KH.....	10-36-01	C P -- ---- --

## Cam and Sprocket Cover Only

2004 & Up.....	10-31-06	C P S SP A
1991 - 2003.....	10-30-06	C P S SP A

## Cam Cover Only

1971 - 1990.....	10-26-06	C P S SP A
1957 - 1970.....	10-33-06	C P S SP A

## Primary Cover Only

2004 & Up.....	10-31-08	C P S SP A
1991 - 2003.....	10-30-08	C P S SP A
1986 - 1990.....	10-29-08	C P S SP A
1977 - 1985.....	10-28-08	C P S SP A
1971 - 1976.....	10-26-08	C P S SP A
1957 - 1966 XLCH.....	10-33-08	C P -- ---- --
1967 - 1970 XLH.....	10-34-08	C P -- ---- --



Side Cover Set P-10-34-01

# Sportster Individual Sets



- Where required, sets are supplied with Flat Washers, Lock Washers, Special Washers, Hex Nuts and or Lock Nuts.
- All sets are available in 24K Gold Plated and also other styles.

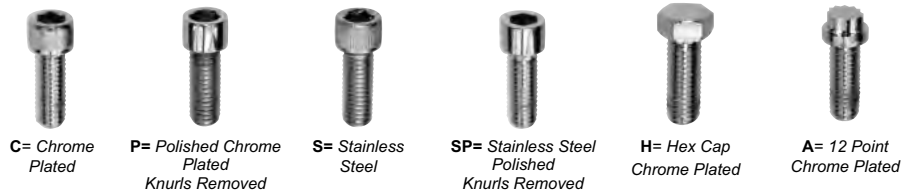

	Styles Available	Part #
<b>Air Cleaner Cover</b>		
1986 & Up.....	C P -- ---- -- --	61-33
1967 - 1978 & 1983 - 1985 (2 Oval Screws).....	C P -- ---- -- --	20-33
1979 - 1985 (3 Screws).....	C P S SP -- A	20-54
<b>Banjo Bolts</b>		
2004 & Up (Brake Line Dual).....	-- P -- ---- -- --	80-118
2004 & Up (Brake Line Front).....	-- P -- ---- -- --	80-117
1984 - 2003 (Brake Line Front).....	-- P -- ---- -- --	80-111
1982 - 2003 (Front and Rear).....	-- P -- ---- -- --	80-110
<b>Belt Sprocket Mount</b>		
2004 & Up.....	C P -- ---- H A	74-59
1991 - 2003 (with Hardened Washers Cast Wheel).....	C P -- ---- H A	74-49
1991 - 1999 (with Hardened Washers & Locknuts Laced Wheel).....	C P -- ---- H A	80-51
<b>Brake Arm Rear</b>		
1974 & Earlier (Allen Screws).....	C P S SP -- A	20-42
1975 - 1976 (Allen Screws).....	C P S SP -- A	20-43
<b>Brake Master Cylinder Mount &amp; Cover Rear</b>		
2004 & Up .....	C P S SP -- --	61-45
1986 - 2003 (Coarse Thread).....	C P S SP -- --	61-09
1982 - 1985 (Fine Thread).....	C P S SP -- A	61-01
1979 - 1981 (Coarse Thread).....	C P S SP -- A	20-01
<b>Chain Guard</b>		
To Swing Arm Allen Screws.....	C P -- ---- H A	20-32
<b>Chain Sprocket to Hub Rear Wheel</b>		
1979 & Up (Spoked Wheel Laced with Lock Nuts).....	C P S SP H A	20-68
1979 & Up (Cast Wheel Mag).....	C P S SP H A	61-68
<b>Clutch Adjustment Allen Plug</b>		
1977 - 1990 (with O'Ring).....	C -- -- ---- -- --	20-63
1971 - 1976 (with O'Ring).....	C -- -- ---- -- --	20-61
<b>Cylinder Base</b>		
1957 - 1985 Base Allens (requires removal of studs includes washers).....	C P -- ---- -- A	20-08
<b>Disc Brake Caliper Mount Front</b>		
2009 XR Style (Single Disc, Dual Disc Buy 2 Sets).....	C P -- ---- -- --	61-41
2004 & Up XL Style (Single Disc, Dual Disc Buy 2 Sets).....	-- P -- ---- -- --	61-43
2000 - 2003 (Single Disc, Dual Disc Buy 2 Sets).....	-- P -- ---- -- --	80-147
1993 - 1999 (Single Disc, Dual Disc Buy 2 Sets).....	C P -- ---- -- --	80-143
1984 - 1992 (Single Disc, Dual Disc Buy 2 Sets).....	C P -- ---- -- --	80-144
1977 - 1983 (Single Disc).....	C -- -- ---- -- --	80-43
1974 - 1977 (Single Disc).....	C P -- ---- -- A	20-49



## Disc Brake Caliper Mount Rear

	Styles Available	Part #
2009 & Up XR Style.....	C P -- ---- -- -- --	61-42
2004 & Up XL Style.....	-- P -- ---- -- -- --	61-69
2000 & Up.....	-- P -- ---- -- -- --	80-148
1987 - 1999.....	C -- -- ---- -- -- --	80-142
1982 - 1986.....	C P S SP -- A --	61-08

## Disc Brake Rotor to Hub Front

1984 & Up (Front Single Disc, Cast Wheel, Dual Disc Buy 2 Sets).....	C -- -- ---- -- -- T	80-42
1984 & Up (Front Single Disc, Laced Wheel, Dual Disc Buy 2 Sets).....	C -- -- ---- -- -- T	80-41
1977 - 1983 (Front Dual Disc Brakes Cast Wheel).....	C -- -- ---- -- -- --	20-04
1977 - 1983 (Front Dual Laced Wheel).....	C -- -- ---- -- -- --	20-04N
1974 - 1978 (Front Single Disc Brakes).....	C -- -- ---- -- -- --	20-55

## Disc Brake Rotor to Hub Rear

1992 & Up (Rear Wheel Cast Wheel).....	C -- -- ---- -- -- T	61-32
1992 & Up (Rear Wheel Laced Wheel).....	C -- -- ---- -- -- T	61-31
1979 - 1991 (Rear Wheel Cast Wheel).....	C -- -- ---- -- -- --	74-01
1979 - 1991 (Rear Wheel Laced Wheel).....	C -- -- ---- -- -- --	20-69

## Fender Bracket

1974 - 1984 XL & FX (Front Fender Mount).....	C -- S SP -- -- --	20-03
---	--------------------	-------

## Fender Mount Only

1984 & Up (Front).....	C P S SP -- -- --	61-04
1972 & Earlier (Front Allen Screws).....	C P S SP -- -- --	20-22

## Fender Rail Rear

2004 & Up.....	C P -- ---- -- -- --	61-53
1995 - 2003.....	C P S SP H -- T	61-54
1957 - 1978 (for Stock Replacement).....	C P -- ---- -- -- --	20-11
1979 - 1981 & 1982 - 1994 (with Sissy Bar).....	C P S SP -- A --	20-53
1982 Style (Tapered Head/ Stock Style).....	C P S SP -- -- --	61-11
1957 - 1978 (with Longer Screws for Mounting Sissy Bars w/stock holes).....	C P S SP -- -- --	20-02
1957 - 1978 (with Sissy Bars Longer than stock).....	C P S SP -- A --	20-10

## Foot Pegs

2004 & Up (Foot Peg Bracket, Shifter and Brake Arm Mount).....	C P -- ---- -- A --	61-35
All Harley's Allen Screws (Front and Rear Special Shoulder Bolts).....	C P -- ---- -- -- --	20-35

## Fork Drain Front

1973 & Up (with copper washers, Available in Buttonhead).....	C P S SP -- -- --	20-58B
1954 - 1972 (with copper washers).....	C P -- ---- -- -- --	20-57

## Fork

1988 & Up 39mm (Triple Tree Top Bolt & Washer).....	C P -- ---- H -- --	80-58
Tube Caps, Triple Tree Top Bolt, Pinch Bolts, Drain Screws & Axle Cap Nuts.....	C P -- ---- -- -- --	80-49
1988 & Up (Tube Allen Caps).....	C P S SP -- -- --	99-23
1977 & Up XL & FX (Damper Mount, with Brass Washer).....	C P -- ---- -- -- --	61-58

## Frame

1985 & Up (Frame Side Cover, Left Side).....	C P S SP -- -- --	61-07
--	-------------------	-------

## Front

1972 & Earlier XL & FX (Front Wheel Pinch Bolt).....	C P S SP -- A --	20-27
--	------------------	-------

## Gas Tank Mount

2004 & Up.....	C P S SP -- A --	61-30
1986 - 2003.....	C P S SP -- -- --	61-12
1972 - 1979 XLCH.....	C P S SP H -- --	20-29
1957 - 1971.....	C P S SP H -- --	20-28



**Sportster**

## Generator Screws

	Styles Available	Part #
1971 - 1984 1/2 .....	C P -- ---- -- A --	20-14
1954 - 1970 .....	C P -- ---- -- A --	20-47

## Handle Bar Clamp

1984 & Up ( <i>Speedo &amp; Tack Bracket Mount with Spacers</i> ).....	C P -- ---- -- -- --	80-55
1981 - 1984 .....	C P S SP -- -- --	80-52
1974 - 1980 & 1997 & Up ( <i>C Models</i> ).....	C P S SP -- -- --	20-52

## Handle Bar Lever & Switch Boxes

2004 & Up ( <i>with Master Cylinder Screws in Buttonheads</i> ).....	C -- S SP -- -- --	61-40B
2004 & Up ( <i>with Master Cylinder Screws</i> ).....	C P S SP -- -- --	61-40
1996 - 2003 ( <i>with Master Cylinder Screws in Buttonheads</i> ).....	-- P -- ---- -- -- --	74-150B
1996 - 2003 ( <i>with Master Cylinder Screws</i> ).....	C P S SP -- -- T	74-150
1996 - 2003 ( <i>with Master Cylinder Screws in Stock Style Fasteners</i> ).....	-- P S SP -- -- --	74-150Y
1982 - 1981 All ( <i>with Master Cylinder Cover - Front</i> ).....	C P S SP -- -- T	74-50
1973 - 1981 All ( <i>with Master Cylinder Cover &amp; Twist Crip</i> ).....	C P S SP -- -- --	20-40
1972 - Earlier XL & 1971 & Earlier 74cu.....	C P S SP -- -- --	20-39

## Handle Bar Rizer Mount

2004 & Up.....	C P -- ---- H A --	80-123
1995 - 2000 ( <i>with Cup Washers</i> ).....	C P -- ---- H A --	61-57
1974 - 1985 ( <i>with Cup Washers</i> ).....	C P -- ---- H A --	80-122

## Head Bolts

1992 & Up ( <i>Evolution</i> ).....	-- -- -- ---- -- A --	61-110
1987 - 1991 ( <i>Evolution</i> ).....	-- -- -- ---- -- A --	61-100
1986 - Only ( <i>with Special Washers</i> ).....	-- -- -- ---- -- A --	80-100
1973 - 1985 ( <i>Iron Head Includes Washers</i> ).....	C P -- ---- H A --	20-17
1957 - 1972 ( <i>900cc. Includes Washers</i> ).....	C P -- ---- -- A --	20-18
1952 - 1956 ( <i>K &amp; KH Model Flat Heads Includes Washers</i> ).....	C P -- ---- -- A --	20-80

## Header Exhaust Clamp

1981 - 1985 ( <i>Iron Head</i> ).....	C P S SP H A --	61-25
1980 - Earlier ( <i>1/4" Diameter</i> ).....	C P S SP H A --	20-25

## Header Exhaust Mount

2004 & Up ( <i>Evolution Header Mount in Acorns</i> ).....	C P S SP -- -- --	50-03A
2004 & Up ( <i>Evolution Header Mount in Flange Nuts</i> ).....	C P S SP -- -- --	50-03Y

## Headlight

1957 & Up ( <i>Headlight Mount Bracket</i> ).....	C P S SP H A --	20-23
---	-----------------	-------

## Intake

1991 - 2001 ( <i>Injected</i> ).....	C P S SP -- A --	61-04
1995 & Up ( <i>Evolution Intake Manifold Mount with Carburetors</i> ).....	C P S SP -- A --	61-39
1988 - 1994 ( <i>Evolution Intake Manifold Mount with Carburetors</i> ).....	C P S SP -- A --	61-38
XR - 1000 ( <i>Intake Manifold Mount</i> ).....	C P S SP -- A --	61-02



Kicker	Styles Available	Part #
1976 & Earlier ( <i>Kicker Arm Upper &amp; Lower Set Fits All Harley's</i> ).....	C P S SP H A --	20-26
<b>Keihin Carb</b>		
1988 - 2006 XL ( <i>Constant Velocity</i> ).....	C P S SP -- A --	61-36
( <i>Constant Velocity Top Cover Only</i> ).....	C P S SP -- A --	61-37
1987 & Earlier XL ( <i>with Float Bowl &amp; Pump Set Butterfly</i> ).....	C P S SP -- A --	80-36
<b>K Model</b>		
Head Bolts & Top Motor Mount ( <i>with Washers</i> ).....	C P -- --- -- A --	20-80
1952 - 1956 ( <i>Lifter Base</i> ).....	-- P -- --- -- A --	74-16
<b>License Plate</b>		
Set - Fits All ( <i>with Buttonhead Allens, Hex Nuts &amp; Washers</i> ).....	C -- S SP -- -- --	20-34
Set - Same as above ( <i>except with Lock Nuts</i> ).....	C -- S SP -- -- --	20-34N
Set - Same as above ( <i>except with Acorn Nuts</i> ).....	-- P S SP -- -- --	20-34A
Set - Available in ( <i>Allens, 12 Points &amp; Hex Caps with Lock Nuts</i> ).....	C P S SP H A T	20-34
Bracket to Fender ( <i>Allens with large Washers &amp; Nuts</i> ).....	C P S SP H A T	20-41
<b>Lifter Base</b>		
2006 & Up XL.....	C P S SP -- A --	61-44
2004 - 2005 ( <i>with Anti-Rotation Screws</i> ).....	C P S SP H A T	61-50
2000 - 2003 ( <i>with Anti-Rotation Screws</i> ).....	C P S SP H A T	61-51
1995 - 1999 ( <i>with Pin Plate Mount</i> ).....	C P S SP H A T	61-52
1991 - 1994 ( <i>with Pin Plate Mount</i> ).....	C P S SP H A T	61-16
1957 - 1990.....	C P S SP H A T	20-16
<b>Magneto Cover</b>		
Allen Screws ( <i>with Allen wrench</i> ).....	C P S SP -- -- --	20-46
<b>Motor Case</b>		
2004 & Up.....	C P S SP H A --	61-27
1991 - 2003.....	C P S SP H A --	61-29
1977 - 1990.....	C P S SP H -- --	20-07
1957 - 1976.....	C P S SP H -- --	20-09
<b>Motor Mount Includes Special Washers &amp; Lock Nuts</b>		
2004 & Up ( <i>with Stabilizer Link Fasteners</i> ).....	C P S SP H A --	61-23
1986 - 2003 ( <i>Evolution Bottom</i> ).....	C P S SP H A --	61-19
1986 - 2003 ( <i>Evolution Center</i> ).....	C P S SP H A --	61-21
1986 - 2003 ( <i>Evolution Forward Top</i> ).....	C P S SP H A --	61-20
1957 - 1985 ( <i>Forward</i> ).....	C P S --- H -- --	20-59
1991 - 2003 ( <i>Rear Allen Screws</i> ).....	C P S SP H A --	61-22
1982 - 1985 ( <i>Rear Allen Screws</i> ).....	C P S SP H -- --	61-05
1979 - 1981 ( <i>Rear Allen Screws 6 each</i> ).....	C P S --- H A --	20-05
1978 & Earlier ( <i>Rear Allen Screws</i> ).....	C P S SP H A --	20-38
1977 - 1985 ( <i>Top Allen Screws</i> ).....	C P S SP H A --	20-51
1957 - 1976 ( <i>Top Motor Strap</i> ).....	C P S SP H A --	20-19
<b>Oil Filter</b>		
1985 - 2003 ( <i>Filter Mount Alternator models</i> ).....	C P S SP -- A --	61-14
<b>Oil Fill or Clutch Adjustment Allen Plug</b>		
1977 - 1991.....	C -- -- --- -- -- --	20-63
1971 - 1976 ( <i>Oil Fill Plug only</i> ).....	C -- -- --- -- -- --	20-60
1971 - 1976 ( <i>Clutch Adjustment Plug only</i> ).....	C -- -- --- -- -- --	20-61
1977 - 1991 ( <i>Set with Allen wrench</i> ).....	C -- -- --- -- -- --	20-64
1971 - 1976 ( <i>Set with Allen wrench</i> ).....	C -- -- --- -- -- --	20-62
<b>Oil Pump Mount</b>		
1998 & Up.....	C P S SP H A --	61-55
1991 - 1997.....	C P S SP H A --	61-56
1977 - 1990.....	C P S SP H A --	20-56
1971 - 1976.....	C P S SP H A --	20-36

# Sportster Individual Sets



**Sportster**

	Styles Available	Part #
<b>Oil Tank</b>		
1981 & Up ( <i>Drain Screw includes Washer</i> ).....	C P -- -- -- A --	80-20
1957 - 1980 ( <i>Drain Screw</i> ).....	C -- -- -- -- A --	20-20
1978 & Earlier XLCH ( <i>Oil Tank Mount Allen Screws</i> ).....	C P S SP H A --	20-24
<b>Point Cover (Electronic Module Cover)</b>		
2004 & Up ( <i>Fits All - Allen Screws with Wrench &amp; Gasket</i> ).....	C -- S SP -- -- --	20-12
1979 - 2003 ( <i>Fits All - Allen Screws with Wrench &amp; Gasket</i> ).....	C -- S SP -- -- --	20-37
1971 - 1978 ( <i>Fits All - Allen Screws with Wrench &amp; Gasket</i> ).....	C -- S SP -- -- --	20-12
<b>Point and Condenser</b>		
1971 -1978 ( <i>Point &amp; Condenser Mount with Flat Washers &amp; Allen wrench</i> ).....	C -- -- -- -- -- --	74-44
<b>Regulator Mount</b>		
1982 - 1992.....	C P S SP -- -- --	61-24
1979 - 1981 and 1993 & Up .....	C P S SP -- -- --	74-24
<b>Rocker Arm Shaft End</b>		
1971 - 1985 ( <i>Allen Plugs</i> ).....	C -- -- -- -- -- --	74-55
( <i>Same as above except in Button Head Stock Style</i> ).....	C -- -- -- -- -- --	74-55B
1957 - 1970 ( <i>Allen Plugs</i> ).....	C -- -- -- -- -- --	74-56
<b>Rocker Box</b>		
1984 & Up ( <i>Evolution Full Rocker Box Mount Set for Inside &amp; Top Mounting Hardware</i> ).....	C P -- -- -- -- --	80-115Y
1984 & Up ( <i>Evolution Motor with Copper &amp; Steel Washers</i> ).....	C P S SP H A --	80-15
1984 & Up ( <i>Same as above except in Button Allens</i> ).....	-- P S SP -- -- --	80-15B
( <i>Tapered Cup Washer Allen set with Copper Washers</i> ).....	-- P -- -- -- -- --	80-15R
1977 - 1985.....	C P S SP H A --	20-50
1957 - 1976.....	C P S SP H A --	20-15
XR 1000 & XR 750.....	C P S SP H A --	61-15
<b>Seat Mount</b>		
1982 - 1996 ( <i>Seat Mount Rear with Washers</i> ).....	C -- S SP H A T	74-67
1997 & Up Harley's ( <i>Seat Mount Fender Rear</i> ).....	C -- S SP -- A T	61-67
<b>Shock Absorber</b>		
2004 & Up .....	C P S SP H A --	61-48
2000 - 2003 .....	C P S SP H A --	61-49
1991 - 1999 ( <i>Shock Mount Set</i> ).....	C P S SP H A --	61-46
1988 - 1990 XLS & 1987 XLH Huger ( <i>Allen Screws with Lock Nuts</i> ).....	C P S SP H A --	61-47
1986 - 1987 XLH, DLX & XLH 1000 ( <i>Allens, Acorns &amp; Lock Nuts</i> ).....	C P S SP H -- --	80-07
1982 - 1985 ( <i>Allen Screws with Lock Nuts</i> ).....	C P S SP H -- --	61-06
1979 - 1981 ( <i>Allen Screws with Lock Nuts</i> ).....	C P S SP H A --	20-06
<b>Shifter Lever Transmission</b>		
1975 - 1976.....	C P S SP H A T	20-31
1974 & Earlier.....	C P S SP H A T	20-30
<b>Sprocket Cover</b>		
1971 - 1976.....	C P S SP H A --	20-13
1954 - 1970.....	C P -- -- -- -- --	20-48



# Sportster Individual Sets



C= Chrome Plated



P= Polished Chrome Plated  
Knurls Removed



S= Stainless Steel



SP= Stainless Steel Polished  
Knurls Removed



H= Hex Cap Chrome Plated



A= 12 Point Chrome Plated



T= Torx Buttonhead Chrome Plated

## Tail Light

	Styles Available	Part #
1999 & Up (Lens Mounting Screws Sold Each).....	C -- -- ---- -- -- --	80-136
1973 - 1998 (Harley Lens Mounting Screws Sold Each).....	C -- -- ---- -- -- --	80-135

## Timing Plug

Fits - All Models (Button Head Allen Screw).....	C -- -- ---- -- A --	20-20
--	----------------------	-------

## Triple Trees

1988 & Up 39mm (Top Bolt & Washer).....	-- P S SP -- -- T	80-58
1987 & Earlier XL & FX (with 4 Screws on Sides of Triple Trees).....	C P S SP -- -- --	20-21
1987 & Earlier XL & FX (Pinch Bolt Allen Screws).....	C P -- ---- H -- --	20-45

## Turn Signals

1986 - 2001 (Turn Signals Cover Set Front & Rear with O'Rings on all models).....	C P S SP -- -- --	61-31
---	-------------------	-------

# Sportster Acorn Style Sets

Gardner-Westcott's **Acorn Style Sets** include slotted studs for easy removal, Our **Show Bike Kit Sets** now have more sets than ever and use the proper height or shank acorn for the application. Flat washers, lock washers or special washers are also included, and are in **Show Chrome Plated**.

## Show Bike Kits

### Part #

1991 - 2003.....	50-136A
1986 - 1990 (Evolution).....	50-135A
1984 - 1985 (Iron Head Alternator).....	50-134A
1977 - 1984 XL.....	50-133A
1971 - 1976 XL.....	50-132A
1957 - 1969 XLCH Models.....	50-131A
1967 - 1970 XLH & 1970 XLCH.....	50-130A
1957 - 1966 XLH Models.....	50-129A



Show Bike Kit  
50-136A

Most Sets Available with Spike Nuts



Spike Nuts



# Sportster Individual Acorn Nut Sets



Sportster

<b>Axle</b>	<b>Part #</b>
1973 - 2007 Up ( <i>Nut Set Rear</i> ).....	31-41A
1973 - 1987 ( <i>Axle Cap Stud and Acorn Set</i> ).....	50-157A
1977 & Up FLH, FLT, FXDWG also 1973 - 1987 FX, XL ( <i>Axle Cap Nut Set</i> ).....	50-159A
<b>Belt Sprocket</b>	
1991 - 1994 ( <i>Laced Wheel</i> ).....	50-67A
<b>Cam Cover</b>	
1991 - 2003 ( <i>Includes Sprocket</i> ).....	50-166A
1971 - 1990.....	50-26A
1952 - 1970 XL & K Models.....	50-41A
<b>Cylinder Base</b>	
1952 - 1985 ( <i>Cylinder Base Nuts</i> ).....	50-54A
<b>Fender Rail</b>	
1957 - 1978 ( <i>Fender Rail Set - Rear</i> ).....	50-52A
<b>Gas Tank</b>	
1984 & Earlier ( <i>Gas Tank Mount Set XLCH Models</i> ).....	50-01A
<b>Generator Screw</b>	
1971 - 1984 1/2.....	50-14A
1957 - 1970.....	50-44A
<b>Handle Bar Clamp</b>	
1982 & Up.....	50-153A
1974 - 1981.....	50-152A
<b>Handle Bar Lever Boxes</b>	
1982 - 1995 ( <i>Handle Bar Lever &amp; Switch Box</i> ).....	50-150A
<b>Head Bolts</b>	
1973 - 1985.....	50-95A
1957 - 1972.....	50-94A
<b>Header Mount</b>	
Set for All Evolution Motors.....	50-03A
<b>License Plate</b>	
Set Fits All Motorcycles.....	50-36A
<b>Lifter Base</b>	
1991 - 1994.....	50-160A
1957 - 1990.....	50-16A
1952 - 1956 K & KH Models.....	50-17A
<b>Motor Mount</b>	
1986 - 2003 ( <i>Top, Front &amp; Rear</i> ).....	50-33A
1957 - 1985 ( <i>Top, Strap</i> ).....	50-56A
1957 - 1985 ( <i>Forward Motor Mount</i> ).....	50-30A
1957 - 1985 ( <i>Forward Motor Mount; extra length for mounting highway peg or controls</i> ).....	50-43A
<b>Oil Filter</b>	
1984 1/2 - 2003 ( <i>Oil Filter Mount Set</i> ).....	50-07A



Slotted Studs  
for easy removal  
washers included  
in Sets



Most Sets  
Available with  
Spike Nuts

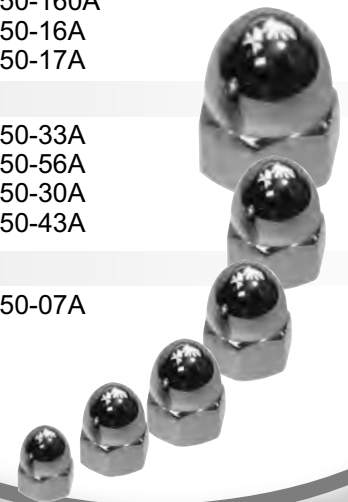



# Sportster Individual Acorn Nut Sets

## Oil Pump

	Part #
1998 & Up ( <i>Mount</i> ).....	50-184A
1991 - 1997 ( <i>Mount</i> ).....	50-156A
1977 - 1990 ( <i>Mount</i> ).....	50-158A

## Oil Tank

1982 & Up ( <i>Drain Plug</i> ).....	50-46A
1981 & Earlier ( <i>Drain Plug</i> ).....	C-20-20

## Point Cover Mount

1979 - 2003 ( <i>Includes Gasket</i> ).....	50-96A
1970 - 1978 ( <i>Includes Gasket</i> ).....	50-97A

## Primary Cover

1991 - 2003 ( <i>Sportster</i> ).....	50-169A
1986 - 1990 ( <i>Evolution XL</i> ).....	50-29A
1977 - 1985 ( <i>Sportsters</i> ).....	50-28A
1971 - 1976 ( <i>Sportsters</i> ).....	50-27A
1967 - 1970 ( <i>XLH &amp; 1970 XLCH</i> ).....	50-49A
1957 - 1969 ( <i>XLCH Models</i> ).....	50-50A
1957 - 1966 ( <i>XLH Models</i> ).....	50-51A

## Rocker Arm Shaft

1971 - 1984 ( <i>End Plug - Right Side</i> ).....	50-71A
1957 - 1985 ( <i>End Plug - Left Side</i> ).....	50-40A

## Rocker Box

All - ( <i>Evolution Motors with Special Washers</i> ).....	50-20A
1977 - 1985.....	50-69A
1957 - 1976.....	50-48A

## Sprocket Cover

1991 & Up.....	50-166A
1977 - 1990.....	50-32A
1971 - 1976.....	50-13A
1952 - 1970 XL & K Models.....	50-53A

## Tachometer

Tachometer Drive Block Off Plug Sportsters Iron Head.....	50-55A
---	--------

## Timing Plug

All - Harley's.....	C-20-20
---------------------	---------

## Triple Tree

XL & FX Models ( <i>Both Sides - Early</i> ).....	50-21A
---	--------



Most  
Sets  
Available  
with  
Spike Nuts





## Inside This Section

*Allen Style*

*Allen Screw Sets.....32*

**45cu  
Flathead**

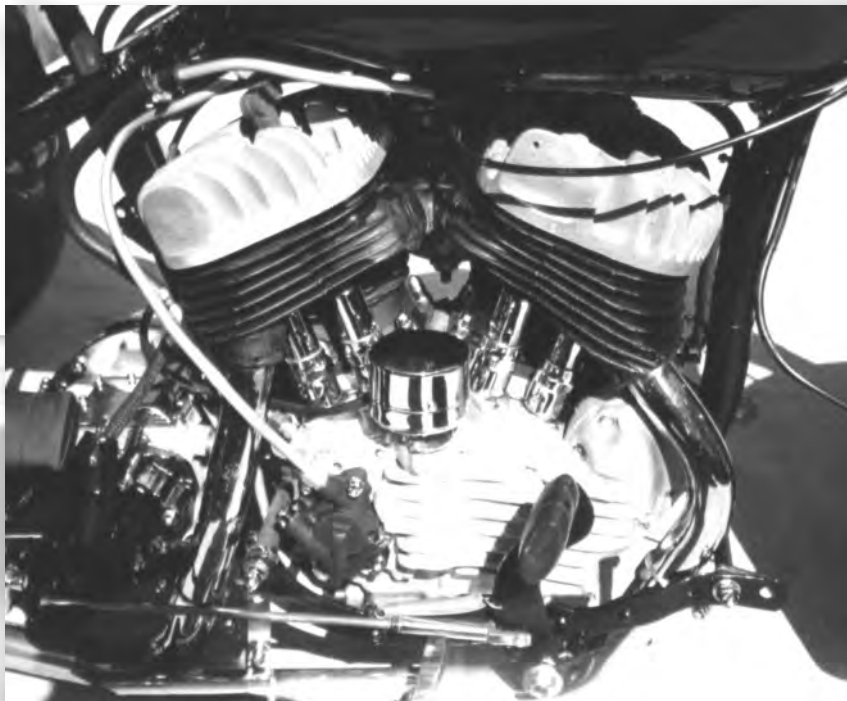



# 45cu. Flathead Allen Style

## Allen Screw Sets

	Part #
Cylinder Base Nut Set Stock Style Chrome.....	C-31-54
Casing Alignment Allen Set with Nuts & Washers Replaces Stud.....	C-45-30
Cam Cover ( <i>with Special Tapered Head</i> ).....	C-45-06
1958 & Up Generator ( <i>with Special Tapered Head</i> ).....	C-45-14
1936 - 1957 Generator ( <i>with Special Tapered Head</i> ).....	C-45-12
Gas Tank & Oil Tank Set.....	C-45-34
Head Bolts - ( <i>Both Iron Heads Includes Washers</i> ).....	C-45-11
Head Bolts - ( <i>Both Aluminum Heads Includes Washers</i> ).....	C-45-10
Inspection Covers - ( <i>Both Allen Screws on Primary</i> ).....	C-45-09
Lifter Base.....	C-74-16
Oil Feed Pump.....	C-45-28
Oil Scavenger Pump.....	C-45-27
Oil Pump Check Value Plug.....	C-80-27
Tank Shifter Shoulder Bolt.....	C-45-13
Top Front & Rear Motor Mount.....	C-45-19
1963 & Earlier Transmission Top Inspection Cover.....	C-45-18
1964 & Up Transmission Top Inspection Cover.....	C-45-21
7/16-16 - 20 x 2 13/16 Head Stud.....	61148
7/16-16 x 1 1/2 Chrome Allen Screws.....	09380
7/16-16 x 1 3/4 Chrome Allen Screws.....	09382
7/16-16 x 2 Chrome Allen Screws.....	09384
7/16-16 x 2 1/2 Chrome Allen Screws.....	09386
7/16-16 x 3 3/4 Chrome Allen Screws 1" thread length.....	09394
7/16 - Head Bolt Flat Washers.....	23375

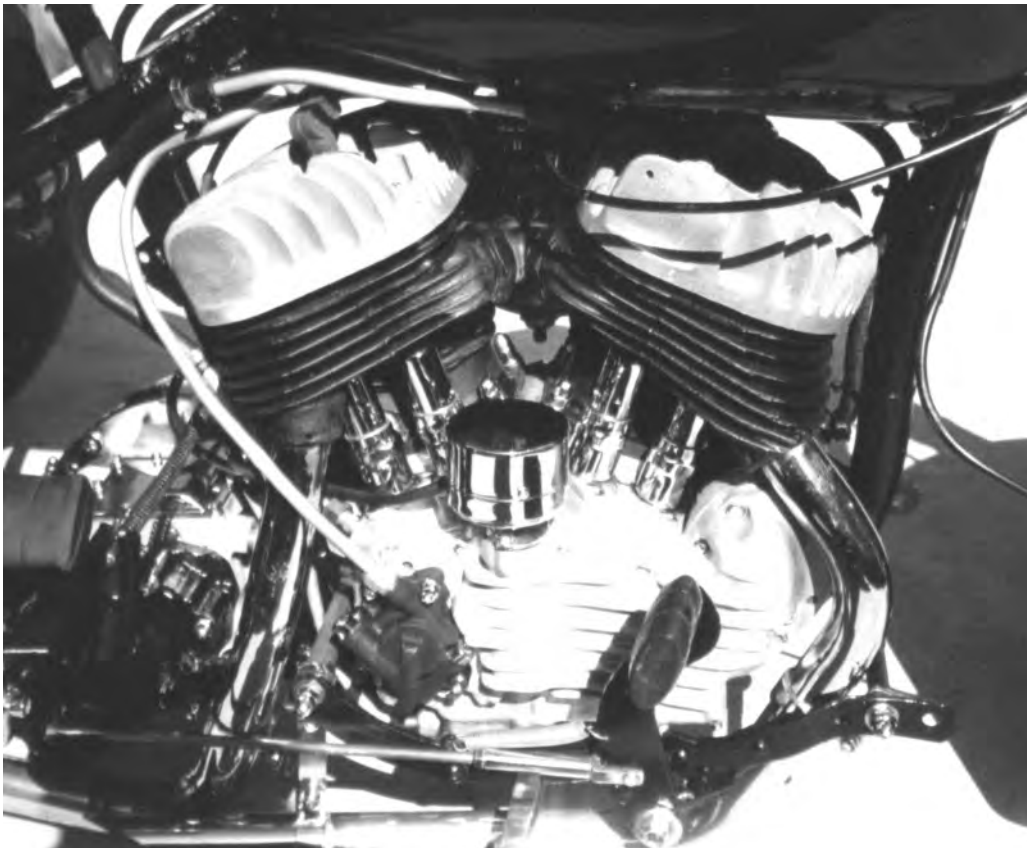



## Inside This Section

<i>Allen Style with Acorn Nuts</i>	
<i>Builders Fastener Sets.....</i>	<i>34</i>
<i>Motor Sets.....</i>	<i>34</i>
<i>Side Cover Sets.....</i>	<i>35</i>
<i>Full Motorcycle Sets.....</i>	<i>35</i>
<i>Individual Sets.....</i>	<i>36</i>





# V-Rod Builder and Motor Sets

"Where there is a bolt, you get a Allen Screw,



Where there is a nut, you get a Acorn Nut"



## Builders Fastener Sets

Gardner-Westcott's perfect combination set of **Chrome Allen Screws** and **Acorn nuts** with Chrome Lock Washers, Flat Washers and Special Washers for the Motor and Transmission of the VRSCA V-Rod contains; Cluch Cover with Cluch Actuator Cover, Alternater Cover with Derby Cover, Forward Sprocket Cover, Cylinder Head Covers, Water Pump, Thermostat Mount, Oil Filter Mount, Electric Start Bracket, Motor Mounts, Oil Pan, Crank Case and Exhaust Header Mounts.

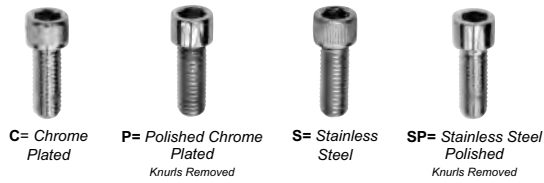

### Styles Available

### Part #

2006 & UP V-Rod.....	C P S SP	GW-03A
2002 - 2005 VRSCA V-Rod 69cu.....	C P S SP	GW-02A

## Motor Sets

Our Motor Sets contain **Chrome Allen Screws** with Chrome Lock Washers, Flat Washers and Special Washers where applicable. includes; Cluch Cover with Cluch Actuator Cover, Alternater Cover with Derby Cover, Forward Sprocket Cover, Cylinder Head Covers, Water Pump, Thermostat Mount, Oil Filter Mount, Electric Start Bracket and Oil Pan Mount.

### Styles Available

### Part #

2002 & Up VRSCA V-Rod 69cu.....	C P S SP	69-02
---------------------------------	----------	-------

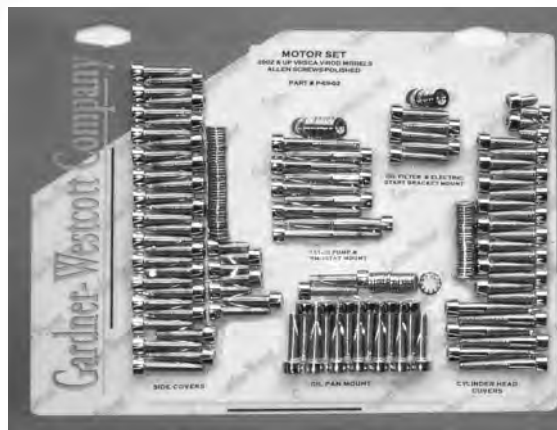

Motor Set 69-02

# V-Rod Side Cover and Full Sets



## Side Cover Sets

Side Cover Sets contains: **Chrome Allen Screws** with Special Washers and also includes; Clutch Cover with Clutch Actuator Cover, Alternater Cover with Derby Cover and Forward Sprocket Cover.

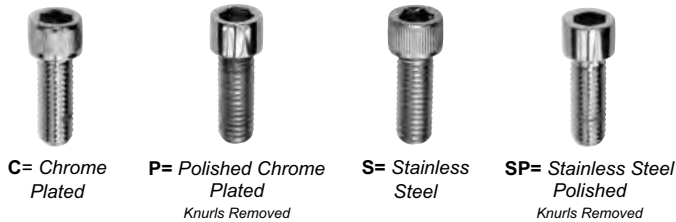

**V-Rod**

	Styles Available	Part #
2002 & Up VRSCA V-Rod 69cu.....	C P S SP	10-69-01

### SETS AVAILABLE FOR ANY YEAR AND MODEL



Side Cover Set  
10-69-01

## Full Motorcycle Sets

Full Motorcycle Sets contains: 1 Each of every application listed under individual sets and are also done in **Show Chrome** finish.

	Styles Available	Part #
2002 - 2005 VRSCA V-Rod 69cu.....	C P -- ---	69-99



## Allen Sets

- Where required, sets are supplied with Flat Washers, Lock Washers, Special Washers, Hex Nuts and/or Lock Nuts where applicable. Some sets are only available in Polished Chrome.

**Sets Available  
For Models  
Not Shown**



C= Chrome Plated



P= Polished Chrome Plated  
Knurls Removed



S= Stainless Steel



SP= Stainless Steel Polished  
Knurls Removed

	Styles Available				Part #
Alternator with Derby Cover.....	C	P	S	SP	10-69-06
Banjo Bolt Set 2006 - 2008.....	--	P	--	----	69-41
Banjo Bolts Set 2002 - 2005.....	--	P	--	----	69-40
Builder Fastener Set.....	C	P	S	SP	GW-02
Clutch Cover with Clutch Actuator Cover.....	C	P	S	SP	10-69-08
Crank Case.....	C	P	S	SP	69-29
Cylinder Head Covers with Cam Covers.....	C	P	S	SP	69-20
Disc Brake Rotor Mount - (Front Dual Disc).....	C	--	--	----	69-42
Disc Brake Rotor Mount - (Rear).....	C	P	S	SP	61-32
Disc Brake Caliper Mount - (Front for Dual Disc 2 Each Needed) Thru. 2005.....	C	P	S	SP	80-147
Disc Brake Caliper Mount - (Rear) 2002 - 2005.....	C	P	S	SP	80-148
Front Fender Mount thru 2009.....	C	P	S	SP	69-22
Frame Screws with Top Covers thru 2009.....	C	P	S	SP	69-48
Handlebar Rizer Mount 2003 - 2010.....	C	P	S	SP	69-57
Handlebar Switch Box with Master Cylinder 2002 - 2005.....	C	P	S	SP	69-50
Handlebar Switch Box with Master Cylinder Stock Style.....	C	--	--	----	69-50Y
Headlight Mount with Gauge Cover (side of Triple Tree and Fork Cap Screws).....	C	P	S	SP	69-23
Motor Set.....	C	P	S	SP	69-02
Motor Mounts and Stabilizer Links.....	C	P	S	SP	69-19
Oil Pan Mount.....	C	P	S	SP	69-32
Oil Filter Mount with Electric Start Bracket Mount.....	C	P	S	SP	69-31
Rear Foot Peg Bracket Mount - (Both).....	C	P	S	SP	69-36
Shock Mount Set 2006 & Up.....	C	P	S	SP	69-45
Shock Mount Set 2002 - 2005.....	C	P	S	SP	69-46
Shifter Arm and Rod Mount.....	C	P	S	SP	69-21
Side Covers.....	C	P	S	SP	10-69-01
Water Pump Cover with Thermostat Mount.....	C	P	S	SP	69-35

## Acorn Nut and Nut Sets Chrome

2002 - 2004 Axle Nut Front in Stock Style.....	50-301Y
2002 - 2004 Axle Nut Front in Chrome Acorn.....	50-301A
2002 - 2013 Axle Nut Rear in Stock Style.....	50-302Y
Exhaust Header Mounts in Stock Style.....	50-303Y
Exhaust Header Mounts in Chrome Acorn.....	50-303A
Fork Stem Nut in Chrome Acorn - early (Only).....	50-195A







## Inside This Section

<i>Allen Plugs.....</i>	<i>38</i>
<i>Valve Stem Covers.....</i>	<i>38</i>
<i>Axle and Axle Nut Sets.....</i>	<i>39</i>
<i>Banjo Bolts.....</i>	<i>40</i>
<i>Bleeder Screw Cover Acorns.....</i>	<i>40</i>
<i>Hole Plug Sets.....</i>	<i>41</i>
<i>Custom Applications.....</i>	<i>42</i>
<i>Cylinder Base Fasteners.....</i>	<i>43</i>
<i>Front End Fasteners.....</i>	<i>43</i>
<i>Head Bolts.....</i>	<i>44</i>
<i>ISO Mount Studs.....</i>	<i>45</i>
<i>Oil Pump Fasteners.....</i>	<i>45</i>
<i>Rocker Box Fasteners.....</i>	<i>46</i>
<i>Rocker Shaft Fasteners.....</i>	<i>47</i>
<i>Specialty Fasteners.....</i>	<i>47</i>
<i>Specialty Fittings.....</i>	<i>48</i>



*The First Name in Exceptional Quality Show Chrome Fasteners*



## Transmission Oil Fill Allen Plugs - Big Twins

Our Transmission Oil Fill Allen Plug is made so you can use an Allen wrench from the top or a standard wrench from the side. The ultimate easy-to-use filler plug is polished and **Show Chrome Plated**.

	<b>Part #</b>
2007 & Up Big Twins (includes O'Ring & Oil Dip Stick).....	C-96-12
1987 - 2006 Big Twins (includes O'Ring & Oil Dip Stick).....	C-80-14
O'Ring replacement (sold 10 per pack).....	09710
1936 - 1986 Big Twins (includes special washer).....	C-80-12
Nylon replacement washers (sold 10 per pack).....	09106

Transmission Oil  
Fill Plug  
Part # C-80-14



Transmission Oil  
Fill Plug  
Part # C-80-12



## Primary Cover Allen Plugs - Sportsters

Replace your stock slotted plugs with Gardner-Westcott's Allen Plugs, Polished and Chrome Plated

	<b>Part #</b>
1/2" Allen Wrench.....	09573

### Individual Plugs

1977 - 1990 (Oil Fill).....	C-20-63
1971 - 1976 (Oil Fill).....	C-20-60
1977 - 1990 (Clutch Adjustment).....	C-20-62
1971 - 1976 (Clutch Adjustment).....	C-20-61

### Sets Include both Plugs & Allen Wrench

1977 - 1990 (Allen Plug Set).....	C-20-64
1971 - 1976 (Allen Plug Set).....	C-20-62



Allen Plug  
Set  
Part # C-20-64

## Valve Cover Sets

Fits All Motorcycles (Set of Two).....	P-31-99
--	---------



## Allen Swing Arm Pivot Bolts

### Part #

1958 - 1985 Big Twins (4 Speed).....	C-31-113
2000 & Up Softails (Frame to Swing Arm Frame Pivot Mount).....	P-88-09
1984 - 1999 Softails (Frame to Swing Arm Frame Pivot Mount).....	P-80-09

## Axle Nut Sets for Big Twins and Sportsters

### Front Axle Nut Sets Chrome

### Part #

2007 & Up Dyna Glide & Softail Models (except springers), 2008 & Up FLT Models & 2010 & Up XL Models & 2006 & Up V-Rod (Includes; 5/8" Hex Nut & Flat Washer).....	C-31-53
Same as above (in Acorn Nuts).....	C-31-53 A
Pre 2007 Dyna Glide & Softail Models & Pre 2008 FLT Models & 1973 & Up FX, FXR & XL Models (Includes; 1/2" Hex Nut, Flat Washer & Lock Washer).....	C-31-44
Same as above (in Acorn Nuts).....	C-31-44A
1973 - 1985 FX, 1982 - 1987 FXR & 1973 - 1987 XL Models (Includes; Axle Nuts, Flat Washers & Lock Washer).....	C-31-46
Same as above (in Acorn Nuts).....	C-31-46A
1949 - 1971 Big Twins & 45cu. Flatheads (Includes; Axle Nuts slotted with Flat Washer, Cotter Pin, Pivot Bolt Stud Nut with Flat Washer, Lock Washer and Sleeve Nut).....	C-31-43
Same as above (in Acorn Nuts without Cotter Pins).....	C-31-43A

### Rear Axle Nut Sets Chrome

2014 & Up FXL & XL & 2008 & Up Softail & Dyna Glide Models (M24 Nut, Flat Washer & 41229-08 Ret. Ring).....	C-31-52
2005 - 2007 Sportsters Models (Includes; Flange Nut, Clip & Washer Stock Style).....	C-31-49Y
2002 - 2004 V-Rod Models (Includes; Nut, Clip and Washer Stock Style).....	50-302Y
2002 - 2013 FLT & 2005 & Up V-Rod Models (Includes; Nut & Clip).....	C-31-48
1989 & Up Style including 2001 - 2007 Softail, Dyna Glide & XL Some Models & FLT thru 2001(Includes; 5/8" Castle Axle Nut, Flat Washer & Cotter Pin).....	C-31-42
Same as above (in Acorn Nuts).....	C-31-42A
1973 - 1988 All XL, FX & FL Models.....	C-31-41
Same as above in Acorn Nuts.....	C-31-41A
1958 - 1972 Big Twins (Includes; Axle Nuts with Lock Washer, Sleeve Nut, Brake Anchor Lock Nut).....	C-31-47
Same as above (in Acorn Nuts).....	C-31-47A

### Front Axle Allen Covers

Fits FLH, FXWG, FXDWG & FLT Models or any 1/2" Dia. Axle Nuts (Tapered Allen Covers with Set Screw Mount for the Allen Axle Look).....	C-31-103
--	----------



Tapered Allen Covers with Set Screws and Caps

Part # C-31-103



Part # C-31-42

**Individual Axle Fasteners Available**



# Specialty HD Fasteners

## Banjo Bolts

	Allen #	12 Pt #	HD #
2013 & Up.....	P-96-110	-----	5001
2013 & Up.....	P-96-111	-----	5002
2006 & Up.....	P-80-119	A-80-119	41750-06B
2004 & Up XL (Models Dual 10mm).....	P-80-117	-----	41736-04A
2004 & Up XL (Models Dual 12mm).....	P-80-118	-----	41737-04A
1982 & Up (Front and or Rear).....	P-80-110	A-80-110	41747-82A
Front 1984 & Up.....	P-80-111	A-80-111	41739-84A
1958 - 1972 Big Twins (Rear Brake to Wheel Cylinder).....	P-80-112	-----	41743-58A
3/8 Aluminum Washer (used with P-80-110).....	09579	-----	-----
7/16 Aluminum Washer (used with P-80-111).....	09825	-----	-----
10mm Aluminum Washer (used with P-80-117).....	09596	-----	41732-04A
12mm Aluminum Washer (used with P-80-118).....	09598	-----	41743-04A



Part # P-80-110



Part # A-80-111



Part # C-31-61



Part # C-31-61 on V-Rod Caliper

## Bleeder Screw Cover Acorns

	Part #
1/4 Hex Bleeder Cover (sold each).....	C-31-60
3/8 Hex Bleeder Cover (sold each).....	C-31-61
7/16 Hex Bleeder Cover (sold each).....	C-31-62
1984 - 1999 All - (2 disc Models Set).....	C-31-63
1984 - 1999 All - (3 disc Models Set).....	C-31-64
1979 - 1984 XL, FX & FXWG (3 @ 3/8 Set).....	C-31-65
1980 - 1984 FLH (2 @ 3/8 Set).....	C-31-66
1972 - 1979 FHL (2 @ 1/4 Set).....	C-31-67

### With Set Screw Mounting



Bleeder Screws Chrome Plated

## Metric Motorcycle

BMW 11mm Hex (sold each).....	C-31-62
Honda & Yamaha 10mm Hex (sold each).....	C-31-68
Dealer Display 5 Each 1/4, 5/16, 3/8.....	C-31-69

## Brake Bleeder Screws Chrome Plated

	Part # Chrome	HD #	Zinc #
1/4-28 x 1".....	45-9404	41749-58	09607
5/16-24 x 1".....	45-9403	-----	-----
3/8-24 x 1 1/8".....	45-9402	44146-77	09606
		& 44048-83	
3/8 x 1 1/2".....	45-9400	-----	-----

## Metric Sizes

8mm x 1.25 x 23.8.....	45-9405	-----	-----
10mm x 1.50 x 27.50.....	45-9406	-----	-----



## Hole Plug Sets

Hole Plug Sets are available in chrome plated, black and brass for stock motor fastener applications supplying hole plugs where there is a Cap Screw on the stock motor. For stock motor fastener applications or for use with Gardner-Westcott Side Cover Sets, Motor Sets or Builder Fastener Sets.

For the hole plug part number just add the lettered prefix to the part number found on **pages 4,5 & 6** in the Big Twin Section and **pages 21 & 22** of the Sportster Section.

### Prefix for Hole Plugs

- HPC** = Chrome Hole Plugs
- HPB** = Black Hole Plugs
- HPA** = Brass Hole Plugs

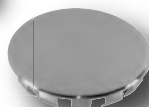

**Also Available in Assortments See pg. 69 for details**

- A-77-C** = Chrome Hole Plugs
- A-77-B** = Black Hole Plugs
- A-77-A** = Brass Hole Plugs

3/16 thru 3/4 - (7 Sizes & 130 Pieces)

## Specialty Fasteners

	<b>Part #</b>
Clutch Inspection Cover ( <i>Big Twins Nylon 1/4" Washer, H-D #31433-84 - sold each</i> ).....	09566
Clutch Adjustment Screw ( <i>1941 - 1984 Big Twin H-D #37357-41 - sold each</i> ).....	61142
Clutch Plate Removal Washer ( <i>Big Twins thru 1984, Zinc Plated - sold each</i> ).....	23593
Disc Brake Rotor to Hub Front ( <i>1984 &amp; Up Wide Torx Head Chrome Plated - sold each</i> ).....	46278-A
Disc Brake Rotor to Hub Rear ( <i>1992 &amp; Up Wide Torx Head Chrome Plated - sold each</i> ).....	46330-A
Disc Brake Rotor to Hub Rear ( <i>1973 - 1984 FX &amp; FLH includes; Locknuts, Thin Hex Caps Set</i> ).....	C-74-51H
Handlebar End Hole Plug, ( <i>Chrome H-D #56238-62 - sold each</i> ).....	43576
Oil Tank Drain ( <i>Washers 1/2 1981 &amp; Up Stainless Steel - sold each</i> ).....	84573
Speedo Trip ( <i>Set Reset Knob Mount Allen Screw Chrome - sold each</i> ).....	12091
Side Cover ( <i>Steel Washer Chrome, 1/4" I.D. Small O.D. Replaces H-D #6099 - sold each</i> ).....	23204
Same as above ( <i>sold in - 100 per package</i> ).....	23203
Tailight Lens Mount ( <i>Allen Screws Chrome 1999 &amp; Up - sold each</i> ).....	10138
Triple Tree Top Stem ( <i>Acorn Nut 1949 &amp; Up FLH, FXWG, FXDWG &amp; V-Rod</i> ).....	50-195A
Windshield Mount ( <i>Rubber &amp; Stainless Steel Washer - sold each</i> ).....	81569





# Specialty HD Fasteners



**C= Chrome Plated**



**P= Polished Chrome Plated  
Knurls Removed**



**A= 12 Point Chrome Plated**

## Custom Applications

	Styles Available	Part #
Arlen Ness - (Swing Arm Wheel Adjustment Allen Screw Set).....	-- P --	99-50
Arlen Ness - (Drag Bars Handlebar Mount Allen Screw Set).....	-- P --	99-52
Bendix Carburetor - (Allen Screw Set).....	C P --	31-37
Cal Products - (Transmission Ratchet Lid Cover Allen Screw Set for 1936 - 1969 Big Twin 4 Speeds).....	C P --	31-03
Cam Covers - (House of Horsepower and S&S Cycle for Stock HD Motor Cases 1936 - 1969 Big Twins).....	-- P --	31-05
Cam Covers - (Cam Covers to Delkron, Sputh or House of Horsepower Motor Case 1936 - 1969 Big Twins).....	C -- --	31-04
Cylinder Base - (1957 - 1985 Sportsters - requires removal of studs, Includes; Washer & 12 Point Screws).....	C P A	20-08
Cylinder Base - (Shovelheads & Panheads - requires removal of studs 12 Points).....	C P A	74-08
Cylinder Head Bolts - (Shovelhead Big Bore including Bonneville Engineering and S&S in 12 Points).....	C P A	74-10
Delkron - (Alternator Motor Case Allen Screw Set).....	C P --	31-02
Dellorto - (38mm & 40mm Pumper Carburetors Allen Screw Set with Allen Wrench).....	C P --	31-36
Granny Trannys - (5 Speed Kicker Fastener Set).....	C P --	31-87
Head Bolts - (Std Panheads both in 12 Point Screws with Special Washers coarse thread).....	-- -- A	31-11
Head Bolts - (Std Shovelheads both 12 Point Screws with Special Washers coarse thread).....	C -- A	31-14
Head Bolts - (Std Panheads both 12 Point Screws with Special Washers fine thread - fits 2000 & Up).....	-- -- A	31-111
Header Mount - (Allen Screws for Shovelheads - Longer than stock 5 1/6"-18x1" sold each).....	-- -- --	10280
Lifter Base - (Big Twins to mount 1977 & Up lifter blocks on 1936 - 1976 Motor Case).....	C P A	31-16
Lifter Base - (Big Twins to mount 1936 - 1976 lifter blocks on 1977 & Up Motors and Custom Motor Cases).....	C P A	31-35
Motor Mounts - (Studs Front extra length Sportsters 1957 - 1984 for mounting forward controls or foot pegs - includes studs, Acorn Nuts & washers).....	-- -- -- C P A	50-43
S & S Cycle Super - (E&G Shorty Full Carb Set).....	C P --	31-38
S & S Cycle Super - (Carburator Air Cleaner Float Bowl & Intake Manifold Allen Screws).....	C P --	31-33
S & S Cycle - (Two Throat Carburator Set).....	C P --	31-34
S & S Cycle - (Big Twin Evolution Motor Case Set).....	C P --	31-57
S & S Cycle - (Big Twin Special application Motor Case Set 4" Bore).....	C P --	31-58
S & S Cycle - (Big Twin Evolution special application Big Bore, CLB full set with fittings).....	C -- --	31-2001B
S & S Cycle - Big Twin Cam Motor Case.....	C P --	C-31-56
T in Custom Primary Cover Inner - (Primary 1965 & Up 4 Speed Big Twins).....	C P --	31-25
Wheel Adjustment bolts - (Rear, extra long 3/8"-16x3" fully threaded Hex Cap Chrome, sold each).....	-- -- --	09347



## Cylinder Base Fasteners

Our Acorn Style Nut has a 9/16" Hex like the 80cu. stock cylinder base nuts, to eliminate clearance problems on the Shovelheads, making it possible to assemble using a box wrench for more tightening control. Our Acorns will easily clear cylinder fins on assembled motors. This special cylinder base nut kit includes the proper Special Washers.

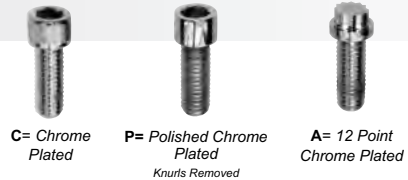

Acorn Style	Styles Available	Part #
1936 - 1984 Big Twins ( <i>special cylinder base nut kit with Special Washers &amp; 9/16 Hex</i> )....	C P --	31-80-A
1957 - 1985 Sportsters & 45cu. Flatheads ( <i>includes; Acorn &amp; Washers</i> ).....	-- -- --	50-54A

## Allen Style

Panheads & Shovelheads ( <i>includes; Allen Nuts &amp; Special Washers</i> ).....	-- -- --	50-80L
1957 - 1985 Sportsters ( <i>includes; Allen Nuts &amp; Special Washers</i> ).....	-- -- --	50-54L
Panheads & Shovelheads ( <i>requires removal of studs, Includes; Allen Nuts &amp; Special Washers</i> ).....	C -- A	74-08
1957 - 1985 Sportsters ( <i>requires removal of studs Includes; Allen Nuts &amp; Special Washers</i> ).....	C -- A	20-08

## Stock Style

1936 - 1984 Big Twins ( <i>High Hex Style - Stock Style # 16602-30 Chrome Plated</i> ).....	C -- --	31-74
Same as above - ( <i>Zinc Plated</i> ).....	-- -- --	31-74
1957 - 1985 Sportsters ( <i>High Hex Style - Stock Style # 16603-73 Chrome Plated</i> ).....	C -- --	31-54
Same as above - ( <i>Zinc Plated</i> ).....	-- -- --	31-54

## Cylinder Base Washers

1936 - 1985 Big Twins ( <i>one piece round Thick Flat Washer Chrome - sold each</i> ).....	-- -- --	23580
1957 - 1985 Sportsters ( <i>one piece round Thick Flat Washers Chrome - sold each</i> ).....	-- -- --	20087

## Front End Fasteners

\* (B) Button Head Allens available

Each Fork Tube Cap Allen Plug is precision machined tapering to the top, than **Show Chrome Plated** and uses a standard 1/2" Allen Wrench and is sold in pairs.

## Allen Fork Tube Caps

1977 & Up Big Twin FLH & FXWG - ( <i>41mm</i> ).....	-- -- --	99-21
1988 & Up Sportster & FXR Models also 1987 & Up FXLR - ( <i>39mm</i> ).....	-- -- --	99-23
1/2 Allen Wrench ( <i>sold each</i> ).....	-- -- --	09573

## Allen Front Fork Leg Drain Screws

1949 - 1976 FLH & 45cu. Flatheads.....	C -- --	74-47
* 1977 & Up FLH, FLT, FXWG & Softail Models ( <i>with Washers &amp; Allen Wrench</i> ).....	C P --	74-45*(B)
1957 - 1972 XL & FX Models.....	C P --	20-57
* 1973 & Up XL, FX, FXR Models ( <i>with Washer &amp; Allen Wrench</i> ).....	C P --	20-58*(B)

## Triple Tree Top Fasteners

1949 & Up FLH, FXWG, FXDWG & VRSCA V-Rod - ( <i>Early</i> ) ( <i>Top Nut Acorn Style with Washer</i> ).....	C -- --	50-195A
1988 & Up XL, FXR & 1991 & Up FXD 39mm ( <i>Top Bolt with Flat Washer in for Stock Style Hex add Suffix H</i> ).....	C P --	80-58H

## Front End Detail Set - 39mm

1988 & Up XL & FXR Models ( <i>This combination Allen and Acorn set Includes; Chrome Fasteners for the Fork Tube Caps, Top Triple Tree Bolt, Drain Screw, Axle Cap, Nuts and Triple Tree Pinch Bolts</i> ).....	C P --	80-49
---	--------	-------



## Head Bolts

For Custom Manufacturers Head bolts see **page 56** in Custom Applications

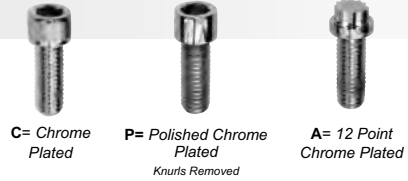

## Evolution and Twin Cam Motors

	Styles Available	Part #
1992 & Up Sportsters & Big Twins (Includes 12 Point Head Bolts).....	-- -- A	61-110
1987 - 1991 Sportsters & Big Twins (Includes Only 12 Point Head Bolts).....	-- -- A	61-100
Same as above (with Head Bolts & Studs).....	-- -- A	61-101
1986 Sportsters Only (Includes Special Washers comes in 12 Point Style).....	-- -- A	80-100
Same as above (with Head Bolts, Washers & Studs).....	-- -- A	80-101
1984 & Earlier also 1985 Big Twins (Includes 12 Point Head Bolts).....	C P A	80-10

## Panhead and Shovelhead Motors

All - Panhead & Shovelheads (Includes Chrome 12 Points & Special Washers).....	-- -- A	74-10
All - Panhead & Shovelheads (Stock Style 9/16 Hex Caps Chrome with Special Washers).....	C -- --	31-09
Same as above in (Zinc Plated).....	-- -- --	31-09
All Panhead & Shovelhead (Includes Acorns & Studs).....	-- -- --	50-68A
74cu. Knucklehead Motors (Polished Chrome Allens with Special Washers).....	-- P --	P-74-09

## Sportsters

1957 - 1972 Sportsters (Includes Chrome 12 Point with Special Washers).....	C P A	20-18
Same as above in (Chrome Hex Caps with Washers, for Stock Style Hex add Suffix H).....	C -- --	20-18H
Same as above in (Acorn Nuts with Studs).....	-- -- --	50-94A
1973 - 1985 (includes Chrome 12 Point with Washers, for Stock Style Hex add Suffix H).....	C P A	20-17H
Same as above in (Acorn Nuts with Studs).....	-- -- --	50-95A

\* Evolution XL's see above

## 45cu Flatheads

Iron Head 45cu. (Chrome Allen Screws with Washers).....	C -- --	45-11
Aluminum Head 45cu. (Chrome Allen Screws with Washers).....	C -- --	45-10

## K & KH Model Flatheads 1952 - 1956

All K Models (includes Chrome Allen Screws with Washers).....	C P A	20-80
---	-------	-------

## Individual Head Bolt Fasteners

Panheads & Shovelhead (Head Bolt Washer in Chrome - sold each).....	C -- --	31-30
1984 & 1985 Evolution (H-D# 16482-85 Head Bolt Washer in Chrome - sold each).....	C -- --	31-32
1985 Evolution Big Twins (Head Bolt Washer in Chrome - sold each).....	-- -- --	23200
H-D Flatheads & Indians (Head Bolt Washer in Chrome - sold each).....	-- -- --	23375
1985 - Late Evolution Big Twins (H-D# 16837-85B Head Stud - sold each).....	-- -- --	61200
1986 & Up Evolution Sportsters (H-D# 16832-86C Head Stud - sold each).....	-- -- --	61201
1987 - 1991 Evolution (H-D# 16480-85A Head Bolt 12 Point in Chrome).....	-- -- --	09270
1981 & Up All (H-D# 16478-85A Head Bolt 12 Point in Chrome).....	-- -- --	09271
1992 & Up Big Twins & Sportsters (H-D# 16480-92 Head Bolt 12 Point in Chrome).....	-- -- --	09272
1999 & Up Twin Cam (H-D# 16834-99A Head Stud).....	-- -- --	61202

Head Bolt Washers

Internal Head Bolts

Head Bolt Stud



23200



23580



C-31-30



09271



09272



61200





## ISO Mount Studs

These rubber ISO Mount Studs exceed the OEM Mount in Tensile Strength, Sheer Resistance and Overall Strength. sold individually

	Part #
1977 -1984 FXS & FXEF Models ( <i>Speedo Dash Mount, etc. Mount as 5/16-18 Male &amp; Female Stud, Replaces H-D #50235-63</i> ).....	09807
1965 & Up Tack Mount FXS, FXEF and others ( <i>Fits Oil Tank &amp; Battery Carrier, Mount has 1/4-20 Studs, same length as original Replaces H-D #62563-65</i> ).....	09808
Same as above with ( <i>Longer Stud on one side Replaces H-D #62563-65</i> ).....	09809



**Specialty Fasteners**

## Oil Pump Fasteners

### Oil Pump Allen Plugs (Top Plugs)

1981 - 1999 80cu. ( <i>Replaces Plugs for Motor Case Oil Screen, Check Valve Spring, Relief Valve &amp; O'Ring, Also Available in 12 Pts. use the A Prefix</i> ).....	C-80-32
1970 - 1980 74cu. & 80cu. ( <i>Replaces Plugs for Motor Case Oil Screen, Check Valve Spring, Relief Valve &amp; O'Ring</i> ).....	C-80-28
1968 - 1969 74cu. ( <i>Replaces Plugs for Motor Case Oil Screen, Check Valve Spring, Relief Valve &amp; O'Ring</i> ).....	C-80-29
1966 - 1967 74cu. ( <i>Replaces Plugs for Motor Case Oil Screen, Oil Check Valve</i> ).....	C-80-30
1952 - 1965 74cu. ( <i>Replaces Plugs for Motor Case Oil Screen, Oil Check Valve</i> ).....	C-80-31



Kit C-80-32

### Individual Allen Plugs

1982 - 1999 Big Twins ( <i>Oil Pump Allen Plugs, Includes O'Ring - 3 per bike Replaces H-D #26263-80, Also Available in 12 Pts. use the A Prefix</i> ).....	C-80-24
1941 - 1980 Big Twins & 45cu. ( <i>Oil Check Valve Allen Plugs, Includes O'Ring Replaces H-D #26362-36</i> ).....	C-80-27
1968 - 1980 Big Twins ( <i>Oil Pump Relief Valve Allen Plug, Includes O'Ring Replaces H-D# 26377-68</i> ).....	C-80-26
1970 - 1980 Big Twins ( <i>Motor Case Oil Screen Allen Plugs, Includes O'Ring Replaces #657</i> ).....	C-80-25
1966 - 1969 Big Twins ( <i>Motor Case Oil Screen Allen Plugs, Includes O'ring Replaces #655</i> ).....	C-80-23
1952 -1965 Big Twins ( <i>Motor Case Oil Screen Allen Plugs, Replaces H-D #24987-52</i> ).....	C-80-22
Replacement Brass Washer ( <i>for C-80-26 10 per pack</i> ).....	09571
Replacement O'Ring ( <i>for C-80-32 10 per pack</i> ).....	09104

	Chrome Allens	Polished Allens	Hex Caps	12 Point	Acorn Set
1992 - 1999 Big Twin 80cu.....	C-80-97.....	P-80-97.....	- .....	A-80-97.....	50-197A
1979 - 1991 Big Twin.....	C-74-32.....	P-74-32.....	C-74-32H.....	A-74-32.....	50-35A
1968 - 1978 Big Twin.....	C-74-28.....	P-74-28.....	- .....	- .....	50-34A
1936 - 1967 Big Twin.....	C-80-13.....	P-80-13.....	- .....	- .....	31-40A
1998 & Up Sportsters.....	C-61-55.....	P-61-55.....	C-61-55H.....	A-61-55.....	50-184A
1991 - 1997 Sportsters.....	C-61-56.....	P-61-56.....	C-61-56H.....	A-61-56.....	50-156A
1977 - 1999 Sportsters.....	C-20-56.....	P-20-56.....	C-20-56H.....	A-20-56.....	50-158A
1971 - 1976 Sportsters.....	C-20-36.....	P-20-36.....	C-20-36H.....	A-20-36.....	-

### Oil Filter Mount

1990 - 1991 FLT & FXR in <i>Chrome Hex Caps</i> ( <i>3/8 x 7/8 Left Hand Thread Sold Each, Replaces H-D #2914</i> ).....	09704
( <i>3/8 x 1 Left Hand Thread Sold Each, Replaces H-D #2913</i> ).....	09703
1999 & Up Twin Cam 88cu. ( <i>Available in Chrome use C Prefix &amp; 12 Pts use A Prefix</i> ).....	P-88-28
1992 - 1999 Big Twin 80cu. ( <i>Available in Chrome use C Prefix &amp; 12 Pts use A Prefix</i> ).....	P-80-116



# Specialty HD Fasteners

## Rocker Box Screw Sets

	Styles Available	Part #
1999 & Up Twin Cam 88cu, 88B & 96cu. (with Washers).....	C P A	88-15H
1999 & Up Twin Cam 88cu, 88B & 96cu. (Socket Head Hex Stock Style w/ Washers).....	C -- --	88-15Y
1984 - 1999 Evolution Motors (with Copper & Steel Washers).....	C P A	80-15H
Same as above (except in Button Allens for that Countersunk Look).....	C -- --	80-15B
Same as above (except with Tapered Cup Washers).....	C -- --	80-15W
Same as above (except with Tapered Cup Washers & Hole Plugs).....	C -- --	80-15R
Full - Rocker Box Mount Set (Includes; all inside & Top Mounting Hardware).....	C P --	80-115Y
1966 - 1981 Shovelheads (Requires Drilling 3/8 Diameter Hole).....	C P A	74-15H
Same as above (except in Button Allens for that Countersunk Look).....	C -- --	74-15B
1981 - 1984 Shovelheads (Requires Drilling 3/8 Diameter Hole).....	C P A	80-08H
1957 - 1976 Sportsters.....	C P A	20-15H
1977 - 1985 Sportsters.....	C P A	20-50H
XR 1000 & XR 750.....	C P A	61-15H

## Rocker Box Nut Sets & Special Washers

### Shovelheads 1966 - 1985 Top

	Part #
Low Crown Acorns (easily clears frame with Special Washers).....	50-15A
Same as above (except in "Stock Style" Includes Hex Nuts & Washers).....	50-15H
Same as above (except in Allen Nut Style).....	50-15L
Same as above (except in Spike Nuts & Washers).....	50-15x

Rocker Box  
Screw Set  
C-80-15w



### Evolution & Twin Cam Motors Top

1984 - 1999 Evolution (Low Crown Acorns, Studs & Washers).....	50-20A
Same as above (except in Spike Nuts, Includes Studs & Washers).....	50-20x
1999 & Up Twin Cam 88cu. (Spike Nuts & Studs).....	50-176x
1999 & Up Twin Cam Motors (Low Crown Acorns, Studs & Washers).....	50-176A

### 1966 & Earlier Shovelheads & 1957 - 1985 Sportsters Side

Left Side - (Rocker Arm Shaft End Acorns Replaces Red Button Nuts).....	50-40A
Same as above (except in Hex Nut Style).....	50-40H
Same as above (except in Allen Nut Style).....	50-40L

Rocker Box  
Nut Set  
50-15A



### Special Chrome Washers with 5/16 I.D. and Small O.D.

Shovelhead & XL (Replaces H-D #6318HW & H-D #6702 - Packed 50 per bag).....	C-6318-HW
Evolution Motors (Copper Washer Replaces H-D #6114 - sold each).....	09568

### Rocker Arm Shaft End Washer (Left Side) Replaces HD #6466W

Shovelheads & Sportsters (Thicker than Stock, reusable Stainless Steel).....	84572H
Same as above (except in Steel Chrome Plated).....	26572H
1971 - 1984 Shovelhead (Rocker Shaft Washer Cam Side).....	09574

## Rocker Arm Shaft End Allen Plugs

	1957 - 1970 XL 1966 - 1970 FLH	1971 - 1985 XL 1971 - 1985 FX & FL
Chrome.....	C-74-56	C-74-55
Brushed Aluminum.....	M-74-56	M-74-55
Black.....	B-74-56	-----
Gold.....	G-74-56	G-74-55
Chrome with 24k Gold Screws.....	CG-74-56	CG-74-55
Button Head Allen.....	N/A	C-74-55B
Acorn Style.....	50-70A	50-71A
12 Point Screws.....	A-74-56	A-74-55



## Common Harley Fittings

### Oil Line Hose Barbs

Part #

Used on Oil Pump, Case, Oil Tank etc.

- 1/8 Pipe x 3/8 Hose - St..... 7-90TD-6x2
- 1/8 Pipe x 3/8 Hose - 90°..... 7-91TD-6x2
- 1/8 Pipe x 3/8 Hose - 45°..... 7-97HB-6x2



### Oil Line Street Elbows

Used on Top of Oil Pump, use with Hose Barbs listed above

- 90° 1/8 Pipe..... 7-116PSE-2
- 45° 1/8 Pipe..... 7-124PSE-2



### Motor Case Breather Fittings

Threads into Case

- Straight 1/4 Pipe x 3/8 Hose..... 7-90TD-6x4
- 90° 1/4 Pipe x 3/8 Hose..... 7-91HB-6x4
- 45° Street Elbow 1/4 Pipe..... 7-124PSE-4
- 90° Street Elbow 1/4 Pipe..... 7-116PSE-4
- Straight 1/4 Pipe x 1/2 Hose..... 7-90HB-8x4



### Oil Vent Tee

For Shovelhead Vent Hose

- 3/8 Hose..... 7-94HBT-6



### Oil Line Nuts & Fasteners

Fits Shovelhead & Iron Head Sportsters

- Oil Line Nuts, Body & Seal..... C-31-152



## Motor Mounts

### Motor Mount Bracket Kit



## Oil Line & Pump Fitting Sets

### 1970 - 1981 Shovelheads

Includes; fittings for Oil Pump, Top End Oil Lines, Oil Tank, Line Tee, Motor Case Vent, Primary Chain Housing, Oil Line Block Off Plugs - (Can be used on any combination of belt or chain drive wet or dry clutch models)

- (4ea.) - Oil Pump (3ea.) - Oil Tank
- (1ea.) - Motor Case Vent (1ea.) - Oil Line Tee
- (3ea.) - Primary Chain Housing
- (8ea.) - Overhead Line Fitting
- (4ea.) - Rubber Seals

Chrome Part #	Brass Part #
C-31-160	31-160

### 1984 - 1991 Evolutions & 1970 - 1984 Shovelheads

Includes; fittings for Oil Pump & Motor Case Vent. (Can be used with belt drive or wet clutch sealed primary).

- (2ea.) - Street Elbow 90° 1/8 Pipe
- (3ea.) - Hose Barb 1/8 Pipe
- (1ea.) - Hose Barb 1/4 Pipe
- (1ea.) - Street Elbow 90° 1/4 Pipe
- (1ea.) - Street Elbow 45° 1/4 Pipe

Chrome Part #	Brass Part #
C-31-163	31-163

### 1968 - 1984 Shovelheads

Includes fittings for Oil Pump

- (2ea.) - Street Elbow 90° 1/8 Pipe
- (3ea.) - Hose Barb 3/8 Pipe
- (1ea.) - Hose Barb 3/8 Pipe-Long

Chrome Part #	Brass Part #
C-31-165	31-165

### 1984 - 1991 Evolution Big Twins

Includes fittings for Oil Pump

- (2ea.) Street Elbow 90°
- (3ea.) Hose Barb 3/8 Hose

Chrome Part #	Brass Part #
C-31-167	31-167

\* See Page 110-114 for more fittings

- 1991 - 1999 Softails (Top Motor Mount Strap & Block made from 5/16" thick hardened steel with Stock Style Hex Caps, Special Washers & Lock Nuts Show Chromed)..... C-99-71H
- Same as above with (Polished Allens)..... P-99-71



# Specialty HD Fasteners

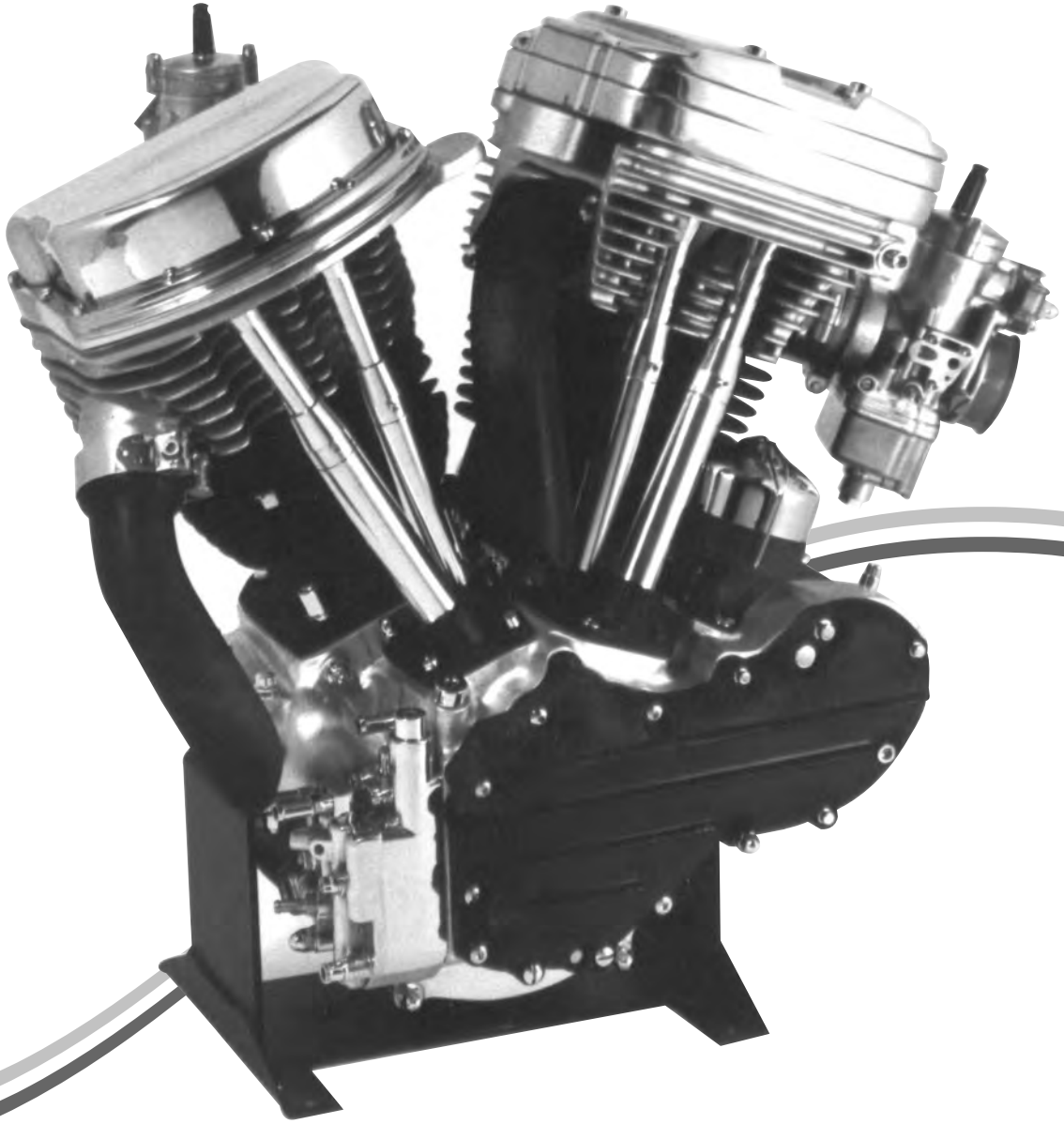

**GARDNER-WESTCOTT HAS FASTENERS  
IN EVERY STYLE FOR EVERY MOTOR**





## Inside This Section

<i>Stock Style Replacement Fasteners</i> .....	50 - 52
<i>Stock Style Fastener Sets</i> .....	53
<i>Studs</i> .....	54





# Stock Style Fasteners

## Stock Style Replacement Fasteners

	G-W #	HD #
Hitch Pin.....	09232	509
1/16 x 1/2 - (Zinc Cotter Pin).....	01587	510
1/16 x 3/4 - (Zinc Cotter Pin).....	01588	515
3/32 x 3/4 - (Zinc Cotter Pin).....	01589	528
3/32 x 1 - (Zinc Cotter Pin).....	01590	534
3/32 x 1 1/4 - (Zinc Cotter Pin).....	01591	513
1/8 x 3/4 - (Zinc Cotter Pin).....	01592	550
1/8 x 1 1/4 - (Zinc Cotter Pin).....	01593	559
5/32 x 1 1/2 - (Zinc Cotter Pin).....	01599	511
3/16 x 1 - (Zinc Cotter Pin).....	01594	566
Evolutions - Rocker Box (1/4 Zinc Allen Screw).....	08214	852
FXRS - Front Caliper Mount (Allen Screw).....	12340	860
1/4-20 x 7/8 (Zinc Allen Screw).....	08212	882
Twin Cam - Rocker Box (Torx Buttonhead Screw).....	46208	941
Hex Head Socket Flange (Zinc).....	46228	945
Point Mount (8/36 x 1/4 Round Machine Screw).....	04127	1047
1936 - 1964 74cu. Primary Cover Slotted Screw (Chrome).....	37157	1210
74cu. - Transmission Shift Dust Cover Screw (Chrome).....	14154	1761
Gas Tank Trim Mount Screw (4/40 x 3/16 Phillips).....	94087	2061W
1936 - 1964 74cu. Derby Cover Slotted Screw (Chrome).....	34186	2265W
FLH - Rear Fender Rail Screw (5/16-24 x 1 1/4 Chrome Oval Head Phillips Chrome).....	40285	2272
1936 - 1969 74cu. Cam Cover Slotted Screw (Zinc).....	31-06	2341
Brake Master Cylinder Cover.....	92132	2573
Brake Master Cylinder Cover.....	89128	2579
Brake Master Cylinder Cover.....	94712	2586A
Shifter Cover Slotted Screw (Chrome 1/4 x 24).....	33250	2597
Brake Line Clamp Mount (10 x 3/8 Chrome Hex SMS).....	55640-W	2652
Shovelhead - Header Mount (Zinc Allen Screw).....	08274	3201W
5/16-18 x 1 1/4 (Chrome Allen Screw).....	12284	3210A
Coil Cover Mount (10/32 x 1/2 Chrome Hex Washer SMS).....	55155	3473
Knucklehead - (8 x 3/8 Hex Sheet Metal Screw Chrome).....	55627	3477
Front Brake Caliper Mount (Hex Washer HD).....	55155-S	3517
8/32 x 1/2 (Zinc Allen).....	08130	3556A
Brake Caliper (12 x 1/2 Chrome Hex Sheet Metal Screw).....	55186WP	3562
Coil Cover Mount (10 x 1/2 Chrome Sheet Metal Screw).....	55641	3566
5/16-18 x 7/8 (Chrome Wide Torx Buttonhead).....	46278W	3655
1966 & Up - Handlebar Switch Box (Chrome Torx Buttonhead).....	46154	3658
Twin Cam - Rocker Box Screw (Chrome Hex Socket Head).....	09649	3692A
Twin Cam - Rocker Box Screw (Zinc Hex Socket Head).....	09462	3692A
Twin Cam - Rocker Box Screw (Chrome Hex Socket Head).....	09648	3693A
Twin Cam - Rocker Box Screw (Zinc Socket Head).....	09463	3693A
1977 & Up 80cu. - Lifter Base (Chrome 12 Point Screw).....	29212	3770
Distributor Hold Down - (1/4-24 Hex Cap).....	11251	3779
Big Twin - Inner Primary Mount Drilled (Zinc 5/16 Hex).....	07280-D	4021
Fork Top Bolt - (Chrome Hex Cap).....	11489	4060
Softail - Shock Mount Bolts.....	09342	4074
Shock Mount Bottom Bolt - (Zinc 1/2-20 x 13/4).....	07423	4081

Cotter Pin



Machine Screw



Wide Torx



**Gardner-Westcott  
Has Available  
Many Stock Style  
Fasteners  
Not Shown**

# Stock Style Fasteners



## Stock Style Fasteners

### Stock Style Replacement Fasteners

	G-W #	HD #
1996 & Up Handlebar Switch Boxes ( <i>Chrome 1/4-20 x 1 1/8 Torx Buttonhead</i> ).....	46216	4123
1/4-20 x 1 1/8 ( <i>Torx Buttonhead</i> ).....	46216	4132
74cu. - Transmission Plate Mount ( <i>3/8 x 1 1/8 Chrome</i> ).....	11333	4336W
FXST - Rear Fork Mount ( <i>3/4 - 16 x 3 Hex Cap Chrome</i> ).....	11600	4969
Brake Tee Mount ( <i>5/16 Shoulder Bolt</i> ).....	09837	5004
Spacer - ( <i>Steel Chrome</i> ).....	20096	5809
Spacer - ( <i>Steel Chrome</i> ).....	20095	5812
Oil Tank & Transmission Drain ( <i>1/2" Nylon Washer</i> ).....	87573	6007
Evolution - Motor Mount ( <i>Chrome 3/8 I.D. Flat Washer</i> ).....	23329	6019
Rubber Backed ( <i>5/16 Stainless Steel Washer</i> ).....	81570	6095
Side Cover ( <i>Chrome 1/4 Special Flat Washer</i> ).....	23204	6099
5/16 x 11/16 x 1/8 - ( <i>Zinc Flat Washer</i> ).....	33570	6109
Evolution - Rocker Box ( <i>1/4 Copper Washer</i> ).....	09568	6114
XL - Motor Mount ( <i>Spacer</i> ).....	23327	6152
Oil Pump - ( <i>Brass Washer</i> ).....	09985	6156
Spacer - ( <i>Steel Chrome</i> ).....	20097	6219
( <i>3/8 Chrome Flat Washer</i> ).....	23571	6353
Transmission Mount ( <i>Chrome 5/16 Flat Washer</i> ).....	33571	6400
1976 & Earlier ( <i>Head Bolt Washer</i> ).....	23580	6469HW
Fx - Seat Mount ( <i>1/4 I.D. Nylon Washer</i> ).....	87569	6410
4 Speed - Transmission ( <i>3/8 I.D. Plain Flat Washer</i> ).....	23326-PL	6442
Top Motor Mount & Belt Pulley ( <i>7/16 x 1 1/8 x 1/8 Chr. FW</i> ).....	23377	6516
Top Motor Mount ( <i>7/16 x 1 1/8 x 5/32 Chr. Thick FW</i> ).....	23379	6522
Oil Pump - ( <i>Brass Washer</i> ).....	09571	6581
1973 & Up FL - ( <i>Front Axle Mount 1/2 x 1 1/8 Flat Washer</i> ).....	23416	6590
39mm - Fork Top Bolt ( <i>Chrome Washer</i> ).....	23492	6655
3/8 x 13/16 x 1/16 - ( <i>Zinc Flat Washer</i> ).....	04571	6701
Shovelhead & XL - Rocker Box ( <i>5/16 Flat Washer</i> ).....	C-6318-HW	6702
Softail Shock Mount ( <i>Flat Washer sold each</i> ).....	23488	6724
5/16 - ( <i>Chrome Flat Washer</i> ).....	26570	6771A
Softail - Swing Arm Mount ( <i>Zinc 3/4 Internal Star Washer</i> ).....	03576	7142
5/16 x 24 - ( <i>Zinc Flange Nut</i> ).....	44549	7593
Shock Stud - ( <i>Chrome 5/8-18 Thin Lock Nut</i> ).....	27559	7647
Generator - ( <i>10/32 Brass Hex Nut</i> ).....	09542	7634
Hex Nut - ( <i>1/4-24 Zinc</i> ).....	06562	7691
Panhead - Rocker Block Mount ( <i>Zinc Jam Flex Nut Zinc</i> ).....	09548	7727
Castle Nut - ( <i>Chrome 1/2 x 20</i> ).....	22555	7734
1/4-20 - ( <i>Zinc Nylon Insert Jam Lock Nut</i> ).....	02546	7742
Hex Nut - ( <i>Zinc 5/16 x 24</i> ).....	06549	7753
Shock Mount - ( <i>Chrome 1/2 x 10 Thin Lock Nut</i> ).....	27555	7812W
Castle Nut - ( <i>Chrome 1/2 x 13</i> ).....	22554	7843
Axle Nut - ( <i>Chrome 5/8-18 with 1 1/16 Hex</i> ).....	15559-H	7986
1989 & Up - ( <i>Axle Castle Nut 5/8-18</i> ).....	22559-H	7987
Castle Nut - ( <i>Rear Axle Chrome M 24</i> ).....	22979	8020
1972 & Earlier - Big Twins ( <i>Chrome Axle Sleeve Nut</i> ).....	16563	8095A
80cu. - Oil Pump ( <i>O'Ring Plug</i> ).....	09104	11105

Polished Allen



Flat and Lock Washers



Castle Nut







## Stock Style Replacement Fasteners

	G-W #	HD #
1984 - 1985 Evolution Big Twin ( <i>Chrome Head Bolt</i> ).....	29340	16478-83
1987 & Up Evolution ( <i>Chrome Long Head Bolt</i> ).....	09271	16478-85A
1984 - 1985 Evolution Big Twin ( <i>Chrome Head Bolt</i> ).....	29352	16480-83
1987 - 1991 Evolution ( <i>Chrome Short Head Bolt</i> ).....	09270	16480-85A
Evolution - ( <i>Chrome Medium Head Bolt</i> ).....	09272	16480-92
1984 - 1985 Evolution ( <i>Washer for Head Bolt</i> ).....	C-31-32	16482-83
Evolution - ( <i>Head Bolt Washers</i> ).....	23200	16482-85
1936 - 1977 74cu. ( <i>Zinc Cylinder Base Nut</i> ).....	09552	16602-30
1957 - 1985 XL ( <i>Zinc Cylinder Base Nut</i> ).....	09550	16603-72
1953 - 1976 74cu. Lifter Base Screw ( <i>Chrome</i> <i>1/4-24 x 7/8 12 Point Screw</i> ).....	09256	18660-53
1984 - 1977 74cu. ( <i>Special Zinc Head Bolt</i> ).....	31-09	16814-48
Lifter Base - ( <i>1/4-24 x 13/16 Oval Slotted Screw</i> ).....	09249	18660-53
80cu.- Wet Clutch Derby Cover ( <i>1/4 Nylon Washer</i> ).....	09566	31433-84
Copper Bushing.....	09581	33288-37
3/4-16 - ( <i>Zinc Jam Esna's sold each</i> ).....	02561	35078-79
Big Twin - Transmission Oil Fill ( <i>Nylon Washer</i> ).....	09106	37091-80
1985 Big Twin - Clutch Adjustment ( <i>Set Screw</i> ).....	61142	37357-41
Axle E-Clip.....	09235	41139-02
Axle E-Clip.....	09233	41296-05
Axle C-Clip.....	09236	41229-08
Axle E-Clip.....	09987	41147-01
1981 - 1984 Big Twin ( <i>Brake Arm Clevis Pin</i> ).....	09419	40919-81
Disc Brake Rotor to Hub ( <i>Chrome 3/8 x 1 Thin Head Hex</i> ).....	11330 LOW	41198-73
E-Clip Rear Axle.....	09233	41296-05
Brake Arm Bracket - Rear Disc ( <i>1/2-13 x 1 1/8 Drilled Hex</i> ).....	09418	41734-73
Brake Bleeder - ( <i>Chrome Screw 1/4-28 x 1</i> ).....	45-9404	41749-58
Brake Rotor Mount Rear - ( <i>Chrome</i> ).....	46330A	43567-92
Brake Caliper - ( <i>Special Chrome 3/8 I.D. Washer</i> ).....	20091	44132-72
Brake Bleeder - ( <i>Chrome Screw 3/8-24 x 1 1/8</i> ).....	45-9402	44146-77
Brake Caliper Mount - ( <i>Front Short Chrome Screw</i> ).....	09340	44174-77
Brake Caliper Mount - ( <i>Front Long Chrome Screw</i> ).....	09341	44173-77
5/16-18 - ( <i>Zink Lock Nut for 09341 &amp; 09340</i> ).....	09549	44177-77
XL, FXR & FLT - Damper Tube Mount ( <i>Screw</i> ).....	10774 LOW	45405-75A
1977 & Up FL - Front Fork Leg Drain ( <i>Brass Washer</i> ).....	09570	45406-75
1977 & Earlier - Transmission Side Cover ( <i>Check Screw &amp; Fork Drain</i> ).....	86588	45830-48
XL & FX - Fork Drain ( <i>4mm Brass Washer</i> ).....	09985	45986-73
1986 - 1992 Softails - Rear Wheel Adjustment ( <i>Chrome 3/8-16 x 2 1/2 Full Thread Hex Cap</i> ).....	09344	47579-86
1993 - 2007 Softails - Rear Wheel Adjustment ( <i>Chrome 3/8-16 x 2 3/4 Full Thread Hex Cap</i> ).....	09351	47579-93
Softail Motor Mount Spacer ( <i>Steel Chrome</i> ).....	20100	48099-00
1982 & Up Floorboard Mount ( <i>Chrome 1/4-20 Shoulder Bolt</i> ).....	09120	50635-82
Shock Mount - ( <i>Chrome 3/8 I.D. Cup Washer</i> ).....	22334	54543-65
Shock Mount - ( <i>Chrome 1/2 I.D. Cup Washer</i> ).....	22418	54545-65



Bleeder Screw

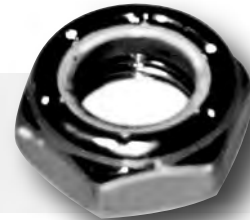

Jam Esna 3/4-16

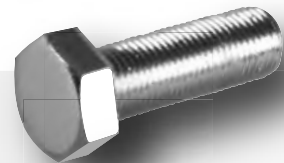

Hex Cap Chrome



# Stock Style Fastener Sets



**Stock Style Fasteners**

Stock Style Replacement Fasteners	G-W #	HD #
Shock Mount - (Chrome 5/8 I.D. Cup Washer).....	22490	54544-65
Handlebar Mount - (Chrome 1/2 I.D. Cup Washer).....	22420	56159-73
FLH & FXWG Speedo - Reset Knob Screws (Chrome 4/40 x 3/4 Round Slotted Screws).....	33091	67217-68

Stock Style Sets	Part #
Cam Cover; Big Twin 1936 - 1969 (Chrome Slotted Screws).....	C-10-27-06Y
Cam Cover; Big Twin 1936 - 1969 (Zinc Slotted Screws).....	10-27-06Y
Front Disc - Brake Caliper Mount, 1993 & Up.....	C-80-143
Front Disc - Brake Caliper Mount, 1984 -1992.....	C-80-144
Rear Disc - Brake Caliper Mount, FL & FX 1973 - 1984.....	A-74-43
Front Disc - Brake Rotor to Hub, 1984 & Up (Cast Wheel Chrome Torx Buttonhead Screws).....	C-80-42T
Front Disc - Brake Rotor to Hub, 1984 & Up (Laced Wheel Chrome Torx Buttonhead Screws).....	C-80-41T
Rear Disc - Brake Rotor to Hub, 1992 & Up (Cast Wheel Chrome Torx Buttonhead Screws).....	C-61-32T
Rear Disc - Brake Rotor to Hub, 1992 & Up (Laced Wheel Chrome Torx Buttonhead Screws).....	C-61-31T
Rear Disc - Brake Rotor to Hub, 1973 - 1980 (Laced Wheel Thin Head Hex Caps with Lock nuts).....	C-74-51H
Rear Disc - Brake Support Bracket Mount, FLH 1981 - 1984 (Includes; Hex Caps & Clevis Pins).....	C-31-08
Disc Brake Support Arm Mount, Big Twin 1973 - 1982 (Drilled Hex Caps with Cotter Pins & Washers).....	C-31-07
Floor Board Hinge Mount, 1982 & Up (Hex Caps with Nuts).....	C-80-104H
Head Bolts - Evolution 1992 & Up (12 Points).....	A-61-110
Head Bolts - Evolution 1987 - 1991 (12 Points).....	A-61-100
Head Bolts - 1984 & early 1985 Big Twins (12 Points).....	A-80-10
Head Bolts - Panhead & Shovelhead with (Chrome 9/16 Hex Caps & Washers).....	C-31-09
Header Mount Flange Nuts Set, Evolution & Twin Cam.....	50-03Y
Header Mount Flange Nuts & Studs, Evolution & Twin Cam.....	50-203Y
Inspection Covers - Big Twins 1936 - 1964 (Chrome Slotted Screws).....	C-10-27-09Y
Lifter Base - 1976 & Earlier Big Twins (Chrome Slotted Screws).....	C-74-16Y
Lifter Base - 1976 & Earlier Big Twins (Zinc Slotted Screws).....	74-16Y
Lifter Base - 1977 - 1998 Big Twins (Chrome 12 Points).....	A-74-26
Motor Case Alignment - Late 74cu. (Studs, Nuts & Washers).....	S-31-29
Primary Cover - Big Twins 1936 - 1964 (Slotted Screws).....	C-10-27-05Y
Rocker Box - Shovelheads (Chrome Hex Nuts & Washers).....	50-15H
Rocker Box - Twin Cam 88cu.1999 & Up (Socket Cap Hex Heads).....	C-88-15Y
Transmission Side Cover, 4 Speed - Big Twin 1936 - 1985 (Chrome Hex Nuts & Washers).....	50-12H
Shock Mount - Softails 1984 - 1999 (Chrome Hex Caps).....	C-80-127H



C-31-09



Set C-31-07



# Stock Style Fasteners

Studs	G-W #	HD #
XL - Chain Adjustment ( <i>Slotted Set Screw 5/16-18 x 2</i> ).....	61134	3250
XL - Chain Adjustment ( <i>Allen Set Screw 5/16-18 x 2</i> ).....	61144	3250-GW
74cu. - Case ( <i>5/16-24 x 5 9/16 Stud</i> ).....	61100	3505
74cu. - Case ( <i>5/16-24 x 5 3/4 Tapered Stud</i> ).....	61101	3506
Transmission Mount ( <i>3/8-24 x 7/16-14 Stud</i> ).....	61146	11733
Evolution - Rocker Box & Exhaust ( <i>5/16-18-24 x 1 11/16 Stud</i> ).....	61129	16715-83
45cu. - Cylinder & 74cu. Transmission ( <i>3/8-16-24 x 1 13/16 Stud</i> ).....	61102	16830-29
XL 900 - Cylinder Base & Inner Primary to Transmission 74cu. ( <i>3/8-16-24 x 2 5/16 Stud</i> ).....	61103	16830-54
XL 1000 - Cylinder Base ( <i>3/8-16-24 x 2 11/32 Stud</i> ).....	61104	16830-72
74cu. - Cylinder Base ( <i>7/16-20-14 x 2 1/2 Stud</i> ).....	61105	16831-30
Evolution - Top Motor Mount ( <i>3/8-16-24 x 2 3/16 Stud</i> ).....	61126	16831-83
80cu. - Cylinder Base ( <i>7/16-14-20 x 2 3/8 Stud</i> ).....	61106	16837-78
Panhead & Shovelhead - Top Motor Mount ( <i>7/16-14-20 X 1 3/4 Stud</i> ).....	61107	16864-48
Panhead - Rocker Block ( <i>5/16-18-24 x 2 1/16 Stud</i> ).....	61145	17647-48
Panhead - Rocker Block Long ( <i>5/16-18-24 x 2 1/4 Stud</i> ).....	61150	17647-48L
XL - Footrest Right ( <i>1/2-13 x 3 7/8 Stud</i> ).....	61138	24751-75
XL - Footrest Left ( <i>1/2-13 x 5 3/4 Stud</i> ).....	61139	24752-75
74cu. - Case ( <i>5/16-24 x 5 3/4 Stud</i> ).....	61108	24805-30
74cu. - Case ( <i>5/16-24 x 5 7/16 Stud</i> ).....	61109	24806-36
74cu. - Case ( <i>5/16-24 x 6 Stud</i> ).....	61110	24809-30
74cu. - Case ( <i>5/16-24 x 5 27/32 Tapered Stud</i> ).....	61111	24815-40
XL - Case ( <i>3/8-16-24 x 3 1/4 Stud</i> ).....	61112	24817-52
74cu. - Transmission Cover ( <i>5/16-18-24 x 1 11/16 Stud</i> ).....	61113	24818-52
Oil Pump FL & 45cu.1941 - 1967 ( <i>1/4-24 x 1 11/16 Stud</i> ).....	61114	24819-36
Oil Pump - 45cu. ( <i>1/4-24 x 1 3/8 Stud</i> ).....	61127	24819-37
Oil Pump - XL 1954 - 1970 ( <i>1/4-28-20 x 2 5/16 Stud</i> ).....	61115	24819-52
Oil Pump - FL 1941 - 1967 ( <i>1/4-24 x 2 1/4 Stud</i> ).....	61116	24820-36
Carburetor Mount & Frt Fork Leg ( <i>5/16-18 x 1 11/16 Stud</i> ).....	61132	24820-78
Big Twin - Transmission Cover ( <i>5/16-18-24 x 1 3/4 Stud</i> ).....	61125	24823-80
Carburetor Mount - 1967 - 1970 ( <i>3/8-16-24 x 2 Stud</i> ).....	61135	24824-67
Big Twin - Transmission Cover ( <i>5/16-18-24 x 1 11/16 Stud</i> ).....	61117	24824-80
XL - Case ( <i>3/8-16 x 3 1/8 Stud</i> ).....	61136	24825-82
Oil Pump - 74cu.1968 - 1969 ( <i>1/4-24-28 x 2 Stud</i> ).....	61118	26390-68
Carburetor Mount - ( <i>5/16-18 x 1 3/4 Stud</i> ).....	61119	29253-78
Carburetor Mount - ( <i>5/16-18-24 1 1/4 Stud</i> ).....	61130	29254-78
Transmission Kicker Cover & Carburetor Mount ( <i>5/16-18-24 x 1 1/2 Stud</i> ).....	61120	33298-65
Big Twin -Transmission Kicker Cover ( <i>5/16-18-24 x 1 3/4 Stud</i> ).....	61121	33299-65
Transmission Bottom Oversize - ( <i>7/16-14 x 3/8-24 x 1 5/8 Stud</i> ).....	61122	34723-47
XL - Clutch Hub ( <i>1/4-20-28 x 2 1/2 Stud</i> ).....	61140	37584-67
XL - Clutch Hub ( <i>1/4-20-28 x 2 Stud</i> ).....	61141	37584-54
Clutch Adjustment - ( <i>3/8-24 x 2 1/4 Slotted Set Screw</i> ).....	61142	27357-41
XL - Clutch ( <i>3/8-24 x 1 1/2 Stud</i> ).....	61131	38130-71
Chain Adjustment - ( <i>3/8-16-24 x 3 13/16 Stud</i> ).....	61123	40018-77
Footrest - XL 80 & Up ( <i>1/2-13 x 3 1/2 Stud</i> ).....	61137	42449-80
Axle Cap 74cu. - 1976 & Earlier ( <i>5/16-18-24 x 1 11/16 Stud</i> ).....	61124	45840-48
Evolution Big Twin Late - Head Cylinder ( <i>3/8 x 6 11/16 Special Stud</i> ).....	61200	16837-85A
Evolution XL - Head Cylinder ( <i>3/8 x 5 3/4 Special Stud</i> ).....	61201	16832-86A
Front Fork Leg Axle Cap - ( <i>5/16-18 x 1 11/16 Stud</i> ).....	61147	45998-73





## Inside This Section

<i>BSA</i> .....	56
<i>Norton</i> .....	56
<i>Royal Enfield</i> .....	56
<i>Triumph</i> .....	57
<i>Acorn Sets</i> .....	58
<i>Head Bolts</i> .....	58
<i>Recoil Inserts</i> .....	58

**British  
Motorcycles**

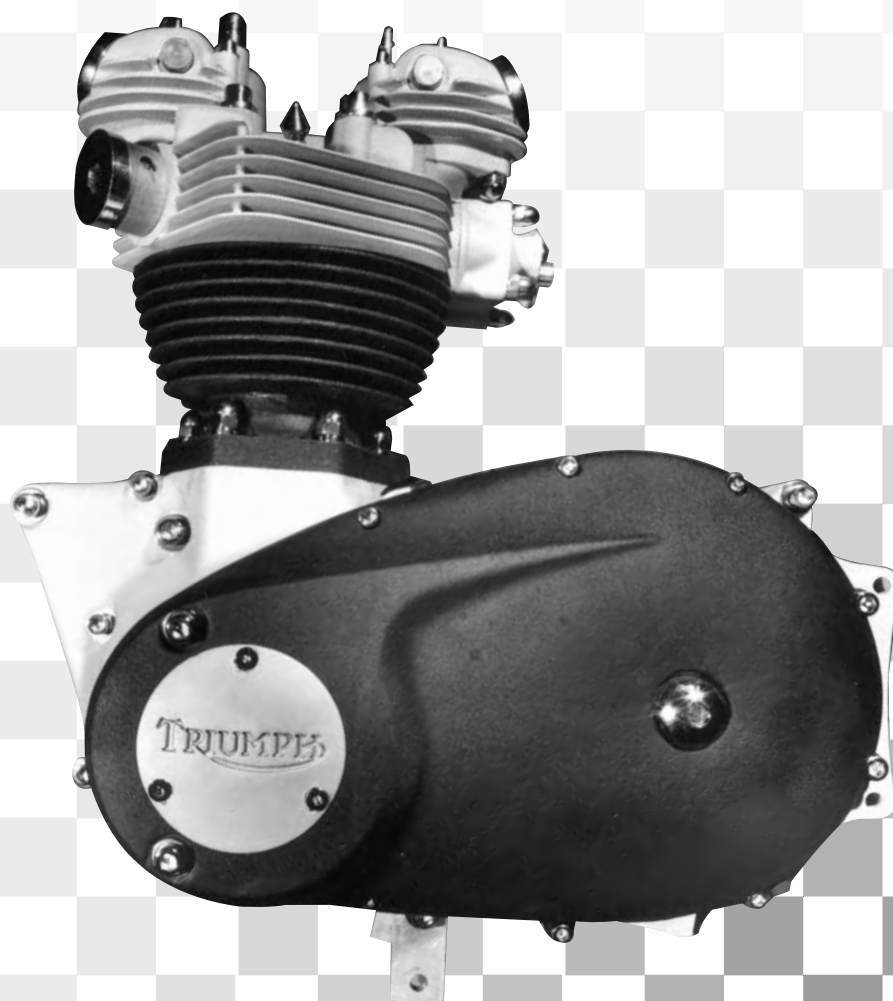



# British Side Cover Sets



**C=** Chrome Plated



**P=** Polished Chrome Plated  
Knurls Removed



**S=** Stainless Steel



**SP=** Stainless Steel Polished  
Knurls Removed

## BSA

	Styles Available	Part #
1969 & Up - 650cc Twin (Timing, Primary & Trans).....	C P S SP	18-35-01
1963 - 1968 650cc & 500cc Twin (Timing, Primary & Trans).....	C P S SP	18-40-01
1954 - 1962 A10 BSA (Right & Left Side Covers).....	C P S SP	18-41-01
1970 & Up - 650cc (Inner Timing Cover).....	C P S SP	18-35-09
1969 - 650cc Twin (Inner Timing Cover).....	C P S SP	18-34-09
1963 - 1968 650cc Twin (Inner Timing Cover).....	C P S SP	18-40-09
1969 & Up - 500cc B50 Single (Right & Left Covers).....	C P S SP	12-16-01
1969 & Up - 500cc B50 Single B-44 & B-25 (Inner Timing Cover).....	C P S SP	18-19-09
1969 & Up - 441 Victor B44 (Timing, Inner Timing & Primary).....	C P S SP	18-19-01
1966 - 1968 4 41 Victor B44 (Timing, Inner Timing & Primary).....	C P S SP	18-17-01
1963 - 1968 500cc B50 Single & B-44, B-25 (Inner Timing Cover).....	C P S SP	18-17-09
1970 & Up - 250cc BSA Starfire (Timing Inspection Cover).....	C P S SP	18-12-06
1970 & Up - 250cc BSA Starfire (Primary Cover).....	C P S SP	18-12-08
1969 - 1971 Rocket 3 Cylinder A-75.....	C P S SP	18-62-01

## Norton

1975 - 1976 Mark 3 (Timing Cover).....	C P S SP	11-22-06
1975 & Up - (Transmission, Primary, Timing, Point & Oil Fill Cover & Electric Start Screws).....	C P S SP	11-21-01
850cc & 750cc - (Timing Cover).....	C P S SP	11-21-06
850cc & 750cc - (Transmission Cover - All Models).....	C P S SP	11-21-07
1975 & Up - 850cc (Primary Cover).....	C P S SP	11-21-08
1975 & Up - 850cc (Electric Start Screws).....	C P S SP	11-21-09
850cc & 750cc - (Point Cover & Transmission Fill Cover Screws with Allen Wrench).....	C P S SP	11-21-04
750cc, 650cc, 600cc & 500cc Atlas - (Timing Cover).....	C P S SP	11-24-06
750cc & 850cc - (Rocker Top Set).....	C P S SP	11-21-02
Norton - (Head Bolt Allen Set).....	C P S SP	11-21-10
750cc - (Primary Cover P-11).....	C P S SP	11-24-08

## Royal Enfield

750cc - Timing Cover.....	C P S SP	14-24-06
750cc - Series #2 1969 - 1970 Timing Cover Set.....	C P S SP	14-23-06
500cc - Single Cylinder Timing Cover.....	C P S SP	14-22-06
500cc - India Timing Cover.....	C P S SP	14-50-06
500cc - India Chassis.....	C P S SP	14-50-20

# British Side Cover Sets

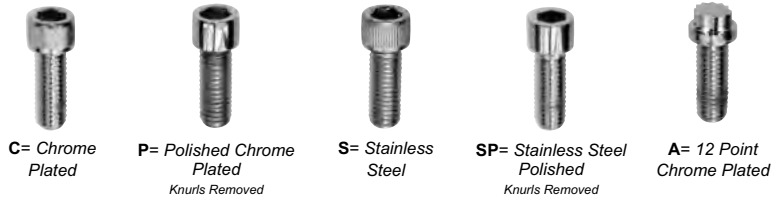

**British Motorcycles**

## Triumph

	Styles Available	Part #
2013 & Up 1215cc Trophy & Tiger Explorer.....	C P S SP --	12-83-01
2003 & Up 600cc 4 Cylinder - (Side Cover Set).....	C P S SP --	12-82-01
2003 & Up 600cc 4 Cylinder - (Oil Pan Cover).....	C P S SP A	12-82-04
2003 & Up Twin - (Alternator Cover).....	C P S SP --	12-80-06
2003 & Up Twin - (Chain Cover with Back).....	C P S SP --	12-80-07
2003 & Up Twin - (Alternator, Chain & Clutch Covers).....	C P S SP --	12-80-08
2003 & Up Twin - (Clutch Side Cover with Shifter Pinch Bolt).....	C P S SP --	12-80-01
2003 & Up Twin - (Handlebar Switch Boxes & Master Cylinder Cover).....	C P S SP --	12-80-50
1981 & Up 750cc Twin - (Electric Start Timing, Trans, Primary & Oil Check Screws)....	C P S SP --	12-22-01
1969 & Up 650cc & 750cc Twin - (Timing, Transmission & Primary).....	C P S SP --	12-21-01
1963 - 1968 650cc - (Timing, Transmission & Primary).....	C P S SP --	12-40-01
1954 - 1962 650cc T6 - (Timing, Transmission & Primary).....	C P S SP --	12-41-01
1954 - 1962 650cc TA6, T110 & T120 - (Timing, Transmission & Primary).....	C P S SP --	12-42-01
1969 - 1975 750cc Trident T150 - (Includes Clutch Adjustment Cover Right & Left Side Covers).....	C P S SP --	T6932
1975 & Up 750cc Trident T160 - (Includes Clutch Adjustment Cover Right & Left Side Covers).....	C P S SP --	12-62-01
1969 & Up 500cc Twin - (Timing, Transmission & Primary).....	C P S SP --	12-20-01
1963 - 1968 500cc Twin - (Timing, Transmission & Primary).....	C P S SP --	12-43-01
1954 - 1962 500cc Twin - (Timing, Transmission & Primary).....	C P S SP --	12-44-01
Triumph & BSA 500cc Single Cylinder B50 - (Right & Left Side Covers).....	C P S SP --	12-16-01
1969 & Up 250cc Single Cylinder (Right & Left Side Covers).....	C P S SP --	12-12-01
1963 - 1968 250cc Single Cylinder (Right & Left Side Cover).....	C P S SP --	12-45-01
1963 & Earlier 250cc Cub Tiger.....	C P S SP --	12-46-01
Triumph & BSA - (Point Cover Screws with Allen Wrench).....	C P S SP --	12-18-04
Trident - (Point Cover Set with Allen Wrench).....	C P S SP --	12-62-04
1973 & Up 750cc Twins - (Rocker Box Set).....	C P S SP --	12-21-02

**Timing, Transmission and Primary Available Separately**

Side Cover Set  
P-12-21-01  
For 1969 & Up  
650cc & 750cc Triumph





# British Acorn Sets

## Triumph

### Acorn Motor Sets

	Part #
1973 & Up 750cc Twins.....	73-102
1969 - 1972 650cc Twins.....	69-102
1963 - 1968 650cc Twins.....	63-102A

### Acorn Individual Sets

1969 & Up - 650cc & 750cc Twins (Primary).....	50-280A
1963 - 1968 650cc Twins (Primary).....	50-284A
1969 & Up - 650cc & 750cc Twins (Timing).....	50-279A
1963 - 1968 650cc Twins (Timing).....	50-283A
1969 & Up 650cc & 750cc Twins (Transmission).....	50-278A
1963 - 1968 650cc Twins (Transmission).....	50-282A

### Acorn Cylinder Base Sets

1973 & Up 750cc Twins.....	12-21-20
1969 - 1972 650cc Twins.....	50-200A
1949 - 1968 650cc Twins.....	50-201A

### Replacement Head Bolts

3/8-26 x 3 3/8.....	# E327
3/8-26 x 5 1/2 with Stud.....	# E1596
3/8-26 x 5 1/2.....	# E1596A
5/16-26 x 3.....	# E4771

### Chrome (Whitworth) Acorn Nuts

1/4-26.....	21569
5/16-26.....	21570
3/8-26.....	21571
7/16-26.....	21572
1/2-26.....	21573
3/4-20.....	21576

### Recoil Threaded Inserts

#### Bulk 10 Per Bag

Recoil Insert 1/4-26.....	R-20043
Recoil Insert 5/16-26.....	R-26503
Recoil Insert 3/8-26.....	R-26603
Recoil Insert 7/16-26.....	R-26703
Recoil Insert 1/2-26.....	R-26803

#### Recoil Thread Repair Kits

Kit for 1/4-26.....	R-30040
Kit for 5/16-26.....	R-36500
Kit for 3/8-26.....	R-36600
Kit for 7/16-26.....	R-36700
Kit for 1/2-26 Includes Top, Install Tool & Inserts.....	R-36800

Slotted Studs  
for easy removal



Head Bolt  
Sets  
Available



H-36500 Re-coil Repair Kit



## Inside This Section

<b>Indian</b>	
Individual Sets.....	60
<b>Victory</b>	
Motor Sets.....	61
Side Cover Sets.....	61
Individual Sets.....	61
Nut Sets.....	61
Washer Set.....	61
<b>Honda</b>	
Motor Sets.....	62
Side Cover Sets.....	62
<b>Kawasaki</b>	
Motor Sets.....	63
Side Cover Sets.....	63
<b>Suzuki</b>	
Side Cover Sets.....	64
<b>Yamaha</b>	
Motor Sets.....	65
Side Cover Sets.....	65
<b>Ultima</b>	
Motor Sets.....	65

Selected  
Motorcycle Brands

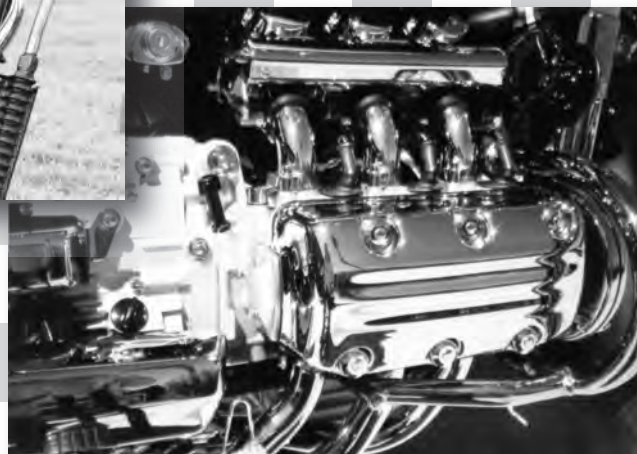



# Indian Motorcycle

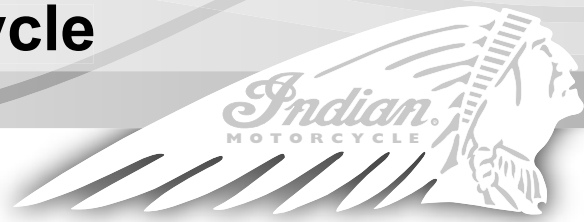

**C=** Chrome Plated



**P=** Polished Chrome Plated  
Knurls Removed



**S=** Stainless Steel



**SP=** Stainless Steel Polished  
Knurls Removed

Part numbers shown are Polished Chrome Allens also available in Stainless Steel and Polished Stainless Steel

## Indian Fastener Sets

### Styles Available

### Part #

Air Cleaner Cover.....	C P S SP	39-11-54
Cam & Sprocket Covers.....	C P S SP	39-11-06
Covers Side Frame.....	C P S SP	39-11-46
Front Fender Mount.....	C P S SP	39-11-04
Axle Nut - Rear.....	C P S SP	39-40-44
Disc Brake Rotor to Hub (one disc) - Front.....	C P S SP	39-11-42
Disc Brake Rotor to Hub - Rear.....	C P S SP	39-11-32
Highway Bar Mount.....	C P S SP	39-11-23
Handlebar Switch Box & Master Cylinder.....	C P S SP	39-11-50
Lifter Base Mount.....	C P S SP	39-11-16
Motor Case Set.....	C P S SP	39-11-29
Primary & Inspection Covers.....	C P S SP	39-11-08
Seat Mount - Rear.....	C P S SP	39-11-67
Master Cylinder Cover - Rear.....	C P S SP	39-11-44
Side Cover Set, Cam, Sprocket, Primary & Inspection Covers.....	C P S SP	39-11-01
Triple Tree Pinch Bolts.....	C P S SP	39-11-45
Exhaust Header Mount Flange Nuts (Chrome).....	C P S SP	92-50Y
Exhaust Header Mount Flange Nuts (Acorn).....	C P S SP	92-50A
Valve Stem Covers.....	-- P -- --	31-99
Valve Stem Covers - Skull.....	-- P -- --	14-31-99
Valve Stem Covers - Flames.....	-- P -- --	17-31-99
License Plate Mount.....	C P S SP	39-34
License Plate Mount - Skull Hex Caps.....	C P S SP	14-39-34
License Plate Mount - Flames.....	C P S SP	17-39-34
 <i>Detail Set - Coil, Horn, with bracket, Cylinder Exhaust Cover</i>		
Air Cleaner & Frame Side Covers.....	C P S SP	39-11-80
 <i>Detail Set - Lower Foot Pegs, Floor Board, Kickstand, Electric Module, Rear Brake Arm, Rear Master Cylinder Cover, Highway Bar, Oil Filter Mount, Starter Motor and Shifter Linkage.....</i>		
	C P S SP	39-11-81





Selected Motorcycle Brands

## Motor Set

	Styles Available	Part #
2009 & Up - 106cu. Motors.....	C P S SP	92-96
2005 - 2010 100cu. Motors.....	C P S SP	92-97
2003½ & Up - 92cu. Freedom Motors.....	C P S SP	92-98
1999 - 2003 Polaris Victory 92cu. (Motor Sets includes Right & left Side Covers, Front Sprocket, Cam Covers, Motor Case & also Includes Detail Sets described below)....	C P S SP	92-99

## Side Cover Set

2005 - 2010 100cu. Motors.....	C P S SP	92-03
2003½ & Up - 92cu. Freedom Motors.....	C P S SP	92-02
1999 - 2003 Polaris Victory 92cu. (Includes Primary with Inspection Cover, Derby Cover, Sensor Mount, Crank Cover and Front Sprocket Cover).....	C P S SP	92-01

## Individual Sets

2003½ & Up - Freedom Motors (Both Cam Covers).....	C P S SP	92-14
2003 & Earlier - (Both Cam Covers with wire holders).....	C P S SP	92-15
Crank Cover - (Right Side Cover).....	C P S SP	92-06
Fender Rail - (Rear).....	C P S SP	92-21
Foot Peg & Bracket Mount - (Front & Rear).....	C P S SP	92-35
Gas Tank Mount.....	C P S SP	92-34
Handle Bar Rizer Mount.....	C P S SP	92-23
Master Cylinder Mount - (Front & Rear with Handle Bar Switch Boxes).....	C P S SP	92-50
Motor Case Set.....	C P S SP	92-29

## Nut Sets in Show Chrome

Exhaust Header Mount Set in Stock Style - (Also Fits Indian and V-Rod).....	C P S SP	92-50Y
Exhaust Header Mount Set in Acorn Style.....	C P S SP	92-50A
Axle Nut Set Front & Rear in Stock Style - (92cu.).....	C P S SP	92-51Y

## Washer Set

Includes special O.D. Flatwashers for the Side Cover Set - (Fits 6mm Allens used to preserve the chrome or paint).....	C P S SP	99-60
--	----------	-------

## 2014 Fastener Sets 106cu.

Cam, Primary, Derby Covers.....	C P S SP	40-06-01
Cam Cover.....	C P S SP	40-06-06
Primary & Derby Cover.....	C P S SP	40-06-08
Axle Nut Rear.....	C P S SP	39-40-44
Disc Brake Caliper Mount - Front - Both.....	C P S SP	40-06-43
Disc Brake Rotor to Hub - Front - Each.....	C P S SP	40-06-42
Disc Brake Rotor to Hub - Rear.....	C P S SP	40-06-32
Gas Cap Mount.....	C P S SP	40-06-35
Engine Guard & Lower Fairing Mount.....	C P S SP	40-06-20
Header Mount Flange Nuts.....	C P S SP	92-50Y
Handlebar Lever & Switch Boxes.....	C P S SP	40-06-50
Motor Case Set.....	C P S SP	40-06-29
Motor Mounts Top, Front & Rear.....	C P S SP	40-06-19
Motor Mounts Top, Front & Rear - Hex Head.....	C P S SP	40-06-19H
Motor Mounts Top, Front & Rear - Allens with Full Washers & Lock Nuts.....	C P S SP	40-06-19M
Belt Sprocket Mount Rear.....	C P S SP	40-06-58
Belt Sprocket Mount Rear - Hex Head.....	C P S SP	40-06-58H
Detail Set - Cross Country - Floor Boards, Kickstand to Case, Front Fender, Triple Tree Pinch Bolts, Shifter Linkage Bracket, Tour Package Mount, Disc Brake Caliper to Leg, Rear Master Cylinder & Front Axle Pinch Bolts.....	C P S SP	40-06-80
License Plate Mount.....	C P S SP	39-34
Valve Stem Caps.....	-- P --	31-99



**C=** Chrome Plated



**P=** Polished Chrome Plated  
Knurls Removed



**S=** Stainless Steel



**SP=** Stainless Steel Polished  
Knurls Removed

## Motor Sets

### Styles Available

### Part #

1500C - Valkrie GL 6 Cylinder 1997 - 2003.....	C P S SP	15-46-99
1100cc. - Shadow V Twin 1995 - 1998 1100C2 American Classic.....	C P S SP	15-40-99
1100cc. - Shadow V Twin 1987 - 1999 1100C.....	C P S SP	15-41-99
750cc. - Magna 1994 - 1999 V-4 VF750CD & VF750C.....	C P S SP	15-44-99
900cc. - 1980 & Up 4 Cylinder Motor Set (Includes; Dyno, Inspection, Oil Pump, Gear Case, Clutch, Crankcase, Point, Cylinder Head, Start Motor & Oil Pan).....	C P S SP	15-24-99
750cc. - 1979 & Up Motor Set (Includes; Generator, Clutch, Oil Pump, Oil Point Cover, Inspection, Point, Crankcase, Oil Pan & Intake Manifold Clamps).....	C P S SP	15-23-99

## Side Cover Sets

900cc. - 4 Cylinder 1980 & Up (Full Side Covers).....	C P S SP	15-24-01
900cc. - 4 Cylinder 1980 & Up (Cylinder Head Cover).....	C P S SP	15-24-02
750cc. - 1979 & Up (Full Side Cover Set).....	C P S SP	15-23-01
750cc. - 4 Cylinder 1969 - 1978 (Right & Left Side Covers).....	C P S SP	15-22-01
750cc. - 4 Cylinder 1969 - 1978 (Cylinder Head Cover Set).....	C P S SP	15-22-02
750cc. - Hondamatic (Right & Left Side Covers).....	C P S SP	15-64-01
CBX - 6 Cylinder 1980 & Up (Right & Left Side Covers).....	C P S SP	15-25-01
CBX - 6 Cylinder 1980 & Up (Cylinder Head Cover & Tachometer Drive Screws).....	C P S SP	15-25-02
500cc. - V Twin (Includes; Clutch, Transmission, Starter Motor, Water Pump & Rear Covers).....	C P S SP	15-26-01
CB 500cc. & 550cc. - 4 Cylinder (Right & Left Side Covers).....	C P S SP	15-19-01
CB 500cc. & 550cc. - 4 Cylinder (Head Cover).....	C P S SP	15-19-02
650cc. - (Right & Left Side Covers).....	C P S SP	15-21-01
450cc. - CL & CB (Right & Left Side Covers).....	C P S SP	15-18-01
360T & CB - (Right & Left Side Covers).....	C P S SP	15-16-01
350cc. - CL & CB (Right & Left Side Covers).....	C P S SP	H-35-20
400cc. 4 CB - 4 Cylinder F & F1 CB 350 4 Cylinder (Right & Left Side Covers).....	C P S SP	15-14-01
400cc. - Hawk Type 1 & 2 1978 & Up (Right & Left Side Cover).....	C P S SP	15-62-01
305cc. - 2 Cylinders (Right & Left Side Covers).....	C P S SP	15-13-01
250 CR Elsinore - (Right & Left Side Covers).....	C P S SP	15-12-01
250cc. - XL (Right & Left Side Covers).....	C P S SP	15-31-01
200 CB T - (Right & Left Side Covers).....	C P S SP	15-11-01
125 CR Elsinore - (Right & Left Side Covers).....	C P S SP	15-28-01
125 CB S1 - (Right & Left Side Covers).....	C P S SP	15-29-01
CB k25 S, XL 125, 100 SL - (Right & Left Side Covers).....	C P S SP	15-30-02



**C=** Chrome Plated



**P=** Polished Chrome Plated Knurls Removed



**S=** Stainless Steel



**SP=** Stainless Steel Polished Knurls Removed

## Motor Sets

	Styles Available	Part #
Vulcan 2000cc. V Twin.....	C P S SP	16-44
Vulcan 1500cc. V Twin 1987 - 1988 VN 1500 Vulcan 88.....	C P S SP	16-41
Vulcan 1500cc. V Twin 1987 - 1988 VN 1500 Vulcan 800.....	C P S SP	16-40
Vulcan 800cc. V Twin 1996 Classic VN 800 BL & 1995 - 1999 VN800A1 & VN800A2.....	C P S SP	16-43
1973 - 1980 900cc. & 1000cc. (Set Includes; Allens for Clutch Cover, Clutch Adjustment Cover, Point Cover, Chain Guard, Point Housing Cover, Kickstarter Cover, Chain Cover, Dyno Cover, Cylinder Head Cover, Intake Manifold, Top Inspection Cover, Handlebar Lever Mount & Inner Point Plate).....	C P S SP	16-73
1981 & Up 1000cc. & 1100cc. - Chain Drive Models (Includes; Allens for Clutch Cover, Timing Inspection & Back Cover, Dyno Cover, Chain Cover with Special Washers, Clutch Adjustment Cover & Intake Manifold & Cylinder Head with End Covers).....	C P S SP	16-81
1981 & Up 1000cc. & 1100cc. - Shaft Drive Motor Set.....	C P S SP	16-80
KZ & GPZ 750cc. & 650cc. - Chain Drive Motor Set.....	C P S SP	16-22
KZ & GPZ 750cc. & 750cc. - Shaft Drive Motor Set.....	C P S SP	16-23

## Side Cover Sets

1981 & Up 1000cc. & 1100cc. KZ & GPZ - Chain Drive - (Rt. & Lt. Side Covers).....	C P S SP	16-30-01
1981 & Up 1000cc. & 1100cc. KZ & GPZ - Shaft Drive - (Rt. & Lt. Side Covers).....	C P S SP	16-31-01
1000cc. & 1100cc. KZ & GPZ 1981 & Up (Cylinder Head Cover).....	C P S SP	16-30-02
900cc. & 1000cc. 1973 - 1980 (Right & Left Side Cover).....	C P S SP	16-33-01
900cc. & 1000cc. 1973 - 1979 (Cylinder Head Cover).....	C P S SP	16-33-02
1000cc KZ 1979 & 1980 (Cylinder Head Covers).....	C P S SP	16-33-03
900cc. Ninja 1984 & Up (Right & Left Side Covers).....	C P S SP	16-25-01
900cc. Ninja 1984 & Up (Cylinder Head Cam Cover).....	C P S SP	16-25-02
750cc. KZ & GPZ - Chain Drive (Right & Left Side covers).....	C P S SP	16-22-01
750cc. KZ & GPZ - Chain Drive (Cylinder Head Cam Cover).....	C P S SP	16-22-02
750cc. 3 Cylinder - 2 Stroke (Right & Left Side Covers).....	C P S SP	16-24-01
650cc. KZ (Right & Left Side Covers).....	C P S SP	16-21-01
650cc. KZ (Cylinder Head).....	C P S SP	16-21-02
500cc. HI (Right & Left Side Covers 3 Cylinder 2 Stroke).....	C P S SP	16-20-01
400 KZ Twin 4 Stroke (Right & Left Side Covers).....	C P S SP	16-58-01
250cc Tecate 3 Wheeler (Right & Left Side Covers).....	C P S SP	16-13-01
1981 & Up - Mikuni Carburetor 5mm CV (Allen Screw Set 4 each).....	C P S SP	16-34
1973 - 1980 Mikuni Carburetor 4mm (Allen Screw Set 4 each).....	C P S SP	16-35
License Plate Mount Set (with Nylon Insert Lock Nuts).....	C P S SP	39-34



## Yamaha Motor Sets

	Styles Available	Part #
Road Star Warrior - 102cu.....	C P S SP	36-46-99
Road Star - 98cu. 1999 & Up ( <i>Push Rod OHV</i> ).....	C P S SP	36-45-99
V-Star - 65cu. 1999 & Up ( <i>50 HC</i> ).....	C P S SP	36-44-99
Royal Star - 70cu 1996.....	C P S SP	36-40-99
V-Max V-4 1200cc VMx12.....	C P S SP	36-43-99
Virago 1100 & 1100 Special Vtwin & XV1100.....	C P S SP	36-41-99
Virago 750cc. Vtwin & XU750.....	C P S SP	36-42-99



## Side Cover Sets

	Styles Available	Part #
2014 & Up 850cc FZ-09 - ( <i>Right &amp; Left Side Covers</i> ).....	C P S SP	36-48-01
1100cc XS - ( <i>Right &amp; Left Side Covers</i> ).....	C P S SP	36-22-01
1100cc XS - ( <i>Cylinder Cam Cover</i> ).....	C P S SP	36-22-02
750cc & 920cc Virago - ( <i>Right &amp; Left Side Covers</i> ).....	C P S SP	36-21-01
License Plate Mount Set ( <i>with Nylon Insert Lock Nuts</i> ).....	C P S SP	39-34

Motor Set C-36-40-99



## Ultima Motor Set

100cu.....	C P S SP	38-100
------------	----------	--------

## Suzuki Side Cover Sets

	Styles Available	Part #
100 & 125 RM - ( <i>Right &amp; Left Side Covers</i> ).....	C P S SP	17-51-01
250 RM - ( <i>Right &amp; Left Side Covers</i> ).....	C P S SP	17-65-01
250 TM - ( <i>Right &amp; Left Side Covers</i> ).....	C P S SP	17-67-01
250 RL - ( <i>Right &amp; Left Side Covers</i> ).....	C P S SP	17-68-01
370 RM - ( <i>Right &amp; Left Side Covers</i> ).....	C P S SP	17-60-01
380 GT - ( <i>Right &amp; Left Side Covers</i> ).....	C P S SP	17-70-01
400 GS - ( <i>Right &amp; Left Side Covers</i> ).....	C P S SP	17-61-01
400 GS - ( <i>Overhead Cam Cover</i> ).....	C P S SP	17-61-02
425 GS - ( <i>Right &amp; Left Side Covers</i> ).....	C P S SP	17-78-01
425 GS - ( <i>Overhead Cam Cover</i> ).....	C P S SP	17-78-02
550 GT - ( <i>Right &amp; Left Side Covers</i> ).....	C P S SP	17-19-01
550 GS - ( <i>Right &amp; Left Side Covers</i> ).....	C P S SP	17-72-01
550 GS - ( <i>Overhead Cam Cover</i> ).....	C P S SP	17-72-02
650 Savage - ( <i>Right &amp; Left Side Covers</i> ).....	C P S SP	17-81-01
750 GT - ( <i>Right &amp; Left Side Covers</i> ).....	C P S SP	17-24-01
750-4 GS - ( <i>Right &amp; Left Side Covers</i> ).....	C P S SP	17-22-01
750-4 GS - ( <i>Overhead Cam Covers</i> ).....	C P S SP	17-22-02
850 GS - ( <i>Right &amp; Left Side Covers</i> ).....	C P S SP	17-79-01
850 GS - ( <i>Overhead Cam Covers</i> ).....	C P S SP	17-79-02
1000 GS - ( <i>Right &amp; Left Side Covers</i> ).....	C P S SP	17-77-01
1000 GS - ( <i>Right &amp; Left Cam Covers</i> ).....	C P S SP	17-77-02
VL 1500 Intruder - 2003 & Up ( <i>Right &amp; Left Side Covers</i> ).....	C P S SP	17-15-01
1100 GS - ( <i>Right &amp; Left Cam Covers</i> ).....	C P S SP	17-83-01
1100 GS - ( <i>Overhead Cam Covers</i> ).....	C P S SP	17-83-02

Side Cover Set  
C-17-77-01

## Motor Sets

VL 1500 Intruder - 2003 & Up.....	C P S SP	17-15-99
License Plate Mount Set ( <i>with Nylon Insert Lock Nuts</i> ).....	C P S SP	39-34



## Inside This Section

### American Thread Chrome Plated

Tray Assortments.....	66-68
Speciality Dealer Assortments.....	69
Shop Master Assortments.....	70
Point of Purchase Floor Unit.....	71

### American Thread Stainless Steel

Tray Assortments.....	72
Allen Screws.....	72
Hex caps.....	72
Hex Nuts and Lock Nuts.....	72
Washers.....	72

### Zinc Plated

Tray Assortments.....	73
Allen Screw.....	73
Hex Caps.....	73
Hex Nuts.....	73
Washers and Lock Nuts.....	73
The Shop Master.....	73

**Assortments in  
Chrome Plated,  
Stainless Steel & Zinc**

**Detailed Custom Assortments with Speciality Lengths and Diameters Available**





Tray Assortments for Harley Twins and Sportsters

# Fastener Assortment Set

*Specially designed for use with Harley Twins and Sportsters*

*A-50 Assortments With Allen Screws, Hex Nuts, Lock Washers and G-W Flatwashers*



Allen Screws with Sliding 6 Drawer Cabinet (A-50-P Shown)

**Contents of each tray in cabinet**

- ▶ Allen Screws # 8/32, 10/24, 10/32, 1/4-28
- ▶ Allen Screws 1/4-20 x 3/8" thru 3"
- ▶ Allen Screws 5/16-18 x 1/2" thru 3"
- ▶ Allen Screws 5/16-24 x 1/2" thru 2 3/4"
- ▶ Allen Screws 3/8-16 x 1/2" thru 3 1/2"
- ▶ Allen Screws 3/8-24 x 1/2" thru 3 1/2"

**Also Available in 12pt. Chrome**

**Knurled or Polished Chrome**

**Stainless or Polished Stainless Steel**



**A-30  
Hex Nuts  
6/32 thru 5/8  
Fine and Coarse**

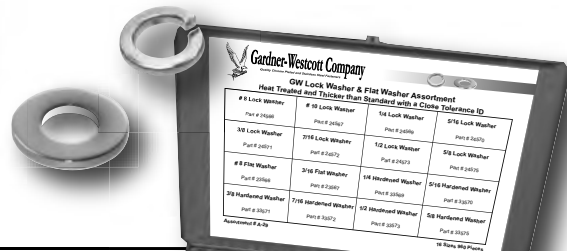

**A-29  
#8 thru 5/8  
Lock Washers and  
G-W Flat Washers**

**Show Speciality Priced Fastener Assortment includes all 8 Trays and 1 Sliding Six Drawer Metal Cabinet**

# Assortments in American Thread



**Assortments  
Chrome**

## Tray Assortments (Chrome Plated)

### Acorn Nuts

Acorn Nuts #8 thru 5/8 Coarse & Fine - (14 Sizes & 109 Pieces).....	A-7	----
Acorn Nuts Low Crown 8/32-5/8-18 - (15 Sizes & 108 Pieces).....	A-148	----



Acorn Nut

### Allen Head Screws

4-40, 6/32, 8/32, 12/24 - (24 Sizes & 240 Pieces).....	A-39	A-39-P
10/24 & 10/32 - (23 Sizes & 230 Pieces).....	A-38	A-38-P
8/32, 10/24, 10/32, 1/4-28 - (24 Sizes & 205 Pieces).....	A-41	A-41-P
1/4-20 - (16 Sizes & 150 Pieces, 3/8" - 3").....	A-40	A-40-P
1/4-20 - (9 Sizes & 61 Pieces, 3 1/4" - 6").....	A-140	A-140-P
5/16-18 - (12 Sizes & 110 Pieces).....	A-42	A-42-P
5/16-24 - (12 Sizes & 115 Pieces, 1/2" - 2 3/4").....	A-43	A-43-P
5/16-24 - (8 Sizes & 48 Pieces, 3" - 4 3/4").....	A-143	A-143-P
5/16-24 - (8 Sizes & Studs HD Motor Case Assortment).....	A-78	A-78-P
3/8-16 - (12 Sizes & 90 Pieces).....	A-44	A-44-P
3/8-24 - (12 Sizes & 85 Pieces).....	A-45	A-45-P
7/16 -14 - (11 Sizes & 72 Pieces).....	A-46	A-46-P
7/16-20 - (10 Sizes & 59 Pieces).....	A-47	A-47-P
1/2-13 - (11 Sizes & 72 Pieces).....	A-48	A-48-P
1/2-20 - (10 Sizes & 57 Pieces).....	A-49	A-49-P
1/4, 5/16, 3/8 Coarse - (24 Sizes & 220 Pieces).....	24-CA	24-CAP
1/4, 5/16, 3/8 Fine - (23 Sizes & 210 Pieces).....	24-FA	24-FAP

Low Crown Acorn



Chrome Allen



Polished Allen

### Button Head Allen Screws

8/32, 10/24, 10/32, 1/4-28 - (20 Sizes & 101 Pieces).....	A-25	----
1/4-20, 5/16-18, 3/8-16 - (24 Sizes & 112 Pieces).....	A-26	----
1/4, 5/16, 3/8 Fine - (24 Sizes & 120 Pieces).....	A-26-F	----
5/16-24, 3/8-24, 1/2-13 - (14 Sizes & 67 Pieces).....	A-27	----



Button Head Allen

### Cotter Pins

1/16, 3/32, 1/8, 3/16 - (9 Sizes & 425 Pieces).....	A-34C	
---	-------	--

### Flat Head Allen Screws

8/32, 10/24, 10/32, 1/4-28 - (24 Sizes & 240 Pieces).....	A-10	----
8/32, 10/32, 1/4-28, 5/16-24, 3/8-24 - (16 Sizes & 160 Pieces).....	A-9	----
1/4, 5/16, 3/8 Coarse - (24 Sizes & 155 Pieces).....	A-28-C	----
1/4, 5/16, 3/8 Fine - (24 Sizes & 155 Pieces).....	A-28-F	----



Flat Head Allen

### Flexloc® Nuts

#10 thru 1/2 Coarse & Fine - (12 Sizes & 110 Pieces).....	A-11	----
---	------	------



Flexloc® Nut

### Flexloc® Jam Nuts

#10 thru 1/2 Coarse & Fine - (12 Sizes & 110 Pieces).....	A-12	----
Nuts & Jam Flexloc Nuts 1/4 thru 5/8 - (24 Sizes & 240 Pieces).....	A-19	----



Flexloc® Jam Nut

### Hex Head Screws



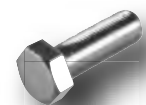







1/4-20 x 3/8 - 3 - (16 Sizes & 150 Pieces).....	A-40HC	----
5/16-18 x 1/2 - 2 3/4 - (12 Sizes & 110 Pieces).....	A-42HC	----
5/16-24 x 1/2 - 2 3/4 - (12 Sizes & 115 Pieces).....	A-43HC	----
3/8-16 x 1/2 - 3 1/2 - (12 Sizes & 90 Pieces).....	A-44HC	----
3/8-24 x 1/2 - 3 1/2 - (12 Sizes & 85 Pieces).....	A-45HC	----
7/16-14 x 3/4 - 3 - (11 Sizes & 72 Pieces).....	A-46HC	----
7/16-20 x 3/4 - 3 1/2 - (11 Sizes & 59 Pieces).....	A-47HC	----



Hex Cap



## Tray Assortments (Chrome Plated)

	Chrome Part #	
<b>Hex Caps</b>		
1/4, 5/16, 3/8 Coarse - (24 Sizes & 220 Pieces).....	24-C	 Hex Cap
1/4, 5/16, 3/8 Fine - (24 Sizes & 220 Pieces).....	24-F	
7/16, 1/2 Coarse - (11 Sizes & 80 Pieces).....	23-C	
7/16, 1/2 Fine - (12 Sizes & 90 Pieces).....	23-F	
<b>Hex Nuts</b>		
6/32 thru 5/8 Coarse & Fine - (16 Sizes & 534 Pieces).....	A-30	 Hex Nut
1/4 thru 3/8 Hex Nuts, Flat & Lock Washers - (12 Sizes & 1200 Pieces).....	12-W	
7/16 thru 5/8 Hex Nuts, Flat & Lock Washers - (12 Sizes & 540 Pieces).....	23-W	
<b>Hole Plugs</b>		
Brass & Chrome 3/16 thru 1 1/2 - (16 Sizes & 219 Pieces).....	A-76	 Hole Plug
Chrome 3/16 thru 3/4 - (7 Sizes & 130 Pieces).....	A-77-C	
Black 3/16 thru 3/4 - (7 Sizes & 130 Pieces).....	A-77-B	
Brass 3/16 thru 3/4 - (7 Sizes & 130 Pieces).....	A-77-A	
<b>Jam Nuts &amp; Jam Lock Nuts</b>		
1/4 thru 5/8 Coarse & Fine - (24 Sizes & 220 Pieces).....	A-14	 Jam Nut & Jam Lock Nut
<b>Lock Nuts Nylon Insert</b>		
#10 thru 5/8 Coarse & Fine - (11 Sizes & 190 Pieces).....	A-8	 Nylon Insert Lock Nut
4/40 thru 3/4 Coarse & Fine - (20 Sizes & 274 Pieces).....	A-18	
<b>Oil Line Fitting (Chrome Plated Brass)</b>		
Special selected fittings for Harley's - (12 Sizes & 75 Pieces).....	A-52	(See Pg. 69 For more Details)
<b>Oval Phillips Head (Machine Screw)</b>		
4/40 thru 3/8 Coarse & Fine - (24 Sizes & 240 Pieces).....	A-175	 Oval Phillips
<b>Spacers</b>		
1/4 & 5/16 I.D. with 1/4 to 1 1/4 Lengths - (16 Sizes & 160 Pieces).....	A-15	 Spacers
3/8 & Up Dia. - (12 Sizes & 106 Pieces).....	A-16	
1/4 & 5/16 I.D. with mixed O.D. & thickness - (24 Sizes).....	A-221	
5/16 & 3/8 I.D. with mixed O.D. & thickness - (24 Sizes).....	A-222	
3/8 & 1/2 I.D. with mixed O.D. & thickness - (16 Sizes).....	A-223	
<b>Spike Nuts</b>		
1/4-20 thru 5/8-18 Coarse & Fine - (11 Sizes & 25 Pieces).....	A-97	 Spike Nuts
<b>Torx Button Head</b>		
8/32, 10/24, 10/32, 1/4-28 - (24 Sizes & 240 Pieces).....	A-180	 Torx Button Head
1/4-20, 5/16, 3/8, 1/2 - (24 Sizes & 235 Pieces).....	A-181	
<b>Washers</b>		
#8 thru 5/8 Flat & Lock Washers - (16 Sizes & 960 Pieces).....	A-31	 Flat Washer
#6 thru 5/8 Internal, External & AN - (22 Sizes & 435 Pieces).....	A-33	
Harley Special Washers - (24 Sizes & 580 Pieces).....	A-68	
Harley Various O.D., I.D in Chrome - (24 Sizes & 298 Pieces).....	A-69	
<b>Washers G-W Heat Treated</b>		
#8 thru 5/8 Flat & Lock Washers - (16 Sizes & 960 Pieces).....	A-29	 Lock Washer
AN #8 thru 3/4 & Std. 1/4 thru 5/8 - (21 Sizes & 435 Pieces).....	A-160	

(See Pg. 69 For more Details)





**Assortments  
Chrome**

## Speciality Dealer Assortments (Chrome Plated)

Allen Head Assortment Groups	Chrome Part #	Polished Chrome Part #
<i>(Includes; 6 Metal Trays &amp; 1 Cabinet with items listed below)</i>		
A-40 - (1/4-20 Sizes) A-41 - (8/32, 10/24, 10/32, 1/4-28 Sizes)		
A-42 - (5/16-18 Sizes) A-43 - (5/16-24 Sizes)		
A-44 - (3/8-16 Sizes) A-45 - (3/8-24 Sizes).....	A-50	A-50-P
<b>12 Point Screw Assortment Groups</b>		
<i>(Includes; 6 Metal Trays &amp; 1 Cabinet with items listed below)</i>		
A-240 - (1/4-20 Sizes) A-241 - (1/4-28 Sizes) A-242 - (5/16-18 Sizes)		
A-243 - (5/16-24 Sizes) A-244 - (3/8-16 Sizes) A-245 - (3/8-24 Sizes).....	A-250	---
<b>Washers for Harley Applications</b>		
<i>(Includes; 1 Metal Tray with items listed below)</i>		
Featuring 24 Sizes - (Drain, Seal, Brass, Copper, Nylon & Stainless Steel for Oil Tank Train, Derby Cover, Fork Drain, Rocker Arm Shaft & Banjo Bolts).....	A-68	---
Featuring 24 Sizes - (Axles, Cylinder, Fender, Head, Motor Mounts, Rocker Box, Triple Tree & more).....	A-69	---
<b>Oil Line Fitting Assortment (Includes; 1 Metal Tray with items listed below)</b>		
Chrome Plated Brass Fittings - (Straight Hose Barb Male Pipe Rigid, Straight Street Elbow, 45° Street Elbow, Hose Tee, Socket Pipe Plug, Hex Head Pipe Plug, Sleeve Nut & Washer Seals).....	A-52	---

## The G-W Hardened Flat Washer

**GARDNER-WESTCOTT COMPANY** is proud to supply the first flat washer strong enough to use on motor mounts or belt sprockets and with the exceptional cosmetic quality to be used on a show bike. This hardened steel washer is thicker than standard flat washers and has a close tolerance ID for a snug fit. It has a standard OD so it can be used anywhere a regular washer was.

Now available in bulk from 1/4" thru 5/8" or in Assortment # A-29 which includes; #8, #10, 1/4, 5/16, 3/8, 7/16, 1/2 and 5/8 diameter G-W Hardened Flat Washers including Lock Washers -- all show chromed, labeled and in a metal tray.



Also Available in Stainless Steel See Pg. 92

G-W Heat Treated Washer & Lock Washer	Chrome Part #	Polished Part #
<i>(Includes; 1 Metal Tray with Items Listed Below)</i>		
Flat Washers - (#8, #10, 1/4, 5/16, 3/8, 7/16, 1/2, 5/8)		
Lock Washers - (#8, #10, 1/4, 5/16, 3/8, 7/16, 1/2, 5/8).....	A-29	---



# Assortments in American Thread

## Shop Master Dealer Assortment (Chrome Plated)

This Dealer Starter Shop Master, is designed for the use with Harley Big Twins and Sportsters. Trays are available individually, or in 6 tray components that can be added to your existing stock. The Allen Screws can be replaced with 12 Point Screws and most assortments are available in Stainless Steel.

### Chrome Shop Master A-100-P

#### A-50-P 6 Trays with Cabinet

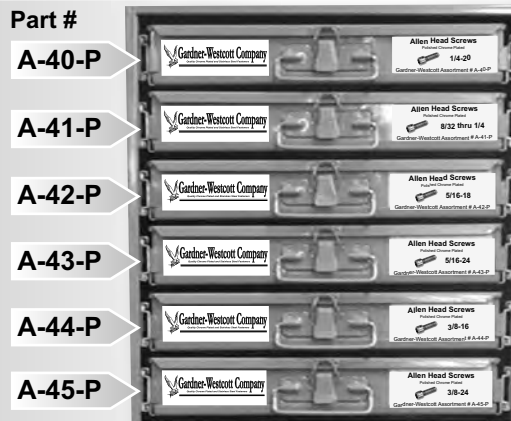

#### Contents of each Tray

Allen Screw - (# 1/4-20 x 3/8" thru 3")

Allen Screw - (# 8/32, 10/24, 10/32, 1/4-28)

Allen Screw - (# 5/16-18 x 1/2" thru 3")

Allen Screw - (# 5/16-24 x 1/2" thru 2 3/4")

Allen Screw - (# 3/8-16 x 3/4" thru 3 1/2")

Allen Screw - (# 3/8-24 x 1/2" thru 3 1/2")

#### A-151 6 Trays with Cabinet



Allen Screw - (# 7/16-14 x 3/4" thru 3 1/4")

Hex Nuts - (6/32 thru 5/8-18 Coarse & Fine)

Lock Nuts Nylon Insert - (4/40 thru 3/4-16 Coarse & Fine)

GW Flat Washer & Lock Washer - (# 8 thru 5/8)

Special Harley Washers - (in various OD, ID & Thickness)

Special Harley Washers - (in brass, copper & nylon)

#### A-152 6 Trays with Cabinet

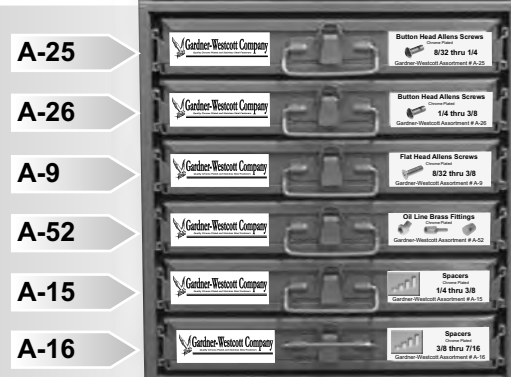

Button Head Allens - (8/32, 10/24, 10/32, & 1/4-28)

Button Head Allens - (1/4-20, 5/16-18, 3/8-16)

Flat Head Allens - (8/32, 10/32, 1/4-28, 5/16-24, 3/8-24)

Harley Oil line fittings - (various applications)

Spacers - (1/4 & 5/16 ID's various thickness)

Spacers - (3/8 & Up ID's various thickness)

You can order individual Trays, 6 Tray components or a complete 18 Tray Shop Master comprising of these 3 Cabinets Tray units A-50-P, A-151 and A-152. All Trays and Cabinets are made of sturdy metal construction for years of durability.



## Point of Purchase Display (Chrome Plated)

**Gardner-Westcott took our most popular selling items and combined them to create this unit for you. It was designed with the Harley-Davidson Dealer in mind. This product display contains 128 different items, all done in Show Chrome Plated.**

- X-23567 ..... #10 Chr. Flatwasher (10 ea.) per card
- X-33569 ..... 1/4 Chr. GW Flatwasher (8 ea.)
- X-33570 ..... 5/16 Chr. GW Flatwasher (8 ea.)
- X-33571 ..... 3/8 Chr. GW Flatwasher (6 ea.)
- X-33572 ..... 7/16 Chr. GW Flatwasher (5 ea.)
- X-33573 ..... 1/2 Chr. GW Flatwasher (4 ea.)
- X-33575 ..... 5/8 Chr. GW Flatwasher (4 ea.)
- X-24569 ..... 1/4 Chr. Lockwasher (10 ea.)
- X-24570 ..... 5/16 Chr. Lockwasher (8 ea.)
- X-24571 ..... 3/8 Chr. Lockwasher (8 ea.)
- X-24572 ..... 7/16 Chr. Lockwasher (5 ea.)
- X-24573 ..... 1/2 Chr. Lockwasher (5 ea.)
- X-24575 ..... 5/8 Chr. Lockwasher (4 ea.)
- X-15542 ..... 10/24 Chr. Hex Nut (8 ea.)
- X-15543 ..... 10/32 Chr. Hex Nut (8 ea.)
- X-15546 ..... 1/4-20 Chr. Hex Nut (8 ea.)
- X-15547 ..... 1/4-28 Chr. Hex Nut (8 ea.)
- X-15548 ..... 5/16-18 Chr. Hex Nut (8 ea.)
- X-15549 ..... 5/16-24 Chr. Hex Nut (6 ea.)
- X-15550 ..... 3/8-16 Chr. Hex Nut (6 ea.)
- X-15551 ..... 3/8-24 Chr. Hex Nut (6 ea.)
- X-17542 ..... 10/24 Chr. Nylon Locknut (7 ea.)
- X-17543 ..... 10/32 Chr. Nylon Locknut (7 ea.)
- X-17546 ..... 1/4-20 Chr. Nylon Locknut (7 ea.)
- X-17547 ..... 1/4-28 Chr. Nylon Locknut (7 ea.)
- X-17548 ..... 5/16-18 Chr. Nylon Locknut (8 ea.)
- X-17549 ..... 5/16-24 Chr. Nylon Locknut (8 ea.)
- X-17550 ..... 3/8-16 Chr. Nylon Locknut (5 ea.)
- X-17551 ..... 3/8-24 Chr. Nylon Locknut (5 ea.)
- X-17553 ..... 7/16-20 Chr. Nylon Locknut (5 ea.)
- X-17554 ..... 1/2-13 Chr. Nylon Locknut (4 ea.)
- X-17555 ..... 1/2-20 Chr. Nylon Locknut (4 ea.)
- X-15559-H ..... 5/8-18 H-D Chr. Axle Nut (1 ea.)
- X-23204 ..... H-D 6099 Chr. Washer (6 ea.)
- X-13128 ..... 8/32 x 3/8 Chr. Buttonhead (5 ea.)
- X-13130 ..... 8/32 x 5/8 Chr. Buttonhead (5 ea.)
- X-13154 ..... 10/24 x 1/2 Chr. Buttonhead (7 ea.)
- X-13157 ..... 10/32 x 5/8 Chr. Buttonhead (7 ea.)
- X-13206 ..... 1/4-20 x 1/2 Chr. Buttonhead (7 ea.)
- X-13208 ..... 1/4-20 x 5/8 Chr. Buttonhead (7 ea.)
- X-13210 ..... 1/4-20 x 3/4 Chr. Buttonhead (7 ea.)
- X-13212 ..... 1/4-20 x 7/8 Chr. Buttonhead (7 ea.)
- X-13214 ..... 1/4-20 x 1 Chr. Buttonhead (7 ea.)
- X-13218 ..... 1/4-20 x 1 1/4 Chr. Buttonhead (7 ea.)
- X-13220 ..... 1/4-20 x 1 1/2 Chr. Buttonhead (7 ea.)
- X-13270 ..... 5/16-18 x 1/2 Chr. Buttonhead (6 ea.)
- X-13274 ..... 5/16-18 x 3/4 Chr. Buttonhead (6 ea.)
- X-13278 ..... 5/16-18 x 7/8 Chr. Buttonhead (6 ea.)
- X-13280 ..... 5/16-18 x 1 Chr. Buttonhead (6 ea.)
- X-13284 ..... 5/16-18 x 1 1/4 Chr. Buttonhead (6 ea.)
- X-13286 ..... 5/16-18 x 1 1/2 Chr. Buttonhead (6 ea.)
- X-13326 ..... 3/8-16 x 3/4 Chr. Buttonhead (4 ea.)
- X-13328 ..... 3/8-16 x 7/8 Chr. Buttonhead (4 ea.)
- X-13330 ..... 3/8-16 x 1 Chr. Buttonhead (4 ea.)
- X-13334 ..... 3/8-16 x 1 1/4 Chr. Buttonhead (4 ea.)
- X-13336 ..... 3/8-16 x 1 1/2 Chr. Buttonhead (4 ea.)
- X-10154 ..... 10/24 x 1/2 Pol. Allen Screw (5 ea.)
- X-10157 ..... 10/32 x 5/8 Pol. Allen Screw (5 ea.)
- X-10208 ..... 1/4-20 x 5/8 Pol. Allen Screw (4 ea.)
- X-10210 ..... 1/4-20 x 3/4 Pol. Allen Screw (4 ea.)
- X-10214 ..... 1/4-20 x 1 Pol. Allen Screw (4 ea.)
- X-10216 ..... 1/4-20 x 1 1/8 Pol. Allen Screw (4 ea.)
- X-10218 ..... 1/4-20 x 1 1/4 Pol. Allen Screw (4 ea.)
- X-10218-A ..... 1/4-20 x 1 3/8 Pol. Allen Screw (4 ea.)



Part# JPOP-HD1  
128 Items



- X-10220 ..... 1/4-20 x 1 1/2 Pol. Allen Screw (3 ea.) per card
- X-10222 ..... 1/4-20 x 1 3/4 Pol. Allen Screw (3 ea.)
- X-10224 ..... 1/4-20 x 2 Pol. Allen Screw (3 ea.)
- X-10226 ..... 1/4-20 x 2 1/4 Pol. Allen Screw (3 ea.)
- X-10228 ..... 1/4-20 x 2 1/2 Pol. Allen Screw (3 ea.)
- X-10215 ..... 1/4-28 X 1 Pol. Allen Screw (4 ea.)
- X-10274 ..... 5/16-18 x 3/4 Pol. Allen Screw (4 ea.)
- X-10280 ..... 5/16-18 x 1 Pol. Allen Screw (4 ea.)
- X-10281 ..... 5/16-24 x 1 Pol. Allen Screw (4 ea.)
- X-10284 ..... 5/16-18 x 1 1/4 Pol. Allen Screw (3 ea.)
- X-10286 ..... 5/16-18 x 1 1/2 Pol. Allen Screw (3 ea.)
- X-10287 ..... 5/16-24 x 1 1/2 Pol. Allen Screw (3 ea.)
- X-10288 ..... 5/16-18 x 1 3/4 Pol. Allen Screw (3 ea.)
- X-10290 ..... 5/16-18 x 2 Pol. Allen Screw (3 ea.)
- X-10292 ..... 5/16-18 x 2 1/4 Pol. Allen Screw (2 ea.)
- X-10294 ..... 5/16-18 x 2 1/2 Pol. Allen Screw (2 ea.)
- X-10326 ..... 3/8-16 x 3/4 Pol. Allen Screw (3 ea.)
- X-10330 ..... 3/8-16 x 1 Pol. Allen Screw (3 ea.)
- X-10331 ..... 3/8-24 x 1 Pol. Allen Screw (3 ea.)
- X-10334 ..... 3/8-16 x 1 1/4 Pol. Allen Screw (3 ea.)
- X-10336 ..... 3/8-16 x 1 1/2 Pol. Allen Screw (3 ea.)
- X-10337 ..... 3/8-24 x 1 1/2 Pol. Allen Screw (5 ea.)
- X-10338 ..... 3/8-16 x 1 3/4 Pol. Allen Screw (2 ea.)
- X-10339 ..... 3/8-24 x 1 3/4 Pol. Allen Screw (3 ea.)
- X-10340 ..... 3/8-16 x 2 Pol. Allen Screw (2 ea.)
- X-10342 ..... 3/8-16 x 2 1/2 Pol. Allen Screw (2 ea.)
- X-10341 ..... 3/8-24 x 2 Pol. Allen Screw (2 ea.)
- X-10343 ..... 3/8-24 x 2 1/4 Pol. Allen Screw (1 ea.)
- X-10344 ..... 3/8-16 x 2 1/2 Pol. Allen Screw (2 ea.)
- X-10345 ..... 3/8-24 x 2 1/2 Pol. Allen Screw (1 ea.)
- X-10346 ..... 3/8-16 x 2 3/4 Pol. Allen Screw (2 ea.)
- X-10376 ..... 7/16-14 x 1 Pol. Allen Screw (2 ea.)
- X-10377 ..... 7/16-20 x 1 Pol. Allen Screw (2 ea.)
- X-10378 ..... 7/16-14 x 1 1/4 Pol. Allen Screw (2 ea.)
- X-10380 ..... 7/16-14 x 1 1/2 Pol. Allen Screw (2 ea.)
- X-10381 ..... 7/16-20 x 1 1/2 Pol. Allen Screw (2 ea.)
- X-10382 ..... 7/16-14 x 1 3/4 Pol. Allen Screw (2 ea.)
- X-10384 ..... 7/16-14 x 2 Pol. Allen Screw (1 ea.)
- X-10416 ..... 1/2-13 x 1 Pol. Allen Screw (2 ea.)
- X-14130 ..... 8/32 x 1/2 Chr. Flat Head Allen Screw (5 ea.)
- X-14132 ..... 8/32 x 5/8 Chr. Flat Head Allen Screw (5 ea.)
- X-14154 ..... 10/24 x 1/2 Chr. Flat Head Allen Screw (5 ea.)
- X-14157 ..... 10/32 x 5/8 Chr. Flat Head Allen Screw (5 ea.)
- X-14210 ..... 1/4-20 x 3/4 Chr. Flat Head Allen Screw (6 ea.)
- X-14212 ..... 1/4-20 x 7/8 Chr. Flat Head Allen Screw (6 ea.)
- X-14274 ..... 5/16-18 x 3/4 Chr. Flat Head Allen Screw (6 ea.)
- X-14278 ..... 5/16-18 x 7/8 Chr. Flat Head Allen Screw (6 ea.)
- X-14330 ..... 3/8-16 x 1 Chr. Flat Head Allen Screw (4 ea.)
- X-14334 ..... 3/8-16 x 1 1/4 Chr. Flat Head Allen Screw (4 ea.)
- X-21546 ..... 1/4-20 Chr. Acorn Nut (3 ea.)
- X-21548 ..... 5/16-18 Chr. Acorn Nut (3 ea.)
- X-21549 ..... 5/16-24 Chr. Acorn Nut (3 ea.)
- X-21550 ..... 3/8-16 Chr. Acorn Nut (2 ea.)
- X-21551 ..... 3/8-24 Chr. Acorn Nut (2 ea.)
- X-21552 ..... 7/16-14 Chr. Acorn Nut (3 ea.)
- X-21553 ..... 7/16-20 Chr. Acorn Nut (3 ea.)
- X-11210 ..... 1/4-20 x 3/4 Chr. Hex Cap Screw (3 ea.)
- X-11218 ..... 1/4-20 x 1 1/4 Chr. Hex Cap Screw (3 ea.)
- X-11220 ..... 1/4-20 x 1 1/2 Chr. Hex Cap Screw (3 ea.)
- X-11274 ..... 5/16-18 x 3/4 Chr. Hex Cap Screw (3 ea.)
- X-11280 ..... 5/16-18 x 1 Chr. Hex Cap Screw (3 ea.)
- X-11286 ..... 5/16-18 x 1 1/2 Chr. Hex Cap Screw (3 ea.)
- X-11291 ..... 5/16-24 x 2 Chr. Hex Cap Screw (2 ea.)
- X-11340 ..... 3/8-16 x 2 Chr. Hex Cap Screw (2 ea.)



## Tray Assortments (Stainless Steel)

### Acorn Nuts

Acorn Nuts #8 thru 5/8 Coarse & Fine - (14 Sizes & 113 Pieces)..... A-7-S

Stainless  
Part #

Polished  
Part #



Low  
Crown  
Acorn Nut

### Allen Head Screws

4-40, 6/32, 8/32, 12/24 - (24 Sizes & 240 Pieces)..... A-39-S  
 1/4-20 - (12 Sizes & 120 Pieces)..... A-40-S  
 8/32, 10/24, 10/32, 1/4-28 - (21 Sizes & 190 Pieces)..... A-41-S  
 5/16-18 - (12 Sizes & 120 Pieces)..... A-42-S  
 5/16-24 - (12 Sizes & 115 Pieces)..... A-43-S  
 3/8-16 - (12 Sizes & 90 Pieces)..... A-44-S  
 3/8-24 - (12 Sizes & 85 Pieces)..... A-45-S  
 7/16-14 Coarse - (12 Sizes & 72 Pieces)..... A-46-S  
 7/16-20 - (11 Sizes & 59 Pieces)..... A-47-S  
 1/4-28, 5/16-24, 3/8-24 Fine - (24 Sizes & 210 Pieces)..... 24-FAS  
 1/4, 5/16, 3/8 Coarse - (24 Sizes & 240 Pieces)..... 24-CAS

A-39-SP  
A-40-SP  
A-41-SP  
A-42-SP  
A-43-SP  
A-44-SP  
A-45-SP  
----  
A-47-SP  
24-FASP  
24-CASP



Stainless  
Steel  
Knurled Allen



Stainless  
Steel  
Polished Allen

### Allen Head Screw Assortment Group

Contains; 1 Metal Cabinet with 6 Trays & the following 6 sets

A-40-S, A-41-S, A-42-S, A-43-S, A-44-S, A-45-S - (83 Sizes & 621 Pieces)..... A-50-S

A-50-SP

### Button Head Allen Screws

8/32, 10/24, 10/32, 1/4-28 - (20 Sizes & 102 Pieces)..... A-25-S  
 1/4-20, 5/16-18, 3/8-16 - (24 Sizes & 114 Pieces)..... A-26-S  
 5/16-24, 3/8-24, 1/2-13 - (14 Sizes & 64 Pieces)..... A-27-S

----  
----  
A-27-SP



Button  
Head Allen



Flat  
Head Allen

### Flat Head Allen Screws

8/32, 10/24, 10/32, 1/4-28 - (20 Sizes & 200 Pieces)..... A-10-S

A-10-SP

### Hex Caps

1/4, 5/16, 3/8 Coarse - (24 Sizes & 227 Pieces)..... A-24-CS  
 1/4, 5/16, 3/8 Fine - (24 Sizes & 227 Pieces)..... A-24-FS  
 7/16, 1/2 Coarse & Fine - (20 Sizes & 155 Pieces)..... A-23-CS

A-24-CSP  
A-24-FSP  
A-23-CSSP

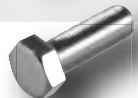

Hex Cap

### Hex Nuts

6/32 thru 5/8 Coarse & Fine - (16 Sizes & 534 Pieces)..... A-30-S  
 1/4 thru 3/8 Hex Nuts, Flat & Lock Washers - (12 Sizes & 1200 Pieces)... 12-W-S

A-30-SP  
12-W-SP



Hex Nut

### Lock Nuts Nylon Insert

6/32 thru 5/8-18 Coarse & Fine - (16 Sizes & 279 Pieces)..... A-32-S

A-32-SP



Nylon  
Insert  
Lock Nut

### Slotted Fillister Head (Machine Screw)

6/32, 8/32, 10/24, 10/32, 12/24, 1/4 - (24 Sizes & 240 Pieces)..... A-178

----



Slotted  
Fillister

### Washers

#8 thru 5/8 Flat & Lock Washers - (16 Sizes & 960 Pieces)..... A-31-S  
 #6 thru 5/8 Internal, External & AN - (22 Sizes & 880 Pieces)..... A-33-S  
 #8 thru 5/8 G-W Flat Washers & Lock Washers..... A-29-S

A-31-SP  
----  
----

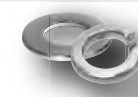

Flat  
&  
Lock  
Washer

# Assortments in American Thread



## Tray Assortments (Zinc Plated)

Part #

### Hex Caps

- 1/4-20 thru 5/16-18 Coarse - (20 Sizes & 270 Pieces)..... A-101-Zinc
- 3/8-16 Coarse - (12 Sizes & 210 Pieces)..... A-102-Zinc
- 7/16 Coarse - (12 Sizes & 165 Pieces)..... A-103-Zinc
- 1/2 Coarse - (12 Sizes & 102 Pieces)..... A-104-Zinc

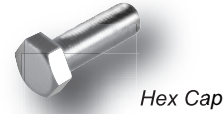

### Hex Nuts

- 6/32 thru 5/8 Coarse & Fine - (16 Sizes & 534 Pieces)..... A-30-Zinc



### Hex Nut & Nylon Insert Lock Nuts

- 8/32 thru 5/8 Coarse & Fine - (16 Sizes & 305 Pieces)..... A-100-Zinc

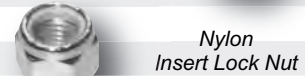

### Nylon Insert Lock Nuts

- 4/40 thru 3/4 Nylon Inserted Lock Nuts - (20 Sizes & 276 Pieces)... A-18-Zinc

### Flat & Lock Washers

- #8 thru 5/8 Flat & Lock Washers - (16 Sizes & 960 Pieces)..... A-31-Zinc



**Assortments  
Stainless**

## The Shop Master (Zinc Plated) A-99 in Grd. 5 and A-99-8 in Grd. 8

Offering a full line of fastener assortments is important. Custom bikes need custom fasteners and that's why we make fastener assortments with the motorcycle builder in mind. Organization of your stock is important - why waste time looking for a nut or bolt. Gardner-Westcott's assortments organize styles and sizes for fast access and easy stock control. All assortments come in metal tray and are labeled inside and outside for your convenience. **You may purchase any Assortments shown below individually.**

	Part #	Contents of each Tray
	A-34	Cotter Pins All Harley Numbers included
<b>A-70 6 Trays in Cabinet</b>	A-71	Round Slotted Screws 4/40, 5/40, 6/32, 8/32
	A-72	Round Slotted Screws 10/24, 10/32, 12/24
	A-73	Flat Head Slotted Screws 4/40, 6/32, 8/32, 10/24, 10/32
	A-74	Pan Head Slotted Sheet Metal Screws #4, 6, 8, 10, 12
	A-75	Flat Head Slotted Sheet Metal Screws #4, 6, 8, 10, 12, 1/4"
	A-76	Hole Plugs 3/16" thru 1"
<b>A-90 4 Trays in Cabinet</b>	A-91	Hex Nuts American Thread #4/40 thru 3/4-16
	A-92	Nylon Lock Nuts American Thread #4/40 thru 3/4-16
	A-93	Flat Washers & Lock Washers #4 thru 3/4"
	A-94	External, Internal Star, AN sm. OD & Fender Ig. OD Washers
<b>A-80 4 Trays in Cabinet</b>	A-82	Hex Cap American Thread 1/4-20 & 1/4-28 Diameter
	A-83	Hex Cap American Thread 5/16-18 & 5/16-24 Diameter
	A-84	Hex Cap American Thread 3/8-16 Diameter
	A-85	Hex Cap American Thread 3/8-24 Diameter
<b>A-81 2 Trays in Cabinet</b>	A-86	Hex Cap American Thread 7/16-14 & 7/16-20 Diameter
	A-87	Hex Cap American Thread 1/2-13 & 1/2-20 Diameter



# Fastener Assortment Set

*Specially designed for use with Harley Twins and Sportsters*

**A-50 or A-50-P Assortments**

**With Allen Screws,  
Hex Nuts, Lock Washers  
and G-W Flatwashers**

Contents of each Tray in Cabinet  
Allen Screws # 8/32, 10/24, 10/32, 1/4-28

Allen Screws 1/4-20 x 3/8" thru 3"

Allen Screws 5/16-18 x 1/2" thru 3"

Allen Screws 5/16-24 x 1/2" thru 2 3/4"

Allen Screws 3/8-16 x 1/2" thru 3 1/2"

Allen Screws 3/8-24 x 1/2" thru 3 1/2"

**Polished  
Stainless  
Steel**



Allen Screws with Sliding 6 Drawer Cabinet  
(A-50-P Shown)

**Polished  
Chrome**



Gardner-Westcott Company Chrome Plated Hex Nut Assortment			
Size	Part #	Part #	Part #
8/32	10/24	10/32	1/4-28
1/4-20	5/16-18	5/16-24	3/8-16
3/8-16	3/8-24	1/2-13	1/2-15
5/8-11	5/8-14	5/8-18	5/8-24
1-10	1-12	1-14	1-18

**A-30 or A-30-P  
Hex Nuts  
6/32 thru 5/8  
Fine and Coarse**

**A-29  
#8 thru 5/8  
Lock Washers and  
G-W Flat Washers**

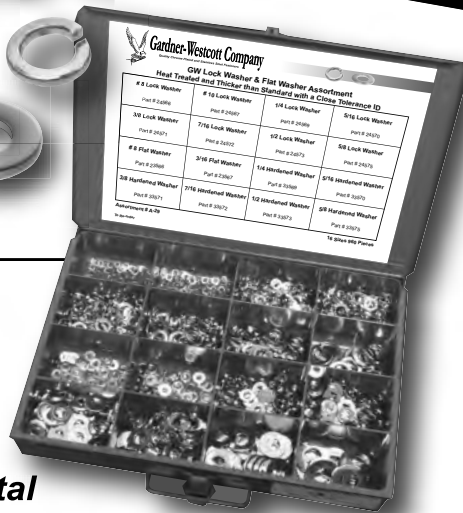

Gardner-Westcott Company Steel Truss Rod and Washer Flat Washer Assortment			
Part #	Part #	Part #	Part #
1/4-20	5/16-18	5/16-24	3/8-16
3/8-16	3/8-24	1/2-13	1/2-15
5/8-11	5/8-14	5/8-18	5/8-24
1-10	1-12	1-14	1-18

**Show Speciality Priced Fastener Assortment  
includes all 8 trays and 1 sliding six drawer metal  
Cabinet in Polished Stainless Steel or Polished Chrome**

**12Pt Sets Also Available**



## Inside This Section

### Metric Thread Chrome Plated

- Tray Assortments..... 76
- Acorn Nuts & Spacers.....76
- Allen Head Screws.....76
- Hex Caps.....76
- Nylon Insert Lock Nuts.....76
- Flat & Lock Washers.....76
- Metric Cruiser Assortment.....77
- Speciality Dealer Assortments..... 77

### Metric Thread Stainless Steel

- Tray Assortments..... 78
- Allen Head Screws.....78
- Hex Caps.....78
- Hex Nuts & Lock Nuts.....78
- Flat & Lock Washers.....78

### Metric Thread Zinc Plated

- Tray Assortments..... 78
- Allen Head Screws.....78
- Hex Caps.....78
- Hex Nuts & Lock Nuts.....78
- Flat & Lock Washers.....78

**Assortments in  
Chrome Plated and  
Stainless Steel**

**Detailed Custom Assortments with Speciality Lengths and Diameters Available**





# Assortments in Metric Thread

## Tray Assortments (Chrome Plated)

### Acorn Nuts and Spacers Combination

Acorn Nuts 4mm thru 12mm  
 Spacers 1/4 x 1/4 thru 3/8 x 1 - (15 Sizes & 140 Pieces)..... A-62

Chrome  
Part #

Polished  
Chrome  
Part #



Acorn Nut

### Allen Head Screws

4mm & 5mm - (24 Sizes & 210 Pieces)..... A-301-C A-301-P  
 5mm & 6mm - (16 Sizes & 240 Pieces)..... A-21 A-21-P  
 6mm with (special 6m x 27m & 8m - 70m) - (16 Sizes & 160 Pieces)..... A-325-C A-325-P  
 6mm (8m - 75m) - (24 Sizes & 120 Pieces)..... A-302-C A-302-P  
 8mm x 1.25 (10m - 80m) - (16 Sizes & 130 Pieces)..... A-326-C A-326-P  
 8mm x 1.25 (10m - 60m)  
 also 8mm x 1.0 (25m - 50m) - (16 Sizes & 124 Pieces)..... A-303-C A-303-P  
 8mm (10m - 50m) & 10m x 1.50 (25m - 65m)..... ----- A-328-P  
 10mm x 1.50 (20m - 75m) - (12 Sizes & 95 Pieces)..... A-327-C A-327-P  
 10mm x 1.50 (20m - 65m)  
 also 10mm x 1.25 (25m - 50m) - (16 Sizes & 120 Pieces)..... A-304-C A-304-P  
 10mm x 1.50 (70m - 100m)  
 also 10mm x 1.25 (55m - 90m) - (12 Sizes & 60 Pieces)..... A-308-C A-308-P  
 12mm x 1.75 (25m - 90m) - (12 Sizes & 60 Pieces)..... A-305-C A-305-P



Chrome Allen



Polished Allen

### Allen Screw Combination

Allens - 5mm x 12 - 10mm x 1.5 x 55  
 Flat Head - 4mm x 12 - 6mm x 16, 6mm x 35  
 Button Head - 6mm x 16 - 6mm x 30 - (25 Sizes & 205 Pieces)..... A-25-C A-25-P



Flat Head Allen

### Button Head Allen Screws

4mm x 6m - 4m x 25, 5mm x 5 - 5m x 30  
 also 6mm x 8m - 6m x 35m - (23 Sizes & 230 Pieces)..... A-315



Button Head

### Hex Caps

6mm x 12 - 6m x 50, 8mm x 12 - 8m x 55  
 also 10mm x 1.25 x 20 - 10m x 1.25 x 50 - (24 Sizes & 205 Pieces)..... 24-M

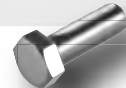

Hex Cap

### Hex Nut and Nylon Insert Lock Nut Combination

Hex Nuts 4mm thru 12mm  
 Lock Nuts 4mm thru 12mm - (24 Sizes & 365 Pieces)..... A-61-C



Hex Nut

### Flat & Lock Washer Combination

Flat Washers 3mm thru 14mm  
 Lock Washers 3mm thru 14mm - (16 Sizes & 430 Pieces)..... A-60-C



Flat & Lock Washers



A-326-P



A-60



A-61



# Assortments in Metric Thread



## Chrome Fastener Assortments for V-Rod and Victory Motorcycles

**Metric  
Chrome**

This Chrome Fastener set up will make it easy to customize the V-Rods. Featuring **Metric Allen Screws**, including special V-Rod lengths Flat Washers, Lock Washers, Hex Nuts and Lock Nuts all in **Show Chrome**. **Part # A-330-P** Contains all six metal tray assortments housed in a metal drawer cabinet.

<b>A-301-P</b>		<b>Allen Screws 4mm and 5mm</b>
<b>A-325-P</b>		<b>Allen Screws 6mm</b>
<b>A-326-P</b>		<b>Allen Screws 8mm</b>
<b>A-327-P</b>		<b>Allen Screws 10mm</b>
<b>A-60</b>		<b>Flat Washers and Lock Washers</b>
<b>A-61</b>		<b>Hex Nuts and Lock Nuts</b>

All above is in Cabinet **Part # A-330-P** with Polished Chrome Allens, it is also available with Knurled Chrome Allens in Cabinet **Part # A-330-C**.

## Metric Cruisers Assortments

**Part # A-300-P** is specially designed for the Metric Cruisers. This assortment offers a wide range of sizes starting at 4mm up to 12mm. Includes coarse special fine thread 8 & 10mm and also with longer lengths. The six metal trays are clearly labeled for ease in identification and the assortment includes the cabinet.

	<b>A-301-P</b>		<b>Allen Screws 4mm and 5mm</b>	
	<b>A-302-P</b>		<b>Allen Screws 6mm</b>	
	<b>A-303-P</b>		<b>Allen Screws 8mm Coarse &amp; Fine</b>	
	<b>A-304-P</b>		<b>Allen Screws 10mm Coarse &amp; Fine</b>	
	<b>A-308-P</b>		<b>Allen Screws 10mm Long Coarse &amp; Fine</b>	
	<b>A-305-P</b>		<b>Allen Screws 12mm</b>	

Not included order separately

Not included order separately

**Part #A-60-C includes Chrome Flat Washers and Lock Washers 3mm to 14mm**

**Part #A-61-C includes Hex Nuts and Lock Nuts in coarse and fine thread 4mm to 12mm**



# Assortments in Metric Thread

## Tray Assortments (Stainless Steel)

### Allen Head Screws

	Stainless Part #	Polished Part #
5mm & 6mm - (16 Sizes & 200 Pieces).....	A-64	A-64-SP
4mm & 5mm - (24 Sizes & 205 Pieces).....	A-301-S	A-301-SP
6mm x 1.0 x 8 thru 6mm x 1.0 x 75 - (16 Sizes & 140 Pieces).....	A-302-S	A-302-SP
8mm x 1.25 x 12 thru 8mm x 1.25 x 80 - (15 Sizes & 120 Pieces).....	A-326-S	A-326-SP
8mm x 1.25 x 10 thru 8mm x 1.25 x 80 - (16 Sizes & 124 Pieces).....	A-303-S	A-303-SP
10mm x 20 thru 10mm x 75 - (12 Sizes & 95 Pieces).....	A-327-S	A-327-SP
10mm x 1.50 x 20 thru 10mm x 1.50 x 75 - (12 Sizes & 90 Pieces).....	A-304-S	A-304-SP
12mm x 1.75 x 25 thru 12mm x 1.75 x 90 - (12 Sizes & 60 Pieces).....	A-305-S	A-305-SP



Stainless Steel Polished Allen

### Hex Caps

6mm x 12 thru 8mm x 1.25 x 50 - (16 Sizes & 160 Pieces).....	A-63	A-63-SP
6mm x 12 - 6m x 50, 8mm x 12 - 8m x 55 also 10mm x 1.25 x 20 - 10m x 1.25 x 50 - (24 Sizes & 205 Pieces).....	24-MS	-----



Hex Cap

### Hex Nut and Nylon Insert Lock Nut Combination

Hex Nuts 4mm thru 12mm Lock Nuts 4mm thru 12mm - (24 Sizes & 365 Pieces).....	A-65-S	A-65-SP
--	--------	---------

### Flat & Lock Washer Combination

Flat Washers 3mm thru 14mm Lock Washers 3mm thru 14mm - (16 Sizes & 430 Pieces).....	A-60-S	A-60-SP
---	--------	---------

## Tray Assortments (Zinc)

### Allen Head Screws

	Zinc Part #
4mm & 5mm - (24 Sizes & 205 Pieces).....	A-301-Z
6mm x 1.0 x 8 thru 6mm x 1.0 x 75 - (16 Sizes & 140 Pieces).....	A-325-Z
8mm x 1.25 x 10 thru 8mm x 1.25 x 80 - (16 Sizes & 124 Pieces).....	A-326-Z
10mm x 1.50 x 20 thru 10mm x 1.50 x 75 - (12 Sizes & 90 Pieces).....	A-327-Z
12mm x 1.75 x 25 thru 12mm x 1.75 x 90 - (12 Sizes & 60 Pieces).....	A-305-Z
8mm x 1.25 x 10 thru 8mm x 1.25 x 80 - (16 Sizes & 124 Pieces).....	A-303-Z
10mm x 1.50 x 20 thru 10mm x 1.50 x 75 - (12 Sizes & 90 Pieces).....	A-304-Z
10mm x 1.50 x 20 thru 10mm x 1.50 x 75 - Long - (12 Sizes & 90 Pieces).....	A-308-Z

Stainless Steel Knurled Allen



### Master Metric Zinc Allen Assortment

4mm & 5mm, 8mm x 1.25, 8mm x 1.0, 10mm x 1.25, 10mm x 1.50, 12mm x 1.75 x 90, 4mm thru 12mm Hex Nuts, Lock Nuts, Flat Washers & Lock Washers all in a (6) trayed cabinet.....	A-300-Z
--	---------

### Hex Caps

6mm x 1.0 x 8 thru 6mm x 1.0 x 75 - (16 Sizes & 140 Pieces).....	A-302-HZ
6mm x 1.0 x 8 thru 6mm x 1.0 x 75 - (16 Sizes & 140 Pieces).....	A-325-HZ
10mm x 20 thru 10mm x 75 - (12 Sizes & 95 Pieces).....	A-327-HZ
12mm x 1.75 x 25 thru 12mm x 1.75 x 90 - (12 Sizes & 60 Pieces).....	A-305-HZ
6mm, 8mm & 10mm - Long - (24 Sizes & 205 Pieces).....	A-24M-HZ



Nylon Insert Lock Nut

### Hex Nut and Nylon Insert Lock Nut Combination

Hex Nuts & Nylon Insert Lock Nuts 4mm thru 12mm - (24 Sizes & 365 Pieces).....	A-61-Z
--	--------

Hex Nut

### Flat & Lock Washer Combination

Flat Washers & Lock Washers 3mm thru 14mm - (16 Sizes & 430 Pieces).....	A-60-Z
--	--------

Flat & Lock Washers

### Flat & Lock Washer Hex Nuts Combination

Flat Washers, Lock Washers & Hex Nuts 6mm, 8mm & 10mm.....	A-12-WMZ
--	----------





## Inside This Section

### American Thread Chrome Plated

Allen Screws.....	80
Button Head Screws.....	80
Flat Head Allen Screws.....	81
12 Point Screws.....	81
Hex Cap Screws.....	82
Torx Button Head Screws.....	82
Stamped Skull & Flame Bolts.....	83
Machine Screws.....	84
Washers.....	85-86
Nuts.....	87
Acorn Nuts and Acorn Covers.....	88
Spacers.....	88
Hole Plugs, Pipe Plugs and Cotter Pins.....	89

### American Stainless Steel

Allen Screws.....	90
Button Head Screws.....	90
Flat Head Allen Screws.....	90
Hex Caps Screws.....	91
Set Screws.....	91
Washers.....	92-93
Nuts.....	93-94
Machine Screws.....	95

### American Zinc Plated

Allen Screws.....	96
Hex Caps.....	96
Washers.....	97
Nuts.....	97
Machine Screws.....	98

**Bulk Fasteners  
Chrome Plated  
Stainless and Zinc**

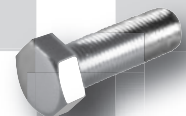



# Bulk Chrome Fasteners American

## Allen Screws Chrome Plated and Polished Chrome



**12xxx**  
for Chrome Allen  
with Knurls



**10xxx**  
for Polished Chrome Allen  
with Knurls Removed

	4/40	6/32	8/32	10/24	10/32	1/4 -20	1/4 -28	5/16 -18	5/16 -24	3/8 -16	3/8 -24	7/16 -14	7/16 -20	1/2 -13	1/2 -20	5/8 -11	5/8 -18
3/8	12088	12104	12128	12152	12153	12204	12205	12268	12269								
1/2	12089	12106	12130	12154	12155	12206	12207	12270	12271	12322	12323						
5/8	12090	12108	12132	12156	12157	12208	12209	12272	12273	12324	12325						
3/4	12091	12110	12134	12158	12159	12210	12211	12274	12275	12326	12327	12374	12375	12414	12415		
7/8		12112	12136	12160	12161	12212	12213	12278	12279	12328	12329						
1		12114	12138	12162	12163	12214	12215	12280	12281	12330	12331	12376	12377	12416	12417	12488	12489
1 1/4			12140	12166	12167	12218	12219	12284	12285	12334	12335	12378	12379	12418	12419	12490	
1 1/2			12142	12168	12169	12220	12221	12286	12287	12336	12337	12380	12381	12420	12421	12492	12493
1 3/4				12170	12171	12222	12223	12288	12289	12338	12339	12382	12383	12422	12423	12494	12495
2				12172	12173	12224	12225	12290	12291	12340	12341	12384	12385	12424	12425	12496	12497
2 1/4				12174	12175	12226	12227	12292	12293	12342	12343	12386	12387	12426	12427	12498	12499
2 1/2				12176	12177	12228	12229	12294	12295	12344	12345	12388	12389	12428	12429	12500	12501
2 3/4					12179	12230	12231	12296	12297	12346	12347	12390	12391	12430	12431	12502	
3						12232	12233	12298	12299	12348	12349	12392	12393	12432	12433	12504	12505
3 1/4						12234	12235	12300	12301	12350	12351	12394	12395	12434	12435	12506	
3 1/2						12236	12237	12302	12303	12352	12353	12396	12397	12436	12437	12508	12509
4						12240	12241	12306	12307	12356	12357	12400		12440	12441	12512	12513
4 1/2						12244		12310	12311	12360	12361	12404		12442	12443	12514	
5						12246		12312	12313	12362	12363	12406		12444	12445	12516	12517
5 1/2								12316	12317	12366	12367	12410		12446	12447	12518	12519
6						12248			12319	12368		12412		12448		12520	

## Button Head Allen Screws Chrome Plated

Button Head Allen



	4/40	6/32	8/32	10/24	10/32	12/24	1/4 -20	1/4 -28	5/16 -18	5/16 -24	3/8 -16	3/8 -24	7/16 -14	7/16 -20	1/2 -13	1/2 -20	5/8 -11
1/4	13087	13102	13126	13150	13151												
3/8	13088	13104	13128	13152	13153		13204	13205	13268	13269							13415
1/2	13089	13106	13130	13154	13155	13186	13206	13207	13270	13271	13322	13323					
5/8	13090	13108	13132	13156	13157		13208	13209	13272	13273	13324						
3/4	13091	13110	13134	13158	13159		13210	13211	13274	13275	13326	13327			13414		
7/8			13136	13160	13161		13212	13213	13278	13279	13328						
1		13114	13138	13162	13163	13194	13214	13215	13280	13281	13330	13331	13376		13416	13417	13488
1 1/4			13140	13166	13167		13218	13219	13284	13285	13334	13335	13378	13379	13418	13419	13490
1 1/2				13168	13169		13220	13221	13286	13287	13336	13337	13380	13381	13420	13421	13492
1 3/4							13222	13223	13288	13289	13338	13339	13382		13422		
2							13224	13225	13290	13291	13340	13341	13384	13385	13424	13425	13496
2 1/4							13226		13292		13342	13343					
2 1/2							13228		13294		13344	13345		13389	13428	13429	13500
2 3/4									13296		13346						
3							13232		13298		13348	13349			13432	13433	13504
3 1/2							13236				13352						13508
4							13240				13356		13400		13440	13441	

# Bulk Chrome Fasteners American



81

## Flat Head Allen Screws Chrome Plated

Flat Head Allen



**American  
Bulk Chrome**

	6/32	8/32	10/24	10/32	12/24	1/4 -20	1/4 -28	5/16 -18	5/16 -24	3/8 -16	3/8 -24	7/16 -14	1/2 -13	1/2 -20
1/4	14102													
3/8	14104	14128	14152	14153		14204	14205							
1/2	14106	14130	14154	14155	14186	14206	14207	14270	14271	14322				
5/8	14108	14132	14156	14157		14208	14209	14272	14273	14324	14325			
3/4	14110	14134	14158	14159	14190	14210	14211	14274	14275	14326	14327	14374	14414	14527
7/8		14136	14160	14161		14212	14213	14278	14279	14328				
1	14114	14138	14162	14163	14194	14214	14215	14280	14281	14330	14331	14376	14416	14417
1 1/4		14140	14166	14167		14218	14219	14284	14285	14334	14335	14378	14418	14419
1 1/2		14142	14168	14169		14220	14221	14286	14287	14336	14337	14380	14420	14421
1 3/4			14170			14222		14288		14338		14382	14422	14423
2						14224		14290		14340		14384	14424	14425
2 1/4								14292		14342		14386	14426	
2 1/2						14228		14294		14344		14388	14428	
2 3/4						14230				14346				
3						14232		14302		14348		14392	14432	
3 1/2						14236				14352		14396	14436	
4						14240		14306					14440	
4 1/2										14360				

## 12 Point Screws Chrome Plated

12 Point Screw



	1/4 -20	1/4 -28	5/16 -18	5/16 -24	3/8 -16	3/8 -24	7/16 -14	7/16 -20	1/2 -13	1/2 -20	5/8 -11	5/8 -18
3/8												
1/2	29206	29207	29270	29271	29322	29323						
5/8	29208	29209	29272	29273								
3/4	29210	29211	29274	29275	29326	29327	29374		29414	29527		
7/8	29212	29213										
1	29214	29215	29280	29281	29330	29331	29376	29377	29416	29417	29488	29489
1 1/4	29218	29219	29284	29285	29334	29335	29378	29379	29418	29419	29490	29491
1 1/2	29220	29221	29286	29287	29336	29337	29380	29381	29420	29421	29492	29493
1 3/4	29222	29223	29288	29289	29338	29339	29382	29383	29422	29423	29494	29495
2	29224	29225	29290	29291	29340	29341	29384	29385	29424	29425	29496	29497
2 1/4	29226	29227	29292	29293	29342	29343	29386	29387	29426	29427	29498	
2 1/2	29228	29229	29294	29295	29344	29345	29388	29389	29428	29429	29500	29501
2 3/4	29230	29231	29296	29297	29346	29347	29390	29391	29430		29502	
3	29232	29233	29298	29299	29348	29349	29392	29393	29432	29433	29504	29505
3 1/4			29300	29301	29350	29351	29394		29434			
3 1/2			29302	29303	29352	29353	29396	29397	29436	29437	29508	29509
4					29356	29357	29400		29440		29512	
4 1/2					29360				29442		29514	
5					29362				29444		29516	



# Bulk Chrome Fasteners American

## Hex Caps Screws Chrome Plated Grade 5 & Grade 8

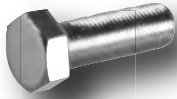

**11xxx**  
for Grade 5  
Chrome Hex Caps

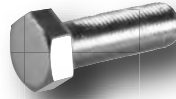

**31xxx**  
for Grade 8  
Chrome Hex Caps

	1/4 -20	1/4 -28	5/16 -18	5/16 -24	3/8 -16	3/8 -24	7/16 -14	7/16 -20	1/2 -13	1/2 -20	9/16 -12	9/16 -18	5/8 -11	5/8 -18
1/2	11206	11207	11270	11271	11322	11323								
5/8	11208	11209	11272	11273	11324	11325								
3/4	11210	11211	11274	11275	11326	11327	11374	11375	11414	11527				
7/8	11212	11213	11278	11279	11328	11329								
1	11214	11215	11280	11281	11330	11331	11376	11377	11416	11417	11452	11453	11488	11489
1 1/4	11218	11219	11284	11285	11334	11335	11378	11379	11418	11419	11454	11455	11490	11491
1 1/2	11220	11221	11286	11287	11336	11337	11380	11381	11420	11421	11456	11457	11492	11493
1 3/4	11222	11223	11288	11289	11338	11339	11382	11383	11422	11423	11458	11459	11494	11495
2	11224	11225	11290	11291	11340	11341	11384	11385	11424	11425	11460	11461	11496	11497
2 1/4	11226	11227	11292	11293	11342	11343	11386	11387	11426	11427	11462	11463	11498	11499
2 1/2	11228	11229	11294	11295	11344	11345	11388	11389	11428	11429	11464	11465	11500	11501
2 3/4	11230	11231	11296	11297	11346	11347	11390	11391	11430	11431	11466	11467	11502	11503
3	11232	11233	11298	11299	11348	11349	11392	11393	11432	11433	11468	11469	11504	11505
3 1/4	11234	11235	11300	11301	11350	11351	11394	11395	11434	11435	11470	11471	11506	11507
3 1/2	11236	11237	11302	11303	11352	11353	11396	11397	11436	11437	11472	11473	11508	11509
4	11240	11241	11306	11307	11356	11357	11400	11401	11440	11441	11476	11477	11512	11513
4 1/2	11244		11310	11311	11360	11361	11404	11405	11442	11443	11478	11479	11514	11515
5	11246		11312	11313	11362	11363	11406	11407	11444	11445	11480	11481	11516	11517
5 1/2	11246-B	11247-C	11316	11317	11366	11367	11410	11411	11446	11447	11482	11483	11518	11519
6	11246-A	11247-A	11318	11319	11368	11369	11412		11448	11449	11484	11485	11520	11521

## Torx Button Head Screws Chrome Plated

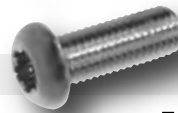

Torx Button Head

	8/32	10/24	10/32	1/4 -20	1/4 -28	5/16 -18	5/16 -24	3/8 -16	1/2 -13
1/4	46126	46150	46151						
3/8	46128	46152	46153	46204	46205				
1/2	46130	46154	46155	46206	46207	46270	46271	46322	
5/8	46132	46156	46157	46208	46209	46272	46273	46324	
3/4	46134	46158	46159	46210	46211	46274	46275	46326	
1		46162	46163	46214	46215	46280	46281	46330	
1 1/4				46218				46334	
1 1/2				46220				46336	46420
2				46224				46340	
2 1/4				46226				46342	



## Emblem Stamped Hex Cap Screws Chrome Plated

Skull Stamped Hex Caps



**14-xxxxx**  
For Skull Stamped  
Hex Caps

Flames Stamped Hex Caps

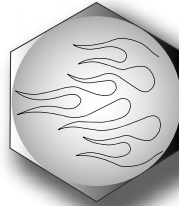

**17-xxxxx**  
For Flame Stamped  
Hex Caps

**American  
Bulk Chrome**

	1/4 -20	1/4 -28	1/4 -24	5/16 -18	5/16 -24	3/8 -16	3/8 -24	7/16 -14	7/16 -20	1/2 -13	1/2 -20	5/8 -11	5/8 -18
3/8													
1/2	14-11206	14-11207	14-11250	14-11270	14-11271	14-11322	14-11323						
5/8	14-11208	14-11209		14-11272	14-11273	14-11324	14-11325						
3/4	14-11210	14-11211	14-11251	14-11274	14-11275	14-11326	14-11327	14-11374	14-11375	14-11414	14-11527		
7/8	14-11212	14-11213	14-11252	14-11278	14-11279	14-11328	14-11329						
1	14-11214	14-11215	14-11256	14-11280	14-11281	14-11330	14-11331	14-11376	14-11377	14-11416	14-11417	14-11488	14-11489
1 1/4	14-11218	14-11219		14-11284	14-11285	14-11334	14-11335	14-11378	14-11379	14-11418	14-11419	14-11490	14-11491
1 1/2	14-11220	14-11221		14-11286	14-11287	14-11336	14-11337	14-11380	14-11381	14-11420	14-11421	14-11492	14-11493
1 3/4	14-11222	14-11223		14-11288	14-11289	14-11338	14-11339	14-11382	14-11383	14-11422	14-11423	14-11494	14-11495
2	14-11224	14-11225		14-11290	14-11291	14-11340	14-11341	14-11384	14-11385	14-11424	14-11425	14-11496	14-11497
2 1/4	14-11226	14-11227		14-11292	14-11293	14-11342	14-11343	14-11386	14-11387	14-11426	14-11427	14-11498	14-11499
2 1/2	14-11228	14-11229		14-11294	14-11295	14-11344	14-11345	14-11388	14-11389	14-11428	14-11429	14-11500	14-11501
2 3/4	14-11230	14-11231		14-11296	14-11297	14-11346	14-11347	14-11390	14-11391	14-11430	14-11431	14-11502	14-11503
3	14-11232	14-11233		14-11298	14-11299	14-11348	14-11349	14-11392	14-11393	14-11432	14-11433	14-11504	14-11505
3 1/4	14-11234	14-11235		14-11300	14-11301	14-11350	14-11351	14-11394	14-11395	14-11434	14-11435	14-11506	14-11507
3 1/2	14-11236	14-11237		14-11302	14-11303	14-11352	14-11353	14-11396	14-11397	14-11436	14-11437	14-11508	14-11509
4	14-11240	14-11241		14-11306	14-11307	14-11356	14-11357	14-11400	14-11401	14-11440	14-11441	14-11512	14-11513
4 1/2				14-11310	14-11311	14-11360	14-11361	14-11404	14-11405	14-11442	14-11443	14-11514	14-11515
5	14-11246			14-11312	14-11313	14-11362	14-11363	14-11406	14-11407	14-11444	14-11445	14-11516	14-11517
5 1/2				14-11316	14-11317	14-11366	14-11367	14-11410	14-11411	14-11446	14-11447	14-11518	14-11519
6		14-11083		14-11318	14-11319	14-11368	14-11369	14-11412		14-11448	14-11449	14-11520	14-11521

## Spike Nuts



**Sizes**

**Part #**

1/4 -20	1/4 -28	5/16 -18	5/16 -24	3/8 -16	3/8 -24
26546	26547	26548	26549	26550	26551

7/16 -14	7/16 -20	1/2 -13	1/2 -20	5/8 -18
26552	26553	26554	26555	26559

*With a longer extended hex for easier applications,  
all done in Ultimate Show Chrome Plated Finish.*



## Machine and Sheet Metal Screws Chrome Plated

**Example:** To order a 8/32 x 5/8 Oval Phillips Machine Screw: Use **Chart #1** for the type of head style required, take those first two digits for the beginning part number which would be "40". Now look up the diameter and length from **Chart #2 or #3** for last three digits for 8/32 x 5/8 is "132". Put the two together for a part number of **40132**, or simply order by style and size.

### Chart #1: Select Styles

Style	Chrome Slotted	Phillips
Round Head	33xxx	38xxx
Flat Head	36xxx	39xxx
Truss Head	51xxx	53xxx
Oval Head	34xxx	40 / 57*
Pan Head	35xxx	41xxx
Fillister	37xxx	n/a
Hex	55xxx	n/a
Round Wood	33xxx	n/a
Flat Wood	47xxx	49xxx
Oval Wood	48xxx	50xxx

\*NOTE: Not all styles available in all sizes

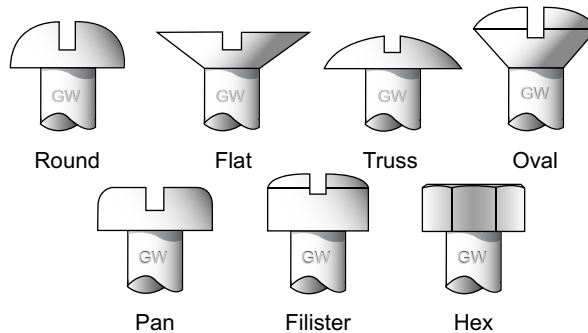

\*NOTE: Oval Phillips Sheet Metal Screws use Prefix 57 not 40

### Chart #2: Machine Screw Sizes

	6/32	8/32	10/24	10/32	12/24	1/4 -20	1/4 -28	5/16 -18	5/16 -24	3/8 -16
3/8	104	128	152	153	184	204				
1/2	106	130	154	155	186	206		270		
5/8		132	156	157	188	208	209			
3/4	110	134	158	159	190	210	211	274	275	
7/8		136	160	161	192	212				
1	114	138	162	163	194	214	215	280	281	330
1 1/4	116	140	166	167	196	218	219	284	285	334
1 1/2	118	142	168	169	198	220	221	286	287	336
1 3/4			170	171		222		288	289	338
2	122		172	173		224		290	291	340



Machine Screw

### Chart #3: Sheet Metal & Wood Screw Sizes

	#6	#8	#10	#12	#14
1/2	616	628	641	654	667
5/8	617	629	642	655	668
3/4	618	630	643	656	669
1	620	632	645	658	671
1 1/4	621	633	646	659	672
1 1/2	622	634	647	660	673
1 3/4	623	680	648	661	674
2	624	635	649	662	675
2 1/4				663	676
2 1/2				664	677



Sheet Metal Screw



Woodscrew





**American Bulk Chrome**

## Washers Chrome Plated

Flat Washers Standard SAE	Hardened Flat Washer "G-W" Washers	AN Flat Washers Small OD Chrome	Lock Washers
---------------------------------	--	---------------------------------------	--------------

Size	Part #
4	23564
6	23565
8	23566
10	23567
12	23568
1/4	23569
5/16	23570
3/8	23571
7/16	23572
1/2	23573
9/16	23574
5/8	23575
3/4	23576

Flat Washer



Size	Part #
1/4	33569
5/16	33570
3/8	33571
7/16	33572
1/2	33573
5/8	33575

Hardened  
Flat Washer



Size	Part #
10	26567
1/4	26569
5/16	26570
3/8	26571
7/16	26572
1/2	26573
9/16	26574
5/8	26575
3/4	26576
1	26577

AN Flat Washer



Size	Part #
4	24564
6	24565
8	24566
10	24567
12	24568
1/4	24569
5/16	24570
3/8	24571
7/16	24572
1/2	24573
9/16	24574
5/8	24575
3/4	24576

Lock Washer



### Also Available in Assortments

All Items shown on this page can be purchased individually

High Collar Lock Washers	Internal Lock Washers	External Countersunk Washers	External Lock Washers
-----------------------------	--------------------------	---------------------------------	--------------------------

Size	Part #
8	25566
10	25567
1/4	25569
5/16	25570
3/8	25571
7/16	25572
1/2	25573
5/8	25575



Size	Part #
6	29565
8	29566
10	29567
12	29568
1/4	29569
5/16	29570
3/8	29571
7/16	29572
1/2	29573
5/8	29575

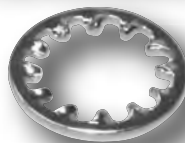

Size	Part #
6	35565
8	35566
10	35567
12	35568
1/4	35569
5/16	35570



Size	Part #
6	32565
8	32566
10	32567
12	32568
1/4	32569
5/16	32570
3/8	32571
7/16	32572
1/2	32573



**Note:** O.D. of Washer is the same as the Head of the Allen Screw



## Washers Chrome Plated

### Cup Washers

Size	Part #
3/8 x 1 1/4	22334
1/2 x 1 1/4	22418
1/2 x 1 7/16	22420
5/8 x 1 1/4	22490



22334  
Cup Washer



22418  
Cup Washer



22420  
Cup Washer



22490  
Cup Washer

Cup Washers Sold Each.

### Super Flat Fender Washers

Size	O.D.	Thickness	Part #
#8	3/4		23134
#10	3/4		23158
#10	1		23162
5/16	5/32	3/64	23128
3/16	1		23162
1/4	7/8		23212
1/4	1		23214
1/4	1 1/4		23218
5/16	1		23280
5/16	3/4		23274
5/16	13/16	3/32	23278
5/16	1 1/8		23282
5/16	1 1/4		23284
5/16	1 1/2		23286
5/16	1 1/2	1/8	23286H
11/32	1 1/32		23283
13/32	11/16	1/16	23326
3/8	3/4	.060	23326A
3/8	7/8		23328
3/8		Heat Treat	23329
3/8	1 1/4		23334
3/8	1 1/2		23336
3/8	1 1/2	1/8	23336H
3/8	2	1/16	23340
7/16	29/32	.190	23374
7/16	15/16		23375
7/16	1	1/8	23376
7/16	1 1/8	5/32	23377
7/16	1 1/8		23379
1/2	13/16		23415
1/2	1 1/8		23416
1/2	1 1/4		23418
1/2	2		23424
9/16	1 3/8		23456
5/8	1 1/2		23492
5/8	1 3/4		23495
21/32	1 1/16		23488
11/16	1 3/8	3/16	23496
11/16	1 3/8	Pivot Shaft	23579
7/16	2		23594

### Finishing Washer

Size	Part #
6	34565
8	34566
10	34567
12	34568
14	34569



Finishing Washer

### Flush Washer

Size	Part #
6	41565
8	41566
10	41567



Flush Washer

### Flat Washer USS Standard

Size	I.D.	O.D.	Part #
1/4	5/16	3/4	23274
5/16	3/8	7/8	23328
3/8	7/16	1	23376
7/16	1/2	1 1/4	23418
1/2	9/16	1 3/8	23456
9/16	5/8	1 1/2	23492



Flat Washer

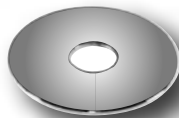

Super  
Flat Washers  
Sold Each.



**American Bulk Chrome**

## Nuts Chrome Plated

### Hex Nuts

Size	Part #
4/40	15536
5/40	15537
6/32	15538
8/32	15540
10/24	15542
10/32	15543
12/24	15544
1/4-20	15546
1/4-28	15547
5/16-18	15548
5/16-24	15549
3/8-16	15550
3/8-24	15551
7/16-14	15552
7/16-20	15553
1/2-13	15554
1/2-20	15555
9/16-12	15556
9/16-18	15557
5/8-11	15558
5/8-18	15559
3/4-10	15560
3/4-16	15561



### Nylon Insert Lock Nuts

Size	Part #
4/40	17536
5/40	17537
6/32	17538
8/32	17540
10/24	17542
10/32	17543
12/24	17544
1/4-20	17546
1/4-28	17547
5/16-18	17548
5/16-24	17549
3/8-16	17550
3/8-24	17551
7/16-14	17552
7/16-20	17553
1/2-13	17554
1/2-20	17555
9/16-12	17556
9/16-18	17557
5/8-11	17558
5/8-18	17559
3/4-10	17560
3/4-16	17561



### Thin Jam Lock Nuts

Size	Part #
1/4-20	27546
1/4-28	27547
5/16-18	27548
5/16-24	27549
3/8-16	27550
3/8-24	27551
7/16-14	27552
7/16-20	27553
1/2-13	27554
1/2-20	27555
9/16-12	27556
9/16-18	27557
5/8-11	27558
5/8-18	27559
3/4-10	27560
3/4-16	27561



### Flexloc® Nuts (All Metal)

Size	Part #
10/24	18542
10/32	18543
1/4-20	18546
1/4-28	18547
5/16-18	18548
5/16-24	18549
3/8-16	18550
3/8-24	18551
7/16-14	18552
7/16-20	18553
1/2-13	18554
1/2-20	18555
9/16-12	18556
9/16-18	18557
5/8-11	18558
5/8-18	18559
3/4-10	18560
3/4-16	18561



All Items shown on this page can be purchased individually

### Slotted Nuts

Size	Part #
1/4-20	22546
1/4-28	22547
5/16-18	22548
5/16-24	22549
3/8-16	22550
3/8-24	22551
7/16-14	22552
7/16-20	22553
1/2-13	22554
1/2-20	22555
9/16-12	22556
9/16-18	22557
5/8-11	22558
5/8-18	22559
3/4-10	22560
3/4-16	22561



### Allen Nuts

Size	Part #
10/24	19542
10/32	19543
1/4-20	19546
1/4-28	19547
5/16-18	19548
5/16-24	19549
3/8-16	19550
3/8-24	19551
7/16-14	19552
7/16-20	19553
1/2-13	19554
1/2-20	19555
5/8-11	19558
5/8-18	19559



### Thin Jam Hex Nuts

Size	Part #
1/4-20	16546
1/4-28	16547
5/16-18	16548
5/16-24	16549
3/8-16	16550
3/8-24	16551
7/16-14	16552
7/16-20	16553
1/2-13	16554
1/2-20	16555
9/16-12	16556
9/16-18	16557
5/8-11	16558
5/8-18	16559
3/4-10	16560
3/4-16	16561



### Thin Jam Flexloc Nuts (All Metal)

Size	Part #
1/4-20	28546
1/4-28	28547
5/16-18	28548
5/16-24	28549
3/8-16	28550
3/8-24	28551
7/16-14	28552
7/16-20	28553
1/2-13	28554
1/2-20	28555
9/16-12	28556
9/16-18	28557
5/8-11	28558
5/8-18	28559
3/4-10	28560
3/4-16	28561





## Nuts Chrome Plated

### Acorn Nuts

Coarse and Fine Thread

Size	Part #
4/40	21536
6/32	21538
8/32	21540
10/24	21542
10/32	21543
12/24	21544
1/4-20	21546
1/4-28	21547
5/16-18	21548
5/16-24	21549
3/8-16	21550
3/8-24	21551
7/16-14	21552
7/16-20	21553
1/2-13	21554
1/2-20	21555
9/16-12	21556
9/16-18	21557
5/8-11	21558
5/8-18	21559
3/4-10	21560
3/4-16	21561
1-14	21565



## Spacers Chrome Plated

ID	OD	Length	Part #
1/4	7/16	3/16	20080
1/4	7/16	1/4	20081
1/4	7/16	3/8	20082
1/4	7/16	1/2	20082-A
1/4	7/16	5/8	20083
1/4	7/16	3/4	20084
1/4	7/16	7/8	20094
1/4	7/16	1 1/16	20085
1/4	5/8	1/8	20040
1/4	5/8	1/4	20036
1/4	5/8	3/8	20037
1/4	5/8	1/2	20038
1/4	5/8	3/4	20039
1/4	5/8	1	20041
5/16	7/16	5/8	20045
5/16	1/2	3/16	20049
5/16	1/2	1/4	20050
5/16	1/2	3/8	20050-A
5/16	1/2	1/2	20051
5/16	1/2	17/32	20093
5/16	1/2	3/4	20052
5/16	1/2	1	20053
5/16	1/2	1 1/4	20054
5/16	5/8	1/8	20055
5/16	5/8	3/16	20056
5/16	5/8	1/4	20057
5/16	5/8	3/8	20058
5/16	5/8	1/2	20059
5/16	5/8	3/4	20060
5/16	5/8	1	20061
3/8	9/16	1/8	20087

ID	OD	Length	Part #
3/8	9/16	3/8	20086
3/8	13/16	5/32	20091
3/8	5/8	1/4	20067
3/8	5/8	3/8	20068
3/8	1	5/16	C-31-32
3/8	5/8	1/2	20069
3/8	13/16	1/2	20092
3/8	5/8	3/4	20070
3/8	13/16	29/32	20092-A
3/8	5/8	1	20072
3/8	5/8	1 1/2	20075
3/8	3/4	1/8 Tapered	20021
3/8	3/4	1/4	20022
3/8	3/4	3/8	20023
3/8	3/4	1/2	20024
3/8	3/4	3/4	20025
3/8	3/4	1	20026
3/8	7/8	5/8	20089
7/16	3/4	3/32	23580
7/16	11/16	5/16	20088
1/2	5/16	15/16	20095
1/2	3/4	1/8	20030
1/2	3/4	1/4	20031
1/2	3/4	1/2	20032
1/2	3/4	3/4	20033
1/2	3/4	1	20034
1/2	7/8	3/8	20097
1/2	15/16	21/32	20096
1/2	1 1/16	5/16	23200
9/16	7/8	3/4	20100
5/8	1 1/2	3/8	C-31-100
13/32	1	.322	23327

### Low Crown Acorn Nuts

Coarse and Fine Thread

Size	Part #
8/32	33540
10/24	33542
10/32	33543
1/4-20	33546
1/4-28	33547
5/16-18	33548
5/16-24	33549
3/8-16	33550
3/8-24	33551
7/16-14	33552
7/16-20	33553
1/2-13	33554
1/2-20	33555
5/8-11	33558
5/8-18	33559



### Acorn Push On Covers

Wrench Size	Part #	Bolt/Nut Diameter
7/16	45552	1/4
1/2	45554	5/16
9/16	45556	3/8
5/8	45558	7/16
11/16	45559	
7/8	45562	
3/4	45560	



All items shown on this page can be purchased individually

### Spike Nuts

Coarse and Fine Thread

Size	Part #
1/4-20	26546
1/4-28	26547
5/16-18	26548
5/16-24	26549
3/8-16	26550
3/8-24	26551
7/16-14	26552
7/16-20	26553
1/2-13	26554
1/2-20	26555
5/8-18	26559



Non-Alcoholic but may be habit forming

Spike Nuts



## Cotter Pins Chrome, Stainless or Zinc

Size	H-D Part #	Chrome Part #	Stainless Part #	Zinc Part #
1/16 x 1/2	510		78580	01587
1/16 x 3/4	512-515		78587	01588
1/16 x 1 1/4			78588A	01588A
5/64 x 3/4			78581	01589
3/32 x 3/4	528	29589	78589	01590
3/32 x 1	531-534	29590	78590	01591
3/32 x 1 1/4	513	29591A	78591	
3/32 x 1 1/2			78591A	
3/32 x 1 3/4		29587		01592
1/8 x 3/4	550	29592	78592	
1/8 x 1			78584	01593
1/8 x 1 1/4	520-559	29593	78593	
1/8 x 1 1/2		29585	78585	
1/8 x 1 3/4			78585A	
1/8 x 2			78595	
5/32 x 1			78585B	01599
5/32 x 1 1/2	511	29588	78588	
5/32 x 1 3/4		29586	78586	01594
3/16 x 1	566	29594	78594	
3/16 x 1 3/4			78597	



Cotter Pin Assortment A-34 Zinc and A-34C Chrome

**American Bulk Chrome**

### Flange & Locking Flange Nuts

Size	Part #	Locking #
1/4-20	44546	44546-L
5/16-18	44548	44548-L
5/16-24	44549	44549-L
3/8-16	44550	44550-L
3/8-24	44551	44551-L
7/16-14	44552	----
1/2-13	44554	----
1/2-20	44555	----
5/8-11	44558	44558-L



### Grease Fittings Chrome Plated

Size	Part #
1/4-28 Straight	57547
1/4-28 90°	57548
1/4-28 45°	57546
1/8 Pipe Straight	57550
1/8 Pipe 45°	57549



### Allen Pipe Plugs

Size	Part #
1/16	31587
1/8	31588
1/4	31569
3/8	31571
1/2	31573
3/4	31576



Note: See Fitting Section for more Pipe Plugs

### Hole Plugs

Size	Part #	Use with Allen Screw
3/16	43567	1/4
1/4	43569	5/16
5/16	43570	3/8
3/8	43571	7/16
7/16	43572	
1/2	43573	
5/8	43575	
3/4	43576	
7/8	43577	
1	43578	
1 1/4	43579	
1 1/2	43580	

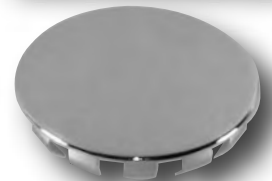

### Wide Base Wing Nut

Size	Part #
1/4-20	23546-W



### Wing Nuts

Size	Part #
1/4-20	23546
5/16-18	23548
3/8-16	23550



All Items shown on this page can be purchased individually



# Bulk Stainless Steel American

## Allen Screws Stainless Steel

	6/32	8/32	10/24	10/32	1/4 -20	1/4 -28	5/16 -18	5/16 -24	3/8 -16	3/8 -24	7/16 -14	1/2 -13	5/8 -11
3/8	73104	73128	73152	73153	73204						Allen		
1/2	73106	73130	73154	73155	73206	73207	73270		73322				
5/8		73132	73156	73157	73208	73209	73272	73273	73324				
3/4	73110	73134	73158	73159	73210	73211	73274	73275	73326	73327	73374	73414	
7/8		73136	73160	73161	73212		73278		73328				
1	73114	73138	73162	73163	73214	73215	73280	73281	73330	73331	73376	73416	
1 1/4		73140	73166	73167	73218	73219	73284	73285	73334	73335	73378	73418	
1 1/2		73142	73168	73169	73220	73221	73286	73287	73336	73337	73380	73420	73492
1 3/4			73170	73171	73222	73223	73288	73289	73338	73339	73382	73422	73494
2	73122		73172	73173	73224	73225	73290	73291	73340	73341	73384	73424	73496
2 1/4			73174		73226	73227	73292		73342		73386	73426	73498
2 1/2			73176		73228		73294	73295	73344	73345	73388	73428	73500
2 3/4					73230		73296		73346			73430	
3					73232		73298	73299	73348		73392	73432	73504
3 1/2					73236		73302		73352	73353	73396	73436	73508
4					73240		73306		73356	73347	73400	73440	73512

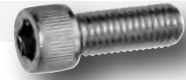

73xxx for  
Stainless Steel  
Allen with Knurls



SP - 73xxx for  
Polished Stainless Steel  
Allen with Knurls  
Removed

## Button Head Allen Screws

	6/32	8/32	10/24	10/32	1/4 -20	1/4 -28	5/16 -18	5/16 -24	3/8 -16	3/8 -24	1/2 -13
1/4	72102	72126	72150	72151							
3/8	72104	72128	72152	72153	72204						
1/2	72106	72130	72154	72155	72206		72270		72322		
5/8		72132	72156	72157	72208		72272				
3/4	72110	72134	72158	72159	72210	72211	72274	72275	72326	72327	
1	72114	72138	72162	72163	72214	72215	72280	72281	72330	72331	72416
1 1/4			72166	72167	72218		72284	72285	72334	72335	72418
1 1/2			72168	72169	72220		72286	72287	72336	72337	72420
1 3/4					72222						
2			72172	72173	72224		72290	72291	72340		72424
2 1/2							72294		72344		72428
3					72232		72298		72348		72432
3 1/2					72236						
4					72240		72306				

72xxx for  
Stainless Steel  
Button Head Allen



SP - 72xxx for  
Polished Stainless Steel  
Button Head Allen

## Flat Head Allen Screws

	6/32	8/32	10/24	10/32	1/4 -20	1/4 -28	5/16 -18	5/16 -24	3/8 -16	1/2 -13	5/8 -11
3/8	71104		71152	71153	71204						
1/2	71106	71130	71154	71155	71206		71270				
5/8		71132	71156	71157	71208		71272				
3/4		71134	71158	71159	71210	71211	71274		71326		
1	71114	71138	71162	71163	71214	71215	71280	71281	71330	71416	71488
1 1/4		71140	71166	71167	71218	71219	71284		71334	71418	71490
1 1/2		71142	71168	71169	71220	71221	71286		71336	71420	71492
1 3/4					71222		71288		71338	71422	71494
2					71224		71290		71340	71424	71496
2 1/2									71344		
3							71298		71348	71432	

71xxx for  
Stainless Steel  
Flat Head Allen



SP - 71xxx for  
Polished Stainless Steel  
Flat Head Allen

# Bulk Stainless Fasteners American



91

## Hex Caps Screws Stainless Steel

**77xxx**  
for Stainless Steel  
Hex Cap Screws

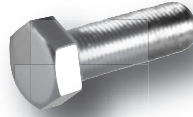

**SP - 77xxx**  
for Polished Stainless Steel  
Hex Cap Screws

NOTE: 9/16 & 5/8 sizes are not listed on chart but certain sizes may be available upon request.

	4/40	6/32	8/32	10/24	10/32	12/24	1/4 -20	1/4 -28	5/16 -18	5/16 -24	3/8 -16	3/8 -24	7/16 -14	7/16 -20	1/2 -13	1/2 -20
3/8	77088		77128	77152	77153		77204	77205	77268							
1/2		77106	77130	77154	77155	77186	77206	77207	77270	77271	77322	77323				
5/8			77132	77156	77157		77208	77209	77272	77273	77324	77325				
3/4			77134	77158	77159		77210	77211	77274	77275	77326	77327			77414	
7/8			77136				77212	77213	77278	77279	77328	77329				
1		77114	77138	77162	77163	77194	77214	77215	77280	77281	77330	77331	77376	77377	77416	77417
1 1/4				77166	77167		77218	77219	77284	77285	77334	77335	77378	77379	77418	77419
1 1/2			77142	77168	77169		77220	77221	77286	77287	77336	77337	77380	77381	77420	77421
1 3/4							77222	77223	77288	77289	77338	77339	77382	77383	77422	77423
2							77224	77225	77290	77291	77340	77341	77384	77385	77424	77425
2 1/4							77226	77227	77292	77293	77342	77343	77386	77387	77426	77427
2 1/2							77228	77229	77294	77295	77344	77345	77388	77389	77428	77429
2 3/4							77230	77231	77296		77346			77391	77430	
3							77232	77233	77298	77299	77348	77349	77392	77393	77432	77433
3 1/4							77234		77300	77301	77350		77394		77434	77435
3 1/2							77236	77237	77302		77352	77353	77396		77436	77437
3 3/4							77238		77304		77354				77438	
4							77240		77306		77356	77357	77400		77440	77441
4 1/2							77244		77310	77311	77360	77361	77404		77442	77443
5							77246		77312	77313	77362		77406		77444	
5 1/2									77316		77366				77446	
6							77246-A		77318		77368		77412		77448	

**American  
Bulk Stainless**

## Set Screws Plain Steel

	6/32	8/32	10/24	10/32	1/4 -20	1/4 -28	5/16 -18	5/16 -24	3/8 -16	3/8 -24
1/4	47102	47126	47150	47151						
3/8	47104	47128	47152	47153	47204	47205	47268			
1/2	47106	47130	47154	47155	47206	47207	47270	47271	47322	47323
5/8	47108	47132	47156	47157	47208	47209	47272	47273	47324	47325
3/4	47110	47134	47158	47159	47210	47211	47274	47275	47326	47327
1	47114	47138	47162	47163	47214	47215	47280	47281	47330	47331
1 1/4			47166	47167	47218	47219	47284	47285	47334	47335
1 1/2			47168	47169	47220	47221	47286	47289	47336	47337
1 3/4					47222		47288			
2					47224	47225	47290	47291	47340	47341
2 1/2					47228		47294		47344	

Set Screws  
Sold Each



**Stainless Steel Available**



# Bulk Stainless Fasteners American

## Washers Stainless Steel

### Flat Washers

Size	Part #
4	75564
6	75565
8	75566
10	75567
1/4	75569
5/16	75570
3/8	75571
7/16	75572
1/2	75573
5/8	75575
3/4	75576



### AN Washers Small OD

Size	Part #
6	84565
8	84566
10	84567
1/4	84569
5/16	84570
3/8	84571
7/16	84572
1/2	84573
5/8	84575
3/4	84576



### Lock Washers

Size	Part #
4	76564
6	76565
8	76566
10	76567
1/4	76569
5/16	76570
3/8	76571
7/16	76572
1/2	76573
5/8	76575
3/4	76576



### Finishing Washers

Size	Part #
6	78565
8	78566
10	78567
1/4	78569
5/16	78570



### High Collar Lock Washers

Size	Part #
1/4	80569
5/16	80570
3/8	80571
1/2	80573



All Items shown on this page can be purchased individually

## GW Stainless Steel Flat Washers

*Thicker than standard flat washers*



Size	Part #
1/4	70569
5/16	70570
3/8	70571
7/16	70572
1/2	70573
5/8	70575

*Our Stainless Steel washer is thicker than standard flat washers and has a close tolerance ID for a snug fit. It has a standard OD so it can be used anywhere a regular washer was.*

## Super Flat Washers

Size	Part #
#6 x 5/8	66108
#8 x 3/4	66134
3/16 x 11/16	66157
3/16 x 3/4	66158
3/16 x 1	66162
3/8 x 1	66330
3/8 x 1 1/4	66334
1/4 x 1	66214
1/4 x 1 1/4	66218
5/16 x 3/4	SP- 66274
5/16 x 1 1/2	66286
3/8 x 7/8	SP- 66328
3/8 x 1 1/2	66336
7/16 x 1	66376
7/16 x 1 1/8	SP- 66377
1/2 x 1 1/4	SP- 66418
1/2 x 1 1/2	66420
1/2 x 2	66424
5/8 x 1 1/2	SP- 66492
5/8 x 1 3/4	66494
3/4 x 1 3/4	66528

(SP-) Super Flat Washers Polished Stainless Steel in that size only

### Internal Lock Washers

Size	Part #
4	82564
6	82565
8	82566
10	82567
1/4	82569
5/16	82570
3/8	82571
7/16	82572
1/2	82573
5/8	82575



### External Lock Washers

Size	Part #
4	83564
6	83565
8	83566
10	83567
1/4	83569
5/16	83570
3/8	83571
7/16	83572
1/2	83573
5/8	83575



### External Countersunk Washers

Size	Part #
6	89565
8	89566
10	89567
1/4	89569
5/16	89570

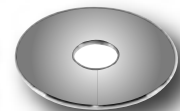





**American Bulk Stainless**

## Washers Stainless Steel

### White Nylon Flat Washers

Size	Part #
8	87566
10	87567
1/4	87569
5/16	87570
3/8	87571
7/16	87572
1/2	87573
5/8	87575

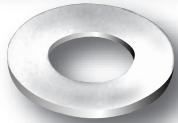

### Neoprene Backed Flat Washers

Size	Part #
8	81566
10	81567
1/4	81569
5/16	81570
3/8	81571
1/2	81573

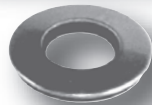

*Available in  
Stainless Steel Polished  
Add SP-81xxx*

### Pipe Plugs Allen Style

Size	Part #
1/8	86588
1/4	86569
3/8	86571
1/2	86573
3/4	86576



### Threaded Rod Stainless Steel

Size	Part #
6/32	63122
8/32	63148
10/24	63180
10/32	63181
1/4-20	63232
1/4-28	63233
5/16-18	63298
5/16-24	63299
3/8-16	63348
3/8-24	63349
7/16-14	63392
7/16-20	63393
1/2-13	63432
1/2-20	63433
5/8-11	63504

Threaded Rod  
Sold in Three Foot Lengths

All Items shown on this page can  
be purchased individually

## Nuts Stainless Steel

### Acorn Nuts

Size	Part #
6/32	68538
8/32	68540
10/24	68542
10/32	68543
1/4-20	68546
1/4-28	68547
5/16-18	68548
5/16-24	68549
3/8-16	68550
3/8-24	68551
7/16-14	68552
7/16-20	68553
1/2-13	68554
1/2-20	68555
5/8-11	68558
5/8-18	68559



### Castle Nuts

Size	Part #
3/8-24	81551
1/2-13	81554
1/2-20	81555
5/8-11	81558



*For Stainless Steel Polished  
order with the Prefix than five digit  
Part # SP-xxxxx*

### Hex Nuts

Size	Part #
6/32	70538
8/32	70540
10/24	70542
10/32	70543
1/4-20	70546
1/4-28	70547
5/16-18	70548
5/16-24	70549
3/8-16	70550
3/8-24	70551
7/16-14	70552
7/16-20	70553
1/2-13	70554
1/2-20	70555
9/16-12	70556
9/16-18	70557
5/8-11	70558
5/8-18	70559
3/4-10	70560
3/4-16	70561



### Nylon Lock Nuts

Size	Part #
4/40	69536
6/32	69538
8/32	69540
10/24	69542
10/32	69543
1/4-20	69546
1/4-28	69547
5/16-18	69548
5/16-24	69549
3/8-16	69550
3/8-24	69551
7/16-14	69552
7/16-20	69553
1/2-13	69554
1/2-20	69555
9/16-12	69556
9/16-18	69557
5/8-11	69558
5/8-18	69559
3/4-10	69560
3/4-16	69561





## Nuts Stainless Steel

### Jam Nuts

Size	Part #
1/4-20	67546
1/4-28	67547
5/16-18	67548
5/16-24	67549
3/8-16	67550
3/8-24	67551
7/16-14	67552
7/16-20	67553
1/2-13	67554
1/2-20	67555
9/16-18	67557
5/8-11	67558
5/8-18	67559
3/4-16	67561
3/4-10	67560



### Jam Locknuts

Size	Part #
1/4-20	66546
1/4-28	66547
5/16-18	66548
5/16-24	66549
3/8-16	66550
3/8-24	66551
7/16-14	66552
7/16-20	66553
1/2-13	66554
1/2-20	66555
5/8-11	66558
5/8-18	66559
3/4-16	66561



### Spin Locks

Size	Part #
1/4-20	65546
5/16-18	65548
5/16-24	65549
3/8-16	65550
3/8-24	65551





American Bulk Stainless

## Machine and Sheet Metal Screws Stainless Steel

**Example:** To order a 8/32 x 5/8 Oval Phillips Machine Screw: Use **Chart #1** for head style required, take those first two digits for the beginning part number which would be "40" Now look up the diameter and length from **Chart #2 or #3** for last three digits for 8/32 x 5/8 is "132" Put the two together for a part number of **89132**, or simply order by style and size.

**Chart #1: Select Styles**

Style	Stainless Steel Slotted	Stainless Steel Phillips
Round Head	99	95
Flat Head	98	94
Truss Head	93	80
Oval Head	97	89
Pan Head	96	92
Fillister	78	n/a
Hex	77	n/a
Round Wood	83	n/a
Flat Wood	85	n/a
Oval Wood	84	81

Include the prefix SP-XXXXX for Stainless Steel Polished

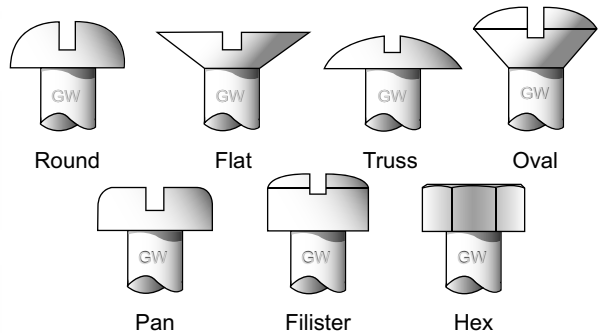

**Chart #2: Machine Screw Sizes**

	6/32	8/32	10/24	10/32	12/24	1/4 -20	1/4 -28	5/16 -18	5/16 -24	3/8 -16
3/8	104	128	152	153	184	204				
1/2	106	130	154	155	186	206		270		
5/8		132	156	157	188	208	209			
3/4	110	134	158	159	190	210	211	274	275	
7/8		136	160	161	192	212			279	
1	114	138	162	163	194	214	215	280	281	330
1 1/4	116	140	166	167	196	218	219	284	285	334
1 1/2	118	142	168	169	198	220	221	286	287	336
1 3/4			170	171		222		288	289	338
2	122		172	173		224		290	291	340



Machine Screw

Head Styles: Oval, Flat or Pan  
Note: Not all styles available in all sizes

**Chart #3: Sheet Metal & Wood Screw Sizes**

	#6	#8	#10	#12	#14
1/2	616	628	641	654	667
5/8	617	629	642	655	668
3/4	618	630	643	656	669
1	620	632	645	658	671
1 1/4	621	633	646	659	672
1 1/2	622	634	647	660	673
1 3/4	623	680	648	661	674
2	624	635	649	662	675
2 1/4	625	636	650	663	676
2 1/2	626	637	651	664	677



Sheet Metal Screw



Woodscrew



# Bulk Zinc Fasteners American

## Allen Screws Zinc Plated



**08xxx**  
for Allen Screws  
with Knurls

	4/40	6/32	8/32	10/24	10/32	1/4 -20	1/4 -28	5/16 -18	5/16 -24	3/8 -16	3/8 -24	7/16 -14	7/16 -20	1/2 -13	1/2 -20
3/8	08088	08104	08128	08152	08153	08204									
1/2	08089	08106	08130	08154	08155	08206	08207	08270	08271	08322	08323				
5/8			08132	08156	08157	08208	08209	08272	08273	08324	08325				
3/4	08091	08110	08134	08158	08159	08210	08211	08274	08275	08326	08327	08374	08375	08414	08415
7/8			08136	08160	08161	08212	08213	08278	08279	08328					
1		08114	08138	08162	08163	08214	08215	08280	08281	08330	08331	08376	08377	08416	08417
1 1/4			08140	08166	08167	08218	08219	08284	08285	08334	08335	08378		08418	08419
1 1/2			08142	08168	08169	08220	08221	08286	08287	08336	08337	08380		08420	08421
1 3/4				08170	08171	08222	08223	08288	08289	08338	08339	08382		08422	08423
2				08172	08173	08224	08225	08290	08291	08340	08341	08384		08424	08425
2 1/4						08226	08227	08292	08293	08342		08386		08426	
2 1/2						08228	08229	08294	08295	08344		08388		08428	
2 3/4						08230		08296		08346				08430	
3						08232		08298		08348				08432	
3 1/4										08350					
3 1/2						08236				08352					
4						08240									
4 1/2						08244									

## Hex Cap Screws Zinc Plated and L-9 Products

	1/4 -20	1/4 -28	5/16 -18	5/16 -24	3/8 -16	3/8 -24	7/16 -14	7/16 -20	1/2 -13	1/2 -20	5/8 -11	5/8 -18
1/2	07206	07207	07270	07271	07322	07323						
5/8	07208	07209	07272	07273	07324	07325						
3/4	07210	07211	07274	07275	07326	07327	07374	07375	07414			
7/8	07212	07213	07278	07279	07328	07329						
1	07214	07215	07280	07281	07330	07331	07376	07377	07416	07417	07488	07489
1 1/4	07218	07219	07284	07285	07334	07335	07378	07379	07418	07419	07490	07491
1 1/2	07220	07221	07286	07287	07336	07337	07380	07381	07420	07421	07492	07493
1 3/4	07222	07223	07288	07289	07338	07339	07382	07383	07422	07423	07494	07495
2	07224	07225	07290	07291	07340	07341	07384	07385	07424	07425	07496	07497
2 1/4	07226	07227	07292	07293	07342	07343	07386	07387	07426	07427	07498	07499
2 1/2	07228	07229	07294	07295	07344	07345	07388	07389	07428	07429	07500	07501
2 3/4	07230	07231	07296	07297	07346	07347	07390	07391	07430	07431	07502	07503
3	07232	07233	07298	07299	07348	07349	07392	07393	07432	07433	07504	07505
3 1/4	07234	07235	07300	07301	07350	07351	07394	07395	07434	07435	07506	07507
3 1/2	07236	07237	07302	07303	07352	07353	07396	07397	07436	07437	07508	07509
4	07240	07241	07306	07307	07356	07357	07400	07401	07440	07441	07512	07513
4 1/2	07244		07310	07311	07360	07361	07404	07405	07442	07443	07514	07515
5	07246		07312	07313	07362	07363	07406	07407	07444	07445	07516	07517
5 1/2			07316	07317	07366	07367	07410	07411	07446	07447	07518	07519
6				07319	07368		07412		07448	07449	07520	07521

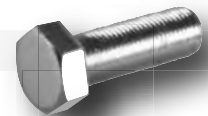

**07xxx**  
for Zinc Hex Cap

**NOTE:**  
Some sizes may  
not be available  
in L-9 Zinc,  
Please call.

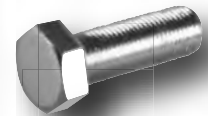

When Ordering  
L-9 Zinc Plated  
Hex Caps  
use 52xxx  
for the first two  
numbers in Part #



American Bulk Zinc

## Washers Zinc Plated and L-9 Products

### Flat Washers and L-9

Size	Part #	L-9 #
4	04564	--
6	04565	--
8	04566	--
10	04567	--
12	04568	--
1/4	04569	55569
5/16	04570	55570
3/8	04571	55571
7/16	04572	55572
1/2	04573	55573
9/16	04574	55574
5/8	04575	55575
3/4	04576	--
7/8	04577	--



### Fender Washers

Size	Part #
10 x 1	01567
1/4 x 1	01569
1/4 x 1 1/4	01218
1/4 x 1 1/2	09569
5/16 x 1 1/4	01284
5/16 x 1 1/2	01570
3/8 x 1 1/2	01571

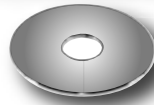

### External Lock Washers

Size	Part #
4	02564
6	02565
8	02566
10	02567
12	02568
1/4	02569
5/16	02570
3/8	02571
7/16	02572
1/2	02573



### Internal Lock Washers

Size	Part #
4	03564
6	03565
8	03566
10	03567
12	03568
1/4	03569
5/16	03570
3/8	03571
7/16	03572
1/2	03573
5/8	03575
3/4	03576



### Lock Washers and L-9

Size	Part #	L-9 #
4	05564	--
6	05565	--
8	05566	--
10	05567	--
12	05568	--
1/4	05569	52569
5/16	05570	52570
3/8	05571	52571
7/16	05572	52572
1/2	05573	52573
9/16	05574	52574
5/8	05575	52575
3/4	05576	--
7/8	05577	--
1	05578	--



## Nuts Zinc Plated and L-9 Products

### Hex Nuts & L-9

Size	Part #	L-9 #
4/40	06536	--
5/40	06537	--
6/32	06538	--
8/32	06540	--
10/24	06542	--
10/32	06543	--
1/4-20	06546	52546
1/4-28	06547	52547
5/16-18	06548	52548
5/16-24	06549	52549
3/8-16	06550	52550
3/8-24	06551	52551
7/16-14	06552	52552
7/16-20	06553	52553
1/2-13	06554	52554
1/2-20	06555	52555
9/16-12	06556	06556
9/16-18	06557	--
5/8-11	06558	52558
5/8-18	06559	52559
3/4-10	06560	--
3/4-16	06561	--



### Nylon Lock Nuts

Size	Part #
4/40	03536
5/40	03537
6/32	03538
8/32	03540
10/24	03542
10/32	03543
1/4-20	03546
1/4-28	03547
5/16-18	03548
5/16-24	03549
3/8-16	03550
3/8-24	03551
7/16-14	03552
7/16-20	03553
1/2-13	03554
1/2-20	03555
9/16-12	03556
9/16-18	03557
5/8-11	03558
5/8-18	03559
3/4-10	03560
3/4-16	03561



### Jam Hex Nuts

Size	Part #
1/4-20	04546
1/4-28	04547
5/16-18	04548
5/16-24	04549
3/8-16	04550
3/8-24	04551
7/16-14	04552
1/2-20	04555
9/16-18	04557
5/8-18	04559
3/4-16	04561



### Jam Lock Nuts

Size	Part #
1/4-20	02546
1/4-28	02547
5/16-18	02548
5/16-24	02549
3/8-16	02550
3/8-24	02551
7/16-14	02552
7/16-20	02553
1/2-13	02554
1/2-20	02555
9/16-12	02556
9/16-18	02557
5/8-11	02558
5/8-18	02559



All items shown on this page can be purchased individually



# Bulk Zinc Fasteners American

## Machine and Sheet Metal Screws Zinc Plated

**Example:** To order a **8/32 x 5/8 Oval Phillips Machine Screw**: Use **Chart #1** for the type of head style required, take those first two digits for the beginning part number which would be **"40"**. Now look up the diameter and length from **Chart #2 or #3** for last three digits for **8/32 x 5/8** is **"132"**. Put the two together for a part number of **40132**, or simply order by style and size.

**Note;** When placing your order please ask for Zinc Plated Screws.

### Chart #1: Select Styles

*Note; Not all Sizes and Styles Available*

Style	Slotted	Phillips
Round Head	04	05
Flat Head	02	03
Truss Head	01	n/a
Pan Head	04	n/a
Fillister	06	n/a



Round

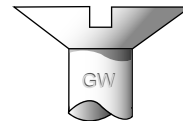

Flat



Truss

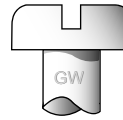

Pan



Fillister

### Chart #2: Machine Screw Sizes

	6/32	8/32	10/24	10/32	12/24	1/4 -20	1/4 -28	5/16 -18	5/16 -24	3/8 -16
3/8	104	128	152	153	184	204				
1/2	106	130	154	155	186	206		270		
5/8		132	156	157	188	208	209			
3/4	110	134	158	159	190	210	211	274	275	
7/8		136	160	161	192	212			279	
1	114	138	162	163	194	214	215	280	281	330
1 1/4	116	140	166	167	196	218	219	284	285	334
1 1/2	118	142	168	169	198	220	221	286	287	336
1 3/4			170	171		222		288	289	338
2	122		172	173		224		290	291	340

Machine Screws are sold each



Machine Screw

### Chart #3: Sheet Metal Sizes

	#6	#8	#10	#12	#14
1/2	616	628	641	654	667
5/8	617	629	642	655	668
3/4	618	630	643	656	669
1	620	632	645	658	671
1 1/4	621	633	646	659	672
1 1/2	622	634	647	660	673
1 3/4	623	680	648	661	674
2	624	635	649	662	675
2 1/4	625	636	650	663	676
2 1/2	626	637	651	664	677

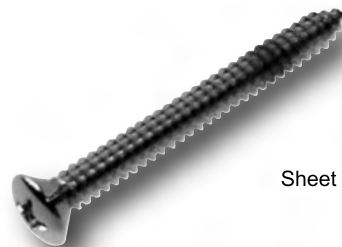

Sheet Metal Screw



## Inside This Section

### Metric Thread Chrome Plated

Allen Screws.....	100
Button Head Screws.....	100
Flat Head Allen Screws.....	100
12 Point Screws.....	101
Hex Cap Screws.....	101
Nuts.....	102
Washers.....	102

### Metric Stainless Steel

Allen Screws.....	103
Button Head Screws.....	103
Flat Head Allen Screws.....	103
Hex Caps Screws.....	103
Washers.....	104
Nuts.....	104
Machine Screws.....	104

### Metric Zinc Plated

Allen Screws.....	105
Hex Caps.....	105
Washers.....	106
Nuts.....	106

**Bulk Fasteners  
Chrome Plated  
Stainless and Zinc**

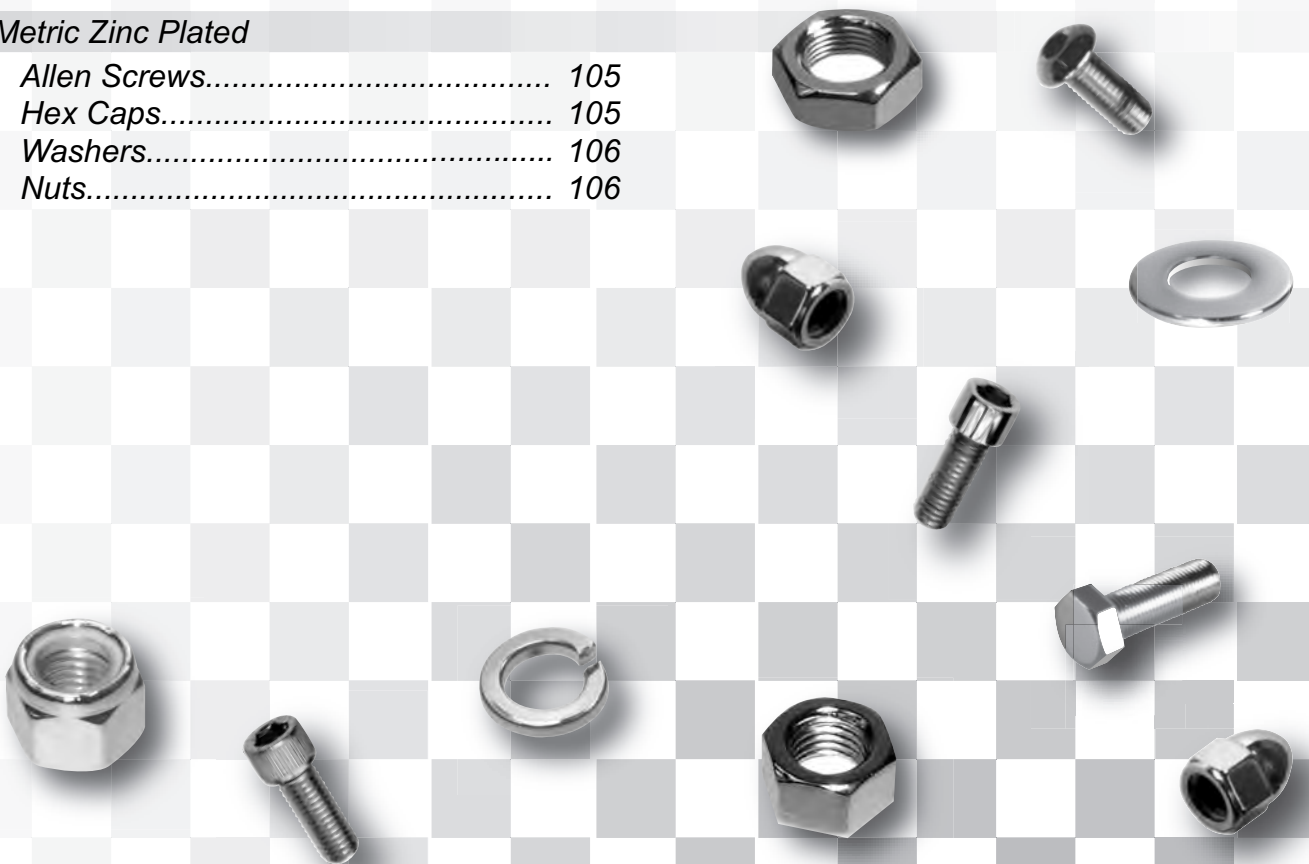



# Bulk Chrome Fasteners Metric

## Allen Screws Chrome Plated and Polished



For Metric Chrome Allen  
with Knurls  
use 12xxx



For Polished Chrome Allen  
with Knurls Removed  
use 10xxx

	4mm/ 0.7	5mm/ 0.8	6mm/ 1.0	8mm/ 1.25	8mm/ 1.0 <small>Fine Thread</small>	10mm/ 1.50 <small>Fine Thread</small>	10mm/ 1.25 <small>Fine Thread</small>	12mm/ 1.75
8		12721	12734					
10	12711	12722	12735	12770				
12	12712	12723	12736	12771				
16	12714	12725	12738	12772				
20	12715	12726	12739	12773	12773F	12794	12816	
25	12716	12727	12740	12774	12774F	12795	12817	12836
27			12740A		12775F			
30	12717	12728	12741	12775	12776F	12796	12818	12837
35		12729	12742	12776	12777F	12797	12819	12838
40		12730	12743	12777	12778F	12798	12820	12839
45		12731	12744	12778	12779F	12799	12821	12840
50		12732	12745	12779		12800	12822	12841
55			12746	12780		12801	12823	12842
60		12733	12747	12781		12802	12824	12843
65			12748	12782		12803	12825	12844
70			12749	12783		12804	12826	12845
75			12750	12784		12805	12827	12846
80			12751	12785		12806	12828	12847
85				12786		12807	12829	12848
90			12753	12787		12808	12830	12849
95			12754					
100			12755	12788		12809	12831	12850
110			12756	12789		12810		
115			12756A					
120			12757	12790		12811		

Key: Read Across For Diameter  
Read Down For Length

Call if you do not see  
the sizes you need !

## Button Head Allen Screws



	4mm/ 0.7	5mm/ 0.8	6mm/ 1.0	8mm/ 1.25	10mm/ 1.50	12mm/ 1.75
6	13709					
8	13710	13721	13734			
10	13711	13722	13735	13770		
12	13712	13723	13736	13771		
16	13714	13725	13738	13772	13793	
20	13715	13726	13739	13773	13794	13835
25	13716	13727	13740	13774	13795	
30		13728	13741	13775	13796	13837
35			13742	13776	13797	13838
40	13719		13743	13777	13798	13839
45				13778	13799	
50				13779	13800	13841
60				13781	13802	13843
70				13783	13804	13845
80				13785	13806	
90				13787	13808	13849
100						13850

## Flat Head Allen Screws



	4mm/ 0.7	5mm/ 0.8	6mm/ 1.0	8mm/ 1.25	10mm/ 1.50
6	14709				
8	14710	14721	14734		
10	14711	14722	14735		
12	14712	14723	14736	14771	
16	14714	14725	14738	14772	14793
20	14715	14726	14739	14773	14794
25	14716	14727	14740	14774	14795
30	14717	14728	14741	14775	14796
35	14718	14729	14742	14776	14797
40	14719	14730	14743	14777	14798
45	14720A	17731	17744	14778	14799





**Metric  
Bulk Chrome**

## Hex Cap Screws Chrome Plated

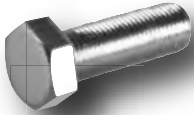

	4mm/ 0.7	5mm/ 0.8	6mm/ 1.0	7mm/ 1.0	8mm/ 1.25	Fine Thread 8mm/ 1.0	10mm/ 1.50	Fine Thread 10mm/ 1.25	Fine Thread 10mm/ 1.00	12mm/ 1.75	Fine Thread 12mm/ 1.50	14mm/ 2.00	Fine Thread 14mm/ 1.50
10	11711	11722	11735	11760	11770	11770F							
16	11712	11725	11738	11762	11772	11772F	11793						
20	11714	11726	11739	11763	11773	11773F	11794	11816	11816F	11835	11856	11873	
25	11715	11727	11740	11764	11774	11774F	11795	11817	11817F	11836	11857	11874	11895
30	11716	11728	11741	11765	11775	11775F	11796	11818	11818F	11837	11858	11875	
35	11717	11729	11742	11766	11776	11776F	11797	11819	11819F	11838	11859	11876	
40		11730	11743	11767	11777	11777F	11798	11820	11820F	11839	11860	11877	
45		11731	11744		11778	11778F	11799	11821	11821F	11840	11861		11899
50		11732	11745	11769	11779	11779F	11800	11822	11822F	11841	11862	11879	
55			11746		11780	11780F	11801	11823	11823F	11842	11863		11901
60			11747		11781	11781F	11802	11824	11824F	11843	11864	11881	
65			11748		11782	11782F	11803	11825	11825F	11844	11865		
70			11749		11783	11783F	11804	11826	11826F	11845	11866	11883	
75			11750		11784	11784F	11805			11846	11867		
80			11751		11785	11785F	11806	11828	11828F	11847	11868	11885	
90			11753		11787	11787F	11808	11830	11830F	11849	11870	11887	
100			11755		11788	11788F	11809	11831	11831F	11850	11871	11888	
110			11756		11789	11789F	11810			11851			
120			11757		11790	11790F	11811			11852			
130										11853		11891	
140					11792	11792F	11813					11892	

## 12 Point Flange



**Key: Read Across For Diameter  
Read Down For Length**

*Call if you do not see  
the sizes you need !*

	6mm/ 1.0	8mm/ 1.25	10mm/ 1.50	12mm/ 1.75
16	29738	29772		
20	29739	29773		
25	29740	29774	29795	29836
30	29741	29775	29796	29837
35	29742	29776	29797	29838
40	29743	29777	29798	29839
45	29744	29778	29799	29840
50	29745	29779	29800	29841
55		29780	29801	29842
60		29781	29802	29843
65		29782	29803	
70		29783	29804	
75		29784		
80		29785	29806	
90			29807	29849
100			29808	29850
110				
120				



**Demand only the finest Quality Fasteners**



## Nuts Chrome Plated

Acorn Nuts	
Size	Part #
4mm x .70	21950
5mm x .80	21952
6mm x 1.0	21954
7mm x 1.0	21956
8mm x 1.0	
8mm x 1.25	21958
10mm x 1.25	21961
10mm x 1.50	21962
12mm x 1.25	21963
12mm x 1.50	21965
12mm x 1.75	21966



Hex Nuts	
Size	Part #
4mm x .70	15950
5mm x .80	15952
6mm x 1.0	15954
7mm x 1.0	15956
8mm x 1.0	15957
8mm x 1.25	15958
10mm x 1.25	15961
10mm x 1.50	15962
12mm x 1.25	15963
12mm x 1.50	15965
12mm x 1.75	15966
14mm x 1.50	15967
14mm x 2.00	15968
16mm x 1.50	15969
16mm x 2.00	15970

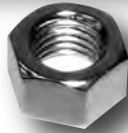

Jam Nuts	
Size	Part #
8mm x 1.0	16957
8mm x 1.25	16958
10mm x 1.25	16961
10mm x 1.50	16962
12mm x 1.25	16963
12mm x 1.50	16965
12mm x 1.75	16966
14mm x 1.50	16967
14mm x 2.00	16968
16mm x 1.50	16969
16mm x 2.00	16970



Nylon Insert Lock Nuts	
Size	Part #
4mm x .70	17950
5mm x .80	17952
6mm x 1.0	17954
7mm x 1.0	17956
8mm x 1.0	17957
8mm x 1.25	17958
10mm x 1.25	17961
10mm x 1.50	17962
12mm x 1.25	17963
12mm x 1.50	17965
12mm x 1.75	17966
14mm x 1.50	17967
14mm x 2.00	17968
16mm x 1.50	17969
16mm x 2.00	17970



## Flange Nuts

Size	Part #
6mm x 1.0	44954
8mm x 1.25	44958
10mm x 1.50	44962
12mm x 1.75	44966
16mm x 2.0	44970



## Flange Lock Nuts

Size	Part #
8mm x 1.25	44958-L
10mm x 1.50	44962-L
12mm x 1.75	44966-L
16mm x 2.0	44970-L



## Washers Chrome Plated

Flat Washers	
Size	Part #
4mm	23985
5mm	23986
6mm	23987
7mm	23988
8mm	23989
10mm	23990
12mm	23991
14mm	23992
16mm	23993



Lock Washers	
Size	Part #
4mm	24985
5mm	24986
6mm	24987
7mm	24988
8mm	24989
10mm	24990
12mm	24991
14mm	24992
16mm	24993



Wave Washers	
Size	Part #
8mm	23989W
12mm	24991W



## Super Flat Washers

Size	Part #
6mm x 10	23735
6mm x 18	23278A
8mm x 24	23773A

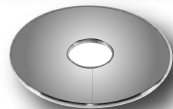

Note: See specification for dimensions  
Page 118



**Metric  
Bulk Stainless**

## Allen Screws Stainless Steel



*73xxx for Stainless Steel  
Allens with Knurls or for  
Polished add SP-73xxx*

	4mm/ 0.7	5mm/ 0.8	6mm/ 1.0	8mm/ 1.25	10mm/ 1.50	12mm/ 1.75
8		73721	73734			
10	73711	73722	73735	73770		
12	73712	73723	73736	73771		
16	73714	73725	73738	73772		
20	73715	73726	73739	73773	73794	73835
25	73716	73727	73740	73774	73795	73836
30	73717	73728	73741	73775	73796	73837
35		73729	73742	73776	73797	73838
40		73730	73743	73777	73798	73839
45		73731	73744	73778	73799	73840
50		73732	73745	73779	73800	73841
55			73746	73780	73801	73842
60			73747	73781	73802	73843
65			73748	73782	73803	73844
70			73749	73783	73804	73845
75			73750	73784	73805	73846
80			73751	73785	73806	73847
90			73753	73787	73808	73849
100				73788	73809	73850

## Button Head Allen Screws



*72xxx for Stainless Steel  
Allen Button Heads or for  
Polished add SP-72xxx*

	4mm/ 0.7	5mm/ 0.8	6mm/ 1.0	8mm/ 1.25	10mm/ 1.50
8	72710	72721	72734		
10	72711	72722	72735	72770	
12	72712	72723	72736	72771	
16	72714	72725	72738	72772	72793
20		72726	72739	72773	72794
25		72727	72740	72774	72795
30		72728	72741	72775	72796

## Flat Head Allen Screws



*71xxx for Stainless Steel  
Flat Head Allens or for  
Polished add SP-71xxx*

	4mm/ 0.7	5mm/ 0.8	6mm/ 1.0	8mm/ 1.25	10mm/ 1.50
6	71709				
8	71710	71721	71734		
10	71711	71722	71735		
12	71712	71723	71736	71771	
16	71714	71725	71738	71772	71793
20	71715	71726	71739	71773	71794
25	71716	71727	71740	71774	71795
30	71717	71728	71741	71775	71796

## Hex Caps Screws



*77xxx for Stainless Steel  
Hex Caps or for Polished  
add SP-77xxx*

	4mm/ 0.7	5mm/ 0.8	6mm/ 1.0	8mm/ 1.25	10mm/ 1.50	12mm/ 1.75
10	77711	77722	77735	77770		
16	77714	77725	77738	77772	77793	
20	77715	77726	77739	77773	77794	77835
25	77716	77727	77740	77774	77795	77836
30	77717	77728	77741	77775	77796	77837
35		77729	77742	77776	77797	77838
40		77730	77743	77777	77798	77839
45		77731	77744	77778	77799	77840
50		77732	77745	77779	77800	77841
55			77746	77780	77801	77842
60			77747	77781	77802	77843
65			77748	77782	77803	77844
70			77749	77783	77804	77845
75			77750	77784	77805	77846
80			77751	77785	77806	77847
90			77753	77787	77808	77849
100			77755	77788	77809	77850
110			77756	77789	77810	77851

## Carriage Bolts



*79xxx for Stainless Steel  
Carriage Bolts or for  
Polished add SP-79xxx*

	10mm/ 1.50
25	79795
50	79800
60	79802

**Key: Read Across For Diameter  
Read Down For Length**

*Call if you do not see  
the sizes you need !*



## Washers Stainless Steel

### Flat Washers

Size	Part #
4mm	75985
5mm	75986
6mm	75987
8mm	75989
10mm	75990
12mm	75991
14mm	75992
16mm	75993



### Lock Washers

Size	Part #
4mm	76985
5mm	76986
6mm	76987
8mm	76989
10mm	76990
12mm	76991
14mm	76992
16mm	76993



### Wave Washers

Size	Part #
5mm	76986W
6mm	76987W
8mm	76989W
10mm	76990W



## Chart #1: Select Styles

**Example:** To order a 6 x 10 Oval Phillips Machine Screw: Use **Chart #1** for head style part number which would be "89". Look up diameter and length from **Chart #2** for last three digits 6 x 10 is 735. Put the two together for a part number of **89735**, or simply order by style and size. **Include the Prefix SP-89735 for Stainless Steel Polished**



Cheesehead

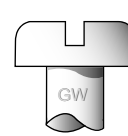

Pan



Oval

## Nuts Stainless Steel

### Hex Nuts

Size	Part #
4mm x .70	70950
5mm x .80	70952
6mm x 1.0	70954
7mm x 1.0	70956
8mm x 1.25	70958
10mm x 1.0	70959
10mm x 1.25	70961
10mm x 1.50	70962
12mm x 1.50	70965
12mm x 1.75	70966



### Jam Nuts

Size	Part #
8mm x 1.25	67958
10mm x 1.50	67962
12mm x 1.75	67966

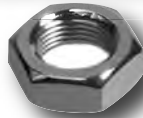

*For Stainless Steel Polished order with the Prefix than five digit Part # SP-xxxxx*

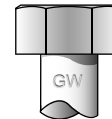

Hex



Flat

## Chart #1: Select Styles

Style	Slotted	Phillips
Round Head	99	N/A
Flat Head	98	94
Truss Head	93	N/A
Oval Head	97	89
Pan Head	96	92
Cheesehead	78	N/A
Hex	77	N/A

## Nylon Inserts

Size	Part #
4mm x .70	69950
5mm x .80	69952
6mm x 1.0	69954
8mm x 1.25	69958
10mm x 1.50	69962
12mm x 1.75	69966



All Items shown on this page can be purchased individually

## Chart #2: Metric Machine Screws

	m3	m4	m5	m6	m8
8mm	701	710	721	734	770
10mm	702	711	722	735	771
12mm	703	712	723	736	772
16mm	705	714	725	738	773
29mm	706	715	726	739	774
25mm	707	716	727	740	775
30mm	708	717	728	741	776
35mm				742	777



## Hex Cap Screws Zinc Plated

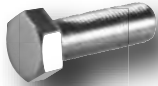

07xxx for Zinc  
Hex Caps

	4mm/ 0.7	5mm/ 0.8	6mm/ 1.0	7mm/ 1.0	8mm/ 1.25	10mm/ 1.50	10mm/ 1.25	12mm/ 1.75	12mm/ 1.50
10	07711	07722	07735	07760	07770				
16	07714	07725	07738	07762	07772	07793			
20	07715	07726	07739	07763	07773	07794	07816	07835	07856
25	07716	07727	07740	07764	07774	07795	07817	07836	07857
30	07717	07728	07741	07765	07775	07796	07818	07837	07858
35		07729	07742	07766	07776	07797	07819	07838	07859
40		07730	07743	07767	07777	07798	07820	07839	07860
45		07731	07744		07778	07799	07821	07840	07861
50		07732	07745	07769	07779	07800	07822	07841	07862
55			07746		07780	07801	07823	07842	07863
60			07747		07781	07802	07824	07843	07864
65			07748		07782	07803	07825	07844	07865
70			07749		07783	07804	07826	07845	07866
75			07750		07784	07805		07846	07867
80			07751		07785	07806	07828	07847	07868
90			07753		07787	07808	07830	07849	07870
100			07755		07788	07809	07831	07850	07871
110			07756		07789	07810		07851	07872
120			07757		07790	07811	07833	07852	

## Allen Screws Zinc Plated



For Metric Zinc Allen  
with Knurls use 08xxx

Key: Read Across For Diameter  
Read Down For Length

Call if you do not see  
the sizes you need !

	4mm/ 0.7	5mm/ 0.8	6mm/ 1.0	8mm/ 1.25	8mm/ 1.0	10mm/ 1.50	10mm/ 1.25	12mm/ 1.75
8		08721	08734					
10	08711	08722	08735	08770				
12	08712	08723	08736	08771				
16	08714	08725	08738	08772				
20	08715	08726	08739	08773		08794		
25	08716	08727	08740	08774	08774F	08795		08836
27			08740A					
30	08717	08728	08741	08775	08776F	08796	08818	08837
35	08718	08729	08742	08776		08797	08819	08838
40	08719	08730	08743	08777	08778F	08798		08839
45	08720	08731	08744	08778		08799	08821	08840
50	08720A	08732	08745	08779		08800	08822	08841
55			08746	08780		08801		08842
60			08747	08781		08802	08824	08843
65			08748	08782		08803	08825	08844
70			08749	08783		08804		08845
75			08750	08784		08805		08846
80				08785		08806		08847
85							08829	
90						08808	08830	08849
95								
100						08809	08831	
110								
115								
120						08811		



# Bulk Zinc Fasteners Metric

## Washers Zinc Plated

### Flat Washers

Size	Part #
4mm	04985
5mm	04986
6mm	04987
8mm	04989
10mm	04990
12mm	04991
14mm	04992
16mm	04993



### Lock Washers

Size	Part #
4mm	05985
5mm	05986
6mm	05987
8mm	05989
10mm	05990
12mm	05991
14mm	05992
16mm	05993



All Items shown on this page can be purchased individually

**Zinc Metric Assortments are Available see Pg. 78**

## Nuts Zinc Plated

### Hex Nuts

Size	Part #
4mm x .70	06950
5mm x .80	06952
6mm x 1.0	06954
7mm x 1.0	06956
8mm x 1.0	06957
8mm x 1.25	06958
10mm x 1.25	06961
10mm x 1.50	06962
12mm x 1.25	06963
12mm x 1.50	06965
12mm x 1.75	06966
14mm x 1.50	06967
14mm x 2.00	06968
16mm x 1.50	06969
16mm x 2.00	06970

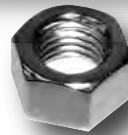

### Nylon Insert Lock Nuts

Size	Part #
4mm x .70	03950
5mm x .80	03952
6mm x 1.0	03954
7mm x 1.0	03956
8mm x 1.0	03957
8mm x 1.25	03958
10mm x 1.25	03961
10mm x 1.50	03962
12mm x 1.25	03963
12mm x 1.50	03965
12mm x 1.75	03966
14mm x 1.50	03967
14mm x 2.00	03968
16mm x 1.50	03969
16mm x 2.00	03970





## Inside This Section

### Electrical

Clamps.....	108
Clutch Removal Washers.....	108
Heat Shrink Tubing.....	108
Electrical Wire.....	108
Wire Assortments.....	108
Nutserts.....	109

**Electrical  
and  
Nutserts**





## Clamps and Ties

### Hose Clamps in Stainless Steel

Entire clamp is Stainless Steel including the screw. This product is manufactured in Sweden with rolled up band edges and smooth inside surface of the clamp this spares the hose and insures a high and uniform tightening force. With the flexible screwdriver you can tighten and slacken the clamp from an angle of 90° without slipping.

Size	Min. Dia.	Max. Dia.	Part #
3	5/16	5/8	67014
4	7/16	3/4	67017
6	1/2	7/8	67020
8	5/8	1 1/16	67024
10	3/4	1 3/16	67028
12	7/8	1 7/16	67032
1	1 1/16	1 5/8	67038
20	1 1/4	1 7/8	67044
24	1 1/2	2 1/16	67050
28	1 3/4	2 3/8	67056
32	2	2 11/16	67065
36	2 5/16	3 1/8	67075
44	2 11/16	3 1/2	67085
48	3	3 7/8	67095



### Line Clamps in Stainless Steel

\*14 x 3/4 Drill Point Sheet Metal Screw, Stainless Steel

Size	Part #
*14 x 3/4	67002
3/16	67003
1/4	67004
5/16	67005
3/8	67006



### Clutch Removal Washers

Clutch Removal Washers for Big Twins thru 1984 zinc plated sold each.

Description	Part #
Clutch Removal Washer	23593

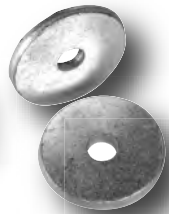

## Tubing

### Fabric Loom

Woven cotton loom with black bituminous coating, sold by the foot.

Inside Diameter	Part #
3/16	62701
1/4	62702
5/16	62703
3/8	62704
7/16	62705
1/2	62706

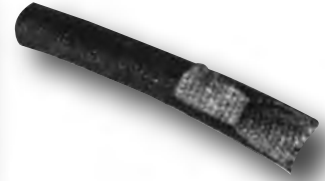

### Heat Shrink Tubing Black

Sold by the foot

Inside Diameter	Part #
3/16	62004
1/4	62005
3/8	62007
1/2	62010

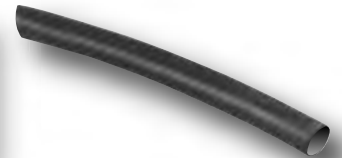

## Electrical Wire

Offering all 12 Harley solid colors with copper stranded thermal plastic insulated wire. Highly resistant to grease, oil and acids. Individual wire in 100 foot spools.

Color	18 Gauge #	16 Gauge #	14 Gauge #
Black	6218	6216	6214
Red	----	6216	6214
Brown	6218	6216	6214
Blue	6218	6216	6214
Grey	6218	6216	----
Green	6218	6216	----
Orange	6218	6216	----
Pink	6218	6216	----
Purple	6218	6216	----
Tan	6218	6216	----
White	6218	6216	----
Yellow	6218	6216	6214



## Electrical Wire Assortments

### Assortment # 62-W

Includes 8 different colors and metal spool rack: 14 gauge black, 16 gauge red and white, 18 gauge blue, green, orange, yellow and tan.

### Assortment # 63-W

Includes all 12 Harley colors and metal spool rack.





## Nutserts

The Benefits of Using **AT SERIES NUTSERTS**®.

- **NON-GRIP** sensitive one length fits "ANY" thickness over .030
- **BLIND** installs from one side of the work.
- **WILL NOT TORQUE LOOSE** properly install and properly used at **SERIES NUTSERTS** will normally break high strength before torquing loose.

**STRONG, PERMANENT STEEL THREADS IN BLIND, BURIED & THROUGH HOLES.**



- Use in almost any material Steel, Aluminum, Fiberglass, Cast Iron, Magnesium and Plastics.
- Vibration proof.
- Nearly flush only .015 protrusion. Installation will not mar the parent material.

**Electrical and Nutserts**

## EASILY INSTALLED INTO APPLICATIONS

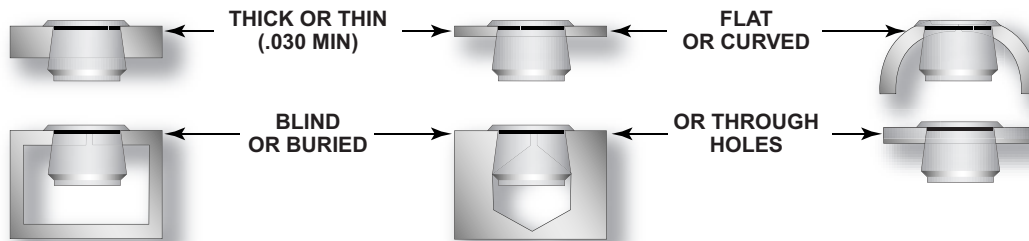

## HERE'S HOW THE AT SERIES NUTSERT® WORKS

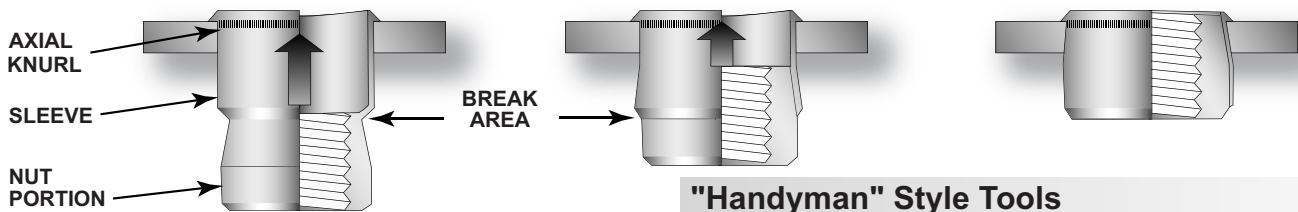

**AT Series Nutserts**® are of a one piece design consisting of a nut portion and a sleeve portion. The **AT Series Nutsert**® is threaded onto the placing tool's mandrel and inserted into a drilled hole.

The rotating tool mandrel exerts a pulling action which "breaks" the nut portion from the sleeve, drawing it into the sleeve...notice the sleeve beginning to expand. The nut portion fully expands the sleeve, which exerts a full 360° swag fit against the side of the hole. You now have a permanent load bearing steel captive nut ready for trouble free use.

## Handyman Style Assortment with Tools

American Part #N312D		Metric Part #N312F	
Quantity	Size	Quantity	Size
15 pcs.	10/32	15 pcs.	5mm
15 pcs.	1/4-20	15 pcs.	6mm
8 pcs.	5/16-18	8 pcs.	8mm
8 pcs.	3/8-16	8 pcs.	10mm



## "Handyman" Style Tools

For the one time or occasional user, the **Hi-Torquer**® Handyman style tool offers an inexpensive alternative to the professional style tool system. For proper **AT Series Nutsert**® installation, the Handyman tool requires the use of a wrench or vise grips to hold the body and a socket wrench to torque the placing screw.

Size	Part #	Size	Part #
4/40	N9536	3/8-16	N9550
6/32	N9538	3/8-24	N9551
8/32	N9540	3mm	N9949
10/24	N9542	4mm	N9950
10/32	N9543	5mm	N9952
1/4-20	N9546	6mm	N9954
1/4-28	N9547	8mm	N9958
5/16-18	N9548	10mm	N9962
5/16-24	N9549		

For Sizes # 4,6,8 & 10-24  
Socket Head Screw  
& Hex Wrench

For Sizes # 10-32, 1/4",  
5/16" & 3/8"  
Hex Head Screw

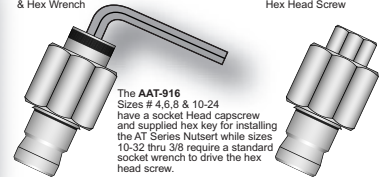

The **AAAT-916** Sizes # 4,6,8 & 10-24 have a socket Head capscrew and supplied hex key for installing the AT Series Nutsert while sizes 10-32 thru 3/8 require a standard socket wrench to drive the hex head screw.

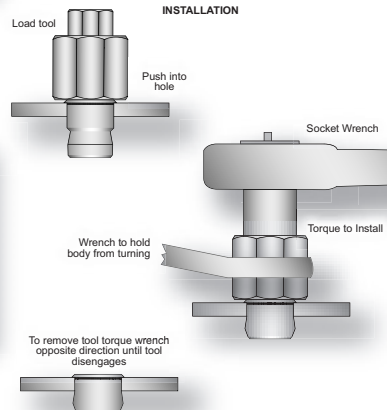



















## Nutserts

Size	Part #	Size	Part #
4/40	N4536	3/8-16	N4550
6/32	N4538	3/8-24	N4551
8/32	N4540	3mm x .5	N4949
10/24	N4542	4mm x .7	N4950
10/32	N4543	5mm x .8	N4952
1/4-20	N4546	6mm x 1.0	N4954
1/4-28	N4547	8mm x 1.25	N4958
5/16-18	N4548	10mm x 1.5	N4962
5/16-24	N4549		

# What better way to make a statement!

Gardner-Westcott Company is now offering a new and different look for engine dress up bolts, the emblem is stamped directly onto the head of the bolts. They are available in decorative Polished Chrome Plated or Stainless Steel versions, in all the sizes needed to give your project that special look.

 <b>Official Licensed Product</b>	<b>Chrome Plated Polished Stainless Steel</b>	 <b>Official Licensed Product</b>	<b>Custom Stampings Available</b>	 <b>Official Licensed Product</b>
<b>Ford Oval Stamped Hex Caps</b> 	<b>Bow Tie Stamped Hex Caps</b> 	<b>Pontiac Stamped Hex Caps</b> 	<b>Mopar Stamped Hex Caps</b> 	
<b>V8 Stamped Hex Caps</b> 	<b>SS Stamped Hex Caps</b> 	<b>GTO Stamped Hex Caps</b> 	<b>Chrysler Stamped Hex Caps</b> 	
<b>Mustang Stamped Hex Caps</b> 	<b>RS Stamped Hex Caps</b> 	<b>GT Stamped Hex Caps</b> 	<b>Dodge Ram Stamped Hex Caps</b> 	
<b>Flames Stamped Hex Caps</b> 	<b>350 Stamped Hex Caps</b> 	<b>454 Stamped Hex Caps</b> 	<b>Skulls Stamped Hex Caps</b> 	



## Inside This Section

### Fittings

<i>Pipe Fittings</i> .....	112
<i>Inverted Flare Fittings</i> .....	113
<i>Compression Fittings</i> .....	114
<i>Special Fittings</i> .....	115
<i>Vacuum Connectors</i> .....	116
<i>Standard Thread Identification</i> .....	117
<i>Specifications and Sizes</i> .....	118
<i>Conversion &amp; Reference Charts</i> .....	119
<i>Style Chart</i> .....	120

**Chrome and Brass  
Fittings**

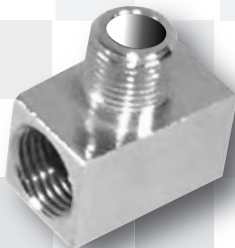



# Chrome and Brass Fittings

## Pipe Fittings

### Straight Hose Barb Male Pipe

Hose Size	Pipe Size	Brass Part #	Chrome Part #
3/8	1/8	90TD-6 x 2	7-90TD-6 x 2
1/4	1/8	90TD-4 x 2	7-90TD-4 x 2
3/8	1/4	90TD-6 x 4	7-90TD-6 x 4
1/2	1/4	90HB-8 x 4	7-90TD-8 x 4



### Straight Hose Barb Male Pipe

Hose Size	Pipe Size	Brass Part #	Chrome Part #
3/16	1/8	90HB-3 x 2	7-90HB-3 x 2
1/4	1/8	90HB-4 x 2	7-90HB-4 x 2
1/4	1/4	90HB-4 x 4	7-90HB-4 x 4
5/16	1/8	90HB-5 x 2	7-90HB-5 x 2
5/16	1/4	90HB-5 x 4	7-90HB-5 x 4
3/8	1/8	90HB-6 x 2	7-90HB-6 x 2
3/8	1/4	90HB-6 x 4	7-90HB-6 x 4



### 90° Hose Barb Male Pipe

Hose Size	Pipe Size	Brass Part #	Chrome Part #
1/4	1/8	91HB-4 x 2	7-91HB-4 x 2
1/4	1/4	91HB-4 x 4	7-91HB-4 x 4
5/16	1/8	91HB-5 x 2	7-91HB-5 x 2
5/16	1/4	91HB-5 x 4	7-91HB-5 x 4
3/8	1/8	91HB-6 x 2	7-91HB-6 x 2
3/8	1/4	91HB-6 x 4	7-91HB-6 x 4
3/8	3/8	91HB-6 x 6	7-91HB-6 x 6



### Street Elbows

Pipe Size	Brass Part #	Chrome Part #
1/8	116PSE-2	7-116PSE-2
1/4	116PSE-4	7-116PSE-4
3/8	116PSE-6	7-116PSE-6



### Street Elbows 45°

Pipe Size	Brass Part #	Chrome Part #
1/8	124PSE-2	7-124PSE-2
1/4	124PSE-4	7-124PSE-4
3/8	124PSE-6	7-124PSE-6



### Socket Pipe Plug

Pipe Size	Brass Part #	Chrome Part #
1/8	107CSP-2	7-107CSP-2
1/4	107CSP-4	7-107CSP-4
3/8	107CSP-6	7-107CSP-6

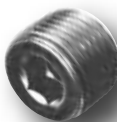

### Slotted Pipe Plug

Pipe Size	Brass Part #	Chrome Part #
1/8	117SPP-2	7-117SPP-2
1/4	117SPP-4	7-117SPP-4
3/8	117SPP-6	7-117SPP-6



### Hex Head Pipe Plug

Pipe Size	Brass Part #	Chrome Part #
1/8	121PP-2	7-121PP-2
1/4	121PP-4	7-121PP-4
3/8	121PP-6	7-121PP-6
1/2	121PP-8	7-121PP-8

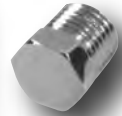

### Square Head Pipe Plug

Pipe Size	Brass Part #	Chrome Part #
1/8	109PP-2	7-109PP-2
1/4	109PP-4	7-109PP-4
3/8	109PP-6	7-109PP-6
1/2	109PP-8	7-109PP-8

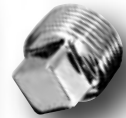

### Close Nipple

Pipe Size	Brass Part #	Chrome Part #
1/8	112PCN-2	7-112PCN-2
1/4	112PCN-4	7-112PCN-4
3/8	112PCN-6	7-112PCN-6



### Long Nipple

Pipe Size	Brass Part #	Chrome Part #
1/8 x 1 1/2	113PLN-2 x 1.5	7-113PLN-2 x 1.5
1/8 x 2	113PLN-2 x 2	7-113PLN-2 x 2
1/8 x 2 1/2	113PLN-2 x 2.5	7-113PLN-2 x 2.5
1/8 x 3	113PLN-2 x 3	7-113PLN-2 x 3
1/4 x 1 1/2	113PLN-4 x 1.5	7-113PLN-4 x 1.5
1/4 x 2	113PLN-4 x 2	7-113PLN-4 x 2
1/4 x 2 1/2	113PLN-4 x 2.5	7-113PLN-4 x 2.5
1/4 x 3	113PLN-4 x 3	7-113PLN-4 x 3
3/8 x 1 1/2	113PLN-6 x 1.5	7-113PLN-6 x 1.5
3/8 x 2	113PLN-6 x 2	7-113PLN-6 x 2



### Hex Nipple

Pipe Size	Brass Part #	Chrome Part #
1/8	122PHN-2	7-122PHN-2
1/4	122PHN-4	7-122PHN-4
3/8	122PHN-6	7-122PHN-6





## Hex Reducing Nipple

Pipe Size	Brass Part #	Chrome Part #
1/4 x 1/8	123PRN-4 x 2	7-123PRN-4 x 2
3/8 x 1/4	123PRN-6 x 4	7-123PRN-6 x 4



## Adapter

Pipe Size	Brass Part #	Chrome Part #
1/8 x 1/8	120PA-2 x 2	7-120PA-2 x 2
1/4 x 1/8	120PA-4 x 2	7-120PA-4 x 2
1/4 x 1/4	120PA-4 x 4	7-120PA-4 x 4
3/8 x 1/4	120PA-6 x 4	7-120PA-6 x 4



## Pipe Bushing

Pipe Size	Brass Part #	Chrome Part #
1/4 x 1/8	110PB-4 x 2	7-110PB-4 x 2
3/8 x 1/8	110PB-6 x 2	7-110PB-6 x 2
3/8 x 1/4	110PB-6 x 4	7-110PB-6 x 4
1/2 x 1/4	110PB-8 x 4	7-110PB-8 x 4
1/2 x 3/8	110PB-8 x 6	7-110PB-8 x 6



## Pipe Thread Lock Nut

Pipe Size	Brass Part #	Chrome Part #
1/8	111PLN-2	7-111PLN-2
1/4	111PLN-4	7-111PLN-4
3/8	111PLN-6	7-111PLN-6



## Pipe Tee

Pipe Size	Brass Part #	Chrome Part #
1/8	101PT-2	7-101PT-2
1/4	101PT-4	7-101PT-4
3/8	101PT-6	7-101PT-6



## Pipe Street Tee

Pipe Size	Brass Part #	Chrome Part #
1/8	127PT-2	7-127PT-2
1/4	127PT-4	7-127PT-4
3/8	127PT-6	7-127PT-6



## 90° Heater Hose Barb

Hose Size	Pipe Size	Brass Part #	Chrome Part #
5/8	3/8	69HHB-10 x 6	7-69HHB-10 x 6
5/8	1/2	69HHB-10 x 8	7-69HHB-10 x 8
3/4	1/2	69HHB-12 x 8	7-69HHB-12 x 8
3/8	3/8	69HHB-6 x 6	7-69HHB-6 x 6
1/2	3/8	69HHB-8 x 6	7-69HHB-8 x 6



## Inverted Flare Fittings

### Brass Inverted Flare Tube Nut

O.D. Tube	Brass Part #	Chrome Part #
3/16	41INB-3	7-41INB-3
1/4	41INB-4	7-41INB-4
5/16	41INB-5	7-41INB-5
3/8	41INB-6	7-41INB-6



Fittings

### Steel Inverted Flare Long Tube Nut

O.D. Tube	Brass Part #	Chrome Part #
3/16	41INL-3	7-41INL-3
1/4	41INL-4	7-41INL-4



### Inverted Flare Male Connectors

O.D. Tube	O.D. Pipe	Brass Part #	Chrome Part #
3/16	1/8	48IC-3 x 2	7-48IC-3 x 2
1/4	1/8	48IC-4 x 2	7-48IC-4 x 2
5/16	1/8	48IC-5 x 2	7-48IC-5 x 2
5/16	1/4	48IC-5 x 4	7-48IC-5 x 4
3/8	1/8	48IC-6 x 2	7-48IC-6 x 2
3/8	1/4	48IC-6 x 4	7-48IC-6 x 4



### Inverted Flare Male Elbow

O.D. Tube	O.D. Pipe	Brass Part #	Chrome Part #
3/16	1/8	49IE-3 x 2	7-49IE-3 x 2
1/4	1/8	49IE-4 x 2	7-49IE-4 x 2
5/16	1/8	49IE-5 x 2	7-49IE-5 x 2
5/16	1/4	49IE-5 x 4	7-49IE-5 x 4
3/8	1/8	49IE-6 x 2	7-49IE-6 x 2
3/8	1/4	49IE-6 x 4	7-49IE-6 x 4



### Inverted Male Rigid Hose Barb

Hose Size	O.D. Tube	Brass Part #	Chrome Part #
1/4	1/4	93HB-4 x 4	7-93HB-4 x 4
1/4	5/16	93HB-4 x 5	7-93HB-4 x 5
5/16	1/4	93HB-5 x 4	7-93HB-5 x 4
5/16	5/16	93HB-5 x 5	7-93HB-5 x 5
5/16	3/8	93HB-5 x 6	7-93HB-5 x 6
3/8	5/16	93HB-6 x 5	7-93HB-6 x 5



### Inverted Flare Reducing Nut

O.D. Tube	Inv. Nut	Brass Part #	Chrome Part #
3/16	1/4	41INR-3 x 4	7-41INR-3 x 4
3/16	5/16	41INR-3 x 5	7-41INR-3 x 5
3/16	9/16	41INR-3 x (918)	7-41INR-3 x (918)
1/4	9/16	41INR-4 x (918)	7-41INR-4 x (918)





# Chrome and Brass Fittings

## Inverted Flare Steel Plug

O.D. Tube	Brass Part #	Chrome Part #
3/16	W131-3	7-W131-3
1/4	W131-4	7-W131-4
5/16	W131-5	7-W131-5
3/8	W131-6	7-W131-6



## Inverted Flare Union Tee

O.D. Tube	Brass Part #	Chrome Part #
3/16	W702-3	7-W702-3
1/4	W702-4	7-W702-4
5/16	W702-5	7-W702-5

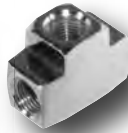

## Inverted Flare Brake Line Union

O.D. Tube	Brass Part #	Chrome Part #
3/16	42IU-3	7-42IU-3
1/4	42IU-4	7-42IU-4
5/16	42IU-5	7-42IU-5
3/8	42IU-6	7-42IU-6



## Brake Line Tee Mount Inverted Flare

O.D. Tube	Brass Part #	Chrome Part #
3/16	W7812	7-W7812
1/4	W7765	7-W7765



## Metric Brake Line Adapter

Inverted Female x Male Thread	Brass Part #	Chrome Part #
3/16 std 10mm x 1.0	202M-10	7-202M-10
10mm x 1.0 x 11mm x 1.5	202M-11	7-202M-11
10mm x 1.0 x 12mm x 1.0	202M-12	7-202M-12
10mm x 1.0 x 13mm x 1.5	202M-13	7-202M-13

Inverted Female x Male Bubble Flare	Brass Part #	Chrome Part #
3/16 std x 3/16 std	200B-3	7-200B-3
3/16 std 10mm x 1.0	200MB-3	7-200MB-3



## Inverted Flare Male Branch Tee

Size	Brass Part #	Chrome Part #
3/16	W600-3 x 2	7-W600-3 x 2
1/4	W600-4 x 2	7-W600-4 x 2
5/16	W600-5 x 2	7-W600-5 x 2
3/8	W600-6 x 4	7-W600-6 x 4



## Compression Fittings Brass

### Compression Sleeve

O.D. Tube	Part #
1/8	6460CS-2
3/16	6460CS-3
1/4	6460CS-4
5/16	6460CS-5
3/8	6460CS-6



### Compression Nut

O.D. Tube	Brass Part #	Chrome Part #
1/8	61CN-2	7-61CN-2
3/16	61CN-3	7-61CN-3
1/4	61CN-4	7-61CN-4
5/16	61CN-5	7-61CN-5
3/8	61CN-6	7-61CN-6



### Compression Tube Inserts

O.D. Tube	Part #
1/8	60TI-2
3/16	60TI-3
1/4	60TI-4
5/16	60TI-5
3/8	60TI-6



### Compression Full Union

O.D. Tube	Brass Part #	Chrome Part #
1/8	62CU-2	7-62CU-2
3/16	62CU-3	7-62CU-3
1/4	62CU-4	7-62CU-4
5/16	62CU-5	7-62CU-5
3/8	62CU-6	7-62CU-6



### Compression 3 Way Tee

O.D. Tube	Brass Part #	Chrome Part #
1/8	64CT-2	7-64CT-2
3/16	64CT-3	7-64CT-3
1/4	64CT-4	7-64CT-4
5/16	64CT-5	7-64CT-5
3/8	64CT-6	7-64CT-6





Fittings

## Compression Male Connector

O.D. Tube	Brass Part #	Chrome Part #
1/8 x 1/8	68CC-2 x 2	7-68CC-2 x 2
3/16 x 1/8	68CC-3 x 2	7-68CC-3 x 2
1/4 x 1/8	68CC-4 x 2	7-68CC-4 x 2
1/4 x 1/4	68CC-4 x 4	7-68CC-4 x 4
5/16 x 1/8	68CC-5 x 2	7-68CC-5 x 2
5/16 x 1/4	68CC-5 x 4	7-68CC-5 x 4
3/8 x 1/8	68CC-6 x 2	7-68CC-6 x 2
3/8 x 1/4	68CC-6 x 4	7-68CC-6 x 4
3/8 x 3/8	68CC-6 x 6	7-68CC-6 x 6
1/2 x 1/4	68CC-8 x 4	7-68CC-8 x 4



## Hose Tee

Hose	Brass Part #	Chrome Part #
1/4	94HBT-4	7-94HBT-4
5/16	94HBT-5	7-94HBT-5
3/8	94HBT-6	7-94HBT-6



## Compression Male Elbow

O.D. Tube	Brass Part #	Chrome Part #
1/8 x 1/8	69CE-2 x 2	7-69CE-2 x 2
3/16 x 1/8	69CE-3 x 2	7-69CE-3 x 2
1/4 x 1/8	69CE-4 x 2	7-69CE-4 x 2
1/4 x 1/4	69CE-4 x 4	7-69CE-4 x 4
5/16 x 1/8	69CE-5 x 2	7-69CE-5 x 2
5/16 x 1/4	69CE-5 x 4	7-69CE-5 x 4
3/8 x 1/8	69CE-6 x 2	7-69CE-6 x 2
3/8 x 1/4	69CE-6 x 4	7-69CE-6 x 4
3/8 x 3/8	69CE-6 x 6	7-69CE-6 x 6

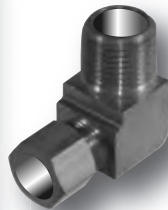

## Transmission Adapter

Inv. Flare Str. Pipe	Brass Part #	Chrome Part #
5/16 x 1/8	22CF-5 x 2	7-22CF-5 x 2



## Special Fittings

### Dual Brake Reducing Adapter

Hose/Hose	Brass Part #	Chrome Part #
3/16 x 1/4	203-3 x 4	7-203-3 x 4
3/16 x 5/16	203-3 x 5	7-203-3 x 5
1/4 x 3/16	203-4 x 3	7-203-4 x 3
1/4 x 5/16	203-4 x 5	7-203-4 x 5
5/16 x 1/4	203-5 x 4	7-203-5 x 4
5/16 x 3/8	203-5 x 6	7-203-5 x 6
3/8 x 5/16	203-6 x 5	7-203-6 x 5
1/4 x 1/4 (9/16-18)	203-7908	7-203-7908
3/16 x 3/16 (9/16-20)	203-7910	7-203-7910
3/16 x 3/16 (9/16-18)	203-7911	7-203-7911
3/16 (9/16-18) x 5/16	203-7912	7-203-7912
3/16 (1/2-20) x 3/16 (9/16-18)	203-7913	7-203-7913
5/16 x 5/16 w/seal	203F-1074	7-203F-1074
1/4 x 5/16 w/seal	203F-7727	7-203F-7727
1/4 x 7/16-20 w/seal	203F-7732	7-203F-7732
3/16 x 5/16 w/seal	203F-7817	7-203F-7817

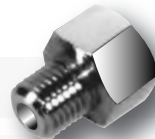

## Metric Brake Union

Thread/Flare	Brass Part #	Chrome Part #
3/16 Std/Bubble 3	300B-3	7-300B-3
10mm x 1.0 Standard	300M-3	7-300M-3
10mm x 1.0 Bubble 2	300MB-3	7-300MB-3



## Hose Splicer

Hose/Hose	Brass Part #	Chrome Part #
3/16 x 3/16	92HB-3 x 3	7-92HB-3 x 3
1/4 x 1/4	92HB-4 x 4	7-92HB-4 x 4
5/16 x 5/16	92HB-5 x 5	7-92HB-5 x 5
3/8 x 3/8	92HB-6 x 6	7-92HB-6 x 6







# Chrome and Brass Fittings

## Drain Cocks

Size	Brass #	Chrome #
1/4	326DC-4	7-326DC-4



## Brake Bleeder Screws Chrome

Size	Part #
3/8-24 x 1 1/2	45-9400
3/8-24 x 1 1/8	45-9402
5/16-24 x 1	45-9403
1/4-28 x 1	45-9404
8mm x 1.25 x 23.8	45-9405
10mm x 1.5 x 27.5	45-9406



## Grease Fittings

Size	Part #
1/4-28 45° (Chrome)	57546
1/4-28 Straight	57547
1/4-28 Straight-Long	57547-L
1/4-28 90°	57548
1/8 45°	57549
1/8 Straight	57550
1/8 90°	57551
1/4-28 90° (Stainless)	88546
1/4-28 Straight	88547
1/8 Straight	88610
1/8 90°	88613
1/8 45°	88688



## Vacuum Connectors

### Vacuum Hose Splicer Plastic

Hose/Hose	Part #
1/8 x 1/8	62NU-2
3/16 x 3/16	62NU-3
1/4 x 1/4	62NU-4
5/16 x 5/16	62NU-5
3/8 x 3/8	62NU-6
3/16 x 1/8	62NUR-3 x 2
3/16 x 1/4	62NUR-3 x 4
1/4 x 1/8	62NUR-4 x 2
1/4 x 3/8	62NUR-4 x 6



### Vacuum Hose Elbow Plastic

Hose/Hose	Part #
3/16 x 3/16	64NE-3
3/16 x 1/8	64NE-3 x 2
3/16 x 1/4	64NE-3 x 4
1/4 x 1/4	64NE-4



### Vacuum Hose Tee Plastic

Hose/Hose	Part #
1/8	64NT-2
3/32	64NT-2.5
1/8 x 3/16 x 1/8	64NT-2 x 3 x 2
3/16	64NT-3
3/16 x 1/8 x 3/16	64NT-3 x 2 x 3
3/16 x 3/16 x 1/8	64NT-3 x 3 x 2
3/16 x 1/4 x 3/16	64NT-3 x 4 x 3
1/4	64NT-4
1/4 x 1/4 x 3/16	64NT-4 x 4 x 3
5/16	64NT-5
3/8	64NT-6
3/8 x 3/8 x 1/4	64NT-6 x 6 x 4



## Steel Brake Line Coil

Size	Part #
3/16	64542
1/4	64546
5/16	64548
3/8	64550



## Vacuum Rubber Caps

I.D.Hose	Part #
1/8	64CAP-2
5/32	64CAP-2.5
3/16	64CAP-3
1/4	64CAP-4
5/16	64CAP-5
3/8	64CAP-6









## American Thread

Size	Decimal Equivalent	Threads Per Inch		Allen Screw		Button Heads		Flat Heads	
		Coarse & Fine		Key Size	Maximum Head O.D.	Key Size	Maximum Head O.D.	Key Size	Maximum Head O.D.
#4	.112	40	40	0/02	.100	1/16	.212	1/16	.255
#5	.125	40	44	3/32	.205	5/64	.238	5/64	.281
#6	.138	32	40	7/64	.226	5/64	.262	5/64	.307
#8	.164	32	36	9/64	.270	3/32	.312	3/32	.359
#10 (3/16)	.190	24	32	5/32	.312	1/8	.361	1/8	.411
1/4	.250	20	28	3/16	.375	5/32	.437	5/32	.531
5/16	.3125	18	24	1/4	.469	3/16	.547	3/16	.656
3/8	.375	16	24	5/16	.562	7/32	.656	7/32	.781
7/16	.4375	14	20	3/8	.656	---	---	1/4	.844
1/2	.500	13	20	3/8	.750	5/16	.875	5/16	.938
5/8	.625	11	18	1/2	.938	3/8	1.00	3/8	1.188
3/4	.750	10	16	5/8	1.125	---	---	---	---

## Metric Thread

Size	Threads Per Inch		Allen Screw		Button Heads		Flat Heads	
	Coarse & Fine		Key Size	Maximum Head O.D.	Key Size	Maximum Head O.D.	Key Size	Maximum Head O.D.
3mm	0.5	---	2.5mm	5.5mm	2mm	5.70mm	2mm	6.40mm
4mm	0.7	---	3mm	7.0mm	2.5mm	7.60mm	2.5mm	8.60mm
5mm	0.8	---	4mm	8.5mm	3mm	9.50mm	3mm	10.60mm
6mm	1.0	---	5mm	10.00mm	4mm	10.50mm	4mm	12.60mm
8mm	1.25	1.00	6mm	13.00mm	5mm	14.00mm	5mm	16.80mm
10mm	1.50	1.25	8mm	16.00mm	6mm	17.50mm	6mm	21.00mm
12mm	1.75	1.50	10mm	18.00mm	8mm	21.00mm	8mm	25.00mm

## Washer Specifications

Size	Flat Washers			AN Washers			GW Washers		
	O.D.	I.D.	Thickness	O.D.	I.D.	Thickness	O.D.	I.D.	Thickness
#6	3/8	5/32	3/64	---	---	---	---	---	---
#8	7/16	3/16	3/64	---	---	---	---	---	---
#10	1/2	7/32	3/64	.437	.203	1/32	---	---	---
#12	9/16	1/4	1/16	---	---	---	---	---	---
1/4	5/8	9/32	1/16	.500	.265	1/16	5/8	.260	.08
5/16	11/16	11/32	1/16	.562	.328	1/16	11/16	.323	.09
3/8	13/16	13/32	1/16	.625	.390	1/16	13/16	.385	.09
7/16	59/64	15/32	1/16	.750	.453	1/16	59/64	.448	.10
1/2	1-1/16	17/32	3/32	.875	.516	1/16	1-1/16	.510	.11
9/16	1-3/16	19/32	3/32	1.062	.578	1/16	---	---	---
5/8	1-5/16	21/32	3/32	1.187	.641	1/16	1-5/16	.635	.12
3/4	1-1/2	13/16	9/64	---	---	---	---	---	---

## Wrench Sizes (Width across flats) - Hex Bolts

American		Metric	
Wrench Size	Bolt Diameter	Wrench Size	Bolt Diameter
7/16	1/4	5.5mm	3mm
1/2	5/16	7mm	4mm
9/16	3/8	8mm	5mm
5/8	7/16	10mm	6mm
3/4	1/2	11mm	7mm
13/16	9/16	13mm	8mm
15/16	5/8	17mm	10mm
1 1/8	3/4	19mm	12mm

## Torx Size and Bit Sizes

Torx Size	Bit Size
6/32	T-10
8/32	T-15
10/24	T-25
10/32	T-25
1/4	T-27
5/16	T-40
3/8	T-45
1/2	T-55
5/8	T-60

## Tensile Strengths of Material Requirements

Material	LBS.
Stainless Steel	85,000
Grade 2	85,000
Grade 5	120,000
Grade 8	150,000

## Metric Flat Washer Specifications

Size	Flat Washers		
	O.D.	I.D.	Thickness
4mm	9	4.3	0.8
5mm	10	5.3	1
6mm	12	6.4	11.6
7mm	14	7.4	1.6
8mm	16	8.4	1.6
10mm	20	10.5	2
12mm	24	13	2.5
14mm	28	15	2.5
16mm	30	17	3
18mm	34	19	3



## American Equivalents

Fraction	Decimal	Millimeter
1/64	.0156	0.397
1/32	.0312	0.794
3/64	.0468	1.191
1/16	.0625	1.588
5/64	.0781	1.984
3/32	.0937	2.381
7/64	.1093	2.778
<b>1/8</b>	<b>.1250</b>	<b>3.175</b>
9/64	.1406	3.572
5/32	.1562	3.969
11/64	.1718	4.366
3/16	.1875	4.763
13/64	.2031	5.159
7/32	.2187	5.556
15/64	.2343	5.953
<b>1/4</b>	<b>.2500</b>	<b>6.350</b>
17/64	.2656	6.747
9/32	.2812	7.144
19/64	.2968	7.541
5/16	.3125	7.938
21/64	.3281	8.334
11/32	.34375	8.731
23/64	.3593	9.128
<b>3/8</b>	<b>.3750</b>	<b>9.525</b>
25/64	.3906	9.922
13/32	.4062	10.319
27/64	.4218	10.716
7/16	.4375	11.113
29/64	.4531	11.509
15/32	.4687	11.906
31/64	.4843	12.303
<b>1/2</b>	<b>.5000</b>	<b>12.700</b>
33/64	.5156	13.097
17/32	.5312	13.494
35/64	.5468	13.891
9/16	.5625	14.288
37/64	.5781	14.684
19/32	.5937	15.081
39/64	.6093	15.478
<b>5/8</b>	<b>.6250</b>	<b>15.875</b>
41/64	.6406	16.272
21/32	.6562	16.669
43/64	.6718	17.066
11/16	.6875	17.463
45/64	.7031	17.859
23/32	.7187	18.256
47/64	.7343	18.653
<b>3/4</b>	<b>.7500</b>	<b>19.050</b>
49/64	.7656	19.447
25/32	.7812	19.844
51/64	.7968	20.241
13/16	.8125	20.638
53/64	.8281	21.034
27/32	.8437	21.431
55/64	.8593	21.828
<b>7/8</b>	<b>.8750</b>	<b>22.225</b>
57/64	.8906	22.622
29/32	.9062	23.019
59/64	.9218	23.416
15/16	.9275	23.813
61/64	.9531	24.209
31/32	.9687	24.606
63/64	.9843	25.003
<b>1"</b>	<b>1.0000</b>	<b>25.400</b>

## Metric Conversion Chart

Inches	Millimeters
1/4	6mm
5/16	8mm
3/8	10mm
1/2	12mm
5/8	16mm
3/4	20mm
1	25mm
1-3/16	30mm
1-3/8	35mm
1-9/16	40mm
1-3/4	45mm
2	50mm
2-3/16	55mm
2-3/8	60mm
2-9/16	65mm
2-3/4	70mm
3	75mm
3-3/16	80mm
3-3/8	85mm
3-1/2	90mm
4	100mm
4-3/8	110mm
4-3/4	120mm

Technical  
Info

## Threads Per Inch American

Coarse	Fine
10/24	10/32
1/4-20	1/4-28
5/16-18	5/16-24
3/8-16	3/8-24
7/16-14	7/16-20
1/2-13	1/2-20
9/16-12	9/16-18
5/8-11	5/8-18
3/4-10	3/4-16

## Threads Pitches Metric

Diameter	Pitch
6mm	1.0
8mm	1.25
8mm Fine	1.0
10mm	1.50
10mm Fine	1.25
12mm	1.75
12mm Fine	1.50
14mm	2.0
14mm Fine	1.50



# Style Chart and Measuring

## Styles in Chrome

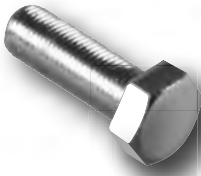

**H= Hex Caps**  
Chrome Plated

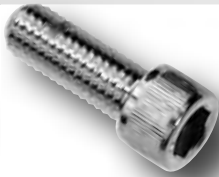

**S= Allen Screws**  
Chrome Plated



**B= Button Head**  
Chrome Plated



**N= 12 Point**  
Chrome Plated



**P= Allen Screws**  
Polished Chrome Plated

## Styles in Stainless Steel



**HS= Hex Bolts**  
Stainless Steel



**SS= Allen Screws**  
Stainless Steel



**SB= Button Head**  
Stainless Steel



**HSP= Hex Bolts**  
Stainless Steel  
Polished



**SSP= Allen Screws**  
Stainless Steel  
Polished

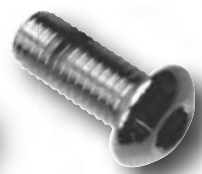

**SBP= Button Head**  
Stainless Steel  
Polished



Round



Flat



Truss



Oval



Pan



Fillister



Hex



Acorn Nut  
and Slotted Stud  
Kits



Sheet Metal  
Screw



Wood Screw



Machine Screw

## How to Measure

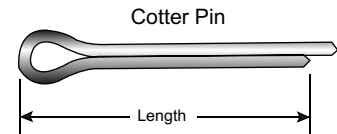
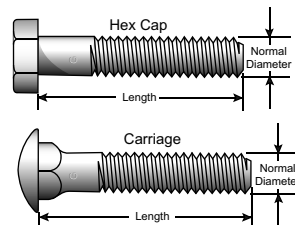
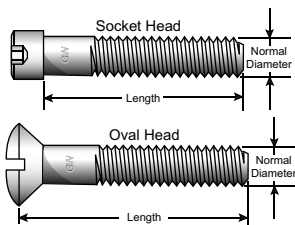
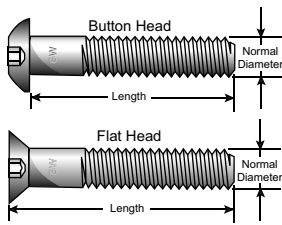

## Actual Shank Sizes

To Determine Sizes of Screws. Lay screw flat within parallel lines shown in border

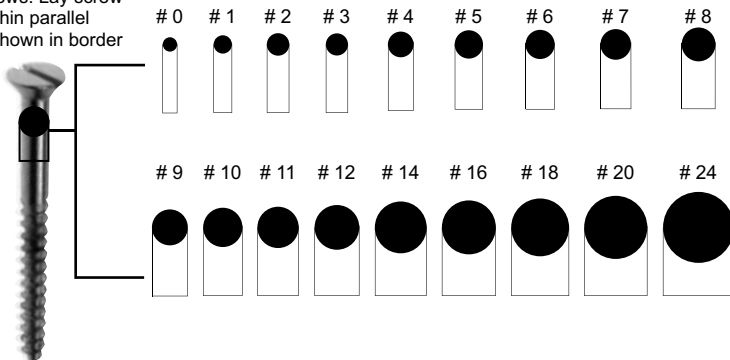

## Bolt Gage

Combined American and Metric gage to measure bolts, nuts and screws is an every day necessity to the dealer. These gages are available and can be ordered by **Part # gage**

