



Gardner-Westcott Company

Quality Chrome Plated and Stainless Steel Fasteners

MOTORCYCLE FASTENER CATALOG

AMERICAN, METRIC AND BRITISH THREADS

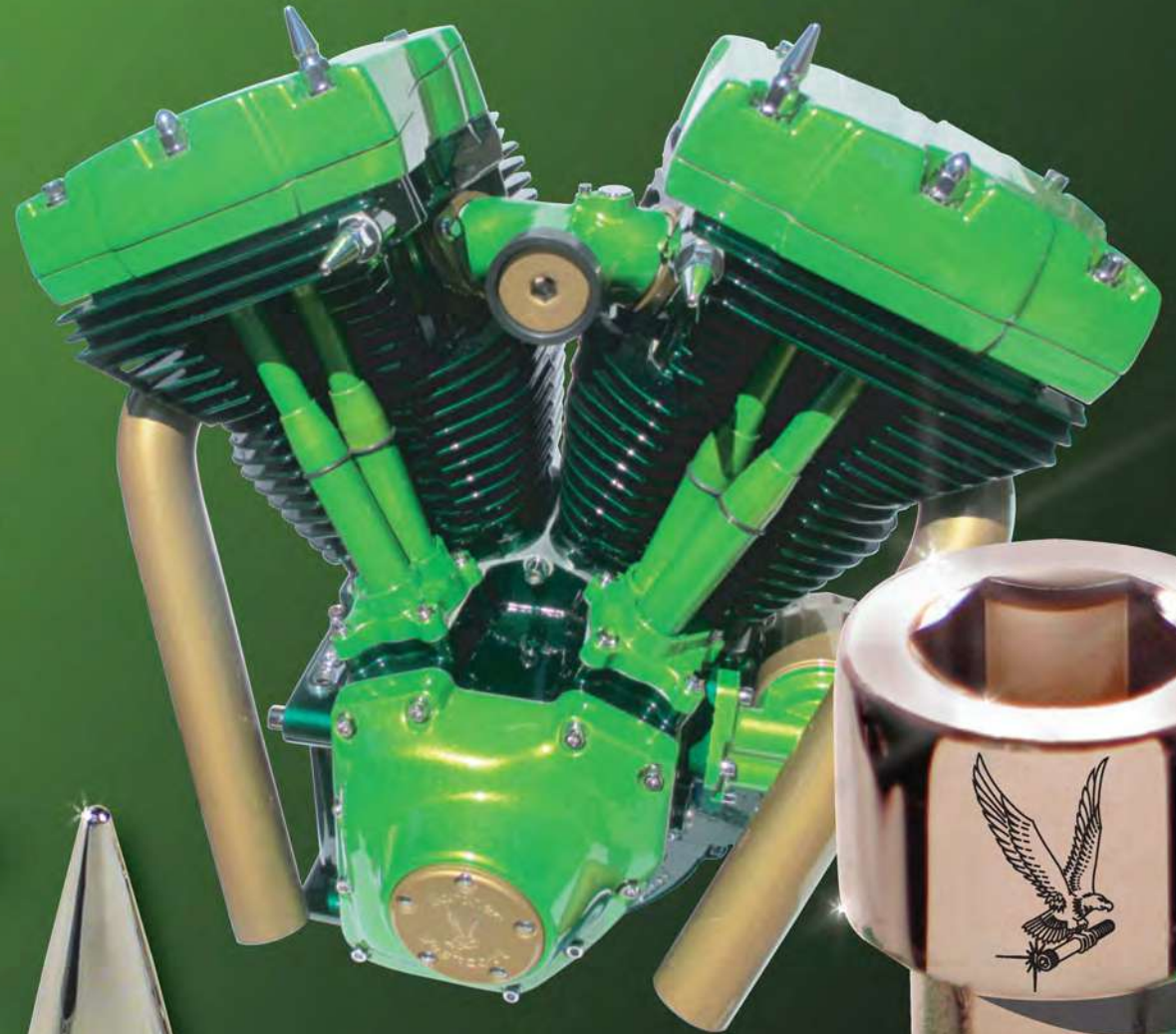
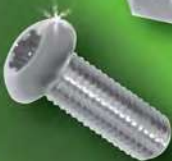

SERVING THE MOTORCYCLE INDUSTRY FOR OVER 40 YEARS

Table of Contents



1

Index	2
Harley-Davidson	3-56
<i>Big Twin</i>	3
<i>Sportster</i>	19
<i>45cu Flathead</i>	31
<i>V-Rod</i>	33
<i>Specialty</i>	37
<i>Stock Style</i>	49
British Motorcycles	55-58
<i>BSA, Norton, Royal Enfield</i>	56
<i>Triumph</i>	57
<i>Acorn Sets</i>	58
Motorcycles Brands and Motors	59-64
	<i>S&S Motors (Call for information)</i>
<i>Indian</i>	60
<i>Victory</i>	61
<i>Honda</i>	62
<i>Kawasaki</i>	63
<i>Suzuki</i>	64
<i>Yamaha</i>	64
<i>Ultima 100cu Motor</i>	64
Assortments (Chrome, Stainless Steel & Zinc)	65-78
<i>American Thread Chrome Plated</i>	66
<i>American Thread Stainless Steel</i>	72
<i>American Thread Zinc Plated</i>	73
<i>Metric Thread Chrome Plated</i>	75
<i>Metric Thread Stainless Steel and Zinc</i>	78
Bulk Fasteners (Chrome, Stainless & Zinc)	79-106
<i>American Thread</i>	80
<i>Metric Thread</i>	99
Electrical and Fittings	107-116
<i>Electrical</i>	108
<i>Fittings, Brass and Chrome</i>	111
Technical Info	Appendix

TERMS.....Cash or COD company check acceptable unless otherwise specified.

CREDIT.....Applications for open account warrants at least three references of reputable firms that you have dealt with in the past year. Terms are net 30 days from date of invoice.If a customer is in arrears on an open account, future shipments will be processed on a COD basis until credit is restored.

PRICING..... All retail prices shown are suggested only and in no way dictate a set price. Prices are subject to change without notice.

SHIPPING..... We ship UPS and by truck, always collect, with any service charges to be paid by customer.

CLAIMS.....We are not responsible for goods damaged in transit and all claims must be filed with the carrier involved.

RETURNS.....Returns for credit require prior notification and authorization. No returns will be accepted after 30 days from date of invoice.

GUARANTEE.....If any part is found to be defective in workmanship or unsatisfactory in any way, we will replace it or give credit where applicable.

MANUFACTURERS PART NUMBERS SHOWN FOR REFERENCE ONLY, HARLEY DAVIDSON AND OTHER MODELS OR BRAND NAMES ARE USED AS REFERENCE ONLY.



Sets

Harley-Davidson

Acorn Nut Sets, Big Twin	15
Acorn Nut Sets, Sportsters	23
Allen Plugs	38
Allen Screw Sets, 45CU Flathead	31
Other Applications, Big Twin	7
Other Applications, Sportsters	23
Axles	39
Axle Nuts Sets	39
Banjo Bolts	40
Bleeder Screw Cover Acorns	40
Builder Set, Big Twin	4
Builder Set, Sportsters	20
Brake Fasteners	40
Custom Applications	42
Cylinder Base Fasteners	43
Front End Fasteners	43
Front End Detail Set	43
Head Bolts	44
ISO Mount Studs	45
Motor Sets, Big Twin	5
Motor Sets, Sportsters	21
Oil Pump Fasteners	47
Primary Cover Allen Plugs	38
Rocker Box Fasteners	46
Rocker Shaft Fasteners	46
Side Cover Sets, Big Twin	6
Side Cover Sets, Sportsters	22
Specialty Fasteners	37
Stock Style Replacement Fasteners	49
Stock Style Replacement Sets	53
Studs	54
Trans Oil Allen Plug	14
Trans Top Cover	14
VRSCA V-Rod	33

British Motorcycles

Side Cover Sets	56
BSA, Norton & Royal Enfield	56
Triumph	57
Acorn Motor Sets	58
Acorn Individual Sets	58

Select Motorcycle Sets

Indian	60
Victory Motor Sets	61
Victory Side Cover Sets	61
Victory Individual Applications Sets	61
Victory Nut Sets	61
Victory Washer Sets	61
Honda Motor Sets	62
Honda Side Cover Sets	62
Kawasaki Motor Sets	63
Kawasaki Side Cover Sets	63
Suzuki Side Cover Sets	64
Yamaha Motor Sets	64
Yamaha Side Cover Sets	64
Ultima Motor Set	64

Assortments

American Thread

Chrome Plated	
Tray Assortments	66
Allen Head Screws	67
Hex Cap Screws	68
12 Point Screws	69
Specialty Dealer Assortments	69
Shop Master	70
Point of Purchase Display	71

Stainless Steel

Tray Assortments	72
Allen Head Screws	72
Hex Cap Screws	72
Nylon Insert Lock Nuts	72
Washers	72

Zinc Plated

Tray Assortments	73
Shop Master	73
Hex Cap Screws	73
Hex Nuts	73
Nylon Insert Lock Nuts	73
Washers	73
Shop Master	73

Metric Thread

Chrome Plated

Tray Assortments	75
Acorn Nuts & Spacers	76
Allen Head Screws	76
Hex Caps	76
Nuts	76
Washers	76
Cruiser Assortment	77
Dealer Assortment	77

Stainless Steel

Allen Head Screws	78
Hex Caps	78
Nuts	78
Washers	78

Zinc Plated

Allen Head Screws	78
Master Allen Assortment	78
Hex Caps	78
Nuts	78
Washers	78

Bulk Fasteners

American Thread

Chrome Plated

Allen Screws	80
Button Head Allens	80
Button Head Torx	80
Cotter Pins	89
Flat Head Allen	81
12 Point Screws	81
Flame Stamped Hex Caps	83
Hex Caps	82
Machine Screws	84
Nuts	87
Polished Allens	80
Sheet Metal Screws	84
Skull Stamped Hex Caps	83
Spacers	88
Spike Nuts	83
G-W Hardened Washers	85
Washers	85
Valve Cover Stems	38

Stainless Steel

Allen Screws	90
Button Head Allen	90
Flat Head Allen	90
Hex Caps	91
Nuts	93
Machine Screws	95
Washers	92

Zinc Plated and L-9 Products

Allen Screws	96
Hex Caps & L-9	96
Nuts & L-9	97
Washers & L-9	97
Machine Screws	98

Metric Thread

Chrome Plated

Allen Screws	100
Hex Caps	101
Nuts	102
Washers	102

Stainless Steel

Allen Screws	103
Hex Caps	103
Nuts	104
Washers	104

Zinc Plated

Allen Screws	105
Hex Caps	105
Nuts	106
Washers	106

Electrical and Fittings

Electrical Wire	108
Heat Shrink Tubing	108
Clamps	108
Clutch Removal Washers	108
Nutserts	109
Fittings	112
Technical Information	117



Inside This Section

Allen Style

<i>Builders Fastener Sets</i>	4
<i>Motor Sets</i>	5
<i>Side Cover Sets</i>	6
<i>Individual Application Sets</i>	7-14

Acorn Style

<i>Show Bike Kits</i>	15
<i>Individual Application Sets</i>	16 -19





Big Twin Builder Fastener Sets

Evolution Shovelhead Panhead Knucklehead Twin Cam 88cu., 96cu., 103cu. & 110cu.

"Where there is a bolt, you get a Allen Screw,



Where there is a nut, you get a Acorn Nut"



The perfect combination of **Allen Screws, Acorn Nuts** and Washers for Motor and Transmission of Big Twins. Contains: Timing Plug, Oil Pump, Side Covers, Clutch and Chain Covers, Top Front & Rear Motor Mount (w/all Stabilizing Link Fasteners, Regulator and Bracket Mount on FXR and FLT Models), Lifter Base, Point Cover, Header Mount, Inner Primary to Casing, Rocker Box, Cylinder Base, Motor Case, Transmission Cover.

Our Builders Fastener Sets Are For Motor and Transmission



C= Chrome Plated



P= Polished Chrome Plated Knurled



S= Stainless Steel



SP= Stainless Steel Polished Knurled



A= 12 Point Chrome Plated

(Please order Head Bolts separately)

Builders Fastener Sets

Styles Available

Part

2009 & Up Twin Cam FLT Models	C P S SP A	GW-72-A
2008 - 2012 Softail Rocker FXCW & FXCWC Models.....	C P S SP A	GW-73-A
2007 & Up Twin Cam Dyna Glide Models	C P S SP A	GW-75-A
2007 & Up Twin Cam Softail (Except FXCW & FXCWC Models).....	C P S SP A	GW-76-A
2007 - 2008 Twin Cam FLT Models 96cu.....	C P S SP A	GW-77-A
2006 - Twin Cam Dyna Glide Models 88cu.....	C P S SP A	GW-78-A
2000 - 2006 Twin Cam Softail Models 88B.....	C P S SP A	GW-79-A
1999 - 2005 Twin Cam Dyna Glide Models 88cu.....	C P S SP A	GW-99-A
1999 - 2006 Twin Cam FLT Models 88cu.....	C P S SP A	GW-98-A
1996 - 1999 Evolution FXST & FLST Softail Models.....	C P -- -- A	GW-95-A
1996 - 1998 Evolution Dyna Glide Models.....	C P -- -- --	GW-96-A
1996 - 1998 Evolution FLT Models.....	C P -- -- A	GW-97-A
1992 - 1995 Evolution Dyna Glide Models.....	C P -- -- --	GW-81-A
1991 - 1995 Evolution FXR & FLT Models.....	C P -- -- --	GW-80-A
1987 - 1990 Evolution FXR & FLT Models.....	C P -- -- A	GW-86-A
1987 - 1995 Evolution FXST & FLST Softail Models.....	C P -- -- --	GW-87-A
1986 - Evolution FXST & FLST Softail Models.....	C P -- -- --	GW-85-A
1984 - 1986 Evolution FXR & FLT Models.....	C P -- -- --	GW-84-A
1985 - 1986 Evolution (4 Speed) Models 1984 & 85 FXST.....	C P -- -- A	GW-83-A
1982 - 1983 Shovelhead (5 Speed) FXR, FXRS & FXRT.....	C P -- -- --	GW-82-A
1979 - 1984 Shovelhead (4 Speed) Models.....	C P -- -- A	GW-88-A
1977 - 1978 Shovelhead.....	C P -- -- --	GW-89-A
1970 - 1976 Shovelhead.....	C P -- -- --	GW-90-A
1966 - 1969 Shovelhead.....	C P -- -- --	GW-91-A
1965 - Panhead.....	C P -- -- --	GW-92-A
1958 - 1964 Panhead.....	C P -- -- --	GW-93-A
1948 - 1957 Panhead.....	C P -- -- --	GW-94-A



Builders Set P-GW-77-A

Most Sets Available in Polished Stainless Steel

Big Twin Motor Sets



Motor Sets include all Side Covers, Lifter Base Timing Plug, Inner Primary Mount, Top, Front and Rear Motor Mounts (with Stabilizing Link Fasteners on FXR and FLT Models), Rocker Box Covers on Pan, Evolution and Twin Cams. Header Mount, Point Cover or Generator Mount. Washers and Nuts supplied where applicable.



Motor Set P-96-76

Big Twin

	Styles Available	Part #
2009 & Up Twin Cam FLT Models	C P S SP A	96-72
2008 - 2012 Softail Rocker FXCW & FXCWC Models.....	C P S SP A	96-73
2007 & 2008 Twin Cam FLT Models	C P S SP A	96-77
2007 & Up Twin Cam Softail (except these models FXCW & FXCWC).....	C P S SP A	96-76
2007 & Up Twin Cam Dyna Glide Models	C P S SP A	96-75
2000 - 2006 Twin Cam Softail 88B.....	C P S SP A	88-79
2006 - Twin Cam Dyna Glide Models 88cu.....	C P S SP A	88-77
1999 - 2005 Twin Cam Dyna Glide Models 88cu.....	C P S SP A	88-99
1999 - 2006 Twin Cam FLT Models 88cu.....	C P S SP A	88-98
1991 - 1998 Evolution Dyna Glide Models.....	C P S SP A	80-81
1991 - 1998 Evolution FLT & FXR Models.....	C P S SP A	80-88
1987 - 1991 Evolution FLT & FXR Models.....	C P S SP A	80-86
1987 - 1999 Evolution FXST & FLST Softail Models.....	C P S SP A	80-87
1986 - Evolution FXST & FLST Softail Models.....	C P S SP A	80-85
1984 - 1986 Evolution (5 Speed) FXR & FLT Models.....	C P S SP A	80-84
1985 - Evolution (4 Speeds) & 1984 - 1985 Softails.....	C P S SP A	80-83
1982 - 1983 Shovelhead (all) FXR Models.....	C P S SP A	80-82
1977 - 1984 Shovelhead FX & FLH (all 4 Speeds).....	C P S SP A	74-89
1970 - 1976 Shovelhead FX & FLH (all) Models.....	C P -- -- A	74-90
1966 - 1969 Shovelhead (all) 74cu. Models.....	C P -- -- --	74-91
1965 - Panhead (with Short Pan Cover Screws).....	C P -- -- --	74-92
1965 - Panhead (with Long Pan Cover Screws).....	C P -- -- --	74-92D
1958 - 1964 Panhead (with Short Pan Cover Screws).....	C P -- -- --	74-93
1958 - 1964 Panhead (with Long Pan Cover Screws).....	C P -- -- --	74-93D
1948 - 1957 Panhead (with Short Pan Cover Screws).....	C P -- -- --	74-94
1948 - 1957 Panhead (with Long Pan Cover Screws).....	C P -- -- --	74-94D
1936 - 1947 Knucklehead	C P -- -- --	74-95

Big Twin Full Motorcycle Sets

Full Motorcycle Sets for 2000 & Up Softail Models contains fasteners for the Motor including Head Bolts, Transmission, Chassie, Wheels and Brake Components. Sets contain one each of every applicable set listed in individual applications. Sets for the full motorcycle are done in **Polished Show Chrome**.

2000 - 2006 FXST & FXSTB Softails.....	P-99-100
2000 - 2006 FXSTS Springer Sotails.....	P-99-101
2000 - 2006 FLSTC & FLSTF Softails.....	P-99-102
2000 - 2006 FLSTS Springer Softails.....	P-99-103

**Please Call
for Any Model
Not Listed**



Big Twin Side Cover Sets

Cam & Primary Cover Sets Includes: Transmission, Chain Clutch or Derby provided where applicable.

	Styles Available	Part #
2007 & Up Twin Cam Softtail Models	C P S SP A	10-12-01
2007 & Up Twin Cam FLT Models	C P S SP A	10-14-01
2006 & Up Twin Cam Dyna Glide Models	C P S SP A	10-15-01
2008 - 2012 Softtail Rocker Models.....	C P S SP A	10-11-01
2000 - 2006 Twin Cam Softtail Models 88B.....	C P S SP A	10-16-01
1999 - 2005 Twin Cam Dyna Glide Models 88cu.....	C P S SP A	10-18-01
1999 - 2006 Twin Cam FLT Models 88cu.....	C P S SP A	10-17-01
1991 - 1998 Dyna Glide Models.....	C P S SP A	10-19-01
1987 - 1999 Softtail Models.....	C P S SP A	10-24-01
1987 - 1998 FXR & FLT (5 Speed Models).....	C P S SP A	10-20-01
1985 - 1986 FXR & FLT (5 Speed Models).....	C P S SP A	10-21-01
1982 - 1984 & 1980 - 1984 FXR 1982 - 1984, 1980 - 1984 FLT.....	C P S SP A	10-22-01
1970 - 1984 FLH & FX (All 4 Speed Models).....	C P -- --- --	10-25-01
1965 - 1969 (Cam, Primary & Chain Inspection Cover Set).....	C P -- --- --	10-23-01
1936 - 1964 (Cam, Primary, Derby & Inspection Cover Set).....	C P -- --- A	10-27-01



Side Cover Set
P-10-12-01

Cam Cover Set Only

1999 & Up Twin Cam 88cu. & 96cu. Dyna & FLT Models; 2000 & Up Softtail Models.....	C P S SP A	10-18-06
1991 - 1998 FXR & Dyna Glide Models.....	C P S SP A	10-20-06
1987 - 1999 Softtail Models.....	C P S SP A	10-24-06
1970 - 1986 FLH & FX Models (All 4 Speeds).....	C P S SP A	10-25-06
1936 - 1969 Big Twins 74cu.....	C P -- --- A	10-27-06

Primary, Clutch and Chain Covers Only

2007 & Up Twin Cam FLT Models 96cu.....	C P S SP A	10-14-08
2006 & Up Twin Cam Dyna Glide & 2007 Softails.....	C P S SP A	10-15-08
Same as above with Spike Nuts & Studs.....	C -- -- --- --	50-179x
1999 - 2006 Twin Cam FLT Models 88cu. (Primary cover only).....	C P S SP A	10-17-08
1999 - 2006 Dyna Glide Models 88cu. (Primary cover only) & 2000 - 2006 Softails.....	C P S SP A	10-18-08
1989 - 1998 FXST, FLST Models & 1991 - 1998 Dyna Glide 80cu. Models.....	C P S SP A	10-24-08N
1987 - 1988 Softtail Models & 1984 - 1986 FXST.....	C P S SP A	10-24-08
1970 - 1984 FX & FLH Models (4 Speeds).....	C P S SP A	10-25-08
1985 - 1998 FXR & FLT Models (5 Speeds).....	C P S SP A	10-21-08
1980 - 1984 FXR & FLT Models (5 Speeds).....	C P S SP A	10-22-08
1965 - 1969 Big Twins.....	C -- -- --- --	10-23-08
1936 - 1964 (Derby & Inspection Covers).....	C P S SP --	10-27-09
1936 - 1964 Big Twins (Primary cover only).....	C P S SP A	10-27-05

Transmission Side Covers

2007 & Up Twin Cam Softtail Models 96cu.....	C P S SP A	10-12-07
2007 & Up Twin Cam FLT Models 96cu.....	C P S SP A	10-14-07
2006 & Up Twin Cam Dyna Glide Models 88cu.....	C P S SP A	10-15-07
1987 - 2006 (Transmission Side Covers only 5 Speeds).....	C P S SP A	10-20-07
1980 - 1986 (Transmission Side Covers only 5 Speeds).....	C P S SP A	10-22-07
1936 - 1984 Big Twins (4 Speeds with removal of studs).....	C P S SP A	74-12

Big Twin Individual Sets



- Where required, sets are supplied with Flat Washers, Lock Washers, Special Washers, Hex Nuts and/or Locknuts.
- Some sets are only available in Polished Chrome.
- All sets are available in 24K Gold Plated.
- Some sets are available in other styles.



Big Twin

	Styles Available							Part #
Air Cleaner Cover								
1984 & Up Big Twin (<i>Stock 1 Screw Round</i>).....	C	P	S	SP	--	--	--	80-54
1979 - 1985 (<i>Stock 3 Screw</i>).....	C	P	S	SP	--	A	--	20-54
1967 - 1978 XL & FL & 1988 XLH (<i>Stock Oval</i>).....	C	P	--	----	--	--	--	20-33

Bendix

Bendix Carburetor Set.....	C	P	--	----	--	--	--	31-37
----------------------------	---	---	----	------	----	----	----	-------

Belt Sprocket to Hub Mount with special washers

2007 & Up Softail & Dyna Glide Models & 2007 FLT Modles.....	C	P	--	----	H	A	--	96-58
2000 - 2006 Dyna Glide & Softail also 2004 - 2006 FLT Models.....	C	P	--	----	H	A	--	88-59
2000 - 2003 FLT Models.....	C	P	--	----	H	A	--	88-49
1980 - 1983 FLTS (<i>1987-1999 FXR, FLT, FXST & FLST, 1991-1999 FXD Cast Wheel</i>).....	C	P	--	----	H	A	--	74-59
1980 - 1984 FX & (<i>1984-1986 FLT, 1983-1985 FLH, 1982-1986 FXR Cast Wheel</i>).....	C	P	S	SP	H	A	--	74-49
1987 - 1990 FXR, FLT, FXST, FLST Models (<i>Laced Wheel</i>).....	C	P	--	----	H	A	--	74-58
1984 - 1985 FXWG & (<i>1986 FXST & FXR, 1992 & Up Big Twins, 1991 & Up XL Laced Wheel</i>)...	C	P	--	----	H	A	--	80-51

Belt Guard Mount

2000 & Up Softail Models.....	C	P	S	SP	H	A	--	88-25
-------------------------------	---	---	---	----	---	---	----	-------

Brake Line Banjo Bolts

2008 & Up FLT Models also 2006 & Up V-Rods, (<i>replaces 41750-06A</i>).....	--	P	--	----	--	A	--	80-119
1984 & Up (<i>Front includes aluminum washers, replaces 41739-84A</i>).....	--	P	--	----	--	A	--	80-111
1982 & Up (<i>Front and or Rear includes aluminum washers, replaces 41747-82A</i>).....	--	P	--	----	--	A	--	80-110
1958 - 1972 (<i>Rear Brake Wheel Cylinder includes washers</i>).....	--	P	--	----	--	--	--	80-112

Brake Caliper Bolts

(See Disc Brake Caliper Mount)

Cam Cover

1999 & Up Twin Cam 88cu. also 2000 & Up Softail Models.....	C	P	S	SP	H	A	--	10-18-06
1987 - 1998 FXR, FLT; also 1991 - 1998 Dyna Glide.....	C	P	S	SP	H	A	--	10-20-06
1970 - 1985 FLH & FX Models (<i>All 4 Speeds</i>).....	C	P	S	SP	H	A	--	10-25-06
1936 - 1969 Big Twins 74cu.....	C	P	--	----	--	--	--	10-27-06

Carburetor Sets

Bendix Carburetor Set.....	C	P	S	SP	--	A	--	31-37
Keihin Carburetor (<i>Butterfly Throttle HD</i>).....	C	P	S	----	--	--	--	80-36
Keihin Carburetor (<i>Constant Velocity HD</i>).....	C	P	S	SP	--	--	--	61-36
Keihin Carburetor (<i>Constant Velocity Top Cover Only</i>).....	C	P	S	SP	--	--	--	61-37
Dellorto Pumper Carb; 38mm & 40mm (<i>with Allen Wrench</i>).....	C	P	--	----	--	--	--	31-36
S&S Super E&G (<i>shorty Full Carb Set</i>).....	C	P	S	----	--	--	--	31-38
S&S Super (<i>with Air Cleaner & Intake Set</i>).....	C	P	S	SP	--	--	--	31-33



Big Twin Individual Sets

Chain Sprocket To Hub

	Styles Available	Part #
1973 - 1984 FX, FLH also 1984 - early & 1985 FXST Softail (<i>Laced Wheel</i>).....	C P S SP H A --	74-48
1973 - 1985 Big Twins (<i>Cast Wheels</i>).....	C P S SP H A --	74-49

Coil

2004 & Up Dyna Glide Models (<i>Coil Cover Mount</i>).....	C P S SP H A --	88-45
1999 - 2003 Dyna Glide Models (<i>Coil Cover Mount</i>).....	C P S SP H A --	88-46

Circuit Breaker

1936 - 1969 Circuit Breaker Mount.....	C P -- ---- -- A --	74-41
--	---------------------	-------

Cylinder

Cylinder Base Allen Screws (<i>requires removal of studs on Pan & Shovelheads</i>).....	C P -- ---- -- A --	74-08
---	---------------------	-------

Derby

1999 & Up Twin Cam Derby (<i>available in Bottonhead Torx & Buttonhead Allens</i>).....	C P S SP -- A T	10-18-09
1970 - 1998 Big Twins (<i>Only Derby Cover</i>).....	C P S SP -- A --	10-20-09
1936 - 1964 Big Twins (<i>Derby & Inspection Covers</i>).....	C P -- ---- -- --	10-27-09

Disc Brake Caliper Mount - Front

2008 & Up Dyna & Softail (<i>except Springers</i>) (<i>Also Part # 96-146 I has no pins</i>).....	-- P -- ---- -- A --	96-146
2008 & Up FLT Models (<i>Also Part # 96-147 I has no pins</i>).....	-- P -- ---- -- A --	96-147
2000 - 2007 (<i>except Springers</i>).....	-- P -- ---- -- A --	80-147
1993 - 1999 (<i>except Springers</i>).....	-- P -- ---- -- --	80-143
1984 - 1992 (<i>except Springers</i>).....	-- P -- ---- -- --	80-144
1988 & Up FXSTS Springer Softails.....	-- P -- ---- -- --	80-145
1997 & Up FLSTS Springer Softails.....	-- P -- ---- -- --	80-146
1977 - 1983 Dual XL & FX.....	C P -- ---- -- --	80-43
1974 - 1977 Single XL & FX.....	C P -- ---- -- A --	20-49

Disc Brake Caliper Mount - Rear

2008 & Up FLT & V-Rod Models (<i>Also Part # 96-148 I has no pins</i>).....	-- P -- ---- -- A --	96-148
2008 & Up Dyna Glide & Softail Models (<i>Also Part # 96-143 I has no pins</i>).....	-- P -- ---- -- A --	96-143
2006 - 2007 Softail FX Models (<i>Also Part # 96-147 I has no pins</i>).....	-- P -- ---- -- A --	80-149
2000 - 2007 (<i>except 2006 & 2007 Softail FX Models</i>).....	-- P -- ---- -- A --	80-148
1987 - 1999 Rear Brake Caliper.....	C -- -- ---- -- --	80-142
1982 - 1986 FXR Rear.....	C P S SP -- A --	61-08
1973 - 1984 Rear FX, FLH & Front FLH (<i>with special washers</i>).....	C P S SP H A --	74-43

Disc Brake Rotor to Hub - Front

1984 & Up Single - (<i>Fits All Cast Wheel, dual disc will require 2 sets</i>).....	C -- -- ---- -- T	80-42
1984 & Up Single - (<i>Fits All Laced Wheel</i>).....	C -- -- ---- -- T	80-41
2014 FLT Models - FLHX, FLHTCU, FLHXS & FLHTK.....	-- P -- ---- -- T	96-42
2006 & Up Dyna Glide, FXD, FXGL Models Brake Rotor to Hub.....	-- P -- ---- -- --	69-42
1974 - 1978 Single - XL & FX.....	C P S SP -- --	20-55
1977 - 1983 Dual - Fits FX & XL, 1982 - 1983 FXR Models (<i>Cast Wheel</i>).....	C -- -- ---- -- --	20-04
1977 - 1983 Dual - Fits FX & XL, 1982 - 1983 FXR Models (<i>Laced Wheel</i>).....	C -- -- ---- -- --	20-04N

Disc Brake Rotor to Hub - Rear

1992 & Up Big Twins (<i>Cast Wheel</i>).....	C -- -- ---- -- T	61-32
1992 & Up Big Twins (<i>Laced Wheel</i>).....	C -- -- ---- -- T	61-31
1981 - 1991 FXR Models, 1984 - 1991 FXST, FLST Models.....	C P S SP -- --	74-52
1977 - 1991 Big Twins (<i>Cast Wheel</i>).....	C P S SP -- --	74-01
1973 - 1984 FX & FLH (<i>with Lock Nuts</i>).....	C P -- ---- H --	74-51
1981 - 1984 FLH (<i>Laced Wheel</i>).....	C -- -- ---- -- --	20-69
1980 - 1981 FLT (<i>Cast Wheel</i>).....	C -- -- ---- -- --	80-76
1982 - 1985 FLT; 1980 - 1981 Right Side Front FLT (<i>Cast Wheel</i>).....	C -- -- ---- -- --	80-75

Disc Brake Support Bracket and Mount - Rear

1973 - 1982 Big Twins, (<i>Hex Caps Chrome includes washers & cotter pins</i>).....	-- -- -- ---- H --	31-07
1981 - 1984 FLH also 1981 - 1982 FX & 1983 FXE Models (<i>Hex Cap and clevis pin and cotter pins</i>).....	-- -- -- ---- H --	31-08

Big Twin Individual Sets



Electrical Panel	Styles Available	Part #
2000 & Up Dyna Glide.....	C P S SP -- A --	88-48
1991 - 2003 Dyna Glide (Electrical Panel Frame Cover).....	C P S SP -- A --	80-48
Fender Mount - Front		
1972 XL & FX.....	C P S SP -- -- --	20-22
1974 - 1983 XL & FX (includes Bracket Mount).....	C P S SP -- -- --	20-03
1984 & Up XL, FX, Dyna's (except) FXDWG.....	C P S SP -- -- --	61-04
Softail & Dyna Wide Glide (with Lock Nuts).....	C P S SP -- -- --	88-04
FXDWG, FXST & FXSTB (only with Acorn Nuts).....	C P S SP H A --	88-04A
Fender Rail-Rear		
2000 & Up FXST Models (call for set).....	C P S SP H -- --	88-21
1986 - 1999 FXST Models.....	C P -- -- -- --	80-46
2003 & Up FLST Models (no bags).....	C P S SP H A --	88-23
1958 - 1978 FLH (no bags or rack).....	C P -- -- -- --	80-05
1980 & Earlier FX (with CTSK holes).....	C P S SP -- -- --	74-21
1980 - 1985 FXWG.....	C P -- -- -- A --	80-21
1984 & Earlier FX (with Sissy Bar).....	C P S SP H -- --	74-23
1984 & Earlier FX (with STD head no bars).....	C P S SP H -- --	80-11
1984 & Earlier FX (with Sissy Bar CTSK holes).....	C P -- -- -- --	74-30
Floorboard Mount		
1982 & Up Floorboard Hinge Bolt Mount Set (Hex Caps with nuts and washers).....	-- -- -- -- H -- --	80-104
Foot Peg Mount		
2006 & Earlier XL, Dyan Glide & Softail (Pin Style 1 Set).....	C P S SP H A --	88-35
1985 & Earlier XL, FX & FLH (Front & Rear special shoulder bolts).....	C -- -- -- -- --	20-35
1982 - 1994 Foot Pegs Mount - FXRS (All 3 Set).....	C P S SP H A --	80-35
Foot Peg & Bracket Mount		
2000 & Up Softail Models Bracket Mount, (both sides with Brake Pedal Mount and Master Cylinder Cover Screws, Shifter Arm and Kickstand Mount).....	C P S SP H A T	88-01
2000 & Up FXST Softail Models (same as above).....	C P S SP H A T	88-03
1991 & Up Dyna Glide.....	C P -- -- -- --	80-105
1974 - 1984 FX Rear.....	C P S SP H A --	74-36
Front Fork Leg Damper Tube		
1975 & Up XL, FX, FXR & FXD (both with washers).....	C -- -- -- -- --	61-58
Front Fork Leg Drain-Front		
1977 & Up FLH, FLT, FXWG & FXDWG Softail also all 41mm Models.....	C P -- -- -- --	74-45
1973 - XL, FX, FXR & FXD thru 2005 Dyna's (with washers & Allen wrench).....	C P -- -- -- --	20-58
1957 - 1972 XL & FX Models.....	C P -- -- -- --	20-57
1947 - 1977 FLH & 45cu. Flatheads.....	C P S -- -- -- --	74-47
Fork Tube Allen Caps		
1988 - 2005 Sportsters & FXR Model, 1987 - 2005 Dyna's 39mm.....	C -- -- -- -- --	99-23
1977 & Up FLH and FXWG.....	C -- -- -- -- --	99-21
Frame Side Cover		
2004 & Up Dyna Glide Models.....	C P S SP -- -- --	88-48
1991 - 2003 FXD Dyna Glide Models (Electrical Panel Cover).....	C P S SP -- -- --	80-48
1982 - 1994 FXR Models.....	C P S SP -- -- --	80-47
Front End Detail Set		
1988 - 2007 XL, FXR and FXD 39mm. (includes fasteners for Fork Tube Caps, Top Triple Tree Bolt, Drain Screw, Axle Cap, Nuts and Triple Tree Pinch Bolts).....	C P -- -- -- --	80-49



Big Twin Individual Sets

Gas Tank Mount

	Styles Available	Part #
Fatbob - FLH and FXEF (<i>Early Style 4 Speeds</i>).....	C P S SP H A --	74-34
Fatbob - Big Twin (<i>4 Speed, Late Style includes: spacers, shims and rear bolts</i>).....	C P -- ---- -- A --	80-134
Fatbob - Big Twins 1985 and 1986.....	C P S SP H A --	80-34
1982 - 1994 FXR & FXRSP, 1982-87 FXRS Models (<i>includes Top Panel Mount</i>).....	C P S SP -- -- --	80-39
1988 - 1994 FXRS Models.....	C P S SP -- -- --	80-70
1984 - 1989 FXST Models.....	C P S ---- -- -- --	80-72
1990 - 1999 FXST and FLST Models.....	C P S ---- -- -- --	80-98
2000 & Up Softail Models (<i>with Speedo Cover and Tank Cover</i>).....	C P S SP H A --	88-34
1991 & Up Dyna Glide Models <i>except</i> FXDWG.....	C P S ---- -- -- --	80-73
2008 & Up FLT.....	C P S SP H A --	96-34

Generator Screws

1958 - 1969 Big Twin.....	C P -- ---- -- A --	74-14
1936 - 1957 Big Twin.....	C P -- ---- -- -- --	74-13

Handlebar Clamp Mount

1984 & Up XL and FXR (<i>Speedo Bracket</i>).....	C P S SP -- -- --	80-55
1981 & Up XL and FX.....	C P S SP -- -- --	80-52
1974 - 1981 XL and FX.....	C P S SP -- -- --	20-52

Handlebar Lever Switch Boxes

2008 & Up with Brake and Master Cylinder Covers, <i>except</i> FLT.....	C P S SP -- -- --	96-50
2009 & Up SE Models.....	C -- S SP -- -- --	96-50B
1996 & Up with Master Cylinder Screws, <i>except</i> 2008 & Up FLT.....	C P S SP -- -- T	74-150
1996 & Up with Master Cylinder Screws, <i>except</i> 2008 & Up FLT (<i>in Buttonhead</i>).....	C P S SP -- -- --	74-150B
1996 & Up with Master Cylinder Screws, <i>except</i> 2008 & Up FLT (<i>in Stock Style</i>).....	C P S SP -- -- --	74-150Y
2008 & Up FLT <i>except</i> SE Models with Master Cylinder Screws.....	C P S SP -- -- --	88-150B
2008 & Up SE Models with Master Cylinder Screws.....	C P S SP -- -- --	96-150B
1982 - 1995 HD with Master Cylinder Screws.....	C P S SP -- -- --	74-50
1982 - 1995 HD with Master Cylinder Screws - HD (<i>in Buttonhead</i>).....	C P S SP -- -- --	74-50B
1973 - 1981 HD with Master Cylinder and Twist Grip Screws.....	C P S SP -- -- --	20-40
1971 Harley's with Switch Mount.....	C P S SP -- -- --	20-39

Handlebar Rizer Mount

1986 - 1996 FXST, FXSTC, 1993 - 2000 FLT, 1995 & Up FLST (<i>with cup washers</i>).....	C P -- ---- H A --	80-123
1991 & Up Dyna Glides and 1997 & Up FXST (<i>with lockwashers and cup washers</i>).....	C P S SP H A --	80-120W
1974 - 1984 FX Models (<i>with lock and cup washers and nuts</i>).....	-- -- -- ---- H -- --	80-122H

Head Bolts

1992 & Up Sportsters and Big Twins.....	-- -- -- ---- -- A --	61-110
1986 - 1991 Big Twins; 1987 - 1991 XL.....	-- -- -- ---- -- A --	61-100
1984 - 1985 Evolution.....	C P -- ---- -- A --	80-10
1948 - 1985 Panhead and Shovelhead (<i>with Special Washers</i>).....	C P -- ---- -- A --	74-10
1948 - 1985 Panhead and Shovelhead (<i>with Special Washers Stock Style Hex</i>).....	C -- -- ---- -- -- --	31-09
Knucklehead 74cu. (<i>with Special Washers</i>).....	C P -- ---- -- -- --	74-09

Header Mount

Shovelhead, (<i>includes gaskets and washers</i>).....	C P S SP H A --	74-20
Evolution Motors (<i>with removal of stud</i>).....	C P S SP -- A --	80-03
Evolution & Big Twin Cam Stock Style Flange Nuts.....	-- P -- ---- -- -- --	50-03Y

Headlight Bracket

Headlight Bracket Mount - XL, FX and FXR.....	C P S SP H A --	20-23
---	-----------------	-------

Inner Primary to Motor Case

1999 - 2006 Dyna Glide 88cu; 2000 - 2007 FLT and Softails.....	C P S SP H A --	88-53
1970 - 1985 Big Twin (<i>4 Speed</i>).....	C P S SP H A --	74-53
1991 - 1998 Big Twin FXR, FLT, FXD and 1999 FXST Softails.....	C P S SP H A --	80-53

Intake Manifold

1991 - 2001 big Twins (<i>Injected Models</i>).....	C P S SP H A --	61-04
1990 - 1994 Big Twins (<i>with Carburetors</i>).....	C P S SP H A --	61-38
1995 & Up Big Twins (<i>with Carburetors</i>).....	C P S SP H A --	61-39

Big Twin Individual Sets



	Styles Available							Part #
Keihin Carburetor								
Harleys Set (<i>butterfly throttle</i>).....	C	P	--	----	--	--	80-36	
Harleys Set (<i>constant velocity</i>).....	C	P	--	----	--	--	61-36	
Constant Velocity Top Cover Only.....	C	P	--	----	--	--	61-37	
Kickstand								
1985 - FLH and FX.....	C	P	S	SP	H	A	--	74-25
Kick Starter								
HD Kick Starter Arm Mount Top and Bottom.....	C	P	S	SP	H	A	--	20-26
License Plate Mount								
Fits All (<i>includes Flat Washers & Hex Nuts</i>).....	C	P	S	SP	H	A	--	20-34
Fits All (<i>includes Flat Washers & Acorn Nuts</i>).....	C	P	S	SP	H	A	--	20-34A
Fits All (<i>includes Flat Washers & Lock Nuts</i>).....	C	P	S	SP	H	A	--	20-34N
Fits All (<i>includes Flat Washers & Spike Nuts</i>).....	C	P	--	----	--	--	--	20-34x
Bracket to Fender (<i>All with large washers & Hex Nuts</i>).....	C	P	S	SP	H	A	--	20-41
Lifter Base								
1999 & Up Twin Cam 88cu. & 96cu. FLT, Dyna Glide & 2000 & Up Softails.....	C	P	S	SP	--	A	--	88-26
1977 - 1999 Big Twin 80cu.....	C	P	S	SP	--	A	--	74-26
1936 - 1976 Big Twin.....	C	P	--	----	--	A	--	74-16
1977 - 1999 Custom Big Twin Old Blocks.....	C	P	--	----	--	A	--	31-35
1977 & Earlier Custom Big Twin New Blocks.....	C	P	--	----	--	A	--	31-16
Magneto Cover								
All Models, (<i>with Allen wrench</i>).....	C	P	S	SP	--	--	--	20-46
Master Cylinder Rear								
Brake Pedal Mnt. with Top Cover, Bracket Mnt. (<i>footpeg brackets both sides</i>).....	C	P	S	SP	H	A	--	88-01
2005 & Up FXST & 2006 & Up Dyna Glides (<i>Rear Master Cylinder Cover</i>).....	C	--	S	SP	--	--	--	96-01
1982 - 1994 FXR (<i>with Reservoir & Cover Mount</i>).....	C	P	S	SP	--	--	--	80-38
1984 - 1985 Fx Cover Mount.....	C	P	S	SP	--	--	--	80-04
1979 - 1983 FX Cover Mount.....	C	P	S	SP	--	--	--	80-01
Motor Case Set								
Big Twin 88B Twin Cam 2000 & Up Softail Models	C	P	--	----	H	A	--	88-31
Big Twin 88cu. Twin Cam Models; 1999 & Up FLT and Dyna Models	C	P	--	----	H	--	--	88-29
1996 - 1999 Big Twin 80cu.....	C	P	--	----	H	--	--	80-157
1983 - 1995 Big Twin 80cu.....	C	P	--	----	H	--	--	80-57
1979 - 1982 Big Twin 80cu.....	C	P	--	----	H	--	--	74-31
Big Twin 74cu.....	C	P	--	----	H	--	--	74-29
Big Twin 74cu. thru 1978 (<i>incl. Tapered studs, Allen Screws, Acorn Nuts, Washers</i>).....	C	P	--	----	--	--	--	74-29YA
Big Twin 74cu. thru 1978 (<i>Same as Above with Hex Cap & Hex Nuts Stock Style</i>).....	C	P	--	----	--	--	--	74-29YH
Motor Mount - Top, Front & Rear								
2009 & Up FLT Models (<i>Top, Front and Rear</i>).....	C	P	S	SP	H	--	--	96-16
2007 - 2008 FLT Models (<i>Top, Front and Rear</i>).....	C	P	S	SP	H	--	--	96-17
2007 & Up Dyna Glides (<i>Top, Front and Rear and Trans</i>).....	C	P	S	SP	H	--	--	96-18
2007 & Up Softails (<i>Top, Front and Rear Post with Spacers</i>).....	C	P	S	SP	H	--	--	96-19
2007 & Up Softails (<i>Top, Rear and Post</i>).....	C	P	S	SP	H	A	--	96-11
2000 - 2006 Softails (<i>Top, Bottom, Front and Rear with Front Spacers</i>).....	C	P	S	SP	H	--	--	88-19
2000 & Up Softail Models, Big Twin 88B (<i>Lower Front Set with Spacers</i>).....	C	P	--	----	H	--	--	88-11
2000 - 2006 Softails (<i>Top, Bottom and Rear only</i>).....	C	P	--	----	H	--	--	88-14
1999 - 2006 Dyna Glide Models.....	C	P	S	SP	H	A	--	88-18
1999 - 2006 FLT Models.....	C	P	S	SP	H	A	--	88-17
1991 - 1998 Dyna Glides.....	C	P	--	----	--	--	--	80-77
1948 - 1984 Big Twin (<i>4 Speeds with Special Washers</i>).....	C	P	S	SP	H	A	--	74-19
1948 - 1985 Big Twin (<i>4 Speeds Top Strap</i>).....	C	P	S	SP	H	A	--	74-11
1982 - 1983 FXRS.....	C	P	--	----	H	A	--	80-19
1984 - 1986 FLT & FXR.....	C	P	S	SP	H	A	--	80-17
1987 - 1990 FLT & FXR.....	C	P	S	SP	H	A	--	80-56
1991 - 1998 FLT & FXR.....	C	P	--	----	--	--	--	80-96
1984 - 1999 Softail & 1985 FX.....	C	P	S	SP	H	A	--	80-18



Oil Filter Mount

	Styles Available	Part #
1999 - 2000 Twin Cam 88cu Models.....	C P S SP -- A --	88-28
1992 - 1999 Big Twins 80cu.....	C P S SP -- A --	80-116

Oil Pump Mount

1992 - 1999 Big Twins 80cu.....	C P -- ---- -- A --	80-97
1979 - 1991 Big Twins.....	C P -- ---- H A --	74-32
1968 - 1978 Big Twins.....	C P -- ---- -- --	74-28
1936 - 1967 Big Twins.....	C P -- ---- -- --	80-13

Oil Pump Top Plug Set

1981 - 1999 80cu. (o-rings & plugs for case oil screen, ck. valve & relief valve).....	C -- -- ---- -- --	80-32
1970 - 1980 74cu. & 80cu. (o-rings, plugs for case oil screen, ck. valve & relief valve).....	C -- -- ---- -- --	80-28
1968 - 1969 74cu. (includes o-ring, plugs for case oil screen, ck. valve & relief valve).....	C -- -- ---- -- --	80-29
1966 - 1967 74cu. (replaces plugs for motor case oil screen, ck. valve & relief valve).....	C -- -- ---- -- --	80-30
1952 - 1965 74cu. (replaces plugs for motor case oil screen, ck. valve & relief valve).....	C -- -- ---- -- --	80-31

Oil Tank Drain Screw

H-D 1981 & Up (with special washer).....	C P -- ---- -- A --	80-20
H-D thru 1980.....	C P -- ---- -- A --	20-20

Pan Covers

1948 - 1965 Panhead (with thick "D" ring).....	C P S SP -- -- --	10-27-03
1948 - 1965 Panhead (with thin "D" ring).....	C P S ---- -- --	10-27-02

Points Cover Mount

1999 & Up Twin Cam 88 Models, Dyna, FLT and 2000 & Up Softails.....	-- P S SP -- -- T	88-12
1979 - 1999 (Buttonhead Allens with gasket and wrench 80cu).....	C P S SP -- -- T	20-37
1970 - 1978 (Buttonhead Allens with gasket and wrench).....	C P S SP -- -- T	20-12
1970 - 1978 (includes Condenser Mount and Point Mount).....	C P -- ---- -- -- T	74-44

Primary Cover, includes clutch and chain covers

2007 & Up FLT Models (Primary & Derby Covers).....	C P S SP -- A --	10-14-08
2006 & Up Dyna Glide and 2007 & Up Softail Models.....	C P S SP -- A --	10-15-08
1999 - 2005 Dyna Glide & 2006 Softail Models.....	C P S SP -- A --	10-18-08
1999 - 2006 FLT Models.....	C P S SP -- A --	10-17-08
1989 - 1998 FXST, FLST; 1991 - 1998 Dyna Glide Models.....	C -- -- ---- -- A --	10-24-08N
1987 - 1988 Softail Models.....	C P S SP -- A --	10-24-08
1970 - 1984 FX & FLH Models (4 Speeds).....	C P S SP -- A --	10-25-08
1985 - 1998 FLT Models (5 Speeds).....	C P S SP -- A --	10-21-08
1980 - 1984 Softail (5 Speed).....	C P S SP -- A --	10-22-08
1965 - 1969 (Primary and Chain Inspection Cover).....	C P -- ---- -- --	10-23-08

Rear Fork

1984 - 1999 Softail Models (Rear Fork Assembly Mount).....	C -- -- ---- H -- --	80-09
2000 & Up Softail Models (Rear Fork Assembly Mount).....	C -- -- ---- H -- --	88-09H

Regulator Mount

2001 & Up Softail Models.....	C P S SP -- A --	88-07
2004 & Up Dyna Glide Models.....	C P S SP -- A --	88-08
2000 & Up 88B Softails (includes Bracket Mount).....	C P S SP -- A --	88-02
1996 - 2003 Dyna Glide Models.....	C P S SP -- A --	80-132
1976 - 1984 Big Twins, FL and FX, 1984 -1986 Softail; 1991 - 1995 Dyna Glide.....	C P S SP -- A --	74-24
1980 & Up FXR & FLT Models (Includes Bracket Mount).....	C P S SP -- A --	80-02
Big Twins 1970 - 1974.....	C P S SP -- -- --	74-27

Rocker Arm Shaft End-Right

1971 - 1984 XL & Shovelhead.....	C P S SP -- A --	74-55
1971 - 1984 Shovelhead (in Buttonheads).....	C P S SP -- A --	74-55B
1966 - 1970 Shovelhead & 1957 - 1970 Sportster.....	C P S SP -- A --	74-56

Big Twin Individual Sets



Big Twin

	Styles Available							Part #
Rocker Boxes								
1999 & Up 88cu. Twin Cam FLT & Dyna Models & 2000 Softails.....	C	P	S	SP	H	A	--	88-15
1984 - 1999 Evolution 80cu. (with copper and steel washers).....	C	P	S	SP	H	A	--	80-15
1984 - 1999 Evolution 80cu. (with taper cup washers).....	C	P	S	SP	H	A	--	80-15W
1981 - 1984 Shovelhead (requires drilling to 3/8 diameter hole).....	C	P	S	SP	H	A	--	80-08
1966 - 1981 Shovelhead (requires drilling to 3/8 diameter hole).....	C	P	S	SP	H	A	--	74-15
Full Rocker Box Mount Set (fits Evolutions with inside & top mounting hardware).....	C	P	--	--	--	--	--	80-115Y
Saddle Bag								
1986 & Up FHLT (Saddle Bag, Racks, Fender Rails & Crash Bars Mount Set).....	C	P	S	SP	--	--	--	80-66
Seat Mount								
1996 & Earlier FX & FXR Models (Fender, Rear with special washers and wrench).....	C	P	S	SP	H	A	--	74-67
1997 & Up FX Models (Rear).....	C	P	S	SP	H	A	T	61-67
Forward FLSTC, FLSTF Softails.....	C	P	S	SP	--	A	--	80-167
Shifter Lever Mount								
1974 - FLH and XL.....	C	P	S	SP	H	A	--	20-30
1974 - 1985 FX.....	C	P	S	SP	H	A	--	74-22
Shock Absorber Mount								
2008 & Up Dyna Glides.....	C	P	S	SP	H	A	--	96-07
2006 - 2007 Dyna Glides.....	C	P	S	SP	H	A	--	96-06
2002 - 2005 Dyna Glide FADX & FXDXI Models.....	C	P	S	SP	H	A	--	88-128
2002 - 2005 Dyna Glide (except FXDX Models).....	C	P	S	SP	H	A	--	88-126
1991 - 2001 Dyna Glide (except FXDS).....	C	P	--	--	H	A	--	80-128
2000 & Up Softail Models (Hex Caps only).....	--	--	--	--	H	--	--	88-06
1984 - 1999 Softail Models (with washers and Hex Caps only).....	--	--	--	--	H	--	--	80-127H
1984 - FXR & 1986 - 1987 XL.....	C	P	--	--	H	A	--	80-07
1973 - 1985 FX & FLH.....	C	P	--	--	H	A	--	80-06
1989 - 1994 FXR.....	C	P	--	--	H	A	--	80-126
Speedo & Track								
1977 - 1985 FXS (Housing Mount on gas tank).....	C	P	S	SP	--	A	--	74-42
1989 - 1994 FXR & XL (Mount and Handlebar Clamp).....	C	P	S	SP	--	--	--	80-55
Star Wheel								
1966 & Earlier FLH (Star Wheel Bearing Cover).....	C	P	--	--	H	A	--	74-35
Swing Arm								
1989 & Up FXR & FLT (Bracket to Frame).....	C	P	S	SP	H	A	--	80-79
1982 - 1988 FXR & FLT (Bracket to Frame).....	C	P	S	SP	H	A	--	80-40
2009 & Up Softail Models (Frame to Swing Arm Frame Pivot Mount).....	--	P	--	--	H	--	--	96-09
2000 - 2008 Softail Models (Frame to Swing Arm Frame Pivot Mount).....	C	P	--	--	H	--	--	88-09
1984 - 1999 Softail Models (Frame to Swing Arm Frame Pivot Mount).....	C	P	--	--	H	--	--	80-09
Tail Light								
1999 & Up Harley's (sold each Tail Light Lens Mount Screws).....	--	P	S	--	--	--	--	80-136
1973 - 1998 Harley's (sold each Tail Light Lens Mount Screws).....	C	--	--	--	--	--	--	80-135
Timing								
1999 & Up Twin Cam Models (Timing Cover Cam Position Sensor Cover).....	C	P	S	SP	H	A	T	88-12
1979 - 1999 80cu. (Buttonhead Allens with gasket and wrench).....	C	P	S	SP	--	--	T	20-37
1970 - 1978 (Buttonhead Allens with gasket and wrench).....	C	P	S	SP	--	--	--	20-12
All H-D (Timing Plug).....	C	P	--	--	--	A	--	20-20
Transmission Mount								
2000 & Up Softail Models (Trans Bracket Mount).....	C	P	S	SP	H	A	--	88-36
1989 - 1999 Softail Models.....	C	P	S	SP	H	A	--	80-158
1941 - 1977 Big Twin (4 Speeds, includes Trans Plate Mount).....	C	P	S	SP	--	--	--	80-59



Big Twin Individual Sets



Transmission Oil Fill Plug

	Styles Available							Part #
2007 & Up Softail Models.....	C	P	--	----	--	--	--	96-12
1987 & 2006 Big Twin (with O'Ring & Dip Stick).....	C	--	--	----	--	--	--	80-14
1936 - 1986 Big Twin (4 Speeds - Includes special washer).....	C	--	--	----	--	--	--	80-12

Transmission Bottom Cover

1999 - 2014 Dyna Glide Models.....	C	P	S	SP	H	A	T	88-78
1993 - 2014 FLT Models.....	C	P	S	SP	H	A	T	80-107

Transmission Side Cover

2007 & Up FLT Models (Trans Outer Back Cover - 6 Speeds).....	C	P	S	SP	--	A	--	10-14-07
2007 & Up Softail Models (Outer & Back Trans Cover - 6 Speeds).....	C	P	S	SP	--	A	--	10-12-07
2006 & Up Dyna Glide (Outer Back Trans Cover - 6 Speeds).....	C	P	S	SP	--	A	--	10-15-07
1987 -2005 (5 Speeds).....	C	P	S	SP	--	A	--	10-20-07
1980 - 1986 Big Twins (5 Speeds).....	C	P	S	SP	--	A	--	10-22-07
1936 - 1984 (4 Speeds - requires removal of studs).....	C	P	S	SP	H	A	T	74-12

Transmission Top and Bottom Cover

1993 - 1998 FLT Models (Includes Oil Fill Cover and Speed Sensor Mount).....	C	P	S	SP	--	A	--	80-106
1991 - 1998 Dyna Glide (Includes Oil Fill Cover and Speed Sensor Mount).....	C	P	S	SP	--	A	--	80-78

Transmission Top Cover

2006 & Up Dyna Glides and 2007 & Up FLT and Softail.....	C	P	S	SP	--	A	--	88-39
1999 - 2005 Dyna Glide Models.....	C	P	S	SP	--	A	--	88-38
1999 - 2005 FLT Models.....	C	P	S	SP	--	A	--	88-37
1998 - 2006 Softail Models.....	C	P	S	SP	--	A	--	80-169
1991 - 1998 Dyna Glide (Includes Oil Fill Cover and Speed Sensor Mount).....	C	P	S	SP	H	A	T	80-108
1988 - 1997 Big Twins (5 Speeds- except FXD Models Fits Softails).....	C	P	S	SP	H	A	T	80-69
1980 - 1987 Big Twins (5 Speeds).....	C	P	S	SP	H	A	T	80-37
1979 - 1985 FL & FX also Big Twins (4 Speeds).....	C	P	S	SP	--	A	T	74-37
1965 - 1978 Big Twins (4 Speeds).....	C	P	--	----	--	--	--	74-38
1936 - 1964 Big Twins (4 Speeds).....	C	P	--	----	--	--	--	74-68

Tripple Tree

1988 & Up FXR, XL also 1991 & Up FXD, FXDL 39mm (Top Bolt & Flat Washer).....	C	P	--	----	H	--	--	80-58
1988 & Up FXR & XL 39mm (Fork, Drain, Axle Caps and Nuts - Full Set).....	C	P	--	----	--	--	--	80-49
1987 & Earlier XL & FX (Pinch Bolts).....	C	P	S	SP	--	--	--	20-45
FXWG & FXST (Pinch Bolts and Headlights Mount).....	C	P	--	----	--	--	--	80-45
XL & FX (sides) also FXR (4 screws on sides).....	C	P	--	----	--	--	T	20-21

Turn Signals

1986 & Up H-D (Turn Signals Cover Mount includes - O'Rings).....	C	P	S	SP	--	--	--	61-13
--	---	---	---	----	----	----	----	-------

Wheel Adjustment Bolts

2007 & Up Dyna Glide Models (Rear).....	C	P	--	----	H	--	--	96-151
2008 & Up All Softail Models (Rear).....	C	P	--	----	H	--	--	96-150
1992 - 2006 Dyna Glide Models (Rear).....	C	P	--	----	H	--	--	80-151
1993 - 2007 All Softail Models (Rear).....	C	P	--	----	H	--	--	80-150
1987 - 1992 All Softail Models (Rear).....	C	P	--	----	H	--	--	80-50
1972 & Earlier Big Twins (Rear).....	C	P	--	----	--	--	--	74-40

Windshield

1984 - 1994 FXRT (with Headlight Cover Mount).....	C	P	S	SP	--	--	--	80-68
1986 & Up FLHT & FLHTC 80cu. (with Spotlight, Dash, Radio Cover and Side of Triple Trees).....	C	P	--	----	--	--	--	80-67

Big Twin Acorn Style Sets



Gardner-Westcott's **Acorn Style Sets** include slotted studs for easy removal. Show Kit Sets contain; Primary, Transmission and Cam Side Covers, Oil Pump, Motor Mounts, Transmission Top, Inner Primary, Header Acorns, Point Cover, Rocker Box, Lifter Base, Timing Plug and Motor Case. Our Show Bike Kits now include more sets than ever and use the proper height or shank Acorn for the application. Flat Washers, Lock Washers or special Washers are included, and are in **Show Chrome Plated**.

Show Bike Kits

Part

2007 & Up Softail Models.....	50-310A
2007 & Up Dyna Glide Models.....	50-311A
2009 & Up FLT Models.....	50-113A
2008 - 2007 FLT Models.....	50-312A
2000 - 2006 Softail Models.....	50-180A
1999 - 2005 Dyna Glide Models.....	50-119A
1999 - 2006 FLT Models.....	50-120A
1996 - 1999 FXST & FLST Softail Models.....	50-118A
1996 - 1998 Dyna Glide.....	50-117A
1996 - 1998 FXR & FLT Models.....	50-116A
1991 - 1995 Dyan Glide FXDB.....	50-114A
1991 - 1995 FXR & FLT Models.....	50-115A
1987 - 1995 FXST & FLST Softail Models.....	50-112A
1987 - 1990 FXR & FLT Models.....	50-113A
1986 - FXST & FLST Softail Models.....	50-111A
1985 - Evolution (4 Speed) & 1984 - 1985 FXST.....	50-101A
1984 - 1986 Evolution (5 Speed) Models.....	50-102A
1982 - 1983 Shovelhead FXR Models.....	50-103A
1979 - 1984 Shovelhead (4 Speed) Models.....	50-104A
1977 - 1978 Shovelhead 74cu.....	50-105A
1970 - 1976 Shovelhead 74cu.....	50-106A
1966 - 1969 Shovelhead 74cu.....	50-107A
1965 - Panhead (with Long D-Ring Screws).....	50-110A
1948 - 1964 Panhead (with Short or Long D-Ring Screws).....	50-108A

Slotted Studs
for easy removal
washers included
in Sets



Show Bike Kit
50-104A



Most Sets
Available with
Spike Nuts



Big Twin Individual Acorn Nut Sets

Axle	Part #
1975 & Earlier FLH Models (<i>Axle Cap; Front Nut, Washers and Studs Front</i>).....	50-157A
1977 & Up FLH, FLT, FXDWG & 1973 - 1987 FX, XL (<i>Axle Cap Nut Set</i>).....	50-159A
1980 - 2007 FLT, 1988 & Up FXR, 1984 & Up Softails (<i>Axle Nut Set Front</i>).....	C-31-44A
1973 - 1988 All Models (<i>Axle Nut Set Rear</i>).....	C-31-41A
Belt Sprocket to Hub	
1999 & Earlier (<i>4 and 5 Speeds</i>).....	50-67A
2000 & Up Dyna and Softail Models also 2004 & Up FLT.....	50-168A
Cam Cover	
1999 & Up Twin Cam 88, 88B & 96cu.....	50-170A
1970 & Up Big Twins 80cu.....	50-24A
1936 - 1969 Big Twins.....	50-72A
Circuit Breaker Base	
1936 - 1957.....	50-73A
Cylinder Base	
1936 - 1984 Shovelhead, Panhead and Knucklehead (<i>special 9/16" Hex Cap</i>).....	C-31-80A
Frame	
1991 & Up Dyna Glide (<i>Side Cover</i>).....	50-148A
Gas Tank Mount	
1993 & Up Dyna Glide FXDWG Models only (<i>includes Dash Mount</i>).....	50-84A
1991 & Up Dyna Glides	50-85A
Generator Screw	
1958 - 1969	50-75A
1936 - 1957	50-76A
Handle Bar Clamp	
1974 - 1981	50-152A
1982 & Up	50-153A
Handle Bar Lever and Switch Box	
1982 - 1995	50-150A
Head Bolt Set	
Panhead & Shovelhead (<i>9/16" Hex Cap for easy use</i>).....	50-68A
Header Mount Set	
Twin Cam Models (<i>Studs & Flange Nuts</i>).....	50-203Y
Twin Cam Models (<i>Studs & Acorn Nuts</i>).....	50-203A
1984 & Up Evolution and Twin Cam 88, 96 & 103cu.....	50-03A
Shovelheads (<i>includes Gaskets, Studs & Washers</i>).....	31-50A
Evolution & Twin Cam (<i>Stock Style</i>).....	50-03Y
License Plate Set	
Fits all Motorcycles.....	50-36A
Lifter Base Set	
1999 & Up Twin Cam 88 & 88B.....	50-171A
1977 - 1999 Big Twins 74cu. & 80cu.....	50-18A
1936 - 1976 Big Twins.....	50-17A
1977 & Up Blocks on pre 1976 Motors.....	50-65A
Motor Case	
2000 & Up Twin Cam 88B & 96cu. Softail (<i>Stud & Acorn Set</i>).....	50-165A
1999 & Up Twin Cam 88 Dyna, 96cu. & FLT (<i>Stud & Acorn Set</i>).....	50-172A
1996 - 1999 Big Twins 80cu. (<i>Stud & Acorn Set</i>).....	50-164A
1983 - 1995 80cu. (<i>Stud & Acorn Set</i>).....	50-163A
1979 - 1982 80cu. (<i>Stud & Acorn Set</i>).....	31-31A
1978 & Earlier 74cu. (<i>Stud & Acorn Set</i>).....	31-29A

Slotted Studs
for easy removal
washers included
in Sets



Most Sets
Available with
Spike Nuts



Big Twin Individual Acorn Nut Sets



Motor Mount Set	Part #
2007 & Up Softail Models.....	50-319A
2007 & Up Dyna Glides.....	50-318A
2009 & Up FLT Models.....	50-316A
2007 - 2008 FLT Models.....	50-317A
2000 - 2006 Softail Models (Top, Front & Rear).....	50-175A
1999 - 2006 Dyna Glides (Top, Front & Rear).....	50-173A
1999 - 2006 FLT Models (Top, Front & Rear).....	50-174A
1991 - 1998 Dyna Glides (Top, Front & Rear).....	50-86A
1991 - 1998 FXR & FLT (Top, Front & Rear).....	50-82A
1987 - 1990 FXR & FLT (Top, Front & Rear).....	50-81A
1987 - 1999 FXST & FLST (Top, Front & Rear).....	50-05A
1985 - 1986 (4 Speed) & 1984 - 1986 FXST (Top, Front & Rear).....	50-39A
1984 - 1986 (5 Speed) FXR & FLT (Top, Front & Rear).....	50-38A
1982 - 1983 FXR & FLT (Top, Front & Rear).....	50-37A
1948 - 1984 (4 Speeds).....	50-19A

Oil Pump	
1992 - 1999 & Up Big Twins 80cu.....	50-197A
1979 - 1991 Big Twins.....	50-35A
1968 - 1978 Shovelheads.....	50-34A
1936 - 1967 Big Twins.....	31-40A

Oil Tank	
1981 & Up (Drain Bolts).....	50-46A
1980 & Earlier (Drain Bolts).....	C-20-20

Points Cover Mount	
1999 & Up Timer Cover Twin Cam 88 & 2000 & Up 88B Softail	50-144A
1979 - 1999, 80cu. (Includes Gasket).....	50-96A
1970 - 1978 (Includes Gasket).....	50-97A

Primary Cover	
2007 & Up FLT Models.....	50-186A
2006 & Up Dyna & 2007 & Up Softail Models.....	50-185A
1999 - 2006 FLT Models.....	50-183A
1999 - 2005 Dyna & Softail Models.....	50-179A
1986 - 1988 Softail Models.....	50-98A
1989 - 1998 Softail Models & 1991 - 1998 Dyna Glide Models.....	50-99A
1985 - 1998 FLH & FXR Models.....	50-31A
1980 - 1984 5 Speeds FXR & FLT Models.....	50-23A
1970 - 1985 (4 Speeds) & 1984 - 1985 FXST.....	50-25A
1965 - 1969 Big Twins.....	50-77A
1936 - 1964 Big Twins.....	50-78A
1965 & Up (Custom using Accessory Stamped Cover).....	50-79A

Regulator Mount and Bracket Mount	
2000 & Up Softail Models.....	50-162A
1997 & Up FLT.....	50-161A
1980 - 1996 FLT & FXR.....	50-04A

Rocker Arm Shaft	
1971 - 1984 Shovelhead (End Plugs).....	50-71A
Shovelheads (End Nuts - Left Side with Special Washers).....	50-40A

Rocker Box	
1999 & Up Twin Cam 88 also 2000 & Up 88B & 96cu.....	50-176A
1984 - 1999 Evolution 80cu. (Includes Special Washers).....	50-20A
1966 - 1984 Shovelhead (Low Crown Includes Special Washers).....	50-15A
Panhead - (Pan Covers Short D Ring length).....	50-91A
Panhead - (Pan Covers Long D Ring length).....	50-92A



Acorn Kit 50-82A



Most Sets Available with Spike Nuts



Big Twin Individual Acorn Nut Sets

Star Wheel

Part

1966 & Earlier..... 50-93A

Timing Plug

Fits All Harley's..... C-20-20

Transmission Side Cover

2007 & Up Softail Models..... 50-322A
 2006 & Up Dyna Glides..... 50-325A
 2007 & Up FLT Models..... 50-324A
 1987 - 2006 Big Twins also 2005 & Earlier Dyna Glides..... 50-42A
 1980 - 1986 Big Twins (5 Speed)..... 50-22A
 1936 - 1985 Big Twins (4 Speed)..... 50-12A

Transmission Top Cover

2006 & Up Dyna Glides, 2007 & Up FLT & Softail Models..... 50-187A
 1999 - 2005 Dyna Glides (Includes Bottom Cover)..... 50-177A
 1999 - 2006 FLT Models (Includes Bottom Cover)..... 50-178A
 1993 - 1998 FLT Models (Includes Bottom Cover)..... 50-149A
 1991 - 1998 Dyna Glides (Includes Bottom Cover)..... 50-87A
 1998 - 2006 Softail Models..... 50-182A
 1988 - 1997 also 1999 & Up FLT Models (5 Speeds except - Dyna Glide Models)..... 50-122A
 1980 - 1987 (5 Speeds)..... 50-06A
 1975 - 1985 (4 Speeds)..... 50-11A
 1965 - 1978 Big Twins..... 50-146A
 1936 - 1964..... 50-147A

Triple Trees

XL, FX & FXR (Both Sides)..... 50-21A
 1949 & Up FL, FLH, FXWG & FXDWG (Top Nut with Washer)..... 50-195A

**IF YOU DONT SEE A SET
PLEASE CALL!**



Acorn Kit 50-195A



Inside This Section

Allen Style

<i>Builders Fastener Sets.....</i>	<i>20</i>
<i>Full Allen Motorcycle Sets.....</i>	<i>20</i>
<i>Motor Sets.....</i>	<i>21</i>
<i>Side Cover Sets.....</i>	<i>22</i>
<i>Individual Sets.....</i>	<i>23-28</i>

Acorn Style

<i>Show Bike Kits.....</i>	<i>28</i>
<i>Individual Sets</i>	<i>29-30</i>

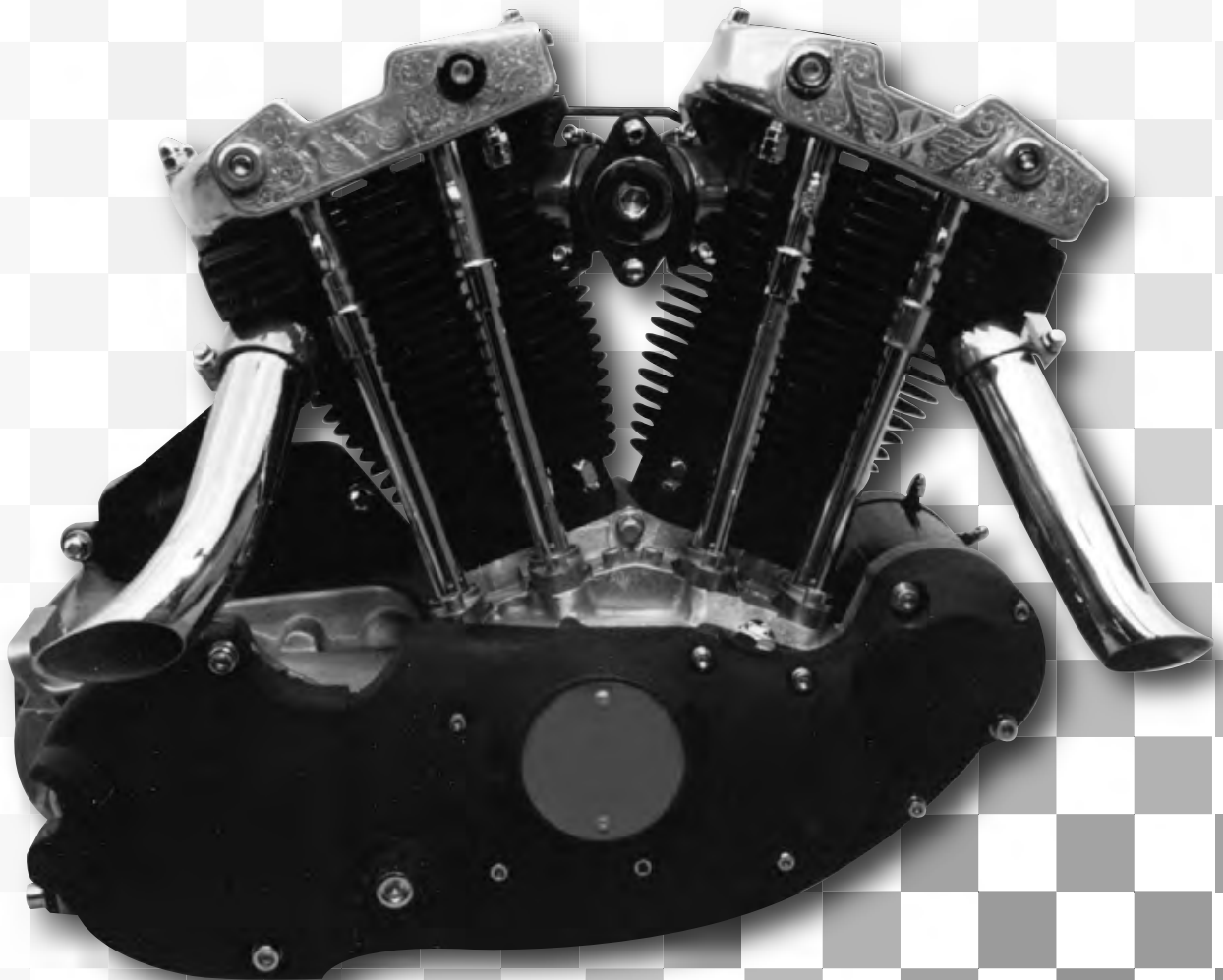



Sportster Builder Sets

"Where there is a bolt, you get a Allen Screw,



Where there is a nut, you get a Acorn Nut"



Gardner-Westcott's combination set of **Chrome Allen Screws** and **Acorn nuts** with Chrome Washers for Sportster Motors.



C= Chrome Plated



P= Polished Chrome Plated
Knurls Removed

Builders Fastener Sets

	Styles Available	Part #
2004 & Up.....	C P	GW-04-A
1992 - 2003 (<i>Evolution</i>).....	C P	GW-61-A
1986 - 1990 (<i>Evolution</i>).....	C P	GW-60-A
1984 1/2 & 1985 (<i>Iron Head Alternator</i>).....	C P	GW-59-A
1979 - 1984 1/2.....	C P	GW-58-A
1977 - 1978.....	C P	GW-57-A
Late 1973 - 1976.....	C P	GW-56-A
1971 - Early 1973.....	C P	GW-55-A
1957 - 1969 XLCH.....	C P	GW-54-A
1967 - 1970 XLH & 1970 XLCH.....	C P	GW-53-A



Builders Set GW-61-A

Full Allen Motorcycle Sets

The Full Allen Set for your Sportster includes; Allens for Motor, Transmission, Chassie and Head Bolts. Where required, Sets supplied with Flat Washers, Lock Washers, Hex Nuts or Lock Nuts.

	Styles Available	Part #
2004 - 2008 (<i>for Dual Disc Models</i>).....	C P	20-66
2004 - 2008 (<i>for Single Disc Models</i>).....	C P	20-67
1991 - 2003 (<i>V2 - 5 Speeds</i>).....	C P	20-81
1988 - 1990.....	C P	20-76
1986 - 1987 (<i>V2</i>).....	C P	20-78
1985 - 1984 1/2 (<i>Alternator</i>).....	C P	20-84
1983 - 1984.....	C P	20-83
1982 - Only.....	C P	20-82
1979 - 1981.....	C P	20-79
1977 - 1978.....	C P	20-77
1967 - 1970 XLH & Up 1990 XLCH.....	C P	20-74
1975 - 1976.....	C P	20-75
1973 - 1974.....	C P	20-73
1972 - Only.....	C P	20-72
1971 - Only.....	C P	20-71
1957 - 1969 XLCH.....	C P	20-70

PLEASE CALL WITH YEAR AND MODEL FOR ANY SPORTSTER SETS NOT LISTED



Motor Sets

All Sportster Motor Sets contain **Allen Screws** for Cam and Primary, Generator or Oil Filter Mount, Sprocket, Rocker Box, Top Motor Mount, Lifter Base, Point or Magneto Cover, Flat Washers, Lock Washers, Special Washers, Hex Nuts and Lock Nuts supplied where needed.



	Styles Available	Part #
2004 & Up.....	C P S SP A	20-85
1991 - 2003 (<i>Evolution</i>).....	C P S SP A	20-86
1986 - 1990 (<i>Evolution</i>).....	C P S SP A	20-87
1984 1/2 & 1985 (<i>Iron Head Alternator</i>).....	C P S SP A	20-88
1977 - 1984 1/2.....	C P S SP A	20-89
1971 - 1976.....	C P S SP A	20-90
1957 - 1969 XLCH.....	C P -- -- --	20-91
1967 - 1970 XLH & 1970 XLCH.....	C P -- -- --	20-92
1957 - 1966 XLH.....	C P -- -- --	20-93
1952 - 1956 K Models.....	C P -- -- --	20-94



Motor Set P-20-89



Sportster Side Cover Sets

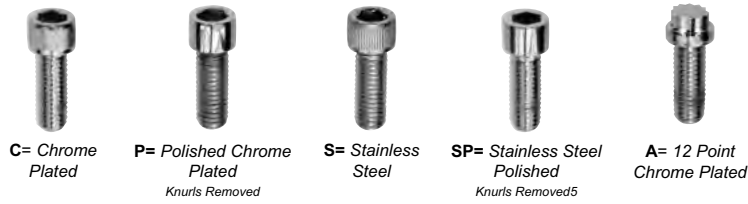

Cam and Primary with Inspection, Sprocket and Oil Fill Check Screws where applicable

	Part #	Styles Available
2004 & Up.....	10-31-01	C P S SP A
1991 - 2003.....	10-30-01	C P S SP A
1986 - 1990.....	10-29-01	C P S SP A
1977 - 1985.....	10-28-01	C P S SP A
1971 - 1976.....	10-26-01	C P S SP A
1957 - 1969 XLCH.....	10-33-01	C P -- ---- --
1967 - 1970 XLH & 1970 XLCH.....	10-34-01	C P -- ---- --
1957 - 1966 XLH & 1952 - 1956 K & KH.....	10-36-01	C P -- ---- --

Cam and Sprocket Cover Only

2004 & Up.....	10-31-06	C P S SP A
1991 - 2003.....	10-30-06	C P S SP A

Cam Cover Only

1971 - 1990.....	10-26-06	C P S SP A
1957 - 1970.....	10-33-06	C P S SP A

Primary Cover Only

2004 & Up.....	10-31-08	C P S SP A
1991 - 2003.....	10-30-08	C P S SP A
1986 - 1990.....	10-29-08	C P S SP A
1977 - 1985.....	10-28-08	C P S SP A
1971 - 1976.....	10-26-08	C P S SP A
1957 - 1966 XLCH.....	10-33-08	C P -- ---- --
1967 - 1970 XLH.....	10-34-08	C P -- ---- --



Side Cover Set P-10-34-01

Sportster Individual Sets



- Where required, sets are supplied with Flat Washers, Lock Washers, Special Washers, Hex Nuts and or Lock Nuts.
- All sets are available in 24K Gold Plated and also other styles.

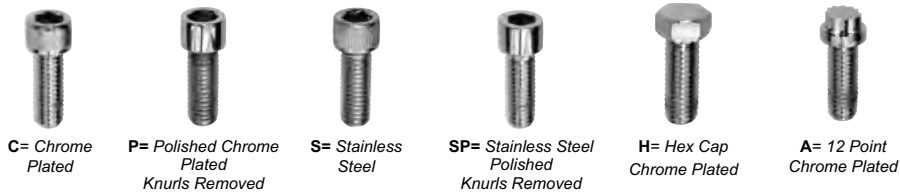

	Styles Available	Part #
Air Cleaner Cover		
1986 & Up.....	C P -- ---- -- --	61-33
1967 - 1978 & 1983 - 1985 (2 Oval Screws).....	C P -- ---- -- --	20-33
1979 - 1985 (3 Screws).....	C P S SP -- A	20-54
Banjo Bolts		
2004 & Up (Brake Line Dual).....	-- P -- ---- -- --	80-118
2004 & Up (Brake Line Front).....	-- P -- ---- -- --	80-117
1984 - 2003 (Brake Line Front).....	-- P -- ---- -- --	80-111
1982 - 2003 (Front and Rear).....	-- P -- ---- -- --	80-110
Belt Sprocket Mount		
2004 & Up.....	C P -- ---- H A	74-59
1991 - 2003 (with Hardened Washers Cast Wheel).....	C P -- ---- H A	74-49
1991 - 1999 (with Hardened Washers & Locknuts Laced Wheel).....	C P -- ---- H A	80-51
Brake Arm Rear		
1974 & Earlier (Allen Screws).....	C P S SP -- A	20-42
1975 - 1976 (Allen Screws).....	C P S SP -- A	20-43
Brake Master Cylinder Mount & Cover Rear		
2004 & Up	C P S SP -- --	61-45
1986 - 2003 (Coarse Thread).....	C P S SP -- --	61-09
1982 - 1985 (Fine Thread).....	C P S SP -- A	61-01
1979 - 1981 (Coarse Thread).....	C P S SP -- A	20-01
Chain Guard		
To Swing Arm Allen Screws.....	C P -- ---- H A	20-32
Chain Sprocket to Hub Rear Wheel		
1979 & Up (Spoked Wheel Laced with Lock Nuts).....	C P S SP H A	20-68
1979 & Up (Cast Wheel Mag).....	C P S SP H A	61-68
Clutch Adjustment Allen Plug		
1977 - 1990 (with O'Ring).....	C -- -- ---- -- --	20-63
1971 - 1976 (with O'Ring).....	C -- -- ---- -- --	20-61
Cylinder Base		
1957 - 1985 Base Allens (requires removal of studs includes washers).....	C P -- ---- -- A	20-08
Disc Brake Caliper Mount Front		
2009 XR Style (Single Disc, Dual Disc Buy 2 Sets).....	C P -- ---- -- --	61-41
2004 & Up XL Style (Single Disc, Dual Disc Buy 2 Sets).....	-- P -- ---- -- --	61-43
2000 - 2003 (Single Disc, Dual Disc Buy 2 Sets).....	-- P -- ---- -- --	80-147
1993 - 1999 (Single Disc, Dual Disc Buy 2 Sets).....	C P -- ---- -- --	80-143
1984 - 1992 (Single Disc, Dual Disc Buy 2 Sets).....	C P -- ---- -- --	80-144
1977 - 1983 (Single Disc).....	C -- -- ---- -- --	80-43
1974 - 1977 (Single Disc).....	C P -- ---- -- A	20-49



Disc Brake Caliper Mount Rear

	Styles Available	Part #
2009 & Up XR Style.....	C P -- ---- -- -- --	61-42
2004 & Up XL Style.....	-- P -- ---- -- -- --	61-69
2000 & Up.....	-- P -- ---- -- -- --	80-148
1987 - 1999.....	C -- -- ---- -- -- --	80-142
1982 - 1986.....	C P S SP -- A --	61-08

Disc Brake Rotor to Hub Front

1984 & Up (Front Single Disc, Cast Wheel, Dual Disc Buy 2 Sets).....	C -- -- ---- -- -- T	80-42
1984 & Up (Front Single Disc, Laced Wheel, Dual Disc Buy 2 Sets).....	C -- -- ---- -- -- T	80-41
1977 - 1983 (Front Dual Disc Brakes Cast Wheel).....	C -- -- ---- -- -- --	20-04
1977 - 1983 (Front Dual Laced Wheel).....	C -- -- ---- -- -- --	20-04N
1974 - 1978 (Front Single Disc Brakes).....	C -- -- ---- -- -- --	20-55

Disc Brake Rotor to Hub Rear

1992 & Up (Rear Wheel Cast Wheel).....	C -- -- ---- -- -- T	61-32
1992 & Up (Rear Wheel Laced Wheel).....	C -- -- ---- -- -- T	61-31
1979 - 1991 (Rear Wheel Cast Wheel).....	C -- -- ---- -- -- --	74-01
1979 - 1991 (Rear Wheel Laced Wheel).....	C -- -- ---- -- -- --	20-69

Fender Bracket

1974 - 1984 XL & FX (Front Fender Mount).....	C -- S SP -- -- --	20-03
---	--------------------	-------

Fender Mount Only

1984 & Up (Front).....	C P S SP -- -- --	61-04
1972 & Earlier (Front Allen Screws).....	C P S SP -- -- --	20-22

Fender Rail Rear

2004 & Up.....	C P -- ---- -- -- --	61-53
1995 - 2003.....	C P S SP H -- T	61-54
1957 - 1978 (for Stock Replacement).....	C P -- ---- -- -- --	20-11
1979 - 1981 & 1982 - 1994 (with Sissy Bar).....	C P S SP -- A --	20-53
1982 Style (Tapered Head/ Stock Style).....	C P S SP -- -- --	61-11
1957 - 1978 (with Longer Screws for Mounting Sissy Bars w/stock holes).....	C P S SP -- -- --	20-02
1957 - 1978 (with Sissy Bars Longer than stock).....	C P S SP -- A --	20-10

Foot Pegs

2004 & Up (Foot Peg Bracket, Shifter and Brake Arm Mount).....	C P -- ---- -- A --	61-35
All Harley's Allen Screws (Front and Rear Special Shoulder Bolts).....	C P -- ---- -- -- --	20-35

Fork Drain Front

1973 & Up (with copper washers, Available in Buttonhead).....	C P S SP -- -- --	20-58B
1954 - 1972 (with copper washers).....	C P -- ---- -- -- --	20-57

Fork

1988 & Up 39mm (Triple Tree Top Bolt & Washer).....	C P -- ---- H -- --	80-58
Tube Caps, Triple Tree Top Bolt, Pinch Bolts, Drain Screws & Axle Cap Nuts.....	C P -- ---- -- -- --	80-49
1988 & Up (Tube Allen Caps).....	C P S SP -- -- --	99-23
1977 & Up XL & FX (Damper Mount, with Brass Washer).....	C P -- ---- -- -- --	61-58

Frame

1985 & Up (Frame Side Cover, Left Side).....	C P S SP -- -- --	61-07
--	-------------------	-------

Front

1972 & Earlier XL & FX (Front Wheel Pinch Bolt).....	C P S SP -- A --	20-27
--	------------------	-------

Gas Tank Mount

2004 & Up.....	C P S SP -- A --	61-30
1986 - 2003.....	C P S SP -- -- --	61-12
1972 - 1979 XLCH.....	C P S SP H -- --	20-29
1957 - 1971.....	C P S SP H -- --	20-28

Sportster Individual Sets



Generator Screws	Styles Available	Part #
1971 - 1984 1/2	C P -- ---- -- A --	20-14
1954 - 1970	C P -- ---- -- A --	20-47
Handle Bar Clamp		
1984 & Up (<i>Speedo & Tack Bracket Mount with Spacers</i>).....	C P -- ---- -- -- --	80-55
1981 - 1984	C P S SP -- -- --	80-52
1974 - 1980 & 1997 & Up (<i>C Models</i>).....	C P S SP -- -- --	20-52
Handle Bar Lever & Switch Boxes		
2004 & Up (<i>with Master Cylinder Screws in Buttonheads</i>).....	C -- S SP -- -- --	61-40B
2004 & Up (<i>with Master Cylinder Screws</i>).....	C P S SP -- -- --	61-40
1996 - 2003 (<i>with Master Cylinder Screws in Buttonheads</i>).....	-- P -- ---- -- -- --	74-150B
1996 - 2003 (<i>with Master Cylinder Screws</i>).....	C P S SP -- -- T	74-150
1996 - 2003 (<i>with Master Cylinder Screws in Stock Style Fasteners</i>).....	-- P S SP -- -- --	74-150Y
1982 - 1981 All (<i>with Master Cylinder Cover - Front</i>).....	C P S SP -- -- T	74-50
1973 - 1981 All (<i>with Master Cylinder Cover & Twist Crip</i>).....	C P S SP -- -- --	20-40
1972 - Earlier XL & 1971 & Earlier 74cu.....	C P S SP -- -- --	20-39
Handle Bar Rizer Mount		
2004 & Up.....	C P -- ---- H A --	80-123
1995 - 2000 (<i>with Cup Washers</i>).....	C P -- ---- H A --	61-57
1974 - 1985 (<i>with Cup Washers</i>).....	C P -- ---- H A --	80-122
Head Bolts		
1992 & Up (<i>Evolution</i>).....	-- -- -- ---- -- A --	61-110
1987 - 1991 (<i>Evolution</i>).....	-- -- -- ---- -- A --	61-100
1986 - Only (<i>with Special Washers</i>).....	-- -- -- ---- -- A --	80-100
1973 - 1985 (<i>Iron Head Includes Washers</i>).....	C P -- ---- H A --	20-17
1957 - 1972 (<i>900cc. Includes Washers</i>).....	C P -- ---- -- A --	20-18
1952 - 1956 (<i>K & KH Model Flat Heads Includes Washers</i>).....	C P -- ---- -- A --	20-80
Header Exhaust Clamp		
1981 - 1985 (<i>Iron Head</i>).....	C P S SP H A --	61-25
1980 - Earlier (<i>1/4" Diameter</i>).....	C P S SP H A --	20-25
Header Exhaust Mount		
2004 & Up (<i>Evolution Header Mount in Acorns</i>).....	C P S SP -- -- --	50-03A
2004 & Up (<i>Evolution Header Mount in Flange Nuts</i>).....	C P S SP -- -- --	50-03Y
Headlight		
1957 & Up (<i>Headlight Mount Bracket</i>).....	C P S SP H A --	20-23
Intake		
1991 - 2001 (<i>Injected</i>).....	C P S SP -- A --	61-04
1995 & Up (<i>Evolution Intake Manifold Mount with Carburetors</i>).....	C P S SP -- A --	61-39
1988 - 1994 (<i>Evolution Intake Manifold Mount with Carburetors</i>).....	C P S SP -- A --	61-38
XR - 1000 (<i>Intake Manifold Mount</i>).....	C P S SP -- A --	61-02



Kicker	Styles Available	Part #
1976 & Earlier (<i>Kicker Arm Upper & Lower Set Fits All Harley's</i>).....	C P S SP H A --	20-26
Keihin Carb		
1988 - 2006 XL (<i>Constant Velocity</i>).....	C P S SP -- A --	61-36
(<i>Constant Velocity Top Cover Only</i>).....	C P S SP -- A --	61-37
1987 & Earlier XL (<i>with Float Bowl & Pump Set Butterfly</i>).....	C P S SP -- A --	80-36
K Model		
Head Bolts & Top Motor Mount (<i>with Washers</i>).....	C P -- --- -- A --	20-80
1952 - 1956 (<i>Lifter Base</i>).....	-- P -- --- -- A --	74-16
License Plate		
Set - Fits All (<i>with Buttonhead Allens, Hex Nuts & Washers</i>).....	C -- S SP -- -- --	20-34
Set - Same as above (<i>except with Lock Nuts</i>).....	C -- S SP -- -- --	20-34N
Set - Same as above (<i>except with Acorn Nuts</i>).....	-- P S SP -- -- --	20-34A
Set - Available in (<i>Allens, 12 Points & Hex Caps with Lock Nuts</i>).....	C P S SP H A T	20-34
Bracket to Fender (<i>Allens with large Washers & Nuts</i>).....	C P S SP H A T	20-41
Lifter Base		
2006 & Up XL.....	C P S SP -- A --	61-44
2004 - 2005 (<i>with Anti-Rotation Screws</i>).....	C P S SP H A T	61-50
2000 - 2003 (<i>with Anti-Rotation Screws</i>).....	C P S SP H A T	61-51
1995 - 1999 (<i>with Pin Plate Mount</i>).....	C P S SP H A T	61-52
1991 - 1994 (<i>with Pin Plate Mount</i>).....	C P S SP H A T	61-16
1957 - 1990.....	C P S SP H A T	20-16
Magneto Cover		
Allen Screws (<i>with Allen wrench</i>).....	C P S SP -- -- --	20-46
Motor Case		
2004 & Up.....	C P S SP H A --	61-27
1991 - 2003.....	C P S SP H A --	61-29
1977 - 1990.....	C P S SP H -- --	20-07
1957 - 1976.....	C P S SP H -- --	20-09
Motor Mount Includes Special Washers & Lock Nuts		
2004 & Up (<i>with Stabilizer Link Fasteners</i>).....	C P S SP H A --	61-23
1986 - 2003 (<i>Evolution Bottom</i>).....	C P S SP H A --	61-19
1986 - 2003 (<i>Evolution Center</i>).....	C P S SP H A --	61-21
1986 - 2003 (<i>Evolution Forward Top</i>).....	C P S SP H A --	61-20
1957 - 1985 (<i>Forward</i>).....	C P S --- H -- --	20-59
1991 - 2003 (<i>Rear Allen Screws</i>).....	C P S SP H A --	61-22
1982 - 1985 (<i>Rear Allen Screws</i>).....	C P S SP H -- --	61-05
1979 - 1981 (<i>Rear Allen Screws 6 each</i>).....	C P S --- H A --	20-05
1978 & Earlier (<i>Rear Allen Screws</i>).....	C P S SP H A --	20-38
1977 - 1985 (<i>Top Allen Screws</i>).....	C P S SP H A --	20-51
1957 - 1976 (<i>Top Motor Strap</i>).....	C P S SP H A --	20-19
Oil Filter		
1985 - 2003 (<i>Filter Mount Alternator models</i>).....	C P S SP -- A --	61-14
Oil Fill or Clutch Adjustment Allen Plug		
1977 - 1991.....	C -- -- --- -- -- --	20-63
1971 - 1976 (<i>Oil Fill Plug only</i>).....	C -- -- --- -- -- --	20-60
1971 - 1976 (<i>Clutch Adjustment Plug only</i>).....	C -- -- --- -- -- --	20-61
1977 - 1991 (<i>Set with Allen wrench</i>).....	C -- -- --- -- -- --	20-64
1971 - 1976 (<i>Set with Allen wrench</i>).....	C -- -- --- -- -- --	20-62
Oil Pump Mount		
1998 & Up.....	C P S SP H A --	61-55
1991 - 1997.....	C P S SP H A --	61-56
1977 - 1990.....	C P S SP H A --	20-56
1971 - 1976.....	C P S SP H A --	20-36

Sportster Individual Sets



	Styles Available	Part #
Oil Tank		
1981 & Up (<i>Drain Screw includes Washer</i>).....	C P -- ---- -- A --	80-20
1957 - 1980 (<i>Drain Screw</i>).....	C -- -- ---- -- A --	20-20
1978 & Earlier XLCH (<i>Oil Tank Mount Allen Screws</i>).....	C P S SP H A --	20-24
Point Cover (Electronic Module Cover)		
2004 & Up (<i>Fits All - Allen Screws with Wrench & Gasket</i>).....	C -- S SP -- -- --	20-12
1979 - 2003 (<i>Fits All - Allen Screws with Wrench & Gasket</i>).....	C -- S SP -- -- --	20-37
1971 - 1978 (<i>Fits All - Allen Screws with Wrench & Gasket</i>).....	C -- S SP -- -- --	20-12
Point and Condenser		
1971 -1978 (<i>Point & Condenser Mount with Flat Washers & Allen wrench</i>).....	C -- -- ---- -- -- --	74-44
Regulator Mount		
1982 - 1992.....	C P S SP -- -- --	61-24
1979 - 1981 and 1993 & Up	C P S SP -- -- --	74-24
Rocker Arm Shaft End		
1971 - 1985 (<i>Allen Plugs</i>).....	C -- -- ---- -- -- --	74-55
(<i>Same as above except in Button Head Stock Style</i>).....	C -- -- ---- -- -- --	74-55B
1957 - 1970 (<i>Allen Plugs</i>).....	C -- -- ---- -- -- --	74-56
Rocker Box		
1984 & Up (<i>Evolution Full Rocker Box Mount Set for Inside & Top Mounting Hardware</i>).....	C P -- ---- -- -- --	80-115Y
1984 & Up (<i>Evolution Motor with Copper & Steel Washers</i>).....	C P S SP H A --	80-15
1984 & Up (<i>Same as above except in Button Allens</i>).....	-- P S SP -- -- --	80-15B
(<i>Tapered Cup Washer Allen set with Copper Washers</i>).....	-- P -- ---- -- -- --	80-15R
1977 - 1985.....	C P S SP H A --	20-50
1957 - 1976.....	C P S SP H A --	20-15
XR 1000 & XR 750.....	C P S SP H A --	61-15
Seat Mount		
1982 - 1996 (<i>Seat Mount Rear with Washers</i>).....	C -- S SP H A T	74-67
1997 & Up Harley's (<i>Seat Mount Fender Rear</i>).....	C -- S SP -- A T	61-67
Shock Absorber		
2004 & Up	C P S SP H A --	61-48
2000 - 2003	C P S SP H A --	61-49
1991 - 1999 (<i>Shock Mount Set</i>).....	C P S SP H A --	61-46
1988 - 1990 XLS & 1987 XLH Huger (<i>Allen Screws with Lock Nuts</i>).....	C P S SP H A --	61-47
1986 - 1987 XLH, DLX & XLH 1000 (<i>Allens, Acorns & Lock Nuts</i>).....	C P S SP H -- --	80-07
1982 - 1985 (<i>Allen Screws with Lock Nuts</i>).....	C P S SP H -- --	61-06
1979 - 1981 (<i>Allen Screws with Lock Nuts</i>).....	C P S SP H A --	20-06
Shifter Lever Transmission		
1975 - 1976.....	C P S SP H A T	20-31
1974 & Earlier.....	C P S SP H A T	20-30
Sprocket Cover		
1971 - 1976.....	C P S SP H A --	20-13
1954 - 1970.....	C P -- ---- -- -- --	20-48



Sportster Individual Sets



C= Chrome Plated



P= Polished Chrome Plated
Knurls Removed



S= Stainless Steel



SP= Stainless Steel Polished
Knurls Removed



H= Hex Cap Chrome Plated



A= 12 Point Chrome Plated



T= Torx Buttonhead Chrome Plated

Tail Light

	Styles Available	Part #
1999 & Up (Lens Mounting Screws Sold Each).....	C -- -- ---- -- -- --	80-136
1973 - 1998 (Harley Lens Mounting Screws Sold Each).....	C -- -- ---- -- -- --	80-135

Timing Plug

Fits - All Models (Button Head Allen Screw).....	C -- -- ---- -- A --	20-20
--	----------------------	-------

Triple Trees

1988 & Up 39mm (Top Bolt & Washer).....	-- P S SP -- -- T	80-58
1987 & Earlier XL & FX (with 4 Screws on Sides of Triple Trees).....	C P S SP -- -- --	20-21
1987 & Earlier XL & FX (Pinch Bolt Allen Screws).....	C P -- ---- H -- --	20-45

Turn Signals

1986 - 2001 (Turn Signals Cover Set Front & Rear with O'Rings on all models).....	C P S SP -- -- --	61-31
---	-------------------	-------

Sportster Acorn Style Sets

Gardner-Westcott's **Acorn Style Sets** include slotted studs for easy removal, Our **Show Bike Kit Sets** now have more sets than ever and use the proper height or shank acorn for the application. Flat washers, lock washers or special washers are also included, and are in **Show Chrome Plated**.

Show Bike Kits

	Part #
1991 - 2003.....	50-136A
1986 - 1990 (Evolution).....	50-135A
1984 - 1985 (Iron Head Alternator).....	50-134A
1977 - 1984 XL.....	50-133A
1971 - 1976 XL.....	50-132A
1957 - 1969 XLCH Models.....	50-131A
1967 - 1970 XLH & 1970 XLCH.....	50-130A
1957 - 1966 XLH Models.....	50-129A



Show Bike Kit
50-136A

Most Sets Available with Spike Nuts



Spike Nuts

Sportster Individual Acorn Nut Sets



Axle	Part #
1973 - 2007 Up (<i>Nut Set Rear</i>).....	31-41A
1973 - 1987 (<i>Axle Cap Stud and Acorn Set</i>).....	50-157A
1977 & Up FLH, FLT, FXDWG also 1973 - 1987 FX, XL (<i>Axle Cap Nut Set</i>).....	50-159A
Belt Sprocket	
1991 - 1994 (<i>Laced Wheel</i>).....	50-67A
Cam Cover	
1991 - 2003 (<i>Includes Sprocket</i>).....	50-166A
1971 - 1990.....	50-26A
1952 - 1970 XL & K Models.....	50-41A
Cylinder Base	
1952 - 1985 (<i>Cylinder Base Nuts</i>).....	50-54A
Fender Rail	
1957 - 1978 (<i>Fender Rail Set - Rear</i>).....	50-52A
Gas Tank	
1984 & Earlier (<i>Gas Tank Mount Set XLCH Models</i>).....	50-01A
Generator Screw	
1971 - 1984 1/2.....	50-14A
1957 - 1970.....	50-44A
Handle Bar Clamp	
1982 & Up.....	50-153A
1974 - 1981.....	50-152A
Handle Bar Lever Boxes	
1982 - 1995 (<i>Handle Bar Lever & Switch Box</i>).....	50-150A
Head Bolts	
1973 - 1985.....	50-95A
1957 - 1972.....	50-94A
Header Mount	
Set for All Evolution Motors.....	50-03A
License Plate	
Set Fits All Motorcycles.....	50-36A
Lifter Base	
1991 - 1994.....	50-160A
1957 - 1990.....	50-16A
1952 - 1956 K & KH Models.....	50-17A
Motor Mount	
1986 - 2003 (<i>Top, Front & Rear</i>).....	50-33A
1957 - 1985 (<i>Top, Strap</i>).....	50-56A
1957 - 1985 (<i>Forward Motor Mount</i>).....	50-30A
1957 - 1985 (<i>Forward Motor Mount; extra length for mounting highway peg or controls</i>).....	50-43A
Oil Filter	
1984 1/2 - 2003 (<i>Oil Filter Mount Set</i>).....	50-07A



Slotted Studs for easy removal washers included in Sets



Most Sets Available with Spike Nuts

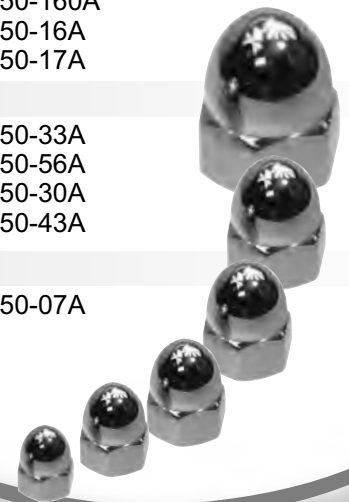



Sportster Individual Acorn Nut Sets

Oil Pump

	Part #
1998 & Up (<i>Mount</i>).....	50-184A
1991 - 1997 (<i>Mount</i>).....	50-156A
1977 - 1990 (<i>Mount</i>).....	50-158A

Oil Tank

1982 & Up (<i>Drain Plug</i>).....	50-46A
1981 & Earlier (<i>Drain Plug</i>).....	C-20-20

Point Cover Mount

1979 - 2003 (<i>Includes Gasket</i>).....	50-96A
1970 - 1978 (<i>Includes Gasket</i>).....	50-97A

Primary Cover

1991 - 2003 (<i>Sportster</i>).....	50-169A
1986 - 1990 (<i>Evolution XL</i>).....	50-29A
1977 - 1985 (<i>Sportsters</i>).....	50-28A
1971 - 1976 (<i>Sportsters</i>).....	50-27A
1967 - 1970 (<i>XLH & 1970 XLCH</i>).....	50-49A
1957 - 1969 (<i>XLCH Models</i>).....	50-50A
1957 - 1966 (<i>XLH Models</i>).....	50-51A

Rocker Arm Shaft

1971 - 1984 (<i>End Plug - Right Side</i>).....	50-71A
1957 - 1985 (<i>End Plug - Left Side</i>).....	50-40A

Rocker Box

All - (<i>Evolution Motors with Special Washers</i>).....	50-20A
1977 - 1985.....	50-69A
1957 - 1976.....	50-48A

Sprocket Cover

1991 & Up.....	50-166A
1977 - 1990.....	50-32A
1971 - 1976.....	50-13A
1952 - 1970 XL & K Models.....	50-53A

Tachometer

Tachometer Drive Block Off Plug Sportsters Iron Head.....	50-55A
---	--------

Timing Plug

All - Harley's.....	C-20-20
---------------------	---------

Triple Tree

XL & FX Models (<i>Both Sides - Early</i>).....	50-21A
---	--------



Most
Sets
Available
with
Spike Nuts





Inside This Section

Allen Style

Allen Screw Sets.....32

**45cu
Flathead**

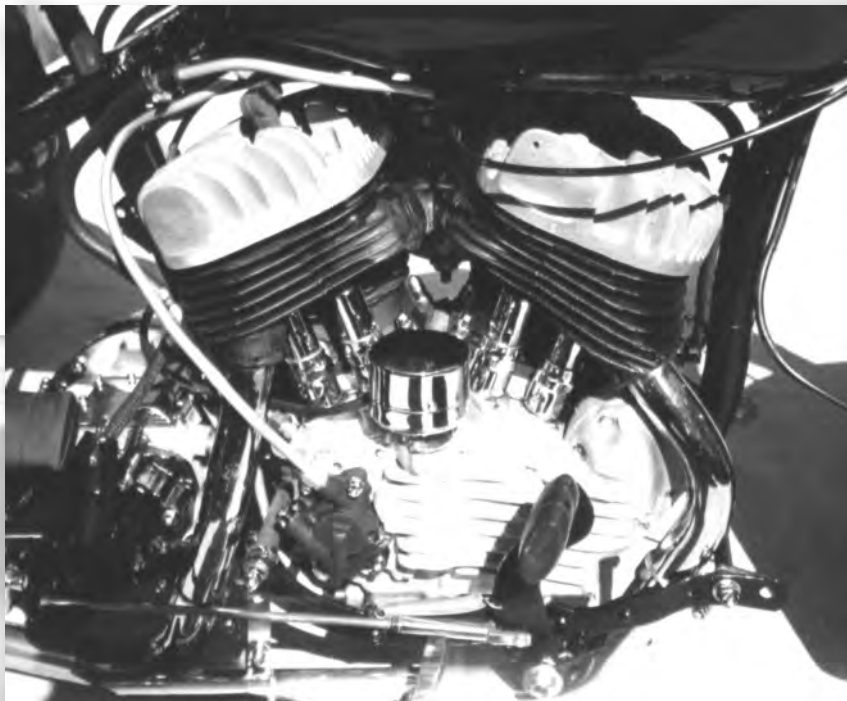



45cu. Flathead Allen Style

Allen Screw Sets

	Part #
Cylinder Base Nut Set Stock Style Chrome.....	C-31-54
Casing Alignment Allen Set with Nuts & Washers Replaces Stud.....	C-45-30
Cam Cover (<i>with Special Tapered Head</i>).....	C-45-06
1958 & Up Generator (<i>with Special Tapered Head</i>).....	C-45-14
1936 - 1957 Generator (<i>with Special Tapered Head</i>).....	C-45-12
Gas Tank & Oil Tank Set.....	C-45-34
Head Bolts - (<i>Both Iron Heads Includes Washers</i>).....	C-45-11
Head Bolts - (<i>Both Aluminum Heads Includes Washers</i>).....	C-45-10
Inspection Covers - (<i>Both Allen Screws on Primary</i>).....	C-45-09
Lifter Base.....	C-74-16
Oil Feed Pump.....	C-45-28
Oil Scavenger Pump.....	C-45-27
Oil Pump Check Value Plug.....	C-80-27
Tank Shifter Shoulder Bolt.....	C-45-13
Top Front & Rear Motor Mount.....	C-45-19
1963 & Earlier Transmission Top Inspection Cover.....	C-45-18
1964 & Up Transmission Top Inspection Cover.....	C-45-21
7/16-16 - 20 x 2 13/16 Head Stud.....	61148
7/16-16 x 1 1/2 Chrome Allen Screws.....	09380
7/16-16 x 1 3/4 Chrome Allen Screws.....	09382
7/16-16 x 2 Chrome Allen Screws.....	09384
7/16-16 x 2 1/2 Chrome Allen Screws.....	09386
7/16-16 x 3 3/4 Chrome Allen Screws 1" thread length.....	09394
7/16 - Head Bolt Flat Washers.....	23375

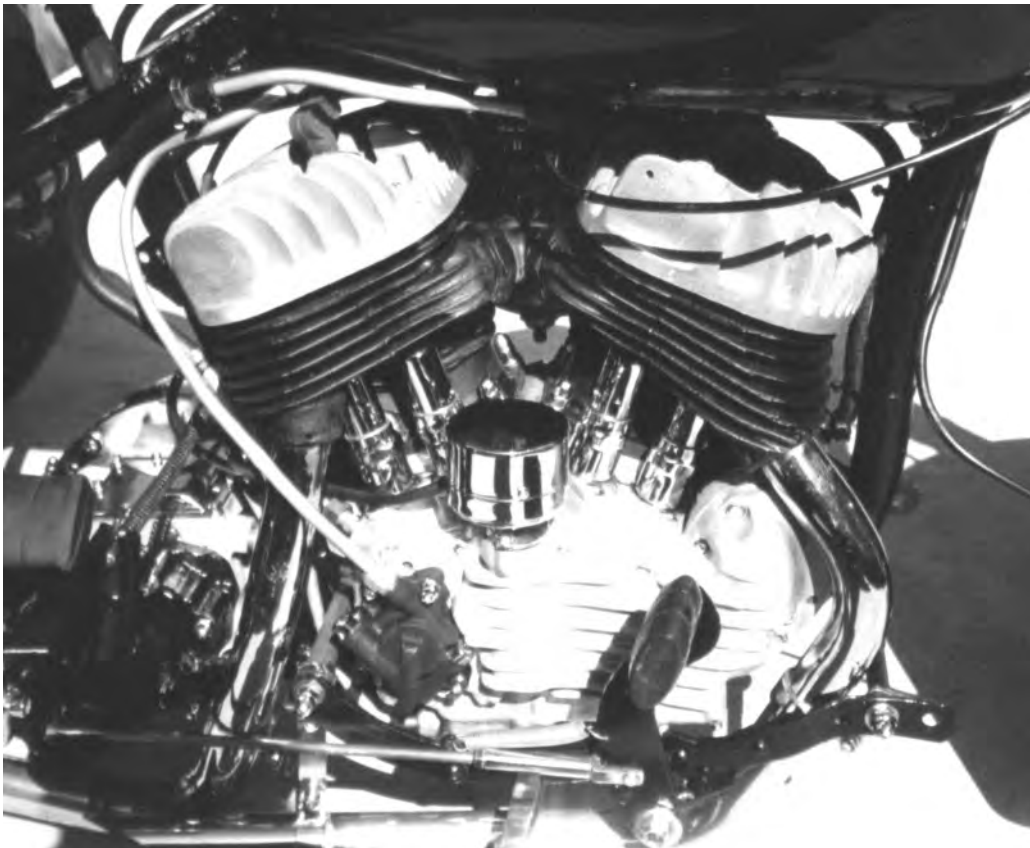



Inside This Section

<i>Allen Style with Acorn Nuts</i>	
<i>Builders Fastener Sets.....</i>	<i>34</i>
<i>Motor Sets.....</i>	<i>34</i>
<i>Side Cover Sets.....</i>	<i>35</i>
<i>Full Motorcycle Sets.....</i>	<i>35</i>
<i>Individual Sets.....</i>	<i>36</i>





V-Rod Builder and Motor Sets

"Where there is a bolt, you get a Allen Screw,



Where there is a nut, you get a Acorn Nut"



Builders Fastener Sets

Gardner-Westcott's perfect combination set of **Chrome Allen Screws** and **Acorn nuts** with Chrome Lock Washers, Flat Washers and Special Washers for the Motor and Transmission of the VRSCA V-Rod contains; Cluch Cover with Cluch Actuator Cover, Alternater Cover with Derby Cover, Forward Sprocket Cover, Cylinder Head Covers, Water Pump, Thermostat Mount, Oil Filter Mount, Electric Start Bracket, Motor Mounts, Oil Pan, Crank Case and Exhaust Header Mounts.

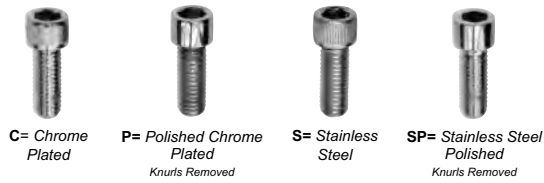

Styles Available

Part

2006 & UP V-Rod.....	C P S SP	GW-03A
2002 - 2005 VRSCA V-Rod 69cu.....	C P S SP	GW-02A

Motor Sets

Our Motor Sets contain **Chrome Allen Screws** with Chrome Lock Washers, Flat Washers and Special Washers where applicable. includes; Cluch Cover with Cluch Actuator Cover, Alternater Cover with Derby Cover, Forward Sprocket Cover, Cylinder Head Covers, Water Pump, Thermostat Mount, Oil Filter Mount, Electric Start Bracket and Oil Pan Mount.

Styles Available

Part

2002 & Up VRSCA V-Rod 69cu.....	C P S SP	69-02
---------------------------------	----------	-------

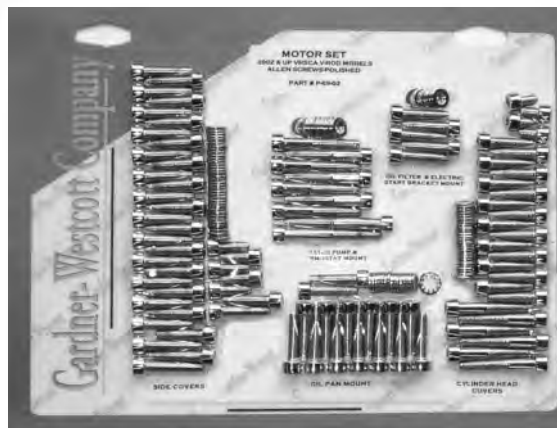

Motor Set 69-02

V-Rod Side Cover and Full Sets



Side Cover Sets

Side Cover Sets contains: **Chrome Allen Screws** with Special Washers and also includes; Clutch Cover with Clutch Actuator Cover, Alternater Cover with Derby Cover and Forward Sprocket Cover.



V-Rod

	Styles Available	Part #
2002 & Up VRSCA V-Rod 69cu.....	C P S SP	10-69-01

SETS AVAILABLE FOR ANY YEAR AND MODEL



Side Cover Set
10-69-01

Full Motorcycle Sets

Full Motorcycle Sets contains: 1 Each of every application listed under individual sets and are also done in **Show Chrome** finish.

	Styles Available	Part #
2002 - 2005 VRSCA V-Rod 69cu.....	C P -- ---	69-99



Allen Sets

- Where required, sets are supplied with Flat Washers, Lock Washers, Special Washers, Hex Nuts and/or Lock Nuts where applicable. Some sets are only available in Polished Chrome.

**Sets Available
For Models
Not Shown**



C= Chrome Plated



P= Polished Chrome Plated
Knurls Removed



S= Stainless Steel



SP= Stainless Steel Polished
Knurls Removed

	Styles Available				Part #
Alternator with Derby Cover.....	C	P	S	SP	10-69-06
Banjo Bolt Set 2006 - 2008.....	--	P	--	----	69-41
Banjo Bolts Set 2002 - 2005.....	--	P	--	----	69-40
Builder Fastener Set.....	C	P	S	SP	GW-02
Clutch Cover with Clutch Actuator Cover.....	C	P	S	SP	10-69-08
Crank Case.....	C	P	S	SP	69-29
Cylinder Head Covers with Cam Covers.....	C	P	S	SP	69-20
Disc Brake Rotor Mount - (Front Dual Disc).....	C	--	--	----	69-42
Disc Brake Rotor Mount - (Rear).....	C	P	S	SP	61-32
Disc Brake Caliper Mount - (Front for Dual Disc 2 Each Needed) Thru. 2005.....	C	P	S	SP	80-147
Disc Brake Caliper Mount - (Rear) 2002 - 2005.....	C	P	S	SP	80-148
Front Fender Mount thru 2009.....	C	P	S	SP	69-22
Frame Screws with Top Covers thru 2009.....	C	P	S	SP	69-48
Handlebar Rizer Mount 2003 - 2010.....	C	P	S	SP	69-57
Handlebar Switch Box with Master Cylinder 2002 - 2005.....	C	P	S	SP	69-50
Handlebar Switch Box with Master Cylinder Stock Style.....	C	--	--	----	69-50Y
Headlight Mount with Gauge Cover (side of Triple Tree and Fork Cap Screws).....	C	P	S	SP	69-23
Motor Set.....	C	P	S	SP	69-02
Motor Mounts and Stabilizer Links.....	C	P	S	SP	69-19
Oil Pan Mount.....	C	P	S	SP	69-32
Oil Filter Mount with Electric Start Bracket Mount.....	C	P	S	SP	69-31
Rear Foot Peg Bracket Mount - (Both).....	C	P	S	SP	69-36
Shock Mount Set 2006 & Up.....	C	P	S	SP	69-45
Shock Mount Set 2002 - 2005.....	C	P	S	SP	69-46
Shifter Arm and Rod Mount.....	C	P	S	SP	69-21
Side Covers.....	C	P	S	SP	10-69-01
Water Pump Cover with Thermostat Mount.....	C	P	S	SP	69-35

Acorn Nut and Nut Sets Chrome

2002 - 2004 Axle Nut Front in Stock Style.....	50-301Y
2002 - 2004 Axle Nut Front in Chrome Acorn.....	50-301A
2002 - 2013 Axle Nut Rear in Stock Style.....	50-302Y
Exhaust Header Mounts in Stock Style.....	50-303Y
Exhaust Header Mounts in Chrome Acorn.....	50-303A
Fork Stem Nut in Chrome Acorn - early (Only).....	50-195A





Inside This Section

<i>Allen Plugs.....</i>	<i>38</i>
<i>Valve Stem Covers.....</i>	<i>38</i>
<i>Axle and Axle Nut Sets.....</i>	<i>39</i>
<i>Banjo Bolts.....</i>	<i>40</i>
<i>Bleeder Screw Cover Acorns.....</i>	<i>40</i>
<i>Hole Plug Sets.....</i>	<i>41</i>
<i>Custom Applications.....</i>	<i>42</i>
<i>Cylinder Base Fasteners.....</i>	<i>43</i>
<i>Front End Fasteners.....</i>	<i>43</i>
<i>Head Bolts.....</i>	<i>44</i>
<i>ISO Mount Studs.....</i>	<i>45</i>
<i>Oil Pump Fasteners.....</i>	<i>45</i>
<i>Rocker Box Fasteners.....</i>	<i>46</i>
<i>Rocker Shaft Fasteners.....</i>	<i>47</i>
<i>Specialty Fasteners.....</i>	<i>47</i>
<i>Specialty Fittings.....</i>	<i>48</i>

**Specialty
Fasteners**



The First Name in Exceptional Quality Show Chrome Fasteners



Transmission Oil Fill Allen Plugs - Big Twins

Our Transmission Oil Fill Allen Plug is made so you can use an Allen wrench from the top or a standard wrench from the side. The ultimate easy-to-use filler plug is polished and **Show Chrome Plated**.

	Part #
2007 & Up Big Twins (includes O'Ring & Oil Dip Stick).....	C-96-12
1987 - 2006 Big Twins (includes O'Ring & Oil Dip Stick).....	C-80-14
O'Ring replacement (sold 10 per pack).....	09710
1936 - 1986 Big Twins (includes special washer).....	C-80-12
Nylon replacement washers (sold 10 per pack).....	09106

Transmission Oil
Fill Plug
Part # C-80-14



Transmission Oil
Fill Plug
Part # C-80-12



Primary Cover Allen Plugs - Sportsters

Replace your stock slotted plugs with Gardner-Westcott's Allen Plugs, Polished and Chrome Plated

	Part #
1/2" Allen Wrench.....	09573

Individual Plugs

1977 - 1990 (Oil Fill).....	C-20-63
1971 - 1976 (Oil Fill).....	C-20-60
1977 - 1990 (Clutch Adjustment).....	C-20-62
1971 - 1976 (Clutch Adjustment).....	C-20-61

Sets Include both Plugs & Allen Wrench

1977 - 1990 (Allen Plug Set).....	C-20-64
1971 - 1976 (Allen Plug Set).....	C-20-62



Allen Plug
Set
Part # C-20-64

Valve Cover Sets

Fits All Motorcycles (Set of Two).....	P-31-99
--	---------



Allen Swing Arm Pivot Bolts

Part

1958 - 1985 Big Twins (4 Speed).....	C-31-113
2000 & Up Softails (Frame to Swing Arm Frame Pivot Mount).....	P-88-09
1984 - 1999 Softails (Frame to Swing Arm Frame Pivot Mount).....	P-80-09

Axle Nut Sets for Big Twins and Sportsters

Front Axle Nut Sets Chrome

Part

2007 & Up Dyna Glide & Softail Models (except springers), 2008 & Up FLT Models & 2010 & Up XL Models & 2006 & Up V-Rod (Includes; 5/8" Hex Nut & Flat Washer).....	C-31-53
Same as above (in Acorn Nuts).....	C-31-53 A
Pre 2007 Dyna Glide & Softail Models & Pre 2008 FLT Models & 1973 & Up FX, FXR & XL Models (Includes; 1/2" Hex Nut, Flat Washer & Lock Washer).....	C-31-44
Same as above (in Acorn Nuts).....	C-31-44A
1973 - 1985 FX, 1982 - 1987 FXR & 1973 - 1987 XL Models (Includes; Axle Nuts, Flat Washers & Lock Washer).....	C-31-46
Same as above (in Acorn Nuts).....	C-31-46A
1949 - 1971 Big Twins & 45cu. Flatheads (Includes; Axle Nuts slotted with Flat Washer, Cotter Pin, Pivot Bolt Stud Nut with Flat Washer, Lock Washer and Sleeve Nut).....	C-31-43
Same as above (in Acorn Nuts without Cotter Pins).....	C-31-43A

Rear Axle Nut Sets Chrome

2014 & Up FXL & XL & 2008 & Up Softail & Dyna Glide Models (M24 Nut, Flat Washer & 41229-08 Ret. Ring).....	C-31-52
2005 - 2007 Sportsters Models (Includes; Flange Nut, Clip & Washer Stock Style).....	C-31-49Y
2002 - 2004 V-Rod Models (Includes; Nut, Clip and Washer Stock Style).....	50-302Y
2002 - 2013 FLT & 2005 & Up V-Rod Models (Includes; Nut & Clip).....	C-31-48
1989 & Up Style including 2001 - 2007 Softail, Dyna Glide & XL Some Models & FLT thru 2001(Includes; 5/8" Castle Axle Nut, Flat Washer & Cotter Pin).....	C-31-42
Same as above (in Acorn Nuts).....	C-31-42A
1973 - 1988 All XL, FX & FL Models.....	C-31-41
Same as above in Acorn Nuts.....	C-31-41A
1958 - 1972 Big Twins (Includes; Axle Nuts with Lock Washer, Sleeve Nut, Brake Anchor Lock Nut).....	C-31-47
Same as above (in Acorn Nuts).....	C-31-47A

Front Axle Allen Covers

Fits FLH, FXWG, FXDWG & FLT Models or any 1/2" Dia. Axle Nuts (Tapered Allen Covers with Set Screw Mount for the Allen Axle Look).....	C-31-103
--	----------



Tapered Allen Covers with Set Screws and Caps

Part # C-31-103



Part # C-31-42

Individual Axle Fasteners Available



Specialty HD Fasteners

Banjo Bolts

	Allen #	12 Pt #	HD #
2013 & Up.....	P-96-110	-----	5001
2013 & Up.....	P-96-111	-----	5002
2006 & Up.....	P-80-119	A-80-119	41750-06B
2004 & Up XL (Models Dual 10mm).....	P-80-117	-----	41736-04A
2004 & Up XL (Models Dual 12mm).....	P-80-118	-----	41737-04A
1982 & Up (Front and or Rear).....	P-80-110	A-80-110	41747-82A
Front 1984 & Up.....	P-80-111	A-80-111	41739-84A
1958 - 1972 Big Twins (Rear Brake to Wheel Cylinder).....	P-80-112	-----	41743-58A
3/8 Aluminum Washer (used with P-80-110).....	09579	-----	-----
7/16 Aluminum Washer (used with P-80-111).....	09825	-----	-----
10mm Aluminum Washer (used with P-80-117).....	09596	-----	41732-04A
12mm Aluminum Washer (used with P-80-118).....	09598	-----	41743-04A



Part # P-80-110



Part # A-80-111



Part # C-31-61



Part # C-31-61 on V-Rod Caliper

Bleeder Screw Cover Acorns

	Part #
1/4 Hex Bleeder Cover (sold each).....	C-31-60
3/8 Hex Bleeder Cover (sold each).....	C-31-61
7/16 Hex Bleeder Cover (sold each).....	C-31-62
1984 - 1999 All - (2 disc Models Set).....	C-31-63
1984 - 1999 All - (3 disc Models Set).....	C-31-64
1979 - 1984 XL, FX & FXWG (3 @ 3/8 Set).....	C-31-65
1980 - 1984 FLH (2 @ 3/8 Set).....	C-31-66
1972 - 1979 FHL (2 @ 1/4 Set).....	C-31-67

With Set Screw Mounting



Bleeder Screws Chrome Plated

Metric Motorcycle

BMW 11mm Hex (sold each).....	C-31-62
Honda & Yamaha 10mm Hex (sold each).....	C-31-68
Dealer Display 5 Each 1/4, 5/16, 3/8.....	C-31-69

Brake Bleeder Screws Chrome Plated

	Part # Chrome	HD #	Zinc #
1/4-28 x 1".....	45-9404	41749-58	09607
5/16-24 x 1".....	45-9403	-----	-----
3/8-24 x 1 1/8".....	45-9402	44146-77 & 44048-83	09606
3/8 x 1 1/2".....	45-9400	-----	-----

Metric Sizes

8mm x 1.25 x 23.8.....	45-9405	-----	-----
10mm x 1.50 x 27.50.....	45-9406	-----	-----



Hole Plug Sets

Hole Plug Sets are available in chrome plated, black and brass for stock motor fastener applications supplying hole plugs where there is a Cap Screw on the stock motor. For stock motor fastener applications or for use with Gardner-Westcott Side Cover Sets, Motor Sets or Builder Fastener Sets.

For the hole plug part number just add the lettered prefix to the part number found on **pages 4,5 & 6** in the Big Twin Section and **pages 21 & 22** of the Sportster Section.

Prefix for Hole Plugs

- HPC** = Chrome Hole Plugs
- HPB** = Black Hole Plugs
- HPA** = Brass Hole Plugs

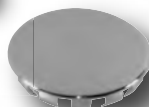

Also Available in Assortments See pg. 69 for details

- A-77-C** = Chrome Hole Plugs
- A-77-B** = Black Hole Plugs
- A-77-A** = Brass Hole Plugs

3/16 thru 3/4 - (7 Sizes & 130 Pieces)

Specialty Fasteners

	Part #
Clutch Inspection Cover (<i>Big Twins Nylon 1/4" Washer, H-D #31433-84 - sold each</i>).....	09566
Clutch Adjustment Screw (<i>1941 - 1984 Big Twin H-D #37357-41 - sold each</i>).....	61142
Clutch Plate Removal Washer (<i>Big Twins thru 1984, Zinc Plated - sold each</i>).....	23593
Disc Brake Rotor to Hub Front (<i>1984 & Up Wide Torx Head Chrome Plated - sold each</i>).....	46278-A
Disc Brake Rotor to Hub Rear (<i>1992 & Up Wide Torx Head Chrome Plated - sold each</i>).....	46330-A
Disc Brake Rotor to Hub Rear (<i>1973 - 1984 FX & FLH includes; Locknuts, Thin Hex Caps Set</i>).....	C-74-51H
Handlebar End Hole Plug, (<i>Chrome H-D #56238-62 - sold each</i>).....	43576
Oil Tank Drain (<i>Washers 1/2 1981 & Up Stainless Steel - sold each</i>).....	84573
Speedo Trip (<i>Set Reset Knob Mount Allen Screw Chrome - sold each</i>).....	12091
Side Cover (<i>Steel Washer Chrome, 1/4" I.D. Small O.D. Replaces H-D #6099 - sold each</i>).....	23204
Same as above (<i>sold in - 100 per package</i>).....	23203
Tailight Lens Mount (<i>Allen Screws Chrome 1999 & Up - sold each</i>).....	10138
Triple Tree Top Stem (<i>Acorn Nut 1949 & Up FLH, FXWG, FXDWG & V-Rod</i>).....	50-195A
Windshield Mount (<i>Rubber & Stainless Steel Washer - sold each</i>).....	81569





Specialty HD Fasteners



C= Chrome Plated



**P= Polished Chrome Plated
Knurls Removed**



A= 12 Point Chrome Plated

Custom Applications

	Styles Available	Part #
Arlen Ness - (Swing Arm Wheel Adjustment Allen Screw Set).....	-- P --	99-50
Arlen Ness - (Drag Bars Handlebar Mount Allen Screw Set).....	-- P --	99-52
Bendix Carburetor - (Allen Screw Set).....	C P --	31-37
Cal Products - (Transmission Ratchet Lid Cover Allen Screw Set for 1936 - 1969 Big Twin 4 Speeds).....	C P --	31-03
Cam Covers - (House of Horsepower and S&S Cycle for Stock HD Motor Cases 1936 - 1969 Big Twins).....	-- P --	31-05
Cam Covers - (Cam Covers to Delkron, Sputh or House of Horsepower Motor Case 1936 - 1969 Big Twins).....	C -- --	31-04
Cylinder Base - (1957 - 1985 Sportsters - requires removal of studs, Includes; Washer & 12 Point Screws).....	C P A	20-08
Cylinder Base - (Shovelheads & Panheads - requires removal of studs 12 Points).....	C P A	74-08
Cylinder Head Bolts - (Shovelhead Big Bore including Bonneville Engineering and S&S in 12 Points).....	C P A	74-10
Delkron - (Alternator Motor Case Allen Screw Set).....	C P --	31-02
Dellorto - (38mm & 40mm Pumper Carburetors Allen Screw Set with Allen Wrench).....	C P --	31-36
Granny Trannys - (5 Speed Kicker Fastener Set).....	C P --	31-87
Head Bolts - (Std Panheads both in 12 Point Screws with Special Washers coarse thread).....	-- -- A	31-11
Head Bolts - (Std Shovelheads both 12 Point Screws with Special Washers coarse thread).....	C -- A	31-14
Head Bolts - (Std Panheads both 12 Point Screws with Special Washers fine thread - fits 2000 & Up).....	-- -- A	31-111
Header Mount - (Allen Screws for Shovelheads - Longer than stock 5 1/6"-18x1" sold each).....	-- -- --	10280
Lifter Base - (Big Twins to mount 1977 & Up lifter blocks on 1936 - 1976 Motor Case).....	C P A	31-16
Lifter Base - (Big Twins to mount 1936 - 1976 lifter blocks on 1977 & Up Motors and Custom Motor Cases).....	C P A	31-35
Motor Mounts - (Studs Front extra length Sportsters 1957 - 1984 for mounting forward controls or foot pegs - includes studs, Acorn Nuts & washers).....	-- -- -- C P A	50-43
S & S Cycle Super - (E&G Shorty Full Carb Set).....	C P --	31-38
S & S Cycle Super - (Carburator Air Cleaner Float Bowl & Intake Manifold Allen Screws).....	C P --	31-33
S & S Cycle - (Two Throat Carburator Set).....	C P --	31-34
S & S Cycle - (Big Twin Evolution Motor Case Set).....	C P --	31-57
S & S Cycle - (Big Twin Special application Motor Case Set 4" Bore).....	C P --	31-58
S & S Cycle - (Big Twin Evolution special application Big Bore, CLB full set with fittings).....	C -- --	31-2001B
S & S Cycle - Big Twin Cam Motor Case.....	C P --	C-31-56
T in Custom Primary Cover Inner - (Primary 1965 & Up 4 Speed Big Twins).....	C P --	31-25
Wheel Adjustment bolts - (Rear, extra long 3/8"-16x3" fully threaded Hex Cap Chrome, sold each).....	-- -- --	09347



Cylinder Base Fasteners

Our Acorn Style Nut has a 9/16" Hex like the 80cu. stock cylinder base nuts, to eliminate clearance problems on the Shovelheads, making it possible to assemble using a box wrench for more tightening control. Our Acorns will easily clear cylinder fins on assembled motors. This special cylinder base nut kit includes the proper Special Washers.

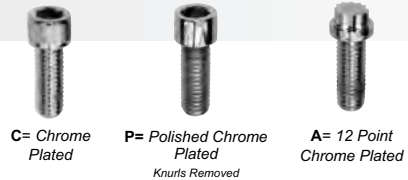

Acorn Style	Styles Available	Part #
1936 - 1984 Big Twins (<i>special cylinder base nut kit with Special Washers & 9/16 Hex</i>)....	C P --	31-80-A
1957 - 1985 Sportsters & 45cu. Flatheads (<i>includes; Acorn & Washers</i>).....	-- -- --	50-54A

Allen Style

Panheads & Shovelheads (<i>includes; Allen Nuts & Special Washers</i>).....	-- -- --	50-80L
1957 - 1985 Sportsters (<i>includes; Allen Nuts & Special Washers</i>).....	-- -- --	50-54L
Panheads & Shovelheads (<i>requires removal of studs, Includes; Allen Nuts & Special Washers</i>).....	C -- A	74-08
1957 - 1985 Sportsters (<i>requires removal of studs Includes; Allen Nuts & Special Washers</i>).....	C -- A	20-08

Stock Style

1936 - 1984 Big Twins (<i>High Hex Style - Stock Style # 16602-30 Chrome Plated</i>).....	C -- --	31-74
Same as above - (<i>Zinc Plated</i>).....	-- -- --	31-74
1957 - 1985 Sportsters (<i>High Hex Style - Stock Style # 16603-73 Chrome Plated</i>).....	C -- --	31-54
Same as above - (<i>Zinc Plated</i>).....	-- -- --	31-54

Cylinder Base Washers

1936 - 1985 Big Twins (<i>one piece round Thick Flat Washer Chrome - sold each</i>).....	-- -- --	23580
1957 - 1985 Sportsters (<i>one piece round Thick Flat Washers Chrome - sold each</i>).....	-- -- --	20087

Front End Fasteners

* (B) Button Head Allens available

Each Fork Tube Cap Allen Plug is precision machined tapering to the top, than **Show Chrome Plated** and uses a standard 1/2" Allen Wrench and is sold in pairs.

Allen Fork Tube Caps

1977 & Up Big Twin FLH & FXWG - (<i>41mm</i>).....	-- -- --	99-21
1988 & Up Sportster & FXR Models also 1987 & Up FXLR - (<i>39mm</i>).....	-- -- --	99-23
1/2 Allen Wrench (<i>sold each</i>).....	-- -- --	09573

Allen Front Fork Leg Drain Screws

1949 - 1976 FLH & 45cu. Flatheads.....	C -- --	74-47
* 1977 & Up FLH, FLT, FXWG & Softail Models (<i>with Washers & Allen Wrench</i>).....	C P --	74-45*(B)
1957 - 1972 XL & FX Models.....	C P --	20-57
* 1973 & Up XL, FX, FXR Models (<i>with Washer & Allen Wrench</i>).....	C P --	20-58*(B)

Triple Tree Top Fasteners

1949 & Up FLH, FXWG, FXDWG & VRSCA V-Rod - (<i>Early</i>) (<i>Top Nut Acorn Style with Washer</i>).....	C -- --	50-195A
1988 & Up XL, FXR & 1991 & Up FXD 39mm (<i>Top Bolt with Flat Washer in for Stock Style Hex add Suffix H</i>).....	C P --	80-58H

Front End Detail Set - 39mm

1988 & Up XL & FXR Models (<i>This combination Allen and Acorn set Includes; Chrome Fasteners for the Fork Tube Caps, Top Triple Tree Bolt, Drain Screw, Axle Cap, Nuts and Triple Tree Pinch Bolts</i>).....	C P --	80-49
---	--------	-------



Head Bolts

For Custom Manufacturers Head bolts see **page 56** in Custom Applications



C= Chrome Plated



P= Polished Chrome Plated
Knurls Removed



A= 12 Point Chrome Plated

Evolution and Twin Cam Motors

	Styles Available	Part #
1992 & Up Sportsters & Big Twins (Includes 12 Point Head Bolts).....	-- -- A	61-110
1987 - 1991 Sportsters & Big Twins (Includes Only 12 Point Head Bolts).....	-- -- A	61-100
Same as above (with Head Bolts & Studs).....	-- -- A	61-101
1986 Sportsters Only (Includes Special Washers comes in 12 Point Style).....	-- -- A	80-100
Same as above (with Head Bolts, Washers & Studs).....	-- -- A	80-101
1984 & Earlier also 1985 Big Twins (Includes 12 Point Head Bolts).....	C P A	80-10

Panhead and Shovelhead Motors

All - Panhead & Shovelheads (Includes Chrome 12 Points & Special Washers).....	-- -- A	74-10
All - Panhead & Shovelheads (Stock Style 9/16 Hex Caps Chrome with Special Washers).....	C -- --	31-09
Same as above in (Zinc Plated).....	-- -- --	31-09
All Panhead & Shovelhead (Includes Acorns & Studs).....	-- -- --	50-68A
74cu. Knucklehead Motors (Polished Chrome Allens with Special Washers).....	-- P --	P-74-09

Sportsters

1957 - 1972 Sportsters (Includes Chrome 12 Point with Special Washers).....	C P A	20-18
Same as above in (Chrome Hex Caps with Washers, for Stock Style Hex add Suffix H).....	C -- --	20-18H
Same as above in (Acorn Nuts with Studs).....	-- -- --	50-94A
1973 - 1985 (includes Chrome 12 Point with Washers, for Stock Style Hex add Suffix H).....	C P A	20-17H
Same as above in (Acorn Nuts with Studs).....	-- -- --	50-95A

* Evolution XL's see above

45cu Flatheads

Iron Head 45cu. (Chrome Allen Screws with Washers).....	C -- --	45-11
Aluminum Head 45cu. (Chrome Allen Screws with Washers).....	C -- --	45-10

K & KH Model Flatheads 1952 - 1956

All K Models (includes Chrome Allen Screws with Washers).....	C P A	20-80
---	-------	-------

Individual Head Bolt Fasteners

Panheads & Shovelhead (Head Bolt Washer in Chrome - sold each).....	C -- --	31-30
1984 & 1985 Evolution (H-D# 16482-85 Head Bolt Washer in Chrome - sold each).....	C -- --	31-32
1985 Evolution Big Twins (Head Bolt Washer in Chrome - sold each).....	-- -- --	23200
H-D Flatheads & Indians (Head Bolt Washer in Chrome - sold each).....	-- -- --	23375
1985 - Late Evolution Big Twins (H-D# 16837-85B Head Stud - sold each).....	-- -- --	61200
1986 & Up Evolution Sportsters (H-D# 16832-86C Head Stud - sold each).....	-- -- --	61201
1987 - 1991 Evolution (H-D# 16480-85A Head Bolt 12 Point in Chrome).....	-- -- --	09270
1981 & Up All (H-D# 16478-85A Head Bolt 12 Point in Chrome).....	-- -- --	09271
1992 & Up Big Twins & Sportsters (H-D# 16480-92 Head Bolt 12 Point in Chrome).....	-- -- --	09272
1999 & Up Twin Cam (H-D# 16834-99A Head Stud).....	-- -- --	61202

Head Bolt Washers

Internal Head Bolts

Head Bolt Stud



23200



23580



C-31-30



09271



09272



61200



ISO Mount Studs

These rubber ISO Mount Studs exceed the OEM Mount in Tensile Strength, Sheer Resistance and Overall Strength. sold individually

	Part #
1977 -1984 FXS & FXEF Models (<i>Speedo Dash Mount, etc. Mount as 5/16-18 Male & Female Stud, Replaces H-D #50235-63</i>).....	09807
1965 & Up Tack Mount FXS, FXEF and others (<i>Fits Oil Tank & Battery Carrier, Mount has 1/4-20 Studs, same length as original Replaces H-D #62563-65</i>).....	09808
Same as above with (<i>Longer Stud on one side Replaces H-D #62563-65</i>).....	09809



Specialty Fasteners

Oil Pump Fasteners

Oil Pump Allen Plugs (Top Plugs)

1981 - 1999 80cu. (<i>Replaces Plugs for Motor Case Oil Screen, Check Valve Spring, Relief Valve & O'Ring, Also Available in 12 Pts. use the A Prefix</i>).....	C-80-32
1970 - 1980 74cu. & 80cu. (<i>Replaces Plugs for Motor Case Oil Screen, Check Valve Spring, Relief Valve & O'Ring</i>).....	C-80-28
1968 - 1969 74cu. (<i>Replaces Plugs for Motor Case Oil Screen, Check Valve Spring, Relief Valve & O'Ring</i>).....	C-80-29
1966 - 1967 74cu. (<i>Replaces Plugs for Motor Case Oil Screen, Oil Check Valve</i>).....	C-80-30
1952 - 1965 74cu. (<i>Replaces Plugs for Motor Case Oil Screen, Oil Check Valve</i>).....	C-80-31



Kit C-80-32

Individual Allen Plugs

1982 - 1999 Big Twins (<i>Oil Pump Allen Plugs, Includes O'Ring - 3 per bike Replaces H-D #26263-80, Also Available in 12 Pts. use the A Prefix</i>).....	C-80-24
1941 - 1980 Big Twins & 45cu. (<i>Oil Check Valve Allen Plugs, Includes O'Ring Replaces H-D #26362-36</i>).....	C-80-27
1968 - 1980 Big Twins (<i>Oil Pump Relief Valve Allen Plug, Includes O'Ring Replaces H-D# 26377-68</i>).....	C-80-26
1970 - 1980 Big Twins (<i>Motor Case Oil Screen Allen Plugs, Includes O'Ring Replaces #657</i>).....	C-80-25
1966 - 1969 Big Twins (<i>Motor Case Oil Screen Allen Plugs, Includes O'ring Replaces #655</i>).....	C-80-23
1952 -1965 Big Twins (<i>Motor Case Oil Screen Allen Plugs, Replaces H-D #24987-52</i>).....	C-80-22
Replacement Brass Washer (<i>for C-80-26 10 per pack</i>).....	09571
Replacement O'Ring (<i>for C-80-32 10 per pack</i>).....	09104

	Chrome Allens	Polished Allens	Hex Caps	12 Point	Acorn Set
1992 - 1999 Big Twin 80cu.....	C-80-97.....	P-80-97.....	-	A-80-97.....	50-197A
1979 - 1991 Big Twin.....	C-74-32.....	P-74-32.....	C-74-32H.....	A-74-32.....	50-35A
1968 - 1978 Big Twin.....	C-74-28.....	P-74-28.....	-	-	50-34A
1936 - 1967 Big Twin.....	C-80-13.....	P-80-13.....	-	-	31-40A
1998 & Up Sportsters.....	C-61-55.....	P-61-55.....	C-61-55H.....	A-61-55.....	50-184A
1991 - 1997 Sportsters.....	C-61-56.....	P-61-56.....	C-61-56H.....	A-61-56.....	50-156A
1977 - 1999 Sportsters.....	C-20-56.....	P-20-56.....	C-20-56H.....	A-20-56.....	50-158A
1971 - 1976 Sportsters.....	C-20-36.....	P-20-36.....	C-20-36H.....	A-20-36.....	-

Oil Filter Mount

1990 - 1991 FLT & FXR in <i>Chrome Hex Caps</i> (<i>3/8 x 7/8 Left Hand Thread Sold Each, Replaces H-D #2914</i>).....	09704
(<i>3/8 x 1 Left Hand Thread Sold Each, Replaces H-D #2913</i>).....	09703
1999 & Up Twin Cam 88cu. (<i>Available in Chrome use C Prefix & 12 Pts use A Prefix</i>).....	P-88-28
1992 - 1999 Big Twin 80cu. (<i>Available in Chrome use C Prefix & 12 Pts use A Prefix</i>).....	P-80-116



Specialty HD Fasteners

Rocker Box Screw Sets

	Styles Available	Part #
1999 & Up Twin Cam 88cu, 88B & 96cu. (with Washers).....	C P A	88-15H
1999 & Up Twin Cam 88cu, 88B & 96cu. (Socket Head Hex Stock Style w/ Washers).....	C -- --	88-15Y
1984 - 1999 Evolution Motors (with Copper & Steel Washers).....	C P A	80-15H
Same as above (except in Button Allens for that Countersunk Look).....	C -- --	80-15B
Same as above (except with Tapered Cup Washers).....	C -- --	80-15W
Same as above (except with Tapered Cup Washers & Hole Plugs).....	C -- --	80-15R
Full - Rocker Box Mount Set (Includes; all inside & Top Mounting Hardware).....	C P --	80-115Y
1966 - 1981 Shovelheads (Requires Drilling 3/8 Diameter Hole).....	C P A	74-15H
Same as above (except in Button Allens for that Countersunk Look).....	C -- --	74-15B
1981 - 1984 Shovelheads (Requires Drilling 3/8 Diameter Hole).....	C P A	80-08H
1957 - 1976 Sportsters.....	C P A	20-15H
1977 - 1985 Sportsters.....	C P A	20-50H
XR 1000 & XR 750.....	C P A	61-15H

Rocker Box Nut Sets & Special Washers

Shovelheads 1966 - 1985 Top

	Part #
Low Crown Acorns (easily clears frame with Special Washers).....	50-15A
Same as above (except in "Stock Style" Includes Hex Nuts & Washers).....	50-15H
Same as above (except in Allen Nut Style).....	50-15L
Same as above (except in Spike Nuts & Washers).....	50-15x

Rocker Box
Screw Set
C-80-15w



Evolution & Twin Cam Motors Top

1984 - 1999 Evolution (Low Crown Acorns, Studs & Washers).....	50-20A
Same as above (except in Spike Nuts, Includes Studs & Washers).....	50-20x
1999 & Up Twin Cam 88cu. (Spike Nuts & Studs).....	50-176x
1999 & Up Twin Cam Motors (Low Crown Acorns, Studs & Washers).....	50-176A

1966 & Earlier Shovelheads & 1957 - 1985 Sportsters Side

Left Side - (Rocker Arm Shaft End Acorns Replaces Red Button Nuts).....	50-40A
Same as above (except in Hex Nut Style).....	50-40H
Same as above (except in Allen Nut Style).....	50-40L

Rocker Box
Nut Set
50-15A



Special Chrome Washers with 5/16 I.D. and Small O.D.

Shovelhead & XL (Replaces H-D #6318HW & H-D #6702 - Packed 50 per bag).....	C-6318-HW
Evolution Motors (Copper Washer Replaces H-D #6114 - sold each).....	09568

Rocker Arm Shaft End Washer (Left Side) Replaces HD #6466W

Shovelheads & Sportsters (Thicker than Stock, reusable Stainless Steel).....	84572H
Same as above (except in Steel Chrome Plated).....	26572H
1971 - 1984 Shovelhead (Rocker Shaft Washer Cam Side).....	09574

Rocker Arm Shaft End Allen Plugs

	1957 - 1970 XL 1966 - 1970 FLH	1971 - 1985 XL 1971 - 1985 FX & FL
Chrome.....	C-74-56	C-74-55
Brushed Aluminum.....	M-74-56	M-74-55
Black.....	B-74-56	-----
Gold.....	G-74-56	G-74-55
Chrome with 24k Gold Screws.....	CG-74-56	CG-74-55
Button Head Allen.....	N/A	C-74-55B
Acorn Style.....	50-70A	50-71A
12 Point Screws.....	A-74-56	A-74-55



Common Harley Fittings

Oil Line Hose Barbs

Part #

Used on Oil Pump, Case, Oil Tank etc.

- 1/8 Pipe x 3/8 Hose - St..... 7-90TD-6x2
- 1/8 Pipe x 3/8 Hose - 90°..... 7-91TD-6x2
- 1/8 Pipe x 3/8 Hose - 45°..... 7-97HB-6x2



Oil Line Street Elbows

Used on Top of Oil Pump, use with Hose Barbs listed above

- 90° 1/8 Pipe..... 7-116PSE-2
- 45° 1/8 Pipe..... 7-124PSE-2



Motor Case Breather Fittings

Threads into Case

- Straight 1/4 Pipe x 3/8 Hose..... 7-90TD-6x4
- 90° 1/4 Pipe x 3/8 Hose..... 7-91HB-6x4
- 45° Street Elbow 1/4 Pipe..... 7-124PSE-4
- 90° Street Elbow 1/4 Pipe..... 7-116PSE-4
- Straight 1/4 Pipe x 1/2 Hose..... 7-90HB-8x4



Oil Vent Tee

For Shovelhead Vent Hose

- 3/8 Hose..... 7-94HBT-6



Oil Line Nuts & Fasteners

Fits Shovelhead & Iron Head Sportsters

- Oil Line Nuts, Body & Seal..... C-31-152



Motor Mounts

Motor Mount Bracket Kit



Oil Line & Pump Fitting Sets

1970 - 1981 Shovelheads

Includes; fittings for Oil Pump, Top End Oil Lines, Oil Tank, Line Tee, Motor Case Vent, Primary Chain Housing, Oil Line Block Off Plugs - (Can be used on any combination of belt or chain drive wet or dry clutch models)

- (4ea.) - Oil Pump (3ea.) - Oil Tank
- (1ea.) - Motor Case Vent (1ea.) - Oil Line Tee
- (3ea.) - Primary Chain Housing
- (8ea.) - Overhead Line Fitting
- (4ea.) - Rubber Seals

Chrome Part #	Brass Part #
C-31-160	31-160

1984 - 1991 Evolutions & 1970 - 1984 Shovelheads

Includes; fittings for Oil Pump & Motor Case Vent. (Can be used with belt drive or wet clutch sealed primary).

- (2ea.) - Street Elbow 90° 1/8 Pipe
- (3ea.) - Hose Barb 1/8 Pipe
- (1ea.) - Hose Barb 1/4 Pipe
- (1ea.) - Street Elbow 90° 1/4 Pipe
- (1ea.) - Street Elbow 45° 1/4 Pipe

Chrome Part #	Brass Part #
C-31-163	31-163

1968 - 1984 Shovelheads

Includes fittings for Oil Pump

- (2ea.) - Street Elbow 90° 1/8 Pipe
- (3ea.) - Hose Barb 3/8 Pipe
- (1ea.) - Hose Barb 3/8 Pipe-Long

Chrome Part #	Brass Part #
C-31-165	31-165

1984 - 1991 Evolution Big Twins

Includes fittings for Oil Pump

- (2ea.) Street Elbow 90°
- (3ea.) Hose Barb 3/8 Hose

Chrome Part #	Brass Part #
C-31-167	31-167

* See Page 110-114 for more fittings

- 1991 - 1999 Softails (Top Motor Mount Strap & Block made from 5/16" thick hardened steel with Stock Style Hex Caps, Special Washers & Lock Nuts Show Chromed)..... C-99-71H
- Same as above with (Polished Allens)..... P-99-71



Specialty HD Fasteners

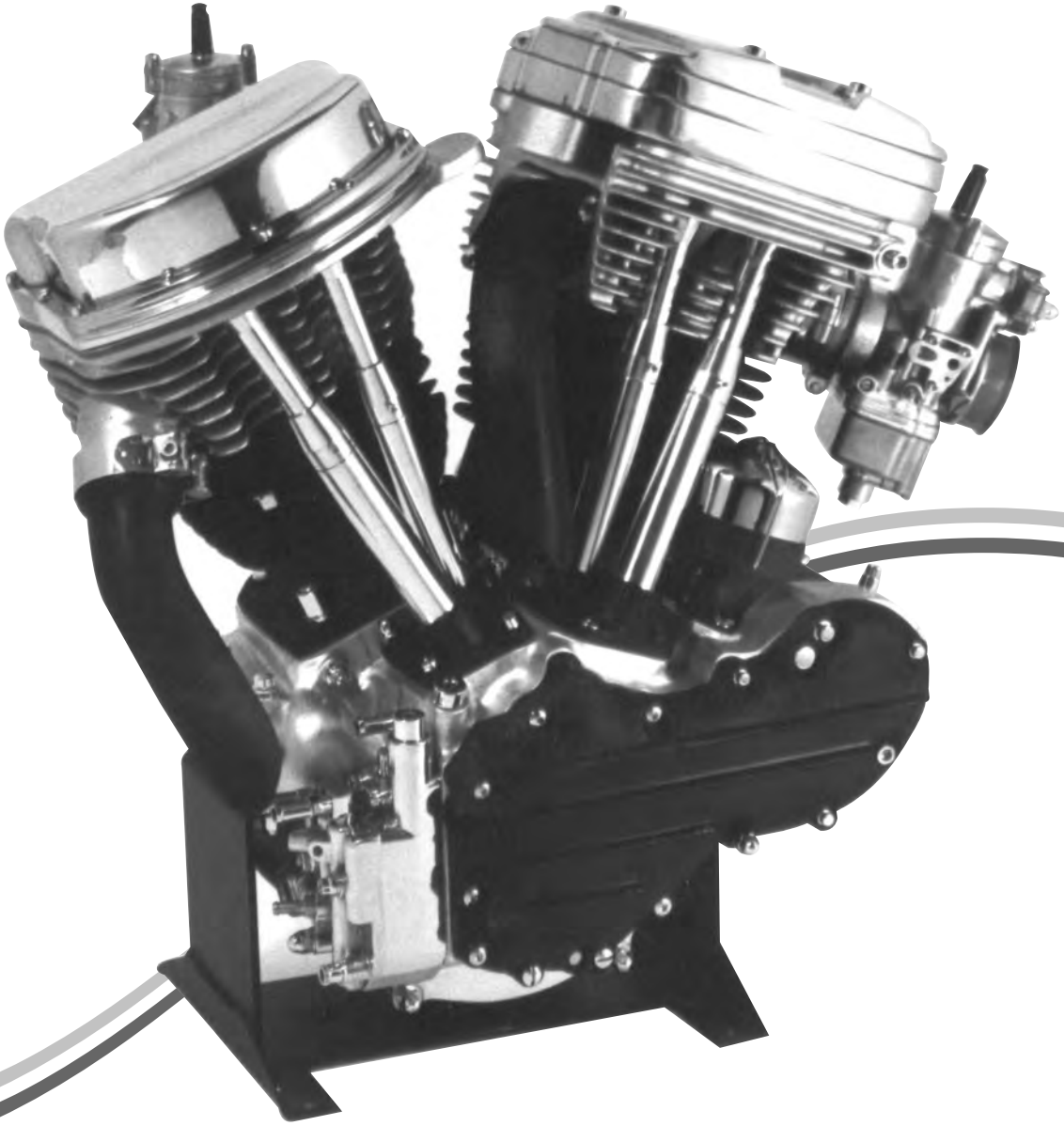

**GARDNER-WESTCOTT HAS FASTENERS
IN EVERY STYLE FOR EVERY MOTOR**





Inside This Section

<i>Stock Style Replacement Fasteners</i>	50 - 52
<i>Stock Style Fastener Sets</i>	53
<i>Studs</i>	54





Stock Style Fasteners

Stock Style Replacement Fasteners

	G-W #	HD #
Hitch Pin.....	09232	509
1/16 x 1/2 - (Zinc Cotter Pin).....	01587	510
1/16 x 3/4 - (Zinc Cotter Pin).....	01588	515
3/32 x 3/4 - (Zinc Cotter Pin).....	01589	528
3/32 x 1 - (Zinc Cotter Pin).....	01590	534
3/32 x 1 1/4 - (Zinc Cotter Pin).....	01591	513
1/8 x 3/4 - (Zinc Cotter Pin).....	01592	550
1/8 x 1 1/4 - (Zinc Cotter Pin).....	01593	559
5/32 x 1 1/2 - (Zinc Cotter Pin).....	01599	511
3/16 x 1 - (Zinc Cotter Pin).....	01594	566
Evolutions - Rocker Box (1/4 Zinc Allen Screw).....	08214	852
FXRS - Front Caliper Mount (Allen Screw).....	12340	860
1/4-20 x 7/8 (Zinc Allen Screw).....	08212	882
Twin Cam - Rocker Box (Torx Buttonhead Screw).....	46208	941
Hex Head Socket Flange (Zinc).....	46228	945
Point Mount (8/36 x 1/4 Round Machine Screw).....	04127	1047
1936 - 1964 74cu. Primary Cover Slotted Screw (Chrome).....	37157	1210
74cu. - Transmission Shift Dust Cover Screw (Chrome).....	14154	1761
Gas Tank Trim Mount Screw (4/40 x 3/16 Phillips).....	94087	2061W
1936 - 1964 74cu. Derby Cover Slotted Screw (Chrome).....	34186	2265W
FLH - Rear Fender Rail Screw (5/16-24 x 1 1/4 Chrome Oval Head Phillips Chrome).....	40285	2272
1936 - 1969 74cu. Cam Cover Slotted Screw (Zinc).....	31-06	2341
Brake Master Cylinder Cover.....	92132	2573
Brake Master Cylinder Cover.....	89128	2579
Brake Master Cylinder Cover.....	94712	2586A
Shifter Cover Slotted Screw (Chrome 1/4 x 24).....	33250	2597
Brake Line Clamp Mount (10 x 3/8 Chrome Hex SMS).....	55640-W	2652
Shovelhead - Header Mount (Zinc Allen Screw).....	08274	3201W
5/16-18 x 1 1/4 (Chrome Allen Screw).....	12284	3210A
Coil Cover Mount (10/32 x 1/2 Chrome Hex Washer SMS).....	55155	3473
Knucklehead - (8 x 3/8 Hex Sheet Metal Screw Chrome).....	55627	3477
Front Brake Caliper Mount (Hex Washer HD).....	55155-S	3517
8/32 x 1/2 (Zinc Allen).....	08130	3556A
Brake Caliper (12 x 1/2 Chrome Hex Sheet Metal Screw).....	55186WP	3562
Coil Cover Mount (10 x 1/2 Chrome Sheet Metal Screw).....	55641	3566
5/16-18 x 7/8 (Chrome Wide Torx Buttonhead).....	46278W	3655
1966 & Up - Handlebar Switch Box (Chrome Torx Buttonhead).....	46154	3658
Twin Cam - Rocker Box Screw (Chrome Hex Socket Head).....	09649	3692A
Twin Cam - Rocker Box Screw (Zinc Hex Socket Head).....	09462	3692A
Twin Cam - Rocker Box Screw (Chrome Hex Socket Head).....	09648	3693A
Twin Cam - Rocker Box Screw (Zinc Socket Head).....	09463	3693A
1977 & Up 80cu. - Lifter Base (Chrome 12 Point Screw).....	29212	3770
Distributor Hold Down - (1/4-24 Hex Cap).....	11251	3779
Big Twin - Inner Primary Mount Drilled (Zinc 5/16 Hex).....	07280-D	4021
Fork Top Bolt - (Chrome Hex Cap).....	11489	4060
Softail - Shock Mount Bolts.....	09342	4074
Shock Mount Bottom Bolt - (Zinc 1/2-20 x 13/4).....	07423	4081

Cotter Pin



Machine Screw



Wide Torx



**Gardner-Westcott
Has Available
Many Stock Style
Fasteners
Not Shown**

Stock Style Fasteners



Stock Style Replacement Fasteners

G-W #

HD #

1996 & Up Handlebar Switch Boxes (<i>Chrome 1/4-20 x 1 1/8 Torx Buttonhead</i>).....	46216	4123
1/4-20 x 1 1/8 (<i>Torx Buttonhead</i>).....	46216	4132
74cu. - Transmission Plate Mount (<i>3/8 x 1 1/8 Chrome</i>).....	11333	4336W
FXST - Rear Fork Mount (<i>3/4 - 16 x 3 Hex Cap Chrome</i>).....	11600	4969
Brake Tee Mount (<i>5/16 Shoulder Bolt</i>).....	09837	5004
Spacer - (<i>Steel Chrome</i>).....	20096	5809
Spacer - (<i>Steel Chrome</i>).....	20095	5812
Oil Tank & Transmission Drain (<i>1/2" Nylon Washer</i>).....	87573	6007
Evolution - Motor Mount (<i>Chrome 3/8 I.D. Flat Washer</i>).....	23329	6019
Rubber Backed (<i>5/16 Stainless Steel Washer</i>).....	81570	6095
Side Cover (<i>Chrome 1/4 Special Flat Washer</i>).....	23204	6099
5/16 x 11/16 x 1/8 - (<i>Zinc Flat Washer</i>).....	33570	6109
Evolution - Rocker Box (<i>1/4 Copper Washer</i>).....	09568	6114
XL - Motor Mount (<i>Spacer</i>).....	23327	6152
Oil Pump - (<i>Brass Washer</i>).....	09985	6156
Spacer - (<i>Steel Chrome</i>).....	20097	6219
(<i>3/8 Chrome Flat Washer</i>).....	23571	6353
Transmission Mount (<i>Chrome 5/16 Flat Washer</i>).....	33571	6400
1976 & Earlier (<i>Head Bolt Washer</i>).....	23580	6469HW
Fx - Seat Mount (<i>1/4 I.D. Nylon Washer</i>).....	87569	6410
4 Speed - Transmission (<i>3/8 I.D. Plain Flat Washer</i>).....	23326-PL	6442
Top Motor Mount & Belt Pulley (<i>7/16 x 1 1/8 x 1/8 Chr. FW</i>).....	23377	6516
Top Motor Mount (<i>7/16 x 1 1/8 x 5/32 Chr. Thick FW</i>).....	23379	6522
Oil Pump - (<i>Brass Washer</i>).....	09571	6581
1973 & Up FL - (<i>Front Axle Mount 1/2 x 1 1/8 Flat Washer</i>).....	23416	6590
39mm - Fork Top Bolt (<i>Chrome Washer</i>).....	23492	6655
3/8 x 13/16 x 1/16 - (<i>Zinc Flat Washer</i>).....	04571	6701
Shovelhead & XL - Rocker Box (<i>5/16 Flat Washer</i>).....	C-6318-HW	6702
Softail Shock Mount (<i>Flat Washer sold each</i>).....	23488	6724
5/16 - (<i>Chrome Flat Washer</i>).....	26570	6771A
Softail - Swing Arm Mount (<i>Zinc 3/4 Internal Star Washer</i>).....	03576	7142
5/16 x 24 - (<i>Zinc Flange Nut</i>).....	44549	7593
Shock Stud - (<i>Chrome 5/8-18 Thin Lock Nut</i>).....	27559	7647
Generator - (<i>10/32 Brass Hex Nut</i>).....	09542	7634
Hex Nut - (<i>1/4-24 Zinc</i>).....	06562	7691
Panhead - Rocker Block Mount (<i>Zinc Jam Flex Nut Zinc</i>).....	09548	7727
Castle Nut - (<i>Chrome 1/2 x 20</i>).....	22555	7734
1/4-20 - (<i>Zinc Nylon Insert Jam Lock Nut</i>).....	02546	7742
Hex Nut - (<i>Zinc 5/16 x 24</i>).....	06549	7753
Shock Mount - (<i>Chrome 1/2 x 10 Thin Lock Nut</i>).....	27555	7812W
Castle Nut - (<i>Chrome 1/2 x 13</i>).....	22554	7843
Axle Nut - (<i>Chrome 5/8-18 with 1 1/16 Hex</i>).....	15559-H	7986
1989 & Up - (<i>Axle Castle Nut 5/8-18</i>).....	22559-H	7987
Castle Nut - (<i>Rear Axle Chrome M 24</i>).....	22979	8020
1972 & Earlier - Big Twins (<i>Chrome Axle Sleeve Nut</i>).....	16563	8095A
80cu. - Oil Pump (<i>O'Ring Plug</i>).....	09104	11105

Polished Allen



Flat and Lock Washers



Castle Nut



**Stock Style
Fasteners**



Stock Style Replacement Fasteners

	G-W #	HD #
1984 - 1985 Evolution Big Twin (<i>Chrome Head Bolt</i>).....	29340	16478-83
1987 & Up Evolution (<i>Chrome Long Head Bolt</i>).....	09271	16478-85A
1984 - 1985 Evolution Big Twin (<i>Chrome Head Bolt</i>).....	29352	16480-83
1987 - 1991 Evolution (<i>Chrome Short Head Bolt</i>).....	09270	16480-85A
Evolution - (<i>Chrome Medium Head Bolt</i>).....	09272	16480-92
1984 - 1985 Evolution (<i>Washer for Head Bolt</i>).....	C-31-32	16482-83
Evolution - (<i>Head Bolt Washers</i>).....	23200	16482-85
1936 - 1977 74cu. (<i>Zinc Cylinder Base Nut</i>).....	09552	16602-30
1957 - 1985 XL (<i>Zinc Cylinder Base Nut</i>).....	09550	16603-72
1953 - 1976 74cu. Lifter Base Screw (<i>Chrome</i> <i>1/4-24 x 7/8 12 Point Screw</i>).....	09256	18660-53
1984 - 1977 74cu. (<i>Special Zinc Head Bolt</i>).....	31-09	16814-48
Lifter Base - (<i>1/4-24 x 13/16 Oval Slotted Screw</i>).....	09249	18660-53
80cu.- Wet Clutch Derby Cover (<i>1/4 Nylon Washer</i>).....	09566	31433-84
Copper Bushing.....	09581	33288-37
3/4-16 - (<i>Zinc Jam Esna's sold each</i>).....	02561	35078-79
Big Twin - Transmission Oil Fill (<i>Nylon Washer</i>).....	09106	37091-80
1985 Big Twin - Clutch Adjustment (<i>Set Screw</i>).....	61142	37357-41
Axle E-Clip.....	09235	41139-02
Axle E-Clip.....	09233	41296-05
Axle C-Clip.....	09236	41229-08
Axle E-Clip.....	09987	41147-01
1981 - 1984 Big Twin (<i>Brake Arm Clevis Pin</i>).....	09419	40919-81
Disc Brake Rotor to Hub (<i>Chrome 3/8 x 1 Thin Head Hex</i>).....	11330 LOW	41198-73
E-Clip Rear Axle.....	09233	41296-05
Brake Arm Bracket - Rear Disc (<i>1/2-13 x 1 1/8 Drilled Hex</i>).....	09418	41734-73
Brake Bleeder - (<i>Chrome Screw 1/4-28 x 1</i>).....	45-9404	41749-58
Brake Rotor Mount Rear - (<i>Chrome</i>).....	46330A	43567-92
Brake Caliper - (<i>Special Chrome 3/8 I.D. Washer</i>).....	20091	44132-72
Brake Bleeder - (<i>Chrome Screw 3/8-24 x 1 1/8</i>).....	45-9402	44146-77
Brake Caliper Mount - (<i>Front Short Chrome Screw</i>).....	09340	44174-77
Brake Caliper Mount - (<i>Front Long Chrome Screw</i>).....	09341	44173-77
5/16-18 - (<i>Zink Lock Nut for 09341 & 09340</i>).....	09549	44177-77
XL, FXR & FLT - Damper Tube Mount (<i>Screw</i>).....	10774 LOW	45405-75A
1977 & Up FL - Front Fork Leg Drain (<i>Brass Washer</i>).....	09570	45406-75
1977 & Earlier - Transmission Side Cover (<i>Check Screw & Fork Drain</i>).....	86588	45830-48
XL & FX - Fork Drain (<i>4mm Brass Washer</i>).....	09985	45986-73
1986 - 1992 Softails - Rear Wheel Adjustment (<i>Chrome 3/8-16 x 2 1/2 Full Thread Hex Cap</i>).....	09344	47579-86
1993 - 2007 Softails - Rear Wheel Adjustment (<i>Chrome 3/8-16 x 2 3/4 Full Thread Hex Cap</i>).....	09351	47579-93
Softail Motor Mount Spacer (<i>Steel Chrome</i>).....	20100	48099-00
1982 & Up Floorboard Mount (<i>Chrome 1/4-20 Shoulder Bolt</i>).....	09120	50635-82
Shock Mount - (<i>Chrome 3/8 I.D. Cup Washer</i>).....	22334	54543-65
Shock Mount - (<i>Chrome 1/2 I.D. Cup Washer</i>).....	22418	54545-65



Bleeder Screw



Jam Esna 3/4-16

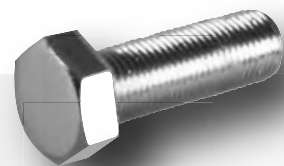

Hex Cap Chrome

Stock Style Fastener Sets



**Stock Style
Fasteners**

Stock Style Replacement Fasteners

	G-W #	HD #
Shock Mount - (Chrome 5/8 I.D. Cup Washer).....	22490	54544-65
Handlebar Mount - (Chrome 1/2 I.D. Cup Washer).....	22420	56159-73
FLH & FXWG Speedo - Reset Knob Screws (Chrome 4/40 x 3/4 Round Slotted Screws).....	33091	67217-68

Stock Style Sets

	Part #
Cam Cover; Big Twin 1936 - 1969 (Chrome Slotted Screws).....	C-10-27-06Y
Cam Cover; Big Twin 1936 - 1969 (Zinc Slotted Screws).....	10-27-06Y
Front Disc - Brake Caliper Mount, 1993 & Up.....	C-80-143
Front Disc - Brake Caliper Mount, 1984 -1992.....	C-80-144
Rear Disc - Brake Caliper Mount, FL & FX 1973 - 1984.....	A-74-43
Front Disc - Brake Rotor to Hub, 1984 & Up (Cast Wheel Chrome Torx Buttonhead Screws).....	C-80-42T
Front Disc - Brake Rotor to Hub, 1984 & Up (Laced Wheel Chrome Torx Buttonhead Screws).....	C-80-41T
Rear Disc - Brake Rotor to Hub, 1992 & Up (Cast Wheel Chrome Torx Buttonhead Screws).....	C-61-32T
Rear Disc - Brake Rotor to Hub, 1992 & Up (Laced Wheel Chrome Torx Buttonhead Screws).....	C-61-31T
Rear Disc - Brake Rotor to Hub, 1973 - 1980 (Laced Wheel Thin Head Hex Caps with Lock nuts).....	C-74-51H
Rear Disc - Brake Support Bracket Mount, FLH 1981 - 1984 (Includes; Hex Caps & Clevis Pins).....	C-31-08
Disc Brake Support Arm Mount, Big Twin 1973 - 1982 (Drilled Hex Caps with Cotter Pins & Washers).....	C-31-07
Floor Board Hinge Mount, 1982 & Up (Hex Caps with Nuts).....	C-80-104H
Head Bolts - Evolution 1992 & Up (12 Points).....	A-61-110
Head Bolts - Evolution 1987 - 1991 (12 Points).....	A-61-100
Head Bolts - 1984 & early 1985 Big Twins (12 Points).....	A-80-10
Head Bolts - Panhead & Shovelhead with (Chrome 9/16 Hex Caps & Washers).....	C-31-09
Header Mount Flange Nuts Set, Evolution & Twin Cam.....	50-03Y
Header Mount Flange Nuts & Studs, Evolution & Twin Cam.....	50-203Y
Inspection Covers - Big Twins 1936 - 1964 (Chrome Slotted Screws).....	C-10-27-09Y
Lifter Base - 1976 & Earlier Big Twins (Chrome Slotted Screws).....	C-74-16Y
Lifter Base - 1976 & Earlier Big Twins (Zinc Slotted Screws).....	74-16Y
Lifter Base - 1977 - 1998 Big Twins (Chrome 12 Points).....	A-74-26
Motor Case Alignment - Late 74cu. (Studs, Nuts & Washers).....	S-31-29
Primary Cover - Big Twins 1936 - 1964 (Slotted Screws).....	C-10-27-05Y
Rocker Box - Shovelheads (Chrome Hex Nuts & Washers).....	50-15H
Rocker Box - Twin Cam 88cu.1999 & Up (Socket Cap Hex Heads).....	C-88-15Y
Transmission Side Cover, 4 Speed - Big Twin 1936 - 1985 (Chrome Hex Nuts & Washers).....	50-12H
Shock Mount - Softails 1984 - 1999 (Chrome Hex Caps).....	C-80-127H



C-31-09



Set C-31-07



Studs	G-W #	HD #
XL - Chain Adjustment (<i>Slotted Set Screw 5/16-18 x 2</i>).....	61134	3250
XL - Chain Adjustment (<i>Allen Set Screw 5/16-18 x 2</i>).....	61144	3250-GW
74cu. - Case (<i>5/16-24 x 5 9/16 Stud</i>).....	61100	3505
74cu. - Case (<i>5/16-24 x 5 3/4 Tapered Stud</i>).....	61101	3506
Transmission Mount (<i>3/8-24 x 7/16-14 Stud</i>).....	61146	11733
Evolution - Rocker Box & Exhaust (<i>5/16-18-24 x 1 11/16 Stud</i>).....	61129	16715-83
45cu. - Cylinder & 74cu. Transmission (<i>3/8-16-24 x 1 13/16 Stud</i>).....	61102	16830-29
XL 900 - Cylinder Base & Inner Primary to Transmission 74cu. (<i>3/8-16-24 x 2 5/16 Stud</i>).....	61103	16830-54
XL 1000 - Cylinder Base (<i>3/8-16-24 x 2 11/32 Stud</i>).....	61104	16830-72
74cu. - Cylinder Base (<i>7/16-20-14 x 2 1/2 Stud</i>).....	61105	16831-30
Evolution - Top Motor Mount (<i>3/8-16-24 x 2 3/16 Stud</i>).....	61126	16831-83
80cu. - Cylinder Base (<i>7/16-14-20 x 2 3/8 Stud</i>).....	61106	16837-78
Panhead & Shovelhead - Top Motor Mount (<i>7/16-14-20 X 1 3/4 Stud</i>).....	61107	16864-48
Panhead - Rocker Block (<i>5/16-18-24 x 2 1/16 Stud</i>).....	61145	17647-48
Panhead - Rocker Block Long (<i>5/16-18-24 x 2 1/4 Stud</i>).....	61150	17647-48L
XL - Footrest Right (<i>1/2-13 x 3 7/8 Stud</i>).....	61138	24751-75
XL - Footrest Left (<i>1/2-13 x 5 3/4 Stud</i>).....	61139	24752-75
74cu. - Case (<i>5/16-24 x 5 3/4 Stud</i>).....	61108	24805-30
74cu. - Case (<i>5/16-24 x 5 7/16 Stud</i>).....	61109	24806-36
74cu. - Case (<i>5/16-24 x 6 Stud</i>).....	61110	24809-30
74cu. - Case (<i>5/16-24 x 5 27/32 Tapered Stud</i>).....	61111	24815-40
XL - Case (<i>3/8-16-24 x 3 1/4 Stud</i>).....	61112	24817-52
74cu. - Transmission Cover (<i>5/16-18-24 x 1 11/16 Stud</i>).....	61113	24818-52
Oil Pump FL & 45cu.1941 - 1967 (<i>1/4-24 x 1 11/16 Stud</i>).....	61114	24819-36
Oil Pump - 45cu. (<i>1/4-24 x 1 3/8 Stud</i>).....	61127	24819-37
Oil Pump - XL 1954 - 1970 (<i>1/4-28-20 x 2 5/16 Stud</i>).....	61115	24819-52
Oil Pump - FL 1941 - 1967 (<i>1/4-24 x 2 1/4 Stud</i>).....	61116	24820-36
Carburetor Mount & Frt Fork Leg (<i>5/16-18 x 1 11/16 Stud</i>).....	61132	24820-78
Big Twin - Transmission Cover (<i>5/16-18-24 x 1 3/4 Stud</i>).....	61125	24823-80
Carburetor Mount - 1967 - 1970 (<i>3/8-16-24 x 2 Stud</i>).....	61135	24824-67
Big Twin - Transmission Cover (<i>5/16-18-24 x 1 11/16 Stud</i>).....	61117	24824-80
XL - Case (<i>3/8-16 x 3 1/8 Stud</i>).....	61136	24825-82
Oil Pump - 74cu.1968 - 1969 (<i>1/4-24-28 x 2 Stud</i>).....	61118	26390-68
Carburetor Mount - (<i>5/16-18 x 1 3/4 Stud</i>).....	61119	29253-78
Carburetor Mount - (<i>5/16-18-24 1 1/4 Stud</i>).....	61130	29254-78
Transmission Kicker Cover & Carburetor Mount (<i>5/16-18-24 x 1 1/2 Stud</i>).....	61120	33298-65
Big Twin -Transmission Kicker Cover (<i>5/16-18-24 x 1 3/4 Stud</i>).....	61121	33299-65
Transmission Bottom Oversize - (<i>7/16-14 x 3/8-24 x 1 5/8 Stud</i>).....	61122	34723-47
XL - Clutch Hub (<i>1/4-20-28 x 2 1/2 Stud</i>).....	61140	37584-67
XL - Clutch Hub (<i>1/4-20-28 x 2 Stud</i>).....	61141	37584-54
Clutch Adjustment - (<i>3/8-24 x 2 1/4 Slotted Set Screw</i>).....	61142	27357-41
XL - Clutch (<i>3/8-24 x 1 1/2 Stud</i>).....	61131	38130-71
Chain Adjustment - (<i>3/8-16-24 x 3 13/16 Stud</i>).....	61123	40018-77
Footrest - XL 80 & Up (<i>1/2-13 x 3 1/2 Stud</i>).....	61137	42449-80
Axle Cap 74cu. - 1976 & Earlier (<i>5/16-18-24 x 1 11/16 Stud</i>).....	61124	45840-48
Evolution Big Twin Late - Head Cylinder (<i>3/8 x 6 11/16 Special Stud</i>).....	61200	16837-85A
Evolution XL - Head Cylinder (<i>3/8 x 5 3/4 Special Stud</i>).....	61201	16832-86A
Front Fork Leg Axle Cap - (<i>5/16-18 x 1 11/16 Stud</i>).....	61147	45998-73

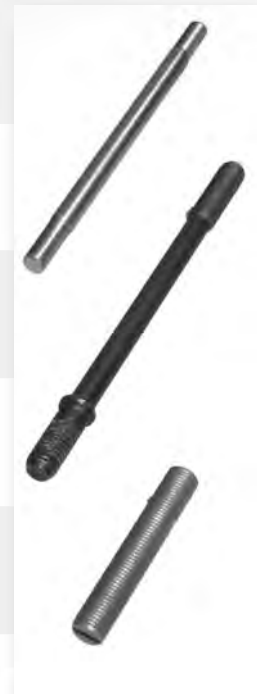



Inside This Section

<i>BSA</i>	56
<i>Norton</i>	56
<i>Royal Enfield</i>	56
<i>Triumph</i>	57
<i>Acorn Sets</i>	58
<i>Head Bolts</i>	58
<i>Recoil Inserts</i>	58

**British
Motorcycles**

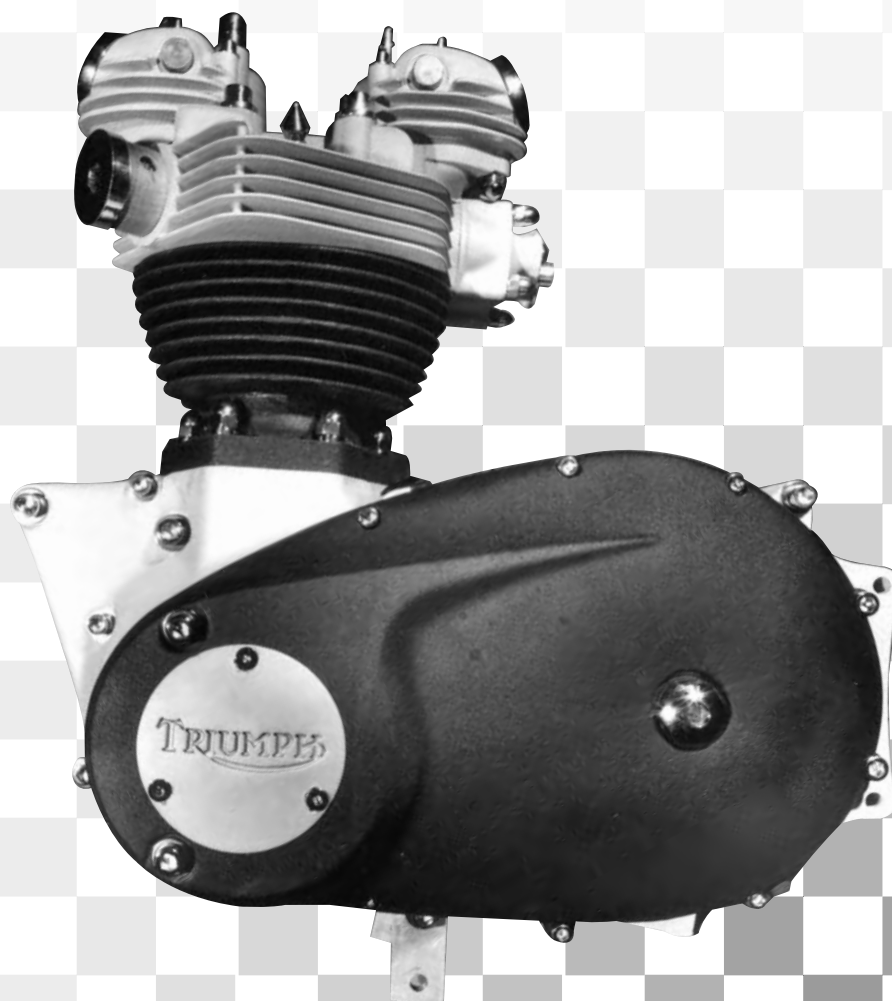



British Side Cover Sets



C= Chrome Plated



P= Polished Chrome Plated
Knurls Removed



S= Stainless Steel



SP= Stainless Steel Polished
Knurls Removed

BSA

	Styles Available	Part #
1969 & Up - 650cc Twin (Timing, Primary & Trans).....	C P S SP	18-35-01
1963 - 1968 650cc & 500cc Twin (Timing, Primary & Trans).....	C P S SP	18-40-01
1954 - 1962 A10 BSA (Right & Left Side Covers).....	C P S SP	18-41-01
1970 & Up - 650cc (Inner Timing Cover).....	C P S SP	18-35-09
1969 - 650cc Twin (Inner Timing Cover).....	C P S SP	18-34-09
1963 - 1968 650cc Twin (Inner Timing Cover).....	C P S SP	18-40-09
1969 & Up - 500cc B50 Single (Right & Left Covers).....	C P S SP	12-16-01
1969 & Up - 500cc B50 Single B-44 & B-25 (Inner Timing Cover).....	C P S SP	18-19-09
1969 & Up - 441 Victor B44 (Timing, Inner Timing & Primary).....	C P S SP	18-19-01
1966 - 1968 4 41 Victor B44 (Timing, Inner Timing & Primary).....	C P S SP	18-17-01
1963 - 1968 500cc B50 Single & B-44, B-25 (Inner Timing Cover).....	C P S SP	18-17-09
1970 & Up - 250cc BSA Starfire (Timing Inspection Cover).....	C P S SP	18-12-06
1970 & Up - 250cc BSA Starfire (Primary Cover).....	C P S SP	18-12-08
1969 - 1971 Rocket 3 Cylinder A-75.....	C P S SP	18-62-01

Norton

1975 - 1976 Mark 3 (Timing Cover).....	C P S SP	11-22-06
1975 & Up - (Transmission, Primary, Timing, Point & Oil Fill Cover & Electric Start Screws).....	C P S SP	11-21-01
850cc & 750cc - (Timing Cover).....	C P S SP	11-21-06
850cc & 750cc - (Transmission Cover - All Models).....	C P S SP	11-21-07
1975 & Up - 850cc (Primary Cover).....	C P S SP	11-21-08
1975 & Up - 850cc (Electric Start Screws).....	C P S SP	11-21-09
850cc & 750cc - (Point Cover & Transmission Fill Cover Screws with Allen Wrench).....	C P S SP	11-21-04
750cc, 650cc, 600cc & 500cc Atlas - (Timing Cover).....	C P S SP	11-24-06
750cc & 850cc - (Rocker Top Set).....	C P S SP	11-21-02
Norton - (Head Bolt Allen Set).....	C P S SP	11-21-10
750cc - (Primary Cover P-11).....	C P S SP	11-24-08

Royal Enfield

750cc - Timing Cover.....	C P S SP	14-24-06
750cc - Series #2 1969 - 1970 Timing Cover Set.....	C P S SP	14-23-06
500cc - Single Cylinder Timing Cover.....	C P S SP	14-22-06
500cc - India Timing Cover.....	C P S SP	14-50-06
500cc - India Chassis.....	C P S SP	14-50-20

British Side Cover Sets

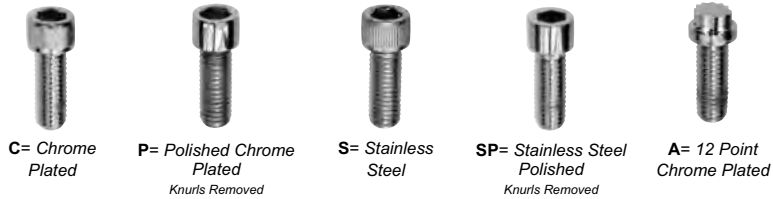

British Motorcycles

Triumph

	Styles Available	Part #
2013 & Up 1215cc Trophy & Tiger Explorer.....	C P S SP --	12-83-01
2003 & Up 600cc 4 Cylinder - (Side Cover Set).....	C P S SP --	12-82-01
2003 & Up 600cc 4 Cylinder - (Oil Pan Cover).....	C P S SP A	12-82-04
2003 & Up Twin - (Alternator Cover).....	C P S SP --	12-80-06
2003 & Up Twin - (Chain Cover with Back).....	C P S SP --	12-80-07
2003 & Up Twin - (Alternator, Chain & Clutch Covers).....	C P S SP --	12-80-08
2003 & Up Twin - (Clutch Side Cover with Shifter Pinch Bolt).....	C P S SP --	12-80-01
2003 & Up Twin - (Handlebar Switch Boxes & Master Cylinder Cover).....	C P S SP --	12-80-50
1981 & Up 750cc Twin - (Electric Start Timing, Trans, Primary & Oil Check Screws)....	C P S SP --	12-22-01
1969 & Up 650cc & 750cc Twin - (Timing, Transmission & Primary).....	C P S SP --	12-21-01
1963 - 1968 650cc - (Timing, Transmission & Primary).....	C P S SP --	12-40-01
1954 - 1962 650cc T6 - (Timing, Transmission & Primary).....	C P S SP --	12-41-01
1954 - 1962 650cc TA6, T110 & T120 - (Timing, Transmission & Primary).....	C P S SP --	12-42-01
1969 - 1975 750cc Trident T150 - (Includes Clutch Adjustment Cover Right & Left Side Covers).....	C P S SP --	T6932
1975 & Up 750cc Trident T160 - (Includes Clutch Adjustment Cover Right & Left Side Covers).....	C P S SP --	12-62-01
1969 & Up 500cc Twin - (Timing, Transmission & Primary).....	C P S SP --	12-20-01
1963 - 1968 500cc Twin - (Timing, Transmission & Primary).....	C P S SP --	12-43-01
1954 - 1962 500cc Twin - (Timing, Transmission & Primary).....	C P S SP --	12-44-01
Triumph & BSA 500cc Single Cylinder B50 - (Right & Left Side Covers).....	C P S SP --	12-16-01
1969 & Up 250cc Single Cylinder (Right & Left Side Covers).....	C P S SP --	12-12-01
1963 - 1968 250cc Single Cylinder (Right & Left Side Cover).....	C P S SP --	12-45-01
1963 & Earlier 250cc Cub Tiger.....	C P S SP --	12-46-01
Triumph & BSA - (Point Cover Screws with Allen Wrench).....	C P S SP --	12-18-04
Trident - (Point Cover Set with Allen Wrench).....	C P S SP --	12-62-04
1973 & Up 750cc Twins - (Rocker Box Set).....	C P S SP --	12-21-02

Timing, Transmission and Primary Available Separately

Side Cover Set
P-12-21-01
For 1969 & Up
650cc & 750cc Triumph





British Acorn Sets

Triumph

Acorn Motor Sets

	Part #
1973 & Up 750cc Twins.....	73-102
1969 - 1972 650cc Twins.....	69-102
1963 - 1968 650cc Twins.....	63-102A

Acorn Individual Sets

1969 & Up - 650cc & 750cc Twins (Primary).....	50-280A
1963 - 1968 650cc Twins (Primary).....	50-284A
1969 & Up - 650cc & 750cc Twins (Timing).....	50-279A
1963 - 1968 650cc Twins (Timing).....	50-283A
1969 & Up 650cc & 750cc Twins (Transmission).....	50-278A
1963 - 1968 650cc Twins (Transmission).....	50-282A

Acorn Cylinder Base Sets

1973 & Up 750cc Twins.....	12-21-20
1969 - 1972 650cc Twins.....	50-200A
1949 - 1968 650cc Twins.....	50-201A

Replacement Head Bolts

3/8-26 x 3 3/8.....	# E327
3/8-26 x 5 1/2 with Stud.....	# E1596
3/8-26 x 5 1/2.....	# E1596A
5/16-26 x 3.....	# E4771

Chrome (Whitworth) Acorn Nuts

1/4-26.....	21569
5/16-26.....	21570
3/8-26.....	21571
7/16-26.....	21572
1/2-26.....	21573
3/4-20.....	21576

Recoil Threaded Inserts

Bulk 10 Per Bag

Recoil Insert 1/4-26.....	R-20043
Recoil Insert 5/16-26.....	R-26503
Recoil Insert 3/8-26.....	R-26603
Recoil Insert 7/16-26.....	R-26703
Recoil Insert 1/2-26.....	R-26803

Recoil Thread Repair Kits

Kit for 1/4-26.....	R-30040
Kit for 5/16-26.....	R-36500
Kit for 3/8-26.....	R-36600
Kit for 7/16-26.....	R-36700
Kit for 1/2-26 Includes Top, Install Tool & Inserts.....	R-36800

Slotted Studs
for easy removal



Head Bolt
Sets
Available



H-36500 Re-coil Repair Kit



Inside This Section

Indian	
Individual Sets.....	60
Victory	
Motor Sets.....	61
Side Cover Sets.....	61
Individual Sets.....	61
Nut Sets.....	61
Washer Set.....	61
Honda	
Motor Sets.....	62
Side Cover Sets.....	62
Kawasaki	
Motor Sets.....	63
Side Cover Sets.....	63
Suzuki	
Side Cover Sets.....	64
Yamaha	
Motor Sets.....	65
Side Cover Sets.....	65
Ultima	
Motor Sets.....	65

**Selected
Motorcycle Brands**

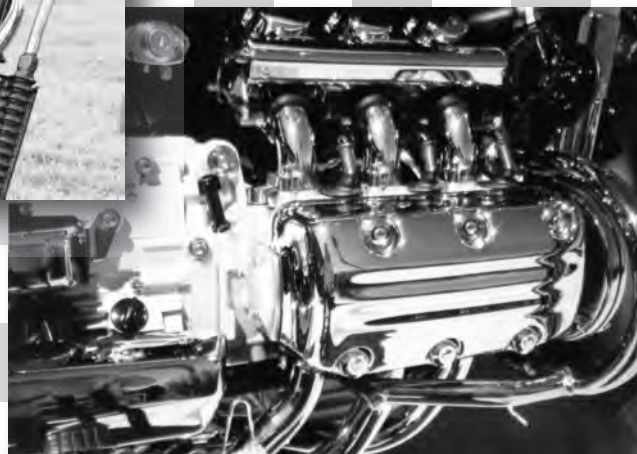



Indian Motorcycle

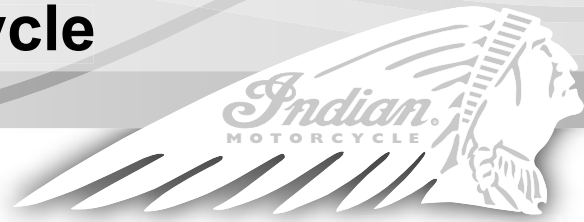

C= Chrome Plated



P= Polished Chrome Plated
Knurls Removed



S= Stainless Steel



SP= Stainless Steel Polished
Knurls Removed

Part numbers shown are Polished Chrome Allens also available in Stainless Steel and Polished Stainless Steel

Indian Fastener Sets

Styles Available

Part

Air Cleaner Cover.....	C P S SP	39-11-54
Cam & Sprocket Covers.....	C P S SP	39-11-06
Covers Side Frame.....	C P S SP	39-11-46
Front Fender Mount.....	C P S SP	39-11-04
Axle Nut - Rear.....	C P S SP	39-40-44
Disc Brake Rotor to Hub (one disc) - Front.....	C P S SP	39-11-42
Disc Brake Rotor to Hub - Rear.....	C P S SP	39-11-32
Highway Bar Mount.....	C P S SP	39-11-23
Handlebar Switch Box & Master Cylinder.....	C P S SP	39-11-50
Lifter Base Mount.....	C P S SP	39-11-16
Motor Case Set.....	C P S SP	39-11-29
Primary & Inspection Covers.....	C P S SP	39-11-08
Seat Mount - Rear.....	C P S SP	39-11-67
Master Cylinder Cover - Rear.....	C P S SP	39-11-44
Side Cover Set, Cam, Sprocket, Primary & Inspection Covers.....	C P S SP	39-11-01
Triple Tree Pinch Bolts.....	C P S SP	39-11-45
Exhaust Header Mount Flange Nuts (Chrome).....	C P S SP	92-50Y
Exhaust Header Mount Flange Nuts (Acorn).....	C P S SP	92-50A
Valve Stem Covers.....	-- P -- --	31-99
Valve Stem Covers - Skull.....	-- P -- --	14-31-99
Valve Stem Covers - Flames.....	-- P -- --	17-31-99
License Plate Mount.....	C P S SP	39-34
License Plate Mount - Skull Hex Caps.....	C P S SP	14-39-34
License Plate Mount - Flames.....	C P S SP	17-39-34
 <i>Detail Set - Coil, Horn, with bracket, Cylinder Exhaust Cover</i>		
Air Cleaner & Frame Side Covers.....	C P S SP	39-11-80
 <i>Detail Set - Lower Foot Pegs, Floor Board, Kickstand, Electric Module, Rear Brake Arm, Rear Master Cylinder Cover, Highway Bar, Oil Filter Mount, Starter Motor and Shifter Linkage.....</i>		
	C P S SP	39-11-81



Selected Motorcycle Brands

Motor Set

	Styles Available	Part #
2009 & Up - 106cu. Motors.....	C P S SP	92-96
2005 - 2010 100cu. Motors.....	C P S SP	92-97
2003½ & Up - 92cu. Freedom Motors.....	C P S SP	92-98
1999 - 2003 Polaris Victory 92cu. (Motor Sets includes Right & left Side Covers, Front Sprocket, Cam Covers, Motor Case & also Includes Detail Sets described below)....	C P S SP	92-99

Side Cover Set

2005 - 2010 100cu. Motors.....	C P S SP	92-03
2003½ & Up - 92cu. Freedom Motors.....	C P S SP	92-02
1999 - 2003 Polaris Victory 92cu. (Includes Primary with Inspection Cover, Derby Cover, Sensor Mount, Crank Cover and Front Sprocket Cover).....	C P S SP	92-01

Individual Sets

2003½ & Up - Freedom Motors (Both Cam Covers).....	C P S SP	92-14
2003 & Earlier - (Both Cam Covers with wire holders).....	C P S SP	92-15
Crank Cover - (Right Side Cover).....	C P S SP	92-06
Fender Rail - (Rear).....	C P S SP	92-21
Foot Peg & Bracket Mount - (Front & Rear).....	C P S SP	92-35
Gas Tank Mount.....	C P S SP	92-34
Handle Bar Rizer Mount.....	C P S SP	92-23
Master Cylinder Mount - (Front & Rear with Handle Bar Switch Boxes).....	C P S SP	92-50
Motor Case Set.....	C P S SP	92-29

Nut Sets in Show Chrome

Exhaust Header Mount Set in Stock Style - (Also Fits Indian and V-Rod).....	C P S SP	92-50Y
Exhaust Header Mount Set in Acorn Style.....	C P S SP	92-50A
Axle Nut Set Front & Rear in Stock Style - (92cu.).....	C P S SP	92-51Y

Washer Set

Includes special O.D. Flatwashers for the Side Cover Set - (Fits 6mm Allens used to preserve the chrome or paint).....	C P S SP	99-60
--	----------	-------

2014 Fastener Sets 106cu.

Cam, Primary, Derby Covers.....	C P S SP	40-06-01
Cam Cover.....	C P S SP	40-06-06
Primary & Derby Cover.....	C P S SP	40-06-08
Axle Nut Rear.....	C P S SP	39-40-44
Disc Brake Caliper Mount - Front - Both.....	C P S SP	40-06-43
Disc Brake Rotor to Hub - Front - Each.....	C P S SP	40-06-42
Disc Brake Rotor to Hub - Rear.....	C P S SP	40-06-32
Gas Cap Mount.....	C P S SP	40-06-35
Engine Guard & Lower Fairing Mount.....	C P S SP	40-06-20
Header Mount Flange Nuts.....	C P S SP	92-50Y
Handlebar Lever & Switch Boxes.....	C P S SP	40-06-50
Motor Case Set.....	C P S SP	40-06-29
Motor Mounts Top, Front & Rear.....	C P S SP	40-06-19
Motor Mounts Top, Front & Rear - Hex Head.....	C P S SP	40-06-19H
Motor Mounts Top, Front & Rear - Allens with Full Washers & Lock Nuts.....	C P S SP	40-06-19M
Belt Sprocket Mount Rear.....	C P S SP	40-06-58
Belt Sprocket Mount Rear - Hex Head.....	C P S SP	40-06-58H
Detail Set - Cross Country - Floor Boards, Kickstand to Case, Front Fender, Triple Tree Pinch Bolts, Shifter Linkage Bracket, Tour Package Mount, Disc Brake Caliper to Leg, Rear Master Cylinder & Front Axle Pinch Bolts.....	C P S SP	40-06-80
License Plate Mount.....	C P S SP	39-34
Valve Stem Caps.....	-- P --	31-99



C= Chrome Plated



P= Polished Chrome Plated
Knurls Removed



S= Stainless Steel



SP= Stainless Steel Polished
Knurls Removed

Motor Sets

Styles Available

Part

1500C - Valkrie GL 6 Cylinder 1997 - 2003.....	C P S SP	15-46-99
1100cc. - Shadow V Twin 1995 - 1998 1100C2 American Classic.....	C P S SP	15-40-99
1100cc. - Shadow V Twin 1987 - 1999 1100C.....	C P S SP	15-41-99
750cc. - Magna 1994 - 1999 V-4 VF750CD & VF750C.....	C P S SP	15-44-99
900cc. - 1980 & Up 4 Cylinder Motor Set (Includes; Dyno, Inspection, Oil Pump, Gear Case, Clutch, Crankcase, Point, Cylinder Head, Start Motor & Oil Pan).....	C P S SP	15-24-99
750cc. - 1979 & Up Motor Set (Includes; Generator, Clutch, Oil Pump, Oil Point Cover, Inspection, Point, Crankcase, Oil Pan & Intake Manifold Clamps).....	C P S SP	15-23-99

Side Cover Sets

900cc. - 4 Cylinder 1980 & Up (Full Side Covers).....	C P S SP	15-24-01
900cc. - 4 Cylinder 1980 & Up (Cylinder Head Cover).....	C P S SP	15-24-02
750cc. - 1979 & Up (Full Side Cover Set).....	C P S SP	15-23-01
750cc. - 4 Cylinder 1969 - 1978 (Right & Left Side Covers).....	C P S SP	15-22-01
750cc. - 4 Cylinder 1969 - 1978 (Cylinder Head Cover Set).....	C P S SP	15-22-02
750cc. - Hondamatic (Right & Left Side Covers).....	C P S SP	15-64-01
CBX - 6 Cylinder 1980 & Up (Right & Left Side Covers).....	C P S SP	15-25-01
CBX - 6 Cylinder 1980 & Up (Cylinder Head Cover & Tachometer Drive Screws).....	C P S SP	15-25-02
500cc. - V Twin (Includes; Clutch, Transmission, Starter Motor, Water Pump & Rear Covers).....	C P S SP	15-26-01
CB 500cc. & 550cc. - 4 Cylinder (Right & Left Side Covers).....	C P S SP	15-19-01
CB 500cc. & 550cc. - 4 Cylinder (Head Cover).....	C P S SP	15-19-02
650cc. - (Right & Left Side Covers).....	C P S SP	15-21-01
450cc. - CL & CB (Right & Left Side Covers).....	C P S SP	15-18-01
360T & CB - (Right & Left Side Covers).....	C P S SP	15-16-01
350cc. - CL & CB (Right & Left Side Covers).....	C P S SP	H-35-20
400cc. 4 CB - 4 Cylinder F & F1 CB 350 4 Cylinder (Right & Left Side Covers).....	C P S SP	15-14-01
400cc. - Hawk Type 1 & 2 1978 & Up (Right & Left Side Cover).....	C P S SP	15-62-01
305cc. - 2 Cylinders (Right & Left Side Covers).....	C P S SP	15-13-01
250 CR Elsinore - (Right & Left Side Covers).....	C P S SP	15-12-01
250cc. - XL (Right & Left Side Covers).....	C P S SP	15-31-01
200 CB T - (Right & Left Side Covers).....	C P S SP	15-11-01
125 CR Elsinore - (Right & Left Side Covers).....	C P S SP	15-28-01
125 CB S1 - (Right & Left Side Covers).....	C P S SP	15-29-01
CB k25 S, XL 125, 100 SL - (Right & Left Side Covers).....	C P S SP	15-30-02



C= Chrome Plated



P= Polished Chrome Plated Knurls Removed



S= Stainless Steel



SP= Stainless Steel Polished Knurls Removed

Selected Motorcycle Brands

Motor Sets

	Styles Available	Part #
Vulcan 2000cc. V Twin.....	C P S SP	16-44
Vulcan 1500cc. V Twin 1987 - 1988 VN 1500 Vulcan 88.....	C P S SP	16-41
Vulcan 1500cc. V Twin 1987 - 1988 VN 1500 Vulcan 800.....	C P S SP	16-40
Vulcan 800cc. V Twin 1996 Classic VN 800 BL & 1995 - 1999 VN800A1 & VN800A2.....	C P S SP	16-43
1973 - 1980 900cc. & 1000cc. (Set Includes; Allens for Clutch Cover, Clutch Adjustment Cover, Point Cover, Chain Guard, Point Housing Cover, Kickstarter Cover, Chain Cover, Dyno Cover, Cylinder Head Cover, Intake Manifold, Top Inspection Cover, Handlebar Lever Mount & Inner Point Plate).....	C P S SP	16-73
1981 & Up 1000cc. & 1100cc. - Chain Drive Models (Includes; Allens for Clutch Cover, Timing Inspection & Back Cover, Dyno Cover, Chain Cover with Special Washers, Clutch Adjustment Cover & Intake Manifold & Cylinder Head with End Covers).....	C P S SP	16-81
1981 & Up 1000cc. & 1100cc. - Shaft Drive Motor Set.....	C P S SP	16-80
KZ & GPZ 750cc. & 650cc. - Chain Drive Motor Set.....	C P S SP	16-22
KZ & GPZ 750cc. & 750cc. - Shaft Drive Motor Set.....	C P S SP	16-23

Side Cover Sets

1981 & Up 1000cc. & 1100cc. KZ & GPZ - Chain Drive - (Rt. & Lt. Side Covers).....	C P S SP	16-30-01
1981 & Up 1000cc. & 1100cc. KZ & GPZ - Shaft Drive - (Rt. & Lt. Side Covers).....	C P S SP	16-31-01
1000cc. & 1100cc. KZ & GPZ 1981 & Up (Cylinder Head Cover).....	C P S SP	16-30-02
900cc. & 1000cc. 1973 - 1980 (Right & Left Side Cover).....	C P S SP	16-33-01
900cc. & 1000cc. 1973 - 1979 (Cylinder Head Cover).....	C P S SP	16-33-02
1000cc KZ 1979 & 1980 (Cylinder Head Covers).....	C P S SP	16-33-03
900cc. Ninja 1984 & Up (Right & Left Side Covers).....	C P S SP	16-25-01
900cc. Ninja 1984 & Up (Cylinder Head Cam Cover).....	C P S SP	16-25-02
750cc. KZ & GPZ - Chain Drive (Right & Left Side covers).....	C P S SP	16-22-01
750cc. KZ & GPZ - Chain Drive (Cylinder Head Cam Cover).....	C P S SP	16-22-02
750cc. 3 Cylinder - 2 Stroke (Right & Left Side Covers).....	C P S SP	16-24-01
650cc. KZ (Right & Left Side Covers).....	C P S SP	16-21-01
650cc. KZ (Cylinder Head).....	C P S SP	16-21-02
500cc. HI (Right & Left Side Covers 3 Cylinder 2 Stroke).....	C P S SP	16-20-01
400 KZ Twin 4 Stroke (Right & Left Side Covers).....	C P S SP	16-58-01
250cc Tecate 3 Wheeler (Right & Left Side Covers).....	C P S SP	16-13-01
1981 & Up - Mikuni Carburetor 5mm CV (Allen Screw Set 4 each).....	C P S SP	16-34
1973 - 1980 Mikuni Carburetor 4mm (Allen Screw Set 4 each).....	C P S SP	16-35
License Plate Mount Set (with Nylon Insert Lock Nuts).....	C P S SP	39-34



Yamaha Motor Sets

	Styles Available	Part #
Road Star Warrior - 102cu.....	C P S SP	36-46-99
Road Star - 98cu. 1999 & Up (<i>Push Rod OHV</i>).....	C P S SP	36-45-99
V-Star - 65cu. 1999 & Up (<i>50 HC</i>).....	C P S SP	36-44-99
Royal Star - 70cu 1996.....	C P S SP	36-40-99
V-Max V-4 1200cc VMx12.....	C P S SP	36-43-99
Virago 1100 & 1100 Special Vtwin & XV1100.....	C P S SP	36-41-99
Virago 750cc. Vtwin & XU750.....	C P S SP	36-42-99



Side Cover Sets

	Styles Available	Part #
2014 & Up 850cc FZ-09 - (<i>Right & Left Side Covers</i>).....	C P S SP	36-48-01
1100cc XS - (<i>Right & Left Side Covers</i>).....	C P S SP	36-22-01
1100cc XS - (<i>Cylinder Cam Cover</i>).....	C P S SP	36-22-02
750cc & 920cc Virago - (<i>Right & Left Side Covers</i>).....	C P S SP	36-21-01
License Plate Mount Set (<i>with Nylon Insert Lock Nuts</i>).....	C P S SP	39-34

Motor Set C-36-40-99



Ultima Motor Set

100cu.....	C P S SP	38-100
------------	----------	--------

Suzuki Side Cover Sets

	Styles Available	Part #
100 & 125 RM - (<i>Right & Left Side Covers</i>).....	C P S SP	17-51-01
250 RM - (<i>Right & Left Side Covers</i>).....	C P S SP	17-65-01
250 TM - (<i>Right & Left Side Covers</i>).....	C P S SP	17-67-01
250 RL - (<i>Right & Left Side Covers</i>).....	C P S SP	17-68-01
370 RM - (<i>Right & Left Side Covers</i>).....	C P S SP	17-60-01
380 GT - (<i>Right & Left Side Covers</i>).....	C P S SP	17-70-01
400 GS - (<i>Right & Left Side Covers</i>).....	C P S SP	17-61-01
400 GS - (<i>Overhead Cam Cover</i>).....	C P S SP	17-61-02
425 GS - (<i>Right & Left Side Covers</i>).....	C P S SP	17-78-01
425 GS - (<i>Overhead Cam Cover</i>).....	C P S SP	17-78-02
550 GT - (<i>Right & Left Side Covers</i>).....	C P S SP	17-19-01
550 GS - (<i>Right & Left Side Covers</i>).....	C P S SP	17-72-01
550 GS - (<i>Overhead Cam Cover</i>).....	C P S SP	17-72-02
650 Savage - (<i>Right & Left Side Covers</i>).....	C P S SP	17-81-01
750 GT - (<i>Right & Left Side Covers</i>).....	C P S SP	17-24-01
750-4 GS - (<i>Right & Left Side Covers</i>).....	C P S SP	17-22-01
750-4 GS - (<i>Overhead Cam Covers</i>).....	C P S SP	17-22-02
850 GS - (<i>Right & Left Side Covers</i>).....	C P S SP	17-79-01
850 GS - (<i>Overhead Cam Covers</i>).....	C P S SP	17-79-02
1000 GS - (<i>Right & Left Side Covers</i>).....	C P S SP	17-77-01
1000 GS - (<i>Right & Left Cam Covers</i>).....	C P S SP	17-77-02
VL 1500 Intruder - 2003 & Up (<i>Right & Left Side Covers</i>).....	C P S SP	17-15-01
1100 GS - (<i>Right & Left Cam Covers</i>).....	C P S SP	17-83-01
1100 GS - (<i>Overhead Cam Covers</i>).....	C P S SP	17-83-02

Side Cover Set
C-17-77-01

Motor Sets

VL 1500 Intruder - 2003 & Up.....	C P S SP	17-15-99
License Plate Mount Set (<i>with Nylon Insert Lock Nuts</i>).....	C P S SP	39-34



Inside This Section

American Thread Chrome Plated

Tray Assortments.....	66-68
Speciality Dealer Assortments.....	69
Shop Master Assortments.....	70
Point of Purchase Floor Unit.....	71

American Thread Stainless Steel

Tray Assortments.....	72
Allen Screws.....	72
Hex caps.....	72
Hex Nuts and Lock Nuts.....	72
Washers.....	72

Zinc Plated

Tray Assortments.....	73
Allen Screw.....	73
Hex Caps.....	73
Hex Nuts.....	73
Washers and Lock Nuts.....	73
The Shop Master.....	73

**Assortments in
Chrome Plated,
Stainless Steel & Zinc**

Detailed Custom Assortments with Speciality Lengths and Diameters Available





Tray Assortments for Harley Twins and Sportsters

Fastener Assortment Set

Specially designed for use with Harley Twins and Sportsters

A-50 Assortments With Allen Screws, Hex Nuts, Lock Washers and G-W Flatwashers



Allen Screws with Sliding 6 Drawer Cabinet (A-50-P Shown)

Contents of each tray in cabinet

- ▶ Allen Screws # 8/32, 10/24, 10/32, 1/4-28
- ▶ Allen Screws 1/4-20 x 3/8" thru 3"
- ▶ Allen Screws 5/16-18 x 1/2" thru 3"
- ▶ Allen Screws 5/16-24 x 1/2" thru 2 3/4"
- ▶ Allen Screws 3/8-16 x 1/2" thru 3 1/2"
- ▶ Allen Screws 3/8-24 x 1/2" thru 3 1/2"

Also Available in 12pt. Chrome

Knurled or Polished Chrome

Stainless or Polished Stainless Steel



**A-30
Hex Nuts
6/32 thru 5/8
Fine and Coarse**

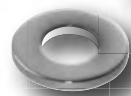

**A-29
#8 thru 5/8
Lock Washers and
G-W Flat Washers**

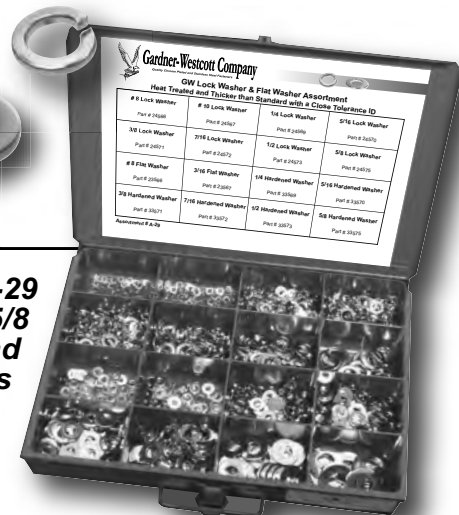

Show Speciality Priced Fastener Assortment includes all 8 Trays and 1 Sliding Six Drawer Metal Cabinet

Assortments in American Thread



**Assortments
Chrome**

Tray Assortments (Chrome Plated)

Acorn Nuts

Acorn Nuts #8 thru 5/8 Coarse & Fine - (14 Sizes & 109 Pieces).....	A-7	----
Acorn Nuts Low Crown 8/32-5/8-18 - (15 Sizes & 108 Pieces).....	A-148	----



Acorn Nut

Allen Head Screws

4-40, 6/32, 8/32, 12/24 - (24 Sizes & 240 Pieces).....	A-39	A-39-P
10/24 & 10/32 - (23 Sizes & 230 Pieces).....	A-38	A-38-P
8/32, 10/24, 10/32, 1/4-28 - (24 Sizes & 205 Pieces).....	A-41	A-41-P
1/4-20 - (16 Sizes & 150 Pieces, 3/8" - 3").....	A-40	A-40-P
1/4-20 - (9 Sizes & 61 Pieces, 3 1/4" - 6").....	A-140	A-140-P
5/16-18 - (12 Sizes & 110 Pieces).....	A-42	A-42-P
5/16-24 - (12 Sizes & 115 Pieces, 1/2" - 2 3/4").....	A-43	A-43-P
5/16-24 - (8 Sizes & 48 Pieces, 3" - 4 3/4").....	A-143	A-143-P
5/16-24 - (8 Sizes & Studs HD Motor Case Assortment).....	A-78	A-78-P
3/8-16 - (12 Sizes & 90 Pieces).....	A-44	A-44-P
3/8-24 - (12 Sizes & 85 Pieces).....	A-45	A-45-P
7/16 -14 - (11 Sizes & 72 Pieces).....	A-46	A-46-P
7/16-20 - (10 Sizes & 59 Pieces).....	A-47	A-47-P
1/2-13 - (11 Sizes & 72 Pieces).....	A-48	A-48-P
1/2-20 - (10 Sizes & 57 Pieces).....	A-49	A-49-P
1/4, 5/16, 3/8 Coarse - (24 Sizes & 220 Pieces).....	24-CA	24-CAP
1/4, 5/16, 3/8 Fine - (23 Sizes & 210 Pieces).....	24-FA	24-FAP

Low Crown Acorn



Chrome Allen



Polished Allen

Button Head Allen Screws

8/32, 10/24, 10/32, 1/4-28 - (20 Sizes & 101 Pieces).....	A-25	----
1/4-20, 5/16-18, 3/8-16 - (24 Sizes & 112 Pieces).....	A-26	----
1/4, 5/16, 3/8 Fine - (24 Sizes & 120 Pieces).....	A-26-F	----
5/16-24, 3/8-24, 1/2-13 - (14 Sizes & 67 Pieces).....	A-27	----



Button Head Allen

Cotter Pins

1/16, 3/32, 1/8, 3/16 - (9 Sizes & 425 Pieces).....	A-34C	
---	-------	--

Flat Head Allen Screws

8/32, 10/24, 10/32, 1/4-28 - (24 Sizes & 240 Pieces).....	A-10	----
8/32, 10/32, 1/4-28, 5/16-24, 3/8-24 - (16 Sizes & 160 Pieces).....	A-9	----
1/4, 5/16, 3/8 Coarse - (24 Sizes & 155 Pieces).....	A-28-C	----
1/4, 5/16, 3/8 Fine - (24 Sizes & 155 Pieces).....	A-28-F	----

Flat Head Allen



Flexloc® Nuts

#10 thru 1/2 Coarse & Fine - (12 Sizes & 110 Pieces).....	A-11	----
---	------	------



Flexloc® Nut

Flexloc® Jam Nuts

#10 thru 1/2 Coarse & Fine - (12 Sizes & 110 Pieces).....	A-12	----
Nuts & Jam Flexloc Nuts 1/4 thru 5/8 - (24 Sizes & 240 Pieces).....	A-19	----



Flexloc® Jam Nut

Hex Head Screws

1/4-20 x 3/8 - 3 - (16 Sizes & 150 Pieces).....	A-40HC	----
5/16-18 x 1/2 - 2 3/4 - (12 Sizes & 110 Pieces).....	A-42HC	----
5/16-24 x 1/2 - 2 3/4 - (12 Sizes & 115 Pieces).....	A-43HC	----
3/8-16 x 1/2 - 3 1/2 - (12 Sizes & 90 Pieces).....	A-44HC	----
3/8-24 x 1/2 - 3 1/2 - (12 Sizes & 85 Pieces).....	A-45HC	----
7/16-14 x 3/4 - 3 - (11 Sizes & 72 Pieces).....	A-46HC	----
7/16-20 x 3/4 - 3 1/2 - (11 Sizes & 59 Pieces).....	A-47HC	----

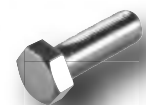











Hex Cap



Assortments in American Thread

Tray Assortments (Chrome Plated)

	Chrome Part #	
Hex Caps		
1/4, 5/16, 3/8 Coarse - (24 Sizes & 220 Pieces).....	24-C	 Hex Cap
1/4, 5/16, 3/8 Fine - (24 Sizes & 220 Pieces).....	24-F	
7/16, 1/2 Coarse - (11 Sizes & 80 Pieces).....	23-C	
7/16, 1/2 Fine - (12 Sizes & 90 Pieces).....	23-F	
Hex Nuts		
6/32 thru 5/8 Coarse & Fine - (16 Sizes & 534 Pieces).....	A-30	 Hex Nut
1/4 thru 3/8 Hex Nuts, Flat & Lock Washers - (12 Sizes & 1200 Pieces).....	12-W	
7/16 thru 5/8 Hex Nuts, Flat & Lock Washers - (12 Sizes & 540 Pieces).....	23-W	
Hole Plugs		
Brass & Chrome 3/16 thru 1 1/2 - (16 Sizes & 219 Pieces).....	A-76	 Hole Plug
Chrome 3/16 thru 3/4 - (7 Sizes & 130 Pieces).....	A-77-C	
Black 3/16 thru 3/4 - (7 Sizes & 130 Pieces).....	A-77-B	
Brass 3/16 thru 3/4 - (7 Sizes & 130 Pieces).....	A-77-A	
Jam Nuts & Jam Lock Nuts		
1/4 thru 5/8 Coarse & Fine - (24 Sizes & 220 Pieces).....	A-14	 Jam Nut & Jam Lock Nut
Lock Nuts Nylon Insert		
#10 thru 5/8 Coarse & Fine - (11 Sizes & 190 Pieces).....	A-8	 Nylon Insert Lock Nut
4/40 thru 3/4 Coarse & Fine - (20 Sizes & 274 Pieces).....	A-18	
Oil Line Fitting (Chrome Plated Brass)		
Special selected fittings for Harley's - (12 Sizes & 75 Pieces).....	A-52	(See Pg. 69 For more Details)
Oval Phillips Head (Machine Screw)		
4/40 thru 3/8 Coarse & Fine - (24 Sizes & 240 Pieces).....	A-175	 Oval Phillips
Spacers		
1/4 & 5/16 I.D. with 1/4 to 1 1/4 Lengths - (16 Sizes & 160 Pieces).....	A-15	 Spacers
3/8 & Up Dia. - (12 Sizes & 106 Pieces).....	A-16	
1/4 & 5/16 I.D. with mixed O.D. & thickness - (24 Sizes).....	A-221	
5/16 & 3/8 I.D. with mixed O.D. & thickness - (24 Sizes).....	A-222	
3/8 & 1/2 I.D. with mixed O.D. & thickness - (16 Sizes).....	A-223	
Spike Nuts		
1/4-20 thru 5/8-18 Coarse & Fine - (11 Sizes & 25 Pieces).....	A-97	 Spike Nuts
Torx Button Head		
8/32, 10/24, 10/32, 1/4-28 - (24 Sizes & 240 Pieces).....	A-180	 Torx Button Head
1/4-20, 5/16, 3/8, 1/2 - (24 Sizes & 235 Pieces).....	A-181	
Washers		
#8 thru 5/8 Flat & Lock Washers - (16 Sizes & 960 Pieces).....	A-31	 Flat Washer
#6 thru 5/8 Internal, External & AN - (22 Sizes & 435 Pieces).....	A-33	
Harley Special Washers - (24 Sizes & 580 Pieces).....	A-68	
Harley Various O.D., I.D in Chrome - (24 Sizes & 298 Pieces).....	A-69	
Washers G-W Heat Treated		
#8 thru 5/8 Flat & Lock Washers - (16 Sizes & 960 Pieces).....	A-29	 Lock Washer
AN #8 thru 3/4 & Std. 1/4 thru 5/8 - (21 Sizes & 435 Pieces).....	A-160	

(See Pg. 69 For more Details)



**Assortments
Chrome**

Speciality Dealer Assortments (Chrome Plated)

Allen Head Assortment Groups	Chrome Part #	Polished Chrome Part #
<i>(Includes; 6 Metal Trays & 1 Cabinet with items listed below)</i>		
A-40 - (1/4-20 Sizes) A-41 - (8/32, 10/24, 10/32, 1/4-28 Sizes)		
A-42 - (5/16-18 Sizes) A-43 - (5/16-24 Sizes)		
A-44 - (3/8-16 Sizes) A-45 - (3/8-24 Sizes).....	A-50	A-50-P
12 Point Screw Assortment Groups		
<i>(Includes; 6 Metal Trays & 1 Cabinet with items listed below)</i>		
A-240 - (1/4-20 Sizes) A-241 - (1/4-28 Sizes) A-242 - (5/16-18 Sizes)		
A-243 - (5/16-24 Sizes) A-244 - (3/8-16 Sizes) A-245 - (3/8-24 Sizes).....	A-250	---
Washers for Harley Applications		
<i>(Includes; 1 Metal Tray with items listed below)</i>		
Featuring 24 Sizes - (Drain, Seal, Brass, Copper, Nylon & Stainless Steel for Oil Tank Train, Derby Cover, Fork Drain, Rocker Arm Shaft & Banjo Bolts).....	A-68	---
Featuring 24 Sizes - (Axles, Cylinder, Fender, Head, Motor Mounts, Rocker Box, Triple Tree & more).....	A-69	---
Oil Line Fitting Assortment (Includes; 1 Metal Tray with items listed below)		
Chrome Plated Brass Fittings - (Straight Hose Barb Male Pipe Rigid, Straight Street Elbow, 45° Street Elbow, Hose Tee, Socket Pipe Plug, Hex Head Pipe Plug, Sleeve Nut & Washer Seals).....	A-52	---

The G-W Hardened Flat Washer

GARDNER-WESTCOTT COMPANY is proud to supply the first flat washer strong enough to use on motor mounts or belt sprockets and with the exceptional cosmetic quality to be used on a show bike. This hardened steel washer is thicker than standard flat washers and has a close tolerance ID for a snug fit. It has a standard OD so it can be used anywhere a regular washer was.

Now available in bulk from 1/4" thru 5/8" or in Assortment # A-29 which includes; #8, #10, 1/4, 5/16, 3/8, 7/16, 1/2 and 5/8 diameter G-W Hardened Flat Washers including Lock Washers -- all show chromed, labeled and in a metal tray.



Also Available in Stainless Steel See Pg. 92

G-W Heat Treated Washer & Lock Washer	Chrome Part #	Polished Part #
<i>(Includes; 1 Metal Tray with Items Listed Below)</i>		
Flat Washers - (#8, #10, 1/4, 5/16, 3/8, 7/16, 1/2, 5/8)		
Lock Washers - (#8, #10, 1/4, 5/16, 3/8, 7/16, 1/2, 5/8).....	A-29	---



Assortments in American Thread

Shop Master Dealer Assortment (Chrome Plated)

This Dealer Starter Shop Master, is designed for the use with Harley Big Twins and Sportsters. Trays are available individually, or in 6 tray components that can be added to your existing stock. The Allen Screws can be replaced with 12 Point Screws and most assortments are available in Stainless Steel, for information on styles, pricing or if you need any assistance in choosing which assortment best fits your needs just give us a call or Email.

Chrome Shop Master A-100-P

A-50-P 6 Trays with Cabinet

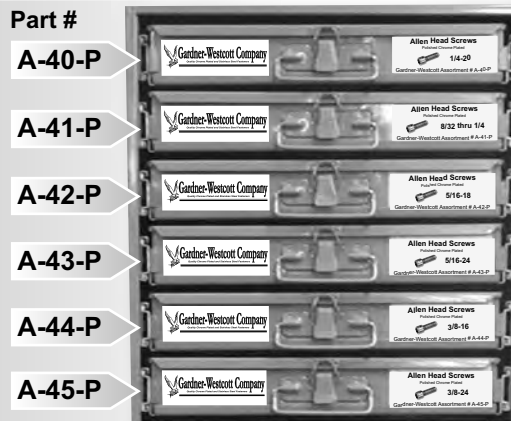

Contents of each Tray

Allen Screw - (# 1/4-20 x 3/8" thru 3")

Allen Screw - (# 8/32, 10/24, 10/32, 1/4-28)

Allen Screw - (# 5/16-18 x 1/2" thru 3")

Allen Screw - (# 5/16-24 x 1/2" thru 2 3/4")

Allen Screw - (# 3/8-16 x 3/4" thru 3 1/2")

Allen Screw - (# 3/8-24 x 1/2" thru 3 1/2")

A-151 6 Trays with Cabinet



Allen Screw - (# 7/16-14 x 3/4" thru 3 1/4")

Hex Nuts - (6/32 thru 5/8-18 Coarse & Fine)

Lock Nuts Nylon Insert - (4/40 thru 3/4-16 Coarse & Fine)

GW Flat Washer & Lock Washer - (# 8 thru 5/8)

Special Harley Washers - (in various OD, ID & Thickness)

Special Harley Washers - (in brass, copper & nylon)

A-152 6 Trays with Cabinet

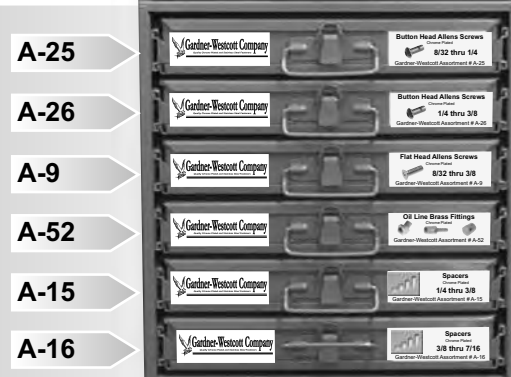

Button Head Allens - (8/32, 10/24, 10/32, & 1/4-28)

Button Head Allens - (1/4-20, 5/16-18, 3/8-16)

Flat Head Allens - (8/32, 10/32, 1/4-28, 5/16-24, 3/8-24)

Harley Oil line fittings - (various applications)

Spacers - (1/4 & 5/16 ID's various thickness)

Spacers - (3/8 & Up ID's various thickness)

You can order individual Trays, 6 Tray components or a complete 18 Tray Shop Master comprising of these 3 Cabinets Tray units A-50-P, A-151 and A-152. All Trays and Cabinets are made of sturdy metal construction for years of durability.



Point of Purchase Display (Chrome Plated)

Gardner-Westcott took our most popular selling items and combined them to create this unit for you. It was designed with the Harley-Davidson Dealer in mind. This product display contains 128 different items, all done in Show Chrome Plated.

- X-23567 #10 Chr. Flatwasher (10 ea.) per card
- X-33569 1/4 Chr. GW Flatwasher (8 ea.)
- X-33570 5/16 Chr. GW Flatwasher (8 ea.)
- X-33571 3/8 Chr. GW Flatwasher (6 ea.)
- X-33572 7/16 Chr. GW Flatwasher (5 ea.)
- X-33573 1/2 Chr. GW Flatwasher (4 ea.)
- X-33575 5/8 Chr. GW Flatwasher (4 ea.)
- X-24569 1/4 Chr. Lockwasher (10 ea.)
- X-24570 5/16 Chr. Lockwasher (8 ea.)
- X-24571 3/8 Chr. Lockwasher (8 ea.)
- X-24572 7/16 Chr. Lockwasher (5 ea.)
- X-24573 1/2 Chr. Lockwasher (5 ea.)
- X-24575 5/8 Chr. Lockwasher (4 ea.)
- X-15542 10/24 Chr. Hex Nut (8 ea.)
- X-15543 10/32 Chr. Hex Nut (8 ea.)
- X-15546 1/4-20 Chr. Hex Nut (8 ea.)
- X-15547 1/4-28 Chr. Hex Nut (8 ea.)
- X-15548 5/16-18 Chr. Hex Nut (8 ea.)
- X-15549 5/16-24 Chr. Hex Nut (6 ea.)
- X-15550 3/8-16 Chr. Hex Nut (6 ea.)
- X-15551 3/8-24 Chr. Hex Nut (6 ea.)
- X-17542 10/24 Chr. Nylon Locknut (7 ea.)
- X-17543 10/32 Chr. Nylon Locknut (7 ea.)
- X-17546 1/4-20 Chr. Nylon Locknut (7 ea.)
- X-17547 1/4-28 Chr. Nylon Locknut (7 ea.)
- X-17548 5/16-18 Chr. Nylon Locknut (8 ea.)
- X-17549 5/16-24 Chr. Nylon Locknut (8 ea.)
- X-17550 3/8-16 Chr. Nylon Locknut (5 ea.)
- X-17551 3/8-24 Chr. Nylon Locknut (5 ea.)
- X-17553 7/16-20 Chr. Nylon Locknut (5 ea.)
- X-17554 1/2-13 Chr. Nylon Locknut (4 ea.)
- X-17555 1/2-20 Chr. Nylon Locknut (4 ea.)
- X-15559-H 5/8-18 H-D Chr. Axle Nut (1 ea.)
- X-23204 H-D 6099 Chr. Washer (6 ea.)
- X-13128 8/32 x 3/8 Chr. Buttonhead (5 ea.)
- X-13130 8/32 x 5/8 Chr. Buttonhead (5 ea.)
- X-13154 10/24 x 1/2 Chr. Buttonhead (7 ea.)
- X-13157 10/32 x 5/8 Chr. Buttonhead (7 ea.)
- X-13206 1/4-20 x 1/2 Chr. Buttonhead (7 ea.)
- X-13208 1/4-20 x 5/8 Chr. Buttonhead (7 ea.)
- X-13210 1/4-20 x 3/4 Chr. Buttonhead (7 ea.)
- X-13212 1/4-20 x 7/8 Chr. Buttonhead (7 ea.)
- X-13214 1/4-20 x 1 Chr. Buttonhead (7 ea.)
- X-13218 1/4-20 x 1 1/4 Chr. Buttonhead (7 ea.)
- X-13220 1/4-20 x 1 1/2 Chr. Buttonhead (7 ea.)
- X-13270 5/16-18 x 1/2 Chr. Buttonhead (6 ea.)
- X-13274 5/16-18 x 3/4 Chr. Buttonhead (6 ea.)
- X-13278 5/16-18 x 7/8 Chr. Buttonhead (6 ea.)
- X-13280 5/16-18 x 1 Chr. Buttonhead (6 ea.)
- X-13284 5/16-18 x 1 1/4 Chr. Buttonhead (6 ea.)
- X-13286 5/16-18 x 1 1/2 Chr. Buttonhead (6 ea.)
- X-13326 3/8-16 x 3/4 Chr. Buttonhead (4 ea.)
- X-13328 3/8-16 x 7/8 Chr. Buttonhead (4 ea.)
- X-13330 3/8-16 x 1 Chr. Buttonhead (4 ea.)
- X-13334 3/8-16 x 1 1/4 Chr. Buttonhead (4 ea.)
- X-13336 3/8-16 x 1 1/2 Chr. Buttonhead (4 ea.)
- X-10154 10/24 x 1/2 Pol. Allen Screw (5 ea.)
- X-10157 10/32 x 5/8 Pol. Allen Screw (5 ea.)
- X-10208 1/4-20 x 5/8 Pol. Allen Screw (4 ea.)
- X-10210 1/4-20 x 3/4 Pol. Allen Screw (4 ea.)
- X-10214 1/4-20 x 1 Pol. Allen Screw (4 ea.)
- X-10216 1/4-20 x 1 1/8 Pol. Allen Screw (4 ea.)
- X-10218 1/4-20 x 1 1/4 Pol. Allen Screw (4 ea.)
- X-10218-A 1/4-20 x 1 3/8 Pol. Allen Screw (4 ea.)



Part# JPOP-HD1
128 Items



- X-10220 1/4-20 x 1 1/2 Pol. Allen Screw (3 ea.) per card
- X-10222 1/4-20 x 1 3/4 Pol. Allen Screw (3 ea.)
- X-10224 1/4-20 x 2 Pol. Allen Screw (3 ea.)
- X-10226 1/4-20 x 2 1/4 Pol. Allen Screw (3 ea.)
- X-10228 1/4-20 x 2 1/2 Pol. Allen Screw (3 ea.)
- X-10215 1/4-28 X 1 Pol. Allen Screw (4 ea.)
- X-10274 5/16-18 x 3/4 Pol. Allen Screw (4 ea.)
- X-10280 5/16-18 x 1 Pol. Allen Screw (4 ea.)
- X-10281 5/16-24 x 1 Pol. Allen Screw (4 ea.)
- X-10284 5/16-18 x 1 1/4 Pol. Allen Screw (3 ea.)
- X-10286 5/16-18 x 1 1/2 Pol. Allen Screw (3 ea.)
- X-10287 5/16-24 x 1 1/2 Pol. Allen Screw (3 ea.)
- X-10288 5/16-18 x 1 3/4 Pol. Allen Screw (3 ea.)
- X-10290 5/16-18 x 2 Pol. Allen Screw (3 ea.)
- X-10292 5/16-18 x 2 1/4 Pol. Allen Screw (2 ea.)
- X-10294 5/16-18 x 2 1/2 Pol. Allen Screw (2 ea.)
- X-10326 3/8-16 x 3/4 Pol. Allen Screw (3 ea.)
- X-10330 3/8-16 x 1 Pol. Allen Screw (3 ea.)
- X-10331 3/8-24 x 1 Pol. Allen Screw (3 ea.)
- X-10334 3/8-16 x 1 1/4 Pol. Allen Screw (3 ea.)
- X-10336 3/8-16 x 1 1/2 Pol. Allen Screw (3 ea.)
- X-10337 3/8-24 x 1 1/2 Pol. Allen Screw (5 ea.)
- X-10338 3/8-16 x 1 3/4 Pol. Allen Screw (2 ea.)
- X-10339 3/8-24 x 1 3/4 Pol. Allen Screw (3 ea.)
- X-10340 3/8-16 x 2 Pol. Allen Screw (2 ea.)
- X-10342 3/8-16 x 2 1/2 Pol. Allen Screw (2 ea.)
- X-10341 3/8-24 x 2 Pol. Allen Screw (2 ea.)
- X-10343 3/8-24 x 2 1/4 Pol. Allen Screw (1 ea.)
- X-10344 3/8-16 x 2 1/2 Pol. Allen Screw (2 ea.)
- X-10345 3/8-24 x 2 1/2 Pol. Allen Screw (1 ea.)
- X-10346 3/8-16 x 2 3/4 Pol. Allen Screw (2 ea.)
- X-10376 7/16-14 x 1 Pol. Allen Screw (2 ea.)
- X-10377 7/16-20 x 1 Pol. Allen Screw (2 ea.)
- X-10378 7/16-14 x 1 1/4 Pol. Allen Screw (2 ea.)
- X-10380 7/16-14 x 1 1/2 Pol. Allen Screw (2 ea.)
- X-10381 7/16-20 x 1 1/2 Pol. Allen Screw (2 ea.)
- X-10382 7/16-14 x 1 3/4 Pol. Allen Screw (2 ea.)
- X-10384 7/16-14 x 2 Pol. Allen Screw (1 ea.)
- X-10416 1/2-13 x 1 Pol. Allen Screw (2 ea.)
- X-14130 8/32 x 1/2 Chr. Flat Head Allen Screw (5 ea.)
- X-14132 8/32 x 5/8 Chr. Flat Head Allen Screw (5 ea.)
- X-14154 10/24 x 1/2 Chr. Flat Head Allen Screw (5 ea.)
- X-14157 10/32 x 5/8 Chr. Flat Head Allen Screw (5 ea.)
- X-14210 1/4-20 x 3/4 Chr. Flat Head Allen Screw (6 ea.)
- X-14212 1/4-20 x 7/8 Chr. Flat Head Allen Screw (6 ea.)
- X-14274 5/16-18 x 3/4 Chr. Flat Head Allen Screw (6 ea.)
- X-14278 5/16-18 x 7/8 Chr. Flat Head Allen Screw (6 ea.)
- X-14330 3/8-16 x 1 Chr. Flat Head Allen Screw (4 ea.)
- X-14334 3/8-16 x 1 1/4 Chr. Flat Head Allen Screw (4 ea.)
- X-21546 1/4-20 Chr. Acorn Nut (3 ea.)
- X-21548 5/16-18 Chr. Acorn Nut (3 ea.)
- X-21549 5/16-24 Chr. Acorn Nut (3 ea.)
- X-21550 3/8-16 Chr. Acorn Nut (2 ea.)
- X-21551 3/8-24 Chr. Acorn Nut (2 ea.)
- X-21552 7/16-14 Chr. Acorn Nut (3 ea.)
- X-21553 7/16-20 Chr. Acorn Nut (3 ea.)
- X-11210 1/4-20 x 3/4 Chr. Hex Cap Screw (3 ea.)
- X-11218 1/4-20 x 1 1/4 Chr. Hex Cap Screw (3 ea.)
- X-11220 1/4-20 x 1 1/2 Chr. Hex Cap Screw (3 ea.)
- X-11274 5/16-18 x 3/4 Chr. Hex Cap Screw (3 ea.)
- X-11280 5/16-18 x 1 Chr. Hex Cap Screw (3 ea.)
- X-11286 5/16-18 x 1 1/2 Chr. Hex Cap Screw (3 ea.)
- X-11291 5/16-24 x 2 Chr. Hex Cap Screw (2 ea.)
- X-11340 3/8-16 x 2 Chr. Hex Cap Screw (2 ea.)



Tray Assortments (Stainless Steel)

Acorn Nuts

Acorn Nuts #8 thru 5/8 Coarse & Fine - (14 Sizes & 113 Pieces)..... A-7-S

Stainless
Part #

Polished
Part #



Low
Crown
Acorn Nut

Allen Head Screws

4-40, 6/32, 8/32, 12/24 - (24 Sizes & 240 Pieces)..... A-39-S

A-39-S

A-39-SP

1/4-20 - (12 Sizes & 120 Pieces)..... A-40-S

A-40-S

A-40-SP

8/32, 10/24, 10/32, 1/4-28 - (21 Sizes & 190 Pieces)..... A-41-S

A-41-S

A-41-SP



Stainless
Steel
Knurled Allen

5/16-18 - (12 Sizes & 120 Pieces)..... A-42-S

A-42-S

A-42-SP

5/16-24 - (12 Sizes & 115 Pieces)..... A-43-S

A-43-S

A-43-SP

3/8-16 - (12 Sizes & 90 Pieces)..... A-44-S

A-44-S

A-44-SP

3/8-24 - (12 Sizes & 85 Pieces)..... A-45-S

A-45-S

A-45-SP

7/16-14 Coarse - (12 Sizes & 72 Pieces)..... A-46-S

A-46-S

7/16-20 - (11 Sizes & 59 Pieces)..... A-47-S

A-47-S

A-47-SP



Stainless
Steel
Polished Allen

1/4-28, 5/16-24, 3/8-24 Fine - (24 Sizes & 210 Pieces)..... 24-FAS

24-FAS

24-FASP

1/4, 5/16, 3/8 Coarse - (24 Sizes & 240 Pieces)..... 24-CAS

24-CAS

24-CASP

Allen Head Screw Assortment Group

Contains; 1 Metal Cabinet with 6 Trays & the following 6 sets

A-40-S, A-41-S, A-42-S, A-43-S, A-44-S, A-45-S - (83 Sizes & 621 Pieces)..... A-50-S

A-50-S

A-50-SP

Button Head Allen Screws

8/32, 10/24, 10/32, 1/4-28 - (20 Sizes & 102 Pieces)..... A-25-S

A-25-S

1/4-20, 5/16-18, 3/8-16 - (24 Sizes & 114 Pieces)..... A-26-S

A-26-S

5/16-24, 3/8-24, 1/2-13 - (14 Sizes & 64 Pieces)..... A-27-S

A-27-S

A-27-SP



Button
Head Allen

Flat Head Allen Screws

8/32, 10/24, 10/32, 1/4-28 - (20 Sizes & 200 Pieces)..... A-10-S

A-10-S

A-10-SP



Flat
Head Allen

Hex Caps

1/4, 5/16, 3/8 Coarse - (24 Sizes & 227 Pieces)..... A-24-CS

A-24-CS

A-24-CSP

1/4, 5/16, 3/8 Fine - (24 Sizes & 227 Pieces)..... A-24-FS

A-24-FS

A-24-FSP

7/16, 1/2 Coarse & Fine - (20 Sizes & 155 Pieces)..... A-23-CS

A-23-CS

A-23-CSSP

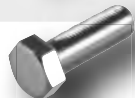

Hex Cap

Hex Nuts

6/32 thru 5/8 Coarse & Fine - (16 Sizes & 534 Pieces)..... A-30-S

A-30-S

A-30-SP

1/4 thru 3/8 Hex Nuts, Flat & Lock Washers - (12 Sizes & 1200 Pieces)... 12-W-S

12-W-S

12-W-SP



Hex Nut

Lock Nuts Nylon Insert

6/32 thru 5/8-18 Coarse & Fine - (16 Sizes & 279 Pieces)..... A-32-S

A-32-S

A-32-SP



Nylon
Insert
Lock Nut

Slotted Fillister Head (Machine Screw)

6/32, 8/32, 10/24, 10/32, 12/24, 1/4 - (24 Sizes & 240 Pieces)..... A-178

A-178



Slotted
Fillister

Washers

#8 thru 5/8 Flat & Lock Washers - (16 Sizes & 960 Pieces)..... A-31-S

A-31-S

A-31-SP

#6 thru 5/8 Internal, External & AN - (22 Sizes & 880 Pieces)..... A-33-S

A-33-S

#8 thru 5/8 G-W Flat Washers & Lock Washers..... A-29-S

A-29-S



Flat
&
Lock
Washer

Assortments in American Thread



Tray Assortments (Zinc Plated)

Part #

Hex Caps

- 1/4-20 thru 5/16-18 Coarse - (20 Sizes & 270 Pieces)..... A-101-Zinc
- 3/8-16 Coarse - (12 Sizes & 210 Pieces)..... A-102-Zinc
- 7/16 Coarse - (12 Sizes & 165 Pieces)..... A-103-Zinc
- 1/2 Coarse - (12 Sizes & 102 Pieces)..... A-104-Zinc

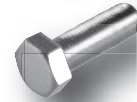

Hex Cap

Hex Nuts

- 6/32 thru 5/8 Coarse & Fine - (16 Sizes & 534 Pieces)..... A-30-Zinc

Hex Nut

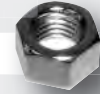

Hex Nut & Nylon Insert Lock Nuts

- 8/32 thru 5/8 Coarse & Fine - (16 Sizes & 305 Pieces)..... A-100-Zinc



Nylon Insert Lock Nut

Nylon Insert Lock Nuts

- 4/40 thru 3/4 Nylon Inserted Lock Nuts - (20 Sizes & 276 Pieces)... A-18-Zinc

Flat & Lock Washers

- #8 thru 5/8 Flat & Lock Washers - (16 Sizes & 960 Pieces)..... A-31-Zinc

Flat & Lock Washer



**Assortments
Stainless**

The Shop Master (Zinc Plated) A-99 in Grd. 5 and A-99-8 in Grd. 8

Offering a full line of fastener assortments is important. Custom bikes need custom fasteners and that's why we make fastener assortments with the motorcycle builder in mind. Organization of your stock is important - why waste time looking for a nut or bolt. Gardner-Westcott's assortments organize styles and sizes for fast access and easy stock control. All assortments come in metal tray and are labeled inside and outside for your convenience. **You may purchase any Assortments shown below individually.**

	Part #	Contents of each Tray
	A-34	Cotter Pins All Harley Numbers included
A-70 6 Trays in Cabinet	A-71	Round Slotted Screws 4/40, 5/40, 6/32, 8/32
	A-72	Round Slotted Screws 10/24, 10/32, 12/24
	A-73	Flat Head Slotted Screws 4/40, 6/32, 8/32, 10/24, 10/32
	A-74	Pan Head Slotted Sheet Metal Screws #4, 6, 8, 10, 12
	A-75	Flat Head Slotted Sheet Metal Screws #4, 6, 8, 10, 12, 1/4"
	A-76	Hole Plugs 3/16" thru 1"
A-90 4 Trays in Cabinet	A-91	Hex Nuts American Thread #4/40 thru 3/4-16
	A-92	Nylon Lock Nuts American Thread #4/40 thru 3/4-16
	A-93	Flat Washers & Lock Washers #4 thru 3/4"
	A-94	External, Internal Star, AN sm. OD & Fender Ig. OD Washers
A-80 4 Trays in Cabinet	A-82	Hex Cap American Thread 1/4-20 & 1/4-28 Diameter
	A-83	Hex Cap American Thread 5/16-18 & 5/16-24 Diameter
	A-84	Hex Cap American Thread 3/8-16 Diameter
	A-85	Hex Cap American Thread 3/8-24 Diameter
A-81 2 Trays in Cabinet	A-86	Hex Cap American Thread 7/16-14 & 7/16-20 Diameter
	A-87	Hex Cap American Thread 1/2-13 & 1/2-20 Diameter



Fastener Assortment Set

Specially designed for use with Harley Twins and Sportsters

**A-50 or A-50-P Assortments
With Allen Screws,
Hex Nuts, Lock Washers
and G-W Flatwashers**

**Polished
Stainless
Steel**



Contents of each Tray in Cabinet
Allen Screws # 8/32, 10/24, 10/32, 1/4-28

Allen Screws 1/4-20 x 3/8" thru 3"

Allen Screws 5/16-18 x 1/2" thru 3"

Allen Screws 5/16-24 x 1/2" thru 2 3/4"

Allen Screws 3/8-16 x 1/2" thru 3 1/2"

Allen Screws 3/8-24 x 1/2" thru 3 1/2"

**Polished
Chrome**



**A-30 or A-30-P
Hex Nuts
6/32 thru 5/8
Fine and Coarse**

**A-29
#8 thru 5/8
Lock Washers and
G-W Flat Washers**

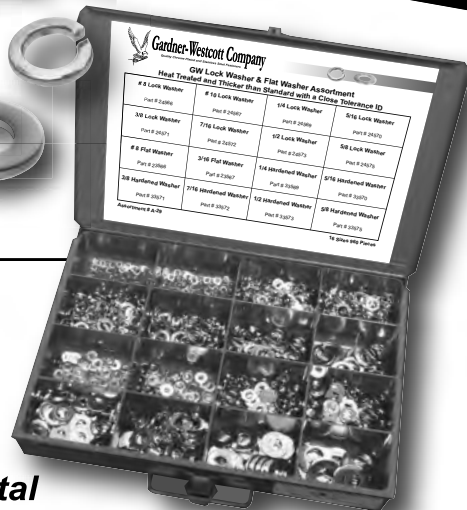

**Show Speciality Priced Fastener Assortment
includes all 8 trays and 1 sliding six drawer metal
Cabinet in Polished Stainless Steel or Polished Chrome**

12Pt Sets Also Available



Inside This Section

Metric Thread Chrome Plated

- Tray Assortments..... 76
- Acorn Nuts & Spacers.....76
- Allen Head Screws.....76
- Hex Caps.....76
- Nylon Insert Lock Nuts.....76
- Flat & Lock Washers.....76
- Metric Cruiser Assortment.....77
- Speciality Dealer Assortments..... 77

Metric Thread Stainless Steel

- Tray Assortments..... 78
- Allen Head Screws.....78
- Hex Caps.....78
- Hex Nuts & Lock Nuts.....78
- Flat & Lock Washers.....78

Metric Thread Zinc Plated

- Tray Assortments..... 78
- Allen Head Screws.....78
- Hex Caps.....78
- Hex Nuts & Lock Nuts.....78
- Flat & Lock Washers.....78

**Assortments in
Chrome Plated and
Stainless Steel**

**Detailed Custom
Assortments with
Speciality Lengths
and Diameters
Available**





Assortments in Metric Thread

Tray Assortments (Chrome Plated)

Acorn Nuts and Spacers Combination

Acorn Nuts 4mm thru 12mm

Spacers 1/4 x 1/4 thru 3/8 x 1 - (15 Sizes & 140 Pieces)..... A-62

Chrome
Part #

Polished
Chrome
Part #



Acorn Nut

Allen Head Screws

4mm & 5mm - (24 Sizes & 210 Pieces)..... A-301-C A-301-P

5mm & 6mm - (16 Sizes & 240 Pieces)..... A-21 A-21-P

6mm with (special 6m x 27m & 8m - 70m) - (16 Sizes & 160 Pieces)..... A-325-C A-325-P

6mm (8m - 75m) - (24 Sizes & 120 Pieces)..... A-302-C A-302-P

8mm x 1.25 (10m - 80m) - (16 Sizes & 130 Pieces)..... A-326-C A-326-P

8mm x 1.25 (10m - 60m)

also 8mm x 1.0 (25m - 50m) - (16 Sizes & 124 Pieces)..... A-303-C A-303-P

8mm (10m - 50m) & 10m x 1.50 (25m - 65m)..... ----- A-328-P

10mm x 1.50 (20m - 75m) - (12 Sizes & 95 Pieces)..... A-327-C A-327-P

10mm x 1.50 (20m - 65m)

also 10mm x 1.25 (25m - 50m) - (16 Sizes & 120 Pieces)..... A-304-C A-304-P

10mm x 1.50 (70m - 100m)

also 10mm x 1.25 (55m - 90m) - (12 Sizes & 60 Pieces)..... A-308-C A-308-P

12mm x 1.75 (25m - 90m) - (12 Sizes & 60 Pieces)..... A-305-C A-305-P



Chrome Allen



Polished Allen

Allen Screw Combination

Allens - 5mm x 12 - 10mm x 1.5 x 55

Flat Head - 4mm x 12 - 6mm x 16, 6mm x 35

Button Head - 6mm x 16 - 6mm x 30 - (25 Sizes & 205 Pieces)..... A-25-C A-25-P



Flat Head Allen

Button Head Allen Screws

4mm x 6m - 4m x 25, 5mm x 5 - 5m x 30

also 6mm x 8m - 6m x 35m - (23 Sizes & 230 Pieces)..... A-315



Button Head

Hex Caps

6mm x 12 - 6m x 50, 8mm x 12 - 8m x 55

also 10mm x 1.25 x 20 - 10m x 1.25 x 50 - (24 Sizes & 205 Pieces)..... 24-M

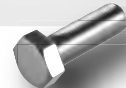

Hex Cap

Hex Nut and Nylon Insert Lock Nut Combination

Hex Nuts 4mm thru 12mm

Lock Nuts 4mm thru 12mm - (24 Sizes & 365 Pieces)..... A-61-C



Hex Nut

Flat & Lock Washer Combination

Flat Washers 3mm thru 14mm

Lock Washers 3mm thru 14mm - (16 Sizes & 430 Pieces)..... A-60-C



Flat & Lock Washers



A-326-P



A-60



A-61

Assortments in Metric Thread



77

Chrome Fastener Assortments for V-Rod and Victory Motorcycles

**Metric
Chrome**

This Chrome Fastener set up will make it easy to customize the V-Rods. Featuring **Metric Allen Screws**, including special V-Rod lengths Flat Washers, Lock Washers, Hex Nuts and Lock Nuts all in **Show Chrome**. **Part # A-330-P** Contains all six metal tray assortments housed in a metal drawer cabinet.

A-301-P		Allen Screws 4mm and 5mm
A-325-P		Allen Screws 6mm
A-326-P		Allen Screws 8mm
A-327-P		Allen Screws 10mm
A-60		Flat Washers and Lock Washers
A-61		Hex Nuts and Lock Nuts

All above is in Cabinet **Part # A-330-P** with Polished Chrome Allens, it is also available with Knurled Chrome Allens in Cabinet **Part # A-330-C**.

Metric Cruisers Assortments

Part # A-300-P is specially designed for the Metric Cruisers. This assortment offers a wide range of sizes starting at 4mm up to 12mm. Includes coarse special fine thread 8 & 10mm and also with longer lengths. The six metal trays are clearly labeled for ease in identification and the assortment includes the cabinet.

	A-301-P		Allen Screws 4mm and 5mm	
	A-302-P		Allen Screws 6mm	
	A-303-P		Allen Screws 8mm Coarse & Fine	
	A-304-P		Allen Screws 10mm Coarse & Fine	
	A-308-P		Allen Screws 10mm Long Coarse & Fine	
	A-305-P		Allen Screws 12mm	

Not included order separately

Part #A-60-C includes Chrome Flat Washers and Lock Washers 3mm to 14mm

Not included order separately

Part #A-61-C includes Hex Nuts and Lock Nuts in coarse and fine thread 4mm to 12mm



Assortments in Metric Thread

Tray Assortments (Stainless Steel)

Allen Head Screws

	Stainless Part #	Polished Part #
5mm & 6mm - (16 Sizes & 200 Pieces).....	A-64	A-64-SP
4mm & 5mm - (24 Sizes & 205 Pieces).....	A-301-S	A-301-SP
6mm x 1.0 x 8 thru 6mm x 1.0 x 75 - (16 Sizes & 140 Pieces).....	A-302-S	A-302-SP
8mm x 1.25 x 12 thru 8mm x 1.25 x 80 - (15 Sizes & 120 Pieces).....	A-326-S	A-326-SP
8mm x 1.25 x 10 thru 8mm x 1.25 x 80 - (16 Sizes & 124 Pieces).....	A-303-S	A-303-SP
10mm x 20 thru 10mm x 75 - (12 Sizes & 95 Pieces).....	A-327-S	A-327-SP
10mm x 1.50 x 20 thru 10mm x 1.50 x 75 - (12 Sizes & 90 Pieces).....	A-304-S	A-304-SP
12mm x 1.75 x 25 thru 12mm x 1.75 x 90 - (12 Sizes & 60 Pieces).....	A-305-S	A-305-SP



Stainless Steel Polished Allen

Hex Caps

6mm x 12 thru 8mm x 1.25 x 50 - (16 Sizes & 160 Pieces).....	A-63	A-63-SP
6mm x 12 - 6m x 50, 8mm x 12 - 8m x 55 also 10mm x 1.25 x 20 - 10m x 1.25 x 50 - (24 Sizes & 205 Pieces).....	24-MS	-----



Hex Cap

Hex Nut and Nylon Insert Lock Nut Combination

Hex Nuts 4mm thru 12mm Lock Nuts 4mm thru 12mm - (24 Sizes & 365 Pieces).....	A-65-S	A-65-SP
--	--------	---------

Flat & Lock Washer Combination

Flat Washers 3mm thru 14mm Lock Washers 3mm thru 14mm - (16 Sizes & 430 Pieces).....	A-60-S	A-60-SP
---	--------	---------

Tray Assortments (Zinc)

Allen Head Screws

	Zinc Part #
4mm & 5mm - (24 Sizes & 205 Pieces).....	A-301-Z
6mm x 1.0 x 8 thru 6mm x 1.0 x 75 - (16 Sizes & 140 Pieces).....	A-325-Z
8mm x 1.25 x 10 thru 8mm x 1.25 x 80 - (16 Sizes & 124 Pieces).....	A-326-Z
10mm x 1.50 x 20 thru 10mm x 1.50 x 75 - (12 Sizes & 90 Pieces).....	A-327-Z
12mm x 1.75 x 25 thru 12mm x 1.75 x 90 - (12 Sizes & 60 Pieces).....	A-305-Z
8mm x 1.25 x 10 thru 8mm x 1.25 x 80 - (16 Sizes & 124 Pieces).....	A-303-Z
10mm x 1.50 x 20 thru 10mm x 1.50 x 75 - (12 Sizes & 90 Pieces).....	A-304-Z
10mm x 1.50 x 20 thru 10mm x 1.50 x 75 - Long - (12 Sizes & 90 Pieces).....	A-308-Z

Stainless Steel Knurled Allen



Master Metric Zinc Allen Assortment

4mm & 5mm, 8mm x 1.25, 8mm x 1.0, 10mm x 1.25, 10mm x 1.50, 12mm x 1.75 x 90, 4mm thru 12mm Hex Nuts, Lock Nuts, Flat Washers & Lock Washers all in a (6) trayed cabinet.....	A-300-Z
--	---------

Hex Caps

6mm x 1.0 x 8 thru 6mm x 1.0 x 75 - (16 Sizes & 140 Pieces).....	A-302-HZ
6mm x 1.0 x 8 thru 6mm x 1.0 x 75 - (16 Sizes & 140 Pieces).....	A-325-HZ
10mm x 20 thru 10mm x 75 - (12 Sizes & 95 Pieces).....	A-327-HZ
12mm x 1.75 x 25 thru 12mm x 1.75 x 90 - (12 Sizes & 60 Pieces).....	A-305-HZ
6mm, 8mm & 10mm - Long - (24 Sizes & 205 Pieces).....	A-24M-HZ



Nylon Insert Lock Nut

Hex Nut and Nylon Insert Lock Nut Combination

Hex Nuts & Nylon Insert Lock Nuts 4mm thru 12mm - (24 Sizes & 365 Pieces).....	A-61-Z
--	--------

Hex Nut

Flat & Lock Washer Combination

Flat Washers & Lock Washers 3mm thru 14mm - (16 Sizes & 430 Pieces).....	A-60-Z
--	--------

Flat & Lock Washers

Flat & Lock Washer Hex Nuts Combination

Flat Washers, Lock Washers & Hex Nuts 6mm, 8mm & 10mm.....	A-12-WMZ
--	----------





Inside This Section

American Thread Chrome Plated

Allen Screws.....	80
Button Head Screws.....	80
Flat Head Allen Screws.....	81
12 Point Screws.....	81
Hex Cap Screws.....	82
Torx Button Head Screws.....	82
Stamped Skull & Flame Bolts.....	83
Machine Screws.....	84
Washers.....	85-86
Nuts.....	87
Acorn Nuts and Acorn Covers.....	88
Spacers.....	88
Hole Plugs, Pipe Plugs and Cotter Pins.....	89

American Stainless Steel

Allen Screws.....	90
Button Head Screws.....	90
Flat Head Allen Screws.....	90
Hex Caps Screws.....	91
Set Screws.....	91
Washers.....	92-93
Nuts.....	93-94
Machine Screws.....	95

American Zinc Plated

Allen Screws.....	96
Hex Caps.....	96
Washers.....	97
Nuts.....	97
Machine Screws.....	98

**Bulk Fasteners
Chrome Plated
Stainless and Zinc**

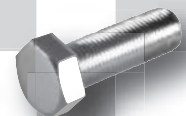



Bulk Chrome Fasteners American

Allen Screws Chrome Plated and Polished Chrome



12xxx
for Chrome Allen
with Knurls



10xxx
for Polished Chrome Allen
with Knurls Removed

	4/40	6/32	8/32	10/24	10/32	1/4 -20	1/4 -28	5/16 -18	5/16 -24	3/8 -16	3/8 -24	7/16 -14	7/16 -20	1/2 -13	1/2 -20	5/8 -11	5/8 -18
3/8	12088	12104	12128	12152	12153	12204	12205	12268	12269								
1/2	12089	12106	12130	12154	12155	12206	12207	12270	12271	12322	12323						
5/8	12090	12108	12132	12156	12157	12208	12209	12272	12273	12324	12325						
3/4	12091	12110	12134	12158	12159	12210	12211	12274	12275	12326	12327	12374	12375	12414	12415		
7/8		12112	12136	12160	12161	12212	12213	12278	12279	12328	12329						
1		12114	12138	12162	12163	12214	12215	12280	12281	12330	12331	12376	12377	12416	12417	12488	12489
1 1/4			12140	12166	12167	12218	12219	12284	12285	12334	12335	12378	12379	12418	12419	12490	
1 1/2			12142	12168	12169	12220	12221	12286	12287	12336	12337	12380	12381	12420	12421	12492	12493
1 3/4				12170	12171	12222	12223	12288	12289	12338	12339	12382	12383	12422	12423	12494	12495
2				12172	12173	12224	12225	12290	12291	12340	12341	12384	12385	12424	12425	12496	12497
2 1/4				12174	12175	12226	12227	12292	12293	12342	12343	12386	12387	12426	12427	12498	12499
2 1/2				12176	12177	12228	12229	12294	12295	12344	12345	12388	12389	12428	12429	12500	12501
2 3/4					12179	12230	12231	12296	12297	12346	12347	12390	12391	12430	12431	12502	
3						12232	12233	12298	12299	12348	12349	12392	12393	12432	12433	12504	12505
3 1/4						12234	12235	12300	12301	12350	12351	12394	12395	12434	12435	12506	
3 1/2						12236	12237	12302	12303	12352	12353	12396	12397	12436	12437	12508	12509
4						12240	12241	12306	12307	12356	12357	12400		12440	12441	12512	12513
4 1/2						12244		12310	12311	12360	12361	12404		12442	12443	12514	
5						12246		12312	12313	12362	12363	12406		12444	12445	12516	12517
5 1/2								12316	12317	12366	12367	12410		12446	12447	12518	12519
6						12248			12319	12368		12412		12448		12520	

Button Head Allen Screws Chrome Plated

Button Head Allen



	4/40	6/32	8/32	10/24	10/32	12/24	1/4 -20	1/4 -28	5/16 -18	5/16 -24	3/8 -16	3/8 -24	7/16 -14	7/16 -20	1/2 -13	1/2 -20	5/8 -11
1/4	13087	13102	13126	13150	13151												
3/8	13088	13104	13128	13152	13153		13204	13205	13268	13269							13415
1/2	13089	13106	13130	13154	13155	13186	13206	13207	13270	13271	13322	13323					
5/8	13090	13108	13132	13156	13157		13208	13209	13272	13273	13324						
3/4	13091	13110	13134	13158	13159		13210	13211	13274	13275	13326	13327			13414		
7/8			13136	13160	13161		13212	13213	13278	13279	13328						
1		13114	13138	13162	13163	13194	13214	13215	13280	13281	13330	13331	13376		13416	13417	13488
1 1/4			13140	13166	13167		13218	13219	13284	13285	13334	13335	13378	13379	13418	13419	13490
1 1/2				13168	13169		13220	13221	13286	13287	13336	13337	13380	13381	13420	13421	13492
1 3/4							13222	13223	13288	13289	13338	13339	13382		13422		
2							13224	13225	13290	13291	13340	13341	13384	13385	13424	13425	13496
2 1/4							13226		13292		13342	13343					
2 1/2							13228		13294		13344	13345		13389	13428	13429	13500
2 3/4									13296		13346						
3							13232		13298		13348	13349			13432	13433	13504
3 1/2							13236				13352						13508
4							13240				13356		13400		13440	13441	

Bulk Chrome Fasteners American



81

Flat Head Allen Screws Chrome Plated

Flat Head Allen



**American
Bulk Chrome**

	6/32	8/32	10/24	10/32	12/24	1/4 -20	1/4 -28	5/16 -18	5/16 -24	3/8 -16	3/8 -24	7/16 -14	1/2 -13	1/2 -20
1/4	14102													
3/8	14104	14128	14152	14153		14204	14205							
1/2	14106	14130	14154	14155	14186	14206	14207	14270	14271	14322				
5/8	14108	14132	14156	14157		14208	14209	14272	14273	14324	14325			
3/4	14110	14134	14158	14159	14190	14210	14211	14274	14275	14326	14327	14374	14414	14527
7/8		14136	14160	14161		14212	14213	14278	14279	14328				
1	14114	14138	14162	14163	14194	14214	14215	14280	14281	14330	14331	14376	14416	14417
1 1/4		14140	14166	14167		14218	14219	14284	14285	14334	14335	14378	14418	14419
1 1/2		14142	14168	14169		14220	14221	14286	14287	14336	14337	14380	14420	14421
1 3/4			14170			14222		14288		14338		14382	14422	14423
2						14224		14290		14340		14384	14424	14425
2 1/4								14292		14342		14386	14426	
2 1/2						14228		14294		14344		14388	14428	
2 3/4						14230				14346				
3						14232		14302		14348		14392	14432	
3 1/2						14236				14352		14396	14436	
4						14240		14306					14440	
4 1/2										14360				

12 Point Screws Chrome Plated

12 Point Screw



	1/4 -20	1/4 -28	5/16 -18	5/16 -24	3/8 -16	3/8 -24	7/16 -14	7/16 -20	1/2 -13	1/2 -20	5/8 -11	5/8 -18
3/8												
1/2	29206	29207	29270	29271	29322	29323						
5/8	29208	29209	29272	29273								
3/4	29210	29211	29274	29275	29326	29327	29374		29414	29527		
7/8	29212	29213										
1	29214	29215	29280	29281	29330	29331	29376	29377	29416	29417	29488	29489
1 1/4	29218	29219	29284	29285	29334	29335	29378	29379	29418	29419	29490	29491
1 1/2	29220	29221	29286	29287	29336	29337	29380	29381	29420	29421	29492	29493
1 3/4	29222	29223	29288	29289	29338	29339	29382	29383	29422	29423	29494	29495
2	29224	29225	29290	29291	29340	29341	29384	29385	29424	29425	29496	29497
2 1/4	29226	29227	29292	29293	29342	29343	29386	29387	29426	29427	29498	
2 1/2	29228	29229	29294	29295	29344	29345	29388	29389	29428	29429	29500	29501
2 3/4	29230	29231	29296	29297	29346	29347	29390	29391	29430		29502	
3	29232	29233	29298	29299	29348	29349	29392	29393	29432	29433	29504	29505
3 1/4			29300	29301	29350	29351	29394		29434			
3 1/2			29302	29303	29352	29353	29396	29397	29436	29437	29508	29509
4					29356	29357	29400		29440		29512	
4 1/2					29360				29442		29514	
5					29362				29444		29516	



Bulk Chrome Fasteners American

Hex Caps Screws Chrome Plated Grade 5 & Grade 8

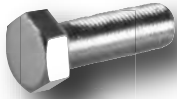

11xxx
for Grade 5
Chrome Hex Caps

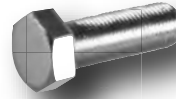

31xxx
for Grade 8
Chrome Hex Caps

	1/4 -20	1/4 -28	5/16 -18	5/16 -24	3/8 -16	3/8 -24	7/16 -14	7/16 -20	1/2 -13	1/2 -20	9/16 -12	9/16 -18	5/8 -11	5/8 -18
1/2	11206	11207	11270	11271	11322	11323								
5/8	11208	11209	11272	11273	11324	11325								
3/4	11210	11211	11274	11275	11326	11327	11374	11375	11414	11527				
7/8	11212	11213	11278	11279	11328	11329								
1	11214	11215	11280	11281	11330	11331	11376	11377	11416	11417	11452	11453	11488	11489
1 1/4	11218	11219	11284	11285	11334	11335	11378	11379	11418	11419	11454	11455	11490	11491
1 1/2	11220	11221	11286	11287	11336	11337	11380	11381	11420	11421	11456	11457	11492	11493
1 3/4	11222	11223	11288	11289	11338	11339	11382	11383	11422	11423	11458	11459	11494	11495
2	11224	11225	11290	11291	11340	11341	11384	11385	11424	11425	11460	11461	11496	11497
2 1/4	11226	11227	11292	11293	11342	11343	11386	11387	11426	11427	11462	11463	11498	11499
2 1/2	11228	11229	11294	11295	11344	11345	11388	11389	11428	11429	11464	11465	11500	11501
2 3/4	11230	11231	11296	11297	11346	11347	11390	11391	11430	11431	11466	11467	11502	11503
3	11232	11233	11298	11299	11348	11349	11392	11393	11432	11433	11468	11469	11504	11505
3 1/4	11234	11235	11300	11301	11350	11351	11394	11395	11434	11435	11470	11471	11506	11507
3 1/2	11236	11237	11302	11303	11352	11353	11396	11397	11436	11437	11472	11473	11508	11509
4	11240	11241	11306	11307	11356	11357	11400	11401	11440	11441	11476	11477	11512	11513
4 1/2	11244		11310	11311	11360	11361	11404	11405	11442	11443	11478	11479	11514	11515
5	11246		11312	11313	11362	11363	11406	11407	11444	11445	11480	11481	11516	11517
5 1/2	11246-B	11247-C	11316	11317	11366	11367	11410	11411	11446	11447	11482	11483	11518	11519
6	11246-A	11247-A	11318	11319	11368	11369	11412		11448	11449	11484	11485	11520	11521

Torx Button Head Screws Chrome Plated



Torx Button Head

	8/32	10/24	10/32	1/4 -20	1/4 -28	5/16 -18	5/16 -24	3/8 -16	1/2 -13
1/4	46126	46150	46151						
3/8	46128	46152	46153	46204	46205				
1/2	46130	46154	46155	46206	46207	46270	46271	46322	
5/8	46132	46156	46157	46208	46209	46272	46273	46324	
3/4	46134	46158	46159	46210	46211	46274	46275	46326	
1		46162	46163	46214	46215	46280	46281	46330	
1 1/4				46218				46334	
1 1/2				46220				46336	46420
2				46224				46340	
2 1/4				46226				46342	



Emblem Stamped Hex Cap Screws Chrome Plated

Skull Stamped Hex Caps



14-xxxxx
For Skull Stamped
Hex Caps

Flames Stamped Hex Caps



17-xxxxx
For Flame Stamped
Hex Caps

**American
Bulk Chrome**

	1/4 -20	1/4 -28	1/4 -24	5/16 -18	5/16 -24	3/8 -16	3/8 -24	7/16 -14	7/16 -20	1/2 -13	1/2 -20	5/8 -11	5/8 -18
3/8													
1/2	14-11206	14-11207	14-11250	14-11270	14-11271	14-11322	14-11323						
5/8	14-11208	14-11209		14-11272	14-11273	14-11324	14-11325						
3/4	14-11210	14-11211	14-11251	14-11274	14-11275	14-11326	14-11327	14-11374	14-11375	14-11414	14-11527		
7/8	14-11212	14-11213	14-11252	14-11278	14-11279	14-11328	14-11329						
1	14-11214	14-11215	14-11256	14-11280	14-11281	14-11330	14-11331	14-11376	14-11377	14-11416	14-11417	14-11488	14-11489
1 1/4	14-11218	14-11219		14-11284	14-11285	14-11334	14-11335	14-11378	14-11379	14-11418	14-11419	14-11490	14-11491
1 1/2	14-11220	14-11221		14-11286	14-11287	14-11336	14-11337	14-11380	14-11381	14-11420	14-11421	14-11492	14-11493
1 3/4	14-11222	14-11223		14-11288	14-11289	14-11338	14-11339	14-11382	14-11383	14-11422	14-11423	14-11494	14-11495
2	14-11224	14-11225		14-11290	14-11291	14-11340	14-11341	14-11384	14-11385	14-11424	14-11425	14-11496	14-11497
2 1/4	14-11226	14-11227		14-11292	14-11293	14-11342	14-11343	14-11386	14-11387	14-11426	14-11427	14-11498	14-11499
2 1/2	14-11228	14-11229		14-11294	14-11295	14-11344	14-11345	14-11388	14-11389	14-11428	14-11429	14-11500	14-11501
2 3/4	14-11230	14-11231		14-11296	14-11297	14-11346	14-11347	14-11390	14-11391	14-11430	14-11431	14-11502	14-11503
3	14-11232	14-11233		14-11298	14-11299	14-11348	14-11349	14-11392	14-11393	14-11432	14-11433	14-11504	14-11505
3 1/4	14-11234	14-11235		14-11300	14-11301	14-11350	14-11351	14-11394	14-11395	14-11434	14-11435	14-11506	14-11507
3 1/2	14-11236	14-11237		14-11302	14-11303	14-11352	14-11353	14-11396	14-11397	14-11436	14-11437	14-11508	14-11509
4	14-11240	14-11241		14-11306	14-11307	14-11356	14-11357	14-11400	14-11401	14-11440	14-11441	14-11512	14-11513
4 1/2				14-11310	14-11311	14-11360	14-11361	14-11404	14-11405	14-11442	14-11443	14-11514	14-11515
5	14-11246			14-11312	14-11313	14-11362	14-11363	14-11406	14-11407	14-11444	14-11445	14-11516	14-11517
5 1/2				14-11316	14-11317	14-11366	14-11367	14-11410	14-11411	14-11446	14-11447	14-11518	14-11519
6		14-11083		14-11318	14-11319	14-11368	14-11369	14-11412		14-11448	14-11449	14-11520	14-11521

Spike Nuts



Sizes

Part #

1/4 -20	1/4 -28	5/16 -18	5/16 -24	3/8 -16	3/8 -24
26546	26547	26548	26549	26550	26551

7/16 -14	7/16 -20	1/2 -13	1/2 -20	5/8 -18
26552	26553	26554	26555	26559

*With a longer extended hex for easier applications,
all done in Ultimate Show Chrome Plated Finish.*



Machine and Sheet Metal Screws Chrome Plated

Example: To order a **8/32 x 5/8 Oval Phillips Machine Screw**: Use **Chart #1** for the type of head style required, take those first two digits for the beginning part number which would be **"40"**. Now look up the diameter and length from **Chart #2 or #3** for last three digits for **8/32 x 5/8** is **"132"**. Put the two together for a part number of **40132**, or simply order by style and size.

Chart #1: Select Styles

Style	Chrome Slotted	Phillips
Round Head	33xxx	38xxx
Flat Head	36xxx	39xxx
Truss Head	51xxx	53xxx
Oval Head	34xxx	40 / 57*
Pan Head	35xxx	41xxx
Fillister	37xxx	n/a
Hex	55xxx	n/a
Round Wood	33xxx	n/a
Flat Wood	47xxx	49xxx
Oval Wood	48xxx	50xxx

*NOTE: Not all styles available in all sizes

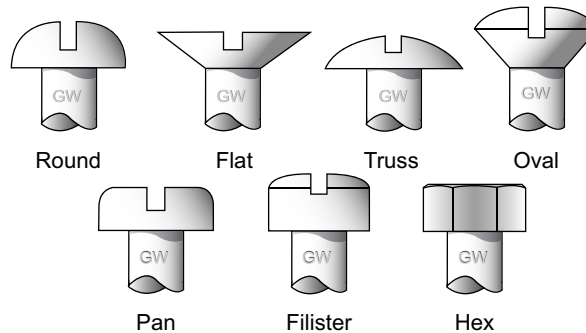

*NOTE: Oval Phillips Sheet Metal Screws use Prefix 57 not 40

Chart #2: Machine Screw Sizes

	6/32	8/32	10/24	10/32	12/24	1/4 -20	1/4 -28	5/16 -18	5/16 -24	3/8 -16
3/8	104	128	152	153	184	204				
1/2	106	130	154	155	186	206		270		
5/8		132	156	157	188	208	209			
3/4	110	134	158	159	190	210	211	274	275	
7/8		136	160	161	192	212				
1	114	138	162	163	194	214	215	280	281	330
1 1/4	116	140	166	167	196	218	219	284	285	334
1 1/2	118	142	168	169	198	220	221	286	287	336
1 3/4			170	171		222		288	289	338
2	122		172	173		224		290	291	340



Machine Screw

Chart #3: Sheet Metal & Wood Screw Sizes

	#6	#8	#10	#12	#14
1/2	616	628	641	654	667
5/8	617	629	642	655	668
3/4	618	630	643	656	669
1	620	632	645	658	671
1 1/4	621	633	646	659	672
1 1/2	622	634	647	660	673
1 3/4	623	680	648	661	674
2	624	635	649	662	675
2 1/4				663	676
2 1/2				664	677



Sheet Metal Screw



Woodscrew



Washers Chrome Plated

Flat Washers Standard SAE

Size	Part #
4	23564
6	23565
8	23566
10	23567
12	23568
1/4	23569
5/16	23570
3/8	23571
7/16	23572
1/2	23573
9/16	23574
5/8	23575
3/4	23576

Flat Washer



Hardened Flat Washer "G-W" Washers

Size	Part #
1/4	33569
5/16	33570
3/8	33571
7/16	33572
1/2	33573
5/8	33575

Hardened
Flat Washer



AN Flat Washers Small OD Chrome

Size	Part #
10	26567
1/4	26569
5/16	26570
3/8	26571
7/16	26572
1/2	26573
9/16	26574
5/8	26575
3/4	26576
1	26577

AN Flat Washer



Lock Washers

Size	Part #
4	24564
6	24565
8	24566
10	24567
12	24568
1/4	24569
5/16	24570
3/8	24571
7/16	24572
1/2	24573
9/16	24574
5/8	24575
3/4	24576

Lock Washer



American
Bulk Chrome

Also Available in Assortments

All Items shown on this page can be purchased individually

High Collar Lock Washers

Size	Part #
8	25566
10	25567
1/4	25569
5/16	25570
3/8	25571
7/16	25572
1/2	25573
5/8	25575



Internal Lock Washers

Size	Part #
6	29565
8	29566
10	29567
12	29568
1/4	29569
5/16	29570
3/8	29571
7/16	29572
1/2	29573
5/8	29575

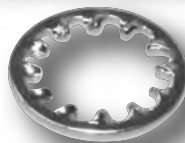

External Countersunk Washers

Size	Part #
6	35565
8	35566
10	35567
12	35568
1/4	35569
5/16	35570



External Lock Washers

Size	Part #
6	32565
8	32566
10	32567
12	32568
1/4	32569
5/16	32570
3/8	32571
7/16	32572
1/2	32573



Note: O.D. of Washer is the same as the Head of the Allen Screw

Having difficulties locating a particular item please call



Washers Chrome Plated

Cup Washers

Size	Part #
3/8 x 1 1/4	22334
1/2 x 1 1/4	22418
1/2 x 1 7/16	22420
5/8 x 1 1/4	22490



22334
Cup Washer

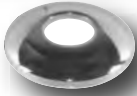

22418
Cup Washer



22420
Cup Washer



22490
Cup Washer

Cup Washers Sold Each.

Super Flat Fender Washers

Size	O.D.	Thickness	Part #
#8	3/4		23134
#10	3/4		23158
#10	1		23162
5/16	5/32	3/64	23128
3/16	1		23162
1/4	7/8		23212
1/4	1		23214
1/4	1 1/4		23218
5/16	1		23280
5/16	3/4		23274
5/16	13/16	3/32	23278
5/16	1 1/8		23282
5/16	1 1/4		23284
5/16	1 1/2		23286
5/16	1 1/2	1/8	23286H
11/32	1 1/32		23283
13/32	11/16	1/16	23326
3/8	3/4	.060	23326A
3/8	7/8		23328
3/8		Heat Treat	23329
3/8	1 1/4		23334
3/8	1 1/2		23336
3/8	1 1/2	1/8	23336H
3/8	2	1/16	23340
7/16	29/32	.190	23374
7/16	15/16		23375
7/16	1	1/8	23376
7/16	1 1/8	5/32	23377
7/16	1 1/8		23379
1/2	13/16		23415
1/2	1 1/8		23416
1/2	1 1/4		23418
1/2	2		23424
9/16	1 3/8		23456
5/8	1 1/2		23492
5/8	1 3/4		23495
21/32	1 1/16		23488
11/16	1 3/8	3/16	23496
11/16	1 3/8	Pivot Shaft	23579
7/16	2		23594

Finishing Washer

Size	Part #
6	34565
8	34566
10	34567
12	34568
14	34569



Finishing Washer

Flush Washer

Size	Part #
6	41565
8	41566
10	41567



Flush Washer

Flat Washer USS Standard

Size	I.D.	O.D.	Part #
1/4	5/16	3/4	23274
5/16	3/8	7/8	23328
3/8	7/16	1	23376
7/16	1/2	1 1/4	23418
1/2	9/16	1 3/8	23456
9/16	5/8	1 1/2	23492



Flat Washer

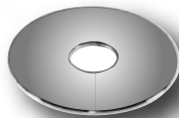

Super
Flat Washers
Sold Each.



American Bulk Chrome

Nuts Chrome Plated

Hex Nuts

Size	Part #
4/40	15536
5/40	15537
6/32	15538
8/32	15540
10/24	15542
10/32	15543
12/24	15544
1/4-20	15546
1/4-28	15547
5/16-18	15548
5/16-24	15549
3/8-16	15550
3/8-24	15551
7/16-14	15552
7/16-20	15553
1/2-13	15554
1/2-20	15555
9/16-12	15556
9/16-18	15557
5/8-11	15558
5/8-18	15559
3/4-10	15560
3/4-16	15561



Nylon Insert Lock Nuts

Size	Part #
4/40	17536
5/40	17537
6/32	17538
8/32	17540
10/24	17542
10/32	17543
12/24	17544
1/4-20	17546
1/4-28	17547
5/16-18	17548
5/16-24	17549
3/8-16	17550
3/8-24	17551
7/16-14	17552
7/16-20	17553
1/2-13	17554
1/2-20	17555
9/16-12	17556
9/16-18	17557
5/8-11	17558
5/8-18	17559
3/4-10	17560
3/4-16	17561



Thin Jam Lock Nuts

Size	Part #
1/4-20	27546
1/4-28	27547
5/16-18	27548
5/16-24	27549
3/8-16	27550
3/8-24	27551
7/16-14	27552
7/16-20	27553
1/2-13	27554
1/2-20	27555
9/16-12	27556
9/16-18	27557
5/8-11	27558
5/8-18	27559
3/4-10	27560
3/4-16	27561



Flexloc® Nuts (All Metal)

Size	Part #
10/24	18542
10/32	18543
1/4-20	18546
1/4-28	18547
5/16-18	18548
5/16-24	18549
3/8-16	18550
3/8-24	18551
7/16-14	18552
7/16-20	18553
1/2-13	18554
1/2-20	18555
9/16-12	18556
9/16-18	18557
5/8-11	18558
5/8-18	18559
3/4-10	18560
3/4-16	18561



All Items shown on this page can be purchased individually

Slotted Nuts

Size	Part #
1/4-20	22546
1/4-28	22547
5/16-18	22548
5/16-24	22549
3/8-16	22550
3/8-24	22551
7/16-14	22552
7/16-20	22553
1/2-13	22554
1/2-20	22555
9/16-12	22556
9/16-18	22557
5/8-11	22558
5/8-18	22559
3/4-10	22560
3/4-16	22561



Allen Nuts

Size	Part #
10/24	19542
10/32	19543
1/4-20	19546
1/4-28	19547
5/16-18	19548
5/16-24	19549
3/8-16	19550
3/8-24	19551
7/16-14	19552
7/16-20	19553
1/2-13	19554
1/2-20	19555
5/8-11	19558
5/8-18	19559



Thin Jam Hex Nuts

Size	Part #
1/4-20	16546
1/4-28	16547
5/16-18	16548
5/16-24	16549
3/8-16	16550
3/8-24	16551
7/16-14	16552
7/16-20	16553
1/2-13	16554
1/2-20	16555
9/16-12	16556
9/16-18	16557
5/8-11	16558
5/8-18	16559
3/4-10	16560
3/4-16	16561



Thin Jam Flexloc Nuts (All Metal)

Size	Part #
1/4-20	28546
1/4-28	28547
5/16-18	28548
5/16-24	28549
3/8-16	28550
3/8-24	28551
7/16-14	28552
7/16-20	28553
1/2-13	28554
1/2-20	28555
9/16-12	28556
9/16-18	28557
5/8-11	28558
5/8-18	28559
3/4-10	28560
3/4-16	28561





Nuts Chrome Plated

Acorn Nuts

Coarse and Fine Thread

Size	Part #
4/40	21536
6/32	21538
8/32	21540
10/24	21542
10/32	21543
12/24	21544
1/4-20	21546
1/4-28	21547
5/16-18	21548
5/16-24	21549
3/8-16	21550
3/8-24	21551
7/16-14	21552
7/16-20	21553
1/2-13	21554
1/2-20	21555
9/16-12	21556
9/16-18	21557
5/8-11	21558
5/8-18	21559
3/4-10	21560
3/4-16	21561
1-14	21565



Low Crown Acorn Nuts

Coarse and Fine Thread

Size	Part #
8/32	33540
10/24	33542
10/32	33543
1/4-20	33546
1/4-28	33547
5/16-18	33548
5/16-24	33549
3/8-16	33550
3/8-24	33551
7/16-14	33552
7/16-20	33553
1/2-13	33554
1/2-20	33555
5/8-11	33558
5/8-18	33559



Acorn Push On Covers

Wrench Size	Part #	Bolt/Nut Diameter
7/16	45552	1/4
1/2	45554	5/16
9/16	45556	3/8
5/8	45558	7/16
11/16	45559	
7/8	45562	
3/4	45560	



Spacers Chrome Plated

ID	OD	Length	Part #
1/4	7/16	3/16	20080
1/4	7/16	1/4	20081
1/4	7/16	3/8	20082
1/4	7/16	1/2	20082-A
1/4	7/16	5/8	20083
1/4	7/16	3/4	20084
1/4	7/16	7/8	20094
1/4	7/16	1 1/16	20085
1/4	5/8	1/8	20040
1/4	5/8	1/4	20036
1/4	5/8	3/8	20037
1/4	5/8	1/2	20038
1/4	5/8	3/4	20039
1/4	5/8	1	20041
5/16	7/16	5/8	20045
5/16	1/2	3/16	20049
5/16	1/2	1/4	20050
5/16	1/2	3/8	20050-A
5/16	1/2	1/2	20051
5/16	1/2	17/32	20093
5/16	1/2	3/4	20052
5/16	1/2	1	20053
5/16	1/2	1 1/4	20054
5/16	5/8	1/8	20055
5/16	5/8	3/16	20056
5/16	5/8	1/4	20057
5/16	5/8	3/8	20058
5/16	5/8	1/2	20059
5/16	5/8	3/4	20060
5/16	5/8	1	20061
3/8	9/16	1/8	20087

ID	OD	Length	Part #
3/8	9/16	3/8	20086
3/8	13/16	5/32	20091
3/8	5/8	1/4	20067
3/8	5/8	3/8	20068
3/8	1	5/16	C-31-32
3/8	5/8	1/2	20069
3/8	13/16	1/2	20092
3/8	5/8	3/4	20070
3/8	13/16	29/32	20092-A
3/8	5/8	1	20072
3/8	5/8	1 1/2	20075
3/8	3/4	1/8 Tapered	20021
3/8	3/4	1/4	20022
3/8	3/4	3/8	20023
3/8	3/4	1/2	20024
3/8	3/4	3/4	20025
3/8	3/4	1	20026
3/8	7/8	5/8	20089
7/16	3/4	3/32	23580
7/16	11/16	5/16	20088
1/2	5/16	15/16	20095
1/2	3/4	1/8	20030
1/2	3/4	1/4	20031
1/2	3/4	1/2	20032
1/2	3/4	3/4	20033
1/2	3/4	1	20034
1/2	7/8	3/8	20097
1/2	15/16	21/32	20096
1/2	1 1/16	5/16	23200
9/16	7/8	3/4	20100
5/8	1 1/2	3/8	C-31-100
13/32	1	.322	23327



All items shown on this page can be purchased individually

Spike Nuts

Coarse and Fine Thread

Size	Part #
1/4-20	26546
1/4-28	26547
5/16-18	26548
5/16-24	26549
3/8-16	26550
3/8-24	26551
7/16-14	26552
7/16-20	26553
1/2-13	26554
1/2-20	26555
5/8-18	26559



Non-Alcoholic but may be habit forming

Spike Nuts

Bulk Chrome Fasteners American



89

Cotter Pins Chrome, Stainless or Zinc

Size	H-D Part #	Chrome Part #	Stainless Part #	Zinc Part #
1/16 x 1/2	510		78580	01587
1/16 x 3/4	512-515		78587	01588
1/16 x 1 1/4			78588A	01588A
5/64 x 3/4			78581	01589
3/32 x 3/4	528	29589	78589	01590
3/32 x 1	531-534	29590	78590	01591
3/32 x 1 1/4	513	29591A	78591	
3/32 x 1 1/2			78591A	
3/32 x 1 3/4		29587		01592
1/8 x 3/4	550	29592	78592	
1/8 x 1			78584	01593
1/8 x 1 1/4	520-559	29593	78593	
1/8 x 1 1/2		29585	78585	
1/8 x 1 3/4			78585A	
1/8 x 2			78595	
5/32 x 1			78585B	01599
5/32 x 1 1/2	511	29588	78588	
5/32 x 1 3/4		29586	78586	01594
3/16 x 1	566	29594	78594	
3/16 x 1 3/4			78597	



Cotter Pin Assortment A-34 Zinc and A-34C Chrome

American Bulk Chrome

Flange & Locking Flange Nuts

Size	Part #	Locking #
1/4-20	44546	44546-L
5/16-18	44548	44548-L
5/16-24	44549	44549-L
3/8-16	44550	44550-L
3/8-24	44551	44551-L
7/16-14	44552	----
1/2-13	44554	----
1/2-20	44555	----
5/8-11	44558	44558-L



Grease Fittings Chrome Plated

Size	Part #
1/4-28 Straight	57547
1/4-28 90°	57548
1/4-28 45°	57546
1/8 Pipe Straight	57550
1/8 Pipe 45°	57549



Allen Pipe Plugs

Size	Part #
1/16	31587
1/8	31588
1/4	31569
3/8	31571
1/2	31573
3/4	31576

Note: See Fitting Section for more Pipe Plugs



Hole Plugs

Size	Part #	Use with Allen Screw
3/16	43567	1/4
1/4	43569	5/16
5/16	43570	3/8
3/8	43571	7/16
7/16	43572	
1/2	43573	
5/8	43575	
3/4	43576	
7/8	43577	
1	43578	
1 1/4	43579	
1 1/2	43580	

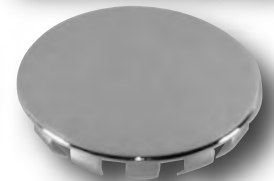

Wide Base Wing Nut

Size	Part #
1/4-20	23546-W



Wing Nuts

Size	Part #
1/4-20	23546
5/16-18	23548
3/8-16	23550



All Items shown on this page can be purchased individually



Bulk Stainless Steel American

Allen Screws Stainless Steel

	6/32	8/32	10/24	10/32	1/4 -20	1/4 -28	5/16 -18	5/16 -24	3/8 -16	3/8 -24	7/16 -14	1/2 -13	5/8 -11
3/8	73104	73128	73152	73153	73204						Allen		
1/2	73106	73130	73154	73155	73206	73207	73270		73322				
5/8		73132	73156	73157	73208	73209	73272	73273	73324				
3/4	73110	73134	73158	73159	73210	73211	73274	73275	73326	73327	73374	73414	
7/8		73136	73160	73161	73212		73278		73328				
1	73114	73138	73162	73163	73214	73215	73280	73281	73330	73331	73376	73416	
1 1/4		73140	73166	73167	73218	73219	73284	73285	73334	73335	73378	73418	
1 1/2		73142	73168	73169	73220	73221	73286	73287	73336	73337	73380	73420	73492
1 3/4			73170	73171	73222	73223	73288	73289	73338	73339	73382	73422	73494
2	73122		73172	73173	73224	73225	73290	73291	73340	73341	73384	73424	73496
2 1/4			73174		73226	73227	73292		73342		73386	73426	73498
2 1/2			73176		73228		73294	73295	73344	73345	73388	73428	73500
2 3/4					73230		73296		73346			73430	
3					73232		73298	73299	73348		73392	73432	73504
3 1/2					73236		73302		73352	73353	73396	73436	73508
4					73240		73306		73356	73347	73400	73440	73512



73xxx for
Stainless Steel
Allen with Knurls



SP - 73xxx for
Polished Stainless Steel
Allen with Knurls
Removed

Button Head Allen Screws

	6/32	8/32	10/24	10/32	1/4 -20	1/4 -28	5/16 -18	5/16 -24	3/8 -16	3/8 -24	1/2 -13
1/4	72102	72126	72150	72151							
3/8	72104	72128	72152	72153	72204						
1/2	72106	72130	72154	72155	72206		72270		72322		
5/8		72132	72156	72157	72208		72272				
3/4	72110	72134	72158	72159	72210	72211	72274	72275	72326	72327	
1	72114	72138	72162	72163	72214	72215	72280	72281	72330	72331	72416
1 1/4			72166	72167	72218		72284	72285	72334	72335	72418
1 1/2			72168	72169	72220		72286	72287	72336	72337	72420
1 3/4					72222						
2			72172	72173	72224		72290	72291	72340		72424
2 1/2							72294		72344		72428
3					72232		72298		72348		72432
3 1/2					72236						
4					72240		72306				

72xxx for
Stainless Steel
Button Head Allen



SP - 72xxx for
Polished Stainless Steel
Button Head Allen

Flat Head Allen Screws

	6/32	8/32	10/24	10/32	1/4 -20	1/4 -28	5/16 -18	5/16 -24	3/8 -16	1/2 -13	5/8 -11
3/8	71104		71152	71153	71204						
1/2	71106	71130	71154	71155	71206		71270				
5/8		71132	71156	71157	71208		71272				
3/4		71134	71158	71159	71210	71211	71274		71326		
1	71114	71138	71162	71163	71214	71215	71280	71281	71330	71416	71488
1 1/4		71140	71166	71167	71218	71219	71284		71334	71418	71490
1 1/2		71142	71168	71169	71220	71221	71286		71336	71420	71492
1 3/4					71222		71288		71338	71422	71494
2					71224		71290		71340	71424	71496
2 1/2									71344		
3							71298		71348	71432	

71xxx for
Stainless Steel
Flat Head Allen



SP - 71xxx for
Polished Stainless Steel
Flat Head Allen

Bulk Stainless Fasteners American



91

Hex Caps Screws Stainless Steel

77xxx
for Stainless Steel
Hex Cap Screws

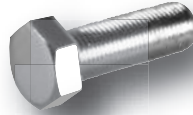

SP - 77xxx
for Polished Stainless Steel
Hex Cap Screws

NOTE: 9/16 & 5/8 sizes are not listed on chart but certain sizes may be available upon request.

	4/40	6/32	8/32	10/24	10/32	12/24	1/4 -20	1/4 -28	5/16 -18	5/16 -24	3/8 -16	3/8 -24	7/16 -14	7/16 -20	1/2 -13	1/2 -20
3/8	77088		77128	77152	77153		77204	77205	77268							
1/2		77106	77130	77154	77155	77186	77206	77207	77270	77271	77322	77323				
5/8			77132	77156	77157		77208	77209	77272	77273	77324	77325				
3/4			77134	77158	77159		77210	77211	77274	77275	77326	77327			77414	
7/8			77136				77212	77213	77278	77279	77328	77329				
1		77114	77138	77162	77163	77194	77214	77215	77280	77281	77330	77331	77376	77377	77416	77417
1 1/4				77166	77167		77218	77219	77284	77285	77334	77335	77378	77379	77418	77419
1 1/2			77142	77168	77169		77220	77221	77286	77287	77336	77337	77380	77381	77420	77421
1 3/4							77222	77223	77288	77289	77338	77339	77382	77383	77422	77423
2							77224	77225	77290	77291	77340	77341	77384	77385	77424	77425
2 1/4							77226	77227	77292	77293	77342	77343	77386	77387	77426	77427
2 1/2							77228	77229	77294	77295	77344	77345	77388	77389	77428	77429
2 3/4							77230	77231	77296		77346			77391	77430	
3							77232	77233	77298	77299	77348	77349	77392	77393	77432	77433
3 1/4							77234		77300	77301	77350		77394		77434	77435
3 1/2							77236	77237	77302		77352	77353	77396		77436	77437
3 3/4							77238		77304		77354				77438	
4							77240		77306		77356	77357	77400		77440	77441
4 1/2							77244		77310	77311	77360	77361	77404		77442	77443
5							77246		77312	77313	77362		77406		77444	
5 1/2									77316		77366				77446	
6							77246-A		77318		77368		77412		77448	

American Bulk Stainless

Set Screws Plain Steel

	6/32	8/32	10/24	10/32	1/4 -20	1/4 -28	5/16 -18	5/16 -24	3/8 -16	3/8 -24
1/4	47102	47126	47150	47151						
3/8	47104	47128	47152	47153	47204	47205	47268			
1/2	47106	47130	47154	47155	47206	47207	47270	47271	47322	47323
5/8	47108	47132	47156	47157	47208	47209	47272	47273	47324	47325
3/4	47110	47134	47158	47159	47210	47211	47274	47275	47326	47327
1	47114	47138	47162	47163	47214	47215	47280	47281	47330	47331
1 1/4			47166	47167	47218	47219	47284	47285	47334	47335
1 1/2			47168	47169	47220	47221	47286	47289	47336	47337
1 3/4					47222		47288			
2					47224	47225	47290	47291	47340	47341
2 1/2					47228		47294		47344	

Set Screws
Sold Each



Stainless Steel Available



Bulk Stainless Fasteners American

Washers Stainless Steel

Flat Washers

Size	Part #
4	75564
6	75565
8	75566
10	75567
1/4	75569
5/16	75570
3/8	75571
7/16	75572
1/2	75573
5/8	75575
3/4	75576



AN Washers Small OD

Size	Part #
6	84565
8	84566
10	84567
1/4	84569
5/16	84570
3/8	84571
7/16	84572
1/2	84573
5/8	84575
3/4	84576



Lock Washers

Size	Part #
4	76564
6	76565
8	76566
10	76567
1/4	76569
5/16	76570
3/8	76571
7/16	76572
1/2	76573
5/8	76575
3/4	76576



Finishing Washers

Size	Part #
6	78565
8	78566
10	78567
1/4	78569
5/16	78570



High Collar Lock Washers

Size	Part #
1/4	80569
5/16	80570
3/8	80571
1/2	80573



All Items shown on this page can be purchased individually

GW Stainless Steel Flat Washers



Thicker than standard flat washers

Size	Part #
1/4	70569
5/16	70570
3/8	70571
7/16	70572
1/2	70573
5/8	70575

Our Stainless Steel washer is thicker than standard flat washers and has a close tolerance ID for a snug fit. It has a standard OD so it can be used anywhere a regular washer was.

Super Flat Washers

Size	Part #
#6 x 5/8	66108
#8 x 3/4	66134
3/16 x 11/16	66157
3/16 x 3/4	66158
3/16 x 1	66162
3/8 x 1	66330
3/8 x 1 1/4	66334
1/4 x 1	66214
1/4 x 1 1/4	66218
5/16 x 3/4	SP- 66274
5/16 x 1 1/2	66286
3/8 x 7/8	SP- 66328
3/8 x 1 1/2	66336
7/16 x 1	66376
7/16 x 1 1/8	SP- 66377
1/2 x 1 1/4	SP- 66418
1/2 x 1 1/2	66420
1/2 x 2	66424
5/8 x 1 1/2	SP- 66492
5/8 x 1 3/4	66494
3/4 x 1 3/4	66528

(SP-) Super Flat Washers Polished Stainless Steel in that size only

Internal Lock Washers

Size	Part #
4	82564
6	82565
8	82566
10	82567
1/4	82569
5/16	82570
3/8	82571
7/16	82572
1/2	82573
5/8	82575



External Lock Washers

Size	Part #
4	83564
6	83565
8	83566
10	83567
1/4	83569
5/16	83570
3/8	83571
7/16	83572
1/2	83573
5/8	83575



External Countersunk Washers

Size	Part #
6	89565
8	89566
10	89567
1/4	89569
5/16	89570

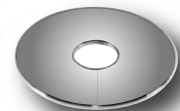



Washers Stainless Steel

White Nylon Flat Washers

Size	Part #
8	87566
10	87567
1/4	87569
5/16	87570
3/8	87571
7/16	87572
1/2	87573
5/8	87575

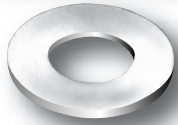

Neoprene Backed Flat Washers

Size	Part #
8	81566
10	81567
1/4	81569
5/16	81570
3/8	81571
1/2	81573

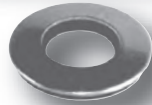

Available in
Stainless Steel Polished
Add SP-81xxx

Pipe Plugs Allen Style

Size	Part #
1/8	86588
1/4	86569
3/8	86571
1/2	86573
3/4	86576



Threaded Rod Stainless Steel

Size	Part #
6/32	63122
8/32	63148
10/24	63180
10/32	63181
1/4-20	63232
1/4-28	63233
5/16-18	63298
5/16-24	63299
3/8-16	63348
3/8-24	63349
7/16-14	63392
7/16-20	63393
1/2-13	63432
1/2-20	63433
5/8-11	63504

Threaded Rod
Sold in Three Foot Lengths

All Items shown on this page can
be purchased individually

Nuts Stainless Steel

Acorn Nuts

Size	Part #
6/32	68538
8/32	68540
10/24	68542
10/32	68543
1/4-20	68546
1/4-28	68547
5/16-18	68548
5/16-24	68549
3/8-16	68550
3/8-24	68551
7/16-14	68552
7/16-20	68553
1/2-13	68554
1/2-20	68555
5/8-11	68558
5/8-18	68559



Castle Nuts

Size	Part #
3/8-24	81551
1/2-13	81554
1/2-20	81555
5/8-11	81558



For Stainless Steel Polished
order with the Prefix than five digit
Part # SP-xxxxx

Hex Nuts

Size	Part #
6/32	70538
8/32	70540
10/24	70542
10/32	70543
1/4-20	70546
1/4-28	70547
5/16-18	70548
5/16-24	70549
3/8-16	70550
3/8-24	70551
7/16-14	70552
7/16-20	70553
1/2-13	70554
1/2-20	70555
9/16-12	70556
9/16-18	70557
5/8-11	70558
5/8-18	70559
3/4-10	70560
3/4-16	70561



Nylon Lock Nuts

Size	Part #
4/40	69536
6/32	69538
8/32	69540
10/24	69542
10/32	69543
1/4-20	69546
1/4-28	69547
5/16-18	69548
5/16-24	69549
3/8-16	69550
3/8-24	69551
7/16-14	69552
7/16-20	69553
1/2-13	69554
1/2-20	69555
9/16-12	69556
9/16-18	69557
5/8-11	69558
5/8-18	69559
3/4-10	69560
3/4-16	69561





Nuts Stainless Steel

Jam Nuts

Size	Part #
1/4-20	67546
1/4-28	67547
5/16-18	67548
5/16-24	67549
3/8-16	67550
3/8-24	67551
7/16-14	67552
7/16-20	67553
1/2-13	67554
1/2-20	67555
9/16-18	67557
5/8-11	67558
5/8-18	67559
3/4-16	67561
3/4-10	67560

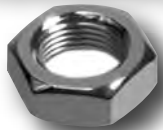

Jam Locknuts

Size	Part #
1/4-20	66546
1/4-28	66547
5/16-18	66548
5/16-24	66549
3/8-16	66550
3/8-24	66551
7/16-14	66552
7/16-20	66553
1/2-13	66554
1/2-20	66555
5/8-11	66558
5/8-18	66559
3/4-16	66561



Spin Locks

Size	Part #
1/4-20	65546
5/16-18	65548
5/16-24	65549
3/8-16	65550
3/8-24	65551



When only the very Best Fasteners will Do!



American Bulk Stainless

Machine and Sheet Metal Screws Stainless Steel

Example: To order a 8/32 x 5/8 Oval Phillips Machine Screw: Use **Chart #1** for head style required, take those first two digits for the beginning part number which would be "40" Now look up the diameter and length from **Chart #2 or #3** for last three digits for 8/32 x 5/8 is "132" Put the two together for a part number of **89132**, or simply order by style and size.

Chart #1: Select Styles

Style	Stainless Steel Slotted	Stainless Steel Phillips
Round Head	99	95
Flat Head	98	94
Truss Head	93	80
Oval Head	97	89
Pan Head	96	92
Fillister	78	n/a
Hex	77	n/a
Round Wood	83	n/a
Flat Wood	85	n/a
Oval Wood	84	81

Include the prefix SP-XXXXX for Stainless Steel Polished

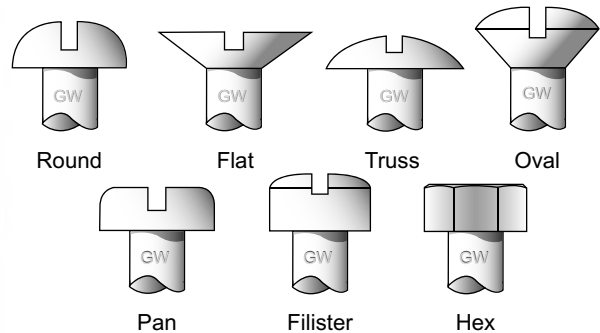

Chart #2: Machine Screw Sizes

	6/32	8/32	10/24	10/32	12/24	1/4 -20	1/4 -28	5/16 -18	5/16 -24	3/8 -16
3/8	104	128	152	153	184	204				
1/2	106	130	154	155	186	206		270		
5/8		132	156	157	188	208	209			
3/4	110	134	158	159	190	210	211	274	275	
7/8		136	160	161	192	212			279	
1	114	138	162	163	194	214	215	280	281	330
1 1/4	116	140	166	167	196	218	219	284	285	334
1 1/2	118	142	168	169	198	220	221	286	287	336
1 3/4			170	171		222		288	289	338
2	122		172	173		224		290	291	340



Machine Screw

Head Styles: Oval, Flat or Pan
Note: Not all styles available in all sizes

Chart #3: Sheet Metal & Wood Screw Sizes

	#6	#8	#10	#12	#14
1/2	616	628	641	654	667
5/8	617	629	642	655	668
3/4	618	630	643	656	669
1	620	632	645	658	671
1 1/4	621	633	646	659	672
1 1/2	622	634	647	660	673
1 3/4	623	680	648	661	674
2	624	635	649	662	675
2 1/4	625	636	650	663	676
2 1/2	626	637	651	664	677



Sheet Metal Screw



Woodscrew



Bulk Zinc Fasteners American

Allen Screws Zinc Plated



08xxx
for Allen Screws
with Knurls

	4/40	6/32	8/32	10/24	10/32	1/4 -20	1/4 -28	5/16 -18	5/16 -24	3/8 -16	3/8 -24	7/16 -14	7/16 -20	1/2 -13	1/2 -20
3/8	08088	08104	08128	08152	08153	08204									
1/2	08089	08106	08130	08154	08155	08206	08207	08270	08271	08322	08323				
5/8			08132	08156	08157	08208	08209	08272	08273	08324	08325				
3/4	08091	08110	08134	08158	08159	08210	08211	08274	08275	08326	08327	08374	08375	08414	08415
7/8			08136	08160	08161	08212	08213	08278	08279	08328					
1		08114	08138	08162	08163	08214	08215	08280	08281	08330	08331	08376	08377	08416	08417
1 1/4			08140	08166	08167	08218	08219	08284	08285	08334	08335	08378		08418	08419
1 1/2			08142	08168	08169	08220	08221	08286	08287	08336	08337	08380		08420	08421
1 3/4				08170	08171	08222	08223	08288	08289	08338	08339	08382		08422	08423
2				08172	08173	08224	08225	08290	08291	08340	08341	08384		08424	08425
2 1/4						08226	08227	08292	08293	08342		08386		08426	
2 1/2						08228	08229	08294	08295	08344		08388		08428	
2 3/4						08230		08296		08346				08430	
3						08232		08298		08348				08432	
3 1/4										08350					
3 1/2						08236				08352					
4						08240									
4 1/2						08244									

Hex Cap Screws Zinc Plated and L-9 Products

	1/4 -20	1/4 -28	5/16 -18	5/16 -24	3/8 -16	3/8 -24	7/16 -14	7/16 -20	1/2 -13	1/2 -20	5/8 -11	5/8 -18
1/2	07206	07207	07270	07271	07322	07323						
5/8	07208	07209	07272	07273	07324	07325						
3/4	07210	07211	07274	07275	07326	07327	07374	07375	07414			
7/8	07212	07213	07278	07279	07328	07329						
1	07214	07215	07280	07281	07330	07331	07376	07377	07416	07417	07488	07489
1 1/4	07218	07219	07284	07285	07334	07335	07378	07379	07418	07419	07490	07491
1 1/2	07220	07221	07286	07287	07336	07337	07380	07381	07420	07421	07492	07493
1 3/4	07222	07223	07288	07289	07338	07339	07382	07383	07422	07423	07494	07495
2	07224	07225	07290	07291	07340	07341	07384	07385	07424	07425	07496	07497
2 1/4	07226	07227	07292	07293	07342	07343	07386	07387	07426	07427	07498	07499
2 1/2	07228	07229	07294	07295	07344	07345	07388	07389	07428	07429	07500	07501
2 3/4	07230	07231	07296	07297	07346	07347	07390	07391	07430	07431	07502	07503
3	07232	07233	07298	07299	07348	07349	07392	07393	07432	07433	07504	07505
3 1/4	07234	07235	07300	07301	07350	07351	07394	07395	07434	07435	07506	07507
3 1/2	07236	07237	07302	07303	07352	07353	07396	07397	07436	07437	07508	07509
4	07240	07241	07306	07307	07356	07357	07400	07401	07440	07441	07512	07513
4 1/2	07244		07310	07311	07360	07361	07404	07405	07442	07443	07514	07515
5	07246		07312	07313	07362	07363	07406	07407	07444	07445	07516	07517
5 1/2			07316	07317	07366	07367	07410	07411	07446	07447	07518	07519
6				07319	07368		07412		07448	07449	07520	07521

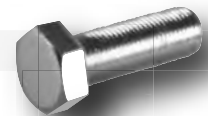

07xxx
for Zinc Hex Cap

NOTE:
Some sizes may
not be available
in L-9 Zinc,
Please call.

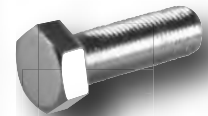

When Ordering
L-9 Zinc Plated
Hex Caps
use 52xxx
for the first two
numbers in Part #



American Bulk Zinc

Washers Zinc Plated and L-9 Products

Flat Washers and L-9

Size	Part #	L-9 #
4	04564	--
6	04565	--
8	04566	--
10	04567	--
12	04568	--
1/4	04569	55569
5/16	04570	55570
3/8	04571	55571
7/16	04572	55572
1/2	04573	55573
9/16	04574	55574
5/8	04575	55575
3/4	04576	--
7/8	04577	--



Fender Washers

Size	Part #
10 x 1	01567
1/4 x 1	01569
1/4 x 1 1/4	01218
1/4 x 1 1/2	09569
5/16 x 1 1/4	01284
5/16 x 1 1/2	01570
3/8 x 1 1/2	01571

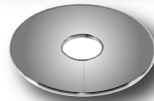

External Lock Washers

Size	Part #
4	02564
6	02565
8	02566
10	02567
12	02568
1/4	02569
5/16	02570
3/8	02571
7/16	02572
1/2	02573



Internal Lock Washers

Size	Part #
4	03564
6	03565
8	03566
10	03567
12	03568
1/4	03569
5/16	03570
3/8	03571
7/16	03572
1/2	03573
5/8	03575
3/4	03576



Lock Washers and L-9

Size	Part #	L-9 #
4	05564	--
6	05565	--
8	05566	--
10	05567	--
12	05568	--
1/4	05569	52569
5/16	05570	52570
3/8	05571	52571
7/16	05572	52572
1/2	05573	52573
9/16	05574	52574
5/8	05575	52575
3/4	05576	--
7/8	05577	--
1	05578	--



Nuts Zinc Plated and L-9 Products

Hex Nuts & L-9

Size	Part #	L-9 #
4/40	06536	--
5/40	06537	--
6/32	06538	--
8/32	06540	--
10/24	06542	--
10/32	06543	--
1/4-20	06546	52546
1/4-28	06547	52547
5/16-18	06548	52548
5/16-24	06549	52549
3/8-16	06550	52550
3/8-24	06551	52551
7/16-14	06552	52552
7/16-20	06553	52553
1/2-13	06554	52554
1/2-20	06555	52555
9/16-12	06556	06556
9/16-18	06557	--
5/8-11	06558	52558
5/8-18	06559	52559
3/4-10	06560	--
3/4-16	06561	--



Nylon Lock Nuts

Size	Part #
4/40	03536
5/40	03537
6/32	03538
8/32	03540
10/24	03542
10/32	03543
1/4-20	03546
1/4-28	03547
5/16-18	03548
5/16-24	03549
3/8-16	03550
3/8-24	03551
7/16-14	03552
7/16-20	03553
1/2-13	03554
1/2-20	03555
9/16-12	03556
9/16-18	03557
5/8-11	03558
5/8-18	03559
3/4-10	03560
3/4-16	03561



Jam Hex Nuts

Size	Part #
1/4-20	04546
1/4-28	04547
5/16-18	04548
5/16-24	04549
3/8-16	04550
3/8-24	04551
7/16-14	04552
1/2-20	04555
9/16-18	04557
5/8-18	04559
3/4-16	04561



Jam Lock Nuts

Size	Part #
1/4-20	02546
1/4-28	02547
5/16-18	02548
5/16-24	02549
3/8-16	02550
3/8-24	02551
7/16-14	02552
7/16-20	02553
1/2-13	02554
1/2-20	02555
9/16-12	02556
9/16-18	02557
5/8-11	02558
5/8-18	02559



All items shown on this page can be purchased individually



Bulk Zinc Fasteners American

Machine and Sheet Metal Screws Zinc Plated

Example: To order a **8/32 x 5/8 Oval Phillips Machine Screw**: Use **Chart #1** for the type of head style required, take those first two digits for the beginning part number which would be **"40"**. Now look up the diameter and length from **Chart #2 or #3** for last three digits for **8/32 x 5/8** is **"132"**. Put the two together for a part number of **40132**, or simply order by style and size.

Note; When placing your order please ask for Zinc Plated Screws.

Chart #1: Select Styles

Note; Not all Sizes and Styles Available

Style	Slotted	Phillips
Round Head	04	05
Flat Head	02	03
Truss Head	01	n/a
Pan Head	04	n/a
Fillister	06	n/a



Round

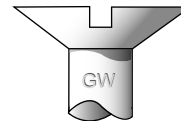

Flat



Truss

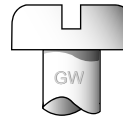

Pan



Fillister

Chart #2: Machine Screw Sizes

	6/32	8/32	10/24	10/32	12/24	1/4 -20	1/4 -28	5/16 -18	5/16 -24	3/8 -16
3/8	104	128	152	153	184	204				
1/2	106	130	154	155	186	206		270		
5/8		132	156	157	188	208	209			
3/4	110	134	158	159	190	210	211	274	275	
7/8		136	160	161	192	212			279	
1	114	138	162	163	194	214	215	280	281	330
1 1/4	116	140	166	167	196	218	219	284	285	334
1 1/2	118	142	168	169	198	220	221	286	287	336
1 3/4			170	171		222		288	289	338
2	122		172	173		224		290	291	340

Machine Screws are sold each



Machine Screw

Chart #3: Sheet Metal Sizes

	#6	#8	#10	#12	#14
1/2	616	628	641	654	667
5/8	617	629	642	655	668
3/4	618	630	643	656	669
1	620	632	645	658	671
1 1/4	621	633	646	659	672
1 1/2	622	634	647	660	673
1 3/4	623	680	648	661	674
2	624	635	649	662	675
2 1/4	625	636	650	663	676
2 1/2	626	637	651	664	677



Sheet Metal Screw



Inside This Section

Metric Thread Chrome Plated

Allen Screws.....	100
Button Head Screws.....	100
Flat Head Allen Screws.....	100
12 Point Screws.....	101
Hex Cap Screws.....	101
Nuts.....	102
Washers.....	102

Metric Stainless Steel

Allen Screws.....	103
Button Head Screws.....	103
Flat Head Allen Screws.....	103
Hex Caps Screws.....	103
Washers.....	104
Nuts.....	104
Machine Screws.....	104

Metric Zinc Plated

Allen Screws.....	105
Hex Caps.....	105
Washers.....	106
Nuts.....	106

**Bulk Fasteners
Chrome Plated
Stainless and Zinc**

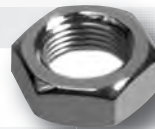
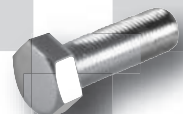



Bulk Chrome Fasteners Metric

Allen Screws Chrome Plated and Polished



For Metric Chrome Allen
with Knurls
use 12xxx



For Polished Chrome Allen
with Knurls Removed
use 10xxx

	4mm/ 0.7	5mm/ 0.8	6mm/ 1.0	8mm/ 1.25	8mm/ 1.0 <small>Fine Thread</small>	10mm/ 1.50 <small>Fine Thread</small>	10mm/ 1.25 <small>Fine Thread</small>	12mm/ 1.75
8		12721	12734					
10	12711	12722	12735	12770				
12	12712	12723	12736	12771				
16	12714	12725	12738	12772				
20	12715	12726	12739	12773	12773F	12794	12816	
25	12716	12727	12740	12774	12774F	12795	12817	12836
27			12740A		12775F			
30	12717	12728	12741	12775	12776F	12796	12818	12837
35		12729	12742	12776	12777F	12797	12819	12838
40		12730	12743	12777	12778F	12798	12820	12839
45		12731	12744	12778	12779F	12799	12821	12840
50		12732	12745	12779		12800	12822	12841
55			12746	12780		12801	12823	12842
60		12733	12747	12781		12802	12824	12843
65			12748	12782		12803	12825	12844
70			12749	12783		12804	12826	12845
75			12750	12784		12805	12827	12846
80			12751	12785		12806	12828	12847
85				12786		12807	12829	12848
90			12753	12787		12808	12830	12849
95			12754					
100			12755	12788		12809	12831	12850
110			12756	12789		12810		
115			12756A					
120			12757	12790		12811		

Key: Read Across For Diameter
Read Down For Length

Call if you do not see
the sizes you need !

Button Head Allen Screws



	4mm/ 0.7	5mm/ 0.8	6mm/ 1.0	8mm/ 1.25	10mm/ 1.50	12mm/ 1.75
6	13709					
8	13710	13721	13734			
10	13711	13722	13735	13770		
12	13712	13723	13736	13771		
16	13714	13725	13738	13772	13793	
20	13715	13726	13739	13773	13794	13835
25	13716	13727	13740	13774	13795	
30		13728	13741	13775	13796	13837
35			13742	13776	13797	13838
40	13719		13743	13777	13798	13839
45				13778	13799	
50				13779	13800	13841
60				13781	13802	13843
70				13783	13804	13845
80				13785	13806	
90				13787	13808	13849
100						13850

Flat Head Allen Screws



	4mm/ 0.7	5mm/ 0.8	6mm/ 1.0	8mm/ 1.25	10mm/ 1.50
6	14709				
8	14710	14721	14734		
10	14711	14722	14735		
12	14712	14723	14736	14771	
16	14714	14725	14738	14772	14793
20	14715	14726	14739	14773	14794
25	14716	14727	14740	14774	14795
30	14717	14728	14741	14775	14796
35	14718	14729	14742	14776	14797
40	14719	14730	14743	14777	14798
45	14720A	17731	17744	14778	14799



**Metric
Bulk Chrome**

Hex Cap Screws Chrome Plated

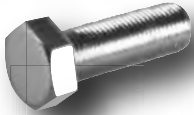

	4mm/ 0.7	5mm/ 0.8	6mm/ 1.0	7mm/ 1.0	8mm/ 1.25	Fine Thread 8mm/ 1.0	10mm/ 1.50	Fine Thread 10mm/ 1.25	Fine Thread 10mm/ 1.00	12mm/ 1.75	Fine Thread 12mm/ 1.50	14mm/ 2.00	Fine Thread 14mm/ 1.50
10	11711	11722	11735	11760	11770	11770F							
16	11712	11725	11738	11762	11772	11772F	11793						
20	11714	11726	11739	11763	11773	11773F	11794	11816	11816F	11835	11856	11873	
25	11715	11727	11740	11764	11774	11774F	11795	11817	11817F	11836	11857	11874	11895
30	11716	11728	11741	11765	11775	11775F	11796	11818	11818F	11837	11858	11875	
35	11717	11729	11742	11766	11776	11776F	11797	11819	11819F	11838	11859	11876	
40		11730	11743	11767	11777	11777F	11798	11820	11820F	11839	11860	11877	
45		11731	11744		11778	11778F	11799	11821	11821F	11840	11861		11899
50		11732	11745	11769	11779	11779F	11800	11822	11822F	11841	11862	11879	
55			11746		11780	11780F	11801	11823	11823F	11842	11863		11901
60			11747		11781	11781F	11802	11824	11824F	11843	11864	11881	
65			11748		11782	11782F	11803	11825	11825F	11844	11865		
70			11749		11783	11783F	11804	11826	11826F	11845	11866	11883	
75			11750		11784	11784F	11805			11846	11867		
80			11751		11785	11785F	11806	11828	11828F	11847	11868	11885	
90			11753		11787	11787F	11808	11830	11830F	11849	11870	11887	
100			11755		11788	11788F	11809	11831	11831F	11850	11871	11888	
110			11756		11789	11789F	11810			11851			
120			11757		11790	11790F	11811			11852			
130										11853		11891	
140					11792	11792F	11813					11892	

12 Point Flange



**Key: Read Across For Diameter
Read Down For Length**

*Call if you do not see
the sizes you need !*

	6mm/ 1.0	8mm/ 1.25	10mm/ 1.50	12mm/ 1.75
16	29738	29772		
20	29739	29773		
25	29740	29774	29795	29836
30	29741	29775	29796	29837
35	29742	29776	29797	29838
40	29743	29777	29798	29839
45	29744	29778	29799	29840
50	29745	29779	29800	29841
55		29780	29801	29842
60		29781	29802	29843
65		29782	29803	
70		29783	29804	
75		29784		
80		29785	29806	
90			29807	29849
100			29808	29850
110				
120				



Demand only the finest Quality Fasteners



Nuts Chrome Plated

Acorn Nuts	
Size	Part #
4mm x .70	21950
5mm x .80	21952
6mm x 1.0	21954
7mm x 1.0	21956
8mm x 1.0	
8mm x 1.25	21958
10mm x 1.25	21961
10mm x 1.50	21962
12mm x 1.25	21963
12mm x 1.50	21965
12mm x 1.75	21966



Hex Nuts	
Size	Part #
4mm x .70	15950
5mm x .80	15952
6mm x 1.0	15954
7mm x 1.0	15956
8mm x 1.0	15957
8mm x 1.25	15958
10mm x 1.25	15961
10mm x 1.50	15962
12mm x 1.25	15963
12mm x 1.50	15965
12mm x 1.75	15966
14mm x 1.50	15967
14mm x 2.00	15968
16mm x 1.50	15969
16mm x 2.00	15970



Jam Nuts	
Size	Part #
8mm x 1.0	16957
8mm x 1.25	16958
10mm x 1.25	16961
10mm x 1.50	16962
12mm x 1.25	16963
12mm x 1.50	16965
12mm x 1.75	16966
14mm x 1.50	16967
14mm x 2.00	16968
16mm x 1.50	16969
16mm x 2.00	16970

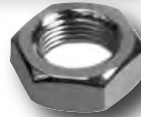

Nylon Insert Lock Nuts	
Size	Part #
4mm x .70	17950
5mm x .80	17952
6mm x 1.0	17954
7mm x 1.0	17956
8mm x 1.0	17957
8mm x 1.25	17958
10mm x 1.25	17961
10mm x 1.50	17962
12mm x 1.25	17963
12mm x 1.50	17965
12mm x 1.75	17966
14mm x 1.50	17967
14mm x 2.00	17968
16mm x 1.50	17969
16mm x 2.00	17970



Flange Nuts

Size	Part #
6mm x 1.0	44954
8mm x 1.25	44958
10mm x 1.50	44962
12mm x 1.75	44966
16mm x 2.0	44970



Flange Lock Nuts

Size	Part #
8mm x 1.25	44958-L
10mm x 1.50	44962-L
12mm x 1.75	44966-L
16mm x 2.0	44970-L



Washers Chrome Plated

Flat Washers	
Size	Part #
4mm	23985
5mm	23986
6mm	23987
7mm	23988
8mm	23989
10mm	23990
12mm	23991
14mm	23992
16mm	23993



Lock Washers	
Size	Part #
4mm	24985
5mm	24986
6mm	24987
7mm	24988
8mm	24989
10mm	24990
12mm	24991
14mm	24992
16mm	24993



Wave Washers	
Size	Part #
8mm	23989W
12mm	24991W



Super Flat Washers

Size	Part #
6mm x 10	23735
6mm x 18	23278A
8mm x 24	23773A

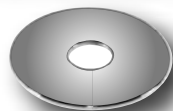

Note: See specification for dimensions
Page 118



**Metric
Bulk Stainless**

Allen Screws Stainless Steel



*73xxx for Stainless Steel
Allens with Knurls or for
Polished add SP-73xxx*

	4mm/ 0.7	5mm/ 0.8	6mm/ 1.0	8mm/ 1.25	10mm/ 1.50	12mm/ 1.75
8		73721	73734			
10	73711	73722	73735	73770		
12	73712	73723	73736	73771		
16	73714	73725	73738	73772		
20	73715	73726	73739	73773	73794	73835
25	73716	73727	73740	73774	73795	73836
30	73717	73728	73741	73775	73796	73837
35		73729	73742	73776	73797	73838
40		73730	73743	73777	73798	73839
45		73731	73744	73778	73799	73840
50		73732	73745	73779	73800	73841
55			73746	73780	73801	73842
60			73747	73781	73802	73843
65			73748	73782	73803	73844
70			73749	73783	73804	73845
75			73750	73784	73805	73846
80			73751	73785	73806	73847
90			73753	73787	73808	73849
100				73788	73809	73850

Button Head Allen Screws



*72xxx for Stainless Steel
Allen Button Heads or for
Polished add SP-72xxx*

	4mm/ 0.7	5mm/ 0.8	6mm/ 1.0	8mm/ 1.25	10mm/ 1.50
8	72710	72721	72734		
10	72711	72722	72735	72770	
12	72712	72723	72736	72771	
16	72714	72725	72738	72772	72793
20		72726	72739	72773	72794
25		72727	72740	72774	72795
30		72728	72741	72775	72796

Flat Head Allen Screws



*71xxx for Stainless Steel
Flat Head Allens or for
Polished add SP-71xxx*

	4mm/ 0.7	5mm/ 0.8	6mm/ 1.0	8mm/ 1.25	10mm/ 1.50
6	71709				
8	71710	71721	71734		
10	71711	71722	71735		
12	71712	71723	71736	71771	
16	71714	71725	71738	71772	71793
20	71715	71726	71739	71773	71794
25	71716	71727	71740	71774	71795
30	71717	71728	71741	71775	71796

Hex Caps Screws

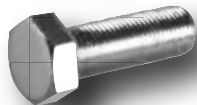

*77xxx for Stainless Steel
Hex Caps or for Polished
add SP-77xxx*

	4mm/ 0.7	5mm/ 0.8	6mm/ 1.0	8mm/ 1.25	10mm/ 1.50	12mm/ 1.75
10	77711	77722	77735	77770		
16	77714	77725	77738	77772	77793	
20	77715	77726	77739	77773	77794	77835
25	77716	77727	77740	77774	77795	77836
30	77717	77728	77741	77775	77796	77837
35		77729	77742	77776	77797	77838
40		77730	77743	77777	77798	77839
45		77731	77744	77778	77799	77840
50		77732	77745	77779	77800	77841
55			77746	77780	77801	77842
60			77747	77781	77802	77843
65			77748	77782	77803	77844
70			77749	77783	77804	77845
75			77750	77784	77805	77846
80			77751	77785	77806	77847
90			77753	77787	77808	77849
100			77755	77788	77809	77850
110			77756	77789	77810	77851

Carriage Bolts



*79xxx for Stainless Steel
Carriage Bolts or for
Polished add SP-79xxx*

	10mm/ 1.50
25	79795
50	79800
60	79802

**Key: Read Across For Diameter
Read Down For Length**

*Call if you do not see
the sizes you need !*



Washers Stainless Steel

Flat Washers

Size	Part #
4mm	75985
5mm	75986
6mm	75987
8mm	75989
10mm	75990
12mm	75991
14mm	75992
16mm	75993



Lock Washers

Size	Part #
4mm	76985
5mm	76986
6mm	76987
8mm	76989
10mm	76990
12mm	76991
14mm	76992
16mm	76993



Wave Washers

Size	Part #
5mm	76986W
6mm	76987W
8mm	76989W
10mm	76990W

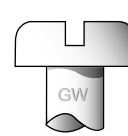

Chart #1: Select Styles

Example: To order a 6 x 10 Oval Phillips Machine Screw: Use **Chart #1** for head style part number which would be "89". Look up diameter and length from **Chart #2** for last three digits 6 x 10 is 735. Put the two together for a part number of **89735**, or simply order by style and size. **Include the Prefix SP-89735 for Stainless Steel Polished**



Cheesehead



Pan



Oval

Nuts Stainless Steel

Hex Nuts

Size	Part #
4mm x .70	70950
5mm x .80	70952
6mm x 1.0	70954
7mm x 1.0	70956
8mm x 1.25	70958
10mm x 1.0	70959
10mm x 1.25	70961
10mm x 1.50	70962
12mm x 1.50	70965
12mm x 1.75	70966



Jam Nuts

Size	Part #
8mm x 1.25	67958
10mm x 1.50	67962
12mm x 1.75	67966

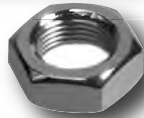

For Stainless Steel Polished order with the Prefix than five digit Part # SP-xxxxx

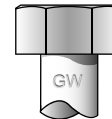

Hex



Flat

Chart #1: Select Styles

Style	Slotted	Phillips
Round Head	99	N/A
Flat Head	98	94
Truss Head	93	N/A
Oval Head	97	89
Pan Head	96	92
Cheesehead	78	N/A
Hex	77	N/A

Nylon Inserts

Size	Part #
4mm x .70	69950
5mm x .80	69952
6mm x 1.0	69954
8mm x 1.25	69958
10mm x 1.50	69962
12mm x 1.75	69966



All Items shown on this page can be purchased individually

Chart #2: Metric Machine Screws

	m3	m4	m5	m6	m8
8mm	701	710	721	734	770
10mm	702	711	722	735	771
12mm	703	712	723	736	772
16mm	705	714	725	738	773
29mm	706	715	726	739	774
25mm	707	716	727	740	775
30mm	708	717	728	741	776
35mm				742	777



Hex Cap Screws Zinc Plated

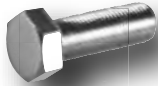

07xxx for Zinc
Hex Caps

	4mm/ 0.7	5mm/ 0.8	6mm/ 1.0	7mm/ 1.0	8mm/ 1.25	10mm/ 1.50	10mm/ 1.25	12mm/ 1.75	12mm/ 1.50
10	07711	07722	07735	07760	07770				
16	07714	07725	07738	07762	07772	07793			
20	07715	07726	07739	07763	07773	07794	07816	07835	07856
25	07716	07727	07740	07764	07774	07795	07817	07836	07857
30	07717	07728	07741	07765	07775	07796	07818	07837	07858
35		07729	07742	07766	07776	07797	07819	07838	07859
40		07730	07743	07767	07777	07798	07820	07839	07860
45		07731	07744		07778	07799	07821	07840	07861
50		07732	07745	07769	07779	07800	07822	07841	07862
55			07746		07780	07801	07823	07842	07863
60			07747		07781	07802	07824	07843	07864
65			07748		07782	07803	07825	07844	07865
70			07749		07783	07804	07826	07845	07866
75			07750		07784	07805		07846	07867
80			07751		07785	07806	07828	07847	07868
90			07753		07787	07808	07830	07849	07870
100			07755		07788	07809	07831	07850	07871
110			07756		07789	07810		07851	07872
120			07757		07790	07811	07833	07852	

Allen Screws Zinc Plated



For Metric Zinc Allen
with Knurls use 08xxx

Key: Read Across For Diameter
Read Down For Length

Call if you do not see
the sizes you need !

	4mm/ 0.7	5mm/ 0.8	6mm/ 1.0	8mm/ 1.25	8mm/ 1.0	10mm/ 1.50	10mm/ 1.25	12mm/ 1.75
8		08721	08734					
10	08711	08722	08735	08770				
12	08712	08723	08736	08771				
16	08714	08725	08738	08772				
20	08715	08726	08739	08773		08794		
25	08716	08727	08740	08774	08774F	08795		08836
27			08740A					
30	08717	08728	08741	08775	08776F	08796	08818	08837
35	08718	08729	08742	08776		08797	08819	08838
40	08719	08730	08743	08777	08778F	08798		08839
45	08720	08731	08744	08778		08799	08821	08840
50	08720A	08732	08745	08779		08800	08822	08841
55			08746	08780		08801		08842
60			08747	08781		08802	08824	08843
65			08748	08782		08803	08825	08844
70			08749	08783		08804		08845
75			08750	08784		08805		08846
80				08785		08806		08847
85							08829	
90						08808	08830	08849
95								
100						08809	08831	
110								
115								
120						08811		



Bulk Zinc Fasteners Metric

Washers Zinc Plated

Flat Washers

Size	Part #
4mm	04985
5mm	04986
6mm	04987
8mm	04989
10mm	04990
12mm	04991
14mm	04992
16mm	04993



Lock Washers

Size	Part #
4mm	05985
5mm	05986
6mm	05987
8mm	05989
10mm	05990
12mm	05991
14mm	05992
16mm	05993



All Items shown on this page can be purchased individually

Zinc Metric Assortments are Available see Pg. 78

Nuts Zinc Plated

Hex Nuts

Size	Part #
4mm x .70	06950
5mm x .80	06952
6mm x 1.0	06954
7mm x 1.0	06956
8mm x 1.0	06957
8mm x 1.25	06958
10mm x 1.25	06961
10mm x 1.50	06962
12mm x 1.25	06963
12mm x 1.50	06965
12mm x 1.75	06966
14mm x 1.50	06967
14mm x 2.00	06968
16mm x 1.50	06969
16mm x 2.00	06970

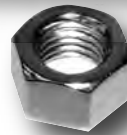

Nylon Insert Lock Nuts

Size	Part #
4mm x .70	03950
5mm x .80	03952
6mm x 1.0	03954
7mm x 1.0	03956
8mm x 1.0	03957
8mm x 1.25	03958
10mm x 1.25	03961
10mm x 1.50	03962
12mm x 1.25	03963
12mm x 1.50	03965
12mm x 1.75	03966
14mm x 1.50	03967
14mm x 2.00	03968
16mm x 1.50	03969
16mm x 2.00	03970

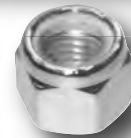



Inside This Section

Electrical

Clamps.....	108
Clutch Removal Washers.....	108
Heat Shrink Tubing.....	108
Electrical Wire.....	108
Wire Assortments.....	108
Nutserts.....	109

**Electrical
and
Nutserts**





Clamps and Ties

Hose Clamps in Stainless Steel

Entire clamp is Stainless Steel including the screw. This product is manufactured in Sweden with rolled up band edges and smooth inside surface of the clamp this spares the hose and insures a high and uniform tightening force. With the flexible screwdriver you can tighten and slacken the clamp from an angle of 90° without slipping.

Size	Min. Dia.	Max. Dia.	Part #
3	5/16	5/8	67014
4	7/16	3/4	67017
6	1/2	7/8	67020
8	5/8	1 1/16	67024
10	3/4	1 3/16	67028
12	7/8	1 7/16	67032
1	1 1/16	1 5/8	67038
20	1 1/4	1 7/8	67044
24	1 1/2	2 1/16	67050
28	1 3/4	2 3/8	67056
32	2	2 11/16	67065
36	2 5/16	3 1/8	67075
44	2 11/16	3 1/2	67085
48	3	3 7/8	67095



Tubing

Fabric Loom

Woven cotton loom with black bituminous coating, sold by the foot.

Inside Diameter	Part #
3/16	62701
1/4	62702
5/16	62703
3/8	62704
7/16	62705
1/2	62706

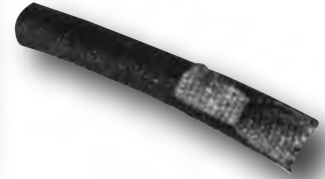

Heat Shrink Tubing Black

Sold by the foot

Inside Diameter	Part #
3/16	62004
1/4	62005
3/8	62007
1/2	62010

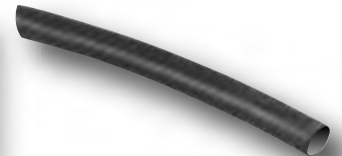

Line Clamps in Stainless Steel

*14 x 3/4 Drill Point Sheet Metal Screw, Stainless Steel

Size	Part #
*14 x 3/4	67002
3/16	67003
1/4	67004
5/16	67005
3/8	67006



Electrical Wire

Offering all 12 Harley solid colors with copper stranded thermal plastic insulated wire. Highly resistant to grease, oil and acids. Individual wire in 100 foot spools.

Color	18 Gauge #	16 Gauge #	14 Gauge #
Black	6218	6216	6214
Red	-----	6216	6214
Brown	6218	6216	6214
Blue	6218	6216	6214
Grey	6218	6216	-----
Green	6218	6216	-----
Orange	6218	6216	-----
Pink	6218	6216	-----
Purple	6218	6216	-----
Tan	6218	6216	-----
White	6218	6216	-----
Yellow	6218	6216	6214



Clutch Removal Washers

Clutch Removal Washers for Big Twins thru 1984 zinc plated sold each.

Description	Part #
Clutch Removal Washer	23593

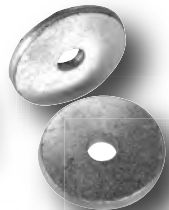

Electrical Wire Assortments

Assortment # 62-W

Includes 8 different colors and metal spool rack: 14 gauge black, 16 gauge red and white, 18 gauge blue, green, orange, yellow and tan.

Assortment # 63-W

Includes all 12 Harley colors and metal spool rack.



Nutserts

The Benefits of Using **AT SERIES NUTSERTS**®.

- **NON-GRIP** sensitive one length fits "ANY" thickness over .030
- **BLIND** installs from one side of the work.
- **WILL NOT TORQUE LOOSE** properly install and properly used at **SERIES NUTSERTS** will normally break high strength before torquing loose.

STRONG, PERMANENT STEEL THREADS IN BLIND, BURIED & THROUGH HOLES.



- Use in almost any material Steel, Aluminum, Fiberglass, Cast Iron, Magnesium and Plastics.
- Vibration proof.
- Nearly flush only .015 protrusion. Installation will not mar the parent material.

Electrical and Nutserts

EASILY INSTALLED INTO APPLICATIONS

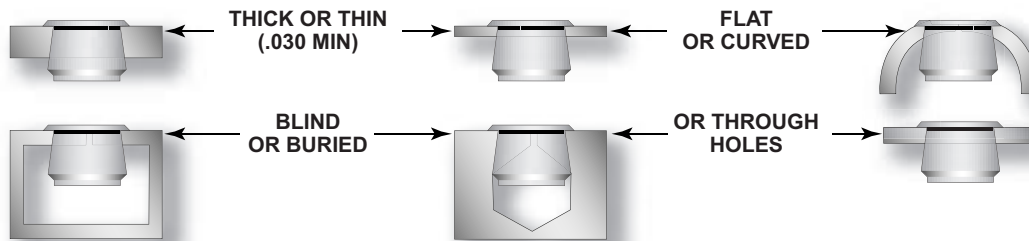

HERE'S HOW THE AT SERIES NUTSERT® WORKS

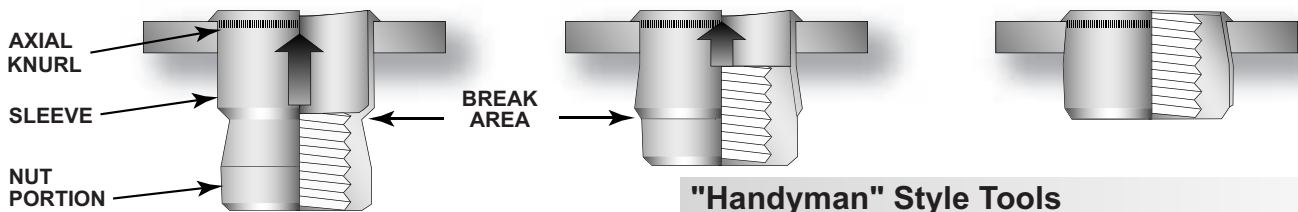

AT Series Nutserts® are of a one piece design consisting of a nut portion and a sleeve portion. The **AT Series Nutsert**® is threaded onto the placing tool's mandrel and inserted into a drilled hole.

The rotating tool mandrel exerts a pulling action which "breaks" the nut portion from the sleeve, drawing it into the sleeve...notice the sleeve beginning to expand. The nut portion fully expands the sleeve, which exerts a full 360° swag fit against the side of the hole. You now have a permanent load bearing steel captive nut ready for trouble free use.

Handyman Style Assortment with Tools

American Part #N312D		Metric Part #N312F	
Quantity	Size	Quantity	Size
15 pcs.	10/32	15 pcs.	5mm
15 pcs.	1/4-20	15 pcs.	6mm
8 pcs.	5/16-18	8 pcs.	8mm
8 pcs.	3/8-16	8 pcs.	10mm



"Handyman" Style Tools

For the one time or occasional user, the **Hi-Torquer**® Handyman style tool offers an inexpensive alternative to the professional style tool system. For proper **AT Series Nutsert**® installation, the Handyman tool requires the use of a wrench or vise grips to hold the body and a socket wrench to torque the placing screw.

Size	Part #	Size	Part #
4/40	N9536	3/8-16	N9550
6/32	N9538	3/8-24	N9551
8/32	N9540	3mm	N9949
10/24	N9542	4mm	N9950
10/32	N9543	5mm	N9952
1/4-20	N9546	6mm	N9954
1/4-28	N9547	8mm	N9958
5/16-18	N9548	10mm	N9962
5/16-24	N9549		

For Sizes # 4,6,8 & 10-24
Socket Head Screw
& Hex Wrench

For Sizes # 10-32, 1/4",
5/16" & 3/8"
Hex Head Screw

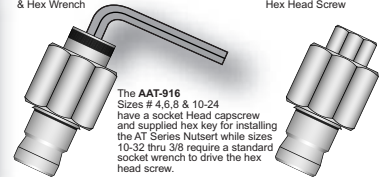

The **AAAT-916** Sizes # 4,6,8 & 10-24 have a socket head capscrew and supplied hex key for installing the AT Series Nutsert while sizes 10-32 thru 3/8 require a standard socket wrench to drive the hex head screw.

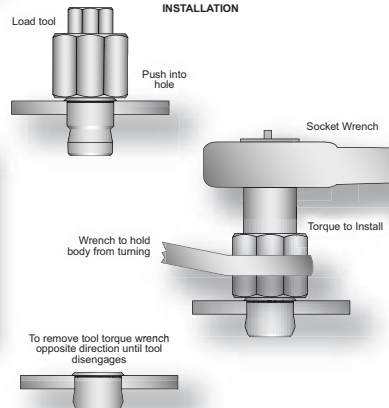

Nutserts

Size	Part #	Size	Part #
4/40	N4536	3/8-16	N4550
6/32	N4538	3/8-24	N4551
8/32	N4540	3mm x .5	N4949
10/24	N4542	4mm x .7	N4950
10/32	N4543	5mm x .8	N4952
1/4-20	N4546	6mm x 1.0	N4954
1/4-28	N4547	8mm x 1.25	N4958
5/16-18	N4548	10mm x 1.5	N4962
5/16-24	N4549		



AUTOMOTIVE CATALOG



Gardner-Westcott also carries a complete line of fasteners for the Auto Enthusiast we have the largest selection in the Industry of Engine Dress Up Kits and Individual Sets Call for a FREE Catalog Today!

What better way to make a statement!

Gardner-Westcott Company is now offering a new and different look for engine dress up bolts, the emblem is stamped directly onto the head of the bolts. They are available in decorative Polished Chrome Plated or Stainless Steel versions, in all the sizes needed to give your project that special look.

 Official Licensed Product Ford Oval Stamped Hex Caps	Chrome Plated Polished Stainless Steel  Bow Tie Stamped Hex Caps	Custom Stampings Available Pontiac Stamped Hex Caps	 OFFICIAL LICENSED PRODUCT <small>MOPAR, JEEP, DODGE, HEAVY, PLYMOUTH, RAM, SRT, CHRYSLER and related names, vehicle model names and other marks are trademarks of Chrysler Group LLC and used under license by licensed users. ©2004 Chrysler Group LLC.</small> Mopar Stamped Hex Caps
V8 Stamped Hex Caps	SS Stamped Hex Caps	GTO Stamped Hex Caps	Chrysler Stamped Hex Caps
Mustang Stamped Hex Caps	RS Stamped Hex Caps	GT Stamped Hex Caps	Dodge Ram Stamped Hex Caps
Flames Stamped Hex Caps	350 Stamped Hex Caps	454 Stamped Hex Caps	Skulls Stamped Hex Caps



Inside This Section

Fittings

<i>Pipe Fittings</i>	112
<i>Inverted Flare Fittings</i>	113
<i>Compression Fittings</i>	114
<i>Special Fittings</i>	115
<i>Vacuum Connectors</i>	116
<i>Standard Thread Identification</i>	117
<i>Specifications and Sizes</i>	118
<i>Conversion & Reference Charts</i>	119
<i>Style Chart</i>	120

**Chrome and Brass
Fittings**





Chrome and Brass Fittings

Pipe Fittings

Straight Hose Barb Male Pipe

Hose Size	Pipe Size	Brass Part #	Chrome Part #
3/8	1/8	90TD-6 x 2	7-90TD-6 x 2
1/4	1/8	90TD-4 x 2	7-90TD-4 x 2
3/8	1/4	90TD-6 x 4	7-90TD-6 x 4
1/2	1/4	90HB-8 x 4	7-90TD-8 x 4



Straight Hose Barb Male Pipe

Hose Size	Pipe Size	Brass Part #	Chrome Part #
3/16	1/8	90HB-3 x 2	7-90HB-3 x 2
1/4	1/8	90HB-4 x 2	7-90HB-4 x 2
1/4	1/4	90HB-4 x 4	7-90HB-4 x 4
5/16	1/8	90HB-5 x 2	7-90HB-5 x 2
5/16	1/4	90HB-5 x 4	7-90HB-5 x 4
3/8	1/8	90HB-6 x 2	7-90HB-6 x 2
3/8	1/4	90HB-6 x 4	7-90HB-6 x 4



90° Hose Barb Male Pipe

Hose Size	Pipe Size	Brass Part #	Chrome Part #
1/4	1/8	91HB-4 x 2	7-91HB-4 x 2
1/4	1/4	91HB-4 x 4	7-91HB-4 x 4
5/16	1/8	91HB-5 x 2	7-91HB-5 x 2
5/16	1/4	91HB-5 x 4	7-91HB-5 x 4
3/8	1/8	91HB-6 x 2	7-91HB-6 x 2
3/8	1/4	91HB-6 x 4	7-91HB-6 x 4
3/8	3/8	91HB-6 x 6	7-91HB-6 x 6



Street Elbows

Pipe Size	Brass Part #	Chrome Part #
1/8	116PSE-2	7-116PSE-2
1/4	116PSE-4	7-116PSE-4
3/8	116PSE-6	7-116PSE-6



Street Elbows 45°

Pipe Size	Brass Part #	Chrome Part #
1/8	124PSE-2	7-124PSE-2
1/4	124PSE-4	7-124PSE-4
3/8	124PSE-6	7-124PSE-6



Socket Pipe Plug

Pipe Size	Brass Part #	Chrome Part #
1/8	107CSP-2	7-107CSP-2
1/4	107CSP-4	7-107CSP-4
3/8	107CSP-6	7-107CSP-6



Slotted Pipe Plug

Pipe Size	Brass Part #	Chrome Part #
1/8	117SPP-2	7-117SPP-2
1/4	117SPP-4	7-117SPP-4
3/8	117SPP-6	7-117SPP-6



Hex Head Pipe Plug

Pipe Size	Brass Part #	Chrome Part #
1/8	121PP-2	7-121PP-2
1/4	121PP-4	7-121PP-4
3/8	121PP-6	7-121PP-6
1/2	121PP-8	7-121PP-8

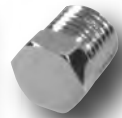

Square Head Pipe Plug

Pipe Size	Brass Part #	Chrome Part #
1/8	109PP-2	7-109PP-2
1/4	109PP-4	7-109PP-4
3/8	109PP-6	7-109PP-6
1/2	109PP-8	7-109PP-8

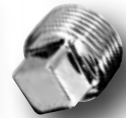

Close Nipple

Pipe Size	Brass Part #	Chrome Part #
1/8	112PCN-2	7-112PCN-2
1/4	112PCN-4	7-112PCN-4
3/8	112PCN-6	7-112PCN-6



Long Nipple

Pipe Size	Brass Part #	Chrome Part #
1/8 x 1 1/2	113PLN-2 x 1.5	7-113PLN-2 x 1.5
1/8 x 2	113PLN-2 x 2	7-113PLN-2 x 2
1/8 x 2 1/2	113PLN-2 x 2.5	7-113PLN-2 x 2.5
1/8 x 3	113PLN-2 x 3	7-113PLN-2 x 3
1/4 x 1 1/2	113PLN-4 x 1.5	7-113PLN-4 x 1.5
1/4 x 2	113PLN-4 x 2	7-113PLN-4 x 2
1/4 x 2 1/2	113PLN-4 x 2.5	7-113PLN-4 x 2.5
1/4 x 3	113PLN-4 x 3	7-113PLN-4 x 3
3/8 x 1 1/2	113PLN-6 x 1.5	7-113PLN-6 x 1.5
3/8 x 2	113PLN-6 x 2	7-113PLN-6 x 2



Hex Nipple

Pipe Size	Brass Part #	Chrome Part #
1/8	122PHN-2	7-122PHN-2
1/4	122PHN-4	7-122PHN-4
3/8	122PHN-6	7-122PHN-6





Hex Reducing Nipple

Pipe Size	Brass Part #	Chrome Part #
1/4 x 1/8	123PRN-4 x 2	7-123PRN-4 x 2
3/8 x 1/4	123PRN-6 x 4	7-123PRN-6 x 4



Adapter

Pipe Size	Brass Part #	Chrome Part #
1/8 x 1/8	120PA-2 x 2	7-120PA-2 x 2
1/4 x 1/8	120PA-4 x 2	7-120PA-4 x 2
1/4 x 1/4	120PA-4 x 4	7-120PA-4 x 4
3/8 x 1/4	120PA-6 x 4	7-120PA-6 x 4



Pipe Bushing

Pipe Size	Brass Part #	Chrome Part #
1/4 x 1/8	110PB-4 x 2	7-110PB-4 x 2
3/8 x 1/8	110PB-6 x 2	7-110PB-6 x 2
3/8 x 1/4	110PB-6 x 4	7-110PB-6 x 4
1/2 x 1/4	110PB-8 x 4	7-110PB-8 x 4
1/2 x 3/8	110PB-8 x 6	7-110PB-8 x 6



Pipe Thread Lock Nut

Pipe Size	Brass Part #	Chrome Part #
1/8	111PLN-2	7-111PLN-2
1/4	111PLN-4	7-111PLN-4
3/8	111PLN-6	7-111PLN-6



Pipe Tee

Pipe Size	Brass Part #	Chrome Part #
1/8	101PT-2	7-101PT-2
1/4	101PT-4	7-101PT-4
3/8	101PT-6	7-101PT-6



Pipe Street Tee

Pipe Size	Brass Part #	Chrome Part #
1/8	127PT-2	7-127PT-2
1/4	127PT-4	7-127PT-4
3/8	127PT-6	7-127PT-6



90° Heater Hose Barb

Hose Size	Pipe Size	Brass Part #	Chrome Part #
5/8	3/8	69HHB-10 x 6	7-69HHB-10 x 6
5/8	1/2	69HHB-10 x 8	7-69HHB-10 x 8
3/4	1/2	69HHB-12 x 8	7-69HHB-12 x 8
3/8	3/8	69HHB-6 x 6	7-69HHB-6 x 6
1/2	3/8	69HHB-8 x 6	7-69HHB-8 x 6



Inverted Flare Fittings

Brass Inverted Flare Tube Nut

O.D. Tube	Brass Part #	Chrome Part #
3/16	41INB-3	7-41INB-3
1/4	41INB-4	7-41INB-4
5/16	41INB-5	7-41INB-5
3/8	41INB-6	7-41INB-6



Fittings

Steel Inverted Flare Long Tube Nut

O.D. Tube	Brass Part #	Chrome Part #
3/16	41INL-3	7-41INL-3
1/4	41INL-4	7-41INL-4



Inverted Flare Male Connectors

O.D. Tube	O.D. Pipe	Brass Part #	Chrome Part #
3/16	1/8	48IC-3 x 2	7-48IC-3 x 2
1/4	1/8	48IC-4 x 2	7-48IC-4 x 2
5/16	1/8	48IC-5 x 2	7-48IC-5 x 2
5/16	1/4	48IC-5 x 4	7-48IC-5 x 4
3/8	1/8	48IC-6 x 2	7-48IC-6 x 2
3/8	1/4	48IC-6 x 4	7-48IC-6 x 4



Inverted Flare Male Elbow

O.D. Tube	O.D. Pipe	Brass Part #	Chrome Part #
3/16	1/8	49IE-3 x 2	7-49IE-3 x 2
1/4	1/8	49IE-4 x 2	7-49IE-4 x 2
5/16	1/8	49IE-5 x 2	7-49IE-5 x 2
5/16	1/4	49IE-5 x 4	7-49IE-5 x 4
3/8	1/8	49IE-6 x 2	7-49IE-6 x 2
3/8	1/4	49IE-6 x 4	7-49IE-6 x 4



Inverted Male Rigid Hose Barb

Hose Size	O.D. Tube	Brass Part #	Chrome Part #
1/4	1/4	93HB-4 x 4	7-93HB-4 x 4
1/4	5/16	93HB-4 x 5	7-93HB-4 x 5
5/16	1/4	93HB-5 x 4	7-93HB-5 x 4
5/16	5/16	93HB-5 x 5	7-93HB-5 x 5
5/16	3/8	93HB-5 x 6	7-93HB-5 x 6
3/8	5/16	93HB-6 x 5	7-93HB-6 x 5



Inverted Flare Reducing Nut

O.D. Tube	Inv. Nut	Brass Part #	Chrome Part #
3/16	1/4	41INR-3 x 4	7-41INR-3 x 4
3/16	5/16	41INR-3 x 5	7-41INR-3 x 5
3/16	9/16	41INR-3 x (918)	7-41INR-3 x (918)
1/4	9/16	41INR-4 x (918)	7-41INR-4 x (918)





Chrome and Brass Fittings

Inverted Flare Steel Plug

O.D. Tube	Brass Part #	Chrome Part #
3/16	W131-3	7-W131-3
1/4	W131-4	7-W131-4
5/16	W131-5	7-W131-5
3/8	W131-6	7-W131-6



Inverted Flare Union Tee

O.D. Tube	Brass Part #	Chrome Part #
3/16	W702-3	7-W702-3
1/4	W702-4	7-W702-4
5/16	W702-5	7-W702-5

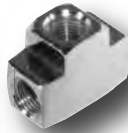

Inverted Flare Brake Line Union

O.D. Tube	Brass Part #	Chrome Part #
3/16	42IU-3	7-42IU-3
1/4	42IU-4	7-42IU-4
5/16	42IU-5	7-42IU-5
3/8	42IU-6	7-42IU-6



Brake Line Tee Mount Inverted Flare

O.D. Tube	Brass Part #	Chrome Part #
3/16	W7812	7-W7812
1/4	W7765	7-W7765

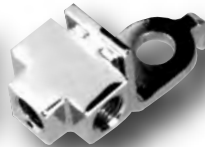

Metric Brake Line Adapter

Inverted Female x Male Thread	Brass Part #	Chrome Part #
3/16 std 10mm x 1.0	202M-10	7-202M-10
10mm x 1.0 x 11mm x 1.5	202M-11	7-202M-11
10mm x 1.0 x 12mm x 1.0	202M-12	7-202M-12
10mm x 1.0 x 13mm x 1.5	202M-13	7-202M-13

Inverted Female x Male Bubble Flare	Brass Part #	Chrome Part #
3/16 std x 3/16 std	200B-3	7-200B-3
3/16 std 10mm x 1.0	200MB-3	7-200MB-3

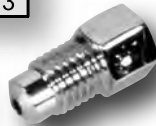

Inverted Flare Male Branch Tee

Size	Brass Part #	Chrome Part #
3/16	W600-3 x 2	7-W600-3 x 2
1/4	W600-4 x 2	7-W600-4 x 2
5/16	W600-5 x 2	7-W600-5 x 2
3/8	W600-6 x 4	7-W600-6 x 4



Compression Fittings Brass

Compression Sleeve

O.D. Tube	Part #
1/8	6460CS-2
3/16	6460CS-3
1/4	6460CS-4
5/16	6460CS-5
3/8	6460CS-6

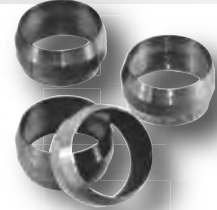

Compression Nut

O.D. Tube	Brass Part #	Chrome Part #
1/8	61CN-2	7-61CN-2
3/16	61CN-3	7-61CN-3
1/4	61CN-4	7-61CN-4
5/16	61CN-5	7-61CN-5
3/8	61CN-6	7-61CN-6



Compression Tube Inserts

O.D. Tube	Part #
1/8	60TI-2
3/16	60TI-3
1/4	60TI-4
5/16	60TI-5
3/8	60TI-6



Compression Full Union

O.D. Tube	Brass Part #	Chrome Part #
1/8	62CU-2	7-62CU-2
3/16	62CU-3	7-62CU-3
1/4	62CU-4	7-62CU-4
5/16	62CU-5	7-62CU-5
3/8	62CU-6	7-62CU-6



Compression 3 Way Tee

O.D. Tube	Brass Part #	Chrome Part #
1/8	64CT-2	7-64CT-2
3/16	64CT-3	7-64CT-3
1/4	64CT-4	7-64CT-4
5/16	64CT-5	7-64CT-5
3/8	64CT-6	7-64CT-6





Compression Male Connector

O.D. Tube	Brass Part #	Chrome Part #
1/8 x 1/8	68CC-2 x 2	7-68CC-2 x 2
3/16 x 1/8	68CC-3 x 2	7-68CC-3 x 2
1/4 x 1/8	68CC-4 x 2	7-68CC-4 x 2
1/4 x 1/4	68CC-4 x 4	7-68CC-4 x 4
5/16 x 1/8	68CC-5 x 2	7-68CC-5 x 2
5/16 x 1/4	68CC-5 x 4	7-68CC-5 x 4
3/8 x 1/8	68CC-6 x 2	7-68CC-6 x 2
3/8 x 1/4	68CC-6 x 4	7-68CC-6 x 4
3/8 x 3/8	68CC-6 x 6	7-68CC-6 x 6
1/2 x 1/4	68CC-8 x 4	7-68CC-8 x 4



Hose Tee

Hose	Brass Part #	Chrome Part #
1/4	94HBT-4	7-94HBT-4
5/16	94HBT-5	7-94HBT-5
3/8	94HBT-6	7-94HBT-6



Compression Male Elbow

O.D. Tube	Brass Part #	Chrome Part #
1/8 x 1/8	69CE-2 x 2	7-69CE-2 x 2
3/16 x 1/8	69CE-3 x 2	7-69CE-3 x 2
1/4 x 1/8	69CE-4 x 2	7-69CE-4 x 2
1/4 x 1/4	69CE-4 x 4	7-69CE-4 x 4
5/16 x 1/8	69CE-5 x 2	7-69CE-5 x 2
5/16 x 1/4	69CE-5 x 4	7-69CE-5 x 4
3/8 x 1/8	69CE-6 x 2	7-69CE-6 x 2
3/8 x 1/4	69CE-6 x 4	7-69CE-6 x 4
3/8 x 3/8	69CE-6 x 6	7-69CE-6 x 6



Transmission Adapter

Inv. Flare Str. Pipe	Brass Part #	Chrome Part #
5/16 x 1/8	22CF-5 x 2	7-22CF-5 x 2



Special Fittings

Dual Brake Reducing Adapter

Hose/Hose	Brass Part #	Chrome Part #
3/16 x 1/4	203-3 x 4	7-203-3 x 4
3/16 x 5/16	203-3 x 5	7-203-3 x 5
1/4 x 3/16	203-4 x 3	7-203-4 x 3
1/4 x 5/16	203-4 x 5	7-203-4 x 5
5/16 x 1/4	203-5 x 4	7-203-5 x 4
5/16 x 3/8	203-5 x 6	7-203-5 x 6
3/8 x 5/16	203-6 x 5	7-203-6 x 5
1/4 x 1/4 (9/16-18)	203-7908	7-203-7908
3/16 x 3/16 (9/16-20)	203-7910	7-203-7910
3/16 x 3/16 (9/16-18)	203-7911	7-203-7911
3/16 (9/16-18) x 5/16	203-7912	7-203-7912
3/16 (1/2-20) x 3/16 (9/16-18)	203-7913	7-203-7913
5/16 x 5/16 w/seal	203F-1074	7-203F-1074
1/4 x 5/16 w/seal	203F-7727	7-203F-7727
1/4 x 7/16-20 w/seal	203F-7732	7-203F-7732
3/16 x 5/16 w/seal	203F-7817	7-203F-7817

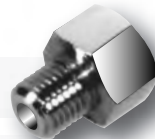

Metric Brake Union

Thread/Flare	Brass Part #	Chrome Part #
3/16 Std/Bubble 3	300B-3	7-300B-3
10mm x 1.0 Standard	300M-3	7-300M-3
10mm x 1.0 Bubble 2	300MB-3	7-300MB-3



Hose Splicer

Hose/Hose	Brass Part #	Chrome Part #
3/16 x 3/16	92HB-3 x 3	7-92HB-3 x 3
1/4 x 1/4	92HB-4 x 4	7-92HB-4 x 4
5/16 x 5/16	92HB-5 x 5	7-92HB-5 x 5
3/8 x 3/8	92HB-6 x 6	7-92HB-6 x 6





Chrome and Brass Fittings

Drain Cocks

Size	Brass #	Chrome #
1/4	326DC-4	7-326DC-4



Brake Bleeder Screws Chrome

Size	Part #
3/8-24 x 1 1/2	45-9400
3/8-24 x 1 1/8	45-9402
5/16-24 x 1	45-9403
1/4-28 x 1	45-9404
8mm x 1.25 x 23.8	45-9405
10mm x 1.5 x 27.5	45-9406



Grease Fittings

Size	Part #
1/4-28 45° (Chrome)	57546
1/4-28 Straight	57547
1/4-28 Straight-Long	57547-L
1/4-28 90°	57548
1/8 45°	57549
1/8 Straight	57550
1/8 90°	57551
1/4-28 90° (Stainless)	88546
1/4-28 Straight	88547
1/8 Straight	88610
1/8 90°	88613
1/8 45°	88688



Vacuum Connectors

Vacuum Hose Splicer Plastic

Hose/Hose	Part #
1/8 x 1/8	62NU-2
3/16 x 3/16	62NU-3
1/4 x 1/4	62NU-4
5/16 x 5/16	62NU-5
3/8 x 3/8	62NU-6
3/16 x 1/8	62NUR-3 x 2
3/16 x 1/4	62NUR-3 x 4
1/4 x 1/8	62NUR-4 x 2
1/4 x 3/8	62NUR-4 x 6



Vacuum Hose Elbow Plastic

Hose/Hose	Part #
3/16 x 3/16	64NE-3
3/16 x 1/8	64NE-3 x 2
3/16 x 1/4	64NE-3 x 4
1/4 x 1/4	64NE-4



Vacuum Hose Tee Plastic

Hose/Hose	Part #
1/8	64NT-2
3/32	64NT-2.5
1/8 x 3/16 x 1/8	64NT-2 x 3 x 2
3/16	64NT-3
3/16 x 1/8 x 3/16	64NT-3 x 2 x 3
3/16 x 3/16 x 1/8	64NT-3 x 3 x 2
3/16 x 1/4 x 3/16	64NT-3 x 4 x 3
1/4	64NT-4
1/4 x 1/4 x 3/16	64NT-4 x 4 x 3
5/16	64NT-5
3/8	64NT-6
3/8 x 3/8 x 1/4	64NT-6 x 6 x 4



Steel Brake Line Coil

Size	Part #
3/16	64542
1/4	64546
5/16	64548
3/8	64550



Vacuum Rubber Caps

I.D.Hose	Part #
1/8	64CAP-2
5/32	64CAP-2.5
3/16	64CAP-3
1/4	64CAP-4
5/16	64CAP-5
3/8	64CAP-6





American Thread

Size	Decimal Equivalent	Threads Per Inch		Allen Screw		Button Heads		Flat Heads	
		Coarse & Fine		Key Size	Maximum Head O.D.	Key Size	Maximum Head O.D.	Key Size	Maximum Head O.D.
#4	.112	40	40	0/02	.100	1/16	.212	1/16	.255
#5	.125	40	44	3/32	.205	5/64	.238	5/64	.281
#6	.138	32	40	7/64	.226	5/64	.262	5/64	.307
#8	.164	32	36	9/64	.270	3/32	.312	3/32	.359
#10 (3/16)	.190	24	32	5/32	.312	1/8	.361	1/8	.411
1/4	.250	20	28	3/16	.375	5/32	.437	5/32	.531
5/16	.3125	18	24	1/4	.469	3/16	.547	3/16	.656
3/8	.375	16	24	5/16	.562	7/32	.656	7/32	.781
7/16	.4375	14	20	3/8	.656	---	---	1/4	.844
1/2	.500	13	20	3/8	.750	5/16	.875	5/16	.938
5/8	.625	11	18	1/2	.938	3/8	1.00	3/8	1.188
3/4	.750	10	16	5/8	1.125	---	---	---	---

Metric Thread

Size	Threads Per Inch		Allen Screw		Button Heads		Flat Heads	
	Coarse & Fine		Key Size	Maximum Head O.D.	Key Size	Maximum Head O.D.	Key Size	Maximum Head O.D.
3mm	0.5	---	2.5mm	5.5mm	2mm	5.70mm	2mm	6.40mm
4mm	0.7	---	3mm	7.0mm	2.5mm	7.60mm	2.5mm	8.60mm
5mm	0.8	---	4mm	8.5mm	3mm	9.50mm	3mm	10.60mm
6mm	1.0	---	5mm	10.00mm	4mm	10.50mm	4mm	12.60mm
8mm	1.25	1.00	6mm	13.00mm	5mm	14.00mm	5mm	16.80mm
10mm	1.50	1.25	8mm	16.00mm	6mm	17.50mm	6mm	21.00mm
12mm	1.75	1.50	10mm	18.00mm	8mm	21.00mm	8mm	25.00mm

Washer Specifications

Size	Flat Washers			AN Washers			GW Washers		
	O.D.	I.D.	Thickness	O.D.	I.D.	Thickness	O.D.	I.D.	Thickness
#6	3/8	5/32	3/64	---	---	---	---	---	---
#8	7/16	3/16	3/64	---	---	---	---	---	---
#10	1/2	7/32	3/64	.437	.203	1/32	---	---	---
#12	9/16	1/4	1/16	---	---	---	---	---	---
1/4	5/8	9/32	1/16	.500	.265	1/16	5/8	.260	.08
5/16	11/16	11/32	1/16	.562	.328	1/16	11/16	.323	.09
3/8	13/16	13/32	1/16	.625	.390	1/16	13/16	.385	.09
7/16	59/64	15/32	1/16	.750	.453	1/16	59/64	.448	.10
1/2	1-1/16	17/32	3/32	.875	.516	1/16	1-1/16	.510	.11
9/16	1-3/16	19/32	3/32	1.062	.578	1/16	---	---	---
5/8	1-5/16	21/32	3/32	1.187	.641	1/16	1-5/16	.635	.12
3/4	1-1/2	13/16	9/64	---	---	---	---	---	---

Wrench Sizes (Width across flats) - Hex Bolts

American		Metric	
Wrench Size	Bolt Diameter	Wrench Size	Bolt Diameter
7/16	1/4	5.5mm	3mm
1/2	5/16	7mm	4mm
9/16	3/8	8mm	5mm
5/8	7/16	10mm	6mm
3/4	1/2	11mm	7mm
13/16	9/16	13mm	8mm
15/16	5/8	17mm	10mm
1 1/8	3/4	19mm	12mm

Torx Size and Bit Sizes

Torx Size	Bit Size
6/32	T-10
8/32	T-15
10/24	T-25
10/32	T-25
1/4	T-27
5/16	T-40
3/8	T-45
1/2	T-55
5/8	T-60

Tensile Strengths of Material Requirements

Material	LBS.
Stainless Steel	85,000
Grade 2	85,000
Grade 5	120,000
Grade 8	150,000

Metric Flat Washer Specifications

Size	Flat Washers		
	O.D.	I.D.	Thickness
4mm	9	4.3	0.8
5mm	10	5.3	1
6mm	12	6.4	11.6
7mm	14	7.4	1.6
8mm	16	8.4	1.6
10mm	20	10.5	2
12mm	24	13	2.5
14mm	28	15	2.5
16mm	30	17	3
18mm	34	19	3



American Equivalents

Fraction	Decimal	Millimeter
1/64	.0156	0.397
1/32	.0312	0.794
3/64	.0468	1.191
1/16	.0625	1.588
5/64	.0781	1.984
3/32	.0937	2.381
7/64	.1093	2.778
1/8	.1250	3.175
9/64	.1406	3.572
5/32	.1562	3.969
11/64	.1718	4.366
3/16	.1875	4.763
13/64	.2031	5.159
7/32	.2187	5.556
15/64	.2343	5.953
1/4	.2500	6.350
17/64	.2656	6.747
9/32	.2812	7.144
19/64	.2968	7.541
5/16	.3125	7.938
21/64	.3281	8.334
11/32	.34375	8.731
23/64	.3593	9.128
3/8	.3750	9.525
25/64	.3906	9.922
13/32	.4062	10.319
27/64	.4218	10.716
7/16	.4375	11.113
29/64	.4531	11.509
15/32	.4687	11.906
31/64	.4843	12.303
1/2	.5000	12.700
33/64	.5156	13.097
17/32	.5312	13.494
35/64	.5468	13.891
9/16	.5625	14.288
37/64	.5781	14.684
19/32	.5937	15.081
39/64	.6093	15.478
5/8	.6250	15.875
41/64	.6406	16.272
21/32	.6562	16.669
43/64	.6718	17.066
11/16	.6875	17.463
45/64	.7031	17.859
23/32	.7187	18.256
47/64	.7343	18.653
3/4	.7500	19.050
49/64	.7656	19.447
25/32	.7812	19.844
51/64	.7968	20.241
13/16	.8125	20.638
53/64	.8281	21.034
27/32	.8437	21.431
55/64	.8593	21.828
7/8	.8750	22.225
57/64	.8906	22.622
29/32	.9062	23.019
59/64	.9218	23.416
15/16	.9275	23.813
61/64	.9531	24.209
31/32	.9687	24.606
63/64	.9843	25.003
1"	1.0000	25.400

Metric Conversion Chart

Inches	Millimeters
1/4	6mm
5/16	8mm
3/8	10mm
1/2	12mm
5/8	16mm
3/4	20mm
1	25mm
1-3/16	30mm
1-3/8	35mm
1-9/16	40mm
1-3/4	45mm
2	50mm
2-3/16	55mm
2-3/8	60mm
2-9/16	65mm
2-3/4	70mm
3	75mm
3-3/16	80mm
3-3/8	85mm
3-1/2	90mm
4	100mm
4-3/8	110mm
4-3/4	120mm

Technical
Info

Threads Per Inch American

Coarse	Fine
10/24	10/32
1/4-20	1/4-28
5/16-18	5/16-24
3/8-16	3/8-24
7/16-14	7/16-20
1/2-13	1/2-20
9/16-12	9/16-18
5/8-11	5/8-18
3/4-10	3/4-16

Threads Pitches Metric

Diameter	Pitch
6mm	1.0
8mm	1.25
8mm Fine	1.0
10mm	1.50
10mm Fine	1.25
12mm	1.75
12mm Fine	1.50
14mm	2.0
14mm Fine	1.50



Style Chart and Measuring

Styles in Chrome



H= Hex Caps
Chrome Plated



S= Allen Screws
Chrome Plated



B= Button Head
Chrome Plated



N= 12 Point
Chrome Plated



P= Allen Screws
Polished Chrome Plated

Styles in Stainless Steel



HS= Hex Bolts
Stainless Steel



SS= Allen Screws
Stainless Steel



SB= Button Head
Stainless Steel



HSP= Hex Bolts
Stainless Steel
Polished



SSP= Allen Screws
Stainless Steel
Polished

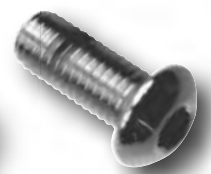

SBP= Button Head
Stainless Steel
Polished



Round



Flat



Truss



Oval



Pan



Fillister



Hex

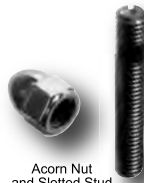

Acorn Nut
and Slotted Stud
Kits

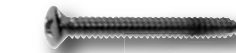

Sheet Metal
Screw



Wood Screw



Machine Screw

How to Measure

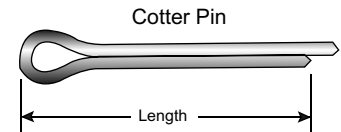
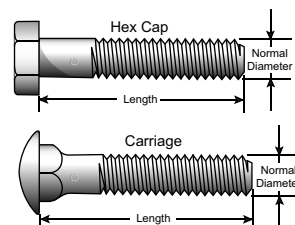
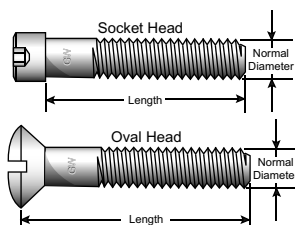
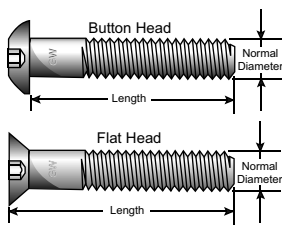

Actual Shank Sizes

To Determine Sizes
of Screws. Lay screw
flat within parallel
lines shown in border

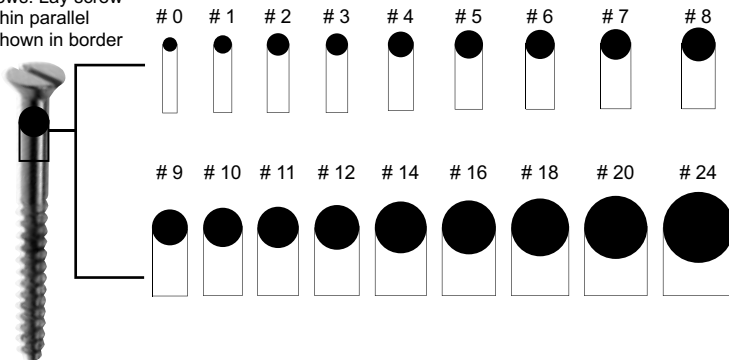

Bolt Gage

Combined American and Metric gage to measure bolts, nuts and screws is an every day necessity to the dealer. These gages are available and can be ordered by **Part # gage**

