

TECHNICAL ENGINEERING

In small sprocket	25	50	100	150	200	250	300
6	0.30						
7	0.38	0.66	0.88	1.06			
8							
9	0.52	0.94	1.31	1.63	1.91	2.16	2.33
10	0.59	1.08	1.51	1.90	2.24	2.55	2.83
11	0.66	1.22	1.71	2.16	2.56	2.93	3.27
12	0.73	1.35	1.90	2.41	2.87	3.30	3.69
13	0.79	1.48	2.09	2.65	3.17	3.65	4.10
14	0.86	1.60	2.28	2.90	3.47	4.00	4.50
15	0.93	1.73	2.46	3.13	3.76	4.34	4.88
16	0.99	1.85	2.64	3.37	4.04	4.67	5.26
17	1.06	1.98	2.82	3.59	4.32	5.00	5.63
18	1.12	2.10	2.99	3.82	4.59	5.32	6.00
19	1.18	2.22	3.17	4.04	4.86	5.63	6.35
20	1.25	2.34	3.34	4.26	5.13	5.94	6.70
21	1.31	2.46	3.51	4.48	5.39	6.24	7.04
22	1.37	2.57	3.67	4.69	5.65	6.54	7.38
23	1.44	2.69	3.84	4.90	5.90	6.83	7.71
	1.50	2.81	4.00	5.11	6.15	7.12	8.04
	1.56	2.92	4.17	5.32	6.40	7.41	8.37
	1.62	3.03	4.34	5.53	6.65	7.70	8.69

TECHNICAL ENGINEERING

General Drive Considerations

One of the main advantages of the roller chain drive is its ability to perform well under widely varying conditions. Despite this ability, there are a number of rules of good design practice which, if considered early in the design process, will enable the user to obtain desirable results.

Basic dimensions and minimum ultimate tensile requirements for single-pitch, double-pitch and attachment roller chains are specified by various standards organizations worldwide. ASME/ANSI, The American Society of Mechanical Engineers and The American National Standards Institute, defines dimensions such as: pitch, roller width, roller diameter, link plate height, link plate thickness and pin diameter. The primary purpose of the standard is to ensure that manufacturers will produce chains and sub-assemblies that are similar dimensionally and therefore interchangeable. In addition, the standard does offer the user some assurance of quality by defining a minimum ultimate tensile strength for each model of chain. However, tensile strength is not always a valid method to differentiate one manufacturer's product from another. It is very important to remember that dimensional standardization does not define quality or performance characteristics.

Minimum Ultimate Tensile Strength: Minimum Ultimate Tensile Strength, MUTS, is the static load required to break the chain. Tensile strength values shown in this catalog are *not* allowable working loads. Load or tension applied to the chain in service should never exceed $\frac{1}{6}$ th of the UTS. If exceeding this value is necessary for a specific application, contact Diamond Chain. **Warning! A roller chain should never be loaded above 50% of MUTS for even one cycle. Doing so will permanently damage the chain.**

Allowable Working Load: Roller chains with equal tensile strengths can have very different working load capacities. Contrary to popular belief, *there is no consistent relationship between a roller chain's working load capacity and its ultimate tensile strength.* A chain with a higher tensile strength than a Diamond chain could have a much lower working load capacity.

Selecting Chain Size: There may be several suitable selections for any particular application. Loads, speeds, environment, cost, required service life or other factors will determine the final selection. Generally, the lowest cost drive will consist of a single strand chain of the smallest pitch that can accommodate the load. The speed and number of teeth of the smallest sprocket, most commonly the driver sprocket, also have an effect on the selection of chain size. As a rule, the smaller the pitch the higher the permissible operating speed.

Selecting Sprockets

Small Sprocket: The smallest sprocket is usually the driver or input sprocket. As the chain enters and exits, it rises and falls as each pitch engages and disengages the sprockets.

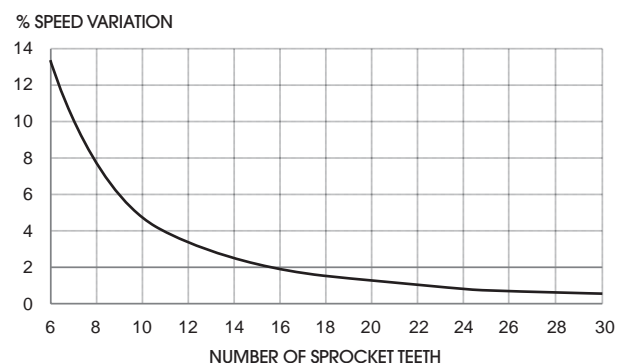
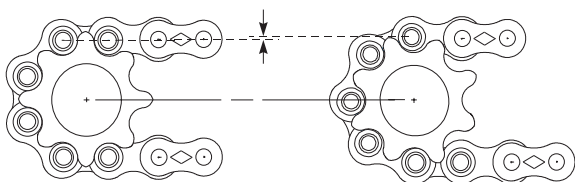

This movement, called chordal action, causes chain speed variations (drive roughness) that may be objectionable in some applications. These speed variations can normally be minimized by increasing the size of the sprockets, as shown.

TECHNICAL ENGINEERING

General Drive Considerations

To minimize the negative effects of chordal action, the following are suggested guidelines for the minimum number of teeth in the smallest sprocket:

Slow Speed	(Type A* lubrication region)	12 Teeth
Medium Speed	(Type B* lubrication region)	17 Teeth
High Speed	(Type C* lubrication region)	25 Teeth

* More detail on type A, B and C lubrication can be found in the Roller Chain Lubrication section of this guide.

Hardened Teeth: Tooth loading *increases* as the number of teeth in the sprocket *decreases*. Hardening of sprocket teeth is recommended when the number of teeth is 25 or less and/or the sprocket will operate in:

1. Drives that are heavily loaded.
2. Abrasive conditions.
3. High speed drives.
4. Drives requiring extremely long life.

Chain Wrap: The recommended minimum wrap angle on the smallest sprocket in the drive is 120° . Wrap angle can be reduced to 90° , if good chain tension adjustment is maintained. If chain tension is not closely maintained with less than 120° wrap, the chain can jump teeth, resulting in damage to itself and/or the sprocket.

Note: For a ratio of 3:1 or less there will always be 120° or more wrap on the small sprocket, regardless of the center distance.

Drive Ratio: The ratio of the sprocket sizes is determined by the desired speed reduction or increase. The maximum recommended ratio for a single reduction is 7:1. In practice, the practical single reduction limit is affected by: the minimum size of the small sprocket, the maximum size of the large sprocket, and the need for sufficient wrap on the small sprocket. It is possible to utilize a reduction as great as 9:1 but a double reduction is preferable. It is important to remember that drive ratio is a function of the number of teeth on the sprockets, not the sprockets' diameters.

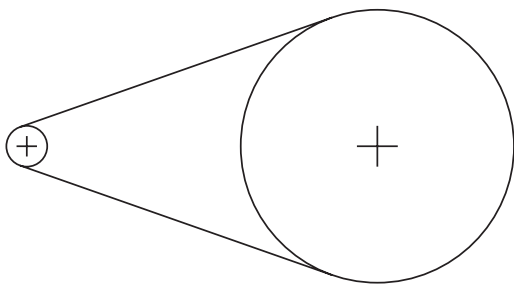

7:1 RATIO

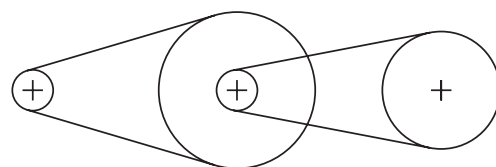

7:1 RATIO (TWO DRIVES)

TECHNICAL ENGINEERING

General Drive Considerations

Drive Arrangements

Shown below are recommended, acceptable, and not recommended drive arrangements, along with preferred direction of travel. Every effort should be made to utilize the recommended or acceptable layouts in order to obtain optimum drive life.

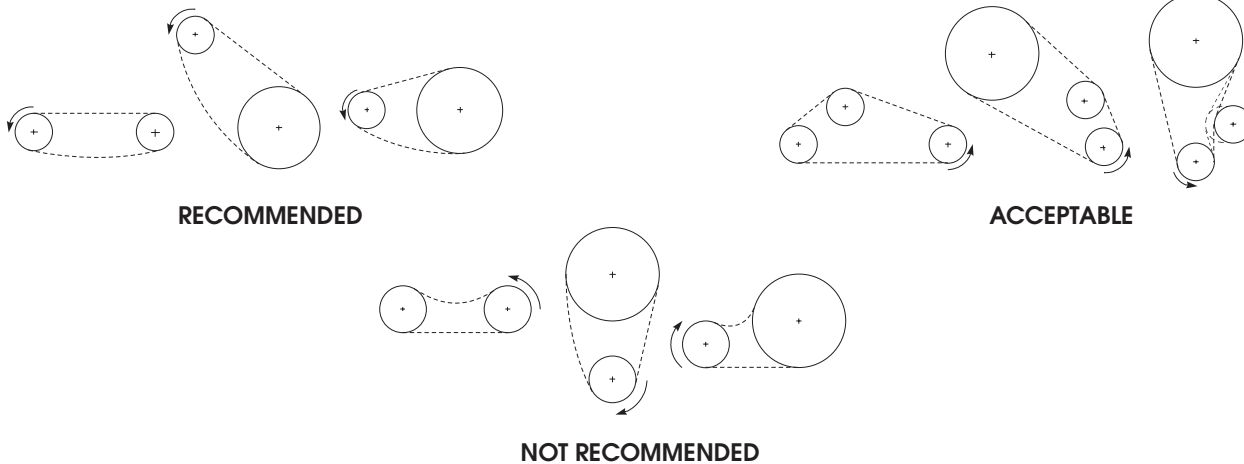

Chain Length: Chain length must be an integral number of pitches (no fractions of pitches). Additionally, every attempt should be made during the design process to define a chain length, which is an even number of pitches including the connecting link. In a fixed center-distance drive this can be done by selecting sprockets that provide a ratio near that desired. In an adjustable center-distance drive this is achieved by providing sufficient adjustment or “take-up” so that an even number of pitches can be used and still operate with proper tension.

If neither of the above conditions can be met, a chain having an odd number of pitches is required. These designs require the use of offset links or “half links.” Offset links are generally costly and will significantly reduce the chain’s load carrying capacity.

Offset Links

If required, Diamond offers two types of offsets: single-pitch and multiple-pitch.

Single-pitch offsets are constructed using hybrid link plates consisting of half pin link plate and half roller link plate contours. Single-pitch offsets are secured within the chain using a slip-fit pin and cotter keys.

Note: Single-pitch offsets can reduce the load capacity of a roller chain by as much as 30%.



TECHNICAL ENGINEERING

General Drive Considerations

Multiple-pitch offsets, commonly two pitches in length, are constructed with the same basic design as a single-pitch offset, with the exception that the offset link itself is riveted together with a standard roller link assembly. Multiple-pitch offsets afford the user superior performance and generally are less costly than single-pitch offsets. However, multiple-pitch offsets still reduce the load carrying capacity of the chain.

Note: Multiple-pitch offsets can offer virtually the same integrity as the base chain. However, some reduction in load carrying capacity can result from their use.

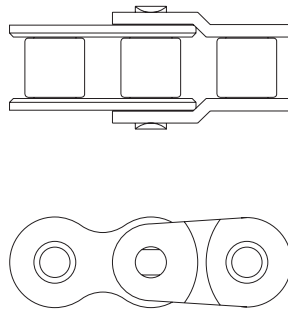

Connecting Links

Connecting links are used to join the ends of the chain together once installed on the drive. Diamond offers two types of cover plates depending upon the application and/or the user's preference: slip-fit or press-fit.

Slip-fit cover sides are supplied when the user prefers ease of assembly and disassembly. The cover plate of a slip-fit connecting link has pitch holes that are larger in diameter than the pins. This allows the user to “slip” the cover plate onto the pins before installing a spring clip or cotters. This style of connecting link is inherently weaker than the base chain because its slip-fit construction does not have the same integrity found in the assembled chain. **Note: Slip-fit connecting links can reduce the chain's working load capacity by as much as 30%.**

Press-fit cover plates are provided when the integrity of the connecting link needs to be equal to that of the base chain. In this design, the cover plate has pitch holes that are smaller in diameter than the pins. This requires the user to “press” the cover plate onto the pins before installing a spring clip or cotters. While more difficult to install, these links do provide the greatest load carrying capability. Diamond does not provide any specific tool for use with the installation of a press-fit cover plate. However, a modified C-Clamp-type device often makes the job much easier.

Note: Never drill out or enlarge the pitch holes of a press-fit connecting link cover side to make the installation easier.

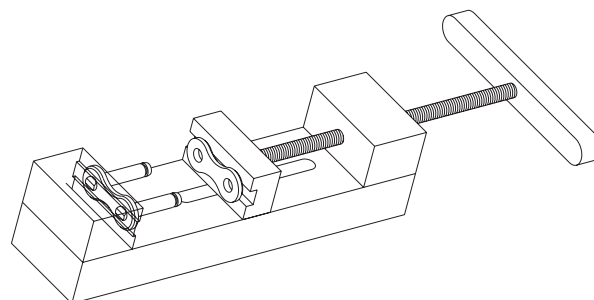

“C-CLAMP”-TYPE DEVICE

TECHNICAL ENGINEERING

General Drive Considerations

Chain Tensioning/Length Adjustment: Proper chain tension is critical to achieving acceptable service life. Chain tensioning may be accomplished by either: adjusting one of the shafts to increase the center distance, using a movable idler sprocket, or removing pitches from the chain to compensate for wear elongation.

For the majority of slow and medium speed chain drives, the total mid-span movement in the slack span should be approximately 4-6% of the drive's center distance. For drives operating at high speeds, impulse or reversing loads, the total movement should be reduced to 2-3% of the center distance. Drives with vertical centers should also be adjusted to the smaller percentage. If the drive incorporates shaft adjustment or an idler, the amount of movement or "take-up" should always allow for the removal of two pitches of chain.

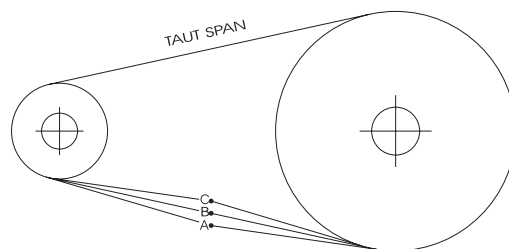

Recommended Possible Mid-Span Movement, A-C, of Slack Span

Dimensions in Inches

Drive Center-Line	Tangent Length Between Sprockets								
	5	10	15	20	30	40	60	80	100
Horizontal to 45	0.25	0.50	0.75	1.00	1.50	2.00	3.00	4.00	5.00
Vertical to 45	0.12	0.25	0.38	0.50	0.75	1.00	1.50	2.00	2.50

Drive Center Distance: The distance between driver and driven sprockets on a two-sprocket drive must be greater than one-half the sum of the sprocket outside diameters to avoid tooth interference. The shortest practical center distance is recommended.

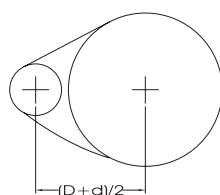

ABSOLUTE MINIMUM CENTER DISTANCE

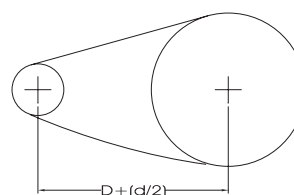

RECOMMENDED MINIMUM CENTER DISTANCE

General guidelines for the selection or determination of the center distance for any two-sprocket drive are:

1. For the average application, a center distance of approximately 40 pitches of chain represents good practice.
2. A center distance of 80 pitches may be considered as an approved maximum.
3. For high speed or pulsating drives a center distance as short as 20 pitches may be desirable to avoid chain whipping and potential drive damage.

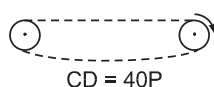
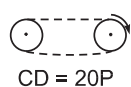

TECHNICAL ENGINEERING

General Drive Considerations

Fixed Centers: When adjustable centers or idlers cannot be used, the exact center distance must be calculated and built into the drive. Drives with fixed centers should be conservatively selected and well lubricated to minimize the rate of chain wear. Adjustment for wear elongation in fixed center distance drives is accomplished *only* by removing links or pitches to compensate for wear elongation.

Chain Wear: The individual joints in a roller chain articulate as they enter and leave the sprockets. This articulation results in wear on the pins and bushings. As material is worn away from these surfaces the chain will gradually elongate.

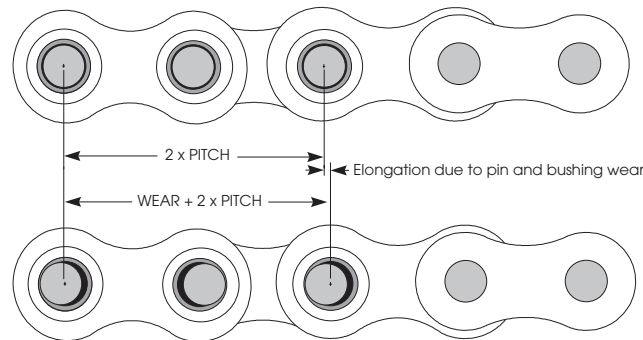

CHAIN DOES NOT “STRETCH” – MATERIAL IS REMOVED FROM PIN AND BUSHING

Elongation is normal and may be minimized by proper lubrication and drive maintenance. The rate of wear is dependent upon: the relationship between the load and the amount of bearing area between pin and bushing, the material and surface condition of the bearing surfaces, the adequacy of lubrication, and the frequency and degree of articulation between pins and bushings. The latter is determined by the quantity of sprockets in the drive, their speeds, the number of teeth and the length of the chain in pitches.

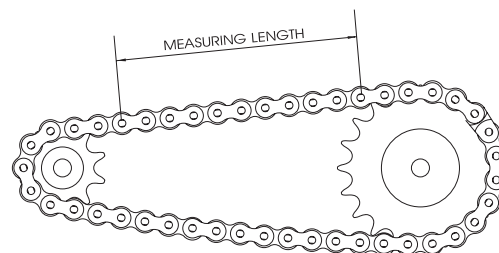

MEASUREMENT OF CHAIN FOR WEAR ELONGATION

Relatively accurate wear measurements can be made by using the above illustration. Measure as closely as possible from the center of one pin to the center of another. The more pitches (pins) contained within the measurement increase the accuracy. If the measured value exceeds the nominal by more than the allowable percentage the chain should be replaced. The maximum allowable wear elongation is approximately 3% for most industrial applications, based upon sprocket design. The allowable chain wear in percent can be calculated using the relationship: $200/N$, where N is the number of teeth in the large sprocket. This relationship is often useful since the normal maximum allowable chain wear elongation of 3% is valid only up to 67 teeth in the large sprocket. In drives having fixed center distances, chains running in parallel or where smoother operation is required, wear should be limited to approximately 1.5%.

For example, if 12 pitches (12 pins) of a #80 chain were measured and the result was 12.360 or greater (using 3% as the maximum allowable wear), the chain should be replaced. Anything less than 12.360 would still be acceptable by most industrial standards.

TECHNICAL ENGINEERING

General Drive Considerations

Chain Sag: In long spans, a relatively small amount of excess chain can cause a substantial sag in the slack span. More detailed information concerning the calculation of chain sag can be found in the Conveyor Chain Selection section of this product guide. In designing drives, it is necessary to provide sufficient clearance to prevent interference between the chain and chain case or other parts of the equipment.

Idler Sprockets: Idler sprockets may be used:

1. To take up slack in chain when shaft centers are not adjustable and are not located at a proper distance to provide a snug-fitting chain.
2. To take up slack in chain developed through normal chain wear. Such take-up will be necessary only at infrequent intervals because chain elongation due to wear occurs at a very slow rate when chain is adequately lubricated.
3. To guide the chain clear of any obstructions.
4. To increase the arc of chain wrap on other sprockets.
5. To provide for a reversed direction of rotation of a sprocket, outside a closed chain.

When an idler is required, it is preferable that it engage slack chain span. If the particular design requires that an idler be installed in the taut span of chain, the service life of the chain will most likely be shortened because of the additional articulation of the chain's joints while under load.

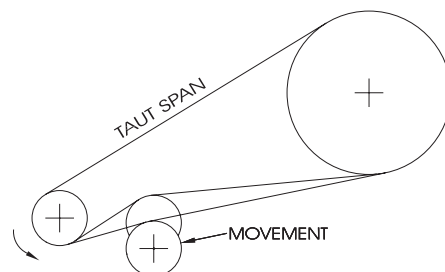

Idler sprockets should be mounted rigidly and firmly so that they will remain in position until some change in position is needed.

When an idler is located within the chain loop it should be located near the larger sprocket. When located outside the chain loop it should be located near the smaller sprocket.

Rarely is it desirable or necessary to provide automatic take-up by means of spring-and-ratchet combinations or dead weight mechanisms. The use of such types of idlers imposes additional and unnecessary loading on the chain joints.

TECHNICAL ENGINEERING

General Drive Considerations

Variable Speed Drives: Many drives must operate over a wide range of speeds and loads. The selected drive must be capable of performing acceptably at any of the required conditions. It is particularly important to be sure the drive is adequate at the most critical operating conditions which are often, but not limited to, the highest and lowest speeds.

Multiple Strand Chains: Used where single strand chains cannot carry the loads. These chains have two or more strands of chain assembled with common pins across the full width of the chain. More information on these types of roller chain can be found in the Multiple Strand Chain section of this guide.

Lubrication: Lubrication is the single most important factor controlling a chain's wear life. Specific methods of lubrication can be found in the Roller Chain Installation section of this guide. However, if the drive is located such that regular lubrication is infrequent or impractical, or if the drive is exposed to contaminants, consider the use of either DURALUBE®, RING LEADER® O-ring or DUST STOPPER™ chain. Details on these products can be found in the Special Lubricated Chain section of this guide.

Environment: If the drive is exposed to water, corrosive agents, contamination, or is in high or low temperature environments, consideration should be given to the use of either Nickel-Plated, Stainless Steel or RING LEADER O-ring chain. More detailed information can be found for these models in the Corrosion/Moisture Resistant and Special Lubricated sections of this product guide.

Temperature Limitations

Standard carbon steel-based chains can routinely be used where temperatures are between 0° and 350° F. For temperatures between 350° and 500° F, specially designed chains having extra internal clearances are recommended. At these temperatures, however, some loss of component hardness and reduced wear life can be expected.

Stainless steel chains should be considered when the operating temperature will be below 0° or above 500° F.

RING LEADER® O-ring chain can be routinely used at temperatures up to 150° F. If temperatures exceed this value, contact Diamond for alternate O-ring materials which may be serviceable up to 450° F.

DURALUBE® roller chains are generally limited to ambient temperatures of 120° F.

DUST STOPPER™ roller chains are generally limited to ambient temperatures of 120° F.

TECHNICAL ENGINEERING

General Drive Considerations

Preloading: After assembly, Diamond applies an initial load to the chains, called preload. This loading approximates the recommended maximum loading in service. Preloading can be done either statically or dynamically. Diamond dynamically preloads all of our 1/4" through 2" pitch Standard and Heavy Series single strand roller chains. Preloading is done to align the various chain components such as pins, bushings and link plates.

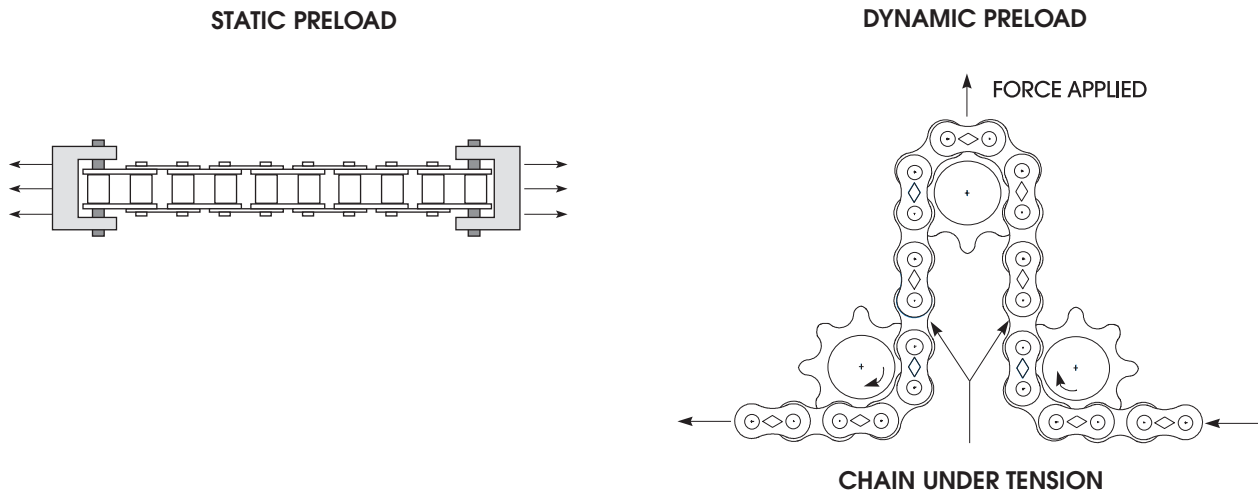

Benefit of Preloading: Preloading helps to greatly eliminate initial elongation often found in "lesser" chains. Elimination of this initial elongation can increase usable service life.

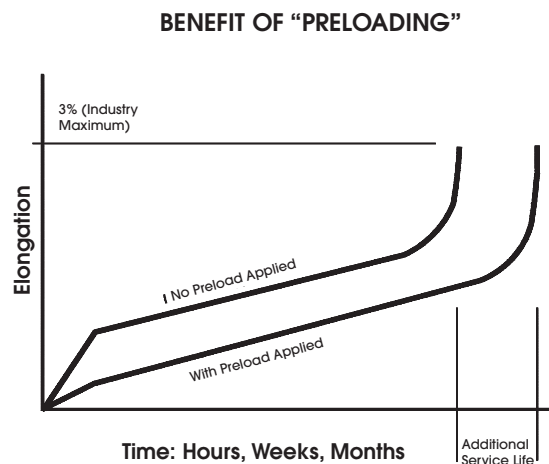

TECHNICAL ENGINEERING

Chain Selection

Drive Chain

This section offers guidance for the selection of economical roller chain drives, capable of meeting the great majority of drive requirements. However, when information is needed on a special problem, or whenever it seems advisable to have any drive selection confirmed or checked, feel free to contact Diamond's application engineers.

The first step in sizing and selection of a roller chain drive is to assess the known information about the drive's requirements and limitations. The following list represents the information required to adequately select a roller chain which will perform acceptably:

1. Source of input power.
2. Type of driven equipment.
3. Input horsepower available.
4. Size and speed of driving shaft.
5. Size and speed of driven shaft.
6. Center distance between shafts.
7. Available center distance adjustment, if any.
8. Space limitations such as maximum sprocket diameters.
9. Available lubrication methods.
10. Hostile environment, if any.

Additionally, the following information, if available, will enhance the ability to select the most appropriate roller chain for the application:

1. Frequent stops and starts.
2. High starting or inertial loads.
3. Extreme temperatures, i.e., above 150° F or below 0° F.
4. Large cyclic load variations in each revolution.
5. Multiple driven shafts.

TECHNICAL ENGINEERING

Chain Selection

Selecting a Chain Size

Step 1 - Determine Service Factor: In drive design, the nominal horsepower available is usually known. However, the peak horsepower actually realized by the chain may be much greater depending on the power source and the type of equipment being driven.

The service factor allows the user to estimate the maximum horsepower to which the drive may be exposed. This maximum horsepower will normally be a function of both the type of input power available combined with the type of equipment being driven. The following table lists some of the more common driver and driven combinations.

Service Factors

Type of Driven Equipment	Power Source Type			Type of Driven Equipment	Power Source Type		
	A	B	C		A	B	C
Agitators for Liquid	1.0	1.0	1.2	Food Processing – Slicers, dough mixers, grinders	1.2	1.3	1.4
Beaters	1.2	1.3	1.4	Kilns & Dryers	1.2	1.3	1.4
Blowers & Fans, Centrifugal	1.0	1.0	1.2	Machine Tools – Drills, grinders, lathes	1.0	1.0	1.2
Boat Propellers	1.2	1.3	1.4	Boring mills, milling machines	1.2	1.3	1.4
Compressors – Centrifugal & lobe	1.2	1.3	1.4	Punch presses, shears	1.4	1.5	1.7
Reciprocating, 3+ cylinders	1.2	1.3	1.4	Machinery, General – Uniform load, non-reversing	1.0	1.0	1.2
Reciprocating, 1 & 2 cylinders	1.4	1.5	1.7	Moderate shock load, non-reversing	1.2	1.3	1.4
Conveyors – Belt or chain, smoothly loaded	1.0	1.0	1.2	Severe shock load, reversing	1.4	1.5	1.7
Heavy duty, not uniformly loaded	1.2	1.3	1.4	Mills – Ball, pebble, tube	1.2	1.3	1.4
Clay Working Machinery – Pug mills	1.2	1.3	1.4	Hammer, rolling	1.4	1.5	1.7
Brick presses, briquetting machinery	1.4	1.5	1.7	Pumps – Centrifugal	1.0	1.0	1.2
Cranes & Hoists	Consult Diamond			Reciprocating, 3+ cylinders	1.2	1.3	1.4
Crushers	1.4	1.5	1.7	Reciprocating, 1 & 2 cylinders	1.4	1.5	1.7
Dredges – Cable, reel, & conveyor drives	1.2	1.3	1.4	Paper Industry – Pulp grinders	1.2	1.3	1.4
Cutter head, jig, & screen drives	1.4	1.5	1.7	Calendars, mixers, sheeters	1.4	1.5	1.7
Elevators, Bucket – Smoothly loaded or fed	1.0	1.0	1.2	Printing Presses, Magazine & Newspaper	1.4	1.5	1.7
Not uniformly loaded or fed	1.2	1.3	1.4	Textile Industry – Calendars, mangles, nappers	1.2	1.3	1.4
Feeders – Rotary table	1.0	1.0	1.2	Carding machinery	1.4	1.5	1.7
Apron, screw, rotary vane	1.2	1.3	1.4	Woodworking Machinery	1.2	1.3	1.4
Reciprocating	1.4	1.5	1.7				

A – Internal combustion engine with hydraulic drive.
B – Electric motor or turbine.
C – Internal combustion engine with mechanical drive.

Step 2 - Calculate the Design Horsepower: The design horsepower is determined by multiplying the input horsepower by the service factor obtained above.

$$\text{Design Horsepower} = \text{Input HP} \times \text{Service Factor}$$

TECHNICAL ENGINEERING

Chain Selection

Step 3a - Make a Preliminary Chain Selection: There may be several suitable solutions when it comes to selecting a drive. Generally, however, the smallest pitch, single strand chain that will convey the required horsepower is often the most economical. Using the following abridged horsepower ratings, an initial chain size can be identified. Enter this rating table with the approximate RPM of the smallest sprocket, driving or driven, and locate the smallest size chain capable of transmitting the required horsepower.

Abridged Horsepower Ratings

ASME/ ANSI #	Number of Teeth	Revolutions Per Minute (RPM)													
		100	300	500	700	900	1200	3000	4000	5000	6000	7000	8000	9000	10000
25	17	0.10	0.29	0.47	0.64	0.82	1.08	2.61	2.65	1.90	1.44	1.14	0.94	0.79	0.67
	21	0.12	0.35	0.58	0.80	1.01	1.34	3.22	3.64	2.60	1.98	1.57	1.29	1.08	0.92
	25	0.15	0.42	0.69	0.95	1.21	1.59	3.84	4.73	3.38	2.57	2.04	1.67	1.40	
35	17	0.34	0.97	1.58	2.18	2.77	3.66	5.64	3.67	2.62	2.00	1.58	1.30		
	21	0.42	1.19	1.95	2.69	3.43	4.52	7.75	5.03	3.60	2.74	2.17			
	25	0.50	1.42	2.32	3.21	4.08	5.38	10.07	6.54	4.68	3.56				
40	17	0.80	2.29	3.74	5.16	6.57	8.66	4.17	2.71	1.94	1.47				
	21	0.98	2.83	4.61	6.37	8.11	10.69	5.72	3.71	2.66					
	25	1.17	3.36	5.49	7.59	9.66	12.73	7.43	4.82						
41	17	0.44	1.26	2.05	2.84	3.61	3.29	0.83	0.54	0.39	0.29				
	21	0.54	1.55	2.54	3.51	4.46	4.52	1.14	0.74	0.53					
	25	0.64	1.85	3.02	4.17	5.31	5.87	1.49	0.96						
50	17	1.55	4.45	7.27	10.04	12.78	16.85	4.98	3.23	2.31					
	21	1.92	5.50	8.98	12.40	15.79	20.81	6.84	4.44						
	25	2.28	6.55	10.69	14.77	18.79	24.77	8.88							
60	17	2.66	7.65	12.49	17.26	21.96	22.77	5.76	3.74						
	21	3.29	9.45	15.43	21.32	27.13	31.26	7.91							
	25	3.92	11.25	18.37	25.38	32.30	40.61	10.27							
80	13	4.76	13.66	22.31	30.81	29.51	19.17	4.85	3.15						
	17	6.22	17.86	29.17	40.29	44.13	28.66	7.25							
	21	7.69	22.07	36.03	49.77	60.59	39.36								
	25	9.15	26.27	42.89	59.25	75.42	51.12								
100	13	9.11	26.16	42.72	51.43	35.28	22.92	5.80							
	17	11.92	34.21	55.87	76.91	52.76	34.27								
	21	14.72	42.26	69.01	95.33	72.43	47.05								
	25	17.52	50.31	82.16	113.48	94.09	61.11								
120	13	15.39	44.18	72.14	59.51	40.82	26.51								
	17	20.12	57.77	94.34	88.99	61.04	39.65								
	21	24.86	71.37	116.54	122.18	83.81	54.44								
	25	29.59	84.96	138.74	158.70	108.86	70.71								
140	13	23.81	68.36	111.52	67.32	46.18	29.99								
	17	31.13	89.39	145.97	100.67	69.05	44.85								
	21	38.46	110.42	180.31	138.22	94.81	61.58								
	25	45.79	131.45	214.66	179.53	123.15	79.99								
160	13	34.54	99.17	124.09	74.91	51.38	33.37								
	17	45.17	129.68	185.56	112.02	76.84	49.91								
	21	55.80	160.20	254.77	153.80	105.50	68.52								
180	13	47.70	136.93	136.35	82.31	56.46	36.67								
	17	62.37	179.07	203.90	123.09	84.43	54.84								
	21	77.05	221.20	279.94	169.00	115.92	75.29								
200	13	63.33	181.81	148.34	89.55	61.43	39.90								
	17	82.81	237.75	221.83	133.91	91.86	59.66								
	21	102.29	293.69	304.56	183.86	126.11									
240	13	101.99	292.82	171.64	103.61	71.07	46.16								
	17	133.37	382.92	256.66	154.94	106.28									
	21	164.76	473.02	352.39	212.73	109.86									

Complete horsepower ratings are located in the Horsepower Rating section of this guide.

If the design horsepower exceeds the capacity of single strand chain or if space limitations (i.e. sprocket diameters) are a consideration, then a multiple strand chain may be required.

TECHNICAL ENGINEERING

Chain Selection

Step 3b - Selecting a Multiple Strand Factor (if required): Multiple strand chain construction is described in detail in the Multiple Strand section of this guide. For the purpose of drive selection it is important to remember that multiple strand chain does not have the ability to transmit an even multiple of its single strand's horsepower. Example: a #80-2 chain cannot transmit two times the horsepower that a #80 single strand chain will. This is because the loading on a multiple strand chain cannot be exactly and evenly distributed across the full width of the chain due to many factors. Therefore, multiple strand chains are de-rated according to their number of strands. The following table provides values to be used in determining the single strand equivalent horsepower used in either the abridged horsepower ratings on the previous page or in the complete ASME/ANSI horsepower ratings located in the Horsepower Rating Table section of this guide.

Multiple Strand Rating Tables

Number of Strands	Multiple Strand Factor
2	1.7
3	2.5
4	3.3
5 or more	Contact Diamond

Calculating the equivalent single strand horsepower is accomplished by multiplying the input horsepower by the service factor and dividing that quantity by the multiple strand factor.

$$\text{HP(single strand eq.)} = \frac{(\text{Input Horsepower} \times \text{Service Factor})}{\text{Multiple Strand Factor}}$$

Once a tentative selection is obtained, refer to the complete ASME/ANSI horsepower ratings to more accurately define the small sprocket's required number of teeth to transmit the required design, single strand or single strand equivalent, horsepower.

In either the abridged or complete horsepower ratings, for exact speeds or numbers of teeth not shown, interpolate between the appropriate columns or lines. Studying the ratings will show that increasing the number of teeth on the small sprocket normally allows the use of a smaller pitch chain. Again, selecting the smallest pitch chain that will transmit the required horsepower makes maximum use of the chain's capacity and usually results in a more cost efficient drive.

Step 4 - Selecting the Large Sprocket: Once the chain and small sprocket sizes have been determined using the complete ASME/ANSI horsepower ratings, determine the number of teeth in the large sprocket by multiplying the number of teeth in the small sprocket by the required speed ratio. It is important to remember that roller chain drive ratios are calculated using the number of teeth on the sprockets, not sprocket diameters.

$$\text{Output RPM} = \text{Input RPM} \div \text{Desired Ratio or,}$$

$$\text{Large Sprocket \# of Teeth} = \text{Small Sprocket \# of Teeth} \times \text{Desired Ratio}$$

Once the sprocket sizes have been determined, check to verify that there is no interference if any limitation was given in the initial drive requirements. If interference is confirmed, it may be possible to select a smaller pitch, multiple strand chain capable of transmitting the required horsepower, allowing the use of smaller diameter sprockets.

TECHNICAL ENGINEERING

Chain Selection

Step 5a - Calculating Chain Length When Ratio is 1:1: If the drive is a 1:1 ratio then the chain length in pitches can be determined easily using the following relationship: the total number of pitches required (chain length) is equal to two times the center distance in pitches plus the number of teeth on one sprocket.

$$\text{Chain Length} = (2 \times \text{Center Distance, in pitches}) + \text{the Number of Teeth on One Sprocket}$$

The total chain length, in pitches, should always be an even number including the terminal connecting link. This avoids the use of offset links which significantly reduce the load carrying capacity of the roller chain.

Step 5b - Calculating Chain Length When Ratio is Not 1:1: The following equation and associated table may be used to calculate the required length of chain, in pitches, when the driver and driven sprockets are different sizes.

$$L = 2C + \frac{N + n}{2} + \frac{.1013 (N - n)^2}{4C} \quad \text{or substituting A for } \frac{.1013 (N - n)^2}{4}, \quad L = 2C + \frac{N + n}{2} + \frac{A}{C}$$

Where: L = Total chain length in pitches

n = Number of teeth on smaller sprocket

N = Number of teeth on larger sprocket

C = Center distance between shafts **in pitches**

VALUES OF A FOR CHAIN LENGTH CALCULATION

N - n	A	N - n	A	N - n	A	N - n	A
1	0.03	26	17.12	51	65.88	76	146.31
2	0.10	27	18.47	52	68.49	77	150.18
3	0.23	28	19.86	53	71.15	78	154.11
4	0.41	29	21.30	54	73.86	79	158.09
5	0.63	30	22.80	55	76.62	80	162.11
6	0.91	31	24.34	56	79.44	81	166.19
7	1.24	32	25.94	57	82.30	82	170.32
8	1.62	33	27.58	58	85.21	83	174.50
9	2.05	34	29.28	59	88.17	84	178.73
10	2.53	35	31.03	60	91.19	85	183.01
11	3.06	36	32.83	61	94.25	86	187.34
12	3.65	37	34.68	62	97.37	87	191.73
13	4.28	38	36.58	63	100.39	88	196.10
14	4.96	39	38.53	64	103.75	89	200.64
15	5.70	40	40.53	65	107.02	90	205.18
16	6.48	41	42.58	66	110.34	91	209.76
17	7.32	42	44.68	67	113.71	92	214.40
18	8.21	43	46.84	68	117.13	93	219.08
19	9.14	44	49.04	69	120.60	94	223.82
20	10.13	45	51.29	70	124.12	95	228.61
21	11.17	46	53.60	71	127.69	96	233.44
22	12.26	47	55.95	72	131.31	97	238.33
23	13.40	48	58.36	73	134.99	98	243.27
24	14.59	49	60.82	74	138.71	99	248.26
25	15.83	50	63.33	75	142.48	100	253.30

Step 5c - Calculating Chain Length (three or more sprocket drive): For three or more sprocket drives, the required chain length must be determined graphically using a layout drawing or by analyzing the drive using Diamond's Drive Selection Software.

Step 6 - Determining the Type of Lubrication Required: The ASME/ANSI horsepower ratings will indicate the recommended type of lubrication: Manual, Oil Bath or Flood-type lubrication depending upon the operating range of the chain selected. More information on lubrication and maintenance can be found in the Installation and Maintenance sections of this guide.

TECHNICAL ENGINEERING

Chain Selection

Drive Selection Example

The first step is to obtain the necessary information in order to accurately select a chain.

For this example, the following requirements are known:

Source of power	-	Mechanically driven internal combustion engine
Driven equipment	-	Two-cylinder pump
Horsepower available	-	25
Driving shaft size	-	2-¼ inches
Driving shaft speed	-	900 rpm
Driven shaft size	-	2 inches
Driven shaft speed	-	300 rpm
Center distance	-	To be determined
Drive arrangement	-	Horizontal shafts on horizontal centers
Space limitations	-	Yes, large sprocket cannot exceed 20 inches in diameter.
Lubrication	-	To be determined
Harsh Environment	-	None

Solution:

1. Select an appropriate service factor from the Service Factors table located in this section.

The service factor for a two-cylinder pump, driven by an internal combustion engine with mechanical drive, is 1.7.

2. Calculate the Design Horsepower from the equation,

Design Horsepower = Input HP x Service Factor or,

Design Horsepower = 25 x 1.7 = 42.5

3. Refer to the *abridged* Horsepower Ratings in this section and see that the 42.5 design horsepower, at 900 RPM, falls within the area for #80 chain. This is the smallest single strand chain which, with a 17-tooth sprocket, will transmit the required power.
4. Refer to the complete ASME/ANSI horsepower rating rating for #80 chain and note that a #80 chain will transmit 44.13 horsepower at 900 rpm on a 17-tooth sprocket.

# of teeth on small sprocket	Revolutions Per Minute - Small Sprocket															
	10	25	50	75	88	100	200	300	400	500	600	700	800	900	1000	1200
11	0.44	1.06	2.07	3.05	3.56	4.03	7.83	11.56	15.23	18.87	22.48	26.07	27.41	22.97	19.61	14.92
12	0.48	1.16	2.26	3.33	3.88	4.39	8.54	12.61	16.62	20.59	24.53	28.44	31.23	26.17	22.35	17.00
13	0.52	1.26	2.45	3.61	4.21	4.76	9.26	13.66	18.00	22.31	26.57	30.81	35.02	29.51	25.20	19.17
14	0.56	1.35	2.63	3.89	4.53	5.12	9.97	14.71	19.39	24.02	28.62	33.18	37.72	32.98	28.16	21.42
15	0.60	1.45	2.82	4.16	4.86	5.49	10.68	15.76	20.77	25.74	30.66	35.55	40.41	36.58	31.23	23.76
16	0.64	1.55	3.01	4.44	5.18	5.86	11.39	16.81	22.16	27.45	32.70	37.92	43.11	40.30	34.41	26.17
17	0.68	1.64	3.20	4.72	5.50	6.22	12.10	17.86	23.54	29.17	34.75	40.29	45.80	44.13	37.68	28.66
18	0.72	1.74	3.39	5.00	5.83	6.59	12.81	18.91	24.93	30.88	36.79	42.66	48.49	48.08	41.05	31.23
19	0.76	1.84	3.57	5.28	6.15	6.95	13.53	19.96	26.31	32.60	38.84	45.03	51.19	52.15	44.52	33.87
20	0.80	1.93	3.76	5.55	6.47	7.32	14.24	21.01	27.70	34.32	40.88	47.40	53.88	56.32	48.08	36.58

TECHNICAL ENGINEERING

Chain Selection

In the General Selection Information section of this guide, it was recommended that the smallest sprocket in a medium speed drive should have a minimum of 17 teeth. So, the 17-tooth sprocket should be suitable for this drive. Consult a sprocket manufacturer's catalog to verify that the 17-tooth #80 sprocket has a maximum bore that will accommodate the required 2- $\frac{1}{4}$ " driver shaft. For the purpose of this example, it will. (If it had not, then a larger number of teeth would have been required for the driver sprocket.)

5. The *driver* speed is 900 rpm and the *driven* speed is to be 300 rpm, so the speed ratio, or reduction, is $900/300 = 3:1$. Therefore, the large sprocket should have $17 \times 3 = 51$ teeth. Again, check with a sprocket manufacturer's guide to be sure that the bore capacity of the sprocket is adequate for a two inch shaft.
6. In the General Selection Information section it is recommended that the center distance be as short as 20 pitches for pulsating drives or $D + d/2$. Using data from the Sprocket Information section, the recommended minimum center distance would be $16.81 + 5.95/2 = 19.79$ inches. An acceptable start would be to select 20 pitches (#80 = 1.00 inch) or 20 inches. Based on the 17/51 tooth sprockets and a center distance of 20 pitches (inches), a chain 76 pitches long including connecting link is required. This calculation was made using the chain length equation presented earlier.
7. Again, referring to the complete ASME/ANSI horsepower ratings for #80 chain, Type B lubrication is required based upon the speed and number of teeth of the 17-tooth sprocket. Oil bath lubrication will be acceptable.
8. Review the initial design requirements to see if this selection is acceptable. The only constraint that was given was that the large sprocket's diameter could not exceed 20 inches. By referring to the Sprocket Information section located in this guide we can verify that the 51-tooth, #80 sprocket has an outside diameter of 16.81 inches, well within the limitation.

No. of Teeth	Pitch Diameter	Outside Diameter	Bottom Diam. for Even Teeth Caliper Diam. for Odd Teeth
6	2.000	2.33	1.375
7	2.305	2.68	1.622
8	2.613	3.01	1.988
9	2.924	3.35	2.254
10	3.236	3.68	2.611
11	3.550	4.01	2.888
12	3.864	4.33	3.239
13	4.179	4.66	3.523
14	4.494	4.98	3.869
15	4.810	5.30	4.158
16	5.126	5.63	4.501
17	5.442	5.95	4.794
18	5.759	6.27	5.134
19	6.076	6.59	5.430
20	6.392	6.91	5.767
21	6.710	7.24	6.066
22	7.027	7.56	6.402
23	7.344	7.88	6.702
24	7.661	8.20	7.036
25	7.979	8.52	7.338
26	8.296	8.84	7.671
27	8.614	9.16	7.974
28	8.931	9.48	8.306
29	9.249	9.80	8.611
30	9.567	10.11	8.942
31	9.985	10.43	9.247
32	10.202	10.75	9.577
33	10.520	11.07	9.883
34	10.838	11.39	10.213
35	11.156	11.71	10.520
36	11.474	12.03	10.849
37	11.792	12.35	11.156
38	12.110	12.67	11.485
39	12.428	12.99	11.792
40	12.746	13.31	12.121
41	13.064	13.63	12.429
42	13.382	13.94	12.757
43	13.700	14.26	13.065
44	14.018	14.58	13.393
45	14.336	14.90	13.702
46	14.654	15.22	14.029
47	14.972	15.54	14.338
48	15.290	15.86	14.665
49	15.608	16.18	14.975
50	15.926	16.50	15.301
51	16.244	16.81	15.611
52	16.562	17.13	15.937
53	16.880	17.45	16.248

TECHNICAL ENGINEERING

Chain Selection

Slow Speed Drives Selection

For drives operating at speeds lower than those shown in the horsepower ratings, chains may be selected on the basis of chain pull.

If chain pull is not known directly, determine it from the amount of horsepower to be transmitted by referring to equations below. By using the input horsepower, RPM and pitch radius of the sprocket (one-half pitch diameter), an approximate chain pull can be determined. An appropriate chain can be selected by comparing chain tensile strengths against the chain pull.

Important - Chain pull must not exceed $\frac{1}{6}$ th of the ultimate tensile strength when the chain is connected using press-fit connecting links and no offset links are used. Chain pull must not exceed $\frac{1}{9}$ th of the ultimate tensile strength when slip-fit connecting links or offset links are used in the chain.

Horsepower, Chain Pull, and Torque Equations

Torque = Force x Lever Arm = Chain Pull x Pitch Radius

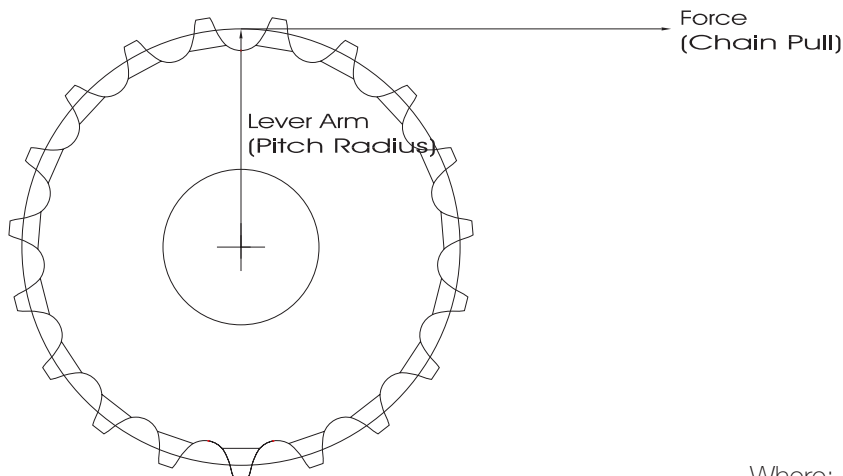

$$H = \frac{L \times S}{33000} = \frac{Q \times N}{5252} = \frac{q \times N}{63025}$$

$$L = \frac{H \times 33000}{S} = \frac{H \times 396000}{P \times T \times N} = \frac{H \times 126050}{D \times N}$$

$$Q = \frac{H \times 5252}{N} \text{ or } q = \frac{H \times 63025}{N}$$

$$S = \frac{T \times P \times N}{12}$$

Where:

D = Pitch diameter of sprocket (inches)

H = Horsepower to be transmitted

L = Load or chain pull (pounds)

N = Speed of sprocket (rev./min.)

P = Pitch of chains (inches)

Q = Torque (foot-pounds)

q = Torque (inch-pounds)

S = Speed of chain (feet/min)

T = Number of teeth on sprocket

TECHNICAL ENGINEERING

Chain Selection

Example of Slow Speed Drive Selection

Again, the first step is to obtain the necessary information.

For this example, the following requirements are known:

Horsepower available	-	2
Driving shaft size	-	2- $\frac{1}{4}$ inches
Driving shaft speed	-	9 rpm
Driven shaft size	-	2- $\frac{1}{4}$ inches
Driven shaft speed	-	3 rpm
Center distance	-	To be determined
Drive arrangement	-	Horizontal shafts on horizontal centers
Space limitations	-	None
Lubrication	-	Manual or Drip
Harsh environment	-	None
Inventory	-	Yes, there is an abundance of #80 chain on the shelf.

Solution:

Determine if the #80 chain will be acceptable and if so, select driver and driven sprocket sizes and center distance.

If we first use the following equation:

$$H = \frac{q \times N}{63025}$$

Where H is the horsepower available, q is the torque in inch-pounds and N is the smallest sprocket's speed in revolutions per minute.

Torque, q, in inch-pounds can also be represented by $F \times d$ where F is the force or tension in the chain, and d is the lever arm, or in this case, the pitch radius of the smallest sprocket.

Applying our known values into the equation we have:

$$2\text{HP} = \frac{q \times 9 \text{ RPM}}{63025} \quad \text{which can be rearranged to}$$

$$q = \frac{(2 \text{ HP} \times 63025)}{9 \text{ RPM}} \quad \text{or } q = 14,006 \text{ inch-pounds}$$

TECHNICAL ENGINEERING

Chain Selection

From the previous statement that chain pull should not exceed $\frac{1}{6}$ to $\frac{1}{9}$ of the chain's tensile strength and we are tentatively trying to use #80 chain, let's assume the more conservative condition and apply $\frac{1}{9}$ to the tensile of #80 chain to arrive at our maximum working load.

$$\begin{aligned} \text{Working load} &= \text{chain tensile strength} \times \frac{1}{9} \\ &= 14,500 \text{ pounds} \times \frac{1}{9} \\ &= 1,611 \text{ pounds} \end{aligned}$$

Since $q = F \times d$, then $14,006 = 1,611 \times d$ or,

$$d \text{ (pitch radius of the sprocket)} = \frac{q}{F} = \frac{14,006}{1,611} = 8.694 \text{ inches (} \times 2 = \text{pitch diameter)}$$

To determine what size sprocket this equates to, we need to again refer to the Sprocket Information section for #80 chain.

No. of Teeth	Pitch Diameter	Outside Diameter	Bottom Diam. for Even Teeth Caliper Diam. for Odd Teeth
54	17.198	17.77	16.573
55	17.517	18.09	16.884
56	17.835	18.41	17.210
57	18.153	18.73	17.521
58	18.471	19.04	17.846
59	18.789	19.36	18.158
60	19.107	19.68	18.482
61	19.426	20.00	18.794
62	19.744	20.32	19.119
63	20.062	20.64	19.431
64	20.380	20.96	19.755
65	20.698	21.27	20.067
66	21.016	21.59	20.391
67	21.335	21.91	20.704
68	21.653	22.23	21.028
69	21.971	22.55	21.340
70	22.289	22.87	21.664
71	22.607	23.19	21.977
72	22.926	23.50	22.301
73	23.244	23.82	22.613
74	23.562	24.14	22.937
75	23.880	24.46	23.250
76	24.198	24.78	23.573
77	24.517	25.10	23.887
78	24.835	25.42	24.210
79	25.153	25.73	24.523
80	25.471	26.05	24.846
81	25.790	26.37	25.160
82	26.108	26.69	25.483
83	26.426	27.01	25.796
84	26.744	27.33	26.119
85	27.063	27.64	26.433
86	27.381	27.96	26.756
87	27.699	28.28	27.070
88	28.017	28.60	27.392
89	28.335	28.92	27.706

Excerpt from Sprocket Diameters - USA Standard #80 Roller Chain

TECHNICAL ENGINEERING

Chain Selection

From this, we see that in order for a #80 chain to be used, the smallest sprocket would need to have a pitch diameter (diameter is twice the pitch radius) of 17.517, or 55 teeth! This is probably not acceptable because in order to arrive at the desired speed reduction, the driver sprocket would need to be 159 teeth.

It is safe to say that the inventory of #80 chain will have to be used on another drive and we should perhaps take another look at this selection process.

From the General Selection section, we know that slow speed drives are recommended to have at least a 12-tooth sprocket. A good approach at this time would be to examine the Sprocket Information section and determine what the diameters are (actually we want the radius) of 12-tooth sprockets for some sizes greater than #80.

Doing this, we note that:

#100 12-tooth, pitch diameter of 4.83", radius of 2.42"

#120 12-tooth, pitch diameter of 5.79", radius of 2.90"

#140 12-tooth, pitch diameter of 6.76", radius of 3.38"

And, by applying our $\frac{1}{9}$ criteria to the tensile strengths of those three models we find:

#100 working load is 2,666 pounds

#120 working load is 3,777 pounds

#140 working load is 5,111 pounds

Now we can replace the above values into the $q = F \times d$ equation.

For #100, $F = q/d = 14,006/2.42 = 5,787$ pounds which EXCEEDS the recommended working load for #100 chain.

For #120, $F = q/d = 14,006/2.90 = 4,829$ pounds which EXCEEDS the recommended working load for #120 chain.

For #140, $F = q/d = 14,006/3.38 = 4,143$ pounds which IS BELOW the recommended working load for #140 chain.

Based on the above, #140 chain operating on a 12-tooth driver is an acceptable solution. In practice, either a larger sprocket or using a smaller multiple strand chain could have resulted in an acceptable solution as well.

The selection of the driven sprocket is done in the same manner as the general drive selection by multiplying the drive ratio by the small sprocket's number of teeth. In this case, the desired ratio is 3:1 so the driven sprocket size will be 3×12 teeth or 36 teeth.

Center distance is calculated as before using 20 pitches as an acceptable minimum. $20 \text{ pitches} \times 1.75 \text{ inches per pitch} = 35.00 \text{ inches}$. Verifying that the sprockets selected will fit into that envelope, using the formula, minimum center distance equals $D + d/2$; $21.05 + 7.58/2 = 24.84 \text{ inches}$. So, 20 pitches should be fine for center distance.

The required chain length can again be calculated using the chain length equation presented earlier for a resulting chain length of 65 pitches. This length would require the use of an offset link which should be avoided whenever possible. Incorporating enough center distance adjustment into the design, permitting the use of a chain either 64 or 66 pitches long, would result in a more desirable design.

TECHNICAL ENGINEERING

Chain Selection

Conveyor Chains

Conveyor designers will find the attributes of precision roller chain valuable in the design and application of a broad spectrum of conveyor or material handling systems. High strength-to-weight ratios combine with precision machined and hardened parts to provide excellent performance, long life and minimized power requirements, all resulting in lower cost/high productivity operations.

Standard Series, single-pitch roller chain built in accordance with ASME/ANSI B29.1, is available with a variety of attachments. These attachments, and details about the chains' configurations, can be found in either the Attachment Chain section or Made-To-Order section of this guide. Standard Series chains range in size from $\frac{1}{4}$ " pitch up to 2" pitch and are commonly used where speeds are relatively high and smooth operation is required. Standard Series chains are very versatile in that attachments with almost any desired spacing can be provided. Stainless steel chains, in many sizes, are also available for installations requiring corrosion resistance or for operation in extreme temperatures.

Double-Pitch Conveyor chains, built in accordance with ASME/ANSI B29.4, are available in sizes ranging from 1" pitch up to 4" pitch. Double-Pitch chains are most often used when speeds are slow to moderate, as their operation is generally not as smooth as single-pitch chains. Additionally, when relatively long shaft centers are present, double-pitch chains can be less costly because their construction requires only half as many components.

Double-Pitch Conveyor chains can be supplied with standard diameter rollers when the design calls for the chain to transport the conveyed product with the chain sliding on the edges of the oval contour link plates.

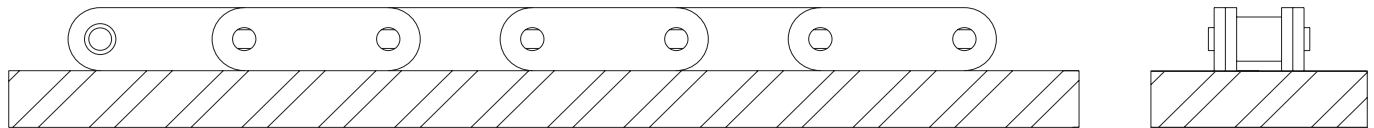

Double-Pitch Conveyor chains can be supplied with oversized carrier rollers when the load is to rest on an attachment but be supported by the rollers. Chains with oversized rollers are recommended when it is necessary to reduce friction by "rolling" rather than "dragging" the product. This type of design can dramatically reduce the power required to operate the conveyor.

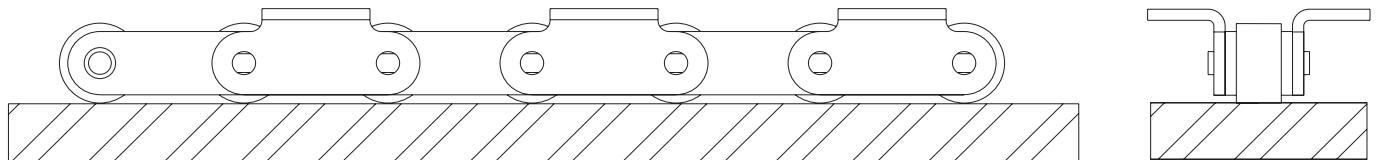

Double-Pitch Conveyor chains are available with a wide variety of standard or made-to-order attachments. Details on attachments and the chains' configurations can be found in either the Standard Attachment Chain section or Made-To-Order section of this guide. Additionally, depending on the model of conveyor chain required, many are available in stainless steel if the environment requires corrosion resistance or when operating temperatures are extreme.

In conveyor applications, roller chains are usually applied at lower speeds and with fewer joint articulations than in power transmission "drive" applications. Therefore, different design considerations and selection procedures are used in selecting conveyor chains.

TECHNICAL ENGINEERING

Chain Selection

Sprockets

Size: Sprockets for conveyors are usually the same size for the head shaft and tail shaft. Sprockets having the largest practical number of teeth are desirable to reduce chordal action, provide for smooth operation and obtain maximum chain wear life. It is recommended that sprockets have a minimum of 15 effective teeth. The number of effective teeth is the number of teeth engaged by the chain rollers in one revolution of the sprocket. If a single-pitch conveyor chain is used the effective teeth equals the number of sprocket teeth. When using double-pitch chain, use single-pitch sprockets only when more than 15 effective (30 actual) teeth are designed in. For drives with less than 30 actual (15 effective) teeth, use special cut double-pitch sprockets for maximum chain and sprocket life. Additionally, if a single-pitch sprocket is used on a double-pitch chain conveyor, an odd number of teeth in the sprocket is desirable. This allows for the chain to engage alternate teeth each revolution, thus distributing the tooth wear more evenly throughout the life of the chain and sprocket.

Hardness: The guidelines for hardening conveyor sprocket teeth are similar to those of power transmission drive sprocket teeth. For drives which are heavily loaded, drives that possess sprockets with a minimum number of teeth, or drives that are exposed to abrasives such as dirt or paper dust, consideration should be given to hardening the sprocket teeth to prolong both chain and sprocket life.

Alignment: Head and tail shafts as well as sprockets should always be aligned using procedures outlined in the Installation section of this guide. Additionally, because the majority of conveyors are designed and operate with two or more strands of chain operating in parallel, head shaft sprockets should be keyed to a common shaft so that the teeth of each sprocket are in alignment to assure equal load distribution on all chains in the conveyor. When chains in a conveyor are connected together with cross-members such as rolls or slats, it is suggested that the tail shaft sprockets also be keyed to the shaft to assure alignment of the sprocket teeth.

Chain Length Matching

With most conveyor applications, chains are expected to operate in parallel and their relationship to one another is critical. Information provided in either the Standard Attachment Chain section or the Made-To-Order section of this guide will describe Diamond's ability to control length uniformity. Please review either of these sections prior to ordering chain.

Take-ups: Take-ups are used to adjust or compensate for the chain's elongation in service. The maximum allowable wear elongation, based upon sprocket design, for most single-pitch chain is approximately 3%. The maximum allowable wear elongation, based on sprocket design, for most double-pitch conveyor chain is approximately 1.5%. Therefore, the amount of take-up required should be either of the above values, depending on the base chain used, or the design should incorporate the ability to remove an entire attachment "cycle" from the chain(s) if necessary to accommodate wear elongation.

Screw-type take-ups are ordinarily used and are located on the tail shaft end of the conveyor if possible. Chain should not be operated with both top and bottom strands taut because lubricant is never allowed to "flow" within the pin/bushing joint, re-establishing a barrier against wear. However, where constant tension is required, such as on conveyors subjected to wide temperature variations, spring- or gravity-type take-ups are acceptable, recognizing that some reduced wear life may result.

An alternate method of maintaining chain tension and allowing for wear elongation is to incorporate a catenary in the design. The most common design allows the chain to be unsupported in the return span of the conveyor. As the chain wears during service the excess lineal length is allowed to "sag" and thus no physical take-up is necessary.

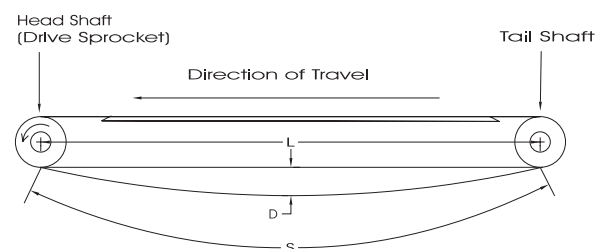

TECHNICAL ENGINEERING

Chain Selection

This type of design can have some negative effects on the operation of the conveyor. First, there may not be sufficient clearance between the conveyor and floor to accommodate the excess chain. This is particularly true if the conveyor is long. Second, there may be a considerable amount of catenary tension. This tension is distributed throughout the entire chain and is added to the working tension. In some cases, it may be great enough to exceed the working load of the chain defined initially in the selection process. Catenary tension must be considered when calculating chain working loads, bearing loads and shaft diameters, but is not a factor in determining the horsepower required to operate the conveyor.

The values for depth of sag as well as catenary tension can be approximated from the following equations:

$$\text{Depth of Sag, } D = \frac{\sqrt{3S^2 - 3L^2}}{4}$$

Where:

D = Depth of chain sag in inches

L = Straight line between points of support, normally shaft centers, in inches

S = Actual amount of chain in return strand in inches
(number of links between points of support x chain pitch)

$$\text{Catenary tension, } T = \frac{W}{12} \left[\frac{S^2}{8D} + \frac{D}{2} \right]$$

Where:

T = Catenary tension in pounds

W = Weight of chain in pounds per foot

S = Actual amount of chain in return strand in inches
(number of links between points of support x chain pitch)

D = Depth of chain sag in inches

If the depth of sag or the amount of catenary tension exceeds the capacity of the machine's design or the chain's working load then a support rail can often be installed under the return span to direct the chain sag or to reduce the magnitude of catenary tension.

It is normal practice not to support the entire return span but to leave a short unsupported section for accumulation of chain slack.

Input Power

It is recommended that the drive sprocket be located on the head shaft so that only the span transporting product will be under maximum tension.

Temperature Limits

For operating limits of conveyor chains, refer to the General Design Considerations section of this guide.

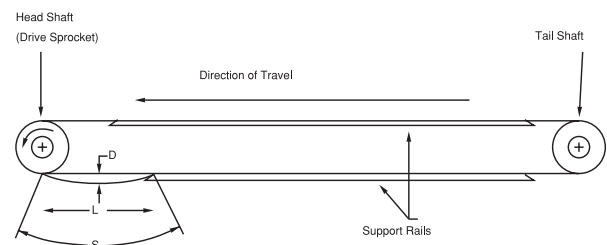

TECHNICAL ENGINEERING

Chain Selection

Lubrication: To attain maximum service life, all chains should be kept clean, free from grit, and well-lubricated. Conveyors commonly operate at slow speed with light loads and as such, lubrication application is not defined as with power transmission drive chains. Generally, lubricant applied to the chain by either manual or drip-type lubrication systems will be satisfactory. The specific grade of lubricant may depend upon the temperature and construction of the conveyor. For extremely high or low temperatures, special lubricants such as synthetic oils or molybdenum disulfide-based lubricants may be required. More information on lubricants and lubrication can be found in the Lubrication section of this guide.

If lubrication is not possible or the chain must operate in a contaminated environment, consideration should be given to either DURALUBE® or RING LEADER® O-ring chain. Information on these products is located in the Special Lubricated section of this guide.

Conveyor Chain Selection

Conveyor chains usually are selected for specific operating conditions on the basis of the maximum anticipated chain pull. However, the spacing of attachments, if required, may be the determining factor in selecting the size of the chain.

The following steps outline the selection of most commonly designed conveyor drives:

1. Obtain required information.
2. Calculate preliminary chain pull.
3. Adjust preliminary chain pull for conveyor speed.
4. Make preliminary chain selection.
5. Finalize chain size selection.
6. Select required sprocket sizes.
7. Calculate total chain length.
8. Determine required horsepower.
9. Determine required lubrication system.

Step 1 - Obtain Required Information: The following information is necessary to properly select most conveyor chains:

1. Conveyor arrangement, i.e., horizontal, vertical or inclined.
2. Required speed in feet per minute.
3. Weight of conveyed material in pounds per foot of conveyor length.
4. Material being conveyed, i.e., wooden pallet, paper box, etc.
5. Weight of attachments or "flights" per foot, if applicable.
6. Size of sprockets.
7. Shaft center distance in feet.
8. Type of operating environment, i.e., clean, dirty, corrosive, etc.
9. Available or allowable lubrication.

TECHNICAL ENGINEERING

Chain Selection

Step 2 - Calculate Preliminary Chain Pull: The preliminary required chain pull may be calculated from the following:

1. For horizontal conveyors:

$$P = [(W_m + 2W_c) \times L \times F_x] + W_m \times L \times F_m$$

2. For inclined conveyors:

$$P = [(W_m + 2W_c) \times L \times F_x] + (W_m + W_c) \times H + W_m \times L \times F_m$$

3. For vertical conveyors:

$$P = (W_m + W_c) H$$

Where:

P = Chain pull, in pounds

W_m = Weight of conveyed material in pounds per foot

L = Conveyor length, commonly shaft center distance, in feet

F_x = Coefficient of friction between chain and conveyor obtained from the Coefficients of Sliding Friction table (if chain is expected to convey the material by sliding on the edges of the link plates) or, from the Coefficients of Rolling Friction table (if the chain is expected to convey the material by rolling on oversized carrier rollers).

F_m = Coefficient of friction between chain and conveyed material. This value can vary significantly and therefore, it is recommended to refer to an engineering handbook for the appropriate value.

L = Horizontal length of conveyor, in feet

H = Vertical height of conveyor, in feet

W_c = Weight of chain and attachments in pounds per foot

TECHNICAL ENGINEERING

Chain Selection

Rolling Coefficients of Friction

Chain Number	Static		Rolling	
	Dry	Lubricated	Dry	Lubricated
C-2042	0.17	0.12	0.14	0.10
C-2052	0.16	0.11	0.13	0.09
C-2062H	0.16	0.11	0.13	0.09
C-2082	0.15	0.10	0.12	0.08
C-2102H	0.14	0.09	0.11	0.07
C-2122H	0.14	0.09	0.11	0.07
C-2162H	0.13	0.08	0.10	0.07

Sliding Coefficients of Friction

	Dry	Lubricated
Static	0.33	0.24
Sliding	0.27	0.21

In the preliminary calculations of chain pull, ignore (Wc) because the required chain size has not been established.

When the conveyed load is supported on the chain rollers, large diameter rollers are recommended.

For multiple strand conveyors, assuming each chain is equally loaded, divide the total chain pull calculated by the number of chains in the conveyor to obtain the equivalent single strand chain pull.

Step 3 - Adjust the Preliminary Chain Pull Based Upon Conveyor Speed: Multiply the calculated single strand chain pull by the load factor for the conveyor chain speed from the Load Factors for Conveyor Speed table.

Load Factors for Conveyor Speed

Chain Speed (feet per minute)	Load Factor	Chain Speed (feet per minute)	Load Factor
Up to 50	1.00	200 to 300	2.2
50 to 100	1.15	300 to 400	3.2
100 to 200	1.50	400 to 500	4.6

Step 4 - Make Preliminary Chain Selection: Using the preliminary chain pull, adjusted for conveyor speed, select a chain with an adequate working load from the Working Loads for Conveyor Chains table. If the conveyor operates in an abrasive or corrosive environment, consider using RING LEADER® O-ring or Stainless Steel chain. Remember that the preliminary chain pull calculations still ignored the weight of the chain and attachments.

Working Loads for Conveyor Chains

ASME/ANSI Chain Number	Pitch (Inches)	Carbon Steel	Heat Treated Stainless	Non-Heat Treated Stainless
25	1/4	125	30
35	3/8	300	150	75
40	1/2	530	260	130
41	1/2	260	130	65
50	5/8	870	430	215
60	3/4	1210	600	300
80	1	2070	1030	515
100	1 1/4	3420
120	1 1/2	4850
140	1 3/4	6570
160	2	8580
C2040, C2042	1	530	260	130
C2050, C2052	1 1/4	870	430	215
C2060, C2062	1 1/2	600	300
C2080, C2082	2	1030	515
C2060H, C2062H	1 1/2	1210
C2080H, C2082H	2	2070
C2100H, C2102H	2 1/2	3420
C2120H, C2122H	3	4850
C2160H, C2162H	4	8580

TECHNICAL ENGINEERING

Chain Selection

Step 5 - Finalize Chain Size Selection: After a preliminary chain has been selected, recalculate the chain pull including the weight of the chain, including attachments, per foot. Nominal values for chain weight and attachment weight can be obtained from the Chain and Attachment Weight table below.

Chain and Attachment Weight

ASME/ANSI or Diamond Number	Weight per Foot Base Chain	Weight for each Straight or Bent Attachment	Weight for each Extended Pin Attachment	ASME/ANSI or Diamond Number	Weight per Foot Base Chain	Weight for each Straight or Bent Attachment	Weight for each Extended Pin Attachment
25	.0840	.0007	C2040	.3400	.0068	.0019
35	.2100	.0019	.0015	C2042	.5000	.0068	.0019
41	.2600	.0033	.0015	C2050	.5800	.0130	.0037
40	.4100	.0030	.0020	C2052	.8100	.0130	.0037
50	.6800	.0090	.0037	C2060H	1.0500	.0310	.0062
60	.9900	.0120	.0062	C2062H	1.4200	.0310	.0062
80	1.7300	.0250	.0150	C2080H	1.4000	.0680	.0150
100	2.5100	.0650	.0250	C2082H	2.1300	.0680	.0150
120	3.6900	.1000	.0450	C2100H	2.4800	.1180	.0250
140	5.0000	.1800	.0670	C2102H	3.5100	.1180	.0250
160	6.5300	.2500	.0960	C2120H	3.6000	.1860	.0450
				C2122H	5.4800	.1860	.0450
				C2160H	6.1800	.4700	.0960
				C2162H	9.3400	.4700	.0960

Calculate the catenary tension from the formula previously shown. Confirm that the catenary tension does not exceed the working load of the preliminary chain selection's chain. If it does exceed the capability of the preliminary selection either increase the size of the selected chain, recalculate catenary tension and compare again or consider installing support rails to minimize the amount of chain in the unsupported span.

Step 6 - Select Required Sprocket Sizes: Select the sprockets for the conveyor using the guidelines previously listed in this section.

Step 7a - Calculate Required Chain Length: If both the headshaft and tailshaft sprockets have the same number of teeth, the total chain length can be calculated from the formula:

$$L = \text{Number of teeth on one sprocket} + (2 \times \text{center distance in pitches})$$

Where:

$$L = \text{total chain length required, in pitches.}$$

Chain length should be an even number of pitches. The total chain length must be exactly divisible by the attachment spacing. For example, if the attachments are located every fourth pitch then the total chain length must be divisible by four.

TECHNICAL ENGINEERING

Chain Selection

Step 7b - Calculate Required Chain Length: If the headshaft and tailshaft sprockets are of unequal size, total chain length can be calculated from the formula:

$$L = 2C + \frac{N + n}{2} + \frac{.1013 (N - n)^2}{4C} \quad \text{or substituting A for } \frac{.1013 (N - n)^2}{4}, \quad L = 2C + \frac{N + n}{2} + \frac{A}{C}$$

Where: L= Total chain length in pitches

n = Number of teeth on smaller sprocket

N = Number of teeth on larger sprocket

C = Center distance between shafts **in pitches**

Values of A For Chain Length Calculation

N - n	A	N - n	A	N - n	A	N - n	A
1	0.03	26	17.12	51	65.88	76	146.31
2	0.10	27	18.47	52	68.49	77	150.18
3	0.23	28	19.86	53	71.15	78	154.11
4	0.41	29	21.30	54	73.86	79	158.09
5	0.63	30	22.80	55	76.62	80	162.11
6	0.91	31	24.34	56	79.44	81	166.19
7	1.24	32	25.94	57	82.30	82	170.32
8	1.62	33	27.58	58	85.21	83	174.50
9	2.05	34	29.28	59	88.17	84	178.73
10	2.53	35	31.03	60	91.19	85	183.01
11	3.06	36	32.83	61	94.25	86	187.34
12	3.65	37	34.68	62	97.37	87	191.73
13	4.28	38	36.58	63	100.39	88	196.10
14	4.96	39	38.53	64	103.75	89	200.64
15	5.70	40	40.53	65	107.02	90	205.18
16	6.48	41	42.58	66	110.34	91	209.76
17	7.32	42	44.68	67	113.71	92	214.40
18	8.21	43	46.84	68	117.13	93	219.08
19	9.14	44	49.04	69	120.60	94	223.82
20	10.13	45	51.29	70	124.12	95	228.61
21	11.17	46	53.60	71	127.69	96	233.44
22	12.26	47	55.95	72	131.31	97	238.33
23	13.40	48	58.36	73	134.99	98	243.27
24	14.59	49	60.82	74	138.71	99	248.26
25	15.83	50	63.33	75	142.48	100	253.30

Again, the total chain length must be exactly divisible by the attachment spacing. For example, if the attachments are located every fourth pitch then the total chain length must be divisible by four.

Step 8 - Determine the Required Input Horsepower: The required input horsepower can be calculated from the formula:

$$HP = \frac{\text{chain pull} \times \# \text{ of chains} \times \text{conveyor speed in feet per minute}}{33,000}$$

Step 9 - Determine the Required Lubrication System: Refer to the guidelines for conveyor lubrication provided earlier in this section.

TECHNICAL ENGINEERING

Chain Selection

Example Conveyor Chain Selection

Given

A horizontal conveyor transports machine components on wooden pallets at 56 feet per minute using two parallel roller chains joined every 12 inches by a steel flight weighing 0.75 pounds each. The maximum weight of a pallet, including the machine components, is 120 pounds. The overall size of the pallet is 36 inches x 36 inches. The length of the conveyor, from center of headshaft to center of tailshaft is 75 feet, allowing a maximum of 25 pallets to be transported at one time. It is desired to utilize a roller chain constructed with oversized carrier rollers. There is no take-up currently designed for the conveyor as the excess chain will be accumulated using a catenary between head and tail shafts.

Determine

Size of roller chain required

Size of sprockets

Recommended method of lubrication

Required input horsepower

Step 1: Obtain the required information. From the given information, we know the following:

Horizontal conveyor.

Speed is to be **56 feet per minute**.

Shaft centers are located **75 feet apart**.

Weight of **conveyed material** is 120 pounds over a 36 inch span, or **40 pounds per foot** of conveyor length.

Conveyed material is a wooden pallet.

The drive is intended to have **two chains** connected with metal flights weighing .75 pounds each, every 12 inches. So, the **weight of the flights is .75 pounds per foot** of conveyor length.

The flights will be attached to the chains every 12 inches. Therefore the **attachments will be spaced every 12 inches**.

No specific sprockets have been defined but must be recommended.

TECHNICAL ENGINEERING

Chain Selection

Step 2: Calculate preliminary chain pull.

Using the equation, $P = [(Wm + 2Wc) \times L \times Fx] + Wm \times L \times Fm$, and the known information, the preliminary chain pull is:

$$P = [(40 + 2 \times 0) \times 75 \times 0.1] + 40 \times 75 \times .5 = 1800 \text{ pounds}$$

Remember we omit the weight of the chain, Wc , in the preliminary chain pull calculation. Additionally, because the given information requested a roller chain having oversized carrier rollers, we selected an average Fx of .1 from the Coefficients of Rolling Resistance table. Because there is a possibility that the pallets may “accumulate,” forcing the chain to “slide” along the bottom surface of the pallets, an approximate coefficient of friction between wood and steel of 0.5 was selected from an engineering handbook.

Step 3: Adjust the preliminary chain pull for conveyor speed. Using the values in the Load Factors for Conveyor Speed table, we would use the factor 1.5, as the given information tells us that the conveyor's speed will be 56 feet per minute.

$$P = \text{preliminary chain pull calculation} \times \text{speed factor}$$

$$P = 1800 \text{ pounds} \times 1.5 = 2700 \text{ pounds}$$

Step 4: Make preliminary chain selection. To arrive at the single strand chain pull, we divide the total chain pull by the number of strands employed. In the example it was stated that the conveyor was to have two chains connected by flights. Therefore, the total chain pull of 2700 pounds can be divided by two to arrive at the single strand chain pull.

$$\text{Single Strand Pull} = \text{Chain pull} / \text{number of chains in drive}$$

$$P = 2700 / 2 = 1350 \text{ pounds.}$$

Using this value we can select a chain size from the Working Loads for Conveyor Chains table. In this example, no specific environment was defined so we can assume carbon steel chains will be acceptable. Based upon the 1350 pound single strand chain pull calculated above, a C2082H chain would be acceptable based on its recommended working load of 2070 pounds.

TECHNICAL ENGINEERING

Chain Selection

Step 5: Finalize chain selection. Now we include the weight of the selected chain and attachments along with the correct coefficient of rolling resistance for C2080H in the chain pull equation to verify that our selection is acceptable. We will assume that the design calls for bent attachments on both sides of the chain at 6-6 spacing (6 pitches of C2082H = 12 inches). Using the equation:

$P = [(Wm + 2Wc) \times L \times Fx] + Wm \times L \times Fm$ along with information extracted from the Chain and Attachment Weight table, and the given information, the finalized chain pull is:

$$P = [(40 + 2 \times 2.266) \times 75 \times 0.08] + 40 \times 75 \times .5 = 1767 \text{ pounds}$$

Multiplying this by the speed factor of 1.5 gives results in $1767 \times 1.5 = 2650$ pounds.

But, because this drive is to be composed of two parallel chains, the single strand chain pull is $2650/2$ or 1325 pounds. This is still well within the limitations for C2082H conveyor chain.

Because there is no take-up designed into the drive other than a catenary under the conveyor, depth of sag and catenary tension must be calculated and considered in the drive's selection.

Using the equations for both sag and tension, and considering the maximum allowable elongation of 1.5% (approximately 27.00 inches), the following values are determined:

$$\text{Depth of Sag, } D = \frac{\sqrt{3S^2 - 3L^2}}{4}$$

$$D = \frac{\sqrt{3(927)^2 - 3(900)^2}}{4}$$

$$D = 96.17 \text{ inches}$$

$$\text{Catenary tension, } T = \frac{W}{12} \left[\frac{S^2}{8D} + \frac{D}{2} \right]$$

$$T = \frac{2.26}{12} \left[\frac{927^2}{8 \times 96.17} + \frac{96.17}{2} \right]$$

$$T = 219.41 \text{ pounds tension due to the catenary}$$

219.41 pounds is well within the capabilities of C2082H's working load. Therefore C2082H can be selected for use on this drive.

TECHNICAL ENGINEERING

Chain Selection

Step 6: Select required sprocket sizes. Using information provided earlier in this section, sprockets having at least 15 effective teeth should be acceptable.

Step 7: Calculate chain length. Both head and tail shafts will have sprockets of equal size. Therefore, chain length can be calculated using the formula:

$$Lc = \text{Number of teeth (itches) on one sprocket} + (2 \times \text{center distance in pitches})$$

$$Lc = 15 + [2 \times (75 \times 6)] = 915 \text{ pitches}$$

Chain length must be a.) an even number of pitches and b.) evenly divisible by the spacing of the attachments. Therefore, 918 pitches is required as the spacing must be evenly divisible by 6.

It is possible to recalculate the depth of sag, D, and the catenary tension, T, using the new chain length, but it would not significantly affect the existing calculations.

Step 8: Determine the required input horsepower. Using the equation:

$$HP = \frac{\text{chain pull} \times \# \text{ of chains} \times \text{conveyor speed in feet per minute}}{33,000}$$

$$HP = \frac{1325 \times 2 \times 56}{33,000} = 4.49 \text{ HP}$$

Step 9: Determine the required lubrication. As stated earlier, the majority of conveyor systems will provide satisfactory service life when lubricated using manual or drip lube systems. Therefore, unless the conveyor is operating in an unusually harsh or contaminated environment, type A or manual lubrication should serve satisfactorily.

TECHNICAL ENGINEERING

Roller Chain Installation

Roller chain, properly selected, installed and maintained, is an extremely versatile means of power transmission. It is possible, however, to greatly reduce a chain's life and even induce failure if the chain is abused through improper installation, operation, or maintenance procedures. In certain applications, chain failure can lead to personal injury or property damage.

A chain's installation, lubrication and maintenance are generally quite simple but as with most similar systems, proper preparation will add greatly to the overall ease and effectiveness of the task.

Areas to be considered prior to, as well as after installation are:

1. Safety.
2. Chain, sprockets, and other drive components.
3. Shaft and sprocket alignment.
4. Chain and connecting link installation.
5. Initial correct tension and provisions for adjustment during service.
6. Provision for adequate lubrication.
7. Appropriate protective guarding.

Safety: When installing or connecting/disconnecting a roller chain:

1. Always lock out equipment power switch before removing or installing chains.
2. ALWAYS USE SAFETY GLASSES to protect your eyes.
3. Wear protective clothing, gloves and safety shoes as appropriate.
4. Support the equipment to prevent uncontrolled movement of chain and parts.
5. Use of pressing equipment is recommended to remove or install press-fit-type connecting/pin links. Tooling must be in good condition and properly used.
6. Do not attempt to connect or disconnect chain unless you know the chain's construction, including the correct direction for connecting link removal or insertion.

TECHNICAL ENGINEERING

Roller Chain Installation

Condition of Components: Shafts, sprockets, bearings, and any other relevant machine framing should be thoroughly examined. Any evidence of damage or wear should be repaired prior to the chain's installation.

Chain Inspection: When reinstalling an existing chain, care should be taken to ensure that it is free of grit and dirt. If necessary, wash the chain in an approved solvent, paying particular attention to flexing the chain's joints while submerged, as this will allow contaminants within the chain's joints to be rinsed away. The chain should be allowed to thoroughly dry, removing any solvents that could reduce the operating lubricant's ability to protect the internal wear surfaces. Once dry, it is critical that the chain be relubricated prior to installation. Suggested lubricants can be determined from a list located later in this section.

When installing a new chain, the manufacturer's lubricant should not be removed. These lubricants were applied under special conditions to provide the best balance between initial wear resistance and surface protection.

Drive Alignment

Misalignment results in uneven loading across the width of the chain and may cause damage ranging from roller link plate and sprocket tooth wear up to and including premature failure from link plate fatigue. Proper drive alignment can be divided into two categories: parallel shafts and parallel sprockets.

Aligning Shafts: Shafts should be parallel and level. This condition may be checked by the use of a feeler bar and a level.

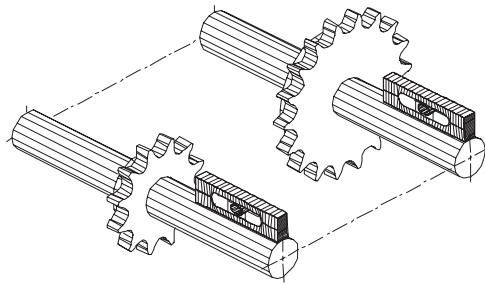

Aligning Sprockets: Sprocket axial alignment can be checked with a straight edge which will extend across the finished sides of the two sprockets. Normally, it is good practice to align the sprockets as close to the shaft bearings as possible. For long center distances, use a taut cord or wire long enough to extend beyond each of the sprockets.

Note: When shafts have appreciable "end float," sprockets should be aligned for the normal running position. Recheck after short running period for any signs of wear on inner faces of roller link plates.

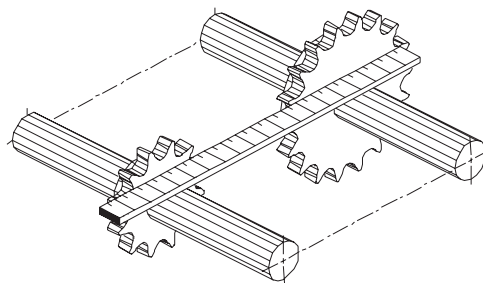

Recheck all preceding adjustments and be certain all sprocket set-screws, as well as any additional hardware, are secure.

TECHNICAL ENGINEERING

Roller Chain Installation

Chain and Connecting Link Installation

Installing the Chain: Fit chain around the sprockets in the drive and bring the free ends together, normally on one of the sprockets, for final connection. If the ends cannot be brought together on a common sprocket, the use of Diamond's chain connecting tool may be employed. Refer to the Chain Tools section of this guide for more detailed information on the connecting tool.

Installing the Connecting Link: The connecting link, depending upon the size and type of chain, may employ either a slip-fit or press-fit cover plate, combined with either a spring clip or cotters as the final retainer.

Press-fit cover plates, discussed in the General Drive Considerations section, are those which have an interference fit on the pins and provide integrity equal to the base chain itself. They do, however, present their own unique degree of difficulty at assembly.

To assemble the press-fit cover plates:

1. Insert the "Master Link," the portion of the link that contains the pins, and provide support or backing to resist the forces needed to drive the cover plate on.
2. Place the press-fit cover plate over the exposed pin ends and ensure that it is aligned properly.
3. Drive the cover plate on until it is flush with the ends of the pins.
4. Obtain a hollow punch (perhaps a small piece of pipe or a discarded chain's roller) and locate it over/around the flush pin end.
5. Alternately from one pitch hole to the other, continue to drive the ends of the link plate onto the pins until it is clear of the spring clip groove or cotter hole. Care should be taken not to drive the plate on so far as to squeeze against or pinch the roller links. This will result in stiff or binding joints.
6. Install the retaining device, either spring clip or cotter.

Caution: Never drill out or enlarge the pitch holes of a press-fit cover plate to make the installation easier. This will lower the integrity of the link.

Slip-fit cover plates, discussed in the General Drive Considerations section, are those which have a clearance fit on the pins. These connecting links are far easier to install but reduce the working load capacity of the chain.

To assemble the slip-fit cover plate:

1. Insert the "Master Link," the portion of the link that contains the pins, into the chain.
2. Slide the plate over the pin ends to a location which clears either the spring clip groove or cotter hole.
3. Install the retaining device, either spring clip or cotter.

Note: When a slip-fit cover plate is used, a chain's working capacity can be reduced as much as 30%.

TECHNICAL ENGINEERING

Roller Chain Installation

Retaining Devices

Spring clips are provided for chain models #25-#60 and provide a quick and easy method for securing the cover plate. Installation is performed by first determining the direction of chain travel and locating the closed end of the clip over the leading pin's groove. Final installation is performed by "snapping" the clip over the trailing pin locking it into the groove. Care should be taken not to bend or deform the clip during installation as this may cause it to come loose during operation.

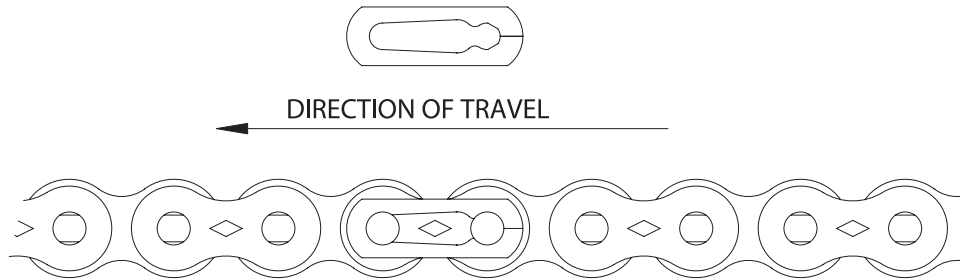

Staggered-leg cotters are normally provided on #80 and larger models' connecting links as the method of retaining the cover plate. Diamond manufactures cotters and specially heat treats them to obtain specific properties which are beneficial in service. After insertion, the legs should not be spread in excess of 90° (included angle) and if removed should not be reused. It is not recommended to use commercial cotters as they may not provide satisfactory performance in severe applications.

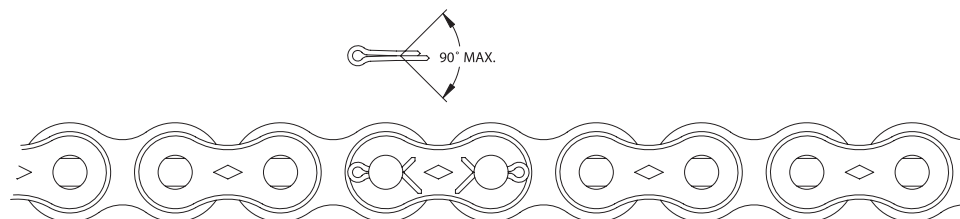

Shepherd's crooks are available upon request for chain models #120-#160. These retaining devices secure the cover plate by passing through both pins of a connecting link with just a single pin. To install, first determine the direction of chain travel and then orient such that the hook-end of the device snaps onto the leading pin of the connecting link. The shepherd's crook should then be crimped slightly in the middle to minimize fretting.

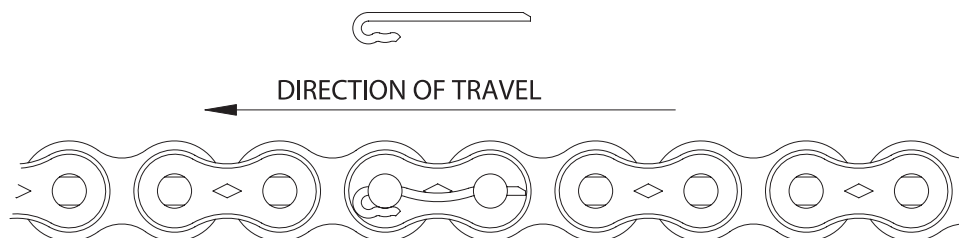

TECHNICAL ENGINEERING

Roller Chain Installation

Retaining Devices

Z-pin cotters are available upon request for chain models #120-#200. These retaining devices are another single-pin method of securing the cover plate. The pins are supplied bent on one end. To retain the cover plate, simply install the z-pin cotter through both pins of a connecting link until the bend stops insertion, then bend the leading end in the opposite direction.

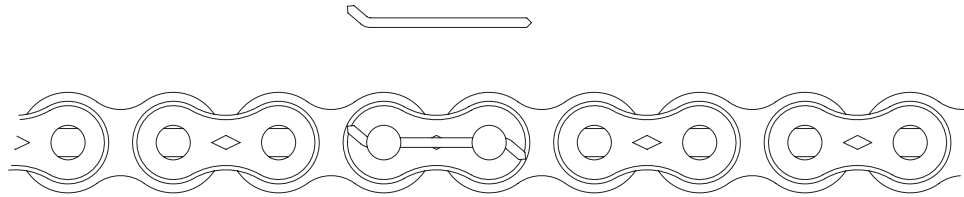

Proper Chain Tension: It should be expected that new chains will elongate slightly more during the first few days of service than in the months of subsequent operation. This is due to the “running-in” of the chain which removes minute imperfections from the surfaces of the pins and bushings. Diamond chains are pre-stressed prior to shipment to remove the majority of this “run-in” but some slight amount should still be expected. Because of this, it is good practice to establish and adjust center distances or idlers for an initially snug-fitting chain. After the initial run-in period, the drive should always be adjusted so that there is some degree of slack in the unloaded section of chain. This slack is very important as it allows the pin/bushing joint to relubricate itself prior to entering the working or loaded portion of the drive.

The following represents recommended mid-span movements for a properly tensioned drive.

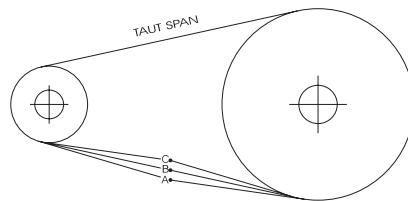

Recommended Possible Mid-Span Movement, A-C, of Slack Span

Dimensions in Inches

Drive Center-Line	Tangent Length Between Sprockets								
	5	10	15	20	30	40	60	80	100
Horizontal to 45	0.25	0.50	0.75	1.00	1.50	2.00	3.00	4.00	5.00
Vertical to 45	0.12	0.25	0.38	0.50	0.75	1.00	1.50	2.00	2.50

TECHNICAL ENGINEERING

Roller Chain Lubrication

Roller chain drives suffer more harm from faulty lubrication than from years of normal service!!!

A roller chain consists of a series of connected journal bearings which must be properly lubricated to obtain the maximum service life. Although many slow speed drives operate successfully with little or no lubrication beyond that initially applied at the time of manufacture, continued proper lubrication will greatly extend the useful life of every chain drive.

Chain drives require lubrication for six primary purposes:

1. Resist wear of the pin-bushing joint.
2. Cushion impact loads.
3. Dissipate heat.
4. Flush away foreign materials.
5. Lubricate chain-sprocket contact surfaces.
6. Prevent rust or corrosion.

In selecting a lubricant, a good grade of clean petroleum oil without additives is most commonly recommended. Certain additives in oil can leave a varnish or gum buildup which will prevent additional lubricant from entering chain joints.

The viscosity of the lubricant greatly affects its ability to flow into the internal areas; therefore, the highest viscosity oil which will flow between the chain link plates and fill the pin-bushing areas will provide the greatest film thickness and best wear life.

Greases, applied to the exterior of the chain, serve no purpose with the exception of protecting the external surfaces from rust or corrosion and should not be relied upon to provide any internal lubricating benefits.

The following table provides a guideline for selecting the proper lubricant viscosity at various ambient temperatures:

Ambient Temperature Degrees F	Recommended Lubricants				
	SUS Viscosity 100 F	SAE Engine Oil	SAE Gear Oil	ISO	AGMA
20-40	200-400	20	80W	46 or 68	1 or 2
40-100	400-650	30	85W	100	3
100-120	650-950	40	90	150	4
120-140	950-1450	50	90	220	5

The elongation of roller chain is the result of wear caused by friction between the link plates and the pin-bushing joint. For any lubricant to reach the critical pin/bushing area it should be applied to the upper edges of link plates in the slack span. Lubricant applied only to the outer edges will not provide an adequate supply to the internal wearing surfaces. However, the chain's rollers will spillage over the link plate edges when lubricant is properly applied.

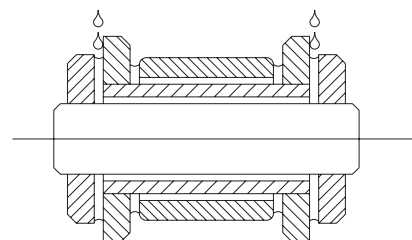

LUBRICANT FLOW INTO THE CHAIN JOINT

TECHNICAL ENGINEERING

Roller Chain Lubrication

Note: When applying lubricant to multiple strand chain, it is important that lubricant be directed to each row of chain link plates, not just the outermost rows; and, in conveying applications, oil should be directed between the rollers and bushings as well as between the chain link plates, as significant wear can result from external loading.

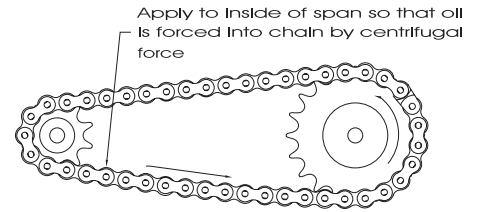

APPLICATION OF LUBRICANT TO CHAIN

Methods of Lubrication

There are three basic methods of lubrication for roller chain drives. Close adherence to these recommended types of lubrication is essential in obtaining the maximum service life of a chain drive. These recommended types of lubrication, as shown in the horsepower rating tables, are determined by the chain speed and the amount of power transmitted.

Manual or Drip Lubrication (Type A): Lubricant applied manually with an oil can or brush is acceptable for slow speed drives, generally not over 600 feet per minute. When lubrication must be accomplished with a minimum amount of oil, it is advisable to equip the system with either felt pads or brushes which are fed by lubricant from a reservoir and carefully positioned to direct oil into the clearances between each row of link plates in the slack span of chain.

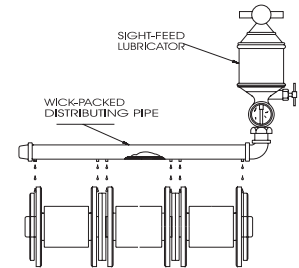

Bath Lubrication (Type B): Lubricant is applied to the chain by allowing the oil level within an enclosed casing to cover the chain at approximately the pitch line at its lowest point of operation. This is by far the most desirable method for chains operating at up to approximately 1500 feet per minute.

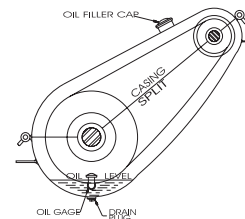

Forced or Circulating Lubrication (Type C): This is similar to bath lubrication with the exception that the lubricant is pumped onto the chain under pressure. The oil should be delivered to the upper edges of each row of link plates across the lower span of chain just prior to the chain's entry into one of the sprockets.

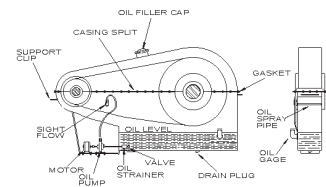

The following table can be used as a guide for determining the type of lubricating system based upon the speed of the chain in feet per minute. The final selection should, however, be based upon the type of lubrication system recommended in the horsepower rating tables for the specific chain, sprocket, speed and horsepower transmitted.

		Chain Speed in Feet/Minute									
Chain No.	35	40	50	60	80	100	120	140	160	200	
Type A	350	300	250	215	165	145	125	110	100	80	
Type B	2650	2200	1900	1750	1475	1250	1170	1050	1000	865	
Type C	Use for speeds higher than Type B limits										

TECHNICAL ENGINEERING

Roller Chain Maintenance

4. Check Sprocket Tooth Wear

Check for roughness or binding when the chain engages or disengages from the sprocket. Inspect the sprocket teeth for reduced tooth section and “hooked” tooth tips. If these conditions are present, the sprocket teeth are excessively worn and the sprocket should be replaced. Do not run new chain on worn sprockets as it will cause the new chain to wear rapidly. Conversely, do not run a worn chain on new sprockets as it will cause the new sprockets to wear rapidly. As a *general* rule, replace the sprockets with every third chain replacement.

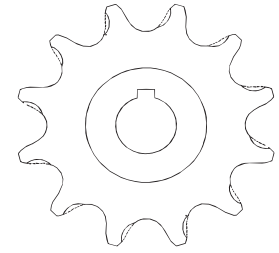

**TOOTH FORM ALTERED
DUE TO WEAR**

5. Check Sprocket Alignment

If there is noticeable wear on the inside surfaces of the chain roller link plates, the sprockets may be misaligned. Realign the sprockets as outlined in the Installation section to prevent further abnormal chain and sprocket wear.

6. Check for Drive Interference

Check for interference between the drive and other parts of the equipment. If there is any, correct it immediately. Interference can cause abnormal and potentially destructive wear on the chain or the interfering part. If the edges of the chain link plates impact against a rigid part, link plate fatigue and chain failure can result.

Check for and eliminate any buildup of debris or foreign material between the chain and sprockets. A relatively small amount of debris in the sprocket roll seat can cause tensile loads great enough to break the chain if forced through the drive.

7. Check for Failure

Inspect the chain for cracked, broken, or deformed parts. If any of these conditions are found, **replace the entire chain**. Even though portions of the chain may appear to be in good condition, in all likelihood, the entire chain has been damaged.

Warning: Roller chains that have been damaged under excessive loading due to an accident, or otherwise, should be completely replaced because the chain, as well as the damaged component, has been loaded to a degree that has impaired its ability to transmit normal loading.

8. Evidence of Lubrication

One of the first indications that a roller chain is not receiving adequate lubrication is that the external areas around the joints will most likely have a reddish/brown (rusty) color. The inadequate lubrication can be confirmed by removing a link (most commonly the connecting link) and examining the surface of the pins. The color of the pins will generally be dark brown, even blue, if the chain has been running with inadequate lubrication. Additionally, the surface of poorly lubricated pins will be rough, grooved, or even show evidence of galling.

Properly lubricated chains will not exhibit the rusty color at the joints, and the pins of the connecting links, when removed, will be generally smooth, shiny and have an obvious coating of lubricant on the surface.

TECHNICAL ENGINEERING

Horsepower Rating Tables

The Horsepower Rating Tables found on the following pages cover Standard Series, Heavy Series and Double-Pitch roller chains. Additionally, Horsepower Rating Tables for Diamond's RING LEADER® O-ring chains, from 5/8" through 1-1/4" pitch are also included.

The power transmission capacity rating listed in the following tables are based upon these conditions:

1. A service factor of one.
2. Chain length of 100 pitches.
3. The use of recommended methods of lubrication.
4. A two-sprocket drive, properly aligned and mounted on parallel horizontal shafts.
5. A non-abrasive environment.

Under the above conditions, a service life of approximately 15,000 hours can be expected.

Standard and Heavy Series Power Transmission Roller Chains

Horsepower Ratings – Single Strand Roller Chain No. 25

# of teeth in small sprocket	Revolutions Per Minute – Small Sprocket																								
	50	100	300	365	500	700	900	1200	1500	1800	2100	2500	3000	3500	4000	4500	5000	5500	6000	7000	8000	9000	10000	11000	12000
11	0.03	0.06	0.19	0.22	0.30	0.42	0.53	0.70	0.87	1.03	1.20	1.42	1.69	1.69	1.38	1.16	0.99	0.86	0.75	0.60	0.49	0.41	0.35	0.30	0.27
12	0.04	0.07	0.20	0.24	0.33	0.46	0.58	0.76	0.95	1.13	1.31	1.55	1.84	1.92	1.57	1.32	1.12	0.97	0.86	0.68	0.56	0.47	0.40	0.34	0.30
13	0.04	0.08	0.22	0.26	0.36	0.49	0.63	0.83	1.03	1.22	1.42	1.67	1.99	2.17	1.77	1.49	1.27	1.10	0.96	0.77	0.63	0.53	0.45	0.39	0.34
14	0.04	0.08	0.24	0.28	0.38	0.53	0.68	0.89	1.10	1.32	1.52	1.80	2.15	2.42	1.98	1.66	1.42	1.23	1.08	0.86	0.70	0.59	0.50	0.43	0.38
15	0.05	0.09	0.25	0.30	0.41	0.57	0.72	0.95	1.18	1.41	1.63	1.93	2.30	2.67	2.20	1.84	1.57	1.36	1.20	0.95	0.78	0.65	0.56	0.48	0.42
16	0.05	0.09	0.27	0.32	0.44	0.61	0.77	1.02	1.26	1.50	1.74	2.06	2.45	2.85	2.42	2.03	1.73	1.50	1.32	1.05	0.86	0.72	0.61	0.53	0.47
17	0.05	0.10	0.29	0.35	0.47	0.64	0.82	1.08	1.34	1.60	1.85	2.19	2.61	3.02	2.65	2.22	1.90	1.64	1.44	1.14	0.94	0.79	0.67	0.58	0.51
18	0.05	0.11	0.30	0.37	0.49	0.68	0.87	1.15	1.42	1.69	1.96	2.32	2.76	3.20	2.89	2.42	2.07	1.79	1.57	1.25	1.02	0.86	0.73	0.63	0.56
19	0.06	0.11	0.32	0.39	0.52	0.72	0.92	1.21	1.50	1.78	2.07	2.45	2.91	3.38	3.13	2.62	2.24	1.94	1.70	1.35	1.11	0.93	0.79	0.69	
20	0.06	0.12	0.34	0.41	0.55	0.76	0.97	1.27	1.58	1.88	2.18	2.58	3.07	3.56	3.38	2.83	2.42	2.10	1.84	1.46	1.20	1.00	0.86	0.74	
21	0.06	0.12	0.35	0.43	0.58	0.80	1.01	1.34	1.66	1.97	2.29	2.70	3.22	3.74	3.64	3.05	2.60	2.26	1.98	1.57	1.29	1.08	0.92		
22	0.07	0.13	0.37	0.45	0.60	0.83	1.06	1.40	1.73	2.07	2.40	2.83	3.37	3.91	3.90	3.27	2.79	2.42	2.12	1.69	1.38	1.16	0.99		
23	0.07	0.13	0.39	0.47	0.63	0.87	1.11	1.46	1.81	2.16	2.51	2.96	3.53	4.09	4.17	3.50	2.98	2.59	2.27	1.80	1.47	1.24	1.04		
24	0.07	0.14	0.40	0.49	0.66	0.91	1.16	1.53	1.89	2.25	2.61	3.09	3.68	4.27	4.45	3.73	3.18	2.76	2.42	1.92	1.57	1.32	0.22		
25	0.08	0.15	0.42	0.51	0.69	0.95	1.21	1.59	1.97	2.35	2.72	3.22	3.84	4.45	4.73	3.96	3.38	2.93	2.57	2.04	1.67	1.40			
26	0.08	0.15	0.44	0.53	0.71	0.99	1.26	1.65	2.05	2.44	2.83	3.35	3.99	4.62	5.01	4.20	3.59	3.11	2.73	2.17	1.77	1.49			
28	0.08	0.16	0.47	0.57	0.77	1.06	1.35	1.78	2.21	2.63	3.05	3.61	4.30	4.98	5.60	4.70	4.01	3.47	3.05	2.42	1.98				
30	0.09	0.18	0.50	0.61	0.82	1.14	1.45	1.91	2.37	2.82	3.27	3.86	4.60	5.34	6.07	5.21	4.45	3.85	3.38	2.68	1.98				
32	0.10	0.19	0.54	0.65	0.88	1.21	1.55	2.04	2.52	3.01	3.49	4.12	4.91	5.69	6.47	5.74	4.90	4.25	3.73	2.96	0.35				
35	0.11	0.21	0.59	0.71	0.96	1.33	1.69	2.23	2.76	3.29	3.81	4.51	5.37	6.23	7.08	6.56	5.60	4.86	4.26	2.76					
40	0.12	0.23	0.67	0.81	1.10	1.52	1.93	2.55	3.15	3.76	4.36	5.15	6.14	7.11	8.09	8.02	6.85	5.93	4.91						
45	0.14	0.26	0.76	0.91	1.24	1.71	2.17	2.86	3.55	4.23	4.90	5.79	6.90	8.00	9.10	9.57	8.17	5.23	1.38						
	TYPE A LUBRICATION				TYPE B LUBRICATION										TYPE C LUBRICATION										

TYPE A LUBRICATION – MANUAL OR DRIP
 TYPE B LUBRICATION – OIL BATH OR SLINGER
 TYPE C LUBRICATION – OIL PUMP

See Lubrication Instructions in the Roller Chain Installation section.
 Ratings shown are for standard steel chain. See the General Drive Selection section for service factors, selection factors and multiple strand factors.

TECHNICAL ENGINEERING

Horsepower Rating Tables

Standard and Heavy Series Power Transmission Roller Chains

Horsepower Ratings – Single Strand Roller Chain No. 35

# of teeth in small sprocket	Revolutions Per Minute – Small Sprocket																								
	50	100	200	240	500	700	900	1200	1500	1800	2100	2500	3000	3500	4000	4500	5000	5500	6000	6500	7000	7500	8000	9000	10000
11	0.11	0.22	0.42	0.50	1.02	1.41	1.80	2.37	2.93	3.49	4.05	3.86	2.94	2.33	1.91	1.60	1.37	1.18	1.04	0.92	0.82	0.74	0.67	0.57	0.48
12	0.12	0.24	0.46	0.55	1.11	1.54	1.96	2.58	3.20	3.81	4.42	4.40	3.35	2.66	2.17	1.82	1.56	1.35	1.18	1.05	0.94	0.85	0.77	0.64	0.55
13	0.13	0.26	0.50	0.60	1.21	1.67	2.12	2.80	3.47	4.13	4.79	4.96	3.77	3.00	2.45	2.05	1.75	1.52	1.33	1.18	1.06	0.95	0.87	0.73	0.62
14	0.14	0.28	0.54	0.64	1.30	1.80	2.29	3.01	3.73	4.45	5.15	5.55	4.22	3.35	2.74	2.30	1.96	1.70	1.49	1.32	1.18	1.07	0.97	0.81	0.10
15	0.15	0.30	0.58	0.69	1.39	1.92	2.45	3.23	4.00	4.76	5.52	6.15	4.68	3.71	3.04	2.55	2.17	1.88	1.65	1.47	1.31	1.18	1.07	0.90	
16	0.16	0.32	0.62	0.73	1.49	2.05	2.61	3.44	4.26	5.08	5.89	6.77	5.15	4.09	3.35	2.81	2.40	2.08	1.82	1.62	1.45	1.30	1.18	0.44	
17	0.17	0.34	0.65	0.78	1.58	2.18	2.77	3.66	4.53	5.40	6.26	7.40	5.64	4.48	3.67	3.07	2.62	2.27	2.00	1.77	1.58	1.43	1.30		
18	0.18	0.36	0.69	0.83	1.67	2.31	2.94	3.87	4.80	5.72	6.63	7.83	6.15	4.88	3.99	3.35	2.86	2.48	2.17	1.93	1.73	1.56	1.41		
19	0.19	0.38	0.73	0.87	1.76	2.44	3.10	4.09	5.06	6.03	7.00	8.27	6.67	5.29	4.33	3.63	3.10	2.69	2.36	2.09	1.87	1.69	0.05		
20	0.20	0.40	0.77	0.92	1.86	2.56	3.26	4.30	5.33	6.35	7.36	8.71	7.20	5.72	4.68	3.92	3.35	2.90	2.55	2.26	2.02	1.42			
21	0.21	0.42	0.81	0.96	1.95	2.69	3.43	4.52	5.60	6.67	7.73	9.14	7.75	6.15	5.03	4.22	3.60	3.12	2.74	2.43	2.17				
22	0.22	0.44	0.85	1.01	2.04	2.82	3.59	4.73	5.86	6.99	8.10	9.58	8.31	6.59	5.40	4.52	3.86	3.35	2.94	2.61	1.42				
23	0.23	0.46	0.89	1.06	2.14	2.95	3.75	4.95	6.13	7.30	8.47	10.01	8.88	7.05	5.77	4.83	4.13	3.58	3.14	2.79					
24	0.24	0.48	0.92	1.10	2.23	3.08	3.92	5.16	6.40	7.62	8.84	10.45	9.47	7.51	6.15	5.15	4.40	3.81	3.35	2.04					
25	0.25	0.50	0.96	1.15	2.32	3.21	4.08	5.38	6.66	7.94	9.20	10.88	10.07	7.99	6.54	5.48	4.68	4.05	3.56	0.12					
26	0.26	0.51	1.00	1.19	2.41	3.33	4.24	5.59	6.93	8.26	9.57	11.32	10.68	8.47	6.93	5.81	4.96	4.30	3.40						
28	0.29	0.55	1.08	1.28	2.60	3.59	4.57	6.02	7.46	8.89	10.31	12.19	11.93	9.47	7.75	6.49	5.55	4.81							
30	0.31	0.59	1.16	1.38	2.79	3.85	4.90	6.45	8.00	9.53	11.05	13.06	13.23	10.50	8.59	7.20	6.15	5.24							
32	0.33	0.63	1.23	1.47	2.97	4.10	5.22	6.88	8.53	10.16	11.78	13.93	14.58	11.57	9.47	7.93	6.76								
35	0.36	0.69	1.35	1.61	3.25	4.49	5.71	7.53	9.33	11.11	12.89	15.23	16.67	13.23	10.83	8.85	0.34								
40	0.41	0.79	1.54	1.84	3.71	5.13	6.53	8.61	10.66	12.70	14.73	17.41	20.37	16.17	11.04	0.34									
45	0.46	0.89	1.73	2.07	4.18	5.77	7.35	9.68	11.99	14.29	16.57	19.59	23.33	15.56	3.11										
	TYPE A LUBE			TYPE B LUBRICATION									TYPE C LUBRICATION												

Horsepower Ratings – Single Strand Roller Chain No. 40

# of teeth in small sprocket	Revolutions Per Minute – Small Sprocket																									
	10	25	50	100	180	200	300	500	700	900	1000	1200	1400	1600	1800	2100	2500	3000	3500	4000	5000	6000	7000	8000	9000	
11	0.06	0.14	0.27	0.52	0.91	1.00	1.48	2.42	3.34	4.25	4.70	5.60	6.49	5.57	4.66	3.70	2.85	2.17	1.72	1.41	1.01	0.77	0.61	0.50		
12	0.06	0.15	0.29	0.56	0.99	1.09	1.61	2.64	3.64	4.64	5.13	6.11	7.09	6.34	5.31	4.22	3.25	2.47	1.96	1.60	1.15	0.87	0.69	0.57		
13	0.07	0.16	0.31	0.61	1.07	1.19	1.75	2.86	3.95	5.02	5.56	6.62	7.68	7.15	5.99	4.76	3.66	2.79	2.21	1.81	1.29	0.98	0.78			
14	0.07	0.17	0.34	0.66	1.15	1.28	1.88	3.08	4.25	5.41	5.98	7.13	8.27	7.99	6.70	5.31	4.09	3.11	2.47	2.02	1.45	1.10	0.87			
15	0.08	0.19	0.36	0.70	1.24	1.37	2.02	3.30	4.55	5.80	6.41	7.64	8.86	8.86	7.43	5.89	4.54	3.45	2.74	2.24	1.60	1.22	0.97			
16	0.08	0.20	0.39	0.75	1.32	1.46	2.15	3.52	4.86	6.18	6.84	8.15	9.45	9.76	8.18	6.49	5.00	3.80	3.02	2.47	1.77	1.34				
17	0.09	0.21	0.41	0.80	1.40	1.55	2.29	3.74	5.16	6.57	7.27	8.66	10.04	10.69	8.96	7.11	5.48	4.17	3.31	2.71	1.94	1.47				
18	0.09	0.22	0.43	0.84	1.48	1.64	2.42	3.96	5.46	6.95	7.69	9.17	10.63	11.65	9.76	7.75	5.97	4.54	3.60	2.95	2.11	1.60				
19	0.10	0.24	0.46	0.89	1.57	1.73	2.56	4.18	5.77	7.34	8.12	9.68	11.22	12.64	10.59	8.40	6.47	4.92	3.91	3.20	2.29	0.09				
20	0.10	0.25	0.48	0.94	1.65	1.82	2.69	4.39	6.07	7.73	8.55	10.18	11.81	13.42	11.44	9.07	6.99	5.31	4.22	3.45	2.47					
21	0.11	0.26	0.51	0.98	1.73	1.91	2.83	4.61	6.37	8.11	8.98	10.69	12.40	14.10	12.30	9.76	7.52	5.72	4.54	3.71	2.66					
22	0.11	0.27	0.53	1.03	1.81	2.01	2.96	4.83	6.68	8.50	9.40	11.20	12.99	14.77	13.19	10.47	8.06	6.13	4.87	3.98	2.85					
23	0.12	0.28	0.55	1.08	1.90	2.10	3.10	5.05	6.98	8.89	9.83	11.71	13.58	15.44	14.10	11.19	8.62	6.55	5.20	4.26	3.05					
24	0.12	0.30	0.58	1.12	1.98	2.19	3.23	5.27	7.28	9.27	10.26	12.22	14.17	16.11	15.03	11.93	9.18	6.99	5.54	4.54	0.87					
25	0.13	0.31	0.60	1.17	2.06	2.28	3.36	5.49	7.59	9.66	10.69	12.73	14.76	16.78	15.98	12.68	9.76	7.43	5.89	4.82						
26	0.13	0.32	0.63	1.22	2.14	2.37	3.50	5.71	7.89	10.04	11.11	13.24	15.35	17.45	16.95	13.45	10.36	7.88	6.25	5.12						
28	0.14	0.35	0.67	1.31	2.31	2.55	3.77	6.15	8.50	10.82	11.97	14.26	16.53	18.79	18.94	15.03	11.57	8.80	6.99	5.72						
30	0.15	0.37	0.72	1.41	2.47	2.74	4.04	6.59	9.11	11.59	12.82	15.28	17.71	20.14	21.01	16.67	12.84	9.76	7.75	6.34						
32	0.16	0.40	0.77	1.50	2.64	2.92	4.31	7.03	9.71	12.36	13.68	16.30	18.89	21.48	23.14	18.37	14.14	10.76	8.54	1.41						
35	0.18	0.43	0.84	1.64	2.88	3.19	4.71	7.69	10.62	13.52	14.96	17.82	20.67	23.49	26.30	21.01	16.17	12.30	9.76							
40	0.21	0.50	0.96	1.87	3.30	3.65	5.38	8.79	12.14	15.45	17.10	20.37	23.62	26.85	30.06	25.67	19.76	15.03								
45	0.23	0.56	1.08	2.11	3.71	4.10	6.06	9.89	13.66	17.39	19.24	22.92	26.57	30.20	33.82	30.63	23.58	5.53								
	TYPE A LUBE				TYPE B LUBRICATION										TYPE C LUBRICATION											

TYPE A LUBRICATION – MANUAL OR DRIP
 TYPE B LUBRICATION – OIL BATH OR SLINGER
 TYPE C LUBRICATION – OIL PUMP

See Lubrication Instructions in the Roller Chain Installation section.
 Ratings shown are for standard steel chain. See the General Drive Selection section for service factors, selection factors and multiple strand factors.

TECHNICAL ENGINEERING

Horsepower Rating Tables

Standard and Heavy Series Power Transmission Roller Chains

Horsepower Ratings – Single Strand Roller Chain No. 41

# of teeth in small sprocket	Revolutions Per Minute – Small Sprocket																							
	10	25	50	100	180	200	300	500	700	900	1000	1200	1400	1600	1800	2100	2500	3000	3500	4000	5000	6000	7000	8000
11	0.03	0.07	0.15	0.28	0.50	0.55	0.81	1.33	1.84	2.34	2.25	1.71	1.36	1.11	0.93	0.74	0.57	0.43	0.34	0.28	0.20	0.15	0.12	0.10
12	0.03	0.08	0.16	0.31	0.54	0.60	0.89	1.45	2.00	2.55	2.57	1.95	1.55	1.27	1.06	0.84	0.65	0.49	0.39	0.32	0.23	0.17	0.14	0.11
13	0.04	0.09	0.17	0.34	0.59	0.65	0.96	1.57	2.17	2.76	2.89	2.20	1.75	1.43	1.20	0.95	0.73	0.56	0.44	0.36	0.26	0.20	0.16	
14	0.04	0.10	0.19	0.36	0.63	0.70	1.04	1.69	2.34	2.97	3.23	2.46	1.95	1.60	1.34	1.06	0.82	0.62	0.49	0.40	0.29	0.22	0.17	
15	0.04	0.10	0.20	0.39	0.68	0.75	1.11	1.81	2.50	3.19	3.53	2.73	2.17	1.77	1.49	1.18	0.91	0.69	0.55	0.45	0.32	0.24	0.19	
16	0.05	0.11	0.21	0.41	0.73	0.80	1.18	1.93	2.67	3.40	3.76	3.01	2.39	1.95	1.64	1.30	1.00	0.76	0.60	0.49	0.35	0.27		
17	0.05	0.12	0.23	0.44	0.77	0.85	1.26	2.05	2.84	3.61	4.00	3.29	2.61	2.14	1.79	1.42	1.10	0.83	0.66	0.54	0.39	0.29		
18	0.05	0.12	0.24	0.46	0.82	0.90	1.33	2.18	3.00	3.82	4.23	3.59	2.85	2.33	1.95	1.55	1.19	0.91	0.72	0.59	0.42	0.32		
19	0.05	0.13	0.25	0.49	0.86	0.95	1.41	2.30	3.17	4.04	4.47	3.89	3.09	2.53	2.12	1.68	1.29	0.98	0.78	0.64	0.46	0.09		
20	0.06	0.14	0.27	0.52	0.91	1.00	1.48	2.42	3.34	4.25	4.70	4.20	3.33	2.73	2.29	1.81	1.40	1.06	0.84	0.69	0.49			
21	0.06	0.14	0.28	0.54	0.95	1.05	1.55	2.54	3.51	4.46	4.94	4.52	3.59	2.94	2.46	1.95	1.50	1.14	0.91	0.74	0.53			
22	0.06	0.15	0.29	0.57	1.00	1.10	1.63	2.66	3.67	4.67	5.17	4.85	3.85	3.15	2.64	2.09	1.61	1.23	0.97	0.80	0.57			
23	0.07	0.16	0.30	0.59	1.04	1.15	1.70	2.78	3.84	4.89	5.41	5.18	4.11	3.37	2.82	2.24	1.72	1.31	1.04	0.85	0.61			
24	0.07	0.16	0.32	0.62	1.09	1.20	1.78	2.90	4.01	5.10	5.64	5.52	4.38	3.59	3.01	2.39	1.84	1.40	1.11	0.91	0.65			
25	0.07	0.17	0.33	0.64	1.13	1.25	1.85	3.02	4.17	5.31	5.88	5.87	4.66	3.81	3.20	2.54	1.95	1.49	1.18	0.96				
26	0.07	0.18	0.34	0.67	1.18	1.30	1.92	3.14	4.34	5.52	6.11	6.23	4.94	4.05	3.39	2.69	2.07	1.58	1.25	1.02				
28	0.08	0.19	0.37	0.72	1.27	1.40	2.07	3.38	4.67	5.95	6.58	6.96	5.52	4.52	3.79	3.01	2.31	1.76	1.40	1.14				
30	0.08	0.20	0.40	0.77	1.36	1.50	2.22	3.63	5.01	6.37	7.05	7.72	6.13	5.01	4.20	3.33	2.57	1.95	1.55	1.27				
32	0.09	0.22	0.42	0.82	1.45	1.60	2.37	3.87	5.34	6.80	7.52	8.50	6.75	5.52	4.63	3.67	2.83	2.15	1.71	1.40				
35	0.10	0.24	0.46	0.90	1.59	1.76	2.59	4.23	5.84	7.44	8.23	9.80	7.72	6.32	5.29	4.20	3.23	2.46	1.95					
40	0.11	0.27	0.53	1.03	1.81	2.01	2.96	4.83	6.68	8.50	9.40	11.20	9.43	7.72	6.47	5.13	3.95	3.01						
45	0.13	0.31	0.60	1.16	2.04	2.26	3.33	5.44	7.51	9.56	10.58	12.60	11.25	9.21	7.72	6.13	4.72	3.59						
	TYPE A LUBRICATION				TYPE B LUBRICATION								TYPE C LUBRICATION											

Horsepower Ratings – Single Strand Roller Chain No. 50

# of teeth in small sprocket	Revolutions Per Minute – Small Sprocket																							
	10	25	50	100	140	200	300	500	700	900	1200	1500	1800	2100	2500	3000	3500	4000	4500	5000	5500	6000	6500	7000
11	0.11	0.27	0.52	1.00	1.39	1.95	2.88	4.70	6.50	8.27	10.24	7.33	5.58	4.42	3.41	2.59	2.06	1.68	1.41	1.20	1.04	0.92	0.81	0.73
12	0.12	0.29	0.56	1.09	1.51	2.13	3.14	5.13	7.09	9.02	11.67	8.35	6.35	5.04	3.88	2.95	2.34	1.92	1.61	1.37	1.19	1.04	0.93	
13	0.13	0.31	0.61	1.19	1.64	2.31	3.40	5.56	7.68	9.77	12.88	9.42	7.16	5.69	4.38	3.33	2.64	2.16	1.81	1.55	1.34	1.18		
14	0.14	0.34	0.66	1.28	1.76	2.48	3.67	5.99	8.27	10.53	13.87	10.52	8.01	6.35	4.89	3.72	2.95	2.42	2.03	1.73	1.50	1.28		
15	0.15	0.36	0.70	1.37	1.89	2.66	3.93	6.41	8.86	11.28	14.86	11.67	8.88	7.05	5.42	4.13	3.27	2.68	2.25	1.92	1.66			
16	0.16	0.39	0.75	1.46	2.02	2.84	4.19	6.84	9.45	12.03	15.85	12.86	9.78	7.76	5.98	4.55	3.61	2.95	2.47	2.11				
17	0.17	0.41	0.80	1.55	2.14	3.02	4.45	7.27	10.04	12.78	16.85	14.08	10.71	8.50	6.55	4.98	3.95	3.23	2.71	2.31				
18	0.18	0.43	0.84	1.64	2.27	3.19	4.71	7.70	10.63	13.53	17.84	15.34	11.67	9.26	7.13	5.42	4.30	3.52	2.95	0.05				
19	0.19	0.46	0.89	1.73	2.39	3.37	4.98	8.12	11.22	14.28	18.83	16.64	12.66	10.05	7.73	5.88	4.67	3.82	3.20					
20	0.20	0.48	0.94	1.82	2.52	3.55	5.24	8.55	11.81	15.04	19.82	17.97	13.67	10.85	8.35	6.35	5.04	4.13	3.46					
21	0.21	0.51	0.98	1.92	2.65	3.73	5.50	8.98	12.40	15.79	20.81	19.34	14.71	11.67	8.99	6.84	5.42	4.44						
22	0.22	0.53	1.03	2.01	2.77	3.90	5.76	9.41	12.99	16.54	21.80	20.73	15.77	12.52	9.64	7.33	5.82	4.76						
23	0.23	0.55	1.08	2.10	2.90	4.08	6.02	9.83	13.58	17.29	22.79	22.16	16.86	13.38	10.30	7.84	6.22	5.09						
24	0.24	0.58	1.13	2.19	3.02	4.26	6.28	10.26	14.18	18.04	23.78	23.62	17.97	14.26	10.98	8.35	6.63	1.36						
25	0.25	0.60	1.17	2.28	3.15	4.44	6.55	10.69	14.77	18.79	24.77	25.11	19.11	15.16	11.67	8.88	7.05							
26	0.26	0.63	1.22	2.37	3.28	4.61	6.81	11.12	15.36	19.55	25.76	26.64	20.26	16.08	12.38	9.42	7.47							
28	0.28	0.67	1.31	2.55	3.53	4.97	7.33	11.97	16.54	21.05	27.75	29.77	22.65	17.97	13.84	10.52	4.74							
30	0.30	0.72	1.41	2.74	3.78	5.32	7.86	12.83	17.72	22.55	29.73	33.01	25.11	19.93	15.34	11.67								
32	0.32	0.77	1.50	2.92	4.03	5.68	8.38	13.68	18.90	24.06	31.71	36.37	27.67	21.96	16.90	12.86								
35	0.35	0.84	1.64	3.19	4.41	6.21	9.16	14.97	20.67	26.31	34.68	41.60	31.65	25.11	19.34	0.94								
40	0.40	0.96	1.88	3.65	5.04	7.10	10.47	17.10	23.63	30.07	39.64	49.11	38.67	30.68	23.62									
45	0.45	1.08	2.11	4.10	5.67	7.98	11.78	19.24	26.58	33.83	44.59	55.24	46.14	36.61	8.64									
	TYPE A LUBRICATION				TYPE B LUBRICATION								TYPE C LUBRICATION											

TYPE A LUBRICATION – MANUAL OR DRIP
 TYPE B LUBRICATION – OIL BATH OR SLINGER
 TYPE C LUBRICATION – OIL PUMP

See Lubrication Instructions in the Roller Chain Installation section.
 Ratings shown are for standard steel chain. See the General Drive Selection section for service factors, selection factors and multiple strand factors.

TECHNICAL ENGINEERING

Horsepower Rating Tables

Standard and Heavy Series Power Transmission Roller Chains

Horsepower Ratings – Single Strand Roller Chain No. 60

# of teeth in small sprocket	Revolutions Per Minute – Small Sprocket																							
	10	25	50	100	120	200	300	400	500	600	800	1000	1200	1400	1600	1800	2000	2500	3000	3500	4000	4500	5000	5500
11	0.19	0.46	0.89	1.72	2.05	3.35	4.95	6.52	8.08	9.63	12.69	15.58	11.85	9.41	7.70	6.45	5.51	3.94	3.00	2.38	1.95	1.63	1.39	1.21
12	0.21	0.50	0.97	1.88	2.24	3.66	5.40	7.12	8.82	10.51	13.85	17.15	13.51	10.72	8.77	7.35	6.28	4.49	3.42	2.71	2.22	1.86	1.59	1.38
13	0.22	0.54	1.05	2.04	2.43	3.96	5.85	7.71	9.55	11.38	15.00	18.58	15.23	12.08	9.89	8.29	7.08	5.06	3.85	3.06	2.50	2.10	1.79	
14	0.24	0.58	1.13	2.19	2.61	4.27	6.30	8.30	10.29	12.26	16.15	20.01	17.02	13.51	11.05	9.26	7.91	5.66	4.31	3.42	2.80	2.34	0.41	
15	0.26	0.62	1.21	2.35	2.80	4.57	6.75	8.90	11.02	13.13	17.31	21.44	18.87	14.98	12.26	10.27	8.77	6.28	4.77	3.79	3.10	2.60		
16	0.27	0.66	1.29	2.51	2.99	4.88	7.20	9.49	11.76	14.01	18.46	22.87	20.79	16.50	13.51	11.32	9.66	6.91	5.26	4.17	3.42	1.78		
17	0.29	0.70	1.37	2.66	3.17	5.18	7.65	10.08	12.49	14.88	19.62	24.30	22.77	18.07	14.79	12.40	10.58	7.57	5.76	4.57	3.74			
18	0.31	0.75	1.45	2.82	3.36	5.49	8.10	10.68	13.23	15.76	20.77	25.73	24.81	19.69	16.11	13.51	11.53	8.25	6.28	4.98	4.08			
19	0.33	0.79	1.53	2.98	3.55	5.79	8.55	11.27	13.96	16.63	21.92	27.16	26.91	21.35	17.48	14.65	12.50	8.95	6.81	5.40	0.20			
20	0.34	0.83	1.61	3.13	3.73	6.10	9.00	11.86	14.70	17.51	23.08	28.59	29.06	23.06	18.87	15.82	13.51	9.66	7.35	5.83				
21	0.36	0.87	1.69	3.29	3.92	6.40	9.45	12.46	15.43	18.38	24.23	30.02	31.26	24.81	20.31	17.02	14.53	10.40	7.91	6.28				
22	0.38	0.91	1.77	3.45	4.11	6.71	9.90	13.05	16.17	19.26	25.39	31.45	33.52	26.60	21.77	18.25	15.58	11.15	8.48					
23	0.40	0.95	1.85	3.61	4.29	7.01	10.35	13.64	16.90	20.13	26.54	32.88	35.84	28.44	23.28	19.51	16.66	11.92	9.07					
24	0.41	0.99	1.93	3.76	4.48	7.32	10.80	14.24	17.64	21.01	27.69	34.31	38.20	30.31	24.81	20.79	17.75	12.70	9.66					
25	0.43	1.04	2.01	3.92	4.67	7.62	11.25	14.83	18.37	21.89	28.85	35.74	40.61	32.23	26.38	22.11	18.87	13.51	10.27					
26	0.45	1.08	2.09	4.08	4.85	7.93	11.70	15.42	19.11	22.76	30.00	37.17	43.07	34.18	27.98	23.44	20.02	14.32	10.90					
28	0.48	1.16	2.26	4.39	5.23	8.54	12.60	16.61	20.58	24.51	32.31	40.03	47.68	38.20	31.26	26.20	22.37	16.01						
30	0.52	1.24	2.42	4.70	5.60	9.15	13.50	17.79	22.05	26.26	34.62	42.89	51.09	42.36	34.67	29.06	24.81	17.75						
32	0.55	1.33	2.58	5.02	5.98	9.76	14.40	18.98	23.52	28.01	36.92	45.75	54.50	46.67	38.20	32.01	27.33	19.56						
35	0.60	1.45	2.82	5.49	6.54	10.67	15.75	20.76	25.72	30.64	40.39	50.03	59.60	53.38	43.69	36.62	31.26	1.35						
40	0.69	1.66	3.22	6.27	7.47	12.20	18.00	23.73	29.39	35.02	46.16	57.18	68.12	65.22	53.38	44.74	38.20							
45	0.77	1.86	3.63	7.05	8.40	13.72	20.25	26.69	33.07	39.39	51.92	64.33	76.63	77.83	63.70	53.38	12.45							
	TYPE A LUBRICATION				TYPE B LUBRICATION								TYPE C LUBRICATION											

Horsepower Ratings – Single Strand Roller Chain No. 60H

# of teeth in small sprocket	Revolutions Per Minute – Small Sprocket																							
	10	25	50	90	100	200	300	400	500	600	800	1000	1200	1400	1600	1800	2000	2500	3000	3500	4000	4500	5000	5500
11	0.22	0.53	1.02	1.80	1.99	3.87	5.72	7.53	9.33	11.12	14.66	15.58	11.85	9.41	7.70	6.45	5.51	3.94	3.00	2.38	1.95	1.63	1.39	1.21
12	0.24	0.57	1.12	1.96	2.17	4.23	6.24	8.22	10.18	12.13	15.99	17.75	13.51	10.72	8.77	7.35	6.28	4.49	3.42	2.71	2.22	1.86	1.59	
13	0.26	0.62	1.21	2.13	2.35	4.58	6.76	8.90	11.03	13.14	17.32	20.02	15.23	12.08	9.89	8.29	7.08	5.06	3.85	3.06	2.50	2.10	1.79	
14	0.28	0.67	1.30	2.29	2.53	4.93	7.27	9.59	11.88	14.15	18.65	22.37	17.02	13.51	11.05	9.26	7.91	5.66	4.31	3.42	2.80	2.34		
15	0.30	0.72	1.40	2.45	2.71	5.28	7.79	10.27	12.73	15.16	19.99	24.76	18.87	14.98	12.26	10.27	8.77	6.28	4.77	3.79	3.10	2.60		
16	0.32	0.77	1.49	2.62	2.90	5.63	8.31	10.96	13.58	16.17	21.32	26.41	20.79	16.50	13.51	11.32	9.66	6.91	5.26	4.17	3.42			
17	0.34	0.81	1.58	2.78	3.08	5.99	8.83	11.64	14.43	17.18	22.65	28.06	22.77	18.07	14.79	12.40	10.58	7.57	5.76	4.57	3.74			
18	0.36	0.86	1.67	2.94	3.26	6.34	9.35	12.33	15.27	18.20	23.98	29.71	24.81	19.69	16.11	13.51	11.53	8.25	6.28	4.98	1.06			
19	0.38	0.91	1.77	3.11	3.44	6.69	9.87	13.01	16.12	19.21	25.32	31.36	26.91	21.35	17.48	14.65	12.50	8.95	6.81	5.40				
20	0.40	0.96	1.86	3.27	3.62	7.04	10.39	13.70	16.97	20.22	26.65	33.01	29.06	23.06	18.87	15.82	13.51	9.66	7.35	5.83				
21	0.42	1.00	1.95	3.44	3.80	7.39	10.91	14.38	17.82	21.23	27.98	34.66	31.26	24.81	20.31	17.02	14.53	10.40	7.91	4.87				
22	0.44	1.05	2.05	3.60	3.98	7.75	11.43	15.07	18.67	22.24	29.31	36.32	33.52	26.60	21.77	18.25	15.58	11.15	8.48					
23	0.46	1.10	2.14	3.76	4.16	8.10	11.95	15.75	19.52	23.25	30.65	37.97	35.84	28.44	23.28	19.51	16.66	11.92	9.07					
24	0.48	1.15	2.23	3.93	4.34	8.45	12.47	16.44	20.37	24.26	31.98	39.62	38.20	30.31	24.81	20.79	17.75	12.70	9.66					
25	0.50	1.20	2.33	4.09	4.52	8.80	12.99	17.12	21.21	25.27	33.31	41.27	40.61	32.23	26.38	22.11	18.87	13.51	10.27					
26	0.52	1.24	2.42	4.25	4.71	9.15	13.51	17.81	22.06	26.28	34.64	42.92	43.07	34.18	27.98	23.44	20.02	14.32	4.17					
28	0.56	1.34	2.61	4.58	5.07	9.86	14.55	19.18	23.76	28.30	37.31	46.22	48.14	38.20	31.26	26.20	22.37	16.01						
30	0.60	1.43	2.79	4.91	5.43	10.56	15.59	20.55	25.46	30.33	39.97	49.52	53.38	42.36	34.67	29.06	24.81	17.75						
32	0.64	1.53	2.98	5.23	5.79	11.27	16.63	21.92	27.15	32.35	42.64	52.82	58.81	46.67	38.20	32.01	27.33	11.45						
35	0.69	1.67	3.26	5.73	6.33	12.32	18.19	23.97	29.70	35.38	46.63	57.77	67.27	53.38	43.69	36.62	31.26							
40	0.79	1.91	3.72	6.54	7.24	14.08	20.79	27.40	33.94	40.43	53.30	66.03	78.66	65.22	53.38	44.74	29.65							
45	0.89	2.15	4.19	7.36	8.14	15.84	23.38	30.82	38.18	45.49	59.96	74.28	88.49	77.83	63.70	37.00								
	TYPE A LUBE			TYPE B LUBRICATION											TYPE C LUBRICATION									

TYPE A LUBRICATION – MANUAL OR DRIP
 TYPE B LUBRICATION – OIL BATH OR SLINGER
 TYPE C LUBRICATION – OIL PUMP

See Lubrication Instructions in the Roller Chain Installation section.
 Ratings shown are for standard steel chain. See the General Drive Selection section for service factors, selection factors and multiple strand factors.

TECHNICAL ENGINEERING

Horsepower Rating Tables

Standard and Heavy Series Power Transmission Roller Chains

Horsepower Ratings – Single Strand Roller Chain No. 80

# of teeth in small sprocket	Revolutions Per Minute – Small Sprocket																										
	10	25	50	75	88	100	200	300	400	500	600	700	800	900	1000	1200	1400	1600	1800	2000	2500	3000	3500	4000	4500		
11	0.44	1.06	2.07	3.05	3.56	4.03	7.83	11.56	15.23	18.87	22.48	26.07	27.41	22.97	19.61	14.92	11.84	9.69	8.12	6.93	4.96	3.77	3.00	2.45			
12	0.48	1.16	2.26	3.33	3.88	4.39	8.54	12.61	16.62	20.59	24.53	28.44	31.23	26.17	22.35	17.00	13.49	11.04	9.25	7.90	5.65	4.30	3.41	2.79			
13	0.52	1.26	2.45	3.61	4.21	4.76	9.26	13.66	18.00	22.31	26.57	30.81	35.02	29.51	25.20	19.17	15.21	12.45	10.43	8.91	6.37	4.85	3.85	3.15			
14	0.56	1.35	2.63	3.89	4.53	5.12	9.97	14.71	19.39	24.02	28.62	33.18	37.72	32.98	28.16	21.42	17.00	13.91	11.66	9.96	7.12	5.42	4.30	3.52			
15	0.60	1.45	2.82	4.16	4.86	5.49	10.68	15.76	20.77	25.74	30.66	35.55	40.41	36.58	31.23	23.76	18.85	15.43	12.93	11.04	7.90	6.01	4.77				
16	0.64	1.55	3.01	4.44	5.18	5.86	11.39	16.81	22.16	27.45	32.70	37.92	43.11	40.30	34.41	26.17	20.77	17.00	14.25	12.16	8.70	6.62	5.25				
17	0.68	1.64	3.20	4.72	5.50	6.22	12.10	17.86	23.54	29.17	34.75	40.29	45.80	44.13	37.68	28.66	22.75	18.62	15.60	13.32	9.53	7.25					
18	0.72	1.74	3.39	5.00	5.83	6.59	12.81	18.91	24.93	30.88	36.79	42.66	48.49	48.08	41.05	31.23	24.78	20.29	17.00	14.51	10.39	7.90					
19	0.76	1.84	3.57	5.28	6.15	6.95	13.53	19.96	26.31	32.60	38.84	45.03	51.19	52.15	44.52	33.87	26.88	22.00	18.44	15.74	11.26	0.36					
20	0.80	1.93	3.76	5.55	6.47	7.32	14.24	21.01	27.70	34.32	40.88	47.40	53.88	56.32	48.08	36.58	29.03	23.76	19.91	17.00	12.16						
21	0.84	2.03	3.95	5.83	6.80	7.69	14.95	22.07	29.08	36.03	42.92	49.77	56.58	60.59	51.73	39.36	31.23	25.56	21.42	18.29	13.09						
22	0.88	2.13	4.14	6.11	7.12	8.05	15.66	23.12	30.47	37.75	44.97	52.14	59.27	64.97	55.47	42.20	33.49	27.41	22.97	19.61	14.03						
23	0.92	2.22	4.33	6.39	7.45	8.42	16.37	24.17	31.85	39.46	47.01	54.51	61.97	69.38	59.30	45.11	35.80	29.30	24.55	20.97	15.00						
24	0.96	2.32	4.52	6.66	7.77	8.78	17.09	25.22	33.24	41.18	49.06	56.88	64.66	72.40	63.21	48.08	38.16	31.23	26.17	22.35	15.99						
25	1.00	2.42	4.70	6.94	8.09	9.15	17.80	26.27	34.62	42.89	51.10	59.25	67.35	75.42	67.20	51.12	40.57	33.20	27.83	23.76	8.16						
26	1.04	2.51	4.89	7.22	8.42	9.52	18.51	27.32	36.01	44.61	53.14	61.62	70.05	78.43	71.27	54.22	43.02	35.22	29.51	25.20							
28	1.12	2.71	5.27	7.77	9.06	10.25	19.93	29.42	38.78	48.04	57.23	66.36	75.44	84.47	79.65	60.59	48.08	39.36	32.98	28.16							
30	1.20	2.90	5.64	8.33	9.71	10.98	21.36	31.52	41.55	51.47	61.32	71.10	80.82	90.50	88.33	67.20	53.33	43.65	36.58	31.23							
32	1.28	3.09	6.02	8.89	10.36	11.71	22.78	33.62	44.32	54.91	65.41	75.84	86.21	96.53	97.31	74.03	58.75	48.08	40.30	5.65							
35	1.40	3.38	6.58	9.72	11.33	12.81	24.92	36.78	48.47	60.05	71.54	82.95	94.29	105.58	111.31	84.68	67.20	55.00	28.15								
40	1.61	3.87	7.53	11.11	12.95	14.64	28.48	42.03	55.40	68.63	81.76	94.80	107.77	120.67	133.51	103.46	82.10	40.16									
45	1.81	4.35	8.47	12.49	14.57	16.47	32.04	47.28	62.32	77.21	91.98	106.65	121.24	135.75	150.20	123.45	72.28										
	TYPE A LUBRICATION				TYPE B LUBRICATION								TYPE C LUBRICATION														

Horsepower Ratings – Single Strand Roller Chain No. 80H

# of teeth in small sprocket	Revolutions Per Minute – Small Sprocket																									
	10	25	50	70	100	200	300	400	500	600	700	800	900	1000	1100	1200	1400	1600	1800	2000	2500	3000	3500	4000	4500	
11	0.49	1.19	2.31	3.19	4.50	8.75	12.91	17.02	21.08	25.12	29.12	27.41	22.97	19.61	17.00	14.92	11.84	9.69	8.12	6.93	4.96	3.77	3.00	2.45		
12	0.54	1.30	2.52	3.48	4.91	9.54	14.09	18.57	23.00	27.40	31.77	31.23	26.17	22.35	19.37	17.00	13.49	11.04	9.25	7.90	5.65	4.30	3.41	2.79		
13	0.58	1.40	2.73	3.77	5.31	10.34	15.26	20.11	24.92	29.68	34.42	35.22	29.51	25.20	21.84	19.17	15.21	12.45	10.43	8.91	6.37	4.85	3.85	3.15		
14	0.63	1.51	2.94	4.06	5.72	11.13	16.43	21.66	26.83	31.97	37.07	39.36	32.98	28.16	24.41	21.42	17.00	13.91	11.66	9.96	7.12	5.42	4.30	2.02		
15	0.67	1.62	3.15	4.35	6.13	11.93	17.61	23.21	28.75	34.25	39.71	43.65	36.58	31.23	27.07	23.76	18.85	15.43	12.93	11.04	7.90	6.01	4.77			
16	0.72	1.73	3.36	4.64	6.54	12.73	18.78	24.75	30.67	36.53	42.36	48.08	40.30	34.41	29.82	26.17	20.77	17.00	14.25	12.16	8.70	6.62				
17	0.76	1.84	3.57	4.94	6.95	13.52	19.95	26.30	32.59	38.82	45.01	51.17	44.13	37.68	32.66	28.66	22.75	18.62	15.60	13.32	9.53	7.25				
18	0.81	1.94	3.78	5.23	7.36	14.32	21.13	27.85	34.50	41.10	47.66	54.17	48.08	41.05	35.59	31.23	24.78	20.29	17.00	14.51	10.39	1.88				
19	0.85	2.05	3.99	5.52	7.77	15.11	22.30	29.40	36.42	43.38	50.30	57.18	52.15	44.52	38.59	33.87	26.88	22.00	18.44	15.74	11.26					
20	0.90	2.16	4.20	5.81	8.18	15.91	23.48	30.94	38.34	45.67	52.95	60.19	56.32	48.08	41.68	36.58	29.03	23.76	19.91	17.00	12.16					
21	0.94	2.27	4.41	6.10	8.59	16.70	24.65	32.49	40.25	47.95	55.60	63.20	60.59	51.73	44.84	39.36	31.23	25.56	21.42	18.29						
22	0.99	2.38	4.62	6.39	8.99	17.50	25.82	34.04	42.17	50.24	58.25	66.21	64.97	55.47	48.08	42.20	33.49	27.41	22.97	19.61						
23	1.03	2.48	4.83	6.68	9.40	18.29	27.00	35.58	44.09	52.52	60.89	69.22	69.45	59.30	51.40	45.11	35.80	29.30	24.55	20.97						
24	1.08	2.59	5.04	6.97	9.81	19.09	28.17	37.13	46.00	54.80	63.54	72.23	74.03	63.21	54.79	48.08	38.16	31.23	26.17	22.35						
25	1.12	2.70	5.25	7.26	10.22	19.88	29.35	38.68	47.92	57.09	66.19	75.24	78.70	67.20	58.25	51.12	40.57	33.20	27.83	23.76						
26	1.17	2.81	5.46	7.55	10.63	20.68	30.52	40.23	49.84	59.37	68.84	78.25	83.47	71.27	61.78	54.22	43.02	35.22	29.51	25.20						
28	1.26	3.03	5.88	8.13	11.45	22.27	32.87	43.32	53.67	63.94	74.13	84.27	93.29	79.65	69.04	60.59	48.08	39.36	32.98	28.16						
30	1.34	3.24	6.31	8.71	12.27	23.86	35.21	46.41	57.50	68.50	79.43	90.29	101.10	88.33	76.57	67.20	53.33	43.65	36.58	12.26						
32	1.43	3.46	6.73	9.29	13.08	25.45	37.56	49.51	61.34	73.07	84.72	96.31	107.84	97.31	84.35	74.03	58.75	48.08	39.43							
35	1.57	3.78	7.36	10.16	14.31	27.84	41.08	54.15	67.09	79.92	92.67	105.34	117.95	111.31	96.49	84.68	67.20	55.00	5.58							
40	1.79	4.32	8.41	11.61	16.35	31.81	46.95	61.89	76.67	91.34	105.90	120.39	134.80	136.00	117.88	103.46	82.10	14.36								
45	2.02	4.86	9.46	13.06	18.40	35.79	52.82	69.62	86.25	102.75	119.14	135.44	151.65	162.28	140.66	123.45								*		
	TYPE A LUBE			TYPE B LUBRICATION								TYPE C LUBRICATION														

TYPE A LUBRICATION – MANUAL OR DRIP
 TYPE B LUBRICATION – OIL BATH OR SLINGER
 TYPE C LUBRICATION – OIL PUMP

See Lubrication Instructions in the Roller Chain Installation section.
 Ratings shown are for standard steel chain. See the General Drive Selection section for service factors, selection factors and multiple strand factors.

*For optimum results, consult Diamond Chain for drives operating in the shaded area.

TECHNICAL ENGINEERING

Horsepower Rating Tables

Standard and Heavy Series Power Transmission Roller Chains

Horsepower Ratings – Single Strand Roller Chain No. 100

# of teeth in small sprocket	Revolutions Per Minute – Small Sprocket																							
	10	25	50	71	100	150	200	300	400	500	600	700	800	900	1000	1100	1200	1400	1600	1800	2000	2500	3000	3500
11	0.85	2.04	3.96	5.55	7.71	11.38	15.00	22.14	29.18	36.15	43.06	40.03	32.77	27.46	23.45	20.32	17.84	14.15	11.58	9.71	8.29	5.93	4.51	3.58
12	0.92	2.22	4.32	6.05	8.41	12.41	16.36	24.15	31.83	39.44	46.98	45.61	37.33	31.29	26.71	23.16	20.32	16.13	13.20	11.06	9.45	6.76	5.14	
13	1.00	2.41	4.68	6.56	9.11	13.45	17.73	26.16	34.48	42.72	50.89	51.43	42.10	35.28	30.12	26.11	22.92	18.18	14.88	12.47	10.65	7.62	5.80	
14	1.08	2.59	5.04	7.06	9.81	14.48	19.09	28.18	37.14	46.01	54.81	57.48	47.05	39.43	33.66	29.18	25.61	20.32	16.63	13.94	11.90	8.52	1.13	
15	1.15	2.78	5.41	7.57	10.51	15.52	20.45	30.19	39.79	49.30	58.72	63.75	52.18	43.73	37.33	32.36	28.40	22.54	18.45	15.46	13.20	9.45		
16	1.23	2.96	5.77	8.07	11.22	16.55	21.82	32.20	42.44	52.58	62.64	70.23	57.48	48.17	41.13	35.65	31.29	24.83	20.32	17.03	14.54	10.41		
17	1.31	3.15	6.13	8.58	11.92	17.59	23.18	34.21	45.10	55.87	66.55	76.91	62.95	52.76	45.05	39.04	34.27	27.19	22.26	18.65	15.93	11.40		
18	1.38	3.33	6.49	9.08	12.62	18.62	24.55	36.23	47.75	59.15	70.47	81.71	68.59	57.48	49.08	42.54	37.33	29.63	24.25	20.32	17.35	0.18		
19	1.46	3.52	6.85	9.59	13.32	19.66	25.91	38.24	50.40	62.44	74.38	86.25	74.38	62.34	53.22	46.13	40.49	32.13	26.30	22.04	18.82			
20	1.54	3.70	7.21	10.09	14.02	20.69	27.27	40.25	53.05	65.73	78.30	90.79	80.33	67.32	57.48	49.82	43.73	34.70	28.40	23.80	20.32			
21	1.61	3.89	7.57	10.60	14.72	21.73	28.64	42.26	55.71	69.01	82.21	95.33	86.43	72.43	61.85	53.61	47.05	37.33	30.56	25.61	21.87			
22	1.69	4.08	7.93	11.10	15.42	22.76	30.00	44.28	58.36	72.30	86.13	99.87	92.68	77.67	66.31	57.48	50.45	40.03	32.77	27.46	23.45			
23	1.77	4.26	8.29	11.60	16.12	23.79	31.36	46.29	61.01	75.59	90.04	104.41	99.07	83.02	70.89	61.44	53.93	42.79	35.03	29.35	25.06			
24	1.84	4.45	8.65	12.11	16.82	24.83	32.73	48.30	63.66	78.87	93.96	108.95	105.60	88.50	75.56	65.49	57.48	45.61	37.33	31.29	5.43			
25	1.92	4.63	9.01	12.61	17.52	25.86	34.09	50.31	66.32	82.16	97.87	113.48	112.27	94.09	80.33	69.63	61.11	48.49	39.69	33.26				
26	2.00	4.82	9.37	13.12	18.23	26.90	35.45	52.33	68.97	85.45	101.79	118.02	119.07	99.79	85.20	73.85	64.81	51.43	42.10	35.28				
28	2.15	5.19	10.09	14.13	19.63	28.97	38.18	56.35	74.27	92.02	109.62	127.10	133.07	111.52	95.22	82.53	72.43	57.48	47.05					
30	2.31	5.56	10.81	15.14	21.03	31.04	40.91	60.38	79.58	98.59	117.45	136.18	147.58	123.68	105.60	91.53	80.33	63.75	49.40					
32	2.46	5.93	11.53	16.15	22.43	33.11	43.64	64.40	84.88	105.16	125.28	145.26	162.58	136.25	116.33	100.84	88.50	70.23	8.82					
35	2.69	6.48	12.61	17.66	24.53	36.21	47.73	70.44	92.84	115.02	137.02	158.88	180.61	155.85	133.07	115.34	101.23	69.02						
40	3.07	7.41	14.41	20.18	28.04	41.38	54.54	80.50	106.11	131.45	156.60	181.58	206.41	190.42	162.58	140.92	122.68							
45	3.46	8.34	16.22	22.71	31.54	46.55	61.36	90.56	119.37	147.89	176.17	204.27	232.21	227.21	194.00	168.15	34.58							*
	TYPE A LUBE			TYPE B LUBRICATION								TYPE C LUBRICATION												

Horsepower Ratings – Single Strand Roller Chain No. 100H

# of teeth in small sprocket	Revolutions Per Minute – Small Sprocket																							
	10	25	50	58	100	200	300	400	500	600	700	800	900	1000	1100	1200	1400	1600	1800	2000	2200	2400	2700	3000
11	0.93	2.23	4.34	5.01	8.45	16.43	24.25	31.96	39.60	47.18	40.03	32.77	27.46	23.45	20.32	17.84	14.15	11.58	9.71	8.29	7.19	6.31	5.28	4.51
12	1.01	2.44	4.74	5.46	9.21	17.93	26.46	34.87	43.20	51.46	45.61	37.33	31.29	26.71	23.16	20.32	16.13	13.20	11.06	9.45	8.19	7.19	6.02	5.14
13	1.09	2.64	5.13	5.92	9.98	19.42	28.66	37.78	46.80	55.75	51.43	42.10	35.28	30.12	26.11	22.92	18.18	14.88	12.47	10.65	9.23	8.10	6.79	5.80
14	1.18	2.84	5.53	6.37	10.75	20.91	30.86	40.68	50.40	60.04	57.48	47.05	39.43	33.66	29.18	25.61	20.32	16.63	13.94	11.90	10.32	9.05	7.59	
15	1.26	3.04	5.92	6.83	11.52	22.41	33.07	43.59	54.00	64.33	63.75	52.18	43.73	37.33	32.36	28.40	22.54	18.45	15.46	13.20	11.44	10.04	8.42	
16	1.35	3.25	6.32	7.28	12.29	23.90	35.27	46.49	57.60	68.62	70.23	57.48	48.17	41.13	35.65	31.29	24.83	20.32	17.03	14.54	12.60	11.06		
17	1.43	3.45	6.71	7.74	13.05	25.39	37.48	49.40	61.20	72.91	76.91	62.95	52.76	45.05	39.04	34.27	27.19	22.26	18.65	15.93	13.80	12.12		
18	1.52	3.65	7.11	8.19	13.82	26.89	39.68	52.31	64.80	77.20	83.80	68.59	57.48	49.08	42.54	37.33	29.63	24.25	20.32	17.35	15.04	2.94		
19	1.60	3.86	7.50	8.65	14.59	28.38	41.89	55.21	68.40	81.48	90.88	74.38	62.34	53.22	46.13	40.49	32.13	26.30	22.04	18.82	16.31			
20	1.68	4.06	7.89	9.10	15.36	29.88	44.09	58.12	72.00	85.77	98.15	80.33	67.32	57.48	49.82	43.73	34.70	28.40	23.80	20.32	7.77			
21	1.77	4.26	8.29	9.56	16.13	31.37	46.30	61.02	75.60	90.06	104.43	86.43	72.43	61.85	53.61	47.05	37.33	30.56	25.61	21.87				
22	1.85	4.46	8.68	10.01	16.89	32.86	48.50	63.93	79.20	94.35	109.40	92.68	77.67	66.31	57.48	50.45	40.03	32.77	27.46	23.45				
23	1.94	4.67	9.08	10.47	17.66	34.36	50.71	66.83	82.80	98.64	114.37	99.07	83.02	70.89	61.44	53.93	42.79	35.03	29.35	2.94				
24	2.02	4.87	9.47	10.92	18.43	35.85	52.91	69.74	86.40	102.93	119.34	105.60	88.50	75.56	65.49	57.48	45.61	37.33	31.29					
25	2.10	5.07	9.87	11.38	19.20	37.34	55.12	72.65	90.00	107.22	124.32	112.27	94.09	80.33	69.63	61.11	48.49	39.69	29.68					
26	2.19	5.28	10.26	11.83	19.97	38.84	57.32	75.55	93.60	111.51	129.29	119.07	99.79	85.20	73.85	64.81	51.43	42.10	11.58					
28	2.36	5.68	11.05	12.75	21.50	41.83	61.73	81.36	100.80	120.08	139.24	133.07	111.52	95.22	82.53	72.43	57.48	47.05						
30	2.53	6.09	11.84	13.66	23.04	44.81	66.14	87.18	108.00	128.66	149.18	147.58	123.68	105.60	91.53	80.33	63.75	19.16						
32	2.69	6.49	12.63	14.57	24.57	47.80	70.55	92.99	115.20	137.24	159.13	162.58	136.25	116.33	100.84	88.50	70.23							
35	2.95	7.10	13.82	15.93	26.88	52.28	77.16	101.71	126.00	150.10	174.04	185.97	155.85	133.07	115.34	101.23	33.74							
40	3.37	8.12	15.79	18.21	30.72	59.75	88.18	116.23	144.00	171.55	198.91	226.11	190.42	162.58	140.92	82.37								
45	3.79	9.13	17.76	20.48	34.55	67.22	99.21	130.76	162.00	192.99	223.77	254.38	227.21	194.00	85.51									*
	TYPE A LUBE			TYPE B LUBRICATION								TYPE C LUBRICATION												

TYPE A LUBRICATION – MANUAL OR DRIP
 TYPE B LUBRICATION – OIL BATH OR SLINGER
 TYPE C LUBRICATION – OIL PUMP

See Lubrication Instructions in the Roller Chain Installation section.
 Ratings shown are for standard steel chain. See the General Drive Selection section
 for service factors, selection factors and multiple strand factors.

*For optimum results, consult Diamond Chain for drives operating in the shaded area.

TECHNICAL ENGINEERING

Horsepower Rating Tables

Standard and Heavy Series Power Transmission Roller Chains

Horsepower Ratings – Single Strand Roller Chain No. 120

# of teeth in small sprocket	Revolutions Per Minute – Small Sprocket																								
	10	25	50	60	75	100	150	200	300	400	500	600	700	800	900	1000	1200	1400	1600	1800	2000	2200	2400	2700	3000
11	1.43	3.44	6.69	7.97	9.88	13.02	19.22	25.33	37.38	49.27	61.04	58.37	46.32	37.91	31.77	27.13	20.64	16.38	13.40	11.23	9.59	8.31	7.30	6.11	
12	1.56	3.75	7.30	8.70	10.78	14.20	20.96	27.63	40.78	53.75	66.59	66.51	52.78	43.20	36.20	30.91	23.51	18.66	15.27	12.80	10.93	9.47	8.31	6.97	
13	1.69	4.07	7.91	9.42	11.67	15.39	22.71	29.93	44.18	58.23	72.14	74.99	59.51	48.71	40.82	34.85	26.51	21.04	17.22	14.43	12.32	10.68	9.37		
14	1.82	4.38	8.52	10.15	12.57	16.57	24.46	32.24	47.58	62.71	77.69	83.81	66.51	54.44	45.62	38.95	29.63	23.51	19.25	16.13	13.77	11.94	10.48		
15	1.95	4.69	9.13	10.87	13.47	17.76	26.20	34.54	50.98	67.19	83.24	92.95	73.76	60.37	50.59	43.20	32.86	26.08	21.34	17.89	15.27	13.24			
16	2.08	5.00	9.74	11.60	14.37	18.94	27.95	36.84	54.37	71.67	88.79	102.39	81.26	66.51	55.74	47.59	36.20	28.73	23.51	19.71	16.83	14.58			
17	2.21	5.32	10.34	12.32	15.27	20.12	29.70	39.14	57.77	76.15	94.34	112.14	88.99	72.84	61.04	52.12	39.65	31.46	25.75	21.58	18.43				
18	2.34	5.63	10.95	13.05	16.16	21.31	31.45	41.45	61.17	80.63	99.89	119.00	96.96	79.36	66.51	56.78	43.20	34.28	28.06	23.51	20.08				
19	2.47	5.94	11.56	13.77	17.06	22.49	33.19	43.75	64.57	85.11	105.44	125.61	105.15	86.06	72.13	61.58	46.85	37.18	30.43	25.50	0.80				
20	2.60	6.26	12.17	14.50	17.96	23.67	34.94	46.05	67.97	89.59	110.99	132.22	113.56	92.95	77.89	66.51	50.59	40.15	32.86	27.54					
21	2.73	6.57	12.78	15.22	18.86	24.86	36.69	48.36	71.37	94.07	116.54	138.83	122.18	100.00	83.81	71.56	54.44	43.20	35.36	27.46					
22	2.86	6.88	13.39	15.95	19.76	26.04	38.43	50.66	74.76	98.55	122.09	145.44	131.01	107.23	89.87	76.73	58.37	46.32	37.91						
23	2.99	7.19	14.00	16.67	20.65	27.22	40.18	52.96	78.16	103.02	127.64	152.05	140.04	114.62	96.06	82.02	62.39	49.51	40.53						
24	3.11	7.51	14.60	17.40	21.55	28.41	41.93	55.26	81.56	107.50	133.19	158.66	149.28	122.18	102.39	87.43	66.51	52.78	43.20						
25	3.24	7.82	15.21	18.12	22.45	29.59	43.67	57.57	84.96	111.98	138.74	165.27	158.70	129.90	108.86	92.95	70.71	56.11	45.37						
26	3.37	8.13	15.82	18.85	23.35	30.78	45.42	59.87	88.36	116.46	144.29	171.88	168.32	137.77	115.46	98.58	74.99	59.51							
28	3.63	8.76	17.04	20.30	25.15	33.14	48.92	64.47	95.15	125.42	155.38	185.11	188.11	153.97	129.03	110.17	83.81	66.51							
30	3.89	9.38	18.25	21.75	26.94	35.51	52.41	69.08	101.95	134.38	166.48	198.33	208.62	170.75	143.10	122.18	92.95	74.99							
32	4.15	10.01	19.47	23.20	28.74	37.88	55.90	73.68	108.75	143.34	177.58	211.55	229.83	188.11	157.65	134.60	102.39								
35	4.54	10.95	21.30	25.37	31.43	41.43	61.14	80.59	118.94	156.78	194.23	231.38	262.89	215.17	180.33	153.97	117.13								
40	5.19	12.51	24.34	28.99	35.92	47.35	69.88	92.11	135.94	179.17	221.98	264.44	306.61	262.89	220.32	176.66									
45	5.84	14.08	27.38	32.62	40.41	53.27	78.61	103.62	152.93	201.57	249.72	297.49	344.94	313.69	213.33	149.79									
	TYPE A LUBE			TYPE B LUBRICATION									TYPE C LUBRICATION												

Horsepower Ratings – Single Strand Roller Chain No. 120H

# of teeth in small sprocket	Revolutions Per Minute – Small Sprocket																								
	5	10	25	50	75	100	150	200	300	400	500	600	700	800	900	1000	1200	1400	1600	1800	2000	2200	2400	2700	3000
11	0.79	1.54	3.72	7.23	10.67	14.06	20.76	27.36	40.38	53.22	65.93	58.37	46.32	37.91	31.77	27.13	20.64	16.38	13.40	11.23	9.59	8.31	7.30	6.11	
12	0.86	1.68	4.05	7.89	11.64	15.34	22.64	29.85	44.05	58.06	71.93	66.51	52.78	43.20	36.20	30.91	23.51	18.66	15.27	12.80	10.93	9.47	8.31	1.06	
13	0.94	1.82	4.39	8.54	12.61	16.62	24.53	32.33	47.72	62.90	77.92	74.99	59.51	48.71	40.82	34.85	26.51	21.04	17.22	14.43	12.32	10.68	9.37		
14	1.01	1.96	4.73	9.20	13.58	17.90	26.42	34.82	51.39	67.73	83.92	83.81	66.51	54.44	45.62	38.95	29.63	23.51	19.25	16.13	13.77	11.94	4.55		
15	1.08	2.10	5.07	9.86	14.55	19.18	28.30	37.31	55.06	72.57	89.91	92.95	73.76	60.37	50.59	43.20	32.86	26.08	21.34	17.89	15.27	13.24			
16	1.15	2.24	5.41	10.52	15.52	20.46	30.19	39.79	58.73	77.41	95.90	102.39	81.26	66.51	55.74	47.59	36.20	28.73	23.51	19.71	16.83				
17	1.23	2.38	5.74	11.17	16.49	21.73	32.08	42.28	62.40	82.25	101.90	112.14	88.99	72.84	61.04	52.12	39.65	31.46	25.75	21.58	18.43				
18	1.30	2.52	6.08	11.83	17.46	23.01	33.96	44.77	66.07	87.09	107.89	122.18	96.96	79.36	66.51	56.78	43.20	34.28	28.06	23.51	4.23				
19	1.37	2.66	6.42	12.49	18.43	24.29	35.85	47.26	69.74	91.93	113.89	132.50	105.15	86.06	72.13	61.58	46.85	37.18	30.43	25.50					
20	1.44	2.80	6.76	13.14	19.40	25.57	37.74	49.74	73.41	96.76	119.88	142.81	113.56	92.95	77.89	66.51	50.59	40.15	32.86	24.58					
21	1.51	2.94	7.09	13.80	20.37	26.85	39.63	52.23	77.08	101.60	125.87	149.95	122.18	100.00	83.81	71.56	54.44	43.20	35.36						
22	1.59	3.08	7.43	14.46	21.34	28.13	41.51	54.72	80.75	106.44	131.87	157.09	131.01	107.23	89.87	76.73	58.37	46.32	37.91						
23	1.66	3.22	7.77	15.12	22.31	29.41	43.40	57.20	84.42	111.28	137.86	164.23	140.04	114.62	96.06	82.02	62.39	49.51	38.38						
24	1.73	3.36	8.11	15.77	23.28	30.68	45.29	59.69	88.10	116.12	143.86	171.37	149.28	122.18	102.39	87.43	66.51	52.78	43.20						
25	1.80	3.50	8.45	16.43	24.25	31.96	47.17	62.18	91.77	120.96	149.85	178.51	158.70	129.90	108.86	92.95	70.71	56.11							
26	1.87	3.64	8.78	17.09	25.22	33.24	49.06	64.66	95.44	125.79	155.84	185.65	168.32	137.77	115.46	98.58	74.99	59.51							
28	2.02	3.93	9.46	18.40	27.16	35.80	52.83	69.64	102.78	135.47	167.83	199.94	188.11	153.97	129.03	110.17	83.81	66.51							
30	2.16	4.21	10.14	19.72	29.10	38.36	56.61	74.61	110.12	145.15	179.82	214.22	208.62	170.75	143.10	122.18	92.95								
32	2.31	4.49	10.81	21.03	31.04	40.91	60.38	79.59	117.46	154.82	191.81	228.50	229.83	188.11	157.65	134.60	102.39								
35	2.52	4.91	11.82	23.00	33.95	44.75	66.04	87.05	128.47	169.34	209.79	249.92	262.89	215.17	180.33	153.97	12.54								
40	2.88	5.61	13.51	26.29	38.80	51.14	75.48	99.48	146.83	193.53	239.76	285.62	321.19	262.89	220.32	118.61									
45	3.24	6.31	15.20	29.58	43.65	57.53	84.91	111.92	165.18	217.72	269.73	321.32	372.57	278.98	148.03										
	TYPE A LUBE			TYPE B LUBRICATION									TYPE C LUBRICATION												

TYPE A LUBRICATION – MANUAL OR DRIP
 TYPE B LUBRICATION – OIL BATH OR SLINGER
 TYPE C LUBRICATION – OIL PUMP

See Lubrication Instructions in the Roller Chain Installation section.
 Ratings shown are for standard steel chain. See the General Drive Selection section for service factors, selection factors and multiple strand factors.

*For optimum results, consult Diamond Chain for drives operating in the shaded area.

TECHNICAL ENGINEERING

Horsepower Rating Tables

Standard and Heavy Series Power Transmission Roller Chains

Horsepower Ratings – Single Strand Roller Chain No. 140

# of teeth in small sprocket	Revolutions Per Minute – Small Sprocket																								
	5	10	25	50	53	75	100	150	200	300	400	500	600	700	800	900	1000	1200	1400	1600	1800	2000	2200	2400	2700
11	1.14	2.21	5.32	10.36	10.95	15.28	20.15	29.73	39.19	57.84	76.24	86.80	66.03	52.40	42.89	35.94	30.69	23.35	18.53	15.16	12.71	10.85	9.40	8.25	
12	1.24	2.41	5.81	11.30	11.95	16.67	21.98	32.44	42.75	63.10	83.17	98.90	75.24	59.70	48.87	40.95	34.97	26.60	21.11	17.28	14.48	12.36	10.72	0.72	
13	1.34	2.61	6.29	12.24	12.94	18.06	23.81	35.14	46.32	68.36	90.10	111.52	84.83	67.32	55.10	46.18	39.43	29.99	23.80	19.48	16.33	13.94	12.08		
14	1.45	2.81	6.78	13.18	13.94	19.45	25.64	37.84	49.88	73.61	97.03	120.21	94.81	75.24	61.58	51.61	44.06	33.52	26.60	21.77	18.25	15.58			
15	1.55	3.01	7.26	14.12	14.93	20.84	27.47	40.54	53.44	78.87	103.96	128.79	105.15	83.44	68.29	57.23	48.87	37.17	29.50	24.15	20.24	17.28			
16	1.65	3.21	7.74	15.06	15.93	22.23	29.30	43.25	57.00	84.13	110.89	137.38	115.83	91.92	75.24	63.05	53.83	40.95	32.50	26.60	22.29				
17	1.75	3.41	8.23	16.00	16.93	23.62	31.13	45.95	60.57	89.39	117.82	145.97	126.86	100.67	82.40	69.05	58.96	44.85	35.59	29.13	24.41				
18	1.86	3.61	8.71	16.95	17.92	25.01	32.97	48.65	64.13	94.65	124.75	154.55	138.22	109.68	89.77	75.24	64.24	48.87	38.78	31.74					
19	1.96	3.82	9.20	17.89	18.92	26.40	34.80	51.36	67.69	99.90	131.68	163.14	149.89	118.95	97.36	81.59	69.66	53.00	42.06	34.42					
20	2.06	4.02	9.68	18.83	19.91	27.79	36.63	54.06	71.25	105.16	138.61	171.73	161.88	128.46	105.15	88.12	75.24	57.23	45.42	35.82					
21	2.17	4.22	10.16	19.77	20.91	29.18	38.46	56.76	74.82	110.42	145.54	180.31	174.17	138.22	113.13	94.81	80.95	61.58	48.87						
22	2.27	4.42	10.65	20.71	21.90	30.57	40.29	59.47	78.38	115.68	152.47	188.90	186.76	148.21	121.30	101.66	86.80	66.03	52.40						
23	2.37	4.62	11.13	21.65	22.90	31.96	42.12	62.17	81.94	120.94	159.40	197.48	199.64	158.43	129.67	108.67	92.78	70.58	56.01						
24	2.48	4.82	11.62	22.60	23.90	33.35	43.95	64.87	85.51	126.20	166.33	206.07	212.80	168.87	138.22	115.83	98.90	75.24	37.90						
25	2.58	5.02	12.10	23.54	24.89	34.74	45.79	67.57	89.07	131.45	173.27	214.66	226.24	179.53	146.94	123.15	105.15	79.99							
26	2.68	5.22	12.58	24.48	25.89	36.13	47.62	70.28	92.63	136.71	180.20	223.24	239.95	190.41	155.85	130.61	111.52	84.83							
28	2.89	5.62	13.55	26.36	27.88	38.91	51.28	75.68	99.76	147.23	194.06	240.42	268.16	212.80	174.17	145.97	124.63	94.81							
30	3.10	6.02	14.52	28.24	29.87	41.68	54.94	81.09	106.88	157.74	207.92	257.59	297.40	236.00	193.16	161.88	138.22	18.64							
32	3.30	6.43	15.49	30.13	31.86	44.46	58.61	86.50	114.01	168.26	221.78	274.76	327.63	259.99	212.80	178.34	152.27								
35	3.61	7.03	16.94	32.95	34.85	48.63	64.10	94.60	124.70	184.03	242.57	300.52	358.00	297.40	243.41	203.99	135.27								
40	4.13	8.03	19.36	37.66	39.83	55.58	73.26	108.12	142.51	210.33	277.22	343.45	409.15	363.35	297.40	153.78									
45	4.65	9.04	21.78	42.37	44.80	62.53	82.42	121.63	160.32	236.62	311.88	386.38	460.29	433.56	221.34										*
	TYPE A LUBRICATION				TYPE B LUBRICATION								TYPE C LUBRICATION												

Horsepower Ratings – Single Strand Roller Chain No. 140H

# of teeth in small sprocket	Revolutions Per Minute – Small Sprocket																								
	5	10	25	44	50	75	100	150	200	300	400	500	600	700	800	900	1000	1200	1400	1600	1800	2000	2200	2400	2700
11	1.21	2.36	5.69	9.79	11.07	16.34	21.54	31.79	41.90	61.84	81.50	86.80	66.03	52.40	42.89	35.94	30.69	23.35	18.53	15.16	12.71	10.85	9.40	8.25	
12	1.32	2.58	6.21	10.68	12.08	17.83	23.50	34.68	45.71	67.46	88.91	98.90	75.24	59.70	48.87	40.95	34.97	26.60	21.11	17.28	14.48	12.36	10.72		
13	1.43	2.79	6.73	11.57	13.08	19.31	25.45	37.57	49.52	73.08	96.32	111.52	84.83	67.32	55.10	46.18	39.43	29.99	23.80	19.48	16.33	13.94			
14	1.55	3.01	7.24	12.46	14.09	20.80	27.41	40.46	53.32	78.70	103.73	124.63	94.81	75.24	61.58	51.61	44.06	33.52	26.60	21.77	18.25	15.58			
15	1.66	3.22	7.76	13.35	15.10	22.28	29.37	43.35	57.13	84.32	111.14	137.69	105.15	83.44	68.29	57.23	48.87	37.17	29.50	24.15	20.24				
16	1.77	3.44	8.28	14.24	16.10	23.77	31.33	46.24	60.94	89.94	118.55	146.87	115.83	91.92	75.24	63.05	53.83	40.95	32.50	26.60	22.29				
17	1.88	3.65	8.80	15.13	17.11	25.25	33.29	49.13	64.75	95.56	125.96	156.05	126.86	100.67	82.40	69.05	58.96	44.85	35.59	29.13					
18	1.99	3.86	9.31	16.02	18.12	26.74	35.24	52.02	68.56	101.19	133.37	165.23	138.22	109.68	89.77	75.24	64.24	48.87	38.78	31.74					
19	2.10	4.08	9.83	16.92	19.12	28.22	37.20	54.90	72.37	106.81	140.78	174.41	149.89	118.95	97.36	81.59	69.66	53.00	42.06	33.55					
20	2.21	4.29	10.35	17.81	20.13	29.71	39.16	57.79	76.18	112.43	148.19	183.59	161.88	128.46	105.15	88.12	75.24	57.23	45.42						
21	2.32	4.51	10.87	18.70	21.14	31.20	41.12	60.68	79.99	118.05	155.60	192.77	174.17	138.22	113.13	94.81	80.95	61.58	48.87						
22	2.43	4.72	11.38	19.59	22.14	32.68	43.08	63.57	83.80	123.67	163.01	201.95	186.76	148.21	121.30	101.66	86.80	66.03	52.40						
23	2.54	4.94	11.90	20.48	23.15	34.17	45.03	66.46	87.60	129.29	170.42	211.13	199.64	158.43	129.67	108.67	92.78	70.58	29.48						
24	2.65	5.15	12.42	21.37	24.16	35.65	46.99	69.35	91.41	134.91	177.83	220.31	212.80	168.87	138.22	115.83	98.90	75.24							
25	2.76	5.37	12.94	22.26	25.16	37.14	48.95	72.24	95.22	140.54	185.24	229.49	226.24	179.53	146.94	123.15	105.15	79.99							
26	2.87	5.58	13.45	23.15	26.17	38.62	50.91	75.13	99.03	146.16	192.65	238.67	239.95	190.41	155.85	130.61	111.52	84.83							
28	3.09	6.01	14.49	24.93	28.18	41.59	54.82	80.91	106.65	157.40	207.47	257.03	268.16	212.80	174.17	145.97	124.63	41.32							
30	3.31	6.44	15.52	26.71	30.20	44.56	58.74	86.69	114.27	168.64	222.28	275.39	297.40	236.00	193.16	161.88	138.22								
32	3.53	6.87	16.56	28.49	32.21	47.54	62.66	92.47	121.88	179.89	237.10	293.74	327.63	259.99	212.80	178.34	152.27								
35	3.86	7.51	18.11	31.16	35.23	51.99	68.53	101.14	133.31	196.75	259.33	321.28	374.76	297.40	243.41	203.99	66.13								
40	4.41	8.59	20.70	35.61	40.26	59.42	78.32	115.59	152.36	224.86	296.38	367.18	437.42	363.35	264.26	74.76									
45	4.97	9.66	23.28	40.06	45.29	66.85	88.11	130.04	171.40	252.96	333.43	413.08	492.09	352.89	132.45										*
	TYPE A LUBE			TYPE B LUBRICATION								TYPE C LUBRICATION													

TYPE A LUBRICATION – MANUAL OR DRIP
 TYPE B LUBRICATION – OIL BATH OR SLINGER
 TYPE C LUBRICATION – OIL PUMP

See Lubrication Instructions in the Roller Chain Installation section.
 Ratings shown are for standard steel chain. See the General Drive Selection section for service factors, selection factors and multiple strand factors.

*For optimum results, consult Diamond Chain for drives operating in the shaded area.

TECHNICAL ENGINEERING

Horsepower Rating Tables

Standard and Heavy Series Power Transmission Roller Chains

Horsepower Ratings – Single Strand Roller Chain No. 160

# of teeth in small sprocket	Revolutions Per Minute – Small Sprocket																								
	5	10	25	47	50	75	100	150	200	300	400	500	600	700	800	900	1000	1100	1200	1400	1600	1800	2000	2200	2400
11	1.65	3.20	7.72	14.16	15.02	22.17	29.23	43.14	56.86	83.91	110.60	96.58	73.47	58.31	47.72	39.99	34.15	29.60	25.98	20.61	16.87	14.14	12.07	10.46	
12	1.80	3.50	8.43	15.45	16.39	24.19	31.88	47.06	62.03	91.54	120.66	110.05	83.72	66.44	54.38	45.57	38.91	33.73	29.60	23.49	19.22	16.11	13.76		
13	1.95	3.79	9.13	16.73	17.76	26.21	34.54	50.98	67.19	99.17	130.71	124.09	94.40	74.91	61.31	51.38	43.87	38.03	33.37	26.48	21.68	18.17			
14	2.10	4.08	9.83	18.02	19.12	28.22	37.20	54.90	72.36	106.80	140.77	138.68	105.50	83.72	68.52	57.43	49.03	42.50	37.30	29.60	24.23	20.30			
15	2.25	4.37	10.53	19.31	20.49	30.24	39.86	58.82	77.53	114.43	150.82	153.80	117.00	92.85	75.99	63.69	54.38	47.13	41.37	32.83	26.87				
16	2.40	4.66	11.23	20.59	21.85	32.25	42.51	62.74	82.70	122.05	160.88	169.43	128.89	102.28	83.72	70.16	59.90	51.92	45.57	36.16	29.60				
17	2.55	4.95	11.94	21.88	23.22	34.27	45.17	66.66	87.87	129.68	170.93	185.56	141.16	112.02	91.69	76.84	65.61	56.87	49.91	39.61	24.21				
18	2.70	5.24	12.64	23.17	24.59	36.29	47.83	70.59	93.04	137.31	180.99	202.17	153.80	122.05	99.90	83.72	71.48	61.96	54.38	43.15					
19	2.85	5.54	13.34	24.45	25.95	38.30	50.48	74.51	98.21	144.94	191.04	219.25	166.79	132.36	108.33	90.79	77.52	67.19	58.97	46.80					
20	3.00	5.83	14.04	25.74	27.32	40.32	53.14	78.43	103.38	152.57	201.10	236.79	180.13	142.95	117.00	98.05	83.72	72.57	63.69	46.79					
21	3.15	6.12	14.74	27.03	28.68	42.33	55.80	82.35	108.54	160.20	211.15	254.77	193.81	153.80	125.88	105.50	90.07	78.08	68.52						
22	3.29	6.41	15.45	28.32	30.05	44.35	58.45	86.27	113.71	167.83	221.21	273.18	207.82	164.91	134.98	113.12	96.58	83.72	73.47						
23	3.44	6.70	16.15	29.60	31.42	46.36	61.11	90.19	118.88	175.45	231.26	286.51	222.15	176.29	144.29	120.92	103.24	89.49	78.54						
24	3.59	6.99	16.85	30.89	32.78	48.38	63.77	94.11	124.05	183.08	241.32	298.97	236.79	187.91	153.80	128.89	110.05	95.39	83.72						
25	3.74	7.28	17.55	32.18	34.15	50.40	66.43	98.04	129.22	190.71	251.37	311.42	251.74	199.77	163.51	137.03	117.00	101.41	32.66						
26	3.89	7.57	18.26	33.46	35.51	52.41	69.08	101.96	134.39	198.34	261.43	323.88	267.00	211.88	173.42	145.33	124.09	107.56							
28	4.19	8.16	19.66	36.04	38.24	56.44	74.40	109.80	144.73	213.60	281.54	348.79	298.39	236.79	193.81	162.42	138.68	36.88							
30	4.49	8.74	21.06	38.61	40.98	60.48	79.71	117.64	155.06	228.85	301.65	373.71	330.92	262.61	214.94	180.13	126.46								
32	4.79	9.32	22.47	41.19	43.71	64.51	85.03	125.49	165.40	244.11	321.76	398.62	364.56	289.30	236.79	198.44	22.58								
35	5.24	10.20	24.57	45.05	47.81	70.55	93.00	137.25	180.91	266.99	351.92	435.99	417.01	330.92	270.86	112.60									
40	5.99	11.65	28.09	51.48	54.63	80.63	106.28	156.86	206.75	305.14	402.19	498.28	509.49	404.31	160.63										
45	6.74	13.11	31.60	57.92	61.46	90.71	119.57	176.47	232.59	343.28	452.47	560.56	607.95	289.10											
	TYPE A LUBE			TYPE B LUBRICATION									TYPE C LUBRICATION												

Horsepower Ratings – Single Strand Roller Chain No. 160H

# of teeth in small sprocket	Revolutions Per Minute – Small Sprocket																								
	2	5	10	25	40	50	75	100	150	200	300	400	500	600	700	800	900	1000	1100	1200	1400	1600	1800	2000	2200
11	0.73	1.75	3.40	8.19	12.86	15.94	23.52	31.00	45.75	60.31	89.00	117.32	96.58	73.47	58.31	47.72	39.99	34.15	29.60	25.98	20.61	16.87	14.14	12.07	
12	0.79	1.91	3.71	8.94	14.03	17.39	25.66	33.82	49.91	65.79	97.10	127.98	110.05	83.72	66.44	54.38	45.57	38.91	33.73	29.60	23.49	19.22	16.11	12.02	
13	0.86	2.07	4.02	9.68	15.20	18.83	27.80	36.64	54.07	71.27	105.19	138.65	124.09	94.40	74.91	61.31	51.38	43.87	38.03	33.37	26.48	21.68	18.17		
14	0.92	2.22	4.33	10.43	16.37	20.28	29.93	39.46	58.23	76.75	113.28	149.31	138.68	105.50	83.72	68.52	57.43	49.03	42.50	37.30	29.60	24.23	20.30		
15	0.99	2.38	4.64	11.17	17.54	21.73	32.07	42.27	62.39	82.24	121.37	159.98	153.80	117.00	92.85	75.99	63.69	54.38	47.13	41.37	32.83	26.87			
16	1.05	2.54	4.94	11.92	18.71	23.18	34.21	45.09	66.55	87.72	129.46	170.64	169.43	128.89	102.28	83.72	70.16	59.90	51.92	45.57	36.16	29.60			
17	1.12	2.70	5.25	12.66	19.88	24.63	36.35	47.91	70.71	93.20	137.55	181.31	185.56	141.16	112.02	91.69	76.84	65.61	56.87	49.91	39.61				
18	1.19	2.86	5.56	13.41	21.05	26.08	38.49	50.73	74.87	98.68	145.64	191.97	202.17	153.80	122.05	99.90	83.72	71.48	61.96	54.38	43.15				
19	1.25	3.02	5.87	14.15	22.22	27.53	40.63	53.55	79.03	104.17	153.74	202.64	219.25	166.79	132.36	108.33	90.79	77.52	67.19	58.97	43.82				
20	1.32	3.18	6.18	14.89	23.39	28.98	42.76	56.37	83.19	109.65	161.83	213.30	236.79	180.13	142.95	117.00	98.05	83.72	72.57	63.69					
21	1.38	3.34	6.49	15.64	24.56	30.42	44.90	59.18	87.35	115.13	169.92	223.97	254.77	193.81	153.80	125.88	105.50	90.07	78.08	68.52					
22	1.45	3.49	6.80	16.38	25.73	31.87	47.04	62.00	91.51	120.61	178.01	234.63	273.18	207.82	164.91	134.98	113.12	96.58	83.72	73.47					
23	1.52	3.65	7.11	17.13	26.90	33.32	49.18	64.82	95.67	126.10	186.10	245.30	292.02	222.15	176.29	144.29	120.92	103.24	89.49	68.24					
24	1.58	3.81	7.42	17.87	28.07	34.77	51.32	67.64	99.83	131.58	194.19	255.96	311.27	236.79	187.91	153.80	128.89	110.05	95.39	21.76					
25	1.65	3.97	7.73	18.62	29.23	36.22	53.45	70.46	103.99	137.06	202.28	266.63	330.32	251.74	199.77	163.51	137.03	117.00	101.41						
26	1.71	4.13	8.03	19.36	30.40	37.67	55.59	73.28	108.14	142.54	210.37	277.29	343.53	267.00	211.88	173.42	145.33	124.09	67.09						
28	1.85	4.45	8.65	20.85	32.74	40.57	59.87	78.91	116.46	153.51	226.56	298.62	369.96	298.39	236.79	193.81	162.42	135.17							
30	1.98	4.77	9.27	22.34	35.08	43.46	64.15	84.55	124.78	164.47	242.74	319.95	396.38	330.92	262.61	214.94	180.13	49.06							
32	2.11	5.08	9.89	23.83	37.42	46.36	68.42	90.18	133.10	175.44	258.92	341.28	422.81	364.56	289.30	236.79	157.70								
35	2.31	5.56	10.82	26.07	40.93	50.71	74.84	98.64	145.58	191.88	283.20	373.28	462.45	417.01	330.92	270.86	22.30								
40	2.64	6.35	12.36	29.79	46.78	57.95	85.53	112.73	166.38	219.30	323.65	426.60	528.51	509.49	345.15	57.42									
45	2.97	7.15	13.91	33.51	52.62	65.19	96.22	126.82	187.17	246.71	364.11	479.93	594.58	495.96	173.00										*
	TYPE A LUBRICATION				TYPE B LUBRICATION								TYPE C LUBRICATION												

TYPE A LUBRICATION – MANUAL OR DRIP
 TYPE B LUBRICATION – OIL BATH OR SLINGER
 TYPE C LUBRICATION – OIL PUMP

See Lubrication Instructions in the Roller Chain Installation section.
 Ratings shown are for standard steel chain. See the General Drive Selection section for service factors, selection factors and multiple strand factors.

*For optimum results, consult Diamond Chain for drives operating in the shaded area.

TECHNICAL ENGINEERING

Horsepower Rating Tables

Standard and Heavy Series Power Transmission Roller Chains

Horsepower Ratings – Single Strand Roller Chain No. 180

# of teeth in small sprocket	Revolutions Per Minute – Small Sprocket																								
	2	5	10	25	43	50	75	100	150	200	300	400	500	600	700	800	900	1000	1100	1200	1400	1600	1800	2000	4500
11	0.94	2.27	4.43	10.66	17.95	20.75	30.62	40.36	59.56	78.51	115.87	148.32	106.13	80.73	64.07	52.44	43.95	37.52	32.52	28.54	22.65	18.54	15.54		
12	1.03	2.48	4.83	11.63	19.58	22.63	33.40	44.03	64.98	85.64	126.40	166.61	120.92	91.99	73.00	59.75	50.07	42.75	37.06	32.52	25.81	21.12	17.70		
13	1.12	2.69	5.23	12.60	21.21	24.52	36.19	47.70	70.39	92.78	136.93	180.49	136.35	103.72	82.31	67.37	56.46	48.21	41.79	36.67	29.10	23.82			
14	1.20	2.90	5.63	13.57	22.84	26.40	38.97	51.36	75.81	99.92	147.47	194.37	152.38	115.92	91.99	75.29	63.10	53.87	46.70	40.98	32.52	26.62			
15	1.29	3.10	6.03	14.54	24.48	28.29	41.75	55.03	81.22	107.06	158.00	208.26	169.00	128.56	102.02	83.50	69.98	59.75	51.79	45.45	36.07				
16	1.37	3.31	6.44	15.51	26.11	30.18	44.54	58.70	86.64	114.19	168.53	222.14	186.17	141.63	112.39	91.99	77.09	65.82	57.05	50.07	39.74				
17	1.46	3.52	6.84	16.48	27.74	32.06	47.32	62.37	92.05	121.33	179.07	236.02	203.90	155.11	123.09	100.75	84.43	72.09	62.49	54.84	43.52				
18	1.54	3.72	7.24	17.45	29.37	33.95	50.10	66.04	97.47	128.47	189.60	249.91	222.15	169.00	134.11	109.77	91.99	78.54	68.08	59.75					
19	1.63	3.93	7.64	18.42	31.00	35.83	52.89	69.71	102.88	135.60	200.13	263.79	240.92	183.27	145.44	119.04	99.76	85.18	73.83	64.80					
20	1.72	4.14	8.05	19.39	32.64	37.72	55.67	73.38	108.30	142.74	210.67	277.68	260.19	197.93	157.07	128.56	107.74	91.99	79.74	69.98					
21	1.80	4.34	8.45	20.36	34.27	39.61	58.45	77.05	113.71	149.88	221.20	291.56	279.94	212.96	169.00	138.32	115.92	98.97	85.79	75.29					
22	1.89	4.55	8.85	21.33	35.90	41.49	61.24	80.71	119.12	157.02	231.73	305.44	300.17	228.35	181.21	148.32	124.30	106.13	91.99						
23	1.97	4.76	9.25	22.30	37.53	43.38	64.02	84.38	124.54	164.15	242.27	319.33	320.87	244.10	193.70	158.54	132.87	113.45	98.33						
24	2.06	4.96	9.65	23.27	39.16	45.26	66.80	88.05	129.95	171.29	252.80	333.21	342.02	260.19	206.47	169.00	141.63	120.92	40.34						
25	2.15	5.17	10.06	24.24	40.79	47.15	69.59	91.72	135.37	178.43	263.33	347.10	363.62	276.62	219.51	179.67	150.57	128.56							
26	2.23	5.38	10.46	25.21	42.43	49.04	72.37	95.39	140.78	185.56	273.87	360.98	385.66	293.38	232.81	190.55	159.69	122.43							
28	2.40	5.79	11.26	27.15	45.69	52.81	77.94	102.73	151.61	199.84	294.93	388.75	431.00	327.87	260.19	212.96	178.47								
30	2.57	6.20	12.07	29.09	48.95	56.58	83.50	110.07	162.44	214.11	316.00	416.51	477.99	363.62	288.56	236.18	128.92								
32	2.75	6.62	12.87	31.02	52.22	60.35	89.07	117.40	173.27	228.39	337.07	444.28	526.58	400.58	317.89	260.19									
35	3.00	7.24	14.08	33.93	57.11	66.01	97.42	128.41	189.52	249.80	368.67	485.93	602.34	458.22	363.62	142.51									
40	3.43	8.27	16.09	38.78	65.27	75.44	111.34	146.75	216.59	285.48	421.34	555.35	688.02	559.83	254.20										
45	3.86	9.31	18.10	43.63	73.43	84.87	125.26	165.10	243.66	321.17	474.00	624.77	774.03	480.00											*
	TYPE A LUBRICATION				TYPE B LUBRICATION								TYPE C LUBRICATION												

Horsepower Ratings – Single Strand Roller Chain No. 180H

# of teeth in small sprocket	Revolutions Per Minute – Small Sprocket																								
	2	5	10	25	37	50	75	100	150	200	300	400	500	600	700	800	900	1000	1100	1200	1400	1600	1800	2000	4500
11	0.99	2.40	4.66	11.24	16.38	21.87	32.27	42.54	62.78	82.75	122.13	148.32	106.13	80.73	64.07	52.44	43.95	37.52	32.52	28.54	22.65	18.54	15.54		
12	1.09	2.62	5.09	12.26	17.87	23.86	35.21	46.41	68.49	90.28	133.24	169.00	120.92	91.99	73.00	59.75	50.07	42.75	37.06	32.52	25.81	21.12	17.70		
13	1.18	2.83	5.51	13.29	19.36	25.84	38.14	50.28	74.20	97.80	144.34	190.25	136.35	103.72	82.31	67.37	56.46	48.21	41.79	36.67	29.10	23.82			
14	1.27	3.05	5.94	14.31	20.85	27.83	41.08	54.14	79.91	105.32	155.44	204.89	152.38	115.92	91.99	75.29	63.10	53.87	46.70	40.98	32.52	26.62			
15	1.36	3.27	6.36	15.33	22.33	29.82	44.01	58.01	85.61	112.85	166.55	219.52	169.00	128.56	102.02	83.50	69.98	59.75	51.79	45.45	36.07				
16	1.45	3.49	6.78	16.35	23.82	31.81	46.94	61.88	91.32	120.37	177.65	234.16	186.17	141.63	112.39	91.99	77.09	65.82	57.05	50.07	39.74				
17	1.54	3.71	7.21	17.37	25.31	33.80	49.88	65.74	97.03	127.89	188.75	248.79	203.90	155.11	123.09	100.75	84.43	72.09	62.49	54.84					
18	1.63	3.92	7.63	18.40	26.80	35.78	52.81	69.61	102.74	135.42	199.86	263.43	222.15	169.00	134.11	109.77	91.99	78.54	68.08	59.75					
19	1.72	4.14	8.06	19.42	28.29	37.77	55.75	73.48	108.45	142.94	210.96	278.06	240.92	183.27	145.44	119.04	99.76	85.18	73.83	64.80					
20	1.81	4.36	8.48	20.44	29.78	39.76	58.68	77.35	114.15	150.46	222.06	292.70	260.19	197.93	157.07	128.56	107.74	91.99	79.74	55.31					
21	1.90	4.58	8.90	21.46	31.27	41.75	61.62	81.21	119.86	157.99	233.17	307.33	279.94	212.96	169.00	138.32	115.92	98.97	85.79						
22	1.99	4.80	9.33	22.48	32.76	43.74	64.55	85.08	125.57	165.51	244.27	321.97	300.17	228.35	181.21	148.32	124.30	106.13	87.35						
23	2.08	5.01	9.75	23.50	34.25	45.72	67.48	88.95	131.28	173.03	255.37	336.60	320.87	244.10	193.70	158.54	132.87	113.45	29.32						
24	2.17	5.23	10.18	24.53	35.74	47.71	70.42	92.82	136.98	180.56	266.48	351.24	342.02	260.19	206.47	169.00	141.63	120.92							
25	2.26	5.45	10.60	25.55	37.22	49.70	73.35	96.68	142.69	188.08	277.58	365.87	363.62	276.62	219.51	179.67	150.57	96.16							
26	2.35	5.67	11.03	26.57	38.71	51.69	76.29	100.55	148.40	195.60	288.68	380.51	385.66	293.38	232.81	190.55	159.69	37.53							
28	2.53	6.10	11.87	28.61	41.69	55.66	82.15	108.28	159.81	210.65	310.89	409.77	431.00	327.87	260.19	212.96	146.32								
30	2.71	6.54	12.72	30.66	44.67	59.64	88.02	116.02	171.23	225.69	333.09	439.04	477.99	363.62	288.56	236.18	30.96								
32	2.89	6.98	13.57	32.70	47.65	63.62	93.89	123.75	182.64	240.74	355.30	468.31	526.58	400.58	317.89	199.60									
35	3.17	7.63	14.84	35.77	52.11	69.58	102.69	135.36	199.77	263.31	388.61	512.22	602.34	458.22	363.62	28.22									
40	3.62	8.72	16.96	40.88	59.56	79.52	117.36	154.69	228.31	300.93	444.13	585.39	725.24	559.83	123.60										
45	4.07	9.81	19.08	45.99	67.00	89.46	132.03	174.03	256.84	338.54	499.64	658.57	750.00	333.00											
	TYPE A LUBRICATION				TYPE B LUBRICATION								TYPE C LUBRICATION												

TYPE A LUBRICATION – MANUAL OR DRIP
 TYPE B LUBRICATION – OIL BATH OR SLINGER
 TYPE C LUBRICATION – OIL PUMP

See Lubrication Instructions in the Roller Chain Installation section.
 Ratings shown are for standard steel chain. See the General Drive Selection section for service factors, selection factors and multiple strand factors.

*For optimum results, consult Diamond Chain for drives operating in the shaded area.

TECHNICAL ENGINEERING

Horsepower Rating Tables

Standard and Heavy Series Power Transmission Roller Chains

Horsepower Ratings – Single Strand Roller Chain No. 200

# of teeth in small sprocket	Revolutions Per Minute – Small Sprocket																								
	2	5	10	25	40	50	75	100	150	200	250	300	400	500	600	700	800	900	1000	1100	1200	1400	1600	1800	4500
11	1.25	3.02	5.88	14.16	22.23	27.54	40.65	53.58	79.08	104.24	129.14	153.84	161.36	115.46	87.83	69.70	57.05	47.81	40.82	35.38	31.05	24.64	20.17		
12	1.37	3.29	6.41	15.45	24.25	30.05	44.35	58.45	86.27	113.71	140.88	167.82	183.86	131.56	100.08	79.42	65.00	54.48	46.51	40.32	35.38	28.08	22.98		
13	1.48	3.57	6.94	16.73	26.28	32.55	48.04	63.33	93.46	123.19	152.62	181.81	207.31	148.34	112.85	89.55	73.30	61.43	52.45	45.46	39.90	31.66			
14	1.59	3.84	7.48	18.02	28.30	35.06	51.74	68.20	100.65	132.66	164.36	195.79	231.69	165.78	126.11	100.08	81.91	68.65	58.61	50.80	44.59	35.38			
15	1.71	4.12	8.01	19.31	30.32	37.56	55.43	73.07	107.84	142.14	176.09	209.78	256.95	183.86	139.87	110.99	90.85	76.13	65.00	56.34	49.45	37.46			
16	1.82	4.39	8.55	20.60	32.34	40.06	59.13	77.94	115.03	151.61	187.83	223.76	283.07	202.55	154.08	122.27	100.08	83.87	71.61	62.07	54.48				
17	1.94	4.67	9.08	21.88	34.36	42.57	62.83	82.81	122.22	161.09	199.57	237.75	310.02	221.83	168.75	133.91	109.61	91.86	78.43	67.98	59.66				
18	2.05	4.94	9.61	23.17	36.38	45.07	66.52	87.68	129.41	170.57	211.31	251.73	331.81	241.69	183.86	145.90	119.42	100.08	85.45	74.07	65.00				
19	2.16	5.22	10.15	24.46	38.40	47.58	70.22	92.55	136.59	180.04	223.05	265.72	350.24	262.11	199.39	158.23	129.51	108.53	92.67	80.32	2.22				
20	2.28	5.49	10.68	25.74	40.42	50.08	73.91	97.42	143.78	189.52	234.79	279.70	368.67	283.07	215.34	170.88	139.87	117.21	100.08	86.75					
21	2.39	5.77	11.22	27.03	42.45	52.59	77.61	102.29	150.97	198.99	246.53	293.69	387.11	304.56	231.69	183.86	150.49	126.11	107.68	32.68					
22	2.51	6.04	11.75	28.32	44.47	55.09	81.30	107.17	158.16	208.47	258.27	307.68	405.54	326.57	248.43	197.15	161.36	135.23	115.46						
23	2.62	6.31	12.28	29.61	46.49	57.59	85.00	112.04	165.35	217.95	270.01	321.66	423.97	349.09	265.56	210.74	172.49	144.55	104.48						
24	2.73	6.59	12.82	30.89	48.51	60.10	88.70	116.91	172.54	227.42	281.75	335.65	442.41	372.10	283.07	224.63	183.86	154.08	21.71						
25	2.85	6.86	13.35	32.18	50.53	62.60	92.39	121.78	179.73	236.90	293.49	349.63	460.84	395.60	300.94	238.82	195.47	163.81							
26	2.96	7.14	13.89	33.47	52.55	65.11	96.09	126.65	186.92	246.37	305.23	363.62	479.27	419.57	319.18	253.29	207.31	151.14							*
	TYPE A LUBRICATION				TYPE B LUBRICATION								TYPE C LUBRICATION												

Horsepower Ratings – Single Strand Roller Chain No. 200H

# of teeth in small sprocket	Revolutions Per Minute – Small Sprocket																								
	2	5	10	25	33	50	75	100	150	200	250	300	400	500	600	700	800	900	1000	1100	1200	1400	1600	1800	4500
11	1.37	3.31	6.44	15.51	20.25	30.17	44.53	58.70	86.63	114.18	141.46	168.52	161.36	115.46	87.83	69.70	57.05	47.81	40.82	35.38	31.05	24.64	20.17		
12	1.50	3.61	7.02	16.92	22.09	32.92	48.58	64.03	94.51	124.57	154.32	183.84	183.86	131.56	100.08	79.42	65.00	54.48	46.51	40.32	35.38	28.08	18.78		
13	1.62	3.91	7.61	18.33	23.93	35.66	52.63	69.37	102.38	134.95	167.18	199.16	207.31	148.34	112.85	89.55	73.30	61.43	52.45	45.46	39.90	31.66			
14	1.75	4.21	8.19	19.74	25.77	38.40	56.68	74.71	110.26	145.33	180.04	214.48	231.69	165.78	126.11	100.08	81.91	68.65	58.61	50.80	44.59	35.38			
15	1.87	4.51	8.78	21.15	27.61	41.15	60.73	80.04	118.13	155.71	192.90	229.80	256.95	183.86	139.87	110.99	90.85	76.13	65.00	56.34	49.45				
16	2.00	4.81	9.36	22.56	29.45	43.89	64.77	85.38	126.01	166.09	205.76	245.12	283.07	202.55	154.08	122.27	100.08	83.87	71.61	62.07	54.48				
17	2.12	5.11	9.95	23.97	31.29	46.63	68.82	90.71	133.88	176.47	218.62	260.44	310.02	221.83	168.75	133.91	109.61	91.86	78.43	67.98	59.66				
18	2.25	5.41	10.53	25.38	33.13	49.38	72.87	96.05	141.76	186.85	231.48	275.76	337.77	241.69	183.86	145.90	119.42	100.08	85.45	74.07	11.75				
19	2.37	5.71	11.12	26.79	34.97	52.12	76.92	101.39	149.63	197.23	244.35	291.08	366.30	262.11	199.39	158.23	129.51	108.53	92.67	80.32					
20	2.50	6.02	11.70	28.20	36.82	54.86	80.97	106.72	157.51	207.61	257.21	306.40	395.60	283.07	215.34	170.88	139.87	117.21	100.08	31.07					
21	2.62	6.32	12.29	29.61	38.66	57.60	85.02	112.06	165.38	217.99	270.07	321.72	425.64	304.56	231.69	183.86	150.49	126.11	107.68						
22	2.75	6.62	12.87	31.02	40.50	60.35	89.07	117.40	173.26	228.37	282.93	337.04	456.40	326.57	248.43	197.15	161.36	135.23	86.70						
23	2.87	6.92	13.46	32.43	42.34	63.09	93.11	122.73	181.14	238.75	295.79	352.36	464.44	349.09	265.56	210.74	172.49	144.55	11.76						
24	3.00	7.22	14.04	33.84	44.18	65.83	97.16	128.07	189.01	249.13	308.65	367.68	484.64	372.10	283.07	224.63	183.86	154.08							
25	3.12	7.52	14.63	35.25	46.02	68.58	101.21	133.40	196.89	259.51	321.51	383.00	504.83	395.60	300.94	238.82	195.47	118.72							
26	3.24	7.82	15.21	36.66	47.86	71.32	105.26	138.74	204.76	269.89	334.37	398.32	525.02	419.57	319.18	253.29	207.31	46.33							
	TYPE A LUBRICATION				TYPE B LUBRICATION								TYPE C LUBRICATION												

TYPE A LUBRICATION – MANUAL OR DRIP
 TYPE B LUBRICATION – OIL BATH OR SLINGER
 TYPE C LUBRICATION – OIL PUMP

See Lubrication Instructions in the Roller Chain Installation section.
 Ratings shown are for standard steel chain. See the General Drive Selection section for service factors, selection factors and multiple strand factors.

* For optimum results, consult Diamond Chain for drives operating in the shaded area.

TECHNICAL ENGINEERING

Horsepower Rating Tables

Standard and Heavy Series Power Transmission Roller Chains

Horsepower Ratings – Single Strand Roller Chain No. 240

# of teeth in small sprocket	Revolutions Per Minute – Small Sprocket																							
	2	5	10	25	36	50	75	100	150	200	250	300	400	500	600	700	800	900	1000	1100	1200	1300	1400	1500
11	2.02	4.86	9.46	22.81	32.36	44.36	65.47	86.30	127.37	167.88	207.99	247.77	186.70	133.59	101.63	80.65	66.01	55.32	47.23	40.94	35.93	31.87	28.51	
12	2.20	5.31	10.32	24.88	35.31	48.40	71.43	94.15	138.95	183.14	226.89	270.30	212.73	152.22	115.80	91.89	75.21	63.03	53.82	46.65	40.94	36.31	2.11	
13	2.39	5.75	11.18	26.95	38.25	52.43	77.38	101.99	150.53	198.41	245.80	292.82	239.87	171.64	130.57	103.61	84.81	71.07	60.68	52.60	46.16	38.13		
14	2.57	6.19	12.04	29.02	41.19	56.46	83.33	109.84	162.11	213.67	264.71	315.34	268.07	191.82	145.92	115.80	94.78	79.43	67.82	58.78	51.59			
15	2.75	6.63	12.90	31.10	44.13	60.50	89.28	117.68	173.68	228.93	283.62	337.87	297.30	212.73	161.83	128.42	105.11	88.09	75.21	65.19				
16	2.94	7.08	13.76	33.17	47.08	64.53	95.24	125.53	185.26	244.19	302.53	360.39	327.52	234.35	178.28	141.47	115.80	97.04	82.86	71.82				
17	3.12	7.52	14.62	35.24	50.02	68.56	101.19	133.37	196.84	259.45	321.43	382.92	358.70	256.66	195.25	154.94	126.82	106.28	90.74					
18	3.30	7.96	15.48	37.32	52.96	72.59	107.14	141.22	208.42	274.71	340.34	405.44	390.81	279.64	212.73	168.81	138.17	115.80	98.87					
19	3.49	8.40	16.34	39.39	55.90	76.63	113.09	149.06	220.00	289.98	359.25	427.97	423.82	303.26	230.70	183.08	149.84	125.58	3.20					
20	3.67	8.84	17.20	41.46	58.84	80.66	119.04	156.91	231.58	305.24	378.16	450.49	457.72	327.52	249.15	197.72	161.83	135.62						
21	3.85	9.29	18.07	43.54	61.79	84.69	125.00	164.76	243.16	320.50	397.07	473.02	492.48	352.39	268.07	212.73	174.12	109.86						
22	4.04	9.73	18.93	45.61	64.73	88.73	130.95	172.60	254.74	335.76	415.97	495.54	528.07	377.85	287.44	228.10	186.70							
23	4.22	10.17	19.79	47.68	67.67	92.76	136.90	180.45	266.32	351.02	434.88	518.07	564.48	403.91	307.26	243.83	199.57							
24	4.40	10.61	20.65	49.76	70.61	96.79	142.85	188.29	277.89	366.29	453.79	540.59	601.69	430.53	327.52	259.91	188.30							
25	4.59	11.06	21.51	51.83	73.55	100.83	148.81	196.14	289.47	381.55	472.70	563.12	639.68	457.72	348.20	276.32	73.47							
26	4.77	11.50	22.37	53.90	76.50	104.86	154.76	203.98	301.05	396.81	491.61	585.64	678.45	485.46	369.30	293.06								
	TYPE A LUBRICATION				TYPE B LUBRICATION								TYPE C LUBRICATION											

Horsepower Ratings – Single Strand Roller Chain No. 240H

# of teeth in small sprocket	Revolutions Per Minute – Small Sprocket																							
	2	5	10	25	27	50	75	100	150	200	250	300	400	500	600	700	800	900	1000	1100	1200	1300	1400	1500
11	2.33	5.62	10.93	26.33	28.35	51.23	75.60	99.65	147.07	193.85	240.16	286.10	186.70	133.59	101.63	80.65	66.01	55.32	47.23	40.94	35.93	31.87	28.51	
12	2.54	6.13	11.92	28.73	30.93	55.88	82.48	108.71	160.44	211.48	262.00	312.11	212.73	152.22	115.80	91.89	75.21	63.03	53.82	46.65	40.94	36.31		
13	2.75	6.64	12.91	31.12	33.51	60.54	89.35	117.77	173.81	229.10	283.83	338.12	239.87	171.64	130.57	103.61	84.81	71.07	60.68	52.60	46.16			
14	2.97	7.15	13.91	33.52	36.09	65.20	96.22	126.83	187.18	246.72	305.66	364.13	268.07	191.82	145.92	115.80	94.78	79.43	67.82	58.78	18.18			
15	3.18	7.66	14.90	35.91	38.66	69.85	103.10	135.89	200.55	264.35	327.50	390.14	297.30	212.73	161.83	128.42	105.11	88.09	75.21	65.19				
16	3.39	8.17	15.89	38.30	41.24	74.51	109.97	144.95	213.92	281.97	349.33	416.15	327.52	234.35	178.28	141.47	115.80	97.04	82.86					
17	3.60	8.68	16.89	40.70	43.82	79.17	116.84	154.01	227.29	299.59	371.16	442.16	358.70	256.66	195.25	154.94	126.82	106.28	90.74					
18	3.81	9.19	17.88	43.09	46.40	83.83	123.72	163.07	240.66	317.21	392.99	468.17	390.81	279.64	212.73	168.81	138.17	115.80	16.92					
19	4.03	9.70	18.87	45.48	48.97	88.48	130.59	172.13	254.03	334.84	414.83	494.18	423.82	303.26	230.70	183.08	149.84	125.58						
20	4.24	10.21	19.87	47.88	51.55	93.14	137.46	181.18	267.40	352.46	436.66	520.19	457.72	327.52	249.15	197.72	161.83	98.33						
21	4.45	10.72	20.86	50.27	54.13	97.80	144.33	190.24	280.78	370.08	458.49	546.19	492.48	352.39	268.07	212.73	174.12							
22	4.66	11.23	21.85	52.67	56.71	102.45	151.21	199.30	294.15	387.71	480.33	572.20	528.07	377.85	287.44	228.10	186.70							
23	4.87	11.74	22.85	55.06	59.28	107.11	158.08	208.36	307.52	405.33	502.16	598.21	564.48	403.91	307.26	243.83	153.53							
24	5.09	12.26	23.84	57.45	61.86	111.77	164.95	217.42	320.89	422.95	523.99	624.22	601.69	430.53	327.52	259.91	48.97							
25	5.30	12.77	24.83	59.85	64.44	116.42	171.83	226.48	334.26	440.58	545.83	650.23	639.68	457.72	348.20	276.32								
26	5.51	13.28	25.83	62.24	67.02	121.08	178.70	235.54	347.63	458.20	567.66	676.24	678.45	485.46	369.30	293.06								*
	TYPE A LUBRICATION				TYPE B LUBRICATION								TYPE C LUBRICATION											

TYPE A LUBRICATION – MANUAL OR DRIP
 TYPE B LUBRICATION – OIL BATH OR SLINGER
 TYPE C LUBRICATION – OIL PUMP

See Lubrication Instructions in the Roller Chain Installation section.
 Ratings shown are for standard steel chain. See the General Drive Selection section
 for service factors, selection factors and multiple strand factors.

*For optimum results, consult Diamond Chain for drives operating in the shaded area.

TECHNICAL ENGINEERING

Horsepower Rating Tables

Double-Pitch Power Transmission Roller Chains

Horsepower Ratings – Double-Pitch Chain No. 2040

# of teeth in small sprocket	Revolutions Per Minute – Small Sprocket																				
	25	50	100	150	200	250	300	350	400	450	500	550	600	700	800	900	1000	1100	1200	1300	
6	0.10	0.17																			
7	0.12	0.21	0.36	0.47	0.55																
8	0.14	0.26	0.45	0.64	0.73	0.82	0.90														
9	0.16	0.30	0.53	0.72	0.89	1.03	1.14	1.24	1.32												
10	0.18	0.34	0.61	0.84	1.04	1.22	1.37	1.50	1.62	1.71	1.79	1.86									
11	0.20	0.38	0.69	0.96	1.19	1.40	1.59	1.76	1.90	2.03	2.14	2.24	2.32								
12	0.22	0.42	0.77	1.07	1.34	1.58	1.80	2.00	2.17	2.33	2.47	2.60	2.70	2.88							
13	0.24	0.46	0.84	1.18	1.48	1.76	2.01	2.23	2.44	2.62	2.79	2.94	3.07	3.30	3.47						
14	0.26	0.50	0.92	1.29	1.62	1.93	2.20	2.46	2.69	2.90	3.09	3.27	3.43	3.70	3.91	4.07					
15	0.28	0.54	0.99	1.39	1.76	2.09	2.40	2.68	2.94	3.17	3.39	3.59	3.77	4.08	4.33	4.52	4.66				
16	0.30	0.57	1.06	1.50	1.89	2.25	2.59	2.89	3.17	3.43	3.67	3.89	4.09	4.44	4.73	4.96	5.13				
17	0.32	0.61	1.13	1.60	2.02	2.41	2.77	3.10	3.41	3.69	3.95	4.19	4.41	4.79	5.11	5.37	5.57	5.72			
18	0.34	0.65	1.20	1.70	2.15	2.57	2.95	3.30	3.63	3.93	4.21	4.47	4.71	5.13	5.48	5.77	5.99	6.16			
19	0.36	0.68	1.27	1.80	2.28	2.72	3.12	3.50	3.85	4.17	4.47	4.75	5.01	5.46	5.83	6.14	6.39	6.58	6.71		
20	0.38	0.72	1.34	1.89	2.40	2.87	3.30	3.70	4.07	4.41	4.73	5.02	5.29	5.77	6.17	6.51	6.77	6.97	7.11		
21	0.40	0.76	1.41	1.99	2.52	3.01	3.47	3.89	4.28	4.64	4.97	5.28	5.57	6.07	6.50	6.85	7.13	7.35	7.50		
22	0.42	0.79	1.47	2.09	2.64	3.16	3.63	4.07	4.48	4.86	5.21	5.53	5.83	6.37	6.81	7.18	7.48	7.70	7.87		
23	0.44	0.83	1.54	2.18	2.76	3.30	3.80	4.26	4.68	5.08	5.44	5.78	6.09	6.60	7.12	7.50	7.81	8.04	8.21	8.31	
24	0.46	0.87	1.61	2.27	2.88	3.44	3.96	4.43	4.88	5.29	5.67	6.02	6.35	6.92	7.41	7.80	8.12	8.36	8.53	8.64	
25	0.48	0.90	1.67	2.36	3.00	3.58	4.11	4.61	5.07	5.50	5.89	6.26	6.59	7.19	7.69	8.10	8.42	8.67	8.84	8.94	
30	0.57	1.08	1.99	2.81	3.56	4.24	4.87	5.45	5.98	6.47	6.93	7.34	7.80	8.39	8.94	9.39	9.72	9.96	10.11	10.10	
35	0.66	1.25	2.30	3.24	4.09	4.86	5.57	6.21	6.81	7.35	7.85	8.30	8.72	9.43	9.99	10.43	10.73	10.93	11.01		
40	0.75	1.41	2.60	3.65	4.59	5.44	6.22	6.93	7.57	8.15	8.68	9.16	9.59	10.31	10.86	11.20	11.50	11.61			
45	0.84	1.58	2.89	4.04	5.07	6.00	6.83	7.59	8.27	8.88	9.43	9.92	10.30	11.00	11.56	11.88	12.03				
50	0.93	1.74	3.17	4.42	5.53	6.52	7.41	8.20	8.91	9.54	10.10	10.59	11.01	11.67	12.11	12.33					
55	1.01	1.90	3.44	4.79	5.97	7.02	7.95	8.77	9.50	10.20	10.70	11.17	11.58	12.18							
60	1.10	2.05	3.71	5.14	6.39	7.49	8.46	9.31	10.00	10.68	11.23	11.69	12.06								
	TYPE A LUBRICATION			TYPE B LUBRICATION					TYPE C LUBRICATION												

TYPE A LUBRICATION – MANUAL DRIP (4-10 DROPS PER MINUTE) OR OIL BATH

TYPE B LUBRICATION – RAPID DRIP (20 DROPS PER MINUTE MINIMUM), OIL BATH OR OIL SLINGER

TYPE C LUBRICATION – CONTINUOUS WITH OIL SLINGER OR OIL STREAM

See Lubrication Instructions in the Roller Chain Installation section.
Ratings shown are for standard steel chain. See the General Drive Selection section for service factors, selection factors and multiple strand factors.

TECHNICAL ENGINEERING

Horsepower Rating Tables

Double-Pitch Power Transmission Roller Chains

Horsepower Ratings – Double-Pitch Chain No. 2050

# of teeth in small sprocket	Revolutions Per Minute – Small Sprocket																			
	25	50	100	150	200	250	300	350	400	450	500	550	600	650	700	750	800	850	900	950
6	0.18	0.31																		
7	0.22	0.40	0.66																	
8	0.27	0.48	0.83	1.09	1.29															
9	0.31	0.56	0.99	1.33	1.60	1.83	2.00													
10	0.35	0.64	1.14	1.56	1.90	2.20	2.44	2.64	2.80											
11	0.39	0.72	1.29	1.78	2.19	2.55	2.86	3.12	3.34	3.53										
12	0.43	0.80	1.44	1.99	2.47	2.89	3.26	3.58	3.86	4.10	4.30									
13	0.47	0.87	1.59	2.20	2.75	3.23	3.65	4.03	4.36	4.65	4.90	5.11	5.29							
14	0.51	0.95	1.73	2.41	3.01	3.55	4.03	4.45	4.83	5.17	5.47	5.73	5.95	6.09						
15	0.54	1.02	1.87	2.61	3.27	3.86	4.39	4.87	5.29	5.68	6.02	6.32	6.58	6.75	6.94					
16	0.58	1.09	2.01	2.81	3.52	4.16	4.74	5.27	5.74	6.16	6.54	6.88	7.18	7.39	7.61	7.79				
17	0.62	1.17	2.14	3.00	3.77	4.46	5.09	5.65	6.17	6.63	7.05	7.42	7.75	7.99	8.24	8.46	8.62			
18	0.66	1.24	2.27	3.19	4.01	4.75	5.42	6.03	6.58	7.09	7.54	7.94	8.31	8.56	8.84	9.08	9.28			
19	0.69	1.31	2.41	3.38	4.25	5.03	5.75	6.40	6.99	7.52	8.01	8.45	8.84	9.12	9.42	9.68	9.90	10.08		
20	0.73	1.38	2.54	3.56	4.48	5.31	6.07	6.76	7.38	7.95	8.47	8.93	9.35	9.65	9.97	10.25	10.49	10.69		
21	0.77	1.45	2.67	3.74	4.71	5.59	6.38	7.11	7.77	8.37	8.91	9.40	9.84	10.16	10.50	10.80	11.06	11.28	11.44	
22	0.81	1.52	2.79	3.92	4.93	5.85	6.69	7.45	8.14	8.77	9.34	9.85	10.31	10.65	11.01	11.32	11.59	11.83	12.00	
23	0.84	1.59	2.92	4.10	5.16	6.12	6.99	7.78	8.50	9.16	9.75	10.29	10.77	11.12	11.50	11.82	12.10	12.35	12.53	
24	0.88	1.66	3.04	4.27	5.37	6.37	7.28	8.11	8.86	9.54	10.16	10.71	11.21	11.57	11.97	12.30	12.59	12.85	13.03	
25	0.91	1.72	3.17	4.44	5.59	6.63	7.57	8.43	9.20	9.91	10.55	11.12	11.64	12.01	12.42	12.75	13.05	13.33	13.50	13.57
30	1.09	2.06	3.77	5.28	6.62	7.84	8.93	9.93	10.82	11.63	12.35	13.00	13.57	13.96	14.39	14.76	15.06	15.30	15.48	
35	1.27	2.38	4.35	6.07	7.59	8.96	10.18	11.28	12.27	13.14	13.92	14.60	15.20	15.58	16.00	16.35	16.62	16.82	16.94	
40	1.44	2.70	4.90	6.82	8.51	10.01	11.34	12.52	13.56	14.48	15.29	15.98	16.56	16.92	17.29	17.58	17.78			
45	1.61	3.00	5.44	7.54	9.37	10.98	12.40	13.65	14.73	15.67	16.47	17.15	17.70	17.96	18.29	18.49				
50	1.78	3.31	5.96	8.23	10.19	11.90	13.39	14.67	15.78	16.71	17.49	18.08	18.62	18.80						
55	1.95	3.60	6.45	8.90	10.95	12.75	14.30	15.60	16.67	17.57	18.37	18.91								
60	2.11	3.90	6.95	9.52	11.70	13.55	15.12	16.45	17.54											
	TYPE A LUBE		TYPE B LUBRICATION					TYPE C LUBRICATION												

TYPE A LUBRICATION – MANUAL DRIP (4-10 DROPS PER MINUTE) OR OIL BATH
 TYPE B LUBRICATION – RAPID DRIP (20 DROPS PER MINUTE MINIMUM), OIL BATH OR OIL SLINGER
 TYPE C LUBRICATION – CONTINUOUS WITH OIL SLINGER OR OIL STREAM

See Lubrication Instructions in the Roller Chain Installation section.
 Ratings shown are for standard steel chain. See the General Drive Selection section for service factors, selection factors and multiple strand factors.

TECHNICAL ENGINEERING

Horsepower Rating Tables

Double-Pitch Power Transmission Roller Chains

Horsepower Ratings – Double-Pitch Chain No. 2060

# of teeth in small sprocket	Revolutions Per Minute – Small Sprocket																			
	25	50	75	100	125	150	175	200	225	250	275	300	350	400	450	500	550	600	650	700
6	0.30																			
7	0.38	0.66	0.88	1.06																
8	0.45	0.80	1.10	1.35	1.57	1.75	1.90													
9	0.52	0.94	1.31	1.63	1.91	2.16	2.38	2.57	2.74											
10	0.59	1.08	1.51	1.90	2.24	2.55	2.83	3.09	3.31	3.51	3.69	3.85								
11	0.66	1.22	1.71	2.16	2.56	2.93	3.27	3.58	3.86	4.12	4.35	4.57	4.93							
12	0.73	1.35	1.90	2.41	2.87	3.30	3.69	4.05	4.39	4.70	4.98	5.25	5.71	6.09						
13	0.79	1.48	2.09	2.65	3.17	3.65	4.10	4.51	4.90	5.26	5.59	5.90	6.45	6.92	7.25					
14	0.86	1.60	2.28	2.90	3.47	4.00	4.50	4.96	5.39	5.80	6.18	6.53	7.16	7.71	8.10	8.51				
15	0.93	1.73	2.46	3.13	3.76	4.34	4.88	5.39	5.87	6.32	6.74	7.14	7.85	8.48	8.92	9.40				
16	0.99	1.85	2.64	3.37	4.04	4.67	5.26	5.82	6.34	6.83	7.29	7.73	8.52	9.21	9.71	10.25	10.70			
17	1.06	1.98	2.82	3.59	4.32	5.00	5.63	6.23	6.79	7.33	7.83	8.30	9.16	9.92	10.47	11.06	11.59	11.99		
18	1.12	2.10	2.99	3.82	4.59	5.32	6.00	6.64	7.24	7.81	8.34	8.85	9.78	10.60	11.21	11.84	12.42	12.88		
19	1.18	2.22	3.17	4.04	4.86	5.63	6.35	7.03	7.67	8.28	8.85	9.39	10.38	11.26	11.93	12.60	13.22	13.73	14.14	
20	1.25	2.34	3.34	4.26	5.09	5.94	6.70	7.42	8.10	8.74	9.35	9.92	10.97	11.86	12.62	13.34	13.99	14.54	14.99	
21	1.31	2.46	3.51	4.48	5.39	6.24	7.04	7.80	8.51	9.19	9.83	10.43	11.54	12.47	13.28	14.05	14.73	15.31	15.80	
22	1.37	2.57	3.67	4.69	5.65	6.54	7.38	8.17	8.92	9.63	10.30	10.93	12.09	13.06	13.92	14.73	15.44	16.05	16.57	
23	1.44	2.69	3.84	4.90	5.90	6.83	7.71	8.54	9.32	10.06	10.76	11.42	12.63	13.63	14.54	15.39	16.12	16.76	17.30	17.78
24	1.50	2.81	4.00	5.11	6.15	7.12	8.04	8.90	9.72	10.49	11.21	11.90	13.16	14.18	15.15	16.03	16.77	17.44	18.00	18.40
25	1.56	2.92	4.17	5.32	6.36	7.41	8.36	9.26	10.10	10.90	11.65	12.37	13.58	14.72	15.75	16.65	17.40	18.09	18.67	19.09
30	1.86	3.48	4.96	6.33	7.60	8.79	9.86	10.95	11.85	12.76	13.74	14.56	15.98	17.28	18.40	19.40	20.22	20.92	21.32	22.00
35	2.16	4.03	5.72	7.29	8.73	10.08	11.29	12.53	13.59	14.67	15.64	16.54	18.09	19.49	20.67	21.73	22.55	23.20	23.78	
40	2.45	4.56	6.46	8.21	9.82	11.31	12.65	14.00	15.16	16.33	17.37	18.34	19.95	21.42	22.62	23.68	24.42	25.08		
45	2.74	5.08	7.18	9.09	10.85	12.48	13.93	15.38	16.62	17.86	18.92	19.98	21.60	23.12	24.29	25.28	25.90			
50	3.02	5.58	7.87	9.95	11.80	13.59	15.13	16.67	17.98	19.28	20.37	21.47	23.12	24.59	25.69					
55	3.30	6.08	8.54	10.77	12.72	14.65	16.26	17.89	19.23	20.59	21.70	22.82	24.45	25.82						
60	3.57	6.56	9.20	11.57	13.60	15.66	17.34	19.03	20.41	21.80	22.92	24.04								
	TYPE A LUBRICATION				TYPE B LUBRICATION				TYPE C LUBRICATION											

Horsepower Ratings – Double-Pitch Chain No. 2080

# of teeth in small sprocket	Revolutions Per Minute – Small Sprocket																			
	10	20	30	40	50	60	70	80	90	100	125	150	175	200	225	250	300	350	400	450
6	0.32	0.56	0.77																	
7	0.39	0.71	0.98	1.23	1.44	1.64	1.81													
8	0.46	0.84	1.19	1.50	1.79	2.05	2.29	2.51	2.71	2.90										
9	0.53	0.98	1.39	1.77	2.12	2.45	2.75	3.04	3.30	3.55	4.11	4.57								
10	0.59	1.11	1.59	2.03	2.44	2.83	3.20	3.54	3.87	4.18	4.88	5.48	6.01							
11	0.66	1.24	1.78	2.28	2.76	3.20	3.63	4.03	4.41	4.78	5.62	6.36	7.02	7.56	8.07					
12	0.72	1.37	1.97	2.53	3.06	3.57	4.05	4.51	4.94	5.36	6.33	7.21	7.95	8.66	9.27	9.82				
13	0.79	1.50	2.16	2.78	3.36	3.92	4.46	4.97	5.46	5.93	7.03	8.02	8.89	9.75	10.42	11.08				
14	0.85	1.62	2.34	3.02	3.66	4.28	4.86	5.43	5.97	6.49	7.71	8.82	9.83	10.76	11.53	12.29	13.60			
15	0.92	1.75	2.52	3.26	3.95	4.62	5.26	5.87	6.46	7.03	8.37	9.59	10.71	11.74	12.60	13.46	14.94			
16	0.98	1.87	2.70	3.49	4.24	4.96	5.65	6.31	6.95	7.56	9.01	10.34	11.57	12.69	13.63	14.59	16.24	17.65		
17	1.05	1.99	2.88	3.72	4.52	5.29	6.03	6.74	7.43	8.09	9.64	11.08	12.36	13.62	14.63	15.69	17.50	19.04		
18	1.11	2.11	3.06	3.95	4.80	5.62	6.41	7.17	7.90	8.60	10.26	11.80	13.21	14.52	15.60	16.76	18.72	20.38	21.77	
19	1.17	2.23	3.23	4.18	5.08	5.95	6.78	7.58	8.36	9.11	10.87	12.50	14.01	15.40	16.55	17.80	19.90	21.67	23.18	
20	1.23	2.35	3.40	4.40	5.36	6.27	7.15	8.00	8.81	9.60	11.47	13.19	14.78	16.26	17.48	18.81	21.04	22.91	24.52	
21	1.30	2.47	3.58	4.63	5.63	6.59	7.51	8.40	9.26	10.09	12.05	13.87	15.54	17.10	18.39	19.79	22.14	24.11	25.80	
22	1.36	2.59	3.75	4.85	5.90	6.90	7.87	8.81	9.67	10.58	12.63	14.53	16.29	17.92	19.28	20.74	23.20	25.27	27.03	
23	1.42	2.71	3.92	5.07	6.16	7.21	8.19	9.20	10.10	11.05	13.20	15.18	17.02	18.72	20.15	21.66	24.23	26.40	28.22	
24	1.48	2.82	4.05	5.28	6.43	7.52	8.54	9.59	10.53	11.52	13.76	15.83	17.74	19.51	21.01	22.55	25.23	27.50	29.38	30.98
25	1.54	2.94	4.20	5.50	6.69	7.83	8.89	9.94	10.95	11.99	14.31	16.46	18.44	20.28	21.86	23.42	26.20	28.57	30.52	32.16
30	1.84	3.51	5.02	6.55	7.97	9.32	10.62	11.74	12.97	14.23	16.96	19.47	21.78	23.92	25.73	27.52	30.70	33.56	35.52	37.26
35	2.14	4.07	5.82	7.58	9.20	10.75	12.23	13.48	14.92	16.35	19.44	22.27	24.86	27.24	29.24	31.21	34.65	37.57	39.66	
40	2.44	4.62	6.60	8.57	10.39	12.09	13.79	15.17	16.80	18.36	21.78	24.88	27.71	30.28	32.42	34.52	38.09	40.96	43.07	
45	2.73	5.16	7.37	9.54	11.55	13.46	15.25	16.82	18.61	20.29	23.99	27.33	30.35	33.07	35.30	37.50	41.10	43.81		
50	3.01	5.69	8.13	10.49	12.68	14.76	16.69	18.43	20.35	22.12	26.09	29.64	32.81	35.65	37.92	40.16	43.70			
55	3.30	6.21	8.90	11.41	13.78	16.01	18.08	20.00	22.02	23.88	28.08	31.80	35.10	38.01	40.30	42.52				
60	3.58	6.73	9.62	12.32	14.85	17.24	19.43	21.53	23.65	25.57	29.97	33.83	37.22	40.14						
	TYPE A LUBRICATION				TYPE B LUBRICATION				TYPE C LUBRICATION											

TYPE A LUBRICATION – MANUAL DRIP (4-10 DROPS PER MINUTE) OR OIL BATH
 TYPE B LUBRICATION – RAPID DRIP (20 DROPS PER MINUTE MINIMUM), OIL BATH OR OIL SLINGER
 TYPE C LUBRICATION – CONTINUOUS WITH OIL SLINGER OR OIL STREAM

See Lubrication Instructions in the Roller Chain Installation section.
 Ratings shown are for standard steel chain. See the General Drive Selection section for service factors, selection factors and multiple strand factors.

TECHNICAL ENGINEERING

Horsepower Rating Tables

RING LEADER® O-ring Chains

Horsepower Ratings – Single Strand No. 50 RING LEADER O-ring Chain

# of teeth in small sprocket	Revolutions Per Minute – Small Sprocket											
	50	100	200	300	400	500	700	900	1200	1400	1800	2000
9	0.36	0.67	1.26	1.81	2.35	2.87	3.89	4.88	6.32	6.02	4.13	3.52
10	0.41	0.76	1.41	2.03	2.63	3.22	4.36	5.46	7.08	7.05	4.83	4.13
11	0.45	0.84	1.56	2.25	2.92	3.57	4.83	6.06	7.85	8.13	5.58	4.76
12	0.49	0.92	1.72	2.47	3.21	3.92	5.31	6.65	8.62	9.26	6.35	5.42
13	0.54	1.00	1.87	2.70	3.50	4.27	5.78	7.25	9.40	10.44	7.16	6.12
14	0.58	1.09	2.03	2.92	3.79	4.63	6.27	7.86	10.18	11.67	8.01	6.84
15	0.63	1.17	2.19	3.15	4.08	4.99	6.75	8.47	10.97	12.60	8.88	7.58
16	0.67	1.26	2.34	3.38	4.37	5.35	7.24	9.08	11.76	13.51	9.78	8.35
17	0.72	1.34	2.50	3.61	4.67	5.71	7.73	9.69	12.55	14.42	10.71	
18	0.76	1.43	2.66	3.83	4.97	6.07	8.22	10.31	13.35	15.34	11.67	
19	0.81	1.51	2.82	4.07	5.27	6.44	8.72	10.93	14.16	16.26	12.66	
20	0.86	1.60	2.98	4.30	5.57	6.80	9.21	11.55	14.96	17.19	13.67	
21	0.90	1.69	3.14	4.53	5.87	7.17	9.71	12.17	15.77	18.12	14.71	
22	0.95	1.77	3.31	4.76	6.17	7.54	10.21	12.80	16.58	19.05		
23	1.00	1.86	3.47	5.00	6.47	7.91	10.71	13.43	17.40	19.99		
24	1.04	1.95	3.63	5.23	6.78	8.29	11.22	14.06	18.22	20.93		
25	1.09	2.03	3.80	5.47	7.08	8.66	11.72	14.70	19.04	21.87		
26	1.14	2.12	3.96	5.70	7.39	9.03	12.23	15.33	19.86	22.82		
28	1.23	2.30	4.29	6.18	8.01	9.79	13.25	16.61	21.52			
30	1.33	2.48	4.62	6.66	8.63	10.54	14.27	17.90	23.18			
32	1.42	2.66	4.96	7.14	9.25	11.30	15.30	19.19	24.86			
35	1.57	2.93	5.46	7.86	10.19	12.45	16.86	21.14				
40	1.81	3.38	6.31	9.08	11.77	14.39	19.47	24.42				
45	2.06	3.84	7.16	10.32	13.36	16.34	22.12					

Horsepower Ratings – Single Strand No. 60 RING LEADER® O-ring Chain

# of teeth in small sprocket	Revolutions Per Minute – Small Sprocket													
	50	100	150	200	300	400	500	600	700	900	1000	1200	1400	1500
9	0.62	1.16	1.67	2.16	3.12	4.04	4.94	5.82	6.68	8.38	9.21	8.77	6.96	6.28
10	0.70	1.30	1.87	2.43	3.49	4.53	5.53	6.52	7.49	9.39	10.32	10.27	8.15	7.35
11	0.77	1.44	2.07	2.69	3.87	5.02	6.13	7.23	8.30	10.41	11.44	11.44	11.85	9.41
12	0.85	1.58	2.28	2.95	4.25	5.51	6.74	7.94	9.12	11.43	12.57	13.51	10.72	9.66
13	0.92	1.73	2.49	3.22	4.64	6.01	7.34	8.65	9.94	12.46	13.70	15.23	12.08	10.90
14	1.00	1.87	2.69	3.49	5.02	6.51	7.96	9.37	10.77	13.50	14.85	17.02	13.51	12.18
15	1.08	2.01	2.90	3.76	5.41	7.01	8.57	10.10	11.60	14.55	15.99	18.85	14.98	13.51
16	1.16	2.16	3.11	4.03	5.80	7.52	9.19	10.83	12.44	15.60	17.15	20.21	16.50	14.88
17	1.24	2.31	3.32	4.30	6.20	8.03	9.81	11.56	13.28	16.65	18.31	21.58	18.07	
18	1.31	2.45	3.53	4.58	6.59	8.54	10.44	12.30	14.13	17.71	19.48	22.95	19.69	
19	1.39	2.60	3.74	4.85	6.99	9.05	11.06	13.04	14.98	18.78	20.65	24.33	21.35	
20	1.47	2.75	3.96	5.13	7.38	9.57	11.69	13.78	15.83	19.85	21.82	25.71	23.06	
21	1.55	2.90	4.17	5.40	7.78	10.08	12.33	14.53	16.69	20.92	23.00	27.11		
22	1.63	3.05	4.39	5.68	8.19	10.60	12.96	15.27	17.55	22.00	24.19	28.50		
23	1.71	3.19	4.60	5.96	8.59	11.13	13.60	16.03	18.41	23.08	25.38	29.90		
24	1.79	3.35	4.82	6.24	8.99	11.65	14.24	16.78	19.28	24.17	26.57	31.31		
25	1.87	3.50	5.04	6.52	9.40	12.17	14.88	17.54	20.14	25.26	27.77			
26	1.95	3.65	5.25	6.81	9.80	12.70	15.53	18.29	21.02	26.35	28.97			
28	2.12	3.95	5.69	7.37	10.62	13.76	16.82	19.82	22.77	28.55	31.39			
30	2.28	4.26	6.13	7.94	11.44	14.82	18.12	21.35	24.53	30.75				
32	2.45	4.56	6.57	8.52	12.27	15.89	19.43	22.89	26.30	32.97				
35	2.69	5.03	7.24	9.38	13.50	17.50	21.40	25.20	29.00					
40	3.11	5.81	8.37	10.80	15.60	20.20	24.70	29.10	33.50					
45	3.53	6.60	9.50	12.30	17.70	23.00	28.10	33.10						

TECHNICAL ENGINEERING

Horsepower Rating Tables

RING LEADER® O-ring Chains

Horsepower Ratings – Single Strand No. 80 RING LEADER O-ring Chain

# of teeth in small sprocket	Revolutions Per Minute – Small Sprocket										
	50	100	150	200	300	400	500	700	900	1000	1100
9	1.45	2.71	3.90	5.05	7.28	9.43	11.53	15.60	17.00	14.51	12.58
10	1.63	3.03	4.37	5.66	8.16	10.57	12.92	17.48	19.91	17.00	14.74
11	1.80	3.36	4.84	6.28	9.04	11.71	14.32	19.38	22.97	19.61	17.00
12	1.98	3.69	5.32	6.89	9.93	12.87	15.73	21.29	26.17	22.35	19.37
13	2.16	4.03	5.80	7.52	10.83	14.03	17.15	23.21	29.10	25.20	21.84
14	2.34	4.36	6.29	8.14	11.73	15.20	18.58	25.15	31.53	28.16	24.41
15	2.52	4.70	6.77	8.77	12.64	16.37	20.01	27.09	33.97	31.23	27.07
16	2.70	5.04	7.26	9.41	13.55	17.55	21.46	29.05	36.42	34.41	
17	2.88	5.38	7.75	10.04	14.47	18.74	22.91	31.01	38.88	37.68	
18	3.07	5.72	8.25	10.68	15.39	19.93	24.37	32.99	41.36	41.05	
19	3.25	6.07	8.74	11.33	16.31	21.13	25.83	34.97	43.85		
20	3.44	6.41	9.24	11.97	17.24	22.34	27.31	36.96	46.34		
21	3.62	6.76	9.74	12.62	18.17	23.55	28.78	38.96			
22	3.81	7.11	10.24	13.27	19.11	24.76	30.27	40.97			
23	4.00	7.46	10.75	13.92	20.05	25.98	31.75	42.98			
24	4.19	7.81	11.25	14.58	20.99	27.20	33.25	45.01			
25	4.37	8.16	11.76	15.23	21.94	28.42	34.75	47.04			
26	4.56	8.52	12.27	15.89	22.89	29.65	36.25				
28	4.94	9.23	13.29	17.22	24.80	32.13	39.27				
30	5.33	9.94	14.32	18.55	26.72	34.61	42.31				
32	5.71	10.66	15.35	19.89	28.64	37.11	45.36				
35	6.29	11.74	16.91	21.91	31.55	40.88	49.97				
40	7.27	13.56	19.53	25.31	36.45	47.22					
45	8.25	15.40	22.18	28.74	41.39	53.63					

Horsepower Ratings – Single Strand No. 100 RING LEADER O-ring Chain

# of teeth in small sprocket	Revolutions Per Minute – Small Sprocket									
	25	50	100	150	200	300	400	500	600	700
9	1.49	2.78	5.19	7.47	9.68	13.94	18.06	22.08	26.02	29.63
10	1.67	3.11	5.81	8.37	10.85	15.62	20.24	24.74	29.15	33.49
11	1.85	3.45	6.44	9.28	12.02	17.32	22.43	27.42	32.31	37.12
12	2.03	3.79	7.08	10.19	13.21	19.02	24.64	30.12	35.49	40.78
13	2.22	4.13	7.72	11.11	14.40	20.74	26.87	32.84	38.70	44.46
14	2.40	4.48	8.36	12.04	15.60	22.47	29.11	35.58	41.92	48.16
15	2.59	4.83	9.01	12.97	16.80	24.20	31.36	38.33	45.17	51.89
16	2.77	5.17	9.66	13.91	18.02	25.95	33.62	41.10	48.43	55.64
17	2.96	5.52	10.31	14.85	19.24	27.71	35.90	43.88	51.70	59.40
18	3.15	5.88	10.96	15.79	20.46	29.47	38.18	46.67	55.00	
19	3.34	6.23	11.62	16.74	21.69	31.24	40.48	49.48	58.30	
20	3.53	6.58	12.29	17.70	22.93	33.02	42.78	52.30	61.63	
21	3.72	6.94	12.95	18.65	24.17	34.81	45.10	55.13		
22	3.91	7.30	13.62	19.62	25.41	36.60	47.42	57.97		
23	4.10	7.66	14.29	20.58	26.66	38.40	49.75	60.82		
24	4.30	8.02	14.96	21.55	27.92	40.21	52.09	63.68		
25	4.49	8.38	15.63	22.52	29.18	42.02	54.44			
26	4.68	8.74	16.31	23.49	30.44	43.84	56.80			
28	5.07	9.47	17.67	25.45	32.97	47.50	61.53			
30	5.47	10.20	19.04	27.42	35.52	51.17	66.29			
32	5.86	10.94	20.41	29.40	38.09	54.86				
35	6.46	12.05	22.49	32.39	41.96	60.44				
40	7.46	13.92	25.97	37.41	48.47	69.81				
45	8.47	15.81	29.50	42.49	55.04					

TECHNICAL SECTION

Sprocket Information

Pitch Diameter: The pitch diameter of a sprocket is the diameter of a circle followed by the centers of the chain pins as the sprocket revolves in mesh with the chain, and is a function of the chain pitch and of the number of teeth in the sprocket. This is a theoretical dimension, not directly measurable but for chain load calculations, one half the pitch diameter is equal to the “distance” in the (force x distance) formula.

Bottom Diameter: The bottom diameter of a sprocket is the diameter of a circle tangent to the bottoms of the tooth spaces. The tolerance on the bottom diameter must be entirely negative to ensure that the chain will mesh properly with the sprocket teeth.

Caliper Diameter: Since the bottom diameter of a sprocket with an odd number of teeth cannot readily be measured directly, the following tables list caliper diameters which enable calculating the dimensions across the bottoms of tooth spaces most nearly opposite. As is true of bottom diameters, tolerances on caliper diameters must be entirely negative.

Outside Diameter: The outside diameter of a sprocket is comparatively unimportant as the tooth length is not vital to proper meshing with the chain. The outside diameter will vary depending on the type of cutter used.

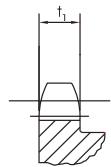
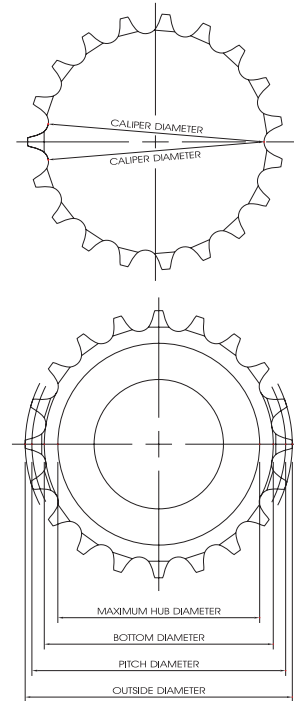

SINGLE

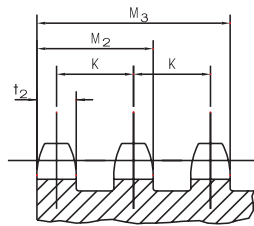

DOUBLE AND TRIPLE

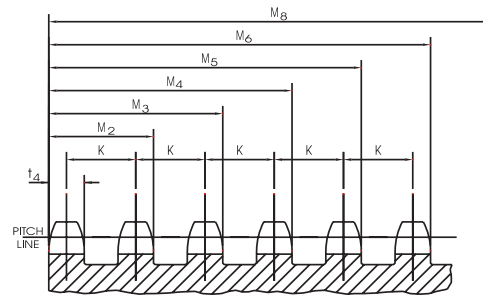

QUADRUPLE AND OTHER MULTIPLES

Standard Series Sprockets

Chain Data for All Sprockets				Single Strand t_1	Double and Triple Strand			For 4 or more Strands							Matching Tolerance on "t" and "M"	Hot Rolled Tolerance on "t" and "M"	
ASME/ANSI & Diamond No.	Pitch P	Roller Width W	Roller Diam.		t_2	M_2	M_3	t_4	M_4	M_5	M_6	M_8	*K				
25	0.250	0.125	0.130	0.110	0.107	0.359	0.611	0.096	0.348	0.600	0.852	1.104	1.356	1.860	0.252	-0.007	-0.021
35	0.375	0.188	0.200	0.168	0.162	0.561	0.960	0.149	0.548	0.947	1.346	1.745	2.144	2.942	0.399	-0.008	-0.027
41	0.500	0.250	0.306	0.227	n/a	n/a	n/a	n/a	n/a	n/a	n/a	n/a	n/a	n/a	n/a	-0.009	-0.032
40	0.500	0.312	0.312	0.284	0.275	0.841	1.407	0.256	0.822	1.388	1.954	2.520	3.086	4.218	0.566	-0.009	-0.035
50	0.625	0.375	0.400	0.343	0.332	1.045	1.758	0.311	1.024	1.737	2.450	3.163	3.876	5.302	0.713	-0.010	-0.036
60	0.750	0.500	0.469	0.459	0.444	1.341	2.238	0.418	1.315	2.212	3.109	4.006	4.903	6.697	0.897	-0.011	-0.036
80	1.000	0.625	0.625	0.575	0.557	1.710	2.863	0.526	1.679	2.832	3.985	5.138	6.291	8.597	1.153	-0.012	-0.040
100	1.250	0.750	0.750	0.692	0.669	2.077	3.485	0.633	2.041	3.449	4.857	6.265	7.673	10.489	1.408	-0.014	-0.046
120	1.500	1.000	0.875	0.924	0.894	2.683	4.472	0.848	2.637	4.426	6.215	8.004	9.793	13.371	1.789	-0.016	-0.057
140	1.750	1.000	1.000	0.924	0.894	2.818	4.742	0.848	2.772	4.696	6.620	8.544	10.468	14.316	1.924	-0.016	-0.057
160	2.000	1.250	1.125	1.156	1.119	3.424	5.729	1.063	3.368	5.673	7.978	10.283	12.588	17.198	2.305	-0.019	-0.062
180	2.250	1.406	1.406	1.301	1.259	3.851	6.443	1.197	3.789	6.381	8.973	11.565	14.157	19.341	2.592	-0.020	-0.068
200	2.500	1.500	1.562	1.389	1.344	4.161	6.978	1.278	4.095	6.912	9.729	12.546	15.363	20.997	2.817	-0.021	-0.072

*K dimensions apply to double and triple strands also.

TECHNICAL SECTION

Sprocket Information

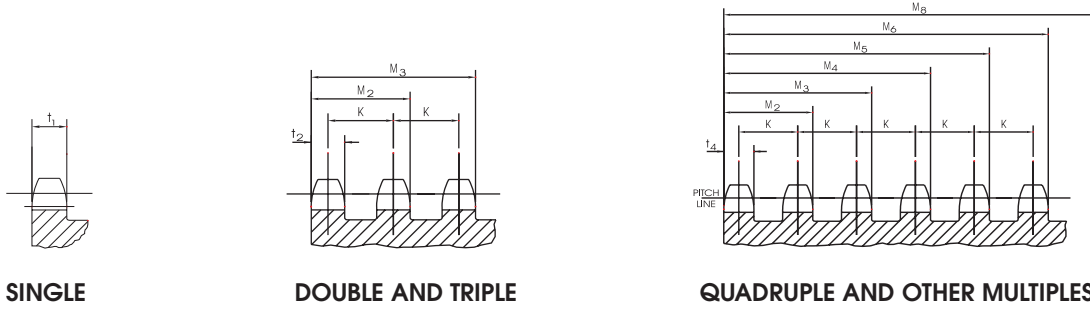

Heavy Series Sprockets

Chain Data for All Sprockets				Single Strand t_1	Double and Triple Strand			For 4 or more Strands							Matching Tolerance on "K" and "M"	Hot Rolled Tolerance on "K" and "M"	
ASME/ANSI & Diamond No.	Pitch P	Roller Width W	Roller Diam.		t_2	M_2	M_3	t_4	M_2	M_3	M_4	M_5	M_6	M_8			*K
60H	0.750	0.500	0.469	0.459	0.444	1.472	2.500	0.418	1.446	2.474	3.502	4.530	5.558	7.614	1.028	-0.11	-0.36
80H	1.000	0.625	0.625	0.575	0.557	1.840	3.123	0.526	1.809	3.092	4.375	5.568	6.941	9.507	1.283	-0.12	-0.40
100H	1.250	0.750	0.750	0.692	0.669	2.208	3.747	0.633	2.172	3.711	5.250	6.789	8.328	11.406	1.539	-0.14	-0.46
120H	1.500	1.000	0.875	0.924	0.894	2.818	4.742	0.848	2.772	4.696	6.620	8.544	10.468	14.316	1.924	-0.16	-0.57
140H	1.750	1.000	1.000	0.924	0.894	2.949	5.004	0.848	2.903	4.958	7.013	9.068	11.123	15.233	2.055	-0.16	-0.57
160H	2.000	1.250	1.125	1.156	1.119	3.555	5.991	1.063	3.499	5.935	8.371	10.807	13.243	18.115	2.436	-0.19	-0.62
180H	2.250	1.406	1.406	1.301	1.259	3.982	6.705	1.197	3.920	6.643	9.366	12.089	14.812	20.258	2.723	-0.20	-0.68
200H	2.500	1.500	1.562	1.389	1.344	4.427	7.510	1.278	4.361	7.444	10.527	13.610	16.693	22.859	3.083	-0.21	-0.72

*K dimensions apply to double and triple strands also.

The following tables list the basic dimensions most common to sprockets. For verification of these values or more detailed information please contact a reputable sprocket manufacturer.

Sprocket Diameters - U.S.A. Std. No. 25 Bushing Chain

No. of Teeth	Pitch Diameter	Outside Diameter	Bottom Diam. for Even Teeth Caliper Diam. for Odd Teeth	No. of Teeth	Pitch Diameter	Outside Diameter	Bottom Diam. for Even Teeth Caliper Diam. for Odd Teeth	No. of Teeth	Pitch Diameter	Outside Diameter	Bottom Diam. for Even Teeth Caliper Diam. for Odd Teeth
6	0.500	0.583	0.370	54	4.300	4.442	4.170	102	8.118	8.264	7.988
7	0.576	0.669	0.432	55	4.379	4.522	4.247	103	8.198	8.344	8.067
8	0.653	0.754	0.523	56	4.459	4.602	4.329	104	8.277	8.424	8.147
9	0.731	0.837	0.591	57	4.538	4.681	4.407	105	8.357	8.503	8.226
10	0.809	0.919	0.679	58	4.618	4.761	4.488	106	8.437	8.583	8.307
11	0.887	1.002	0.748	59	4.697	4.841	4.566	107	8.516	8.662	8.385
12	0.966	1.083	0.836	60	4.777	4.920	4.647	108	8.596	8.742	8.466
13	1.045	1.167	0.907	61	4.857	5.000	4.725	109	8.675	8.822	8.544
14	1.124	1.246	0.994	62	4.936	5.080	4.806	110	8.755	8.901	8.625
15	1.203	1.326	1.066	63	5.016	5.159	4.884	111	8.834	8.981	8.703
16	1.282	1.407	1.152	64	5.095	5.239	4.965	112	8.914	9.060	8.784
17	1.361	1.487	1.225	65	5.175	5.319	5.044	113	8.994	9.140	8.863
18	1.440	1.568	1.310	66	5.254	5.398	5.124	114	9.073	9.220	8.943
19	1.519	1.648	1.383	67	5.334	5.478	5.203	115	9.153	9.299	9.022
20	1.598	1.729	1.468	68	5.413	5.558	5.283	116	9.232	9.379	9.102
21	1.678	1.809	1.543	69	5.493	5.637	5.362	117	9.312	9.458	9.181
22	1.757	1.889	1.627	70	5.572	5.717	5.442	118	9.391	9.538	9.261
23	1.836	1.969	1.702	71	5.652	5.796	5.521	119	9.471	9.618	9.340
24	1.915	2.049	1.785	72	5.732	5.876	5.602	120	9.550	9.697	9.420
25	1.995	2.129	1.861	73	5.811	5.956	5.680	121	9.630	9.777	9.499
26	2.074	2.209	1.944	74	5.891	6.035	5.761	122	9.709	9.856	9.579
27	2.154	2.289	2.020	75	5.970	6.115	5.839	123	9.789	9.936	9.658
28	2.233	2.369	2.103	76	6.050	6.195	5.920	124	9.869	10.016	9.739
29	2.312	2.449	2.179	77	6.129	6.274	5.998	125	9.949	10.095	9.818
30	2.392	2.529	2.262	78	6.209	6.354	6.079	126	10.028	10.175	9.898
31	2.471	2.609	2.338	79	6.288	6.433	6.157	127	10.108	10.255	9.977
32	2.551	2.688	2.421	80	6.368	6.513	6.238	128	10.187	10.334	10.057
33	2.630	2.768	2.497	81	6.448	6.593	6.317	129	10.267	10.414	10.136
34	2.710	2.848	2.580	82	6.527	6.672	6.397	130	10.346	10.493	10.216
35	2.789	2.928	2.656	83	6.607	6.752	6.476	131	10.426	10.573	10.295
36	2.869	3.008	2.739	84	6.686	6.832	6.556	132	10.505	10.652	10.375
37	2.948	3.087	2.815	85	6.766	6.911	6.635	133	10.585	10.732	10.454
38	3.028	3.167	2.898	86	6.845	6.991	6.715	134	10.664	10.811	10.534
39	3.107	3.247	2.975	87	6.925	7.070	6.794	135	10.744	10.891	10.613
40	3.187	3.327	3.057	88	7.004	7.150	6.874	136	10.823	10.970	10.693
41	3.266	3.406	3.134	89	7.084	7.230	6.953	137	10.903	11.050	10.772
42	3.346	3.486	3.216	90	7.164	7.309	7.034	138	10.983	11.130	10.853
43	3.425	3.566	3.293	91	7.243	7.389	7.112	139	11.062	11.209	10.932
44	3.505	3.646	3.375	92	7.323	7.468	7.193	140	11.142	11.289	11.012
45	3.584	3.725	3.452	93	7.402	7.548	7.271	141	11.221	11.369	11.091
46	3.664	3.805	3.534	94	7.482	7.628	7.352	142	11.301	11.448	11.171
47	3.743	3.885	3.611	95	7.561	7.707	7.430	143	11.380	11.528	11.250
48	3.823	3.964	3.693	96	7.641	7.787	7.511	144	11.460	11.607	11.330
49	3.902	4.044	3.770	97	7.720	7.866	7.589	145	11.540	11.687	11.409
50	3.982	4.124	3.852	98	7.800	7.946	7.670	146	11.619	11.767	11.489
51	4.061	4.203	3.929	99	7.880	8.026	7.749	147	11.699	11.846	11.567
52	4.141	4.283	4.011	100	7.959	8.105	7.829	148	11.773	11.926	11.649
53	4.220	4.363	4.088	101	8.039	8.185	7.908	149	11.858	12.005	11.727

Odd tooth "bottom diameters" equal pitch minus .130".

TECHNICAL SECTION

Sprocket Information

Sprocket Diameters - U.S.A. Std. No. 35 Bushing Chain

No. of Teeth	Pitch Diameter	Outside Diameter	Bottom Diam. for Even Teeth Caliper Diam. for Odd Teeth	No. of Teeth	Pitch Diameter	Outside Diameter	Bottom Diam. for Even Teeth Caliper Diam. for Odd Teeth	No. of Teeth	Pitch Diameter	Outside Diameter	Bottom Diam. for Even Teeth Caliper Diam. for Odd Teeth
6	0.750	0.88	0.550	54	6.449	6.66	6.249	102	12.177	12.40	11.977
7	0.864	1.00	0.642	55	6.569	6.78	6.366	103	12.297	12.52	12.095
8	0.980	1.13	0.780	56	6.688	6.90	6.488	104	12.416	12.64	12.216
9	1.096	1.26	0.879	57	6.807	7.02	6.604	105	12.535	12.76	12.334
10	1.214	1.38	1.014	58	6.927	7.14	6.727	106	12.655	12.87	12.455
11	1.331	1.50	1.117	59	7.046	7.26	6.844	107	12.774	12.99	12.573
12	1.449	1.63	1.249	60	7.165	7.38	6.965	108	12.893	13.11	12.693
13	1.567	1.75	1.356	61	7.284	7.50	7.082	109	13.013	13.23	12.812
14	1.685	1.87	1.485	62	7.404	7.62	7.204	110	13.132	13.35	12.932
15	1.804	1.99	1.594	63	7.523	7.74	7.321	111	13.251	13.47	13.050
16	1.922	2.11	1.722	64	7.642	7.86	7.442	112	13.371	13.59	13.171
17	2.041	2.23	1.832	65	7.762	7.98	7.560	113	13.490	13.71	13.289
18	2.159	2.35	1.959	66	7.881	8.10	7.681	114	13.609	13.83	13.409
19	2.278	2.47	2.070	67	8.000	8.22	7.798	115	13.729	13.95	13.528
20	2.397	2.59	2.197	68	8.120	8.34	7.920	116	13.848	14.07	13.648
21	2.516	2.71	2.309	69	8.239	8.46	8.037	117	13.968	14.19	13.767
22	2.635	2.83	2.435	70	8.358	8.58	8.158	118	14.087	14.31	13.887
23	2.754	2.95	2.547	71	8.478	8.69	8.276	119	14.206	14.43	14.005
24	2.873	3.07	2.673	72	8.597	8.81	8.397	120	14.326	14.55	14.126
25	2.992	3.19	2.786	73	8.716	8.93	8.514	121	14.445	14.67	14.244
26	3.111	3.31	2.911	74	8.836	9.05	8.636	122	14.564	14.78	14.364
27	3.230	3.43	3.025	75	8.955	9.17	8.753	123	14.683	14.90	14.482
28	3.349	3.55	3.149	76	9.074	9.29	8.874	124	14.803	15.02	14.603
29	3.468	3.67	3.263	77	9.194	9.41	8.992	125	14.923	15.14	14.722
30	3.588	3.79	3.388	78	9.313	9.53	9.113	126	15.042	15.26	14.842
31	3.707	3.91	3.502	79	9.432	9.65	9.230	127	15.161	15.38	14.960
32	3.826	4.03	3.626	80	9.552	9.77	9.352	128	15.280	15.50	15.080
33	3.945	4.15	3.741	81	9.671	9.89	9.469	129	15.400	15.62	15.199
34	4.064	4.27	3.864	82	9.790	10.01	9.590	130	15.519	15.74	15.319
35	4.183	4.39	3.979	83	9.910	10.13	9.708	131	15.638	15.86	15.437
36	4.303	4.51	4.103	84	10.029	10.25	9.829	132	15.758	15.98	15.558
37	4.422	4.63	4.218	85	10.148	10.37	9.946	133	15.877	16.10	15.676
38	4.541	4.75	4.341	86	10.268	10.49	10.068	134	15.997	16.22	15.797
39	4.660	4.87	4.456	87	10.387	10.61	10.185	135	16.116	16.34	15.915
40	4.780	4.99	4.580	88	10.506	10.73	10.306	136	16.235	16.46	16.035
41	4.899	5.11	4.695	89	10.626	10.84	10.424	137	16.355	16.58	16.154
42	5.018	5.23	4.818	90	10.745	11.06	10.545	138	16.474	16.70	16.274
43	5.137	5.35	4.934	91	10.864	11.06	10.662	139	16.593	16.81	16.392
44	5.257	5.47	5.057	92	10.984	11.20	10.784	140	16.713	16.93	16.513
45	5.376	5.59	5.173	93	11.103	11.32	10.901	141	16.832	17.05	16.631
46	5.495	5.71	5.295	94	11.222	11.44	11.022	142	16.951	17.17	16.751
47	5.614	5.83	5.411	95	11.342	11.56	11.140	143	17.071	17.29	16.870
48	5.734	5.95	5.534	96	11.461	11.68	11.261	144	17.190	17.41	16.990
49	5.853	6.07	5.650	97	11.580	11.80	11.378	145	17.309	17.53	17.108
50	5.972	6.19	5.772	98	11.700	11.92	11.500	146	17.429	17.65	17.229
51	6.091	6.31	5.888	99	11.819	12.04	11.617	147	17.548	17.77	17.347
52	6.211	6.43	6.011	100	11.938	12.16	11.738	148	17.668	17.89	17.468
53	6.330	6.54	6.127	101	12.058	12.28	11.856	149	17.787	18.01	17.586

Odd tooth "bottom diameters" equal pitch minus .200".

Sprocket Diameters - U.S.A. Std. No. 40 Roller Chain

No. of Teeth	Pitch Diameter	Outside Diameter	Bottom Diam. for Even Teeth Caliper Diam. for Odd Teeth	No. of Teeth	Pitch Diameter	Outside Diameter	Bottom Diam. for Even Teeth Caliper Diam. for Odd Teeth	No. of Teeth	Pitch Diameter	Outside Diameter	Bottom Diam. for Even Teeth Caliper Diam. for Odd Teeth
6	1.000	1.170	0.688	54	8.599	8.890	8.287	102	16.236	16.530	15.924
7	1.152	1.340	0.811	55	8.758	9.040	8.443	103	16.395	16.690	16.081
8	1.307	1.510	0.995	56	8.917	9.200	8.605	104	16.555	16.850	16.243
9	1.462	1.670	1.128	57	9.076	9.360	8.761	105	16.714	17.010	16.400
10	1.618	1.840	1.306	58	9.236	9.520	8.924	106	16.873	17.170	16.561
11	1.775	2.000	1.445	59	9.395	9.680	9.080	107	17.032	17.330	16.718
12	1.932	2.170	1.620	60	9.554	9.840	9.242	108	17.191	17.480	16.879
13	2.089	2.330	1.762	61	9.713	10.000	9.398	109	17.350	17.640	17.036
14	2.247	2.490	1.935	62	9.872	10.160	9.560	110	17.509	17.800	17.197
15	2.405	2.650	2.080	63	10.031	10.320	9.716	111	17.669	17.960	17.355
16	2.563	2.810	2.251	64	10.190	10.480	9.878	112	17.828	18.120	17.516
17	2.721	2.980	2.397	65	10.349	10.640	10.034	113	17.987	18.280	17.673
18	2.879	3.140	2.567	66	10.508	10.800	10.196	114	18.146	18.440	17.834
19	3.038	3.300	2.716	67	10.667	10.960	10.352	115	18.305	18.600	17.991
20	3.196	3.460	2.884	68	10.826	11.120	10.514	116	18.464	18.760	18.152
21	3.355	3.620	3.034	69	10.986	11.270	10.670	117	18.623	18.920	18.309
22	3.513	3.780	3.201	70	11.145	11.430	10.833	118	18.783	19.080	18.471
23	3.672	3.940	3.351	71	11.304	11.590	10.989	119	18.942	19.240	18.628
24	3.831	4.100	3.519	72	11.463	11.750	11.151	120	19.101	19.390	18.789
25	3.989	4.260	3.669	73	11.622	11.910	11.307	121	19.260	19.550	18.946
26	4.148	4.420	3.836	74	11.781	12.070	11.469	122	19.419	19.710	19.107
27	4.307	4.580	3.988	75	11.940	12.230	11.625	123	19.578	19.870	19.264
28	4.466	4.740	4.154	76	12.099	12.390	11.787	124	19.737	20.030	19.425
29	4.625	4.900	4.306	77	12.258	12.550	11.943	125	19.897	20.190	19.583
30	4.783	5.060	4.471	78	12.417	12.710	12.105	126	20.056	20.350	19.744
31	4.942	5.220	4.624	79	12.577	12.870	12.262	127	20.215	20.510	19.909
32	5.101	5.380	4.789	80	12.736	13.030	12.424	128	20.374	20.670	20.062
33	5.260	5.540	4.942	81	12.895	13.190	12.581	129	20.533	20.830	20.220
34	5.419	5.700	5.107	82	13.054	13.340	12.742	130	20.692	20.990	20.380
35	5.578	5.860	5.260	83	13.213	13.500	12.899	131	20.851	21.150	20.538
36	5.737	6.020	5.425	84	13.372	13.660	13.060	132	21.011	21.310	20.699
37	5.896	6.180	5.579	85	13.531	13.820	13.217	133	21.170	21.460	20.856
38	6.055	6.330	5.743	86	13.690	13.980	13.378	134	21.329	21.620	21.017
39	6.214	6.490	5.897	87	13.849	14.140	13.535	135	21.488	21.780	21.174
40	6.373	6.650	6.061	88	14.008	14.300	13.696	136	21.647	21.940	21.335
41	6.532	6.810	6.215	89	14.168	14.460	13.854	137	21.806	22.100	21.493
42	6.691	6.970	6.379	90	14.327	14.620	14.015	138	21.965	22.260	21.653
43	6.850	7.130	6.534	91	14.486	14.780	14.172	139	22.124	22.420	21.811
44	7.009	7.290	6.697	92	14.645	14.940	14.333	140	22.284	22.580	21.972
45	7.168	7.450	6.852	93	14.804	15.100	14.490	141	22.443	22.740	22.129
46	7.327	7.610	7.015	94	14.963	15.260	14.651	142	22.602	22.900	22.290
47	7.486	7.770	7.170	95	15.122	15.410	14.808	143	22.761	23.060	22.448
48	7.645	7.930	7.333	96	15.281	15.570	14.969	144	22.920	23.220	22.608
49	7.804	8.090	7.488	97	15.440	15.730	15.126	145	23.079	23.370	22.766
50	7.963	8.250	7.651	98	15.600	15.890	15.288	146	23.238	23.530	22.926
51	8.122	8.410	7.806	99	15.759	16.050	15.445	147	23.398	23.690	23.084
52	8.281	8.570	7.969	100	15.918	16.210	15.606	148	23.557	23.850	23.245
53	8.440	8.730	8.124	101	16.077	16.370	15.763	149	23.716	24.010	23.403

Odd tooth "bottom diameters" equal pitch minus .306".

TECHNICAL SECTION

Sprocket Information

Sprocket Diameters - U.S.A. Std. No. 41 Roller Chain

No. of Teeth	Pitch Diameter	Outside Diameter	Bottom Diam. for Even Teeth Caliper Diam. for Odd Teeth	Machining tolerances on bottom diameters and caliper diameters should be in the minus direction. Tolerances on outside diameters are not critical.	No. of Teeth	Pitch Diameter	Outside Diameter	Bottom Diam. for Even Teeth Caliper Diam. for Odd Teeth	Machining tolerances on bottom diameters and caliper diameters should be in the minus direction. Tolerances on outside diameters are not critical.	No. of Teeth	Pitch Diameter	Outside Diameter	Bottom Diam. for Even Teeth Caliper Diam. for Odd Teeth	Machining tolerances on bottom diameters and caliper diameters should be in the minus direction. Tolerances on outside diameters are not critical.
6	1.000	1.17	0.694		54	8.599	8.89	8.293		102	16.236	16.53	15.930	
7	1.152	1.34	0.817	55	8.758	9.04	8.449	103	16.395	16.69	16.087			
8	1.307	1.51	1.001	56	8.917	9.20	8.611	104	16.555	16.85	16.249			
9	1.462	1.67	1.134	57	9.076	9.36	8.767	105	16.714	17.01	16.406			
10	1.618	1.84	1.312	58	9.236	9.52	8.930	106	16.873	17.17	16.567			
11	1.775	2.00	1.451	59	9.395	9.68	9.086	107	17.032	17.33	16.724			
12	1.932	2.17	1.626	60	9.554	9.84	9.248	108	17.191	17.48	16.885			
13	2.089	2.33	1.768	61	9.713	10.00	9.404	109	17.350	17.64	17.042			
14	2.247	2.49	1.941	62	9.872	10.16	9.566	110	17.509	17.80	17.203			
15	2.405	2.65	2.086	63	10.031	10.32	9.722	111	17.669	17.96	17.361			
16	2.563	2.81	2.257	64	10.190	10.48	9.884	112	17.828	18.12	17.522			
17	2.721	2.98	2.403	65	10.349	10.64	10.040	113	17.987	18.28	17.679			
18	2.879	3.14	2.573	66	10.508	10.80	10.202	114	18.146	18.44	17.840			
19	3.038	3.30	2.722	67	10.667	10.96	10.358	115	18.305	18.60	17.997			
20	3.196	3.46	2.890	68	10.826	11.12	10.520	116	18.464	18.76	18.158			
21	3.355	3.62	3.040	69	10.986	11.27	10.676	117	18.623	18.92	18.315			
22	3.513	3.78	3.207	70	11.145	11.43	10.839	118	18.783	19.08	18.477			
23	3.672	3.94	3.357	71	11.304	11.59	10.995	119	18.942	19.24	18.634			
24	3.831	4.10	3.525	72	11.463	11.75	11.157	120	19.101	19.39	18.795			
25	3.989	4.26	3.675	73	11.622	11.91	11.313	121	19.260	19.55	18.955			
26	4.148	4.42	3.842	74	11.781	12.07	11.475	122	19.419	19.71	19.113			
27	4.307	4.58	3.994	75	11.940	12.23	11.631	123	19.578	19.87	19.270			
28	4.466	4.74	4.160	76	12.099	12.39	11.793	124	19.737	20.03	19.431			
29	4.625	4.90	4.312	77	12.258	12.55	11.949	125	19.897	20.19	19.589			
30	4.783	5.06	4.477	78	12.417	12.71	12.111	126	20.056	20.35	19.750			
31	4.942	5.22	4.630	79	12.577	12.87	12.268	127	20.215	20.51	19.907			
32	5.101	5.38	4.795	80	12.736	13.03	12.430	128	20.374	20.67	20.068			
33	5.260	5.54	4.948	81	12.895	13.19	12.587	129	20.533	20.83	20.226			
34	5.419	5.70	5.113	82	13.054	13.34	12.748	130	20.692	20.99	20.386			
35	5.578	5.86	5.266	83	13.213	13.50	12.905	131	20.851	21.15	20.544			
36	5.737	6.02	5.431	84	13.372	13.66	13.066	132	21.011	21.31	20.705			
37	5.896	6.18	5.585	85	13.531	13.82	13.223	133	21.170	21.46	20.862			
38	6.055	6.33	5.749	86	13.690	13.98	13.384	134	21.329	21.62	21.023			
39	6.214	6.49	5.903	87	13.849	14.14	13.541	135	21.488	21.78	21.180			
40	6.373	6.65	6.067	88	14.008	14.30	13.702	136	21.647	21.94	21.341			
41	6.532	6.81	6.221	89	14.168	14.46	13.860	137	21.806	22.10	21.499			
42	6.691	6.97	6.385	90	14.327	14.62	14.021	138	21.965	22.26	21.659			
43	6.850	7.13	6.540	91	14.486	14.78	14.179	139	22.124	22.42	21.817			
44	7.009	7.29	6.703	92	14.645	14.94	14.339	140	22.284	22.58	21.978			
45	7.168	7.45	6.858	93	14.804	15.10	14.496	141	22.443	22.74	22.135			
46	7.327	7.61	7.021	94	14.963	15.26	14.657	142	22.602	22.90	22.296			
47	7.486	7.77	7.176	95	15.122	15.41	14.814	143	22.761	23.06	22.454			
48	7.645	7.93	7.339	96	15.281	15.57	14.975	144	22.920	23.22	22.614			
49	7.804	8.09	7.494	97	15.440	15.73	15.132	145	23.079	23.37	22.772			
50	7.963	8.25	7.657	98	15.600	15.89	15.292	146	23.238	23.53	22.933			
51	8.122	8.41	7.812	99	15.759	16.05	15.451	147	23.398	23.69	23.090			
52	8.281	8.57	7.975	100	15.918	16.21	15.612	148	23.557	23.85	23.251			
53	8.440	8.73	8.130	101	16.077	16.37	15.769	149	23.716	24.01	23.409			

Odd tooth "bottom diameters" equal pitch minus .312".

Sprocket Diameters - U.S.A. Std. No. 50 Roller Chain

No. of Teeth	Pitch Diameter	Outside Diameter	Bottom Diam. for Even Teeth Caliper Diam. for Odd Teeth	Machining tolerances on bottom diameters and caliper diameters should be in the minus direction. Tolerances on outside diameters are not critical.	No. of Teeth	Pitch Diameter	Outside Diameter	Bottom Diam. for Even Teeth Caliper Diam. for Odd Teeth	Machining tolerances on bottom diameters and caliper diameters should be in the minus direction. Tolerances on outside diameters are not critical.	No. of Teeth	Pitch Diameter	Outside Diameter	Bottom Diam. for Even Teeth Caliper Diam. for Odd Teeth	Machining tolerances on bottom diameters and caliper diameters should be in the minus direction. Tolerances on outside diameters are not critical.
6	1.250	1.46	0.850		54	10.749	11.11	10.349		102	20.295	20.66	19.895	
7	1.441	1.67	1.004	55	10.948	11.31	10.544	103	20.494	20.86	20.092			
8	1.633	1.88	1.233	56	11.147	11.50	10.747	104	20.693	21.06	20.293			
9	1.827	2.09	1.399	57	11.346	11.70	10.942	105	20.892	21.26	20.490			
10	2.023	2.30	1.623	58	11.544	11.90	11.144	106	21.091	21.46	20.691			
11	2.219	2.50	1.796	59	11.743	12.10	11.339	107	21.290	21.66	20.888			
12	2.415	2.71	2.015	60	11.942	12.30	11.542	108	21.489	21.86	21.089			
13	2.612	2.91	2.193	61	12.141	12.50	11.737	109	21.688	22.05	21.286			
14	2.809	3.11	2.409	62	12.340	12.70	11.940	110	21.887	22.25	21.487			
15	3.006	3.32	2.589	63	12.539	12.90	12.135	111	22.086	22.45	21.684			
16	3.204	3.52	2.804	64	12.738	13.10	12.338	112	22.285	22.65	21.885			
17	3.401	3.72	2.967	65	12.936	13.30	12.532	113	22.484	22.85	22.082			
18	3.599	3.92	3.199	66	13.135	13.50	12.735	114	22.683	23.05	22.283			
19	3.797	4.12	3.384	67	13.334	13.69	12.930	115	22.881	23.25	22.479			
20	3.995	4.32	3.595	68	13.533	13.89	13.133	116	23.080	23.45	22.680			
21	4.194	4.52	3.782	69	13.732	14.09	13.328	117	23.279	23.65	22.877			
22	4.392	4.72	3.992	70	13.931	14.29	13.531	118	23.478	23.85	23.078			
23	4.590	4.92	4.179	71	14.130	14.49	13.726	119	23.677	24.04	23.275			
24	4.788	5.12	4.388	72	14.329	14.69	13.929	120	23.876	24.24	23.476			
25	4.987	5.32	4.577	73	14.527	14.89	14.124	121	24.075	24.44	23.672			
26	5.185	5.52	4.785	74	14.726	15.09	14.326	122	24.273	24.64	23.873			
27	5.384	5.72	4.975	75	14.925	15.29	14.522	123	24.472	24.84	24.070			
28	5.582	5.92	5.182	76	15.124	15.49	14.724	124	24.671	25.04	24.271			
29	5.781	6.12	5.372	77	15.323	15.69	14.920	125	24.870	25.24	24.468			
30	5.979	6.32	5.579	78	15.522	15.88	15.122	126	25.070	25.44	24.670			
31	6.178	6.52	5.770	79	15.721	16.08	15.318	127	25.268	25.64	24.866			
32	6.376	6.72	5.976	80	15.920	16.28	15.520	128	25.467	25.84	25.067			
33	6.575	6.92	6.168	81	16.118	16.48	15.716	129	25.666	26.03	25.264			
34	6.774	7.12	6.374	82	16.317	16.68	15.917	130	25.865	26.23	25.465			
35	6.972	7.32	6.565	83	16.516	16.88	16.113	131	26.063	26.43	25.661			
36	7.171	7.52	6.771	84	16.715	17.08	16.315	132	26.262	26.63	25.862			
37	7.370	7.72	6.963	85	16.914	17.28	16.511	133	26.461	26.83	26.059			
38	7.569	7.92	7.169	86	17.113	17.48	16.713	134	26.660	27.03	26.260			
39	7.767	8.12	7.361	87	17.312	17.68	16.909	135	26.859	27.23	26.457			
40	7.966	8.32	7.566	88	17.511	17.87	17.111	136	27.058	27.43	26.658			
41	8.165	8.52	7.759	89	17.710	18.07	17.307	137	27.257	27.62	26.855			
42	8.363	8.72	7.963	90	17.909	18.27	17.509	138	27.456	27.82	27.056			
43	8.562	8.91	8.157	91	18.107	18.47	17.704	139	27.655	28.02	27.253			
44	8.761	9.11	8.361	92	18.306	18.67	17.906	140	27.854	28.22	27.454			
45	8.960	9.31	8.555	93	18.505	18.87	18.102	141	28.053	28.42	27.651			
46	9.159	9.51	8.759	94	18.704	19.07	18.304	142	28.252	28.62	27.852			
47	9.357	9.71	8.952	95	18.903	19.27	18.500	143	28.451	28.82	28.049			
48	9.556	9.91	9.156	96	19.102	19.47	18.702	144	28.650	29.02	28.250			
49	9.755	10.11	9.350	97	19.301	19.67	18.898	145	28.849	29.22	28.447			
50	9.954	10.31	9.554	98</										

TECHNICAL SECTION

Sprocket Information

Sprocket Diameters - U.S.A. Std. No. 60 Roller Chain

No. of Teeth	Pitch Diameter	Outside Diameter	Bottom Diam. for Even Teeth Caliper Diam. for Odd Teeth	No. of Teeth	Pitch Diameter	Outside Diameter	Bottom Diam. for Even Teeth Caliper Diam. for Odd Teeth	No. of Teeth	Pitch Diameter	Outside Diameter	Bottom Diam. for Even Teeth Caliper Diam. for Odd Teeth
6	1.500	1.75	1.031	54	12.899	13.33	12.430	102	24.354	24.79	23.885
7	1.729	2.01	1.217	55	13.137	13.57	12.663	103	24.593	25.03	24.121
8	1.960	2.26	1.491	56	13.376	13.81	12.907	104	24.832	25.27	24.363
9	2.193	2.51	1.691	57	13.615	14.04	13.141	105	25.071	25.51	24.599
10	2.427	2.76	1.958	58	13.853	14.28	13.385	106	25.309	25.75	24.840
11	2.662	3.00	2.166	59	14.092	14.52	13.618	107	25.548	25.99	25.076
12	2.898	3.25	2.429	60	14.331	14.76	13.862	108	25.787	26.23	25.318
13	3.134	3.49	2.642	61	14.569	15.00	14.096	109	26.025	26.46	25.553
14	3.371	3.74	2.902	62	14.808	15.24	14.339	110	26.264	26.70	25.795
15	3.607	3.98	3.119	63	15.046	15.48	14.573	111	26.503	26.94	26.031
16	3.844	4.22	3.376	64	15.285	15.72	14.816	112	26.742	27.18	26.273
17	4.082	4.46	3.595	65	15.524	15.96	15.050	113	26.980	27.42	26.508
18	4.319	4.70	3.850	66	15.762	16.19	15.293	114	27.219	27.66	26.750
19	4.557	4.95	4.072	67	16.001	16.43	15.528	115	27.458	27.90	26.986
20	4.794	5.19	4.326	68	16.240	16.67	15.771	116	27.697	28.14	27.228
21	5.032	5.43	4.549	69	16.478	16.91	16.005	117	27.936	28.38	27.464
22	5.270	5.67	4.801	70	16.717	17.15	16.248	118	28.174	28.61	27.705
23	5.508	5.91	5.026	71	16.956	17.39	16.483	119	28.413	28.85	27.941
24	5.746	6.15	5.277	72	17.194	17.63	16.725	120	28.651	29.09	28.182
25	5.984	6.39	5.503	73	17.433	17.87	16.960	121	28.889	29.33	28.418
26	6.222	6.63	5.753	74	17.671	18.11	17.203	122	29.128	29.57	28.659
27	6.460	6.87	5.981	75	17.910	18.34	17.437	123	29.367	29.81	28.895
28	6.699	7.11	6.230	76	18.149	18.58	17.680	124	29.606	30.05	29.137
29	6.937	7.35	6.458	77	18.387	18.82	17.914	125	29.845	30.29	29.373
30	7.175	7.59	6.706	78	18.626	19.06	18.157	126	30.083	30.52	29.614
31	7.413	7.83	6.935	79	18.865	19.30	18.392	127	30.322	30.76	29.851
32	7.652	8.07	7.183	80	19.103	19.54	18.635	128	30.561	31.00	30.092
33	7.890	8.30	7.412	81	19.342	19.78	18.870	129	30.800	31.24	30.328
34	8.129	8.54	7.660	82	19.581	20.02	19.112	130	31.038	31.48	30.569
35	8.367	8.78	7.890	83	19.819	20.26	19.347	131	31.277	31.72	30.806
36	8.605	9.02	8.137	84	20.058	20.49	19.589	132	31.516	31.96	31.047
37	8.844	9.26	8.367	85	20.297	20.73	19.825	133	31.754	32.20	31.283
38	9.082	9.50	8.613	86	20.536	20.97	20.067	134	31.993	32.44	31.524
39	9.321	9.74	8.845	87	20.774	21.21	20.302	135	32.232	32.67	31.761
40	9.559	9.98	9.090	88	21.013	21.45	20.544	136	32.471	32.91	32.002
41	9.798	10.22	9.322	89	21.252	21.69	20.780	137	32.709	33.15	32.238
42	10.036	10.46	9.567	90	21.490	21.93	21.021	138	32.948	33.39	32.479
43	10.275	10.70	9.799	91	21.729	22.17	21.257	139	33.187	33.63	32.716
44	10.513	10.94	10.044	92	21.968	22.41	21.499	140	33.425	33.87	32.956
45	10.752	11.18	10.276	93	22.206	22.64	21.734	141	33.664	34.11	33.193
46	10.990	11.42	10.522	94	22.445	22.88	21.976	142	33.903	34.35	33.434
47	11.229	11.65	10.754	95	22.683	23.12	22.211	143	34.142	34.58	33.670
48	11.467	11.89	10.999	96	22.922	23.36	22.453	144	34.380	34.82	33.911
49	11.706	12.13	11.231	97	23.161	23.60	22.689	145	34.619	35.06	34.148
50	11.945	12.37	11.476	98	23.400	23.84	22.931	146	34.858	35.30	34.389
51	12.183	12.61	11.708	99	23.638	24.08	23.166	147	35.096	35.54	34.625
52	12.422	12.85	11.953	100	23.877	24.32	23.408	148	35.335	35.78	34.866
53	12.660	13.09	12.186	101	24.116	24.55	23.644	149	35.574	36.02	35.103

Odd tooth "bottom diameters" equal pitch minus .469".

Sprocket Diameters - U.S.A. Std. No. 80 Roller Chain

No. of Teeth	Pitch Diameter	Outside Diameter	Bottom Diam. for Even Teeth Caliper Diam. for Odd Teeth	No. of Teeth	Pitch Diameter	Outside Diameter	Bottom Diam. for Even Teeth Caliper Diam. for Odd Teeth	No. of Teeth	Pitch Diameter	Outside Diameter	Bottom Diam. for Even Teeth Caliper Diam. for Odd Teeth
6	2.000	2.33	1.375	54	17.198	17.77	16.573	102	32.473	33.06	31.848
7	2.305	2.68	1.622	55	17.517	18.09	16.884	103	32.791	33.38	32.162
8	2.613	3.01	1.988	56	17.835	18.41	17.210	104	33.109	33.69	32.484
9	2.924	3.35	2.254	57	18.153	18.73	17.521	105	33.428	34.01	32.799
10	3.236	3.68	2.611	58	18.471	19.04	17.846	106	33.746	34.33	33.121
11	3.550	4.01	2.888	59	18.789	19.36	18.158	107	34.064	34.65	33.435
12	3.864	4.33	3.239	60	19.107	19.68	18.482	108	34.382	34.97	33.757
13	4.179	4.66	3.523	61	19.426	20.00	18.794	109	34.701	35.29	34.072
14	4.494	4.98	3.869	62	19.744	20.32	19.119	110	35.019	35.61	34.394
15	4.810	5.30	4.158	63	20.062	20.64	19.431	111	35.337	35.92	34.709
16	5.126	5.63	4.501	64	20.380	20.96	19.755	112	35.655	36.24	35.030
17	5.442	5.95	4.794	65	20.698	21.27	20.067	113	35.974	36.56	35.345
18	5.759	6.27	5.134	66	21.016	21.59	20.391	114	36.292	36.88	35.667
19	6.076	6.59	5.430	67	21.335	21.91	20.704	115	36.610	37.20	35.982
20	6.392	6.91	5.767	68	21.653	22.23	21.028	116	36.929	37.52	36.304
21	6.710	7.24	6.066	69	21.971	22.55	21.340	117	37.247	37.83	36.618
22	7.027	7.56	6.402	70	22.289	22.87	21.664	118	37.565	38.15	36.940
23	7.344	7.88	6.702	71	22.607	23.19	21.977	119	37.883	38.47	37.255
24	7.661	8.20	7.036	72	22.926	23.50	22.301	120	38.202	38.79	37.577
25	7.979	8.52	7.338	73	23.244	23.82	22.613	121	38.520	39.11	37.892
26	8.296	8.84	7.671	74	23.562	24.14	22.937	122	38.838	39.43	38.213
27	8.614	9.16	7.974	75	23.880	24.46	23.250	123	39.156	39.74	38.528
28	8.931	9.48	8.306	76	24.198	24.78	23.573	124	39.475	40.06	38.850
29	9.249	9.80	8.611	77	24.517	25.10	23.887	125	39.793	40.38	39.165
30	9.567	10.11	8.942	78	24.835	25.42	24.210	126	40.111	40.70	39.486
31	9.885	10.43	9.247	79	25.153	25.73	24.523	127	40.430	41.02	39.801
32	10.202	10.75	9.577	80	25.471	26.05	24.846	128	40.748	41.34	40.123
33	10.520	11.07	9.883	81	25.790	26.37	25.160	129	41.066	41.65	40.438
34	10.838	11.39	10.213	82	26.108	26.69	25.483	130	41.384	41.97	40.759
35	11.156	11.71	10.520	83	26.426	27.01	25.796	131	41.703	42.29	41.075
36	11.474	12.03	10.849	84	26.744	27.33	26.119	132	42.021	42.61	41.396
37	11.792	12.35	11.156	85	27.063	27.64	26.433	133	42.339	42.93	41.711
38	12.110	12.67	11.485	86	27.381	27.96	26.756	134	42.657	43.25	42.032
39	12.428	12.99	11.792	87	27.699	28.28	27.070	135	42.976	43.56	42.348
40	12.746	13.31	12.121	88	28.017	28.60	27.392	136	43.294	43.88	42.669
41	13.064	13.63	12.429	89	28.335	28.92	27.706	137	43.612	44.20	42.984
42	13.382	13.94	12.757	90	28.654	29.24	28.029	138	43.931	44.52	43.306
43	13.700	14.26	13.065	91	28.972	29.56	28.343	139	44.249	44.84	43.621
44	14.018	14.58	13.393	92	29.290	29.87	28.665	140	44.567	45.16	43.942
45	14.336	14.90	13.702	93	29.608	30.19	28.979	141	44.885	45.47	44.258
46	14.654	15.22	14.029	94	29.927	30.51	29.302	142	45.204	45.79	44.579
47	14.972	15.54	14.338	95	30.245	30.83	29.616	143	45.522	46.11	44.894
48	15.290	15.86	14.665	96	30.563	31.15	29.938	144	45.840	46.43	45.215
49	15.608	16.18	14.975	97	30.882	31.47	30.252	145	46.159	46.75	45.531
50	15.926	16.50	15.301	98	31.200	31.78	30.573	146	46.477	47.07	45.852
51	16.244	16.81	15.611	99	31.518	32.10	30.889	147	46.795	47.38	46.167
52	16.562	17.13	15.937	100	31.836	32.42	31.211	148	47.113	47.70	46.488
53	16.880	17.45	16.248	101	32.155	32.74	31.526	149	47.432	48.02	46.804

Odd tooth "bottom diameters" equal pitch minus .625".

TECHNICAL SECTION

Sprocket Information

Sprocket Diameters - U.S.A. Std. No. 100 Roller Chain

No. of Teeth	Pitch Diameter	Outside Diameter	Bottom Diam. for Even Teeth Caliper Diam. for Odd Teeth	Machining tolerances on bottom diameters and caliper diameters should be in the minus direction. Tolerances on outside diameters are not critical.	No. of Teeth	Pitch Diameter	Outside Diameter	Bottom Diam. for Even Teeth Caliper Diam. for Odd Teeth	Machining tolerances on bottom diameters and caliper diameters should be in the minus direction. Tolerances on outside diameters are not critical.	No. of Teeth	Pitch Diameter	Outside Diameter	Bottom Diam. for Even Teeth Caliper Diam. for Odd Teeth	Machining tolerances on bottom diameters and caliper diameters should be in the minus direction. Tolerances on outside diameters are not critical.
6	2.500	2.92	1.750		54	21.498	22.21	20.748		102	40.591	41.32	39.841	
7	2.881	3.35	2.059	55	21.896	22.61	21.137	103	40.989	41.72	40.234			
8	3.266	3.77	2.516	56	22.293	23.01	21.543	104	41.386	42.12	40.636			
9	3.655	4.18	2.850	57	22.691	23.41	21.932	105	41.784	42.52	41.030			
10	4.045	4.60	3.295	58	23.089	23.81	22.339	106	42.182	42.91	41.432			
11	4.437	5.01	3.642	59	23.486	24.20	22.728	107	42.580	43.31	41.825			
12	4.830	5.42	4.080	60	23.884	24.60	23.134	108	42.978	43.71	42.228			
13	5.223	5.82	4.435	61	24.282	25.00	23.524	109	43.376	44.11	42.621			
14	5.617	6.23	4.867	62	24.680	25.40	23.930	110	43.774	44.51	43.024			
15	6.012	6.63	5.229	63	25.077	25.80	24.320	111	44.171	44.90	43.417			
16	6.407	7.03	5.657	64	25.475	26.19	24.725	112	44.569	45.30	43.819			
17	6.803	7.44	6.024	65	25.873	26.59	25.115	113	44.967	45.70	44.213			
18	7.197	7.84	6.448	66	26.271	26.99	25.521	114	45.365	46.10	44.615			
19	7.595	8.24	6.819	67	26.668	27.39	25.911	115	45.763	46.50	45.009			
20	7.991	8.64	7.241	68	27.066	27.79	26.316	116	46.161	46.89	45.411			
21	8.387	9.04	7.614	69	27.464	28.19	26.707	117	46.559	47.29	45.804			
22	8.783	9.44	8.033	70	27.862	28.58	27.112	118	46.957	47.69	46.207			
23	9.180	9.84	8.409	71	28.259	28.98	27.502	119	47.354	48.09	46.600			
24	9.577	10.25	8.827	72	28.657	29.38	27.907	120	47.752	48.49	47.002			
25	9.973	10.65	9.204	73	29.055	29.78	28.298	121	48.149	48.88	47.395			
26	10.370	11.05	9.620	74	29.453	30.18	28.703	122	48.547	49.28	47.797			
27	10.767	11.44	9.999	75	29.850	30.57	29.093	123	48.945	49.68	48.191			
28	11.164	11.84	10.414	76	30.248	30.97	29.498	124	49.343	50.08	48.593			
29	11.561	12.24	10.795	77	30.646	31.37	29.889	125	49.741	50.48	48.987			
30	11.958	12.64	11.208	78	31.044	31.77	30.294	126	50.139	50.87	49.389			
31	12.356	13.04	11.590	79	31.441	32.17	30.685	127	50.537	51.27	49.783			
32	12.753	13.44	12.003	80	31.839	32.57	31.089	128	50.935	51.67	50.185			
33	13.150	13.84	12.385	81	32.237	32.96	31.481	129	51.333	52.07	50.579			
34	13.547	14.24	12.797	82	32.635	33.36	31.885	130	51.730	52.47	50.980			
35	13.945	14.64	13.181	83	33.033	33.76	32.277	131	52.128	52.86	51.375			
36	14.342	15.04	13.592	84	33.430	34.16	32.680	132	52.526	53.26	51.776			
37	14.740	15.44	13.976	85	33.828	34.56	33.072	133	52.924	53.66	52.170			
38	15.137	15.84	14.387	86	34.226	34.95	33.476	134	53.322	54.06	52.572			
39	15.534	16.23	14.772	87	34.624	35.35	33.868	135	53.720	54.46	52.966			
40	15.932	16.63	15.182	88	35.021	35.75	34.271	136	54.118	54.85	53.368			
41	16.329	17.03	15.568	89	35.419	36.15	34.663	137	54.515	55.25	53.762			
42	16.727	17.43	15.977	90	35.817	36.55	35.067	138	54.913	55.65	54.163			
43	17.124	17.83	16.363	91	36.215	36.94	35.459	139	55.311	56.05	54.558			
44	17.522	18.23	16.772	92	36.612	37.34	35.862	140	55.709	56.45	54.959			
45	17.920	18.63	17.159	93	37.010	37.74	36.255	141	56.107	56.84	55.353			
46	18.317	19.02	17.567	94	37.408	38.14	36.658	142	56.505	57.24	55.755			
47	18.715	19.42	17.954	95	37.806	38.54	37.050	143	56.903	57.64	56.149			
48	19.112	19.82	18.362	96	38.203	38.93	37.453	144	57.300	58.04	56.550			
49	19.510	20.22	18.750	97	38.601	39.33	37.846	145	57.698	58.44	56.945			
50	19.908	20.62	19.158	98	38.999	39.73	38.249	146	58.096	58.83	57.346			
51	20.305	21.02	19.545	99	39.397	40.13	38.642	147	58.494	59.23	57.741			
52	20.703	21.42	19.953	100	39.795	40.53	39.045	148	58.892	59.63	58.142			
53	21.100	21.81	20.341	101	40.193	40.92	39.438	149	59.290	60.03	58.537			

Odd tooth "bottom diameters" equal pitch minus .750".

Sprocket Diameters - U.S.A. Std. No. 120 Roller Chain

No. of Teeth	Pitch Diameter	Outside Diameter	Bottom Diam. for Even Teeth Caliper Diam. for Odd Teeth	Machining tolerances on bottom diameters and caliper diameters should be in the minus direction. Tolerances on outside diameters are not critical.	No. of Teeth	Pitch Diameter	Outside Diameter	Bottom Diam. for Even Teeth Caliper Diam. for Odd Teeth	Machining tolerances on bottom diameters and caliper diameters should be in the minus direction. Tolerances on outside diameters are not critical.	No. of Teeth	Pitch Diameter	Outside Diameter	Bottom Diam. for Even Teeth Caliper Diam. for Odd Teeth	Machining tolerances on bottom diameters and caliper diameters should be in the minus direction. Tolerances on outside diameters are not critical.
6	3.000	3.50	2.125		54	25.798	26.65	24.923		102	48.709	49.59	47.834	
7	3.457	4.02	2.495	55	26.275	27.13	25.389	103	49.186	50.06	48.305			
8	3.920	4.52	3.045	56	26.752	27.61	25.877	104	49.664	50.54	48.789			
9	4.386	5.02	3.444	57	27.229	28.09	26.344	105	50.141	51.02	49.260			
10	4.854	5.52	3.979	58	27.707	28.57	26.832	106	50.619	51.50	49.744			
11	5.324	6.01	4.395	59	28.184	29.04	27.299	107	51.096	51.97	50.215			
12	5.796	6.50	4.921	60	28.661	29.52	27.786	108	51.573	52.45	50.698			
13	6.268	6.99	5.347	61	29.138	30.00	28.263	109	52.051	52.93	51.169			
14	6.741	7.47	5.866	62	29.616	30.48	28.741	110	52.528	53.41	51.653			
15	7.215	7.96	6.300	63	30.093	30.96	29.208	111	53.005	53.88	52.124			
16	7.689	8.44	6.814	64	30.570	31.43	29.695	112	53.483	54.36	52.608			
17	8.163	8.92	7.253	65	31.047	31.91	30.163	113	53.961	54.84	53.080			
18	8.638	9.41	7.763	66	31.525	32.39	30.650	114	54.438	55.32	53.563			
19	9.113	9.89	8.207	67	32.002	32.87	31.118	115	54.915	55.80	54.034			
20	9.589	10.37	8.714	68	32.479	33.34	31.604	116	55.393	56.27	54.518			
21	10.064	10.85	9.161	69	32.957	33.82	32.079	117	55.870	56.75	54.989			
22	10.540	11.33	9.665	70	33.434	34.30	32.559	118	56.347	57.23	55.472			
23	11.016	11.81	10.115	71	33.911	34.78	33.028	119	56.824	57.71	55.944			
24	11.492	12.29	10.617	72	34.388	35.26	33.513	120	57.301	58.18	56.426			
25	11.968	12.77	11.070	73	34.866	35.73	33.983	121	57.778	58.66	56.899			
26	12.444	13.25	11.569	74	35.343	36.21	34.468	122	58.256	59.14	57.381			
27	12.921	13.73	12.024	75	35.820	36.69	34.937	123	58.734	59.62	57.854			
28	13.397	14.21	12.522	76	36.298	37.17	35.423	124	59.212	60.09	58.337			
29	13.874	14.69	12.978	77	36.775	37.64	35.892	125	59.690	60.57	58.809			
30	14.350	15.17	13.475	78	37.252	38.12	36.377	126	60.167	61.05	59.292			
31	14.827	15.65	13.933	79	37.730	38.60	36.847	127	60.644	61.53	59.765			
32	15.303	16.13	14.428	80	38.207	39.08	37.332	128	61.122	62.00	60.247			
33	15.780	16.61	14.887	81	38.684	39.56	37.802	129	61.599	62.48	60.720			
34	16.257	17.09	15.382	82	39.162	40.03	38.287	130	62.076	62.96	61.201			
35	16.734	17.57	15.842	83	39.639	40.51	38.757	131	62.554	63.44	61.674			
36	17.211	18.05	16.336	84	40.116	40.99	39.241	132	63.031	63.91	62.156			
37	17.687	18.52	16.796	85	40.594	41.47	39.712	133	63.509	64.39	62.629			
38	18.164	19.00	17.289	86	41.071	41.94	40.196	134	63.986	64.87	63.111			
39	18.641	19.48	17.751	87	41.548	42.42	40.666	135	64.464	65.35	63.584			
40	19.118	19.96	18.243	88	42.026	42.90	41.151	136	64.941	65.82	64.066			
41	19.595	20.44	18.706	89	42.503	43.38	41.621	137	65.418	66.30	64.539			
42	20.072	20.92	19.197	90	42.981	43.85	42.106	138	65.896	66.78	65.021			
43	20.549	21.39	19.661	91	43.458	44.33	42.576	139	66.373	67.26	65.494			
44	21.026	21.87	20.151	92	43.935	44.81	43.060	140	66.851	67.73	65.976			
45	21.503	22.35	20.615	93	44.412	45.29	43.530	141	67.328	68.21	66.449			
46	21.980	22.83	21.105	94	44.889	45.77	44.014	142	67.806	68.69	66.931			
47	22.458	23.31	21.570	95	45.367	46.24	44.485	143	68.283	69.17	67.404			
48	22.935	23.79	22.060	96	45.844	46.72	44.969	144	68.760					

TECHNICAL SECTION

Sprocket Information

Sprocket Diameters - U.S.A. Std. No. 140 Roller Chain

No. of Teeth	Pitch Diameter	Outside Diameter	Bottom Diam. for Even Teeth Caliper Diam. for Odd Teeth	Machining tolerances on bottom diameters and caliper diameters should be in the minus direction. Tolerances on outside diameters are not critical.	No. of Teeth	Pitch Diameter	Outside Diameter	Bottom Diam. for Even Teeth Caliper Diam. for Odd Teeth	Machining tolerances on bottom diameters and caliper diameters should be in the minus direction. Tolerances on outside diameters are not critical.	No. of Teeth	Pitch Diameter	Outside Diameter	Bottom Diam. for Even Teeth Caliper Diam. for Odd Teeth	Machining tolerances on bottom diameters and caliper diameters should be in the minus direction. Tolerances on outside diameters are not critical.
6	3.500	4.08	2.500		54	30.097	31.10	29.097		102	56.827	57.85	55.827	
7	4.033	4.68	2.932	55	30.654	31.65	29.641	103	57.384	58.41	56.377			
8	4.573	5.28	3.573	56	31.211	32.21	30.211	104	57.941	58.96	56.941			
9	5.117	5.86	4.042	57	31.768	32.77	30.755	105	58.498	59.52	57.491			
10	5.663	6.44	4.663	58	32.324	33.33	31.324	106	59.055	60.08	58.055			
11	6.212	7.01	5.148	59	32.881	33.89	31.869	107	59.612	60.64	58.605			
12	6.762	7.58	5.762	60	33.438	34.44	32.438	108	60.169	61.19	59.169			
13	7.313	8.15	6.259	61	33.995	35.00	32.983	109	60.726	61.75	59.719			
14	7.864	8.72	6.864	62	34.551	35.56	33.551	110	61.283	62.31	60.283			
15	8.417	9.28	7.371	63	35.108	36.11	34.097	111	61.840	62.87	60.833			
16	8.970	9.85	7.970	64	35.665	36.67	34.665	112	62.397	63.42	61.397			
17	9.524	10.41	8.483	65	36.222	37.23	35.211	113	62.954	63.98	61.946			
18	10.078	10.98	9.078	66	36.779	37.79	35.779	114	63.511	64.54	62.511			
19	10.632	11.54	9.596	67	37.336	38.35	36.325	115	64.068	65.09	63.062			
20	11.187	12.10	10.187	68	37.892	38.90	36.892	116	64.625	65.65	63.625			
21	11.742	12.66	10.709	69	38.449	39.46	37.439	117	65.182	66.21	64.176			
22	12.297	13.22	11.297	70	39.006	40.02	38.006	118	65.739	66.77	64.739			
23	12.852	13.78	11.822	71	39.563	40.57	38.553	119	66.296	67.32	65.290			
24	13.407	14.34	12.407	72	40.120	41.13	39.120	120	66.853	67.88	65.853			
25	13.963	14.90	12.935	73	40.677	41.69	39.667	121	67.410	68.44	66.404			
26	14.518	15.46	13.518	74	41.233	42.25	40.233	122	67.967	68.99	66.967			
27	15.074	16.02	14.049	75	41.790	42.80	40.781	123	68.524	69.55	67.518			
28	15.630	16.58	14.630	76	42.347	43.36	41.347	124	69.081	70.11	68.081			
29	16.186	17.14	15.162	77	42.904	43.92	41.895	125	69.639	70.67	68.633			
30	16.742	17.70	15.742	78	43.461	44.48	42.461	126	70.195	71.22	69.195			
31	17.298	18.26	16.276	79	44.018	45.03	43.009	127	70.752	71.78	69.746			
32	17.854	18.82	16.854	80	44.575	45.59	43.575	128	71.308	72.34	70.308			
33	18.410	19.38	17.389	81	45.132	46.15	44.123	129	71.866	72.90	70.860			
34	18.966	19.94	17.966	82	45.689	46.71	44.689	130	72.423	73.45	71.423			
35	19.523	20.49	18.503	83	46.246	47.26	45.237	131	72.980	74.01	71.974			
36	20.079	21.05	19.079	84	46.802	47.82	45.802	132	73.537	74.57	72.537			
37	20.635	21.61	19.617	85	47.359	48.38	46.350	133	74.094	75.12	73.088			
38	21.192	22.17	20.192	86	47.915	48.93	46.915	134	74.650	75.68	73.650			
39	21.748	22.73	20.731	87	48.472	49.49	47.484	135	75.207	76.24	74.202			
40	22.305	23.29	21.305	88	49.029	50.05	48.029	136	75.765	76.79	74.765			
41	22.861	23.84	21.845	89	49.586	50.61	48.578	137	76.322	77.35	75.316			
42	23.418	24.40	22.418	90	50.144	51.16	49.144	138	76.879	77.91	75.879			
43	23.974	24.96	22.958	91	50.700	51.72	49.692	139	77.435	78.47	76.431			
44	24.531	25.52	23.531	92	51.257	52.28	50.257	140	77.992	79.02	76.992			
45	25.087	26.08	24.072	93	51.814	52.83	50.806	141	78.549	79.58	77.545			
46	25.644	26.63	24.644	94	52.371	53.39	51.371	142	79.106	80.14	78.106			
47	26.201	27.19	25.196	95	52.928	53.95	51.920	143	79.664	80.69	78.659			
48	26.757	27.75	25.757	96	53.485	54.51	52.485	144	80.220	81.25	79.220			
49	27.314	28.31	26.300	97	54.042	55.06	53.034	145	80.777	81.81	79.773			
50	27.871	28.87	26.871	98	54.599	55.62	53.599	146	81.334	82.37	80.334			
51	28.427	29.42	27.414	99	55.156	56.18	54.149	147	81.891	82.92	80.887			
52	28.984	29.98	27.984	100	55.713	56.74	54.713	148	82.448	83.48	81.448			
53	29.541	30.54	28.528	101	56.270	57.29	55.263	149	83.005	84.04	82.001			

Odd tooth "bottom diameters" equal pitch minus 1.000".

Sprocket Diameters - U.S.A. Std. No. 160 Roller Chain

No. of Teeth	Pitch Diameter	Outside Diameter	Bottom Diam. for Even Teeth Caliper Diam. for Odd Teeth	Machining tolerances on bottom diameters and caliper diameters should be in the minus direction. Tolerances on outside diameters are not critical.	No. of Teeth	Pitch Diameter	Outside Diameter	Bottom Diam. for Even Teeth Caliper Diam. for Odd Teeth	Machining tolerances on bottom diameters and caliper diameters should be in the minus direction. Tolerances on outside diameters are not critical.	No. of Teeth	Pitch Diameter	Outside Diameter	Bottom Diam. for Even Teeth Caliper Diam. for Odd Teeth	Machining tolerances on bottom diameters and caliper diameters should be in the minus direction. Tolerances on outside diameters are not critical.
6	4.000	4.66	2.875		54	34.397	35.54	33.272		102	64.945	66.11	63.820	
7	4.610	5.35	3.369	55	35.033	36.18	33.894	103	65.582	66.75	64.449			
8	5.226	6.03	4.101	56	35.669	36.81	34.544	104	66.218	67.39	65.093			
9	5.848	6.70	4.634	57	36.306	37.45	35.167	105	66.855	68.03	65.722			
10	6.472	7.36	5.347	58	36.942	38.09	35.817	106	67.491	68.66	66.366			
11	7.099	8.01	5.902	59	37.578	38.73	36.440	107	68.128	69.30	66.995			
12	7.727	8.66	6.602	60	38.215	39.36	37.090	108	68.765	69.94	67.638			
13	8.357	9.31	7.171	61	38.851	40.00	37.713	109	69.401	70.57	68.268			
14	8.988	9.96	7.863	62	39.487	40.64	38.362	110	70.038	71.21	68.913			
15	9.620	10.61	8.442	63	40.124	41.27	38.986	111	70.674	71.85	69.541			
16	10.252	11.26	9.127	64	40.760	41.91	39.635	112	71.311	72.48	70.186			
17	10.885	11.90	9.713	65	41.396	42.55	40.259	113	71.948	73.12	71.815			
18	11.518	12.54	10.393	66	42.033	43.19	40.908	114	72.585	73.76	71.460			
19	12.151	13.19	10.985	67	42.669	43.82	41.532	115	73.221	74.39	72.089			
20	12.785	13.83	11.600	68	43.306	44.46	42.181	116	73.858	75.03	72.733			
21	13.419	14.47	12.256	69	43.942	45.10	42.805	117	74.494	75.67	73.362			
22	14.053	15.11	12.928	70	44.578	45.73	43.453	118	75.130	76.30	74.005			
23	14.688	15.75	13.528	71	45.215	46.37	44.078	119	75.767	76.94	74.655			
24	15.323	16.39	14.198	72	45.851	47.01	44.726	120	76.403	77.58	75.278			
25	15.958	17.03	14.801	73	46.488	47.64	45.352	121	77.039	78.21	75.908			
26	16.593	17.67	15.468	74	47.124	48.28	45.999	122	77.676	78.85	76.551			
27	17.228	18.31	16.073	75	47.760	48.92	46.625	123	78.313	79.49	77.181			
28	17.863	18.95	16.738	76	48.397	49.56	47.272	124	78.950	80.12	77.825			
29	18.498	19.59	17.346	77	49.033	50.19	47.898	125	79.587	80.76	78.455			
30	19.134	20.23	18.009	78	49.670	50.83	48.545	126	80.222	81.40	79.097			
31	19.769	20.87	18.619	79	50.306	51.47	49.171	127	80.859	82.03	79.728			
32	20.405	21.51	19.280	80	50.943	52.10	49.818	128	81.495	82.67	80.370			
33	21.040	22.15	19.892	81	51.579	52.74	50.444	129	82.132	83.31	81.001			
34	21.676	22.78	20.551	82	52.216	53.38	51.091	130	82.769	83.94	81.644			
35	22.312	23.42	21.164	83	52.852	54.01	51.717	131	83.405	84.58	82.274			
36	22.947	24.06	21.822	84	53.489	54.65	52.364	132	84.042	85.22	82.917			
37	23.583	24.70	22.437	85	54.125	55.29	52.991	133	84.678	85.85	83.547			
38	24.219	25.34	23.094	86	54.761	55.92	53.637	134	85.315	86.49	84.190			
39	24.855	25.98	23.710	87	55.398	56.56	54.264	135	85.951	87.13	84.821			
40	25.491	26.61	24.366	88	56.034	57.20	54.909	136	86.588	87.76	85.463			
41	26.127	27.25	24.983	89	56.671	57.84	55.538	137	87.225	88.40	86.094			
42	26.763	27.89	25.638	90	57.307	58.47	56.182	138	87.861	89.04	86.736			
43	27.399	28.53	26.256	91	57.944	59.11	56.810	139	88.498	89.68	87.367			
44	28.035	29.16	26.910	92	58.580	59.75	57.455	140	89.134	90.31	88.009			
45	28.671	29.80	27.529	93	59.216	60.38	58.083	141	89.771	90.95	88.640			
46	29.307	30.44	28.182	94	59.853	61.02	58.728	142	90.407	91.59	89.282			
47	29.943	31.08	28.802	95	60.489	61.66	59.356	143	91.044	92.22	89.913			
48	30.580	31.71	29.455	96	61.126	6								

TECHNICAL SECTION

Sprocket Information

Sprocket Diameters - U.S.A. Std. No. 180 Roller Chain

No. of Teeth	Pitch Diameter	Outside Diameter	Bottom Diam. for Even Teeth Caliper Diam. for Odd Teeth	No. of Teeth	Pitch Diameter	Outside Diameter	Bottom Diam. for Even Teeth Caliper Diam. for Odd Teeth	No. of Teeth	Pitch Diameter	Outside Diameter	Bottom Diam. for Even Teeth Caliper Diam. for Odd Teeth
5	3.828	4.45	2.235	45	32.255	33.53	30.830	85	60.891	62.20	59.474
6	4.500	5.25	3.094	46	32.971	34.24	31.565	86	61.607	62.92	60.201
7	5.186	6.02	3.650	47	33.686	34.96	32.262	87	62.323	63.63	60.907
8	5.879	6.78	4.473	48	34.402	35.68	32.996	88	63.039	64.35	61.633
9	6.579	7.53	5.073	49	35.118	36.40	33.694	89	63.755	65.07	62.339
10	7.281	8.28	5.875	50	35.834	37.11	34.428	90	64.471	65.78	63.065
11	7.986	9.01	6.499	51	36.549	37.83	35.126	91	65.187	66.50	63.771
12	8.693	9.75	7.287	52	37.265	38.55	35.859	92	65.903	67.21	64.497
13	9.402	10.48	7.927	53	37.981	39.27	36.558	93	66.619	67.93	65.203
14	10.112	11.21	8.706	54	38.696	39.98	37.290	94	67.335	68.65	65.929
15	10.822	11.93	9.357	55	39.412	40.70	37.990	95	68.051	69.36	66.636
16	11.533	12.66	10.127	56	40.128	41.42	38.722	96	68.767	70.08	67.361
17	12.245	13.39	10.787	57	40.844	42.13	39.422	97	69.483	70.80	68.068
18	12.957	14.11	11.551	58	41.560	42.85	40.154	98	70.199	71.51	68.793
19	13.670	14.83	12.217	59	42.276	43.57	40.855	99	70.916	72.23	69.501
20	14.383	15.56	12.977	60	42.991	44.28	41.585	100	71.631	72.95	70.225
21	15.096	16.28	13.648	61	43.707	45.00	42.287	101	72.348	73.66	70.933
22	15.810	17.00	14.404	62	44.423	45.72	43.017	102	73.064	74.38	71.658
23	16.524	17.72	15.079	63	45.139	46.43	43.719	103	73.780	75.10	72.365
24	17.238	18.44	15.832	64	45.855	47.15	44.449	104	74.496	75.81	73.090
25	17.952	19.16	16.511	65	46.571	47.87	45.151	105	75.212	76.53	73.798
26	18.666	19.88	17.260	66	47.287	48.58	45.881	106	75.928	77.25	74.522
27	19.381	20.60	17.942	67	48.003	49.30	46.584	107	76.644	77.96	75.230
28	20.096	21.32	18.690	68	48.719	50.02	47.313	108	77.360	78.68	75.954
29	20.810	22.04	19.374	69	49.435	50.73	48.016	109	78.076	79.39	76.662
30	21.525	22.76	20.119	70	50.151	51.45	48.745	110	78.792	80.11	77.386
31	22.240	23.48	20.806	71	50.867	52.17	49.448	111	79.508	80.83	78.095
32	22.955	24.19	21.549	72	51.583	52.88	50.177	112	80.225	81.54	78.819
33	23.670	24.91	22.237	73	52.299	53.60	50.880	113	80.941	82.26	79.527
34	24.385	25.63	22.979	74	53.015	54.32	51.609	114	81.657	82.98	80.251
35	25.101	26.35	23.669	75	53.730	55.03	52.313	115	82.373	83.69	80.959
36	25.816	27.07	24.410	76	54.446	55.75	53.040	116	83.089	84.41	81.683
37	26.531	27.79	25.101	77	55.162	56.47	53.745	117	83.805	85.12	82.392
38	27.246	28.50	25.840	78	55.879	57.18	54.473	118	84.521	85.84	83.115
39	27.962	29.22	26.533	79	56.594	57.90	55.177	119	85.237	86.56	83.824
40	28.677	29.94	27.271	80	57.310	58.62	55.904	120	85.953	87.27	84.547
41	29.393	30.66	27.965	81	58.027	59.33	56.610	121	86.670	87.99	85.256
42	30.108	31.37	28.702	82	58.743	60.05	57.337	122	87.386	88.71	85.980
43	30.824	32.09	29.397	83	59.459	60.77	58.042	123	88.102	89.42	86.689
44	31.539	32.81	30.133	84	60.175	61.48	58.769	124	88.818	90.14	87.412

Odd tooth "bottom diameters" equal pitch minus 1.406".

Sprocket Diameters - U.S.A. Std. No. 200 Roller Chain

No. of Teeth	Pitch Diameter	Outside Diameter	Bottom Diam. for Even Teeth Caliper Diam. for Odd Teeth	No. of Teeth	Pitch Diameter	Outside Diameter	Bottom Diam. for Even Teeth Caliper Diam. for Odd Teeth	No. of Teeth	Pitch Diameter	Outside Diameter	Bottom Diam. for Even Teeth Caliper Diam. for Odd Teeth
6	5.000	5.83	3.438	54	42.995	44.42	41.433	102	81.182	82.64	79.620
7	5.762	6.69	4.055	55	43.792	45.22	42.212	103	81.977	83.44	80.406
8	6.532	7.54	4.970	56	44.587	46.02	43.025	104	82.772	84.24	81.210
9	7.310	8.37	5.637	57	45.382	46.81	43.802	105	83.567	85.03	81.996
10	8.090	9.20	6.528	58	46.177	47.61	44.615	106	84.365	85.83	82.803
11	8.872	10.02	7.219	59	46.972	48.41	45.393	107	85.160	86.62	83.589
12	9.660	10.83	8.098	60	47.767	49.20	46.205	108	85.955	87.42	84.393
13	10.447	11.64	8.808	61	48.565	50.00	46.987	109	86.752	88.22	85.181
14	11.235	12.46	9.673	62	49.360	50.80	47.798	110	87.547	89.01	85.985
15	12.025	13.26	10.397	63	50.155	51.59	48.577	111	88.342	89.81	86.771
16	12.815	14.07	11.253	64	50.950	52.39	49.388	112	89.137	90.60	87.575
17	13.605	14.87	11.985	65	51.745	53.19	50.168	113	89.935	91.40	88.364
18	14.397	15.68	12.835	66	52.540	53.98	50.978	114	90.730	92.20	89.168
19	15.190	16.48	13.576	67	53.337	54.78	51.760	115	91.525	92.99	89.954
20	15.982	17.29	14.420	68	54.132	55.58	52.570	116	92.322	93.79	90.760
21	16.775	18.09	15.166	69	54.927	56.37	53.351	117	93.117	94.58	91.547
22	17.567	18.89	16.005	70	55.722	57.17	54.180	118	93.912	95.38	92.350
23	18.360	19.69	16.755	71	56.517	57.96	54.941	119	94.707	96.18	93.137
24	19.152	20.49	17.590	72	57.315	58.76	55.753	120	95.502	96.97	93.940
25	19.947	21.29	18.346	73	58.110	59.56	56.535	121	96.297	97.77	94.727
26	20.740	22.09	19.178	74	58.905	60.35	57.343	122	97.092	98.56	95.530
27	21.535	22.89	19.937	75	59.700	61.15	58.125	123	97.889	99.36	96.320
28	22.330	23.69	20.768	76	60.495	61.95	58.933	124	98.687	100.16	97.125
29	23.122	24.49	21.526	77	61.292	62.74	59.717	125	99.482	100.95	97.909
30	23.917	25.29	22.355	78	62.087	63.54	60.525	126	100.278	101.75	98.716
31	24.712	26.09	23.118	79	62.882	64.33	61.308	127	101.074	102.54	99.504
32	25.505	26.88	23.943	80	63.677	65.13	62.115	128	101.869	103.34	100.307
33	26.300	27.68	24.708	81	64.475	65.93	62.901	129	102.665	104.14	101.095
34	27.095	28.48	25.533	82	65.270	66.72	63.708	130	103.461	104.93	101.899
35	27.890	29.28	26.300	83	66.065	67.52	64.491	131	104.257	105.73	102.687
36	28.685	30.08	27.123	84	66.860	68.32	65.298	132	105.052	106.52	103.490
37	29.480	30.87	27.891	85	67.657	69.11	66.083	133	105.848	107.32	104.278
38	30.275	31.67	28.713	86	68.452	69.91	66.890	134	106.644	108.12	105.082
39	31.070	32.47	29.483	87	69.247	70.70	67.674	135	107.439	108.91	105.870
40	31.865	33.27	30.303	88	70.042	71.50	68.480	136	108.235	109.71	106.673
41	32.660	34.06	31.074	89	70.837	72.30	69.264	137	109.031	110.50	107.461
42	33.455	34.86	31.893	90	71.635	73.09	70.073	138	109.827	111.30	108.265
43	34.250	35.66	32.665	91	72.430	73.89	70.857	139	110.622	112.10	109.053
44	35.045	36.46	33.493	92	73.225	74.68	71.663	140	111.418	112.89	109.856
45	35.840	37.25	34.256	93	74.020	75.48	72.447	141	112.214	113.69	110.644
46	36.635	38.05	35.073	94	74.815	76.28	73.253	142	113.009	114.48	111.447
47	37.430	38.85	35.847	95	75.612	77.07	74.040	143	113.805	115.28	112.236
48	38.225	39.64	36.663	96	76.407	77.87	74.845	144	114.601	116.07	113.039
49	39.020	40.44	37.438	97	77.202	78.66	75.626	145	115.396	116.87	113.827
50	39.815	41.24	38.253	98	77.997	79.46	76.435	146	116.192	117.67	114.630
51	40.610	42.03	39.029	99	78.795	80.26	77.223	147	116.988	118.46	115.419
52	41.405	42.83	39.843	100	79.590	81.05	78.028	148	117.784	119.26	116.222
53	42.200	43.63	40.619	101	80.385	81.85	78.813	149	118.579	120.05	117.010

Odd tooth "bottom diameters" equal pitch minus 1.562".