

CustomAcces

HARLEY DAVIDSON SPORTSTER 883

M O U N T I N G I N S T R U C T I O N S

REF BTM0001

SEMIFAIRING BATWING SML SPORT MODEL



ID	PART	DESCRIPTION	QTY	REF
1		Semifairing	1	BTMF001N
2		Sport screen	1	BTMP001
3		Upper left support	1	SOP4P5SLBTM0001
4		Upper right support	1	SOP4P5SRBTM0001
5		Lower left support	1	SOP4P5ILBTM0001
6		Lower right support	1	SOP4P5IRBTM0001
7		ANSIB 18.3 CLASE 12.9 UNC 3/8"x51 Allen screw	2	TORNI-ANSIB-846
8		Ø10,5 xØ16 x15 spacer	2	CASQUI-----845
9		M5 silentblock	4	SILENBTM5-046/1
10		M5x1 nylon washer	4	ARNV0000000245
11		M5x16 Ø11 ISO 7380 Allen screw	4	TORNI-I7380-493
12		M5 ISO 7380 screw cap	4	TAPON-----85
13		M4x12 ISO 7380 Allen screw	3	TORNI-I7380-800
14		M4x0,5 nylon washer	6	ARNV00000000311
15		M4 nut	3	TUERCAE985-0290
16		M4 cap nut	3	TAPON-----91
17		Cable ties	1	ABR-00101100539

CustomAcces

HARLEY DAVIDSON SPORTSTER 883

MOUNTING INSTRUCTIONS

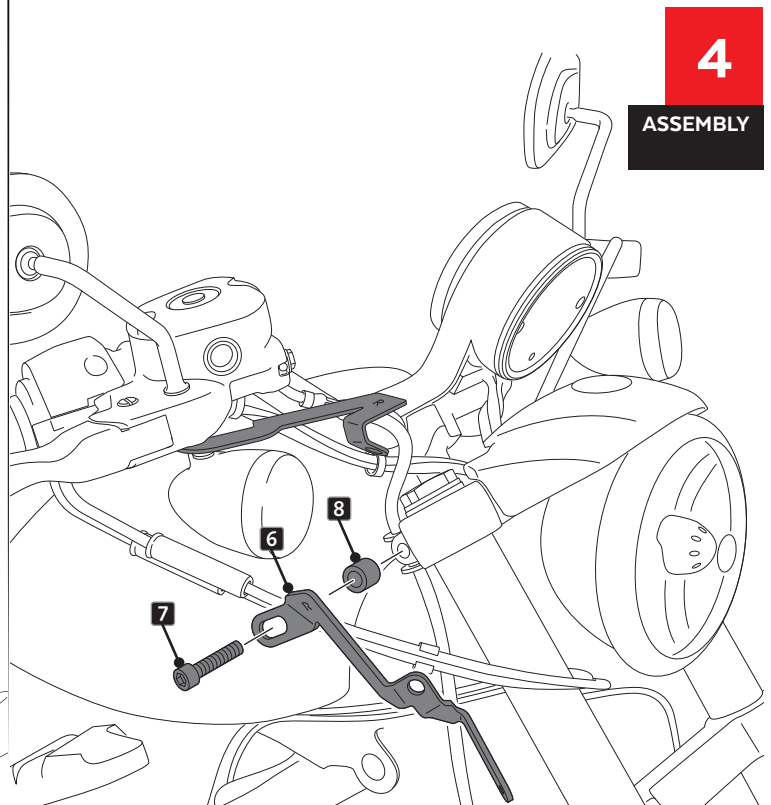
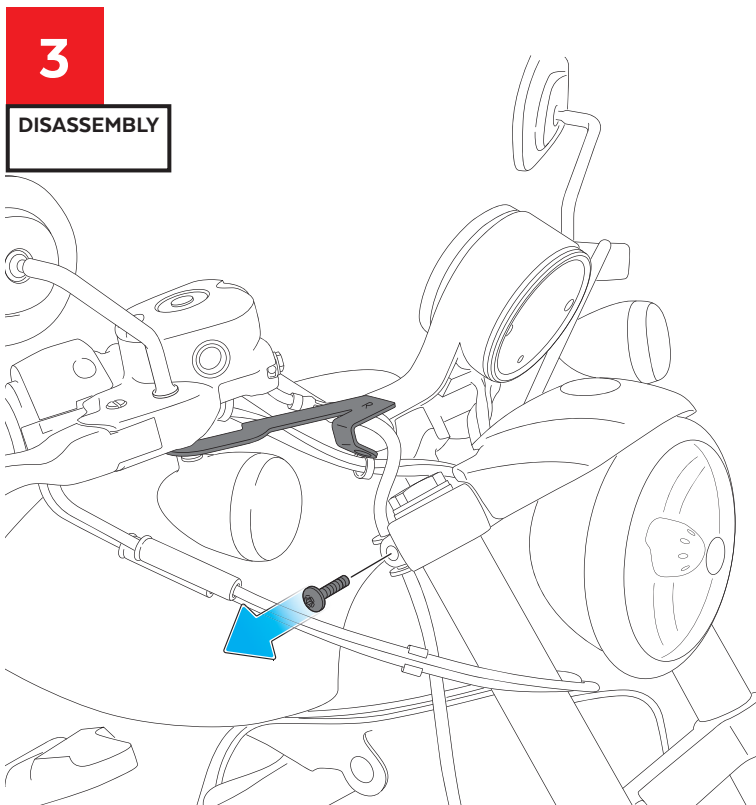
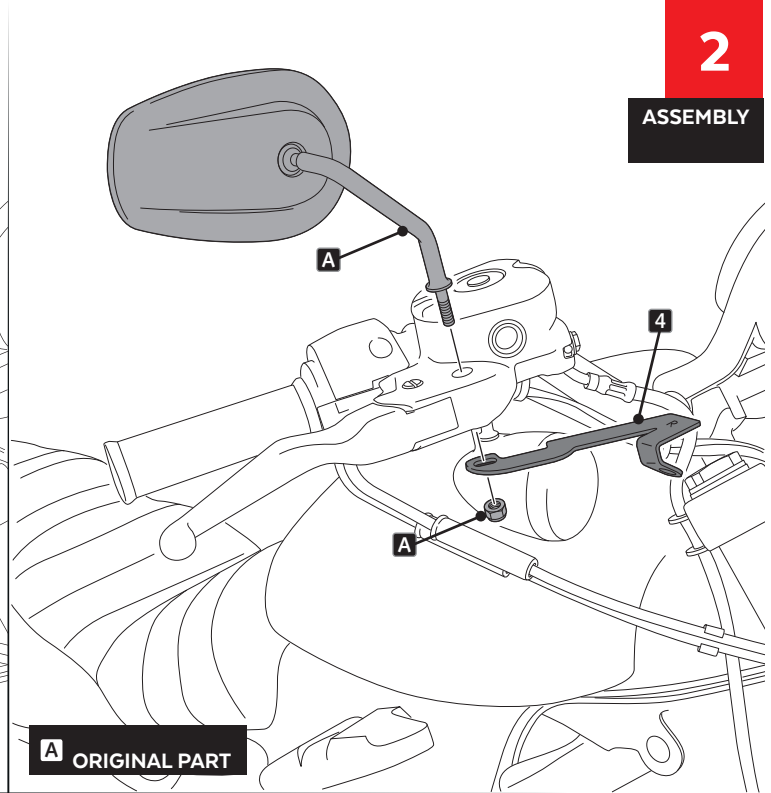
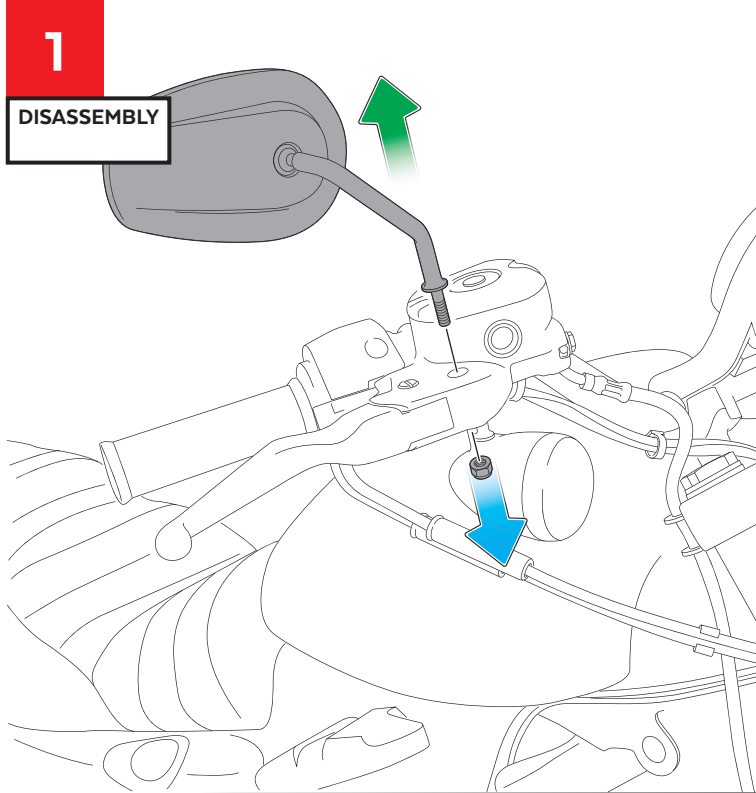

CustomAcces

HARLEY DAVIDSON SPORTSTER 883

MOUNTING INSTRUCTIONS

5

ASSEMBLY

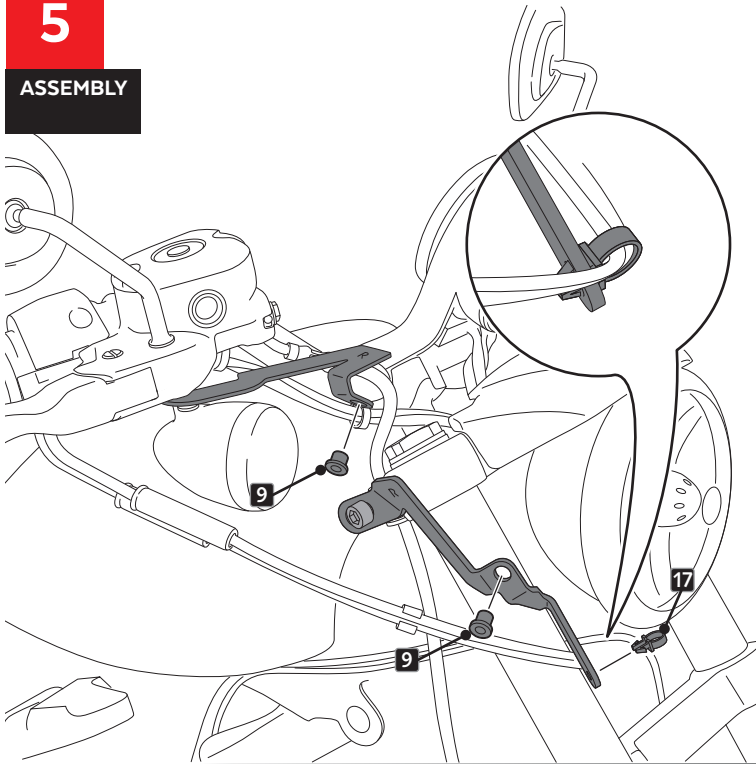

6

ASSEMBLY

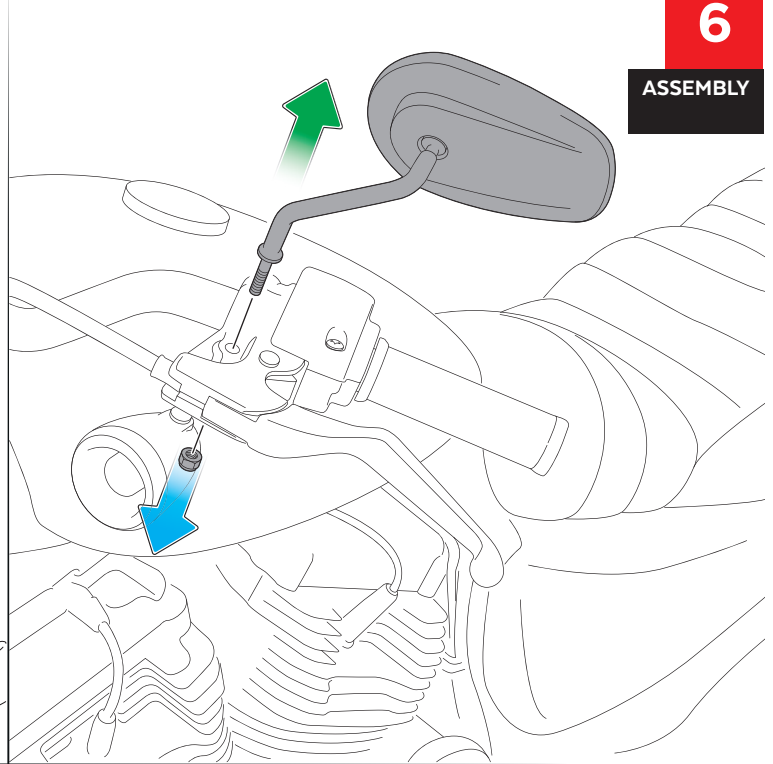

7

ASSEMBLY

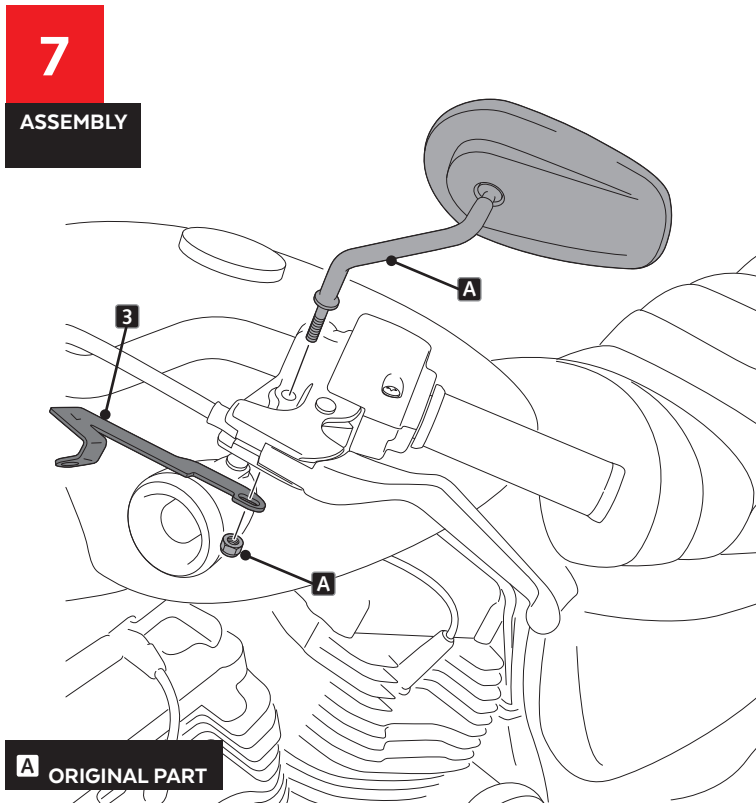

8

ASSEMBLY

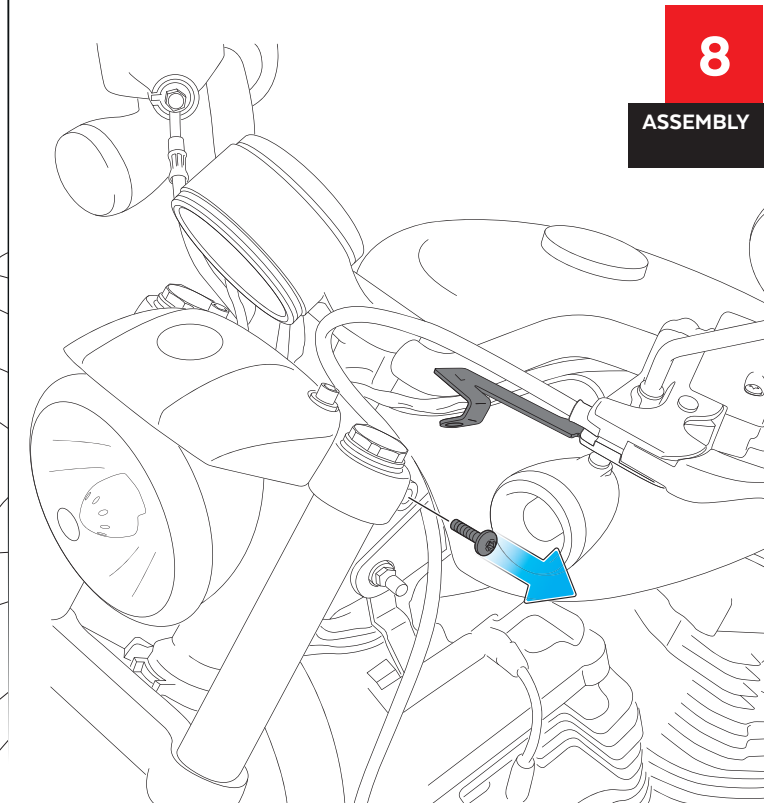

A ORIGINAL PART

CustomAcces

HARLEY DAVIDSON SPORTSTER 883

MOUNTING INSTRUCTIONS

9

ASSEMBLY

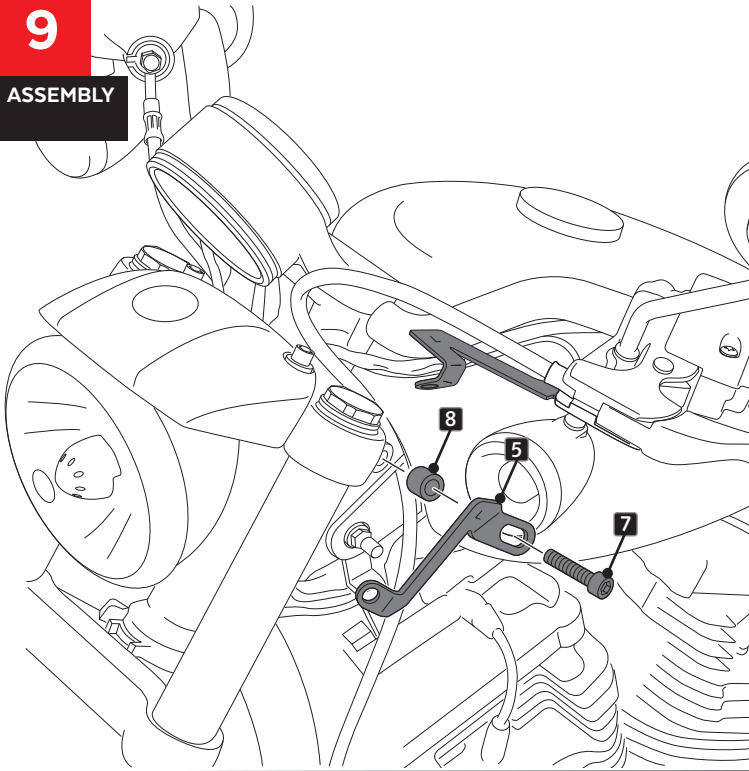

10

ASSEMBLY

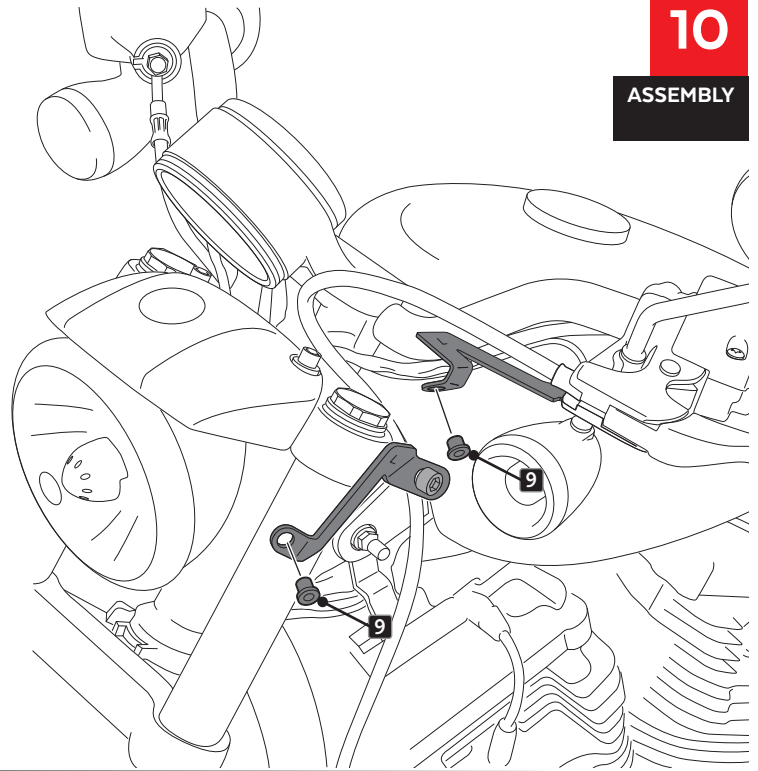

11

ASSEMBLY

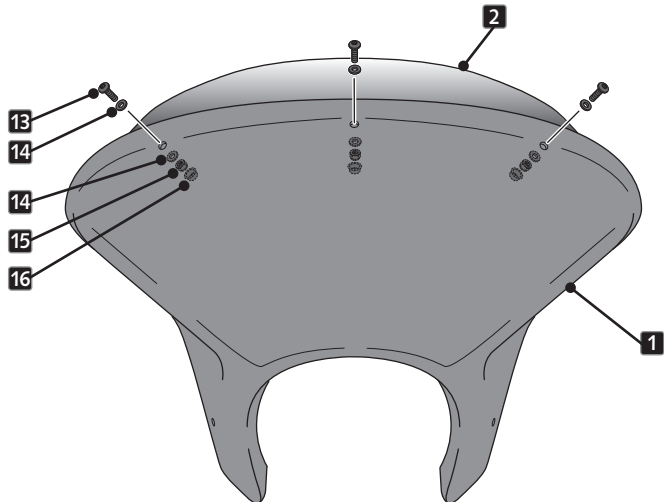

12

ASSEMBLY

