

Items Supplied >

1 – FRONT EXHAUST HEADPIPE W/ HEATSHIELD
1 – REAR EXHAUST HEADPIPE W/ HEATSHIELD
1 – EXHAUST BRACKET
1 – EXHAUST MUFFLER
4 – CLAMPS, HS-24
2 – CLAMPS, HS-28
2 – CLAMPS, 27-61 MSC
2 – BOLT, HEX 5/16-18 x 5/8"
2 – SCREW, BUTTON ¼-20 x 3/8"
2 – BILLET MUFFLER TIPS

Application(s) >

KAWASAKI VN900

06-13

Instruction Manual >

4718 – 4818 – 4918

Page 1 of 2

PRIOR TO INSTALLATION, MAKE SURE YOUR STOCK HEADPIPE GASKETS ARE IN GOOD SHAPE. IF YOU HAVE ANY DOUBTS AS TO THEIR CONDITION, REPLACE THEM.

Read all instructions carefully and completely before installing your new exhaust system

1. Remove stock exhaust system and remove stock upper and lower exhaust mounts on the right side frame rail, retain 2 flange bolts from stock upper bracket for later reinstallation. The two stock exhaust brackets will not be used in combination with the Cobra Exhaust System.
2. Loosen and move the right side floorboard assembly out of the way to ease installation of the exhaust.
3. Remove the exhaust bracket from the box and mount it to the motorcycle frame using the stock bolts retained in Step 1, but **DO NOT TIGHTEN** at this time, see Figure 1.
4. Install the front and rear head pipes onto the motorcycle using the supplied Cobra flanges and stock acorn nuts. Make sure the pipes are parallel to each other. **DO NOT TIGHTEN.**
5. Remove the muffler assembly from the box and slide two supplied 27 - 61MSC clamps onto the muffler tubes. The clamps should be orientated as shown in Figure 1. Slide the muffler onto the head pipes by tapping it onto the head pipes with your hand as you push the mufflers forward making sure the muffler slides as far forward as possible. Secure the muffler to the exhaust-mounting bracket using the supplied 5/16-18 bolts but **DO NOT TIGHTEN.**
6. Make sure the muffler assembly is parallel to the ground (this is critical) then tighten the following in order: exhaust bracket to the frame, muffler assembly to the exhaust bracket, head pipe flanges to the motor (slowly tighten opposing acorn nut) and muffler clamps. (NOTE: If the muffler clamps are slid to far up the muffler or past the three slots, the clamps will not tighten.)
7. On the front and rear heatshields unscrew the remaining hose clamps and feed the tail end of the clamp through the clips on the inside. The screw end of the hose clamps should be accessible for tightening but not visible when the heatshields are mounted to the pipes.
8. To install the front heatshield, first slide the rear portion of the heatshield over the muffler, continue to slowly slide it forward pushing the front of the shield gently into place between the frame and motor (Hint: Spread the hose clamps apart slightly to make it easier to slide them over the muffler assembly and head pipes). Snug the heatshield clamps but **DO NOT TIGHTEN.**
9. Install the rear heatshield the same way as the front heatshield.

CONTINUE TO NEXT PAGE!

** Cobra® recommends you always wear a helmet while riding. Please never operate your motorcycle while under the influence of alcohol and/or drugs. Enjoy the new look of your motorcycle and please ride safely.*

10. Install one billet tip on each heatshield making sure the ends of the tips are parallel with each other. On Slashdown models, make sure the angled ends of the tips are parallel with each other. Fasten the tips with the supplied $\frac{1}{4}$ " x 20 buttonhead screws making sure they snug up against the heatshield leaving no gap between the tip and heatshield when tightened. **If it is difficult to slide the tips into the heatshields loosen the clamps on the heatshield and adjust until aligned, avoiding this may cause damage to the chrome tips.**
11. Tighten the clamps on the heatshields.
12. Reinstall the right side floorboard assembly; tighten the bolts to factory specifications.
13. Make sure all the hardware (brackets, headpipes, heatshields, and baffles) have been tightened and cleaned before starting the motorcycle.

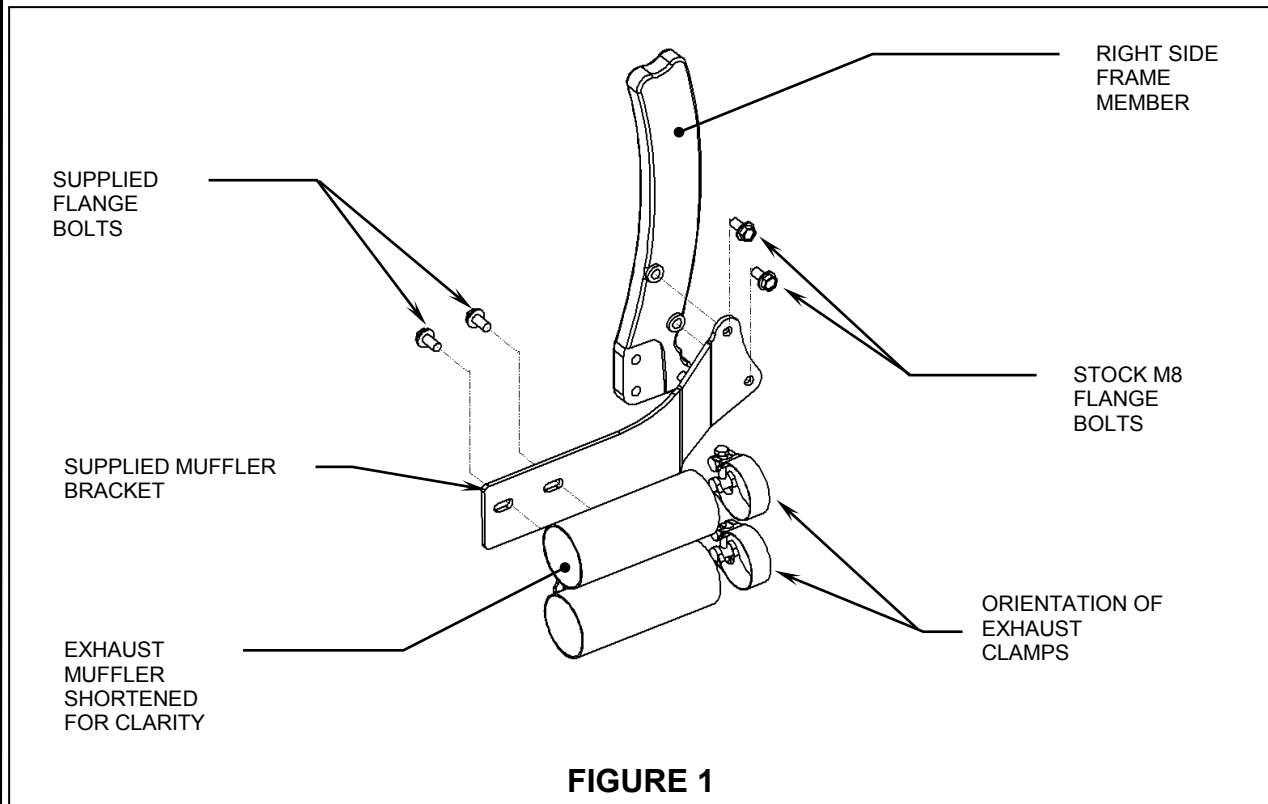

FIGURE 1

IMPORTANT: Cobra highly recommends using a Fi2000® Fuel Management System to help eliminate lean conditions and popping sounds. Cobra Part# 92-1968.

Before starting your engine remove all fingerprints from chrome with a quality wax or chrome polish. Failure to do so can cause discoloration. Due to fluctuations in fuel injection/carburetion settings, timing, etc., Cobra Engineering does not warrant against chrome discoloration.

California does not allow the use of aftermarket exhaust systems that remove original equipment catalyts, (except for racing use only) unless the Air Resources Board has issued an Executive Order for that system.