

BULLY



Chrome Trim & Accessories



BULLY™ BULL BARS

**MIRROR POLISHED
STAINLESS STEEL**

Mandrel Bent 3" Tubing - Seamless Weld

- All kits include removable mirror polished stainless steel skid plate
- Each kit is custom designed for each vehicle with no drilling
- Pre-drilled holes for optional auxiliary lights

CHEVY / GMC / CADILLAC

NR-101	92-94	GM Full Size Blazer/Jimmy
	88-98	GM C/K Full Size Truck 1500
	88-00	GM C/K Full Size Truck 2500/3500
	92-99	GM Suburban
	95-99	GM Tahoe/Yukon
NR-102	99-06	GM Silverado/Sierra 1500
	2007	GM Silverado/Sierra 1500 (Classic Edition)
	00-06	GM Suburban/Tahoe 1500
	00-06	GM Yukon XL/Yukon 1500
	01-06	GM Avalanche 1500 (With or Without Cladding)
NR-103	99-06	GM Silverado/Sierra 2500LD
	2007	GM Silverado/Sierra 2500LD (Classic Edition)
	01-06	GM Silverado/Sierra 1500HD/2500HD/3500
	2007	GM Silverado/Sierra 1500HD/2500HD/3500 (Classic Edition)
	00-06	GM Suburban/Tahoe 2500
NR-104	00-06	GM Yukon XL/Yukon 2500
	01-06	GM Avalanche 2500 (With or Without Cladding)
	07-11	GM Silverado/Sierra 1500
NR-105	07-11	GM Escalade
NR-106	07-11	GM Avalanche 1500
	07-11	GM Suburban/Tahoe 1500
	07-11	GM Yukon XL/Yukon/Yukon Denali 1500
	07-11	GM Avalanche 2500
NR-107	07-11	GM Suburban/Tahoe 2500
	07-11	GM Yukon XL/Yukon 2500
	04-07	GM Colorado/Canyon
NR-108	07-11	GM Silverado/Sierra 2500HD/3500

NISSAN

NR-601	05-11	Frontier
	05-11	Pathfinder
	05-11	X-Terra
NR-602	04-11	Armada
	04-11	Titan

FORD

NR-301	97-02	Expedition 4WD
	99-02	Expedition 2WD
	97-03	F150/250LD, 4WD
	2004	F150/250LD, 4WD (Heritage Model)
	99-03	F150/250LD, 2WD
	01-03	F150 Super Crew
NR-302	00-06	Excursion
	99-04	F250/350/450/550 Superduty
NR-303	04-08	F-150
NR-304	05-07	F250/350/450/550 Superduty
NR-305	08-11	F250/350/450/550 Superduty
NR-306	09-11	Ford F-150

DODGE

NR-201	94-01	Ram 1500 (Excl. 99-01 Sport Models)
	94-02	Ram 2500/3500 (Excl. 99-02 Sport Models)
NR-202	02-05	Ram 1500
	03-08	Ram 2500/3500
	06-09	Ram MEGA CAB
	06-08	Ram 1500
NR-204	09-11	Ram 1500
NR-205	10-11	Ram 2500/3500

TOYOTA

NR-401	01-up	Sequoia
	99-06	Tundra
NR-402	03-11	4-Runner
NR-403	05-11	Tacoma
NR-404	07-11	FJ Cruiser
NR-405	07-11	Tundra

HONDA

NR-801	06-11	Ridgeline
---------------	-------	-----------

HUMMER

NR-901	06-11	H3
---------------	-------	----





BULLY
TM

STEP XTR[®] BARS

EASY TO INSTALL - NO DRILLING REQUIRED

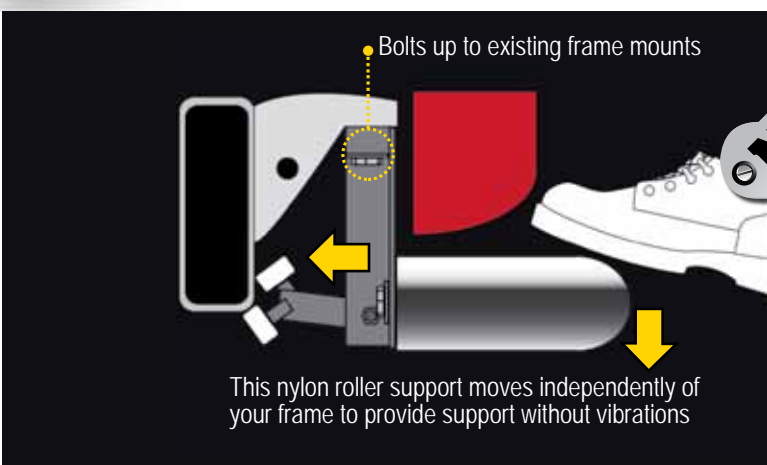

NEW

**THE PERFECT DOOR GUARD
TO PROTECT
YOUR TRUCK**
Stainless Steel Construction

**UP TO 410 LBS
SOLID SUPPORT**

- Bolts up solid to existing body mounts
- Durable finish - will not rust
- Strong - sturdy support system
- Style & function

NB-XTR Applications

CHEVY / GMC	
99-11	Silverado, Sierra 1500 Extended Cab
04-11	Silverado, Sierra 1500 Crew Cab
01-11	Silverado, Sierra 2500 HD, 3500 Extended Cab
01-11	Silverado, Sierra 2500 HD, 3500 Crew Cab
00-11	Suburban, Tahoe, Yukon XL, Yukon
DODGE	
02-2008	Dodge Ram Quad Cab 1500
03-2008	Dodge Ram Quad Cab 2500, 3500



Also available in black powder coated steel. To order add "B" to the part number (example: NB-XTRB)

STAINLESS STEEL STEP BARS

Polished and Black Powder Coated

Bully Step Bars are a step above the rest. They are made of the highest quality materials and are backed by our lifetime warranty. Bully step bars are mandrel bent for a smooth appearance. They go through a 6 stage polishing process to create a mirror like shine. The stainless retention clips will not rust, this guarantees a strong bond between the bar and step pad. Bully Step Bars have been designed to use existing holes in the truck's frame, so no drilling is required on most vehicles and mounting is as easy as possible. All of these features combine to ensure that Bully Step Bars will add a rugged, finished appearance to your truck...*for the life of your truck.*

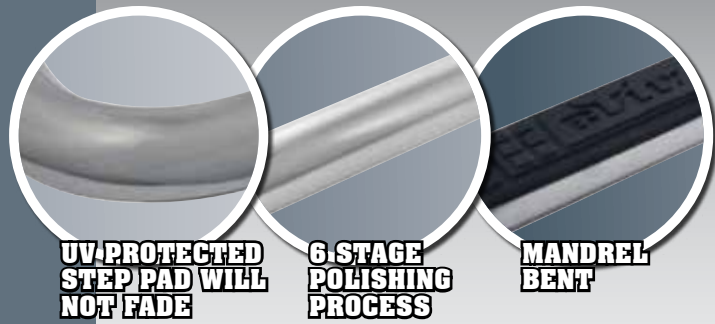

CHEVY / GMC		
NB-101	88-98	GM C/K Full size Standard Cab 1500/2500/3500 2 Door
NB-102	88-98	GM C/K Full size Extended Cab 1500/2500/3500 2 Door
NB-103	99-11	GM Silverado/Sierra Standard Cab 1500 2 Door
	01-11	GM Silverado/Sierra Standard Cab 2500HD/3500 2 Door
NB-104	99-00	GM Silverado/Sierra Extended Cab 1500/2500LD 3 Door
NB-105	00-11	GM Silverado/Sierra Extended Cab 1500/2500LD 4 Door
	01-11	GM Silverado/Sierra 2500HD/3500 Extended Cab 4 Door
NB-106	00-11	GM Suburban/Yukon XL 1500 4 Door
	04-11	GM Avalanche 1500 (Without Clad Molding) 4 Door
NB-107	00-11	GM Tahoe/Yukon 1500 4 Door
NB-109	01-11	GM Silverado/Sierra 1500HD/2500HD/3500 Crew Cab 4 Door
	04-11	GM Silverado/Sierra 1500 Crew Cab 4 Door
NB-111	82-03	GM S-Series P/U 2 Door/3 Door
NB-112	01-03	GM S-Series P/U Crew Cab 4 Door
NB-113	01-08	GM Trailblazer/Envoy 4 Door
NB-114	02-06	GM Avalanche 1500 (With Clad Molding) 4 Door
NB-120	03-11	Hummer H2 4 Door
NB-121	04-06	GM Colorado/Canyon Crew Cab 4 Door

FORD / LINCOLN		
NB-301	97-03	Ford F-150/250LD Standard Cab 2 Door
	2004	Ford F-150/250LD Standard Cab 2 Door (Heritage Model)
NB-302	97-98	Ford F-150/250LD Extended Cab 3 Door
NB-303	99-03	Ford F-150/250LD Extended Cab 4 Door
	2004	Ford F-150/250LD Extended Cab 4 Door (Heritage Model)
NB-304	01-03	Ford F-150 Super Crew 4 Door
NB-305	99-11	Ford F-250/350SD Extended Cab 4 Door
NB-306	99-11	Ford F-250/350/450/550SD Crew Cab 4 Door
NB-307	99-11	Ford F-250/350/450/550SD Standard Cab 2 Door
NB-308	02-05	Ford Explorer 4 Door
NB-319	04-08	Ford F-150 Standard Cab 2 Door
NB-320	04-08	Ford F-150 Extended Cab 4 Door
NB-321	04-08	Ford F-150 Super Crew 4 Door
	06-08	Lincoln Mark LT 4 Door
NB-322	09-11	Ford F-150 Standard Cab 2 Door
NB-323	09-11	Ford F-150 Extended Cab
NB-324	09-11	Ford F-150 Super Crew 4 Door

STAINLESS STEEL STEP BARS

Also available in black powder coated steel.
To order add "B" to the part number
(example: NB-101B)



Lifetime warranty applies to stainless steel bars. Black powder coated bars have a 3 year warranty.



BULLY
TM

DODGE

NB-201	94-01	Ram 1500 Std. Cab 2 Door
NB-201	94-02	Ram 2500 / 3500 Std. Cab 2 Door
NB-202	94-01	Ram 1500 / 2500 / 3500 Club Cab 2 Door
NB-203	98-01	Ram 1500 Quad Cab 4 Door
	98-02	Ram 2500 / 3500 Quad Cab 4 Door
NB-204	00-04	Dakota Quad Cab 4 Door
NB-209	02-08	Ram 1500 Standard Cab 2 Door
	03-up	Ram 2500 / 3500 Std. Cab 2 Door
NB-210	02-08	Ram 1500 Quad Cab 4 Door
	03-09	Ram 2500 / 3500 Quad Cab 4 Door
NB-211	05-11	Ram Dakota Quad Cab 4 Door
NB-212	04-08	Durango 4 Door
NB-213	06-08	Ram Mega Cab 1500 / 2500 / 3500 4 Door
NB-214	09-11	Ram 1500 Standard Cab 2 Door
NB-215	09-11	Ram 1500 Quad Cab 4 Door
NB-216	09-11	Ram 1500 Crew Cab 4 Door

NISSAN

NB-604	04-11	Titan King Cab 4 Door
NB-605	04-11	Titan Crew Cab 4 Door
NB-606	05-11	Frontier King Cab 4 Door
NB-607	05-11	Frontier Crew Cab 4 Door

TOYOTA

NB-401	01-04	Tacoma Crew Cab 4 Door
NB-402	99-06	Tundra Ext. Cab 4 Door
NB-403	95-04	Tacoma Ext. Cab 4WD 2 Door
NB-408	04-06	Tundra Double Cab 4 Door
NB-409	05-11	Tacoma Ext. Cab 4 Door
NB-410	05-11	Tacoma Crew Cab (Short Bed) 4 Door
NB-411	05-11	Tacoma Crew Cab (Long Bed) 4 Door
NB-412	07-11	Tundra Ext. Cab 4 Door
NB-413	07-11	Tundra Crew Max 4 Door
NB-414	06-11	FJ Crusier

JEEP

NB-506	97-06	Wrangler 2 Door
NB-507	05-06	Wrangler Unlimited 4 Door
NB-508	07-11	Wrangler 2 Door
NB-509	07-11	Wrangler Unlimited 4 Door

4' OVAL STEP BARS

Stainless Steel

CHEVY / GMC

NC-105	00-11	GM Silverado/Sierra Extended Cab 1500/2500LD 4 dr.
	01-11	GM Silverado/Sierra 2500HD/3500 Extended Cab 4 dr.
NC-106	00-11	GM Suburban/Yukon XL 1500 4 Door
	04-11	GM Avalanche 1500 (With Out Clad Molding) 4 Door
NC-107	00-11	GM Tahoe/Yukon 1500 4 Door
NC-109	01-11	GM Silverado/Sierra 1500HD/2500HD/3500 Crew Cab 4 Door
	04-11	GM Silverado/Sierra 1500 Crew Cab 4 Door

FORD

NC-303	99-03	F-150/250LD Extended Cab 4 Door
	2004	F-150/250LD Extended Cab 4 Door (Heritage Model)
NC-304	01-03	F-150 Super Crew 4 Door
NC-305	99-up	F-250/350SD Extended Cab 4 Door
NC-306	99-up	F-250/350/450/550SD Crew Cab 4 Door
NC-320	04-08	F-150 Super Cab 4 Door
NC-321	04-08	F-150 Super Crew 4 Door
NC-323	09-11	F-150 Super Cab 4 Door
NC-324	09-11	F-150 Super Crew 4 Door

DODGE

NC-210	02-08	Ram Quad Cab 1500 4 Door
	03-09	Ram Quad Cab 2500/3500 4 Door
NC-215	09-11	Ram Quad Cab 1500
NC-216	09-11	Ram Crew Cab 1500

TOYOTA

NC-401	04-06	Tundra Double Cab 4 Door
NC-409	05-11	Tacoma Extended Cab 4 Door
NC-410	05-11	Tacoma Crew Cab (Short Bed) 4 Door
NC-412	07-11	Tundra Double Cab 4 Door
NC-413	07-11	Tundra Crew Max 4 Door
NC-414	07-11	FJ Cruiser

NISSAN

NC-604	04-11	Titan King Cab 4 Door
NC-605	04-11	Titan Crew Cab 4 Door

HUMMER

NC-902	06-11	H3
--------	-------	----



- 4' Oval Tubing provides style and wider surface area
- Made from high grade Stainless Steel
- Extra wide step pad for a more secure footing
- Mirror Polished finish available

UV PROTECTED STEP PAD WILL NOT FADE OR CRACK



WHEEL-TO-WHEEL BARS

Stainless Steel

CHEVY / GMC

NB-152	00-11	Silverado / Sierra 1500 Ext. Cab 4 Door (SB)
	01-11	Silverado / Sierra 2500HD / 3500 Ext. Cab 4 Door
NB-153	01-11	Silverado / Sierra 1500HD / 2500HD / 3500 Crew Cab 4 Door (SB)

FORD

NB-351	99-03	F-150 / 250 LD Ext. Cab 4 Door (SB)
NB-352	99-11	F-250 / 350 Super Duty Ext. Cab 4 Door (SB)
NB-353	99-11	F-250 / 350 / 450 / 550 Super Duty Crew Cab 4 Door (SB)
NB-354	01-03	F-150 Supercrew 4 Door (SB)
NB-355	04-08	F-150 Ext. Cab 4 Door (SB)
NB-356	04-08	F-150 Supercrew 4 Door (SB)

DODGE

NB-251	02-08	Ram Quad Cab 1500 4 Door (SB)
	03-09	Ram Quad Cab 2500 / 3500 4 Door (SB)
NB-252	98-01	Ram Quad Cab 1500 4 Door (SB)
	98-02	Ram Quad Cab 2500 / 3500 4 Door (SB)



Also available in black powder coated steel. To order add "B" to the part number (example: NB-101B)

CURVED ENDS FOR A CLEANER LOOK

These Wheel-To-Wheel Bars are designed to enhance the truck's appearance. They feature curved ends and welded end caps for a cleaner look.



EXCLUSIVE! UNIVERSAL ADJUSTABLE STEP

Patent# 6,663,125

AS-500 Sold In Pairs

These revolutionary steps can be mounted on most trucks or S.U.V.'s and can be adjusted to the height of the vehicle. From stock to lifted trucks, the cog gear design allows the perfect high adjustment. They are made of a strong lightweight material that will never rust and are warranted for the life of the product.

- Mirror Polished T-304 3" Stainless Steel Tubing
- Non-Slip High Impact Plastic Step Pad
- Polished Die-Cast T-6 Aluminum Brackets
- Solid Frame Supported Chassis Mount
- Multi-Level Adjustment For Different Vehicle Height Settings

350 LBS
CAPACITY



BULLY
TM

CHEVY

73-87	Full Size Truck / Blazer
76-91	Suburban
88-98	C/K Full Size Truck Std. Cab, Ext. Cab, Crew Cab
92-99	Suburban / Tahoe 1500 / 2500
99-11	Silverado 1500 / 2500 Std. Cab, Ext. Cab
01-11	Silverado 2500 / 3500 (Heavy Duty) Std. Cab, Ext. Cab, Crew Cab

GMC

73-87	Full Size Truck / Blazer
76-91	Suburban
88-98	C/K Full Size Truck Std. Cab, Ext. Cab, Crew Cab
92-99	Suburban / Yukon 1500 / 2500
99-11	Sierra 1500 / 2500 Std. Cab, Ext. Cab
01-11	Sierra 2500 / 3500 (Heavy Duty) Std. Cab, Ext. Cab, Crew Cab

FORD

97-11	F-150 / 250LD Std. Cab, Ext. Cab
99-11	F-250 / 350 / 450 / 550SD (Super Duty) STD. Cab, Ext. Cab
97-11	Expedition
00-08	Excursion
01-11	F-150 Supercrew

DODGE

74-93	Ram
94-01	Ram 1500 Std. Cab, Club Cab, Quad Cab
94-02	Ram 2500 / 3500 Std. Cab, Club Cab, Quad Cab
02-11	Ram 1500 Std. Cab, Quad Cab
03-11	Ram 2500 / 3500 Std. Cab, Club Cab, Quad Cab
97-11	Dakota Std. Cab, Ext. Cab, Quad Cab
98-11	Durango

NISSAN

86-99	Pick-Up
87-99	Pathfinder

TOYOTA

74-95	Pick-Up
-------	---------



TRUCK BED SIDE STEP

Patent Pending

New revolutionary Truck Bed Step allows easy access to the front of the bed and tool boxes. Constructed from heavy duty Powder Coated Steel and Anodized Cast Aluminum.

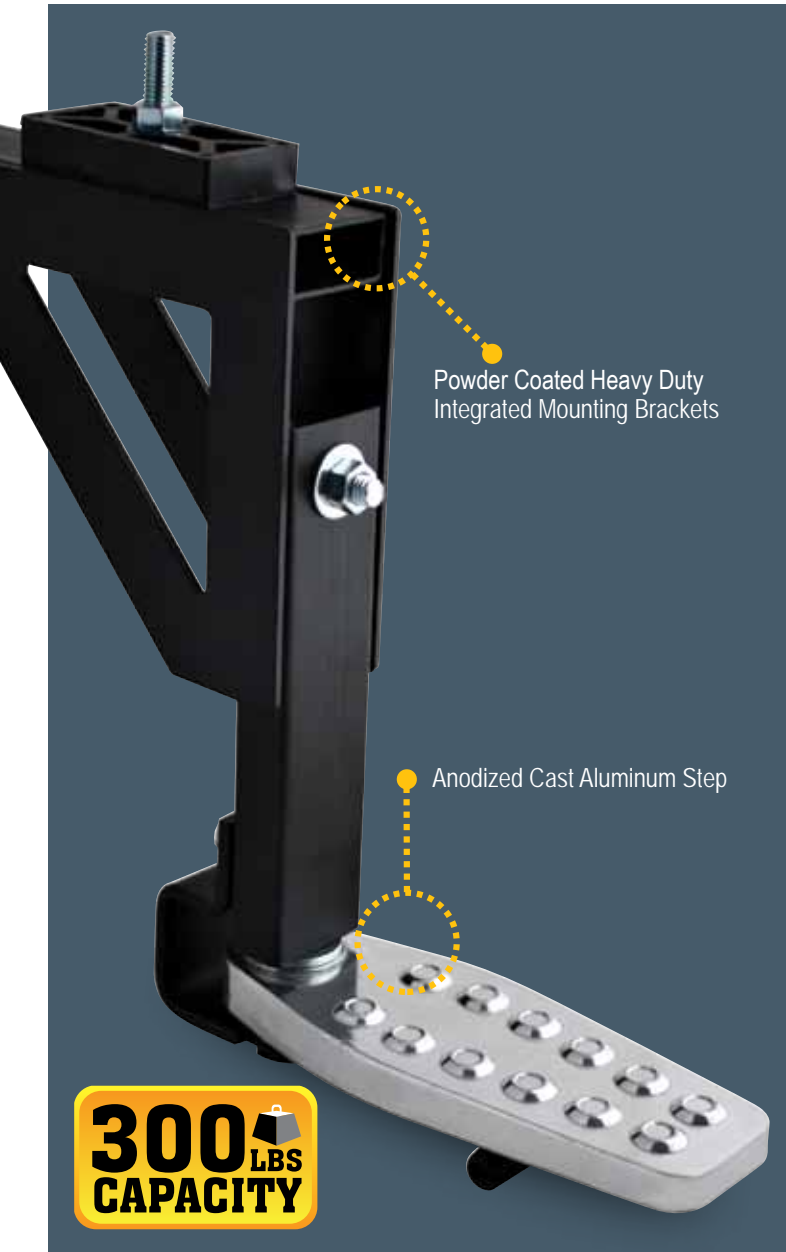

Powder Coated Heavy Duty Integrated Mounting Brackets

Anodized Cast Aluminum Step

AS-550

Truck Bed Side Step

- Installs on both driver and passenger side
- Some applications require a single hole to be drilled for installation



CHEVY / GMC

88-00	GM C/K Truck 1500/2500/3500
99-07	Silverado/Sierra 1500/2500LD (Classic Edition)
01-07	Silverado/Sierra 1500HD, 2500HD, 3500 (Classic edition)
07-11	Silverado/Sierra 1500/2500HD/3500

FORD

86-96	F-150
86-98	F-250
97-03	F-150 / 250LD
2004	F-150 (Heritage)
99-11	F-250 / 350 Super Duty
04-11	F-150 / F-150 Supercrew

DODGE

94-02	Ram 2500 / 3500
02-up	Ram 1500
03-up	Ram 2500 / 3500

ALUMINUM STEPS

AS-200

Aluminum Step

- Solid Mount
- Non-Slip Step Pad
- Strong, Lightweight and Paintable
- 200 LBS Capacity

FORD

81-98	F-Series Super Duty Pick-Ups
81-96	F-150 / 250 Pick-Ups
95-96	F-150 Lightning



AS-400

Chrome Steel Step

- Fits most trucks, SUV's and vans*
- Diamond Stamped Surface
- Triple Chrome Plated
- Sold in single units



EXCLUSIVE! ADJUSTABLE TAILGATE HITCH STEP

Patent Pending

AS-55 I

- Collapsible design slides and rotates 180 degrees for easy storage
- Easily extends and locks into place
- Powder coated heavy duty steel construction
- Fits 2" hitch receivers

400 LBS
CAPACITY



1/8" Thick Dimpled
Stainless Steel Step Plate

BULLYTM

ALUMINUM STEP



AS-600

Aluminum Step

- Solid Mount
- Non-Slip Step Pad
- Strong, Lightweight and Paintable

350 LBS
CAPACITY

CHEVY / GMC

99-11	Silverado / Sierra 1500 / 2500LD (All Doors)
01-11	Silverado / Sierra 1500 / 2500 / 3500HD (All Doors)
02-11	Avalanche 1500 (All Doors)
88-99	Full Size C/K Truck 1500 / 2500 / 3500 (All Doors)
86-00	Full Size C/K Crew Cab (All Doors)
92-99	Suburban / Tahoe / Yukon
76-91	Suburban
73-87	Full Size Pick-Ups
76-93	S-10 / Sonoma Pick-Ups / Blazer / Jimmy

FORD

67-96	Full Size Vans
99-11	F-250 / 350 / 450 / 550 Super Duty (Front Only)
00-11	Excursion (Front Only)
01-11	F-150 Supercrew (All Doors)
97-11	F-150 / 250LD Pick-Up (All Doors)
97-02	Expedition (All Doors)
67-80	Full Size Pick-Ups / Bronco
91-01	Explorer (Exclude Eddie Bauer)
75-02	Full Size E-Series Van

NISSAN

98-up	Frontier (All Doors)
00-up	X-terra (All Doors)
86-01	Pathfinder
86-97	Hard Body
72-86	Pick-Up

DODGE

02-11	Ram 1500 (All Doors)
03-11	Ram 2500 / 3500 (All Doors)
94-11	Ram 1500 (All Doors)
94-02	Ram 2500 / 3500 (All Doors)
97-11	Dakota (All Doors)
74-93	Full Size Pick-Ups
74-92	Ram Charger
83-91	Raider

JEEP

93-98	Grand Cherokee
-------	----------------

ISUZU

84-02	Trooper
91-02	Amigo
89-93	Pick-Up
91-02	Rodeo

MITSUBISHI

78-94	Pick-Up
83-99	Montero

MAZDA

91-94	Navajo
83-93	B Series Pick-Up

HITCH MOUNTED STEP



CR-605 Multi-purpose Utility Step

The 605 series has all the same attributes as the 600 series except that they now include a removable adaptor that allows the step to fit both 1 1/4" & 2" hitch receivers.

CR-600 Multi-purpose Utility Step

This Hitch Mounted Utility Step Allows You to Gain Easy access to Luggage Racks, Truck Beds or SUV Interiors. It fits All Standard 2" Hitch Receivers.



CR-605L Multi-purpose Utility Step

This hitch step has all the attributes of the CR-605, but with the added safety feature of an integrated L.E.D. brake light.

CR-600L Multi-purpose Utility Step

The Patented CR-600L has a Built-In Red L.E.D. Light Strip Which Acts as an Additional Brake Light.

BOLT-ON BILLET GRILLES

Easy To Install

- Mounts Easily Over Existing Stock Grille
- Machined from T-6 Billet Aluminum
- High Polish Finish

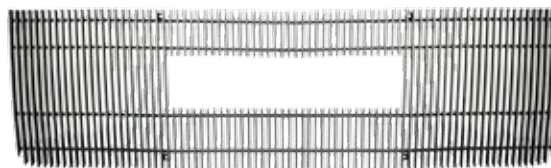
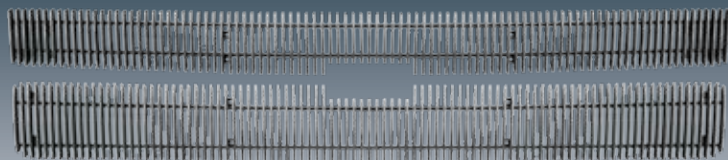

Shown is BG-458

BILLET
TM

CHEVY

BG-152	94-98	C/K Pick-up 1500/2500/3500
	94-99	Suburban/ Tahoe
BG-153	99-02	Silverado 1500/2500
	00-06	Suburban/Tahoe
BG-154	03-05	Silverado 1500/1500HD
	04-06	Avalanche (Without Clad Molding)
	03-04	Silverado 2500HD/3500
BG-155	02-06	Avalanche (With Clad Molding)
BG-156	04-up	Colorado
BG-157	05-07	Silverado 2500HD/3500 (Classic Edition)
	06-07	Silverado 1500/1500HD (Classic Edition)
BG-158	07-up	Suburban/Tahoe (Horizontal)
	07-up	Avalanche (Horizontal)
BG-159	07-up	Suburban/Tahoe (Vertical)
	07-up	Avalanche (Vertical)
BG-160	07-up	Silverado 1500 (Horizontal)
BG-161	07-up	Silverado 1500 (Vertical)
BG-162	07-up	Silverado 2500HD/3500 (Horizontal)
BG-163	07-up	Silverado 2500HD/3500 (Vertical)

CADILLAC

BG-851	03-06	Cadillac Escalade (Vertical)
BG-852	03-06	Cadillac Escalade (Horizontal)

CHRYSLER

BG-575	05-up	300 (Horizontal)
BG-576	05-up	300 (Vertical)

HUMMER

BG-751	03-up	H2 (Without OE Brush Guard)
BG-752	05-up	H3

DODGE

BG-351	94-01	Ram 1500 (Except Sport model)
	94-02	Ram 2500/3500 (Except Sport model)
BG-352	02-05	Ram 1500
	03-05	Ram 2500/3500
BG-353	02-05	Ram 1500 (Bumper Insert)
	03-05	Ram 2500/3500 (Bumper Insert)
BG-354	97-04	Dakota
	98-03	Durango
BG-355	05-up	Dakota
BG-356	06-08	Ram 1500/2500/3500 (Horizontal)
BG-357	06-08	Ram 1500/2500/3500 (Vertical)
BG-375	05-up	Magnum
BG-376	06-up	Charger

GMC

BG-452	99-02	Sierra 1500/2500
	00-06	Yukon XL/Yukon
BG-453	03-06	Sierra 1500/1500HD/2500/3500
	2007	Sierra 1500/1500HD/2500/3500 (Classic Edition)
BG-454	04-up	Canyon
BG-455	07-up	Yukon/Yukon XL (Horizontal)
BG-456	07-up	Yukon/Yukon XL (Vertical)
BG-457	07-up	Sierra 1500 (Horizontal)
BG-458	07-up	Sierra 1500 (Vertical)
BG-459	07-up	Sierra 2500HD/3500 (Horizontal)
BG-460	07-up	Sierra 2500HD/3500 (Vertical)

JEEP

BG-520	07-up	Wrangler
---------------	-------	----------

FORD

BG-251	99-03	F-150/250LD (Honeycomb grill)
	01-03	F-150 Supercrew (Honeycomb grill)
	2004	F-150/250LD Heritage (Honeycomb grill)
BG-252	99-04	F-250/350 SuperDuty (3pc. Kit)
BG-253	99-03	F-150/250LD (Bar grill)
	2004	F-150/250LD Heritage (Bar grill)
BG-254	99-03	F-150/250LD (Bumper Insert)
	2004	F-150/250LD Heritage (Bumper Insert)
BG-255	03-06	Expedition
BG-256	03-06	Expedition (Bumper insert)
BG-257	04-08	F-150 (Honeycomb grill) (Flush mount)
BG-258	04-08	F-150 (Honeycomb grill) (Contoured mount)
BG-259	04-08	F-150 (Bar grill)
BG-260	04-08	F-150 (Bumper Insert)
BG-261	05-07	F-250/350 Superduty (6pc. Kit)
BG-262	05-up	Mustang GT
BG-263	05-up	Mustang (Non GT)
BG-264	07-up	Expedition
BG-265	08-up	F-250/350 Superduty

NISSAN

BG-651	04-07	Titan/Armada (3pc. Kit)
BG-652	04-07	Titan/Armada (Bumper Insert)
BG-653	05-up	Frontier/Pathfinder
BG-654	05-up	X-Terra
BG-675	05-06	Altima

TOYOTA

BG-951	05-up	Tacoma (3pc. Kit)
BG-952	05-up	Tacoma Bumper Insert
BG-953	06-up	FJ Cruiser
BG-954	07-up	Tundra

STAINLESS STEEL GRILLE INSERT



SG-241



99-03 Ford F-150 / 250LD (Bar Grill)
2004 Ford F-150 Heritage (Bar Grill)

SG-242



99-03 Ford F-150 / 250LD (Honeycomb Grill)
2004 Ford F-150 Heritage (Honeycomb Grill)

SG-243



04-Up Ford F-150 (Honeycomb Grill)

SG-261



99-03 Ford F-150 / 250LD (Bar Grill)
2004 Ford F-150 Heritage (Bar Grill)

SG-341



94-01 Dodge Ram 1500 (Except Sport Model)
94-02 Dodge Ram 2500 / 3500 (Except Sport Model)

SG-342



02-05 Dodge Ram 1500
03-05 Dodge Ram 2500 / 3500

SG-351



94-01 Dodge Ram 1500 (Except Sport Model)
94-02 Dodge Ram 2500 / 3500 (Except Sport Model)

SG-361



94-01 Dodge Ram 1500 (Except Sport Model)
94-02 Dodge Ram 2500 / 3500 (Except Sport Model)

STAINLESS STEEL GRILLE INSERT

Mirror Polished T-304 Stainless Steel
Mounts Over Existing Factory Grille
No Cutting Or Drilling Required

SG-131



94-98 Chevy C/K Full Size Truck 1500 / 2500 / 3500
94-99 Chevy Suburban / Tahoe

SG-132



99-02 Chevy Silverado 1500 / 2500LD
00-06 Chevy Suburban / Tahoe

SG-133



03-05 Chevy Silverado 1500 / 1500HD
04-06 Chevy Avalanche (Without Clad Molding)
03-04 Chevy Silverado 2500HD / 3500

SG-143



03-05 Chevy Silverado 1500 / 1500HD
04-06 Chevy Avalanche (Without Clad Molding)
03-04 Chevy Silverado 2500HD / 3500

SG-142



99-02 Chevy Silverado 1500 / 2500LD
00-06 Chevy Suburban / Tahoe

SG-141



94-98 Chevy C/K Full Size Truck 1500 / 2500 / 3500
94-99 Chevy Suburban / Tahoe

SG-161



94-98 Chevy C/K Full Size Truck 1500 / 2500 / 3500
94-99 Chevy Suburban / Tahoe

SG-162



99-02 Chevy Silverado 1500 / 2500LD
00-06 Chevy Suburban / Tahoe

SG-231



99-03 Ford F-150 / 250LD (Bar Grill)
2004 Ford F-150 Heritage (Bar Grill)

SG-462



99-02 GMC Sierra 1500 / 2500LD
00-06 GMC Yukon XL / Yukon

BULLY
TM

TONNEAU COVERS

SNAP TRAC TONNEAU COVER

Unique Plastic Snaps Secure Easily Into Track
Without The Hassles Of Alignment.

No Drill Installation With Clamp-on Tracks.

High Quality Automotive Grade, All Weather Vinyl.



Three center support bows provide a clean look & prevent water pooling.



Protect your cargo from the elements.





Secure Easily Into Track



Clamp-on aluminum track system makes for quick installation

APPLICATION CHART

PART #	YEAR	MAKE	MODEL	DESCRIPTION
CHEVROLET/GMC				
TNS-1001	1988-1998	Chevy/GMC	C/K	Std/Ext Cab, 6.5' Short Bed Fleetside
TNS-1002	1999-2007	Chevy/GMC	Silverado/Sierra Classic	Std/Ext/Crew Cab, 6.5' Short Bed
TNS-1003	1994-2004	Chevy/GMC	S-10/Sonoma	Std/Ext Cab, 6' Short Bed
TNS-1004	1982-1993	Chevy/GMC	S-10/Sonoma	Std/Ext Cab, 6' Short Bed
TNS-1005	1999-2006	Chevy/GMC	Silverado/Sierra	Std/Ext Cab, 6.5' Short Bed Stepside*
TNS-1006	1988-1998	Chevy/GMC	C/K	Std/Ext Cab, 6.4' Short Bed Stepside*
TNS-1007	2004-2007	Chevy/GMC	Silverado/Sierra Classic	Crew Cab 1500, 5.8' Short Bed
TNS-1008	2004-2007	Chevy/GMC	Colorado/Canyon	Std/Ext Cab, 6' Short Bed
TNS-1009	2007-11	Chevy	Silverado	Std/Ext/Crew Cab, 6.6' Short Bed
TNS-1010	2007-11	Chevy	Silverado	Std/Ext/Crew Cab, 5.75' Bed
TNS-1011	2007-11	GMC	Sierra	Std/Ext/Crew Cab, 6.6' Short Bed
TNS-1012	2007-11	GMC	Sierra	Std/Ext/Crew Cab, 5.75' Bed
DODGE				
TNS-2001	2002-2008	Dodge	Ram 1500/2500/3500	Std/Ext/Quad/Mega Cab, 6.3' Short Bed w/o Spoiler*
TNS-2002	2000-2004	Dodge	Dakota	Quad Cab, 5' 4" Short Bed
TNS-2003	1994-2001	Dodge	Ram 1500/2500/3500	Std/Ext/Quad Cab, 6' Short Bed
TNS-2004	1997-2004	Dodge	Dakota	Std/Ext Cab, 6.4' Short Bed
TNS-2005	2005-2007	Dodge	Dakota	Std/Ext Cab, 6.5' Short Bed
TNS-2006	2009-11	Dodge	Ram	Crew Cab, 5.8' Bed
TNS-2007	2009-11	Dodge	Ram	Std/Quad Cab, 6.5' Bed
FORD				
TNS-3001	1997-2003	Ford	F-150	Std/Ext Cab, 6.5' Short Bed, Styleside
TNS-3002	1997-2003	Ford	F-150	Std/Ext Cab, 6.5' Short Bed, Flareside
TNS-3003	1999-2007	Ford	F-250/F-350/F-450	Std/Ext/Crew Cab, 6.5' Short Bed
TNS-3004	2004-2007	Ford	F-150	Std/Ext Cab, 6.5' Short Bed, Styleside
TNS-3005	2001-2003	Ford	F-150	Supercrew Cab, 5.5' Short Bed
TNS-3006	1993-2007	Ford	Ranger	Std/Ext Cab, 6' Short Bed
TNS-3007	2004-2007	Ford	F-150	Supercrew Cab, 5.5' Short Bed
TNS-3008	2008-11	Ford	F-250 Super Duty	Std/Ext/Crew Cab, Short Bed, W/Tailgate Step
TNS-3009	2009-11	Ford	F-150	Std/Ext/Crew Cab, 5.5' Short Bed
TNS-3010	2009-11	Ford	F-150	Std/Ext/Crew Cab, 6.5' Short Bed
NISSAN				
TNS-4001	2004-2008	Nissan	Titan	Crew Cab, 5.5' Short Bed
TNS-4002	2004-2008	Nissan	Titan	Extended (King) Cab, 6.5' Short Bed
TNS-4003	2005-2008	Nissan	Frontier	Crew Cab, 5' Short Bed
TNS-4004	2005-2008	Nissan	Frontier	King Cab, 6' Short Bed
TOYOTA				
TNS-5001	1995-2004	Toyota	Tacoma	Std/Ext Cab, Short Bed
TNS-5002	2005-2008	Toyota	Tacoma	Double Cab, 5' Short Bed
TNS-5003	2005-2008	Toyota	Tacoma	Access Cab, 6' Short Bed
TNS-5004	2004-2006	Toyota	Tundra	Double Cab, 6.2" Short Bed
TNS-5005	1999-2006	Toyota	Tundra	Access Cab, 6.2' Short Bed
TNS-5006	2007-11	Toyota	Tundra	CrewMax, 5.5' Short Bed
TNS-5007	2007-11	Toyota	Tundra	Regular/Double Cab, 6.5' Short Bed

*REQUIRES DRILLING FOR INSTALLATION

PERFORMANCE GRILLES

Bully's new performance grilles and bumper fillers offer a new way to enhance your vehicles appearance with a styledchrome look. All performance grilles & bumper fillers are a direct O.E.M. replacement.

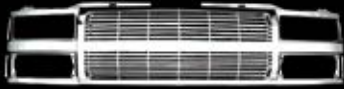

PFG-1101

94-02 CK Pick-Up 1500/2500/3500 (Composite Headlight)
94-99 Suburban/Tahoe

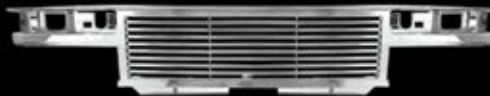

PFG-1103

98-04 S-10/Blazer (Base Model)

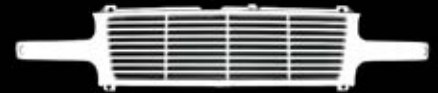

PFG-1105

99-02 Silverado 1500
00-06 Suburban/Tahoe



PFG-1205

99-02 Silverado 1500



PFG-1106

03-05 Silverado 1500
03-06 Silverado 2500HD/3500
02-06 Avalanche (w/o Body Cladding)



PFG-1604

06-07 Silverado 1500 (Classic Edition)



PFG-1607

04-07 Colorado/Canyon



PFG-5601

05-08 300 / 300C

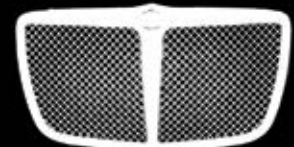

PFG-5901

05-08 300 / 300C



PFG-8301

02-06 Escalade
02-06 Escalade EXT
03-06 Escalade ESV



PFG-3102

94-01 Ram 1500
94-02 Ram 2500 / 3500



PFG-3103

02-05 Ram 1500
03-05 Ram 2500 / 3500



PFG-3302

02-05 Ram 1500
03-05 Ram 2500 / 3500



PFG-3603

06-up Ram 1500/2500/3500



PFG-4801

94-02 C/K Sierra 1500/2500/3500
94-99 Suburban/Yukon



PFG-4102

03-06 Sierra 1500/2500HD/3500



PFG-4201
94-02 C/K Sierra 1500/2500/3500
94-99 Suburban/Yukon



PFG-4601
94-02 C/K Sierra 1500/2500/3500
94-99 Suburban/Yukon



PFG-4603
07-up Yukon XL/Yukon



PFG-7001
02-04 Liberty



PFG-9601
07-09 Tundra



PFG-2101
97-98 F-150 / F-250LD
97-98 Expedition



PFG-2402
99-03 F-150
2004 F-150 Heritage
99-02 Expedition

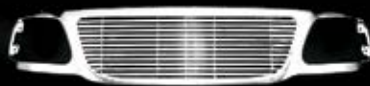

PFG-2102
99-03 F-150
2004 F-150 Heritage
99-02 Expedition



PFG-2103
04-08 F-150
06-07 Lincoln Mark LT



PFG-2603
04-08 F-150
06-07 Lincoln Mark LT



PFG-2104
99-04 F-250 / 350 Super Duty
00-04 Excursion



PFG-2504
99-04 F-250 / 350 Super Duty
00-04 Excursion



PFG-2604
05-07 F-250/350 Super Duty



PFG-2605
99-04 Ford F-250/350 Super Duty

STAINLESS STEEL DOOR HANDLE COVER KITS

- Constructed from T-304 Stainless Steel
- Custom designed to fit your vehicle
- Covers Door Handle and Housing
- Easy Peel-N-Stick Installation

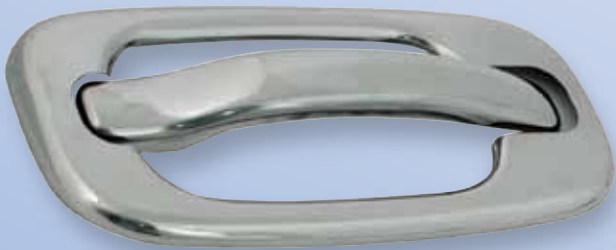

CHEVY



TOYOTA



CHEVY



BEFORE

AFTER



FORD

CHEVY / GMC

SDK-101	88-98	GM C/K Truck 1500/2500/3500 (With Passenger Key Hole)	Reg Cab & Ext Cab	2 Door	4 Piece Kit
SDK-102	88-00	GM C/K Truck 1500/2500/3500 (With Passenger Key Hole)	Crew Cab	4 Door	8 Piece Kit
	92-99	GM Suburban, Tahoe, Yukon (With Passenger Key Hole)			
SDK-103	99-06	Silverado/Sierra 1500/2500LD (With Passenger Key Hole)	Reg Cab & Ext Cab	2 Door	4 Piece Kit
	2007	Silverado/Sierra 1500/2500LD (With Passenger Key Hole) Classic Edition			
	01-06	Silverado/Sierra 2500HD, 3500 (With Passenger Key Hole)			
	2007	Silverado/Sierra 2500HD, 3500 (With Passenger Key Hole) Classic Edition			
SDK-104	01-06	Silverado/Sierra 1500HD, 2500HD, 3500 (With Passenger Key Hole)	Crew Cab	4 Door	8 Piece Kit
	2007	Silverado/Sierra 1500HD, 2500HD, 3500 (With Passenger Key Hole) Classic Edition			
	00-03	Suburban, Tahoe, Yukon, Yukon XL (With Passenger Key Hole)			
	02-03	Avalanche (With Passenger Key Hole)			
SDK-105	04-06	Silverado/Sierra 1500/2500LD (Without Passenger Key Hole)	Reg Cab & Ext Cab	2 Door	4 Piece Kit
	2007	Silverado/Sierra 1500/2500LD (Without Passenger Key Hole) Classic Edition			
	04-06	Silverado/Sierra 2500HD, 3500 (Without Passenger Key Hole)			
	2007	Silverado/Sierra 2500HD, 3500 (Without Passenger Key Hole) Classic Edition			
SDK-106	04-06	Silverado/Sierra 1500, 1500HD, 2500HD, 3500 (Without Passenger Key Hole)	Crew Cab	4 Door	8 Piece Kit
	2007	Silverado/Sierra 1500, 1500HD, 2500HD, 3500 (Without Passenger Key Hole) Classic Edition			
	04-06	Suburban, Tahoe, Yukon, Yukon XL (Without Passenger Key Hole)			
	04-06	Avalanche (Without Passenger Key Hole)			
SDK-107	07-up	Silverado/Sierra 1500/1500HD/2500HD/3500 (Without Passenger Key Hole)	Reg Cab & Ext Cab	2 Door	6 Piece Kit
SDK-108	07-up	Silverado/Sierra 1500, 1500HD, 2500HD, 3500 (Without Passenger Key Hole)	Crew Cab	4 Door	12 Piece Kit
	07-up	Suburban, Tahoe, Yukon, Yukon XL (Without Passenger Key Hole)			
	07-up	Avalanche (Without Passenger Key Hole)			

TOYOTA

SDK-701	05-up	Tacoma	Reg Cab & Ext Cab	2 Door	4 Piece Kit
SDK-702	05-up	Tacoma	Crew Cab	4 Door	8 Piece Kit
SDK-703	07-up	Tundra	Reg Cab & Ext Cab	2 Door	4 Piece Kit
SDK-704	07-up	Tundra	Crew Cab	4 Door	8 Piece Kit

STAINLESS STEEL DOOR HANDLE COVER KITS



BULLY
TM

FORD					
SDK-201	97-03	F-150/250LD	Reg Cab & Ext Cab	2 Door	4 Piece Kit
	2004	F-150 (Heritage)			
SDK-202	01-03	F-150 SuperCrew	Crew Cab	4 Door	8 Piece Kit
	97-02	Expedition with Integrated Key Pad		4 Door	8 Piece Kit
SDK-203	99-up	F-250/350 SD (With Passenger Key Hole)	Reg Cab & Ext Cab	2 Door	4 Piece Kit
SDK-204	99-up	F-250/350 SD (With Passenger Key Hole)	Crew Cab	4 Door	8 Piece Kit
	00-up	Excursion (With Passenger Key Hole)	4 Door	8 Piece Kit	
SDK-205	04-08	F-150 (With Passenger Key Hole)	Reg Cab & Ext Cab	2 Door	4 Piece Kit
SDK-206	04-08	F-150 SuperCrew (With Passenger Key Hole)	Crew Cab		
SDK-207	04-08	F-150 with Integrated Key pad (Without Passenger Key Hole)	Reg Cab & Ext Cab	2 Door	4 Piece Kit
SDK-208	04-08	F-150 with Integrated Key pad (Without Passenger Key Hole)	Crew Cab	4 Door	8 Piece Kit
DODGE					
SDK-302	02-08	Ram 1500 (With Passenger Key Hole)	Reg Cab	2 Door	4 Piece Kit
	03-08	Ram 2500, 3500 (With Passenger Key Hole)			
SDK-303	02-08	Ram 1500 (With Passenger Key Hole)	Quad Cab	4 Door	8 Piece Kit
	03-08	Ram 2500, 3500 (With Passenger Key Hole)			
SDK-304	02-08	Ram 1500 (Without Passenger Key Hole)	Reg Cab	2 Door	4 Piece Kit
	03-08	Ram 2500, 3500 (Without Passenger Key Hole)			
SDK-305	02-08	Ram 1500 (Without Passenger Key Hole)	Quad Cab	4 Door	8 Piece Kit
	03-08	Ram 2500, 3500 (Without Passenger Key Hole)			
	04-08	Durango (Without Passenger Key Hole)		4 Door	8 Piece Kit
NISSAN					
SDK-601	04-up	Titan (Without Passenger Key Hole)	Reg Cab & Ext Cab	2 Door	4 Piece Kit
SDK-602	04-up	Titan (Without Passenger Key Hole)	Crew Cab	4 Door	8 Piece Kit

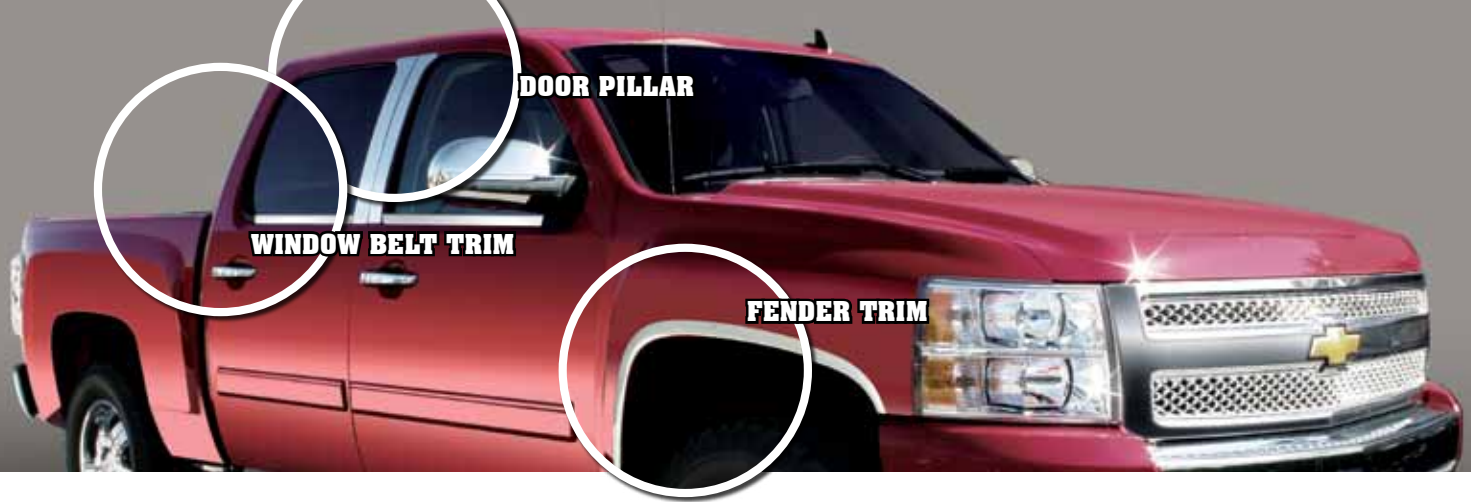

STAINLESS STEEL WINDOW BELT

- Made out of T-504 stainless steel
- Easy peel and stick

CHEVY/GMC		
SDW-101	99-06	GM Silverado/Sierra 1500/2500HD/3500 (Std & Ext Cab 2 Door)
SDW-102	00-06	GM Silverado/Sierra 1500/2500HD/3500 (Crew Cab 4 Door)
SDW-103	00-06	GM Tahoe/Yukon
SDW-104	07-up	GM Silverado/Sierra 1500/2500HD/3500 (Std & Ext Cab 2 Door)
SDW-105	07-up	GM Silverado/Sierra 1500/2500HD/3500 (Crew Cab 4 Door)

STAINLESS STEEL DOOR PILLARS

NO DRILLING

- Made out of T-504 stainless steel
- Each kit is custom designed for each vehicle
- Easy peel and stick

CHEVY / GMC		
SDP-103	00-06	Suburban/Tahoe/Yukon XL/Yukon
	02-06	Escalade/Escalade EXT/Escalade ESV
SDP-104	00-06	Silverado/Sierra 1500/2500HD/3500 (Extended Cab 2 Door)
SDP-105	00-06	Silverado/Sierra 1500/2500HD/3500 (Crew Cab 4 Door)
SDP-106	07-up	Silverado/Sierra 1500/2500HD/3500 (Extended Cab 2 Door)
SDP-107	07-up	Silverado/Sierra 1500/2500HD/3500 (Crew Cab 4 Door)
	07-up	Suburban/Tahoe/Yukon XL/Yukon
SDP-108	07-up	Avalanche
	07-up	Escalade
CHRYSLER		
SDP-501	05-up	300/300C
DODGE		
SDP-302	02-08	Ram1500 (Quad Cab 4 Door)
	03-09	Ram 2500/3500 (Quad Cab 4 Door)

FORD		
SDP-201	01-03	F-150 Supercrew
SDP-202	04-08	F-150 Supercrew
SDP-203	99-07	F-250/350 Superduty (Crew Cab 4 Door)
SDP-204	08-up	F-250/350 Superduty (Crew Cab 4 Door)
SDP-205	98-02	Expedition/Navigator
SDP-206	03-up	Expedition/Navigator
NISSAN		
SDP-601	04-up	Titan (Crew Cab 4 Door)
TOYOTA		
SDP-901	07-up	Tundra (Crew Max 4 Door)

STAINLESS STEEL FENDER TRIMS

ADD STYLE

- Patented easy mounting clip mounts securely without drilling for most applications
- Made out of T-304 stainless steel

CHEVY / GMC		
WF-2201	83-94	Blazer / Jimmy
WF-2210	73-87	Full Size C/K Pick-Up
WF-2203	88-98	Full Size C/K Pick-Up 1500 / 2500 / 3500
WF-2203L	88-98	Full Size C/K Pick-Up 1500 / 2500 / 3500
WF-2220	99-06	Silverado / Sierra 1500 / 2500 / 3500
WF-2220L	99-06	Silverado / Sierra 1500 / 2500 / 3500
WF-2203	92-99	Suburban
WF-2203L	92-99	Suburban
WF-2220	00-06	Suburban / Yukon XL
WF-2220L	00-06	Suburban / Yukon XL
WF-2203	92-99	Tahoe / Yukon
WF-2218	95-99	Tahoe / Yukon
WF-2221L	00-06	Tahoe / Yukon
WF-2202	82-93	S-10 / S-15 / Sonoma
WF-2211	94-03	S-10 / S-15 / Sonoma
WF-2211L	94-03	S-10 / S-15 / Sonoma
WF-2223L	07-up	Silverado 1500
WF-2224L	07-up	Sierra 1500
WF-2225	07-up	Tahoe / Yukon
WF-2226	07-up	Suburban / Yukon XL

DODGE		
WF-2107	94-01	Ram 1500
WF-2107	94-02	Ram 2500 / 3500
WF-2107L	94-01	Ram 1500
WF-2107L	94-02	Ram 2500 / 3500
WF-2109	02-07	Ram 1500
WF-2109	03-07	Ram 2500 / 3500
WF-2110	09-up	RAM 1500 (NON HEMI MODEL)
FORD		
WF-2614	80-86	F-150 / F-250 / F-350
WF-2601	87-96	F-150 / F-250 / F-350
WF-2619	97-03	F-150
WF-2620	99-07	F-250 / F-350 Superduty
WF-2621	04-07	F-150
WF-2621L	04-07	F-150
WF-2619	97-02	Expedition
WF-2622	03-06	Expedition
WF-2623	02-05	Explorer
WF-2624	08-up	F-250 / 350

STAINLESS STEEL MIRROR COVERS

MADE OF T304 STAINLESS STEEL

Covers Factory Side Mirrors
Easy Peel-N-Stick Installation

CHEVY / GMC			APPS.	DOOR	PIECES
SDM-102C	99-06	Silverado/Sierra 1500/2500LD		ALL	2
	01-06	Silverado/Sierra 1500HD, 2500HD, 3500	Standard Mirror	ALL	2
	2007	Silverado/Sierra 1500,1500HD, 2500HD, 3500 (Classic Edition)	Non Towing	ALL	2
	00-06	Suburban, Tahoe, Yukon, Yukon XL		ALL	2
	01-06	Avalanche		ALL	2
DODGE			APPS.	DOOR	PIECES
SDM-302C	02-08	Ram 1500	Standard Mirror	ALL	2
	03-09	Ram 2500, 3500	Non Towing	ALL	2
FORD			APPS.	DOOR	PIECES
SDM-201C	97-03	F-150/250LD	Without Edge	ALL	2
	2004	F-150 (Heritage)	Turn Signal	ALL	2
	01-03	F-150 SuperCrew		ALL	2
SDM-202	99-07	F-250/350 SD	Standard Mirror	ALL	2
	00-06	Excursion	Non Towing	4	2
SDM-203	99-07	F-250/350 SD	Towing Mirror (Telescopic)	ALL	2
SDM-204	04-08	F-150	XLT/FX4/LARIAT	ALL	2
	04-08	F-250/350 Super Duty		ALL	2



BULLY
TM

STAINLESS STEEL LOGO TRIMS

PRECISION CUT

Mirror Polished

3M Peel-and-Stick Installation

Custom Look and Fit



FLAMES	STANDARD	CHEVY / GMC	
SDX-101D	ST-101D	99-02	Silverado 1500 Door Emblem Trim 2 Pieces Included
SDX-102D	ST-102D	01-06	Silverado 2500 / 3500 Door Emblem Trim 2 Pieces Included
SDX-122T	ST-122T	99-06	Silverado / Suburban / Tahoe "Chevrolet" Tailgate Emblem 1 Piece Included
SDX-123T	ST-123T	99-06	Silverado 1500 / 1500HD / 2500HD "Silverado" Tailgate Emblem 1 Piece Included
FLAMES	STANDARD	FORD	
SDX-202F	ST-202F	97-03	F-150 "XL / XLT" Fender Emblem 2 Pieces Included
SDX-203F	ST-203F	97-03	F-150 "XLT Triton V8" Fender Emblem 2 Piece Included
SDX-204F	ST-204F	99-04	F-250 / 350 "Superduty XL / XLT" Fender Emblem 2 Pieces Included
SDX-221T	ST-221T	97-03	F-150 "F-150" Tailgate Emblem 1 Piece Included
SDX-222T	ST-222T	01-03	F-150 Supercrew "Supercrew Logo" Tailgate Emblem 1 Piece Included
SDX-223T	ST-223T	99-04	F-250 / 350 Superduty F-250 / 350 "Superduty" Tailgate Emblem 1 Piece Included
SDX-226T	ST-226T		Universal Ford Logo 6" "Ford Oval" Tailgate Emblem 1 Piece Included
FLAMES	STANDARD	DODGE	
SDX-301D	ST-301D	94-01	Ram 1500 / 2500 / 3500 "V8" and "V-10" Door Emblem 2 Pieces Included

STAINLESS STEEL TAILGATE HANDLE

Made Of T304 Stainless Steel
Covers Door Handle And Housing
Easy Peel-n-stick Installation



CHEVY / GMC			APPS.	DOOR	PIECES
SDT-101	88-98	GM C/K Truck 1500 / 2500 / 3500	ALL	ALL	2
SDT-102	2007	Silverado/Sierra 1500 (Classic Edition)	ALL	ALL	2
	01-06	Silverado/Sierra 1500HD, 2500HD, 3500	ALL	ALL	2
	2007	Silverado/Sierra 1500HD, 2500HD, 3500 (Classic Edition)		ALL	2
SDT-103	00-06	Suburban, Tahoe, Yukon, Yukon XL	Liftgate Window	ALL	2
SDT-104	00-06	Suburban, Tahoe, Yukon, Yukon XL	Cargo Door	ALL	2
SDT-105	07-up	Silverado/Sierra 1500/2500/3500 (Without Lock)	ALL	ALL	2
SDT-106	07-up	Silverado/Sierra 1500/2500/3500 (With Lock)	ALL	ALL	2
SDT-108	92-99	GM Suburban / Tahoe	Cargo Door	ALL	2
	99-00	Cadillac Escalade	Cargo Door	ALL	2
FORD			APPS.	DOOR	PIECES
SDT-201	97-03	F-150/250LD	ALL	ALL	2
	2004	F-150 (Heritage)	ALL	ALL	2
	01-03	F-150 SuperCrew	ALL	ALL	2
	99-07	F-250/350 Super Duty	ALL	ALL	2
SDT-202	04-up	F-150	ALL	ALL	2
	04-up	F-150 SuperCrew	ALL	ALL	2
	08-up	F-250/350 Super Duty	ALL	4	2
DODGE			APPS.	DOOR	PIECES
SDT-302	02-08	Ram 1500	ALL	ALL	2
	03-09	Ram 2500, 3500	ALL	ALL	2
TOYOTA			APPS.	DOOR	PIECES
SDT-701	05-up	Tacoma	ALL	ALL	2
SDT-702	07-up	Tundra w/o Back up Camera	ALL	ALL	2



STAINLESS STEEL FUEL DOOR COVERS

Made of T-304 Stainless Steel
Covers Factory Side Fuel Door
Easy Peel-N-Stick Installation
Polished or Brushed Finishes



CHEVY / GMC		
SDG-101	91-98	C/K Pick-up 1500, 2500, 3500
	92-99	Suburban
	94-99	Tahoe/Yukon
SDG-102	99-06	Silverado/Sierra 1500/2500LD
	01-06	Silverado/Sierra 1500HD, 2500, 3500
	00-11	Suburban, Yukon XL
	00-06	Tahoe, Yukon
	01-11	Avalanche
SDG-103	07-11	Tahoe/Yukon
SDG-104	07-11	Silverado/Sierra 1500
SDG-105	04-08	Colorado / Canyon
DODGE		
SDG-301	94-01	Ram 1500
	94-02	Ram 2500, 3500
	97-04	Dakota
SDG-302	02-08	Ram 1500
	03-09	Ram 2500, 3500
SDG-303	09-11	Ram 1500, 2500, 3500
SDG-501	05-11	Dodge Magnum
SDG-502	02-07	Jeep Liberty

FORD		
SDG-201	97-03	F-150/250LD
	2004	F-150 (Heritage)
	99-11	F-250/350 Super Duty
	97-06	Expedition
	00-06	Excursion
SDG-202	04-08	F-150
	04-08	F-150 SuperCrew
SDG-203	09-11	F150
SDG-251	98-03	Mustang
SDG-252	05-08	Mustang
CHRYSLER		
SDG-501	05-11	300
TOYOTA		
SDG-401	03-06	Tundra
SDG-402	07-11	Tundra
NISSAN		
SDG-601	04-11	Titan

Also available in Brushed. To order add "B" to the part number (example: SDG-101B)



BILLET FUEL DOORS

Bully's billet aluminum gas doors are of the highest quality. They provide a quick way to give your truck or suv a custom look.

No drilling or cutting
Stainless steel hardware
Anodized, chrome and chrome
with lock models available

CHEVY / GMC		
GD-101	91-98	C/K Pick-Up 1500 / 2500 / 3500
	92-99	Suburban
	94-99	Tahoe / Yukon
GD-102	99-00	Escalade
	99-00	Yukon Denali
	99-06	Silverado / Sierra 1500
	01-06	Silverado / Sierra 1500HD / 2500 / 3500
	00-06	Suburban / Yukon XL / Denali XL
GD-110	00-06	Tahoe / Yukon / Yukon Denali
	02-06	Avalanche
	02-06	Escalade / Escalade EXT
	03-06	Escalade ESV
GD-103	03-05	Hummer H2 With Lock
GD-103	07-11	Silverado / Sierra 1500 / 2500HD / 3500
GD-104	07-11	Tahoe / Yukon / Suburban / Escalade
GD-105	07-11	Avalanche / Escalade ESV / Escalade EXT

FORD		
GD-301	94-01	Ram 1500
	94-02	Ram 2500 / 3500
	97-05	Dakota
GD-302	02-08	Ram 1500
	03-09	Ram 2500 / 3500
GD-303	09-11	Ram 1500 / 2500 / 3500
DODGE		
GD-201	97-03	F-150 / 250LD (EXC Supercrew)
	2004	F-150 (Heritage)
	99-11	F-250 / 350 Superduty
	00-06	Excursion
	97-02	Expedition / Navigator
GD-202	03-06	Expedition / Navigator
	04-08	F150 (EXCLUDE Flareside)
GD-203	09-11	F150
TOYOTA		
GD-401	07-11	Tundra
JEEP		
GD-801	97-06	Wrangler

P = Anodized
C = Chrome plated

CK = Chrome plated with lock



UNIVERSAL AIR VENTS

Bully's new line of Universal Fender & Hood Air Vents captures the look and style of today's performance look.

- Triple Chrome Plated
- Easy Peel & Stick Installation

A. CZ-222

Oval Fender ABS Air Vent

- 6 Piece Kit

B. CZ-223

Diamond Fender ABS Air Vent

- 6 Piece Kit

C. CZ-240E

Super Mesh Body Accents

- 6 Piece Kit

D. CZ-256

Universal Fender Ports

- 6 Piece Kit

E. CZ-4007

Touring Edition Fender Accent

F. TT-003

Dual Fin ABS Fender Air Vent

G. TT-008

Single Fin ABS Fender Air Vent

H. TT-009

Single Fin Mldsize ABS Fender Air Vent

I. TT-012C / TT012DF

Single Fin Mldsize ABS Fender Air Vent

J. TT-013C / TT013DF

Dual Fin Mldsize ABS Fender Air Vent

K. CZ-242C

Universal Body Air Vent

L. CZ-288B

Pro-Street Hood Scoop



M. CZ-4008
Universal Mini Hood Scoop



N-O. TT-014C / TT-014DF
Vector Hood Scoop

- Chrome or Dry Carbon Finish
- Ingergrated Mesh Grille

P. CZ-277B
Vector Hood Scoop



STAINLESS STEEL TRIBAL FLAME TRIMS

Made Of T304 Stainless Steel

Mirror Polished
Easy Peel-N-Stick Installation

BULLY
TM



TT-051 UNIVERSAL FLAME



A-D. TT-085 Heavy Duty, TT-086 Sport Edition,
TT-087 Limited Edition, TT-088 El Jefe



Stainless Steel Hitch Ornament
E. ST-701P Accent for Your Ball Mount / Hitch cover



Universal Flame Emblems
F. TT-051 Large 1 Piece
G. TT-152 Small 1 Piece



Licensed Flame Emblem
H. TT-151 Chevy Flame Emblem
I. TT-351 Dodge Flame Emblem



Dual Layer Emblem
J. TT-091 Bull Skull

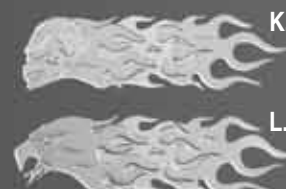

K-L. TT-081 Flame Skull
TT-082 Flame Eagle



M. TT-089 Universal Truck Body Accent

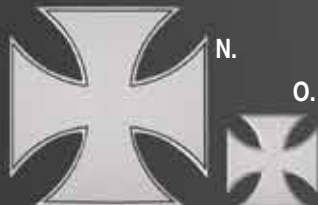

Cross Trims
N. TT-061 Large Iron Cross Trim
O. TT-062 Small Iron Cross Trim



P. TT-097 Trucker Girl Includes 2 Pieces

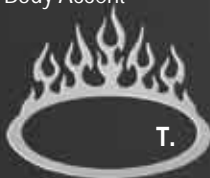

Ford Oval Flame Emblems
S. TT-201 Large 6" 1 Piece
T. TT-202 Small 4" 1 Piece
U. TT-203 FORD Oval Flame
04-08 FORD F-150 (Not Shown)



Q. TT-093 Charging Bull



R. TT-090 Cross



Skull Trims
V. TT-071 ABS Plastic 3D Skull Trim
W. TT-062 Skull & Crossbones Trim
X. TT-092 Dual Layer Skull & Crossbones Trim



Tailgate Handle Flame Kit
Y. TT-002 Small Includes 2 Pieces
Designed to Fit 97-03 F-Series

NOVELTY HITCH

COVERS • Fits 1.25" and 2" Hitch Receivers
• Chrome Plated



CR-402
Propeller



CR-412
Baseball



CR-416
Soccer Ball



CR-413
Football

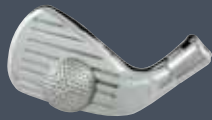

CR-418
Golf Club



CR-419
Auto Ice \$



CR-421
Cross

NOVELTY HITCH COVERS WITH LED LIGHT

• Fits 1.25" and 2" Hitch Receivers
• Chrome Plated



CR-018
Skull



CR-420L
Bull Skull



CR-402L
Propeller w/

LICENSED HITCH

COVERS • Fits 1.25" and 2" Hitch Receivers
• Triple Chrome Die-cast Metal



CR-141G - CR-141



CR-211



CR-132



CR-311



CR-004A



CR-005N



CR-690

LICENSED HITCH COVERS

• Custom Dual Layer Stainless Steel Hitch Covers
• Fits 1.25" and 2" Hitch Receivers



CRB-01A



CRB-02A



CRB-03A



CRB-04A



CRB-05A



CRB-06A



CRB-09



CRB-10



CRB-11



CRB-13



CRB-15



CRB-17

HITCH BRAKE LIGHT

• High impact ABS housing
• Fits most standard 2" hitches



CR-007



CR-007C



CR-007D



CR-007G



CR-007F

LED HITCH BRAKE LIGHT • Super Bright LED's • Fits most standard 2" hitches

CR-017C Chevy*



CR-017F Ford*



CR-017D Dodge*



CR-017G GMC*



* New versions feature colored LED accent lights which light up a design in front of the brake light

CR-017 Oval



CR-025 4" Square w/ multi-reflector



COLLEGIATE HITCH COVERS & HELMETS

- Officially licensed school logos and colors
- Fits into most standard 2" hitch receivers



CR-901
Nebraska
Cornhuskers



CR-902
Michigan
Wolverines



CR-903
Tennessee
Volunteers



CR-904
Texas
Longhorns



CR-905
Texas A&M
Aggies



CR-910
Kansas
Jayhawks



CR-911
Kansas City
Wildcats



CR-913
Clemson
Tigers



CR-915
Florida
Gators



CR-916
Florida State
Seminoles



CR-918
North Carolina
Tarheels



CR-924
Iowa
Hawkeyes



CR-922
Kentucky
Wildcats



CR-925
Michigan State
Spartans



CR-928
Oklahoma State
Cowboys



CR-931
LSU
Tigers



CR-935
University of
Missouri Tigers



CR-937
Oklahoma
Sooners



CR-938
University of
Virginia Cavaliers



CR-940
Washington State
Cougars



CR-943
Notre Dame
Fighting Irish



CR-949
North Carolina
State Wolfpack



CR-951
University of Miami
Hurricanes

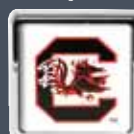

CR-953
University of South
Carolina Gamecocks



CR-960
Virginia Tech
Hokies



CR-944
Ohio State
Buckeyes



CR-H915
Florida
Gators



Hitch Covers (Patent 413,291)



CR-H907
Arkansas
Razorbacks



CR-H916
Florida State
Seminoles



CR-H930
Georgia
Bulldogs



CR-H910
Kansas
Jayhawks



CR-H903
Tennessee
Volunteers



CR-H905
Texas A&M
Aggies



CR-H901
Nebraska
Cornhuskers



CR-H937
Oklahoma
Sooners



CR-H911
Kansas State
Wildcats



CR-H922
Kentucky
Wildcats



CR-H931
LSU
Tigers



CR-H951
University
of Miami Hurricanes



CR-H902
Michigan
Wolverines



CR-H908
Alabama
Crimson Tide



CR-H919
Penn State
Nittany Lions



CR-H904
Texas
Longhorns



CR-H906
Texas Tech
Red Raiders



CR-H925
Michigan
State Spartans



CR-H935
University of
Missouri Tigers



CR-H918
North Carolina
Tarheels



CR-H949
North Carolina
State Wolfpack



CR-H953
University of South
Carolina Gamecocks



CR-H938
University of Virginia
Cavaliers



CR-H960
Virginia Tech
Hokies



CR-H939
Washington
Huskies



CR-H940
Washington
State Cougars



CR-H945
Oregon
Ducks



CR-H946
Oregon State
Beavers

BULLY™

PEDALS, LOCKS AND MIRRORS

TRUCK PEDALS



- Easy installation
- Fits most trucks and SUV's
- Non-slip textured aluminum alloy

FOR AUTOMATIC TRANSMISSION



BILLET MIRRORS

BTM-041P



BTM-031P



- Easily Replaces Factory Rear View Mirror
- CNC Machined From Aircraft Grade 6061 Billet Aluminum

- Mirrors Coated To Reduce Glare
- Polished and Anodized Finish
- Universal Fit



INTEGRATED O.E. TAILGATE LOCK Patent# 6,318,135

These Tailgate Locks Have Been Designed to Give Your Truck an O.E. Look While Securing the Tailgate To Help Prevent Theft. These Patented Tailgate Locks Are Perfect For Truck Caps and Tonneau Covers. Available for Chevy, GMC, Ford, and Dodge Applications.

- High Impact Plastic Bezel with the Original Factory Look
- Locks the Handle to Keep Tailgate from Opening



Shown LH-008



PART#	YR	APPLICATION
LH-002	88-98	GM Silverado / Sierra 1500 / 2500 / 3500
LH-003	99-06	GM Silverado / Sierra 1500 / 2500 / 3500
LH-004	87-96	Ford F-Series
LH-005	97-up	Dodge Dakota
LH-006	94-01	Dodge Ram 1500
	94-02	Dodge Ram 2500 / 3500
LH-007	02-08	Dodge Ram 1500
	03-09	Dodge Ram 2500 / 3500
LH-008	07-11	Silverado/Sierra 1500/2500HD/3500

CONTRACTOR CONSOLES

The Perfect Organizer For Bench & Bucket Seats

CN-108



- Spacious storage compartment helps you keep your vehicle clean and organized
- Removable waste basket can be placed on either side
- Removable flip-out coin tray to access hidden secret storage
- Dual adjustable cup holders are designed with a special spring push-button to easily insert, remove and secure your drinks.

CN-101



- For use in front or rear seat
- Use with bench seats or on the floor
- Jewel case holder for cds, dvds or video games
- Storage area for loose articles (cell phones, garage door openers, etc.)
- Padded armrest
- Two drink holders

124809



- Huge storage compartment is perfect for tools, paperwork, cell phones CD's and cassettes – Keeps your vehicle clean and organized
- Reinforced hinge and lid supports writing surface steady while writing
- Oversized dual adjustable cup holders secure different size cups and bottles
- Special spring-loaded push button design makes securing cups and bottles easy to insert

BULLY
TM



THIRD BRAKE LIGHT

DURABLE POLYCARBONATE LENS

- Integrated cargo light
- Clear / Smoke lens with free from reflector
- Installs in minutes using existing factory plug
- Add "S" for Smoke lens



TB-203



TB-102

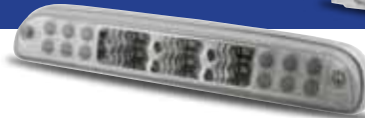

TB-202



TB-201



TB-301



TB-302



TB-204



TB-401



TB-601

CHEVY / GMC

TB-101	94-98	C/K Truck 1500 (Ext. Cab Only)
	94-00	C/K Truck 2500 / 3500 (Ext Cab Only)
TB-102	99-06	Silverado / Sierra 1500 (All Cab Styles)
	2007	Silverado / Sierra 1500 (All Cab Styles) (Classic Edition)
	01-06	Silverado / Sierra 2500 / 3500HD (All Cab Styles)
TB-103	00-06	Tahoe / Suburban / Yukon / Yukon XL (Liftgate Only)
	TB-104	07-up

FORD

TB-201	97-03	F-150 / 250LD (Std. Cab / Ext. Cab)
TB-202	01-03	F-150 Supercrew
TB-203	99-up	F-250 / 350 Super Duty (All Cab Styles)
	95-03	Ranger
TB-204	04-08	F-150 (All Cab Styles)
TB-205	09-up	F-150 (All Cab Styles)
TB-301	94-01	Ram 1500 (All Cabs Styles)
	TB-302	94-02
02-08		Ram 1500 (All Cab Styles)
03-09		Ram 2500 / 3500 (All Cab Styles)

TOYOTA

TB-401	99-06	Tundra
TB-402	07-11	Tundra (All Cab Styles)

NISSAN

TB-601	04-up	Titan
---------------	-------	-------

DIAMOND REFLECTOR SERIES

CHEVY / GMC

TB-101P	94-98	C/K Truck 1500 (Ext. Cab Only)
	94-00	C/K Truck 2500 / 3500 (Ext Cab Only)

FORD

TB-102P	99-06	Silverado / Sierra 1500 (All Cab Styles)
	2007	Silverado / Sierra 1500 (All Cab Styles) (Classic Edition)
	01-06	Silverado / Sierra 2500 / 3500HD (All Cab Styles)
	2007	Silverado / Sierra 2500 / 3500HD (All Cab Styles) (Classic Edition)
TB-201P	97-03	F-150 / 250LD (Std. Cab / Ext. Cab)
TB-302P	02-08	Ram 1500 (All Cab Styles)
	03-09	Ram 2500 / 3500 (All Cab Styles)



TB-101P



TB-302P

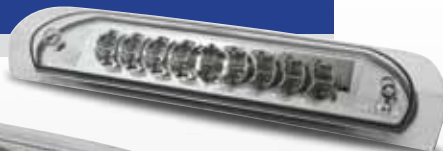

TB-102P

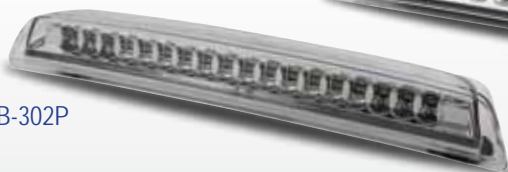

TB-201P

CHEVY / GMC

SDC-101	94-98	GM C/K Truck 1500 (All Cabs)
	94-00	GM C/K Truck 2500 / 3500 (All Cabs)
SDC-102	99-06	Silverado / Sierra 1500 / 2500LD (All Cabs)
	2007	Silverado / Sierra 1500 / 2500LD (All Cabs) (Classic Edition)
	01-06	Silverado / Sierra 1500HD / 2500HD / 3500 (All Cabs)
	2007	Silverado / Sierra 1500HD / 2500HD / 3500 (All Cabs) (Classic Edition)

FORD

SDC-201	97-03	F-150 / 250LD (All Cabs)
	01-03	F-150 Supercrew
SDC-202	99-up	F-250 / 350 Super Duty (All Cabs)
SDC-203	04-up	F-150 (All Cabs)

DODGE

SDC-301	94-01	Ram 1500 (All Cabs)
	94-02	Ram 2500 / 3500 (All Cabs)
SDC-302	02-up	Ram 1500 (All Cabs)
	03-up	Ram 2500 / 3500 (All Cabs)

THIRD BRAKE LIGHT COVERS

- Automotive Grade ABS Plastic Construction
- Durable Triple Chrome Plating
- Installs In Minutes With 3M Adhesive Tape
- Each Unit Is Custom Fit Designed

SDC-201



BACK UP LIGHT, LIGHT STRIP



BULLY™ **UNIVERSAL CLAMP-ON BACKUP LIGHT** PL-807



- Bright 55 watt H-3 halogen flood beam
- Tap into your backup wire without splicing (Scotch lock T-Tap included)
- Simply the easiest back-up light to install
- No drilling, easy to install on bumper

Patented clamp technology securely mounts with no drilling.

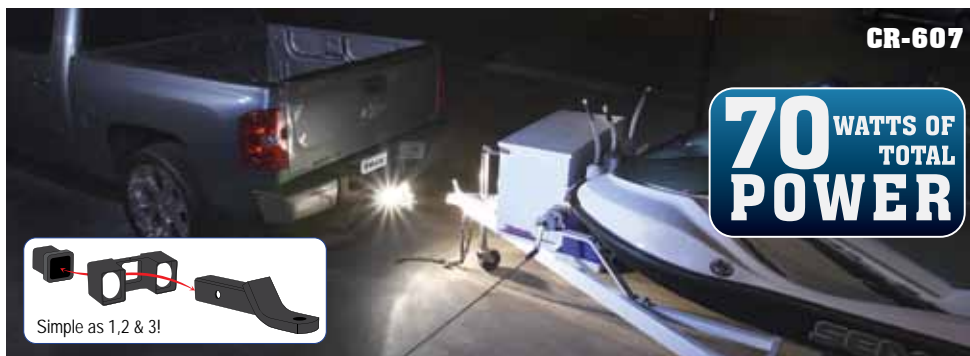

CR-607

70 WATTS OF TOTAL POWER

- Mounts easily onto any 2" Ball Mount securely
- No need to remove when towing
- Lights up in reverse or manually by built-in switch
- Complete with wire harness and a quick connect plug
- Weather resistant high impact ABS housing
- Installs in minutes
- Integrated 3 way switch



3 PIECE SET

LIGHT STRIPS

TLB-001

Functions as an additional:
Running light, Brake light,
Turn signals, Hazard light

- 48" configuration fits most mini / mid size trucks and SUV's
- 60" configuration fits most full size trucks and SUV's
- Weatherproof construction
- Installs in minutes using standard 4 pin trailer harness (included)
- Quick peel and stick installation

BULLY™

INTRODUCING...

**VERSATILE
UTILITY
CARGO RACKS**

CG-902

**Adjustable to Fit Full Size
& Mini Trucks**

- Fully adjustable crossbar height: 23.5" or 26.5"
- 2" diameter steel tubing
- Heavy duty powder coat paint finish
- Easy installation



**USE AS A SINGLE
FRONT-MOUNTED RACK**

**500 LBS
CAPACITY**





CG-901
For All Full Size & Mini

- Easy to install - mounts to either side of the truck bed
- Removable when not in use
- Adjustable length and tilt for customized use
- Heavy duty powder coat finish

ADJUSTABLE LENGTH AND TILT
for customized use

Adjustable Length: 18" - 32"
Adjustable Tilt: 0° or 20°

250 LBS
CAPACITY

NAVIGATOR™



CG-903
Fits all Vans with Rain Gutters

- No drilling, clamps securely to rain gutter
- Heavy duty powder coat paint finish

Width adjustment from:
5" - 80.75"

500 LBS
CAPACITY



3 CROSSBAR
HEIGHT SETTINGS

CG-09
Super Strength Water Proof Material

Product dimensions:
54" x 34" x 18.5"

18
Cubic
FEET



NEW

**AERODYNAMIC
CARGO CARRIER**

To Fit Most Cars, SUV's and Van Cargo Racks

CG-09, CG-08, CG-07
Aerodynamically Designed to
Reduce Drag and Save Gas

- Folds flat for easy storage
- Mounts to either cross bars or side rails

CG-13
Durable Weather Resistant Material

- Maximize your vehicle space
- Folds flat for easy storage
- Mounts to either cross bars or side rails

CG-07 Super Strength Water Proof Material

Product dimensions:
53" x 31" x 17"

15
Cubic
FEET



CG-08 Water Resistant Material

Product dimensions:
53" x 31" x 17"

15
Cubic
FEET



CG-13 Water Resistant Material

Product dimensions:
39" x 33" x 18"

13
Cubic
FEET



CARGO RACKS

CR-112F Receiver Mounted Folding Cargo Rack

- Mounts on any 2" hitch receiver
- Easy installation, no drilling required
- Does not include 5/8" hitch pin

500 LBS
CAPACITY

Cargo space:
20" x 60"

it folds!

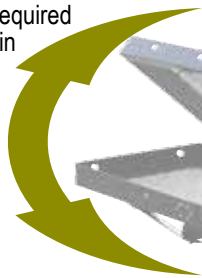

CR-112 Receiver Mounted Cargo Rack

- Mounts on any 2" hitch receiver
- Easy installation, no drilling required
- Does not include 5/8" hitch pin

Cargo space:
20" x 60"

500 LBS
CAPACITY



CR-114N Receiver Mounted Tubular Cargo Rack

- Mounts on any 2" hitch receiver
- Side rails keep cargo on the carrier
- Black powdercoated tubular steel
- Easy installation, no drilling required
- Does not include 5/8" hitch pin

Cargo space:
20" x 45"

350 LBS
CAPACITY



SAFETY REFLECTOR



INTRODUCING...

CARGO X-TRAS

CG-18 Roof Rack Cargo Net

- Secures cargo onto roof rack
- Adjustable hooks allow secure attachment
- Fits most OEM and aftermarket roof racks

Product dimensions:
34" x 40"



NEW

CG-17 Hitch Rack Cargo Net

- Secures cargo onto hitch rack
- Adjustable hooks allow secure attachment

Product dimensions:
20" x 55"



CG-19 Weatherproof Storage Bag

- Keeps storage dry and protected
- Folds flat for easy storage
- Large available cargo space
- Also good for: truck beds, trunks and garages
- Perfect for hitch mounted cargo carriers

Product dimensions:
60" x 18" x 18"

20
Cubic
FEET



TRUCK NET

CG-21

Truck Bed Net

- Secures loads in truck bed easily
- Durable UV and weather resistant construction

Product dimensions:
78" x 60"

NEW



**ADJUSTABLE HOOKS
ALLOW SECURE
ATTACHMENT**



CG-22

Hammock-Style Storage Net

- Organize and secure vehicle cargo
- For use inside trunk or truck bed
- All hardware included

Product dimensions:
45" x 60" x 12"



TAILGATE NETS

- Simple to install
- Reduces air drag
- All necessary hardware included
- Heavy duty industrial reinforced fabric with extra wide nylon edging to prevent stretching and fraying

TR-02 (Solid Black with Bully logo)
Fits: Mini / Mid-Size

TR-03 (Solid Black with Bully logo)
Fits: Full size trucks

TR-05 (Black with Skull and Bully logo)
Fits: Mini / Mid-Size

TR-06 (Black with Skull and Bully logo)
Fits: Full size trucks



CM-01

Universal Cargo Liner

PROTECT YOUR CARGO AREA FROM SPILLS & OTHER DEBRIS

- Fits most sport utility vehicles as well as trunks
- Whips clean & folds up easily for storage

Product dimensions:
41" x 39" (53" including flaps)



STRONG INDUSTRIAL FABRIC WITH A NON-SKID BASE

CG-02 Space Max

ELIMINATES CLUTTER AND MAXIMIZES YOUR VEHICLE'S SPACE!

Perfect for behind the seat storage for pick-up trucks as well as your car's trunk.

- Reinforced with nylon edging for strength
- Universal fit



5 LARGE & 10 SMALL POCKETS

DURABLE MOISTURE RESISTANT MATERIAL



SPARE TIRE COVERS

Durable, Weather Resistant

- Keeps spare tire clean and dry
- Slips on stays put with built in elastic band

CM-02 (solid black vinyl, shown on Jeep)
Fits diameters: 26.5" - 29.5"

CM-03 (solid black vinyl)
Fits diameters: 29.5" - 32.5"

CM-04MG (forest camo)
Fits diameters: 26.5" - 29.5"



CG-20 Aluminum Dock Plate Ramp Kit

- Allows you to easily load ATV's, mowers, hand trucks and other wheeled vehicles
- Easily convert (2) 2" x 10" or 2" x 8" wood planks into durable loading ramps



* Wood planks not included

**700 LBS
CAPACITY**



NAVIGATOR™

TAILGATE GAP COVERS

- Folds down into the tailgate gap upon closing
- Made of long lasting, durable polypropylene plastic
- Quick and easy adhesive installation

FORD Applications:

TR-201

97-UP	F-150 / 250 Light Duty
99-UP	F-250 / 350 Super Duty
01-UP	F-150 Super Crew

CHEVY / GMC Applications:

TR-101

99-UP	Silverado / Sierra 1500 / 2500 Light Duty
01-UP	Silverado / Sierra 1500 / 2500 / 3500 Heavy Duty

US Patent # 5,664,822
Canadian Patent # 2,177,132
Japanese Patent # 2,843,793

- Provides maximum truck bed protection when used with bed liners
- Load, haul and off-load gravel, soil, rock, bark or construction materials without bed damage and material loss
- Helps prevent dust from entering trucks with canopies and toppers

NEW

CR-110S

Universal Truck Bed Light

- Put light where you need it most
- Easy installation without drilling
- Mount with enclosed magnet
- Fits all truck models and bed sizes



(2) "C" batteries required, not included.



BEFORE

AFTER

BEFORE

AFTER

**BRIDGES THE GAP
BETWEEN THE TRUCK
BED AND TAILGATE**

CG-900 Cargo Revolver

New revolutionary design uses the principal of leverage to move heavy loads with minimal effort.

- Constructed from heavy duty powder coated steel
- Ideal for under tonneau cover use
- Closed tailgate locks system securely
- Entire rack removes completely in seconds leaving complete access to your truck bed

Applications:

CHEVY / GMC

88-98	C/K Pick-Up Truck 1500
88-00	C/K Pick-Up Truck 2500 / 3500
99-UP	Silverado / Sierra 1500 / 2500LD
01-UP	Silverado / Sierra 1500HD / 3500

FORD

97-03	F-150 / 250LD
2004	F-150 (Heritage)
99-UP	F-250 / 350 Supercrew
04-UP	F-150 / F-150 Supercrew

DODGE

94-02	Ram 2500 / 3500
02-UP	Ram 1500
03-UP	Ram 2500 / 3500

NISSAN

04-UP	Nissan Titan
-------	--------------



OTHER USES...



AT HOME / SHOPPING



OUTDOOR ACTIVITIES

MOVE 150 LBS OF CARGO IN & OUT OF YOUR TRUCK BED INSTANTLY!

WTD-810 Patent # 5,971,684 Pop-Up Truck

Spring loaded Pop-up tie-downs, mount flush into your skate pockets and with a push of a button, it pops up ready for use.

- Mounts securely into stake holes without drilling
- Made from high grade stainless steel that will never rust
- Works with or without bed liners
- Sold in pairs



LOCKS DOWN, FLUSH & POPS UP WHEN NEEDED

WTD-823 Patent # 6,039,520 Stainless Steel Truck

- Adjustable to clamp-on in any position along your truck bed side rails with no drilling
- Works on all truck beds with inside lip
- Perfect for inside camper shells and most tonneau covers
- Sold in pairs



FLIP UP AND IT FORMS A HOOD, FLIP IT DOWN AND IT TUCKS NEATLY OUT OF THE WAY

SNUG-A-LUG

WK-107

Universal Spare Tire Lock

- Locks the lug wrench and tire together for convenience and to prevent theft
- Fits most standard spare tire carriers
- Installs easily with no drilling required

Lug nuts: **4 - 8**

Rim width: **Up to 12"**

Rim diameter: **8.5" - 16" wheel**



**ALSO FOR
ATV TRAILERS**



SPR-180

The Separator Cargo Retainer

- One size fits all - adjusts from 37" - 75"
- Tightens & loosens by simply turning the bar
- Also great for SUV's



**RUBBER GRIPS
PROTECT YOUR
VEHICLE**

NAVIGATOR™

CG-701

3-Bike Foldable Hitch Mount Rack

2-IN-1 DESIGN: FITS 1 1/4" AND 2" HITCH RECEIVERS

- Holds up to 3 Bikes (90lbs. max)
- Folds for easy compact storage (storage bag included)
- Adjustable frame saver cradle holders



**NYLON BIKE
CRADLE HOLDERS**

**DURABLE RUBBER
MOUNTING STRAPS**

**SECURITY LOCK PREVENTS
BIKE RACK THEFT. (HITCH
PIN, NOT INCLUDED)**



LED TAIL LAMPS



The future in lighting is here today. APC is waaay ahead of the curve with these taillamps. Our fully functional LED models are available today with increased lighting capacity and quicker response to brake pressure than previous incandescent models. At 60 mph, that's almost a full car length increase in stopping distance. Most experts agree that more than one life will be saved due to the advent of LED technology.

APC's LED taillamps offer the highest quality fit, function, and finish. They're OE replacement legal, easy to install, and offer precision engineering, for that great custom vehicle look.



406618TL CLEAR LENS

Applications

88-02 Chevrolet / GMC CK Pick-Up
92-94 Chevrolet Blazer (Fullsize)
92-99 Chevrolet / GMC Suburban
99-00 Cadillac Escalade
95-99 Chevrolet Tahoe
00-00 Chevrolet Tahoe Limited & Z71
92-99 GMC Yukon
99-00 GMC Yukon Denali

Available in Red Lens - Part # 406618TLR



406623TL CLEAR LENS

Applications

99-02 Chevrolet Silverado (Fleetside)
99-03 GMC Sierra (Fleetside)

Available in Red Lens - Part # 406623TLR



406629TL CLEAR LENS

Applications (Lift Gate Models Only)

00-06 Chevrolet / GMC Suburban
00-06 Chevrolet Tahoe
00-06 GMC Yukon
00-06 GMC Yukon XL
01-06 GMC Yukon Denali
01-06 GMC Yukon Denali XL

Available in Red Lens - Part # 406629TLR



406573TL CLEAR LENS

Applications

97-03 Ford F-150 (Styleside)
04-04 Ford F-150 (Heritage Model)

Available in Red Lens - Part # 406573TLR



406636TL CLEAR LENS

Applications

03-06 Chevrolet Silverado (Fleetside)

Available in Red Lens - Part # 406636TLR



406816TL CLEAR LENS

Applications

02-06 Dodge Ram

Available in Red Lens - Part # 406816TLR



406542TL CLEAR LENS

Applications

97-02 Ford Expedition

Available in Red Lens - Part # 406542TLR

HEADLAMPS

403660HL
CHROME HOUSING



APC Headlamps have a look all their own. Designed to be a direct replacement for stock headlamps, all replacement hardware is included allowing for an instant and easy upgrade to your vehicle.

FEATURES & BENEFITS

- Easy installation
- OE replacement
- No drilling necessary
- All replacement hardware included
- Great custom look with great fitment



Applications

88-02 Chevrolet / GMC CK Pick-Up (Fullsize)
92-94 Chevrolet Blazer (Fullsize)
92-99 Chevrolet / GMC Suburban
95-99 Chevrolet Tahoe
00-00 Chevrolet Tahoe Limited & Z71
92-99 GMC Yukon



Available in Black Housing - Part# 403660HLB

403660HLD
CHROME HOUSING



Applications

88-02 Chevrolet / GMC CK Pick-Up
92-94 Chevrolet Blazer (Fullsize)
92-99 Chevrolet / GMC Suburban
95-99 Chevrolet Tahoe
00-00 Chevrolet Tahoe Limited & Z71
92-99 GMC Yukon



Available in Black Housing - Part # 403660HLDB

403650HL
CHROME HOUSING



Applications

99-02 Chevrolet Silverado
00-06 Chevrolet Suburban
00-06 Chevrolet Tahoe



Available in Black Housing - Part # 403650HLB

403680HLD
CHROME HOUSING



Applications

03-06 Chevrolet Silverado
07-07 Chevrolet Silverado Classic



Available in Black Housing - Part # 403680HLDB

403621HLD
CHROME HOUSING



Applications

98-04 Chevrolet S10 Pick-Up
98-05 Chevrolet Blazer (S-Series)

403620HL
CHROME HOUSING



Applications

97-03 Ford F-150 / 250LD
97-02 Ford Expedition



Available in Black Housing - Part # 403620HLB

403622HL
CHROME HOUSING



Applications

99-04 Ford F250/F350 Super Duty
00-04 Ford Excursion



Available in Black Housing - Part # 403622HLB

403624HL
CHROME HOUSING



Applications

93-97 Ford Ranger

403619HL
CHROME HOUSING



Applications

98-00 Ford Ranger



DIAMOND CUT TAIL LAMPS



The latest upgrade for OE replacement taillights. Diamond Cut Reflectors feature all the benefits of the Euro Style taillights, plus the reflective and diffusion attributes of LED technology.



407507TLC CLEAR LENS

Applications

88-02 Chevrolet / GMC CK Pick-Up
92-94 Chevrolet Blazer (Fullsize)
92-99 Chevrolet / GMC Suburban
99-00 Cadillac Escalade
95-99 Chevrolet Tahoe
00-00 Chevrolet Tahoe Limited & Z71
92-99 GMC Yukon
99-00 GMC Yukon Denali

Available in Black Housing - Part # 407507TLB



407509TLC CLEAR LENS

Applications

94-04 Chevrolet S10
94-04 GMC S15 Sonoma
96-00 Isuzu Hombre

Available in Black Housing - Part # 407509TLB



407505TLC CLEAR LENS

Applications

99-02 Chevrolet Silverado (Fleetside)
99-03 GMC Sierra (Fleetside)

Available in Black Housing - Part # 407505TLB



407508TLC CLEAR LENS

Applications (Lift Gate Models Only)

00-06 Chevrolet Suburban
02-06 Chevrolet Tahoe
00-06 GMC Yukon
00-06 GMC Yukon XL
01-06 GMC Yukon Denali
01-06 GMC Yukon Denali XL

Available in Black Housing - Part # 407508TLB



407536TLC CLEAR LENS

Applications

94-01 Dodge Ram
02-02 Dodge Ram 2500 / 3500

Available in Black Housing - Part # 407536TLB



407524TLC CLEAR LENS

Applications

02-06 Dodge Ram

Available in Black Housing - Part # 407524TLB



Diamond Cut Reflectors meet or exceed SAE / DOT specifications and can give your vehicle that little extra custom quality look. OE replacement legal and precision engineered, these lights are easy to install and offer a quality fit and finish at an economical price.



BRIGHT LED LOOK USING STANDARD BULBS!

FEATURES & BENEFITS

- Easy installation
- Uses the vehicle's OEM bulbs and sockets
- Great custom look with great fitment



407511TLC
CLEAR LENS

Applications
97-02 Ford Expedition

Available in Black Lens - Part # 407511TLB



407523TLC
CLEAR LENS

Applications
04-07 Ford F150 (Flareside)

Available in Black Lens - Part # 407523TLB



407512TLC
CLEAR LENS

Applications
03-06 Ford Expedition

Available in Black Lens - Part # 407512TLB



407515TLC
CLEAR LENS

Applications
98-01 Ford Explorer
98-01 Lincoln Mountaineer

Available in Black Lens - Part # 407515TLB



407591TLC
CLEAR LENS

Applications
98-02 Lincoln Navigator

Available in Black Lens - Part # 407591TLB



407592TLB
CLEAR LENS

Applications
03-06 Lincoln Navigator

Available in Black Lens - Part # 407592TLB

DIAMOND CUT PARKING LAMPS



Diamond Cut Reflectors meet or exceed SAE / DOT specifications and can give your vehicle that little extra custom quality look. OE replacement legal and precision engineered, these lights are easy to install and offer a quality fit and finish at an economical price.



FEATURES & BENEFITS

- Easy installation
- Great custom look with great fitment



USES YOUR VEHICLE'S OEM BULBS AND SOCKETS

403462PBS
BLACK HOUSING
WITH CLEAR LENS

403462PLS
CHROME HOUSING
WITH SMOKED LENS

403462PLD
CHROME HOUSING
WITH CLEAR LENS



Applications

- 03-06 Chevrolet Silverado
- 07-07 Chevrolet Silverado Classic
- 02-06 Chevrolet Avalanche w/o Body Cladding





403460PLD
CHROME HOUSING
WITH CLEAR LENS



Available in Chrome Housing w/
Smoke Lens - Part # 403463PLS

Applications

- 99-02 Chevrolet Silverado
- 00-06 Chevrolet Suburban
- 00-06 Chevrolet Tahoe



Available in Chrome Housing w/
Smoke Lens - Part # 403460PLS

Applications

- 94-02 Chevrolet / GMC CK Pick-Up
- 94-94 Chevrolet Blazer (Full Size)
- 94-99 Chevrolet / GMC Suburban
- 95-99 Chevrolet Tahoe
- 00-00 Chevrolet Tahoe Limited & Z71
- 94-99 GMC Yukon

403461PBD
BLACK HOUSING
WITH CLEAR LENS

403461PLS
CHROME HOUSING
WITH SMOKED LENS

403461PLD
CHROME HOUSING
WITH CLEAR LENS



Applications

- 98-04 Chevrolet S-10
- 98-05 Chevrolet Blazer (S-Series)

403465PLS
CHROME HOUSING
WITH SMOKED LENS

403465PLD
CHROME HOUSING
WITH CLEAR LENS

403465PBD
BLACK HOUSING
WITH CLEAR LENS



Applications

- 07-08 FJ Cruiser

EURO STYLE TAIL LAMPS



With the most options on the market today, making your taillight choice is a breeze with APC. We offer all the latest taillight fashions from Euro Styling and OE replacement, to state of the art LED technology.

Fit and finish is the key to this product line and we've taken the lead hands down! All our products meet or exceed SAE/DOT compliance and are specifically designed to set you apart from the crowd.

EURO STYLE lights are precision engineered, sonic welded and come standard with factory hardware and mounting instructions. They're legal replacements for OE equipment and offer a quality fit and function along with structural integrity and easy installation.



404110TLR CHROME HOUSING

Applications

- 88-02 Chevrolet / GMC CK Pick-Up (Fullsize)
- 92-94 Chevrolet Blazer (Fullsize)
- 92-99 Chevrolet / GMC Suburban
- 99-00 Cadillac Escalade
- 95-99 Chevrolet Tahoe
- 00-00 Chevrolet Tahoe Limited & Z71
- 92-99 GMC Yukon
- 99-00 GMC Yukon Denali

Available in Black Housing - Part # 404110TLB



404120TLR CHROME HOUSING

Applications

- 94-04 Chevrolet S10 Pick-Up
- 94-04 GMC S15 Sonoma Pick-Up
- 96-00 Isuzu Hombre

Available in Black Housing - Part # 404120TLB



404118TLR CHROME HOUSING

Applications

- 99-02 Chevrolet Silverado (Fleetside)
- 99-03 GMC Sierra (Fleetside)

Available in Black Housing - Part # 404118TLB



404512TLR CHROME HOUSING

Applications

- 94-04 Chevrolet S10 Pick-Up
- 94-04 GMC S15 Sonoma Pick-Up
- 96-00 Isuzu Hombre

Available in Black Housing - Part # 404512TLB



404111TLR CHROME HOUSING

Applications

- 82-93 Chevrolet S10 Pick-Up
- 82-93 GMC S15 Pick-Up
- 83-94 Chevrolet Blazer (S-Series)
- 83-94 GMC Jimmy (S-Series)

Available in Black Housing - Part # 404111TLB



404117TLR CHROME HOUSING

Applications

- 73-87 Chevrolet CK Suburban
- 73-87 Chevrolet CK Silverado
- 73-87 GMC CK Suburban
- 73-87 GMC CK Sierra

Available in Black Housing - Part # 404117TLB



404203TLR CHROME HOUSING

Applications

- 00-06 Chevrolet Suburban
- 00-06 Chevrolet Tahoe
- 00-06 GMC Yukon
- 00-06 GMC Yukon XL
- 01-06 GMC Yukon Denali
- 01-06 GMC Yukon Denali XL

Available in Black Housing - Part # 404203TLB



404115TLR CHROME HOUSING

Applications

- 95-05 Chevrolet Blazer (S-Series)
- 95-01 GMC Jimmy
- 98-00 GMC Envoy
- 95-01 Oldsmobile Bravada

Available in Black Housing - Part # 404115TLB



404130TLR CHROME HOUSING



Applications

97-03 Ford F150 / F250 Light Duty (Styleside)
04-04 Ford F150 Heritage (Styleside)
99-06 Ford F250 / F350 / F450 /
F550 Super Duty

Available in Black Housing - Part # 404130TLB

404526TLR CHROME HOUSING



Applications

97-03 Ford F150
(Flareside) / Supercrew

Available in Black Housing - Part # 404526TLB

404131TLR CHROME HOUSING



Applications

93-00 Ford Ranger

Available in Black Housing - Part # 404131TLB

404534TLR CHROME HOUSING



Applications

97-02 Ford Expedition

Available in Black Housing - Part # 404534TLB

404132TLR CHROME HOUSING



Applications

01-05 Ford Explorer Sport Trac

Available in Black Housing - Part # 404132TLB

404536TLR CHROME HOUSING



Applications

98-02 Lincoln Navigator

Available in Black Housing - Part # 404536TLB

404120TLR CHROME HOUSING



Applications

94-01 Dodge Ram Pick-Up
02-02 Dodge Ram 2500 / 3500 Pick-Up

Available in Black Housing - Part # 404120TLB

404122TLR CHROME HOUSING



Applications

97-04 Dodge Dakota

Available in Black Housing - Part # 404122TLB

404170TLR CHROME HOUSING



Applications

86-97 Nissan Hardbody Z20 Pick-Up

Available in Black Housing - Part # 404170TLB

404586TLR CHROME HOUSING



Applications

95-04 Toyota Tacoma

Available in Black Housing - Part # 404586TLB



PARKING • CORNER • BUMPER

LAMPS

LAMPS

LAMPS



APC's Clear Corners and Bumper Lenses remain the aftermarket industry's leading clear corner lens because of its style and design. Every APC Clear Corner and Bumper Lens meets or exceeds federal regulation FMVSS108 and assures an ultra clear lens along with side reflux reflectors as required.

FEATURES & BENEFITS

- Engineered to OE specifications
- Retains OE hardware
- Legal replacement for OE corner or bumper lens
- Easy installation



403021PL
CLEAR PARKING LAMP

403021PLE
EURO CLEAR PARKING LAMP



Applications

94-02 Chevrolet / GMC CK Pick-Up (Fullsize)
94-94 Chevrolet Blazer (Fullsize)
94-99 Chevrolet / GMC Suburban
95-99 Chevrolet Tahoe
00-00 Chevrolet Tahoe Limited & Z71
94-99 GMC Yukon

403021CL
CLEAR CORNER LAMP

403021CLE
EURO CLEAR CORNER LAMP



Applications

94-02 Chevrolet CK Pick-Up (Fullsize)
94 -94 Chevrolet Blazer (Fullsize)
94-99 Chevrolet Suburban
95-99 Chevrolet Tahoe
00-00 Chevrolet Tahoe Limited & Z71

403050CL
CLEAR CORNER LAMP

403050CLE
EURO CLEAR CORNER LAMP



Applications

94-02 GMC CK Pick-Up (Fullsize)
94-99 GMC Suburban
94-99 GMC Yukon

402028BL
CLEAR BUMPER LAMP



Applications

82-93 Chevrolet S10 Pick-Up
82-93 GMC S15 Pick-Up
83-94 Chevrolet Blazer (S-Series)
83-94 GMC Jimmy (S-Series)

403022CL
CLEAR CORNER LAMP



Applications

82-93 Chevrolet S10 Pick-Up
82-93 GMC S15 Pick-Up
83-94 Chevrolet Blazer (S-Series)
83-94 GMC Jimmy (S-Series)

403027CLD
DIAMOND CLEAR CORNER LAMPS



Applications

98-04 Chevrolet S10 Pick-Up
98-05 Chevrolet Blazer (S-Series)

403020CL
CLEAR CORNER LAMP

403020CLE
EURO CLEAR CORNER LAMP



Applications

88-93 Chevrolet CK Pick-Up (Fullsize)
92-93 Chevrolet Blazer (Fullsize)
92-93 Chevrolet / GMC Suburban

403033CL
CLEAR CORNER LAMP WITH FOG LAMP



Applications

98-04 Chevrolet S10 Pick-Up
98-05 Chevrolet Blazer (S-Series)



403052CL
CLEAR CORNER LAMP

Applications

99-07 GMC Sierra
00-06 GMC Yukon
00-06 GMC Yukon XL



403023CL
CLEAR CORNER LAMP

403023CLE
EURO CLEAR CORNER LAMP

Applications

94-97 Chevrolet S10 Pick-Up
95-97 Chevrolet Blazer (S-Series)



403029CL
CLEAR CORNER LAMP

403029CLE
EURO CLEAR CORNER LAMP

Applications

99-02 Chevrolet Silverado
00-06 Chevrolet Suburban
00-06 Chevrolet Tahoe



403154PLE
EURO BLACK PARKING LAMP

Applications

03-06 Chevrolet Silverado
02-06 Chevrolet Avalanche
(w/o body cladding)



403153PLE
EURO CLEAR PARKING LAMP

Applications

03-06 Chevrolet Silverado
02-06 Chevrolet Avalanche
(w/o body cladding)



403042CL
CLEAR CORNER LAMP

403042CLD
DIAMOND CLEAR CORNER LAMP

Applications

97-03 Ford F150 / F250 LD
97-02 Ford Expedition



403041CL
CLEAR CORNER LAMP

403041CLD
DIAMOND CLEAR CORNER LAMP

Applications

93-97 Ford Ranger



403043CLE
EURO CLEAR CORNER LAMP

Applications

98-00 Ford Ranger



403032CL
CLEAR CORNER LAMP

403032CLE
EURO CLEAR CORNER LAMP

Applications

97-04 Dodge Dakota
97-03 Dodge Durango



403110CL
CLEAR CORNER LAMP

Applications

86-97 Nissan Z20 Hardbody Pick-Up



NEW

Digital Brake Controller

24 mhz ...for a safer, more reliable and smoother synchronized braking.



wheel adjusts percentage of braking desired

large, easy to read digital led display

TC-301

This is the most powerful electronic brake controller on the market. With a super micro chip this has a response time of 0.3 seconds, 80 times faster than most. Providing a major increase in safety...

- Can handle up to 8 brake systems

Trailer Connex™

trailer connectors

Eliminate the hassle and mess of traditional trailer connector wires. These are sleek, safe and simple to use. They eliminate the spaghetti type mess of other wires. They are made of the most durable, rugged design and construction. Just plug in and tow.



- TC-500**
- 5 flat to 5 flat
 - 3 feet extended
 - Heavy duty jacket

- TC-501**
- 7 RV round to 4/5 flat
 - 3 feet extended
 - Heavy duty jacket



BUILT-IN

Audio Tester

trailer adapters (US patent 7,339,465 B1)

For the first time an individual person towing can easily test their lights, BRAKE lights and all electrical functions on their trailer while sitting inside of the tow vehicle. Simply click on the built-in "test" switch indicating "trailer" then test each trailer function individually, listening for each function to beep indicating a good working circuit. Should you discover a problem on your trailer by not hearing a beep on one of its functions, you can flip the "test" switch to check your vehicle's connections isolating exactly where your problem exists.

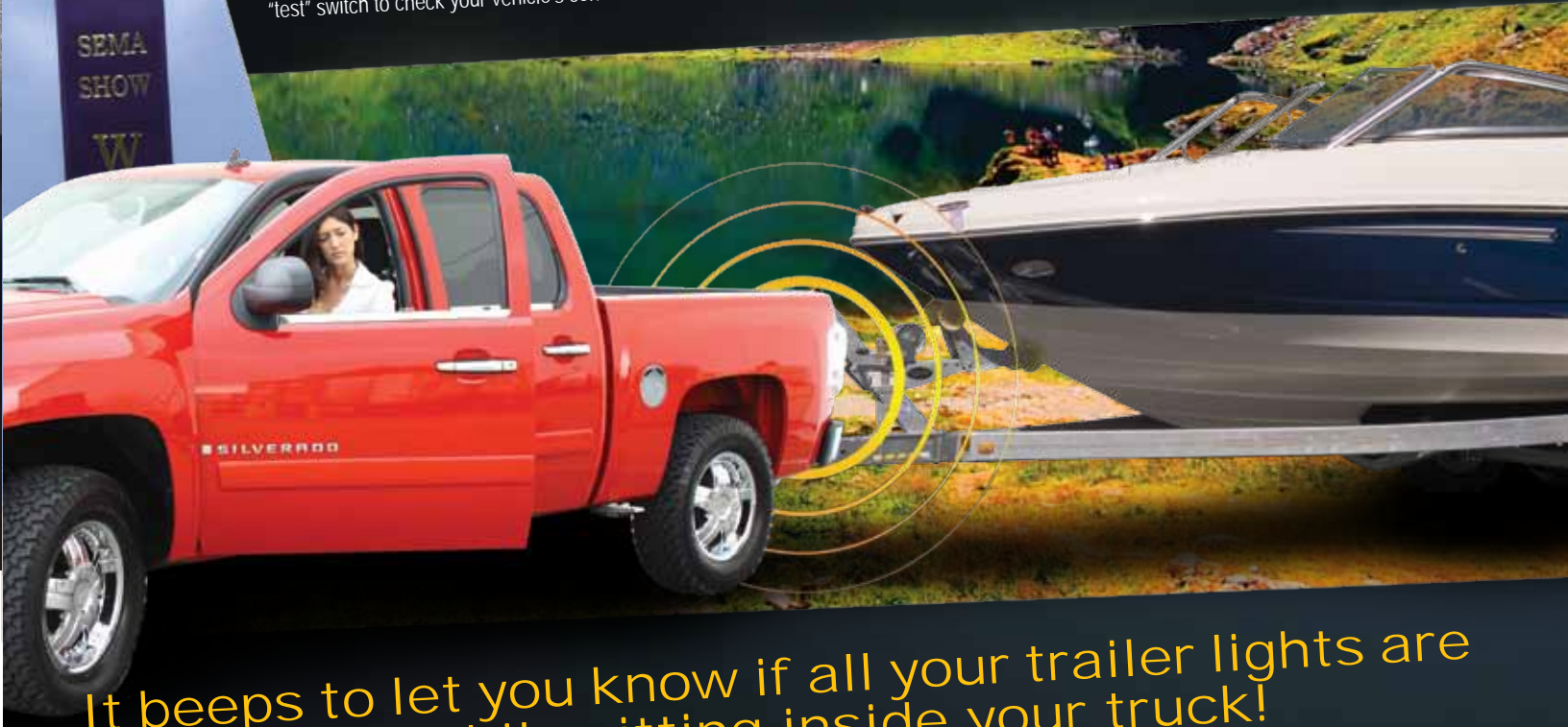

It beeps to let you know if all your trailer lights are functioning while sitting inside your truck!

- Tests all of your **trailer or truck** towing circuits, brakes lights & all electrical functions from the comfort of your vehicle.
- Switch on the "built-in" tester and test each **trailer or truck** electrical towing functions individually - A beep tone indicates good working circuit.
- Isolate any problems immediately to your **trailer or truck**.
- Switch the tester off and you're good to go!

- Popular Mechanics editor's choice award
- Sema best new product award

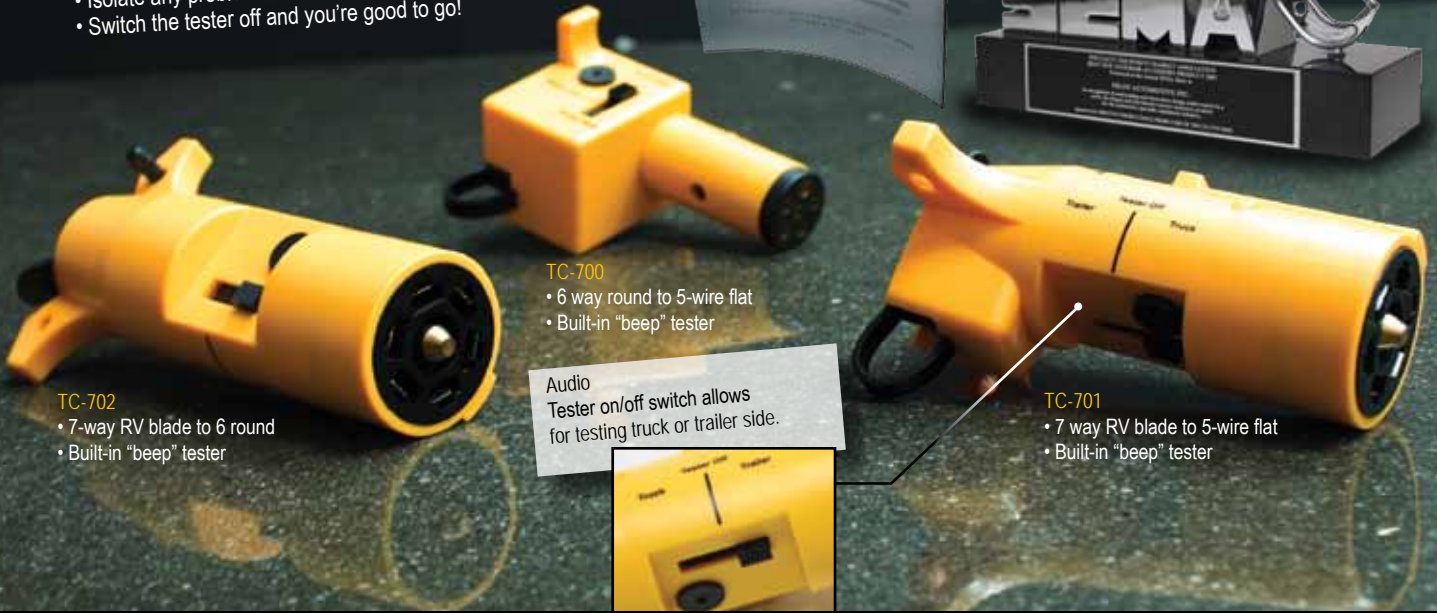

TC-702

- 7-way RV blade to 6 round
- Built-in "beep" tester

TC-700

- 6 way round to 5-wire flat
- Built-in "beep" tester

Audio Tester on/off switch allows for testing truck or trailer side.

TC-701

- 7 way RV blade to 5-wire flat
- Built-in "beep" tester

Combination Adapters

with 12v receptacles (patent 6,305,945 b1 patent 6,309,824 b1)

TC-182

- 7 RV blade to 6 pin round with a 5 flat and dual 12 volt Receptacles.

TC-129

- 6 pin round to a 5 flat and dual 12 volt Receptacles

TC-127

- 7 RV blade to 7 RV blade with a 5 flat and dual 12 volt Receptacles.



12 VOLT
RECEPTACLE



Perfect for today's electronic lifestyle...

Convenient 12V receptacles right where it's most handy for:

- Compressors
- Spot lights
- Vacuum
- Coolers
- Stereo
- TV
- Etc.



General Trailer

wiring & plugs



TC-109
• 6 pole round kit

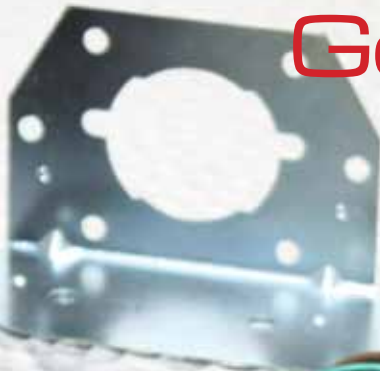

TC-115
• 6 pole round trailer (replacement plug)



TC-126
• 4 wire flat / 48" wire extension



TC-101
• 4 pole flat with 12" wire



c. TC-110
• Tail light converter



TC-107
• 7 RV blade round receptacle (replacement plug)



TC-102
• 4 flat with 60" wire



TC-103
• 4 pole flat with 24' wire



TC-104
• 4 pole round kit



TC-116
• 7 blade RV round trailer (replacement plug)



TC-106
• Universal bulb kit



Multiple & Single

electrical adapters



TC-161
• 4 flat to 7 RV blade



TC-124 Multiple adapter
• 4 flat to 6 pin round & 4 flat



TC-125 Multiple adapter
• 4 flat to 7 RV blade & 4 flat



TC-133
• 4 flat to 6 pin round



TC-131
• 6 pin round to 4 flat flex wire



TC-113
• 6 pin round to 4 flat.



TC-111
• 7 RV blade to 4 flat.



TC-132
• 7 pin round to 4 flat.



TC-114
• 4 pin round to 4 flat flex wire

TC-112
• 7 RV blade to 6 pin round.



TC-108
• 7 RV blade to 5 flat.

Typical Electrical

connectors used in towing



Normal applications: small utility, boat, jet ski, snowmobile and camper trailers.

Normal applications: large industrial and RV trailers.

Normal applications: utility, boat and camper trailers with one added function.

Normal applications: Horse trailers and car haulers.

Note: brake & auxiliary interchanges need to be checked prior to connecting.

Connectors	Function	Color	Trailer side	Vehicle side	Minimum wire gauge	
					4 way & 5 way	6 way & 7 way
7 way	Right turn	Green	Right turn signal	Right turn wiring harness	18	16
6 way	Left turn	Yellow	Left turn signal	Left turn wiring harness	18	16
5 way	Tail & marker	Brown	Tail & marker lights	Taillight wiring harness	18	16
4 way	Ground	White	Trailer ground point	Vehicle ground point	16	12
	Brake	Blue	Break-away switch	Electric brake control	18	12
	Battery	Red	Break-away kit	Fused battery or block	18	12
	Back up	Purple	Back up lights	Back up wiring harness	18	16

Warning: This chart displays the most commonly used wire colors to identify trailer functions in the industry but not all manufacturers correspond to these standards. Therefore you should always take caution to match trailer to vehicle wires by function prior to connection.



2
PIECE KIT



SUBMERSIBLE

NAVIGATOR™

2 Piece L.E.D. Submersible Combo Trailer Lighting Kit- For All Trailers Under 80" Wide

Polypropylene housing
Acrylic lens
4"(l) x 1-1/8"(h) x 2"(w)
25 ft. trailer harness
NV-5054 (clear lens, red light)

48" wire pigtail lead
License bracket
Mounting hardware
Pair of submersible tail lights
Super Flux L.E.D.



Removable chrome trims

On/off switch



Clear Dome Utility Lamp

Polycarbonate lens / Aluminum base plate
Bulb #194
4-1/8" (l) x 2-3/8"(h) x 7/8"(w)
NV-5028C

On/off switch



Interior Dome Utility Lamp

Polycarbonate lens is screwed on to galvanized steel base plate
Bulb #1141
4-9/16" (l) x 2-9/16"(h) x 1-3/4"(w)
NV-5021C



12 VOLT

Utility Lamp

Polypropylene housing
Glass lens
Bulb #H3-55W
5-1/2"(l) x 3"(h) x 2-1/2"(w)
NV-5029C (clear lens)

MINI LIGHT BAR

a. NV-5007R

- Functions as identification light for over 80" in width
- Polycarbonate lens is snapped on to the housing and then riveted on to the corrosion-resistant steel bar
- Pre-wired with lead wire for easy installation
- Bulb #194
- Operates at 12 volts

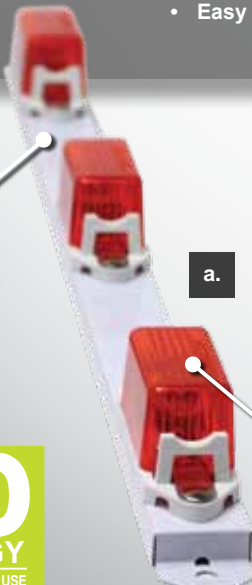

a.

Corrosion-resistant steel bar

Polycarbonate lens

b.

LED TECHNOLOGY

Rated for 100,000 hours of use



LED STROBE MAGNETIC LIGHT

b. NV-5091A

- LED bulbs
- Strong plastic amber housing
- Magnetic base mounts to vehicle's metal surface
- Compact size and light weight
- Cigarette lighter plug
- Easy installation

MAGNETIC BASE
Mounts to vehicles' metal surface



12 VOLT

b.

REVOLVING LIGHT

c. NV-5090A

- Single bulb with rotating reflector
- Strong plastic amber housing
- Magnetic base mounts to vehicle's metal surface
- Compact size and light weight
- Cigarette lighter plug
- Easy installation
- #97 replacement incandescent bulb



c.

Cigarette plug lighter



BULLY™ **UNIVERSAL CLAMP-ON BACKUP LIGHT**

PL-807

- Bright 55 watt H-3 halogen flood beam
- Tap into your backup wire without splicing (Scotch lock T-Tap included)
- Simply the easiest back-up light to install
- No drilling, easy to install on bumper



Patented clamp technology securely mounts with no drilling.

PATENTED CLAMP SECURES LIGHTS ONTO ANY REAR BUMPER!

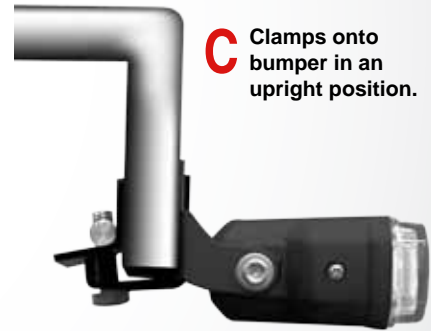
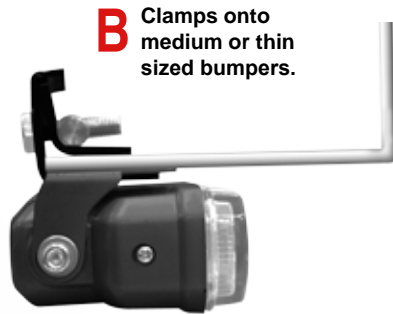

BALL MOUNT HITCH LIGHT

CR-607

- Mounts onto any 2" ball mount
- Does not need to be removed when towing
- Activates when vehicle is put in reverse
- Compact size and light weight
- Installs in minutes
- High impact ABS housing



**70 WATTS
OF TOTAL POWER**

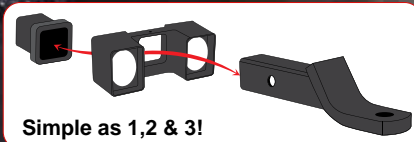

Simple as 1, 2 & 3!

SUBMERSIBLE COMBO TRAILER LIGHTING KIT

CONSTRUCTED FROM
POLYPROPYLENE HOUSING
ACRYLIC LENS

A. 2 Piece Submersible Combo Trailer Lighting Kit

Polypropylene housing
Acrylic lens
submersible light
Bulb #1157
8-1/16"(l) x 2-7/8"(h) x 3"(w)
NV-5024 (red lens)

KIT INCLUDES

25 ft. trailer harness
48" wire pigtail lead
License plate bracket
Mounting hardware

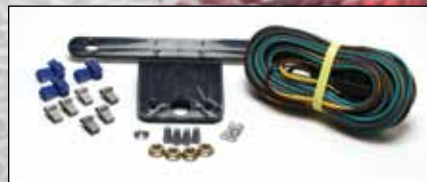

2
PIECE KIT

✓ DOT & SAE
COMPLIANT



B. 2 Piece Submersible Combo Trailer Lighting Kit

Polypropylene housing
Acrylic lens
submersible light
Bulb #1157 & #194
6-1/8"(l) x 4-5/8"(h) x 3"(w)
NV-5018 (red lens)



12 VOLT

SUBMERSIBLE



Rear Identification Light

KIT INCLUDES

5 Ft trailer harness
48" wire pigtail lead
License plate bracket
Mounting hardware



NAVIGATOR™

2
PIECE KIT





4
PIECE KIT



**A. 4 Piece Combo Trailer Lighting Kit—
For All Trailers Under 80" Wide**

Polypropylene housing
Acrylic lens
Taillights with front side marker/clearance
Side markers with reflector
5-1/4"(l) x 4-5/8"(h) x 3"(w)
NV-5017 (amber lens)

25 Ft. trailer harness
48" wire pigtail lead
License bracket
Mounting hardware
Bulb #1157 & #194



KIT INCLUDES

Connectors
25" wiring harness
Bulb #1157



**2 Piece Tow Light Kit with
Magnetic Base**

ABS housing
Acrylic lens
Bulb #1157
2-3/16"(h) x 1-1/4"(w)
NV-5041 (red lens)

2
PIECE KIT



Tie Down Straps

truck accessories



TD24-2 Bungee cord set
 • Tough and super-elastic
 • 2 pieces 24" x 8mm



TD32-2 Bungee cord set
 • Tough and super-elastic
 • 2 pieces 32" x 9mm



TD501-1 Ratchet tie-down
 • Easy to use:
 attach and pump handle
 • Vise-like gripping power
 • Bully tough-cut and abrasion resistant
 • 27' length / 10000lbs break strength / 3300lbs work load limit



TD200-1 Cambuckle
 • Easy to use:
 attach and pump handle
 • Vise-like gripping power
 • Bully tough-cut and abrasion resistant
 • 10' length / 1200lbs break strength / 400lbs work load limit



TD304-1 Ratchet tie-down
 • Easy to use:
 attach and pump handle
 • Vise-like gripping power
 • Bully tough-cut and abrasion resistant
 • 15' length / 5000lbs break strength / 1666lbs work load limit



TD400-1 Cambuckle
 • Easy to use:
 attach and pump handle
 • Vise-like gripping power
 • Bully tough-cut and abrasion resistant
 • 15' length / 400lbs break strength / 135lbs work load limit



TD600-1 Tow strap
 • Rust-resistant zinc plated hooks
 • Tow disable vehicles
 • Fully weather proof
 • 13' length / 6800lbs break strength / 2266lbs work load limit



TD601-1 Tow strap
 • Rust-resistant zinc plated hooks
 • Tow disabled vehicles
 • Fully weather proof
 • 15' length / 10000lbs break strength / 3333lbs work load limit

TD602-1 Tow strap
 • Rust-resistant zinc plated hooks
 • Tow disabled vehicles
 • Fully weather proof
 • 25' length / 10000lbs break strength / 3333lbs work load limit

TD603-1 Recovery strap
 • Rust-resistant zinc plated hooks
 • Tow disabled vehicles
 • Fully weather proof
 • 20' length / 10000lbs break strength / 3333lbs work load limit

WTD-811
Clamp on truck bed hooks

- Fits virtually all trucks
- Adjustable anywhere on your rail
- Clamps securely without drilling



WTD-820

- Maximize your vehicle space
- Folds flat for easy storage
- 5 year limited warranty
- 39" x 32" x 18"



WTD-810 Pop-up tie down

- Spring loaded
- Mounts flush into stake pockets

Patent #: 5,971,684
Patent #: 6,039,520



WTD-823 Stainless steel truck clamps

- Mounts anywhere under a truck bed's side rail with no drilling required
- Not limited by stake pocket holes
- Can be used to tie down cargo of any shape or size



Hitch Receiver Lock

patent 6,412,315

CR-094 5/8" Receiver lock (up to 5,000lbs.)

CR-094 1/2" Receiver lock (up to 3,500lbs.)

- Revolutionary single piece hitch receiver lock exceeds industry class III and IV GTW standards
- Bullet shaped tip allows easy alignment and insertion of pin through the receiver and ball mount
- Case hardened stainless steel cam locks the pin

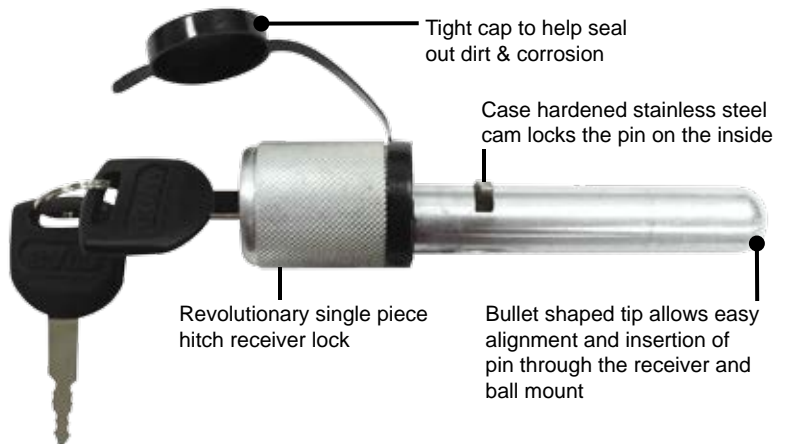

CR-091A 1/2" Swivel locking hitch pin Patent #: 5499894

- Patented swivel cup replaces ordinary cotter pin
- Place 1/8" pad lock through clip for added security
- Class II
- Up to 3,500 lb



CR-091 5/8" Swivel locking hitch pin Patent #: 5499894

- Patented swivel cup replaces ordinary cotter pin
- Place 3/16" pad lock through clip for added security
- Class III and IV
- Up to 10,000 lbs



CR-088 1/2" Hitch pin with pull pin (1/2" up to 3500lbs. Class II)

- CR-089 5/8" Hitch pin with pull pin (5/8" up to 10,000lbs class III & IV)
- Class II and III.



CR-1001

- One pin fits all: 5/8" for class III, IV, V 1/2" for Class II
- Load rating tested to: 5/8" - 33,000lbs 1/2" - 22,000lbs



Universal receiver lock

- 5/8" stainless steel sleeve prevents rust (Spins to prevent cutting)
- Easy 1/4 turn locks & unlocks head using rugged tubular keys that won't bend or break
- Patent design can't be false locked or popped open

CR-1001S

- One pin fits all: 5/8" for class III, IV, V 1/2" for Class II
- Load rating tested to: 5/8" - 33,000lbs 1/2" - 22,000lbs



CR-1201S Universal steel receiver lock with Stainless steel coupler lock

- One pin fits all: 5/8" for class III, IV, V 1/2" for Class II
- Load rating tested to: 5/8" - 33,000lbs 1/2" - 22,000lbs



CR-1202 Universal steel receiver lock with Stainless steel coupler lock

- One pin fits all: 5/8" for class III, IV, V 1/2" for Class II
- Load rating tested to: 5/8" - 33,000lbs 1/2" - 22,000lbs



CR-104 Trailer safety cable

- Class III 5,000 lbs. rated
- 36" safety cable with snap hooks
- Sold as a pair
- Easy to use
- SAE approved



BC-190 Wheel bearing protectors

- Fits 1.98" HUB grease cap bore diameter
- Keeps water and dirt out of wheel HUBS
- Reduces wheel bearing failure



CR-106 Trailer coupler

- 1-7/8" ball
- 2-1/2" wide channel



CR-107 Trailer coupler

- 2" ball
- 2-1/2" wide channel



Hitch Balls

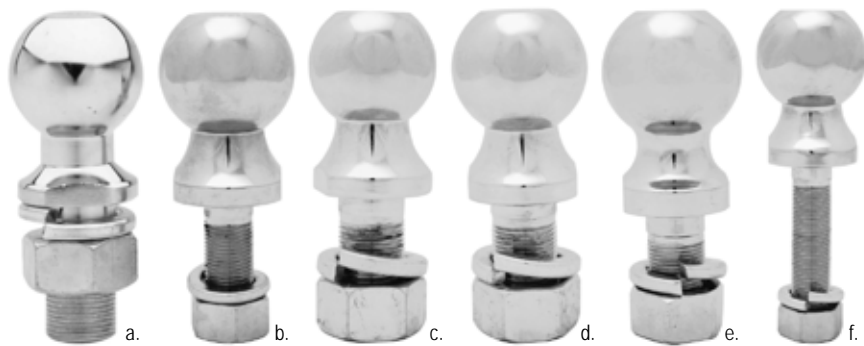

The Bully steel hitch balls and ball mounts are of hot forged solid steel construction. Tested to exceed V-5 specifications, all of the hitch balls and ball mounts comply with safety specifications, and requirements of SAE J684 VESC regulations V-5. Hitch load rating must equal or exceed the trailer gross vehicle weight rating (GTWR).



PART #	FINISH	GTW/TW	BALL (dia.)	SHANK (dia.)	SHANK (length)
a. CR-750	Chrome	2,000	1-7/8"		2-1/8"
b. CR-751	Chrome	3,500	2"		2-1/8"
c. CR-752	Chrome	2,000	1-7/8"	1"	2-1/8"
d. CR-753	Chrome	5,000	2"	1"	2-1/8"
e. CR-754	Chrome	7,500	2-5/16"	1"	2-1/8"
f. CR-757	Chrome	3,500	2"	3/4"	3-3/8"
g. CR-760	Stainless Steel	2,000	1-7/8"	1"	2-1/8"
h. CR-761	Stainless Steel	7,000	2"	1"	2-1/8"

Hitch Ball Mounts



PART #	FINISH	GTW/TW	HOLE SIZE	DROP	RISE	LENGTH	TUBE
a. CR-701	Stainless steel	6,000 / 600	1"	2"			
b. CR-702	Stainless steel		1"	3-1/4"			
c. CR-706	Blk painted	6,000 / 600	1"	3"	2"	9-1/2"	2"
d. CR-709	Blk painted	6,000 / 600		5-1/4"	4"		
e. CR-714	Blk painted	3500 / 350		2-1/2"	2"		
f. CR-713	Blk painted	3500 / 350		1-1/4"	3/4"		
f. CR-790	Blk painted	6,000 / 600		2"	3/4"		
g. CR-791	Blk painted	6,000 / 600		3-1/4"	2"		