

Installation instructions:

AKRAPOVIC RACING & EVOLUTION EXHAUST SYSTEM for the KAWASAKI ZX-10R (2008)

Congratulations on purchasing an Akrapovic exhaust system. Please read these installation instructions carefully. If you have any trouble installing the system please contact your authorized dealer!

IMPORTANT INFORMATION

Exclusion of Certain Liability

1. The manufacturer, importer or dealer shall not be liable for any incidental damage including personal injury or any other damages caused by improper installation or operation of the Akrapovic exhaust system. When installing the Akrapovic exhaust system be careful that the exhaust system does not touch other parts sensitive to high temperature.
2. Akrapovic makes no representation or warranties with regard to damage caused by the improper installation, use and maintenance of the Akrapovic exhaust system. The warranty is limited to defects recognized by our technical department and to normal use, and excludes items subject to normal wear (gaskets and damping wool). The guarantee is void in case of accident, modification, improper or competition use.
3. Do not attempt to install the Akrapovic exhaust system on a motorcycle for which it was not made or tested by Akrapovic.
4. When the exhaust system gets very hot during operation, be careful not to burn yourself on the exhaust system or parts which are in direct contact with it, even when the motor is not running. Also protect other people, especially children, from the injuries mentioned above.
5. In some cases Akrapovic exhaust system kits contain chemical products (ceramic anti-seizing grease; bolt sealant). Handle with care, do not inhale or swallow. Avoid excessive contact with skin, eyes or mucous membranes. Keep out of reach of children.
6. Technical specifications of Akrapovic exhaust systems and related products subject to change without notice.

Symbols The following symbols are used throughout these installation instructions:

 CAUTION OR WARNING

 INSTALLATION TIP

 TOOLS
REQUIRED

 TIGHTENING
TORQUE



USE BOLT SEALANT; Apply 3 to 4 small drops of bolt sealant onto the cleaned and degreased threads before tightening bolts. **WARNING! Avoid contact with skin, eyes and mucous membranes. Do not inhale fumes. Keep out of the reach of children.**



USE ANTI-SEIZING GREASE (white tube); Prevents seizing, corrosion and excessive wear between the titanium components of your exhaust system. **WARNING! Avoid eye contact. Avoid excessive skin contact. Keep out of the reach of children.**



USE ANTI-SEIZE LEAD-FREE COPPER PASTE (black tube); Provides trouble-free and long-lasting protection against seizing, corrosion and rusting of bolts, threaded ends, nuts, joints, etc. Also protects against vibration, wear and impact. **WARNING! Avoid eye contact. Avoid excessive skin contact. Keep out of the reach of children.**

INSTALLATION INSTRUCTIONS

 **BEFORE INSTALLING CHECK SCHEMATIC OF THE EXHAUST SYSTEM!**

 **IF ANY ITEMS IN THE AKRAPOVIC EXHAUST SYSTEM PACKAGE ARE MISSING PLEASE CONTACT YOUR AUTHORIZED DEALER. KEEP THE SCHEMATIC FOR FUTURE REFERENCE.**

 **THESE INSTALLATION INSTRUCTIONS MUST BE READ CAREFULLY IN ORDER TO ENSURE PROPER INSTALLATION AND OPERATION OF THE AKRAPOVIC EXHAUST SYSTEM.**

 **THE EXHAUST SYSTEM CAN BE EXTREMELY HOT. ALLOW THE MOTORCYCLE TO COOL DOWN BEFORE BEGINNING INSTALLATION.**

 **WE ADVISE YOU TO LEAVE INSTALLATION TO A QUALIFIED SERVICEMAN. IMPROPER INSTALLATION MAY RESULT IN A SHORTER LIFETIME OF THE EXHAUST SYSTEM AND/OR DAMAGE TO THE MOTORCYCLE.**



T-handle 12mm wrench
T-handle 13mm wrench
T-handle swiveling 10mm wrench
T-handle swiveling 12mm wrench
T-handle 4mm three hexagon key wrench
Combination 12mm wrench
Combination 13mm wrench
Combination 17mm wrench
Spring puller
Small flat screwdriver

REMOVAL OF STOCK EXHAUST SYSTEM:

1. Put the motorcycle on a side stand, we recommend a racing stand. Make sure, that surface is solid and flat.
2. Unscrew and remove fuel tank side panels and riders seat (Figure 1, 2, 3, 4).



Figure 1



Figure 2



Figure 3



Figure 4

3. Remove the safety pin and cables from the exhaust valve servo motor (Figure 5, 6, 7, 8). **!WARNING:** do not turn the the servo motor wheel with force (only by ignition key switching!) or the servo motor could be damaged.



Figure 5



Figure 6



Figure 7



Figure 8

4. Unscrew the bolts from the metal clamp at the muffler - catalytic converter box joint and muffler sub-frame bracket. Remove the muffler together with exhaust valve cables (Figure 9, 10, 11). **!WARNING:** be carefull not to damage the cables or any other part of the motorcycle during removal!



Figure 9

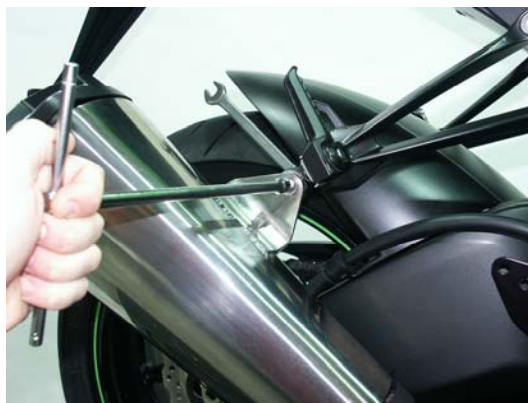

Figure 10



Figure 11

5. Unscrew and remove the stock heatshield (**Figure 12**). Unscrew the bolt from the metal clamp from the catalytic converter box – header tube set joint (**Figure 13**). Unscrew the bolts from the catalytic converter box brackets and remove the catalytic converter box (**Figure 14, 15**).



Figure 12



Figure 13



Figure 14



Figure 15

6. Unscrew and remove the lower part of the cowling (Figure 16, 17, 18).

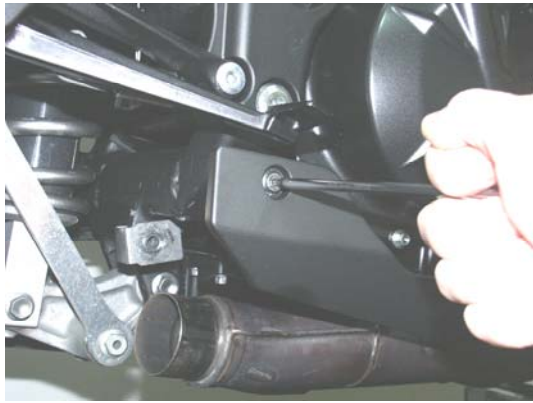

Figure 16



Figure 17



Figure 18

7. For easier access unscrew the bolts of the upper cowling shown in figures (Figure 19, 20).



Figure 19



Figure 20

8. Unscrew the lambda sensors and the water cooler lower bracket (Figure 21, 22). **!WARNING:** do not disconnect the cooling system tubes!



Figure 21



Figure 22

9. Unscrew the nuts from the header tube set flanges and remove them (Figure 23, 24). **!WARNING:** make sure not to damage the cooling fins of the water cooler or any other part of the motorcycle! Leave the stock gaskets in the exhaust ports.



Figure 23



Figure 24

INSTALLATION OF THE AKRAPOVIC RACING OR EVOLUTION EXHAUST SYSTEM:

1. Install the additional Akrapovic spacer under stock water cooler bracket and tighten the bracket back to the engine block (Figure 25, 26, 27). Do not tighten the water cooler to the bracket yet!



Figure 25



Figure 26

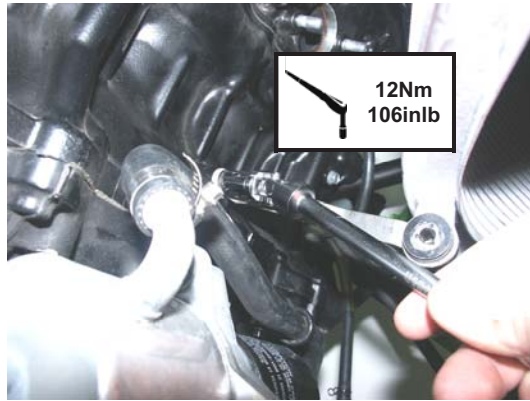

Figure 27

2. Set up the sleeves together with the flanges and short springs ; make sure they are correctly oriented (Figure 28, 29, 30). Tighten the flanges (to specified torque). **WARNING:** make sure not to damage the cooling fins of the water cooler or any other part of the motorcycle!



Figure 28



Figure 29



Figure 30

3. Insert the header tubes properly and attach the springs; make sure not to damage the cooling fins (**Figure 31, 32**). Tighten the lambda sensors (**Figure 33**). **!WARNING: grease only the threads of the lambda sensors!**



Figure 31



Figure 32

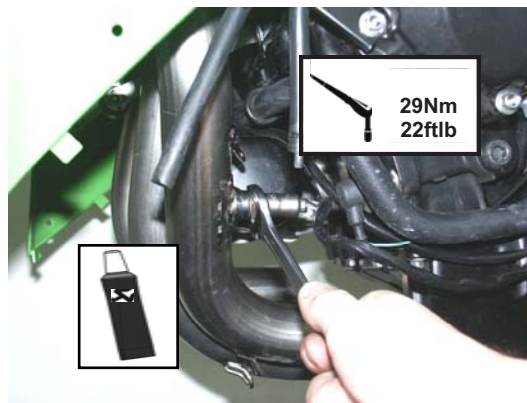

Figure 33

4. Make sure the collectors are correctly oriented. Slide the collectors onto the header tubes and attach the springs (**Figure 34, 35**). **For Evolution exhaust only:** coat the interior side of the input bushes of the titanium collectors with Akrapovic ceramic anti-seizing grease (white tube). Make sure, that springs pull the collectors all the way to the header tubes – use rubber mallet if necessary to tap the collectors into place!

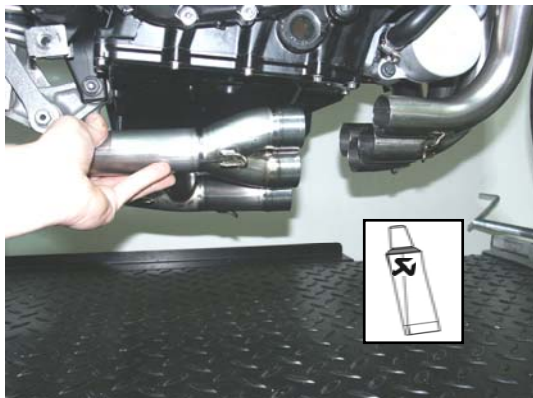

Figure 34



Figure 35

5. Slide the link pipe onto the collectors and attach the springs (Figure 36, 37). For Evolution exhaust only: coat the interior side of the input bushes of the titanium link pipe with Akrapovic ceramic anti-seizing grease (white tube). Make sure, that springs pull the link pipe all the way to the collectors – use rubber mallet if necessary to tap the link-pipe into place! Tighten the bolt of link-pipe bracket (Figure 38).

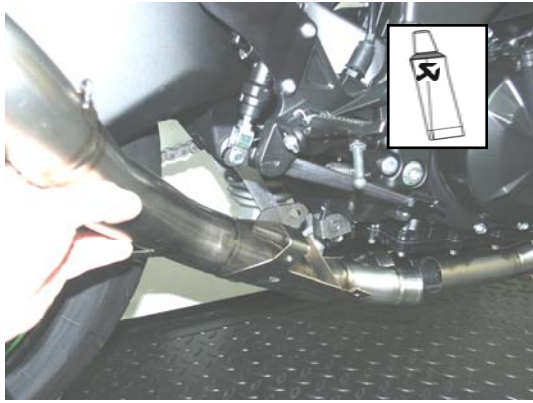

Figure 36



Figure 37

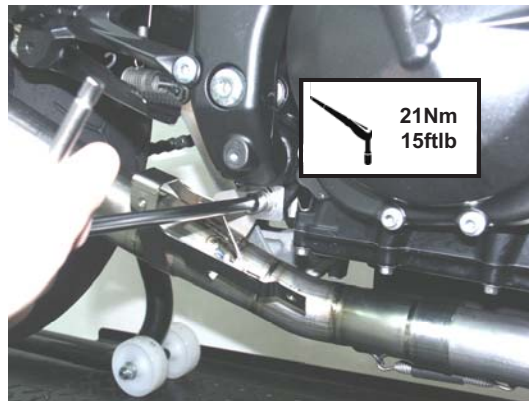

Figure 38

6. Correctly position the carbon-fiber clamp and slide it onto the muffler - bear in mind the left offset of the carbon-fiber clamp viewed from the rear. **!WARNING:** open the clamp slightly wider than the diameter of the outer sleeve of the muffler – do not scrape it along the muffler outer sleeve! (Figure 39).



Figure 39

7. Position the muffler correctly, slide it onto the outlet side of the link pipe and attach the springs (**Figure 40, 41**). Tighten the bolt on the carbon-fiber clamp/stock muffler bracket joint using Akrapovic bolt, washer, aluminium spacer and nut as shown in figures (**Figure 42, 43, 44, 45**). Make sure, that the link pipe or muffler are not touching the frame or any other part of the motorcycle.



Figure 40



Figure 41



Figure 42



Figure 43



Figure 44



Figure 45

8. Tighten the bracket to the water cooler (**Figure 46**). Reinstall the lower part of the cowling (**Figure 47, 48, 49**).

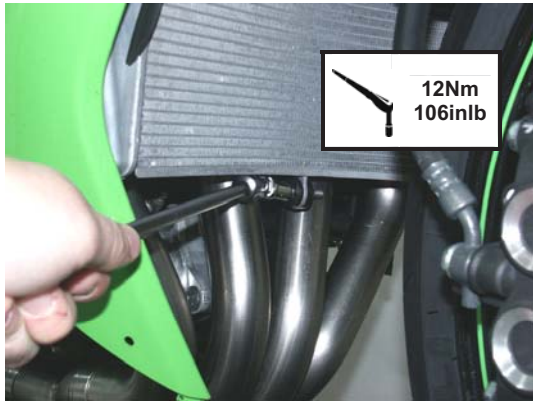

Figure 46



Figure 47

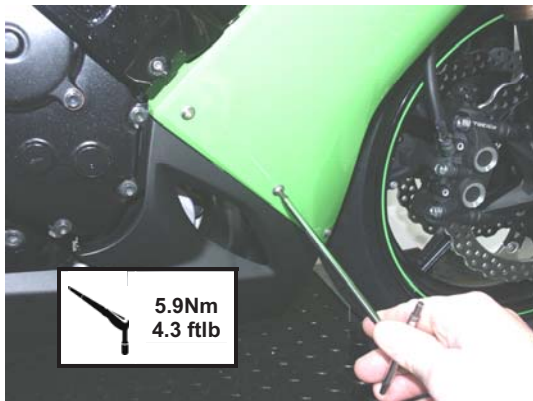

Figure 48

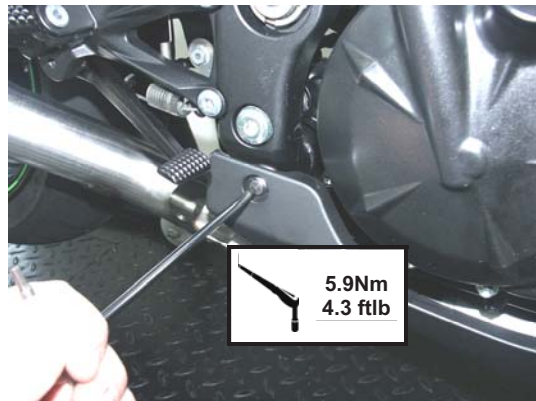

Figure 49

9. Reinstall the stock heatshield using stock bolts and washers (**Figure 50, 51**).



Figure 50

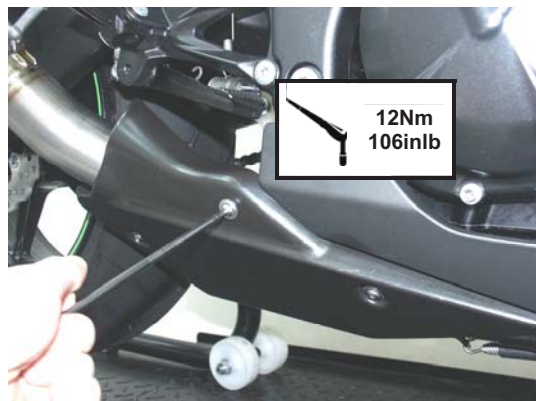

Figure 51

final installation:

1. Clean grease spots:
 - a. Muffler – carbon-fiber outer sleeve: use a soft dry cloth.
 - b. Muffler – titanium outer sleeve: use a soft cloth sprayed with a multi-purpose spray lubricant (WD-40 or equivalent).
 - c. Muffler – carbon-fiber outlet cap: use a soft dry cloth.
 - d. RACING - stainless steel link pipe, collectors and header tubes: use a soft cloth sprayed with a contact cleaner, then wipe with a soft dry cloth
 - e. EVOLUTION - titanium link pipe, collectors and header tubes : use a soft cloth sprayed with a multi-purpose spray lubricant (WD-40 or equivalent).

Cleaning will prevent spots from burning onto the surface. Do not use aggressive chemical cleaners, because they can damage the sticker.

Position of the correctly installed Akrapovic **RACING** or **EVOLUTION** exhaust system (**Figure 52**).



Figure 52

2. Check the operation of the brakes and suspension. Make sure all the bolts are sufficiently tightened. In case the exhaust system touches the cowling or other parts repeat the adjustment of the exhaust system or contact your authorized dealer.

! IT IS NORMAL IF WHITE SMOKE COMES OUT OF THE MUFFLER ON FIRST OPERATION.

! DO NOT STAND BEHIND THE MUFFLER ON FIRST OPERATION.

! DO NOT USE AUTOMOTIVE WHEEL CLEANERS OR ANY CLEANING PRODUCTS WHICH CONTAIN ACIDIC ADDITIVES TO CLEAN AKRAPOVIC EXHAUST SYSTEMS.

MAINTENANCE OF THE AKRAPOVIC EXHAUST SYSTEM

1. Clean the titanium exhaust components with a multi-purpose spray lubricant (WD-40 or equivalent), carbon fiber exhaust components with soft and dry cloth and stainless steel components with soft cloth sprayed with contact cleaner, then wipe with soft and dry cloth. Do not use aggressive chemical cleaners, because they can damage the sticker. A change in the color of the exhaust system is normal due to the high temperatures.
2. The wearing out of the muffler silencing material depends on the type of the engine and riding style. Contact your dealer/serviceman if visible changes appear on muffler's outer sleeve or the noise level is increased.
3. Periodically make sure all the bolts and springs are sufficiently tight.

KAWASAKI ZX-10R Complete system/Racing, model year 2008 (R1)

Product code: S-K10R5-ZC
S-K10R5-ZT

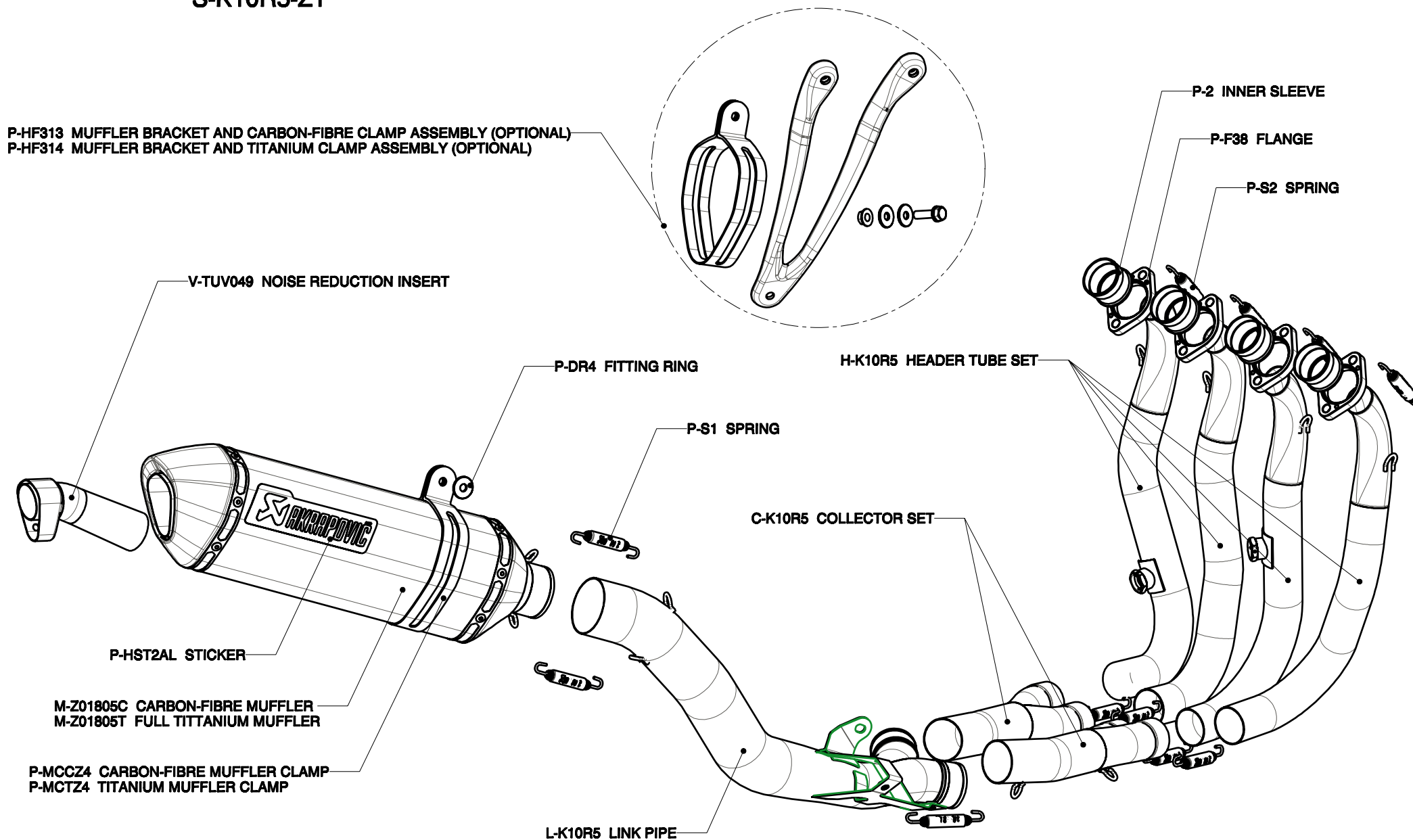

KAWASAKI ZX-10R Complete system/Evolution, model year 2008 (E1)

Product code: S-K10RFT5T-ZC
S-K10RFT5T-ZT

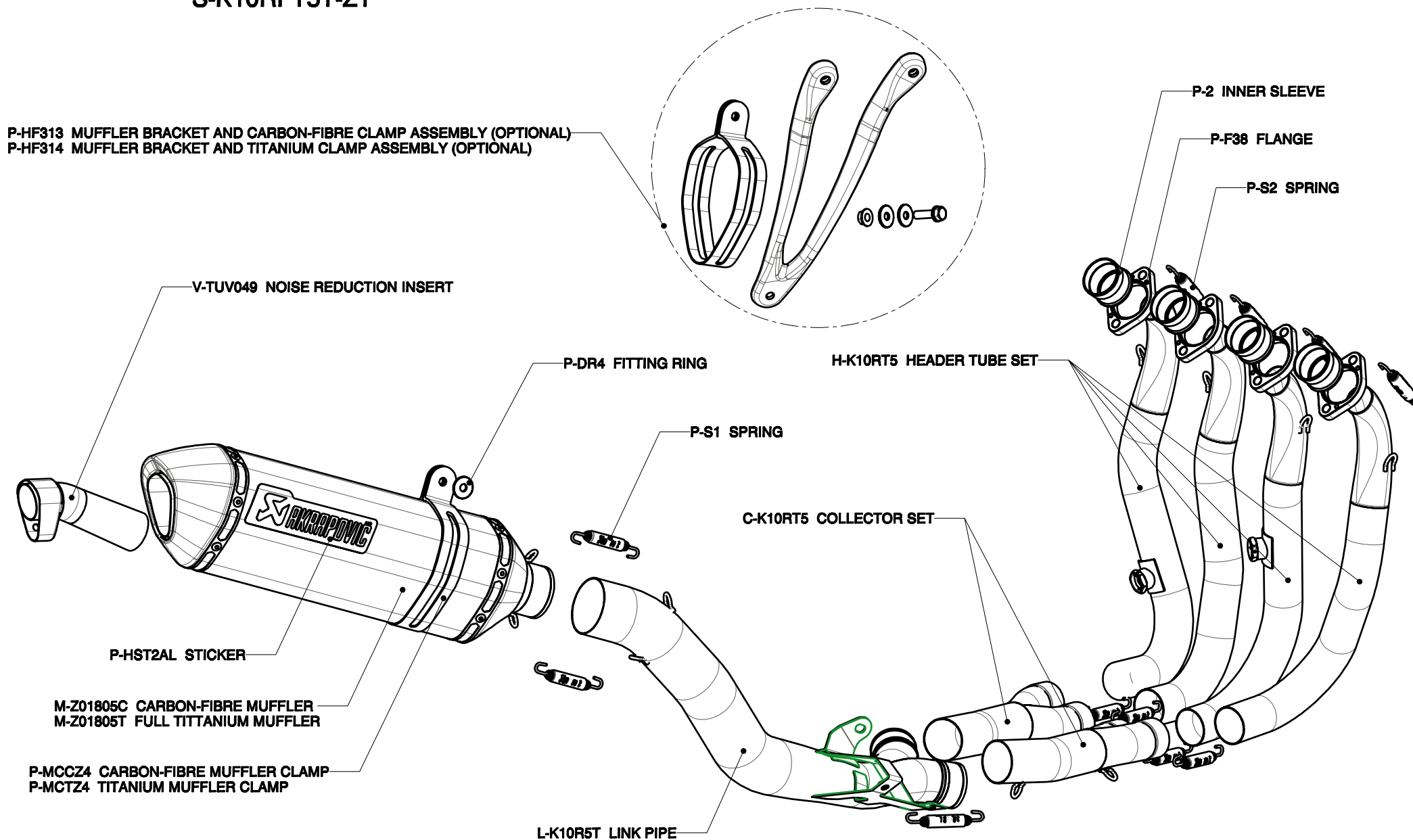

KAWASAKI ZX-10R/Evolution line/KIT EVO7-CZ Model year:2008

Product code: S-K10RFT5T-XT

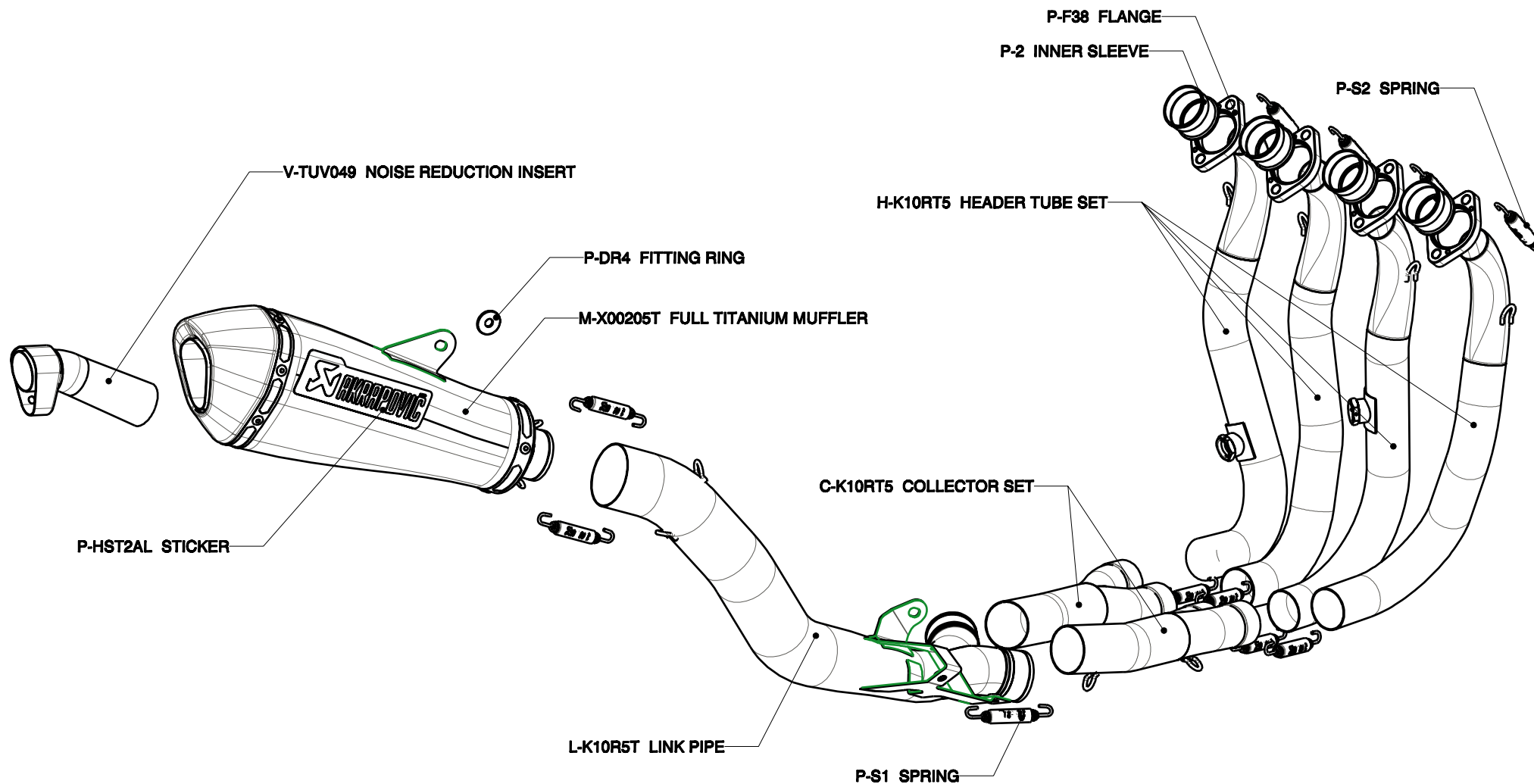

KAWASAKI ZX-10R /EVOLUTION LINE tube set with Street legal SLIP ON Mufflers ,Model year 2008

Product code: S-K10RFT5T-ZC/1
S-K10RFT5T-ZT/1

WARNING! IN CASE OF COMBINATION WITH EVOLUTION TUBE SET THE SLIP-ON HOMOLOGATION IS NOT VALID!

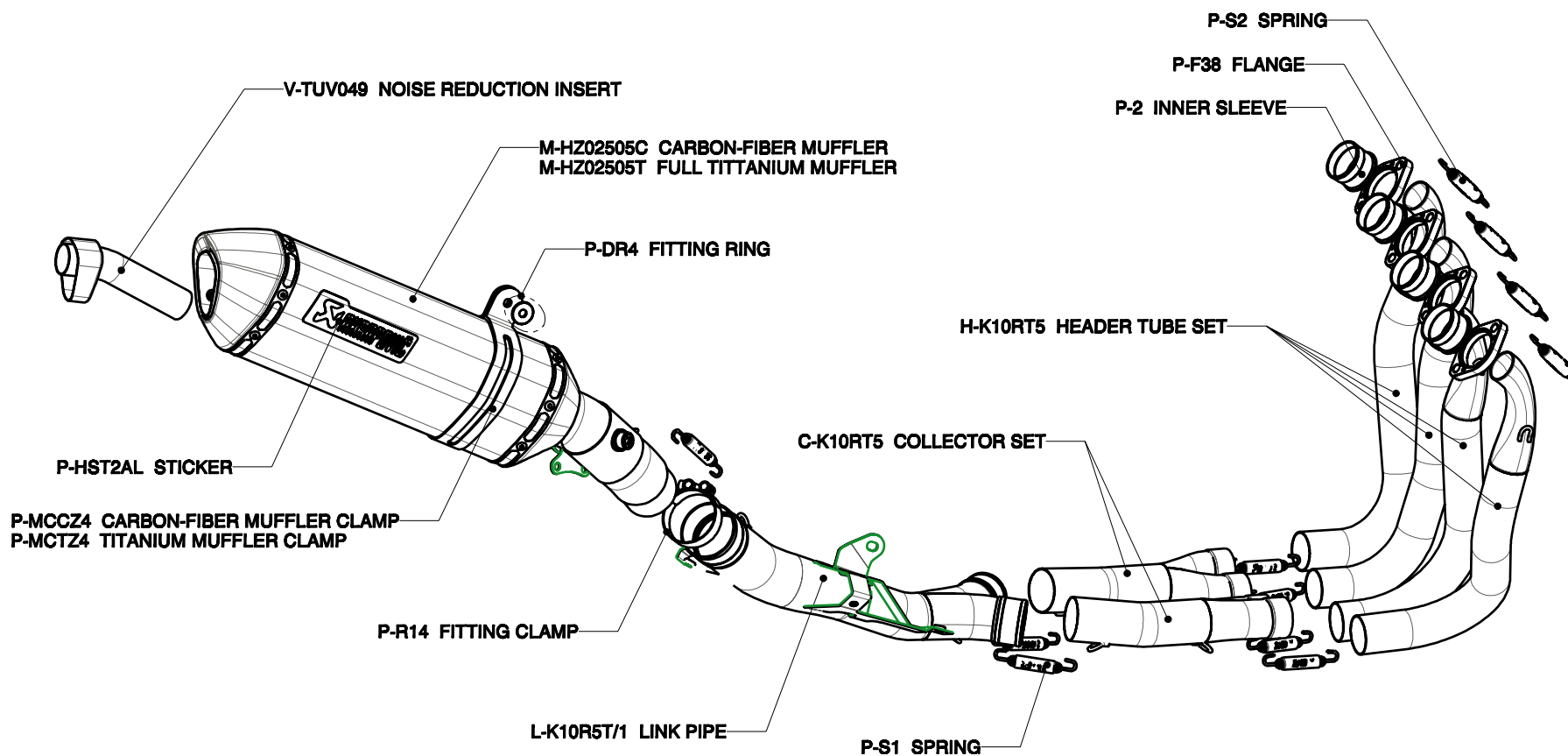

KAWASAKI ZX-10R /RACING LINE tube set with Street legal SLIP ON Mufflers ,Model year 2008

Product code: S-K10R5-ZC/1
S-K10R5-ZT/1

WARNING! IN CASE OF COMBINATION WITH RACING TUBE SET THE SLIP-ON HOMOLOGATION IS NOT VALID!

