



## Installation instructions

Akrapovič Exhaust System  
**Slip-On**  
for the  
**YAMAHA V-MAX**

**Congratulations on purchasing an Akrapovič exhaust system. Please read the entire installation manual prior to undertaking any activities related to installation of your new Akrapovič exhaust system. In case you do not fully understand the manual or any of its parts, please contact your authorized dealer!**

**This product should be installed by someone with sufficient knowledge of exhaust systems and their installation, and appropriate hand or power tools. If you are not qualified for this work, please utilize a certified mechanic for installation. By installing Your Akrapovič exhaust system, you indicate that you have read the installation manual in its entirety and you agree with the terms stated herein.**

**It is your responsibility to follow all installation instruction guidelines supplied with the Akrapovič exhaust system and undertake all necessary safety precautions. Akrapovič d.d. assumes no responsibility for damages occurring from misuse, abuse, improper installation, improper operation, lack of responsible care, or all previously stated reasons resulting from incompatibility with other manufacturer's products and/or systems.**

## **IMPORTANT INFORMATION**

### **Exclusion of Certain Liability**

1. The manufacturer, importer or dealer shall not be liable for any incidental damage including personal injury or any other damages caused by improper installation or operation of the Akrapovič exhaust system. When installing the Akrapovič exhaust system be careful that the exhaust system does not touch other parts sensitive to high temperature.
2. Akrapovič makes no representation or warranties with regard to damage caused by the improper installation, use and maintenance of the Akrapovič exhaust system. The warranty is limited to defects recognized by our technical department and due to normal use, and excludes items subject to normal wear (gaskets and damping wool). The guarantee is void in case of accident, modification, improper or competition use.
3. Do not attempt to install the Akrapovič exhaust system on a vehicle model for which it was not made or tested by Akrapovič.
4. When the exhaust system gets very hot during operation, be careful not to burn yourself on the exhaust system or parts which are in direct contact with it, even when the engine is not running. Also protect other people, especially children, from the injuries mentioned above.
5. In some cases Akrapovič exhaust system kits contain chemical products (ceramic anti-seizing grease; bolt sealant). Handle with care, do not inhale or swallow. Avoid excessive contact with skin, eyes or mucous membranes. Keep out of reach of children.
6. Technical specifications of Akrapovič exhaust systems and related products are subject to change without notice.
7. Before removing the original exhaust system from your vehicle, please compare the parts you received with the list of materials provided in the installation manual in order to assure that you have all the parts necessary for the installation of your new Akrapovič exhaust system.
8. Although this manual consists of instructions for installation in written form, as well as photographs and pictures representing individual steps of the installation, please note that the photographs and pictures are symbolic and are intended for representation of general overview only. The photographs and pictures contained herein should serve as a guideline only and actual installation of the exhaust system may not correspond with the photographs and pictures entirely.
9. The process of uninstalling the original exhaust system may vary depending on the existing exhaust system. Please follow the original exhaust system manufacturer's instructions for uninstalling the original exhaust system.

## Symbols

The following symbols are used throughout these installation instructions:



TOOLS REQUIRED



TIGHTENING TORQUE



INSTALLATION TIP



CAUTION OR WARNING



**USE BOLT SEALANT;** Apply 3 to 4 small drops of bolt sealant onto the cleaned and degreased threads before tightening the bolts. **WARNING! Avoid contact with skin, eyes and mucous membranes. Do not inhale fumes. Keep out of reach of children.**



**USE ANTI-SEIZE LEAD-FREE COPPER PASTE** (black tube); Provides trouble-free and long-lasting protection against seizing, corrosion and rusting of bolts, threaded ends, nuts, joints, etc. Also protects against vibration, wear and impact. **WARNING! Avoid eye contact. Avoid excessive skin contact. Keep out of reach of children.**



**USE ANTI-SEIZING GREASE** (white tube); Prevents seizing, corrosion and excessive wear between the titanium components of your exhaust system. **WARNING! Avoid eye contact. Avoid excessive skin contact. Keep out of reach of children.**

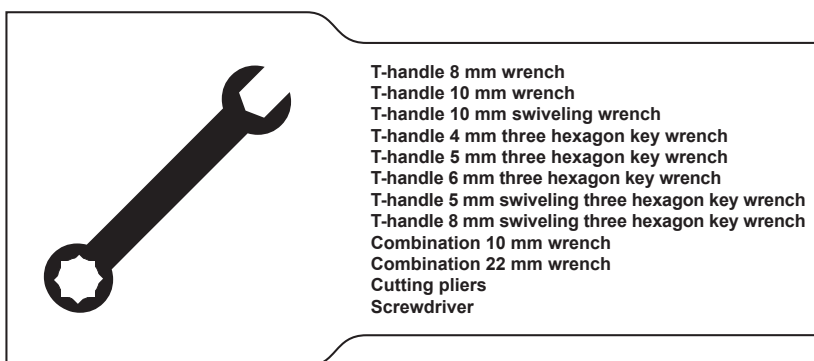

**BEFORE INSTALLING, CHECK SCHEMATIC OF THE EXHAUST SYSTEM!**



**IF ANY ITEMS IN THE AKRAPOVIČ EXHAUST SYSTEM PACKAGE ARE MISSING, PLEASE CONTACT YOUR AUTHORIZED DEALER. KEEP THE SCHEMATIC FOR FUTURE REFERENCE.**



**THESE INSTALLATION INSTRUCTIONS MUST BE READ CAREFULLY IN ORDER TO ENSURE PROPER INSTALLATION AND OPERATION OF THE AKRAPOVIČ EXHAUST SYSTEM.**



**THE EXHAUST SYSTEM CAN BE EXTREMELY HOT. ALLOW THE EXHAUST AND ENGINE TO COOL DOWN BEFORE BEGINNING INSTALLATION.**



**WE ADVISE YOU TO LEAVE INSTALLATION TO A QUALIFIED SERVICEMAN. IMPROPER INSTALLATION MAY RESULT IN A SHORTER LIFETIME OF THE EXHAUST SYSTEM AND/OR DAMAGE TO THE VEHICLE.**

**REMOVAL OF STOCK EXHAUST SYSTEM:**

1. Put the motorcycle on a side stand, we recommend a racing stand. Make sure, that surface is solid and flat.
2. Unscrew the marked bolts and remove the stock heat shield. Perform the process on both sides of the motorcycle (Figure 1).



Figure 1

3. Unscrew the bolt from muffler sub-frame bracket and untighten the metal clamp at the muffler - catalytic converter box joint. Remove the stock muffler. Perform the process on both sides of the motorcycle (Figure 2).



Figure 2

4. For OPEN SLIP-ON only: pull the small handle for opening the back of the seat (Figure 3). Unscrew the marked bolts and remove the rider's seat (Figure 4).



Figure 3



Figure 4

5. For OPEN SLIP-ON only: unscrew the marked bolts and remove the passenger's seat (Figure 5).



Figure 5

6. For OPEN SLIP-ON only: unlock the left side panel with ignition key and remove the left side panel (Figure 6).



Figure 6

7. For OPEN SLIP-ON only: unscrew the marked bolt and remove the right side panel (Figure 7).



Figure 7

8. For OPEN SLIP-ON only: unscrew the marked bolts and remove six plastic fasteners (Figure 8, 9). Remove the seat cowling.

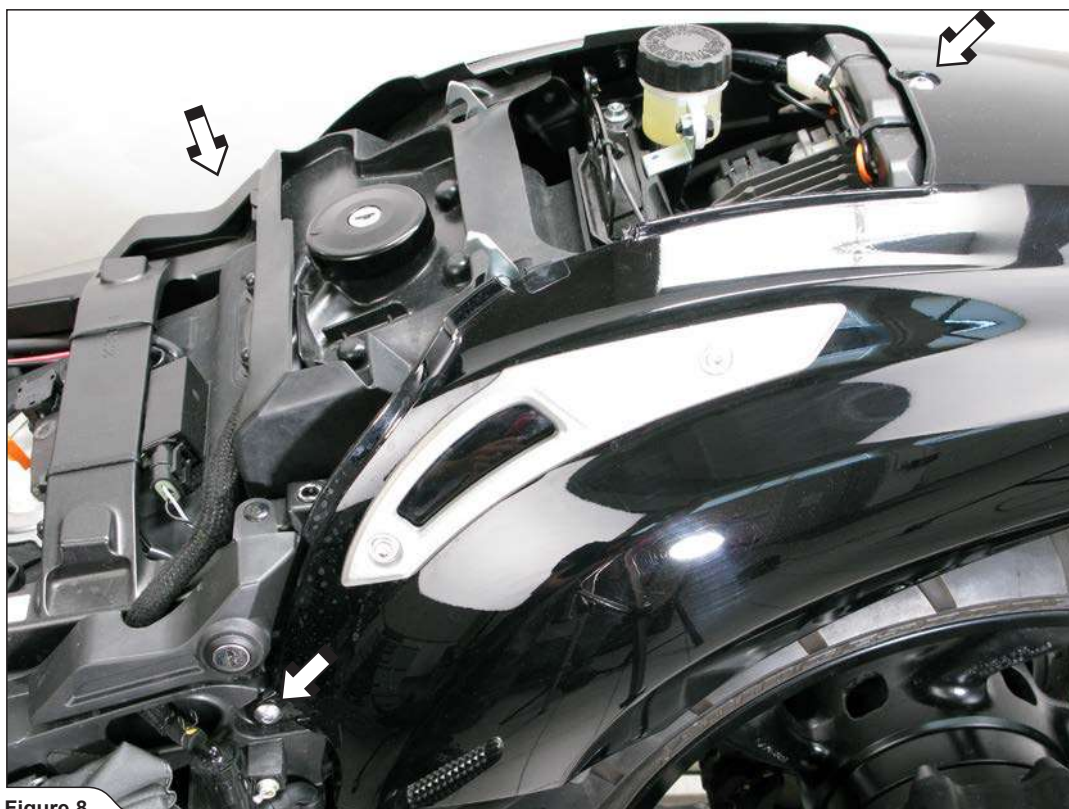

Figure 8



Figure 9

9. For OPEN SLIP-ON only: unscrew the marked bolts and remove the exhaust valve cover (Figure 10).

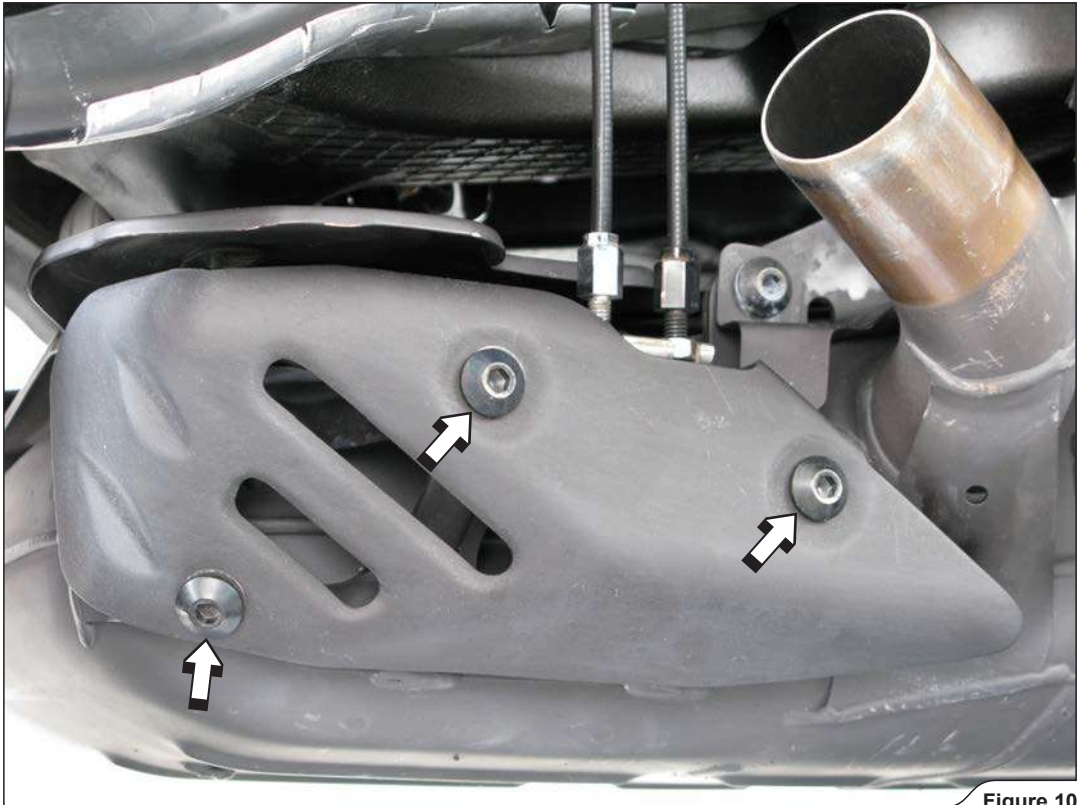

Figure 10



10. For OPEN SLIP-ON only: unscrew the nuts for easier removal the exhaust valve cables (Figure 11).



Figure 11

11. For OPEN SLIP-ON only: unscrew the marked bolts and remove the stock servo motor and anhook the cable of the exhaust valve (Figure 12, 13).

- ! WARNING: do not turn the the servo motor wheel with force or the servo motor could be damaged.
- ! WARNING: do not disconnect or remove the servo motor!



Figure 12

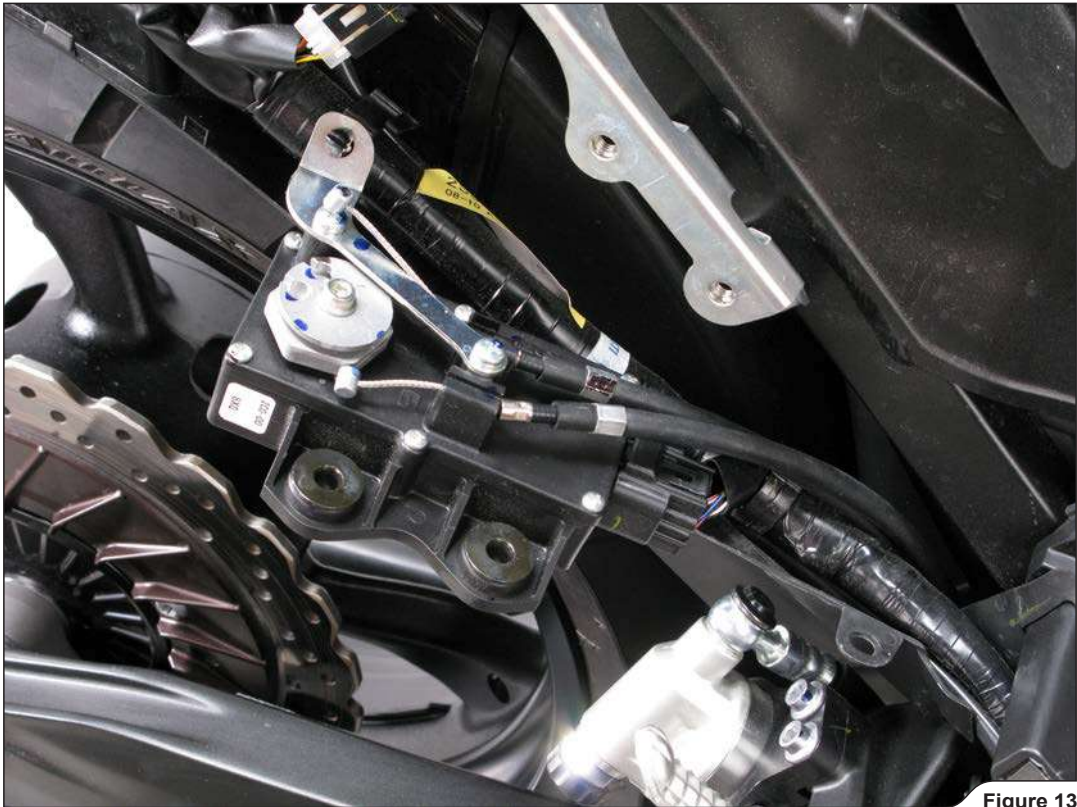

Figure 13

12. For OPEN SLIP-ON only: reattach the servo motor (Figure 14).

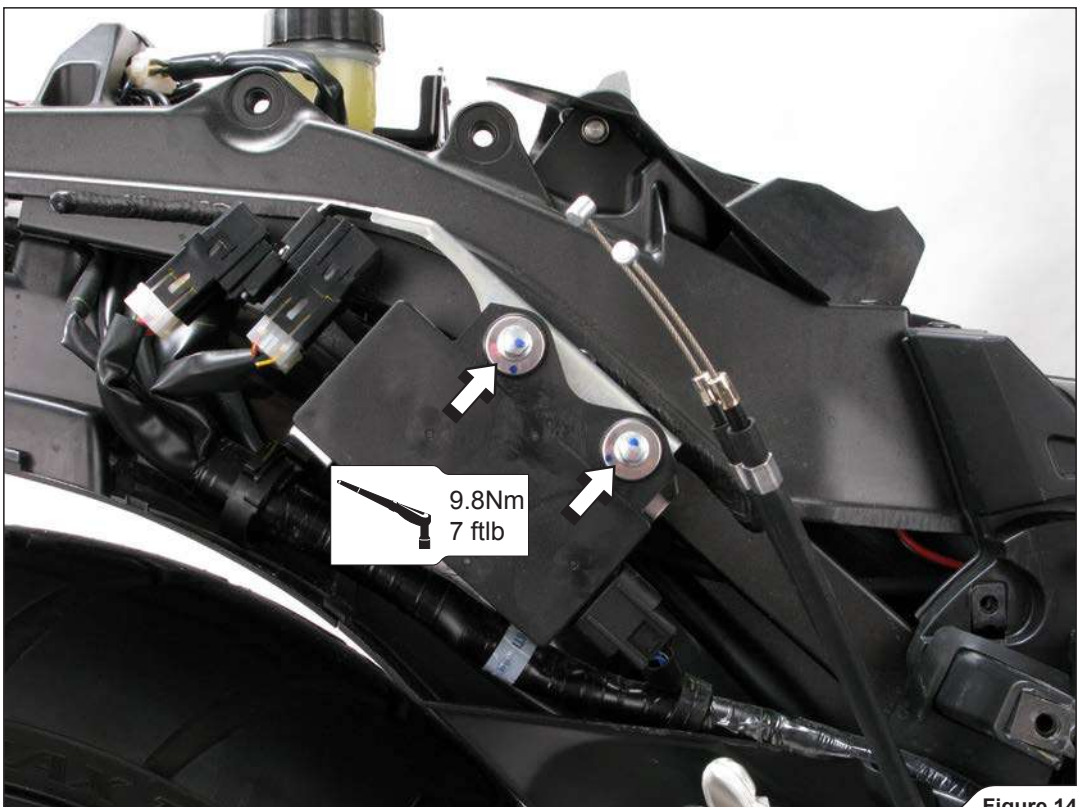

Figure 14

13. For OPEN SLIP-ON only: untighten the metal clamps at the catalytic converter box-header tubes joint (Figure 15).



Figure 15

14. For OPEN SLIP-ON only: untighten the metal clamp at the catalytic converter box - header tube joint and unscrew the marked bolts from chassis hanging brackets of the catalytic converter box (Figure 16).



Figure 16

15. For OPEN SLIP-ON only: untighten the metal clamp at the catalytic converter box - header tube joint and unscrew the marked bolt from chassis hanging bracket of the catalytic converter box (Figure 17).



Figure 17

16. For OPEN SLIP-ON only: loosen up the nuts of the front header tubes (Figure 18).



Figure 18

17. For OPEN SLIP-ON only: remove the stock catalytic converter box and unscrew the lambda sensor (Figure 19).  
! **WARNING:** support the stock catalytic converter box during this procedure or it may fall off and damage you or the motorcycle!



Figure 19

**INSTALLATION OF THE AKRAPOVIČ SLIP-ON EXHAUST SYSTEM:**

1. For OPEN SLIP-ON only: reposition the marked stock metal clamp with stock graphite gasket from stock catalytic converter box onto the Akrapovič collector (Figure 20, 21).  
! **WARNING:** do not damage the stock graphite gasket!



Figure 20



Figure 21

2. **For OPEN SLIP-ON only:** coat the bolts and interior of the metal clamps with Akrapovič antseize lead-free copper paste (black tube) and corectly install them onto the Akrapovič collector (**Figure 22**).  
**!** **WARNING:** use anti-seize copper paste on bolt threads and interior of the metal clamp!

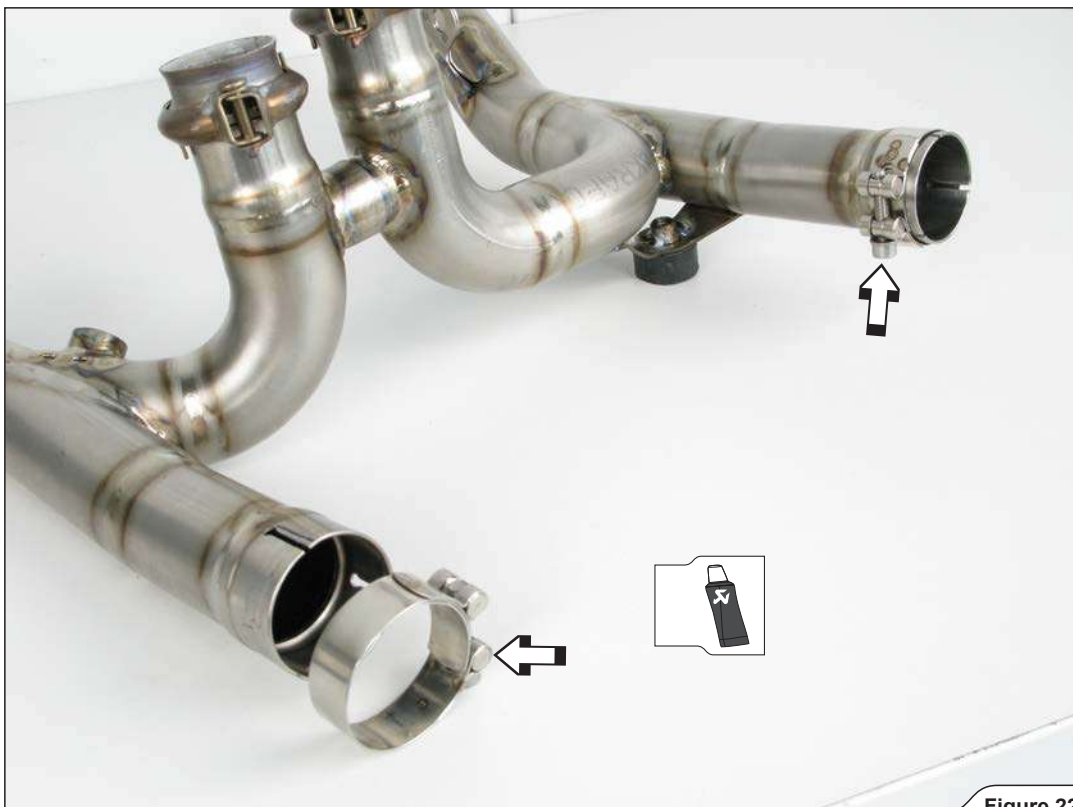

Figure 22

3. **For OPEN SLIP-ON only:** slide the collector onto the stock header tubes and hand tighten the marked bolts using stock bolts and Akrapovič nuts (**Figure 23**).  
**!** **WARNING:** be careful not to damage the stock graphite gaskets during installation Akrapovič collector onto the rear stock header tubes!

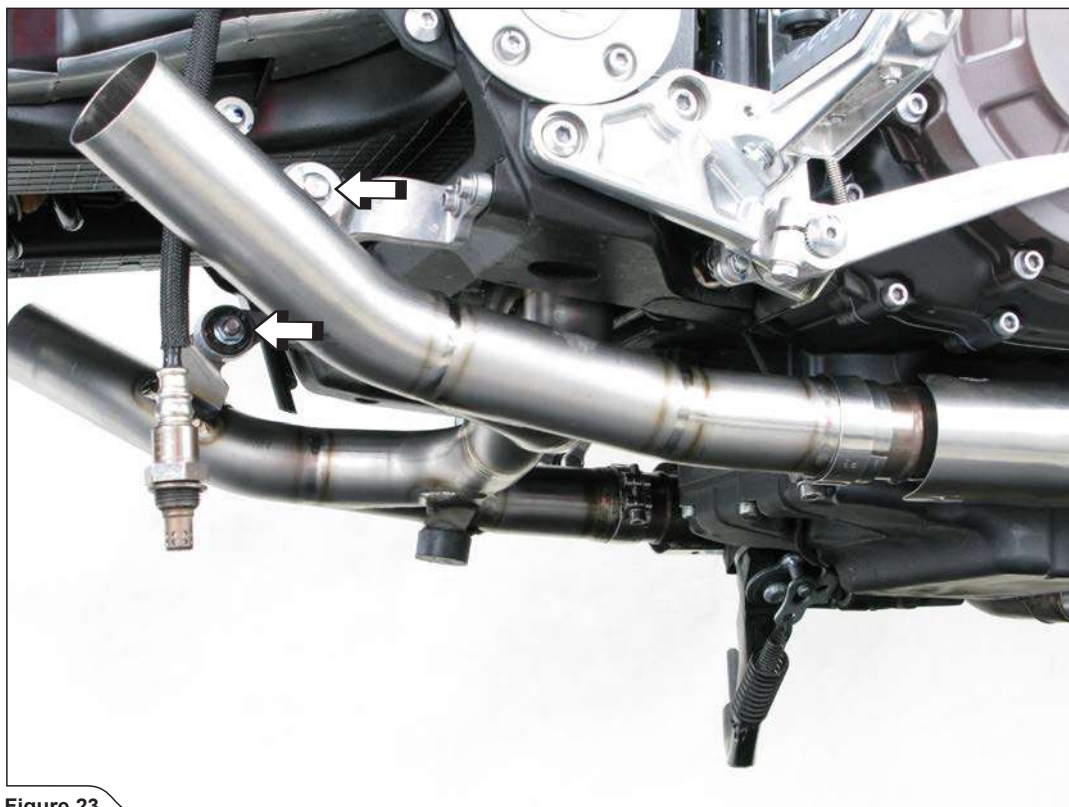

Figure 23

4. **For OPEN SLIP-ON only:** tighten the nuts of the stock header tubes (**Figure 24**). Tightening torque: 22Nm/16ftlb.

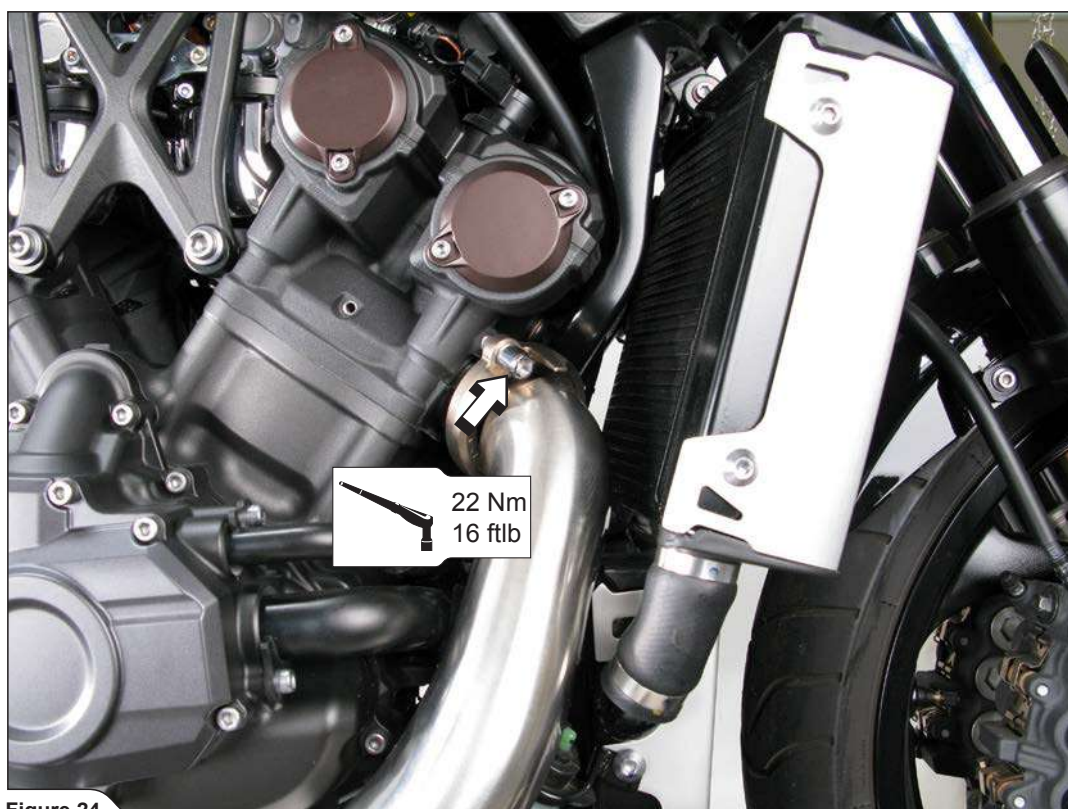

Figure 24

5. **For OPEN SLIP-ON only:** tighten the marked bolts of stock collector brackets and metal clamps (**Figure 25, 26**). Tightening torque for bolts of stock collector brackets: 22Nm/16 ftlb. Tightening torque for metal clamps: 9,8Nm/7ftlb.

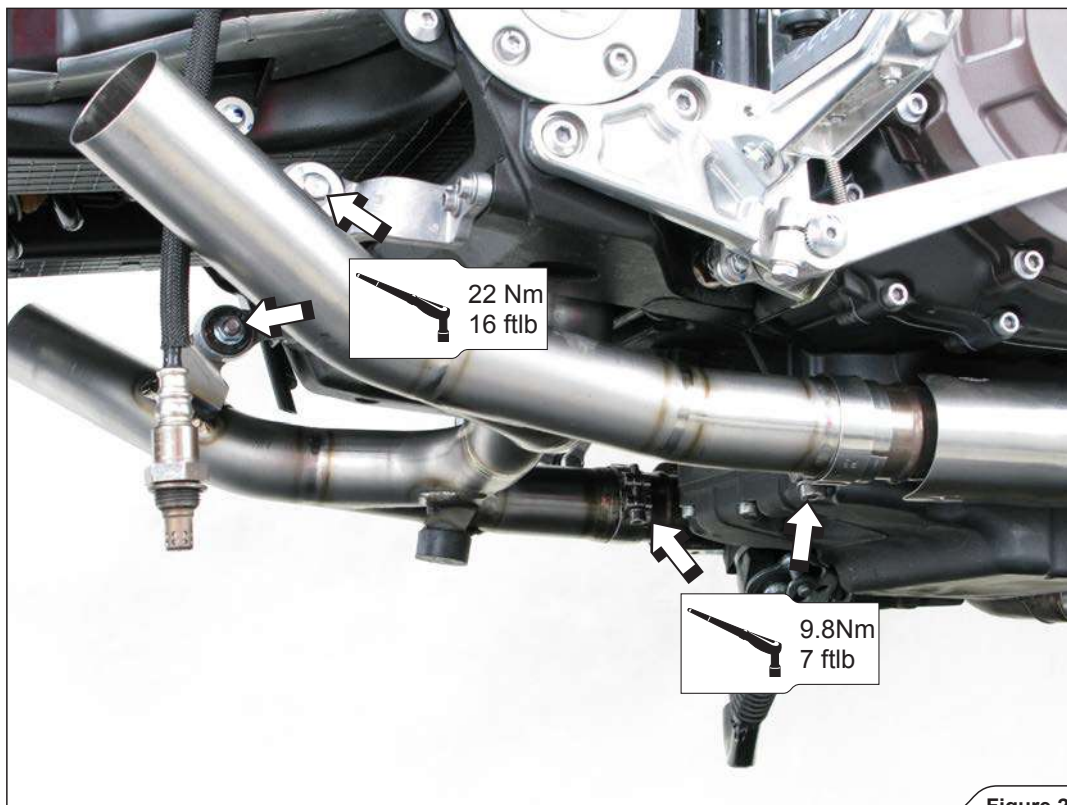

Figure 25

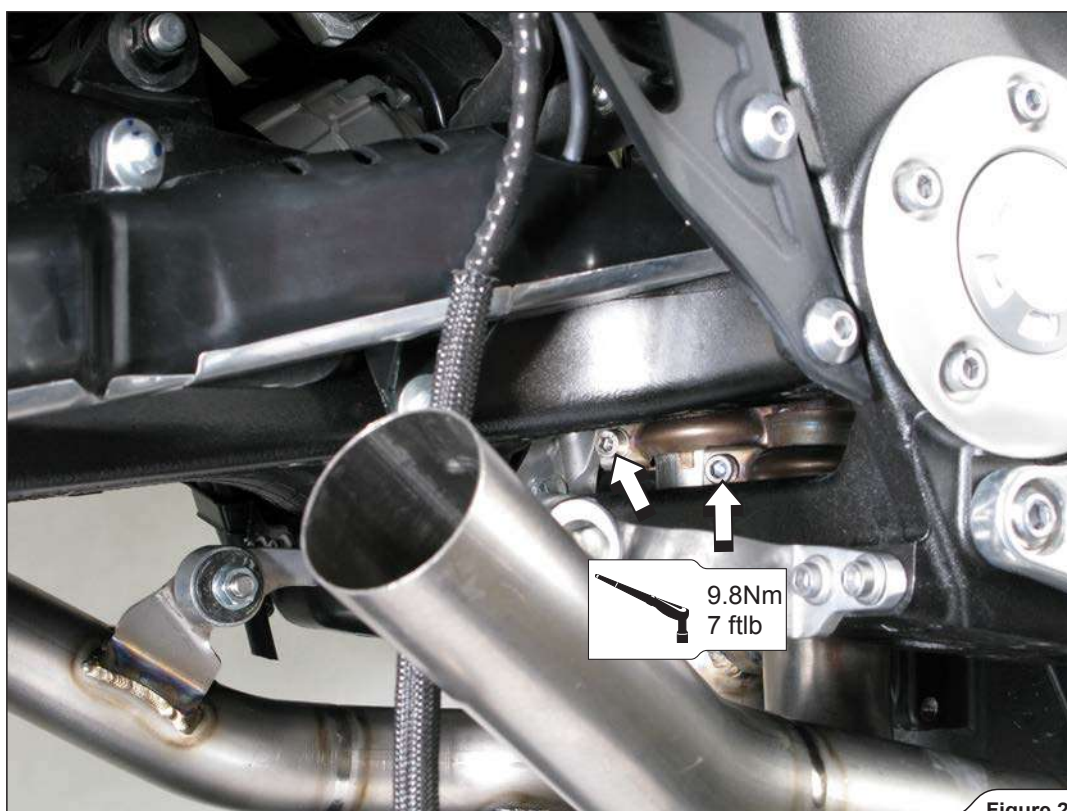

Figure 26



6. **For OPEN SLIP-ON only:** disconnect the connector of the lambda sensor and correctly reposition the electrical lead of the lambda sensor, so it can be installed onto the Akrapovič collector (Figure 27). Tighten the lambda sensor and attach the electrical lead of the lambda sensor using plastic ties; cut away excess (Figure 28, 29, 30).
- ! **WARNING:** grease only the threads of the lambda sensor with Akrapovič anti-seize lead-free copper paste (black tube)!

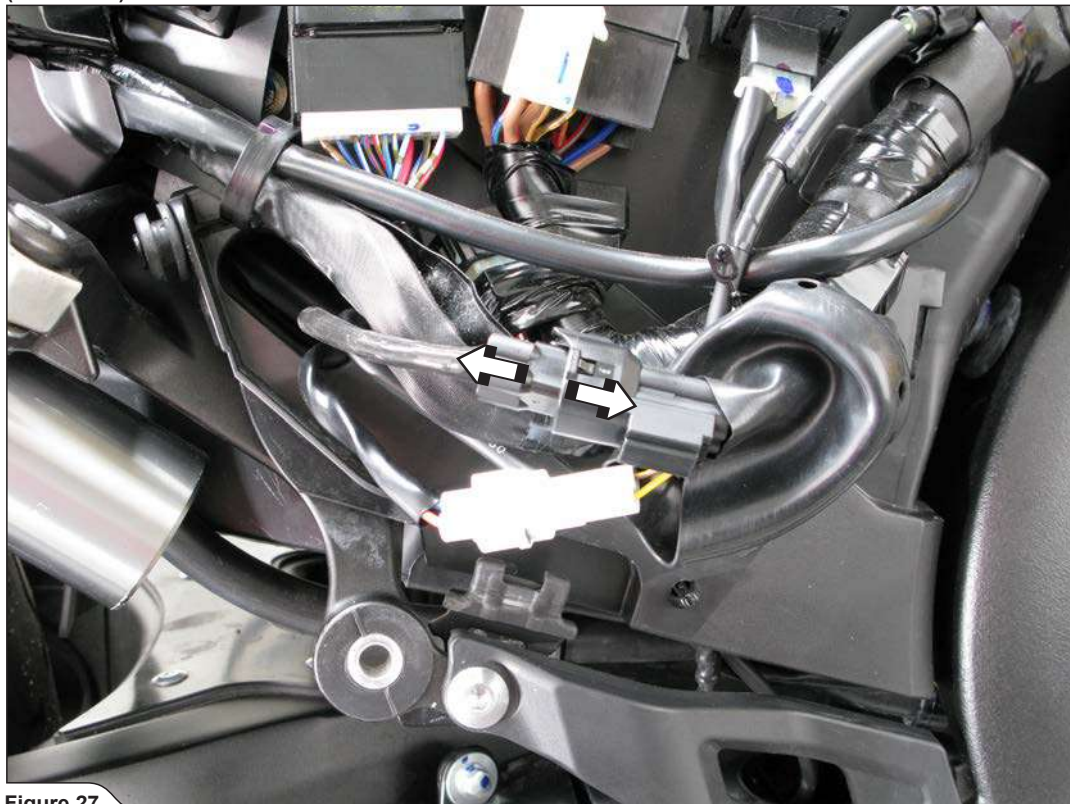

Figure 27

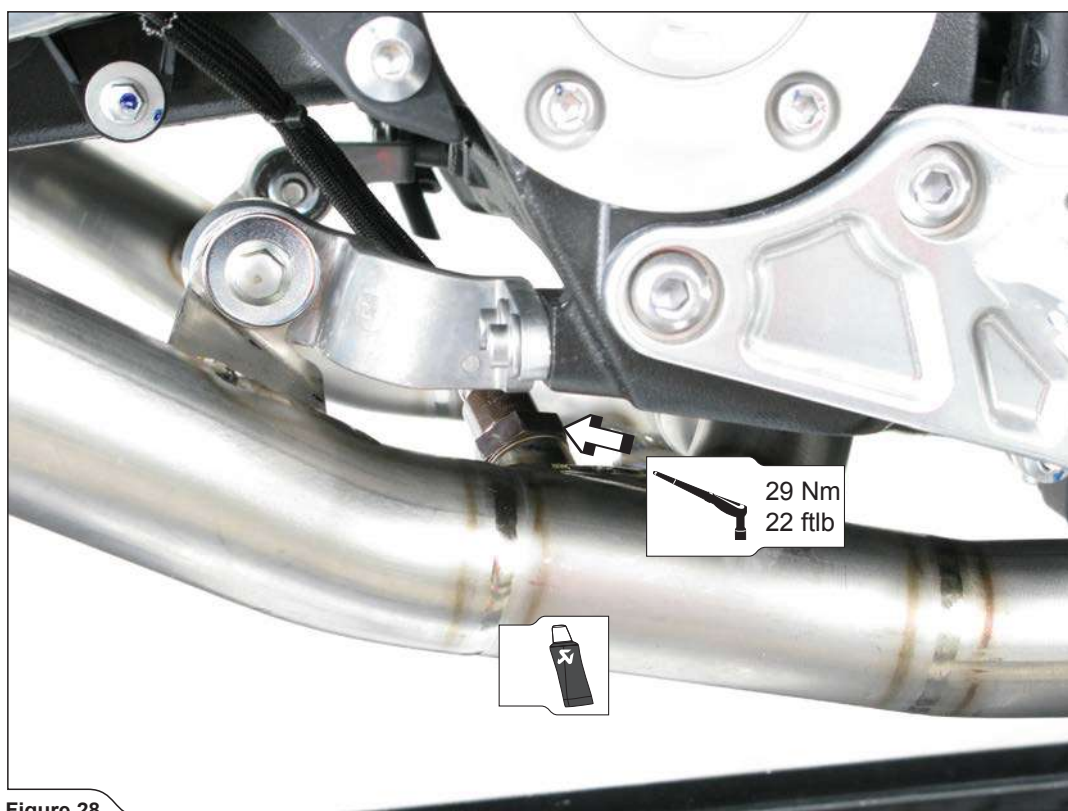

Figure 28



Figure 29

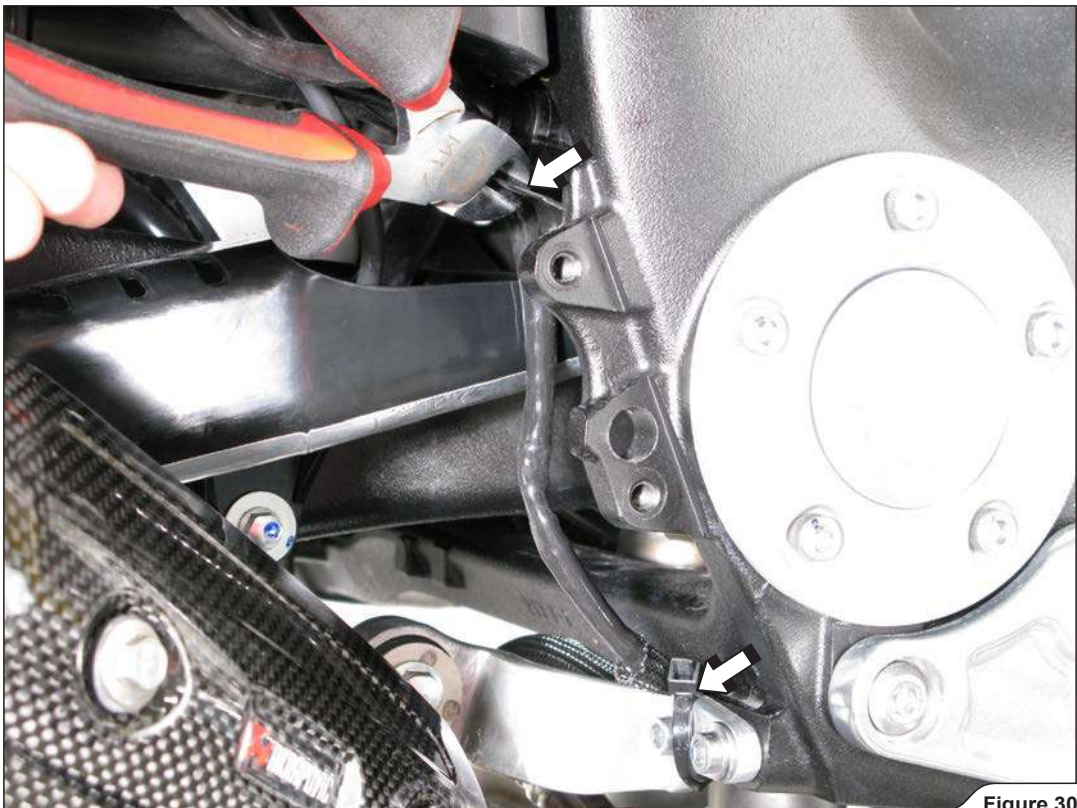

Figure 30

7. Install the heat / distance washers correctly (**Figure 31**). Install the heat shield brackets and correctly attach the metal clamps (**Figure 32**).



Figure 31



Figure 32

8. **For STREET LEGAL SLIP-ON only:** correctly position the Akrapovič carbon-fiber heat shields and slide them onto the catalytic converter box (**Figure 33**).



Figure 33

9. **For OPEN SLIP-ON only:** correctly position the Akrapovič carbon-fiber heat shields and slide them onto the Akrapovič collector (**Figure 34**).



Figure 34

10. **For BOTH SLIP-ON systems:** coat the bolts and interior of the metal clamps with Akrapovič antseize lead-free copper paste (black tube) and correctly install them onto the Akrapovič mufflers (**Figure 35**).
- ! **WARNING:** use anti-seize copper paste on bolt threads and interior of the metal clamp!



Figure 35

11. **For BOTH SLIP-ON systems:** position the mufflers correctly, slide them onto the outlet sides of the catalytic converter box or Akrapovič collector. Align the mufflers in respect to the motorcycle and tighten the metal clamps and the bolts of the muffler brackets using stock bolts and Akrapovič nuts (**Figure 36**). Tightening torque for stock muffler brackets: 22Nm/16 ftlb. Tightening torque for metal clamps: 9,8Nm/7ftlb.

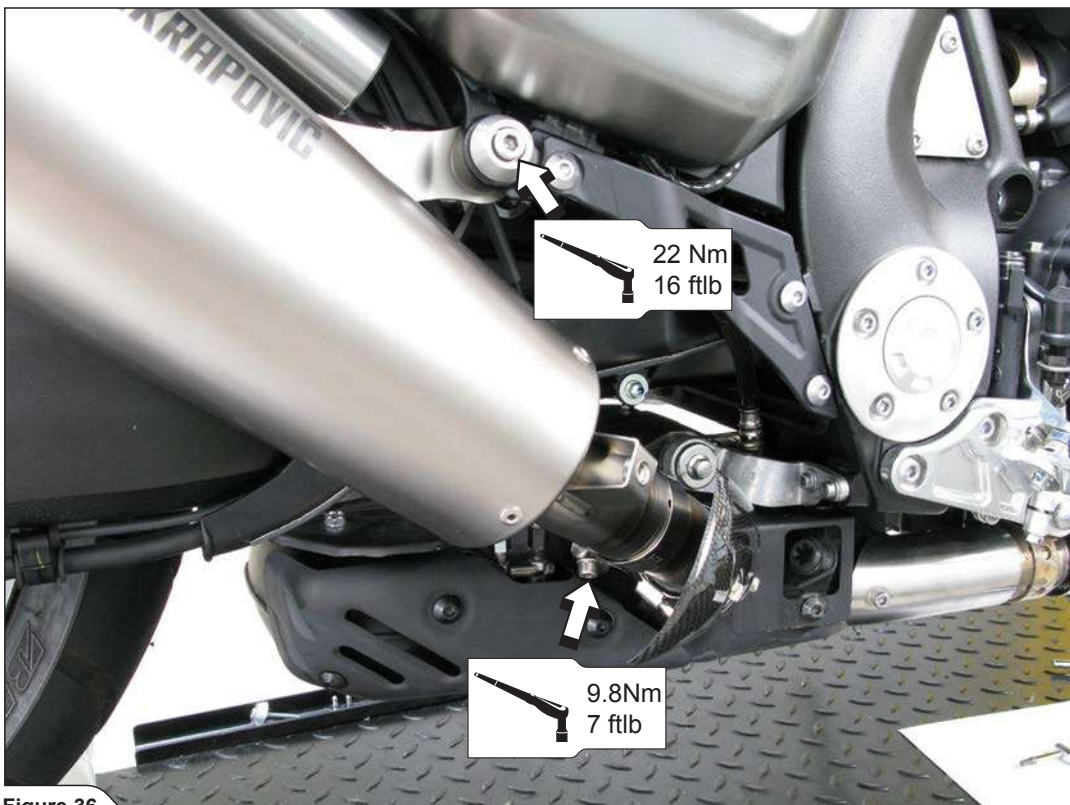

Figure 36

12. For BOTH SLIP - ON system: tighten the heat shield metal clamp and the heat shield's bolts (Figure 37). Perform the process on both sides of the motorcycle.  
! **WARNING:** make sure the heat shield is not touching the collector or any part of the motorcycle!

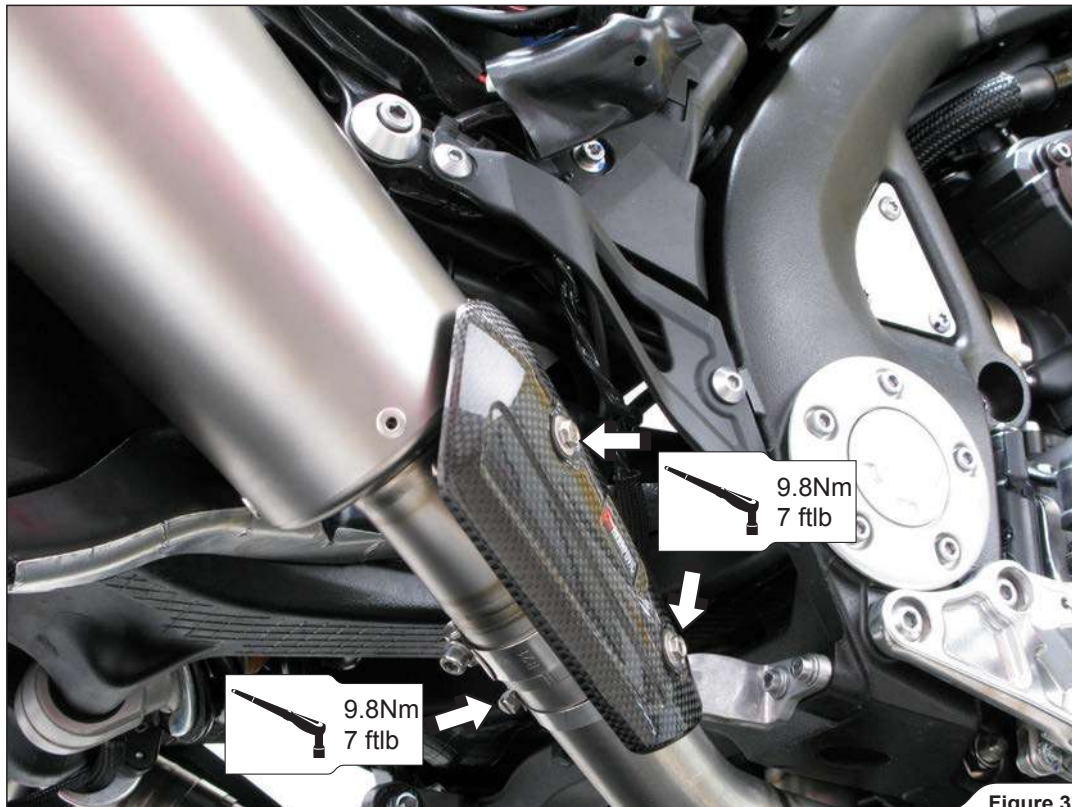

Figure 37

13. For OPEN SLIP-ON only: attach the seat cowling, seat panels, seats in the reverse order from the order in which they were removed (Figure 38, 39, 40, 41).

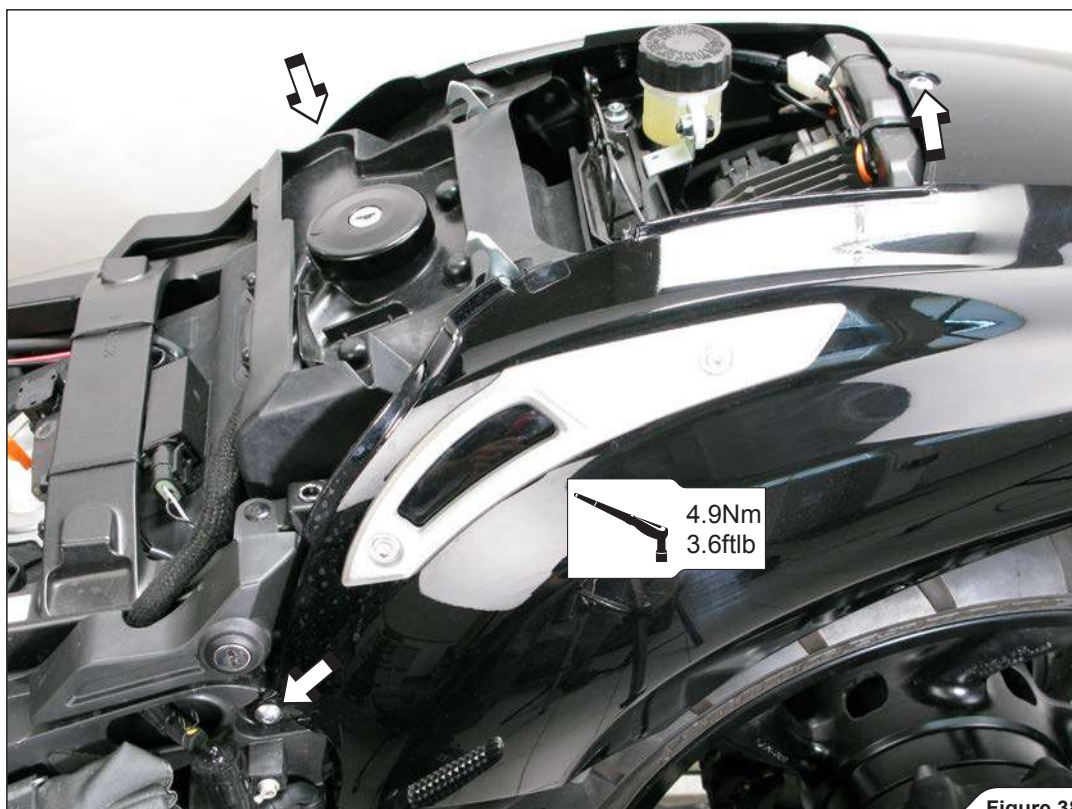

Figure 38

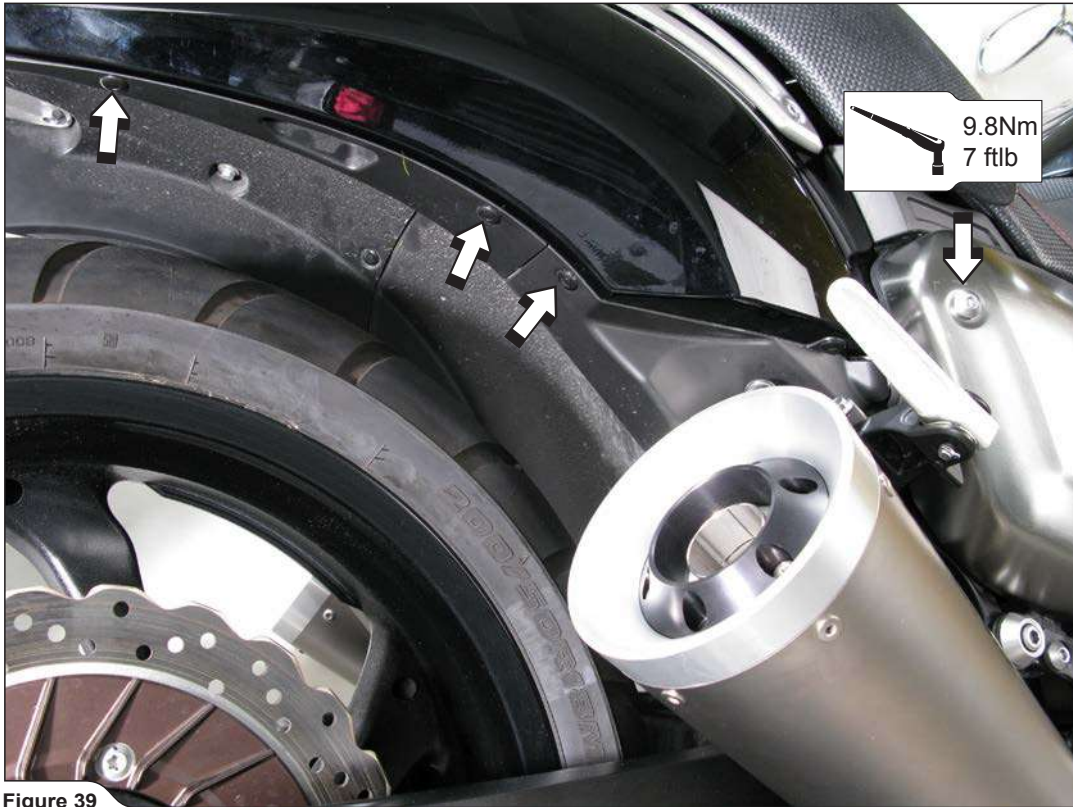

Figure 39

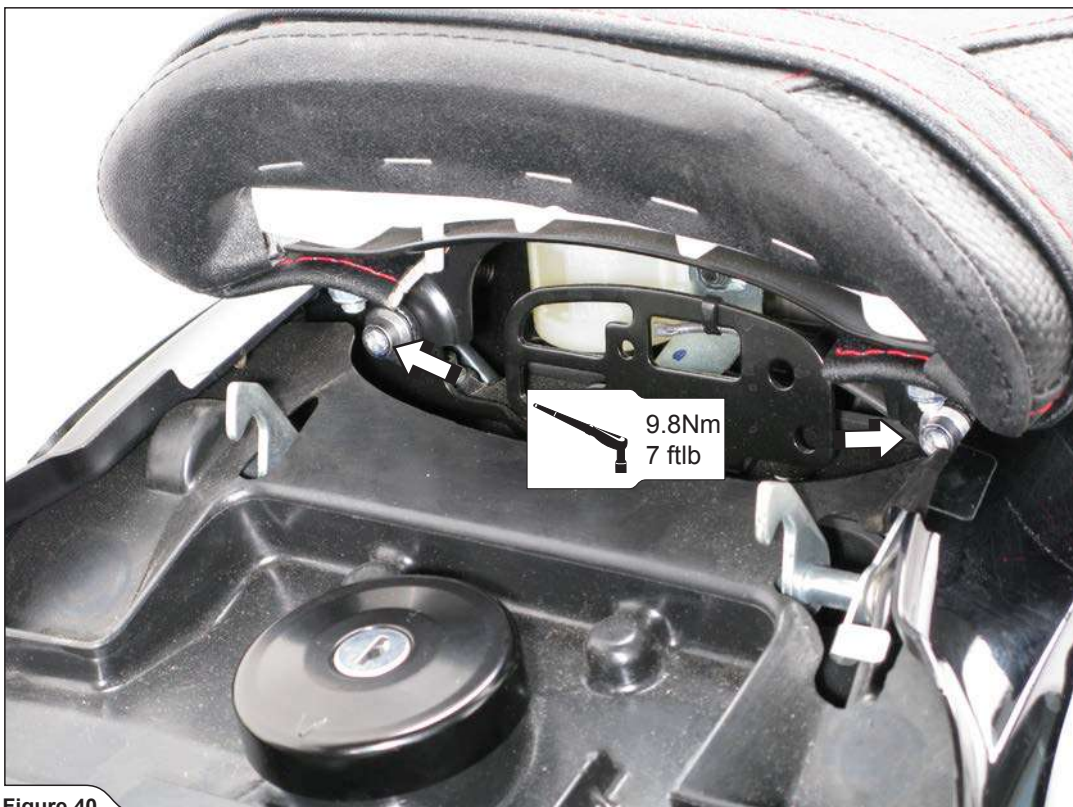

Figure 40



Figure 41



**Final installation:**

Clean grease spots:

- a. Muffler – titanium outer sleeve: use a soft cloth sprayed with a multi-purpose spray lubricant (WD-40 or equivalent).
- b. Collector – titanium: use a soft cloth sprayed with a multi-purpose spray lubricant (WD-40 or equivalent).
- c. Heat shield – carbon-fiber: use a soft dry cloth.

Cleaning will prevent spots from burning onto the surface. Do not use aggressive chemical cleaners, because they can damage the sticker.

**! WARNING: make sure all the bolts are sufficiently tightened. In case the exhaust system touches the cowling or other parts repeat the adjustment of the exhaust system or contact your authorized dealer!**

**! WARNING: after running engine for 30 minutes, tighten the bolts of the Akrapovič carbon-fiber heat shield!**

**! WARNING: check vehicle manufacturer manual for tightening torques (for dismantled stock parts)!**

**! IT IS NORMAL IF WHITE SMOKE COMES OUT OF THE MUFFLER ON FIRST OPERATION.**

**! DO NOT STAND BEHIND THE MUFFLER ON FIRST OPERATION.**

**! DO NOT USE AUTOMOTIVE WHEEL CLEANERS OR ANY CLEANING PRODUCTS WHICH CONTAIN ACIDIC ADDITIVES TO CLEAN AKRAPOVIČ EXHAUST SYSTEMS.**

**MAINTENANCE OF THE AKRAPOVIČ EXHAUST SYSTEM:**

1. Clean the titanium exhaust components with a multi-purpose spray lubricant (WD-40 or equivalent), carbon fiber exhaust components with soft and dry cloth and stainless steel components with soft cloth sprayed with contact cleaner, then wipe with soft and dry cloth. A change in the color of the exhaust system is normal due to the high temperatures.
2. Periodically make sure all the bolts and springs are sufficiently tight.

**YAMAHA V-MAX, SLIP-ON exhaust system / Street legal**  
**Product codes: S-Y17SO1-HBAV**

**WARNING! IN COMBINATION WITH OPTIONAL COLLECTOR, THE SLIP-ON HOMOLOGATION IS NOT VALID!**

