

COD. 500002826 rev2

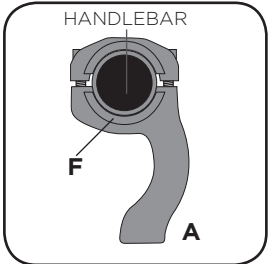

For handlebars fatbar
28 mm. / 1.102 inch.

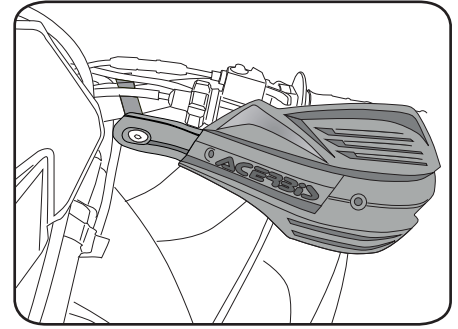
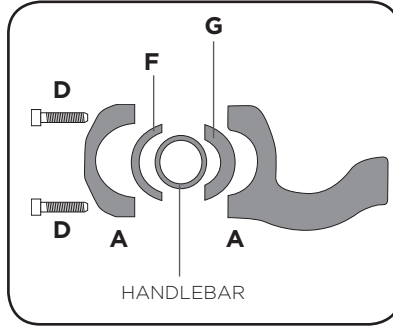
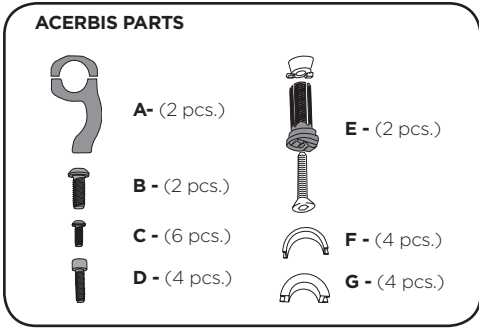
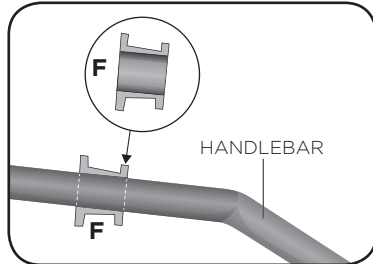

Corret position of the parts "F" on
handlebar 28 mm, 1.102 inch.

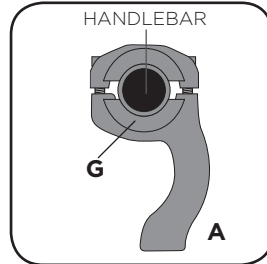

For handlebars
22mm / 0.866 inch .

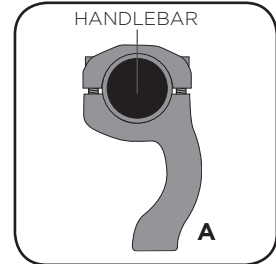

For handlebars twin all
28mm / 1.102 inch

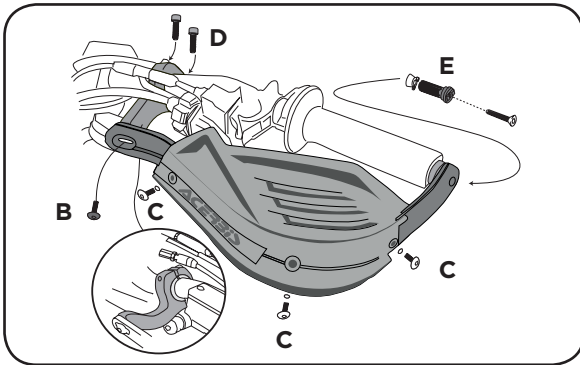

FOR TO INCREASE VENTILATION

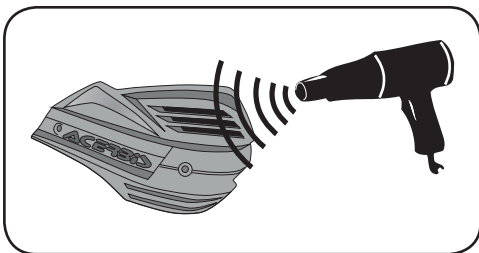

Heat hanguard (max 80 °c)

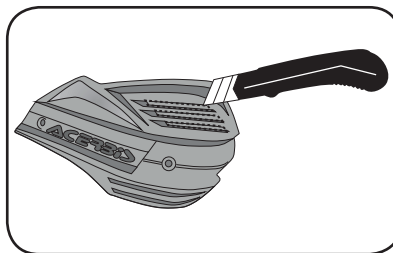

Cut the hanguard

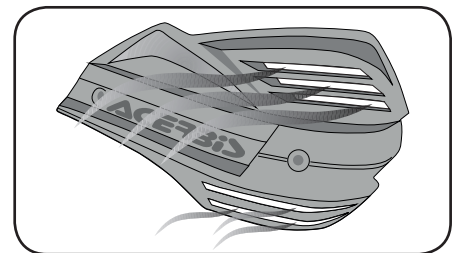

WARNING!

Use at your own risk. Check the security of your device before you ride. This handguard will not prevent injury in the event of a crash. They are designed to deflect cold weather, flying dirt and small branches you might hit while riding, they will not protect against impact with a hard surface or hard objects during use. Be sure that you follow the instructions for installing the handguard. Do not ride if there is missing or damaged hardware. If you find this is the case, take immediately back to your dealer. Check to be sure the throttle and other controls are free every time you ride. Failure to heed instructions and this warning could lead to interference with the controls, loss of control, and an accident. Acerbis recommends that installation be done by a licensed mechanic and that only acerbis original parts are used during fitting. Acerbis makes no guarantees or representations, express or implied, regarding the fitness of its products for any particular purpose. Acerbis makes no guarantees or representations, express or implied, regarding the extent to which its products protect individuals or property from injury or death or damage.