

Security Tech Germany



# 2019 SAFETY CATALOG



Security Tech Germany

# SAFETY WHEN YOU NEED IT ABUS NEXT



ABUS Next eliminates potential shut downs and lost revenue by delivering safety padlocks and devices FAST. Place an order by 6 p.m. EST and it is eligible for next-day delivery (shipping charges apply).\*

**ABUS NEXT, you make the call, WE make it happen.**

Call for more details! **800.352.ABUS**

## Eligible Products

41 Series

72 Series

74 Series

Select safety devices



\*Up to 100 stock KD and KA padlocks or devices, call for large quantity requests. Next Day shipping charges apply.



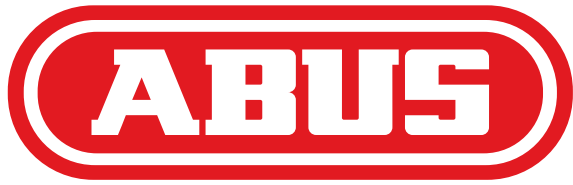

Security Tech Germany



**THE OFFICIAL LOCK OF  
THE PHOENIX SUNS**

**Safety Padlocks**

**Safety Devices**

**Safety Kits and Stations**

**Industrial Padlocks**

**General Information**  
Key Blank Chart, Icon Glossary,  
Terms and Conditions

Safety Padlocks

Safety Devices

Safety Kits and Stations

Industrial Padlocks

General Information

# INSULATED 74

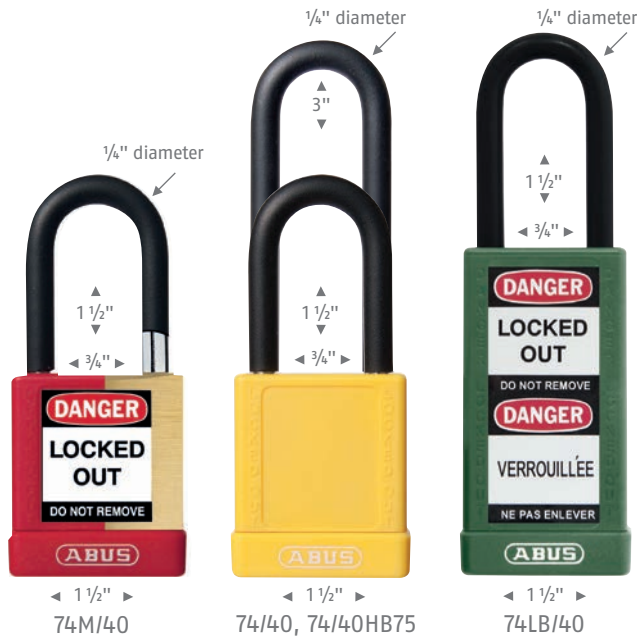

- 6-pin cylinder offers maximum number of key differs and is key-retaining
- Plastic-covered lock body and shackle are non-magnetic and dielectric, providing intrinsically safe protection
- Under the plastic casing, the NANO PROTECT™-coated steel shackle and aluminum or brass lock body are robust and chemical resistant
- All brass lock body available (74M) for extreme corrosion resistance
- Aluminum locks contain 70% recycled materials. All 74 series locks are produced in a facility achieving zero waste to landfill operations at a 98% diversion rate
- Ships with LOTO labels in English, Spanish and French
- Meets OSHA Lockout/Tagout Guidelines
- Comes key-retaining and is available keyed-different, keyed-alike or master-keyed



Item	Shackle Height	Pins in Cylinder	Key Options	Case Pk Qty
74/40	1 1/2"	6	KA, KD, MK, GMK	6
74HB/40-75	3"	6	KA, KD, MK, GMK	6
74LB/40	1 1/2"	6	KA, KD, MK, GMK	6
74M/40	1 1/2"	6	KA, KD, MK, GMK	6
74MHB/40-75	3"	6	KA, KD, MK, GMK	6
74MLB/40	1 1/2"	6	KA, KD, MK, GMK	6



# HIGH SECURITY 76



- 8-pin cylinder offers more than 150,000 key differs and up to 30,000 real guaranteed key differs under a master key
- Solid aluminum lock body encased by a colored plastic cover
- Robust lock body can endure harsh environments and is corrosion resistant
- Protected keyway eliminates cross-keying and reduces risk for employees
- Variety of shackle options: steel, stainless steel, plastic and sheathed steel cable shackle
- Improved key durability for increased breaking and torsion resistance
- Meets OSHA Lockout/Tagout Guidelines

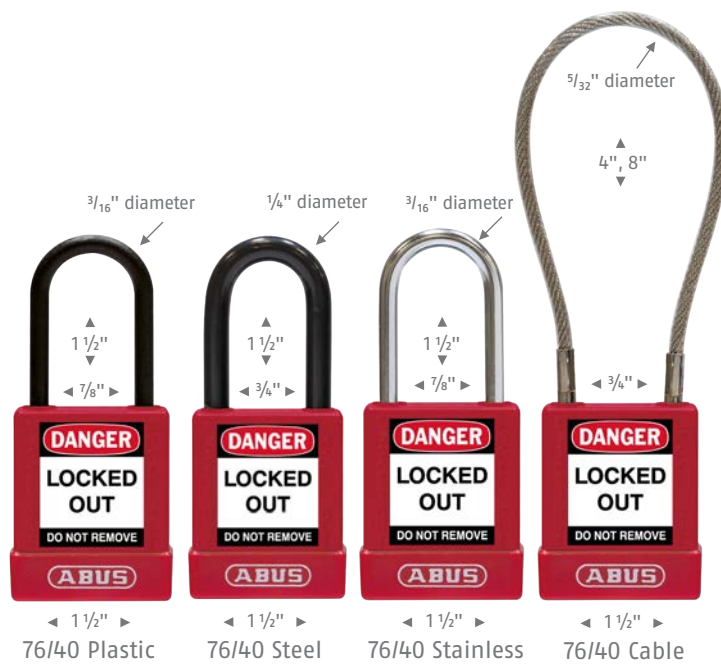

Item	Shackle Height	Pins in Cylinder	Key Options	Shackle Material	Case Pk Qty
76/40	1 1/2"	8	KA, KD, MK, GMK	Plastic	6
76/40	1 1/2"	8	KA, KD, MK, GMK	Steel w/Plastic Slv	6
76/40	3"	8	KA, KD, MK, GMK	Steel w/Plastic Slv	6
76/40	1 1/2"	8	KA, KD, MK, GMK	Stainless	6
76/40	3"	8	KA, KD, MK, GMK	Stainless	6
76/40	4"	8	KA, KD, MK, GMK	Cable	6
76/40	8"	8	KA, KD, MK, GMK	Cable	6



# ALUMINUM 72



- Lightweight, anodized aluminum lock body offers superior chemical and corrosion resistance and is ideal for laser engraving
- NANO PROTECT™-coated hardened steel shackle provides superior corrosion resistance and is available in multiple shackle heights
- Meets OSHA lockout/tagout guidelines
- Available keyed-different, keyed-alike or master-keyed



Item	Shackle Height	Pins in Cylinder	Key Options	Case Pk Qty
72/30	1 1/16"	5	KA, KD, MK, GMK	6
72/40	1 1/16"	6	KA, KD, MK, GMK	6
72/40HB40	1 9/16"	6	KA, KD, MK, GMK	6
72/40HB75	3"	6	KA, KD, MK, GMK	6
72/40HB100	4"	6	KA, KD, MK, GMK	6

- NANO Protect™
- CORROSION PLATING
- DOUBLE BOLTED
- KA AVAILABLE
- MK AVAILABLE
- PARACENTRIC KEYWAY
- REKEYABLE
- SELF-LOCKING
- VALIDATED



# CABLE ALUMINUM 72



- Lightweight, anodized aluminum lock body offers superior chemical and corrosion resistance
- Highly flexible cable in two sizes for multi-purpose security solutions
- Laser engraving available for easy identifications
- Meets OSHA Lockout/Tagout Guidelines

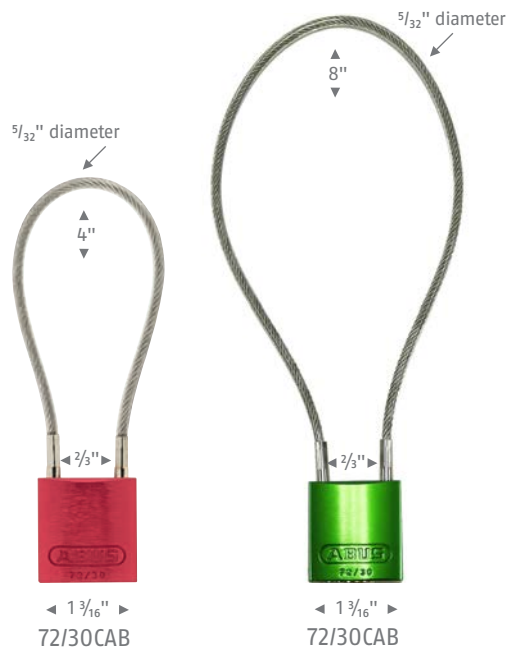

Item	Shackle Height	Pins in Cylinder	Key Options	Case Pk Qty
72/30CAB	4"	5	KA, KD, MK, GMK	6
72/30CAB	8"	5	KA, KD, MK, GMK	6



# LAMINATED STEEL 41



- 5-pin cylinder offers high number of key differs
- Steel shackle and body plates are individually coated with ETERNA™ plating for rust protection
- Vinyl bumper provides easy identification and protection
- Made from high-quality recycled steel
- Tough, countersunk rivets
- Meets OSHA lockout/tagout guidelines
- Available keyed-different, keyed-alike or master-keyed



\*Available only with blue bumper.

Item	Shackle Height	Pins in Cylinder	Key Options	Case Pk Qty
41/30*	5/8"	4 or 5	KA, KD, MK, GMK	6
41/40	3/4"	4 or 5	KA, KD, MK, GMK	6
41/40HB50	2"	4 or 5	KA, KD, MK, GMK	6
41/45*	1"	4 or 5	KA, KD, MK, GMK	6
41/45HB50*	2"	4 or 5	KA, KD, MK, GMK	6
41/50*	1"	4 or 5	KA, KD, MK, GMK	6
41/50HB50*	2"	4 or 5	KA, KD, MK, GMK	6





# NON-SPARKING BRASS T84MB



- Shackle and body made from solid brass
- Inner components made from non-corrosive materials
- Precision pin tumbler
- Plastic casing available in 6 different colors
- Available keyed-different, keyed-alike or master-keyed



Item	Shackle Height	Pins in Cylinder	Key Options	Case Pk Qty
T84MB/30*	9/16"	3	KA, KD, MK, GMK	12
T84MB/40	13/16"	4	KA, KD, MK, GMK	12
T84MB/50*	15/16"	5	KA, KD, MK, GMK	6



\*Available only with black jacket.



## LASER ENGRAVING

ABUS offers custom laser engraving on all Safety Series padlocks. Laser engraving is a great way to customize padlocks in the safety industry, providing quick and easy identification.



Please note: Engraving on bottom of lock is not available.

## ABUS CHARTING

Available for KA, KD or MK locks

- End-user is checked by our proprietary charting software to see if we have shipped an order in the past
- All codes that have been shipped in the past are automatically excluded from production
- The codes used in an order are then double-checked and entered by in-house customer service professional
- Over 40,000 unique codes available and possibility to create more unique key differs
- Charting across multiple series is available to unlock the full potential of the diverse safety lock offering: 41 Series, 72 Series and 74 Series



## WEATHERPROOF CAP

- Rubberized cap fits on the bottom of 72 Series padlocks
- Durable weather cover with drainage system
- Protects lock cylinder from water, ice, dirt and grime



## CUSTOM SAFETY KITS

Build a custom kit that is modified to meet your facility needs! See page 22 for more information.



Choose the pouch/toolbox, padlocks & devices you would like in your customized kit.



We build your kit to fit the product you selected.



We ensure customized kits are delivered to your facility on time.



We keep record of what each kit includes so reordering is quick and easy.



K915 Deluxe Pouch Kit

## KEYING SYSTEMS

ABUS is experienced in creating comprehensive and intelligent keying systems based on user needs and requirements. We assist customers by designing large keying systems with multiple levels in which master keys or even grand master keys can be used to open all keyed-different or keyed-alike locks from different groups.

A locking system is a combination of different locking cylinders that have a certain relation to each other. Depending on what is needed, the functionalities of the cylinder can be bundled and exactly assigned. Within a locking system there are single keys, master keys and grand master keys – this makes it possible to distribute certain access rights among different employees.

### Keyed Different:



Each padlock has its own unique key.

### Keyed Alike:



Each padlock can be opened with the same key.

### Keyed Different with Master Key:

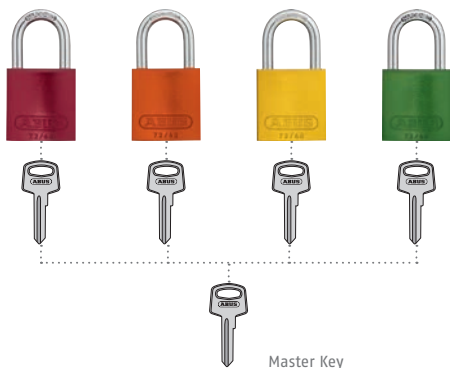

Each padlock has its own key. The master key can open all padlocks.

### Keyed Different with Grand Master Key:

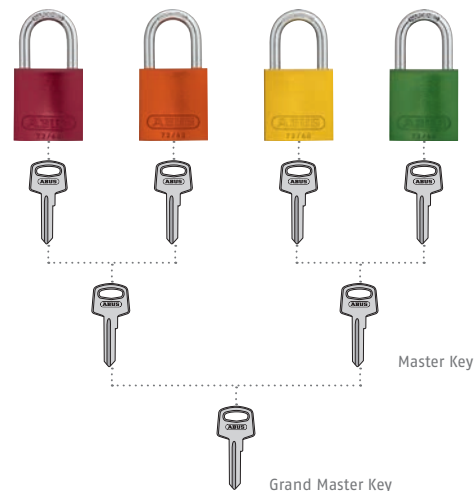

Each padlock has its own key. The padlocks of each group can be opened with their respective master key. All padlocks can be opened with the grand master key.

# LOCKOUT/TAGOUT HASPS



ST0801

ST0802



ST0701

ST0702



AL0701

AL0702



H770

- Holds up to 6 padlocks
- Available with or without pry-resistant interlocking tabs for added security
- High-quality materials for different areas of application: recycled steel, spark-resistant aluminum or non-conductive plastic
- Steel and aluminum: 1" or 1 1/2" closed hole available



Item	Opening Diameter	#Lock Holes	Material	Tabs	Case Pk Qty
ST0701	1"	6	Recycled Steel	No	1
ST0702	1 1/2"	6	Recycled Steel	No	1
ST0801	1"	6	Recycled Steel	Yes	1
ST0802	1 1/2"	6	Recycled Steel	Yes	1
AL0701	1"	6	Aluminum	No	1
AL0702	1 1/2"	6	Aluminum	No	1
H770	1"	6	Plastic	No	1

# SAFETY REDBOX™



- Safety where you want it, when you need it: portable, convenient lockout box
- High level of stability in spite of low weight
- Ergonomic and space-saving fold-away handle
- Inside is exposed to light from all sides for better visibility of contents
- Lid features innovative and secure locking mechanism
- Patented lockable wall bracket, also facilitates storing of padlocks



Item	Diameter of Holes	Holds #Locks	Material	Case Pk Qty
B835 RED	9/32"	12	Recycled Steel	1



# SAFELEX™ CABLE LOCKOUT

# STANDARD CABLE LOCKOUT

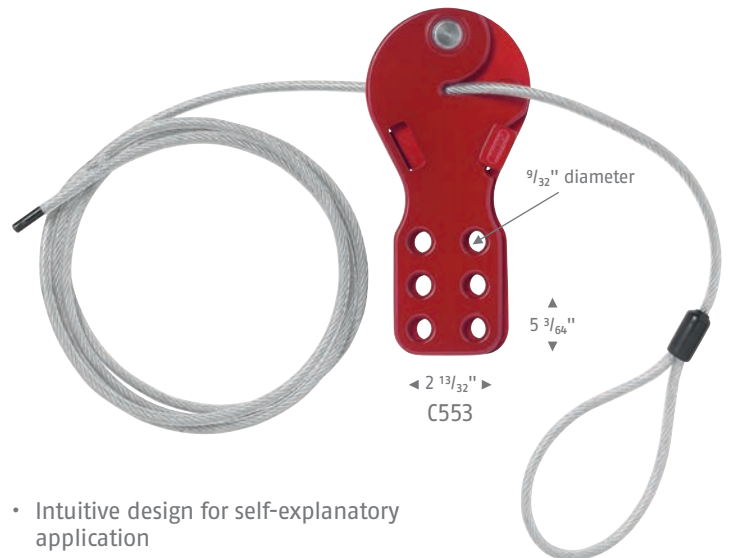
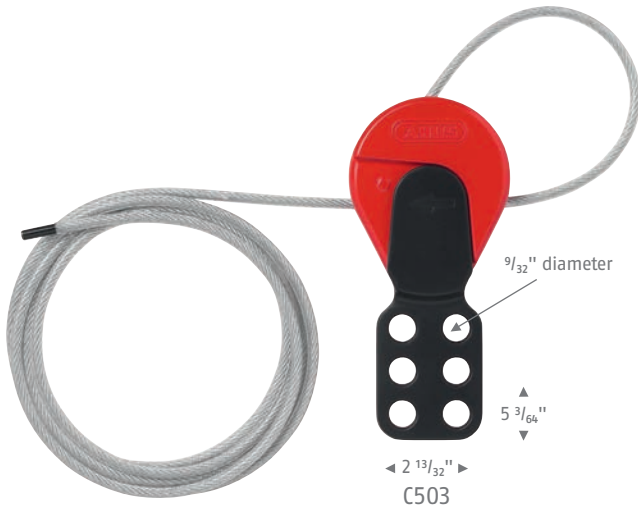

- Intuitive design for self-explanatory application
- Patented grip mechanism for secure fixation of the cable
- Retightening possible at any time, even when locked
- Isolated, exchangeable metal cable in different lengths
- Holds up to 6 padlocks

- Intuitive design for self-explanatory application
- Isolated, exchangeable metal cable in different lengths
- Holds up to 6 padlocks



Item	Cable Length	Cable Diameter	Holds #Locks	Case Pk Qty
C503	3'	5/32"	6	12
C506	6'	5/32"	6	12
C509	9'	5/32"	6	12
C515	15'	5/32"	6	10

Item	Cable Length	Cable Diameter	Holds #Locks	Case Pk Qty
C553	3'	5/32"	6	8
C556	6'	5/32"	6	8
C559	9'	5/32"	6	12
C565	15'	5/32"	6	10

# BALL VALVE LOCKOUT

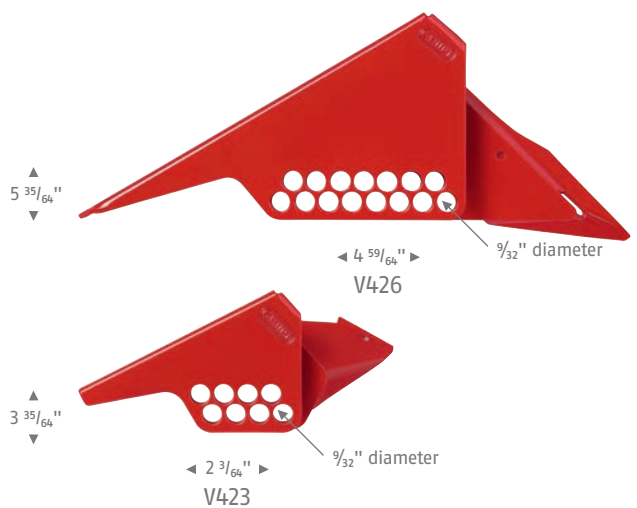
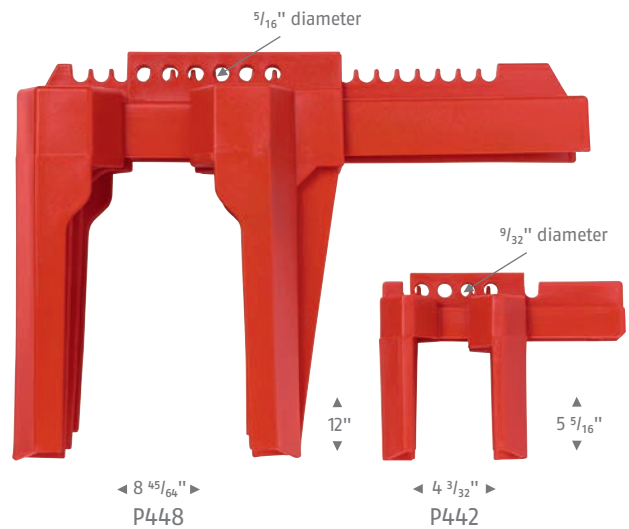
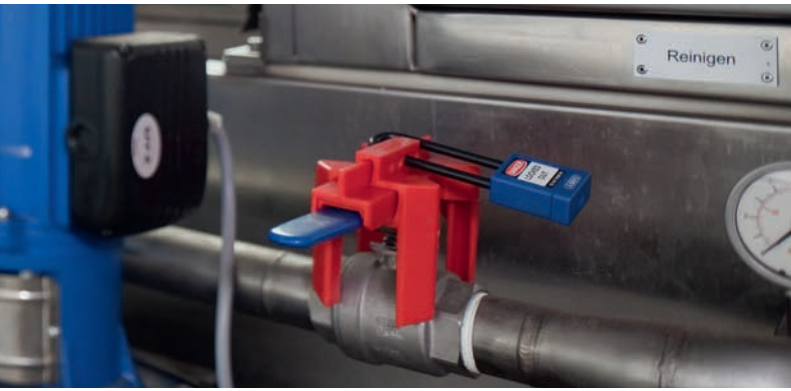

- Made from high-quality polypropylene; long-lasting and non-conductive
- Two sizes: Fits ball valves from 1/2" to 8"
- Well-positioned padlock holes for better grip on the valve
- Holds 1 padlock

- Stable and secure, made from powder-coated steel
- Two sizes for most common ball valves
- Various holes for exact positioning of padlock gives stability
- Best used on hard-to-reach pipes



Item	Holds #Locks	Max Handle Thickness	Max Handle Width	Case Pk Qty
V442	1	25/64"	29/32"	1
V448	1	15/16"	1 11/16"	1

Item	Holds #Locks	Max Handle Thickness	Max Handle Width	Case Pk Qty
V423	1	9/32"	1 29/64"	1
V426	1	25/64"	1 31/32"	1



# GATE VALVE LOCKOUT



# FORKLIFT/PLUG LOCKOUT



- Made from high-quality polypropylene: long-lasting and non-conductive
- Five sizes: Fits gate valves from 1" to 13"
- Holds 1 padlock with up to 23/64" shackle diameter
- Predetermined breaking point at the top for threaded valves
- Stickers in various languages included

- Lockout for plug, forklift, and gas cylinder
- Made in the USA from recycled plastic
- Plug Lockouts: 120 volt plug, 250 volt-sp plug, 15-50 Amp 3P plug
- Forklift Lockouts:
  - Electric Driver Forklifts: Battery plug 50-250 Amp, starter battery negative (-) terminal
  - Propane Driver Forklifts: LP gas cylinder shutoff valve, LP gas tank coupling

Item	Holds #Locks	Fits Gate Valve Size	Case Pk Qty
V303	1	1 - 2 1/2"	1
V305	1	2 1/2 - 5"	1
V307	1	5 - 6 1/2"	1
V310	1	6 1/2 - 10"	1
V313	1	10 - 13"	1

Item	Holds #Locks	Case Pk Qty
00457	6	1



# POWER PLUG LOCKOUT

# SWITCH LOCKOUT

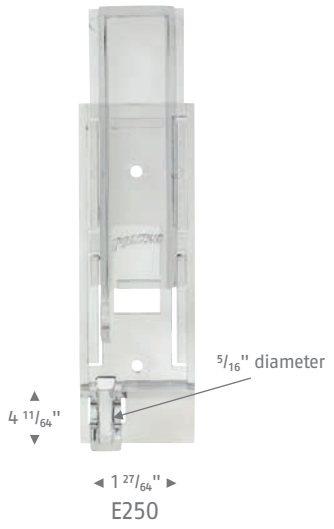
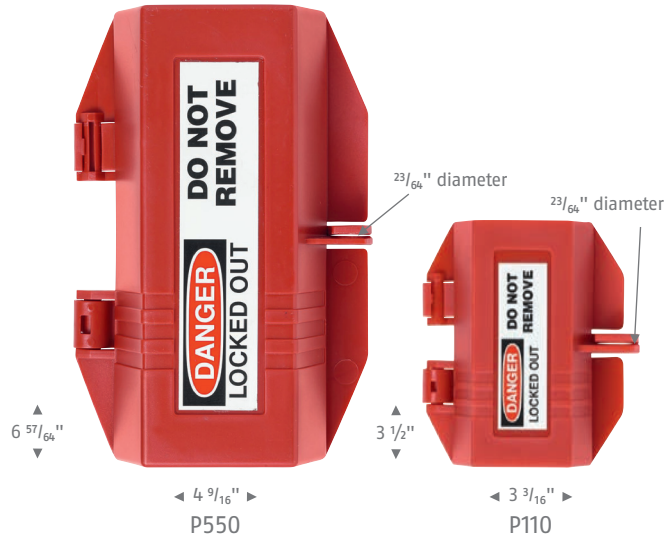

- Made from high-quality polypropylene: long-lasting, robust and non-conductive
- 2 Sizes: For standard plugs or high-voltage plugs
- Cable tunnel on both sides to secure plug connections
- Warning stickers in different languages included
- Holds up to 4 padlocks with a shackle diameter up to 23/64"

- Made from high-quality polycarbonate housing: long-lasting and robust
- Easy installation: Remove the screws from the wall switch plate and use them to mount the device onto the plate
- Sliding mechanism makes the device very easy to use
- Offers extra durability with hinge-less design
- Holds 1 padlock with up to 5/16" shackle diameter

Item	Holds #Locks	Warning Sticker Languages	Case Pk Qty
P110	2	English, Spanish, French	1
P550	4	English, Spanish, French	1

Item	Holds #Locks	Case Pk Qty
E250	1	1

# PANEL HANDLE LOCKOUT

# PUSH BUTTON LOCKOUT



- Prohibits the movement of handles or levers on electrical panels
- Nylon base and a flexible stainless steel strip with 20 holes prevents handle from moving once locked with a lockout padlock
- Recommended for all handles and levers that do not have a built-in lockout arrangement
- Accommodates 1 padlock, with shackles up to 1/4"

- Provides a lockout solution for oversize electrical push buttons on electrical panels or controls stations
- Can also be used on heavy machinery
- Installs in seconds Made from durable plastic (acrylic)
- Accommodates 1 padlock with a maximum shackle diameter of 1/4"

Item	Holds #Locks	Case Pk Qty
00456	1	1

Item	Holds #Locks	Warning Sticker Languages	Case Pk Qty
00455	1		1

# SINGLE BREAKER LOCKOUT

# MULTI BREAKER LOCKOUT

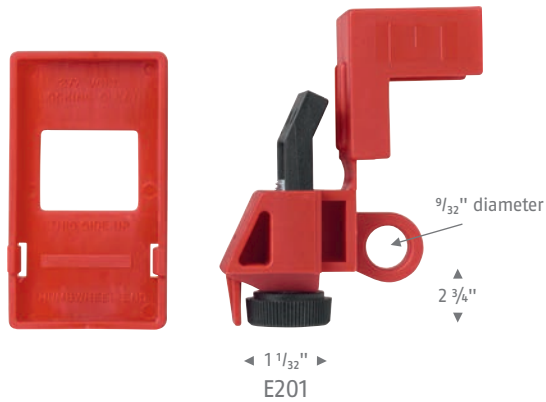

- Made from high-quality materials: long-lasting, robust and non-conductive
- Easy-to-use with screwing mechanism for secure fixation
- Can be used on common single-pole circuit breakers
- Comes with adapter for blade-type electric fuses
- Holds 1 padlock
- Voltage 120/277

- Made from high-quality materials: long-lasting, robust and non-conductive
- Easy-to-use with screwing mechanism for secure fixation
- Holds up to 2 padlocks with a shackle diameter up to 9/32"
- Can be used on common multi-pole circuit breakers that employ a tie bar
- Voltage 120/277

Item	Holds #Locks	Max. Width of Circuit Breaker	Case Pk Qty
E201	1	5/8"	1

Item	Holds #Locks	Max. Thickness of Bond Bridge	Case Pk Qty
E202	2	23/64"	1

# COMPRESSED AIR LOCKOUT

# GAS CYLINDER LOCKOUT

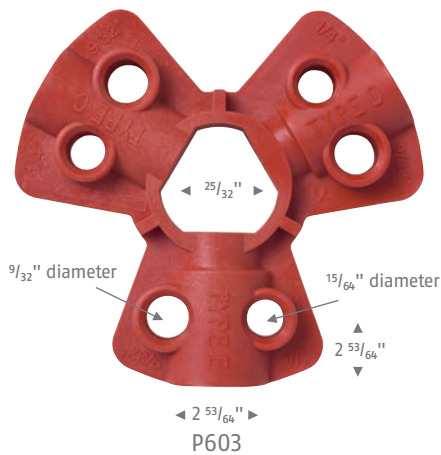

- Made from fiber-glass reinforced nylon: long-lasting, robust and non-conductive
- 3 different connections for most common compressed air couplings with 19/32" outside diameter
- The hole in the middle can be used to attach and store the lockout device directly at the connection
- Holds 1 padlock with 1/4" and 1 padlock with 9/32" shackle diameter per connection

Item	Holds #Locks	Case Pk Qty
P603	6	1

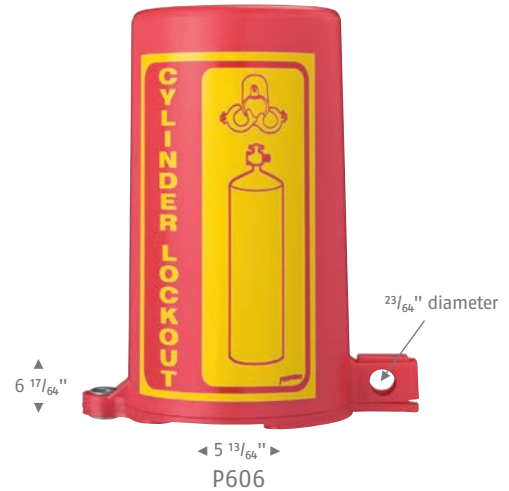

- Made from high-quality polypropylene: long-lasting, robust and non-conductive
- Warning sticker included
- Holds 1 padlock with up to 23/64" shackle diameter

Item	Holds #Locks	Inside Height	Inside Diameter	Case Pk Qty
P606	1	5 15/32"	3 5/64"	1

# LOCKOUT TAGS

# LOCKOUT LABELS



T100



T102

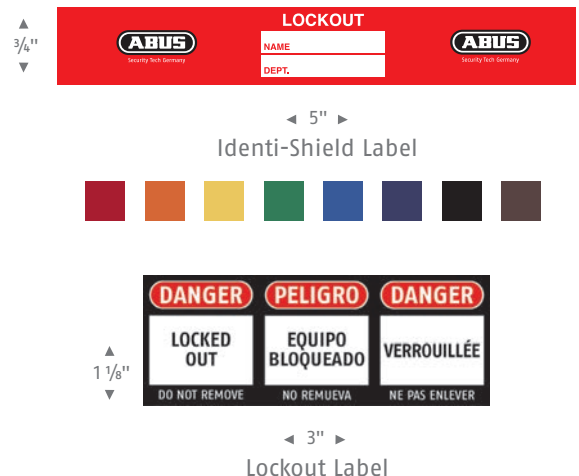

Lockout Label

- Prevent accidental or unexpected start-up or release of stored energy when working on equipment or machinery
- Laminated vinyl with grommet and matte surface to withstand moisture
  - Available tag types: DO NOT OPERATE; OUT OF SERVICE

- Identi-shield labels: vinyl labels to add custom color and identification to standard padlocks
- Lockout labels: vinyl labels in multiple languages for lockout padlocks

Item	Tag Material	Tag Text	Case Pk Qty
T100	Laminated Vinyl	DO NOT OPERATE	10
T102	Laminated Vinyl	OUT OF SERVICE	10



Item	Label Material	Case Pk Qty
Identi-Shield Label	Vinyl	10
Lockout Label (74/40 and 74/40HB75)	Vinyl	10
Lockout Label (74LB/40)	Vinyl	10





















# CUSTOM SAFETY KITS

Build a custom kit that is modified to meet your facility needs.

ABUS Custom Kits allow you to select the devices and padlocks your facility requires to ensure your LOTO program operates smoothly.

Whether you need one or more ABUS Custom Kits, you have the flexibility of ordering your personalized kit frequently or building additional kits contingent on your LOTO program.

 <p><b>SELECT</b></p>	 <p><b>BUILD</b></p>	 <p><b>DELIVER</b></p>	 <p><b>REORDER</b></p>
<p>Choose the pouch/toolbox, padlocks &amp; devices you would like in your customized kit.</p>	<p>We build your kit to fit the product you selected.</p>	<p>We ensure customized kits are delivered to your facility on time.</p>	<p>We keep record of what each kit includes so reordering is quick and easy.</p>

<p><b>Locks</b></p>  <p>72 Aluminum</p>	<p><b>Cable LO</b></p>  <p>C503-C515</p>  <p>C553-C565</p>	<p><b>Gate Valve LO</b></p>  <p>V303</p>  <p>V305</p>	<p><b>Switch LO</b></p>  <p>E250</p>	<p><b>Panel Handle LO</b></p>  <p>00456</p>	<p><b>Tags</b></p>  <p>T100</p>
 <p>74 Insulated</p>			<p><b>Breaker LO</b></p>  <p>E201</p>	<p><b>Push Button LO</b></p>  <p>00455</p>	 <p>T102</p>
<p><b>Hasps</b></p>  <p>ST0701</p>  <p>ST0702</p>	<p><b>Ball Valve LO</b></p>  <p>P442</p>  <p>P423</p>	<p><b>Power Plug LO</b></p>  <p>P110</p>  <p>P550</p>	<p><b>Air LO</b></p>  <p>E202</p>  <p>P603</p>	<p><b>Forklift/Plug LO</b></p>  <p>00457</p>	

# PRE-BUILT SAFETY KITS

ABUS offers a variety of pre-built safety kits that meet a variety of needs. These kits offer the most popular combinations of lockout/tagout components to ensure your facility is OSHA compliant.

	K900 Basic Pouch Kit	K905 Standard Pouch Kit	K915 Deluxe Pouch Kit	K925 Electrical Toolbox Kit	K930 Valve Toolbox Kit	K945 Operator Toolbox Kit
B100 Small Pouch	1					
B102 Large Pouch		1	1			
B200 Toolbox				1	1	1
74/40 Insulated Padlock	2	2	2	3	3	1
74HB/40-75 Insulated Padlock			2			
C506 6' Safelex™ Cable Lockout					1	
E201 Single-Pole Breaker Lockout	1			3	1	
E202 Multi-Pole Breaker Lockout		1	3			1
E250 Wall Switch Lockout			1		1	
P110 Small Power Plug Lockout			1	1		
P550 Large Power Plug Lockout			1	1		
ST0701 1" Hasp	1	1	2	3	1	1
ST0702 1.5" Hasp	1	1	2			
T100 Do Not Operate Tag & Cable Ties 10pk	1	1	1	1	1	1
V303 1-2.5" Gate Valve Lockout		1		1	1	
V305 2.5"-5" Gate Valve Lockout		1	1		1	
V442 Small Ball Valve Lockout					2	



# LOCKOUT STATIONS



- Lockout/Tagout Stations centralize LOTO activity
- Available in different sizes
- Portable and wall-mounted
- Designed with durability for industrial settings
- Each hook can hold 2 padlocks or 2 hasps



Item	Board Width	Board Height	Holds # Locks	Holds # Hasps	Case Pk Qty
71130	11"	11"	3	2	1
71140	15"	15"	8	2	1
71150	15"	23"	12	2	1
71160	23"	23"	28	4	1



# LOCKPOINT SAFETY CENTER



- OSHA 1910-147 LOTO compliance
- Made of heavy gauge steel to survive industrial settings
- Replaces all standard lock stations
- Combines all LOTO processes at one or more mobile locations
- Encourages the use of Lean Principles and 5S in LOTO
- Reduces risk by having all documents and certificates in one accessible location – ready for spot inspections
- Reduces cost by using one unit for multiple work areas

## AVAILABLE ACCESSORIES



Padlock Bar



Document Holders



Desk Pad



Basket

Item	Case Pk Qty
LockPoint	1

\*wheels, locks, and devices not standard and can be purchased separately

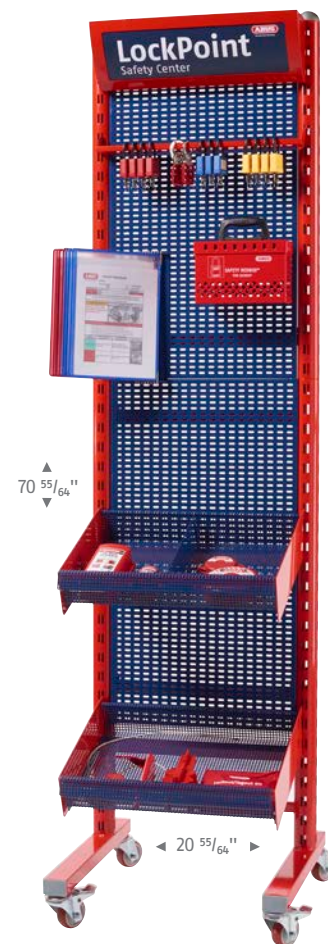

# LAMINATED STEEL 41

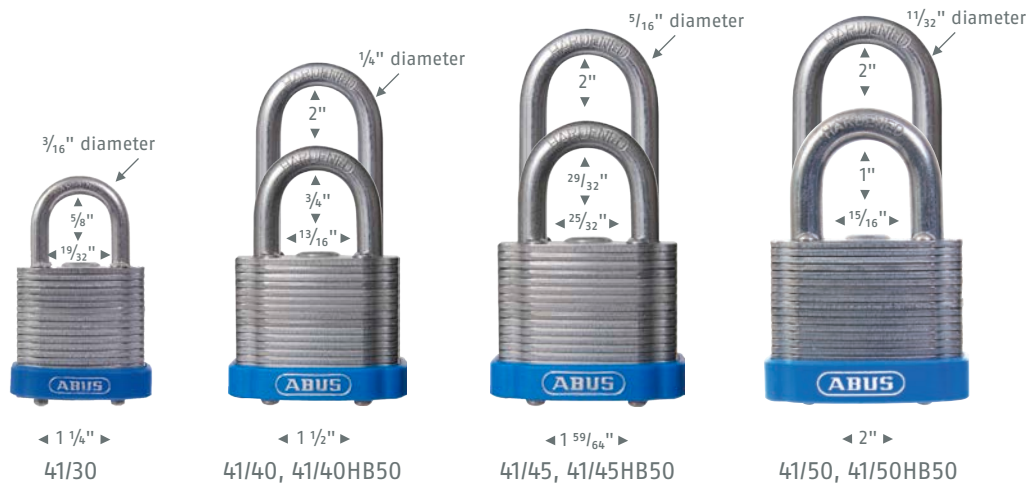

- Laminated steel with ETERNA™ coating on each laminate for extreme corrosion resistance
- ETERNA™: Non-hazardous, cadmium-free plating
- Tough, countersunk rivets
- Hardened steel shackle
- High-precision 5-pin tumbler, drilling and pulling protected
- Plastic bumper for easy identification

Item	Shackle Height	Pins in Cylinder	Key Options	Case Pk Qty
41/30 B	5/8"	4 or 5	KD, KA, MK	4
41/40 C	3/4"	4 or 5	KD	6
41/40 B	3/4"	4 or 5	KD, KA, MK	6
41/40HB50 B	2"	4 or 5	KD, KA, MK	6
41/45 B	29/32"	4 or 5	KD	6
41/45HB50 B	2"	4 or 5	KD, KA, MK	6
41/50 C	1"	4 or 5	KD	6
41/50 B	1"	4 or 5	KD, KA, MK	6
41/50HB50 B	2"	4 or 5	KD, KA	6



# WEATHERPROOF BRASS 70

# BRASS 75IB

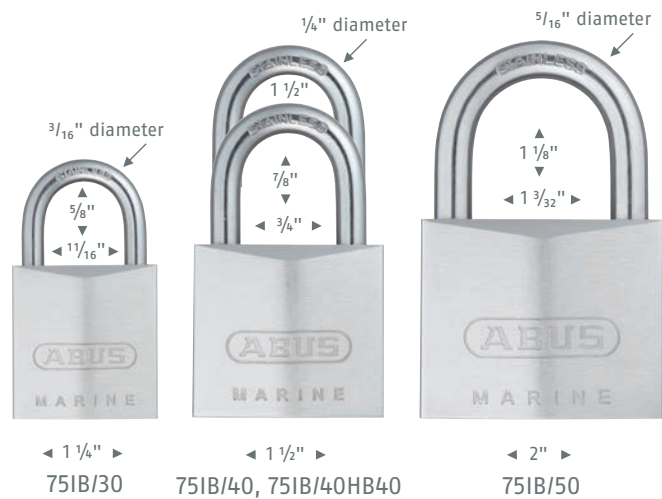
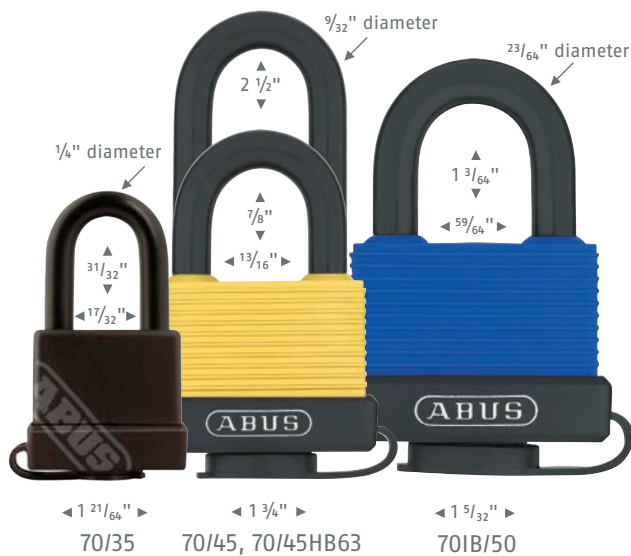

- Solid brass body with shock-absorbing vinyl cover provide ultimate weather resistance
- Cylinder cover with drainage channels protects padlock from water and dirt
- Inner components made from rust-free materials
- IB: comes with stainless steel shackle

- High-precision reversible keyway with up to 150,000 key differs
- Body made from solid brass or pearl-nickel-plated brass
- Shackle made from stainless steel
- Dimple key
- Key-retaining: 75IB/40 + 75IB/50
- Self-locking: 75IB/30



Item	Shackle Height	Pins in Cylinder	Key Options	Case Pk Qty
70/35 B	$3\frac{1}{32}$ "	4	KD	12
70/45 C	$\frac{7}{8}$ "	5	KD, KA	6
70/45HB63 B	$2\frac{1}{2}$ "	5	KD, KA	6
70IB/45 C	$\frac{7}{8}$ "	5	KD, KA, MK	6
70IB/45HB63 B	$2\frac{1}{2}$ "	5	KD, KA, MK	6
70IB/50 C	$1\frac{3}{64}$ "	5	KD, KA, MK	6

Item	Shackle Height	Pins in Cylinder	Key Options	Case Pk Qty
75IB/30 B	$\frac{5}{8}$ "	8	KD, KA	12
75IB/40 B	$\frac{7}{8}$ "	8	KD, KA	12
75IB/40HB40 B	$1\frac{1}{2}$ "	8	KD, KA	12
75IB/50	$1\frac{1}{8}$ "	10	KD, KA	6



# WEATHERPROOF DISKUS® 24IB

# HARDENED STEEL DISKUS® 28

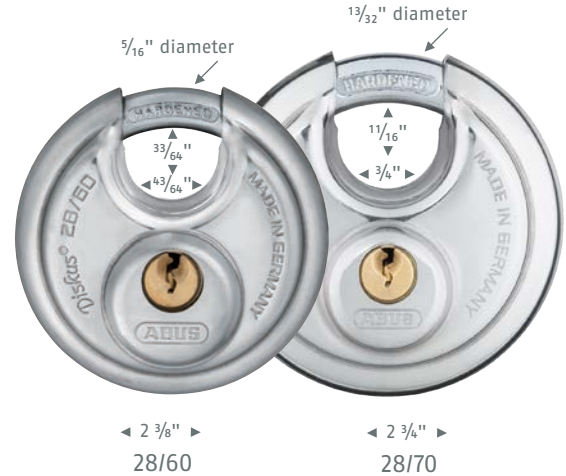
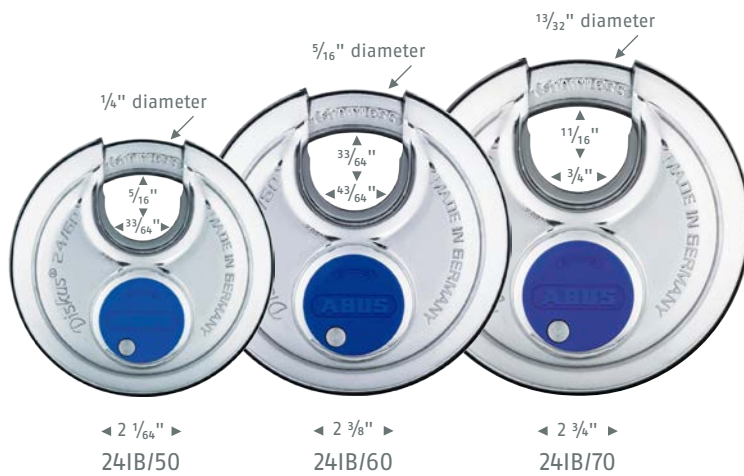

- Original Diskus® design: 360° protection
- 100% non-corrosive: shackle and all inner components made of stainless steel
- Diskus® Deep-Welding Technology provides maximum strength and pry resistance
- Precision pin cylinder - extra plated for ultimate corrosion resistance

- Original Diskus® design: 360° protection
- Diskus® Deep-Welding Technology provides maximum strength and pry resistance
- Shackle made from hardened steel
- Precision pin cylinder with anti-pick pins

Item	Shackle Height	Pins in Cylinder	Key Options	Case Pk Qty
24IB/50 B	5/16"	4	KD, KA	6
24IB/60 C	33/64"	4	KD, KA	6
24IB/60 B	33/64"	4	KD, KA, MK	6
24IB/70 C	11/16"	5	KD	6
24IB/70 B	11/16"	5	KD, KA, MK	6

Item	Shackle Height	Pins in Cylinder	Key Options	Case Pk Qty
28/60 B	33/64"	4	KD, KA	6
28/70 C	11/16"	5	KD	6
28/70 B	11/16"	5	KD, KA	6



# PROFESSIONAL BRASS 83

# STEEL ROCK 83

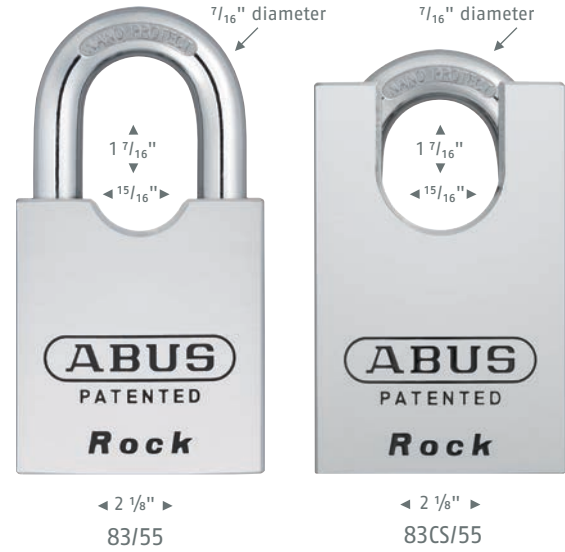
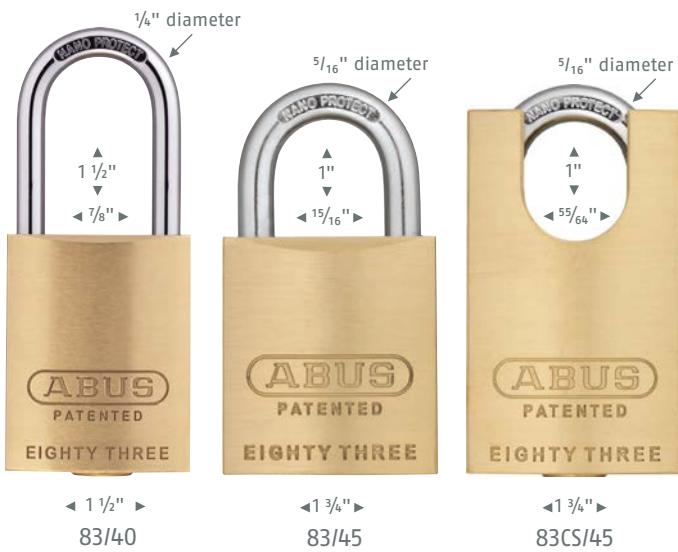

- Body made of solid brass
- Shackle made of hardened steel with NANO PROTECT™ coating for extra corrosion resistance
- Patented "Z-bar" converts key-retaining to non-key-retaining and vice versa within seconds
- Patented "Pinning Window" for simple rekeying
- Can be keyed into many popular keyways
- Shackle can be changed in seconds

- Body and shackle made from hardened steel, chrome-plated with NANO PROTECT™ coating for an extreme corrosion resistance
- Patented "Z-Bar" converts key-retaining to non-key-retaining and vice versa within seconds
- RK: cylinder can be re-keyed to match an existing key
- CS: shackle guard protects shackle from attack

Item	Cyl Cover Available	Shackle Height (in)	Pins in Cylinder	Case Pk Qty
83/40	Y	1, 1 1/2, 3, 4	5-6	6
83/45	Y	1, 2, 3, 4, 6	5-6	6
83CS/45	Y	1, 2, 3, 4, 6	5-6	6
83IC/45	Y	1, 2, 3, 4, 6	-	6
83KnK/45	Y	1, 2, 3, 4, 6	-	6

Item	Cyl Cover Available	Shackle Height (in)	Pins in Cylinder	Case Pk Qty
83/55	N	1, 1 7/16, 3	5-6	6
83CS/55	N	1, 1 7/16, 3	5-6	6
83KnK/55	N	1, 1 7/16, 3	-	6
83CS-IC/55	N	1, 1 7/16, 3	-	6
83CS-KnK/55	N	1, 1 7/16, 3	-	6

\*83AL/40 and 83/40 come standard with a 1 1/2" shackle



# WEATHERPROOF 83

# COMBINATION 180IB

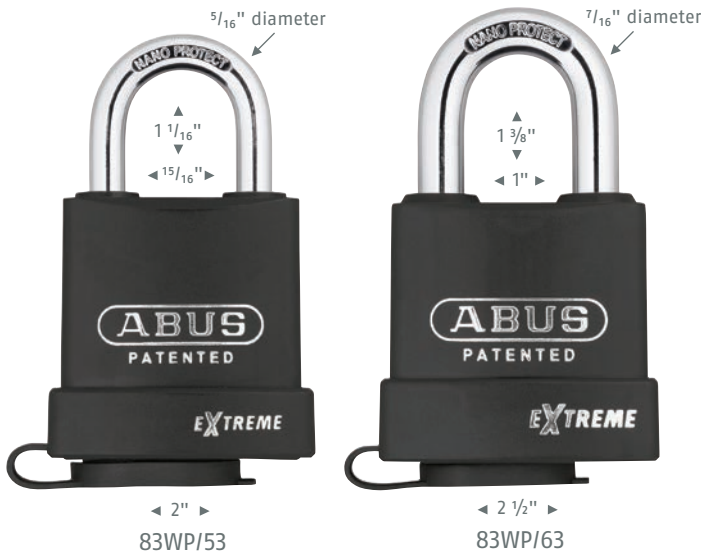

- Shackle and body made of hardened steel with NANO PROTECT™ coating for extra corrosion resistance
- RK: cylinder can be re-keyed to match an existing key
- Patented "Z-Bar" converts key retaining to non-key retaining and vice versa in seconds
- Patented "Pinning Window" for simple rekeying
- Durable weather cover with drainage system
- 83WP/53: shackle can be changed in seconds

- Solid forged brass body provides superior protection and weather resistance
- Stainless steel shackle and corrosion-resistant inner components for ultimate rust protection
- Precision locking mechanism with special protection against manipulation
- 4-digit resettable code
- Resetting tool included

Item	Shackle Height (in)	Pins in Cylinder	Case Pk Qty
83WP/53	1 1/16, 2 1/2, 3, 4	5-6	6
83WP-IC/53	1 1/16, 2 1/2, 3, 4	-	6
83WP-KnK/53	1 1/16, 2 1/2, 3, 4	-	6
83WP-LFIC/53	1 1/16, 2 1/2, 3, 4	-	6
83WP/63	1 3/8, 2 1/2	5-6	6
83WP-IC/63	1 3/8, 2 1/2	-	6
83WP-KnK/63	1 3/8, 2 1/2	-	6

Item	Shackle Height	Dials	Shackle Material	Case Pk Qty
180IB/50 C	1"	4	Stainless	6
180IB/50HB63 C	2 1/2"	4	Stainless	6



# TRADITIONAL BRASS 55



- Solid brass body offers maximum corrosion resistance
- Available with hardened steel or brass shackle
- Inner components made from non-corrosive materials
- Perfect solution for outdoor security applications

Item	Shackle Height	Pins in Cylinder	Shackle Material	Key Options	Case Pk Qty
55/25 C	7/16"	3	Steel	KD, KA	12
55/30 C	33/64"	3	Steel	KD	12
55/30 B	33/64"	3	Steel	KD, KA	12
55MB/30 C	33/64"	3	Brass	KD	12

Item	Shackle Height	Pins in Cylinder	Shackle Material	Key Options	Case Pk Qty
55/40 C	7/8"	4	Steel	KD	12
55/40 B	7/8"	4	Steel	KD, KA	12
55MB/40 C	7/8"	4	Brass	KD, KA	12
55MB/40 B	7/8"	4	Brass	KD, KA	12
55HB/40 MB C	2 1/2"	4	Brass	KD	6
55/45 C	5/16"	4	Steel	KD	6
55/45 B	5/16"	4	Steel	KD, KA	6
55/50 C	15/16"	5	Steel	KD	6
55/50 B	15/16"	5	Steel	KD, KA	6
55MB/50 C	15/16"	5	Brass	KD, KA	6
55/60 C	1 1/4"	5	Steel	KD, KA	6



# COMBINATION 145

# 78



- Solid and lightweight aluminum body
- 3- or 4-digit individually resettable code
- Ideal for securing toolboxes, luggage, lockers, cabinets and more

- 3-dial combination
- Extra protection against manipulation
- Hardened steel body
- Colored dial for individuality and easy recognition
- 78KC: Key Control - pin tumbler has master key function



Item	Shackle Height	Dials	Shackle Material	Case Pk Qty
145/20 C	7/8"	3	Steel	6
145/30 C	63/64"	3	Steel	6
145/40 C	1 1/64"	4	Steel	6



Item	Shackle Height	Shackle Material	Case Pk Qty
78/50 C	27/32"	Steel	6
78KC/50 B	27/32"	Steel	12





# MONOBLOCK BRASS 82

# STEEL 92

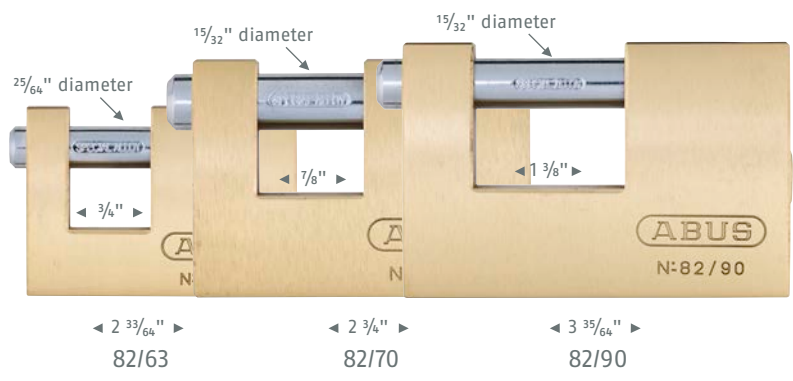
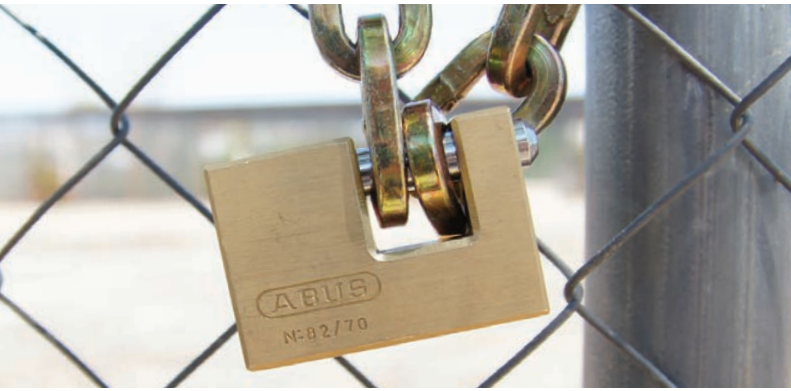

- Brass body offers strength and rust resistance
- Unique padlock design with hardened steel shackle and pin provides maximum resistance to bolt cutters
- Ultimate security when paired with ABUS security chain

- Body made from solid brass with steel jacket
- Hardened steel shackle with NANO PROTECT™ coating
- Precision pin tumbler
- Perfect for use with ABUS security chain

Item	Pins in Cylinder	Key Options	Case Pk Qty
82/63 B	5	KD, KA	6
82/70 B	5	KD, KA	6
82/90 B	5	KD, KA	6

Item	Pins in Cylinder	Key Options	Case Pk Qty
92/65 B	5	KD, KA	3
92/80 B	5	KD, KA	3



# INTEGRAL HASP D141



- Universal hasp with integrated Diskus® lock
- Ideal for use on double doors (utility vans, storage sheds)
- Easy to operate with one hand
- Solid metal locking case prevents successful attacks on the integrated padlock
- Zinc-plated for extreme corrosion resistance
- Mounting hardware included (screws, drilling template and spacers up to 1/5" height)
- Available with or without Diskus® lock

Item	Body Material	Body Color	Case Pk Qty
D141/200 C (w/26/70 Diskus)	Steel	Black	13
D141/200 B (Hasp only)	Steel	Black	13
D141/200 C (w/26/70 Diskus)	Steel	White	13
D141/200 B (Hasp only)	Steel	White	13

3 1/8"



8 7/16"  
D1141/200



# PUSH BUTTON KEYGARAGE™

# DIAL KEYGARAGE™

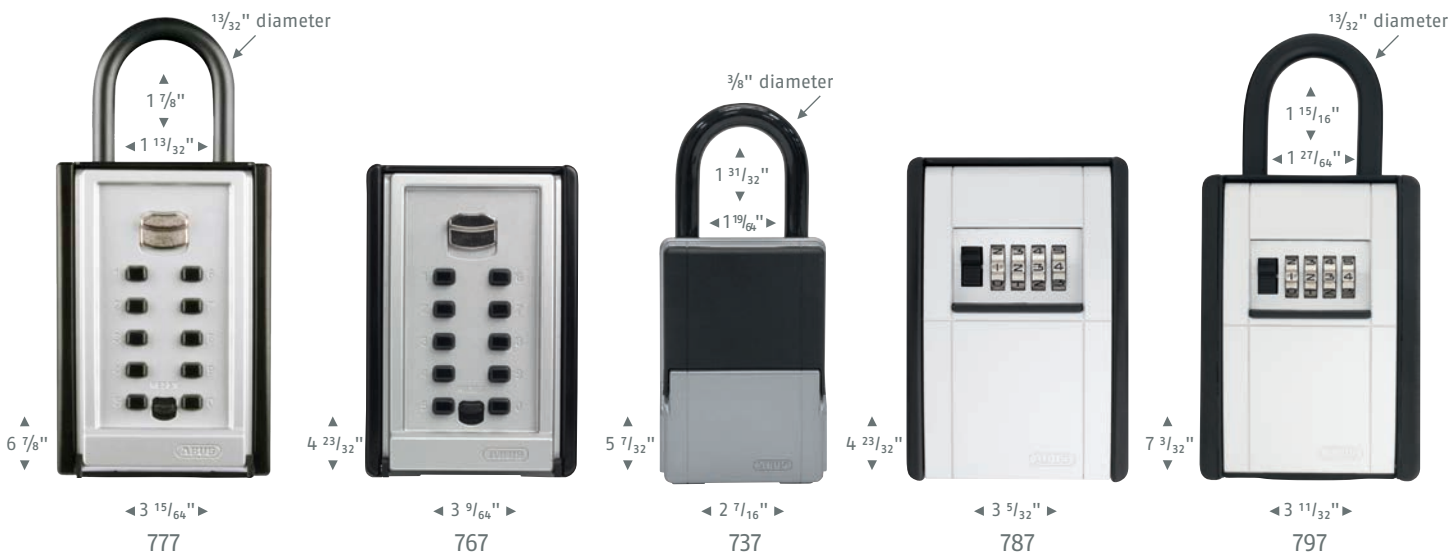

- Large solid metal housing offers more capacity than conventional key boxes
- 10 push-button resettable combination: Set your own PIN
- Push buttons provide faster access than dials
- Large hinged front door protects buttons
- 767: For wall mounting, 777: For attaching with shackle
- Holds up to 8 cards or 20 keys

- Ideal protected storage for keys and other valuables
- Solid metal housing; locking cover made from zinc die-cast
- 4-digit individually resettable code
- Protective cover with sliding mechanism
- 787: For wall mounting, 797: For attaching with shackle
- 787, 797: Holds up to 8 cards or 20 keys
- 737: Compact KeyGarage™ holds up to 6 keys

Item	Shackle Height	Buttons	Case Pk Qty
767 C	-	10	1
777 C	1 7/8"	10	1

Item	Shackle Height	Dials	Case Pk Qty
737 C	1 31/32"	4	1
787 C	-	4	1
797 C	1 15/16"	4	1



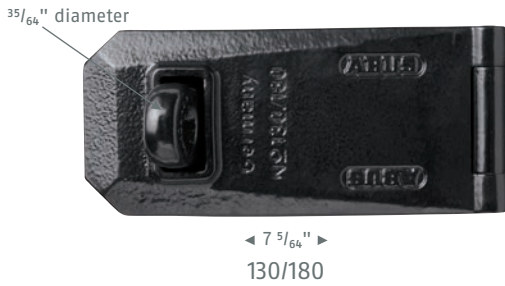

## GRANIT™ HASP 130

- Two hardened hinge pins
- Tough white heart malleable iron
- Hardened staple
- Includes coach bolts and back plate



## HARDENED STEEL HASP 125

- Extra-strong hinge
- Hardened staple
- Includes coach bolts and back plates
- Extremely high corrosion resistance



Item	Body Material	Case Pk Qty
130/180 C	White Heart Malleable Iron	1

Item	Body Material	Case Pk Qty
125/150 C	Coated Hardened Steel	3

Staple  
Width: 5/8"  
Height: 1/2"  
Depth: 7/8"



◀ 4 11/16" ▶  
140/120

◀ 7 3/8" ▶  
140/190  
(shown)

## STAINLESS STEEL HASP 140

- Hasp and hinge pins made of stainless steel
- Tough construction with hardened staple
- Hinge pins protected against attack
- Ideal in combination with Diskus® padlocks



Item	Body Material	Case Pk Qty
140/120 C	Stainless Steel	3
140/190 C	Stainless Steel	3

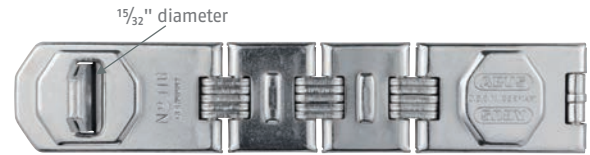

◀ 6 7/64" ▶  
110/155

◀ 7 43/64" ▶  
110/195

◀ 9 1/16" ▶  
110/230  
(shown)

## CONCEALED HINGE PIN HASP 110

- Hardened steel for extra strength
- Seamless eye loop prevents prying
- Center-lock pin resists being driven out at end
- Hidden screws and hinge pins for extra security



Item	Body Material	Case Pk Qty
110/155 C	Hardened Steel	3
110/195 C	Hardened Steel	3
110/230 C	Hardened Steel	3

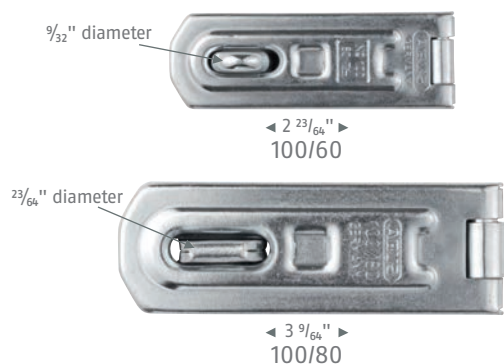

## CONCEALED HINGE PIN HASP 100

- Hardened staple and hinge pins (not for 100/60)
- Concealed hinge pin
- Corrosion-protected
- Hidden screws



Item	Body Material	Case Pk Qty
100/60 C	Steel	3
100/80 C	Steel	3

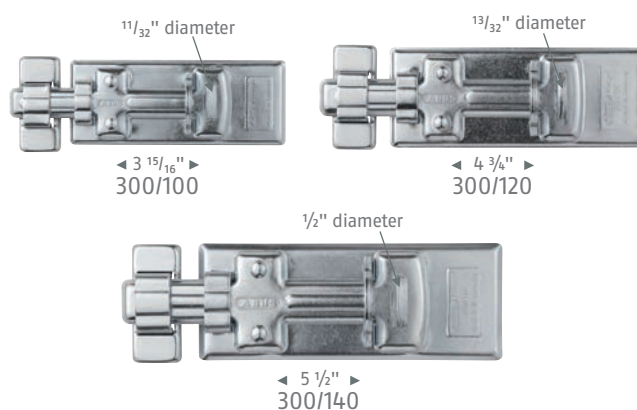

## HARDENED HASP 300

- Hardened steel sliding locking bolt
- Zinc chrome finish for corrosion protection
- Hidden screws for extra security



Item	Body Material	Case Pk Qty
300/100 C	Zinc-coated Hardened Steel	6
300/120 C	Zinc-coated Hardened Steel	6
300/140 C	Zinc-coated Hardened Steel	6

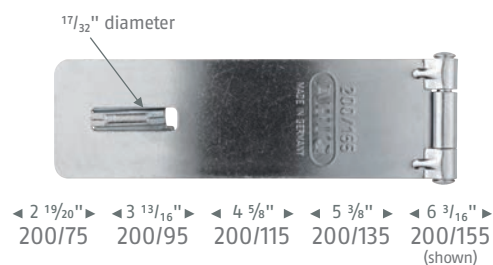

## HARDENED HASP 200

- Hardened steel for extra strength
- Galvanized finish for corrosion protection
- Seamless eye loop prevents prying
- Hidden screws and hinge pins for extra security



Item	Body Material	Case Pk Qty
200/75 C	Hardened Steel	6
200/95 C	Hardened Steel	6
200/115 C	Hardened Steel	6
200/135 C	Hardened Steel	6
200/155 C	Hardened Steel	6

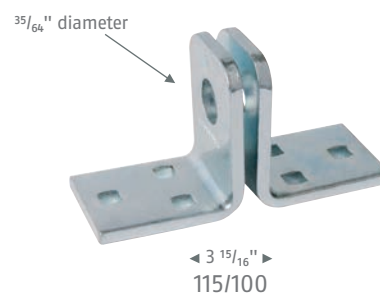

## FIXED STAPLE HASP 115

- Corrosion-protected
- Hardened bolt
- Hidden screws



Item	Body Material	Case Pk Qty
115/100 C	Steel	3

# MULTILOOP CABLE LOCK



- $\frac{15}{16}$ " strong premium steel cable
- PVC-coating to prevent damage to surroundings
- Silicone coating on the lock body with "soft touch" properties for better grip
- Integrated adapter in the body for a conversion from one loop to a double-loop cable
- 210: Keyed, available keyed-alike or keyed-different
- 215: Combination

Item	Cable Diameter	Cable Length	Body Material	Case Pk Qty
210/185 C	0.39	3	Steel	1
215/185 C	0.39	3	Steel	1



210/185

215/185

# COBRA STEEL CABLE

# STEEL CABLE

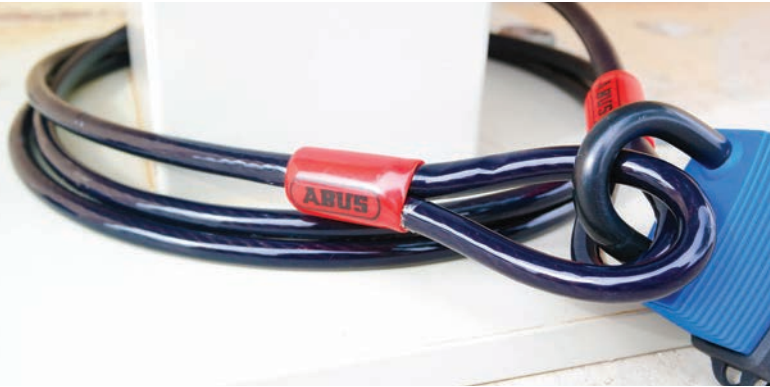

10/500 Cable

66 Cable

- Flexible steel cable
- ABUS loop cables protect bike components like front and rear wheel, frame and seat as the ideal complement to the ABUS U-shackle-locks, padlocks or frame locks
- Ideal to secure bicycles, surf boards, garden tools, etc.

- Braided steel wires for strength and flexibility
- Protective coating prevents scratching
- Self coiling for convenient storage

Item	Diameter	Length	Body Material	Case Pk Qty
8/200 Non-Coiled C	5/16"	78 47/64"	Steel	1
8/250 Non-Coiled C	5/16"	98 27/64"	Steel	1
10/500 Non-Coiled C	25/64"	196 27/32"	Steel	1
10/1000 Non-Coiled C	25/64"	393 45/64"	Steel	1
1850/185 Coiled B	5/16"	72 53/64"	Steel	1

Item	Diameter	Length	Body Material	Case Pk Qty
46 Coiled C	7/16"	72"	Steel	5
66 Coiled C	5/16"	72"	Steel	10
86 Coiled C	1/4"	72"	Steel	10

# MAXIMUM SECURITY CHAIN

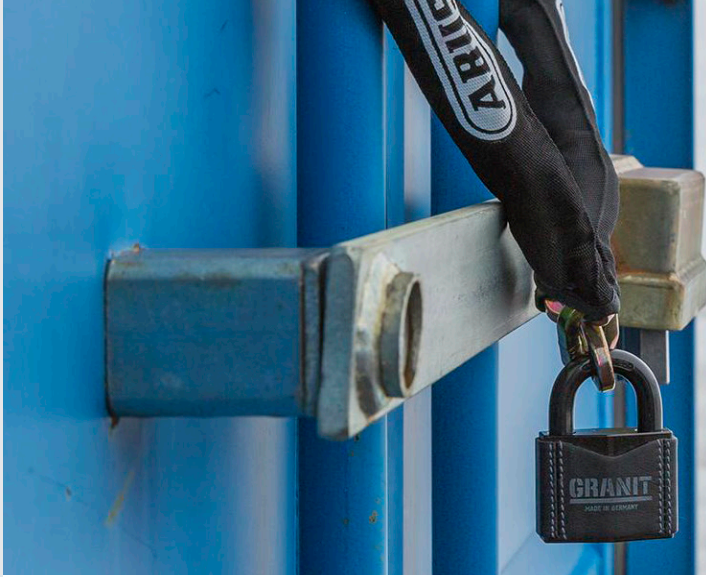

- Chain made from hardened steel
- Square-shaped links provide top security against all types of aggressive attacks
- Fabric sleeve prevents surroundings from damage
- Available in pre-cut (2', 6', 10') or custom lengths
- Loop chain comes with a larger loop on one end, making the chain go further

Item	Cutting Force	Inside Height	Thickness	Inside Width
6KS	4 tons	1 1/8"	1/4"	3/8"
8KS	6 tons	1 3/8"	5/16"	1/2"
10KS	8 tons	1 1/2"	3/8"	5/8"
12KS	10 tons	2 1/4"	1/2"	3/4"
14KS	12 tons	2"	9/16"	3/4"
12KS Loop 2.5'	10 tons	2 1/4"	1/2"	3/4"
12KS Loop 4'	10 tons	2 1/4"	1/2"	3/4"
12KS Loop 5'	10 tons	2 1/4"	1/2"	3/4"



12KS Loop



# FLOOR & WALL ANCHOR

# WALL ANCHOR



◀ 6 1/2" ▶  
WBA100

- 6 5/16" shackle made of hardened steel for extreme resistance against the most aggressive attacks
- Extra wide shackle for easy locking
- Due to its flat shape and the use of high-quality plastic, it is possible to drive over the anchor in fixed position
- Can be used indoors and outdoors as wall or floor anchor
- Includes mounting hardware

Item	Case Pk Qty
WBA100	1



◀ 4 1/3" ▶  
WA50

- Hardened steel wall anchor
- Can be used indoors and outdoors
- Includes hardware for wall or floor mounting

Item	Case Pk Qty
WA50	1



Security Tech Germany

# SAFETY WHEN YOU NEED IT ABUS NEXT

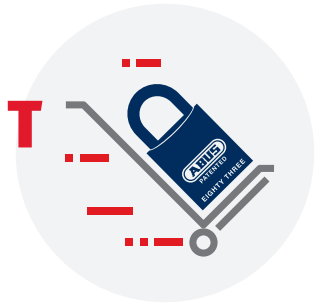

ABUS Next eliminates potential shut downs and lost revenue by delivering safety padlocks and devices FAST. Place an order by 6 p.m. EST and it is eligible for next-day delivery (shipping charges apply).\*

**ABUS NEXT, you make the call, WE make it happen.**

Call for more details! **800.352.ABUS**

## Eligible Products

41 Series

72 Series

74 Series

Select safety devices



\*Up to 100 stock KD and KA padlocks or devices, call for large quantity requests. Next Day shipping charges apply.



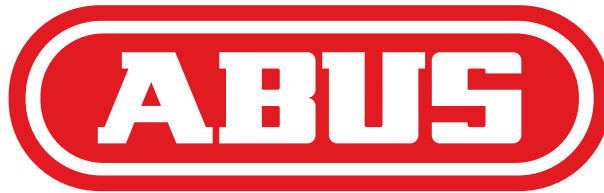

Security Tech Germany



# 2019 SECURITY CATALOG

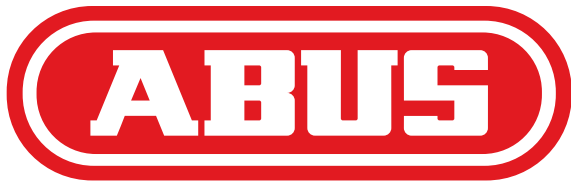

Security Tech Germany



**THE OFFICIAL LOCK OF  
THE PHOENIX SUNS**

**Padlocks**

**Hasps**

**Accessories**

**Vitess™ High Security**

**General Information**

Padlocks

Hasps

Accessories

Vitess™ High Security

General Information

# HIGH SECURITY DISKUS® 20



- Original Diskus® design: 360° protection
- 100% non-corrosive stainless steel inside and out
- Diskus® Deep-Welding Technology provides maximum strength and pry resistance
- Shackle made from stainless steel
- Anti-cut plate
- ABUS-Plus disk cylinder: highest protection against manipulation, extremely high number of key differs, drilling and pulling protected

Item	Shackle Height	Pins in Cylinder	Key Options	Case Pk Qty
20/70 B	43/64" "	6	KD, KA, MK	6
20/80 B	45/64" "	6	KD, KA, MK	3



# WEATHERPROOF DISKUS® 24IB



- Original Diskus® design: 360° protection
- 100% non-corrosive: shackle and all inner components made of stainless steel
- Diskus® Deep-Welding Technology provides maximum strength and pry resistance
- Precision pin cylinder - extra plated for ultimate corrosion resistance

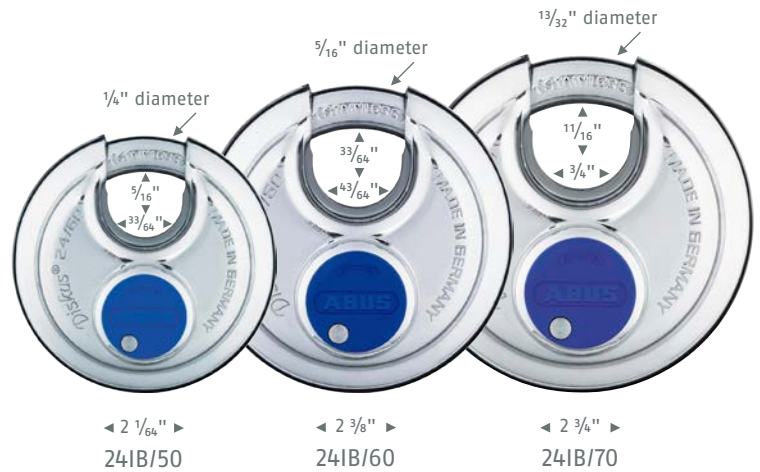

Item	Shackle Height	Pins in Cylinder	Key Options	Case Pk Qty
24IB/50 B	5/16"	4	KD, KA	6
24IB/60 C	33/64"	4	KD, KA	6
24IB/60 B	33/64"	4	KD, KA, MK	6
24IB/70 C	11/16"	5	KD	6
24IB/70 B	11/16"	5	KD, KA, MK	6



# DIMPLE-KEY DISKUS® 25

# STAINLESS STEEL DISKUS® 26

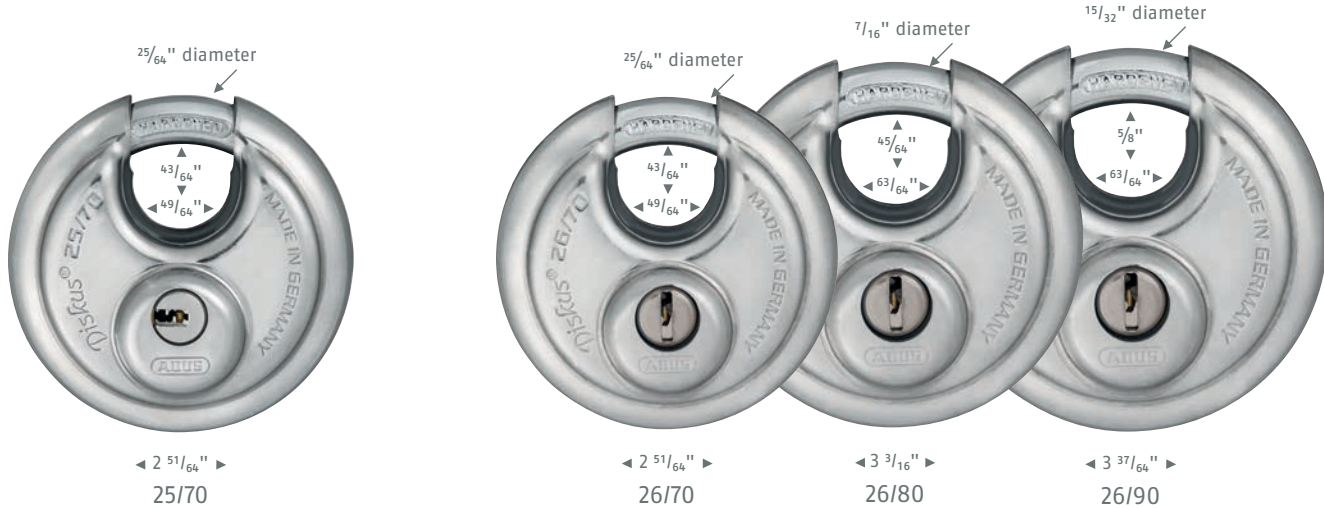

- High precision reversible key with 8,000 key differs
- Spare keys can only be ordered with assigned code
- 100% non-corrosive stainless steel inside and out
- Shackle made from hardened steel
- Original Diskus® design: 360° protection
- Anti-cut plate
- Diskus® Deep-Welding Technology provides maximum strength and pry resistance
- Key retaining: lock retains key until locked

- 100% non-corrosive stainless steel inside and out
- Massive inner base for enhanced security
- Anti-cut plate
- Shackle made from special alloy hardened steel
- Precision pin cylinder, drilling and pulling protected
- Diskus® Deep-Welding Technology provides maximum strength and pry resistance
- Original Diskus® design: 360° protection
- Key retaining: lock retains key until locked

Item	Shackle Height	Pins in Cylinder	Key Options	Case Pk Qty
25/70 B	43/64" (left), 49/64" (right)	8	KD	6

Item	Shackle Height	Pins in Cylinder	Key Options	Case Pk Qty
26/70 B	43/64" (left), 49/64" (right)	5	KD, KA, MK	6
26/80 B	45/64" (left), 63/64" (right)	6	KD, KA, MK	3
26/90 B	5/8" (left), 63/64" (right)	6	KD, KA, MK	3



# HARDENED STEEL DISKUS® 28

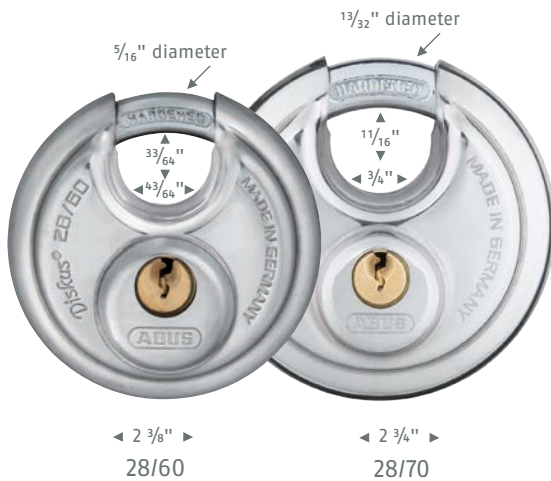

- Original Diskus® design: 360° protection
- Diskus® Deep-Welding Technology provides maximum strength and pry resistance
- Shackle made from hardened steel
- Precision pin cylinder with anti-pick pins

Item	Shackle Height	Pins in Cylinder	Key Options	Case Pk Qty
28/60 B	33/64" "	4	KD, KA	6
28/70 C	11/16" "	5	KD	6
28/70 B	11/16" "	5	KD, KA	6





# GRANIT™ 37[RK]/55

# 37ST/55



37/55, 37/55HB50, 37/55HB75

- Shackle and body made from hardened alloy steel
- ABUS-Plus disk cylinder, highest protection against manipulation, high number of key differs
- Black Granit™ coating for high corrosion resistance
- Cylinder can be rekeyed to match an existing key
- 2 keys, 1 with LED light



37ST/55

- Body and shackle made of stainless steel
- Inner parts made of non-corrosive materials
- ABUS-PLUS disk cylinder, highest protection against manipulation, high number of key differs
- Cylinder inserts from the top: optimum drill and pull resistance
- 2 keys, 1 with LED light

Item	Shackle Height	Pins in Cylinder	Key Options	Case Pk Qty
37RK/55 B	1 3/64" B	7	KD, KA, MK	3
37/55 B	1 3/64" B	7	KD	1
37/55HB50 B	2" B	7	KD, KA, MK	3
37/55HB75 B	3" B	7	KD, KA, MK	4

Item	Shackle Height	Pins in Cylinder	Key Options	Case Pk Qty
37/55 ST-C	1 3/64" B	7	KD	2



# GRANIT™ 37RK/70

# 37[RK]/60, 80



- Body and shackle made from hardened alloy steel
- ABUS-Plus disk cylinder, highest protection against manipulation, high number of key differs
- Cylinder inserted from the top: optimum drill and pull resistance
- Black Granit™ coating for high corrosion resistance
- Cylinder can be rekeyed to match an existing key
- 2 keys, 1 with LED light

- Body and shackle made from hardened alloy steel
- ABUS-Plus disk cylinder, highest protection against manipulation, high number of key differs
- Cylinder inserted from the top: optimum drill and pull resistance (37RK/80)
- Shackle guard protects shackle from attacks
- Black Granit™ coating for high corrosion resistance
- Cylinder can be rekeyed to match an existing key
- 2 keys, 1 with LED light

Item	Shackle Height	Pins in Cylinder	Key Options	Case Pk Qty
37RK/70 B	1 3/8"	7	KD, KA, MK	1

Item	Shackle Height	Pins in Cylinder	Key Options	Case Pk Qty
37RK/60 B	5/8"	7	KD	1
37/60 B	5/8"	7	KD	1
37RK/80 B	55/64"	7	KD, KA, MK	1

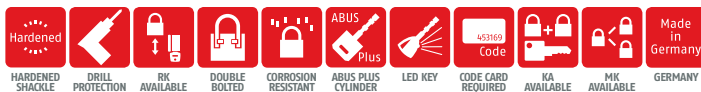

# LAMINATED STEEL 41

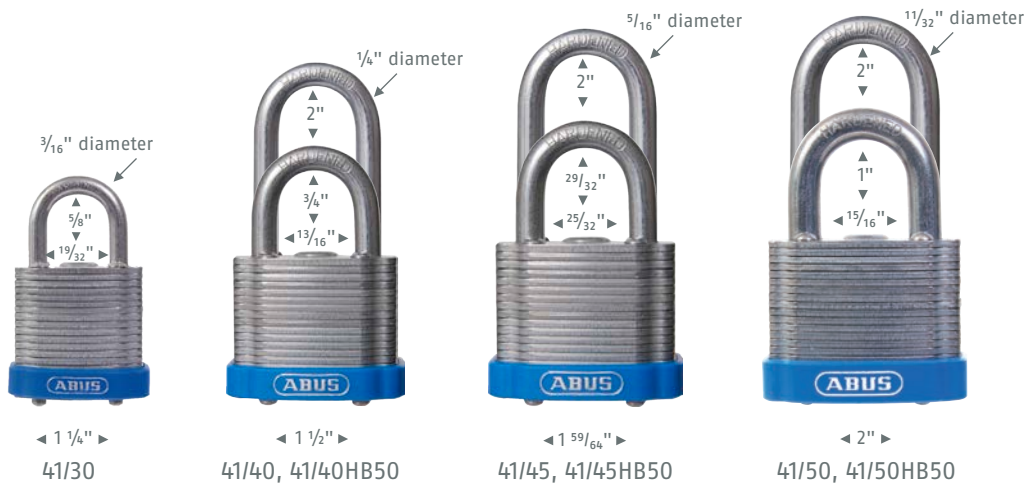

- Laminated steel with ETERNA™ coating on each laminate for extreme corrosion resistance
- ETERNA™: Non-hazardous, cadmium-free plating
- Tough, countersunk rivets
- Hardened steel shackle
- High-precision 5-pin tumbler, drilling and pulling protected
- Plastic bumper for easy identification

Item	Shackle Height	Pins in Cylinder	Key Options	Case Pk Qty
41/30 B	5/8"	4 or 5	KD, KA, MK	4
41/40 C	3/4"	4 or 5	KD	6
41/40 B	3/4"	4 or 5	KD, KA, MK	6
41/40HB50 B	2"	4 or 5	KD, KA, MK	6
41/45 B	29/32"	4 or 5	KD	6
41/45HB50 B	2"	4 or 5	KD, KA, MK	6
41/50 C	1"	4 or 5	KD	6
41/50 B	1"	4 or 5	KD, KA, MK	6
41/50HB50 B	2"	4 or 5	KD, KA	6



# LAMINATED STEEL 45

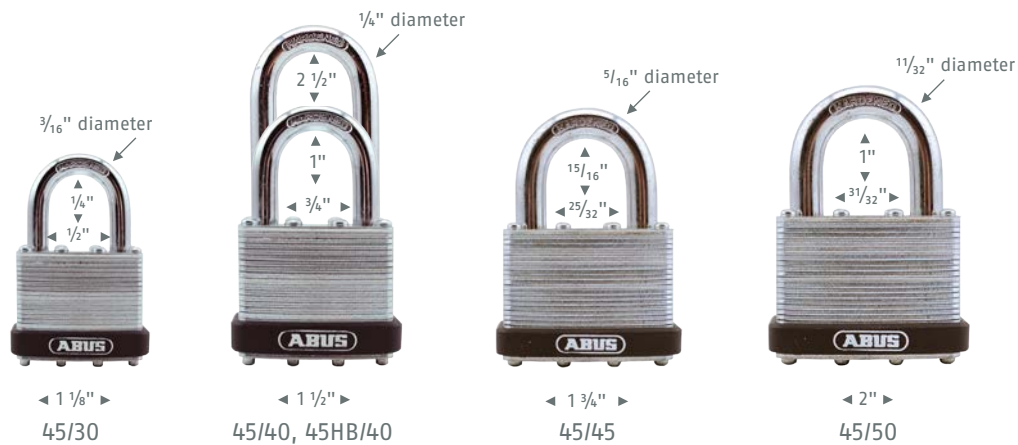

- Laminated steel, individually galvanized
- Hardened steel shackle, difficult to cut
- Tough steel rivets
- Cylinder protected against drilling and pulling

Item	Shackle Height	Pins in Cylinder	Key Options	Case Pk Qty
45/30 C	1/4"	4	KD	6
45/40 C	1"	4	KD	6
45HB/40 C	2 1/2"	4	KD	6
45/45 C	15/16"	4	KD	6
45/50 C	1"	4	KD	6



# TRADITIONAL BRASS 55



- Solid brass body offers maximum corrosion resistance
- Available with hardened steel or brass shackle
- Inner components made from non-corrosive materials
- Perfect solution for outdoor security applications

Item	Shackle Height	Pins in Cylinder	Shackle Material	Key Options	Case Pk Qty
55/25 C	7/16"	3	Steel	KD, KA	12
55/30 C	33/64"	3	Steel	KD	12
55/30 B	33/64"	3	Steel	KD, KA	12
55MB/30 C	33/64"	3	Brass	KD	12

Item	Shackle Height	Pins in Cylinder	Shackle Material	Key Options	Case Pk Qty
55/40 C	7/8"	4	Steel	KD	12
55/40 B	7/8"	4	Steel	KD, KA	12
55MB/40 C	7/8"	4	Brass	KD, KA	12
55MB/40 B	7/8"	4	Brass	KD, KA	12
55HB/40 MB C	2 1/2"	4	Brass	KD	6
55/45 C	5/16"	4	Steel	KD	6
55/45 B	5/16"	4	Steel	KD, KA	6
55/50 C	15/16"	5	Steel	KD	6
55/50 B	15/16"	5	Steel	KD, KA	6
55MB/50 C	15/16"	5	Brass	KD, KA	6
55/60 C	1 1/4"	5	Steel	KD, KA	6





# TRADITIONAL BRASS 65

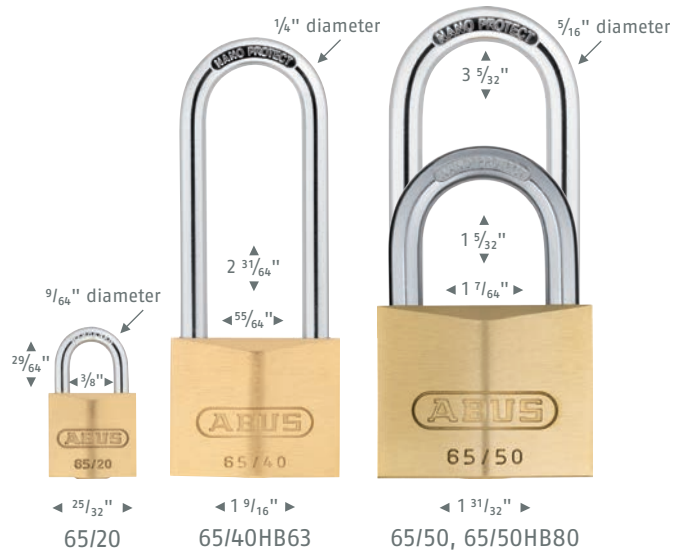

- Body made from solid brass
- Shackle made from hardened steel with NANO PROTECT™ coating
- Inner components made from non-corrosive materials
- Precision pin tumbler

Item	Shackle Height	Pins in Cylinder	Key Options	Case Pk Qty
65/20 C	29/64"	3	KD, KA	6
65/40HB63 C	2 31/64"	5	KD, KA	6
65/50 C	1 5/32"	5	KD, KA	6
65/50HB80 C	3 5/32"	5	KD, KA	6



Padlocks

Hasps

Accessories

Wissens™ High Security

General Information

# HIGH SECURITY BRASS 85

# CHROME-PLATED BRASS 88

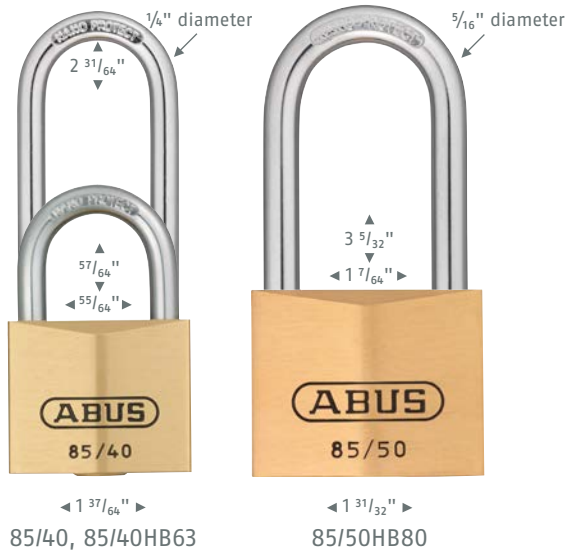

- Body made of solid brass
- Inner components made of non-corrosive materials
- Hardened steel shackle with NANO PROTECT™ coating
- Precision pin cylinder with mushroom pins
- Paracentric keyway for increased protection against manipulation
- Can be made keyed alike to already existing keys/locks
- Automatic locking: Locking without key by pushing down the shackle

- Lock body made from solid brass
- Chrome-plated lock body for better corrosion resistance
- Double bolted
- Shackle made from hardened alloy steel
- ABUS-Plus disc cylinder: highest protection against manipulation
- Cylinder can be re-keyed to match an existing key
- Key retaining: locking only with the key (lock retains key until locked)

Item	Shackle Height	Pins in Cylinder	Key Options	Case Pk Qty
85/40 B	$\frac{57}{64}$ "	5	KD, KA, MK	6
85/40HB63 B	$2 \frac{31}{64}$ "	5	KD, KA, MK	3
85/50HB80 B	$3 \frac{5}{32}$ "	5	KD, KA, MK	3

Item	Shackle Height	Pins in Cylinder	Key Options	Case Pk Qty
88/40 C	$\frac{57}{64}$ "	7	KD	6
88/40 B	$\frac{57}{64}$ "	7	KD, KA	6
88/50 C	$1 \frac{1}{64}$ "	7	KD	6
88/50 B	$1 \frac{1}{64}$ "	7	KD, KA	6



# WEATHERPROOF BRASS 70

# BRASS 75IB

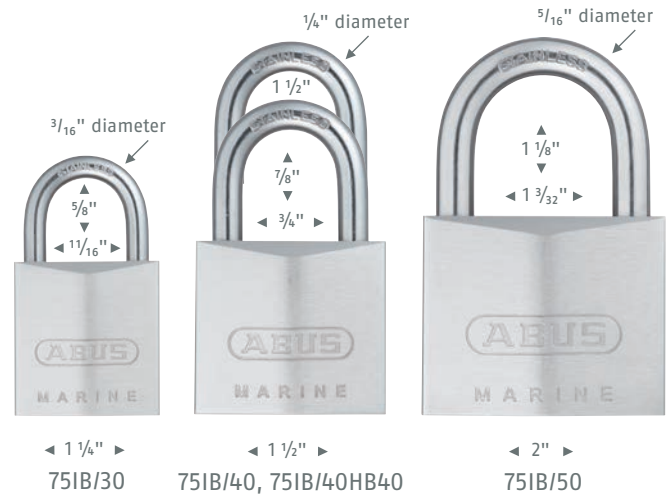
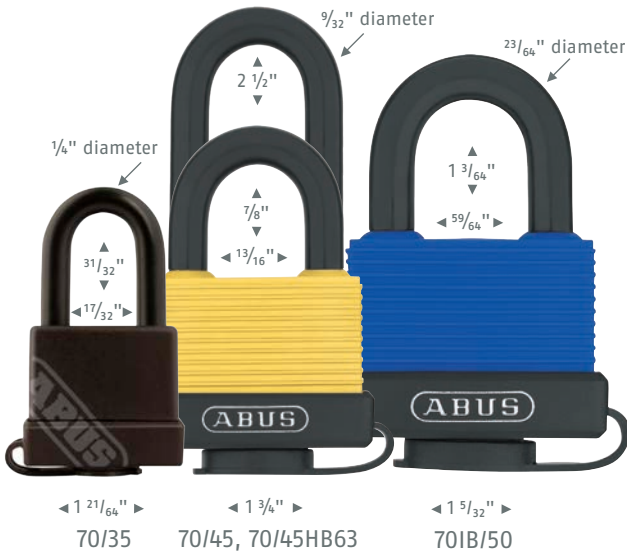

- Solid brass body with shock-absorbing vinyl cover provide ultimate weather resistance
- Cylinder cover with drainage channels protects padlock from water and dirt
- Inner components made from rust-free materials
- IB: comes with stainless steel shackle

- High-precision reversible keyway with up to 150,000 key differs
- Body made from solid brass or pearl-nickel-plated brass
- Shackle made from stainless steel
- Dimple key
- Key-retaining: 75IB/40 + 75IB/50
- Self-locking: 75IB/30



Item	Shackle Height	Pins in Cylinder	Key Options	Case Pk Qty
70/35 B	$\frac{31}{32}$ "	4	KD	12
70/45 C	$\frac{7}{8}$ "	5	KD, KA	6
70/45HB63 B	$2\frac{1}{2}$ "	5	KD, KA	6
70IB/45 C	$\frac{7}{8}$ "	5	KD, KA, MK	6
70IB/45HB63 B	$2\frac{1}{2}$ "	5	KD, KA, MK	6
70IB/50 C	$1\frac{3}{4}$ "	5	KD, KA, MK	6

Item	Shackle Height	Pins in Cylinder	Key Options	Case Pk Qty
75IB/30 B	$\frac{5}{8}$ "	8	KD, KA	12
75IB/40 B	$\frac{7}{8}$ "	8	KD, KA	12
75IB/40HB40 B	$1\frac{1}{2}$ "	8	KD, KA	12
75IB/50	$1\frac{1}{8}$ "	10	KD, KA	6





# WEATHERPROOF BRASS 84IB

# BRASS T84MB

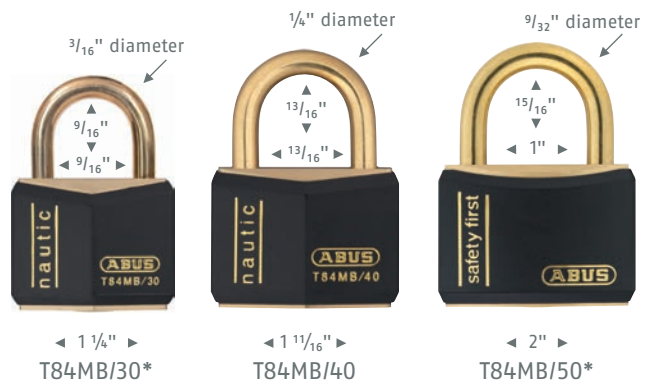

- Lock body made of nickel-plated solid brass
- Shackle made of stainless steel
- Inner components made of non-corrosive materials
- Precision pin tumbler
- Self-locking: locking without a key by pushing down the shackle

- Body and shackle made of solid brass
- Inner components made of non-corrosive materials
- Precision pin tumbler



Item	Shackle Height	Key Options	Case Pk Qty
84IB/40 C	53/64"	KD	6
84IB/50 C	31/32"	KD	6
84IBHB/50 C	2"	KD	6

Item	Shackle Height	Pins in Cylinder	Key Options	Case Pk Qty
T84MB/30* C	9/16"	3	KD, KA	12
T84MB/40 C	13/16"	4	KD	12
T84MB/40 B	13/16"	4	KD, KA	12
T84MB/50* C	15/16"	5	KD, KA	6



\*Available only with black jacket.



# MONOBLOCK BRASS 82

# STEEL 92

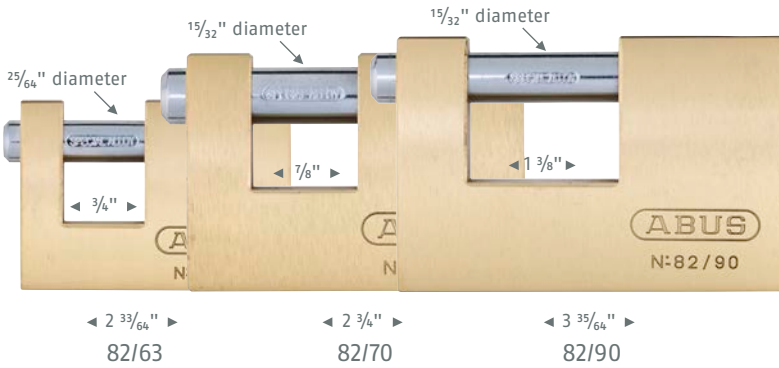

- Brass body offers strength and rust resistance
- Unique padlock design with hardened steel shackle and pin provides maximum resistance to bolt cutters
- Ultimate security when paired with ABUS security chain

- Body made from solid brass with steel jacket
- Hardened steel shackle with NANO PROTECT™ coating
- Precision pin tumbler
- Perfect for use with ABUS security chain

Item	Pins in Cylinder	Key Options	Case Pk Qty
82/63 B	5	KD, KA	6
82/70 B	5	KD, KA	6
82/90 B	5	KD, KA	6

Item	Pins in Cylinder	Key Options	Case Pk Qty
92/65 B	5	KD, KA	3
92/80 B	5	KD, KA	3



# TITALIUM™ 54TI

# 80TI



- Solid lock body made of TITALIUM™ aluminum alloy: light, but secure
- Hardened steel shackle, difficult to cut
- Just as strong as traditional brass padlocks



- Solid lock body made from TITALIUM™ aluminum alloy: higher security, less weight
- Hardened steel shackle with NANO PROTECT™ coating
- Paracentric keyway for increased protection against manipulation
- Just as strong as traditional brass padlocks

Item	Shackle Height	Pins in Cylinder	Key Options	Case Pk Qty
54TI/30 C	$35/64$ "	3	KD	6
54TI/35 C	$5/8$ "	3	KD	6
54TI/40 C	$53/64$ "	4	KD	6
54TI/40HB63 C	$2 31/64$ "	4	KD	6

Item	Shackle Height	Pins in Cylinder	Key Options	Case Pk Qty
80TI/40HB40 C	$1 9/16$ "	6	KD, KA	4
80TI/50 C	$1 3/8$ "	6	KD, KA	4



# TITALIUM™ 64TI

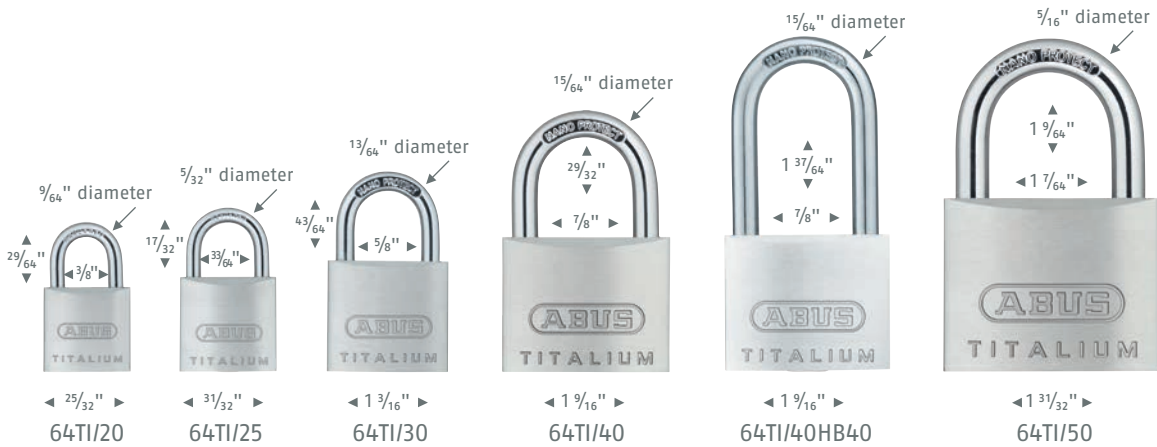

- Solid lock body made from TITALIUM™ aluminum alloy: higher security, less weight
- Hardened steel shackle with NANO PROTECT™ coating for superior corrosion resistance
- Paracentric keyway for increased protection against manipulation
- Just as strong as traditional brass padlocks

Item	Shackle Height	Pins in Cylinder	Key Options	Case Pk Qty
64TI/20 C	29/64"	3	KD	6
64TI/25 C	17/32"	4	KD	6
64TI/30 C	43/64"	4	KD	6
64TI/40 C	29/32"	5	KD	6
64TI/40HB40 C	1 37/64"	5	KD, KA	6
64TI/50 C	1 9/64"	5	KD, KA	6



# 83 SERIES®

## The Locksmith's Padlock of Choice



### Features

#### KnK Cylinder Compatibility

Most OEM KnK cylinder assemblies will fit into the new 83 Series® padlocks. The use of special adapters is required. KnK Adapter Kit Includes: Bible Cover, Schlage® & Primus®, Medeco®, Mul-T-Lock®, Ilco®/Sargent KnK Drivers.



KnK Adapter Kit

#### Shackle Changing Tools

There are two new shackle changing tools for use with ABUS 83 Series®. Version 1 is a solid aluminum, steel tip tool designed for use in the workshop environment. Version 2 is an economy version of this tool, designed for use in a van or onsite and when only a smaller number of shackles needs to be changed. A flat bladed screwdriver can no longer be used to remove the shackle, reducing the likelihood of a consumer accidentally doing so.



Professional Aluminum Shackle Change Tool

#### Easy Shackle Change Feature

The popular "Easy Shackle Change" feature has been expanded to all 83ALs, 83/45, 83KnK/45, 83/50, 83MAR/45, 83WPIB/53, 83WP/53 and most IC padlocks.

#### Shackle Collar and Chain

With an ABUS shackle collar and chain, you can affix any one of our 83 Series® padlocks to a specific location to help prevent loss and contamination of the padlock. The shackle collar slides up the leg of the shackle and holds the chain attached to the padlock when open. Shackle collars are available for 5/16", 3/8" and 7/16" diameter shackles and can be purchased individually or in a collar kit which includes 6 collars of each size.



Shackle Collar

#### 3-in-1 Bolt Driver

The 3-in-1 bolt driver setup has been retained for the large steel-bodied padlocks. Changing shackles becomes much simpler using this tools as the spring does not need to be reset. The 3-in-1 bolt driver is used in the 83/55, 83CS/55, 83/80 and 83WP/63 Series as well as all IC padlocks.



3-in-1 Bolt Driver

#### Symmetrical Z-Bar

A new 83 Series® Z-bar has been designed for use in converting from key-retaining to non-key-retaining in seconds. It looks similar to the existing Z-bar, but is symmetrical and has a black dot printed on it, distinguishing it from the old Z-bar which is produced with a red dot. The old Z-bar is shaped differently than the new Z-bar, therefore the two are not interchangeable.



New Z-Bar

#### 83 Service Kit

ABUS 83 Series® Service Kit is the perfect way to keep all your parts for the 83 Series organized in your shop or in your van. The kit includes a variety of shackles for the 83/45, cylinders, KnK bible covers and adapters, Z-bars, Easy Shackle Change Tools and much more.



83 Service Kit

#### Cylinder Cover

A rubberized weatherproof cylinder cover is available for select 83 Series® padlocks. The cover fits snugly on the bottom of the lock and protects the cylinder from precipitation and debris.



Cylinder Cover

### Keyways

100 YALE No. 8	200 Kwikset 5-Pin	300 & 306 Schlage C	EVER Schlage EVER	400 Corbin 60 59A1 59A2 5981 5982	410 Corbin L4	700 Sargent L4-LC	800 Weiser Falcon	888 ABUS	900 Arrow	1000 Russwin D1-D4	3000 Schlage C-L

Schlage C 300 is 6-5 pin loaded and Schlage C 306 is 6-6 pin loaded  
Schlage Everest EVER is a composite that will fit all Everest C keyways

# PROFESSIONAL TITALIUM™ 83

# BRASS 83

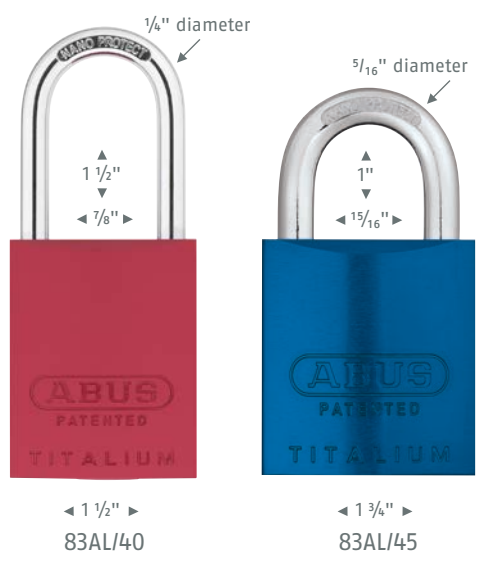

- Solid lock body made of TITALIUM™ aluminum alloy
- Shackle made of hardened steel with NANO PROTECT™ coating for extra corrosion resistance
- Patented "Z-bar" converts key-retaining to non-key-retaining and vice versa within seconds
- Patented "Pinning Window" for simple rekeying
- Can be keyed into many popular keyways
- Shackle can be changed in seconds

- Body made of solid brass
- Shackle made of hardened steel with NANO PROTECT™ coating for extra corrosion resistance
- Patented "Z-bar" converts key-retaining to non-key-retaining and vice versa within seconds
- Patented "Pinning Window" for simple rekeying
- Can be keyed into many popular keyways
- Shackle can be changed in seconds



Item	Cyl Cover Available	Shackle Height (in)	Pins in Cylinder	Case Pk Qty
83AL/40	Y	1, 1 1/2, 3, 4	5-6	6
83AL/45	Y	1, 2, 3, 4, 6	5-6	6
83AL-IC/40	Y	1, 1 1/2, 3, 4	-	6

Item	Cyl Cover Available	Shackle Height (in)	Pins in Cylinder	Case Pk Qty
83/40	Y	1, 1 1/2, 3, 4	5-6	6
83/45	Y	1, 2, 3, 4, 6	5-6	6
83CS/45	Y	1, 2, 3, 4, 6	5-6	6
83IC/45	Y	1, 2, 3, 4, 6	-	6
83KnKI/45	Y	1, 2, 3, 4, 6	-	6

\*83AL/40 and 83/40 come standard with a 1 1/2" shackle



# HARDENED STEEL LFIC 83

# PROFESSIONAL PLATED 83



83S/45 LFIC



83/50



83CS/50

- Body made from hardened steel with NANO PROTECT™ coating - same superior corrosion resistance as 83WP
- Hardened steel shackle with NANO PROTECT™ coating, available in different heights
- Padlock can be ordered without shackle to customize lock
- Accepts LFIC Schlage® cylinders
- Accepts all 83WP/53 compatible shackles
- Shackle can be changed in seconds

- Body made of chrome-plated solid brass
- Shackle made of hardened steel with NANO PROTECT™ coating for extra corrosion resistance
- Patented "Z-bar" converts key-retaining to non-key-retaining and vice versa within seconds
- Patented "Pinning Window" for simple rekeying
- Can be keyed into many popular keyways
- Shackle can be changed in seconds

Item	Cyl Cover Available	Shackle Height (in)	Pins in Cylinder	Case Pk Qty
83S/45 LFIC	N	1 3/16, 2 1/2, 3, 4	-	5-6

Item	Cyl Cover Available	Shackle Height (in)	Pins in Cylinder	Case Pk Qty
83/50	Y	1 3/64, 2, 3, 4	5-6	6
83CS/50	Y	1 7/64, 2, 3, 4	5-6	6
83IC/50	Y	1, 2, 3, 4	-	6
83KnK/50	Y	1, 2, 3, 4	-	6
83CS-KnK/50	Y	1, 2, 3, 4	-	6



# STEEL ROCK 83

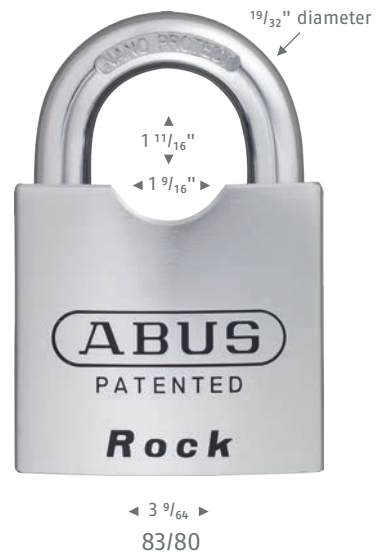
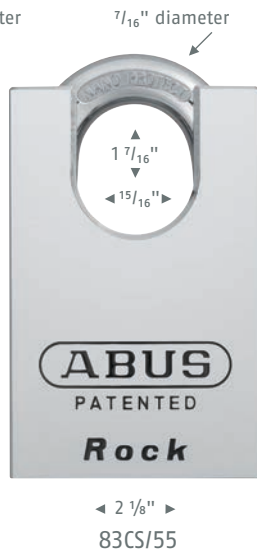

- Body and shackle made from hardened steel, chrome-plated with NANO PROTECT™ coating for an extreme corrosion resistance
- Patented "Z-Bar" converts key-retaining to non-key-retaining and vice versa within seconds
- RK: cylinder can be re-keyed to match an existing key
- CS: shackle guard protects shackle from attack

- Can be adapted to meet various requirements within seconds - no special tools needed
- Body and shackle made from hardened steel, chrome-plated with NANO PROTECT™ coating for an extreme corrosion resistance
- Double bolted
- Patented "Z-Bar" converts key-retaining to non-key-retaining and vice versa within seconds

Item	Cyl Cover Available	Shackle Height (in)	Pins in Cylinder	Case Pk Qty
83/55	N	1, 1 7/16, 3	5-6	6
83CS/55	N	1, 1 7/16, 3	5-6	6
83KnK/55	N	1, 1 7/16, 3	-	6
83CS-IC/55	N	1, 1 7/16, 3	-	6
83CS-KnK/55	N	1, 1 7/16, 3	-	6

Item	Cyl Cover Available	Shackle Height (in)	Pins in Cylinder	Case Pk Qty
83/80	N	1 11/16	5-6	6





# WEATHERPROOF 83

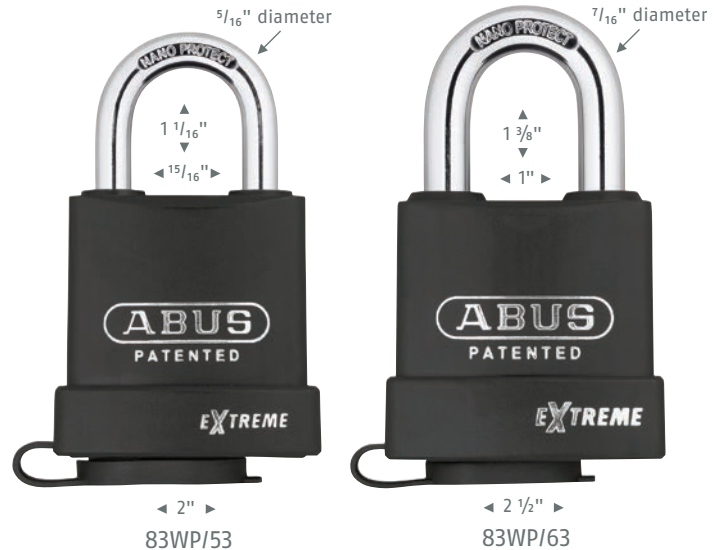
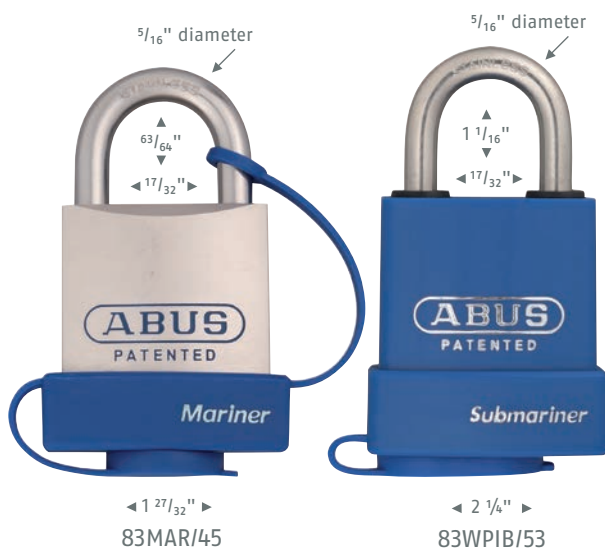

- Brass body with extra plating for perfect corrosion resistance
- Shackle made of stainless steel
- Durable weather cover with drainage system
- Patented "Z-bar" converts key-retaining to non-key-retaining and vice versa within seconds
- Patented "Pinning Window" for simple rekeying
- Can be keyed into many popular keyways
- Shackle can be changed in seconds

- Shackle and body made of hardened steel with NANO PROTECT™ coating for extra corrosion resistance
- RK: cylinder can be re-keyed to match an existing key
- Patented "Z-Bar" converts key retaining to non-key retaining and vice versa in seconds
- Patented "Pinning Window" for simple rekeying
- Durable weather cover with drainage system
- 83WP/53: shackle can be changed in seconds

Item	Shackle Height (in)	Pins in Cylinder	Case Pk Qty
84MAR/45	1, 2, 3, 4	5-6	6
83WPIB/53	1 1/8	5-6	6

Item	Shackle Height (in)	Pins in Cylinder	Case Pk Qty
83WP/53	1 1/16, 2 1/2, 3, 4	5-6	6
83WP-IC/53	1 1/16, 2 1/2, 3, 4	-	6
83WP-KnK/53	1 1/16, 2 1/2, 3, 4	-	6
83WP-LFIC/53	1 1/16, 2 1/2, 3, 4	-	6
83WP/63	1 3/8, 2 1/2	5-6	6
83WP-IC/63	1 3/8, 2 1/2	-	6
83WP-KnK/63	1 3/8, 2 1/2	-	6



# INTERCHANGEABLE CORE

## Features

- Accepts 6-pin and 7-pin SFIC cylinders
- Available in solid aluminum, solid brass, solid brass chrome-plated and solid hardened steel bodied padlocks
- Double-ball shackle locking
- Hardened steel shackle with NANO PROTECT™ coating for extreme corrosion resistance
- 3-in-1 bolt driver makes it easy to change shackles as the spring does not need to be reset
- Patented "Z-bar" allows padlock to be easily converted from non-key-retaining to key-retaining in seconds
- Shackles available in a choice of materials - hardened steel shackle with NANO PROTECT™ coating for extreme corrosion resistance, stainless steel and brass
- Shackles available in a range of lengths from 1" to 6"
- New! Exchange shackles in seconds with the easy shackle change tool (not available on 83AL-IC/40, 83CS-IC/55 or 83WP-IC/63)
- 83WP-LFIC/53 and 83S/45 LFIC accept LFIC Schlage® cylinders

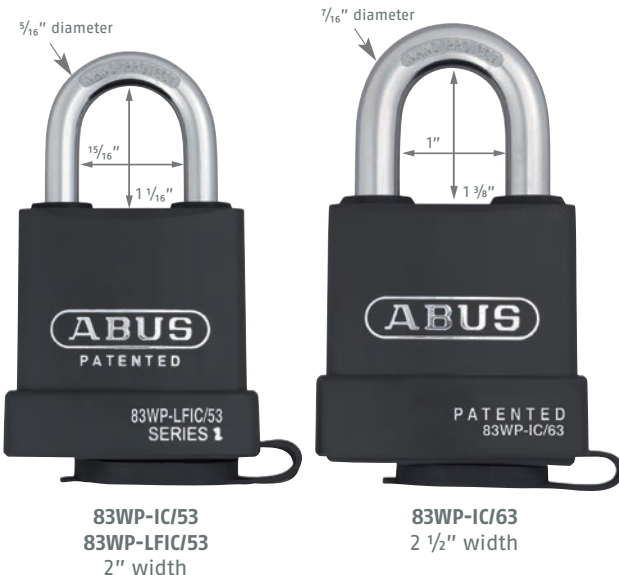

## All Drivers Included



Item	Shackle Height (in)	Case Pk Qty
83AL-IC/40	1, 1 1/2, 3, 4	6
83IC/45	1, 2, 3, 4, 6	6
83S/45 LFIC	1 3/16, 2 1/2, 3, 4	6
83IC/50	1, 2, 3, 4	6
83CS-IC/55	1, 1 7/16, 3	6
83WP-IC/53	1 1/16, 2 1/2, 3, 4	6
83WP-LFIC/53	1 1/16, 2 1/2, 3, 4	6
83WP-IC/63	1 3/8, 2 1/2	6

# DIAL COMBINATION 78



- 3-dial combination
- Extra protection against manipulation
- Hardened steel body
- Colored dial for individuality and easy recognition
- 78KC: Key Control - pin tumbler has master key function

Item	Shackle Height	Shackle Material	Case Pk Qty
78/50 C	27/32"	Steel	6
78KC/50 B	27/32"	Steel	12



# COMBINATION 145

# TSA 147/148



- Solid and lightweight aluminum body
- 3- or 4-digit individually resettable code
- Ideal for securing toolboxes, luggage, lockers, cabinets and more

- Individually resettable 3-digit code
- Visible red indicator at shackle: lock was opened by TSA
- To reset red indicator open lock and turn shackle by 360°



Item	Shackle Height	Dials	Shackle Material	Case Pk Qty
145/20 C	7/8"	3	Steel	6
145/30 C	63/64"	3	Steel	6
145/40 C	1 1/64"	4	Steel	6

Item	Shackle Height	Dials	Shackle Material	Case Pk Qty
147TSA/30 C	25/32"	3	Steel	12
148TSA/30 C	1 29/64"	3	Cable	12



# BAKPAK™ 151



- Shackle diameter 1/8"
- Individually resettable 3-digit code
- Shackle opens by pressing the lever at the side



Item	Shackle Height	Dials	Shackle Material	Case Pk Qty
151/20 C	19/32"	3	Steel	12

# COMBINATION 155



- Hardened steel shackle
- Individually resettable 4-digit code

Item	Shackle Height	Dials	Shackle Material	Case Pk Qty
155/40 C	1 3/64"	4	Steel	6



# COMBINATION 158

# 160



- Solid body made of zinc die-cast
- Double bolted shackle
- Shackle made from hardened steel
- 158/40: individually resettable 3-digit code
- 158/45KC and 158/50: individually resettable 4-digit code
- 158/45KC: override key available for purchase

- Solid chrome-plated zinc body
- Hardened steel shackle
- Polished chrome finish for superior weather resistance
- 160/40: individually resettable 3-digit code
- 160/50: individually resettable 4-digit code



Item	Shackle Height	Dials	Shackle Material	Case Pk Qty
158/40 C	$1\frac{1}{32}$ "	3	Steel	3
158/50 C	$1\frac{5}{16}$ "	4	Steel	3
158/45KC B	$63\frac{3}{64}$ "	4	Steel	12

Item	Shackle Height	Dials	Shackle Material	Case Pk Qty
160/40 C	$57\frac{3}{64}$ "	3	Steel	6
160/50 C	$1\frac{1}{32}$ "	4	Steel	6
160/50HB50 C	$1\frac{31}{32}$ "	4	Steel	6



# COMBINATION 180IB

# 190



- Solid forged brass body provides superior protection and weather resistance
- Stainless steel shackle and corrosion-resistant inner components for ultimate rust protection
- Precision locking mechanism with special protection against manipulation
- 4-digit resettable code
- Resetting tool included

- Heavy-duty combination lock
- Solid hardened steel jacket
- 4-digit resettable code
- Precision locking mechanism with special manipulation protection
- Shackle guard protects shackle from attacks

Item	Shackle Height	Dials	Shackle Material	Case Pk Qty
180IB/50 C	1"	4	Stainless	6
180IB/50HB63 C	2 1/2"	4	Stainless	6

Item	Shackle Height	Dials	Shackle Material	Case Pk Qty
190CS/60 C	1 3/16"	4	Steel	2



# COMBIFLEX CABLE LOCK

# MULTILOOP CABLE LOCK



1/16" cable diameter  
25" cable length

2501/65



1/16" cable diameter  
33" cable length

2502/85

- 3-digit individual resettable code
- Braided steel, automatic roll up cable
- Light weight plastic case
- Fits perfect in every pocket or bag



210/185

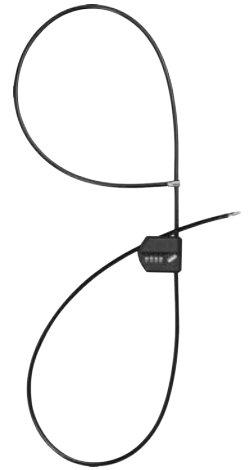

215/185

- 15/16" strong premium steel cable
- PVC-coating to prevent damage to surroundings
- Silicone coating on the lock body with "soft touch" properties for better grip
- Integrated adapter in the body for a conversion from one loop to a double-loop cable
- 210: Keyed, available keyed-alike or keyed-different
- 215: Combination

Item	Cable Length	Dials	Shackle Material	Case Pk Qty
2501/65 C	25"	3	Cable	3
2502/85 C	33"	3	Cable	3

Item	Cable Diameter	Cable Length	Body Material	Case Pk Qty
210/185 C	0.39	3	Steel	1
215/185 C	0.39	3	Steel	1



RESETTABLE CODE



Security Tech Germany



# PUSH BUTTON KEYGARAGE™

# DIAL KEYGARAGE™

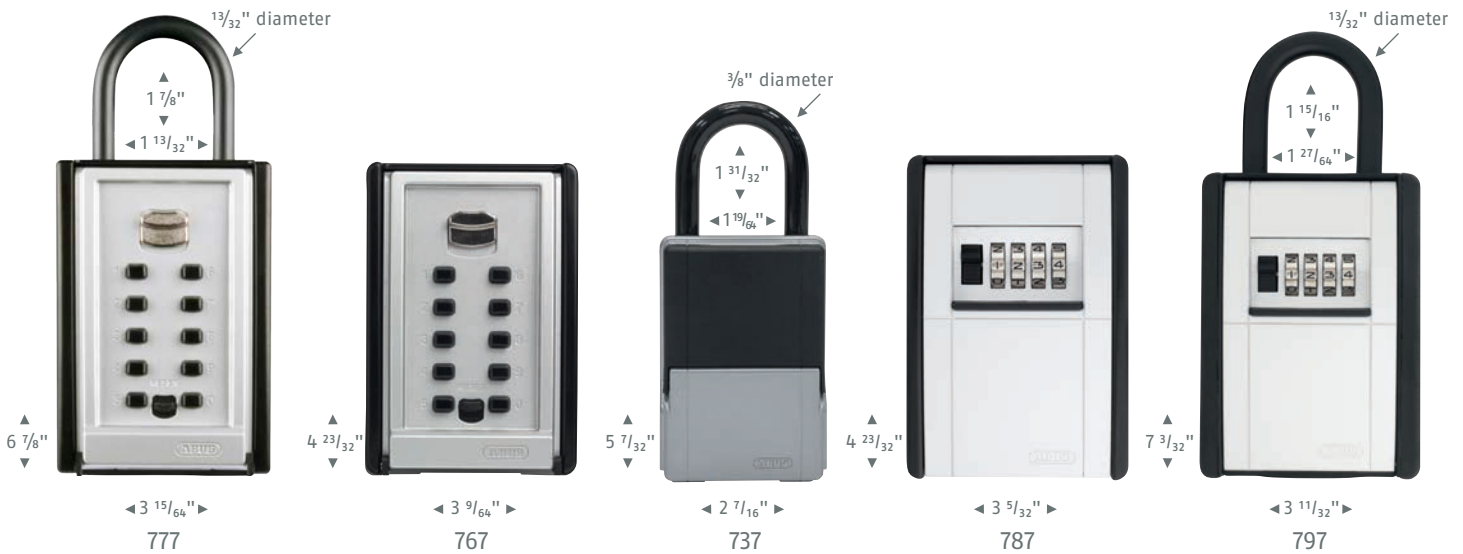

- Large solid metal housing offers more capacity than conventional key boxes
- 10 push-button resettable combination: Set your own PIN
- Push buttons provide faster access than dials
- Large hinged front door protects buttons
- 767: For wall mounting, 777: For attaching with shackle
- Holds up to 8 cards or 20 keys

- Ideal protected storage for keys and other valuables
- Solid metal housing; locking cover made from zinc die-cast
- 4-digit individually resettable code
- Protective cover with sliding mechanism
- 787: For wall mounting, 797: For attaching with shackle
- 787, 797: Holds up to 8 cards or 20 keys
- 737: Compact KeyGarage™ holds up to 6 keys

Item	Shackle Height	Buttons	Case Pk Qty
767 C	-	10	1
777 C	1 7/8"	10	1

Item	Shackle Height	Dials	Case Pk Qty
737 C	1 31/32"	4	1
787 C	-	4	1
797 C	1 15/16"	4	1



# INTEGRAL HASP D141



- Universal hasp with integrated Diskus® lock
- Ideal for use on double doors (utility vans, storage sheds)
- Easy to operate with one hand
- Solid metal locking case prevents successful attacks on the integrated padlock
- Zinc-plated for extreme corrosion resistance
- Mounting hardware included (screws, drilling template and spacers up to 1/5" height)
- Available with or without Diskus® lock

Item	Body Material	Body Color	Case Pk Qty
D141/200 C (w/26/70 Diskus)	Steel	Black	13
D141/200 B (Hasp only)	Steel	Black	13
D141/200 C (w/26/70 Diskus)	Steel	White	13
D141/200 B (Hasp only)	Steel	White	13

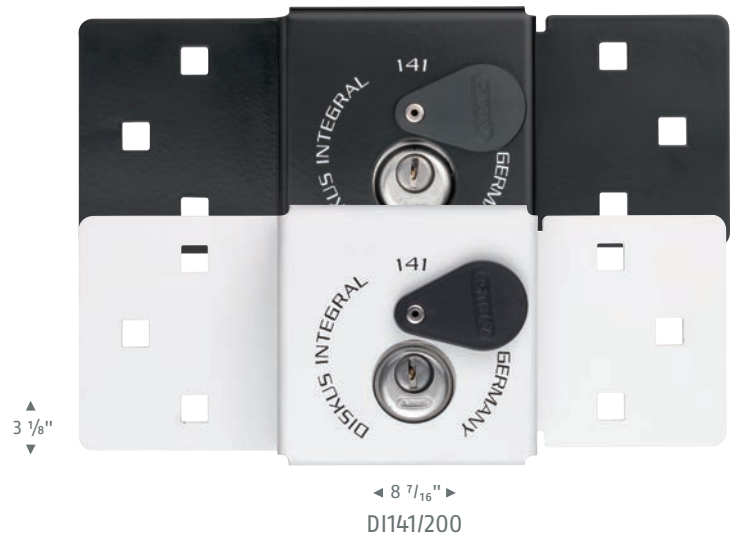

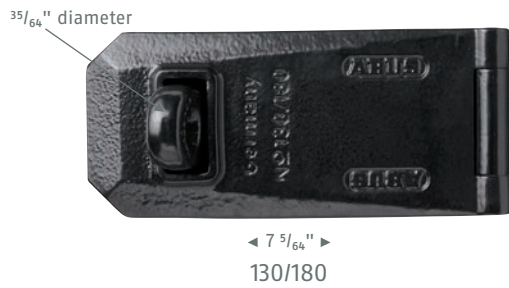

## GRANIT™ HASP 130

- Two hardened hinge pins
- Tough white heart malleable iron
- Hardened staple
- Includes coach bolts and back plate



## HARDENED STEEL HASP 125

- Extra-strong hinge
- Hardened staple
- Includes coach bolts and back plates
- Extremely high corrosion resistance



Item	Body Material	Case Pk Qty
130/180 C	White Heart Malleable Iron	1

Item	Body Material	Case Pk Qty
125/150 C	Coated Hardened Steel	3

Staple  
Width: 5/8"  
Height: 1/2"  
Depth: 7/8"



◀ 4 11/16" ▶  
140/120

◀ 7 3/8" ▶  
140/190  
(shown)



◀ 6 7/16" ▶  
110/155

◀ 7 43/64" ▶  
110/195

◀ 9 1/16" ▶  
110/230  
(shown)

## STAINLESS STEEL HASP 140

- Hasp and hinge pins made of stainless steel
- Tough construction with hardened staple
- Hinge pins protected against attack
- Ideal in combination with Diskus® padlocks



## CONCEALED HINGE PIN HASP 110

- Hardened steel for extra strength
- Seamless eye loop prevents prying
- Center-lock pin resists being driven out at end
- Hidden screws and hinge pins for extra security



Item	Body Material	Case Pk Qty
140/120 C	Stainless Steel	3
140/190 C	Stainless Steel	3

Item	Body Material	Case Pk Qty
110/155 C	Hardened Steel	3
110/195 C	Hardened Steel	3
110/230 C	Hardened Steel	3

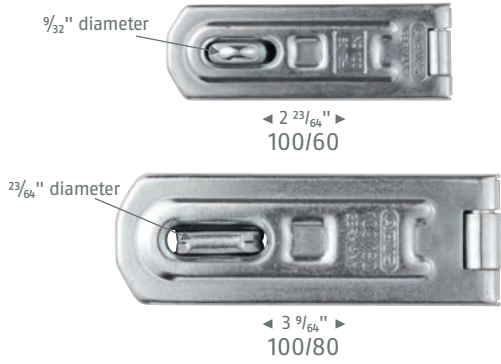

### CONCEALED HINGE PIN HASP 100

- Hardened staple and hinge pins (not for 100/60)
- Concealed hinge pin
- Corrosion-protected
- Hidden screws



Item	Body Material	Case Pk Qty
100/60 C	Steel	3
100/80 C	Steel	3

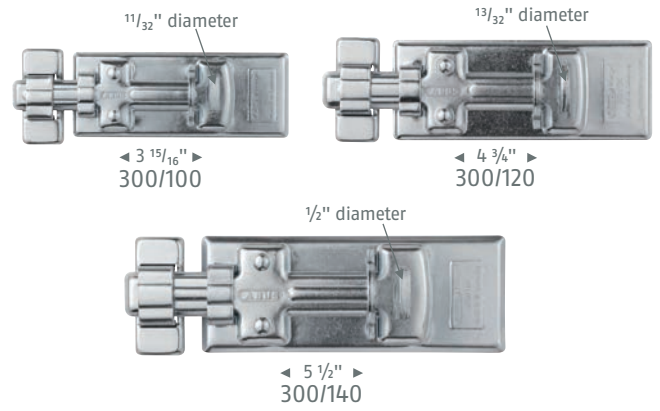

### HARDENED HASP 300

- Hardened steel sliding locking bolt
- Zinc chrome finish for corrosion protection
- Hidden screws for extra security



Item	Body Material	Case Pk Qty
300/100 C	Zinc-coated Hardened Steel	6
300/120 C	Zinc-coated Hardened Steel	6
300/140 C	Zinc-coated Hardened Steel	6

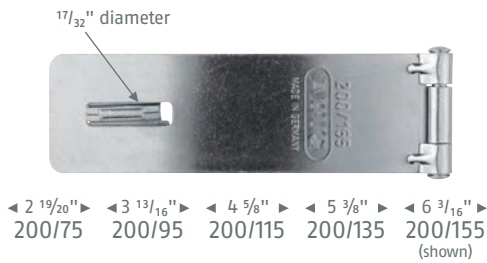

### HARDENED HASP 200

- Hardened steel for extra strength
- Galvanized finish for corrosion protection
- Seamless eye loop prevents prying
- Hidden screws and hinge pins for extra security



Item	Body Material	Case Pk Qty
200/75 C	Hardened Steel	6
200/95 C	Hardened Steel	6
200/115 C	Hardened Steel	6
200/135 C	Hardened Steel	6
200/155 C	Hardened Steel	6

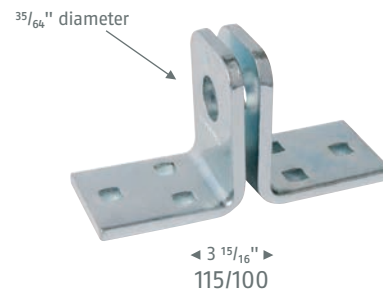

### FIXED STAPLE HASP 115

- Corrosion-protected
- Hardened bolt
- Hidden screws



Item	Body Material	Case Pk Qty
115/100 C	Steel	3

# COBRA STEEL CABLE

# STEEL CABLE

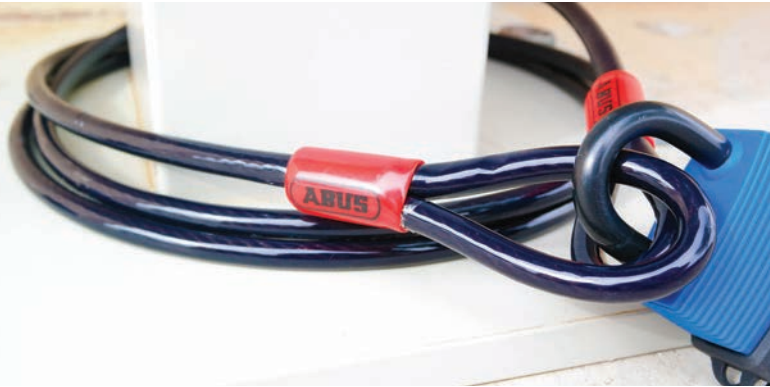

10/500 Cable



66 Cable

- Flexible steel cable
- ABUS loop cables protect bike components like front and rear wheel, frame and seat as the ideal complement to the ABUS U-shackle-locks, padlocks or frame locks
- Ideal to secure bicycles, surf boards, garden tools, etc.

- Braided steel wires for strength and flexibility
- Protective coating prevents scratching
- Self coiling for convenient storage

Item	Diameter	Length	Body Material	Case Pk Qty
8/200 Non-Coiled C	5/16"	78 47/64"	Steel	1
8/250 Non-Coiled C	5/16"	98 27/64"	Steel	1
10/500 Non-Coiled C	25/64"	196 27/32"	Steel	1
10/1000 Non-Coiled C	25/64"	393 45/64"	Steel	1
1850/185 Coiled B	5/16"	72 53/64"	Steel	1

Item	Diameter	Length	Body Material	Case Pk Qty
46 Coiled C	7/16"	72"	Steel	5
66 Coiled C	5/16"	72"	Steel	10
86 Coiled C	1/4"	72"	Steel	10

# MAXIMUM SECURITY CHAIN



- Chain made from hardened steel
- Square-shaped links provide top security against all types of aggressive attacks
- Fabric sleeve prevents surroundings from damage
- Available in pre-cut (2', 6', 10') or custom lengths
- Loop chain comes with a larger loop on one end, making the chain go further

Item	Cutting Force	Inside Height	Thickness	Inside Width
6KS	4 tons	1 1/8"	1/4"	3/8"
8KS	6 tons	1 3/8"	5/16"	1/2"
10KS	8 tons	1 1/2"	3/8"	5/8"
12KS	10 tons	2 1/4"	1/2"	3/4"
14KS	12 tons	2"	9/16"	3/4"
12KS Loop 2.5'	10 tons	2 1/4"	1/2"	3/4"
12KS Loop 4'	10 tons	2 1/4"	1/2"	3/4"
12KS Loop 5'	10 tons	2 1/4"	1/2"	3/4"



12KS Loop

# FLOOR & WALL ANCHOR

# WALL ANCHOR



◀ 6 1/2" ▶  
WBA100

- 6 5/16" shackle made of hardened steel for extreme resistance against the most aggressive attacks
- Extra wide shackle for easy locking
- Due to its flat shape and the use of high-quality plastic, it is possible to drive over the anchor in fixed position
- Can be used indoors and outdoors as wall or floor anchor
- Includes mounting hardware

Item	Case Pk Qty
WBA100	1



◀ 4 1/3" ▶  
WA50

- Hardened steel wall anchor
- Can be used indoors and outdoors
- Includes hardware for wall or floor mounting

Item	Case Pk Qty
WA50	1

# FILE CABINET BARS



- Constructed of 16-gauge steel
- Conveniently located knob allows easy and smooth operation
- Reversible for left and right side mounting
- Available in five different lengths
- Built-in spring-loaded hinge
- Mounting screws included
- Meets the DOD's Industrial Security Requirements



Item	Case Pk Qty
1-Drawer	10
2-Drawer	10
3-Drawer	10
4-Drawer	10
5-Drawer	10



# VITESSTM HIGH SECURITY

## What is ABUS Vitess™ High Security System?

The highest level of keyway security, ABUS Vitess™ High Security System is distributed under meticulous guidelines to protect the exclusivity of the individual true key profiles. Choose ABUS Vitess™ when the highest level of security and protection against unauthorized duplication is needed. ABUS Vitess™ High Security Key Control System meets the security requirements of locksmiths, distributors and end users.

ABUS locking systems offer the US market a new and innovative high security solution. Our advanced key control features are applied for patent (protection until 2034), with lifetime trademark thereafter (trademark applied). As an added security measure, we stock exclusive keyways. To increase security measures, our unique key shapes are not easily duplicated. This allows for the highest level of security.

Our high security locking systems are versatile. We work with our customers to build the right keying system for their needs. Our products are ideal for a variety of facilities, including court houses, law enforcement stations, universities, department stores, hotel and hospitality chains and much more. With our model of "local work supporting local economy," ABUS USA is proud to offer products to the US market that are stocked and assembled right here in the US.

## Highlights

- Geographic exclusivity on key blanks
- Once granted, patents protect against unauthorized key manufacture through 2034
- Vitess™ precision paracentric curved key, unique intop system and profile check pin offer increased pick resistance with lifetime trademark (if granted and always renewed)
- Drill resistant cylinder housing and plug
- Pre-loaded housing reduces assembly time, no tools or follower necessary
- Extremely high tolerance creating less wear
- All key sections and master keying available at all levels of security
- ABUS cylinders and cores can be pinned using ABUS pinning kit
- Keys can be cut with commonly available key cutting machines with the purchase of the appropriate jaws
- Thicker curved keys for added strength
- Two-year product warranty and a life-time warranty against key breakage
- Made in Germany guarantees premium quality and a long product service life

## ABUS Vitess™ Key Control Levels

ABUS Vitess™ High Security System consists of five programs:

**Level 1:** Dealer Open Non-Exclusive Keyway

**Level 2:** Regional Dealer Based Keyways, contracted to Dealer by Distributor assigned by zip code region

**Level 3:** National/Regional End-user/Institutional Exclusive Keyways, contracted and sold through normal channels of distribution

**Level 4:** National Distributor Exclusive Keyways, contracted to Dealer by Distributor

**Level 5:** State Dealer Based Keyways contracted to Dealer by Distributor

More details of each program along with initial investments can be found in the ABUS Vitess™ Price List.

## Vitess™ Keyway Information

The Vitess™ High Security system uses true keyway differs. No sidebars are used, offering a higher security level. ABUS has over 3000 true keyway differs available.

## Vitess™ Cylinder Form

Vitess™ locks and cylinders are available in two different forms:

### COM (Combinated)

Fully assembled cylinder available KD, KA, MK. Includes two cut keys.

### UNCOM (Uncombinated)

Pre-loaded housing with un-combinated cores and accessories. Key blanks sold separate.

## Master Keying

ABUS Vitess™ locks and cylinders may be master-keyed to meet virtually any requirement. Contact Tech Support to discuss special needs.

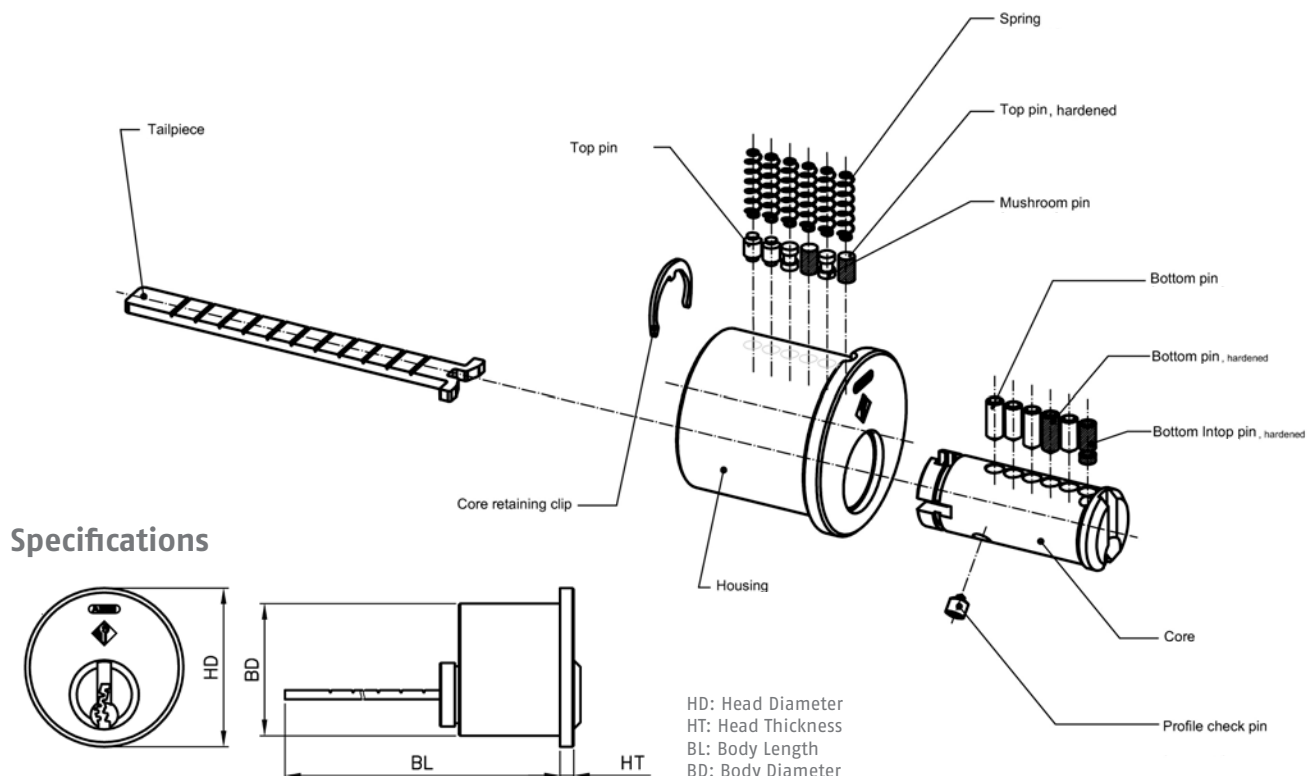

## CONVENTIONAL RIM CYLINDERS

Commonly used on apartment and condominium doors, ABUS rim cylinders are used on vertical deadbolt locks and are also designed for commercial exit and panic devices. Rim cylinders are available with either horizontal (standard) or vertical break-off tailpiece.

### Technical

- Cylinder housing and plug are made of high quality nickel-plated brass
- Key material: nickel silver
- Technical copy protection by Intop system
- Pinning: 4 pins made of nickel silver and 2 hardened steel pins in the 1st and 3rd position for increased drill protection
- 14mm diameter core advantage – more space to allocate up to 13 pin lengths which gives extremely high combinatory capabilities



Item	HD - Head Diameter	HT - Head Thickness	BL - Body Length w/cam	BD - Body Diameter
Rim Cylinder	1.337" (33.95mm)	0.118" (3mm)	1.075" (27.3mm)	1.146" (29.1mm)

### RIM Cylinder Part Numbers

Part #	Description
10511	Rim Pre-Load Housing, Horizontal Tailpiece and Retaining Clip
10597	Rim Pre-Load Housing with Uncombined Core, Horizontal Tailpiece and Retaining Clip (Level 2, 3, 4, 5)
10514	Rim Cylinder Combined KD/KA, Horizontal Tailpiece w/ 2 cut keys
10599	Rim Core Uncombined (Level 2, 3, 4, 5)

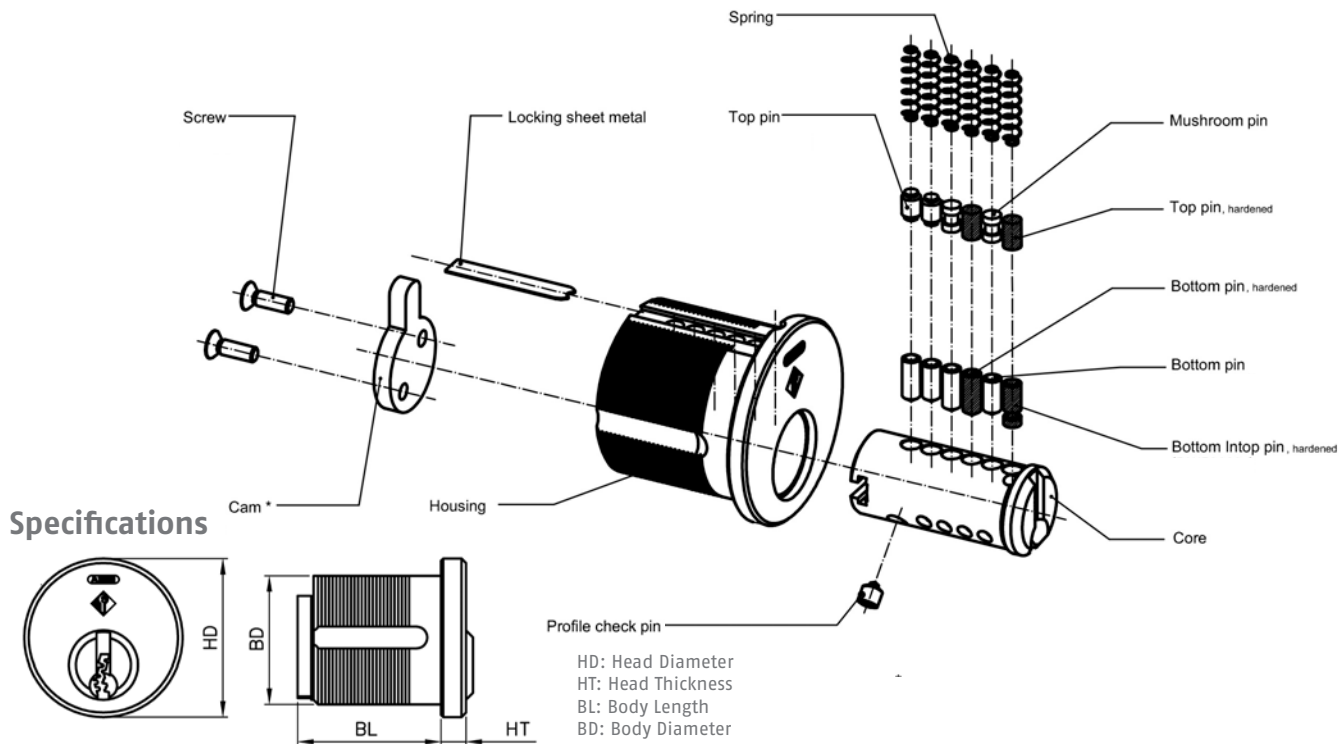

## CONVENTIONAL MORTISE CYLINDERS

ABUS Vitess™ mortise cylinders are designed to replace several original manufacturers' cylinders in their locksets offering the highest level of security available on the market today. Made to standard U.S. dimensions, these rugged cylinders are available in a variety of finishes and lengths.

### Technical

- Currently available in mortise housing lengths 1 1/8" and 1 1/4" with core extension
- Technical copy protection by Intop system
- Cylinder housing and plug are made of high quality nickel-plated brass
- Key material: nickel silver
- 5 mortise cam options available
- Pinning: 4 pins made of nickel silver and 2 hardened steel pins in the 1st and 3rd position for increased drill protection
- 14mm diameter core advantage – more space to allocate up to 13 pin lengths which gives extremely high combinatory capabilities



Item	HD - Head Diameter	HT - Head Thickness	BL - Body Length w/cam	BD - Body Diameter
1-1/8" Mortise Cylinder	1.370" (34.8mm)	0.138" (3.5mm)	1.042" (26.47mm)	1.150" (29.2mm)
1-1/4" Mortise Cylinder	1.370" (34.8mm)	0.138" (3.5mm)	1.200" (30.47mm)	1.150" (29.2mm)

# CONVENTIONAL MORTISE CYLINDERS

## Mortise Cylinder Part Numbers

Part #	Description
10500	Mortise 1-1/8" Pre-Load Housing, Adams Rite® Cam
10585	Mortise 1-1/8" Pre-Load Housing, w/o Cam
10586	Mortise 1-1/8" Pre-Load Housing with Uncombined core, Adams Rite® Cam (Level 2, 3, 4, 5)
10587	Mortise 1-1/8" Pre-Load Housing with Uncombined Core, w/o Cam (Level 2, 3, 4, 5)
10501	Mortise 1-1/8" Cylinder Combined KD/KA, Adams Rite® Cam w/ 2 cut keys
10589	Mortise 1-1/8" Cylinder Combined KD/KA, w/o Cam w/ 2 cut keys
10590	Mortise 1-1/4" Pre-Load Housing w/core extension, Adams Rite® Cam
10591	Mortise 1-1/4" Pre-Load Housing w/core extension, w/o Cam
10592	Mortise 1-1/4" Pre-Load Housing with Uncombined Core, Adams Rite® Cam (Level 2, 3, 4, 5)
10593	Mortise 1-1/4" Pre-Load Housing with Uncombined Core, w/o Cam (Level 2, 3, 4, 5)
10594	Mortise 1-1/4" Cylinder Combined KD/KA, Adams Rite® Cam w/ 2 cut keys
10595	Mortise 1-1/4" Cylinder Combined KD/KA, w/o Cam w/2 cut keys
10596	Mortise Uncombined Core (for 1-1/8" and 1-1/4") (Level 2, 3, 4, 5)

## Cams for Conventional Mortise Cylinders

<b>Order Code</b>	SZ01	SZ06	SZ09	SZ11	SZ12
<b>Description</b>	Mortise Cam (Adams Rite®)	Mortise Cam (Schlage® L)	Mortise Cam (Sargent®)	Mortise Cam (Corbin Russwin®)	Mortise Cam (Yale®)

Part #	Description
10506	SZ01 Mortise Cam (Adams Rite®) *Standard Cam
10507	SZ06 Mortise Cam (Schlage® L)
10508	SZ09 Mortise Cam (Sargent®)
10509	SZ11 Mortise Cam (Corbin Russwin®)
10510	SZ12 Mortise Cam (Yale®)

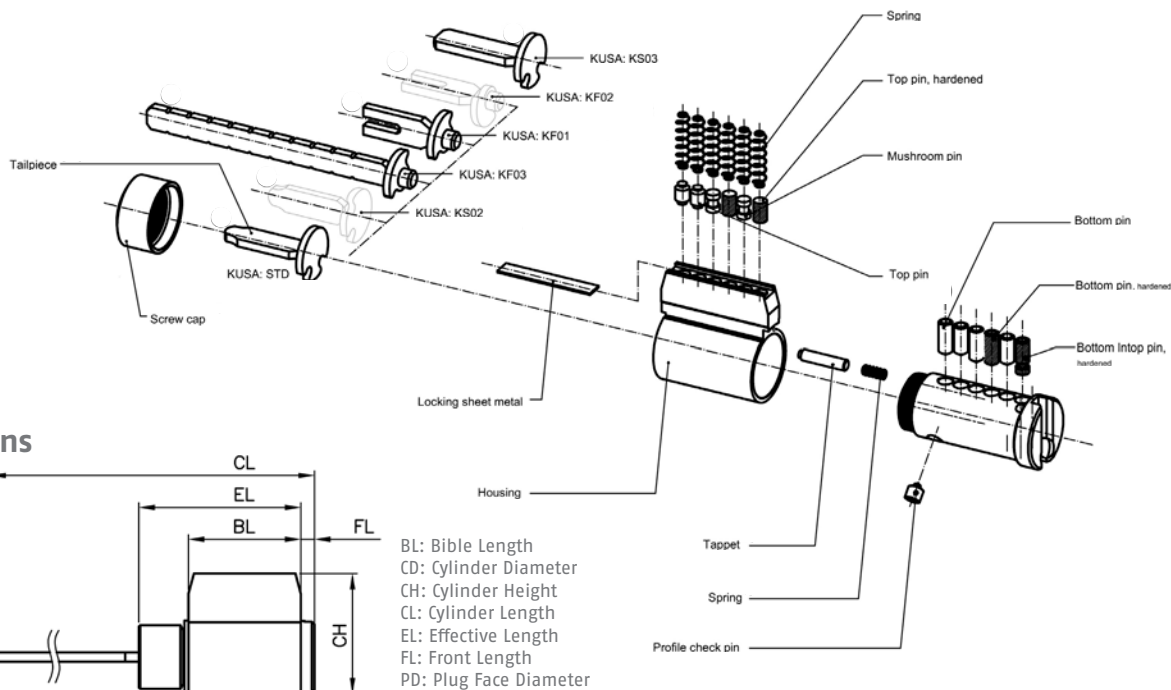

**Specifications**

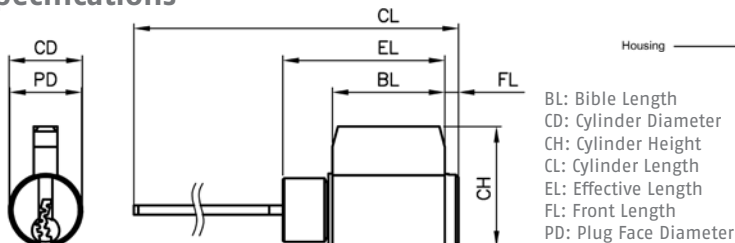

**KEY-IN-KNOB/LEVER, DEADBOLT CYLINDERS**

ABUS Vitess™ Key-in-Knob/Key-in-Lever and Deadbolt cylinders are designed to replace several original manufacturers' cylinders in their locksets offering the highest level of security available on the market today. These cylinders are manufactured to exact manufacturers' specifications to ensure precise fit and operation. ABUS Key in Knob/Key in Lever cylinders will improve the security of standard cylindrical locksets by Schlage® type cylinders.

**Technical**

- Cylinder housing and plug are made of high quality nickel-plated brass
- Key material: nickel silver
- Technical copy protection by Intop system
- Fixed tailpieces at the cylinder can be adjusted to horizontal or vertical orientation
- Tailpieces for free wheel function can be adjusted to different free-wheel positions. Free-wheel 180°
- Pinning: 4 pins made of nickel silver and 2 hardened steel pins in the 1st and 3rd position for increased drill protection
- 14mm diameter core advantage – more space to allocate up to 13 pin lengths which gives extremely high combinatory capabilities



Item	BL - Bible Length	CD - Cylinder Diameter	CH - Cylinder Height	CL - Cylinder length	EL - Effective Length	FL - Front Length	PD - Plug Face Diameter
KiK/KiL Cylinder	1.024" (26mm)	0.634" (16.1mm)	1.039" (26.4mm)	*see below	1.290" (32.76mm)	0.110" (2.8mm)	0.622" (15.8mm)
Tailpieces (*Cylinder length depends on tailpiece)		STD		KF03	KF01	KS03	
		Cylinder Length	2.15" (54.66mm)	3.62" (91.91mm)	2.07" (52.66mm)	2.21" (56.06mm)	

**Key-in-Knob, Key-in-Lever and Deadbolt Cylinder Part Numbers**

Part #	Description
10519	KnK/KiL Pre-Load Housing w/Tailpieces (4pk)
10600	KnK/KiL Pre-Load Housing with Uncombined Cylinder Core and Tailpieces (4pk) (Level 2, 3, 4, 5)
10520	KnK/KiL Cylinder Combined KD/KA w/Tailpieces (4pk) w/2 cut keys
10602	KnK/KiL Uncombined Core (Level 2, 3, 4, 5)

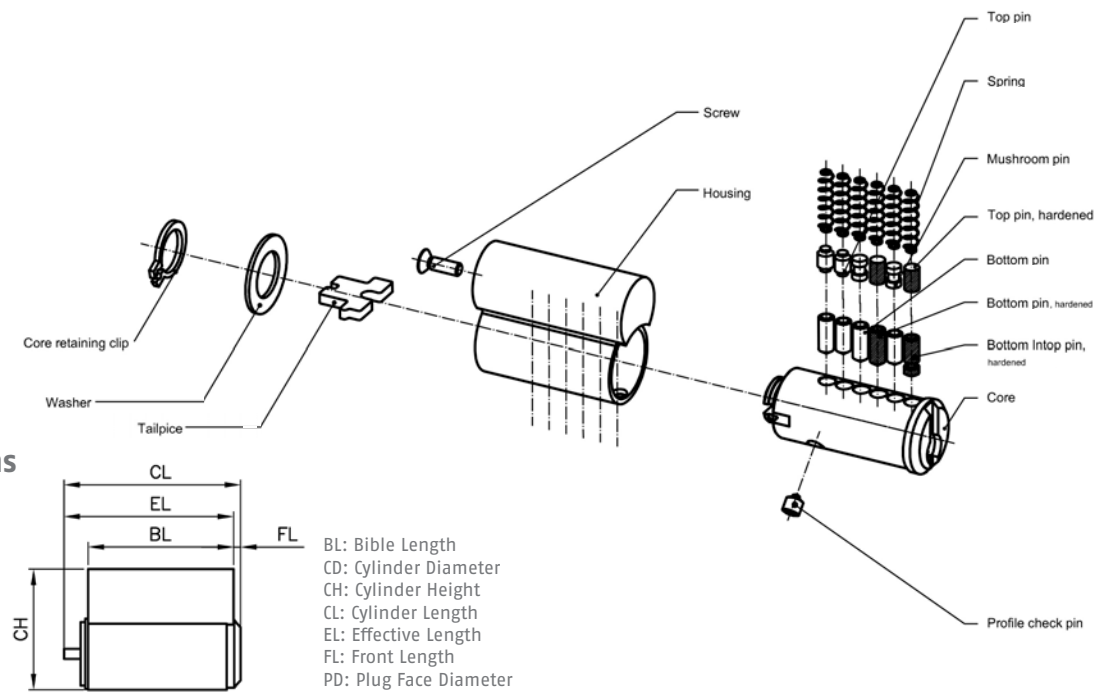

## 83 SERIES™ CYLINDER INSERT

ABUS manufactures heavy duty padlocks made from the highest quality materials that withstand the most rigorous testing procedures. Vitess™ 83 cylinder insert can be used together with ABUS 83 Series™ padlocks, now offering patented key control. The locking insert can be pinned without disassembling the core for quick assembly. ABUS padlocks are used in a wide variety of applications including storage rooms, perimeter fences, armories and more.



### Technical

- Cylinder and housing made of high quality nickel-plated brass
- Key material: nickel silver
- Technical copy protection by Intop system
- Pinning: 4 pins made of nickel silver and 2 hardened steel pins in the 1st and 3rd position for increased drill protection
- 14mm diameter core advantage – more space to allocate up to 13 pin lengths which gives extremely high combinatory capabilities



Item	BL - Bible Length	CD - Cylinder Diameter	CH - Cylinder Height	CL - Cylinder length	EL - Effective Length	FL - Front Length	PD - Plug Face Diameter
83 Insert	1.283" (32.6mm)	0.632" (16.05mm)	1.053" (26.75mm)	1.526" (38.75mm)	1.490" (37.85mm)	0.035" (0.9mm)	0.587" (14.9mm)

### 83 Series Cylinder Insert Part Numbers

Part #	Description
10525	83 Series™ Pre-Load Housing
10603	83 Series™ Pre-Load Housing with Uncombined Core (Level 2, 3, 4, 5)
10526	83 Series™ Padlock Cylinder Combined KD/KA w/2 cut keys
10605	83 Series™ Cylinder Uncombined Core (Level 2, 3, 4, 5)

# TUMBLER PINS

ABUS Vitesse™ system uses its own pins.

## Technical

- ABUS Vitesse™ 14mm core allows for much more space to allocate more pin lengths
- Main competitors have a smaller core diameter
- Longer pins for less wear on pins and key top
- Pins made of nickel silver including hardened steel drill protection pins in the 1st and 3rd position



## Tumbler Pin Part Numbers

Part #	Description
10536	Bottom Pin InTop "hardened steel" no. 5
10537	Bottom Pin "hardened steel" no. Z
10538	Bottom Pin "hardened steel" no. Y
10539	Bottom Pin "hardened steel" no. X
10540	Bottom Pin "hardened steel" no. 0
10541	Bottom Pin "hardened steel" no. 1
10542	Bottom Pin "hardened steel" no. 2
10543	Bottom Pin "hardened steel" no. 3
10544	Bottom Pin "hardened steel" no. 4
10545	Bottom Pin "hardened steel" no. 5
10546	Bottom Pin "hardened steel" no. 6
10547	Bottom Pin "hardened steel" no. 7
10548	Bottom Pin "hardened steel" no. 8
10549	Bottom Pin "hardened steel" no. 9
10550	Bottom Pin "nickel silver" no. Z
10551	Bottom Pin "nickel silver" no. Y
10552	Bottom Pin "nickel silver" no. X
10553	Bottom Pin "nickel silver" no. 0
10554	Bottom Pin "nickel silver" no. 1
10555	Bottom Pin "nickel silver" no. 2
10556	Bottom Pin "nickel silver" no. 3
10557	Bottom Pin "nickel silver" no. 4
10558	Bottom Pin "nickel silver" no. 5

Part #	Description
10559	Bottom Pin "nickel silver" no. 6
10560	Bottom Pin "nickel silver" no. 7
10561	Bottom Pin "nickel silver" no. 8
10562	Bottom Pin "nickel silver" no. 9
10575	Profile Check Pin
10563	Master Wafer no. 2
10564	Master Wafer no. 3
10565	Master Wafer no. 4
10566	Master Wafer no. 5
10567	Master Wafer no. 6
10568	Master Wafer no. 7
10569	Master Wafer no. 8
10570	Master Wafer no. 9
10571	Master Wafer no. 10
10572	Master Wafer no. 11
10573	Master Wafer no. 12
10574	Master Wafer no. 13
10608	Top Mushroom Pins
10609	Top Pin "hardened steel"
10610	Top Pin "nickel silver"
10611	Top Pin "hardened steel" (only used for cut 8/9)
10612	Top Pin "nickel silver" (only used for cut 8/9)
10613	Top Housing Spring

# SPARE PARTS AND COMPONENTS

## Mortise Cylinder Components Part Numbers

Part #	Description
10619	Mortise Cylinder Core Extender for 1-1/4"
10513	Cylinder Fixing Bolt for Mortise Cam (Pkg 50)

## RIM Cylinder Components Part Numbers

Part #	Description
10512	Rim Core Retaining Clip (Pkg 50)
10577	Rim Cylinder Tailpiece Horizontal
10620	Rim Cylinder Tailpiece Vertical



## KnK/KiL Cylinder Components Part Numbers

Part #	Description
10578	KnK/KiL Screw Cap
10579	KnK/KiL Tappet
10580	KnK/KiL Spring
10621	KnK/KiL Tailpieces (4pk)

## 83 Padlock Cylinder Insert Parts

Part #	Description
10581	83 Series™ Cylinder Core Retaining Clip
10582	83 Series™ Cylinder Core Washer
10583	83 Series™ Cylinder Core Tailpiece
10584	83 Series™ Cylinder Core Retaining Screw





## KEYS AND KEYING

All ABUS keys are manufactured from the highest quality nickel silver material. The key's paracentric curved profile provides higher protection against picking and manipulation and key copy protection. The key bow size is perfect for easy identification and handling.

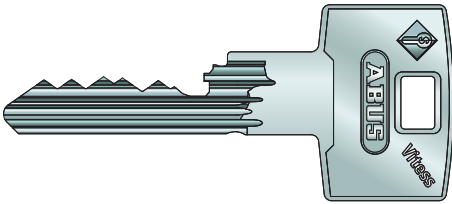

### ABUS Vitess™ Key Blanks

- Innovative key design protected by U.S. and international intellectual property rights
- Patent applied key control offers the ultimate in high security
- Able to cut on most popular key machines with the purchase of appropriate jaw
- Custom coining die required for all programs, excluding Level 1 Open Locksmith Keyway
- Custom coining die with customers name or logo requires one time setup die fee of \$250 net. If initial order is 1000 keys (blank or cut), setup die fee is waived
- Graphic/Logos available upon request with no extra surcharge
- **Specify keyway when reordering**
- **NOTE:** Key blanks available in multiples of 100 only. Minimum order quantity of 500 for coined keys (cut or blank).

Part #	Description
10531	Vitess™ Key Blanks (Pkg 100)
10606	Vitess™ Cut Key

### Technical

- High quality nickel silver material
- Key combination is read from tip to bow
- No. 9 pin is the longest with the deepest cut, No. 2 pin is the shortest, with the shallowest cut
- For pinning rules, please reference ABUS Vitess™ Service Manual

### Warranty

ABUS guarantees that if a key should break under normal usage, ABUS will replace it at no charge

### Form

ABUS Vitess™ Personalized Key Program Form, AV#28 needs to be completed and returned to ABUS USA to order your custom coined keys. This is required for all levels with the exception of Level 1, which is not available for custom coined keys.

### Managing Key Blank Inventory

It is important to keep an accurate record of key blank inventory and a detailed log of keys issued in case a question arises. Each incoming order of ABUS Vitess™ blanks should be logged with a transaction on a Restricted Key Order Form, signed and dated by the employee who received and counted the blanks. All inaccurate cuts should also be documented on one of these forms, signed and dated by the employee who handled the transaction and logged into the main book. The total number of key blanks received, minus inaccurate cuts and keys issued, should always equal the number still on hand. The dealer should reconcile the log periodically and also log any discrepancies at that time. Discrepancies may indicate a breach in security or a careless employee.

## PINNING KIT

ABUS provides all the necessary tools for both the retail and institutional locksmith to service and maintain our locks in the field. The ABUS Vitess™ pinning kit is set up modularly, making it easy to access the parts needed.

- The ABUS Vitess™ pinning kit is a stable, durable plastic kit, which comes with all necessary components for the Vitess™ High Security program.
- The threefold latch with two buckles and a safety cover prevents unintentional opening.

Part #	Description
10531	Vitess™ Key Blanks (Pkg 100)

### Pinning Kit Contents

- Index with item numbers
- Labels for the single inserts
- Includes: Top and bottom hardened steel pins, top and bottom nickel silver pins, housing top springs, master wafers, profile check pin, mortise cams



## SECURITY CARD

### Technical

- ABUS Vitess™ Security Cards are used as authorization for the Vitess™ program
- Cards have a signature panel on the back and are issued by the servicing locksmith who directly supports the system owner
- The owner must present the I.D. card to obtain duplicate keys or additions to his system
- The signature will be validated by the dealer

Part #	Description
10622	Vitess™ Security Signature Card
10623	Vitess™ Security Signature Card - Duplicate/Replacement

### Forms

- ABUS Vitess™ Security Card Order Form #AV27 needs to be completed and returned to ABUS USA to order your customized security cards
- ABUS Vitess™ Security Card Signature Registration Form #AV25 is kept on file with the Dealer for signature validation of the purchasing owner of the program



## SUPPLIES, SERVICE EQUIPMENT & TOOLS

Part #	Description
10615	Complete Assembly Tool Kit
10616	Grooved Follower
10617	Filling Device 3pc Kit
10618	Plastic Plugs



Assembly Tool Kit



Follower



Filling Device

## FORMS

All ABUS Vitess™ forms can be found online.

### #AV21 Vitess™ Conidentiality Agreement

All who purchase a Vitess™ program sign this document and return to ABUS USA.

### #AV22 Vitess™ Distributor Agreement

Distributor, Dealer and ABUS USA sign this agreement when purchasing a Vitess™ program (Level 2 and higher). Distributor returns signed agreement to ABUS USA for signatures. ABUS USA returns fully executed agreements back to the Distributor and Dealer for their records.

### #AV23 Vitess™ Dealer Agreement

Distributors have their Dealer sign this form when purchasing a Vitess™ program. The Distributor returns 3 originals to ABUS for signature and ABUS returns fully executed agreements back to Distributor to keep on file and Dealer.

### #AV24 Vitess™ Source Authorization Form

This form is used if you already own a Vitess™ program and have a need to request another Distributor source for your program. This form is completed and returned to ABUS USA.

### #AV25 Vitess™ Security Card Signature Registration Form

This form is for the Dealers to keep record of purchasing owners of a Vitess™ system. The owner signs the form and their security card for future verification when ordering duplicate keys or products. The Dealer keeps this form for their records on file.

### #AV26 Vitess™ Master Key Request Form

This form is completed when ordering a master key system and returned to ABUS USA

### #AV27 Vitess™ Security Card Order Form

This form is completed to order customized security cards with the Dealer's name on it and Dealer's Account numbers assigned by the Distributor they purchased the program from. This form needs to be returned to ABUS USA to order the security cards. (Required for levels 2-5)

### #AV28 Vitess™ Personalized Key Program Order Form

This form is completed to order your personalized coined keys and returned to ABUS USA. (Required for levels 2-5) Level 1 is not available for coined keys.

# ICON GLOSSARY

 **100% RUST-FREE**  
All parts of the lock are made from non-corrosive materials

 **CORROSION RESISTANT**  
Highly corrosion resistant due to surface protection

 **PARACENTRIC KEYWAY**  
Resists professional picking by special key profile

 **DRILL PROTECTION**  
Cylinder is protected against drilling and leverage

 **BOLT CUTTER PROTECTION**  
Bolt cutter attack resistant

 **SAW RESISTANT**  
Saw attack resistant

 **HAMMER RESISTANT**  
Hammer & impact attack resistant

 **HARDENED SHACKLE**  
Shackle made from hardened steel

 **CORROSION PLATING**  
Sophisticated plating for extreme corrosion resistance

 **ALUMINUM ALLOY**  
Lock body made from special aluminum alloy - light but secure

 **GERMANY**  
Development and production in Germany

 **SHACKLE GUARD**  
Shackle access restricted, protecting shackle from attack

 **STEEL BALL LOCKING**  
Solid steel ball locking

 **DOUBLE-BOLTED**  
Both sides of the shackle are secured by bolts or balls – increased protection against attacks and manipulation

 **SELF-LOCKING**  
The lock is locked automatically by pushing down the shackle – no key needed for locking

 **KEY-RETAINING**  
A key is needed for locking. Lock retains key until locked

 **RK AVAILABLE**  
Cylinder can be taken out and can be rekeyed to match an existing key

 **KA AVAILABLE**  
Available keyed-alike (several locks with the same key)

 **MK AVAILABLE**  
Available master-keyed (one key opens many different locks)

 **RESETTABLE CODE**

 **ABUS-PLUS**  
Original ABUS-Plus disk cylinder – highest precision, highest security

 **DIMPLE KEY**  
No sharp edges and can be inserted either way up

 **LED KEY**

 **CODE CARD**  
Spare keys are made only upon presentation of Code Card

 **SAMPLE KEY AVAILABLE**  
New locks can be made up to a sample key

 **UL VALIDATED**

 **SUSTAINABLE SOLUTIONS**

# KEY BLANKS

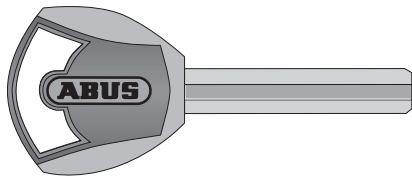

**90040 ABUS PLUS**  
Works with: 20, 37, 88

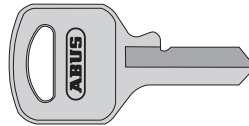

**90130**  
Works with: 55/25, 54TI/25

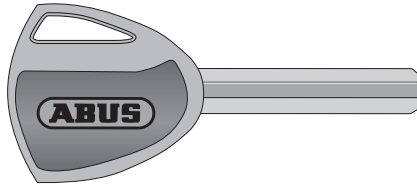

**90042 ABUS PLUS LED**  
Works with: 20, 37, 88

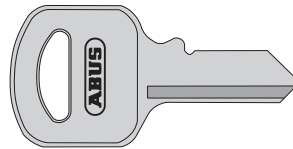

**90140**  
Works with: 55/30, 54TI/30

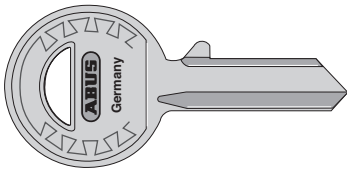

**KBR: 90010, KBL: 90020**  
Works with: 24IB/(50, 60, 70) 28/70KA, 41/(30, KA/MK 4-pin)

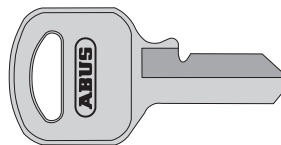

**90140**  
Works with: 55/35, 54TI/35

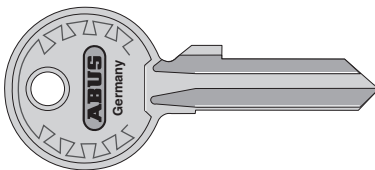

**KBR: 90015, KBL: 90016**  
Works with: 24IB/70KD, 24RK, 26, 28/70, 41KD 5-pin

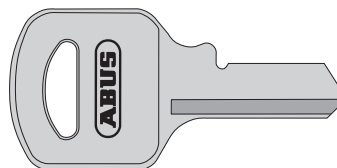

**90150**  
Works with: 55/40, 54TI/40

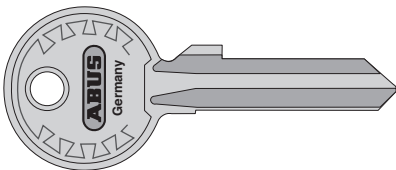

**KBR: 90420, KBL: 90430**  
Works with: 24, 26, 82/(62, 70), 92/65 5-pin

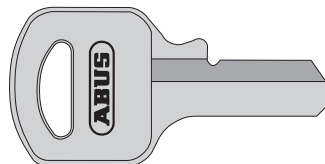

**90160**  
Works with: 55/45, 54TI/45

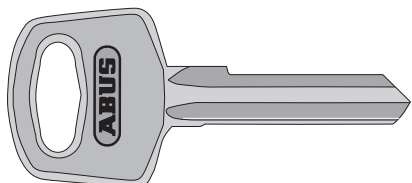

**90085**  
Works with: 34/55, 34CS/55

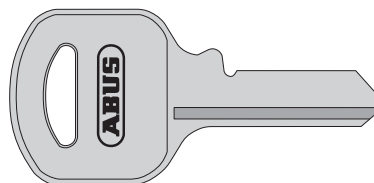

**90170**  
Works with: 55/50, 54TI/50

**90018**  
72/40, 74

# KEY BLANKS

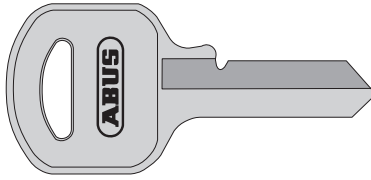

**90180**  
Works with: 55/60, 54TI/60

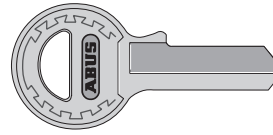

**90220**  
Works with: 65/20

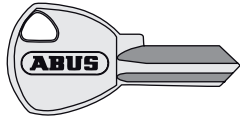

**90185**  
Works with: 64TI/20

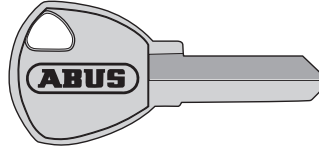

**90230**  
Works with: 65/30 + 35 Old

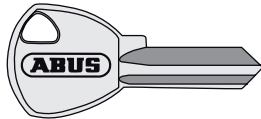

**90184**  
Works with: 64TI/25

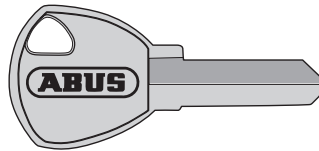

**90233**  
Works with: 65/30 + 35, 64TI/30 + 35 New



**90190**  
Works with: 65/15 L

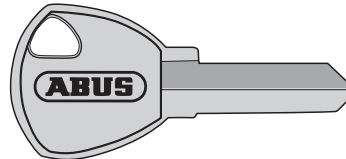

**90240**  
Works with: 65/40 + 45 Old

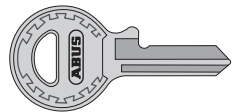

**90200**  
Works with: 65/15 R

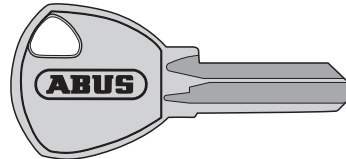

**90243**  
Works with: 65/40 + 45, 64TI/40, T65, 70, 70AL

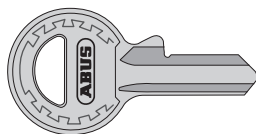

**90215**  
Works with: 65/20

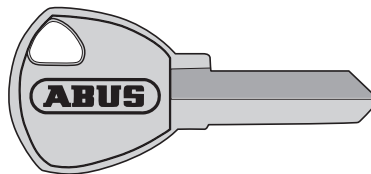

**90250**  
Works with: 65/40 + 45, 64TI/40, T65, 70, 70AL

# KEY BLANKS

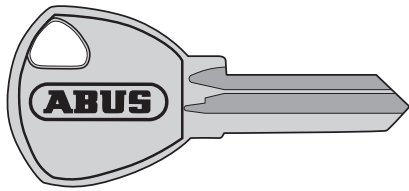

**90183**

Works with: 65/50 + 60, 64TI/50 + 60

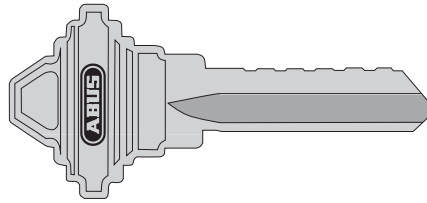

**83017A**

Works with: 83 Series - #300 Schlage

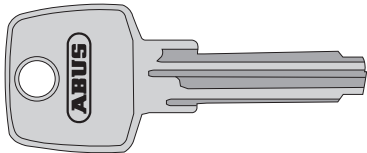

**90255**

Works with: 75/30 + 40, 25/70

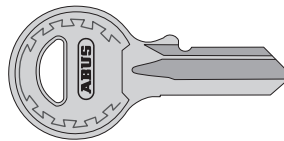

**90320**

Works with: T84MB/30 L

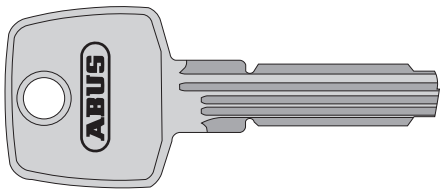

**90256**

Works with: 75/50 + 60

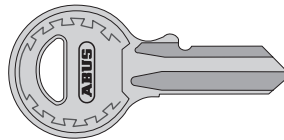

**90330**

Works with: T84MB/30 R

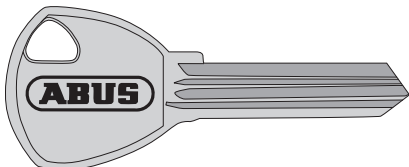

**90186**

Works with: 80TI/40 + 50

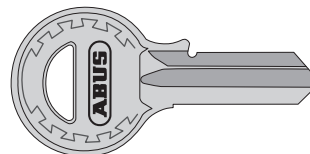

**90340**

Works with: T84MB/40 L

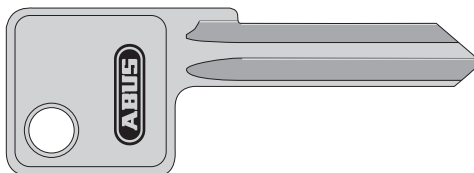

**83618A**

Works with: 83 Series - #100 Yale No. 8

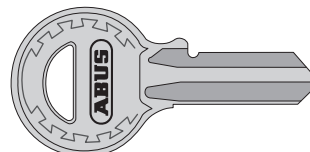

**90350**

Works with: T84MB/40 R

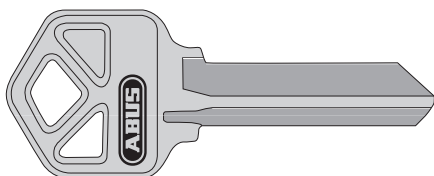

**83016**

Works with: 83 Series - #200 Kwikset

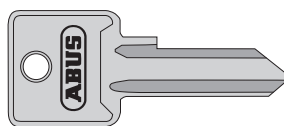

**90390**

Works with: 85/20 + 25 R

# KEY BLANKS

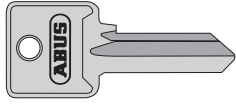

**90380**

Works with: 85/20 + 25 L

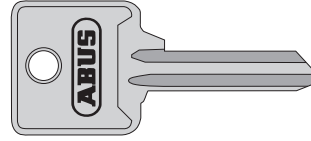

**90430**

Works with: 85/40 R, 82/63 + 70

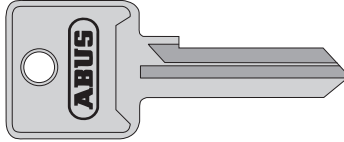

**90400**

Works with: 85/30 L

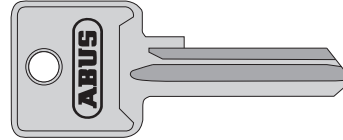

**90440**

Works with: 85/50+60 L, 82/90

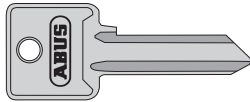

**90410**

Works with: 85/30 R

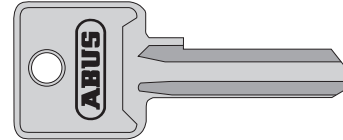

**90450**

Works with: 85/50+60 R, 82/90, 92/80

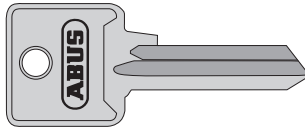

**90420**

Works with: 85/40 L, 82/63 + 70

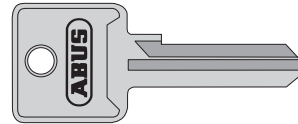

**90590**

Works with: 85/70 L