

EBC[®] BRAKES

— 2018 EDITION —

WORLD'S LARGEST RANGE OF PREMIUM REPLACEMENT MOTORCYCLE BRAKES

Brake pads, rotors, braided stainless
brake lines, clutches and much more
with four manufacturing plants in the
UK and USA producing over 10 million
components each year



Welcome to 2018 and the latest EBC Catalog with, as always, all the new brakes and clutches you need for your customers.

With over 35 years in the USA motorcycle market, we can only thank again our thousands of loyal dealers for their support through the years. Carrying EBC as an alternative product line to genuine parts continues to make good commercial sense, saves inventory dollars, increases hit rate on sales and offers a truly long-term solution to stocking aftermarket parts.

EBC also represents a sound investment as products do not perish or age, and with the help of your distributor and the stock rotation programs that many of them offer you, you don't get left with a bunch of old mis-matched inventory which could easily happen with other "New kid on the block" brands.

WHATS NEW FOR 2018?

NEW RANGE OF CLUTCHES FOR HARLEY-DAVIDSON®

Standard CK clutch kits with coil springs or diaphragm springs where required plus a range of SRC and SRK kits and clutch replacement tools.



UTVX ROTORS

A new range of sport rotors for the Side X Side market is included this year, see the UTVX range.

BRAIDED BRAKE HOSES

Stainless steel braided brake hoses - factory built and individually pressure tested after assembly.



Inside this catalog you will find a wall poster that will help show customers the designs of our rotors and give basic pad selection pointers.

Once again **THANK YOU DEALERS** and have a great 2018 selling season.



CATALOG COPYRIGHT

This catalog forms a copyright under US law.

This includes, but is not limited to, the series of brake pad, brake shoe, clutch and brake rotor design numbers with or without the prefixes FA, EPFA, GPFA, MXS, or suffixes R, HH, X, SV. These design numbers prefixes and suffixes form the tools of many years of work and set EBC products apart and easily distinguished from other manufacturers brands or numbers.

Any copying, imitation, in full or in part, by any third party, will result in prosecution to the fullest extent of US law.

Also included within this catalog are registered or applied for individual trademarks, such as

- EBC
- Double-H
- Pro-lite
- SD-System
- Dirt Racer

- Street Racer
- DRC
- DRCF
- SRC
- SRK

- SV Series
- VLD Series
- VR Series

All of the above are active trademarks and/or brands used by EBC Brakes licencees.

CONTENTS

PAD & SHOE APPLICATIONS

Harley-Davidson®	08-17	Recommended 2018 Dealer Inventory.....	232-233
Japanese Bikes (Honda, Kawasaki, Suzuki, Yamaha)	18-109	Road Racing Applications and Pads for Aftermarket Calipers.....	234-238
Non-Japanese Bikes Adly, AJP, Alphasports (See Hyosung), Alta Motors, Aprilia, Argo, Arctic Cat, ATK, Bajaj, Benelli, Bennche, Beta, BMW, Bombardier/BRP, Buell, Bultaco, Cagiva, Can-Am, CF Moto, Cobra, CPI, CSC, CZ/Jawa, Daelim, Derbi, Dinli, Ducati, EBR, E-Ton, Gas-Gas, Gogoro, Hisun, Husaberg, Husqvarna, Hyosung, Indian, Italjet, John Deere, Kioti/Mechron, KTM, Kymco, Laverda, LEM, Lifan, Maico/M-Star, Malaguti, Massimo, Montesa, Moto-Guzzi, Motus, MZ/MUZ, MV (Agusta), Norton, Peugeot, Piaggio, Polaris, Polini, Royal Enfield, Sachs, Scorpa, SDG, Sherco, Sym, TGB/Peirspeed, Thumpstar, T.M., Tomos, Triumph, U.M. (United Motors), Unison, Vertemati, VOR, Vespa, Victory, Zero Electric Bike	110-231	Golf Cart Brake Shoes	239-246
		Cycle Disc Brakes	247-257
		Cycle Disc Brake Pad Buyers Guide.....	258-272
		Brake Lines.....	273-288

BRAKE APPLICATIONS

BUYERS GUIDE BRAKE PADS

Buyers Guide - Brake Pads	289-482
---------------------------------	---------

BUYERS GUIDE BRAKE PADS

BUYERS GUIDE BRAKE SHOES

Buyers Guide - Brake Shoes.....	483-498
Buyers Guide - Golf Cart Brake Shoes	499-501
Illustrations and Sizes - Brake Shoes.....	502-509
Illustrations and Sizes - Golf Cart Brake Shoes	509
Diameter Chart - Brake Shoes	509

BUYERS GUIDE BRAKE SHOES

DISC BUYERS GUIDE

Streetbikes	510-542
Dirtbikes / ATV / UTV	543-563

DISC BUYERS GUIDE

CLUTCH APPLICATIONS

Japanese Bikes (Honda, Kawasaki, Suzuki, Yamaha)	564-591
Non-Japanese Bikes (Arctic Cat, AJP, Aprilia, Benelli, BMW, Harley-Davidson®, KTM, Lifan, Moriwaki/Honda, Triumph).....	591-608

CLUTCH APPLICATIONS

CLUTCH BUYERS GUIDE

Buyers Guide - Clutches	609-627
DRC Buyers Guide	628-635
SRC Buyers Guide	636-642
SRK Buyers Guide.....	643-649

CLUTCH BUYERS GUIDE

ACCESSORY PAGES

Carburettor Jets - Pilot Jets.....	650-652
Carburettor Jets - Main Jets.....	653-654
Brake Fluid & Caliper Lube.....	654

ACCESSORY PAGES

COPYRIGHT NOTICE The part numbers, illustrations and listings in this publication are the copyright of EBC Brakes and any reproduction in part or whole or similarity, without advance authority in writing is contrary to international law and copyright holders will enforce vigorously. Vehicle manufacturers names and model numbers are indicated for cross reference purposes only. All products in this catalogue are manufactured by EBC Brakes and are not original equipment parts.

MOTORCYCLE BRAKE PADS

Aramid Fiber Organic FA Series Pads

"X" Pads

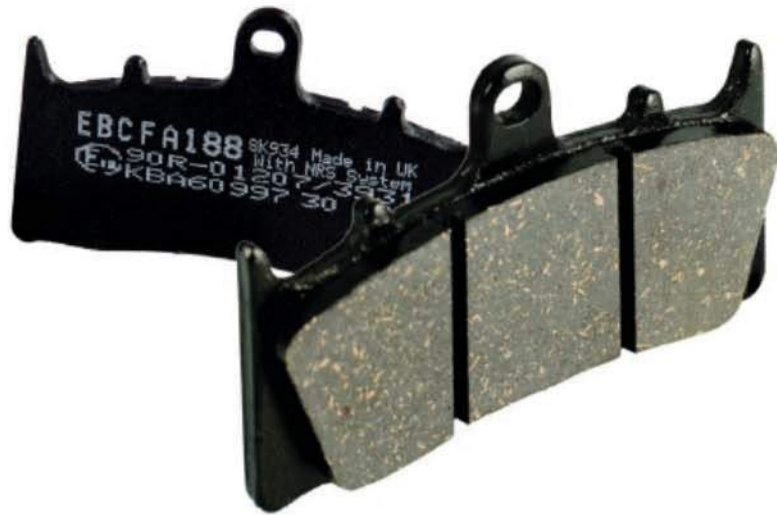

FA series organic brake pads will deliver fingertip stopping power and superb brake feel and control, the preferred choice for many sportbike riders. This compound has low disc attack characteristics and gives medium lifetime.

"X" series moto-x sport and enduro pads, cool running based pad compound for sport use in moto-x and ATV applications. For mud, sand or wet conditions requiring longer life, use our sintered range below.

Double-H™ Pads

MXS Series Pads

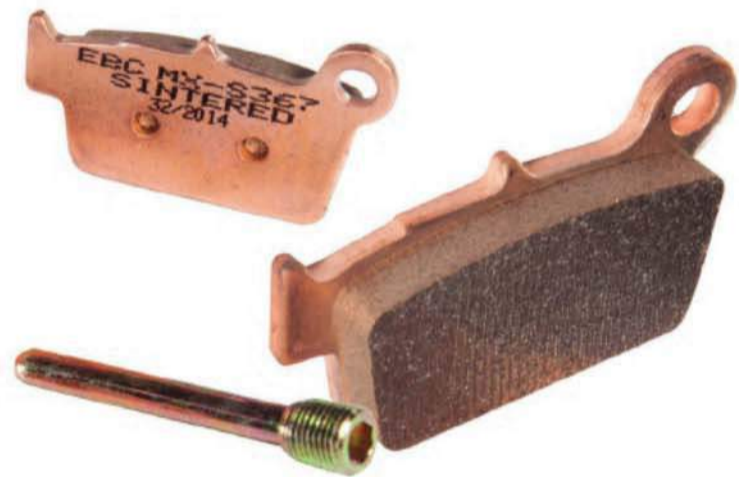

FA series with HH suffix, EBC's American-made ultra high friction Double-H™ sintered copper alloy brake pads for maximum stopping power and lifetime. With stainless steel radiator plates to reduce heat transfer and double compact for wider pads.

"MXS" moto-x race pads, ultra high friction American-made sintered copper alloy with diamond ground surface finish for fast brake-in. With external hex drive slider pins, these pads are suitable for all fast moto-x riding.

"R" Series Pads

SV Pads



"R" series American-made sintered copper alloy ATV and Moto-X replacement pads for sport and utility off road riding.

"SV" series severe duty ATV pads, high density copper alloy for longest possible life in utility applications on ATV, especially in wet, mud, dust and dirt conditions.

MOTORCYCLE BRAKE PADS

EPFA Trackday Pads

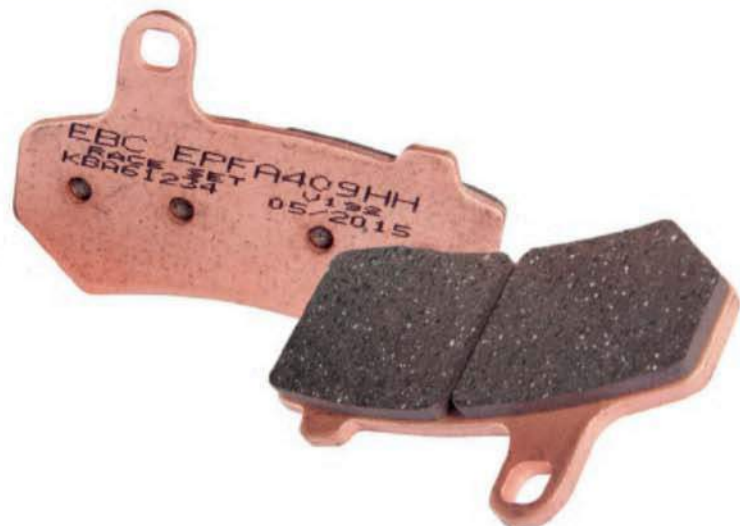

EPFA trackday pads give long life in street use with improved fade resistance and heat cycling plus improved noise characteristics, making this a great pad for heavy streetbikes and cruisers as well as faster superbikes. Great for intermittent track use.

GPFX Race Series Pads

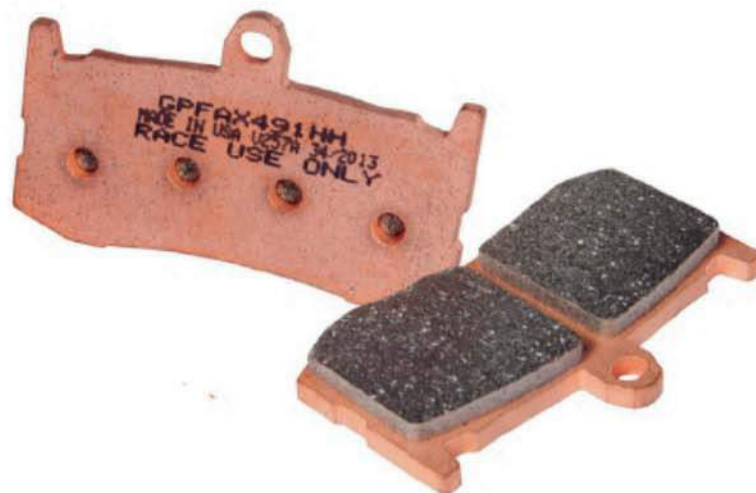

GPFX pads are an ultra high friction RACE ONLY pad, not designed for street use due to their high friction level.

SFA Organic Scooter Pads



A superb general replacement pad for urban use on scooter mopeds, mopeds and moped. Made using aramid fibres, these pads give above average lifetime, reduced rotor wear characteristics and offer great value for money.

SFA-HH Sintered Scooter Pads

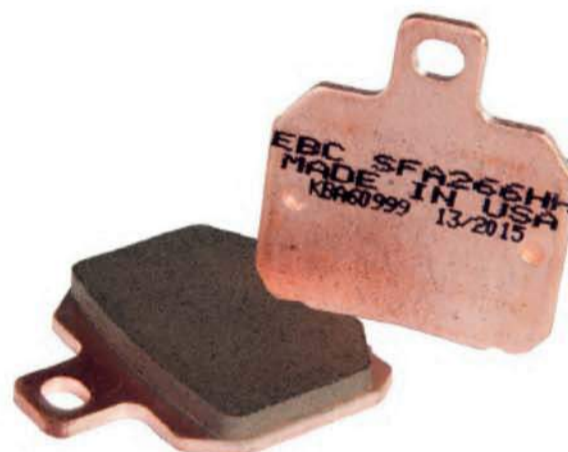

These American-made sintered scooter pads are long lasting with high performance HH rated stopping power for perfect braking - wet or dry. The HH pads target the faster and heavier scooter market and work well with stainless steel brake discs.

SFAC Carbon Scooter Pads



A high durability carbon organic compound giving higher pad performance and longer life for the mid to heavy scooter range. UK-made using 30% copper powder by weight with carbon granules.

MOTORCYCLE BRAKE ROTORS

X and XC Series Sportbike Rotors



X and XC series rotors feature mill hard stainless steel high friction rotor blades for maximum brake effect and are direct size for size replacements for OEM rotors. These lightweight rotors feature our patented SD system square drive button system.

VMD Classic Style Rotors



These lightweight, black anodised vintage rotors are new to our range. The vintage fitment benefits from billet aluminium construction; lightweight, less unsprung weight enables better handling and stopping power. Perfect for the Café racer scene.

Sportbike VR Series Rotors

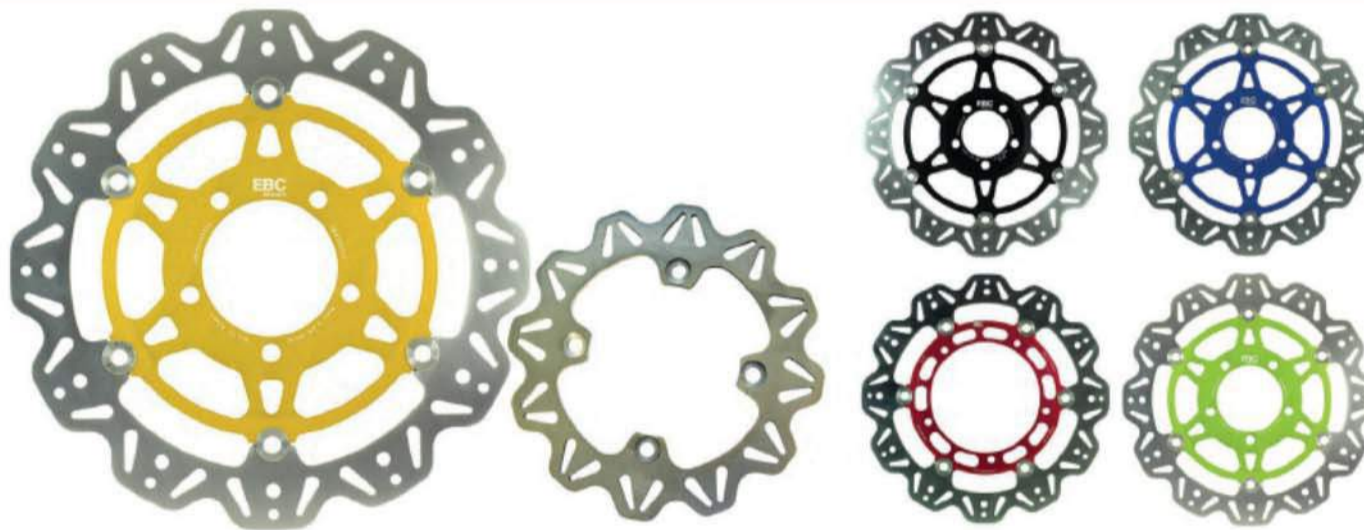

Vee profile lightweight rotors with alloy hubs and ground stainless steel rotor blades for fast street bikes. Choose from black or colored hub options as shown above. To order prefix with VR and suffix with chosen color BLK, RED, BLU, GRN, GLD. For rear rotors just the VR number.

Supermoto Brake Rotor

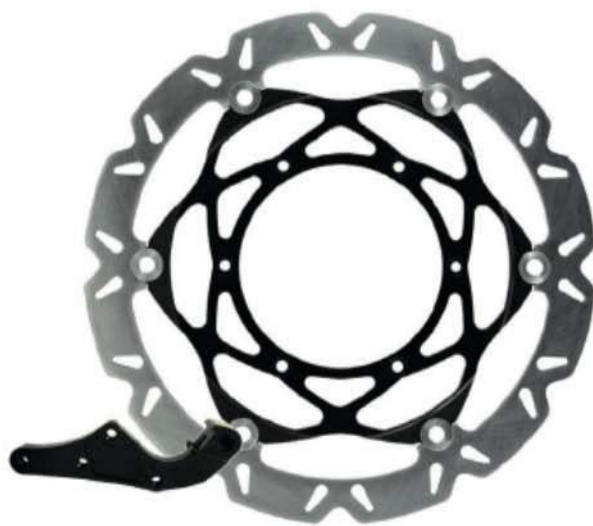

SMX rotor with vee design contoured rotor, 320mm rotor upgrade kits complete with relocation bracket.

Rear Brake Rotors



Made from stainless steel and available in full circle or contoured profile, suitable for performance street use or racing with new lightweight hole pattern construction.

MOTORCYCLE BRAKE ROTORS

MD Series Stainless Scooter Rotors



Made from mill hard rolled steel, these rotors are machined to match the original units, mechanically de-stressed to avoid rotor distortion, surface finished for precise smoothness and then zinc coated to prevent corrosion or rusting.

VR Series Stainless Scooter Rotors



Made in the UK using German mill rolled heat treated and precision ground stainless steel, the new VR series stainless profiled scooter sport rotors are the lightest and best looking on the market and can be used with any type of brake pad.

UTVX Rotors for ATV/Quad/4x4



These self cleaning rotors look great and give an improved brake performance. Made in our British manufacturing facility using durable, tough German mill rolled stainless steel, heat treated & diamond ground to give great braking for less than OEM prices.

CX Extreme Off Road Rotors



CX Extreme self-cleaning lightweight stainless rotors are a size-for-size replacement/upgrade for front and rear fitment on all modern motocross machines.

Oversize MX Rotors



250 or 280mm motocross oversize rotor kit complete with billet aluminum relocation brackets for improved brake power and control with vee design rotor.

BRAKE ROTORS FOR AMERICAN MOTORCYCLES

5 Button Fully Floating

Polished Stainless Steel

10 Button Fully Floating



Custom polished brake rotor for American motorcycles, the new EBC range of high luster brake rotors features stainless steel brake rotor rings/blades and a polished stainless steel center hub. Newer units feature the contoured and slotted rotor profile as shown above which greatly improves bed-in and reduces rotor damage (rotor galling). The reason we have opted for stainless steel center hubs is due to the weight and heavy nature of larger American built motorcycles which can lead to more vibration or frame shake.

5 Button Fully Floating

Black Chrome

10 Button Fully Floating



Made in the UK these quality fully floating brake rotors feature stainless steel center hubs for maximum strength in either a polished stainless or black chrome over stainless finish. The EBC rotors use a patented SD or "Square Drive" button system which will guarantee a lifetime of warp free/vibration free braking on your machine. As with all EBC big twin brake rotors, all components and hardware are stainless but in addition to the high lustre center hub, we have applied a black chrome finish to improve the cosmetics.

Solid Stainless Steel Rotor

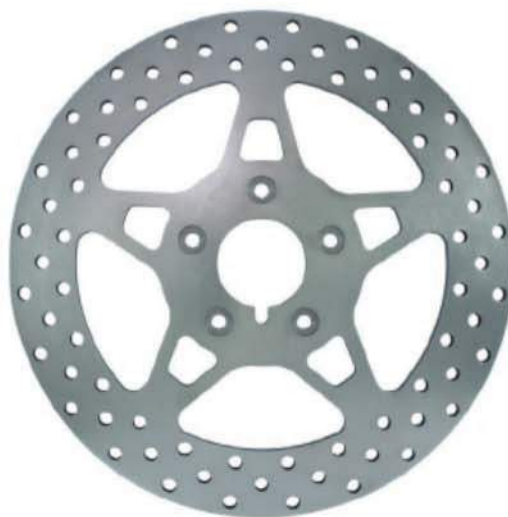

We also offer a five spoke $\frac{1}{4}$ " thick solid rotor for front fitments and $\frac{3}{16}$ " for rear fitments.

MOTORCYCLE CLUTCH OPTIONS

CK/CKF Series Clutch Kits

DRC/DRCF Series Clutch Kits



CK complete engine sets of stack height controlled friction plates feature the EBC Brakes' unique alloy particle impregnated clutch facings that prevent burn up or slippage. CKF carbon fiber impregnated kits for ATV and moto-x use are built to last longer, grip and feel better than cork kits.

DRC is the ultimate clutch rebuild kit for your ATV and Moto-X machine. The DRCF kit swaps the stock type cork friction plates for a set of severe duty carbon fiber lined friction plates for better heat and wear abilities.

SRC/SRK Series Clutch Kits

CSK Coil & Diaphragm Clutch Kits



SRC is an aramid fiber lined plate set with heavy duty clutch springs (diaphragm type springs included where required). Ideal for heavy sport bikes, faster riders and production based race use. SRK series includes a full engine set of aramid lined friction plates with clutch springs and steel separator plates.

CSK sets include either coiled springs or diaphragm springs where appropriate. Coil springs are spiral wound with 4 to 8 pieces per set, made from heat treated high carbon steel delivering the right tension for your bike. Diaphragm springs are dish shaped flat steel pressure rings.

Clutch Removal Tools



Made in the UK by EBC Brakes, these laser cut clutch tools make clutch removal, loosening of the drive shaft bolts and re-tightening a breeze, without any fear of damage to your expensive clutch basket. Tools can be extended to create more leverage if required with any simple workshop tool or tube. EBC Brakes produce a clutch tool for almost every clutch plate design known.

FRONT: AMERICAN PRODUCED MOTORCYCLES

* symbol after part# = 2 pieces reqd.
i.e. 2 pad sets or 2 contour rotors

FRONT

HARLEY-DAVIDSON®

YEAR	Organic Pads /Shoes	Semi-Sintered V-Pads™	Chrome Back V-Pads™	Sintered Double-H™ Pads	EPFA Fast Road Use & Track Days	Solid Front Rotor	5 Bobbin Style Rotor	10 Bobbin Polished Rotor	5 Bobbin Black Chrome Centered Rotor	10 Bobbin Black Chrome Centered Rotor
HARLEY-DAVIDSON®										
F-150 Pick Up Truck Special Edition (PADS AND DISCS SOLD AS AXLE SETS - ORDER 1 SET OF P/N0)	00-04	DP61259				GD7130*				
HARLEY-DAVIDSON® SPORTSTER										
XL, XLH, XLCH, XLS, XLX	54-78	N/A					N/A			
XLH, XLCH (Rivet Type)	73-77	FA26					N/A			
79-81 (Twin fronts)	79-81	FA71*	FA71V*				N/A			
82-83 (Twin fronts) (Girling caliper)	82-83	FA71*	FA71V*				N/A			
84-Early 87 (Girling caliper)	84-Early 87	FA94	FA94V		FA94HH	FSD007	FSD009	FSD022	FSD009BLK	FSD022BLK
Late 87-99	Late 87-99	FA94	FA94V		FA94HH	FSD007	FSD009	FSD022	FSD009BLK	FSD022BLK
XL 50 50th Anniversary Sportster	07	FA381	FA381V		FA381HH	EPFA381HH	FSD008	FSD010	FSD023	FSD010BLK
XLH883 Sportster	00-03	FA400	FA400V	FA400VLD	FA400HH	EPFA400HH	FSD008	FSD010	FSD023	FSD010BLK
XLH883r Sportster Flat Track	00-03	FA400	FA400V	FA400VLD	FA400HH	EPFA400HH	FSD008	FSD010	FSD023	FSD010BLK
XL883 Sportster Hugger	00-03	FA400	FA400V	FA400VLD	FA400HH	EPFA400HH	FSD008	FSD010	FSD023	FSD010BLK
XL53c Sportster Custom (883cc)	00-03	FA400	FA400V	FA400VLD	FA400HH	EPFA400HH	FSD008	FSD010	FSD023	FSD010BLK
XL883 Sportster Standard	04-08	FA381	FA381V		FA381HH	EPFA381HH	FSD008	FSD010	FSD023	FSD010BLK
XL883 C Sportster Custom	04-10	FA381	FA381V		FA381HH	EPFA381HH	FSD008	FSD010	FSD023	FSD010BLK
XL883 L 883 Low	04-10	FA381	FA381V		FA381HH	EPFA381HH	FSD008	FSD010	FSD023	FSD010BLK
XL883 L Superlow	11-13	FA381	FA381V		FA381HH	EPFA381HH	FSD008	FSD010	FSD023	FSD010BLK
XL883 L Super Low (Cast Wheel)	14-18	FA640	FA640V		FA640HH	MD526		N/A		N/A
XL883 N Iron	09-10	FA381	FA381V		FA381HH	EPFA381HH	FSD008	FSD010	FSD023	FSD010BLK
XL883 N Iron (Cast Wheel)	11-13	FA381	FA381V		FA381HH	EPFA381HH	FSD008	FSD010	FSD023	FSD010BLK
XL883 N Iron (Cast Wheel)	14-15	FA640	FA640V		FA640HH	MD526		N/A		N/A
XL883 N Iron	16-18	FA640	FA640V		FA640HH		TBA	N/A		N/A
XL883 R 100th Anniversary Edition	03	FA400*	FA400V*	FA400VLD*	FA400HH*	EPFA400HH*	FSD008*	FSD010*	FSD023*	FSD010BLK*
XL883 R Sportster R	05-13	FA381*	FA381V*		FA381HH*	EPFA381HH*	FSD008*	FSD010*	FSD023*	FSD010BLK*
XL883 R Roadster	10	FA381*	FA381V*		FA381HH*	EPFA381HH*	FSD008*	FSD010*	FSD023*	FSD010BLK*
XL883 R Roadster (Cast Wheel)	11-13	FA381*	FA381V*		FA381HH*	EPFA381HH*	FSD008*	FSD010*	FSD023*	FSD010BLK*
XL883 R Roadster (Cast Wheel)	14-15	FA640	FA640V		FA640HH	MD526		N/A		N/A
XL1200c Sportster Custom	00-03	FA400	FA400V	FA400VLD	FA400HH	EPFA400HH	FSD008	FSD010	FSD023	FSD010BLK
XL1200s Sportster Sport	00-03	FA400*	FA400V*	FA400VLD*	FA400HH*	EPFA400HH*	FSD008*	FSD010*	FSD023*	FSD010BLK*
XL1200 R Sportster Roadster	04-08	FA381*	FA381V*		FA381HH*	EPFA381HH*	FSD002*	FSD004*	FSD021*	FSD004BLK*
XL1200 C Sportster Custom	04-10	FA381	FA381V		FA381HH	EPFA381HH	FSD002	FSD004	FSD021	FSD004BLK
XL1200 C Sportster Custom (Cast & Spoke Wheels)	11-13	FA381	FA381V		FA381HH	EPFA381HH	FSD002	FSD004	FSD021	FSD004BLK
XL1200 C Custom (Spoke Wheel)	14-18	FA640	FA640V		FA640HH	MD526		N/A		N/A
XL1200 CX Roadster	16-18	FA640*	FA640V*		FA640HH*		TBA	N/A		N/A
XL1200 L Sportster Low (Spoke Wheel)	07-11	FA381	FA381V		FA381HH	EPFA381HH	FSD008	FSD010	FSD023	FSD010BLK
XL1200 L Sportster Low (Cast Wheel)	07-11	FA381	FA381V		FA381HH	EPFA381HH	FSD008	FSD010	FSD023	FSD010BLK
XL1200 N Nightster (Spoke wheel)	08-12	FA381	FA381V		FA381HH	EPFA381HH	FSD008	FSD010	FSD023	FSD010BLK
XL1200 T Superlow	14-17	FA640	FA640V		FA640HH	MD526		N/A		N/A
XL1200 V Seventy Two	12-13	FA381	FA381V		FA381HH	EPFA381HH	FSD008	FSD010	FSD023	FSD010BLK
XL1200 V Seventy Two	14-16	FA640	FA640V		FA640HH	MD526		N/A		N/A
XL1200 X Forty Eight	10-13	FA381	FA381V		FA381HH	EPFA381HH	FSD008	FSD010	N/A	FSD010BLK
XL1200 X Forty Eight	14-17	FA640	FA640V		FA640HH	MD526		N/A		N/A
XL1200 X Forty Eight	18	FA640	FA640V		FA640HH	MD530				
XL1200 Forty Eight Anniversary	18	FA640	FA640V		FA640HH	MD530				
XR1200	08-10				FA296HH*		MD523X*	N/A*		N/A*
XR1200 X	10-12				FA296HH*		MD523X*	N/A*		N/A*
HARLEY-DAVIDSON® STREET										
XG 500 Street (494cc)	14-15	USE VEE PAD	FA643V		FA643HH	MD531		N/A		N/A
XG 500 Street (300mm Discs)	16-18	FA209/2	FA209/2V		FA209/2HH	MD536		N/A		N/A
XG 750 Street (749cc)	14-15	USE VEE PAD	FA643V		FA643HH	MD531		N/A		N/A
XG 750 Street (300mm Discs)	16-18	FA209/2	FA209/2V		FA209/2HH	MD536		N/A		N/A
XG 750 A Street Rod (300mm Discs)	17-18	FA209/2*	FA209/2V*		FA209/2HH*	MD536*		N/A		N/A

* This symbol indicates a rotor made of billet steel, and should be only used with EBC FA Kevlar® Organic or Vee pads.

Line #

REAR: AMERICAN PRODUCED MOTORCYCLES

* symbol after part# = 2 pieces reqd.
i.e. 2 pad sets or 2 contour rotors

Line #

HARLEY-DAVIDSON®

		REAR								
YEAR	Organic Pads /Shoes	Semi-Sintered V-Pads™	Chrome Back V-Pads™	Sintered Double-H™ Pads	EPFA Fast Road Use & Track Days	Solid Rear Rotor	10 Bobbin Polished Rotor	10 Bobbin Black Chrome Rotor		
1	F-150 Pick Up Truck Special Edition									
2	(PADS AND DISCS SOLD AS AXLE SETS - ORDER 1 SET OF P/N0)	00-04	DP61633				GD7154*			
3										
4	HARLEY-DAVIDSON® SPORTSTER									
5	XL, XLH, XLCH, XLS, XLX	54-78	N/A				N/A			
6	XLH, XLCH (Rivet Type)	73-77	FA72	FA72V			N/A			
7	79-81 (Twin fronts)	79-81	FA72	FA72V			N/A			
8	82-83 (Twin fronts) (Girling caliper)	82-83	FA78	FA78V			N/A			
9	84-Early 87 (Girling caliper)	84-Early 87	FA78	FA78V	FA78HH		N/A	N/A		
10	Late 87-99	Late 87-99	FA200	FA200V	FA200HH	EPFA200HH	RSD007	RSD019	RSD019BLK	
11	XL 50 50th Anniversary Sportster	07	FA387	FA387V	FA387HH	EPFA387HH	RSD008	RSD020	RSD020BLK	
12	XLH883 Sportster	00-03	USE VEE PAD	FA400V	FA400VLD	FA400HH	EPFA400HH	RSD008	RSD020	RSD020BLK
13	XLH883r Sportster Flat Track	00-03	USE VEE PAD	FA400V	FA400VLD	FA400HH	EPFA400HH	RSD008	RSD020	RSD020BLK
14	XL883 Sportster Hugger	00-03	USE VEE PAD	FA400V	FA400VLD	FA400HH	EPFA400HH	RSD008	RSD020	RSD020BLK
15	XL53c Sportster Custom (883cc)	00-03	USE VEE PAD	FA400V	FA400VLD	FA400HH	EPFA400HH	RSD008	RSD020	RSD020BLK
16	XL883 Sportster Standard	04-08	FA387	FA387V	FA387HH	EPFA387HH	RSD008	RSD020	RSD020BLK	
17	XL883 C Sportster Custom	04-10	FA387	FA387V	FA387HH	EPFA387HH	RSD008	RSD020	RSD020BLK	
18	XL883 L 883 Low	04-10	FA387	FA387V	FA387HH	EPFA387HH	RSD008	RSD020	RSD020BLK	
19	XL883 L Superlow	11-13	FA387	FA387V	FA387HH	EPFA387HH	MD524			
20	XL883 L Super Low (Cast Wheel)	14-18	FA254	FA254V	FA254HH		MD524			
21	XL883 N Iron	09-10	FA387	FA387V	FA387HH	EPFA387HH	RSD008	RSD020	RSD020BLK	
22	XL883 N Iron (Cast Wheel)	11-13	FA387	FA387V	FA387HH	EPFA387HH	MD524			
23	XL883 N Iron (Cast Wheel)	14-15	FA254	FA254V	FA254HH		MD524			
24	XL883 N Iron	16-18	FA254	FA254V	FA254HH		MD524			
25	XL883 R 100th Anniversary Edition	03	USE VEE PAD	FA400V	FA400VLD	FA400HH	EPFA400HH	RSD008	RSD020	RSD020BLK
26	XL883 R Sportster R	05-13	FA387	FA387V	FA387HH	EPFA387HH	RSD008	RSD020	RSD020BLK	
27	XL883 R Roadster	10	FA387	FA387V	FA387HH	EPFA387HH	RSD008	RSD020	RSD020BLK	
28	XL883 R Roadster (Cast Wheel)	11-13	FA387	FA387V	FA387HH	EPFA387HH	MD524			
29	XL883 R Roadster (Cast Wheel)	14-15	FA254	FA254V	FA254HH		MD524			
30	XL1200c Sportster Custom	00-03	USE VEE PAD	FA400V	FA400VLD	FA400HH	EPFA400HH	RSD008	RSD020	RSD020BLK
31	XL1200s Sportster Sport	00-03	USE VEE PAD	FA400V	FA400VLD	FA400HH	EPFA400HH	RSD008	RSD020	RSD020BLK
32	XL1200 R Sportster Roadster	04-08	FA387	FA387V	FA387HH	EPFA387HH	RSD008	RSD020	RSD020BLK	
33	XL1200 C Sportster Custom	04-10	FA387	FA387V	FA387HH	EPFA387HH	RSD008	RSD020	RSD020BLK	
34	XL1200 C Sportster Custom (Cast & Spoke Wheels)	11-13	FA387	FA387V	FA387HH	EPFA387HH	RSD008	RSD020	RSD020BLK	
35	XL1200 C Custom (Spoke Wheel)	14-18	FA254	FA254V	FA254HH		MD524			
36	XL1200 CX Roadster	16-18	FA254	FA254V	FA254HH		MD524			
37	XL1200 L Sportster Low (Spoke Wheel)	07-11	FA387	FA387V	FA387HH	EPFA387HH	RSD008	RSD020	RSD020BLK	
38	XL1200 L Sportster Low (Cast Wheel)	07-11	FA387	FA387V	FA387HH	EPFA387HH	MD524			
39	XL1200 N Nightster (Spoke wheel)	08-12	FA387	FA387V	FA387HH	EPFA387HH	RSD008	RSD020	RSD020BLK	
40	XL1200 T Superlow	14-17	FA254	FA254V	FA254HH		MD524			
41	XL1200 V Seventy Two	12-13	FA387	FA387V	FA387HH	EPFA387HH	RSD008	RSD020	RSD020BLK	
42	XL1200 V Seventy Two	14-16	FA254	FA254V	FA254HH		MD524			
43	XL1200 X Forty Eight	10-13	FA387	FA387V	FA387HH	EPFA387HH	RSD008	RSD020	RSD020BLK	
44	XL1200 X Forty Eight	14-17	FA254	FA254V	FA254HH		MD524			
45	XL1200 X Forty Eight	18	FA254	FA254V	FA254HH		MD524			
46	XL1200 Forty Eight Anniversary	18	FA254	FA254V	FA254HH		MD524			
47	XR1200	08-10	FA387	FA387V	FA387HH	EPFA387HH	MD524			
48	XR1200 X	10-12	FA387	FA387V	FA387HH	EPFA387HH	MD524			
49										
50	HARLEY-DAVIDSON® STREET									
51	XG 500 Street (494cc)	14-15	USE VEE PAD	FA643V	FA643HH		MD532			
52	XG 500 Street (300mm Discs)	16-18	USE VEE PAD	FA181V	FA181HH		MD537			
53	XG 750 Street (749cc)	14-15	USE VEE PAD	FA643V	FA643HH		MD532			
54	XG 750 Street (300mm Discs)	16-18	USE VEE PAD	FA181V	FA181HH		MD537			
55	XG 750 A Street Rod (300mm Discs)	17-18	USE VEE PAD	FA181V	FA181HH		MD537			
56										
57										

All names & numbers are for reference purposes only. ® Registered trademarks of Harley—Davidson® Motor Corp or Buell.

Recommended Fittings: FA400 for use on polished chrome show rotors. FA400HH recommended fitting as replacement for OE.

NOTE: — Some models may have a second rotor fitted as an optional extra. Please double check with your customer exactly which side the front rotor is fitted and if twin rotor or single.

⊗ This symbol indicates a rotor made of billet steel, and should be only used with EBC FA Kevlar® Organic or Vee pads.

BRAKE APPLICATIONS

FRONT: AMERICAN PRODUCED MOTORCYCLES

* symbol after part# = 2 pieces reqd.
i.e. 2 pad sets or 2 contour rotors

FRONT

HARLEY-DAVIDSON® DYNA

YEAR

Organic Pads /Shoes	Semi-Sintered V-Pads™	Chrome Back V-Pads™	Sintered Double-H™ Pads	EPFA Fast Road Use & Track Days	Solid Front Rotor	5 Bobbin Style Rotor	10 Bobbin Polished Rotor	5 Bobbin Black Chrome Centered Rotor	10 Bobbin Black Chrome Centered Rotor
---------------------	-----------------------	---------------------	-------------------------	---------------------------------	-------------------	----------------------	--------------------------	--------------------------------------	---------------------------------------

Line #

FX, FXE (Rivet Type)	73-77	FA26					N/A			1		
FX, FXE, FXS	Late 78-83	FA71	FA71V				N/A			2		
FX, FXE, FXS	84-86	FA94*	FA94V*		FA94HH*	EPFA94HH*	FSD007*	FSD009*	FSD022*	FSD009BLK*	FSD022BLK*	3
FXWG, FXSB	83	FA71	FA71V					N/A				4
FL, FLH	49-71	N/A										5
FL, FLH	58-62	N/A										6
FL, FLH (Banana caliper)	72-84	FA24/2	FA24/2V					N/A				7
FL, FLH (Banana caliper)	72-80	FA24/2	FA24/2V					N/A				8
FL, FLH	81-84	FA24/2	FA24/2V					N/A				9
FXD, FXDL, FXDWG, FXR, FXRS, FXRT, FXRD, FXLR	82-83	FA71	FA71V					N/A				10
FXD, FXDL, FXDWG, FXR, FXRS, FXRT, FXRD, FXLR	84-Early 87	FA94*	FA94V*		FA94HH*	EPFA94HH*	FSD007*	FSD009*	FSD022*	FSD009BLK*	FSD022BLK*	11
FXD, FXDL, FXDWG, FXR, FXRS, FXRT, FXRD, FXLR	Late 87-99	FA94*	FA94V*		FA94HH*	EPFA94HH*	FSD007*	FSD009*	FSD022*	FSD009BLK*	FSD022BLK*	12
FLD Switchback	12-16		FA457V	FA457VLD	FA457HH	EPFA457HH	MD516 ♦		N/A		N/A	13
FXD Super Glide	00-03	FA400	FA400V	FA400VLD	FA400HH	EPFA400HH	FSD008	FSD010	FSD022	FSD010BLK	FSD022BLK	14
FXD Super Glide (Cast wheel)	08-10		FA457V	FA457VLD	FA457HH	EPFA457HH	MD516 ♦		N/A		N/A	15
FXDF Fat Bob (Cast wheel)	08-17		FA457V*	FA457VLD*	FA457HH*	EPFA457HH*		MD518*	N/A		N/A	16
FXDX Super Glide Sport	00-03	FA400*	FA400V*	FA400VLD*	FA400HH*	EPFA400HH*	FSD008*	FSD010*	FSD023*	FSD010BLK*	FSD023BLK*	17
FXDL Low Rider	00-03	FA400*	FA400V*	FA400VLD*	FA400HH*	EPFA400HH*	FSD008*	FSD010*	FSD023*	FSD010BLK*	FSD023BLK*	18
FXDWG Wide Glide	00-03	FA400*	FA400V*	FA400VLD*	FA400HH*	EPFA400HH*	FSD008*	FSD010*	FSD023*	FSD010BLK*	FSD023BLK*	19
FXDWG Wide Glide (Spoke wheel)	08		FA457V	FA457VLD	FA457HH	EPFA457HH		MD518	N/A		N/A	20
FXDS-CON Dyna Convertible	00-02	FA400*	FA400V*	FA400VLD*	FA400HH*	EPFA400HH*	FSD008*	FSD010*	FSD023*	FSD010BLK*	FSD023BLK*	21
FXDX Super Glide Sport	01-03	FA400*	FA400V*	FA400VLD*	FA400HH*	EPFA400HH*	FSD008*	FSD010*	FSD023*	FSD010BLK*	FSD023BLK*	22
FXDi Super Glide 1450	04-05	FA400	FA400V	FA400VLD	FA400HH	EPFA400HH	FSD008	FSD010	FSD023	FSD010BLK	FSD023BLK	23
FXDi 35 35th Anniversary Super Glide (Spoke wheels)	06	FA400	FA400V	FA400VLD	FA400HH	EPFA400HH		MD518	N/A		N/A	24
FXDX Super Glide Sport	04-05	FA400*	FA400V*	FA400VLD*	FA400HH*	EPFA400HH*	FSD008*	FSD010*	FSD023*	FSD010BLK*	FSD023BLK*	25
FXDLi Low Rider 1450	04-05	FA400	FA400V	FA400VLD	FA400HH	EPFA400HH	FSD008	FSD010	FSD023	FSD010BLK	FSD023BLK	26
FXDLi Dyna Low Rider (Spoke wheels)	06	FA400	FA400V	FA400VLD	FA400HH	EPFA400HH		MD518	N/A		N/A	27
FXDWGi Wide Glide 1450	04-05	FA400	FA400V	FA400VLD	FA400HH	EPFA400HH	FSD008	FSD010	FSD023	FSD010BLK	FSD023BLK	28
FXDWGi Dyna Wide Glide (Spoke wheels)	06-07	FA400	FA400V	FA400VLD	FA400HH	EPFA400HH		MD518	N/A		N/A	29
FXDWG Dyna Wide Glide (Spoke Wheels)	08-17		FA457V	FA457VLD	FA457HH	EPFA457HH		MD518	N/A		N/A	30
FXDC/FXDCi Super Glide Custom	05	FA400	FA400V	FA400VLD	FA400HH	EPFA400HH	FSD008	FSD010	FSD023	FSD010BLK	FSD023BLK	31
FXDCi Dyna Superglide Custom (Spoke wheels)	06-07	FA400	FA400V	FA400VLD	FA400HH	EPFA400HH		MD518	N/A		N/A	32
FXDC Super Glide Custom (Spoke wheel)	08-14		FA457V	FA457VLD	FA457HH	EPFA457HH		MD518	N/A		N/A	33
FXDBi Street Bob (Spoke wheels)	06-07	FA400	FA400V	FA400VLD	FA400HH	EPFA400HH		MD518	N/A		N/A	34
FXDB Street Bob (Spoke wheel)	08-17		FA457V	FA457VLD	FA457HH	EPFA457HH		MD518	N/A		N/A	35
FXDBC Street Bob LTD	16		FA457V*	FA457VLD*	FA457HH*	EPFA457HH*		MD518*	N/A*	N/A	N/A*	36
FXDi Super Glide (Cast wheel)	06-07	FA400	FA400V	FA400VLD	FA400HH	EPFA400HH	MD516 ♦		N/A		N/A	37
FXDLi Low Rider (Cast wheel)	06-07	FA400	FA400V	FA400VLD	FA400HH	EPFA400HH	MD516 ♦		N/A		N/A	38
FXDLi Low Rider (Spoke wheel)	06-07	FA400	FA400V	FA400VLD	FA400HH	EPFA400HH		MD518	N/A		N/A	39
FXDL Low Rider (Cast wheel)	08-13		FA457V	FA457VLD	FA457HH	EPFA457HH	MD516 ♦		N/A		N/A	40
FXDL Low Rider (Spoke wheel)	08-09		FA457V	FA457VLD	FA457HH	EPFA457HH		MD518	N/A		N/A	41
FXDL Low Rider (Cast wheel)	14-17		FA457V*	FA457VLD*	FA457HH*	EPFA457HH*	MD516* ♦		N/A*		N/A*	42
FXDL Low Rider (Spoke wheel)	14-17		FA457V*	FA457VLD*	FA457HH*	EPFA457HH*		MD518*	N/A*		N/A*	43
FXDCi Superglide Custom (Cast wheel)	06	FA400	FA400V	FA400VLD	FA400HH	EPFA400HH	MD516* ♦		N/A*		N/A*	44

♦ NEW FLOATING CONVERSION AVAILABLE TO REPLACE MD516 ORIGINAL SOLID DISC - ORDER MD516X

HARLEY-DAVIDSON® SOFTAIL

FXST, FXSTB, FXSTC, FXSTS, FLST, FLSTC, FLSTF, FLSTS, FLSTN	84-Early 87	FA94	FA94V		FA94HH		FSD007	FSD009	FSD022	FSD009BLK	FSD022BLK	48
FXST, FXSTB, FXSTC, FXSTS, FLST, FLSTC, FLSTF, FLSTS, FLSTN	Late 87-99	FA94	FA94V		FA94HH		FSD007	FSD009	FSD022	FSD009BLK	FSD022BLK	49
FXST/FXSTi Softail Standard	00-05	FA400	FA400V	FA400VLD	FA400HH	EPFA400HH	FSD008	FSD010	FSD023	FSD010BLK	FSD023BLK	50
FXSTB/FXSTBi Night Train	00-05	FA400	FA400V	FA400VLD	FA400HH	EPFA400HH	FSD008	FSD010	FSD023	FSD010BLK	FSD023BLK	51
FXSTD/FXSTD Softail Deuce/i	00-07	FA400	FA400V	FA400VLD	FA400HH	EPFA400HH	FSD008	FSD010	FSD023	FSD010BLK	FSD023BLK	52
FXSTS/FXSTSi Softail Springer	00-05	FA94	FA94V		FA94HH		FSD007	FSD009	FSD022	FSD009BLK	FSD022BLK	53
FLSTF/FLSTFi Fat Boy	00-06	FA400	FA400V	FA400VLD	FA400HH	EPFA400HH	FSD008	FSD010	FSD023	FSD010BLK	FSD023BLK	54
FLSTFi Fat Boy 15th Anniversary Edition	05	FA400	FA400V	FA400VLD	FA400HH	EPFA400HH	FSD008	FSD010	FSD023	FSD010BLK	FSD023BLK	55
FLSTF/FLSTFi Fat Boy	07	FA400	FA400V	FA400VLD	FA400HH	EPFA400HH	FSD008	FSD010	FSD023	FSD010BLK	FSD023BLK	56
FLSTF Fat Boy	08-14		FA457V	FA457VLD	FA457HH	EPFA457HH	FSD008	FSD010	FSD023	FSD010BLK	FSD023BLK	57

* This symbol indicates a rotor made of billet steel, and should be only used with EBC FA Kevlar® Organic or Vee pads.

REAR: AMERICAN PRODUCED MOTORCYCLES

* symbol after part# = 2 pieces reqd.
i.e. 2 pad sets or 2 contour rotors

HARLEY-DAVIDSON® DYNA YEAR

			REAR							
Line #		YEAR	Organic Pads /Shoes	Semi-Sintered V-Pads™	Chrome Back V-Pads™	Sintered Double-H™ Pads	EPFA Fast Road Use & Track Days	Solid Rear Rotor	10 Bobbin Polished Rotor	10 Bobbin Black Chrome Rotor
1	FX, FXE (Rivet Type)	73-77	FA24/2	FA24/2V					N/A	
2	FX, FXE, FXS	Late 78-83	FA24/2	FA24/2V					N/A	
3	FX, FXE, FXS	84-86	FA78	FA78V		FA78HH			N/A	
4	FXWG, FXSB	83	FA78	FA78V		FA78HH			N/A	
5	FL, FLH	49-71	N/A							
6	FL, FLH	58-62	N/A							
7	FL, FLH (Banana caliper)	72-84	FA24/2	FA24/2V					N/A	
8	FL, FLH (Banana caliper)	72-80	FA24/2	FA24/2V					N/A	
9	FL, FLH	81-84	FA79	FA79V					N/A	
10	FXD, FXDL, FXDWG, FXR, FXRS, FXRT, FXRD, FXLR	82-83	FA78	FA78V		FA78HH			N/A	
11	FXD, FXDL, FXDWG, FXR, FXRS, FXRT, FXRD, FXLR	84-Early 87	FA78	FA78V		FA78HH			N/A	
12	FXD, FXDL, FXDWG, FXR, FXRS, FXRT, FXRD, FXLR	Late 87-99	FA200	FA200V		FA200HH	EPFA200HH	RSD007	RSD019	RSD019BLK
13	FLD Switchback	12-16		FA458V	FA458VLD	FA458HH	EPFA458HH	RSD008	RSD020	
14	FXD Super Glide	00-03	USE VEE PAD	FA400V	FA400VLD	FA400HH	EPFA400HH	RSD008	RSD020	RSD020BLK
15	FXD Super Glide (Cast wheel)	08-10		FA458V	FA458VLD	FA458HH	EPFA458HH	RSD008	RSD020	
16	FXDF Fat Bob (Cast wheel)	08-17		FA458V	FA458VLD	FA458HH	EPFA458HH	RSD008	RSD020	
17	FXDX Super Glide Sport	00-03	USE VEE PAD	FA400V	FA400VLD	FA400HH	EPFA400HH	RSD008	RSD020	RSD020BLK
18	FXDL Low Rider	00-03	USE VEE PAD	FA400V	FA400VLD	FA400HH	EPFA400HH	RSD008	RSD020	RSD020BLK
19	FXDWG Wide Glide	00-03	USE VEE PAD	FA400V	FA400VLD	FA400HH	EPFA400HH	RSD008	RSD020	RSD020BLK
20	FXDWG Wide Glide (Spoke wheel)	08		FA458V	FA458VLD	FA458HH	EPFA458HH	RSD008	RSD020	
21	FXDS-CON Dyna Convertible	00-02	USE VEE PAD	FA400V	FA400VLD	FA400HH	EPFA400HH	RSD008	RSD020	RSD020BLK
22	FXDXT Superglide T-Sport	01-03	USE VEE PAD	FA400V	FA400VLD	FA400HH	EPFA400HH	RSD008	RSD020	RSD020BLK
23	FXDi Super Glide 1450	04-05	USE VEE PAD	FA400V	FA400VLD	FA400HH	EPFA400HH	RSD008	RSD020	RSD020BLK
24	FXDi 35 35th Anniversary Super Glide (Spoke wheels)	06	USE VEE PAD	FA400V	FA400VLD	FA400HH	EPFA400HH	RSD008	RSD020	
25	FXDXi Super Glide Sport	04-05	USE VEE PAD	FA400V	FA400VLD	FA400HH	EPFA400HH	RSD008	RSD020	RSD020BLK
26	FXDLi Low Rider 1450	04-05	USE VEE PAD	FA400V	FA400VLD	FA400HH	EPFA400HH	RSD008	RSD020	RSD020BLK
27	FXDLi Dyna Low Rider (Spoke wheels)	06	USE VEE PAD	FA400V	FA400VLD	FA400HH	EPFA400HH	RSD008	RSD020	
28	FXDWGi Wide Glide 1450	04-05	USE VEE PAD	FA400V	FA400VLD	FA400HH	EPFA400HH	RSD008	RSD020	RSD020BLK
29	FXDWGi Dyna Wide Glide (Spoke wheels)	06-07	USE VEE PAD	FA400V	FA400VLD	FA400HH	EPFA400HH	RSD008	RSD020	
30	FXDWG Dyna Wide Glide (Spoke Wheels)	08-17		FA458V	FA458VLD	FA458HH	EPFA458HH	RSD008	RSD020	
31	FXDC/FXDCi Super Glide Custom	05	USE VEE PAD	FA400V	FA400VLD	FA400HH	EPFA400HH	RSD008	RSD020	RSD020BLK
32	FXDCi Dyna Superglide Custom (Spoke wheels)	06-07	USE VEE PAD	FA400V	FA400VLD	FA400HH	EPFA400HH	RSD008	RSD020	
33	FXDC Super Glide Custom (Spoke wheel)	08-14		FA458V	FA458VLD	FA458HH	EPFA458HH	RSD008	RSD020	
34	FXDBi Street Bob (Spoke wheels)	06-07	USE VEE PAD	FA400V	FA400VLD	FA400HH	EPFA400HH	RSD008	RSD020	
35	FXDB Street Bob (Spoke wheel)	08-17		FA458V	FA458VLD	FA458HH	EPFA458HH	RSD008	RSD020	
36	FXDBC Street Bob LTD	16		FA458V	FA458VLD	FA458HH	EPFA458HH	RSD008	RSD020	
37	FXDi Super Glide (Cast wheel)	06-07	USE VEE PAD	FA400V	FA400VLD	FA400HH	EPFA400HH	RSD008	RSD020	
38	FXDLi Low Rider (Cast wheel)	06-07	USE VEE PAD	FA400V	FA400VLD	FA400HH	EPFA400HH	RSD008	RSD020	
39	FXDLi Low Rider (Spoke wheel)	06-07	USE VEE PAD	FA400V	FA400VLD	FA400HH	EPFA400HH	RSD008	RSD020	
40	FXDL Low Rider (Cast wheel)	08-13		FA458V	FA458VLD	FA458HH	EPFA458HH	RSD008	RSD020	
41	FXDL Low Rider (Spoke wheel)	08-09		FA458V	FA458VLD	FA458HH	EPFA458HH	RSD008	RSD020	
42	FXDL Low Rider (Cast wheel)	14-17		FA458V	FA458VLD	FA458HH	EPFA458HH	RSD008	RSD020	
43	FXDL Low Rider (Spoke wheel)	14-17		FA458V	FA458VLD	FA458HH	EPFA458HH	RSD008	RSD020	
44	FXDCi Superglide Custom (Cast wheel)	06	USE VEE PAD	FA400V	FA400VLD	FA400HH	EPFA400HH	RSD008	RSD020	
45										
46										
47	HARLEY-DAVIDSON® SOFTAIL									
48	FXST, FXSTB, FXSTC, FXSTS, FLST, FLSTC, FLSTF, FLSTS, FLSTN	84-Early 87	FA78	FA78V		FA78HH			N/A	N/A
49	FXST, FXSTB, FXSTC, FXSTS, FLST, FLSTC, FLSTF, FLSTS, FLSTN	Late 87-99	FA200	FA200V		FA200HH	EPFA200HH	RSD007	RSD019	RSD019BLK
50	FXST/FXSTi Softail Standard	00-05	USE VEE PAD	FA400V	FA400VLD	FA400HH	EPFA400HH	RSD008	RSD020	RSD020BLK
51	FXSTB/FXSTBi Night Train	00-05	USE VEE PAD	FA400V	FA400VLD	FA400HH	EPFA400HH	RSD008	RSD020	RSD020BLK
52	FXSTD/FXSTD Softail Deuce/i	00-07	USE VEE PAD	FA400V	FA400VLD	FA400HH	EPFA400HH	RSD008	RSD020	RSD020BLK
53	FXSTS/FXSTSi Softail Springer	00-05	USE VEE PAD	FA400V	FA400VLD	FA400HH	EPFA400HH	RSD008	RSD020	RSD020BLK
54	FLSTF/FLSTFi Fat Boy	00-06	USE VEE PAD	FA400V	FA400VLD	FA400HH	EPFA400HH	RSD008	RSD020	RSD020BLK
55	FLSTFi Fat Boy 15th Anniversary Edition	05	USE VEE PAD	FA400V	FA400VLD	FA400HH	EPFA400HH	RSD008	RSD020	RSD020BLK
56	FLSTF/FLSTFi Fat Boy	07	FA434	FA434V	FA434VLD	FA434HH	EPFA434HH	RSD008	RSD020	RSD020BLK
57	FLSTFi Fat Boy	08-14		FA458V	FA458VLD	FA458HH	EPFA458HH	RSD008	RSD020	RSD020BLK

All names & numbers are for reference purposes only. ® Registered trademarks of Harley—Davidson® Motor Corp or Buell.

Recommended Fittings: FA400 for use on polished chrome show rotors. FA400HH recommended fitting as replacement for OE.

NOTE: — Some models may have a second rotor fitted as an optional extra. Please double check with your customer exactly which side the front rotor is fitted and if twin rotor or single.

⊗ This symbol indicates a rotor made of billet steel, and should be only used with EBC FA Kevlar® Organic or Vee pads.

BRAKE APPLICATIONS

FRONT: AMERICAN PRODUCED MOTORCYCLES

* symbol after part# = 2 pieces reqd.
i.e. 2 pad sets or 2 contour rotors

FRONT

HARLEY-DAVIDSON® SOFTAIL

YEAR	Organic Pads /Shoes	Semi-Sintered V-Pads™	Chrome Back V-Pads™	Sintered Double-H™ Pads	EPFA Fast Road Use & Track Days	Solid Front Rotor	5 Bobbin Style Rotor	10 Bobbin Polished Rotor	5 Bobbin Black Chrome Centered Rotor	10 Bobbin Black Chrome Centered Rotor	
FLSTF Fat Boy	15-17			FA296HH		MD530		N/A		N/A	
FLSTFB Fat Boy LO	10-14	FA457V	FA457VLD	FA457HH	EPFA457HH	FSD008	FSD010	FSD023	FSD010BLK	FSD023BLK	
FLSTFB Fat Boy LO	15-17			FA296HH		MD530		N/A		N/A	
FLFB Fat Boy	18			FA296HH		MD530					
FLFBS Fat Boy 114	18			FA296HH		MD530					
FLFBS Fat Boy Anniversary	18			FA296HH		MD530					
FLSTC/FLSTC Heritage Classic/i	00-07	FA400	FA400V	FA400VLD	FA400HH	EPFA400HH	FSD008	FSD010	FSD023	FSD010BLK	FSD023BLK
FLSTS Heritage Springer	00-03	FA94	FA94V		FA94HH		FSD008	FSD010	FSD023	FSD010BLK	FSD023BLK
FLSTN/FLSTNi Softail Deluxe	05-07	FA400	FA400V	FA400VLD	FA400HH	EPFA400HH	FSD008	FSD010	FSD023	FSD010BLK	FSD023BLK
FLSTSC/FLSTSCi Springer Classic	05-07	FA94	FA94V		FA94HH		FSD008	FSD010	FSD023	FSD010BLK	FSD023BLK
FLST/FLSTi Heritage Softail	06	FA400	FA400V	FA400VLD	FA400HH	EPFA400HH	FSD008	FSD010	FSD023	FSD010BLK	FSD023BLK
FLSTSB Softail Cross Bones	08-11	FA94	FA94V		FA94HH		FSD008	FSD010	FSD023	FSD010BLK	FSD023BLK
FXST/FXSTi Softail Standard	06-07	FA400	FA400V	FA400VLD	FA400HH	EPFA400HH	FSD008	FSD010	FSD023	FSD010BLK	FSD023BLK
FXST Softail Standard	08-14		FA457V	FA457VLD	FA457HH	EPFA457HH	FSD008	FSD010	FSD023	FSD010BLK	FSD023BLK
FXST Softail Standard	15			FA296HH		MD526		N/A		N/A	
FXSTB/FXSTBi Night Train Softail	06-07	FA400	FA400V	FA400VLD	FA400HH	EPFA400HH	FSD008	FSD010	FSD023	FSD010BLK	FSD023BLK
FXSTB Night Train (Spoke wheel)	08-09		FA457V	FA457VLD	FA457HH	EPFA457HH	FSD008	FSD010	FSD023	FSD010BLK	FSD023BLK
FXSTC Softail Custom	07	FA400	FA400V	FA400VLD	FA400HH	EPFA400HH	FSD008	FSD010	FSD023	FSD010BLK	FSD023BLK
FXSTC Softail Custom (Spoke wheel)	08-10		FA457V	FA457VLD	FA457HH	EPFA457HH	FSD008	FSD010	FSD023	FSD010BLK	FSD023BLK
FLSTSC/FLSTSCi Springer Softail Classic	06-07	FA94	FA94V		FA94HH		FSD008	FSD010	FSD023	FSD010BLK	FSD023BLK
FLSTC Heritage Softail Classic	07	FA400	FA400V	FA400VLD	FA400HH	EPFA400HH	FSD008	FSD010	FSD023	FSD010BLK	FSD023BLK
FLSTC Heritage Softail Classic	08-14		FA457V	FA457VLD	FA457HH	EPFA457HH	FSD008	FSD010	FSD023	FSD010BLK	FSD023BLK
FLSTC Heritage Softail Classic	15-17			FA296HH		MD526		N/A		N/A	
FLHC Heritage Classic	18			FA296HH		MD526					
FLHCS Heritage Classic 114	18			FA296HH		MD526					
FLHCS Heritage Classic 114 Anniversary	18			FA296HH		MD526					
FLSTN Softail Deluxe (Spoke wheel)	08-14		FA457V	FA457VLD	FA457HH	EPFA457HH	FSD008	FSD010	FSD023	FSD010BLK	FSD023BLK
FLSTN Softail Deluxe	15-17			FA296HH		MD526		N/A		N/A	
FLS Softail Slim	12-14		FA457V	FA457VLD	FA457HH	EPFA457HH	FSD008	FSD010	FSD023	FSD010BLK	FSD023BLK
FLS Softail Slim	15-17			FA296HH		MD526		N/A		N/A	
FLSL Softail Slim	18			FA296HH		MD526		N/A		N/A	
FXCW Rocker (Cast wheel)	08-09		FA457V	FA457VLD	FA457HH	EPFA457HH	FSD008	FSD010	FSD023	FSD010BLK	FSD023BLK
FXCWC Rocker C (Cast wheel)	08-11		FA457V	FA457VLD	FA457HH	EPFA457HH	FSD008	FSD010	FSD023	FSD010BLK	FSD023BLK
FXS Blackline	11-13		FA457V	FA457VLD	FA457HH	EPFA457HH	FSD008	FSD010	FSD023	FSD010BLK	FSD023BLK
FXSB Breakout	13-14		FA457V	FA457VLD	FA457HH	EPFA457HH	FSD008	FSD010	FSD023	FSD010BLK	FSD023BLK
FXSB Breakout	15-17			FA296HH				TBA	N/A	N/A	
FXBR Breakout	18			FA296HH		FSD008					
FXBRS Breakout 114	18			FA296HH		FSD008					
FXBRS Breakout 114 Anniversary	18			FA296HH		FSD008					
FLDE Deluxe	18			FA296HH		MD526					
FXBB Street Bob	18			FA296HH		MD526					
FXFB Fat Bob	18			FA296HH*		FSD008*					
FXBS Fat Bob	18			FA296HH*		FSD008*					
FXLR Low Rider	18			FA296HH		MD526					

HARLEY-DAVIDSON® S SERIES

FLSS Softail Slim S	16-17			FA296HH			TBA	N/A		N/A
FLSTFBS Fat Boy S	16-17			FA296HH			TBA	N/A		N/A
FXDLS Dyna Low Rider S	17		FA457V*	FA457VLD*	FA457HH*	EPFA457HH*	MD516* ♦			

HARLEY-DAVIDSON® TOURING

FLT, FLHT, FLHTCI (Ultraglide®, Electraglide®, Electraglide Classic®/Ultra Classic®)	80-83	FA72*	FA72V*					N/A*			
FLT, FLHT, FLHTCI (Ultraglide®, Electraglide®, Electraglide Classic®/Ultra Classic®)	84-85	FA94*	FA94V*		FA94HH*	EPFA94HH*		N/A*			
FLT, FLHT, FLHTCI (Ultraglide®, Electraglide®, Electraglide Classic®/Ultra Classic®)	86-99	FA94*	FA94V*		FA94HH*	EPFA94HH*	FSD007*	FSD009*		FSD009BLK*	
FLHR, FLHRCI (Road King®, Road King Classic®)	94-99	FA94*	FA94V*		FA94HH*	EPFA94HH*	FSD007*	FSD009*	FSD022*	FSD009BLK*	FSD022BLK*
FLHRI/FLHR Road King	00-07	FA400*	FA400V*	FA400VLD*	FA400HH*	EPFA400HH*	FSD008*	FSD010*	FSD023*	FSD010BLK*	FSD023BLK*
FLHRCI Road King Classic	00-07	FA400*	FA400V*	FA400VLD*	FA400HH*	EPFA400HH*	FSD008*	FSD010*	FSD023*		FSD023BLK*

* This symbol indicates a rotor made of billet steel, and should be only used with EBC FA Kevlar® Organic or Vee pads.

Line #

REAR: AMERICAN PRODUCED MOTORCYCLES

* symbol after part# = 2 pieces reqd.
i.e. 2 pad sets or 2 contour rotors

HARLEY-DAVIDSON® SOFTAIL

Line #

		REAR								
	YEAR	Organic Pads /Shoes	Semi-Sintered V-Pads™	Chrome Back V-Pads™	Sintered Double-H™ Pads	EPFA Fast Road Use & Track Days	Solid Rear Rotor	10 Bobbin Polished Rotor	10 Bobbin Black Chrome Rotor	
1	FLSTF Fat Boy	15-17		FA458V	FA458VLD	FA458HH	EPFA458HH	RSD008	RSD020	RSD020BLK
2	FLSTFB Fat Boy LO	10-14		FA458V	FA458VLD	FA458HH	EPFA458HH	RSD008	RSD020	RSD020BLK
3	FLSTFB Fat Boy LO	15-17		FA458V	FA458VLD	FA458HH	EPFA458HH	RSD008	RSD020	RSD020BLK
4	FLFB Fat Boy	18		FA710V		FA710HH			TBA	
5	FLFBS Fat Boy 114	18		FA710V		FA710HH			TBA	
6	FLFBS Fat Boy Anniversary	18		FA710V		FA710HH			TBA	
7	FLSTC/FLSTC Heritage Classic/i	00-07	USE VEE PAD	FA400V	FA400VLD	FA400HH	EPFA400HH	RSD008	RSD020	RSD020BLK
8	FLSTS Heritage Springer	00-03	USE VEE PAD	FA400V	FA400VLD	FA400HH	EPFA400HH	RSD008	RSD020	RSD020BLK
9	FLSTN/FLSTNi Softail Deluxe	05-07	USE VEE PAD	FA400V	FA400VLD	FA400HH	EPFA400HH	RSD008	RSD020	RSD020BLK
10	FLSTSC/FLSTSCi Springer Classic	05-07	USE VEE PAD	FA400V	FA400VLD	FA400HH	EPFA400HH	RSD008	RSD020	RSD020BLK
11	FLST/FLSTI Heritage Softail	06	USE VEE PAD	FA400V	FA400VLD	FA400HH	EPFA400HH	RSD008	RSD020	RSD020BLK
12	FLSTSB Softail Cross Bones	08-11		FA458V	FA458VLD	FA458HH	EPFA458HH	RSD008	RSD020	RSD020BLK
13	FXST/FXSTI Softail Standard	06-07	FA434	FA434V	FA434VLD	FA434HH	EPFA434HH	RSD008	RSD020	RSD020BLK
14	FXST Softail Standard	08-14		FA458V	FA458VLD	FA458HH	EPFA458HH	RSD008	RSD020	RSD020BLK
15	FXST Softail Standard	15		FA458V	FA458VLD	FA458HH	EPFA458HH	RSD008	RSD020	RSD020BLK
16	FXSTB/FXSTBi Night Train Softail	06-07	FA434	FA434V	FA434VLD	FA434HH	EPFA434HH	RSD008	RSD020	RSD020BLK
17	FXSTB Night Train (Spoke wheel)	08-09		FA458V	FA458VLD	FA458HH	EPFA458HH	RSD008	RSD020	RSD020BLK
18	FXSTC Softail Custom	07	FA434	FA434V	FA434VLD	FA434HH	EPFA434HH	RSD008	RSD020	RSD020BLK
19	FXSTC Softail Custom (Spoke wheel)	08-10		FA458V	FA458VLD	FA458HH	EPFA458HH	RSD008	RSD020	RSD020BLK
20	FLSTSC/FLSTSCi Springer Softail Classic	06-07	USE VEE PAD	FA400V	FA400VLD	FA400HH	EPFA400HH	RSD008	RSD020	RSD020BLK
21	FLSTC Heritage Softail Classic	07	USE VEE PAD	FA400V	FA400VLD	FA400HH	EPFA400HH	RSD008	RSD020	RSD020BLK
22	FLSTC Heritage Softail Classic	08-14		FA458V	FA458VLD	FA458HH	EPFA458HH	RSD008	RSD020	RSD020BLK
23	FLSTC Heritage Softail Classic	15-17		FA458V	FA458VLD	FA458HH	EPFA458HH	RSD008	RSD020	RSD020BLK
24	FLHC Heritage Classic	18		FA710V		FA710HH			RSD016	RSD016BLK
25	FLHCS Heritage Classic 114	18		FA710V		FA710HH			RSD016	RSD016BLK
26	FLHCS Heritage Classic 114 Anniversary	18		FA710V		FA710HH			RSD016	RSD016BLK
27	FLSTN Softail Deluxe (Spoke wheel)	08-14		FA458V	FA458VLD	FA458HH	EPFA458HH	RSD008	RSD020	RSD020BLK
28	FLSTN Softail Deluxe	15-17		FA458V	FA458VLD	FA458HH	EPFA458HH	RSD008	RSD020	RSD020BLK
29	FLS Softail Slim	12-14		FA458V	FA458VLD	FA458HH	EPFA458HH	RSD008	RSD020	RSD020BLK
30	FLS Softail Slim	15-17		FA458V	FA458VLD	FA458HH	EPFA458HH	RSD008	RSD020	RSD020BLK
31	FLSL Softail Slim	18		FA710V		FA710HH			RSD016	RSD016BLK
32	FXCW Rocker (Cast wheel)	08-09		FA458V	FA458VLD	FA458HH	EPFA458HH	RSD008	RSD020	RSD020BLK
33	FXCWC Rocker C (Cast wheel)	08-11		FA458V	FA458VLD	FA458HH	EPFA458HH	RSD008	RSD020	RSD020BLK
34	FXS Blackline	11-13		FA458V	FA458VLD	FA458HH	EPFA458HH	RSD008	RSD020	RSD020BLK
35	FXSB Breakout	13-14		FA458V	FA458VLD	FA458HH	EPFA458HH	RSD008	RSD020	RSD020BLK
36	FXSB Breakout	15-17		FA458V	FA458VLD	FA458HH	EPFA458HH		TBA	TBA
37	FXBR Breakout	18		FA710V		FA710HH			TBA	
38	FXBRS Breakout 114	18		FA710V		FA710HH			TBA	
39	FXBRS Breakout 114 Anniversary	18		FA710V		FA710HH			TBA	
40	FLDE Deluxe	18		FA710V		FA710HH			RSD016	RSD016BLK
41	FXBB Street Bob	18		FA710V		FA710HH			RSD016	RSD016BLK
42	FXFB Fat Bob	18		FA710V		FA710HH			TBA	
43	FXBS Fat Bob	18		FA710V		FA710HH			TBA	
44	FXLR Low Rider	18		FA710V		FA710HH			RSD016	RSD016BLK
45										
46	HARLEY-DAVIDSON® S SERIES									
47	FLSS Softail Slim S	16-17		FA458V	FA458VLD	FA458HH	EPFA458HH		TBA	
48	FLSTFBS Fat Boy S	16-17		FA458V	FA458VLD	FA458HH	EPFA458HH		TBA	
49	FXDLS Dyna Low Rider S	17		FA458V	FA458VLD	FA458HH	EPFA458HH	RSD008	RSD020	RSD020BLK
50										
51	HARLEY-DAVIDSON® TOURING									
52	FLT, FLHT, FLHTCI (Ultraglide®, Electraglide®, Electraglide Classic®/Ultra Classic®)	80-83	FA79	FA79V					N/A	
53	FLT, FLHT, FLHTCI (Ultraglide®, Electraglide®, Electraglide Classic®/Ultra Classic®)	84-85	FA79	FA79V					N/A	
54	FLT, FLHT, FLHTCI (Ultraglide®, Electraglide®, Electraglide Classic®/Ultra Classic®)	86-99	FA201	FA201V		FA201HH	EPFA201HH	MD509SR		
55	FLHR, FLHRCi (Road King®, Road King Classic®)	94-99	FA201	FA201V		FA201HH	EPFA201HH	MD509SR		
56	FLHRCi Road King	00-07	USE VEE PAD	FA400V	FA400VLD	FA400HH	EPFA400HH	RSD008	RSD020	RSD020BLK
57	FLHRCi Road King Classic	00-07	USE VEE PAD	FA400V	FA400VLD	FA400HH	EPFA400HH	RSD008	RSD020	RSD020BLK

All names & numbers are for reference purposes only. ® Registered trademarks of Harley—Davidson® Motor Corp or Buell.

Recommended Fittings: FA400 for use on polished chrome show rotors. FA400HH recommended fitting as replacement for OE.

NOTE: — Some models may have a second rotor fitted as an optional extra. Please double check with your customer exactly which side the front rotor is fitted and if twin rotor or single.

⊗ This symbol indicates a rotor made of billet steel, and should be only used with EBC FA Kevlar® Organic or Vee pads.

BRAKE APPLICATIONS

FRONT: AMERICAN PRODUCED MOTORCYCLES

* symbol after part# = 2 pieces reqd.
i.e. 2 pad sets or 2 contour rotors

FRONT

HARLEY-DAVIDSON® TOURING

YEAR	Organic Pads /Shoes	Semi-Sintered V-Pads™	Chrome Back V-Pads™	Sintered Double-H™ Pads	EPFA Fast Road Use & Track Days	Solid Front Rotor	5 Bobbin Style Rotor	10 Bobbin Polished Rotor	5 Bobbin Black Chrome Centered Rotor	10 Bobbin Black Chrome Centered Rotor	
FLHR Road King (Spoke Wheel Type)	08-16	FA409*	FA409V*	FA409VLD*	FA409HH*	EPFA409HH*	MD520*	N/A*		N/A*	
FLHR Road King (Cast Wheel Type)	15-18	FA409*	FA409V*	FA409VLD*	FA409HH*	EPFA409HH*	MD529	N/A*		N/A*	
FLHRC Road King Classic	08-18	FA409*	FA409V*	FA409VLD*	FA409HH*	EPFA409HH*	MD520	N/A*		N/A*	
FLHT/FLHTi Electra Glide Standard	00-07	FA400*	FA400V*	FA400VLD*	FA400HH*	EPFA400HH*	FSD008*	FSD010*	FSD023*	FSD010BLK*	FSD023BLK*
FLTR/FLTR-i Road Glide	00-07	FA400*	FA400V*	FA400VLD*	FA400HH*	EPFA400HH*	FSD008*	FSD010*	FSD023*	FSD010BLK*	FSD023BLK*
FLTR Road Glide	08-09	FA409*	FA409V*	FA409VLD*	FA409HH*	EPFA409HH*	MD520*	N/A*		N/A*	
FLTRX Road Glide	15-18	FA409*	FA409V*	FA409VLD*	FA409HH*	EPFA409HH*	MD529	N/A*		N/A*	
FLTRX Road Glide Custom	10-12	FA409*	FA409V*	FA409VLD*	FA409HH*	EPFA409HH*	MD520*	N/A*		N/A*	
FLTRXS Road Glide Special	15-17	FA409*	FA409V*	FA409VLD*	FA409HH*	EPFA409HH*	MD529	N/A*		N/A*	
FLTRXS Road Glide Special	18	FA409*	FA409V*	FA409VLD*	FA409HH*	EPFA409HH*	TBA	N/A*		N/A*	
FLTRU Road Glide Ultra	11-12	FA409*	FA409V*	FA409VLD*	FA409HH*	EPFA409HH*	MD520	N/A*		N/A*	
FLTRU Road Glide Ultra	16-18	FA409*	FA409V*	FA409VLD*	FA409HH*	EPFA409HH*	MD529	N/A*		N/A*	
FLHTCU-i Electra Glide Ultra Classic	00-07	FA400*	FA400V*	FA400VLD*	FA400HH*	EPFA400HH*	FSD008*	FSD010	FSD023*	FSD010BLK*	FSD023BLK*
FLHRS/FLHRSi Road King Custom	04-07	FA400*	FA400V*	FA400VLD*	FA400HH*	EPFA400HH*	FSD008*	FSD010*	FSD023*	FSD010BLK*	FSD023BLK*
FLHTC/FLHTCi Electra Glide Classic	04-07	FA400*	FA400V*	FA400VLD*	FA400HH*	EPFA400HH*	FSD008*	FSD010*	FSD023*	FSD010BLK*	FSD023BLK*
FLHTC Electra Glide Classic	08-12	FA409*	FA409V*	FA409VLD*	FA409HH*	EPFA409HH*	MD520*	N/A*		N/A*	
FLHTCU Ultra Classic Electra Glide	08-13	FA409*	FA409V*	FA409VLD*	FA409HH*	EPFA409HH*	MD520*	N/A*		N/A*	
FLHTCU Ultra Classic Electra Glide	14-18	FA409*	FA409V*	FA409VLD*	FA409HH*	EPFA409HH*	MD529*	N/A*		N/A*	
FLHTCUL Ultra Classic Electra Glide Low	15-16	FA409*	FA409V*	FA409VLD*	FA409HH*	EPFA409HH*	MD529*	N/A*		N/A*	
FLHT Electra Glide Standard	08-10	FA409*	FA409V*	FA409VLD*	FA409HH*	EPFA409HH*	MD520*	N/A*		N/A*	
FLHTK Electra Glide Ultra LTD	10-13	FA409*	FA409V*	FA409VLD*	FA409HH*	EPFA409HH*	MD529*	N/A*		N/A*	
FLHTK Electra Glide Ultra LTD	15-18	FA409*	FA409V*	FA409VLD*	FA409HH*	EPFA409HH*	MD529*	N/A*		N/A*	
FLHTK Electra Glide Ultra LTD Anniversary	15-18	FA409*	FA409V*	FA409VLD*	FA409HH*	EPFA409HH*	MD529*	N/A*		N/A*	
FLHTK Electra Glide Ultra LTD Shrine Edition	15-18	FA409*	FA409V*	FA409VLD*	FA409HH*	EPFA409HH*	MD529*	N/A*		N/A*	
FLHTKL Electra Glide Ultra LTD Low	15-18	FA409*	FA409V*	FA409VLD*	FA409HH*	EPFA409HH*	MD529*	N/A*		N/A*	
FLHRXS Road King Special	18	FA409*	FA409V*	FA409VLD*	FA409HH*	EPFA409HH*	MD529*	N/A*		N/A*	
FLHX/FLHXi Street Glide	06-07	FA400*	FA400V*	FA400VLD*	FA400HH*	EPFA400HH*	FSD008*	FSD010*	FSD023*	FSD010BLK*	FSD023BLK*
FLHX Street Glide	08-13	FA409*	FA409V*	FA409VLD*	FA409HH*	EPFA409HH*	MD520*	N/A*		N/A*	
FLHX Street Glide	14-18	FA409*	FA409V*	FA409VLD*	FA409HH*	EPFA409HH*	MD529*	N/A*		N/A*	
FLHXS Street Glide Special	15-18	FA409*	FA409V*	FA409VLD*	FA409HH*	EPFA409HH*	MD529*	N/A*		N/A*	
FLHX Street Glide Anniversary	18	FA409*	FA409V*	FA409VLD*	FA409HH*	EPFA409HH*	MD529*	N/A*		N/A*	
FLHXS Street Glide Special Anniversary	18	FA409*	FA409V*	FA409VLD*	FA409HH*	EPFA409HH*	MD529*	N/A*		N/A*	
HARLEY-DAVIDSON® TRIKE											
FLHTCUTG Tri Glide Ultra Classic Trike	09-13	USE V PAD	FA409V*	FA409VLD*	FA409HH*	EPFA409HH*	MD520*	N/A*		N/A*	
FLHXX Street Glide Trike	10-11	USE V PAD	FA409V*	FA409VLD*	FA409HH*	EPFA409HH*	MD520*	N/A*		N/A*	
FLRT Freewheeler Trike	15-18	FA638*	FA638V*		FA638HH*		MD530*	N/A*		N/A*	
FLHTCUTG Tri Glide Ultra Trike	14-18	FA638*	FA638V*		FA638HH*		MD530*	N/A*		N/A*	
FLHTCUTG Tri Glide Ultra Trike Anniversary	18	FA638*	FA638V*		FA638HH*		MD530*	N/A*		N/A*	
HARLEY-DAVIDSON® V-ROD											
V-Rod (Hayes Caliper)	02-05	FA400*	FA400V*	FA400VLD*	FA400HH*	EPFA400HH*	MD514LS/RS	N/A*		N/A*	
V-Rod (Brembo Caliper)	06	FA409*	FA409V*	FA409VLD*	FA409HH*	EPFA409HH*	MD516* ♦	N/A*		N/A*	
VRSCAW V-Rod	07	FA409*	FA409V*	FA409VLD*	FA409HH*	EPFA409HH*	MD516* ♦	N/A*		N/A*	
VRSCAW V-Rod (Spoke wheel)	08-09	FA409*	FA409V*	FA409VLD*	FA409HH*	EPFA409HH*	MD518*	N/A*		N/A*	
VRSCR Street Rod	06-07	FA409*	FA409V*	FA409VLD*	FA409HH*	EPFA409HH*	MD516* ♦	N/A*		N/A*	
VRSCD Night Rod (Cast Wheel)	06-08	FA409*	FA409V*	FA409VLD*	FA409HH*	EPFA409HH*	MD516* ♦	N/A*		N/A*	
VRSCDX Night Rod Special (Cast Wheel)	07-17	FA409*	FA409V*	FA409VLD*	FA409HH*	EPFA409HH*	MD516* ♦	N/A*		N/A*	
VRSC 10th Anniversary V Rod	12	FA409*	FA409V*	FA409VLD*	FA409HH*	EPFA409HH*	MD516* ♦	N/A*		N/A*	
VRSCX V-Rod	07	FA409*	FA409V*	FA409VLD*	FA409HH*	EPFA409HH*	MD518*	N/A*		N/A*	
VRSCF V-Rod Muscle	09-17	FA409*	FA409V*	FA409VLD*	FA409HH*	EPFA409HH*	MD516* ♦	N/A*		N/A*	

♦ NEW FLOATING CONVERSION AVAILABLE TO REPLACE MD516 ORIGINAL SOLID DISC - ORDER MD516X

* This symbol indicates a rotor made of billet steel, and should be only used with EBC FA Kevlar® Organic or Vee pads.

APPLICATIONS
BRAKE

Line #
1
2
3
4
5
6
7
8
9
10
11
12
13
14
15
16
17
18
19
20
21
22
23
24
25
26
27
28
29
30
31
32
33
34
35
36
37
38
39
40
41
42
43
44
45
46
47
48
49
50
51
52
53
54
55
56
57

REAR: AMERICAN PRODUCED MOTORCYCLES

* symbol after part# = 2 pieces reqd.
i.e. 2 pad sets or 2 contour rotors

HARLEY-DAVIDSON® TOURING

Line #

			REAR								
		YEAR	Organic Pads /Shoes	Semi-Sintered V-Pads™	Chrome Back V-Pads™	Sintered Double-H™ Pads	EPFA Fast Road Use & Track Days	Solid Rear Rotor	10 Bobbin Polished Rotor	10 Bobbin Black Chrome Rotor	
1	FLHR Road King (Spoke Wheel Type)	08-16	FA409	FA409V	FA409VLD	FA409HH	EPFA409HH		MD521		
2	FLHR Road King (Cast Wheel Type)	15-18	FA409	FA409V	FA409VLD	FA409HH	EPFA409HH		MD521		
3	FLHRC Road King Classic	08-18	FA409	FA409V	FA409VLD	FA409HH	EPFA409HH		MD521		
4	FLHT/FLHTi Electra Glide Standard	00-07	USE VEE PAD	FA400V	FA400VLD	FA400HH	EPFA400HH	RSD008	RSD020	RSD020BLK	
5	FLTR/FLTR-i Road Glide	00-07	USE VEE PAD	FA400V	FA400VLD	FA400HH	EPFA400HH	RSD008	RSD020	RSD020BLK	
6	FLTR Road Glide	08-09	FA409	FA409V	FA409VLD	FA409HH	EPFA409HH		MD521		
7	FLTRX Road Glide	15-18	FA409	FA409V	FA409VLD	FA409HH	EPFA409HH		MD521		
8	FLTRX Road Glide Custom	10-12	FA409	FA409V	FA409VLD	FA409HH	EPFA409HH		MD521		
9	FLTRXS Road Glide Special	15-17	FA409	FA409V	FA409VLD	FA409HH	EPFA409HH		MD521		
10	FLTRXS Road Glide Special	18	FA409	FA409V	FA409VLD	FA409HH	EPFA409HH		MD521		
11	FLTRU Road Glide Ultra	11-12	FA409	FA409V	FA409VLD	FA409HH	EPFA409HH		MD521		
12	FLTRU Road Glide Ultra	16-18	FA409	FA409V	FA409VLD	FA409HH	EPFA409HH		MD521		
13	FLHTCU-i Electra Glide Ultra Classic	00-07	USE VEE PAD	FA400V	FA400VLD	FA400HH	EPFA400HH	RSD008	RSD020	RSD020BLK	
14	FLHRS/FLHRSi Road King Custom	04-07	USE VEE PAD	FA400V	FA400VLD	FA400HH	EPFA400HH	RSD008	RSD020	RSD020BLK	
15	FLHTC/FLHTCi Electra Glide Classic	04-07	USE VEE PAD	FA400V	FA400VLD	FA400HH	EPFA400HH	RSD008	RSD020	RSD020BLK	
16	FLHTC Electra Glide Classic	08-12	FA409	FA409V	FA409VLD	FA409HH	EPFA409HH		MD521		
17	FLHTCU Ultra Classic Electra Glide	08-13	FA409	FA409V	FA409VLD	FA409HH	EPFA409HH		MD521		
18	FLHTCU Ultra Classic Electra Glide	14-18	FA409	FA409V	FA409VLD	FA409HH	EPFA409HH		MD521		
19	FLHTCUL Ultra Classic Electra Glide Low	15-16	FA409	FA409V	FA409VLD	FA409HH	EPFA409HH		MD521		
20	FLHT Electra Glide Standard	08-10	FA409	FA409V	FA409VLD	FA409HH	EPFA409HH		MD521		
21	FLHTK Electra Glide Ultra LTD	10-13	FA409	FA409V	FA409VLD	FA409HH	EPFA409HH		MD521		
22	FLHTK Electra Glide Ultra LTD	15-18	FA409	FA409V	FA409VLD	FA409HH	EPFA409HH		MD521		
23	FLHTK Electra Glide Ultra LTD Anniversary	15-18	FA409	FA409V	FA409VLD	FA409HH	EPFA409HH		MD521		
24	FLHTK Electra Glide Ultra LTD Shrine Edition	15-18	FA409	FA409V	FA409VLD	FA409HH	EPFA409HH		MD521		
25	FLHTKL Electra Glide Ultra LTD Low	15-18	FA409	FA409V	FA409VLD	FA409HH	EPFA409HH		MD521		
26	FLHRXS Road King Special	18	FA409	FA409V	FA409VLD	FA409HH	EPFA409HH		MD521		
27	FLHX/FLHXi Street Glide	06-07	USE VEE PAD	FA400V	FA400VLD	FA400HH	EPFA409HH	RSD008	RSD020	RSD020BLK	
28	FLHX Street Glide	08-13	FA409	FA409V	FA409VLD	FA409HH	EPFA409HH		MD521		
29	FLHX Street Glide	14-18	FA409	FA409V	FA409VLD	FA409HH	EPFA409HH		MD521		
30	FLHXS Street Glide Special	15-18	FA409	FA409V	FA409VLD	FA409HH	EPFA409HH		MD521		
31	FLHX Street Glide Anniversary	18	FA409	FA409V	FA409VLD	FA409HH	EPFA409HH		MD521		
32	FLHXS Street Glide Special Anniversary	18	FA409	FA409V	FA409VLD	FA409HH	EPFA409HH		MD521		
33	HARLEY-DAVIDSON® TRIKE										
34											
35	FLHTCUTG Tri Glide Ultra Classic Trike	09-13	USE VEE PAD	FA605/4V		FA605/4HH			N/A*		
36	FLHXX Street Glide Trike	10-11	USE VEE PAD	FA605/4V		FA605/4HH			N/A*		
37	FLRT Freewheeler Trike	15-18	FA641/4	FA641/4V		FA641/4HH			N/A*		
38	FLHTCUTG Tri Glide Ultra Trike	14-18	FA641/4	FA641/4V		FA641/4HH			N/A*		
39	FLHTCUTG Tri Glide Ultra Trike Anniversary	18	FA641/4	FA641/4V		FA641/4HH			N/A*		
40	HARLEY-DAVIDSON® V-ROD										
41											
42	V-Rod (Hayes Caliper)	02-05	FA400	FA400V	FA400VLD	FA400HH	EPFA400HH	MD515			
43	V-Rod (Brembo Caliper)	06	FA409	FA409V	FA409VLD	FA409HH	EPFA409HH	MD517			
44	VRSCAW V-Rod	07	FA409	FA409V	FA409VLD	FA409HH	EPFA409HH	MD517			
45	VRSCAW V-Rod (Spoke wheel)	08-09	FA409	FA409V	FA409VLD	FA409HH	EPFA409HH	MD517			
46	VRSCR Street Rod	06-07	FA409	FA409V	FA409VLD	FA409HH	EPFA409HH	MD517			
47	VRSCD Night Rod (Cast Wheel)	06-08	FA409	FA409V	FA409VLD	FA409HH	EPFA409HH	MD517			
48	VRSCDX Night Rod Special (Cast Wheel)	07-17	FA409	FA409V	FA409VLD	FA409HH	EPFA409HH	MD517			
49	VRSC 10th Anniversary V Rod	12	FA409	FA409V	FA409VLD	FA409HH	EPFA409HH	MD517			
50	VRSCX V-Rod	07	FA409	FA409V	FA409VLD	FA409HH	EPFA409HH	MD517			
51	VRSCF V-Rod Muscle	09-17	FA409	FA409V	FA409VLD	FA409HH	EPFA409HH	MD525			
52											
53											
54											
55											
56											
57											

All names & numbers are for reference purposes only. ® Registered trademarks of Harley—Davidson® Motor Corp or Buell.

Recommended Fittings: FA400 for use on polished chrome show rotors. FA400HH recommended fitting as replacement for OE.

NOTE: — Some models may have a second rotor fitted as an optional extra. Please double check with your customer exactly which side the front rotor is fitted and if twin rotor or single.

⊗ This symbol indicates a rotor made of billet steel, and should be only used with EBC FA Kevlar® Organic or Vee pads.

BRAKE APPLICATIONS

FRONT: AMERICAN PRODUCED MOTORCYCLES

USA BUILT MOTORCYCLE BRAKE ROTORS - FRONT - HOW TO CHOOSE

APPLICATIONS

BRAKE

⊛ This symbol indicates a rotor made of billet steel, and should be only used with EBC FA Kevlar® Organic or Vee pads.

FRONT 11.5"/292mm	Solid Rotor	Floating Conversion - Full Circle Rotor Blade - 5 Bobbin Type	Floating Conversion - Contoured Rotor Blade - 5 Bobbin Type	Floating Conversion - Full Circle Rotor Blade - 10 Bobbin Type	Floating Conversion - Contoured Rotor Blade - 10 Bobbin Type
Narrow band 50mm bore with speedo slot Pads FA216/3, FA400, FA457, FA640	FSD001	FSD003 or FSD003BLK	FSD005C or FSD005CBLK	FSD028 or FSD028BLK	FSD024C or FSD024CBLK
Narrow band 56mm bore - no speedo slot Pads FA216/3, FA400, FA457, FA640	FSD002	FSD004 or FSD004BLK	FSD006C or FSD006CBLK	FSD021 or FSD021BLK	FSD025C or FSD025CBLK
Wide band 50mm bore Pads FA94, FA381, FA400, FA457	FSD007	FSD009 or FSD009BLK	FSD011C or FSD011CBLK	FSD022 or FSD022BLK	FSD026C or FSD026CBLK
Wide band 56mm bore Pads FA94, FA381, FA400, FA457	FSD008	FSD010 or FSD010BLK	FSD012C or FSD012CBLK	FSD023 or FSD023BLK	FSD027C or FSD027CBLK

All floating discs have polished stainless center hubs and stainless rotor blades unless marked BLK for black chrome finish on center hub.

REAR: AMERICAN PRODUCED MOTORCYCLES

USA BUILT MOTORCYCLE BRAKE ROTORS - REAR - HOW TO CHOOSE

REAR 11.5"/292mm	Solid Rotor	Floating Conversion - Full Circle Rotor Blade - 5 Bobbin Type	Floating Conversion - Contoured Rotor Blade - 5 Bobbin Type	Floating Conversion - Full Circle Rotor Blade - 10 Bobbin Type	Floating Conversion - Contoured Rotor Blade - 10 Bobbin Type
Narrow band 50mm bore Pads FA216/3	RSD001	Not Made	Not Made	RSD015 or RSD015BLK	RSD013C or RSD013CBLK
Narrow band 56mm bore Pads FA216/3	RSD002	Not Made	Not Made	RSD016 or RSD016BLK	RSD014C or RSD014CBLK
Wide band 50mm bore Pads FA200, FA201, FA387, FA400, FA434, FA458	RSD007	Not Made	Not Made	RSD019 or RSD019BLK	RSD017C or RSD017CBLK
Wide band 56mm bore Pads FA200, FA201, FA387, FA400, FA434, FA458	RSD008	Not Made	Not Made	RSD020 or RSD020BLK	RSD018C or RSD018CBLK

All floating discs have polished stainless center hubs and stainless rotor blades unless marked BLK for black chrome finish on center hub.

All names & numbers are for reference purposes only. ® Registered trademarks of Harley—Davidson® Motor Corp or Buell.

Recommended Fittings: FA400 for use on polished chrome show rotors. FA400HH recommended fitting as replacement for OE.

NOTE: — Some models may have a second rotor fitted as an optional extra. Please double check with your customer exactly which side the front rotor is fitted and if twin rotor or single.

⊗ This symbol indicates a rotor made of billet steel, and should be only used with EBC FA Kevlar® Organic or Vee pads.

**BRAKE
APPLICATIONS**

FRONT: HONDA



HONDA



DISC PAD CHOICES - FRONT

BRAKE ROTOR CHOICES - FRONT

			Semi-Sintered V-Pads™	Sintered/HH Pads/Grooved Shoes	SV Series Severe Duty Pads			UTVX Rotor			
CHF 50/50 P/S Metropolitan	02-11	333									
CRF 50 F	04-17	301		N/A							
Dream 50 R CBR (AR02)	04	FA197		FA197HH			TBA				
MB5	82	FA54		FA54HH			N/A				
MR 50 K Elsinore	74-75	301		N/A							
NA 50 Express II	79-81	301									
NB 50/NB 50 M Aero 50	83-87	301									
NC 50 Express	77-80	301									
NC 50 Express	81-83	301									
NCH 50 Metropolitan	13-16	333									
NN 50 MD Gyro	84	301									
NPS 50 Ruckus/NPS 50 S	03-16	333									
NQ 50 D/NQ 50 Spree/Spree Special	84-87	301									
NS 50 F	90	303									
NSR 50 R (RS50) Mini 50	04	FA197		FA197HH			TBA				
NU 50/NU 50 M Urban Express	82-83	333									
NX 50 M Express SR	81-82	301									
P 50		301									
PA 50	78-81	301									
PA 50	82-83	301									
QA 50 K		303									
SA 50 Elite LX/SR	88-93	301									
SA 50 Elite SR/SA 50 P Elite S	94-01	333									
SB 50/SB 50 P Elite/Elite ES	88-90	301									
SE 50/SE 50 P Elite/Elite 50 S	87-88	301									
TG 50/TG 50 M Gyro S	85-86	301									
XR 50 R	00-03	301		N/A							
Z 50 R	80-99	301		N/A							
Z 50 RD	86	301		N/A							
ZB 50	88	303		303G							
CR 60 R	83-84	333		333G							
ATC 70	79-85	NONE		NONE							
C70 Passport	80-83	303									
CRF 70 F	04-14	333		333G							
CT 70 Trail	77-82	303		303G							
CT 70 Trail	91-94	303		303G							
SL 70 / K1	70-73	303		303G							
TRX 70 Fourtrax	86-87	346*		346G*							
XR 70 R	97-03	333		333G							
XL 75	77/79	304		304G							
XL 75	78	303		303G							
CH 80 Elite	85-07	303									
CR 80 R	80-81	304		304G							
CR 80 R	82	304		304G							
CR 80 R	83-84	333		333G							
CR 80 R	85	333		333G							
CR 80 R	86-91	FA84X		FA84R■		MD6004D					
CR 80 R	92-95	FA84X		FA84R■		MD6004D					
CR 80 R/RB Expert	96-02	FA84X		FA84R■		MD6058D					MD6058C
CRF 80 F	04-14	333		333G							
NH 80 MD Aero	83-84	303									
NH 80 Aero	85	303									
XL 80 S	80-85	304		304G							
XR 80	79-84	304		304G							
XR 80 R	85-04	333		333G							
CR 85 R/RB	03-07	FA84X		FA84R■		MD6058D					MD6058C

FRONT

Line #

APPLICATIONS

BRAKE

* This symbol indicates a rotor made of billet steel, and should be only used with EBC FA Kevlar® Organic or Vee pads.

SAFETY NOTICE - With vehicles primarily designed for off highway use such as quads now being used on the highway, we would recommend the use of X or MXS pads for highway use and ONLY using the R and SV higher density / harder pad series for off road riding.

*-2 Sets Required. ■ - Also available in MX-S race compound. **SAFETY WARNING:- DO NOT USE HH PADS ON REAR UNLESS ALSO USED ON FRONT TO AVOID BRAKE IMBALANCE**

FRONT: HONDA Cont'd

REAR: HONDA

Line #	BRAKE ROTOR CHOICES - FRONT						DISC PAD CHOICES - REAR				BRAKE ROTOR CHOICES - REAR					
	CC Custom Rotor	CX Extreme® /Vee-Rotor	OS Series Oversize 250/280mm Rotor Kit	OSX Series Oversize 280mm Rotor Kit	Relocating Bracket for 250/280mm Rotor	SMX Series Oversize 320mm Rotor Kit	Relocating Bracket for 320mm Rotor		Semi-Sintered V-Pads™	Sintered/HH Pads/Grooved Shoes	SV Series Severe Duty Pads	Standard Rotor	UTVX Rotor	Vintage Rotor	Contour Profile Rotor	CX Extreme® /Vee-Rotor
1																
2																
3																
4																
5																
6																
7																
8																
9																
10																
11																
12																
13																
14																
15																
16																
17																
18																
19																
20																
21																
22																
23																
24																
25																
26																
27																
28																
29																
30																
31																
32																
33																
34																
35																
36																
37																
38																
39																
40																
41																
42																
43																
44																
45																
46																
47																
48																
49		MD6058CX	OS6058C	OSX6058	BRK026											
50																
51																
52																
53																
54																
55																
56		MD6058CX	OS6058C	OSX6058	BRK026											

REAR

This symbol indicates a rotor made of billet steel, and should be only used with EBC FA Kevlar® Organic or Vee pads. SAFETY NOTICE - With vehicles primarily designed for off highway use such as quads now being used on the highway, we would recommend the use of X or MXS pads for highway use and ONLY using the R and SV higher density / harder pad series for off road riding.

BRAKE APPLICATIONS

*-2 Sets Required. ■ - Also available in MX-S race compound. SAFETY WARNING:- DO NOT USE HH PADS ON REAR UNLESS ALSO USED ON FRONT TO AVOID BRAKE IMBALANCE

FRONT: HONDA



HONDA



DISC PAD CHOICES - FRONT

BRAKE ROTOR CHOICES - FRONT

	Semi-Sintered V-Pads™	Sintered/HH Pads/Grooved Shoes	SV Series Severe Duty Pads	Standard Rotor Left	Standard Rotor Right	UTVX Rotor	Vintage Rotor Left	Vintage Rotor Right	Contour Profile Rotor
EZ 90 Cub	303	303G							
TRX 90 Fourtrax/Sportrax	303*	303G*							
TRX 90 EX	303*	303G*							
TRX 90 X	303*	303G*							
CRF 100 F	333	333G							
NSF 100 R	FA197	FA197HH							MD1169C
NSF 100 R (Note - CF=new floating conversion available)									MD1169CF
SL 100 K	303	303G							
XL 100 (Up to F # 1020001)	303	303G							
XL 100 (From F # 1020001)	304	304G							
XL 100 K	304	304G							
XL 100	304	304G							
XL 100	303	303G							
XL 100 S	304	304G							
XR 100	304	304G							
XR 100 R	333	333G							
ATC 110	NONE	NONE							
CRF 110 R	333	333G							
CT 110 Trail	303	303G							
NHX 110 Elite	SFA323	SFA323HH		MD931D					
ATC 125 M	303	303G							
CB 125 S	304								
CB 125 S	330								
CB 125 TT	FA124/2	FA124/2HH		N/A					
CBR 125 R (6 Bolt Front Disc / Canada)	FA375	FA375HH			MD644				
CBR 125 RWB/RC/RD (5 Bolt Front Disc / Canada)	FA375	FA375HH			MD1166RS				
CG 125 (CA/KS/KSE) Drum Front Brake	352								
CG 125 (ES) Disc Front Brake	FA54	FA54R			N/A				
CH 125 Elite	303								
CL 125 A (Scrambler Twin)	306	306G							
CL 125 S (Single)	303	303G							
CL 125 S1 (Single) up to frame # 1120001	303	303G							
CL 125 S1 (Single) from frame # 1120002	304	304G							
CR 125 M Elsinore	304	304G							
CR 125 R Elsinore	324	324G							
CR 125 R	330	330G							
CR 125 R	331	331G							
CR 125 R	FA92X	FA92R		MD6087D					
CR 125 R	FA92X	FA92R		MD6087D					
CR 125 R	FA125X	FA125R■		MD6087D					
CR 125 R	FA125X	FA125R■		MD6008D					
CR 125 R	FA125X	FA125R■		MD6003D					
CR 125 R	FA125X	FA125R■		MD6001D					MD6001C
CR 125 R	FA185X	FA185R■		MD6037D					MD6037C
CR 125 R	FA185X	FA185R■		MD6037D					MD6037C
CR 125 R	FA185X	FA185R■		MD6037D					MD6037C
CR 125 R	FA185X	FA185R■		MD6037D					MD6037C
CRF 125 F (17/14" Small Wheels)	FA185X	FA185R■		MD6390D					MD6390C
CRF 125 FB (19/16" Big Wheels)	FA185X	FA185R■		MD6390D					MD6390C
CRG 125 (Mexico)	TBA				TBA				
CT 125	304	304G							
Elite 125 (Mexico)	TBA			TBA					
MT 125 / K1 Elsinore	304	304G							
MSX 125 GROM (Non ABS)	FA375	FA375HH			MD1183				MD1183C
MSX 125 GROM (ABS)	FA375	FA375HH			MD1191				MD1191C

Line #

1

2

3

4

5

6

7

8

9

10

11

12

13

14

15

16

17

18

19

20

21

22

23

24

25

26

27

28

29

30

31

32

33

34

35

36

37

38

39

40

41

42

43

44

45

46

47

48

49

50

51

52

53

54

55

56

APPLICATIONS

BRAKE

⚠ This symbol indicates a rotor made of billet steel, and should be only used with EBC FA Kevlar® Organic or Vee pads. SAFETY NOTICE - With vehicles primarily designed for off highway use such as quads now being used on the highway, we would recommend the use of X or MXS pads for highway use and ONLY using the R and SV higher density / harder pad series for off road riding.

*-2 Sets Required. ■ - Also available in MX-S race compound. SAFETY WARNING:- DO NOT USE HH PADS ON REAR UNLESS ALSO USED ON FRONT TO AVOID BRAKE IMBALANCE

FRONT: HONDA



HONDA



DISC PAD CHOICES - FRONT

BRAKE ROTOR CHOICES - FRONT

MSX 125 GROM (When Fitted With Brembo Single Pin Aftermarket Calipers)	FA266	FA266V	FA266HH							
NH 125 Aero	303									
NX 125	350		N/A							
NXR 125 (JC30)	352		N/A							
PCX 125 (WW 125 EX2A)	SFA603		SFA603HH		MD9134D					
SL 125 K	303		303G							
SS 125 A (Supersport 125)	306									
TL 125 K	304		304G							
TL 125 S	304		304G							
TRX 125 Fourtrax	303*		303G*							
XL 125 K/76	304		304G							
XL 125	303		303G							
XL 125 S	304		304G							
XL 125 S	330		330G							
CRF 150 F	FA185X		FA185R■		MD6317D					MD6317C
CRF 150 R	FA84X		FA84R■		MD6314D					MD6314C
CH 150/150 D Elite/Elite Deluxe	303									
NXR 150 (KD02)	352		N/A							
NXR 150 (KD03) Front Disc Model	FA185X		FA185R■		N/A					
NXR 150 (KD03) Front Drum Model	352		N/A							
PCX 150 (WW150)	SFA603		SFA603HH		MD9134D					
SH 150i	SFA323		SFA323HH		MD970D					
CD 175	306									
CD 175 K	306									
CL 175/175 K	308									
MR 175 Elsinore	304		304G							
SL 175 K	309		N/A							
XL 175 K	312		312G							
XL 175	312		312G							
ATC 185	303		303G							
ATC 185 S	303		303G							
XL 185 S	304		304G							
XR 185	304		304G							
ATC 200	303		303G							
ATC 200 E Big Red	303		303G							
ATC 200 ES Big Red	303		303G							
ATC 200 M	303		303G							
ATC 200 S	303		303G							
ATC 200 X	FA84X		FA84R	FA84SV	MD6059D					
ATC 200 X	FA84X		FA84R	FA84SV	MD6059D					
CM 200 T Twinstar	312									
TLR 200 Reflex	304		304G							
TR 200 Fatcat	304		304G							
TRX 200 Fourtrax	339*		339G*							
TRX 200 SX Fourtrax	345*		345G*							
TRX 200 Fourtrax	345*		345G*							
TRX 200 D Type II Fourtrax	345*		345G*							
XL 200 R	304		304G							
XR 200 R	304		304G							
XR 200 R Pro Link	304		304G							
XR 200 R	304		304G							
CRF 230 F	FA185X		FA185R■		MD6001D					MD6001C
CRF 230 L	FA185X		FA185R■		MD6001D					MD6001C
CRF 230 M	FA185X		FA185R■		MD6001D					MD6001C
ATC 250 R	FA54X		FA54R	FA54SV	MD6060D					

FRONT

Line #

1
2
3
4
5
6
7
8
9
10
11
12
13
14
15
16
17
18
19
20
21
22
23
24
25
26
27
28
29
30
31
32
33
34
35
36
37
38
39
40
41
42
43
44
45
46
47
48
49
50
51
52
53
54
55
56

APPLICATIONS
BRAKE

* This symbol indicates a rotor made of billet steel, and should be only used with EBC FA Kevlar® Organic or Vee pads.
 SAFETY NOTICE - With vehicles primarily designed for off highway use such as quads now being used on the highway, we would recommend the use of X or MXS pads for highway use and ONLY using the R and SV higher density / harder pad series for off road riding.

*-2 Sets Required. ■ - Also available in MX-S race compound. **SAFETY WARNING:- DO NOT** USE HH PADS ON REAR UNLESS ALSO USED ON FRONT TO AVOID BRAKE IMBALANCE

FRONT: HONDA



HONDA



DISC PAD CHOICES - FRONT

BRAKE ROTOR CHOICES - FRONT

ATC 250 R	82	FA54X	FA54R	FA54SV	MD6060D					
ATC 250 R	83-84	FA84X	FA84R	FA84SV	MD6059D					
ATC 250 R	85-86	FA92X	FA92R		MD6059D					
ATC 250 ES Big Red	85-87	306	306G							
ATC 250 SX	85-87	306	306G							
CB 250 N/T		FA45			MD1036LS			VMD1036		
CB 250 Nighthawk	91-08	312								
CBR 250 R (Non ABS Model)	11-14	FA226	FA226HH			MD1180X				
CBR 250 RA (ABS Model)	11-14	FA388	FA388HH			MD1180X				
CH 250 Elite	85-86	330								
CH 250 Elite	87-90	330								
CM 250 C Custom	82-83	312								
CM 250 T		FA45			MD1036LS			VMD1036		
CMX 250 C/CD Rebel	85-87	FA86	FA86HH			MD1030				
CMX 250 C Rebel	96/97/99-14	FA228	FA228HH		MD1030					
CMX 250 C2	99-00	FA228			MD1030					
CMX 250 X	15	FA228			MD1030					
CN 250 Helix	86-87	FA69	FA69HH		MD908D					
CN 250 Helix	92-93	FA69/2			MD908D					
CN 250 Helix	94-01/05-07	SFA142	SFA142HH		MD908D					
CR 250 M Elsinore	73-76	312	312G							
CR 250 R Elsinore	78-80	324	324G							
CR 250 R Elsinore	81	327	327G							
CR 250 R	82	328	328G							
CR 250 R	83	328	328G							
CR 250 R	84-85	FA92X	FA92R		MD6087D					
CR 250 R	86	FA92X	FA92R		MD6087D					
CR 250 R	87-88	FA125X	FA125R■		MD6087D					
CR 250 R	89	FA125X	FA125R■		MD6008D					
CR 250 R	90-91	FA125X	FA125R■		MD6003D					
CR 250 R	92-94	FA125X	FA125R■		MD6001D					MD6001C
CR 250 R	95-96	FA185X	FA185R■		MD6037D					MD6037C
CR 250 R	97-01	FA185X	FA185R■		MD6037D					MD6037C
CR 250 R	02-03	FA185X	FA185R■		MD6037D					MD6037C
CR 250 R	04-07	FA185X	FA185R■		MD6037D					MD6037C
CRF 250 L (Non ABS)	13-17	FA465X	FA465R■							MD6372C
CRF 250 LA (ABS)	17	FA465X	FA465R■							MD6372C
CRF 250 Rally (Non ABS)	17	FA465X	FA465R■							MD6409C
CRF 250 Rally (ABS)	17	FA465X	FA465R■							MD6409C
CRF 250 R (240mm F/Disc)	04-14	FA185X	FA185R■		MD6037D					MD6037C
CRF 250 R (260mm F/Disc)	15-17	FA185X	FA185R■							MD6389C
CRF 250 X	04-17	FA185X	FA185R■		MD6037D					MD6037C
FL 250 Odyssey	77-84	N/A	N/A							
FL 250 Odyssey Handbrake	77-84									
MR 250 Elsinore	76	311	311G							
MT 250 K/76	74-76	311	311G							
NSS 250/250 A/AS Reflex	01-07	SFA281	SFA281HH		MD922D					
NX 250	88-90	FA185X	FA185R■		MD6001D					MD6001C
PS 250 Big Ruckus	05-06	SFA388	SFA388HH		MD922D					
TL 250	75-76	304	304G							
TRX 250 Fourtrax	85-87	339*	339G*							
TRX 250 R Fourtrax	86-87	FA125X*	FA125R*		MD6046D	MD6046D				
TRX 250 R Fourtrax	88-89	FA125X*	FA125R*		MD6006D	MD6006D				
TRX 250 X Fourtrax	87-92	FA84X*	FA84R*	FA84SV*	MD6006D	MD6006D				
TRX 250 EX Sportrax	01-08	FA84X*	FA84R*	FA84SV*	MD6006D	MD6006D				

Line #

FRONT

APPLICATIONS

BRAKE

⚠ This symbol indicates a rotor made of billet steel, and should be only used with EBC FA Kevlar® Organic or Vee pads. SAFETY NOTICE - With vehicles primarily designed for off highway use such as quads now being used on the highway, we would recommend the use of X or MXS pads for highway use and ONLY using the R and SV higher density / harder pad series for off road riding.

*-2 Sets Required. ■ - Also available in MX-S race compound. SAFETY WARNING:- DO NOT USE HH PADS ON REAR UNLESS ALSO USED ON FRONT TO AVOID BRAKE IMBALANCE

FRONT: HONDA



HONDA



DISC PAD CHOICES - FRONT

BRAKE ROTOR CHOICES - FRONT

TRX 250 TE Recon ES	97-14	345*	345G*							
TRX 250 TM Recon	97-14	345*	345G*							
TRX 250 X	09-14	FA84X*	FA84R*	FA84SV*	MD6006D	MD6006D				
VTR 250 Interceptor	88-89	FA80/2			N/A					
VTR 250 Interceptor	90	FA124/2	FA124/2HH		N/A					
XL 250 K/76	72-76	311	311G							
XL 250 S	78-80	312	312G							
XL 250 S	81	312	312G							
XL 250 R Pro Link	82-87	330	330G							
XR 250	79-80	312	312G							
XR 250 R Pro Link	81-82	327	327G							
XR 250 R Pro Link	84-87	FA92X	FA92R		MD6087D					
XR 250 R Pro Link	88-89	FA125X	FA125R■		MD6087D					
XR 250 R Pro Link	90	FA125X	FA125R■		MD6087D					
XR 250 R Pro Link	91-95	FA125X	FA125R■		MD6001D					MD6001C
XR 250 R	96-04	FA185X	FA185R■		MD6001D					MD6001C
XR 250 L	91-92	FA125X	FA125R■		MD6001D					MD6001C
XR 250 L	93-96	FA185X	FA185R■		MD6001D					MD6001C
CB 300 F	15	FA226	FA226HH			MD1180X				
CBR 300 R (Non ABS Model)	15	FA226	FA226HH			MD1180X				
CBR 300 RA (ABS Model)	15	FA226	FA226HH			MD1180X				
NSS 300 Forza (Non ABS)	14-16	SFA388	SFA388HH			TBA				
NSS 300 Forza (Non ABS) - Parking brake shoe	14-16	333								
NSS 300 A Forza (ABS)	14-16	SFA388	SFA388HH			TBA				
NSS 300 A Forza (ABS) - Parking brake shoe	14-16	333								
TRX 300 (2WD) Fourtrax	88-00	345*	345G*							
TRX 300 FW Fourtrax (4WD)	88-00	347*	347G*							
TRX 300 EX Fourtrax	93-08	FA84X*	FA84R*	FA84SV*	MD6006D	MD6006D				
TRX 300 X	09-11	FA84X*	FA84R*	FA84SV*	MD6006D	MD6006D				
ATC 350 X	85	FA92X	FA92R		MD6059D					
ATC 350 X	86	FA125X	FA125R		MD6059D					
CB 350 F/G		FA13	FA13V		N/A					
CB 350 K		314								
FL 350 R Odyssey	85-87	339*	339G*							
SL 350 K	69-70	314								
SL 350 K	69-73	308								
TRX 350/TRX 350 D Fourtrax/Foreman	86-89	342*	342G*							
TRX 350 TE Fourtrax Rancher ES/FE Fourtrax Rancher 4x4 ES	00-06	347*♣	347G*							
TRX 350 TM Fourtrax Rancher/FM Fourtrax Rancher 4x4	00-06	347*♣	347G*							
XL 350 R	84-85	FA92X	FA92R		MD6087D					
XR 350 R	83	331	331G							
XR 350 R	84-85	FA92X	FA92R		MD6087D					
CB 360		314								
CB 360 G/T	74-76	FA13	FA13V		N/A					
CJ 360 T/76/77	76-77	314								
CB 400 F	75-77	FA13	FA13V		N/A					
CB 400 A Hondamatic	78	FA45			N/A					
CB 400 T MKI Hawk	78-79	314								
CB 400 T MK II Hawk	78-79	FA45			N/A					
CB 400 T Hawk	80-81	FA45			MD1036LS			VMD1036		
CB-1 (CB 400F)	89-90	FA142	FA142V	FA142HH		MD1038RS				
CM 400 A/T	79-81	FA45			MD1036LS			VMD1036		
♣ Note - Aftermarket disc conversion kit replacement pad info (these conversion kits are not an EBC product)										
- please check the websites for the 2 companies listed below for full fitment details on these kits)										
ATV Work XBD 100 disc conversion kit replacement pads		FA271X*		FA271R*						
Super ATV disc conversion kit replacement pads		FA395X*		FA395R*						

Line #

FRONT

APPLICATIONS

BRAKE

⚡ This symbol indicates a rotor made of billet steel, and should be only used with EBC FA Kevlar® Organic or Vee pads.

SAFETY NOTICE - With vehicles primarily designed for off highway use such as quads now being used on the highway, we would recommend the use of X or MXS pads for highway use and ONLY using the R and SV higher density / harder pad series for off road riding.

*-2 Sets Required. ■ - Also available in MX-S race compound. SAFETY WARNING:- DO NOT USE HH PADS ON REAR UNLESS ALSO USED ON FRONT TO AVOID BRAKE IMBALANCE

FRONT: HONDA



HONDA



DISC PAD CHOICES - FRONT

BRAKE ROTOR CHOICES - FRONT

		Semi-Sintered V-Pads™	Sintered/HH Pads/Grooved Shoes	SV Series Severe Duty Pads	Standard Rotor Left	Standard Rotor Right	UTVX Rotor	Vintage Rotor Left	Vintage Rotor Right	Contour Profile Rotor
CM 400 C Custom	81		FA69/2		MD1036LS			VMD1036		
CM 400 E	80-81		314							
FL 400 R Pilot	89-90		339*	339G*						
TRX 400 EX Fourtrax	99-00		FA84X*	FA84R*	FA84SV*	MD6006D	MD6006D			
TRX 400 EX Sportrax	01-08		FA84X*	FA84R*	FA84SV*	MD6006D	MD6006D			
TRX 400 FW Fourtrax Foreman	95-01/03		347*♣	347G*						
TRX 400 FM Fourtrax Foreman	02		347*♣	347G*						
TRX 400 FA Fourtrax Rancher AT	04-07		347*♣	347G*						
TRX 400 FGA Fourtrax Rancher AT Gpscape	04-07		347*♣	347G*						
TRX 400 X	09-13		FA84X*	FA84R*	FA84SV*	MD6006D	MD6006D			
XR 400 R	96-04		FA185X	FA185R■	MD6001D					MD6001C
TRX 420 TM Fourtrax Rancher	07-13		FA84X*	FA84R*	FA84SV*	MD6302D	MD6302D			
TRX 420 TM1 Rancher	14-15		FA84X*	FA84R*	FA84SV*	TBA	TBA			
TRX 420 TE Fourtrax Rancher ES	07-13		FA84X*	FA84R*	FA84SV*	MD6302D	MD6302D			
TRX 420 TE1 Rancher ES	14-15		FA84X*	FA84R*	FA84SV*	TBA	TBA			
TRX 420 FPA Power Steering Fourtrax Rancher AT	09-12		FA84X*	FA84R*	FA84SV*	MD6302D	MD6302D			
TRX 420 FA Fourtrax Rancher AT	09-14		FA84X*	FA84R*	FA84SV*	MD6302D	MD6302D			
TRX 420 FA1 Rancher 4 x 4/Auto/DCT	14-15		FA84X*	FA84R*	FA84SV*	MD6387D	MD6387D			
TRX 420 FA2 Rancher 4 x 4/Auto/DCT/EPS	14-15		FA84X*	FA84R*	FA84SV*	MD6387D	MD6387D			
TRX 420 FA5 Rancher 4 x 4/Auto/DCT/IRS	14-15		FA84X*	FA84R*	FA84SV*	MD6387D	MD6387D			
TRX 420 FA6 Fourtrax Rancher 4 x 4/Auto/DCT/IRS/EPS	14-15		FA84X*	FA84R*	FA84SV*	MD6387D	MD6387D			
TRX 420 FPE Fourtrax Rancher 4 x 4 ES/EPS	09-13		FA84X*	FA84R*	FA84SV*	MD6302D	MD6302D			
TRX 420 FE Fourtrax Rancher 4 x 4/ES	07-13		FA84X*	FA84R*	FA84SV*	MD6302D	MD6302D			
TRX 420 FE1 Rancher 4 x 4/ES	14-15		FA84X*	FA84R*	FA84SV*	MD6387D	MD6387D			
TRX 420 FPM Fourtrax Rancher 4 x 4 PS	09-13		FA84X*	FA84R*	FA84SV*	MD6302D	MD6302D			
TRX 420 FM Fourtrax Rancher 4 x 4	07-13		FA84X*	FA84R*	FA84SV*	MD6302D	MD6302D			
TRX 420 FM1 Rancher 4 x 4	14-15		FA84X*	FA84R*	FA84SV*	MD6387D	MD6387D			
TRX 420 FM2 Rancher 4 x 4/EPS	14-15		FA84X*	FA84R*	FA84SV*	MD6387D	MD6387D			
CB 450 K	70-71		FA12	FA12V		N/A				
CB 450 K	72-74		FA13	FA13V		N/A				
CB 450 T Hawk	82		FA90		MD1036LS			VMD1036		
CB 450 SC Nighthawk	82		FA90		MD1036LS			VMD1036		
CB 450 SC Nighthawk	83-86		FA69	FA69HH	MD1040LS					
CB 450 DX-K	89-92		FA122*		N/A	N/A				
CM 450 E	82-83		314							
CM 450 C Custom (to CM 001211)	82		FA69/2		MD1036LS			VMD1036		
CM 450 C Custom (from CM 001212)	82		FA90		MD1036LS			VMD1036		
CM 450 A Hondamatic	82		FA69/2		MD1036LS			VMD1036		
CM 450 A Hondamatic	83		FA90		MD1040LS					
CMX 450 C Rebel	86-87		FA69	FA69HH	MD1041LS					
CR 450 R	81		327	327G						
CRF 450 R	02-03		FA185X	FA185R■	MD6037D					MD6037C
CRF 450 R (240mm F/Disc)	04-14		FA185X	FA185R■	MD6037D					MD6037C
CRF 450 R (260mm F/Disc)	15-16		FA185X	FA185R■						MD6389C
CRF 450 RX (18" Rear wheel)	17		FA185X	FA185R■						MD6389C
CRF 450 X	05-17		FA185X	FA185R■	MD6037D					MD6037C
TRX 450 ES Fourtrax Foreman ES	98-01		347S*	347SG*						
TRX 450 S Fourtrax Foreman S	98-01		347S*	347SG*						
TRX 450 FE Fourtrax Foreman ES	02-04		347*♣	347G*						
TRX 450 FM Fourtrax Foreman S	02-04		347*♣	347G*						
TRX 450 R/ER	04-11		FA185X*	FA185R*■	MD6006D	MD6006D				
♣ Note - Aftermarket disc conversion kit replacement pad info (these conversion kits are not an EBC product - please check the websites for the 2 companies listed below for full fitment details on these kits)										
ATV Work XBD 100 disc conversion kit replacement pads			FA271X*	FA271R*						
Super ATV disc conversion kit replacement pads			FA395X*	FA395R*						

Line #

APPLICATIONS

BRAKE

⚡ This symbol indicates a rotor made of billet steel, and should be only used with EBC FA Kevlar® Organic or Vee pads.

SAFETY NOTICE - With vehicles primarily designed for off highway use such as quads now being used on the highway, we would recommend the use of X or MXS pads for highway use and ONLY using the R and SV higher density / harder pad series for off road riding.

*-2 Sets Required. ■ - Also available in MX-S race compound. SAFETY WARNING:- DO NOT USE HH PADS ON REAR UNLESS ALSO USED ON FRONT TO AVOID BRAKE IMBALANCE

FRONT: HONDA



HONDA



DISC PAD CHOICES - FRONT

BRAKE ROTOR CHOICES - FRONT

			Semi-Sintered V-Pads™	Sintered/HH Pads/Grooved Shoes	SV Series Severe Duty Pads			UTVX Rotor				Line #	
CR 480 R	82			327G								1	
CR 480 R	83			328G								2	
CB 500 K			FA13			N/A						3	
CB 500 T/76	75-76		FA13			N/A						4	
CB 500 F (Non ABS)	13-17		FA196	FA196V	FA196HH						TBA	5	
CB 500 FA (ABS)	13-17		FA196	FA196V	FA196HH						TBA	6	
CB 500 X (Non ABS)	13-17		FA196	FA196V	FA196HH						TBA	7	
CB 500 XA (ABS)	13-17		FA196	FA196V	FA196HH						TBA	8	
CBR 500 R (Non ABS)	13-17		FA196	FA196V	FA196HH						TBA	9	
CBR 500 RA (ABS)	13-17		FA196	FA196V	FA196HH						TBA	10	
CR 500 R	84-85		FA92X		FA92R	MD6087D						11	
CR 500 R	86		FA92X		FA92R	MD6087D						12	
CR 500 R	87-88		FA125X		FA125R■	MD6087D						13	
CR 500 R	89		FA125X		FA125R■	MD6008D						14	
CR 500 R	90-91		FA125X		FA125R■	MD6003D						15	
CR 500 R	92-94		FA125X		FA125R■	MD6001D					MD6001C	16	
CR 500 R	95-01		FA185X		FA185R■	MD6037D					MD6037C	17	
CX 500	78-79		FA29			N/A						18	
CX 500 C Custom	79-81		FA29			N/A						19	
CX 500 D Deluxe	79-81		FA29			N/A						20	
CX 500 C Custom	82		FA69		FA69HH	N/A						21	
CX 500 TC Turbo	82		FA69*		FA69HH*	N/A	N/A					22	
FT 500 Ascot	82-83		FA69		FA69HH	MD1131LS						23	
GB 500	89-90		FA69		FA69HH	MD1001						24	
GL 500 Silverwing	81-82		FA69		FA69HH	N/A						25	
GL 500 I Silverwing Interstate	81-82		FA69/2*			N/A	N/A					26	
SXS 500 M2 Pioneer	Left 15-17		FA712X		FA712R	FA712SV	MD6341D⊕					27	
	Right		FA713X		FA713R		MD6341D⊕					28	
TRX 500 FA Fourtrax Rubicon	01-04		347*♣		347G*							29	
TRX 500 FA5 Foreman Rubicon 4 x 4/Auto/DCT	15		FA84X*		FA84R*	FA84SV*	MD6387D	MD6387D				30	
TRX 500 FA6 Foreman Rubicon 4 x 4/Auto/DCT/EPS	15		FA84X*		FA84R*	FA84SV*	MD6387D	MD6387D				31	
TRX 500 FGA Fourtrax Foreman Rubicon Gpscape	04		347*♣		347G*							32	
TRX 500 FA/FAA Fourtrax Foreman Rubicon	05-14		FA410X*		FA410R*	FA410SV*	MD6251D	MD6251D				33	
TRX 500 FGA Fourtrax Foreman Rubicon Gpscape	05-08		FA410X*		FA410R*	FA410SV*	MD6251D	MD6251D				34	
TRX 500 FE/FEA Fourtrax Foreman 4x4/ES	05-11		FA410X*		FA410R*	FA410SV*	MD6251D	MD6251D				35	
TRX 500 FE Fourtrax Foreman 4x4	12-13		FA84X*		FA84R*	FA84SV*	MD6365D	MD6365D				36	
TRX 500 FE1 Foreman ES	14-15		FA84X*		FA84R*	FA84SV*	MD6387D	MD6387D				37	
TRX 500 FE2 Foreman ES/EPS	14-15		FA84X*		FA84R*	FA84SV*	MD6387D	MD6387D				38	
TRX 500 FM/FMA Fourtrax Foreman 4x4	05-11		FA410X*		FA410R*	FA410SV*	MD6251D	MD6251D				39	
TRX 500 FM Fourtrax Foreman 4x4	12-13		FA84X*		FA84R*	FA84SV*	MD6365D	MD6365D				40	
TRX 500 FM Foreman	14-15		FA84X*		FA84R*	FA84SV*	MD6387D	MD6387D				41	
TRX 500 FM2 Foreman /EPS	14-15		FA84X*		FA84R*	FA84SV*	MD6387D	MD6387D				42	
TRX 500 FM5 Foreman Rubicon 4 x 4	15		FA84X*		FA84R*	FA84SV*	MD6387D	MD6387D				43	
TRX 500 FM6 Foreman Rubicon 4 x 4/EPS	15		FA84X*		FA84R*	FA84SV*	MD6387D	MD6387D				44	
TRX 500 FPE Fourtrax Foreman 4x4 ES/EPS	08-11		FA410X*		FA410R*	FA410SV*	MD6251D	MD6251D				45	
TRX 500 FPE Fourtrax Foreman 4x4	12-13		FA84X*		FA84R*	FA84SV*	MD6365D	MD6365D				46	
TRX 500 FPM Fourtrax Foreman 4x4/EPS	08-11		FA410X*		FA410R*	FA410SV*	MD6251D	MD6251D				47	
TRX 500 FPM Fourtrax Foreman 4x4	12-13		FA84X*		FA84R*	FA84SV*	MD6365D	MD6365D				48	
TRX 500 TM5/TM6 Fourtrax Foreman 2x4	05-06		FA410X*		FA410R*	FA410SV*	MD6251D	MD6251D				49	
VF 500 C V30 Magna	84-85		FA69		FA69HH		MD1047LS					50	
VF 500 F Interceptor	84-86		FA69*		FA69HH*		MD1006	MD1006			MD1006C*	51	
VT 500 C Shadow	83-86		FA69		FA69HH		MD1047LS					52	
♣ Note - Aftermarket disc conversion kit replacement pad info (these conversion kits are not an EBC product)													53
- please check the websites for the 2 companies listed below for full fitment details on these kits)													54
ATV Work XBD 100 disc conversion kit replacement pads			FA271X*		FA271R*							55	
Super ATV disc conversion kit replacement pads			FA395X*		FA395R*							56	

FRONT

APPLICATIONS
BRAKE
HONDA
SAFETY NOTICE - With vehicles primarily designed for off highway use such as quads now being used on the highway, we would recommend the use of X or MXS pads for highway use and ONLY using the R and SV higher density / harder pad series for off road riding.
⊕ This symbol indicates a rotor made of billet steel, and should be only used with EBC FA Kevlar® Organic or Vee pads.

*-2 Sets Required. ■ - Also available in MX-S race compound. **SAFETY WARNING:- DO NOT USE HH PADS ON REAR UNLESS ALSO USED ON FRONT TO AVOID BRAKE IMBALANCE**

FRONT: HONDA Cont'd

REAR: HONDA

Line #	BRAKE ROTOR CHOICES - FRONT						DISC PAD CHOICES - REAR				BRAKE ROTOR CHOICES - REAR					
	CC Custom Rotor	CX Extreme® /Vee-Rotor	OS Series Oversize 250/280mm Rotor Kit	OSX Series Oversize 280mm Rotor Kit	Relocating Bracket for 250/280mm Rotor	SMX Series Oversize 320mm Rotor Kit	Relocating Bracket for 320mm Rotor		Semi-Sintered V-Pads™	Sintered/HH Pads/ Grooved Shoes	SV Series Severe Duty Pads	Standard Rotor	UTVX Rotor	Vintage Rotor	Contour Profile Rotor	CX Extreme® /Vee-Rotor
1								330		330G						
2								331		331G						
3								316								
4								316								
5								FA140	FA140V	FA140HH					TBA	
6								FA140	FA140V	FA140HH					TBA	
7								FA140	FA140V	FA140HH					TBA	
8								FA140	FA140V	FA140HH					TBA	
9								FA140	FA140V	FA140HH					TBA	
10								FA140	FA140V	FA140HH					TBA	
11								331		331G						
12								344		344G						
13								FA131X		FA131R■		MD6009D				
14								FA131X		FA131R■		MD6002D				
15								FA131X		FA131R■		MD6002D				
16		MD6001CX	OS6001EC	OSX6001E	BRK004	N/A	N/A	FA131X		FA131R■		MD6002D				MD6002CX
17		MD6037CX	OS6037C	OSX6037	BRK008	SMX6037	BRK009	FA131X		FA131R■		MD6002D				MD6002CX
18								321								
19								321								
20								321								
21								321								
22								FA69	FA69V	FA69HH		N/A				
23								FA69	FA69V	FA69HH		MD1048				
24								340								
25								321								
26								321								
27								FA714X		FA714R	FA714SV	MD6217D⊗				
28																
29								343		343G						
30								FA373X		FA373R	FA373SV	MD6217D				
31								FA373X		FA373R	FA373SV	MD6217D				
32								343		343G						
33								343		343G						
34								343		343G						
35								343		343G						
36								343		343G						
37								351		351G						
38								351		351G						
39								343		343G						
40								343		343G						
41								351		351G						
42								351		351G						
43								FA373X		FA373R	FA373SV	MD6217D				
44								FA373X		FA373R	FA373SV	MD6217D				
45								343		343G						
46								343		343G						
47								343		343G						
48								343		343G						
49								343		343G						
50								321								
51		VR1006*						FA69	FA69V	FA69HH		MD1006		MD1006C	VR1006	
52								313								
53																
54																
55																
56																

BRAKE APPLICATIONS

⊗ This symbol indicates a rotor made of billet steel, and should be only used with EBC FA Kevlar® Organic or Vee pads.

SAFETY NOTICE - With vehicles primarily designed for off highway use such as quads now being used on the highway, we would recommend the use of X or MXS pads for highway use and ONLY using the R and SV higher density / harder pad series for off road riding.

*-2 Sets Required. ■ - Also available in MX-S race compound. **SAFETY WARNING:- DO NOT USE HH PADS ON REAR UNLESS ALSO USED ON FRONT TO AVOID BRAKE IMBALANCE**

FRONT: HONDA

APPLICATIONS

BRAKE



HONDA



DISC PAD CHOICES - FRONT

BRAKE ROTOR CHOICES - FRONT

		Semi-Sintered V-Pads™	Sintered/HH Pads/Grooved Shoes	SV Series Severe Duty Pads	Standard Rotor Left	Standard Rotor Right	UTVX Rotor	Vintage Rotor Left	Vintage Rotor Right	Contour Profile Rotor
VT 500 FT Ascot	83-84		FA69H		MD1047LS					
XL 500 S	79-81		312							
XL 500 R Pro Link	82		332							
XR 500	79-80		324							
XR 500 R Pro Link	81-82		327							
XR 500 R Pro Link	83-84		FA92X		MD6087D					
CB 550 F	75-77	FA13V			N/A					
CB 550 K1/76	74-78	FA13V			N/A					
CB 550 SC Nighthawk	83		FA69H		MD1047LS					
599 (CB 600 F)	04/06		FA226*		MD1139	MD1139				MD1139C*
CBR 600 F Hurricane	87-90		FA121*		MD1001	MD1001				
CBR 600 F2 EBC Floating Rotor Conversion 310mm (Note - Will Require Relocation Brackets - BRK15S)	91-94		FA203*		MD601LS	MD601LS				
CBR 600 F2 Solid rotor	91-94		FA203*		MD1001	MD1001				
CBR 600 F3/SJR/SE	95-98		FA226*		MD1003X	MD1003X				MD1003XC*
CBR 600 F4 (Carb Model)	99-00				MD1014X	MD1014X				MD1014XC*
CBR 600 F4i Sport (Injection Model)	01-06				MD1141X	MD1141X				MD1141XC*
CBR 600 RR	03-04				MD1152X	MD1152X				MD1152XC*
CBR 600 RR	05-06				MD1152X	MD1152X				MD1152XC*
CBR 600 RR	07-17				MD1152X	MD1152X				MD1152XC*
CBR 600 RRA (ABS Model)	09-17				MD1152X	MD1152X				MD1152XC*
FSC 600/D Silverwing Non ABS Model (256mm f/disc)	02-06		SFA281		MD1006					MD1006C
FSC 600/D Silverwing Non ABS Model (256mm f/disc) Parking brake	02-06		SFA257/2							
FSC 600 A Silverwing ABS Model (276mm f/disc)	03-14		SFA281		MD1172LS					
FSC 600 A Silverwing ABS Model (276mm f/disc) Parking brake	03-10		SFA257/2							
FSC 600 D Silverwing Non ABS Model (276mm f/disc)	07-10		SFA281		MD1172LS					
FSC 600 D Silverwing Non ABS Model (276mm f/disc) Parking brake	07-10		SFA257/2							
VLX 600 Shadow (VT 600 C/CD)	88-93		FA124/2	FA124/2V	MD1047LS					
VT 600 C/CD/CD2 Shadow/Shadow Deluxe VLX	94-07		FA196	FA196V	MD1047LS					
XL 600 V Transalp	89-90		FA69		MD6044D					
XL 600 R	83-87		FA92X		MD6087D					
XR 600 R	85-87		FA92X		MD6087D					
XR 600 R	88-90		FA125X	FA125R■	MD6087D					
XR 600 R	91-92		FA125X	FA125R■	MD6001D					MD6001C
XR 600 R	93-00		FA185X	FA185R■	MD6001D					MD6001C
CB 650	79-81	FA45V			MD1036LS			VMD1036		
CB 650 C Custom	80	FA45V			MD1036LS			VMD1036		
CB 650 C Custom	81	FA45*	FA45V*		MD1036LS	MD1036RS		VMD1036	VMD1036	
CB 650	82	FA69	FA69V	FA69HH	N/A					
CB 650 SC Nighthawk	82	FA90*	FA90V*		MD1036LS	MD1036RS		VMD1036	VMD1036	
CB 650 SC Nighthawk	83-85	FA69*	FA69V*	FA69HH*	MD1001	MD1001				
CB 650 F (Non ABS)	18	FA142*	FA142V*	FA142HH*	MD1186C					
CB 650 F (ABS)	18	FA142*	FA142V*	FA142HH*	MD1187C					
CBR 650 F (Non ABS Model)	14-18	FA142*		FA142HH*	MD1186C					TBA*
CBR 650 FA (ABS Model)	14-18	FA142*		FA142HH*	MD1187C					TBA*
CX 650 C Custom	83	FA69	FA69V	FA69HH	MD1047LS					
CX 650 T Turbo	83	FA69*	FA69V	FA69HH*	N/A	N/A				
GL 650 Silverwing/GL 650 Silverwing Interstate	83	FA69*	FA69V*	FA69HH*	MD1040LS	MD1040RS				
NT 650 Hawk GT	88-91	FA142	FA142V	FA142HH	MD1021LS					
NX 650	88-89	FA124/2		FA124/2HH	MD6010D					
TRX 650 FA Rincon	03-05	347*♣		347G*						
TRX 650 FGA Fourtrax Rincon Gpscape	04-05	347*♣		347G*						
♣ Note - Aftermarket disc conversion kit replacement pad info (these conversion kits are not an EBC product - please check the websites for the 2 companies listed below for full fitment details on these kits)										
ATV Work XBD 100 disc conversion kit replacement pads		FA271X*		FA271R*						
Super ATV disc conversion kit replacement pads		FA395X*		FA395R*						

Line #

This symbol indicates a rotor made of billet steel, and should be only used with EBC FA Kevlar® Organic or Vee pads. SAFETY NOTICE - With vehicles primarily designed for off highway use such as quads now being used on the highway, we would recommend the use of X or MXS pads for highway use and ONLY using the R and SV higher density / harder pad series for off road riding.

*-2 Sets Required. ■ - Also available in MX-S race compound. SAFETY WARNING:- DO NOT USE HH PADS ON REAR UNLESS ALSO USED ON FRONT TO AVOID BRAKE IMBALANCE

FRONT: HONDA

APPLICATIONS

BRAKE



HONDA



DISC PAD CHOICES - FRONT

BRAKE ROTOR CHOICES - FRONT

		Semi-Sintered V-Pads™	Sintered/HH Pads/Grooved Shoes	SV Series Severe Duty Pads	Standard Rotor Left	Standard Rotor Right	UTVX Rotor	Vintage Rotor Left	Vintage Rotor Right	Contour Profile Rotor
XR 650 L	93-15		FA185R■		MD6010D					
XR 650 R	00-07		FA185R■		MD6001D					MD6001C
TRX 680 FGA Fourtrax Rincon Gpscape	06-09		FA410R*	FA410SV*	MD6251D	MD6251D				
TRX 680 FA Fourtrax Rincon	06-15		FA410R*	FA410SV*	MD6251D	MD6251D				
CB 700 SC/S Nighthawk	84-86	FA69*	FA69HH*		MD1001	MD1001				
CTX 700 (Top Fairing/Manual G/Box)	14-17	FA196	FA196HH							TBA
CTX 700 D (Top Fairing/Auto G/Box)	14-17	FA196	FA196HH							TBA
CTX 700 D (Top Fairing/Auto G/Box) - Parking brake	14-17	SFA257/2								
CTX 700 N (Naked/Manual G/Box)	14-16	FA196	FA196HH							TBA
CTX 700 ND (Naked/Auto G/Box)	14-16	FA196	FA196HH							TBA
CTX 700 ND (Naked/Auto G/Box) - Parking brake	14-16	SFA257/2								
MUV 700 Big Red	09-13	Left	FA476X		MD6341D☉					
		Right	FA477X		MD6341D☉					
NC 700 X (Manual G/box)	12-17		FA196	FA196HH						MD1186C
NC 700 XD (Auto G/box/ABS)	12-17		FA388	FA388HH						MD1187C
NC 700 XD (Auto G/box/Non ABS)	12-17		FA196	FA196HH						MD1186C
NC 700 XD (Auto G/box) - Parking brake	12-17		SFA257/2							
NM4	15-16		FA196	FA196HH						TBA
NM4 - Parking brake	15-16		SFA257/2							
NSA 700 A9 DN-01	09-11		SFA388*	SFA388HH*	TBA	TBA				
NSA 700 A9 DN-01 Parking Brake	09-11		SFA257/2							
NT 700 VVA (ABS)	10-13			FA388HH*	MD1008	MD1008				
SXS 700 M2 Pioneer (2 Seat)	14-16	Left	FA712X	FA712R	FA712SV	MD6341D☉				
		Right	FA713X	FA713R	FA713SV	MD6341D☉				
SXS 700 M4 Pioneer (4 Seat)	14-16	Left	FA712X	FA712R	FA712SV	MD6341D☉				
		Right	FA713X	FA713R	FA713SV	MD6341D☉				
TRX 700 XX	08-11		FA185X*	FA185R■	MD6006D	MD6006D				
VF 700 C Magna	84	FA69*	FA69HH*		MD1040LS	MD1040RS				
VF 700 C Magna	85-86	FA69*	FA69HH*		MD1040LS	MD1040RS				
VF 700 C Magna	87	FA69/3	FA69/3HH		MD1059LS					
VF 700 F Interceptor	84	FA69*	FA69HH*		MD1001	MD1001				
VF 700 F Interceptor	85	FA69*	FA69HH*		MD1001	MD1001				
VF 700 S Sabre	84-85	FA69*	FA69HH*		MD1001	MD1001				
VFR 700 F/F2 Interceptor	86-87	FA124*	FA124HH*		MD1001	MD1001				
VT 700 C Shadow	84-85	FA90*	FA90V*		MD1040LS	MD1040RS				
VT 700 C Shadow	86-87	FA69	FA69HH		MD1047LS					
CB 750 A Hondamatic	76-78	FA13	FA13V		N/A					
CB 750 C Custom	80	FA45	FA45V		MD1052LS				VMD1052	
CB 750 C Custom	81	FA45*	FA45V*		MD1036LS	MD1036RS		VMD1036	VMD1036	
CB 750 C Custom	82	FA69/2*	FA69/2V*		MD1036LS	MD1036RS		VMD1036	VMD1036	
CB 750 C (from frame CM 204182)	82	FA90*	FA90V*		MD1036LS	MD1036RS		VMD1036	VMD1036	
CB 750 F Supersport	75-76	FA13	FA13V		MD1062LS			VMD1062		
CB 750 F Supersport	77-78	FA31*	FA31V*		N/A	N/A				
CB 750 F Supersport	79-80	FA30*	FA30V*		MD1036LS	MD1036RS		VMD1036	VMD1036	
CB 750 F Supersport	81-82	FA69/2*			MD1036LS	MD1036RS		VMD1036	VMD1036	
CB 750 K	70-75	FA12	FA12V		N/A					
CB 750 76	70-76	FA12	FA12V		MD1062LS			VMD1062		
CB 750 K	77-78	FA13	FA13V		MD1062LS			VMD1062		
CB 750 K	79-82	FA45	FA45V		MD1052LS			VMD1052		
CB 750 L Limited Edition	79	FA45	FA45V		MD1052LS			VMD1052		
CB 750 SC Nighthawk	82-83	FA69*	FA69HH*		MD1036LS	MD1036RS		VMD1036	VMD1036	
CB 750 Nighthawk	91-03	FA196	FA196HH		MD1021LS					
RVF 750 R (RC45)	94-95	FA187*	FA187HH*		MD1012LS	MD1012RS				
VF 750 C V45 Magna	82-83	FA69*	FA69HH*		MD1040LS	MD1040RS				
VF 750 C Magna/Magna Delux CD/C2	94-03	FA196	FA196HH		MD1021LS					
VF 750 C V45 Magna	88	FA69/3	FA69/3HH		MD1059LS					

Line #

This symbol indicates a rotor made of billet steel, and should be only used with EBC FA Kevlar® Organic or Vee pads. SAFETY NOTICE - With vehicles primarily designed for off highway use such as quads now being used on the highway, we would recommend the use of X or MXS pads for highway use and ONLY using the R and SV higher density / harder pad series for off road riding.

FRONT

*-2 Sets Required. ■ - Also available in MX-S race compound. SAFETY WARNING:- DO NOT USE HH PADS ON REAR UNLESS ALSO USED ON FRONT TO AVOID BRAKE IMBALANCE

FRONT: HONDA Cont'd

REAR: HONDA

Line #	BRAKE ROTOR CHOICES - FRONT						DISC PAD CHOICES - REAR				BRAKE ROTOR CHOICES - REAR					
	CC Custom Rotor	CX Extreme® /Vee-Rotor	OS Series Oversize 250/280mm Rotor Kit	OSX Series Oversize 280mm Rotor Kit	Relocating Bracket for 250/280mm Rotor	SMX Series Oversize 320mm Rotor Kit	Relocating Bracket for 320mm Rotor		Semi-Sintered V-Pads™	Sintered/HH Pads/ Grooved Shoes	SV Series Severe Duty Pads	Standard Rotor	UTVX Rotor	Vintage Rotor	Contour Profile Rotor	CX Extreme® /Vee-Rotor
1		MD6010CX	N/A	N/A	N/A	SMX6010	BRK009	FA131X		FA131R■		MD6045D				MD6045CX
2		MD6001CX	OS6001C	OSX6001	BRK008	SMX6001	BRK009	FA131X		FA131R■		MD6181D			MD6181C	MD6181CX
3								FA373X		FA373R	FA373SV	MD6217D☉				
4								FA373X		FA373R	FA373SV	MD6217D☉				
5								343								
6								FA140	FA140V	FA140HH					TBA	
7								FA140	FA140V	FA140HH					TBA	
8																
9								FA140	FA140V	FA140HH					TBA	
10								FA140	FA140V	FA140HH					TBA	
11																
12								FA478X				MD6341D☉				
13								FA479X				MD6341D☉				
14								FA140	FA140V	FA140HH					MD1185C	
15								FA174	FA174V	FA174HH					MD1185C	
16								FA140	FA140V	FA140HH					MD1185C	
17																
18								FA140	FA140V	FA140HH					TBA	
19																
20								SFA196		SFA196HH		TBA				
21																
22										FA261HH		MD1016				
23								FA714X		FA714R		MD6217D☉				
24																
25								FA714X		FA714R		MD6217D☉				
26																
27								FA410X		FA410R		MD6331D				
28								321								
29								343								
30								343								
31								FA69/3	FA69/3V	FA69/3HH		MD1068				
32								FA69/3	FA69/3V	FA69/3HH		MD1079				
33								321								
34								FA69/3	FA69/3V	FA69/3HH		MD1006				
35								321								
36								343								
37								320								
38								320								
39								320								
40								320								
41								320								
42								FA32	FA32V			MD1064				
43								FA31	FA31V			MD1064				
44								FA30	FA30V			MD1071	VMD1071			
45								FA69	FA69V			MD1082				
46								320								
47								320								
48								320								
49								320								
50								320								
51								320								
52								321								
53								FA143				MD1013☉				
54								321								
55								343								
56								343								

REAR

⊗ This symbol indicates a rotor made of billet steel, and should be only used with EBC FA Kevlar® Organic or Vee pads.
SAFETY NOTICE - With vehicles primarily designed for off highway use such as quads now being used on the highway, we would recommend the use of X or MXS pads for highway use and ONLY using the R and SV higher density / harder pad series for off road riding.

BRAKE APPLICATIONS

*-2 Sets Required. ■ - Also available in MX-S race compound. **SAFETY WARNING:- DO NOT USE HH PADS ON REAR UNLESS ALSO USED ON FRONT TO AVOID BRAKE IMBALANCE**

FRONT: HONDA



HONDA



DISC PAD CHOICES - FRONT

BRAKE ROTOR CHOICES - FRONT

VF 750 F V45 Interceptor	83-84	FA69*		FA69HH*		MD1001	MD1001		
VFR 750 F Interceptor	86	FA124*		FA124HH*		MD1001	MD1001		
VFR 750 F	90-93	FA142*		FA142HH*		MD1008	MD1008		
VFR 750 F	94-97	FA142*		FA142HH*		MD1003X	MD1003X		MD1003XC*
VFR 750 R (RC 30)	90	FA187*		FA187HH*		MD1010LS	MD1010RS		
VF 750 S Sabre	82-83	FA69*	FA69V*	FA69HH*		MD1001	MD1001		
VT 750 C Shadow	83	FA90*	FA90V*			MD1040LS	MD1040RS		
VT 750 C/CD Shadow/Shadow Deluxe	98-02	FA196	FA196V	FA196HH		MD1159			
VT 750 DC Shadow Spirit	01-02	FA196	FA196V	FA196HH		MD1159			
VT 750 DC Shadow Spirit	03-07	FA196	FA196V	FA196HH		MD1159			
VT 750 C2 Shadow Spirit	07-14	FA196	FA196V	FA196HH			MD1159		
VT 750 CSE Shadow Spirit (ABS/Rear Disc Model)	13-14			FA388HH			TBA		
VT 750 CD Shadow American Classic Edition 750 Deluxe	02-03	FA196	FA196V	FA196HH		MD1159			
VT 750 Shadow Aero	04-07	FA196	FA196V	FA196HH		MD1159			
VT 750 Shadow Aero	08-15	FA196	FA196V	FA196HH			MD1159		
VT 750 C2B Shadow Phantom	10-15	FA196	FA196V	FA196HH			MD1159		
VT 750 RS Shadow	10-14	FA196	FA196V	FA196HH		MD1159			
VFR 800 Fi Interceptor	98-99			FA261HH*		MD1014X	MD1014X		MD1014XC*
VFR 800 Interceptor	00-05			FA261HH*		MD1014X	MD1014X		MD1014XC*
VFR 800 Interceptor	06-09			FA388HH*		MD1014X	MD1014X		MD1014XC*
VFR 800 A Interceptor ABS	02-05			FA261HH*		MD1157X	MD1157X		MD1157XC*
VFR 800 A Interceptor ABS	06-11	FA388*		FA388HH*		MD1157X	MD1157X		MD1157XC*
VFR 800 F Interceptor (Non ABS Model)	14-15			FA390HH*		MD1188X	MD1188X		
VFR 800 FD Interceptor DLX (ABS Model)	14-15			FA390HH*		MD1188X	MD1188X		
VT 800 C Shadow	88	FA69	FA69V	FA69HH		MD1047LS			
PC 800 Pacific Coast	89-90/94-98	FA142*	FA142V*	FA142HH*		MD1001	MD1001		
CB 900 C Custom	80	FA30*	FA30V*			MD1036LS	MD1036RS	VMD1036	VMD1036
CB 900 C Custom	81	FA29*	FA29V*			MD1036LS	MD1036RS	VMD1036	VMD1036
CB 900 C Custom	82	FA69/2*	FA69/2V*			MD1036LS	MD1036RS	VMD1036	VMD1036
CB 900 F Supersport	81-82	FA69/2*				MD1036LS	MD1036RS	VMD1036	VMD1036
CBR 900 RR Fireblade	93-94	FA187*		FA187HH*		MD1014X	MD1014X		MD1014XC*
CBR 900 RR Fireblade	95-97	FA187*		FA187HH*		MD1003X	MD1003X		MD1003XC*
CBR 900 RR Fireblade	98-99			FA265HH*		MD1134X	MD1134X		MD1134XC*
919 (CB 900 F)	02-07	FA187*		FA187HH*		MD1141X	MD1141X		MD1141XC*
CBR 929 RR (929cc model)	00-01			FA265HH*		MD1137X	MD1137X		MD1137XC*
CBR 954 RR (954cc model)	02-03			FA265HH*		MD1137X	MD1137X		MD1137XC*
CBX	79-80	FA31*				MD1036LS	MD1036RS	VMD1036	VMD1036
CBX	81-82	FA69/2*				N/A	N/A		
CB 1000 C Custom	83	FA69*	FA69V*	FA69HH*		MD1040LS	MD1040RS		
CB 1000	94-95	FA187*		FA187HH*		MD1056	MD1056		
CB 1000 R	10-16			FA390HH*		MD1152X	MD1152X		MD1152XC*
CBF 1000 A8 (Canada)	08			FA388HH*		MD1160	MD1160		
CBR 1000 F (Hurricane)	87-88	FA124*		FA124HH*		MD1008	MD1008		
CBR 1000 F	90-91	FA142*		FA142HH*		MD1008	MD1008		
CBR 1000 F	93-99	FA189*		FA189HH*		MD1008	MD1008		
CBR 1000 RR	04-05			FA390HH*		MD1153X	MD1153X		MD1153XC*
CBR 1000 RR	06-07			FA390HH*		MD1161X	MD1161X		MD1161XC*
CBR 1000 RR	08-15			FA390HH*		MD1171X	MD1171X		MD1171XC*
CBR 1000 RRA ABS Model	09-16			FA390HH*		MD1171X	MD1171X		MD1171XC*
CBR 1000 RRA ABS Model (Nissin Front Caliper)	17			FA700HH*		TBA	TBA		TBA*
CBR 1000 RR SP (Brembo Front Calipers)	14-17			FA447HH*		MD1171X	MD1171X		MD1171XC*
CRF 1000 LAG/LAH Africa Twin (Manual Clutch/ABS)	16-17			FA679HH*					TBA*
CRF 1000 LADG/LADH Africa Twin (DCT/ABS)	16-17			FA679HH*					TBA*
CRF 1000 LADG/LADH Africa Twin (DCT/ABS) - Parking Brake	16-17	SFA257/2							
GL 1000 K/76/L Goldwing (6 Bolt Fixing)	75-77	FA29*	FA29V*			MD1074LS	MD1074RS		
GL 1000 Goldwing	78	FA29*	FA29V*			N/A	N/A		

Line #

FRONT

APPLICATIONS

BRAKE

⊗ This symbol indicates a rotor made of billet steel, and should be only used with EBC FA Kevlar® Organic or Vee pads.

SAFETY NOTICE - With vehicles primarily designed for off highway use such as quads now being used on the highway, we would recommend the use of X or MXS pads for highway use and ONLY using the R and SV higher density / harder pad series for off road riding.

*-2 Sets Required. ■ - Also available in MX-S race compound. **SAFETY WARNING:- DO NOT USE HH PADS ON REAR UNLESS ALSO USED ON FRONT TO AVOID BRAKE IMBALANCE**

FRONT: HONDA Cont'd

REAR: HONDA

Line #	BRAKE ROTOR CHOICES - FRONT						DISC PAD CHOICES - REAR				BRAKE ROTOR CHOICES - REAR					
	CC Custom Rotor	CX Extreme® /Vee-Rotor	OS Series Oversize 250/280mm Rotor Kit	OSX Series Oversize 280mm Rotor Kit	Relocating Bracket for 250/280mm Rotor	SMX Series Oversize 320mm Rotor Kit	Relocating Bracket for 320mm Rotor		Semi-Sintered V-Pads™	Sintered/HH Pads/Grooved Shoes	SV Series Severe Duty Pads	Standard Rotor	UTVX Rotor	Vintage Rotor	Contour Profile Rotor	CX Extreme® /Vee-Rotor
1								FA69/3	FA69/3V	FA69/3HH		MD1068				
2								FA69/3	FA69/3V	FA69/3HH		MD1006				
3								FA196	FA196V	FA196HH		MD1007				
4	MD1003CC*							FA196	FA196V	FA196HH		MD1007			MD1007C	
5								FA143				MD1011				
6								321								
7								321								
8								343								
9								343								
10								343								
11								343								
12								FA254	FA254V	FA254HH		TBA				
13								343								
14								343								
15								343								
16								343								
17								343								
18	MD1014CC*	VR1014BLK*								FA261HH		MD1165			MD1165C	N/A
19	MD1014CC*	VR1014BLK*								FA261HH		MD1164			MD1164C	N/A
20	MD1014CC*	VR1014BLK*								FA261HH		MD1165			MD1165C	N/A
21										FA261HH		MD1164			MD1164C	
22										FA261HH		MD1164			MD1164C	
23										FA488HH		MD1190			TBA	
24										FA488HH		MD1190			TBA	
25								343								
26								343								
27								FA29	FA29V			MD1071		VMD1071		
28								FA29	FA29V			MD1071		VMD1071		
29								FA69	FA69V			MD1082				
30								FA69	FA69V			MD1082				
31	MD1014CC*	VR1014BLK*						FA174	FA174V	FA174HH		MD1004			MD1004C	VR1004
32	MD1003CC*	VR1003BLK*						FA174	FA174V	FA174HH		MD1004			MD1004C	VR1004
33	MD1134CC*	VR1134BLK*						FA174	FA174V	FA174HH		MD1004			MD1004C	VR1004
34	MD1141CC*	VR1141BLK*						FA174	FA174V	FA174HH		MD1020			MD1020C	VR1020
35	MD1137CC*	VR1137BLK*						FA174	FA174V	FA174HH		MD1004			MD1004C	VR1004
36	MD1137CC*	VR1137BLK*						FA174	FA174V	FA174HH		MD1004			MD1004C	VR1004
37								FA31	FA31V			MD1071		VMD1071		
38								FA69	FA69V			MD1082				
39								FA69	FA69V	FA69HH		MD1078				
40								FA174	FA174V	FA174HH		MD1016				
41	MD1152CC*	VR1152BLK*								FA488HH		MD1177			MD1177C	N/A
42										FA388HH		TBA				
43								FA69/3	FA69/3V	FA69/3HH		MD1001				
44								FA196	FA196V	FA196HH		MD1016				
45								FA189		FA189HH		MD1006				
46	MD1153CC*	VR1153BLK*						FA174	FA174V	FA174HH		MD1004			MD1004C	VR1004
47	MD1161CC*	VR1161BLK*						FA436	FA436V	FA436HH		MD1004			MD1004C	VR1004
48		VR1171BLK*						FA436	FA436V	FA436HH		MD1004			MD1004C	VR1004
49		VR1171BLK*						FA436	FA436V	FA436HH		MD1004			MD1004C	VR1004
50								FA436	FA436V	FA436HH		TBA			TBA	
51		VR1171BLK*						FA436	FA436V	FA436HH		MD1004			MD1004C	VR1004
52								FA174	FA174V	FA174HH					TBA	
53								FA174	FA174V	FA174HH					TBA	
54																
55								FA32	FA32V			MD1064				
56								FA32	FA32V			MD1064				

REAR

* This symbol indicates a rotor made of billet steel, and should be only used with EBC FA Kevlar® Organic or Vee pads.

SAFETY NOTICE - With vehicles primarily designed for off highway use such as quads now being used on the highway, we would recommend the use of X or MXS pads for highway use and ONLY using the R and SV higher density / harder pad series for off road riding.

BRAKE APPLICATIONS

*-2 Sets Required. ■ - Also available in MX-S race compound. **SAFETY WARNING:- DO NOT USE HH PADS ON REAR UNLESS ALSO USED ON FRONT TO AVOID BRAKE IMBALANCE**

FRONT: HONDA

APPLICATIONS

BRAKE



HONDA



DISC PAD CHOICES - FRONT

BRAKE ROTOR CHOICES - FRONT

												Line #	
				Semi-Sintered V-Pads™	Sintered/HH Pads/Grooved Shoes	SV Series Severe Duty Pads	Standard Rotor Left	Standard Rotor Right	UTVX Rotor	Vintage Rotor Left	Vintage Rotor Right	Contour Profile Rotor	
GL 1000 Goldwing (5 Bolt Fixing)		79	FA29*	FA29V*			MD1036LS	MD1036RS		VMD1036	VMD1036		1
Pioneer 1000 SXS (2 Seater)	Left	16-18	FA701X		FA701R	FA701SV	MD6410D						2
	Right		FA702X		FA702R	FA702SV		MD6410D					3
Pioneer 1000 SXS (4 Seater)	Left	16-18	FA701X		FA701R	FA701SV	MD6410D						4
	Right		FA702X		FA702R	FA702SV		MD6410D					5
RC 213 V-S		15-17			FA447HH*								6
RVT 1000 R (RC51)		00-06			FA265HH*		MD1138X	MD1138X				MD1138XC*	7
VF 1000 F Interceptor		84	FA69*		FA69HH*		MD1001	MD1001					8
VF 1000 R		85-86	FA69*		FA69HH*		MD1146	MD1146					9
VTR 1000 F Super Hawk		98-05	FA187*		FA187HH*		MD1003X	MD1003X				MD1003XC*	10
XL 1000 VA8 Varadero (Canada)		08			FA388HH*		MD1014X					MD1014XC*	11
CB 1100 (Non ABS)		13-14			FA296HH*		TBA	TBA					12
CB 1100 A (ABS)		13-14			FA388HH*		TBA	TBA					13
CB 1100 EX (ABS)		14-17			FA296HH*		TBA	TBA					14
CB 1100 F Supersport		83	FA69*		FA69HH*		MD1001	MD1001					15
CBR 1100 XX Blackbird		97-98			FA261HH*		MD1120X	MD1120X				MD1120XC*	16
CBR 1100 XX Blackbird		99-03			FA261HH*		MD1136X	MD1136X				MD1136XC*	17
GL 1100/1100 I Goldwing (5 Bolt Fixing)		80	FA30*	FA30V*			MD1036LS	MD1036RS		VMD1036	VMD1036		18
GL 1100/1100 I Goldwing/Interstate (5 Bolt Fixing)		81	FA29*	FA29V*			MD1036LS	MD1036RS		VMD1036	VMD1036		19
GL 1100/1100 I Goldwing/Interstate (5 Bolt Fixing)		82	FA69/2*	FA69/2V			MD1036LS	MD1036RS		VMD1036	VMD1036		20
GL 1100/1100 I Goldwing/Interstate (5 Bolt Fixing)		83	FA69*	FA69V	FA69HH*		MD1036LS	MD1036RS		VMD1036	VMD1036		21
GL 1100 A Goldwing Aspencade (5 Bolt Fixing)		82-83	FA69/2*	FA69/2V			MD1133	MD1133					22
ST 1100		91-02	FA142*		FA142HH*		MD1021LS	MD1021RS					23
ST 1100 A ABS Model		95	FA142*		FA142HH*		MD1021LS	MD1021RS					24
ST 1100 A ABS Model		96-02			FA261HH*		MD1008	MD1008					25
VF 1100 C V65 Magna		83-86	FA69*	FA69V*	FA69HH*		MD1040LS	MD1040RS					26
VF 1100 S V65 Sabre		84-85	FA69*	FA69V*	FA69HH*		MD1001	MD1001					27
VT 1100 C Shadow		85-86	FA69*	FA69V*	FA69HH*		MD1040LS	MD1040RS					28
VT 1100 C Shadow		87-94	FA69/3	FA69/3V	FA69/3HH			MD1080RS					29
VT 1100 C Shadow		95-96	FA196	FA196V	FA196HH			MD1167RS					30
VT 1100 C Shadow Spirit		97-07	FA196	FA196V	FA196HH			MD1167RS					31
VT 1100 C2 Shadow American Classic Edition		95-99	FA196	FA196V	FA196HH		MD1179						32
VT 1100 C2 Shadow Sabre		00-07	FA196	FA196V	FA196HH		MD1179						33
VT 1100 C2-2 Shadow 1100 American Classic Edition		97	FA196	FA196V	FA196HH		MD1179						34
VT 1100 C3 Shadow Aero		98-02	FA196	FA196V	FA196HH		MD1179						35
VT 1100 D2 Shadow American Classic Edition		99	FA196	FA196V	FA196HH		MD1179						36
VT 1100 T Shadow American Classic Edition Tourer		98-01	FA196	FA196V	FA196HH		MD1179						37
GL 1200/1200 I/1200 A (5mm rotor) Goldwing		84-85	FA69/3*	FA69/3V	FA69/3HH*		MD1083LS	MD1083RS					38
GL 1200 L (10mm rotor) Goldwing		85	FA69/3*	FA69/3V	FA69/3HH*		MD1125	MD1125					39
GL 1200 I Goldwing (5mm rotor)		86-87	FA69/3*	FA69/3V	FA69/3HH*		MD1083LS	MD1083RS					40
GL 1200 A/SEi Goldwing (10mm rotor)		86-87	FA69/3*	FA69/3V	FA69/3HH*		MD1125	MD1125					41
VFR 1200 F (Manual Gearbox Model)		10-14			FA499/4HH*		MD1176X	MD1176X					42
VFR 1200 FD (Automatic Transmission Model)		10-14			FA499/4HH*		MD1176X	MD1176X					43
VFR 1200 FD (Automatic Transmission Model) - Parking brake		10-14	SFA257/2										44
VFR 1200 XA (Manual G/Box)		16-17			FA388HH*		TBA	TBA					45
VFR 1200 XD DCT (Automatic Transmission Model)		16-17			FA388HH*		TBA	TBA					46
VFR 1200 XD DCT (Automatic Transmission Model) - Parking Brake		16-17	SFA257/2										47
CTX 1300		14			FA388HH*		TBA	TBA					48
CTX 1300 DLX (ABS)		14			FA388HH*		TBA	TBA					49
ST 1300/ST 1300 A (ABS)		02-07			FA261HH*		MD1154X	MD1154X				MD1154XC*	50
ST 1300/ST 1300 A (ABS)		08-13			FA388HH*		MD1154X	MD1154X				MD1154XC*	51
VT 1300 CX Fury (Non ABS Model)		10-15	FA196	FA196V	FA196HH		TBA						52
VT 1300 CXA Fury (ABS Model)		10-15			FA388HH		TBA						53
VT 1300 CS Sabre (Non ABS)		10-15	FA196	FA196V	FA196HH		TBA						54
VT 1300 CSA Sabre (ABS)		11-14			FA388HH		TBA						55
VT 1300 CR Stateline(Non ABS)		10-15	FA196	FA196V	FA196HH		TBA						56

FRONT

* This symbol indicates a rotor made of billet steel, and should be only used with EBC FA Kevlar® Organic or Vee pads.
 SAFETY NOTICE - With vehicles primarily designed for off highway use such as quads now being used on the highway, we would recommend the use of X or MXS pads for highway use and ONLY using the R and SV higher density / harder pad series for off road riding.

*-2 Sets Required. ■ - Also available in MX-S race compound. **SAFETY WARNING:- DO NOT** USE HH PADS ON REAR UNLESS ALSO USED ON FRONT TO AVOID BRAKE IMBALANCE

FRONT: HONDA Cont'd

REAR: HONDA

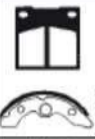
Line #	BRAKE ROTOR CHOICES - FRONT						DISC PAD CHOICES - REAR				BRAKE ROTOR CHOICES - REAR				
	CC Custom Rotor	CX Extreme® /Vee-Rotor	OS Series Oversize 250/280mm Rotor Kit	OSX Series Oversize 280mm Rotor Kit	Relocating Bracket for 250/280mm Rotor	SMX Series Oversize 320mm Rotor Kit	Relocating Bracket for 320mm Rotor		Semi-Sintered V-Pads™	Sintered/HH Pads/ Grooved Shoes	SV Series Severe Duty Pads	Standard Rotor	UTVX Rotor	Vintage Rotor	Contour Profile Rotor
1							FA32	FA32V			MD1064				
2							FA703X		FA703R		MD6410D				
3							FA704X		FA704R		MD6410D				
4							FA703X		FA703R		MD6410D				
5							FA704X		FA704R		MD6410D				
6							FA266	FA266V	FA266HH						
7	MD1138CC*						FA174	FA174V	FA174HH		MD1004			MD1004C	
8							FA69/3	FA69/3V	FA69/3HH		MD1079				
9							FA109				N/A				
10	MD1003CC*	VR1003BLK*					FA174	FA174V	FA174HH		MD1004			MD1004C	VR1004
11	MD1014CC*	VR1014BLK*	MD1014X	MD1014X					FA261HH		MD1006			MD1006C	VR1006
12							FA174	FA174V	FA174HH		TBA				
13							FA174	FA174V	FA174HH		TBA				
14							FA174	FA174V	FA174HH		TBA				
15							FA69	FA69V	FA69HH		MD1068				
16		VR1120BLK*							FA261HH		MD1006			MD1006C	VR1006
17		VR1136BLK*							FA261HH		MD1006			MD1006C	VR1006
18							FA29	FA29V			MD1071		VMD1071		
19							FA29	FA29V			MD1071		VMD1071		
20							FA69	FA69V			MD1082				
21							FA69	FA69V	FA69HH		MD1082				
22							FA69	FA69V			MD1082				
23							FA196	FA196V	FA196HH		MD1077⚠				
24							FA196	FA196V	FA196HH		MD1077⚠				
25								FA261V	FA261HH		MD1135				
26							FA69/3	FA69/3V	FA69/3HH		MD1078				
27							FA69/3	FA69/3V	FA69/3HH		MD1079				
28							343								
29							343								
30							343								
31							343								
32							FA174	FA174V	FA174HH		MD1016				
33							FA174	FA174V	FA174HH		MD1016				
34							FA174	FA174V	FA174HH		MD1016				
35							FA174	FA174V	FA174HH		MD1016				
36							FA174	FA174V	FA174HH		MD1016				
37							FA174	FA174V	FA174HH		MD1016				
38							FA69/3	FA69/3V	FA69/3HH		MD1082				
39							FA69/3	FA69/3V	FA69/3HH		MD1082				
40							FA69/3	FA69/3V	FA69/3HH		MD1082				
41							FA69/3	FA69/3V	FA69/3HH		MD1082				
42									FA488HH		MD1175				
43								FA636V	FA636HH		MD1175				
44															
45								FA636V	FA636HH		MD1175				
46								FA636V	FA636HH		MD1175				
47															
48								FA261V	FA261HH		TBA				
49								FA261V	FA261HH		TBA				
50								FA261V	FA261HH		MD1163⚠				
51								FA261V	FA261HH		MD1163⚠				
52							FA174	FA174V	FA174HH		MD1159				
53									FA261HH		TBA				
54							FA174	FA174V	FA174HH		TBA				
55									FA261/2HH		TBA				
56							FA174	FA174V	FA174HH		TBA				

REAR

⚠ This symbol indicates a rotor made of billet steel, and should be only used with EBC FA Kevlar® Organic or Vee pads.

SAFETY NOTICE - With vehicles primarily designed for off highway use such as quads now being used on the highway, we would recommend the use of X or MXS pads for highway use and ONLY using the R and SV higher density / harder pad series for off road riding.

BRAKE APPLICATIONS

*-2 Sets Required. ■ - Also available in MX-S race compound. **SAFETY WARNING:- DO NOT USE HH PADS ON REAR UNLESS ALSO USED ON FRONT TO AVOID BRAKE IMBALANCE**

FRONT: KAWASAKI

APPLICATIONS

BRAKE



KAWASAKI



* This symbol indicates a rotor made of billet steel, and should be only used with EBC FA Kevlar® Organic or Vee pads.
 SAFETY NOTICE - With vehicles primarily designed for off highway use such as quads now being used on the highway, we would recommend the use of X or MXS pads for highway use and ONLY using the R and SV higher density / harder pad series for off road riding.

DISC PAD CHOICES - FRONT

BRAKE ROTOR CHOICES - FRONT

AR 50 A	82	SFA83	FA83HH		MD4040LS					
KDX 50 A	03-06	613	613G							
KSF 50 A (KFX 50)	03-05	614*	614G*							
KFX 50 (KSF 50 B)	07-09/13-17	338*	338G*							
KX 60 A	83-84	715	715G							
KX 60 B	85-03	715	715G							
KX 65 A	00-17	FA302X	FA302R	MD6166D						
AR 80 A	82	SFA83	FA83HH		MD4040LS					
KD 80 M	80-87	603	603G							
KD 80 N	88-90	FA83X	FA83R		TBA					
KDX 80 A	80-81	701	701G							
KDX 80 B	82-83	701	701G							
KDX 80 C	84-88	714	714G							
KSF 80 A (KFX 80)	03-06	614*	614G*							
KX 80 C	81-82	701	701G							
KX 80 E	83	714	714G							
KX 80 E	84-85	FA83X	FA83R		MD6027D					
KX 80 G	86-87	FA83X	FA83R		MD6027D					
KX 80 J	87	FA83X	FA83R		MD6027D					
KX 80 L/N/R	88-91	FA83X	FA83R		MD6027D					
KX 80 R	92-96	FA83X	FA83R		MD6026D					
KX 80 R/W	97-00	FA258X	FA258R		MD6026D					
KX 85 A/C	01-17	FA258X	FA258R		MD6186D					MD6186C
KFX 90 (KSF 90 A)	07-17	338*	338G*							
KE 100 A	76-81	603	603G							
KE 100 B	82-01	603	603G							
KM 100 A	76-81	603	603G							
KX 100 B	95-96	FA83X	FA83R		MD6026D					
KX 100 B/C	97-00	FA258X	FA258R		MD6026D					
KX 100 D/F	01-09/11-17	FA258X	FA258R		MD6186D					MD6186C
KLF 110 A/B Mojave	87-88	603*	603G*							
KLT 110 A	84-86	603	603G							
KLX 110 (KLX 110 A/C)	02-17	715	715G							
KLX 110 L (KLX 110 D)	10-17	715	715G							
BN 125 A Eliminator	01-09	FA197	FA197HH			MD4137RS				
KD 125 A	75-79	704	704G							
KE 125 A	76-83	704	704G							
KLX 125 A	03-06	604	604G							
KLX 125 L (B)	03-06	FA230X	FA230R		MD6212D					
KX 125 A	74-81	704	704G							
KX 125 B	82	FA83X	FA83R		N/A					
KX 125 B/C/D	83-85	FA67X	FA67R		N/A					
KX 125 E	86	FA67X	FA67R		MD6036D					
KX 125 E/F	87-88	FA130X	FA130R		MD6036D					
KX 125 G/H/J	89-93	FA135X	FA135R■		MD6015D					MD6015C
KX 125 K	94	FA185X	FA185R■		MD6015D					MD6015C
KX 125 K/L	95-02	FA185X	FA185R■		MD6015D					MD6015C
KX 125 M	03-05	FA185X	FA185R■		MD6213D					MD6213C
Z 125 Pro (BR 125 JHF)	17	FA691	FA691HH							MD4171C
KLX 140 A (KLX 140) (17" front/14" rear wheels)	08-17	FA135X	FA135R■							MD6328C
KLX 140 B (KLX 140 L) (19" front/16" rear wheel)	08-17	FA135X	FA135R■							MD6328C
KLX 140 AHF (KLX 140 G) (21" front/18" rear wheel)	17	FA135X	FA135R■							MD6328C
KLX 150 S	09-11	FA135X	FA135R■							MD6363C
KLT 160 A	85	603	603G							
KDX 175 A	80-82	704	704G							
KE 175 D	80-83	704	704G							

Line #

FRONT

*-2 Sets Required. ■ - Also available in MX-S race compound. **SAFETY WARNING:- DO NOT USE HH PADS ON REAR UNLESS ALSO USED ON FRONT TO AVOID BRAKE IMBALANCE**

FRONT: KAWASAKI Cont'd

REAR: KAWASAKI

Line #

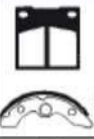
BRAKE ROTOR CHOICES - FRONT							DISC PAD CHOICES - REAR				BRAKE ROTOR CHOICES - REAR					
CC Custom Rotor	CX Extreme® /Vee-Rotor	OS Series Oversize 250/280mm Rotor Kit	OSX Series Oversize 280mm Rotor Kit	Relocating Bracket for 250/280mm Rotor	SMX Series Oversize 320mm Rotor Kit	Relocating Bracket for 320mm Rotor		Semi-Sintered V-Pads™	Sintered/HH Pads/ Grooved Shoes	SV Series Severe Duty Pads	Standard Rotor	UTVX Rotor	Vintage Rotor	Contour Profile Rotor	CX Extreme® /Vee-Rotor	
1							706		706G							
2							706		706G							
3							602		602G							
4							702		702G							
5							702		702G							
6							FA152X		FA152R		MD6024D			MD6024C		
7	MD6015CX						FA152X		FA152R■		MD6024D			MD6024C		
8	MD6083CX						FA152X		FA152R■		MD6105D				MD6105CX	
9							705		705G							
10							705		705G							
11							705		705G							
12	MD6083CX						FA152X		FA152R■		MD6105D				MD6105CX	
13							706		706G							
14							706									
15							706									
16							706									
17							FA85	FA85V	FA85HH		MD4032					
18							FA141				MD4042					
19							FA197		FA197HH					MD4163C		
20							FA197		FA197HH					MD4163C		
21							605		605G							
22							602		602G							
23	MD6083CX						FA152X		FA152R■		MD6105D				MD6105CX	
24	MD6015CX						FA152X		FA152R■		MD6105D				MD6105CX	
25							708									
26							605		605G							
27							703		703G							
28							703		703G							
29							703		703G							
30							FA67X		FA67R		MD6107D					
31							706		706G							
32							705		705G							
33							705		705G							
34							705		705G							
35							602		602G							
36		OS6015C	OSX6015	BRK023	SMX6015	BRK024	FA152X		FA152R■		MD6085D					
37	MD6330CX	OS6330C	OSX6330	BRK021★	SMX6330	BRK022★	FA131X		FA131R■		MD6105D				MD6105CX	
38	★ - When installing oversize disc kit also order Hose Bracket															
39	KHB1 and also kit needs longer hose use Goodridge ref 62024															
40		OS6329C	OSX6329	BRK019	SMX6329	BRK020	FA131X		FA131R■					MD6326C		
41							FA131X		FA131R■					MD6352C		
42							FA84X		FA84R	FA84SV	MD6132D					
43							605		605G							
44							602		602G							
45							602		602G							
46							FA67X		FA67R		MD6161D					
47							FA67X		FA67R		MD6161D					
48	MD6015CX						FA152X		FA152R■		MD6024D			MD6024C	MD6024CX	
49	MD6015CX	OS6015C	OSX6015	BRK023	SMX6015	BRK024	FA152X		FA152R■		MD6024D			MD6024C	MD6024CX	
50	MD6015CX	OS6015C	OSX6015	BRK023	SMX6015	BRK024	FA131X		FA131R■		MD6024D			MD6024C	MD6024CX	
51	MD6213CX	OS6213C	OSX6213	BRK023	SMX6213	BRK024	FA131X		FA131R■		MD6208D			MD6208C	MD6208CX	
52	MD6264CX	OS6264C	OSX6264	BRK023	SMX6264	BRK024	FA131X		FA131R■		MD6208D			MD6208C	MD6208CX	
53	MD6213CX	OS6213C	OSX6213	BRK023	SMX6213	BRK024	FA367X		FA367R■		MD6208D			MD6208C	MD6208CX	
54	MD6264CX	OS6264C	OSX6264	BRK023	SMX6264	BRK024	FA367X		FA367R■		MD6208D			MD6208C	MD6208CX	
55	MD6264CX	OS6264C	OSX6264	BRK023	SMX6264	BRK024	FA367X		FA367R■					MD6208C	MD6208CX	
56	MD6388CX	N/A	N/A	N/A	SMX6264	BRK024	FA367X		FA367R■					MD6208C	MD6208CX	

REAR

BRAKE APPLICATIONS

⚠ This symbol indicates a rotor made of billet steel, and should be only used with EBC FA Kevlar® Organic or Vee pads. SAFETY NOTICE - With vehicles primarily designed for off highway use such as quads now being used on the highway, we would recommend the use of X or MXS pads for highway use and ONLY using the R and SV higher density / harder pad series for off road riding.

*-2 Sets Required. ■ - Also available in MX-S race compound. **SAFETY WARNING:- DO NOT USE HH PADS ON REAR UNLESS ALSO USED ON FRONT TO AVOID BRAKE IMBALANCE**

Part numbers, prefixes, suffixes, photos and illustrations shown in this catalog are trademarks and/or copyrights of EBC Brakes or the trademark owner Freeman Automotive (UK) Ltd and use without express written permission of the owners is punishable by law.

FRONT: KAWASAKI



KAWASAKI



DISC PAD CHOICES - FRONT

BRAKE ROTOR CHOICES - FRONT

		Semi-Sintered V-Pads™	Sintered/HH Pads/Grooved Shoes	SV Series Severe Duty Pads	Standard Rotor Left	Standard Rotor Right	UTVX Rotor	Vintage Rotor Left	Vintage Rotor Right	Contour Profile Rotor
KH 400 A					N/A					
KLF 400 B Bayou (4 x 4)	Left		FA165R	FA165SV	MD6131D					
	Right		FA135R	FA135SV		MD6131D				
KLX 400 SR (KLX 400 A)			FA185R■		MD6017D					MD6017C
KLX 400 R (KLX 400 B)			FA185R■		MD6017D					MD6017C
KSF 400 A (KFX 400)			FA84R*	FA84SV*	MD6210D	MD6210D				
KVF 400 A/B Prairie			FA54R*	FA54SV*	MD6131D	MD6131D				
KVF 400 C (4 x 4) Prairie			FA54R*	FA54SV*	MD6131D	MD6131D				
KVF 400 D (2 x 4) Prairie			FA54R*	FA54SV*	MD6131D	MD6131D				
S3/S3-A (400cc)					N/A					
KDX 420 B			705G							
KX 420 A			705G							
KZ 440 A					MD4047LS					
KZ 440 A			FA68HH		MD4047LS					
KZ 440 B										
KZ 440 K/D (LTD)					MD4047LS					
KZ 440 D (LTD)			FA68HH		MD4010LS					
KZ 440 G			FA68HH		MD4010LS					
EN 450 A (454 LTD)			FA85HH		MD4006LS					
KAF 450 B (Mule 1000)			N/A*							
KDX 450 A			705G							
KFX 450 R (KSF 450 B)	Left		FA342R	FA342SV	MD6137D					
	Right		FA349R	FA349SV		MD6137D				
KLX 450 R A			FA185R■							MD6264C
KX 450 F (D)			FA185R■			MD6264D				MD6264C
KX 450 F E/F (4T)			FA185R■							MD6264C
KX 450 F (F/H) (4T) 270mm Front Rotor			FA185R■							MD6388C
EX 500 A Solid rotor			FA129HH		MD4016					
EX 500 A EBC floating conversion			FA129HH		MD714X					
EX 500 D Ninja 500 Solid rotor			FA129HH			MD4016				
EX 500 D Ninja 500 EBC floating conversion			FA129HH			MD714X				
EN 500 A/B			FA85HH		MD4006LS					
EN 500 C Vulcan			FA85HH		MD4124LS					
HI 500 Mach III										
HI-A 500 S Mach III										
HI-B 500 Mach III										
HI-C 500 Mach III										
HI-D 500			FA55		MD4069LS			VMD4069		
HI-E 500			FA55		MD4069LS			VMD4069		
HI-F 500			FA55		MD4069LS			VMD4069		
KH 500 A			FA33		MD4052LS			VMD4052		
KX 500 A/B			FA67R							
KX 500 B			FA67R							
KX 500 C/D			FA130R		MD6036D					
KX 500 E			FA135R■		MD6015D					MD6015C
KX 500 E			FA185R■		MD6015D					MD6015C
KX 500 E			FA185R■		MD6015D					MD6015C
KAF 540 C (Mule 2010)			N/A*							
KAF 540 D (Mule 2020)			N/A*							
KAF 540 E (Mule 2030)			N/A*							
KZ 550 A					MD4053LS					
KZ 550 A			FA68HH		MD4006LS					
KZ 550 C (LTD)			FA68HH		MD4006LS					
KZ 550 D (GPz)			FA68HH*		MD4010LS	MD4010RS				
KZ 550 F (Spectre) (LTD)			FA68HH		MD4006LS					

Line #

FRONT

APPLICATIONS
BRAKE

* This symbol indicates a rotor made of billet steel, and should be only used with EBC FA Kevlar® Organic or Vee pads.
SAFETY NOTICE - With vehicles primarily designed for off highway use such as quads now being used on the highway, we would recommend the use of X or MXS pads for highway use and ONLY using the R and SV higher density / harder pad series for off road riding.

*-2 Sets Required. ■ - Also available in MX-S race compound. SAFETY WARNING:- DO NOT USE HH PADS ON REAR UNLESS ALSO USED ON FRONT TO AVOID BRAKE IMBALANCE

FRONT: KAWASAKI Cont'd

REAR: KAWASAKI

Line #
1
2
3
4
5
6
7
8
9
10
11
12
13
14
15
16
17
18
19
20
21
22
23
24
25
26
27
28
29
30
31
32
33
34
35
36
37
38
39
40
41
42
43
44
45
46
47
48
49
50
51
52
53
54
55
56

BRAKE ROTOR CHOICES - FRONT							DISC PAD CHOICES - REAR				BRAKE ROTOR CHOICES - REAR						
CC Custom Rotor	CX Extreme® /Vee-Rotor	OS Series Oversize 250/280mm Rotor Kit	OSX Series Oversize 280mm Rotor Kit	Relocating Bracket for 250/280mm Rotor	SMX Series Oversize 320mm Rotor Kit	Relocating Bracket for 320mm Rotor		Semi-Sintered V-Pads™	Sintered/HH Pads/ Grooved Shoes	SV Series Severe Duty Pads	Standard Rotor	UTVX Rotor	Vintage Rotor	Contour Profile Rotor	CX Extreme® /Vee-Rotor		
							708										
							710		710G								
	MD6017CX	OS6017C	OSX6017	BRK023	SMX6017	BRK024	FA131X		FA131R■		MD6014D			MD6014C	MD6014CX		
	MD6017CX	OS6017C	OSX6017	BRK023	SMX6017	BRK024	FA131X		FA131R■		MD6014D			MD6014C	MD6014CX		
							FA137X		FA137R	FA137SV	MD6211D						
							710		710G								
							710		710G								
							710		710G								
							708										
							605		605G								
							605		605G								
							706										
							706										
							706										
							706										
							706										
							706										
							709										
							720*		N/A*								
							605		605G								
							FA84X		FA84R	FA84SV				MD6304C			
	MD6264CX	OS6264C	OSX6264	BRK023	SMX6264	BRK024	FA367X		FA367R■					MD6208C●	MD6208CX		
							MD6208C● = PLAIN UNDRILLED DISC FOR ENDURO USE. REAR FITMENTS ONLY. ORDER MD6208CE.										
	MD6264CX	OS6264C	OSX6264	BRK023	SMX6264	BRK024	FA367X		FA367R■		MD6208D			MD6208C	MD6208CX		
	MD6264CX	OS6264C	OSX6264	BRK023	SMX6264	BRK024	FA367X		FA367R■		MD6208D			MD6208C	MD6208CX		
	MD6388CX	N/A	N/A	N/A	SMX6264	BRK024	FA367X		FA367R■					MD6208C	MD6208CX		
							706										
							706										
							FA67/3				MD4051						
							FA67/3				MD4051						
							709										
							709										
							N/A										
							N/A										
							N/A										
							N/A										
							710										
							710										
							710										
							710										
							602		602G								
							FA67X		FA67R		MD6161D						
							FA67X		FA67R		MD6161D						
							FA152X		FA152R■		MD6024D			MD6024C	MD6024CX		
	MD6015CX	OS6015C	OSX6015	BRK023	SMX6015	BRK024	FA152X		FA152R■		MD6024D			MD6024C	MD6024CX		
	MD6015CX	OS6015C	OSX6015	BRK023	SMX6015	BRK024	FA131X		FA131R■		MD6024D			MD6024C	MD6024CX		
							720*		N/A*								
							720*		N/A*								
							720*		N/A*								
							709										
							709										
							709										
							FA68	FA68V	FA68HH		MD4169						
							709										

● This symbol indicates a rotor made of billet steel, and should be only used with EBC FA Kevlar® Organic or Vee pads.

SAFETY NOTICE - With vehicles primarily designed for off highway use such as quads now being used on the highway, we would recommend the use of X or MXS pads for highway use and ONLY using the R and SV higher density / harder pad series for off road riding.

BRAKE APPLICATIONS

*-2 Sets Required. ■ - Also available in MX-S race compound. **SAFETY WARNING:- DO NOT USE HH PADS ON REAR UNLESS ALSO USED ON FRONT TO AVOID BRAKE IMBALANCE**

FRONT: KAWASAKI



KAWASAKI



DISC PAD CHOICES - FRONT

BRAKE ROTOR CHOICES - FRONT

KZ 550 H (GPz)	82-83	FA68*	FA68HH*		MD4099	MD4099				
KZ 550 M (LTD)	83	FA68	FA68HH		MD4006LS					
ZR 550 B Zephyr	90-92	FA129*	FA129HH*		MD4008X	MD4008X				MD4008XC*
ZR 550 B Zephyr	93	FA129*	FA129HH*		MD4008X	MD4008X				MD4008XC*
ZX 550 A (GPz)	84-86	FA85*	FA85HH*		MD4002LS	MD4002RS				
KL 600 A	84	FA67X	FA67R		MD6080D					
KL 600 B (KLR)	85-86	FA67X	FA67R		MD6080D					
ZL 600 A	86-87	FA85	FA85V	FA85HH	MD4016					
ZL 600 B Eliminator	96-97	FA129	FA129V	FA129HH		MD4008				MD4008C
ZX 600 A/B Ninja	85-87	FA85*	FA85HH*		MD4028	MD4028				
ZX 600 C Ninja 600 R	88-96	FA129*	FA129HH*		MD4026LS	MD4026RS				
ZX 600 E (Ninja ZX6)	93-95	FA158*	FA158HH*		MD4008X	MD4008X				MD4008XC*
ZX 600 E (ZZR 600)	96-05	FA158*	FA158HH*		MD4153X	MD4153X				MD4153XC*
ZX 600 D (ZX6)	90-93	FA158*	FA158HH*		MD4141X	MD4141X				MD4141XC*
ZX6R (ZX 600 F)	95-97	FA158*	FA158HH*		MD4008X	MD4008X				MD4008XC*
ZX6R (ZX 600 G/J)	98-02	FA188*	FA188HH*		MD4136X	MD4136X				MD4136XC*
ZX6R (ZX 600 P/R)	07-12		FA417/4HH*							MD4152XC*
ZX6RR (ZX 600 K/M) 599cc	03-04		FA369/4HH*		MD4151X	MD4151X				MD4151XC*
ZX6RR (ZX 600 N) 599cc	05-06		FA369/4HH*							MD4152XC*
ZZR 600 (ZX 600 J)	05	FA188*	FA188HH*		MD4136X	MD4136X				MD4136XC*
ZZR 600 J	06-08	FA188*	FA188HH*		MD4136X	MD4136X				MD4136XC*
KAF 620 A (Mule 2510)		719*	N/A*							
KAF 620 B (Mule 2520)		719*	N/A*							
KAF 620 C (Mule 2500)		719*	N/A*							
KAF 620 E Mule 3010		719*	N/A*							
KAF 620 F Mule 3020		719*	N/A*							
KAF 620 G Mule 3000		719*	N/A*							
KAF 620 H Mule 3010 4x4	03-05	719*	N/A*							
KAF 620 K Mule 3010 Trans 4x4	05-07	719*	N/A*							
KAF 620 J Mule 3010 Trans 4x4	05	719*	N/A*							
KAF 620 M (Mule 4010 4x4)	09-17	719*	N/A*							
KAF 620 N (Mule 4010 4x4 Hardwoods Green)	09	719*	N/A*							
KAF 620 P (Mule 4000)	09-17	719*	N/A*							
KAF 620 R (Mule 4010 Trans 4x4)	09-17	719*	N/A*							
KAF 620 S (Mule 4010 Trans 4x4 Hardwoods Green HD)	09-17	719*	N/A*							
KAF 620 T (Mule 4010 4x4 SE)	16-17	719*	N/A*							
KAF 620 V (Mule 4010 Trans 4x4 SE)	16-17	719*	N/A*							
ZX6R (ZX 636 A) 636cc	02	FA188*	FA188HH*		MD4136X	MD4136X				MD4136XC*
ZX6R (ZX 636 B) 636cc	03-04		FA369/4HH*		MD4151X	MD4151X				MD4151XC*
ZX6R (ZX 636 C) 636cc	05-06		FA369/4HH*							MD4152XC*
ZX6R (ZX 636 E) Non ABS	13-17		FA296HH*							MD4155XC*
ZX6R (ZX 636 E) 636 cc/Non ABS /30th Anniversary Edition	15		FA296HH*							MD4155XC*
ZX6R (ZX 636 E) 636 cc/Non ABS/ KRT Edition	16-17		FA296HH*							MD4155XC*
ZX6R (ZX 636 F) ABS Model	13-17		FA296HH*							MD4155XC*
ZX6R (ZX 636 F) 636 cc/ABS/30th Anniversary Edition ABS	15		FA296HH*							MD4155XC*
ZX6R (ZX 636 F) 636 cc/ABS/ KRT Edition	16-17		FA296HH*							MD4155XC*
EN 650 Vulcan S (Non ABS) - EN 650 A	15-17		FA281HH			TBA				
EN 650 Vulcan S (ABS) - EN 650 B	15-17		FA281HH			TBA				
ER 650 C ER-6n	Left 09-10	FA229	FA229V	FA229HH						MD4159XC
	Right	FA231	FA231V	FA231HH						MD4159XC
EX 650 Ninja 650 R (A/C) Ninja 650R	Left 06-10	FA229	FA229V	FA229HH						MD4159XC
	Right	FA231	FA231V	FA231HH						MD4159XC
EX 650 Ninja 650 R (EX 650 C)	Left 11	FA229	FA229V	FA229HH						MD4159XC
	Right	FA231	FA231V	FA231HH						MD4159XC
EX 650 Ninja 650 (EX 650 E) Non ABS	Left 12-16	FA229	FA229V	FA229HH						MD4159XC
	Right	FA231	FA231V	FA231HH						MD4159XC

Line #

FRONT

APPLICATIONS

⚠ This symbol indicates a rotor made of billet steel, and should be only used with EBC FA Kevlar® Organic or Vee pads.

SAFETY NOTICE - With vehicles primarily designed for off highway use such as quads now being used on the highway, we would recommend the use of X or MXS pads for highway use and ONLY using the R and SV higher density / harder pad series for off road riding.

*-2 Sets Required. ■ - Also available in MX-S race compound. **SAFETY WARNING:- DO NOT USE HH PADS ON REAR UNLESS ALSO USED ON FRONT TO AVOID BRAKE IMBALANCE**

FRONT: KAWASAKI Cont'd

REAR: KAWASAKI

Line #	BRAKE ROTOR CHOICES - FRONT						DISC PAD CHOICES - REAR				BRAKE ROTOR CHOICES - REAR				
	CC Custom Rotor	CX Extreme® /Vee-Rotor	OS Series Oversize 250/280mm Rotor Kit	OSX Series Oversize 280mm Rotor Kit	Relocating Bracket for 250/280mm Rotor	SMX Series Oversize 320mm Rotor Kit	Relocating Bracket for 320mm Rotor		Semi-Sintered V-Pads™	Sintered/HH Pads/ Grooved Shoes	SV Series Severe Duty Pads	Standard Rotor	UTVX Rotor	Vintage Rotor	Contour Profile Rotor
1							FA68	FA68V	FA68HH		MD4024				
2							709								
3	MD4008CC*	VR4008BLK*					FA141				MD4009			MD4009C	VR4009
4	MD4008CC*	VR4008BLK*					FA192	FA192V	FA192HH		MD4009			MD4009C	VR4009
5							FA85	FA85V	FA85HH		MD4001				
6							602		602G						
7							602		602G						
8							709								
9	MD4008CC	VR4008BLK					709								
10							FA85	FA85V	FA85HH		MD4015				
11							FA129	FA129V	FA129HH		MD4027				
12	MD4008CC*	VR4008BLK*					FA192	FA192V	FA192HH		MD4009			MD4009C	VR4009
13	MD4153CC*	VR4153BLK*					FA192	FA192V	FA192HH		MD4009			MD4009C	VR4009
14	MD4141CC*						FA129	FA129V	FA129HH		MD4007			MD4007C	
15	MD4008CC*	VR4008BLK*					FA192	FA192V	FA192HH		MD4023			MD4023C	VR4023
16	MD4136CC*	VR4136BLK*					FA192	FA192V	FA192HH		MD4138			MD4138C	VR4138
17	MD4152CC*	VR4152BLK*					FA192	FA192V	FA192HH					MD4138C	VR4138
18							FA192	FA192V	FA192HH		MD4138			MD4138C	VR4138
19	MD4152CC*	VR4152BLK*					FA192	FA192V	FA192HH		MD4138			MD4138C	VR4138
20	MD4136CC*	VR4136BLK*					FA192	FA192V	FA192HH		MD4138			MD4138C	VR4138
21	MD4136CC*	VR4136BLK*					FA192	FA192V	FA192HH		MD4138			MD4138C	VR4138
22							720*		N/A*						
23							720*		N/A*						
24							720*		N/A*						
25							720*		N/A*						
26							720*		N/A*						
27							720*		N/A*						
28							720*		N/A*						
29							720*		N/A*						
30							720*		N/A*						
31							720*		N/A*						
32							720*		N/A*						
33							720*		N/A*						
34							720*		N/A*						
35							720*		N/A*						
36							720*		N/A*						
37							720*		N/A*						
38	MD4136CC*	VR4136BLK*					FA192	FA192V	FA192HH		MD4138			MD4138C	VR4138
39							FA192	FA192V	FA192HH		MD4138			MD4138C	
40	MD4152CC*	VR4152BLK*					FA192	FA192V	FA192HH					MD4138C	VR4138
41		VR4155BLK*					FA436		FA436HH					MD4165C	VR4165
42		VR4155BLK*					FA436		FA436HH					MD4165C	VR4165
43		VR4155BLK*					FA436		FA436HH					MD4165C	VR4165
44		VR4155BLK*					FA436		FA436HH					MD4165C	VR4165
45		VR4155BLK*					FA436		FA436HH					MD4165C	VR4165
46		VR4155BLK*					FA436		FA436HH					MD4165C	VR4165
47							FA174	FA174V	FA174HH		TBA				
48							FA174	FA174V	FA174HH		TBA				
49		VR4159BLK					FA192	FA192V	FA192HH					MD4138C	VR4138
50		VR4159BLK													
51		VR4159BLK					FA192	FA192V	FA192HH					MD4138C	VR4138
52		VR4159BLK													
53		VR4159BLK					FA192	FA192V	FA192HH					MD4138C	VR4138
54		VR4159BLK													
55		VR4159BLK					FA192	FA192V	FA192HH					MD4138C	VR4138
56		VR4159BLK													

REAR

⊛ This symbol indicates a rotor made of billet steel, and should be only used with EBC FA Kevlar® Organic or Vee pads.
 SAFETY NOTICE - With vehicles primarily designed for off highway use such as quads now being used on the highway, we would recommend the use of X or MXS pads for highway use and ONLY using the R and SV higher density / harder pad series for off road riding.

BRAKE APPLICATIONS

*-2 Sets Required. ■ - Also available in MX-S race compound. **SAFETY WARNING:- DO NOT USE HH PADS ON REAR UNLESS ALSO USED ON FRONT TO AVOID BRAKE IMBALANCE**

FRONT BRAKE Fitments for KAWASAKI

APPLICATIONS

BRAKE



KAWASAKI



DISC PAD CHOICES - FRONT

BRAKE ROTOR CHOICES - FRONT

			Semi-Sintered V-Pads™	Sintered/HH Pads/Grooved Shoes	SV Series Severe Duty Pads	Standard Rotor Left	Standard Rotor Right	UTVX Rotor	Vintage Rotor Left	Vintage Rotor Right	Contour Profile Rotor
EX 650 Ninja 650 (EX 650 F) ABS Model	Left	13-16	FA229	FA229V	FA229HH						MD4156AXC
	Right		FA231	FA231V	FA231HH						MD4156XC
Ninja 650 (EX 650 KHF/KHFA - ABS)		17	FA226*		FA226HH*						TBA*
Ninja 650 (EX 650 JHF - Non ABS)		17	FA226*		FA226HH*						TBA*
KL 650 A (KLR)		87-07	FA130X	FA130V	FA130R	MD6042D					MD6042C
KL 650 B Tengai		90-91	FA129		FA129R	MD6081D					
KL 650 E (KLR 650)		08-15			FA228HH						MD6309C
KLE 650 A/C Versys	Left	07-14	FA229		FA229HH						MD4159XC
	Right		FA231		FA231HH						MD4159XC
KLE 650 D Versys (ABS Model)	Left	14	FA229		FA229HH						MD4156AXC
	Right		FA231		FA231HH						MD4159XC
KLE 650 F Versys/Versys LT (ABS Model)		15	FA142*	FA142V*	FA142HH*						TBA*
KLE 650 F Versys/Versys LT (ABS Model)		16	FA142*	FA142V*	FA142HH*						TBA*
KLX 650 R A		93-95	FA185X		FA185R■	MD6015D					MD6015C
KLX 650 R D		96	FA185X		FA185R■	MD6015D					MD6015C
KLX 650 C		93-96	FA185X		FA185R■	MD6086D					
KVF 650 A/B Prairie	Left	02-03			FA342R	FA342SV	MD6188D		UTVX6188		
	Right				FA349R	FA349SV		MD6188D	UTVX6188		
KVF 650 D Brute Force 4x4	Left	05-11			FA342R	FA342SV	MD6188D		UTVX6188		
	Right				FA349R	FA349SV		MD6188D	UTVX6188		
KVF 650 E1 Brute Force 4x4 Hardwoods Green HD	Left	05-09			FA342R	FA342SV	MD6188D		UTVX6188		
	Right				FA349R	FA349SV		MD6188D	UTVX6188		
KVF 650 F Brute Force 650 4x4i	Left	06-11	FA165X		FA165R	FA165SV	MD6188D		UTVX6188		
	Right		FA135X		FA135R	FA135SV		MD6188D	UTVX6188		
KVF 650 F Brute Force 4x4i	Left	08	FA165X		FA165R	FA165SV	MD6188D		UTVX6188		
	Right		FA135X		FA135R	FA135SV		MD6188D	UTVX6188		
KVF 650 F Brute Force 650 4x4i	Left	12	FA165X		FA165R	FA165SV	MD6188D		UTVX6188		
	Right		FA135X		FA135R	FA135SV		MD6188D	UTVX6188		
KVF 650 G Brute Force 650 4x4i Hardwood Green HD	Left	06-10	FA165X		FA165R	FA165SV	MD6188D		UTVX6188		
	Right		FA135X		FA135R	FA135SV		MD6188D	UTVX6188		
KVF 650 H Brute Force 4x4i	Left	07-08	FA165X		FA165R	FA165SV	MD6188D		UTVX6188		
	Right		FA135X		FA135R	FA135SV		MD6188D	UTVX6188		
KZ 650 B		77-79	FA33				MD4052LS			VMD4052	
KZ 650 C Custom use to F/No. 23100		77-79	FA33				MD4059LS	MD4059RS	VMD4059	VMD4059	
KZ 650 C Custom use from F/No. 23101		79	FA73				MD4059LS	MD4059RS	VMD4059	VMD4059	
KZ 650 D SR Series		78-79	FA33*				MD4059LS	MD4059RS	VMD4059	VMD4059	
KZ 650 D SR Series		79	FA73*				MD4059LS	MD4059RS	VMD4059	VMD4059	
KZ 650 E (LTD)		80	FA73				MD4064LS			VMD4064	
KZ 650 F		80	FA73				MD4064LS			VMD4064	
KZ 650 H (CSR)		81-83	FA68	FA68V	FA68HH		MD4065LS				
W 650 (EJ 650 A)		00-02	FA231		FA231HH			MD4008			MD4008C
Z 650 (EER 650 GHF / Non ABS)		17	FA142*	FA142V*	FA142HH*						TBA*
Z 650 (EER 650 HHF / Non ABS)		17	FA142*	FA142V*	FA142HH*						TBA*
KSV 700 A/B (KFX 700 V Force)	Left	04			FA342R	FA342SV	MD6137D				
	Right				FA349R	FA349SV		MD6137D			
KVF 700 A (Prairie 700 4x4) (KFX 700)	Left	04-09			FA342R	FA342SV	MD6188D		UTVX6188		
	Right				FA349R	FA349SV		MD6188D	UTVX6188		
KVF 700 B/C (KFX 700 4x4)	Left	04-09			FA342R	FA342SV	MD6188D		UTVX6188		
	Right				FA349R	FA349SV		MD6188D	UTVX6188		
KVF 700 D Team Green Special Edition	Left	05-06			FA342R	FA342SV	MD6188D		UTVX6188		
	Right				FA349R	FA349SV		MD6188D	UTVX6188		
KZ 700 A		84	FA68*	FA68V*	FA68HH*		MD4010LS	MD4010RS			
VN 700 A Vulcan		85	FA85*	FA85V*	FA85HH*		MD4010LS	MD4010RS			
ZN 700 A (LTD)		84-85	FA85*	FA85V*	FA85HH*		MD4067LS	MD4067RS			
H2/H2-A Mach IV (750-2T)		72-73	FA55				MD4069LS			VMD4069	
H2-B/H-C Mach IV (750-2T)		74-75	FA55				MD4069LS			VMD4069	

Line #

FRONT

* This symbol indicates a rotor made of billet steel, and should be only used with EBC FA Kevlar® Organic or Vee pads. SAFETY NOTICE - With vehicles primarily designed for off highway use such as quads now being used on the highway, we would recommend the use of X or MXS pads for highway use and ONLY using the R and SV higher density / harder pad series for off road riding.

*-2 Sets Required. ■ - Also available in MX-S race compound. SAFETY WARNING:- DO NOT USE HH PADS ON REAR UNLESS ALSO USED ON FRONT TO AVOID BRAKE IMBALANCE

FRONT: KAWASAKI

APPLICATIONS

BRAKE



KAWASAKI



DISC PAD CHOICES - FRONT

BRAKE ROTOR CHOICES - FRONT

Model	Side	Year	DISC PAD CHOICES - FRONT			BRAKE ROTOR CHOICES - FRONT					Line #		
				Semi-Sintered V-Pads™	Sintered/HH Pads/Grooved Shoes	SV Series Severe Duty Pads							
KRF 750 A/B Teryx 4x4	Left	08	FA165X		FA165R	FA165SV	MD6325D		UTVX6325				1
	Right		FA135X		FA135R	FA135SV		MD6325D	UTVX6325				2
KRF 750 C/D Teryx 4x4 LE	Left	08	FA165X		FA165R	FA165SV	MD6325D		UTVX6325				3
	Right		FA135X		FA135R	FA135SV		MD6325D	UTVX6325				4
KRF 750 F Teryx 4x4 NRA Outdoors	Left	08	FA165X		FA165R	FA165SV	MD6325D		UTVX6325				5
	Right		FA135X		FA135R	FA135SV		MD6325D	UTVX6325				6
KRF 750 G/N Teryx 750 Fi 4x4	Left	09-13	FA165X		FA165R	FA165SV	MD6325D		UTVX6325				7
	Right		FA135X		FA135R	FA135SV		MD6325D	UTVX6325				8
KRF 750 J/K/P/R Teryx 750 Fi 4x4 LE	Left	09-13	FA165X		FA165R	FA165SV	MD6325D		UTVX6325				9
	Right		FA135X		FA135R	FA135SV		MD6325D	UTVX6325				10
KRF 750 L Teryx 750 Fi 4x4 LE Sport	Left	09	FA165X		FA165R	FA165SV	MD6325D		UTVX6325				11
	Right		FA135X		FA135R	FA135SV		MD6325D	UTVX6325				12
KRF 750 M Teryx 750 Fi 4x4 NRA Outdoors	Left	09	FA165X		FA165R	FA165SV	MD6325D		UTVX6325				13
	Right		FA135X		FA135R	FA135SV		MD6325D	UTVX6325				14
KRF 750 S Teryx 750 Fi 4x4 Sport LE Sport	Left	10-13	FA165X		FA165R	FA165SV	MD6325D		UTVX6325				15
	Right		FA135X		FA135R	FA135SV		MD6325D	UTVX6325				16
KRF 750 T/V Teryx 750 Fi 4x4 SGE	Left	10-11	FA165X		FA165R	FA165SV	MD6325D		UTVX6325				17
	Right		FA135X		FA135R	FA135SV		MD6325D	UTVX6325				18
KRT 750 A (Teryx 4 750 4x4)	Left	12-13	FA165X		FA165R	FA165SV	MD6399D		UTVX6399				19
	Right		FA135X		FA135R	FA135SV		MD6399D	UTVX6399				20
KRT 750 A (Teryx 4 750 4x4 EPS)	Left	12-13	FA165X		FA165R	FA165SV	MD6399D		UTVX6399				21
	Right		FA135X		FA135R	FA135SV		MD6399D	UTVX6399				22
KRT 750 C (Teryx 4 750 4x4 EPS LE)	Left	12-13	FA165X		FA165R	FA165SV	MD6399D		UTVX6399				23
	Right		FA135X		FA135R	FA135SV		MD6399D	UTVX6399				24
KRT 750 D (Teryx 4 750 4x4 EPS Realtree)	Left	12-13	FA165X		FA165R	FA165SV	MD6399D		UTVX6399				25
	Right		FA135X		FA135R	FA135SV		MD6399D	UTVX6399				26
KVF 750 A Brute Force 750 4x4i	Left	05-07	FA165X		FA165R	FA165SV	MD6188D		UTVX6188				27
	Right		FA135X		FA135R	FA135SV		MD6188D	UTVX6188				28
KVF 750 B/E Brute Force 750 4x4i Hardwoods Green HD	Left	05/08-09	FA165X		FA165R	FA165SV	MD6188D		UTVX6188				29
	Right		FA135X		FA135R	FA135SV		MD6188D	UTVX6188				30
KVF 750 B Brute Force 750 4x4i	Left	06-07	FA165X		FA165R	FA165SV	MD6188D		UTVX6188				31
	Right		FA135X		FA135R	FA135SV		MD6188D	UTVX6188				32
KVF 750 C/D Brute Force 750 4x4i	Left	05-11	FA165X		FA165R	FA165SV	MD6188D		UTVX6188				33
	Right		FA135X		FA135R	FA135SV		MD6188D	UTVX6188				34
KVF 750 E Brute Force 750 4x4i NRA Outdoors	Left	08-10	FA165X		FA165R	FA165SV	MD6188D		UTVX6188				35
	Right		FA135X		FA135R	FA135SV		MD6188D	UTVX6188				36
KVF 750 F Brute Force 750 4x4i	Left	08/10-11	FA165X		FA165R	FA165SV	MD6188D		UTVX6188				37
	Right		FA135X		FA135R	FA135SV		MD6188D	UTVX6188				38
KVF 750 G Brute Force 750 4x4 i/EPS	Left	12-17	FA165X		FA165R	FA165SV	MD6188D		UTVX6188				39
	Right		FA135X		FA135R	FA135SV		MD6188D	UTVX6188				40
KVF 750 H Brute Force 750 4x4 i / EPS / Camo	Left	12-17	FA165X		FA165R	FA165SV	MD6188D		UTVX6188				41
	Right		FA135X		FA135R	FA135SV		MD6188D	UTVX6188				42
KVF 750 J Brute Force 750 4x4 i / EPS	Left	12-17	FA165X		FA165R	FA165SV	MD6188D		UTVX6188				43
	Right		FA135X		FA135R	FA135SV		MD6188D	UTVX6188				44
KVF 750 L Brute Force 750 4x4i	Left	12-17	FA165X		FA165R	FA165SV	MD6188D		UTVX6188				45
	Right		FA135X		FA135R	FA135SV		MD6188D	UTVX6188				46
KZ 750 B		76-79	FA33				MD4052LS			VMD4052			47
KZ 750 E		80-82	FA68*	FA68V*	FA68HH*		MD4010LS	MD4010RS					48
KZ 750 F (LTD)		83	FA68*	FA68V*	FA68HH*		MD4010LS	MD4010RS					49
KZ 750 G (LTD)		80	FA73				N/A						50
KZ 750 H (LTD)		80-83	FA68*	FA68V*	FA68HH*		MD4010LS	MD4010RS					51
KZ 750 K (LTD)		83-84	FA85	FA85V	FA85HH		MD4070LS						52
KZ 750 L		83	FA68*	FA68V*	FA68HH*		MD4010LS	MD4010RS					53
KZ 750 M (CSR)		82	FA68	FA68V	FA68HH		MD4066LS						54
KZ 750 N Spectre		82-83	FA68*	FA68V*	FA68HH*		MD4010LS	MD4010RS					55
KZ 750 R (GPz)		82	FA68*		FA68HH*		MD4010LS	MD4010RS					56

FRONT

* This symbol indicates a rotor made of billet steel, and should be only used with EBC FA Kevlar® Organic or Vee pads.
 SAFETY NOTICE - With vehicles primarily designed for off highway use such as quads now being used on the highway, we would recommend the use of X or MXS pads for highway use and ONLY using the R and SV higher density / harder pad series for off road riding.

*-2 Sets Required. ■ - Also available in MX-S race compound. **SAFETY WARNING:- DO NOT USE HH PADS ON REAR UNLESS ALSO USED ON FRONT TO AVOID BRAKE IMBALANCE**

FRONT: KAWASAKI



KAWASAKI



DISC PAD CHOICES - FRONT

BRAKE ROTOR CHOICES - FRONT

											Line #
		Sintered/HH Pads/Grooved Shoes	Sintered/HH Pads/Grooved Shoes	SV Series Severe Duty Pads	Standard Rotor Left	Standard Rotor Right	UTVX Rotor	Vintage Rotor Left	Vintage Rotor Right	Contour Profile Rotor	
VN 750 A Vulcan		FA85*	FA85V*	FA85HH*	MD4010LS	MD4010RS					1
Z 750 (ZR 750 J)	Left	FA229	FA229V	FA229HH	MD4141X					MD4141XC*	2
	Right	FA231	FA231V	FA231HH		MD4141X					3
Z 750 S (ZR 750 K)	Left	FA229	FA229V	FA229HH	MD4141X					MD4141XC*	4
	Right	FA231	FA231V	FA231HH		MD4141X					5
ZR 750 C		FA129*	FA129V*	FA129HH*	MD4008X	MD4008X				MD4008XC*	6
ZR 750 F (ZR-7)	Left	FA229	FA229V	FA229HH	MD4141X					MD4141XC*	7
	Right	FA231	FA231V	FA231HH		MD4141X					8
ZR7-S (ZR 750) H	Left	FA229	FA229V	FA229HH	MD4141X					MD4141XC*	9
	Right	FA231	FA231V	FA231HH		MD4141X					10
ZX 750 A (GPz)		FA85*		FA85HH*	MD4028	MD4028					11
ZX 750 E Turbo		FA85*		FA85HH*	MD4016	MD4016					12
ZX 750 F Ninja		FA129*		FA129HH*	MD4071LS	MD4071RS					13
ZX 750 H (ZX-7)		FA158*		FA158HH*	MD4012X	MD4012X				MD4012XC*	14
Ninja ZX-750 J/L (ZX-7)		FA158*		FA158HH*	MD4022X	MD4022X				MD4022XC*	15
Ninja ZX 7R (ZX 750 K/M)		FA158*		FA158HH*	MD4022X	MD4022X				MD4022XC*	16
Ninja ZX 7R (ZX 750 P) (Six piston pad) Tokico caliper		FA188*		FA188HH*	MD4022X	MD4022X				MD4022XC*	17
ZX7RR (ZX 750 N) (Six piston pad) Nissin caliper		FA424*		FA424HH*	MD4022X	MD4022X				MD4022XC*	18
KRF 800 B/F (Teryx)	Left	FA165X		FA165R	FA165SV	MD6399D		UTVX6399			19
	Right	FA135X		FA135R	FA135SV		MD6399D	UTVX6399			20
KRF 800 C/G (Teryx LE)	Left	FA165X		FA165R	FA165SV	MD6399D		UTVX6399			21
	Right	FA135X		FA135R	FA135SV		MD6399D	UTVX6399			22
KRF 800 D/H (Teryx Camo)	Left	FA165X		FA165R	FA165SV	MD6399D		UTVX6399			23
	Right	FA135X		FA135R	FA135SV		MD6399D	UTVX6399			24
KRT 800 B/F (Teryx 4)	Left	FA165X		FA165R	FA165SV	MD6399D		UTVX6399			25
	Right	FA135X		FA135R	FA135SV		MD6399D	UTVX6399			26
KRT 800 C/G (Teryx 4 LE)	Left	FA165X		FA165R	FA165SV	MD6399D		UTVX6399			27
	Right	FA135X		FA135R	FA135SV		MD6399D	UTVX6399			28
KRT 800 D/H (Teryx 4 Camo)	Left	FA165X		FA165R	FA165SV	MD6399D		UTVX6399			29
	Right	FA135X		FA135R	FA135SV		MD6399D	UTVX6399			30
VN 800 A Vulcan		FA85	FA85V	FA85HH	MD4124LS						31
VN 800 B Vulcan Classic		FA229	FA229V	FA229HH	MD4125LS						32
VN 800 Drifter C/E		FA229	FA229V	FA229HH	MD4125LS						33
KAF 820 A Mule PRO - FXT	Left	FA165X		FA165R	FA165SV	MD6398D		UTVX6398			34
	Right	FA135X		FA135R	FA135SV		MD6398D	UTVX6398			35
KAF 820 BF Mule PRO - FXT/EPS	Left	FA165X		FA165R	FA165SV	MD6398D		UTVX6398			36
	Right	FA135X		FA135R	FA135SV		MD6398D	UTVX6398			37
KAF 820 C Mule PRO - FXT/EPS LE	Left	FA165X		FA165R	FA165SV	MD6398D		UTVX6398			38
	Right	FA135X		FA135R	FA135SV		MD6398D	UTVX6398			39
KAF 820 D Mule PRO - FXT/EPS Camo	Left	FA165X		FA165R	FA165SV	MD6398D		UTVX6398			40
	Right	FA135X		FA135R	FA135SV		MD6398D	UTVX6398			41
KAF 820 E Mule PRO - FX	Left	FA165X		FA165R	FA165SV	MD6398D		UTVX6398			42
	Right	FA135X		FA135R	FA135SV		MD6398D	UTVX6398			43
KAF 820 F Mule PRO - FX/EPS	Left	FA165X		FA165R	FA165SV	MD6398D		UTVX6398			44
	Right	FA135X		FA135R	FA135SV		MD6398D	UTVX6398			45
KAF 820 G Mule PRO - FX/EPS LE	Left	FA165X		FA165R	FA165SV	MD6398D		UTVX6398			46
	Right	FA135X		FA135R	FA135SV		MD6398D	UTVX6398			47
KAF 820 H Mule PRO - FX/EPS Camo	Left	FA165X		FA165R	FA165SV	MD6398D		UTVX6398			48
	Right	FA135X		FA135R	FA135SV		MD6398D	UTVX6398			49
KAF 820 J Mule PRO - FXT Ranch Edition	Left	FA165X		FA165R	FA165SV	MD6398D		UTVX6398			50
	Right	FA135X		FA135R	FA135SV		MD6398D	UTVX6398			51
Z1/A/B 900		FA55			MD4069LS			VMD4069			52
KZ 900 B LTD		FA33*			MD4076LS	MD4076RS		VMD4076	VMD4076		53
KZ 900 A		FA33			MD4052LS			VMD4052			54
VN 900 Vulcan Classic LT (Spoke wheels & Screen) (D)		FA229	FA229V	FA229HH	MD4158						55
VN 900 B (Spoke Wheels) Vulcan Classic		FA229	FA229V	FA229HH	MD4158						56

FRONT

APPLICATIONS
BRAKE
SAFETY NOTICE - With vehicles primarily designed for off highway use such as quads now being used on the highway, we would recommend the use of X or MXS pads for highway use and ONLY using the R and SV higher density / harder pad series for off road riding.

*** This symbol indicates a rotor made of billet steel, and should be only used with EBC FA Kevlar® Organic or Vee pads.**

*-2 Sets Required. ■ - Also available in MX-S race compound. **SAFETY WARNING:- DO NOT USE HH PADS ON REAR UNLESS ALSO USED ON FRONT TO AVOID BRAKE IMBALANCE**

FRONT: KAWASAKI Cont'd

REAR: KAWASAKI

Line #

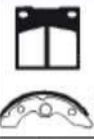
BRAKE ROTOR CHOICES - FRONT							DISC PAD CHOICES - REAR				BRAKE ROTOR CHOICES - REAR				
CC Custom Rotor	CX Extreme® /Vee-Rotor	OS Series Oversize 250/280mm Rotor Kit	OSX Series Oversize 280mm Rotor Kit	Relocating Bracket for 250/280mm Rotor	SMX Series Oversize 320mm Rotor Kit	Relocating Bracket for 320mm Rotor		Semi-Sintered V-Pads™	Sintered/HH Pads/ Grooved Shoes	SV Series Severe Duty Pads	Standard Rotor	UTVX Rotor	Vintage Rotor	Contour Profile Rotor	CX Extreme® /Vee-Rotor
1							709								
2	MD4141CC*						FA192	FA192V	FA192HH		MD4138			MD4138C	
3															
4	MD4141CC*						FA192	FA192V	FA192HH		MD4138			MD4138C	
5															
6	MD4008CC*	VR4008BLK*					FA129	FA129V	FA129HH		MD4007			MD4007C	VR4007
7	MD4141CC*						FA231	FA231V	FA231HH		MD4142			MD4142C	
8															
9	MD4141CC						FA231	FA231V	FA231HH		MD4142			MD4142C	
10	MD4141CC														
11							FA85	FA85V	FA85HH		MD4019⚡				
12							FA85	FA85V	FA85HH		MD4017⚡				
13							FA129	FA129V	FA129HH		MD4007			MD4007C	
14	MD4012CC*	VR4012BLK*					FA161	FA161V	FA161HH		MD4013			MD4013C	VR4013
15	MD4022CC*	VR4022BLK*					FA161	FA161V	FA161HH		MD4013			MD4013C	VR4013
16	MD4022CC*	VR4022BLK*					FA161	FA161V	FA161HH		MD4013			MD4013C	VR4013
17	MD4022CC*	VR4022BLK*					FA161	FA161V	FA161HH		MD4013			MD4013C	VR4013
18	MD4022CC*	VR4022BLK*					FA254	FA254V	FA254HH		MD4013			MD4013C	VR4013
19							N/A								
20															
21							N/A								
22															
23							N/A								
24															
25							N/A								
26															
27							N/A								
28															
29							N/A								
30															
31							709								
32							709								
33							FA231	FA231V	FA231HH		MD4148⚡				
34							FA686X		FA686R		MD6398D	UTVX6398			
35							FA686X		FA686R		MD6398D	UTVX6398			
36							FA686X		FA686R		MD6398D	UTVX6398			
37							FA686X		FA686R		MD6398D	UTVX6398			
38							FA686X		FA686R		MD6398D	UTVX6398			
39							FA686X		FA686R		MD6398D	UTVX6398			
40							FA686X		FA686R		MD6398D	UTVX6398			
41							FA686X		FA686R		MD6398D	UTVX6398			
42							FA686X		FA686R		MD6398D	UTVX6398			
43							FA686X		FA686R		MD6398D	UTVX6398			
44							FA686X		FA686R		MD6398D	UTVX6398			
45							FA686X		FA686R		MD6398D	UTVX6398			
46							FA686X		FA686R		MD6398D	UTVX6398			
47							FA686X		FA686R		MD6398D	UTVX6398			
48							FA686X		FA686R		MD6398D	UTVX6398			
49							FA686X		FA686R		MD6398D	UTVX6398			
50							FA686X		FA686R		MD6398D	UTVX6398			
51							FA686X		FA686R		MD6398D	UTVX6398			
52							713								
53							FA37				MD4073				
54							713								
55							USE VPAD	FA231/2V	FA231HH		MD4085⚡				
56							USE VPAD	FA231/2V	FA231HH		MD4085⚡				

REAR

⚡ This symbol indicates a rotor made of billet steel, and should be only used with EBC FA Kevlar® Organic or Vee pads.

SAFETY NOTICE - With vehicles primarily designed for off highway use such as quads now being used on the highway, we would recommend the use of X or MXS pads for highway use and ONLY using the R and SV higher density / harder pad series for off road riding.

BRAKE APPLICATIONS

*-2 Sets Required. ■ - Also available in MX-S race compound. SAFETY WARNING:- DO NOT USE HH PADS ON REAR UNLESS ALSO USED ON FRONT TO AVOID BRAKE IMBALANCE

FRONT: KAWASAKI



KAWASAKI



DISC PAD CHOICES - FRONT

BRAKE ROTOR CHOICES - FRONT

		Sintered/HH Pads/Grooved Shoes	Sintered/HH Pads/Grooved Shoes	SV Series Severe Duty Pads	Standard Rotor Left	Standard Rotor Right	UTVX Rotor	Vintage Rotor Left	Vintage Rotor Right	Contour Profile Rotor
VN 900 C (Cast Wheels) Vulcan Custom	07-16	FA229	FA229V	FA229HH	MD4158					
ZL 900 A Eliminator	85-86	FA85*	FA85V*	FA85HH*	MD4016	MD4016				
Z 900 (ZR 900 AHF/Non ABS)	17	FA347*	FA347V*	FA347HH*						TBA*
Z 900 (ZR 900 BHF/ABS)	17	FA347*	FA347V*	FA347HH*						TBA*
ZX 900 A Ninja	84-86	FA85*		FA85HH*	MD4016	MD4016				
ZX-9R B Ninja	94-95	FA158*		FA158HH*	MD4022X	MD4022X				MD4022XC*
ZX-9R B Ninja	96-97	FA188*		FA188HH*	MD4022X	MD4022X				MD4022XC*
ZX-9R (ZX 900 C)	98-99	FA188*		FA188HH*	MD4167X	MD4167X				MD4167XC*
ZX-9R (ZX 900 E)	00-01	FA188*		FA188HH*	MD4012X	MD4012X				MD4012XC*
ZX-9R (ZX 900 F)	02-03			FA347HH*	MD4022X	MD4022X				MD4022XC*
KAF 950 A (Mule 2510 Diesel)		719*		N/A						
KAF 950 B (Mule 3010 Diesel)	03-05	719*		N/A						
KAF 950 D Mule 3010 Diesel 4x4	08	719*		N/A						
KAF 950 E Mule 3010 Trans 4x4 Diesel	08	719*		N/A						
KAF 950 F (Mule 4010 Diesel 4x4)	09-12	719*		N/A						
KAF 950 G (Mule 4010 Trans 4x4 Diesel)	09-12	719*		N/A						
KAF 950 H (Mule 4010 Trans 4x4 Diesel Realtree)	10	719*		N/A						
KAF 1000 A - Mule Pro DXT/ Diesel	Left 16-17	FA165X		FA165R	FA165SV	MD6398D		UTVX6398		
	Right	FA135X		FA135R	FA135SV		MD6398D	UTVX6398		
KAF 1000 B - Mule Pro DXT/Diesel EPS	Left 16-17	FA165X		FA165R	FA165SV	MD6398D		UTVX6398		
	Right	FA135X		FA135R	FA135SV		MD6398D	UTVX6398		
KAF 1000 C - Mule Pro DXT EPS LE/Diesel	Left 16-17	FA165X		FA165R	FA165SV	MD6398D		UTVX6398		
	Right	FA135X		FA135R	FA135SV		MD6398D	UTVX6398		
KAF 1000 D - Mule Pro DX /Diesel	Left 16-17	FA165X		FA165R	FA165SV	MD6398D		UTVX6398		
	Right	FA135X		FA135R	FA135SV		MD6398D	UTVX6398		
KAF 1000 E - Mule Pro DX EPS/Diesel	Left 16-17	FA165X		FA165R	FA165SV	MD6398D		UTVX6398		
	Right	FA135X		FA135R	FA135SV		MD6398D	UTVX6398		
KAF 1000 F - Mule Pro DX EPS LE/Diesel	Left 16-17	FA165X		FA165R	FA165SV	MD6398D		UTVX6398		
	Right	FA135X		FA135R	FA135SV		MD6398D	UTVX6398		
KLZ 1000 B - Versys (ABS Model)	15-17	FA158*		FA158HH*		TBA*				
KZ 1000 A	77-78	FA33			MD4052LS			VMD4052		
KZ 1000 A	79-80	FA73*			MD4064LS	MD4064RS		VMD4064	VMD4064	
KZ 1000 B (LTD)	77-78	FA33*			MD4076LS	MD4076RS		VMD4076	VMD4076	
KZ 1000 B (LTD)	79-80	FA73*			MD4064LS	MD4064RS		VMD4064	VMD4064	
KZ 1000 C Police series	78	FA33*			MD4076LS	MD4076RS		VMD4076	VMD4076	
KZ 1000 C	79-81	FA73*			MD4064LS	MD4064RS		VMD4064	VMD4064	
KZ 1000 D (Z1-R series)	78	FA33*			MD4076LS	MD4076RS		VMD4076	VMD4076	
KZ 1000 D (Z1-R series)	80	FA73*			MD4076LS	MD4076RS		VMD4076	VMD4076	
KZ 1000 E ST & Shaft	79-80	FA62*			MD4078LS	MD4078RS		VMD4078	VMD4078	
KZ 1000 G Classic	80	FA73*			MD4064LS	MD4064RS		VMD4064	VMD4064	
KZ 1000 J	81-82	FA68*		FA68HH*	MD4006LS	MD4006RS				
KZ 1000 J	83	FA68*		FA68HH*	MD4038	MD4038				
KZ 1000 K (LTD)	81-82	FA68*	FA68V*	FA68HH*	MD4006LS	MD4006RS				
KZ 1000 M (CSR)	81-82	FA68*	FA68V*	FA68HH*	MD4080LS	MD4080RS				
KZ 1000 P (Police)	82-01	FA68*		FA68HH*	MD4091LS	MD4091RS				
KZ 1000 P (Police)	Left 02-03/05	FA229		FA229HH	MD4091					
	Right	FA231		FA231HH		MD4091				
KZ 1000 R (Replica)	82-83	FA68*		FA68HH*	MD4038	MD4038				
Z 1000 (ZR 1000 A)	03-05			FA347HH*	MD4154X	MD4154X				MD4154XC*
Z 1000 (ZR 1000 A)	06			FA347HH*	MD4154X	MD4154X				MD4154XC*
Z 1000 (ZR 1000 B)	07-08			FA417/4HH*						MD4152XC*
Z 1000 (ZR 1000 C)	07			FA417/4HH*						MD4152XC*
Z 1000 (ZR 1000 D) Non ABS	10-13			FA379HH*						TBA*
Z 1000 ABS (ZR 1000 G) ABS Model	14-16			FA379HH*						TBA*
ZG 1000 A Concours	94-05	FA129*	FA129V*	FA129HH*	MD4008X	MD4008X				MD4008XC*
ZG 1000 A Concours	06	FA129*	FA129V*	FA129HH*	MD4008X	MD4008X				MD4008XC*

Line #

FRONT

APPLICATIONS

BRAKE

*** This symbol indicates a rotor made of billet steel, and should be only used with EBC FA Kevlar® Organic or Vee pads.**
SAFETY NOTICE - With vehicles primarily designed for off highway use such as quads now being used on the highway, we would recommend the use of X or MXS pads for highway use and ONLY using the R and SV higher density / harder pad series for off road riding.

*-2 Sets Required. ■ - Also available in MX-S race compound. **SAFETY WARNING:- DO NOT USE HH PADS ON REAR UNLESS ALSO USED ON FRONT TO AVOID BRAKE IMBALANCE**

FRONT: KAWASAKI Cont'd

REAR: KAWASAKI

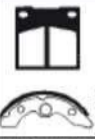
Line #	BRAKE ROTOR CHOICES - FRONT						DISC PAD CHOICES - REAR				BRAKE ROTOR CHOICES - REAR					
	CC Custom Rotor	CX Extreme® /Vee-Rotor	OS Series Oversize 250/280mm Rotor Kit	OSX Series Oversize 280mm Rotor Kit	Relocating Bracket for 250/280mm Rotor	SMX Series Oversize 320mm Rotor Kit	Relocating Bracket for 320mm Rotor	 USE VPAD	Semi-Sintered V-Pads™	Sintered/HH Pads/ Grooved Shoes	SV Series Severe Duty Pads	Standard Rotor	UTVX Rotor	Vintage Rotor	Contour Profile Rotor	CX Extreme® /Vee-Rotor
1																
2																
3																TBA
4																TBA
5																
6	MD4022CC*	VR4022BLK*														
7	MD4022CC*	VR4022BLK*														
8																
9	MD4012CC*	VR4012BLK*														
10	MD4022CC*	VR4022BLK*														
11																
12																
13																
14																
15																
16																
17																
18																
19																
20																
21																
22																
23																
24																
25																
26																
27																
28																
29																
30																
31																
32																
33																
34																
35																
36																
37																
38																
39																
40																
41																
42																
43																
44																
45																
46																
47																
48																
49	MD4154CC*	VR4154BLK*														
50	MD4154CC*	VR4154BLK*														
51	MD4152CC*	VR4152BLK*														
52	MD4152CC*	VR4152BLK*														
53																
54																
55	MD4008CC*	VR4008BLK*														
56	MD4008CC*	VR4008BLK*														

REAR

⚡ This symbol indicates a rotor made of billet steel, and should be only used with EBC FA Kevlar® Organic or Vee pads.

SAFETY NOTICE - With vehicles primarily designed for off highway use such as quads now being used on the highway, we would recommend the use of X or MXS pads for highway use and ONLY using the R and SV higher density / harder pad series for off road riding.

BRAKE APPLICATIONS

*-2 Sets Required. ■ - Also available in MX-S race compound. **SAFETY WARNING:- DO NOT USE HH PADS ON REAR UNLESS ALSO USED ON FRONT TO AVOID BRAKE IMBALANCE**

FRONT: KAWASAKI



KAWASAKI



DISC PAD CHOICES - FRONT

BRAKE ROTOR CHOICES - FRONT

Model	Year	Side	FA85*	Sintered/HH Pads/Grooved Shoes	SV Series Severe Duty Pads	Standard Rotor		UTVX Rotor	Vintage Rotor		Contour Profile Rotor	Line #
						Left	Right		Left	Right		
ZL 1000 A	87		FA85*	FA85V*	FA85HH*	MD4016	MD4016					1
ZX 1000 A (Ninja)	86-87		FA85*		FA85HH*	MD4016	MD4016					2
ZX 1000 B Ninja ZX10	88-90		FA129*		FA129HH*	MD4021	MD4021					3
Ninja 1000 ABS (ZX 1000 H)	12-13				FA379HH*						TBA*	4
Ninja 1000 (ZX 1000 G)	11-13				FA379HH*						TBA*	5
Ninja 1000 ABS (ZX 1000 M)	14-15				FA379HH*						TBA*	6
Ninja 1000 H2 (ZX 1000 N)	15-17				FA447HH*	TBA	TBA					7
Ninja 1000 H2R (ZX 1000 P)	15-17				FA447HH*	TBA	TBA					8
Ninja ZX-10 RR (ZX1000 Z)	17				FA447HH*	TBA	TBA					9
ZX10 R (ZX 1000 C/D)	04-07				FA369/4HH*						MD4152XC*	10
ZX10 R (ZX 1000 E/F)	08-10				FA379HH*						MD4161XC*	11
ZX10 R (ZX 1000 J Non ABS)	11-15				FA379HH*						MD4161XC*	12
ZX10 R (ZX 1000 J - 30th Anniversary Edition Non ABS)	15				FA379HH*						MD4161XC*	13
ZX10 R (ZX 1000 K) ABS Model	11-15				FA379HH*						MD4161XC*	14
ZX10 R (ZX 1000 K - 30th Anniversary Edition ABS Version)	15				FA379HH*						MD4161XC*	15
ZX10 R Ninja (ZX 1000 SGF/SHF/SJF)	16-18				FA447HH*	MD4170X	MD4170X					16
ZX10 R Ninja KRT Replica (ZX 1000 SGFA/SHFA/SJFA)	16-18				FA447HH*	MD4170X	MD4170X					17
KZ 1100 A	81-83		FA68*	FA68V*	FA68HH*	MD4006LS	MD4006RS					18
KZ 1100 B (GPz)	81		FA68*		FA68HH*	MD4006LS	MD4006RS					19
KZ 1100 B (GPz)	82		FA68*		FA68HH*	MD4038	MD4038					20
KZ 1100 D (Spectre)	82-83		FA68*	FA68V*	FA68HH*	MD4006LS	MD4006RS					21
KZ 1100 L (LTD)	83		FA68*	FA68V*	FA68HH*	MD4006LS	MD4006RS					22
ZN 1100 B (LTD)	84-85		FA85*	FA85V*	FA85HH*	MD4084	MD4084					23
ZR 1100 A Zephyr	92-95		FA158*		FA158HH*	MD4012X	MD4012X				MD4012XC*	24
ZR 1100 B Zephyr	96	Left	FA229		FA229HH	MD4012X					MD4012XC	25
		Right	FA231		FA231HH		MD4012X				MD4012XC	26
ZX 1100 A (GPz)	83-84		FA85*		FA85HH*	MD4016	MD4016					27
ZX 1100 C (ZX-11) Ninja	90-93		FA158*		FA158HH*	MD4012X	MD4012X				MD4012XC*	28
ZX 1100 D (ZX-11) Ninja	93-01		FA158*		FA158HH*	MD4022X	MD4022X				MD4022XC*	29
GPz 1100 (ZX 1100 E)	95-97	Left	FA229		FA229HH	MD4008X					MD4008C	30
		Right	FA231		FA231HH		MD4008X				MD4008C	31
GPz 1100 ABS Models (ZX 1100 F)	96-97	Left	FA229		FA229HH	MD4008X					MD4008XC	32
		Right	FA231		FA231HH		MD4132X				MD4132XC	33
(ZR 1100 C) ZRX 1100	99-00		FA188*		FA188HH*	MD4012X	MD4012X				MD4012XC*	34
ZG 1200 A/B (Voyager XII)	86-03		FA85*	FA85V*	FA85HH*	MD4087	MD4087					35
ZRX 1200 R (ZR 1200 A)	01-05		FA188*		FA188HH*	MD4012X	MD4012X				MD4012XC*	36
ZX12R (ZX 1200 A/B)	00-03		FA188*		FA188HH*	MD4022X	MD4022X				MD4022XC*	37
ZX12R (ZX 1200 B)	04-05				FA369/4HH*	MD4154X	MD4154X				MD4154XC*	38
ZZR 1200 (ZX 1200 C)	02-05		FA158*		FA158HH*	MD4022X	MD4022X				MD4022XC*	39
KZ 1300 A	79-82		FA62*			MD4089LS	MD4089RS		VMD4089	VMD4089		40
KZ 1300 B (Touring)	80		FA62*			MD4089LS	MD4089RS		VMD4089	VMD4089		41
ZN 1300 A (Voyager)	83-88		FA85*		FA85HH*	MD4091	MD4091					42
Concours 14 (ZG 1400 A/C/E) ABS	08-16				FA417/4HH*						MD4155XC*	43
Concours 14 (ZG 1400 B/D)	08-10				FA417/4HH*						MD4155XC*	44
ZX14 Ninja (ZX 1400 A/C)	06-11				FA417/4HH*						MD4155XC*	45
ZX14 R Ninja ZX 1400 E	12-14				FA417/4HH*						MD4155XC*	46
ZX14 R Ninja (ABS Model) ZX 1400 FB/H	13-17				FA417/4HH*						MD4155XC*	47
ZX14 R Ninja (ABS/SE Model) ZX 1400 J	16-17				FA447HH*						TBA*	48
VN 1500 A Vulcan 88	87-99		FA85	FA85V	FA85HH	MD4124LS						49
VN 1500 B Vulcan 88 SE	87-90		FA85	FA85V	FA85HH	MD4094LS						50
VN 1500 C	96-97		FA85	FA85V	FA85HH	MD4124LS						51
VN 1500 D/E Vulcan Classic	96-00		FA229	FA229V	FA229HH	MD4125LS						52
VN 1500 E Vulcan Classic	01-04		FA229	FA229V	FA229HH	MD4125LS						53
VN 1500 G Nomad	99-00	Left	FA229	FA229V	FA229HH	MD4150						54
		Right	FA231	FA231V	FA231HH		MD4150					55
												56

*-2 Sets Required. ■ - Also available in MX-S race compound. **SAFETY WARNING:- DO NOT USE HH PADS ON REAR UNLESS ALSO USED ON FRONT TO AVOID BRAKE IMBALANCE**

APPLICATIONS

BRAKE

⊛ This symbol indicates a rotor made of billet steel, and should be only used with EBC FA Kevlar® Organic or Vee pads.
SAFETY NOTICE - With vehicles primarily designed for off highway use such as quads now being used on the highway, we would recommend the use of X or MXS pads for highway use and ONLY using the R and SV higher density / harder pad series for off road riding.

FRONT: KAWASAKI Cont'd

REAR: KAWASAKI

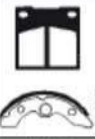
Line #	BRAKE ROTOR CHOICES - FRONT						DISC PAD CHOICES - REAR				BRAKE ROTOR CHOICES - REAR					
	CC Custom Rotor	CX Extreme® /Vee-Rotor	OS Series Oversize 250/280mm Rotor Kit	OSX Series Oversize 280mm Rotor Kit	Relocating Bracket for 250/280mm Rotor	SMX Series Oversize 320mm Rotor Kit	Relocating Bracket for 320mm Rotor		Semi-Sintered V-Pads™	Sintered/HH Pads/ Grooved Shoes	SV Series Severe Duty Pads	Standard Rotor	UTVX Rotor	Vintage Rotor	Contour Profile Rotor	CX Extreme® /Vee-Rotor
1								FA85	FA85V	FA85HH		MD4017				
2								FA85	FA85V	FA85HH		MD4019				
3								FA129	FA129V	FA129HH		MD4015				
4								FA192	FA192V	FA192HH					MD4157C	
5								FA192	FA192V	FA192HH					MD4157C	
6								FA192	FA192V	FA192HH					MD4157C	
7								FA266		FA266HH					TBA	
8								FA266		FA266HH					TBA	
9								FA436	FA436V	FA436HH		MD4165				
10	MD4152CC*	VR4152BLK*						FA192	FA192V	FA192HH					MD4138C	VR4138
11		VR4161BLK*						FA192	FA192V	FA192HH					MD4138C	VR4138
12		VR4161BLK*						FA436	FA436V	FA436HH					MD4165C	VR4165
13		VR4161BLK*						FA436	FA436V	FA436HH					MD4165C	VR4165
14		VR4161BLK*						FA436	FA436V	FA436HH					MD4165C	VR4165
15		VR4161BLK*						FA436	FA436V	FA436HH					MD4165C	VR4165
16								FA436		FA436HH		MD4165				
17								FA436		FA436HH		MD4165				
18								FA68	FA68V	FA68HH		MD4054				
19								FA68	FA68V	FA68HH		MD4054				
20								FA68	FA68V	FA68HH		MD4054				
21								FA68	FA68V	FA68HH		MD4054				
22								FA68	FA68V	FA68HH		MD4054				
23								FA85	FA85V	FA85HH		MD4085				
24	MD4012CC*	VR4012BLK*						FA129	FA129V	FA129HH		MD4027			MD4027C	VR4027
25	MD4012CC	VR4012BLK						FA129	FA129V	FA129HH		MD4027			MD4027C	VR4027
26	MD4012CC	VR4012BLK														
27								FA85	FA85V			MD4017				
28	MD4012CC*	VR4012BLK*						FA129	FA129V	FA129HH		MD4015			MD4015C	VR4015
29	MD4022CC*	VR4022BLK*						FA161	FA161V	FA161HH		MD4014			MD4014C	VR4014
30	MD4008CC							FA192	FA192V	FA192HH		MD4130			MD4130C	VR4130
31	MD4008CC															
32								FA192	FA192V	FA192HH		MD4130			MD4130C	VR4130
33																
34	MD4012CC*	VR4012BLK*						FA161	FA161V	FA161HH		MD4133			MD4133C	VR4133
35								FA85	FA85V	FA85HH		MD4088				
36	MD4012CC*	VR4012BLK*						FA161	FA161V	FA161HH		MD4133			MD4133C	VR4133
37	MD4022CC*	VR4022BLK*						FA161	FA161V	FA161HH		MD4023			MD4023C	VR4023
38	MD4154CC*	VR4154BLK*						FA161	FA161V	FA161HH		MD4023			MD4023C	VR4023
39	MD4022CC*	VR4022BLK*						FA161	FA161V	FA161HH		MD4133			MD4133C	VR4133
40								FA36	FA36V			MD4090				
41								FA36	FA36V			MD4090				
42								FA85	FA85V	FA85HH		MD4092				
43	MD4155CC*	VR4155BLK*						FA254	FA254V	FA254HH					MD4160C	VR4160
44	MD4155CC*	VR4155BLK*						FA254	FA254V	FA254HH					MD4160C	VR4160
45	MD4155CC*	VR4155BLK*						FA254	FA254V	FA254HH					MD4157C	VR4157
46	MD4155CC*	VR4155BLK*						FA254	FA254V	FA254HH					MD4157C	VR4157
47	MD4155CC*	VR4155BLK*						FA254	FA254V	FA254HH					MD4157C	VR4157
48								FA254	FA254V	FA254HH		MD4157				
49								FA85	FA85V	FA85HH		MD4054				
50								FA85	FA85V	FA85HH		MD4054				
51								FA85	FA85V	FA85HH		MD4128				
52								FA85	FA85V	FA85HH		MD4128				
53								FA231	FA231V	FA231HH		MD4148				
54								FA85	FA85V	FA85HH		MD4147				
55																
56																

BRAKE APPLICATIONS

⚠ This symbol indicates a rotor made of billet steel, and should be only used with EBC FA Kevlar® Organic or Vee pads.
SAFETY NOTICE - With vehicles primarily designed for off highway use such as quads now being used on the highway, we would recommend the use of X or MXS pads for highway use and ONLY using the R and SV higher density / harder pad series for off road riding.

*-2 Sets Required. ■ - Also available in MX-S race compound. **SAFETY WARNING:- DO NOT USE HH PADS ON REAR UNLESS ALSO USED ON FRONT TO AVOID BRAKE IMBALANCE**

FRONT: KAWASAKI

APPLICATIONS

BRAKE



KAWASAKI



* This symbol indicates a rotor made of billet steel, and should be only used with EBC FA Kevlar® Organic or Vee pads.
 SAFETY NOTICE - With vehicles primarily designed for off highway use such as quads now being used on the highway, we would recommend the use of X or MXS pads for highway use and ONLY using the R and SV higher density / harder pad series for off road riding.

DISC PAD CHOICES - FRONT

BRAKE ROTOR CHOICES - FRONT

				Semi-Sintered V-Pads™	Sintered/HH Pads/Grooved Shoes	SV Series Severe Duty Pads	Standard Rotor Left	Standard Rotor Right	UTVX Rotor	Vintage Rotor Left	Vintage Rotor Right	Contour Profile Rotor	Line #
VN 1500 G Nomad	Left	01	FA229	FA229V	FA229HH		MD4150						1
	Right		FA231	FA231V	FA231HH			MD4150					2
VN 1500 Drifter J/R		99-05	FA229	FA229V	FA229HH		MD4125LS						3
VN 1500 N Vulcan 1500 Classic Fi		00-02	FA229	FA229V	FA229HH		MD4125LS						4
VN 1500 N/T Vulcan 1500 Classic		05-06	FA229	FA229V	FA229HH		MD4125LS						5
VN 1500 N Vulcan 1500 Classic		07-08	FA229	FA229V	FA229HH		MD4125LS						6
VN 1500 L Vulcan 1500 Nomad F1	Left	01-05	FA229	FA229V	FA229HH		MD4150						7
	Right		FA231	FA231V	FA231HH			MD4150					8
VN 1500 P Vulcan Mean Streak		02-03	FA188*		FA188HH*		MD4022X	MD4022X				MD4022XC*	9
VN 1600 A Vulcan Classic	Left	01-06	FA229	FA229V	FA229HH		MD4158						10
	Right		FA231	FA231V	FA231HH			MD4158					11
VN 1600 A Vulcan Classic	Left	03-08	FA229	FA229V	FA229HH		MD4158						12
	Right		FA231	FA231V	FA231HH			MD4158					13
VN 1600 B Mean Streak		04	FA188*		FA188HH*		MD4022X	MD4022X				MD4022XC*	14
VN 1600 B/E/F Mean Streak		05-06			FA369/4HH*		MD4022X	MD4022X				MD4022XC*	15
VN 1600 B Mean Streak		07-08			FA369/4HH*		MD4022X	MD4022X				MD4022XC*	16
VN 1600 D	Left	05-06	FA229	FA229V	FA229HH		MD4158						17
	Right		FA231	FA231V	FA231HH			MD4158					18
VN 1600 D Nomad	Left	07-08	FA229	FA229V	FA229HH		MD4158						19
	Right		FA231	FA231V	FA231HH			MD4158					20
VN 1700 A Vulcan 1700 Voyager		09-13	FA158*		FA158HH*		MD4158	MD4158					21
VN 1700 B Vulcan 1700 Voyager ABS		09-17	FA158*		FA158HH*		MD4158	MD4158					22
VN 1700 C Vulcan 1700 Nomad	Left	09-13	FA229	FA229V	FA229HH		MD4158						23
	Right		FA231	FA231V	FA231HH			MD4158					24
VN 1700 C Vulcan 1700 Nomad 2T	Left	09	FA229	FA229V	FA229HH		MD4158						25
	Right		FA231	FA231V	FA231HH			MD4158					26
VN 1700 D Voyager Nomad		14	FA158*		FA158HH*		TBA*						27
VN 1700 E Vulcan 1700 Classic	Left	09-11	FA229	FA229V	FA229HH		MD4158						28
	Right		FA231	FA231V	FA231HH			MD4158					29
VN 1700 G Vulcan 1700 Classic LT	Left	09-11	FA229	FA229V	FA229HH		MD4158						30
	Right		FA231	FA231V	FA231HH			MD4158					31
VN 1700 J Voyager Vaquero		11-13	FA158*		FA158HH*		TBA*						32
VN 1700 K Vulcan Vaquero ABS		14-16	FA158*		FA158HH*		TBA*						33
VN 1700 K Vulcan Vaquero ABS SE		14	FA158*		FA158HH*		TBA*						34
VN 2000 D Vulcan Ltd		05-06	FA158*		FA158HH*		MD4158	MD4158					35
VN 2000 A/G Vulcan		04-09	FA158*		FA158HH*		MD4158	MD4158					36
VN 2000 E/H Vulcan Classic		06-09	FA158*		FA158HH*		MD4158	MD4158					37
VN 2000 F/J Vulcan Classic LT		06-10	FA158*		FA158HH*		MD4158	MD4158					38
													39
													40
													41
													42
													43
													44
													45
													46
													47
													48
													49
													50
													51
													52
													53
													54
													55
													56

*-2 Sets Required. ■ - Also available in MX-S race compound. **SAFETY WARNING:- DO NOT USE HH PADS ON REAR UNLESS ALSO USED ON FRONT TO AVOID BRAKE IMBALANCE**

FRONT: KAWASAKI Cont'd

REAR: KAWASAKI

Line #	BRAKE ROTOR CHOICES - FRONT						DISC PAD CHOICES - REAR				BRAKE ROTOR CHOICES - REAR				
	CC Custom Rotor	CX Extreme® /Vee-Rotor	OS Series Oversize 250/280mm Rotor Kit	OSX Series Oversize 280mm Rotor Kit	Relocating Bracket for 250/280mm Rotor	SMX Series Oversize 320mm Rotor Kit	Relocating Bracket for 320mm Rotor		Semi-Sintered V-Pads™	Sintered/HH Pads/Grooved Shoes	SV Series Severe Duty Pads	Standard Rotor	UTVX Rotor	Vintage Rotor	Contour Profile Rotor
1							USE VPAD	FA231/3V	FA231HH		MD4147⊕				
2															
3							FA231	FA231V	FA231HH		MD4148⊕				
4							USE VPAD	FA231/3V	FA231HH		MD4148⊕				
5							USE VPAD	FA231/3V	FA231HH		MD4148⊕				
6							USE VPAD	FA231/2V	FA231HH		MD4148⊕				
7							USE VPAD	FA231/3V	FA231HH		MD4147⊕				
8															
9	MD4022CC*	VR4022BLK*					USE VPAD	FA231/3V	FA231HH		MD4146⊕			N/A	N/A
10							USE VPAD	FA231/3V	FA231HH		MD4146⊕			N/A	N/A
11															
12							USE VPAD	FA231/2V	FA231HH		MD4146⊕			N/A	N/A
13															
14	MD4022CC*	VR4022BLK*					USE VPAD	FA231/3V	FA231HH		MD4146⊕			N/A	N/A
15	MD4022CC*	VR4022BLK*					USE VPAD	FA231/3V	FA231HH		MD4146⊕			N/A	N/A
16	MD4022CC*	VR4022BLK*					USE VPAD	FA231/2V	FA231HH		MD4146⊕			N/A	N/A
17							USE VPAD	FA231/2V	FA231HH		MD4146⊕				
18															
19							USE VPAD	FA231/2V	FA231HH		MD4146⊕				
20															
21							USE VPAD	FA231/2V	FA231HH		TBA				
22							USE VPAD	FA231/2V	FA231HH		TBA				
23							USE VPAD	FA231/2V	FA231HH		TBA				
24															
25							USE VPAD	FA231/2V	FA231HH		TBA				
26															
27							USE VPAD	FA231/2V	FA231HH		TBA				
28							USE VPAD	FA231/2V	FA231HH		TBA				
29															
30							USE VPAD	FA231/2V	FA231HH		TBA				
31															
32							USE VPAD	FA231/2V	FA231HH		TBA				
33							USE VPAD	FA231/2V	FA231HH		TBA				
34							USE VPAD	FA231/2V	FA231HH		TBA				
35							USE VPAD	FA231/2V	FA231HH		MD4147⊕				
36							USE VPAD	FA231/2V	FA231HH		MD4147⊕				
37							USE VPAD	FA231/2V	FA231HH		MD4147⊕				
38							USE VPAD	FA231/2V	FA231HH		MD4147⊕				
39															
40															
41															
42															
43															
44															
45															
46															
47															
48															
49															
50															
51															
52															
53															
54															
55															
56															

REAR

⊕ This symbol indicates a rotor made of billet steel, and should be only used with EBC FA Kevlar® Organic or Vee pads.
 SAFETY NOTICE - With vehicles primarily designed for off highway use such as quads now being used on the highway, we would recommend the use of X or MXS pads for highway use and ONLY using the R and SV higher density / harder pad series for off road riding.

BRAKE APPLICATIONS

*-2 Sets Required. ■ - Also available in MX-S race compound. **SAFETY WARNING:- DO NOT USE HH PADS ON REAR UNLESS ALSO USED ON FRONT TO AVOID BRAKE IMBALANCE**

FRONT: SUZUKI

APPLICATIONS

BRAKE



SUZUKI



DISC PAD CHOICES - FRONT

BRAKE ROTOR CHOICES - FRONT

			Semi-Sintered V-Pads™	Sintered/HH Pads/Grooved Shoes	SV Series Severe Duty Pads	Standard Rotor Left	Standard Rotor Right	UTVX Rotor	Vintage Rotor Left	Vintage Rotor Right	Contour Profile Rotor
AC 50 R	70-71	603									
AS 50 Sport/Colt	68-69	603									
FA 50 T/X/MX/Z/D/E/F/G/H/J/K/L/M	80-91	614									
FS 50 T/X	80-81	614									
FZ 50 N/T/X/Z/D	79-83	601									
GSXR 50 (RB 50 H)	87	FA67		FA67HH		MD3010LS					
JR 50 C/N/T/X/Z/RD/F/G/H/J/K/L/M/N/P/R/V/W/X/Y/K1-K6	78-06	613		613G							
LT 50 E/F/G/H	84-87	NONE		NONE							
LT-A 50 K QuadSport	02-05	614*		614G*							
LTZ 50 K/ZK QuadSport	06-11/17-18	614*		614G*							
OR 50 T	80	604									
RM 50 C/N/T	78-80	603		603G							
RM 50 X	81	604		604G							
RM 60 N/T	79-80	603		603G							
RM 60 X/Z/D	81-83	604		604G							
RM 60 K	03	715		715G							
RM 65 K	03-05	FA302X		FA302R		MD6166D					
DR-Z 70 K/L	08-09/15-18	301									
DS 80 T/X/Z/D/F/G/H/J/K/L/M/N/P/R/S/T/V/W/X/Y	80-00	604		604G							
JR 80 K	01-04	604		604G							
LT 80 H/J/K/L/M/N/P/R/S/T/V/W/X/Y/K1-K6	87-06	614*		614G*							
RM 80 T/X	80-81	604		604G							
RM 80 Z/D/E/F	82-85	615		615G							
RM 80 G/H/J/K	86-89	FA83X		FA83R		MD6018D					MD6018C
RM 80 L/M/N/P/R/S	90-95	FA83X		FA83R		MD6018D					MD6018C
RM 80 T/V/W/X/Y/K1	96-01	FA230X		FA230R		MD6018D					MD6018C
RM 85 LK/K	02-04	FA230X		FA230R		MD6018D					MD6018C
RM 85 L/K/L/L	05-12/15-17	FA258X		FA258R		MD6030D					MD6030C
LT-Z 90 K/Z/L QuadSport	07-11/14-18	604*		604G*							
TC 90 Blazer	70	602		602G							
TC 90 R/J Blazer	71-72	603		603G							
TS 90 Honcho	70	602		602G							
TS 90 R/J Honcho	71-72	603		603G							
A 100 A/B Gofer	76-77	602									
B 100 P Magnum (118cc)	65-66	602									
DR 100 D/E/F/G/H/J/K/L	83-90	604		604G							
DS 100 C/N/T/X	78-81	602		602G							
RM 100 K	03	FA258X		FA258R		MD6186D					MD6186C
SP 100 D	83	617		617G							
TC 100 K/L/M Blazer	73-75	603		603G							
TC 100 A/B Blazer	76-77	602		602G							
TS 100 K/L/M Honcho	73-75	603		603G							
TS 100 A/B Honcho	76-77	602		602G							
TS 100 A/B/C/N/T/X	76-81	602		602G							
RM 100 A/B/C	76-78	603		603G							
RM 100 N/T/X	79-81	603		603G							
B 105 P Bearcat (118cc)	67-68	602		602G							
DR-Z 110 K	03-05	715		715G							
B 120 (118cc)	71-77	602									
KT 120 Trail	68-70	602		602G							
TC 120 Trailcat	68-71	602		602G							
DR 125 Z/D	82-83	602		602G							
DR 125 E	84	602		602G							
DR 125 G/H/J/SER/SES/SET	86-96	FA54X		FA54R■		MD6073D					
DR-Z 125 K/L	03-16	604		604G							
DR-Z 125 LK/LL	03-16	FA230X		FA230R		MD6212D					

Line #

FRONT

⚠ This symbol indicates a rotor made of billet steel, and should be only used with EBC FA Kevlar® Organic or Vee pads. SAFETY NOTICE - With vehicles primarily designed for off highway use such as quads now being used on the highway, we would recommend the use of X or MXS pads for highway use and ONLY using the R and SV higher density / harder pad series for off road riding.

*-2 Sets Required. ■ - Also available in MX-S race compound. SAFETY WARNING:- DO NOT USE HH PADS ON REAR UNLESS ALSO USED ON FRONT TO AVOID BRAKE IMBALANCE

FRONT: SUZUKI Cont'd

REAR: SUZUKI

Line #

BRAKE ROTOR CHOICES - FRONT							DISC PAD CHOICES - REAR				BRAKE ROTOR CHOICES - REAR				
CC Custom Rotor	CX Extreme® /Vee-Rotor	OS Series Oversize 250/280mm Rotor Kit	OSX Series Oversize 280mm Rotor Kit	Relocating Bracket for 250/280mm Rotor	SMX Series Oversize 320mm Rotor Kit	Relocating Bracket for 320mm Rotor		Semi-Sintered V-Pads™	Sintered/HH Pads/ Grooved Shoes	SV Series Severe Duty Pads	Standard Rotor	UTVX Rotor	Vintage Rotor	Contour Profile Rotor	CX Extreme® /Vee-Rotor
1							603								
2							603								
3							614								
4							614								
5							601								
6							604								
7							613		613G						
8							613		613G						
9							604		604G						
10							604		604G						
11							604								
12							603		603G						
13							604		604G						
14							603		603G						
15							604		604G						
16							715		715G						
17		MD6166CX					FA54X		FA54R		MD6166D				MD6166CX
18							301								
19							604		604G						
20							604		604G						
21							618		618G						
22							604		604G						
23							502		502G						
24							502		502G						
25							FA83X		FA83R		MD6025D			MD6025C	
26			OS6018C	OSX6018	BRK001	N/A	N/A	FA83X	FA83R		MD6025D			MD6025C	
27			OS6018C	OSX6018	BRK001	N/A	N/A	FA83X	FA83R		MD6025D			MD6025C	
28		MD6030CX	OSS6030C	OSXS6030	BRK029	N/A	N/A	FA401X	FA401R		MD6246D			MD6246C	MD6246CX
29							618		618G						
30							602		602G						
31							602		602G						
32							602		602G						
33							602		602G						
34							603								
35							602								
36							604		604G						
37							602		602G						
38		MD6186CX	OS6186C	OSX6186	BRK025	N/A	N/A	FA84X	FA84R		MD6187D			MD6187C	
39							604		604G						
40							602		602G						
41							602		602G						
42							602		602G						
43							602		602G						
44							602		602G						
45							603		603G						
46							617		617G						
47							602		602G						
48							603		603G						
49							602								
50							602		602G						
51							602		602G						
52							602		602G						
53							602		602G						
54							602		602G						
55							604		604G						
56							604		604G						

REAR

⚠ This symbol indicates a rotor made of billet steel, and should be only used with EBC FA Kevlar® Organic or Vee pads.
 SAFETY NOTICE - With vehicles primarily designed for off highway use such as quads now being used on the highway, we would recommend the use of X or MXS pads for highway use and ONLY using the R and SV higher density / harder pad series for off road riding.

BRAKE APPLICATIONS

*-2 Sets Required. ■ - Also available in MX-S race compound. **SAFETY WARNING:- DO NOT USE HH PADS ON REAR UNLESS ALSO USED ON FRONT TO AVOID BRAKE IMBALANCE**

FRONT: SUZUKI



SUZUKI



DISC PAD CHOICES - FRONT

BRAKE ROTOR CHOICES - FRONT

DS 125 N/T/X	79-81	602								
GN 125 Z/D	82-83	602								
GN 125 E	91-96	FA67		FA67HH	N/A					
LT 125 D	83	NONE		NONE						
LT 125 E	84	NONE		NONE						
LT 125 F/G/H	85-87	NONE		NONE						
RM 125 A/B/C	76-78	602		602G						
RM 125 NT	79-80	602		602G						
RM 125 X/Z/D	81-83	618		618G						
RM 125 E	84	622		622G						
RM 125 F/G	85-86	FA106X		FA106R	MD6163D					
RM 125 H	87	FA135X		FA135R■	MD6163D					
RM 125 J	88	FA135X		FA135R■	MD6163D					
RM 125 K	89	FA135X		FA135R■	MD6017D					MD6017C
RM 125 L	90	FA135X		FA135R■	MD6017D					MD6017C
RM 125 M/N/P	91-93	FA135X		FA135R■	MD6017D					MD6017C
RM 125 R/S	94-95	FA135X		FA135R■	MD6017D					MD6017C
RM 125 T/V/W	96-98	FA185X		FA185R■	MD6017D					MD6017C
RM 125 X/Y/K	99-05	FA185X		FA185R■	MD6017D					MD6017C
RM 125 K	06-08	FA185X		FA185R■	MD6017D					MD6017C
RV 125 K Tracker	73	603		603G						
RV 125 L/M/A/B Tracker	74-77	602		602G						
SP 125 Z/D	82-83	602		602G						
SP 125 G/H/J	86-88	FA54X		FA54R■	MD6073D					
T 125 / 11 / R Stinger	69-71	602								
TC 125 J/K Prospector	72-73	603		603G						
TC 125 L/M/A/B Prospector	74-77	602		602G						
TM 125 K/L/M Challenger	73-75	603		603G						
TS 125 T/X	80-81	602		602G						
S32 (150cc) Single Cam Front Brake	65	605								
S32-2 (150cc)	66-67	N/A								
LT 160 EK/EL/EM/EN	89-92	624*		624G*						
LT-F 160 M/N/P/R/S/T/V/W/X/Y/K1/K3	91-01/03	624*		624G*						
LT 160 K QuadSport	03-04	624*		624G*						
PE 175 T/X	80-81	602		602G						
PE 175 Z/D/E	82-84	618		618G						
RS 175 T/X/Z	80-82	602		602G						
DS 185 T	80	602		602G						
GT 185 K Adventurer (Drum Brake)	73	N/A								
GT 185 L/M/A/B Adventurer	74-76	FA55				N/A				
LT 185 E/F/G/H	84-87	NONE		NONE						
TS 185 T/X	80-81	602		602G						
DR 200 G/H/J	86-90	FA54X		FA54R■	MD6073D					
DR 200 SE	96-09/13/15-16	FA54X		FA54R■	MD6073D					
RV 200 L Van-Van	16-17	FA231		FA231HH	MD6281D					
SP 200 G/H/J	86-88	FA54X		FA54R■	MD6073D					
T 200 X5 Invader	68-69	N/A								
TC 200 X5 Stingray	67-69	N/A								
UH 200 ALBurgman ABS	14-16	SFA388		SFA388HH		MD9117D				
LT 230 GEF/GEG	85-86	625*		625G*						
LT 230 EH Early axle 64710 22A00	86	FA128X*		FA128R*	FA128SV*	MD6020D	MD6020D			
LT 230 EH Late axle 64710 22A01	86	FA128X*		FA128R*	FA128SV*	MD6020D	MD6020D			
LT 230 EJ/EK/EL/EM/EN/EP	87-93	FA128X*		FA128R*	FA128SV*	MD6020D	MD6020D			
LT 230 SF/SG	85-86	FA128X*		FA128R*	FA128SV*	MD6020D	MD6020D			
LT 230 SH up to F. no. 2108531	87	FA128X*		FA128R*	FA128SV*	MD6020D	MD6020D			
LT 230 SH from F. no. 2108532/SJ	87-88	FA128X*		FA128R*	FA128SV*	MD6020D	MD6020D			

Line #

FRONT

APPLICATIONS

BRAKE

⊛ This symbol indicates a rotor made of billet steel, and should be only used with EBC FA Kevlar® Organic or Vee pads.

SAFETY NOTICE - With vehicles primarily designed for off highway use such as quads now being used on the highway, we would recommend the use of X or MXS pads for highway use and ONLY using the R and SV higher density / harder pad series for off road riding.

*-2 Sets Required. ■ - Also available in MX-S race compound. SAFETY WARNING:- DO NOT USE HH PADS ON REAR UNLESS ALSO USED ON FRONT TO AVOID BRAKE IMBALANCE

FRONT: SUZUKI Cont'd

REAR: SUZUKI

Line #

BRAKE ROTOR CHOICES - FRONT							DISC PAD CHOICES - REAR				BRAKE ROTOR CHOICES - REAR				
CC Custom Rotor	CX Extreme® /Vee-Rotor	OS Series Oversize 250/280mm Rotor Kit	OSX Series Oversize 280mm Rotor Kit	Relocating Bracket for 250/280mm Rotor	SMX Series Oversize 320mm Rotor Kit	Relocating Bracket for 320mm Rotor		Semi-Sintered V-Pads™	Sintered/HH Pads/ Grooved Shoes	SV Series Severe Duty Pads	Standard Rotor	UTVX Rotor	Vintage Rotor	Contour Profile Rotor	CX Extreme® /Vee-Rotor
1							602		602G						
2							602								
3							602								
4							621		621G						
5							605		605G						
6							621		621G						
7							602		602G						
8							617		617G						
9							616		616G						
10							616		616G						
11							616		616G						
12							616		616G						
13							N/A		FA84/3R		MD6014D				
14	MD6017CX	OS6017EC	OSX6017E	BRK031	N/A		FA152X		FA152R■		MD6014D			MD6014C	MD6014CX
15	MD6017CX	OS6017EC	OSX6017E	BRK031	N/A		FA152X		FA152R■		MD6014D			MD6014C	MD6014CX
16	MD6017CX	OS6017EC	OSX6017E	BRK031	N/A		FA152/2X		FA152/2R■		MD6014D			MD6014C	MD6014CX
17	MD6017CX	OS6017EC	OSX6017E	BRK031	N/A		FA152/2X		FA152/2R■		MD6014D			MD6014C	MD6014CX
18	MD6017CX	OS6017C	OSX6017	BRK023	SMX6017	BRK024	FA131X		FA131R■		MD6014D			MD6014C	MD6014CX
19	MD6017CX	OS6017C	OSX6017	BRK023	SMX6017	BRK024	FA131X		FA131R■		MD6157D			MD6157C	MD6157CX
20	MD6017CX	OS6017C	OSX6017	BRK023	SMX6017	BRK024	FA131X		FA131R■		MD6305D			MD6305C	MD6305CX
21							602		602G						
22							602		602G						
23							602		602G						
24							602		602G						
25							602		602G						
26							602		602G						
27							602		602G						
28							602		602G						
29							602		602G						
30							605								
31							605								
32							605		605G						
33							605		605G						
34							605		605G						
35							619		619G						
36							619		619G						
37							617		617G						
38							602		602G						
39							602								
40							602								
41							605		605G						
42							602		602G						
43							602		602G						
44							602		602G						
45							603								
46							602		602G						
47							605								
48							605								
49	VR9117						SFA413		SFA413HH						VR9117
50							605		605G						
51							FA84X		FA84R	FA84SV	MD6021D				
52							FA84X		FA84R	FA84SV	MD6063D				
53							FA84X		FA84R	FA84SV	MD6063D				
54							N/A		FA84/3R		MD6021D				
55							N/A		FA84/3R		MD6021D				
56							N/A		FA84/3R		MD6063D				

REAR

⚠ This symbol indicates a rotor made of billet steel, and should be only used with EBC FA Kevlar® Organic or Vee pads.
 SAFETY NOTICE - With vehicles primarily designed for off highway use such as quads now being used on the highway, we would recommend the use of X or MXS pads for highway use and ONLY using the R and SV higher density / harder pad series for off road riding.

BRAKE APPLICATIONS

*-2 Sets Required. ■ - Also available in MX-S race compound. **SAFETY WARNING:- DO NOT USE HH PADS ON REAR UNLESS ALSO USED ON FRONT TO AVOID BRAKE IMBALANCE**

FRONT: SUZUKI



SUZUKI



DISC PAD CHOICES - FRONT

BRAKE ROTOR CHOICES - FRONT

		Semi-Sintered V-Pads™	Sintered/HH Pads/Grooved Shoes	SV Series Severe Duty Pads	Standard Rotor Left	Standard Rotor Right	UTVX Rotor	Vintage Rotor Left	Vintage Rotor Right	Contour Profile Rotor
LT-F 230 G/H	625*		625G*							
DR 250 Z/D	602		602G							
DR 250 F	FA54X		FA54R■		MD6074D					
DR 250 L/M/N/P/R/S	FA135X		FA135R■		MD6040D					
DR 250 S/SE	FA135X		FA135R■		MD6040D					
DR-Z 250 K	FA185X		FA185R■		MD6017D					MD6017C
DS 250 T	605		605G							
GN 250 Z/D/F	N/A									
GN 250 J	FA51				MD3014LS			VMD3014		
GS 250 TT/TX	FA51				MD3014LS			VMD3014		
GSX 250 R	FA226		FA226HH							
GT 250 K/L/M/A/B Hustler	FA55					MD3014RS				
GW 250 L	FA142	FA142V	FA142HH		MD3105LS					
GZ 250 X/Y/K/LO Marauder	FA106				N/A					
LT 250 EFF/EFG	625*		625G*							
LT-F 250 J/K/L/M/N/P/R/S/T/V/W/X/Y/K1 250 Quadrunner	628*		628G*							
LT 250 SK/SL	FA128X*		FA128R*	FA128SV*	MD6020D	MD6020D				
LT 250 RF/RG	FA128X*		FA128R*	FA128SV*	MD6020D	MD6020D				
LT 250 RH/RJ/RK/RL/RM/RN	FA128X*		FA128R*	FA128SV*	MD6020D	MD6020D				
LT-F 250 FX/FY/FK1/FK2 Quadrunner	628*		628G*							
LT-F 250 K/L Ozark	FA54X*		FA54R*	FA54SV*	MD6207D	MD6207D				
LT-Z 250 K QuadSport	FA84X*		FA84R*	FA84SV*	MD6210D	MD6210D				
LT-4WD H/J/K/L/M/N/P/R/S/T/V 250 Quadrunner	628*		628G*							
LT-F 4WD V/W Quadrunner 250	628*		628G*							
LT-F 4WD V/W Quadrunner 4WD (250cc)	FA54X*		FA54R*	FA54SV*	MD6195D	MD6195D				
PE 250 B/C/N/T/X	605		605G							
RM 250 A/B/C/C2	602		602G							
RM 250 N	605		605G							
RM 250 T	618		618G							
RM 250 X/Z	621		621G							
RM 250 D	622		622G							
RM 250 E	622		622G							
RM 250 F/G	FA106X		FA106R		MD6163D					
RM 250 H/J	FA135X		FA135R■		MD6163D					
RM 250 K	FA135X		FA135R■		MD6017D					MD6017C
RM 250 L	FA135X		FA135R■		MD6017D					MD6017C
RM 250 M/N/P	FA135X		FA135R■		MD6017D					MD6017C
RM 250 R/S	FA135X		FA135R■		MD6017D					MD6017C
RM 250 T/V/W	FA185X		FA185R■		MD6017D					MD6017C
RM 250 X/Y/K	FA185X		FA185R■		MD6017D					MD6017C
RM 250 K	FA185X		FA185R■		MD6017D					MD6017C
RMX 250 K/M/N/P	FA135X		FA135R■		MD6017D					MD6017C
RMX 250 R/S	FA135X		FA135R■		MD6017D					MD6017C
RMX 250 T/V/W	FA185X		FA185R■		MD6017D					MD6017C
RMX 250 X/Y	FA185X		FA185R■		MD6017D					MD6017C
RM-Z 250 K	FA185X		FA185R■		MD6213D					MD6213C
RM-Z 250 K7	FA185X		FA185R■		MD6254D					MD6254C
RM-Z 250 K/L	FA185X		FA185R■							MD6254C
RS 250 T/X	602		602G							
SP 250 Z/D	620		620G							
SP 250 F	FA54X		FA54R■		MD6074D					
T10 - 250cc (E/No T10 16816 onwards - Twin Leading Shoe F/Brake - Cable Rear Brake)	608									
T20 X6 - 250cc	608									
T 250 11/R/J Hustler	608									
TC 250 X6 Scrambler	608									

Line #
1
2
3
4
5
6
7
8
9
10
11
12
13
14
15
16
17
18
19
20
21
22
23
24
25
26
27
28
29
30
31
32
33
34
35
36
37
38
39
40
41
42
43
44
45
46
47
48
49
50
51
52
53
54
55
56

APPLICATIONS

BRAKE

⊛ This symbol indicates a rotor made of billet steel, and should be only used with EBC FA Kevlar® Organic or Vee pads.

SAFETY NOTICE - With vehicles primarily designed for off highway use such as quads now being used on the highway, we would recommend the use of X or MXS pads for highway use and ONLY using the R and SV higher density / harder pad series for off road riding.

*-2 Sets Required. ■ - Also available in MX-S race compound. SAFETY WARNING:- DO NOT USE HH PADS ON REAR UNLESS ALSO USED ON FRONT TO AVOID BRAKE IMBALANCE

FRONT: SUZUKI Cont'd

REAR: SUZUKI

Line #

BRAKE ROTOR CHOICES - FRONT							DISC PAD CHOICES - REAR				BRAKE ROTOR CHOICES - REAR				
CC Custom Rotor	CX Extreme® /Vee-Rotor	OS Series Oversize 250/280mm Rotor Kit	OSX Series Oversize 280mm Rotor Kit	Relocating Bracket for 250/280mm Rotor	SMX Series Oversize 320mm Rotor Kit	Relocating Bracket for 320mm Rotor		Semi-Sintered V-Pads™	Sintered/HH Pads/ Grooved Shoes	SV Series Severe Duty Pads	Standard Rotor	UTVX Rotor	Vintage Rotor	Contour Profile Rotor	CX Extreme® /Vee-Rotor
1							605		605G						
2							602		602G						
3							602		602G						
4	MD6040CX	OS6040C	OSX6040	BRK031	N/A	N/A	FA152X		FA152R■		MD6038D				MD6038CX
5	MD6040CX	OS6040C	OSX6040	BRK031	N/A	N/A	FA152X		FA152R■		MD6038D				MD6038CX
6	MD6017CX	OS6017C	OSX6017	BRK023	SMX6017	BRK024	FA152/2X		FA152/2R■		MD6110D				MD6110CX
7							605		605G						
8							602								
9							602								
10							606								
11							FA496	FA496V	FA496HH						
12							609								
13							FA496	FA496V	FA496HH		MD3093				
14							602								
15							634		634G						
16							629		629G						
17							FA84X		FA84R	FA84SV	MD6063D				
18							N/A		FA84/3R		MD6062D				
19							FA137X		FA137R	FA137SV	MD6021D				
20							629		629G						
21							636		636G						
22							636		636G						
23							629		629G						
24							629		629G						
25							606		606G						
26							605		605G						
27							605		605G						
28							620		620G						
29							620		620G						
30							616		616G						
31							616		616G						
32							618		618G						
33							618		618G						
34							N/A		FA84/3R		MD6014D				
35	MD6017CX	OS6017EC	OSX6017E	BRK031	N/A	N/A	FA152X		FA152R■		MD6014D			MD6014C	MD6014CX
36	MD6017CX	OS6017EC	OSX6017E	BRK031	N/A	N/A	FA152X		FA152R■		MD6014D			MD6014C	MD6014CX
37	MD6017CX	OS6017EC	OSX6017E	BRK031	N/A	N/A	FA152/2X		FA152/2R■		MD6014D			MD6014C	MD6014CX
38	MD6017CX	OS6017EC	OSX6017E	BRK031	N/A	N/A	FA152/2X		FA152/2R■		MD6014D			MD6014C	MD6014CX
39	MD6017CX	OS6017C	OSX6017	BRK023	SMX6017	BRK024	FA131X		FA131R■		MD6014D			MD6014C	MD6014CX
40	MD6017CX	OS6017C	OSX6017	BRK023	SMX6017	BRK024	FA131X		FA131R■		MD6157D			MD6157C	MD6157CX
41	MD6017CX	OS6017C	OSX6017	BRK023	SMX6017	BRK024	FA131X		FA131R■		MD6305D			MD6305C	MD6305CX
42	MD6017CX	OS6017EC	OSX6017E	BRK031	N/A	N/A	FA152X		FA152R■		MD6014D			MD6014C	MD6014CX
43	MD6017CX	OS6017EC	OSX6017E	BRK031	N/A	N/A	FA152X		FA152R■		MD6014D			MD6014C	MD6014CX
44	MD6017CX	OS6017C	OSX6017	BRK023	SMX6017	BRK024	FA152X		FA152R■		MD6014D			MD6014C	MD6014CX
45	MD6017CX	OS6017C	OSX6017	BRK023	SMX6017	BRK024	FA131X		FA131R■		MD6157D			MD6157C	MD6157CX
46	MD6213CX	OS6213C	OSX6213	BRK023	SMX6213	BRK024	FA367X		FA367R■		MD6208D			MD6208C	MD6208CX
47	MD6254CX	OS6254C	OSX6254	BRK023	SMX6254	BRK024	FA367X		FA367R■		MD6255D			MD6255C	MD6255CX
48	MD6254CX	OS6254C	OSX6254	BRK023	SMX6254	BRK024	FA367X		FA367R■					MD6255C	MD6255CX
49							605		605G						
50							602		602G						
51							602		602G						
52															
53							609								
54							609								
55							609								
56							609								

REAR

⚠ This symbol indicates a rotor made of billet steel, and should be only used with EBC FA Kevlar® Organic or Vee pads.

SAFETY NOTICE - With vehicles primarily designed for off highway use such as quads now being used on the highway, we would recommend the use of X or MXS pads for highway use and ONLY using the R and SV higher density / harder pad series for off road riding.

BRAKE APPLICATIONS

*-2 Sets Required. ■ - Also available in MX-S race compound. **SAFETY WARNING:- DO NOT USE HH PADS ON REAR UNLESS ALSO USED ON FRONT TO AVOID BRAKE IMBALANCE**

FRONT: SUZUKI

APPLICATIONS

BRAKE



SUZUKI



DISC PAD CHOICES - FRONT

BRAKE ROTOR CHOICES - FRONT

			Semi-Sintered V-Pads™	Sintered/HH Pads/Grooved Shoes	SV Series Severe Duty Pads	Standard Rotor Left	Standard Rotor Right	UTVX Rotor	Vintage Rotor Left	Vintage Rotor Right	Contour Profile Rotor
TS 250 R/J/K/L/M/A/B/C/N/T/X	71-81	605		605G							
TU 250 XK/XL	09-16	FA229		FA229HH		N/A					
LT 300 EH/EJ/EK	87-89	625*		625G*							
LT-F 4WD XM/N/P/R/S/T/V/W King Quad 300	91-98	633*		633G*							
GS 300 L	82-83	N/A									
GS 300 L	85	612									
LT-F 300 FX/FY/FK1 King Quad	99-01	633*		633G*							
LT-F 300 FK2 King Quad	Left 02	FA165X		FA165R	FA165SV	MD6206D					
	Right	FA135X		FA135R	FA135SV		MD6206D				
T 305 Raider	68-69	608									
DR 350 L/M/N/P/R/S/T	90-96	FA135X		FA135R■		MD6040D					
DR 350 V/W/X	97-99	FA185X		FA185R■		MD6017D					MD6017C
DR 350 S/SE	90-95	FA135X		FA135R■		MD6040D					
DR 350 SET/SEV	96-97	FA135X		FA135R■		MD6040D					
DR 350 SEW/SEX	98-99	FA185X		FA185R■		MD6017D					MD6017C
T 350 Rebel	69-72	608									
DR 370 C/N	78-79	602		602G							
RM 370 A/B	76-77	602		602G							
SP 370 C/N	78-79	605		605G							
GT 380 J Sebring (Drum Brake)	72	608									
GT 380 K/L/M/A/B Sebring	73-77	FA55					MD3014RS				
AN 400 K/SK Burgman	03-06	SFA283/4		SFA283/4HH		MD994D					
AN 400 K/AK/AL Burgman	Left 07-16	SFA228		SFA228HH		MD994D					
	Right	SFA197		SFA197HH			MD994D				
AN 400 Z Burgman (ABS)	Left 14-16	SFA228		SFA228HH		MD994D					
	Right	SFA197		SFA197HH			MD994D				
DR 400 T	80	602		602G							
DR-Z 400 S	00-16	FA185X		FA185R■		MD6017D					MD6017C
DR-Z 400 SM	05-09/13-16	FA185X		FA185R■		MD6247D					MD6247C
DR-Z 400 Y/K/EY/EK	00-07	FA185X		FA185R■		MD6017D					MD6017C
GS 400 B/C (Disc Brake)	77-78	FA35					MD3014RS				
GS 400 XB/XC (Drum Brake)	77-78	612									
GSF 400 M/N/P Bandit	91-93	FA129		FA129HH		MD3006X					MD3006XC
GN 400 T/XT/XX/TX/TZ	80-82	FA51				MD3014LS			VMD3014		
LT-A 400 FK/FCK Eiger (4WD Auto)	02-07	FA54X*		FA54R*	FA54SV*	MD6195D	MD6195D				
LT-A 400 FK King Quad Auto 4WD	Left 08-09	FA413X		FA413R	FA413SV	MD6195D					
	Right	FA414X		FA414R	FA414SV		MD6195D				
LT-A 400 K Eiger (Auto 2WD)	02-04/06	FA54X*		FA54R*	FA54SV*	MD6195D	MD6195D				
LT-A 400 FK/FL King Quad 400 AS	Left 08-10	FA413X		FA413R	FA413SV	MD6195D					
	Right	FA414X		FA414R	FA414SV		MD6195D				
LT-A 400 FCK King Quad 400 AS Camo	Left 09	FA413X		FA413R	FA413SV	MD6195D					
	Right	FA414X		FA414R	FA414SV		MD6195D				
LT-A 400 FQK King Quad 400	Left 08-09	FA413X		FA413R	FA413SV	MD6195D					
AS Anniversary Edition	Right	FA414X		FA414R	FA414SV		MD6195D				
LT-A 400 FL King Quad 400 Asi	Left 11-16	FA413X		FA413R	FA413SV	MD6195D					
	Right	FA414X		FA414R	FA414SV		MD6195D				
LT-A 400 FCL King Quad 400 Asi Camo	Left 11-16	FA413X		FA413R	FA413SV	MD6195D					
	Right	FA414X		FA414R	FA414SV		MD6195D				
LT-F 400 FK/FCK (Eiger 4WD)	02-07	FA54X*		FA54R*	FA54SV*	MD6195D	MD6195D				
LT-F 400 K Eiger Manual 2WD	02	FA54X*		FA54R*	FA54SV*	MD6195D	MD6195D				
LT-F 400 K	03-08	FA54X*		FA54R*	FA54SV*	MD6195D	MD6195D				
LT-F 400 K Manual 2WD	Left 08	FA413X		FA413R	FA413SV	MD6195D					
	Right	FA414X		FA414R	FA414SV		MD6195D				
LT-F 400 F King Quad 400 FS	Left 08-10	FA413X		FA413R	FA413SV	MD6195D					
	Right	FA414X		FA414R	FA414SV		MD6195D				

Line #

* This symbol indicates a rotor made of billet steel, and should be only used with EBC FA Kevlar® Organic or Vee pads.
 SAFETY NOTICE - With vehicles primarily designed for off highway use such as quads now being used on the highway, we would recommend the use of X or MXS pads for highway use and ONLY using the R and SV higher density / harder pad series for off road riding.

*-2 Sets Required. ■ - Also available in MX-S race compound. **SAFETY WARNING:- DO NOT USE HH PADS ON REAR UNLESS ALSO USED ON FRONT TO AVOID BRAKE IMBALANCE**

FRONT: SUZUKI



SUZUKI



DISC PAD CHOICES - FRONT

BRAKE ROTOR CHOICES - FRONT

LT-F 400 FCK King Quad 400 FS Camo	Left	08-09	FA413X		FA413R	FA413SV	MD6195D				
	Right		FA414X		FA414R	FA414SV		MD6195D			
LT-F 400 FQK King Quad 400	Left	09	FA413X		FA413R	FA413SV	MD6195D				
FS Anniversary Edition	Right		FA414X		FA414R	FA414SV		MD6195D			
LT-F 400 FL King Quad 400 FSi	Left	11-16	FA413X		FA413R	FA413SV	MD6195D				
	Right		FA414X		FA414R	FA414SV		MD6195D			
LT-F 400 FCL King Quad 400 FSi Camo	Left	11-16	FA413X		FA413R	FA413SV	MD6195D				
	Right		FA414X		FA414R	FA414SV		MD6195D			
LT-Z 400 K/ZK/L/ZL QuadSport		03-14	FA84X*		FA84R*■		MD6210D	MD6210D			
TM 400 R/J/K/L/M Cyclone		71-75	602		602G						
TS 400 J/K/L/M/A/B		72-77	605		605G						
RM 400 C		78	602		602G						
RM 400 N		79	605		605G						
RM 400 T		80	618		618G						
SP 400 T		80	605		605G						
PE 400 T/X		80-81	605		605G						
GS 425 N (Spoke Wheel)		79	FA35				MD3014LS		VMD3014		
GS 425 EN (Cast Wheel)		79	FA35				MD3014LS		VMD3014		
GS 425 LN		79	FA38	FA038V			MD3014LS		VMD3014		
GS 450 E		80-83	FA51				MD3014LS		VMD3014		
GS 450 GA		82-85	FA51				MD3014LS		VMD3014		
GS 450 L		80-88	FA51				MD3014LS		VMD3014		
GS 450 T		81-82	FA51				MD3014LS		VMD3014		
GS 450 TXZ		82	FA51				MD3014LS		VMD3014		
GS 450 TXD		83	612								
LT-A 450 XCK King Quad 450 AXi Camo	Left	07-09	FA413X		FA413R	FA413SV	MD6261D				
	Right		FA414X		FA414R	FA414SV		MD6261D			
LT-A 450 XZK King Quad 450 AXi Limited	Left	08-09	FA413X		FA413R	FA413SV	MD6261D				
	Right		FA414X		FA414R	FA414SV		MD6261D			
LT-A 450 XK/XL King Quad 4x4 AXi	Left	07-10	FA413X		FA413R	FA413SV	MD6261D				
	Right		FA414X		FA414R	FA414SV		MD6261D			
LT-R 450 K	Left	06-11	FA165X		FA165R■		MD6277D				
	Right		FA135X		FA135R■			MD6277D			
LT-R 450 ZK Quadracer Limited Edition	Left	08-10	FA165X		FA165R■		MD6277D				
	Right		FA135X		FA135R■			MD6277D			
RMX 450 ZL		10	FA185X		FA185R■						MD6254C
RM-Z 450 K/ZK		05-07	FA185X		FA185R■		MD6254D				MD6254C
RM-Z 450 K/L		08-17	FA185X		FA185R■						MD6254C
RM 465 X/Z		81-82	621		621G						
DR 500 X/Z/D		81-83	602		602G						
GS 500 E		89-95	FA129		FA129HH			MD3006X			MD3006XC
GS 500 E/K		96-03	FA231		FA231HH			MD3006X			MD3006XC
GS 500 FK		04-10	FA231		FA231HH			MD3006X			MD3006XC
GT 500 A/B Titan		76-77	FA55					MD3019RS		VMD3019	
LT 500 R		87-90	FA128X*		FA128R*	FA128SV*	MD6022D	MD6022D			
LT-F 500 F Quadrunner	Left	98-02	FA165X		FA165R	FA165SV	MD6145D				
	Right		FA135X		FA135R	FA135SV		MD6145D			
LT-F 500 F Vinson Quadrunner		03-07	FA54X*		FA54R*	FA54SV*	MD6195D	MD6195D			
LT-A 500 FY/FK1 Quadmaster	Left	00-01	FA165X		FA165R	FA165SV	MD6145D				
	Right		FA135X		FA135R	FA135SV		MD6145D			
LT-A 500 FK2 Vinson 4WD		02-07	FA54X*		FA54R*	FA54SV*	MD6195D	MD6195D			
LT-A 500 FCK/FK Vinson 4WD		03-07	FA54X*		FA54R*	FA54SV*	MD6195D	MD6195D			
LT-A 500 XPZ King Quad 500 AXi	Left	09/13	FA413X		FA413R	FA413SV	MD6355D				
Power Steering Limited	Right		FA414X		FA414R	FA414SV		MD6355D			

Line #

1
2
3
4
5
6
7
8
9
10
11
12
13
14
15
16
17
18
19
20
21
22
23
24
25
26
27
28
29
30
31
32
33
34
35
36
37
38
39
40
41
42
43
44
45
46
47
48
49
50
51
52
53
54
55
56

APPLICATIONS
BRAKE

* This symbol indicates a rotor made of billet steel, and should be only used with EBC FA Kevlar® Organic or Vee pads.
SAFETY NOTICE - With vehicles primarily designed for off highway use such as quads now being used on the highway, we would recommend the use of X or MXS pads for highway use and ONLY using the R and SV higher density / harder pad series for off road riding.

*-2 Sets Required. ■ - Also available in MX-S race compound. SAFETY WARNING:- DO NOT USE HH PADS ON REAR UNLESS ALSO USED ON FRONT TO AVOID BRAKE IMBALANCE

FRONT: SUZUKI

APPLICATIONS

BRAKE



SUZUKI



DISC PAD CHOICES - FRONT

BRAKE ROTOR CHOICES - FRONT

												Line #	
				Semi-Sintered V-Pads™	Sintered/HH Pads/Grooved Shoes	SV Series Severe Duty Pads	Standard Rotor Left	Standard Rotor Right	UTVX Rotor	Vintage Rotor Left	Vintage Rotor Right	Contour Profile Rotor	
LT-A 500 XL King Quad 500AXi	Left	11-16	FA413X		FA413R	FA413SV	MD6355D						1
	Right		FA414X		FA414R	FA414SV		MD6355D					2
LT-A 500 XPC	Left	09-16	FA413X		FA413R	FA413SV	MD6355D						3
King Quad 500 AXi Power Steering Camo	Right		FA414X		FA414R	FA414SV		MD6355D					4
LT-A 500 XCL King Quad 500 AXi Camo	Left	11-16	FA413X		FA413R	FA413SV	MD6355D						5
	Right		FA414X		FA414R	FA414SV		MD6355D					6
LT-A 500 XPK/XPL King Quad 500 AXi Power Steering	Left	09-16	FA413X		FA413R	FA413SV	MD6355D						7
	Right		FA414X		FA414R	FA414SV		MD6355D					8
RE 5 M/A (Rotary)			FA55*				MD3019LS	MD3019RS		VMD3019	VMD3019		9
SP 500 XZ/D		81-83	605		605G								10
RM 500 D/E		83-84	622		622G								11
T 500 1 Cobra		68	612										12
T 500 2/3/R/J/K/L/M Titan		69-75	612										13
GS 550 B		77	FA38	FA038V			MD3019LS			VMD3019			14
GS 550 C/N/EC/EN		77-79	FA38	FA038V			MD3020LS						15
GS 550 ET		80	FA65				MD3014LS			VMD3014			16
GS 550 MZ		82	FA65*				MD3014LS	MD3014RS		VMD3014	VMD3014		17
GS 550 LT		80	FA65				MD3020LS						18
GS 550 LX		81	FA65				MD3022LS						19
GS 550 LZ		82	FA65				MD3022LS						20
GS 550 L		83-86	FA63		FA63HH		MD3014LS			VMD3014			21
GS 550 TX		81	FA65				MD3022LS						22
GS 550 E/ES		83-86	FA63*		FA63HH*		MD3024LS	MD3024RS					23
GT 550 J Indy (Drum Front Brake)		72	N/A										24
GT 550 K/L/M Indy		73-75	FA55					MD3019RS			VMD3019		25
GT 550 A/B Indy (Tokico Caliper)		76-77	FA55					MD3019RS			VMD3019		26
GT 550 B Indy (Asco Caliper)		77	FA38	FA038V				MD3019RS			VMD3019		27
GSF 600 Bandit S		96-98	FA142		FA142HH		MD3003X	MD3003X				MD3003XC*	28
GSF 600 S/SK Bandit	Left	00-03	FA229		FA229HH		MD3003X					MD3003XC	29
	Right		FA231		FA231HH			MD3003X				MD3003XC	30
GSX 600 FJ Katana		88	FA146*		FA146HH*		MD3001	MD3001					31
GSX 600 F Katana		89-97	FA146*		FA146HH*		MD3003X	MD3003X				MD3003XC*	32
GSX 600 F/FK Katana	Left	98-02	FA229		FA229HH		MD3003X					MD3003XC*	33
	Right		FA231		FA231HH			MD3003X				MD3003XC*	34
GSX 600 FK - Katana	Left	03-06	FA229		FA229HH		MD3090X					MD3090XC	35
	Right		FA231		FA231HH			MD3090X				MD3090XC	36
GSX-R 600 W		92-93	FA145*		FA145HH*		MD3007X	MD3007X				MD3007XC*	37
GSX-R 600 V/W/X/Y/K/ZK		97-03	FA158*		FA158HH*		MD3058X	MD3058X				MD3058XC*	38
GSX-R 600 K/XK (Radial Caliper)		04-05			FA379HH*		MD3104X	MD3104X				MD3104XC*	39
GSX-R 600 K (Tokico Radial Caliper)		06-07			FA379HH*		MD3091X	MD3091X				MD3091XC*	40
GSX-R 600 K (Tokico Radial Caliper)		08-10			FA379HH*		MD3100X	MD3100X				MD3100XC*	41
GSX-R 600 L (Brembo Radial Caliper)		11-17			FA447HH*		MD3100X	MD3100X				MD3100XC*	42
RF 600 R		94-97	FA142*		FA142HH*		MD3003X	MD3003X				MD3003XC*	43
SP 600 F		85-87	FA106/2X		FA106/2R		MD6075D						44
QUV 620 FK5 Side x Side		05	719*		N/A								45
AN 650 K Burgman (Non ABS)		03	SFA142*		SFA142HH*		MD987D	MD987D					46
AN 650 K/L Burgman (Non ABS)		04-12	SFA142*		SFA142HH*		MD994D	MD994D					47
AN 650 AK/AL Burgman (ABS)		04-12	SFA142*		SFA142HH*		MD994D	MD994D					48
AN 650 L Burgman (ABS)		13-16	SFA142*		SFA142HH*		MD9144D	MD9144D					49
AN 650 ZL Burgman Executive (ABS)		13-17	SFA142*		SFA142HH*		MD9144D	MD9144D					50
DL 650 K V-Strom	Left	04-06	FA229		FA229HH		MD3088X					MD3088XC	51
	Right		FA231		FA231HH		MD3088X					MD3088XC	52
DL 650 K V-Strom	Left	07-09	FA229		FA229HH		MD3092X					MD3092XC	53
	Right		FA231		FA231HH		MD3092X					MD3092XC	54
DL 650 AK/A V-Strom (ABS Model)	Left	07-17	FA229		FA229HH		MD3092X					MD3092XC	55
	Right		FA231		FA231HH		MD3092X					MD3092XC	56

FRONT

* This symbol indicates a rotor made of billet steel, and should be only used with EBC FA Kevlar® Organic or Vee pads.
 SAFETY NOTICE - With vehicles primarily designed for off highway use such as quads now being used on the highway, we would recommend the use of X or MXS pads for highway use and ONLY using the R and SV higher density / harder pad series for off road riding.

*-2 Sets Required. ■ - Also available in MX-S race compound. SAFETY WARNING:- DO NOT USE HH PADS ON REAR UNLESS ALSO USED ON FRONT TO AVOID BRAKE IMBALANCE

FRONT: SUZUKI Cont'd

REAR: SUZUKI

Line #

BRAKE ROTOR CHOICES - FRONT							DISC PAD CHOICES - REAR				BRAKE ROTOR CHOICES - REAR				
CC Custom Rotor	CX Extreme® /Vee-Rotor	OS Series Oversize 250/280mm Rotor Kit	OSX Series Oversize 280mm Rotor Kit	Relocating Bracket for 250/280mm Rotor	SMX Series Oversize 320mm Rotor Kit	Relocating Bracket for 320mm Rotor		Semi-Sintered V-Pads™	Sintered/HH Pads/ Grooved Shoes	SV Series Severe Duty Pads	Standard Rotor	UTVX Rotor	Vintage Rotor	Contour Profile Rotor	CX Extreme® /Vee-Rotor
1							N/A								
2							N/A								
3							N/A								
4							N/A								
5							N/A								
6							N/A								
7							N/A								
8							N/A								
9							634								
10							605		605G						
11							618		618G						
12							609								
13							609								
14							611								
15							FA36	FA36V			MD3014RS		VMD3014		
16							FA36	FA36V			MD3014RS		VMD3014		
17							FA36	FA36V			MD3014RS		VMD3014		
18							FA36	FA36V			MD3014RS		VMD3014		
19							FA36	FA36V			MD3014RS		VMD3014		
20							611								
21							606								
22							FA36	FA36V			MD3014RS		VMD3014		
23							FA63	FA63V	FA63HH		MD3025				
24							609								
25							609								
26							611								
27							611								
28	MD3003CC*	VR3003BLK*					FA63	FA63V	FA63HH		MD3008			MD3008C	VR3008
29	MD3003CC	VR3003BLK					FA63	FA63V	FA63HH		MD3008			MD3008C	VR3008
30	MD3003CC	VR3003BLK													
31							FA63	FA63V	FA63HH		MD3002			MD3002C	
32	MD3003CC*	VR3003BLK*					FA63	FA63V	FA63HH		MD3002			MD3002C	VR3002
33	MD3003CC*	VR3003BLK*					FA63	FA63V	FA63HH		MD3008			MD3008C	VR3008
34	MD3003CC*	VR3003BLK*													
35	MD3090CC	VR3090BLK					FA63	FA63V	FA63HH		MD3008			MD3008C	VR3008
36	MD3090CC	VR3090BLK													
37		VR3007BLK*					FA63	FA63V	FA63HH		MD3008			MD3008C	VR3008
38	MD3058CC*	VR3058BLK*					FA63	FA63V	FA63HH		MD3060			MD3060C	VR3060
39		VR3104BLK*					FA254	FA254V	FA254HH		MD3060			MD3060C	VR3060
40	MD3091CC*	VR3091BLK*					FA419	FA419V	FA419HH		MD3060			MD3060C	VR3060
41		VR3100BLK*					FA419	FA419V	FA419HH		MD3060			MD3060C	VR3060
42		VR3100BLK*					FA436	FA436V	FA436HH		MD3060			MD3060C	VR3060
43	MD3003CC*	VR3003BLK*					FA63	FA63V	FA63HH		MD3008			MD3008C	VR3060
44							602		602G						
45							720*		N/A						
46		VR987*					SFA412		SFA412HH		MD988D				VR988
47		VR994*					SFA412		SFA412HH		MD988D				VR998
48		VR994*					SFA412		SFA412HH		MD988D				VR998
49		VR9144BLK*					SFA412		SFA412HH		MD988D				VR998
50		VR9144BLK*					SFA412		SFA412HH		MD988D				VR998
51		VR3088BLK					FA174		FA174HH		MD6232D				MD6232CX
52		VR3088BLK													
53		VR3092BLK					FA174		FA174HH		MD6232D				MD6232CX
54		VR3092BLK													
55		VR3092BLK					FA174		FA174HH		MD6232D				MD6232CX
56		VR3092BLK													

REAR

⚠ This symbol indicates a rotor made of billet steel, and should be only used with EBC FA Kevlar® Organic or Vee pads.

SAFETY NOTICE - With vehicles primarily designed for off highway use such as quads now being used on the highway, we would recommend the use of X or MXS pads for highway use and ONLY using the R and SV higher density / harder pad series for off road riding.

BRAKE APPLICATIONS

*-2 Sets Required. ■ - Also available in MX-S race compound. **SAFETY WARNING:- DO NOT USE HH PADS ON REAR UNLESS ALSO USED ON FRONT TO AVOID BRAKE IMBALANCE**

FRONT: SUZUKI

APPLICATIONS

BRAKE



SUZUKI



DISC PAD CHOICES - FRONT

BRAKE ROTOR CHOICES - FRONT

													Line #
				Semi-Sintered V-Pads™	Sintered/HH Pads/Grooved Shoes	SV Series Severe Duty Pads	Standard Rotor Left	Standard Rotor Right	UTVX Rotor	Vintage Rotor Left	Vintage Rotor Right	Contour Profile Rotor	
DL 650 XT V-Strom ABS (DL 650 XAL)	Left	15-17	FA229		FA229HH		MD3092X					MD3092XC	1
	Right		FA231		FA231HH		MD3092X					MD3092XC	2
DL 650 AAL V-Strom (ABS Adventure)	Left	12-15	FA229		FA229HH		MD3092X					MD3092XC	3
	Right		FA231		FA231HH		MD3092X					MD3092XC	4
DR 650 SL/SM		90-91	FA147X		FA147R		MD6076D						5
DR 650 S/SE		92-95	FA147X		FA147R		MD6078D						6
DR 650 SE/SEK/SEL		96-16	FA185X		FA185R■		MD6094D						7
GR 650 D/XD Tempter		83	FA65	FA65V			MD3014LS			VMD3014			8
GS 650 E		81-82	FA65*	FA65V*			MD3014LS	MD3014RS		VMD3014	VMD3014		9
GS 650 G		81-83	FA65*	FA65V*			MD3014LS	MD3014RS		VMD3014	VMD3014		10
GS 650 GL		81-83	FA65	FA65V			MD3022LS						11
GS 650 MD		83	FA65*	FA65V*			MD3014LS	MD3014RS		VMD3014	VMD3014		12
GSX 650 FK/FL		08-10	FA158*		FA158HH*		MD3092X	MD3092X				MD3092XC*	13
LS 650 F/P/PK Savage		86-88/95-04	FA106	FA106V			MD3017LS						14
LS 650 K/L (Boulevard S40 650cc)		05-15	FA106	FA106V			MD3017LS						15
SFV 650 K/L	Left	09-10/13-15	FA229		FA229HH		MD3103X					MD3103XC	16
	Right		FA231		FA231HH			MD3103X				MD3103XC	17
SV 650 X/Y/K/SK	Left	99-02	FA229		FA229HH		MD3003X					MD3003XC	18
	Right		FA231		FA231HH			MD3003X				MD3003XC	19
SV 650 K/SK	Left	03-10	FA229		FA229HH		MD3090X					MD3090XC	20
	Right		FA231		FA231HH			MD3090X				MD3090XC	21
SV 650 AK ABS	Left	07-10	FA229		FA229HH		MD3103X					MD3103XC	22
	Right		FA231		FA231HH			MD3103X				MD3103XC	23
SV 650 AL (ABS)	Left	16-17	FA229		FA229HH		MD3103X					MD3103XC	24
	Right		FA231		FA231HH			MD3103X				MD3103XC	25
SV 650 SAK ABS	Left	07-10	FA229		FA229HH		MD3103X					MD3103XC	26
	Right		FA231		FA231HH			MD3103X				MD3103XC	27
XN 85 D (673cc)		83	FA65*	FA65V*			MD3028LS	MD3028RS					28
LT-A 700 XK/XCK King Quad	Left	05-07	FA413X		FA413R	FA413SV	MD6261D						29
	Right		FA414X		FA414R	FA414SV		MD6261D					30
LT-V 700 FK Twin Peaks 700 4x4	Left	04-05			FA342R	FA342SV	MD6188D		UTVX6188				31
	Right				FA349R	FA349SV		MD6188D	UTVX6188				32
GS 700 E		85	FA51*	FA51V*			MD3028LS	MD3028RS					33
GV 700 GLF		85	FA51*	FA51V*			MD3030LS	MD3030RS					34
VS 700 GLE		86-87	FA103	FA103V	FA103HH		MD3073LS						35
VS 700 G		86-87	FA103	FA103V	FA103HH		MD3032LS						36
VS 700 GL		86-87	FA103	FA103V	FA103HH		MD3031LS						37
GS 750 B (8 Valve)		77	FA35	FA35V			MD3019LS			VMD3019			38
GS 750 C/N (8 Valve)		78-79	FA35	FA35V			MD3020LS						39
GS 750 E (8 Valve)		78-79	FA35*	FA35V*			MD3014LS	MD3014RS		VMD3014	VMD3014		40
GS 750 LN (8 Valve)		79	FA38*	FA38V*			MD3014LS	MD3014RS		VMD3014	VMD3014		41
GS 750 E (16 Valve)		80-82	FA51*	FA51V*			MD3014LS	MD3014RS		VMD3014	VMD3014		42
GS 750 L (16 Valve)		80-81	FA51*	FA51V*			MD3014LS	MD3014RS		VMD3014	VMD3014		43
GS 750 T (16 Valve)		82-83	FA51	FA51V			MD3022LS						44
GS 750 E		83	FA51*	FA51V*			MD3028LS	MD3028RS					45
GS 750 SD		83	FA65*	FA65V*			MD3014LS	MD3014RS		VMD3014	VMD3014		46
GSR 750 L (Non ABS)	Left	15-16	FA229		FA229HH		MD3092X					MD3092XC	47
	Right		FA231		FA231HH			MD3092X				MD3092XC	48
GSR 750 AL (ABS)	Left	15-16	FA229		FA229HH		MD3092X					MD3092XC	49
	Right		FA231		FA231HH			MD3092X				MD3092XC	50
GSX-R 750 RG/G/H		86-87	FA103*		FA103HH		MD3005	MD3005					51
GSX-R 750 J/K/L/M/N/WP		88-93	FA145*		FA145HH*		MD3007X	MD3007X				MD3007XC*	52
GSX-R 750 W		94-95	FA188*		FA188HH*		MD3007X	MD3007X				MD3007XC*	53
GSX-R 750 T/V/W/X		96-99	FA188*		FA188HH*		MD3058X	MD3058X				MD3058XC*	54
GSX-R 750 Y/K		00-03	FA158*		FA158HH*		MD3058X	MD3058X				MD3058XC*	55
GSX-R 750 K/XK (Tokico Radial Caliper)		04-05			FA379HH*		MD3104X	MD3104X				MD3104XC*	56

FRONT

* This symbol indicates a rotor made of billet steel, and should be only used with EBC FA Kevlar® Organic or Vee pads.
 SAFETY NOTICE - With vehicles primarily designed for off highway use such as quads now being used on the highway, we would recommend the use of X or MXS pads for highway use and ONLY using the R and SV higher density / harder pad series for off road riding.

*-2 Sets Required. ■ - Also available in MX-S race compound. **SAFETY WARNING:- DO NOT USE HH PADS ON REAR UNLESS ALSO USED ON FRONT TO AVOID BRAKE IMBALANCE**

FRONT: SUZUKI Cont'd

REAR: SUZUKI

Line #

BRAKE ROTOR CHOICES - FRONT							DISC PAD CHOICES - REAR				BRAKE ROTOR CHOICES - REAR				
CC Custom Rotor	CX Extreme® /Vee-Rotor	OS Series Oversize 250/280mm Rotor Kit	OSX Series Oversize 280mm Rotor Kit	Relocating Bracket for 250/280mm Rotor	SMX Series Oversize 320mm Rotor Kit	Relocating Bracket for 320mm Rotor		Semi-Sintered V-Pads™	Sintered/HH Pads/ Grooved Shoes	SV Series Severe Duty Pads	Standard Rotor	UTVX Rotor	Vintage Rotor	Contour Profile Rotor	CX Extreme® /Vee-Rotor
1	VR3092BLK						FA174		FA174HH		MD6232D				MD6232CX
2	VR3092BLK														
3	VR3092BLK						FA174		FA174HH		MD6232D				MD6232CX
4	VR3092BLK														
5							FA157X		FA157R		MD6077D				
6							FA157X		FA157R		MD6077D				
7	MD6094CX	N/A	N/A	N/A	SMX6094	BRK003	FA152X		FA152R■		MD6095D				MD6095CX
8							606								
9							FA36	FA36V			MD3027				
10							FA36	FA36V			MD3027				
11							FA36	FA36V			MD3027				
12							FA36	FA36V			MD3027				
13	MD3092CC*	VR3092BLK*					FA174	FA174V	FA174HH		MD3093			MD3093C	VR3093
14							606								
15							606								
16							FA496	FA496V	FA496HH		MD3093			MD3093C	
17															
18	MD3003CC	VR3003BLK					FA63	FA63V	FA63HH		MD3008			MD3008C	VR3008
19	MD3003CC	VR3003BLK													
20	MD3090CC	VR3090BLK					FA174	FA174V	FA174HH		MD3060			MD3060C	VR3060
21	MD3090CC	VR3090BLK													
22							FA174	FA174V	FA174HH		MD3093			MD3093C	
23															
24							FA496	FA496V	FA496HH		MD3093			MD3093C	
25															
26							FA174	FA174V	FA174HH		MD3093			MD3093C	
27															
28							FA36	FA36V			MD3014RS		VMD3014		
29							N/A								
30															
31							N/A								
32															
33							FA36	FA36V			MD3029				
34							626								
35							626								
36							626								
37							626								
38							FA36	FA36V			MD3019RS		VMD3019		
39							FA36	FA36V			MD3014RS		VMD3014		
40							FA36	FA36V			MD3014RS		VMD3014		
41							FA36	FA36V			MD3014RS		VMD3014		
42							FA36	FA36V			MD3014RS		VMD3014		
43							FA36	FA36V			MD3014RS		VMD3014		
44							634								
45							FA36	FA36V			MD3029				
46							FA36	FA36V			MD3014RS		VMD3014		
47	VR3092BLK														
48	VR3092BLK						FA174	FA174V	FA174HH		MD3093			MD3093C	VR3093
49	VR3092BLK														
50	VR3092BLK						FA174	FA174V	FA174HH		MD3093			MD3093C	VR3093
51							FA63	FA63V	FA63HH		MD3009				
52	VR3007BLK*						FA63	FA63V	FA63HH		MD3008			MD3008C	VR3008
53	VR3007BLK*						FA63	FA63V	FA63HH		MD3008			MD3008C	VR3008
54	MD3058CC*	VR3058BLK*					FA63	FA63V	FA63HH		MD3060			MD3060C	VR3060
55	MD3058CC*	VR3058BLK*					FA63	FA63V	FA63HH		MD3060			MD3060C	VR3060
56	VR3104BLK*						FA254	FA254V	FA254HH		MD3060			MD3060C	VR3060

REAR

This symbol indicates a rotor made of billet steel, and should be only used with EBC FA Kevlar® Organic or Vee pads.

SAFETY NOTICE - With vehicles primarily designed for off highway use such as quads now being used on the highway, we would recommend the use of X or MXS pads for highway use and ONLY using the R and SV higher density / harder pad series for off road riding.

BRAKE APPLICATIONS

*-2 Sets Required. ■ - Also available in MX-S race compound. **SAFETY WARNING:- DO NOT USE HH PADS ON REAR UNLESS ALSO USED ON FRONT TO AVOID BRAKE IMBALANCE**

FRONT: SUZUKI



SUZUKI



DISC PAD CHOICES - FRONT

BRAKE ROTOR CHOICES - FRONT

		Semi-Sintered V-Pads™	Sintered/HH Pads/Grooved Shoes	SV Series Severe Duty Pads	Standard Rotor Left	Standard Rotor Right	UTVX Rotor	Vintage Rotor Left	Vintage Rotor Right	Contour Profile Rotor
GSX-R 750 K (Tokico Radial Caliper)	06-07		FA379HH*		MD3091X	MD3091X				MD3091XC*
GSX-R 750 K (Tokico Radial Caliper)	08-10		FA379HH*		MD3100X	MD3100X				MD3100XC*
GSX-R 750 L (Brembo Radial Caliper)	11-17		FA447HH*		MD3100X	MD3100X				MD3100XC*
GSX 750 F Katana	89-97	FA146*	FA146HH*		MD3003X	MD3003X				MD3003XC*
GSX 750 F/FK Katana	98-02	Left FA229	FA229HH		MD3003X					MD3003XC
		Right FA231	FA231HH			MD3003X				MD3003XC
GSX 750 FK Katana	03-06	Left FA229	FA229HH		MD3090X					MD3090XC
		Right FA231	FA231HH			MD3090X				MD3090XC
GSX-S 750 L	15-18	Left FA229	FA229HH		MD3092X					MD3092XC
		Right FA231	FA231HH			MD3092X				MD3092XC
GSX-S 750 LZ5	15-18	Left FA229	FA229HH		MD3092X					MD3092XC
		Right FA231	FA231HH			MD3092X				MD3092XC
GT 750 J LE Mans (Front Drum Brake Model)	72	N/A								
GT 750 K/L/M/A/B	73-77	FA55*			MD3019LS	MD3019RS		VMD3019	VMD3019	
LT-A 750 XK/XL King Quad 750 AXi	08-15	Left FA413X	FA413R	FA413SV	MD6261D					
		Right FA414X	FA414R	FA414SV		MD6261D				
LT-A 750 XCK/XCL King Quad 750 AXi Camo	08-16	Left FA413X	FA413R	FA413SV	MD6261D					
		Right FA414X	FA414R	FA414SV		MD6261D				
LT-A 750 XZ King Quad 750 AXi Limited	08-09/14	Left FA413X	FA413R	FA413SV	MD6261D					
		Right FA414X	FA414R	FA414SV		MD6261D				
LT-A 750 XR King Quad 750 AXi Rockstar Edition	09	Left FA413X	FA413R	FA413SV	MD6355D					
		Right FA414X	FA414R	FA414SV		MD6355D				
LT-A 750 XP King Quad 750 AXi Power Steering	09-16	Left FA413X	FA413R	FA413SV	MD6355D					
		Right FA414X	FA414R	FA414SV		MD6355D				
LT-A 750 XPZ King Quad 750 AXi Power Steering Limited	09/15-16	Left FA413X	FA413R	FA413SV	MD6355D					
		Right FA414X	FA414R	FA414SV		MD6355D				
LT-A 750 XPC/XPL King Quad 750 AXi Power Steering Camo	09-16	Left FA413X	FA413R	FA413SV	MD6355D					
		Right FA414X	FA414R	FA414SV		MD6355D				
VS 750 G Intruder	88-91	FA103	FA103V	FA103HH		MD3032RS				
VL 800 K Intruder Volusia	01-04	FA231	FA231V	FA231HH		MD3095RS				
VL 800 ZK Intruder Volusia	03-04	FA231	FA231V	FA231HH		MD3095RS				
VL 800 K/CK/L C50 Boulevard	05-15	FA231	FA231V	FA231HH		MD3095RS				
VL 800 TK/TL C50T Boulevard Tourer	05-15	FA231	FA231V	FA231HH		MD3095RS				
VL 800 BTL4 (Boulevard C50 B.O.S.S./Cast Wheels)	14	FA231	FA231V	FA231HH		MD3095RS				
VL 800 CL3 (Boulevard C50 B.O.S.S./Cast Wheels)	13	FA231	FA231V	FA231HH		MD3095RS				
VS 800 Intruder GL/GLK	92-04	FA103	FA103V	FA103HH		MD3032RS				
VS 800 K/ZK/L (S50 Boulevard)	05-09	FA103	FA103V	FA103HH		MD3032RS				
VX 800 L/M/N/P	90-93	FA129	FA129V	FA129HH	MD3033LS					
VZ 800 Marauder V/W/X/Y/K	97-04	FA231	FA231V	FA231HH		MD3045				
VZ 800 K/ZK (M50 Boulevard)	05-10	FA231	FA231V	FA231HH		MD3096RS				
GS 850 GN	79	FA35*	FA35V*		MD3014LS	MD3014RS		VMD3014	VMD3014	
GS 850 G	80-81	FA51*	FA51V*		MD3014LS	MD3014RS		VMD3014	VMD3014	
GS 850 G	80-83	FA51*	FA51V*		MD3014LS	MD3014RS		VMD3014	VMD3014	
RF 900 R	94-95	FA145*		FA145HH*	MD3006X	MD3006X				MD3006XC*
RF 900 R	96-98	FA145*		FA145HH*	MD3006X	MD3006X				MD3006XC*
DL 1000 K/L V-Strom	02-12	Left FA229	FA229HH		MD3088X					MD3088XC
		Right FA231	FA231HH		MD3088X					MD3088XC
DL 1000 AL V-Strom Adventure	12	Left FA229	FA229HH		MD3088X					MD3088XC
		Right FA231	FA231HH		MD3088X					MD3088XC
DL 1000 AL (V-Strom ABS)	14-18		FA379HH*		TBA*					
DL 1000 AAL (V-Strom Adventure ABS)	14-16		FA379HH*		TBA*					
DL 1000 XT V-Strom (XAL8/ABS)	18		FA379HH*		TBA*					
GS 1000 C/N	78-79	FA38	FA38V		MD3020LS					
GS 1000 EC/EN/SN/LN	78-79	FA38*	FA38V*		MD3014LS	MD3014RS		VMD3014	VMD3014	
GS 1000 ET/ST/SZ	80-82	FA65*			MD3014LS	MD3014RS		VMD3014	VMD3014	
GS 1000 G	80-81	FA51*			MD3014LS	MD3014RS		VMD3014	VMD3014	

Line #

FRONT

APPLICATIONS

BRAKE

* This symbol indicates a rotor made of billet steel, and should be only used with EBC FA Kevlar® Organic or Vee pads.

SAFETY NOTICE - With vehicles primarily designed for off highway use such as quads now being used on the highway, we would recommend the use of X or MXS pads for highway use and ONLY using the R and SV higher density / harder pad series for off road riding.

*-2 Sets Required. ■ - Also available in MX-S race compound. SAFETY WARNING:- DO NOT USE HH PADS ON REAR UNLESS ALSO USED ON FRONT TO AVOID BRAKE IMBALANCE

FRONT: SUZUKI Cont'd

REAR: SUZUKI

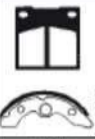
Line #	BRAKE ROTOR CHOICES - FRONT						DISC PAD CHOICES - REAR				BRAKE ROTOR CHOICES - REAR					
	CC Custom Rotor	CX Extreme® /Vee-Rotor	OS Series Oversize 250/280mm Rotor Kit	OSX Series Oversize 280mm Rotor Kit	Relocating Bracket for 250/280mm Rotor	SMX Series Oversize 320mm Rotor Kit	Relocating Bracket for 320mm Rotor		Semi-Sintered V-Pads™	Sintered/HH Pads/Grooved Shoes	SV Series Severe Duty Pads	Standard Rotor	UTVX Rotor	Vintage Rotor	Contour Profile Rotor	CX Extreme® /Vee-Rotor
1	MD3091CC*	VR3091BLK*						FA419	FA419V	FA419HH		MD3060			MD3060C	VR3060
2		VR3100BLK*						FA419	FA419V	FA419HH		MD3060			MD3060C	VR3060
3		VR3100BLK*						FA436	FA436V	FA436HH		MD3060			MD3060C	VR3060
4	MD3003CC*	VR3003BLK*						FA63	FA63V	FA63HH		MD3002			MD3002C	VR3002
5	MD3003CC	VR3003BLK						FA63	FA63V	FA63HH		MD3008			MD3008C	VR3008
6	MD3003CC	VR3003BLK														
7	MD3090CC	VR3090BLK						FA63	FA63V	FA63HH		MD3008			MD3008C	VR3008
8	MD3090CC	VR3090BLK														
9		VR3092BLK						FA174	FA174V	FA174HH		MD3093			MD3093C	VR3093
10		VR3092BLK														
11		VR3092BLK						FA174	FA174V	FA174HH		MD3093			MD3093C	VR3093
12		VR3092BLK														
13								634								
14								634								
15								N/A								
16																
17								N/A								
18																
19								N/A								
20																
21								N/A								
22																
23								N/A								
24																
25								N/A								
26																
27								N/A								
28																
29								626								
30								626								
31								626								
32								626								
33								626								
34								626								
35								626								
36								626								
37								626								
38								FA146	FA146V	FA146HH		MD3061				
39								626								
40								626								
41								FA36	FA36V			MD3014RS		VMD3014		
42								FA36	FA36V			MD3014RS		VMD3014		
43								FA36	FA36V			MD3027				
44	MD3006CC*	VR3006BLK*						FA222				MD3008			MD3008C	VR3008
45	MD3006CC*	VR3006BLK*						FA63	FA63V			MD3008			MD3008C	VR3008
46		VR3088BLK						FA174		FA174HH		MD6232D				MD6232CX
47		VR3088BLK														
48		VR3088BLK						FA174		FA174HH		MD6232D				MD6232CX
49		VR3088BLK														
50								FA419		FA419HH		TBA				MD6232CX
51								FA419		FA419HH		TBA				MD6232CX
52								FA419		FA419HH		TBA				
53								FA36	FA36V			MD3014RS		VMD3014		
54								FA36	FA36V			MD3014RS		VMD3014		
55								FA36	FA36V			MD3014RS		VMD3014		
56								FA36	FA36V			MD3014RS		VMD3014		

REAR

* This symbol indicates a rotor made of billet steel, and should be only used with EBC FA Kevlar® Organic or Vee pads.

SAFETY NOTICE - With vehicles primarily designed for off highway use such as quads now being used on the highway, we would recommend the use of X or MXS pads for highway use and ONLY using the R and SV higher density / harder pad series for off road riding.

BRAKE APPLICATIONS

*-2 Sets Required. ■ - Also available in MX-S race compound. **SAFETY WARNING:- DO NOT USE HH PADS ON REAR UNLESS ALSO USED ON FRONT TO AVOID BRAKE IMBALANCE**

FRONT: SUZUKI

APPLICATIONS

BRAKE



SUZUKI



DISC PAD CHOICES - FRONT

BRAKE ROTOR CHOICES - FRONT

		Semi-Sintered V-Pads™	Sintered/HH Pads/Grooved Shoes	SV Series Severe Duty Pads	Standard Rotor Left	Standard Rotor Right	UTVX Rotor	Vintage Rotor Left	Vintage Rotor Right	Contour Profile Rotor
GS 1000 GL	80-81		FA51*		MD3014LS	MD3014RS		VMD3014	VMD3014	
GSX-R 1000 K	01-02		FA188*		MD3058X	MD3058X				MD3058XC*
GSX-R 1000 K	03			FA369/4HH*	MD3089X	MD3089X				MD3089XC*
GSX-R 1000 K/ZK (Tokico Radial Caliper)	04			FA379HH*	MD3104X	MD3104X				MD3104XC*
GSX-R 1000 K (Tokico Radial Caliper)	05-06			FA379HH*	MD3091X	MD3091X				MD3091XC*
GSX-R 1000 K (Tokico Radial Caliper)	07-08			FA379HH*	MD3091X	MD3091X				MD3091XC*
GSX-R 1000 K/L (Tokico Radial Caliper)	09-11			FA379HH*	MD3102X	MD3102X				MD3102XC*
GSX-R 1000 L (Brembo Radial Caliper)	12-16			FA447HH*	MD3102X	MD3102X				MD3102XC*
GSX-R 1000 ZL Special Edition (Brembo Radial Caliper)	13			FA447HH*	MD3102X	MD3102X				MD3102XC*
GSX-R 1000 AL ABS (Brembo Radial Caliper/310mm Disc)	15-16			FA447HH*	MD3102X	MD3102X				MD3102XC*
GSX-R 1000 AL ABS (Brembo Radial Caliper/320mm Disc)	17			FA447HH*	MD3107X	MD3107X				MD3107XC*
GSX-R 1000 R RAL (Brembo Radial Caliper/320mm Disc)	17			FA447HH*	MD3107X	MD3107X				MD3107XC*
GSX-S 1000 L (Non ABS)	16-18			FA447HH*	MD3109X	MD3109X				MD3109XC*
GSX-S 1000 AL (ABS)	16-18			FA447HH*	MD3109X	MD3109X				MD3109XC*
GSX-S 1000F L (Non ABS)	16-18			FA447HH*	MD3109X	MD3109X				MD3109XC*
GSX-S 1000F AL (ABS)	16-18			FA447HH*	MD3109X	MD3109X				MD3109XC*
SV 1000 K/SK	03-07		FA158*	FA158HH*	MD3088X	MD3088X				MD3088XC*
TL 1000 S	97-01		FA158*	FA158HH*	MD3058X	MD3058X				MD3058XC*
TL 1000 R/RK	98-03		FA188*	FA188HH*	MD3058X	MD3058X				MD3058XC*
GS 1100 E	80-83		FA65*		MD3014LS	MD3014RS		VMD3014	VMD3014	
GS 1100 LT	80		FA65*	FA65V*	MD3014LS	MD3014RS		VMD3014	VMD3014	
GS 1100 G	82-83		FA51*		MD3014LS	MD3014RS		VMD3014	VMD3014	
GS 1100 GL	82-83		FA51*		MD3014LS	MD3014RS		VMD3014	VMD3014	
GS 1100 GK	82-83		FA51*		MD3014LS	MD3014RS		VMD3014	VMD3014	
GS 1100 SD	83		FA65*		MD3014LS	MD3014RS		VMD3014	VMD3014	
GSX 1100 G	91-93		FA129*	FA129HH*	MD3037LS	MD3037RS				
GSX 1100 F Katana	88-93		FA146*	FA146HH*	MD3039LS	MD3039RS				
GSX-R 1100 G/H/J	86-88		FA103*	FA103HH*	MD3004	MD3004				
GSX-R 1100 K/L/M/N	89-92		FA145*	FA145HH*	MD3007X	MD3007X				MD3007XC*
GSX-R 1100 W	93-98		FA188*	FA188HH*	MD3007X	MD3007X				MD3007XC*
GS 1150 ES	83-86		FA103*	FA103HH*	MD3039LS	MD3039RS				
GSF 1200 S	96-99		FA145*	FA145HH*	MD3006X	MD3006X				MD3006XC*
GSF 1200 SAV Bandit - ABS	97		FA145*	FA145HH*	MD3075LS	MD3075RS				
GSF 1200 SK/K Bandit	01-05		FA188*	FA188HH*	MD3006X	MD3006X				MD3006XC*
GV 1200 GL Madura	85-86		FA51*		MD3030LS	MD3030RS				
GSF 1250 AK/SAK (ABS)	07-10		FA158*	FA158HH*	MD3092X	MD3092X				MD3092XC*
GSF 1250 SK Bandit	07-10		FA158*	FA158HH*	MD3092X	MD3092X				MD3092XC*
GSX 1250 FAL	11-14		FA158*	FA158HH*	MD3092X	MD3092X				MD3092XC*
GSX 1250 SAL Bandit	16		FA158*	FA158HH*	MD3092X	MD3092X				MD3092XC*
GSX 1300 R/RK/RZK Hayabusa	99-07		FA188*	FA188HH*	MD3058X	MD3058X				MD3058XC*
GSX 1300 RK/RL Hayabusa	08-12			FA379HH*	MD3098X	MD3098X				MD3098XC*
GSX 1300 RAL ABS Hayabusa (Brembo Calipers)	13-17			FA447HH*	MD3098X	MD3098X				MD3098XC*
GSX 1300 RZL (Hayabusa 50th Anniversary Edition)	14			FA447HH*	MD3098X	MD3098X				MD3098XC*
GSX 1300 BKAK/K B-King ABS	08-10			FA347HH*	MD3098X	MD3098X				MD3098XC*
GSX 1300 BKK/K B-King	08-10			FA347HH*	MD3098X	MD3098X				MD3098XC*
GV 1400 G (up to frame No. 103764) (Cavalcade)	86		FA103*	FA103V*	FA103HH*	MD3042	MD3042			
GV 1400 G (From frame No. 103765) (Cavalcade)	86		FA146*	FA146V*	FA146HH*	MD3042	MD3042			
GV 1400 GCG/GDH/GTH/GCH/GDJ (Cavalcade)	86-88		FA146*	FA146V*	FA146HH*	MD3042	MD3042			
VS 1400 GLP/GLF/GLPK Intruder	87-04		FA103	FA103V	FA103HH		MD3032RS			
VS 1400 GLPK/K/L (Boulevard S83) (1400cc)	05-10		FA103	FA103V	FA103HH		MD3032RS			
VL 1500 W/X Intruder Legendary Classic	98-99		FA103	FA103V	FA103HH		MD3078RS			
VL 1500 Y/K Intruder Legendary Classic	00-01		FA103	FA103V	FA103HH		MD3078RS			
VL 1500 K Intruder LC	Left 02-04		FA229	FA229V	FA229HH	MD3087LS				
	Right		FA231	FA231V	FA231HH		MD3087RS			
VL 1500 BK/K/TK (C90/C90T Boulevard)	Left 05-10		FA229	FA229V	FA229HH	MD3087LS				
	Right		FA231	FA231V	FA231HH		MD3087RS			

Line #

* This symbol indicates a rotor made of billet steel, and should be only used with EBC FA Kevlar® Organic or Vee pads.
 SAFETY NOTICE - With vehicles primarily designed for off highway use such as quads now being used on the highway, we would recommend the use of X or MXS pads for highway use and ONLY using the R and SV higher density / harder pad series for off road riding.

*-2 Sets Required. ■ - Also available in MX-S race compound. SAFETY WARNING:- DO NOT USE HH PADS ON REAR UNLESS ALSO USED ON FRONT TO AVOID BRAKE IMBALANCE

FRONT: SUZUKI Cont'd

REAR: SUZUKI

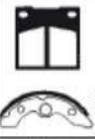
Line #	BRAKE ROTOR CHOICES - FRONT						DISC PAD CHOICES - REAR				BRAKE ROTOR CHOICES - REAR				
	CC Custom Rotor	CX Extreme® /Vee-Rotor	OS Series Oversize 250/280mm Rotor Kit	OSX Series Oversize 280mm Rotor Kit	Relocating Bracket for 250/280mm Rotor	SMX Series Oversize 320mm Rotor Kit	Relocating Bracket for 320mm Rotor		Semi-Sintered V-Pads™	Sintered/HH Pads/ Grooved Shoes	SV Series Severe Duty Pads	Standard Rotor	UTVX Rotor	Vintage Rotor	Contour Profile Rotor
1							FA36	FA36V			MD3014RS		VMD3014		
2	MD3058CC*	VR3058BLK*					FA254	FA254V	FA254HH		MD3060			MD3060C	VR3060
3	MD3089CC*	VR3089BLK					FA254	FA254V	FA254HH		MD3060			MD3060C	VR3060
4		VR3104BLK*					FA254	FA254V	FA254HH		MD3060			MD3060C	VR3060
5	MD3091CC*	VR3091BLK*					FA254	FA254V	FA254HH		MD3060			MD3060C	VR3060
6	MD3091CC*	VR3091BLK*					FA419	FA419V	FA419HH		MD3060			MD3060C	VR3060
7		VR3102BLK*					FA436	FA436V	FA436HH		MD3060			MD3060C	VR3060
8		VR3102BLK*					FA436	FA436V	FA436HH		MD3060			MD3060C	VR3060
9		VR3102BLK*					FA436	FA436V	FA436HH		MD3060			MD3060C	VR3060
10		VR3102BLK*					FA436	FA436V	FA436HH		MD3106			MD3106C	VR3106
11		VR3107BLK*					FA436	FA436V	FA436HH		MD3106			MD3106C	VR3106
12		VR3107BLK*					FA436	FA436V	FA436HH		MD3106			MD3106C	VR3106
13		VR3109BLK*					FA174	FA174V	FA174HH		MD3108			MD3108C	VR3108
14		VR3109BLK*					FA174	FA174V	FA174HH		MD3108			MD3108C	VR3108
15		VR3109BLK*					FA174	FA174V	FA174HH		MD3108			MD3108C	VR3108
16		VR3109BLK*					FA174	FA174V	FA174HH		MD3108			MD3108C	VR3108
17	MD3088CC*	VR3088BLK*					FA174	FA174V	FA174HH		MD3060			MD3060C	VR3060
18	MD3058CC*	VR3058BLK*					FA63	FA63V	FA63HH		MD3060			MD3060C	VR3060
19	MD3058CC*	VR3058BLK*					FA63	FA63V	FA63HH		MD3060			MD3060C	VR3060
20							FA36	FA36V			MD3014RS		VMD3014		
21							FA36	FA36V			MD3014RS		VMD3014		
22							FA36	FA36V			MD3027				
23							FA36	FA36V			MD3027				
24							FA36	FA36V			MD3027				
25							FA36	FA36V			MD3014RS		VMD3014		
26							FA146	FA146V	FA146HH		MD3038				
27							FA103	FA103V	FA103HH		MD3036				
28							FA63	FA63V	FA63HH		MD3009				
29		VR3007BLK*					FA63	FA63V	FA63HH		MD3008			MD3008C	VR3008
30		VR3007BLK*					FA63	FA63V	FA63HH		MD3008			MD3008C	VR3008
31							FA103	FA103V	FA103HH		MD3039				
32	MD3006CC*	VR3006BLK*					FA63	FA63V	FA63HH		MD3008			MD3008C	VR3008
33							FA63	FA63V	FA63HH		MD3076				
34	MD3006CC*	VR3006BLK*					FA63	FA63V	FA63HH		MD3008			MD3008C	VR3008
35							FA36	FA36V			MD3041				
36	MD3092CC*	VR3092BLK*					FA174	FA174V	FA174HH		MD3093			MD3093C	VR3093C
37	MD3092CC*	VR3092BLK*					FA174	FA174V	FA174HH		MD3093			MD3093C	VR3093C
38	MD3092CC*	VR3092BLK*					FA174	FA174V	FA174HH		MD3093			MD3093C	VR3093C
39	MD3092CC*	VR3092BLK*					FA174	FA174V	FA174HH		MD3093			MD3093C	VR3093C
40	MD3058CC*	VR3058BLK*					FA63	FA63V	FA63HH		MD3008			MD3008C	VR3008
41	MD3098CC*	VR3098BLK*					FA419	FA419V	FA419HH		MD3099			MD3099C	VR3099
42	MD3098CC*	VR3098BLK*					FA419	FA419V	FA419HH		MD3099			MD3099C	VR3099
43	MD3098CC*	VR3098BLK*					FA419	FA419V	FA419HH		MD3099			MD3099C	VR3099
44	MD3098CC*	VR3098BLK*					FA419	FA419V	FA419HH		MD3099			MD3099C	VR3099
45	MD3098CC*	VR3098BLK*					FA419	FA419V	FA419HH		MD3099			MD3099C	VR3099
46							FA103	FA103V	FA103HH		MD3043				
47							FA150	FA150V	FA150HH		MD3043				
48							FA150	FA150V	FA150HH		MD3043				
49							FA103	FA103V	FA103HH		MD3044				
50							FA103	FA103V	FA103HH		MD3044				
51							FA103	FA103V	FA103HH		MD3079				
52							FA103	FA103V	FA103HH		MD3086				
53							FA366	FA366V/LD	FA366HH		MD3086				
54															
55							FA366	FA366V/LD	FA366HH		MD3086				
56															

⚠ This symbol indicates a rotor made of billet steel, and should be only used with EBC FA Kevlar® Organic or Vee pads.
 SAFETY NOTICE - With vehicles primarily designed for off highway use such as quads now being used on the highway, we would recommend the use of X or MXS pads for highway use and ONLY using the R and SV higher density / harder pad series for off road riding.

BRAKE APPLICATIONS

*-2 Sets Required. ■ - Also available in MX-S race compound. **SAFETY WARNING:- DO NOT USE HH PADS ON REAR UNLESS ALSO USED ON FRONT TO AVOID BRAKE IMBALANCE**

FRONT: SUZUKI



SUZUKI



DISC PAD CHOICES - FRONT

BRAKE ROTOR CHOICES - FRONT

												Line #
			Semi-Sintered V-Pads™	Sintered/HH Pads/Grooved Shoes	SV Series Severe Duty Pads	Standard Rotor Left	Standard Rotor Right	UTVX Rotor	Vintage Rotor Left	Vintage Rotor Right	Contour Profile Rotor	
VL 1500 BL (Boulevard C90 B.O.S.S.)	13-15	FA196	FA196V	FA196HH		TBA						1
VL 1500 BTL (Boulevard C90T B.O.S.S. / With Windshield)	13-14	FA196	FA196V	FA196HH		TBA						2
VL 1500 L (Boulevard C90)	13	FA196	FA196V	FA196HH		TBA						3
VL 1500 TL (Boulevard C90T/ With Windshield)	13-15	FA196	FA196V	FA196HH		TBA						4
VZ 1500 K/L M90 Boulevard	Left 09/13-15	FA229	FA229V	FA229HH		MD3090X					MD3090XC	5
	Right	FA231	FA231V	FA231HH			MD3090X				MD3090XC	6
VZ 1600 K Marauder	04	FA188		FA188HH		MD4022X	MD4022X				MD4022XC*	7
VZ 1600 K (M95 Boulevard)	05			FA369/4HH*		MD4022X	MD4022X				MD4022XC*	8
VLR 1800 TK/TL (C109RT Boulevard Touring)	08-10	FA388*		FA388HH*		MD3090X	MD3090X				MD3090XC*	9
VLR 1800 K (C109R Boulevard)	08-10	FA388*		FA388HH*		MD3090X	MD3090X				MD3090XC*	10
VZR 1800 K/L (Boulevard M109R)	06-14			FA379HH*		MD3091X	MD3091X				MD3091XC*	11
VZR 1800 NK (Boulevard Limited M109R2)	08-09			FA379HH*		MD3091X	MD3091X				MD3091XC*	12
VZR 1800 ZK/ZL (Boulevard RZ Limited (M109RZ)	08-14			FA379HH*		MD3091X	MD3091X				MD3091XC*	13
VZR 1800 BL4-BL7 (Boulevard B.O.S.SM109R)	14-17			FA379HH*		MD3091X	MD3091X				MD3091XC*	14
												15
												16
												17
												18
												19
												20
												21
												22
												23
												24
												25
												26
												27
												28
												29
												30
												31
												32
												33
												34
												35
												36
												37
												38
												39
												40
												41
												42
												43
												44
												45
												46
												47
												48
												49
												50
												51
												52
												53
												54
												55
												56

FRONT

APPLICATIONS
BRAKE
SAFETY NOTICE - With vehicles primarily designed for off highway use such as quads now being used on the highway, we would recommend the use of X or MXS pads for highway use and ONLY using the R and SV higher density / harder pad series for off road riding.
*** This symbol indicates a rotor made of billet steel, and should be only used with EBC FA Kevlar® Organic or Vee pads.**

*-2 Sets Required. ■ - Also available in MX-S race compound. **SAFETY WARNING:- DO NOT USE HH PADS ON REAR UNLESS ALSO USED ON FRONT TO AVOID BRAKE IMBALANCE**

FRONT: YAMAHA



YAMAHA



DISC PAD CHOICES - FRONT

BRAKE ROTOR CHOICES - FRONT

			Semi-Sintered V-Pads™	Sintered/HH Pads/Grooved Shoes	SV Series Severe Duty Pads	Standard Rotor Left	Standard Rotor Right	UTVX Rotor	Vintage Rotor Left	Vintage Rotor Right	Contour Profile Rotor
3 (50cc Scooter) (XF 50 W/X/Y/Z/A)	07-11	530									
CA 50 K/L/N/S Riva	83-86	501									
CE 50 E	86-87	501									
CG 50 EU/W/A/B	88-91	501									
CY 50 D/E/F/K/L Jog	92-94/98-99	519									
CY 50 N Jog	01	519									
CV 50 L Riva	84	503									
CW 50 W/TA Riva Zuma	89-90	518									
CW 50 K Riva	98	503									
CW 50 (Bws)	98-99	SFA193		SFA193HH		MD916D					
CW 50 L/TL Zuma/Zuma II	99	SFA193		SFA193HH		MD904D					
CW 50 M/N Zuma II	00-01	SFA193		SFA193HH		MD923D					MD923C
DT 50 U/W/A (DTL/C)	88-90	518		518G							
EW 50 Stunt (5LH2/5YN1)	01-03	SFA268		SFA268HH		MD923D					MD923C
LB 50 P Chappy	80-82	504									
LC 50 G/H Champ	80-81	519									
MJ 50 J Towny	82	501									
PW 50 H/J/K/N/S/T	81-87	501		N/A							
PW 50 A/B/D/E/F/G/H/J/K/L/M/N/P/R/S/T/V/W/X/Y/B/D/E/F	90-09/12-15	501		N/A							
QT 50 G/2G/H/J/K/L/N/S/T Yamahopper	80-87	501									
RX 50 MK/K/L	83-84	FA70				N/A					
SH 50 T/EMT/U/MU/W/MW/A/MA/B/D/MD/E/F/K/L Razz	87-94/98-99	501									
SH 50 ED Mint (3PR1/4CK1/3/4)	89-94	519									
TT-R 50 E	06-09/12-14	301									
XC 50 V/W/X/Y/Z/A/D/E/F/G/H Vino Classic	06-17	530									
YFM 50 S/T/R Raptor	04-07	503*		503G*							
YFZ 50 Y	17-18	346*		346G*							
YJ 50 R Vino 50	01-04	530									
YJ 50 RA Vino Classic	02-05	530									
YSR 50 T/U/W/A/B/D	87-92	FA101				N/A					
YZ 50 G	80	502		502G							
Zuma 50 2T (YW 50 P/R/S/T/X/Y/Z/A)	02-05/08-11	SFA169		SFA169HH		N/A					
Zuma 50 F (Twin Headlights) F 4T (YW 50 F)	12-16	SFA384									
Zuma 50 FX (Single Headlight) 4T (YW 50 FX)	14-16	SFA384									
YF 60 S (Moto 4)	86	NONE		NONE							
YT 60 L/N (Tri-Zinger)	84-85	NONE		NONE							
YZ 60 H/J/K	81-83	502		502G							
BW 80 S/T/U/A	86-88/90	502		502G							
CV 80 K/L/N/S/T Riva	83-87	503									
DT 80 H/J	81-82	504		504G							
DT 80 K	83	503		503G							
LB 80 11 - A Chappy (3VS2/4RP1)	95-98	503									
PW 80 K/N	83-85	502		502G							
PW 80 B	91	502		502G							
PW 80 D/E/F/G/H/J/K/L/M/N/P/R/S/T/V	92-08	502		502G							
V 80 (3NX3/4)	94	503									
V 80 (4GC5/6/3NX6)	98	503									
V 80 D (4GC2/3/4) - 3 = Single Seat / 4 = Dual Street	94-96	503									
YFM 80 N/S (Moto 4)	85-86	NONE		NONE							
YFM 80 T/U	87-88	518*		518G*							
YFM 80 D/E/F/G/H/J/K/L/M/N Badger	92-01	503*		503G*							
YFM 80 W/R Raptor	02-08	503*		503G*							
YFM 80 G Grizzly	05-08	503*		503G*							
YZ 80 G/H/J/K/L/N	80-85	502		502G							
YZ 80 S/T/U	86-88	FA119X		FA119R		MD6029D					
YZ 80 W/A/B/D	89-92	FA119X		FA119R		MD6029D					

Line #
1
2
3
4
5
6
7
8
9
10
11
12
13
14
15
16
17
18
19
20
21
22
23
24
25
26
27
28
29
30
31
32
33
34
35
36
37
38
39
40
41
42
43
44
45
46
47
48
49
50
51
52
53
54
55
56

APPLICATIONS

BRAKE

⚠ This symbol indicates a rotor made of billet steel, and should be only used with EBC FA Kevlar® Organic or Vee pads.
SAFETY NOTICE - With vehicles primarily designed for off highway use such as quads now being used on the highway, we would recommend the use of X or MXS pads for highway use and ONLY using the R and SV higher density / harder pad series for off road riding.

*-2 Sets Required. ■ - Also available in MX-S race compound. **SAFETY WARNING:- DO NOT USE HH PADS ON REAR UNLESS ALSO USED ON FRONT TO AVOID BRAKE IMBALANCE**

FRONT: YAMAHA Cont'd

REAR: YAMAHA

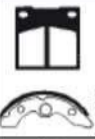
Line #	BRAKE ROTOR CHOICES - FRONT						DISC PAD CHOICES - REAR				BRAKE ROTOR CHOICES - REAR					
	CC Custom Rotor	CX Extreme® /Vee-Rotor	OS Series Oversize 250/280mm Rotor Kit	OSX Series Oversize 280mm Rotor Kit	Relocating Bracket for 250/280mm Rotor	SMX Series Oversize 320mm Rotor Kit	Relocating Bracket for 320mm Rotor		Semi-Sintered V-Pads™	Sintered/HH Pads/Grooved Shoes	SV Series Severe Duty Pads	Standard Rotor	UTVX Rotor	Vintage Rotor	Contour Profile Rotor	CX Extreme® /Vee-Rotor
1								530								
2								519								
3								519								
4								519								
5								503								
6								503								
7								503								
8								518								
9								503								
10								503								
11								503								
12								503								
13								518		518G						
14								503								
15								504								
16								519								
17								501								
18								501		N/A						
19								501		N/A						
20								501								
21								504								
22								519								
23								519								
24								301								
25								530								
26								527		527G						
27								307		307G						
28								530								
29								530								
30								503								
31								502		502G						
32								531								
33		VR9159						530								
34		VR9159						530								
35								518		518G						
36								518		518G						
37								502		502G						
38								519		N/A						
39								503								
40								504		504G						
41								503		503G						
42								503								
43								518		518G						
44								518		518G						
45								503		503G						
46								503								
47								503								
48								503								
49								506		506G						
50								506		506G						
51								527		527G						
52								527		527G						
53								527		527G						
54								502		502G						
55								502		502G						
56								502		502G						

REAR

⚠ This symbol indicates a rotor made of billet steel, and should be only used with EBC FA Kevlar® Organic or Vee pads.
 SAFETY NOTICE - With vehicles primarily designed for off highway use such as quads now being used on the highway, we would recommend the use of X or MXS pads for highway use and ONLY using the R and SV higher density / harder pad series for off road riding.

BRAKE APPLICATIONS

*-2 Sets Required. ■ - Also available in MX-S race compound. **SAFETY WARNING:- DO NOT USE HH PADS ON REAR UNLESS ALSO USED ON FRONT TO AVOID BRAKE IMBALANCE**

FRONT: YAMAHA



YAMAHA



DISC PAD CHOICES - FRONT

BRAKE ROTOR CHOICES - FRONT

		Semi-Sintered V-Pads™	Sintered/HH Pads/Grooved Shoes	SV Series Severe Duty Pads	Standard Rotor Left	Standard Rotor Right	UTVX Rotor	Vintage Rotor Left	Vintage Rotor Right	Contour Profile Rotor
YZ 80 E/F/G/H/J/K/L/M/N	93-01		FA119X	FA119R						MD6030C
YZ 85 P/R/S/T/N/W/X/Y/Z/A/B/D/E/F/G (17/14" wheel models)	02-16		FA119X	FA119R						MD6030C
JYM 90 T Axis	01		SFA169	SFA169HH						
TT-R 90 M/N/P/R/ES/S/ET/EV/EW	00-07		502	502G						
YA 90 Axis	91-95		SFA169	SFA169HH						
YA 90 Axis	96		SFA169	SFA169HH						
YFM 90 R Raptor (No Rear Parking Brake)	09		536*	536G*						
YFM 90 R Raptor (With Rear Parking Brake)	10-13		536*	536G*						
YFM 90 RYXG/H Raptor 90	16-17		346*	346G*						
DT 100 G/H/J	80-82		504	504G						
DT 100 K	83		503	503G						
MX 100 G/H/J	80-82		504	504G						
MX 100 K	83		503	503G						
RT 100 A/D/E/F/G/H/J/K/L/M	91-00		503	503G						
RX 100	01-03		503							
RX 100	04		503							
RX 100 C	04		503							
RXZ 100 S	88-95		503							
XC 100 Jog	05-06		530							
YA 100 W Grand Axis	01-03		SFA169	SFA169HH		MD904D				
YFM 100 T/U Champ	87-88		518*	518G*						
YFM 100 W/A/B Champ	89-91		503*	503G*						
YW 100 BW's	97-08		SFA169	SFA169HH		MD904D				
YZ 100 F/G/H	80-81		504	504G						
YZ 100 J/K	82-83		503	503G						
T 105 E Crypton	99-02		SFA275	SFA275HH			MD963D			
T 105 SE Crypton	10		SFA464				TBA			
T 110	11-13		SFA464				TBA			
T 110 C	11-13		SFA464				TBA			
TT-R 110 E	08-15		502	502G						
AF 115 S Fino	12		SFA464				TBA			
AT 115 (21P1)	07		SFA275	SFA275HH			TBA			
AT 115 C Nuvo	05-06		SFA275	SFA275HH			TBA			
RXS 115 (3HB6/7)	94-97		FA81				N/A			
RXS 115 (3HB8)	99		FA275	FA275HH			N/A			
DT 125 G/H	80-81		506	506G						
IT 125 G/H	80-81		504	504G						
TT-R 125 M/N/P/R/S/E (17"/14" wheels for drum brakes)	00-09		503	503G						
TT-R 125 LWM/L/LE 19/16" wheels disc front rear drum	00-09/11-15		FA119X	FA119R		MD6158D				MD6158C
WR 125 K	98		FA135X	FA135R■		MD6028D				MD6028C
XA 125 Cygnus (2BK1)	12		SFA464				TBA			
XC 125 N/S/T/C/U/W/Z Riva	85-92		521							
XC 125 E/F/K Riva	93-94/98		521							
XT 125 J/K/KC	82-83		506	506G						
YBA 125 Vision	01		FA142	FA142HH			TBA			
YBA 125 Enticer	05		FA181X	FA181HH			TBA			
YBA 125 Enticer	05		506							
YBA 125 Enticer	07-12		FA181X	FA181TT			TBA			
YBR 125	01		503							
YBR 125	11-13		531							
YBR 125 C	08-13		531							
YBR 125 E	06-13		531							
YBR 125 EB	02-05		FA197	FA197HH			N/A			
YBR 125 EB	06-08		FA197	FA197HH			N/A			
YBR 125 ED	01		527							
YBR 125 ED (Cast Wheel)	07-09		FA101			MD2097RS				

FRONT

Line #

APPLICATIONS
BRAKE
YAMAHA
 * This symbol indicates a rotor made of billet steel, and should be only used with EBC FA Kevlar® Organic or Vee pads.
 SAFETY NOTICE - With vehicles primarily designed for off highway use such as quads now being used on the highway, we would recommend the use of X or MXS pads for highway use and ONLY using the R and SV higher density / harder pad series for off road riding.

*-2 Sets Required. ■ - Also available in MX-S race compound. **SAFETY WARNING:- DO NOT USE HH PADS ON REAR UNLESS ALSO USED ON FRONT TO AVOID BRAKE IMBALANCE**

FRONT: YAMAHA Cont'd

REAR: YAMAHA

Line #	BRAKE ROTOR CHOICES - FRONT						DISC PAD CHOICES - REAR				BRAKE ROTOR CHOICES - REAR					
	CC Custom Rotor	CX Extreme® /Vee-Rotor	OS Series Oversize 250/280mm Rotor Kit	OSX Series Oversize 280mm Rotor Kit	Relocating Bracket for 250/280mm Rotor	SMX Series Oversize 320mm Rotor Kit	Relocating Bracket for 320mm Rotor		Semi-Sintered V-Pads™	Sintered/HH Pads/Grooved Shoes	SV Series Severe Duty Pads	Standard Rotor	UTVX Rotor	Vintage Rotor	Contour Profile Rotor	CX Extreme® /Vee-Rotor
1		MD6030CX	OSY6030C	OSXY6030	BRK036	N/A	N/A	N/A		FA84/3R		MD6031D			MD6031C	MD6031CX
2		MD6030CX	OSY6030C	OSXY6030	BRK036	N/A	N/A	N/A		FA84/3R		MD6031D			MD6031C	MD6031CX
3								503								
4								503		503G						
5								518								
6								503								
7								FA83X		FA83R		MD6282D				
8								FA67X		FA67R		MD6282D				
9								307		307G						
10								504		504G						
11								503		503G						
12								504		504G						
13								503		503G						
14								503		503G						
15								503								
16								503								
17								503								
18								503								
19								530								
20								527								
21								506		506G						
22								506		506G						
23								527								
24								506		506G						
25								506		506G						
26								518								
27								530								
28								530								
29								530								
30								503		503G						
31								531								
32								531								
33								531								
34								518								
35								518								
36								506		506G						
37								506		506G						
38								503		503G						
39								503		503G						
40			OS6028EC	OSX6028E	BRK035	N/A	N/A	FA152X		FA152R■		MD6011D				
41								530								
42								506								
43								527								
44								503		503G						
45								527								
46								506								
47								506								
48								535								
49								503								
50								527								
51								531								
52								531								
53								527								
54								527								
55								527								
56								531								

REAR

⚠ This symbol indicates a rotor made of billet steel, and should be only used with EBC FA Kevlar® Organic or Vee pads.
 SAFETY NOTICE - With vehicles primarily designed for off highway use such as quads now being used on the highway, we would recommend the use of X or MXS pads for highway use and ONLY using the R and SV higher density / harder pad series for off road riding.

BRAKE APPLICATIONS

*-2 Sets Required. ■ - Also available in MX-S race compound. **SAFETY WARNING:- DO NOT USE HH PADS ON REAR UNLESS ALSO USED ON FRONT TO AVOID BRAKE IMBALANCE**

FRONT: YAMAHA



YAMAHA



DISC PAD CHOICES - FRONT

BRAKE ROTOR CHOICES - FRONT

			Semi-Sintered V-Pads™	Sintered/HH Pads/Grooved Shoes	SV Series Severe Duty Pads	Standard Rotor Left	Standard Rotor Right	UTVX Rotor	Vintage Rotor Left	Vintage Rotor Right	Contour Profile Rotor
YBR 125 ED Cast Wheel	10-13	FA101					MD2097RS				
YBR 125 ESD Cast Wheel	07-09	FA101					MD2097RS				
YBR 125 ESD (Cast Wheel)	10-13	FA101					MD2097RS				
YBR 125 ESG	11-13	FA464					MD2104RS				
YBR 125 K	02-06	527									
YBR 125 R	11-12	FA464					MD2104RS				
YFA1 W/A/B Breeze	89-91	503*		503G*							
YFA1 D/E/F/G/H/J/K/L/M/N/P/R/S Breeze	92-04	503*		503G*							
YFM 125 S/G Grizzly	04-13	503*		503G*							
YFM 125 R Raptor	11-13	FA54X*		FA54R*	FA54SV*	MD6054D	MD6054D				
YJ 125 S/T/V/W/X/Y Vino	04-09	SFA101		SFA101HH			N/A				
YT 125 G/H/J (Tri Moto)	80-82	NONE		NONE							
YT 125 J/K/L/N (Tri Moto)	82-85	NONE		NONE							
YW 125 Y/Z/A/B/D/E/F Zuma (Rear Drum Model)	09-15	SFA492				MD986D					
YW 125 G Zuma (Rear Disc Model)	16	SFA196		SFA196HH							
YW 125 X	10-13	SFA632									
YZ 125 F/G/H/J	80-82	507		507G							
YZ 125 K	83	507		507G							
YZ 125 L	84	508		508G							
YZ 125 N	85	FA105X		FA105R		MD6324D					
YZ 125 S/T	86-87	FA105X		FA105R		MD6067D					
YZ 125 U	88	FA105X		FA105R		MD6039D					
YZ 125 W	89	FA135X		FA135R■		MD6016D					
YZ 125 A	90	FA135X		FA135R■		MD6012D					
YZ 125 B	91	FA135X		FA135R■		MD6012D					
YZ 125 D/E	92-93	FA135X		FA135R■		MD6028D					MD6028C
YZ 125 F/G/H/J	94-97	FA135X		FA135R■		MD6028D					MD6028C
YZ 125 K/L/M	98-00	FA185X		FA185R■		MD6028D					MD6028C
YZ 125 N	01	FA185X		FA185R■		MD6356D					MD6356C
YZ 125 P	02	FA185X		FA185R■		MD6356D					MD6356C
YZ 125 R/S	03-04	FA185X		FA185R■		MD6356D					MD6356C
YZ 125 T/V/W	05-07	FA185X		FA185R■		MD6356D					MD6356C
YZ 125 X/Y/Z/A/B/D/E/F/G (2T)	08-16	FA450X		FA450R■							MD6356C
YZ 125 H/J (2T)	17-18	FA450X		FA450R■							MD6392C
RX-Z 135	87-89	FA81					N/A				
RX-Z 135	93-97	FA81					N/A				
RX-Z 135	00-05	FA81					N/A				
FZ 150	07-08	FA464					TBA				
SR 150	95	510									
YZF-R 15 (150cc)	10-13	FA464					TBA				
XC 155 F/G S-Max	15-16	SFA196		SFA196HH							
FZ 16 (160cc)	10-13	FA181X		FA181HH			TBA				
FZ 16 S (160cc)	12-13	FA181X		FA181HH			TBA				
FZ 16 ST (160cc)	11-13	FA181X		FA181HH			TBA				
DT 175 G/H	80-81	506		506G							
IT 175 G/H/J/K	80-83	507		507G							
MX 175 G/H	80-81	504		504G							
YT 175 J/K (Tri Moto)	82-83	503		503G							
RT 180 A/B/D	90-92	FA101X		FA101R		N/A					
RT 180 E/G/H/J	93-97	FA101X		FA101R		N/A					
XC 180 K/KC/L/LC/N/NC/ZL/ZLC/ZN/ZNC/DN/DWC Riva	83-85	521									
SR 185 H/J	81-82	506									
BW 200 N/S/ES/ET/EU	85-87	503		503G							
IT 200 L/N	84-85	517		517G							
IT 200 S	86	FA105X		FA105R		MD6039D					
TW 200 T/TC/U/UC/W/WC/A/AC/B/BC	87-91	506		506G							

Line #

1

2

3

4

5

6

7

8

9

10

11

12

13

14

15

16

17

18

19

20

21

22

23

24

25

26

27

28

29

30

31

32

33

34

35

36

37

38

39

40

41

42

43

44

45

46

47

48

49

50

51

52

53

54

55

56

APPLICATIONS

BRAKE

YAMAHA

SAFETY NOTICE - With vehicles primarily designed for off highway use such as quads now being used on the highway, we would recommend the use of X or MXS pads for highway use and ONLY using the R and SV higher density / harder pad series for off road riding.

*** This symbol indicates a rotor made of billet steel, and should be only used with EBC FA Kevlar® Organic or Vee pads.**

*-2 Sets Required. ■ - Also available in MX-S race compound. **SAFETY WARNING:- DO NOT USE HH PADS ON REAR UNLESS ALSO USED ON FRONT TO AVOID BRAKE IMBALANCE**

FRONT: YAMAHA Cont'd

REAR: YAMAHA

Line #

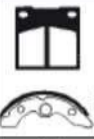
BRAKE ROTOR CHOICES - FRONT							DISC PAD CHOICES - REAR				BRAKE ROTOR CHOICES - REAR				
CC Custom Rotor	CX Extreme® /Vee-Rotor	OS Series Oversize 250/280mm Rotor Kit	OSX Series Oversize 280mm Rotor Kit	Relocating Bracket for 250/280mm Rotor	SMX Series Oversize 320mm Rotor Kit	Relocating Bracket for 320mm Rotor		Semi-Sintered V-Pads™	Sintered/HH Pads/ Grooved Shoes	SV Series Severe Duty Pads	Standard Rotor	UTVX Rotor	Vintage Rotor	Contour Profile Rotor	CX Extreme® /Vee-Rotor
1							531								
2							531								
3							531								
4							531								
5							527								
6							531								
7							506	506G							
8							527	527G							
9							527	527G							
10							FA84X	FA84R	FA84SV		MD6236D				
11							530								
12							FA20X	N/A			N/A				
13							FA21X	FA21R			N/A				
14							533								
15	VR9133						SFA213	SFA213HH			MD9150D				VR9150
16	VR9133						533								
17							506	506G							
18							517	517G							
19							517	517G							
20							517	517G							
21							506	506G							
22							FA101X	FA101R			MD6011D				
23							N/A	FA84/3R			MD6011D				
24							FA152X	FA152R■			MD6011D				
25							FA152/2X	FA152/2R■			MD6011D				
26		OS6028EC	OSX6028E	BRK035	N/A	N/A	FA152/2X	FA152/2R■			MD6011D				
27		OS6028EC	OSX6028E	BRK035	N/A	N/A	FA152/2X	FA152/2R■			MD6011D				
28	MD6028CX	OS6028C	OSX6028	BRK008	SMX6028	BRK009	FA131X	FA131R■			MD6135D			MD6135C	MD6135CX
29	MD6356CX	OS6028C	OSX6028	BRK008	SMX6028	BRK009	FA131X	FA131R■			MD6135D			MD6135C	MD6135CX
30	MD6356CX	OS6028C	OSX6028	BRK008	SMX6028	BRK009	FA131X	FA131R■			MD6190D			MD6190C	MD6190CX
31	MD6356CX	OS6028C	OSX6028	BRK008	SMX6028	BRK009	FA367X	FA367R■			MD6190D			MD6190C	MD6190CX
32	MD6356CX	OS6028C	OSX6028	BRK008	SMX6028	BRK009	FA367X	FA367R■			MD6190D			MD6190C	MD6190CX
33	MD6356CX	OS6728C	OSX6728	BRK002	SMX6728	BRK034	FA367X	FA367R■						MD6190C	MD6190CX
34	MD6392CX						FA367X	FA367R■						MD6190C	MD6190CX
35							504								
36							527								
37							527								
38							531								
39							528								
40							FA343				TBA				
41	VR9145						SFA213	SFA213HH							VR9133
42							535								
43							535								
44							535								
45							506	506G							
46							506	506G							
47							506	506G							
48							FA21X	FA21R			N/A				
49							506	506G							
50							527	527G							
51							537								
52							503								
53							503	503G							
54							517	517G							
55							517	517G							
56							503	503G							

REAR

⚠ This symbol indicates a rotor made of billet steel, and should be only used with EBC FA Kevlar® Organic or Vee pads.

SAFETY NOTICE - With vehicles primarily designed for off highway use such as quads now being used on the highway, we would recommend the use of X or MXS pads for highway use and ONLY using the R and SV higher density / harder pad series for off road riding.

BRAKE APPLICATIONS

*-2 Sets Required. ■ - Also available in MX-S race compound. SAFETY WARNING:- DO NOT USE HH PADS ON REAR UNLESS ALSO USED ON FRONT TO AVOID BRAKE IMBALANCE

FRONT: YAMAHA



YAMAHA



DISC PAD CHOICES - FRONT

BRAKE ROTOR CHOICES - FRONT

		Semi-Sintered V-Pads™	Sintered/HH Pads/Grooved Shoes	SV Series Severe Duty Pads	Standard Rotor Left	Standard Rotor Right	UTVX Rotor	Vintage Rotor Left	Vintage Rotor Right	Contour Profile Rotor
TW 200 D/E/F/G/H/J/EK/EC/L/M	92-00	527	527G							
TW 200 N/NC/P/PC/R/RC/S/SC/T/TC/NVC/W/WC/X/Y/Z/A/B/D/E/F	01-15	FA275X	FA275HH		MD6067D					
WR 200 D	92	FA135X	FA135R		MD6066D					
XC 200 T/ZCT/U/W/ZU/ZW/ZA/ZB Riva	87-91	521								
XT 200 J/K/KC	82-83	506	506G							
YFM 200 N/D (Moto 4)	85-89	503*	503G*							
YFS 200 U/W/A/B/D/E/F/G/H/J/K/L/M/N/P Blaster	88-02	503*	503G*							
YFS 200 R/S/T/V Blaster	03-06	FA54X*	FA54R*	FA54SV*	MD6054D	MD6054D				
YTM 200 K/L/N (Tri Moto)	83-85	503	503G							
YTM 200 E (Tri Moto)	83-84	503	503G							
YTM 200 E (Tri Moto)	85	503	503G							
TT 225 S/T	86-87	FA101X	FA101R		MD6067D					
TT-R 225 L/M/N/P/R/S	99-03	FA101X	FA101R		MD6067D					
YFM 225 S/T/U (Moto 4)	86-88	503*	503G*							
YTM 225 D (Tri Moto)	83-85	503	503G							
YTM 225 D (Tri Moto)	85-86	503	503G							
XT 225 D/DC/E/EC/F/FC/G/GC/F/FH/J/JC/K/KC/L/M/MC	92-00	FA101X	FA101R		MD6067D					
XT 225 N/NC/P/PC/R/RC/S/SC/T/TC/NVC/W/WC	01-07	FA275X			MD6067D					
TT-R 230 T/V/W/X/Y/A/B/D/E/F	05-09/11-15	FA135X	FA135R■		MD6067D					
YFU1TW Pro Hauler	89	528*	528G*							
YFU1W Pro Hauler	89	528*	528G*							
CP 250 V/W/X Morphus	06-08	SFA199	SFA199HH			MD9107D				
DT 250 A	74	510	510G							
DT 250 B/C/D/E/F	75-79	528	528G							
IT 250 F/G	77-80	507	507G							
IT 250 H/J	81-82	507	507G							
IT 250 K	83	508	508G							
SR 250 G/H/J/TH EXCiter I/II	80-82	528								
SR 250 K	93	522								
SR 250	93-08	522								
SRX 250 T	87	FA104	FA104HH			MD2011			MD2011C	
TT 250 G/H/J	80-82	507	507G							
TT-R 250 L/M/N/P/R/S/T/V	99-06	FA135X	FA135R■		MD6066D					
WR 250 ZB	91	FA135X	FA135R■		MD6012D					
WR 250 Z	92-97	FA135X	FA135R■		MD6028D				MD6028C	
WR 250 F (4T)	01	FA185X	FA185R■		MD6356D				MD6356C	
WR 250 F (4T)	02	FA185X	FA185R■		MD6356D				MD6356C	
WR 250 F (4T)	03-04	FA185X	FA185R■		MD6356D				MD6356C	
WR 250 F (4T)	05-06	FA185X	FA185R■		MD6356D				MD6356C	
WR 250 F (4T)	07-18	FA185X	FA185R■						MD6356C	
WR 250 X (Supermotard)	08-11	FA142	FA142HH						MD6323C	
WR 250 R	08-15	FA185X	FA185R■						MD6320C	
XT 250 G/H/J/K/L	80-84	506	506G							
XT 250 X/Y/Z/A/B/D/E/F/G/H	08-17	FA275X	FA275HH		MD6067D					
XTZ 250 Lander	07-14	FA135X	FA135R■		MD6068D					
XTZ 250 Lander	16-18	FA465X	FA465R■		MD6068D					
XTZ 250 X	08-10	FA135X	FA135R■		MD6068D					
XV 250 U/W/A	88-90	FA81				MD2019RS				
XV 250 Virago G/H/J/L/M/N/P/R/T/V/W	95-07	FA199	FA199V	FA199HH	MD2067					
XV 250 V-Star	08-12	FA199	FA199V	FA199HH	MD2067					
XV 250 V-Star	13-14	FA199		FA199HH	MD2067					
YBR 250	10-12	FA464				TBA				

Line #

1

2

3

4

5

6

7

8

9

10

11

12

13

14

15

16

17

18

19

20

21

22

23

24

25

26

27

28

29

30

31

32

33

34

35

36

37

38

39

40

41

42

43

44

45

46

47

48

49

50

51

52

53

54

55

56

APPLICATIONS

BRAKE

⚠ This symbol indicates a rotor made of billet steel, and should be only used with EBC FA Kevlar® Organic or Vee pads. SAFETY NOTICE - With vehicles primarily designed for off highway use such as quads now being used on the highway, we would recommend the use of X or MXS pads for highway use and ONLY using the R and SV higher density / harder pad series for off road riding.

*-2 Sets Required. ■ - Also available in MX-S race compound. SAFETY WARNING:- DO NOT USE HH PADS ON REAR UNLESS ALSO USED ON FRONT TO AVOID BRAKE IMBALANCE

FRONT: YAMAHA Cont'd

REAR: YAMAHA

Line #

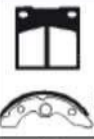
BRAKE ROTOR CHOICES - FRONT							DISC PAD CHOICES - REAR				BRAKE ROTOR CHOICES - REAR				
CC Custom Rotor	CX Extreme® /Vee-Rotor	OS Series Oversize 250/280mm Rotor Kit	OSX Series Oversize 280mm Rotor Kit	Relocating Bracket for 250/280mm Rotor	SMX Series Oversize 320mm Rotor Kit	Relocating Bracket for 320mm Rotor		Semi-Sintered V-Pads™	Sintered/HH Pads/ Grooved Shoes	SV Series Severe Duty Pads	Standard Rotor	UTVX Rotor	Vintage Rotor	Contour Profile Rotor	CX Extreme® /Vee-Rotor
1							503		503G						
2							503		503G						
3							FA152/2X		FA152/2R		MD6121D				
4							537								
5							503		503G						
6							FA21X		FA21R	FA21SV	N/A				
7							FA155X		FA155R		MD6050D				
8							FA84X		FA84R	FA84SV	MD6237D				
9							FA21X		FA21R		N/A				
10							FA21X		FA21R		N/A				
11							FA21X		FA21R		N/A				
12							503		503G						
13							527		527G						
14							FA21X		FA21R	FA21SV	N/A				
15							FA21X		FA21R		N/A				
16							FA21X		FA21R		N/A				
17							503		503G						
18							503		503G						
19							527		527G						
20							523*		523G*						
21							523*		523G*						
22							SFA408		SFA408HH		MD9108D				
23							510		510G						
24							510		510G						
25							528		528G						
26							510		510G						
27							510		510G						
28							506								
29							506								
30							527								
31	VR2011						510								
32							506		506G						
33							FA152X		FA152R■		MD6121D				
34							FA152X		FA152R■		MD6011D				
35		OS6028EC	OSX6028E	BRK035	N/A	N/A	FA152X		FA152R■		MD6011D				
36	MD6356CX	OS6028C	OSX6028	BRK008	SMX6028	BRK009	FA131X		FA131R■		MD6135D			MD6135C	MD6135CX
37	MD6356CX	OS6028C	OSX6028	BRK008	SMX6028	BRK009	FA131X		FA131R■		MD6190D			MD6190C●	MD6190CX
38							MD6190C ● = PLAIN UNDRILLED DISC FOR ENDURO USE. REAR FITMENTS ONLY. ORDER MD6190CE.								
39	MD6356CX	OS6028C	OSX6028	BRK008	SMX6028	BRK009	FA367X		FA367R■		MD6190D			MD6190C●	MD6190CX
40							MD6190C ● = PLAIN UNDRILLED DISC FOR ENDURO USE. REAR FITMENTS ONLY. ORDER MD6190CE.								
41	MD6356CX	OS6028C	OSX6028	BRK008	SMX6028	BRK009	FA367X		FA367R■		MD6190D			MD6190C●	MD6190CX
42							MD6190C ● = PLAIN UNDRILLED DISC FOR ENDURO USE. REAR FITMENTS ONLY. ORDER MD6190CE.								
43	MD6356CX	OS6028C	OSX6028	BRK008	SMX6028	BRK009	FA367X		FA367R■					MD6190C●	MD6190CX
44							MD6190C ● = PLAIN UNDRILLED DISC FOR ENDURO USE. REAR FITMENTS ONLY. ORDER MD6190CE.								
45							FA367X		FA367R■					MD6319C	
46							FA367X		FA367R■					MD6319C	
47							506		506G						
48							FA152X		FA152R■		MD6244D				
49							FA152X		FA152R■		MD6244D				
50							FA152X		FA152R■		MD6244D				
51							FA152X		FA152R■		MD6244D				
52							506								
53							527								
54							527								
55							535								
56							535								

REAR

● This symbol indicates a rotor made of billet steel, and should be only used with EBC FA Kevlar® Organic or Vee pads.

SAFETY NOTICE - With vehicles primarily designed for off highway use such as quads now being used on the highway, we would recommend the use of X or MXS pads for highway use and ONLY using the R and SV higher density / harder pad series for off road riding.

BRAKE APPLICATIONS

*-2 Sets Required. ■ - Also available in MX-S race compound. SAFETY WARNING:- DO NOT USE HH PADS ON REAR UNLESS ALSO USED ON FRONT TO AVOID BRAKE IMBALANCE

FRONT: YAMAHA



YAMAHA



DISC PAD CHOICES - FRONT

BRAKE ROTOR CHOICES - FRONT

			Semi-Sintered V-Pads™	Sintered/HH Pads/Grooved Shoes	SV Series Severe Duty Pads	Standard Rotor Left	Standard Rotor Right	UTVX Rotor	Vintage Rotor Left	Vintage Rotor Right	Contour Profile Rotor
YFB 250 D/E/F Timberwolf	92-94	503*		503G*							
YFB 250 G/H/UH/J/UJ/UK/K	95-98	528*		528G*							
YFB 250 F Timberwolf	94-00	528*		528G*							
YFM 250 W/A/B	89-91	528*		528G*							
YFM 250 XL/M Bear Tracker	99-00	528*		528G*							
YFM 250 X Beartracker	01-04	FA54X*		FA54R*	FA54SV*	MD6054D	MD6054D				
YFM 250 B Bruin	05-06	FA54X*		FA54R*	FA54SV*	MD6054D	MD6054D				
YFM 250 B Big Bear	07-09	FA54X*		FA54R*	FA54SV*	MD6054D	MD6054D				
YFM 250 R Raptor	Left 08-13	FA443X		FA443R	FA443SV	MD6054D					
	Right	FA444X		FA444R	FA444SV		MD6054D				
YFM 250 RSPX/RSEY Special Edition	Left 08-09	FA443X		FA443R	FA443SV	MD6054D					
	Right	FA444X		FA444R	FA444SV		MD6054D				
YFM 250 RSPXC Special Edition Custom	Left 08	FA443X		FA443R	FA443SV	MD6054D					
	Right	FA444X		FA444R	FA444SV		MD6054D				
YFM 250 RSPA Special Edition	Left 11	FA443X		FA443R	FA443SV	MD6054D					
	Right	FA444X		FA444R	FA444SV		MD6054D				
YP 250 Majesty	97	SFA199		SFA199HH			MD903D				MD903C
YP 250 Majesty	00-03	SFA199		SFA199HH			MD903D				MD903C
YS 250 Fazer	06-10	FA197		FA197HH			MD2106RS				
YTZ 250 N/S (Tri Moto)	85-86	FA101X		FA101R		MD6047D					
YZ 250 G	80	507		507G							
YZ 250 H	81	507		507G							
YZ 250 J/K/L	82-84	508		508G							
YZ 250 N/S	85-	FA105X		FA105R		MD6324D					
YZ 250 S/T	86-87	FA105X		FA105R		MD6067D					
YZ 250 U	88	FA105X		FA105R		MD6039D					
YZ 250 W	89	FA135X		FA135R■		MD6016D					
YZ 250 WRW	89	FA135X		FA135R■		MD6016D					
YZ 250 WRA	90	FA135X		FA135R■		MD6028D					MD6028C
YZ 250 A/B	90-91	FA135X		FA135R■		MD6012D					
YZ 250 D/E	92-93	FA135X		FA135R■		MD6028D					MD6028C
YZ 250 F/G/H/J	94-97	FA135X		FA135R■		MD6028D					MD6028C
YZ 250 K/L/M	98-00	FA185X		FA185R■		MD6028D					MD6028C
YZ 250 N	01	FA185X		FA185R■		MD6356D					MD6356C
YZ 250 P	02	FA185X		FA185R■		MD6356D					MD6356C
YZ 250 R/S (2T)	03-04	FA185X		FA185R■		MD6356D					MD6356C
YZ 250 T/V/W (2T)	05-07	FA185X		FA185R■		MD6356D					MD6356C
YZ 250 X/Y/Z/A/B/D/E/F/G/H/J (2T)	08-18	FA450X		FA450R■							MD6356C
YZ 250 XG (2T)	16	FA450X		FA450R■							MD6356C
YZ 250 F (4T)	01	FA185X		FA185R■		MD6356D					MD6356C
YZ 250 F (4T)	02	FA185X		FA185R■		MD6356D					MD6356C
YZ 250 F (4T)	03-04	FA185X		FA185R■		MD6356D					MD6356C
YZ 250 F (4T)	05-06	FA185X		FA185R■		MD6356D					MD6356C
YZ 250 F (4T)	07-15	FA450X		FA450R■							MD6356C
YZ 250 FG (4T/270mm F/Disc)	16-18	FA450X		FA450R■							MD6392C
YZ 250 FGY 60th Anniversary Model (4T/270mm F/Disc)	16	FA450X		FA450R■							MD6392C
YFM 300 G Grizzly	12-13	FA83X*		FA83R*		MD6283D	MD6283D				
YZF R3 (321cc)	15-17	FA663		FA663HH			MD2119X				MD2119XC
BW 350 T/U	87-88	517		517G							
R5/5A/5B - 350cc	70-72	513									
RD 350 A/B	73-75	FA11					TBA				
RZ 350 L/N/NC11	84-85	FA81*				MD2011	MD2011				MD2011C*
TT 350 S/T	86-87	FA105X		FA105R		MD6039D					
TY 350 N/S	85-86	517		517G							
XT 350 N/S	85-86	FA101X		FA101R		MD6068D					
XT 350 T/U/W/A	87-90	FA101X		FA101R		MD6068D					

Line #

1

2

3

4

5

6

7

8

9

10

11

12

13

14

15

16

17

18

19

20

21

22

23

24

25

26

27

28

29

30

31

32

33

34

35

36

37

38

39

40

41

42

43

44

45

46

47

48

49

50

51

52

53

54

55

56

APPLICATIONS

BRAKE

⊛ This symbol indicates a rotor made of billet steel, and should be only used with EBC FA Kevlar® Organic or Vee pads.

SAFETY NOTICE - With vehicles primarily designed for off highway use such as quads now being used on the highway, we would recommend the use of X or MXS pads for highway use and ONLY using the R and SV higher density / harder pad series for off road riding.

*-2 Sets Required. ■ - Also available in MX-S race compound. SAFETY WARNING:- DO NOT USE HH PADS ON REAR UNLESS ALSO USED ON FRONT TO AVOID BRAKE IMBALANCE

FRONT: YAMAHA Cont'd

REAR: YAMAHA

Line #

BRAKE ROTOR CHOICES - FRONT							DISC PAD CHOICES - REAR				BRAKE ROTOR CHOICES - REAR				
CC Custom Rotor	CX Extreme® /Vee-Rotor	OS Series Oversize 250/280mm Rotor Kit	OSX Series Oversize 280mm Rotor Kit	Relocating Bracket for 250/280mm Rotor	SMX Series Oversize 320mm Rotor Kit	Relocating Bracket for 320mm Rotor		Semi-Sintered V-Pads™	Sintered/HH Pads/ Grooved Shoes	SV Series Severe Duty Pads	Standard Rotor	UTVX Rotor	Vintage Rotor	Contour Profile Rotor	CX Extreme® /Vee-Rotor
1							528		528G						
2							528		528G						
3							528		528G						
4							FA21X		FA21R	FA21SV	N/A				
5							528		528G						
6							528		528G						
7							532		532G						
8							532		532G						
9							FA84X		FA84R	FA84SV	MD6236D				
10															
11							FA84X		FA84R	FA84SV	MD6236D				
12															
13							FA84X		FA84R	FA84SV	MD6236D				
14															
15							FA84X		FA84R	FA84SV	MD6236D				
16															
17							516								
18							SFA275		SFA275HH		MD953D			MD953C	
19							535								
20							FA101X		FA101R		N/A				
21							506		506G						
22							510		510G						
23							506		506G						
24							506		506G						
25							506		506G						
26							FA101X		FA101R		MD6011D				
27							N/A		FA84/3R		MD6011D				
28							N/A		FA84/3R		MD6011D				
29			OS6028EC	OSX6028E	BRK035	N/A	N/A	FA152X	FA152R■		MD6011D				
30								FA152X	FA152R■		MD6011D				
31			OS6028EC	OSX6028E	BRK035	N/A	N/A	FA152/2X	FA152/2R■		MD6011D				
32			OS6028EC	OSX6028E	BRK035	N/A	N/A	FA152/2X	FA152/2R■		MD6011D				
33	MD6028CX	OS6028C	OSX6028	BRK008	SMX6028	BRK009	FA131X	FA131R■			MD6135D			MD6135C	MD6135CX
34	MD6356CX	OS6028C	OSX6028	BRK008	SMX6028	BRK009	FA131X	FA131R■			MD6135D			MD6135C	MD6135CX
35	MD6356CX	OS6028C	OSX6028	BRK008	SMX6028	BRK009	FA131X	FA131R■			MD6190D			MD6190C	MD6190CX
36	MD6356CX	OS6028C	OSX6028	BRK008	SMX6028	BRK009	FA367X	FA367R■			MD6190D			MD6190C	MD6190CX
37	MD6356CX	OS6028C	OSX6028	BRK008	SMX6028	BRK009	FA367X	FA367R■			MD6190D			MD6190C	MD6190CX
38	MD6356CX	OS6728C	OSX6728	BRK002	SMX6728	BRK034	FA367X	FA367R■						MD6190C	MD6190CX
39	MD6356CX	OS6728C	OSX6728	BRK002	SMX6728	BRK034	FA367X	FA367R■						MD6190C	MD6190CX
40	MD6356CX	OS6028C	OSX6028	BRK008	SMX6028	BRK009	FA131X	FA131R■			MD6135D			MD6135C	MD6135CX
41	MD6356CX	OS6028C	OSX6028	BRK008	SMX6028	BRK009	FA131X	FA131R■			MD6190D			MD6190C	MD6190CX
42	MD6356CX	OS6028C	OSX6028	BRK008	SMX6028	BRK009	FA367X	FA367R■			MD6190D			MD6190C	MD6190CX
43	MD6356CX	OS6028C	OSX6028	BRK008	SMX6028	BRK009	FA367X	FA367R■			MD6190D			MD6190C	MD6190CX
44	MD6356CX	OS6728C	OSX6728	BRK002	SMX6728	BRK034	FA367X	FA367R■						MD6190C	MD6190CX
45	MD6392CX		OSX6392	TBA	SMX6392	TBA	FA367X	FA367R■						MD6190C	MD6190CX
46	MD6392CX		OSX6392	TBA	OSX6392	TBA	FA367X	FA367R■						MD6190C	MD6190CX
47							FA67X	FA67R	FA67SV		MD6369D				
48	VR2119BLK						FA662	FA662HH			MD2123			MD2123C	VR2123
49							504	504G							
50							514								
51							514								
52	VR2011						FA88	FA88V	FA88HH		MD2011			MD2011C	VR2011
53							506	506G							
54							504	504G							
55							506	506G							
56							506	506G							

REAR

⚠ This symbol indicates a rotor made of billet steel, and should be only used with EBC FA Kevlar® Organic or Vee pads.

SAFETY NOTICE - With vehicles primarily designed for off highway use such as quads now being used on the highway, we would recommend the use of X or MXS pads for highway use and ONLY using the R and SV higher density / harder pad series for off road riding.

BRAKE APPLICATIONS

*-2 Sets Required. ■ - Also available in MX-S race compound. **SAFETY WARNING:- DO NOT USE HH PADS ON REAR UNLESS ALSO USED ON FRONT TO AVOID BRAKE IMBALANCE**

FRONT: YAMAHA



YAMAHA



DISC PAD CHOICES - FRONT

BRAKE ROTOR CHOICES - FRONT

XT 350 B/D/E/F/G/H/J/K/L/M	91-00	FA101X	FA101R		MD6068D					
YFM 350 ER	87-88	503*	503G*							
YFM 350 ER	89-92	528*	528G*							
YFM 350 ER	93-95	528*	528G*							
YFM 350 FX Wolverine	95-05	FA54X*	FA54R*	FA54SV*	MD6123D	MD6123D				
YFM 350 V Wolverine (2WD)	06	FA54X*	FA54R*	FA54SV*	MD6215D	MD6215D				
YFM 350 G Grizzly 2x4 (2WD)	07-11	FA54X*	FA54R*	FA54SV*	MD6215D	MD6215D				
YFM 350 FGI Grizzly Auto IRS 4x4	07-11	FA54X*	FA54R*	FA54SV*	MD6215D	MD6215D				
YFM 350 FG Grizzly Auto 4x4	07-13	FA54X*	FA54R*	FA54SV*	MD6215D	MD6215D				
YFM 350 FW Big Bear	87-88	520*	520G*							
YFM 350 FW Big Bear	89-95	524*	524G*							
YFM 350 FW Big Bear	96-98	524*	524G*							
YFM 350 XT	87	FA101X*	FA101R*		MD6051D	MD6051D				
YFM 350 FWBL/LC Big Bear	99	FA54X*	FA54R*	FA54SV*	MD6123D	MD6123D				
YFM 350 XU Warrior	88	FA101X*	FA101R*		MD6051D	MD6051D				
YFM 350 XW Warrior	89	FA54X*	FA54R*	FA54SV*	MD6054D	MD6054D				
YFM 350 X Warrior	90-04	FA54X*	FA54R*	FA54SV*	MD6054D	MD6054D				
YFM 350 U	96-98	524*	524G*							
YFZ 350 Banshee T/U/W	87-89	FA101X*	FA101R*		MD6051D	MD6051D				
YFZ 350 A/B/D/E/F/G/H/J/K/L/M/N/P/R/S/T/V Banshee	90-06	FA54X*	FA54R*	FA54SV*	MD6054D	MD6054D				
YFM 350 UL/JULC	99	FA54X*	FA54R*	FA54SV*	MD6123D	MD6123D				
YFM 350 FA 350 Bruin 4x4 Auto	04-06	FA54X*	FA54R*	FA54SV*	MD6215D	MD6215D				
YFM 350 A 350 Bruin 2x4 Auto	04-06	FA54X*	FA54R*	FA54SV*	MD6215D	MD6215D				
YFM 350 R Raptor	04-13	FA84X*	FA84R*	FA84SV*	MD6054D	MD6054D				
YFM 350 X Wolverine (2WD)	06-09	FA54X*	FA54R*	FA54SV*	MD6215D	MD6215D				
YFP 350 U Terrapro	88	528*	528G*							
FZR 400 U/SUC/W/SWC	88-89	FA88*	FA88HH*		MD2020LS	MD2020RS				
FZR 400 A	90	FA123*	FA123HH*		MD2022LS	MD2022RS				
FZR 400 RRSP/RR	91-92	FA252*	FA252HH*		MD2001X	MD2001X				MD2001XC*
RD 400 C/D/E	76-78	FA11				N/A				
RD 400 F Daytona	79	FA41	FA41V			MD2025			VMD2025	
SR 400	15-16	FA179	FA179V	FA179HH		MD2076				
WR 400 FK	98	FA185X		FA185R■	MD6028D					MD6028C
WR 400 FL/FM	99-00	FA185X		FA185R■	MD6028D					MD6028C
WR 400 FN	01	FA185X		FA185R■	MD6017D					MD6017C
XS 400 2G/H	80-81	513								
XS 400 SG/SH	80-81	FA41	FA41V			MD2019RS				
XS 400 SJ	82	513								
XS 400 J/K Maxim	82-83	FA81				MD2019RS				
XS 400 R/J/RK	82-83	FA81				MD2011				MD2011C
XJ 400 S Seca II	93	FA179		FA179HH	MD2031LS					
YFM 400 FW Kodiak	93-98	524*	524G*							
YFM 400 FW Kodiak	99	FA54X*	FA54R*	FA54SV*	MD6123D	MD6123D				
YFM 400 N (2x4) Big Bear	03-04	FA54X*	FA54R*	FA54SV*	MD6123D	MD6123D				
YFM 400 FA Kodiak Auto	03	FA54X*	FA54R*	FA54SV*	MD6215D	MD6215D				
YFM 400 FA Kodiak	00-02	FA54X*	FA54R*	FA54SV*	MD6123D	MD6123D				
YFM 400 FAH Kodiak 4x4/Hunter	00-02	FA54X*	FA54R*	FA54SV*	MD6123D	MD6123D				
YFM 400 Kodiak 2WD A	00-01	FA54X*	FA54R*	FA54SV*	MD6123D	MD6123D				
YFM 400 Big Bear 2WD NM/NMC/NN/NHN/P/HP	00-02	FA54X*	FA54R*	FA54SV*	MD6123D	MD6123D				
YFM 400 S Big Bear 2WD	04	FA54X*	FA54R*	FA54SV*	MD6123D	MD6123D				
YFM 400 FWB Big Bear	00-01	FA54X*	FA54R*	FA54SV*	MD6123D	MD6123D				
YFM 400 FW/FH/F Big Bear 4WD/Real Tree-tra	00-04	FA54X*	FA54R*	FA54SV*	MD6123D	MD6123D				
YFM 400 F (Big Bear 4x4)	05-06	FA54X*	FA54R*	FA54SV*	MD6123D	MD6123D				
YFM 400 FWNHM/FHM Big Bear Buckmaster 4WD	01	FA54X*	FA54R*	FA54SV*	MD6123D	MD6123D				
YFM 400 A Kodiak 2WD	03-04	FA54X*	FA54R*	FA54SV*	MD6215D	MD6215D				
YFM 400 FA Kodiak 4WD	04	FA54X*	FA54R*	FA54SV*	MD6215D	MD6215D				

FRONT

Line #

APPLICATIONS

BRAKE

* This symbol indicates a rotor made of billet steel, and should be only used with EBC FA Kevlar® Organic or Vee pads.

SAFETY NOTICE - With vehicles primarily designed for off highway use such as quads now being used on the highway, we would recommend the use of X or MXS pads for highway use and ONLY using the R and SV higher density / harder pad series for off road riding.

*-2 Sets Required. ■ - Also available in MX-S race compound. **SAFETY WARNING:- DO NOT USE HH PADS ON REAR UNLESS ALSO USED ON FRONT TO AVOID BRAKE IMBALANCE**

FRONT: YAMAHA Cont'd

REAR: YAMAHA

Line #

BRAKE ROTOR CHOICES - FRONT							DISC PAD CHOICES - REAR				BRAKE ROTOR CHOICES - REAR				
CC Custom Rotor	CX Extreme® /Vee-Rotor	OS Series Oversize 250/280mm Rotor Kit	OSX Series Oversize 280mm Rotor Kit	Relocating Bracket for 250/280mm Rotor	SMX Series Oversize 320mm Rotor Kit	Relocating Bracket for 320mm Rotor		Semi-Sintered V-Pads™	Sintered/HH Pads/ Grooved Shoes	SV Series Severe Duty Pads	Standard Rotor	UTVX Rotor	Vintage Rotor	Contour Profile Rotor	CX Extreme® /Vee-Rotor
1							527		527G						
2							FA21X		FA21R	FA21SV	N/A				
3							FA21X		FA21R	FA21SV	N/A				
4							FA21X		FA21R	FA21SV	N/A				
5							FA84X		FA84R	FA84SV	MD6053D				
6							532		532G						
7							532		532G						
8							N/A				N/A				
9							532		532G						
10							FA21X		FA21R	FA21SV	N/A				
11							FA21X		FA21R	FA21SV	N/A				
12							516		516G						
13							FA84X		FA84R		N/A				
14							516		516G						
15							FA84X		FA84R		MD6053D				
16							FA84X		FA84R	FA84SV	MD6053D				
17							FA84X		FA84R	FA84SV	MD6055D				
18							516		516G						
19							FA84X		FA84R		MD6053D				
20							FA84X		FA84R	FA84SV	MD6237D				
21							516		516G						
22							532		532G						
23							532		532G						
24							FA84X		FA84R	FA84SV	MD6236D				
25							532		532G						
26							523*		523G*						
27							FA104	FA104V	FA104HH		MD2021				
28							FA104	FA104V	FA104HH		MD2021				
29	MD2001CC*	VR2001BLK*					FA104	FA104V	FA104HH		MD2021			MD2021C	VR2021
30							FA11				N/A				
31							FA41	FA41V			MD2025		VMD2025		
32							510								
33			OS6028C	OSX6028	BRK008	SMX6028	BRK009	FA152X	FA152R■		MD6011D				
34		MD6028CX	OS6028C	OSX6028	BRK008	SMX6028	BRK009	FA131X	FA131R■		MD6135D			MD6135C	MD6135CX
35		MD6017CX	OS6028C	OSX6028	BRK008	SMX6028	BRK009	FA131X	FA131R■		MD6135D			MD6135C	MD6135CX
36							516								
37							516								
38							516								
39							516								
40		VR2011					516								
41							FA88	FA88V	FA88HH		MD2002				
42							516		516G						
43							528		528G						
44							516		516G						
45							516		516G						
46							FA307X		FA307R	FA307SV	MD6174D				
47							FA307X		FA307R	FA307SV	MD6174D				
48							FA307X		FA307R	FA307SV	MD6174D				
49							516		516G						
50							516								
51							516		516G						
52							516		516G						
53							532		532G						
54							516		516						
55							532		532G						
56							532		532G						

REAR

⚠ This symbol indicates a rotor made of billet steel, and should be only used with EBC FA Kevlar® Organic or Vee pads.

SAFETY NOTICE - With vehicles primarily designed for off highway use such as quads now being used on the highway, we would recommend the use of X or MXS pads for highway use and ONLY using the R and SV higher density / harder pad series for off road riding.

BRAKE APPLICATIONS

*-2 Sets Required. ■ - Also available in MX-S race compound. SAFETY WARNING:- DO NOT USE HH PADS ON REAR UNLESS ALSO USED ON FRONT TO AVOID BRAKE IMBALANCE

FRONT: YAMAHA



YAMAHA



DISC PAD CHOICES - FRONT

BRAKE ROTOR CHOICES - FRONT

											Line #	
		Semi-Sintered V-Pads™	Sintered/HH Pads/Grooved Shoes	SV Series Severe Duty Pads	Standard Rotor Left	Standard Rotor Right	UTVX Rotor	Vintage Rotor Left	Vintage Rotor Right	Contour Profile Rotor		
YFM 400 FA Kodiak (Auto 4x4)	05-06		FA54X*	FA54R*	FA54SV*	MD6215D	MD6215D				1	
YFM 400 FG Grizzly 4x4	07-08		FA54X*	FA54R*	FA54SV*	MD6215D	MD6215D				2	
YFM 400 F Big Bear 4WD	04-06		FA54X*	FA54R*	FA54SV*	MD6123D	MD6123D				3	
YFM 400 FBH Big Bear 400 Hunter IRS	07-10		FA54X*	FA54R*	FA54SV*	MD6215D	MD6215D				4	
YFM 400 FBEW Big Bear 400 IRS Exploring Edition	07		FA54X*	FA54R*	FA54SV*	MD6215D	MD6215D				5	
YFM 400 FB Big Bear 4WD IRS	08-12		FA54X*	FA54R*	FA54SV*	MD6215D	MD6215D				6	
YP 400 T/V/W/X/Y/Z/B/D/E Majesty	05-10/12-14		SFA179	SFA179HH		MD9102D					7	
YZ 400 FK	98		FA185X	FA185R■		MD6028D				MD6028C	8	
YZ 400 FL	99		FA185X	FA185R■		MD6028D				MD6028C	9	
IT 425 G	80		507	507G							10	
WR 426 FN	01		FA185X	FA185R■		MD6356D				MD6356C	11	
WR 426 FP	02		FA185X	FA185R■		MD6356D				MD6356C	12	
YZ 426 FM	00		FA185X	FA185R■		MD6028D				MD6028C	13	
YZ 426 FN	01		FA185X	FA185R■		MD6356D				MD6356C	14	
YZ 426 FP	02		FA185X	FA185R■		MD6356D				MD6356C	15	
WR 450 F	03-04		FA185X	FA185R■		MD6356D				MD6356C	16	
											17	
WR 450 F	05-06		FA185X	FA185R■		MD6356D				MD6356C	18	
											19	
WR 450 F	07-15		FA185X	FA185R■						MD6356C	20	
											21	
WR 450 F	16-18		FA450X	FA450R	MXS450					MD6392C	22	
											23	
YFM 450 FA Kodiak	03-04		FA54X*	FA54R*	FA54SV*	MD6215D	MD6215D				24	
YFM 450 FG Grizzly 4x4	07-08		FA54X*	FA54R*	FA54SV*	MD6215D	MD6215D				25	
YFM 450 FX Wolverine Auto 4x4	06-10		FA54X*	FA54R*	FA54SV*	MD6215D	MD6215D				26	
YFM 450 FG Grizzly Auto 4x4 IRS	07		FA54X*	FA54R*	FA54SV*	MD6215D	MD6215D				27	
YFM 450 FG Grizzly Auto 4x4	08-13		FA54X*	FA54R*	FA54SV*	MD6215D	MD6215D				28	
YFM 450 FGP Grizzly 450 Auto/4x4/EPS	11-13		FA54X*	FA54R*	FA54SV*	MD6215D	MD6215D				29	
YFM 450 FA Kodiak (Auto 4x4)	05-06		FA54X*	FA54R*	FA54SV*	MD6215D	MD6215D				30	
YFM 450 FXSEW Wolverine Sport Special Edition	07		FA54X*	FA54R*	FA54SV*	MD6215D	MD6215D				31	
YFZ 450 LES Limited Edition	Left 04		FA165X	FA165R	FA165SV	MD6054D					32	
	Right		FA135X	FA135R	FA135SV		MD6054D				33	
YFZ 450 SET Special Edition	Left 05		FA165X	FA165R	FA135SV	MD6054D					34	
	Right		FA135X	FA135R	FA135SV		MD6054D				35	
YFZ 450 BB Bill Balance Edition	Left 06-07		FA165X	FA165R	FA165SV	MD6054D					36	
	Right		FA135X	FA135R	FA135SV		MD6054D				37	
YFZ 450 SPV/SEW/SPX Special Edition	Left 06-08		FA165X	FA165R	FA165SV	MD6054D					38	
	Right		FA135X	FA135R	FA135SV		MD6054D				39	
YFZ 450 S/T	Left 04-05		FA165X	FA165R		MD6054D					40	
	Right		FA135X	FA135R			MD6054D				41	
YFZ 450 V/W/X/Y/B/D	Left 06-09/12-13		FA165X	FA165R		MD6054D					42	
	Right		FA135X	FA135R			MD6054D				43	
YFZ 450 BB/DB	12-13		FA84X*	FA84R*	FA84SV*	MD6054D	MD6054D				44	
YFZ 450 R	Left 09-12		FA165X	FA165R	FA165SV	MD6054D					45	
	Right		FA135X	FA135R	FA135SV		MD6054D				46	
YFZ 450 R R	Left 14-15		FA165X	FA165R	FA165SV	MD6054D					47	
	Right		FA135X	FA135R	FA135SV		MD6054D				48	
YFZ 450 E RSE	Left 14		FA165X	FA165R	FA165SV	MD6054D					49	
	Right		FA135X	FA135R	FA135SV		MD6054D				50	
YXR 450 F	Left 04-09		FA165X	FA165R	FA165SV	MD6241D		UTVX6241			51	
	Right		FA135X	FA135R	FA135SV		MD6241D	UTVX6241			52	
▲ - 190mm Oversize Rear Disc Kit Available Order OS6242C / Separate Bracket Ref = BRK030												53
YZ 450 F	03-04		FA185X	FA185R■		MD6356D				MD6356C	54	
YZ 450 F	05-06		FA185X	FA185R■		MD6356D				MD6356C	55	
YZ 450 F	07		FA185X	FA185R■						MD6356C	56	

FRONT

APPLICATIONS
BRAKE
YAMAHA
SAFETY NOTICE - With vehicles primarily designed for off highway use such as quads now being used on the highway, we would recommend the use of X or MXS pads for highway use and ONLY using the R and SV higher density / harder pad series for off road riding.

*** This symbol indicates a rotor made of billet steel, and should be only used with EBC FA Kevlar® Organic or Vee pads.**

*-2 Sets Required. ■ - Also available in MX-S race compound. **SAFETY WARNING:- DO NOT USE HH PADS ON REAR UNLESS ALSO USED ON FRONT TO AVOID BRAKE IMBALANCE**

FRONT: YAMAHA Cont'd

REAR: YAMAHA

Line #	BRAKE ROTOR CHOICES - FRONT						DISC PAD CHOICES - REAR				BRAKE ROTOR CHOICES - REAR				
	CC Custom Rotor	CX Extreme® /Vee-Rotor	OS Series Oversize 250/280mm Rotor Kit	OSX Series Oversize 280mm Rotor Kit	Relocating Bracket for 250/280mm Rotor	SMX Series Oversize 320mm Rotor Kit	Relocating Bracket for 320mm Rotor		Semi-Sintered V-Pads™	Sintered/HH Pads/ Grooved Shoes	SV Series Severe Duty Pads	Standard Rotor	UTVX Rotor	Vintage Rotor	Contour Profile Rotor
1							FA307X		FA307R	FA307SV	MD6252D				
2							FA307X		FA307R	FA307SV	MD6252D				
3							532		532G						
4							N/A				N/A				
5							N/A				N/A				
6							N/A				N/A				
7							SFA408		SFA408HH		MD9103D				
8			OS6028C	OSX6028	BRK008	SMX6028	BRK009	FA152X	FA152R■		MD6011D				
9		MD6028CX	OS6028C	OSX6028	BRK008	SMX6028	BRK009	FA131X	FA131R■		MD6135D			MD6135C	MD6135CX
10							528		528G						
11		MD6356CX	OS6028C	OSX6028	BRK008	SMX6028	BRK009	FA131X	FA131R■		MD6135D			MD6135C	MD6135CX
12		MD6356CX	OS6028C	OSX6028	BRK008	SMX6028	BRK009	FA131X	FA131R■		MD6190D			MD6190C●	MD6190CX
13		MD6028CX	OS6028C	OSX6028	BRK008	SMX6028	BRK009	FA131X	FA131R■		MD6135D			MD6135C	MD6135CX
14		MD6356CX	OS6028C	OSX6028	BRK008	SMX6028	BRK009	FA131X	FA131R■		MD6135D			MD6135C	MD6135CX
15		MD6356CX	OS6028C	OSX6028	BRK008	SMX6028	BRK009	FA131X	FA131R■		MD6190D			MD6190C	MD6190CX
16		MD6356CX	OS6028C	OSX6028	BRK008	SMX6028	BRK009	FA367X	FA367R■		MD6190D			MD6190C●	MD6190CX
17							MD6190C ● = PLAIN UNDRILLED DISC FOR ENDURO USE. REAR FITMENTS ONLY. ORDER MD6190CE.								
18		MD6356CX	OS6028C	OSX6028	BRK008	SMX6028	BRK009	FA367X	FA367R■		MD6190D			MD6190C●	MD6190CX
19							MD6190C ● = PLAIN UNDRILLED DISC FOR ENDURO USE. REAR FITMENTS ONLY. ORDER MD6190CE.								
20		MD6356CX	OS6028C	OSX6028	BRK008	SMX6028	BRK009	FA367X	FA367R■					MD6190C●	MD6190CX
21							MD6190C ● = PLAIN UNDRILLED DISC FOR ENDURO USE. REAR FITMENTS ONLY. ORDER MD6190CE.								
22		MD6392CX	TBA	TBA	TBA	TBA	FA367X	FA367R	MXS367					MD6190C●	MD6190CX
23							MD6190C ● = PLAIN UNDRILLED DISC FOR ENDURO USE. REAR FITMENTS ONLY. ORDER MD6190CE.								
24							FA307X		FA307R	FA307SV	MD6174D				
25							FA307X		FA307R	FA307SV	MD6252D				
26							FA307X		FA307R	FA307SV	MD6174D				
27							FA307X		FA307R	FA307SV	MD6252D				
28							N/A				N/A				
29							N/A				N/A				
30							FA307X		FA307R	FA307SV	MD6252D				
31							FA307X		FA307R	FA307SV	MD6174D				
32							FA84X		FA84R		MD6236D				
33															
34							FA84X		FA84R		MD6236D				
35															
36							FA323X		FA323R		MD6263D				
37															
38							FA323X		FA323R		MD6263D				
39															
40							FA84X		FA84R		MD6236D				
41															
42							FA323X		FA323R		MD6263D				
43															
44							FA323X		FA323R		MD6263D				
45							FA323X		FA323R		MD6263D				
46															
47							FA323X		FA323R		MD6263C				
48															
49							FA323X		FA323R		MD6263C				
50															
51							FA428X		FA428R	FA428SV	MD6242D▲	UTVX6242			
52															
53											OS6242▲				
54		MD6356CX	OS6028C	OSX6028	BRK008	SMX6028	BRK009	FA367X	FA367R■		MD6190D			MD6190C	MD6190CX
55		MD6356CX	OS6028C	OSX6028	BRK008	SMX6028	BRK009	FA367X	FA367R■		MD6190D			MD6190C	MD6190CX
56		MD6356CX	OS6028C	OSX6028	BRK008	SMX6028	BRK009	FA367X	FA367R■					MD6190C	MD6190CX

BRAKE APPLICATIONS

● This symbol indicates a rotor made of billet steel, and should be only used with EBC FA Kevlar® Organic or Vee pads.
 SAFETY NOTICE - With vehicles primarily designed for off highway use such as quads now being used on the highway, we would recommend the use of X or MXS pads for highway use and ONLY using the R and SV higher density / harder pad series for off road riding.

*-2 Sets Required. ■ - Also available in MX-S race compound. **SAFETY WARNING:- DO NOT USE HH PADS ON REAR UNLESS ALSO USED ON FRONT TO AVOID BRAKE IMBALANCE**

FRONT: YAMAHA



YAMAHA



DISC PAD CHOICES - FRONT

BRAKE ROTOR CHOICES - FRONT

											Line #	
			Semi-Sintered V-Pads™	Sintered/HH Pads/Grooved Shoes	SV Series Severe Duty Pads	Standard Rotor Left	Standard Rotor Right	UTVX Rotor	Vintage Rotor Left	Vintage Rotor Right	Contour Profile Rotor	
YZ 450 F	08-15	FA450X		FA450R■							MD6356C	1
YZ 450 F (4T/270mm F/Disc)	16-18	FA450X		FA450R■							MD6392C	2
YZ 450 F 60th Anniversary Model (4T/270mm F/Disc)	16	FA450X		FA450R■							MD6392C	3
IT 465 H/J	81-82	508		508G								4
YZ 465 G	80	508		508G								5
YZ 465 H	81	508		508G								6
IT 490 K/L	83-84	508		508G								7
YZ 490 J	82	508		508G								8
YZ 490 K	83	508		508G								9
YZ 490 L	84	508		508G								10
YZ 490 N	85	FA105X		FA105R		MD6324D						11
YZ 490 S/T	86-87	FA105X		FA105R		MD6067D						12
YZ 490 U/W	88-89	FA105X		FA105R		MD6039D						13
RZ 500	84-86	FA88*		FA88HH*		MD2069⊕	MD2069⊕					14
SR 500 E/F/G/H	79-81	FA34	FA34V			MD2023LS						15
TT 500 G/H	80-81	507		507G								16
WR 500 Z	92-93	FA135X		FA135R■		MD6016D						17
XP 500 Y/Z/A (T-Max) 4B51	09-11	SFA252*		SFA252HH*		MD2107	MD2107				MD2107C*	18
XP 500 F/G (T-Max 530cc)	15-16	SFA252*		SFA252HH*		MD2098	MD2098				MD2098C*	19
XP 500 F/G (T-Max 530cc) Parking Brake	15		SFA621V									20
XS 500 B	75	FA11					N/A					21
XS 500 C/D/E	76-78	FA34				MD2024	MD2024		VMD2024	VMD2024		22
XT 500 G/H	80-81	528		528G								23
XV 500 K Virago	83	FA81				MD2023LS						24
XV 535 Virago T/TC/U/A/AC/E/EC/F/FC/SF/SFC	87-94	FA136					MD2023RS					25
XV 535 Virago G/GC/SG/SGC/H/HC/SH/SHC/J/JC/SJ/SJC	95-99	FA179	FA179V	FA179HH			MD2076					26
XJ 550 H/J/K Maxim	81-83	FA70					MD2023RS					27
XJ 550 R Seca	81-83	FA70					MD2023RS					28
XT 550 J/K	82-83	510		510G								29
XZ 550 RJ	82	FA81				MD2076						30
XZ 550 RK	83	FA81*				MD2011	MD2011				MD2011C*	31
YFM 550 FGY/Z/A/B/D/E 4WD Grizzly Auto FI	Left 09-14	FA443X		FA443R		MD6291D						32
	Right	FA444X		FA444R			MD6291D					33
YFM 550 FGPY/Z/A/B/D/E EPS Grizzly Auto FI	Left 09-14	FA443R		FA443X		MD6291D						34
	Right	FA444X		FA444R			MD6291D					35
FJ 600 L/N	84-85	FA88*		FA88HH*		MD2011	MD2011				MD2011C*	36
FZ 600 S/T/U	86-88	FA88*		FA88HH*		MD2011	MD2011				MD2011C*	37
FZR 600 W	89	FA88*		FA88HH*		MD2001X	MD2001X				MD2001XC*	38
FZR 600 A/R	90-99	FA160*		FA160HH*		MD2001X	MD2001X				MD2001XC*	39
FZ6 (FZ 600 S) (2 piston caliper)	04-06	FA199*		FA199HH*		MD2082X	MD2082X				MD2082XC*	40
FZ6 V/X/Y (4 Piston Caliper)	07-09	FA252*		FA252HH*		MD2082X	MD2082X				MD2082XC*	41
FZ6R (2 Piston Caliper)	09-17	FA199*		FA199HH*		MD2082X	MD2082X				MD2082XC*	42
SRX 600 S	86	FA104*		FA104HH*		MD2011	MD2011				MD2011C*	43
TT 600 K/L	83-84	508		508G								44
TT 600 N/S	85-86	FA101X		FA101R		MD6039D						45
XJ 600 S Seca IISD/SDC/SE/EF/SFC/SG/SH/SJ/SK	92-98	FA179		FA179HH		MD2031LS						46
XT 600 L/LC/N/LN/S/SC	84-86	FA81		FA81R		MD6070D						47
XT 600 T/TC/U/UC/W/WC	87-89	FA81		FA81R		MD6070D						48
XT 600 E	90-95	FA172X		FA172R		MD6070D						49
YFM 600 FW Grizzly	98-00	FA84X*		FA84R*	FA84SV*	MD6140D	MD6140D					50
YFM 600 FWA Grizzly/Hunter Edition	01	FA84X*		FA84R*	FA84SV*	MD6140D	MD6140D					51
YFM 600 HM Grizzly Hunting	00	FA84X*		FA84R*	FA84SV*	MD6140D	MD6140D					52
YFM 660 R Raptor	01-05	FA84X*		FA84R*	FA84SV*	MD6054D	MD6054D					53
YX 600 S/SC/T/TC/UC/U/W/WC/A/AC Radian	86-90	FA88*		FA88HH*		MD2011	MD2011				MD2011C*	54
YZF 600 R	95-96	FA160*		FA160HH*		MD2001X	MD2001X				MD2001XC*	55
(YZF 600 R) R	97-07	FA252*		FA252HH*		MD2074X	MD2074X				MD2074XC*	56

FRONT

APPLICATIONS
BRAKE
YAMAHA
SAFETY NOTICE - With vehicles primarily designed for off highway use such as quads now being used on the highway, we would recommend the use of X or MXS pads for highway use and ONLY using the R and SV higher density / harder pad series for off road riding.
⊕ This symbol indicates a rotor made of billet steel, and should be only used with EBC FA Kevlar® Organic or Vee pads.

*-2 Sets Required. ■ - Also available in MX-S race compound. **SAFETY WARNING:- DO NOT USE HH PADS ON REAR UNLESS ALSO USED ON FRONT TO AVOID BRAKE IMBALANCE**

FRONT: YAMAHA Cont'd

REAR: YAMAHA

Line #

BRAKE ROTOR CHOICES - FRONT							DISC PAD CHOICES - REAR				BRAKE ROTOR CHOICES - REAR				
CC Custom Rotor	CX Extreme® /Vee-Rotor	OS Series Oversize 250/280mm Rotor Kit	OSX Series Oversize 280mm Rotor Kit	Relocating Bracket for 250/280mm Rotor	SMX Series Oversize 320mm Rotor Kit	Relocating Bracket for 320mm Rotor		Semi-Sintered V-Pads™	Sintered/HH Pads/ Grooved Shoes	SV Series Severe Duty Pads	Standard Rotor	UTVX Rotor	Vintage Rotor	Contour Profile Rotor	CX Extreme® /Vee-Rotor
1	MD6356CX	OS6728C	OSX6728	BRK002	SMX6728	BRK034	FA367X		FA367R■					MD6190C	MD6190CX
2	MD6392CX		OSX6392	TBA	SMX6392	TBA	FA367X		FA367R■					MD6190C	MD6190CX
3	MD6392CX		OSX6392	TBA	SMX6392	TBA	FA367X		FA367R■					MD6190C	MD6190CX
4							510		510G						
5							528		528G						
6							510		510G						
7							510		510G						
8							510		510G						
9							506		506G						
10							510		510G						
11							510		510G						
12							510		510G						
13							510		510G						
14							FA104	FA104V	FA104HH		MD2070⊛				
15							510								
16							528		528G						
17							FA152X		FA152R■		MD6011D				
18							SFA408		SFA408HH		MD2011			MD2011C	
19							SFA319		SFA319HH		MD9143D			MD9143C	
20															
21							512								
22							FA34	FA34V			MD2025		VMD2025		
23							510		510G						
24							512								
25							515								
26							515								
27							512								
28							516								
29							510		510G						
30							512								
31	VR2011*						512								
32							FA445X		FA445R		MD6292D				
33							FA446X		FA446R		MD6292D				
34							FA445X		FA445R		MD6292D				
35							FA446X		FA446R		MD6292D				
36	VR2011*						FA88	FA88V	FA88HH		MD2011			MD2011C	VR2011
37	VR2011*						FA104	FA104V	FA104HH		MD2002			MD2002C	VR2002
38	MD2001CC*	VR2001BLK*					FA88	FA88V	FA88HH		MD2002			MD2002C	VR2002
39	MD2001CC*	VR2001BLK*					FA88	FA88V	FA88HH		MD2002			MD2002C	VR2002
40	MD2082CC*	VR2082BLK*					FA174	FA174V	FA174HH		MD2093			MD2093C	VR2093
41	MD2082CC*	VR2082BLK*					FA174	FA174V	FA174HH		MD2093			MD2093C	VR2093
42	MD2082CC*	VR2082BLK*					FA140	FA140V	FA140HH		MD2117				VR2117
43	VR2011*						FA104	FA104V	FA104HH		MD2002			MD2002C	VR2002
44							506		506G						
45							506		506G						
46							FA104	FA104V	FA104HH		MD2002				
47							510		510G						
48							510		510G						
49							FA101X		FA101R		MD6072D				
50							516		516G						
51							516		516G						
52							516		516G						
53							FA84X		FA84R	FA84SV	MD6237D				
54	VR2011*						512								
55	MD2001CC*	VR2001BLK*					FA88	FA88V	FA88HH		MD2002			MD2002C	VR2002
56	MD2074CC*	VR2074BLK*					FA88	FA88V	FA88HH		MD2002			MD2002C	VR2002

REAR

⊛ This symbol indicates a rotor made of billet steel, and should be only used with EBC FA Kevlar® Organic or Vee pads.
 SAFETY NOTICE - With vehicles primarily designed for off highway use such as quads now being used on the highway, we would recommend the use of X or MXS pads for highway use and ONLY using the R and SV higher density / harder pad series for off road riding.

BRAKE APPLICATIONS

*-2 Sets Required. ■ - Also available in MX-S race compound. **SAFETY WARNING:- DO NOT USE HH PADS ON REAR UNLESS ALSO USED ON FRONT TO AVOID BRAKE IMBALANCE**

FRONT: YAMAHA

APPLICATIONS

BRAKE



YAMAHA



DISC PAD CHOICES - FRONT

BRAKE ROTOR CHOICES - FRONT

												Line #
			Semi-Sintered V-Pads™	Sintered/HH Pads/Grooved Shoes	SV Series Severe Duty Pads	Standard Rotor Left	Standard Rotor Right	UTVX Rotor	Vintage Rotor Left	Vintage Rotor Right	Contour Profile Rotor	
YZF 600 RR (R6)	99-02	FA252*		FA252HH*		MD2074X	MD2074X				MD2074XC*	1
YZF 600 R6 RR	03-04	FA252*		FA252HH*		MD2082X	MD2082X				MD2082XC*	2
YZF-R6 T/W/W (310mm rotor)	05-07			FA380HH*		MD2095X	MD2095X				MD2095XC*	3
YZF-R6 X/Y/Z/A/B/D/E/F/G (310mm Rotor)	08-16			FA380HH*		MD2105X	MD2105X				MD2105XC*	4
YZF-R6 H (320mm Rotor)	17			FA380HH*		MD2124X	MD2124X				MD2124XC*	5
YZF-R6 S (YZFR 6 S) (298mm rotor/5 Bolt Fixing)	06-09	FA252*		FA252HH*		MD2082X	MD2082X				MD2082XC*	6
TX 650 A/XS 650 B/C	74-76	FA11					N/A					7
XJ 650 G/H/J/K Maxim	80-83	FA61	FA61V			MD2023LS			VMD2023			8
XJ 650 LH Midnight	81	FA61	FA61V			MD2024			VMD2024			9
XJ 650 RJ Seca	82	FA34*				MD2019LS	MD2019RS					10
XJ 650 LK Seca	83	FA81*				MD2011	MD2011				MD2011C*	11
XJ 650 LJ Seca Turbo	82	FA81*				MD2011	MD2011				MD2011C*	12
XS2/TX 650	72-73	FA11					N/A					13
XS 650 D/E/F/2F	77-79	FA34	FA34V			MD2024			VMD2024			14
XS 650 S	78-80	FA34	FA34V				MD2023RS					15
XS 650 G/H/SH	80-81	FA34	FA34V				MD2023RS					16
XS 650 S Heritage Special	82-83	FA34	FA34V			MD2023LS	MD2023RS		VMD2023	VMD2023		17
XVS 650 V Star Custom	97-11/13-14	FA179	FA179V	FA179HH			MD2076RS					18
XVS 650 V Star Classic	98-10	FA179	FA179V	FA179HH			MD2076RS					19
XVS 650 V-Star Silverado	03-10	FA179	FA179V	FA179HH			MD2076RS					20
YFM 660 F Grizzly/660 Hunter Edition	02-08	FA84X*		FA84R*	FA84SV*	MD6189D	MD6189D					21
YFM 660 FAHDV/W Ducks Unlimited Edition/Side x Side	06-07	FA84X*		FA84R*	FA84SV*	MD6189D	MD6189D					22
YXR 660 FA/FD/FE/FH/FS/FW	Left 04-07	FA165X		FA165R	FA165SV	MD6241D		UTVX6241				23
	Right	FA135X		FA135R	FA135SV		MD6241D	UTVX6241				24
▲ 190mm Oversize Rear Disc Kit Available Order OS6242C / Separate Bracket Ref = BRK030												
FZ 700 T/A Genesis	87	FA88*	FA88V*	FA88HH*		MD2011	MD2011				MD2011C*	27
FZX 700 S/T Fazer	86-87	FA88*	FA88V*	FA88HH*		MD2011	MD2011				MD2011C*	28
FZ-07 (689cc/2 Cyl)	15-17	FA252*		FA252HH*		MD2127X	MD2127X				MD2127XC*	29
FZ-07 A (689cc/2 Cyl/ABS)	17	FA252*		FA252HH*		MD2127X	MD2127X				MD2127XC*	30
XJ 700 N/X/S	85-86	FA88*		FA88HH*		MD2011	MD2011				MD2011C*	31
XV 700 L/N/C/S	84-87	FA88*		FA88HH*		MD2011	MD2011				MD2011C*	32
XSR 700 (MTM 690-U)	18	FA252*		FA252HH*							MD2127XC*	33
YFM 700 R – Raptor 50th Anniversary Edition	Left 06	FA165X		FA165R	FA165SV	MD6054D						34
	Right	FA135X		FA135R	FA135SV		MD6054D					35
YFM 700 R Raptor	Left 06-12	FA165X		FA165R	FA165SV	MD6054D						36
	Right	FA135X		FA135R	FA135SV		MD6054D					37
YFM 700 R Raptor	Left 13-14	FA165X		FA165R	FA165SV	MD6054D						38
	Right	FA135X		FA135R	FA135SV		MD6054D					39
YFM 700 RS Raptor Special Edition	Left 07-08	FA165X		FA165R	FA165SV	MD6054D						40
	Right	FA135X		FA135R	FA135SV		MD6054D					41
YFM 700 R Raptor Special Edition	Left 09-15	FA165X		FA165R	FA165SV	MD6054D						42
	Right	FA135X		FA135R	FA135SV		MD6054D					43
YFM 700 FGP Grizzly Auto 4x4 (Power steering) EPS	Left 07-14	FA443X		FA443R	FA443SV	MD6291D						44
	Right	FA444X		FA444R	FA444SV		MD6291D					45
YFM 700 FGPD Ducks Unlimited Edition	Left 07-09	FA443X		FA443R	FA443SV	MD6291D						46
	Right	FA443X		FA443R	FA443SV		MD6291D					47
YFM 700 FG Grizzly	Left 08-14	FA443X		FA443R	FA443SV	MD6291D						48
	Right	FA444X		FA444R	FA444SV		MD6291D					49
YFM 700 FGPS Grizzly	Left 09-14	FA443X		FA443R	FA443SV	MD6291D						50
FI Auto 4x4 EPS Special Edition	Right	FA444X		FA444R	FA444SV		MD6291D					51
YFM 700 D Grizzly 4WD	Left 15	FA443X		FA443R	FA443SV	MD6291D						52
	Right	FA444X		FA444R	FA444SV		MD6291D					53
YFM 700 P Grizzly EPS/4WD	Left 15	FA443X		FA443R	FA443SV	MD6291D						54
	Right	FA444X		FA444R	FA444SV		MD6291D					55

* This symbol indicates a rotor made of billet steel, and should be only used with EBC FA Kevlar® Organic or Vee pads.
 SAFETY NOTICE - With vehicles primarily designed for off highway use such as quads now being used on the highway, we would recommend the use of X or MXS pads for highway use and ONLY using the R and SV higher density / harder pad series for off road riding.

*-2 Sets Required. ■ - Also available in MX-S race compound. **SAFETY WARNING:- DO NOT USE HH PADS ON REAR UNLESS ALSO USED ON FRONT TO AVOID BRAKE IMBALANCE**

FRONT: YAMAHA Cont'd

REAR: YAMAHA

Line #	BRAKE ROTOR CHOICES - FRONT						DISC PAD CHOICES - REAR				BRAKE ROTOR CHOICES - REAR					
	CC Custom Rotor	CX Extreme® /Vee-Rotor	OS Series Oversize 250/280mm Rotor Kit	OSX Series Oversize 280mm Rotor Kit	Relocating Bracket for 250/280mm Rotor	SMX Series Oversize 320mm Rotor Kit	Relocating Bracket for 320mm Rotor		Semi-Sintered V-Pads™	Sintered/HH Pads/Grooved Shoes	SV Series Severe Duty Pads	Standard Rotor	UTVX Rotor	Vintage Rotor	Contour Profile Rotor	CX Extreme® /Vee-Rotor
1	MD2074CC*	VR2074BLK*						FA275		FA275HH		MD2084			MD2084C	VR2084
2	MD2082CC*	VR2082BLK*						FA174	FA174V	FA174HH		MD2091			MD2091C	VR2091
3	MD2095CC*	VR2095BLK*						FA174	FA174V	FA174HH		MD2091			MD2091C	VR2091
4		VR2105BLK*						FA174	FA174V	FA174HH		MD2091			MD2091C	VR2091
5		VR2124BLK*						FA436	FA436V	FA436HH		MD2091			MD2091C	VR2091
6	MD2082CC*	VR2082BLK*						FA174	FA174V	FA174HH		MD2091			MD2091C	VR2091
7								514								
8								512								
9								512								
10								515								
11		VR2011*						515								
12		VR2011*						515								
13								514								
14								514								
15								FA34	FA34V			MD2025		VMD2025		
16								514								
17								514								
18								515								
19								515								
20								515								
21								FA344X		FA344R	FA344SV	MD6197D⊕				
22								FA344X		FA344R		MD6197D⊕				
23								FA428X		FA428R	FA428SV	MD6242D▲	UTVX6242			
24																
25																
26												OS6242▲				
27		VR2011*						FA88	FA88V	FA88HH		MD2011		MD2011C	VR2011	
28		VR2011*						FA88	FA88V	FA88HH		MD2069⊕				
29		VR2127BLK*						FA174	FA174V	FA174HH		MD2120		MD2120C	VR2120	
30		VR2127BLK*						FA174	FA174V	FA174HH		MD2120		MD2120C	VR2120	
31		VR2011*						515								
32		VR2011*						515								
33		VR2127BLK*						FA174	FA174V	FA174HH				MD2120C	VR2120	
34								FA428X		FA428R	FA428SV	MD6263D				
35																
36								FA428X		FA428R	FA428SV	MD6263D				
37																
38								FA323X		FA323R		MD6263C				
39																
40								FA428X		FA428R	FA428SV	MD6263D				
41																
42								FA428X		FA428R	FA428SV	MD6263C				
43																
44								FA445X		FA445R	FA445SV	MD6292D				
45								FA446X		FA446R	FA446SV	MD6292D				
46								FA445X		FA445R	FA445SV	MD6292D				
47								FA446X		FA446R	FA446SV	MD6292D				
48								FA445X		FA445R	FA445SV	MD6292D				
49								FA446X		FA446R	FA446SV	MD6292D				
50								FA445X		FA445R	FA445SV	MD6292D				
51								FA446X		FA446R	FA446SV	MD6292D				
52								FA445X		FA445R	FA445SV	MD6292D				
53								FA446X		FA446R	FA446SV	MD6292D				
54								FA445X		FA445R	FA445SV	MD6292D				
55								FA446X		FA446R	FA446SV	MD6292D				
56																

BRAKE APPLICATIONS

⊕ This symbol indicates a rotor made of billet steel, and should be only used with EBC FA Kevlar® Organic or Vee pads.

▲ SAFETY NOTICE - With vehicles primarily designed for off highway use such as quads now being used on the highway, we would recommend the use of X or MXS pads for highway use and ONLY using the R and SV higher density / harder pad series for off road riding.

*-2 Sets Required. ■ - Also available in MX-S race compound. **SAFETY WARNING:- DO NOT USE HH PADS ON REAR UNLESS ALSO USED ON FRONT TO AVOID BRAKE IMBALANCE**

FRONT: YAMAHA

APPLICATIONS

BRAKE



YAMAHA



DISC PAD CHOICES - FRONT

BRAKE ROTOR CHOICES - FRONT

Model	Side	Year	DISC PAD CHOICES - FRONT			BRAKE ROTOR CHOICES - FRONT					Line #	
			Standard Rotor Left	Standard Rotor Right	UTVX Rotor	Vintage Rotor Left	Vintage Rotor Right	Contour Profile Rotor				
YFM 700 D Grizzly 4WD Hunter	Left	15	FA443X	FA443R	FA443SV	MD6291D						1
	Right		FA444X	FA444R	FA444SV		MD6291D					2
YFM 700 P Grizzly EPS Hunter	Left	15	FA443X	FA443R	FA443SV	MD6291D						3
	Right		FA444X	FA444R	FA444SV		MD6291D					4
YXR 700 F Rhino	Left	08	FA165X	FA165R	FA165SV	MD6241D		UTVX6241				5
	Right		FA135X	FA135R	FA135SV		MD6241D	UTVX6241				6
YXR 700 F Rhino Parking brake		08										7
YXP 700 A Pro Hauler 700		04-06	N/A									8
YXR 700 Rhino FI Auto 4x4 Ducks Unlimited Version	Left	09	FA165X	FA165R	FA165SV	MD6241D		UTVX6241				9
	Right		FA135X	FA135R	FA135SV		MD6241D	UTVX6241				10
YXR 700 Rhino FI Auto 4x4 Ducks Unlimited Version Parking brake		09										11
YXR 700 Rhino FI Auto 4x4 Sport Edition	Left	09/11-13	FA165X	FA165R	FA165SV	MD6241D		UTVX6241				12
	Right		FA135X	FA135R	FA135SV		MD6241D	UTVX6241				13
YXR 700 Rhino FI Auto 4x4 Sport Edition Parking brake		09/11-13										14
YXR 700 Rhino FI Auto 4x4	Left	09/11-13	FA165X	FA165R	FA165SV	MD6241D		UTVX6241				15
	Right		FA135X	FA135R	FA135SV		MD6241D	UTVX6241				16
YXR 700 Rhino FI Auto 4x4 Parking brake		09/11-13										17
YXC 700 D Viking VI	Left	15-16	FA642X	FA642R	FA642SV	MD6382D		UTVX6382				18
	Right		FA645X	FA645R	FA645SV		MD6382D	UTVX6382				19
YXC 700 D Viking VI Parking Brake		15-16										20
YXC 700 P Viking VI EPS	Left	15-16	FA642X	FA642R	FA642SV	MD6382D		UTVX6382				21
	Right		FA645X	FA645R	FA645SV		MD6382D	UTVX6382				22
YXC 700 P Viking VI EPS Parking Brake		15-16										23
YXC 700 P Viking VI EPS SE	Left	15-16	FA642X	FA642R	FA642SV	MD6382D		UTVX6382				24
	Right		FA645X	FA645R	FA645SV		MD6382D	UTVX6382				25
YXC 700 P Viking VI EPS SE Parking Brake		15-16										26
YXC 700 P Viking VI EPS Ranger Edition	Left	16	FA642X	FA642R	FA642SV	MD6382D		UTVX6382				27
	Right		FA645X	FA645R	FA645SV		MD6382D	UTVX6382				28
YXC 700 P Viking VI EPS Ranger Edition Parking Brake		16										29
YXM 700 DVD Viking	Left	14-16	FA642X	FA642R	FA642SV	MD6382D		UTVX6382				30
	Right		FA645X	FA645R	FA645SV		MD6382D	UTVX6382				31
YXM 700 DVD Viking Parking Brake		14-16	FA497X			MD6381D						32
YXM 700 P/VP Viking EPS	Left	14-16	FA642X	FA642R	FA642SV	MD6382D		UTVX6382				33
	Right		FA645X	FA645R	FA645SV		MD6382D	UTVX6382				34
YXM 700 P/VP Viking EPS Parking Brake		14-16	FA497X			MD6381D						35
YXM 700 PS/VPS Viking EPSSE	Left	14-16	FA642X	FA642R	FA642SV	MD6382D		UTVX6382				36
	Right		FA645X	FA645R	FA645SV		MD6382D	UTVX6382				37
YXM 700 PS/VPS Viking EPSSE Parking Brake		14-16										38
YXE 70 WD Wolverine	Left	16	FA642X	FA642R	FA642SV	MD6382D		UTVX6382				39
	Right		FA645X	FA645R	FA645SV		MD6382D	UTVX6382				40
YXE 70 WD Wolverine R Spec	Left	16	FA642X	FA642R	FA642SV	MD6382D		UTVX6382				41
	Right		FA645X	FA645R	FA645SV		MD6382D	UTVX6382				42
YXE 70 WP Wolverine R Spec EPS	Left	16	FA642X	FA642R	FA642SV	MD6382D		UTVX6382				43
	Right		FA645X	FA645R	FA645SV		MD6382D	UTVX6382				44
FZ 750 N/S/SC/U/UC		85-88	FA88*	FA88HH*		MD2069	MD2069					45
FZR 750 Genesis RU/RT		87-88	FA123*	FA123HH*		MD2003X	MD2003X				MD2003XC*	46
FZR 750 (OW01)		89-92	FA145*	FA145HH*		MD2009LS	MD2009RS					47
TX 750/TX 750 A		73-74	FA11				N/A					48
XJ 750 J/K/MK Maxim		82	FA81*			MD2019LS	MD2019RS					49
XJ 750 R Seca		81-83	FA70*	FA70V*		MD2023LS	MD2023RS		VMD2023	VMD2023		50
XS 750 D/2D/E/F		77-79	FA34*	FA34V*		MD2025	MD2025		VMD2025	VMD2025		51
XS 750 S	Left	78-79	FA61	FA61V		MD2025			VMD2025			52
	Right		FA41	FA41V			MD2025			VMD2025		53
XV 750 H/J/K/MK Virago		81-83	FA61	FA61V		MD2023LS			VMD2023			54
XV 750 U/UC/W/WC/A/A/C/B/BC/D/DE/E/EC Virago		88-94	FA88*	FA88V*	FA88HH*	MD2011	MD2011				MD2011C*	55
XV 750 F/FC/G/GC/H/H/C/J/JC Virago		94-97	FA88*	FA88V*	FA88HH*	MD2067	MD2067					56

FRONT

* This symbol indicates a rotor made of billet steel, and should be only used with EBC FA Kevlar® Organic or Vee pads.
 SAFETY NOTICE - With vehicles primarily designed for off highway use such as quads now being used on the highway, we would recommend the use of X or MXS pads for highway use and ONLY using the R and SV higher density / harder pad series for off road riding.

*-2 Sets Required. ■ - Also available in MX-S race compound. **SAFETY WARNING:- DO NOT USE HH PADS ON REAR UNLESS ALSO USED ON FRONT TO AVOID BRAKE IMBALANCE**

FRONT: YAMAHA Cont'd

REAR: YAMAHA

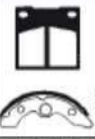
Line #	BRAKE ROTOR CHOICES - FRONT						DISC PAD CHOICES - REAR				BRAKE ROTOR CHOICES - REAR				
	CC Custom Rotor	CX Extreme® /Vee-Rotor	OS Series Oversize 250/280mm Rotor Kit	OSX Series Oversize 280mm Rotor Kit	Relocating Bracket for 250/280mm Rotor	SMX Series Oversize 320mm Rotor Kit	Relocating Bracket for 320mm Rotor		Semi-Sintered V-Pads™	Sintered/HH Pads/ Grooved Shoes	SV Series Severe Duty Pads	Standard Rotor	UTVX Rotor	Vintage Rotor	Contour Profile Rotor
1							FA445X		FA445R	FA445SV	MD6292D				
2							FA446X		FA446R	FA446SV	MD6292D				
3							FA445X		FA445R	FA445SV	MD6292D				
4							FA446X		FA446R	FA446SV	MD6292D				
5							FA165X		FA165R	FA165SV	MD6332D	UTVX6332			
6							FA135X		FA135R	FA135SV	MD6332D	UTVX6332			
7							FA497X		FA497R		MD6333D				
8							534*		534G*						
9							FA165X		FA165R	FA165SV	MD6332D	UTVX6332			
10							FA135X		FA135R	FA135SV	MD6332D	UTVX6332			
11							FA497X		FA497R		MD6333D				
12							FA165X		FA165R	FA165SV	MD6332D	UTVX6332			
13							FA135X		FA135R	FA135SV	MD6332D	UTVX6332			
14							FA497X		FA497R		MD6333D				
15							FA165X		FA165R	FA165SV	MD6332D	UTVX6332			
16							FA135X		FA135R	FA135SV	MD6332D	UTVX6332			
17							FA497X		FA497R		MD6333D				
18							FA674X		FA674R	FA674SV	MD6382D	UTVX6382			
19							FA675X		FA675R	FA675SV	MD6382D	UTVX6382			
20							FA497X		FA497R		MD6381D				
21							FA674X		FA674R	FA674SV	MD6382D	UTVX6382			
22							FA675X		FA675R	FA675SV	MD6382D	UTVX6382			
23							FA497X		FA497R		MD6381D				
24							FA674X		FA674R	FA674SV	MD6382D	UTVX6382			
25							FA675X		FA675R	FA675SV	MD6382D	UTVX6382			
26							FA497X		FA497R		MD6381D				
27							FA674X		FA674R	FA674SV	MD6382D	UTVX6382			
28							FA675X		FA675R	FA675SV	MD6382D	UTVX6382			
29							FA497X		FA497R		MD6381D				
30							FA674X		FA674R	FA674SV	MD6382D	UTVX6382			
31							FA675X		FA675R	FA675SV	MD6382D	UTVX6382			
32							FA497X		FA497R		MD6381D				
33							FA674X		FA674R	FA674SV	MD6382D	UTVX6382			
34							FA675X		FA675R	FA675SV	MD6382D	UTVX6382			
35							FA497X		FA497R		MD6381D				
36							FA674X		FA674R	FA674SV	MD6382D	UTVX6382			
37							FA675X		FA675R	FA675SV	MD6382D	UTVX6382			
38							FA497X		FA497R		MD6381D				
39							FA674X		FA674R	FA674SV	MD6382D	UTVX6382			
40							FA675X		FA675R	FA675SV	MD6382D	UTVX6382			
41							FA674X		FA674R	FA674SV	MD6382D	UTVX6382			
42							FA675X		FA675R	FA675SV	MD6382D	UTVX6382			
43							FA674X		FA674R	FA674SV	MD6382D	UTVX6382			
44							FA675X		FA675R	FA675SV	MD6382D	UTVX6382			
45							FA88	FA88V	FA88HH		MD2069				
46	MD2003CC*	VR2003BLK*					FA88	FA88V	FA88HH		MD2011			MD2011C	VR2011
47							FA88	FA88V	FA88HH		MD2008				
48							515								
49							515								
50							515								
51							FA34	FA34V			MD2025		VMD2025		
52							FA34	FA34V			MD2025		VMD2025		
53															
54							512								
55		VR2011*					515								
56							515								

REAR

SAFETY NOTICE - With vehicles primarily designed for off highway use such as quads now being used on the highway, we would recommend the use of X or MXS pads for highway use and ONLY using the R and SV higher density / harder pad series for off road riding.

⚠ This symbol indicates a rotor made of billet steel, and should be only used with EBC FA Kevlar® Organic or Vee pads.

BRAKE APPLICATIONS

*-2 Sets Required. ■ - Also available in MX-S race compound. **SAFETY WARNING:- DO NOT USE HH PADS ON REAR UNLESS ALSO USED ON FRONT TO AVOID BRAKE IMBALANCE**

FRONT: YAMAHA



YAMAHA



DISC PAD CHOICES - FRONT

BRAKE ROTOR CHOICES - FRONT

		Sintered/HH Pads/Grooved Shoes	Sintered/HH Pads/Grooved Shoes	SV Series Severe Duty Pads	Standard Rotor Left	Standard Rotor Right	UTVX Rotor	Vintage Rotor Left	Vintage Rotor Right	Contour Profile Rotor
YZF 750 R/SP	93-96	FA190*	FA190HH*		MD2003X	MD2003X				MD2003XC*
YZF 750 R7 OW02 Race Version	99-01	FA424*	FA424HH*		N/A	N/A				
YZF 750 R7 OW02 Road Version	99-01	FA252*	FA252HH*		MD2083	MD2083				
FZ8	11-13		FA380HH*		MD2095X	MD2095X				MD2095XC*
FJ-09 (847cc/3 Cyl)	15-16	FA252*	FA252HH*		MD2119X	MD2119X				MD2119XC*
FZ-09 (847cc/3 Cyl)	14-17	FA252*	FA252HH*		MD2119X	MD2119X				MD2119XC*
XS 850 G/H	80-81	FA34*	FA34V*		MD2025	MD2025		VMD2025	VMD2025	
XS 850 L/S	80-81	FA61	FA61V		MD2024	MD2024		VMD2024	VMD2024	
	Left									
	Right									
TDM 850 D/E	92-93	FA123*	FA123V*	FA123HH*	MD2001X	MD2001X				MD2001XC*
XJ 900 RK Seca	83	FA88*	FA88V*	FA88HH*	MD2069	MD2069				
XSR 900 ABS (MTM 850)	16-17		FA380HH*		MD2119X	MD2119X				MD2119XC*
XV 920 R	81-82	FA34*	FA34V*		MD2019LS	MD2019RS				
XV 920 J Virago	82	FA70*	FA70V*		MD2019LS	MD2019RS				
XV 920 K	83	FA61	FA61V		MD2024			VMD2024		
XV 920 MK Virago	83	FA61	FA61V		MD2024			VMD2024		
SCR 950 (SCR 950 H)	17	FA179	FA179V	FA179HH	TBA					
XVS 950 (V-Star 950)	09-14	FA179	FA179V	FA179HH	MD2089X					MD2089XC
XVS 950 (V-Star 950 Tourer)	09-14	FA179	FA179V	FA179HH	MD2089X					MD2089XC
XVS 950 Bolt (Standard Rear Shocks)	14-16	FA179	FA179V	FA179HH						MD2074XC
XVS 950 Bolt C Spec (Remote Reservoir Rear Shocks)	15-18	FA179	FA179V	FA179HH						MD2074XC
XVS 950 Bolt R Spec (Remote Reservoir Rear Shocks)	14-18	FA179	FA179V	FA179HH						MD2074XC
FZR 1000 Genesis T/U	87-88	FA123*		FA123HH*	MD2003X	MD2003X				MD2003XC*
FZR 1000 Genesis W	89	FA123*		FA123HH*	MD2003X	MD2003X				MD2003XC*
FZR 1000 EX UP A	90-91	FA160*		FA160HH*	MD2003X	MD2003X				MD2003XC*
FZR 1000 EX UP D/E	92-93	FA182*		FA182HH*	MD2003X	MD2003X				MD2003XC*
FZR 1000 EX UP F/G	94-96	FA190*		FA190HH*	MD2003X	MD2003X				MD2003XC*
FZ1 (FZS 1000 N/P/R/T) (FZ1)	01-05	FA252*		FA252HH*	MD2074X	MD2074X				MD2074XC*
FZ1 (FZS 1000 V/W/X/Y/Z/A/B/D/E) (FZ1)	06-14			FA380HH*	MD2101X	MD2101X				MD2101XC*
FZ-10	17			FA380HH*	MD2124X	MD2124X				MD2124XC*
GTS 1000 A	93-96	FA191			N/A					
XV 1000 L/N	84-85	FA88*		FA88HH*	MD2068	MD2068				
YXP 1000 A Pro Hauler 1000	04-05	534*		534G*						
YZX 1000 R	16	FA676X*		FA676R*	FA676SV*	MD6395D	MD6395D	UTVX6395*		
YZX 1000 R SE	16	FA676X*		FA676R*	FA676SV*	MD6395D	MD6395D	UTVX6395*		
YZF 1000 R Thunderace	97-	FA252*		FA252HH*	MD2074X	MD2074X				MD2074XC*
YZFR1	98-01	FA252*		FA252HH*	MD2074X	MD2074X				MD2074XC*
YZFR1	02-03	FA252*		FA252HH*	MD2074X	MD2074X				MD2074XC*
YZFR1 (5VY)	04-06			FA380HH*	MD2094X	MD2094X				MD2094XC*
YZF-R1 LE	06			FA380HH*	MD2112X	MD2112X				
YZF-R1 (6 piston caliper)	07-08	FA442/4*		FA442/4HH*	MD2102X	MD2102X				MD2102XC*
YZF-R1 (6 piston caliper)	09-14	FA442/4*		FA442/4HH*	MD2102X	MD2102X				MD2102XC*
YZF-R1	15-17			FA380HH*	MD2124X	MD2124X				MD2124XC*
YZF-R1 M	15-17			FA380HH*	MD2124X	MD2124X				MD2124XC*
YZF-R1 S	16-17			FA380HH*	MD2124X	MD2124X				MD2124XC*
FJ 1100 L/N	84-85	FA88*		FA88HH*	MD2068	MD2068				
XJ 1100 J	82	FA70*			MD2024	MD2024		VMD2024	VMD2024	
XS 1100 E/F/G/H	78-81	FA34*			MD2024	MD2024		VMD2024	VMD2024	
XS 1100 S	79-81	FA61	FA61V		MD2024			VMD2024		
	Left									
	Right					MD2024				
XS 1100 L Midnight Special	80	FA61	FA61V		MD2024			VMD2024		
	Left									
	Right					MD2024				
XS 1100 L Midnight Special	81	FA70*	FA70V*		MD2024	MD2024		VMD2024	VMD2024	
XV 1100 All models	86-97	FA88*	FA88V*	FA88HH*	MD2011	MD2011				MD2011C*
XVS 1100 V-Star L/M/N/P/R/V/T-F V-Star Custom	99-08	FA199*	FA199V*	FA199HH*	MD2076	MD2076				
XVS 1100 A V-Star Classic	01-03	FA199*	FA199V*	FA199HH*	MD2076	MD2076				

Line #

APPLICATIONS

BRAKE

*** This symbol indicates a rotor made of billet steel, and should be only used with EBC FA Kevlar® Organic or Vee pads.**

SAFETY NOTICE - With vehicles primarily designed for off highway use such as quads now being used on the highway, we would recommend the use of X or MXS pads for highway use and ONLY using the R and SV higher density / harder pad series for off road riding.

*-2 Sets Required. ■ - Also available in MX-S race compound. **SAFETY WARNING:- DO NOT USE HH PADS ON REAR UNLESS ALSO USED ON FRONT TO AVOID BRAKE IMBALANCE**

FRONT: YAMAHA Cont'd

REAR: YAMAHA

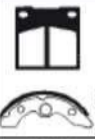
Line #	BRAKE ROTOR CHOICES - FRONT						DISC PAD CHOICES - REAR				BRAKE ROTOR CHOICES - REAR				
	CC Custom Rotor	CX Extreme® /Vee-Rotor	OS Series Oversize 250/280mm Rotor Kit	OSX Series Oversize 280mm Rotor Kit	Relocating Bracket for 250/280mm Rotor	SMX Series Oversize 320mm Rotor Kit	Relocating Bracket for 320mm Rotor		Semi-Sintered V-Pads™	Sintered/HH Pads/ Grooved Shoes	SV Series Severe Duty Pads	Standard Rotor	UTVX Rotor	Vintage Rotor	Contour Profile Rotor
1	MD2003CC*	VR2003BLK*					FA88	FA88V	FA88HH		MD2002			MD2002C	VR2002
2							N/A				N/A				
3							FA267		FA267HH		MD2086				
4	MD2095CC	VR2095BLK*					FA174	FA174V	FA174HH		MD2116			MD2116C	VR2116
5		VR2119BLK*					FA174	FA174V	FA174HH		MD2120			MD2120C	VR2120
6		VR2119BLK*					FA174	FA174V	FA174HH		MD2120			MD2120C	VR2120
7							FA34	FA34V			MD2025		VMD2025		
8							FA34	FA34V			MD2025		VMD2025		
9															
10	MD2001CC*	VR2001BLK*					FA88	FA88V	FA88HH		MD2002			MD2002C	VR2002
11							FA88	FA88V	FA88HH		MD2069				
12		VR2119BLK*					FA174	FA174V	FA174HH		MD2120			MD2120C	VR2120
13							515								
14							515								
15							515								
16							515								
17							FA319/2	FA319/2V	FA319/2HH					MD2130C	
18	MD2089CC	VR2089BLK					FA319/2	FA319/2V	FA319/2HH		MD2103				VR2103
19	MD2089CC	VR2089BLK					FA319/2	FA319/2V	FA319/2HH		MD2103				VR2103
20	MD2074CC						FA319/2	FA319/2V	FA319/2HH					MD2130C	
21	MD2074CC						FA319/2	FA319/2V	FA319/2HH					MD2130C	
22	MD2074CC						FA319/2	FA319/2V	FA319/2HH					MD2130C	
23	MD2003CC*	VR2003BLK*					FA88	FA88V	FA88HH		MD2011			MD2011C	VR2011
24	MD2003CC*	VR2003BLK*					FA88	FA88V	FA88HH		MD2011			MD2011C	VR2011
25	MD2003CC*	VR2003BLK*					FA88	FA88V	FA88HH		MD2011			MD2011C	VR2011
26	MD2003CC*	VR2003BLK*					FA88	FA88V	FA88HH		MD2011			MD2011C	VR2011
27	MD2003CC*	VR2003BLK*					FA88	FA88V	FA88HH		MD2011			MD2011C	VR2011
28	MD2074CC*	VR2074BLK*					FA348		FA348HH		MD2011			MD2011C	VR2011
29		VR2101BLK*					FA174	FA174V	FA174HH		MD2093			MD2093C	VR2093
30		VR2124BLK*					FA174	FA174V	FA174HH		MD2091			MD2091C	VR2091
31							FA88	FA88V	FA88HH		MD2075				
32							515								
33							534*		534G*						
34							FA677X*		FA677R*	FA677SV*	MD6395D*	UTVX6395*			
35							FA677X*		FA677R*	FA677SV*	MD6395D*	UTVX6395*			
36	MD2074CC*	VR2074BLK*					FA88	FA88V	FA88HH		MD2002			MD2002C	VR2002
37	MD2074CC*	VR2074BLK*					FA267		FA267HH		MD2086			MD2086C	VR2086
38	MD2074CC*	VR2074BLK*					FA275		FA275HH		MD2084			MD2084C	VR2084
39	MD2094CC*	VR2094BLK*					FA174	FA174V	FA174HH		MD2091			MD2091C	VR2091
40							FA174	FA174V	FA174HH		MD2118				
41	MD2102CC*	VR2102BLK*					FA174	FA174V	FA174HH		MD2091			MD2091C	VR2091
42	MD2102CC*	VR2102BLK*					FA174	FA174V	FA174HH		MD2091			MD2091C	VR2091
43		VR2124BLK*					FA436	FA436V	FA436HH		MD2125			MD2125C	VR2125
44		VR2124BLK*					FA436	FA436V	FA436HH		MD2125			MD2125C	VR2125
45		VR2124BLK*					FA436	FA436V	FA436HH		MD2125			MD2125C	VR2125
46							FA88	FA88V	FA88HH		MD2068				
47							FA41	FA41V			MD2024		VMD2024		
48							FA34	FA34V			MD2024		VMD2024		
49							FA34	FA34V			MD2024		VMD2024		
50															
51							FA34	FA34V			MD2024		VMD2024		
52															
53							FA41	FA41V			MD2024		VMD2024		
54		VR2011*					515								
55							FA88	FA88V	FA88HH		MD2092				
56							FA88	FA88V	FA88HH		MD2092				

BRAKE APPLICATIONS

⚠ This symbol indicates a rotor made of billet steel, and should be only used with EBC FA Kevlar® Organic or Vee pads.
SAFETY NOTICE - With vehicles primarily designed for off highway use such as quads now being used on the highway, we would recommend the use of X or MXS pads for highway use and ONLY using the R and SV higher density / harder pad series for off road riding.

*-2 Sets Required. ■ - Also available in MX-S race compound. **SAFETY WARNING:- DO NOT USE HH PADS ON REAR UNLESS ALSO USED ON FRONT TO AVOID BRAKE IMBALANCE**

FRONT: YAMAHA



YAMAHA



DISC PAD CHOICES - FRONT

BRAKE ROTOR CHOICES - FRONT

XVS 1100 V-Star Silverado 03	FA199*	FA199V*	FA199HH*	MD2076	MD2076				
XVS 1100 AT V-Star Silverado 04-09	FA199*	FA199V*	FA199HH*	MD2074X	MD2074X				MD2074XC*
XVS 1100 AS V-Star Classic 04-09	FA199*	FA199V*	FA199HH*	MD2074X	MD2074X				MD2074XC*
XVS 1100 W-M V-Star Custom Midnight 07-08	FA199*	FA199V*	FA199HH*	MD2076	MD2076				
FJ 1200 S/T 86-87	FA88*		FA88HH*	MD2068	MD2068				
FJ 1200 W 89-90	FA123*		FA123HH*	MD2001X	MD2001X				MD2001XC*
FJ 1200 A 90-92	FA123*		FA123HH*	MD2001X	MD2001X				MD2001XC*
FJ 1200 A 92-93	FA160*		FA160HH*	MD2046	MD2046				
XT 1200 Z Super Tenere 12-13			FA380HH*						MD2095XC*
XT 1200 Z Super Tenere ES 14-18			FA380HH*						MD2095XC*
XVZ12 TK Venture 83	FA88*	FA88V*	FA88HH*	MD2081	MD2081				
XVZ12 L/KC2 Venture 84	FA88*	FA88V*	FA88HH*	MD2081	MD2081				
XVZ12 TDK/DL/DKC2 Venture Royale 83-84	FA88*	FA88V*	FA88HH*	MD2081	MD2081				
XVZ12 DN Venture Royale 85	FA88*	FA88V*	FA88HH*	MD2081	MD2081				
V-Max VMX 12 N/S/U/W/A/B/D 85-92	FA88*		FA88HH*	MD2068	MD2068				
VMX 12 (V-Max 1200 All Models) 93-07	FA160*		FA160HH*	MD2129X	MD2129X				MD2129XC*
FJR 1300 R 03	FA252*		FA252HH*	MD2074X	MD2074X				MD2074XC*
FJR 1300 S/AS/T/AT 04-05	FA252*		FA252HH*	MD2089X	MD2089X				MD2089XC*
FJR 1300 A (Manual Gear Shift Model) 06-12			FA423/4HH*	MD2089X	MD2089X				MD2089XC*
FJR 1300 A 13-18			FA423/4HH*	MD2089X	MD2089X				MD2089XC*
FJR 1300 ES 14-18			FA423/4HH*	MD2089X	MD2089X				MD2089XC*
FJR 1300 AE (Electric Gear Shift Model) 06-09			FA423/4HH*	MD2089X	MD2089X				MD2089XC*
XVS 1300 V-Star 07-14	FA199*	FA199V*	FA199HH*	MD2074X	MD2074X				MD2074XC*
XVS 1300 V-Star De Luxe 13-14	FA199*	FA199V*	FA199HH*	MD2074X	MD2074X				MD2074XC*
XVS 1300 V-Star Tourer 07-14	FA199*	FA199V*	FA199HH*	MD2074X	MD2074X				MD2074XC*
XVS 1300 Stryker 11-14	FA179	FA179V	FA179HH	MD2101X					MD2101XC
XVZ 13 D Series Venture Royale 86-93	FA123*	FA123V*	FA123HH*	MD2096	MD2096				
XVZ 13 T/U Venture 87-88	FA123*	FA123V*	FA123HH*	MD2096	MD2096				
XVZ 1300 LTK Venture 96-98	FA123*	FA123V*	FA123HH*	MD2076	MD2076				
XVZ 1300 Venture MM Limited Edition 01	FA123*	FA123V*	FA123HH*	MD2076	MD2076				
XVZ 1300 Royal Star 96-97/00	FA123*	FA123V*	FA123HH*	MD2076	MD2076				
XVZ 1300 Royal Star Boulevard 99-01	FA123*	FA123V*	FA123HH*	MD2076	MD2076				
XVZ 1300 Royal Star Standard 98	FA123*	FA123V*	FA123HH*	MD2076	MD2076				
XVZ 1300 Royal Star Venture 99-07	FA123*	FA123V*	FA123HH*	MD2076	MD2076				
XVZ 1300 Royal Star Venture S 08-13	FA179*	FA179V*	FA179HH*	MD2076	MD2076				
XVZ 1300 Royal Star Midnight Tour Deluxe 06-07	FA179*	FA179V*	FA179HH*	MD2076	MD2076				
XVZ 1300 Royal Star Midnight Venture 02-07	FA179*	FA179V*	FA179HH*	MD2076	MD2076				
XVZ 1300 Royal Star Tour Classic 96-00	FA123*	FA123V*	FA123HH*	MD2076	MD2076				
XVZ 1300 Royal Star Tour Deluxe 97-01	FA123*	FA123V*	FA123HH*	MD2076	MD2076				
XVZ 1300 Royal Star Tour Deluxe 05-07	FA179*	FA179V*	FA179HH*	MD2076	MD2076				
XV 1600 Road Star 99-05	FA179*	FA179V*	FA179HH*	MD2076	MD2076				
XV 1600 Road Star Silverado 99-09	FA179*	FA179V*	FA179HH*	MD2076	MD2076				
XV 1600 Road Star Midnight 03	FA179*	FA179V*	FA179HH*	MD2076	MD2076				
XV 1600 Midnight Star 02-03	FA179*	FA179V*	FA179HH*	MD2076	MD2076				
VMX 1700 V-Max (6 piston radial caliper) 09-16	FA442/4*		FA442/4HH*						MD2109XC*
XV 1700 Road Star (9 Spoke Cast wheels - XV17 AS/AW) 04-08	FA252*	N/A	FA252HH*	MD2074X	MD2074X				MD2074XC*
XV 1700 Road Star (Spoke wheel / Solid Front Discs - XV17 ATW) 05-07	FA252*		FA252HH*	MD2076	MD2076				
XV 1700 Road Star S (9 Spoke Cast wheels - XV17 AS) 08-14	FA252*		FA252HH*	MD2074X	MD2074X				MD2074XC*
XV 1700 Road Star Midnight (9 Spoke Cast Wheels - XV17 AM) 04-07	FA252*		FA252HH*	MD2074X	MD2074X				MD2074XC*
XV 1700 Road Star Midnight Warrior (3 Spoke Cast Wheels - XV17 PCT) 05	FA252*		FA252HH*	MD2074X	MD2074X				MD2074XC*
XV 1700 Road Star Midnight Warrior (5 Spoke Cast Wheels - XV17 PCM) 06-09	FA252*		FA252HH*	MD2082X	MD2082X				MD2082XC*
XV 1700 Road Star Midnight Silverado (9 Spoke Cast wheels - XV17 ATM) 04-07	FA252*		FA252HH*	MD2074X	MD2074X				MD2074XC*
XV 1700 Road Star (Spoke wheel / Solid Front Discs - XV17 ATW) 05-07	FA252*		FA252HH*	MD2076	MD2076				
XV 1700 Road Star Silverado (Spoke Wheel / Solid Discs - XV17 AT) 07-10	FA252*		FA252HH*	MD2076	MD2076				
XV 1700 Road Star Silverado S (9 Spoke Cast Wheel - XV17 ATS) 11-14	FA252*		FA252HH*	MD2074X	MD2074X				MD2074XC*
XV 1700 Road Star Warrior (3 Spoke Cast Wheels - XV17 PC) 04-05	FA252*		FA252HH*	MD2074X	MD2074X				MD2074XC*

Line #

FRONT

APPLICATIONS

BRAKE

This symbol indicates a rotor made of billet steel, and should be only used with EBC FA Kevlar® Organic or Vee pads.

SAFETY NOTICE - With vehicles primarily designed for off highway use such as quads now being used on the highway, we would recommend the use of X or MXS pads for highway use and ONLY using the R and SV higher density / harder pad series for off road riding.

*-2 Sets Required. ■ - Also available in MX-S race compound. **SAFETY WARNING:- DO NOT USE HH PADS ON REAR UNLESS ALSO USED ON FRONT TO AVOID BRAKE IMBALANCE**

FRONT: YAMAHA

REAR: YAMAHA

BRAKE ROTOR CHOICES - FRONT

DISC PAD CHOICES - REAR

BRAKE ROTOR CHOICES - REAR

Line #

CC Custom Rotor	CX Extreme® /Vee-Rotor	OS Series Oversize 250/280mm Rotor Kit	OSX Series Oversize 280mm Rotor Kit	Relocating Bracket for 250/280mm Rotor	SMX Series Oversize 320mm Rotor Kit	Relocating Bracket for 320mm Rotor		Semi-Sintered V-Pads™	Sintered/HH Pads/ Grooved Shoes	SV Series Severe Duty Pads	Standard Rotor	UTVX Rotor	Vintage Rotor	Contour Profile Rotor	CX Extreme® /Vee-Rotor
							FA88	FA88V	FA88HH		MD2092				
1							FA88	FA88V	FA88HH		MD2092			MD2092C	VR2092
2	MD2074CC*	VR2074BLK*					FA88	FA88V	FA88HH		MD2092			MD2092C	VR2092
3	MD2074CC*	VR2074BLK*					FA88	FA88V	FA88HH		MD2092				
4							FA88	FA88V	FA88HH		MD2092				
5							FA88	FA88V	FA88HH		MD2068⊕				
6		VR2001BLK*					FA88	FA88V	FA88HH		MD2068⊕				N/A
7		VR2001BLK*					FA88	FA88V	FA88HH		MD2068⊕				N/A
8							FA88	FA88V	FA88HH		MD2068⊕				
9							FA319/2	FA319/2V	FA319/2HH					MD2115C	
10							FA319/2	FA319/2V	FA319/2HH					MD2115C	
11							FA88	FA88V	FA88HH		MD2081⊕				
12							FA88	FA88V	FA88HH		MD2081⊕				
13							FA88	FA88V	FA88HH		MD2081⊕				
14							FA88	FA88V	FA88HH		MD2081⊕				
15							FA88	FA88V	FA88HH		MD2068⊕				
16							FA88	FA88V	FA88HH		MD2068⊕				
17	MD2074CC*	VR2074BLK*					FA319/2	FA319/2V	FA319/2HH		MD2092			MD2092C	VR2092
18	MD2089CC*	VR2089BLK*					FA319/2	FA319/2V	FA319/2HH		MD2092			MD2092C	VR2092
19	MD2089CC*	VR2089BLK*					FA319/2	FA319/2V	FA319/2HH		MD2100			MD2100C	VR2100
20	MD2089CC*	VR2089BLK*					FA319/2	FA319/2V	FA319/2HH		MD2100			MD2100C	VR2100
21	MD2089CC*	VR2089BLK*					FA319/2	FA319/2V	FA319/2HH		MD2100			MD2100C	VR2100
22	MD2089CC*	VR2089BLK*					FA319/2	FA319/2V	FA319/2HH		MD2100			MD2100C	VR2100
23	MD2074CC*	VR2074BLK*					FA319/2	FA319/2V	FA319/2HH		MD2103			MD2103C	VR2103
24	MD2074CC*	VR2074BLK*					FA319/2	FA319/2V	FA319/2HH		MD2103			MD2103C	VR2103
25	MD2074CC*	VR2074BLK*					FA319/2	FA319/2V	FA319/2HH		MD2103			MD2103C	VR2103
26		VR2101BLK					FA319/2	FA319/2V	FA319/2HH		MD2114			MD2114C	N/A
27							FA123	FA123V	FA123HH		MD2049				
28							FA123	FA123V	FA123HH		MD2049				
29							FA123	FA123V	FA123HH		MD2078⊕				
30							FA123	FA123V	FA123HH		MD2078⊕				
31							FA123	FA123V	FA123HH		MD2078⊕				
32							FA123	FA123V	FA123HH		MD2078⊕				
33							FA123	FA123V	FA123HH		MD2078⊕				
34							FA123	FA123V	FA123HH		MD2078⊕				
35							FA123	FA123V	FA123HH		MD2078⊕				
36							FA123	FA123V	FA123HH		MD2078⊕				
37							FA123	FA123V	FA123HH		MD2078⊕				
38							FA123	FA123V	FA123HH		MD2078⊕				
39							FA123	FA123V	FA123HH		MD2078⊕				
40							FA123	FA123V	FA123HH		MD2078⊕				
41							FA123	FA123V	FA123HH		MD2078⊕				
42							FA123	FA123V	FA123HH		MD2088				
43							FA123	FA123V	FA123HH		MD2088				
44							FA123	FA123V	FA123HH		MD2088				
45							FA319/2	FA319/2V	FA319/2HH					MD2108C	
46	MD2074CC*	VR2074BLK*					N/A	FA123V	FA123HH		MD2088			N/A	N/A
47							N/A	FA123V	FA123HH		MD2088				
48	MD2074CC*	VR2074BLK*					N/A	FA123V	FA123HH		MD2088			N/A	N/A
49	MD2074CC*	VR2074BLK*					N/A	FA123V	FA123HH		MD2088			N/A	N/A
50	MD2074CC*	VR2074BLK*					N/A	FA319/2V	FA319/2HH		MD2092			MD2092C	VR2092
51	MD2082CC*						N/A	FA319/2V	FA319/2HH		MD2092			MD2092C	VR2092
52	MD2074CC*	VR2074BLK*					N/A	FA123V	FA123HH		MD2088			N/A	N/A
53							N/A	FA123V	FA123HH		MD2088				
54							N/A	FA123V	FA123HH		MD2088				
55	MD2074CC*	VR2074BLK*					N/A	FA123V	FA123HH		MD2088			N/A	N/A
56	MD2074CC*	VR2074BLK*					N/A	FA319/2V	FA319/2HH		MD2092			MD2092C	VR2092

REAR

BRAKE APPLICATIONS

⊕ This symbol indicates a rotor made of billet steel, and should be only used with EBC FA Kevlar® Organic or Vee pads. SAFETY NOTICE - With vehicles primarily designed for off highway use such as quads now being used on the highway, we would recommend the use of X or MXS pads for highway use and ONLY using the R and SV higher density / harder pad series for off road riding.

*-2 Sets Required. ■ - Also available in MX-S race compound. SAFETY WARNING:- DO NOT USE HH PADS ON REAR UNLESS ALSO USED ON FRONT TO AVOID BRAKE IMBALANCE

Part numbers, prefixes, suffixes, photos and illustrations shown in this catalog are trademarks and/or copyrights of EBC Brakes or the trademark owner Freeman Automotive (UK) Ltd and use without express written permission of the owners is punishable by law.



YAMAHA



FRONT: YAMAHA

DISC PAD CHOICES - FRONT

BRAKE ROTOR CHOICES - FRONT

												Line #
			Semi-Sintered V-Pads™	Sintered/HH Pads/Grooved Shoes	SV Series Severe Duty Pads	Standard Rotor Left	Standard Rotor Right	UTVX Rotor	Vintage Rotor Left	Vintage Rotor Right	Contour Profile Rotor	
XV 1700 Road Star Warrior (5 Spoke Cast Wheels - XV17 PC)	06-08	FA252*		FA252HH*		MD2082X	MD2082X				MD2082XC*	1
XV 1900 Roadliner	06-07	FA252*		FA252HH*		MD2074X	MD2074X				MD2074XC*	2
XV 1900 Roadliner Midnight	06-09	FA252*		FA252HH*		MD2074X	MD2074X				MD2074XC*	3
XV 1900 Roadliner S	06-10/12-14	FA252*		FA252HH*		MD2074X	MD2074X				MD2074XC*	4
XV 1900 Raider	08-14	FA252*		FA252HH*		MD2082X	MD2082X				MD2082XC*	5
XV 1900 Raider S	08-14	FA252*		FA252HH*		MD2082X	MD2082X				MD2082XC*	6
XV 1900 Raider SCL	12-14	FA252*		FA252HH*		MD2082X	MD2082X				MD2082XC*	7
XV 1900 Stratoliner	06-09	FA252*		FA252HH*		MD2074X	MD2074X				MD2074XC*	8
XV 1900 Stratoliner Midnite	06-08	FA252*		FA252HH*		MD2074X	MD2074X				MD2074XC*	9
XV 1900 Stratoliner S	06-14	FA252*		FA252HH*		MD2074X	MD2074X				MD2074XC*	10
XV 1900 Stratoliner Deluxe	11-14	FA252*		FA252HH*		MD2074X	MD2074X				MD2074XC*	11
												12
												13
												14
												15
												16
												17
												18
												19
												20
												21
												22
												23
												24
												25
												26
												27
												28
												29
												30
												31
												32
												33
												34
												35
												36
												37
												38
												39
												40
												41
												42
												43
												44
												45
												46
												47
												48
												49
												50
												51
												52
												53
												54
												55
												56

FRONT

* This symbol indicates a rotor made of billet steel, and should be only used with EBC FA Kevlar® Organic or Vee pads.
 SAFETY NOTICE - With vehicles primarily designed for off highway use such as quads now being used on the highway, we would recommend the use of X or MXS pads for highway use and ONLY using the R and SV higher density / harder pad series for off road riding.

*-2 Sets Required. ■ - Also available in MX-S race compound. **SAFETY WARNING:- DO NOT USE HH PADS ON REAR UNLESS ALSO USED ON FRONT TO AVOID BRAKE IMBALANCE**

FRONT: YAMAHA

REAR: YAMAHA

BRAKE ROTOR CHOICES - FRONT

DISC PAD CHOICES - REAR

BRAKE ROTOR CHOICES - REAR

Line #

CC Custom Rotor	CX Extreme® /Vee-Rotor	OS Series Oversize 250/280mm Rotor Kit	OSX Series Oversize 280mm Rotor Kit	Relocating Bracket for 250/280mm Rotor	SMX Series Oversize 320mm Rotor Kit	Relocating Bracket for 320mm Rotor		Semi-Sintered V-Pads™	Sintered/HH Pads/Grooved Shoes	SV Series Severe Duty Pads	Standard Rotor	UTVX Rotor	Vintage Rotor	Contour Profile Rotor	CX Extreme® /Vee-Rotor
1	MD2082CC*						N/A	FA319/2V	FA319/2HH		MD2092			MD2092C	VR2092
2	MD2074CC*	VR2074BLK*					FA319/2	FA319/2V	FA319/2HH		MD2099				N/A
3	MD2074CC*	VR2074BLK*					FA319/2	FA319/2V	FA319/2HH		MD2099				N/A
4	MD2074CC*	VR2074BLK*					FA319/2	FA319/2V	FA319/2HH		MD2099				N/A
5	MD2082CC*	VR2082BLK*					FA319/2	FA319/2V	FA319/2HH		MD2114			MD2114C	N/A
6	MD2082CC*	VR2082BLK*					FA319/2	FA319/2V	FA319/2HH		MD2114			MD2114C	N/A
7	MD2082CC*	VR2082BLK*					FA319/2	FA319/2V	FA319/2HH		MD2114			MD2114C	N/A
8	MD2074CC*	VR2074BLK*					FA319/2	FA319/2V	FA319/2HH		MD2099				N/A
9	MD2074CC*	VR2074BLK*					FA319/2	FA319/2V	FA319/2HH		MD2099				N/A
10	MD2074CC*	VR2074BLK*					FA319/2	FA319/2V	FA319/2HH		MD2099				N/A
11	MD2074CC*	VR2074BLK*					FA319/2	FA319/2V	FA319/2HH		MD2099				N/A
12															
13															
14															
15															
16															
17															
18															
19															
20															
21															
22															
23															
24															
25															
26															
27															
28															
29															
30															
31															
32															
33															
34															
35															
36															
37															
38															
39															
40															
41															
42															
43															
44															
45															
46															
47															
48															
49															
50															
51															
52															
53															
54															
55															
56															

REAR

⚠ This symbol indicates a rotor made of billet steel, and should be only used with EBC FA Kevlar® Organic or Vee pads.

SAFETY NOTICE - With vehicles primarily designed for off highway use such as quads now being used on the highway, we would recommend the use of X or MXS pads for highway use and ONLY using the R and SV higher density / harder pad series for off road riding.

BRAKE APPLICATIONS

*-2 Sets Required. ■ - Also available in MX-S race compound. **SAFETY WARNING:- DO NOT USE HH PADS ON REAR UNLESS ALSO USED ON FRONT TO AVOID BRAKE IMBALANCE**

FRONT: Non-Japanese Bikes

APPLICATIONS

BRAKE



ADLY



DISC PAD CHOICES - FRONT

BRAKE ROTOR CHOICES - FRONT

		SFA83	Sintered/HH Pads/Grooved Shoes	SV Series Severe Duty Pads	Standard Rotor Left	Standard Rotor Right	UTVX Rotor	Vintage Rotor Left	Vintage Rotor Right	Contour Profile Rotor
Jet 50	07-09	SFA83	SFA83HH		TBA					
Fox 50	07-09	SFA169	SFA169HH		MD904D					
Noble 50/Thunderbike	07-09	SFA83	SFA83HH		TBA					
Panther 50	07-08	SFA83	SFA83HH		TBA					
Jaguar 90 R	07-08	TBA*								
Pursuit 90 R	07-08	TBA*								
Cross X Road 150/300	07-08	TBA*			N/A	N/A				
Cross X Over 150/300	07-08	TBA*			N/A	N/A				
Interceptor 150/300	07-08	TBA*			N/A	N/A				
Thunderbike 150	07-09	SFA83	SFA83HH		MD923D					
Cross X Road 200 R	07-08	TBA*			N/A	N/A				
Q 280/300	07-08	TBA*			N/A	N/A				
Interceptor 300	06	FA83X*	FA83R*		N/A	N/A				
300 Utility	06	FA83X*	FA83R*		N/A	N/A				
AJP										
PR3 240 Enduro	14-17	FA465X	FA465R■		TBA					
PR4 240 Enduro	14-17	FA465X	FA465R■							TBA
PR4 240 Extreme	17	FA465X	FA465R■							TBA
PR5 250 Enduro	14-17	FA465X	FA465R■							TBA
PR5 250 Extreme	17	FA465X	FA465R■							TBA
PR7 650 Adventure	17	FA465X	FA465R■							TBA
ALPHASPORTS (SEE HYOSUNG)										
ALTA MOTORS (Electric)										
Redshift - MX	16-18	FA181X	FA181R■							TBA
Redshift - SM	16-18	FA244	FA244H							TBA
APRILIA										
Mojito Custom 50	04-06	SFA193	SFA193HH		MD943D					
Mojito Retro 50	04-05	SFA193	SFA193HH		MD943D					
MX 50	04	FA194	FA194HH		MD6214D					
Rally 50 (Air Cooled)	04-05	SFA193	SFA193HH		MD943D					
RS 50 Replica	99-05	FA194	FA194HH		MD672LS					
RX 50/RX 50 Racing	04	FA194	FA194HH		MD6214D					
Scarabeo 50 Street (Drum rear)	99-05	SFA193	SFA193HH		MD945D					
Scarabeo 50 Ditech (Rear rotor model)	02-08	SFA193	SFA193HH		MD945D					
Sportcity 50 (4T)	08-12	SFA353	SFA353HH		MD924D					
SR 50	99-03	SFA193	SFA193HH		MD943D					
SR 50 (Factory)	04-15	SFA193	SFA193HH		MD943D					
SR 50 Motard (4T)	12-15	SFA353	SFA353HH		MD924D					
Scarabeo 100 4T	04-14	SFA193	SFA193HH		MD945D					
RS 125	06-12	FA432	FA432HH			MD621X				MD621XC
Atlantic 200	04-06	SFA324	SFA324HH		MD997D					
Scarabeo 125/250 GT	04-05	SFA256	SFA256HH		MD952D					
Sportcity 125 (4T)	08-14	SFA256	SFA256HH		MD952D					
Mojito Custom 150	05-09	SFA301	SFA301HH		MD943D					
Scarabeo 150	99-06	SFA256	SFA256HH		MD952D					
Scarabeo 200	08-14	SFA324	FA324HH		MD952D					
RS 250	99-03	FA244*	FA244HH*		MD660LS	MD660RS				
Scarabeo 250	06-08	SFA324	FA324HH		MD952D					
Sport City 250	07-14	SFA256*	SFA256HH*		MD952D	MD952D				
Sport City Cube 250	08-09	SFA256	SFA256HH		MD952D					
MXV 4.5	09-12	FA185X	FA185R■		TBA					
Atlantic 500 ie	03-05	SFA256*	SFA256HH*		MD952D	MD952D				

Line #

FRONT

* This symbol indicates a rotor made of billet steel, and should be only used with EBC FA Kevlar® Organic or Vee pads.
 SAFETY NOTICE - With vehicles primarily designed for off highway use such as quads now being used on the highway, we would recommend the use of X or MXS pads for highway use and ONLY using the R and SV higher density / harder pad series for off road riding.

*-2 Sets Required. ■ - Also available in MX-S race compound. **SAFETY WARNING:- DO NOT USE HH PADS ON REAR UNLESS ALSO USED ON FRONT TO AVOID BRAKE IMBALANCE**

FRONT: Non-Japanese Bikes Cont'd

REAR: Non-Japanese Bikes

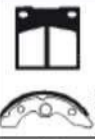
Line #	BRAKE ROTOR CHOICES - FRONT						DISC PAD CHOICES - REAR				BRAKE ROTOR CHOICES - REAR					
	CC Custom Rotor	CX Extreme® /Vee-Rotor	OS Series Oversize 250/280mm Rotor Kit	OSX Series Oversize 280mm Rotor Kit	Relocating Bracket for 250/280mm Rotor	SMX Series Oversize 320mm Rotor Kit	Relocating Bracket for 320mm Rotor		Semi-Sintered V-Pads™	Sintered/HH Pads/ Grooved Shoes	SV Series Severe Duty Pads	Standard Rotor	UTVX Rotor	Vintage Rotor	Contour Profile Rotor	CX Extreme® /Vee-Rotor
1								503								
2								503								
3								503								
4								503								
5								TBA								
6								TBA								
7								TBA				TBA				
8								TBA				N/A				
9								TBA				N/A				
10								SFA83		SFA83HH		MD982D				
11								TBA				N/A				
12								TBA				N/A				
13								FA83X		FA83R		N/A				
14								FA83X		FA83R		N/A				
15																
16																
17								FA367X		FA367R		TBA				
18								FA367X		FA367R					TBA	
19								FA367X		FA367R					TBA	
20								FA367X		FA367R					TBA	
21								FA367X		FA367R					TBA	
22								FA367X		FA367R					TBA	
23																
24																
25																
26																
27								FA368X		FA368R■					TBA	
28								FA368X		FA368R					TBA	
29																
30																
31								817								
32								817								
33								FA60				N/A				
34								893								
35								FA60				MD664				
36								FA60				N/A				
37								893								
38								SFA193		SFA193HH		MD943D				
39								816								
40								SFA193		SFA193HH		MD943D				
41								SFA298		SFA298HH		MD996D				
42								816								
43								816								
44								FA298		SFA298HH		MD664			MD664C	
45								SFA298		SFA298HH		MD996D				
46								SFA298		SFA298HH		MD942D				
47								816								
48								816								
49								SFA298		SFA298HH		MD942D				
50								SFA298		SFA298HH		TBA				
51								FA47		FA47HH		MD665				
52								SFA298		SFA298HH		MD942D				
53								SFA298		SFA298HH		MD942D				
54								SFA298		SFA298HH		MD942D				
55								FA367X		FA367R■		TBA				
56								SFA298		SFA298HH		MD990D				

This symbol indicates a rotor made of billet steel, and should be only used with EBC FA Kevlar® Organic or Vee pads. SAFETY NOTICE - With vehicles primarily designed for off highway use such as quads now being used on the highway, we would recommend the use of X or MXS pads for highway use and ONLY using the R and SV higher density / harder pad series for off road riding.

BRAKE APPLICATIONS

*-2 Sets Required. ■ - Also available in MX-S race compound. **SAFETY WARNING:- DO NOT USE HH PADS ON REAR UNLESS ALSO USED ON FRONT TO AVOID BRAKE IMBALANCE**

FRONT: Non-Japanese Bikes

APPLICATIONS

BRAKE



APRILIA



DISC PAD CHOICES - FRONT

BRAKE ROTOR CHOICES - FRONT

											Line #
Scarabeo 500 ie	03-14	SFA256*	SFA256HH*		MD952D	MD952D					1
Pegaso 650 ie (All models)	99-04	FA209/2	FA209/2HH		MD6129D						2
RVX 4.5/5.5	06-12	FA185X	FA185R■		TBA						3
SXV 4.5/5.5	09-12		MXS405		TBA						4
Dorsoduro 750 (ABS)	08-15	FA432*	FA432HH*		TBA						5
Shiver SL 750	07-14	FA432*	FA432HH*		MD621X	MD621X				MD621XC*	6
Mana 850	08-12	FA432*	FA432HH*		MD621X	MD621X				MD621XC*	7
Mana 850 Parking brake	08-12	SFA257/2									8
Mana 850 GT ABS	09-16	FA432*	FA432HH*		TBA	TBA					9
Mana 850 GT ABS Parking brake	09-16	SFA257/2									10
RSV 1000 Mille/SP	98-01	FA244*	FA244HH*		MD666X	MD666X				MD666XC*	11
RSV Mille R/1000 Mille (inc Radial Mount Caliper)	01-03		FA322/4HH*		MD621X	MD621X				MD621XC*	12
RSV 1000 R Factory/R	04-12		FA322/4HH*		MD621X	MD621X				MD621XC*	13
RSV Tuono (Standard Caliper)	02-05	FA244*	FA244HH*		MD621X	MD621X				MD621XC*	14
RSV Tuono R/Factory R (Radial Caliper)	02-12		FA322/4HH*		MD621X	MD621X				MD621XC*	15
Tuono V4 R APRC ABS	12-15		FA630HH*		TBA	TBA					16
RSV4 R	09-12		FA447HH*		MD2003X	MD2003X				MD2003XC*	17
RSV4 Factory	09-12		FA447HH*		MD2003X	MD2003X				MD2003XC*	18
RSV4 R APRC	11-12		FA447HH*		MD2003X	MD2003X				MD2003XC*	19
RSV4 Factory APRC SE	11-12		FA447HH*		MD2003X	MD2003X				MD2003XC*	20
RSV4 Factory APRC ABS	13-15		FA447HH*		MD2003X	MD2003X				MD2003XC*	21
RSV4 R APRC ABS	13-15		FA447HH*		MD2003X	MD2003X				MD2003XC*	22
SL 1000 Falco	00-05	FA244*	FA244HH*		MD666X	MD666X				MD666XC*	23
ETV 1000 Caponord (Non ABS - Bolt fixing)	01-03	FA209/2*	FA209/2HH*		MD6307D	MD6307D					24
ETV 1000 Caponord Rally (Non ABS - Bush fixing)	03	FA209/2*	FA209/2HH*		MD6406D	MD6406D					25
ETV 1000 Caponord (ABS - Bush fixing)	04-07	FA209/2*	FA209/2HH*		MD6406D	MD6406D					26
RST Futura 1000	01-05	FA244*	FA244HH*		MD2001X	MD2001X				MD2001XC*	27
Caponord 1200	14-15		FA630HH*		TBA	TBA					28
Dorsoduro 1200	11-14	FA244*	FA244HH*		TBA						29
											30
											31
ARGO											32
AR 150-18	07-08	TBA				TBA					33
AR 150-2	07-08	TBA			N/A						34
											35
ARCTIC CAT (ATV)											36
50 2 x 4 Youth (2T)	04-06	346*	346G*								37
50 DVX Sport (4T)	06-08	346*	346G*								38
50 4 x 4 Auto Youth	06-08	346*	346G*								39
90 2 x 4 Youth (2T) Rear Drum Model	02-04	346*	346G*								40
90 2 x 4 Youth (4T) Rear Drum Model	04-05	346*	346G*								41
90 2 x 4 Youth (4T) Rear Disc Model	06	346*	346G*								42
90 DVX	06-12	346*	346G*								43
90 DVX SE	09	346*	346G*								44
90 DVX SE	09	346*	346G*								45
90 Reverse Gear Model (2 x 4 Utility)	10-13	346*	346G*								46
150 Utility 2 x 4	09-13	303*	303G*								47
250 2 x 4 Utility	99-04	FA271X*	FA271R*		MD6173D	MD6173D	UTVX6173*				48
250 2 x 4 Utility	05-09	FA395X*	FA395R*	FA395SV*	MD6173D	MD6173D	UTVX6173*				49
250 4 x 4 Utility	01-04	FA271X*	FA271R*		MD6173D	MD6173D	UTVX6173*				50
250 4 x 4 Utility	05/08	FA395X*	FA395R*	FA395SV*	MD6173D	MD6173D	UTVX6173*				51
250 DVX Sport	06-08	FA377X*	FA377R*		MD6267D	MD6267D					52
300 (4 x 4)	98-04	FA271X*	FA271R*		MD6173D	MD6173D	UTVX6173*				53
300 4 x 4 Utility	05	FA395X*	FA395R*	FA395SV*	MD6173D	MD6173D	UTVX6173*				54
300 ATV 2 x 4 Utility (Mid Size)	10-14	FA377X*	FA377R*		MD6267D	MD6267D					55
300 DVX	09-12	FA377X*	FA377R*		MD6267D	MD6267D					56
350 ATV	12	FA395X*	FA395R*	FA395SV*	MD6173D	MD6173D	UTVX6173*				56

FRONT

* This symbol indicates a rotor made of billet steel, and should be only used with EBC FA Kevlar® Organic or Vee pads. SAFETY NOTICE - With vehicles primarily designed for off highway use such as quads now being used on the highway, we would recommend the use of X or MXS pads for highway use and ONLY using the R and SV higher density / harder pad series for off road riding.

*-2 Sets Required. ■ - Also available in MX-S race compound. SAFETY WARNING:- DO NOT USE HH PADS ON REAR UNLESS ALSO USED ON FRONT TO AVOID BRAKE IMBALANCE

FRONT: Non-Japanese Bikes Cont'd

REAR: Non-Japanese Bikes

Line #	BRAKE ROTOR CHOICES - FRONT						DISC PAD CHOICES - REAR				BRAKE ROTOR CHOICES - REAR				
	CC Custom Rotor	CX Extreme® /Vee-Rotor	OS Series Oversize 250/280mm Rotor Kit	OSX Series Oversize 280mm Rotor Kit	Relocating Bracket for 250/280mm Rotor	SMX Series Oversize 320mm Rotor Kit	Relocating Bracket for 320mm Rotor		Semi-Sintered V-Pads™	Sintered/HH Pads/ Grooved Shoes	SV Series Severe Duty Pads	Standard Rotor	UTVX Rotor	Vintage Rotor	Contour Profile Rotor
1							SFA298		SFA298HH		MD990D				
2							FA173				MD6128D				
3							FA367X		FA367R■		TBA				
4							FA367X		FA367R■		TBA				
5			TBA	TBA			FA213	FA213V	FA213HH		TBA				
6							FA213		FA213HH		TBA				
7		VR621BLK*					FA256		FA256HH		MD858			MD858C	VR858
8															
9							FA256		FA256HH		MD872			MD872C	VR872
10															
11							FA266	FA266V	FA266HH		MD613			MD613C	
12		VR621BLK*					FA266	FA266V	FA266HH		MD613			MD613C	VR613
13		VR621BLK*					FA266	FA266V	FA266HH		MD613			MD613C	VR613
14		VR621BLK*					FA266	FA266V	FA266HH		MD613			MD613C	VR613
15		VR621BLK*					FA266	FA266V	FA266HH		MD613			MD613C	VR613
16							FA266	FA266V	FA266HH		MD613				
17		VR2003BLK*					FA266	FA266V	FA266HH		MD613			MD613C	VR613
18		VR2003BLK*					FA266	FA266V	FA266HH		MD613			MD613C	VR613
19		VR2003BLK*					FA266	FA266V	FA266HH		MD613			MD613C	VR613
20		VR2003BLK*					FA266	FA266V	FA266HH		MD613			MD613C	VR613
21		VR2003BLK*					FA266	FA266V	FA266HH		MD613			MD613C	VR613
22		VR2003BLK*					FA266	FA266V	FA266HH		MD613			MD613C	VR613
23							FA266	FA266V	FA266HH		MD613			MD613C	
24							FA266	FA266V	FA266HH		MD6308D				
25							FA266	FA266V	FA266HH		MD6308D				
26							FA266	FA266V	FA266HH		MD6308D				
27		VR2001BLK*					FA181X		FA181HH		MD697			MD697C	N/A
28							FA213	FA213V	FA213HH		TBA				
29			TBA	TBA			FA213	FA213V	FA213HH		TBA				
30															
31															
32							TBA				N/A				
33							TBA				N/A				
34															
35															
36							N/A								
37							FA305X		FA305R		MD6267D				
38							FA305X		FA305R		MD6267D				
39							307		307G						
40							307		307G						
41							FA305X		FA305R						
42							FA305X		FA305R		MD6267D				
43							FA305X		FA305R		MD6267D				
44							FA305X		FA305R		MD6267D				
45							FA305X		FA305R		MD6267D				
46							FA305X		FA305R		MD6267D				
47							FA271X		FA271R		MD6173D	UTVX6173			
48							FA395X		FA395R	FA395SV	MD6173D	UTVX6173			
49							FA271X		FA271R		MD6173D	UTVX6173			
50							FA395X		FA395R	FA395SV	MD6173D	UTVX6173			
51							FA355/4X		FA355/4R		MD6268D				
52							FA271X		FA271R		MD6173D	UTVX6173			
53							FA395X		FA395R	FA395SV	MD6173D	UTVX6173			
54							FA377X*		FA377R*		TBA				
55							FA355/4X		FA355/4R		MD6268D				
56							FA395X		FA395R	FA395SV	MD6173D	UTVX6173			

⚠ This symbol indicates a rotor made of billet steel, and should be only used with EBC FA Kevlar® Organic or Vee pads.
 SAFETY NOTICE - With vehicles primarily designed for off highway use such as quads now being used on the highway, we would recommend the use of X or MXS pads for highway use and ONLY using the R and SV higher density / harder pad series for off road riding.

BRAKE APPLICATIONS

*-2 Sets Required. ■ - Also available in MX-S race compound. **SAFETY WARNING:- DO NOT USE HH PADS ON REAR UNLESS ALSO USED ON FRONT TO AVOID BRAKE IMBALANCE**

FRONT: Non-Japanese Bikes

APPLICATIONS

BRAKE



ARCTIC CAT (ATV)



* This symbol indicates a rotor made of billet steel, and should be only used with EBC FA Kevlar® Organic or Vee pads.
 SAFETY NOTICE - With vehicles primarily designed for off highway use such as quads now being used on the highway, we would recommend the use of X or MXS pads for highway use and ONLY using the R and SV higher density / harder pad series for off road riding.

		DISC PAD CHOICES - FRONT			BRAKE ROTOR CHOICES - FRONT						
											Line #
366 4 x 4 Auto Utility	08-09	FA395X*	FA395R*	FA395SV*	MD6173D	MD6173D	UTVX6173*				1
366 SE	10	FA395X*	FA395R*	FA395SV*	MD6173D	MD6173D	UTVX6173*				2
400 4 x 4 ACT	04	FA271X*	FA271R*		MD6173D	MD6173D	UTVX6173*				3
400 4 x 4 Auto ACT	04	FA271X*	FA271R*		MD6173D	MD6173D	UTVX6173*				4
400 2 x 4 Utility	98-04	FA271X*	FA271R*		MD6173D	MD6173D	UTVX6173*				5
400 2 x 4 Auto Utility	04	FA271X*	FA271R*		MD6173D	MD6173D	UTVX6173*				6
400 4 x 4 Utility	00-04	FA271X*	FA271R*		MD6173D	MD6173D	UTVX6173*				7
400 4 x 4 Utility	05-07	FA395X*	FA395R*	FA395SV*	MD6173D	MD6173D	UTVX6173*				8
400 4 x 4 VP Utility	05-06	FA395X*	FA395R*	FA395SV*	MD6173D	MD6173D	UTVX6173*				9
400 4 x 4 Auto Utility	04	FA271X*	FA271R*		MD6173D	MD6173D	UTVX6173*				10
400 4 x 4 Auto Utility	05-08	FA395X*	FA395R*	FA395SV*	MD6173D	MD6173D	UTVX6173*				11
400 4 x 4 Auto LE Utility	05-07	FA395X*	FA395R*	FA395SV*	MD6173D	MD6173D	UTVX6173*				12
400 4 x 4 Auto VP Utility	05-06	FA395X*	FA395R*	FA395SV*	MD6173D	MD6173D	UTVX6173*				13
400 DVX Sport	04-08	FA84X*	FA84R*■		MD6210D	MD6210D					14
400 DVX TS Sport	06-07	FA84X*	FA84R*■		MD6210D	MD6210D					15
400 4 x 4 Auto TBX Utility	04	FA271X*	FA271R*		MD6173D	MD6173D	UTVX6173*				16
400 4 x 4 Auto TBX Utility	05-06	FA395X*	FA395R*	FA395SV*	MD6173D	MD6173D	UTVX6173*				17
400 TRV	09	FA395X*	FA395R*	FA395SV*	MD6173D	MD6173D	UTVX6173*				18
400 TRV H1	10	FA395X*	FA395R*	FA395SV*	MD6173D	MD6173D	UTVX6173*				19
400 TRV	13	FA395X*	FA395R*	FA395SV*	TBA	TBA					20
400 4 x 4 Auto TRV Multirider	06	FA395X*	FA395R*	FA395SV*	MD6173D	MD6173D	UTVX6173*				21
400 4 x 4 Auto TRV Plus Multirider	07	FA395X*	FA395R*	FA395SV*	MD6173D	MD6173D	UTVX6173*				22
400 ATV (Core/Mid Size)	13-14	FA395X*	FA395R*	FA395SV*	MD6375D	MD6375D					23
425i	12	FA395X*	FA395R*	FA395SV*	MD6173D	MD6173D	UTVX6173*				24
425i SE	12	FA395X*	FA395R*	FA395SV*	MD6173D	MD6173D	UTVX6173*				25
450 H1 EFI	10	FA395X*	FA395R*	FA395SV*	MD6173D	MD6173D	UTVX6173*				26
450i	11-12	FA395X*	FA395R*	FA395SV*	MD6173D	MD6173D	UTVX6173*				27
450i GT	12	FA395X*	FA395R*	FA395SV*	MD6173D	MD6173D	UTVX6173*				28
450 TRV	11-12	FA395X*	FA395R*	FA395SV*	MD6173D	MD6173D	UTVX6173*				29
450i TRV	11	FA395X*	FA395R*	FA395SV*	MD6173D	MD6173D	UTVX6173*				30
450 ATV (Core/Mid Size)	13-14	FA395X*	FA395R*	FA395SV*	MD6375D	MD6375D					31
XC 450i	11-12	FA395X*	FA395R*	FA395SV*	MD6173D	MD6173D	UTVX6173*				32
450i XC	13	FA395X*	FA395R*	FA395SV*	MD6375D	MD6375D					33
454 Bearcat 2 x 4	97-98	FA271X*	FA271R*		MD6173D	MD6173D	UTVX6173*				34
454 Bearcat 4 x 4	96-98	FA271X*	FA271R*		MD6173D	MD6173D	UTVX6173*				35
500 4 x 4 Auto Utility	98-04	FA271X*	FA271R*		MD6173D	MD6173D	UTVX6173*				36
500 4 x 4 Auto Utility	05-08	FA395X*	FA395R*	FA395SV*	MD6173D	MD6173D	UTVX6173*				37
500 4 x 4 Auto LE Utility	05-06	FA395X*	FA395R*	FA395SV*	MD6173D	MD6173D	UTVX6173*				38
500 4 x 4 Manual G/Box Utility	98-04	FA271X*	FA271R*		MD6173D	MD6173D	UTVX6173*				39
500 4 x 4 Manual G/Box Utility	05-09	FA395X*	FA395R*	FA395SV*	MD6173D	MD6173D	UTVX6173*				40
500 4 x 4 Auto TBX Utility	04	FA271X*	FA271R*		MD6173D	MD6173D	UTVX6173*				41
500 4 x 4 Auto TBX Utility	05-06	FA395X*	FA395R*	FA395SV*	MD6173D	MD6173D	UTVX6173*				42
500 4 x 4 Auto TRV Utility	04	FA271X*	FA271R*		MD6173D	MD6173D	UTVX6173*				43
500 4 x 4 Auto TRV Multirider	05-06/08	FA395X*	FA395R*	FA395SV*	MD6173D	MD6173D	UTVX6173*				44
500 ATV (Mid Size)	13-14	FA395X*	FA395R*	FA395SV*	MD6375D	MD6375D					45
500 ATV XT (Mid Size)	13-14	FA395X*	FA395R*	FA395SV*	MD6375D	MD6375D					46
500 TRV	13	FA395X*	FA395R*	FA395SV*	MD6375D	MD6375D					47
550 HI EFI	09-10	FA395X*	FA395R*	FA395SV*	MD6173D	MD6173D	UTVX6173*				48
550 HI EFI LE	09-10	FA395X*	FA395R*	FA395SV*	MD6173D	MD6173D	UTVX6173*				49
550 TRV	11	FA395X*	FA395R*	FA395SV*	MD6173D	MD6173D	UTVX6173*				50
550 TRV Cruiser	11	FA395X*	FA395R*	FA395SV*	MD6173D	MD6173D	UTVX6173*				51
550 TRV EFI	09-10	FA395X*	FA395R*	FA395SV*	MD6173D	MD6173D	UTVX6173*				52
550 TRV Efi LE	09-10	FA395X*	FA395R*	FA395SV*	MD6173D	MD6173D	UTVX6173*				53
550i	11-12	FA395X*	FA395R*	FA395SV*	MD6173D	MD6173D	UTVX6173*				54
550i LTD	11-12	FA395X*	FA395R*	FA395SV*	MD6173D	MD6173D	UTVX6173*				55
550i GT	11-12	FA395X*	FA395R*	FA395SV*	MD6173D	MD6173D	UTVX6173*				56

*-2 Sets Required. ■ - Also available in MX-S race compound. **SAFETY WARNING:- DO NOT USE HH PADS ON REAR UNLESS ALSO USED ON FRONT TO AVOID BRAKE IMBALANCE**

FRONT: Non-Japanese Bikes Cont'd

REAR: Non-Japanese Bikes

Line #	BRAKE ROTOR CHOICES - FRONT						DISC PAD CHOICES - REAR				BRAKE ROTOR CHOICES - REAR				
	CC Custom Rotor	CX Extreme® /Vee-Rotor	OS Series Oversize 250/280mm Rotor Kit	OSX Series Oversize 280mm Rotor Kit	Relocating Bracket for 250/280mm Rotor	SMX Series Oversize 320mm Rotor Kit	Relocating Bracket for 320mm Rotor		Semi-Sintered V-Pads™	Sintered/HH Pads/ Grooved Shoes	SV Series Severe Duty Pads	Standard Rotor	UTVX Rotor	Vintage Rotor	Contour Profile Rotor
1							FA395X		FA395R	FA395SV	MD6173D	UTVX6173			
2							FA395X		FA395R	FA395SV	MD6173D	UTVX6173			
3							FA271X		FA271R		MD6173D	UTVX6173			
4							FA271X		FA271R		MD6173D	UTVX6173			
5							FA271X		FA271R		MD6173D	UTVX6173			
6							FA271X		FA271R		MD6173D	UTVX6173			
7							FA271X		FA271R		MD6173D	UTVX6173			
8							FA395X		FA395R	FA395SV	MD6173D	UTVX6173			
9							FA395X		FA395R	FA395SV	MD6173D	UTVX6173			
10							FA271X		FA271R		MD6173D	UTVX6173			
11							FA395X		FA395R	FA395SV	MD6173D	UTVX6173			
12							FA395X		FA395R	FA395SV	MD6173D	UTVX6173			
13							FA395X		FA395R	FA395SV	MD6173D	UTVX6173			
14							FA137X		FA137R	FA137SV	MD6211D				
15							FA137X		FA137R	FA137SV	MD6211D				
16							FA271X		FA271R		MD6173D	UTVX6173			
17							FA395X		FA395R	FA395SV	MD6173D	UTVX6173			
18							FA395X		FA395R	FA395SV	MD6173D	UTVX6173			
19							FA395X		FA395R	FA395SV	MD6173D	UTVX6173			
20							FA395X		FA395R	FA395SV	TBA				
21							FA395X		FA395R	FA395SV	MD6173D	UTVX6173			
22							FA395X		FA395R	FA395SV	MD6173D	UTVX6173			
23							FA395X		FA395R	FA395SV	MD6375D				
24							FA395X		FA395R	FA395SV	MD6173D	UTVX6173			
25							FA395X		FA395R	FA395SV	MD6173D	UTVX6173			
26							FA395X		FA395R	FA395SV	MD6173D	UTVX6173			
27							FA395X		FA395R	FA395SV	MD6173D	UTVX6173			
28							FA395X		FA395R	FA395SV	MD6173D	UTVX6173			
29							FA395X		FA395R	FA395SV	MD6173D	UTVX6173			
30							FA395X		FA395R	FA395SV	MD6173D	UTVX6173			
31							FA395X		FA395R	FA395SV	MD6375D				
32							FA395X		FA395R	FA395SV	MD6173D	UTVX6173			
33							FA395X		FA395R	FA395SV	MD6375D				
34							FA271X		FA271R		MD6173D	UTVX6173			
35							FA271X		FA271R		MD6173D	UTVX6173			
36							FA271X		FA271R		MD6173D	UTVX6173			
37							FA395X		FA395R	FA395SV	MD6173D	UTVX6173			
38							FA395X		FA395R	FA395SV	MD6173D	UTVX6173			
39							FA271X		FA271R		MD6173D	UTVX6173			
40							FA395X		FA395R	FA395SV	MD6173D	UTVX6173			
41							FA271X		FA271R		MD6173D	UTVX6173			
42							FA395X		FA395R	FA395SV	MD6173D	UTVX6173			
43							FA271X		FA271R		MD6173D	UTVX6173			
44							FA395X		FA395R	FA395SV	MD6173D	UTVX6173			
45							FA395X		FA395R	FA395SV	MD6375D				
46							FA395X		FA395R	FA395SV	MD6375D				
47							FA395X		FA395R	FA395SV	MD6375D				
48							FA395X		FA395R	FA395SV	MD6173D	UTVX6173			
49							FA395X		FA395R	FA395SV	MD6173D	UTVX6173			
50							FA395X		FA395R	FA395SV	MD6173D	UTVX6173			
51							FA395X		FA395R	FA395SV	MD6173D	UTVX6173			
52							FA395X		FA395R	FA395SV	MD6173D	UTVX6173			
53							FA395X		FA395R	FA395SV	MD6173D	UTVX6173			
54							FA395X		FA395R	FA395SV	MD6173D	UTVX6173			
55							FA395X		FA395R	FA395SV	MD6173D	UTVX6173			
56							FA395X		FA395R	FA395SV	MD6173D	UTVX6173			

BRAKE APPLICATIONS

⚠ This symbol indicates a rotor made of billet steel, and should be only used with EBC FA Kevlar® Organic or Vee pads.
 SAFETY NOTICE - With vehicles primarily designed for off highway use such as quads now being used on the highway, we would recommend the use of X or MXS pads for highway use and ONLY using the R and SV higher density / harder pad series for off road riding.

*-2 Sets Required. ■ - Also available in MX-S race compound. **SAFETY WARNING:- DO NOT USE HH PADS ON REAR UNLESS ALSO USED ON FRONT TO AVOID BRAKE IMBALANCE**

FRONT: Non-Japanese Bikes

APPLICATIONS

BRAKE



ARCTIC CAT (ATV)



DISC PAD CHOICES - FRONT

BRAKE ROTOR CHOICES - FRONT

550i GT TRV	11	FA395X*	FA395R*	FA395SV*	MD6173D	MD6173D	UTVX6173*			
550i TRV Cruiser	11	FA395X*	FA395R*	FA395SV*	MD6173D	MD6173D	UTVX6173*			
550 GT TRV	11-12	FA395X*	FA395R*	FA395SV*	MD6173D	MD6173D	UTVX6173*			
550 GT S TRV	10	FA395X*	FA395R*	FA395SV*	MD6173D	MD6173D	UTVX6173*			
550 S	10	FA395X*	FA395R*	FA395SV*	MD6173D	MD6173D	UTVX6173*			
550 S LTD	10	FA395X*	FA395R*	FA395SV*	MD6173D	MD6173D	UTVX6173*			
550 ATV (Mid Sized)	13-14	FA395X*	FA395R*	FA395SV*	MD6375D	MD6375D				
550 ATV LTD (Mid Sized)	13-14	FA395X*	FA395R*	FA395SV*	MD6375D	MD6375D				
550 ATV XT (Mid Sized)	13-14	FA395X*	FA395R*	FA395SV*	MD6375D	MD6375D				
550 TRV LTD	13	FA395X*	FA395R*	FA395SV*	MD6375D	MD6375D				
650 H1 4 x 4 Auto Utility	04	FA271X*	FA271R*		MD6173D	MD6173D	UTVX6173*			
650 H1 4 x 4 Auto Utility	05/08	FA271X*	FA271R*		MD6173D	MD6173D	UTVX6173*			
650 H1 4 x 4 Auto LE Utility	07	FA271X*	FA271R*		MD6173D	MD6173D	UTVX6173*			
650 H1 4 x 4 SE Auto Utility	06	FA271X*	FA271R*		MD6173D	MD6173D	UTVX6173*			
650 H1	10	FA395X*	FA395R*	FA395SV*	MD6173D	MD6173D	UTVX6173*			
650 Mudpro	10-11	FA395X*	FA395R*	FA395SV*	MD6173D	MD6173D	UTVX6173*			
650 H1 Mudpro	10	FA395X*	FA395R*	FA395SV*	MD6173D	MD6173D	UTVX6173*			
650 H1 TRV	09	FA395X*	FA395R*	FA395SV*	MD6173D	MD6173D	UTVX6173*			
650 H1 TBX 4 x 4 Auto Utility	07	FA395X*	FA395R*	FA395SV*	MD6173D	MD6173D	UTVX6173*			
650 H1 TRV 4 x 4 Auto Plus Multirider	07	FA395X*	FA395R*	FA395SV*	MD6173D	MD6173D	UTVX6173*			
650 H1 TRV 4 x 4 Auto Plus LE Multirider	07	FA395X*	FA395R*	FA395SV*	MD6173D	MD6173D	UTVX6173*			
650 H1 TRV 4 x 4 Auto	08	FA395X*	FA395R*	FA395SV*	MD6173D	MD6173D	UTVX6173*			
650 TBX	09	FA395X*	FA395R*	FA395SV*	MD6173D	MD6173D	UTVX6173*			
650 V2 4 x 4 Auto Utility	04-06	FA395X*	FA395R*	FA395SV*	MD6173D	MD6173D	UTVX6173*			
650 V2 4 x 4 Auto LE Utility	04-05	FA395X*	FA395R*	FA395SV*	MD6173D	MD6173D	UTVX6173*			
650 V2 4 x 4 Auto LE TS Utility	06	FA395X*	FA395R*	FA395SV*	MD6173D	MD6173D	UTVX6173*			
700 Diesel Utility	07-08	FA395X*	FA395R*	FA395SV*	MD6173D	MD6173D	UTVX6173*			
700i GT	11-12	FA395X*	FA395R*	FA395SV*	MD6173D	MD6173D	UTVX6173*			
700 TRV H2 EFI Cruiser	09-10	FA395X*	FA395R*	FA395SV*	MD6173D	MD6173D	UTVX6173*			
700 TRV	11-12	FA395X*	FA395R*	FA395SV*	MD6173D	MD6173D	UTVX6173*			
700 TRV Cruiser	11-12	FA395X*	FA395R*	FA395SV*	MD6173D	MD6173D	UTVX6173*			
700 TRV GT	11-12	FA395X*	FA395R*	FA395SV*	MD6173D	MD6173D	UTVX6173*			
700 EFI 4 x 4 Utility	07-08	FA395X*	FA395R*	FA395SV*	MD6173D	MD6173D	UTVX6173*			
700 EFI 4 x 4 LE Utility	06	FA395X*	FA395R*	FA395SV*	MD6173D	MD6173D	UTVX6173*			
700 EFI 4 x 4 SE Utility	06	FA395X*	FA395R*	FA395SV*	MD6173D	MD6173D	UTVX6173*			
700 EFI Cruiser	11	FA395X*	FA395R*	FA395SV*	MD6173D	MD6173D	UTVX6173*			
700 EFI 4 x 4 Auto M4	08	FA395X*	FA395R*	FA395SV*	MD6173D	MD6173D	UTVX6173*			
700 EFI 4 x 4 Auto TRV LE	08	FA395X*	FA395R*	FA395SV*	MD6173D	MD6173D	UTVX6173*			
700 H1 EFI	09-10	FA395X*	FA395R*	FA395SV*	MD6173D	MD6173D	UTVX6173*			
700 H1 EFI LE	09-10	FA395X*	FA395R*	FA395SV*	MD6173D	MD6173D	UTVX6173*			
700 H1 EFI 4 x 4 Auto SE	08-09	FA395X*	FA395R*	FA395SV*	MD6173D	MD6173D	UTVX6173*			
700 H1 TBX EFI	10	FA395X*	FA395R*	FA395SV*	MD6173D	MD6173D	UTVX6173*			
700 Super Duty Diesel	10-11	FA395X*	FA395R*	FA395SV*	MD6173D	MD6173D	UTVX6173*			
700 Mudpro	10-11	FA395X*	FA395R*	FA395SV*	MD6173D	MD6173D	UTVX6173*			
700 H1 EFI Mudpro	09-10	FA395X*	FA395R*	FA395SV*	MD6173D	MD6173D	UTVX6173*			
700i	11-12	FA395X*	FA395R*	FA395SV*	MD6173D	MD6173D	UTVX6173*			
700i LTD	11-12	FA395X*	FA395R*	FA395SV*	MD6173D	MD6173D	UTVX6173*			
700i Mudpro	11-13	FA395X*	FA395R*	FA395SV*	MD6173D	MD6173D	UTVX6173*			
700i Mudpro LTD	11	FA395X*	FA395R*	FA395SV*	MD6173D	MD6173D	UTVX6173*			
700 S	10	FA395X*	FA395R*	FA395SV*	MD6173D	MD6173D	UTVX6173*			
700 S LTD	10	FA395X*	FA395R*	FA395SV*	MD6173D	MD6173D	UTVX6173*			
700 TBX LTD	11	FA395X*	FA395R*	FA395SV*	MD6173D	MD6173D	UTVX6173*			
700 ATV (Core/Mid Size)	13-14	FA395X*	FA395R*	FA395SV*	TBA	TBA				
700 ATV Diesel	12-13	FA395X*	FA395R*	FA395SV*	MD6375D	MD6375D				
700 ATV LTD	12-14	FA395X*	FA395R*	FA395SV*	MD6375D	MD6375D				
700 ATV XT	13-14	FA395X*	FA395R*	FA395SV*	MD6375D	MD6375D				

Line #

FRONT

* This symbol indicates a rotor made of billet steel, and should be only used with EBC FA Kevlar® Organic or Vee pads.
 SAFETY NOTICE - With vehicles primarily designed for off highway use such as quads now being used on the highway, we would recommend the use of X or MXS pads for highway use and ONLY using the R and SV higher density / harder pad series for off road riding.

*-2 Sets Required. ■ - Also available in MX-S race compound. **SAFETY WARNING:- DO NOT USE HH PADS ON REAR UNLESS ALSO USED ON FRONT TO AVOID BRAKE IMBALANCE**

FRONT: Non-Japanese Bikes Cont'd

REAR: Non-Japanese Bikes

Line #	BRAKE ROTOR CHOICES - FRONT						DISC PAD CHOICES - REAR				BRAKE ROTOR CHOICES - REAR				
	CC Custom Rotor	CX Extreme® /Vee-Rotor	OS Series Oversize 250/280mm Rotor Kit	OSX Series Oversize 280mm Rotor Kit	Relocating Bracket for 250/280mm Rotor	SMX Series Oversize 320mm Rotor Kit	Relocating Bracket for 320mm Rotor		Semi-Sintered V-Pads™	Sintered/HH Pads/ Grooved Shoes	SV Series Severe Duty Pads	Standard Rotor	UTVX Rotor	Vintage Rotor	Contour Profile Rotor
1							FA395X		FA395R	FA395SV	MD6173D	UTVX6173			
2							FA395X		FA395R	FA395SV	MD6173D	UTVX6173			
3							FA395X		FA395R	FA395SV	MD6173D	UTVX6173			
4							FA395X		FA395R	FA395SV	MD6173D	UTVX6173			
5							FA395X		FA395R	FA395SV	MD6173D	UTVX6173			
6							FA395X		FA395R	FA395SV	MD6173D	UTVX6173			
7							FA395X		FA395R	FA395SV	MD6375D				
8							FA395X		FA395R	FA395SV	MD6375D				
9							FA395X		FA395R	FA395SV	MD6375D				
10							FA395X		FA395R	FA395SV	MD6375D				
11							FA271X		FA271R		MD6173D	UTVX6173			
12							FA271X		FA271R		MD6173D	UTVX6173			
13							FA271X		FA271R		MD6173D	UTVX6173			
14							FA271X		FA271R		MD6173D	UTVX6173			
15							FA395X		FA395R	FA395SV	MD6173D	UTVX6173			
16							FA395X		FA395R	FA395SV	MD6173D	UTVX6173			
17							FA395X		FA395R	FA395SV	MD6173D	UTVX6173			
18							FA395X		FA395R	FA395SV	MD6173D	UTVX6173			
19							FA395X		FA395R	FA395SV	MD6173D	UTVX6173			
20							FA395X		FA395R	FA395SV	MD6173D	UTVX6173			
21							FA395X		FA395R	FA395SV	MD6173D	UTVX6173			
22							FA395X		FA395R	FA395SV	MD6173D	UTVX6173			
23							FA395X		FA395R	FA395SV	MD6173D	UTVX6173			
24							FA395X		FA395R	FA395SV	MD6173D	UTVX6173			
25							FA395X		FA395R	FA395SV	MD6173D	UTVX6173			
26							FA395X		FA395R	FA395SV	MD6173D	UTVX6173			
27							FA395X		FA395R	FA395SV	MD6173D	UTVX6173			
28							FA395X		FA395R	FA395SV	MD6173D	UTVX6173			
29							FA395X		FA395R	FA395SV	MD6173D	UTVX6173			
30							FA395X		FA395R	FA395SV	MD6173D	UTVX6173			
31							FA395X		FA395R	FA395SV	MD6173D	UTVX6173			
32							FA395X		FA395R	FA395SV	MD6173D	UTVX6173			
33							FA395X		FA395R	FA395SV	MD6173D	UTVX6173			
34							FA395X		FA395R	FA395SV	MD6173D	UTVX6173			
35							FA395X		FA395R	FA395SV	MD6173D	UTVX6173			
36							FA395X		FA395R	FA395SV	MD6173D	UTVX6173			
37							FA395X		FA395R	FA395SV	MD6173D	UTVX6173			
38							FA395X		FA395R	FA395SV	MD6173D	UTVX6173			
39							FA395X		FA395R	FA395SV	MD6173D	UTVX6173			
40							FA395X		FA395R	FA395SV	MD6173D	UTVX6173			
41							FA395X		FA395R	FA395SV	MD6173D	UTVX6173			
42							FA395X		FA395R	FA395SV	MD6173D	UTVX6173			
43							FA395X		FA395R	FA395SV	MD6173D	UTVX6173			
44							FA395X		FA395R	FA395SV	MD6173D	UTVX6173			
45							FA395X		FA395R	FA395SV	MD6173D	UTVX6173			
46							FA395X		FA395R	FA395SV	MD6173D	UTVX6173			
47							FA395X		FA395R	FA395SV	MD6173D	UTVX6173			
48							FA395X		FA395R	FA395SV	MD6173D	UTVX6173			
49							FA395X		FA395R	FA395SV	MD6173D	UTVX6173			
50							FA395X		FA395R	FA395SV	MD6173D	UTVX6173			
51							FA395X		FA395R	FA395SV	MD6173D	UTVX6173			
52							FA395X		FA395R	FA395SV	MD6173D	UTVX6173			
53							FA395X		FA395R	FA395SV	TBA				
54							FA395X		FA395R	FA395SV	MD6375D				
55							FA395X		FA395R	FA395SV	MD6375D				
56							FA395X		FA395R	FA395SV	MD6375D				

REAR

This symbol indicates a rotor made of billet steel, and should be only used with EBC FA Kevlar® Organic or Vee pads.
 SAFETY NOTICE - With vehicles primarily designed for off highway use such as quads now being used on the highway, we would recommend the use of X or MXS pads for highway use and ONLY using the R and SV higher density / harder pad series for off road riding.

BRAKE APPLICATIONS

*-2 Sets Required. ■ - Also available in MX-S race compound. **SAFETY WARNING:- DO NOT USE HH PADS ON REAR UNLESS ALSO USED ON FRONT TO AVOID BRAKE IMBALANCE**

FRONT: Non-Japanese Bikes

APPLICATIONS

BRAKE



ARCTIC CAT (ATV)



DISC PAD CHOICES - FRONT

BRAKE ROTOR CHOICES - FRONT

700 TBX	13	FA395X*	FA395R*	FA395SV*	MD6375D	MD6375D				
700 TRV XT	13	FA395X*	FA395R*	FA395SV*	MD6375D	MD6375D				
1000 Mudpro	10-13	FA395X*	FA395R*	FA395SV*	MD6271D	MD6271D	UTVX6271*			
1000 H2 Mudpro EFI	10	FA395X*	FA395R*	FA395SV*	MD6173D	MD6173D	UTVX6173*			
1000 TRV Cruiser	11	FA395X*	FA395R*	FA395SV*	MD6173D	MD6173D	UTVX6173*			
1000 TRV H2 EFI Cruiser	09-10	FA395X*	FA395R*	FA395SV*	MD6173D	MD6173D	UTVX6173*			
Thundercat 1000 H2	08-10	FA395X*	FA395R*	FA395SV*	MD6173D	MD6173D	UTVX6173*			
Thundercat 1000 H2 LE	10	FA395X*	FA395R*	FA395SV*	MD6173D	MD6173D	UTVX6173*			
1000 TRV H2 Efi	10	FA395X*	FA395R*	FA395SV*	MD6173D	MD6173D	UTVX6173*			
1000 XT	13-14	FA395X*	FA395R*	FA395SV*	TBA	TBA				
ARCTIC CAT (SIDE X SIDE)										
550 H1 EFI Prowler	09	FA395X*	FA395R*	FA395SV*	MD6271D	MD6271D	UTVX6271*			
HDX 500 Prowler	14	FA395X*	FA395R*	FA395SV*	MD6271D	MD6271D	UTVX6271*			
HDX 500 LTD Prowler	14	FA395X*	FA395R*	FA395SV*	MD6271D	MD6271D	UTVX6271*			
HDX 500 XT Prowler	14	FA395X*	FA395R*	FA395SV*	MD6271D	MD6271D	UTVX6271*			
XT 550	10-11	FA395X*	FA395R*	FA395SV*	MD6271D	MD6271D	UTVX6271*			
XT 550 Prowler	11-14	FA395X*	FA395R*	FA395SV*	MD6271D	MD6271D	UTVX6271*			
XT 650 H1 Prowler	06-09	FA395X*	FA395R*	FA395SV*	MD6271D	MD6271D	UTVX6271*			
650 H1 Prowler	07	FA395X*	FA395R*	FA395SV*	MD6271D	MD6271D	UTVX6271*			
650 Prowler 4 x 4/M4	08	FA395X*	FA395R*	FA395SV*	MD6271D	MD6271D	UTVX6271*			
HDX 700 Prowler	11-14	FA395X*	FA395R*	FA395SV*	MD6271D	MD6271D	UTVX6271*			
HDX 700 LTD Prowler	14	FA395X*	FA395R*	FA395SV*	MD6271D	MD6271D	UTVX6271*			
XTX 700 H1 LE Prowler	08	FA395X*	FA395R*	FA395SV*	MD6271D	MD6271D	UTVX6271*			
XTX 700 H1 EFI Prowler	09	FA395X*	FA395R*	FA395SV*	MD6271D	MD6271D	UTVX6271*			
XTX 700 Prowler	11-14	FA395X*	FA395R*	FA395SV*	MD6271D	MD6271D	UTVX6271*			
Prowler 700 HDX Trail	14-17	FA395*	FA395R*	FA395SV*	MD6271D	MD6271D	UTVX6271*			
XTZ 1000 Prowler	10-14	FA395X*	FA395R*	FA395SV*	MD6271D	MD6271D	UTVX6271*			
Wildcat 1000 GT	11-12	FA395X*	FA395R*	FA395SV*	MD6271D	MD6271D	UTVX6271*			
Wildcat 1000 GT	13-14	FA395X*	FA395R*	FA395SV*	TBA	TBA				
Wildcat 1000 LTD	13-14	FA395X*	FA395R*	FA395SV*	TBA	TBA				
Wildcat X1000	13-14	FA395X*	FA395R*	FA395SV*	TBA	TBA				
Wildcat 4 X1000	14	TBA*	TBA*	TBA*	TBA	TBA				
Wildcat 4 1000	13-14	TBA*	TBA*	TBA*	TBA	TBA				
Wildcat 4 LTD 1000	14	TBA*	TBA*	TBA*	TBA	TBA				
Wildcat 1000	15-18	FA610X*	FA610R*	FA610SV*	TBA	TBA				
Wildcat 1000 4	15-18	FA610X*	FA610R*	FA610SV*	TBA	TBA				
Wildcat X EPS 1000	15-18	FA610X*	FA610R*	FA610SV*	TBA	TBA				
Note - Hand Brake Pads And Disc Not Available For Any Models In This Range Of Quads.										
ATK										
50 MXLQ	03	TBA								
50 MXN/TN	03	TBA								
50 MXA	03	TBA								
50 MXE/MXLO	03	TBA								
125 (2 Stroke Enduro)	03	FA181X	FA181R■		TBA					
124 (4 Stroke Enduro)	03	TBA			N/A					
250/260 (2 Stroke Enduro)	03	FA181X	FA181R■		N/A					
250 (2T)	04	FA181X	FA181R■		MD6032D					MD6032C
GT 250 R V-Twin Sport	11	FA86*	FA86HH*		MD690	MD690				
GV 250 V-Twin Cruiser	11	FA86	FA86HH		N/A					
370 (2T)	04	FA181X	FA181R■		MD6032D					MD6032C
450 MX	05	TBA			TBA					
450 MX	07	FA181X	FA181R■		N/A					
450 XC	05	TBA			TBA					
450 XC	07	FA181X	FA181R■		N/A					

Line #

FRONT

* This symbol indicates a rotor made of billet steel, and should be only used with EBC FA Kevlar® Organic or Vee pads.
 SAFETY NOTICE - With vehicles primarily designed for off highway use such as quads now being used on the highway, we would recommend the use of X or MXS pads for highway use and ONLY using the R and SV higher density / harder pad series for off road riding.

*-2 Sets Required. ■ - Also available in MX-S race compound. **SAFETY WARNING:- DO NOT USE HH PADS ON REAR UNLESS ALSO USED ON FRONT TO AVOID BRAKE IMBALANCE**

FRONT: Non-Japanese Bikes Cont'd

REAR: Non-Japanese Bikes

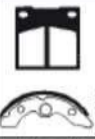
Line #	BRAKE ROTOR CHOICES - FRONT						DISC PAD CHOICES - REAR				BRAKE ROTOR CHOICES - REAR				
	CC Custom Rotor	CX Extreme® /Vee-Rotor	OS Series Oversize 250/280mm Rotor Kit	OSX Series Oversize 280mm Rotor Kit	Relocating Bracket for 250/280mm Rotor	SMX Series Oversize 320mm Rotor Kit	Relocating Bracket for 320mm Rotor		Semi-Sintered V-Pads™	Sintered/HH Pads/ Grooved Shoes	SV Series Severe Duty Pads	Standard Rotor	UTVX Rotor	Vintage Rotor	Contour Profile Rotor
1							FA395X		FA395R	FA395SV	MD6375D				
2							FA395X		FA395R	FA395SV	MD6375D				
3							FA395X		FA395R	FA395SV	MD6271D	UTVX6271			
4							FA395X		FA395R	FA395SV	MD6173D	UTVX6173			
5							FA395X		FA395R	FA395SV	MD6173D	UTVX6173			
6							FA395X		FA395R	FA395SV	MD6173D	UTVX6173			
7							FA395X		FA395R	FA395SV	MD6173D	UTVX6173			
8							FA395X		FA395R	FA395SV	MD6173D	UTVX6173			
9							FA395X		FA395R	FA395SV	MD6173D	UTVX6173			
10							FA395X		FA395R	FA395SV	TBA				
11															
12															
13							FA395X		FA395R	FA395SV	N/A				
14							FA395X		FA395R	FA395SV	N/A				
15							FA395X		FA395R	FA395SV	N/A				
16							FA395X		FA395R	FA395SV	N/A				
17							FA395X		FA395R	FA395SV	N/A				
18							FA395X		FA395R	FA395SV	N/A				
19							FA395X		FA395R	FA395SV	N/A				
20							FA395X		FA395R	FA395SV	N/A				
21							FA395X		FA395R	FA395SV	N/A				
22							FA395X*		FA395R*	FA395SV*	MD6173D*	UTVX6173*			
23							FA395X*		FA395R*	FA395SV*	MD6173D*	UTVX6173*			
24							FA395X		FA395R	FA395SV	N/A				
25							FA395X		FA395R	FA395SV	N/A				
26							FA395X		FA395R	FA395SV	N/A				
27							FA395X		FA395R	FA395SV	MD6173D	UTVX6173			
28							FA395X*		FA395R*	FA395SV*	MD6173D*	UTVX6173*			
29							FA395X*		FA395R*	FA395SV*	MD6173D*	UTVX6173*			
30							FA395X*		FA395R*	FA395SV*	TBA*				
31							FA395X*		FA395R*	FA395SV*	TBA*				
32							FA395X*		FA395R*	FA395SV*	TBA*				
33							FA395X*		FA395R*	FA395SV*	TBA*				
34							FA395X*		FA395R*	FA395SV*	TBA*				
35							FA395X*		FA395R*	FA395SV*	TBA*				
36							FA395X*		FA395R*	FA395SV*	TBA*				
37							FA395X*		FA395R*	FA395SV*	TBA*				
38							FA395X*		FA395R*	FA395SV*	TBA*				
39															
40															
41															
42							TBA								
43							TBA								
44							TBA								
45							TBA								
46							FA208X		FA208R■		TBA				
47							TBA				N/A				
48							FA208X		FA208R■		N/A				
49		MD6032CX					FA208X		FA208R■		MD6035D			MD6035C	MD6035CX
50							FA86		FA86HH		MD689				
51							606								
52		MD6032CX					FA208X		FA208R■		MD6035D			MD6035C	MD6035CX
53							TBA				TBA				
54							FA208X		FA208R■		N/A				
55							TBA				TBA				
56							FA208X		FA208R■		N/A				

BRAKE APPLICATIONS
 This symbol indicates a rotor made of billet steel, and should be only used with EBC FA Kevlar® Organic or Vee pads.
 SAFETY NOTICE - With vehicles primarily designed for off highway use such as quads now being used on the highway, we would recommend the use of X or MXS pads for highway use and ONLY using the R and SV higher density / harder pad series for off road riding.

*-2 Sets Required. ■ - Also available in MX-S race compound. **SAFETY WARNING:- DO NOT USE HH PADS ON REAR UNLESS ALSO USED ON FRONT TO AVOID BRAKE IMBALANCE**

FRONT: Non-Japanese Bikes

APPLICATIONS

BRAKE



ATK



DISC PAD CHOICES - FRONT

BRAKE ROTOR CHOICES - FRONT

450 Enduro	05	TBA			TBA					
Enduro 450	07	FA181X	FA181R■		N/A					
450 Motard	05	TBA			TBA					
Motard 450	07	FA95	FA95HH		N/A					
500 Enduro	03	FA181X	FA181R■		N/A					
500/600 Super Motard	02-03	FA95	FA95HH		N/A					
500 (2T)	04	FA181X	FA181R■		MD6032D					MD6032C
560	84-85	FA47X	FA47R		N/A					
560	86	FA47X	FA47R		N/A					
560	87-88	FA47X	FA47R		N/A					
560 & other models	89-91	FA126X	FA126R		N/A					
All models	92	FA126X	FA126R		N/A					
All models	93-96	FA135X	FA135R■		N/A					
All models	97-99	FA181X	FA181R■		N/A					
600 DTM Dirt Track Motard	03	FA95	FA95HH		N/A					
605 Enduro	03	FA181X	FA181R■		N/A					
620 (2T) Intimidator	04	FA181X	FA181R■		MD6032D					MD6032C
GT 650 R V-Twin Sport	11	FA86*	FA86HH*		MD690	MD690				
GV 650 V-Twin Cruiser	11	FA86*	FA86HH*		MD691	MD691				
700 (2T) Intimidator	04	FA181X	FA181R■		MD6032D					MD6032C
700 Intimidator	05	TBA			TBA					
BAJAJ										
Chetak 150	04-08	TBA								
BENELLI										
Caffenero Scooter 150		SFA228	SFA228HH		TBA					
Zafferano Scooter 250 EFI	Left	SFA228	SFA228HH		TBA					
	Right	SFA197	SFA197HH			TBA				
TNT 300										
BN 302 R										
TNT 600										
BENNCHE (ATV)										
500 Gray Wolf	15-16	FA84X*	FA84R*	FA84SV*	TBA	TBA				
700 Gray Wolf	15-16	FA84X*	FA84R*	FA84SV*	TBA	TBA				
BENNCHE (UTV SIDE X SIDE)										
250 Cowboy	Left	FA165X	FA165R	FA165SV	TBA					
	Right	FA135X	FA135R	FA135SV		TBA				
250 Spire	Left	FA165X	FA165R	FA165SV	TBA					
	Right	FA135X	FA135R	FA135SV		TBA				
400 Bighorn	Left	FA165X	FA165R	FA165SV	TBA					
	Right	FA135X	FA135R	FA135SV		TBA				
400 Bighorn Parking Brake	11-16									
400 Cowboy	Left	FA165X	FA165R	FA165SV	TBA					
	Right	FA135X	FA135R	FA135SV		TBA				
400 Cowboy Parking Brake	15-16									
500 Bighorn	Left	FA165X	FA165R	FA165SV	TBA					
	Right	FA135X	FA135R	FA135SV		TBA				
500 Bighorn Parking Brake	15-16									
700 Bighorn	Left	FA165X	FA165R	FA165SV	TBA					
	Right	FA135X	FA135R	FA135SV		TBA				
700 Bighorn Parking Brake	15-16									
700 X Bighorn	Left	FA165X	FA165R	FA165SV	TBA					
	Right	FA135X	FA135R	FA135SV		TBA				

Line #

FRONT

* This symbol indicates a rotor made of billet steel, and should be only used with EBC FA Kevlar® Organic or Vee pads.
 SAFETY NOTICE - With vehicles primarily designed for off highway use such as quads now being used on the highway, we would recommend the use of X or MXS pads for highway use and ONLY using the R and SV higher density / harder pad series for off road riding.

*-2 Sets Required. ■ - Also available in MX-S race compound. **SAFETY WARNING:- DO NOT USE HH PADS ON REAR UNLESS ALSO USED ON FRONT TO AVOID BRAKE IMBALANCE**

FRONT: Non-Japanese Bikes Cont'd

REAR: Non-Japanese Bikes

Line #	BRAKE ROTOR CHOICES - FRONT						DISC PAD CHOICES - REAR				BRAKE ROTOR CHOICES - REAR					
	CC Custom Rotor	CX Extreme® /Vee-Rotor	OS Series Oversize 250/280mm Rotor Kit	OSX Series Oversize 280mm Rotor Kit	Relocating Bracket for 250/280mm Rotor	SMX Series Oversize 320mm Rotor Kit	Relocating Bracket for 320mm Rotor		Semi-Sintered V-Pads™	Sintered/HH Pads/ Grooved Shoes	SV Series Severe Duty Pads	Standard Rotor	UTVX Rotor	Vintage Rotor	Contour Profile Rotor	CX Extreme® /Vee-Rotor
1																
2																
3																
4																
5																
6																
7		MD6032CX														
8																
9																
10																
11																
12																
13																
14																
15																
16																
17		MD6032CX														
18																
19																
20		MD6032CX														
21																
22																
23																
24																
25																
26																
27																
28																
29																
30																
31																
32																
33																
34																
35																
36																
37																
38																
39																
40																
41																
42																
43																
44																
45																
46																
47																
48																
49																
50																
51																
52																
53																
54																
55																
56																

⚠ This symbol indicates a rotor made of billet steel, and should be only used with EBC FA Kevlar® Organic or Vee pads.
 SAFETY NOTICE - With vehicles primarily designed for off highway use such as quads now being used on the highway, we would recommend the use of X or MXS pads for highway use and ONLY using the R and SV higher density / harder pad series for off road riding.

BRAKE APPLICATIONS

*-2 Sets Required. ■ - Also available in MX-S race compound. **SAFETY WARNING:- DO NOT USE HH PADS ON REAR UNLESS ALSO USED ON FRONT TO AVOID BRAKE IMBALANCE**

FRONT: Non-Japanese Bikes

APPLICATIONS

BRAKE



BENNCHE (UTV SIDE X SIDE)



DISC PAD CHOICES - FRONT

BRAKE ROTOR CHOICES - FRONT

													Line #
700 X Bighorn Parking Brake		15-16											1
500 Cowboy	Left	14-16	FA165X		FA165R	FA165SV	TBA						2
	Right		FA135X		FA135R	FA135SV		TBA					3
500 Cowboy Parking Brake		14-16											4
700 Cowboy	Left	14-16	FA165X		FA165R	FA165SV	TBA						5
	Right		FA135X		FA135R	FA135SV		TBA					6
700 Cowboy Parking Brake		14-16											7
800 Spire	Left	14-16	FA165X		FA165R	FA165SV	TBA						8
	Right		FA135X		FA135R	FA135SV		TBA					9
1000 Cowboy	Left	15-16	FA165X		FA165R	FA165SV	TBA						10
	Right		FA135X		FA135R	FA135SV		TBA					11
1000 Cowboy Parking Brake		15-16											12
1000 Spire	Left	14-16	FA165X		FA165R	FA165SV	TBA						13
	Right		FA135X		FA135R	FA135SV		TBA					14
1000 Spire Parking Brake		14-16											15
1000 X Spire	Left	14-16	FA165X		FA165R	FA165SV	TBA						16
	Right		FA135X		FA135R	FA135SV		TBA					17
1000 X Spire Parking Brake		14-16											18
													19
BETA													20
Eikon 50 Team		02-03	SFA115		SFA115HH		MD901D						21
Mini Trial 50		09-12	FA351				N/A						22
Rev 50/80		02-06	FA115X		FA115R		N/A						23
RR 50 Motard		06	FA167		FA167HH		N/A						24
Evo 80 Junior		09-12	FA303X				N/A						25
Evo 80		09-12	FA303X				N/A						26
125 TR32/33		86-87	FA99X		N/A		N/A						27
125 TR34		88	FA99X		N/A		N/A						28
125 TR34/35		89-90	FA115X		FA115R■		N/A						29
Evo 125 (2T)		10-15	FA303X				N/A						30
Eikon 150		04	SFA47		SFA47HH		N/A						31
Rev 3 125/200/250/270		00-04	FA303X				N/A						32
Rev 3 125/200		05	FA303X				N/A						33
Rev 3 125/200		06-08	FA303X				N/A						34
Alp 200 4T		00-06	FA115X		FA115R■		N/A						35
Evo 200 (2T)		10-15	FA303X				N/A						36
240 TR33		86-88	FA99X		N/A		N/A						37
Evo 250 (2T)		09-15	FA303X				N/A						38
Evo 250 (4T)		09-15	FA303X				N/A						39
Rev 3 250/270		05-08	FA303X				N/A						40
RR 250 (2T)		13-15	FA185X		FA185R■							N/A	41
RR 250 4T		05-08	FA185X		FA185R■		N/A						42
260 TR34		86-88	FA99X		N/A		N/A						43
260 TR34/35/Zero		89-92	FA115X		FA115R■		N/A						44
Synt/Gara		93-96	FA115X		FA115R■		N/A						45
Evo 300 (2T)		09-15	FA303X				N/A						46
Evo 300 (4T)		09-15	FA303X				N/A						47
RR 300 (2T)		13-15	FA185X		FA185R■							N/A	48
RR 350 4T		11-15	FA185X		FA185R■							MD6367C◆	49
RS 350 4T		11-12	FA185X		FA185R■		N/A						50
RR 390 4T		15	FA185X		FA185R■							N/A	51
RR 400 4T		05-11	FA185X		FA185R■		N/A						52
RR 400 4T		12-14	FA185X		FA185R■							MD6367C◆	53
SM 400 4T		10-11	FA185X		FA185R■		N/A						54
RR 430 (4T)		15	FA185X		FA185R■							N/A	55

FRONT

⚠ This symbol indicates a rotor made of billet steel, and should be only used with EBC FA Kevlar® Organic or Vee pads. SAFETY NOTICE - With vehicles primarily designed for off highway use such as quads now being used on the highway, we would recommend the use of X or MXS pads for highway use and ONLY using the R and SV higher density / harder pad series for off road riding.

Note on MD6367C ◆ Remove old speedo pick up magnet and refit to new EBC disc

*-2 Sets Required. ■ - Also available in MX-S race compound. SAFETY WARNING:- DO NOT USE HH PADS ON REAR UNLESS ALSO USED ON FRONT TO AVOID BRAKE IMBALANCE

FRONT: Non-Japanese Bikes Cont'd

REAR: Non-Japanese Bikes

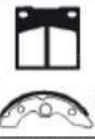
Line #	BRAKE ROTOR CHOICES - FRONT						DISC PAD CHOICES - REAR				BRAKE ROTOR CHOICES - REAR					
	CC Custom Rotor	CX Extreme® /Vee-Rotor	OS Series Oversize 250/280mm Rotor Kit	OSX Series Oversize 280mm Rotor Kit	Relocating Bracket for 250/280mm Rotor	SMX Series Oversize 320mm Rotor Kit	Relocating Bracket for 320mm Rotor		Semi-Sintered V-Pads™	Sintered/HH Pads/ Grooved Shoes	SV Series Severe Duty Pads	Standard Rotor	UTVX Rotor	Vintage Rotor	Contour Profile Rotor	CX Extreme® /Vee-Rotor
1							FA428X		FA428R			TBA				
2							FA165X		FA165R	FA165SV		TBA				
3							FA135X		FA135R	FA135SV		TBA				
4							FA428X		FA428R			TBA				
5							FA165X		FA165R	FA165SV		TBA				
6							FA135X		FA135R	FA135SV		TBA				
7							FA428X		FA428R			TBA				
8							FA165X		FA165R	FA165SV		TBA				
9							FA135X		FA135R	FA135SV		TBA				
10							FA165X		FA165R	FA165SV		TBA				
11							FA135X		FA135R	FA135SV		TBA				
12							FA428X		FA428R			TBA				
13							FA165X		FA165R	FA165SV		TBA				
14							FA135X		FA135R	FA135SV		TBA				
15							FA428X		FA428R			TBA				
16							FA165X		FA165R	FA165SV		TBA				
17							FA135X		FA135R	FA135SV		TBA				
18							FA428X		FA428R			TBA				
19																
20																
21							SFA115		SFA115HH			MD901D				
22							N/A					N/A				
23							FA115X		FA115R			N/A				
24							FA115		FA115HH			N/A				
25							FA115X		FA115R			N/A				
26							FA403X					N/A				
27									841G							
28							FA116					N/A				
29							FA115X		FA115R■			N/A				
30							FA495X					N/A				
31							SFA298		SFA298HH			N/A				
32							FA303X					N/A				
33							FA303X					N/A				
34							FA403X					N/A				
35							FA115X		FA115R■			N/A				
36							FA495X					N/A				
37									841G							
38							FA495X					N/A				
39							FA495X					N/A				
40							FA403X					N/A				
41							FA367X		FA367R■					N/A		
42							FA367X		FA367R■			N/A				
43							FA116					N/A				
44							FA164X		FA164R			N/A				
45							FA156X		N/A			N/A				
46							FA495X					N/A				
47							FA495X					N/A				
48							FA367X		FA367R■					N/A		
49							FA367X		FA367R■					MD6368C		
50							FA367X		FA367R■			N/A				
51							FA367X		FA367R■					N/A		
52							FA367X		FA367R■			N/A				
53							FA367X		FA367R■					MD6368C		
54							FA367X		FA367R■			N/A				
55							FA367X		FA367R■					N/A		
56																

This symbol indicates a rotor made of billet steel, and should be only used with EBC FA Kevlar® Organic or Vee pads. SAFETY NOTICE - With vehicles primarily designed for off highway use such as quads now being used on the highway, we would recommend the use of X or MXS pads for highway use and ONLY using the R and SV higher density / harder pad series for off road riding.

BRAKE APPLICATIONS

*-2 Sets Required. ■ - Also available in MX-S race compound. **SAFETY WARNING:- DO NOT USE HH PADS ON REAR UNLESS ALSO USED ON FRONT TO AVOID BRAKE IMBALANCE**

FRONT: Non-Japanese Bikes



BETA



DISC PAD CHOICES - FRONT

BRAKE ROTOR CHOICES - FRONT

			Semi-Sintered V-Pads™	Sintered/HH Pads/Grooved Shoes	SV Series Severe Duty Pads	Standard Rotor Left	Standard Rotor Right	UTVX Rotor	Vintage Rotor Left	Vintage Rotor Right	Contour Profile Rotor
RS 430 (4T)	15	FA185X		FA185R■							N/A
RR 450 4T	05-11	FA185X		FA185R■		N/A					
RR 450 4T	12-14	FA185X		FA185R■							MD6367C◆
RS 450 4T	08-14	FA185X		FA185R■		N/A					
SM 450 4T	10-11	FA185X		FA185R■		N/A					
RR 480 4T	15	FA185X		FA185R■							N/A
RR 498 4T	15	FA185X		FA185R■							N/A
RS 500 (4T)	15	FA185X		FA185R■							N/A
RR 520 4T	11-12	FA185X		FA185R■		N/A					
RR 525 4T	05-09	FA185X		FA185R■							MD6367C◆
RR 525 4T	10-11	FA185X		FA185R■							N/A
SM 525 4T	10-11	FA185X		FA185R■		N/A					
RS 520 4T	08-14	FA185X		FA185R■		N/A					
Note on MD6367C ◆ Remove old speedo pick up magnet and refit to new EBC disc											
BMW											
C1 125	99-03	SFA209/2		SFA209/2HH		MD968D					
C1 200	01-03	SFA209/2		SFA209/2HH		MD968D					
G 310 R	17-18	FA606		FA606HH		TBA					
G 310 GS	17-18	FA606		FA606HH		TBA					
G 450 X	08-11	FA181X		FA181R■							MD6343C
R 45/45 N (Single rotor with ATE caliper)	78-09/80	FA57	FA57V			MD606LS					
R 45/45 N (Twin rotor with ATE caliper)	08-09/80	FA57*	FA57V*			MD606LS	MD606RS				
R 45/45 N (Single rotor with ATE caliper)	10/80-85	FA57	FA57V			MD606LS					
R 45/45 N (Twin rotor with ATE caliper)	10/80-85	FA57*	FA57V*			MD606LS	MD606RS				
R 45/45 N (Single rotor with Brembo caliper)	78-09/80	FA18	FA18V	FA18HH		MD606LS					
R 45/45 N (Twin rotor with Brembo caliper)	78-09/80	FA18*	FA18V*	FA18HH*		MD606LS	MD606RS				
R 45/45 N (Single rotor with Brembo caliper)	10/80-85	FA18*	FA18V*	FA18HH*		MD606LS					
R 45/45 N (Twin rotor with Brembo calipers)	10/80-85	FA18*	FA18V*	FA18HH*		MD606LS	MD606RS				
R 45 T	80-85	FA57	FA57V			MD606LS					
R 50/5/60/5/60/6/75/5	69-76	864									
C 600 Sport (Scooter) (K18C)	12-14	SFA142*		SFA142HH*		TBA	TBA				
C 600 Sport (Scooter) (K18C) Parking Brake	12-14	SFA257/2									
R 60/7 (Single rotor)	76-80	FA22	FA22V			MD602LS					
R 60/7 (Double rotor model)	76-80	FA22*	FA22V*			MD602LS	MD602RS				
R 60 TIC (Single rotor)	78-82	FA22	FA22V			MD602LS					
R 60 TIC (Double rotor model)	78-82	FA22*	FA22V*			MD602LS	MD602RS				
C 650 GT (Scooter) (K19C)	12-15	SFA142*		SFA142HH*		TBA	TBA				
C 650 GT (Scooter) (K19C) Parking Brake	12-15	SFA257/2									
C 650 GT Special Edition (Scooter)	15	SFA142*		SFA142HH*		TBA	TBA				
C 650 GT Special Edition (Scooter) Parking Brake	15	SFA257/2									
F 650 (E169/0161)	09/93-96	FA209/2	FA209/2V	FA209/2HH		MD650					
F 650 (E169/0162 Funduro/High Screen/19" Front Wheel)	97-00	FA209/2	FA209/2V	FA209/2HH		MD650					
F 650 CS Scarver (K14/0174/0184/Belt Drive/17" Cast Wheel)	00-03	FA209/2	FA209/2V	FA209/2HH		MD834					
F 650 CS Scarver (K14/0177/0187/Belt Drive/17" Cast Wheel)	04-07	FA209/2	FA209/2V	FA209/2HH		MD834					
F 650 GS (R13/0172/0182)	99-03	FA209/2	FA209/2V	FA209/2HH		MD834					
F 650 GS (R13/0175/0185/Single Cylinder/19" Front Wheel)	04-07	FA209/2	FA209/2V	FA209/2HH		MD834					
F 650 GS (K72/0218/0228/798 cc Twin Cylinder/Cast Wheels)	07-13	FA209/2	FA209/2V	FA209/2HH		MD834X					
F 650 GS (30 Years GS/798 cc Twin Cylinder/Cast Wheels)	11	FA209/2	FA209/2V	FA209/2HH		MD834X					
F 650 GS Dakar (R13/0173/0183/21" Front Wheel)	99-03	FA209/2	FA209/2V	FA209/2HH		MD834					
F 650 GS Dakar (R13/0176/0186/Single Cylinder/21" Front Wheel)	04-07	FA209/2	FA209/2V	FA209/2HH		MD834					
F 650 ST (E169/163/168/Strada/18" Front Wheel/Low Screen)	97-00	FA209/2	FA209/2V	FA209/2HH		MD650					
G 650 GS (R131/Single Cylinder/Chain Drive/Cast Wheels)	09-15	FA209/2	FA209/2V	FA209/2HH		MD834X					
G 650 GS Sertao (Spoke Wheel/Single Cylinder/Chain Drive)	10-14	FA209/2	FA209/2V	FA209/2HH		MD834X					
G 650 XChallenge	07-09	FA209/2	FA209/2V	FA209/2HH							MD809C
G 650 Xmoto	07-09	FA244	FA244V	FA244HH		MD621X					MD621XC

FRONT

Line #
1
2
3
4
5
6
7
8
9
10
11
12
13
14
15
16
17
18
19
20
21
22
23
24
25
26
27
28
29
30
31
32
33
34
35
36
37
38
39
40
41
42
43
44
45
46
47
48
49
50
51
52
53
54
55
56

APPLICATIONS
BRAKE
BETA
SAFETY NOTICE - With vehicles primarily designed for off highway use such as quads now being used on the highway, we would recommend the use of X or MXS pads for highway use and ONLY using the R and SV higher density / harder pad series for off road riding.
◆ This symbol indicates a rotor made of billet steel, and should be only used with EBC FA Kevlar® Organic or Vee pads.

*-2 Sets Required. ■ - Also available in MX-S race compound. **SAFETY WARNING:- DO NOT USE HH PADS ON REAR UNLESS ALSO USED ON FRONT TO AVOID BRAKE IMBALANCE**

FRONT: Non-Japanese Bikes Cont'd

REAR: Non-Japanese Bikes

Line #	BRAKE ROTOR CHOICES - FRONT						DISC PAD CHOICES - REAR				BRAKE ROTOR CHOICES - REAR					
	CC Custom Rotor	CX Extreme® /Vee-Rotor	OS Series Oversize 250/280mm Rotor Kit	OSX Series Oversize 280mm Rotor Kit	Relocating Bracket for 250/280mm Rotor	SMX Series Oversize 320mm Rotor Kit	Relocating Bracket for 320mm Rotor		Semi-Sintered V-Pads™	Sintered/HH Pads/ Grooved Shoes	SV Series Severe Duty Pads	Standard Rotor	UTVX Rotor	Vintage Rotor	Contour Profile Rotor	CX Extreme® /Vee-Rotor
1							FA367X		FA367R■						N/A	
2							FA367X		FA367R■		N/A					
3							FA367X		FA367R■					MD6368C		
4							FA367X		FA367R■		N/A					
5							FA367X		FA367R■		N/A					
6							FA367X		FA367R■						N/A	
7							FA367X		FA367R■						N/A	
8							FA367X		FA367R■						N/A	
9							FA367X		FA367R■		N/A					
10							FA367X		FA367R■					MD6368C		
11							FA367X		FA367R■					N/A		
12							FA367X		FA367R■		N/A					
13							FA367X		FA367R■		N/A					
14																
15																
16																
17							SFA213		SFA213HH		MD968D					
18							SFA213		SFA213HH		MD968D					
19							FA213	FA213V	FA213HH		TBA					
20							FA213	FA213V	FA213HH		TBA					
21			OS6343C	OSX6343	BRK011	SMX6343	BRK012	FA368X		FA368R■		MD6342D			MD6342C	
22							860									
23							860									
24							861									
25							861									
26							860									
27							860									
28							861									
29							861									
30							861									
31							860									
32							SFA196		SFA196HH		TBA					
33																
34							860									
35							860									
36							860									
37							860									
38							SFA196		SFA196HH		TBA					
39																
40							SFA196		SFA196HH		TBA					
41																
42							FA213	FA213V	FA213HH		MD651					
43							FA213	FA213V	FA213HH		MD651					
44							FA213	FA213V	FA213HH		MD651					
45							FA213	FA213V	FA213HH		MD651					
46							FA213	FA213V	FA213HH		MD651					
47							FA213	FA213V	FA213HH		MD651					
48							FA213	FA213V	FA213HH		MD671					
49							FA213	FA213V	FA213HH		MD671					
50							FA213	FA213V	FA213HH		MD651					
51							FA213	FA213V	FA213HH		MD651					
52							FA213	FA213V	FA213HH		MD651					
53							FA213	FA213V	FA213HH		MD651					
54							FA213	FA213V	FA213HH		MD651					
55							FA213	FA213V	FA213HH						MD810C	
56							FA213	FA213V	FA213HH		MD845					

BRAKE APPLICATIONS

⚠ This symbol indicates a rotor made of billet steel, and should be only used with EBC FA Kevlar® Organic or Vee pads.
 SAFETY NOTICE - With vehicles primarily designed for off highway use such as quads now being used on the highway, we would recommend the use of X or MXS pads for highway use and ONLY using the R and SV higher density / harder pad series for off road riding.

*-2 Sets Required. ■ - Also available in MX-S race compound. **SAFETY WARNING:- DO NOT USE HH PADS ON REAR UNLESS ALSO USED ON FRONT TO AVOID BRAKE IMBALANCE**

FRONT: Non-Japanese Bikes

APPLICATIONS

BRAKE



BMW



DISC PAD CHOICES - FRONT

BRAKE ROTOR CHOICES - FRONT

G 650 XCountry	07-09	FA209/2	FA209/2V	FA209/2HH		MD809			MD809C
R 65 (Single rotor)	07/88-08/89	FA77	FA77V			N/A			
R 65 (Double rotor model)	07/88-08/89	FA18*	FA18V*	FA18HH*		MD605LS	MD605RS		
R 65 GS	87-92	FA18	FA18V	FA18HH			MD606RS		
R 65 GS	87-92	FA18	FA18V	FA18HH		MD606RS			
R 65 LS	81-85	FA57*	FA57V*			MD606LS	MD606RS		
R 65 LS (Brembo caliper)	81-85	FA18*	FA18V*	FA18HH*		MD606LS	MD606RS		
R 65 RT	85-88	FA18*	FA18V*	FA18HH*		MD605LS	MD605RS		
R 65 T	80-85	FA57	FA57V			MD606LS			
R 65 T (Brembo caliper)	80-85	FA18	FA18V	FA18HH		MD606LS			
F 700 GS (Twin cylinder model/798cc/Spoke wheel)	11-17	FA209/2*	FA209/2V*	FA209/2HH*		MD834X	MD834X		
K 75/75-S (Non ABS)	84-08/88	FA18*	FA18V*	FA18HH*		MD604LS	MD604RS		
K 75/75-2 (Non ABS)	84-07/90	FA18*	FA18V*	FA18HH*		MD603LS	MD603RS		
K 75/75-2 (Non ABS)	09/88-96	FA171*	FA171V*	FA171HH*		MD604LS	MD604RS		
K 75/75-S (ABS Model)	08/90-96	FA171*	FA171V*	FA171HH*		MD603LSⓄ	MD603RSⓄ		
K 75 C	85-08/88	FA18*	FA18V*	FA18HH*		MD604LS	MD604RS		
K 75 C	02/88-90	FA171*	FA171V*	FA171HH*		MD604LS	MD604RS		
K 75 RT (Non ABS)	89-96	FA171*	FA171V*	FA171HH*		MD604LS	MD604RS		
K 75 RT (ABS Model)	89-96	FA171*	FA171V*	FA171HH*		MD603LSⓄ	MD603RSⓄ		
K 75 S (Non ABS)	85-09/88	FA18*	FA18V*	FA18HH*		MD604LS	MD604RS		
K 75 S (Non ABS Model)	09/88-95	FA171*	FA171V*	FA171HH*		MD604LS	MD604RS		
K 75 S (ABS Model)	85-09/88	FA18*	FA18V*	FA18HH*		MD603LSⓄ	MD603RSⓄ		
K 75 S (ABS Model)	09/88-95	FA171*	FA171V*	FA171HH*		MD603LSⓄ	MD603RSⓄ		
R 75/6 (Single rotor) 75/7	73-79	FA22	FA22V			MD602LS			
R 75/6 (Twin rotor) 75/7	73-79	FA22*	FA22V*			MD602LS	MD602RS		
F 800 GS (Twin cylinder model/798cc/Spoke wheel)	08-17	FA209/2*	FA209/2V*	FA209/2HH*		MD834X	MD834X		
F 800 GS Adventure (Twin cylinder model/798cc/Spoke wheel)	12-17	FA209/2*	FA209/2V*	FA209/2HH*		MD834X	MD834X		
F 800 GT	13-15	FA244*	FA244V*	FA244HH*		TBA	TBA		
F 800 R (Disc has fixed bobbins)	09-14	FA244*	FA244V*	FA244HH*		N/A	N/A		
F 800 R (Disc has fixed bobbins)	15			FA630HH*		N/A	N/A		
F 800 S/ST (Disc has loose bobbins)	06-08	FA244*	FA244V*	FA244HH*		MD803	MD803		
F 800 ST (Disc has fixed bobbins)	09-13	FA244*	FA244V*	FA244HH*		N/A	N/A		
R 80 GS	80-87	FA18		FA18HH		MD606RS			
R 80 GS	87-95	FA77	FA77V			MD606RS			
R 80 PD/CH	90-95	FA77	FA77V			MD606RS			
R 80 (Single rotor)	77-09/80	FA22	FA22V			MD602LS			
R 80 (Double rotor)	77-09/80	FA22*	FA22V*			MD602LS	MD602RS		
R 80 (Single rotor)	10/80-84	FA22	FA22V			MD602LS			
R 80 (Double rotor)	10/80-84	FA22*	FA22V*			MD602LS	MD602RS		
R 80/R 80 RT (Single rotor)	84-07/90	FA77	FA77V			N/A			
R 80 RT (Double rotor)	82-84	FA18*	FA18V*	FA18HH*		MD602LS	MD602RS		
R 80/R 80 RT (Double rotor)	84-08/88	FA18*	FA18V*	FA18HH*		MD605LS	MD605RS		
R 80/R 80 RT (Single rotor)	08/90-95	FA77	FA77V				MD605RS		
R 80/R 80 RT (Double rotor)	09/88-95	FA171*	FA171V*	FA171HH*		MD605LS	MD605RS		
R 80 ST	82-84	FA18	FA18V	FA18HH			MD606RS		
R 80 TIC	78-08/80	FA22*	FA22V*			MD602LS	MD602RS		
R 80 TIC	09/80-85	FA18*	FA18V*	FA18HH*		MD602LS	MD602RS		
R 80 Mystic	94-95	FA407*		FA407HH*		MD605LS	MD605RS		
R 80 R	91-94	FA407*		FA407HH*		MD605LS	MD605RS		
R 850 C (Cast wheel/ABS)	97-00	FA407*		FA407HH*		MD652Ⓞ	MD652Ⓞ		MD652C*
R 850 C (Spoke wheel/ABS)	97-00	FA407*		FA407HH*		MD652Ⓞ	MD652Ⓞ		MD652C*
R 850 GS	96	FA77	FA77V			MD605RS			
R 850 GS (Std & ABS models)	96-00	FA407*		FA407HH*		MD652	MD652		MD652C*
R 850 R (Cast wheel/ABS)	94-02	FA407*		FA407HH*		MD607LSⓄ	MD607RSⓄ		

Line #
1
2
3
4
5
6
7
8
9
10
11
12
13
14
15
16
17
18
19
20
21
22
23
24
25
26
27
28
29
30
31
32
33
34
35
36
37
38
39
40
41
42
43
44
45
46
47
48
49
50
51
52
53
54
55
56

* This symbol indicates a rotor made of billet steel, and should be only used with EBC FA Kevlar® Organic or Vee pads.
 SAFETY NOTICE - With vehicles primarily designed for off highway use such as quads now being used on the highway, we would recommend the use of X or MXS pads for highway use and ONLY using the R and SV higher density / harder pad series for off road riding.

Ⓞ - remove ABS ring from old rotor and refit to new EBC rotor. Note: Ensure all mounting surfaces are clean and when refitting bolts use a thread lock cement to hold them in place.

*-2 Sets Required. ■ - Also available in MX-S race compound. SAFETY WARNING:- DO NOT USE HH PADS ON REAR UNLESS ALSO USED ON FRONT TO AVOID BRAKE IMBALANCE

FRONT: Non-Japanese Bikes Cont'd

REAR: Non-Japanese Bikes

Line #	BRAKE ROTOR CHOICES - FRONT						DISC PAD CHOICES - REAR				BRAKE ROTOR CHOICES - REAR				
	CC Custom Rotor	CX Extreme® /Vee-Rotor	OS Series Oversize 250/280mm Rotor Kit	OSX Series Oversize 280mm Rotor Kit	Relocating Bracket for 250/280mm Rotor	SMX Series Oversize 320mm Rotor Kit	Relocating Bracket for 320mm Rotor		Semi-Sintered V-Pads™	Sintered/HH Pads/ Grooved Shoes	SV Series Severe Duty Pads	Standard Rotor	UTVX Rotor	Vintage Rotor	Contour Profile Rotor
1							FA213	FA213V	FA213HH		MD810			MD810C	
2							861								
3							861								
4							861								
5							861								
6							862								
7							862								
8							861								
9							861								
10							861								
11							FA213	FA213V	FA213HH		MD671				
12							863								
13							861								
14							861								
15							FA18	FA18V	FA18HH		MD611Ⓣ				
16							861								
17							861								
18							FA18	FA18V	FA18HH		MD611				
19							FA18	FA18V	FA18HH		MD661Ⓣ				
20							FA18	FA18V	FA18HH		MD611				
21							FA18	FA18V	FA18HH		MD611				
22							FA18	FA18V	FA18HH		MD661Ⓣ				
23							FA18	FA18V	FA18HH		MD661Ⓣ				
24							860								
25							860								
26							FA213	FA213V	FA213HH		MD671				
27							FA213	FA213V	FA213HH		MD671				
28							FA213	FA213V	FA213HH		MD671				
29							FA213	FA213V	FA213HH		MD671				
30							FA213	FA213V	FA213HH		MD671				
31							FA213	FA213V	FA213HH		MD671				
32							FA213	FA213V	FA213HH		MD671				
33							861								
34							859								
35							859								
36							860								
37							860								
38							861								
39							861								
40							861								
41							861								
42							861								
43							861								
44							859								
45							861								
46							860								
47							861								
48							859								
49							859								
50							FA363	FA363V	FA363HH		N/A				
51							FA363	FA363V	FA363HH		N/A				
52							859								
53							FA363	FA363V	FA363HH		MD653			MD653C	
54							FA363	FA363V	FA363HH		MD653Ⓣ				
55															
56															

Ⓣ This symbol indicates a rotor made of billet steel, and should be only used with EBC FA Kevlar® Organic or Vee pads.
 SAFETY NOTICE - With vehicles primarily designed for off highway use such as quads now being used on the highway, we would recommend the use of X or MXS pads for highway use and ONLY using the R and SV higher density / harder pad series for off road riding.

BRAKE APPLICATIONS

*-2 Sets Required. ■ - Also available in MX-S race compound. **SAFETY WARNING:- DO NOT USE HH PADS ON REAR UNLESS ALSO USED ON FRONT TO AVOID BRAKE IMBALANCE**

FRONT: Non-Japanese Bikes

APPLICATIONS

BRAKE



BMW



DISC PAD CHOICES - FRONT

BRAKE ROTOR CHOICES - FRONT

			Semi-Sintered V-Pads™	Sintered/HH Pads/Grooved Shoes	SV Series Severe Duty Pads	Standard Rotor Left	Standard Rotor Right	UTVX Rotor	Vintage Rotor Left	Vintage Rotor Right	Contour Profile Rotor
R 850 R (Spoke wheel)	94-05/96	FA407*		FA407HH*		MD652	MD652				MD652C*
R 850 RT (Cast wheel/ABS)	96-01	FA407*		FA407HH*		MD607LSⓄ	MD607RSⓄ				
R 850 RT (Spoke wheel)	96-01	FA407*		FA407HH*		MD652	MD652				MD652C*
R 850 RT	06			FA335HH*		MD620	MD620				
R 850 R	03-06			FA294HH*		MD616	MD616				
R 90 S	73-76	FA22*	FA22V*			MD602LS	MD602RS				
R 90/6 (Single rotor)	73-76	FA22	FA22V			MD602LS					
R 90/6 (Twin rotor)	73-76	FA22*	FA22V*			MD602LS	MD602RS				
HP4 (1000cc)	13-14			FA447HH*		TBA	TBA				
K1 (16 valve - Non ABS)	88-93	FA407*		FA407HH*		MD607LS	MD607RS				
K1 (16 valve - ABS models)	88-93	FA407*		FA407HH*		MD607LSⓄ	MD607RSⓄ				
K 100 (Non ABS - 8 valve model)	82-09/88	FA18*	FA18V*	FA18HH*		MD604LS	MD604RS				
K 100/2 (Non ABS - 8 valve model)	87-08/88	FA18*	FA18V*	FA18HH*		MD604LS	MD604RS				
K 100/2 (Non ABS - 8 valve model)	09/88-90	FA171*	FA171V*	FA171HH*		MD604LS	MD604RS				
K 100/2 (ABS - 8 valve model)	87-08/88	FA18*	FA18V*	FA18HH*		MD603LSⓄ	MD603RSⓄ				
K 100/2 (ABS - 8 valve model)	09/88-90	FA171*	FA171V*	FA171HH*		MD603LSⓄ	MD603RSⓄ				
K 100 LT (Non ABS - 8 valve model)	86-08/88	FA18*	FA18V*	FA18HH*		MD604LS	MD604RS				
K 100 LT (Non ABS - 8 valve model)	09/88-91	FA171*	FA171V*	FA171HH*		MD604LS	MD604RS				
K 100 LT (ABS - 8 valve model)	86-/8/88	FA18*	FA18V*	FA18HH*		MD603LSⓄ	MD603RSⓄ				
K 100 LT (ABS - 8 valve model)	09/88-91	FA171*	FA171V*	FA171HH*		MD603LSⓄ	MD603RSⓄ				
K 100 RS (Non ABS - 8 valve)	83-09/88	FA18*	FA18V*	FA18HH*		MD604LS	MD604RS				
K 100 RS (Non ABS - 8 valve)	10/88-89	FA171*	FA171V*	FA171HH*		MD604LS	MD604RS				
K 100 RS (ABS Model - 8 valve)	83-09/88	FA18*	FA18V*	FA18HH*		MD603LSⓄ	MD603RSⓄ				
K 100 RS (ABS Model - 8 valve)	10/88-89	FA171*	FA171V*	FA171HH*		MD603LSⓄ	MD603RSⓄ				
K 100 RT (Non ABS - 8 valve)	83-09/88	FA18*	FA18V*	FA18HH*		MD604LS	MD604RS				
K 100 RT (Non ABS - 8 valve)	10/88-89	FA171*	FA171V*	FA171HH*		MD604LS	MD604RS				
K 100 RT (ABS - 8 valve)	83-09/88	FA18*	FA18V*	FA18HH*		MD603LSⓄ	MD603RSⓄ				
K 100 RT (ABS - 8 valve)	10/88-89	FA171*	FA171V*	FA171HH*		MD603LSⓄ	MD603RSⓄ				
K 100 RS (16 valve - Non ABS)	89-92	FA407*		FA407HH*		MD607LS	MD607RS				
K 100 RS (16 valve - ABS Models)	89-92	FA407*		FA407HH*		MD607LSⓄ	MD607RSⓄ				
R 100 GS	86-94	FA77	FA77V				MD605RS				
R 100 PD	89-96	FA77	FA77V				MD605RS				
R 100 (Single rotor)	76-77	FA22	FA22V			MD602LS					
R 100 (Twin rotor)	76-77	FA22*	FA22V*			MD602LS	MD602RS				
R 100/7T (Single rotor)	77-09/80	FA22	FA22V			MD602LS					
R 100/7T (Twin rotor)	77-09/80	FA22*	FA22V*			MD602LS	MD602RS				
R 100/7T (Spoke wheel)	09/80-84	FA18*	FA18V*	FA18HH*		MD606LS	MD606RS				
R 100/7T (Cast wheel)	09/80-84	FA18*	FA18V*	FA18HH*		MD602LS	MD602RS				
R 100 S	76-08/80	FA22*	FA22V*			MD602LS	MD602RS				
R 100 RS	76-09/80	FA22*	FA22V*			MD602LS	MD602RS				
R 100 RS	10/80-84	FA18*	FA18V*	FA18HH*		MD602LS	MD602RS				
R 100 RS	86-08/88	FA18*	FA18V*	FA18HH*		MD605LS	MD605RS				
R 100 RS	09/88-08/89	FA171*	FA171V*	FA171HH*		MD605LS	MD605RS				
R 100 RS	9/9-92	FA171*	FA171V*	FA171HH*		MD605LS	MD605RS				
R 100 RT	78-09/80	FA22*	FA22V*			MD602LS	MD602RS				
R 100 RT	10/80-84	FA18*	FA18V*	FA18HH*		MD602LS	MD602RS				
R 100 RT	87-08/88	FA18*	FA18V*	FA18HH*		MD605LS	MD605RS				
R 100 RT	09/88-08/89	FA171*	FA171V*	FA171HH*		MD605LS	MD605RS				
R 100 RT	09/89-95	FA171*	FA171V*	FA171HH*		MD605LS	MD605RS				
R 100 Mystic	93-96	FA407*		FA407HH*		MD605LS	MD605RS				
R 100 R	91-95	FA407*		FA407HH*		MD605LS	MD605RS				
S 1000 R Naked	14-15			FA604/4HH*		N/A	N/A				
S 1000 RR	10-17			FA604/4HH*		N/A	N/A				
S 1000 RR (Models fitted with Forged race wheels 7 spoke type)	15-17			FA604/4HH*		MD862X	MD862X				

FRONT

Line #

Ⓞ This symbol indicates a rotor made of billet steel, and should be only used with EBC FA Kevlar® Organic or Vee pads. SAFETY NOTICE - With vehicles primarily designed for off highway use such as quads now being used on the highway, we would recommend the use of X or MXS pads for highway use and ONLY using the R and SV higher density / harder pad series for off road riding.

Ⓞ - remove ABS ring from old rotor and refit to new EBC rotor. Note: Ensure all mounting surfaces are clean and when refitting bolts use a thread lock cement to hold them in place.

*-2 Sets Required. ■ - Also available in MX-S race compound. SAFETY WARNING:- DO NOT USE HH PADS ON REAR UNLESS ALSO USED ON FRONT TO AVOID BRAKE IMBALANCE

FRONT: Non-Japanese Bikes Cont'd

REAR: Non-Japanese Bikes

Line #	BRAKE ROTOR CHOICES - FRONT						DISC PAD CHOICES - REAR				BRAKE ROTOR CHOICES - REAR					
	CC Custom Rotor	CX Extreme® /Vee-Rotor	OS Series Oversize 250/280mm Rotor Kit	OSX Series Oversize 280mm Rotor Kit	Relocating Bracket for 250/280mm Rotor	SMX Series Oversize 320mm Rotor Kit	Relocating Bracket for 320mm Rotor		Semi-Sintered V-Pads™	Sintered/HH Pads/ Grooved Shoes	SV Series Severe Duty Pads	Standard Rotor	UTVX Rotor	Vintage Rotor	Contour Profile Rotor	CX Extreme® /Vee-Rotor
1							FA363	FA363V	FA363HH		MD653				MD653C	
2							FA363	FA363V	FA363HH		MD653①					
3											① - remove rotor outer ring from centre casting and refit.					
4							FA363	FA363V	FA363HH		MD653				MD653C	
5							FA363	FA363V	FA363HH		MD653					
6							FA363	FA363V	FA363HH		MD653					
7							860									
8							860									
9							860									
10							FA213		FA213HH		MD832					
11							FA18	FA18V	FA18HH		MD611					
12							FA18	FA18V	FA18HH		MD661②					
13							FA18	FA18V	FA18HH		MD611					
14							FA18	FA18V	FA18HH		MD611					
15							FA18	FA18V	FA18HH		MD611					
16							FA18	FA18V	FA18HH		MD661②					
17							FA18	FA18V	FA18HH		MD661②					
18							FA18	FA18V	FA18HH		MD611					
19							FA18	FA18V	FA18HH		MD611					
20							FA18	FA18V	FA18HH		MD661②					
21							FA18	FA18V	FA18HH		MD661②					
22							FA18	FA18V	FA18HH		MD611					
23							FA18	FA18V	FA18HH		MD611					
24							FA18	FA18V	FA18HH		MD661②					
25							FA18	FA18V	FA18HH		MD661②					
26							FA18	FA18V	FA18HH		MD611					
27							FA18	FA18V	FA18HH		MD661					
28							FA18	FA18V	FA18HH		MD661②					
29							FA18	FA18V	FA18HH		MD661②					
30							FA18	FA18V	FA18HH		MD611					
31							FA18	FA18V	FA18HH		MD661②					
32							859									
33							859									
34							860									
35							860									
36							860									
37							860									
38							861									
39							861									
40							860									
41							860									
42							FA18	FA18V	FA18HH		MD602LS					
43							861									
44							861									
45							859									
46							860									
47							FA18	FA18V	FA18HH		MD602LS					
48							861									
49							861									
50							859									
51							859									
52							859									
53							FA213	FA213V	FA213HH		MD832					
54							FA213	FA213V	FA213HH		MD832					
55							FA213	FA213V	FA213HH		MD832					
56																

REAR

⚠ This symbol indicates a rotor made of billet steel, and should be only used with EBC FA Kevlar® Organic or Vee pads.
 SAFETY NOTICE - With vehicles primarily designed for off highway use such as quads now being used on the highway, we would recommend the use of X or MXS pads for highway use and ONLY using the R and SV higher density / harder pad series for off road riding.

BRAKE APPLICATIONS

*-2 Sets Required. ■ - Also available in MX-S race compound. **SAFETY WARNING:- DO NOT USE HH PADS ON REAR UNLESS ALSO USED ON FRONT TO AVOID BRAKE IMBALANCE**

FRONT: Non-Japanese Bikes

APPLICATIONS

BRAKE



BMW



DISC PAD CHOICES - FRONT

BRAKE ROTOR CHOICES - FRONT

											Line #	
			Semi-Sintered V-Pads™	Sintered/HH Pads/Grooved Shoes	SV Series Severe Duty Pads	Standard Rotor Left	Standard Rotor Right	UTVX Rotor	Vintage Rotor Left	Vintage Rotor Right	Contour Profile Rotor	
S 1000 XR	14-17			FA630HH*		N/A	N/A					1
K 1100 LT (Non ABS)	89-07/93	FA407*		FA407HH*		MD607LS	MD607RS					2
K 1100 LT (ABS)	89-07/93	FA407*		FA407HH*		MD607LSⓉ	MD607RSⓉ					3
K 1100 LT (Non ABS)	08/93-99	FA407*		FA407HH*		MD607LS	MD607RS					4
K 1100 LT (ABS Model)	08/93-99	FA407*		FA407HH*		MD607LSⓉ	MD607RSⓉ					5
K 1100 RS (Non ABS Model)	92-96	FA407*		FA407HH*		MD607LS	MD607RS					6
K 1100 RS (ABS Model)	92-96	FA407*		FA407HH*		MD607LSⓉ	MD607RSⓉ					7
R 1100 GS (STD & ABS)	93-99	FA407*		FA407HH*		MD652	MD652				MD652C*	8
R 1100 GS (STD & ABS)	93-99	FA407*		FA407HH*		MD652Ⓣ	MD652Ⓣ				MD652C*	9
R 1100 R (Spoke wheel)	93-96	FA407*		FA407HH*		MD652	MD652				MD652C*	10
R 1100 R (Cast wheel)	93-01	FA407*		FA407HH*		MD607LS	MD607RS					11
R 1100 RS	92-01	FA407*		FA407HH*		MD607LS	MD607RS					12
R 1100 S	96-11/00	FA407*		FA407HH*		MD687	MD687					13
R 1100 S (With integral ABS)	12/00-06			FA294HH*		MD616Ⓣ	MD616Ⓣ					14
R 1100 S (Non ABS)	12/00-06			FA335HH*		MD803	MD803					15
R 1100 S (With Integral ABS)	02/01-06			FA294HH*		MD616Ⓣ	MD616Ⓣ					16
R 1100 RT (Cast wheel/ABS)	94-01	FA407*		FA407HH*		MD607LSⓉ	MD607RSⓉ					17
R 1100 RT (Spoke wheel)	94-01	FA407*		FA407HH*		MD652	MD652				MD652C*	18
R 1150 GS (R21/0415/0495)	98-10/01	FA407*		FA407HH*		MD652	MD652				MD652C*	19
R 1150 GS (Evo R21/0415/0495)	11/01-03			FA335HH*		MD652	MD652				MD652C*	20
R 1150 GS (Evo R21A/0441/0492)	07/01-06			FA335HH*		MD652	MD652				MD652C*	21
R 1150 R	01-06			FA294HH*		MD616	MD616					22
R 1150 R Rockster/Edition 80	03-05			FA294HH*		MD616	MD616					23
R 1150 RS (Integral ABS)	01-05			FA294HH*		MD616Ⓣ	MD616Ⓣ					24
R 1150 RT (Integral ABS)	00-05			FA335HH*		MD620Ⓣ	MD620Ⓣ					25
HP2 (Enduro)	05-08	FA209/2	FA209/2V	FA209/2HH		MD687	MD687					26
HP2 Megamoto (Disc has loose bobbins)	Nov 07			FA335HH*		MD803	MD803					27
HP2 Megamoto (Disc has fixed bobbins)	Dec 07-09			FA335HH*		N/A	N/A					28
HP2 Sport (Disc has fixed bobbins)	08-11			FA447HH*		N/A	N/A					29
R 1200 (Independence)	00-03	FA407*		FA407HH*		MD652	MD652				MD652C*	30
R 1200 C (Cast Wheel/ABS)	96-03	FA407*		FA407HH*		MD652Ⓣ	MD652Ⓣ				MD652C*	31
R 1200 C (Spoke Wheel/ABS)	96-03	FA407*		FA407HH*		MD652Ⓣ	MD652Ⓣ				MD652C*	32
R 1200 CL	02-04			FA294HH*		MD652Ⓣ	MD652Ⓣ				MD652C*	33
R 1200 C Montauk	04-05			FA294HH*		MD652Ⓣ	MD652Ⓣ				MD652C*	34
R 1200 GS Air/Oil Cooled (K25/0307/Cast/Spoke Wheel) (Disc has loose buttons)	02-07			FA335HH*		MD687	MD687					35
R 1200 GS/M Air/Oil Cooled (K25/0303/Cast/Spoke wheel) (Disc has fixed bobbins)	06-12			FA335HH*		N/A	N/A					36
R 1200 GS Adventure Air/Oil Cooled (K25/0382/Spoke wheel) (Disc has loose buttons)	05-07			FA335HH*		MD687	MD687					37
R 1200 GS Adventure/M Air/Oil Cooled (K25/0380/Spoke wheel) (Disc has fixed bobbins)	06-13			FA335HH*		N/A	N/A					38
R 1200 GS (Liquid Cooled/Radial Mount Caliper)	13-15			FA630HH*		N/A	N/A					39
R 1200 GS Adventure (Liquid Cooled/Radial Mount Caliper)	14-15			FA630HH*		N/A	N/A					40
R 1200 ST (K28/0328) Disc has loose bobbins	03-11/07			FA335HH*		MD803	MD803					41
R 1200 ST (K28/0328) Disc has fixed bobbins	12/07-08			FA335HH*		N/A	N/A					42
R 1200 R (K27) Disc has loose bobbins	06-11/07			FA294HH*		MD804Ⓣ	MD804Ⓣ					43
R 1200 R (K27) Disc has fixed bobbins	08-14			FA294HH*		N/A	N/A					44
R 1200 S (K29/0366) Disc Has Loose Bobbins	06-11/07			FA335HH*		MD803Ⓣ	MD803Ⓣ					45
R 1200 S (K29/0366) Disc Has Fixed Bobbins	12/07-10			FA335HH*		N/A	N/A					46
R 1200 R	15			FA630HH*		N/A	N/A					47
R 1200 RS	15			FA630HH*		N/A	N/A					48
R 1200 RT (K26/0368) Disc Has Loose Bobbins	03-11/07			FA335HH*		MD803Ⓣ	MD803Ⓣ					49
R 1200 RT (K26/0368) Disc Has Fixed Bobbins	12/07-13			FA335HH*		N/A	N/A					50
R 1200 RT (Radial Caliper) Disc Has Fixed Bobbins	14			FA630HH*		N/A	N/A					51

FRONT

Ⓣ - remove ABS ring from old rotor and refit to new EBC rotor. Note: Ensure all mounting surfaces are clean and when refitting bolts use a thread lock cement to hold them in place.

*-2 Sets Required. ■ - Also available in MX-S race compound. SAFETY WARNING:- DO NOT USE HH PADS ON REAR UNLESS ALSO USED ON FRONT TO AVOID BRAKE IMBALANCE



FRONT: Non-Japanese Bikes Cont'd

REAR: Non-Japanese Bikes

Line #	BRAKE ROTOR CHOICES - FRONT						DISC PAD CHOICES - REAR				BRAKE ROTOR CHOICES - REAR				
	CC Custom Rotor	CX Extreme® /Vee-Rotor	OS Series Oversize 250/280mm Rotor Kit	OSX Series Oversize 280mm Rotor Kit	Relocating Bracket for 250/280mm Rotor	SMX Series Oversize 320mm Rotor Kit	Relocating Bracket for 320mm Rotor		Semi-Sintered V-Pads™	Sintered/HH Pads/ Grooved Shoes	SV Series Severe Duty Pads	Standard Rotor	UTVX Rotor	Vintage Rotor	Contour Profile Rotor
1							FA363	FA363V	FA363HH		MD671				
2							FA18	FA18V	FA18HH		MD611				
3							FA18	FA18V	FA18HH		MD661Ⓣ				
4							FA18	FA18V	FA18HH		MD661				
5							FA18	FA18V	FA18HH		MD661Ⓣ				
6							FA18	FA18V	FA18HH		MD661				
7							FA18	FA18V	FA18HH		MD661Ⓣ				
8							FA363	FA363V	FA363HH		MD653			MD653C	
9							FA363	FA363V	FA363HH		MD653Ⓣ			MD653C	
10							FA363	FA363V	FA363HH		MD653			MD653C	
11							FA363	FA363V	FA363HH		MD653Ⓣ				
12							FA18	FA18V	FA18HH		MD661				
13							FA363	FA363V	FA363HH		MD653			MD653C	
14							FA363	FA363V	FA363HH		MD653Ⓣ				
15							FA363	FA363V	FA363HH		MD653				
16							FA363	FA363V	FA363HH		MD653Ⓣ				
17							FA363	FA363V	FA363HH		MD653Ⓣ				
18							FA363	FA363V	FA363HH		MD653			MD653C	
19							FA363	FA363V	FA363HH		MD653			MD653C	
20							FA363	FA363V	FA363HH		MD653			MD653C	
21							FA363	FA363V	FA363HH		MD653			MD653C	
22							FA363	FA363V	FA363HH		MD653				
23							FA363	FA363V	FA363HH		MD653				
24							FA363	FA363V	FA363HH		MD653Ⓣ				
25							FA363	FA363V	FA363HH		MD653Ⓣ				
26							FA363	FA363V	FA363HH		MD671				
27							FA363	FA363V	FA363HH		MD671				
28							FA363	FA363V	FA363HH		MD671				
29							FA363	FA363V	FA363HH		MD671				
30							FA363	FA363V	FA363HH		N/A				
31							FA363	FA363V	FA363HH		N/A				
32							FA363	FA363V	FA363HH		N/A				
33							FA304	FA304V	FA304HH		N/A				
34							FA363	FA363V	FA363HH		N/A				
35															
36							FA363	FA363V	FA363HH		MD671				
37															
38							FA363	FA363V	FA363HH		MD671				
39															
40							FA363	FA363V	FA363HH		MD671				
41															
42							FA363	FA363V	FA363HH		MD671				
43							FA209/2	FA209/2V	FA209/2HH		TBA				
44							FA209/2	FA209/2V	FA209/2HH		TBA				
45							FA363	FA363V	FA363HH		MD671				
46							FA363	FA363V	FA363HH		MD671				
47							FA363	FA363V	FA363HH		MD671				
48							FA363	FA363V	FA363HH		MD671				
49							FA363	FA363V	FA363HH		MD671Ⓣ				
50							FA363	FA363V	FA363HH		MD671Ⓣ				
51							FA363	FA363V	FA363HH		TBA				
52							FA363	FA363V	FA363HH		TBA				
53							FA363	FA363V	FA363HH		MD671Ⓣ				
54							FA363	FA363V	FA363HH		MD671Ⓣ				
55							FA209/2	FA209/2V	FA209/2HH		TBA				
56															

REAR

Ⓣ This symbol indicates a rotor made of billet steel, and should be only used with EBC FA Kevlar® Organic or Vee pads.
 SAFETY NOTICE - With vehicles primarily designed for off highway use such as quads now being used on the highway, we would recommend the use of X or MXS pads for highway use and ONLY using the R and SV higher density / harder pad series for off road riding.

BRAKE APPLICATIONS

*-2 Sets Required. ■ - Also available in MX-S race compound. **SAFETY WARNING:- DO NOT USE HH PADS ON REAR UNLESS ALSO USED ON FRONT TO AVOID BRAKE IMBALANCE**

FRONT: Non-Japanese Bikes Cont'd

REAR: Non-Japanese Bikes

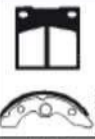
Line #	BRAKE ROTOR CHOICES - FRONT						DISC PAD CHOICES - REAR				BRAKE ROTOR CHOICES - REAR				
	CC Custom Rotor	CX Extreme® /Vee-Rotor	OS Series Oversize 250/280mm Rotor Kit	OSX Series Oversize 280mm Rotor Kit	Relocating Bracket for 250/280mm Rotor	SMX Series Oversize 320mm Rotor Kit	Relocating Bracket for 320mm Rotor		Semi-Sintered V-Pads™	Sintered/HH Pads/ Grooved Shoes	SV Series Severe Duty Pads	Standard Rotor	UTVX Rotor	Vintage Rotor	Contour Profile Rotor
1							FA18	FA18V	FA18HH		MD661Ⓢ				
2							FA18	FA18V	FA18HH		MD661Ⓢ				
3							FA304	FA304V	FA304HH		MD615ⓈⓈ				
4							FA304	FA304V	FA304HH		MD615ⓈⓈ				
5							FA304	FA304V	FA304HH		MD615ⓈⓈ				
6							FA18	FA18V	FA18HH		MD661Ⓢ				
7									FA438HH		MD688				
8															
9															
10							MWL002								
11							FA671	FA671V	FA671HH		MD671				
12							FA671	FA671V	FA671HH		MD671				
13							FA671	FA671V	FA671HH		MD671				
14							FA671	FA671V	FA671HH		MD671				
15							FA671	FA671V	FA671HH		MD671				
16							FA671	FA671V	FA671HH		MD671				
17							FA671	FA671V	FA671HH		MD671				
18							FA363	FA363V	FA363HH		MD688				
19							USEVORHHPAD	FA209/2V	FA209/2HH		TBA				
20							USEVORHHPAD	FA209/2V	FA209/2HH		TBA				
21							USEVORHHPAD	FA209/2V	FA209/2HH		TBA				
22							FA363	FA363V	FA363HH		MD671				
23															
24															
25							330		330G						
26							330		330G						
27							330		330G						
28							330		330G						
29							N/A				MD6221D				
30							FA165/2X		FA165/2R		MD6285D				
31							FA377X		FA377R		MD6282D				
32							FA307X		FA307R	FA307SV	MD6223D	UTVX6223			
33															
34							FA307X		FA307R	FA307SV	MD6223D	UTVX6223			
35															
36							FA307X		FA307R	FA307SV	MD6223D	UTVX6223			
37															
38							FA307X		FA307R	FA307SV	MD6223D	UTVX6223			
39															
40							FA307X		FA307R	FA307SV	MD6223D	UTVX6223			
41															
42							FA307X		FA307R	FA307SV	MD6223D	UTVX6223			
43															
44							FA266		FA266R		MD6230D				
45							FA307X		FA307R	FA307SV	MD6230D				
46															
47							FA266		FA266R		MD6230D				
48							FA317X		FA317R	FA317SV	MD6230D				
49															
50							FA266		FA266R		MD6230D				
51							FA317X		FA317R	FA317SV	MD6230D				
52															
53							FA266		FA266R		MD6230D				
54							FA317X		FA317R	FA317SV	MD6224D				
55															
56							FA266		FA266R		MD6230D				

REAR

Ⓢ This symbol indicates a rotor made of billet steel, and should be only used with EBC FA Kevlar® Organic or Vee pads.
 SAFETY NOTICE - With vehicles primarily designed for off highway use such as quads now being used on the highway, we would recommend the use of X or MXS pads for highway use and ONLY using the R and SV higher density / harder pad series for off road riding.

BRAKE APPLICATIONS

*-2 Sets Required. ■ - Also available in MX-S race compound. **SAFETY WARNING:- DO NOT USE HH PADS ON REAR UNLESS ALSO USED ON FRONT TO AVOID BRAKE IMBALANCE**

FRONT: Non-Japanese Bikes



BOMBARDIER/BRP



DISC PAD CHOICES - FRONT

BRAKE ROTOR CHOICES - FRONT

Traxter Footshift	Left	01	FA307X	FA307R	FA307SV	MD6229D					
	Right	01	FA317X	FA317R	FA317SV		MD6229D				
Quest 500 (4 x 4)	Left	02-04	FA307X	FA307R	FA307SV	MD6224D					
	Right		FA317X	FA317R	FA317SV		MD6224D				
Traxter Max	Left	03-05	FA307X	FA307R	FA307SV	MD6245D					
	Right		FA317X	FA317R	FA317SV		MD6245D				
Quest 500 (2 x 4)	Left	02	FA307X	FA307R	FA307SV	MD6224D					
	Right		FA317X	FA317R	FA317SV		MD6224D				
Quest 650 (2 x 4)	Left	02	FA307X	FA307R	FA307SV	MD6224D					
	Right		FA317X	FA317R	FA317SV		MD6224D				
Quest 650 (4 x 4)	Left	02-04	FA307X	FA307R	FA307SV	MD6224D					
	Right		FA317X	FA317R	FA317SV		MD6224D				
Quest 650 XT (4 x 4)	Left	02	FA307X	FA307R	FA307SV	MD6224D					
	Right		FA317X	FA317R	FA317SV		MD6224D				
Quest Max 650	Left	03-	FA307X	FA307R	FA307SV	MD6224D					
	Right		FA317X	FA317R	FA317SV		MD6224D				
DS 650	Left	00-05	FA307X	FA307R	FA307SV	MD6171D					
	Right		FA317X	FA317R	FA317SV		MD6171D				
DS 650 Baja/X	Left	01-06	FA307X	FA307R	FA307SV	MD6171D					
	Right		FA317X	FA317R	FA317SV		MD6171D				
Traxter Max 650	Left	04-05	FA307X	FA307R	FA307SV	MD6245D					
	Right		FA317X	FA317R	FA317SV		MD6245D				
Sarasota 1000 Side x Side		05	N/A								
Traxter XL	Left	04	FA307X	FA307R	FA307SV	MD6245D					
	Right		FA317X	FA317R	FA317SV		MD6245D				
Quest Max/STD/XT	Left	04-05	FA307X	FA307R	FA307SV	MD6245D					
	Right		FA317X	FA317R	FA317SV		MD6245D				
FRONT											
BUELL											
M2 Cyclone® (Disc has Countersunk bolt holes)		94-97	FA210				MD719RS				
S1 Lightning® (Disc has Countersunk bolt holes)		94-97	FA210				MD719RS				
S2 Thunderbolt® (Disc has Countersunk bolt holes)		94-97	FA210				MD719RS				
S3 Thunderbolt® (Disc has Countersunk bolt holes)		94-97	FA210				MD719RS				
M2 Cyclone® (Disc has Countersunk bolt holes)		98-00	FA424	FA424HH			MD719RS				
S1 Lightning® (Disc has Countersunk bolt holes)		98-00	FA424	FA424HH			MD719RS				
S1 White Lightning® (Disc has Countersunk bolt holes)		98-00	FA424	FA424HH			MD719RS				
S3 Thunderbolt® (Disc has Countersunk bolt holes)		98-00	FA424	FA424HH			MD719RS				
S3T Thunderbolt® (Disc has Countersunk bolt holes)		98-00	FA424	FA424HH			MD719RS				
X1 Lightning (Disc has Countersunk bolt holes)		98-00	FA424	FA424HH			MD719RS				
M2 Cyclone (Disc has Counterbored bolt holes)		00-05	FA424	FA424HH			MD734RS				
X1 Lightning (Disc has Counterbored bolt holes)		00-05	FA424	FA424HH			MD734RS				
Blast		00-07	FA196	FA196V	FA196HH		N/A				
Firebolt XB9R		02-07			FA345HH		MD735RS				
XB9S Lightning		03-04			FA345HH		MD735RS				
XB9SX Lightning City X		05-09			FA345HH		MD735RS				
XB9SX Lightning		08-10			FA345HH		MD735RS				
XB12 S Lightning		04-08			FA345HH		MD735RS				
XB12 X Ulysses		06-10			FA345HH		MD735RS				
XB12 XT Ulysses		08-10			FA345HH		MD735RS				
XB12 SCG Lightning		06-08			FA345HH		MD735RS				
XB12 Ss Lightning Long		06-08			FA345HH		MD735RS				
XB12 Ss Lightning		09-10			FA454/HH		MD735RS				
XB12 STT Lightning		08			FA345HH		MD735RS				
XB12 SCG Lightning		09-10			FA454/4HH		MD735RS				
XB12 R Firebolt		04-08			FA345HH		MD735RS				
XB12 R Firebolt		09-10			FA454/4HH		MD735RS				

Line #

1
2
3
4
5
6
7
8
9
10
11
12
13
14
15
16
17
18
19
20
21
22
23
24
25
26
27
28
29
30
31
32
33
34
35
36
37
38
39
40
41
42
43
44
45
46
47
48
49
50
51
52
53
54
55
56

APPLICATIONS

BRAKE

⚠ This symbol indicates a rotor made of billet steel, and should be only used with EBC FA Kevlar® Organic or Vee pads.
SAFETY NOTICE - With vehicles primarily designed for off highway use such as quads now being used on the highway, we would recommend the use of X or MXS pads for highway use and ONLY using the R and SV higher density / harder pad series for off road riding.

*-2 Sets Required. ■ - Also available in MX-S race compound. **SAFETY WARNING:- DO NOT USE HH PADS ON REAR UNLESS ALSO USED ON FRONT TO AVOID BRAKE IMBALANCE**

FRONT: Non-Japanese Bikes Cont'd

REAR: Non-Japanese Bikes

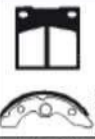
Line #	BRAKE ROTOR CHOICES - FRONT						DISC PAD CHOICES - REAR				BRAKE ROTOR CHOICES - REAR				
	CC Custom Rotor	CX Extreme® /Vee-Rotor	OS Series Oversize 250/280mm Rotor Kit	OSX Series Oversize 280mm Rotor Kit	Relocating Bracket for 250/280mm Rotor	SMX Series Oversize 320mm Rotor Kit	Relocating Bracket for 320mm Rotor		Semi-Sintered V-Pads™	Sintered/HH Pads/ Grooved Shoes	SV Series Severe Duty Pads	Standard Rotor	UTVX Rotor	Vintage Rotor	Contour Profile Rotor
1							FA317X		FA317R	FA317SV	MD6230D				
2															
3							FA317X		FA317R	FA317SV	MD6225D				
4															
5							FA317X		FA317R	FA317SV	MD6225D				
6															
7							FA317X		FA317R	FA317SV	MD6225D				
8															
9							FA317X		FA317R	FA317SV	MD6225D				
10															
11							FA317X		FA317R	FA317SV	MD6225D				
12															
13							FA317X		FA317R	FA317SV	MD6225D				
14															
15							FA317X		FA317R	FA317SV	MD6225D				
16															
17							FA307X		FA307R	FA307SV	MD6172D				
18															
19							FA307X		FA307R	FA307SV	MD6172D				
20															
21							FA317X		FA317R	FA317SV	MD6225D				
22															
23							N/A								
24							FA317X		FA317R	FA317SV	MD6225D				
25															
26							FA317X		FA317R	FA317SV	MD6225D				
27															
28															
29															
30							FA251				MD511				
31							FA251				MD511				
32							FA251				MD511				
33							FA251				MD511				
34							FA140	FA140V	FA140HH		MD511				
35							FA140	FA140V	FA140HH		MD511				
36							FA140	FA140V	FA140HH		MD511				
37							FA140	FA140V	FA140HH		MD511				
38							FA140	FA140V	FA140HH		MD511				
39							FA140	FA140V	FA140HH		MD511				
40							FA140	FA140V	FA140HH		MD511				
41							FA140	FA140V	FA140HH		MD511				
42							FA140	FA140V	FA140HH		N/A				
43							FA140	FA140V	FA140HH		MD522				
44							FA140	FA140V	FA140HH		MD522				
45							FA140	FA140V	FA140HH		MD522				
46							FA140	FA140V	FA140HH		MD522				
47							FA140	FA140V	FA140HH		MD522				
48							FA140	FA140V	FA140HH		MD522				
49							FA140	FA140V	FA140HH		MD522				
50							FA140	FA140V	FA140HH		MD522				
51							FA140	FA140V	FA140HH		MD522				
52							FA140	FA140V	FA140HH		MD522				
53							FA140	FA140V	FA140HH		MD522				
54							FA140	FA140V	FA140HH		MD522				
55							FA140	FA140V	FA140HH		MD522				
56							FA140	FA140V	FA140HH		MD522				

⚠ This symbol indicates a rotor made of billet steel, and should be only used with EBC FA Kevlar® Organic or Vee pads.
 SAFETY NOTICE - With vehicles primarily designed for off highway use such as quads now being used on the highway, we would recommend the use of X or MXS pads for highway use and ONLY using the R and SV higher density / harder pad series for off road riding.

BRAKE APPLICATIONS

*-2 Sets Required. ■ - Also available in MX-S race compound. **SAFETY WARNING:- DO NOT USE HH PADS ON REAR UNLESS ALSO USED ON FRONT TO AVOID BRAKE IMBALANCE**

FRONT: Non-Japanese Bikes

APPLICATIONS

BRAKE



BUELL



DISC PAD CHOICES - FRONT

BRAKE ROTOR CHOICES - FRONT

			Semi-Sintered V-Pads™	Sintered/HH Pads/Grooved Shoes	SV Series Severe Duty Pads	Standard Rotor Left	Standard Rotor Right	UTVX Rotor	Vintage Rotor Left	Vintage Rotor Right	Contour Profile Rotor
1125R	08-10			FA454/4HH			MD735RS				
1125CR	09-10			FA454/4HH			MD735RS				
BULTACO											
Brinco (Electric Trials Bike - C/R/RE/S Models)	15-17	CFA689									N/A
CAGIVA											
Mito 125	92-02	FA95		FA95HH			MD614X				
WMX 125 (Rimoldi hub)	-85	UGS		944G							
WMX 125	86	FA47X		FA47R		N/A					
WMX 125/250	87-88	FA134X		FA134R		N/A					
WMX 125/250	89-91	FA134X		FA134R		N/A					
WMX 250	-85	FA47X		FA47R		N/A					
WMX 500	84-86	FA47X		FA47R		N/A					
Alazzurra 650/Elefant 650	85-86	FA47		FA47HH		N/A					
Elefant 650	86-87	FA120				MD6265D					
Raptor 650/V-Raptor 650	00-02	FA244*		FA244HH*		MD660LS	MD660RS				
Gran Canyon 900	99-00	FA142*		FA142HH*		N/A	N/A				
Raptor 1000/V-Raptor 1000	00-02	FA244*		FA244HH*		MD660LS	MD660RS				
CAN-AM (ATV)											
DS 70 (2 x 4/4T) Mini	08-15	346*		346G*							
DS 90 (2 x 4/4T)	07-15	346*		346G*							
DS 90 X (2 x 4/4T)	08-15	FA83X*		FA83R*		MD6335D	MD6335D				
Rally 200 (4A7A/B/C/D/E/F)	07	FA83X*		FA83R*		MD6220D	MD6220D				
DS 250 (3J7A/B/C)	07-15	FA377X*		FA377R*		MD6283D	MD6283D				
Outlander 400 (4 x 4 STD) (2D7A/B/C/D/E/F/G/H)	Left 07-14	FA307X		FA307R	FA307SV	MD6222D		UTVX6222			
	Right	FA317X		FA317R	FA317SV		MD6222D	UTVX6222			
Outlander 400 (XT 4 x 4) (2E7A/B/C/D/E/F)	Left 07-14	FA307X		FA307R	FA307SV	MD6222D		UTVX6222			
	Right	FA317X		FA317R	FA317SV		MD6222D	UTVX6222			
Outlander Max 400 (STD 4 x 4) (2F7B/C/D/E/F/G/H/J)	Left 07-14	FA307X		FA307R	FA307SV	MD6222D		UTVX6222			
	Right	FA317X		FA317R	FA317SV		MD6222D	UTVX6222			
Outlander Max 400 (XT 4 x 4) (2G7A/B/C/D/E)	Left 07-13	FA307X		FA307R	FA307SV	MD6222D		UTVX6222			
	Right	FA317X		FA317R	FA317SV		MD6222D	UTVX6222			
DS 450 (2 x 4/EF)	08-15			FA468R*		MD6322C	MD6322C				
DS 450 X (2 x 4/EF)	08-09			FA468R*		MD6322C	MD6322C				
DS 450 Xxc/Xxm	09-15			FA468R*		MD6322C	MD6322C				
Outlander L 450 EFI	Left 15	FA618X		FA618R	FA618SV	MD6370D		UTVX6370			
	Right	FA617X		FA617R	FA617SV		MD6370D	UTVX6370			
Outlander L 450 Max EFI	Left 15	FA618X		FA618R	FA618SV	MD6370D		UTVX6370			
	Right	FA617X		FA617R	FA617SV		MD6370D	UTVX6370			
Outlander 500 (STD 4 x 4) (2T7A/B/C/D)	Left 07-12	FA307X		FA307R	FA307SV	MD6222D		UTVX6222			
	Right	FA317X		FA317R	FA317SV		MD6222D	UTVX6222			
Outlander 500 (XT 4 x 4) (2U7A/B/C/D)	Left 07-12	FA307X		FA307R	FA307SV	MD6222D		UTVX6222			
	Right	FA317X		FA317R	FA317SV		MD6222D	UTVX6222			
Outlander Max 500 (STD 4 x 4) (2W7A/B/C)	Left 07-12	FA307X		FA307R	FA307SV	MD6222D		UTVX6222			
	Right	FA317X		FA317R	FA317SV		MD6222D	UTVX6222			
Outlander Max 500 (XT 4 x 4) (2X7A/B/C)	Left 07-12	FA307X		FA307R	FA307SV	MD6222D		UTVX6222			
	Right	FA317X		FA317R	FA317SV		MD6222D	UTVX6222			
Outlander 500 4 x 4 (STD/DPS/XT)	Left 13-15	FA618X		FA618R	FA618SV	MD6370D		UTVX6370			
	Right	FA617X		FA617R	FA617SV		MD6370D	UTVX6370			
Outlander 500 Max 4 x 4 (STD/DPS/XT)	Left 13-14	FA618X		FA618R	FA618SV	MD6370D		UTVX6370			
	Right	FA617X		FA617R	FA617SV		MD6370D	UTVX6370			
Outlander L 500 EFI	Left 15	FA618X		FA618R	FA618SV	MD6370D		UTVX6370			
	Right	FA617X		FA617R	FA617SV		MD6370D	UTVX6370			

Line #

* This symbol indicates a rotor made of billet steel, and should be only used with EBC FA Kevlar® Organic or Vee pads. SAFETY NOTICE - With vehicles primarily designed for off highway use such as quads now being used on the highway, we would recommend the use of X or MXS pads for highway use and ONLY using the R and SV higher density / harder pad series for off road riding.

*-2 Sets Required. ■ - Also available in MX-S race compound. **SAFETY WARNING:- DO NOT USE HH PADS ON REAR UNLESS ALSO USED ON FRONT TO AVOID BRAKE IMBALANCE**

FRONT: Non-Japanese Bikes Cont'd

REAR: Non-Japanese Bikes

Line #	BRAKE ROTOR CHOICES - FRONT						DISC PAD CHOICES - REAR				BRAKE ROTOR CHOICES - REAR					
	CC Custom Rotor	CX Extreme® /Vee-Rotor	OS Series Oversize 250/280mm Rotor Kit	OSX Series Oversize 280mm Rotor Kit	Relocating Bracket for 250/280mm Rotor	SMX Series Oversize 320mm Rotor Kit	Relocating Bracket for 320mm Rotor		Semi-Sintered V-Pads™	Sintered/HH Pads/ Grooved Shoes	SV Series Severe Duty Pads	Standard Rotor	UTVX Rotor	Vintage Rotor	Contour Profile Rotor	CX Extreme® /Vee-Rotor
1							FA460HH				N/A					
2							FA460HH				N/A					
3																
4																
5							CFA619								N/A	
6																
7																
8							FA47		FA47HH		MD638					
9							UGS		841G							
10							UGS		977G							
11							UGS		977G							
12							FA67X		FA67R		N/A					
13							UGS		841G							
14							UGS		982G							
15							FA47		FA47HH		N/A					
16							FA163				MD6259D					
17							FA266	FA266V	FA266HH		MD617					
18							FA165/2X				MD6160D					
19							FA266	FA266V	FA266HH		MD617					
20																
21																
22							307		307G							
23							307		307G							
24							FA83X		FA83R		MD6334D					
25							FA307X		FA307R		MD6285D					
26							FA377X		FA377R		MD6282D					
27							FA307X		FA307R	FA307SV	MD6223D	UTVX6223				
28																
29							FA307X		FA307R	FA307SV	MD6223D	UTVX6223				
30																
31							FA307X		FA307R	FA307SV	MD6223D	UTVX6223				
32																
33							FA307X		FA307R	FA307SV	MD6223D	UTVX6223				
34																
35									FA398R		MD6321C					
36									FA398R		MD6321C					
37									FA398R		MD6321C					
38																
39							FA617X		FA617R		MD6370D	UTVX6370				
40																
41							FA617X		FA617R		MD6370D	UTVX6370				
42							FA307X		FA307R	FA307SV	MD6223D	UTVX6223				
43																
44							FA307X		FA307R	FA307SV	MD6223D	UTVX6223				
45																
46							FA307X		FA307R	FA307SV	MD6223D	UTVX6223				
47																
48							FA307X		FA307R	FA307SV	MD6223D	UTVX6223				
49																
50																
51							FA617X		FA617R	FA617R	MD6370D	UTVX6370				
52																
53							FA617X		FA617R		MD6370D	UTVX6370				
54																
55							FA617X		FA617R		MD6370D	UTVX6370				
56																

⚠ This symbol indicates a rotor made of billet steel, and should be only used with EBC FA Kevlar® Organic or Vee pads.
 SAFETY NOTICE - With vehicles primarily designed for off highway use such as quads now being used on the highway, we would recommend the use of X or MXS pads for highway use and ONLY using the R and SV higher density / harder pad series for off road riding.

BRAKE APPLICATIONS

*-2 Sets Required. ■ - Also available in MX-S race compound. **SAFETY WARNING:- DO NOT USE HH PADS ON REAR UNLESS ALSO USED ON FRONT TO AVOID BRAKE IMBALANCE**

FRONT: Non-Japanese Bikes

APPLICATIONS

BRAKE



CAN-AM (ATV)



* This symbol indicates a rotor made of billet steel, and should be only used with EBC FA Kevlar® Organic or Vee pads.
 SAFETY NOTICE - With vehicles primarily designed for off highway use such as quads now being used on the highway, we would recommend the use of X or MXS pads for highway use and ONLY using the R and SV higher density / harder pad series for off road riding.

DISC PAD CHOICES - FRONT

BRAKE ROTOR CHOICES - FRONT

Model	Side	Year	DISC PAD CHOICES - FRONT			BRAKE ROTOR CHOICES - FRONT					Line #	
			Standard Rotor Left	Standard Rotor Right	UTVX Rotor	Vintage Rotor Left	Vintage Rotor Right	Contour Profile Rotor				
Outlander L 500 Max EFI	Left	15	FA618X	FA618R	FA618SV	MD6370D		UTVX6370				1
	Right		FA617X	FA617R	FA617SV		MD6370D	UTVX6370				2
Renegade 500 (4 x 4/EFI)	Left	07-08	FA307X	FA307R	FA307SV	MD6223D		UTVX6223				3
	Right		FA317X	FA317R	FA317SV		MD6223D	UTVX6223				4
Renegade 500 (4 x 4/EFI)	Left	09-12	FA307X	FA307R	FA307SV	MD6223D		UTVX6223				5
	Right		FA317X	FA317R	FA317SV		MD6223D	UTVX6223				6
Renegade 500 STD/EFI	Left	12-15	FA618X	FA618R	FA618SV	MD6370D		UTVX6370				7
	Right		FA617X	FA617R	FA617SV		MD6370D	UTVX6370				8
DS 650 X (3B7A/B)	Left	07	FA307X	FA307R	FA307SV	MD6171D						9
	Right	07	FA317X	FA317R	FA317SV		MD6171D					10
Outlander 650 (4 x 4 STD) (2N7A/B/C/D/E/F/G/H)	Left	07-12	FA307X	FA307R	FA307SV	MD6222D		UTVX6222				11
	Right		FA317X	FA317R	FA317SV		MD6222D	UTVX6222				12
Outlander 650 (XT 4 x 4) (2P7A/B/C/D/E/F)	Left	07-12	FA307X	FA307R	FA307SV	MD6222D		UTVX6222				13
	Right		FA317X	FA317R	FA317SV		MD6222D	UTVX6222				14
Outlander Max 650 (STD 4 x 4) (2R7A/B/C/D/E/F/G/H/J/K)	Left	07-12	FA307X	FA307R	FA307SV	MD6222D		UTVX6222				15
	Right		FA317X	FA317R	FA317SV		MD6222D	UTVX6222				16
Outlander Max 650 (XT 4 x 4) (2S7A/B/C/D/E/F)	Left	07-12	FA307X	FA307R	FA307SV	MD6222D		UTVX6222				17
	Right		FA317X	FA317R	FA317SV		MD6222D	UTVX6222				18
Outlander 650 4x4 (STD/DPS/XT)	Left	13-15	FA618X	FA618R	FA618SV	MD6370D		UTVX6370				19
	Right		FA617X	FA617R	FA617SV		MD6370D	UTVX6370				20
Outlander 650 Mmr	Left	15	FA618X	FA618R	FA618SV	MD6370D		UTVX6370				21
	Right		FA617X	FA617R	FA617SV		MD6370D	UTVX6370				22
Outlander Max 650 X - TP	Left	12	FA307X	FA307R	FA307SV	MD6222D		UTVX6222				23
	Right		FA317X	FA317R	FA317SV		MD6222D	UTVX6222				24
Outlander 650 Max 4 x 4 (STD/DPS/XT)	Left	13	FA618X	FA618R	FA618SV	MD6370D		UTVX6370				25
	Right		FA617X	FA617R	FA617SV		MD6370D	UTVX6370				26
Outlander 800 (STD 4 x 4) (2H7A/B/C/D/E/F/G/H)	Left	07-08	FA307X	FA307R	FA307SV	MD6222D		UTVX6222				27
	Right		FA317X	FA317R	FA317SV		MD6222D	UTVX6222				28
Outlander 800 (XT 4 x 4) (2J7A/B/C/D/E/F)	Left	07-08	FA307X	FA307R	FA307SV	MD6222D		UTVX6222				29
	Right		FA317X	FA317R	FA317SV		MD6222D	UTVX6222				30
Outlander 800 R EFI	Left	09	FA307X	FA307R	FA307SV	MD6222D		UTVX6222				31
	Right		FA317X	FA317R	FA317SV		MD6222D	UTVX6222				32
Outlander 800 R XT	Left	09-10	FA307X	FA307R	FA307SV	MD6222D		UTVX6222				33
	Right		FA317X	FA317R	FA317SV		MD6222D	UTVX6222				34
Outlander 800 R STD	Left	12-15	FA618X	FA618R	FA618SV	MD6370D		UTVX6370				35
	Right		FA617X	FA617R	FA617SV		MD6370D	UTVX6370				36
Outlander 800 R 4 X4 (STD/DPS/XT/XT-P)	Left	14	FA618X	FA618R	FA618SV	MD6370D		UTVX6370				37
	Right		FA617X	FA617R	FA617SV		MD6370D	UTVX6370				38
Outlander Max 800 R EFI	Left	09-12	FA307X	FA307R	FA307SV	MD6222D		UTVX6222				39
	Right		FA317X	FA317R	FA317SV		MD6222D	UTVX6222				40
Outlander Max 800 R XT	Left	09-12	FA307X	FA307R	FA307SV	MD6222D		UTVX6222				41
Outlander Max 800 R 4 X4 (STD/XT/XT-P)	Left	13	FA618X	FA618R	FA618SV	MD6370D		UTVX6370				42
	Right		FA617X	FA617R	FA617SV		MD6370D	UTVX6370				43
Outlander 800 R XT	Left	12-13	FA618X	FA618R	FA618SV	MD6370D		UTVX6370				44
	Right		FA617X	FA617R	FA617SV		MD6370D	UTVX6370				45
Outlander 800 R Mmr	Left	15	FA618X	FA618R	FA618SV	MD6370D		UTVX6370				46
	Right		FA617X	FA617R	FA617SV		MD6370D	UTVX6370				47
Outlander Max 800 (Ltd 4 x 4) (2M7A/B/C)	Left	07-12	FA307X	FA307R	FA307SV	MD6222D		UTVX6222				48
	Right		FA317X	FA317R	FA317SV		MD6222D	UTVX6222				49
Outlander Max 800 (STD 4 x 4) (2K7A/B/C/D/E/F/G/H/J)	Left	07-12	FA307X	FA307R	FA307SV	MD6222D		UTVX6222				50
	Right		FA317X	FA317R	FA317SV		MD6222D	UTVX6222				51
Outlander Max 800 (XT 4 x 4) (2L7A/B/C/D/E/F)	Left	07-08	FA307X	FA307R	FA307SV	MD6222D		UTVX6222				52
	Right		FA317X	FA317R	FA317SV		MD6222D	UTVX6222				53
Outlander 800 R Xmr	Left	11-12	FA307X	FA307R	FA307SV	MD6222D		UTVX6222				54
	Right		FA317X	FA317R	FA317SV		MD6222D	UTVX6222				55

*-2 Sets Required. ■ - Also available in MX-S race compound. **SAFETY WARNING:- DO NOT USE HH PADS ON REAR UNLESS ALSO USED ON FRONT TO AVOID BRAKE IMBALANCE**

FRONT: Non-Japanese Bikes Cont'd

REAR: Non-Japanese Bikes

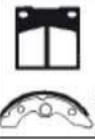
Line #	BRAKE ROTOR CHOICES - FRONT						DISC PAD CHOICES - REAR				BRAKE ROTOR CHOICES - REAR					
	CC Custom Rotor	CX Extreme® /Vee-Rotor	OS Series Oversize 250/280mm Rotor Kit	OSX Series Oversize 280mm Rotor Kit	Relocating Bracket for 250/280mm Rotor	SMX Series Oversize 320mm Rotor Kit	Relocating Bracket for 320mm Rotor		Semi-Sintered V-Pads™	Sintered/HH Pads/ Grooved Shoes	SV Series Severe Duty Pads	Standard Rotor	UTVX Rotor	Vintage Rotor	Contour Profile Rotor	CX Extreme® /Vee-Rotor
1																
2									FA617X	FA617R		MD6370D	UTVX6370			
3									FA307X	FA307R	FA307SV	MD6223D	UTVX6223			
4																
5									FA307X	FA307R	FA307SV	MD6223D	UTVX6223			
6																
7									FA618X	FA618R	FA618SV	MD6370D	UTVX6370			
8									FA617X	FA617R	FA617SV	MD6370D	UTVX6370			
9									FA307X	FA307R	FA307SV	MD6172D				
10																
11									FA307X	FA307R	FA307SV	MD6223D	UTVX6223			
12																
13									FA307X	FA307R	FA307SV	MD6223D	UTVX6223			
14																
15									FA307X	FA307R	FA307SV	MD6223D	UTVX6223			
16																
17									FA307X	FA307R	FA307SV	MD6223D	UTVX6223			
18																
19																
20									FA617X	FA617R	FA617SV	MD6370D	UTVX6370			
21																
22									FA617X	FA617R		MD6370D	UTVX6370			
23									FA307X	FA307R	FA307SV	MD6223D	UTVX6223			
24																
25																
26									FA617X	FA617R	FA617SV	MD6370D	UTVX6370			
27									FA307X	FA307R	FA307SV	MD6223D	UTVX6223			
28																
29									FA307X	FA307R	FA307SV	MD6223D	UTVX6223			
30																
31									FA307X	FA307R	FA307SV	MD6223D	UTVX6223			
32																
33									FA307X	FA307R	FA307SV	MD6223D	UTVX6223			
34																
35																
36									FA617X	FA617R	FA617SV	MD6370D	UTVX6370			
37																
38									FA617X	FA617R	FA617SV	MD6370D	UTVX6370			
39									FA307X	FA307R	FA307SV	MD6223D	UTVX6223			
40																
41									FA307X	FA307R	FA307SV	MD6223D	UTVX6223			
42																
43									FA617X	FA617R	FA617SV	MD6370D	UTVX6370			
44																
45									FA617X	FA617R	FA617SV	MD6370D	UTVX6370			
46																
47									FA617X	FA617R		MD6370D	UTVX6370			
48									FA307X	FA307R	FA307SV	MD6223D	UTVX6223			
49																
50									FA307X	FA307R	FA307SV	MD6223D	UTVX6223			
51																
52									FA307X	FA307R	FA307SV	MD6223D	UTVX6223			
53																
54									FA307X	FA307R	FA307SV	MD6223D	UTVX6223			
55																
56																

REAR

This symbol indicates a rotor made of billet steel, and should be only used with EBC FA Kevlar® Organic or Vee pads.
 SAFETY NOTICE - With vehicles primarily designed for off highway use such as quads now being used on the highway, we would recommend the use of X or MXS pads for highway use and ONLY using the R and SV higher density / harder pad series for off road riding.

BRAKE APPLICATIONS

*-2 Sets Required. ■ - Also available in MX-S race compound. **SAFETY WARNING:- DO NOT USE HH PADS ON REAR UNLESS ALSO USED ON FRONT TO AVOID BRAKE IMBALANCE**

FRONT: Non-Japanese Bikes

APPLICATIONS

BRAKE



CAN-AM (ATV)



DISC PAD CHOICES - FRONT

BRAKE ROTOR CHOICES - FRONT

Model	Side	Line #	DISC PAD CHOICES - FRONT			BRAKE ROTOR CHOICES - FRONT					
				Sintered/HH Pads/ Grooved Shoes	SV Series Severe Duty Pads	Standard Rotor Left	Standard Rotor Right	UTVX Rotor	Vintage Rotor Left	Vintage Rotor Right	Contour Profile Rotor
Outlander 800 R XXC	Left	11	FA307X	FA307R	FA307SV	MD6222D		UTVX6222			
	Right		FA317X	FA317R	FA317SV		MD6222D	UTVX6222			
Outlander Max 800 R X-TP	Left	12	FA307X	FA307R	FA307SV	MD6222D		UTVX6222			
	Right		FA317X	FA317R	FA317SV		MD6222D	UTVX6222			
Renegade 800 X (4 x 4/EFI)	Left	08	FA307X	FA307R	FA307SV	TBA					
	Right		FA317X	FA317R	FA317SV		TBA				
Renegade 800 (4 x 4/EFI)	Left	07-08	FA307X	FA307R	FA307SV	TBA					
	Right		FA317X	FA317R	FA317SV		TBA				
Renegade 800 R EFI	Left	09-11	FA307X	FA307R	FA307SV	TBA					
	Right		FA317X	FA317R	FA317SV		TBA				
Renegade 800 R STD EFI	Left	12-15	FA618X	FA618R	FA618SV	MD6370D		UTVX6370			
	Right		FA617X	FA617R	FA617SV		MD6370D	UTVX6370			
Renegade 800 R X	Left	09-10	FA307X	FA307R	FA307SV	MD6223D		UTVX6223			
	Right		FA317X	FA317R	FA317SV		MD6223D	UTVX6223			
Renegade 800 R XXC	Left	11	FA307X	FA307R	FA307SV	MD6223D		UTVX6223			
	Right		FA317X	FA317R	FA317SV		MD6223D	UTVX6223			
Renegade 800 R XXC	Left	12-14	FA618X	FA618R	FA618SV	MD6370D		UTVX6370			
	Right		FA617X	FA617R	FA617SV		MD6370D	UTVX6370			
Outlander 1000 STD	Left	12	FA618X	FA618R	FA618SV	MD6370D		UTVX6370			
	Right		FA617X	FA617R	FA617SV		MD6370D	UTVX6370			
Outlander 1000 XT	Left	12	FA618X	FA618R	FA618SV	MD6370D		UTVX6370			
	Right		FA617X	FA617R	FA617SV		MD6370D	UTVX6370			
Outlander 1000 4 x 4 (DPS/XT/XT-P)	Left	13	FA618X	FA618R	FA618SV	MD6370D		UTVX6370			
	Right		FA617X	FA617R	FA617SV		MD6370D	UTVX6370			
Outlander 1000 4 x 4 (LTD)	Left	13	FA618X	FA618R	FA618SV	MD6370D		UTVX6370			
	Right		FA617X	FA617R	FA617SV		MD6370D	UTVX6370			
Outlander 1000 4 x 4 (Xmr)	Left	13	FA618X	FA618R	FA618SV	MD6370D		UTVX6370			
	Right		FA617X	FA617R	FA617SV		MD6370D	UTVX6370			
Outlander Max 1000 4 x 4 (DPS/XT/XT-P)	Left	13	FA618X	FA618R	FA618SV	MD6370D		UTVX6370			
	Right		FA617X	FA617R	FA617SV		MD6370D	UTVX6370			
Outlander 6 x 6 XT	Left	14-15	FA618X	FA618R	FA618SV	MD6370D		UTVX6370			
	Right		FA617X	FA617R	FA617SV		MD6370D	UTVX6370			
Renegade 1000 STD EFI	Left	12-14	FA618X	FA618R	FA618SV	MD6370D		UTVX6370			
	Right		FA617X	FA617R	FA617SV		MD6370D	UTVX6370			
Renegade 1000 XXC	Left	12-14	FA618X	FA618R	FA618SV	MD6370D		UTVX6370			
	Right		FA617X	FA617R	FA617SV		MD6370D	UTVX6370			
CAN-AM (SIDE X SIDE)											
Commander 800 (XT/DPS)	Left	11-15	FA165X	FA165R	FA165SV	MD6366D		UTVX6366			
	Right		FA135X	FA135R	FA135SV		MD6366D	UTVX6366			
Commander 800 R (STD)	Left	11-15	FA165X	FA165R	FA165SV	MD6366D		UTVX6366			
	Right		FA135X	FA135R	FA135SV		MD6366D	UTVX6366			
Commander 800 R XT	Left	11-14	FA165X	FA165R	FA165SV	MD6366D		UTVX6366			
	Right		FA135X	FA135R	FA135SV		MD6366D	UTVX6366			
Defender 799cc	Left	16	FA682X	FA682R		MD6396D					
	Right		FA683X	FA683R			MD6396D				
Defender DPS 799cc	Left	16	FA682X	FA682R		MD6396D					
	Right		FA683X	FA683R			MD6396D				
Defender XT 799cc	Left	16	FA682X	FA682R		MD6396D					
	Right		FA683X	FA683R			MD6396D				
Defender XT Cab 799cc	Left		FA682X	FA682R		MD6396D					
	Right		FA683X	FA683R			MD6396D				
Commander 1000 STD	Left	11-15	FA165X	FA165R	FA165SV	MD6366D		UTVX6366			
	Right		FA135X	FA135R	FA135SV		MD6366D	UTVX6366			
Commander 1000 (DPS)	Left	13-15	FA165X	FA165R	FA165SV	MD6366D		UTVX6366			
	Right		FA135X	FA135R	FA135SV		MD6366D	UTVX6366			

* This symbol indicates a rotor made of billet steel, and should be only used with EBC FA Kevlar® Organic or Vee pads.
 SAFETY NOTICE - With vehicles primarily designed for off highway use such as quads now being used on the highway, we would recommend the use of X or MXS pads for highway use and ONLY using the R and SV higher density / harder pad series for off road riding.

*-2 Sets Required. ■ - Also available in MX-S race compound. **SAFETY WARNING:- DO NOT USE HH PADS ON REAR UNLESS ALSO USED ON FRONT TO AVOID BRAKE IMBALANCE**

FRONT: Non-Japanese Bikes Cont'd

REAR: Non-Japanese Bikes

Line #	BRAKE ROTOR CHOICES - FRONT						DISC PAD CHOICES - REAR				BRAKE ROTOR CHOICES - REAR				
	CC Custom Rotor	CX Extreme® /Vee-Rotor	OS Series Oversize 250/280mm Rotor Kit	OSX Series Oversize 280mm Rotor Kit	Relocating Bracket for 250/280mm Rotor	SMX Series Oversize 320mm Rotor Kit	Relocating Bracket for 320mm Rotor		Semi-Sintered V-Pads™	Sintered/HH Pads/ Grooved Shoes	SV Series Severe Duty Pads	Standard Rotor	UTVX Rotor	Vintage Rotor	Contour Profile Rotor
1							FA307X		FA307R	FA307SV	MD6223D	UTVX6223			
2															
3							FA307X		FA307R	FA307SV	MD6223D	UTVX6223			
4															
5							FA307X		FA307R	FA307SV	TBA				
6															
7							FA307X		FA307R	FA307SV	TBA				
8															
9							FA307X		FA307R	FA307SV	TBA				
10															
11							FA618X		FA618R	FA618SV	MD6370D	UTVX6370			
12							FA617X		FA617R	FA617SV	MD6370D	UTVX6370			
13							FA307X		FA307R	FA307SV	MD6223D	UTVX6223			
14															
15							FA307X		FA307R	FA307SV	MD6223D	UTVX6223			
16															
17							FA618X		FA618R	FA618SV	MD6370D	UTVX6370			
18							FA617X		FA617R	FA617SV	MD6370D	UTVX6370			
19											TBA				
20							FA617X		FA617R	FA617SV	MD6370D	UTVX6370			
21															
22							FA617X		FA617R	FA617SV	MD6370D	UTVX6370			
23															
24							FA617X		FA617R	FA617SV	MD6370D	UTVX6370			
25															
26							FA617X		FA617R	FA617SV	MD6370D	UTVX6370			
27															
28							FA617X		FA617R	FA617SV	MD6370D	UTVX6370			
29															
30							FA617X		FA617R	FA617SV	MD6370D	UTVX6370			
31							FA618X		FA618R	FA618SV	MD6370D	UTVX6370			
32							FA617X		FA617R	FA617SV	MD6370D	UTVX6370			
33							FA618X		FA618R	FA618SV	MD6370D	UTVX6370			
34							FA617X		FA617R	FA617SV	MD6370D	UTVX6370			
35							FA618X		FA618R	FA618SV	MD6370D	UTVX6370			
36							FA617X		FA617R	FA617SV	MD6370D	UTVX6370			
37															
38															
39							FA135X		FA135R	FA135SV	MD6366D	UTVX6366			
40															
41							FA135X		FA135R	FA135SV	MD6366D	UTVX6366			
42															
43							FA135X		FA135R	FA135SV	MD6366D	UTVX6366			
44															
45							FA684X		FA684R		MD6396D				
46							FA685X		FA685R		MD6396D				
47							FA684X		FA684R		MD6396D				
48							FA685X		FA685R		MD6396D				
49							FA684X		FA684R		MD6396D				
50							FA685X		FA685R		MD6396D				
51							FA684X		FA684R		MD6396D				
52							FA685X		FA685R		MD6396D				
53							FA135X		FA135R	FA135SV	MD6366D	UTVX6366			
54															
55							FA135X		FA135R	FA135SV	MD6366D	UTVX6366			
56															

REAR

This symbol indicates a rotor made of billet steel, and should be only used with EBC FA Kevlar® Organic or Vee pads.
 SAFETY NOTICE - With vehicles primarily designed for off highway use such as quads now being used on the highway, we would recommend the use of X or MXS pads for highway use and ONLY using the R and SV higher density / harder pad series for off road riding.

BRAKE APPLICATIONS

*-2 Sets Required. ■ - Also available in MX-S race compound. **SAFETY WARNING:- DO NOT USE HH PADS ON REAR UNLESS ALSO USED ON FRONT TO AVOID BRAKE IMBALANCE**

FRONT: Non-Japanese Bikes

APPLICATIONS

BRAKE



CAN-AM (SIDE X SIDE)



DISC PAD CHOICES - FRONT

BRAKE ROTOR CHOICES - FRONT

Model	Side	Year	DISC PAD CHOICES - FRONT			BRAKE ROTOR CHOICES - FRONT					Line #	
			Sintered/HH Pads/Grooved Shoes	Semi-Sintered V-Pads™	SV Series Severe Duty Pads	Standard Rotor Left	Standard Rotor Right	UTVX Rotor	Vintage Rotor Left	Vintage Rotor Right		Contour Profile Rotor
Commander 1000 LTD	Left	12-15	FA165X		FA165SV	MD6366D		UTVX6366				1
	Right		FA135X		FA135SV		MD6366D	UTVX6366				2
Commander 1000 X	Left	11-13	FA165X		FA165SV	MD6366D		UTVX6366				3
	Right		FA135X		FA135SV		MD6366D	UTVX6366				4
Commander 1000 XT	Left	11-15	FA165X		FA165SV	MD6366D		UTVX6366				5
	Right		FA135X		FA135SV		MD6366D	UTVX6366				6
Commander 1000 XT-P	Left	14-15	FA165X		FA165SV	MD6366D		UTVX6366				7
	Right		FA135X		FA135SV		MD6366D	UTVX6366				8
Commander Max 1000 - DPS/XT	Left	14	FA642X		FA642SV	TBA						9
	Right		FA645X		FA645SV		TBA					10
Commander Max 1000 - LTD	Left	15	FA642X		FA642SV	TBA						11
	Right		FA645X		FA645SV		TBA					12
Defender 976cc	Left	16	FA682X			MD6396D						13
	Right		FA683X				MD6396D					14
Defender DPS 976cc	Left	16	FA682X			MD6396D						15
	Right		FA683X				MD6396D					16
Defender XT 976cc	Left	16	FA682X			MD6396D						17
	Right		FA683X				MD6396D					18
Defender XT Cab 976cc	Left	16	FA682X			MD6396D						19
	Right		FA683X				MD6396D					20
Maverick 1000 - Std	Left	13	FA165X		FA165SV	MD6366D		UTVX6366				21
	Right		FA135X		FA135SV		MD6366D	UTVX6366				22
Maverick 1000 - XRS	Left	13	FA165X		FA165SV	MD6366D		UTVX6366				23
	Right		FA135X		FA135SV		MD6366D	UTVX6366				24
Maverick 1000 - STD/XRS/XRS - DPS	Left	15	FA642X		FA642SV	TBA						25
	Right		FA645X		FA645SV		TBA					26
Maverick 1000 - XDS - DPS	Left	15	FA642X		FA642SV	TBA						27
	Right		FA645X		FA645SV		TBA					28
Maverick 1000 - XMR	Left	14-15	FA642X		FA642SV	TBA						29
	Right		FA645X		FA645SV		TBA					30
Maverick 1000 - XXC	Left	14-15	FA642X		FA642SV	TBA						31
	Right		FA645X		FA645SV		TBA					32
Maverick Max 1000 - Std	Left	14-15	FA642X		FA642SV	TBA						33
	Right		FA645X		FA645SV		TBA					34
Maverick Max 1000 - XDS - DPS	Left	15	FA642X		FA642SV	TBA						35
	Right		FA645X		FA645SV		TBA					36
Maverick Max 1000 - XRS - DPS	Left	14-15	FA642X		FA642SV	TBA						37
	Right		FA645X		FA645SV		TBA					38
Maverick X3	Left	17	FA682X			MD6411D		UTVX6411				39
	Right		FA683X			MD6411D		UTVX6411				40
Maverick X3 Max	Left	17	FA682X			MD6411D		UTVX6411				41
	Right		FA683X			MD6411D		UTVX6411				42
Maverick X3 Turbo	Left	18	FA682X			MD6411D		UTVX6411				43
	Right		FA683X			MD6411D		UTVX6411				44
Maverick X3 Max Turbo	Left	18	FA682X			MD6411D		UTVX6411				45
	Right		FA683X			MD6411D		UTVX6411				46
Maverick X3 Turbo R	Left	18	FA682X			MD6411D		UTVX6411				47
	Right		FA683X			MD6411D		UTVX6411				48
Maverick X3 Max Turbo R	Left	18	FA682X			MD6411D		UTVX6411				49
	Right		FA683X			MD6411D		UTVX6411				50
CAN-AM (Spyder)												
Spyder RS SE5		08-09	FA474*	FA474V*		MD801	MD801					51
Spyder RS SM5		08-09	FA474*	FA474V*		MD801	MD801					52
Spyder RS Phantom Black		09	FA474*	FA474V*		MD801	MD801					53
Spyder RT		10-12	FA474*	FA474V*		MD801	MD801					54

* This symbol indicates a rotor made of billet steel, and should be only used with EBC FA Kevlar® Organic or Vee pads.
 SAFETY NOTICE - With vehicles primarily designed for off highway use such as quads now being used on the highway, we would recommend the use of X or MXS pads for highway use and ONLY using the R and SV higher density / harder pad series for off road riding.

*-2 Sets Required. ■ - Also available in MX-S race compound. **SAFETY WARNING:- DO NOT USE HH PADS ON REAR UNLESS ALSO USED ON FRONT TO AVOID BRAKE IMBALANCE**

FRONT: Non-Japanese Bikes Cont'd

REAR: Non-Japanese Bikes

Line #	BRAKE ROTOR CHOICES - FRONT						DISC PAD CHOICES - REAR				BRAKE ROTOR CHOICES - REAR				
	CC Custom Rotor	CX Extreme® /Vee-Rotor	OS Series Oversize 250/280mm Rotor Kit	OSX Series Oversize 280mm Rotor Kit	Relocating Bracket for 250/280mm Rotor	SMX Series Oversize 320mm Rotor Kit	Relocating Bracket for 320mm Rotor		Semi-Sintered V-Pads™	Sintered/HH Pads/ Grooved Shoes	SV Series Severe Duty Pads	Standard Rotor	UTVX Rotor	Vintage Rotor	Contour Profile Rotor
1							FA135X		FA135R	FA135SV	MD6366D	UTVX6366			
2															
3							FA135X		FA135R	FA135SV	MD6366D	UTVX6366			
4															
5							FA135X		FA135R	FA135SV	MD6366D	UTVX6366			
6															
7							FA135X		FA135R	FA135SV	MD6366D	UTVX6366			
8															
9							FA307X		FA307R	FA307SV	MD6370D	UTVX6370			
10							FA317X		FA317R	FA317SV	MD6370D	UTVX6370			
11							FA307X		FA307R	FA307SV	MD6370D	UTVX6370			
12							FA317X		FA317R	FA317SV	MD6370D	UTVX6370			
13							FA684X		FA684R		MD6396D				
14							FA685X		FA685R		MD6396D				
15							FA684X		FA684R		MD6396D				
16							FA685X		FA685R		MD6396D				
17							FA684X		FA684R		MD6396D				
18							FA685X		FA685R		MD6396D				
19							FA684X		FA684R		MD6396D				
20							FA685X		FA685R		MD6396D				
21							FA307X		FA307R	FA307SV	MD6370D	UTVX6370			
22							FA317X		FA317R	FA317SV	MD6370D	UTVX6370			
23							FA307X		FA307R	FA307SV	MD6370D	UTVX6370			
24							FA317X		FA317R	FA317SV	MD6370D	UTVX6370			
25							FA307X		FA307R	FA307SV	MD6370D	UTVX6370			
26							FA317X		FA317R	FA317SV	MD6370D	UTVX6370			
27							FA307X		FA307R	FA307SV	MD6370D	UTVX6370			
28							FA317X		FA317R	FA317SV	MD6370D	UTVX6370			
29							FA307X		FA307R	FA307SV	MD6370D	UTVX6370			
30							FA317X		FA317R	FA317SV	MD6370D	UTVX6370			
31							FA307X		FA307R	FA307SV	MD6370D	UTVX6370			
32							FA317X		FA317R	FA317SV	MD6370D	UTVX6370			
33							FA307X		FA307R	FA307SV	MD6370D	UTVX6370			
34							FA317X		FA317R	FA317SV	MD6370D	UTVX6370			
35							FA307X		FA307R	FA307SV	MD6370D	UTVX6370			
36							FA317X		FA317R	FA317SV	MD6370D	UTVX6370			
37							FA307X		FA307R	FA307SV	MD6370D	UTVX6370			
38							FA317X		FA317R	FA317SV	MD6370D	UTVX6370			
39							FA682X		FA682R		MD6412D	UTVX6412			
40							FA683X		FA683R		MD6412D	UTVX6412			
41							FA682X		FA682R		MD6412D	UTVX6412			
42							FA683X		FA683R		MD6412D	UTVX6412			
43							FA682X		FA682R		MD6412D	UTVX6412			
44							FA683X		FA683R		MD6412D	UTVX6412			
45							FA682X		FA682R		MD6412D	UTVX6412			
46							FA683X		FA683R		MD6412D	UTVX6412			
47							FA682X		FA682R		MD6412D	UTVX6412			
48							FA683X		FA683R		MD6412D	UTVX6412			
49							FA682X		FA682R		MD6412D	UTVX6412			
50							FA683X		FA683R		MD6412D	UTVX6412			
51															
52															
53							FA473	FA473V			MD802				
54							FA473	FA473V			MD802				
55							FA473	FA473V			MD802				
56							FA473	FA473V			MD802				

REAR

This symbol indicates a rotor made of billet steel, and should be only used with EBC FA Kevlar® Organic or Vee pads.
 SAFETY NOTICE - With vehicles primarily designed for off highway use such as quads now being used on the highway, we would recommend the use of X or MXS pads for highway use and ONLY using the R and SV higher density / harder pad series for off road riding.

BRAKE APPLICATIONS

*-2 Sets Required. ■ - Also available in MX-S race compound. **SAFETY WARNING:- DO NOT USE HH PADS ON REAR UNLESS ALSO USED ON FRONT TO AVOID BRAKE IMBALANCE**

FRONT: Non-Japanese Bikes



CAN-AM (SPYDER)



DISC PAD CHOICES - FRONT

BRAKE ROTOR CHOICES - FRONT

			Semi-Sintered V-Pads™	Sintered/HH Pads/Grooved Shoes	SV Series Severe Duty Pads	Standard Rotor Left	Standard Rotor Right	UTVX Rotor	Vintage Rotor Left	Vintage Rotor Right	Contour Profile Rotor
Spyder RT LTD	10-12	FA474*	FA474V*			MD801	MD801				
Spyder RT-S	10-12	FA474*	FA474V*			MD801	MD801				
Spyder RS	10-12	FA474*	FA474V*			MD801	MD801				
Spyder RS-S	10-12	FA474*	FA474V*			MD801	MD801				
Spyder RS (Brembo Caliper)	13-16		FA630V*	FA630HH*		MD853	MD853				
Spyder RS-S (Brembo Caliper)	13-16		FA630V*	FA630HH*		MD853	MD853				
Spyder RT (3 Cyl Eng/ 6 Speed)	13-17		FA630V*	FA630HH*		MD853	MD853				
Spyder RT LTD (3 Cyl Eng/ 6 Speed)	13-17		FA630V*	FA630HH*		MD853	MD853				
Spyder RT-S (3 Cyl Eng/ 6 Speed)	13-15		FA630V*	FA630HH*		MD853	MD853				
Spyder RT-S (Special Series)	16-17		FA630V*	FA630HH*		MD853	MD853				
Spyder ST (Brembo Calipers)	13-16		FA630V*	FA630HH*		MD853	MD853				
Spyder ST LTD (Brembo Calipers)	13-15		FA630V*	FA630HH*		MD853	MD853				
Spyder ST-S (Brembo Calipers)	13-16		FA630V*	FA630HH*		MD853	MD853				
Spyder F3 (SE6/SM6)	15-17		FA630V*	FA630HH*		MD853	MD853				
Spyder F3 LTD	16-17		FA630V*	FA630HH*		MD853	MD853				
Spyder F3-S (SE6/SM6)	15-17		FA630V*	FA630HH*		MD853	MD853				
Spyder F3-S (Special Series)	16		FA630V*	FA630HH*		MD853	MD853				
Spyder F3-S Daytona 500	17		FA630V*	FA630HH*		MD853	MD853				
Spyder F3-T	16-17		FA630V*	FA630HH*		MD853	MD853				
NOTE - Always replace all 3 sets of pads at the same time on all CAN AM Spyder models.											
CF MOTO (ATV)											
400 C-Force	14-16	FA453X*		FA453R*		N/A					
400 C-Force - Parking brake	14-16										
500 C-Force	14-16	FA453X*		FA453R*		N/A					
500 C-Force - Parking brake	14-16										
500 C-Force HO EPS	14-16	FA453X*		FA453R*		N/A					
800 C-Force EPS	14-16	FA453X*		FA453R*		N/A					
CF MOTO (Side X Side)											
500 U-Force EPS	Left 14-16	FA135X		FA135R		N/A					
	Right	FA165X		FA165R			N/A				
500 Z-Force	Left 14-16	FA135X		FA135R		N/A					
	Right	FA165X		FA165R			N/A				
800 U-Force	Left 13-17	FA135X		FA135R		N/A					
	Right	FA165X		FA165R			N/A				
800 Z-Force	Left 15-16	FA135X		FA135R		N/A					
	Right	FA165X		FA165R			N/A				
800 EX Z-Force	Left 14-16	FA135X		FA135R		N/A					
	Right	FA165X		FA165R			N/A				
COBRA (MINI BIKES)											
CM 50	05-06	TBA									
King 50	02-03	N/A				N/A					
King 50	04-06	FA325X		FA325R		N/A					
P3	05-06	TBA									
DC 65	06	TBA				N/A					
COBRA (QUADS)											
ECX 50 (Quad)	06	TBA*				N/A	N/A				
ECX 70 (Quad)	06	TBA*				N/A	N/A				
CPI											
Apache 50/90	06-08	TBA*									
Enduro 50	06-08	FA115X		FA115R		N/A					
GTR 50 (2 Pin Pad Fixing Front Caliper)	05-09	SFA194		SFA194HH		N/A					

Line #

1

2

3

4

5

6

7

8

9

10

11

12

13

14

15

16

17

18

19

20

21

22

23

24

25

26

27

28

29

30

31

32

33

34

35

36

37

38

39

40

41

42

43

44

45

46

47

48

49

50

51

52

53

54

55

56

APPLICATIONS

BRAKE

⚠ This symbol indicates a rotor made of billet steel, and should be only used with EBC FA Kevlar® Organic or Vee pads.

SAFETY NOTICE - With vehicles primarily designed for off highway use such as quads now being used on the highway, we would recommend the use of X or MXS pads for highway use and ONLY using the R and SV higher density / harder pad series for off road riding.

*-2 Sets Required. ■ - Also available in MX-S race compound. **SAFETY WARNING:- DO NOT USE HH PADS ON REAR UNLESS ALSO USED ON FRONT TO AVOID BRAKE IMBALANCE**

FRONT: Non-Japanese Bikes Cont'd

REAR: Non-Japanese Bikes

Line #	BRAKE ROTOR CHOICES - FRONT						DISC PAD CHOICES - REAR				BRAKE ROTOR CHOICES - REAR					
	CC Custom Rotor	CX Extreme® /Vee-Rotor	OS Series Oversize 250/280mm Rotor Kit	OSX Series Oversize 280mm Rotor Kit	Relocating Bracket for 250/280mm Rotor	SMX Series Oversize 320mm Rotor Kit	Relocating Bracket for 320mm Rotor		Semi-Sintered V-Pads™	Sintered/HH Pads/ Grooved Shoes	SV Series Severe Duty Pads	Standard Rotor	UTVX Rotor	Vintage Rotor	Contour Profile Rotor	CX Extreme® /Vee-Rotor
1								FA473	FA473V			MD802				
2								FA473	FA473V			MD802				
3								FA473	FA473V			MD802				
4								FA473	FA473V			MD802				
5									FA631V	FA631HH		MD854				
6									FA631V	FA631HH		MD854				
7									FA631V	FA631HH		MD854				
8									FA631V	FA631HH		MD854				
9									FA631V	FA631HH		MD854				
10									FA631V	FA631HH		MD854				
11									FA631V	FA631HH		MD854				
12									FA631V	FA631HH		MD854				
13									FA631V	FA631HH		MD854				
14									FA631V	FA631HH		MD854				
15									FA631V	FA631HH		MD854				
16									FA631V	FA631HH		MD854				
17									FA631V	FA631HH		MD854				
18									FA631V	FA631HH		MD854				
19									FA631V	FA631HH		MD854				
20																
21																
22																
23								FA344X		FA344R		TBA				
24								FA232X		FA232R						
25								FA344X		FA344R		TBA				
26								FA232X		FA232R						
27								FA317X		FA317R		TBA				
28								FA344X		FA344R		TBA				
29																
30																
31								FA67X		FA67R		N/A				
32								FA67X		FA67R		N/A				
33								FA651X		FA651R		N/A				
34								FA651X		FA651R		N/A				
35								FA67X		FA67R		N/A				
36								FA67X		FA67R		N/A				
37								FA651X		FA651R		N/A				
38								FA651X		FA651R		N/A				
39								FA651X		FA651R		N/A				
40								FA651X		FA651R		N/A				
41																
42																
43								TBA								
44								CFA331				N/A				
45								FA325X		FA325R		N/A				
46								TBA								
47								FA325X		FA325R		N/A				
48																
49																
50								TBA				N/A				
51								TBA				N/A				
52																
53																
54								TBA				N/A				
55								FA115X		FA115R		N/A				
56								SFA260		SFA260HH		N/A				

REAR

This symbol indicates a rotor made of billet steel, and should be only used with EBC FA Kevlar® Organic or Vee pads.
 SAFETY NOTICE - With vehicles primarily designed for off highway use such as quads now being used on the highway, we would recommend the use of X or MXS pads for highway use and ONLY using the R and SV higher density / harder pad series for off road riding.

BRAKE APPLICATIONS

*-2 Sets Required. ■ - Also available in MX-S race compound. **SAFETY WARNING:- DO NOT USE HH PADS ON REAR UNLESS ALSO USED ON FRONT TO AVOID BRAKE IMBALANCE**

FRONT: Non-Japanese Bikes

APPLICATIONS

BRAKE



CPI



DISC PAD CHOICES - FRONT

BRAKE ROTOR CHOICES - FRONT

GTR 50 (1 Pin Pad Fixing Front Caliper)	05-09	SFA266	SFA266HH		N/A					
Oliver City 50	05-09	SFA235			N/A					
GTR 125 (2 Pin Pad Fixing Front Caliper)	05-09	SFA194	SFA194HH		N/A					
GTR 125 (1 Pin Pad Fixing Front Caliper)	05-09	SFA266	SFA266HH		N/A					
GTR 150 (2 Pin Pad Fixing Front Caliper)	05-09	SFA194	SFA194HH		N/A					
GTR 150 (1 Pin Pad Fixing Front Caliper)	05-09	SFA266	SFA266HH		N/A					
Enduro 250	07-08	FA115X	FA115R		N/A					
CSC										
RX3 Cyclone 250	15-16	FA664								N/A
CZ/JAWA										
Scrambler Cross 125-380 (Single/twin port models)	65-76	950								
Jawa 250/400 Cross	65-76	950								
250/380 (Models 513/514) Full width front hub models	77-79	N/A								
DAELIM										
A-Four (50cc)	06-08	SFA264	SFA264HH		N/A					
E-Five 50	03-09	SFA257			TBA					
S-Five 50	01-09	SFA257			TBA					
Cordi 50	01-09	SFA54	SFA54HH		N/A					
Delfino 100	01-09	SFA257			TBA					
Daystar 125	03-09	FA196	FA196HH			N/A				
History 125	01-08	SFA54	SFA54HH			N/A				
Roadwin 125	04-09	FA196	FA196HH		N/A					
S1-125	06-09	SFA661/4			TBA					
S2-125	06-09	SFA142	SFA142HH			TBA				
S2-250	06-09	SFA142	SFA142HH		TBA					
DERBI										
Atlantis 50 (All models)	99-01	SFA115	SFA115HH		MD943D					
Predator	99-01	SFA115	SFA115HH		MD964D					
Senda R 50	02-05	FA115X	FA115R		N/A					
Senda Supermoto	04-05	FA115X	FA115R		N/A					
GPR 50 Replica	03-05	FA167	FA167HH		N/A					
GPR 50 Nude	04-05	FA266	FA266HH		N/A					
GRP 80 Cup	05	FA266	FA266HH		N/A					
GPR 125/Nude (Radial Caliper)	05-06	FA399			N/A					
Atlantis Bullet/City	02-05	SFA115	SFA115HH		MD964D					
Boulevard 150	03-05	SFA350	SFA350HH		MD924D					
GP 150	02-06	SFA115	SFA115HH		MD943D					
DINLI										
Diamond Back 90	06	TBA*								
DMX 270	05-06	TBA*			TBA					
DMX 450	05-06	TBA*			TBA					
DUCATI										
250/350/450 Desmo/Single	-76	928								
250/350/450 Desmo/Single (4 bolt fixing)	74-77	FA18	FA18HH		MD634LS					
Scrambler Sixty 2 (Cast wheels/399cc)	16-17	FA209/2	FA209/2V	FA209/2HH	TBA					
Supersport 400 (Single disc)	93-97	FA95	FA95HH		MD2003X					MD2003XC
Supersport 400 (Twin disc)	93-97	FA95*	FA95HH*		MD2003X	MD2003X				MD2003XC*
400 Monster	95-97	FA95	FA95HH		MD2003X					MD2003XC
Monster 400 (Single disc)	00-02	FA244	FA244HH		MD614X					MD614XC
Monster 400 (Twin disc)	03-04	FA244*	FA244HH*		MD614X	MD614X				MD614XC*

Line #

FRONT

* This symbol indicates a rotor made of billet steel, and should be only used with EBC FA Kevlar® Organic or Vee pads.
 SAFETY NOTICE - With vehicles primarily designed for off highway use such as quads now being used on the highway, we would recommend the use of X or MXS pads for highway use and ONLY using the R and SV higher density / harder pad series for off road riding.

*-2 Sets Required. ■ - Also available in MX-S race compound. **SAFETY WARNING:- DO NOT USE HH PADS ON REAR UNLESS ALSO USED ON FRONT TO AVOID BRAKE IMBALANCE**

FRONT: Non-Japanese Bikes Cont'd

REAR: Non-Japanese Bikes

Line #	BRAKE ROTOR CHOICES - FRONT						DISC PAD CHOICES - REAR				BRAKE ROTOR CHOICES - REAR				
	CC Custom Rotor	CX Extreme® /Vee-Rotor	OS Series Oversize 250/280mm Rotor Kit	OSX Series Oversize 280mm Rotor Kit	Relocating Bracket for 250/280mm Rotor	SMX Series Oversize 320mm Rotor Kit	Relocating Bracket for 320mm Rotor		Semi-Sintered V-Pads™	Sintered/HH Pads/Grooved Shoes	SV Series Severe Duty Pads	Standard Rotor	UTVX Rotor	Vintage Rotor	Contour Profile Rotor
1							SFA298		SFA298HH		N/A				
2							503								
3							SFA260		SFA260HH		N/A				
4							SFA298		SFA298HH		N/A				
5							SFA260		SFA260HH		N/A				
6							SFA298		SFA298HH		N/A				
7							FA115X		FA115R		N/A				
8															
9															
10							FA140							N/A	
11															
12															
13							950								
14							950								
15							950								
16															
17															
18							TBA								
19							TBA								
20							TBA								
21							TBA								
22							TBA								
23							824								
24							FA54X		FA54HH		N/A				
25							FA197		FA197HH		MD814				
26							SFA54		SFA54HH		TBA				
27							SFA197		SFA197HH		TBA				
28							SFA197		SFA197HH		TBA				
29															
30															
31							624								
32							SFA115		SFA115HH		MD964D				
33							FA115X		FA115R		N/A				
34							FA115X		FA115R		N/A				
35							FA115		FA115HH		N/A				
36							FA115		FA115HH		N/A				
37							FA115		FA115HH		N/A				
38							FA115		FA115HH		N/A				
39							816								
40							816								
41							624								
42															
43															
44							FA83X		FA83R		N/A				
45							TBA				TBA				
46							TBA				TBA				
47															
48															
49							929								
50							921								
51							FA213	FA213V	FA213HH		MD2002				
52		VR2003BLK					FA47		FA47HH		MD2002			MD2002C	VR2002
53		VR2003BLK*					FA47		FA47HH		MD2002			MD2002C	VR2002
54		VR2003BLK					FA47		FA47HH		MD2002			MD2002C	VR2002
55		VR614BLK					FA47		FA47HH		MD2002			MD2002C	VR2002
56		VR614BLK*					FA47		FA47HH		MD2002			MD2002C	VR2002

⚠ This symbol indicates a rotor made of billet steel, and should be only used with EBC FA Kevlar® Organic or Vee pads.
SAFETY NOTICE - With vehicles primarily designed for off highway use such as quads now being used on the highway, we would recommend the use of X or MXS pads for highway use and ONLY using the R and SV higher density / harder pad series for off road riding.

BRAKE APPLICATIONS

*-2 Sets Required. ■ - Also available in MX-S race compound. **SAFETY WARNING:- DO NOT USE HH PADS ON REAR UNLESS ALSO USED ON FRONT TO AVOID BRAKE IMBALANCE**

FRONT: Non-Japanese Bikes

APPLICATIONS

BRAKE



DUCATI



DISC PAD CHOICES - FRONT

BRAKE ROTOR CHOICES - FRONT

		Sintered/HH Pads/Grooved Shoes	Sintered/HH Pads/Grooved Shoes	SV Series Severe Duty Pads	Standard Rotor Left	Standard Rotor Right	UTVX Rotor	Vintage Rotor Left	Vintage Rotor Right	Contour Profile Rotor			
400 Monster (Japan)	00-04	FA244	FA244HH		MD614X					MD614XC			1
Monster Dark ie 400 (Japan)	05-06	FA244*	FA244HH*		MD614X	MD614X				MD614XC*			2
Monster Dark ie 400 (Single disc)	05	FA244	FA244HH		MD614X					MD614XC			3
Monster 400 ie (Japan)	07-08	FA181*	FA181H*		MD626X	MD626X				MD626XC*			4
500 GTL	75	FA47*	FA47HH*		N/A	N/A							5
500 GTV Pantah	77	FA47*	FA47HH*		N/A	N/A							6
500 Sport Desmo	77	FA47*	FA47HH*		N/A	N/A							7
500 Pantah	79	FA47*	FA47HH*		MD657LS	MD657RS							8
549cc - Supermoto (549cc)	93-95	FA95*	FA95HH*		TBA	TBA							9
600 Pantah	81	FA18*	FA18HH*		MD657LS	MD657RS							10
Monster 600 (Twin disc)	93-97	FA95*	FA95HH*		MD2003X	MD2003X				MD2003XC*			11
600 Monster (Single disc)	93-99	FA95	FA95HH		MD2003X					MD2003XC			12
600 Monster Dark	98-99	FA95	FA95HH		MD2003X					MD2003XC			13
600 Monster City/City Dark	99	FA95	FA95HH		MD614X					MD614XC			14
600 Monster	00-01	FA244	FA244HH		MD614X					MD614XC			15
600 Supersport (Single disc)	91-97	FA95	FA95HH		MD2003X					MD2003XC			16
620 IE Monster	02-04	FA244*	FA244HH*		MD614X	MD614X				MD614XC*			17
620 IE Monster (Series 1 - Twin Pin Pad Fixing Caliper)	05	FA244*	FA244HH*		MD614X	MD614X				MD614XC*			18
620 IE Monster (Series 2 - Single Pin Pad Fixing Caliper)	05-06	FA181*	FA181HH*		MD626X	MD626X				MD626XC*			19
620 Sport	03	FA244*	FA244HH*		MD614X	MD614X				MD614XC*			20
Monster 620 Dark	03-04	FA244	FA244HH		MD2003X					MD2003XC			21
620 Multistrada (Twin Disc/Single Pin Pad Fixing)	06	FA181*	FA181HH*		MD626X	MD626X				MD626XC*			22
620 Multistrada Dark (Single Disc/Twin Pin Pad Fixing)	06	FA244	FA244HH		MD2003X					MD2003XC			23
650 Pantah	-84	FA18*	FA18HH*		N/A	N/A							24
695 Monster	06-09	FA181*	FA181HH*		MD626X	MD626X				MD626XC*			25
696 Monster	08-15	FA244*	FA244HH*		MD614X	MD614X				MD614XC*			26
M 696 Monster 20th Anniversary Model	13-14	FA244*	FA244HH*		MD614X	MD614X				MD614XC*			27
748 R (2 pad caliper)	00	FA244*	FA244HH*		MD636X	MD636X				MD636XC*			28
748 R (4 pad caliper)	01-02		FA322/4HH*		MD636X	MD636X				MD636XC*			29
748 Biposto	95-98	FA95*	FA95HH*		MD2003X	MD2003X				MD2003XC*			30
748 Biposto	99-02	FA244*	FA244HH*		MD614X	MD614X				MD614XC*			31
748 SP	95-97	FA95*	FA95HH*		TBA	TBA							32
748 SP	98	FA95*	FA95HH*		MD2003X	MD2003X				MD2003XC*			33
748 SP/Monoposto	99-02	FA244*	FA244HH*		MD614X	MD614X				MD614XC*			34
748 (Biposto)	00-02	FA244*	FA244HH*		TBA	TBA							35
748 (Monoposto)	00-02	FA244*	FA244HH*		TBA	TBA							36
748 SPS	98-99	FA244	FA244HH		MD633X	MD633X				MD633XC*			37
748 Testa Bassa (Mono/Biposto)	01	FA244*	FA244HH*		MD614X	MD614X				MD614XC*			38
749 Dark (Monoposto/Biposto)	04-06		FA322/4HH*		MD622X	MD622X				MD622XC*			39
749 R (Radial caliper)	04-06		FA322/4HH*		MD622X	MD622X				MD622XC*			40
749 S (Monoposto/Biposto)	03-06		FA322/4HH*		MD622X	MD622X				MD622XC*			41
749 (Monoposto/Biposto)	03-06		FA322/4HH*		MD622X	MD622X				MD622XC*			42
750 Sport (4 bolt fixing)	74	FA16	FA16HH		MD634LS								43
750 SS (4 bolt fixing)	75-76	FA18*	FA18HH*		MD634LS	MD634RS							44
751 F1	86	FA18*	FA18HH*		N/A	N/A							45
750 Paso	87-90	FA18*	FA18HH*		MD630LS	MD630RS							46
750 Sport	88-90	FA18*	FA18HH*		MD630LS	MD630RS							47
750 Supersport (Single disc)	91-98	FA95	FA95HH		MD2003X					MD2003XC			48
Supersport 750 (Twin disc)	91-98	FA95*	FA95HH*		MD2003X	MD2003X				MD2003XC			49
750 Supersport	99	FA244*	FA244HH*		MD2003X	MD2003X				MD2003XC*			50
750 Supersport IE	00-02	FA244*	FA244HH*		MD614X	MD614X				MD614XC*			51
750 Sport	01-02	FA244*	FA244HH*		MD614X	MD614X				MD614XC*			52
750 Monster (Single disc)	96-97	FA95	FA95HH		MD2003X					MD2003XC			53
750 Monster (Twin disc)	96-98	FA95*	FA95HH*		MD2003X	MD2003X				MD2003XC*			54
750 Monster City/City Dark	99	FA95*	FA95HH*		MD2003X	MD2003X				MD2003XC*			55
750 Monster/Monster Dark	99	FA95*	FA95HH*		MD2003X	MD2003X				MD2003XC*			56

Line #

FRONT

* This symbol indicates a rotor made of billet steel, and should be only used with EBC FA Kevlar® Organic or Vee pads.
 SAFETY NOTICE - With vehicles primarily designed for off highway use such as quads now being used on the highway, we would recommend the use of X or MXS pads for highway use and ONLY using the R and SV higher density / harder pad series for off road riding.

*-2 Sets Required. ■ - Also available in MX-S race compound. **SAFETY WARNING:- DO NOT USE HH PADS ON REAR UNLESS ALSO USED ON FRONT TO AVOID BRAKE IMBALANCE**

FRONT: Non-Japanese Bikes Cont'd

REAR: Non-Japanese Bikes

Line #	BRAKE ROTOR CHOICES - FRONT						DISC PAD CHOICES - REAR				BRAKE ROTOR CHOICES - REAR					
	CC Custom Rotor	CX Extreme® /Vee-Rotor	OS Series Oversize 250/280mm Rotor Kit	OSX Series Oversize 280mm Rotor Kit	Relocating Bracket for 250/280mm Rotor	SMX Series Oversize 320mm Rotor Kit	Relocating Bracket for 320mm Rotor		Semi-Sintered V-Pads™	Sintered/HH Pads/ Grooved Shoes	SV Series Severe Duty Pads	Standard Rotor	UTVX Rotor	Vintage Rotor	Contour Profile Rotor	CX Extreme® /Vee-Rotor
1		VR614BLK						FA47		FA47HH		MD2002			MD2002C	VR2002
2		VR614BLK*						FA47		FA47HH		MD2002			MD2002C	VR2002
3		VR614BLK*						FA47		FA47HH		MD2002			MD2002C	VR2002
4		VR626BLK*						FA47		FA47HH		MD2002			MD2002C	VR2002
5								N/A								
6								FA47		FA47HH		N/A				
7								FA47		FA47HH						
8								FA47		FA47HH		MD657				
9								FA115		FA115HH		TBA				
10								FA47		FA47HH		N/A				
11		VR2003BLK*						FA47		FA47HH		MD2002			MD2002C	VR2002
12		VR2003BLK						FA47		FA47HH		MD2002			MD2002C	VR2002
13		VR2003BLK						FA47		FA47HH		MD2002			MD2002C	VR2002
14		VR614BLK						FA47		FA47HH		MD2002			MD2002C	VR2002
15		VR614BLK						FA47		FA47HH		MD2002			MD2002C	VR2002
16		VR2003BLK						FA47		FA47HH		MD2002			MD2002C	VR2002
17		VR614BLK*						FA47		FA47HH		MD2002			MD2002C	VR2002
18		VR614BLK*						FA47		FA47HH		MD2002			MD2002C	VR2002
19		VR626BLK*						FA47		FA47HH		MD2002			MD2002C	VR2002
20		VR614BLK*						FA266	FA266V	FA266HH		MD2002			MD2002C	VR2002
21		VR2003BLK						FA47		FA47HH		MD2002			MD2002C	VR2002
22		VR626BLK*						FA266	FA266V	FA266HH		MD2002			MD2002C	VR2002
23		VR2003BLK						FA266	FA266V	FA266HH		MD2002			MD2002C	VR2002
24								FA18	FA18V	FA18HH		N/A				
25		VR626BLK*						FA47		FA47HH		MD2002			MD2002C	VR2002
26		VR614BLK*						FA266	FA266V	FA266HH		MD2002			MD2002C	VR2002
27		VR614BLK*						FA266	FA266V	FA266HH		MD2002			MD2002C	VR2002
28								FA47		FA47HH		MD632			MD632C	
29								FA47		FA47HH		MD632			MD632C	
30		VR2003BLK*						FA47		FA47HH		MD632			MD632C	VR632
31		VR614BLK*						FA47		FA47HH		MD632			MD2002C	VR2002
32								FA47		FA47HH		MD632			MD632C	
33		VR2003BLK*						FA47		FA47HH		MD632			MD632C	VR632
34		VR614BLK*						FA47		FA47HH		MD2002			MD2002C	VR2002
35								FA47		FA47HH		MD632				
36								FA47		FA47HH		MD632				
37								FA47		FA47HH		MD632			MD632C	
38		VR614BLK*						FA47		FA47HH		MD632			MD632C	VR632
39		VR622BLK*						FA266	FA266V	FA266HH		MD618			MD618C	VR618
40		VR622BLK*						FA266	FA266V	FA266HH		MD618			MD618C	VR618
41		VR622BLK*						FA266	FA266V	FA266HH		MD618			MD618C	VR618
42		VR622BLK*						FA266	FA266V	FA266HH		MD618			MD618C	VR618
43								N/A								
44								FA18	FA18V	FA18HH		N/A				
45								FA18	FA18V	FA18HH		N/A				
46								FA47	FA47V	FA47HH		MD631				
47								FA18	FA18V	FA18HH		MD631				
48		VR2003BLK						FA47		FA47HH		MD2002			MD2002C	VR2002
49		VR2003BLK*						FA47		FA47HH		MD2002			MD2002C	VR2002
50		VR2003BLK*						FA266	FA266V	FA266HH		MD2002			MD2002C	VR2002
51		VR614BLK*						FA266	FA266V	FA266HH		MD2002			MD2002C	VR2002
52		VR614BLK*						FA266	FA266V	FA266HH		MD2002			MD2002C	VR2002
53		VR2003BLK						FA47		FA47HH		MD2002			MD2002C	VR2002
54		VR2003BLK*						FA47		FA47HH		MD2002			MD2002C	VR2002
55		VR2003BLK*						FA47		FA47HH		MD2002			MD2002C	VR2002
56		VR2003BLK*						FA47		FA47HH		MD2002			MD2002C	VR2002

REAR

⚠ This symbol indicates a rotor made of billet steel, and should be only used with EBC FA Kevlar® Organic or Vee pads.
SAFETY NOTICE - With vehicles primarily designed for off highway use such as quads now being used on the highway, we would recommend the use of X or MXS pads for highway use and ONLY using the R and SV higher density / harder pad series for off road riding.

BRAKE APPLICATIONS

*-2 Sets Required. ■ - Also available in MX-S race compound. **SAFETY WARNING:- DO NOT USE HH PADS ON REAR UNLESS ALSO USED ON FRONT TO AVOID BRAKE IMBALANCE**

FRONT: Non-Japanese Bikes



DUCATI



DISC PAD CHOICES - FRONT

BRAKE ROTOR CHOICES - FRONT

		Semi-Sintered V-Pads™	Sintered/HH Pads/Grooved Shoes	SV Series Severe Duty Pads	Standard Rotor Left	Standard Rotor Right	UTVX Rotor	Vintage Rotor Left	Vintage Rotor Right	Contour Profile Rotor
750 Monster	00-01	FA244*	FA244HH*		MD614X	MD614X				MD614XC*
750 ie Monster	02	FA244*	FA244HH*		MD614X	MD614X				MD614XC*
796 Hypermotard	10-12	FA244*	FA244HH*		MD865X	MD865X				MD865XC*
796 Monster (Non ABS)	10-13	FA244*	FA244HH*		MD841X	MD841X				MD841XC*
796 Monster (ABS)	10-15	FA244*	FA244HH*		MD841X	MD841X				MD841XC*
M 796 Monster 20th Anniversary Model	13-14	FA244*	FA244HH*		MD841X	MD841X				MD841XC*
797 Monster	17		FA630HH*		MD841X	MD841X				MD841XC*
Monster 800	03-04	FA244*	FA244HH*		MD614X	MD614X				MD614XC*
Monster S2R (803cc)	05-07	FA181*	FA181HH*		MD626X	MD626X				MD626XC*
Monster S2R Dark (803cc)	05-06	FA181*	FA181HH*		MD626X	MD626X				MD626XC*
800 Sport	03	FA244*	FA244HH*		MD614X	MD614X				MD614XC*
800 Supersport	03-05	FA244*	FA244HH*		MD614X	MD614X				MD614XC*
Scrambler Classic (Spoke wheels/803cc)	15-16		FA630HH		MD868X					MD868XC
Scrambler Icon (Cast wheels/803cc)	15-16		FA630HH		MD868X					MD868XC
Scrambler Urban Enduro (Spoke wheels/803cc)	15-16		FA630HH		MD868X					MD868XC
Scrambler Full Throttle (Cast wheels/803cc)	15-16		FA630HH		MD868X					MD868XC
Scrambler Flat Track Pro (Cast wheels/803cc)	16		FA630HH		MD868X					MD868XC
Scrambler Café Racer (Cast Wheels/803cc)	17		FA630HH		MD868X					MD868XC
821 Hypermotard SP	13-15		FA630HH*		MD841X	MD841X				MD841XC*
821 Hypermotard SP	13-15		FA630HH*		MD841X	MD841X				MD841XC*
821 Hyperstrada	13-15		FA630HH*		MD841X	MD841X				MD841XC*
Monster 821	15-17		FA630HH*		MD841X	MD841X				MD841XC*
Monster Dark 821	15		FA630HH*		MD841X	MD841X				MD841XC*
Monster Stripe 821	15-17		FA630HH*		MD841X	MD841X				MD841XC*
848 (Radial 2 pad caliper)	08-10	FA244*	FA244HH*		MD843X	MD843X				MD843XC*
848 Evo (Monobloc front calipers)	10-13		FA447HH*		MD843X	MD843X				MD843XC*
848 Evo Corse Special Edition (Monobloc front calipers)	12-13		FA447HH*		N/A	N/A				
848 Streetfighter	12-15	FA244*	FA244HH*		N/A	N/A				
851 Superbike Biposto	89-92	FA95*	FA95HH*		MD2003X	MD2003X				MD2003XC*
860 GT/GTS	75-76	FA18*	FA18HH*		MD634LS	MD634RS				
888 SP4/SP5	92-93	FA95*	FA95HH*		TBA	TBA				TBA*
888 Superbike Strada	94-95	FA95*	FA95HH*		MD2003X	MD2003X				MD2003XC*
899 Panigale	14-15		FA630HH*		MD843X	MD843X				MD843XC*
900 GTS (4 bolt fixing)	75-76	FA18*	FA18HH*		MD634LS	MD634RS				
900 SS Darmah (4 bolt fixing)	76-77	FA18*	FA18HH*		MD634LS	MD634RS				
900 SS - Darmah (6 bolt fixing)	78	FA18*	FA18HH*		MD609LS	MD609RS				
900 Hailwood Replica (6 bolt fixing)	79	FA18*	FA18HH*		MD609LS	MD609RS				
900 Supersport	89-90	FA95*	FA95HH*		MD2001X	MD2001X				MD2001XC*
900 Supersport/Superlight	91-97	FA95*	FA95HH*		MD2003X	MD2003X				MD2003XC*
900 Supersport	98-99	FA244*	FA244HH*		MD2003X	MD2003X				MD2003XC*
900 Supersport CR USA	98	FA95*	FA95HH*		MD2003X	MD2003X				MD2003XC*
900 Supersport FE	98	FA95*	FA95HH*		MD2003X	MD2003X				MD2003XC*
900 Supersport IE	00-01	FA244*	FA244HH*		MD614X	MD614X				MD614XC*
900 Sport	02	FA244*	FA244HH*		MD614X	MD614X				MD614XC*
900 Monster	93-99	FA95*	FA95HH*		MD2003X	MD2003X				MD2003XC*
900 Monster Cromo/Special	98	FA95*	FA95HH*		MD2003X	MD2003X				MD2003XC*
900 Monster City/City Dark	99	FA95*	FA95HH*		MD2003X	MD2003X				MD2003XC*
900 IE Monster	00-01	FA244*	FA244HH*		MD614X	MD614X				MD614XC*
900 MH Evoluzione	00-01	FA244*	FA244HH*		MD614X	MD614X				MD614XC*
906 Paso	88-89	FA18*	FA18HH*		TBA	TBA				
907 IE	90-91	FA95*	FA95HH*		MD2001X	MD2001X				MD2001XC*
907 IE	92-93	FA95*	FA95HH*		MD2003X	MD2003X				MD2003XC*
Monster S4 Foggy (916cc)	02	FA244*	FA244HH*		MD624	MD624				
Monster S4 (916cc)	01-02	FA244*	FA244HH*		MD624	MD624				
ST4 (916cc)	99	FA244*	FA244HH*		MD2003X	MD2003X				MD2003XC*
ST4 (916cc)	00	FA244*	FA244HH*		TBA	TBA				

Line #

FRONT

APPLICATIONS

BRAKE

* This symbol indicates a rotor made of billet steel, and should be only used with EBC FA Kevlar® Organic or Vee pads.

SAFETY NOTICE - With vehicles primarily designed for off highway use such as quads now being used on the highway, we would recommend the use of X or MXS pads for highway use and ONLY using the R and SV higher density / harder pad series for off road riding.

*-2 Sets Required. ■ - Also available in MX-S race compound. **SAFETY WARNING:- DO NOT USE HH PADS ON REAR UNLESS ALSO USED ON FRONT TO AVOID BRAKE IMBALANCE**

FRONT: Non-Japanese Bikes Cont'd

REAR: Non-Japanese Bikes

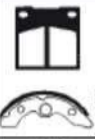
Line #	BRAKE ROTOR CHOICES - FRONT						DISC PAD CHOICES - REAR				BRAKE ROTOR CHOICES - REAR					
	CC Custom Rotor	CX Extreme® /Vee-Rotor	OS Series Oversize 250/280mm Rotor Kit	OSX Series Oversize 280mm Rotor Kit	Relocating Bracket for 250/280mm Rotor	SMX Series Oversize 320mm Rotor Kit	Relocating Bracket for 320mm Rotor		Semi-Sintered V-Pads™	Sintered/HH Pads/ Grooved Shoes	SV Series Severe Duty Pads	Standard Rotor	UTVX Rotor	Vintage Rotor	Contour Profile Rotor	CX Extreme® /Vee-Rotor
1		VR614BLK*						FA47		FA47HH		MD2002			MD2002C	VR2002
2		VR614BLK*						FA47		FA47HH		MD2002			MD2002C	VR2002
3								FA266	FA266V	FA266HH		MD627			MD627C	VR627
4		VR841BLK*						FA266	FA266V	FA266HH		MD627			MD627C	VR627
5		VR841BLK*						FA266	FA266V	FA266HH		MD627			MD627C	VR627
6		VR841BLK*						FA266	FA266V	FA266HH		MD627			MD627C	VR627
7		VR841BLK*						FA213	FA213V	FA213HH		MD878			MD878C	VR878
8		VR614BLK*						FA47		FA47HH		MD2002			MD2002C	VR2002
9		VR626BLK*						FA47		FA47HH		MD627			MD627C	VR627
10		VR626BLK*						FA47		FA47HH		MD627			MD627C	VR627
11		VR614BLK*						FA47		FA47HH		MD2002			MD2002C	VR2002
12		VR614BLK*						FA266	FA266V	FA266HH		MD2002			MD2002C	VR2002
13								FA213	FA213V	FA213HH		MD2002			MD2002C	
14								FA213	FA213V	FA213HH		MD2002			MD2002C	
15								FA213	FA213V	FA213HH		MD2002			MD2002C	
16								FA213	FA213V	FA213HH		MD2002			MD2002C	
17								FA213	FA213V	FA213HH		MD2002			MD2002C	
18									FA213V	FA213HH		MD2002			MD2002C	
19		VR841BLK*							FA266V	FA266HH		MD627			MD627C	VR627
20		VR841BLK*							FA266V	FA266HH		MD627			MD627C	VR627
21		VR841BLK*							FA266V	FA266HH		MD627			MD627C	VR627
22		VR841BLK*							FA266V	FA266HH		MD2002			MD2002C	VR2002
23		VR841BLK*							FA266V	FA266HH		MD2002			MD2002C	VR2002
24		VR841BLK*							FA266V	FA266HH		MD2002			MD2002C	VR2002
25		VR843BLK*						FA266	FA266V	FA266HH		MD627			MD627C	VR627
26		VR843BLK*						FA266	FA266V	FA266HH		MD627			MD627C	VR627
27								FA266	FA266V	FA266HH		MD695			MD695C	VR695
28								FA266	FA266V	FA266HH		MD627				
29		VR2003BLK*						FA47		FA47HH		MD2002			MD2002C	VR2002
30								FA18	FA18V	FA18HH		MD634LS				
31								FA47		FA47HH		MD2002			MD2002C	
32		VR2003BLK*						FA47		FA47HH		MD2002			MD2002C	VR2002
33		VR843BLK*						FA266	FA266V	FA266HH		MD2002			MD2002C	VR2002
34								FA18	FA18V	FA18HH		MD634LS				
35								FA18	FA18V	FA18HH		MD634LS				
36								FA18	FA18V	FA18HH		MD634LS				
37								FA18	FA18V	FA18HH		MD609LS				
38		VR2001BLK*						FA47		FA47HH		MD2002			MD2002C	VR2002
39		VR2003BLK*						FA47		FA47HH		MD2002			MD2002C	VR2002
40		VR2003BLK*						FA266	FA266V	FA266HH		MD2002			MD2002C	VR2002
41		VR2003BLK*						FA47		FA47HH		MD2002			MD2002C	VR2002
42		VR2003BLK*						FA47		FA47HH		MD2002			MD2002C	VR2002
43		VR614BLK*						FA266	FA266V	FA266HH		MD2002			MD2002C	VR2002
44		VR614BLK*						FA266	FA266V	FA266HH		MD2002			MD2002C	VR2002
45		VR2003BLK*						FA47		FA47HH		MD2002			MD2002C	VR2002
46		VR2003BLK*						FA47		FA47HH		MD2002			MD2002C	VR2002
47		VR2003BLK*						FA47		FA47HH		MD2002			MD2002C	VR2002
48		VR614BLK*						FA47		FA47HH		MD2002			MD2002C	VR2002
49		VR614BLK*						FA266	FA266V	FA266HH		MD632			MD632C	VR632
50								FA18		FA18HH		MD631				
51		VR2001BLK*						FA47		FA47HH		MD2002			MD2002C	VR2002
52		VR2003BLK*						FA47		FA47HH		MD2002			MD2002C	VR2002
53		VR624BLK*						FA47		FA47HH		MD2002				VR2002
54		VR624BLK*						FA47		FA47HH		MD2002				VR2002
55		VR2003BLK*						FA266	FA266V	FA266HH		MD2002			MD2002C	VR2002
56								FA266	FA266V	FA266HH		MD2002				

REAR

⚠ This symbol indicates a rotor made of billet steel, and should be only used with EBC FA Kevlar® Organic or Vee pads.
 SAFETY NOTICE - With vehicles primarily designed for off highway use such as quads now being used on the highway, we would recommend the use of X or MXS pads for highway use and ONLY using the R and SV higher density / harder pad series for off road riding.

BRAKE APPLICATIONS

*-2 Sets Required. ■ - Also available in MX-S race compound. **SAFETY WARNING:- DO NOT USE HH PADS ON REAR UNLESS ALSO USED ON FRONT TO AVOID BRAKE IMBALANCE**

FRONT: Non-Japanese Bikes

APPLICATIONS

BRAKE



DUCATI



DISC PAD CHOICES - FRONT

BRAKE ROTOR CHOICES - FRONT

		Semi-Sintered V-Pads™	Sintered/HH Pads/Grooved Shoes	SV Series Severe Duty Pads	Standard Rotor Left	Standard Rotor Right	UTVX Rotor	Vintage Rotor Left	Vintage Rotor Right	Contour Profile Rotor
ST4 (916cc)	01-02	FA244*	FA244HH*		MD614X	MD614X				MD614XC*
916 (Biposto)	94-96	FA95*	FA95HH*		MD2003X	MD2003X				MD2003XC*
916 Sienna	94-98	FA95*	FA95HH*		TBA	TBA				
Supersport (936cc)	17		FA630HH*		MD841X	MD841X				ND841XC*
Supersport S (936cc)	17		FA630HH*		MD841X	MD841X				ND841XC*
939 Hypermotard	16-17		FA630HH*		MD841X	MD841X				MD841XC*
939 Hypermotard SP	16-17		FA630HH*		MD841X	MD841X				MD841XC*
939 Hyperstrada	16		FA630HH*		MD841X	MD841X				MD841XC*
ST2 (944cc)	97-99	FA244*	FA244HH*		MD2003X	MD2003X				MD2003XC*
ST2 (944cc)	00-03	FA244*	FA244HH*		MD614X	MD614X				MD614XC*
950 Multistrada (936cc)	17		FA630HH*		MD841X	MD841X				MD841XC*
959 Panigale ABS	16-17		FA630HH*		MD843X	MD843X				MD843XC*
ST3S (ABS Model) (992cc)	06-07	FA244*	FA244HH*		MD624	MD624				
916 SPS (996cc)	97-98	FA244*	FA244HH*		TBA	TBA				
Monster S4R (996cc) (2 pad caliper)	05-06	FA244*	FA244HH*		MD624	MD624				
996 SPS (996cc)	99	FA244*	FA244HH*		MD624	MD624				
996 (996cc) (Monoposto/Biposto)	99-01	FA244*	FA244HH*		MD624	MD624				
996 R	01		FA322/4HH*		MD636X	MD636X				MD636XC*
996 S	01	FA244*	FA244HH*		MD624	MD624				
Monster S4R (996cc)	03-06	FA244*	FA244HH*		MD624	MD624				
S4RS Monster (998cc) (Radial 4 pad caliper)	06		FA322/4HH*		MD843X	MD843X				MD843XC*
S4R Testastretta Monster (998cc) (Radial 4 pad caliper)	07-08		FA322/4HH*		MD843X	MD843X				MD843XC*
S4RS Testastretta Monster (998cc) (Radial 4 pad caliper)	07-		FA322/4HH*		MD843X	MD843X				MD843XC*
S4RS (Tricolore/Monster Testastretta) (998cc) (Radial 4 pad caliper)	08		FA322/4HH*		MD843X	MD843X				MD843XC*
ST4S (Non ABS/996cc)	01-05	FA244*	FA244HH*		MD624	MD624				
ST4S (ABS Model/996cc)	03-05	FA244*	FA244HH*		MD624	MD624				
Desmosedici RR (D16RR/989cc)	08		FA447HH*		MD694X	MD694X				MD694XC*
998 Matrix (998cc)	04		FA322/4HH*		MD633X	MD633X				MD633XC*
998 R (998cc)	02		FA322/4HH*		TBA	TBA				
998 S Bayliss/Bostrom	02		FA322/4HH*		MD633X	MD633X				MD633XC*
998 S (998cc) (4 pad caliper)	02-04		FA322/4HH*		MD633X	MD633X				MD633XC*
998 (998cc) (2 pad caliper) (Monoposto/Biposto)	02-03	FA244*	FA244HH*		MD633X	MD633X				MD633XC*
999 S (Std Caliper Mount) (Monoposto/Biposto)	03-04		FA322/4HH*		MD622X	MD622X				MD622XC*
999 (Std mount caliper)	03-06		FA322/4HH*		MD622X	MD622X				MD622XC*
999 R (Radial mount caliper)	03-06		FA322/4HH*		MD622X	MD622X				MD622XC*
999 R Fila (Radial mount caliper)	03-		FA322/4HH*		MD622X	MD622X				MD622XC*
999 R Xerox	06		FA322/4HH*		MD622X	MD622X				MD622XC*
999 S (Radial mount caliper) Monoposto/Biposto	05-06		FA322/4HH*		MD622X	MD622X				MD622XC*
1000 R1 Hailwood Replica (6 bolt fixing)	84	FA18*	FA18HH*		MD609LS	MD609RS				
GT 1000 (992cc)	07-10	FA209/2*	FA209/2HH*		MD614X	MD614X				MD614XC*
GT 1000 Touring - Sport Classic	09	FA209/2*	FA209/2HH*		MD614X	MD614X				MD614XC*
Monster 1000 Dark	03	FA244*	FA244HH*		MD614X	MD614X				MD614XC*
Monster 1000 ie (992cc)	04-05	FA244	FA244HH		MD614X	MD614X				MD614XC*
Monster 1000 S ie (992cc)	03-05	FA244*	FA244HH*		MD614X	MD614X				MD614XC*
Monster S2R 1000 (992cc)	06-08	FA244*	FA244HH*		MD614X	MD614X				MD614XC*
Multistrada 1000 DS (992cc)	03-05	FA244*	FA244HH*		MD682	MD682				
Multistrada S 1000 DS (992cc)	05-06	FA244*	FA244HH*		MD682	MD682				
Paul Smart 1000 LE (992cc)	06	FA209/2*	FA209/2HH*		MD614X	MD614X				MD614XC*
Sport 1000 S	07-09	FA244*	FA244HH*		MD614X	MD614X				MD614XC*
Sport Classic 1000 (992cc) (Monoposto - Japan/Biposto - Europe)	06-08	FA209/2*	FA209/2HH*		MD614X	MD614X				MD614XC*
Supersport 1000 DS (992cc)	03-06	FA244*	FA244HH*		MD614X	MD614X				MD614XC*
1098	07-08		FA447HH*		MD694X	MD694X				MD694XC*
1098 S Tricolore	07		FA447HH*		MD694X	MD694X				MD694XC*
1098 S	07-08		FA447HH*		MD694X	MD694X				MD694XC*
1098 R	08-09		FA447HH*		N/A	N/A				
Streetfighter (1099cc)	09-12		FA447HH*		N/A	N/A				

Line #

FRONT

* This symbol indicates a rotor made of billet steel, and should be only used with EBC FA Kevlar® Organic or Vee pads.
 SAFETY NOTICE - With vehicles primarily designed for off highway use such as quads now being used on the highway, we would recommend the use of X or MXS pads for highway use and ONLY using the R and SV higher density / harder pad series for off road riding.

*-2 Sets Required. ■ - Also available in MX-S race compound. **SAFETY WARNING:- DO NOT USE HH PADS ON REAR UNLESS ALSO USED ON FRONT TO AVOID BRAKE IMBALANCE**

FRONT: Non-Japanese Bikes Cont'd

REAR: Non-Japanese Bikes

Line #	BRAKE ROTOR CHOICES - FRONT						DISC PAD CHOICES - REAR				BRAKE ROTOR CHOICES - REAR					
	CC Custom Rotor	CX Extreme® /Vee-Rotor	OS Series Oversize 250/280mm Rotor Kit	OSX Series Oversize 280mm Rotor Kit	Relocating Bracket for 250/280mm Rotor	SMX Series Oversize 320mm Rotor Kit	Relocating Bracket for 320mm Rotor		Semi-Sintered V-Pads™	Sintered/HH Pads/ Grooved Shoes	SV Series Severe Duty Pads	Standard Rotor	UTVX Rotor	Vintage Rotor	Contour Profile Rotor	CX Extreme® /Vee-Rotor
1		VR614BLK*						FA47		FA47HH		MD2002			MD2002C	VR2002
2		VR2003BLK*						FA47		FA47HH		MD632			MD632C	VR632
3								FA47		FA47HH		MD632				
4		VR841BLK*							FA266V	FA266HH		MD880			MD880C	VR880
5		VR841BLK*							FA266V	FA266HH		MD880			MD880C	VR880
6		VR841BLK*							FA266V	FA266HH		MD878			MD878C	VR878
7		VR841BLK*							FA266V	FA266HH		MD878			MD878C	VR878
8		VR841BLK*							FA266V	FA266HH		MD627			MD627C	VR627
9		VR2003BLK*						FA266	FA266V	FA266HH		MD2002			MD2002C	VR2002
10		VR614BLK*						FA266	FA266V	FA266HH		MD2002			MD2002C	VR2002
11		VR841BLK*						FA181X		FA181HH		TBA				
12		VR843BLK*						FA266	FA266V	FA266HH		MD2002			MD2002C	VR2002
13		VR624BLK*						FA266	FA266V	FA266HH		MD2002				VR2002
14								FA47		FA47HH		MD632				
15		VR624BLK*						FA47		FA47HH		MD627				VR627
16		VR624BLK*						FA47		FA47HH		MD632				VR632
17		VR624BLK*						FA47		FA47HH		MD632				VR632
18								FA47		FA47HH		MD632			MD632C	
19		VR624BLK*						FA47		FA47HH		MD632				VR632
20		VR624BLK*						FA47		FA47HH		MD627				VR627
21		VR843BLK*						FA47		FA47HH		MD627			MD627C	VR627
22		VR843BLK*						FA47		FA47HH		MD627			MD627C	VR627
23		VR843BLK*						FA47		FA47HH		MD627			MD627C	VR627
24								FA47		FA47HH		MD627			MD627C	VR627
25		VR624BLK*						FA266	FA266V	FA266HH		MD2002				VR2002
26		VR624BLK*						FA266	FA266V	FA266HH		MD2002				VR2002
27		VR694BLK*						FA266	FA266V	FA266HH		MD618			MD618C	VR618
28								FA47		FA47HH		MD632			MD632C	
29								FA47		FA47HH		MD632				
30								FA47		FA47HH		MD632			MD632C	
31								FA47		FA47HH		MD632			MD632C	
32								FA47		FA47HH		MD632			MD632C	
33		VR622BLK*						FA266	FA266V	FA266HH		MD618			MD618C	VR618
34		VR622BLK*						FA266	FA266V	FA266HH		MD618			MD618C	VR618
35		VR622BLK*						FA266	FA266V	FA266HH		MD618			MD618C	VR618
36		VR622BLK*						FA266	FA266V	FA266HH		MD618			MD618C	VR618
37		VR622BLK*						FA266	FA266V	FA266HH		MD618			MD618C	VR618
38		VR622BLK*						FA266	FA266V	FA266HH		MD618			MD618C	VR618
39								FA18	FA18V	FA18HH		MD609LS				
40		VR614BLK*						FA213	FA213V	FA213HH		MD2002			MD2002C	VR2002
41		VR614BLK*						FA213	FA213V	FA213HH		MD2002			MD2002C	VR2002
42		VR614BLK*						FA47		FA47HH		MD2002			MD2002C	VR2002
43		VR614BLK*						FA47		FA47HH		MD2002			MD2002C	VR2002
44		VR614BLK*						FA47		FA47HH		MD2002			MD2002C	VR2002
45		VR614BLK*						FA47		FA47HH		MD627				
46								FA266	FA266V	FA266HH		MD627				
47								FA266	FA266V	FA266HH		MD627				
48		VR614BLK*						FA213	FA213V	FA213HH		MD2002			MD2002C	VR2002
49		VR614BLK*						FA213	FA213V	FA213HH		MD2002			MD2002C	VR2002
50		VR614BLK*						FA213	FA213V	FA213HH		MD2002			MD2002C	VR2002
51		VR614BLK*						FA266	FA266V	FA266HH		MD2002			MD2002C	VR2002
52		VR694BLK*						FA266	FA266V	FA266HH		MD695			MD695C	VR695
53		VR694BLK*						FA266	FA266V	FA266HH		MD695			MD695C	VR695
54		VR694BLK*						FA266	FA266V	FA266HH		MD695			MD695C	VR695
55								FA266	FA266V	FA266HH		MD695			MD695C	VR695
56								FA266	FA266V	FA266HH		MD695			MD695C	VR695

REAR

This symbol indicates a rotor made of billet steel, and should be only used with EBC FA Kevlar® Organic or Vee pads.

SAFETY NOTICE - With vehicles primarily designed for off highway use such as quads now being used on the highway, we would recommend the use of X or MXS pads for highway use and ONLY using the R and SV higher density / harder pad series for off road riding.

BRAKE APPLICATIONS

*-2 Sets Required. ■ - Also available in MX-S race compound. **SAFETY WARNING:- DO NOT USE HH PADS ON REAR UNLESS ALSO USED ON FRONT TO AVOID BRAKE IMBALANCE**

FRONT: Non-Japanese Bikes

APPLICATIONS

BRAKE



DUCATI



DISC PAD CHOICES - FRONT

BRAKE ROTOR CHOICES - FRONT

			Semi-Sintered V-Pads™	Sintered/HH Pads/Grooved Shoes	SV Series Severe Duty Pads	Standard Rotor Left	Standard Rotor Right	UTVX Rotor	Vintage Rotor Left	Vintage Rotor Right	Contour Profile Rotor
Streetfighter S (1099cc)	09-12			FA447HH*		N/A	N/A				
Hypermotard 1100	07-09	FA244*		FA244HH*		MD865X	MD865X				MD865XC*
Hypermotard 1100 Evo	10-12	FA447*		FA447HH*		MD865X	MD865X				MD865XC*
Hypermotard 1100 Evo SP	10-13	FA447*		FA447HH*		MD865X	MD865X				MD865XC*
Hypermotard 1100 S	07-09			FA447HH*		MD865X	MD865X				MD865XC*
Monster 1100 (Non ABS)	09-10	FA244*		FA244HH*		MD843X	MD843X				MD843XC*
Monster 1100 (ABS)	12	FA244*		FA244HH*		MD843X	MD843X				MD843XC*
Monster 1100 S (Non ABS)	09-10	FA244*		FA244HH*		MD843X	MD843X				MD843XC*
Monster 1100 S (ABS)	12	FA244*		FA244HH*		MD843X	MD843X				MD843XC*
Monster 1100 Evo (ABS)	12-14	FA244*		FA244HH*		MD843X	MD843X				MD843XC*
1100 Monster Diesel	13-14	FA244*		FA244HH*		MD843X	MD843X				MD843XC*
M 1100 Monster 1100 Evo 20th Anniversary Model	13-14	FA244*		FA244HH*		MD843X	MD843X				MD843XC*
Multistrada 1100 (1078cc)	07-09	FA244*		FA244HH*		MD682	MD682				
Multistrada 1100 S (1078cc)	07-09	FA244*		FA244HH*		MD682	MD682				
1198	09-12			FA447HH*		N/A	N/A				
1198 S	09-10			FA447HH*		N/A	N/A				
1198 SP	11-12			FA447HH*		N/A	N/A				
1198 R Special Edition	11			FA447HH*		N/A	N/A				
1199 Panigale	12-15			FA447HH*		N/A	N/A				
1199 Panigale S	12-15			FA447HH*		N/A	N/A				
1199 Panigale S Tricolore	12-14			FA447HH*		N/A	N/A				
1199 Panigale R	13-15			FA447HH*		N/A	N/A				
1199 Panigale Superleggera	14			FA447HH*		TBA	TBA				
1200 Monster	14-17			FA630HH*		MD841X	MD841X				MD841XC*
1200 Monster Stripe	15			FA447HH*		TBA	TBA				
1200 S Monster	14-17			FA447HH*		MD841X	MD841X				MD841XC*
1200 R Monster	16-17			FA447HH*		MD841X	MD841X				MD841XC*
Multistrada 1200	10-15	FA244*		FA244HH*		MD841X	MD841X				MD841XC*
Multistrada 1200	16-17			FA630HH*		MD841X	MD841X				MD841XC*
Multistrada 1200 Enduro	16			FA630HH*		MD841X	MD841X				MD841XC*
Multistrada 1200 Enduro	17-18			FA630HH*		MD841X	MD841X				MD841XC*
Multistrada 1200 (Pikes Peak)	16-17			FA447HH*		MD841X	MD841X				MD841XC*
Multistrada 1200 S (Sport)	10	FA244*		FA244HH*		MD841X	MD841X				MD841XC*
Multistrada 1200 S (Pikes Peak)	11-14	FA244*		FA244HH*		MD841X	MD841X				MD841XC*
Multistrada 1200 S (Touring)	10-14	FA244*		FA244HH*		MD841X	MD841X				MD841XC*
Multistrada 1200 S Grandtourismo	13-14	FA244*		FA244HH*		MD841X	MD841X				MD841XC*
Multistrada 1200 DVT (Single Pin Pad Fixing)	15-16			FA630HH*		TBA	TBA				
Multistrada 1200 S	16-17			FA447HH*		MD841X	MD841X				MD841XC*
Multistrada 1200 S DVT	15-17			FA447HH*		TBA	TBA				
Multistrada 1200 S D/Air	16-17			FA447HH*		TBA	TBA				
Diavel AMG	12-13			FA447HH*		MD841X	MD841X				MD841XC*
Diavel ABS	11-17			FA447HH*		MD841X	MD841X				MD841XC*
Diavel Carbon ABS	11-14			FA447HH*		TBA	TBA				TBA
Diavel Carbon ABS	16-17			FA447HH*		MD841X	MD841X				MD841XC*
Diavel Cromo (ABS)	11-14			FA447HH*		MD841X	MD841X				MD841XC*
Diavel Dark (ABS)	13-15			FA447HH*		MD841X	MD841X				MD841XC*
Diavel Strada (ABS)	13-15			FA447HH*		MD841X	MD841X				MD841XC*
1262 Xdiavel	16-17			FA630HH*		MD841X	MD841X				MD841XC*
1262 Xdiavel S	16-17			FA447HH*		MD841X	MD841X				MD841XC*
1299 Panigale	15-17			FA447HH*		TBA	TBA				
1299 Panigale S	15-17			FA447HH*		TBA	TBA				
1299 Panigale R	15-17			FA447HH*		TBA	TBA				
EBR											
1190RS (Sport)	14-15			FA454/4HH			MD735RS				
1190RX (Sport)	14-15			FA454/4HH			MD735RS				

Line #

* This symbol indicates a rotor made of billet steel, and should be only used with EBC FA Kevlar® Organic or Vee pads.
 SAFETY NOTICE - With vehicles primarily designed for off highway use such as quads now being used on the highway, we would recommend the use of X or MXS pads for highway use and ONLY using the R and SV higher density / harder pad series for off road riding.

FRONT

*-2 Sets Required. ■ - Also available in MX-S race compound. **SAFETY WARNING:- DO NOT USE HH PADS ON REAR UNLESS ALSO USED ON FRONT TO AVOID BRAKE IMBALANCE**

FRONT: Non-Japanese Bikes Cont'd

REAR: Non-Japanese Bikes

Line #	BRAKE ROTOR CHOICES - FRONT						DISC PAD CHOICES - REAR				BRAKE ROTOR CHOICES - REAR				
	CC Custom Rotor	CX Extreme® /Vee-Rotor	OS Series Oversize 250/280mm Rotor Kit	OSX Series Oversize 280mm Rotor Kit	Relocating Bracket for 250/280mm Rotor	SMX Series Oversize 320mm Rotor Kit	Relocating Bracket for 320mm Rotor		Semi-Sintered V-Pads™	Sintered/HH Pads/ Grooved Shoes	SV Series Severe Duty Pads	Standard Rotor	UTVX Rotor	Vintage Rotor	Contour Profile Rotor
1							FA266	FA266V	FA266HH		MD695			MD695C	VR695
2							FA266	FA266V	FA266HH		MD627			MD627C	VR627
3							FA266	FA266V	FA266HH		MD627			MD627C	VR627
4							FA266	FA266V	FA266HH		MD627			MD627C	VR627
5							FA266	FA266V	FA266HH		MD627			MD627C	VR627
6		VR843BLK*					FA266	FA266V	FA266HH		MD627			MD627C	VR627
7		VR843BLK*					FA266	FA266V	FA266HH		TBA			TBA	TBA
8		VR843BLK*					FA266	FA266V	FA266HH		MD627			MD627C	VR627
9		VR843BLK*					FA266	FA266V	FA266HH		TBA			TBA	TBA
10		VR843BLK*					FA266	FA266V	FA266HH		TBA			TBA	TBA
11		VR843BLK*					FA266	FA266V	FA266HH		TBA			TBA	TBA
12		VR843BLK*					FA266	FA266V	FA266HH		TBA			TBA	TBA
13							FA266	FA266V	FA266HH		MD627				
14							FA266	FA266V	FA266HH		MD627				
15							FA266	FA266V	FA266HH		MD695			MD695C	VR695
16							FA266	FA266V	FA266HH		MD695			MD695C	VR695
17							FA266	FA266V	FA266HH		MD695			MD695C	VR695
18							FA266	FA266V	FA266HH		MD695			MD695C	VR695
19							FA266	FA266V	FA266HH		MD880			MD880C	VR880
20							FA266	FA266V	FA266HH		MD880			MD880C	VR880
21							FA266	FA266V	FA266HH		MD880			MD880C	VR880
22							FA266	FA266V	FA266HH		MD880			MD880C	VR880
23							FA266	FA266V	FA266HH		MD880			MD880C	VR880
24		VR841BLK*					FA266	FA266V	FA266HH		MD880			MD880C	VR880
25							FA266	FA266V	FA266HH		MD880			MD880C	VR880
26		VR841BLK*					FA266	FA266V	FA266HH		MD880			MD880C	VR880
27		VR841BLK*					FA266	FA266V	FA266HH		MD880			MD880C	VR880
28		VR841BLK*					FA266	FA266V	FA266HH		MD880			MD880C	VR880
29		VR841BLK*						FA209/2V	FA209/2HH		MD879				
30		VR841BLK*						FA209/2V	FA209/2HH		TBA				TBA
31		VR841BLK*					FA181X		FA181HH		TBA				TBA
32		VR841BLK*						FA209/2V	FA209/2HH		MD879				
33		VR841BLK*					FA266	FA266V	FA266HH		TBA				TBA
34		VR841BLK*					FA266	FA266V	FA266HH		TBA				TBA
35		VR841BLK*					FA266	FA266V	FA266HH		TBA				TBA
36		VR841BLK*					FA266	FA266V	FA266HH		TBA				TBA
37							FA181X		FA181HH		TBA				
38		VR841BLK*						FA209/2V	FA209/2HH		MD879				
39							FA181X		FA181HH		TBA				
40							FA181X		FA181HH		TBA				
41		VR841BLK*						FA209/2V	FA209/2HH		TBA				TBA
42		VR841BLK*						FA209/2V	FA209/2HH		MD879				
43								FA209/2V	FA209/2HH		MD879				
44		VR841BLK*						FA209/2V	FA209/2HH		MD879				
45		VR841BLK*						FA209/2V	FA209/2HH		TBA				TBA
46		VR841BLK*						FA209/2V	FA209/2HH		TBA				TBA
47		VR841BLK*						FA209/2V	FA209/2HH		TBA				TBA
48		VR841BLK*						FA209/2V	FA209/2HH		MD879				
49		VR841BLK*						FA209/2V	FA209/2HH		MD879				
50							FA266	FA266V	FA266HH		MD880			MD880C	VR880
51							FA266	FA266V	FA266HH		MD880			MD880C	VR880
52							FA266	FA266V	FA266HH		MD880			MD880C	VR880
53															
54															
55									FA460HH		N/A				
56									FA460HH		N/A				

⚠ This symbol indicates a rotor made of billet steel, and should be only used with EBC FA Kevlar® Organic or Vee pads.
 SAFETY NOTICE - With vehicles primarily designed for off highway use such as quads now being used on the highway, we would recommend the use of X or MXS pads for highway use and ONLY using the R and SV higher density / harder pad series for off road riding.

BRAKE APPLICATIONS

*-2 Sets Required. ■ - Also available in MX-S race compound. **SAFETY WARNING:- DO NOT USE HH PADS ON REAR UNLESS ALSO USED ON FRONT TO AVOID BRAKE IMBALANCE**

FRONT: Non-Japanese Bikes

APPLICATIONS

BRAKE



EBC



DISC PAD CHOICES - FRONT

BRAKE ROTOR CHOICES - FRONT

			Semi-Sintered V-Pads™	Sintered/HH Pads/Grooved Shoes	SV Series Severe Duty Pads	Standard Rotor Left	Standard Rotor Right	UTVX Rotor	Vintage Rotor Left	Vintage Rotor Right	Contour Profile Rotor
1190SX (Naked)	14-15			FA454/4HH			MD735RS				
E-TON											
IXL 40 Rascal	98-01	N/A									
RXL 40E Viper Junior	01-06	N/A									
Viper 40E	99-08	N/A									
AXL 50 Lightning 50	99-00	338*		338G*							
Beamer 50 (PN2)	04-08	SFA169		SFA169HH		TBA					
Bramer 50 III	09	SFA169		SFA169HH		TBA					
Beamer II (PN2B)		SFA169		SFA169HH		TBA					
Beamer Matrix (PN2C)		SFA169		SFA169HH		TBA					
Beamer Matrix II (PN2E)		SFA169		SFA169HH		TBA					
Beamer R2 50 (PN2G)		SFA264		SFA264HH		N/A					
BXL 50 Draco	05-06	338*		338G*							
Matrix 50	09	SFA264		SFA264HH		TBA					
NXL 50 Lightning 50	01-02	338*		338G*							
Sport 50	09	SFA264		SFA264HH		TBA					
TXL 50 Wizz 50	98-99	338*		338G*							
Viper 50 Mini RXL 50 M (4T)	03-08	338*		338G*							
Viper 50 Mini RXL 50 M (4T) Parking Brake											
Viper 50 RXL 50	03-06	338*		338G*							
Viper 70 RXL 70/70M (2T/4T)	05-09	338*		338G*							
AXL 90 Thunder	99-00	338*		338G*							
DXL 90 Sierra	99-03	614*		614G*							
NXL 90 Thunder	01-02	338*		338G*							
RXL 90 Viper 90	03-06	338*		338G*							
RXL 90 R Viper 90 R Reverse (2T/4T)	03-09	338*		338G*							
BXL 100 Draco	05-06	338*		338G*							
Beamer R4 - 150 (PN2F)		SFA264		SFA264HH		N/A					
CXL 150 Yukon II/Challenger	02-09	303*		303G*							
EXL 150 Yukon ST	05-06	FA83X*		FA83R*		N/A	N/A				
Matrix R4 - 150	09	SFA264		SFA264HH		TBA					
RXL 150 Viper R	05-09	303*		303G*							
RXL 150 Viper	05-06	303*		303G*							
YXL 150 Yukon	00-02	303*		303G*							
Yukon ELX 150	05-06	FA83X*		FA83R*		N/A	N/A				
Viper EXL 150 ST Quad	05-06	FA83X*		FA83R*		N/A	N/A				
Vector VXL 250 ST Quad	06-09	FA83X*		FA83R*		N/A	N/A				
GAS-GAS											
EC 50 (Boy)	01-04	FA291X				N/A					
EC 50 Boy (Air Cooled)	05	FA115X		FA115HH■		N/A					
EC 50 Boy (LC)	05	FA303X				N/A					
EC 50 (Rookie)	01-04	FA167		FA167HH		N/A					
EC 50	05	FA194		FA194HH		N/A					
HP 50 Wild	03-05	FA181X*		FA181R*■		N/A	N/A				
SM 50 (Rookie)	01-04	FA167		FA167HH		N/A					
SM 50	05	FA194		FA194HH		N/A					
TXT 50 (Boy)	01	FA291X				N/A					
TXT 50 (Boy)	04-11	FA115X		FA115R■		N/A					
TXT 50/80 (Rookie)	02-03	FA291X				N/A					
MC 65	05-06	FA351X				N/A					
TXT 70 Rookie/Cadet	10-11	FA303X				N/A					
TXT 80 Rookie/Cadet	04-08	FA303X				N/A					
TXT 80 Cadet Pro	15	FA303X				N/A					
Enduros 125/250	00	FA181X		FA181R■		N/A					

Line #

FRONT

* This symbol indicates a rotor made of billet steel, and should be only used with EBC FA Kevlar® Organic or Vee pads. SAFETY NOTICE - With vehicles primarily designed for off highway use such as quads now being used on the highway, we would recommend the use of X or MXS pads for highway use and ONLY using the R and SV higher density / harder pad series for off road riding.

*-2 Sets Required. ■ - Also available in MX-S race compound. **SAFETY WARNING:- DO NOT USE HH PADS ON REAR UNLESS ALSO USED ON FRONT TO AVOID BRAKE IMBALANCE**

FRONT: Non-Japanese Bikes Cont'd

REAR: Non-Japanese Bikes

Line #	BRAKE ROTOR CHOICES - FRONT						DISC PAD CHOICES - REAR				BRAKE ROTOR CHOICES - REAR					
	CC Custom Rotor	CX Extreme® /Vee-Rotor	OS Series Oversize 250/280mm Rotor Kit	OSX Series Oversize 280mm Rotor Kit	Relocating Bracket for 250/280mm Rotor	SMX Series Oversize 320mm Rotor Kit	Relocating Bracket for 320mm Rotor		Semi-Sintered V-Pads™	Sintered/HH Pads/Grooved Shoes	SV Series Severe Duty Pads	Standard Rotor	UTVX Rotor	Vintage Rotor	Contour Profile Rotor	CX Extreme® /Vee-Rotor
1									FA460HH			N/A				
2																
3																
4								330		330G						
5								330		330G						
6								330		330G						
7								TBA		TBA						
8								TBA								
9								TBA								
10								TBA								
11								TBA								
12								TBA								
13								SFA83		SFA83HH		N/A				
14								FA83X		FA83R		N/A				
15								SFA83		SFA83HH		TBA				
16								TBA		TBA						
17								TBA								
18								TBA		TBA						
19								FA83X		FA83R		N/A				
20								FA232X								
21								FA83X		FA83R		N/A				
22								FA83X		FA83R		N/A				
23								330		330G						
24								330		330G						
25								330		330G						
26								FA83X		FA83R		N/A				
27								FA83X		FA83R		N/A				
28								FA83X		FA83R		N/A				
29								SFA83		SFA83HH		N/A				
30								FA165X		FA165R		N/A				
31								330		330G						
32								SFA83		SFA83HH		TBA				
33								FA165X		FA165R		N/A				
34								FA165X		FA165R		N/A				
35								330		330G						
36								330		330G						
37								330		330G						
38								FA83X		FA83R		N/A				
39																
40																
41								FA291X				N/A				
42								FA351X				N/A				
43								FA351X				N/A				
44								FA291X				N/A				
45								FA291X				N/A				
46								FA181X		FA181R■		N/A				
47								FA291X				N/A				
48								FA291X				N/A				
49								FA291X				N/A				
50								FA115X		FA115R		N/A				
51								FA291X				N/A				
52								FA115X				N/A				
53								FA351X				N/A				
54								FA351X				N/A				
55								FA351X				N/A				
56								FA208X		FA208R■		N/A				

BRAKE APPLICATIONS
 This symbol indicates a rotor made of billet steel, and should be only used with EBC FA Kevlar® Organic or Vee pads.
 SAFETY NOTICE - With vehicles primarily designed for off highway use such as quads now being used on the highway, we would recommend the use of X or MXS pads for highway use and ONLY using the R and SV higher density / harder pad series for off road riding.

*-2 Sets Required. ■ - Also available in MX-S race compound. **SAFETY WARNING:- DO NOT USE HH PADS ON REAR UNLESS ALSO USED ON FRONT TO AVOID BRAKE IMBALANCE**

FRONT: Non-Japanese Bikes

APPLICATIONS

BRAKE



GAS-GAS



DISC PAD CHOICES - FRONT

BRAKE ROTOR CHOICES - FRONT

			Semi-Sintered V-Pads™	Sintered/HH Pads/Grooved Shoes	SV Series Severe Duty Pads	Standard Rotor Left	Standard Rotor Right	UTVX Rotor	Vintage Rotor Left	Vintage Rotor Right	Contour Profile Rotor
EC 125/200/250/300	00-09	FA185X		FA185R■		MD6289D					MD6289C
EC 125/200/250/300 (All models/2T) (See note)	10-12	FA185X		FA185R■							MD6289C
HP 125	07-08	FA181X*		FA181R*■		N/A	N/A				
JTX 125/200/270/320	95-98	FA115X		FA115R■		N/A					
MC 125	05	FA185X		FA185R■		MD6289D					MD6289C
MX 125/250	01-08	FA185X		FA185R■		MD6289D					MD6289C
Pampera 125/250/370	96-97	FA115X		FA115R■		N/A					
Pampera 125/250/280	04	FA194		FA194HH		N/A					
Pampera 125/450	05-06	FA194		FA194HH		N/A					
SM 125/250 (2T)	01-05	FA95		FA95HH		N/A					
TXT 125/200/249/280/321	00-03	FA291X				N/A					
TXT 125/200/250/280/300 (TXT Pro)	04-15	FA303X				N/A					
TXT 125/200/250/280/300 (TXT Racing)	14-15	FA644X				N/A					
Enduro EC 200/250/300	97-99	FA181X		FA181R■		N/A					
HP 200	08	FA181X*		FA181R*■		N/A	N/A				
MX 200/250/300	99-00	FA181X		FA181R■		N/A					
TX 200/270/320	98	FA115X		FA115R■		N/A					
TX 200 Radonne (4T)	14-15	FA303X				N/A					
TXT 200/270/321	99	FA291X				N/A					
Contact JT25 (238cc)	93-94	FA115X		FA115R■		N/A					
HP 240 Wild	03-05	FA181X*		FA181R*■		N/A	N/A				
HP 250 Wild	08	FA181X*		FA181R*■		N/A	N/A				
Pampera 250/320	98-99	FA115X		FA115R■		N/A					
Pampera 250	02-03	FA194		FA194HH		N/A					
TXT 250/280/300 Raga	07-11	FA303X				N/A					
HP 300 Wild	03-05	FA181X*		FA181R*■		N/A	N/A				
HP 300 RV	06	FA181X*		FA181R*■		N/A	N/A				
TXT 300 Raga	07	FA303X				N/A					
SM 400 FSE (2T)	01-02	FA95		FA95HH		N/A					
EC 450	09	FA185X		FA185R■		N/A					
FSE 450	05-08	FA185X		FA185R■		N/A					
HP 450	03-08	FA181X*		FA181R*■		N/A	N/A				
SM 450	03-05	FA95		FA95HH		N/A					
NOTE EC models may also be known as XC models											
EC 515	09	FA185X		FA185R■							
HP 515 Wild	09	FA181X*		FA181R*■		N/A	N/A				
NOTE EC models may also be known as XC models											
GOGORO (Electric Scooter)											
Smart Scooter	15-17	SFA266		SFA266HH		MD9162D					
HISUN (ATV)											
110 Axis	14-16	FA83X*		FA83R*		TBA	TBA				
110 Forge	14-16	FA83X*		FA83R*		TBA	TBA				
400 Forge	Left 15-16	FA165X		FA165R	FA165SV	TBA					
	Right	FA135X		FA135R	FA135SV		TBA				
400 Forge - Parking brake	15-16										
500 Forge	Left 15-16	FA165X		FA165R	FA165SV	TBA					
	Right	FA135X		FA135R	FA135SV		TBA				
500 Forge - Parking brake	15-16										
700 Forge	Left 15-16	FA165X		FA165R	FA165SV	TBA					
	Right	FA135X		FA135R	FA135SV		TBA				
700 Forge - Parking brake	15-16										
800 Tactic	Left 15-16	FA165X		FA165R	FA165SV	TBA					
	Right	FA135X		FA135R	FA135SV		TBA				

Line #

FRONT

* This symbol indicates a rotor made of billet steel, and should be only used with EBC FA Kevlar® Organic or Vee pads.
 SAFETY NOTICE - With vehicles primarily designed for off highway use such as quads now being used on the highway, we would recommend the use of X or MXS pads for highway use and ONLY using the R and SV higher density / harder pad series for off road riding.

*-2 Sets Required. ■ - Also available in MX-S race compound. **SAFETY WARNING:- DO NOT USE HH PADS ON REAR UNLESS ALSO USED ON FRONT TO AVOID BRAKE IMBALANCE**

FRONT: Non-Japanese Bikes Cont'd

REAR: Non-Japanese Bikes

Line #	BRAKE ROTOR CHOICES - FRONT						DISC PAD CHOICES - REAR				BRAKE ROTOR CHOICES - REAR					
	CC Custom Rotor	CX Extreme® /Vee-Rotor	OS Series Oversize 250/280mm Rotor Kit	OSX Series Oversize 280mm Rotor Kit	Relocating Bracket for 250/280mm Rotor	SMX Series Oversize 320mm Rotor Kit	Relocating Bracket for 320mm Rotor		Semi-Sintered V-Pads™	Sintered/HH Pads/ Grooved Shoes	SV Series Severe Duty Pads	Standard Rotor	UTVX Rotor	Vintage Rotor	Contour Profile Rotor	CX Extreme® /Vee-Rotor
1								FA131X		FA131R■		MD6253D			MD6253C	
2								FA367X		FA367R■					MD6253C	
3								FA181X		FA181R■		N/A				
4								FA115X		FA115R■		N/A				
5								FA131X		FA131R■		MD6253D			MD6253C	
6								FA131X		FA131R■		MD6253D			MD6253C	
7								FA115X		FA115R■		N/A				
8								FA291X				N/A				
9								FA131X		FA131R		MD6253D			MD6253C	
10								FA131X				MD6253D			MD6253C	
11								FA291X				N/A				
12								FA351X				N/A				
13								FA351X				N/A				
14								FA131X		FA131R■		MD6253D			MD6253C	
15								FA181X		FA181R■		N/A				
16								FA131X		FA131R■		MD6253D			MD6253C	
17								FA115X		FA115R■		N/A				
18								FA351X				N/A				
19								FA291X				N/A				
20								FA115X		FA115R■		N/A				
21								FA181X		FA181R■		N/A				
22								FA181X		FA181R■		N/A				
23			N/A	N/A				FA115X		FA115R■		N/A				
24								FA291X				N/A				
25								FA351X				N/A				
26								FA181X		FA181R■		N/A				
27								FA181X		FA181R■		N/A				
28								FA351X				N/A				
29								FA131X		FA131R■		MD6253D			MD6253C	
30								FA131X		FA131R■		N/A				
31								FA131X		FA131R■		N/A				
32								FA181X		FA181R■		N/A				
33								FA131X		FA131R■		MD6253D			MD6253C	
34																
35								FA131X		FA131R■		TBA				
36								FA181X		FA181R■		N/A				
37																
38																
39																
40		VR9162						SFA67		SFA67HH		MD9163D				VR9163
41																
42																
43								FA67X		FA67R		TBA				
44								FA67X		FA67R		TBA				
45								FA135X		FA135R	FA135SV	TBA				
46								FA165X		FA165R	FA165SV	TBA				
47								FA428X		FA428R		TBA				
48								FA135X		FA135R	FA135SV	TBA				
49								FA165X		FA165R	FA165SV	TBA				
50								FA428X		FA428R		TBA				
51																
52								FA135X		FA135R	FA135SV	TBA				
53								FA165X		FA165R	FA165SV	TBA				
54								FA428X		FA428R		TBA				
55								FA135X		FA135R	FA135SV	TBA				
56								FA165X		FA165R	FA165SV	TBA				

REAR

This symbol indicates a rotor made of billet steel, and should be only used with EBC FA Kevlar® Organic or Vee pads.
 SAFETY NOTICE - With vehicles primarily designed for off highway use such as quads now being used on the highway, we would recommend the use of X or MXS pads for highway use and ONLY using the R and SV higher density / harder pad series for off road riding.

BRAKE APPLICATIONS

*-2 Sets Required. ■ - Also available in MX-S race compound. **SAFETY WARNING:- DO NOT USE HH PADS ON REAR UNLESS ALSO USED ON FRONT TO AVOID BRAKE IMBALANCE**

FRONT: Non-Japanese Bikes Cont'd

REAR: Non-Japanese Bikes

Line #	BRAKE ROTOR CHOICES - FRONT						DISC PAD CHOICES - REAR				BRAKE ROTOR CHOICES - REAR				
	CC Custom Rotor	CX Extreme® /Vee-Rotor	OS Series Oversize 250/280mm Rotor Kit	OSX Series Oversize 280mm Rotor Kit	Relocating Bracket for 250/280mm Rotor	SMX Series Oversize 320mm Rotor Kit	Relocating Bracket for 320mm Rotor		Semi-Sintered V-Pads™	Sintered/HH Pads/ Grooved Shoes	SV Series Severe Duty Pads	Standard Rotor	UTVX Rotor	Vintage Rotor	Contour Profile Rotor
1							FA428X		FA428R		TBA				
2							FA135X		FA135R	FA135SV	TBA				
3							FA165X		FA165R	FA165SV	TBA				
4							FA428X		FA428R	TBA					
5															
6															
7							FA428X		FA428R	FA428SV	TBA				
8															
9							FA428X		FA428R	FA428SV	TBA				
10															
11							FA135X		FA135R	FA135SV	TBA				
12							FA165X		FA165R	FA165SV	TBA				
13							FA428X		FA428R	TBA					
14							FA135X		FA135R	FA135SV	TBA				
15							FA165X		FA165R	FA165SV	TBA				
16							FA428X		FA428R	TBA					
17							FA135X		FA135R	FA135SV	TBA				
18							FA165X		FA165R	FA165SV	TBA				
19							FA428X		FA428R	TBA					
20							FA135X		FA135R	FA135SV	TBA				
21							FA165X		FA165R	FA165SV	TBA				
22							FA428X		FA428R	TBA					
23							FA135X		FA135R	FA135SV	TBA				
24							FA165X		FA165R	FA165SV	TBA				
25							FA428X		FA428R	TBA					
26							FA135X		FA135R	FA135SV	TBA				
27							FA165X		FA165R	FA165SV	TBA				
28							FA428X		FA428R	TBA					
29							FA135X		FA135R	FA135SV	TBA				
30							FA165X		FA165R	FA165SV	TBA				
31							FA428X		FA428R	TBA					
32							FA135X		FA135R	FA135SV	TBA				
33							FA165X		FA165R	FA165SV	TBA				
34							FA428X		FA428R	TBA					
35							FA135X		FA135R	FA135SV	TBA				
36							FA165X		FA165R	FA165SV	TBA				
37							FA135X		FA135R	FA135SV	TBA				
38							FA165X		FA165R	FA165SV	TBA				
39							FA428X		FA428R	TBA					
40							FA135X		FA135R	FA135SV	TBA				
41							FA165X		FA165R	FA165SV	TBA				
42							FA428X		FA428R	TBA					
43							FA135X		FA135R	FA135SV	TBA				
44							FA165X		FA165R	FA165SV	TBA				
45							FA428X		FA428R	TBA					
46															
47															
48							FA67X		FA67R		N/A				
49			OS6125C	OSX6125	BRK010	SMX6125	BRK007	FA67X	FA67R		MD6126D				
50			OS6125C	OSX6125	BRK010	SMX6125	BRK007	FA208X	FA208■		MD6126D				
51	MD6032CX	OS6032C	OSX6032	BRK011	SMX6032	BRK012	FA208X	FA208■			MD6035D			MD6035C●	MD6035CX
52															
53															
54							FA208X	FA208■			MD6035D			MD6035C	
55															
56							FA208X	FA208■			MD6035D			MD6035C	

REAR

MD6035C● = PLAIN UNDRILLED DISC FOR ENDURO USE. REAR FITMENTS ONLY. ORDER MD6035CE.

*-2 Sets Required. ■ - Also available in MX-S race compound. **SAFETY WARNING:- DO NOT USE HH PADS ON REAR UNLESS ALSO USED ON FRONT TO AVOID BRAKE IMBALANCE**

Part numbers, prefixes, suffixes, photos and illustrations shown in this catalog are trademarks and/or copyrights of EBC Brakes or the trademark owner Freeman Automotive (UK) Ltd and use without express written permission of the owners is punishable by law.

This symbol indicates a rotor made of billet steel, and should be only used with EBC FA Kevlar® Organic or Vee pads. SAFETY NOTICE - With vehicles primarily designed for off highway use such as quads now being used on the highway, we would recommend the use of X or MXS pads for highway use and ONLY using the R and SV higher density / harder pad series for off road riding.

BRAKE APPLICATIONS

FRONT: Non-Japanese Bikes

APPLICATIONS

BRAKE



HUSABERG



DISC PAD CHOICES - FRONT

BRAKE ROTOR CHOICES - FRONT

FS Supermotard Models (FTE 4 piston radial caliper)	05-08				MD6270D					MD6270C
TE 250 (2T)	11-14	FA181X								MD6032C
TE 300 (2T)	11-14	FA181X								MD6032C
FE 390	10-12	FA181X								MD6032C
FE 450	09-14	FA181X								MD6032C
FX 450	10-11	FA181X								MD6032C
FE 501	13-14	FA181X								MD6032C
FE 570	09-12	FA181X								MD6032C
FS 570 Supermoto	10-11	FA433/4		FA433/4HH	TBA					
HUSQVARNA										
Husky Boy	98-99				N/A					
Husky Boy Racing S	00	984								
Husky Boy Drum Front & Rear	00-02	984								
Husky Boy Racing J	00	984								
Husky Boy J	01-02	FA115X		FA115R	N/A					
Husky Boy R	01	FA115X		FA115R	N/A					
Husky Boy S	01-02	FA115X		FA115R	N/A					
CR 50 Junior	05	FA351X			N/A					
CR 50 Junior Basic	05	TBA			N/A					
CR 50 Senior Pro	05	FA351X			N/A					
CR 50	11	FA325X		FA325R	N/A					
SM 50	02	FA167		FA167HH	TBA					
SM 50	11	FA325X		FA325R	N/A					
TE 50 Boy	05	TBA								
WR 50	02	FA167		FA167HH	N/A					
WRS 50 Scooter	98-00	SFA115		SFA115HH		MD964D				
CR 65	12	FA357X		FA357R						N/A
TC 85 (2T 17/14" Wheels)	14-15	FA612TT		FA612R						TBA
TC 85 (2T 19/16" Wheels)	14-15	FA612TT		FA612R						TBA
TE 100	05	FA351X			N/A					
CR 125	73-77	N/A								
CR 125	78			801G						
CR 125	79-81			801G						
CR 125	82-84			803G						
CR 125	85-86	FA47X		FA47R	N/A					
CR 125	91	FA134X		FA134R	N/A					
CR 125	92-94	FA135X		FA135R	MD6125D					
CR 125	95-99	FA181X		FA181R	MD6125D					N/A
CR 125 (45mm dia. Marzocchi forks = 60mm caliper mount centers)	00-01	FA181X		FA181R	MD6184D					MD6184C
CR 125 (48mm dia. Marzocchi or Kayaba forks = 95mm caliper mount centers)	00-01	FA181X		FA181R	MD6184D					MD6184C
CR 125 (45mm dia. Marzocchi forks = 60mm caliper mount centers)	02-04	FA181X		FA181R	MD6184D					MD6184C
CR 125 (48mm dia. Marzocchi or Kayaba forks = 95mm caliper mount centers)	02-04	FA181X		FA181R	MD6184D					MD6184C
CR 125 (45mm dia. Marzocchi forks = 60mm caliper mount centers)	05	FA181X		FA181R	MD6184D					MD6184C

Line #

FRONT

* This symbol indicates a rotor made of billet steel, and should be only used with EBC FA Kevlar® Organic or Vee pads.
 SAFETY NOTICE - With vehicles primarily designed for off highway use such as quads now being used on the highway, we would recommend the use of X or MXS pads for highway use and ONLY using the R and SV higher density / harder pad series for off road riding.

*-2 Sets Required. ■ - Also available in MX-S race compound. **SAFETY WARNING:- DO NOT USE HH PADS ON REAR UNLESS ALSO USED ON FRONT TO AVOID BRAKE IMBALANCE**

FRONT: Non-Japanese Bikes Cont'd

REAR: Non-Japanese Bikes

Line #

BRAKE ROTOR CHOICES - FRONT							DISC PAD CHOICES - REAR				BRAKE ROTOR CHOICES - REAR						
CC Custom Rotor	CX Extreme® /Vee-Rotor	OS Series Oversize 250/280mm Rotor Kit	OSX Series Oversize 280mm Rotor Kit	Relocating Bracket for 250/280mm Rotor	SMX Series Oversize 320mm Rotor Kit	Relocating Bracket for 320mm Rotor		Semi-Sintered V-Pads™	Sintered/HH Pads/ Grooved Shoes	SV Series Severe Duty Pads	Standard Rotor	UTVX Rotor	Vintage Rotor	Contour Profile Rotor	CX Extreme® /Vee-Rotor		
1							FA208X		FA208R■		MD6035D			MD6035C			
2	MD6032CX	OS6932C	OSX6932	BRK013	SMX6932	BRK014	FA368X		FA368R■					MD6035C●	MD6035CX		
3							MD6035C● = PLAIN UNDRILLED DISC FOR ENDURO USE. REAR FITMENTS ONLY. ORDER MD6035CE.										
4	MD6032CX	OS6932C	OSX6932	BRK013	SMX6932	BRK014	FA368X		FA368R■					MD6035C●	MD6035CX		
5							MD6035C● = PLAIN UNDRILLED DISC FOR ENDURO USE. REAR FITMENTS ONLY. ORDER MD6035CE.										
6	MD6032CX	OS6932C	OSX6932	BRK013	SMX6932	BRK014	FA368X		FA368R■					MD6035C●	MD6035CX		
7							MD6035C● = PLAIN UNDRILLED DISC FOR ENDURO USE. REAR FITMENTS ONLY. ORDER MD6035CE.										
8	MD6032CX	OS6932C	OSX6932	BRK013	SMX6932	BRK014	FA368X		FA368R■					MD6035C●	MD6035CX		
9							MD6035C● = PLAIN UNDRILLED DISC FOR ENDURO USE. REAR FITMENTS ONLY. ORDER MD6035CE.										
10	MD6032CX	OS6932C	OSX6932	BRK013	SMX6932	BRK014	FA368X		FA368R■					MD6035C●	MD6035CX		
11							MD6035C● = PLAIN UNDRILLED DISC FOR ENDURO USE. REAR FITMENTS ONLY. ORDER MD6035CE.										
12	MD6032CX	OS6932C	OSX6932	BRK013	SMX6932	BRK014	FA368X		FA368R■					MD6035C●	MD6035CX		
13							MD6035C● = PLAIN UNDRILLED DISC FOR ENDURO USE. REAR FITMENTS ONLY. ORDER MD6035CE.										
14	MD6032CX	OS6932C	OSX6932	BRK013	SMX6932	BRK014	FA368X		FA368R■					MD6035C●	MD6035CX		
15							MD6035C● = PLAIN UNDRILLED DISC FOR ENDURO USE. REAR FITMENTS ONLY. ORDER MD6035CE.										
16							FA368X		FA368R■					MD6035C			
17																	
18																	
19									N/A		N/A						
20							984										
21							984										
22							984										
23							984										
24							984										
25							984										
26							TBA										
27							TBA										
28							FA325X				N/A						
29							FA325X		FA325R		N/A						
30							FA115		FA115HH		TBA						
31							FA325X		FA325R		N/A						
32							TBA										
33							FA115		FA115HH		N/A						
34							624										
35							FA602X		FA602R					N/A			
36							FA602X		FA602R					TBA			
37							FA602X		FA602R					TBA			
38							TBA										
39							N/A										
40							N/A										
41									801G								
42									801G								
43									802G								
44							FA251				MD6126D						
45							FA84X		FA84R■		MD6126D						
46		OS6125C	OSX6125	BRK010	SMX6125	BRK007	FA208X		FA208R■		MD6126D						
47																	
48		OS6184HC	OSX6184H	BRK010	SMX6184H	BRK007	FA208X		FA208R■		MD6287D						
49																	
50		OS6184KC	OSX6184K	BRK011	SMX6184K	BRK012	FA208X		FA208R■		MD6287D						
51																	
52		OS6184HC	OSX6184H	BRK010	SMX6184H	BRK007	FA208X		FA208R■		MD6295D						
53																	
54		OS6184KC	OSX6184K	BRK011	SMX6184K	BRK012	FA208X		FA208R■		MD6295D						
55																	
56		OS6184HC	OSX6184H	BRK010	SMX6184H	BRK007	FA368X		FA368R■		MD6295D						

REAR

⚠ This symbol indicates a rotor made of billet steel, and should be only used with EBC FA Kevlar® Organic or Vee pads.

SAFETY NOTICE - With vehicles primarily designed for off highway use such as quads now being used on the highway, we would recommend the use of X or MXS pads for highway use and ONLY using the R and SV higher density / harder pad series for off road riding.

BRAKE APPLICATIONS

*-2 Sets Required. ■ - Also available in MX-S race compound. SAFETY WARNING:- DO NOT USE HH PADS ON REAR UNLESS ALSO USED ON FRONT TO AVOID BRAKE IMBALANCE

FRONT: Non-Japanese Bikes



HUSQVARNA



DISC PAD CHOICES - FRONT

BRAKE ROTOR CHOICES - FRONT

		Semi-Sintered V-Pads™	Sintered/HH Pads/Grooved Shoes	SV Series Severe Duty Pads	Standard Rotor Left	Standard Rotor Right	UTVX Rotor	Vintage Rotor Left	Vintage Rotor Right	Contour Profile Rotor
CR 125 (48mm dia. Marzocchi or Kayaba forks = 95mm caliper mount centers) 05	FA181X		FA181R■		MD6184D					MD6184C
CR 125 (45mm dia. Marzocchi forks = 60mm caliper mount centers) 06-08	FA181X		FA181R■		MD6184D					MD6184C
CR 125 (48mm dia. Marzocchi or Kayaba forks = 95mm caliper mount centers) 06-08	FA181X		FA181R■		MD6184D					MD6184C
CR 125 (Kayaba Forks) 09-13	FA181X		FA181R■							MD6184C
SC 125 73-74	N/A									
SM 125 98-99	FA181X		FA181R■		MD6125D					N/A
SM 125 (45mm dia. Marzocchi forks = 60mm caliper mount centers) 00	FA181X		FA181R■		MD6184D					MD6184C
SM 125 (48mm dia. Marzocchi or Kayaba forks = 95mm caliper mount centers) 00	FA181X		FA181R■		MD6184D					MD6184C
SMS 125 (2T) (45mm dia. Marzocchi forks = 60mm caliper mount centers) 02-11	FA181X		FA181R■		MD6184D					MD6184C
SMS 125 (2T) (48mm dia. Marzocchi or Kayaba forks = 95mm caliper mount centers) 02-11	FA181X		FA181R■		MD6184D					MD6184C
SMS-4 125 (4T) (45mm dia. Marzocchi forks = 60mm caliper mount centers) 10-11	FA181X		FA181R■		MD6184D					MD6184C
SMS-4 125 (4T) (48mm dia. Marzocchi or Kayaba forks = 95mm caliper mount centers) 10-11	FA181X		FA181R■		MD6184D					MD6184C
TC 125 (2T) 14-15	FA181X		FA181R■							MD6032C
TE 125 (45mm dia. Marzocchi forks = 60mm caliper mount centers) 11	FA181X		FA181R■							MD6184C
TE 125 (48mm dia. Marzocchi or Kayaba forks = 95mm caliper mount centers) 11	FA181X		FA181R■							MD6184C
TE 125 (2T) 14-15	FA181X		FA181R■							MD6032C
WR 125 73-74	N/A									
WR 125 79			801G							
WR 125 80-81			802G							
WR 125 82-84			803G							
WR 125 87-88	FA134X		FA134R		N/A					
WR 125 91	FA134X		FA134R		N/A					
WR 125 93-94	FA135X		FA135R■		MD6125D					
WR 125 95-99	FA181X		FA181R■		MD6125D					N/A
WR 125 (45mm dia. Marzocchi forks = 60mm caliper mount centers) 00-01	FA181X		FA181R■		MD6184D					MD6184C
WR 125 (48mm dia. Marzocchi or Kayaba forks = 95mm caliper mount centers) 00-01	FA181X		FA181R■		MD6184D					MD6184C
WR 125 (45mm dia. Marzocchi forks = 60mm caliper mount centers) 02-05	FA181X		FA181R■		MD6184D					MD6184C
WR 125 (48mm dia. Marzocchi or Kayaba forks = 95mm caliper mount centers) 02-05	FA181X		FA181R■		MD6184D					MD6184C
WR 125 (45mm dia. Marzocchi forks = 60mm caliper mount centers) 06-08	FA181X		FA181R■		MD6184D					MD6184C
WR 125 (48mm dia. Marzocchi or Kayaba forks = 95mm caliper mount centers) 06-08	FA181X		FA181R■		MD6184D					MD6184C
WR 125 (Kayaba Forks) 09-13	FA181X		FA181R■							MD6184C
WRE 125 93-99	FA181X		FA181R■		MD6125D					N/A
WRE 125 (45mm dia. Marzocchi forks = 60mm caliper mount centers) 00	FA181X		FA181R■		MD6184D					MD6184C
WRE 125 (48mm dia. Marzocchi or Kayaba forks = 95mm caliper mount centers) 00	FA181X		FA181R■		MD6184D					MD6184C
WRE 125 (45mm dia. Marzocchi forks = 60mm caliper mount centers) 02-11	FA181X		FA181R■		MD6184D					MD6184C

Line #
1
2
3
4
5
6
7
8
9
10
11
12
13
14
15
16
17
18
19
20
21
22
23
24
25
26
27
28
29
30
31
32
33
34
35
36
37
38
39
40
41
42
43
44
45
46
47
48
49
50
51
52
53
54
55
56

FRONT

APPLICATIONS
BRAKE
SAFETY NOTICE - With vehicles primarily designed for off highway use such as quads now being used on the highway, we would recommend the use of X or MXS pads for highway use and ONLY using the R and SV higher density / harder pad series for off road riding.

This symbol indicates a rotor made of billet steel, and should be only used with EBC FA Kevlar® Organic or Vee pads.

*-2 Sets Required. ■ - Also available in MX-S race compound. **SAFETY WARNING:- DO NOT USE HH PADS ON REAR UNLESS ALSO USED ON FRONT TO AVOID BRAKE IMBALANCE**

FRONT: Non-Japanese Bikes Cont'd

REAR: Non-Japanese Bikes

Line #	BRAKE ROTOR CHOICES - FRONT						DISC PAD CHOICES - REAR				BRAKE ROTOR CHOICES - REAR					
	CC Custom Rotor	CX Extreme® /Vee-Rotor	OS Series Oversize 250/280mm Rotor Kit	OSX Series Oversize 280mm Rotor Kit	Relocating Bracket for 250/280mm Rotor	SMX Series Oversize 320mm Rotor Kit	Relocating Bracket for 320mm Rotor		Semi-Sintered V-Pads™	Sintered/HH Pads/ Grooved Shoes	SV Series Severe Duty Pads	Standard Rotor	UTVX Rotor	Vintage Rotor	Contour Profile Rotor	CX Extreme® /Vee-Rotor
1																
2			OS6184KC	OSX6184K	BRK011	SMX6184K	BRK012	FA368X		FA368R■		MD6295D				
3																
4			OS6184HC	OSX6184H	BRK010	SMX6184H	BRK007	FA368X		FA368R■		MD6288D			MD6288C	
5																
6			OS6184KC	OSX6184K	BRK011	SMX6184K	BRK012	FA368X		FA368R■		MD6288D			MD6288C	
7			OS6184KC	OSX6184K	BRK011	SMX6184K	BRK011	FA368X		FA368R■					TBA	
8								N/A								
9			OS6125C	OSX6125	BRK010	SMX6125	BRK007	FA208X		FA208R■		MD6126D				
10																
11			OS6184HC	OSX6184H	BRK010	SMX6184H	BRK007	FA208X		FA208R■		MD6287D				
12																
13			OS6184KC	OSX6184K	BRK011	SMX6184K	BRK012	FA208X		FA208R■		MD6287D				
14																
15			OS6184HC	OSX6184H	BRK010	SMX6184H	BRK007	FA208X		FA208R■		MD6287D				
16																
17			OS6184KC	OSX6184K	BRK011	SMX6184K	BRK012	FA208X		FA208R■		MD6287D				
18																
19			OS6184HC	OSX6184H	BRK010	SMX6184H	BRK007	FA208X		FA208R■		MD6287D				
20																
21			OS6184KC	OSX6184K	BRK011	SMX6184K	BRK012	FA208X		FA208R■		MD6287D				
22		MD6032CX		OSX6032	BRK013	SMX6032	BRK014	FA368X		FA368R■					MD6035C	MD6035CX
23																
24			OS6184HC	OSX6184H	BRK010	SMX6184H	BRK007	FA368X		FA368R■					TBA	
25																
26			OS6184KC	OSX6184K	BRK011	SMX6184K	BRK012	FA368X		FA368R■					TBA	
27		MD6032CX		OSX6032	BRK013	SMX6032	BRK014	FA368X		FA368R■					MD6035C	MD6035CX
28								N/A								
29										801G						
30										802G						
31										802G						
32										802G						
33								FA251				MD6126D				
34								FA84X		FA84R■		MD6126D				
35			OS6125C	OSX6125	BRK010	SMX6125	BRK007	FA208X		FA208R■		MD6126D				
36																
37			OS6184HC	OSX6184H	BRK010	SMX6184H	BRK007	FA208X		FA208R■		MD6287D				
38																
39			OS6184KC	OSX6184K	BRK011	SMX6184K	BRK012	FA208X		FA208R■		MD6287D				
40																
41			OS6184HC	OSX6184H	BRK010	SMX6184H	BRK007	FA208X		FA208R■		MD6295D				
42																
43			OS6184KC	OSX6184K	BRK011	SMX6184K	BRK012	FA208X		FA208R■		MD6295D				
44																
45			OS6184HC	OSX6184H	BRK010	SMX6184H	BRK007	FA368X		FA368R■		MD6288D			MD6288C	
46																
47			OS6184KC	OSX6184K	BRK011	SMX6184K	BRK012	FA368X		FA368R■		MD6288D			MD6288C	
48			OS6184KC	OSX6184K	BRK011	SMX6184K	BRK011	FA368X		FA368R■					TBA	
49			OS6125C	OSX6125	BRK010	SMX6125	BRK007	FA208X		FA208R■		MD6126D				
50																
51			OS6184HC	OSX6184H	BRK010	SMX6184H	BRK007	FA208X		FA208R■		MD6287D				
52																
53			OS6184KC	OSX6184K	BRK011	SMX6184K	BRK012	FA208X		FA208R■		MD6287D				
54																
55			OS6184HC	OSX6184H	BRK010	SMX6184H	BRK007	FA208X		FA208R■		MD6287D				
56																

⚠ This symbol indicates a rotor made of billet steel, and should be only used with EBC FA Kevlar® Organic or Vee pads.
 SAFETY NOTICE - With vehicles primarily designed for off highway use such as quads now being used on the highway, we would recommend the use of X or MXS pads for highway use and ONLY using the R and SV higher density / harder pad series for off road riding.

BRAKE APPLICATIONS

*-2 Sets Required. ■ - Also available in MX-S race compound. **SAFETY WARNING:- DO NOT USE HH PADS ON REAR UNLESS ALSO USED ON FRONT TO AVOID BRAKE IMBALANCE**

FRONT: Non-Japanese Bikes



HUSQVARNA



DISC PAD CHOICES - FRONT

BRAKE ROTOR CHOICES - FRONT

WRE 125 (48mm dia. Marzocchi or Kayaba forks = 95mm caliper mount centers)	02-11	FA181X	FA181R■	MD6184D					MD6184C
WXE 125	07	FA167	FA167HH	MD6184D					MD6184C
XC 125	82-84		803G						
XC 125	85-86	FA47X	FA47R	N/A					
CR 240	80-81		802G						
CR 240	82-84		803G						
CR 240	85-86	FA47X	FA47R	N/A					
CR 240	87-88	FA134X	FA134R	N/A					
WR 240	78		801G						
WR 240	80-81		802G						
WR 240	82-84		803G						
WR 240	87-88	FA134X	FA134R	N/A					
WR 240	90-91	FA134X	FA134R	N/A					
CR 250	71-74	N/A							
CR 250	75-79		801G						
CR 250	80-81		802G						
CR 250	82-84		803G						
CR 250	85-86	FA47X	FA47R	N/A					
CR 250	87-88	FA134X	FA134R	N/A					
CR 250	91	FA134X	FA134R	N/A					
CR 250	92-94	FA135X	FA135R■	MD6125D					
CR 250	95-99	FA181X	FA181R■	MD6125D					N/A
CR 250 (45mm dia. Marzocchi forks = 60mm caliper mount centers)	00-01	FA181X	FA181R■	MD6184D					MD6184C
CR 250 (48mm dia. Marzocchi or Kayaba forks = 95mm caliper mount centers)	00-01	FA181X	FA181R■	MD6184D					MD6184C
CR 250 (45mm dia. Marzocchi forks = 60mm caliper mount centers)	02-04	FA181X	FA181R■	MD6184D					MD6184C
CR 250 (48mm dia. Marzocchi or Kayaba forks = 95mm caliper mount centers)	02-04	FA181X	FA181R■	MD6184D					MD6184C
CR 250 (45mm dia. Marzocchi forks = 60mm caliper mount centers)	05	FA181X	FA181R■	MD6184D					MD6184C
CR 250 (48mm dia. Marzocchi or Kayaba forks = 95mm caliper mount centers)	05	FA181X	FA181R■	MD6184D					MD6184C
FC 250 (4T)	14-15	FA181X	FA181R■						MD6032C
FE 250 (4T)	14-15	FA181X	FA181R■						MD6032C
TC 250 (45mm dia. Marzocchi forks = 60mm caliper mount centers)	02-03	FA181X	FA181R■	MD6184D					MD6184C
TC 250 (48mm dia. Marzocchi or Kayaba forks = 95mm caliper mount centers)	02-03	FA181X	FA181R■	MD6184D					MD6184C
TC 250 (45mm dia. Marzocchi forks = 60mm caliper mount centers)	05-08	FA181X	FA181R■	MD6184D					MD6184C
TC 250 (48mm dia. Marzocchi or Kayaba forks = 95mm caliper mount centers)	05-08	FA181X	FA181R■	MD6184D					MD6184C
TC 250 (45mm dia. Marzocchi forks = 60mm caliper mount centers)	09-12	FA181X	FA181R■						MD6184C
TC 250 (48mm dia. Marzocchi or Kayaba forks = 95mm caliper mount centers)	09-12	FA181X	FA181R■						MD6184C
TC 250 R (4T) (Kayaba Forks)	13	FA181X	FA181R■	MD6184D					MD6184C
TC 250 (2T)	14-15	FA181X	FA181R■						MD6032C
TE 250 (45mm dia. Marzocchi forks = 60mm caliper mount centers)	02-05	FA181X	FA181R■	MD6184D					MD6184C
TE 250 (48mm dia. Marzocchi or Kayaba forks = 95mm caliper mount centers)	02-05	FA181X	FA181R■	MD6184D					MD6184C

Line #
1
2
3
4
5
6
7
8
9
10
11
12
13
14
15
16
17
18
19
20
21
22
23
24
25
26
27
28
29
30
31
32
33
34
35
36
37
38
39
40
41
42
43
44
45
46
47
48
49
50
51
52
53
54
55
56

APPLICATIONS

BRAKE

This symbol indicates a rotor made of billet steel, and should be only used with EBC FA Kevlar® Organic or Vee pads.

SAFETY NOTICE - With vehicles primarily designed for off highway use such as quads now being used on the highway, we would recommend the use of X or MXS pads for highway use and ONLY using the R and SV higher density / harder pad series for off road riding.

*-2 Sets Required. ■ - Also available in MX-S race compound. **SAFETY WARNING:- DO NOT USE HH PADS ON REAR UNLESS ALSO USED ON FRONT TO AVOID BRAKE IMBALANCE**

FRONT: Non-Japanese Bikes Cont'd

REAR: Non-Japanese Bikes

Line #

BRAKE ROTOR CHOICES - FRONT							DISC PAD CHOICES - REAR				BRAKE ROTOR CHOICES - REAR					
CC Custom Rotor	CX Extreme® /Vee-Rotor	OS Series Oversize 250/280mm Rotor Kit	OSX Series Oversize 280mm Rotor Kit	Relocating Bracket for 250/280mm Rotor	SMX Series Oversize 320mm Rotor Kit	Relocating Bracket for 320mm Rotor		Semi-Sintered V-Pads™	Sintered/HH Pads/ Grooved Shoes	SV Series Severe Duty Pads	Standard Rotor	UTVX Rotor	Vintage Rotor	Contour Profile Rotor	CX Extreme® /Vee-Rotor	
1																
2		OS6184KC	OSX6184K	BRK011	SMX6184K	BRK012	FA208X		FA208R■		MD6287D					
3							FA131X		FA131R■		TBA					
4								802G								
5								801G								
6								801G								
7								801G								
8								802G								
9								802G								
10								801G								
11								802G								
12								802G								
13								802G								
14							FA251				MD6126D					
15								801G								
16								801G								
17								801G								
18								801G								
19								802G								
20								802G								
21							FA251				MD6126D					
22							FA84X		FA84R■		MD6126D					
23		OS6125C	OSX6125	BRK010	SMX6125	BRK007	FA208X		FA208R■		MD6126D					
24																
25		OS6184HC	OSX6184H	BRK010	SMX6184H	BRK007	FA208X		FA208R■		MD6287D					
26																
27		OS6184KC	OSX6184K	BRK011	SMX6184K	BRK012	FA208X		FA208R■		MD6287D					
28																
29		OS6184HC	OSX6184H	BRK010	SMX6184H	BRK007	FA208X		FA208R■		MD6295D					
30																
31		OS6184KC	OSX6184K	BRK011	SMX6184K	BRK012	FA208X		FA208R■		MD6295D					
32																
33		OS6184HC	OSX6184H	BRK010	SMX6184H	BRK007	FA368X		FA368R■		MD6295D					
34																
35		OS6184KC	OSX6184K	BRK011	SMX6184K	BRK012	FA368X		FA368R■		MD6295D					
36		MD6032CX		OSX6032	BRK013	SMX6032	BRK014	FA368X	FA368R■					MD6035C	MD6035CX	
37		MD6032CX		OSX6032	BRK013	SMX6032	BRK014	FA368X	FA368R■					MD6035C	MD6035CX	
38																
39		OS6184HC	OSX6184H	BRK010	SMX6184H	BRK007	FA208X		FA208R■		MD6295D					
40																
41		OS6184KC	OSX6184K	BRK011	SMX6184K	BRK012	FA208X		FA208R■		MD6295D					
42																
43		OS6184HC	OSX6184H	BRK010	SMX6184H	BRK007	FA368X		FA368R■		MD6288D			MD6288C		
44																
45		OS6184KC	OSX6184K	BRK011	SMX6184K	BRK012	FA368X		FA368R■		MD6288D			MD6288C		
46																
47		OS6184HC	OSX6184H	BRK010	SMX6184H	BRK007	FA368X		FA368R■					TBA		
48																
49		OS6184KC	OSX6184K	BRK011	SMX6184K	BRK012	FA368X		FA368R■					TBA		
50		OS6184KC	OSX6184K	BRK011	SMX6184K	BRK011	FA368X		FA368R■					TBA		
51		MD6032CX		OSX6032	BRK013	SMX6032	BRK014	FA368X	FA368R■					MD6035C	MD6035CX	
52																
53		OS6184HC	OSX6184H	BRK010	SMX6184H	BRK007	FA208X		FA208R■		MD6295D					
54																
55		OS6184KC	OSX6184K	BRK011	SMX6184K	BRK012	FA208X		FA208R■		MD6295D					
56																

REAR

⚠ This symbol indicates a rotor made of billet steel, and should be only used with EBC FA Kevlar® Organic or Vee pads.
 SAFETY NOTICE - With vehicles primarily designed for off highway use such as quads now being used on the highway, we would recommend the use of X or MXS pads for highway use and ONLY using the R and SV higher density / harder pad series for off road riding.

BRAKE APPLICATIONS

*-2 Sets Required. ■ - Also available in MX-S race compound. **SAFETY WARNING:- DO NOT USE HH PADS ON REAR UNLESS ALSO USED ON FRONT TO AVOID BRAKE IMBALANCE**

FRONT: Non-Japanese Bikes

APPLICATIONS

BRAKE



HUSQVARNA



*** This symbol indicates a rotor made of billet steel, and should be only used with EBC FA Kevlar® Organic or Vee pads.**
SAFETY NOTICE - With vehicles primarily designed for off highway use such as quads now being used on the highway, we would recommend the use of X or MXS pads for highway use and ONLY using the R and SV higher density / harder pad series for off road riding.

DISC PAD CHOICES - FRONT

BRAKE ROTOR CHOICES - FRONT

		DISC PAD CHOICES - FRONT			BRAKE ROTOR CHOICES - FRONT					Line #	
			Sintered/HH Pads/ Grooved Shoes	SV Series Severe Duty Pads							
TE 250 (45mm dia. Marzocchi forks = 60mm caliper mount centers)	06-08	FA181X	FA181R■		MD6184D					MD6184C	1
TE 250 (48mm dia. Marzocchi or Kayaba forks = 95mm caliper mount centers)	06-08	FA181X	FA181R■		MD6184D					MD6184C	2
TE 250 (45mm dia. Marzocchi forks = 60mm caliper mount centers)	09-12	FA181X	FA181R■							MD6184C	3
TE 250 (48mm dia. Marzocchi or Kayaba forks = 95mm caliper mount centers)	09-12	FA181X	FA181R■							MD6184C	4
TE 250 (2T)	14-15	FA181X	FA181R■							MD6032C	5
TXC 250 Cross Country (45mm dia. Marzocchi forks = 60mm caliper mount centers)	08	FA181X	FA181R■		MD6184D					MD6184C	6
TXC 250 Cross Country (48mm dia. Marzocchi or Kayaba forks = 95mm caliper mount centers)	08	FA181X	FA181R■		MD6184D					MD6184C	7
TXC 250 Cross Country (45mm dia. Marzocchi forks = 60mm caliper mount centers)	09-12	FA181X	FA181R■							MD6184C	8
TXC 250 Cross Country (48mm dia. Marzocchi or Kayaba forks = 95mm caliper mount centers)	09-12	FA181X	FA181R■							MD6184C	9
TXC 250 R Cross Country (Kayaba Forks)	13	FA181X	FA181R■							MD6184C	10
WR 250	71-74	N/A									11
WR 250	75-78		801G								12
WR 250	80-81		802G								13
WR 250	82-84		803G								14
WR 250	87-88	FA134X	FA134R		N/A						15
WR 250	90-91	FA134X	FA134R		N/A						16
WR 250	92-94	FA135X	FA135R■		MD6125D						17
WR 250	95-99	FA181X	FA181R■		MD6125D					N/A	18
WR 250 (45mm dia. Marzocchi forks = 60mm caliper mount centers)	00-01	FA181X	FA181R■		MD6184D					MD6184C	19
WR 250 (48mm dia. Marzocchi or Kayaba forks = 95mm caliper mount centers)	00-01	FA181X	FA181R■		MD6184D					MD6184C	20
WR 250 (45mm dia. Marzocchi forks = 60mm caliper mount centers)	02-05	FA181X	FA181R■		MD6184D					MD6184C	21
WR 250 (48mm dia. Marzocchi or Kayaba forks = 95mm caliper mount centers)	02-05	FA181X	FA181R■		MD6184D					MD6184C	22
WR 250 (45mm dia. Marzocchi forks = 60mm caliper mount centers)	06-09	FA181X	FA181R■		MD6184D					MD6184C	23
WR 250 (48mm dia. Marzocchi or Kayaba forks = 95mm caliper mount centers)	06-09	FA181X	FA181R■		MD6184D					MD6184C	24
WR 250 (Kayaba Forks)	09-13	FA181X	FA181R■							MD6184C	25
XC 250	80-81		802G								26
XC 250	82-84		803G								27
XC 250	85-86	FA47X	FA47R		N/A						28
XC 250	87-88	FA134X	FA134R		N/A						29
WR 260	90-91	FA134X	FA134R		N/A						30
WR 300 (Kayaba Forks)	09-13	FA181X	FA181R■							MD6184C	31
TE 300 (2T)	14-15	FA181X	FA181R■							MD6032C	32
TE 310 (4T) (45mm dia. Marzocchi forks = 60mm caliper mount centers)	09-10	FA181X	FA181R■		MD6184D					MD6184C	33
TE 310 (4T) (48mm dia. Marzocchi or Kayaba forks = 95mm caliper mount centers)	09-10	FA181X	FA181R■		MD6184D					MD6184C	34
TE 310 (4T) (45mm dia. Marzocchi forks = 60mm caliper mount centers)	11-12	FA181X	FA181R■		MD6184D					MD6184C	35
TE 310 (4T) (48mm dia. Marzocchi or Kayaba forks = 95mm caliper mount centers)	11-12	FA181X	FA181R■		MD6184D					MD6184C	36
TE 310 R (4T) (Kayaba Forks)	13	FA181X	FA181R■		MD6184D					MD6184C	37

FRONT

*-2 Sets Required. ■ - Also available in MX-S race compound. **SAFETY WARNING:- DO NOT USE HH PADS ON REAR UNLESS ALSO USED ON FRONT TO AVOID BRAKE IMBALANCE**

FRONT: Non-Japanese Bikes Cont'd

REAR: Non-Japanese Bikes

Line #	BRAKE ROTOR CHOICES - FRONT						DISC PAD CHOICES - REAR				BRAKE ROTOR CHOICES - REAR					
	CC Custom Rotor	CX Extreme® /Vee-Rotor	OS Series Oversize 250/280mm Rotor Kit	OSX Series Oversize 280mm Rotor Kit	Relocating Bracket for 250/280mm Rotor	SMX Series Oversize 320mm Rotor Kit	Relocating Bracket for 320mm Rotor		Semi-Sintered V-Pads™	Sintered/HH Pads/ Grooved Shoes	SV Series Severe Duty Pads	Standard Rotor	UTVX Rotor	Vintage Rotor	Contour Profile Rotor	CX Extreme® /Vee-Rotor
1																
2			OS6184HC	OSX6184H	BRK010	SMX6184H	BRK007	FA368X		FA368R■		MD6288D				
3																
4			OS6184KC	OSX6184K	BRK011	SMX6184K	BRK012	FA368X		FA368R■		MD6288D				
5																
6			OS6184HC	OSX6184H	BRK010	SMX6184H	BRK007	FA368X		FA368R■					TBA	
7																
8			OS6184KC	OSX6184K	BRK011	SMX6184K	BRK012	FA368X		FA368R■					TBA	
9		MD6032CX		OSX6032	BRK013	SMX6032	BRK014	FA368X		FA368R■					MD6035C	MD6035CX
10																
11			OS6184HC	OSX6184H	BRK010	SMX6184H	BRK007	FA368X		FA368R■		MD6288D			MD6288C	
12																
13			OS6184KC	OSX6184K	BRK011	SMX6184K	BRK012	FA368X		FA368R■		MD6288D			MD6288C	
14																
15			OS6184HC	OSX6184H	BRK010	SMX6184H	BRK007	FA368X		FA368R■					TBA	
16																
17			OS6184KC	OSX6184K	BRK011	SMX6184K	BRK012	FA368X		FA368R■					TBA	
18			OS6184KC	OSX6184K	BRK011	SMX6184K	BRK011	FA368X		FA368R■					TBA	
19										801G						
20										801G						
21										802G						
22										802G						
23										802G						
24								FA251				MD6126D				
25								FA84X		FA84R■		MD6126D				
26			OS6125C	OSX6125	BRK010	SMX6125	BRK007	FA208X		FA208R■		MD6126D				
27																
28			OS6184HC	OSX6184H	BRK010	SMX6184H	BRK007	FA208X		FA208R■		MD6287D				
29																
30			OS6184KC	OSX6184K	BRK011	SMX6184K	BRK012	FA208X		FA208R■		MD6287D				
31																
32			OS6184HC	OSX6184H	BRK010	SMX6184H	BRK007	FA208X		FA208R■		MD6295D				
33																
34			OS6184KC	OSX6184K	BRK011	SMX6184K	BRK012	FA208X		FA208R■		MD6295D				
35																
36			OS6184HC	OSX6184H	BRK010	SMX6184H	BRK007	FA208X		FA208R■		MD6288D			MD6288C	
37																
38			OS6184KC	OSX6184K	BRK011	SMX6184K	BRK012	FA208X		FA208R■		MD6288D			MD6288C	
39			OS6184KC	OSX6184K	BRK011	SMX6184K	BRK011	FA208X		FA208R■					TBA	
40																
41										802G						
42										802G						
43										801G						
44										802G						
45			OS6184KC	OSX6184K	BRK011	SMX6184K	BRK011	FA251				MD6126D				
46		MD6032CX		OSX6032	BRK013	SMX6032	BRK014	FA208X		FA208R■					TBA	
47								FA368X		FA368R■					MD6035C	MD6035CX
48			OS6184HC	OSX6184H	BRK010	SMX6184H	BRK007	FA368X		FA368R■		MD6288D			MD6288C	
49																
50			OS6184KC	OSX6184K	BRK011	SMX6184K	BRK012	FA368X		FA368R■		MD6288D			MD6288C	
51																
52			OS6184HC	OSX6184H	BRK010	SMX6184H	BRK007	FA368X		FA368R■					TBA	
53																
54			OS6184KC	OSX6184K	BRK011	SMX6184K	BRK012	FA368X		FA368R■					TBA	
55			OS6184KC	OSX6184K	BRK011	SMX6184K	BRK011	FA368X		FA368R■					TBA	
56																

⚠ This symbol indicates a rotor made of billet steel, and should be only used with EBC FA Kevlar® Organic or Vee pads.
 SAFETY NOTICE - With vehicles primarily designed for off highway use such as quads now being used on the highway, we would recommend the use of X or MXS pads for highway use and ONLY using the R and SV higher density / harder pad series for off road riding.

BRAKE APPLICATIONS

*-2 Sets Required. ■ - Also available in MX-S race compound. **SAFETY WARNING:- DO NOT USE HH PADS ON REAR UNLESS ALSO USED ON FRONT TO AVOID BRAKE IMBALANCE**

FRONT: Non-Japanese Bikes



HUSQVARNA



DISC PAD CHOICES - FRONT

BRAKE ROTOR CHOICES - FRONT

TXC 310 Cross Country (45mm dia. Marzocchi forks = 60mm caliper mount centers)	12	FA181X	FA181R■						MD6184C
TXC 310 Cross Country (48mm dia. Marzocchi or Kayaba forks = 95mm caliper mount centers)	12	FA181X	FA181R■						MD6184C
TXC 310 R Cross Country (Kayaba Forks)	13	FA181X	FA181R■						MD6184C
FC 350 (4T)	14-15	FA181X	FA181R■						MD6032C
FE 350 (4T)	14-15	FA181X	FA181R■						MD6032C
TE 350	90-91	FA134X	FA134R	N/A					
TE 350	92-94	FA135X	FA135R■	MD6125D					
TE 350	95-97	FA181X	FA181R■	MD6125D					N/A
360 Automatic	75-77	N/A							
CR 360	75-78		801G						
CR 360	92-94	FA135X	FA135R■	MD6125D					
WR 360	75-78		801G						
WR 360	92-94	FA135X	FA135R■	MD6125D					
WR 360	95-99	FA181X	FA181R■	MD6125D					N/A
WR 360 Cross Country (45mm dia. Marzocchi forks = 60mm caliper mount centers)	00-01	FA181X	FA181R■	MD6184D					MD6184C
WR 360 Cross Country (48mm dia. Marzocchi or Kayaba forks = 95mm caliper mount centers)	00-01	FA181X	FA181R■	MD6184D					MD6184C
WR 360 Cross Country (45mm dia. Marzocchi forks = 60mm caliper mount centers)	02	FA181X	FA181R■	MD6184D					MD6184C
WR 360 Cross Country (48mm dia. Marzocchi or Kayaba forks = 95mm caliper mount centers)	02	FA181X	FA181R■	MD6184D					MD6184C
ACC 390	80-81		801G						
ACCE 390	80-81		801G						
CR 390	75-79		801G						
CR 390	80-81		801G						
CR 390 Automatic	78		801G						
WR 390	78		801G						
CR 400	71-74		801G						
SM 400 R	02	FA95	FA95HH	MD6293D					
TE 400 (45mm dia. Marzocchi forks = 60mm caliper mount centers)	02	FA181X	FA181R■	MD6184D					MD6184C
TE 400 (48mm dia. Marzocchi or Kayaba forks = 95mm caliper mount centers)	02	FA181X	FA181R■	MD6184D					MD6184C
WR 400	75-78		801G						
WR 400	87-88	FA134X	FA134R	N/A					
TE 410	95-99	FA181X	FA181R■	MD6125D					N/A
TE 410 (45mm dia. Marzocchi forks = 60mm caliper mount centers)	00	FA181X	FA181R■	MD6184D					MD6184C
TE 410 (48mm dia. Marzocchi or Kayaba forks = 95mm caliper mount centers)	00	FA181X	FA181R■	MD6184D					MD6184C
TE 410 (45mm dia. Marzocchi forks = 60mm caliper mount centers)	06	FA181X	FA181R■	MD6184D					MD6184C
TE 410 (48mm dia. Marzocchi or Kayaba forks = 95mm caliper mount centers)	06	FA181X	FA181R■	MD6184D					MD6184C
TE 410 E (45mm dia. Marzocchi forks = 60mm caliper mount centers)	00	FA181X	FA181R■	MD6184D					MD6184C
TE 410 E (48mm dia. Marzocchi or Kayaba forks = 95mm caliper mount centers)	00	FA181X	FA181R■	MD6184D					MD6184C
430 Automatic	87-88	FA134X	FA134R	N/A					
CR 430	80-81		802G						
CR 430	87-88	FA134X	FA134R	N/A					
WR 430	80-81		802G						
WR 430	87-88	FA134X	FA134R	N/A					

Line #

FRONT

APPLICATIONS
BRAKE

⊛ This symbol indicates a rotor made of billet steel, and should be only used with EBC FA Kevlar® Organic or Vee pads.
SAFETY NOTICE - With vehicles primarily designed for off highway use such as quads now being used on the highway, we would recommend the use of X or MXS pads for highway use and ONLY using the R and SV higher density / harder pad series for off road riding.

*-2 Sets Required. ■ - Also available in MX-S race compound. SAFETY WARNING:- DO NOT USE HH PADS ON REAR UNLESS ALSO USED ON FRONT TO AVOID BRAKE IMBALANCE

FRONT: Non-Japanese Bikes Cont'd

REAR: Non-Japanese Bikes

Line #
1
2
3
4
5
6
7
8
9
10
11
12
13
14
15
16
17
18
19
20
21
22
23
24
25
26
27
28
29
30
31
32
33
34
35
36
37
38
39
40
41
42
43
44
45
46
47
48
49
50
51
52
53
54
55
56

BRAKE ROTOR CHOICES - FRONT							DISC PAD CHOICES - REAR				BRAKE ROTOR CHOICES - REAR				
CC Custom Rotor	CX Extreme® /Vee-Rotor	OS Series Oversize 250/280mm Rotor Kit	OSX Series Oversize 280mm Rotor Kit	Relocating Bracket for 250/280mm Rotor	SMX Series Oversize 320mm Rotor Kit	Relocating Bracket for 320mm Rotor		Semi-Sintered V-Pads™	Sintered/HH Pads/ Grooved Shoes	SV Series Severe Duty Pads	Standard Rotor	UTVX Rotor	Vintage Rotor	Contour Profile Rotor	CX Extreme® /Vee-Rotor
		OS6184HC	OSX6184H	BRK010	SMX6184H	BRK007	FA368X		FA368R■					TBA	
		OS6184KC	OSX6184K	BRK011	SMX6184K	BRK012	FA368X		FA368R■					TBA	
		OS6184KC	OSX6184K	BRK011	SMX6184K	BRK011	FA368X		FA368R■					TBA	
	MD6032CX		OSX6032	BRK013	SMX6032	BRK014	FA368X		FA368R■					MD6035C	MD6035CX
	MD6032CX		OSX6032	BRK013	SMX6032	BRK014	FA368X		FA368R■					MD6035C	MD6035CX
							FA251				MD6126D				
							FA84X		FA84R■		MD6126D				
		OS6125C	OSX6125	BRK010	SMX6125	BRK007	FA208X		FA208R■		MD6126D				
								801G							
								801G							
							FA84X		FA84R■		MD6126D				
								801G							
		OS6125C	OSX6125	BRK010	SMX6125	BRK007	FA208X		FA208R■		MD6126D				
		OS6184HC	OSX6184H	BRK010	SMX6184H	BRK007	FA208X		FA208R■		MD6126D				
		OS6184KC	OSX6184K	BRK011	SMX6184K	BRK012	FA208X		FA208R■		MD6287D				
		OS6184HC	OSX6184H	BRK010	SMX6184H	BRK007	FA208X		FA208R■		MD6287D				
		OS6184KC	OSX6184K	BRK011	SMX6184K	BRK012	FA208X		FA208R■		MD6295D				
		OS6184HC	OSX6184H	BRK010	SMX6184H	BRK007	FA208X		FA208R■		MD6295D				
		OS6184KC	OSX6184K	BRK011	SMX6184K	BRK012	FA208X		FA208R■		MD6295D				
								801G							
								801G							
								801G							
								801G							
								801G							
								801G							
		OS6184HC	OSX6184H	BRK010	SMX6184H	BRK007	FA208X		FA208R■		MD6295D				
		OS6184KC	OSX6184K	BRK011	SMX6184K	BRK012	FA208X		FA208R■		MD6295D				
								801G							
		OS6125C	OSX6125	BRK010	SMX6125	BRK007	FA208X		FA208R■		MD6126D				
		OS6184HC	OSX6184H	BRK010	SMX6184H	BRK007	FA208X		FA208R■		MD6287D				
		OS6184KC	OSX6184K	BRK011	SMX6184K	BRK012	FA208X		FA208R■		MD6287D				
		OS6184HC	OSX6184H	BRK010	SMX6184H	BRK007	FA368X		FA368R■		MD6288D			MD6288C	
		OS6184KC	OSX6184K	BRK011	SMX6184K	BRK012	FA368X		FA368R■		MD6288D			MD6288C	
		OS6184HC	OSX6184H	BRK010	SMX6184H	BRK007	FA208X		FA208R■		MD6126D				
		OS6184KC	OSX6184K	BRK011	SMX6184K	BRK012	FA208X		FA208R■		MD6126D				
								802G							
								801G							
								802G							
								802G							
								802G							

REAR

* This symbol indicates a rotor made of billet steel, and should be only used with EBC FA Kevlar® Organic or Vee pads.
 SAFETY NOTICE - With vehicles primarily designed for off highway use such as quads now being used on the highway, we would recommend the use of X or MXS pads for highway use and ONLY using the R and SV higher density / harder pad series for off road riding.

BRAKE APPLICATIONS

*-2 Sets Required. ■ - Also available in MX-S race compound. **SAFETY WARNING:- DO NOT USE HH PADS ON REAR UNLESS ALSO USED ON FRONT TO AVOID BRAKE IMBALANCE**

FRONT: Non-Japanese Bikes



HUSQVARNA



DISC PAD CHOICES - FRONT

BRAKE ROTOR CHOICES - FRONT

WR-E 430	80-81		802G							
WR-E 430	82-84		803G							
WRU 430	82-84		803G							
XC 430	80-81		802G							
XC 430	87-88	FA134X	FA134R		N/A					
CR 450	71-74		801G							
FS 450 Supermoto	14-15		FA447HH							TBA
SM 450 R	03-06	FA95	FA95HH		MD6293D					
SMR 450 RR (Radial caliper)	06-08		FA322/4HH		MD6293D					
SM 450 R (Radial caliper)	07-10		FA322/4HH		MD6293D					
TC 449 (4T) (45mm dia. Marzocchi forks = 60mm caliper mount centers)	11-12	FA181X	FA181R■							MD6184C
TC 449 (4T) (48mm dia. Marzocchi or Kayaba forks = 95mm caliper mount centers)	11-12	FA181X	FA181R■							MD6184C
TE 449 (4T) (45mm dia. Marzocchi forks = 60mm caliper mount centers)	11-12	FA181X	FA181R■							MD6184C
TE 449 (4T) (48mm dia. Marzocchi or Kayaba forks = 95mm caliper mount centers)	11-12	FA181X	FA181R■							MD6184C
FC 450 (4T)	14-15	FA181X	FA181R■							MD6032C
FE 450 (4T)	14-15	FA181X	FA181R■							MD6032C
TC 450 (45mm dia. Marzocchi forks = 60mm caliper mount centers)	03	FA181X	FA181R■		MD6184D					MD6184C
TC 450 (48mm dia. Marzocchi or Kayaba forks = 95mm caliper mount centers)	03	FA181X	FA181R■		MD6184D					MD6184C
TC 450 (45mm dia. Marzocchi forks = 60mm caliper mount centers)	05-08	FA181X	FA181R■		MD6184D					MD6184C
TC 450 (48mm dia. Marzocchi or Kayaba forks = 95mm caliper mount centers)	05-08	FA181X	FA181R■		MD6184D					MD6184C
TC 450 (45mm dia. Marzocchi forks = 60mm caliper mount centers)	09-10	FA181X	FA181R■							MD6184C
TC 450 (48mm dia. Marzocchi or Kayaba forks = 95mm caliper mount centers)	09-10	FA181X	FA181R■							MD6184C
TE 450 (4T) (45mm dia. Marzocchi forks = 60mm caliper mount centers)	03-05	FA181X	FA181R■		MD6184D					MD6184C
TE 450 (4T) (48mm dia. Marzocchi or Kayaba forks = 95mm caliper mount centers)	03-05	FA181X	FA181R■		MD6184D					MD6184C
TE 450 (45mm dia. Marzocchi forks = 60mm caliper mount centers)	06-08	FA181X	FA181R■		MD6184D					MD6184C
TE 450 (48mm dia. Marzocchi or Kayaba forks = 95mm caliper mount centers)	06-08	FA181X	FA181R■		MD6184D					MD6184C
TE 450 (45mm dia. Marzocchi forks = 60mm caliper mount centers)	10	FA181X	FA181R■							MD6184C
TE 450 (48mm dia. Marzocchi or Kayaba forks = 95mm caliper mount centers)	10	FA181X	FA181R■							MD6184C
TXC 450 Cross Country (45mm dia. Marzocchi forks = 60mm caliper mount centers)	08	FA181X	FA181R■		MD6184D					MD6184C
TXC 450 Cross Country (48mm dia. Marzocchi or Kayaba forks = 95mm caliper mount centers)	08	FA181X	FA181R■		MD6184D					MD6184C
TXC 450 Cross Country (45mm dia. Marzocchi forks = 60mm caliper mount centers)	09-11	FA181X	FA181R■							MD6184C
TXC 450 Cross Country (48mm dia. Marzocchi or Kayaba forks = 95mm caliper mount centers)	09-11	FA181X	FA181R■							MD6184C
WR 450	71-72		801G							
AE 500	82-84		803G							
CR 500	82-84		803G							
CR 500	85-86	FA47X	FA47R		N/A					

Line #

FRONT

APPLICATIONS
BRAKE

⚠ This symbol indicates a rotor made of billet steel, and should be only used with EBC FA Kevlar® Organic or Vee pads.
SAFETY NOTICE - With vehicles primarily designed for off highway use such as quads now being used on the highway, we would recommend the use of X or MXS pads for highway use and ONLY using the R and SV higher density / harder pad series for off road riding.

*-2 Sets Required. ■ - Also available in MX-S race compound. SAFETY WARNING:- DO NOT USE HH PADS ON REAR UNLESS ALSO USED ON FRONT TO AVOID BRAKE IMBALANCE

FRONT: Non-Japanese Bikes Cont'd

REAR: Non-Japanese Bikes

Line #	BRAKE ROTOR CHOICES - FRONT						DISC PAD CHOICES - REAR				BRAKE ROTOR CHOICES - REAR					
	CC Custom Rotor	CX Extreme® /Vee-Rotor	OS Series Oversize 250/280mm Rotor Kit	OSX Series Oversize 280mm Rotor Kit	Relocating Bracket for 250/280mm Rotor	SMX Series Oversize 320mm Rotor Kit	Relocating Bracket for 320mm Rotor		Semi-Sintered V-Pads™	Sintered/HH Pads/ Grooved Shoes	SV Series Severe Duty Pads	Standard Rotor	UTVX Rotor	Vintage Rotor	Contour Profile Rotor	CX Extreme® /Vee-Rotor
1																
2										802G						
3										802G						
4										802G						
5										802G						
6										801G						
7								FA368X		FA368R■					MD6035C	MD6035CX
8								FA208X		FA208R■		MD6295D				
9								FA368X		FA368R■		MD6288D			MD6288C	
10								FA368X		FA368R■		MD6288D			MD6288C	
11																
12			OS6184HC	OSX6184H	BRK010	SMX6184H	BRK007	FA368X		FA368R■					TBA	
13																
14			OS6184KC	OSX6184K	BRK011	SMX6184K	BRK012	FA368X		FA368R■					TBA	
15																
16			OS6184HC	OSX6184H	BRK010	SMX6184H	BRK007	FA368X		FA368R■					TBA	
17																
18			OS6184KC	OSX6184K	BRK011	SMX6184K	BRK012	FA368X		FA368R■					TBA	
19		MD6032CX		OSX6032	BRK013	SMX6032	BRK014	FA368X		FA368R■					MD6035C	MD6035CX
20		MD6032CX		OSX6032	BRK013	SMX6032	BRK014	FA368X		FA368R■					MD6035C	MD6035CX
21																
22			OS6184HC	OSX6184H	BRK010	SMX6184H	BRK007	FA208X		FA208R■		MD6295D				
23																
24			OS6184KC	OSX6184K	BRK011	SMX6184K	BRK012	FA208X		FA208R■		MD6295D				
25																
26			OS6184HC	OSX6184H	BRK010	SMX6184H	BRK007	FA368X		FA368R■		MD6288D				
27																
28			OS6184KC	OSX6184K	BRK011	SMX6184K	BRK012	FA368X		FA368R■		MD6288D			MD6288C	
29																
30			OS6184HC	OSX6184H	BRK010	SMX6184H	BRK007	FA368X		FA368R■					TBA	
31																
32			OS6184KC	OSX6184K	BRK011	SMX6184K	BRK012	FA368X		FA368R■					TBA	
33																
34			OS6184HC	OSX6184H	BRK010	SMX6184H	BRK007	FA208X		FA208R■		MD6295D				
35																
36			OS6184KC	OSX6184K	BRK011	SMX6184K	BRK012	FA208X		FA208R■		MD6295D				
37																
38			OS6184HC	OSX6184H	BRK010	SMX6184H	BRK007	FA368X		FA368R■		MD6288D			MD6288C	
39																
40			OS6184KC	OSX6184K	BRK011	SMX6184K	BRK012	FA368X		FA368R■		MD6288D			MD6288C	
41																
42			OS6184HC	OSX6184H	BRK010	SMX6184H	BRK007	FA368X		FA368R■					TBA	
43																
44			OS6184KC	OSX6184K	BRK011	SMX6184K	BRK012	FA368X		FA368R■					TBA	
45																
46			OS6184HC	OSX6184H	BRK010	SMX6184H	BRK007	FA368X		FA368R■		MD6288D			MD6288C	
47																
48			OS6184KC	OSX6184K	BRK011	SMX6184K	BRK012	FA368X		FA368R■		MD6288D			MD6288C	
49																
50			OS6184HC	OSX6184H	BRK010	SMX6184H	BRK007	FA368X		FA368R■					TBA	
51																
52			OS6184KC	OSX6184K	BRK011	SMX6184K	BRK012	FA368X		FA368R■					TBA	
53																
54										801G						
55										802G						
56										801G						
										802G						

REAR

⚠ This symbol indicates a rotor made of billet steel, and should be only used with EBC FA Kevlar® Organic or Vee pads.
 SAFETY NOTICE - With vehicles primarily designed for off highway use such as quads now being used on the highway, we would recommend the use of X or MXS pads for highway use and ONLY using the R and SV higher density / harder pad series for off road riding.

BRAKE APPLICATIONS

*-2 Sets Required. ■ - Also available in MX-S race compound. **SAFETY WARNING:- DO NOT USE HH PADS ON REAR UNLESS ALSO USED ON FRONT TO AVOID BRAKE IMBALANCE**

FRONT: Non-Japanese Bikes



HUSQVARNA



DISC PAD CHOICES - FRONT

BRAKE ROTOR CHOICES - FRONT

CR 500	87-88	FA134X	FA134R		N/A					
XC 500	82-84		803G							
XC 500	85-86	FA47X	FA47R		N/A					
XC 500	87-88	FA134X	FA134R		N/A					
FC 501 (4T)	14	FA181X	FA181R■							MD6032C
FE 501 (4T)	14-15	FA181X	FA181R■							MD6032C
SM 510 R	05	FA95	FA95HH		MD6293D					
SM 510 R (Radial caliper)	06-10		FA322/4HH		MD6293D					
TC 510	87-88	FA47X	FA47R		N/A					
TC 510	89-	FA134X	FA134R		N/A					
TC 510	90	FA134X	FA134R		N/A					
TC 510 (45mm dia. Marzocchi forks = 60mm caliper mount centers)	04	FA181X	FA181R■		MD6184D					MD6184C
TC 510 (48mm dia. Marzocchi or Kayaba forks = 95mm caliper mount centers)	04	FA181X	FA181R■		MD6184D					MD6184C
TC 510 (45mm dia. Marzocchi forks = 60mm caliper mount centers)	05-09	FA181X	FA181R■		MD6184D					MD6184C
TC 510 (48mm dia. Marzocchi or Kayaba forks = 95mm caliper mount centers)	05-09	FA181X	FA181R■		MD6184D					MD6184C
TE 510	87-88	FA47X	FA47R		N/A					
TE 510	89	FA134X	FA134R		N/A					
TE 510	90	FA134X	FA134R		N/A					
TE 510 (45mm dia. Marzocchi forks = 60mm caliper mount centers)	04-05	FA181X	FA181R■		MD6184D					MD6184C
TE 510 (48mm dia. Marzocchi or Kayaba forks = 95mm caliper mount centers)	04-05	FA181X	FA181R■		MD6184D					MD6184C
TE 510 (45mm dia. Marzocchi forks = 60mm caliper mount centers)	06-08	FA181X	FA181R■		MD6184D					MD6184C
TE 510 (48mm dia. Marzocchi or Kayaba forks = 95mm caliper mount centers)	06-08	FA181X	FA181R■		MD6184D					MD6184C
TE 510 (45mm dia. Marzocchi forks = 60mm caliper mount centers)	09-10	FA181X	FA181R■							MD6184C
TE 510 (48mm dia. Marzocchi or Kayaba forks = 95mm caliper mount centers)	09-10	FA181X	FA181R■							MD6184C
TE 511 (45mm dia. Marzocchi forks = 60mm caliper mount centers)	11-12	FA181X	FA181R■							MD6184C
TE 511 (48mm dia. Marzocchi or Kayaba forks = 95mm caliper mount centers)	11-12	FA181X	FA181R■							MD6184C
TX 510	87-88	FA47X	FA47R		N/A					
TXC 510 Cross Country (45mm dia. Marzocchi forks = 60mm caliper mount centers)	08	FA181X	FA181R■		MD6184D					MD6184C
TXC 510 Cross Country (48mm dia. Marzocchi or Kayaba forks = 95mm caliper mount centers)	08	FA181X	FA181R■		MD6184D					MD6184C
TXC 510 Cross Country (45mm dia. Marzocchi forks = 60mm caliper mount centers)	09-10	FA181X	FA181R■							MD6184C
TXC 510 Cross Country (48mm dia. Marzocchi or Kayaba forks = 95mm caliper mount centers)	09-10	FA181X	FA181R■							MD6184C
TXC 511 Cross Country (45mm dia. Marzocchi forks = 60mm caliper mount centers)	11-12	FA181X	FA181R■							MD6184C
TXC 511 Cross Country (48mm dia. Marzocchi or Kayaba forks = 95mm caliper mount centers)	11-12	FA181X	FA181R■							MD6184C
WMX 510	89	FA134X	FA134R		N/A					
WXE 510	89	FA134X	FA134R		N/A					
SM 570 R (4 bolt front disc)	01-	FA95	FA95HH		MD6293D					
SM 570 R	02-04	FA95	FA95HH		MD6293D					

Line #
1
2
3
4
5
6
7
8
9
10
11
12
13
14
15
16
17
18
19
20
21
22
23
24
25
26
27
28
29
30
31
32
33
34
35
36
37
38
39
40
41
42
43
44
45
46
47
48
49
50
51
52
53
54
55
56

FRONT

APPLICATIONS
BRAKE

⚠ This symbol indicates a rotor made of billet steel, and should be only used with EBC FA Kevlar® Organic or Vee pads.
SAFETY NOTICE - With vehicles primarily designed for off highway use such as quads now being used on the highway, we would recommend the use of X or MXS pads for highway use and ONLY using the R and SV higher density / harder pad series for off road riding.

*-2 Sets Required. ■ - Also available in MX-S race compound. **SAFETY WARNING:- DO NOT USE HH PADS ON REAR UNLESS ALSO USED ON FRONT TO AVOID BRAKE IMBALANCE**

FRONT: Non-Japanese Bikes Cont'd

REAR: Non-Japanese Bikes

Line #

BRAKE ROTOR CHOICES - FRONT							DISC PAD CHOICES - REAR				BRAKE ROTOR CHOICES - REAR				
CC Custom Rotor	CX Extreme® /Vee-Rotor	OS Series Oversize 250/280mm Rotor Kit	OSX Series Oversize 280mm Rotor Kit	Relocating Bracket for 250/280mm Rotor	SMX Series Oversize 320mm Rotor Kit	Relocating Bracket for 320mm Rotor		Semi-Sintered V-Pads™	Sintered/HH Pads/ Grooved Shoes	SV Series Severe Duty Pads	Standard Rotor	UTVX Rotor	Vintage Rotor	Contour Profile Rotor	CX Extreme® /Vee-Rotor
1									802G						
2									802G						
3									801G						
4									802G						
5	MD6032CX		OSX6032	BRK013	SMX6032	BRK014	FA368X		FA368R■					MD6035C	MD6035CX
6	MD6032CX		OSX6032	BRK013	SMX6032	BRK014	FA368X		FA368R■					MD6035C	MD6035CX
7							FA208X		FA208R■		MD6295D				
8							FA368X		FA368R■		MD6288D				
9									801G						
10									801G						
11							FA251				MD6126D				
12															
13		OS6184HC	OSX6184H	BRK010	SMX6184H	BRK007	FA208X		FA208R■		MD6295D				
14															
15		OS6184KC	OSX6184K	BRK011	SMX6184K	BRK012	FA208X		FA208R■		MD6295D				
16															
17		OS6184HC	OSX6184H	BRK010	SMX6184H	BRK007	FA368X		FA368R■		MD6288D			MD6288C	
18															
19		OS6184KC	OSX6184K	BRK011	SMX6184K	BRK012	FA368X		FA368R■		MD6288D			MD6288C	
20															
21									801G						
22									801G						
23							FA251				MD6126D				
24		OS6184HC	OSX6184H	BRK010	SMX6184H	BRK007	FA208X		FA208R■		MD6295D				
25															
26		OS6184KC	OSX6184K	BRK011	SMX6184K	BRK012	FA208X		FA208R■		MD6295D				
27															
28		OS6184HC	OSX6184H	BRK010	SMX6184H	BRK007	FA368X		FA368R■		MD6288D			MD6288C	
29															
30		OS6184KC	OSX6184K	BRK011	SMX6184K	BRK012	FA368X		FA368R■		MD6288D			MD6288C	
31															
32		OS6184HC	OSX6184H	BRK010	SMX6184H	BRK007	FA368X		FA368R■					TBA	
33															
34		OS6184KC	OSX6184K	BRK011	SMX6184K	BRK012	FA368X		FA368R■					TBA	
35															
36		OS6184HC	OSX6184H	BRK010	SMX6184H	BRK007	FA368X		FA368R■					TBA	
37															
38		OS6184KC	OSX6184K	BRK011	SMX6184K	BRK012	FA368X		FA368R■					TBA	
39									801G						
40															
41		OS6184HC	OSX6184H	BRK010	SMX6184H	BRK007	FA368X		FA368R■		MD6288D			MD6288C	
42															
43		OS6184KC	OSX6184K	BRK011	SMX6184K	BRK012	FA368X		FA368R■		MD6288D			MD6288C	
44															
45		OS6184HC	OSX6184H	BRK010	SMX6184H	BRK007	FA368X		FA368R■					TBA	
46															
47		OS6184KC	OSX6184K	BRK011	SMX6184K	BRK012	FA368X		FA368R■					TBA	
48															
49		OS6184HC	OSX6184H	BRK010	SMX6184H	BRK007	FA368X		FA368R■					TBA	
50															
51		OS6184KC	OSX6184K	BRK011	SMX6184K	BRK012	FA368X		FA368R■					TBA	
52									801G						
53									801G						
54							FA208X		FA208R■		MD6287D				
55							FA208X		FA208R■		MD6295D				
56															

REAR

⚠ This symbol indicates a rotor made of billet steel, and should be only used with EBC FA Kevlar® Organic or Vee pads.

SAFETY NOTICE - With vehicles primarily designed for off highway use such as quads now being used on the highway, we would recommend the use of X or MXS pads for highway use and ONLY using the R and SV higher density / harder pad series for off road riding.

BRAKE APPLICATIONS

*-2 Sets Required. ■ - Also available in MX-S race compound. SAFETY WARNING:- DO NOT USE HH PADS ON REAR UNLESS ALSO USED ON FRONT TO AVOID BRAKE IMBALANCE

FRONT: Non-Japanese Bikes



HUSQVARNA



DISC PAD CHOICES - FRONT

BRAKE ROTOR CHOICES - FRONT

		Semi-Sintered V-Pads™	Sintered/HH Pads/Grooved Shoes	SV Series Severe Duty Pads	Standard Rotor Left	Standard Rotor Right	UTVX Rotor	Vintage Rotor Left	Vintage Rotor Right	Contour Profile Rotor
TC 570 (45mm dia. Marzocchi forks = 60mm caliper mount centers)	02-03	FA181X	FA181R■		MD6184D					MD6184C
TC 570 (48mm dia. Marzocchi or Kayaba forks = 95mm caliper mount centers)	02-03	FA181X	FA181R■		MD6184D					MD6184C
TE 570 (45mm dia. Marzocchi forks = 60mm caliper mount centers)	01	FA181X	FA181R■		MD6184D					MD6184C
TE 570 (48mm dia. Marzocchi or Kayaba forks = 95mm caliper mount centers)	01	FA181X	FA181R■		MD6184D					MD6184C
TE 570 (45mm dia. Marzocchi forks = 60mm caliper mount centers)	02-04	FA181X	FA181R■		MD6184D					MD6184C
TE 570 (48mm dia. Marzocchi or Kayaba forks = 95mm caliper mount centers)	02-04	FA181X	FA181R■		MD6184D					MD6184C
LT 610 (6 bolt front disc)	00	FA244	FA244HH		MD6294D					
SM 610 (6 bolt front disc)	98-99	FA244	FA244HH		MD6294D					
SM 610 R (45mm dia. Marzocchi forks = 60mm caliper mount centers)	00	FA244	FA244HH		MD6184D					MD6184C
SM 610 R (48mm dia. Marzocchi or Kayaba forks = 95mm caliper mount centers)	00	FA244	FA244HH		MD6184D					MD6184C
SM 610 S (4 bolt front disc)	02-06	FA244	FA244HH		MD6293D					
SM 610 S (Radial caliper)	06		FA322/4HH		MD6293D					
SM 610 IE	07-09		FA322/4HH		MD6293D					
TC 610	91	FA134X	FA134R		N/A					
TC 610	92-94	FA135X	FA135R■		MD6125D					
TC 610/E	95-99	FA181X	FA181R■		MD6125D					N/A
TC 610 (45mm dia. Marzocchi forks = 60mm caliper mount centers)	00	FA181X	FA181R■		MD6184D					MD6184C
TC 610 (48mm dia. Marzocchi or Kayaba forks = 95mm caliper mount centers)	00	FA181X	FA181R■		MD6184D					MD6184C
TE 610	91	FA134X	FA134R		N/A					
TE 610	92-94	FA135X	FA135R■		MD6125D					
TE 610 (45mm dia. Marzocchi forks = 60mm caliper mount centers)	00	FA181X	FA181R■		MD6184D					MD6184C
TE 610 (48mm dia. Marzocchi or Kayaba forks = 95mm caliper mount centers)	00	FA181X	FA181R■		MD6184D					MD6184C
TE 610 E	95-99	FA181X	FA181R■		MD6125D					N/A
TE 610 E (45mm dia. Marzocchi forks = 60mm caliper mount centers)	00	FA181X	FA181R■		MD6184D					MD6184C
TE 610 E (48mm dia. Marzocchi or Kayaba forks = 95mm caliper mount centers)	00	FA181X	FA181R■		MD6184D					MD6184C
TE 610 E (45mm dia. Marzocchi forks = 60mm caliper mount centers)	02-03	FA181X	FA181R■		MD6184D					MD6184C
TE 610 E (48mm dia. Marzocchi or Kayaba forks = 95mm caliper mount centers)	02-03	FA181X	FA181R■		MD6184D					MD6184C
TE 610 IE (45mm dia. Marzocchi forks = 60mm caliper mount centers)	06-09	FA181X	FA181R■		MD6184D					MD6184C
TE 610 IE (48mm dia. Marzocchi or Kayaba forks = 95mm caliper mount centers)	06-09	FA181X	FA181R■		MD6184D					MD6184C
SM 630	09-10		FA322/4HH		MD6293D					
SMR 630	06	FA95	FA95HH		MD6293D					
SMS 630	10-11		FA322/4HH		MD6293D					
TE 630 (45mm dia. Marzocchi forks = 60mm caliper mount centers)	10	FA181X	FA181R■		MD6184D					MD6184C
TE 630 (48mm dia. Marzocchi or Kayaba forks = 95mm caliper mount centers)	10	FA181X	FA181R■		MD6184D					MD6184C
STR 650 CRC	07		FA322/4HH		MD6293D					
TR 650 Terra (Spoke Wheels)	13	FA209/2	FA209/2V	FA209/2HH	MD834					

Line #

FRONT

APPLICATIONS

BRAKE

⚠ This symbol indicates a rotor made of billet steel, and should be only used with EBC FA Kevlar® Organic or Vee pads.

SAFETY NOTICE - With vehicles primarily designed for off highway use such as quads now being used on the highway, we would recommend the use of X or MXS pads for highway use and ONLY using the R and SV higher density / harder pad series for off road riding.

*-2 Sets Required. ■ - Also available in MX-S race compound. SAFETY WARNING:- DO NOT USE HH PADS ON REAR UNLESS ALSO USED ON FRONT TO AVOID BRAKE IMBALANCE

FRONT: Non-Japanese Bikes Cont'd

REAR: Non-Japanese Bikes

Line #	BRAKE ROTOR CHOICES - FRONT						DISC PAD CHOICES - REAR				BRAKE ROTOR CHOICES - REAR					
	CC Custom Rotor	CX Extreme® /Vee-Rotor	OS Series Oversize 250/280mm Rotor Kit	OSX Series Oversize 280mm Rotor Kit	Relocating Bracket for 250/280mm Rotor	SMX Series Oversize 320mm Rotor Kit	Relocating Bracket for 320mm Rotor		Semi-Sintered V-Pads™	Sintered/HH Pads/ Grooved Shoes	SV Series Severe Duty Pads	Standard Rotor	UTVX Rotor	Vintage Rotor	Contour Profile Rotor	CX Extreme® /Vee-Rotor
1																
2			OS6184HC	OSX6184H	BRK010	SMX6184H	BRK007	FA208X		FA208R■		MD6295D				
3																
4			OS6184KC	OSX6184K	BRK011	SMX6184K	BRK012	FA208X		FA208R■		MD6295D				
5																
6			OS6184HC	OSX6184H	BRK010	SMX6184H	BRK007	FA208X		FA208R■		MD6287D				
7																
8			OS6184KC	OSX6184K	BRK011	SMX6184K	BRK012	FA208X		FA208R■		MD6287D				
9																
10			OS6184HC	OSX6184H	BRK010	SMX6184H	BRK007	FA208X		FA208R■		MD6287D				
11																
12			OS6184KC	OSX6184K	BRK011	SMX6184K	BRK012	FA208X		FA208R■		MD6287D				
13								FA208X		FA208R■		MD6295D				
14								FA208X		FA208R■		MD6126D				
15																
16			OS6184HC	OSX6184H	BRK010	SMX6184H	BRK007	FA208X		FA208R■		MD6287D				
17																
18			OS6184KC	OSX6184K	BRK011	SMX6184K	BRK012	FA208X		FA208R■		MD6287D				
19								FA208X		FA208R■		MD6287D				
20								FA208X		FA208R■		MD6288D				
21								FA208X		FA208R■		MD6295D				
22								FA251				MD6126D				
23								FA84X		FA84R■		MD6126D				
24			OS6125C	OSX6125	BRK010	SMX6125	BRK007	FA208X		FA208R■		MD6126D				
25																
26			OS6184HC	OSX6184H	BRK010	SMX6184H	BRK007	FA208X		FA208R■		MD6287D				
27																
28			OS6184KC	OSX6184K	BRK011	SMX6184K	BRK012	FA208X		FA208R■		MD6287D				
29								FA251				MD6126D				
30								FA84X		FA84R■		MD6126D				
31																
32			OS6184HC	OSX6184H	BRK010	SMX6184H	BRK007	FA208X		FA208R■		MD6287D				
33																
34			OS6184KC	OSX6184K	BRK011	SMX6184K	BRK012	FA208X		FA208R■		MD6287D				
35			OS6125C	OSX6125	BRK010	SMX6125	BRK007	FA208X		FA208R■		MD6126D				
36																
37			OS6184HC	OSX6184H	BRK010	SMX6184H	BRK007	FA208X		FA208R■		MD6126D				
38																
39			OS6184KC	OSX6184K	BRK011	SMX6184K	BRK012	FA208X		FA208R■		MD6126D				
40																
41			OS6184HC	OSX6184H	BRK010	SMX6184H	BRK007	FA208X		FA208R■		MD6287D				
42																
43			OS6184KC	OSX6184K	BRK011	SMX6184K	BRK012	FA208X		FA208R■		MD6287D				
44																
45			OS6184HC	OSX6184H	BRK010	SMX6184H	BRK007	FA208X		FA208R■		MD6287D				
46																
47			OS6184KC	OSX6184K	BRK011	SMX6184K	BRK012	FA208X		FA208R■		MD6287D				
48								FA208X		FA208R■		MD6295D				
49								FA208X		FA208R■		MD6295D				
50								FA208X		FA208R■		MD6295D				
51																
52			OS6184HC	OSX6184H	BRK010	SMX6184H	BRK007	FA208X		FA208R■		MD6295D				
53																
54			OS6184KC	OSX6184K	BRK011	SMX6184K	BRK012	FA208X		FA208R■		MD6295D				
55								FA208X		FA208R■		MD6295D				
56								FA213	FA213V	FA213HH		MD671				

REAR

This symbol indicates a rotor made of billet steel, and should be only used with EBC FA Kevlar® Organic or Vee pads.
 SAFETY NOTICE - With vehicles primarily designed for off highway use such as quads now being used on the highway, we would recommend the use of X or MXS pads for highway use and ONLY using the R and SV higher density / harder pad series for off road riding.

BRAKE APPLICATIONS

*-2 Sets Required. ■ - Also available in MX-S race compound. **SAFETY WARNING:- DO NOT USE HH PADS ON REAR UNLESS ALSO USED ON FRONT TO AVOID BRAKE IMBALANCE**

FRONT: Non-Japanese Bikes Cont'd

REAR: Non-Japanese Bikes

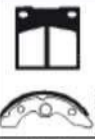
Line #	BRAKE ROTOR CHOICES - FRONT						DISC PAD CHOICES - REAR				BRAKE ROTOR CHOICES - REAR				
	CC Custom Rotor	CX Extreme® /Vee-Rotor	OS Series Oversize 250/280mm Rotor Kit	OSX Series Oversize 280mm Rotor Kit	Relocating Bracket for 250/280mm Rotor	SMX Series Oversize 320mm Rotor Kit	Relocating Bracket for 320mm Rotor		Semi-Sintered V-Pads™	Sintered/HH Pads/ Grooved Shoes	SV Series Severe Duty Pads	Standard Rotor	UTVX Rotor	Vintage Rotor	Contour Profile Rotor
1							FA213	FA213V	FA213HH		MD671				
2							FA213	FA213V	FA213HH		MD671				
3							FA213	FA213V	FA213HH		MD671				
4															
5															
6							TBA								
7							TBA								
8							TBA								
9							TBA								
10									FA282R		MD6301D				
11									FA282R		MD6301D				
12									FA282R		MD6301D				
13							SFA86		SFA86HH		TBA				
14							602								
15							FA86		FA86HH		MD689			MD689C	
16							FA86		FA86HH		MD689			MD689C	
17							606								
18							SFA86		SFA86HH		TBA				
19							FA54X		FA54R■		TBA				
20							FA86		FA86HH		MD689			MD689C	
21							FA86		FA86HH		MD689			MD689C	
22							FA86		FA86HH		MD689			MD689C	
23							FA86		FA86HH		TBA				
24							FA86		FA86HH		TBA				
25															
26															
27							FA216/3	FA216/3V	FA216/3HH		N/A				
28							FA216/3	FA216/3V	FA216/3HH		N/A				
29							FA216/3	FA216/3V	FA216/3HH		N/A				
30							FA18	FA18V	FA18HH		N/A				
31							FA18	FA18V	FA18HH		N/A				
32							FA18	FA18V	FA18HH		N/A				
33							FA18	FA18V	FA18HH		N/A				
34							FA18	FA18V	FA18HH		N/A				
35							FA18	FA18V	FA18HH		N/A				
36							FA18	FA18V	FA18HH		N/A				
37							FA18	FA18V	FA18HH		N/A				
38							FA18	FA18V	FA18HH		N/A				
39							FA196	FA196V	FA196HH		TBA				
40							FA196	FA196V	FA196HH		TBA				
41							FA196	FA196V	FA196HH		TBA				
42							FA196	FA196V	FA196HH		TBA				
43							FA196	FA196V	FA196HH		TBA				
44							FA377				MD534				
45							FA377				MD534				
46							FA377				MD534				
47											MD534				
48							FA196	FA196V	FA196HH		TBA				
49															
50															
51							SFA115		SFA115HH		MD948D				
52							624								
53							SFA115		SFA115HH		MD950D				
54							TBA								
55							624								
56							624								

BRAKE APPLICATIONS
 This symbol indicates a rotor made of billet steel, and should be only used with EBC FA Kevlar® Organic or Vee pads.
 SAFETY NOTICE - With vehicles primarily designed for off highway use such as quads now being used on the highway, we would recommend the use of X or MXS pads for highway use and ONLY using the R and SV higher density / harder pad series for off road riding.

*-2 Sets Required. ■ - Also available in MX-S race compound. **SAFETY WARNING:- DO NOT USE HH PADS ON REAR UNLESS ALSO USED ON FRONT TO AVOID BRAKE IMBALANCE**

FRONT: Non-Japanese Bikes

APPLICATIONS

BRAKE



ITALJET



Formula 125 LC	96-03
Jet Set 125/150	03
Torpedo 125 4T	99-04
Torpedo 150	03

JOHN DEERE (ATV & SIDE X SIDE)

Trail Buck 500/650 EX/EXT	Left	04-05
	Right	
Buck 500/650 EX/EXT	Left	04-08
	Right	
TX Gator Utility 9461		04-05
TX Turf Gator 9462		04-05
4PX Gator 4x2/4 x 4 Trail 9345		04-05
HPX Gator 4x2/4 x 4 9446		04-08
HPX 4x2 (Petrol) Gator		10-11
HPX 4x2 (Petrol) Gator Parking Brake		10-11
HPX 4 x 4/4 x 4 Trail (Petrol) Gator		10-11
HPX 4 x 4 (Diesel) - Gator (SN040000)		10
HPX 4 x 4 (Diesel) - Gator (SN040001 - 090000/090001-)		10-11
XUV 620i (Petrol) - Gator		10
XUV 625i (Petrol) - Gator		11
XUV 825i (Petrol) - Gator		11
XUV 850 D (Diesel) - Gator		10
XUV 855 D (Diesel) - Gator		11

KIOTI/MECHRON

2200 UTV (Side x Side)	09-14
------------------------	-------

KTM

50 SX/SXR Pro Junior/Senior/Adventure	96-03
50 SX Mini Adventure	04-07
50 SX Pro Senior LC	02-03
50 SX Pro Senior LC/Mini Senior Adventure	02-07
50 Supermoto	06
SX 50 Junior LC	07-09
SX 50 Mini (F & R 10" wheels)	09-16
50 SX Pro Senior LC (F 12"/R 10" wheels)	04-16
60 SX	98-99
60 SX	00
65 SX	98-99
65 SX	00-01
65 SX	02-03
65 SX	04-08
SX 65	09-16
XC 65	08
XC 65	09-10
80 MX	86-92
85 SX (17"/14" Wheels)	03-10
85 SX (19"/16" Wheels)	03-10
85 SX (17"/14" Wheels)	11
85 SX (19"/16" Wheels)	11
85 SX (17"/14" Wheels/220mm F/Disc)	12-15
85 SX (19"/16" Wheels/220mm F/Disc)	12
85 SX (17"/14" Wheels/240mm F/Disc)	16-17
85 SX (19"/16" Wheels/240mm F/Disc)	13-17
XC 85	08-09

DISC PAD CHOICES - FRONT

BRAKE ROTOR CHOICES - FRONT

SFA115		SFA115HH		MD941D					
SFA350		SFA350HH		TBA					
SFA115		SFA115HH		MD951D					
SFA115		SFA115HH		MD951D					
FA307X		FA307R	FA307SV	MD6245D					
FA317X		FA317R	FA317SV		MD6245D				
FA307X		FA307R	FA307SV	MD6245D					
FA317X		FA317R	FA317SV		MD6245D				
		FA398R*	FA398SV*	N/A	N/A				
		FA398R*	FA398SV*	N/A	N/A				
		FA398R*	FA398SV*	N/A	N/A				
		FA398R*	FA398SV*	N/A	N/A				
		FA398R*	FA398SV*	N/A	N/A				
		FA398R*	FA398SV*	N/A	N/A				
		FA398R*	FA398SV*	N/A	N/A				
		FA398R*	FA398SV*	N/A	N/A				
		FA398R*	FA398SV*	N/A	N/A				
		FA609R*		N/A	N/A				
		FA609R*		N/A	N/A				
		FA610R*		N/A	N/A				
		FA610R*		N/A	N/A				
		FA609R*		N/A	N/A				
		FA610R*		N/A	N/A				
FA622X*		FA622R*	FA622SV*	N/A	N/A				
N/A									
N/A									
FA325X		FA325R		N/A					
FA325X		FA325R		N/A					
FA325X		FA325R		N/A					
FA325X		FA325R		N/A					
FA325X		FA325R							N/A
FA325X		FA325R							N/A
FA115X		FA115R■		MD6192D					MD6192C
FA115X		FA115R■		MD6192D					MD6192C
FA115X		FA115R	MXS115	MD6192D					MD6192C
FA115X		FA115R■		MD6192D					MD6192C
FA357X		FA357R		MD6192D					MD6192C
FA357X		FA357R							MD6243C
FA357X		FA357R							MD6243C
FA357X		FA357R							MD6243C
FA357X		FA357R							MD6243C
FA47/2X				N/A					
FA357X		FA357R							MD6258C
FA357X		FA357R							MD6258C
FA357X		FA357R							MD6258C
FA357X		FA357R							MD6258C
FA612X		FA612R							MD6407C
FA612X		FA612R							MD6407C
FA612X		FA612R							MD6379C
FA612X		FA612R							MD6379C
FA357X		FA357R							MD6258C

Line #
1
2
3
4
5
6
7
8
9
10
11
12
13
14
15
16
17
18
19
20
21
22
23
24
25
26
27
28
29
30
31
32
33
34
35
36
37
38
39
40
41
42
43
44
45
46
47
48
49
50
51
52
53
54
55
56

* This symbol indicates a rotor made of billet steel, and should be only used with EBC FA Kevlar® Organic or Vee pads.
 SAFETY NOTICE - With vehicles primarily designed for off highway use such as quads now being used on the highway, we would recommend the use of X or MXS pads for highway use and ONLY using the R and SV higher density / harder pad series for off road riding.

*-2 Sets Required. ■ - Also available in MX-S race compound. **SAFETY WARNING:- DO NOT USE HH PADS ON REAR UNLESS ALSO USED ON FRONT TO AVOID BRAKE IMBALANCE**

FRONT: Non-Japanese Bikes Cont'd

REAR: Non-Japanese Bikes

Line #	BRAKE ROTOR CHOICES - FRONT						DISC PAD CHOICES - REAR				BRAKE ROTOR CHOICES - REAR				
	CC Custom Rotor	CX Extreme® /Vee-Rotor	OS Series Oversize 250/280mm Rotor Kit	OSX Series Oversize 280mm Rotor Kit	Relocating Bracket for 250/280mm Rotor	SMX Series Oversize 320mm Rotor Kit	Relocating Bracket for 320mm Rotor		Semi-Sintered V-Pads™	Sintered/HH Pads/ Grooved Shoes	SV Series Severe Duty Pads	Standard Rotor	UTVX Rotor	Vintage Rotor	Contour Profile Rotor
1							SFA115		SFA115HH		MD950D				
2							816								
3							816								
4							816								
5															
6															
7							FA317X		FA317R	FA317SV	MD6225D				
8															
9							FA317X		FA317R	FA317SV	MD6225D				
10															
11									FA398R*	FA398SV*	N/A*				
12									FA398R*	FA398SV*	N/A*				
13									FA398R*	FA398SV*	N/A*				
14									FA398R*	FA398SV*	N/A*				
15									FA398R*	FA398SV*	N/A*				
16									FA398R*	FA398SV*	N/A*				
17									FA398R*	FA398SV*	N/A*				
18									FA398R*	FA398SV*	N/A*				
19									FA609R*		N/A*				
20									FA609R*		N/A*				
21									FA609R*		N/A*				
22									FA609R*		N/A*				
23									FA609R*		N/A*				
24									FA609R*		N/A*				
25															
26															
27							FA622X*		FA622R*	FA622SV*	N/A*				
28															
29															
30							N/A								
31							N/A								
32							N/A								
33							N/A								
34							FA325X		FA325R		N/A				
35							N/A								
36							FA325X		FA325R					N/A	
37							FA325X		FA325R					N/A	
38							873								
39							FA337X		FA337R		MD6216D				
40							873								
41							FA337X		FA337R		MD6216D				
42							FA337X		FA337R		MD6216D				
43		MD6243CX					FA325X		FA325R					MD6249C	MD6249CX
44		MD6243CX					FA357X		FA357R					MD6249C	MD6249CX
45		MD6243CX					FA325X		FA325R					MD6249C	MD6249CX
46		MD6243CX					FA357X		FA357R					MD6249C	MD6249CX
47									814G						
48			OS6258C	OSX6258	BRK028	N/A	FA357X		FA357R					MD6257C	
49			OS6258C	OSX6258	BRK028	N/A	FA357X		FA357R					MD6257C	
50			OS6258C	OSX6258	BRK028	N/A	FA602X		FA602R					MD6360C	
51			OS6258C	OSX6258	BRK028	N/A	FA602X		FA602R					MD6360C	
52			N/A	OSX6407	BRK027	N/A	FA602X		FA602R						
53			N/A	OSX6407	BRK027	N/A	FA602X		FA602R						
54			N/A	N/A	N/A	N/A	FA602X		FA602R						
55			N/A	N/A	N/A	N/A	FA602X		FA602R						
56			OS6258C	OSX6258	BRK028	N/A	FA357X		FA357R					MD6257C	

REAR

* This symbol indicates a rotor made of billet steel, and should be only used with EBC FA Kevlar® Organic or Vee pads.
 SAFETY NOTICE - With vehicles primarily designed for off highway use such as quads now being used on the highway, we would recommend the use of X or MXS pads for highway use and ONLY using the R and SV higher density / harder pad series for off road riding.

BRAKE APPLICATIONS

*-2 Sets Required. ■ - Also available in MX-S race compound. **SAFETY WARNING:- DO NOT USE HH PADS ON REAR UNLESS ALSO USED ON FRONT TO AVOID BRAKE IMBALANCE**

FRONT: Non-Japanese Bikes

APPLICATIONS

BRAKE



KTM



DISC PAD CHOICES - FRONT

BRAKE ROTOR CHOICES - FRONT

			Semi-Sintered V-Pads™	Sintered/HH Pads/Grooved Shoes	SV Series Severe Duty Pads	Standard Rotor Left	Standard Rotor Right	UTVX Rotor	Vintage Rotor Left	Vintage Rotor Right	Contour Profile Rotor
SX 105	07-11	FA357X		FA357R							MD6258C
XC 105	08-09	FA357X		FA357R							MD6258C
D-XC/E-XC/E-GS 125	90-91	FA67X		FA67R		MD6034D					
D-XC/E-XC/E-GS 125 Grimeca Calipers	90-91	FA132X		FA132R		MD6034D					
D-XC/E-XC/E-GS 125 Brembo Calipers	92-93	FA181X		FA181R■		MD6034D					
D-XC/E-XC/E-GS 125 Grimeca Calipers	92-93	FA132X		FA132R		MD6034D					
EXC 125	87	FA126X		FA126R		N/A					
EXC 125	88	FA132X		FA132R		N/A					
EXC 125 Brembo Calipers	89	FA67X		FA67R		MD6034D					
EXC 125 Grimeca Calipers	89	FA132X		FA132R		MD6034D					
EXC/EGS 125 (Standard forks)	94	FA181X		FA181R■		MD6032D					MD6032C
EXC 125 (Standard forks)	95-99	FA181X		FA181R■		MD6032D					MD6032C
EXC 125 (Upside down forks)	00-03	FA181X		FA181R■		MD6032D					MD6032C
EXC 125 (Upside down forks)	04-08	FA181X		FA181R■		MD6032D					MD6032C
EXE 125	00	FA181X		FA181R■		MD6032D					MD6032C
GSXC/GS 125	85	FA47X		FA47R		N/A					
LC2 125	96-98	FA181X		FA181R■		N/A					
Sting 125	97-99	FA95		FA95HH		N/A					
MX 125	83			811G							
MX 125	84			814G							
MX/MXC 125	85	FA47X		FA47R		N/A					
MX/MXC/GS 125	86	FA47X		FA47R		N/A					
MX 125	87	FA126X		FA126R		N/A					
MX 125	88	FA132X		FA132R							
MX 125 Brembo Calipers	89	FA67X		FA67R		N/A					
MX 125 Grimeca Calipers	89	FA132X		FA132R		N/A					
MX 125 Brembo Calipers	90-91	FA67X		FA67R		N/A					
MX 125 Grimeca Calipers	90-91	FA132X		FA132R		N/A					
MX 125 Brembo Calipers	92-93	FA181X		FA181R■		MD6032D					MD6032C
MX 125 Grimeca Calipers	92-93	FA132X		FA132R		MD6032D					MD6032C
SM 125 Supermoto	00	FA181X		FA181R■		TBA					
SX 125 (Standard forks)	94-99	FA181X		FA181R■		MD6032D					MD6032C
SX 125 (Upside down forks)	00-03	FA181X		FA181R■		MD6032D					MD6032C
SX 125 (Upside down forks)	04-08	FA181X		FA181R■		MD6032D					MD6032C
SX 125 (Upside down forks)	09-16	FA181X		FA181R■							MD6032C
SX 150	08	FA181X		FA181R■		MD6032D					MD6032C
SX 150	09-17	FA181X		FA181R■							MD6032C
XC 150	10-15	FA181X		FA181R■		MD6032D					MD6032C
EXC/EGS 200 (Standard forks)	98-99	FA181X		FA181R■		MD6032D					MD6032C
EXC/EGS 200 (Upside down forks)	00-03	FA181X		FA181R■		MD6032D					MD6032C
XC/EXC 200 (Upside down forks)	04-08	FA181X		FA181R■		MD6032D					MD6032C
XC-W 200	07-09	FA181X		FA181R■		MD6032D					MD6032C
XC-W 200	10-16	FA181X		FA181R■		MD6032D					MD6032C
XC 200	06-09	FA181X		FA181R■		MD6032D					MD6032C
DXC/EXC 250 Grimeca Calipers	90	FA132X		FA132R		MD6034D					
D-XC/E-XC/E-GS 250 Brembo Calipers	91	FA67X		FA67R		MD6034D					
D-XC/E-XC/E-GS 250	91	FA132X		FA132R		MD6034D					
D-XC/E-XC/T-XC/E-GS 250 (Grimeca calipers)	92-93	FA132X		FA132R		MD6032D					MD6032C
EXC/EGS 250	88	FA132X		FA132R		N/A					
EXC/EGS 250 Brembo Calipers	89	FA67X		FA67R		MD6034D					
EXC/EGS 250 Grimeca Calipers	89	FA132X		FA132R		MD6034D					
EXC/EGS 250 (Standard forks)	94	FA181X		FA181R■		MD6032D					MD6032C
EXC 250 (Standard forks)	95-99	FA181X		FA181R■		MD6032D					MD6032C
EXC 250 (Upside down forks)	00-03	FA181X		FA181R■		MD6032D					MD6032C
XC/EXC 250 (Upside down forks)	04-07	FA181X		FA181R■		MD6032D					MD6032C

Line #

FRONT

MD6035C● = PLAIN UNDRILLED DISC FOR ENDURO USE. REAR FITMENTS ONLY. ORDER MD6035CE.

*-2 Sets Required. ■ - Also available in MX-S race compound. **SAFETY WARNING:- DO NOT USE HH PADS ON REAR UNLESS ALSO USED ON FRONT TO AVOID BRAKE IMBALANCE**



FRONT: Non-Japanese Bikes Cont'd

REAR: Non-Japanese Bikes

Line #	BRAKE ROTOR CHOICES - FRONT						DISC PAD CHOICES - REAR				BRAKE ROTOR CHOICES - REAR					
	CC Custom Rotor	CX Extreme® /Vee-Rotor	OS Series Oversize 250/280mm Rotor Kit	OSX Series Oversize 280mm Rotor Kit	Relocating Bracket for 250/280mm Rotor	SMX Series Oversize 320mm Rotor Kit	Relocating Bracket for 320mm Rotor		Semi-Sintered V-Pads™	Sintered/HH Pads/ Grooved Shoes	SV Series Severe Duty Pads	Standard Rotor	UTVX Rotor	Vintage Rotor	Contour Profile Rotor	CX Extreme® /Vee-Rotor
1			OS6258C	OSX6258	BRK028	N/A	N/A	FA357X		FA357R					MD6257C	
2			OS6258C	OSX6258	BRK028	N/A	N/A	FA357X		FA357R					MD6257C	
3								FA67X		FA67R		N/A				
4								FA132X		FA132R		N/A				
5								FA67X		FA67R		N/A				
6								FA67X		FA67R		N/A				
7								FA126X		FA126R		N/A				
8								FA132X		FA132R		MD6227D				
9								FA67X		FA67R		MD6227D				
10								FA132X		FA132R		MD6227D				
11		MD6032CX	OS6032EC	OSX6032E	BRK015	SMX6032E	BRK016	FA208X		FA208R■		MD6035D			MD6035C●	MD6035CX
12		MD6032CX	OS6032EC	OSX6032E	BRK015	SMX6032E	BRK016	FA208X		FA208R■		MD6035D			MD6035C●	MD6035CX
13		MD6032CX	OS6032C	OSX6032	BRK011	SMX6032	BRK012	FA208X		FA208R■		MD6035D			MD6035C●	MD6035CX
14		MD6032CX	OS6032C	OSX6032	BRK011	SMX6032	BRK012	FA368X		FA368R■		MD6035D			MD6035C●	MD6035CX
15		MD6032CX	OS6032C	OSX6032	BRK011	SMX6032	BRK012	FA208X		FA208R■		MD6035D			MD6035C●	MD6035CX
16										814G						
17								FA208X		FA208R■		N/A				
18								FA208X		FA208R		N/A				
19										812G						
20										814G						
21										814G						
22								FA47X		FA47R		MD6227D				
23								FA126X		FA126R		N/A				
24								FA132X		FA132R		MD6227D				
25								FA67X		FA67R		MD6227D				
26								FA132X		FA132R		MD6227D				
27								FA67X		FA67R		N/A				
28								FA132X		FA132R		N/A				
29		MD6032CX	OS6032EC	OSX6032E	BRK015	SMX6032E	BRK016	FA67X		FA67R		N/A				
30								FA67X		FA67R		N/A				
31								FA208X		FA208R■		MD6035D			MD6035C	
32		MD6032CX	OS6032EC	OSX6032E	BRK015	SMX6032E	BRK016	FA208X		FA208R■		MD6035D			MD6035C	MD6035CX
33		MD6032CX	OS6032C	OSX6032	BRK011	SMX6032	BRK012	FA208X		FA208R■		MD6035D			MD6035C	MD6035CX
34		MD6032CX	OS6032C	OSX6032	BRK011	SMX6032	BRK012	FA368X		FA368R■		MD6035D			MD6035C	MD6035CX
35		MD6032CX	OS6932C	OSX6932	BRK013	SMX6932	BRK014	FA368X		FA368R■					MD6035C	MD6035CX
36		MD6032CX	OS6032C	OSX6032	BRK011	SMX6032	BRK012	FA368X		FA368R■		MD6035D			MD6035C	MD6035CX
37		MD6032CX	OS6932C	OSX6932	BRK013	SMX6932	BRK014	FA368X		FA368R■					MD6035C	MD6035CX
38		MD6032CX	OS6932C	OSX6932	BRK013	SMX6932	BRK014	FA368X		FA368R■		MD6035D			MD6035C●	MD6035CX
39		MD6032CX	OS6032EC	OSX6032E	BRK015	SMX6032E	BRK016	FA208X		FA208R■		MD6035D			MD6035C●	MD6035CX
40		MD6032CX	OS6032C	OSX6032	BRK011	SMX6032	BRK012	FA208X		FA208R■		MD6035D			MD6035C●	MD6035CX
41		MD6032CX	OS6032C	OSX6032	BRK011	SMX6032	BRK012	FA368X		FA368R■		MD6035D			MD6035C●	MD6035CX
42		MD6032CX	OS6032C	OSX6032	BRK011	SMX6032	BRK012	FA368X		FA368R■		MD6035D			MD6035C●	MD6035CX
43		MD6032CX	OS6932C	OSX6932	BRK013	SMX6932	BRK014	FA368X		FA368R■		MD6035D			MD6035C●	MD6035CX
44		MD6032CX	OS6032C	OSX6032	BRK011	SMX6032	BRK012	FA368X		FA368R■		MD6035D			MD6035C●	MD6035CX
45								FA132X		FA132R		N/A				
46								FA67X		FA67R		N/A				
47								FA132X		FA132R		N/A				
48								FA67X		FA67R		N/A				
49								FA132X		FA132R		MD6227D				
50								FA67X		FA67R		MD6227D				
51								FA132X		FA132R		MD6227D				
52		MD6032CX	OS6032EC	OSX6032E	BRK015	SMX6032E	BRK016	FA208X		FA208R■		MD6035D			MD6035C●	MD6035CX
53		MD6032CX	OS6032EC	OSX6032E	BRK015	SMX6032E	BRK016	FA208X		FA208R■		MD6035D			MD6035C●	MD6035CX
54		MD6032CX	OS6032C	OSX6032	BRK011	SMX6032	BRK012	FA208X		FA208R■		MD6035D			MD6035C●	MD6035CX
55		MD6032CX	OS6032C	OSX6032	BRK011	SMX6032	BRK012	FA368X		FA368R■		MD6035D			MD6035C●	MD6035CX
56																

BRAKE APPLICATIONS

⚠ This symbol indicates a rotor made of billet steel, and should be only used with EBC FA Kevlar® Organic or Vee pads.

SAFETY NOTICE - With vehicles primarily designed for off highway use such as quads now being used on the highway, we would recommend the use of X or MXS pads for highway use and ONLY using the R and SV higher density / harder pad series for off road riding.

*-2 Sets Required. ■ - Also available in MX-S race compound. **SAFETY WARNING:- DO NOT USE HH PADS ON REAR UNLESS ALSO USED ON FRONT TO AVOID BRAKE IMBALANCE**

FRONT: Non-Japanese Bikes

APPLICATIONS

BRAKE



KTM



DISC PAD CHOICES - FRONT

BRAKE ROTOR CHOICES - FRONT

			Semi-Sintered V-Pads™	Sintered/HH Pads/Grooved Shoes	SV Series Severe Duty Pads	Standard Rotor Left	Standard Rotor Right	UTVX Rotor	Vintage Rotor Left	Vintage Rotor Right	Contour Profile Rotor
EXC-F 250	06-07	FA181X		FA181R■		MD6032D					MD6032C
250 R Freeride 4T	15-16	FA612X		FA612R							TBA
GS 250	86	FA47X		FA47R		N/A					
GSXC/GS 250	85	FA47X		FA47R		N/A					
MX 250	88	FA132X		FA132R		N/A					
MX 250 Grimeca Calipers	89	FA132X		FA132R		N/A					
MX 250 Brembo Calipers	89	FA67X		FA67R		N/A					
MX 250 Brembo Calipers	90	FA67X		FA67R		N/A					
MX 250 Brembo Calipers	91	FA67X		FA67R		N/A					
MX 250 Grimeca Calipers	91	FA132X		FA132R		N/A					
MX 250 Brembo Calipers	92-93	FA181X		FA181R■		MD6032D					MD6032C
MX/EXC 250	87	FA126X		FA126R		N/A					
MX/MXC/GS 250	84			814G							
MX/MXC 250	85	FA47X		FA47R		N/A					
MX/MXC 250	86	FA47X		FA47R		N/A					
SX 250 (Standard Forks)	94-99	FA181X		FA181R■		MD6032D					MD6032C
SX 250 (Upside down forks)	00-02	FA181X		FA181R■		MD6032D					MD6032C
SX 250 (Upside down forks)	03-08	FA181X		FA181R■		MD6032D					MD6032C
SX 250 (2T) (Upside down forks)	09-16	FA181X		FA181R■							MD6032C
SX-F 250	05-08	FA181X		FA181R■		MD6032D					MD6032C
SX-F 250 Factory Edition (4T)	15	FA181X		FA181R■							MD6032C
SX-F 250 (4T)	09-16	FA181X		FA181R■							MD6032C
XC 250	06-09	FA181X		FA181R■		MD6032D					MD6032C
XC 250 (2T)	10-16	FA181X		FA181R■		MD6032D					MD6032C
XC-W 250	06-08	FA181X		FA181R■		MD6032D					MD6032C
XC-W 250	10-16	FA181X		FA181R■		MD6032D					MD6032C
XC-F 250	06-09	FA181X		FA181R■		MD6032D					MD6032C
XC-F 250	10-16	FA181X		FA181R■							MD6032C
XC-F-W 250	06-10	FA181X		FA181R■		MD6032D					MD6032C
XC-F-W 250	12-16	FA181X		FA181R■							MD6032C
XC-F-W 250 Six Days	11	FA181X		FA181R■		MD6032D					MD6032C
EGS 300 (Standard forks)	94-98	FA181X		FA181R■		MD6032D					MD6032C
EXC 300 (Standard forks)	94-98	FA181X		FA181R■		MD6032D					MD6032C
EXC 300 (Upside down forks)	99-03	FA181X		FA181R■		MD6032D					MD6032C
EXC 300 (Upside down forks)	04-05	FA181X		FA181R■		MD6032D					MD6032C
GSXC/GS 300	85	FA47X		FA47R		N/A					
MX/MXC 300	85	FA47X		FA47R		N/A					
MXC 300 (Standard forks)	94-98	FA181X		FA181R■		MD6032D					MD6032C
MXC 300 (Upside down forks)	99-03	FA181X		FA181R■		MD6032D					MD6032C
MXC 300 (Upside down forks)	04-06	FA181X		FA181R■		MD6032D					MD6032C
MX/MXC/GS 300	86	FA47X		FA47R		N/A					
SX 300	94-96	FA181X		FA181R■		MD6032D					MD6032C
XC 300	06-09	FA181X		FA181R■		MD6032D					MD6032C
XC 300	10-16	FA181X		FA181R■		MD6032D					MD6032C
XC-W 300	06-09	FA181X		FA181R■		MD6032D					MD6032C
XC-W 300	10-16	FA181X		FA181R■		MD6032D					MD6032C
XC-W 300 Six Days (2T)	14-16	FA181X		FA181R■		MD6032D					MD6032C
DXC/EXC/EGS 350 Brembo Calipers	90-91	FA67X		FA67R		MD6034D					
DXC/EXC/EGS 350 Grimeca Calipers	90-91	FA132X		FA132R		MD6034D					
EXC 350 Brembo Calipers	89	FA67X		FA67R		MD6034D					
EXC 350 Grimeca Calipers	89	FA132X		FA132R		MD6034D					
EXC 350 LC4 (Standard forks)	94-95	FA181X		FA181R■		MD6032D					MD6032C
MX/MXC/GS 350	86	FA47X		FA47R		N/A					
MX/EXC 350	87	FA126X		FA126R		N/A					
MX/EXC/EGS 350	88	FA132X		FA132R		N/A					

Line #

FRONT

MD6035C● = PLAIN UNDRILLED DISC FOR ENDURO USE. REAR FITMENTS ONLY. ORDER MD6035CE.

*-2 Sets Required. ■ - Also available in MX-S race compound. **SAFETY WARNING:- DO NOT** USE HH PADS ON REAR UNLESS ALSO USED ON FRONT TO AVOID BRAKE IMBALANCE



FRONT: Non-Japanese Bikes Cont'd

REAR: Non-Japanese Bikes

Line #	BRAKE ROTOR CHOICES - FRONT						DISC PAD CHOICES - REAR				BRAKE ROTOR CHOICES - REAR					
	CC Custom Rotor	CX Extreme® /Vee-Rotor	OS Series Oversize 250/280mm Rotor Kit	OSX Series Oversize 280mm Rotor Kit	Relocating Bracket for 250/280mm Rotor	SMX Series Oversize 320mm Rotor Kit	Relocating Bracket for 320mm Rotor		Semi-Sintered V-Pads™	Sintered/HH Pads/ Grooved Shoes	SV Series Severe Duty Pads	Standard Rotor	UTVX Rotor	Vintage Rotor	Contour Profile Rotor	CX Extreme® /Vee-Rotor
1		MD6032CX	OS6032C	OSX6032	BRK011	SMX6032	BRK012	FA368X		FA368R■		MD6035D			MD6035C●	MD6035CX
2								FA602X		FA602R					MD6360C	
3								FA47X		FA47R		MD6227D				
4										814G						
5								FA132X		FA132R		MD6227D				
6								FA132X		FA132R		MD6227D				
7								FA67X		FA67R		MD6227D				
8								FA67X		FA67R		N/A				
9								FA67X		FA67R		N/A				
10								FA132X		FA132R		N/A				
11		MD6032CX	OS6032EC	OSX6032E	BRK015	SMX6032E	BRK016	FA67		FA67R		N/A				
12								FA126		FA126R		N/A				
13										814G						
14										814G						
15								FA47X		FA47R		MD6227D				
16		MD6032CX	OS6032EC	OSX6032E	BRK015	SMX6032E	BRK016	FA208X		FA208R■		MD6035D			MD6035C	MD6035CX
17		MD6032CX	OS6032C	OSX6032	BRK011	SMX6032	BRK012	FA208X		FA208R■		MD6035D			MD6035C	MD6035CX
18		MD6032CX	OS6032C	OSX6032	BRK011	SMX6032	BRK012	FA368X		FA368R■		MD6035D			MD6035C	MD6035CX
19		MD6032CX	OS6932C	OSX6932	BRK013	SMX6932	BRK014	FA368X		FA368R■					MD6035C	MD6035CX
20		MD6032CX	OS6032C	OSX6032	BRK011	SMX6032	BRK012	FA368X		FA368R■		MD6035D			MD6035C	MD6035CX
21		MD6032CX	OS6932C	OSX6932	BRK013	SMX6932	BRK014	FA368X		FA368R■					MD6035C	MD6035CX
22		MD6032CX	OS6932C	OSX6932	BRK013	SMX6932	BRK014	FA368X		FA368R■					MD6035C	MD6035CX
23		MD6032CX	OS6032C	OSX6032	BRK011	SMX6032	BRK012	FA368X		FA368R■		MD6035D			MD6035C●	MD6035CX
24		MD6032CX	OS6932C	OSX6932	BRK013	SMX6932	BRK014	FA368X		FA368R■		MD6035D			MD6035C●	MD6035CX
25		MD6032CX	OS6032C	OSX6032	BRK011	SMX6032	BRK012	FA368X		FA368R■		MD6035D			MD6035C●	MD6035CX
26		MD6032CX	OS6932C	OSX6932	BRK013	SMX6932	BRK014	FA368X		FA368R■		MD6035D			MD6035C●	MD6035CX
27		MD6032CX	OS6032C	OSX6032	BRK011	SMX6032	BRK012	FA368X		FA368R■		MD6035D			MD6035C●	MD6035CX
28		MD6032CX	OS6932C	OSX6932	BRK013	SMX6932	BRK014	FA368X		FA368R■		MD6035D			MD6035C●	MD6035CX
29		MD6032CX	OS6032C	OSX6032	BRK011	SMX6032	BRK012	FA368X		FA368R■		MD6035D			MD6035C●	MD6035CX
30		MD6032CX	OS6932C	OSX6932	BRK013	SMX6932	BRK014	FA368X		FA368R■					MD6035C●	MD6035CX
31		MD6032CX	OS6032C	OSX6032	BRK011	SMX6032	BRK012	FA368X		FA368R■		MD6035D			MD6035C●	MD6035CX
32		MD6032CX	OS6032EC	OSX6032E	BRK015	SMX6032E	BRK016	FA208X		FA208R■		MD6035D			MD6035C●	MD6035CX
33		MD6032CX	OS6032EC	OSX6032E	BRK015	SMX6032E	BRK016	FA208X		FA208R■		MD6035D			MD6035C●	MD6035CX
34		MD6032CX	OS6032C	OSX6032	BRK011	SMX6032	BRK012	FA208X		FA208R■		MD6035D			MD6035C●	MD6035CX
35		MD6032CX	OS6032C	OSX6032	BRK011	SMX6032	BRK012	FA368X		FA368R■		MD6035D			MD6035C●	MD6035CX
36										814G						
37										814G						
38		MD6032CX	OS6032EC	OSX6032E	BRK015	SMX6032E	BRK016	FA208X		FA208R■		MD6035D			MD6035C	MD6035CX
39		MD6032CX	OS6032C	OSX6032	BRK011	SMX6032	BRK012	FA208X		FA208R■		MD6035D			MD6035C	MD6035CX
40		MD6032CX	OS6032C	OSX6032	BRK011	SMX6032	BRK012	FA368X		FA368R■		MD6035D			MD6035C	MD6035CX
41								FA47X		FA47R		MD6227D				
42		MD6032CX	OS6032C	OSX6032	BRK011	SMX6032	BRK012	FA208X		FA208R■		MD6035D			MD6035C	MD6035CX
43		MD6032CX	OS6032C	OSX6032	BRK011	SMX6032	BRK012	FA368X		FA368R■		MD6035D			MD6035C●	MD6035CX
44		MD6032CX	OS6932C	OSX6932	BRK013	SMX6932	BRK014	FA368X		FA368R■		MD6035D			MD6035C●	MD6035CX
45		MD6032CX	OS6032C	OSX6032	BRK011	SMX6032	BRK012	FA368X		FA368R■		MD6035D			MD6035C●	MD6035CX
46		MD6032CX	OS6932C	OSX6932	BRK013	SMX6932	BRK014	FA368X		FA368R■		MD6035D			MD6035C●	MD6035CX
47		MD6032CX	OS6932C	OSX6932	BRK013	SMX6932	BRK014	FA368X		FA368R■		MD6035D			MD6035C●	MD6035CX
48								FA67		FA67R		N/A				
49								FA132X		FA132R		N/A				
50								FA67X		FA67R		MD6227D				
51								FA132X		FA132R		MD6227D				
52		MD6032CX	OS6032C	OSX6032	BRK011	SMX6032	BRK012	FA208X		FA208R■		MD6035D			MD6035C	MD6035CX
53								FA47X		FA47R		MD6227D				
54								FA126X		FA126R		N/A				
55								FA132X		FA132R		MD6227D				
56																

⚠ This symbol indicates a rotor made of billet steel, and should be only used with EBC FA Kevlar® Organic or Vee pads.
 SAFETY NOTICE - With vehicles primarily designed for off highway use such as quads now being used on the highway, we would recommend the use of X or MXS pads for highway use and ONLY using the R and SV higher density / harder pad series for off road riding.

BRAKE APPLICATIONS

*-2 Sets Required. ■ - Also available in MX-S race compound. **SAFETY WARNING:- DO NOT USE HH PADS ON REAR UNLESS ALSO USED ON FRONT TO AVOID BRAKE IMBALANCE**

FRONT: Non-Japanese Bikes

APPLICATIONS

BRAKE



KTM



DISC PAD CHOICES - FRONT

BRAKE ROTOR CHOICES - FRONT

MX 350 Brembo Calipers	90-91	FA67X	FA67R		N/A					
MX 350 Grimeca Calipers	90-91	FA132X	FA132R		N/A					
MX 350 Brembo Calipers	89	FA67X	FA67R		N/A					
MX 350 Grimeca Calipers	89	FA132X	FA132R		N/A					
EXC 350 (Standard forks)	96-97	FA181X	FA181R		MD6032D					MD6032C
EXC-F 350	12-16	FA181X	FA181R							MD6032C
SX-F 350	11-16	FA181X	FA181R		MD6032D					MD6032C
XC-F 350	11-16	FA181X	FA181R							MD6032C
XC-F-W 350	12-16	FA181X	FA181R							MD6032C
XC-F-W 350 Six Days (4T)	14-16	FA181X	FA181R							MD6032C
SX 360 (Standard forks)	96-97	FA181X	FA181R		MD6032D					MD6032C
EXC 380 (Standard forks)	98-99	FA181X	FA181R		MD6032D					MD6032C
EXC 380 (Upside down forks)	00-03	FA181X	FA181R		MD6032D					MD6032C
SX 380 (Standard forks)	98-99	FA181X	FA181R		MD6032D					MD6032C
SX 380 (Upside down forks)	00-03	FA181X	FA181R		MD6032D					MD6032C
390 Duke (300mm Solid front disc)	15-16	FA606	FA606HH			MD864				
390 Duke (300mm Floating front disc option)	15-16	FA606	FA606HH							MD864XC
RC 390 (300mm Solid front disc)	15-16	FA606	FA606HH			MD864				
RC 390 (300mm Floating front disc option)	15-16	FA606	FA606HH							MD864XC
Duke 400 LC4	94-98	FA95	FA95HH		MD6199D					MD6199C
EGS 400/EGS-E/LSE (LC4 Enduro)	96-99	FA181X	FA181R		MD6130D					
EXC/EGS 400 (USD)	00-02	FA181X	FA181R		MD6032D					MD6032C
EXC 400 Racing (USD)	00-03	FA181X	FA181R		MD6032D					MD6032C
XC/EXC 400	04-07	FA181X	FA181R		MD6032D					MD6032C
LC4-E 400 Enduro	00-01	FA181X	FA181R		MD6130D					
SC 400 (Supercompetition LC4)	96-99	FA181X	FA181R		MD6032D					MD6032C
SX 400 (Upside down forks)	00-02	FA181X	FA181R		MD6032D					MD6032C
XC-W 400	08-09	FA181X	FA181R		MD6032D					MD6032C
XC-W 400	10-11	FA181X	FA181R		MD6032D					MD6032C
EXC 440	94-95	FA181X	FA181R		MD6032D					MD6032C
SX 440	94-95	FA181X	FA181R		MD6032D					MD6032C
EXC 450	03	FA181X	FA181R		MD6032D					MD6032C
EXC 450 (4T)	09	FA181X	FA181R		MD6032D					MD6032C
EXC 450	10-11	FA181X	FA181R		MD6032D					MD6032C
EXC-R 450	08	FA181X	FA181R		MD6032D					MD6032C
SMR 450	04		MXS406		MD6270D					MD6270C
SMR 450	05-06		MXS405		MD6270D					MD6270C
450 SMR	07-12	FA433/4	FA433/4HH							MD6313C
SX 450	09-12		FA462R*							MD6336C
SX-F 450 (USD)	03-08	FA181X	FA181R		MD6032D					MD6032C
SX-F 450 (USD)	09-16	FA181X	FA181R							MD6032C
XC 450	08-12		FA462R*							MD6336C
XC/EXC 450	04-07	FA181X	FA181R		MD6032D					MD6032C
XC-F 450	08-09	FA181X	FA181R		MD6032D					MD6032C
XC-F 450	13-16	FA181X	FA181R		MD6032D					MD6032C
XCR-W 450 (4T)	08	FA181X	FA181R		MD6032D					MD6032C
XCR-W 450	13	FA181X	FA181R							MD6032C
450 XC-W (4T) Six Days/Champion Edition	10	FA181X	FA181R		MD6032D					MD6032C
XC-W 450	08-09	FA181X	FA181R		MD6032D					MD6032C
XC-W 450	12-16	FA181X	FA181R							MD6032C
XC-W 450 Champions Edition	10	FA181X	FA181R							MD6032C
XC-W 450 Six Days	10-11	FA181X	FA181R		MD6032D					MD6032C
EXC 500	12-16	FA181X	FA181R							MD6032C
EXC 500 Six Days	16	FA181X	FA181R							MD6032C
XC-W 500	12-16	FA181X	FA181R							MD6032C

Line #

FRONT

MD6035C = PLAIN UNDRILLED DISC FOR ENDURO USE. REAR FITMENTS ONLY. ORDER MD6035CE.

*-2 Sets Required. ■ - Also available in MX-S race compound. **SAFETY WARNING:- DO NOT USE HH PADS ON REAR UNLESS ALSO USED ON FRONT TO AVOID BRAKE IMBALANCE**



FRONT: Non-Japanese Bikes Cont'd

REAR: Non-Japanese Bikes

Line #	BRAKE ROTOR CHOICES - FRONT						DISC PAD CHOICES - REAR				BRAKE ROTOR CHOICES - REAR					
	CC Custom Rotor	CX Extreme® /Vee-Rotor	OS Series Oversize 250/280mm Rotor Kit	OSX Series Oversize 280mm Rotor Kit	Relocating Bracket for 250/280mm Rotor	SMX Series Oversize 320mm Rotor Kit	Relocating Bracket for 320mm Rotor		Semi-Sintered V-Pads™	Sintered/HH Pads/ Grooved Shoes	SV Series Severe Duty Pads	Standard Rotor	UTVX Rotor	Vintage Rotor	Contour Profile Rotor	CX Extreme® /Vee-Rotor
1									FA67X	FA67R		N/A				
2									FA132X	FA132R		N/A				
3									FA67X	FA67R		MD6227D				
4									FA132X	FA132R		MD6227D				
5		MD6032CX	OS6032C	OSX6032	BRK011	SMX6032	BRK012		FA208X	FA208R		MD6035D			MD6035C	MD6035CX
6		MD6032CX	OS6932C	OSX6932	BRK013	SMX6932	BRK014		FA368X	FA368R					MD6035C	MD6035CX
7		MD6032CX	OS6932C	OSX6932	BRK013	SMX6932	BRK014		FA368X	FA368R		MD6035D			MD6035C	MD6035CX
8		MD6032CX	OS6932C	OSX6932	BRK013	SMX6932	BRK014		FA368X	FA368R					MD6035C	MD6035CX
9		MD6032CX	OS6932C	OSX6932	BRK013	SMX6932	BRK014		FA368X	FA368R					MD6035C	MD6035CX
10		MD6032CX	OS6932C	OSX6932	BRK013	SMX6932	BRK014		FA368X	FA368R					MD6035C	MD6035CX
11		MD6032CX	OS6032EC	OSX6032E	BRK015	SMX6032E	BRK016		FA208X	FA208R		MD6035D			MD6035C	MD6035CX
12		MD6032CX	OS6032EC	OSX6032E	BRK015	SMX6032E	BRK016		FA208X	FA208R		MD6035D			MD6035C	MD6035CX
13		MD6032CX	OS6032C	OSX6032	BRK011	SMX6032	BRK012		FA208X	FA208R		MD6035D			MD6035C	MD6035CX
14		MD6032CX	OS6032EC	OSX6032E	BRK015	SMX6032E	BRK016		FA208X	FA208R		MD6035D			MD6035C	MD6035CX
15		MD6032CX	OS6032C	OSX6032	BRK011	SMX6032	BRK012		FA208X	FA208R		MD6035D			MD6035C	MD6035CX
16									FA213	FA213V	FA213HH	MD850				
17									FA213	FA213V	FA213HH	MD850				
18									FA213	FA213V	FA213HH	MD850				
19									FA213	FA213V	FA213HH	MD850				
20									FA208X	FA208R		MD6371D			MD6371C	
21									FA208X	FA208R		MD6371D				
22		MD6032CX	OS6032C	OSX6032	BRK011	SMX6032	BRK012		FA208X	FA208R		MD6035D			MD6035C	MD6035CX
23		MD6032CX	OS6032C	OSX6032	BRK011	SMX6032	BRK012		FA208X	FA208R		MD6035D			MD6035C	MD6035CX
24		MD6032CX	OS6032C	OSX6032	BRK011	SMX6032	BRK012		FA368X	FA368R		MD6035D			MD6035C	MD6035CX
25									FA208X	FA208R		MD6371D				
26			OS6032EC	OSX6032E	BRK015	SMX6032E	BRK016		FA208X	FA208R		MD6371D			MD6371C	
27		MD6032CX	OS6032C	OSX6032	BRK011	SMX6032	BRK012		FA208X	FA208R		MD6035D			MD6035C	MD6035CX
28		MD6032CX	OS6032C	OSX6032	BRK011	SMX6032	BRK012		FA368X	FA368R		MD6035D			MD6035C	MD6035CX
29		MD6032CX	OS6932C	OSX6932	BRK013	SMX6932	BRK014		FA368X	FA368R		MD6035D			MD6035C	MD6035CX
30		MD6032CX	OS6032EC	OSX6032E	BRK015	SMX6032E	BRK016		FA208X	FA208R		MD6032D			MD6035C	MD6035CX
31		MD6032CX	OS6032EC	OSX6032E	BRK015	SMX6032E	BRK016		FA208X	FA208R		MD6035D			MD6035C	MD6035CX
32		MD6032CX	OS6032C	OSX6032	BRK011	SMX6032	BRK012		FA208X	FA208R		MD6035D			MD6035C	MD6035CX
33		MD6032CX	OS6032C	OSX6032	BRK011	SMX6032	BRK012		FA368X	FA368R		MD6035D			MD6035C	MD6035CX
34		MD6032CX	OS6932C	OSX6932	BRK013	SMX6932	BRK014		FA368X	FA368R		MD6035D			MD6035C	MD6035CX
35		MD6032CX	OS6032C	OSX6032	BRK011	SMX6032	BRK012		FA368X	FA368R		MD6035D			MD6035C	MD6035CX
36									FA368X	FA368R		MD6035D			MD6035C	
37									FA368X	FA368R		MD6035D			MD6035C	
38									FA368X	FA368R		MD6035D			MD6035C	
39										FA463R		MD6337D				
40		MD6032CX	OS6032C	OSX6032	BRK011	SMX6032	BRK012		FA368X	FA368R		MD6035D			MD6035C	MD6035CX
41		MD6032CX	OS6932C	OSX6932	BRK013	SMX6932	BRK014		FA368X	FA368R		MD6035D			MD6035C	MD6035CX
42										FA463R		MD6337D				
43		MD6032CX	OS6032C	OSX6032	BRK011	SMX6032	BRK012		FA368X	FA368R		MD6035D			MD6035C	MD6035CX
44		MD6032CX	OS6032C	OSX6032	BRK011	SMX6032	BRK012		FA368X	FA368R		MD6035D			MD6035C	MD6035CX
45		MD6032CX	OS6932C	OSX6932	BRK013	SMX6932	BRK014		FA368X	FA368R		MD6035D			MD6035C	MD6035CX
46		MD6032CX	OS6032C	OSX6032	BRK011	SMX6032	BRK012		FA368X	FA368R		MD6035D			MD6035C	MD6035CX
47		MD6032CX	OS6032C	OSX6032	BRK011	SMX6032	BRK012		FA368X	FA368R					MD6035C	MD6035CX
48		MD6032CX	OS6032C	OSX6032	BRK011	SMX6032	BRK012		FA368X	FA368R		MD6035D			MD6035C	MD6035CX
49		MD6032CX	OS6032C	OSX6032	BRK011	SMX6032	BRK012		FA368X	FA368R		MD6035D			MD6035C	MD6035CX
50		MD6032CX	OS6932C	OSX6932	BRK013	SMX6932	BRK014		FA368X	FA368R					MD6035C	MD6035CX
51		MD6032CX	OS6032C	OSX6032	BRK011	SMX6032	BRK012		FA368X	FA368R					MD6035C	MD6035CX
52		MD6032CX	OS6932C	OSX6932	BRK013	SMX6932	BRK014		FA368X	FA368R		MD6035D			MD6035C	MD6035CX
53		MD6032CX	OS6932C	OSX6932	BRK013	SMX6932	BRK014		FA368X	FA368R					MD6035C	MD6035CX
54		MD6032CX	OS6932C	OSX6932	BRK013	SMX6932	BRK014		FA368X	FA368R					MD6035C	MD6035CX
55		MD6032CX	OS6932C	OSX6932	BRK013	SMX6932	BRK014		FA368X	FA368R					MD6035C	MD6035CX
56																

BRAKE APPLICATIONS

⚠ This symbol indicates a rotor made of billet steel, and should be only used with EBC FA Kevlar® Organic or Vee pads.
 SAFETY NOTICE - With vehicles primarily designed for off highway use such as quads now being used on the highway, we would recommend the use of X or MXS pads for highway use and ONLY using the R and SV higher density / harder pad series for off road riding.

*-2 Sets Required. ■ - Also available in MX-S race compound. **SAFETY WARNING:- DO NOT USE HH PADS ON REAR UNLESS ALSO USED ON FRONT TO AVOID BRAKE IMBALANCE**

FRONT: Non-Japanese Bikes

APPLICATIONS

BRAKE



KTM



DISC PAD CHOICES - FRONT

BRAKE ROTOR CHOICES - FRONT

			Semi-Sintered V-Pads™	Sintered/HH Pads/Grooved Shoes	SV Series Severe Duty Pads	Standard Rotor Left	Standard Rotor Right	UTVX Rotor	Vintage Rotor Left	Vintage Rotor Right	Contour Profile Rotor
LC-4 MX/EXC 500	89	FA132X		FA132R		MD6034D					
LC-4 MX 500 Brembo Calipers	90-91	FA67X		FA67R		N/A					
LC-4 EXC 500 Brembo Calipers	90-91	FA67X		FA67R		MD6034D					
LC-4 MX 500 Grimeca Calipers	90-91	FA132X		FA132R		N/A					
LC-4 EXC 500 Grimeca Calipers	90-91	FA132X		FA132R		MD6034D					
MX/MXC/XC-GS 500	85	FA47X				N/A					
MX 500	92-94	FA181X		FA181R■		N/A					
MX 500	95	FA181X		FA181R■		N/A					
SX 505	09-12			FA462R*							MD6336C
SX-F 505	07-08	FA181X		FA181R■		MD6032D					MD6032C
XC-F 505	08-09	FA181X		FA181R■		MD6032D					MD6032C
EXC 520	01-03	FA181X		FA181R■		MD6032D					MD6032C
SX 520	01-03	FA181X		FA181R■		MD6032D					MD6032C
EXC 525	03	FA181X		FA181R■		MD6032D					MD6032C
EXC 525	04-07	FA181X		FA181R■		MD6032D					MD6032C
MXC 525 (Desert Racing)	03	FA181X		FA181R■		MD6032D					MD6032C
MXC 525 (Desert Racing)	04	FA181X		FA181R■		MD6032D					MD6032C
SMR 525	04			MXS406		TBA					
SMR 525	05			MXS405		N/A					
SX 525	03-06	FA181X		FA181R■		MD6032D					MD6032C
XC 525	08-12			FA462R*							MD6336C
XC 525 Desert Racing	07	FA181X		FA181R■		MD6032D					MD6032C
EXC-R 530	08	FA181X		FA181R■		MD6032D					MD6032C
EXC 530 (4T)	09-10	FA181X		FA181R■		MD6032D					MD6032C
EXC 530 (4T)	11	FA181X		FA181R■		MD6032D					MD6032C
XCR-W 530	08	FA181X		FA181R■							MD6032C
XC-W 530	08-09	FA181X		FA181R■		MD6032D					MD6032C
XC-W 530 (4T) Six Days	10	FA181X		FA181R■		MD6032D					MD6032C
MXC 550	96	FA181X		FA181R■		MD6032D					MD6032C
SMR 560	06			MXS405		MD6270D					MD6270C
560 SMR	07	FA433/4		FA433/4HH							MD6313C
LC4 MX/EXC 600	89	FA132X		FA132R		MD6034D					
LC4 MX 600 Brembo Calipers	90-91	FA67X		FA67R		N/A					
LC4 EXC 600 Brembo Calipers	90-91	FA67X		FA67R		MD6034D					
LC4 MX 600 Grimeca Calipers	90-91	FA132X		FA132R		N/A					
LC4 EXC 600 Grimeca Calipers	90-91	FA132X		FA132R		MD6034D					
LC4 EXC 600	92-93	FA132X		FA132R		MD6034D					
Duke 620 LC4	94-98	FA95		FA95HH		MD6199D					MD6199C
EGS 620 Enduro/EGS-E/LSE	96-99	FA181X		FA181R■		MD6130D					MD6130CF
EGS-E 620 Adventure/Rallye	99	FA181X		FA181R■		MD6032D					MD6032C
LC4 620 SC Supermoto	00	FA181X		FA181R■		MD6199D					MD6199C
SC 620 Supercompetition	96-00	FA181X		FA181R■		MD6032D					MD6032C
SX 620/EXC/EGS	94	FA181X		FA181R■		MD6032D					MD6032C
SX EXC/EGS 620	95	FA181X		FA181R■		MD6032D					MD6032C
SX 620	96-99	FA181X		FA181R■		MD6032D					MD6032C
LC4 625 SC Supermoto	02	FA181X		FA181R■		MD6199D					MD6199C
LC4 625 SC Supercompetition	02	FA181X		FA181R■		MD6032D					MD6032C
SMC 625	05-06	FA244		FA244HH							MD6199C
SXC 625	03-04	FA181X		FA181R■		MD6032D					MD6032C
SXC 625	05-06	FA181X		FA181R■		MD6032D					MD6032C
640 Duke (Jet Black/Yellow/Adrenalin Orange)	03-06	FA244		FA244HH		MD6199D					MD6199C
Duke II 640 Orpheus/Titan/Lime	01-	FA244		FA244HH		MD6199D					MD6199C
Duke II 640 Black/Orange	02	FA244		FA244HH		MD6199D					MD6199C
LC4-E 640 Enduro	00-04	FA181X		FA181R■		MD6130D					MD6130CF
LC4-E 640 Supermoto	00-04	FA181X		FA181R■		MD6199D					MD6199C

Line #

FRONT

MD6035C● = PLAIN UNDRILLED DISC FOR ENDURO USE. REAR FITMENTS ONLY. ORDER MD6035CE.

*-2 Sets Required. ■ - Also available in MX-S race compound. **SAFETY WARNING:- DO NOT USE HH PADS ON REAR UNLESS ALSO USED ON FRONT TO AVOID BRAKE IMBALANCE**



FRONT: Non-Japanese Bikes Cont'd

REAR: Non-Japanese Bikes

Line #	BRAKE ROTOR CHOICES - FRONT						DISC PAD CHOICES - REAR				BRAKE ROTOR CHOICES - REAR				
	CC Custom Rotor	CX Extreme® /Vee-Rotor	OS Series Oversize 250/280mm Rotor Kit	OSX Series Oversize 280mm Rotor Kit	Relocating Bracket for 250/280mm Rotor	SMX Series Oversize 320mm Rotor Kit	Relocating Bracket for 320mm Rotor		Semi-Sintered V-Pads™	Sintered/HH Pads/ Grooved Shoes	SV Series Severe Duty Pads	Standard Rotor	UTVX Rotor	Vintage Rotor	Contour Profile Rotor
1							FA132X		FA132R		N/A				
2							FA67X		FA67R		MD6035D			MD6035C	
3							FA67X		FA67R		MD6035D			MD6035C	
4							FA132X		FA132R		MD6035D			MD6035C	
5							FA132X		FA132R		MD6035D			MD6035C	
6									814G						
7							FA67X		FA67R		N/A				
8							FA208X		FA208R		N/A				
9									FA463R		MD6337D				
10		MD6032CX	OS6032C	OSX6032	BRK011	SMX6032	BRK012	FA368X	FA368R		MD6035D			MD6035C	MD6035CX
11		MD6032CX	OS6032C	OSX6032	BRK011	SMX6032	BRK012	FA368X	FA368R		MD6035D			MD6035C	MD6035CX
12		MD6032CX	OS6032C	OSX6032	BRK011	SMX6032	BRK012	FA208X	FA208R		MD6035D			MD6035C	MD6035CX
13		MD6032CX	OS6032C	OSX6032	BRK011	SMX6032	BRK012	FA208X	FA208R		MD6035D			MD6035C	MD6035CX
14		MD6032CX	OS6032C	OSX6032	BRK011	SMX6032	BRK012	FA208X	FA208R		MD6035D			MD6035C	MD6035CX
15		MD6032CX	OS6032C	OSX6032	BRK011	SMX6032	BRK012	FA368X	FA368R		MD6035D			MD6035C	MD6035CX
16		MD6032CX	OS6032C	OSX6032	BRK011	SMX6032	BRK012	FA208X	FA208R		MD6035D			MD6035C	MD6035CX
17		MD6032CX	OS6032C	OSX6032	BRK011	SMX6032	BRK012	FA208X	FA208R		MD6035D			MD6035C	MD6035CX
18							FA368X	FA368R		TBA					
19							FA368X	FA368R		MD6035D				MD6035C	
20		MD6032CX	OS6032C	OSX6032	BRK011	SMX6032	BRK012	FA368X	FA368R		MD6035D			MD6035C	MD6035CX
21									FA463R		MD6337D				
22		MD6032CX	OS6032C	OSX6032	BRK011	SMX6032	BRK012	FA368X	FA368R		MD6035D			MD6035C	MD6035CX
23		MD6032CX	OS6032C	OSX6032	BRK011	SMX6032	BRK012	FA368X	FA368R		MD6035D			MD6035C	MD6035CX
24		MD6032CX	OS6032C	OSX6032	BRK011	SMX6032	BRK012	FA368X	FA368R		MD6035D			MD6035C	MD6035CX
25		MD6032CX	OS6932C	OSX6932	BRK013	SMX6932	BRK014	FA368X	FA368R		MD6035D			MD6035C	MD6035CX
26		MD6032CX	OS6032C	OSX6032	BRK011	SMX6032	BRK012	FA368X	FA368R		MD6035D			MD6035C	MD6035CX
27		MD6032CX	OS6032C	OSX6032	BRK011	SMX6032	BRK012	FA368X	FA368R		MD6035D			MD6035C	MD6035CX
28		MD6032CX	OS6932C	OSX6932	BRK013	SMX6932	BRK014	FA368X	FA368R		MD6035D			MD6035C	MD6035CX
29		MD6032CX	OS6032EC	OSX6032E	BRK015	SMX6032E	BRK016	FA208X	FA208R		MD6035D			MD6035C	MD6035CX
30							FA368X	FA368R		MD6035D				MD6035C	
31							FA368X	FA368R		MD6035D				MD6035C	
32							FA132X		FA132R		N/A				
33							FA67X		FA67R		MD6371D				
34							FA67X		FA67R		MD6371D				
35							FA132X		FA132R		MD6371D				
36							FA132X		FA132R		MD6371D				
37							FA67X		FA67R		MD6371D				
38							FA208X		FA208R		MD6371D			MD6371C	
39							FA208X		FA208R		MD6371D			MD6371C	
40			OS6032EC	OSX6032E	BRK015	SMX6032E	BRK016	FA208X	FA208R		MD6371D			MD6371C	
41							FA208X		FA208R		MD6371D			MD6371C	
42			OS6032EC	OSX6032E	BRK015	SMX6032E	BRK016	FA208X	FA208R		MD6371D			MD6371C	
43			OS6032EC	OSX6032E	BRK015	SMX6032E	BRK016	FA67X	FA67R		MD6371D			MD6371C	
44			OS6032EC	OSX6032E	BRK015	SMX6032E	BRK016	FA208X	FA208R		MD6371D			MD6371C	
45			OS6032EC	OSX6032E	BRK015	SMX6032E	BRK016	FA208X	FA208R		MD6371D			MD6371C	
46							FA208X		FA208R		MD6371D			MD6371C	
47			OS6032C	OSX6032	BRK011	SMX6032	BRK012	FA208X	FA208R		MD6371D			MD6371C	
48							FA208X		FA208R		MD6035D			MD6035C	
49		MD6032CX	OS6032C	OSX6032	BRK011	SMX6032	BRK012	FA208X	FA208R		MD6035D			MD6035C	MD6035CX
50		MD6032CX	OS6032C	OSX6032	BRK011	SMX6032	BRK012	FA368X	FA368R		MD6035D			MD6035C	MD6035CX
51							FA213	FA213V	FA213HH		MD6035D			MD6035C	
52							FA208X		FA208R		MD6371D			MD6371C	
53							FA208X		FA208R		MD6371D			MD6371C	
54							FA208X		FA208R		MD6371D			MD6371C	
55							FA208X		FA208R		MD6371D			MD6371C	
56															

⚠ This symbol indicates a rotor made of billet steel, and should be only used with EBC FA Kevlar® Organic or Vee pads.
SAFETY NOTICE - With vehicles primarily designed for off highway use such as quads now being used on the highway, we would recommend the use of X or MXS pads for highway use and ONLY using the R and SV higher density / harder pad series for off road riding.

BRAKE APPLICATIONS

*-2 Sets Required. ■ - Also available in MX-S race compound. **SAFETY WARNING:- DO NOT USE HH PADS ON REAR UNLESS ALSO USED ON FRONT TO AVOID BRAKE IMBALANCE**

FRONT: Non-Japanese Bikes

APPLICATIONS

BRAKE



KTM



DISC PAD CHOICES - FRONT

BRAKE ROTOR CHOICES - FRONT

		Semi-Sintered V-Pads™	Sintered/HH Pads/Grooved Shoes	SV Series Severe Duty Pads	Standard Rotor Left	Standard Rotor Right	UTVX Rotor	Vintage Rotor Left	Vintage Rotor Right	Contour Profile Rotor
LC-4 640 Adventure R	99-02		FA181R	MXS181	MD6130D					MD6130CF
LC-4 Adventure	03		FA181R	MXS181	MD6130D					MD6130CF
LC-4 640 Adventure R	04		FA209/2*		MD6266D	MD6266D				
LC-4 640 Adventure	05-07		FA209/2*		MD6266D	MD6266D				
640 Duke (Jet Black/Yellow/Adrenalin Orange)	03-06		FA244	FA244HH	MD6199D					MD6199C
SMC 660 Supermoto	03-04		FA95	FA95HH	TBA					
SMC 640 LC4	05-06		FA244	FA244HH	TBA					
SMC 660	05-06		FA244	FA244HH	TBA					
690 Duke (4 Separate Pad Caliper Type)	08-11			FA322/4HH	MD614X					MD614XC
690 Duke (2 Pad Type Caliper)	12-15		FA244	FA244HH	MD856X					MD856XC
690 Duke R	10-11			FA322/4HH	MD614X					MD614XC
690 Rally Factory Rep	07-08		FA209/2	FA209/2HH	TBA					
690 Enduro	08		FA181X	FA181R■	MD6130D					MD6130CF
690 Enduro R	10-16		FA209/2	FA209/2HH						MD6299C
690 SMC	08-11			FA322/4HH	MD6199D					MD6199C
690 SMR	07-09			FA322/4HH	MD614X					MD614XC
690 Supermoto	02-08		FA244	FA244HH	TBA					
950 Adventure/S	04-06		FA209/2*	FA209/2HH*	MD6266D	MD6266D				
950 R Super Enduro	07-08		FA209/2	FA209/2HH	MD6299D					
950 Supermoto	05-07			FA322/4HH*	MD680	MD680				MD680C*
950 Supermoto R	07-08			FA322/4HH*	MD680	MD680				MD680C*
990 Adventure (ABS Model)	Left 07-12		FA209/2	FA209/2HH	MD844X					MD844XC
	Right		FA209/2	FA209/2HH		MD848X				MD848XC
990 Adventure Baja Edition (ABS)	Left 13-14		FA209/2	FA209/2HH	MD844X					MD844XC
	Right		FA209/2	FA209/2HH		MD848X				MD848XC
990 Adventure R (Non ABS)	09-12		FA209/2*	FA209/2HH*	MD6299D	MD6299D				MD6299C*
990 Adventure S (Non ABS)	06-08		FA209/2*	FA209/2HH*	MD6299D	MD6299D				MD6299C*
990 SM-T	10-14			FA322/4HH*	MD680	MD680				MD680C*
990 SM-R	09-11			FA447HH*	MD680	MD680				MD680C*
990 Superduke	05-11			FA322/4HH*	MD633X	MD633X				MD633XC*
990 Superduke R	09-11			FA322/4HH*	MD633X	MD633X				MD633XC*
1190 Adventure	13-16		FA244*	FA244HH*	TBA	TBA				
1190 Adventure R	13-16		FA244*	FA244HH*	TBA	TBA				
1190 RC8	08-12			FA447HH*	MD633X	MD633X				MD633XC*
1190 RC8 R	09-14			FA447HH*	MD633X	MD633X				MD633XC*
1290 Super Adventure	15-16		FA244*	FA244HH*	TBA	TBA				
1290 Superduke R	14-16			FA447HH*	TBA	TBA				
KYMCO (STREET)										
Agility 50 (4T)	05-15		SFA228	SFA228HH	MD971D					
Campagno 50i (4T/SE50BG)	14		SFA228	SFA228HH	TBA					
Cobra Racer 50 (SF10AG)	00-04		SFA233		MD971D					
Cobra Cross/Racer 50 (SF10AF)	05-06		SFA233		MD971D					
Filly 50	02-05		SFA228	SFA228HH	TBA					
Like 50 (2T)	09-14		SFA305	SFA305HH	TBA					
Like 50 LX (2T)	12-14		SFA305	SFA305HH	TBA					
People 50 (2T)	02-12		SFA305	SFA305HH	MD989D					
People S50 (4T)	05-09		SFA305	SFA305HH	MD989D					
Sento 50	09-12		SFA228	SFA228HH	TBA					
Sting 50 (2T)	07-11		SFA228	SFA228HH	MD971D					
Super 8 (50cc) (2T)	07-14		SFA305	SFA305HH	TBA					
Super 9 (2T/AC)	02-09		SFA197	SFA197HH		MD981D				
Vitality 50 (4T)	05-08		SFA228	SFA228HH	MD971D					
Yup 50	02-06		SFA228	SFA228HH	MD971D					
ZX 50 Super Fever	02-05		SFA233		MD971D					
Campagno 110i (4T/SE22BD)	13-15		SFA228	SFA228HH	TBA					

Line #

FRONT

* This symbol indicates a rotor made of billet steel, and should be only used with EBC FA Kevlar® Organic or Vee pads. SAFETY NOTICE - With vehicles primarily designed for off highway use such as quads now being used on the highway, we would recommend the use of X or MXS pads for highway use and ONLY using the R and SV higher density / harder pad series for off road riding.

*-2 Sets Required. ■ - Also available in MX-S race compound. SAFETY WARNING:- DO NOT USE HH PADS ON REAR UNLESS ALSO USED ON FRONT TO AVOID BRAKE IMBALANCE

FRONT: Non-Japanese Bikes Cont'd

REAR: Non-Japanese Bikes

Line #	BRAKE ROTOR CHOICES - FRONT						DISC PAD CHOICES - REAR				BRAKE ROTOR CHOICES - REAR				
	CC Custom Rotor	CX Extreme® /Vee-Rotor	OS Series Oversize 250/280mm Rotor Kit	OSX Series Oversize 280mm Rotor Kit	Relocating Bracket for 250/280mm Rotor	SMX Series Oversize 320mm Rotor Kit	Relocating Bracket for 320mm Rotor		Semi-Sintered V-Pads™	Sintered/HH Pads/ Grooved Shoes	SV Series Severe Duty Pads	Standard Rotor	UTVX Rotor	Vintage Rotor	Contour Profile Rotor
1							FA208X		FA208R■		MD6371D			MD6371C	
2							FA208X		FA208R■		MD6371D				
3							FA208X		FA208R■		MD6371D				
4							FA208X		FA208R■		MD6371D				
5							FA208X		FA208R■		MD6371D			MD6371C	
6							FA208X		FA208R■		MD6371D			MD6371C	
7							FA208X		FA208R■		MD6371D				
8							FA208X		FA208R■		MD6371D				
9		VR614BLK					FA213	FA213V	FA213HH		MD681			MD681C	VR681
10							FA213	FA213V	FA213HH		MD857			MD857C	
11		VR614BLK					FA213	FA213V	FA213HH		MD681			MD681C	VR681
12							FA208X		FA208R■		MD6269D				
13							FA208X		FA208R■		MD6035D			MD6035C	
14							FA208X		FA208R■					MD6269C	
15							FA208X		FA208R■		MD6298D				
16							FA208X		FA208R■		MD681			MD681C	VR681
17							FA208X		FA208R■		MD681				
18							FA181X		FA181HH		MD6269D				
19							FA181X		FA181HH		MD6298D				
20							FA181X		FA181HH		MD681			MD681C	
21							FA181X		FA181HH		MD681			MD681C	
22							FA181X		FA181HH		MD6298D				
23															
24							FA181X		FA181HH		MD6298D				
25															
26							FA181X		FA181R		MD6298D				
27							FA181X		FA181HH		MD6298D				
28							FA181X		FA181HH		MD681			MD681C	
29							FA181X		FA181HH		MD681			MD681C	
30							FA213	FA213V	FA213HH		MD681			MD681C	
31							FA213	FA213V	FA213HH		MD681			MD681C	
32							FA181X		FA181HH		TBA				
33							FA181X		FA181HH		TBA				
34							FA266	FA266V	FA266HH		MD812				
35							FA266	FA266V	FA266HH		MD812				
36							FA181X		FA181HH		TBA				
37							FA266	FA266V	FA266HH		TBA				
38															
39															
40							303								
41							302								
42							303								
43							303								
44							303								
45							303								
46							303								
47							818								
48							818								
49							303								
50							303								
51							820								
52							SFA305		SFA305HH		MD971D				
53							303								
54							303								
55							303								
56							302								

REAR

* This symbol indicates a rotor made of billet steel, and should be only used with EBC FA Kevlar® Organic or Vee pads.
 SAFETY NOTICE - With vehicles primarily designed for off highway use such as quads now being used on the highway, we would recommend the use of X or MXS pads for highway use and ONLY using the R and SV higher density / harder pad series for off road riding.

BRAKE APPLICATIONS

*-2 Sets Required. ■ - Also available in MX-S race compound. **SAFETY WARNING:- DO NOT USE HH PADS ON REAR UNLESS ALSO USED ON FRONT TO AVOID BRAKE IMBALANCE**

FRONT: Non-Japanese Bikes

APPLICATIONS

BRAKE



KYMCO (STREET)



DISC PAD CHOICES - FRONT

BRAKE ROTOR CHOICES - FRONT

		Semi-Sintered V-Pads™	Sintered/HH Pads/Grooved Shoes	SV Series Severe Duty Pads	Standard Rotor Left	Standard Rotor Right	UTVX Rotor	Vintage Rotor Left	Vintage Rotor Right	Contour Profile Rotor
Agility 125	06-15	SFA228	SFA228HH		MD971D					
People S 125	05-09	SFA305	SFA305HH		MD989D					
Bet & Win 150/250	02-08	SFA197	SFA197HH			MD973D				
People 150	07-12	SFA305	SFA305HH		MD989D					
Quannon 150 (RK30E)	09-12	FA197	FA197HH			N/A				
Super 8 (150cc)	07-14	SFA305	SFA305HH		TBA					
Downtown 200i	11-12	SFA142	SFA142HH							MD9128C
Like 200i	10-15	SFA305	SFA305HH		TBA					
People GT 200i	11-12	SFA324	SFA324HH			TBA				
People S 200	05-10	SFA305	SFA305HH			MD989D				
Yager GT 200i	09-12	SFA197	SFA197HH			TBA				
Grandvista 250	05-10	SFA197	SFA197HH			MD973D				
People 250	03-07	SFA197	SFA197HH			MD9100D				
People S 250	07-11	SFA228	SFA228HH		TBA					
		SFA197	SFA197HH			TBA				
Venox 250	03-08	FA196	FA196HH		MD1101					
XCiting 250 (All models)	05-11	SFA142*	SFA142HH*		N/A	N/A				
Downtown 300i	10-15	SFA142	SFA142HH							MD9128C
People GT 300i	11-15	SFA324	SFA324HH			TBA				
XCiting 500 (All models)	04-14	SFA142*	SFA142HH*		TBA	TBA				
My Road 700 i	11-15	SFA432*	SFA432HH*		TBA	TBA				
KYMCO (ATV)										
MXer 50 Mongoose (2T)	04-08	346*	346G*							
Mongoose 50 (4T) (Rear disc model)	08-09	346*	346G*							
Mongoose 70 (4T)	07-16	346*	346G*							
Mongoose 90	02-16	346*	346G*							
Mongoose 90 R (Reverse Gear)	02-14	346*	346G*							
MXer 150	03-05	303*	303G*							
MXU 150	05-14	303*	303G*							
KXR 250 Mongoose	04-09	FA377X*	FA377R*			MD6267D	MD6267D			
MXU 250	04-10	FA377X*	FA377R*			MD6267D	MD6267D			
MXU 270	16	FA377X*	FA377R*			TBA	TBA			
Mongoose 300	06-16	FA377X*	FA377R*			MD6267D	MD6267D			
MXU 300	05-14	FA377X*	FA377R*			MD6267D	MD6267D			
Maxxer 375 4 x 4 IRS	10-12	FA395X*	FA395R*		FA395SV*	MD6173D	MD6173D	UTVX6173*		
MXU 375 4 x 4 IRS	08-12	FA395X*	FA395R*		FA395SV*	MD6173D	MD6173D	UTVX6173*		
Maxxer 450 4 x 4 IRS	11-16	FA395X*	FA395R*		FA395SV*	MD6173D	MD6173D	UTVX6173*		
MXU 450 4 x 4 IRS	11-14	FA395X*	FA395R*		FA395SV*	MD6173D	MD6173D	UTVX6173*		
MXU 450 4 x 4 IRS LE	11-14	FA395X*	FA395R*		FA395SV*	MD6173D	MD6173D	UTVX6173*		
MXU 500 4 x 4 (Carb models)	07-09	FA377X*	FA377R*			MD6173D	MD6173D	UTVX6173*		
MXU 500 4 x 4 IRS (Carb Models)	10-11	FA600X*	FA600R*			MD6173D	MD6173D	UTVX6173*		
MXU 500i IRS (All EFI Models)	10-11	FA600X*	FA600R*			MD6173D	MD6173D	UTVX6173*		
MXU 700i (All Models)	14-16	FA600X*	FA600R*			MD6173D	MD6173D	UTVX6173*		
KYMCO (SIDE X SIDE)										
UXV 450i (All EFI models)	15-16	FA377X*	FA377R*		TBA	TBA	TBA*			
UXV 500 4 x 4 (All Carb models)	08-14	FA377X*	FA377R*		TBA	TBA	TBA*			
UXV 500 I (All EFI models)	13-16	FA377X*	FA377R*		TBA	TBA	TBA*			
UXV 700i 4 x 4 (All models)	14-16	FA377X*	FA377R*		TBA	TBA	TBA*			
LAVARDA										
Alpino 500/Montjuic	76	FA47	FA47HH		N/A	N/A				
650 Sport Formula	94-95	FA95*	FA95HH*		MD2003X	MD2003X				MD2003XC*
668 Diamante/Ghost/Strike	96-98	FA95*	FA95HH*		MD2003X	MD2003X				MD2003XC*
750 Strike Bifaro/Mono Legend	98-00	FA95*	FA95HH*		MD2003X	MD2003X				MD2003XC*

Line #

* This symbol indicates a rotor made of billet steel, and should be only used with EBC FA Kevlar® Organic or Vee pads.
 SAFETY NOTICE - With vehicles primarily designed for off highway use such as quads now being used on the highway, we would recommend the use of X or MXS pads for highway use and ONLY using the R and SV higher density / harder pad series for off road riding.

*-2 Sets Required. ■ - Also available in MX-S race compound. **SAFETY WARNING:- DO NOT USE HH PADS ON REAR UNLESS ALSO USED ON FRONT TO AVOID BRAKE IMBALANCE**

FRONT: Non-Japanese Bikes Cont'd

REAR: Non-Japanese Bikes

Line #	BRAKE ROTOR CHOICES - FRONT						DISC PAD CHOICES - REAR				BRAKE ROTOR CHOICES - REAR					
	CC Custom Rotor	CX Extreme® /Vee-Rotor	OS Series Oversize 250/280mm Rotor Kit	OSX Series Oversize 280mm Rotor Kit	Relocating Bracket for 250/280mm Rotor	SMX Series Oversize 320mm Rotor Kit	Relocating Bracket for 320mm Rotor		Semi-Sintered V-Pads™	Sintered/HH Pads/ Grooved Shoes	SV Series Severe Duty Pads	Standard Rotor	UTVX Rotor	Vintage Rotor	Contour Profile Rotor	CX Extreme® /Vee-Rotor
1																
2																
3																
4																
5																
6																
7																
8																
9																
10																
11																
12																
13																
14																
15																
16																
17																
18																
19																
20																
21																
22																
23																
24																
25																
26																
27																
28																
29																
30																
31																
32																
33																
34																
35																
36																
37																
38																
39																
40																
41																
42																
43																
44																
45																
46																
47																
48																
49																
50																
51																
52																
53																
54																
55																
56																

⚠ This symbol indicates a rotor made of billet steel, and should be only used with EBC FA Kevlar® Organic or Vee pads.
 SAFETY NOTICE - With vehicles primarily designed for off highway use such as quads now being used on the highway, we would recommend the use of X or MXS pads for highway use and ONLY using the R and SV higher density / harder pad series for off road riding.

BRAKE APPLICATIONS

*-2 Sets Required. ■ - Also available in MX-S race compound. **SAFETY WARNING:- DO NOT USE HH PADS ON REAR UNLESS ALSO USED ON FRONT TO AVOID BRAKE IMBALANCE**

FRONT: Non-Japanese Bikes Cont'd

REAR: Non-Japanese Bikes

Line #	BRAKE ROTOR CHOICES - FRONT						DISC PAD CHOICES - REAR				BRAKE ROTOR CHOICES - REAR					
	CC Custom Rotor	CX Extreme® /Vee-Rotor	OS Series Oversize 250/280mm Rotor Kit	OSX Series Oversize 280mm Rotor Kit	Relocating Bracket for 250/280mm Rotor	SMX Series Oversize 320mm Rotor Kit	Relocating Bracket for 320mm Rotor		Semi-Sintered V-Pads™	Sintered/HH Pads/Grooved Shoes	SV Series Severe Duty Pads	Standard Rotor	UTVX Rotor	Vintage Rotor	Contour Profile Rotor	CX Extreme® /Vee-Rotor
1		VR2003BLK*						FA47		FA47HH		MD2002			MD2002C	VR2002
2		VR2003BLK*						FA47		FA47HH		MD2002			MD2002C	VR2002
3								FA18	FA18V	FA18HH		N/A				
4								FA18	FA18V	FA18HH		N/A				
5								FA18	FA18V	FA18HH		MD609LS				
6								FA18	FA18V	FA18HH		N/A				
7																
8																
9										FA325R		N/A				
10																
11																
12								FA165/2X				N/A				
13																
14																
15								UGS		822G						
16								UGS		822G						
17								FA106/2X		FA106/2R		N/A				
18								FA132X		FA132R		N/A				
19								FA67X		FA67R		N/A				
20								UGS		841G						
21								UGS		841G						
22								FA99X		N/A		N/A				
23								FA115X		FA115R■		N/A				
24								FA208X		FA208R■		N/A				
25																
26																
27								893								
28								893								
29								SFA193		SFA193HH		MD901D				
30								SFA193				MD901D				
31								893								
32								818								
33								893								
34								SFA193				MD901D				
35								SFA193		SFA193HH		MD901D				
36								SFA298		SFA298HH		TBA				
37																
38																
39								FA135X		FA135R		TBA				
40								FA165X		FA165R		TBA				
41								FA135X		FA135R		TBA				
42								FA165X		FA165R		TBA				
43																
44																
45								FA428X		FA428R		TBA				
46																
47								FA428X		FA428R		TBA				
48																
49								FA165X		FA165R		TBA				
50								FA135X		FA135R		TBA				
51								FA428X		FA428R		TBA				
52																
53								FA165X		FA165R		TBA				
54								FA135X		FA135R		TBA				
55								FA165X		FA165R		TBA				
56								FA135X		FA135R		TBA				

* This symbol indicates a rotor made of billet steel, and should be only used with EBC FA Kevlar® Organic or Vee pads.
 SAFETY NOTICE - With vehicles primarily designed for off highway use such as quads now being used on the highway, we would recommend the use of X or MXS pads for highway use and ONLY using the R and SV higher density / harder pad series for off road riding.

BRAKE APPLICATIONS

*-2 Sets Required. ■ - Also available in MX-S race compound. **SAFETY WARNING:- DO NOT USE HH PADS ON REAR UNLESS ALSO USED ON FRONT TO AVOID BRAKE IMBALANCE**

FRONT: Non-Japanese Bikes

APPLICATIONS

BRAKE



MASSIMO (SIDE X SIDE)



DISC PAD CHOICES - FRONT

BRAKE ROTOR CHOICES - FRONT

			Semi-Sintered V-Pads™	Sintered/HH Pads/Grooved Shoes	SV Series Severe Duty Pads	Standard Rotor Left	Standard Rotor Right	UTVX Rotor	Vintage Rotor Left	Vintage Rotor Right	Contour Profile Rotor
550 EPS Alligator	Left	15-16	FA165X	FA165R		TBA					
	Right		FA135X	FA135R			TBA				
700 Knight	Left	15-16	FA165X	FA165R		TBA					
	Right		FA135X	FA135R			TBA				
700 Alligator	Left	15-16	FA165X	FA165R		TBA					
	Right		FA135X	FA135R			TBA				
700 Alligator - Parking brake		15-16									
700-4 Alligator EPS	Left	15-16	FA165X	FA165R		TBA					
	Right		FA135X	FA135R			TBA				
MSU 700	Left	15-16	FA165X	FA165R		TBA					
	Right		FA135X	FA135R			TBA				
MSU 700 - Parking brake		15-16									
MSU 700-5	Left	15-16	FA165X	FA165R		TBA					
	Right		FA135X	FA135R			TBA				
MSU 800	Left	15-16	FA165X	FA165R		TBA					
	Right		FA135X	FA135R			TBA				
MSU 800 - Parking brake		15-16									
1000 Militia	Left	15-16	TBA			TBA					
	Right		TBA				TBA				
1000 S Militia	Left	15-16	TBA			TBA					
	Right		TBA				TBA				
1000 XS Militia	Left	15-16	TBA			TBA					
	Right		TBA				TBA				
MONTESA											
4RT Cota (250cc)		05-08	FA303X			N/A					
4RT Cota Standard Edition (260cc)		09-17	FA303X			N/A					
4RT Cota Repsol Edition (260cc)		14-17	FA644X			N/A					
4RT Cota 300RR		16	FA644X			N/A					
314 R		94-96	FA115X	FA115R■		N/A					
315 R		97-00	FA115X	FA115R■		N/A					
315 R		01-04	FA303X			N/A					
MOTO-GUZZI											
V35/35 II/35 III - 350		77-87	FA47*	FA47HH*		N/A	N/A				
V35 C - 350		82-86	FA47*	FA47HH*		N/A	N/A				
V35 Florida - 350		86-90	FA47*	FA47HH*		N/A	N/A				
NTX 350		87-90	FA47	FA47HH		N/A	N/A				
350 Nevada		92-97	FA47*	FA47HH*		N/A	N/A				
350 Nevada Club		98-99	FA47*	FA47HH*		N/A	N/A				
V50/50 III - 500		77-84	FA47*	FA47HH*		N/A	N/A				
V50 C - 500		82-86	FA47*	FA47HH*		N/A	N/A				
NTX 650		87-90	FA47	FA47HH		N/A	N/A				
V65 C - 650		82-85	FA47*	FA47HH*		N/A	N/A				
V65 Florida - 650		86-92	FA47*	FA47HH*		N/A	N/A				
V75 - 750		92-96	FA47*	FA47HH*		N/A	N/A				
750 SP		90-92	FA47*	FA47HH*		N/A	N/A				
750 Targa		90-92	FA47*	FA47HH*		N/A	N/A				
California Vintage 750		06-10	FA244	FA244HH		MD614X	MD614X				MD614XC*
Nevada 750		91-97	FA47*	FA47HH*		N/A	N/A				
750 Nevada Club (Up To LK112433)		98-01	FA47*	FA47HH*		N/A	N/A				
750 Nevada Club (From LK112434)		98-01	FA47*	FA47HH*		N/A	N/A				
750 Nevada Base/Club		02-03	FA244	FA244HH		MD614X					MD614XC
Nevada Classic 750ie		04-09	FA244	FA244HH		MD614X					MD614XC
V750 ie Brevia		03-08	FA244	FA244HH		MD614X					MD614XC
V7 Classic		08-12	FA244	FA244HH		MD614X					MD614XC

Line #

FRONT

* This symbol indicates a rotor made of billet steel, and should be only used with EBC FA Kevlar® Organic or Vee pads.
 SAFETY NOTICE - With vehicles primarily designed for off highway use such as quads now being used on the highway, we would recommend the use of X or MXS pads for highway use and ONLY using the R and SV higher density / harder pad series for off road riding.

*-2 Sets Required. ■ - Also available in MX-S race compound. **SAFETY WARNING:- DO NOT USE HH PADS ON REAR UNLESS ALSO USED ON FRONT TO AVOID BRAKE IMBALANCE**

FRONT: Non-Japanese Bikes Cont'd

REAR: Non-Japanese Bikes

Line #	BRAKE ROTOR CHOICES - FRONT						DISC PAD CHOICES - REAR				BRAKE ROTOR CHOICES - REAR				
	CC Custom Rotor	CX Extreme® /Vee-Rotor	OS Series Oversize 250/280mm Rotor Kit	OSX Series Oversize 280mm Rotor Kit	Relocating Bracket for 250/280mm Rotor	SMX Series Oversize 320mm Rotor Kit	Relocating Bracket for 320mm Rotor		Semi-Sintered V-Pads™	Sintered/HH Pads/ Grooved Shoes	SV Series Severe Duty Pads	Standard Rotor	UTVX Rotor	Vintage Rotor	Contour Profile Rotor
1							FA428X		FA428R		TBA				
2															
3							FA165X		FA165R		TBA				
4							FA135X		FA135R		TBA				
5							FA165X		FA165R		TBA				
6							FA135X		FA135R		TBA				
7							FA428X		FA428R		TBA				
8							FA165X		FA165R		TBA				
9							FA135X		FA135R		TBA				
10							FA165X		FA165R		TBA				
11							FA135X		FA135R		TBA				
12							FA428X		FA428R		TBA				
13							FA165X		FA165R		TBA				
14							FA135X		FA135R		TBA				
15							FA165X		FA165R		TBA				
16							FA135X		FA135R		TBA				
17							FA428X		FA428R		TBA				
18							FA165X		FA165R		TBA				
19							FA135X		FA135R		TBA				
20							FA165X		FA165R		TBA				
21							FA135X		FA135R		TBA				
22							FA165X		FA165R		TBA				
23							FA135X		FA135R		TBA				
24															
25															
26							FA351X				N/A				
27							FA351X				N/A				
28							FA351X				N/A				
29							FA351X				N/A				
30							FA47X		FA47R		N/A				
31							FA47X		FA47R		N/A				
32							FA351X				N/A				
33															
34															
35							FA47		FA47HH		N/A				
36							FA47		FA47HH		N/A				
37							FA47		FA47HH		N/A				
38							FA47		FA47HH		N/A				
39							FA47		FA47HH		N/A				
40							FA47		FA47HH		N/A				
41							FA47		FA47HH		N/A				
42							FA47		FA47HH		N/A				
43							FA47		FA47HH		N/A				
44							FA47		FA47HH		N/A				
45							FA47		FA47HH		N/A				
46							FA47		FA47HH		N/A				
47							FA47		FA47HH		N/A				
48							FA47		FA47HH		N/A				
49		VR614BLK					FA209/2	FA209/2V	FA209/2HH		MD692			MD692C	N/A
50							FA47		FA47HH		N/A				
51							FA47		FA47HH		N/A				
52							FA266	FA266V	FA266HH		MD871				
53		VR614BLK					FA266	FA266V	FA266HH		MD871				N/A
54		VR614BLK					FA266	FA266V	FA266HH		MD871				N/A
55		VR614BLK					FA266	FA266V	FA266HH		MD871				N/A
56		VR614BLK					FA266	FA266V	FA266HH		MD871				N/A

REAR

This symbol indicates a rotor made of billet steel, and should be only used with EBC FA Kevlar® Organic or Vee pads. SAFETY NOTICE - With vehicles primarily designed for off highway use such as quads now being used on the highway, we would recommend the use of X or MXS pads for highway use and ONLY using the R and SV higher density / harder pad series for off road riding.

BRAKE APPLICATIONS

*-2 Sets Required. ■ - Also available in MX-S race compound. **SAFETY WARNING:- DO NOT USE HH PADS ON REAR UNLESS ALSO USED ON FRONT TO AVOID BRAKE IMBALANCE**

FRONT: Non-Japanese Bikes



MOTO-GUZZI



DISC PAD CHOICES - FRONT

BRAKE ROTOR CHOICES - FRONT

V7 Cafe Classic	11-12	FA244	FA244HH		MD614X					MD614XC
V7 Racer	10-11	FA244	FA244HH		MD614X					MD614XC
V7 Racer	12-15	FA244	FA244HH		MD614X					MD614XC
V7 Special	12-15	FA244	FA244HH		MD614X					MD614XC
V7 Stone	12-15	FA244	FA244HH		MD614X					MD614XC
850 II/III Le Mans	78-84	FA18*	FA18HH*		N/A	N/A				
850 T3/T4/T5	79-88	FA18*	FA18HH*		N/A	N/A				
Daytona 1000	92-95	FA95*	FA95HH*		MD667	MD667				
Daytona 1000 RS	97-98	FA95*	FA95HH*		N/A	N/A				
California 1000 II/III	83-93	FA18*	FA18HH*		N/A	N/A				
1000 SP II/III	83-94	FA18*	FA18HH*		N/A	N/A				
1000 GT	87-91	FA18*	FA18HH*		N/A	N/A				
1000 (S)	89-94	FA18*	FA18HH*		N/A	N/A				
1000 Le Mans	84-93	FA18*	FA18HH*		N/A	N/A				
Strada 1000	93-94	FA18*	FA18HH*		N/A	N/A				
Quota 1000	92-97	FA126*	FA126HH*		N/A	N/A				
MGS-01 1000 cc	04-05		FA322/4HH*		MD621X	MD621X				MD621XC*
V10 Centauro	97-99	FA95*	FA95HH*		MD614X	MD614X				MD614XC*
VII Sport/Scuro/Naked	99-00	FA244*	FA244HH*		MD614X	MD614X				MD614XC*
VII Le Mans Series	01-06	FA244*	FA244HH*		MD614X	MD614X				MD614XC*
California Stone Series	02-06	FA244	FA244V	FA244HH	-	MD614X				MD614XC
California EV/Special Series	02-06	FA244*	FA244V*	FA244HH*	MD614X	MD614X				MD614XC*
Breva 1100 (Non ABS Model)	02-07	FA244*	FA244V*	FA244HH*	MD2003X	MD2003X				MD2003XC*
1100 Breva	05-12	FA244*	FA244V*	FA244HH*	MD624	MD624				
California 1100	94-97	FA18*	FA18V*	FA18HH*	N/A	N/A				
California EVII	97-01	FA95*	FA095V*	FA95HH*	MD614X	MD614X				MD614XC*
1100 Griso (1064cc/Standard Mount Calipers)	05-12	FA244*	FA244V*	FA244HH*	MD621X	MD621X				MD621XC*
Sport 1100	94-99	FA95*	FA244V*	FA95HH*	MD614X	MD614X				MD614XC*
Sport Corsa 1100	98-99	FA95*	FA244V*	FA95HH*	N/A	N/A				
California Jackel 1100	99-01	FA244*	FA244V*	FA244HH*	MD614X	MD614X				MD614XC*
California Special 1100	99-01	FA244*	FA244V*	FA244HH*	MD614X	MD614X				MD614XC*
Quota 1100 ES	99-01	FA209/2*	FA244V*	FA209/2HH*	N/A	N/A				
Griso 1200 8V (1151cc/Radial Mount Calipers)	09-12	FA244*	FA244V*	FA244HH*						MD621XC*
Griso SE 1200 8V (1151cc/Radial Mount Calipers)	09-15	FA244*	FA244V*	FA244HH*						MD621XC*
Norge 1200 GT 4V	06-12	FA244*	FA244V*	FA244HH*	MD624	MD624				
Norge 1200 GT 8V	10-15	FA244*	FA244V*	FA244HH*	MD624	MD624				
Stelvio 1200 NTX (ABS)	09-15	FA244*	FA244V*	FA244HH*	MD624	MD624				
California 1400 Custom	13-15	FA244*	FA244V*	FA244HH*	TBA	TBA				
California 1400 Touring	13-15	FA244*	FA244V*	FA244HH*	TBA	TBA				
MOTUS										
MST-01	12-13			FA322/4HH*	TBA	TBA				
MST	14-17	FA244*		FA244HH*	TBA	TBA				
MSTR-01	12-13			FA322/4HH*	TBA	TBA				
MSTR	14-17			FA447HH*	TBA	TBA				
MZ/MUZ										
Moskito/SX 50/RX 50	97-05	SFA83		SFA83HH	N/A					
Moskito 125 R	00-05	SFA83		SFA83HH	N/A					
RT 125	02-05	FA197		FA197HH	N/A					
SX/SM 125	02-05	FA131X		FA131R	N/A					
500 Country	93-98	FA18		FA18HH		MD623RS				
Mastiff 660	00-03	FA177			N/A					
Baghira 660 (All models)	00-05	FA177			N/A					
Skorpion Tour/Traveller	99-02	FA126		FA126HH		MD619RS				
1000 S	03-05	FA145*		FA145HH*	MD855X	MD855X				MD855XC*

Line #

FRONT

APPLICATIONS

BRAKE

* This symbol indicates a rotor made of billet steel, and should be only used with EBC FA Kevlar® Organic or Vee pads.

SAFETY NOTICE - With vehicles primarily designed for off highway use such as quads now being used on the highway, we would recommend the use of X or MXS pads for highway use and ONLY using the R and SV higher density / harder pad series for off road riding.

*-2 Sets Required. ■ - Also available in MX-S race compound. SAFETY WARNING:- DO NOT USE HH PADS ON REAR UNLESS ALSO USED ON FRONT TO AVOID BRAKE IMBALANCE

FRONT: Non-Japanese Bikes Cont'd

REAR: Non-Japanese Bikes

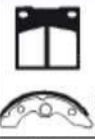
Line #	BRAKE ROTOR CHOICES - FRONT						DISC PAD CHOICES - REAR				BRAKE ROTOR CHOICES - REAR					
	CC Custom Rotor	CX Extreme® /Vee-Rotor	OS Series Oversize 250/280mm Rotor Kit	OSX Series Oversize 280mm Rotor Kit	Relocating Bracket for 250/280mm Rotor	SMX Series Oversize 320mm Rotor Kit	Relocating Bracket for 320mm Rotor		Semi-Sintered V-Pads™	Sintered/HH Pads/ Grooved Shoes	SV Series Severe Duty Pads	Standard Rotor	UTVX Rotor	Vintage Rotor	Contour Profile Rotor	CX Extreme® /Vee-Rotor
1		VR614BLK						FA266	FA266V	FA266HH		MD871				N/A
2		VR614BLK						FA266	FA266V	FA266HH		MD871				N/A
3		VR614BLK						FA256		FA256HH		N/A				N/A
4		VR614BLK						FA256		FA256HH		N/A				N/A
5		VR614BLK						FA256		FA256HH		N/A				N/A
6								FA18		FA18HH		N/A				
7								FA18		FA18HH		N/A				
8								FA47		FA47HH		N/A				
9								FA47		FA47HH		N/A				
10								FA18		FA18HH		N/A				
11								FA18		FA18HH		N/A				
12								FA18		FA18HH		N/A				
13								FA18		FA18HH		N/A				
14								FA18		FA18HH		N/A				
15								FA18		FA18HH		N/A				
16								FA163				N/A				
17		VR621BLK*						FA266	FA266V	FA266HH		N/A				N/A
18		VR614BLK*						FA47		FA47HH		N/A				N/A
19		VR614BLK*						FA47		FA47HH		MD692			MD692C	N/A
20		VR614BLK*						FA47		FA47HH		MD692			MD692C	N/A
21		VR614BLK*						FA209/2	FA209/2V	FA209/2HH		MD692			MD692C	N/A
22		VR614BLK*						FA209/2	FA209/2V	FA209/2HH		MD692			MD692C	N/A
23		VR2003BLK*						FA181X		FA181HH		N/A				N/A
24		VR624BLK*						FA181X		FA181HH		MD840				N/A
25								FA18		FA18HH		N/A				
26		VR614BLK*						FA209/2	FA209/2V	FA209/2HH		N/A				N/A
27		VR621BLK*						FA181X		FA181HH		MD840			MD840C	N/A
28		VR614BLK*						FA47		FA47HH		N/A				N/A
29								FA47		FA47HH		N/A				
30		VR614BLK*						FA209/2	FA209/2V	FA209/2HH		N/A				N/A
31		VR614BLK*						FA209/2	FA209/2V	FA209/2HH		N/A				N/A
32								FA181X		FA181HH		N/A				
33		VR621BLK*						FA181X		FA181HH		MD840			MD840C	N/A
34		VR621BLK*						FA181X		FA181HH		MD840			MD840C	N/A
35		VR624BLK*						FA181X		FA181HH		MD840				N/A
36		VR624BLK*						FA181X		FA181HH		MD840				N/A
37								FA181X		FA181HH		MD840				
38								FA209/2	FA209/2V	FA209/2HH		TBA				
39								FA209/2	FA209/2V	FA209/2HH		TBA				
40																
41																
42								FA266	FA266V	FA266HH		TBA				
43								FA266	FA266V	FA266HH		TBA				
44								FA266	FA266V	FA266HH		TBA				
45								FA266	FA266V		FA266HH	TBA				
46																
47																
48								503								
49								TBA								
50								FA165/2X				N/A				
51								FA165/2X				N/A				
52								978								
53								FA173				N/A				
54								FA173				N/A				
55								FA47		FA47HH		MD637				
56								FA254	FA254V	FA254HH		TBA				

⚠ This symbol indicates a rotor made of billet steel, and should be only used with EBC FA Kevlar® Organic or Vee pads.
SAFETY NOTICE - With vehicles primarily designed for off highway use such as quads now being used on the highway, we would recommend the use of X or MXS pads for highway use and ONLY using the R and SV higher density / harder pad series for off road riding.

BRAKE APPLICATIONS

*-2 Sets Required. ■ - Also available in MX-S race compound. **SAFETY WARNING:- DO NOT USE HH PADS ON REAR UNLESS ALSO USED ON FRONT TO AVOID BRAKE IMBALANCE**

FRONT: Non-Japanese Bikes

APPLICATIONS

BRAKE



MV (AGUSTA)



DISC PAD CHOICES - FRONT

BRAKE ROTOR CHOICES - FRONT

F3 675 (Brembo Calipers)	12-14		FA244HH*		TBA	TBA				
F3 675 Serie Oro (Brembo Calipers)	12-13		FA447HH*		TBA	TBA				
Brutale 675 (Brembo Calipers)	12-14		FA244HH*		TBA	TBA				
F4 750 (All model) (Nissin Calipers)	99-03		FA424HH*		MD675	MD675				
Brutale 750 (All models) (Nissin Calipers)	03-05		FA424HH*		MD675	MD675				
Brutale 800 (Brembo Calipers)	12-14		FA244HH*		TBA	TBA				
F3 800 Serie Oro (Brembo Calipers)	13-14		FA447HH*		TBA	TBA				
Rivale 800	13-14		FA630HH*		TBA	TBA				
Turismo Veloce 800	14		FA630HH*		TBA	TBA				
Turismo Veloce Louso 800	14		FA630HH*		TBA	TBA				
Brutale 910 S (Nissin Calipers)	05-08		FA424HH*		MD675	MD675				
Brutale 910 R (Brembo Calipers)	05-08		FA322/4HH*		TBA	TBA				
Brutale 989 R	08-09		FA244HH*		MD675	MD675				
Brutale 990 R	10-11		FA244HH*		MD675	MD675				
F4 (998cc)	10-14		FA447HH*		TBA	TBA				
F4R (998cc)	12-14		FA447HH*		TBA	TBA				
F4RR (998cc)	12-14		FA447HH*		TBA	TBA				
F4 1000 (All models) (Nissin Calipers)	04-06		FA424HH*		MD675	MD675				
F4R 1000 (Brembo Calipers)	06-07		FA322/4HH*		TBA	TBA				
F4R 312R 1000 (Brembo calipers)	07		FA322/4HH*		TBA	TBA				
Brutale 1078cc RR	08-09		FA447HH*		TBA	TBA				
F4CC (1078cc)	07-08		FA435/4HH*		TBA	TBA				
F4RR 1078	08-09		FA447HH*		TBA	TBA				
Brutale 1090	13-14		FA244HH*		TBA	TBA				
Brutale 1090 R	12-14		FA244HH*		TBA	TBA				
Brutale 1090 RR	10-14		FA447HH*		TBA	TBA				
FRONT										
NORTON										
750 MK V Commando Roadster/Interstate	73	FA27	N/A	FA27	N/A					
850 MK 1 Commando Hi Rider/Interstate	73	FA27	N/A	FA27	N/A					
850 MK 1A Commando Roadster/Interstate	73	FA27	N/A	FA27	N/A					
850 MK 11/11A Commando Roadster/Hi Rider/Interstate	74	FA27	N/A	FA27	N/A					
850 MK 111 Commando Roadster/Hi Rider/Interstate	75	FA27	N/A	FA27	N/A					
PEUGEOT										
Scoot Elec	04-05	303								
Speedfight 2 X-Team (A/C)	02-05	SFA115	SFA115HH		MD925D					
Vivacity X-Race 50/Pulsa 50	02-05	SFA115	SFA115HH		MD901D					
Metal-X All models	02-05	SFA115	SFA115HH		MD901D					
Jet Force 50	03-05	SFA115	SFA115HH		TBA					
Trekker 50	02-05	SFA115	SFA115HH		MD901D					
Looxor 50	02-05	SFA115	SFA115HH		MD954D					
Elyseo 50	02	SFA115	SFA115HH		MD901D					
Elyseo 50	03-05	SFA115	SFA115HH		MD901D					
Elystar 50 P	03-05	SFA115	SFA115HH		MD947D					
Ludix 50 Trend/One/Snake/Bullet (10" wheels)	04-05	SFA115	SFA115HH		MD904D					
Ludix 50 Elegance/Ambition (14" wheels)	04-05	SFA115	SFA115HH		MD901D					
X Race 50 LNDP LC/100 NP AC Speedfight	03-05	SFA115	SFA115HH		MD925D					
Elyseo 100	03-05	SFA115	SFA115HH		MD947D					
Looxor 100	02-05	SFA115	SFA115HH		MD954D					
Elyseo 125/150	03-05	SFA194	SFA194HH		MD977D					
Elystar 125/150 P	03-05	SFA194	SFA194HH		MD980D					
Jet Force 125 EFI/Compressor	03-05	SFA194	SFA194HH		TBA					
Ludix 125	04-05	SFA115	SFA115HH		MD901D					

Line #
1
2
3
4
5
6
7
8
9
10
11
12
13
14
15
16
17
18
19
20
21
22
23
24
25
26
27
28
29
30
31
32
33
34
35
36
37
38
39
40
41
42
43
44
45
46
47
48
49
50
51
52
53
54
55
56

* This symbol indicates a rotor made of billet steel, and should be only used with EBC FA Kevlar® Organic or Vee pads.
 SAFETY NOTICE - With vehicles primarily designed for off highway use such as quads now being used on the highway, we would recommend the use of X or MXS pads for highway use and ONLY using the R and SV higher density / harder pad series for off road riding.

*-2 Sets Required. ■ - Also available in MX-S race compound. **SAFETY WARNING:- DO NOT USE HH PADS ON REAR UNLESS ALSO USED ON FRONT TO AVOID BRAKE IMBALANCE**

FRONT: Non-Japanese Bikes Cont'd

REAR: Non-Japanese Bikes

Line #	BRAKE ROTOR CHOICES - FRONT						DISC PAD CHOICES - REAR				BRAKE ROTOR CHOICES - REAR					
	CC Custom Rotor	CX Extreme® /Vee-Rotor	OS Series Oversize 250/280mm Rotor Kit	OSX Series Oversize 280mm Rotor Kit	Relocating Bracket for 250/280mm Rotor	SMX Series Oversize 320mm Rotor Kit	Relocating Bracket for 320mm Rotor		Semi-Sintered V-Pads™	Sintered/HH Pads/ Grooved Shoes	SV Series Severe Duty Pads	Standard Rotor	UTVX Rotor	Vintage Rotor	Contour Profile Rotor	CX Extreme® /Vee-Rotor
1								FA266	FA266V	FA266HH		TBA				
2								FA266	FA266V	FA266HH		TBA				
3								FA266	FA266V	FA266HH		TBA				
4										FA320HH		MD696				
5										FA320HH		MD696				
6								FA266	FA266V	FA266HH		TBA				
7								FA266	FA266V	FA266HH		TBA				
8								FA266	FA266V	FA266HH		TBA				
9								FA266	FA266V	FA266HH		TBA				
10								FA266	FA266V	FA266HH		TBA				
11										FA320HH		MD696				
12										FA320HH		MD696				
13										FA320HH		MD696				
14										FA320HH		MD696				
15										FA320HH		MD696				
16										FA320HH		MD696				
17										FA320HH		MD696				
18										FA320HH		MD696				
19										FA320HH		MD696				
20										FA320HH		MD696				
21										FA320HH		MD696				
22										FA320HH		MD696				
23										FA320HH		MD696				
24										FA320HH		MD696				
25										FA320HH		MD696				
26										FA320HH		MD696				
27										FA320HH		MD696				
28										FA320HH		MD696				
29										FA320HH		MD696				
30										FA320HH		MD696				
31										FA320HH		MD696				
32										FA320HH		MD696				
33										FA320HH		MD696				
34										FA320HH		MD696				
35										FA320HH		MD696				
36								303								
37								303								
38								303								
39								303								
40								SFA115		SFA115HH		MD901D				
41								303								
42								303								
43								303								
44								SFA115		SFA115HH		MD925D				
45								SFA350		SFA350HH		MD978D				
46								303								
47								303								
48								SFA115		SFA115HH		MD925D				
49								SFA115		SFA115HH		MD925D				
50								SFA115		SFA115HH		MD901D				
51								SFA350		SFA350HH		MD978D				
52								SFA350		SFA350HH		MD978D				
53								SFA350		SFA350HH		MD978D				
54								303								
55																
56																

REAR

This symbol indicates a rotor made of billet steel, and should be only used with EBC FA Kevlar® Organic or Vee pads.
 SAFETY NOTICE - With vehicles primarily designed for off highway use such as quads now being used on the highway, we would recommend the use of X or MXS pads for highway use and ONLY using the R and SV higher density / harder pad series for off road riding.

BRAKE APPLICATIONS

*-2 Sets Required. ■ - Also available in MX-S race compound. **SAFETY WARNING:- DO NOT USE HH PADS ON REAR UNLESS ALSO USED ON FRONT TO AVOID BRAKE IMBALANCE**

FRONT: Non-Japanese Bikes



PIAGGIO



DISC PAD CHOICES - FRONT

BRAKE ROTOR CHOICES - FRONT

Fly 50 (2T)	05-06	SFA353			MD910D					
Fly 50 (4T/2V)	07-10	SFA353			MD910D					
Fly 50 (4T/4V)	11-15	SFA353			MD910D					
LT 50	97-05	SFA260			MD956D					
Typhoon 50/SE	06	SFA83/2			MD9126D					
Typhoon 50 (2T/10" Wheels)	07-09	SFA83/2			MD9126D					
Typhoon 50 (4T/4V/12" Wheels)	10-11	SFA83/2			MD9126D					
Typhoon 50 (4T/4V/14" Wheels)	12-15	SFA353			TBA					
Typhoon 125 (4T/12" Wheels)	10-15	SFA353			TBA					
Fly 150 (4T/2V)	06-12	SFA353			MD910D					
Fly 150 (4T/3V)	13-15	SFA353			MD9126D					
LT 150	98-05	SFA260			MD956D					
BV 200 (Grimeca Caliper)	02-06	SFA194			MD961D					
BV 250 (Heng Tong Caliper)	06-11	SFA353			MD961D					
MP3 (250cc) 3 Wheeler (12" Rear Wheel)	07-09	SFA260*			MD9112D	MD9112D				
MP3 (250cc) 3 Wheeler Parking brake	07-09	SFA257/2								
MP3 (250cc) 3 Wheeler (14" Rear Wheel)	10-15	SFA260*			MD9112D	MD9112D				
MP3 (250cc) 3 Wheeler Parking brake	10-15	SFA257/2								
BV 300 Tourer	10-12	SFA353			MD983D					
BV 350 (4T/4V/330cc)	12-14	SFA353			TBA					
MP 3 400 ie (Three wheeler)	07-15	SFA260*			MD9112D	MD9112D				
MP 3 400 ie (Three wheeler) Parking brake	07-15	SFA257/2								
BV 500	06-12	SFA266*			MD961D	MD961D				
MP 3 500 (Three wheeler - 12" Front/14" Rear Wheel)	07-14	SFA260*			MD9112D	MD9112D				
MP 3 500 (Three wheeler) Parking brake	07-14	SFA257/2								
MP 3 500 (Three wheeler - 12" Front/14" Rear Wheel)	15-16	SFA681*			MD9158D	MD9158D				
MP 3 500 Sport ABS (Three wheeler)	15-16	SFA257/2								
X9 500 Evolution	05-09	SFA181*			MD983D	MD983D				
POLARIS (ATV)										
50 Outlaw	08-16	346*								
50 Predator (2 stroke)	04-06	346*								
Scrambler (3 Wheeler)	85-86	503								
50 Scrambler	01-03	346*								
90 Outlaw	07-16	346*								
90 Predator	03-06	346*								
90 Scrambler X	01-03	346*								
90 Sportsman	01-16	346*								
110 Outlaw	16	346*								
200 Phoenix (AA/AB Model/Rear Drum Model)	05	FA159X*			MD6219D	MD6219D				
200 Phoenix (AC/AD Model and Following/Rear Drum Model)	06-09	FA83X*			MD6274D	MD6274D				
200 Phoenix (Rear Drum Model)	10-14				MD6274D	MD6274D				
200 Phoenix Quadricycle Model (EA/EB/Rear disc model)	05	FA159X*			MD6219D	MD6219D				
200 Phoenix Quadricycle Model (EC/ED Models/Rear disc model)	05-09	FA83X*			MD6274D	MD6274D				
200 Phoenix Quadricycle Model (Rear disc model)	10				MD6274D	MD6274D				
200 Sawtooth (Rear Drum Model)	06-07	FA83X*			MD6274D	MD6274D				
200 Sawtooth Quadricycle (Rear Disc Model)	06/08	FA83X*			MD6274D	MD6274D				
250 2 x 4/4 x 4	90	FA159X*			MD6149D	MD6149D				
250 2 x 4/4 x 4	93	FA159X*			MD6150D	MD6150D				
250 Cyclone X	87	503*								
250 Big Boss 4 x 6	89-90	FA159X*			MD6147D	MD6147D				
250 Big Boss 4 x 6 Middle Axle Brake	89-90	FA159X*			MD6149D					
250 Big Boss 4 x 6	91-92	FA159X*			MD6150D	MD6150D				
250 Big Boss 4 x 6 Middle Axle Brake	91-92	FA159X*			MD6149D					
250 Big Boss 6 x 6	91	FA159X*			MD6149D	MD6149D				
250 Big Boss 6 x 6 Middle Axle Brake	91	FA159X			MD6149D					

Line #

1
2
3
4
5
6
7
8
9
10
11
12
13
14
15
16
17
18
19
20
21
22
23
24
25
26
27
28
29
30
31
32
33
34
35
36
37
38
39
40
41
42
43
44
45
46
47
48
49
50
51
52
53
54
55
56

APPLICATIONS

BRAKE

⚠ This symbol indicates a rotor made of billet steel, and should be only used with EBC FA Kevlar® Organic or Vee pads.
SAFETY NOTICE - With vehicles primarily designed for off highway use such as quads now being used on the highway, we would recommend the use of X or MXS pads for highway use and ONLY using the R and SV higher density / harder pad series for off road riding.

*-2 Sets Required. ■ - Also available in MX-S race compound. **SAFETY WARNING:- DO NOT USE HH PADS ON REAR UNLESS ALSO USED ON FRONT TO AVOID BRAKE IMBALANCE**

FRONT: Non-Japanese Bikes Cont'd

REAR: Non-Japanese Bikes

Line #	BRAKE ROTOR CHOICES - FRONT						DISC PAD CHOICES - REAR				BRAKE ROTOR CHOICES - REAR					
	CC Custom Rotor	CX Extreme® /Vee-Rotor	OS Series Oversize 250/280mm Rotor Kit	OSX Series Oversize 280mm Rotor Kit	Relocating Bracket for 250/280mm Rotor	SMX Series Oversize 320mm Rotor Kit	Relocating Bracket for 320mm Rotor		Semi-Sintered V-Pads™	Sintered/HH Pads/ Grooved Shoes	SV Series Severe Duty Pads	Standard Rotor	UTVX Rotor	Vintage Rotor	Contour Profile Rotor	CX Extreme® /Vee-Rotor
1								816								
2								816								
3								816								
4								816								
5								899								
6								893								
7								893								
8								816								
9								816								
10								816								
11								SFA321		SFA321HH		MD956D				
12								816								
13								SFA194		SFA194HH		MD961D				
14								SFA353		SFA353HH		MD961D				
15								SFA425		SFA425HH		MD960D				
16																
17								SFA418		SFA418HH		MD960D				
18																
19								SFA353		SFA353HH		MD960D				
20								SFA418		SFA418HH		TBA				
21								SFA353		SFA353HH		MD960D				
22																
23								SFA266		SFA266HH		MD960D				
24								SFA353		SFA353HH		MD960D				
25																
26								SFA353		SFA353HH		MD960D				
27																
28								SFA266		SFA266HH		MD960D				
29																
30																
31								307		307G						
32								307		307G						
33								FA40				N/A				
34								307		307G						
35								307		307G						
36								307		307G						
37								307		307G						
38								307		307G						
39								307		307G						
40								306		306G						
41								306		306G						
42								306		306G						
43								FA67X		FA67R		MD6311D				
44								FA67X		FA67R		MD6311D				
45								FA67X		FA67R		MD6311D				
46								306		306G						
47								FA67X		FA67R		MD6311D				
48								FA232X		FA232R	FA232SV	N/A				
49								FA232X		FA232R	FA232SV	N/A				
50								FA40				N/A				
51								FA232X		FA232R	FA232SV	N/A				
52																
53								FA232X		FA232R	FA232SV	N/A				
54																
55								FA232X		FA232R	FA232SV	N/A				
56																

REAR

This symbol indicates a rotor made of billet steel, and should be only used with EBC FA Kevlar® Organic or Vee pads. SAFETY NOTICE - With vehicles primarily designed for off highway use such as quads now being used on the highway, we would recommend the use of X or MXS pads for highway use and ONLY using the R and SV higher density / harder pad series for off road riding.

BRAKE APPLICATIONS

*-2 Sets Required. ■ - Also available in MX-S race compound. **SAFETY WARNING:- DO NOT USE HH PADS ON REAR UNLESS ALSO USED ON FRONT TO AVOID BRAKE IMBALANCE**

FRONT: Non-Japanese Bikes



POLARIS (ATV)



DISC PAD CHOICES - FRONT

BRAKE ROTOR CHOICES - FRONT

	Semi-Sintered V-Pads™	Sintered/HH Pads/Grooved Shoes	SV Series Severe Duty Pads	Standard Rotor Left	Standard Rotor Right	UTVX Rotor	Vintage Rotor Left	Vintage Rotor Right	Contour Profile Rotor
FA159X*		FA159R*	FA159SV*	MD6150D	MD6150D				
FA159X*		FA159R*	FA159SV*	MD6149D					
FA159X*		FA159R*	FA159SV*	MD6147D	MD6147D				
FA159X*		FA159R*	FA159SV*	MD6150D	MD6150D				
FA159X*		FA159R*	FA159SV*	MD6150D	MD6150D				
FA159X*		FA159R*	FA159SV*	MD6155D	MD6155D				
FA159X*		FA159R*	FA159SV*	MD6155D	MD6155D				
FA159X*		FA159R*	FA159SV*	MD6262D	MD6262D				
503*		503G*							
FA159X*		FA159R*	FA159SV*	MD6147D	MD6147D				
FA159X*		FA159R*	FA159SV*	MD6150D	MD6150D				
FA54*		FA54R*	FA54SV*	MD6147D	MD6147D				
FA159X*		FA159R*	FA159SV*	MD6147D	MD6147D				
FA159X*		FA159R*	FA159SV*	MD6150D	MD6150D				
FA159X*		FA159R*	FA159SV*	MD6155D	MD6155D				
FA159X*		FA159R*	FA159SV*	MD6150D	MD6150D				
FA159X*		FA159R*	FA159SV*	MD6150D	MD6150D				
FA159X*		FA159R*	FA159SV*	MD6149D	MD6149D				
FA395X*		FA395R*	FA395SV*	MD6272D	MD6272D				
FA159X*		FA159R*	FA159SV*	MD6272D	MD6272D				
FA395X*		FA395R*	FA395SV*	MD6272D	MD6272D				
FA159X*		FA159R*	FA159SV*	MD6272D	MD6272D				
FA159X*		FA159R*	FA159SV*	MD6272D	MD6272D				
FA159X*		FA159R*	FA159SV*	MD6272D	MD6272D				
FA159X*		FA159R*	FA159SV*	MD6150D	MD6150D				
FA159X*		FA159R*	FA159SV*	MD6150D	MD6150D				
FA159X*		FA159R*	FA159SV*	MD6202D	MD6202D	UTVX6202*			
FA159X*		FA159R*	FA159SV*	MD6155D	MD6155D				
FA159X*		FA159R*	FA159SV*	MD6155D	MD6155D				
		FA159R*	FA159SV*	MD6155D	MD6155D				
		FA159R*	FA159SV*	MD6202D	MD6202D	UTVX6202*			
FA452X*		FA452R*	FA452SV*	MD6202D	MD6202D	UTVX6202*			
FA452X*		FA452R*	FA452SV*	MD6202D	MD6202D	UTVX6202*			
FA452X*		FA452R*	FA452SV*	MD6202D	MD6202D	UTVX6202*			
FA452X*		FA452R*	FA452SV*	MD6202D	MD6202D	UTVX6202*			
FA159X*		FA159R*	FA159SV*	MD6155D	MD6155D				
FA159X*		FA159R*	FA159SV*	MD6155D	MD6155D				
FA159X*		FA159R*	FA159SV*	MD6155D	MD6155D				
		FA159R*	FA159SV*	MD6155D	MD6155D				
FA159X*		FA159R*	FA159SV*	MD6202D	MD6202D	UTVX6202*			
		FA159R*	FA159SV*	MD6149D	MD6149D				
		FA159R*	FA159SV*	MD6202D	MD6202D	UTVX6202*			
FA159X*		FA159R*	FA159SV*	MD6155D	MD6155D				
		FA159R*	FA159SV*	MD6262D	MD6262D				
		FA159R*	FA159SV*	MD6202D	MD6202D	UTVX6202*			
		FA159R*	FA159SV*	MD6262D	MD6262D				
		FA159R*	FA159SV*	MD6202D	MD6202D	UTVX6202*			
FA159X*		FA159R*	FA159SV*	MD6150D	MD6150D				
FA159X*		FA159R*	FA159SV*	MD6149D	MD6149D				
FA159X*		FA159R*	FA159SV*	MD6150D	MD6150D				
FA159X*		FA159R*	FA159SV*	MD6149D	MD6149D				
FA159X*		FA159R*	FA159SV*	MD6150D	MD6150D				
FA159X*		FA159R*	FA159SV*	MD6149D	MD6149D				
FA159X*		FA159R*	FA159SV*	MD6149D					

FRONT

Line #

APPLICATIONS

BRAKE

* This symbol indicates a rotor made of billet steel, and should be only used with EBC FA Kevlar® Organic or Vee pads.
 SAFETY NOTICE - With vehicles primarily designed for off highway use such as quads now being used on the highway, we would recommend the use of X or MXS pads for highway use and ONLY using the R and SV higher density / harder pad series for off road riding.

Ⓢ Plain edged rotor will not allow fitment of optional speedo pick up.

*-2 Sets Required. ■ - Also available in MX-S race compound. **SAFETY WARNING:- DO NOT USE HH PADS ON REAR UNLESS ALSO USED ON FRONT TO AVOID BRAKE IMBALANCE**

FRONT: Non-Japanese Bikes Cont'd

REAR: Non-Japanese Bikes

Line #	BRAKE ROTOR CHOICES - FRONT						DISC PAD CHOICES - REAR				BRAKE ROTOR CHOICES - REAR				
	CC Custom Rotor	CX Extreme® /Vee-Rotor	OS Series Oversize 250/280mm Rotor Kit	OSX Series Oversize 280mm Rotor Kit	Relocating Bracket for 250/280mm Rotor	SMX Series Oversize 320mm Rotor Kit	Relocating Bracket for 320mm Rotor		Semi-Sintered V-Pads™	Sintered/HH Pads/ Grooved Shoes	SV Series Severe Duty Pads	Standard Rotor	UTVX Rotor	Vintage Rotor	Contour Profile Rotor
1							FA232X		FA232R	FA232SV	N/A				
2															
3							FA232X		FA232R	FA232SV	N/A				
4							FA232X		FA232R	FA232SV	N/A				
5							FA232X		FA232R	FA232SV	N/A				
6							FA270X		FA270R	FA270SV	MD6156D				
7							FA270X		FA270R	FA270SV	MD6156D				
8							N/A		FA314R	FA314SV	MD6256D	UTVX6256			
9							FA40				N/A				
10							FA232X		FA232R	FA232SV	N/A				
11							FA232X		FA232R	FA232SV	N/A				
12							FA232X		FA232R	FA232SV	N/A				
13							FA232X		FA232R	FA232SV	N/A				
14							FA232X		FA232R	FA232SV	N/A				
15							FA270X		FA270R	FA270SV	N/A				
16							FA232X		FA232R	FA232SV	N/A				
17							FA232X		FA232R	FA232SV	N/A				
18															
19							FA395X*		FA395R*	FA395SV	MD6273D*				
20							FA159X		FA159R	FA159SV	MD6273D				
21							FA395X*		FA395R*	FA395SV	MD6273D*				
22							FA159X*		FA159R*	FA159SV*	MD6273D*				
23							FA159X		FA159R	FA159SV	MD6273D				
24							FA232X		FA232R	FA232SV	N/A				
25							FA232X		FA232R	FA232SV	N/A				
26							FA232X		FA232R	FA232SV	N/A				
27							FA475X		FA475R	FA475SV	MD6275D	UTVX6275			
28							FA270X		FA270R	FA270SV	MD6156D				
29							FA270X		FA270R	FA270SV	MD6156D				
30							N/A		FA314R	FA314SV	MD6200D				
31							N/A		FA314R	FA314SV	MD6200D				
32							N/A		FA314R	FA314SV	MD6200D				
33									FA354R*	FA354SV*	MD6275D*	UTVX6275*			
34									FA354R*	FA354SV*	MD6275D*	UTVX6275*			
35									FA354R*	FA354SV*	MD6275D*	UTVX6275*			
36									FA354R*	FA354SV*	MD6275D*	UTVX6275*			
37							FA270X		FA270R	FA270SV	MD6156D				
38							FA270X		FA270R	FA270SV	MD6156D				
39							FA270X		FA270R	FA270SV	MD6156D				
40							N/A		FA314R	FA314SV	MD6200D				
41							FA159X*		FA159R*	FA159SV*	MD6200D*				
42							N/A		FA314R	FA314SV	MD6200D				
43							N/A		FA314R	FA314SV	MD6200D				
44							FA270X		FA270R	FA270SV	MD6156D				
45							N/A		FA314R	FA314SV	MD6256D	UTVX6256			
46							N/A		FA314R	FA314SV	MD6256D	UTVX6256			
47							N/A		FA314R	FA314SV	MD6256D	UTVX6256			
48							N/A		FA314R	FA314SV	MD6256D	UTVX6256			
49							FA270X		FA270R	FA270SV	N/A				
50							FA270X		FA270R	FA270SV	N/A				
51							FA232X		FA232R	FA232SV	N/A				
52							FA232X		FA232R	FA232SV	N/A				
53							FA232X		FA232R	FA232SV	N/A				
54							FA232X		FA232R	FA232SV	N/A				
55															
56															

REAR

⚠ This symbol indicates a rotor made of billet steel, and should be only used with EBC FA Kevlar® Organic or Vee pads.
SAFETY NOTICE - With vehicles primarily designed for off highway use such as quads now being used on the highway, we would recommend the use of X or MXS pads for highway use and ONLY using the R and SV higher density / harder pad series for off road riding.

BRAKE APPLICATIONS

*-2 Sets Required. ■ - Also available in MX-S race compound. **SAFETY WARNING:- DO NOT USE HH PADS ON REAR UNLESS ALSO USED ON FRONT TO AVOID BRAKE IMBALANCE**

FRONT: Non-Japanese Bikes

APPLICATIONS

BRAKE



POLARIS (ATV)



DISC PAD CHOICES - FRONT

BRAKE ROTOR CHOICES - FRONT

	Semi-Sintered V-Pads™	Sintered/HH Pads/Grooved Shoes	SV Series Severe Duty Pads	Standard Rotor Left	Standard Rotor Right	UTVX Rotor	Vintage Rotor Left	Vintage Rotor Right	Contour Profile Rotor
350 Sportsman 4 x 4	93	FA159X*	FA159R*	FA159SV*	MD6149D	MD6149D			
350 Trail Boss L 2 x 4	91-93	FA159X*	FA159R*	FA159SV*	MD6150D	MD6150D			
350 Trail Boss L 4 x 4	91	FA159X*	FA159R*	FA159SV*	MD6149D	MD6149D			
400 L 2 x 4	94-95	FA159X*	FA159R*	FA159SV*	MD6150D	MD6150D			
400 L 4 x 4	94	FA159X*	FA159R*	FA159SV*	MD6149D	MD6149D			
400 Big Boss L 6 x 6	94-95	FA159X*	FA159R*	FA159SV*	MD6149D	MD6149D			
400 Big Boss L 6 x 6 Middle Axle Brake	94-95	FA159X*	FA159R*	FA159SV*	MD6149D	MD6149D			
400 Big Boss L 6 x 6	96	FA159X*	FA159R*	FA159SV*	MD6149D	MD6149D			
400 Big Boss L 6 x 6 Middle Axle Brake	96		FA273R*		MD6153D				
400 Big Boss L 6 x 6	97	FA159X*	FA159R*	FA159SV*	MD6149D	MD6149D			
400 Big Boss L 6 x 6 Middle Axle Brake	97	FA159X*	FA159R*	FA159SV*	MD6149D	MD6149D			
400 Hawkeye H.O. 2 x 4	13-14	FA159X*	FA159R*	FA159SV*	MD6202D	MD6202D	UTVX6202*		
400 Scrambler L 4 x 4	95-97	FA159X*	FA159R*	FA159SV*	MD6150D	MD6150D			
400 Scrambler (2 x 4/4 x 4)	00	FA159X*	FA159R*	FA159SV*	MD6155D	MD6155D			
400 Scrambler 4 x 4	98-02	FA159X*	FA159R*	FA159SV*	MD6155D●	MD6155D●			
400 Scrambler 2 x 4	02	FA159X*	FA159R*	FA159SV*	MD6155D●	MD6155D●			
400 Sport L	94-98	FA159X*	FA159R*	FA159SV*	MD6150D	MD6150D			
400 Sport	99-00	FA159X*	FA159R*	FA159SV*	MD6150D	MD6150D			
400 Sportsman L 4 x 4	94-97	FA159X*	FA159R*	FA159SV*	MD6149D	MD6149D			
400 Sportsman	01-02	FA159X*	FA159R*	FA159SV*	MD6149D	MD6149D			
400 Sportsman 400	03	FA159X*	FA159R*	FA159SV*	MD6149D	MD6149D			
400 Sportsman 400 (Code CH42AA/AE/AG)	04	FA159X*	FA159R*	FA159SV*	MD6149D	MD6149D			
400 Sportsman 400 (Code CH42AQ/AR/AS/AT/AV)	04	FA159X*	FA159R*	FA159SV*	MD6202D	MD6202D	UTVX6202*		
400 Sportsman HO 4 x 4	08-10	FA159X*	FA159R*	FA159SV*	MD6272D	MD6272D			
400 Sportsman HO 4 x 4	11-14	FA159X*	FA159R*	FA159SV*	MD6202D	MD6202D	UTVX6202*		
400 Trail Blazer	03	FA159X*	FA159R*	FA159SV*	MD6155D	MD6155D			
400 Xplorer L 4 x 4	95-98	FA159X*	FA159R*	FA159SV*	MD6149D	MD6149D			
400 Xplorer L 4 x 4	99-00	FA159X*	FA159R*	FA159SV*	MD6149D	MD6149D			
400 Xplorer 4 x 4	01-02	FA159X*	FA159R*	FA159SV*	MD6155D	MD6155D			
400 Xplorer	01-02	FA159X*	FA159R*	FA159SV*	MD6149D	MD6149D			
425 Magnum 2 x 4	95-98	FA159X*	FA159R*	FA159SV*	MD6150D	MD6150D			
425 Magnum 4 x 4	95-98	FA159X*	FA159R*	FA159SV*	MD6149D	MD6149D			
425 Magnum 6 x 6	96	FA159X*	FA159R*	FA159SV*	MD6149D	MD6149D			
425 Magnum 6 x 6 Middle Axle Brake	96		FA273R		MD6153D				
425 Magnum 6 x 6	97	FA159X*	FA159R*	FA159SV*	MD6149D	MD6149D			
425 Magnum 6 x 6 Middle Axle Brake	97	FA159X*	FA159R*	FA159SV*	MD6149D	MD6149D			
425 Xpedition (4 x 4)	00	FA159X*	FA159R*	FA159SV*	MD6149D	MD6149D			
450 S Outlaw	08	FA456X*	FA456R*		MD6219D	MD6219D			
450 Outlaw MXR	09-10	FA456X*	FA456R*		MD6219D	MD6219D			
450 Sportsman	06		FA159R*	FA159SV*	MD6202D	MD6202D	UTVX6202*		
450 Sportsman	07		FA159R*	FA159SV*	MD6202D	MD6202D	UTVX6202*		
455cc Diesel 4 x 4 EBS	99-00	FA159X*	FA159R*	FA159SV*	MD6149D	MD6149D			
455cc Diesel	01	FA159X*	FA159R*	FA159SV*	MD6149D	MD6149D			
500 ATP HO (4 x 4)	04-05	FA159X*	FA159R*	FA159SV*	MD6202D	MD6202D	UTVX6202*		
500 ATV Pro 4 x 4 PPS	02		FA159R*	FA159SV*	MD6202D	MD6202D	UTVX6202*		
500 Big Boss 6 x 6	98-99	FA159X*	FA159R*	FA159SV*	MD6149D	MD6149D			
500 Big Boss 6 x 6 Middle Axle Brake	98-99	FA159X*	FA159R*	FA159SV*	MD6149D	MD6149D			
500 Magnum (4 x 4)	99-00	FA159X*	FA159R*	FA159SV*	MD6149D	MD6149D			
500 Magnum	01	FA159X*	FA159R*	FA159SV*	MD6149D	MD6149D			
500 Magnum (2 x 39906 x 4 HDS)	02		FA159R*	FA159SV*	MD6149D	MD6149D			
500 Magnum 4 x 4 HDS	02-03		FA159R*	FA159SV*	MD6202D	MD6202D	UTVX6202*		
500 Outlaw	06-07	FA159X*	FA159R*	FA159SV*	MD6219D	MD6219D			
500 Predator/TLD	03-07	FA159X*	FA159R*	FA159SV*	MD6219D	MD6219D			
500 Scrambler 2 x 4	01-02	FA159X*	FA159R*	FA159SV*	MD6155D●	MD6155D●			
500 Scrambler 2 x 4	07-08		FA159R*	FA159SV*	MD6262D	MD6262D			

Line #

FRONT

This symbol indicates a rotor made of billet steel, and should be only used with EBC FA Kevlar® Organic or Vee pads. SAFETY NOTICE - With vehicles primarily designed for off highway use such as quads now being used on the highway, we would recommend the use of X or MXS pads for highway use and ONLY using the R and SV higher density / harder pad series for off road riding.

● Plain edged rotor will not allow fitment of optional speedo pick up.

*-2 Sets Required. ■ - Also available in MX-S race compound. SAFETY WARNING:- DO NOT USE HH PADS ON REAR UNLESS ALSO USED ON FRONT TO AVOID BRAKE IMBALANCE

FRONT: Non-Japanese Bikes Cont'd

REAR: Non-Japanese Bikes

Line #	BRAKE ROTOR CHOICES - FRONT						DISC PAD CHOICES - REAR				BRAKE ROTOR CHOICES - REAR					
	CC Custom Rotor	CX Extreme® /Vee-Rotor	OS Series Oversize 250/280mm Rotor Kit	OSX Series Oversize 280mm Rotor Kit	Relocating Bracket for 250/280mm Rotor	SMX Series Oversize 320mm Rotor Kit	Relocating Bracket for 320mm Rotor		Semi-Sintered V-Pads™	Sintered/HH Pads/ Grooved Shoes	SV Series Severe Duty Pads	Standard Rotor	UTVX Rotor	Vintage Rotor	Contour Profile Rotor	CX Extreme® /Vee-Rotor
1									FA232X		FA232R	FA232SV	N/A			
2									FA232X		FA232R	FA232SV	N/A			
3									FA232X		FA232R	FA232SV	N/A			
4									FA232X		FA232R	FA232SV	N/A			
5									FA232X		FA232R	FA232SV	N/A			
6									FA232X		FA232R	FA232SV	N/A			
7																
8									FA232X		FA232R	FA232SV	N/A			
9																
10									FA232X		FA232R	FA232SV	N/A			
11																
12									FA475X		FA475R		MD6274D			
13									FA232X		FA232R	FA232SV	N/A			
14									FA270X		FA270R	FA270SV	MD6156D			
15									FA270X		FA270R	FA270SV	MD6156D			
16									FA270X		FA270R	FA270SV	MD6156D			
17									FA232X		FA232R	FA232SV	N/A			
18									FA270X		FA270R	FA270SV	MD6156D			
19									FA232X		FA232R	FA232SV	N/A			
20									FA270X		FA270R	FA270SV	N/A			
21									N/A		FA314R*	FA314SV*	MD6201D*			
22									N/A		FA314R*	FA314SV*	MD6201D*			
23									N/A		FA314R*	FA314SV*	MD6201D*			
24									FA159X		FA159R	FA159SV	MD6273D			
25									FA475X		FA475R		MD6275D	UTVX6275		
26									FA270X		FA270R	FA270SV	MD6156D			
27									FA232X		FA232R	FA232SV	N/A			
28									FA270X		FA270R	FA270SV	MD6169D			
29									FA270X		FA270R	FA270SV	MD6156D			
30									FA270X		FA270R	FA270SV	MD6169D			
31									FA232X		FA232R	FA232SV	N/A			
32									FA232X		FA232R	FA232SV	N/A			
33									FA232X		FA232R	FA232SV	N/A			
34																
35									FA232X		FA232R	FA232SV	N/A			
36																
37									FA270X		FA270R	FA270SV	MD6156D			
38									FA159X		FA159R		MD6218D			
39									FA159X		FA159R		MD6290D			
40									N/A		FA314R	FA314SV	MD6201D			
41									N/A		FA314R	FA314SV	MD6275D	UTVX6275		
42									FA270X		FA270R	FA270SV	N/A			
43									FA270X		FA270R	FA270SV	N/A			
44									FA159X*		FA159R*	FA159SV*	MD6200D			
45									N/A		FA314R	FA314SV	MD6200D			
46									FA232X		FA232R	FA232SV	N/A			
47																
48									FA270X		FA270R	FA270SV	MD6156D			
49									FA270X		FA270R	FA270SV	MD6156D			
50									N/A		FA314R	FA314SV	MD6200D			
51									N/A		FA314R	FA314SV	MD6200D			
52									FA159X		FA159R	FA159SV	MD6290D			
53									FA159X		FA159R	FA159SV	MD6218D			
54									FA270X		FA270R	FA270SV	MD6156D			
55									N/A		FA314R	FA314SV	MD6256D	UTVX6256		
56																

REAR

⚠ This symbol indicates a rotor made of billet steel, and should be only used with EBC FA Kevlar® Organic or Vee pads.
SAFETY NOTICE - With vehicles primarily designed for off highway use such as quads now being used on the highway, we would recommend the use of X or MXS pads for highway use and ONLY using the R and SV higher density / harder pad series for off road riding.

BRAKE APPLICATIONS

*-2 Sets Required. ■ - Also available in MX-S race compound. **SAFETY WARNING:- DO NOT USE HH PADS ON REAR UNLESS ALSO USED ON FRONT TO AVOID BRAKE IMBALANCE**

FRONT: Non-Japanese Bikes



POLARIS (ATV)



DISC PAD CHOICES - FRONT

BRAKE ROTOR CHOICES - FRONT

	Semi-Sintered V-Pads™	Sintered/HH Pads/Grooved Shoes	SV Series Severe Duty Pads	Standard Rotor Left	Standard Rotor Right	UTVX Rotor	Vintage Rotor Left	Vintage Rotor Right	Contour Profile Rotor
500 Scrambler 4 x 4	97	FA159X*	FA159R*	FA159SV*	MD6150D	MD6150D			
500 Scrambler 4 x 4	98-04	FA159X*	FA159R*	FA159SV*	MD6155D●	MD6155D●			
500 Scrambler 4 x 4	05-09		FA159R	FA159SV	MD6155D●	MD6155D●			
500 Scrambler 4 x 4	10-12		FA159R*	FA159SV*	MD6202D	MD6202D	UTVX6202*		
500 Sportsman 4 x 4	96	FA159X*	FA159R*	FA159SV*	MD6149D	MD6149D			
500 Sportsman 4 x 4	97	FA159X*	FA159R*	FA159SV*	MD6149D	MD6149D			
500 Sportsman/Worker 4 x 4 EBS/500 RSE	98-02	FA159X*	FA159R*	FA159SV*	MD6149D	MD6149D			
500 Sportsman HO/EFI	03-06		FA159R*	FA159SV*	MD6202D	MD6202D	UTVX6202*		
500 Sportsman EFI/HO	07-08		FA159R*	FA159SV*	MD6202D	MD6202D	UTVX6202*		
500 Sportsman HO (Built up to 15/12/2008)	08		FA159R*	FA159SV*	MD6202D	MD6202D	UTVX6202*		
500 Sportsman HO (Built from 16/12/2008)	09-12	FA159X*	FA159R*	FA159SV*	MD6202D	MD6202D	UTVX6202*		
500 Sportsman X2	06-08		FA159R*	FA159SV*	MD6202D	MD6202D	UTVX6202*		
500 Sportsman 6 x 6	00-08		FA159R*	FA159SV*	MD6149D	MD6149D			
500 Sportsman X 2 EFI	07-09	FA159X*	FA159R*	FA159SV*	MD6202D	MD6202D	UTVX6202*		
500 Sportsman Forest	12	FA159X*	FA159R*	FA159SV*	MD6202D	MD6202D	UTVX6202*		
500 Sportsman Touring H.O.	08-11	FA159X*	FA159R*	FA159SV*	MD6202D	MD6202D	UTVX6202*		
500 Sportsman Touring H.O.	11-13	FA159X*	FA159R*	FA159SV*	MD6202D	MD6202D	UTVX6202*		
500 Sportsman EFI Quad H.O.	08-11		FA159R*	FA159SV*	MD6202D	MD6202D	UTVX6202*		
500 XP Sportsman	09	FA475X*	FA475R*	FA475SV*	MD6339D	MD6339D			
500 Xplorer 4 x 4	97	FA159X*	FA159R*	FA159SV*	MD6149D	MD6149D			
525 S Outlaw	08-10	FA456X*	FA456R*		MD6219D	MD6219D			
525 Outlaw IRS	08-11	FA456X*	FA456R*		MD6219D	MD6219D			
550 Sportsman	11-13	FA475X*	FA475R*	FA475SV*	MD6339D	MD6339D			
550 Sportsman EPS	10-14	FA475X*	FA475R*	FA475SV*	MD6339D	MD6339D			
550 Sportsman Forest	10-12	FA475X*	FA475R*	FA475SV*	MD6339D	MD6339D			
550 XP Sportsman EPS	09-11	FA475X*	FA475R*	FA475SV*	MD6339D	MD6339D			
550 Sportsman X2	10-14	FA475X*	FA475R*	FA475SV*	MD6339D	MD6339D			
550 Sportsman Touring EPS	10-14	FA475X*	FA475R*	FA475SV*	MD6339D	MD6339D			
570 Sportsman Ace	15	FA452X*	FA452R*	FA452SV*	MD6202D	MD6202D	UTVX6202*		
570 Sportsman Ace Euro	15	FA452X*	FA452R*	FA452SV*	MD6202D	MD6202D	UTVX6202*		
570 Sportsman EFI (Inc EPS Models)	11-15	FA159X*	FA159R*	FA159SV*	MD6202D	MD6202D	UTVX6202*		
570 Sportsman Touring EFI	14-15	FA159X*	FA159R*	FA159SV*	MD6202D	MD6202D	UTVX6202*		
600 Sportsman 4 x 4	03-05		FA159R*	FA159SV*	MD6202D	MD6202D	UTVX6202*		
700 Sportsman (4 x 4)/EFI	02-06		FA159R*	FA159SV*	MD6202D	MD6202D	UTVX6202*		
700 Sportsman MV	05-06		FA159R*	FA159SV*	MD6202D	MD6202D	UTVX6202*		
700 Sportsman EFI	07		FA159R*	FA159SV*	MD6202D	MD6202D	UTVX6202*		
700 Sportsman X 2	08	FA159X*	FA159R*	FA159SV*	MD6202D	MD6202D	UTVX6202*		
800 Sportsman EFI	05-06		FA159R*	FA159SV*	MD6202D	MD6202D	UTVX6202*		
800 Sportsman EFI (Built up to 15/12/2008)	08		FA159R*	FA159SV*	MD6202D	MD6202D	UTVX6202*		
800 Sportsman EFI (Built up after 16/12/2008)	09		FA159R*	FA159SV*	MD6202D	MD6202D	UTVX6202*		
800 Sportsman EFI	10-13		FA159R*	FA159SV*	MD6202D	MD6202D	UTVX6202*		
800 Sportsman X 2 EFI	07-09	FA159X*	FA159R*	FA159SV*	MD6202D	MD6202D	UTVX6202*		
800 Sportsman EFI Intl/HO	07-11		FA159R*	FA159SV*	MD6202D	MD6202D	UTVX6202*		
800 Sportsman	12-14	FA475X*	FA475R*	FA475SV*	MD6339D	MD6339D			
800 Sportsman Forest	12	FA475X*	FA475R*	FA475SV*	MD6339D	MD6339D			
800 Sportsman Touring/EFI	08-09	FA159X*	FA159R*	FA159SV*	MD6202D	MD6202D	UTVX6202*		
800 Sportsman Big Boss/EFI 6 x 6/EFI	09-14	FA159X*	FA159R*	FA159SV*	MD6202D	MD6202D	UTVX6202*		
850 Forest	15	FA475X*	FA475R*	FA475SV*	MD6339D	MD6339D			
850 Scrambler	15	FA475X*	FA475R*	FA475SV*	MD6339D	MD6339D			
850 Sportsman Touring EPS	10-13	FA475X*	FA475R*	FA475SV*	MD6339D	MD6339D			
850 Sportsman Touring H.O. EPS	13-15	FA475X*	FA475R*	FA475SV*	MD6339D	MD6339D			
850 Sportsman Forest	12	FA475X*	FA475R*	FA475SV*	MD6339D	MD6339D			
850 XP H.O. Scrambler	13-15	FA475X*	FA475R*	FA475SV*	MD6339D	MD6339D			
850 XP Sportsman	09-13	FA475X*	FA475R*	FA475SV*	MD6339D	MD6339D			

Line #

1

2

3

4

5

6

7

8

9

10

11

12

13

14

15

16

17

18

19

20

21

22

23

24

25

26

27

28

29

30

31

32

33

34

35

36

37

38

39

40

41

42

43

44

45

46

47

48

49

50

51

52

53

54

55

56

APPLICATIONS

BRAKE

SAFETY NOTICE - With vehicles primarily designed for off highway use such as quads now being used on the highway, we would recommend the use of X or MXS pads for highway use and ONLY using the R and SV higher density / harder pad series for off road riding.

⊛ This symbol indicates a rotor made of billet steel, and should be only used with EBC FA Kevlar® Organic or Vee pads.

FRONT

● Plain edged rotor will not allow fitment of optional speedo pick up.

*-2 Sets Required. ■ - Also available in MX-S race compound. **SAFETY WARNING:- DO NOT USE HH PADS ON REAR UNLESS ALSO USED ON FRONT TO AVOID BRAKE IMBALANCE**

FRONT: Non-Japanese Bikes Cont'd

REAR: Non-Japanese Bikes

Line #	BRAKE ROTOR CHOICES - FRONT						DISC PAD CHOICES - REAR				BRAKE ROTOR CHOICES - REAR				
	CC Custom Rotor	CX Extreme® /Vee-Rotor	OS Series Oversize 250/280mm Rotor Kit	OSX Series Oversize 280mm Rotor Kit	Relocating Bracket for 250/280mm Rotor	SMX Series Oversize 320mm Rotor Kit	Relocating Bracket for 320mm Rotor		Semi-Sintered V-Pads™	Sintered/HH Pads/ Grooved Shoes	SV Series Severe Duty Pads	Standard Rotor	UTVX Rotor	Vintage Rotor	Contour Profile Rotor
1							FA232X		FA232R	FA232SV	N/A				
2							FA270X		FA270R	FA270SV	MD6156D				
3							N/A		FA314R	FA314SV	MD6256D	UTVX6256			
4							N/A		FA314R	FA314SV	MD6256D	UTVX6256			
5							FA232X		FA232R	FA232SV	MD6201D				
6							FA232X		FA232R	FA232SV	MD6154D				
7							FA270X		FA270R	FA270SV	N/A				
8							N/A		FA314R	FA314SV	MD6201D				
9							N/A		FA314R	FA314SV	MD6275D	UTVX6275			
10							N/A		FA314R	FA314SV	MD6275D	UTVX6275			
11							FA475X		FA475R	FA475SV	MD6275D	UTVX6275			
12							N/A		FA314R	FA314SV	MD6275D*	UTVX6275*			
13							N/A		FA313R	FA313SV	MD6170D				
14							FA159X		FA159R	FA159SV	MD6275D	UTVX6275			
15							N/A		FA314R*	FA314SV*	MD6275D*	UTVX6275*			
16							FA159X*		FA159R*	FA159SV*	MD6275D*	UTVX6275*			
17									FA354R		MD6275D*	UTVX6275*			
18							N/A		FA314R*	FA314SV*	MD6275D*	UTVX6275*			
19							FA475X		FA475R	FA475SV	MD6339D				
20							FA232X		FA232R	FA232SV	N/A				
21							FA159X		FA159R		MD6218D				
22							FA159X		FA159R		MD6290D				
23							FA475X		FA475R	FA475SV	MD6339D				
24							FA475X		FA475R	FA475SV	MD6339D				
25							FA475X		FA475R	FA475SV	MD6339D				
26							FA475X		FA475R	FA475SV	MD6339D				
27							FA475X		FA475R	FA475SV	MD6339D				
28							FA475X		FA475R	FA475SV	MD6339D				
29									FA354R*	FA354SV*	MD6275D*	UTVX6275*			
30									FA354R*	FA354SV*	MD6275D*	UTVX6275*			
31							FA475X		FA475R		MD6275D	UTVX6275			
32							FA475X		FA475R		MD6275D	UTVX6275			
33							N/A		FA314R	FA314SV	MD6201D				
34							N/A		FA314R	FA314SV	MD6201D				
35							N/A		FA314R	FA314SV	MD6201D				
36							N/A		FA314R	FA314SV	MD6275D	UTVX6275			
37							FA159X		FA159R	FA159SV	MD6275D	UTVX6275			
38							N/A		FA314R	FA314SV	MD6201D				
39							N/A		FA314R	FA314SV	MD6275D	UTVX6275			
40							N/A		FA314R	FA314SV	MD6275D	UTVX6275			
41							N/A		FA475R	FA475SV	MD6275D	UTVX6275			
42							FA159X*		FA159R*	FA159SV*	MD6275D	UTVX6275			
43							N/A		FA314R	FA314SV	MD6275D	UTVX6275			
44							FA475X		FA475R	FA475SV	MD6339D				
45							FA475X		FA475R	FA475SV	MD6339D				
46							FA159X*		FA159R*	FA159SV*	MD6275D*	UTVX6275*			
47									FA314RⓉ	FA314SVⓉ	MD6275DⓉ	UTVX6275Ⓣ			
48									Ⓣ 3 Sets Required						
49							FA475X*		FA475R*		MD6339D*				
50							FA475X*		FA475R*		MD6339D*				
51							FA475X		FA475R	FA475SV	MD6339D				
52							FA475X		FA475R	FA475SV	MD6339D				
53							FA475X		FA475R	FA475SV	MD6339D				
54							FA475X		FA475R	FA475SV	MD6339D				
55							FA475X		FA475R	FA475SV	MD6339D				
56															

Ⓣ This symbol indicates a rotor made of billet steel, and should be only used with EBC FA Kevlar® Organic or Vee pads.
 SAFETY NOTICE - With vehicles primarily designed for off highway use such as quads now being used on the highway, we would recommend the use of X or MXS pads for highway use and ONLY using the R and SV higher density / harder pad series for off road riding.

BRAKE APPLICATIONS

*-2 Sets Required. ■ - Also available in MX-S race compound. **SAFETY WARNING:- DO NOT USE HH PADS ON REAR UNLESS ALSO USED ON FRONT TO AVOID BRAKE IMBALANCE**

FRONT: Non-Japanese Bikes Cont'd

REAR: Non-Japanese Bikes

Line #	BRAKE ROTOR CHOICES - FRONT						DISC PAD CHOICES - REAR				BRAKE ROTOR CHOICES - REAR				
	CC Custom Rotor	CX Extreme® /Vee-Rotor	OS Series Oversize 250/280mm Rotor Kit	OSX Series Oversize 280mm Rotor Kit	Relocating Bracket for 250/280mm Rotor	SMX Series Oversize 320mm Rotor Kit	Relocating Bracket for 320mm Rotor		Semi-Sintered V-Pads™	Sintered/HH Pads/ Grooved Shoes	SV Series Severe Duty Pads	Standard Rotor	UTVX Rotor	Vintage Rotor	Contour Profile Rotor
1							FA475X		FA475R	FA475SV	MD6339D				
2							FA475X		FA475R	FA475SV	MD6339D				
3							FA475X*		FA475R*	FA475SV*	MD6339D*				
4							FA475X*		FA475R*	FA475SV*	MD6339D*				
5							FA475X*		FA475R*	FA475SV*	MD6339D*				
6							FA475X*		FA475R*	FA475SV*	MD6339D*				
7															
8															
9							FA456X*		FA456R*	FA456SV*	MD6338D*	UTVX6338*			
10							FA456X*		FA456R*	FA456SV*	MD6408D*	UTVX6408*			
11							FA456X*		FA456R*	FA456SV*	MD6408D*	UTVX6408*			
12															
13															
14									FA354R*	FA354SV*	MD6275D*	UTVX6275*			
15															
16															
17							N/A		FA354R*	FA354SV*	MD6275D*	UTVX6275*			
18							N/A		FA354R*	FA354SV*	MD6275D*	UTVX6275*			
19							N/A		FA354R*	FA354SV*	MD6275D*	UTVX6275*			
20							N/A		FA354R*	FA354SV*	MD6275D*	UTVX6275*			
21							N/A		FA354R*	FA354SV*	MD6275D*	UTVX6275*			
22							N/A		FA354R*	FA354SV*	MD6275D*	UTVX6275*			
23							N/A		FA354R*	FA354SV*	MD6275D*	UTVX6275*			
24							N/A		FA354R*	FA354SV*	MD6275D*	UTVX6275*			
25							N/A		FA354R*	FA354SV*	MD6275D*	UTVX6275*			
26							N/A		FA354R*	FA354SV*	MD6201D*				
27							N/A		FA273R		N/A				
28							N/A		FA354R*	FA354SV*	MD6201D*				
29							N/A		FA354R*	FA354SV*	MD6201D*				
30							N/A		FA354R*	FA354SV*	MD6201D*				
31							N/A		FA354R*	FA354SV*	MD6201D*				
32							N/A		FA354R*	FA354SV*	MD6201D*				
33							N/A		FA354R*	FA354SV*	MD6275D*	UTVX6275*			
34							N/A		FA354R*	FA354SV*	MD6201D*				
35							FA475X		FA475R	FA475SV*	MD6339D				
36									FA354R*	FA354SV*	MD6275D*	UTVX6275*			
37									FA354R*	FA354SV*	MD6275D*	UTVX6275*			
38							N/A		FA354R*	FA354SV*	MD6275D*	UTVX6275*			
39							N/A		FA354R*	FA354SV*	MD6275D*	UTVX6275*			
40							N/A		FA354R*	FA354SV*	MD6275D*	UTVX6275*			
41							N/A		FA354R*	FA354SV*	MD6275D*	UTVX6275*			
42							FA452X*		FA452R*	FA452SV*	MD6275D*	UTVX6275*			
43							N/A		FA354R*	FA354SV*	MD6275D*	UTVX6275*			
44							N/A		FA354R*	FA354SV*	MD6275D*	UTVX6275*			
45							N/A		FA354R*	FA354SV*	MD6275D*	UTVX6275*			
46							N/A		FA354R*	FA354SV*	MD6275D*	UTVX6275*			
47							N/A		FA354R*	FA354SV*	MD6275D*	UTVX6275*			
48							N/A		FA354R*	FA354SV*	MD6275D*	UTVX6275*			
49							FA452X*		FA452R*	FA452SV*	MD6275D*	UTVX6275*			
50							FA354X*	FA354X*	FA354X*			FA354SV*	MD6275D*	UTVX6275*	
51							FA354X*	FA354X*	FA354X*			FA354SV*	MD6275D*	UTVX6275*	
52							FA656X*		FA656R*	FA656SV*	MD6275D*	UTVX6275*			
53							FA656X*		FA656R*	FA656SV*	MD6275D*	UTVX6275*			
54							N/A		FA354R*	FA354SV*	MD6275D*	UTVX6275*			
55							N/A		FA354R*	FA354SV*	MD6374D*	UTVX6374*			
56							N/A		FA354R*	FA354SV*	MD6275D*	UTVX6275*			

BRAKE APPLICATIONS

⚠ This symbol indicates a rotor made of billet steel, and should be only used with EBC FA Kevlar® Organic or Vee pads.
SAFETY NOTICE - With vehicles primarily designed for off highway use such as quads now being used on the highway, we would recommend the use of X or MXS pads for highway use and ONLY using the R and SV higher density / harder pad series for off road riding.

*-2 Sets Required. ■ - Also available in MX-S race compound. **SAFETY WARNING:- DO NOT USE HH PADS ON REAR UNLESS ALSO USED ON FRONT TO AVOID BRAKE IMBALANCE**

FRONT: Non-Japanese Bikes

APPLICATIONS

BRAKE



POLARIS RANGER (SIDE X SIDE MODELS)



1000 Ranger Diesel	15
1000 Ranger Diesel Crew	15
PPS/PTV 4 x 4/ Series 10	
PPS/PTV 6 x 6/ Series 10	
PPS/UTV 2 x 4 Series 10	
PPS/UTV 4 x 6 Series 10	
1500 PPS/UTV 2 x 4 Series 11	
PPS LUH 6 x 6	02
PPS/ Series 11 2 x 4/ 4 x 4	
PPS/ Series 11 6 x 6	
Ranger Handbrake Pads (Various Models 05 - 16)	05-16

POLARIS RZR (SIDE X SIDE MODELS)

RZR 170	09-15
RZR 570	12-13
RZR 570	14-15
RZR 800 (Inc EPS Models)	08-14
RZR-4 800 EPS	12
RZR 900 (50" Inch All Options)	15
RZR-S 900 (60" Inch All Options)	15
RZR XP 900 (Inc EPS Models)	11-14
RZR 4 XP 900	12-15
RZR XP 1000	14-15
RZR XP Turbo	16
RZR XP 4 Turbo	16

POLARIS (SLINGSHOT)

Slingshot	15-16
Slingshot	16-17
Slingshot SL	15-16
Slingshot SL	16-17
Slingshot SLR	17

POLINI (MINI MOTOS)

Polini Calipers (Round shape threaded pad)	
Mad Ass 125	10-11

ROYAL ENFIELD

Continental GT	13-17
Bullet 500 EFI (Pricol caliper/Drum rear)	10-15
Bullet 500 EFI (Brembo caliper Front & Rear)	16-17
Classic 500 (Pricol caliper/Drum rear)	10-15
Classic 500 (Brembo caliper Front & Rear)	16-17
Classic 500 Battle Green (Pricol caliper/Drum rear)	10-15
Classic 500 Chrome (Pricol caliper/Drum rear)	10-15
Classic 500 Chrome (Brembo caliper Front & Rear)	16-17
Classic 500 Desert Storm (Pricol caliper/Drum rear)	10-15

SACHS

Mad Ass 50	09
Mad Ass 125	10-11

SCORPA

SR 125 (2T)	11
SY 125 F	05-09
T-Ride 125	11

DISC PAD CHOICES - FRONT

BRAKE ROTOR CHOICES - FRONT

	Semi-Sintered V-Pads™	Sintered/HH Pads/Grooved Shoes	SV Series Severe Duty Pads	Standard Rotor Left	Standard Rotor Right	UTVX Rotor	Vintage Rotor Left	Vintage Rotor Right	Contour Profile Rotor
FA656X*		FA656R*	FA656SV*	MD6338D	MD6338D	UTVX6338*			
FA656X*		FA656R*	FA656SV*	MD6338D	MD6338D	UTVX6338*			
FA159X*		FA159R*	FA159SV*	MD6202D	MD6202D	UTVX6202*			
FA159X*		FA159R*	FA159SV*	MD6149D	MD6149D				
N/A		FA354R*	FA354SV*	MD6202D	MD6202D	UTVX6202*			
N/A		FA354R*	FA354SV*	MD6202D	MD6202D	UTVX6202*			
N/A		FA354R*	FA354SV*	MD6202D	MD6202D	UTVX6202*			
FA159X*		FA159R*	FA159SV*	MD6149D	MD6149D				
N/A		FA354R*	FA354SV*	MD6202D	MD6202D	UTVX6202*			
N/A		FA354R*	FA354SV*	MD6202D	MD6202D	UTVX6202*			
N/A		FA490R*	N/A	MD6353D	MD6353D	UTVX6353*			
FA456X*		FA456R*	FA456SV*	MD6312D	MD6312D	UTVX6312*			
FA456X*		FA456R*	FA456SV*	MD6338D	MD6338D	UTVX6338*			
FA456X*		FA456R*	FA456SV*	MD6312D	MD6312D	UTVX6312*			
FA452X*		FA452R*	FA452SV*	MD6338D	MD6338D	UTVX6338*			
FA657X*		FA657R*	FA657SV*	MD6338D	MD6338D	UTVX6338*			
FA657X*		FA657R*	FA657SV*	MD6338D	MD6338D	UTVX6338*			
FA656X*		FA656R*	FA656SV*	MD6338D	MD6338D	UTVX6338*			
FA656X*		FA656R*	FA656SV*	MD6338D	MD6338D	UTVX6338*			
FA656X*		FA656R*	FA656SV*	MD6380D	MD6380D	UTVX6380*			
N/A*		FA680R*■	N/A*	MD6397D	MD6397D	N/A*			
N/A*		FA680R*■	N/A*	MD6397D	MD6397D	N/A*			
FA669/4				MD533	MD533				
TBA				MD533	MD533				
FA669/4				MD533	MD533				
TBA				MD533	MD533				
TBA				MD533	MD533				
FA293		FA293S		N/A					
SFA86		SFA86HH		N/A					
FA209/2	FA209/2V	FA209/2HH		MD626X					
FA228		FA228HH		MD847					
FA181X		FA181HH		MD847					
FA228		FA228HH		MD847					
FA181X		FA181HH		MD847					
FA228		FA228HH		MD847					
FA228		FA228HH		MD847					
FA181X		FA181HH		MD847					
FA228		FA228HH		MD847					
SFA86		SFA86HH		N/A					
SFA86		SFA86HH		N/A					
FA303X				N/A					
FA115X		FA115R■		N/A					
FA465X		FA465R■		N/A					

Line #

FRONT

* This symbol indicates a rotor made of billet steel, and should be only used with EBC FA Kevlar® Organic or Vee pads. SAFETY NOTICE - With vehicles primarily designed for off highway use such as quads now being used on the highway, we would recommend the use of X or MXS pads for highway use and ONLY using the R and SV higher density / harder pad series for off road riding.

*-2 Sets Required. ■ - Also available in MX-S race compound. SAFETY WARNING:- DO NOT USE HH PADS ON REAR UNLESS ALSO USED ON FRONT TO AVOID BRAKE IMBALANCE

FRONT: Non-Japanese Bikes Cont'd

REAR: Non-Japanese Bikes

Line #	BRAKE ROTOR CHOICES - FRONT						DISC PAD CHOICES - REAR				BRAKE ROTOR CHOICES - REAR				
	CC Custom Rotor	CX Extreme® /Vee-Rotor	OS Series Oversize 250/280mm Rotor Kit	OSX Series Oversize 280mm Rotor Kit	Relocating Bracket for 250/280mm Rotor	SMX Series Oversize 320mm Rotor Kit	Relocating Bracket for 320mm Rotor		Semi-Sintered V-Pads™	Sintered/HH Pads/ Grooved Shoes	SV Series Severe Duty Pads	Standard Rotor	UTVX Rotor	Vintage Rotor	Contour Profile Rotor
1							N/A		FA354R*	FA354SV*	MD6275D*	UTVX6275*			
2							N/A		FA354R*	FA354SV*	MD6275D*	UTVX6275*			
3							N/A		FA314R	FA314SV	MD6200D				
4							N/A		FA313R	FA313SV	MD6200D				
5							N/A		FA354R	FA354SV	MD6201D				
6							N/A		FA354R	FA354SV	MD6201D				
7							N/A		FA354R	FA354SV	MD6201D				
8							N/A		FA313R	FA313SV	MD6170D				
9							N/A		FA354R*	FA354SV*	MD6201D*				
10							N/A		FA354R*	FA354SV*	MD6201D*				
11							FA659X		FA659R						
12															
13															
14							N/A		FA489R	N/A	MD6344D	UTVX6344			
15							FA159X*		FA159R*	FA159SV*	MD6275D*	UTVX6275*			
16							FA159X*		FA159R*	FA159SV*	MD6275D*	UTVX6275*			
17							FA159X*		FA159R*	N/A	MD6275D*	UTVX6275*			
18							N/A		FA354R*	FA354SV*	MD6275D*	UTVX6275*			
19							FA456X*		FA456R*	FA456SV*	MD6338D*	UTVX6338*			
20							FA456X*		FA456R*	FA456SV*	MD6338D*	UTVX6338*			
21							N/A		FA354R*	FA354SV*	MD6374D*	UTVX6374*			
22							FA656X*		FA656R*	FA656SV*	MD6374D*	UTVX6374*			
23							FA656X*		FA656R*	FA656SV*	MD6380D*	UTVX6380*			
24							FA656X*		FA656R*	FA656SV*	MD6397D*	N/A*			
25							FA656X*		FA656R*	FA656SV*	MD6397D*	N/A*			
26															
27															
28							FA670				MD533				
29							TBA				MD533				
30							FA670				MD533				
31							TBA				MD533				
32							TBA				MD533				
33															
34															
35							FA293	FA293S	N/A						
36							SFA54		SFA054HH		N/A				
37															
38															
39							FA213	FA213V	FA213HH		MD651				
40							N/A								
41							FA213	FA213V	FA213HH		MD651				
42							N/A								
43							FA213	FA213V	FA213HH		MD651				
44							N/A								
45							N/A								
46							FA213	FA213V	FA213HH		MD651				
47							N/A								
48															
49															
50							SFA54		SFA054HH		N/A				
51							SFA54		SFA054HH		N/A				
52															
53															
54							FA351X				N/A				
55							FA351X				N/A				
56							FA350X				N/A				

This symbol indicates a rotor made of billet steel, and should be only used with EBC FA Kevlar® Organic or Vee pads. SAFETY NOTICE - With vehicles primarily designed for off highway use such as quads now being used on the highway, we would recommend the use of X or MXS pads for highway use and ONLY using the R and SV higher density / harder pad series for off road riding.

BRAKE APPLICATIONS

*-2 Sets Required. ■ - Also available in MX-S race compound. **SAFETY WARNING:- DO NOT USE HH PADS ON REAR UNLESS ALSO USED ON FRONT TO AVOID BRAKE IMBALANCE**

FRONT: Non-Japanese Bikes

APPLICATIONS

BRAKE



SCORPA



DISC PAD CHOICES - FRONT

BRAKE ROTOR CHOICES - FRONT

			Semi-Sintered V-Pads™	Sintered/HH Pads/Grooved Shoes	SV Series Severe Duty Pads	Standard Rotor Left	Standard Rotor Right	UTVX Rotor	Vintage Rotor Left	Vintage Rotor Right	Contour Profile Rotor
TY-S 125 F	04-09	FA115X		FA115R■		N/A					
SY 175 F	05-08	FA115X		FA115R■		N/A					
TYS 175 F	06-08	FA115X		FA115R■		N/A					
SY 200 F (4T)	08-09	FA303X				N/A					
SY 250 (2T)	03-10	FA303X				N/A					
SY 250 Long Ride	05-09	FA303X				N/A					
SY 250 F	06-10	FA303X				N/A					
SY 250 FR	11	FA303X				N/A					
T-Ride 250 F	06-08	FA194		FA194HH		N/A					
T-Ride 250 F	09-10	FA465X		FA465R■		N/A					
SR 280 (2T)	11	FA303X				N/A					
4 Trick	06-08	N/A		N/A		N/A					
SDG											
50 HL Mini	04-07	TBA				TBA					
107 Speed Mini		TBA				TBA					
125 Pro Mini		TBA				TBA					
SHERCO											
0.5/0.8/1.25/2.0 (2T)	03-10	FA115X		FA115R■		N/A					
ST 1.25 (2T)	12-14	FA612X		FA612R		N/A					
2.5/2.9 (Trials) (2T)	03-09	FA303X				N/A					
2.5i Enduro	05-10	FA181X		FA181R■		N/A					
ST 2.5 (2T)	12-14	FA612X		FA612R		N/A					
290 X-Ride	12-14	FA83X		FA83R		N/A					
ST 2.9 (2T)	12-14	FA612X		FA612R		N/A					
3.2 (4T) (Trials)	05-10	FA303X				N/A					
4.5i Enduro	05-10	FA181X		FA181R■		N/A					
4.5 Supermoto	04-07	FA181X		FA181R■		N/A					
4.5i F Supermoto	08-10			FA322/4HH		N/A					
4.5i SM	12-14			FA322/4HH		N/A					
5.1i Enduro	05-10	FA181X		FA181R■		N/A					
SYM											
DD 50	02-12	SFA151				MD933D					
Fiddle 50 Drum front model	99-12	303									
Fiddle 50 Front disc model	08-11	SFA264		SFA264HH		TBA					
Jet Euro 50	99-12	SFA264		SFA264HH		MD9116D					
Jet 50 EVO	14	SFA264		SFA264HH		MD9116D					
Mio 50	05-14	SFA151				MD933D					
RS 50	04-12	SFA306				N/A					
Simply 50	07-12	SFA264		SFA264HH		TBA					
Symba 100	09-14	820									
Fiddle II 125 (AW 125 W)	08-14	SFA264		SFA264HH		TBA					
HD 125 (LH 125 W)	08-12	SFA305		SFA305HH		TBA					
HS 125/200	04-08	SFA305		SFA305HH		N/A					
Sym Wolf 150 Classic	11-14	FA86		FA86			N/A				
HD 200	08-12	SFA305		SFA305HH		TBA					
HD 200 EVO	12-14	SFA264		SFA264HH		N/A					
RD 200 EVO	12-14	SFA306				N/A					
RV 250 (LM 250 W)	07-12	SFA355/4		SFA355/4HH		TBA					
Citycom 300i (LH 300W)	08-14	SFA264		SFA264HH		TBA					
Quadlander 300	07-10	FA377X*		FA377R*		TBA	TBA				
Quadlander 600	08-10	FA54X*		FA54R*		TBA	TBA				

Line #

FRONT

⚠ This symbol indicates a rotor made of billet steel, and should be only used with EBC FA Kevlar® Organic or Vee pads. SAFETY NOTICE - With vehicles primarily designed for off highway use such as quads now being used on the highway, we would recommend the use of X or MXS pads for highway use and ONLY using the R and SV higher density / harder pad series for off road riding.

*-2 Sets Required. ■ - Also available in MX-S race compound. SAFETY WARNING:- DO NOT USE HH PADS ON REAR UNLESS ALSO USED ON FRONT TO AVOID BRAKE IMBALANCE

FRONT: Non-Japanese Bikes Cont'd

REAR: Non-Japanese Bikes

Line #	BRAKE ROTOR CHOICES - FRONT						DISC PAD CHOICES - REAR				BRAKE ROTOR CHOICES - REAR					
	CC Custom Rotor	CX Extreme® /Vee-Rotor	OS Series Oversize 250/280mm Rotor Kit	OSX Series Oversize 280mm Rotor Kit	Relocating Bracket for 250/280mm Rotor	SMX Series Oversize 320mm Rotor Kit	Relocating Bracket for 320mm Rotor		Semi-Sintered V-Pads™	Sintered/HH Pads/ Grooved Shoes	SV Series Severe Duty Pads	Standard Rotor	UTVX Rotor	Vintage Rotor	Contour Profile Rotor	CX Extreme® /Vee-Rotor
1								FA351X				N/A				
2								FA351X				N/A				
3								FA351X				N/A				
4								FA351X				N/A				
5								FA351X				N/A				
6								FA351X				N/A				
7								FA351X				N/A				
8								FA351X				N/A				
9								FA115X		FA115HH		N/A				
10								FA350X				N/A				
11								FA351X				N/A				
12								N/A		N/A		N/A				
13																
14																
15								TBA				TBA				
16								TBA				TBA				
17								TBA				TBA				
18																
19																
20								FA115X		FA115R■		N/A				
21								FA351X								
22								FA351X				N/A				
23								FA367X		FA367R■		N/A				
24								FA351X								
25								FA83X		FA83R		N/A				
26								FA351X								
27								FA351X				N/A				
28								FA367X		FA367R■		N/A				
29								FA367X		FA367R■		N/A				
30								FA367X		FA367R■		N/A				
31								FA367X		FA367R■		N/A				
32								FA367X		FA367R■		N/A				
33																
34																
35								333								
36								302								
37								303								
38								303								
39								303								
40								302								
41								TBA								
42								303								
43								303								
44								820								
45								820								
46								820								
47								820								
48								820								
49								SFA427		SFA427HH		N/A				
50								SFA427				N/A				
51								SFA427		SFA427HH		TBA				
52								SFA264		SFA264HH		TBA				
53								FA377X		FA377R		TBA				
54								FA377X		FA377R		TBA				
55																
56																

⚠ This symbol indicates a rotor made of billet steel, and should be only used with EBC FA Kevlar® Organic or Vee pads.
 SAFETY NOTICE - With vehicles primarily designed for off highway use such as quads now being used on the highway, we would recommend the use of X or MXS pads for highway use and ONLY using the R and SV higher density / harder pad series for off road riding.

BRAKE APPLICATIONS

*-2 Sets Required. ■ - Also available in MX-S race compound. **SAFETY WARNING:- DO NOT USE HH PADS ON REAR UNLESS ALSO USED ON FRONT TO AVOID BRAKE IMBALANCE**

FRONT: Non-Japanese Bikes



TGB/PEIRSPEED



DISC PAD CHOICES - FRONT

BRAKE ROTOR CHOICES - FRONT

		SFA83	Sintered/HH Pads/Grooved Shoes	SV Series Severe Duty Pads	Standard Rotor Left	Standard Rotor Right	UTVX Rotor	Vintage Rotor Left	Vintage Rotor Right	Contour Profile Rotor
Laser R5/i (49cc)	08-11	SFA83	SFA83HH		TBA					
R 50 X	06-11	SFA93			MD9115D					
Sunset 50	06-08	SFA83	SFA83HH		MD923D					
101S - 50 Key West	05-11	SFA83	SFA83HH		MD923D					
Delivery 50 (Up to Eng/No 609099)	04-05	SFA264	SFA264HH		MD923D					
Delivery 50 (From Eng/No 609100)	06-11	SFA83	SFA83HH		MD923D					
Delivery 151	04-11	SFA93			MD9115D					
Laser R9/i (151cc)	08-11	SFA93			MD9115D					
Sunset 151	06-08	SFA83	SFA83HH		MD923D					
Outback 425 C 4 x 4	07-09	FA377X*	FA377R*		N/A	N/A				
Outback 425 SE 4 x 4 Auto	07-09	FA377X*	FA377R*		N/A	N/A				
Outback 425 Real Tree Camo Edition 4 x 4 Auto	07-09	FA377X*	FA377R*		N/A	N/A				
THUMPSTAR										
Thumpstar Junior 90cc	04-07	SFA169	SFA169HH		N/A					
Thumpstar Supa 110cc	04-07	SFA169	SFA169HH		N/A					
Thumpstar Expert 125	06-07	SFA169	SFA169HH		N/A					
Thumpstar Pro 125	05-07	SFA169	SFA169HH		N/A					
T.M.										
MX Models 85/100	02-03	FA181X	FA181R■		N/A					
MX 85 JR (2T)	04	FA181X	FA181R■		N/A					
MX 85 JR (2T)	05-08	FA181X	FA181R■		N/A					
EN 125 (2T)	01-04	FA181X	FA181R■		N/A					
EN 125 (2T)	05-08	FA181X	FA181R■		N/A					
MX Models 125/250/300	02-03	FA181X	FA181R■		N/A					
SMM 125 Black Dream (2T)	04-08	N/A			N/A					
SMR 125 (2T)	05-08	FA95	FA95HH		N/A					
MX 144 (2T)	07-08	FA181X	FA181R■		N/A					
EN 250 (2T)	01-04	FA181X	FA181R■		N/A					
EN 250 (2T)	05-08	FA181X	FA181R■		N/A					
EN 250 F-ES (4T)	01-04	FA181X	FA181R■		N/A					
EN 250 F-ES (4T)	05-08	FA181X	FA181R■		N/A					
MX 250/300 (2T)	04	FA181X	FA181R■		N/A					
MX 250/300 (2T)	05-08	FA181X	FA181R■		N/A					
MX 250 F (4T)	02-04	FA181X	FA181R■		N/A					
MX 250 F (4T)	05-07	FA181X	FA181R■		N/A					
EN 300 (2T)	01-04	FA181X	FA181R■		N/A					
EN 300 (2T)	05-08	FA181X	FA181R■		N/A					
EN 450 F-ES (4T)	04	FA181X	FA181R■		N/A					
EN 450 F-ES (4T)	05-08	FA181X	FA181R■		N/A					
MX 450 F	04	FA181X	FA181R■		N/A					
MX 450 F	05-08	FA181X	FA181R■		N/A					
SMM 450 Black Dream ES (4T)	05-08	N/A			N/A					
SMR 450 F ES (4T)	05-08	FA95	FA95HH		N/A					
SMX 450 F Competition (4T)	05-08		FA322/4HH		N/A					
EN 530 F-ES (4T)	04-08	FA181X	FA181R■		N/A					
EN 530 F-ES (4T)	05-08	FA181X	FA181R■		N/A					
MX 530 F (4T)	04	FA181X	FA181R■		N/A					
MX 530 F (4T)	05-08	FA181X	FA181R■		N/A					
SMM 530 Black Dream ES (4T)	05-08	N/A			N/A					
SMR 530 F ES (4T)	05-08	FA95	FA95HH		N/A					
SMX 530 F Competition	05-08		FA322/4HH		N/A					
SMX 660 F	04	FA95	FA95HH		N/A					

Line #
1
2
3
4
5
6
7
8
9
10
11
12
13
14
15
16
17
18
19
20
21
22
23
24
25
26
27
28
29
30
31
32
33
34
35
36
37
38
39
40
41
42
43
44
45
46
47
48
49
50
51
52
53
54
55
56

APPLICATIONS
BRAKE

⊛ This symbol indicates a rotor made of billet steel, and should be only used with EBC FA Kevlar® Organic or Vee pads.
SAFETY NOTICE - With vehicles primarily designed for off highway use such as quads now being used on the highway, we would recommend the use of X or MXS pads for highway use and ONLY using the R and SV higher density / harder pad series for off road riding.

FRONT

*-2 Sets Required. ■ - Also available in MX-S race compound. SAFETY WARNING:- DO NOT USE HH PADS ON REAR UNLESS ALSO USED ON FRONT TO AVOID BRAKE IMBALANCE

FRONT: Non-Japanese Bikes Cont'd

REAR: Non-Japanese Bikes

Line #	BRAKE ROTOR CHOICES - FRONT						DISC PAD CHOICES - REAR				BRAKE ROTOR CHOICES - REAR					
	CC Custom Rotor	CX Extreme® /Vee-Rotor	OS Series Oversize 250/280mm Rotor Kit	OSX Series Oversize 280mm Rotor Kit	Relocating Bracket for 250/280mm Rotor	SMX Series Oversize 320mm Rotor Kit	Relocating Bracket for 320mm Rotor		Semi-Sintered V-Pads™	Sintered/HH Pads/ Grooved Shoes	SV Series Severe Duty Pads	Standard Rotor	UTVX Rotor	Vintage Rotor	Contour Profile Rotor	CX Extreme® /Vee-Rotor
1							897									
2							SFA83				MD9115D					
3							897									
4							897									
5							897									
6							897									
7							820									
8							820									
9							820									
10							FA377X		FA377R		N/A					
11							FA377X		FA377R		N/A					
12							FA377X		FA377R		N/A					
13																
14																
15							SFA169		SFA169HH		N/A					
16							SFA169		SFA169HH		N/A					
17							SFA169		SFA169HH		N/A					
18							SFA169		SFA169HH		N/A					
19																
20																
21							FA208X		FA208R■		N/A					
22							FA131X		FA131R■		N/A					
23							FA367X		FA367R■		N/A					
24							FA131X		FA131R■		N/A					
25							FA367X		FA367R■		N/A					
26							FA131X		FA131R■		N/A					
27							FA47		FA47HH		N/A					
28							FA367X		FA367R■		N/A					
29							FA367X		FA367R■		N/A					
30							FA131X		FA131R■		N/A					
31							FA367X		FA367R■		N/A					
32							FA131X		FA131R■		N/A					
33							FA367X		FA367R■		N/A					
34							FA131X		FA131R■		N/A					
35							FA367X		FA367R■		N/A					
36							FA131X		FA131R■		N/A					
37							FA367X		FA367R■		N/A					
38							FA131X		FA131R■		N/A					
39							FA367X		FA367R■		N/A					
40							FA131X		FA131R■		N/A					
41							FA367X		FA367R■		N/A					
42							FA131X		FA131R■		N/A					
43							FA131X		FA131R■		N/A					
44							FA47		FA47HH		N/A					
45							FA131X		FA131R■		N/A					
46							FA131X		FA131R■		N/A					
47							FA131X		FA131R■		N/A					
48							FA367X		FA367R■		N/A					
49							FA131X		FA131R■		N/A					
50							FA367X		FA367R■		N/A					
51							FA47		FA47HH		N/A					
52							FA367X		FA367R■		N/A					
53							FA367X		FA367R■		N/A					
54							FA131X		FA131R■		N/A					
55																
56																

BRAKE APPLICATIONS

⚠ This symbol indicates a rotor made of billet steel, and should be only used with EBC FA Kevlar® Organic or Vee pads. SAFETY NOTICE - With vehicles primarily designed for off highway use such as quads now being used on the highway, we would recommend the use of X or MXS pads for highway use and ONLY using the R and SV higher density / harder pad series for off road riding.

*-2 Sets Required. ■ - Also available in MX-S race compound. **SAFETY WARNING:- DO NOT USE HH PADS ON REAR UNLESS ALSO USED ON FRONT TO AVOID BRAKE IMBALANCE**

FRONT: Non-Japanese Bikes



TOMOS



DISC PAD CHOICES - FRONT

BRAKE ROTOR CHOICES - FRONT

			Semi-Sintered V-Pads™	Sintered/HH Pads/Grooved Shoes	SV Series Severe Duty Pads	Standard Rotor Left	Standard Rotor Right	UTVX Rotor	Vintage Rotor Left	Vintage Rotor Right	Contour Profile Rotor
MC 36	05-07	TBA									
Revival/TS/Streetmate	03-08	SFA116				N/A					
MC 50 Senior Pro	03-08	FA116				N/A					
MC 50 Senior	03-04/05-07	TBA									
MC 50 Senior Pro	05-07	TBA				N/A					
MC 50 Junior	03-04	TBA									
MC 50 Junior	05-07	TBA									
MC 80 (Drum Model)	05-07	TBA									
TRIUMPH (MERIDEN PRODUCED MACHINES)											
Cub 500		858									
T120 (650cc/Twin Leading Shoe)	66-70	853									
T140 V Bonneville (Drum Rear Brake/5 Speed G/Box)	73-74	FA16		FA16HH		MD656Ⓞ	MD656Ⓞ		VMD656Ⓞ	VMD656Ⓞ	
T140 V Bonneville (Discs All Round/5 Speed G/Box)	75-78	FA16		FA16HH		MD656Ⓞ	MD656Ⓞ		VMD656Ⓞ	VMD656Ⓞ	
T140 Silver Jubilee Bonneville	77	FA16		FA16HH		MD656Ⓞ	MD656Ⓞ		VMD656Ⓞ	VMD656Ⓞ	
T140 E Bonneville	78-83	FA16		FA16HH		MD656Ⓞ	MD656Ⓞ		VMD656Ⓞ	VMD656Ⓞ	
T140 D Bonneville (Lester Alloy Wheels/6 Bolt disc)	79-81	FA16		FA16HH		MD838Ⓞ	MD838Ⓞ				
T140 ES (Electric Start)	80-81	FA16		FA16HH		MD656Ⓞ	MD656Ⓞ		VMD656Ⓞ	VMD656Ⓞ	
T140 E/ES (Executive/Morris Alloy Wheels/5 Bolt disc)	81-83	FA16		FA16HH		N/A	N/A		N/A	N/A	
TSS 750 (8 Valve)	83	FA16		FA16HH		MD656Ⓞ	MD656Ⓞ		VMD656Ⓞ	VMD656Ⓞ	
TSX 750 (8 Valve)	83	FA16		FA16HH		MD656Ⓞ	MD656Ⓞ		VMD656Ⓞ	VMD656Ⓞ	
T140 Bonneville (L.F. Harris Production Bike/Brembo Calipers)	85-88	FA18*	FA18V*	FA18HH*		N/A	N/A				
Ⓞ MD656 = 4 bolt fixing. Ⓞ MD838 = 6 bolt fixing. Listing should be correct but please check quantity of bolts on the original disc and order accordingly.											
TRIUMPH (HINCKLEY PRODUCED MACHINES)											
Daytona 600	03-04	FA236*		FA236HH*		MD662X	MD662X				MD662XC*
Speedfour 600	02-05	FA236*		FA236HH*		MD662X	MD662X				MD662XC*
TT 600	00-03	FA236*		FA236HH*		MD662X	MD662X				MD662XC*
Daytona 650	05	FA236*		FA236HH*		MD662X	MD662X				MD662XC*
Daytona 675	06-08			FA347HH*		MD800X	MD800X				MD800XC*
Daytona 675 (Black Nissin Monobloc Radial Caliper & Nissin Rear)	09-12			FA491HH*		MD800X	MD800X				MD800XC*
Daytona 675 SE (Black Nissin Monobloc Radial Front Caliper & Nissin Rear)	12			FA491HH*		MD800X	MD800X				MD800XC*
Daytona 675 (Black Nissin Monobloc Radial Front Caliper & Brembo Rear/Inc ABS Models)	13-17			FA491HH*		MD852X	MD852X				MD852XC*
Daytona 675 R (Brembo calipers Front & Nissin Rear)	11-12			FA447HH*		MD800X	MD800X				MD800XC*
Daytona 675 R (Brembo calipers Front & Rear/Inc ABS Models)	13-17			FA447HH*		MD852X	MD852X				MD852XC*
Street Triple 675 (Nissin Rear Caliper) Up to Vin # 560476	07-12	FA226*		FA226HH*		MD800X	MD800X				MD800XC*
Street Triple R 675 (Nissin Front Radial/Nissin Rear Caliper)											
Up to Vin # 540476	09-12			FA347HH*		MD800X	MD800X				MD800XC*
Street Triple 675 (Brembo Rear Caliper) From Vin #560477	13-17	FA226*		FA226HH*		MD800X	MD800X				MD800XC*
Street Triple R 675 (Nissin Front Radial/Brembo Rear Caliper)											
From Vin # 560477	13-17			FA347HH*		MD800X	MD800X				MD800XC*
Street Triple RX SE 675 (Nissin Front Radial/Brembo Rear Caliper/ABS)	15			FA491HH*		MD800X	MD800X				MD800XC*
Daytona 750 (3 cyl)	92	FA236*		FA236HH*		MD640X	MD640X				
Speed Triple 750/900 (Carb Models)	94-96	FA236*		FA236HH*		MD640	MD640				
Bonneville America (790cc)	02-06	FA196	FA196V	FA196HH		MD649					
Bonneville America (790cc) Floating disc conversion						MD601LS					
Bonneville T100 (790cc & 865cc)	02-09	FA196	FA196V	FA196HH		MD649					
Bonneville T100 (790cc & 865cc) Floating disc conversion						MD601LS					
Bonneville 800 (790cc)	01-06	FA196	FA196V	FA196HH		MD649					
Bonneville 800 (790cc) Floating disc conversion						MD601LS					
Speedmaster (790cc/Carbs)	03-04	FA142*	FA142V*	FA142HH*		MD649	MD649				
Speedmaster (790cc/Carbs) Floating disc conversion						MD601LS	MD601RS				
Tiger 800 (Non ABS/Cast Wheels)	11-14	FA226*		FA226HH*		MD842X	MD842X				MD842XC*
Tiger 800 (With ABS/Cast Wheels)	11-14	FA226*		FA226HH*		MD842X	MD842X				MD842XC*
Tiger 800 XR (With ABS/Cast Wheels)	15-17	FA226*		FA226HH*		MD842X	MD842X				MD842XC*

Line #
1
2
3
4
5
6
7
8
9
10
11
12
13
14
15
16
17
18
19
20
21
22
23
24
25
26
27
28
29
30
31
32
33
34
35
36
37
38
39
40
41
42
43
44
45
46
47
48
49
50
51
52
53
54
55
56

APPLICATIONS

BRAKE

Ⓞ This symbol indicates a rotor made of billet steel, and should be only used with EBC FA Kevlar® Organic or Vee pads.

SAFETY NOTICE - With vehicles primarily designed for off highway use such as quads now being used on the highway, we would recommend the use of X or MXS pads for highway use and ONLY using the R and SV higher density / harder pad series for off road riding.

*-2 Sets Required. ■ - Also available in MX-S race compound. SAFETY WARNING:- DO NOT USE HH PADS ON REAR UNLESS ALSO USED ON FRONT TO AVOID BRAKE IMBALANCE

FRONT: Non-Japanese Bikes Cont'd

REAR: Non-Japanese Bikes

Line #	BRAKE ROTOR CHOICES - FRONT						DISC PAD CHOICES - REAR				BRAKE ROTOR CHOICES - REAR					
	CC Custom Rotor	CX Extreme® /Vee-Rotor	OS Series Oversize 250/280mm Rotor Kit	OSX Series Oversize 280mm Rotor Kit	Relocating Bracket for 250/280mm Rotor	SMX Series Oversize 320mm Rotor Kit	Relocating Bracket for 320mm Rotor		Semi-Sintered V-Pads™	Sintered/HH Pads/Grooved Shoes	SV Series Severe Duty Pads	Standard Rotor	UTVX Rotor	Vintage Rotor	Contour Profile Rotor	CX Extreme® /Vee-Rotor
1								TBA								
2								TBA								
3								FA116				N/A				
4								TBA								
5								TBA				N/A				
6								TBA								
7								TBA								
8								TBA								
9																
10																
11								858								
12								854								
13								N/A								
14								FA16		FA16HH		MD656Ⓢ		VMD656Ⓢ		
15								FA16		FA16HH		MD656Ⓢ		VMD656Ⓢ		
16								FA16		FA16HH		MD656Ⓢ		VMD656Ⓢ		
17								FA16		FA16HH		MD838Ⓢ				
18								FA16		FA16HH		MD656Ⓢ		VMD656Ⓢ		
19								FA16		FA16HH		N/A		N/A		
20								FA16		FA16HH		MD656Ⓢ		VMD656Ⓢ		
21								FA16		FA16HH		MD656Ⓢ		VMD656Ⓢ		
22								FA18	FA18V	FA18HH		N/A				
23																
24																
25																
26		VR662BLK*						FA140	FA140V	FA140HH		MD648		MD648C	VR648	
27		VR662BLK*						FA140	FA140V	FA140HH		MD648		MD648C	VR648	
28		VR662BLK*						FA140	FA140V	FA140HH		MD648		MD648C	VR648	
29		VR662BLK*						FA140	FA140V	FA140HH		MD648		MD648C	VR648	
30		VR800BLK*						FA140	FA140V	FA140HH		MD648		MD648C	VR648	
31		VR800BLK*						FA140	FA140V	FA140HH		MD648		MD648C	VR648	
32		VR800BLK*						FA140	FA140V	FA140HH		MD648		MD648C	VR648	
33																
34		VR800BLK*						FA213	FA213V	FA213HH		MD851		MD851C		
35		VR800BLK*						FA140	FA140V	FA140HH		MD648		MD648C	VR648	
36								FA213	FA213V	FA213HH		MD851		MD851C		
37		VR800BLK*						FA140	FA140V	FA140HH		MD648		MD648C	VR648	
38																
39		VR800BLK*						FA140	FA140V	FA140HH		MD648		MD648C	VR648	
40		VR800BLK*						FA213	FA213V	FA213HH		MD851		MD851C		
41																
42		VR800BLK*						FA213	FA213V	FA213HH		MD851		MD851C		
43		VR800BLK*						FA213	FA213V	FA213HH		MD851		MD851C		
44		VR640BLK*						FA215/2	FA215/2V	FA215/2HH		MD641			VR641	
45								FA215/2	FA215/2V	FA215/2HH		MD641			VR641	
46		MD649CX						FA214/2	FA214/2V	FA214/2HH		MD643			VR643	
47																
48		MD649CX						FA214/2	FA214/2V	FA214/2HH		MD663			VR663	
49																
50		MD649CX						FA214/2	FA214/2V	FA214/2HH		MD663			VR663	
51																
52		MD649CX*						FA214/2	FA214/2V	FA214/2HH		MD643			VR643	
53																
54		VR842BLK*						FA140	FA140V	FA140HH		MD663		MD663C	VR663	
55		VR842BLK*						FA140	FA140V	FA140HH		MD820		MD820C	VR820	
56		VR842BLK*						FA140	FA140V	FA140HH		MD820		MD820C	VR820	

Ⓢ This symbol indicates a rotor made of billet steel, and should be only used with EBC FA Kevlar® Organic or Vee pads.
SAFETY NOTICE - With vehicles primarily designed for off highway use such as quads now being used on the highway, we would recommend the use of X or MXS pads for highway use and ONLY using the R and SV higher density / harder pad series for off road riding.

BRAKE APPLICATIONS

*-2 Sets Required. ■ - Also available in MX-S race compound. **SAFETY WARNING:- DO NOT USE HH PADS ON REAR UNLESS ALSO USED ON FRONT TO AVOID BRAKE IMBALANCE**

FRONT: Non-Japanese Bikes



TRIUMPH
(HINCKLEY PRODUCED MACHINES)



DISC PAD CHOICES - FRONT

BRAKE ROTOR CHOICES - FRONT

FA226*		FA226HH*		MD842X	MD842X				MD842XC*
FA226*		FA226HH*		MD842X	MD842X				MD842XC*
FA226*		FA226HH*		MD842X	MD842X				MD842XC*
FA226*		FA226HH*		MD842X	MD842X				MD842XC*
FA226*		FA226HH*		MD842X	MD842X				MD842XC*
FA226*		FA226HH*		MD842X	MD842X				MD842XC*
FA226*		FA226HH*		MD842X	MD842X				MD842XC*
FA226*		FA226HH*		MD842X	MD842X				MD842XC*
FA226*		FA226HH*		MD842X	MD842X				MD842XC*
FA196	FA196V	FA196HH		MD649					
				MD601LS					
FA196	FA196V	FA196HH		MD822					
FA196	FA196V	FA196HH		MD822					
FA196	FA196V	FA196HH		MD649					
				MD601LS					
FA196	FA196V	FA196HH		MD821					
				MD821X					MD821XC
FA196	FA196V	FA196HH		MD821					
				MD821X					MD821XC
FA196	FA196V	FA196HH		MD822					
FA142	FA142V	FA142HH		MD873					
FA196	FA196V	FA196HH		MD822					
FA142	FA142V	FA142HH		MD873					
FA196	FA196V	FA196HH		MD822					
FA196	FA196V	FA196HH		MD822					
FA196	FA196V	FA196HH		MD822					
FA196	FA196V	FA196HH		MD821					
				MD821X					MD821XC
FA142	FA142V	FA142HH		TBA					
FA142*	FA142V*	FA142HH*		MD649	MD649				
				MD601LS	MD601RS				
FA142*	FA142V*	FA142HH*		MD649	MD649				
				MD601LS	MD601RS				
FA196	FA196V	FA196HH		MD822					
FA196	FA196V	FA196HH		MD821					
					MD821X				
FA196	FA196V	FA196HH		MD642LS					
				MD629X					MD629XC
FA214	FA214V	FA214HH		MD644					
FA215	FA215V	FA215HH			MD644				
FA196*	FA196V*	FA196HH*		MD649	MD649				
				MD601LS	MD601RS				
FA196	FA196V*	FA196HH		MD649					
				MD601LS					
FA196	FA196V	FA196HH		MD822					
				MD822X					MD821XC
FA196	FA196V	FA196HH		MD822					
				MD822X					MD821XC
FA190*		FA190HH*		MD640	MD640				
FA196	FA196V	FA196HH		MD642LS					
				MD629X					
FA236*		FA236HH*		MD647X	MD647X				MD647XC*
FA196*	FA196V*	FA196HH*		MD649	MD649				

Line #
1
2
3
4
5
6
7
8
9
10
11
12
13
14
15
16
17
18
19
20
21
22
23
24
25
26
27
28
29
30
31
32
33
34
35
36
37
38
39
40
41
42
43
44
45
46
47
48
49
50
51
52
53
54
55
56

APPLICATIONS

BRAKE

⚠ This symbol indicates a rotor made of billet steel, and should be only used with EBC FA Kevlar® Organic or Vee pads.
SAFETY NOTICE - With vehicles primarily designed for off highway use such as quads now being used on the highway, we would recommend the use of X or MXS pads for highway use and ONLY using the R and SV higher density / harder pad series for off road riding.

FRONT

*-2 Sets Required. ■ - Also available in MX-S race compound. **SAFETY WARNING:- DO NOT USE HH PADS ON REAR UNLESS ALSO USED ON FRONT TO AVOID BRAKE IMBALANCE**

FRONT: Non-Japanese Bikes Cont'd

REAR: Non-Japanese Bikes

Line #	BRAKE ROTOR CHOICES - FRONT						DISC PAD CHOICES - REAR				BRAKE ROTOR CHOICES - REAR					
	CC Custom Rotor	CX Extreme® /Vee-Rotor	OS Series Oversize 250/280mm Rotor Kit	OSX Series Oversize 280mm Rotor Kit	Relocating Bracket for 250/280mm Rotor	SMX Series Oversize 320mm Rotor Kit	Relocating Bracket for 320mm Rotor		Semi-Sintered V-Pads™	Sintered/HH Pads/ Grooved Shoes	SV Series Severe Duty Pads	Standard Rotor	UTVX Rotor	Vintage Rotor	Contour Profile Rotor	CX Extreme® /Vee-Rotor
1		VR842BLK*						FA140	FA140V	FA140HH		MD820			MD820C	VR820
2		VR842BLK*						FA140	FA140V	FA140HH		MD820			MD820C	VR820
3		VR842BLK*						FA140	FA140V	FA140HH		MD820			MD820C	VR820
4		VR842BLK*						FA140	FA140V	FA140HH		MD663			MD663C	VR663
5		VR842BLK*						FA140	FA140V	FA140HH		MD820			MD820C	VR820
6		VR842BLK*						FA140	FA140V	FA140HH		MD820			MD820C	VR820
7		VR842BLK*						FA140	FA140V	FA140HH		MD820			MD820C	VR820
8		VR842BLK*						FA140	FA140V	FA140HH		MD820			MD820C	VR820
9		VR842BLK*						FA140	FA140V	FA140HH		MD820			MD820C	VR820
10		MD649CX						FA214/2	FA214/2V	FA214/2HH		MD643				VR643
11																
12								FA214/2	FA214/2V	FA214/2HH		MD643				
13								FA214/2	FA214/2V	FA214/2HH		MD643				
14		MD649CX						FA214/2	FA214/2V	FA214/2HH		MD663				VR663
15																
16								FA214/2	FA214/2V	FA214/2HH		MD663			MD663C	
17																
18								FA214/2	FA214/2V	FA214/2HH		MD663			MD663C	
19																
20								FA214/2	FA214/2V	FA214/2HH		MD663				
21								FA214/2	FA214/2V	FA214/2HH		MD874				
22								FA214/2	FA214/2V	FA214/2HH		MD663				
23								FA214/2	FA214/2V	FA214/2HH		MD874				
24								FA214/2	FA214/2V	FA214/2HH		MD663				
25								FA214/2	FA214/2V	FA214/2HH		MD663				
26								FA214/2	FA214/2V	FA214/2HH		MD663				
27								FA214/2	FA214/2V	FA214/2HH		MD663			MD663C	
28																
29								FA140	FA140V	FA140HH		MD874				
30		MD649CX*						FA214/2	FA214/2V	FA214/2HH		MD643				VR643
31																
32		MD649CX*						FA214/2	FA214/2V	FA214/2HH		MD643				VR643
33																
34																
35								FA214/2	FA214/2V	FA214/2HH		MD643				
36																
37								FA214/2	FA215/2V	FA214/2HH		MD643				
38																
39		MD821XC														
40								FA196	FA196V	FA196HH		MD643				VR643
41		VR629BLK														
42								FA215/2	FA214V	FA215/2HH		MD645				
43																
44		MD649CX*										MD643				VR643
45																
46		MD649CX						FA214/2	FA214/2V	FA214/2HH		MD663				VR663
47																
48								FA214/2	FA214/2V	FA214/2HH		MD663				
49																
50								FA214/2	FA214/2V	FA214/2HH		MD663				
51																
52		VR640BLK*						FA215/2	FA215/2V	FA215/2HH		MD641				VR641
53								FA196	FA196V	FA196HH		MD643				VR643
54																
55								FA214/2	FA214/2V	FA214/2HH		MD648			MD648C	VR648
56		MD649CX*						FA196	FA196V	FA196HH		MD643				VR643

REAR

* This symbol indicates a rotor made of billet steel, and should be only used with EBC FA Kevlar® Organic or Vee pads.

SAFETY NOTICE - With vehicles primarily designed for off highway use such as quads now being used on the highway, we would recommend the use of X or MXS pads for highway use and ONLY using the R and SV higher density / harder pad series for off road riding.

BRAKE APPLICATIONS

*-2 Sets Required. ■ - Also available in MX-S race compound. **SAFETY WARNING:- DO NOT USE HH PADS ON REAR UNLESS ALSO USED ON FRONT TO AVOID BRAKE IMBALANCE**

FRONT: Non-Japanese Bikes

APPLICATIONS

BRAKE



TRIUMPH
(HINCKLEY PRODUCED MACHINES)



DISC PAD CHOICES - FRONT

BRAKE ROTOR CHOICES - FRONT

		Semi-Sintered V-Pads™	Sintered/HH Pads/Grooved Shoes	SV Series Severe Duty Pads	Standard Rotor Left	Standard Rotor Right	UTVX Rotor	Vintage Rotor Left	Vintage Rotor Right	Contour Profile Rotor
Thunderbird Sport Floating disc conversion					MD601LS	MD601RS				
Daytona 900 (3 cyl) 93-96	FA236*		FA236HH*		MD640	MD640				
Street Twin (900cc) 16	FA142		FA142HH		MD873					
Street Twin (900cc) Floating disc conversion					MD873X					
Street Cup (900cc) 17	FA142	FA142V	FA142HH		TBA					
Street Twin (900cc) 16-17	FA142	FA142V	FA142HH		MD873					
Street Twin (900cc) Floating disc conversion					MD873X					
Thunderbird 95-03	FA196	FA196V	FA196HH		MD642LS					
Thunderbird Floating disc conversion					MD629X					
Thruxton 900 04-15	FA142	FA142V	FA142HH		MD629X					MD629XC
Thruxton 900 SE 12	FA142	FA142V	FA142HH		MD629X					MD629XC
Thruxton 900 Ace Café SE 14-15	FA142	FA142V	FA142HH		MD629X					MD629XC
Trident 900 Left 92-98	FA214	FA214V	FA214HH		MD646LS					
Trident 900 Right	FA215	FA215V	FA215HH			MD646RS				
Trophy 900 (3 cyl) (up to VIN 9082) Left 92-93	FA214	FA214V	FA214HH		MD646LS					
Trophy 900 (3 cyl) (up to VIN 9082) Right	FA215	FA215V	FA215HH			MD646RS				
Trophy 900 (3 cyl) (from VIN 9083) 94-01	FA236*		FA236HH*		MD640	MD640				
Daytona 955i (6 bolt) (single sided swinging arm) front disc 98-00	FA236*		FA236HH*		MD647X	MD647X				MD647XC*
Daytona 955i (from VIN132513) (5 bolt) (Single sided s/arm) 01-04	FA236*		FA236HH*		MD669X	MD669X				MD669XC*
Daytona 955i (from VIN132513) (5 bolt front disc) (Double sided s/arm) 01-04	FA236*		FA236HH*		MD669X	MD669X				MD669XC*
Speed Triple (Efi 955cc - 6 Bolt Front Disc) 99-04	FA236*		FA236HH*		MD647X	MD647X				MD647XC*
T595 Daytona (6 bolt) front disc 97	FA236*		FA236HH*		MD647X	MD647X				MD647XC*
Tiger 955icc (Spoke wheel) (up to VIN 198874) 99-04	FA196*	FA196V*	FA196HH*		MD649	MD649				
Tiger 955icc (Spoke wheel) (up to VIN 198874) Floating disc conversion 99-04					MD601LS	MD601RS				
Tiger 955icc (cast wheel model) (from VIN 198875) 04-06	FA196*	FA196V*	FA196HH*		MD676	MD676				
Daytona 1000 (4 cyl) 92	FA236*		FA236HH*		MD640	MD640				
Speed Triple (1050cc - Nissin Radial F/Caliper/220mm R/Disc) 05-06			FA347HH*		MD679X	MD679X				MD679XC*
Speed Triple (1050cc - 4 Pad Brembo F/Caliper /220mm R/Disc/Non ABS Model) 07-09			FA322/4HH*		MD817X	MD817X				MD679XC*
Speed Triple (1050cc - 4 Pad Brembo F/Caliper /220mm R/Disc/ABS Model) 07-09			FA322/4HH*		MD817X	MD817X				MD679XC*
Speed Triple (1050cc - 4 Pad Brembo F/Caliper /220mm R/Disc/Non ABS Model) 10-12			FA604/4HH*		MD817X	MD817X				MD679XC*
Speed Triple (1050cc - 4 Pad Brembo F/Caliper /220mm R/Disc/ABS Model) 10-12			FA604/4HH*		MD817X	MD817X				MD679XC*
Speed Triple R (1050cc - 2 Pad Brembo F/Caliper/255mm R/Disc/Non ABS Model) 13-15			FA447HH*		MD679X	MD679X				MD679XC*
Speed Triple R (1050cc - 2 Pad Brembo F/Caliper/255mm R/Disc/ABS Model) 13-17			FA447HH*		MD679X	MD679X				MD679XC*
Speed Triple S (1050cc - 2 Pad Brembo F/Caliper /255mm R/Disc/ABS Model) 16-17			FA447HH*		MD679X	MD679X				MD679XC*
Sprint (All carb models) Up to VIN 9082 Left 93	FA214	FA214V	FA214HH		MD646X					
Sprint (All carb models) Up to VIN 9082 Right	FA215	FA215V	FA215HH			MD646RS				
Sprint (All carb models) from VIN 9083 94-98	FA236*		FA236HH*		MD640X	MD640X				
Sprint RS (up to VIN 139276) (6 bolt front disc) (double sided swinging arm) 99-01	FA236*		FA236HH*		MD647X	MD647X				MD647XC*
Sprint RS (from VIN 139277) (6 bolt front disc) FA215/2V Note: up to VIN 161317 double sided swinging arm 02	FA236*		FA236HH*		MD647X	MD647X				MD647XC*
Sprint RS (from VIN 139277) (Single sided swing arm up to VIN 161317) (6 bolt front disc) Note: from VIN 161318 double sided swinging arm 03-04	FA236*		FA236HH*		MD647X	MD647X				MD647XC*
Sprint GT (1050cc/ABS) 10-11	FA236*		FA236HH*		MD817X	MD817X				MD817XC*
Sprint GT SE (1050cc/ABS) 13-16	FA236*		FA236HH*		MD817X	MD817X				MD817XC*
Sprint ST 955i (Front Disc With Offset/6 Bolt Fixing) 99-04	FA236*		FA236HH*		MD647X	MD647X				MD647XC*
Sprint ST 1050 (5 Spoke Wheel/Non ABS/ F Disc With Offset/5 Bolt Fixing) Vin 208167> 05-10	FA236*		FA236HH*		MD669X	MD669X				MD669XC*

Line #

* This symbol indicates a rotor made of billet steel, and should be only used with EBC FA Kevlar® Organic or Vee pads.
 SAFETY NOTICE - With vehicles primarily designed for off highway use such as quads now being used on the highway, we would recommend the use of X or MXS pads for highway use and ONLY using the R and SV higher density / harder pad series for off road riding.

FRONT

*-2 Sets Required. ■ - Also available in MX-S race compound. **SAFETY WARNING:- DO NOT USE HH PADS ON REAR UNLESS ALSO USED ON FRONT TO AVOID BRAKE IMBALANCE**

FRONT: Non-Japanese Bikes Cont'd

REAR: Non-Japanese Bikes

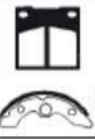
Line #	BRAKE ROTOR CHOICES - FRONT						DISC PAD CHOICES - REAR				BRAKE ROTOR CHOICES - REAR					
	CC Custom Rotor	CX Extreme® /Vee-Rotor	OS Series Oversize 250/280mm Rotor Kit	OSX Series Oversize 280mm Rotor Kit	Relocating Bracket for 250/280mm Rotor	SMX Series Oversize 320mm Rotor Kit	Relocating Bracket for 320mm Rotor		Semi-Sintered V-Pads™	Sintered/HH Pads/ Grooved Shoes	SV Series Severe Duty Pads	Standard Rotor	UTVX Rotor	Vintage Rotor	Contour Profile Rotor	CX Extreme® /Vee-Rotor
1																
2		VR640BLK*						FA215/2	FA215/2V	FA215/2HH		MD641				VR641
3								FA214/2		FA214/2HH		MD874				
4																
5								FA214/2	FA214/2V	FA214/2HH		MD874				
6								FA214/2	FA214/2V	FA214/2HH		MD874				
7																
8								FA196	FA196V	FA196HH		MD643				VR643
9		VR629BLK														
10		VR629BLK						FA214/2	FA214/2V	FA214/2HH		MD663		MD663C		VR663
11		VR629BLK						FA214/2	FA214/2V	FA214/2HH		MD663		MD663C		VR663
12		VR629BLK						FA214/2	FA214/2V	FA214/2HH		MD663		MD663C		VR663
13		VR646BLK						FA215/2	FA215/2V	FA215/2HH		MD641				VR641
14		VR646BLK														
15		VR646BLK						FA215/2	FA215/2V	FA215/2HH		MD641				VR641
16		VR646BLK														
17		VR640BLK*						FA215/2	FA215/2V	FA215/2HH		MD641				VR641
18		VR647BLK*						FA214/2	FA214/2V	FA214/2HH		MD648		MD648C		VR648
19		VR669BLK*						FA140	FA140V	FA140HH		MD648		MD648C		
20		VR669BLK*						FA140	FA140V	FA140HH		MD648		MD648C		
21								FA214/2	FA214/2V	FA214/2HH		MD648		MD648C		VR648
22		VR647BLK*						FA214/2	FA214/2V	FA214/2HH		MD648		MD648C		VR648
23		MD649CX*						FA196	FA196V	FA196HH		MD643				VR643
24																
25								FA215/2	FA215/2V	FA215/2HH		MD677				
26		VR640BLK*						FA215/2	FA215/2V	FA215/2HH		MD641				VR641
27								FA214/2	FA214/2V	FA214/2HH		MD648		MD648C		VR648
28																
29								FA214/2	FA214/2V	FA214/2HH		MD648		MD663C		VR663
30																
31								FA214/2	FA214/2V	FA214/2HH		MD648				
32																
33								FA214/2	FA214/2V	FA214/2HH		MD663		MD663C		VR663
34																
35								FA214/2	FA214/2V	FA214/2HH		MD820				
36																
37								FA214/2	FA214/2V	FA214/2HH		MD663		MD663C		VR648
38																
39								FA214/2	FA214/2V	FA214/2HH		TBA				
40																
41								FA214/2	FA214/2V	FA214/2HH		TBA				
42		VR646BLK						FA215/2		FA215/2HH		MD641				VR641
43		VR646BLK														
44		VR640BLK*						FA215/2	FA215/2V	FA215/2HH		MD641				VR641
45																
46		VR647BLK*						FA215/2	FA215/2V	FA215/2HH		MD663		MD663C		VR663
47																
48		VR647BLK*						FA215/2		FA215/2HH		MD663		MD663C		VR663
49																
50		VR647BLK*						FA214/2	FA214/2V	FA214/2HH		MD663		MD663C		VR663
51		VR817BLK*						FA214/2	FA214/2V	FA214/2HH		MD820		MD820C		VR820
52		VR817BLK*						FA214/2	FA214/2V	FA214/2HH		MD820		MD820C		VR820
53								FA214/2	FA214/2V	FA214/2HH		MD663		MD663C		VR663
54																
55		VR669BLK*						FA214/2	FA214/2V	FA214/2HH		MD663		MD663C		VR663
56																

REAR

⚠ This symbol indicates a rotor made of billet steel, and should be only used with EBC FA Kevlar® Organic or Vee pads.
 SAFETY NOTICE - With vehicles primarily designed for off highway use such as quads now being used on the highway, we would recommend the use of X or MXS pads for highway use and ONLY using the R and SV higher density / harder pad series for off road riding.

BRAKE APPLICATIONS

*-2 Sets Required. ■ - Also available in MX-S race compound. **SAFETY WARNING:- DO NOT USE HH PADS ON REAR UNLESS ALSO USED ON FRONT TO AVOID BRAKE IMBALANCE**

FRONT: Non-Japanese Bikes

APPLICATIONS

BRAKE



DISC PAD CHOICES - FRONT

BRAKE ROTOR CHOICES - FRONT

	Semi-Sintered V-Pads™	Sintered/HH Pads/Grooved Shoes	SV Series Severe Duty Pads	Standard Rotor Left	Standard Rotor Right	UTVX Rotor	Vintage Rotor Left	Vintage Rotor Right	Contour Profile Rotor
Sprint ST 1050 (5 Spoke Wheel/ABS/									
F Disc With Offset/5 Bolt Fixing) Vin 208167>	05-10	FA236*	FA236HH*	MD669X	MD669X				MD669XC*
Sprint ST 1050i (Non ABS Model - No Offset On Front Disc)	11-12	FA236*	FA236HH*	MD817X	MD817X				MD817XC*
Sprint ST 1050i (ABS Model - No Offset On Front Disc)	11-12	FA236*	FA236HH*	MD817X	MD817X				MD817XC*
Tiger 1050 (Radial Caliper)	07-15		FA347HH*	MD679X	MD679X				MD679XC*
Tiger 1050 SE (Radial Caliper/ABS)	11-13		FA347HH*	MD679X	MD679X				MD679XC*
Tiger 1050 Sport (Radial Caliper/ABS)	13-17		FA347HH*	MD679X	MD679X				MD679XC*
Bonneville T120 (1200cc)	16-17	FA142*	FA142V*	FA142HH*	MD873	MD873			
Bonneville T120 (1200cc) Floating disc conversion				MD873X	MD873X				
Bonneville T120 Black (1200cc)	16-17	FA142*	FA142V*	FA142HH*	MD873	MD873			
Bonneville T120 Black (1200cc) Floating disc conversion				MD873X	MD873X				
Daytona 1200 (4 cyl)	93-98	FA236*		FA236HH*	MD640	MD640			
Thrupton (1200cc)	16-17	FA142*	FA142V*	FA142HH*	MD873	MD873			
Thrupton (1200cc) Floating disc conversion				MD873X	MD873X				
Thrupton R (1200cc)	16-17			FA447HH*	TBA	TBA			
Trophy 1200 (4 cyl) (up to VIN 4901)	Left 92-93	FA214	FA214V	FA214HH	MD646LS				
	Right	FA215	FA215V	FA215HH		MD646RS			
Trophy 1200 (4 cyl) (from VIN 4902)	94-01	FA236*		FA236HH*	MD640X	MD640X			
Tiger Explorer 1200 (1215cc/Cast Wheels)	12-15	FA236*		FA236HH*	MD842X	MD842X			MD842XC*
Tiger Explorer XC 1200									
(Up to Vin # 740276/1215cc/Cast & Spoke Wheels)	13-15	FA236*		FA236HH*	MD842X	MD842X			MD842XC*
Tiger Explorer XC 1200									
(Vin # 740277 onwards/1215cc/Spoke Wheels)	16-17		FA630V*	FA630HH*		MD842X	MD842X		MD842XC*
Tiger Explorer XCa 1200 (1215cc/Spoke Wheels)	16-17		FA630V*	FA630HH*		MD842X	MD842X		MD842XC*
Tiger Explorer XCx 1200 (1215cc/Spoke Wheels/STD & Low)	16-17		FA630V*	FA630HH*		MD842X	MD842X		MD842XC*
Tiger Explorer XR 1200 (1215cc/Cast Wheels)	16-17		FA630V*	FA630HH*		MD842X	MD842X		MD842XC*
Tiger Explorer XRx 1200 (1215cc/Cast Wheels/STD & Low)	16-17		FA630V*	FA630HH*		MD842X	MD842X		MD842XC*
Tiger Explorer XRt 1200 (1215cc/Cast Wheels)	16-17		FA630V*	FA630HH*		MD842X	MD842X		MD842XC*
Trophy SE (1215cc)	13-17			FA423/4HH*	MD817X	MD817X			MD817XC*
Rocket III (2300cc)	04-09			FA236HH*	MD669X	MD669X			MD669XC*
Rocket III Classic (2300cc)	07-09			FA236HH*	MD669X	MD669X			MD669XC*
Rocket III Roadster (2300cc)	11-17			FA236HH*	TBA	TBA			
Rocket III Touring (2300cc) ABS & Non ABS	09-17			FA236HH*	TBA	TBA			
Thunderbird (1600cc/Cast wheel)	09-17	FA236*		FA236HH*		MD825	MD825		
Thunderbird (1600cc/Windscreen)	12	FA236*		FA236HH*		MD825	MD825		
Thunderbird Commander (1700cc/Cast wheel)	14-17	FA236*		FA236HH*		MD825	MD825		
Thunderbird LT (1700cc/Cast wheel)	14-17	FA236*		FA236HH*		MD825	MD825		
Thunderbird Storm (1700cc/Cast wheel)	09-17	FA236*		FA236HH*		MD825	MD825		
Thunderbird NightStorm (1700cc/Cast wheel)	09-17	FA236*		FA236HH*	MD825	MD825			
U.M. (UNITED MOTORS)									
Dirt Tracker 50 (DT 50)	00-05								
DTF 50	06-08	SFA169		SFA169HH	N/A				
Moontrax 50 R	03-06	TBA*							
Squirt 50	04-05	TBA*							
Xpeed 50 Special Edition	00-05	SFA83		SFA83HH	MD923D				
Xpeed 50 R	07-08	SFA83		SFA83HH	N/A				
Zyclone 50	04-05	SFA235			MD923D				
Dirt Thrasher 90	04-05	TBA*							
DTF 90	06-08	SFA264		SFA264HH	N/A				
Earthlander 90 R	05-06	TBA*							
Moontrax 90 R	03-06	TBA*							
Reptile 90	00-05	TBA*							
DTF 110	06-08	SFA264		SFA264HH	N/A				
Dirt Tracker 125/200 (DT 125/200)	00-05	FA56							
Matrix 150 XX (Single piston caliper)	05-06	SFA54		SFA54HH		N/A			

Line #

FRONT

* This symbol indicates a rotor made of billet steel, and should be only used with EBC FA Kevlar® Organic or Vee pads. SAFETY NOTICE - With vehicles primarily designed for off highway use such as quads now being used on the highway, we would recommend the use of X or MXS pads for highway use and ONLY using the R and SV higher density / harder pad series for off road riding.

*-2 Sets Required. ■ - Also available in MX-S race compound. SAFETY WARNING:- DO NOT USE HH PADS ON REAR UNLESS ALSO USED ON FRONT TO AVOID BRAKE IMBALANCE

FRONT: Non-Japanese Bikes Cont'd

REAR: Non-Japanese Bikes

Line #	BRAKE ROTOR CHOICES - FRONT						DISC PAD CHOICES - REAR				BRAKE ROTOR CHOICES - REAR					
	CC Custom Rotor	CX Extreme® /Vee-Rotor	OS Series Oversize 250/280mm Rotor Kit	OSX Series Oversize 280mm Rotor Kit	Relocating Bracket for 250/280mm Rotor	SMX Series Oversize 320mm Rotor Kit	Relocating Bracket for 320mm Rotor		Semi-Sintered V-Pads™	Sintered/HH Pads/Grooved Shoes	SV Series Severe Duty Pads	Standard Rotor	UTVX Rotor	Vintage Rotor	Contour Profile Rotor	CX Extreme® /Vee-Rotor
1																
2		VR669BLK*						FA214/2	FA214/2V	FA214/2HH		MD820			MD820C	VR820
3		VR817BLK*						FA214/2	FA214/2V	FA214/2HH		MD820			MD820C	VR820
4		VR817BLK*						FA214/2	FA214/2V	FA214/2HH		MD820			MD820C	VR820
5		VR679BLK*						FA214/2	FA214/2V	FA214/2HH		MD663				VR663
6		VR679BLK*						FA214/2	FA214/2V	FA214/2HH		MD663				VR663
7		VR679BLK*						FA214/2	FA214/2V	FA214/2HH		MD663				VR663
8								FA214/2	FA214/2V	FA214/2HH		TBA				
9																
10								FA214/2	FA214/2V	FA214/2HH		TBA				
11																
12		VR640BLK*						FA215/2	FA215/2V	FA215/2HH		MD641				VR641
13								FA214/2	FA214/2V	FA214/2HH		MD851				
14																
15								FA214/2	FA214/2V	FA214/2HH		MD851				
16		VR646BLK						FA215/2	FA215/2V	FA215/2HH		MD641				VR641
17		VR646BLK														
18		VR640BLK*						FA215/2	FA215/2V	FA215/2HH		MD641				VR641
19		VR842BLK*						FA214/2	FA214/2V	FA214/2HH		MD863				TBA
20																
21		VR842BLK*						FA214/2	FA214/2V	FA214/2HH		MD863				TBA
22																
23		VR842BLK*						FA214/2	FA214/2V	FA214/2HH		MD863				TBA
24		VR842BLK*						FA214/2	FA214/2V	FA214/2HH		MD863				TBA
25		VR842BLK*						FA214/2	FA214/2V	FA214/2HH		MD863				TBA
26		VR842BLK*						FA214/2	FA214/2V	FA214/2HH		MD863				TBA
27		VR842BLK*						FA214/2	FA214/2V	FA214/2HH		MD863				TBA
28		VR842BLK*						FA214/2	FA214/2V	FA214/2HH		MD863				TBA
29								FA214/2	FA214/2V	FA214/2HH		TBA				
30		VR669BLK*							FA209/2V	FA209/2HH		MD699☼			N/A	N/A
31		VR669BLK*							FA209/2V	FA209/2HH		MD699☼			N/A	N/A
32									FA209/2V	FA209/2HH		MD699☼				
33									FA209/2V	FA209/2HH		MD699☼				
34									FA209/2V	FA209/2HH		MD831				
35									FA209/2V	FA209/2HH		MD831				
36									FA209/2V	FA209/2HH		MD831				
37									FA209/2V	FA209/2HH		MD831				
38									FA209/2V	FA209/2HH		MD831				
39										FA209/2HH		MD831				
40																
41																
42																
43								TBA								
44								FA83X		FA83R		N/A				
45								TBA								
46								503								
47								TBA								
48								504								
49								TBA								
50								TBA								
51								FA83X		FA83R		N/A				
52								FA83X		FA83R		N/A				
53								TBA								
54								TBA								
55																
56								TBA				TBA				

☼ This symbol indicates a rotor made of billet steel, and should be only used with EBC FA Kevlar® Organic or Vee pads.
 SAFETY NOTICE - With vehicles primarily designed for off highway use such as quads now being used on the highway, we would recommend the use of X or MXS pads for highway use and ONLY using the R and SV higher density / harder pad series for off road riding.

BRAKE APPLICATIONS

*-2 Sets Required. ■ - Also available in MX-S race compound. **SAFETY WARNING:- DO NOT USE HH PADS ON REAR UNLESS ALSO USED ON FRONT TO AVOID BRAKE IMBALANCE**

FRONT: Non-Japanese Bikes



U.M. (UNITED MOTORS)



DISC PAD CHOICES - FRONT

BRAKE ROTOR CHOICES - FRONT

											Line #
		SFA323	SFA323HH								
Matrix II - 150	07-08	TBA				N/A					1
Matrix II - 150 Handbrake Shoes	07-08										2
Powermax 150 XX (Single piston caliper)	05-06	SFA54	SFA54HH			N/A					3
Powermax 150 XX (Single piston caliper) Handbrake Shoes	05-06	TBA									4
Powermax 150 XX (Two piston caliper)	05-06	SFA323	SFA323HH			N/A					5
Powermax 150 XX (Two piston caliper) Handbrake Shoes	05-06	TBA									6
DSF 200	06-08	FA135X	FA135R■		N/A						7
Duel Sport Moto 2000 (DS 200)	00-05	FA56									8
DTF 200	06-08	FA135X	FA135R■		N/A						9
Earthlander 200	05-06	TBA*									10
Renegade 200	03-06	FA196	FA196HH		TBA						11
SMF 200	08	FA135X	FA135R■		N/A						12
V2C 250 T	06-08	FA86	FA86HH		N/A						13
V2S 250 R	06-08	FA86*	FA86HH*		MD691	MD691					14
Xpeed 250 i	08	SFA228	SFA228HH		N/A						15
	Left	SFA197	SFA197HH			N/A					16
	Right	TBA*			N/A	N/A					17
Bull 320 Side x Side	08	FA54X*	FA54R■		N/A	N/A					18
MTX 450	08	FA86*	FA86HH*		N/A	N/A					19
V2C 650 S	06-08	FA86*	FA86HH*		N/A	N/A					20
V2S 650 R	06-08	FA86*	FA86HH*		MD690	MD690				MD690C*	21
UNISON											
Desert Cat Mini 50 (2T)	04-	346*	346G*								22
Desert Cat 70/90/100 (4T)	04-	346*	346G*								23
Desert Cat 90 (2T)	04-	346*	346G*								24
Desert Cat 150	04-	FA83X*	FA83R		N/A	N/A					25
Black Widow 150	04-	FA83X*	FA83R		N/A	N/A					26
Mobility 250	04-	FA83X*	FA83R		N/A	N/A					27
Rage 250	04-	TBA*	TBA*		N/A	N/A					28
Mobility 500 (Side x Side)	12-	FA453X*	FA453R*		N/A	N/A					29
Mobility 500 (Side x Side) Parking Brake		FA232X	FA232R								30
Mobility 650 (Side x Side)	12-	TBA*	TBA*		N/A	N/A					31
VERTEMATI											
C 450/500/570 (MX)	03-04	FA181X	FA181R■		N/A						32
E 450/501/570 (Enduro)	03-04	FA181X	FA181R■		N/A						33
S 450/501/570/E (Super Motard)	03-04	FA158	FA158HH		N/A						34
SR 450/SR 600 Motard Racing	03-04	FA158	FA158HH		N/A						35
495	99-02	FA181X	FA181R■		N/A						36
VOR											
EN/EN-E 450/530	04	FA181X	FA181R■		N/A						37
MX 450/530	04	FA181X	FA181R■		N/A						38
SM-E 450/530	04	FA95	FA95HH		N/A						39
VESPA											
LX 50	05-15	SFA260	SFA260HH		MD910D						40
Primavera 50 (4T/4V)	13-15	SFA353	SFA353HH		MD910D						41
S50 (4T/4V)	08-15	SFA260	SFA260HH		MD910D						42
Sprint 50 (4T/4V)	14-15	SFA353	SFA353HH		MD910D						43
ET4 150cc	99-04	SFA260	SFA260HH		MD910D						44
LX 150 ie	05-15	SFA260	SFA260HH		MD910D						45
LXV 150 ie	10-15	SFA260	SFA260HH		MD910D						46
PX 150 (All models)	05-06	SFA186				MD910D					47
Primavera 150 (4T/3V/ie)	13-15	SFA353	SFA353HH		MD910D						48
S150 ie	08-15	SFA260	SFA260HH		MD910D						49

*-2 Sets Required. ■ - Also available in MX-S race compound. **SAFETY WARNING:- DO NOT USE HH PADS ON REAR UNLESS ALSO USED ON FRONT TO AVOID BRAKE IMBALANCE**

APPLICATIONS

BRAKE

This symbol indicates a rotor made of billet steel, and should be only used with EBC FA Kevlar® Organic or Vee pads.

SAFETY NOTICE - With vehicles primarily designed for off highway use such as quads now being used on the highway, we would recommend the use of X or MXS pads for highway use and ONLY using the R and SV higher density / harder pad series for off road riding.



FRONT: Non-Japanese Bikes Cont'd

REAR: Non-Japanese Bikes

Line #	BRAKE ROTOR CHOICES - FRONT						DISC PAD CHOICES - REAR				BRAKE ROTOR CHOICES - REAR				
	CC Custom Rotor	CX Extreme® /Vee-Rotor	OS Series Oversize 250/280mm Rotor Kit	OSX Series Oversize 280mm Rotor Kit	Relocating Bracket for 250/280mm Rotor	SMX Series Oversize 320mm Rotor Kit	Relocating Bracket for 320mm Rotor		Semi-Sintered V-Pads™	Sintered/HH Pads/Grooved Shoes	SV Series Severe Duty Pads	Standard Rotor	UTVX Rotor	Vintage Rotor	Contour Profile Rotor
1							SFA264		SFA264HH		N/A				
2															
3							TBA				TBA				
4															
5							TBA				TBA				
6															
7							FA115X		FA115R		N/A				
8															
9							FA115X		FA115R		N/A				
10							FA83X		FA83R		N/A				
11							TBA								
12							FA115X		FA115R		N/A				
13							602								
14							FA86		FA86HH		N/A				
15							SFA197		SFA197HH		N/A				
16															
17							TBA				N/A				
18							FA54X		FA54R■		N/A				
19							FA86		FA86HH		N/A				
20							FA86		FA86HH		MD689			MD689C	
21															
22															
23							N/A				N/A				
24							307		307G						
25							307		307G						
26							TBA				N/A				
27							TBA				N/A				
28							TBA		TBA		N/A				
29							TBA		TBA		N/A				
30							TBA		TBA		N/A				
31															
32							TBA		TBA		N/A				
33															
34															
35							FA208X		FA208R■		N/A				
36							FA208X		FA208R■		N/A				
37							FA208X		FA208R■		N/A				
38							FA208X		FA208R■		N/A				
39							FA208X		FA208R■		N/A				
40															
41															
42							FA208X		FA208R■		N/A				
43							FA208X		FA208R■		N/A				
44							FA208X		FA208R■		N/A				
45															
46															
47							899								
48							816								
49							899								
50							816								
51							899								
52							899								
53							899								
54							903								
55							816								
56							899								

This symbol indicates a rotor made of billet steel, and should be only used with EBC FA Kevlar® Organic or Vee pads. SAFETY NOTICE - With vehicles primarily designed for off highway use such as quads now being used on the highway, we would recommend the use of X or MXS pads for highway use and ONLY using the R and SV higher density / harder pad series for off road riding.

BRAKE APPLICATIONS

*-2 Sets Required. ■ - Also available in MX-S race compound. **SAFETY WARNING:- DO NOT USE HH PADS ON REAR UNLESS ALSO USED ON FRONT TO AVOID BRAKE IMBALANCE**

FRONT: Non-Japanese Bikes

APPLICATIONS

BRAKE



VESPA



DISC PAD CHOICES - FRONT

BRAKE ROTOR CHOICES - FRONT

Sprint 150 (4T/3V/ie)	14-15	SFA353		SFA353HH		MD910D				
946 (155cc/ABS/4T/3V/ie)	13-15	SFA353		SFA353HH		TBA				
GT 200 L (Grimeca caliper)	05-09	SFA194		SFA194HH		MD956D				
GT 200 L Gran Turismo (Heng Tong caliper)	05-09	SFA353		SFA353HH		MD956D				
ET 250cc	97-04	SFA260		SFA260HH		MD910D				
GT 60 (250cc Ltd Edition)	06-08	SFA353		SFA353HH		MD956D				
GTS 250	05-09	SFA353		SFA353HH		MD956D				
GTV 250	07-09	SFA353		SFA353HH		MD956D				
LXV 250	07-09	SFA353		SFA353HH		MD956D				
GTS 300 ie	08-15	SFA353		SFA353HH		MD956D				
GTS 300 Super	10-15	SFA353		SFA353HH		MD956D				
GTV 300 ie	10-15	SFA353		SFA353HH		MD956D				
VICTORY										
V92C (All models single front rotor)	98-03	FA244	FA244V	FA244HH		MD727				
V92SC	00-03	FA244*	FA244V*	FA244HH*		MD727	MD727			
Broadwalk (Spoke Wheels)	13-14			FA347HH		TBA				
Cross Country	10-17			FA347HH*		TBA	TBA			
Cross Country 8 - Ball	15-16			FA347HH*		TBA	TBA			
Cross Country Touring	13-17			FA347HH*		TBA	TBA			
Cory Ness Victory Cross Country	11-12			FA347HH*		TBA	TBA			
Cross Roads	10-13			FA347HH*		TBA	TBA			
Cross Roads Classic (Spoke Wheels)	13-14			FA347HH*		TBA	TBA			
Cross Roads 8-Ball (Cast Wheels)	14			FA347HH*		TBA	TBA			
Empulse TT	16	FA244*	FA244V*	FA244HH*		TBA	TBA			
Gunner	15-17			FA347HH		TBA				
Hammer	05-07	FA244*	FA244V*	FA244HH*		MD678	MD678			
Hammer	08-11			FA347HH*		MD678	MD678			
Hammer 8 Ball	10-16			FA347HH		MD678				
Hammer S	07	FA244*	FA244V*	FA244HH*		MD678	MD678			
Hammer S	08-17			FA347HH*		MD678	MD678			
Hard Ball	12-13			FA347HH*		MD678	MD678			
HighBall (Cast Wheels & Spoke Wheels)	14-17			FA347HH		TBA				
Jackpot	10-16			FA347HH		MD678				
Cory Ness Jackpot	08-10			FA347HH		MD678				
Judge	13-17			FA347HH			MD678			
King Pin	04-07	FA244	FA244V	FA244HH		MD678				
King Pin	08-12			FA347HH		MD678				
King Pin Tour	04-07	FA244	FA244V	FA244HH		MD678				
Kingpin Tour	08-09			FA347HH		MD678				
Kingpin 8-Ball	08-11			FA347HH		MD678				
Kingpin-Low	09			FA347HH		MD678				
Magnum	15-17			FA347HH*		TBA	TBA			
Magnum X-1	15-17			FA347HH*		TBA	TBA			
Ness Signature Series	05-07	FA244	FA244V	FA244HH		MD678				
Octane 1200cc	17	FA209/2	FA209/2V	FA209/2HH		MD534				
Vegas	03-07	FA244	FA244V	FA244HH		MD678				
Vegas	08-17			FA347HH		MD678				
Vegas 8-Ball	05-07	FA244	FA244V	FA244HH		MD678				
Vegas 8-Ball	08-17			FA347HH		MD678				
Vegas Jackpot	06-07	FA244	FA244V	FA244HH		MD678				
Vegas Jackpot	08-12			FA347HH		MD678				
Zach Nes Vegas	11			FA347HH		MD678				
Vegas Low	08-09			FA347HH		MD678				
Vision 8 Ball	10-11			FA261HH*		MD678	MD678			
Vision Street	08-09			FA261HH*		MD678	MD678			

Line #

FRONT

* This symbol indicates a rotor made of billet steel, and should be only used with EBC FA Kevlar® Organic or Vee pads.
SAFETY NOTICE - With vehicles primarily designed for off highway use such as quads now being used on the highway, we would recommend the use of X or MXS pads for highway use and ONLY using the R and SV higher density / harder pad series for off road riding.

*-2 Sets Required. ■ - Also available in MX-S race compound. SAFETY WARNING:- DO NOT USE HH PADS ON REAR UNLESS ALSO USED ON FRONT TO AVOID BRAKE IMBALANCE

FRONT: Non-Japanese Bikes Cont'd

REAR: Non-Japanese Bikes

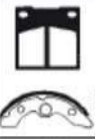
Line #	BRAKE ROTOR CHOICES - FRONT						DISC PAD CHOICES - REAR				BRAKE ROTOR CHOICES - REAR					
	CC Custom Rotor	CX Extreme® /Vee-Rotor	OS Series Oversize 250/280mm Rotor Kit	OSX Series Oversize 280mm Rotor Kit	Relocating Bracket for 250/280mm Rotor	SMX Series Oversize 320mm Rotor Kit	Relocating Bracket for 320mm Rotor		Semi-Sintered V-Pads™	Sintered/HH Pads/ Grooved Shoes	SV Series Severe Duty Pads	Standard Rotor	UTVX Rotor	Vintage Rotor	Contour Profile Rotor	CX Extreme® /Vee-Rotor
1							816									
2							SFA321		SFA321HH		TBA					
3							SFA321		SFA321HH		MD956D					
4							SFA321		SFA321HH		MD956D					
5							899									
6							SFA321		SFA321HH		MD956D					
7							SFA321		SFA321HH		MD956D					
8							SFA321		SFA321HH		MD956D					
9							SFA321		SFA321HH		MD956D					
10							SFA321		SFA321HH		MD956D					
11							SFA321		SFA321HH		MD956D					
12							SFA321		SFA321HH		MD956D					
13																
14																
15							FA209/2	FA209/2V	FA209/2HH		MD727					
16							FA209/2	FA209/2V	FA209/2HH		MD727					
17							FA196	FA196V	FA196HH		TBA					
18							FA196	FA196V	FA196HH		MD678					
19							FA196	FA196V	FA196HH		MD678					
20							FA196	FA196V	FA196HH		TBA					
21							FA196	FA196V	FA196HH		MD678					
22							FA196	FA196V	FA196HH		TBA					
23							FA196	FA196V	FA196HH		TBA					
24							FA196	FA196V	FA196HH		TBA					
25							FA266	FA266V	FA266HH		TBA					
26							FA196	FA196V	FA196HH		MD678					
27							FA209/2	FA209/2V	FA209/2HH		MD678					
28							FA196	FA196V	FA196HH		MD678					
29							FA196	FA196V	FA196HH		MD678					
30							FA209/2	FA209/2V	FA209/2HH		MD678					
31							FA196	FA196V	FA196HH		MD678					
32							FA196	FA196V	FA196HH		MD678					
33							FA196	FA196V	FA196HH		TBA					
34							FA196	FA196V	FA196HH		MD678					
35							FA196	FA196V	FA196HH		MD678					
36							FA196	FA196V	FA196HH		MD678					
37							FA209/2	FA209/2V	FA209/2HH		MD678					
38							FA196	FA196V	FA196HH		MD678					
39							FA209/2	FA209/2V	FA209/2HH		MD727					
40							FA196	FA196V	FA196HH		MD678					
41							FA196	FA196V	FA196HH		MD678					
42							FA196	FA196V	FA196HH		MD678					
43							FA196	FA196V	FA196HH		MD678					
44							FA196	FA196V	FA196HH		MD678					
45							FA209/2	FA209/2V	FA209/2HH		MD678					
46							FA213	FA213V	FA213HH		MD534					
47							FA209/2	FA209/2V	FA209/2HH		MD678					
48							FA196	FA196V	FA196HH		MD678					
49							FA209/2	FA209/2V	FA209/2HH		MD678					
50							FA196	FA196V	FA196HH		MD678					
51							FA209/2	FA209/2V	FA209/2HH		MD678					
52							FA196	FA196V	FA196HH		MD678					
53							FA196	FA196V	FA196HH		MD678					
54							FA196	FA196V	FA196HH		MD678					
55							FA196	FA196V	FA196HH		MD678					
56							FA196	FA196V	FA196HH		MD678					

REAR

This symbol indicates a rotor made of billet steel, and should be only used with EBC FA Kevlar® Organic or Vee pads.
 SAFETY NOTICE - With vehicles primarily designed for off highway use such as quads now being used on the highway, we would recommend the use of X or MXS pads for highway use and ONLY using the R and SV higher density / harder pad series for off road riding.

BRAKE APPLICATIONS

*-2 Sets Required. ■ - Also available in MX-S race compound. **SAFETY WARNING:- DO NOT USE HH PADS ON REAR UNLESS ALSO USED ON FRONT TO AVOID BRAKE IMBALANCE**

RECOMMENDED 2018 DEALER INVENTORY — BRAKE PADS

APPLICATIONS

BRAKE

This symbol indicates a rotor made of billet steel, and should be only used with EBC FA Kevlar® Organic or Vee pads.

SAFETY NOTICE - With vehicles primarily designed for off highway use such as quads now being used on the highway, we would recommend the use of X or MXS pads for highway use and ONLY using the R and SV higher density / harder pad series for off road riding.

Honda (S suffix = Street, D= Dirt, A= ATV)			Kawasaki (S suffix = Street, D= Dirt, A= ATV)			Suzuki (S suffix = Street, D= Dirt, A= ATV)			Yamaha (S suffix = Street, D= Dirt, A= ATV)			Accessory Store (In this column suffixes mean Model i.e. S means Suzuki) — NO HARLEY DAVIDSON FITMENTS INCLUDED		
FA84R	(A)	10	FA129	(S)	4	FA63	(S)	6	FA252HH	(S)	6	FA63	(S)	6
FA69/3	(S)	8	FA158	(S)	4	FA188HH	(S)	6	FA380HH	(S)	6	FA69	(H)	6
FA84X	(A)	8	FA158HH	(S)	4	FA379HH	(S)	6	FA152X	(D)	5	FA68	(K)	5
FA261HH	(S)	8	FA347HH	(S)	4	FA36	(A)	4	FA152R	(D)	5	FA54X	(H/S/K/Y)	4
FA390HH	(S)	8	FA36	(S)	4	FA84R	(A)	4	FA21R	(A)	4	FA85	(K)	4
FA54R	(D)	6	FA369/4HH	(S)	4	FA128X	(D/A)	4	FA54X	(A/D)	4	FA88	(Y)	4
FA69	(S)	6	FA379HH	(S)	4	FA129	(S)	4	FA54R	(A/D)	4	FA158	(S/K)	4
FA69/3HH	(S)	6	FA84R	(A)	4	FA145	(S)	4	FA61	(S)	4	FA188HH	(S/K)	4
FA54X	(D)	4	FA85	(S)	4	FA152X	(D)	4	FA84R	(A)	4	FA261HH	(H)	4
FA131X	(D)	4	FA161	(S)	3	FA152R	(D)	4	FA84X	(A)	4	FA379HH	(K/S)	4
FA131R	(D)	4	FA229HH	(S)	3	FA188	(D)	4	FA155X	(A)	4	FA447HH	(T/D/BMW/S)	4
FA436	(S)	4	FA231HH	(S)	3	FA63HH	(S)	4	FA155R	(A)	4	FA630HH	(BMW/D)	4
FA124/2HH	(S)	4	FA33	(S)	2	FA158HH	(S)	4	FA252	(S)	4	FA34	(Y)	4
FA174HH	(S)	4	FA128R	(A)	2	FA369/4HH	(S)	4	FA88HH	(S)	4	FA36	(S)	3
FA265HH	(S)	4	FA128X	(A)	2	FA447HH	(S)	4	FA179HH	(S)	4	FA69/3	(H)	3
FA296HH	(S)	4	FA129HH	(S)	2	FA137R	(A)	3	FA88	(S)	3	FA84R	(K/K/S/Y)	3
FA388HH	(S)	4	FA129V	(S)	2	FA146	(S)	3	FA123V	(S)	3	FA18	(D)	2
MXS346	(D)	4	FA130X	(D)	2	FA103V	(S)	3	FA34	(S)	2	FA22	(BMW)	2
FA174	(S)	3	FA131R	(D)	2	FA35	(S)	2	FA41	(S)	2	FA29	(H)	2
FA185X	(D)	3	FA131X	(D)	2	FA38	(S)	2	FA70	(S)	2	FA33	(K)	2
FA189	(S)	3	FA135R	(D/A)	2	FA51	(S)	2	FA81	(S)	2	FA38	(S)	2
FA189HH	(S)	3	FA135X	(D/A)	2	FA54X	(D)	2	FA84/3R	(A)	2	FA41	(Y)	2
FA29	(S)	2	FA141	(S)	2	FA54R	(D)	2	FA95	(S)	2	FA51	(S)	2
FA30	(S)	2	FA152R	(D)	2	FA65	(S)	2	FA101X	(A/D)	2	FA54R	(H/K/S/Y)	2
FA31	(S)	2	FA152X	(D)	2	FA84X	(A)	2	FA101R	(A/D)	2	FA61	(Y)	2
FA69/2	(S)	2	FA161HH	(S)	2	FA103	(S)	2	FA104	(S)	2	FA62	(K)	2
FA90	(D)	2	FA188	(S)	2	FA128R	(D/A)	2	FA123	(S)	2	FA65	(S)	2
FA92X	(D/A)	2	FA188HH	(S)	2	FA135X	(D)	2	FA135X	(D/A)	2	FA69/2	(H)	2
FA121	(S)	2	FA192HH	(S)	2	FA135R	(D)	2	FA135R	(D/A)	2	FA70	(Y)	2
FA124	(S)	2	FA249	(S)	2	FA142	(S)	2	FA160	(S)	2	FA81	(Y)	2
FA124/2	(S)	2	FA249HH	(S)	2	FA158	(S)	2	FA165X	(D/A)	2	FA90	(H)	2
FA125X	(D)	2	FA417/4HH	(S)	2	FA366	(S)	2	FA165R	(D/A)	2	FA95	(D)	2
FA125R	(D)	2	FA54X	(D)	2	FA372R	(A)	2	FA179	(S)	2	FA101X	(Y)	2
FA142	(S)	2	FA62	(S)	2	FA103HH	(S)	2	FA182	(S)	2	FA103	(S)	2
FA185R	(D)	2	FA67R	(S)	2	FA142HH	(S)	2	FA190	(S)	2	FA121	(H)	2
FA346X	(S)	2	FA67X	(D)	2	FA145HH	(S)	2	FA323R	(A)	2	FA123	(Y)	2
FA346R	(D)	2	FA68	(S)	2	FA146HH	(S)	2	FA367R	(D)	2	FA124	(H)	2
FA187	(S)	2	FA68HH	(S)	2	FA150HH	(S)	2	FA123HH	(S)	2	FA124/2	(H)	2
FA196	(S)	2	FA68V	(S)	2	FA447HH	(S)	2	FA160HH	(S)	2	FA125X	(H)	2
FA203	(S)	2	FA73	(S)	2	MXS185	(D)	2	FA190HH	(S)	2	FA128R	(K/S)	2
FA226	(S)	2	FA83R	(D)	2	MXS152	(D)	2	FA199HH	(S)	2	FA129	(K/S)	2
FA69HH	(S)	2	FA83X	(D)	2	MXS131	(D)	2	FA267HH	(S)	2	FA142	(H/S/T)	2
FA124HH	(S)	2	FA84X	(A)	2	MXS367	(D)	2	FA275HH	(S)	2	FA145	(S)	2
FA142HH	(S)	2	FA85HH	(S)	2	FA38V	(S)	2	FA348HH	(S)	2	FA146	(S)	2
FA187HH	(S)	2	FA85V	(S)	2	FA51V	(S)	2	FA423/4HH	(S)	2	FA160	(Y)	2
FA203HH	(S)	2	MXS131	(D)	2	FA63V	(S)	2	FA442/4HH	(S)	2	FA161	(K)	2
FA226HH	(S)	2	MXS135	(D)	2	FA65V	(S)	2	MXS135	(D)	2	FA171	(BMW)	2
FA436HH	(S)	2	MXS152	(D)	2	FA145V	(S)	2	MXS185	(D)	2	FA179	(Y)	2
FA499/4HH	(S)	2	MXS185	(D)	2	FA146V	(S)	2	MXS152	(D)	2	FA181R	(KTM)	2
MXS54	(D)	2	MXS367	(D)	2	FA150V	(S)	2	MXS131	(D)	2	FA185X	(H/K/S/Y)	2
MXS84	(D)	2	FA447HH	(S)	2	FA84/3R	(A)	1	MXS367	(D)	2	FA187	(H)	2
MXS125	(D)	2	FA137R	(A)	1	FA106X	(D)	1	FA41V	(S)	2	FA188	(S/K)	2
MXS131	(D)	2	FA161V	(S)	1	FA137X	(A)	1	FA61V	(S)	2	FA196	(H/T)	2
MXS185	(D)	2	FA165X	(D)	1	FA147X	(S)	1	FA70V	(S)	2	FA203	(H)	2
FA69V	(S)	2	FA174	(S)	1	FA152/2X	(D)	1	FA88V	(S)	2	FA208R	(KTM)	2
FA69/2V	(S)	2	FA185X	(D)	1	FA152/2R	(D)	1	FA199V	(S)	2	FA216/3	(HD)	2
FA69/3V	(S)	2	FA192	(S)	1	FA157X	(D)	1	FA179V	(S)	2	FA226	(H/T)	2
FA90V	(S)	2	FA192V	(S)	1	FA222	(S)	1	FA182HH	(S)	2	FA407	(BMW)	2
FA124V	(S)	2	FA229	(S)	1	FA230X	(D)	1	FA307X	(A)	2	FA252	(Y)	2
FA124/2V	(S)	2	FA229V	(S)	1	FA230R	(D)	1	FA307R	(A)	2	FA346R	(H)	2
FA142V	(S)	2	FA231	(S)	1	FA229	(S)	1	FA488HH	(S)	2	FA367R	(K/S/Y)	2
FA196HH	(S)	2	FA231V	(S)	1	FA231	(S)	1	FA499/4HH	(S)	2	FA368R	(KTM)	2
FA261/2HH	(S)	2	FA237X	(S)	1	FA413R	(A)	1	FA676	(A)	2	FA63HH	(S)	2
FA346HH	(S)	2	FA254	(S)	1	FA414R	(A)	1	FA676R	(A)	2	FA69HH	(H)	2
FA373X	(A)	2	FA258R	(D)	1	FA419	(S)	1	FA21X	(A)	1	FA69/3HH	(H)	2
FA373R	(A)	2	FA258X	(D)	1	FA436	(S)	1	FA105X	(D)	1	FA85HH	(K)	2
FA447HH	(S)	2	FA302R	(D)	1	FA496	(S)	1	FA119X	(D)	1	FA88HH	(Y)	2
FA679HH	(S)	2	FA302X	(D)	1	FA436HH	(S)	1	FA119R	(D)	1	FA123HH	(Y)	2
FA12	(S)	1	FA305R	(D)	1	FA496HH	(S)	1	FA136	(S)	1	FA129HH	(K/S)	2
FA13	(S)	1	FA305X	(D)	1	MXS54	(D)	1	FA152/2X	(D)	1	FA142HH	(S/H)	2
FA32	(S)	1	FA342R	(A)	1	MXS135	(D)	1	FA152/2R	(D)	1	FA158HH	(S/K)	2
FA84/2R	(A)	1	FA342SV	(A)	1	MXS152/2	(D)	1	FA199	(S)	1	FA161HH	(K)	2
FA86	(S)	1	FA349R	(A)	1	FA36V	(S)	1	FA267	(S)	1	FA187HH	(H)	2
FA92R	(D/A)	1	FA349SV	(A)	1	FA229V	(S)	1	FA275	(S)	1	FA226HH	(H/T)	2
FA111X	(A)	1	FA37	(S)	1	FA231V	(S)	1	FA428X	(A)	1	FA252HH	(Y)	2
FA111R	(A)	1	FA55	(S)	1	FA229HH	(S)	1	FA428R	(A)	1	FA265HH	(H)	2
FA140	(S)	1	MXS258	(D)	1	FA231HH	(S)	1	FA104HH	(S)	1	FA294HH	(BMW)	2
FA410X	(A)	1	MXS84	(D)	1	FA258X	(D)	1	FA319/2HH	(S)	1	FA296HH	(H/HD)	2
FA410R	(A)	1	FA690HH	(S)	1	FA258R	(D)	1	MXS152/2	(D)	1	FA335HH	(BMW)	2
FA12V	(S)	1				FA302X	(D)	1	FA174V	(S)	1	FA369/4HH	(K/S)	2
FA13V	(S)	1				FA317R	(A)	1	FA275X	(D)	1	FA380HH	(Y)	2
FA32V	(S)	1				FA366	(S)	1	FA323X	(D)	1	FA390HH	(H)	4
FA174V	(S)	1				FA366V	(S)	1	FA344X	(A)	1	FA442/4HH	(Y)	2
						FA366HH	(S)	1	FA344R	(A)	1	FA491HH	(T)	2
						FA367X	(D)	1	FA344SV	(A)	1	FA604/4HH	(BMW)	2
						FA367R	(D)	1	FA443X	(A)	1	FA604/4HH	(BMW/S)	2
						FA401X	(D)	1	FA443R	(A)	1	FA213	(BMW/S)	2
						FA401R	(D)	1	FA444X	(A)	1	FA13	(H)	1
									FA444R	(A)	1	FA32	(H)	1
									FA445X	(A)	1	FA84X	(H/K/S/Y)	1
									FA445R	(A)	1	FA104	(Y)	1
									FA446X	(A)	1	FA125R	(H)	1
									FA446R	(A)	1	FA131X	(H)	1
									FA450X	(A)	1	FA131R	(H)	1
									FA450R	(D)	1	FA135X	(K/S)	1
									FA476X	(A)	1	FA135R	(K/S)	1
									FA477X	(A)	1	FA140	(H/T)	1
									FA478X	(A)	1	FA152X	(K/S)	1
									FA478R	(A)	1	FA152R	(K/S)	1
									FA497X	(A)	1	FA152/2X	(K/S)	1
									FA11	(S)	1	FA174	(H/K/S/Y)	1
									FA674	(A)	1	FA192	(K)	1
									FA675	(A)	1	FA363	(BMW)	1
									FA677	(A)	1	FA192HH	(K)	1
									FA674R	(A)	1	FA363HH	(BMW)	1
									FA675R	(A)	1			
									FA677R	(A)	1			

RECOMMENDED 2018 DEALER INVENTORY — BRAKE PADS/SHOES

Harley Davidson (Marked S but of course Harley only make streetbikes)		
FA400HH	(S)	6
FA94HH	(S)	4
FA409HH	(S)	4
FA200HH	(S)	3
FA400V	(S)	3
FA409V	(S)	3
FA71	(S)	2
FA72	(S)	2
FA200	(S)	2
FA381	(S)	2
FA400	(S)	2
FA409	(S)	2
FA434	(S)	2
FA381HH	(S)	2
FA94V	(S)	2
FA434HH	(S)	2
FA457HH	(S)	2
FA458HH	(S)	2
FA605/4HH	(S)	2
FA24/2	(S)	2
FA24/2V	(S)	2
FA71V	(S)	2
FA94V	(S)	2
FA216/3	(S)	2
FA216/3HH	(S)	2
FA216/3V	(S)	2
FA296HH	(S)	2
FA381	(S)	2
FA381V	(S)	2
FA381HH	(S)	2
FA387	(S)	2
FA387HH	(S)	2
FA387V	(S)	2
FA409	(S)	2
FA457V	(S)	2
FA434HH	(S)	2
FA457HH	(S)	2
FA458V	(S)	2
FA605/4V	(S)	2
FA640	(S)	2
FA640V	(S)	2
FA640HH	(S)	2
FA78	(S)	1
FA79	(S)	1
FA201	(S)	1
FA387	(S)	1
FA201HH	(S)	1
FA387HH	(S)	1
FA72V	(S)	1
FA78V	(S)	1
FA79V	(S)	1
FA200V	(S)	1
FA201V	(S)	1
FA254	(S)	1
FA254V	(S)	1
FA254HH	(S)	1
FA434V	(S)	1
FA638	(S)	2
FA638V	(S)	2
FA638HH	(S)	2

Ducati (S Suffix means Streetbike)		
FA47	(S)	2
FA95	(S)	2
FA95HH	(S)	2
FA18V	(S)	2
FA95V	(S)	2
FA209/2	(S)	2
FA209/2V	(S)	2
FA209/2HH	(S)	2
FA244	(S)	2
FA244V	(S)	2
FA244HH	(S)	2
FA266HH	(S)	2
FA322/2HH	(S)	2
FA447HH	(S)	2
FA630HH	(S)	2
FA47HH	(S)	1
FA266	(S)	1
FA266V	(S)	1

Triumph (S Suffix means Streetbike)		
FA196	(S)	2
FA196HH	(S)	2
FA196V	(S)	2
FA209/2	(S)	2
FA209/2V	(S)	2
FA209/2HH	(S)	2
FA214HH	(S)	2
FA215/2HH	(S)	2
FA226	(S)	2
FA226HH	(S)	2
FA236	(S)	2
FA236V	(S)	2
FA236HH	(S)	2
FA322/2HH	(S)	2
FA347HH	(S)	2
FA491HH	(S)	2
FA447HH	(S)	2
FA604/4HH	(S)	2
FA630HH	(D)	2
FA214	(S)	1
FA215	(S)	1
FA215/2	(S)	1

Polaris (A Suffix means ATV)		
FA159R	(A)	4
FA354R	(A)	3
FA354SV	(A)	3
FA83R	(A)	2
FA159X	(A)	2
FA159SV	(A)	2
FA232R	(A)	2
FA270R	(A)	2
FA452X	(A)	2
FA452R	(A)	2
FA456X	(A)	2
FA456R	(A)	2
FA475X	(A)	2
FA475R	(A)	2
FA489R	(A)	2
FA490R	(A)	2
FA680R	(A)	2
FA270X	(A)	1
FA273R	(A)	1
FA314R	(A)	1

KTM (D Suffix means Dirtbike, S means Streetbike)		
FA208R	(D)	4
FA368X	(D)	3
FA368R	(D)	3
FA181X	(D)	2
FA181R	(D)	2
FA208X	(D)	2
FA433/3HH	(D)	2
FA447HH	(S)	2
FA463R	(D)	2
FA325X	(D)	1
FA325R	(D)	1
FA357X	(D)	1
FA357R	(D)	1
FA462R	(D)	1
FA612X	(D)	1
FA612R	(D)	1

Honda — Shoes			
Item Code	Qty for Dealer to Stock	Franchise	Market Segment
347	6	H	A
351	4	H	A
333	4	H	D/S
315	4	H	S/A
343	3	H	S/A
304	3	H	D
306	3	H	A
340	3	H	D/A
303	3	H	A
345	2	H	A
338	2	KTM/P	D
330	2	H	D
321	2	H	S
301	2	H	S
347G	2	H	A
347S	2	H	A
351G	2	H	A
313	2	H	S
333G	1	H	D
304G	1	H	D
338G	1	H/K	D/A
322	1	KTM	D
315G	1	H	D/A
310	1	H	S/D
320	1	H	S
306G	1	H	A
340G	1	H	A
318	1	H	S/D
343G	1	H	A
307G	1	P	A
339	1	H	A
346	1	H	A

Kawasaki — Shoes			
Item Code	Rank in Overall Shoe Sales (not just this franchise)	Franchise	Market Segment
706	4	K	D/A
709	3	K	S
715	2	K/S	D
705	2	K	D/A
720	2	K/S	A
710	2	K	A/S
718	1	K	A
719	1	K	A
715G	1	K/S	D
705G	1	K	D/A
706G	1	K	A

Suzuki — Shoes			
Item Code	Rank in Overall Shoe Sales (not just this franchise)	Franchise	Market Segment
606	4	S/K	D/A
626	3	S	S/A
602	3	S/K	S/D
636	3	S	A
604	2	S	D
603	2	S/K	D/A
628	2	S/K	A
633	2	S	A
634	2	S	A/S
614	2	S/K	D/A
636G	2	S	A
605	2	S	D/A
629	1	S	A
618	1	S/K	D/A
603G	1	K	D/A
634G	1	S	A
633G	1	S	A
604G	1	S	D/A
613	1	S/K	D/A
602G	1	S	D
606G	1	S	A
628G	1	K/S	A

Yamaha — Shoes			
Item Code	Rank in Overall Shoe Sales (not just this franchise)	Franchise	Market Segment
503	5	Y	A/D
516	4	Y	S/A
528	4	Y	S/D/A
515	4	Y	S
527	3	Y	S/D/A
524	3	Y	A
532	3	Y	S
506	3	Y	D/A/S
503G	3	Y	D/A
501	3	Y	S/D/A
516G	3	Y	A
531	2	Y	S
524G	2	Y	A
532G	2	Y	D
502	2	S/Y	D
512	2	Y	S
528G	2	Y	D/A
530	1	Y	S
510	1	Y	D/S
506G	1	Y	D/A
518	1	Y	D/A
504	1	Y	D
527G	1	Y	D/A
514	1	Y	S
507	1	Y	D
520	1	Y	A

Accessory Store — Shoes			
Item Code	Rank in Overall Shoe Sales (not just this franchise)	Franchise	Market Segment
347	1	H	A
351	2	H	A
333	3	H	D/S
503	4	Y	A/D
315	5	H	S/A
343	6	H	S/A
304	7	H	D
516	8	Y	S/A
306	9	H	A
340	10	H	D/A
303	11	H	A
345	12	H	A
528	13	Y	S/D/A
338	14	KTM/P	D
330	15	H	D
321	16	H	S
515	17	Y	S
301	18	H	S
527	19	Y	S/D/A
347G	20	H	A
524	21	Y	A
532	22	Y	S
606	23	S/K	D/A
626	24	S	S/A
602	25	S/K	S/D
347S	26	H	A
706	27	K	D/A
506	28	Y	D/A/S
709	29	K	S
636	30	S	A

BRAKE APPLICATIONS
 This symbol indicates a rotor made of billet steel, and should be only used with EBC FA Kevlar® Organic or Vee pads.
 SAFETY NOTICE - With vehicles primarily designed for off highway use such as quads now being used on the highway, we would recommend the use of X or MXS pads for highway use and ONLY using the R and SV higher density / harder pad series for off road riding.

ROAD RACING APPLICATIONS

APPLICATIONS

BRAKE

* This symbol indicates a rotor made of billet steel, and should be only used with EBC FA Kevlar® Organic or Vee pads.
 SAFETY NOTICE - With vehicles primarily designed for off highway use such as quads now being used on the highway, we would recommend the use of X or MXS pads for highway use and ONLY using the R and SV higher density / harder pad series for off road riding.

Make & Model	Year	FRONT					REAR		
		Organic Pads or Shoes	Sintered/HH Pads Grooved shoes	Sintered Pads EPFA	Sintered Pads GPFAX	Brake Rotor Left	Brake Rotor Right	Organic Pads or Shoes	Brake Rotor
HONDA									
RS125	88-89	FA124					N/A	FA151	MD713
RS125	90-94	FA226	FA226HH	EPFA226HH			MD1003X	FA151	MD713
RS125	95-03	FA239	FA239HH	EPFA239HH			MD1003X	FA151	MD713
RS125 (Radial caliper)	04-07		FA347HH	EPFA347HH	GPFAX347HH		MD1003X	FA151	MD713
NSF250 R (Moto 3)	12-13		FA347HH	EPFA347HH	GPFAX347HH		N/A	FA151	N/A
RS250	88-89	FA124*				MD1003X	MD1003X	FA151	MD724
RS250	90-94	FA226*	FA226HH*	EPFA226HH*		MD1003X	MD1003X	FA151	MD724
RS250	95-02	FA239*	FA239HH*	EPFA239HH*		MD1003X	MD1003X	FA151	MD724
MORIWAKI									
MD250H	08-13		FA347HH	EPFA347HH	GPFAX347HH		MD1003X	FA151	N/A
YAMAHA									
TZ125	94-97	FA145	FA145HH	EPFA145HH			MD711RD	FA162	MD732
TZ250	89-90	FA145*	FA145HH*	EPFA145HH*		MD711LD	MD711RD	FA162	MD732
TZ250	91	FA145*	FA145HH*	EPFA145HH*		MD711LD	MD711RD	FA162	MD2021
TZ250	92-96	FA145*	FA145HH*	EPFA145HH*		MD711LD	MD711RD	FA162	MD732
TZ250	97-01	FA145*	FA145HH*	EPFA145HH*		MD730LD	MD730RD	FA162	MD732
TZ250 (Radial Caliper)	02-10		FA347HH*	EPFA347HH*	GPFAX347HH*	MD730LD	MD730RD	FA162	MD732

PADS FOR AFTERMARKET CALIPERS

	STANDARD ORGANIC PAD	OPTIONAL ORGANIC PAD	SEMI-SINTERED VEE PAD	CHROME BACKED SEMI-SINTERED VEE PAD	FULLY SINTERED PAD	EPFA FULLY SINTERED TRACK DAY PAD	GPFAX FULLY SINTERED RACE PAD
AMERICAN SUSPENSION CALIPERS							
B17 Phantom 2 piston brake caliper	FA18	N/A	FA18V	N/A	N/A	N/A	N/A
B17 Mach 8 Radial mount 4 Piston caliper	N/A	N/A	N/A	N/A	N/A	N/A	N/A
B17 Mach 8 Standard mount 2 Piston caliper	FA18	N/A	FA18V	N/A	N/A	N/A	N/A
P26 2 Piston Caliper	FA18	N/A	FA18V	N/A	N/A	N/A	N/A
AP LOCKHEED							
2 Piston / 2 Pin (CP2195/CP2696 -38E0)	FA16	FA16S	N/A		FA16HH	EPFA16HH	GPFAX16HH
2 Piston Sidecar caliper (CP2576/2577/3176/3177/3178)	N/A	N/A	N/A		N/A	N/A	N/A
2 Piston / 1 Pin (CP4226 - 2S0)	FA272	N/A	N/A		N/A	N/A	N/A
2 Piston / 1 Pin (CP4227 - 2S0)	FA272	N/A	N/A		N/A	N/A	N/A
6 Piston / No Pins (CP3366/67)	N/A	N/A	N/A		N/A	N/A	N/A
6 Piston / 2 Pins (CP4466)	N/A	N/A	N/A		N/A	EPFA263HH	N/A
4 Piston (CP3086/CP3369/CP4484 D27)	N/A	N/A	N/A		N/A	N/A	N/A
4 Piston (CP4485/CP4679)	N/A	N/A	N/A		N/A	N/A	N/A
4 Piston Radial 2 Piece (CP4488)	N/A	N/A	N/A		N/A	N/A	N/A
4 Piston (CP4680) 1 Piece Pad	N/A	N/A	N/A		N/A	N/A	N/A
4 Piston Radial Mount / 4 Seperate Pads (CP6688 - 8E0M/9E0M)	N/A	N/A	N/A		FA435/4HH	EPFA435/4HH	N/A
2 Piston / 1 Pin (CP7003-2S0) Radial mount	N/A	N/A	N/A		N/A	N/A	N/A
4 Piston Sidecar Caliper (CP7030-3S0 / 5S0)	N/A	N/A	N/A		N/A	N/A	N/A
4 Piston Radial Monobloc 1 Piece Pad (CP7853 D27 2E0/3E0)	N/A	N/A	N/A		N/A	N/A	N/A
BERINGER							
2 Piston Quad Caliper	N/A	N/A	N/A		N/A	N/A	N/A
4 Piston (Old Design)	FA158	N/A	N/A		FA158HH	EPFA158HH	N/A
4 Piston (Radial)	N/A	N/A	N/A		MXS405	N/A	N/A
6 Piston (Old Design)	FA249	N/A	N/A		FA249HH	EPFA249HH	N/A
6 Piston (Old design/2 piston)	FA47	FA47S	N/A		FA47HH	N/A	N/A
6 Piston (Old Design /Endurance)	FA249/2	N/A	N/A		N/A	N/A	N/A
6 Piston (New Design)	N/A	N/A	N/A		MXS406	N/A	N/A

PADS FOR AFTERMARKET CALIPERS

BREMBO

	STANDARD ORGANIC PAD	OPTIONAL ORGANIC PAD	SEMI-SINTERED VEE PAD	CHROME BACKED SEMI-SINTERED VEE PAD	FULLY SINTERED PAD	EPFA FULLY SINTERED TRACK DAY PAD	GPFA FULLY SINTERED RACE PAD
120A44110 P2/34 Supersport Rear Caliper	FA266	N/A	FA266V	N/A	FA266HH	N/A	N/A
122A99021 P2/24 Off Road Caliper	FA181TT	N/A	N/A	N/A	FA181R	EPFA181HH	N/A
20 4756 52/62 - 4 Piston P4 30/34 @40mm Spacing (Single pin pad fixing)	FA95	N/A	FA95V		FA95HH	EPFA95HH	N/A
20 5161 43 or 81 - 2 Piston P 2/32 Rear caliper (Single Pad Fixing Pin / With Anti Rattle Shim)	FA47	FA47S	N/A		FA47HH	N/A	N/A
20 5165 55/68 - Goldline 4 piston P4 30/34 @ 40mm Spacing (Single Pin pad Fixing)	FA95	N/A	FA95V		FA95HH	EPFA95HH	N/A
20 6800 10/20 - Goldline4 piston P4 30/34 @ 65mm Spacing (Two Pin Pad Fixing)	FA244	N/A	FA244V		FA244HH	EPFA244HH	GPFA244HH
20 6950 51 - 2 Piston P2/32 Rear Caliper (Single Pad Fixing Pin / With Wire Clip)	FA266	N/A	FA266V		FA266HH	N/A	N/A
20 6951 12/50/63 - P2/34 Rear Caliper (Single Pad Fixing Pin / With Wire Clip)	FA266	N/A	FA266V		FA266HH	N/A	N/A
20 7850 11/21 - 4 Piston P4 /34 @ 65mm Spacing (Wire clip pad retention Only)	N/A	N/A	N/A		FA322/4HH	EPFA322/4HH	N/A
20 8343 11/21 or 35/45 - 4 Piston P4 /34 @ 100mm Spacing (Wire clip pad retention Only)	N/A	N/A	N/A		FA322/4HH	EPFA322/4HH	N/A
20.9883 Radial Mount 100mm Monobloc Caliper	N/A	N/A	N/A	N/A	FA447HH	EPFA447HH	GPFA447HH
206121 P4/24 Rear Caliper	N/A	N/A	N/A	N/A	N/A	N/A	N/A
220988530 P4/34 Radial Mount 100mm Monobloc Caliper	N/A	N/A	N/A	N/A	FA447HH	EPFA447HH	GPFA447HH
220A0610 P4 30/34 Radial Mount Caliper 108mm 2 PinPad Fixing	FA244	N/A	FA244V	N/A	FA244HH	EPFA244HH	GPFA244HH
220A16810 P4 30/34 Radial Mount Caliper 100mm 2 PinPad Fixing	FA244	N/A	FA244V	N/A	FA244HH	EPFA244HH	GPFA244HH
220A16820 P30/34 Yamaha R1 07-10 Radial Mount	FA244	N/A	FA244V	N/A	FA244HH	EPFA244HH	GPFA244HH
220A39710 P4/34 Radial Mount 108mm Monobloc Caliper	N/A	N/A	N/A	N/A	FA447HH	EPFA447HH	GPFA447HH
220A80210 P4 30/34 Radial Mount Caliper 108mm 2 PinPad Fixing	FA244	N/A	FA244V	N/A	FA244HH	EPFA244HH	GPFA244HH
220A80310 P4 30/34 Radial Mount 100mm 2 Pin Pad Fixing	FA244	N/A	FA244V	N/A	FA244HH	EPFA244HH	GPFA244HH
220B01010 - GP4-RX 4 Piston Radial Mount @ 108mm Spacing					FA447HH	EPFA447HH	GPFA447HH
X1017.40/41 4 Piston / 40mm Axial Monobloc Caliper	N/A	N/A	N/A			EPFA218/2HH	GPFA218/2HH
X20-60-01 -2 Piston P2/24 Rear Caliper Rear caliper @ 64mm Spacing	N/A	N/A	N/A		N/A	N/A	N/A
X20-61-01 -4 Piston P4/24 Rear Caliper Rear caliper @ 64mm Spacing	N/A	N/A	N/A		N/A	N/A	N/A
X97.37.60/61- 4 Piston Monobloc 32/36 Radial mount@ 108mm (Single Pin Fixing)	N/A	N/A	N/A		FA218HH	EPFA218HH	N/A
X9737 80/81 Radial Mount 108mm Endurance Caliper	N/A	N/A	N/A	N/A	N/A	EPFA295HH	N/A
X97C4 60/61 P4/34 Radial Monobloc 108mm 4 Pad Type Caliper	N/A	N/A	N/A	N/A	FA435/4HH	EPFA435/4HH	N/A
X98-88-70 -2 Piston P2/34 Rear Caliper Rear caliper @ 64mm Spacing	N/A	N/A	N/A		N/A	N/A	N/A
X99.C04 60/61 - 4 Piston P 34/34 Radial Mount Caliper @ 108mm Spacing (4 Pad Set)	N/A	N/A	N/A		N/A	EPFA435/4HH	N/A
XA07680 - 2 Piston P2 34 Radial Mount) (Note Only Sold As Set Of 4 pads)	N/A	N/A	N/A		FA435/4HH	EPFA435/4HH	N/A
XA1J040 P2/30 Rear Caliper	N/A	N/A	N/A	N/A	N/A	N/A	N/A
XA1K480 Motocross Radial Caliper	N/A	N/A	N/A	N/A	N/A	N/A	N/A
XA3.B8.30/31 - 4 Piston P32/36 Radial Mount Caliper @ 108mm Spacing (Titanium Pistons)	N/A	N/A	N/A		N/A	EPFA218/2HH	GPFA218/2HH
XA3.B8.60/61 - 4 Piston P32/36 Radial Mount Caliper @ 108mm Spacing (Aluminium Pistons)	N/A	N/A	N/A		N/A	EPFA218/2HH	GPFA218/2HH
XA3.J7.50/51 - 4 Piston P 34/38 Radial Mount @ 108mm Spacing (Pinless Fixing)	N/A	N/A	N/A		N/A		GPFA611HH
XA3.J7.60/61 - 4 Piston P 34/38 Radial Mount @ 108mm Spacing (Pinless Fixing / Lithium Body)	N/A	N/A	N/A		N/A		GPFA611HH
XA32950 P4/34 Axial Radial Mount 65mm - 4 Pad Set	N/A	N/A	N/A	N/A	FA322/4HH	EPFA322/4HH	N/A
XA69510 P4 30/34 Motard Radial Mount 108mm 2 Pin Pad Fixing	FA244	N/A	FA244V	N/A	FA244HH	EPFA244HH	GPFA244HH
XA78910 P4 30/34 Motard Radial Caliper 100mm Mount 2 Pin Pad Fixing	FA244	N/A	FA244V	N/A	FA244HH	EPFA244HH	GPFA244HH
XA7G2 10/11 P4 32/36 Radial Mount Caliper 100mm	N/A	N/A	N/A	N/A	N/A	EPFA218/2HH	GPFA218/2HH
XA7G2.40/41 4 Piston / 100mm CNC Monobloc Caliper	N/A	N/A	N/A			EPFA218/2HH	GPFA218/2HH
XA8.Y3.310/11 - 4 Piston P 34/38 Radial Mount @ 130mm Spacing (Pinless Fixing)	N/A	N/A	N/A		N/A		GPFA611HH
XA9.33.10/11- 4 Piston P32/36 Radial Mount Monobloc @108mm Spacing (Single Pin fixing)	N/A	N/A	N/A		FA218HH	EPFA218HH	N/A
XB0 B1 30/31 P4 30/34							GPFA673HH
XB2P710/XB2P711 Endurance Caliper							GPFA646HH
XQ21361 P2/28 Off Road Caliper	FA181	N/A	N/A	N/A	FA181R	EPFA181HH	N/A
XQ21390 PF 26 Off Road Rear Caliper	FA368	N/A	N/A	N/A	FA368R	EPFA368HH	N/A
M4-32 Monoblock Radial Front Caliper	N/A	N/A	N/A	N/A	FA630HH	EPFA630HH	GPFA630HH

EBC

4 Piston	FA216/2	N/A	N/A		FA216/2HH	N/A	N/A
----------	---------	-----	-----	--	-----------	-----	-----

FTE

4 Piston Radial Supermoto	N/A	N/A	N/A		MXS405	N/A	N/A
Piston Radial Supermoto	N/A	N/A	N/A		MXS406	N/A	N/A

⚠ This symbol indicates a rotor made of billet steel, and should be only used with EBC FA Kevlar® Organic or Vee pads.
 SAFETY NOTICE - With vehicles primarily designed for off highway use such as quads now being used on the highway, we would recommend the use of X or MXS pads for highway use and ONLY using the R and SV higher density / harder pad series for off road riding.

BRAKE APPLICATIONS

PADS FOR AFTERMARKET CALIPERS

APPLICATIONS

BRAKE

⚠ This symbol indicates a rotor made of billet steel, and should be only used with EBC FA Kevlar® Organic or Vee pads. SAFETY NOTICE - With vehicles primarily designed for off highway use such as quads now being used on the highway, we would recommend the use of X or MXS pads for highway use and ONLY using the R and SV higher density / harder pad series for off road riding.

	STANDARD ORGANIC PAD	OPTIONAL ORGANIC PAD	SEMI-SINTERED VEE PAD	CHROME BACKED SEMI-SINTERED VEE PAD	FULLY SINTERED PAD	EPFA FULLY SINTERED TRACK DAY PAD	GPFA FULLY SINTERED RACE PAD
GMA							
2 Piston rear (large) caliper model A (CCI #09-997)	FA36	N/A	FA36V		N/A	N/A	N/A
2 Piston (small) caliper model B (CCI # 09-996)	FA76	N/A	FA76V		FA76HH	N/A	N/A
4 Piston model F	FA115	N/A	FA115V		FA115HH	N/A	N/A
HARRISON BILLET							
Big 4 Piston (1296033)	FA47	FA47S	N/A		FA47HH	N/A	N/A
Big 6 Piston (1296033)	FA47	FA47S	N/A		FA47HH	N/A	N/A
2 Piston (1296040)	FA175		N/A		FA175HH	EPFA175HH	N/A
Slim Design	FA175		N/A		FA175HH	EPFA175HH	N/A
Mini 6	FA175		N/A		FA175HH	EPFA175HH	N/A
HHI - HAWG HALTERS							
4 Piston - All Types	FA216/3	N/A	FA216/3V	FA216/3VLD	FA216/3HH	N/A	N/A
4 Piston -Sprocket brake	FA623	N/A	N/A		FA623HH	N/A	N/A
6 Piston - All Types	FA424	N/A	N/A		FA424HH	EPFA424HH	N/A
IRON PEGASUS							
Small caliper (Single Pin Fixing)	FA47	FA47S	N/A		FA47HH	N/A	N/A
Small caliper (2 Pin Fixing)	FA115	N/A	FA115V		FA115HH	N/A	N/A
ISR							
22-023-0A (2 Piston)	FA11	N/A	N/A		N/A	N/A	N/A
22-025-XX (4 Piston)	FA47	FA47S	N/A		FA47HH	N/A	N/A
22-026-0A (Sprocket Caliper)	FA11	N/A	N/A		N/A	N/A	N/A
22-027 (2 Piston Rear)	FA47	FA47S	N/A		FA47HH	N/A	N/A
22-028 (2 Piston)	FA47	FA47S	N/A		FA47HH	N/A	N/A
22-029 (Rear 2 Piston)	FA47	FA47S	N/A		FA47HH	N/A	N/A
22-030 (2 Piston Rear)	FA16	FA16S	N/A		FA16HH	EPFA16HH	GPFA16HH
22-032 (6 Piston Large)	FA175	N/A	N/A		FA175HH	N/A	N/A
22-033 (2 Piston HD)	FA16	FA16S	N/A		FA16HH	EPFA16HH	GPFA16HH
22-034 (6 Piston Small)	FA184	N/A	N/A		N/A	N/A	N/A
22-036 (2 Piston)	FA184	N/A	N/A		N/A	N/A	N/A
22-042 (6 Piston Racing)	FA175	N/A	N/A		FA175HH	N/A	N/A
22-043 (4 Piston)	FA184	N/A	N/A		N/A	N/A	N/A
Radial 6 Piston Monoblock	FA184	N/A	N/A		N/A	N/A	N/A
JAYBRAKE							
Dual / Quad (300-04) (2 & 4 Piston)	FA115	N/A	FA115V		FA115HH	N/A	N/A
J-Four (300-44) (4 Piston)	FA188	N/A	N/A		FA188HH	EPFA188HH	N/A
J-Six (300-64) (6 Piston)	FA243	N/A	N/A		FA243HH	N/A	N/A
6 PF-L (6 Piston for 13" disc - Full Height Friction)	N/A	N/A	N/A		FA455HH	N/A	N/A
6 PF-L (6 Piston for 11.5" disc - Lower Height Friction)	N/A	N/A	N/A		FA649HH	N/A	N/A
Early Design 2 Piston	FA76	N/A	FA76V		FA76HH	N/A	N/A
LYNDALL BRAKES							
<i>IMPORTANT NOTE - DO NOT USE FULLY SINTERED PADS ON LYNDALL COMPOSITE ROTORS.</i>							
PAD REF 7058	FA200	N/A	FA200V		N/A	N/A	N/A
PAD REF 7059	FA94	N/A	FA94V		N/A	N/A	N/A
PAD REF 7138	FA95	N/A	FA95V		N/A	N/A	N/A
PAD REF 7153	FA115	N/A	FA115V		N/A	N/A	N/A
PAD REF 7157	FA201	N/A	FA201V		N/A	N/A	N/A
PAD REF 7174	FA244	N/A	FA244		N/A	N/A	N/A
PAD REF 7175	N/A	N/A	N/A		N/A	N/A	N/A
PAD REF 7176	FA196	N/A	FA196V		N/A	N/A	N/A
PAD REF 7177	N/A	N/A	N/A		N/A	N/A	N/A
PAD REF 7182	FA216/3	N/A	FA216/3V		N/A	N/A	N/A

*-2 Sets Required. ■ - Also available in MX-S race compound. **SAFETY WARNING:- DO NOT USE HH PADS ON REAR UNLESS ALSO USED ON FRONT TO AVOID BRAKE IMBALANCE**

PADS FOR AFTERMARKET CALIPERS

**BRAKE
APPLICATIONS**

LYNDALL BRAKES Contd.

	STANDARD ORGANIC PAD	OPTIONAL ORGANIC PAD	SEMI-SINTERED VEE PAD	CHROME BACKED SEMI-SINTERED VEE PAD	FULLY SINTERED PAD	EPFA FULLY SINTERED TRACK DAY PAD	GPFA FULLY SINTERED RACE PAD
PAD REF 7183	FA216/3	N/A	FA216/3V		N/A	N/A	N/A
PAD REF 7195	FA400	N/A	FA400V		N/A	N/A	N/A
PAD REF 7196	FA434	N/A	FA434V		N/A	N/A	N/A
PAD REF 7202	FA424	N/A	N/A		N/A	N/A	N/A
PAD REF 7230	FA209/2	N/A	FA209/2V		N/A	N/A	N/A
PAD REF 7231	N/A	N/A	N/A		N/A	N/A	N/A
PAD REF 7233	FA381	N/A	FA381V		N/A	N/A	N/A
PAD REF 7234	FA387	N/A	FA387V		N/A	N/A	N/A
PAD REF 7254	FA409	N/A	FA409V		N/A	N/A	N/A
PAD REF 7255	N/A	N/A	FA605/4V		N/A	N/A	N/A
PAD REF 7256	N/A	N/A	FA457V		N/A	N/A	N/A
PAD REF 7257	N/A	N/A	FA458V		N/A	N/A	N/A

MAGURA

4 Piston Radial Supermoto Caliper	FA433/4	N/A	N/A		FA433/4HH	EPFA433/4HH	N/A
-----------------------------------	---------	-----	-----	--	-----------	-------------	-----

MOTOMASTER

4 Piston	FA158	N/A	N/A		FA158HH	EPFA158HH	N/A
----------	-------	-----	-----	--	---------	-----------	-----

NOVA/LEGENDS

4 Piston	FA216/3	N/A	FA216/3V	FA216/3VLD	FA216/3HH	N/A	N/A
----------	---------	-----	----------	------------	-----------	-----	-----

OMP

4 Piston (Front and Rear fitment)	FA95	N/A	FA95V		FA95HH	EPFA95HH	N/A
6 Piston	FA116	N/A	N/A		N/A	N/A	N/A
Sprocket caliper	FA116	N/A	N/A		N/A	N/A	N/A

PERFORMANCE MACHINE

112 X 6B	FA249	N/A	N/A		FA249HH	EPFA249HH	N/A
112 X 6QC	FA249	N/A	N/A		FA249HH	EPFA249HH	N/A
112 X 6RSB	FA190	N/A	FA190V		FA190HH	EPFA190HH	N/A
112 X 6SSB	FA190	N/A	FA190V		FA190HH	EPFA190HH	N/A
124 X 4HR	FA216/2	N/A	N/A		FA216/2HH	N/A	N/A
125 X 2	FA115	N/A	FA115V		FA115HH	N/A	N/A
125 X 4R	FA216/3	N/A	FA216/3V	FA216/3VLD	FA216/3HH	N/A	N/A
125 X 4RSPH	FA216/3	N/A	FA216/3V	FA216/3VLD	FA216/3HH	N/A	N/A
125 X 4S	FA115	N/A	FA115V		FA115HH	N/A	N/A
125 X 4SL	FA115	N/A	FA115V		FA115HH	N/A	N/A
125 X 6	FA210	N/A	FA210V		N/A	N/A	N/A
125 X 6QC	FA190	N/A	FA190V		FA190HH	N/A	N/A
137 X 4	FA216/2	N/A	N/A		FA216/2HH	N/A	N/A
137 X 4 (2006)	N/A	N/A	N/A		FA420HH	N/A	N/A
137 X 4B	FA216/3	N/A	FA216/3V	FA216/3VLD	FA216/3HH	N/A	N/A
137 X 6	FA210	N/A	FA210V		N/A	N/A	N/A
162 X 2	FA32	N/A	FA32V		N/A	N/A	N/A

PFM

6 Piston Superbike caliper	N/A	N/A	N/A		N/A	EPFA263HH	N/A
----------------------------	-----	-----	-----	--	-----	-----------	-----

PRE TECH

4 Piston (Uni P401)	FA180	N/A	N/A		FA180HH	N/A	N/A
4 Piston (P402) Lockheed Replacement Caliper	FA158	N/A	N/A		FA158HH	EPFA158HH	N/A
6 Piston	FA190	N/A	FA190V		FA190HH	EPFA190HH	N/A
6 Piston (Radial Mount)	FA249	N/A	N/A		FA249HH	EPFA249HH	N/A

⚠ This symbol indicates a rotor made of billet steel, and should be only used with EBC FA Kevlar® Organic or Vee pads.
SAFETY NOTICE - With vehicles primarily designed for off highway use such as quads now being used on the highway, we would recommend the use of X or MXS pads for highway use and ONLY using the R and SV higher density / harder pad series for off road riding.

*-2 Sets Required. ■ - Also available in MX-S race compound. **SAFETY WARNING:- DO NOT USE HH PADS ON REAR UNLESS ALSO USED ON FRONT TO AVOID BRAKE IMBALANCE**

Part numbers, prefixes, suffixes, photos and illustrations shown in this catalog are trademarks and/or copyrights of EBC Brakes or the trademark owner Freeman Automotive (UK) Ltd and use without express written permission of the owners is punishable by law.

PADS FOR AFTERMARKET CALIPERS

APPLICATIONS

BRAKE

⊛ This symbol indicates a rotor made of billet steel, and should be only used with EBC FA Kevlar® Organic or Vee pads. SAFETY NOTICE - With vehicles primarily designed for off highway use such as quads now being used on the highway, we would recommend the use of X or MXS pads for highway use and ONLY using the R and SV higher density / harder pad series for off road riding.

	STANDARD ORGANIC PAD	OPTIONAL ORGANIC PAD	SEMI-SINTERED VEE PAD	CHROME BACKED SEMI-SINTERED VEE PAD	FULLY SINTERED PAD	EPFA FULLY SINTERED TRACK DAY PAD	GPFA FULLY SINTERED RACE PAD
PRO-ONE							
2 Piston	FA47	FA47S	N/A		FA47HH	N/A	N/A
4 Piston	FA158	N/A	N/A		FA158HH	EPFA158HH	N/A
P.V.M							
2 Piston Rear Caliper (Note Only 2 Pads Required)	N/A	N/A	N/A		FA435/4HH	EPFA435/4HH	N/A
4 Piston Radial Mount Caliper	N/A	N/A	N/A		FA435/4HH	EPFA435/4HH	N/A
4 Piston race caliper (Old Design)	FA211/2	N/A	N/A		N/A	N/A	N/A
6 Piston (Old large design)	N/A	N/A	N/A		N/A		GFA183HH
6 Piston (New small design)	N/A	N/A	N/A		N/A		GFA276HH
REVTECH							
CCI Polished Caliper (Front/Rear)	FA95	N/A	FA95V		FA95HH	EPFA95HH	N/A
New Black 4 Piston Caliper	FA216/3	N/A	FA216/3V	FA216/3VLD	FA216/3HH	N/A	N/A
6 Piston VR1000 Race Caliper	N/A	N/A	N/A		N/A	N/A	N/A
SPONDON							
4 Piston Caliper	N/A	N/A	N/A		N/A	N/A	N/A
4 Piston Caliper	N/A	N/A	N/A		N/A	N/A	N/A
SPIEGLER							
4 Piston Caliper S4B	N/A	N/A	N/A		N/A	N/A	N/A
8 Piston Caliper S8B	N/A	N/A	N/A		N/A	N/A	N/A
THUNDERHEART							
4 Piston Caliper	FA216/3	N/A	FA216/3V	FA216/3VLD	FA216/3HH	N/A	N/A
6 Piston Caliper	FA249	N/A	N/A		FA249HH	N/A	N/A
WILWOOD							
PS1 Caliper (Part # 150-4091K)	FA271X	N/A	N/A		FA271R	N/A	N/A
GP300/310 (Part # 150-8733-2)	FA95	N/A	FA95V		FA95HH	EPFA95HH	N/A
GP320 (Part # 154-8596K)	FA95/2	N/A	N/A		N/A	N/A	N/A

GOLF CART BRAKE SHOES



CLUB CAR



Engine Type

BRAKE SHOES - FRONT

BRAKE SHOES - REAR

Left Brake Shoe

Right Brake Shoe

Left Brake Shoe

Right Brake Shoe



Line #

Line #	Model	Year	Engine Type	Left Brake Shoe	Right Brake Shoe	Left Brake Shoe	Right Brake Shoe
1	Café Express	81-94	Gasoline	N/A	N/A	GOLFS5	GOLFS5
2	Café Express	95-04	Gasoline	N/A	N/A	GOLFS2	GOLFS2
3	Carryall 1	81-94	Gasoline	N/A	N/A	GOLFS5	GOLFS5
4	Carryall 1	95-04	Gasoline	N/A	N/A	GOLFS2	GOLFS2
5	Carryall 2	81-94	Gasoline	N/A	N/A	GOLFS5	GOLFS5
6	Carryall 2	95-04	Gasoline	N/A	N/A	GOLFS2	GOLFS2
7	Carryall 2 Plus	81-94	Gasoline	N/A	N/A	GOLFS5	GOLFS5
8	Carryall 2 Plus	95-04	Gasoline	N/A	N/A	GOLFS2	GOLFS2
9	Carryall 232	81-94	Gasoline	N/A	N/A	GOLFS5	GOLFS5
10	Carryall 232	95-04	Gasoline	N/A	N/A	GOLFS2	GOLFS2
11	Carryall 252	81-94	Gasoline	N/A	N/A	GOLFS5	GOLFS5
12	Carryall 252	95-04	Gasoline	N/A	N/A	GOLFS2	GOLFS2
13	Carryall 272	81-94	Gasoline	N/A	N/A	GOLFS5	GOLFS5
14	Carryall 272	95-04	Gasoline	N/A	N/A	GOLFS2	GOLFS2
15	Carryall 294	81-94	Gasoline	N/A	N/A	GOLFS5	GOLFS5
16	Carryall 294	95-04	Gasoline	N/A	N/A	GOLFS2	GOLFS2
17	Carryall 295	81-94	Gasoline	N/A	N/A	GOLFS5	GOLFS5
18	Carryall 295	95-04	Gasoline	N/A	N/A	GOLFS2	GOLFS2
19	Carryall 472	81-94	Gasoline	N/A	N/A	GOLFS5	GOLFS5
20	Carryall 472	95-04	Gasoline	N/A	N/A	GOLFS2	GOLFS2
21	Carryall 6	81-94	Gasoline	N/A	N/A	GOLFS5	GOLFS5
22	Carryall 6	95-04	Gasoline	N/A	N/A	GOLFS2	GOLFS2
23	Champion	81-94	Gasoline	N/A	N/A	GOLFS5	GOLFS5
24	Champion	95-04	Gasoline	N/A	N/A	GOLFS2	GOLFS2
25	DS	81-94	Gasoline	N/A	N/A	GOLFS5	GOLFS5
26	DS	95-04	Gasoline	N/A	N/A	GOLFS2	GOLFS2
27	DS	95-	Gasoline	N/A	N/A	GOLFS1	GOLFS1
28	DS	95-	Electric	N/A	N/A	GOLFS1	GOLFS1
29	Fairway Villager	81-94	Gasoline	N/A	N/A	GOLFS5	GOLFS5
30	Fairway Villager	95-04	Gasoline	N/A	N/A	GOLFS2	GOLFS2
31	Pioneer 1200	81-94	Gasoline	N/A	N/A	GOLFS5	GOLFS5
32	Pioneer 1200	95-04	Gasoline	N/A	N/A	GOLFS2	GOLFS2
33	Pioneer 1200SE	81-94	Electric	N/A	N/A	GOLFS5	GOLFS5
34	Pioneer 1200SE	95-04	Electric	N/A	N/A	GOLFS2	GOLFS2
35	Pioneer 900	81-94	Gasoline	N/A	N/A	GOLFS5	GOLFS5
36	Pioneer 900	95-04	Gasoline	N/A	N/A	GOLFS2	GOLFS2
37	Precedent Signature 4Pass	04-	Gasoline	N/A	N/A	GOLFS1	GOLFS1
38	Precedent Signature 4Pass	04-	Electric	N/A	N/A	GOLFS1	GOLFS1
39	Precedent	81-94	Gasoline	N/A	N/A	GOLFS5	GOLFS5
40	Precedent	81-94	Electric	N/A	N/A	GOLFS5	GOLFS5
41	Precedent	95-04	Gasoline	N/A	N/A	GOLFS2	GOLFS2
42	Precedent	95-04	Electric	N/A	N/A	GOLFS2	GOLFS2
43	Precedent	04-	Gasoline	N/A	N/A	GOLFS1	GOLFS1
44	Precedent	04-	Electric	N/A	N/A	GOLFS1	GOLFS1
45	Precedent L2	04-	Gasoline	N/A	N/A	GOLFS1	GOLFS1
46	Precedent L2	04-	Electric	N/A	N/A	GOLFS1	GOLFS1
47	Precedent Professional IQ	04-	Gasoline	N/A	N/A	GOLFS1	GOLFS1
48	Precedent Professional IQ	04-	Electric	N/A	N/A	GOLFS1	GOLFS1
49	Precedent Signature	04-	Gasoline	N/A	N/A	GOLFS1	GOLFS1
50	Precedent Signature	04-	Electric	N/A	N/A	GOLFS1	GOLFS1
51	Precedent Villager 4	04-	Gasoline	N/A	N/A	GOLFS1	GOLFS1
52	Precedent Villager 4	04-	Electric	N/A	N/A	GOLFS1	GOLFS1
53	Precedent Villager 4 IQ	04-	Gasoline	N/A	N/A	GOLFS1	GOLFS1
54	Precedent Villager 4 IQ	04-	Electric	N/A	N/A	GOLFS1	GOLFS1
55	Precedent Professional	04-	Gasoline	N/A	N/A	GOLFS1	GOLFS1
56	Precedent Professional	04-	Electric	N/A	N/A	GOLFS1	GOLFS1

BRAKE APPLICATIONS

GOLF CART BRAKE SHOES

BRAKE APPLICATIONS



CLUB CAR



Engine Type

BRAKE SHOES - FRONT

Left Brake Shoe



Right Brake Shoe



BRAKE SHOES - REAR

Left Brake Shoe



Right Brake Shoe



Line #

Model	Year	Engine Type	Left Brake Shoe	Right Brake Shoe	Left Brake Shoe	Right Brake Shoe	Line #
Transporter 4	81-94	Gasoline	N/A	N/A	GOLFS5	GOLFS5	1
Transporter 4	95-04	Gasoline	N/A	N/A	GOLFS2	GOLFS2	2
Transporter 6	81-94	Gasoline	N/A	N/A	GOLFS5	GOLFS5	3
Transporter 6	95-04	Gasoline	N/A	N/A	GOLFS2	GOLFS2	4
Turf 1	81-94	Gasoline	N/A	N/A	GOLFS5	GOLFS5	5
Turf 1	95-04	Gasoline	N/A	N/A	GOLFS2	GOLFS2	6
Turf 2	81-94	Gasoline	N/A	N/A	GOLFS5	GOLFS5	7
Turf 2	95-04	Gasoline	N/A	N/A	GOLFS2	GOLFS2	8
Turf 252	81-94	Gasoline	N/A	N/A	GOLFS5	GOLFS5	9
Turf 252	95-04	Gasoline	N/A	N/A	GOLFS2	GOLFS2	10
Turf 6	81-94	Gasoline	N/A	N/A	GOLFS5	GOLFS5	11
Turf 6	95-04	Gasoline	N/A	N/A	GOLFS2	GOLFS2	12
Villager 2+2	81-94	Gasoline	N/A	N/A	GOLFS5	GOLFS5	13
Villager 2+2	95-04	Gasoline	N/A	N/A	GOLFS2	GOLFS2	14
Villager 6	81-94	Gasoline	N/A	N/A	GOLFS5	GOLFS5	15
Villager 6	95-04	Gasoline	N/A	N/A	GOLFS2	GOLFS2	16
Villager 8	81-94	Gasoline	N/A	N/A	GOLFS5	GOLFS5	17
Villager 8	95-04	Gasoline	N/A	N/A	GOLFS2	GOLFS2	18
X2	81-94	Gasoline	N/A	N/A	GOLFS5	GOLFS5	19
X2	95-04	Gasoline	N/A	N/A	GOLFS2	GOLFS2	20
XRT1200	81-94	Gasoline	N/A	N/A	GOLFS5	GOLFS5	21
XRT1200	95-04	Gasoline	N/A	N/A	GOLFS2	GOLFS2	22
XRT1200	05-	Gasoline	N/A	N/A	GOLFS1	GOLFS1	23
XRT1200SE	81-94	Electric	N/A	N/A	GOLFS5	GOLFS5	24
XRT1200SE	95-04	Electric	N/A	N/A	GOLFS2	GOLFS2	25
XRT1200SE	05-	Gasoline	N/A	N/A	GOLFS1	GOLFS1	26
XRT1500	81-94	Gasoline	N/A	N/A	GOLFS5	GOLFS5	27
XRT1500	95-04	Gasoline	N/A	N/A	GOLFS2	GOLFS2	28
XRT1550SE	81-94	Electric	N/A	N/A	GOLFS5	GOLFS5	29
XRT1550SE	95-04	Electric	N/A	N/A	GOLFS2	GOLFS2	30
XRT800	81-94	Gasoline	N/A	N/A	GOLFS5	GOLFS5	31
XRT800	95-04	Gasoline	N/A	N/A	GOLFS2	GOLFS2	32
XRT800E	81-94	Electric	N/A	N/A	GOLFS5	GOLFS5	33
XRT800E	95-04	Electric	N/A	N/A	GOLFS2	GOLFS2	34
XRT810	81-94	Gasoline	N/A	N/A	GOLFS5	GOLFS5	35
XRT810	95-04	Gasoline	N/A	N/A	GOLFS2	GOLFS2	36
XRT810E	81-94	Electric	N/A	N/A	GOLFS5	GOLFS5	37
XRT810E	95-04	Electric	N/A	N/A	GOLFS2	GOLFS2	38
XRT850	81-94	Gasoline	N/A	N/A	GOLFS5	GOLFS5	39
XRT850	95-04	Gasoline	N/A	N/A	GOLFS2	GOLFS2	40
XRT900	81-94	Gasoline	N/A	N/A	GOLFS5	GOLFS5	41
XRT900	95-04	Gasoline	N/A	N/A	GOLFS2	GOLFS2	42
XRT950 2x4	81-94	Gasoline	N/A	N/A	GOLFS5	GOLFS5	43
XRT950 2x4	95-04	Gasoline	N/A	N/A	GOLFS2	GOLFS2	44
XRT950EX 4x4	81-94	Gasoline	N/A	N/A	GOLFS5	GOLFS5	45
XRT950EX 4x4	95-04	Gasoline	N/A	N/A	GOLFS2	GOLFS2	46
EZGO							47
Express L4	12-15	Electric	N/A	N/A	GOLFS1	GOLFS1	49
Express L4	12-15	Gasoline	N/A	N/A	GOLFS1	GOLFS1	50
Express L6	12-16	Electric	N/A	N/A	GOLFS1	GOLFS1	51
Express L6	12-16	Gasoline	N/A	N/A	GOLFS1	GOLFS1	52
Express S4	12-16	Electric	N/A	N/A	GOLFS1	GOLFS1	53
Express S4	12-16	Gasoline	N/A	N/A	GOLFS1	GOLFS1	54
Express S6	12-16	Electric	N/A	N/A	GOLFS1	GOLFS1	55
Express S6	12-16	Gasoline	N/A	N/A	GOLFS1	GOLFS1	56

GOLF CART BRAKE SHOES



EZGO



Engine Type

BRAKE SHOES - FRONT

BRAKE SHOES - REAR



Line #

Line #	Model	Year	Engine Type	Left Brake Shoe	Right Brake Shoe	Left Brake Shoe	Right Brake Shoe
1	Marathon 3 Wheel	89-92	Electric	N/A	N/A	GOLFS1	GOLFS1
2	Marathon 4 Wheel	89-92	Electric	N/A	N/A	GOLFS1	GOLFS1
3	Marathon GX444 2-cycle	91-93	Gasoline	N/A	N/A	GOLFS1	GOLFS1
4	Marathon GX444 4-cycle	91-93	Gasoline	N/A	N/A	GOLFS1	GOLFS1
5	Marathon Spirit GX444J 2-Cycle	91	Gasoline	N/A	N/A	GOLFS1	GOLFS1
6	Marathon Spirit GX444J 4-Cycle	91-93	Gasoline	N/A	N/A	GOLFS1	GOLFS1
7	Medalist	93-96	Electric	N/A	N/A	GOLFS1	GOLFS1
8	Medalist	93-95	Gasoline	N/A	N/A	GOLFS1	GOLFS1
9	Medalist	96-99	Gasoline	N/A	N/A	GOLFS1	GOLFS1
10	Medalist (DCS)	95-96	Electric	N/A	N/A	GOLFS1	GOLFS1
11	MPT 1000	10-12	Electric	N/A	N/A	GOLFS1	GOLFS1
12	MPT 800	10-12	Electric	N/A	N/A	GOLFS1	GOLFS1
13	RXV Standard	09-16	Gasoline	N/A	N/A	GOLFS1	GOLFS1
14	RXV with Lights	09-16	Gasoline	N/A	N/A	GOLFS1	GOLFS1
15	RXV with Lights and Rear Seat	09-16	Gasoline	N/A	N/A	GOLFS1	GOLFS1
16	ST 400	10-12	Electric	N/A	N/A	GOLFS1	GOLFS1
17	ST Sport II	11-12	Electric	N/A	N/A	GOLFS1	GOLFS1
18	Terrain 250	12-16	Electric	N/A	N/A	GOLFS1	GOLFS1
19	TXT Standard	96	Electric	N/A	N/A	GOLFS1	GOLFS1
20	TXT Standard	08-13	Electric	N/A	N/A	GOLFS1	GOLFS1
21	TXT Standard	96	Gasoline	N/A	N/A	GOLFS1	GOLFS1
22	TXT Standard	10-13	Gasoline	N/A	N/A	GOLFS1	GOLFS1
23	TXT Standard (DCS)	1996	Electric	N/A	N/A	GOLFS1	GOLFS1
24	TXT Standard Redesigned	14-17	Electric	N/A	N/A	GOLFS1	GOLFS1
25	TXT Standard Redesigned	14-16	Gasoline	N/A	N/A	GOLFS1	GOLFS1
26	TXT with Lights	96	Electric	N/A	N/A	GOLFS1	GOLFS1
27	TXT with Lights	08-13	Electric	N/A	N/A	GOLFS1	GOLFS1
28	TXT with Lights	96	Gasoline	N/A	N/A	GOLFS1	GOLFS1
29	TXT with Lights	10-13	Gasoline	N/A	N/A	GOLFS1	GOLFS1
30	TXT with Lights (DCS)	96	Electric	N/A	N/A	GOLFS1	GOLFS1
31	TXT with Lights and Rear Seat	13-16	Gasoline	N/A	N/A	GOLFS1	GOLFS1
32	TXT with Lights Redesigned	14	Electric	N/A	N/A	GOLFS1	GOLFS1
33	YAMAHA						
34	YAMAHA						
35	DR2A17	17	Gasoline	N/A	N/A	GOLFS1	GOLFS1
36	DR2A17 EFI	17	Gasoline	N/A	N/A	GOLFS1	GOLFS1
37	DR2A17 PTV	17	Gasoline	N/A	N/A	GOLFS1	GOLFS1
38	DR2A18	18	Gasoline	N/A	N/A	GOLFS1	GOLFS1
39	DR2A18 EFI	18	Gasoline	N/A	N/A	GOLFS1	GOLFS1
40	DR2A18 PTV	18	Gasoline	N/A	N/A	GOLFS1	GOLFS1
41	DR2E17 AC	17	Electric	N/A	N/A	GOLFS1	GOLFS1
42	DR2E17 PTV	17	Electric	N/A	N/A	GOLFS1	GOLFS1
43	DR2E18	18	Gasoline	N/A	N/A	GOLFS1	GOLFS1
44	DR2E18 AC	18	Gasoline	N/A	N/A	GOLFS1	GOLFS1
45	DR2E18 PTV	18	Gasoline	N/A	N/A	GOLFS1	GOLFS1
46	DRIVE-YDRA	11	Gasoline	GOLFS1	GOLFS1	GOLFS1	GOLFS1
47	DRIVE-YDRE	11	Electric	GOLFS1	GOLFS1	GOLFS1	GOLFS1
48	G1-A3	82	Gasoline	N/A	N/A	GOLFS1	GOLFS1
49	G1-AM	86	Gasoline	N/A	N/A	GOLFS1	GOLFS1
50	G1-AM3	83	Gasoline	N/A	N/A	GOLFS1	GOLFS1
51	G1-AM5	85	Gasoline	N/A	N/A	GOLFS1	GOLFS1
52	G1-E3	82	Electric	N/A	N/A	GOLFS1	GOLFS1
53	G1-EM	86	Electric	N/A	N/A	GOLFS1	GOLFS1
54	G1-EM3	83	Electric	N/A	N/A	GOLFS1	GOLFS1
55	G1-EM4	84	Electric	N/A	N/A	GOLFS1	GOLFS1
56	G1-EM5	85	Electric	N/A	N/A	GOLFS1	GOLFS1

BRAKE APPLICATIONS

GOLF CART BRAKE SHOES

BRAKE APPLICATIONS



YAMAHA



Engine Type

BRAKE SHOES - FRONT

Left Brake Shoe



Right Brake Shoe



BRAKE SHOES - REAR

Left Brake Shoe



Right Brake Shoe



Line #

		Engine Type	Left Brake Shoe	Right Brake Shoe	Left Brake Shoe	Right Brake Shoe	Line #
G11-AP	96	Gasoline	N/A	N/A	GOLFS2	GOLFS2	1
G11AJ	93	Gasoline	GOLFS1	GOLFS1	GOLFS1	GOLFS1	2
G11AK	94	Gasoline	GOLFS1	GOLFS1	GOLFS1	GOLFS1	3
G11AR	97	Gasoline	N/A	N/A	GOLFS2	GOLFS2	4
G11AS	98	Gasoline	GOLFS2	GOLFS2	GOLFS2	GOLFS2	5
G11AT	99	Gasoline	GOLFS2	GOLFS2	GOLFS2	GOLFS2	6
G11AU	00	Gasoline	GOLFS2	GOLFS2	GOLFS2	GOLFS2	7
G11AW	01	Gasoline	GOLFS2	GOLFS2	GOLFS2	GOLFS2	8
G14AM	95	Gasoline	GOLFS2	GOLFS2	GOLFS2	GOLFS2	9
G14AP	96	Gasoline	GOLFS2	GOLFS2	GOLFS2	GOLFS2	10
G14EM	95	Electric	GOLFS2	GOLFS2	GOLFS2	GOLFS2	11
G14EP	96	Electric	GOLFS2	GOLFS2	GOLFS2	GOLFS2	12
G16AP	96	Gasoline	GOLFS2	GOLFS2	GOLFS2	GOLFS2	13
G16AR	97	Gasoline	GOLFS2	GOLFS2	GOLFS2	GOLFS2	14
G16AS	98	Gasoline	GOLFS2	GOLFS2	GOLFS2	GOLFS2	15
G16AT	99	Gasoline	GOLFS2	GOLFS2	GOLFS2	GOLFS2	16
G16AU	00	Gasoline	GOLFS2	GOLFS2	GOLFS2	GOLFS2	17
G16AW	01	Gasoline	GOLFS2	GOLFS2	GOLFS2	GOLFS2	18
G16AX	02	Gasoline	GOLFS2	GOLFS2	GOLFS2	GOLFS2	19
G16EP	96	Electric	GOLFS2	GOLFS2	GOLFS2	GOLFS2	20
G16ER	97	Electric	GOLFS2	GOLFS2	GOLFS2	GOLFS2	21
G16ES	98	Electric	GOLFS2	GOLFS2	GOLFS2	GOLFS2	22
G16ET	99	Electric	GOLFS2	GOLFS2	GOLFS2	GOLFS2	23
G16EU	00	Electric	GOLFS2	GOLFS2	GOLFS2	GOLFS2	24
G16EW	01	Electric	GOLFS2	GOLFS2	GOLFS2	GOLFS2	25
G16EX	02	Electric	GOLFS2	GOLFS2	GOLFS2	GOLFS2	26
G19EP	96	Electric	GOLFS2	GOLFS2	GOLFS2	GOLFS2	27
G19ER	97	Electric	GOLFS2	GOLFS2	GOLFS2	GOLFS2	28
G19ES	98	Electric	GOLFS2	GOLFS2	GOLFS2	GOLFS2	29
G19ET	99	Electric	GOLFS2	GOLFS2	GOLFS2	GOLFS2	30
G19EU	00	Electric	GOLFS2	GOLFS2	GOLFS2	GOLFS2	31
G19EW	01	Electric	GOLFS2	GOLFS2	GOLFS2	GOLFS2	32
G19EX	02	Electric	GOLFS2	GOLFS2	GOLFS2	GOLFS2	33
G1A	79	Gasoline	TBA	TBA	TBA	TBA	34
G1A1	80	Gasoline	TBA	TBA	TBA	TBA	35
G1A2	81	Gasoline	TBA	TBA	TBA	TBA	36
G1AM	86	Gasoline	N/A	N/A	GOLFS1	GOLFS1	37
G1AM4	84	Gasoline	N/A	N/A	GOLFS1	GOLFS1	38
G1AM5	85	Gasoline	N/A	N/A	GOLFS1	GOLFS1	39
G1AMD	89	Gasoline	N/A	N/A	GOLFS1	GOLFS1	40
G1E	80	Gasoline	TBA	TBA	TBA	TBA	41
G1E2	81	Electric	TBA	TBA	TBA	TBA	42
G2-A	86	Gasoline	GOLFS1	GOLFS1	GOLFS1	GOLFS1	43
G2-AB	88	Gasoline	GOLFS1	GOLFS1	GOLFS1	GOLFS1	44
G2-AC	88	Gasoline	GOLFS1	GOLFS1	GOLFS1	GOLFS1	45
G2-AD	89	Gasoline	GOLFS1	GOLFS1	GOLFS1	GOLFS1	46
G2-AF	90	Gasoline	GOLFS1	GOLFS1	GOLFS1	GOLFS1	47
G2-AG	91	Gasoline	GOLFS1	GOLFS1	GOLFS1	GOLFS1	48
G2-AM5	85	Gasoline	GOLFS1	GOLFS1	GOLFS1	GOLFS1	49
G2-E	86	Electric	GOLFS1	GOLFS1	GOLFS1	GOLFS1	50
G2-E5	85	Electric	GOLFS1	GOLFS1	GOLFS1	GOLFS1	51
G2-EB	87-88	Electric	GOLFS1	GOLFS1	GOLFS1	GOLFS1	52
G2-EC	88	Electric	GOLFS1	GOLFS1	GOLFS1	GOLFS1	53
G2-ED	89	Electric	GOLFS1	GOLFS1	GOLFS1	GOLFS1	54
G2-EF	90	Electric	GOLFS1	GOLFS1	GOLFS1	GOLFS1	55
G2-EG	91	Electric	GOLFS1	GOLFS1	GOLFS1	GOLFS1	56

GOLF CART BRAKE SHOES



YAMAHA



Engine Type

BRAKE SHOES - FRONT

BRAKE SHOES - REAR

Left Brake Shoe

Right Brake Shoe

Left Brake Shoe

Right Brake Shoe



Line #

Line #	Part #	Engine Type	Left Brake Shoe	Right Brake Shoe	Left Brake Shoe	Right Brake Shoe
1	G20AU	Gasoline	GOLFS2	GOLFS2	GOLFS2	GOLFS2
2	G20AW	Gasoline	GOLFS2	GOLFS2	GOLFS2	GOLFS2
3	G20AX	Gasoline	GOLFS2	GOLFS2	GOLFS2	GOLFS2
4	G21AW	Gasoline	GOLFS2	GOLFS2	GOLFS2	GOLFS2
5	G21AX	Gasoline	GOLFS2	GOLFS2	GOLFS2	GOLFS2
6	G21AY	Gasoline	GOLFS2	GOLFS2	GOLFS2	GOLFS2
7	G21AZ	Gasoline	GOLFS2	GOLFS2	GOLFS2	GOLFS2
8	G22AA	Gasoline	GOLFS2	GOLFS2	GOLFS2	GOLFS2
9	G22AB	Gasoline	GOLFS2	GOLFS2	GOLFS2	GOLFS2
10	G22AC	Gasoline	GOLFS2	GOLFS2	GOLFS2	GOLFS2
11	G22AD	Gasoline	GOLFS2	GOLFS2	GOLFS2	GOLFS2
12	G22AD-LE	Gasoline	GOLFS2	GOLFS2	GOLFS2	GOLFS2
13	G22AE	Gasoline	GOLFS2	GOLFS2	GOLFS2	GOLFS2
14	G22AY	Gasoline	GOLFS2	GOLFS2	GOLFS2	GOLFS2
15	G22AZ	Gasoline	GOLFS2	GOLFS2	GOLFS2	GOLFS2
16	G22EA	Electric	GOLFS2	GOLFS2	GOLFS2	GOLFS2
17	G22EB	Electric	GOLFS2	GOLFS2	GOLFS2	GOLFS2
18	G22EC	Electric	GOLFS2	GOLFS2	GOLFS2	GOLFS2
19	G22ED	Electric	GOLFS2	GOLFS2	GOLFS2	GOLFS2
20	G22ED-LE	Electric	GOLFS2	GOLFS2	GOLFS2	GOLFS2
21	G22EE	Electric	GOLFS2	GOLFS2	GOLFS2	GOLFS2
22	G22EY	Electric	GOLFS2	GOLFS2	GOLFS2	GOLFS2
23	G22EZ	Electric	GOLFS2	GOLFS2	GOLFS2	GOLFS2
24	G23AC	Gasoline	GOLFS2	GOLFS2	GOLFS2	GOLFS2
25	G23AE	Gasoline	GOLFS2	GOLFS2	GOLFS2	GOLFS2
26	G23AF	Gasoline	GOLFS2	GOLFS2	GOLFS2	GOLFS2
27	G23AG	Gasoline	GOLFS2	GOLFS2	GOLFS2	GOLFS2
28	G23AZ	Gasoline	GOLFS2	GOLFS2	GOLFS2	GOLFS2
29	G23EC	Electric	GOLFS2	GOLFS2	GOLFS2	GOLFS2
30	G23EE	Electric	GOLFS2	GOLFS2	GOLFS2	GOLFS2
31	G23EF	Electric	GOLFS2	GOLFS2	GOLFS2	GOLFS2
32	G23EZ	Electric	GOLFS2	GOLFS2	GOLFS2	GOLFS2
33	G27AC	Gasoline	GOLFS2	GOLFS2	GOLFS2	GOLFS2
34	G27AE	Gasoline	GOLFS2	GOLFS2	GOLFS2	GOLFS2
35	G27AF	Gasoline	GOLFS2	GOLFS2	GOLFS2	GOLFS2
36	G27AZ	Gasoline	GOLFS2	GOLFS2	GOLFS2	GOLFS2
37	G27EC	Gasoline	GOLFS2	GOLFS2	GOLFS2	GOLFS2
38	G27EE	Electric	GOLFS2	GOLFS2	GOLFS2	GOLFS2
39	G27EF	Electric	GOLFS2	GOLFS2	GOLFS2	GOLFS2
40	G27EZ	Electric	GOLFS2	GOLFS2	GOLFS2	GOLFS2
41	G28AA	Gasoline	N/A	N/A	GOLFS2	GOLFS2
42	G28AC	Gasoline	N/A	N/A	GOLFS2	GOLFS2
43	G28AE	Gasoline	N/A	N/A	GOLFS2	GOLFS2
44	G28AF	Gasoline	N/A	N/A	GOLFS2	GOLFS2
45	G28AG	Gasoline	N/A	N/A	GOLFS2	GOLFS2
46	G28AZ	Gasoline	N/A	N/A	GOLFS2	GOLFS2
47	G2AB	Gasoline	GOLFS1	GOLFS1	GOLFS1	GOLFS1
48	G3A	Gasoline	N/A	N/A	GOLFS1	GOLFS1
49	G3E	Electric	GOLFS1	GOLFS1	GOLFS1	GOLFS1
50	G5AF	Gasoline	GOLFS1	GOLFS1	GOLFS1	GOLFS1
51	G5AG	Gasoline	GOLFS1	GOLFS1	GOLFS1	GOLFS1
52	G5AH	Gasoline	GOLFS1	GOLFS1	GOLFS1	GOLFS1
53	G5AJ	Gasoline	GOLFS1	GOLFS1	GOLFS1	GOLFS1
54	G5AK	Gasoline	GOLFS1	GOLFS1	GOLFS1	GOLFS1
55	G5AM	Gasoline	GOLFS1	GOLFS1	GOLFS1	GOLFS1
56	G5EF	Electric	GOLFS1	GOLFS1	GOLFS1	GOLFS1

BRAKE APPLICATIONS

GOLF CART BRAKE SHOES

BRAKE APPLICATIONS



YAMAHA



Engine Type

BRAKE SHOES - FRONT



BRAKE SHOES - REAR



Model	Part #	Engine Type	BRAKE SHOES - FRONT		BRAKE SHOES - REAR		Line #
			Left Brake Shoe	Right Brake Shoe	Left Brake Shoe	Right Brake Shoe	
G5EG	91	Electric	GOLFS1	GOLFS1	GOLFS1	GOLFS1	1
G5EH	92	Electric	GOLFS1	GOLFS1	GOLFS1	GOLFS1	2
G8AF	90	Gasoline	GOLFS1	GOLFS1	GOLFS1	GOLFS1	3
G8AG	91	Gasoline	GOLFS1	GOLFS1	GOLFS1	GOLFS1	4
G8AH	92	Gasoline	GOLFS1	GOLFS1	GOLFS1	GOLFS1	5
G8AJ	93	Gasoline	GOLFS1	GOLFS1	GOLFS1	GOLFS1	6
G8AK	94	Gasoline	GOLFS1	GOLFS1	GOLFS1	GOLFS1	7
G8EF	90	Electric	GOLFS1	GOLFS1	GOLFS1	GOLFS1	8
G8EG	91	Electric	GOLFS1	GOLFS1	GOLFS1	GOLFS1	9
G8EH	92	Electric	GOLFS1	GOLFS1	GOLFS1	GOLFS1	10
G8EJ	92	Electric	GOLFS1	GOLFS1	GOLFS1	GOLFS1	11
G8EK	94	Electric	GOLFS1	GOLFS1	GOLFS1	GOLFS1	12
G8EKP	94	Electric	GOLFS1	GOLFS1	GOLFS1	GOLFS1	13
G9AG	91	Gasoline	GOLFS2	GOLFS2	GOLFS2	GOLFS2	14
G9AH	92	Gasoline	GOLFS2	GOLFS2	GOLFS2	GOLFS2	15
G9AJ	93	Gasoline	GOLFS2	GOLFS2	GOLFS2	GOLFS2	16
G9AJ LATE	93	Gasoline	GOLFS2	GOLFS2	GOLFS2	GOLFS2	17
G9AK	94	Gasoline	GOLFS2	GOLFS2	GOLFS2	GOLFS2	18
G9EG	91	Electric	GOLFS2	GOLFS2	GOLFS2	GOLFS2	19
G9EG	91	Electric	GOLFS1	GOLFS1	GOLFS1	GOLFS1	20
G9EH1	92	Electric	GOLFS1	GOLFS1	GOLFS1	GOLFS1	21
G9EH2	92	Electric	GOLFS2	GOLFS2	GOLFS2	GOLFS2	22
G9EJ	93	Electric	GOLFS2	GOLFS2	GOLFS2	GOLFS2	23
G9EK	94	Electric	GOLFS2	GOLFS2	GOLFS2	GOLFS2	24
G9EKP	94	Electric	GOLFS2	GOLFS2	GOLFS2	GOLFS2	25
YDRA	07	Gasoline	TBA	TBA	TBA	TBA	26
YDRA SVL	09	Gasoline	TBA	TBA	TBA	TBA	27
YDRA SVS	09	Gasoline	TBA	TBA	TBA	TBA	28
YDRA2	09	Gasoline	TBA	TBA	TBA	TBA	29
YDRA3	10	Gasoline	TBA	TBA	TBA	TBA	30
YDRA3 PTV	10	Gasoline	TBA	TBA	TBA	TBA	31
YDRA3 SVL	10	Gasoline	TBA	TBA	TBA	TBA	32
YDRA3 SVS	10	Gasoline	TBA	TBA	TBA	TBA	33
YDRA3 P	10	Gasoline	TBA	TBA	TBA	TBA	34
YDRAX	11	Gasoline	TBA	TBA	TBA	TBA	35
YDRAX P	11	Gasoline	TBA	TBA	TBA	TBA	36
YDRAX P PTV	11	Gasoline	TBA	TBA	TBA	TBA	37
YDRAX PSVL	11-13	Gasoline	TBA	TBA	TBA	TBA	38
YDRAX PSVS	11-13	Gasoline	TBA	TBA	TBA	TBA	39
YDRAX SVL	11	Gasoline	TBA	TBA	TBA	TBA	40
YDRAX SVL-2	12	Gasoline	TBA	TBA	TBA	TBA	41
YDRAX SVL-3	13	Gasoline	TBA	TBA	TBA	TBA	42
YDRAX SVS	11	Gasoline	TBA	TBA	TBA	TBA	43
YDRAX SVS-2	12	Gasoline	TBA	TBA	TBA	TBA	44
YDRAX2	12	Gasoline	TBA	TBA	TBA	TBA	45
YDRAX2 PTV	12	Gasoline	TBA	TBA	TBA	TBA	46
YDRAX3	13	Gasoline	TBA	TBA	TBA	TBA	47
YDRAX3 CAM	13	Gasoline	TBA	TBA	TBA	TBA	48
YDRAX3 PTV	13	Gasoline	TBA	TBA	TBA	TBA	49
YDRAX3 F	13	Gasoline	TBA	TBA	TBA	TBA	50
YDRAX4	14	Gasoline	TBA	TBA	TBA	TBA	51
YDRAX4 CAM	14	Gasoline	TBA	TBA	TBA	TBA	52
YDRAX4 F	14	Gasoline	TBA	TBA	TBA	TBA	53
YDRAX4 PTV	14	Gasoline	TBA	TBA	TBA	TBA	54
YDRAX4 PTV4	14	Gasoline	TBA	TBA	TBA	TBA	55
YDRAX4 PTV6	14	Gasoline	TBA	TBA	TBA	TBA	56

GOLF CART BRAKE SHOES



YAMAHA



Engine Type

BRAKE SHOES - FRONT

BRAKE SHOES - REAR

Left Brake Shoe

Right Brake Shoe

Left Brake Shoe

Right Brake Shoe



Line #

Line #	Model	Year	Engine Type	Left Brake Shoe	Right Brake Shoe	Left Brake Shoe	Right Brake Shoe
1	YDRAX5	15	Gasoline	GOLFS1	GOLFS1	GOLFS1	GOLFS1
2	YDRAX5 PTV	15	Gasoline	GOLFS1	GOLFS1	GOLFS1	GOLFS1
3	YDRAX5 PTV4	15	Gasoline	GOLFS1	GOLFS1	GOLFS1	GOLFS1
4	YDRAX5 PTV6	15	Gasoline	GOLFS1	GOLFS1	GOLFS1	GOLFS1
5	YDRAX5 SPOR	15	Gasoline	GOLFS1	GOLFS1	GOLFS1	GOLFS1
6	YDRAX5 SUP	15	Gasoline	GOLFS1	GOLFS1	GOLFS1	GOLFS1
7	YDRAX5 F	15	Gasoline	GOLFS1	GOLFS1	GOLFS1	GOLFS1
8	YDRAX6	16	Gasoline	N/A	N/A	GOLFS1	GOLFS1
9	YDRAX6 PTV	16	Gasoline	N/A	N/A	GOLFS1	GOLFS1
10	YDRAX6 SPO	16	Gasoline	N/A	N/A	GOLFS1	GOLFS1
11	YDRAX6 SUP	16	Gasoline	N/A	N/A	GOLFS1	GOLFS1
12	YDRAX6 F	16	Gasoline	N/A	N/A	GOLFS1	GOLFS1
13	YDRE	07	Electric	TBA	TBA	TBA	TBA
14	YDRE 2	09	Electric	TBA	TBA	TBA	TBA
15	YDRE 3	10	Electric	TBA	TBA	TBA	TBA
16	YDRE 3 PTV	10	Electric	TBA	TBA	TBA	TBA
17	YDRE 3 SVL	10	Electric	TBA	TBA	TBA	TBA
18	YDRE 3 SVS	10	Electric	TBA	TBA	TBA	TBA
19	YDRE SVL	09	Gasoline	TBA	TBA	TBA	TBA
20	YDRE SVS	09	Gasoline	TBA	TBA	TBA	TBA
21	YDRE X	11	Electric	TBA	TBA	TBA	TBA
22	YDRE X PTV	11	Electric	TBA	TBA	TBA	TBA
23	YDRE X SVL	11	Electric	TBA	TBA	TBA	TBA
24	YDRE X SVL-2	12	Electric	TBA	TBA	TBA	TBA
25	YDRE X SVL-3	13	Electric	TBA	TBA	TBA	TBA
26	YDRE X SVS	11	Electric	TBA	TBA	TBA	TBA
27	YDRE X SVS-2	12	Electric	TBA	TBA	TBA	TBA
28	YDRE X2	12	Electric	TBA	TBA	TBA	TBA
29	YDRE X2 PTV	12	Electric	TBA	TBA	TBA	TBA
30	YDRE X3	13	Electric	TBA	TBA	TBA	TBA
31	YDRE X3 CAM	13	Electric	TBA	TBA	TBA	TBA
32	YDRE X3 PTV	13	Electric	TBA	TBA	TBA	TBA
33	YDRE X5	15	Electric	GOLFS1	GOLFS1	GOLFS1	GOLFS1
34	YDRE X5 ACP	15	Electric	GOLFS1	GOLFS1	GOLFS1	GOLFS1
35	YDRE X5 ACS	15	Electric	GOLFS1	GOLFS1	GOLFS1	GOLFS1
36	YDRE X5 PTV	15	Electric	GOLFS1	GOLFS1	GOLFS1	GOLFS1
37	YDRE X5 PTV4	15	Electric	GOLFS1	GOLFS1	GOLFS1	GOLFS1
38	YDRE X5 PTV6	15	Electric	GOLFS1	GOLFS1	GOLFS1	GOLFS1
39	YDRE X5 SPO	15	Electric	GOLFS1	GOLFS1	GOLFS1	GOLFS1
40	YDRE X6	16	Electric	N/A	N/A	GOLFS1	GOLFS1
41	YDRE X6 AC	16	Electric	N/A	N/A	GOLFS1	GOLFS1
42	YDRE X6 PTV	16	Electric	N/A	N/A	GOLFS1	GOLFS1
43	YDRE X6 PTV4	16	Electric	N/A	N/A	GOLFS1	GOLFS1
44	YDRE X6 PTV6	16	Electric	N/A	N/A	GOLFS1	GOLFS1
45	YDRE X6 SPO	16	Electric	N/A	N/A	GOLFS1	GOLFS1
46	YDRE X6 SUP	16	Electric	N/A	N/A	GOLFS1	GOLFS1
47	YTF1	09	Gasoline	TBA	TBA	TBA	TBA
48	YTF1 A18	18	Gasoline	GOLFS1	GOLFS1	GOLFS1	GOLFS1
49	YTF1 AX3 SP	13	Gasoline	TBA	TBA	TBA	TBA
50	YTF1 AX4 F	14	Gasoline	TBA	TBA	TBA	TBA
51	YTF1 AX4 SP	14	Gasoline	TBA	TBA	TBA	TBA
52	YTF1 AX5 SP	15	Gasoline	GOLFS1	GOLFS1	GOLFS1	GOLFS1
53	YTF1 AX6 F	16	Gasoline	N/A	N/A	GOLFS1	GOLFS1
54	YTF1 AX6 SP	16	Gasoline	N/A	N/A	GOLFS1	GOLFS1
55	YTF1 EX3 SP	13	Electric	TBA	TBA	TBA	TBA
56	YTF1 EX4 SP	14	Electric	TBA	TBA	TBA	TBA

BRAKE APPLICATIONS

GOLF CART BRAKE SHOES

APPLI
CATIONS
BRAKE



YAMAHA



Engine
Type

BRAKE SHOES - FRONT

BRAKE SHOES - REAR

Left Brake Shoe

Right Brake Shoe

Left Brake Shoe

Right Brake Shoe



Line #

Model	Part #	Engine Type	Left Brake Shoe	Right Brake Shoe	Left Brake Shoe	Right Brake Shoe	Line #
YTF1 EX5 AC	15	Electric	N/A	N/A	GOLFS1	GOLFS1	1
YTF1 EX6 AC	16	Electric	N/A	N/A	GOLFS1	GOLFS1	2
YTF1 P	10	Gasoline	TBA	TBA	TBA	TBA	3
YTF1 X	11	Gasoline	TBA	TBA	TBA	TBA	4
YTF1 X2	12	Gasoline	TBA	TBA	TBA	TBA	5
YTF1 X3	13	Gasoline	TBA	TBA	TBA	TBA	6
YTF1 XP	11	Gasoline	TBA	TBA	TBA	TBA	7
YTF2	09	Gasoline	GOLFS1	GOLFS1	GOLFS1	GOLFS1	8
YTF2	09	Gasoline	GOLFS1	GOLFS1	GOLFS1	GOLFS1	9
YTF2 A18	18	Gasoline	GOLFS1	GOLFS1	GOLFS1	GOLFS1	10
YTF2 AT X5	15	Gasoline	GOLFS1	GOLFS1	GOLFS1	GOLFS1	11
YTF2 AT X5-2	15	Gasoline	GOLFS1	GOLFS1	GOLFS1	GOLFS1	12
YTF2 AT X5-3	15	Gasoline	GOLFS1	GOLFS1	GOLFS1	GOLFS1	13
YTF2 AT X5-4	15	Gasoline	GOLFS1	GOLFS1	GOLFS1	GOLFS1	14
YTF2 AX 4	14	Gasoline	GOLFS1	GOLFS1	GOLFS1	GOLFS1	15
YTF2 AX 4F	14	Gasoline	GOLFS1	GOLFS1	GOLFS1	GOLFS1	16
YTF2 AX 5F	15	Gasoline	GOLFS1	GOLFS1	GOLFS1	GOLFS1	17
YTF2 AX 6-BE	16	Gasoline	GOLFS1	GOLFS1	GOLFS1	GOLFS1	18
YTF2 AX 6F	16	Gasoline	GOLFS1	GOLFS1	GOLFS1	GOLFS1	19
YTF2 E18	18	Gasoline	GOLFS1	GOLFS1	GOLFS1	GOLFS1	20
YTF2 EX5	15	Electric	N/A	N/A	GOLFS1	GOLFS1	21
YTF2 P	10	Gasoline	GOLFS1	GOLFS1	GOLFS1	GOLFS1	22
YTF2 X	11	Gasoline	GOLFS1	GOLFS1	GOLFS1	GOLFS1	23
YTF2 X SVB2	11-13	Gasoline	GOLFS1	GOLFS1	GOLFS1	GOLFS1	24
YTF2 X2	12	Gasoline	GOLFS1	GOLFS1	GOLFS1	GOLFS1	25
YTF2 X3	13	Gasoline	GOLFS1	GOLFS1	GOLFS1	GOLFS1	26
YTF2 XP	11	Gasoline	GOLFS1	GOLFS1	GOLFS1	GOLFS1	27
YTF2 XP SVB	11-13	Gasoline	GOLFS1	GOLFS1	GOLFS1	GOLFS1	28
							29
							30
							31
							32
							33
							34
							35
							36
							37
							38
							39
							40
							41
							42
							43
							44
							45
							46
							47
							48
							49
							50
							51
							52
							53
							54
							55
							56

CYCLE DISC BRAKES

EBC Brakes offers three pad compounds for your mountain bike:

Green Coded X-Country Compound - No Suffix

EBC Brakes X-Country mountain bike brake pads are an all round pad for trekking, cross country use or riding for pleasure. This compound is the perfect choice if you are unsure which type of pad is best for you.

Where the brake disc is unhardened and the use of a resin pad is recommended, this range of EBC Brakes X-Country mountain bike replacement brake pads is the perfect choice due to low disc abrasion features and it delivers long lifetime and excellent stopping power.

Red Coded Downhill Compound -"R" Suffix

"R" suffix brake pads are designed for downhill use and are extra high in friction. Lifetime is quite short but performance is great with low disc damage and very little heat transfer into the hydraulics.

EBC Brakes "R" suffix mountain bike replacement brake pads are an organic compound suitable for use on all disc types. Some brake systems use nylon or plastic fluid lines which are prone to softening and swelling when overheated. Sintered pads are not suitable for use with these systems as they generate too much heat, therefore we recommend using the "R" suffix brake pads.

Gold Coded Double-H Sintered Compound For Wet Riding - "HH" Suffix

Double-H™ sintered brake pads last much longer than organic brake pads because they have a higher friction rating and give longer life and better brake performance and are therefore great value for money. These high quality brake pads are made in the USA and are used by some of the world's greatest mountain bike sportsmen.

This compound is not suitable for use with a mountain bike where the discs are for use only with resin pads - EBC Brakes® Double-H™ replacement mountain bike brake pads will score the unhardened brake discs.

All EBC Brakes replacement mountain bike brake pads are made using magnetic stainless steel backing plates. Where required, EBC Brakes mountain bike brake pads come with improved strength retraction clips.

CYCLE BRAKE ROTORS

VR SERIES "VEE" ROTOR - Standard Size Replacement Brake Rotor

- Premium heat treated stainless steel
- Diamond ground surface finish
- Ultra lightweight Vee profile for better braking
- Suitable for use with any type of brake pad
- International standard 160 mm Ø / 6 bolt fitting

This EBC brake rotor is a direct size for size replacement for any disc brake system fitted with an IS 160mm size original rotor.

Order part number VR160.

OVERSIZE BRAKE ROTOR KITS

EBC offers two upgrade options with these oversize brake rotor conversion kits - 160/165mm-180mm (medium power upgrade) and 160/165mm 203mm (mega power upgrade) and the option of full circle profile or new lightweight contoured profile.

These mount on most standard 6 bolt wheel hubs and together with the bracket provided fit most forks with 50mm IS mount or 74mm post mount. Your caliper is relocated outwards giving you a stronger brake and better brake feel. Easy to fit - no other changes are necessary to your caliper, cables, hydraulics or lever. All you need are two allen keys.

These are premium quality heat treated stainless steel rotors, diamond ground and compatible with every type of mountain bike brake pad. Kits are available to convert standard 160/165mm up to 180mm

(order part number MTBD160-180 for circle profile or MTBD160-180C for contour) or 160/165mm to 203mm or 180mm to 203mm (order part number MTBD160-203 for circle profile or MTBD160-203C for contour).



AN ADAPTOR IS
REQUIRED WHEN
FITTING TO
CENTERLOCK HUBS

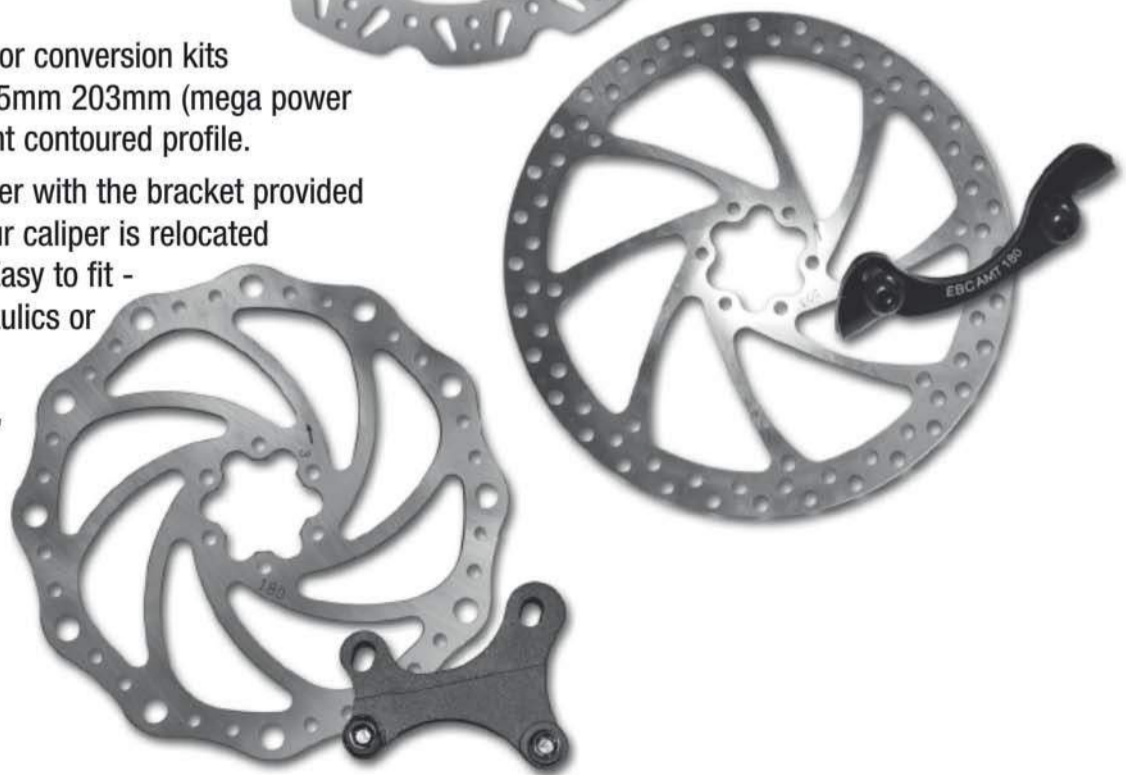

CYCLE DISC BRAKE PADS

APPLICATIONS
BRAKE



ALHONGA

	Hydraulic/ Mechanical	DOT/ Mineral	Standard Brake Pads	"R" Sintered Brake Pads	"HH" Sintered Brake Pads	Line #
HJ-OD03	HYDRAULIC	MINERAL	CFA370	CFA370R	CFA370HH	1
HJ-OD04	HYDRAULIC	MINERAL	CFA327	CFA327R	CFA327HH	2
HJ-OD05	HYDRAULIC	MINERAL	CFA327	CFA327R	CFA327HH	3
HJ-MD11	MECHANICAL		CFA327	CFA327R	CFA327HH	4
HJ-MD15	MECHANICAL		TBA	TBA	TBA	5
HJ-Latoo	MECHANICAL		CFA327	CFA327R	CFA327HH	6

ALLIGATOR

Gatorbrake 6 Piston	HYDRAULIC		CFA383	N/A	N/A	9
---------------------	-----------	--	--------	-----	-----	---

APOLLO

Shockwave & X Rated Bikes (Mechanical Caliper)	MECHANICAL		CFA653	N/A	N/A	12
--	------------	--	--------	-----	-----	----

APSE ARTEK

ADC-DB01	HYDRAULIC	MINERAL	CFA370	CFA370R	CFA370HH	15
ADC-SLP	HYDRAULIC	MINERAL	CFA370	CFA370R	CFA370HH	16
ADC-Elite	HYDRAULIC	MINERAL	CFA370	CFA370R	CFA370HH	17
ADC-IE	HYDRAULIC	MINERAL	CFA370	CFA370R	CFA370HH	18
ADC-R01	MECHANICAL/HYDRAULIC	MINERAL	CFA370	CFA370R	CFA370HH	19
ADC-01	MECHANICAL		CFA421	CFA421R	CFA421HH	20
ADC-02	MECHANICAL		CFA421	CFA421R	CFA421HH	21
ADC-03	MECHANICAL		CFA688	N/A	N/A	22
ADC-04	MECHANICAL		CFA688	N/A	N/A	23
ADC-05	MECHANICAL		CFA615	CFA615R	N/A	24
ADC-06	MECHANICAL		CFA439	CFA439R	CFA439HH	25
ADC-07	MECHANICAL		CFA370	CFA370R	CFA370HH	26
ADC-08	MECHANICAL		CFA421	CFA421R	CFA421HH	27
ADC-09	MECHANICAL		CFA421	CFA421R	CFA421HH	28
ADC-10	MECHANICAL		CFA421	CFA421R	CFA421HH	29
ADC-11	MECHANICAL		CFA615	CFA615R	N/A	30
ADC-4.1	MECHANICAL		CFA653	N/A	N/A	31
ADC-4.7	MECHANICAL		CFA653	N/A	N/A	32

ASSESS

E-Solex	MECHANICAL		CFA688	N/A	N/A	35
C470	MECHANICAL		CFA439	CFA439R	CFA439HH	36
C425	MECHANICAL		CFA439	CFA439R	CFA439HH	37
C420	MECHANICAL		CFA439	CFA439R	CFA439HH	38
C355	MECHANICAL		CFA439	CFA439R	CFA439HH	39

AVID

BB5 Mechanical (All Mountain & Road)	MECHANICAL		CFA439	CFA439R	CFA439HH	42
BB7 Mechanical (All Mountain & Road)	MECHANICAL		CFA394	CFA394R	CFA394HH	43
Code (2008-2010)	HYDRAULIC	DOT ▲	CFA440	CFA440R	CFA440HH	44
Code (2011-)	HYDRAULIC	DOT ▲	CFA616	CFA616R	CFA616HH	45
Code R	HYDRAULIC	DOT ▲	CFA616	CFA616R	CFA616HH	46
Code 5	HYDRAULIC	DOT ▲	CFA440	CFA440R	CFA440HH	47
Code 7	HYDRAULIC	DOT ▲	CFA440	CFA440R	CFA440HH	48
DB1	HYDRAULIC	DOT ▲	CFA472	CFA472R	CFA472HH	49
DB3	HYDRAULIC	DOT ▲	CFA472	CFA472R	CFA472HH	50
DB5	HYDRAULIC	DOT ▲	CFA472	CFA472R	CFA472HH	51
Elixir 1	HYDRAULIC	DOT ▲	CFA472	CFA472R	CFA472HH	52
Elixir 3	HYDRAULIC	DOT ▲	CFA472	CFA472R	CFA472HH	53
Elixir 5	HYDRAULIC	DOT ▲	CFA472	CFA472R	CFA472HH	54
Elixir 7	HYDRAULIC	DOT ▲	CFA472	CFA472R	CFA472HH	55
Elixir 7 Trail	HYDRAULIC	DOT ▲	CFA633	CFA633R	CFA633HH	56

CYCLE DISC BRAKE PADS



AVID

Line #

	Hydraulic/ Mechanical	DOT/ Mineral	Standard Brake Pads	"R" Sintered Brake Pads	"HH" Sintered Brake Pads
1	Elixir 9	HYDRAULIC	DOT ▲	CFA472	CFA472R CFA472HH
2	Elixir 9 Trail	HYDRAULIC	DOT ▲	CFA633	CFA633R CFA633HH
3	Elixir CR	HYDRAULIC	DOT ▲	CFA472	CFA472R CFA472HH
4	Elixir R	HYDRAULIC	DOT ▲	CFA472	CFA472R CFA472HH
5	Elixir Via GT	HYDRAULIC	DOT ▲	CFA472	CFA472R CFA472HH
6	Elixir XO (2011-2012)	HYDRAULIC	DOT ▲	CFA472	CFA472R CFA472HH
7	Elixir XO Trail	HYDRAULIC	DOT ▲	CFA633	CFA633R CFA633HH
8	Elixir XX	HYDRAULIC	DOT ▲	CFA472	CFA472R CFA472HH
9	Elixir XX World Cup	HYDRAULIC	DOT ▲	CFA472	CFA472R CFA472HH
10	Juicy 3	HYDRAULIC	DOT ▲	CFA394	CFA394R CFA394HH
11	Juicy 5	HYDRAULIC	DOT ▲	CFA394	CFA394R CFA394HH
12	Juicy 7	HYDRAULIC	DOT ▲	CFA394	CFA394R CFA394HH
13	Juicy Carbon	HYDRAULIC	DOT ▲	CFA394	CFA394R CFA394HH
14	Juicy Ultimate	HYDRAULIC	DOT ▲	CFA394	CFA394R CFA394HH
15	Juicy Ultimate 7	HYDRAULIC	DOT ▲	CFA394	CFA394R CFA394HH

▲ Avid Recommend The Use Of Dot 5.1 Brake Fluid

BENGAL

19	Ares	HYDRAULIC	MINERAL	CFA421	CFA421R CFA421HH
20	Ares 1	HYDRAULIC	MINERAL	CFA421	CFA421R CFA421HH
21	Ares 3	HYDRAULIC	MINERAL	CFA421	CFA421R CFA421HH
22	Ares 5	HYDRAULIC	MINERAL	CFA327	CFA327R CFA327HH
23	Ares Pro	HYDRAULIC	MINERAL	CFA327	CFA327R CFA327HH
24	Helix 1.0	HYDRAULIC	DOT	CFA421	CFA421R CFA421HH
25	Helix 1.1	HYDRAULIC	DOT	CFA421	CFA421R CFA421HH
26	Helix 2.1	HYDRAULIC	DOT	CFA421	CFA421R CFA421HH
27	Helix 2.5	HYDRAULIC	DOT	CFA421	CFA421R CFA421HH
28	Helix 3	HYDRAULIC	DOT	CFA421	CFA421R CFA421HH
29	Helix 3SL	HYDRAULIC	DOT	CFA421	CFA421R CFA421HH
30	Helix 4X	HYDRAULIC	DOT	CFA493	CFA493R CFA493HH
31	Helix 5	HYDRAULIC	DOT	CFA421	CFA421R CFA421HH
32	Helix 5L	HYDRAULIC	DOT	CFA421	CFA421R CFA421HH
33	Helix 7	HYDRAULIC	DOT	CFA421	CFA421R CFA421HH
34	Helix 7B	HYDRAULIC	DOT	CFA327	CFA327R CFA327HH
35	Helix 7C	HYDRAULIC	DOT	CFA421	CFA421R CFA421HH
36	Helix 7.5	HYDRAULIC	DOT	CFA421	CFA421R CFA421HH
37	MB 300	MECHANICAL		CFA421	CFA421R CFA421HH
38	MB 500	MECHANICAL		CFA421	CFA421R CFA421HH
39	MB 600	MECHANICAL		CFA421	CFA421R CFA421HH
40	MB 600T	MECHANICAL		CFA421	CFA421R CFA421HH
41	MB 700	MECHANICAL		CFA421	CFA421R CFA421HH
42	ML 700	MECHANICAL		CFA421	CFA421R CFA421HH
43	MB 700T	MECHANICAL		CFA421	CFA421R CFA421HH
44	MB 839	MECHANICAL		CFA421	CFA421R CFA421HH
45	MB 839M	MECHANICAL		CFA421	CFA421R CFA421HH
46	MB 840	MECHANICAL		CFA421	CFA421R CFA421HH
47	MB 845	MECHANICAL		CFA421	CFA421R CFA421HH
48	MB 845A	MECHANICAL		CFA421	CFA421R CFA421HH
49	MB 845B	MECHANICAL		CFA421	CFA421R CFA421HH
50	MB 849A	MECHANICAL		CFA421	CFA421R CFA421HH
51	MB 849B	MECHANICAL		CFA421	CFA421R CFA421HH
52	Strida	MECHANICAL		CFA421	CFA421R CFA421HH
53					
54					
55					
56					

BRAKE APPLICATIONS

CYCLE DISC BRAKE PADS



BRAKEFORCEONE

	Hydraulic/ Mechanical	DOT/ Mineral	Standard Brake Pads	"R" Sintered Brake Pads	"HH" Sintered Brake Pads	Line #
BFO 1 Brake	HYDRAULIC	MINERAL	CFA449	CFA449R	CFA449HH	1
H20	HYDRAULIC	WATER	CFA449	CFA449R	CFA449HH	2
Kill Hill	HYDRAULIC	MINERAL	CFA449	CFA449R	CFA449HH	3

CAMPAGNOLO

H11	HYDRAULIC	MINERAL	TBA	N/A	N/A	6
H11 EPS	HYDRAULIC	MINERAL	TBA	N/A	N/A	7
Potenza 11	HYDRAULIC	MINERAL	TBA	N/A	N/A	8

CANNONDALE

Coda Expert	HYDRAULIC	MINERAL	CFA284A	CFA284AR	CFA284AHH	11
Coda Standard	HYDRAULIC	MINERAL	CFA284	CFA284R	N/A	12

CLARKS

Clim 8	HYDRAULIC	MINERAL	CFA383	N/A	N/A	15
CMD-5	MECHANICAL		CFA339			16
CMD-7	MECHANICAL		CFA339			17
CMD-8	MECHANICAL					18
CMD-9	MECHANICAL					19
CMD-11	MECHANICAL					20
CMD-12	MECHANICAL		CFA339			21
CMD-15	MECHANICAL		CFA394	CFA394R	CFA394HH	22
CMD-16	MECHANICAL					23
CMD-17	MECHANICAL		CFA439	CFA439R	CFA439HH	24
Exo	HYDRAULIC	DOT	CFA360	CFA360R	CFA360HH	25
HDB-540	HYDRAULIC	DOT	CFA370	CFA370R	CFA370HH	26
HDB-600	HYDRAULIC	DOT	CFA370	CFA370R	CFA370HH	27
HDB-790	HYDRAULIC	DOT	CFA370	CFA370R	CFA370HH	28
M2	HYDRAULIC	MINERAL	CFA614	CFA614R	CFA614HH	29
Skeletal	HYDRAULIC	DOT	CFA360	CFA360R	CFA360HH	30
S2	HYDRAULIC	DOT	CFA327	CFA327R	CFA327HH	31

DIATECH

Anchor			CFA364	N/A	N/A	34
Kinetic			CFA285	CFA285R	N/A	35
Nifon			CFA285	CFA285R	N/A	36
Aero Mechanical	MECHANICAL		CFA285	CFA285R	N/A	37
Spiral Y2K			CFA316	CFA316R	N/A	38

EBERLE

Eberle EM			CFA340	CFA340R	CFA340HH	41
-----------	--	--	--------	---------	----------	----

FORMULA

4 Racing XC	HYDRAULIC	DOT	CFA325	CFA325R	CFA325HH	44
Activa	MECHANICAL		CFA365	N/A	N/A	45
B4	HYDRAULIC	DOT	CFA325	CFA325R	CFA325HH	46
C1	HYDRAULIC	DOT	CFA470	CFA470R	CFA470HH	47
CR3	HYDRAULIC	DOT	CFA470	CFA470R	CFA470HH	48
Cura	HYDRAULIC	MINERAL	CFA470	CFA470R	CFA470HH	49
Cura-E	HYDRAULIC	MINERAL	CFA470	CFA470R	CFA470HH	50
Evoluzion	HYDRAULIC	DOT	CFA274	CFA274R	N/A	51
Extreme FR & DH	HYDRAULIC	DOT	CFA325	CFA325R	CFA325HH	52
Mega	HYDRAULIC	DOT	CFA470	CFA470R	CFA470HH	53
MD1	MECHANICAL		CFA290	CFA290R	N/A	54
MD1 2002	MECHANICAL		CFA365	N/A	N/A	55
Oro	HYDRAULIC	DOT	CFA402	CFA402R	CFA402HH	56

CYCLE DISC BRAKE PADS



FORMULA

Line #

	Hydraulic/ Mechanical	DOT/ Mineral	Standard Brake Pads	"R" Sintered Brake Pads	"HH" Sintered Brake Pads	
1	R0	HYDRAULIC	DOT	CFA470	CFA470R	CFA470HH
2	R0R	HYDRAULIC	DOT	CFA470	CFA470R	CFA470HH
3	R1	HYDRAULIC	DOT	CFA470	CFA470R	CFA470HH
4	R1R	HYDRAULIC	DOT	CFA470	CFA470R	CFA470HH
5	RR1	HYDRAULIC	DOT	CFA470	CFA470R	CFA470HH
6	RX	HYDRAULIC	DOT	CFA470	CFA470R	CFA470HH
7	T1	HYDRAULIC	DOT	CFA470	CFA470R	CFA470HH
8	T1R	HYDRAULIC	DOT	CFA470	CFA470R	CFA470HH
9	The One	HYDRAULIC	DOT	CFA470	CFA470R	CFA470HH
10	FSA					
11						
12	K-Force	HYDRAULIC	MINERAL	CFA614	CFA614R	CFA614HH
13	Afterburner	HYDRAULIC	MINERAL	CFA614	CFA614R	CFA614HH
14	GIANT					
15						
16	MPH 2000	HYDRAULIC	DOT	CFA333	CFA333R	CFA333HH
17	MPH 2001-2005	HYDRAULIC	DOT	CFA338	CFA338R	CFA338HH
18	MPH 1	HYDRAULIC	DOT	CFA333	CFA333R	CFA333HH
19	MPH 2	HYDRAULIC	DOT	CFA338	CFA338R	CFA338HH
20	MPH 3	HYDRAULIC	DOT	CFA338	CFA338R	CFA338HH
21	Root	HYDRAULIC	DOT	CFA327	CFA327R	CFA327HH
22	Root 2	HYDRAULIC	DOT	CFA327	CFA327R	CFA327HH
23	GRIMECA					
24						
25	System 1	HYDRAULIC	DOT	CFA309	CFA309R	N/A
26	System 6			CFA365	N/A	N/A
27	System 7			CFA311	CFA311R	CFA311HH
28	System 8	HYDRAULIC	DOT	CFA310	CFA310R	CFA310HH
29	System 9			CFA365	N/A	N/A
30	System 11 (6 Pad Set)	HYDRAULIC	DOT	N/A	N/A	N/A
31	System 12	HYDRAULIC	DOT	CFA359	CFA359R	CFA359HH
32	System 13			CFA325	CFA325R	CFA325HH
33	System 15	HYDRAULIC	DOT	CFA309	CFA309R	N/A
34	System 16			CFA359	CFA359R	CFA359HH
35	System 17 (6 Pad Set)	HYDRAULIC	DOT	N/A	N/A	N/A
36	Early Hydraulic 4 Piston	HYDRAULIC	DOT	CFA308	CFA308R	N/A
37	Early Mechanical	MECHANICAL		CFA309	CFA309R	N/A
38	GUSSET					
39						
40	Chute	MECHANICAL		CFA327	CFA327R	CFA327HH
41	Hydro Chute	HYDRAULIC	DOT	CFA394	CFA394R	CFA394HH
42	HAYES					
43						
44	CX Pro/Expert/Comp	MECHANICAL		CFA421	CFA421R	CFA421HH
45	CX 5	MECHANICAL		CFA421	CFA421R	CFA421HH
46	Dyno Comp/Sport	HYDRAULIC	DOT	CFA466	CFA466R	CFA466HH
47	El Camino	HYDRAULIC	DOT	CFA404	CFA404R	CFA404HH
48	G 1	HYDRAULIC	DOT	CFA277	CFA277R	CFA277HH
49	G 2	HYDRAULIC	DOT	CFA277	CFA277R	CFA277HH
50	GX 2	MECHANICAL		CFA421	CFA421R	CFA421HH
51	HFX-9	HYDRAULIC	DOT	CFA277	CFA277R	CFA277HH
52	HFX-Mag	HYDRAULIC	DOT	CFA277	CFA277R	CFA277HH
53	MX 1	MECHANICAL		CFA277	CFA277R	CFA277HH
54	MX 2	MECHANICAL		CFA421	CFA421R	CFA421HH
55	MX 3	MECHANICAL		CFA421	CFA421R	CFA421HH
56	MX 4	MECHANICAL		CFA421	CFA421R	CFA421HH

BRAKE APPLICATIONS

CYCLE DISC BRAKE PADS

APPLI
CATIONS
BRAKE



HAYES

	Hydraulic/ Mechanical	DOT/ Mineral	Standard Brake Pads	"R" Sintered Brake Pads	"HH" Sintered Brake Pads	Line #
MX 5	MECHANICAL		CFA421	CFA421R	CFA421HH	1
MX Expert			CFA421	CFA421R	CFA421HH	2
Prime Pro/Expert/Comp/Sport	HYDRAULIC	DOT	CFA620	CFA620R	CFA620HH	3
Radar	HYDRAULIC	MINERAL	CFA466	CFA466R	CFA466HH	4
Sole	HYDRAULIC	DOT	CFA421	CFA421R	CFA421HH	5
Stroker Ace	HYDRAULIC	DOT	CFA494	CFA494R	CFA494HH	6
Stroker Ryde	HYDRAULIC	DOT	CFA466	CFA466R	CFA466HH	7
Stroker Trail	HYDRAULIC	DOT	CFA467	CFA467R	CFA467HH	8

HOPE

Closed 2	HYDRAULIC	DOT	CFA247B	CFA247BR	CFA247BHH	11
DH 4	HYDRAULIC	DOT	CFA247B	CFA247BR	CFA247BHH	12
E4	HYDRAULIC	DOT	CFA647	CFA647R	CFA647HH	13
M4	HYDRAULIC	DOT	CFA289/4	CFA289/4R	CFA289/4HH	14
Mini	HYDRAULIC	DOT	CFA318	CFA318R	CFA318HH	15
Mono 6	HYDRAULIC	DOT	CFA385	CFA385R	CFA385HH	16
Mono 6 Ti	HYDRAULIC	DOT	CFA385	CFA385R	CFA385HH	17
Mono M4	HYDRAULIC	DOT	CFA639	CFA639R	CFA639HH	18
Mono Mini	HYDRAULIC	DOT	CFA386	CFA386R	CFA386HH	19
Mono Trial	HYDRAULIC	DOT	CFA422	N/A	N/A	20
Open 2	HYDRAULIC	DOT	CFA247B	CFA247BR	CFA247BHH	21
RX 4-SH	HYDRAULIC	MINERAL	CFA647	CFA647R	CFA647HH	22
RX 4-SR	HYDRAULIC	DOT	CFA647	CFA647R	CFA647HH	23
Trial Zone	HYDRAULIC	DOT	CFA422	N/A	N/A	24
V2	HYDRAULIC	DOT	CFA469	CFA469R	CFA469HH	25
V4	HYDRAULIC	DOT	CFA639	CFA639R	CFA639HH	26
X2	HYDRAULIC	DOT	CFA487	CFA487R	CFA487HH	27
XC4	HYDRAULIC	DOT	CFA300	CFA300R	CFA300HH	28

JOYTECH

Joytech Mechanical	MECHANICAL		CFA392	N/A	N/A	31
--------------------	------------	--	--------	-----	-----	----

MAGURA

Clara (2000-01)	HYDRAULIC	MINERAL	CFA286	N/A	CFA286HH	34
Clara (2002)	HYDRAULIC	MINERAL	CFA326	CFA326R	CFA326HH	35
Gustav	HYDRAULIC	MINERAL	CFA280	CFA280R	CFA280HH	36
Julie (2001-08)	HYDRAULIC	MINERAL	CFA331	CFA331R	CFA331HH	37
Julie (2009-11)	HYDRAULIC	MINERAL	CFA449	CFA449R	CFA449HH	38
Louise (1999-01)	HYDRAULIC	MINERAL	CFA286	N/A	CFA286HH	39
Louise (2002-06)	HYDRAULIC	MINERAL	CFA326	CFA326R	CFA326HH	40
Louise (2007-11)	HYDRAULIC	MINERAL	CFA449	CFA449R	CFA449HH	41
Marta (2002-08)	HYDRAULIC	MINERAL	CFA451	CFA451R	CFA451HH	42
Marta (2009-11)	HYDRAULIC	MINERAL	CFA449	CFA449R	CFA449HH	43
Marta SL (2003-08)	HYDRAULIC	MINERAL	CFA451	CFA451R	CFA451HH	44
Marta SL (2009-11)	HYDRAULIC	MINERAL	CFA449	CFA449R	CFA449HH	45
MT2/MT4/MT4E/MT6/MT8 (2012-)	HYDRAULIC	MINERAL	CFA619	CFA619R	CFA619HH	46
MT5/MT7 (2015-4 Pads Per Caliper)	HYDRAULIC	MINERAL	CFA660/4	CFA660/4R	CFA660/4HH	47
MT5/MT7 (2015-One Piece Type Pad)	HYDRAULIC	MINERAL	CFA689	N/A	N/A	48
MT5E	HYDRAULIC	MINERAL	CFA660/4	CFA660/4R	CFA660/4HH	49
MTS	HYDRAULIC	MINERAL	CFA619	CFA619R	CFA619HH	50
Mt Trail (2 Piston Rears)	HYDRAULIC	MINERAL	CFA619	CFA619R	CFA619HH	51
Mt Trail (4 Piston Fronts)	HYDRAULIC	MINERAL	CFA660/4	CFA660/4R	CFA660/4HH	52

PAUL COMPONENTS

Klamper	MECHANICAL		CFA472	CFA472R	CFA472HH	55
---------	------------	--	--------	---------	----------	----

CYCLE DISC BRAKE PADS



PRO STOP

Line #

	Hydraulic/ Mechanical	DOT/ Mineral	Standard Brake Pads	"R" Sintered Brake Pads	"HH" Sintered Brake Pads
1	HYDRAULIC	MINERAL	CFA278	CFA278R	N/A
2			CFA278	CFA278R	N/A
3					
4					
5			CFA286	CFA286R	CFA286HH
6			CFA378	N/A	N/A
7			CFA439	CFA439R	CFA439HH
8			CFA326	CFA326R	CFA326HH
9			CFA277	CFA277R	CFA277HH
10			CFA394	CFA394R	CFA394HH
11	HYDRAULIC	DOT	CFA439	CFA439R	CFA439HH
12	HYDRAULIC	MINERAL	CFA370	CFA370R	CFA370HH
13	MECHANICAL		CFA439	CFA439R	CFA439HH
14	MECHANICAL		CFA439	CFA439R	CFA439HH
15					
16					
17	HYDRAULIC	DOT	CFA327	CFA327R	CFA327HH
18	HYDRAULIC	DOT	CFA327	CFA327R	CFA327HH
19	HYDRAULIC	DOT			
20	HYDRAULIC	DOT	CFA421	CFA421R	CFA421HH
21	HYDRAULIC	DOT	CFA332	N/A	N/A
22	HYDRAULIC	DOT	CFA421	CFA421R	CFA421HH
23	HYDRAULIC	DOT	CFA421	CFA421R	CFA421HH
24	HYDRAULIC	DOT	CFA421	CFA421R	CFA421HH
25					
26					
27	MECHANICAL		CFA614	CFA614R	CFA614HH
28	MECHANICAL		CFA614	CFA614R	CFA614HH
29					
30					
31	MECHANICAL/HYDRAULIC	ATF	CFA242	CFA242R	CFA242HH
32					
33					
34	MECHANICAL		CFA288	CFA288R	N/A
35					
36					
37	MECHANICAL		CFA614	CFA614R	CFA614HH☒
38	MECHANICAL		CFA614	CFA614R	CFA614HH☒
39	MECHANICAL		CFA614	CFA614R	CFA614HH☒
40	HYDRAULIC	MINERAL	CFA327	CFA327R	CFA327HH☒
41	MECHANICAL		CFA614	CFA614R	CFA614HH☒
42	MECHANICAL		CFA614	CFA614R	CFA614HH☒
43	HYDRAULIC	MINERAL	CFA327	CFA327R	CFA327HH☒
44	HYDRAULIC	MINERAL	CFA327	CFA327R	CFA327HH☒
45	MECHANICAL		CFA327	CFA327R	CFA327HH☒
46	HYDRAULIC	MINERAL	CFA327	CFA327R	CFA327HH☒
47	HYDRAULIC	MINERAL	CFA614	CFA614R	CFA614HH☒
48	MECHANICAL		CFA327	CFA327R	CFA327HH☒
49	MECHANICAL		CFA327	CFA327R	CFA327HH☒
50	MECHANICAL		CFA327	CFA327R	CFA327HH☒
51	HYDRAULIC	MINERAL	CFA327	CFA327R	CFA327HH☒
52	HYDRAULIC	MINERAL	CFA327	CFA327R	CFA327HH☒
53	HYDRAULIC	MINERAL	CFA327	CFA327R	CFA327HH☒
54	MECHANICAL		CFA327	CFA327R	CFA327HH☒
55	MECHANICAL		CFA327	CFA327R	CFA327HH☒
56	HYDRAULIC	MINERAL	CFA327	CFA327R	CFA327HH☒

BRAKE
APPLICATIONS

CYCLE DISC BRAKE PADS



SHIMANO

BRAKE APPLICATIONS

	Hydraulic/ Mechanical	DOT/ Mineral	Standard Brake Pads	"R" Sintered Brake Pads	"HH" Sintered Brake Pads	Line #
BR-M486	HYDRAULIC	MINERAL	CFA327	CFA327R	CFA327HH☒	1
BR-M495	MECHANICAL		CFA327	CFA327R	CFA327HH☒	2
BR-S500 Alfine	HYDRAULIC	MINERAL	CFA370	CFA370R	CFA370HH☒	3
BR-C501 Nexave	MECHANICAL		CFA327	CFA327R	CFA327HH☒	4
BR-S501 Alfine	HYDRAULIC	MINERAL	CFA370	CFA370R	CFA370HH☒	5
BR-R505	MECHANICAL		CFA614	CFA614R	CFA614HH☒	6
BR-RS505	HYDRAULIC	MINERAL	CFA614	CFA614R	CFA614HH	7
BR-M515 Deore	MECHANICAL		CFA327	CFA327R	CFA327HH☒	8
BR-R515	MECHANICAL		CFA614	CFA614R	CFA614HH☒	9
BR-M515 La Deore	MECHANICAL		CFA327	CFA327R	CFA327HH☒	10
BR-R517	MECHANICAL		CFA614	CFA614R	CFA614HH☒	11
BR-M525 Deore	HYDRAULIC	MINERAL	CFA327	CFA327R	CFA327HH☒	12
BR-M535 Deore	HYDRAULIC	MINERAL	CFA370	CFA370R	CFA370HH	13
BR-M545	MECHANICAL		CFA370	CFA370R	CFA370HH	14
BR-M555 Deore XT	HYDRAULIC	MINERAL	CFA329	CFA329R	CFA329HH	15
BR-M575	HYDRAULIC	MINERAL	CFA327	CFA327R	CFA327HH	16
BR-M585 Deore LX	HYDRAULIC	MINERAL	CFA370	CFA370R	CFA370HH	17
BR-M595 Deore	HYDRAULIC	MINERAL	CFA370	CFA370R	CFA370HH☒	18
BR-M596 Deore	HYDRAULIC	MINERAL	CFA370	CFA370R	CFA370HH☒	19
BR-C601 Nexave	MECHANICAL		CFA327	CFA327R	CFA370HH☒	20
BR-M601 Hone	HYDRAULIC	MINERAL	CFA370	CFA370R	CFA370HH	21
BR-T605	HYDRAULIC	MINERAL	CFA370	CFA370R	CFA370HH	22
BR-T615 Deore	HYDRAULIC	MINERAL	CFA327	CFA327R	CFA327HH☒	23
BR-M615 Deore	HYDRAULIC	MINERAL	CFA614	CFA614R	CFA614HH☒	24
BR-M640 Zee	HYDRAULIC	MINERAL	CFA493	CFA493R	CFA493HH☒	25
BR-M665 SLX	HYDRAULIC	MINERAL	CFA370	CFA370R	CFA370HH	26
BR-T665 Deore LX	HYDRAULIC	MINERAL	CFA370	CFA370R	CFA370HH☒	27
BR-M666 SLX	HYDRAULIC	MINERAL	CFA614	CFA614R	CFA614HH☒	28
BR-T675 Deore LX	HYDRAULIC	MINERAL	CFA327	CFA327R	CFA327HH☒	29
BR-M675 SLX	HYDRAULIC	MINERAL	CFA614	CFA614R	CFA614HH☒	30
BR-S700 Alfine	HYDRAULIC	MINERAL	CFA614	CFA614R	CFA614HH☒	31
BR-M755 Deore XT	HYDRAULIC	MINERAL	CFA310	CFA310R	CFA310HH	32
BR-M765 Deore XT	HYDRAULIC	MINERAL	CFA370	CFA370R	CFA370HH	33
BR-M775 Deore XT	HYDRAULIC	MINERAL	CFA370	CFA370R	CFA370HH	34
BR-M776 Deore XT	HYDRAULIC	MINERAL	CFA370	CFA370R	CFA370HH☒	35
BR-M785 Deore XT	HYDRAULIC	MINERAL	CFA614	CFA614R	CFA614HH☒	36
BR-R785	HYDRAULIC	MINERAL	CFA614	CFA614R	CFA614HH☒	37
BR-RS785	HYDRAULIC	MINERAL	CFA614	CFA614R	CFA614HH☒	38
BR-M Deore XT785	HYDRAULIC	MINERAL	CFA614	CFA614R	CFA614HH☒	39
BR-M800 Saint	HYDRAULIC	MINERAL	CFA370	CFA370R	CFA370HH	40
BR-TX805 Tourney TX	MECHANICAL		CFA327	CFA327R	CFA327HH☒	41
BR-RS805	HYDRAULIC	MINERAL	CFA614	CFA614R	CFA614HH☒	42
BR-M810 Saint	HYDRAULIC	MINERAL	CFA493	CFA493R	CFA493HH	43
BR-M820 Saint	HYDRAULIC	MINERAL	CFA493	CFA493R	CFA493HH☒	44
BR-C901 Nexave	HYDRAULIC	MINERAL	CFA329	CFA329R	CFA329HH	45
BR-M965 XTR	HYDRAULIC	MINERAL	CFA370	CFA370R	CFA370HH	46
BR-M966 XTR	HYDRAULIC	MINERAL	CFA370	CFA370R	CFA370HH	47
BR-M975 XTR	HYDRAULIC	MINERAL	CFA370	CFA370R	CFA370HH	48
BR-M985 XTR	HYDRAULIC	MINERAL	CFA614	CFA614R	CFA614HH☒	49
BR-M987 XTR	HYDRAULIC	MINERAL	CFA614	CFA614R	CFA614HH☒	50
BR-M3050 Acera	HYDRAULIC	MINERAL	CFA327	CFA327R	CFA327HH☒	51
BR-M4050 Alivio	HYDRAULIC	MINERAL	CFA327	CFA327R	CFA327HH☒	52
BR-U5000 Metrea	HYDRAULIC	MINERAL	CFA327	CFA327R	CFA327HH☒	53
BR-M6000 Deore	HYDRAULIC	MINERAL	CFA327	CFA327R	CFA327HH☒	54
BR-M7000 Slx	HYDRAULIC	MINERAL	CFA614	CFA614R	CFA614HH☒	55
BR-M8000 Deore XT	HYDRAULIC	MINERAL	CFA614	CFA614R	CFA614HH☒	56

CYCLE DISC BRAKE PADS



SHIMANO

Line #

Hydraulic/
Mechanical

DOT/
Mineral

Standard
Brake Pads

"R" Sintered
Brake Pads

"HH" Sintered
Brake Pads

BRAKE
APPLICATIONS

1	BR-M9000 XTR Race	HYDRAULIC	MINERAL	CFA614	CFA614R	CFA614HH ☒
2	BR-M9020 XT Trail	HYDRAULIC	MINERAL	CFA614	CFA614R	CFA614HH ☒
3	BR-R9170	HYDRAULIC	MINERAL	CFA614	CFA614R	CFA614HH ☒
4	☒ Please check your discs are suitable for use with Sintered Pads.					
5	Using Sintered pads on non hardened discs can cause very					
6	high wear or heat distortion.					
7						
8	SRAM					
9	Code R			CFA616	CFA616R	CFA616HH
10	Code RSC			CFA616	CFA616R	CFA616HH
11	DB1	HYDRAULIC	DOT*	CFA472	CFA472R	CFA472HH
12	DB3	HYDRAULIC	DOT*	CFA472	CFA472R	CFA472HH
13	DB5	HYDRAULIC	DOT*	CFA472	CFA472R	CFA472HH
14	Force Series	HYDRAULIC	DOT*	CFA667	N/A	N/A
15	Guide Ultimate	HYDRAULIC	DOT*	CFA633	CFA633R	CFA633HH
16	Guide RSC	HYDRAULIC	DOT*	CFA633	CFA633R	CFA633HH
17	Guide RS	HYDRAULIC	DOT*	CFA633	CFA633R	CFA633HH
18	Guide R	HYDRAULIC	DOT*	CFA633	CFA633R	CFA633HH
19	Guide RE	HYDRAULIC	DOT*	CFA616	CFA616R	CFA616HH
20	Hydro HC	HYDRAULIC	DOT*	CFA667	N/A	N/A
21	Hydro R	HYDRAULIC	DOT*	CFA667	N/A	N/A
22	Komfy	HYDRAULIC	DOT*	CFA394	CFA394R	CFA394HH
23	Level Ultimate	HYDRAULIC	DOT*	CFA667	N/A	N/A
24	Level TLM	HYDRAULIC	DOT*	CFA667	N/A	N/A
25	Level TL	HYDRAULIC	DOT*	CFA667	N/A	N/A
26	Level T	HYDRAULIC	DOT*	CFA472	CFA472R	CFA472HH
27	Level	HYDRAULIC	DOT*	CFA472	CFA472R	CFA472HH
28	Red Series (Inc. Etap)	HYDRAULIC	DOT*	CFA667	N/A	N/A
29	Rival Series	HYDRAULIC	DOT*	CFA667	N/A	N/A
30	S Series	HYDRAULIC	DOT*	CFA667	N/A	N/A
31	XO	HYDRAULIC	DOT*	CFA472	CFA472R	CFA472HH
32	XX	HYDRAULIC	DOT*	CFA472	CFA472R	CFA472HH
33	XX World Cup	HYDRAULIC	DOT*	CFA472	CFA472R	CFA472HH
34	*SRAM Recommend The Use Of Dot 5.1 Brake Fluid					
35						
36	SR SUNTOUR					
37	DB7 XCM	MECHANICAL		CFA391	N/A	N/A
38	Suntour DB700	HYDRAULIC		CFA341	N/A	CFA341HH
39						
40	TEKTRO					
41	Early Lyra, Novella, lo, lox, Auriga	MECHANICAL		CFA330	CFA330R	CFA330HH
42	Late MD-M311 Novela	MECHANICAL		CFA615	CFA615R	N/A
43	Auriga Pro	HYDRAULIC	MINERAL	CFA327	CFA327R	CFA327HH
44	HD-C300 Mota	HYDRAULIC	MINERAL	CFA327	CFA327R	CFA327HH
45	HD-C500 Lyra	HYDRAULIC	MINERAL	CFA648	CFA648R	N/A
46	HD-E350 (E-Bike)	HYDRAULIC	MINERAL	CFA327	CFA327R	CFA327HH
47	HD-E500 Auriga E-Comp (E-Bike)	HYDRAULIC	MINERAL	CFA327	CFA327R	CFA327HH
48	HD-E510 Auriga E-Sub (E-Bike)	HYDRAULIC	MINERAL	CFA391	N/A	N/A
49	HD-E520 Auriga E-Sub (E-Bike)	HYDRAULIC	MINERAL	CFA327	CFA327R	CFA327HH
50	HD-E525 Auriga E-Twin (E-Bike)	HYDRAULIC	MINERAL	CFA327	CFA327R	CFA327HH
51	HD-E530 Auriga E-Tune (E-Bike)	HYDRAULIC	MINERAL	CFA327	CFA327R	CFA327HH
52	HD-E710 Dorado (E-Bike)	HYDRAULIC	MINERAL	CFA695	N/A	CFA695HH
53	HD-E715 Dorado (E-Bike)	HYDRAULIC	MINERAL	CFA327	CFA327R	CFA327HH
54	HD-E725 Dorado 4P (E-Bike)	HYDRAULIC	MINERAL	CFA493	CFA493R	CFA493HH
55	HD-M282 Junior	HYDRAULIC	MINERAL	CFA327	CFA327R	CFA327HH
56	HD-M285	HYDRAULIC	MINERAL	CFA327	CFA327R	CFA327HH

CYCLE DISC BRAKE PADS

APPLI
CATIONS
BRAKE



TEKTRO

	Hydraulic/ Mechanical	DOT/ Mineral	Standard Brake Pads	"R" Sintered Brake Pads	"HH" Sintered Brake Pads	Line #
HD-M286	HYDRAULIC	MINERAL	CFA327	CFA327R	CFA327HH	1
HD-M290 Auriga	HYDRAULIC	MINERAL	CFA327	CFA327R	CFA327HH	2
HD-M291 Auriga	HYDRAULIC	MINERAL	CFA327	CFA327R	CFA327HH	3
HD-M330 HdC 330	HYDRAULIC	MINERAL	CFA327	CFA327R	CFA327HH	4
HD-M500 Aquila	HYDRAULIC	MINERAL	CFA327	CFA327R	CFA327HH	5
HD-M500 Gemini	HYDRAULIC	MINERAL	CFA327	CFA327R	CFA327HH	6
HD-M501 Gemini	HYDRAULIC	MINERAL	CFA327	CFA327R	CFA327HH	7
HD-M510 Gemini	HYDRAULIC	MINERAL	CFA327	CFA327R	CFA327HH	8
HD-M520 Gemini SI	HYDRAULIC	MINERAL	CFA327	CFA327R	CFA327HH	9
HD-M521 Gemini SI	HYDRAULIC	MINERAL	CFA327	CFA327R	CFA327HH	10
HD-M532 Draco 2	HYDRAULIC	MINERAL	CFA327	CFA327R	CFA327HH	11
HD-M725 Orion	HYDRAULIC	MINERAL	CFA327	CFA327R	CFA327HH	12
HD-M730 Orion	HYDRAULIC	MINERAL	CFA327	CFA327R	CFA327HH	13
HD-M735 Orion 4+2P 2 Piston Rear	HYDRAULIC	MINERAL	CFA327	CFA327R	CFA327HH	14
HD-M735 Orion 4+2P 4 Piston Front	HYDRAULIC	MINERAL	CFA493	CFA493R	CFA493HH	15
HD-M740 Orion SI	HYDRAULIC	MINERAL	CFA327	CFA327R	CFA327HH	16
HD-M745 Orion 4P	HYDRAULIC	MINERAL	CFA493	CFA493R	CFA493HH	17
HD-R310	HYDRAULIC	MINERAL	CFA614	CFA614R	CFA614HH	18
HD-R510 Twist R	HYDRAULIC	MINERAL	CFA614	CFA614R	CFA614HH	19
HD-T285	HYDRAULIC	MINERAL	CFA327	CFA327R	CFA327HH	20
HD-T290 Vela	HYDRAULIC	MINERAL	CFA327	CFA327R	CFA327HH	21
HD-T510 Auriga Sub	HYDRAULIC	MINERAL	CFA391	N/A	N/A	22
HD-T511 Auriga Sub	HYDRAULIC	MINERAL	CFA391	N/A	N/A	23
HD-T515 Auriga Twin	HYDRAULIC	MINERAL	CFA391	N/A	N/A	24
HD-T520 Auriga Sub	HYDRAULIC	MINERAL	CFA327	CFA327R	CFA327HH	25
HD-T525 Auriga Twin	HYDRAULIC	MINERAL	CFA327	CFA327R	CFA327HH	26
HD-T530 Auriga Tune	HYDRAULIC	MINERAL	CFA327	CFA327R	CFA327HH	27
HD-T700 Volans	HYDRAULIC	MINERAL	CFA391	N/A	N/A	28
HD-T710 Volans	HYDRAULIC	MINERAL	CFA327	CFA327R	CFA327HH	29
MD-C400 Mira	MECHANICAL		CFA327	CFA327R	CFA327HH	30
MD-C510	MECHANICAL		CFA327	CFA327R	CFA327HH	31
MD-M280	MECHANICAL		CFA327	CFA327R	CFA327HH	32
MD-M300 Aries	MECHANICAL		CFA327	CFA327R	CFA327HH	33
MD-U510	MECHANICAL		CFA327	CFA327R	CFA327HH	34
TRICKSTUFF						35
Cleg 2	HYDRAULIC	DOT	CFA472	CFA472R	CFA472HH	37
Cleg 4 Mkl	HYDRAULIC	DOT	CFA310	CFA310R	CFA310HH	38
TRP						39
Dash	HYDRAULIC	MINERAL	CFA370	CFA370R	CFA370HH	41
HY/RD	MECHANICAL/HYDRAULIC	MINERAL	CFA327	CFA327R	CFA327HH	42
Hylex	HYDRAULIC	MINERAL	CFA327	CFA327R	CFA327HH	43
Hylex RS	HYDRAULIC	MINERAL	CFA327	CFA327R	CFA327HH	44
Hywire	HYDRAULIC	MINERAL	CFA327	CFA327R	CFA327HH	45
Parabox	MECHANICAL/HYDRAULIC	MINERAL	CFA327	CFA327R	CFA327HH	46
Parabox R	MECHANICAL/HYDRAULIC	MINERAL	CFA327	CFA327R	CFA327HH	47
Quadiem	MECHANICAL		CFA493	CFA493R	CFA493HH	48
Quadiem G-Spec	MECHANICAL		CFA493	CFA493R	CFA493HH	49
Quadiem SL	MECHANICAL		CFA493	CFA493R	CFA493HH	50
Slate T4	HYDRAULIC	MINERAL	CFA493	CFA493R	CFA493HH	51
Slate X2	HYDRAULIC	MINERAL	CFA327	CFA327R	CFA327HH	52
Spyke	MECHANICAL		CFA327	CFA327R	CFA327HH	53
Spyre	MECHANICAL		CFA327	CFA327R	CFA327HH	54
Spyre C	MECHANICAL		CFA327	CFA327R	CFA327HH	55
Spyre SLC	MECHANICAL		CFA327	CFA327R	CFA327HH	56

CYCLE DISC BRAKE PADS



VOXA

Line #

	Hydraulic/ Mechanical	DOT/ Mineral	Standard Brake Pads	"R" Sintered Brake Pads	"HH" Sintered Brake Pads
1 MD35			CFA339	CFA339R	CFA339HH
2					
3 ZOOM					
4 DB 280	MECHANICAL		CFA370	CFA370R	CFA370HH
5 DB 320	MECHANICAL		CFA370	CFA370R	CFA370HH
6 DB 325	MECHANICAL		CFA370	CFA370R	CFA370HH
7 DB 350	MECHANICAL		CFA439	CFA439R	CFA439HH
8 DB 450	MECHANICAL		CFA439	CFA439R	CFA439HH
9 DB 550	MECHANICAL		CFA653	N/A	N/A
10 DB 650	MECHANICAL		CFA653	N/A	N/A
11 HB 100	HYDRAULIC	MINERAL	CFA653	N/A	N/A
12 HB 850	HYDRAULIC	MINERAL	CFA653	N/A	N/A
13 HB 870	HYDRAULIC	MINERAL	CFA653	N/A	N/A
14 HB 875	HYDRAULIC	MINERAL	CFA370	CFA370R	CFA370HH
15					
16					
17					
18					
19					
20					
21					
22					
23					
24					
25					
26					
27					
28					
29					
30					
31					
32					
33					
34					
35					
36					
37					
38					
39					
40					
41					
42					
43					
44					
45					
46					
47					
48					
49					
50					
51					
52					
53					
54					
55					
56					

BRAKE APPLICATIONS

CYCLE DISC BRAKE PADS BUYERS GUIDE

NOTE:- Size identification is shown as follows

Dimension 1=Width or Diameter, Dimension 2=Height or Diameter, Dimension 3=Thickness (Material and backplate)

CFA242

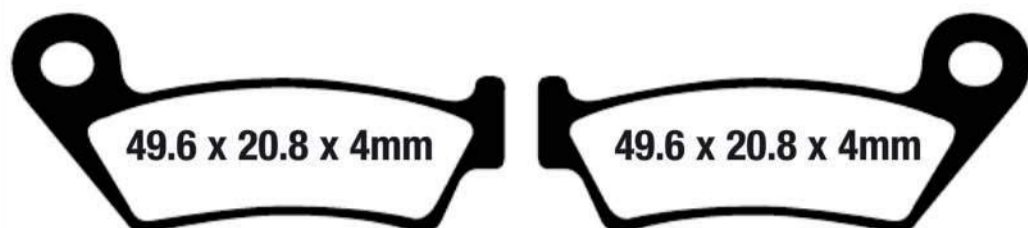

ROCK SHOX/AMP

D1

STD	CFA242	Premium Organic All Round Pad Blend
OPTIONS	CFA242R	High Friction Organic Pad Blend
	CFA242HH	Double-H Sintered Long Lasting Pad Blend

CFA247B



HOPE

Closed 2

DH 4

Open 2

STD	CFA247B	Premium Organic All Round Pad Blend
OPTIONS	CFA247BR	High Friction Organic Pad Blend
	CFA242BHH	Double-H Sintered Long Lasting Pad Blend

CFA274

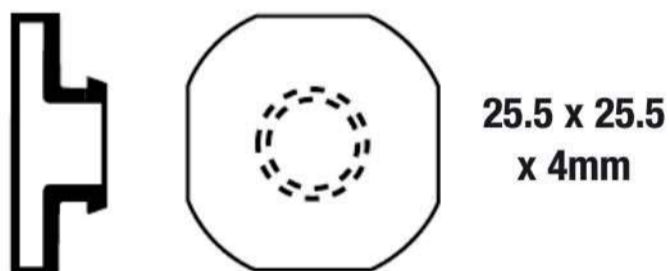

FORMULA

Evoluzion

STD	CFA274	Premium Organic All Round Pad Blend
OPTION	CFA274R	High Friction Organic Pad Blend

CFA277

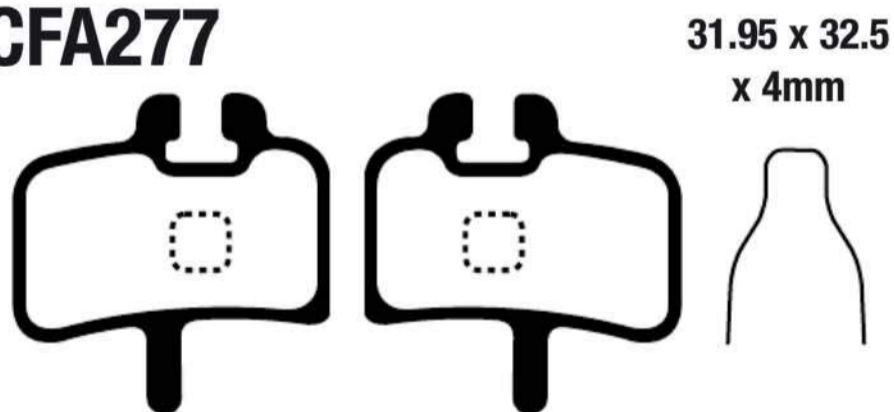

HAYES

G 1

G 2

HFX-9

HFX-Mag

MX 1

PROMAX

DSK 905/907/908/918

STD	CFA277	Premium Organic All Round Pad Blend
OPTIONS	CFA277R	High Friction Organic Pad Blend
	CFA277HH	Double-H Sintered Long Lasting Pad Blend

CFA278

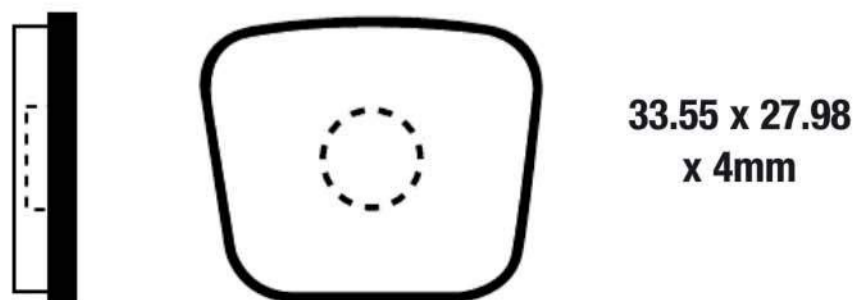

PRO STOP

Pro Stop

Pro Stop 2

STD	CFA278	Premium Organic All Round Pad Blend
OPTION	CFA278R	High Friction Organic Pad Blend

CFA280



MAGURA
Gustav

STD	CFA280	Premium Organic All Round Pad Blend
OPTIONS	CFA280R	High Friction Organic Pad Blend
	CFA280HH	Double-H Sintered Long Lasting Pad Blend

CFA284

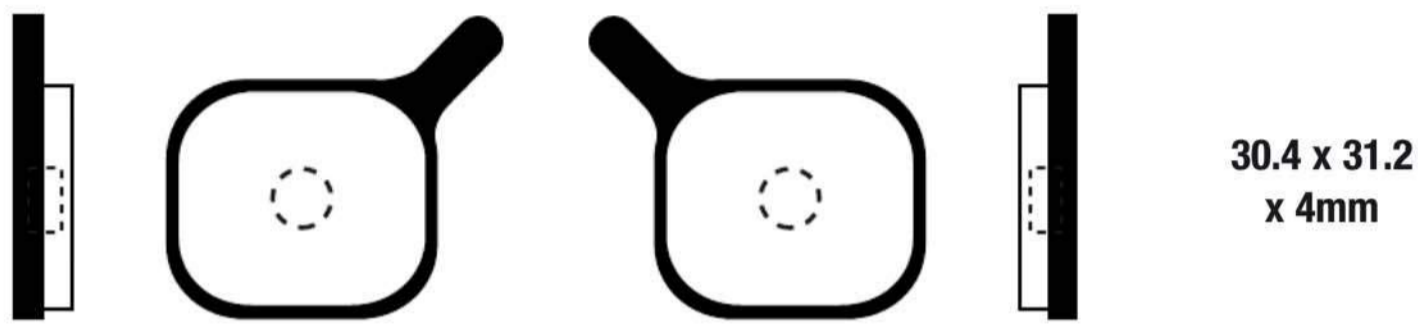

CANNONDALE
Coda Standard

STD	CFA284	Premium Organic All Round Pad Blend
OPTION	CFA284R	High Friction Organic Pad Blend

CFA284A

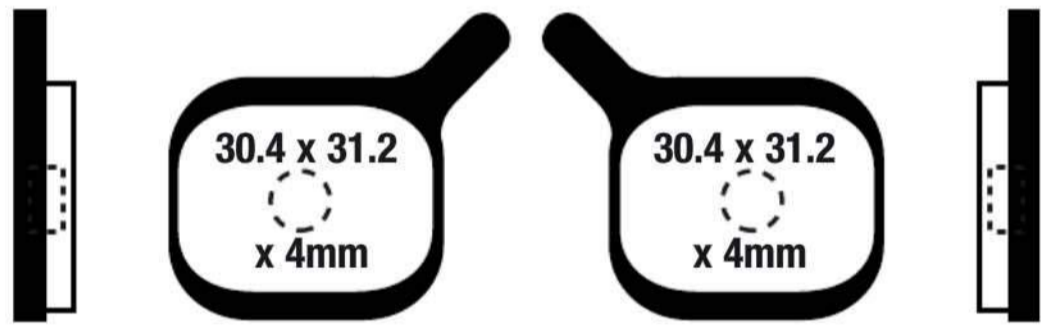

STD	CFA284A	Premium Organic All Round Pad Blend
OPTIONS	CFA284AR	High Friction Organic Pad Blend
	CFA284AHH	Double-H Sintered Long Lasting Pad Blend

CFA285



DIATECH
Kinetic
Nifon
Aero Mechanical

STD	CFA285	Premium Organic All Round Pad Blend
OPTION	CFA285R	High Friction Organic Pad Blend

CFA286

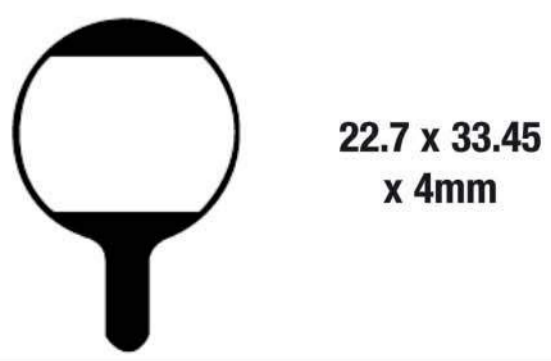

MAGURA
Clara (2000-01)
Louise (1999-01)

PROMAX
DSK 200/400/420/610/650

STD	CFA286	Premium Organic All Round Pad Blend
OPTIONS	CFA286R	High Friction Organic Pad Blend
	CFA286HH	Double-H Sintered Long Lasting Pad Blend

CFA288



24.7 x 37
x 4mm

RST
Disc X/DX

STD	CFA288	Premium Organic All Round Pad Blend
OPTION	CFA288R	High Friction Organic Pad Blend

CFA289/4

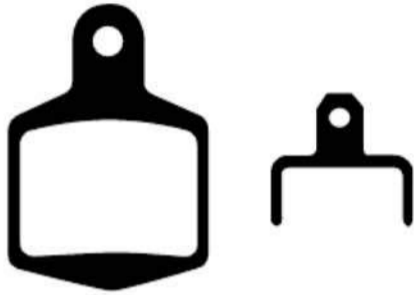

20 x 27.98 x 4mm
Set includes
return springs

HOPE
M4

STD	CFA289/4	Premium Organic All Round Pad Blend
OPTIONS	CFA289/4R	High Friction Organic Pad Blend
	CFA289/4HH	Double-H Sintered Long Lasting Pad Blend

CFA290

A. 23 x 23.75 x 4mm
B. 23.3 x 23.26 x 4mm

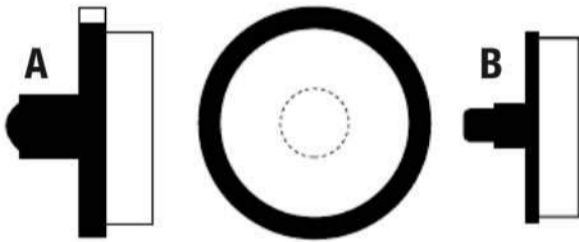

FORMULA
MD1

STD	CFA290	Premium Organic All Round Pad Blend
OPTION	CFA290R	High Friction Organic Pad Blend

CFA300

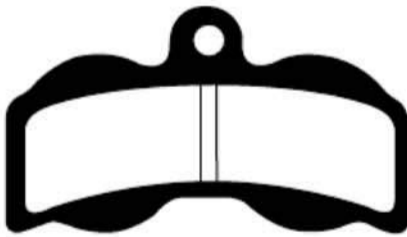

40.5 x 22.85 x
4mm

HOPE
XC4

STD	CFA300	Premium Organic All Round Pad Blend
OPTIONS	CFA300R	High Friction Organic Pad Blend
	CFA300HH	Double-H Sintered Long Lasting Pad Blend

CFA308

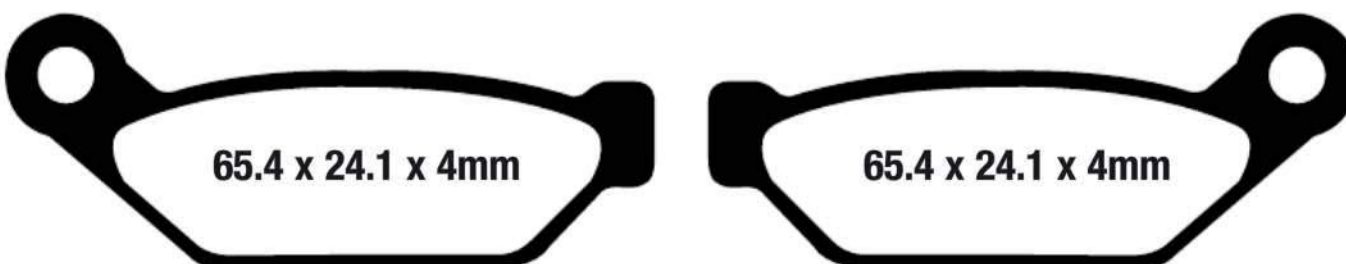

65.4 x 24.1 x 4mm

65.4 x 24.1 x 4mm

GRIMECA
Early Hydraulic 4 Piston

STD	CFA308	Premium Organic All Round Pad Blend
OPTION	CFA308R	High Friction Organic Pad Blend

CFA309



GRIMECA
System 1
System 15
Early Mechanical

STD	CFA309	Premium Organic All Round Pad Blend
OPTION	CFA309R	High Friction Organic Pad Blend

CFA310



37.1 x 25.4 x 4mm
Set includes
return springs

GRIMECA
System 8
SHIMANO
BR-M755 Deore XT

TRICKSTUFF
Cleg 4 MkII

STD	CFA310	Premium Organic All Round Pad Blend
OPTIONS	CFA310R	High Friction Organic Pad Blend
	CFA310HH	Double-H Sintered Long Lasting Pad Blend

CFA311

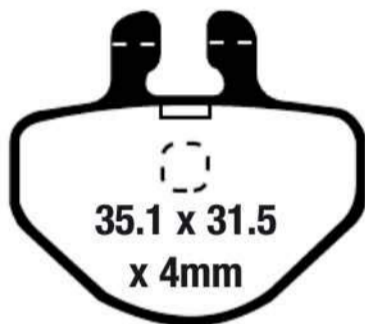

GRIMECA
System 7

STD	CFA311	Premium Organic All Round Pad Blend
OPTIONS	CFA311R	High Friction Organic Pad Blend
	CFA311HH	Double-H Sintered Long Lasting Pad Blend

CFA316



24.15 x 24.3
x 4mm

DIATECH
Spiral Y2K

STD	CFA316	Premium Organic All Round Pad Blend
OPTION	CFA316R	High Friction Organic Pad Blend

CFA318



HOPE
Mini

STD	CFA318	Premium Organic All Round Pad Blend
OPTIONS	CFA318R	High Friction Organic Pad Blend
	CFA318HH	Double-H Sintered Long Lasting Pad Blend

CFA325

Set includes upgraded
return springs



FORMULA
4 Racing XC
B4
Extreme FR & DH

GRIMECA
System 13

STD	CFA325	Premium Organic All Round Pad Blend
OPTIONS	CFA325R	High Friction Organic Pad Blend
	CFA325HH	Double-H Sintered Long Lasting Pad Blend

CFA326



42.9 x 24.75
x 4mm

MAGURA
Clara (2002)
Louise (2002-06)

PROMAX
DSK 901/903

STD	CFA326	Premium Organic All Round Pad Blend
OPTIONS	CFA326R	High Friction Organic Pad Blend
	CFA326HH	Double-H Sintered Long Lasting Pad Blend

CFA327



30.68 x 35
x 4mm

Set includes
return springs

ALHONGA

HJ-OD04
HJ-OD05
HJ-MD11
HJ-Latoo

BENGAL

Ares 5
Ares Pro
Helix 7B

CLARKS

S2

GIANT

Root
Root 2

GUSSET

Chute

QUAD

QHD-1 Sting
QHD-1.2 Rapide

SHIMANO

BR-M315
BR-M355
BR-M365
BR-M375
BR-M395
BR-M415

BR-M416
BR-M416A
BR-M445
BR-M446
BR-M447
BR-M465
BR-M475
BR-M485
BR-M486
BR-M495
BR-C501 Nexave
BR-M515 Deore
BR-M515 La Deore
BR-M525 Deore
BR-M575
BR-C601 Nexave
BR-T615 Deore
BR-T675 Deore LX
BR-TX805 Tourney TX
BR-M3050 Acera
BR-M4050 Alivio
BR-U5000 Metrea
BR-M6000 Deore
TEKTRO
Auriga Pro
HD-C300 Mota

HD-E350 (E-Bike)
HD-E500 Auriga
E-Comp (E-Bike)
HD-E520 Auriga
E-Sub (E-Bike)
HD-E525 Auriga
E-Twin (E-Bike)
HD-E530 Auriga
E-Tune (E-Bike)
HD-E715 Dorado (E-Bike)
HD-M282 Junior
HD-M285
HD-M286
HD-M290 Auriga
HD-M291 Auriga
HD-M330 HDc 330
HD-M500 Aquila
HD-M500 Gemini
HD-M501 Gemini
HD-M510 Gemini
HD-M520 Gemini SI
HD-M521 Gemini SI
HD-M532 Draco 2
HD-M725 Orion
HD-M730 Orion

HD-M735 Orion 4+2P
2 Piston Rear
HD-M740 Orion SI
HD-T285
HD-T290 Vela
HD-T520 Auriga Sub
HD-T525 Auriga Twin
HD-T530 Auriga Tune
HD-T710 Volans
MD-C400 Mira
MD-C510
MD-M280
MD-M300 Aries
MD-U510
TRP
HY/RD
Hylex
Hylex RS
Hywire
Parabox
Parabox R
Slate X2
Spyke
Spyre
Spyre C
Spyre SLC

Please check your discs are suitable for use with Sintered Pads. Using Sintered pads on non hardened discs can cause very high wear or heat distortion.

STD	CFA327	Premium Organic All Round Pad Blend
OPTIONS	CFA327R	High Friction Organic Pad Blend
	CFA327HH	Double-H Sintered Long Lasting Pad Blend

CFA329

Set includes return
springs



29 x 26.32
x 4mm



29 x 26.32
x 4mm



SHIMANO
BR-M555 Deore XT
BR-C901 Nexave

STD	CFA329	Premium Organic All Round Pad Blend
OPTIONS	CFA329R	High Friction Organic Pad Blend
	CFA329HH	Double-H Sintered Long Lasting Pad Blend

CFA330



25.4 x 37.45
x 4mm

TEKTRO
Early Lyra, Novella, Io, Iox,
Auriga

STD	CFA330	Premium Organic All Round Pad Blend
OPTIONS	CFA330R	High Friction Organic Pad Blend
	CFA330HH	Double-H Sintered Long Lasting Pad Blend

CFA331



47.2 x 28.8
x 4mm

MAGURA
Julie (2001-08)

STD	CFA331	Premium Organic All Round Pad Blend
OPTIONS	CFA331R	High Friction Organic Pad Blend
	CFA331HH	Double-H Sintered Long Lasting Pad Blend

CFA332



24.6 x 25.6
x 4mm

QUAD
QHD-5 Dime

STD	CFA332	Premium Organic All Round Pad Blend
------------	---------------	-------------------------------------

CFA333

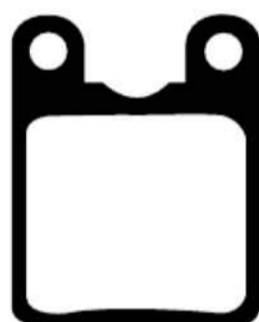

25.17 x 31.55
x 4mm

GIANT
MPH 2000
MPH 1

STD	CFA333	Premium Organic All Round Pad Blend
OPTIONS	CFA333R	High Friction Organic Pad Blend
	CFA333HH	Double-H Sintered Long Lasting Pad Blend

CFA338



25 x 31.65
x 4mm

GIANT
MPH 2001-2005
MPH 2
MPH 3

STD	CFA338	Premium Organic All Round Pad Blend
OPTIONS	CFA338R	High Friction Organic Pad Blend
	CFA338HH	Double-H Sintered Long Lasting Pad Blend

CFA339

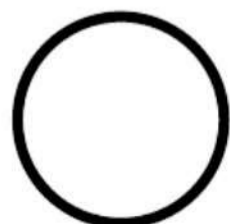

21.55Ø x 4mm

CLARKS
CMD-5
CMD-7
CMD-12

VOXA
MD35

STD	CFA339	Premium Organic All Round Pad Blend
OPTIONS	CFA339R	High Friction Organic Pad Blend
	CFA339HH	Double-H Sintered Long Lasting Pad Blend

CFA340

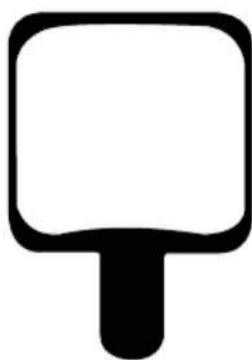

23.9 x 34.9
x 4mm

EBERLE
Eberle EM

STD	CFA340	Premium Organic All Round Pad Blend
OPTIONS	CFA340R	High Friction Organic Pad Blend
	CFA340HH	Double-H Sintered Long Lasting Pad Blend

CFA341



23 x 23
x 4mm

SR SUNTOUR
Suntour DB700

STD	CFA341	Premium Organic All Round Pad Blend
OPTION	CFA341HH	Double-H Sintered Long Lasting Pad Blend

CFA359



42.4 x 26.1
x 4mm

GRIMECA
System 12
System 16

STD	CFA359	Premium Organic All Round Pad Blend
OPTIONS	CFA359R	High Friction Organic Pad Blend
	CFA359HH	Double-H Sintered Long Lasting Pad Blend

CFA360



39.4 x 21.8
x 4mm

39.4 x 21.8
x 4mm

CLARKS
Exo
Skeletal

STD	CFA360	Premium Organic All Round Pad Blend
OPTIONS	CFA360R	High Friction Organic Pad Blend
	CFA360HH	Double-H Sintered Long Lasting Pad Blend

CFA364

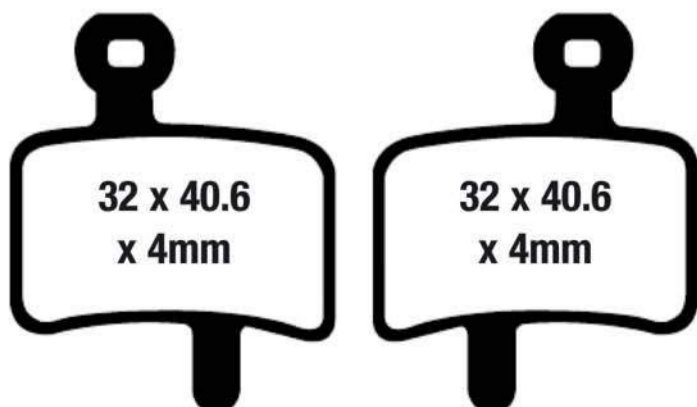

32 x 40.6
x 4mm

32 x 40.6
x 4mm

DIATECH
Anchor

STD	CFA364	Premium Organic All Round Pad Blend
------------	---------------	-------------------------------------

CFA365

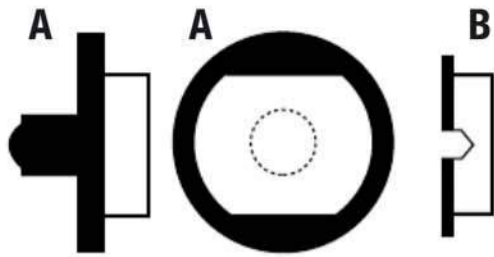

**24.9 x 23.87
x 7.24mm**
Pad B retained by screw

FORMULA
Activa
MD1 2002

GRIMECA
System 6
System 9

STD CFA365 Premium Organic All Round Pad Blend

CFA370



34.4 x 27 x 4mm
Set includes upgraded
return springs

ALHONGA
HJ-OD03
APSE ARTEK
ADC-DB01
ADC-SLP
ADC-Elite
ADC-IE
ADC-R01
ADC-07
CLARKS
HDB-540
HDB-600
HDB-790
PROMAX
Solve

SHIMANO
BR-S500 Alfine
BR-S501 Alfine
BR-M535 Deore
BR-M545
BR-M585 Deore LX
BR-M595 Deore
BR-M596 Deore
BR-M601 Hone
BR-T605
BR-M665 SLX
BR-T665 Deore LX
BR-M765 Deore XT
BR-M775 Deore XT
BR-M776 Deore XT

BR-M800 Saint
BR-M965 XTR
BR-M966 XTR
BR-M975 XTR
TRP
Dash
ZOOM
DB 280
DB 320
DB 325
HB 875

STD CFA370 Premium Organic All Round Pad Blend

OPTIONS CFA370R High Friction Organic Pad Blend

CFA370HH Double-H Sintered Long Lasting Pad Blend

CFA378

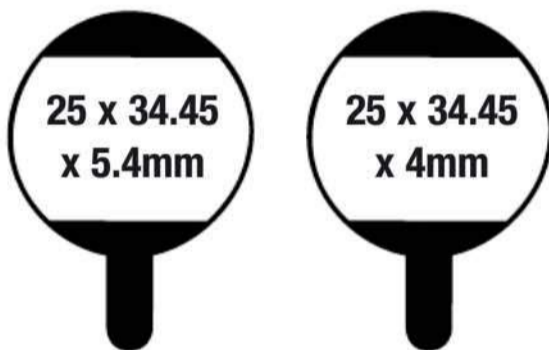

**25 x 34.45
x 5.4mm**

**25 x 34.45
x 4mm**

PROMAX
DSK 320/700

STD CFA378 Premium Organic All Round Pad Blend

CFA383



52.05 x 30.1 x 4mm

ALLIGATOR
Gatorbrake 6 Piston
CLARKS
Clim 8

STD CFA383 Premium Organic All Round Pad Blend

CFA385

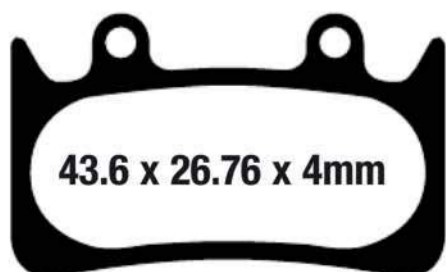

43.6 x 26.76 x 4mm

HOPE
Mono 6
Mono 6 Ti

STD CFA385 Premium Organic All Round Pad Blend

OPTIONS CFA385R High Friction Organic Pad Blend

CFA385HH Double-H Sintered Long Lasting Pad Blend

CFA386



30.1 x 28
x 4mm

Set includes upgraded
return springs

HOPE
Mono Mini

STD	CFA386	Premium Organic All Round Pad Blend
OPTIONS	CFA386R	High Friction Organic Pad Blend
	CFA386HH	Double-H Sintered Long Lasting Pad Blend

CFA391



23.1 x 37.25
x 4mm

SR SUNTOUR
DB7 XCM

TEKTRO
HD-E510 Auriga
E-Sub (E-Bike)
HD-T510 Auriga Sub
HD-T511 Auriga Sub
HD-T515 Auriga Twin
HD-T700 Volans

STD	CFA391	Premium Organic All Round Pad Blend
------------	---------------	-------------------------------------

CFA392



24.5 x 20.5
x 4mm

JOYTECH
Joytech Mechanical

STD	CFA392	Premium Organic All Round Pad Blend
------------	---------------	-------------------------------------

CFA394



32 x 34.12
x 4mm



32 x 34.12
x 4mm

AVID
BB7 Mechanical
(All Mountain & Road)
Juicy 3
Juicy 5
Juicy 7
Juicy Carbon
Juicy Ultimate
Juicy Ultimate 7
CLARKS
CMD-15

GUSSET
Hydro Chute
PROMAX
DSK 950
SRAM
Komfy

STD	CFA394	Premium Organic All Round Pad Blend
OPTIONS	CFA394R	High Friction Organic Pad Blend
	CFA394HH	Double-H Sintered Long Lasting Pad Blend

CFA402



27.1 x 33.7
x 4mm

FORMULA
Oro

STD	CFA402	Premium Organic All Round Pad Blend
OPTIONS	CFA402R	High Friction Organic Pad Blend
	CFA402HH	Double-H Sintered Long Lasting Pad Blend

CFA404

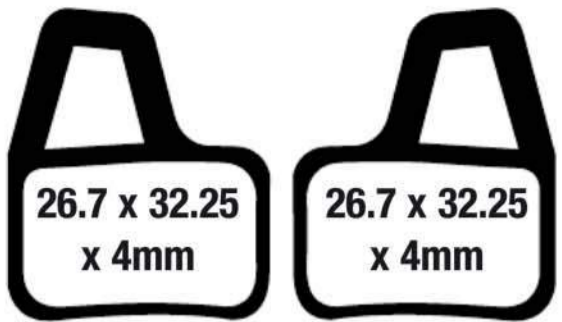

Set includes
return springs



HAYES
El Camino

STD	CFA404	Premium Organic All Round Pad Blend
OPTIONS	CFA404R	High Friction Organic Pad Blend
OPTIONS	CFA404HH	Double-H Sintered Long Lasting Pad Blend

CFA421



22.58 x 29.6
x 4mm

APSE ARTEK

- ADC-01
- ADC-02
- ADC-08
- ADC-09
- ADC-10

BENGAL

- Ares
- Ares 1
- Ares 3
- Helix 1.0

- Helix 1.1
- Helix 2.1
- Helix 2.5
- Helix 3
- Helix 3SL
- Helix 5
- Helix 5L
- Helix 7
- Helix 7C
- Helix 7.5
- MB 300

- MB 500
- MB 600
- MB 600T
- MB 700
- ML 700
- MB 700T
- MB 839
- MB 839M
- MB 840
- MB 845
- MB 845A

- MB 845B
- MB 849A
- MB 849B
- Strida

HAYES

- CX
- Pro/Expert/Comp
- CX 5
- GX 2
- MX 2
- MX 3

- MX 4
- MX 5
- MX Expert
- Sole

QUAD

- QHD-4 Axis
- QHD-6 Tork
- QHD-7 Nano/Nano Lite
- QHD-SP

STD	CFA421	Premium Organic All Round Pad Blend
OPTIONS	CFA421R	High Friction Organic Pad Blend
OPTIONS	CFA421HH	Double-H Sintered Long Lasting Pad Blend

CFA422



27.25 x
34.15
x 4mm

HOPE
Mono Trial
Trial Zone

STD	CFA422	Premium Organic All Round Pad Blend
------------	---------------	-------------------------------------

CFA439

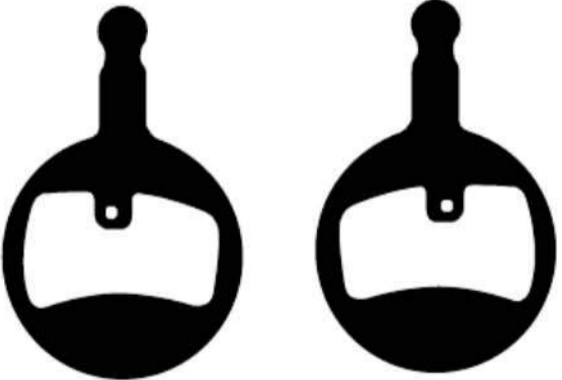

23.8 x 36.99
x 4mm

APSE ARTEK

- ADC-06
- ASSESS**
- C470
- C425
- C420
- C355

AVID

- BB5 Mechanical (All Mountain & Road)
- CLARKS**
- CMD-17
- PROMAX**
- DSK 310/715/720

- Decipher
- Render
- Render R
- ZOOM**
- DB 350
- DB 450

STD	CFA439	Premium Organic All Round Pad Blend
OPTIONS	CFA439R	High Friction Organic Pad Blend
OPTIONS	CFA439HH	Double-H Sintered Long Lasting Pad Blend

CFA440



41.25 x 34.77
x 4mm

AVID
Code (2008-2010)
Code 5
Code 7

STD	CFA440	Premium Organic All Round Pad Blend
OPTIONS	CFA440R	High Friction Organic Pad Blend
OPTIONS	CFA440HH	Double-H Sintered Long Lasting Pad Blend

CFA449

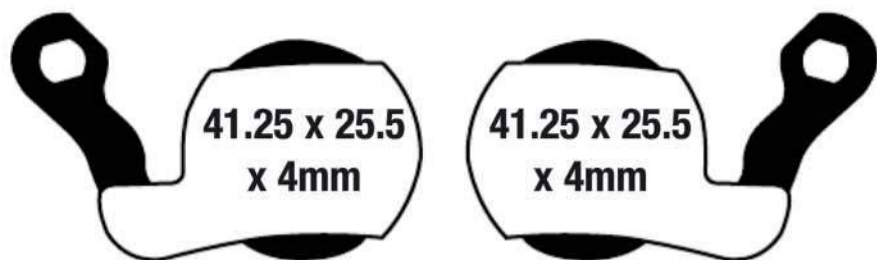

BRAKEFORCEONE

BFO 1 Brake
H20
Kill Hill

MAGURA

Julie (2009-11)
Louise (2007-11)
Marta (2009-11)
Marta SL (2009-11)

STD	CFA449	Premium Organic All Round Pad Blend
OPTIONS	CFA449R	High Friction Organic Pad Blend
	CFA449HH	Double-H Sintered Long Lasting Pad Blend

CFA451



MAGURA

Marta (2002-08)
Marta SL (2003-08)

STD	CFA451	Premium Organic All Round Pad Blend
OPTIONS	CFA451R	High Friction Organic Pad Blend
	CFA451HH	Double-H Sintered Long Lasting Pad Blend

CFA466

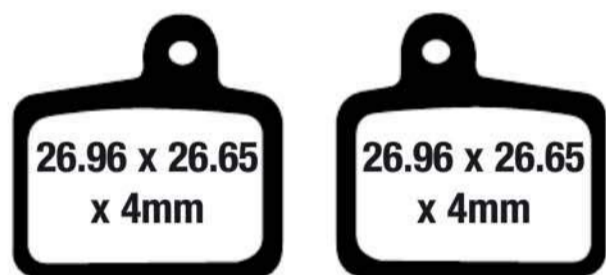

HAYES

Dyno Comp/Sport
Radar
Stroker Ryde

STD	CFA466	Premium Organic All Round Pad Blend
OPTIONS	CFA466R	High Friction Organic Pad Blend
	CFA466HH	Double-H Sintered Long Lasting Pad Blend

CFA467

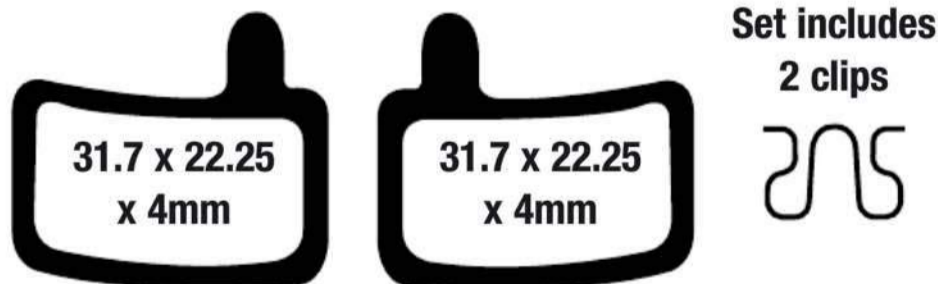

HAYES

Stroker Trail

STD	CFA467	Premium Organic All Round Pad Blend
OPTIONS	CFA467R	High Friction Organic Pad Blend
	CFA467HH	Double-H Sintered Long Lasting Pad Blend

CFA469

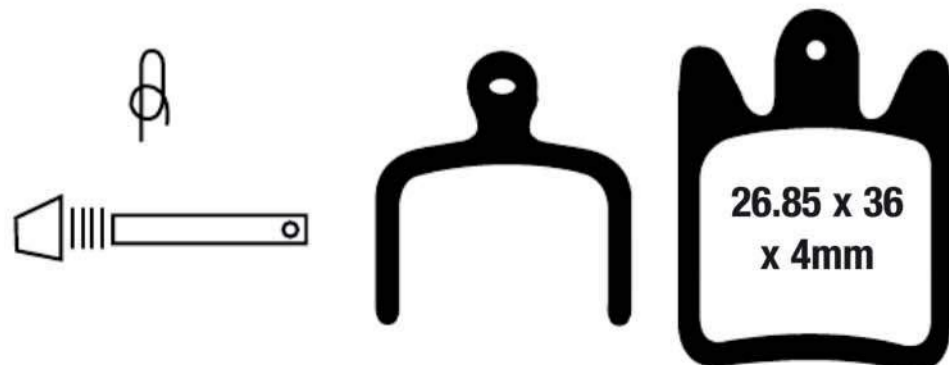

HOPE

V2

STD	CFA469	Premium Organic All Round Pad Blend
OPTIONS	CFA469R	High Friction Organic Pad Blend
	CFA469HH	Double-H Sintered Long Lasting Pad Blend

CFA470



28 x 33.3
x 4mm

FORMULA	Mega	RR1
C1	R0	RX
CR3	R0R	T1
Cura	R1	T1R
Cura-E	R1R	The One

STD	CFA470	Premium Organic All Round Pad Blend
OPTIONS	CFA470R	High Friction Organic Pad Blend
	CFA470HH	Double-H Sintered Long Lasting Pad Blend

CFA472



29.8 x 33.15
x 4mm

AVID
DB1
DB3
DB5
Elixir 1
Elixir 3
Elixir 5
Elixir 7

Elixir 9
Elixir CR
Elixir R
Elixir Via GT
Elixir XO (2011-2012)
Elixir XX
Elixir XX World Cup

PAUL COMPONENTS XO
Klamper XX
SRAM XX World Cup
TRICKSTUFF Cleg 2

STD	CFA472	Premium Organic All Round Pad Blend
OPTIONS	CFA472R	High Friction Organic Pad Blend
	CFA472HH	Double-H Sintered Long Lasting Pad Blend

CFA487



26.75 x 30.7
x 4mm

HOPE
X2

STD	CFA487	Premium Organic All Round Pad Blend
OPTIONS	CFA487R	High Friction Organic Pad Blend
	CFA487HH	Double-H Sintered Long Lasting Pad Blend

CFA493



39.75 x 23.75
x 4mm



BENGAL

Helix 4X

SHIMANO

BR-M640 Zee

BR-M810 Saint

BR-M820 Saint

TEKTRO

HD-E725 Dorado 4P (E-Bike)

HD-M735 Orion 4+2P 4 Piston Front

HD-M745 Orion 4P

TRP

Quadiem

Quadiem G-Spec

Quadiem SL

Slate T4

STD	CFA493	Premium Organic All Round Pad Blend
OPTIONS	CFA493R	High Friction Organic Pad Blend
	CFA493HH	Double-H Sintered Long Lasting Pad Blend

CFA494

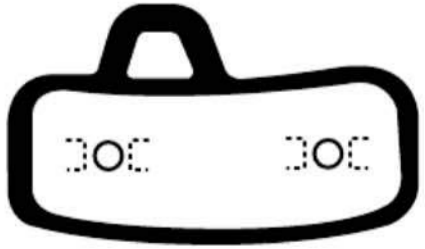

40.4 x 24
x 4mm



HAYES
Stroker Ace

STD	CFA494	Premium Organic All Round Pad Blend
OPTIONS	CFA494R	High Friction Organic Pad Blend
	CFA494HH	Double-H Sintered Long Lasting Pad Blend

CFA614



32.3 x 29.7
x 4mm

CLARKS

M2
FSA
K-Force
Afterburner
REVER
MTN 1
MCX 1

SHIMANO

BR-CX75
BR-CX77
BR-RS305
BR-R315
BR-R317
BR-RS405 Tiagra
BR-R505

BR-RS505
BR-R515
BR-R517
BR-M615 Deore
BR-M666 SLX
BR-M675 SLX
BR-S700 Alfine
BR-M785 Deore XT

BR-R785
BR-RS785
BR-M Deore XT785
BR-RS805
BR-M985 XTR
BR-M987 XTR
BR-M7000 Slx
BR-M8000 Deore XT

BR-M9000 XTR
Race
BR-M9020 XT Trail
BR-R9170
TEKTRO
HD-R310
HD-R510 Twist R

STD	CFA614	Premium Organic All Round Pad Blend
OPTIONS	CFA614R	High Friction Organic Pad Blend
	CFA614HH	Double-H Sintered Long Lasting Pad Blend

CFA615



33.5 x 22.7
x 4.15mm

APSE ARTEK

ADC-05
ADC-11

TEKTRO

Late MD-M311 Novela

STD	CFA615	Premium Organic All Round Pad Blend
OPTION	CFA615R	High Friction Organic Pad Blend

CFA616



37.6 x 24.2
x 4mm

AVID

Code (2011-)
Code R

SRAM

Code R
Code RSC
Guide RE

STD	CFA616	Premium Organic All Round Pad Blend
OPTIONS	CFA616R	High Friction Organic Pad Blend
	CFA616HH	Double-H Sintered Long Lasting Pad Blend

CFA619



30.06 x 33.8
x 4mm

MAGURA

MT2/MT4/MT4E/MT6/MT8 (2012-)
MTS
Mt Trail (2 Piston Rears)

STD	CFA619	Premium Organic All Round Pad Blend
OPTIONS	CFA619R	High Friction Organic Pad Blend
	CFA619HH	Double-H Sintered Long Lasting Pad Blend

CFA620



31.65 x 33.3
x 4mm

HAYES

Prime Pro/Expert/Comp/Sport

STD	CFA620	Premium Organic All Round Pad Blend
OPTIONS	CFA620R	High Friction Organic Pad Blend
	CFA620HH	Double-H Sintered Long Lasting Pad Blend

CFA633



40.68 x 28.25
x 4mm

AVID
Elixir 7 Trail
Elixir 9 Trail
Elixir XO Trail

SRAM
Guide Ultimate
Guide RSC
Guide RS
Guide R

STD	CFA633	Premium Organic All Round Pad Blend
OPTIONS	CFA633R	High Friction Organic Pad Blend
	CFA633HH	Double-H Sintered Long Lasting Pad Blend

CFA639

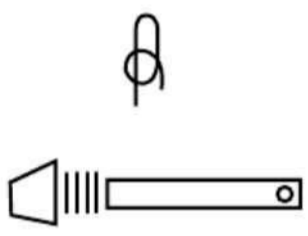

39.85 x 25.5
x 4mm

HOPE
Mono M4
V4

STD	CFA639	Premium Organic All Round Pad Blend
OPTIONS	CFA639R	High Friction Organic Pad Blend
	CFA639HH	Double-H Sintered Long Lasting Pad Blend

CFA647



37 x 28.7
x 4mm

HOPE
E4
RX 4-SH
RX 4-SR

STD	CFA647	Premium Organic All Round Pad Blend
OPTIONS	CFA647R	High Friction Organic Pad Blend
	CFA647HH	Double-H Sintered Long Lasting Pad Blend

CFA648

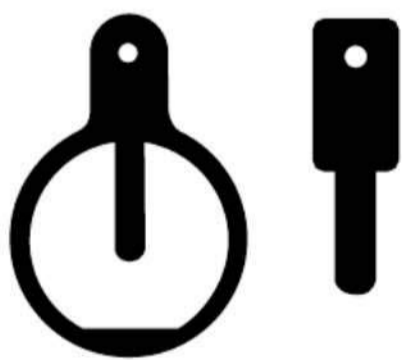

22.8 x 33.6
x 4mm
With clip

TEKTRO
HD-C500 Lyra

STD	CFA648	Premium Organic All Round Pad Blend
OPTION	CFA648R	High Friction Organic Pad Blend

CFA653



18.6 x 23.05
x 3.9mm

APOLLO
Shockwave & X Rated Bikes
(Mechanical Caliper)
APSE ARTEK
ADC-4.1
ADC-4.7

ZOOM
DB 550
DB 650
HB 100
HB 850
HB 870

STD	CFA653	Premium Organic All Round Pad Blend
------------	---------------	-------------------------------------

CFA660/4



18.98 x 29.6
x 3.55mm

MAGURA

MT5/MT7 (2015-4 Pads Per Caliper)
MT5E
MT Trail (4 Piston Fronts)

STD	CFA660/4	Premium Organic All Round Pad Blend
OPTIONS	CFA660/4R	High Friction Organic Pad Blend
	CFA660/4HH	Double-H Sintered Long Lasting Pad Blend

CFA667



30.95 x 26.15
x 4mm

SRAM

Force Series
Hydro HC
Hydro R
Level Ultimate

Level TLM
Level TL
Red Series (Inc. Etap)
Rival Series
S Series

STD	CFA667	Premium Organic All Round Pad Blend
------------	---------------	-------------------------------------

CFA688

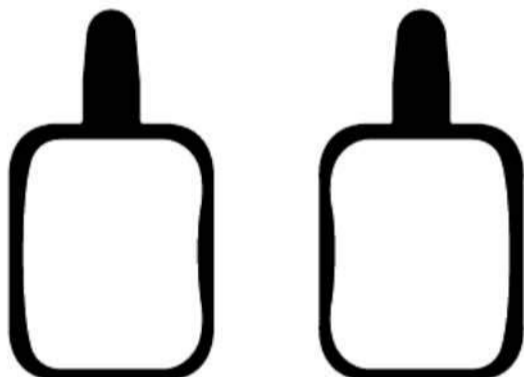

21 x 37.6
x 4.2mm

APSE ARTEK

ADC-03
ADC-04
ASSESS
E-Solex

STD	CFA688	Premium Organic All Round Pad Blend
------------	---------------	-------------------------------------

CFA689



43.25 x 28.8
x 3.4mm

MAGURA

MT5/MT7 (2015-One Piece Type Pad)

STD	CFA689	Premium Organic All Round Pad Blend
------------	---------------	-------------------------------------

CFA695



38.2 x 35.7
x 4mm

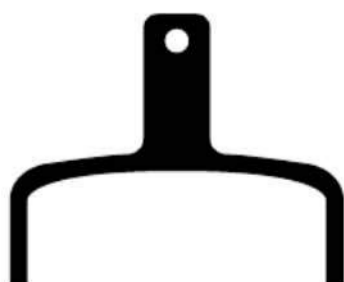

TEKTRO

HD-E710 Dorado (E-Bike)

STD	CFA695	Premium Organic All Round Pad Blend
OPTION	CFA695HH	Double-H Sintered Long Lasting Pad Blend

BRAKE LINES

EBC Brakes braided brake lines are manufactured in Great Britain from the highest quality materials, with braided stainless steel PTFE hose and grade 303 stainless steel precision machined fittings. At EBC Brakes we do not use mild steel or aluminum components in our brake lines, instead we choose stainless steel for every fitting, as this material offers maximum quality in terms of strength and corrosion resistance. EBC brake line kits are supplied 100% complete and include brand new stainless steel bolts for maximum visuals.

EBC Brakes braided hoses fit many bikes in front, rear and race designs. Braided hoses improve brake pressure transfer to the caliper and disc pads, they help improve lever feel and reduce "bulging" which may happen with standard rubber hoses. Braided hoses are also more resistant to abrasion or cuts common with off road riding and thereby improve safety.

EBC brake lines are designed and built to last, that's why every line is offered with a lifetime warranty. Every individual line is pressure tested after assembly and as an absolute guarantee of quality, EBC brake lines are manufactured to Federal Motor Vehicle Safety Standards (FMVSS-106) and have the following approvals: DOT, TÜV, ISO9001, DEKRA, ARAI, CCC AND ADR.



BLM is our standard braided hose series whereas BLMR series race hoses have fewer lines and are the choice for track and performance use giving an even firmer lever feel and improving service time. Racing kits take the shortest route from the master cylinder to the caliper. The lines usually bypass any Y-splitters in the existing system, this reduces the number of places where the brakes can leak. The two lines from the master cylinder are a lot easier to bleed than a system with a Y piece as each line bleeds independent of the other whereas with a Y piece they don't until fluid is below the Y piece.

Hose numbers are suffixed with a number and letter designating the number of hoses in the kits and front or rear, for example;

BLM6038-1F is a kit with a single hose for front fitment

BLM8111-3F is a kit with three hoses for front fitment

BLM8113-1R is a kit with a single hose for rear fitment

BLMR8114-2F is a race kit with two hoses for front fitment.

We do not sell BLMR race hoses for rear fitments, only front.

Some kits are sold as complete bike sets only and examples of numbering are

BLM8169-4FR which is a four hose kit for a complete bike (front and rear).

All motorcycle brake lines (except Harley) are supplied with black stainless fittings, clear hose and red/blue EBC Brakes heat shrink.

HARLEY-DAVIDSON® BRAKE LINES

EBC Harley-Davidson® lines are supplied in a unique finish, with chromed stainless fittings, black hose and black/space-grey EBC Brakes heat shrink.

Additionally, where many competitors use 'off the shelf' components, EBC Harley-Davidson® lines are manufactured using our own bespoke design of chrome plated hardware and brackets, ensuring perfect fitment for complex Harley-Davidson® brake line assemblies.

MOTOCROSS AND OFF-ROAD BRAKE LINES

EBC Brakes motocross and off-road brake lines are supplied with a hardened plastic sheath around the lower portion of the hose, to provide additional protection against damage which could otherwise result from the harsh and unforgiving conditions of off-road terrain. These brake lines are built to withstand a lifetime of off-road abuse, ensuring high performance and safe riding for the lifetime of the vehicle.



BRAKE LINES

APPLICATIONS
BRAKE



APRILIA



		OE Replacement Brake Lines (Front)	Race Standard Brake Lines (Front)	OE Replacement Brake Lines (Rear)	Line #
RS 250	94-97	BLM8008-3F	BLMR8008-2F	BLM8008-1R	1
RS 250	98-99	BLM8009-3F	BLMR8009-2F	BLM8009-1R	2
RS 250	00-02	BLM8010-3F	BLMR8010-2F	BLM8010-1R	3
Pegaso 650	93-96	BLM8002-1F		BLM8002-1R	4
Pegaso 650	97-03	BLM8003-1F		BLM8002-1R	5
Pegaso Strada 650	97-09	BLM8004-1F		BLM8004-1R	6
RST 1000 Futura	01-04	BLM8013-3F	BLMR8013-2F	BLM8013-1R	7
RSV 1000 Mille	98-03	BLM8015-3F	BLMR8015-2F	BLM8015-1R	8
RSV 1000 Mille R	03-04	BLM8017-3F	BLMR8017-2F	BLM8017-1R	9
RSV 1000 Mille Tuono	03-09	BLM8018-3F	BLMR8018-2F	BLM8018-1R	10
RSV 1000 R + RSV4 Non ABS	08-13	BLM8019-3F	BLMR8019-2F	BLM8019-1R	11
RSV 1000 R Factory My	04-09	BLM8020-3F	BLMR8019-2F	BLM8020-1R	12
SL 1000 Falco	99-03	BLM8022-3F	BLMR8022-2F	BLM8022-1R	13
Tuono V4 R + V4 R APRC	11	BLM8023-2F	BLMR8023-2F	BLM8023-1R	14
					15
					16
BIMOTA					
SB6	ALL	BLM8024-3F	BLMR8024-2F	BLM8024-1R	17
					18
					19
BMW					
F650	94-00	BLM8025-1F		BLM8025-1R	20
F650 GS/Dakar Non ABS	00-07	BLM8026-1F		BLM8026-1R	21
R65 Flexible Front	81-85	BLM8077-3F			22
R65 Flexible Front	85-88	BLM8078-1F			23
R65 Full Front	81-85	BLM8079-3F			24
R80 GS Flexible Front	86-94	BLM8086-1F			25
R80 GS Full Front	80-85	BLM8087-1F			26
R80 R Flexible Front	94	BLM8088-1F			27
R80 RT	84-90	BLM8089-2F		BLM8089-1R	28
R80 RT Flexible Front	82-84	BLM8090-3F			29
R80 ST Flexible Front	82-85	BLM8091-1F			30
R100/R100 CS Full Front	80-84	BLM8043-3F			31
R100 GS	91-96	BLM8044-1F			32
R100 GS Flexible Front	91-96	BLM8044-1F			33
R100 RS	87-93	BLM8046-4F			34
R1100 GS ABS	94-00	BLM8054-4F		BLM8054-1R	35
R1100 GS Non ABS	94-00	BLM8055-3F			36
R1100 R	95-96	BLM8056-4FR		Supplied as front & rear kit complete	37
R1100 R	97-01	BLM8057-4FR		Supplied as front & rear kit complete	38
R1100 RS ABS	93-00	BLM8058-5FR		Supplied as front & rear kit complete	39
R1100 RT ABS	95-00	BLM8059-5FR		Supplied as front & rear kit complete	40
R1100 S ABS	98-04	BLM8060-5FR		Supplied as front & rear kit complete	41
R1100 S Non ABS	01/98-01/01	BLM8062-4FR		Supplied as front & rear kit complete	42
R1100 S Non ABS	02/01-11/03	BLM8063-4FR		Supplied as front & rear kit complete	43
R1150 GS ABS (Retaining Hardline)	11/99-02	BLM8064-5FR		Supplied as front & rear kit complete	44
R1150 GS ABS 2 (Retaining Hardline)	11/99-02	BLM8065-5FR		Supplied as front & rear kit complete	45
R1150 GS Non ABS (Replacing Hardline)	11/99-02	BLM8066-3F		BLM8066-1R	46
R1150 GS Non ABS (Retaining Hardline)	11/99-02	BLM8067-3F		BLM8066-1R	47
R1150 GS Non ABS Evo Brakes	03-04	BLM8068-4F		BLM8066-1R	48
R1150 GS Non ABS Evo Brakes	11/99-02	BLM8069-4F		BLM8066-1R	49
R1150 R	00-02	BLM8070-5FR		Supplied as front & rear kit complete	50
R1150 RT ABS	01	BLM8071-4F			51
R1200 C ABS	96-05	BLM8072-4F		BLM8072-1R	52
R1200 R ABS	11-13	BLM8073-4F		BLM8073-1R	53
R850 C ABS	00-01	BLM8072-4F		BLM8072-1R	54
R850 GS ABS	00-01	BLM8054-4F		BLM8054-1R	55
R850 R ABS	97-01	BLM8094-5FR		Supplied as front & rear kit complete	56

FRONT

REAR

BRAKE LINES

BRAKE APPLICATIONS



Line #

BMW

1	R850 R	95-96
2	R850 R	97-01
3	S1000 RR Non ABS	10-14

CAGIVA

6	Raptor 650 (Naked)	03-06
7	Elefant 900	93-00
8	Elefant 900 IE	91-92
9	V-Raptor 1000 (Faired)	2003-

DUCATI

12	M 400 Monster	94-02
13	Pantah 600TL	84-85
14	600 SS	94-98
15	M 600 Monster	94-02
16	M 620 Monster	02-04
17	M 696 Monster	06-08
18	748 Biposta/Strada	95-98
19	748 Biposta/Strada/SPS	99-03
20	748R	99-02
21	749	03-05
22	749S	04-05
23	750/906 Paso	86-94
24	750 SS	91-93
25	750 SS	94-97
26	750 SS	98-02
27	M 750 Monster	96-02
28	851 SP/888 Strada	92-93
29	851 SP3	1991
30	851 Strada	88-92
31	848	2007-
32	900 Superlight	94-97
33	900 SS	94-97
34	900 SS	98-02
35	900 SS Supersport	1977
36	900 SS/Superlight	91-93
37	M 900 Monster	93-99
38	907 IE	91-94
39	916 Biposta/SP	98-01
40	916 Biposta/Strada	94-97
41	ST2	97-03
42	ST4	98-03
43	996	98-01
44	996 R	00-01
45	S4/S4R Monster	00-08
46	999 R	03-05
47	998	01-03
48	999	02-05
49	Sport Classic 2006	2006
50	1098/1098R/1098S/1198/1198S	2007

FRONT

OE Replacement
Brake Lines (Front)

Race Standard
Brake Lines (Front)

OE Replacement
Brake Lines (Rear)

BLM8056-4FR

BLM8057-4FR

BLM8100-3F

BLMR8100-2F

Supplied as front & rear kit complete

Supplied as front & rear kit complete

BLM8100-1R

BLM8107-3F

BLM8104-3F

BLM8103-1F

BLM8108-3F

BLM8104-1R

BLM8103-1R

BLM8108-1R

BLM8141-1F

BLM8148-3F

BLM8116-1F

BLM8141-1F

BLM8143-3F

BLM8144-2F

BLM8117-3F

BLM8111-3F

BLM8119-3F

BLM8109-2F

BLMR8143-2F

BLMR8117-2F

BLMR8118-2F

BLMR8119-2F

BLMR8120-2F

BLM8121-3F

BLM8116-1F

BLMR8124-2F

BLMR8125-2F

BLM8141-1F

BLMR8126-2F

BLM8127-3F

BLM8128-3F

BLMR8110-2F

BLMR8129-2F

BLMR8129-2F

BLMR8125-2F

BLMR8132-3F

BLMR8129-2F

BLM8146-3F

BLM8134-3F

BLM8111-3F

BLM8117-3F

BLM8151-3F

BLM8152-3F

BLM8111-3F

BLM8119-3F

BLMR8146-2F

BLMR8118-2F

BLMR8117-2F

BLMR8111-2F

BLMR8119-2F

BLMR8149-2F

BLMR8138-2F

BLMR8111-2F

BLMR8113-2F

BLM8150-3F

BLM8114-3F

BLMR8114-2F

BLM5000-1F

BLM5001-4F

BLM5002-2R

BLM5003-2R

REAR

HARLEY DAVIDSON

53	FLD Switchback	12-14
54	FLH/FLT All Models (Except FLTR) ABS (Complete 4 Line Kit)	09-13
55	FLH/FLT All Models (Rear Only)	92-96
56	FLH/FLT All Models (Rear Only)	97-07

BRAKE LINES

APPLICATIONS
BRAKE



HARLEY DAVIDSON



		OE Replacement Brake Lines (Front)	Race Standard Brake Lines (Front)	OE Replacement Brake Lines (Rear)	Line #
FLH/FLT All Models (Rear Only)	08-13			BLM5004-1R	1
FLH/FLT All Models ABS (M/C To ABS Box Only)	09-13	BLM5005-1F			2
FLH/FLT All Models ABS (M/C To ABS Box Only)	14-15	BLM5006-1F			3
FLH/FLT All Models* Non ABS (3 Line Kit) (Use Original HD Caliper Bolts)	08-13	BLM5007-3F			4
FLHR Road King ABS (Complete 4 Line Kit)	2008	BLM5008-4F			5
FLHR* Non ABS (3 Line Kit) (Use Original HD Caliper Bolts)	14-15	BLM5009-3F			6
FLHR/FLHR-I Road King Non ABS (3 Line Kit)	94-07	BLM5010-3F			7
FLHR/FLHRC ABS (M/C To ABS Box Only)	2008	BLM5011-1F			8
FLHRC Road King Classic Non ABS (3 Line Kit)	99-07	BLM5010-3F			9
FLHRS/FLHRSI Road King Non ABS (3 Line Kit)	04-07	BLM5013-3F			10
FLHT/FLHTC/FLHTCU Electra Glide Non ABS (3 Line Kit)	96-07	BLM5014-3F			11
FLHT/FLHTC/FLHTCU/FLHX ABS (Complete 4 Line Kit)	2008	BLM5015-4F			12
FLHX Street Glide Non ABS (3 Line Kit)	06-07	BLM5014-3F			13
FLHX* Non ABS (3 Line Kit) (Use Original HD Caliper Bolts)	14-15	BLM5009-3F			14
FLS Softail Slim	13-15	BLM5018-1F			15
FLST All Models (Rear Only)	08-13			BLM5019-2R	16
FLST Fat Boy/Softail (Rear Only)	84-99			BLM5020-2R	17
FLST Fat Boy/Softail (Rear Only)	00-06			BLM5021-2R	18
FLST Heritage Softail	84-90	BLM5022-1F			19
FLST Heritage Softail (Rear Only)	2007			BLM5023-2R	20
FLST-SB Softail Cross Bones	10-11	BLM5024-1F			21
FLSTC ABS (M/C To ABS Box Only)	11-15	BLM5025-1F			22
FLSTC Heritage Classic ABS (Dual Front Kit)	11-15	BLM5026-2F			23
FLSTC Heritage Softail Classic	87-08	BLM5022-1F			24
FLSTC Heritage Softail Classic	09-12	BLM5028-1F			25
FLSTF ABS (M/C To ABS Box Only)	2011	BLM5029-1F			26
FLSTF Fat Boy	90-11	BLM5022-1F			27
FLSTF Fat Boy (Rear Only)	2007			BLM5031-2R	28
FLSTF Fatboy ABS (Dual Front Kit)	2011	BLM5032-2F			29
FLSTF/FLSTFB/FLSTF	12-13	BLM5018-1F			30
FLSTF/FLSTN/FLSTB/FLS ABS (M/C To ABS Box Only)	12-15	BLM5034-1F			31
FLSTF/FLSTN/FLSTFB/FLS ABS (Dual Front Kit)	12-15	BLM5035-2F			32
FLSTFB ABS (M/C To ABS Box Only)	2011	BLM5036-1F			33
FLSTFB Fatboy Low ABS (Dual Front Kit)	2011	BLM5037-2F			34
FLSTN Softail Deluxe	05-13	BLM5018-1F			35
FLSTN Softail Deluxe ABS (Dual Front Kit)	11-12	BLM5035-2F			36
FLSTS Heritage Softail	97-03	BLM5040-1F			37
FLSTSC Heritage Softail Classic	05-07	BLM5041-1F			38
FLTR Road Glide ABS (Complete 4 Line Kit)	08-13	BLM5042-4F			39
FLTR/FLTR-I Road Glide Non ABS (3 Line Kit)	98-07	BLM5010-3F			40
FLTRX/FLTRXS ABS (M/C To ABS Box Only)	2015	BLM5044-1F			41
FLTRX/FLTRXS Non ABS (3 Line Kit) (Use Original HD Caliper Bolts)	2015	BLM5045-3F			42
FXCW/FXCWC Softail Rocker	08-11	BLM5046-1F			43
FXCWC ABS (M/C To ABS Box Only)	2011	BLM5047-1F			44
FXCWC Rocker ABS (Dual Front Kit)	2011	BLM5048-2F			45
FXD Models (Rear Only)	91-99			BLM5049-2R	46
FXD Models (Rear Only)	00-07			BLM5050-2R	47
FXD Models (Rear Only)	08-13			BLM5051-1R	48
FXD/FXDC	00-05	BLM5052-1F			49
FXD35 35th Anniversary	06-07	BLM5053-1F			50
FXDB Dyna Daytona	91-92	BLM5054-3F			51
FXDB-S Sturgis	91-92	BLM5055-1F			52
FXDBI Street Bob	06-15	BLM5056-1F			53
FXDC	06-14	BLM5057-1F			54
FXDC Dyna Glide Custom	90-92	BLM5058-1F			55
FXDC Dyna Glide Custom (Twin Disc)	91-92	BLM5054-3F			56

FRONT

REAR

BRAKE LINES

APPLI
CATIONS
BRAKE



HARLEY DAVIDSON



		OE Replacement Brake Lines (Front)	Race Standard Brake Lines (Front)	OE Replacement Brake Lines (Rear)	Line #
XL 883L Low	05-15	BLM5115-1F			1
XL 883 N Iron	10-13	BLM5113-1F		BLM5105-2R	2
XL 883 N Iron	14-15	BLM5119-1F			3
XL 1200 Classic	96-03	BLM5107-1F		BLM5106-2R	4
XL 1200 Custom	96-03	BLM5108-1F		BLM5106-2R	5
XL 1200 R	04-11	BLM5109-3F		BLM5105-2R	6
XL 1200 Sport	96-03	BLM5110-3F		BLM5106-2R	7
XL 1200 Sportster	88-03	BLM5111-1F		BLM5106-2R	8
XL 1200 C	04-13	BLM5112-1F		BLM5105-2R	9
XL 1200 C/XL 1200 CP (Pullback Bar)	12-13	BLM5113-1F		BLM5105-2R	10
XL 1200 CP (Drag Bar)	12	BLM5114-1F		BLM5105-2R	11
XL 1200 L Low	07-11	BLM5115-1F		BLM5105-2R	12
XL 1200 N Nightster	08-12	BLM5112-1F		BLM5105-2R	13
XL 1200 V Seventy Two	12-15	BLM5117-1F			14
XL 1200 X Forty Eight	12-13	BLM5118-1F		BLM5105-2R	15
XL 1200 X Forty Eight	14-15	BLM5119-1F			16
					17
					18
HONDA					
CBR 125 R	05-13	BLM1057-1F		BLM1057-1R	19
MSX 125	16-17	BLM1167-1F		BLM1167-1R	20
NSR 125 RK-R3	90-03	BLM1110-1F		BLM1110-1R	21
XLR 125	00-03	BLM1159-1F			22
CB 250 Hornet Import	1996	BLM1010-1F		BLM1010-1R	23
CBR 250 R	11-13	BLM1058-1F		BLM1058-1R	24
CBR 250 RRM-RRX (MC22)	90-99		BLMR1060-2F	BLM1060-1R	25
CBR 300 R	15-17	BLM1170-1F		BLM1170-1R	26
CBR 300 R ABS	15-17	BLM1168-4F		BLM1168-3R	27
CB1 (Super 400)	92-96	BLM1000-2F	BLMR1000-2F	BLM1000-1R	28
NT Bros 400/600/650	88-95	BLM1114-1F		BLM1114-1R	29
RVF 400 RRR-RRT (NC35)	94-96	BLM1120-3F	BLMR1120-2F	BLM1120-1R	30
VFR 400 RRL-RRM (NC30)	90-92		BLMR1135-2F	BLM1135-1R	31
CB 450 DXK	89-92	BLM1019-3F		BLM1019-1R	32
CB 500 V-3	97-03	BLM1024-1F		BLM1024-1R	33
CBF 500	04-08	BLM1048-1F		BLM1048-1R	34
CB 500 F ABS	13-15	BLM1163-2F		BLM1163-2R	35
CB 500 F ABS	16-17	BLM1162-2F		BLM1162-2R	36
CBR 500 R ABS	13-15	BLM1163-2F		BLM1163-2R	37
CBR 500 R ABS	16-17	BLM1162-2F		BLM1162-2R	38
CB 600 F5-F8 Hornet	05-08		BLMR1028-2F	BLM1028-1R	39
CB 600 FW-F4 Hornet	98-05	BLM1029-3F	BLMR1029-2F	BLM1029-1R	40
CBF 600 S	04-06	BLM1049-3F	BLMR1049-2F	BLM1049-1R	41
CBR 600 F	11-13		BLMR1063-2F	BLM1063-1R	42
CBR 600 FH-FL	87-90	BLM1064-3F	BLMR1064-2F	BLM1064-1R	43
CBR 600 FM-FR	91-94	BLM1065-3F	BLMR1065-2F	BLM1065-1R	44
CBR 600 FS-FW	95-98	BLM1066-3F	BLMR1066-2F	BLM1066-1R	45
CBR 600 FX-F4/Sport	99-04	BLM1067-3F	BLMR1067-2F	BLM1067-1R	46
CBR 600 RR3-RR4	03-04	BLM1069-3F	BLMR1069-2F	BLM1069-1R	47
CBR 600 RR5	2005		BLMR1070-2F	BLM1070-1R	48
CBR 600 RR6	2006		BLMR1071-2F	BLM1071-1R	49
CBR 600 RR7	2007		BLMR1072-2F	BLM1072-1R	50
CBR 600 RR Non ABS	08-13		BLMR1068-2F	BLM1068-1R	51
CBR 600 RR ABS	09-17	BLM1164-4F		BLM1164-2R	52
VT 600 CN-CW Shadow	92-98	BLM1146-1F			53
XL 600 LMF Paris Dakar	1985	BLM1154-1F			54
XL 600 VH-VT Transalp	87-96	BLM1156-1F		BLM1156-1R	55
XL 600 VV-VX Transalp	97-99		BLMR1157-2F	BLM1156-1R	56

FRONT

REAR

BRAKE LINES



Line #

HONDA

			OE Replacement Brake Lines (Front)	Race Standard Brake Lines (Front)	OE Replacement Brake Lines (Rear)
1	NT 650 V Deauville (Nissin Calipers)	98-03	BLM1115-3F		BLM1115-1R
2	NX 650 J-T Dominator	88-96	BLM1117-1F		BLM1117-1R
3	NX 650 V-X Dominator	97-99	BLM1118-1F		BLM1117-1R
4	SLR 650 V-W	97-98	BLM1123-1F		
5	XL 650 Y-3 Transalp	00-05		BLMR1157-2F	BLM1156-1R
6	CB 750 F Supersport		BLM1032-3F		BLM1032-1R
7	CB 750 F2N-Y	92-02	BLM1037-3F		BLM1037-1R
8	RVF 750 RR-RS (RC45)	94-95	BLM1121-3F	BLMR1121-2F	BLM1121-1R
9	VFR 750 FL-FP	90-93	BLM1138-3F	BLMR1138-2F	BLM1138-1R
10	VFR 750 FR-FV	94-97	BLM1139-3F	BLMR1139-2F	BLM1139-1R
11	VFR 750 RJ-RL (RC30)	88-90		BLMR1140-2F	BLM1140-1R
12	VT 750 V-W Shadow	97-98	BLM1148-1F		
13	XRV 750 L-3 Africa Twin	90-03	BLM1161-3F	BLMR1161-2F	BLM1161-1R
14	Pacific Coast PC800	89-98	BLM1119-3F		
15	VFR 800 FW-FY Non ABS	98-00	BLM1141-10FR		Supplied as front & rear kit complete
16	VFR 800 V-TEC ABS	02-10	BLM1142-13FR		Supplied as front & rear kit complete
17	VFR 800 V-TEC Non ABS	02-10	BLM1143-10FR		Supplied as front & rear kit complete
18	CB 900 F2-F3 Hornet	02-06	BLM1042-3F	BLMR1042-2F	BLM1042-1R
19	CBR 900 RR2-RR3	02-03		BLMR1073-2F	BLM1073-1R
20	CBR 900 RRN-RRS Retaining Bundy	92-95	BLM1074-3F		
21	CBR 900 RRN-S Fireblade	92-95	BLM1075-3F	BLMR1075-2F	BLM1075-1R
22	CBR 900 RRT-RRX Retaining Bundy	96-99	BLM1076-3F	BLMR1076-2F	BLM1076-1R
23	CBR 900 RRT-X Fireblade	96-99	BLM1077-3F	BLMR1076-2F	BLM1076-1R
24	CBR 900 RRY-RR1	00-01		BLMR1073-2F	BLM1078-1R
25	CB 1000 P-T Big One	93-96	BLM1001-3F	BLMR1001-2F	BLM1001-1R
26	CB 1000 R	08-14		BLMR1002-2F	BLM1002-1R
27	CBF 1000	2006	BLM1046-3F		BLM1046-1R
28	CBR 1000 FH-FJ	87-88	BLM1050-3F		BLM1050-1R
29	CBR 1000 FK-FN	89-92	BLM1051-3F		BLM1051-1R
30	CBR 1000 FP-FR	93-99	BLM1052-10FR		Supplied as front & rear kit complete
31	CBR 1000 RR	04-05	BLM1054-2F	BLMR1053-2F	BLM1054-1R
32	CBR 1000 RR	06-08		BLMR1054-2F	BLM1053-1R
33	CBR 1000 RR (Non ABS)	09-14		BLMR1055-2F	BLM1055-1R
34	CBR 1000 RR ABS	09-17	BLM1165-4F		BLM1165-2R
35	CBR 1000 RR ABS (INC SP1/SP2)	2017	BLM1166-4F		BLM1166-2R
36	VTR 1000 SP1-SP2	99-08		BLMR1149-2F	BLM1149-1R
37	VTR 1000 FV-F4	97-05	BLM1150-3F	BLMR1150-2F	BLM1150-1R
38	XL 1000 VW-V3 Varedero	98-06	BLM1152-10FR		Supplied as front & rear kit complete
39	CB 1100 RC-RD	82-83	BLM1003-3F		BLM1003-1R
40	CB 1100 SF-X11	99-02	BLM1004-10FR		Supplied as front & rear kit complete
41	CBR 1100 XX Blackbird	96-08	BLM1056-10FR		Supplied as front & rear kit complete
42	GL 1100 A-B Goldwing	80-81	BLM1097-3F		BLM1097-1R
43	GL 1100 AD Aspencade	1983	BLM1098-2F		BLM1098-1R
44	GL 1100 DC Deluxe	1982	BLM1099-3F		BLM1099-1R
45	ST 1100 ABS/TCS/CBS	02-03	BLM1124-16FR		Supplied as front & rear kit complete
46	ST 1100 AN-AS Pan European ABS	92-95	BLM1125-7FR		Supplied as front & rear kit complete
47	ST 1100 L-2 Pan European Non ABS	90-02	BLM1126-3F		BLM1126-2R
48	GL 1200 AE-AH Aspencade	84-87	BLM1100-3F		BLM1100-1R
49	CB 1300 (SL38)	97-03	BLM1007-3F		BLM1007-1R
50	CB 1300 UK Model	02-03	BLM1008-3F	BLMR1008-2F	BLM1008-1R
51	CB 1300 SA ABS	05-06	BLM1009-4F		BLM1009-3R
52	F6C (GL 1500 CV-CW) Valkyrie	96-03	BLM1094-3F		BLM1094-1R
53	V65 Magna		BLM1127-3F		
54	GL 1500 J-SEY Goldwing	88-00	BLM1101-4FR		Supplied as front & rear kit complete
55					
56					

FRONT

REAR

BRAKE
APPLICATIONS

BRAKE LINES

APPLICATIONS
BRAKE



HONDA OFF-ROAD



		OE Replacement Brake Lines (Front)	Race Standard Brake Lines (Front)	OE Replacement Brake Lines (Rear)	Line #
CR 85 R	03-08	BLM6002-1F		BLM6002-1R	1
CR 85 R Expert	03-08	BLM6002-1F		BLM6003-1R	2
CR 125 R/250 R	97-07	BLM6000-1F		BLM6000-1R	3
CRF 230 L	2008-	BLM6004-1F		BLM6004-1R	4
CRF 250 F/450 F	03-04	BLM6005-1F		BLM6005-1R	5
CRF 250 L	13-17	BLM6012-1F		BLM6012-1R	6
CRF 250 R/CRF 450 R	04-08	BLM6006-1F		BLM6006-1R	7
CRF 250 R/CRF 450 R	09-17	BLM6007-1F		BLM6007-1R	8
CRF 250 X/CRF 450 X	05-17	BLM6008-1F		BLM6008-1R	9
CRF 450 R/RX	2016-	BLM6007-1F		BLM6013-1R	10
XR 400 R	96-04	BLM6009-1F		BLM6009-1R	11
CR 500	97-04	BLM6000-1F		BLM6000-1R	12
XR 650 L	2004-	BLM6010-1F		BLM6010-1R	13
XR 650 R	00-03	BLM6011-1F		BLM6011-1R	14
XR 650 R	2004-	BLM6010-1F		BLM6010-1R	15
					16
					17
KAWASAKI					
KDX 125 A1-B2	90-94	BLM4032-1F		BLM4032-1R	18
KDX 200/220	95-99	BLM4033-1F		BLM4033-1R	19
KDX 200 E1	90-94	BLM4032-1F		BLM4032-1R	20
ZZR 250 H1-H2	90-92	BLM4178-1F		BLM4178-1R	21
KR1-KR1S	89-92	BLM4051-3F	BLMR4051-2F	BLM4051-1R	22
EX 300 Ninja	13-15	BLM4182-1F		BLM4182-1R	23
EX 300 Ninja ABS	16-17	BLM4183-2F			24
KLX 300 R	97-99	BLM4048-1F		BLM4048-1R	25
ZXR 400 L1-L9	91-03	BLM4169-3F	BLMR4169-2F	BLM4169-1R	26
GPZ 500 S A1-A6	87-93	BLM4018-1F			27
GPZ 500 S D1-E8	94-01	BLM4019-1F		BLM4019-1R	28
GPZ 500 S E9-E10	02-04	BLM4020-2F	BLMR4020-2F	BLM4019-1R	29
KLE 500 A1-A7	91-99	BLM4043-1F		BLM4043-1R	30
KLE 500 B	05-06	BLM4044-1F		BLM4044-1R	31
Vulcan 500	96-97	BLM4066-1F			32
ZR 550 B2-B6 Zephyr	91-98	BLM4136-3F		BLM4136-1R	33
ZX 550 A1-A4 (GPZ550)	83-91	BLM4150-5F		BLM4150-1R	34
ER6 F/N	13-14	BLM4008-2F		BLM4008-1R	35
ER6 F/N	06-09	BLM4009-2F	BLMR4009-2F	BLM4009-1R	36
ER6 F/N	10-12	BLM4010-2F	BLMR4010-2F	BLM4010-1R	37
GPX 600 R C1-C7	88-96	BLM4012-3F	BLMR4012-2F	BLM4012-1R	38
GPZ 600 R A1-A5	85-90	BLM4021-5F		BLM4021-1R	39
KLR 600 A1/B1-B4	84-90	BLM4046-1F			40
ZL 600 B1 Eliminator	95-97	BLM4129-1F			41
ZZR 600 D1-D3	90-93	BLM4179-3F	BLMR4179-2F	BLM4179-1R	42
ZZR 600 D4-E12H	94-06	BLM4180-3F	BLMR4179-2F	BLM4180-1R	43
ZX6R	07-08	BLM4151-2F	BLMR4151-2F	BLM4151-1R	44
ZX6R	09-12	BLM4152-3F	BLMR4152-2F	BLM4152-1R	45
ZX6R	13-16	BLM4153-2F	BLMR4153-2F	BLM4153-1R	46
ZX6R ABS	13-17	BLM4184-3F		BLM4184-1R	47
ZX6R B1/ZX6RR K1	2003	BLM4154-2F	BLMR4154-2F	BLM4154-1R	48
ZX6R F1-F3	95-97	BLM4155-3F	BLMR4155-2F	BLM4155-1R	49
ZX6R G1-G2	98-99	BLM4156-3F	BLMR4156-2F	BLM4156-1R	50
ZX6R J1-J2/A1P (636)	00-02	BLM4157-3F	BLMR4157-2F	BLM4157-1R	51
ZX6RR 04	2004	BLM4158-2F	BLMR4158-2F	BLM4158-1R	52
ZX6RR ZX636	05-06	BLM4159-2F	BLMR4159-2F	BLM4159-1R	53
KLR 650 A1-A3/C1-C8	87-02	BLM4047-1F		BLM4047-1R	54
KLX 650 C1-C2	93-96	BLM4049-1F		BLM4049-1R	55
Versys 650 ABS	06-10	BLM4052-5FR		Supplied as front & rear kit complete	56

FRONT

REAR

BRAKE LINES



KAWASAKI



Line #

Line #	Model	Year
1	Versys 650 ABS	11-13
2	Versys 650 Non ABS	06-10
3	Versys 650 Non ABS	2011
4	W 650	03-04
5	ZX7R P1-P7/ZX7RR N1	96-03
6	GPX 750 R F1-F3	87-91
7	VN 750 A Front	86-94
8	Z 750	03-05
9	Z 750	06-07
10	Z 750	08-11
11	Z 750 R	2011
12	Z 750 Y1 Twin Ltd	1982
13	ZR-7	2006
14	ZR-7 F1-F5/ZR-7S H3	99-03
15	ZR 750 C1-C4/D1 Zephyr	91-99
16	ZXR 750 H1-H2	89-90
17	ZXR 750 J1-J2	91-92
18	ZXR 750 K1-L1	91-96
19	ZXR 750 M1-M2	92-94
20	VN 800 A1-A3/B2-B8 Classic/E1-E2 Drifter	95-03
21	W 800 Inc Special Edition	11-13
22	Z 800 Non ABS	2013
23	Z 800 E 2013 2 Pot	2013
24	GPZ 900 R A1-A6	84-89
25	GPZ 900 R A7-A8	90-96
26	VN 900/VN 900 Custom	06-13
27	Z 900 ABS	2017
28	ZX9R B1-B2	94-95
29	ZX9R B3-B4	96-97
30	ZX9R C1-C2	98-99
31	ZX9R E1-E2	00-01
32	ZX9R F1P-F2P	02-04
33	GTR 1000 A5-A14	90-99
34	Z 1000	07-09
35	Z 1000	10-13
36	Z 1000	2015-
37	Z 1000 ABS	15-17
38	Z 1000 SX	11-13
39	Z 1000 SX	14-17
40	ZL 1000	87-90
41	ZR 1000 A1-A2	03-06
42	ZX10R	04-05
43	ZX10R	2006
44	ZX10R	2007
45	ZX10R	08-10
46	ZX10R (Non ABS)	11-14
47	ZX10R ABS	11-17
48	GPZ 1100 S E1-E2	95-99
49	ZR 1100 A1-A4/B1 Zephyr	92-97
50	ZRX 1100 C1-C2	97-01
51	ZZR 1100 C1-C3	90-92
52	ZZR 1100 D1-D9	92-01
53	ZRX 1200 A1-A3P/ZRX 1200S B1-B3P	01-04
54	ZRX 1200 R	2006
55	ZX12R A1-B2	99-03
56	ZX12R B3-B4	04-05

FRONT

OE Replacement
Brake Lines (Front)

Race Standard
Brake Lines (Front)

OE Replacement
Brake Lines (Rear)

OE Replacement Brake Lines (Front)	Race Standard Brake Lines (Front)	OE Replacement Brake Lines (Rear)
BLM4053-7FR		Supplied as front & rear kit complete
BLM4054-2F		BLM4054-1R
BLM4055-2F		BLM4055-1R
BLM4067-1F		
BLM4160-3F	BLMR4160-2F	BLM4160-1R
BLM4013-3F	BLMR4013-2F	BLM4013-1R
BLM4064-3F		
BLM4112-2F	BLMR4112-2F	BLM4112-1R
BLM4113-2F	BLMR4113-2F	BLM4113-1R
BLM4070-2F	BLMR4070-2F	BLM4070-1R
BLM4119-2F		BLM4119-1R
BLM4121-3F		
BLM4130-2F		BLM4130-1R
BLM4131-3F	BLMR4131-2F	BLM4131-1R
BLM4137-3F	BLMR4137-2F	BLM4137-1R
BLM4170-3F	BLMR4170-2F	BLM4170-1R
BLM4171-3F	BLMR4171-2F	BLM4171-1R
BLM4172-3F	BLMR4172-2F	BLM4172-1R
BLM4173-3F	BLMR4173-2F	BLM4173-1R
BLM4065-1F		
BLM4068-1F		
BLM4122-2F	BLMR4122-2F	BLM4122-1R
BLM4123-2F		
BLM4024-5F		BLM4024-1R
BLM4025-3F	BLMR4025-2F	BLM4025-1R
BLM4031-1F		BLM4031-1R
BLM4187-3F		BLM4187-2R
BLM4161-3F	BLMR4161-2F	BLM4161-1R
BLM4162-3F	BLMR4161-2F	BLM4161-1R
BLM4163-3F	BLMR4163-2F	BLM4163-1R
BLM4164-3F	BLMR4164-2F	BLM4164-1R
BLM4165-3F	BLMR4165-2F	BLM4165-1R
BLM4030-3F		BLM4030-1R
BLM4070-2F	BLMR4070-2F	BLM4070-1R
	BLMR4071-2F	BLM4071-1R
BLM4072-2F		BLM4072-1R
BLM4188-4F		BLM4188-1R
	BLMR4085-2F	BLM4085-1R
BLM4189-4F		BLM4189-1R
BLM4128-3F		BLM4128-1R
BLM4132-2F	BLMR4132-2F	BLM4132-1R
BLM4142-2F	BLMR4142-2F	BLM4142-1R
BLM4143-2F	BLMR4143-2F	BLM4143-1R
BLM4144-2F	BLMR4144-2F	BLM4144-1R
	BLMR4145-2F	BLM4145-1R
BLM4146-3F	BLMR4146-2F	BLM4146-1R
BLM4185-4F		BLM4185-2R
BLM4016-3F		BLM4016-1R
BLM4133-3F	BLMR4133-2F	BLM4133-1R
BLM4138-3F	BLMR4138-2F	BLM4138-1R
BLM4174-3F	BLMR4174-2F	BLM4174-1R
BLM4175-3F	BLMR4175-2F	BLM4175-1R
BLM4139-3F	BLMR4139-2F	BLM4139-1R
BLM4140-3F		BLM4140-1R
BLM4147-3F	BLMR4147-2F	BLM4147-1R
	BLMR4148-2F	BLM4147-1R

REAR

BRAKE
APPLICATIONS

BRAKE LINES

APPLI
CATIONS
BRAKE



KAWASAKI



		OE Replacement Brake Lines (Front)	Race Standard Brake Lines (Front)	OE Replacement Brake Lines (Rear)	Line #
ZX12R B6	05-07	BLM4149-3F	BLMR4149-2F	BLM4147-1R	1
ZZR 1200	02-04	BLM4176-3F		BLM4176-1R	2
Z 1300 A1-A5	79-84	BLM4090-3F		BLM4090-1R	3
ZG 1300 A1-A3	87-90	BLM4127-3F		BLM4127-1R	4
ZZR 1400 (Non ABS)	06-10	BLM4177-3F	BLMR4177-2F	BLM4177-1R	5
ZZR 1400 ABS	07-17	BLM4186-6F		BLM4186-3R	6
VN 1500 B2-B6 Vulcan/C1-C2 Classic	88-96	BLM4056-1F		BLM4056-1R	7
VN 1500 D1-D2/E1 Classic/J1-J2 Drifter	96-99	BLM4057-1F		BLM4057-1R	8
VN 1500 E2 Classic Tourer/Nomad	01-04	BLM4058-3F		BLM4058-1R	9
VN 1500 E2 Classic/G1-G2 Nomad	98-99	BLM4059-2F		BLM4059-1R	10
VN 1600 A3H Classic	03-06		BLMR4060-2F	BLM4060-1R	11
VN 1600 B2H Meanstreak	03-06	BLM4061-3F		BLM4061-1R	12
VN 1700 Classic	2009		BLMR4062-2F		13
VN 2000	03-09	BLM4063-3F	BLMR4063-2F	BLM4063-1R	14
					15
					16
KAWASAKI OFF ROAD					
KX 85	00-11	BLM6017-1F		BLM6017-1R	17
KX 100	97-11	BLM6017-1F		BLM6017-1R	18
KX 125/250	03-05	BLM6018-1F		BLM6017-1R	19
KDX 200 R/220 R	05-06	BLM6014-1F		BLM6014-1R	20
KX 250	06-07	BLM6019-1F		BLM6019-1R	21
KX 250 F	04-05	BLM6018-1F		BLM6017-1R	22
KX 250 F	2006	BLM6021-1F		BLM6021-1R	23
KX 250 F	07-08	BLM6022-1F		BLM6022-1R	24
KX 250 F	2009	BLM6023-1F		BLM6023-1R	25
KX 250 F	2011	BLM6024-1F		BLM6024-1R	26
RM 250	06-08	BLM6029-1F		BLM6029-1R	27
KLX 300 R	05-08	BLM6015-1F		BLM6015-1R	28
DR-Z 400 E	00-07	BLM6013-1F		BLM6013-1R	29
KLX 450 R	08-09	BLM6016-1F		BLM6016-1R	30
KX 450 F	06-08	BLM6021-1F		BLM6021-1R	31
KX 450 F	09-17	BLM6023-1F		BLM6023-1R	32
KX 500	95-04	BLM6018-1F		BLM6017-1R	33
KLR 650	08-17	BLM6105-1F		BLM6105-1R	34
					35
					36
KTM OFF ROAD					
125/200/250 EXC	00-03	BLM6032-1F		BLM6032-1R	37
125/200/250 SX	04-05	BLM6033-1F			38
125/200 EXC	98-99			BLM6032-1R	39
125/200 SX/MXC	00-03	BLM6035-1F		BLM6032-1R	40
125/200 SX/MXC	95-99	BLM6036-1F		BLM6032-1R	41
125 EXC/SX/SXS	04-17	BLM6038-1F		BLM6038-1R	42
150 SX	04-17	BLM6038-1F		BLM6038-1R	43
200 EXC/XC/XCW MXC	00-09	BLM6038-1F			44
250 MXC/SXC	00-01	BLM6038-1F			45
250 EXC/SX	03-09			BLM6038-1R	46
250 SX-F/SX-F Factory	11-17	BLM6038-1F		BLM6038-1R	47
250 EXC/XC/XCF	02-09	BLM6038-1F			48
250 SX/MXC	00-02	BLM6035-1F		BLM6032-1R	49
250 SX/MXC	94-99	BLM6036-1F		BLM6032-1R	50
360/380 EXC	00-03	BLM6032-1F		BLM6032-1R	51
300/360/380 SX/MXC	00-02	BLM6035-1F		BLM6032-1R	52
360/380 SX/MXC	94-99	BLM6036-1F		BLM6032-1R	53
300 EXC/MXC	04-09			BLM6038-1R	54
300 EXC/XC/MXC	06-09	BLM6038-1F			55
350 SX-F	16-17	BLM6038-1F		BLM6038-1R	56

FRONT

REAR

BRAKE LINES

BRAKE APPLICATIONS



Line #

KTM OFF-ROAD

Line #	Model	Year
1	380 EXC/MXC/SX	00-02
2	400/520 SX/MXC	00-02
3	400/540/620 SC/EXC	98-99
4	400/540/620 SX	96-99
5	400 EXC/MXC	00-09
6	450/525 SX	04-05
7	450 EXC/MXC/SXS/XC	03-09
8	450 SX-F Factory	16-17
9	505 XC	08-09
10	520 SC/EXC	00-02
11	520 EXC/SX/MXC	00-02
12	525 EXC/MXC/SX/XC	03-07
13	525 MXC	2003
14	525 SX/450SX	2003
15	530 EXC/XCR/XCW	08-09
16	625 SC/SXC	02-07
17	660 Rallye	00-03

LAVERDA

Line #	Model	Year
20	750 Formula/750 SS	97-02
21	Mirage 1200	78-79

MOTO GUZZI

Line #	Model	Year
24	750 Targa	90-94
25	1000 Le Mans MK5	88-94
26	1000 Mille Gt	88-91
27	1000 Spada MK1-MK2	80-88
28	1000 Spada MK3	89-95
29	1000 T3 California	
30	1100 California EV	97-02
31	1100 California Jackal	99-01
32	1100 California MK3	94-97
33	1100 Sport Carb	96-99

MV AGUSTA

Line #	Model	Year
36	F3 675 Agusta	2013
37	Brutale S 750	2004
38	F4 750	00-04
39	F4 1000 S	2004

SUZUKI

Line #	Model	Year
42	DR 350 SES-SEX	95-99
43	DR 350 SL-SR	90-94
44	GSF 400 M-R Bandit	91-95
45	GS 500 EK-ER	89-94
46	GS 500 ES-K4	95-05
47	GS 500 F	03-09
48	RG 500 G-CH	85-89
49	GSF 600 S Bandit	1995
50	GSF 600 T-X Bandit	96-99
51	GSF 600 Y-K4 Bandit	00-05
52	GSR 600	06-10
53	GSR 600 ABS	06-11
54	GSX 600 FJ-FV	88-97
55	GSX 600 FW-K3	98-03
56	GSXR 600	04-05

FRONT

OE Replacement
Brake Lines (Front)

Race Standard
Brake Lines (Front)

OE Replacement
Brake Lines (Rear)

BLM6038-1F
BLM6035-1F
BLM6036-1F
BLM6032-1F
BLM6038-1F
BLM6033-1F
BLM6038-1F
BLM6038-1F
BLM6038-1F
BLM6032-1F
BLM6038-1F
BLM6038-1F
BLM6036-1F
BLM6036-1F
BLM6038-1F
BLM6038-1F
BLM6038-1F

BLM8160-2F
BLM8162-3F

BLM8176-3FR
BLM8167-4FR
BLM8168-4FR
BLM8169-4FR
BLM8170-4FR
BLM8171-5FR
BLM8172-2F
BLM8173-3FR
BLM8174-3FR
BLM8175-3F

BLM8192-2F
BLM8191-3F
BLM8194-3F
BLM8193-3F

BLM3005-1F
BLM3006-1F
BLM3041-2F
BLM3024-1F
BLM3025-1F
BLM3026-1F
BLM3137-3F
BLM3042-3F
BLM3043-3F
BLM3044-3F
BLM3049-2F
BLM3050-5FR
BLM3071-3F
BLM3072-3F
BLM3097-2F

BLMR8194-2F

BLMR3137-2F

BLMR3042-2F

BLMR3043-2F

BLMR3044-2F

BLMR3049-2F

BLMR3071-2F

BLMR3072-2F

BLMR3097-2F

REAR

BLM6038-1R
BLM6032-1R
BLM6032-1R

BLM8160-1R
BLM8162-1R

Supplied as front & rear kit complete
Supplied as front & rear kit complete
Supplied as front & rear kit complete
Supplied as front & rear kit complete
Supplied as front & rear kit complete

Supplied as front & rear kit complete
Supplied as front & rear kit complete
BLM8175-1R

BLM8192-1R
BLM8191-1R
BLM8193-1R

BLM3005-1R
BLM3006-1R
BLM3041-1R
BLM3024-1R
BLM3025-1R
BLM3026-1R
BLM3137-1R
BLM3042-1R
BLM3042-1R
BLM3044-1R
BLM3049-1R
Supplied as front & rear kit complete

BLM3071-1R
BLM3072-1R
BLM3097-1R

BRAKE LINES

APPLICATIONS
BRAKE



SUZUKI



		OE Replacement Brake Lines (Front)	Race Standard Brake Lines (Front)	OE Replacement Brake Lines (Rear)	Line #
GSXR 600	06-10	BLM3098-2F	BLMR3098-2F	BLM3098-1R	1
GSXR 600	11-17	BLM3099-2F	BLMR3099-2F	BLM3099-1R	2
GSXR 600 K1-K3	01-03	BLM3100-2F	BLMR3100-2F	BLM3100-1R	3
GSXR 600 V-W	97-98	BLM3101-2F	BLMR3101-2F	BLM3101-1R	4
GSXR 600 X-Y	99-00	BLM3102-2F	BLMR3101-2F	BLM3102-1R	5
RF 600 RP-RV	93-97	BLM3130-3F	BLMR3130-2F	BLM3130-1R	6
VS 600 GLS-GLT Intruder	95-97	BLM3155-1F			7
DL 650 ABS	2013	BLM3003-5FR		Supplied as front & rear kit complete	8
DR 650 RSEM-SET	91-97	BLM3008-1F		BLM3008-1R	9
GX 650 GTX-GTD	81-85	BLM3031-3F		BLM3031-1R	10
GSF 650 Bandit Non ABS	2008	BLM3045-2F			11
GSF 650 Bandit Non ABS	05-07	BLM3046-2F	BLMR3046-2F	BLM3046-1R	12
GSF 650 A Bandit ABS	05-13	BLM3047-7FR		Supplied as front & rear kit complete	13
GSF 650 S Bandit K5 - K8 Non ABS	05-13	BLM3048-2F	BLMR3048-2F	BLM3048-1R	14
GSX 650 F Non ABS	07-13	BLM3073-2F	BLMR3073-2F	BLM3073-1R	15
LS 650 FG/PJ-PT Savage	87-98	BLM3129-1F			16
SV 650 Unfaired	03-13	BLM3143-3F	BLMR3143-2F	BLM3143-1R	17
SV 650 S Faired	03-13	BLM3144-3F	BLMR3144-2F	BLM3143-1R	18
SV 650 SX-SK2	99-02	BLM3145-3F	BLMR3145-2F	BLM3145-1R	19
SV 650 X-K1	99-02	BLM3146-3F	BLMR3146-2F	BLM3145-1R	20
SVF 650 Gladius Non ABS	09-13	BLM3147-2F	BLMR3147-2F	BLM3147-1R	21
V-Strom 650	04-12	BLM3153-3F	BLMR3153-2F	BLM3153-1R	22
GSR 750	11-13	BLM3051-2F			23
GSX 750 EE/EF/ES	84-89	BLM3074-5F		BLM3074-1R	24
GSX 750 FK-FV	89-97	BLM3077-3F	BLMR3077-2F	BLM3077-1R	25
GSX 750 FW-K3	98-03	BLM3078-3F	BLMR3078-2F	BLM3078-1R	26
GSX 750 W-K1	97-02	BLM3081-3F	BLMR3081-2F	BLM3081-1R	27
GSXR 750	11-16	BLM3099-2F	BLMR3099-2F	BLM3099-1R	28
GSXR 750	06-10	BLM3098-2F	BLMR3098-2F	BLM3098-1R	29
GSXR 750 K4/K5	04-05	BLM3097-2F	BLMR3097-2F	BLM3097-1R	30
GSXR 750 L	1990	BLM3109-3F	BLMR3109-2F	BLM3109-1R	31
GSXR 750 M	1991	BLM3110-3F	BLMR3110-2F	BLM3110-1R	32
GSXR 750 T-W	96-98	BLM3101-2F	BLMR3101-2F	BLM3101-1R	33
GSXR 750 WN-WP	92-93	BLM3112-3F	BLMR3112-2F	BLM3112-1R	34
GSXR 750 WR-WS	94-95	BLM3113-2F	BLMR3113-2F	BLM3113-1R	35
GSXR 750 X	1999	BLM3102-2F	BLMR3101-2F	BLM3102-1R	36
GSXR 750 Y-K3	00-03	BLM3115-2F	BLMR3115-2F	BLM3115-1R	37
GSX-S 750	2017	BLM3166-3F		BLM3166-2R	38
GSX-S 750 Z	2017	BLM3166-3F		BLM3166-2R	39
VS 750 GLPG-GLPM Intruder	85-91	BLM3155-1F			40
DR 800 SL-SM	90-91	BLM3010-1F		BLM3010-1R	41
VS 800 GLM-GLV Intruder	91-97	BLM3155-1F			42
VX 800 L-R	90-95	BLM3158-1F		BLM3158-1R	43
VZ 800 V-W Marauder	97-98	BLM3159-1F			44
GS 850 GN-GT	79-80	BLM3035-3F		BLM3035-1R	45
GS 850 GX-GG	81-88	BLM3036-3F		BLM3036-1R	46
GSXR 1000	12-14	BLM3082-2F	BLMR3082-2F	BLM3082-1R	47
GSXR 1000 ABS	15-16	BLM3083-3F		BLM3082-1R	48
GSXR 1000 ABS	2017	BLM3167-3F		BLM3167-2R	49
GSXR 1000 K5/K6	05-06	BLM3084-2F	BLMR3084-2F	BLM3084-1R	50
GSXR 1000 K7 - K8	07-08	BLM3085-2F	BLMR3085-2F	BLM3085-1R	51
GSXR 1000 K9 - K11	09-11	BLM3086-2F	BLMR3086-2F	BLM3086-1R	52
GSXR 1000 K1-K2	01-02	BLM3087-2F	BLMR3087-2F	BLM3087-1R	53
GSXR 1000 K3-K4	03-04	BLM3088-2F	BLMR3088-2F	BLM3088-1R	54
GSXS 1000 F ABS	15-17	BLM3168-3F		BLM3168-2R	55
SV 1000 N	03-06	BLM3141-2F	BLMR3141-2F	BLM3141-1R	56

FRONT

REAR

BRAKE LINES

Line #	SUZUKI	Year	FRONT			REAR		
			OE Replacement Brake Lines (Front)	Race Standard Brake Lines (Front)	OE Replacement Brake Lines (Rear)			
1	SV 1000 SK3-K7	03-07	BLM3142-2F	BLMR3142-2F	BLM3142-1R			
2	TL 1000 RW-RK1	98-02	BLM3148-2F	BLMR3148-2F	BLM3148-1R			
3	TL 1000 SV-SX	97-01	BLM3149-2F	BLMR3149-2F	BLM3149-1R			
4	GSX 1100 FJ-FR	88-94	BLM3057-3F		BLM3057-1R			
5	GSX 1100 GM-GN	91-94	BLM3058-3F		BLM3058-1R			
6	GSXR 1100 WP-WT	93-96	BLM3095-2F	BLMR3095-2F	BLM3095-1R			
7	GSF 1200 K1-K5 Bandit	01-06	BLM3037-3F	BLMR3037-2F	BLM3037-1R			
8	GSF 1200 T-Y Bandit	96-00	BLM3038-3F	BLMR3038-2F	BLM3038-1R			
9	GSF 1250 Bandit	06-13	BLM3039-2F	BLMR3039-2F	BLM3039-1R			
10	GSF 1250 A Bandit ABS	07-13	BLM3040-8F					
11	B-King	07-10	BLM3000-2F		BLM3000-1R			
12	GSX 1300 R Hayabusa	99-06	BLM3060-2F	BLMR3060-2F	BLM3060-1R			
13	GSX 1300 R Hayabusa Non ABS	07-14	BLM3061-2F	BLMR3061-2F	BLM3061-1R			
14	GSX1300 R Hayabusa ABS	13-17	BLM3169-3F*		BLM3169-2R*			
15	*Premium kit including stainless steel replacement front master cylinder to ABS hardline							
16	GSX1300 R Hayabusa ABS	13-17	BLM3169A-3F**		BLM3169A-2R**			
17	**Kit supplied with full length flexible hoses to replace all original hardlines							
18	GSX1300 R Hayabusa ABS	13-17	BLM3170-3F***		BLM3170-2R***			
19	***Kit supplied with full length front master cylinder to ABS and rear master cylinder to ABS hose to replace original hardline							
20	GSX 1400	01-09	BLM3062-3F	BLMR3062-2F	BLM3062-1R			
21	VZR 1800	2006-	BLM3160-3F	BLMR3160-2F	BLM3160-1R			
22								
23	SUZUKI OFF ROAD							
24	DRZ 125/DRZ 125L	2003-	BLM6077-1F					
25	DRZ 250	04-07	BLM6078-1F		BLM6078-1R			
26	RM-Z 250	04-09	BLM6080-1F		BLM6080-1R			
27	RM-Z 250	2011	BLM6081-1F		BLM6081-1R			
28	DRZ 400	05-07	BLM6079-1F					
29	RM-Z 450	05-07	BLM6080-1F		BLM6080-1R			
30	RM-Z 450	08-09	BLM6083-1F		BLM6083-1R			
31	RM-Z 450	2011	BLM6084-1F		BLM6084-1R			
32								
33	TRIUMPH							
34	Bonneville/T100 (<Ch 437492)	01-12	BLM8195-1F					
35	Bonneville America	03-06	BLM8196-1F		BLM8196-1R			
36	Bonneville Thruxton 900	03-13	BLM8197-1F		BLM8197-1R			
37	Daytona 600	03-04	BLM8198-2F	BLMR8198-2F	BLM8198-1R			
38	Daytona 675	06-13	BLM8199-2F	BLMR8199-2F	BLM8199-1R			
39	Daytona 750/1000	91-93	BLM8200-3F	BLMR8200-2F	BLM8200-1R			
40	Daytona 900/1200	92-97	BLM8201-3F	BLMR8201-2F	BLM8201-1R			
41	Daytona 955i	01-03	BLM8202-2F	BLMR8202-2F	BLM8202-1R			
42	Daytona 955i	99-00	BLM8202-2F	BLMR8202-2F	BLM8203-1R			
43	Daytona T595	97-00	BLM8202-2F	BLMR8202-2F	BLM8204-1R			
44	Legend	98-01	BLM8205-1F		BLM8205-1R			
45	Rocket III (Standard Bars)	04-15	BLM8206-3F		BLM8206-1R			
46	Rocket III Classic (Higher Bars)	04-15	BLM8207-3F		BLM8206-1R			
47	Scrambler 865	06-13	BLM8208-1F					
48	Speed Four	03-06	BLM8209-2F		BLM8209-1R			
49	Speed III	94-96	BLM8210-3F	BLMR8210-2F	BLM8210-1R			
50	Speed III T509	97-03	BLM8211-2F	BLMR8211-2F	BLM8211-1R			
51	Speed Triple 1050	04-10	BLM8212-3F	BLMR8212-2F	BLM8212-1R			
52	Speedmaster	03-11	BLM8213-2F	BLMR8213-2F	BLM8213-1R			
53	Sprint	93-97	BLM8214-3F	BLMR8214-2F	BLM8214-1R			
54	Sprint RS	99-05	BLM8215-2F		BLM8215-1R			
55	Sprint ST 1050 (Non ABS) To Vin 291665	05-12	BLM8216-2F		BLM8216-1R			
56	Sprint ST/Executive	98-03	BLM8217-2F	BLMR8217-2F	BLM8217-1R			

BRAKE LINES

APPLICATIONS
BRAKE



TRIUMPH



		OE Replacement Brake Lines (Front)	Race Standard Brake Lines (Front)	OE Replacement Brake Lines (Rear)	Line #
Sprint ST/Executive Late 03 On	2003-	BLM8218-2F		BLM8218-1R	1
Street Triple 675	06-15	BLM8219-2F	BLMR8219-2F	BLM8219-1R	2
Street Triple 675R	09-15	BLM8220-2F	BLMR8220-2F	BLM8220-1R	3
Thunderbird (Low Bar)	95-02	BLM8221-1F		BLM8205-1R	4
Thunderbird 900 Sport	98-03	BLM8222-3F		BLM8222-1R	5
Thunderbird/Adventurer	95-03	BLM8223-1F		BLM8205-1R	6
Tiger	93-99	BLM8224-3F	BLMR8224-2F	BLM8224-1R	7
Tiger 1050 (Non ABS)	2013	BLM8225-3F		BLM8225-1R	8
Tiger 800 XC	11-14		BLMR8226-2F	BLM8226-1R	9
Tiger 955	00-03	BLM8227-2F		BLM8227-1R	10
Trident 750/900	-1991	BLM8228-3F	BLMR8228-2F	BLM8228-1R	11
Trident 750/900	91-98	BLM8229-3F	BLMR8229-2F	BLM8228-1R	12
Trophy 900/1200 (From Vin 71699)	2003-	BLM8230-2F		BLM8230-1R	13
Trophy 900/1200 (Up To Vin 71698)	-2003	BLM8231-3F	BLMR8231-2F	BLM8231-1R	14
TT 600	00-03	BLM8232-2F	BLMR8232-2F	BLM8232-1R	15
					16
					17
					18
					19
					20
					21
					22
					23
					24
					25
					26
					27
					28
					29
					30
					31
					32
					33
					34
					35
					36
					37
					38
					39
					40
					41
					42
					43
					44
					45
					46
					47
					48
					49
					50
					51
					52
					53
					54
					55
					56

YAMAHA

DT 125 X	2006	BLM2002-1F		BLM2002-1R	18
YZFR 125	08-13	BLM2146-1F		BLM2146-1R	19
FZ1 Fazer	06-13	BLM2010-3F	BLMR2010-2F	BLM2010-1R	20
TZ 250	1991-		BLMR2078-2F	BLM2078-1R	21
YZF 300 R Non ABS	2017	BLM2156-1F		BLM2156-1R	22
YZF 300 R ABS	2017	BLM2155-3F		BLM2155-1R	23
XT 350	85-96	BLM2116-1F		BLM2116-1R	24
FZR 400 RR	92-96	BLM2024-3F	BLMR2024-2F	BLM2024-1R	25
FZR 400 RRSP	91-92	BLM2025-3F	BLMR2025-2F	BLM2025-1R	26
FZ6	04-06	BLM2011-3F	BLMR2011-2F	BLM2011-1R	27
FZ6 S2	07-08	BLM2012-2F	BLMR2012-2F	BLM2011-1R	28
FZ 600	87-88	BLM2013-3F	BLMR2013-2F	BLM2013-1R	29
FZR 600	89-90	BLM2026-3F	BLMR2026-2F	BLM2026-1R	30
FZR 600 Genesis	91-93	BLM2027-3F	BLMR2027-2F	BLM2027-1R	31
FZR 600 R	94-96	BLM2028-2F		BLM2028-1R	32
FZS 600 Fazer	98-03	BLM2032-3F	BLMR2032-2F	BLM2032-1R	33
R6	08-15		BLMR2049-2F	BLM2049-1R	34
R6	06-07		BLMR2048-2F	BLM2048-1R	35
R6	2005	BLM2047-3F	BLMR2047-2F	BLM2047-1R	36
R6	03-04	BLM2046-2F		BLM2046-1R	37
R6	98-02	BLM2045-2F		BLM2045-1R	38
XJ 600	84-92	BLM2084-3F		BLM2084-1R	39
XJ 600 N	94-97	BLM2085-1F		BLM2085-1R	40
XJ 600 N/S Diversion	98-03	BLM2086-2F		BLM2086-1R	41
XJ 600 S Diversion	92-97	BLM2087-1F		BLM2085-1R	42
XJ6/XJ6 Diversion/XJ6 SP	09-13	BLM2083-2F	BLMR2083-2F	BLM2083-1R	43
XT 600 Tenere	86-90	BLM2118-1F		BLM2118-1R	44
XT 600 E	93-03	BLM2119-1F		BLM2119-1R	45
YF 600 R Thundercat	96-03	BLM2144-2F		BLM2144-1R	46
XVS 650 Drag Star	97-03	BLM2137-1F			47
XVS 650 A Drag Star Classic	98-03	BLM2138-1F			48
SZR 660	96-97	BLM2067-1F		BLM2067-1R	49
XT 660 R	04-13	BLM2120-1F		BLM2120-1R	50
XT 660 X	04-13	BLM2121-1F		BLM2121-1R	51
XT 660 Z	09-13	BLM2122-3F		BLM2122-1R	52
XTZ 660	91-99	BLM2119-1F		BLM2119-1R	53
FZ-07	16-17	BLM2157-3F			54
MT-07	14-17	BLM2153-3F		BLM2153-4R	55
XSR 700	16-17	BLM2154-3F		BLM2154-4R	56

BRAKE LINES

APPLICATIONS
BRAKE



YAMAHA OFF-ROAD



		OE Replacement Brake Lines (Front)	Race Standard Brake Lines (Front)	OE Replacement Brake Lines (Rear)	Line #
YZ 85	01-17	BLM6102-1F		BLM6093-1R	1
YZ 125/250	06-07	BLM6091-1F		BLM6091-1R	2
YZ 125/250	08-17	BLM6092-1F		BLM6092-1R	3
YZ 125/250/250 F	03-05	BLM6094-1F		BLM6094-1R	4
WR 250 F	07-11	BLM6086-1F		BLM6086-1R	5
WR 250 R	08-09	BLM6087-1F		BLM6087-1R	6
WR 250 X	08-09	BLM6088-1F		BLM6088-1R	7
YZ 250 F	01-02	BLM6093-1F		BLM6093-1R	8
YZ 250 F	06-08	BLM6091-1F		BLM6091-1R	9
YZ 250 F/YZ 450 F	10-11	BLM6097-1F		BLM6087-1R	10
WR 450 F	04-06	BLM6089-1F		BLM6089-1R	11
WR 450 F	07-11	BLM6090-1F		BLM6090-1R	12
YZ 450 F	03-05	BLM6099-1F		BLM6099-1R	13
YZ 450 F	2007	BLM6098-1F		BLM6098-1R	14
YZ 450 F	08-17	BLM6100-1F		BLM6100-1R	15
					16
					17
					18
					19
					20
					21
					22
					23
					24
					25
					26
					27
					28
					29
					30
					31
					32
					33
					34
					35
					36
					37
					38
					39
					40
					41
					42
					43
					44
					45
					46
					47
					48
					49
					50
					51
					52
					53
					54
					55
					56

FRONT

REAR

EBC BRAKE PAD BUYERS GUIDE

NOTE:- Size identification is shown as follows

Dimension 1=Width or Diameter, Dimension 2=Height or Diameter, Dimension 3=Thickness (Material and backplate)

FA11



ISR AFTERMARKET CALIPER

22-023-0A (2 Piston)

22-026-0A (Sprocket Caliper)

YAMAHA

RD 250 B

75 F

RD 350 A/B

73-75 F

RD 400 C/D/E

76-78 F & R

XS 500 B

75 F

XS 2/TX 650

72-73 F

TX 650 A / XS 650 B/C

74-76 F

TX 750 / TX 750 A

73-74 F

Equivalents OE#

1A1 W0045 00	306 25811 05
306 25811 00	306 25811 06
306 25811 01	409 W0045 00
306 25811 02	409 25811 00
306 25811 03	409 25811 01
306 25811 04	

Dealer Stocking Recommendation

STD FA11 Premium Organic Street Pad Blend

Single/Pair	Popularity #	Rec Stocking Level
1	Y31	1

FA12

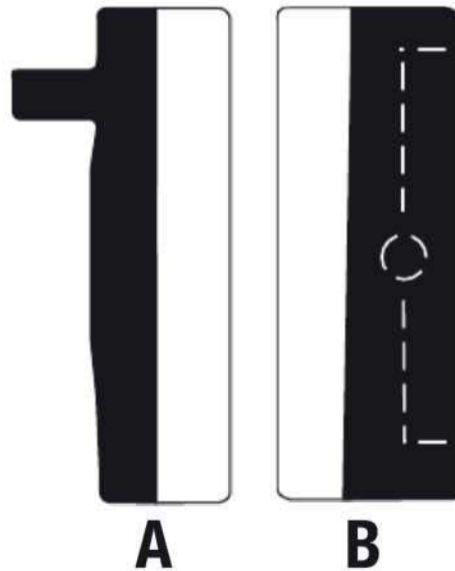
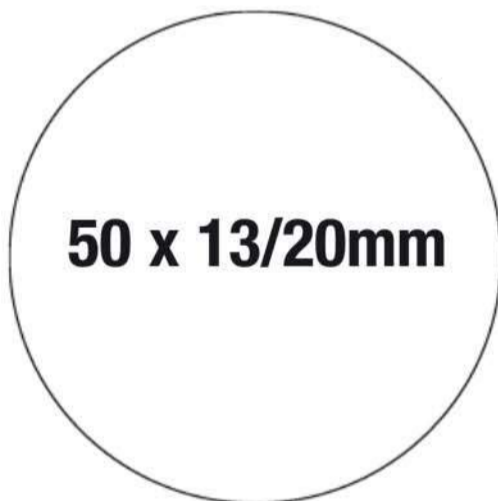

HONDA

CB 450 K3/K4

70-71 F

CB 750 K1/K2/K3/K4/K5/76

70-76 F

Equivalents OE#

45105 300 040 A	45106 341 000 B
45105 341 000 A	45106 341 003 B
45105 341 003 A	45106 300 004 B

STD FA12 Premium Organic Street Pad Blend

OPTIONS FA12V Semi Sintered Long Lasting Street Pad Blend

Dealer Stocking Recommendation

Single/Pair	Popularity #	Rec Stocking Level
1	H34	1

FA13



HONDA

CB 350 F/F1/G		F
CB 360 G/T/T 76	74-76	F
CB 400 F	75-77	F
CB 450 K5-K7	72-74	F
CB 500 K/K1/K2		F
CB 500 T/76	75-76	F
CB 550 F	75-77	F
CB 550 K/K1/76	74-78	F
CB 750 A 'Hondamatic'	76-78	F
CB 750 F Supersport	75-76	F
CB 750 K	77-78	F

Equivalents OE#

45102 393 700	45105 390 006 A
45105 323 006 A	45106 323 013 B
45105 323 013 A	45106 323 023 B
45105 323 023 A	45106 323 036 B
45105 323 036 A	45106 323 043 B
45105 323 043 A	45106 390 003 B
45105 390 003 A	

STD	FA13	Premium Organic Street Pad Blend
OPTIONS	FA13V	Semi Sintered Long Lasting Street Pad Blend

Dealer Stocking Recommendation

Single/Pair	Popularity #	Rec Stocking Level
1	H29	1

FA16



AP/LOCKHEED AFTERMARKET CALIPER

2 piston/2 pin (CP2195/CP2696-38E0)

DUCATI

750 Sport 74 F

ISR AFTERMARKET CALIPER

22-030 (2 Piston Rear)

22-033 (2 Piston HD)

TRIUMPH (Meriden Produced Models)

T 140 V Bonneville	73-74	F
T 140 V Bonneville	75-78	F & R
T 140 Silver Jubilee Bonneville	77	F & R
T 140 E Bonneville	78-83	F & R
T140 D Bonneville (Lester Alloy Wheels/ 6 Bolt disc)	79-81	F & R
T 140 ES (750cc)	80-81	F & R
T140 E/ES (Executive/Morris Alloy Wheels/ 5 Bolt disc)	81-83	F & R
T 150 V (Trident 3 cyl)	73-74	F & R
T 160 V (Trident 3 cyl)	75	F & R
TSS 750 (8 valve)	83	F & R
TSX 750	83	F & R

STD	FA16	Premium Organic Street Pad Blend
OPTIONS	FA16HH	Street Performance Sintered Pad Blend
	EPFA16HH	Fast Street Use & Track Day Sintered Pad Blend
	GPFA16HH	RACE USE ONLY
	FA16S	Green - Race Use

Equivalents OE#

474/537
CP2195
99-2769

Dealer Stocking Recommendation

Single/Pair	Popularity #	Rec Stocking Level
1	H29	1

FA18



**55.7 x 55
x 9mm**

AMERICAN SUSPENSION CALIPER

B17 Phantom 2 piston brake caliper
B17 Mach 8 Standard mount 2 Piston caliper
P26 2 Piston caliper

BMW

R 45/45 N (with Brembo calipers)	78-85	F
R 65 (double disc model)	07/88-08/89	F
R 65 GS 87-92	F	
R 65 RT 85-88	F	
R 65 LS (Brembo caliper)	81-85	F
R 65 T (Brembo caliper)	80-85	F
R 80 RT (Double disc)	82-84	F
R 80/R 80 RT (Double Disc)	84-08/88	F
R 80 GS 80-87	F	
R 80 ST 82-84	F	
R 80 TIC	09/80-85	F
R 100/7T (Spoke wheel)	09/80-84	F
R 100/7T (Cast wheel)	09/80-84	F
R 100 S 09/80-80	F & R	
R 100 RS	10/80-84	F & R
R 100 RS	86-08/88	F
R 100 RT	87-08/88	F
R 100 RT	10/80-84	F & R
R 1100 RS	92-01	R
K 75/75-2	84-07/90	F
K 75/75-2 (ABS Model)	08/90-96	R
K 75 C 85-08/88		
K 75 RT 89-96	R	
K 75 S (Non ABS)	85-09/88	F & R
K 75 S (Non ABS Model)	09/88-95	R
K 75 S (ABS Model)	85-09/88	F & R
K 75 S (ABS Model)	09/88-95	R
K 100 (Non ABS - 8 valve model)	82-09/88	F & R
K 100/2	87-08/88	F & R
K 100/2	09/88-90	R
K 100 LT	86-08/88	F & R
K 100 LT	09/88-91	R
K 100 RS/RT	83-09/88	F & R
K 100 RS/RT	10/88-89	R
K 100 RS (16 valve models)	89-92	R
K1 (16 valve models)	88-93	R
K 1100 LT	89-99	R
K 1100 RS	92-96	R
K 1200 RS	96-05	R
K 1200 GT	03-06	R

DUCATI

250/350/450 Desmo	74-77	F
600 Pantah	81	F
650 Pantah	-84	F & R
750 SS 75-76	F & R	
751 F1 86	F & R	
750 Paso	87-90	F
750 Sport	88-90	F & R
860 GT/GTS	75-76	F & R
900 GTS	75-76	F & R

900 SS - Darmah	76-78	F & R
900 Hailwood Replica	79	F & R
906 Paso	88-89	F & R
1000 R1 Hailwood Replica	84	F & R

INDIAN

Chief Blackhawk	11	R
Chief Blackhawk Dark	11	R
Chief Classic	11-13	R
Chief Deluxe (Brembo calipers)	09-10	R
Chief Roadmaster (Brembo calipers)	09-11	R
Chief Standard (Brembo calipers)	09-11	R
Chief Vintage (Brembo calipers)	09-13	R
Dark Horse (Brembo calipers)	10-13	R
Bomber (Brembo calipers)	10-11	R

LAVERDA

Jota 1000	76	F & R
RGS 1000	83	F & R
1000 SFC	85-86	F & R
Mirage 1200	76	F & R

MOTO GUZZI

850 II/III Le Mans	78-84	F & R
850 T3/T4/T5	79-88	F & R
California 1000 II/III	83-93	F & R
1000 SP II/III	83-94	F & R
1000 GT	87-91	F & R
1000 S 89-94	F & R	
1000 Le-Mans	84-93	F & R
Strada 1000	93-94	F & R
California 1100	94-97	F & R

MUZ

500 Country	93-98	F
-------------	-------	---

TRIUMPH (Meriden Produced Models)

T 140 Bonneville	85-88	F & R
------------------	-------	-------

Equivalents OE#

34 11 1 451 995	34 21 2 332 998	61654630
34 11 1 454 724	14654601	000 2865 46010
34 11 1 458 388	14654650	000 1865 46600
34 11 2 301 360	0795 39 856	000 2865 46010
34 21 7 657 025	0797 39 856	N50250062
34 21 1 236 221	0960 39 656	

STD	FA18	Premium Organic Street Pad Blend
OPTIONS	FA18HH	Street Performance Sintered Pad Blend
	FA18V	Semi Sintered Long Lasting Street Pad Blend

Dealer Stocking Recommendation

Single/Pair	Popularity #	Rec Stocking Level
2	-	2

BUYERS GUIDE BRAKE PADS
NOTE:- Size identification is shown as follows
Dimension 1=Width or Diameter, Dimension 2=Height or Diameter, Dimension 3=Thickness (Material and backplate)

FA20



45 x 8 mm

YAMAHA

YT 125 G/H/J 'Tri Moto'

80-82

R

Equivalents OE#

3X3 W0045 00
3X3 25811 00

Dealer Stocking Recommendation

Single/Pair	Popularity #	Rec Stocking Level
-	-	-

STD FA20X Carbon Dual Purpose Pad Blend

FA21



47 x 16.2 mm

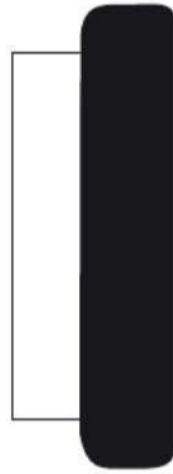

YAMAHA

YT 125 J/K/L/N 'Tri Moto'

81-85

R

YT 175 J/K 'Tri Moto'

82-83

R

YTM 200 K/L/N 'Tri Moto'

83-85

R

YTM 200 EK/EL 'Tri Moto'

83-84

R

YTM 200 ERN 'Tri Moto'

85

R

YFM 200 N/DXS/DXT/DXU/D/DXW

85-89

R

YTM 225 DXK/DXL/DXN 'Tri Moto'

83-85

R

YTM 225 DRN/DRS 'Tri Moto'

85-86

R

YFM 225 S/T/U (Moto 4)

86-88

R

YFM 250 W/A/B

89-91

R

YFM 350 ERT /ERU

87-88

R

YFM 350 FWT/FWU/FWW/FWA/FWB/FWD/FWE

87-95

R

/FWF/FWG Big Bear

89-95

R

YFM 350 ERW/ERA/ERD/ERE/ERF/ERG

89-95

R

Equivalents OE#

2HR W0045 00
5V6 W0045 00
5V6 W0045 01

Dealer Stocking Recommendation

Single/Pair	Popularity #	Rec Stocking Level
2	FA21X = Y2 FA21R = Y24	FA21X = 8 FA21R = 4

STD FA21X Carbon Dual Purpose Pad Blend

OPTIONS FA21R Utility Grade Sintered Pad Blend

FA21SV High Durability Off Road Sintered Blend

FA22

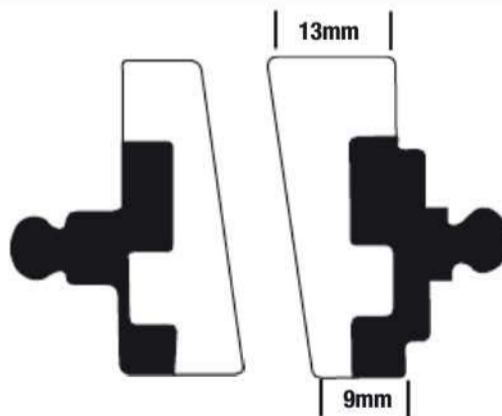

NOTE:

1 PAD LEFT HAND
1 PAD RIGHT HAND
TAPERED FINISH

71.8 x 35mm

BMW

R 60/7

76-80

F

R 90/6

73-76

F

R 60 TIC

78-82

F

R 100

76-77

F

R 75/6, 75/7

73-79

F

R 100/7T

77-09/80

F

R 80

77-84

F

R 100 S

76-08/80

F

R 80 TIC

78-08/80

F

R 100 RS

76-09/80

F

R 90 S

73-76

F

R 100 RT

78-09/80

F

Equivalents OE#

34 11 2 301 358 | 34 11 2 301 355 | 34 11 2 301 356

Dealer Stocking Recommendation

Single/Pair	Popularity #	Rec Stocking Level
2	-	2

STD FA22 Premium Organic Street Pad Blend

OPTIONS FA22V Semi Sintered Long Lasting Street Pad Blend

FA24/2

FA24 use FA24/2



**113.8 x 66.8
x 7mm**

HARLEY DAVIDSON

FX/FXE/FXEF/FXWG/FXS	73-83	R
FL/FLH	72-84	F
FL/FLH	72-80	R

(BANANA CALIPER)

Equivalents OE#

44005 74	8009003
44135 74	44005 78

STD FA24/2 Premium Organic Street Pad Blend
OPTIONS FA24/2V Semi Sintered Long Lasting Street Pad Blend

Dealer Stocking Recommendation

Single/Pair	Popularity #	Rec Stocking Level
1	HD2	4

FA26

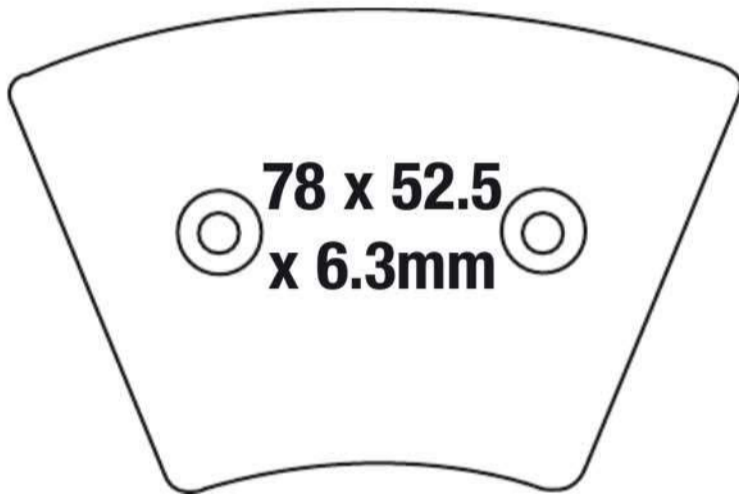

**78 x 52.5
x 6.3mm**

COMPLETE WITH TWO RIVETS

HARLEY DAVIDSON

XLH/XLCH	73-77	F
FX/FXE	73-77	F

Equivalents OE#

44281 74	12438
----------	-------

STD FA26 Premium Organic Street Pad Blend

Dealer Stocking Recommendation

Single/Pair	Popularity #	Rec Stocking Level
1	HD8	1

FA27



**44.4 x 55.4
x 9.5mm**

NORTON

750 MK V Commando Roadster / Interstate	73	F&R
850 MK 1 Commando Hi Rider / Interstate	73	F&R
850 MK 1A Commando Roadster / Interstate	73	F&R
850 MK 11/11A Commando Roadster /Hi Rider / Interstate	74	F&R
850 MK 111 Commando Roadster / Hi Rider / Interstate	75	F&R

Equivalents OE#

06-6005	06-6186	06-1894
---------	---------	---------

STD FA27 Premium Organic Street Pad Blend

FA29

FA30

FA31



FA29 - 67 x 49.2 x 11 mm

FA30 - 67 x 49.2 x 10 mm

FA31 67 x 49.2 x 9 mm

FA29 HONDA

CX 500	78-79	F
CX 500 C Custom	79-81	F
CX 500 D Deluxe	79-81	F
CB 900 C Custom	80	R
CB 900 C Custom	81	F & R
GL 1000 K/76/L Goldwing	75-77	F
GL 1000 Goldwing	78-79	F
GL 1100/1100 I Goldwing	80	R
GL 1100/1100 I Goldwing Interstate	81	F & R

FA30 HONDA

CB 750 F Supersport	79-80	F & R
CB 900 C Custom	80	F

FA31 HONDA

CB 750 F Supersport	77-78	F & R
CBX	79-80	F & R

Dealer Stocking Recommendation

Single/Pair	Popularity #	Rec Stocking Level
2	FA29 - H6	FA29 - 6
	FA30 - H23	FA30 - 2
	FA31 - H27	FA31 - 2

Equivalents OE# - FA29

43105 461 771	45105 415 772
43105 461 772	
45105 415 006	
45105 415 770	

Equivalents OE# - FA30

43105 461 771	45105 438 004
43105 461 772	45105 438 007
45105 415 006	45105 438 008
45105 415 770	06455 410 405
45105 415 772	06435 410 305
45105 438 000	06435 415 405

Equivalents OE# - FA31

43105 461 770	45105 410 007
45105 371 006	45105 410 016
45105 410 004	45105 410 026
45105 410 006	

STD FA29 Premium Organic Street Pad Blend

OPTIONS FA29V Semi Sintered Long Lasting Street Pad Blend

STD FA30 Premium Organic Street Pad Blend

OPTIONS FA30V Semi Sintered Long Lasting Street Pad Blend

STD FA31 Premium Organic Street Pad Blend

OPTIONS FA31V Semi Sintered Long Lasting Street Pad Blend

FA32

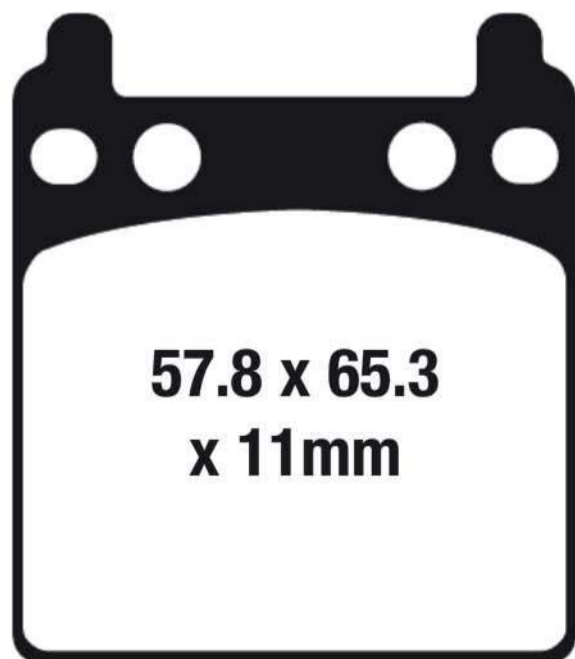

57.8 x 65.3
x 11mm

HONDA

CB 750 F Supersport	75-76	R
GL 1000 'All models'	75-79	R

PERFORMANCE MACHINE AFTERMARKET CALIPER

162 X 2

Equivalents OE#

43211 371 006	43211 431 671
43211 392 006	43211 431 672
43211 392 016	43211 431 673

STD FA32 Premium Organic Street Pad Blend

OPTIONS FA32V Semi Sintered Long Lasting Street Pad Blend

Dealer Stocking Recommendation

Single/Pair	Popularity #	Rec Stocking Level
1	H20	1

FA33

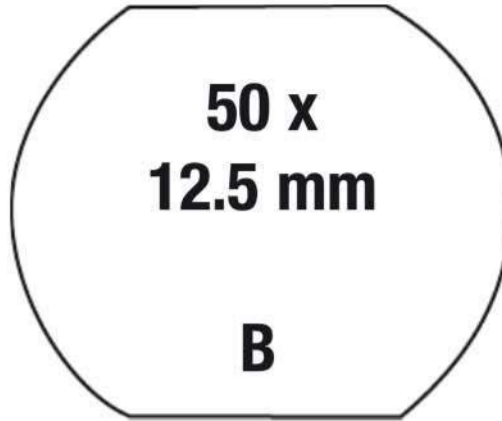

KAWASAKI

S2-A (350cc)	72-73	F
S3/S3-A (400cc)	74-75	F
KH 400 A3/A4/A5	76-78	F
KH 500 A8	76	F
KZ 650 B1/B2/B2A/B3	77-79	F
KZ 650 C1/C2/C3 (up to T F/no 023100)	77-79	F
KZ 650 D1/D1A 'SR Series'	78-79	F
KZ 750 B1/B2/B3/B4	76-79	F
KZ 900 A4/A5	76-77	F
KZ 900 B1 'LTD'	76	F
KZ 1000 A1/A2/A2A	77-78	F
KZ 1000 B1/B2 'Ltd'	77-78	F
KZ 1000 C1/C1A 'Police Series'	78	F
KZ 1000 D1 (ZI-R Series)	78	F

Equivalents OE#

43050 005 A	43050 008 A	43050 1006	43050 5003	43051 008 B
43050 006 A	43050 009 A	43050 5001	43051 006 B	43051 011 B
43050 007 A	43050 011A	43050 5002	43051 007 B	

Dealer Stocking Recommendation

Single/Pair	Popularity #	Rec Stocking Level
2	K15	2

STD FA33 Premium Organic Street Pad Blend

FA34



YAMAHA

SR 500 E/F/G/H	78-81	F
XS 500 C/D/E	76-78	F & R
XJ 650 RJ 'Seca'	82	F
XS 650 D/E/F/2F	77-79	F
XS 650 SE/SF/SG	78-80	F & R
XS 650 G/H/SH	80-81	F
XS 650 SJ/SK Heritage Special	82-83	F
XS 750 D/2D/E/F	77-79	F & R
XS 750 SE/SF	78-79	R
XS 850 G/H	80-81	F & R
XS 850 LG/LH/SG/SH	80-81	R
XV 920 RH/RJ	81-82	F
XS 1100 E/F/G/H	78-81	F & R
XS 1100 SF/SG/SH	79-81	R
XS 1100 LG 'Midnight Special'	80	R

Equivalents OE#

1J3 20000 10	1J3 20000 63	1J9 20000 02	2J2 W0046 00	3H5 W0045 00
1J3 20000 13	1J3 20000 64	1L9 W0045 00	2J2 W0046 01	3H5 W0045 01
1J3 20000 20	1J3 20000 70	1L9 W0046 00	2M0 W0046 00	4KO W0045 00
1J3 20000 30	1J3 W00045 00	1U4 W0046 01	2M0 W0046 01	4KO W0045 01
1J3 20000 40	1J3 W0046 00	1U4 W0046 02	3G1 W0046 00	3H5 W0045 11

Dealer Stocking Recommendation

Single/Pair	Popularity #	Rec Stocking Level
2	Y2	10

STD FA34 Premium Organic Street Pad Blend

OPTIONS FA34V Semi Sintered Long Lasting Street Pad Blend

**BUYERS GUIDE
BRAKE PADS**

**NOTE:- Size identification is shown as follows
Dimension 1 =Width or Diameter, Dimension 2=Height or Diameter, Dimension 3=Thickness (Material and backplate)**

FA35

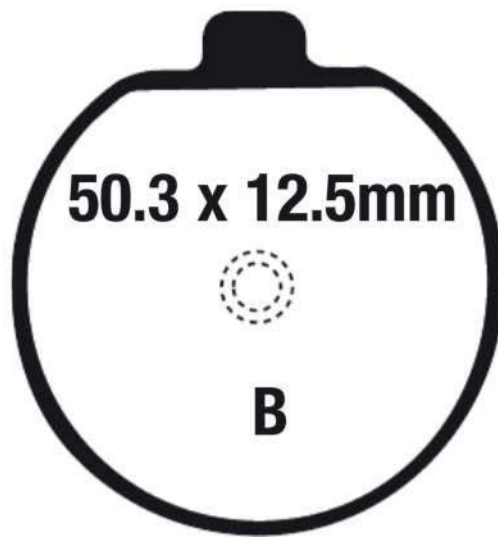
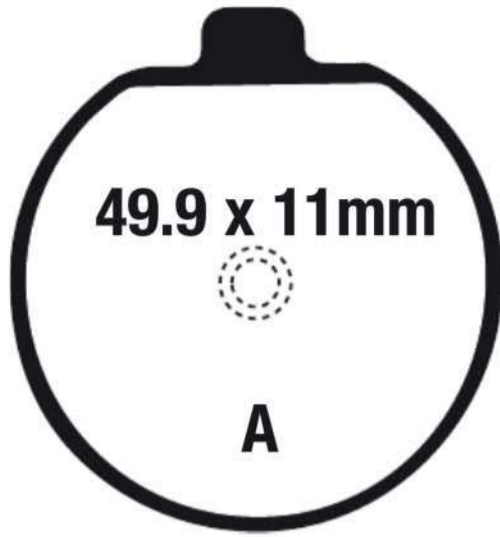

SUZUKI

GS 400 B/C (Disc Brake)	77-78	F
GS 425 N (Spoke Wheel)	79	F
GS 425 EN (Cast Wheel)	79	F
GS 750 B/C/N (8 Valve)	77-79	F
GS 750 EC/EN (8 Valve)	78-79	F
GS 850 GN	79	F

Equivalents OE#

59100 45820	59300 44822
59100 45821	59300 45890
59300 44810	59300 45891
59300 44820	
59300 44821	

STD FA35 Premium Organic Street Pad Blend
OPTIONS FA35V Semi Sintered Long Lasting Street Pad Blend

Dealer Stocking Recommendation

Single/Pair	Popularity #	Rec Stocking Level
2	S56	2

FA36



Equivalents OE#

43050 010	69101 45840	69130 45021
43050 1013	69130 34220	69130 45030
43082 1059	69130 34240	69130 45100
69100 34860	69130 45000	69130 45101
69100 34870	69130 45001	69130 45990
69101 45810	69130 45010	8009001
69101 45820	69130 45011	
69101 45830	69130 45020	

Dealer Stocking Recommendation

Single/Pair	Popularity #	Rec Stocking Level
1	K6 S2	8

GMA AFTERMARKET CALIPER

2 Piston Rear (large) caliper model A (CCI #09-997)

KAWASAKI

KZ 650 C3 (from F/no 023101)	-79	R
KZ 650 D1/D1A/D2 'SR Series'	78-79	R
KZ 1000 A1/A2/A2A	77-78	R
KZ 1000 A3/A3A/A4	79-80	R
KZ 1000 B3/B4 'Ltd'	79-80	R
KZ 1000 C1/C1A 'Police Series'	78	R
KZ 1000 C2/C3/C4	79-81	R
KZ 1000 D1/D3 (Z1-R Series)	78-80	R
KZ 1000 E1/E2 ST & Shaft	79-80	R
KZ 1000 G1 'Classic'	80	R
KZ 1300 A1/A2/A3/A4	79-82	R
KZ 1300 B2 'Touring'	80	R

SUZUKI

XN 85 D (673cc)	83	R
GS 550 C/N/EC/EN/ET	77-80	R
GS 550 MZ	82	R
GS 550 LT/LX	80-81	R
GS 550 TX	81	R
GS 650 EX/EZ	81-82	R
GS 650 GX/GZ/GD	81-83	R
GS 650 GLX/GLZ/GLD	81-83	R
GS 650 MD	83	R

SUZUKI Contd.

GS 700 EF/ESF	85	R
GS 750 B/C/N/EC/EN/LN (8 valve)	77-79	R
GS 750 ET/EX/EZ (16 Valve)	80-82	R
GS 750 LT/LX (16 Valve)	80-81	R
GS 750 ED/ESD	83	R
GS 750 SD	83	R
GS 850 GN/GT/GX/GLT/GLX/GLZ/GZ/GLD/GD	79-83	R
GS 1000 C/N/EC/CN/SN/LN	78-79	R
GS 1000 ET/ST/SZ	80-82	R
GS 1000 GT/GX	80-81	R
GS 1000 GLT/GLX	80-81	R
GS 1000 ET/EX/EZ/ED/ESD	80-83	R
GS 1100 LT	80	R
GS 1100 GZ/GD	82-83	R
GS 1100 GLZ/GLD	82-83	R
GS 1100 GKZ/GK2/GKD	82-83	R
GS 1100 SD	83	R
GV 1200 GLF/GLF2/GLG "Madura"	85-86	R

STD FA36 Premium Organic Street Pad Blend
OPTIONS FA36V Semi Sintered Long Lasting Street Pad Blend

FA37

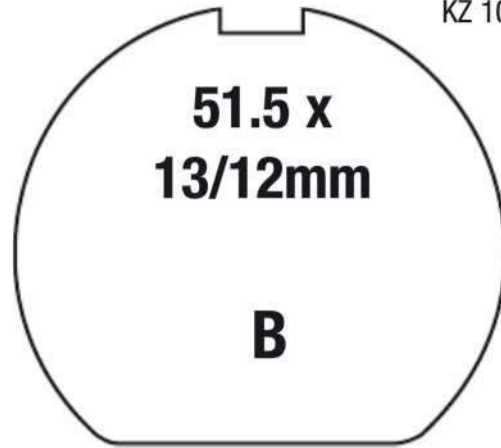

KAWASAKI

KZ 650 C1/C2/C3 (up to F/no 023100)	77-79	R
KZ 750 B1/B2/B3/B4	76-79	R
KZ 900 B1 'Ltd'	76	R
KZ 1000 B1/B2 'Ltd'	77-78	R

Equivalents OE#

43051 009 B	43050 1006
43050 1008A	43050 5002

STD FA37 Premium Organic Street Pad Blend

Dealer Stocking Recommendation

Single/Pair	Popularity #	Rec Stocking Level
1	K23	1

FA38

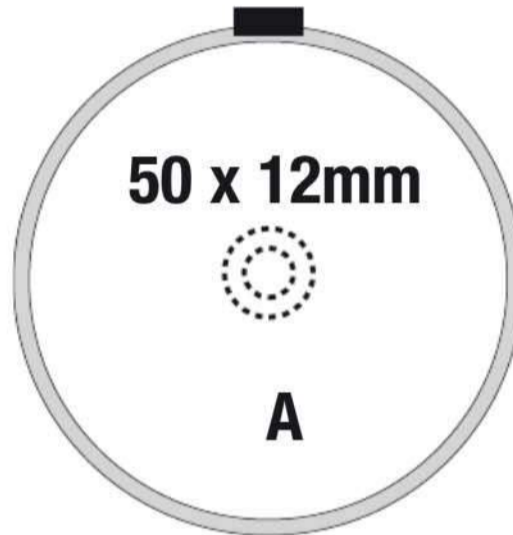
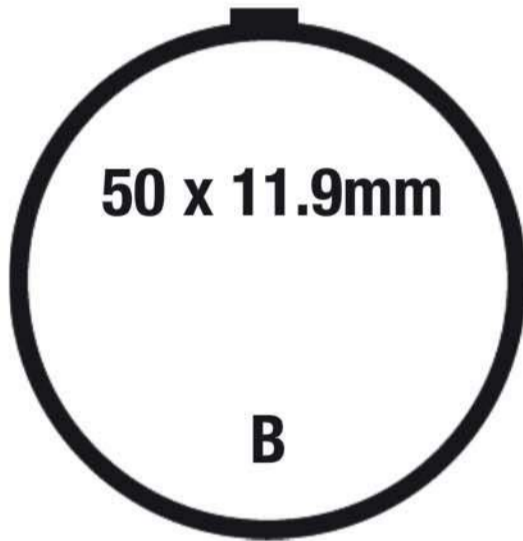

SUZUKI

GS 425 LN	79	F
GS 550 B/C/N/EC/EN	77-79	F
GT 550 B Indy	77	F
GS 750 LN (8 Valve)	79	F
GS 1000 C/N	78-79	F
GS 1000 EC/EN/SN/LN	78-79	F

Equivalents OE#

59100 11850	59300 47830
59100 34820	59300 47840
59300 45820	59300 47850
59300 47810	59300 47870
59300 47820	

STD FA38 Premium Organic Street Pad Blend

OPTIONS FA38V Semi Sintered Long Lasting Street Pad Blend

Dealer Stocking Recommendation

Single/Pair	Popularity #	Rec Stocking Level
2	S27	2

FA40

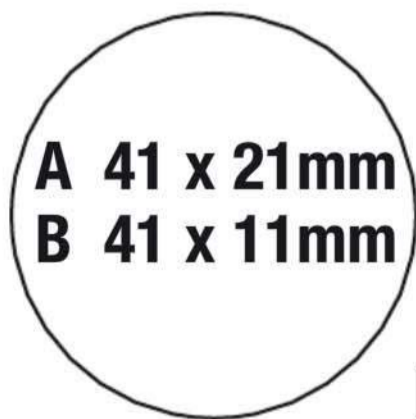

HONDA

FL 250 Odyssey	77-84	R
----------------	-------	---

POLARIS

Scrambler (3 wheeler)	85-86	R
Cyclone 250 X	87	R
Trail Boss (2x4)	85-87	R

Equivalents OE#

2200 256	45340 107 722 A	45340 149 720 A	45345 107 720 B	45345 149 000 B	45350 107 720
45340 107 720 A	45340 149 000 A	45340 950 000 A	45345 107 721 B	45345 149 003 B	45350 107 720 B
45340 107 721 A	45340 149 003 A	45345 950 000 B	45345 107 722 B	45345 149 720 B	45350 950 000

STD FA40 Premium Organic Off Road Pad Blend

OPTIONS FA40R Utility Grade Sintered Pad Blend

Dealer Stocking Recommendation

Single/Pair	Popularity #	Rec Stocking Level
1	H32	1

BUYERS GUIDE
BRAKE PADS

NOTE:- Size identification is shown as follows
Dimension 1=Width or Diameter, Dimension 2=Height or Diameter, Dimension 3=Thickness (Material and backplate)

FA41

Marked with a blue tag to avoid confusion with FA61



YAMAHA

RD 400 F Daytona	79	F & R
XS 400 SG/SH	80-81	F
XS 750 SE/SF (Right)	78-79	F
XS 850 LG/LH/SG/SH Right	80-81	F
XS 1100 SF/SG/SH Right	79-81	F

YAMAHA

XS 1100 LG 'Midnight ' Special' Right	80	F
XS 1100 LH 'Midnight Special'	81	R
XJ 1100 J	82	R

Equivalents OE#

2G2 W0045 00	3J6 W0045 01
2R8 W0045 003	4W1 W0046 00
3J6 W0045 00	

STD FA41 Premium Organic Street Pad Blend
OPTIONS FA41V Semi Sintered Long Lasting Street Pad Blend

Dealer Stocking Recommendation

Single/Pair	Popularity #	Rec Stocking Level
2	Y22	2

FA45



HONDA

CB 250 N/T		F
CM 250 T		F
CB 400 A 'Hondamatic'	78	F
CB 400 MK11 'Hawk'	78-79	F
CM 400 A/T	79-81	F
CB 650	79-81	F
CB 650 C Custom	80	F
CB 650 C Custom	81	F
CB 750 C Custom	80	F
CB 750 C Custom	81	F
CB 750 K	79-82	F
CB 750 L 'Limited Edition'	79	F

Equivalents OE#

45105 413 003	45105 425 006
45105 413 305	45105 471 006
45105 413 871	45105 MA5 671
45105 425 003	

STD FA45 Premium Organic Street Pad Blend
OPTIONS FA45V Semi Sintered Long Lasting Street Pad Blend

Dealer Stocking Recommendation

Single/Pair	Popularity #	Rec Stocking Level
2	H30	2

FA47 FA47/2



APRILIA

RS 250	99-03	R
ATK		
560	84-88	F
All models	92	R

BERINGER AFTERMARKET CALIPER

6 Piston (Old Design/2 Piston)

BREMBO AFTERMARKET CALIPER

20 5161 43 or 81 - 2 Piston P 2/32 Rear Caliper

CAGIVA

Mito 125	92-92	R
WMX 125	86	F
WMX 250	-85	F
WMX 500	84-86	F
Alazzurra 650/Elefant 650	85-86	F & R

DUCATI

Supersport 400	93-97	R
400 Monster	95-04	R
Monster Dark ie 400 (Japan)	05-06	R
Monster 400 ie (Japan)	07-08	F
500 GTL	75	F
500 GTV Pantah	77	F & R
500 Sport Desmo	77	F & R
500 Pantah	79	F & R
600 Pantah	81	R
600 Monster	93-01	R
600 Monster Dark	98-99	R
600 Monster City/City Dark	99	R
600 Supersport	91-97	R
620 IE Monster	02-04	R
Monster Dark 620	03-04	R
Monster 620	05-06	R
Monster 620ie (Twin Pin Front Caliper)	05	R
Monster 620ie (Single Pin Front Caliper)	05	R
695 Monster	06-09	R
748 SP	95-98	R
748 SP/Monoposto	99-02	R
748 Biposto	95-02	R
748 SPS	98-99	R
748 R	00-02	R
748 Testa Bassa (Mono/Biposto)	01	R
750 Paso	87-90	R
750 Supersport	91-98	R
750 Monster	96-98	R
750 Monster City/City Dark	99	R
750 Monster/Monster Dark	99	R
750 Monster	00-01	R
Monster ie 750	02	R
800 Sport	03	F
Monster 800	03-04	R
Monster S2R (803cc)	05-07	R
Monster S2R Dark (803cc)	05-06	R
851 Superbike Biposto	89-92	R
888 SP4/SP5	92-93	R
888 Superbike Strada	94-95	R
900 Supersport	89-90	R
900 Supersport/Superlight	91-97	R
900 Supersport CR USA	98	R
900 Supersport FE	98	R
900 Monster	93-99	R
900 Monster Cromo/Special	98	R
900 Monster City/City Dark	99	R
900 IE Monster	00-01	R
907 IE	90-93	R
916 Biposto-Sienna	94-98	R
916 SPS (996cc)	97-98	R
Monster S4 (916cc)	01-02	R
ST4 (916cc)	01-02	R
Monster S4R (996cc) (2 pad caliper)	05-06	R
996 SPS (996cc)	99	R
996 (996cc) (Monoposto/Biposto)	99-01	R
996 R	01	R
996 S	01	R
Monster S4R (996cc)	03-06	R
S4RS Monster (998cc) (Radial 4 pad caliper)	06	R
S4R/S4RS Testastretta Monster (998cc) Radial 4 pad caliper)	07-08	R
998 Matrix (998cc)	04	R
998 R (998cc)	02	R
998 S Bayliss/Bostrom	02	R
998 S (998cc) (4 pad caliper)	02-04	R
998 (998cc) (2 pad caliper) (Monoposto/Biposto)	02-03	R
Monster 1000 Dark	03	R
Monster 1000 ie (992cc)	04-05	R
Monster 1000 S ie (992cc)	03-05	R
Monster S2R 1000 (992cc)	06-08	R

HARRISON AFTERMARKET CALIPER

Big 4 Piston (1296033)
Big 6 Piston (1296033)

HUSQVARNA

CR 125	85-86	F
XC 125	85-86	F
CR 240	85-86	F
CR 250	85-86	F
XC 250	85-86	F
CR 500	85-86	F
XC 500	85-86	F
TC 510	87-88	F
TE 510	87-88	F
TX 510	87-88	F

IRON PEGASUS AFTERMARKET CALIPER

Small caliper (Single Pin Fixing)

ISR AFTERMARKET CALIPER

22-025-XX (4 Piston)
22-027 (2 Piston Rear)
22-028 (2 Piston)
22-029 (Rear 2 Piston)

KTM

GSXC/GS 125	85	F
MX/MXC 125	85	F
MX/MXC/GS 125	86	F & R
GS 250	86	F & R
GSXC/GS 250	85	F
MX/MXC 250	85	F
MX/MXC 250	86	F & R
GSXC/GS 300	85	F
MX/MXC 300	85	F
MX/MXC/GS 300	86	F & R
MX/MXC/GS 350	86	F & R
MX/MXC/XC-GS 500	85	F

LAVERDA

Alpine 500/Montjuic	76	F & R
650 Sport	94-95	R
668 Diamante/Ghost/Strike	96-98	R
750 Strike Bifaro/Monofaro	98-00	R
750 S Formula/Sport	98-00	R
750 S Carenta	98-00	R

MAICO/M-STAR

Front Disc Models

MONTESA

314 R	94-96	R
315 R	97-00	R

MOTO GUZZI

V35/35II/35III (350)	77-87	F & R
V 35 C (350)	82-86	F & R
V 35 Florida (350)	86-90	F & R
NTX 350	87-90	F & R
350 Nevada	92-97	F & R
350 Nevada Club	98-99	F & R
V 50/50 III (500)	77-84	F & R
V 50 C (500)	82-86	F & R
NTX 650	87-90	F & R
V 65 C (650)	82-85	F & R
V 65 Florida (650)	86-92	F & R
V 75 (750)	92-96	F & R
750 SP	90-92	F & R
750 Targa	90-92	F & R
Nevada 750	91-97	F & R
750 Nevada Club (Up To LK112433)	98-01	F & R
750 Nevada Club (From LK112434)	98-01	F
Daytona 1000	92-95	R
Daytona 1000 RS	97-98	R
V10 Centauro	97-99	R
Sport 1100	94-99	R
Sport Corsa 1100	98-99	R
V 11 Sport/Scuro/Naked	99-00	R
V11 Le Mans Series	01-06	R

MZ

Skorpion Tour/Traveller	95-02	R
-------------------------	-------	---

PRO ONE

2 piston

TM (DIRT)

SMM 125 Black Dream (2T)	04-08	R
SMM 450 Black Dream ES (4T)	05-08	R
SMM 530 Black Dream ES (4T)	05-08	R

SFA47 ONLY

BETA

Eikon 150	04	F
-----------	----	---

MALAGUTI

F18 (150cc)	02-04	F
Ciak 150	02-03	F

FA47/2

KTM

80 MX	86-92	F
-------	-------	---

BUYERS GUIDE
BRAKE PADS

NOTE:- Size identification is shown as follows
Dimension 1=Width or Diameter, Dimension 2=Height or Diameter, Dimension 3=Thickness (Material and backplate)

FA47 Contd. FA47/2 Contd.

STD	FA47	Premium Organic Street Pad Blend
OPTIONS	FA47HH	Street Performance Sintered Pad Blend
	FA47R	Utility Grade Sintered Pad Blend
	FA47X	Carbon Dual Purpose Pad Blend
	SFA47	Premium Organic Scooter Pad Blend
	SFA47HH	Scooter Performance Sintered Pad Blend
STD	FA47/2	Premium Organic Off Road Pad Blend

Equivalents OE#

8103662	8113222	8000 39730	19654600	000 316546600
8113016	8113323	8000 46147	19654601	000 276546100
8113064	8113662	323 627	491 13 409 044	047 002 00037
8113118	19654600	326 446	613 4 008 1A	612 4 054 1A
8113196	8000 29070	341 170	613 4 007 1A	613 4 073 1A

Dealer Stocking Recommendation

Single/Pair	Popularity #	Rec Stocking Level
1	-	FA47 - 1 FA47/2 - 0

FA51



SUZUKI

GN 250 J	88	F
GS 250 TT/TX	80-81	F
GN 400 T/XT/XX/TX/TZ	80-82	F
GS 450 ET/ST/EX/SX/EZ/ED	80-83	F
GS 450 GAZ/GAD/GAF	82-85	F
GS 450 LT/LX/LZ/LD/LF/LG/LH/LJ	80-88	F
GS 450 TX/TZ	81-82	F
GS 450 TXZ	82	F
GS 700 EF/ESF	85	F
GV 700 GLF/GLF2	85	F
GS 750 ET/EX/EZ (16 Valve)	80-82	F
GS 750 LT/LX (16 Valve)	80-81	F
GS 750 TZ/TD (16 Valve)	82-83	F
GS 750 ED/ESD	83	F
GS 850 GT/GX/GLX/GLZ/GLD/GZ/GLD/GD	80-83	F
GS 1000 GT/GX	80-81	F
GS 1000 GLT/GLX	80-81	F
GS 1100 GZ/GD	82-83	F
GS 1100 GLZ/GLD	82-83	F
GS 1100 GKZ/GK2/GKD	82-83	F
GV 1200 GLF/GLF2/GLG 'Madura'	85-86	F

Equivalents OE#

59130 45230	59302 45840
59300 38310	59300 05810
59301 45810	59300 05811
59301 45811	59330 38300
59301 45850	

STD	FA51	Premium Organic Street Pad Blend
OPTIONS	FA51V	Semi Sintered Long Lasting Street Pad Blend

Dealer Stocking Recommendation

Single/Pair	Popularity #	Rec Stocking Level
2	S16	2

BUYERS GUIDE
BRAKE PADS

NOTE:- Size identification is shown as follows
Dimension 1=Width or Diameter, Dimension 2=Height or Diameter, Dimension 3=Thickness (Material and backplate)

FA54



41.3 x 45 x
7.5mm

Equivalents OE#

43082 1201	43082 1028	3GD W0045 00
45105 166 007	43082 1201	5LP W0045 00
45105 GE3 601	43082 1212	59100 38870
45105 GE3 602	43082 1241	59100 38880
45105 GC4 601	59300 42810	59101 38810
45105 GC4 602	59300 44870	59101 38820
45105 GW6 004	59340 13A00	59101 38850
45112 GC4 601	59340 22A00	59101 38860
45112 GC4 831	59340 42A10	K4308-21241
800070854	59340 42A00	69301 HP8900
43082 0043	59340 44A00	59301 HP8900

STD	FA54X	Carbon Dual Purpose Pad Blend
	FA54R	Utility Grade Sintered Pad Blend
OPTIONS	FA54SV	High Durability Off Road Sintered Blend
	MXS54	Sintered Sport Off Road Pad Blend
	SFA54	Premium Organic Scooter Pad Blend
	SFA54HH	Scooter Performance Sintered Pad Blend

Dealer Stocking Recommendation

Single/Pair	Popularity #	Rec Stocking Level
1	FA54R - H9/S15/Y14 FA54X - H10/Y8/S11	FA54R - 3 FA54X - 4

HONDA

MB 5	82	F
CG 125 ES12/ES2/3/4 (VC30)	01-04	F
ATC* 250 R	81-82	F

* - ATC is a Registered Trademark of Honda Motor Corporation

HYOSUNG

TE 450 S	07-12	F
KAWASAKI		
KX 65 A1/A2/A3/A4/A5/A6F/A7F/A8F/A9F/AAF/ABF/ACF/ADF/AEF/AF/AGF/AHF	00-17	R
Z 125 Pro (BR125 JHF)	17	R
KLX 150 S	09	R
KVF 300 A1-A4/B1-B4 'Prairie'	99-02	F
KVF 360 A1/A2/A3/A6F/A7F/A8F/A9F/AAF/ABF/ACF Prairie 360 4x4	03-12	F
KVF 360 B1/B2/B3/B6F/B7F/B8F/B9F Prairie 360	03-09	F
KVF 360 C1/C2/C3/C6F/C7F/C8F/C9F/CAF/CBF Prairie 360 4x4 Hardwoods Green HD	03-11	F
KVF 400 C1-C4/D1-D4	99-02	F

SUZUKI

RM 65 K3/K4/K5	03-05	R
DR 125 G/H/J/SER/SES/SET	86-96	F
SP 125 G/H/J	86-88	F
DR 200 G/H/J/SET/SEV/SEW/SE/SEY/SEK1/SEK2/SEK3/SEK4/SEK5/SEK6/SEK7/SEK8/SEK9/SEL3/SEL5/SEL6	86-88/96-09/13/15-16	F
SP 200 G/H/J	86-88	F
DR 250 F	85	F
LT-F 250 K2/K3/K4/K5/K6/K7/K8/K9/L2/L3/L4 Ozark	02-14	F
LT-F 4WD V/W Quadrunner 4WD (250cc)	97-98	F
SP 250 F	85	F
SP 250 F	85	F
LT-A 400 K2/K3/K4/K6/FCK5/FCK6/FCK7 Eiger	02-04/06	F
LT-A 400 FK2/FK3/FK4/FK5/FK6/FK7	02-07	F
LT-F 400 FK2/FK3/FK4/FK5/FK6/FCK6/FCK7/FK7 (Eiger 4WD Auto)	02-07	F
LT-F 400 K3/4/5/6/7	03-08	F
LT-A 500 FK2/FK3/FK4/FCK5/FK5/FCK6/FK6/FCK7/FK7 Vinson 4WD	02-07	F
LT-F 500 FK3/FK4/FK5 Vinson Quadrunner	03-06	F

YAMAHA

YFM 125 RA/RB/RD Raptor	11-13	F
YFS 200 R/S/T/V Blaster	03-06	F
YFM 250 XN/XHN/XP/XHP/XR/XHR/XS	01-04	F
YFM 250 BT/BV Bruin	05-06	F
YFM 250 BW/BX/BY Big Bear	07-09	F
YFM 350 XW/XA/XB/XD/XE/XF/XG/XH/XJ/XK/XL/XM/XN/XP/XR/XS Warrior	89-04	F
YFZ 350 A/B/D/E/F/G/H/J/K/L/M/N/P/R/S/T/V	90-06	F
YFM 350 FXG/FXH/FXJ/FXK/FXL/FXM/FXN/FXP/FXR/FXS/FXT	95-05	F
YFM 350 AS/AT Bruin 2x4	04-05	F
YFM 350 FAS/FAT Bruin 4x4	04-05	F
YFM 350 FWBL/LC Big Bear	99	F
YFM 350 UL/ULC	99	F
YFM 350 GW/GX/GY/GZ/GA Grizzly 2x4 (2WD)	07-11	F
YFM 350 XV/XW/XX/XY Wolverine (2WD)	06-09	F
YFM 350 FGIW/FGIX/FGIY/FGIZ/FGIA Grizzly Auto IRS 4x4	07-11	F
YFM 350 FGW/FGX/FGY/FGZ/FGA/FGB/FGD Grizzly Auto 4x4	07-13	F
YFM 400 FWBM/FWBN "Big Bear"	00-01	F
YFM 400 FAM/FAN/FAP Kodiak	00-02	F
YFM 400 AM/AN	00-01	F
YFM 400 NM/NMC/NN/NHN/P/HP	00-02	F
YFM 400 FAHM/MC/NC/P Kodiak 4x4 Kodiak Hunter	00-02	F
YFM 400 FWNM/FMC/FWNN/FWNN/FHP/FP/FR/FS/FT/FV Big Bear 4WD	00-06	F
YFM 400 NR/NS (2x4) Big Bear	03-04	F
YFM 400 FAR/FAS Kodiak Auto	03-04	F
YFM 400 AR/AS Kodiak 2WD	03-04	F
YFM 400 FAS/FAT/FAHT/FAV Kodiak 4WD	04-05	F
YFM 400 S Big Bear 2WD	04	F
YFM 400 FS/FT Big Bear 4WD	04-05	F
YFM 400 FWBL Kodiak	99	F
YFM 400 FGW/FGX Grizzly 4x4	07-08	F
YFM 400 FBHW/FBHX/Y/Z Big Bear 400 Hunter IRS	07-10	F
YFM 400 FBEW Big Bear 400 IRS Exploring Edition	07	F
YFM 400 FBW/FBX/FBY/FBA/FBB Big Bear 4WD IRS	08-12	F
YFM 450 FAT/FAHT/FAV Kodiak 4WD	05-06	F
YFM 450 FGW/FGX Grizzly 4x4	07-08	F
YFM 450 FXV/FXW/FXX/FXY/FXZ Wolverine Auto 4x4	06-10	F
YFM 450 FXSEW Wolverine Sport Special Edition	07	F
YFM 450 FGW Grizzly Auto 4x4 IRS	07	F
YFM 450 FGX/FGY/FGZ/FGA/FGB/FGD Grizzly 450 Auto 4x4	08-13	F
YFM 450 FGPA/B/D (Grizzly 450 Auto/4x4/EPS)	11-13	F

POLARIS

Trail Boss	87	F
------------	----	---

SYM

Quadlander 600	08-10	F
----------------	-------	---

U.M (United Motors)

MTX 450	08	F&R
---------	----	-----

SFA54

DAELIM

Cordi 50	01-09	F
History 125	01-09	F&R
S1-125	06-09	R

SACHS

Madass 50	09	R
Madass 125	10-11	R

U.M (United Motors)

Matric 150 XX	05-06	F
Powermax 150 XX	05-06	Fa

BUYERS GUIDE
BRAKE PADS

NOTE:- Size identification is shown as follows
Dimension 1=Width or Diameter, Dimension 2=Height or Diameter, Dimension 3=Thickness (Material and backplate)

FA55

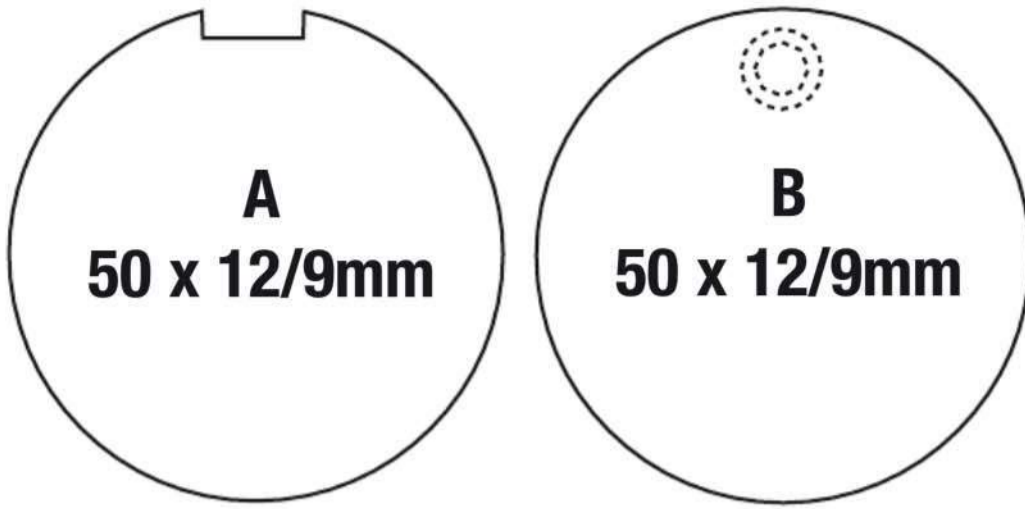

KAWASAKI

Z1 A/B 900	73-75	F
HI-D/HI-E/HI-F 500	73-75	F
H2/H2-A Mach IV	72-73	F
H2-B/H2-C Mach IV	74-75	F

SUZUKI

RE 5 M/A (Rotary)	75-76	F
GT 185 L/M/A/B Adventurer	74-76	F
GT 250 K/L Hustler	73-74	F
GT 250 M/A/B Hustler	75-77	F
GT 380 K/L/M/A/B Sebring	73-77	F
GT 550 K/L/M Indy	73-75	F
GT 550 A/B Indy (Tokico Caliper)	76-77	F
GT 750 K/L/M/A/B "Le Mans"	73-77	F

Equivalents OE#

59100 18840	59100 31830	43051 001
59100 18841	59100 31831	43082 001
59100 36830/1	59300 18810	
59100 39810	59300 36840	

STD FA55 Premium Organic Street Pad Blend

Dealer Stocking Recommendation

Single/Pair	Popularity #	Rec Stocking Level
2	K24	2

FA57



BMW

R45/45 N (with ATE calipers)	78-85	F
R 45 T	80-85	F
R 65 LS	81-85	F
R 65 T	80-85	F

Equivalents OE#

34 22 3 302 359
34 11 1 238 083

STD FA57 Premium Organic Street Pad Blend

OPTIONS FA57V Semi Sintered Long Lasting Street Pad Blend

Dealer Stocking Recommendation

Single/Pair	Popularity #	Rec Stocking Level
2	-	2

FA58 Use FA161

FA60

APRILIA
RS 50 (Replica)
RX 50/RX 50 Replica
MX 50

99-05 R
04 R
04 R



Equivalents OE# 8213104

STD FA60 Premium Organic Street Pad Blend

**BUYERS GUIDE
BRAKE PADS**

FA61 NOTE: Marked with green tag to avoid confusion with FA41



YAMAHA

XJ 650 G/H/J/K 'Maxim'	80-83	F
XJ 650 LH 'Midnight'	81	F
XS 750 SE/SF Left	78-79	F
XV 750 H/J/K/MK Virago	81-83	F
XS 850 LG/LH/SG/SH Left	80-81	F
XV 920 K/MK 'Virago'	83	F
XS 1100 SF/SG/SH Left	79-81	F
XS 1100 LG 'Midnight Special' Left	80	F

Equivalents OE#

2G2 W0045 01	3J6 W0045 11	4H7 W0045 12
2G2 W0045 10	4H7 W0045 00	4W5 W0045 00
3J6 W0045 10	4H7 W0045 10	

STD FA61 Premium Organic Street Pad Blend
OPTIONS FA61V Semi Sintered Long Lasting Street Pad Blend

Dealer Stocking Recommendation

Single/Pair 1	Popularity # Y4	Rec Stocking Level 6
-------------------------	---------------------------	--------------------------------

FA62



KAWASAKI

KZ 1000 E1/E2 ST & Shaft	79-80	F
KZ 1300 A1/A2/A3/A4	79-82	F
KZ 1300 B2 'Touring'	80	F

Dealer Stocking Recommendation

Single/Pair 2	Popularity # K24	Rec Stocking Level 2
-------------------------	----------------------------	--------------------------------

STD FA62 Premium Organic Street Pad Blend

Equivalents OE#

43082 1004
43082 1058

**NOTE:- Size identification is shown as follows
Dimension 1=Width or Diameter, Dimension 2=Height or Diameter, Dimension 3=Thickness (Material and backplate)**

FA63



**52.6 x 53
x 9mm**

SUZUKI

GSF 400 M/N/P Bandit	91-93	R
GS 500 EK/EL/EM/EN/EP/ER/ES/ET/EV/EW/EX/EY/K1/K2/K3/FK4-FK9/FLO	89-10	R
GS 550 LD/LF/LG	83-86	F
GS 550 ED/ESD/ES3/ES/EF/ESF/ESG	83-86	F & R
RF 600 RR/RS/RT/RV	94-97	R
GSX 600 FJ/FK/FL/FM/FN/FP/FR/FT/FW/FX/FY/FK1/FK2/FK3/FK4 /FK5/FK6 'Katana'	88-06	R
GSX-R 600 WN/WP	92-93	R
GSF 600 Bandit ST/SV/SW	96-98	R
GSF 600 SY/SK1/SK2/SK3	00-03	R
GSXR 600 V/W/X/Y/K1/K2/K3/ZK3	97-03	R
SV 650 X/Y/K1/SK1/K2/SK2	99-02	R
GSX 750 FK/FL/FM/FN/FP/FR/FS/FT/FV 'Katana'	89-97	R
GSX 750 FW/FX/FY/FK1/FK2/FK3/FK4/FK5/FK6 Katana	98-06	R
GSXR 750 RG/G/H/J/K/L/M/N/WP	86-93	R
GSX-R 750 WR/WS/T/V/W/X	94-99	R
GSXR 750 Y/K1/K2/K3	00-03	R
RF 900 RT/RV	96-98	R
TL1000 SV/SW/SX/SY/SK1	97-01	R
TL 1000 RW/RX/RY/RK1/RK2/RK3	98-03	R
GSXR 1100 G/H/J/K/L/M/N	86-92	R
GSXR 1100 WP/WR/WS/WT/WV/WW/WW	86-98	R
GSF 1200 Bandit SV/SAV/SW/SAW/SX/SAX/SY/SK1/SK2/SK3/K1/K2 /K3/SK4/SK5	97-05	R
GSX 1300 RX/RY/RK1/RK2/RZK3/RK4/RZK4/RK5/RZK6/RK6 Hayabusa	99-06	R

Equivalents OE#

59100 16820	59130 16750	69130 06B00	69100 05830	69130 30B21	69100 05860
59100 16830	59130 16810	69130 16700	69100 05890	69130 33C00	69101 05820
59130 16700	59130 30B00	69130 16740	69100 06810	69130 21820	
59130 16720	59130 30B10	69130 20A10	69100 20810	69130 34C00	
59130 16730	59130 30B20	69130 20810	69100 34860	69100 20810	
59130 16740	69100 21820	69130 21E00	69130 27A10	69100 05870	

STD	FA63	Premium Organic Street Pad Blend
OPTIONS	FA63HH	Street Performance Sintered Pad Blend
OPTIONS	FA63V	Semi Sintered Long Lasting Street Pad Blend

Dealer Stocking Recommendation

Single/Pair	Popularity #	Rec Stocking Level
2	S1	10

FA65



**71.6 x 45.2
x 11.5mm**

SUZUKI

GS 550 ET	80	F
GS 550 MZ	82	F
GS 550 LT/LX	80-81	F
GS 550 LZ	82	F
GS 550 TX	81	F
GR 650 D/XD Tempter	83	F
GS 650 EX/EZ	81-82	F
GS 650 GX/GZ/GD	81-83	F
GS 650 GLX/GLZ/GLD	81-83	F
GS 650 MD	83	F
XN 85 D (673cc)	83	F
GS 750 SD	83	F
GS 1000 ET/ST/SZ	80-82	F
GS 1100 ET/EX/EZ/ED/ESD	80-83	F
GS 1100 LT	80	F
GS 1100 SD	83	F

Equivalents OE#

59300 49820
59300 49821
59300 49850

STD	FA65	Premium Organic Street Pad Blend
OPTIONS	FA65V	Semi Sintered Long Lasting Street Pad Blend

Dealer Stocking Recommendation

Single/Pair	Popularity #	Rec Stocking Level
2	S23	2

FA67

FA67/3



FA67

CAGIVA

WMX 125/250 89-91 R

CF MOTO

500 U-Force EPS 14-16 R

800 U-Force 13-17 R

GOGORO

SmartScooter 15-17 R

KAWASAKI

KX 125 B2/C1/D1 83-85 F

KX 125 E1 86 F & R

KX 125 E2/F1 87-88 R

KDX 200 C1-C3/E1-E4 86-92 F

KL 250 D2-D22 (KLR 250) 85-05 F

KL 250 G4/G5/G6/G7/G8 "Super Sherpa" 00-04 R

KX 250 C1/C2/D1 83-85 F

KX 250 D2 86 F & R

KX 250 E1/F1 87-88 R

KXT 250 A2/B1 'Tecate' 85-86 F & R

KXT 250 B2 'Tecate' 87 F

KLF 300 B1-B17 Bayou 88-04 F

KX 500 A1/A2/B1 83-85 F

KX 500 B2 86 F & R

KX 500 C1/D1 87-88 R

KL 600 A1/B1/B2 (KLR) 84-86 F

KL 650 A1-A19/A6F/A7F (KLR) 87-07 R

KL 650 B2/B3 (TENGA) 90-91 R

KTM

D-XC/E-XC/E-GS 125 90-91 F & R

D-XC/E-XC/E-GS 125 92-93 R

EXC 125 Brembo Calipers 89 F & R

MX 125 Brembo Calipers 89-91 F & R

MX 125 92-93 R

D-XC/E-XC/E-GS 250 Brembo Calipers 91 F & R

D-XC/E-XC/T-XC/E-GS 250 Grimeca 92-93 R

EXC/EGS 250 Brembo Calipers 89 F & R

MX 250 Brembo calipers 89-91 F & R

MX 250 Brembo calipers 93 R

DXC/EXC/EGS 350 Brembo calipers 90-91 F & R

EXC 350 Brembo calipers 89 F & R

MX 350 Brembo calipers 90-91 F & R

LC-4 MX/EXC 500 Brembo calipers 90-91 F & R

MX 500 92-94 R

LC4 MX/EXC 600 Brembo calipers 90-91 F & R

LC4 EXC 600 92-93 R

SX 620/EXC/EGS 94 R

MAICO/M-STAR

MX 500 95 R

POLARIS

200 Phoenix Quadricycle (EA/EB/Rear Disc Model) 05 R

200 Phoenix Quadricycle (EC/ED/Rear Disc Model) 05-09 R

SUZUKI

GSXR 50 (RB 50 H) 87 F

GN 125 EM/EN/EP/ER/ES/ET 91-96 F

YAMAHA

YFM 90 RZ/RA/RB/RD Raptor 10-13 R

YFM 300 GB/GD Grizzly 12-13 R

FA67/3

KAWASAKI EX 500 D1-D12/D6F/D7F/D8F/D9F 94-09 R

43050 1063	43082 1070	59130 26820	59300 36821	0453812
43050 1064	43082 1073	59300 04830	59300 36822	0452883
43050 1073	43082 1084	59300 04831	59300 36871	0453201
43050 1082	43082 1092	59300 04850	59301 33810	0453200
43082 1027	43082 1096	59300 26830	59301 39810	7030 081520
430821031	43082 1209	59300 33810	59301 39811	7030 0855A0
43082 1051	59100 33810	59300 36810	59301 39812	
43082 1063	59100 33812	59300 36811	1SC F5806 00	
43082 1064	59100 33820	59300 36820	43D F5906 01	

Equivalents OE#

FA67

Equivalents OE#

FA67/3

Equivalents OE#

FA67/2

238 07 6340

240 07 6340

43082 1056

43082 1067

43082 1116

43082 1163

STD	FA67	Premium Organic Street Pad Blend
OPTIONS	FA67HH	Street Performance Sintered Pad Blend
	FA67SV	High Durability Off Road Sintered Blend
	FA67X	Carbon Dual Purpose Pad Blend
	FA67R	Utility Grade Sintered Pad Blend
STD	FA67/3	Premium Organic Street Pad Blend

Dealer Stocking Recommendation

Single/Pair	Popularity #	Rec Stocking Level
2	K8	FA67X - 6
		FA67R - 6
		FA67/2 - 0
		FA67/3 - 0

FA68



**67.8 x 40.7
x 9.5mm**

Equivalents OE#

43082 1007	43082 1025
43082 1008	43082 1026
43082 1021	
43082 1022	

STD	FA68	Premium Organic Street Pad Blend
OPTIONS	FA68HH	Street Performance Sintered Pad Blend
	FA68V	Semi Sintered Long Lasting Street Pad Blend

Dealer Stocking Recommendation

KAWASAKI			
KZ 305 A1/A2 (CSR)	81-82	F	
KZ 305 B1 (CSR)	82	F	
KZ 305 B2/B3 (LTD)	87-88	F	
KZ 440 A4	83	F	
KZ 440 D5 (LTD)	83	F	
KZ 440 G1	82	F	
KZ 550 A2/A3/A4	81-83	F	
KZ 550 C1/C2/C3/C4 (LTD)	80-83	F	
KZ 550 D1 (GPz)	81	F & R	
KZ 550 F1 (Spectre) F2 (LTD)	83-84	F	
KZ 550 H1/H2 (GPz)	82-83	F & R	
KZ 550 M1 (LTD)	83	F	
KZ 650 H1/H2/H3 (CSR)	81-83	F	
KZ 700 A1	84	F & R	
KZ 750 E1/E2/E3	80-82	F & R	
KZ 750 F1 (LTD)	83	F & R	
KZ 750 H1/H2/H3/H4 (LTD)	80-83	F & R	
KZ 750 L3	83	F & R	
KZ 750 M1 (CSR)	82	F	
KZ 750 N1/N2 'Spectre'	82-83	F & R	
KZ 750 R1 (GPz)	82	F & R	
KZ 1000 J1/J2/J3	81-83	F & R	
KZ 1000 K1/K2 (LTD)	81-82	F & R	
KZ 1000 M1/M2 (CSR)	81-82	F & R	
KZ 1000 P1-P20 'Police'	82-01	F & R	
KZ 1000 P21-P22 'Police'	02-03	R	
KZ 1000 R1/R2 'Replica'	82-83	F & R	
KZ 1100 A1/A2/A3	81-83	F & R	
KZ 1100 B1/B2 (GPz)	81-82	F & R	
KZ 1100 D1/D2 'Spectre'	82-83	F & R	
KZ 1100 L1 (LTD)	83	F & R	

Single/Pair	Popularity #	Rec Stocking Level
2	K5	6

FA69

FA69/2

FA69/3



FA69 90 x 49 x 10mm
FA69/2 90 x 49 x 9mm
FA69/3 90 x 49 x 11.3mm

HONDA

CN 250 Helix	86-87	F
CB 450 SC 'Nighthawk'	83-86	F
CMX 450 C Rebel	86-87	F
CX 500 C Custom	82	F
CX 500 TC Turbo	82	F & R
FT 500 'Ascot'	82-83	F & R
GB 500	89-90	F
GL 500 Silverwing	81-82	F
VT 500 C 'Shadow'	83-86	F
VT 500 FT 'Ascot'	83-84	F
VF 500 C 'V30 Magna'	84-85	F
VF 500 F 'Interceptor'	84-86	F & R
CB 550 SC 'Nighthawk'	83	F
XL 600 V Transalp	89-90	F
CB 650	82	F
CB 650 SC 'Nighthawk'	83-85	F
CX 650 C 'Custom'	83	F
CX 650 T 'Turbo'	83	F & R
GL 650 Silverwing/GL 650 Silverwing Interstate	83	F
CB 700 SC/S 'Nighthawk'	84-86	F

HONDA Contd.

VF 700 C 'Magna'	84	F
VF 700 C 'Magna'	85-86	F
VF 700 F 'Interceptor'	84-85	F
VF 700 S 'Sabre'	84-85	F
VT 700 C Shadow	86-87	F
CB 750 F Supersport	81-82	R
CB 750 SC 'Nighthawk'	82-83	F
VF 750 C 'V45 Magna'	82-83	F
VF 750 F 'V45 Interceptor'	83-84	F
VF 750 S 'Sabre'	82-83	F
VT 800 C Shadow	88	F
CB 900 C Custom	82	R
CB 900 F Supersport	81-82	R
CBX	81-82	R
CB 1000 C Custom	83	F & R

NOTE:- Size identification is shown as follows

Dimension 1=Width or Diameter, Dimension 2=Height or Diameter, Dimension 3=Thickness (Material and backplate)

FA69 Cont/...

HONDA Contd.

VF 1000 F 'Interceptor'	84	F
VF 1000 R	85-86	F
CB 1100 F Supersport	83	F & R
GL 1100/1100 I Goldwing/Interstate	82	R
GL 1100/1100 I Goldwing/Interstate	83	F & R
GL 1100 A Goldwing Aspencade	82-83	R
VF 1100 C V65 Magna	83-86	F
VF 1100 S V65 Sabre	84-85	F
VT 1100 C Shadow	85-86	F

FA69/2

HONDA

CN 250 Helix	92-93	F
CM 400 C Custom	81	F
CM 450 C Custom (to CM 001211)	82	F
CM 450 A Hondamatic	82	F
GL 500 I Silverwing Interstate	81-82	F
CB 750 C Cus tom	82	F
CB 750 F Supersport	81-82	F
CB 900 C Custom	82	F
CB 900 F Supersport	81-82	F
CBX	81-82	F
GL 1100/1100 I Goldwing/Interstate	82	F

FA69/3

HONDA

CBR 600 F 'Hurricane'	87-90	R
VF 700 F 'Interceptor'	84-85	R
VF 700 C Magna	87	F
VFR 700 F/F2 'Interceptor'	86-87	R
VF 750 F V45 'Interceptor'	83-84	R
VFR 750 F 'Interceptor'	86	R
VF 750 C V45 Magna	88	F
CBR 1000 F (Hurricane)	87-88	R
VF 1000 F 'Interceptor'	84	R
GL 1100 A Goldwing Aspencade	82-83	F
VF 1100 C 'V65 Magna'	83-86	R
VF 1100 S 'V65 Sabre'	84-85	R
VT 1100 C Shadow	87-93	F
GL 1200/1200 I/1200 A Goldwing	84-85	F & R
GL 1200 L Goldwing	85	F & R
GL 1200 I/1200 A/GL12SE-i Goldwing	86-87	F & R
GL 1500 Goldwing All models	88-89	R
GL 1500/1500 SE/A/I Goldwing	90-00	R

Dealer Stocking Recommendation

Single/Pair	Popularity #	Rec Stocking Level
2	FA69 - H1	FA69 - 10
	FA69/2 - H16	FA69/2 - 2
	FA69/3 - H2	FA69/3 - 10

Equivalents OE# - FA69

06455 MA3 405	43105 MA3 004	43105 MJ6 004	45105 MB0 008	45105 MK4 004
451A0 MM9 670	43105 MA3 007	43105 MJ6 007	45105 MB1 701	45105 MK6 671
431A0 MC7 024	43105 MC7	43105 MJ6 014	45105 MB1 702	45105 MK7 671
451A0 MM9 670	004/007/024	45105 MA6 671	45105 MC4 004	45105 MK7 672
43105 KE7 702	43105 MC7 014	45105 MB0 007	45105 MJ1 672	45105 MM9 781

Equivalents OE# FA69/2

06455 443 405	45105 443 761	006/016/026
45105 KL8 405	45105 443 762	45105 KN8 712
45105 KL8 405	45105 KL8 004	45105 MC7 004
43105 KN8 007	45105 KL8 007	45105 MC7 007
43105 MJ6	45105 KL8 014	45105 MC7 014
721/722/723	45105 KL8 712	45105 MC7 024
43105 MJ6 724	45105 KN8 007/	

Equivalents OE# FA69/3

06455 MT8 405	43105 ML7 006
06435 ML7 405	43105 ML7 007
43105 MB4 007/017	43105 ML7 017
43105 MB4 008	43105 ML7 027
43105 MB6 018/008	43105 MN5 008
43105 MG9 007/017	43105 MT8 008

STD FA69 Premium Organic Street Pad Blend

OPTIONS FA69HH Street Performance Sintered Pad Blend

OPTIONS FA69V Semi Sintered Long Lasting Street Pad Blend

STD FA69/2 Premium Organic Street Pad Blend

OPTIONS FA69/2V Semi Sintered Long Lasting Street Pad Blend

STD FA69/3 Premium Organic Street Pad Blend

OPTIONS FA69/3HH Street Performance Sintered Pad Blend

OPTIONS FA69/3V Semi Sintered Long Lasting Street Pad Blend

Dimension 1=Width or Diameter, Dimension 2=Height or Diameter, Dimension 3=Thickness (Material and backplate)

FA70

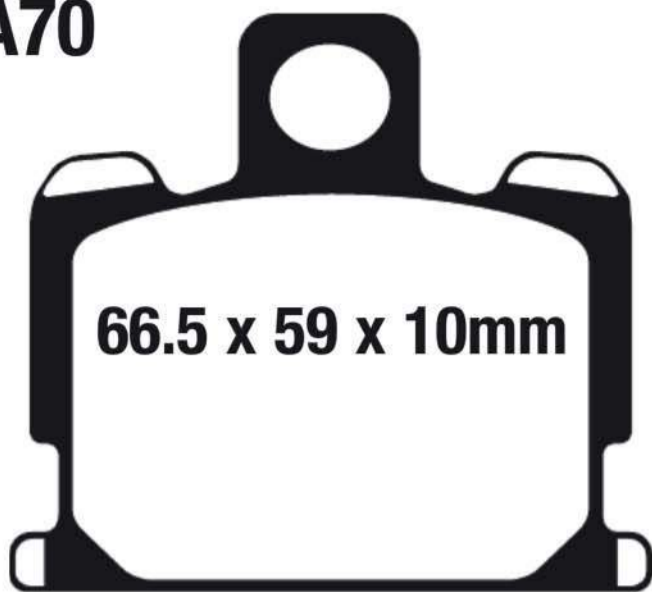

66.5 x 59 x 10mm

YAMAHA

RX 50 MK/K/L	83-84	F
XJ 550 H/J/K 'Maxim'	81-83	F
XJ 550 RH/RJ/RK 'Seca'	81-83	F
XJ 750 RH/RJ/RK 'Seca'	81-83	F
XV 920 J 'Virago'	82	F
XJ 1100 J	82	F
XS 1100 LH 'Midnight Special'	81	F

Equivalents OE#

23W W0045 01	4L3 W0045 00	4W1 W0045 00	4W1 W0045 20
23W W0045 10	4L3 W0045 10	4W1 W0045 00	4W1 W0045 30

STD FA70 Premium Organic Street Pad Blend
OPTIONS FA70V Semi Sintered Long Lasting Street Pad Blend

Dealer Stocking Recommendation

Single/Pair 2	Popularity # Y11	Rec Stocking Level 2
-------------------------	----------------------------	--------------------------------

FA71



69.5 x 53.8
x 6.5mm

1 Left pad / 1 Right pad

HARLEY DAVIDSON

FX, FXE, FXEF, FXWG, FXS	Late 78-83	F
XL, XLH, XLCH, XLS, XLX	79-83	F
FXD/FXDL/FXDWG/FXR/FXRS/FXRT/FXRD/FXLR	82-83	F

Equivalents OE#

44032 77
44032 79

Dealer Stocking Recommendation

Single/Pair 2	Popularity # HD4	Rec Stocking Level 4
-------------------------	----------------------------	--------------------------------

STD FA71 Premium Organic Street Pad Blend
OPTIONS FA71V Semi Sintered Long Lasting Street Pad Blend

FA72

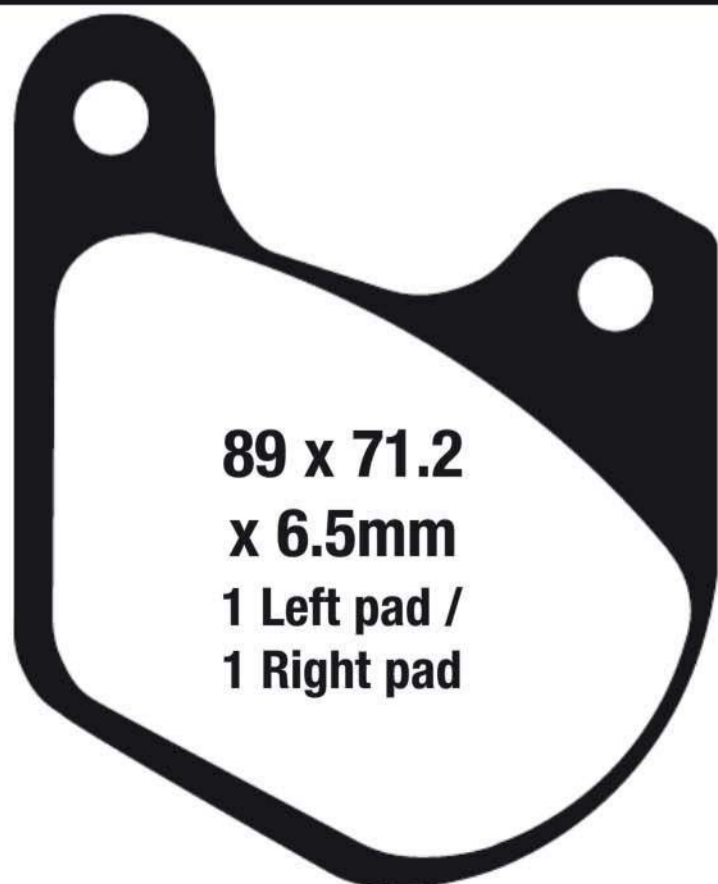

89 x 71.2
x 6.5mm
1 Left pad /
1 Right pad

HARLEY DAVIDSON

XL, XLH, XLCH, XLS, XLX	79-81	R
FLT, FLHT, FLHTC	80-83	F

Equivalents OE#

43395 80

Dealer Stocking Recommendation

Single/Pair 2	Popularity # HD7	Rec Stocking Level 2
-------------------------	----------------------------	--------------------------------

STD FA72 Premium Organic Street Pad Blend
OPTIONS FA72V Semi Sintered Long Lasting Street Pad Blend

FA73

KAWASAKI

KZ 440 A1/A2/A3	80-82	F
KZ 440 K1/D1/D2/D3/D4 (Ltd)	80-82	F
KZ 550 A1	80	F
KZ 650 C1/C2/C3 (from F/no 023101)	77-79	F
KZ 650 D2 "SR Series"	79	F
KZ 650 E1 (Ltd)	80	F
KZ 650 F1	80	F
KZ 750 G1 (Ltd)	80	F
KZ 1000 C2/C3/C4	79-81	F
Z 1000 A3/A3A/A4	79-80	F
Z 1000 B3.B4 (Ltd)	79-80	F
Z 1000 D3 (Z1-R)	80	F
Z 1000 G1 Classic	80	F

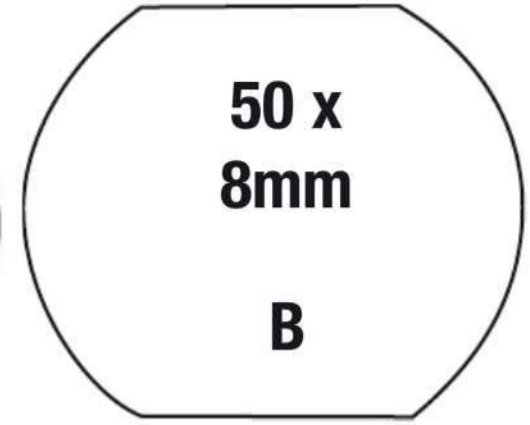

Equivalents OE#	43082 1001
	43082 1005

STD FA73 Premium Organic Street Pad Blend

Dealer Stocking Recommendation

Single/Pair	Popularity #	Rec Stocking Level
2	K26	2

FA76

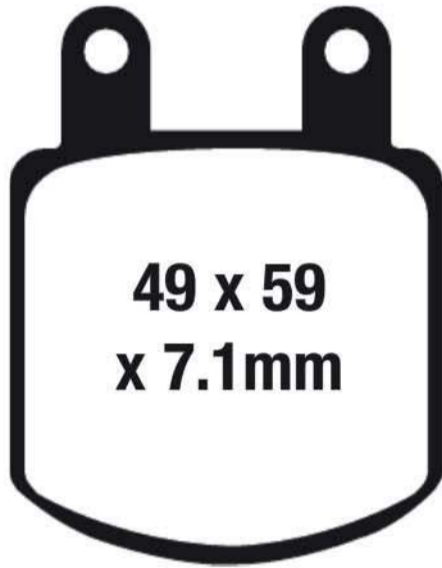

GMA AFTERMARKET CALIPER

2 Piston (small) caliper model B (CCI # 09-996)

JAYBRAKE AFTERMARKET CALIPER

Early Design 2 Piston

Equivalents OE#	310 292
	43 09 11

STD FA76 Premium Organic Street Pad Blend

OPTIONS FA76HH Street Performance Sintered Pad Blend

OPTIONS FA76V Semi Sintered Long Lasting Street Pad Blend

Dealer Stocking Recommendation

Single/Pair	Popularity #	Rec Stocking Level
1	-	1

FA77



Dealer Stocking Recommendation

Single/Pair	Popularity #	Rec Stocking Level
1	-	1

Equivalents OE#	34 11 1 354 720
	18654660

BMW

R 65	07/88-08/9	F
R 80/R 80 RT	84-95	F
R 80 GS	87-95	F
R 80 PD/CH	90-95	F
R 100 GS	86-90	F
R 100 PD	89-96	F
R 850 GS	96	F

STD FA77 Premium Organic Street Pad Blend

OPTIONS FA77V Semi Sintered Long Lasting Street Pad Blend

FA78

NOW INCLUDES SHIMS
REF SHFA78

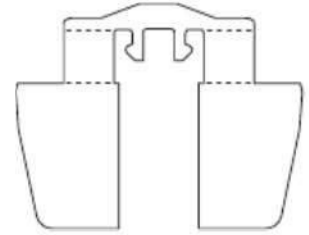

**74.2 x 49
x 12mm**

HARLEY DAVIDSON
FXST, FXSTB, FXSTC, FXSTS, FLST, FLSTC,
FLSTF, FLSTS, FLSTN
FX, FXE, FXEF, FXWG, FXS
FXWG, FXSB
XL, XLH, XLCH, XLS, XLX
FXD, FXDL, FXDWG, FXR, FXRS, FXRT, FXRD, FXLR

84-Early 87 R
84-86 R
83 R
82-Early 87 R
82-Early 87 R

Equivalents OE#	44209 82
	44209 82A

STD	FA78	Premium Organic Street Pad Blend
OPTIONS	FA78HH	Street Performance Sintered Pad Blend
	FA78V	Semi Sintered Long Lasting Street Pad Blend

Dealer Stocking Recommendation	<u>Single/Pair</u>	<u>Popularity #</u>	<u>Rec Stocking Level</u>
	1	HD6	2

FA79

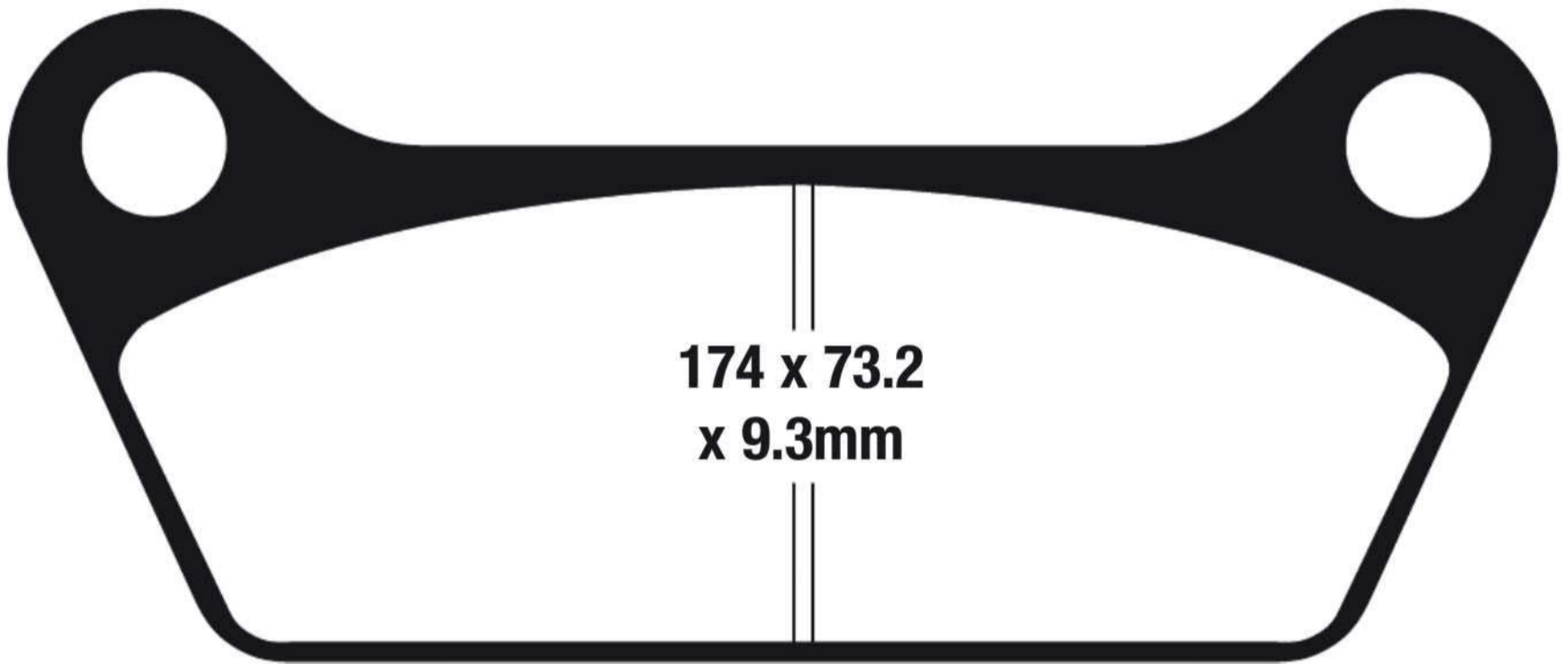

**174 x 73.2
x 9.3mm**

HARLEY DAVIDSON
FL, FLH 81-84 R
FLT, FLHT, FLHTC 80-85 R

Equivalents OE#	43957 80
-----------------	----------

STD	FA79	Premium Organic Street Pad Blend
OPTIONS	FA79V	Semi Sintered Long Lasting Street Pad Blend

Dealer Stocking Recommendation	<u>Single/Pair</u>	<u>Popularity #</u>	<u>Rec Stocking Level</u>
	1	HD7	1

BUYERS GUIDE
BRAKE PADS

NOTE:- Size identification is shown as follows
Dimension 1=Width or Diameter, Dimension 2=Height or Diameter, Dimension 3=Thickness (Material and backplate)

FA80/2

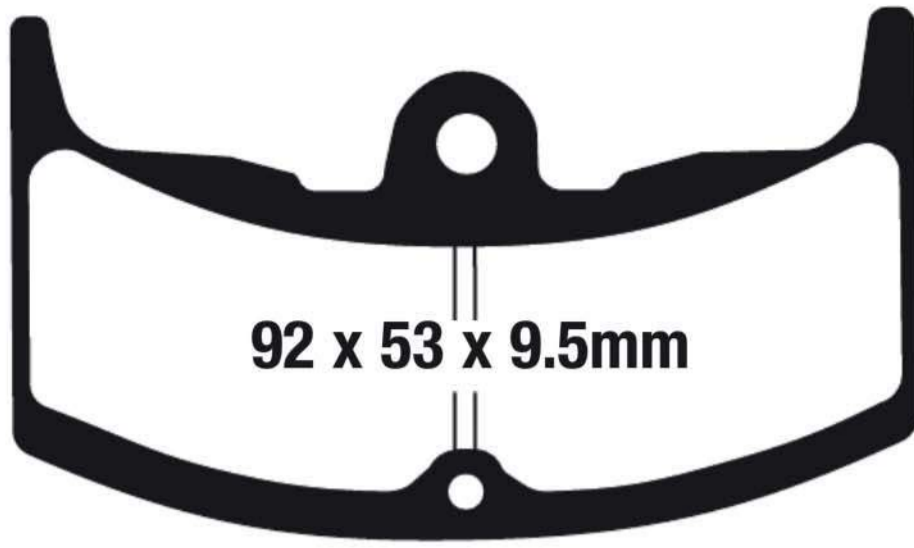

92 x 53 x 9.5mm

HONDA
VTR 250 Intceptor

88-89 F

Equivalents OE#
45105 MA6 004
45105 MA6 007

STD FA80/2 Premium Organic Street Pad Blend

Dealer Stocking Recommendation

Single/Pair	Popularity #	Rec Stocking Level
1	-	1

FA81



68 x 60 x 10.5mm

YAMAHA

RXS 115 (3HB6/7)	94-97	F
RX-Z 135 (3XL3/5PV1/5PV2)	00-05	F
RX-Z 135 (2UX/3UK1)	87-89	F
RX-Z 135 (3UK3/3RSA/3RSB)	93-97	F
XV 250 U/UC/W/WC/A/AC	88-90	F
RZ 350 L/N/NC11	84-85	F
XS 400 J/K 'Maxim'	82-83	F
XS 400 RJ/RK	82-83	F
XV 500 K 'Virago'	83	F
XZ 550 RJ	82	F
XZ 550 RK	83	F
XT 600 L/LC/N/LN/S/SC	84-86	F
XT 600 T/TC/U/UC/W/WC	87-89	F
XJ 650 LK 'Seca'	83	F
XJ 650 LJ 'Seca Turbo'	82	F
XJ 750 J/K/MK 'Maxim'	82	F

Equivalents OE#

11H W0045 00	29L W0045 00	43F W0045 00
11H W0045 01	29L W0045 10	43F W0045 01
11H W0045 11	2KJ W0045 00	4XB W0045 00
11L W0045 00	2UJ W0045 00	52R W0045 00
11U W0045 00	2UJ W0045 01	5R2 W0045 00
11U W0045 10	34L W0045 10	
22U W0045 10	3XL W0045 00	

STD FA81 Premium Organic Street Pad Blend
OPTIONS FA81R High Durability Off Road Sintered Blend

Dealer Stocking Recommendation

Single/Pair	Popularity #	Rec Stocking Level
2	Y9	2

**BUYERS GUIDE
BRAKE PADS**

**NOTE:- Size identification is shown as follows
Dimension 1=Width or Diameter, Dimension 2=Height or Diameter, Dimension 3=Thickness (Material and backplate)**

FA83 FA83/2

A. 47.5 x 37 x 10mm
B. 85 x 42.5 x 17.8mm



FA83

ADLY

Noble 50/Thunderbike	07-09	F
Interceptor 300	06	F & R
300 Utility	06	F & R

BOMBARDIER/BRP

Rally 200	03-06	F
-----------	-------	---

CAN AM

DS 90 X (2X4/4T)	08-15	F & R
Rally 200 (4A7A/B/C/D/E/F)	07	F

DINLI

Diamond Back 90	06	R
-----------------	----	---

E-TON

BXL-50 Draco	05-06	R
RXL-50 M Viper (4T)		R
Viper 50 RXL 50	03-06	R
Viper 70 RXL 70/70 M	05-09	R
RXL 90 Viper 90	03-06	R
RXL 90 R Viper 90 R Reverse	03-09	R
BXL 100 Draco	05-06	R
Yukon EXL 150	05-06	F
Viper EXL 150 ST Quad	05-06	F
Vector 250 ST Quad VXL	06-09	F&R
EXL 150 Yukon ST	05-06	F

HISUN

110 Axis	14-16	F
110 Forge	14-16	F

KAWASAKI

KX 80 E2/E3	84-85	F
KX 80 G1/G2	86-87	F
KX 80 J2/L1-L3/N1-N3/R1-R6	87-96	F
KD 80 N1/N2/N3	88-90	F
KX 100 B5/B6	95-96	F
KX 125 B1	82	F
KX 250 B1	82	F
KXT 250 A1 'Tecate'	84	R

SUZUKI

RM 80 G/H/J/K	86-89	F
RM 80 L/M/N/P/R/S	90-95	F & R
RM 80 T/V/W/X/Y	96-00	R
RM 85 K2/K3/LK3/K4/LK4	02-04	R

POLARIS

200 Phoenix (AC/AD Models And Following/Rear Drum Models)	05-09	F
200 Phoenix Quadricycle (Rear Disc Model)	05-09	F
200 Sawtooth (Rear Drum Model)	06-08	F
200 Sawtooth Quadricycle (Rear Disc Model)	06	F

SHERCO

290 X-Ride	12-14	F & R
------------	-------	-------

UM (UNITED MOTORS)

X-Peed 50/Special Edition	00-05	F
X-Peed 50 R	07-08	F
Earthlander 90 R	05-06	R
Earthlander 200	05-06	R
Moontrax 50 R	03-06	R
Moontrax 90 R	03-06	R

UNISON

Desert Cat 150	04-	F
Black Widow 150	04-	F
Mobility 250	04-	F
Rage 250	04-	F

YAMAHA

YFM 90 RY Raptor	09-	R
YFM 300 GB/GD Grizzly	12-13	F

ZERO ELECTRIC BIKE

DS ZF6.0/DF9.0 (2 Pin Fixing Pad)	10-12	F
MX (2 Pin Fixing Pad)	10-12	F
S ZF6.0 (2 Pin Fixing Pad)	10-12	F
X (2 Pin Fixing Pad)	10-12	F
XU (2 Pin Fixing Pad)	11-12	F

SFA83

ADLY

Fox 50	07-09	F
Jet 50	07-09	F
Panther 50	07-08	F
Thunderbike 150	07-09	F & R

E-TON

Matrix 50	09	R
Matrix R4-150	09	R

HYOSUNG

SD 50 Sense	06-12	F
SF 50 Rally	06-12	F
SB 50 M	06-08	F
SF 50 B Prima	06-12	F

KAWASAKI

AR 50 A1	82	F
AR 80 A1	82	F

MZ

Moskito/SX 50/RX 50	97-05	F
Moskito 125 R	00-05	F

TGB Scooter

Laser R5/i (49cc)	08-11	F
Delivery 50 (From F/No 609100)	06-11	F
101 S (50)/ Key West	05-11	F
R 50 X	06-11	R
Sunset 50	06-08	F
Sunset 151	06-08	F

FA83/2

PIAGGIO

Typhoon 50/SE	06	F
Typhoon 50 (2T)	07-09	F

43022 MAC 000	43082 1083	0453036
43050 1040	43082 1115	GF5359902
43050 1043	43082 1164	0454293
43050 1044	69100 02821	0453036
43050 1051	59100 02820	0453200
43050 1169	59100 02821	43D F5906 00
43082 1065	59100 02830	1SC F5805 00
43082 1079	705 600 285	
43082 1081	45110 J4FT 000	

FA83
Equivalents OE#

FA83/2
Equivalents OE#

497417
647171

Dealer Stocking
Recommendation

Single/Pair	Popularity #	Rec Stocking Level
1	FA83X - K11	FA83X - 2
1	FA83R - K21	FA83R - 1

STANDARD	FA83	Premium Organic Street Pad Blend
OPTIONS	FA83HH	Street Performance Sintered Pad Blend
	FA83R	Utility Grade Sintered Pad Blend
	FA83X	Carbon Dual Purpose Pad Blend
	SFA83	Premium Organic Scooter Pad Blend
STANDARD	FA83/2	Premium Organic Street Pad Blend
	FA83/2HH	Street Performance Sintered Pad Blend
	SFA83/2	Premium Organic Scooter Pad Blend
	SFA83/2HH	Scooter Performance Sintered Pad Blend

FA84 46 x 45 x 7.8mm

FA84/2 46 x 45 x 6.5/7.8mm

(1 piece each size per set)

FA84/3 46 x 45 x 6.5mm



FA84

ARCTIC CAT

DVX 400	04-08	F
400 DVX (2 x 4) Sport	04-08	F
400 DVX TS Sport	06-07	F

BENNCHE

500 Gray Wolf	15-16	F
700 Gray Wolf	15-16	F

HONDA

CR 80 R/RB Expert	86-02	F
CR 85 R/85 R Expert	03-07	F
CRF 150 R/RB	07-16	F
ATC 200 X	83-85	F
ATC 200 X	86-87	F&R
ATC 250 R	83-84	F&R
TRX 250 X	87-92	F&R
TRX 250 EX	01-08	F
TRX 250 X	09-14	F
TRX 300 X	09-11	F&R
ATC 350 X	85-86	R
TRX 300 EX Fourtrax/Sporttrax	93-08	F&R
TRX 400 EX Fourtrax/Sporttrax	99-08	F&R
TRX 400 X	09-14	F&R
TRX 420 TE Fourtrax Rancher ES	07-13	F
TRX 420 TE1 Fourtrax Rancher ES	14-15	F
TRX 420 TM Fourtrax Rancher	07-13	F
TRX 420 TM1 Fourtrax Rancher	14-15	F
TRX 420 FPA Power Steering Fourtrax Rancher AT/IRS	09-14	F
TRX 420 FA Fourtrax Rancher AT/IRS	09-14	F
TRX 420 FA1 Fourtrax Rancher 4x4 Auto/DCT	14-15	F
TRX 420 FA2 Fourtrax Rancher 4x4 Auto - DCT/Power Steering	14	F
TRX 420 FA6 Fourtrax Rancher 4x4 Auto - DCT/IRS/EPS	14-15	F
TRX 420 FPE Fourtrax Rancher 4x4 ES/EPS	09-13	F
TRX 420 FE Fourtrax Rancher 4x4/ES	07-13	F
TRX 420 FE1 Fourtrax Rancher 4x4/ES	14-15	F
TRX 420 FPM Fourtrax Rancher 4x4 PS	09-13	F
TRX 420 FM Fourtrax Rancher 4x4	07-13	F
TRX 420 FM1 Fourtrax Rancher 4x4	14-15	F
TRX 420 FM2 Fourtrax Rancher 4x4 With Power Steering	14	F
TRX 500 FA5 Foreman Rubicon 4 x 4 /Auto/DCT	15	F
TRX 500 FA6 Foreman Rubicon 4 x 4 /Auto/DCT/EPS	15	F
TRX 500 FPM Fourtrax Foreman	12-13	F
TRX 500 FM Fourtrax Foreman	12-13	F
TRX 500 FM1 Foreman	14-15	F
TRX 500 FM2 Foreman/EPS	14-15	F
TRX 500 FPE Fourtrax Foreman	12-13	F
TRX 500 FE Fourtrax Foreman	12-13	F
TRX 500 FE1 Foreman ES	14-15	F
TRX 500 FE2 Foreman ES/EPS	14-15	F
TRX 500 FM5 Rubicon 4 x 4	15	F
TRX 500 FM6 Rubicon 4 x 4 / EPS	15	F

* - ATC is a Registered Trademark of Honda Motor Corporation

HUSQVARNA

CR 125	92-94	R
WR 125	93-94	R
CR 250	92-94	R
WR 250	92-94	R
TE 350	92-94	R
CR 360	92-94	R
WR 360	92-94	R
TC 610	92-94	R
TE 610	92-94	R

KAWASAKI

KX 80 L1-L3/N1/N2/N3/R1-R7/W1/W/W3	88-00	R
KX 85 A1/A2/A3/A4/A5/A6F/A7F/A8F/A9F/AAF/ABF/ACF /ADF/CEF/CFF/CGF/CHF	01-17	R
KX 100 B5/B6/B7/C1/C2/C3/D1/D2/D3/D4/D5/D6F/D7F /D8F/D9F/DBF/DCF/DDF/FEF/FFF/FGF/FHF	95-17	R
KLX 140 A8F/A9F/AAF/ABF/ACF/ADF/AEF/AFF/AGF /AHF (KLX 140)	08-17	R
KLX 140 B8F/B9F/BAF/BBF/BCF/BDF/BEF/BFF/BGF /BHF (KLX 140 L)	08-17	R
KLX 140 CHF/ (KLX 140 G)	17	R
KSF 250 A1-A18 'Mojave'	87-04	R
KXT 250 B2 'Tecate'	87	R
KXF 250 A1/A2 Tecate	87-88	R

KAWASAKI Contd.

KEF 300 A1/A2/A3/A4/A5/A6 Lakota	95-00	R
KEF 300 B1/B2/B3 Lakota Sport	01-03	R
KSF 400 A1/A2/A3/A6F (KFX 400)	03-06	F
KFX 450 R (KSF 450 B8F/B9F/BAF/BBF/BCS)	08-12	R

SUZUKI

RM 100 K3	03	R
LT 230 EH/EJ/EK/EL/EM/EN/EP	86-93	R
LT 250 SK/SL	89-90	R
LT-Z 250 K4/K5/K6/K7/K8/K9 QuadSport	04-11	F
LT-Z 400 K3/K4/K5/K6/K7/K8/K9/ZK9/LZ/ZL2/L3 QuadSport	03-13	F

YAMAHA

YFM 125 RA/RB/RD Raptor	11-13	R
YFS 200 R/S/T/V Blaster	03-06	R
YFM 250 RX/RZ/RA/RB/RD Raptor	08-13	R
YFM 250 RSPX/RSEY Special Edition	08	R
YFM 250 RSPXC Special Edition Custom	08-09	R
YFM 250 RSPA Special Edition	11	R
YFM 350 XT/XU/XW/XA/XB/XD/XE/XF/XG/XH/XJ/XK/XL /XM/XN/XP/XR/XS Warrior	87-04	R
YFM 350 FXG/FXH/FXJ/FXKFXL/FXM/FXN/FXP/FXR/FXS/FXT	95-05	R
YFM 350 RS/RT/RV/RW/RX/RZ/RA/RB/RD Raptor	04-13	F&R
YFZ 350 T/U/W/A/B/D/E/F/G/H/J/K/L/M/N/P/R/S/T/V Banshee	87-06	R
YFZ 450 S/T	04-05	R
YFZ 450 LES Limited Edition	04	R
YFZ 450 SET Special Edition	05	R
YFZ 450 BB/DB	12-13	F
YFM 600 FWAK/FWK/FWALLC/FWAM/MC	98-00	F
YFM 600 HM/HMC	00	F
YFM 600 FWAN/FWAHN	01	F
YFM 660 RN/RP/RPB/RR/RS/RT Raptor	01-05	F&R
YFM 660 FAP/FHAP/FSAP/FAR/FHS/FHT/FS/FT/FV /FAW/FGHW/FGX/FGHX Grizzly/660 Hunter Edition	02-08	F
YFM 660 FAHDV/W Ducks Unlimited Edition/Side x Side	06-08	F

FA84/2

HONDA

ATC 200 X	83-85	R
ATC 250 R	82	R

FA84/3

SUZUKI

RM 125 J	88	R
LT 230 SF/SG/SH/SJ	85-88	R
LT 250 RF/RG	85-86	R

YAMAHA

YZ 80 E/F/G/H/J/K/L/M/N	93-01	R
YZ 85 P/R/S/T/V/W/X/Y/Z/A/B/D/E/F/G	02-16	R
YZ 125 W	89	R
YZ 250 W/WRW	89	R

**NOTE:- Size identification is shown as follows
Dimension 1=Width or Diameter, Dimension 2=Height or Diameter, Dimension 3=Thickness (Material and backplate)**

FA84 CONTD. FA84/2 CONTD. FA84/3 CONTD.

Equivalents OE# - FA84

06435 HA5 405	43082 S006	5LP W0046 50
06435 HP5 602	43120 HA5 305	5LP W0045 00
06435 HP7 A01	69140 19A00	43082 1205
06455 GBF JD1	69140 19A01	59300 42850
43106 961 006	69140 19A11	59300 42860
45105 961 000	69140 19A10	59300 42870
45110 HB7 007	1UY W0046 00	3406-031
451A0 HB5 670	431A0 HA5 690	3406-032
43082 1066	4D3 W0046 50	
43082 1082	4WV W0045 00	

STD	FA84X	Carbon Dual Purpose Pad Blend
OPTIONS	FA84R	Utility Grade Sintered Pad Blend
	FA84SV	High Durability Off Road Sintered Blend
	MXS84	Sintered Sport Off Road Pad Blend
STD	FA84/2R	Utility Grade Sintered Pad Blend
STD	FA84/3R	Utility Grade Sintered Pad Blend
OPTION	MXS84/3	Sintered Sport Off Road Pad Blend

FA84
Dealer Stocking
Recommendation

FA84/2
Dealer Stocking
Recommendation

FA84/3
Dealer Stocking
Recommendation

Competitor X Ref

Equivalents OE# - FA84/2

43120 HC0 007
43120 965 000
431A0 965 000
431A0 965 670
45105 961 006

Equivalents OE# - FA84/3

69140 26C00
3JD W0046 01
3JD W0046 10
3JD W0046 00
5PA W0046 50

Single/Pair	Popularity #	Rec Stocking Level
1	FA84R - H2/K20/S10/Y20 FA84X - H3/S9/K14/Y19	FA84R - 14 FA84X - 12

Single/Pair	Popularity #	Rec Stocking Level
1	FA84/2R - H15 FA84/2X - N/A	FA84/2R - 1 FA84/2X - 1

Single/Pair	Popularity #	Rec Stocking Level
1	FA84/3R - S12/Y12 FA84/3X - N/A	FA84/3R - 1 FA84/3X - 1

SBS	Vesrah	Ferodo
562= FA84/2 584= FA84/3	VD127/334/336	FDB661

FA85

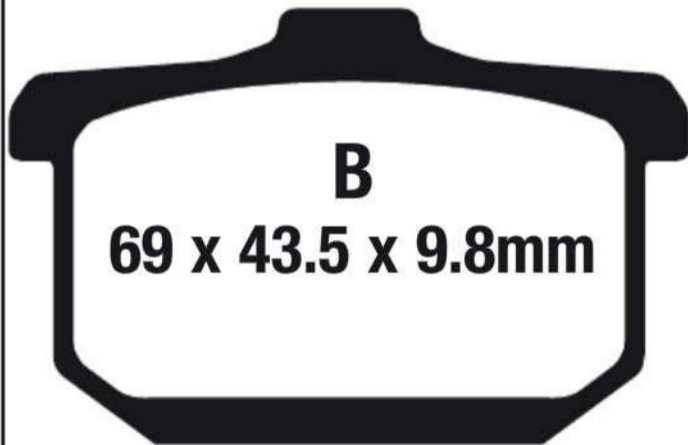

KAWASAKI

EX 250 E1/E2 'Ninja'	86-87	F & R
EL 250 B2/B3 Eliminator	88-89	F
EL 250 E1/E2/E3/E4 250 HS	91-95	F
EL 250 F2 'EL252'	97-99	F
EX 305 B1 (GPz)	83	F
EN 450 A1/A2/A3/A4/A5/A6 (454 Ltd)	85-90	F
EN 500 A1/A2/A3/A4/A5/A6	90-95	F
EN 500 C1-C10/C6F/C7F/C8F/C9F Vulcan	96-09	F
ZX 550 A1/A2/A3 (GPz)	84-86	F & R
ZL 600 A1/A2	86-87	F
ZX 600 A1/A2/A3/B1 'Ninja'	85-87	F & R
VN 700 A1 'Vulcan'	85	F
ZN 700 A1/A2 (LTD)	84-85	F & R
KZ 750 K1/K2 (LTD)	83-84	F
VN 750 A2-A21/A6F 'Vulcan'	86-06	F
ZX 750 A1/A2/A2L/ A3 (GPz)	83-85	F & R
ZX 750 E1/E2 'Turbo'	84-85	F & R
VN 800 A1-A11 Vulcan	95-05	F
ZL 900 A1/A2 'Eliminator'	85-86	F & R
ZX 900 A1/A2/A3 Ninja	84-86	F & R
ZG 1000 A1/A2/A3/A4/A5/A7/A8 'Concours'	86-93	F & R
ZG 1000 A9-A20 'Concours'	94-05	R
ZG 1000 A6F Concours	06	R

ZL 1000 A1	87	F & R
ZX 1000 A1/A2 'Ninja'	86-87	F & R
ZN 1100 B1/B2 (LTD)	84-85	F & R
ZX 1100 A1/A2 (GPz)	83-84	F & R
ZG 1200 A1/A2/B1-B4/B6-B17 'Voyager XII'	86-03	F & R
ZN 1300 A1/A2/A3/A4/A5/A6 'Voyager'	83-88	F & R
VN 1500 A1-A13 'Vulcan'	87-99	F & R
VN 1500 B1/B2/B3/B4/Vulcan 88 SE/C3/C4 'Vulcan'	87-97	F & R
VN 1500 D1/D2/E1/E2 Vulcan Classic	96-97	R
VN 1500 G1/G1A/G2A Nomad	99-00	R

Equivalents OE#

43082 1029	43082 1061	43082 1167
43082 1031	43082 1062	
43082 1057	43082 1080	

**Dealer Stocking
Recommendation**

Single/Pair	Popularity #	Rec Stocking Level
2	K1	10

STD	FA85	Premium Organic Street Pad Blend
OPTIONS	FA85HH	Street Performance Sintered Pad Blend
	FA85V	Semi Sintered Long Lasting Street Pad Blend

BUYERS GUIDE
BRAKE PADS

NOTE:- Size identification is shown as follows
Dimension 1=Width or Diameter, Dimension 2=Height or Diameter, Dimension 3=Thickness (Material and backplate)

FA86

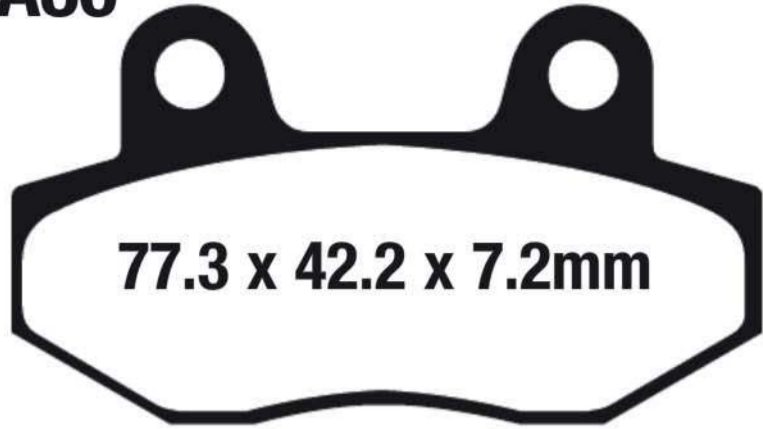

77.3 x 42.2 x 7.2mm

ATK

GT 250 R V-Twin Sport	11	F&R
GV 250 V-Twin	11	F
GT 650 R V-Twin Sport	11	F&R
GV 650 V-Twin Cruiser	11	F&R

HONDA

CMX 250 C/CD Rebel	85-87	F
--------------------	-------	---

HYOSUNG

RX 125		F
GT 250	06-12	F&R
GT 250 R	06-12	F&R
GV 250	06-12	F
GT 650 R	06-12	F&R
GT 650 S	06-12	F&R
GT 650	06-12	F&R
GV 650	06-12	F&R
ST7 Custom	10-11	R

U.M.

V2C 250 T	06-08	F
V2S 250 R	06-08	F&R
V2C 650 S	06-08	F&R
V2S 650/650 R	06-08	F&R

SFA86

HYOSUNG

MS3 125	06-07	F&R
MS3 250	06-12	F&R

SACHS

Mad Ass 50	09	F
Mad Ass 125	10-11	F

Dealer Stocking Recommendation

Single/Pair	Popularity #	Rec Stocking Level
1	H28	1

STD	FA86	Premium Organic Street Pad Blend
OPTIONS	FA86HH	Street Performance Sintered Pad Blend
	SFA86	Premium Organic Scooter Pad Blend
	SFA86HH	Scooter Performance Sintered Pad Blend

Equivalents OE#

45105 GE2 004	45105 KK4 007	45105 KR3 602	251 0037A
45105 GE2 006	45105 KR3 007	45105 KR3 603	45105 KK4 014
45105 GE2 305	45105 KR3 014	451A0 KR3 603	45105 KR3 004
45105 KK4 004	45105 KR3 601	59300 HG5 800	

**BUYERS GUIDE
BRAKE PADS**

**NOTE:- Size identification is shown as follows
Dimension 1=Width or Diameter, Dimension 2=Height or Diameter, Dimension 3=Thickness (Material and backplate)**

FA88



**64 x 55
x 9mm**

NOTE:- Size identification is shown as follows

YAMAHA

RZ 350 L/N/NC11	84-85	R
FZR 400 U/SUC/W/SWC	88-89	F
XJ 400 S Seca II	93	R
RZ 500	84-86	F
FJ 600 L/LC/N/NC	84-85	F & R
FZ 600 S/SC/T/TC/U/UC	86-88	F
YX 600 S/SC/T/U/W/A/TC/UC/WC/AC 'Radian'	86-90	F
FZR 600 W/WC	89	F & R
FZR 600 AC/RAC/RA/RBC/RD/RDC/RE/REC/RF/RFC /RG/RGC/RH/RHC/RJ/RJC/RK/RKC/RL/RLC	90-00	R
YZF 600 RG/RGC/RH/RHC	95-96	R
YZF 600 RJ/RK/RL/RM/RN/RP/RR/RS/RT/RV/RW	97-07	R
FZ 700 T/TC Genesis	87	F & R
FZX 700 S/SC/T/TC 'Fazer'	86-87	F & R
XJ 700 N/NC/XN/XNC/XS/XSC/S/SC	85-86	F
XV 700 L/LC/N/NC/CS/CT/CTC/CSC/SS/SSC/ST/STC	84-87	F
FZ 750 N/S/SC/U/UC	85-88	F & R
XV 750 U/UC/W/WC/A/AC/B/BC/D/DE/E/EC/F/FC /G/GC/H/HC/J/JC Virago	88-97	F
FZR 750 'Genesis' RU/RT	87-88	R
FZR 750 (OW01)	89-92	R
YFZ 750 R/SP	93-96	R
TDM 850 D/DC/E/EC	92-93	R
XJ 900 RK 'Seca'	83	F & R
XV 1000 L/LC/N/NC	84-85	F
FZR 1000 'Genesis' T/TC/U/UC	87-88	R
FZR 1000 W/WC/A/AC/B/BC EX-UP	89-91	R
FZR 1000 D/DC/E/EC/F/FC/G/GC EX-UP	92-96	R
GTS 1000 AE/AEC/AF/AFC	93-96	R
YZF 1000 R (RJ)	97	R
FJ 1100 L/LC/N/NC	84-85	F & R
XV 1100 'All Models'	86-97	F

XVS 1100 ATS V-Star Silverado/Custom	04-08	R
XVS 1100 AS V-Star Classic	04-08	R
XVS 1100 V Star Custom/V Star Classic	99-09	R
XVS 1100 V-Star Silverado	03-09	R
XVS 1100 W-M V-Star Custom Midnight	07-09	R
FJ 1200 S/SC/T/TC	86-87	F & R
FJ 1200 W/WC/A/ACB/BC/D/DC/AD/ADC/AE/AEC	89-93	R
VMX 12 - (V-Max 1200 All Models)	93-07	R
XVZ 12 TK 'Venture'	83	F & R
XVZ 12 L/KC2 Venture	84	F & R
XVZ 12 TDK/DL/DKC2 Venture Royale	83-84	F & R
XVZ 12 DN 'Venture Royale'	85	F & R
V-Max VMX 12 N/NC/S/SC/U/UC/W/WC/A /AC/B/BC/D/DC	85-92	F & R

Equivalents OE#

1FK W0045 00	26H W0045 10	31A W0046 10	4FM W0045 10
1FK W0045 10	26H W0045 11	38A W0045 01	4FM W0045 20
1FK W0046 01	26H W0046 00	3HE W0045 00	4FM W0045 30
1FK W0046 02	26H W0046 01	3HE W0045 11	4FM W0046 00
1UF W0045 00	29L W0045 00	43F W0045 00	3PA W0045 00
1UF W0045 01	29L W0045 10	47X W0045 00	3XF W0045 50
26H W0045 00	29L W0046 01	47X W0045 01	
26H W0045 01	31A W0046 00	4FM W0045 00	

STD	FA88	Premium Organic Street Pad Blend
	FA88HH	Street Performance Sintered Pad Blend
OPTIONS	FA88V	Semi Sintered Long Lasting Street Pad Blend
	EPFA88HH	Fast Street Use & Track Day Sintered Pad Blend

**Dealer Stocking
Recommendation**

Single/Pair	Popularity #	Rec Stocking Level
2	Y1	10

FA90



91 x 51 x 10mm

HONDA

CB 450 T 'Hawk'	82	F
CB 450 SC 'Nighthawk'	82	F
CM 450 C Custom (from CM 001212)	82	F
CM 450 A Hondamatic	83	F
CB 650 SC 'Nighthawk'	82	F
VT 700 C 'Shadow'	84-85	F
CB 750 C (from CM 204182)	82	F
VT 750 C 'Shadow'	83	F

Equivalents OE#

45105 MA5 771
45105 MA5 772
45105 MC9 305

Dealer Stocking Recommendation

Single/Pair	Popularity #	Rec Stocking Level
2	H26	2

STD	FA90	Premium Organic Street Pad Blend
OPTIONS	FA90V	Semi Sintered Long Lasting Street Pad Blend

FA92



81 x 42 x 7.5mm

HONDA

CR 125 R	84-86	F
ATC* 250 R	85-86	F & R
CR 250 R	84-86	F
TRX 250 R	86-89	R
XR 250 R Pro Link	84-87	F
ATC* 350 X	85	F
XR 350 R	84-85	F
XL 350 R	84-85	F
CR 500 R	84-86	F
XR 500 R Pro Link	83-84	F
XL 600 R	83-87	F
XR 600 R	85-87	F

* - ATC is a Registered Trademark of Honda Motor Corporation

Equivalents OE# FA92

45105 G04 601	45105 KE1 743	451A0 MG3 670
45105 HA2 671	45105 KE1 744	451A0 K13 731
45105 HB9 008	45105 KS5 004	43105 HB9 008
45105 KA3 731	45105 KS5 006	431A0 HB9 008
45105 KE1 742	45105 MG3 006	

Dealer Stocking Recommendation

Single/Pair	Popularity #	Rec Stocking Level
1	FA92X - H19	FA92X - 2
	FA92R - H20	FA92R - 1

STD	FA92X	Carbon Dual Purpose Pad Blend
OPTIONS	FA92R	Utility Grade Sintered Pad Blend

**BUYERS GUIDE
BRAKE PADS**

**NOTE:- Size identification is shown as follows
Dimension 1=Width or Diameter, Dimension 2=Height or Diameter, Dimension 3=Thickness (Material and backplate)**

SFA93

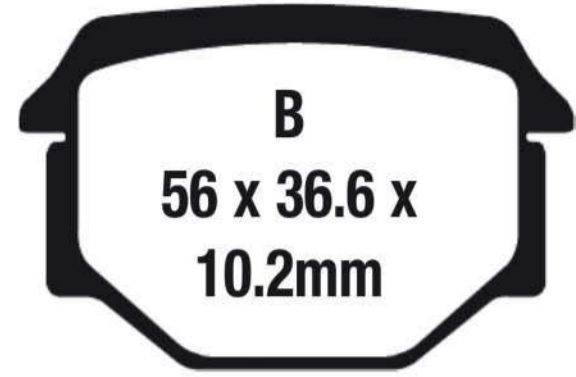
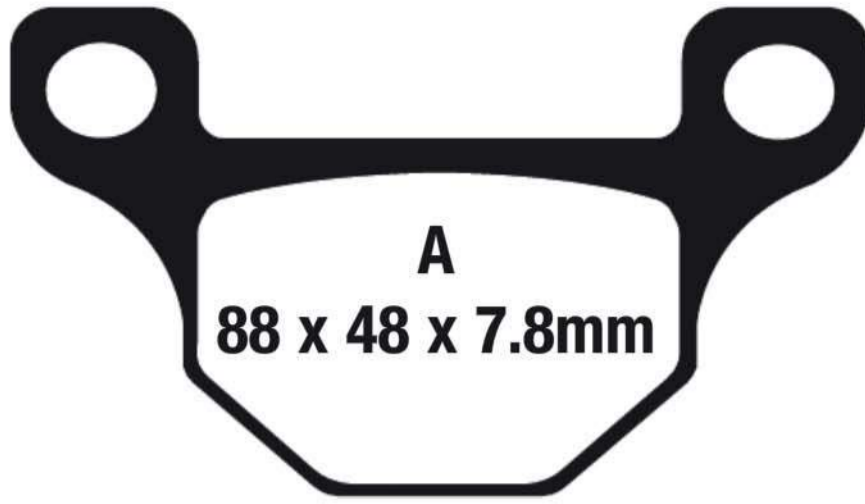

TGB Scooter

Delivery 151	05-11	F
R 50 X	06-11	F

Equivalents OE#

413610

Dealer Stocking Recommendation

Single/Pair	Popularity #	Rec Stocking Level
-------------	--------------	--------------------

STD SFA93 Premium Organic Scooter Pad Blend

FA94



HARLEY DAVIDSON

FXD, FXDL, FXDWG, FXR, FXRS, FXRT, FXRD, FXLR	84-99	F
FXST, FXSTB, FXSTC, FXSTS, FLST, FLSTC, FLSTF, FLSTS, FLSTN	84-99	F
FX, FXE, FXEF, FXWG, FXS	84-86	F
XL, XLH, XLCH, XLS, XLX	84-99	F
FLT, FLHT, FLHTCI	84-99	F
FLHR, FLHRCI	94-99	F
FXSTS/FLSTSi	00-05	F
FLSTSC/FLSTSCI Springer Classic	05-07	F
FLSTSB Softail Cross Bones	08-11	F

LYNDALL BRAKES

PAD REF 7059

Supplied complete with M6 screw 12mm thread length/17mm total length & washer

1 Threaded Pad / 1 Plain Pad

STD	FA94	Premium Organic Street Pad Blend
OPTIONS	FA94HH	Street Performance Sintered Pad Blend
	FA94V	Semi Sintered Long Lasting Street Pad Blend
	EPFA94HH	Fast Street Use & Track Day Sintered Pad Blend

Equivalents OE#

43063 83	44603 839	44247-98A
44603 83A	44063 83C	

Dealer Stocking Recommendation

Single/Pair	Popularity #	Rec Stocking Level
2	HD3	6

FA95 69.2 x 51 x 8.2mm

FA95/2 69.2 x 51 x 11.2mm

ATK

Motard 450	07	F
600 DTM Dirt Track Motard	03	F

BREMBO AFTERMARKET CALIPER

20 5165 55/68 - Goldline 4 Piston P4 30/34 @40mm spacing (single pin pad fixing)
 20 4756 52/62 - 4 Piston P4 30/34 @40mm spacing (single pin pad fixing)

CAGIVA

Mito 125	92-02	F
----------	-------	---

DUCATI

Supersport 400	93-97	F
400 Monster	95-97	F
(549cc) Supermoto	93-95	F
600 Monster	93-99	F
600 Monster Dark	98-99	F
600 Monster City/City Dark	99	F
600 Supersport	91-97	F
748 SP/Biposto	95-98	F
750 Supersport	91-98	F
750 Monster	96-98	F
750 Monster City/City Dark	99	F
750 Monster/Monster Dark	99	F
851 Superbike Biposto	89-92	F
888 SP4/SP5	92-93	F
888 Superbike Strada	94-95	F
900 Supersport	89-90	F
900 Supersport/Superlight	91-97	F
900 Supersport - CR USA	98	F
900 Supersport FE	98	F
900 Monster	93-99	F
900 Monster Cromo/Special	98	F
900 Monster City/City Dark	99	F
907 IE	90-93	F
916 Biposto-Senna	94-98	F

GAS-GAS

SM 125/250 (2T)	01-05	F
SM 400 FSE (2T)	01-02	F
SM 450	03-05	F

HUSQVARNA

SM 400 R	02	F
SM 450 R	03-06	F
SM 510 R	05	F
SM 570 R	01-04	F
SMR 630	06	F

INDIAN

Chief Blackhawk (Brembo calipers)	11	F
Chief Blackhawk Dark (Brembo calipers)	11	F
Chief Classic (Brembo calipers)	11-13	F
Chief Standard (Brembo calipers)	09-11	F
Chief Deluxe (Brembo calipers)	09	F
Chief Roadmaster (Brembo calipers)	09-11	F
Chief Vintage (Brembo calipers)	09-13	F
Bomber (Brembo calipers)	10-11	F
Dark Horse (Brembo calipers)	10-13	F

KTM

Duke 125	11	F
Duke 400 LC4	94-98	F
Duke 620 LC4	94-98	F
SMC 660 Supermoto	03-04	F

LAVERDA

650 Sport	94-95	F
668 Diamante/Ghost/Strike	96-98	F
750 S Formula/Sport	98-00	F
750 Strike Bifaro/Monofaro	98-00	F
750 S Carenta	98-00	F

LYNDALL BRAKES

PAD REF 7138



MOTO GUZZI

Daytona 1000	92-95	F
Daytona 1000 RS	97-98	F
V10 Centauro	97-99	F
California EVII	97-01	F
Sport 1100	94-99	F
Sport Corsa 1100	98-99	F

OMP AFTERMARKET CALIPER

4 Piston (Front and Rear)

REVTECH AFTERMARKET CALIPER

CCI Polished Caliper (Front/Rear)

TM (DIRT)

SMR 125 (2T)	05-08	F
SMR 450 F ES (4T)	05-08	F
SMR 530 F ES (4T)	05-08	F

VOR DIRT

SM-E 450/530	04	F
--------------	----	---

WILWOOD AFTERMARKET CALIPER

GP 300/310 (Part # 150-8733-2)

FA95/2

WILWOOD AFTERMARKET CALIPER

GP 320 (Part # 154-8596K)

Equivalents OE#

613 4 004 24	047 00 20000 36	107 A486 53
000 3065 46300	583 13 209 000	07009R
000 3065 46000	573 13 030 000	N50250061
000 3065 46020	5002517	

Dealer Stocking Recommendation

Single/Pair	Popularity #	Rec Stocking Level
2	-	2

STD	FA95	Premium Organic Street Pad Blend
	FA95HH	Street Performance Sintered Pad Blend
	EPFA95HH	Fast Street Use & Track Day Sintered Pad Blend
	GPFA95HH	Fast Street Use & Track Day Sintered Pad Blend
	FA95V	Semi Sintered Long Lasting Street Pad Blend
STD	FA95/2	Premium Organic Street Pad Blend

FA99

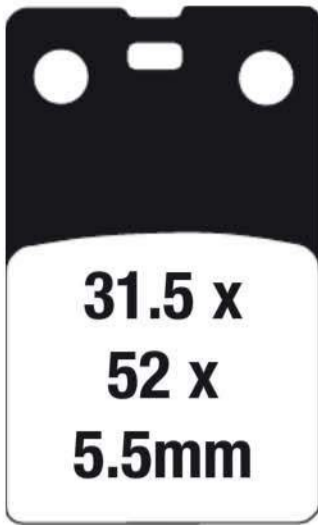

BETA

125 TR 32/33	86-87	F
125 TR 34	88	F
240 TR 33	86-88	F
260 TR 34	86-88	F

MAICO/M-STAR

Rotor models	86	F
Rotor models	87-88	F & R

Equivalents OE#

266 07 6340
510 362 4 282

Dealer Stocking Recommendation

Single/Pair	Popularity #	Rec Stocking Level
1	-	1

STD	FA99X	Carbon Dual Purpose Pad Blend
OPTIONS	FA99R	Utility Grade Sintered Pad Blend

FA101

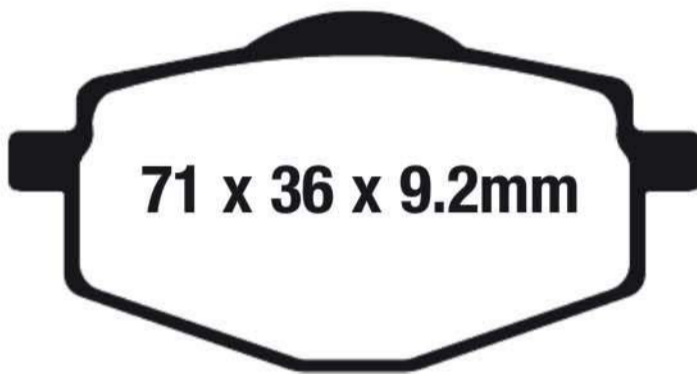

YAMAHA

YSR 50 T/U/W/A/B/D	87-92	F
YBR 125 ESD (4P26/4P2A/4P2G) Cast Wheel	07-13	F
YBR 125 ED (4P28/4P2C/4P2J) Cast Wheel	07-13	F
YZ 125 U	88	R
RT 180 A/B/D/E/G/H/J	90-97	F
XT 225 D/DC/E/EC/F/FC/G/GC/F/FH/J/JC/K/KC/L	92-98	F
TT 225 S/T	86-87	F
TT-R 225 L/M/N/P/R/S	99-04	F
YTZ 250 N/S 'Tri Moto'	85-86	F & R
YZ 250 U	88	R
XT 350 N/NC/S/SC/T/TC/U/UC/W/WC/A/B/BC/D/E/EC/F/FC/G/GC/H/HC/J/JC/K/KC/L/M	85-00	F
YFM 350 XT/XU Warrior	87-88	F
YFZ 350 Banshee T/U/W	87-89	F
XT 600 EA/EB/ED/EDC/EE/EEC/EF/EFC/EG/EGC	90-95	R
TT 600 N/S	85-86	F

SFA101

YAMAHA

YJ 125 S/T/V/W/X Vino	04-09	F
-----------------------	-------	---

Equivalents OE#

1UY W0045 00	34X W0046 00	3BN W0045 01
1UY W0045 01	34X W0046 01	3FY W0045 00
1UY W0045 02	34X W0046 02	3XP W0045 00
1UY W0045 03	38W W0045 00	3XP W0046 00
2VN W0046 00	38W W0045 01	3UH W0045 01
2VN W0046 01	3BN W0045 00	

STD	FA101	Premium Organic Street Pad Blend
OPTIONS	FA101X	Carbon Dual Purpose Pad Blend
OPTIONS	FA101R	Utility Grade Sintered Pad Blend
STD	SFA101	Premium Organic Scooter Pad Blend
OPTIONS	SFA101HH	Scooter Performance Sintered Pad Blend

Dealer Stocking Recommendation

Single/Pair	Popularity #	Rec Stocking Level
2	FA101X - Y17 FA101R - Y21	FA101X - 2 FA101R - 2

FA103



**58 x 53.5 x
8.7mm**

SUZUKI

VS 700 All models	86-87	F
VS 750 GLPJ/GLPK/GLPL/GLPM 'Intruder'	88-91	F
GSX-R 750 RG/G/H	86-87	F
VS 800 GLN/GLP/GLR/GLS/GLT/GLV/GLW/GLX/GLY/GLK1/GLK2/GLK3/GLK4	92-04	F
VS 800 K5/K6/K7/K8/ZK8/K9 S50 Boulevard	05-09	F
GSX 1100 FJ/FK/FL/FM/FN/FP "Katana"	88-93	R
GSX-R 1100 G/H/J	86-88	F
GV 1400 GDG/GTG (up to frame no. 103764)	86	F & R
VS 1400 GLPH/GLFH/GLPJ/GLPL/GLPM/GLPN/GLPP/GLPR/GLPS/GLPT /GLPV/GLPW/GLPX/GLPY/GLPK1/GLPK2/GLPK3 Intruder	87-03	F & R
VS 1400 GLPK5/GLPK6/K7/K8/K9/ZK9/LO Boulevard S83 (1400cc)	05-10	F & R
VL 1500 W/X/Y/K1 'Intruder Legendary Classic'	98-01	F & R

Equivalents OE#

59100 06820	59100 30820	59130 00810	59130 30B21	69130 48B00
59100 10810	59130 00A00	59130 24A00	69100 38810	69130 38820
59100 20810	59130 00A10	59130 27A00	69100 38840	69130 48810
59100 20820	59130 06B10	59130 27A10	69130 38B10	
59100 30810	59130 06B20	59130 30B00	69130 38B00	

STD	FA103	Premium Organic Street Pad Blend
OPTIONS	FA103HH	Street Performance Sintered Pad Blend
	FA103V	Semi Sintered Long Lasting Street Pad Blend

Dealer Stocking Recommendation

Single/Pair	Popularity #	Rec Stocking Level
2	S3	10

FA104



58 x 56 x 8.8mm

YAMAHA

SRX 250 T/TC	87	F
FZR 400 U/SUC/W/SWC	88-89	R
FZR 400 A/RRSP/RR	90-92	R
RZ 500	84-86	R
FZ 600 S/SC/T/TC/U/UC	86-88	R
SRX 600 S/SC	86	F & R
XJ 600 S Seca II SD/SDC/SE/SEC/EF/SFC/SG/SGC/SH /SHC/SJ/SJC/SK/SKC	92-98	R

Equivalents OE#

1KT W0046 50	51L W0046 00
1KT W0046 51	51L W0046 01
1KT W0046 52	51L W0046 02
3TJ W0046 00	

STD	FA104	Premium Organic Street Pad Blend
OPTIONS	FA104HH	Street Performance Sintered Pad Blend
	FA104V	Semi Sintered Long Lasting Street Pad Blend

Dealer Stocking Recommendation

Single/Pair	Popularity #	Rec Stocking Level
1	Y10	2

FA105



YAMAHA

YZ 125 N/S/T/U	85-88	F
IT 200 S	86	F
YZ 250 N/S/T/U	85-88	F
TT 350 S/T	86-87	F
YZ 490 N/S/T	85-87	F
YZ 490 U/W	88-89	F

Equivalents OE#

56A W0046 00	2HH W0045 01
1LX W0045 00	
1LN W0045 01	
2HH W0045 00	

STD	FA105X	Carbon Dual Purpose Pad Blend
OPTIONS	FA105R	Utility Grade Sintered Pad Blend

Dealer Stocking Recommendation

Single/Pair	Popularity #	Rec Stocking Level
1	Y27	1

FA106

FA106/2



DO NOT REFIT ORIGINAL SHIM ON BACK OF PAD

SUZUKI

RM 125 F/G	85-86	F
GZ 250 X/Y/K1/K2/K3/K4/K5/K6/K7/K8 Marauder	99-09	F
RM 250 F/G	85-86	F
TU 250 X/K9/L1	09-11	F
LS 650 FG/PG/PH/FH/PJ/PS/PT/PV/PW/PX/PY/PK1 /PK2/PK3/PK4 Savage	86-88/95-04	F
LS 650 K5/K6/K7/K8/K9/L1/L2/L3/L4/L5 Boulevard S40 (650cc)	05-15	F

FA106/2

MAICO/M-STAR

Most '86 models F&R

SUZUKI

SP 600 F	85-87	F
----------	-------	---

Equivalents OE#

- FA106

59300 14840
59300 24830
59340 14600
59340 24B00
59340 24B10

Equivalents OE#

- FA106/2

59300 14830
59340 14500
59340 14501
59340 14510

NOTE: As stocks of FA106X sell through, EBC will only offer an FA106 design in 8.2mm thickness as this is purely a road bike.

STD	FA106	Premium Organic Street Pad Blend
------------	--------------	----------------------------------

OPTIONS	FA106R	Utility Grade Sintered Pad Blend
----------------	---------------	----------------------------------

OPTIONS	FA106V	Semi Sintered Long Lasting Street Pad Blend
----------------	---------------	---

STD	FA106/2X	Carbon Dual Purpose Pad Blend
------------	-----------------	-------------------------------

OPTIONS	FA106/2R	Utility Grade Sintered Pad Blend
----------------	-----------------	----------------------------------

Dealer Stocking Recommendation

Single/Pair	Popularity #	Rec Stocking Level
1	-	1

FA109



HONDA
VF 1000 R

85-86 R

**50 x 55 x
11.3mm**

Equivalents OE#

43105 MJ4 007
43105 MJ4 008

Dealer Stocking Recommendation

Single/Pair	Popularity #	Rec Stocking Level
1	-	1

STD FA109 Premium Organic Street Pad Blend

FA111

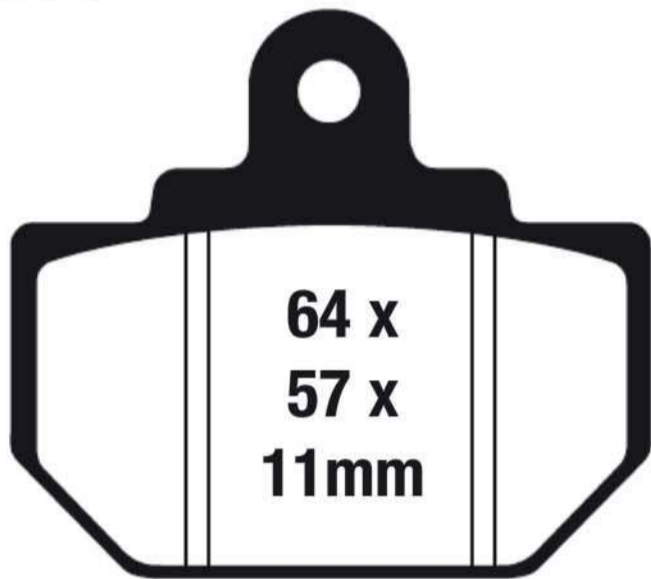

HONDA
FL 350 R 'Odyssey'
FL 400 R Pilot

85-87 R
89-90 R

**64 x
57 x
11mm**

Equivalents OE#

43105 HE0 305	431A0 HE0 670
43105 VM0 008	431A0 VM0 008
43105 VM0 771	06435 VM0 405

Dealer Stocking Recommendation

Single/Pair	Popularity #	Rec Stocking Level
1	H36	1

STD FA111X Carbon Dual Purpose Pad Blend

OPTIONS FA111R Utility Grade Sintered Pad Blend

FA115

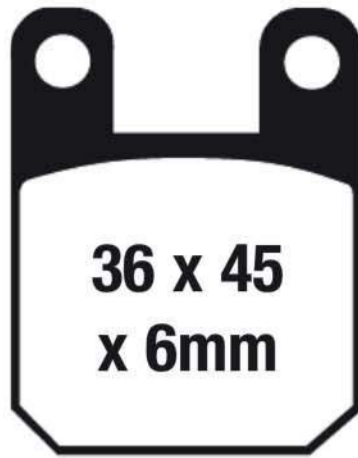

36 x 45
x 6mm

ATK			
560	87-88	R	
BETA			
RR 50 Motard	06	R	
Evo 80 Junior	09-12	R	
Synt/Gara	93-96	F	
125 TR 34/35	89-90	F & R	
260 TR 34/35/Zero	89-92	F	
Rev 50/80	02-06	F & R	
Alp 200 4T	00-06	F & R	
CPI			
Enduro 50	06-08	F & R	
Enduro 250	07-08	F & R	
DERBI			
Senda R 50	02-05	F & R	
GRP 50 Nude	04-05	R	
GPR 50 Replica	03-05	R	
GRP 80 Cup	05	R	
Senda Supermoto	04-05	F & R	
GPR 125/Nude (Radial Caliper)	05-06	R	
DUCATI			
(549cc) Supermoto	93-95	R	
GAS-GAS			
EC 50 Boy (Air Cooled)	05	F	
TXT 50 (Boy)	04-11	F & R	
MC 65	05-06	R	
JTX 125/200/270/320	95-98	F & R	
Pampera 125/250/370	96-97	F & R	
TX 200/270/320	98	F & R	
Contact JT25 (238cc)	93-94	F & R	
Pampera 250/320	98-99	F & R	
GMA AFTERMARKET CALIPER			
4 Piston Model F			
HONDA			
XR 6 50cc	03-05	F	
HUSQVARNA			
Husky Boy 50 J/S/R	01-02	F	
SM 50	02	R	
WR 50	02	R	
IRON PEGASUS AFTERMARKET CALIPER			
Small caliper (2 pin fixing)			
JAYBRAKE AFTERMARKET CALIPER			
Dual 7 Quad (300-04) (2 & 4 Piston)			
KTM			
60 SX	98-00	F	
65 SX	98-01	F	
LYNDALL BRAKES			
PAD REF 7153			
MAICO/M-STAR			
Disc models	89-96	F & R	
MONTESA			
314 R	94-96	F	
315 R	97-00	F	

PERFORMANCE MACHINE AFTERMARKET CALIPER

125 X 2			
125 X 4S			
125 X 4SL			
PEUGEOT			
Metal-X	02-05	F	
Ludix 125	04-05	F	
SCORPA			
TY-S 125	04-09	F	
SY-125 F	05-09	F	
SY-175 F	05-08	F	
TY-S 175 F	06-08	F	
T-Ride 250 F	06-08	R	
SHERCO DIRT			
0.5/0.8/1.25/2.0	03-10	F & R	
UM (UNITED MOTORS)			
DSF 200	06-08	R	
DTF 200	06-08	R	
SMF 200	08	R	
SFA115			
BETA			
Eikon 50 Team	02-03	F & R	
DERBI			
Atlantis 50	02-05	F	
GP1 50	02-06	F	
Predator	99-01	F & R	
Atlantis Bullet/City	02-05	F	
HUSQVARNA			
WRS 50 Scooter	99-00	F	
ITALJET			
Dragster 50 LC	98-03	F & R	
Formula 50 (Air Cooled)	99-03	F	
Formula 50 (Liquid Cooled)	96-03	F & R	
Torpedo 50	98-03	F	
Formula 125 LC	96-03	F & R	
Torpedo 125 4T	99-03	F	
Torpedo 150	03	F	
PEUGEOT			
Speedfight 2 Torero 50	02-05	F	
Vivacity X-Race 50/Pulsa 50	02-05	F	
Trekker 50	02-05	F	
Looxor 50	02-05	F	
Looxor 100	02-05	F & R	
Elyseo 50	02-05	F	
Elyseo 50	03-05	F & R	
Elyseo 100	03-05	F & R	
Elystar 50 P	03-05	F	
Jet Force 50	03-05	F & R	
Speedfight X-Race 50	02-05	F	
LNDP LC/100 NP AC	03-05	F & R	
Ludix 50 (10" wheels)	04-05	F	
Ludix 50 (14" wheels)	04-05	F	

STD	FA115	Premium Organic Street Pad Blend
OPTIONS	FA115X	Carbon Dual Purpose Pad Blend
OPTIONS	FA115R	Utility Grade Sintered Pad Blend
OPTIONS	FA115HH	Street Performance Sintered Pad Blend
OPTIONS	FA115V	Semi Sintered Long Lasting Street Pad Blend
OPTIONS	MXS115	Sintered Sport Off Road Pad Blend
STD	SFA115	Premium Organic Scooter Pad Blend
OPTIONS	SFA115HH	Scooter Performance Sintered Pad Blend

Equivalents OE#

8113181	252-0002A
510 015 4 282	61340051A
4AJ W0045 00	

Dealer Stocking Recommendation

Single/Pair	Popularity #	Rec Stocking Level
1	-	1

FA116



ATK
560 & other models

89-91 R

BETA
125 TR34
260 TR34

88 R
86-88 R

OMP AFTERMARKET CALIPERS

6 Piston
Sprocket Brake

MALAGUTI

Yesterday
F15 Firefox
F12 Phantom (A/C)

98-04 F
02-04 F
98-04 F

TOMOS

Revival/TS/Roadmate
MC 50 Senior Pro

03-08 F
03-08 F&R

Equivalents OE#

119 419 000
119 468 000
07010R

STD FA116	Premium Organic Street Pad Blend
STD SFA116	Premium Organic Scooter Pad Blend

Dealer Stocking Recommendation

Single/Pair	Popularity #	Rec Stocking Level
1	-	1

FA119



YAMAHA

YZ 80 S/T/U/W/A/B/D/E/F/G/H/J/K/L/M/N

86-01 F

YZ 85 P/R/S/T/V/W/X/Y/Z/A/B/D/E/F/G

02-16 F

TT-R 125 LWM/LN/LP/LER/LR/LES/LS/LET/LT/LEV/LV
/LW/LEW/LX/LEX/LEY/LEA/LEB/LED/LEE/LEF

00-15 F

Equivalents OE#

1LR W0046 00	2HF W0046 02	4ES W0045 00
2HF W0046 00	3UN W0045 00	5PA W0045 00

STD FA119X	Carbon Dual Purpose Pad Blend
FA119R	Utility Grade Sintered Pad Blend

Dealer Stocking Recommendation

Single/Pair	Popularity #	Rec Stocking Level
1	FA119X - Y26 FA119R - Y32	1 1

FA120



CAGIVA

Elefant 650

86-87 F

Equivalents OE#

8000 45453

STD FA120	Carbon Dual Purpose Pad Blend
------------------	-------------------------------

Dealer Stocking Recommendation

Single/Pair	Popularity #	Rec Stocking Level
1	-	1

FA121

HONDA
CBR 600 F 'Hurricane'

87-90 F

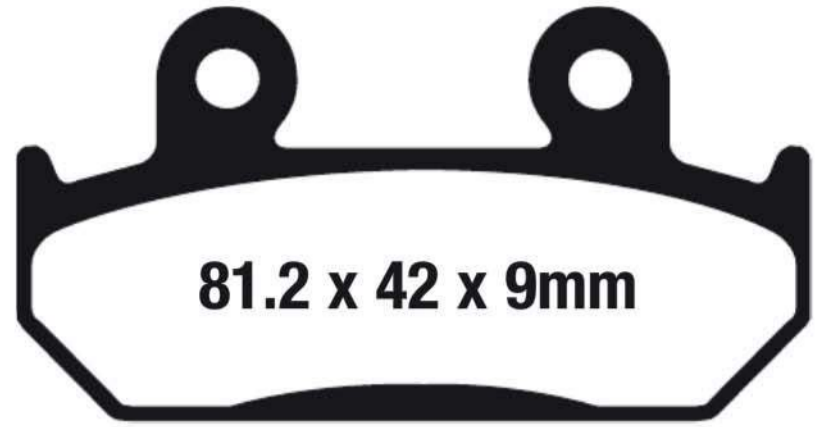

81.2 x 42 x 9mm

SAME AS FA203 EXCEPT REDUCED THICKNESS

Equivalents OE#

45105 KT7 751	45105 ML4 004	45105 ML4 024	45105 MN4 008
45105 KT7 761	45105 ML4 006	45105 ML7 017	
45105 KT8 004	45105 ML4 008	45105 ML0 007	
45105 ML4 000	45105 ML4 014	45105 MN4 007	

Dealer Stocking Recommendation

STD FA121 Premium Organic Street Pad Blend
OPTION FA121HH Street Performance Sintered Pad Blend

Single/Pair	Popularity #	Rec Stocking Level
2	H12	2

FA122



55 x 52.6 x 9.4mm

HONDA STREET BIKE
CB 450 DX-K

89-92 F & R

Equivalents OE#

43105 KK9 691

Dealer Stocking Recommendation

Single/Pair	Popularity #	Rec Stocking Level
1	H29	1

STD FA122 Premium Organic Street Pad Blend

**BUYERS GUIDE
BRAKE PADS**

Dimension 1=Width or Diameter, Dimension 2=Height or Diameter, Dimension 3=Thickness (Material and backplate)

NOTE:- Size identification is shown as follows

FA123

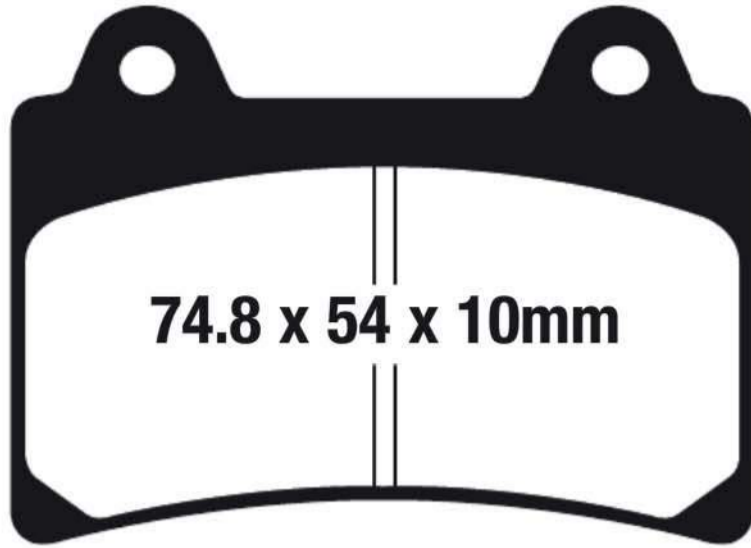

YAMAHA

FZR 400 A	90	F
FZR 750 Genesis RU/RT	87-88	F
TDM 850 D/DC/E/EC	92-93	F
FZR 1000 Genesis T/TC/U/UC	87-88	F
FZR 1000 W/WC Genesis	89	F
FJ 1200 W/WC	89-90	F
FJ 1200 A/AC/B/BC/D/DC	90-92	F
XVZ 13 D Series 'Venture Royale	86-93	F & R
XVZ 1300 T/TC/U/UC Venture	87-88	F & R
XVZ 13 'Royal Star' All models	96-01	F & R
XVZ 1300 TF Royal Star Midnight Venture	02-07	R
XVZ 1300 Royal Star Tour Deluxe	06-08	R
XVZ 1300 Royal Star Midnight Tour Deluxe	06-10	R
XVZ 1300 Royal Star Boulevard	99-00	F & R
XVZ 1300 Royal Star Tour Deluxe	97-01	F & R
XVZ 1300 Royal Star Tour Deluxe	05-07	R
XVZ 1300 LTK Venture	96-98	F & R
XVZ 1300 Venture MM Limited Edition	01	R
XVZ 1300 Royal Star	96-97/00	F & R
XVZ 1300 Royal Star Boulevard	99-01	F & R
XVZ 1300 Royal Star Midnight Venture	02-07	R
XVZ 1300 Royal Star Standard	98	F & R
XVZ 1300 Royal Star Tour Classic	96-00	F & R
XVZ 1300 Royal Star Venture	99-07	R
XVZ 1300 Royal Star Venture S	08-13	R
XV 1300 Royal Star Midnight Tour Deluxe	06-07	R
XV 1600 Road Star/Midnight Star	99-02	R
XV 1600 Road Star	01-05	R
XV 1600 Road Star Silverado	07-09	R

XV 1600 Road Star Midnight	03	R
XV 1600 Midnight Star	02-03	R
XV 1700 Road Star S (9 Spoke Cast) XV17ASX/ASY /ASZ/ASA/ASB	08-14	R
XV 1700 Road Star Silverado Spoke Wheel XV17 ATW	07	R
XV 1700 Road Star Silverado S (9 Spoke Cast Wheel) XV17 ATSA/ATSB	11-14	R
XV 1700 Road Star Silverado Spoke Wheel XV17 ATX/ATY/ATZ	08-10	R
XV 1700 Road Star 9 Spoke Cast XV17 AWX	08	R
XV 1700 Road Star (Solid front discs/spoke wheels) XV17 AT/ATC/AV/AVC/ATW	05-07	R
XV 1700 Road Star Midnight (Floating front discs/9 spoke cast wheels) (XV17 AMT/ATMC/AMV/AMVC)	05-06	R
XV 1700 Road Star Front floating discs/9 spoke cast wheels XV17 AWT/AWTC/AWV/AWVC	05-06	R
XV 1700 Road Star Cast Wheels 9 spoke XV17 AS/ASC /AWY/AW/AWWC	04-09	R
XV 1700 Road Star Midnight Floating front discs/cast wheels spoke XV17 AMS/AMSC/AMW/AMWC	04/07	R
XV 1700 Road Star Midnight Silverado Floating front discs/cast spoke wheels XV17 ATMS/ATMSC /ATMTC/ATMW/ATMV/ATMVC	04-07	R

Equivalents OE#

1NL W0045 00	1RK W0045 50	2GH W0045 01
1NL W0045 01	1RK W0046 00	3EN W0045 00
1RK W0045 00	2GH W0045 00	4KG W0045 00

STD	FA123	Premium Organic Street Pad Blend
OPTION	FA123HH	Street Performance Sintered Pad Blend
OPTION	FA123V	Semi Sintered Long Lasting Street Pad Blend

Dealer Stocking Recommendation

Single/Pair	Popularity #	Rec Stocking Level
2	Y9	4

**BUYERS GUIDE
BRAKE PADS**

**NOTE:- Size identification is shown as follows
Dimension 1=Width or Diameter, Dimension 2=Height or Diameter, Dimension 3=Thickness (Material and backplate)**

FA124

FA124/2

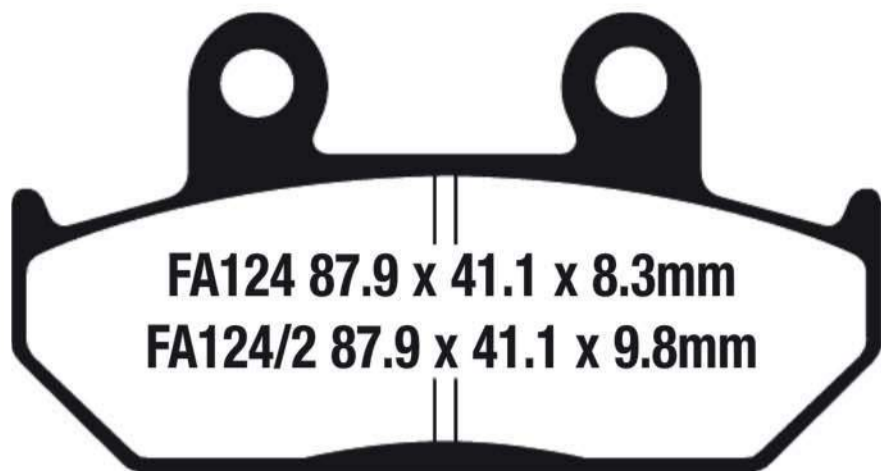

FA124		
HONDA		
RS 125	88-89	F
RS 250	88-89	F
VFR 700 F/F2 'Interceptor'	86-87	F
VFR 750 F 'Interceptor'	86	F
CBR 1000 F (Hurricane)	87-88	F

FA124/2		
HONDA		
CB 125 TT	90	F
VTR 250 Interceptor	90	F
VLX 600 Shadow (VT 600 C/CD)	88-93	F
NX 650	88-89	F
GL 1500 Goldwing All models	88-00	F

Equivalents OE#

FA124

45105 ML7 006	45105 MM5 008
45105 ML7 007	45105 MS6 901
45105 MM5 007	45105 NF4 000

Equivalents OE# FA124/2

06455 MT8 405	45105 MN9 008	45105 MT8 008
06455 MS8 405	45105 MR1 671	45106 MW3 671
45105 KV0 701	45105 MS8 008	69100 10840
45105 MN5 008	45105 MT2 007	
45105 MN5 018	45105 MT2 008	

STD	FA124	Premium Organic Street Pad Blend
OPTIONS	FA124HH	Street Performance Sintered Pad Blend
STD	FA124/2	Premium Organic Street Pad Blend
OPTIONS	FA124/2HH	Street Performance Sintered Pad Blend
OPTIONS	FA124/2V	Semi Sintered Long Lasting Street Pad Blend

Dealer Stocking Recommendation

Single/Pair	Popularity #	Rec Stocking Level
2	FA124 - H21 FA124/2 - H13	FA124 - 2 FA124/2 - 2

FA125



**ALSO SEE FA185 FOR
OVERSIZE PAD**

HONDA		
CR 125 R	87-94	F
CR 250 R	87-94	F
TRX 250 R	86-89	F
XR 250 L	91-92	F
XR 250 R Pro Link	88-95	F
ATC* 350 X	86	F
CR 500 R	87-94	F
XR 600 R	88-92	F

* - ATC is a Registered Trademark of Honda Motor Corporation

Equivalents OE#

45105 HA5 671A	45106 HA5 671B
45105 HA5 672A	45106 KS6 701A
45105 HA5 672B	45106 KS6 701B
45105 KS6 831A	45106 KS6 831B
45105 KT0 405	
45105 KZ1 405	

STD	FA125X	Carbon Dual Purpose Pad Blend
OPTIONS	FA125R	Utility Grade Sintered Pad Blend
OPTIONS	MXS125	Sintered Sport Off Road Pad Blend

Dealer Stocking Recommendation

Single/Pair	Popularity #	Rec Stocking Level
1	FA125X - H18 FA125R - H13	FA125X - 2 FA125R - 2

FA126



67.5 x 51 x 7mm

ATK

560 & other models
All Models

89-91 F
92 F

KTM

MX/EXC 250
MX/EXC 350

87 F & R
87 F & R

MOTO GUZZI

Quota 1000

92-97 F

MZ

Skorpion Tour/Traveller

95-02 F

Equivalents OE#

000 306 5430310

STD	FA126	Premium Organic Off Road Pad Blend
OPTIONS	FA126R	Utility Grade Sintered Pad Blend
OPTIONS	FA126HH	Street Performance Sintered Pad Blend

Dealer Stocking Recommendation

Single/Pair	Popularity #	Rec Stocking Level
1	-	1

FA128

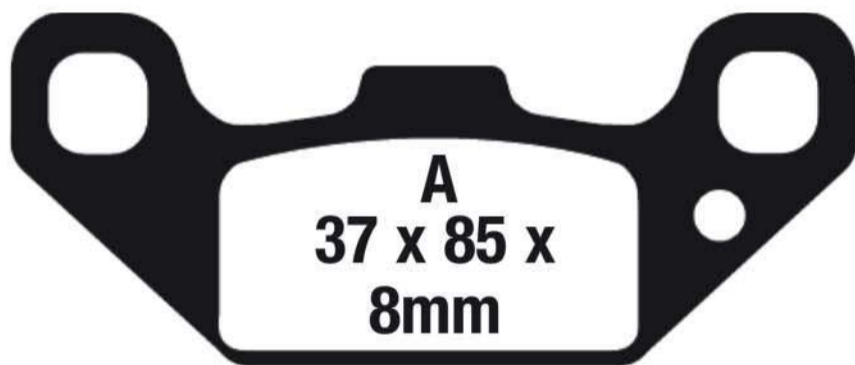

A
37 x 85 x 8mm

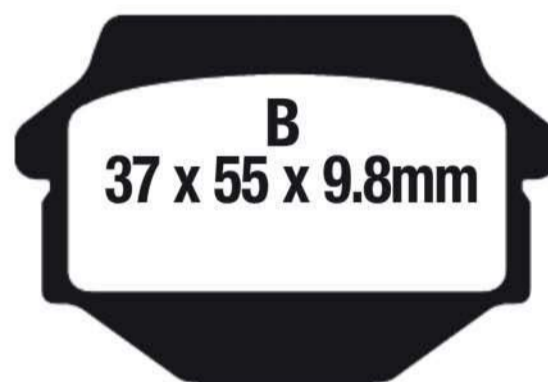

B
37 x 55 x 9.8mm

MUST FIT IN COMPLETE FRONT AXLE SETS (2 PAIRS)

KAWASAKI

KSF 250 A1/A2/A3/A4/A5/A6/A7/A8/A9/A10/A11
-A18 'Mojave' 87-03 F
KXF 250 A1/A2 Tecate 87-88 F
KEF 300 A1/A2/A3/A4/A5/A6 Lakota 95-00 F
KEF 300 B1/B2/B3 Lakota Sport 01-03 F

SUZUKI

LT 230 SF/SG/SH/SJ 85-88 F
LT 230 EH/EJ/EK/EL/EM/EN/EP 86-93 F
LT 250 SK/SL 89-90 F
LT 250 RF/RG 85-86 F
LT 250 RH/RJ/RK/RL/RM/RN 87-92 F
LT 500 RH/RJ/RK/RL 87-90 F

Equivalents OE#

43082 1067
59100 43810
59300 03840

STD	FA128X	Carbon Dual Purpose Pad Blend
OPTIONS	FA128R	Utility Grade Sintered Pad Blend
OPTIONS	FA128SV	High Durability Off Road Sintered Blend

Dealer Stocking Recommendation

Single/Pair	Popularity #	Rec Stocking Level
2	K18/S19	2

Dimension 1=Width or Diameter, Dimension 2=Height or Diameter, Dimension 3=Thickness (Material and backplate)

NOTE:- Size identification is shown as follows

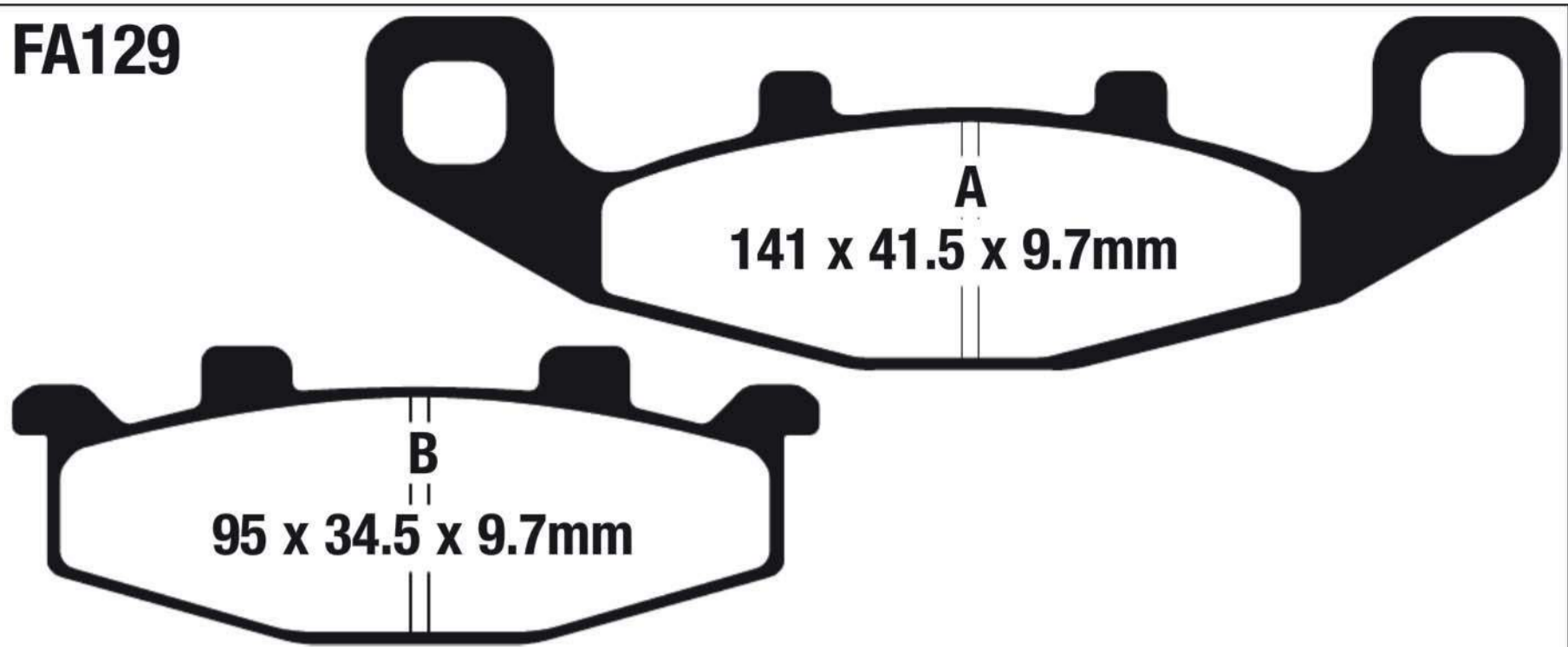

KAWASAKI			SUZUKI		
EX 250 F2-F19/D6F/D7F Ninja 250	88-07	F	ZX 1100 C1-C4 ZX11 Ninja	90-93	R
EX 500 A1-A7/D1-D12/D6F/D7F/D8F/D9F	87-09	F	ZR 1100 A1/A2/A3/A4 Zephyr	92-95	R
ZR 550 B1/B2/B3/B4 Zephyr	90-93	F	ZR 1100 B1 Zephyr	96	R
ZL 600 B2/B3 Eliminator	96-97	F	SUZUKI		
ZX 600 C1-C9 Ninja 600R	88-96	F & R	GSF 400 M/N/P Bandit	91-93	F
ZX 600 D1/D2/D3/D4(ZX6)	90-93	R	GS 500 EK/EL/EM/EN/EP/ER/ES	89-95	F
KL 650 B2/B3 Tengai	90-91	F	VX 800 L/M/N/P	90-93	F
ZR 750 C1/C2/C3 Zephyr	91-93	F & R	GSX 1100 GM/GN/GP	91-93	F
ZX 750 F1/F2/F3/F4 Ninja	87-90	F & R			
ZG 1000 A9-A20 Concours	94-05	F			
ZG 1000 A6F Concours	06	F			
ZX 1000 B1/B2/B3 Ninja (ZX10)	88-90	F & R			

Equivalents OE#	43082 1068	43082 1095	43082 1124	43082 1189	59301 45860
	43082 1069	43082 1104	43082 1134	43082 1145	
	43082 1074	43082 1114	43082 1139	59100 01820	
	43082 1088	43082 1123	43082 1161	59100 26810	

STD	FA129	Premium Organic Street Pad Blend
OPTIONS	FA129HH	Street Performance Sintered Pad Blend
OPTIONS	FA129R	Utility Grade Sintered Pad Blend
OPTIONS	EPFA129HH	Fast Street Use & Track Day Sintered Pad Blend
OPTIONS	FA129V	Semi Sintered Long Lasting Street Pad Blend

Dealer Stocking Recommendation	Single/Pair	Popularity #	Rec Stocking Level
	2	K2/S8	10

FA130

A
73.3 x 49.3
x 7mm

B
60.8 x 62.8
x 9mm

Equivalents OE#

43082 1072
43082 1078
43082 1078

Dealer Stocking Recommendation

Single/Pair	Popularity #	Rec Stocking Level
1	K22	2

STD	FA130X	Carbon Dual Purpose Pad Blend
OPTIONS	FA130R	Utility Grade Sintered Pad Blend

KAWASAKI		
KX 125 E2/F1	87-88	F
KX 250 E1/F1	87-88	F
KX 500 C1/D1	87-88	F
KL 650 A1-A19/A6F/A7F (KLR)	87-07	F

FA131



ATK

Motard 450	07	R
GAS-GAS		
Enduro EC 200/250/300	99-00	R
EC 125/200/250/300	01-09	R
MC 125	05	R
MC 125/250	01-04	R
Pampera 125/450	05-06	R
SM 125/250 (2T)	01-05	R
MX 200/250/300	99-00	R
SM 400 FSE (2T)	01-02	R
EC 450	09	R
FSE 450	05-08	R
SM 450	03-05	R
EC 515	09	R

HONDA

Dream 50 R (CB 50) (AR02)	04	R
NSR 50 R (RS 50)	04	R
CR 80 R/RB Expert	92-02	R
CR 85 R/85 R Expert	03-07	R
NSF 100 R	06	R
CR 125 R	87-01	R
CRF 230 L	08-11	R
CRF 230 M	09-11	R
CR 250 R	87-01	R
XR 250 R	90-04	R
XR 250 L	91-96	R
XR 400 R	96-04	R
CR 500 R	87-01	R
XR 600 R	91-00	R
XR 650 L	93-16	R
XR 650 R	00-07	R

HUSQVARNA

WXE 125	07	R
---------	----	---

KAWASAKI

KX 125 K2/K3/K4/K5/L1/L2/L3/L4/M1/M2/M3	95-05	R
KLX 250 S (KLX 250 H6F/H7F)	06-07	R
KLX 250 S (KLX 250 T9F/TAF/TBF/TCF/TDF/TEF)	09-14	R
KLX 250 SF (KLX 250 W9F/TAF) Supermotard	09-10	R
KX 250 K2/K3/K4/K5/L1/L2/L3/L4/M1/M2/R1	95-05	R
KX 250 R6F/R7F	06	R
KLX 300 R A2-A10/A6F/A7F	97-06	R
KLX 400 SR (KLX 400 A1/A2)	03-04	R
KLX 400 R (KLX 400 B1/B2)	03-04	R
KX 500 E8-E16	96-04	R
KLX 650 R D1	96	R

SUZUKI

RM 125 T/V/W/X/K1/K2/K3/K4/K5/K6/K7/K8	96-08	R
RM 250 T/V/W/X/K1/K2/K3/K4/K5/K6/K7/K8	96-08	R
RMX 250 X/Y	99-00	R
DR-Z 400 SY/SK1/SK2/SK3/SK4/SK5/SK6/SK7/ SK8/SK9/SL1/SL2/SL3/SL4/SL5/SL6	00-16	R
DR-Z 400 EY/Y/EK1/EK2/K2/K3/EK3/K4/EK4/EK5/EK6/EK7	00-07	R
DR-Z 400 SMK5/SMK6/SMK7/SMK8/SMK9/SML3 /SML4/SML5/SML6	05-09/13-6	R

T.M.

MX 85 JR (2T)	04-	R
EN 125 (2T)	01-04	R
MX Models 125/250/300	02-04	R
SMR 125 (2T)	05-08	R
EN 250 (2T)	01-03	R
EN 250 F-ES (4T)	04-	R
EN 300 (2T)	01-04	R
EN 450 F-ES (4T)	04-	R
MX 450 F	04-	R
SMR 450 F ES (4T)	05-08	R
SMX 450 F Competition (4T)	05-08	R
EN 530 F-ES (4T)	04-	R
MX 530 F (4T)	04-	R
SMX 660 F	04	R

YAMAHA

YZ 125 K/L/M/N/P	98-02	R
WR 250 FN/FP	01-02	R
YZ 250 K/L/M/N/P/FN/FP	98-02	R
WR 400 FL/FM	99-00	R
YZ 400 FL	99	R
YZ 426 FM/FN/FP	00-02	R
WR 426 FN/FP	01-02	R

Equivalent OE#

06435 KCZ 000	43106 GT4 004B	43082 S010	59100 09860	69100 36870
06435 GT4 405	43106 GW2 004B	43082 S012	59100 09880	69100 37810
43080 0090	43106 KS6 701B	5DH W0046 00	69100 36820	69100 37830
43105 GT4 004A	43106 KS6 702B	5GR W0046 00	69100 36830	69095
43105 GW2 004A	43082 0006	5MV W0046 00	69100 36840	
43105 KS6 701A	43082 1173	59100 09840	69100 36850	
43105 KS6 702A	43082 1292	59100 09850	69100 36860	

STD	FA131X	Carbon Dual Purpose Pad Blend
OPTIONS	FA131R	Utility Grade Sintered Pad Blend
OPTIONS	MXS131	Sintered Sport Off Road Pad Blend
OPTIONS	EPFA131HH	Fast Street Use & Track Day Sintered Pad Blend

Dealer Stocking Recommendation

Single/Pair	Popularity #	Rec Stocking Level
1	FA131R - H7/K13	FA131R - 4
1	FA131X - H4/K19	FA131X - 4

FA132

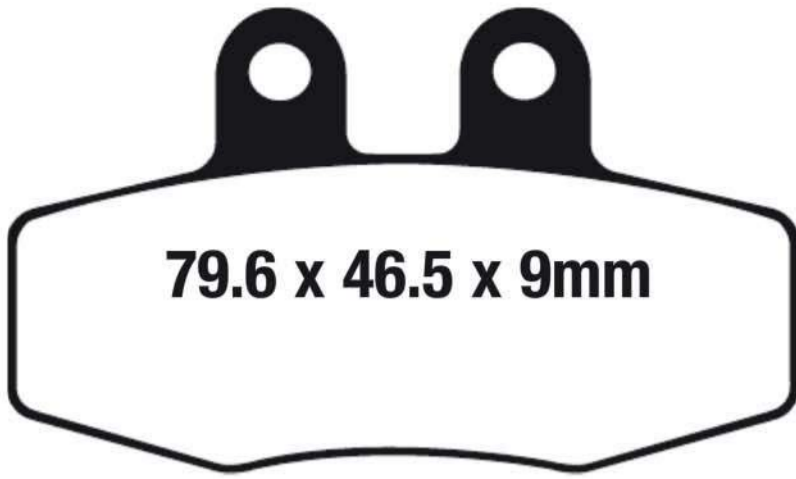

79.6 x 46.5 x 9mm

KTM

D-XC/E-XC/E-GS 125 Grimeca caliper	90-91	F & R
D-XC/E-XC/E-GS 125 Grimeca caliper	92-93	F
EXC/MX 125	88	F & R
EXC 125 Brembo caliper	89	F & R
MX 125 Grimeca caliper	89-91	F & R
MX 125 Grimeca caliper	92-93	F
DXC/EXC 250 Grimeca caliper	90	F & R
D-XC/E-XC/E-GS 250	91	F & R
D-XC/E-XC/T-XC/E-GS 250 Grimeca caliper	92-93	F
EXC/EGS 250	88	F & R
EXC/EGS 250 Grimeca caliper	89	F & R
MX 250	88-91	F & R
DXC/EXC/EGS 350 Grimeca caliper	90-91	F & R
EXC 350 Grimeca caliper	89	F & R
MC/EXC/EGS 350	88	F & R
MX 350 Grimeca caliper	89-91	F & R
LC-4 MX/EXC 500	89	F & R
LC-4 MX/EXC 500 Grimeca Caliper	90-91	F & R
LC-4 MX/EXC 600	89	F & R
LC4 MX/EXC 600 Grimeca caliper	90-91	F & R
LC4 EXC 600	92-93	F

Equivalents OE#

565 13209243

565 13209323

STD	FA132X	Carbon Dual Purpose Pad Blend
OPTIONS	FA132R	Utility Grade Sintered Pad Blend

Dealer Stocking Recommendation

Single/Pair	Popularity #	Rec Stocking Level
1	-	1

FA134

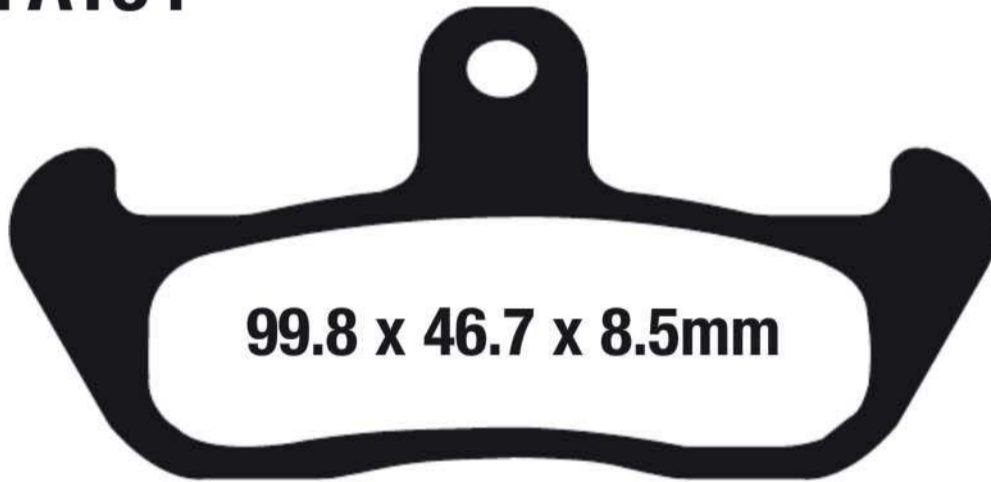

99.8 x 46.7 x 8.5mm

CAGIVA

WMX 125/250	87-91	F
HUSQVARNA		
CR 125	91	F
WR 125	87-88	F
WR 125	91	F
CR 240	87-88	F
WR 240	87-88	F
WR 240	90-91	F
CR 250	87-88	F
CR 250	91	F
WR 250	87-88	F
WR 250	90-91	F
XC 250	87-88	F
WR 260	90-91	F
TE 350	90-91	F

HUSQVARNA Contd.

WR 400	87-88	F
430 Automatic	87-88	F
CR 430	87-88	F
WR 430	87-88	F
XC 430	87-88	F
CR 500	87-88	F
XC 500	87-88	F
TC 510	89-	F
TC 510	90	F
TE 510	89	F
TE 510	90	F
WMX 510	89	F
WXE 510	89	F
TC 610	91	F
TE 610	91	F

Equivalents OE#

N/A

Dealer Stocking Recommendation

STD	FA134X	Carbon Dual Purpose Pad Blend
OPTIONS	FA134R	Utility Grade Sintered Pad Blend

Single/Pair	Popularity #	Rec Stocking Level
1	-	1

FA135

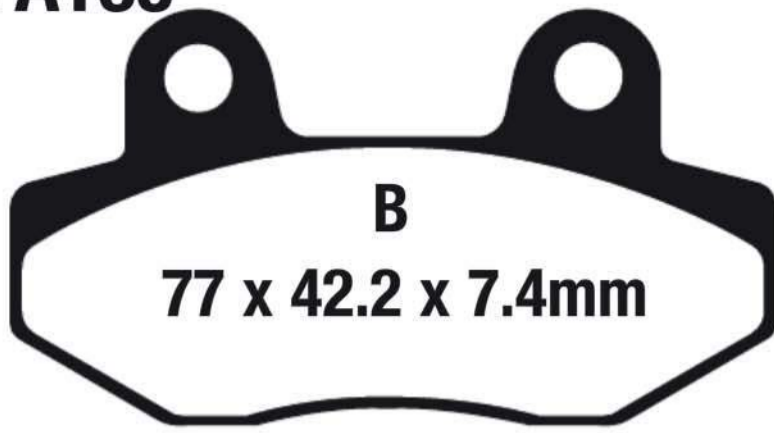

B
77 x 42.2 x 7.4mm

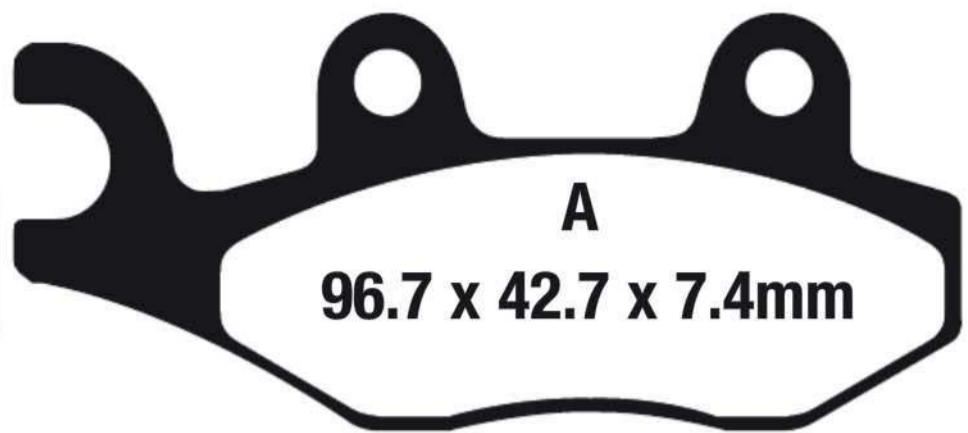

A
96.7 x 42.7 x 7.4mm

ATK

All Models 93-96

BENNCHE

250 Cowboy 15-16
250 Spire 15-16
400 Bighorn 11-16
400 Cowboy 15-16
500 Bighorn 15-16
500 Cowboy 14-16
700 Bighorn 15-16
700 Cowboy 14-16
700 X Bighorn 15-16
800 Spire 14-16
1000 Cowboy 15-16
1000 Spire 14-16
1000 X Spire 14-16

CAN-AM SIDE X SIDE

Commander 800 (XT/DPS) 11-15
Commander 800 R (STD) 11-15
Commander XT 800 R 11-15
Commander 1000 STD 11-15
Commander 1000 XT 11-15
Commander 1000 XT-P 14-15
Commander 1000 X 11-13
Commander 1000 LTD 12-15

CF MOTO

500 U-Force EPS 14-16
500 Z-Force 14-16
800 U-Force 13-17
800 Z-Force 15-16
800 EX Z-Force 14-16

HISUN

250 Sector 15-16
250 Strike 15-16
400 Forge 15-16
HS 400 15-16
450 Sector 15-16
500 Forge 15-16
HS 500 15-16
550 Sector 15-16
700 Forge 15-16
HS 700 15-16
750 Sector 15-16
HS 750 Crew 15-16
HS 800 Crew 15-16
800 Strike 15-16
800 Tactic 15-16
1000 Sector 15-16
1000 Strike 15-16
1000 Strike Crew 15-16
1000 Tactic 15-16

HUSQVARNA

CR 125 92-94
WR 125 93-94
CR 250 92-94
WR 250 92-94
TE 350 92-94
CR 360 92-94
WR 360 92-94
TC 610 92-94
TE 610 92-94

KAWASAKI

KX 125 G1/H1/H2/J1/J2 89-93
KLX 140 A8F/A9F/AAF/ABF/ACF/ADF/AEF/AFF/AGF/AHF (KLX 140) 08-17
KLX 140 B8F/B9F/BAF/BBF/BCF/BDF/BEF/BFF/BGF/BHF (KLX 140 L) 08-17
KLX 140 CHF (KLX 140 G) 17
KLX 150 S 09
KDX 200 E5/E6 93-94
KDX 250 D1/D2/D3/D4 91-94
KLX 250 S (KLX 250 T9F/TAF/TBF/TCF/TDF/TEF) 09-14

KAWASAKI Contd.

F & R	KLX 250 SF (KLX 250 W9F/WAF) Supermotard	09-10	F
	KX 250 G1/H1/H2/J1/J2	89-93	F
F (Right)	KLF 300 C1-C17 'Bayou' (Left)	89-05	F (Right)
F (Right)	KLF 400 B1-B7 'Bayou' (Left)	93-99	F (Right)
F&R (Right)	KX 500 E1-E5	89-93	F
F&R (Right)	KVF 650 FCS (Brute Force 650 4x4i)	12	F (Right)
F&R (Right)	KVF 650 H7F/H8F Brute Force 4x4i	07-08	F (Right)
F&R (Right)	KVF 650 F6F/F7F/F8F/F9F/FAF/FBF Brute Force 650 4x4i	06-11	F (Right)
F&R (Right)	KVF 650 G6F/G7F/G8F/G9F/GAF Brute Force 650 4x4i		
F&R (Right)	Hardwoods Green HD	06-10	F (Right)
F&R (Right)	KRF 750 A8F/B8F (Teryx 750 4x4)	08	F (Right)
F&R (Right)	KRF 750 L9F (Teryx 750 F1 4x4 Le Sport)	09	F (Right)
F&R (Right)	KRF 750 C8F/D8F (Teryx 750 4x4 LE)	08	F (Right)
F&R (Right)	KRF 750 F8F (Teryx 750 4x4 NRA Outdoors)		
F&R (Right)	KVF 750 A1/A6F/A7F Brute Force 750 4x4i	05-07	F (Right)
F&R (Right)	KVF 750 B6F/B7F/B7FA Brute Force 750 4x4i	06-07	F (Right)
F Right & R	KVF 750 A1/A6F/B6F/B7FA/C7F/D8F/F8F/D9F/E9F/DAF/DBF Brute Force 750 4x4	05-11	F (Right)
F Right & R	KVF 750 F8F/FAF/FBF Brute Force 750 4x4i	08/10-11	F (Right)
F Right & R	KVF 750 GCF/GDF/GEF/GFF/GGF/GHF (Brute Force 750 4x4i/EPS)	12-17	F (Right)
F Right & R	KVF 750 HCF/HDF/HEF/HFF/GGF/GHF (Brute Force 750 4x4i/EPS)	12-17	F (Right)
F Right & R	KVF 750 JCF/JDF/JEF/JFF/JGF/JHF (Brute Force 750 4x4i/EPS)	12-17	F (Right)
F Right & R	KVF 750 LCF/LDF/LEF/LFF/LGF/LHF (Brute Force 750 4x4i)	12-17	F (Right)
F (Left)	KRF 750 F8F (Teryx 750 4x4 NRA Outdoors)	08	F (Right)
F (Left)	KRF 750 G9F/NAF/NBF/NDF/NCS (Teryx 750 Fi 4x4)	09-13	F (Right)
F (Left)	KRF 750 M9F (Teryx 750 F1 4x4 NRA Outdoors)	09	F (Right)
F (Left)	KRF 750 SAF/SAFA/SBF/SBFA/SCS/SCSA/SDF (Teryx 750 Fi 4x4 Sport)	10-13	F (Right)
F (Left)	KRF 750 TAF/VBF/VCS (Teryx 750 Fi 4x4 SGE)	10-12	F (Right)
F (Right)	KRF 750 J9FA/K9F/PAF/PBF/RAF/RBF/RCS/RDF/PCF/PDF (Teryx 750 F1 4x4 LE)	09-13	F (Right)
F (Right)	KRT 750 ACF/ADF (Teryx 4 750 4X4)	12-13	F (Right)
F (Right) & R (Left)	KRT 750 ACFA/ADFA (Teryx 4 750 4X4 EPS)	12-13	F (Right)
F (Right) & R (Left)	KRT 750 CCF/CDF (Teryx 4 750 4X4 EPS LE)	12-13	F (Right)
F (Right) & R (Left)	KRT 750 DCF/DDF (Teryx 4 750 4X4 EPS Realtree)	12-13	F (Right)
F (Right) & R (Left)	KVF 750 B1/E8F/E9F Brute Force 750 4x4i		
F (Right) & R (Left)	Hardwoods Green HD	05/08-09	F (Right)
F (Right) & R (Left)	KVF 750 E8FA/E9FA/EAF Brute Force 750 4x4i		
F (Right) & R (Left)	NRA Outdoors	08-09	F (Right)
F (Right) & R (Left)	KRF 800 BEF/BFF/FGF/FHF (Teryx)	14-17	F (Right)
F (Right) & R (Left)	KRF 800 CEF/CFF/GGF/GHF (Teryx LE)	14-17	F (Right)
F (Right) & R (Left)	KRF 800 DEF/DFE/HGF/HFF (Teryx Camo)	14-17	F (Right)
F (Right) & R (Left)	KRT 800 BEF/BFF/FGF/FHF (Teryx 4)	14-17	F (Right)
F (Right) & R (Left)	KRT 800 CEF/CFF/GGF/GHF (Teryx 4 LE)	14-17	F (Right)
F (Right) & R (Left)	KRT 800 DEF/DFE/HGF/HFF (Teryx 4 Camo)	14-17	F (Right)
F (Right) & R (Left)	KAF 820 AFF/AGF/AHF Mule Pro - FXT	15-17	F (Right)
F (Right) & R (Left)	KAF 820 BFF/BGF/BHF Mule Pro - FXT /EPS	15-17	F (Right)
F (Right) & R (Left)	KAF 820 CFF/CGF/CHF Mule Pro - FXT /EPS LE	15-17	F (Right)
F (Right) & R (Left)	KAF 820 DFF/DGF/DHF Mule Pro - FXT /EPS Camo	15-17	F (Right)
F	KAF 820 EGF/EHF Mule Pro - FX	16-17	F (Right)
F	KAF 820 FGF/FHF Mule Pro - FX/EPS	16-17	F (Right)
F	KAF 820 GGF/GHF Mule Pro - FX/EPS LE	16-17	F (Right)
F	KAF 820 HGF/HHF Mule Pro - FX/EPS Camo	16-17	F (Right)
F	KAF 820 JGF/JHF Mule Pro - FXT Ranch Edition	16-17	F (Right)
F	KAF 1000 AGF/AHF - Mule Pro DXT/Diesel	16-17	F (Right)
F	KAF 1000 BGF/BHF - Mule Pro DXT/Diesel EPS	16-17	F (Right)
F	KAF 1000 CGF/CHF - Mule Pro DXT EPS LE/Diesel	16-17	F (Right)
F	KAF 1000 DGF/DHF - Mule Pro DX/Diesel	16-17	F (Right)
F	KAF 1000 EGF/EHF - Mule Pro DX EPS/Diesel	16-17	F (Right)
F	KAF 1000 FGF/FHF - Mule Pro DX EPS LE/Diesel	16-17	F (Right)
F	MASSIMO		
F	250 Gunner	15-16	F (Right)
F	250 Gunner S	15-16	F (Right)
F	MSU 400	15-16	R (Right)
F	500 Alligator	15-16	F (Right)
F	500 Knight	15-16	F (Right) & R (Right)
F	MSA 500	13-16	F (Left) & R (Left)
F	MSU 500	15-16	R (Right)
F	550 EPS Alligator	15-16	F (Right)
F	700 Alligator	15-16	F (Right) & R (Right)

FA135 Contd.

MASSIMO Contd.

700 Knight	15-16	F (Right) & R (Right)
700-4 Alligator EPS	15-16	F (Right) & R (Right)
MSU 700	15-16	F (Right) & R (Right)
MSU 700-5	15-16	F (Right) & R (Right)
MSA 800	14-16	F (Left) & R (Left)
MSU 800	15-16	F (Right) & R (Right)
1000 Militia	15-16	R (Right)
1000 S Militia	15-16	R (Right)
1000 XS Militia	15-16	R (Right)

MZ

SX/SM 125	02-05	F
-----------	-------	---

SUZUKI

RM 125 H/J/K/L/M/N/P	87-93	F
DR 250 L/M/N/P/R/S	90-95	F
RM 250 H/J/K/L/M/N/P	87-93	F
RMX 250 K/M/N/P/R/S	89-95	F
DR 250 SL/SM/SN/SEP/SER/SES	90-95	F
LT-F 300 FK2	02	F (Right)
DR 350 SL/SM/SN/SP/SEP/SES/SET/SEW	90-97	F
DR 350 L/M/N/P/R/S/T/V	90-97	F
LT-R 450 K6/K7/K8/K9	06-11	F (Right)
LT-R 450 ZK8/ZK9 Quad Racer Ltd Edition	08-09	F (Right)
LT-F 500 FW/FX/FY/FK1/FK2/Z0 Quadrunner	98-02	F (Right)
LT-A 500 FY/FK1 Quadmaster	00-01	F (Right)

UM (UNITED MOTORS)

DSF 200	06-08	F
DTF 200	06-08	F
SMF 200	08	F

YAMAHA

YZ 125 W/A/B/D/E	89-93	F
WR 125 K	98	F
WR 200 D	92	F
TT-R 230 T/V/W/X/Y/A/B/D/E/F	05-15	F
TT-R 250 L/M/N/P/R/S/T/V	99-06	F
XTZ 250 Lander (F 21" / R 18" Wheels)	07-14	F
XTZ 250 X (F & R 17" Wheels)	08-10	F
YZ 250 WRW/WRA	89-90	F

YAMAHA Contd.

YZ 250 W/A/B/D/E	89-93	F
WR 250 ZB/ZD/ZE/ZF/ZG/ZH/ZJ	91-97	F
YXR 450 Rhino (All models)	06-09	F (Right)
YFZ 450 RY/RZ/RA/RB/RD/RE/RSE/RF	09-15	F (Right)
YFZ 450 S/T/V/W/X/Y/B/D	04-09/12-13	F (Right)
YFZ 450 LES Special Edition	04	F (Right)
YFZ 450 SET Special Edition	05	F (Right)
YFZ 450 SEW Special Edition	07	F (Right)
YFZ 450 BBV/BBW Bill Balance Edition	06-07	F (Right)
YFZ 450 SPV/SEW/SEX Special Edition	06-08	F (Right)
WR 500 ZD/ZE	92-93	F
YXR 660 Rhino	04-07	F (Right)
YFM 700 RV/RW/RX/RY/RA/RB/RD/RE Raptor	06-14	F (Right)
YFM 700 RSEW/RSPX/RSEA/RSEY/RSEZ/RSEB/RSED/RSE/RSF Special Edition	07-15	F (Right)
YXM 700 Viking Fi 4 x 4	14	R
YXM 700 Viking Fi 4 x 4 EPS	14	R
YXR 700 Rhino (All models)	08-13	F(Right) & R(Right)
YXR 700 Rhino (All models)	08-13	F(Right) & R(Right)

251-0006A	43082 0082	43082 1093	59100 09840	59300 08810	5B4 W0045 10	715500336
3SP W0045 00	43082 0087	43082 1117	59100 09850	59300 26830	5GF W0045 00	9023002000
3XP W0045 00	43082 0099	43082 1129	59100 09860	59300 27810	5RM W0045 10	9060-080910
43082 0022	43082 0100	4EW W0045 00	59100 09870	59300 27830	5TG W0045 00	7030 0853A0
43082 0060	43082 0146	4EW W0045 01	59100 09880	59300 27850	5TG W0045 20	53P F5805 00
43082 0075	43082 1089	4MX W0045 00	59100 09890	59300 27860	705601149	

STD	FA135X	Carbon Dual Purpose Pad Blend
OPTIONS	FA135R	Utility Grade Sintered Pad Blend
	MXS135	Sintered Sport Off Road Pad Blend
	FA135SV	High Durability Off Road Sintered Blend

Dealer Stocking Recommendation

Single/Pair	Popularity #	Rec Stocking Level
1	FA135R - Y16/S18/K8 FA135X - Y13/S13/K12	FA135R - 2 FA135X - 2

FA136

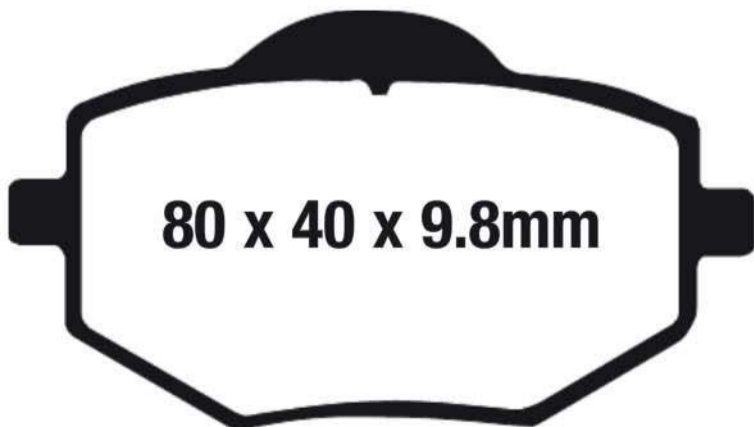

80 x 40 x 9.8mm

YAMAHA ROAD BIKE

XV 535 T/TC/U/A/AC/E/EC/F/FC/SF/SFC	87-94	F
-------------------------------------	-------	---

Equivalent OE#

3JB W0045 00

Dealer Stocking Recommendation

Single/Pair	Popularity #	Rec Stocking Level
1	Y33	1

STD	FA136	Premium Organic Street Pad Blend
------------	--------------	----------------------------------

BUYERS GUIDE
BRAKE PADS

NOTE:- Size identification is shown as follows
Dimension 1=Width or Diameter, Dimension 2=Height or Diameter, Dimension 3=Thickness (Material and backplate)

FA137



**47 x 45.1 x
7.5mm**

ARCTIC CAT

400 DVX (2 x 4) Sport

04-08

R

400 DVX TS Sport

06-07

R

HYOSUNG

TE 450

06

R

KAWASAKI

KSF 400 A1/A2/A3/A6F (KFX 400)

03-06

R

SUZUKI

LT 250 RJ/RK/RL/RM/RN

88-92

R

LT-Z 400 K3/K4/K5/K6/K7/K8/K9/ZK9/L0/LZ/ZL2/L3 QuadSport

03-13

R

LT-R 450 K6/K7/K8/K9

06-11

R

LT-R 450 ZK8/ZK9 Quad Racer Ltd Edition

08-09

R

LT 500 RH/RJ/RK/RL

87-90

R

Equivalents OE#

3406 075	69100 01810	69140 35B00	69140 43B10
43082 S007	69100 07810	69140 43B00	

STD	FA137X	Carbon Dual Purpose Pad Blend
	FA137R	Utility Grade Sintered Pad Blend
	FA137SV	High Durability Off Road Sintered Blend

Dealer Stocking Recommendation

Single/Pair	Popularity #	Rec Stocking Level
1	S22	1

FA140

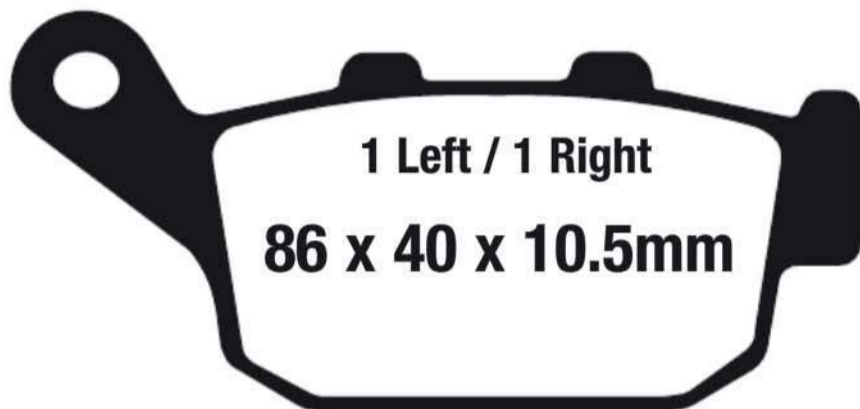

**1 Left / 1 Right
86 x 40 x 10.5mm**

HONDA

CB-1 (CB 400 F)

89-90

R

CB 500 F (Non ABS)

13-17

F

CB 500 FA (ABS)

13-17

F

CB 500 X (Non ABS)

13-17

F

CB 500 XA (ABS)

13-17

F

CBR 500 R (Non ABS)

13-17

F

CBR 500 RA (ABS)

13-17

F

NT 650 Hawk GT

88-91

R

CTX 700 (Top Fairing/Manual G/Box)

14

R

CTX 700 D (Top Fairing/Auto G/Box)

14

R

CTX 700 N (Naked/Manual G/Box)

14

R

CTX 700 ND (Naked/Auto G/Box)

14

R

NC 700 (Top Fairing / Manual G/box)

14

R

NC 700 D (Naked / Manual G/box)

14

R

NM4 - NC 700 JD (DCT)

15-16

R

NC 700 X (2 Piston F/Caliper & Manual G/box)

12-14

R

KAWASAKI

KLE 650 FFF/FFFAS Versys/Versys LT

15

R

Z 800 BGF (ABS)

16

R

Z 900 (ZR 900 AHF/NON ABS)

17

R

Z 900 (ZR 900 BHF/ABS)

17

R

TRIUMPH

Bonneville Bobber (1200cc)

17

R

Daytona 600

03-04

R

Daytona 650

05

R

Daytona 675 SE

12

R

Daytona 955i (From VIN132513)

01-06

R

Speedfour 600

02-05

R

Daytona 675

06-08

R

Daytona 675 R

11-12

R

675 Daytona Black Monobloc radial caliper

09-13

R

Street Triple 675

07-12

R

Street Triple R 675 (Radial caliper)

09-12

R

Tiger 800 (Cast Wheels)

11-14

R

Tiger 800 (With ABS/Cast Wheels)

11-14

R

Tiger 800 XR (With ABS/Cast Wheels)

15-17

R

Tiger 800 XR Touring (With ABS/Cast Wheels)

15

R

Tiger 800 XRt (With ABS/Cast Wheels)

16-17

R

Tiger 800 XRx (With ABS/Cast Wheels/STD & Low)

15-17

R

Tiger 800 XC (Spoke Wheels)

11-14

R

Tiger 800 XC (With ABS/Spoke Wheels)

11-17

R

Tiger 800 XCx (With ABS/Spoke Wheels)

15-17

R

Tiger 800 XCx (With ABS/Spoke Wheels/STD & Low)

15-17

R

YAMAHA

FZ6R (Y/Z/A)

09-11

R

FZ6R

09-17

R

BUELL

M2 Cyclone, S1 Lightning, S1 White Lightning, S3 Thunderbolt, S3T Thunderbolt, X1 Lightning

98-05

R

XB9R

02-07

R

XB9S

03-04

R

XB9SX Lightning City X

05-09

R

XB9SX Lightning

08-10

R

XB12R

04-08

R

XB12S

04-08

R

XB12X Ulysses

06-10

R

XB12XT Ulysses

08-10

R

XB12 SCG Lightning

06-10

R

XB12 SS Lightning Long

06-09

R

XB12 STT Lightning

08

R

Blast

00-07

R

XB 12 R Firebolt

09-10

R

XB 12 SS Lightning

09-10

R

CSC

RX3 Cyclone 250

15-16

R

Equivalents OE#

06435 KT7 405	43106 KT7 762B	20S W0046 00
06435 MG2 J01	45105 KV3 831	43082 0117
06435 MG3 D32	69100 04830	Z49-111
43105 KT7 761A	T2020602	Z49-107
43105 KT7 762A	H0301-T	43082 0151
43106 KT7 761B	69101 44850	

STD	FA140	Premium Organic Street Pad Blend
OPTIONS	FA140HH	Street Performance Sintered Pad Blend
	FA140V	Semi Sintered Long Lasting Street Pad Blend

Dealer Stocking Recommendation

Single/Pair	Popularity #	Rec Stocking Level
1	H31	1

NOTE:- Size identification is shown as follows
Dimension 1=Width or Diameter, Dimension 2=Height or Diameter, Dimension 3=Thickness (Material and backplate)

FA141

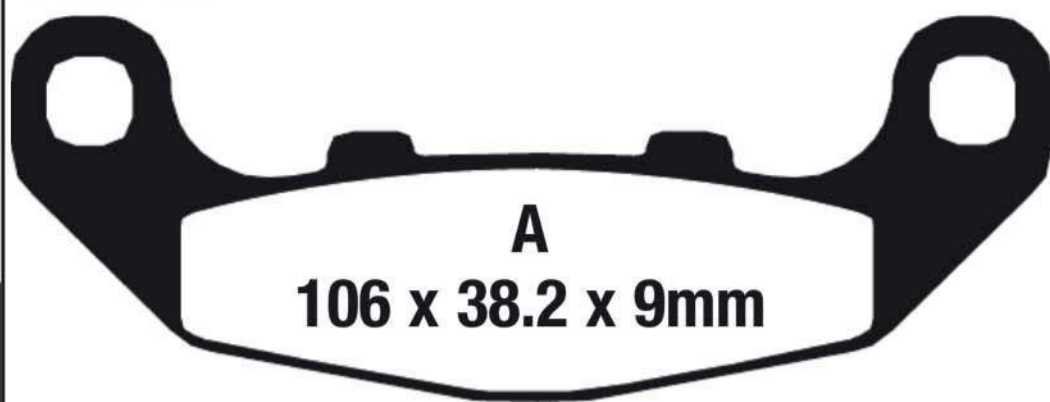

A
106 x 38.2 x 9mm

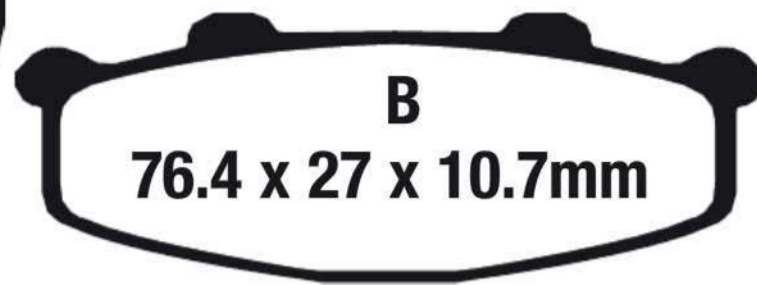

B
76.4 x 27 x 10.7mm

KAWASAKI

EX 250 F2-F19/D6F/D7F Ninja 250	88-07	R
ZR 550 B1/B2/B3 Zephyr	90-92	R

Equivalents OE#

43082 1075	43082 1087	43082 1144
43082 1076	43082 1125	43082 1145
43082 1085	43082 1127	

Dealer Stocking Recommendation

Single/Pair	Popularity #	Rec Stocking Level
1	K10	2

STD FA141 Premium Organic Street Pad Blend

FA142

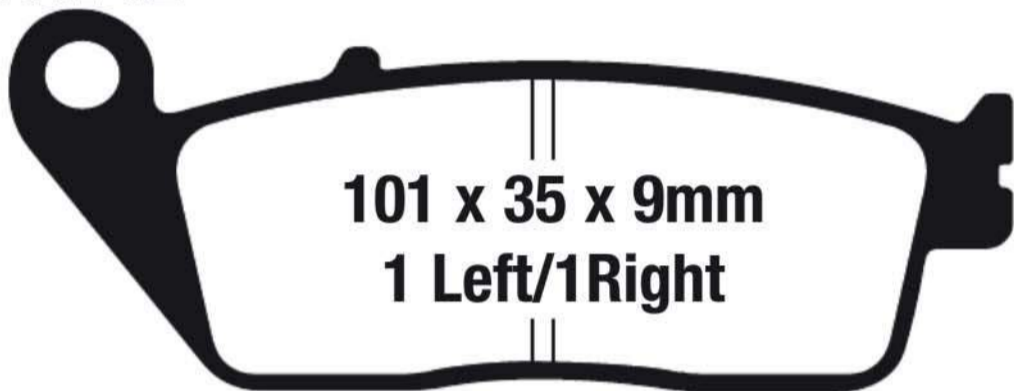

101 x 35 x 9mm
1 Left/1 Right

NOTE

Later supplies have clip notch. Both designs ok for front brake use

CAGIVA

Gran Canyon 900	99-00	F
-----------------	-------	---

HONDA

CB-1 (CB 400 F)	89-90	F
CB 650 F (Non ABS)	18	F
CB 650 F (ABS)	18	F
CBR 650 F (Non ABS Model)	14-18	F
CBR 650 FA (ABS Model)	14-18	F
NT 650 Hawk GT	88-91	F
VFR 750 F	90-97	F
PC 800 Pacific Coast	89-90/94-98	F
CBR 1000 F	90-91	F
ST 1100	91-02	F
ST 1100 A	95	F
GL 1500 C/CT/CF/FD Valkyrie/Valkyrie Tourer	97-03	F

KAWASAKI

KLE 650 FFF/FFFAS/FGF/FGFAS Versys/Versys LT	15-16	F
NEW Versys 650	15	F
NEW Vulcan S 650 ABS	15	F
Z 650 (ER 650 GHF/Non ABS)	17	F
Z 650 (ER 650 HHF/ABS)	17	F

SUZUKI

GW 250 L4/L5 (Naked)	14-15	F
GW 250 FL5 (Fairing)	15	F
RF 600 RR/RS/RT/RV	94-97	F
GSF 600 Bandit ST/SV/SW	96-98	F

TRIUMPH

Bonneville T100 (900cc)	17	F
Bonneville T100 Black (900cc)	17	F
Bonneville Bobber (1200cc)	17	F
Bonneville T120	16-17	F
Bonneville T120 Black	16-17	F
Speedmaster(790cc/Carbs)	03-04	F
Speedmaster (865cc/Carbs)	05-07	F
Speedmaster (865cc/EFI)	08-10	F

Street Cup (900cc)	17	F
Street Twin (900cc)	16-17	F
Thrupton 900	04-15	F
Thrupton 900 Ace Café SE	14-15	F
Thrupton SE (865cc)	12	F
Thrupton 1200 (1200cc)	16-17	F
YAMAHA		
YBA 125 Vision (5AP1)	01	F

SFA142/SFA142HH

BMW

C 600 Sport	12-14	F
C 650 GT	12-15	F
C 650 GT Special Edition	15	F

DAELIM

S2-125	06-09	F
S2-250	06-09	F

HONDA

CN 250 Helix	94-01/05-07	F
--------------	-------------	---

KYMCO STREET

Downtown 200i	11-12	F
Xciting 250	05-11	F
Downtown 300i	10-15	F
Xciting 500	04-14	F

SUZUKI

AN 650 K3/K4/K5/K6/K7/K8/K9/L1 Burgman (Non ABS)	03-11	F
AN 650 AK6/AK7/AK8/AK9/AL1/AL2/L3/L4/L5/L6 Burgman (ABS)	06-16	F
AN 650 ZL3/ZL4/ZL5/ZL6/ZL7 Burgman Executive (ABS)	13-17	F

Equivalents OE#

06455 MW3 405	45106 ML7 922B	5AP W0045 00
06455 KFR 701	45106 MR4 901	43082 0151
45105 ML7 921A	59300 21820	59100 21860
45105 KAZ 004	59300 21840	59100 21870
45105 MV4 008	59300 21850	59101 26810
45106 ML7 922	34 11 8 524 942	59101 26820

Dealer Stocking Recommendation

Single/Pair	Popularity #	Rec Stocking Level
1	H18	2

STD FA142 Premium Organic Street Pad Blend

FA142HH Street Performance Sintered Pad Blend

OPTIONS

FA142V Semi Sintered Long Lasting Street Pad Blend

SFA142 Premium Organic Scooter Pad Blend

SFA142HH Scooter Performance Sintered Pad Blend

FA143



HONDA

VFR 750 R (RC 30)	90	R
RVF 750 R (RC 45)	94-95	R

Equivalents OE#

43105 MR7 007A	43106 MR7 007B
43105 MR7 017A	43106 MR7 017B

Dealer Stocking Recommendation

Single/Pair	Popularity #	Rec Stocking Level
1	-	1

STD FA143 Premium Organic Street Pad Blend

FA145

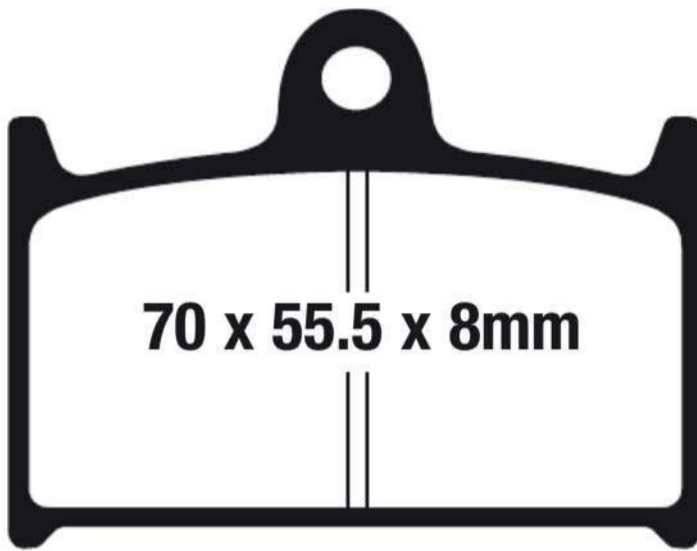

MZ

1000 S	03-05	F
--------	-------	---

SUZUKI

GSX-R 600 WN/WP	92-93	F
RF 900 RR/RS/RS2/RT/RV/RW	94-98	F
GSX-R 1100 K/L/M/N	89-92	F
GSF 1200 SV/SAV/SW/SAW/SX/SAX/SY	97-00	F

YAMAHA

TZ 125	94-	F
TZ 250	89-01	F
FZR 750 (OW01)	89-92	F

Equivalents OE#

59100 33830	59130 33C10	3LC 25811 00
59100 40810	59130 40C00	3MW W0045 00
59130 17C00	59300 17810	3TC W0045 00
59130 33C00	3FV W0045 00	

Dealer Stocking Recommendation

Single/Pair	Popularity #	Rec Stocking Level
2	S4	8

STD FA145 Premium Organic Street Pad Blend

OPTIONS FA145HH Street Performance Sintered Pad Blend

EPFA145HH Fast Street Use & Track Day Sintered Pad Blend

FA146



SUZUKI

GSX 600 FJ/FK/FL/FM/FN/FP/FR/FS/FT 'Katana'	88-97	F
GSX 750 FK/FL/FM/FN/FP/FR/FS/FT/FV 'Katana'	89-97	F
VX 800 L/M/N/P	90-93	R
GSX 1100 FJ/FK/FL/FM/FN/FP 'Katana'	88-93	F
GSX 1100 GM/GN/GP	91-93	R
GV 1400 GDG (from F No:103765)	86	F
GV 1400 GCG/GDH/GTH/GCH/GDJ	86-88	F

Equivalents OE#

59100 19820	59130 26D00	69100 45890
59100 24810	59130 45C10	69130 34C00
59130 19C00	59130 48B00	69130 45C00
59130 20C00	59130 48B00	69130 45C10
59130 24A10	69100 34860	

Dealer Stocking Recommendation

Single/Pair	Popularity #	Rec Stocking Level
2	S5	6

STD FA146 Premium Organic Street Pad Blend

OPTIONS FA146HH Street Performance Sintered Pad Blend

FA146V Semi Sintered Long Lasting Street Pad Blend

Dimension 1=Width or Diameter, Dimension 2=Height or Diameter, Dimension 3=Thickness (Material and backplate)

NOTE:- Size identification is shown as follows

FA147

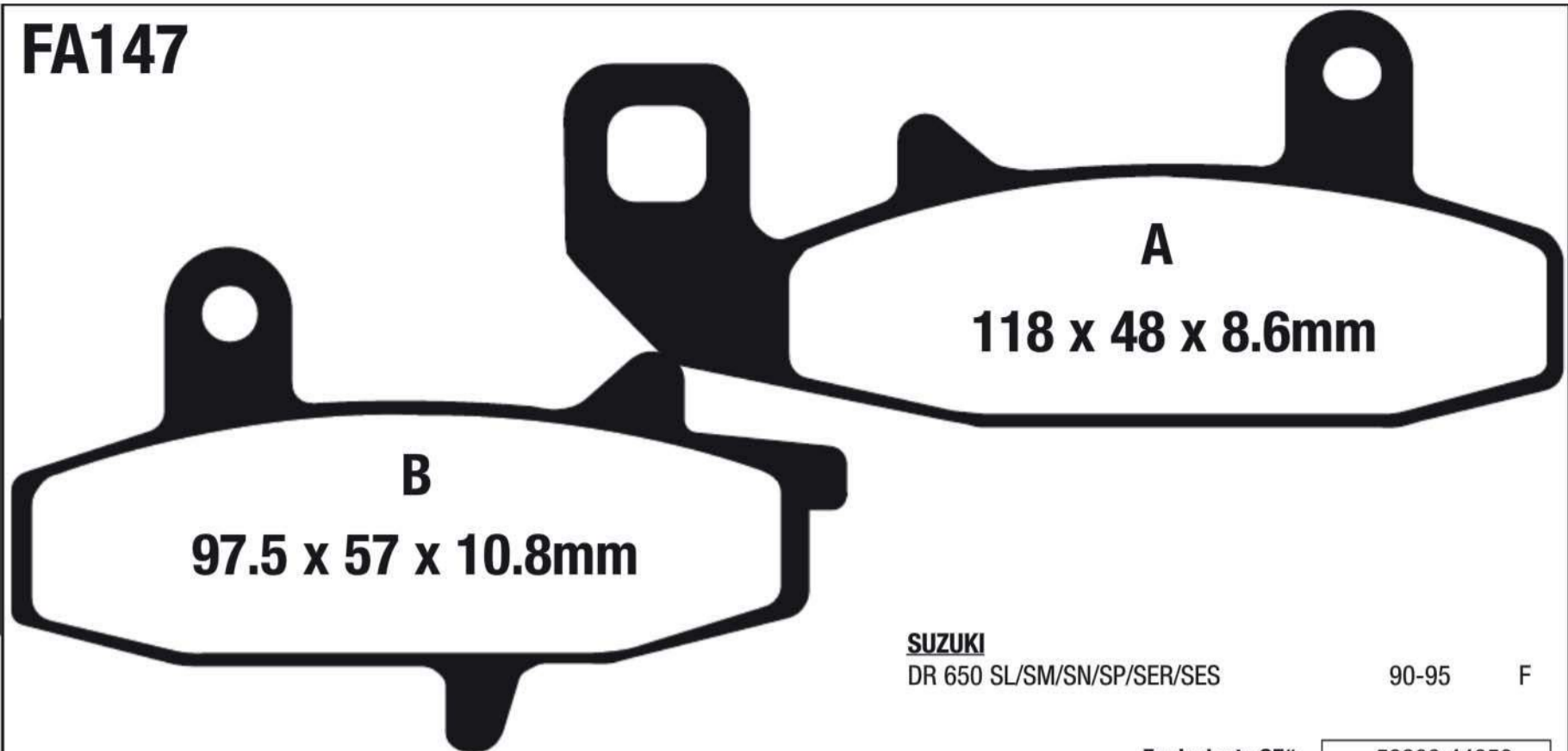

SUZUKI
DR 650 SL/SM/SN/SP/SER/SES 90-95 F

Equivalents OE# 59300 44850

STD	FA147X	Carbon Dual Purpose Pad Blend
OPTIONS	FA147R	Utility Grade Sintered Pad Blend

Dealer Stocking Recommendation

Single/Pair	Popularity #	Rec Stocking Level
1	-	1

FA150



SUZUKI
GV 1400 GDG (from F No:103765) 86 R
GV 1400 Cavalcade GCG/GDH/GTH/GCH/GDJ 86-88 R

Equivalents OE#

59130 38B10	69130 24A03
69100 24860	69130 24A04
69130 24A02	

STD	FA150	Premium Organic Street Pad Blend
OPTIONS	FA150HH	Street Performance Sintered Pad Blend
	FA150V	Semi Sintered Long Lasting Street Pad Blend

Dealer Stocking Recommendation

Single/Pair	Popularity #	Rec Stocking Level
2	H33	8

FA151

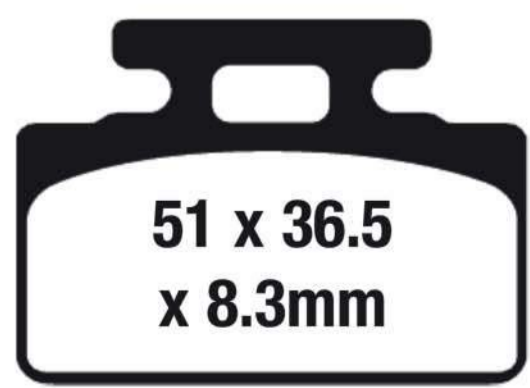

HONDA
RS 125 88-07 R
RS 250 88-02 R
MORIWAKI/HONDA
MD 250 H 08-13 R
SYM
MIO 50 05-14 F
DD 50 02-12 F

Equivalents OE# 45105 GM9 743A

STD	FA151	Premium Organic Street Pad Blend
------------	--------------	----------------------------------

Dealer Stocking Recommendation

Single/Pair	Popularity #	Rec Stocking Level
2	-	6

FA152

FA152/2



FA152

KAWASAKI

KX 125 G1/H1/H2/J1/J2/K1	89-94	R
KDX 200 E1-E6	89-94	R
KDX 200 H1-H10/H6F	95-06	R
KDX 220 R A4/A5/A6/A7/A8/A9/A10/A11/A12/A6F	97-06	R
KLX 250 R D2/D3/D4	94-96	R
KX 250 G1/H1/H2/J1/J2/K1	89-94	R
KDX 250 D1/D2/D3/D4	91-94	R
KX 500 E1-E7	89-95	R
KLX 650 A1-A3 (KLX 650 R)	93-96	R
KLX 650 C1-C4 (KLX 650)	93-96	R

SUZUKI

RM 125 K/L	89-90	R
RMX 250 K/L/M/N/P/R/S/T/V/W	89-98	R
DR 250 L/M/N/P/R/S	90-95	R
DR 250 SL/SM/SN/SEP/SER/SES	90-95	R
RM 250 K/L	89-90	R
DR 350 L/M/N/P/R/S/T	90-96	R
DR 350 SL/SM/SN/SP/SEP/SES/SET/SEW/SEX	90-99	R
DR 650 SET/SEV/SEW/SEX/SEY/SEK1/SEK2/ SEK3/SEK4/SEK5/SEK6/SEK7/SEK8/SEK9/ SEL1/SEL2/SEL3/SEL4/SEL5/SEL6	96-16	R

YAMAHA

YZ 125 A	90	R
WR 125 K	98	R
TT-R 250 L/M/N/P/R/S/T/V	99-06	R
XT 250 X/Y/Z/A/B/D/E/F/G/H	08-17	R
XTZ 250 Lander (F 21" / R 18" Wheels)	07-14	R
XTZ 250 Lander (F 21" / R 18" Wheels)	16-18	R
XTZ 250 X (F & R 17" Wheels)	08-10	R
YZ 250 A	90	R
YZ 250 WRA	90	R
WR 250 ZB/ZD/ZE/ZF/ZG/ZH/ZJ	91-97	R
YZ 400 FK	98	R
WR 400 FK	98	R
WR 500 ZD/ZE	92-93	R
YXR 700 Rhino Parking brake	08-09	F

FA152/2

SUZUKI

RM 125 M/N/P/R/S	91-95	R
RM 250 M/N/P/R/S	91-95	R
DR-Z 250 K1/K2/K3/K4/K5/K6/K7	01-07	R

YAMAHA

YZ 125 B/D/E/F/G/H/J	91-97	R
YZ 250 B/D/E/F/G/H/J	91-97	R
WR 200 D	92	R

Equivalents OE#

FA152

43082 1090	43082 1151	3CS W0046 00
43082 1118	69140 15D00	3CS 25806 00
43082 1131	69140 28C00	
43082 1137	5XT W0046 50	

Equivalents OE#

FA152/2

69100 43820	69140 27C20	4GY W0046 00
69100 43840	69140 43D00	4GV W0046 00
69100 43850	69140 43840	5GF W0046 00
69130 05D00	3SP W0046 00	271-5000082
69140 26C00	3XP W0046 00	5000082
69140 27C10	4DA W0046 00	

STD	FA152X	Carbon Dual Purpose Pad Blend
OPTIONS	FA152R	Utility Grade Sintered Pad Blend
OPTIONS	MXS152	Sintered Sport Off Road Pad Blend
STD	FA152/2X	Carbon Dual Purpose Pad Blend
OPTIONS	FA152/2R	Utility Grade Sintered Pad Blend
OPTIONS	MXS152/2	Sintered Sport Off Road Pad Blend

FA152

Dealer Stocking Recommendation

Single/Pair	Popularity #	Rec Stocking Level
1	FA152R - K3/S7/Y6	5
1	FA152X - K4/S6/Y6	5

FA152/2

Dealer Stocking Recommendation

Single/Pair	Popularity #	Rec Stocking Level
1	FA152/2X - S20/Y18	1
1	FA152/2R - S17/Y15	1

BUYERS GUIDE
BRAKE PADS

NOTE:- Size identification is shown as follows
Dimension 1=Width or Diameter, Dimension 2=Height or Diameter, Dimension 3=Thickness (Material and backplate)

NOTE:- Size identification is shown as follows
Dimension 1=Width or Diameter, Dimension 2=Height or Diameter, Dimension 3=Thickness (Material and backplate)

FA155

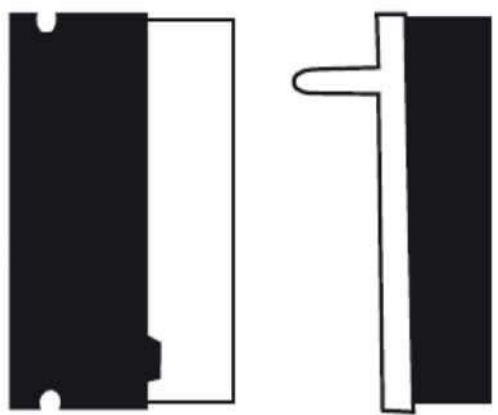
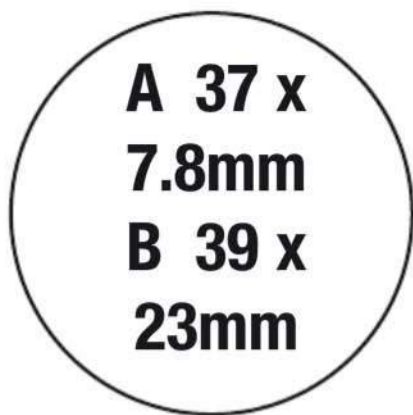

YAMAHA
YFS 200 U/W/A/B/D/E/F/G/H
/J/K/L/M/N/P 'Blaster'

88-02 R

Equivalents OE#

2XJ 25811 00

STD	FA155X	Carbon Dual Purpose Pad Blend
OPTIONS	FA155R	Utility Grade Sintered Pad Blend Race

Dealer Stocking Recommendation

<u>Single/Pair</u>	<u>Popularity #</u>	<u>Rec Stocking Level</u>
1	FA155R - Y23	4
1	FA155X - Y5	4

FA156



BETA
SYNT/GARA

93-96 R

Equivalents OE#

N/A

STD	FA156X	Carbon Dual Purpose Pad Blend
------------	---------------	-------------------------------

Dealer Stocking Recommendation

<u>Single/Pair</u>	<u>Popularity #</u>	<u>Rec Stocking Level</u>
1	-	1

FA157

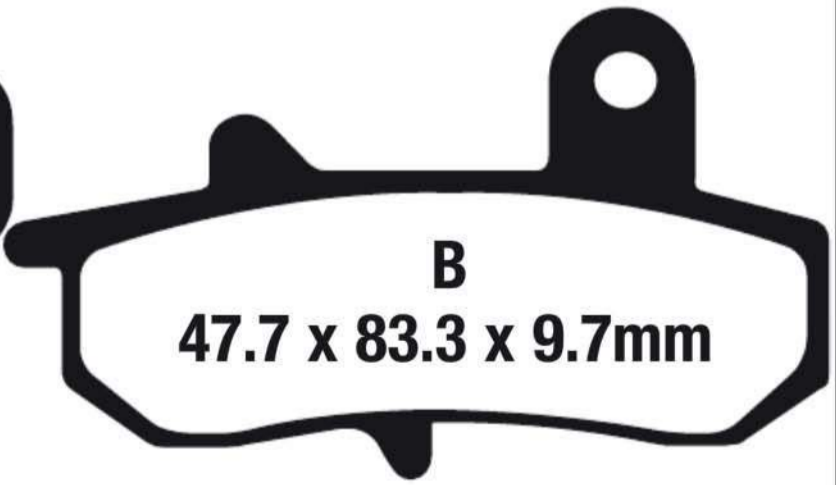
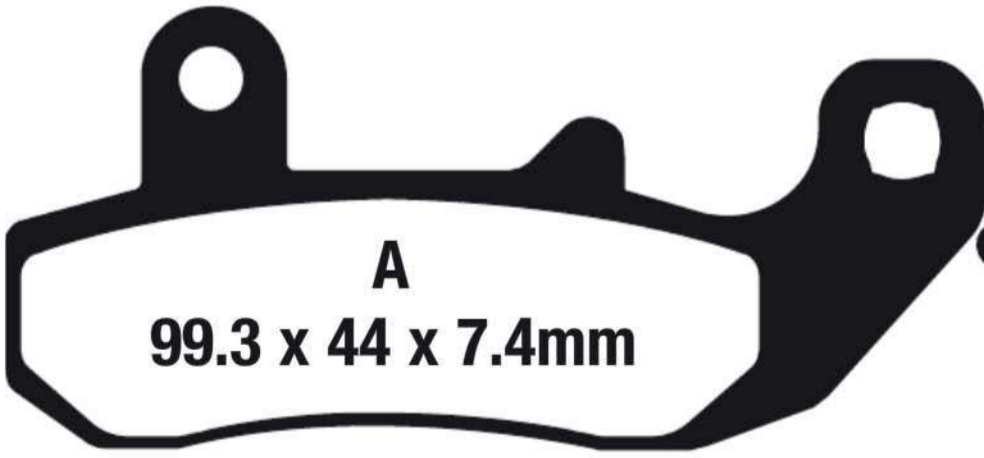

SUZUKI
DR 650SL/SM/SN/SP/SER/SES 90-95 R

Equivalents OE#

69100 44860 | 69100 12810

STD	FA157X	Carbon Dual Purpose Pad Blend
OPTIONS	FA157R	Utility Grade Sintered Pad Blend Race

Dealer Stocking Recommendation

<u>Single/Pair</u>	<u>Popularity #</u>	<u>Rec Stocking Level</u>
1	-	1

FA158

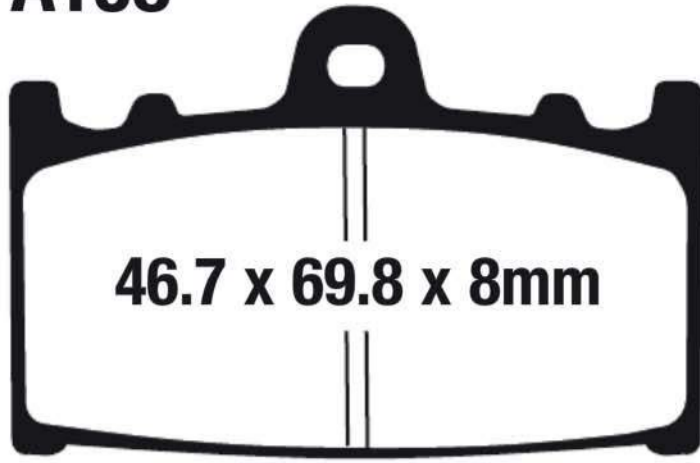

46.7 x 69.8 x 8mm

KAWASAKI

ZX 600 D1-D4 (ZX6)	90-93	F
ZX 600 E1-E13 (Ninja ZX6)	93-05	F
ZX6R (ZX 600 F1/F2/F3)	94-97	F
ZXR 750 HI/H2/J1/J2/L1/L2/L3 'Ninja' ZX-7	89-95	F
ZX 750 K1/K2/M1/M2 Ninja ZX- 7R	91-95	F
ZX9R B1/B2 Ninja	94-95	F
KLZ 1000 BFF/BFFAS/BGF/BGFAS/BHF - Versys	15-17	F
ZX 1100 C1-C4/D1-D9 (ZX11)	90-01	F
ZR 1100 A1/A2/A3/A4 Zephyr	92-95	F
ZZR 1200 (ZX 1200 C1/C2/C3)	02-04	F
VN 1700 Vulcan Voyager	09	F
VN 1700 A9FA/AAF/ABF/ACF/ADF Vulcan 1700 Voyager	09-13	F
VN 1700 B9FA/BAF/BBF/BCF/BDF/BEF/BFF/BGF/BHF Vulcan 1700 Voyager ABS	09-17	F
VN 1700 Voyager Vaquero JBF/JBFA/JCF/JCFA/JDF	11-13	F
VN 1700 KEF/KFF/KFG Voyager Vaquero ABS	14-16	F

KAWASAKI Contd.

VN 1700 KEFA Voyager Vaquero ABS SE	14	F
VN 2000 A1/A2/A6F/A7F/G8F/G9F Vulcan	04-09	F
VN 2000 D1/D6F Vulcan Ltd	05-06	F
VN 2000 E6F/E7F/H8F/H9F Vulcan Classic	06-09	F
VN 2000 F6F/F7F/J8F/J9F/JAF Vulcan Classic LT	06-10	F

SUZUKI

GSXR 600 V/W/X/Y/K1/K2/K3/ZK3	97-03	F
GSX 650 FK8/FK9	08-10	F
GSXR 750 Y/K1/K2/K3	00-03	F
SV 1000 K3/SK3/K4/SK4/K5/SK5/SK6/SK7	03-07	F
TL 1000 SV/SW/SX/SY/SK1	97-01	F
GSF 1250 SAK7/SAK8/SAK9 (ABS)	07-11	F
GSF 1250 SK7/SK8/SK9 Bandit	07-11	F
GSX 1250 FAL1/FAL2	11-12	F
GSX 1250 SAL6	16	F

HUSABERG

All supermotard models	00-03	F
------------------------	-------	---

VERTEMATI

S 450/501/570 E (Super Motard)	03-04	F
SR 450/SR 600 Motard Racing	03-04	F

AP/LOCKHEED AFTERMARKET CALIPERS

4 Piston (Old Design)

MOTOMASTER AFTERMARKET CALIPERS

4 Piston

PRE TECH AFTERMARKET CALIPERS

4 Piston (P402) Lockheed Replacement Caliper

PRO-ONE AFTERMARKET CALIPERS

4 Piston

Competitor X Ref

SBS 631	Vesrah VD344	Ferodo FDB574
-------------------	------------------------	-------------------------

Equivalents OE#

43082 0016	43082 1113	59100 32830	59130 32020	600079
43082 1097	43082 1120	59101 35810	59130 32C00	
43082 1102	43082 1142	59300 34830	59130 32C10	
43082 1110	43082 1288	59130 22D00	59130 32C20	
43082 1111	59100 22810	59130 32000	59130 38C00	

STD	FA158	Premium Organic Street Pad Blend
OPTIONS	FA158HH	Street Performance Sintered Pad Blend
	EPFA158HH	Fast Street Use & Track Day Sintered Pad Blend

Dealer Stocking Recommendation

Single/Pair	Popularity #	Rec Stocking Level
2	K7	6

FA159

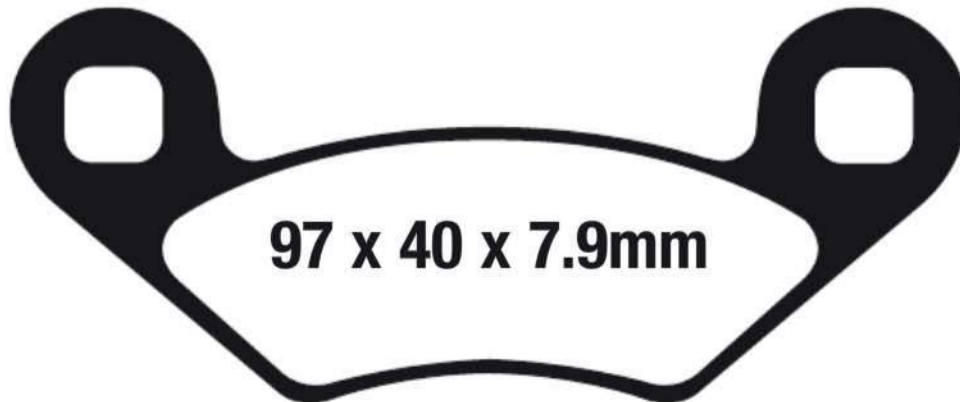

97 x 40 x 7.9mm

POLARIS

All disc front brake models - check application pages for main fitments.

DANGER MUST BE FITTED IN COMPLETE FRONT AXLE SETS TO AVOID PULLING LEFT OR RIGHT

Equivalents OE#

1910036	1930643	2201149
1910042	1930731	2201398
1910129	1930815	2202412
1910333	2200465	2203452
1911171	2200901	2203792

STD	FA159X	Carbon Dual Purpose Pad Blend
OPTIONS	FA159R	Utility Grade Sintered Pad Blend
	FA159SV	High Durability Off Road Sintered Blend

Dealer Stocking Recommendation

Single/Pair	Popularity #	Rec Stocking Level
2	P1	4

FA160

For later pad FZR 1000 92-93 with 6mm pin holes use FA182



YAMAHA

FZR 600 AC/RA/RAC/RBC/RD/RDC/RE/REC/ RF/RFC/RG/RGC/RH/RHC/RJ/RJC/RK/RKC/RL/RLC	90-99	F
YZF 600 RG/RGC/RH/RHC	95-96	F
FZR 1000 EX-UP /A/AC/B/BC	90-91	F
FJ 1200 AD/ADC/AE/AEC	92-93	F
VMX 12 - (V-Max 1200 All Models)	93-07	F

Equivalents OE#

3GM W0045 00
3GM W0045 01
3GM W0045 11

STD	FA160	Premium Organic Street Pad Blend
OPTIONS	FA160HH	Street Performance Sintered Pad Blend

Dealer Stocking Recommendation

Single/Pair	Popularity #	Rec Stocking Level
2	Y3	8

FA161



KAWASAKI

ZXR 750 H1/H2/J1/J2/L1/L2/L3 Ninja ZX-7	89-95	R
ZX 750 K1/K2/M1/M2 Ninja ZX-7R	91-95	R
Ninja ZX-7R (ZX 750 P1-P8)	96-03	R
(ZR 1100 C3/C4) ZRX 1100	99-00	R
ZX 1100 D1-D9 (ZX11)	93-01	R
ZX 12 R (ZX 1200 A1/A2/B1/B2/B3/B4)	00-05	R
ZRX 1200 R (ZR 1200 A1/A2/A3/A4/A5)	01-05	R
ZZR 1200 (ZX 1200 C1/C2/C3/C4)	02-05	R
ZX 12R (ZX 1200 A1/A2/B1-B4)	00-05	R

Equivalents OE#

43082 1003	43082 1200
43082 1098	43082 1180
43082 1103	43082 1257
43082 1141	43082 1291

STD	FA161	Premium Organic Street Pad Blend
OPTIONS	FA161HH	Street Performance Sintered Pad Blend
	FA161V	Semi Sintered Long Lasting Street Pad Blend

Dealer Stocking Recommendation

Single/Pair	Popularity #	Rec Stocking Level
1	K9	2

FA162

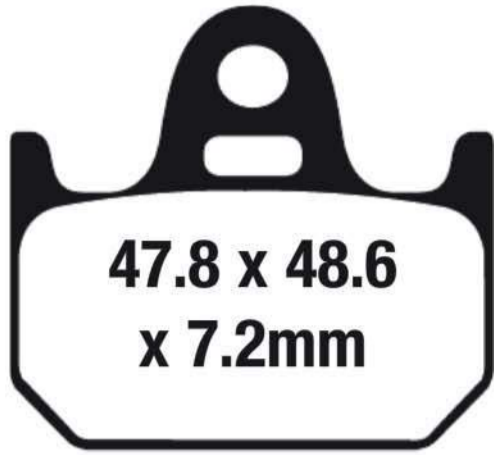

**47.8 x 48.6
x 7.2mm**

YAMAHA

TZ 125	94-	R
TZ 250	89-01	R
TZ 250 (Radial Calipers)	02-10	R

Equivalents OE#

3CL W0046 00	3LC W0046 00
3LC 25811 50	4TW W0046 00

Dealer Stocking Recommendation

Single/Pair	Popularity #	Rec Stocking Level
1	-	0

STD FA162 Premium Organic Street Pad Blend

FA163



99.5 x 52 x 7.8mm

CAGIVA

Elefant 650 86-87 R

MOTO GUZZI

Quota 1000 92-97 R

Equivalents OE#

00 306 546 300

Dealer Stocking Recommendation

Single/Pair	Popularity #	Rec Stocking Level
1	-	0

STD FA163 Premium Organic Street Pad Blend

FA164



74.2 x 40.5 x 6.7mm

BETA

260 TR34/35/Zero 89-92 R

Equivalents OE#

N/A

Dealer Stocking Recommendation

Single/Pair	Popularity #	Rec Stocking Level
1	-	0

STD FA164X Carbon Dual Purpose Pad Blend

OPTIONS FA164R Utility Grade Sintered Pad Blend

FA165

FA165/2

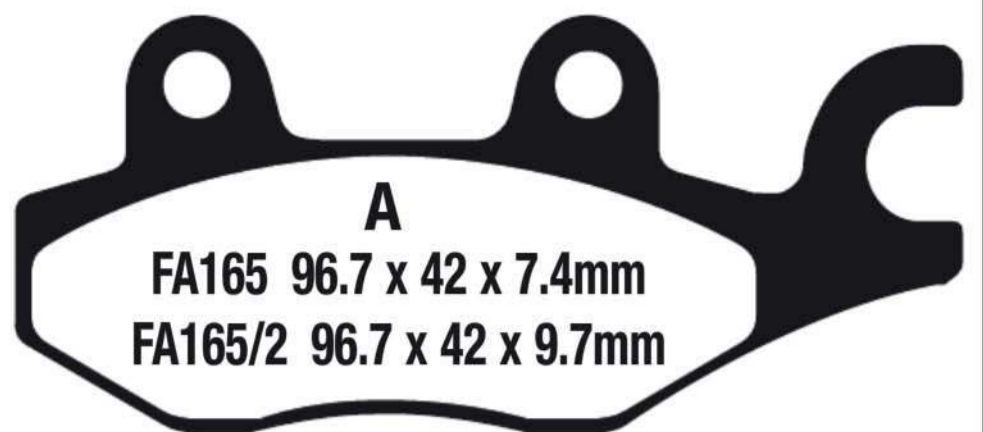
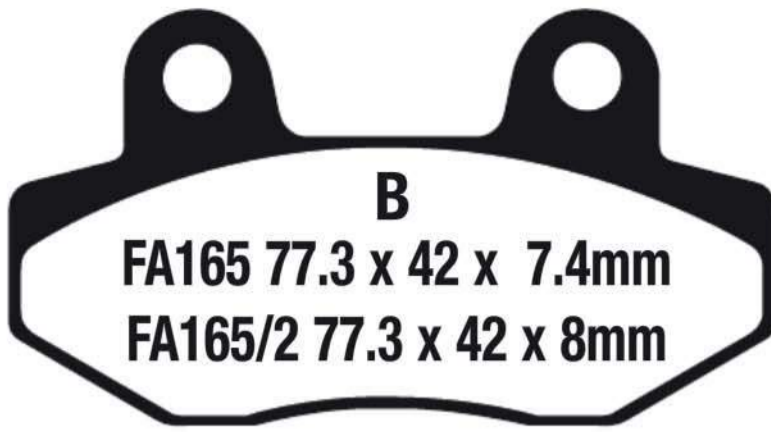

B
FA165 77.3 x 42 x 7.4mm
FA165/2 77.3 x 42 x 8mm

A
FA165 96.7 x 42 x 7.4mm
FA165/2 96.7 x 42 x 9.7mm

BUYERS GUIDE
BRAKE PADS

NOTE:- Size identification is shown as follows
 Dimension 1=Width or Diameter, Dimension 2=Height or Diameter, Dimension 3=Thickness (Material and backplate)

BENNCHE

250 Cowboy	15-16	F (Left)
250 Spire	15-16	F (Left)
400 Bighorn	11-16	F&R (Left)
400 Cowboy	15-16	F&R (Left)
500 Bighorn	15-16	F&R (Left)
500 Cowboy	14-16	F&R (Left)
700 Bighorn	15-16	F&R (Left)
700 Cowboy	14-16	F&R (Left)
700 X Bighorn	15-16	F&R (Left)
800 Spire	14-16	F&R (Left)
1000 Cowboy	15-16	F&R (Left)
1000 Spire	14-16	F&R (Left)
1000 X Spire	14-16	F&R (Left)

CAN-AM

Commander 800 STD		F Left
Commander 800 R XT/DPS	11-15	F Left
Commander 800 R XT	11-14	F Left
Commander 1000 STD	11-15	F Left
Commander 1000 XT	11-15	F Left
Commander 1000 XT-P	14-15	F Left
Commander 1000 X	11-13	F Left
Commander 1000 LTD	12-15	F Left
Commander 1000 DPS	13-15	F Left
Maverick 1000 - STD	13	F Left
Maverick 1000 - XRS	13	F Left

CF MOTO

500 U-Force EPS	14-16	F (Right)
500 Z-Force	14-16	F (Right)
800 U-Force	13-17	F (Right)
800 Z-Force	15-16	F (Right)
800 EX Z-Force	14-16	F (Right)

E-TON QUADS

CXL 150 Yukon II/Challenger	02-09	R
RXL 150 Viper R	05-09	R
RXL 150 Viper	05-06	R

HISUN

250 Sector	15-16	F (Left)
250 Strike	15-16	F (Left)
400 Forge	15-16	F (Left) & R (Right)
HS 400	15-16	F (Left) & R (Right)
450 Sector	15-16	F (Left) & R (Right)
500 Forge	15-16	F (Left) & R (Right)
HS 500	15-16	F (Left) & R (Right)
550 Sector	15-16	F (Left) & R (Right)
700 Forge	15-16	F (Left) & R (Right)
HS 700	15-16	F (Left) & R (Right)
750 Sector	15-16	F (Left) & R (Right)
HS 750 Crew	15-16	F (Left) & R (Right)
800 Tactic	15-16	F (Left) & R (Right)
HS 800 Crew	15-16	F (Left) & R (Right)
800 Strike	15-16	F (Left) & R (Right)
1000 Sector	15-16	F (Left) & R (Right)
1000 Strike	15-16	F (Left) & R (Right)
1000 Strike Crew	15-16	F (Left) & R (Right)
1000 Tactic	15-16	F (Left) & R (Right)

KAWASAKI

KLF 300 C1-C17 Bayou (Right)	89-05	F Left
KLF 400 B1-B7 Bayou (Right)	93-99	F Left
KVF 650 H7F/H8F Brute Force 4x4i	07-08	F Left
KVF 650 F6F/F7F/F8F/F9F/FAF/FBF Brute Force 650 4x4i	06-11	F Left
KVF 650 G6F/G7F/G8F/G9F/FGAF Brute Force 650 4x4i Hardwoods Green HD	06-10	F Left
KVF 650 FCS (Brute Force 650 4x4i)	12	F Left
KVF 750 A1/B6F/B7FA/A6F/C7F/D8F/F8F/D9F/DAF/DBF Brute Force 750 4x4	05-11	F Left
KVF 750 A1/A6F/A7F Brute Force 750 4x4i	05-07	F Left
KVF 750 B6F/B7F/B7FA Brute Force 750 4x4i	06-07	F Left
KVF 750 F8F/FAF/FBF Brute Force 750 4x4i	08/10-11	F Left
KVF 750 B1/E8F/E9F Brute Force 750 4x4i Hardwoods Green HD	05/08-09	F Left

KAWASAKI Contd.

KVF 750 E8FA/E9FA/EAF Brute Force 750 4x4i NRA Outdoors	08-09	F Left
KVF 750 GCF/GDF/GEF/GFF/GGF/GHF (Brute Force 750 4x4i/EPS)	12-17	F Left
KVF 750 HCF/HDF/HEF/HFF/GGF/GHF (Brute Force 750 4x4i/EPS)	12-17	F Left
KVF 750 JCF/JDF/JEF/JFF/JGF/JHF (Brute Force 750 4x4i/EPS)	12-17	F Left
KVF 750 LCF/LDF/LEF/LFF/LGF/LHF (Brute Force 750 4x4i)	12-17	F Left
KRF 750 A8F/B8F (Teryx 750 4x4)	08	F Left
KRF 750 C8F/D8F (Teryx 750 4x4 LE)	08	F Left
KRF 750 F8F (Teryx 750 4x4 NRA Outdoors)	08	F Left
KRF 750 G9F/NAF/NBF/NDF/NCS (Teryx 750 Fi 4x4)	09-13	F Left
KRF 750 J9FA/K9F/PAF/PBF/RAF/RBF/RCS/RDF/PCF/PDF (Teryx 750 Fi 4x4 LE)	09-13	F Left
KRF 750 L9F (Teryx 750 Fi 4x4 Le Sport)	09	F Left
KRF 750 M9F (Teryx 750 Fi 4x4 NRA Outdoors)	09	F Left
KRF 750 SAF/SAFA/SBF/SBFA/SCS/SCSA (Teryx 750 Fi 4x4 Sport)	10-12	F Left
KRF 750 SAF (RUV) Teryx 4x4 Le Sport	10	F Left
KRF 750 TAF/VBF/VCS (Teryx 750 Fi 4x4 SGE)	10-12	F Left
KRT 750 ACF/ADF (Teryx 4 750 4X4)	12-13	F Left
KRT 750 ACFA/ADFA (Teryx 4 750 4X4 EPS)	12-13	F Left
KRT 750 CCF/CDF (Teryx 4 750 4X4 EPS LE)	12-13	F Left
KRT 750 DCF/DDF (Teryx 4 750 4X4 EPS Realtree)	12-13	F Left
KRF 800 BEF/BFF/FGF/FHF (Teryx)	14-17	F Left
KRF 800 CEF/CFF/GGF/GHF (Teryx LE)	14-17	F Left
KRF 800 DEF/CFF/HGF/HHF (Teryx Camo)	14-17	F Left
KRT 800 BEF/BFF/FGF/FHF (Teryx 4)	14-17	F Left
KRT 800 BEF/BFF/FGF/FHF (Teryx 4)	14-17	F Left
KRT 800 CEF/CFF/GGF/GHF (Teryx 4 LE)	14-17	F Left
KRT 800 DEF/DDF/HGF/HHF (Teryx 4 Camo)	14-17	F Left
KAF 820 AFF/AGF/AHF Mule PRO - FXT	15-17	F Left
KAF 820 BFF/BGF/BHF Mule PRO - FXT /EPS	15-17	F Left
KAF 820 CFF/CGF/CHF Mule PRO - FXT /EPS LE	15-17	F Left
KAF 820 DFF/DGF/DHF Mule PRO - FXT /EPS Camo	15-17	F Left
KAF 820 EGF/EHF Mule PRO - FX	16-17	F Left
KAF 820 FGF/FHF Mule PRO - FX/EPS	16-17	F Left
KAF 820 GGF/GHF Mule PRO - FX/EPS LE	16-17	F Left
KAF 820 HGF/HHF Mule PRO - FX/EPS Camo	16-17	F Left
KAF 820 JGF/JHF Mule PRO - FXT Ranch Edition	16-17	F Left
KAF 1000 AGF/AHF - Mule Pro DXT/ Diesel	16-17	F Left
KAF 1000 BGF/BHF - Mule Pro DXT/Diesel EPS	16-17	F Left
KAF 1000 CGF/CHF - Mule Pro DXT EPS LE/Diesel	16-17	F Left
KAF 1000 DGF/DHF - Mule Pro DX /Diesel	16-17	F Left
KAF 1000 EGF/EHF - Mule Pro DX EPS/Diesel	16-17	F Left
KAF 1000 FGF/FHF - Mule Pro DX EPS LE/Diesel	16-17	F Left

MASSIMO

250 Gunner	15-16	F Left
250 Gunner S	15-16	F Left
MSU 400	15-16	R Left
500 Alligator	15-16	F Left
500 Knight	15-16	F Left & R Right
MSA 500	13-16	F Right & R Right
MSU 500	15-16	F Right & F Left
550 EPS Alligator	15-16	F Left
700 Alligator	15-16	F Left & R Left
700 Knight	15-16	F Left & R Left
700-4 Alligator EPS	15-16	F Left & R Left
MSU 700	15-16	F Left & R Left
MSU 700-5	15-16	F Left & R Left
MSA 800	14-16	F Right & R Right
MSU 800	15-16	F Left & R Left
1000 Militia	15-16	R Left
1000 S Militia	15-16	R Left
1000 XS Militia	15-16	R Left

SUZUKI

LT-F 300 FK2 King Quad	02	F Left
LT-R 450 K6/K7/K8/K9	06-11	F Left
LT-R 450 ZK8/ZK9 Quad Racer Ltd Edition	08-09	F Left
LT-F 500 FW/FX/FY/FK1/FK2 Quadrunner (Right)	98-02	F Left
LT-A 500 FY/FK1 Quadmaster (Right)	00-01	F Left

YAMAHA

YFZ 450 S/TV/W/X/Y/B/D	04-09/12-13	F Left
YFZ 450 RY/RZ/RA/RB/RD/RE/RSE/RF	09-15	F Left
YXR 450 Rhino (All models)	06-09	F Left

FA165 FA165/2 Contd.

YAMAHA Contd.

YFZ 450 SEW/SEX Special Edition	07-08	F Left
YFZ 450 BBV/BBW Bill Balance Edition	06-07	F Left
YFZ 450 SPV/SEW/SPX Special Edition	06-08	F Left
YFZ 450 LES Limited Edition	04	F Left
YFZ 450 SET Special Edition	05	F Left
YXR 660 Rhino	04-07	F Left
YFM 700 RV/RW/RX/RV/RA/RB/RD/RE Raptor	06-14	F Left
YFM 700 R RSEW/RSPX/RSEY/RSEZ/RSEA/RSEB/RSED /RSE/RSF Special Edition	07-15	F Left
YXR 700 Rhino (All models)	08-13	F Left & R Left

FA165/2

CAGIVA

Gran Canyon 900	99-00	R
-----------------	-------	---

MZ

RT 125	02-05	R
SX/SM 125	02-05	R

LIFAN

LF 200 GY-S	05-08	R
-------------	-------	---

Equivalents OE#

FA165/2

A45120 168 000
5B4 W0045 00

STD	FA165/2X	Carbon Dual Purpose Pad Blend
OPTIONS	FA165/2R	Utility Grade Sintered Pad Blend
OPTIONS	FA165/2SV	High Durability Off Road Sintered Blend

STD	FA165X	Carbon Dual Purpose Pad Blend
OPTIONS	FA165R	Utility Grade Sintered Pad Blend
OPTIONS	FA165SV	High Durability Off Road Sintered Blend
OPTIONS	MXS165	Sintered Sport Off Road Pad Blend

Equivalents OE# FA165

3304-567	43082 0138	5TG W0045 30
3LD W0046 00	43082 1094	705601150
3LD W0046 10	59300 09840	715500335
43082 0023	59300 09850	9090-080810
43082 0069	5B4 W0045 00	7030 081420
43082 0126	5TG W0045 10	

Dealer Stocking Recommendation

Single/Pair	Popularity #	Rec Stocking Level
1	FA165X - K25	1

FA167

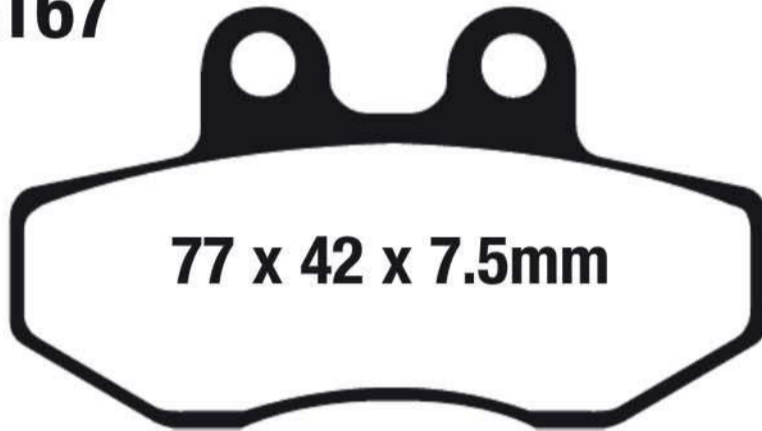

77 x 42 x 7.5mm

Equivalents OE#

8113373	00H 0470 2141
8113604	

STD	FA167	Premium Organic Street Pad Blend
OPTIONS	FA167HH	Street Performance Sintered Pad Blend

Dealer Stocking Recommendation

Single/Pair	Popularity #	Rec Stocking Level
1	-	0

BETA

RR 50 Motard	06	F
--------------	----	---

DERBI

GPR 50 Replica	03-05	F
----------------	-------	---

GAS-GAS

EC 50 (Rookie)	01-04	F
----------------	-------	---

SM 50 (Rookie)	01-04	F
----------------	-------	---

HONDA

XR 6 50cc	03-05	F
-----------	-------	---

HUSQVARNA

SM 50	02	F
-------	----	---

WR 50	02	F
-------	----	---

WXE 125	07	F
---------	----	---

SFA169

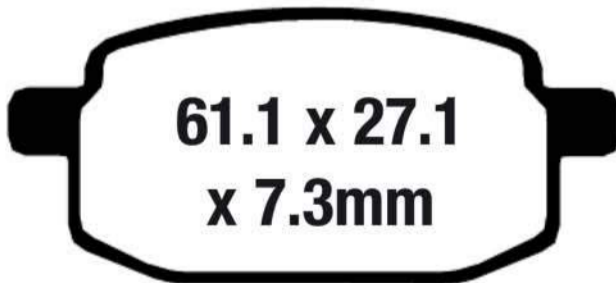

61.1 x 27.1
x 7.3mm

Equivalents OE#

3XG W0045 00	45120 107 000
2NA W0045 01	750003
5CP W0045 00	

Dealer Stocking Recommendation

Single/Pair	Popularity #	Rec Stocking Level
-	N/A	-

STD	SFA169	Premium Organic Scooter Pad Blend
OPTIONS	SFA169HH	Scooter Performance Sintered Pad Blend

ADLY

Fox 50	07-09	F
--------	-------	---

E-TON

Beamer 50 (PN2)	04-08	F
-----------------	-------	---

Beamer II (PN2B)		F
------------------	--	---

Beamer 50 III	09	F
---------------	----	---

Beamer Matrix (PN2C)		F
----------------------	--	---

Beamer Matrix II (PN2E)		F
-------------------------	--	---

THUMPSTAR

Thumpstar Junior 90cc	04-07	F&R
-----------------------	-------	-----

Thumpstar Supa 110cc	04-07	F&R
----------------------	-------	-----

Thumpstar Expert 125	06-07	F&R
----------------------	-------	-----

Thumpstar Pro 125	05-07	F&R
-------------------	-------	-----

UM (UNITED MOTORS)

DTF 50	06-08	F
--------	-------	---

YAMAHA

YW 50 P/R/S/T/X/Y/Z Zuma	02-05/08-10	F
--------------------------	-------------	---

JYM90T Axis 4RT6	01	F
------------------	----	---

YA 90 Axis (4CY1/5 - 4EN5/6)	91-95	F
------------------------------	-------	---

YA 90 Axis (4CY7-4EN7)	96	F
------------------------	----	---

YA 100 W Grand Axis (5TC/4/5)	01-03	F
-------------------------------	-------	---

YW 100 BW's (4VPS/PC/PV/PX/5XR1/R2/R3/R4)	97-08	F
---	-------	---

BUYERS GUIDE
BRAKE PADS

NOTE:- Size identification is shown as follows
Dimension 1=Width or Diameter, Dimension 2=Height or Diameter, Dimension 3=Thickness (Material and backplate)

FA171

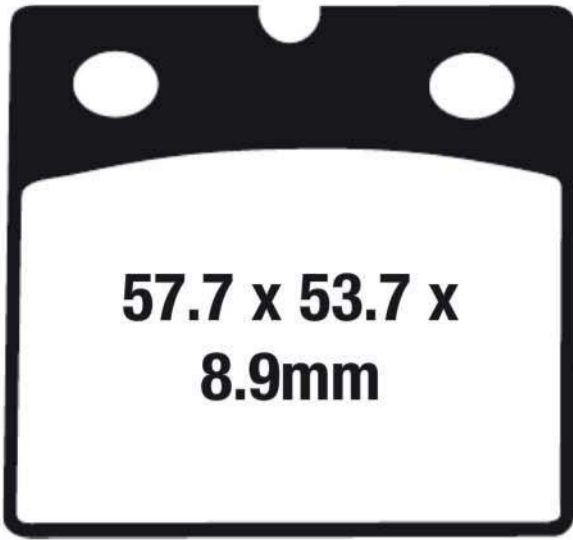

**57.7 x 53.7 x
8.9mm**

BMW

R 80/R 80 RT (Double disc)	09/88-95	F
R 100 RS	09/88-92	F
R 100 RT	09/88-95	F
K 75/75-2 (Non ABS)	09/88-96	F
K 75/75-2 (ABS Model)	08/90-96	F
K 75 C	09/88-90	F
K 75 RT	89-96	F
K 75 S	09/88-95	F
K 100/2	09/88-90	F
K 100 LT	09/88-91	F
K 100 RS (Non ABS - 8 valve)	10/88-89	F
K 100 RS (ABS Model - 8 valve)	10/88-89	F
K 100 RT (Non ABS - 8 valve)	10/88-89	F
K 100 RT (ABS - 8 valve)	10/88-89	F

Equivalents OE#

34 11 2 310 494	34 11 2 331 175
34 11 2 311 175	34 11 2 314 546

STD	FA171	Premium Organic Street Pad Blend
OPTIONS	FA171HH	Street Performance Sintered Pad Blend
	FA171V	Semi Sintered Long Lasting Street Pad Blend

Dealer Stocking Recommendation

Single/Pair	Popularity #	Rec Stocking Level
1	N/A	1

FA172

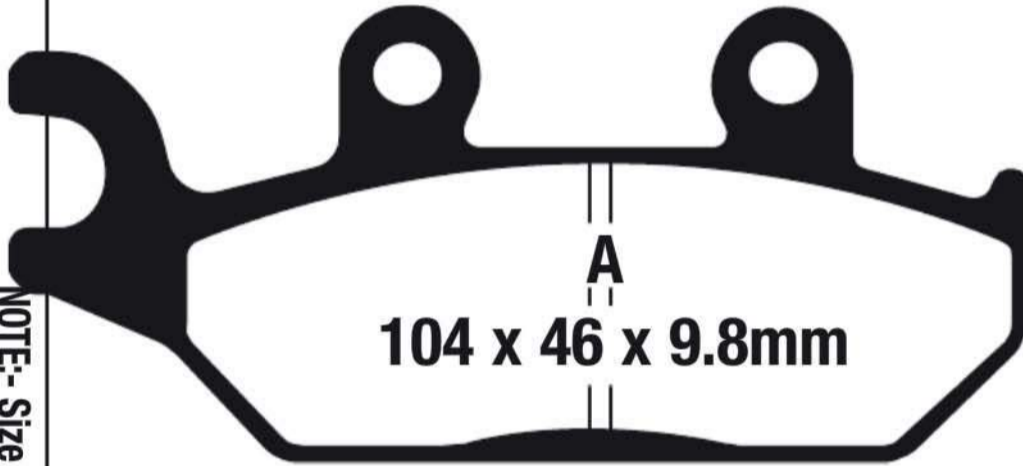

104 x 46 x 9.8mm

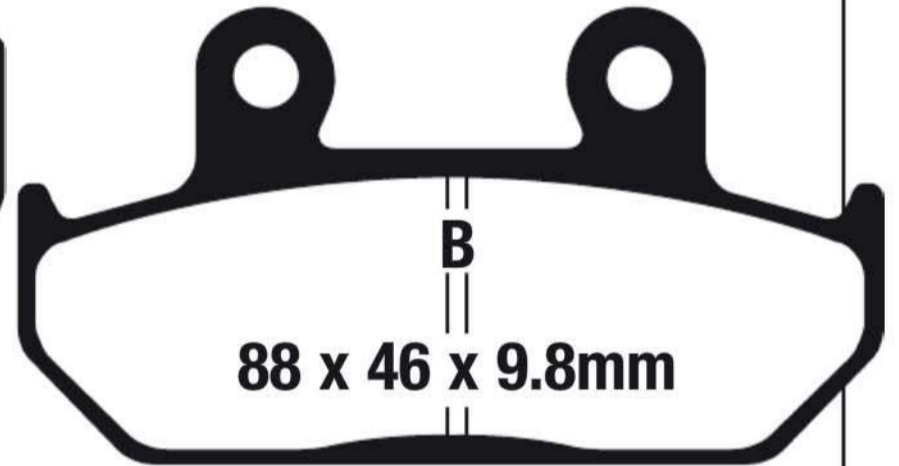

88 x 46 x 9.8mm

YAMAHA

XT 600 EA/EB/ED/EDC/EE/EEC/EF/EFC/EG/EGC	90-95	F
--	-------	---

Equivalents OE#

3YF W0045 00	3TB W0045 00
--------------	--------------

STD	FA172X	Carbon Dual Purpose Pad Blend
OPTIONS	FA172R	Utility Grade Sintered Pad Blend

Dealer Stocking Recommendation

Single/Pair	Popularity #	Rec Stocking Level
1	-	1

BUYERS GUIDE
BRAKE PADS

Dimension 1=Width or Diameter, Dimension 2=Height or Diameter, Dimension 3=Thickness (Material and backplate)

NOTE:- Size identification is shown as follows

FA173

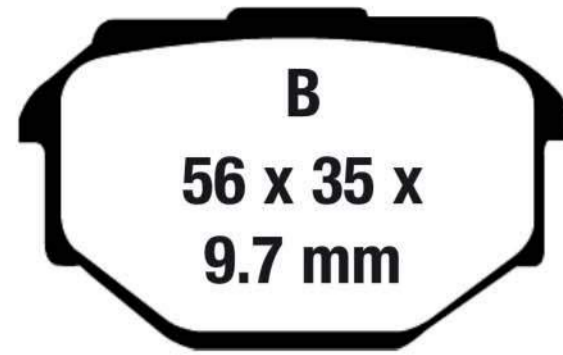
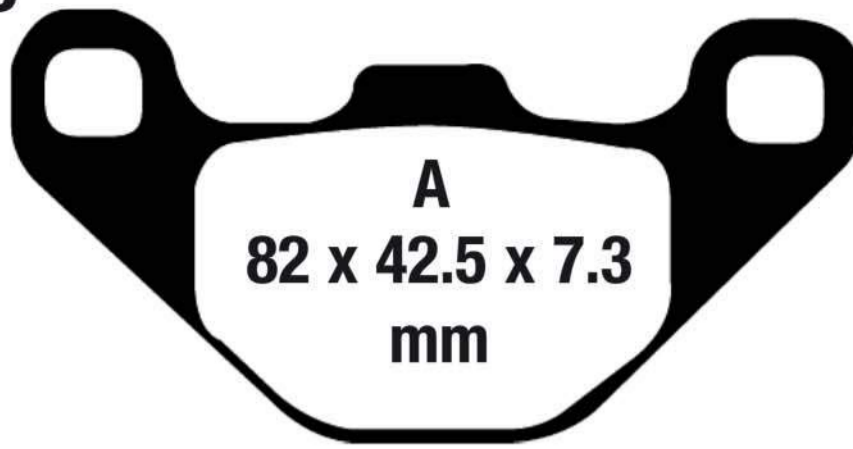

APRILIA

Pegaso 650 ie (All models) 99-04 R

MZ

Mastiff 660 00-03 R

Baghira 660 (All models) 00-05 R

Equivalents OE#

STD FA173 Premium Organic Street Pad Blend

Dealer Stocking Recommendation

Single/Pair	Popularity #	Rec Stocking Level
1	-	1

FA174

HONDA

599 (CB 600 F)	04/06	R
CBR 600 F2/F3/SJR/SE	91-98	R
CBR 600 F4 (Carb Model)	99-00	R
CBR 600 F4i Sport Injection Model)	01-06	R
CBR 600 RR	03-06	R
NC 700 XD (Auto G/Box)	12-14	R
919 (CB 900 F)	02-07	R
CBR 900 RR Fireblade	93-99	R
CBR 929 RR (929cc model)	00-01	R
CBR 954 RR (954cc model)	02-03	R
CB 1000	94-95	R
CBR 1000 RR	04-05	R
CRF 1000 LAG/LAH Africa Twin	16-17	R
CRF 1000 LADG/LADH Africa Twin	16-17	R
RVT 1000 R (RC51)	00-05	R
VTR 1000 F 'Superhawk'	98-05	R
CB 1100 (Non ABS)	13-14	R
CB 1100 A (ABS)	13-14	R
CB 1100 EX (ABS)	14-17	R
VT 1100 C2 American Classic Edition/C2-2/C3/C2 Sabre	95-07	R
VT 1100 T Shadow American Classic Edition Tourer	98-01	R
VT 1300 CX Fury (Non ABS Model)	10-15	R
VT 1300 CS Sabre (Non ABS)	10-14	R
VT 1300 CR Stateline (Non ABS)	10-15	R
VT 1300 CT Interstate (Non ABS)	10-15	R
VTX 1300 S	03-07	R
VTX 1300 C	04-11	R
VTX 1300 R	05-11	R
VTX 1300 T	08-11	R

KAWASAKI

EN 650 Vulcan S (Non ABS) EN 650 AFF/AGF/CHF	15-17	R
EN 650 Vulcan S (ABS) EN 650 BFF/BGF/DHF	15-17	R
KLE 650 FGF/FGFAS Versys/Versys LT	16	R
Ninja 650 (EX 650 KH/KHFA - ABS)	17	R
Ninja 650 (EX 650 JHF -NON ABS)	17	R
Z 650 (ER650GHF/ NON ABS)	17	R
Z 650 (ER650HHF/ ABS)	17	R
KLZ 1000 BFF/BFFAS/BGF/BGFAS/BHF Versys 1000	15-17	R
Z 1000 (ZR 1000 B7F)	07	R
Z 1000 (ABS) ZR 1000 C7F	07	R
ZR 1000 B7F/B8F	07-08	R

SUZUKI

DL 650 V-Strom K4/K5/K6/K7/K8/K9	04-09	R
DL 650 AK7/AK8/AK9/AL1/AL2/AL3/AL4/AL5/AL6/AL7 V-Strom (ABS Model)	07-17	R
DL 650 XT XAL5/XAL6/XAL7 V-Strom XT (ABS Model)	15-17	R
DL 650 V-Strom ABS Adventure AAL2/AAL3/AAL4/AAL5	12-15	R
GSX 650 FK8/FK9/FLO	08-09	R
SV 650 K3/SK3/K4/SK4/K5/SK5/K6/SK6/K7/SK7/SK8/K8/K9	03-10	R
SV 650 AK7/AK8/K7/K8/K9/AK9 ABS	07-10	R
SV 650 SAK7/SAK8/SAK9 ABS	07-10	R
GSX-S 750 L5/L6	15-16	R

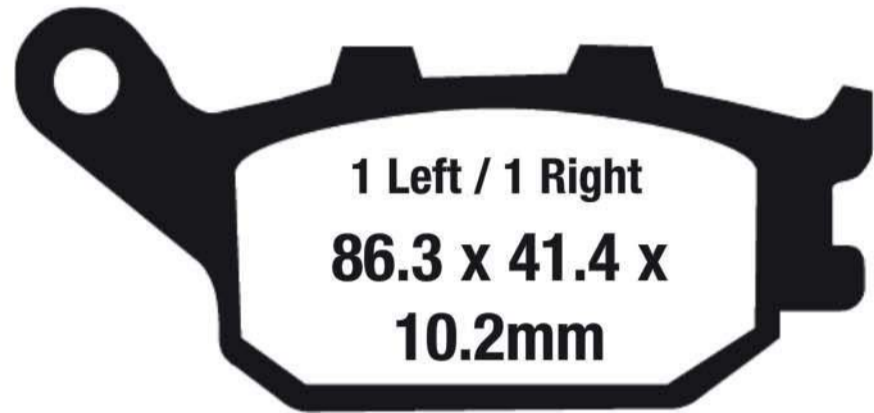

GSX-S 750 ZL5	15	R
DL 1000 K2/K3/K4/K5/K6/K7/K8/K9/L2 V-Strom	02-12	R
DL 1000 AL2 V-Strom Adventure	12	R
GSX-S 1000 L6/L7/L8 (Naked - Non ABS)	16-18	R
GSX-S 1000 AL6/AL7/AL8 (Naked-ABS)	16-18	R
GSX-S 1000F L6/L7/L8 (Faired-Non ABS)	16-18	R
GSX-S 1000F AL6/AL7/AL8 (Faired-ABS)	16-18	R
SV 1000 K3/SK3/K4/SK4/K5/SK5/SK6/SK7	03-07	R
GSF 1250 SAK7/SAK8/SAK9 (ABS)	07-10	R
GSF 1250 SK7/SK8/SK9 Bandit	07-10	R
GSX 1250 FAL1/FAL2	11-14	R
GSX 1250 SAL6 Bandit	16	R
YAMAHA		
YZF 600 RRR/RRS (R6)	03-04	R
FZ6	04-06	R
FZ6 (4 piston caliper)	07-09	R
FZ6R	12-14	R
FZ-07 (689cc/2 Cyl)	15-17	R
FZ-07 A (689cc/2 Cyl/ABS)	17	R
XSR 700 (MTM 690-U)	18	R
FJ-09 (847cc/3 Cyl)	15-16	R
FZ-09 (847cc/3 Cyl)	14-17	R
XSR 900 (MTM 850)	16-17	R
YZF-R1 (5VY)	04-06	R
YZF R1 LE	06	R
(FZ1) FZS 1000 V/W/X/Y/Z/A/B/D/E	06-14	R
FZ-10	17	R
YZF-R6 T/V/W (310mm rotor)	05-07	R
YZF-R6S (YZF-R6 SV/SW/SX/SY) (298mm rotor)	06-09	R
YZF-R6 X/Y/Z/A/B/D/E/F/G	08-16	R
YZF-R1 (6 piston radial caliper)	07-14	R
FZ8	11-13	R

Equivalents OE#

43082 0073	43105 MWO 425	69100 08860
43105/6 MV9 008	43082 0166	69100 16851
43105 MWO 405	69100 06830	69100 16852
5XV W0046 00	69100 08850	5VX 25806 00

Dealer Stocking Recommendation

Single/Pair	Popularity #	Rec Stocking Level
1	H14	1

STD FA174 Premium Organic Street Pad Blend

OPTIONS FA174HH Street Performance Sintered Pad Blend

FA174V Semi Sintered Long Lasting Street Pad Blend

FA175



**33.7 x 50.5
x 7mm**

**HARRISON BILLET AFTERMARKET
CALIPER**
2 Piston (1296040)
Slim Design
Mini 6

ISR AFTERMARKET CALIPER
22-032 (6 Piston Large)
22-042 (6 Piston Racing)

**Dealer Stocking
Recommendation**

Single/Pair	Popularity #	Rec Stocking Level
1	H14	1

STD	FA175	Premium Organic Street Pad Blend
OPTIONS	FA175HH	Street Performance Sintered Pad Blend
	FA175S	Green - Race Use
	CFK175	Premium Organic Street Pad Blend
	EPFA175HH	Fast Street Use & Track Day Sintered Pad Blend

FA177



87 x 53 x 7.5mm

MZ

Mastiff 660 00-03 F
Baghira 660 (All models) 00-05 F

Dealer Stocking Recommendation

Single/Pair	Popularity #	Rec Stocking Level
1	-	1

STD FA177 Premium Organic Street Pad Blend

FA179

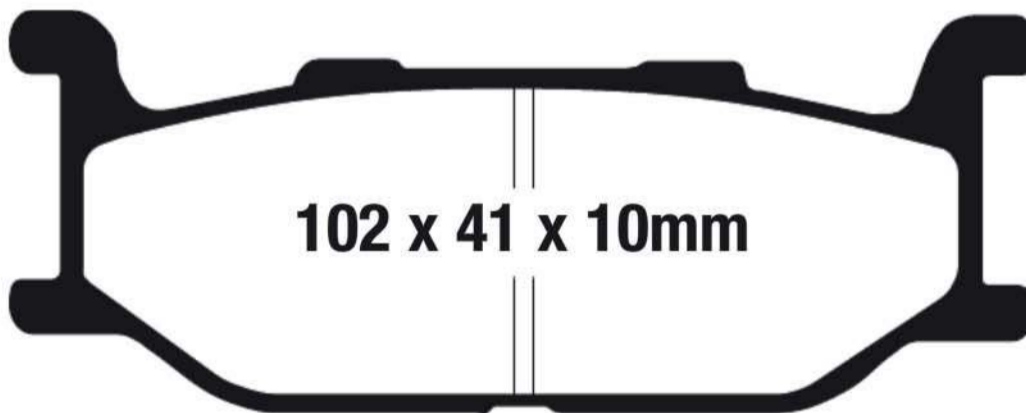

102 x 41 x 10mm

YAMAHA

SR 400 F	15-16	F
XJ 400 S "Seca II"	93	F
XP 400 T/V/W/X/Y/Z/B Majesty	05-10/12/13	F
XP 500 T-Max (5GJ5)	01	F
XV 535 G/GC/SG/SGC/H/HC/SH/SHCJ/JC/SJ/SJC/K	95-99	F
XJ 600 S "Seca II"		
SD/SDC/SE/SEC/SF/SFC/SG/SGC/SH/SHC//SJ/SJC/SK/SKC	98	F
XVS 650 V Star Custom	97-11/13-14	F
XVS 650 V-Star Classic	98-10	F
XVS 650 V-Star Silverado	03-10	F
SR 400 F	15-16	F
SCR 950 (SCR 950 H)	17	F
XVS 950 (V-Star 950)	09-14	F
XVS 950 (V-Star 950 Tourer)	09-14	F
XVS 950 Bolt (Standard Rear Shocks)	14-16	F
XVS 950 Bolt C Spec (Remote Reservoir Rear Shocks)	18	F
XVS950 Bolt R Spec (Remote Reservoir Rear Shocks)	18	F
XVZ 1300 Royal Midnight Venture Star	02-07	F
XVZ 1300 Royal Star Tour Deluxe	06-08	F
XVZ 1300 Royal Star Tour Deluxe	05-07	F
XVZ 1300 Venture MM Limited Edition	01	F
XVZ 1300 Royal Star Midnight Venture	02-07	F
XVS 1300 Stryker	11-14	F
XVZ 1300 Royal Star Venture S	08-13	F
XVZ 1300 Royal Star Venture	99-07	F
XV 1300 Royal Star Midnight Tour Deluxe	06-07	F
XV 1600 Road Star	01-05	F
XV 1600 Road Star Silverado	07-09	F
XV 1600 Road Star Midnight	03	F
XV 1600 Road Star Midnight	02-08	F

Equivalents OE#

3YX W0045 00	4TR W0045 00	5RU W0045 00
4BP W0045 00	4WM W0045 00	
4KM W0045 00	5BN W0045 00	

**Dealer Stocking
Recommendation**

Single/Pair	Popularity #	Rec Stocking Level
1	Y25	1

STD FA179 Premium Organic Street Pad Blend

OPTIONS FA179HH Street Performance Sintered Pad Blend

OPTIONS FA179V Semi Sintered Long Lasting Street Pad Blend

OPTIONS SFA179 Premium Organic Scooter Pad Blend

OPTIONS SFA179HH Scooter Performance Sintered Pad Blend

FA180

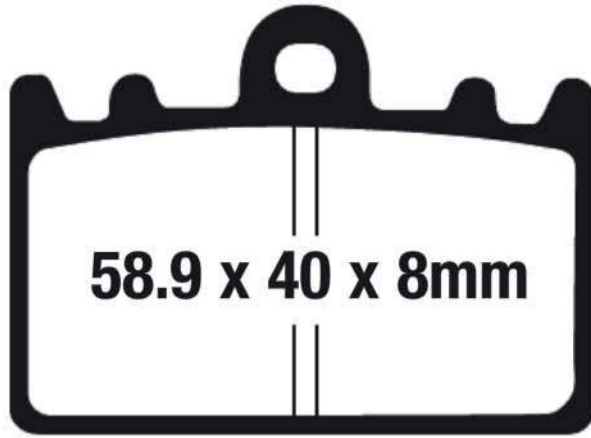

58.9 x 40 x 8mm

PRE TECH AFTERMARKET CALIPER
4 Piston (Uni P401)

Equivalents OE#

STD FA180 Premium Organic Street Pad Blend
OPTIONS FA180HH Street Performance Sintered Pad Blend

Dealer Stocking Recommendation

Single/Pair	Popularity #	Rec Stocking Level
2	-	2

FA181



1 Left / 1 Right
94 x 37.3 x 7.5mm

ALTA MOTORS (Electric)

Redshift - MX 16-18 F
Redshift - SM 16-18 F

APRILIA

RST 1000 Futura 01-05 R

ATK

All Models 97- F
125 (2 stroke enduro) 03 F
250/260 (2 stroke enduro) 03 F
450 MX 07 F
450 XC 07 F
Enduro 450 07 F
500 Enduro 03 F
605 Enduro 03 F
700 (2T) Intimidator 04 F
620 (2T) Intimidator 04 F
500 (2T) 04 F
370 (2T) 04 F
250 (2T) 04 F

BMW

G 450 X 08-11 F

DUCATI

Monster 400 ie (Japan) 07-08 F
Monster S2R (803cc) 05-07 F
Monster S2R Dark (803cc) 05-06 F
620 Multistrada (Twin Disc/Single pin pad fixing) 06 F
Multistrada Dark 620 03-05 F
Monster 620 05-06 F
Monster 620ie (Series 2 - Single Pin Pad Fixing Caliper) 05 F
Monster 695 06-09 F
950 Multistrada (936cc) 17 R
Multistrada 1200 15-16 R
Multistrada 1200 Enduro 17 R
Multistrada 1200 S 15-17 R
Multistrada 1200 S D/air 16-17 R

GAS-GAS

Wild HP 300/450 03-06 F&R
Enduros 125/250 00 F
Enduro EC 200/250/300 99-00 F
MX 200/250/300 99-00 F
Wild HP 300/450 03-06 F&R

HARLEY DAVIDSON

XG 500 Street (300mm Discs) 16-18 R
XG 750 Street (300mm Discs) 16-18 R
XG 750 A Street Rod (300mm Discs) 17-18 R

HUSABERG

All Models (fixing pin at end of brake pad) 93-99 F
All MX/Enduro Models 00-08 F
TE250 (2T) 11-14 F
TE300 (2T) 11-14 F

FE390 (4T) 10-12 F
FE450 (4T) 09-14 F
FX450 (4T) 10-11 F
FE501(4T) 11-14 F
FE570(4T) 09-12 F

HUSQVARNA

CR 125 95-12 F
SM 125 98-00 F
SMS 125 (2T) 02-11 F
SMS-4-125 (4T) 10-11 F
TC 125 (2T) 14 F
TE 125 11 F
TE 125 (2T) 14 F
WR 125 95-10 F
WRE 125 93-11 F
CR 250 95-05 F
FC 250 (4T) 14 F
FE 250 (4T) 14 F
TC 250 02-11 F
TC 250 R (4T) (Kayaba Forks) 13 F
TE 250 02-12 F
TE 250 (2T) 14 F
TXC 250 Cross Country 08-12 F
TXC 250 R (4T) (Kayaba Forks) 13 F
TC 250 (2T) 14-15 F
WR 250 95-12 F
TE 300 (2T) 14 F
WR 300 09-12 F
TE 310 (4T) 09-12 F
TE 310 R (4T) (Kayaba Forks) 13 F
TXC 310 Cross Country 12 F
TXC 310 R (4T) (Kayaba Forks) 13 F
FC 350 (3T) 14 F
FE 350 (4T) 14 F
TE 350 95-97 F
WR 360 95-02 F
TE 400 02 F
TE 410 95-00 F
TE 410 06 F
TE 410 E 00 F
TC 449 11-12 F
TE 449 (4T) 11-12 F
FC 450 (4T) 14 F
FE 450 (4T) 14 F
TE 450 03-05 F
TE 450 06-11 F
TXC 450 Cross Country 08-10 F
FE 501 (4T) 14-15 F
TC 510 04-09 F
TE 510 04-10 F
TXC 510 Cross Country 08-12 F
TE 511 (4T) 11-12 F
TXC 511 Cross Country 11-12 F
TC 570 02-03 F
TE 570 01-04 F
TC 610/E 95-99 F
TC 610 00 F
TE 610 00 F
TE 610/E 95-03 F
TE 610/IE 06-09 F
TE 630 10-11 F

KTM

SX 125 94-16 F
XC/EXC 04-08 R
SX 150 08-17 F
XC 150 10-15 F
XC-W 200 06-16 F

FA181 Contd.

KTM Contd.

XC 200	06-08
SX 250 (2T)	94-16
SX-F 250 (4T)	06-16
SX-F 250 Factory Edition	15
XC/EXC 250	94-07
XC/EXCF 250	06-07
XC-F 250	06-16
XC-F-W 250	06-16
XCF-W 250 Six Days	11
XC 250 (2T)	06-16
XC-W 250	06-16
EGS 300 (Standard forks)	94-98
EXC 300 (Standard Forks)	94-98
EXC 300	04-07
EXC 300 (Upside down forks)	99-05
MXC 300 (Standard forks)	94-98
MXC 300 (Upside down forks)	99-06
SX 300	94-96
XC 300 (2T)	06-16
XC-W 300	06-16
XC-W 300 Six Days	14-16
EXC 350 LC4	94-95
EXC-F 350	12
EXC-R 530	08
EXC 350/SX 350	96-97
SX-F 350	11-16
XC-F 350	11-16
XCF-W 350	12-16
XCF-W 350 Side Days	14-16
EXC 380/SX 380	98-03
EGS 400/EGS-E/LSE	96-99
EXC/EGS 400	00-02
EXC 400 Racing	00
LC4-E 400 Enduro	00-01
SC 400 (Supercompetition LC4)	96-99
SX 400	00-02
XC/EXC 400	04-07
XC-W 400	08-09
XC-W 400	10-11
EXC 440	94-95
SX 440	94-95
EXC 450/SX 450	03-07
EXC 450 (4T)	09-10
EXC 450	10-16
SX-F 450	03-16
EXC-R 450	08
XCR-W 450	08
XC-F 450	08-16
450 XC-W (4T) Six Days/Champion Edition	10
XC-W 450 Six Days	10-11
XC-W 450	08-09
XC-W 450 Champions Edition	10
XC-W 450	12-16
EXC 500	12-16
EXC 500 Six Days	16
MX 500	92-95
XC-W 500	12-16
XC-F 505	08
EXC 520/SX 520	01-03
EXC 525	03-07
MXC 525	03-04
SX 525	03-05
XC 525 Desert Racing	07
EXC 530 (4T)	09-11
EXC 530	10-11
XCR-W 530	08
XC-W 530 Six Day	10-11
XC-W 530 (4T) Six Days	10
MXC 550	96
EGS 620 Enduro/EGS0E/LSE	96-99
EGS-E 620 Adventure/Rallye	99
LC4 620 SC Supermoto	00
SC 620 Supercompetition	96-00
SX 620 EXC/EGS	94
SX EXC/EGS 620	95

KTM Contd.

SX 620	96-99	F
LC4 625 SC Supermoto/Supercompetition	02	F
SXC 625	03-06	F
LC4-E 640 Enduro/Supermoto	00-04	F
LC-4 640 Adventure R	01-03	F
LC-4 Adventure	03	F
690 Enduro	08	F
950 Supermoto	05-08	R
950 Adventure/S	04-06	R
950 R Super Enduro	07-08	R
SX-F 505	07	F
990 Adventure S (Non ABS)	06-08	R
990 Adventure (ABS Model)	07-12	R
990 Adventure Baja Edition (ABS)	13-14	R
990 Adventure R	09-12	R
990 SM-T	10-14	R
990 SM-R	09-11	R
1190 Adventure	13-16	R
1190 Adventure R	13-16	R
1290 Super Adventure	13-16	R
MAICO/M-STAR		
Disc models	97-99	F
MOTO GUZZI		
1100 Brevia	05-12	R
Griso 1100	05-08	R
Quota 1100 ES	99-01	R
1100 Griso (1064cc) Standard Mount Caliper	05-12	R
1200 Griso SE (8v) (Radial caliper) 1151cc	09-15	R
Griso 1200 8V (1151cc)	09-12	R
Norge 1200 GT/2V	06-12	R
Norge 1200 GT 8V	10-15	R
Stelvio 1200 NTX 8V (ABS)	09-15	R
ROYAL ENFIELD		
Bullet 500 EFI (Brembo caliper Front & Rear)	16-17	F
Classic 500 (Brembo caliper Front & Rear)	16-17	F
Classic 500 Chrome (Brembo caliper Front & Rear)	16-17	F
SHERCO DIRT		
2.5i Enduro	05-12	F
4.5i Enduro	05-12	F
4.5 Supermoto	04-07	F
5.1i Enduro	05-12	F
TM		
MX Models 85/100	02-08	F
MX Models 125/250/300	02-08	F
MX 144 (2T)	07-08	F
MX 450 F	04-08	F
MX 530 F (4T)	04-08	F
EN 125 (2T)	01-08	F
EN 250 (2T)	01-08	F
EN 250 F-ES (4T)	01-08	F
EN 300 (2T)	01-08	F
EN 450 F-ES (4T)	04-08	F
EN 530 F-ES (4T)	04-08	F
VERTEMATI		
495	99-02	F
C 450/500/570 (MX)	03-04	F
E 450/501/570 (Enduro)	03-04	F
VOR		
MX 450/530	04	F
EN/EN-E 450/530	04	F
YAMAHA		
YBA 125 Enticer (3P41)	05	F
YBA 125 Enticer (16C1/3P42/3)	07-12	F
FZ16 (160cc) (IES1/2/3)	10-13	F
FZ16S (160cc) (IES4)	12-13	F
FZ16ST-Fazer (IKS2/3)	11-13	F
ZERO ELECTRIC BIKES		
FX ZF2.8/ZF5.7	15	F
SFA181		
PIAGGIO		
X9 500	05-09	F

Equivalents OE#

8133516	34 11 7 717 309	770 13 020 000
070044	61340721A	777 13 030 000
000306546250	800096934	GU05654630
107861750	8A0074181	594715A
M9467Z04	546 13 209 044	
34 11 7 717 292	546 13 209 244	

Dealer Stocking Recommendation

Single/Pair
1

Popularity #

-

Rec Stocking Level

1

STD	FA181X	Carbon Dual Purpose Pad Blend
	FA181R	Utility Grade Sintered Pad Blend
	MXS181	Sintered Sport Off Road Pad Blend
	FA181HH	Street Performance Sintered Pad Blend
	EPFA181HH	Fast Street Use & Track Day Sintered Pad Blend
	SFA181	Premium Organic Scooter Pad Blend
	SFA181HH	Scooter Performance Sintered Pad Blend

BUYERS GUIDE
BRAKE PADS

Dimension 1=Width or Diameter, Dimension 2=Height or Diameter, Dimension 3=Thickness (Material and backplate)

NOTE:- Size identification is shown as follows

FA182



YAMAHA
FZR 1000 EX-UP D/DC/E/EC

92-93 F

Equivalents OE#

3GM W0045 50

Dealer Stocking Recommendation

Single/Pair	Popularity #	Rec Stocking Level
2	Y30	2

STD FA182 Premium Organic Street Pad Blend

OPTIONS FA182HH Street Performance Sintered Pad Blend

FA183

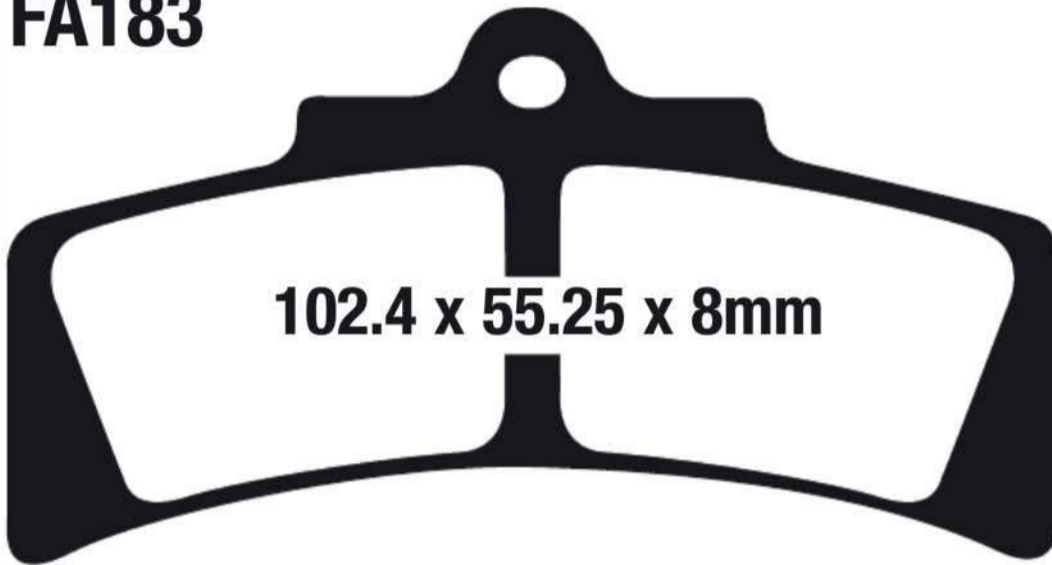

PVM AFTERMARKET CALIPER
6 Piston (old large design)

Dealer Stocking Recommendation

Single/Pair	Popularity #	Rec Stocking Level
1	-	1

STD GFA183HH Sintered Race Use Only (Closed Circuit)

FA184



ISR AFTERMARKET CALIPER
22-034 (6 Piston Small)
22-036 (2 Piston)
22-043 (4 Piston)
Radial 6 Piston Monoblock

Equivalents OE#

ISR 29-002

STD FA184 Premium Organic Street Pad Blend

BUYERS GUIDE
BRAKE PADS

NOTE:- Size identification is shown as follows
Dimension 1=Width or Diameter, Dimension 2=Height or Diameter, Dimension 3=Thickness (Material and backplate)

FA185



1 pad left
1 pad right

94 x 34.2 x 7mm

NOTE:- Size identification is shown as follows

APRILIA

RXV 4.5/5.5	06-11	F
BETA		
RR 250 (2T)	15	F
RR 250 4T	05-08	F
RR 300 (2T)	15	F
RR 350 4T Enduro	11-15	F
RS 350 Dual Sport	11-12	F
RR 390 (4T)	15	F
RR 400 4T	10-11	F
RR 400 T Enduro	12-14	F
RS 400 Dual Sport	08-11	F
SM 400 Supermoto	10-11	F
RR 430 (4T)	15	F
RS 430 (4T)	15	F
RR 450 4T	05-11	F
RR 450 4T Enduro	12-14	F
RS 450 Dual Sport	08-14	F
SM 450 Supermoto	10-11	F
RR 480 (4T)	15	F
RR 498 (4T)	15	F
RS 500 (4T)	15	F
RS 520 Dual Sport	08-14	F
SM 520 Supermoto	10-11	F
RR 525 4T	10-11	F
RR 525 4T Enduro	05-09	F

GAS-GAS

EC 125/200/250/300	01-12	F
MC 125	05	F
MX 125/250	01-04	F
EC 450	09	F
FSE 450	05-08	F
EC 515	09	F

HONDA

CR 125 R	95-07	F
CRF 125 F (17/14" Small Wheels)	14-16	F
CRF 125 F (19/16" Large Wheels)	14-16	F
CRF 150 F	07-16	F
NXR 150 (KD02/KD03)	03-08	F
CRF 230 F	03-15	F
CRF 230 L	08-11	F
CRF 230 M	09-11	F
CR 250 R	95-07	F
CRF 250 R	04-17	F
CRF 250 X	04-17	F
NX 250	88-90	F
XR 250 L	93-96	F
XR 250 R	96-04	F
XR 400 R	96-04	F
CRF 450 R	02-17	F
CRF 450 X	05-17	F
CRF 450 RX (18" Rear wheel)	17	F
TRX 450 R/ER	04-11	F
CR 500 R	95-01	F
XR 600 R	93-00	F
XR 650 R	00-02	F
XR 650 L	93-16	F
XR 650 R	00-07	F
TRX 700 XX	08-11	F

KAWASAKI

KX 125 K1/K2/K3/K4/K5/L1/L2/L3/L4/M1-M3	94-05	F
KDX 200 H1-H11/H6F	95-06	F
KDX 220 R A4-A12/A6F	97-06	F
KX 250 K1/K2/K3/K4/K5/L1-L4/M1/M2/R1/R6F/R7F	94-07	F
KX 250 N1/N2/T6F/T7F/T8F (KX 250 F)	04-08	F
KX 250 F (W9F/XAFB/YBF/YCF/ZDF/ZEF/ZFF/ZGF/AHF) (4T)	09-17	F
KLX 250 R D2/D3/D4	94-96	F
KLX 250 S (KLX 250 H6F/H7F)	06-07	F
KLX 300 R A2-A10/A6F/A7F	97-07	F
KLX 400 SR (KLX 400 A1/A2)	03-04	F
KLX 400 R (KLX 400 B1/B2)	03-04	F
KLX 450 R (A8F/A9F/AAF/ABF/ACF)	08-12	F
KX 450 F (D6F/D7F/D8F)	06-08	F
KX 450 F (E9F/EAF/EBF/FCF/FDF/FEF/FFF/HGF/HHF) (4T)	09-17	F
KX 500 E6-E16	94-04	F
KLX 650 R A1/A2/A3/C1/C2/C3/C4/D1	93-96	F

SUZUKI

RM 125 T/V/W/X/Y/K1/K2/K3/K4/K5/K6/K7/K8	96-08	F
DR-Z 250 K1/K2/K3/K4/K5/K6/K7	01-07	F
RM 250 T/V/W/X/Y/K1/K2/K3/K4/K5/K6/K7/K8	96-08	F
RMX 250 T/V/W/X/Y	96-00	F
RM-Z 250 K4/K5/K6/K7/K8/K9/L0/L1/L2/L3/L4/L5/L6/L7	04-17	F
DR 350 SEW/SEX	98-99	F
DR-Z 400 SY/SK1-SK9/SL1/SL2/SL3/SL4/SL5/SL5	00-16	F
DR-Z 400 EY/EK1/EK2/K2/K3/EK3/K4/EK4/K5/EK5/K6/EK6/EK7	00-07	R
DR-Z 400 SMK5/SMK6/SMK7/SMK8/SMK9/SML3/SML4/SML5/SML6	05-09/13-16	F
RM-Z 450 K5/K6/K7/ZK7/K8/K9/L0/L1/L2/L3/L4/L5/L6/L7	05-17	F
DR 650 SET/SEV/SEW/SEX/SEY/SEK1/SEK2/SEK3/SEK4/SEK5/SEK6 /SEK7/SEK8/SEK9/SEL1/SEL2/SEL3/SEL4/SEL5/SEL6	96-16	F

YAMAHA

YZ 125 K/L/M/N/P/R/S/T/V/W	98-07	F
WR 250 FN/FP/FR/FS/FT/FV/FW/FX/FY/FZ/FA/FB/FD/FE/FF/FG/FH/FJ	01-18	F
WR 250 RX/RV/RZ/RA/RB/RD/RE/RF	08-15	F
YZ 250 K/L/M/N/P/FP/R/FR/S/FS/FT/T/FV/V/W	98-07	F
WR 400 FK/FL/FM	98-00	F
YZ 400 FK/FL	98-99	F
YZ 426 FM/FN/FP	00-02	F
WR 426 FN/FP	01-02	F
YZ 450 FR/FS/FT/FV/FW	03-07	F
WR 450 FW/FX/FY/FZ/FA/FB/FD/FE/FF	07-15	F

ZERO ELECTRIC BIKE

DS ZF8.5/ZF11.4 (Nissin calipers)	13	F
DS ZF8.5/ZF11.4 (Nissin Fr calipers)	14	F
FX ZF2.8/ZF5.7 (Nissin calipers)	13	F
FX ZF2.8/ZF5.7 (Nissin Fr calipers)	14	F
MX ZF2.8/ZF5.7 (Nissin calipers)	13	F
S ZF8.5/ZF11.4 (Nissin calipers)	13	F
S ZF8.5/ZF11.4 (Nissin Fr calipers)	14	F
SR ZF11.4 (Nissin Fr calipers)	14	F

Dealer Stocking Recommendation

Single/Pair	Popularity #	Rec Stocking Level
1	-	1

Equivalents OE#

06455 KBR 731	43082 1149	59300 36850	5MV W0045 01	25 25361
06455 KCZ 000	43082 1152	59300 36870	072 5000035	06455 HP1 016
45105 MY6 405	43082 1172	59300 36880	5000035	06455 KHA 941
45105 MY6 415	43082 1218	59300 36890	K4308 21286	43082 0132
45105 KTO 405	43082 1286	59301 36810	43082 0026	32D W0045 00
45105 KZ1 405	43082 5009	5DH W0045 00	2525361000	
43082 0026	59300 13830	5DH W0045 10	43082 0049	

STD	FA185X	Carbon Dual Purpose Pad Blend
	MXS185	Sintered Sport Off Road Pad Blend
	FA185R	Utility Grade Sintered Pad Blend
	EPFA185HH	Fast Street Use & Track Day Sintered Pad Blend

SFA186

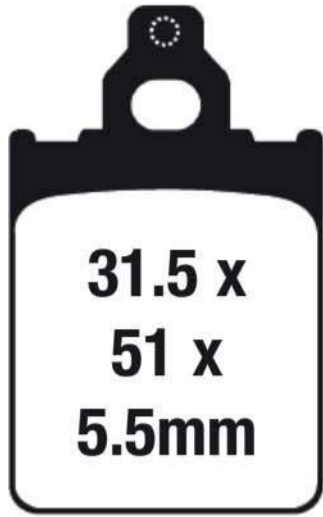

31.5 x
51 x
5.5mm

STD SFA186 Premium Organic Scooter Pad Blend

VESPA

PX 150 (All models)

05-06

F

Equivalents OE#

494762
498414
800067127

Dealer Stocking Recommendation

Single/Pair	Popularity #	Rec Stocking Level
-	-	-

FA187



68 x 54 x 8mm

STD FA187 Premium Organic Street Pad Blend

OPTIONS FA187HH Street Performance Sintered Pad Blend

EPFA187HH Fast Street Use & Track Day Sintered Pad Blend

Dealer Stocking Recommendation

Single/Pair	Popularity #	Rec Stocking Level
2	H24	2

HONDA

VFR 750 R (RC 30)

90

F

RVF 750 R (RC45)

94-95

F

919 (CB 900 F)

02-07

F

CBR 900 RR Fireblade

93-97

F

VTR 1000 F 'Superhawk'

98-05

F

CB 1000

94-95

F

Equivalents OE#

06455 MZ1 405	45105 MR7 681
45105 MN8 006	45105 MWO 405
45105 MR7 006	45105 MWO 415
45105 MR7 612	45106 KV3 701

FA188



89 x 53 x 8.3mm
(inc fitted shim)

STD FA188 Premium Organic Street Pad Blend

OPTIONS FA188HH Street Performance Sintered Pad Blend

EPFA188HH Fast Street Use & Track Day Sintered Pad Blend

Dealer Stocking Recommendation

Single/Pair	Popularity #	Rec Stocking Level
2	S21	2

JAYBRAKE AFTERMARKET CALIPERS

J-Four (300-44) (4 Piston)

KAWASAKI

ZX-6R (ZX 600 G1/G2)

98-99

F

ZX6R (ZX 600 J1/J2/J3)

00-02

F

ZX6R (ZX 636 A1)

02

F

ZZR 600 (ZX 600 J4/J6F/J7F/J8F)

05-08

F

Ninja ZX 7R (6 Piston Pad) (ZX 750 P1-P8)

Tokico Caliper

96-03

F

ZX-9R B3/B4/C1/C2 "Ninja"

96-99

F

ZX9R (ZX 900 E1/E2)

00-01

F

(ZR 1100 C3/C4) ZRX 1100

99-00

F

ZRX 1200 R (ZR 1200 A1/A2/A3/A4/A5)

01-05

F

ZX12R (ZX 1200 A1/A2/B1/B2)

00-03

F

VN 1500 P1/P2 'Vulcan 1500 Mean Streak'

02-03

F

VN 1600 B1 Mean Streak

04

F

SUZUKI

GSX-R 750 WR/WS/T/V/W/X

94-99

F

GSXR 1000 K1/K2

01-02

F

GSX-R 1100 WP/WR/WS/WT/WV/WW

93-98

F

TL 1000 RW/RX/RV/RK1/RK2/RK3

98-03

F

GSX 1200 SK1/SK/SK3/K1/K2/K3/SK4/SK5

01-05

F

GSX 1300 RX/RV/RK1/RK2/RZK3/RK4/RZK4/

RK5/RK6/RZK6 Hayabusa

99-06

F

VZ 1600 K4 Marauder

04

F Left

Equivalents OE#

59130 46E00	59300 33890	43082 1224	43082 1258	43082 1274
59300 46840	43082 1179	43082 1227	43082 1259	K4308 21274
59300 33870	43082 1199	43082 1250	43082 1272	

FA189

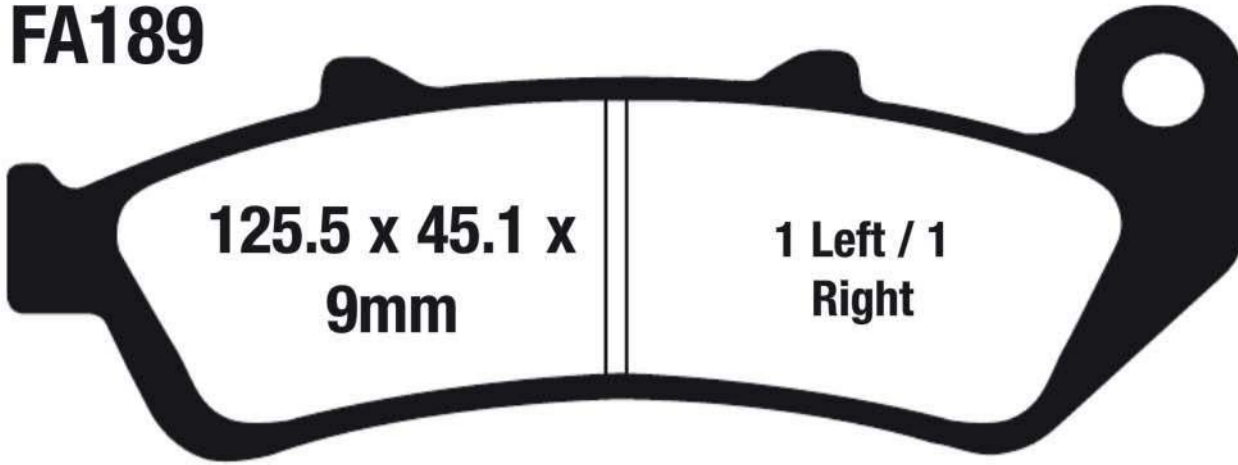

**125.5 x 45.1 x
9mm**

**1 Left / 1
Right**

Equivalents OE#

06455 MZ2 405

★ SAFETY NOTICE ★

LINKED BRAKE

FIT ALL THREE SETS AT PAD CHANGE

HONDA
CBR 1000 F

93-99 F & R

STD	FA189	Premium Organic Street Pad Blend
OPTIONS	FA189HH	Street Performance Sintered Pad Blend

Dealer Stocking
Recommendation

<u>Single/Pair</u>	<u>Popularity #</u>	<u>Rec Stocking Level</u>
3	H32	2

FA190

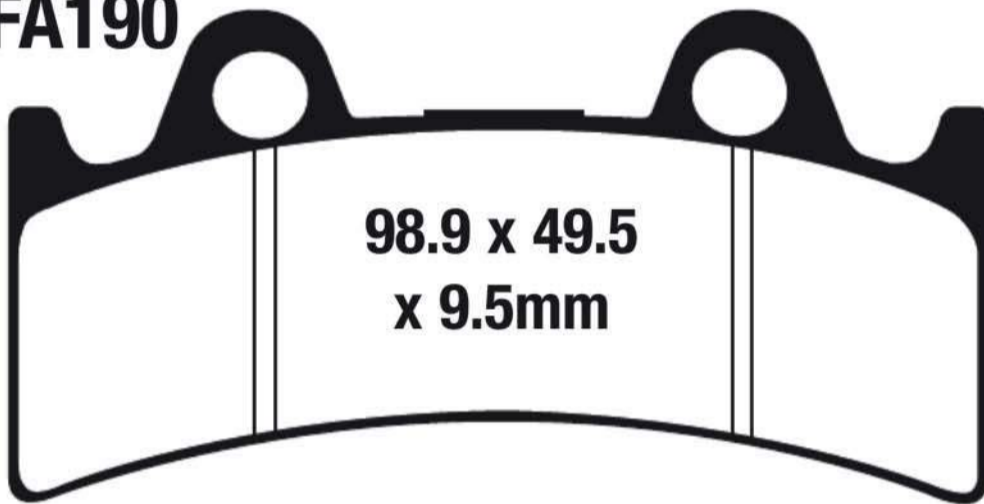

**98.9 x 49.5
x 9.5mm**

PERFORMANCE MACHINE AFTERMARKET CALIPER

112 X 6RSB
112 X 6SSB
125 X 6QC

PRE TECH AFTERMARKET CALIPER

6 Piston

TRIUMPH

Daytona Super III (3 cyl)

94-97 F

YAMAHA

YZF 750 R/SP

93-96 F

FZR 1000 EX-UP F/FC/G/GC

94-96 F

Equivalents OE#

4FM W0045 00
4FM W0045 10

Dealer Stocking
Recommendation

<u>Single/Pair</u>	<u>Popularity #</u>	<u>Rec Stocking Level</u>
2	Y29	2

STD	FA190	Premium Organic Street Pad Blend
OPTIONS	FA190HH	Street Performance Sintered Pad Blend
	EPFA190HH	Fast Street Use & Track Day Sintered Pad Blend
	FA190V	Semi Sintered Long Lasting Street Pad Blend

NOTE:- Size identification is shown as follows

Dimension 1=Width or Diameter, Dimension 2=Height or Diameter, Dimension 3=Thickness (Material and backplate)



FA191

YAMAHA
GTS 1000 AE/AEC/AF/AFC

93-96

F

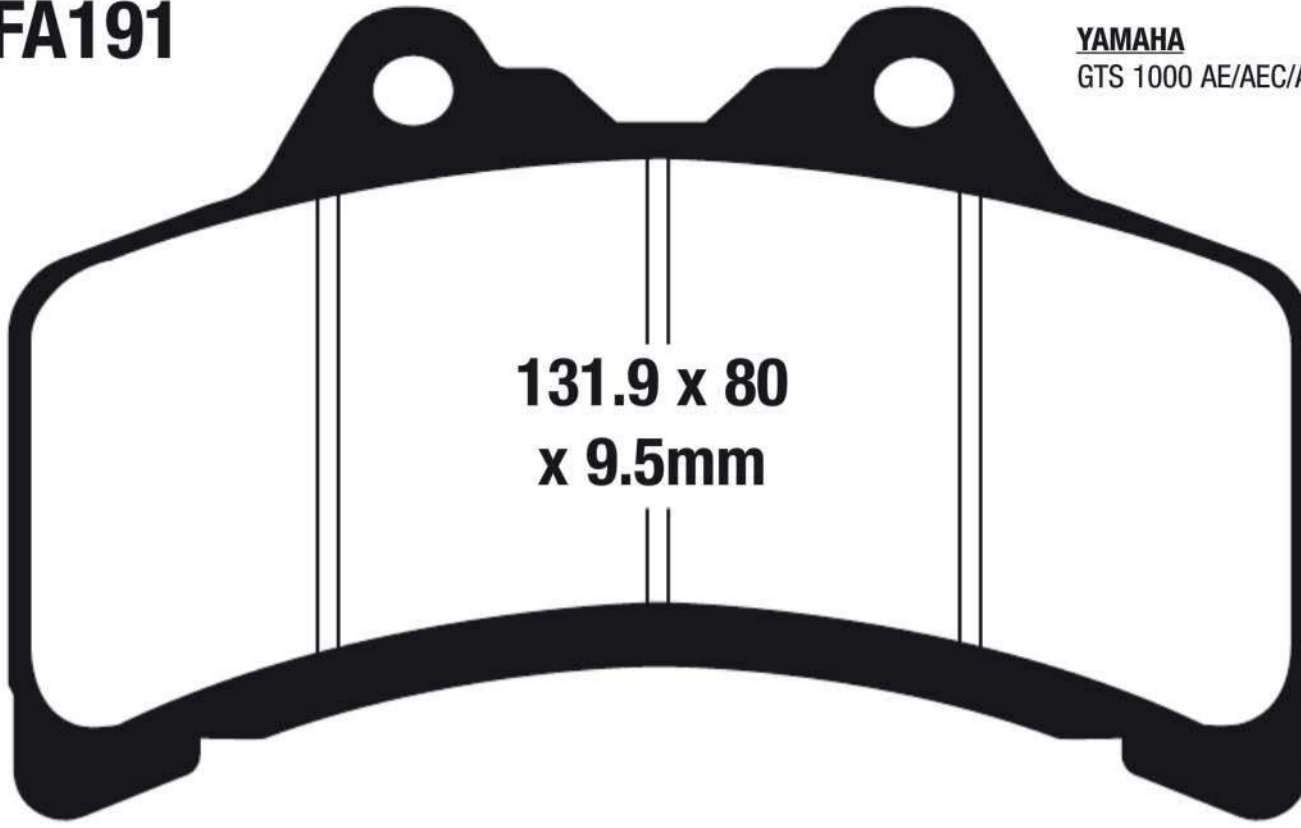

**131.9 x 80
x 9.5mm**

Equivalents OE#

4BH W0045 01

Dealer Stocking Recommendation

Single/Pair	Popularity #	Rec Stocking Level
1	-	1

STD FA191 Premium Organic Street Pad Blend

FA192

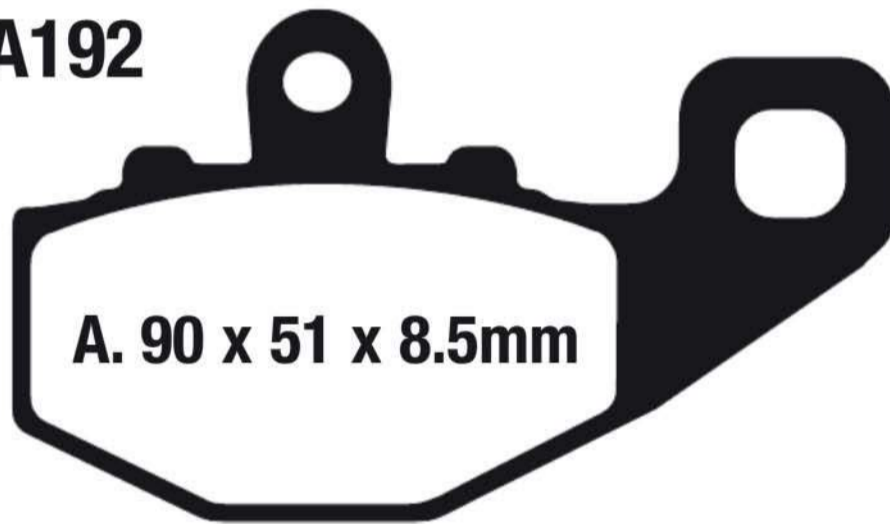

A. 90 x 51 x 8.5mm

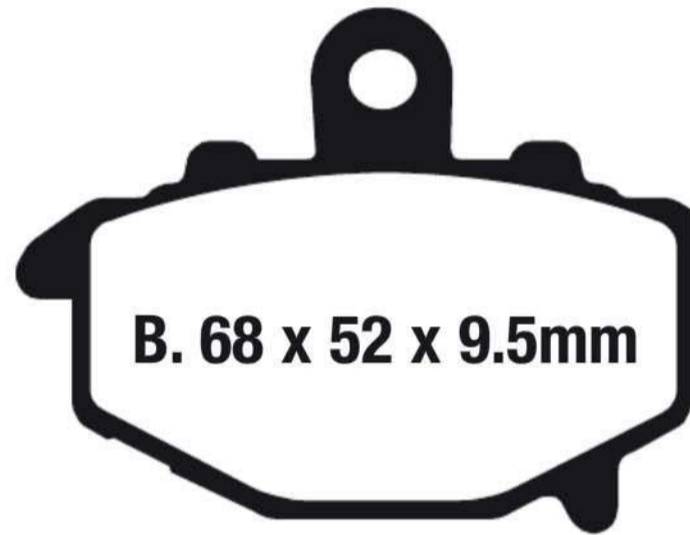

B. 68 x 52 x 9.5mm

KAWASAKI

ZR 550 B4 Zephyr	93	R
ZX 6R (ZX600 F1/F2/F3/G1/G2)	94-99	R
ZX 6R (ZX 600 J1/J2/J3)	00-02	R
ZX 6RR (ZX 600 K1/M1/N1) 599cc	03-05	R
ZX 6R (ZX 636 A1)	02	R
ZX 6R (ZX 636 B1/B2/C1/C6F/D6F) 636cc	03-06	R
ZX 6R (ZX 600 P7F/P8F/R9F/RAF/RBF/RCF)	07-12	R
ZX 600 E1-E13 (Ninja ZX6)	93-05	R
ZZR 600 (ZX 600 J4/J6F/J7F/J8F)	05-08	R
ER 650 C9F/CAF ER-6N	09-10	R
EX 650 Ninja 650 R A6F/A7F/A8F/C9F/CAF	06-10	R
EX 650 Ninja (EX 650 ECF/EDS/EEF/EFF/EGF) (Non ABS)	12-16	R
EX 650 Ninja (EX 650 FDS/FEF/FFF/FGF) (ABS Model)	13-16	R
EX 650 R (EX 650 CBF)	11	R
KLE 650 A7F/A8F/A9F/CAF/CBF/CCF/CDF/CEF Versys	07-14	R
KLE 650 DEF Versys (ABS Model)	14	R
Z 750 S (ZR 750 K1/K6F)	05-06	R
ZX-9R B1/B2/B3/B4 Ninja	94-97	R
ZX-9R (ZX 900 C1/C2)	98-99	R
ZX-9R (ZX 900 E1/E2/F1/F2)	00-03	R
Z 1000 (ZR 1000 A1/A2/A3)	03-05	R
Z 1000 (ZR 1000 A6F)	06	R
ZX-10 R (ZX 1000 C1/C2/D6F)	04-06	R
ZX10R (ZX 1000 E8F/E9F/FAF)	08-10	R
Z 1000 (ZR 1000 DAF/DBF/DCF/DDF/DDFA) Non ABS	10-13	R
Z 1000 ABS (ZR 1000 GEF/GEFA/GFF/GGF) ABS	14-16	R
Z 1000 HCF/HDF Ninja 1000 ABS	12-13	R
1000 Ninja (ZX 1000 GBF/GCF/GDF)	11-13	R
1000 Ninja ABS (ZX 1000 MEF/MFF)	14-15	R
GPZ 1100 (ZX 1100 E1-E3/F1)	95-97	R

Equivalents OE#

43082 0004	43082 1157
43082 0068	43082 1160
43082 0111	43082 1171
43082 0119	43082 1213

Dealer Stocking Recommendation

Single/Pair	Popularity #	Rec Stocking Level
1	K16	1

STD FA192	Premium Organic Street Pad Blend
OPTIONS FA192HH	Street Performance Sintered Pad Blend
FA192V	Semi Sintered Long Lasting Street Pad Blend

**BUYERS GUIDE
BRAKE PADS**

**NOTE:- Size identification is shown as follows
Dimension 1=Width or Diameter, Dimension 2=Height or Diameter, Dimension 3=Thickness (Material and backplate)**

SFA193



**39.8 x 51.2 x
7mm**

STD	SFA193	Premium Organic Scooter Pad Blend
OPTIONS	SFA193HH	Scooter Performance Sintered Pad Blend

APRILIA

Scarabeo Road 50 (Drum rear)	99-05	F
Scarabeo 50 Ditech (rear disc model)	02-08	F & R
SR 50	99-03	F & R
SR 50 (Factory)	04-15	F
Rally 50 (Air cooled)	04-05	F
Mojito Retro 50	04-05	F
Mojito Custom 50	04-06	F
Scarabeo 100 4T	04-14	F

MALAGUTI

Phantom F12	98-04	F & R
Ciak 50	02-04	F
F10 Jetline	02-04	F
F15 Firefox (LC)	04	R

PIAGGIO

Typhoon 50 (2T/10" Wheels)	07-09	F
----------------------------	-------	---

YAMAHA

CW 50 (BW's)	98-99	F
CW 50 M/N Zuma II	00-01	F
CW 50 L/TL Zuma/Zuma II	99	F

Equivalents OE#

4V F5811 00

5MF F5811 00

5ME F5811 00

FA194

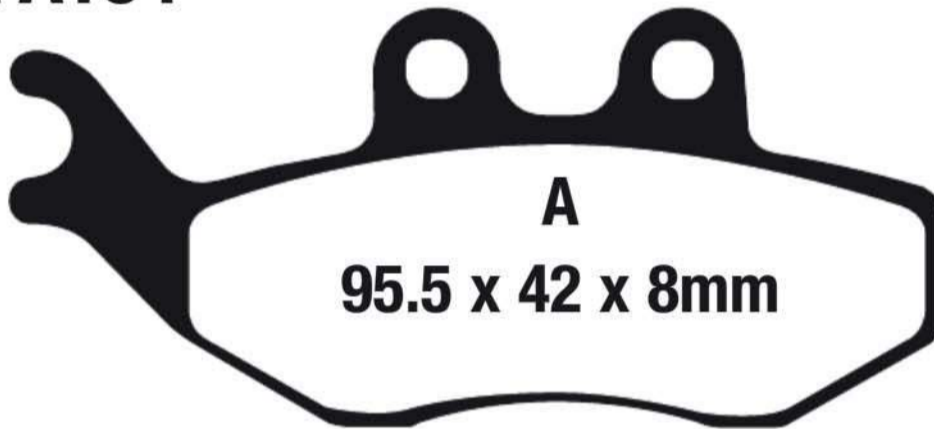

A
95.5 x 42 x 8mm

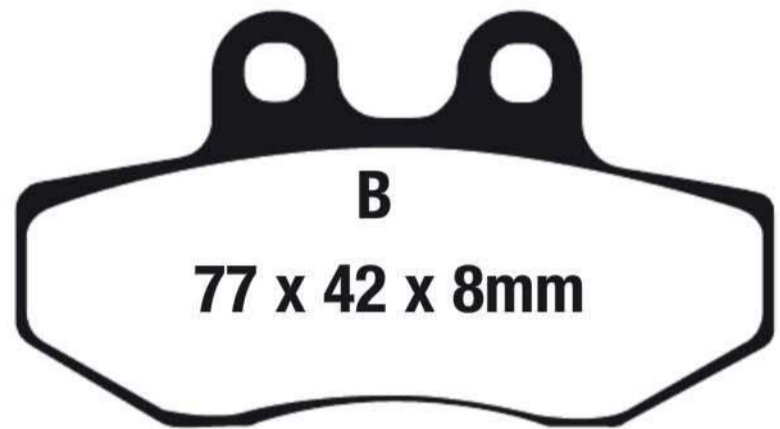

B
77 x 42 x 8mm

Equivalents OE#

8113478	1119 495 00
8113523	494628

APRILIA

RS 50 "Replica"	99-05	F
RX 50/RX 50 Racing	04	F
MX 50	04	F

GAS-GAS

EC 50	05	F
SM 50	05	F
Pampera 125/250/280	04	F
Pampera 125/450	05-06	F
Pampera 250	02-03	R

SCORPA

4T-Ride 250 F	06-08	F
---------------	-------	---

VESPA

GT 200 L Granturismo (Grimeca caliper)	05-09	F
--	-------	---

SFA194

GPI

GTR 50	05-09	F
GTR 150/180	05-09	F

PEUGEOT

Elyseo 125/150	03-05	F
Elystar 125/150 P	03-05	F
Jet Force 125 EFI/Compressor	03-05	F

PIAGGIO

BV 200 (Grimeca Caliper)	02-06	F & R
--------------------------	-------	-------

STD	FA194	Premium Organic Street Pad Blend
OPTIONS	FA194HH	Street Performance Sintered Pad Blend
	SFA194	Premium Organic Scooter Pad Blend
	SFA194HH	Scooter Performance Sintered Pad Blend

FA196

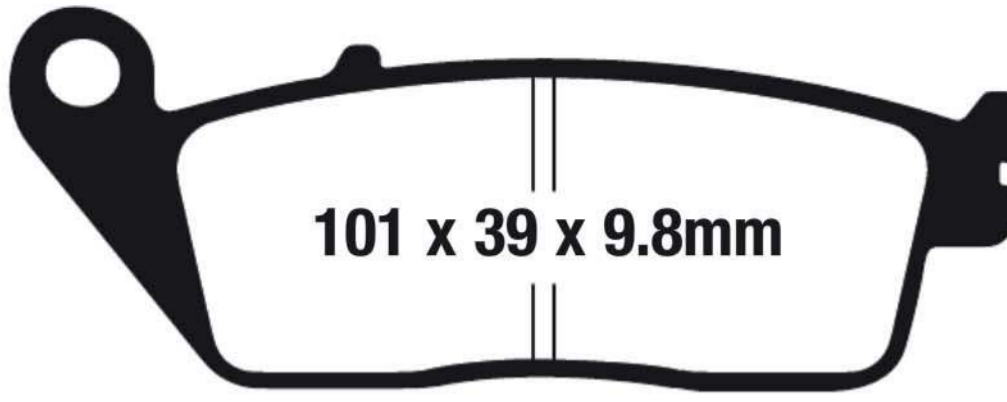

101 x 39 x 9.8mm

1 Left/1 Right

BMW

C600 Sport 12-14 R

C650GT 12-14 R

BUELL

Blast 00-07 F

DAELIM

Roadwin 125 04-09 F

Daystar 125 03-09 F

HONDA

CB 500 F (Non ABS) 13-17 F

CB 500 FA (ABS) 13-17 F

CB 500 X (Non ABS) 13-17 F

CB 500 XA (ABS) 13-17 F

CBR 500 R (Non ABS) 13-17 F

CBR 500 RA (ABS) 13-17 F

VT 600 C/CD/CD2 Shadow VLX/Deluxe 94-07 F

CTX 700 (Top Faring/Manual G/Box) 14-17 F

CTX 700 D (Top Faring/Auto G/Box) 14-17 F

CTX 700 N (Naked/Manual G/Box) 14-16 F

CTX 700 ND (Naked/Auto G/Box) 14-16 F

NM4 - NC 700 JD (DCT) 15-16 F

NC 700 X (Manual G/Box) 12-14 F

VF 750 C Magna/Magna Deluxe CD/C2 94-03 F

VFR 750 F 90-97 R

CB 750 Nighthawk 91-03 F

VT 750 C/CD/CD2 98-02 F

VT 750 CD/DC/DCA/DCB Shadow Spirit 01-08 F

VT 750 CDA/CDB/CDC/CDD Shadow Ace 750 Deluxe 02-03 F

VT 750 C2/C2F Shadow Spirit 07-13 F

VT 750 T Shadow Tourer 09 F

VT 750 C/CA Shadow Aero 04-07 F

VT 750 C2 Shadow Spirit 07-14 F

VT 750 DC/DCA/DCB Shadow Spirit 01-07 F

VT 750 RS Shadow 10-14 F

VT 750C2B Shadow Phantom 10-15 F

VT 750 Shadow Aero 08-15 F

CBR 1000 F 90-91 R

ST 1100 91-02 R

ST 1100 A 'ABS Model' 95 R

VT 1100 C Shadow/Shadow Spirit 94-07 F

VT 1100 C2 American Classic Edition/C2-2/C3/C2 Sabre 95-07 F

VT 1100 T Shadow American Classic Edition Tourer 98-01 F

VT 1300 CX Fury (Non ABS Model) 10-15 F

VT 1300 CS Sabre (Non ABS) 10-14 F

VT 1300 CR Stateline (Non ABS) 10-15 F

VT 1300 CT Interstate (Non ABS) 10-15 F

VTX 1300 C 04-11 F

VTX 1300 S 03-07 F

VTX 1300 R 05-11 F

VTX 1300 T 08-11 F

GL 1500 C/CT/CF/CD Valkyrie/Valkyrie Tourer 97-03 R

INDIAN

Chief Classic (Spoke Wheel/Nissin Calipers) 14-17 R

Chief Dark Horse 16-17 R

Chief Vintage (Spoke Wheel/Nissin Calipers) 14-17 R

Chieftan (Cast Wheel/Nissin Calipers) 14-17 R

Roadmaster (Cast Wheel/Nissin Calipers) 15-17 R

Springfield 16-17 R

KYMCO STREET

Venox 250 03-07 F

LYNDALL BRAKES

PAD REF 7176

SUZUKI

VL 1500 BL3/BL4/BL5 (Boulevard C90 B.O.S.S./Cast Wheels) 13-15 F

VL 1500 BLT3 (Boulevard C90 B.O.S.S./With Windshield) 13 F

VL1500 L3 (Boulevard C90) 13 F

VL1500 TL3/TL4/TL5 (Boulevard C90T / With Windshield) 13-15 F

TRIUMPH

Adventurer 96-01 F & R

America 865cc (Cast wheel) 06-17 F

America LT 865cc (Cast wheel/Wind Shield) 14-17 F

Bonneville America 02-06 F

Bonneville 800 01-06 F

Bonneville (865cc/cast wheel) 09-15 F

TRIUMPH Contd.

Bonneville/Bonneville Black 06-08 F

Bonneville SE (865cc/cast wheel) 09-12 F

Bonneville T100 (Spoke wheels/865cc) 10-15 F

Bonneville T100 (865cc) Steve McQueen 12 F

Bonneville T100 02-09 F

Bonneville T100 (865cc) 10-14 F

Bonneville T100 (865cc) Steve McQueen 12 F

Bonneville T100 Black 14-15 F

Bonneville T100 Spirit SE (Spoke Wheels) 15 F

Bonneville T100 Newchurch SE (Cast Wheels) 15 F

Bonneville T214 (Black/Spoke Wheel) 15 F

Legend TT 98-01 F & R

Speedmaster 800 03-04 F

Scrambler (865cc/Carbs) 06-09 F

Scrambler (865cc/EFI) 10-16 F

Scrambler (900cc/EFI) 17 F

Speedmaster(865cc/EFI) Cast Wheel Eng # 392060 to 46049/ 6 Bolt F/Disc 09-10 F

Speedmaster(865cc/EFI) 5 Spoke Cast Wheel Eng # 46050 Onwards/ 5 Bolt F/Disc 11-17 F

Thunderbird 95-03 F & R

Thunderbird Sport 98-03 F & R

Tiger (885cc) 97-99 F & R

Tiger 885i 98-99 F & R

Tiger 955cc 99-04 F & R

Tiger 955 (Cast wheel model) 04-06 F

VICTORY

Broadwalk (Spoke Wheels) 13-14 F

Vegas 08-17 R

Vegas Low 08-09 R

Vegas Jackpot 08-12 R

Hammer 08-11 R

Hammer S 08-17 R

Hammer 8 Ball 10-16 R

Highball (Cast & Spoke Wheel) 12-17 R

King Pin 08-12 R

Kingpin Tour 08-09 R

Kingpin 8-Ball 08-11 R

Kingpin-Low 09 R

Vegas 8-Ball 08-17 R

Vision Street 08-09 R

Vision Tour (All models) 08-17 R

Cory Ness Jackpot 08-10 R

Cory Ness Victory Cross Country 11-12 R

Cross Country 10-17 R

Cross Country Touring 13-17 R

Cross Country 8-Ball 15-16 R

Cross Roads 10-13 R

Cross Roads Classis (Spoke Wheel) 13-14 R

Cross Roads 8 Ball (Cast Wheel) 14 R

Gunner 15-17 R

Vision 8 Ball 10-11 R

Jackpot 10-16 R

Magnum 15-17 R

Magnum X-1 15-17 R

Arlen Ness Victory Vision 09-12 R

Zach Ness Vegas 11-12 R

Judge 12-17 R

Hard Ball (Spoke Wheel) 12-13 R

SFA196

BMW

C600 Sport 12-14 R

C650 GT 12-15 R

C650 GT Special Edition 15 R

HONDA

FSC600/D Silverwing 02-10 F

FSC600 A Silverwing ABS Model (276mm front disc) 03-14 F

NSA 700 A9 "DN-01" 09-11 R

YAMAHA

YW125 G Zuma (Rear Disc Model) 16 F

XC155 F/G S-Max 15-16 F

FA196 Contd.

Dealer Stocking Recommendation

Single/Pair	Popularity #	Rec Stocking Level
1	H22	2

Equivalents OE#

06435 MT3 405	43105 MS9 612A	T2020077
06455 MAA 405	43105 MT3/6 007	T2020194
06455 MG3 D31	43105 MT4 007A	2203679
06455 MG3 D32	43106 ML7 921B	34 21 8 524 952
43105 ML7 921A	45106 MN8 671B	59300 06810
43105 ML7 922A	45106 MS9 612B	2203679
43105 MS2 007A	45106 MW3 671	1DK W0045 20

STD	FA196	Premium Organic Street Pad Blend
OPTIONS	FA196HH	Street Performance Sintered Pad Blend
OPTIONS	FA196V	Semi Sintered Long Lasting Street Pad Blend
OPTIONS	SFA196	Premium Organic Scooter Pad Blend
OPTIONS	SFA196HH	Scooter Performance Sintered Pad Blend

FA197

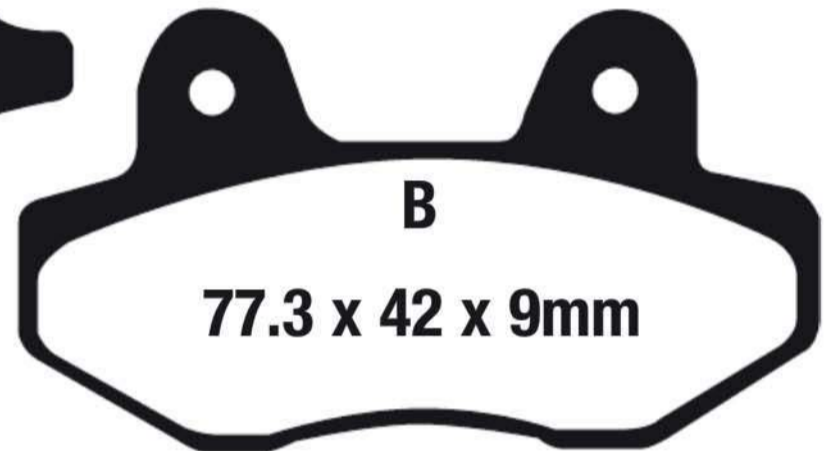
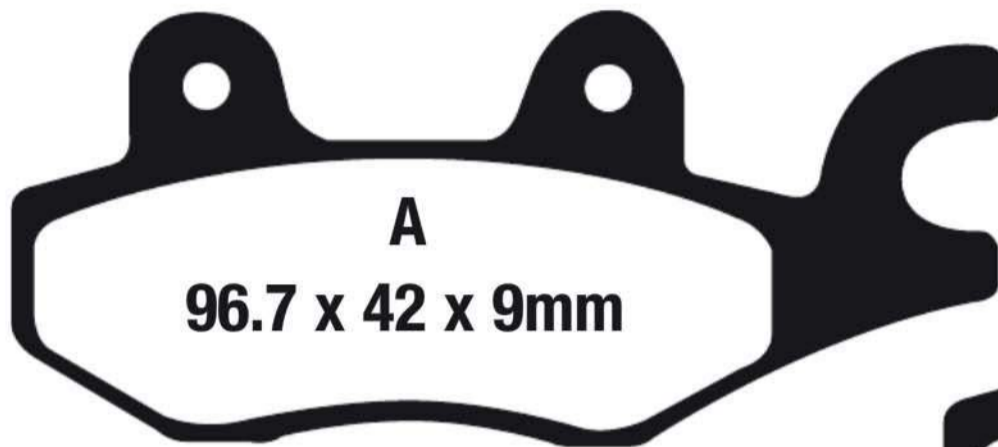

DAELIM

Roadwin 125

04-09 R

HONDA

Dream 50 R (CB 50) (AR02)

04 F

NSR 50 R (RS 50)

04 F

NSF 100 R

06 F

KAWASAKI

BN 125 A4-A8/A6F/A7F/A9F Eliminator

01-09 F

EX 250 (Ninja 250 R) J8F/J9F/JAF/JBF/JCF

08-12 F & R

EX 300 ADF/ADFA/AEF/AEFA/AES/AFF/AGF Ninja 300 (Non ABS)

13-16 F & R

EX 300 AEF/AEFA/AES/AFF/AGFA Ninja SE 300 (Non ABS)

14-16 F & R

EX 300 BDF/BDFA/BEF/BES/BFF/BGF Ninja 300 (ABS Model)

13-16 F & R

EX 300 BEFA/BESA/BFFA/BGFA Ninja/Ninja SE 300 (ABS Model)

14-16 F & R

EL 650 E8F/E9F/EAF/EBF/ECF/EDF/EEF/EFF (KLR 650)

08-15 R

KYMCO STREET

Quannon 150 (RK30E)

09-12 F & R

MZ

RT 125

02-05 F

SFA197

YAMAHA

YBR 125 EB (5RR2/3/4/5/6/8/9)

02-08 F

YS 250 Fazer (5D41/2/3/56C1)

06-10 F

DAELIM

S2-250

06-09 R

S2-125

06-09 R

KYMCO STREET

Super 9 AC

02-09 F

Bet & Win 150/250

02-08 F & R

Like 200i

10-15 R

Grand Vista 250 (SH 50 DF)

05-11 F

People 250

03-07 R

People S 250

07-11 F Right

Yager GT 200 i

09-12 F & R

SUZUKI

UH 200 AL4/AL5/AL6 Burgman ABS

14-16 F

AN 400 K7/K8/K9/AK9/AL0/AL1/AL2/AL3/AL4/AL5/AL6 Burgman

07-16 F Right

AN 400 ZAL4/ZAL5/ZAL6

14-16 F Right

UM (UNITED MOTORS)

X-Peed 250 i

08 R Right

Equivalents OE#

43082 0080	59100 05820
43082 0081	4510A KW6 900
43082 0128	9023001000
43082 1238	06455 KR3 415
4510A KW6 9000	59401 HP7 600
45105 KBE 3050 M2	252 0033A
43150 KBE 3060	5HH W0045 10
45150 LLB5 3050	

STD	FA197	Premium Organic Street Pad Blend
OPTIONS	FA197HH	Street Performance Sintered Pad Blend
OPTIONS	EPFA197HH	Fast Street Use & Track Day Sintered Pad Blend
OPTIONS	GPFA197HH	RACE USE ONLY
OPTIONS	SFA197	Premium Organic Scooter Pad Blend
OPTIONS	SFA197HH	Scooter Performance Sintered Pad Blend

Dealer Stocking Recommendation	Single/Pair	Popularity #	Rec Stocking Level
	1		1

FA199

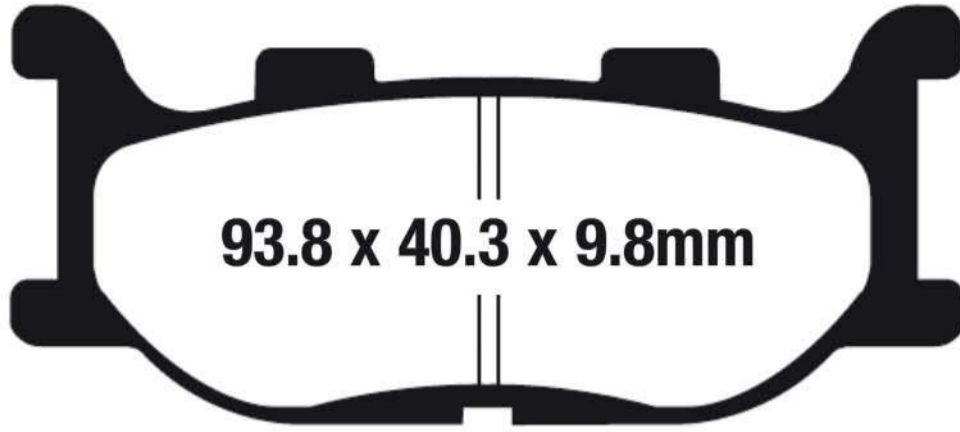

93.8 x 40.3 x 9.8mm

YAMAHA ROAD

XV 250 Virago All models	95-07
XV 250 V-Star	08-13
FZ6	04-06
FZ6R	09-17
XVS 1100 V Star Custom/V Star Classic	99-09
XVS 1100 V-Star Silverado	03-09
XVS 1100 W-M V-Star Custom Midnight	07
XVS 1300 V-Star 1300 Tourer	07-14
XVS 1300 V-Star	07-14
XVS 1300 V-Star Deluxe	13-14

SFA199

YAMAHA ROAD

CP 250 V/W/X Morphus	06-08
YP 250 Majesty (5CV1)	97
YP 250 Majesty (5GM2/9-5SJ2/5/9)	00-03
XP 500 T-Max (5VUA/15B1)	05-08

STD FA199	Premium Organic Street Pad Blend
OPTIONS FA199HH	Street Performance Sintered Pad Blend
OPTIONS FA199V	Semi Sintered Long Lasting Street Pad Blend
OPTIONS SFA199	Premium Organic Scooter Pad Blend
OPTIONS SFA199HH	Scooter Performance Sintered Pad Blend

Dealer Stocking Recommendation

Equivalents OE#

4HM W0045 00	4GA W0045 00	5VX W0045 00
4EB W0045 00	1B7 W0045 00	5VU W0045 00

<u>Single/Pair</u>	<u>Popularity #</u>	<u>Rec Stocking Level</u>
1	-	1

FA200



104 x 62.4 x 11.2mm

86.20mm



**Abutment Shims (2 per set)
(REF SHFA200/201)**

Note: Only fit abutment shims to caliper if they have been fitted by factory from new.

Some early models of this caliper do not require enclosed shims. If your vehicle has shims fitted then replace with this new set. If in any doubt contact EBC Brakes for clarification. In any event it is essential that the pads (with or without shims fitted) are a snug fit in the caliper but also are free to slide on the sliders arms. Do not force pads into the caliper which could cause an over-tight situation and brake seizure may occur.

Equivalents OE#

44209 87B	44213 87
44209 87C	8009004

STD FA200	Premium Organic Street Pad Blend
OPTIONS FA200HH	Street Performance Sintered Pad Blend
OPTIONS FA200V	Semi Sintered Long Lasting Street Pad Blend
OPTIONS EPFA200HH	Fast Street Use & Track Day Sintered Pad Blend

Dealer Stocking Recommendation

<u>Single/Pair</u>	<u>Popularity #</u>	<u>Rec Stocking Level</u>
1	HD1	4

NOTE:- Size identification is shown as follows
Dimension 1=Width or Diameter, Dimension 2=Height or Diameter, Dimension 3=Thickness (Material and backplate)

FA201



HARLEY DAVIDSON

FLT, FLHT, FLTHCI
FLHR, FLHRCI

86-99 R
94-99 R

LYNDALL BRAKES

PAD REF 7157



**Abutment Shims (2 per set)
(REF SHFA200/201)**

Note: Only fit abutment shims to caliper if they have been fitted by factor from new.

Some early models of this caliper do not require enclosed shims. If your vehicle has shims fitted then replace with this new set. If in any doubt contact EBC Brakes for clarification. In any event it is essential that the pads (with or without shims fitted) are a snug fit in the caliper but also are free to slide on the sliders arms. Do not force pads into the caliper which could cause an over-tight situation and brake seizure may occur.

Equivalents OE#	43957 86	43957 86B
	43957 86A	43957 86D

STD	FA201	Premium Organic Street Pad Blend
OPTIONS	FA201HH	Street Performance Sintered Pad Blend
	FA201V	Semi Sintered Long Lasting Street Pad Blend

Dealer Stocking Recommendation

<u>Single/Pair</u>	<u>Popularity #</u>	<u>Rec Stocking Level</u>
1	HD5	2

FA203

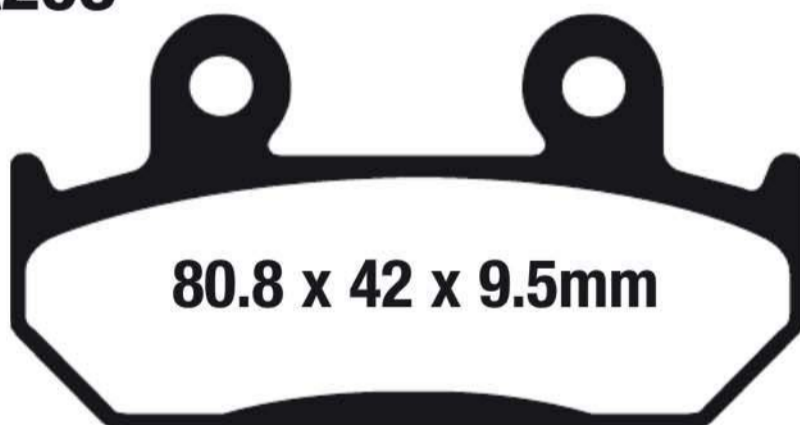

HONDA

CBR 600 F2

91-94 F

Equivalents OE#

45105 MV1 008
45105 MV8 405

STD	FA203	Premium Organic Street Pad Blend
OPTIONS	FA203HH	Street Performance Sintered Pad Blend
	EPFA203HH	Fast Street Use & Track Day Sintered Pad Blend

Dealer Stocking Recommendation

<u>Single/Pair</u>	<u>Popularity #</u>	<u>Rec Stocking Level</u>
2	H11	4

FA208



1 Left/1 Right
78.13 x 41.2
x 9mm

ATK

All Models	97-03	R
125 (2 stroke enduro)	03	R
250/260 (2 stroke engine)	03	R
450 MX	07	R
450 XC	07	R
Enduro 450	07	R
500 Enduro	03	R
605 Enduro	03	R
700 (2T) Intimidator	04	R
620 (2T) Intimidator	04	R
500 (2T)	04	R
370 (2T)	04	R
250 (2T)	04	R

GAS-GAS

Enduros 125/250	00	R
-----------------	----	---

HUSABERG

All Models	95-12	R
------------	-------	---

HUSQVARNA

CR 125	95-04	R
SM 125	98-00	R
SMS 125 (2T)	02-11	R
SMS-4-125 (4T)	10-11	R
WR 125	95-05	R
WRE 125	93-11	R
CR 250	95-04	R
TC 250	02-03	R
TE 250	02-05	R
WR 250	95-05	R
WR 250	06-12	R
XC-W 250	10	R
XCF-W 250	10	R
TE 300 (2T)	11	R
WR 300	09-12	R
TE 350	95-97	R
WR 360	95-02	R
SM 400 R	02	R
TE 400	02	R
TE 410	95-00	R
TE 410 E	00	R
SM 450 R	03-06	R
TC 450	03	R
TE 450	03-05	R
SM 510 R	05-	R
TC 510	04	R
TE 510	04-05	R
SM 570 R (4 bolt front disc)	01-04	R
TC 570	02-03	R
TE 570	01-04	R
LT 610 (6 bolt front disc)	00	R
SM 610 (6 bolt front disc)	98-99	R
SM 610 R	00	R
SM 610/S (4 bolt front disc)	02-06	R
SM 610 S (Radial caliper)	06	R
SM 610 IE	07-09	R
TC 610/E	95-99	R
TC 610	00	R
TE 610	00	R
TE 610/E	95-03	R
TE 610/IE	06-09	R
SM 630	09-10	R
SMR 630	06	R
SMS 630	10-11	R
STR 650 CRC	07	R

KTM

EXC/EGS 200	98-03	R
SX 250	94-02	R
EGS 300 (Standard forks)	94-98	R
EXC 300 (Standard forks)	94-98	R
EXC 300 (Upside down forks)	99-03	R
MXC 300 (Standard forks)	94-98	R
MXC 300 (Upside down forks)	99-03	R
SX 300	94-96	R
EXC 350 LC4	94-95	R
EXC 350/SX 360	96-97	R
EXC 380/SX 380	98-03	R
Duke 400 LC4	94-98	R
EGS 400/EGS-E/LSE (LC4 Enduro)	96-99	R
EXC/EGS 400	00-02	R
EXC 400 Racing	00	R
LC4-E 400 Enduro	00-01	R
SC 400 Supercompetition LC4	96-99	R
SX 400	00-02	R
EXC 440	94-95	R
EXC 450	03	R
MX 500	95	R
EXC 520/SX 520	01-03	R
EXC 525	03	R
MXC 525	03-04	R
MXC 550	96	R
Duke 620 LC4	94-98	R
EGS 620 Enduro/EGS-E/LSE	96-99	R
EGS-E 620 Adventure/rallye	99	R
LC4 620 SC Supermoto	00	R
SC 620 Supercompetition	96-00	R
SX EXC/EGS 620	95	R
SX 620	96-99	R
LC4 625 SC Supermoto/Supercompetition	02	R
SMC 625	05	R
SXC 625	03-04	R
Duke II 640 Orpheus/Titan/Lime	01-	R
Duke II 640 Black/Orange	02	R
LC4-E 640 Enduro/Supermoto	00-04	R
LC-4 640 Adventure-R	99-02	R
LC-4 640 Adventure	03	R
LC-4 640 Adventure R	04	R
LC-4 640 Adventure	05-07	R
640 Duke Jet Black/Yellow/Adrenalin Orange	03-05	R
SMC 640 LC4	05	R
SMC 660 Supermoto	03-04	R
SMC 660	05	R
690 Rally Factory Rep	07-08	R
690 Enduro	08	R
690 Enduro R	10-16	R
690 SMC	08-11	R
690 Supermoto	02-08	R

MAICO/M-STAR

Disc models	97-99	R
-------------	-------	---

T.M.

MX Models 85.100	02-04	R
------------------	-------	---

VERTEMATI

495	99-02	R
C 450/500/570 (MX)	03-04	R
E 450/501/570 (Enduro)	03-04	R
S 450/501/570/E (Super Motard)	03-04	R
SR 450/SR 600 Motard Racing	03-04	R

VOR

SM-E 450/530	04	R
MX 450/530	04	R
EN/EN-E 450/530	04	R

ZERO ELECTRIC BIKE

DS ZF8.5/ZF11.4 (J.Juan R calipers)	14	F
FX ZF2.8/ZF5.7 (J.Juan R calipers)	14	F
FX ZF2.8/ZF5.7 (J.Juan calipers)	15	F
S ZF8.5/ZF11.4 (J.Juan R calipers)	14	F
SR ZF11.4 (Nissan Fr calipers)	14	F

STD	FA208X	Carbon Dual Purpose Pad Blend
OPTIONS	FA208R	Utility Grade Sintered Pad Blend
	MXS208	Sintered Sport Off Road Pad Blend
	EPFA208HH	Fast Street Use & Track Day Sintered Pad Blend

Dealer Stocking Recommendation

Single/Pair	Popularity #	Rec Stocking Level
1	-	1

Equivalent OE#

800079072
870079072
090074
090070

BUYERS GUIDE
BRAKE PADS

NOTE:- Size identification is shown as follows
Dimension 1=Width or Diameter, Dimension 2=Height or Diameter, Dimension 3=Thickness (Material and backplate)

FA209 USE FA209/2

FA209/2

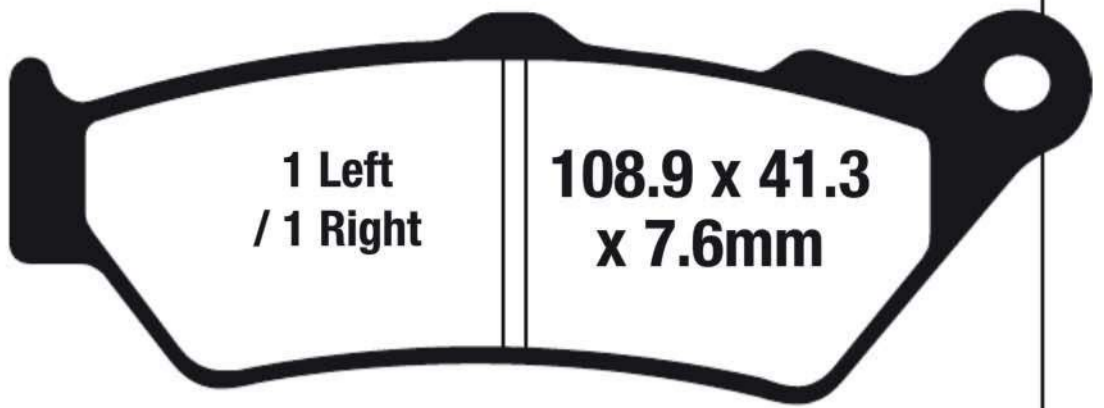

APRILIA

Pegaso 650 ie (All models)	99-04	F
ETV 1000 Caponord (Non ABS - Bolt fixing)	01-03	F
ETV 1000 Caponord Rally (Non ABS - Bush fixing)	03	F
ETV 1000 Caponord (ABS - Bush fixing)	04-07	F

BMW

F 650 (E169/0161)	09/93-96	F
F 650 (E169/0162) Funduro/High Screen/19" front wheel	97-00	F
F 650 CS "Scarver" (K14/0174/0184) (Belt drive/17" cast wheel)	00-03	F
F 650 CS Scarver K14/0177/0187 Belt Drive 17" cast wheel	04-07	F
F 650 GS (R13/0172/0182)	99-03	F
F 650 GS Dakar (R13/0173/0183) 21" front wheel	99-03	F
F 650 GS (R13/0175/0185) Single cylinder 19" front wheel	04-07	F
F 650 GS Dakar (R13/0176/0186) 21" front wheel	04-07	F
F 650 GS (K72/0218/0228) (798cc twin cylinder/cast wheel)	06-17	F
F 650 GS (30 Years GS) (Twin Cylinder 798cc/Cast Wheel)	11	F
F 650 GS "Sertao" (Spoke wheel/single cylinder/chain drive)	10-17	F
F 650 ST (E169/163/168) Strada (18" front wheel/low screen)	97-00	F
G 650 GS (R131) (Single cylinder/chain drive/Cast Wheels)	09-15	F
G 650 Xchallenge	07-09	F
G 650 Xcountry	07-08	F
F 700 GS (Twin Cylinder/798cc/Cast Wheel)	11-17	F
F 800 GS (Twin Cylinder/798cc/spoke wheel)	08-17	F
F 800 GS Adventure (Twin Cylinder/798cc/spoke wheel)	12-17	F
HP-2 Enduro	05-09	F
R 1200 GS Water Cooled Model	13-15	R
R 1200 GS Adventure Water Cooled Model	14-15	R
R 1200 R	15	R
R 1200 RS	15	R
R 1200 RT (Radial F/Caliper)	14-15	R
RNineT (K21/1170cc)	14-15	R
K 1600 GT	11-15	R
K 1600 GTL	11-15	R
K 1600 GTL Exclusive	15	R

DUCATI

Scrambler Sixty 2 (Cast Wheels/399cc)	16-17	F
GT 1000 (992cc)	07-10	F
GT 1000 Touring Sport Classic	09	F
Paul Smart 1000 LE (992cc)	06	F
Sport Classic 1000 (992cc)	06-08	F
Diavel ABS	11-15	R
Diavel Carbon ABS	11-15	R
Diavel Carbon ABS	16-17	R
Diavel AMG	12	R
Diavel Cromo	12-14	R
Diavel Dark (ABS)	13-14	R
Diavel Strada	13-15	R
Multistrada 1200	16-17	R
Multistrada 1200 Enduro	16	R
Multistrada 1200 Pikes Peak	16-17	R
1200 Multistrada DVT	15	R
1200 S Multistrada DVT	15	R
Multistrada 1200 S	16-17	R
1262 XDiavel	16-17	R
1262 XDiavel S	16-17	R

HARLEY DAVIDSON

XG 500 Street (300mm Discs)	16-18	F
XG 750 Street (300mm Discs)	16-18	F
XG 750 A Street Rod (300mm Discs)	17-18	F

HUSQVARNA

TR 650 Terra (Spoke wheel)	13	F
TR 650 Strada (Cast wheel)	13	F

INDIAN

Scout	17	F
Scout Sixty	17	F

KTM

LC4 640 Adventure R	04	F
LC4 640 Adventure	05-07	F
690 Rally Factory Rep	07-08	F
690 Enduro R	10-16	F
950 Adventure/S	04-06	F
950 Supermoto R	07	F
950 Super Enduro	07-08	R
950 R Super Enduro	07-08	F
990 Adventure (ABS Model)	07-12	F Left & Right
990 Adventure Baja Edition (ABS)	13-14	F Left & Right
LC-R 640 Adventure R	04	F
LC-R 640 Adventure	05-07	F
990 Adventure S	06-08	F
990 Adventure R	09-12	F

LYNDALL BRAKES

PAD REF 7230

MOTO GUZZI

Quota 1100 ES	99-01	F
California EVII	97-01	R
California Jackel 1100	99-01	R
California Special 1100	99-01	R
California Stone Series	02-06	R
California EV/Special Series	02-06	R
California Vintage 750	06-10	R
California 1400 Custom	13-15	R
California 1400 Touring	13-15	R

ROYAL ENFIELD

Continental GT 13-17 F

TRIUMPH - (USE FA209/2HH & FA209/2V ONLY)

Rocket III 2300cc	04-09	R
Rocket III Classic	07-09	R
Rocket III Roadster	11-17	R
Rocket III Touring (ABS & Non ABS)	09-17	R
Thunderbird 1600 (Cast wheel)	09-17	R
Thunderbird 1600 (Windscreen)	12	R
Thunderbird Commander (1700cc/Cast wheel)	14-17	R
Thunderbird LT (1700cc/Cast wheel)	14-17	R
Thunderbird NightStorm (1700cc/Cast wheel)	09-17	R
Thunderbird Storm (1700cc/Cast wheel)	09-17	R

VICTORY

V92C/V92SC	98-03	R
Hammer	05-07	R
Hammer S	07	R
Octane 1200cc	17	F
Vegas 8 Ball/Jackpot	05-07	R
Ness Signature Series	05-07	R
King Pin	06-07	R
King Pin Tour	04-07	R
Vegas	03-07	R

ZERO ELECTRIC BIKE

DS ZF9.4/ZF12.5 (J.Juan calipers)	15	R
DS ZF9.8/ZF13.0 (J.Juan Calipers)	16-17	R
DSR ZF13.0 (J.Juan Calipers)	17	R
FX ZF2.8/ZF5.7 (J.Juan Calipers)	15	R
FX ZF3.3/ZF6.5 (J.Juan Calipers)	16-17	R
FXS ZF3.3/ZF6.5 (J.Juan Calipers)	17	R
S ZF9.4/ZF12.5 (J.Juan calipers)	15	R
S ZF9.8/ZF13.0 (J.Juan Calipers)	16-17	R
SR ZF12.5 (J.Juan calipers)	15	R
SR ZF13.0 (J.Juan Calipers)	16-17	R

SFA209/2

BMW

C1 125	99-03	F
C1 200	01-03	F

BUYERS GUIDE
BRAKE PADS

Dimension 1=Width or Diameter, Dimension 2=Height or Diameter, Dimension 3=Thickness (Material and backplate)

NOTE:- Size identification is shown as follows

FA209 USE FA209/2 FA209/2

Dealer Stocking Recommendation

Single/Pair	Popularity #	Rec Stocking Level
1	-	1

FA209/2 - Equivalents OE#

888268	000 365 46250	34 21 8 534 821
2202491	06455 MAN 911	34 21 8 554 424
2204724	34 11 2 345 445	600 13 0 18 000
2206139	34 11 7 651 958	600 13 030 000
8113627	34 11 7 660 340	61340941A
8113988	34 11 7 697 086	T 202048
41300169	34 11 7 705 216	T 2020692
000 306 546 260	34 11 7 711 498	
000 365 46000	34 21 7 724 609	

STD	FA209	USE FA209/2
OPTIONS	FA209HH	USE FA209/2HH
STD	FA209/2	Premium Organic Street Pad Blend
OPTIONS	FA209/2HH	Street Performance Sintered Pad Blend
OPTIONS	FA209/2V	Semi Sintered Long Lasting Street Pad Blend
OPTIONS	SFA209/2	Premium Organic Scooter Pad Blend
OPTIONS	SFA209/2HH	Scooter Performance Sintered Pad Blend

BUYERS GUIDE
BRAKE PADS

FA210

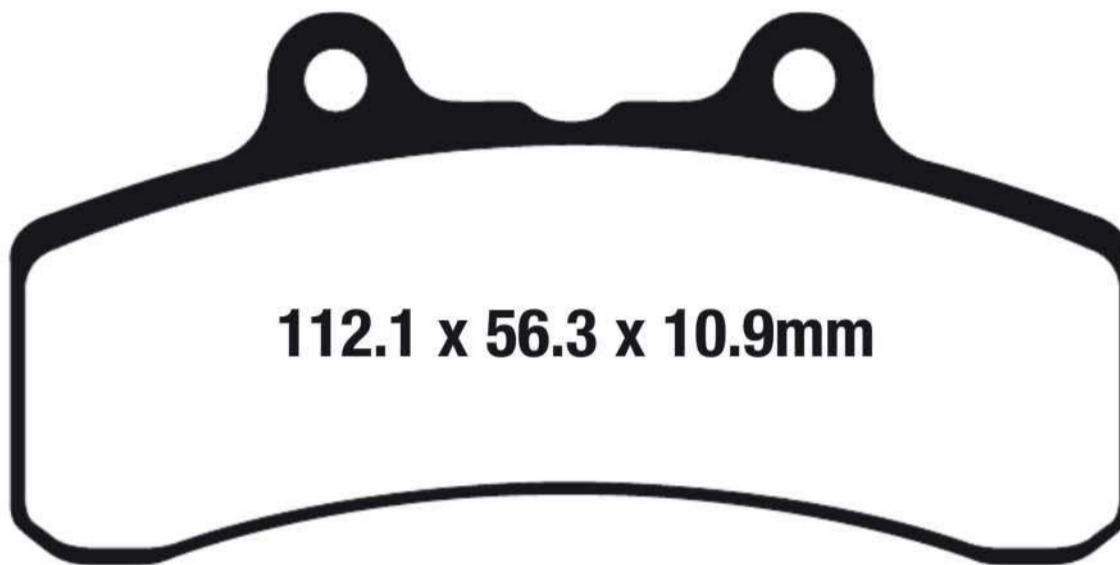

BUELL

S2/S3 Thunderbolt	94-97	F
M2 Cyclone	94-97	F
S1 Lightning	94-97	F

PERFORMANCE MACHINE AFTERMARKET CALIPER

125 X 6

137 X 6

Equivalents OE#

42386 84Y

STD	FA210	Premium Organic Street Pad Blend
OPTIONS	FA210V	Semi Sintered Long Lasting Street Pad Blend

Dealer Stocking Recommendation

Single/Pair	Popularity #	Rec Stocking Level
1	-	2

FA211 USE EPFA295HH FA211/2

FA211/2

PFM AFTERMARKET CALIPER

4 Piston race caliper (old design)

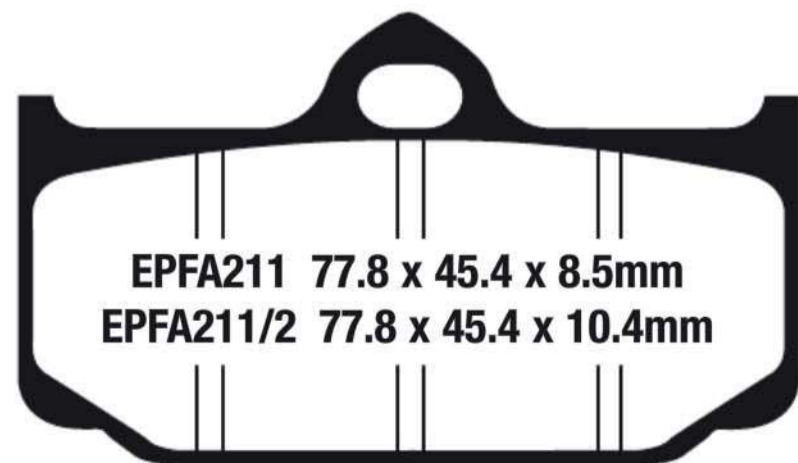

Equivalents OE#

N/A

Dealer Stocking Recommendation

STD	EPFA211	Fast Street Use & Track Day Sintered Pad Blend
STD	EPFA211/2	Fast Street Use & Track Day Sintered Pad Blend

Single/Pair	Popularity #	Rec Stocking Level
2	-	2

NOTE:- Size identification is shown as follows
Dimension 1=Width or Diameter, Dimension 2=Height or Diameter, Dimension 3=Thickness (Material and backplate)

FA213



1 Left/1Right
78.13 x 41.2
x 9mm

BUYERS GUIDE
BRAKE PADS

Dimension 1=Width or Diameter, Dimension 2=Height or Diameter, Dimension 3=Thickness (Material and backplate)

NOTE:- Size identification is shown as follows

APRILIA

Dorsoduro 750	08-15	R
Shiver 750 SL	07-15	R
Caponord 1200	14-15	R
Dorsoduro 1200	11-14	R

BMW

F 650 (E169/0161)	09/93-96	R
F 650 (E169/0162) Funduro/High Screen/19" front wheel	97-00	R
F 650 CS Scarver (K14/0174/0184) (Belt drive/17" cast wheel)	00-03	R
F 650 CS Scarver K14/0177/0187 Belt drive 17" cast wheel	04-07	R
F 650 GS (R13/0172/0182)	99-03	R
F 650 GS Dakar (R13/0173/0183) 21" front wheel	99-03	R
F 650 GS (R13/0175/0185) Single cylinder 19" front wheel	04-07	R
F 650 GS Dakar (R13/0176/0186) 21" front wheel	04-07	R
F 650 GS (K72/0218/0228) (798cc twin cylinder/cast wheel)	06-17	R
F 650 GS (30 Years GS) (Twin cylinder 798cc/cast wheel)	11	R
F 650 GS Sertao (Spoke wheel/single cylinder/chain drive)	10-14	R
F 650 ST (E169/163/168) Strada (18" front wheel/low screen)	97-00	R
G 310 R	17-18	R
G 310 GS	17-18	R
G 650 GS (R131) (Single cylinder/chain drive/Cast Wheels)	09-15	R
G 650 Xchallenge	07-09	R
G 650 Xmoto	07-09	R
G 650 Xcountry	07-09	R
F 700 GS (Twin Cylinder/798cc/Cast Wheel)	11-17	R
F 800 GS (Twin Cylinder/798cc/spoke wheel)	08-17	R
F 800 GS Adventure (Twin Cylinder/798cc/spoke wheel)	12-17	R
F 800 GT	13-15	R
F 800 R	09-15	R
F 800 S/ST	06-13	R
S 1000 R Naked	14-15	R
S 1000 RR	10-17	R
S 1000 RR (Models fitted with Forged race wheels 7 spoke type)	15-17	R
HP4 (1000cc)	13-14	R

DUCATI

Scrambler Sixty 2 (Cast Wheels/399cc)	16-17	R
797 Monster	17	R
Scrambler Classic (Spoke Wheels/803cc)	15-17	R
Scrambler Icon (Cast Wheels/803cc)	15-17	R
Scrambler Urban Enduro(Spoke Wheels/803cc)	15-17	R
Scrambler Full Throttle (Cast Wheels/803cc)	15-17	R
Scrambler Flat Tracker Pro(Cast Wheels/803cc)	16-17	R
Scrambler Café Racer (Cast wheels/803cc)	17	R
GT 1000 (992cc)	07-10	R
GT 1000 Touring Sport Classic	09	R
Paul Smart 1000 LE (992cc)	06	R
Sport 1000 S	07-09	R
Sport Classic 1000 (992cc)	06-08	R

HUSQVARNA

TR 650 Terra (Spoke wheel)	13	R
TR 650 Strada (Cast wheel)	13	R
900 Nuda	12-13	R
900 Nuda R	12-13	R

INDIAN

Scout	17	R
Scout Sixty	17	R

KTM

Duke 390	15-16	R
RC390	15-16	R
690 Duke (4 Pad Type Caliper)	08-11	R
690 Duke (2 Pad Type Caliper)	12-15	R
690 Duke R (4 Pad Type Caliper)	10-11	R
990 Superduke	05-11	R
990 Superduke R	07-11	R

ROYAL ENFIELD

Bullet 500 EFI (Brembo caliper Front & Rear)	16-17	R
Continental GT	13-17	R
Classic 500 (Brembo caliper Front & Rear)	16-17	R
Classic 500 Chrome (Brembo caliper Front & Rear)	16-17	R

TRIUMPH

Daytona 675	13-17	R
Daytona 675 R	13-17	R
Street Triple 675	13-17	R
Street Triple R 675	13-17	R
Street Triple 675 RXSE (ABS)	15	R

VICTORY

Octane 1200cc	17	R
---------------	----	---

ZERO ELECTRIC BIKE

DS ZF9.4/ZF12.5 (J.Juan calipers)	15	R
DS ZF9.8/ZF13.0 (J.Juan Calipers)	16-17	R
DSR ZF13.0 (J.Juan Calipers)	17	R
FX ZF2.8/ZF5.7 (J.Juan Calipers)	15	R
FX ZF3.3/ZF6.5 (J.Juan Calipers)	16-17	R
FXS ZF3.3/ZF6.5 (J.Juan Calipers)	17	R
S ZF9.4/ZF12.5 (J.Juan calipers)	15	R
S ZF9.8/ZF13.0 (J.Juan Calipers)	16-17	R
SR ZF12.5 (J.Juan calipers)	15	R
SR ZF13.0 (J.Juan Calipers)	16-17	R

SFA213

BMW

C1 125	99-03	R
C1 200	01-03	R

YAMAHA

YW125 G Zuma (Rear Disc Model)	16	R
XC155 F/G - S-Max	15-16	R

Equivalent OE#

34 21 7 660 343	5VK W0046 00
61340761A	5VK F5806 00
T2024901	2206146
750 13 090 000	594698
1DK W0046 00	

Dealer Stocking Recommendation	Single/Pair	Popularity #	Rec Stocking Level
	1	-	1

OPTIONS	STD	FA213	Premium Organic Street Pad Blend
		FA213HH	Street Performance Sintered Pad Blend
		SFA213	Premium Organic Scooter Pad Blend
		SFA213HH	Scooter Performance Sintered Pad Blend

FA214 FA214/2

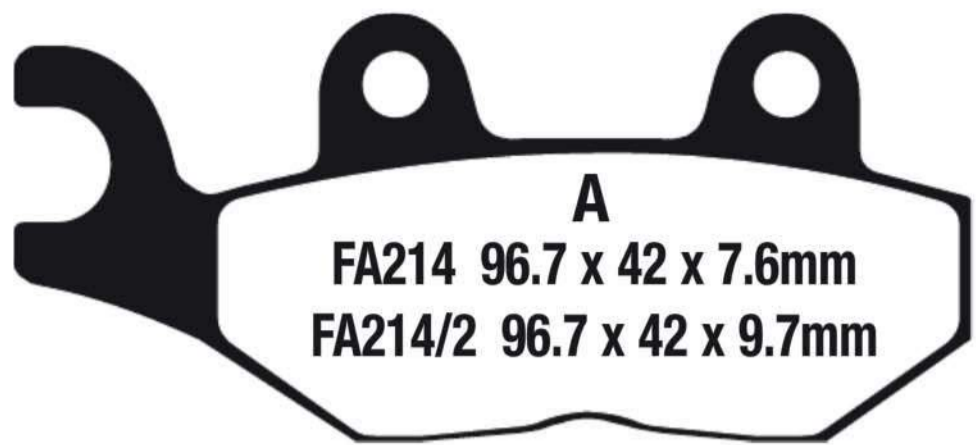
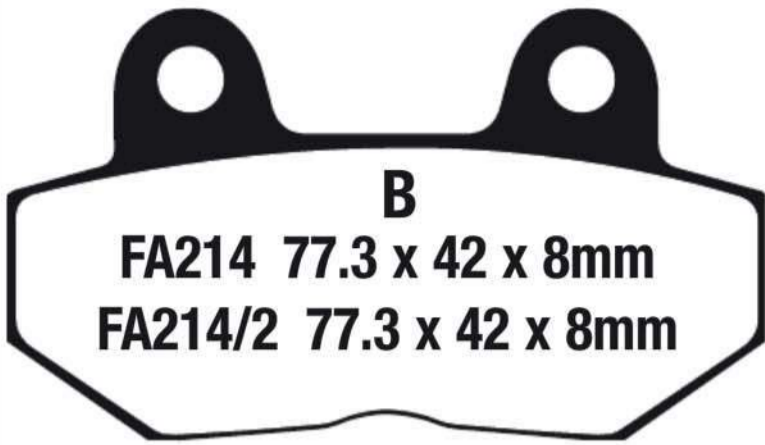

FA214

TRIUMPH

Sprint (All carb models up to VIN 9082)	93	F Left
Tiger 885cc	92-98	F Left
Trident 900	92-98	F Left
Trophy 900 (3 cyl)	92-93	F Left
Trophy 1200 (4 cyl)	92-93	F Left

FA214/2

TRIUMPH

America (Cast wheel/865cc)	06-17	R
America LT (Cast wheel/865cc/Wind Shield)	14-17	R
Bonneville/Bonneville Black	06-08	R
Bonneville America	02-06	R
Bonneville 800	01-06	R
Bonneville (865cc/Cast Wheel)	09-15	R
Bonneville SE (865cc/Cast wheel)	09-12	R
Bonneville T100	02-09	R
Bonneville T100 (865cc)	10-12	R
Bonneville T100 (Spoke wheels/865cc)	10-14	R
Bonneville T100 Black (Spoke wheels/865cc)	14-15	R
Bonneville T100 (865cc) Steve McQueen	12	R
Bonneville T100 Spirit SE (Spoke Wheels)	15	R
Bonneville T100 Newchurch SE (Cast Wheels)	15	R
Bonneville T214 (Black/Spoke Wheel)	15	R
Bonneville T100 (900cc)	17	R
Bonneville T100 Black (900cc)	17	R
Bonneville T120 (1200cc)	16-17	R
Bonneville T120 Black (1200cc)	16-17	R
T595 Daytona	97	R
Speedmaster 800	03-04	R
Speedmaster (790cc/Carbs)	03-04	R
Speedmaster (865cc/Carbs)	05-07	R
Speedmaster (865cc/EFI) Cast Wheel Eng # 392060 to 46049/ 6 Bolt F/Disc	09-10	R
Speedmaster (865cc/EFI) 5 Spoke Cast Wheel Eng # 46050 Onwards/ 5 Bolt F/Disc	11-17	R

FA214/2 Contd.

TRIUMPH Contd.

Speedmaster(865cc/EFI)	08-10	R
Scrambler (865cc/Carbs)	06-09	R
Scrambler (865cc/EFI)	10-16	R
Scrambler (900cc/EFI)	17	R
Street Cup (900cc)	17	R
Street Twin (900cc)	16-17	R
Daytona 955i	98-00	R
Daytona 955i(from VIN No 132513)	01-04	R
Speed Triple (EFI)	97-01	R
Speed Triple 955cc	02-04	R
Speed Triple (Radial caliper 1050cc)	05-13	R
Speed Triple (1050cc)	08-15	R
Speed Triple R (1050cc)	13-17	R
Speed Triple S (1050cc - 2Pad Brembo F/Caliper/255mm R/Disc/ABS Model)	13-17	R
Sprint GT (1050cc/ABS)	10-12	R
Sprint GT SE (1050cc/ABS)	13-16	R
Sprint RS (from VIN 139277)	03-04	R
Sprint ST (Up to VIN 139276)	99-01	R
Sprint 1050 ST (from VIN 208167)	05-10	R
Sprint 1050 ST Zero Offset Disc	11-12	R
Thrupton SE (865cc)	12	R
Thrupton 900	04-15	R
Thrupton 900 Ace Café SE	14-15	R
Thrupton (1200cc)	16	R
Thrupton R (1200cc)	16	R
Tiger 1200 Explorer (1215cc/Cast Wheels)	12-15	R
Tiger 1050 (Radial Caliper)	07-15	R
Tiger 1050 SE (Radial Caliper/ABS)	11-13	R
Tiger 1050 Sport (Radial Caliper/ABS)	13-17	R
Tiger Explorer XC 1200 (1215cc/Spoke Wheels)	13-15	R
Trophy SE (1215cc)	13-15	R

STD	FA214	Premium Organic Street Pad Blend
OPTIONS	FA214HH	Street Performance Sintered Pad Blend
OPTIONS	FA214V	Semi Sintered Long Lasting Street Pad Blend
STD	FA214/2	Premium Organic Street Pad Blend
OPTIONS	FA214/2HH	Street Performance Sintered Pad Blend
OPTIONS	FA214/2V	Semi Sintered Long Lasting Street Pad Blend

FA214

Equivalents OE#

T2020071-T301

FA214/2

Equivalents OE#

T2025045

T2020555

T2020556

Dealer Stocking
Recommendation

Single/Pair

1

Popularity #

-

Rec Stocking Level

1

FA215 FA215/2

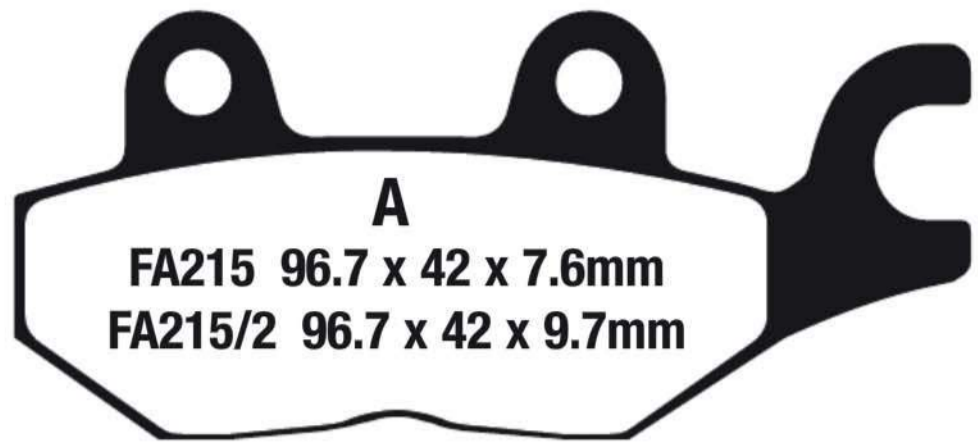
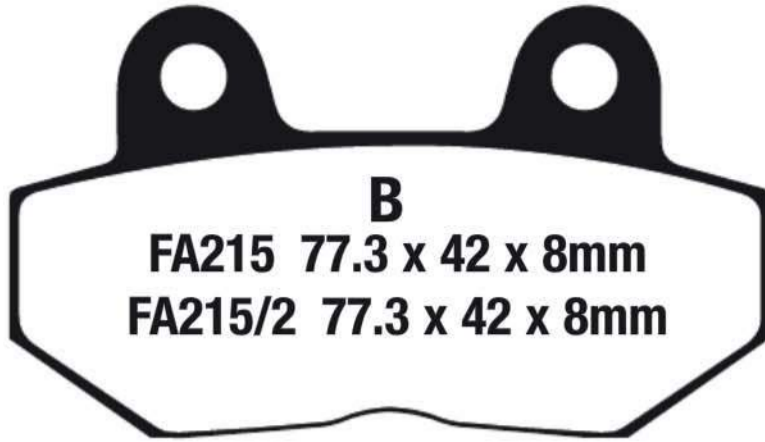

NOTE:- Size identification is shown as follows

FA215

TRIUMPH

Sprint (All carb models)	93	F Right
Tiger (885cc)	92-96	F Right
Trident 900	92-98	F Right
Trophy 900 (3 cyl)	92-93	F Right
Trophy 1200 (4 cyl)	92-93	F Right

FA215/2

TRIUMPH

Daytona 750 (3 cyl)	92	R
Dayton 1000 (4 cyl)	92	R
Daytona 900 (3 cyl)	93-96	R
Daytona Super III (3 cyl)	94-97	R
Daytona 1200 (4 cyl)	93-98	R
Speed Triple (Carb models)	94-97	R
Sprint (All carb models up to VIN 9082)	93	R
Sprint (All carb models from VIN 9083)	94-98	R
Sprint RS (Up to VIN 139276)	99-01	R
Sprint RS (From VIN 139277)	02	R
Tiger	92-96	R
Tiger 885cc	92-98	R
Tiger 955 (cast wheel model)	04-06	R
Trident 900	92-98	R
Trophy 900 (3 cyl)	92-01	R
Trophy 1200 (4 cyl)	92-01	R
Tiger 1050 (Twin sided s/arm)	07-12	R

STD	FA215	Premium Organic Street Pad Blend
OPTIONS	FA215HH	Street Performance Sintered Pad Blend
OPTIONS	FA215V	Semi Sintered Long Lasting Street Pad Blend
STD	FA215/2	Premium Organic Street Pad Blend
OPTIONS	FA215/2HH	Street Performance Sintered Pad Blend
OPTIONS	FA215/2V	Semi Sintered Long Lasting Street Pad Blend

FA215

Equivalents OE#

T2020072-T301

FA215/2

Equivalents OE#

T2020560

Dealer Stocking Recommendation

Single/Pair	Popularity #	Rec Stocking Level
1	-	1

FA216 Use FA216/3
FA216/2
FA216/3



FA216/2
EBC AFTERMARKET CALIPER
 4 Piston
PERFORMANCE MACHINE AFTERMARKET CALIPER
 124 x 4HR
 137 x 4

FA216/3
HHI - HAWG HALTERS AFTERMARKET CALIPERS
 4 Piston - All types
INDIAN
 All models 02-08 F&R
LYNDALL BRAKES
 PAD REF 7182 & 7183
NOVA/LEGENDS AFTERMARKET CALIPER
 4 Piston
PERFORMANCE MACHINE AFTERMARKET CALIPER
 125 x 4R
 125 x 4RSPH
 137 x 4B
REVTECH AFTERMARKET CALIPER
 New Black 4 Piston Caliper
THUNDERHEART AFTERMARKET CALIPER
 4 Piston Caliper

STD	FA216	Use FA216/3
OPTIONS	FA216HH	Use FA216/3HH
OPTIONS	EPFA216HH	Discontinued
STD	FA216/2	Premium Organic Street Pad Blend
OPTIONS	FA216/2HH	Street Performance Sintered Pad Blend
STD	FA216/3	Premium Organic Street Pad Blend
OPTIONS	FA216/3HH	Street Performance Sintered Pad Blend
OPTIONS	FA216/3V	Semi Sintered Long Lasting Street Pad Blend
OPTIONS	FA216/3VLD	Semi Sintered Long Lasting Street Pad Chrome Backed

Dealer Stocking Recommendation

<u>Single/Pair</u>	<u>Popularity #</u>	<u>Rec Stocking Level</u>
1	-	1

Equivalent OE#

PM 0052/1602
8009008
8009007
43114 43206

BUYERS GUIDE
BRAKE PADS
 NOTE:- Size identification is shown as follows
 Dimension 1=Width or Diameter, Dimension 2=Height or Diameter, Dimension 3=Thickness (Material and backplate)

FA218

FA218/2

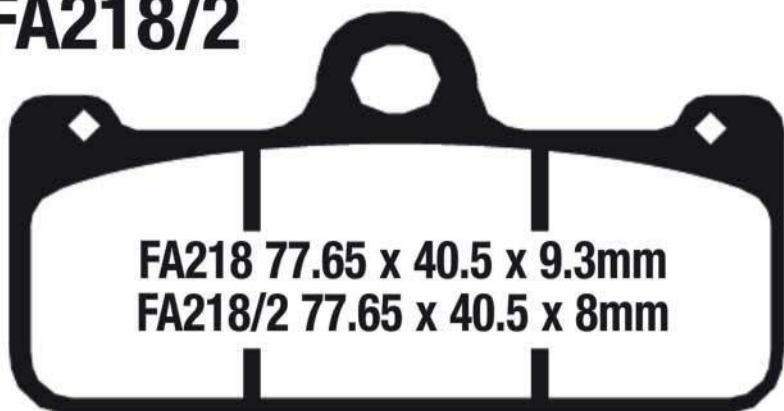

FA218 77.65 x 40.5 x 9.3mm
FA218/2 77.65 x 40.5 x 8mm

BREMBO AFTERMARKET CALIPER

XA9.33.10/11 - 4 Piston P32/36 Radial Mount @ 108mm (Single pin fixing)
 X97.37.60/61 - 4 Piston Monobloc 32/36 Radial mount @ 108mm (single pin fixing)

FA218/2

BREMBO AFTERMARKET CALIPER

XA3.B8.30/31 - 4 Piston P32/36 Radial Mount Caliper @ 108mm Spacing (Titanium Pistons)
 XA3.B8.60/61 - 4 Piston P32/36 Radial Mount Caliper @ 108mm Spacing (Aluminium Pistons)
 X1017.40/41 - 4 Piston/40mm Axial Monobloc
 XA762.40/41 100mm CNC Monobloc

Equivalents OE# - **FA218**

107 A486 02

Equivalents OE# - **FA218/2**

107 A486 03

107684820

107684830

M028Z04

Dealer Stocking Recommendation

STD EPFA218HH Fast Street Use & Track Day Sintered Pad Blend

STD EPFA218/2HH Fast Street Use & Track Day Sintered Pad Blend

Single/Pair

Popularity #

Rec Stocking Level

FA222



52.6 x 56.3
x 9mm

SUZUKI

RF 900 RR/RS/RS2

94-95 R

Equivalents OE#

69130 31E00

Dealer Stocking Recommendation

Single/Pair

Popularity #

Rec Stocking Level

1

S25

2

STD FA222 Premium Organic Street Pad Blend

NOTE:- Size identification is shown as follows

Dimension 1=Width or Diameter, Dimension 2=Height or Diameter, Dimension 3=Thickness (Material and backplate)

FA226

HONDA

RS 125	90-94	F
CBR 250 R (Non ABS)	11-14	F
RS 250	90-94	F
CB300F	15	F
CBR300R (Non ABS Model)	15	F
CBR300RA (ABS Model)	15	F
CBR 600 F3/SJR/SE	95-98	F
599	04/06	F

KAWASAKI

Ninja 650 (EX 650 KH/KHFA - ABS)	17	F
Ninja 650 (EX 650 JHF - Non ABS)	17	F

SUZUKI

GSX 250R	17-18	F
----------	-------	---

TRIUMPH

Street Triple 675	07-17	F
Tiger 800 (Cast Wheels)	11-14	F
Tiger 800 (With ABS/Cast Wheels)	11-14	F

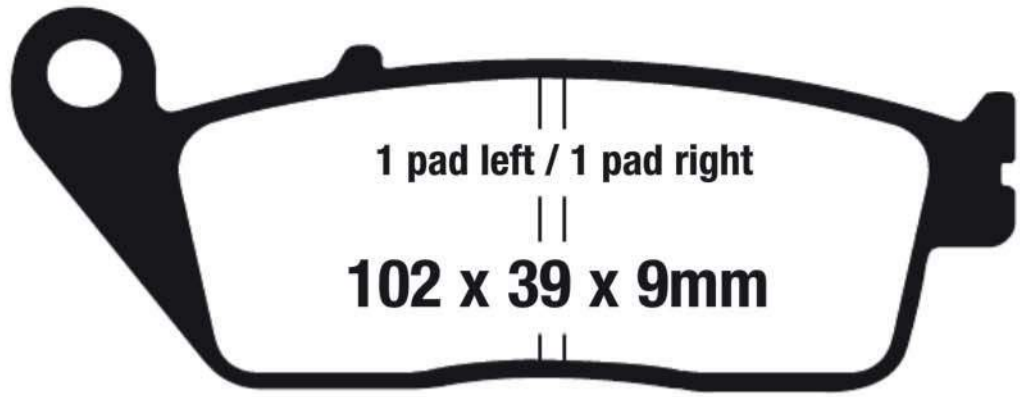

Tiger 800 XR (With ABS/Cast Wheels)	15-17	F
Tiger 800 XR Touring (With ABS/Cast Wheels)	15	F
Tiger 800 XRt (With ABS/Cast Wheels)	16-17	F
Tiger 800 XRx (With ABS/Cast Wheels)	15-17	F
Tiger 800 XC (Spoke Wheels)	11-14	F
Tiger 800 XC (With ABS/Spoke Wheels)	11-17	F
Tiger 800 XC Adventure (With ABS/Spoke Wheels)	15	F
Tiger 800 XCa (With ABS/Spoke Wheels)	15-17	F
Tiger 800 XCx (With ABS/Spoke Wheels/STD & Low)	15-17	F

Equivalents OE#

06455 MAL G01
06455 MV4 405
06455 MR4 405

STD	FA226	Premium Organic Street Pad Blend
OPTIONS	FA226HH	Street Performance Sintered Pad Blend
	EPFA226HH	Fast Street Use & Track Day Sintered Pad Blend

Dealer Stocking Recommendation

Single/Pair	Popularity #	Rec Stocking Level
2	H29	4

FA228

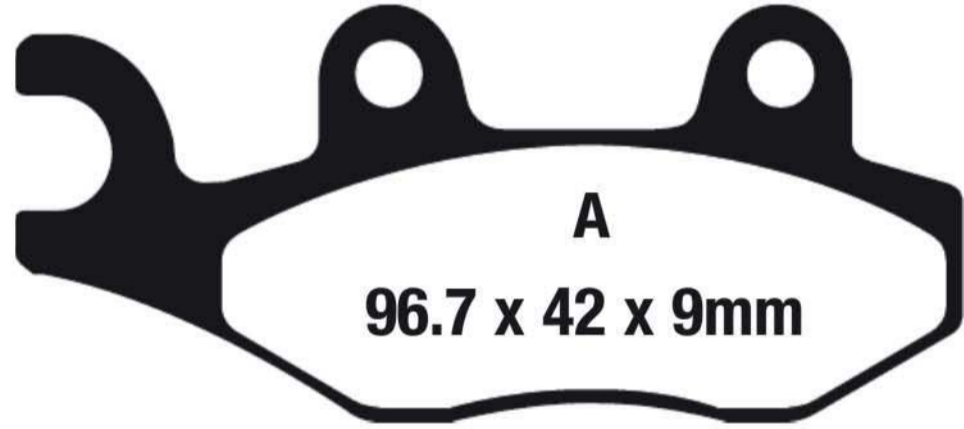
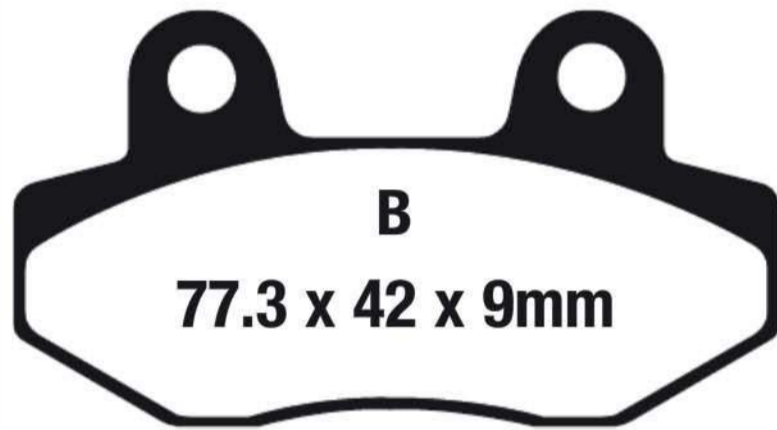

HONDA

CMX 250 C 'Rebel'	96/97/99-14	F
CMX 250 C2	99-00	F
CMX 250 X	15	F

KAWASAKI

KL 650 E8F/E9F/EAF/EBF/ECF/EDF/EEF/EFF (KLR 650)	08-15	F
--	-------	---

ROYAL ENFIELD

Bullet 500 EFI (Pricol caliper/Drum rear)	10-15	F Left
Classic 500 (Pricol caliper/Drum rear)	10-15	F Left
Classic 500 Battle Green (Pricol caliper/Drum rear)	10-15	F Left
Classic 500 Chrome (Pricol caliper/Drum rear)	10-15	F Left
Classic 500 Desert Storm (Pricol caliper/Drum rear)	10-15	F Left

SUZUKI

AN 400 K7/K8/K9/AK9/AL1/AL2/AL3/AL4/AL5/AL6 Burgman	07-16	F Left
AN 400 ZAL4/ZAL5/ZAL6	14-16	F Left

SFA228 BENELLI

Caffenero Scooter 150		F
Zafferano Scooter 250 EFI		R

KYMCO STREET

Agility 50 (4T)	05-15	F
Campagno 50i (4T/SE50BG)	14	F
Filly 50	02-05	F
Sento 50	09-12	F
Sting 50 (2T)	07-11	F
Vitality 50 (4T)	05-08	F
Yup 50	02-06	F
Campagno 110i (4T/SE22BD)	13-15	F
Agility 125	06-15	F
People S 250	07-11	F Left

U.M. (UNITED MOTORS)

Xpeed 250 i	08	F Left
-------------	----	--------

Equivalents OE#

06455 KEB 900	45150 KEC8 3050
43082 0060	59100 05830
45105 KCE 3050 M2	92559
45105 LEA1306	

Dealer Stocking Recommendation

Single/Pair	Popularity #	Rec Stocking Level
1	-	1

STD	FA228	Premium Organic Street Pad Blend
OPTIONS	FA228HH	Street Performance Sintered Pad Blend
	SFA228	Premium Organic Scooter Pad Blend
	SFA228HH	Scooter Performance Sintered Pad Blend

FA229

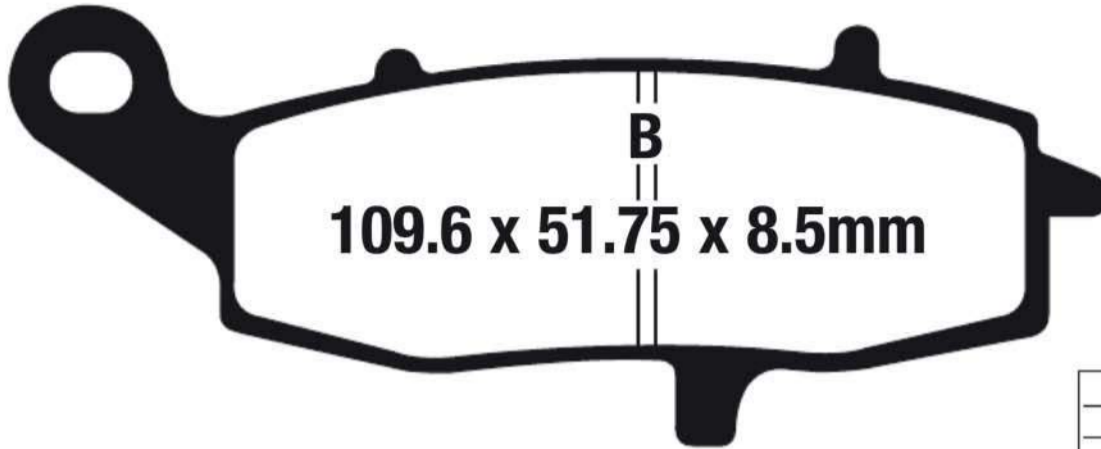
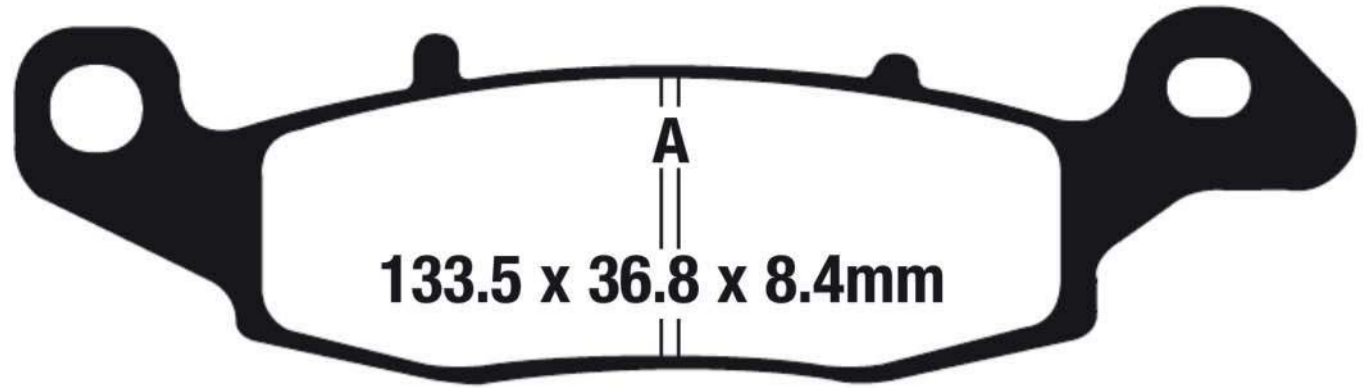

Equivalents OE#

43082 0050	43082 1244	43082 1282
43082 1187	43082 1245	43082 0008
43082 1177	59300 33830	59302 33810
43082 1223	59301 33820	43802 0009
43082 1234	59301 33830	

Dealer Stocking Recommendation

Single/Pair	Popularity #	Rec Stocking Level
1	-	2

STD FA229	Premium Organic Street Pad Blend
OPTIONS FA229HH	Street Performance Sintered Pad Blend
OPTIONS EPFA229HH	Fast Street Use & Track Day Sintered Pad Blend
OPTIONS FA229V	Semi Sintered Long Lasting Street Pad Blend

KAWASAKI

ER 650 C9F/CAF ER-6N	09-10	F Left
EX 650 Ninja 650 R A6F/A7F/A8F/C9F/CAF	06-10	F Left
EX 650 Ninja (EX 650 ECF/EDS/EEF/EFF/EGF) (Non ABS)	12-15	F Left
EX 650 Ninja (EX 650 FDS/FEF/FFF/FGF) (ABS Model)	13-15	F Left
EX650 R (EX 650 CBF)	11	F Left
KLE 650 A7F/A8F/A9F/CAF/CBF/CCF/CDF/CEF Versys	07-14	F Left
KLE 650 DEF Versys (ABS Model)	14	F Left
ZR 750 F2 (ZR-7)	00	F Left
ZR7-S (ZR 750 H1/H2/H3/H4/H5)	01-05	F Left
Z 750 S (ZR 750 K1/K6F)	05-06	F Left
VN 800 B1-B10	96-05	F
VN 800 Drifter C1/C2/E1/E2/E3/E4/E5/E6F	99-06	F
VN 900 D6F/D7F/D8F/D9F/DAF/DBF/DCF/DDF/DEF/DFF/DGF Vulcan Classic LT	06-16	F Left
VN 900 Vulcan Classic B6F/B7F/B8F/B9F/BAF/BBF/BCF/BDFA /BEF/BEFA/BFF/BFFA/BGF/BGFA	06-16	F
VN 900 C7F/C8F/C9F/CAF/CBF/CCF/CDFA/CEFA/CFE /CGF (Cast Wheels)	07-16	F
KZ 1000 P21-P22/P24	02-03/05	F Left
GPZ 1100 (ZX 1100 E1/E2/E3)	95-97	F Left
ZR 1100 B1 Zephyr	96	F Left
VN 1500 G1/G1A/G2A/G3 Nomad	99-02	F Left
VN 1500 Drifter J1/J2/R1/R2/R3/R4/R5	99-05	F
VN 1500 D1/D2/E1-E7 Vulcan Classic	96-04	F
VN 1500 N1/N2/N3 Vulcan Classic Fi/L2/L3/L4/L5 Nomad Fi	00-05	F Left
VN 1500 N4/N6F/N7F/N8F/N8FA Vulcan 1500 Classic	05-08	F
VN 1600 A1/A2/A3/A6F/A7F/A7FA/A8F/A8FA Vulcan Classic	03-08	F Left
VN 1600 D1 Nomad D6F/D7F/D7FA/D8F/D8FA	05-08	F Left
VN 1700 C9F/CAF/CBF/CCF/CDF Vulcan 1700 Nomad	09-13	F Left
VN 1700 C9FA Vulcan 1700 Nomad 2T	09	F Left
VN 1700 E9F/EAF/EBF Vulcan 1800 Classic	09-12	F Left
VN 1700 G9F/GAF Vulcan 1700 Classic LT	09-11	F Left

SUZUKI

TU 250 XK9/XL1/XL2/XL3/XL4/XL5/XL6	09-16	F
GSF 600 SY/SK1/SK2/SK3/AL1	00-03	F Left
GSX 600 FW/FX/FY/FK1-FK6 Katana	98-06	F Left
DL 650 K4/K5/K6/K7/K8/K9 V-Strom	04-09	F Left
DL 650 AK7/AK8/AK9/AL1/AL2/AL3/AL4/AL5 /AL6/AL7 V-Strom	07-17	F Left
DL 650 XT XAL5/XAL6/XAL7 V-Strom XT (ABS Model)	15-17	F Left
DL 650 V-Strom ABS Adventure AAL2/AAL3/AAL4/AAL5	12-15	F Left
SFV 650 K9/L3/L4	09-10/13-14	F Left
SV 650 X/Y/K1/SK1/K2/SK2/K3/SK3/K4/SK4/K5/SK5/ K6/SK6/K7/SK7/SK8/K8/SK9/SF8/SF9/SFL0	99-10	F Left
SV 650 AK7/AK8/K7/K8/K9/L0 ABS	07-10	F Left
SV 650 AL7 ABS	16-17	F Left
SV 650 SAK7/SAK8/SAK9/SFA8/SFA9/SFL0 ABS	07-10	F Left
GSR 750 L5/L6 (Non ABS)	15-16	F Left
GSR 750 AL5/AL6 (ABS)	15-16	F Left
GSX 750 FW/FX/FY/FK1-FK6/K6/SK6	98-06	F Left
GSX-S 750 L5/L6/L7/L8	15-18	F Left
GSX-S 750 ZL5/ZL6/ZL7/ZL8	15-18	F Left
DL 1000 K2/K3/K4/K5/K6/K7/K8/K9/L2 V-Strom	02-12	F Left
DL 1000 AL2 V-Strom Adventure	12	F Left
VL 1500 K2/K3/K4	02-03	F Left
VL 1500 BK5/K5/TK5/BK6/K6/TK6/K7/TK7/K8/TK8/K9 /TK9 Boulevard C90/C90T	05-10	F Left
VZ 1500 K9/L3/L4/L5 M90 Boulevard	09/13-15	F Left

NOTE:- Size identification is shown as follows

Dimension 1=Width or Diameter, Dimension 2=Height or Diameter, Dimension 3=Thickness (Material and backplate)

BUYERS GUIDE
BRAKE PADS

FA230

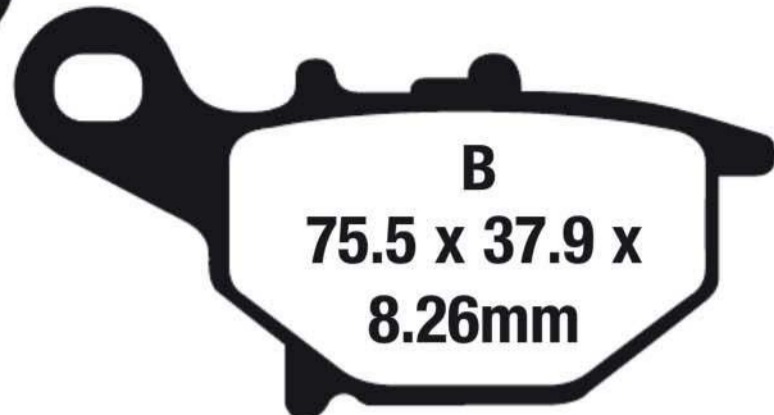
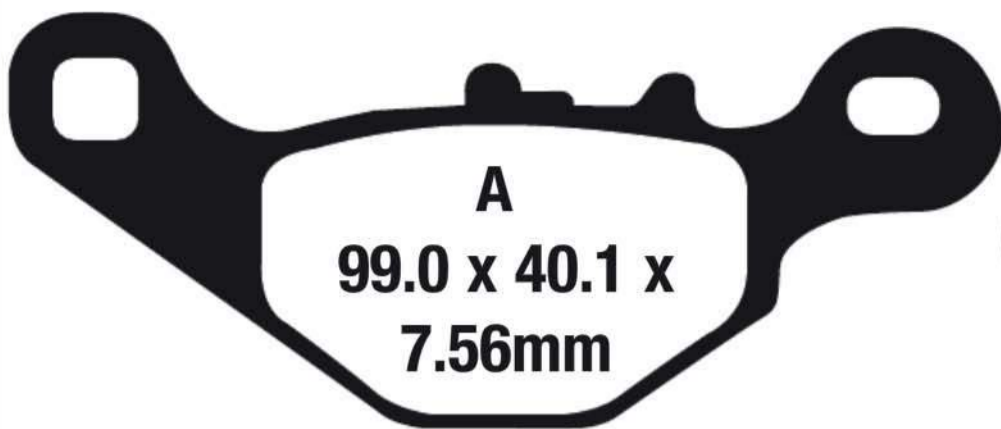

SUZUKI

RM 80 T/V/W/X/Y/K1	96-01	F
RM 85 K2/K3/LK3/K4/LK4	02-04	F
DR-Z 125 LK3/LK4/LK5/LK6/LK7/LK8/LK9/LL2/LL3/LL4/LL5/LL6	03-16	F

KAWASAKI

KLX 125 L (B1/B2/B3/B6F)	03-06	F
--------------------------	-------	---

Equivalents OE#

59300 03880	59300 20890
59300 20830	43082 S005
59300 20841	43082 S015

STD	FA230X	Carbon Dual Purpose Pad Blend
OPTIONS	FA230R	Utility Grade Sintered Pad Blend

Dealer Stocking Recommendation

Single/Pair	Popularity #	Rec Stocking Level
	-	-

FA231

A. 133.5 x 36.8 x 8.4mm
B. 109.6 x 51.75 x 8.5mm

FA231/2

A. 133.5 x 36.8 x 10.7mm
B. 109.6 x 51.75 x 10.7mm

FA231/3

A. 133.5 x 36.8 x 10.4mm
B. 109.6 x 51.75 x 11.4mm

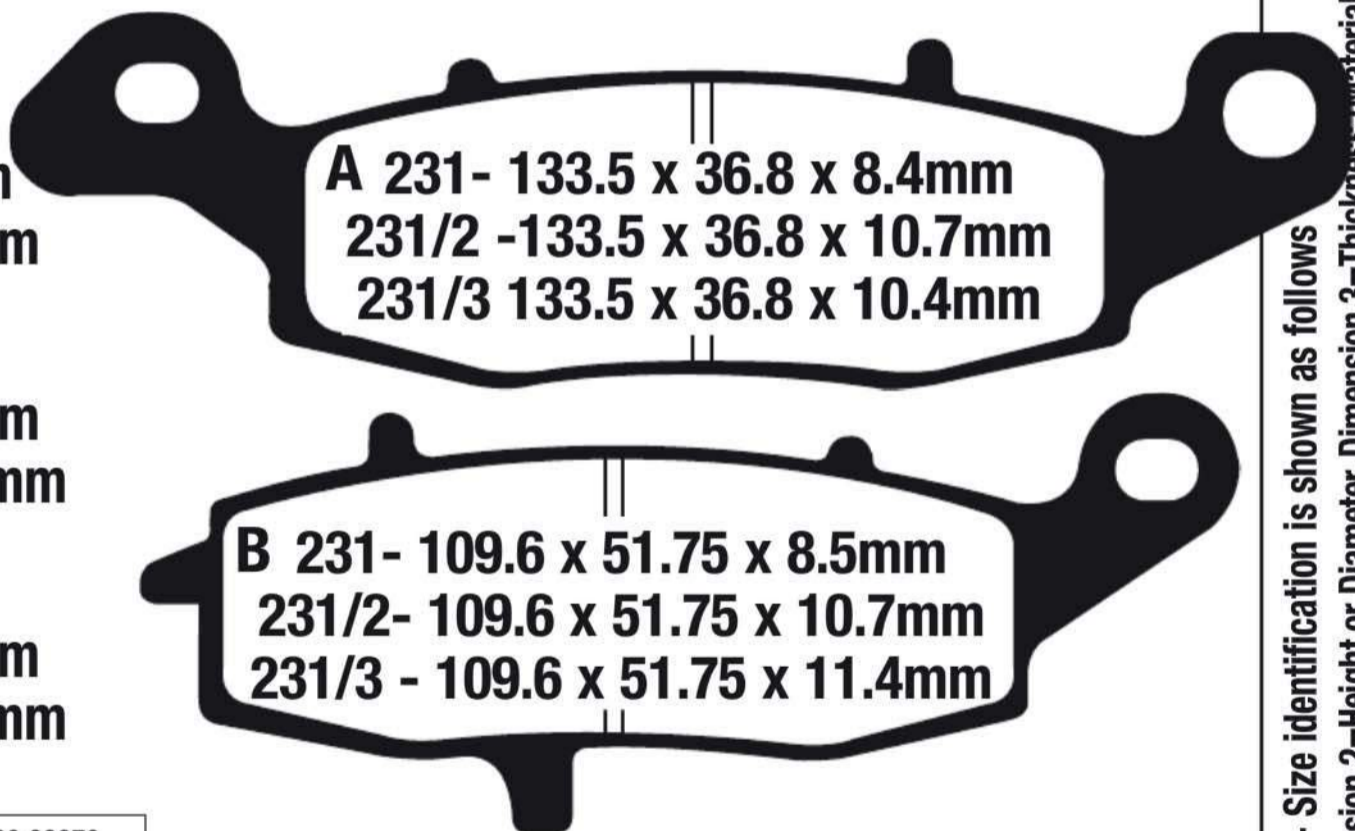

Equivalents OE#

43082 0016	43082 1246	59100 33870
43082 0063	43082 1248	59101 33820
43082 0051	43082 1260	59101 33830
43082 1188	43082 1264	59102 33810
43082 1178	43082 1265	K4308 1264
43082 1226	43082 1283	69100 01880
43082 1232	43083 1275	43082 0010
43082 1235	59100 33850	

KAWASAKI

ER 650 C9F/CAF ER-6N	09-10	F Right
EX 650 Ninja 650 R A6F/A7F/A8F/C9F/CAF	06-10	F Right
EX 650 Ninja (EX 650 ECF/EDS/EEF/EFF/EGF) (Non ABS)	12-16	F Right
EX 650 Ninja (EX 650 FDS/FEF/FFF/FGF) (ABS Model)	13-16	F Right
EX 650 R (EX 650 CBF)	11	F Right
KLE 650 A7F/A8F/A9F/CAF/CBF/CCF/BCF/EDF Versys	07-13	F Right
KLE 650 DEF Versys (ABS Model)	14	F Right
W 650 (EJ 650 A2/A3/A4)	00-02	F
ZR 750 F2 (ZR-7/ZR7'S')	00-01	F Right & R
ZR7-S (ZR 750 H1/H2/H3/H4/H5)	01-05	F Right & R
Z 750 S (ZR 750 K1/K6F)	05-06	F Right
VN 800 Drifter C1/C2/E1/E2/E3/E4/E5/E6F	99-06	R ▲
VN 900 D6F/D7F/D8F/D9F/DAF/DBF/DCF/DDF/DEF/DFF/DGF Vulcan Classic LT	06-16	R ▲

STD	FA231	Premium Organic Street Pad Blend
OPTIONS	FA231HH	Street Performance Sintered Pad Blend
OPTIONS	FA231V	Semi Sintered Long Lasting Street Pad Blend
OPTIONS	EPFA231HH	Fast Street Use & Track Day Sintered Pad Blend
OPTIONS	FA231/2V	Semi Sintered Long Lasting Street Pad Blend
OPTIONS	FA231/3V	Semi Sintered Long Lasting Street Pad Blend

Dealer Stocking Recommendation

Single/Pair	Popularity #	Rec Stocking Level
1	-	1

★ = REAR FA231/2V @10.7mm (HH USE FA231HH) ▲ = REAR FA231/3V @ 11.4mm (HH USE FA231HH)

FA231

A. 133.5 x 36.8 x 8.4mm

B. 109.6 x 51.75 x 8.5mm

FA231/2

A. 133.5 x 36.8 x 10.7mm

B. 109.6 x 51.75 x 10.7mm

FA231/3

A. 133.5 x 36.8 x 10.4mm

B. 109.6 x 51.75 x 11.4mm

KAWASAKI Contd.

VN 900 Vulcan Classic B6F/B7F/B8F/B9F/BAF/BBF/BCF/BDFA /BEF/BEFA/BFF/BFFA/BGF/BGFA	06-16	R ▲
VN 900 C7F/C8F/C9F/CAF/CBF/CCF/CDF/CEFA /CFF/CGF (Cast Wheels)	07-16	R ▲
KZ 1000 P21-P22/P23	02-03/05	F Right
GPZ 1100 (ZX 1100 E1/E2/E3/F1)	95-97	F Right
ZR 1100 B1 ZEPHYR	96	F Right
VN 1500 G1/G1A/G2A/G3/L2/L3/L4/L5/L6 Nomad Fi	99-05	F Right & R
VN 1500 Drifter J1/J2/R1/R2/R3/R4/R5	99-05	R
VN 1500 N1/N2/N3 Vulcan Classic Fi	00-02	R ★
VN 1500 E4/E5/E6/E7 Vulcan Classic	01-04	R
VN 1500 P1/P2 Mean Streak	02-03	R ★
VN 1500 N4/N6F/N7F/N8F/N8FA Vulcan 1500 Classic	05-08	R ▲
VN 1600 A1/A2/A3/A6F/A7F/A7FA/A8F/A8FA Vulcan Classic	03-08	F Right ▲
VN 1600 B1 Mean Streak	04	R ★
VN 1600 D1/D6F/D7F/D7FA/D8F/D8FA Nomad	05-08	F Right & R ▲
VN 1600 B2/B6F/B7F/B7FA/B8F/B8FA Mean Streak	05-08	R
VN 1700 A9FA/AAF/ABF/ACF/ADF Vulcan 1700 Voyager	09-13	R
VN 1700 B9FA/BAF/BBF/BCF/BDF/BEF/BFF/BGF/BHF Vulcan 1700 Voyager ABS	09-17	R
VN 1700 C9F/CAF/CBF/CCF/CDF Vulcan 1700 Nomad	09-13	F Right & R ▲
VN 1700 DEF/DEFA Vulcan 1700 Nomad ABS	14	R ▲
VN 1700 C9FA Vulcan 1700 Nomad 2T	09	F Right & R ▲
VN 1700 E9F/EAF/EBF/ECF Vulcan 1700 Classic	09-12	F Right & R ▲
VN 1700 G9F/GAF Vulcan 1700 Classic LT	09-11	F Right & R ▲
VN 1700 JBF/JBFA/JCF/JCFA/JDF Vulcan Vaquero	11-13	F Right & R ▲
VN 1700 KEF/KFF/KFG Vulcan Vaquero ABS	14-16	R ▲
VN 1700 KEFA Vulcan Vaquero ABS SE	14	R ▲
VN 2000 D1/D6F Vulcan Ltd	05-06	R ▲
VN 2000 E6F/E7F/H8F/H9F Vulcan Classic	06-09	R ▲
VN 2000 F6F/F7F/J8F/J9F/JAF Vulcan Classic LT	06-10	R ▲

SUZUKI

RV 200 L6/L7 Van-Van	16-17	F
GS 500 ET/EV/EW/EX/EY/K1/K2/K3/FK4/FK5/FK6 /FK7/FK8/FK9/FLO	96-10	F
GSF 600 SY/SK1/SK2/SK3	00-03	F Right
GSX 600 FW/FX/FY/FK1-FK6 Katana	98-06	F Right
DL 650 K4/K5/K6/K7/K8/K9 V-Strom	04-09	F Right
DL 650 AK7/AK8/AK9/AL1/AL2/AL3/AL4/AL5 /AL6/AL7 V-Strom	07-17	F Right
DL 650 XT XAL5/XAL6/XAL7 V-Strom XT (ABS Model)	15-17	F Right
DL 650 V-Strom ABS Adventure AAL2/AAL3/AAL4/AAL5	12-14	F Right
SFV 650 K9/L3/L4	09-10/13-14	F Right
SV 650 XY/K1/SK1/K2/SK2/K3/SK3/K4/SK4/K5/SK5/K6/ SK6/SK7/SK8/K8/SK9	99-10	F Right
SV 650 AK7/AK8/K7/K8/K9 ABS	07-10	F Right
SV 650 AL7 ABS	16-17	F Right

SV 650 SAK7/SAK8/SAK9 ABS	07-10	F Right
GSR 750 L5/L6 (Non ABS)	15-16	F Right
GSR 750 AL5/AL6 (ABS)	15-16	F Right
GSX 750 FW/FX/FY/FK1-FK6 Katana	98-06	F Right
GSX 750 W/X/Y Inazuma	98-00	F Right
GSX-S 750 L5/L6/L7/L8	15-18	F Right
GSX-S 750 ZL5/ZL6/ZL7/ZL8	15-18	F Right
VL 800 K1/K2/K3/K4 Intruder Volusia	01-04	F
VL 800 TK5/TK6/TK7/TK8/RK9/TL1/TL2/TL3/TL4/TL5 C50T Boulevard Touring	05-15	F
VL 800 ZK3/ZK4 Volusia Ltd (Seat trimmed with chrome studs)	03-04	F
VL 800 K5/CK5/K6/CK6/K7/ZK8/K9/ZK9/L1/L2/L3/L4/L5 C50 Boulevard	05-15	
VL 800 BTL4 (Boulevard C50 B.O.S.S./Cast Wheels)	14	F
VL 800 CL3 (Boulevard C50 Special Edition/Cast Wheels)	13	F
VZ 800 Marauder V/W/X/Y/K1/K2/K3/K4	97-04	F
VZ 800 K5/K6/BK6/K7/ZK7/K8/ZK8/ZK9/ZK9 M50 Boulevard	05-09	F
VZ 800 L0/L1/L2/L3/L4/L5 M50 Boulevard	10-15	F
DL 1000 K2/K3/K4 V-Strom	02-04	F Right
DL 1000 K2/K3/K4/K5/K6/K7/K8/K9	02-09	F Right
DL 1000 AL2 V-Strom Adventure	12	F Right
VL 1500 K2/K3/K4	02-04	F Right
VL 1500 BK5/K5/TK5/BK6/K6/TK6/K7/TK7/K8/TK8/K9/TK9 Boulevard C90/C90T	05-09	F Right
VL 1500 BL3/BL4/BL5 (Boulevard C90 B.O.S.S./Cast Wheels)	13-15	R ▲
VL 1500 BLT3 (Boulevard C90 B.O.S.S./With Windshield)	13	R ▲
VL 1500 L3 (C90 Boulevard)	13	R ▲
VL 1500 TL3/TL4/TL5 (C90T Boulevard/With Windshield)	13-15	R ▲
VZ 1500 K9/L3/L4/L5 M90 Boulevard	09/13-15	F Right & R ▲
VZ 1600 K4 Marauder	04	R ★
VZ 1600 K5 M95 Boulevard/Marauder	05	R ★
VLR 1800 TK8/TK9 C109 RT Touring	08-10	R ▲
VLR 1800 K8/K9/L0 C109 R	08-10	R ▲
VZR 1800 K6/K7/K8/K9/L1/L2/L3/L4 (Boulevard M109R)	06-14	R ▲
VZR 1800 NK8/NK9 (Boulevard Limited M109R2)	08-09	R ▲
VZR 1800 ZK8/ZK9/ZL1/ZL2/ZL3/ZL4 (Boulevard RZ Limited M109RZ)	08-14	R ▲
VZR 1800 BL4/BL5/BL6/BL7 (Boulevard B.O.S.S. M109R)	14-17	R ▲

★ = REAR FA231/2V @10.7mm (HH USE FA231HH) ▲ = REAR FA231/3V @ 11.4mm (HH USE FA231HH)

FA232

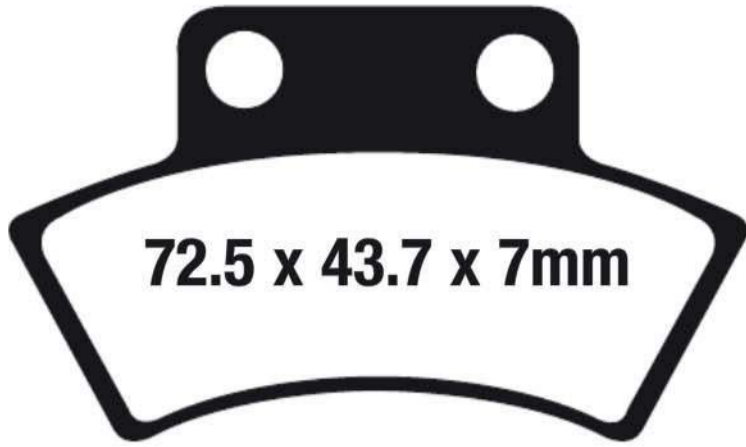

72.5 x 43.7 x 7mm

CF MOTO

400 C-Force 14-16 Parking brake
500 C-Force 14-16 Parking brake

E-TON QUADS

RXL-50M Viper (4T) Parking brake

This pad has increased friction area. Can be fitted in place of FA178 to improve wear life on Polaris ATV's

POLARIS

All disc rear brake models - check application pages for main fitments.

Equivalents OE#

1930814
2200464
2200899

STD	FA232X	Carbon Dual Purpose Pad Blend
OPTIONS	FA232R	Utility Grade Sintered Pad Blend
	FA232SV	High Durability Off Road Sintered Blend

Dealer Stocking Recommendation

<u>Single/Pair</u>	<u>Popularity #</u>	<u>Rec Stocking Level</u>
1	P2	2

SFA233



1 left / 1 right
75.1 x 37.2 x 9.5mm

KYMCO STREET

Cobra Racer 50 (SF10AG) 00-04 F
Cobra Cross/Racer 50 (SF10AF) 05-06 F
ZX 50 Super Fever 02-05 F

Equivalents OE#

45105 KCX E050

STD SFA233 Premium Organic Scooter Pad Blend

Dealer Stocking Recommendation

<u>Single/Pair</u>	<u>Popularity #</u>	<u>Rec Stocking Level</u>

SFA235



59.5 x 44.5 x 9mm

CPI

Oliver City 50 05-09 F

UM (UNITED MOTORS)

Zyclone 50 04-05 R

Equivalents OE#

45150 KBK9000 MZ
45110 J4FT 0000

STD SFA235 Premium Organic Scooter Pad Blend

Dealer Stocking Recommendation

<u>Single/Pair</u>	<u>Popularity #</u>	<u>Rec Stocking Level</u>

NOTE:- Size identification is shown as follows
Dimension 1=Width or Diameter, Dimension 2=Height or Diameter, Dimension 3=Thickness (Material and backplate)

FA236

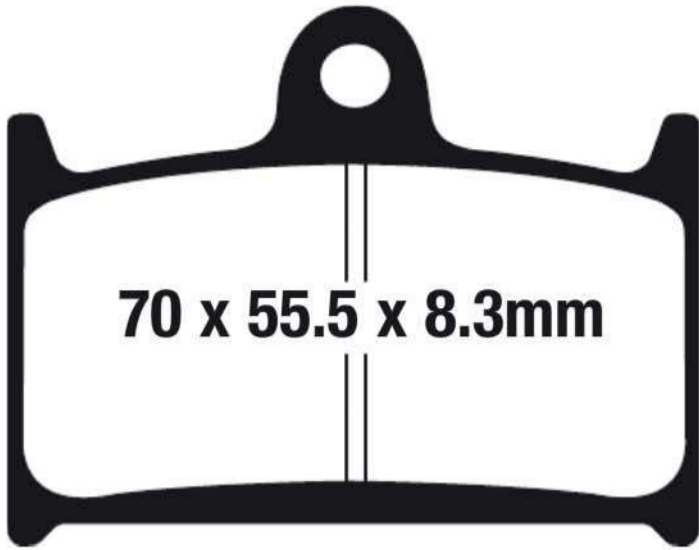

70 x 55.5 x 8.3mm

Equivalents OE#

T2020245

TRIUMPH

Daytona 600	03-04	F
T595 Daytona	97	F
Daytona 955i	98-00	F
Daytona 955i (From VIN 132513)	01-04	F
Daytona 650	05	F
Daytona 675 SE	12	
Daytona 750 (3 cyl)	92	F
Daytona 100 (4 cyl)	92	F
Daytona 900 (3 cyl)	93-96	F
Daytona 1200 (4 cyl)	93-98	F
Speed Triple (Carb models)	94-97	F
Speed Triple (EFI)	97-01	F
Speed Triple 955cc (from VIN 141872)	02-04	F
Speedfour 600	02-05	F
Rocket III 2300cc	04-09	F
Rocket III Classic	07-09	F
Rocket III Roadster	11-17	F
Rocket III Touring (ABS & Non ABS)	09-17	F
Sprint (carb models from VIN 9083)	94-98	F
Sprint GT (1050cc/ABS)	10-12	F
Sprint GT SE (1050cc/ABS)	13-16	F
Sprint RS (up to VIN 139276)	99-01	F
Sprint RS (from VIN 139277)	02	F
Sprint RS (From VIN 139277)	03-04	F
Sprint ST (up to VIN 139276)	99-01	F
Sprint ST (From VIN 139277)	02-04	F
Sprint 1050 ST (From VIN 208167)	05-10	F
Sprint 1050 ST	11-12	F
Trophy 900 (3cyl)	94-01	F
Tiger Explorer XC 1200 (Up to Vin # 740276/1215cc /Cast & Spoke Wheels)	13-15	F
Trophy 1200 (4 cyl)	94-01	F
Thunderbird 1600 (Cast wheel)	09-17	F
Thunderbird (1600cc/Windscreen)	12	F
Thunderbird Commander (1700cc/Cast wheel)	14-17	F
Thunderbird LT (1700cc/Cast wheel)	14-17	F
Thunderbird NightStorm (1700cc/Cast wheel)	09-17	F
Thunderbird Storm (1700cc/Cast wheel)	09-17	F
TT 600	00-03	F

STD	FA236	Premium Organic Street Pad Blend
OPTIONS	FA236HH	Street Performance Sintered Pad Blend

Dealer Stocking Recommendation

Single/Pair	Popularity #	Rec Stocking Level
2	-	2

FA239

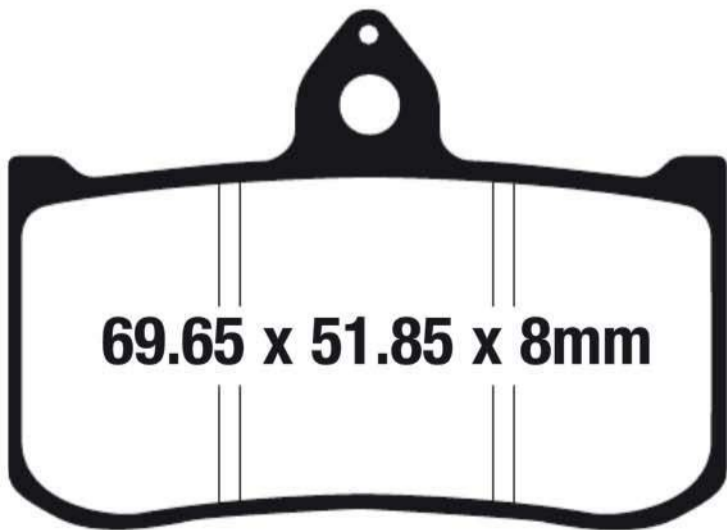

69.65 x 51.85 x 8mm

HONDA (RACE BIKES)

RS 125/250	95-03
------------	-------

Equivalents OE#

45105 NX4 770

STD	GFA239	Sintered Race Use Only (Closed Circuit)
OPTIONS	EPFA239HH	Fast Street Use & Track Day Sintered Pad Blend

Dealer Stocking Recommendation

Single/Pair	Popularity #	Rec Stocking Level
1	-	0

**BUYERS GUIDE
BRAKE PADS**

**NOTE:- Size identification is shown as follows
Dimension 1=Width or Diameter, Dimension 2=Height or Diameter, Dimension 3=Thickness (Material and backplate)**

FA243

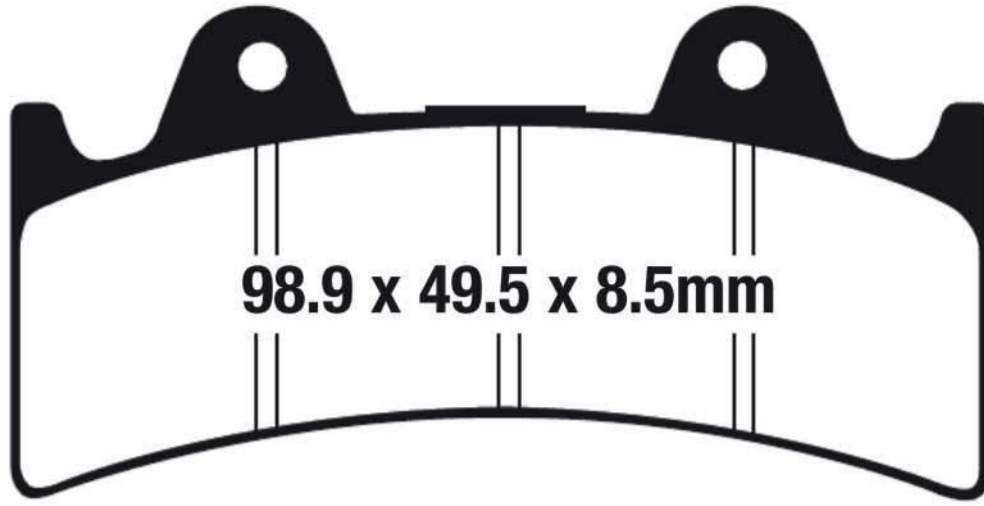

JAYBRAKE AFTERMARKET CALIPER
J-Six (300-64) (6 Piston)

98.9 x 49.5 x 8.5mm

Equivalents OE#

N/A

STD FA243 Premium Organic Street Pad Blend
OPTIONS FA243HH Street Performance Sintered Pad Blend

Dealer Stocking Recommendation

Single/Pair
2

Popularity #
-

Rec Stocking Level
0

FA244



75 x 55 x 8.7mm

ALTA MOTORS (Electric)

Redshift - SM 16-18 F

APRILIA

RS 250 99-03 F
RSV 1000/Mille/SP 98-01 F
RSV Tuono (Standard Mount Caliper) 02-09 F
Tuono V4 R STD 11-13 F
Tuono V4 R APRC 11-13 F
SL 1000 "Falco" 00-05 F
Dorsoduro 1200 11-14 F

BREMBO AFTERMARKET CALIPER

20 6800 10/20 Goldline 4 Plston P4 30/34 @ 65mm Spacing (Two pin pad fixing)

BMW

G 650 X-Moto 07-09 F
F 800 GT 13-15 F
F 800 S/ST 06-13 F
F 800 R 09-14 F

DUCATI

400 Monster 00-02 F
400 Monster (Japan) 00-04 F
Monster Dark ie 400 (Single disc) 05-06 F
600 Monster 00-01 F
Monster 620 ie (Single disc) 02-04 F
Monster 620 Dark 03-04 F
620 Multistrada Dark (Single disc/twin pin pad fixing) 06 F
620 Sport 03 F
620ie Monster (Series 1 - Twin Pin Pad Fixing Caliper) 05 F
696 Monster 08-15 F
M 696 Monster - 20th Anniversary Model 13-14 F
748 SPS 98-99 F
748 R (2 pad caliper) 00 F

DUCATI Contd.

748 SP/Monoposto 99-02 F
748 (Biposto) 00-02 F
748 (Monoposto) 00-02 F
748 Testa Bassa 01 F
750 Supersport 99 F
750 Supersport IE 00-02 F
750 Sport 01-02 F
750 Monster 00-01 F
Monster ie 750 02 F
Hypermotard 796 10-13 F
796 Monster (Non ABS) 10-14 F
796 Monster (ABS) 10-15 F
M 796 Monster -20th Anniversary Model 13-14 F
Monster 800 03-04 F
800 Sport 03 F
800 Supersport 03-05 F
848 (Radial 2 pad caliper) 08-09 F
848 Streetfighter 12-15 F
900 Supersport 98-99 F
900 Supersport IE 00-01 F
900 Sport 02 F
ST2 (944cc) 00-03 F
Monster 1000 ie (992cc) 04-05 F
900 IE Monster 00-01 F
900 MH Evoluzione 00-01 F
916 SPS (996cc) 97-98 F
Monster S4 Foggy (916cc) 01-02 F
ST4 (916cc) 99-02 F
ST2 (944cc) 97-99 F
996 SPS (996cc) 99 F

BUYERS GUIDE
BRAKE PADS

NOTE:- Size identification is shown as follows
Dimension 1=Width or Diameter, Dimension 2=Height or Diameter, Dimension 3=Thickness (Material and backplate)

FA244 Contd.

DUCATI Contd.

996 (996cc) (Monoposto/Biposto)	99-01	F
996 S	01	F
Sport 1000 S	07-09	F
Supersport 1000 DS (992cc)	03-06	F
ST3 S (ABS) (992cc)	06-07	F
Monster S4R (996cc) (2 pad caliper)	05-06	F
Monster S4R (996cc)	03-06	F
ST4S (Non ABS/996cc)	01-05	F
ST4S (ABS Model/996cc)	03-05	F
996 Monster (ABS)	10-12	F
998 (998cc) (2 pad caliper) (Monoposto/Biposto)	02-03	F
Monster 1000 Dark	03	F
Monster 1000 ie (992cc)	04-05	F
Monster 1000 S ie (992cc)	03-05	F
Monster S2R 1000 (992cc)	06-08	F
Multistrada 1000 DS (992cc)	03-05	F
Multistrada S 1000 DS (992cc)	05-06	F
Hypermotard 1100	07-09	F
Monster 1100	09-10	F
Monster 1100 S	09-10	F
1100 Monster Evo	11-13	F
M 1100 Evo Monster - 20th Anniversary Model	13	F
Monster 1100 (ABS)	09-10	F
1100 Monster S (ABS)	09-10	F
1100 Monster - Diesel	13	F
Multistrada 1100 (1078cc)	07-09	F
Multistrada 1100 S (1078cc)	07-09	F
Multistrada 1200	10-15	F
Multistrada 1200 S (Sport)	10	F
Multistrada 1200 S Pikes Peak	11-14	F
Multistrada 1200 S Grandtourismo	13-14	F
Multistrada 1200 S Touring	10-14	F

HUSQVARNA

LT 610	00	F
SM 610 R/610 S/610	99-06	F
900 Nuda	12-13	F

KTM

SMC 625	05	F
Duke II 640 Orpheus/Titan/Lime	01-	F
Duke II 640 Black/Orange	02	F
640 Duke (Jet Black/Yellow/Adrenalin Orange)	03-05	F
SMC 640 LC4	05	F
SMC 660	05	F
690 Duke (2 Pad Type Caliper)	12-15	F
1190 Adventure	13-16	F
1190 Adventure R	13-16	F
1290 Super Adventure	13-16	F
690 Supermoto	02-08	F

LYNDALL BRAKES

PAD REF 7174

MOTO GUZZI

750 Nevada Base/Club	02-03	F
Nevada Classic 750 ie	04-09	F
V7 Cafe Classic	11-12	F
V 750 ie Brevia	03-08	F
V7 Classic	08-12	F
V7 Racer	10-15	F
V7 Special	12-15	F
V7 Stone	12-15	F
California Jackel 1100	99-01	F
California Special 1100	99-01	F
Griso 1100	05-08	F
V11 Sport/Scura/Naked	99-00	F
V11 Le Mans Series	01-06	F
California Stone Series	02-06	F
California EV Series	02-06	F
California Vintage 750	06-10	F
1100 Brevia	05-12	F
1100 Griso (1064cc) Standard mount caliper	05-12	F
Griso 1200 8V (1151cc)	09-12	F
1200 Griso SE (8v) (Radial caliper) 1151cc	09-14	F
Norge 1200 GT/2V	06-12	F
Norge 1200 GT 8V	10-14	F
Stelvio 1200 NTX 8V (ABS)	09-15	F
California 1400 Custom	13-15	F
California 1400 Touring	13-15	F

MOTUS

MST	14-17	R
-----	-------	---

MV (AGUSTA)

Brutale 675	12-14	F
F3 675	12-14	F
Brutale 800	12-14	F
Brutale 989 R	08-09	F
Brutale 990 R	10-11	F
Brutale 1090	13-14	F
Brutale 1090R	12-14	F

VICTORY

V92C/SC	98-03	F
Empulse TT	16	F
Hammer	05-07	F
Hammer S	07	F
Vegas 8 Ball/Jackpot	05-07	F
Ness Signature Series	05-07	F
King Pin Tour	04-07	F
Vegas	03-07	F

Equivalents OE#

613 4 0201A	2202492
613 4 004 2A	34 11 7 696 593
613 4 041 1A	107670821
4HM W0045 00	07BB1950
4HM W0045 50	07BB19RC
800095542	107 670 823
8000B6714	2201170

Dealer Stocking Recommendation

Single/Pair	Popularity #	Rec Stocking Level
2	-	2

STD	FA244	Premium Organic Street Pad Blend
	FA244HH	Street Performance Sintered Pad Blend
OPTIONS	EPFA244HH	Fast Street Use & Track Day Sintered Pad Blend
	GPFA244HH	Race Only Sintered Pad Blend
	FA244V	Semi Sintered Long Lasting Street Pad Blend

BUYERS GUIDE
BRAKE PADS

Dimension 1=Width or Diameter, Dimension 2=Height or Diameter, Dimension 3=Thickness (Material and backplate)

NOTE:- Size identification is shown as follows

FA249

FA249/2

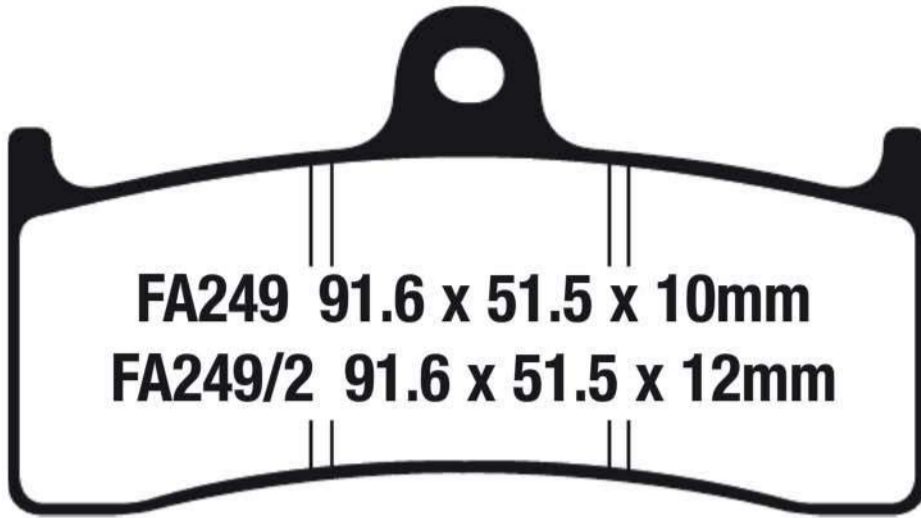

BERINGER AFTERMARKET CALIPER
6 Piston (Old Design)
PERFORMANCE MACHINE AFTERMARKET CALIPER
112 X 6B
112 X 6QC
PRE TECH AFTERMARKET CALIPER
6 Piston (Radial Mount)
THUNDERHEART AFTERMARKET CALIPER
6 Piston Caliper

FA249/2
BERINGER AFTERMARKET CALIPER
6 Piston (Old Design/Endurance)

STD	FA249	Premium Organic Street Pad Blend
OPTIONS	FA249HH	Street Performance Sintered Pad Blend
	EPFA249HH	Fast Street Use & Track Day Sintered Pad Blend
	FA249PM	Premium Organic Street Pad Blend
STD	FA249/2	Premium Organic Street Pad Blend

Equivalents OE#	42386 984
	43115
	43207

Dealer Stocking Recommendation

Single/Pair	Popularity #	Rec Stocking Level
2	-	2

FA251

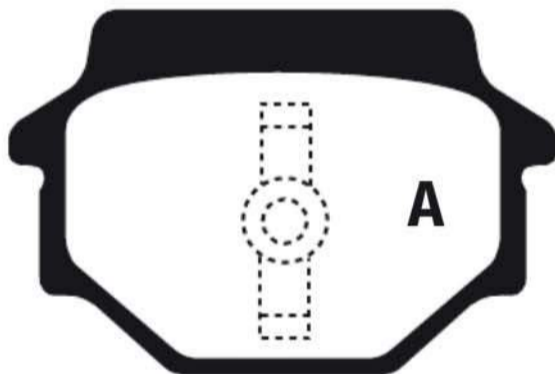

55.5 x 37 x 10mm

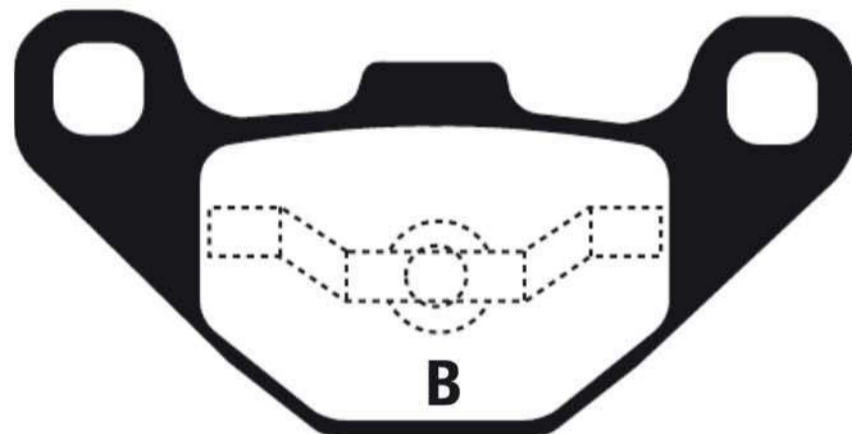

85 x 43 x 8mm

BUELL

S2/S3 Thunderbolt	94-97	R
M2 Cyclone	94-97	R
S1 Lightning	94-97	R

HISUN

110 Axis	14-16	R
110 Forge	14-16	R

HUSQVARNA

CR 125	91	R
WR 125	91	R
WR 240	90-91	R
CR 250	91	R
WR 250	90-91	R
WR 260	90-91	R
TE 350	90-91	R
TC 510	90	R
TE 510	90	R
TC 610	91	R
TE 610	91	R

STD	FA251	Premium Organic Street Pad Blend
------------	--------------	----------------------------------

Dealer Stocking Recommendation

SAME AS FA67 BUT WITH ANTI-DROP OUT HARDWARE

Equivalents OE#

42385 94Y

Single/Pair	Popularity #	Rec Stocking Level
1	-	1

FA252

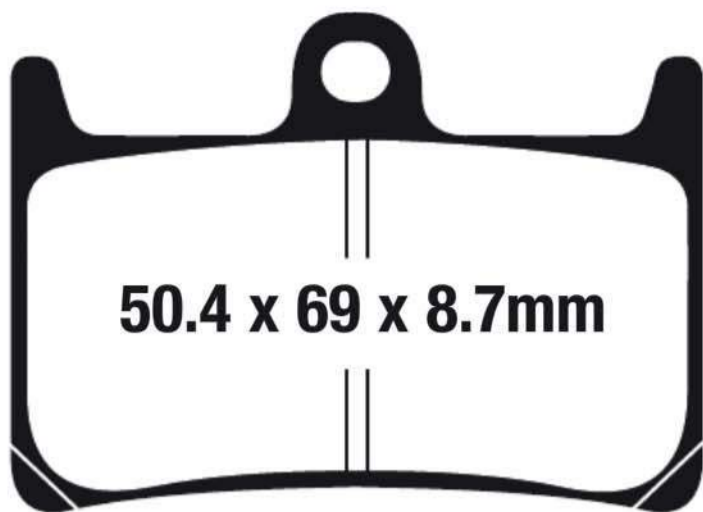

50.4 x 69 x 8.7mm

BUYERS GUIDE
BRAKE PADS

Dimension 1=Width or Diameter, Dimension 2=Height or Diameter, Dimension 3=Thickness (Material and backplate)

NOTE:- Size identification is shown as follows

YAMAHA

FZR 400 RRSP/RR/RW	91-92
YZF 600 RJ/RK/RL/RM/RN/RP/RR/RS/RT/RV	97-07
YZF 600 RRL/RRM/RRN/RRP/RRR/RRS "R6"	99-04
YZF R6S (YZFR SV/SW/SX/SY) (298mm rotor)	06-09
FZ6 W/X/Y (4 piston caliper)	07-09
FZ-07 (689cc/2Cyl)	15-17
FZ-07 A (689cc/2Cyl/ABS)	17
XSR 700 (MTM 690-U)	18
YZF 750 R7 OW02 Road version	99-01
FJ-09 (847cc/3 Cyl)	15-16
FZ-09 (847cc/3 Cyl)	14-17
FZS 1000 N/NC/P/PC/R/RC/S/RS/T 'FZ1'	01-05
YZF 1000 RJ	97
YZF R1	98-03
FJR 1300 R/RC	03-05
XV 1700 Road Star S 9 Spoke Cast XV17 ASX/ASY/ASZ/ASA/ASB	08-14
XV 1700 Road Star Silverado Spoke Wheel XV17 ATW	07
XV 1700 Road Star Silverado S 9 Spoke Cast Wheel XV17 ATSA/ATSB	11-14
XV 1700 Road Star Midnight Warrior 5 Spoke Cast Wheel XV17	
PCMV/PCMVC/PCMW/PCMX/PCMY	06-09
XV 1700 Road Star Warrior 5 Spoke Cast Wheel XV17 PCV/PCW/PCX	06-08
XV 1700 Road Star Silverado Spoke Wheel XV17 ATX/ATY/ATZ	08-10
XV 1700 Road Star 9 Spoke Cast XV17 AWX	08
XV 1700 Road Star (Solid front discs/Spoke wheels)	
XV17 AT/ATC/AV/AVC/ATW	05-07
XV 1700 Road Star Midnight (Floating front discs/ 9 Spoke Cast Wheel) (XV17 AMT/AMTC/AMV/AMVC	05-06
XV 1700 Road Star Midnight Warrior (Front floating discs/ 3 spoke cast wheel) XV17 PCTC/PCT/PCTB/PCTCB	05
XV 1700 Road Star (Front floating discs/9 spoke cast wheels) XV17 AWT/AWTC/AWW/AWVC	05-06

YAMAHA Contd.

F	XV 1700 Road Star 9 spoke cast wheels		
F	XV17 AS/ASC/AWY/AW/AWC	04-07/09	F
F	XV 1700 Road Star Midnight Floating front discs/ 9 spoke cast wheels XV17 AMS/AMSC/AMW/AMWC	04-07	F
F	XV 1700 Road Star Midnight Silverado (Floating front discs/9 cast spoke wheels) XV17 ATMS/ATMSC/ATMT/ATMW/ATMTC/ATMV/ATMVC	04-07	F
F	XV 1700 Road Star Warrior (Floating disc/3 spoke cast wheels) (XV17 PCS/PCT)	04-05	F
F	XV 1900 Roadliner	06-07	F
F	XV 1900 Roadliner Midnight	06-09	F
F	XV 1900 Roadliner S	06-10/12-13	F
F	XV 1900 Stratoliner	06-09	F
F	XV 1900 Stratoliner Midnight	06-08	F
F	XV 1900 Stratoliner S	06-14	F
F	XV 1900 Stratoliner Deluxe	11-14	F
F	XV 1900 Raider	08-14	F
F	XV 1900 Raider S	08-14	F
F	XV 1900 Raider SCL	12-14	F
F	SFA252		
F	YAMAHA		
F	XP 500 Y/Z/A (T-Max)	09-11	F

Equivalents OE#

1D7 W0045 00	5VN W0045 00
3MA W0045 00	5SL W0045 00
3TJ W0045 00	5SL 25805 00
4SV W0045 00	1WS 25805 00

STD	FA252	Premium Organic Street Pad Blend
	FA252HH	Street Performance Sintered Pad Blend
OPTIONS	EPFA252HH	Fast Street Use & Track Day Sintered Pad Blend
	SFA252	Premium Organic Scooter Pad Blend
	SFA252HH	Scooter Performance Sintered Pad Blend

Dealer Stocking Recommendation

Single/Pair	Popularity #	Rec Stocking Level
2	-	2

FA254



HARLEY DAVIDSON

XL883 L Super Low (Cast Wheel)	14-18	R
XL883 N Iron (Cast Wheel)	14-18	R
XL883 R Roadster (Cast Wheel)	14-15	R
XL1200 C Custom (Spoke Wheel)	14-18	R
XL1200 CX Roadster	16-18	R
XL1200 T Superlow	14-18	R
XL1200 V Seventy Two	14-16	R
XL1200 X Forty Eight	14-17	R
XL1200 Forty Eight Anniversary	18	R

HONDA

VT 750 C2E Shadow Aero (ABS/Rear Disc Model)	13-14	R
VT 750 C2S Shadow Spirit (ABS/Rear Disc Model)	13-14	R

KAWASAKI

ZX-7RR (ZX 750 N1/N2)	96-99	R
Concours 14 (ZG 1400 B8F/B9F/DAF)	08-10	R
Concours 14 ABS (ZG 1400 A8F/A9F/CAF/CBF/CCF/CDF/CEF/EFF/EGF)	08-16	R
ZX14R Ninja (ZX 1400 A6F/A7F/C8F/C9F/CAF/CBF/ECF/ECFA/EDF/EDFA/EEF)	06-14	R
ZX14R Ninja ABS (ZX 1400 FDF/FEFA/FFFA/FFFB/HGF/HHF) ABS Model	13-17	R
ZX14 R Ninja (ABS/SE Model) ZX1400 JGF/JHF	16-17	R

MZ

1000 S	03-05	R
--------	-------	---

SUZUKI

GSXR 600 K4/K5/XK5	04-05	R
GSXR 750 K4/K5/XK5	04-05	R
GSXR 1000 K1/K2/K3/K4/ZK4/K5/K6	01-06	R

Equivalents OE#

43082 0055	69100 18810
43082 1182	41300053
69100 40820	

STD	FA254	Premium Organic Street Pad Blend
OPTION	FA254HH	Street Performance Sintered Pad Blend
OPTION	FA254V	Semi Sintered Long Lasting Street Pad Blend

Dealer Stocking Recommendation

Single/Pair	Popularity #	Rec Stocking Level
1	-	1

FA256

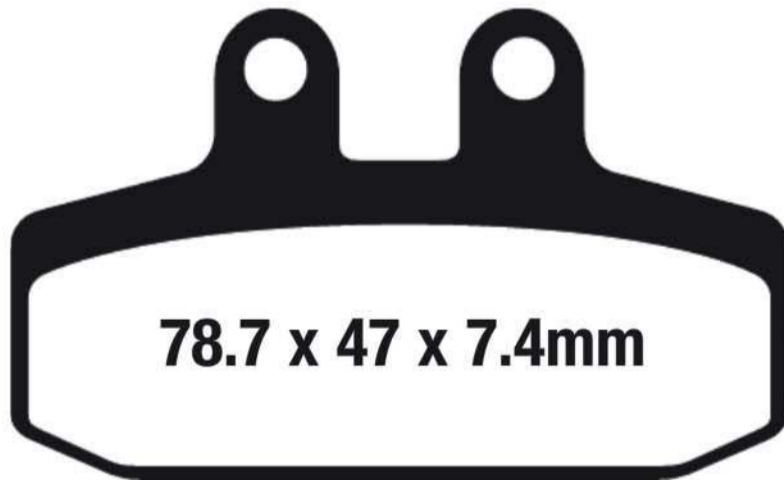

APRILIA

Mana 850	08-12	R
Mana 850 GT ABS	09-15	R

MOTO GUZZI

V7 Racer	12-15	R
V7 Special	12-15	R
V7 Stone	12-15	R

SFA256

APRILIA

Scarabeo 150	99-03	F
Atlantic 500	03-05	F
Scarabeo 125/250 GT	04-05	F
Sport City 125 (4T)	08-14	F
Sporty City 250	07-14	F
Sport City Cube 250	08-09	F
Scarabeo 500/ie	03-14	F

Equivalents OE#

8113865

STD	FA256	Premium Organic Street Pad Blend
OPTIONS	FA256HH	Street Performance Sintered Pad Blend
OPTIONS	SFA256	Premium Organic Scooter Pad Blend
OPTIONS	SFA256HH	Scooter Performance Sintered Pad Blend

Dealer Stocking Recommendation

Single/Pair	Popularity #	Rec Stocking Level
1	-	1

SFA257



41.1 x 43
x 7.7mm

DAELIM

E-Five 50
S-Five 50
Delfino 100

03-09 F
01-09 F
01-09 F

Equivalents OE#

45105 GAZ 5000

STD SFA257 Premium Organic Scooter Pad Blend

Dealer Stocking Recommendation

Single/Pair	Popularity #	Rec Stocking Level
1	-	-

SFA257/2



41.1 x 43
x 5.3mm

APRILIA

Mana 850 Parking brake 08-12
Mana 850 GT ABS (Parking brake) 09-15

BMW

C600 Sport 12-14
G650 GT 12-15
G650 GT Special Edition 15

HONDA

FSC 600/D Parking brake 02-06
FSC 600 A Parking brake 03-11
FSC 600 D Parking brake 07-10
CTX700D (Auto G/Box) Parking Brake 14-17
CTX700ND (Naked/Auto G/Box) Parking Brake 12-16
NM4 - NC 700 JD (DCT) 15-16 F
NSA 700 A9 (DN01) 09-11
CRF 1000 LADG/LADH Africa Twin (DCT/ABS) - Parking Brake 16-17
VFR 1200 FD (Auto G/Box) Parking Brake 10-14
VFR 1200 XD DCT (Automatic Transmission Model) - Parking Brake 16-17

PIAGGIO

MP3 (250cc) (3 wheeler) Parking Brake 07-15
MP3 400ie (Three wheeler) Parking Brake 07-15
MP3 500 (Three wheeler - 12" Front / 14" Rear Wheel) 07-14
MP3 500 Sport ABS (Three wheeler - 13" Front / 14" Rear Wheel) 15-16

Equivalents OE#

06436 MCT 006	34 21 8 526 263
648476	06436 MCT 016
649830	06455 MG3 D32
34 21 8 526 263	

STD SFA257/2 Premium Organic Scooter Pad Blend

Dealer Stocking Recommendation

Single/Pair	Popularity #	Rec Stocking Level
1	-	-

FA258

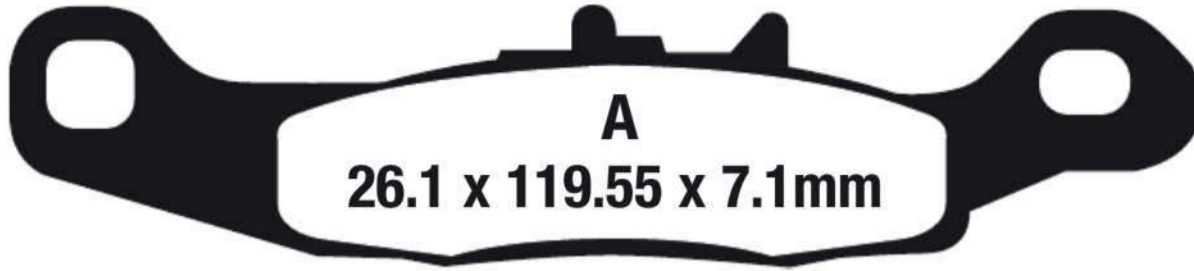

A
26.1 x 119.55 x 7.1mm

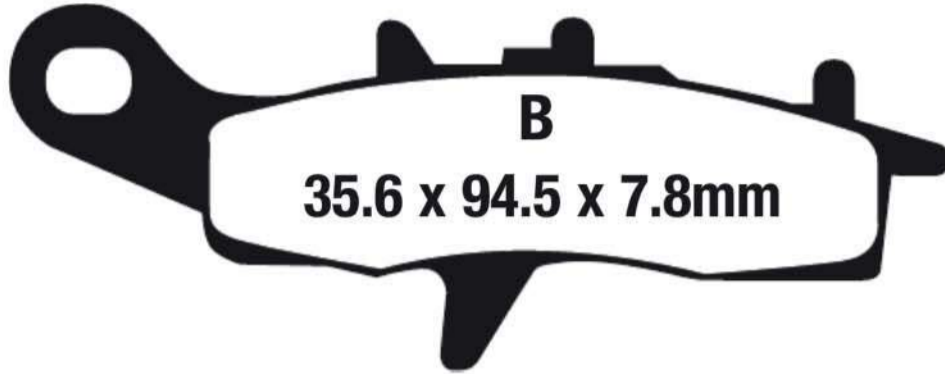

B
35.6 x 94.5 x 7.8mm

Equivalents OE#

43082 1196	43082 1255
43082 1206	59301 03820

KAWASAKI

KX 80 R7/W1/W2/W3
 KX 85 A1/A2/A3/A4/A5/A6F/A7F/A8F/A9F/AAF/ABF/ACF/ADF/CEF/CFF/CGF/CHF
 KX 100 B7/C1/C2/C3/D1/D2/D3/D4/D5/D6F/D7F/D8F/D9F/DBF/DCF/DDF/FEF/FFF/FGF/FHF
 KL 250 G4/G5/G6/G7/G8 "Super Sherpa"

SUZUKI

RM 85 LK5/K5/LK6/K6/K7/LK7/K8/LK8/K9/LK9/L0/LL0/L2/LL2/LL5/LL6/LL7
 RM 100 K3

97-00	F
01-17	F
97-09/11-17	F
00-04	F
05-12/15-17	F
03	F

STD	FA258X	Carbon Dual Purpose Pad Blend
OPTION	FA258R	Utility Grade Sintered Pad Blend

Dealer Stocking Recommendation

Single/Pair	Popularity #	Rec Stocking Level
1	-	1

SFA260



35 x 49
x 7mm

CPI

GTR 50 05-09 R
 GTR 150 05-09 R

PIAGGIO

MP3 250 (12" Rear Wheel) 07-09 F
 MP3 250 LE (14" Rear Wheel) 10-14 F
 MP3 400ie (Three wheeler) 07-14 F
 MP3 500 (Three wheeler - 12" Front / 14" Rear Wheel) 07-14 F

VESPA

ET2 50cc 97-05 F
 LX 50 05-15 F
 S 50 4T/4V 08-15 F
 ET4 150cc 99-05 F
 LX 150 ie 05-15 F
 LXV 150 ie 10-15 F
 S 150 ie 08-15 F

Equivalents OE#

494097	494938
494938	647157
498846	

STD	SFA260	Premium Organic Scooter Pad Blend
OPTION	SFA260HH	Scooter Performance Sintered Pad Blend

Dealer Stocking Recommendation

Single/Pair	Popularity #	Rec Stocking Level
1	-	-

FA261

FA261/2

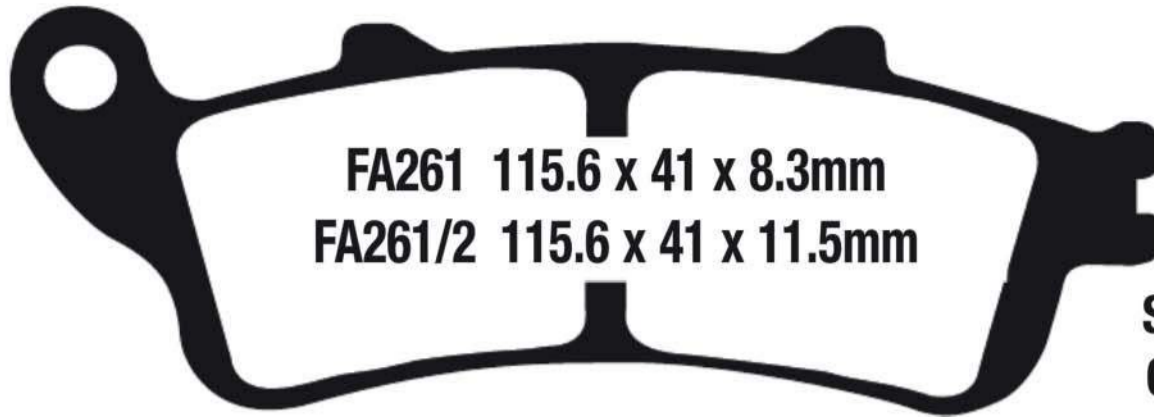

FA261 115.6 x 41 x 8.3mm
FA261/2 115.6 x 41 x 11.5mm

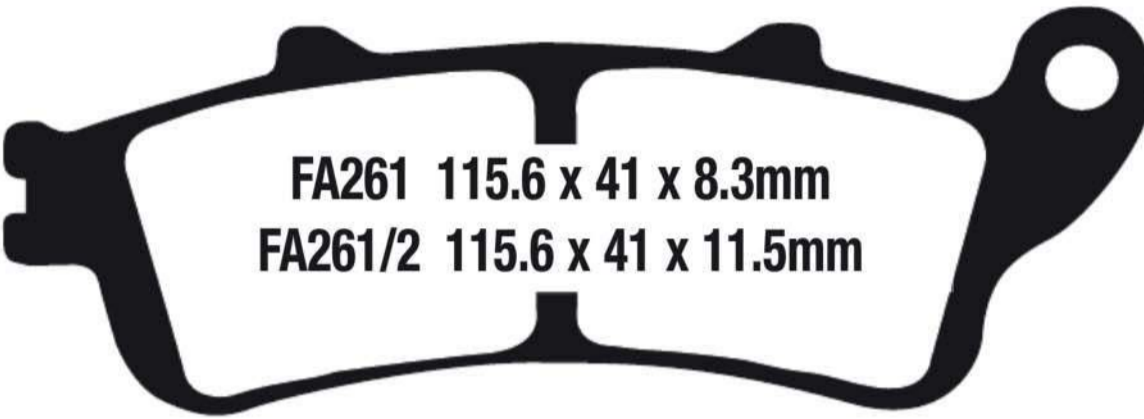

FA261 115.6 x 41 x 8.3mm
FA261/2 115.6 x 41 x 11.5mm

NOTE
DO NOT REFIT O/E SHIM/INSULATOR ON FA261HH ONLY TO FA261/2HH VERSION.

★ SAFETY NOTICE ★
LINKED BRAKE
FIT ALL THREE SETS AT PAD CHANGE

FA261

HONDA

NT 700 V/VA	10-13	R
VFR 800 Fi Interceptor	98-05	F & R
VFR 800 A Interceptor ABS	02-05	F & R
VFR 800 Interceptor	06-09	R
XL 1000 VA Varadero (Canada)	08	R
CBR 1100 XX 'Blackbird'	97-03	F & R
CTX 1300	14	R
CTX 1300 DLX (ABS)	14	R
ST 1100 A ABS model	96-02	F & R
ST 1300 ABS/ST 1300	02-13	R
VT 1300 CXA (Fury ABS)	10-15	R
GL 1800/1800 A (ABS) Goldwing All models	01-17	F
F6B Goldwing (GL1800B)	13-17	F
F6B Goldwing Deluxe (GL1800BD)	13-17	F
NRX 1800 Rune (DA/DB/EA/EB)	04-05	F & R
VTX 1800 R (Cast Wheels)	02-08	F & R
VTX 1800 C/C1/C2/C3	02-08	F & R
VTX 1800 S (Spoke Wheels)	02-07	F
VTX 1800 F1/F2/F3	05-11	F
VTX 1800 N1/N2/N3	04-11	F
VTX 1800 T1/T2	07-11	F

VICTORY

Vision Street	08-09	F
Vision Tour (All models)	08-17	F
Vision 8 Ball	10-11	F
Arlen Ness Victory Vision	09-12	F

FA261/2

HONDA

VT 1300 CSA Sabre ABS	10-14	R
VT 1300 CRA Stateline ABS	10-15	R
VT 1300 CTA Interstate ABS	10-15	R
GL 1800/1800 A (ABS) Goldwing (All models)	01-17	R
Goldwing F6B (GL1800B)	13-17	R
Goldwing F6B Deluxe (GL1800BD)	13-17	R
GL 1800 C Valkyrie	14-15	R
VTX 1800 S (Spoke Wheels)	02-07	R
VTX 1800 F1/F2/F3	05-11	R
VTX 1800 N1/N2/N3	04-11	R
VTX 1800 T1/T2	07-11	R

Equivalents OE# - FA261

06435 MAJ G41	06455 KPB 406
06435 MAT 006	2204195
06455 MAJ G41	2204724
06455 MCA 006	

Equivalents OE# - FA261/2

06435 MCA 016	06435 MFR A01
06435 MLA 016	06435 MCA 006

Dealer Stocking Recommendation

Single/Pair	Popularity #	Rec Stocking Level
2	-	4

STD	FA261HH	Street Performance Sintered Pad Blend
OPTIONS	FA261V	Semi Sintered Long Lasting Street Pad Blend
OPTIONS	EPFA261HH	Fast Street Use & Track Day Sintered Pad Blend
OPTIONS	FA261/2HH	Street Performance Sintered Pad Blend
OPTIONS	FA261/2V	Semi Sintered Long Lasting Street Pad Blend
OPTIONS	EPFA261/2HH	Fast Street Use & Track Day Sintered Pad Blend

EPFA263

AP/LOCKHEED AFTERMARKET CALIPER

6 Piston/2 Pins (CP4466)

PFM AFTERMARKET CALIPER

6 Piston Superbike Caliper

RACE USE ONLY

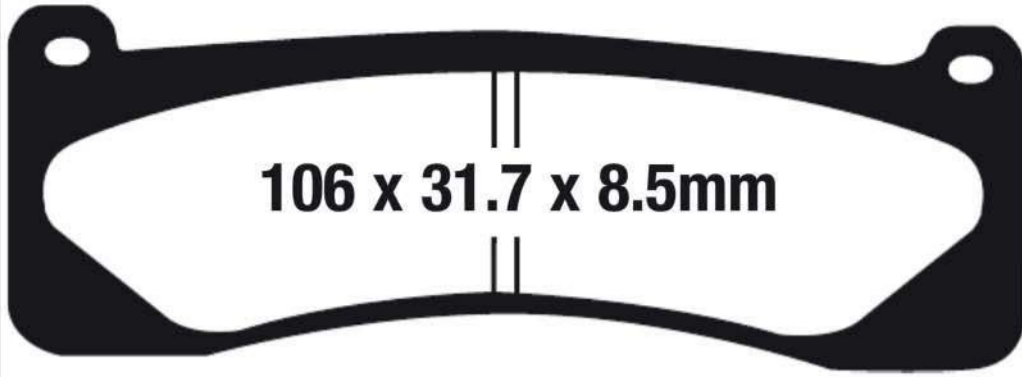

106 x 31.7 x 8.5mm

Equivalents OE#

CD4466/4467

STD EPFA263HH Fast Street Use & Track Day Sintered Pad Blend

Dealer Stocking Recommendation

Single/Pair
2

Popularity #
-

Rec Stocking Level
2

SFA264

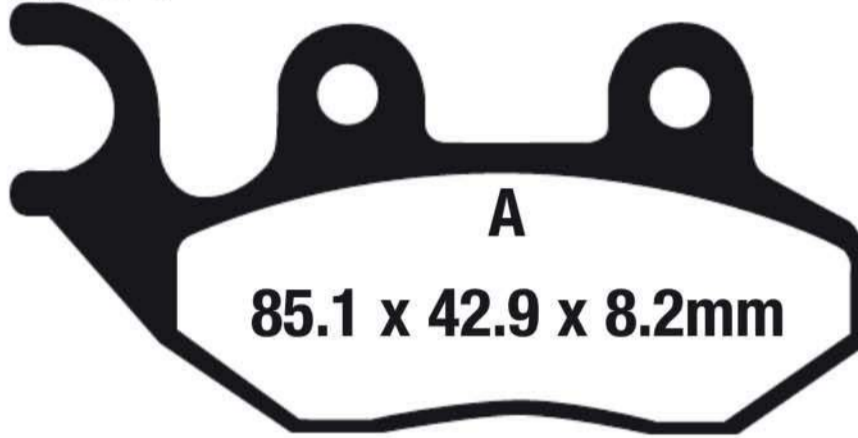

85.1 x 42.9 x 8.2mm

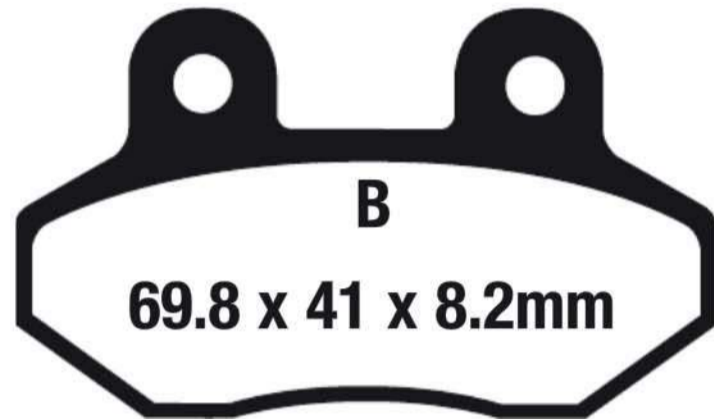

69.8 x 41 x 8.2mm

DAELIM

A-Four (50cc)

06-09

F

E-TON

Beamer R4-150 (PN2F)

F

Beamer R2 50 (PN2G)

F

Matrix 50

09

F

Matrix R4-150

09

F

Sport 50

09

F

SYM

Fiddle 50

08-11

F

Jet Euro 50

99-12

F

Jet 50 EVO

14

F

Simply 50

07-12

F

Fiddle II 125 (AW 125 W)

08-14

F

HD200 EVO

13-14

F & R

Citycom 300i (LH 300W)

08-14

F & R

TGB SCOOTER

Delivery 50 (Up to E/No 609099)

05-06

F

U.M.

DTF 90

06-08

F

DTF 110

06-08

F

Matrix 150 XX

05-06

F

Matrix II-150

07-08

R

ZERO ELECTRIC BIKE

DS ZF6.0/DF9.0 (2 Pin Fixing Pad)

10-12

F

MX (2 Pin Fixing Pad)

10-12

F

S ZF6.0 (2 Pin Fixing Pad)

10-12

F

X (2 Pin Fixing Pad)

10-12

F

XU (2 Pin Fixing Pad)

11-12

F

Equivalents OE#

413612

STD SFA264 Premium Organic Scooter Pad Blend

OPTION SFA264HH Scooter Performance Sintered Pad Blend

FA265

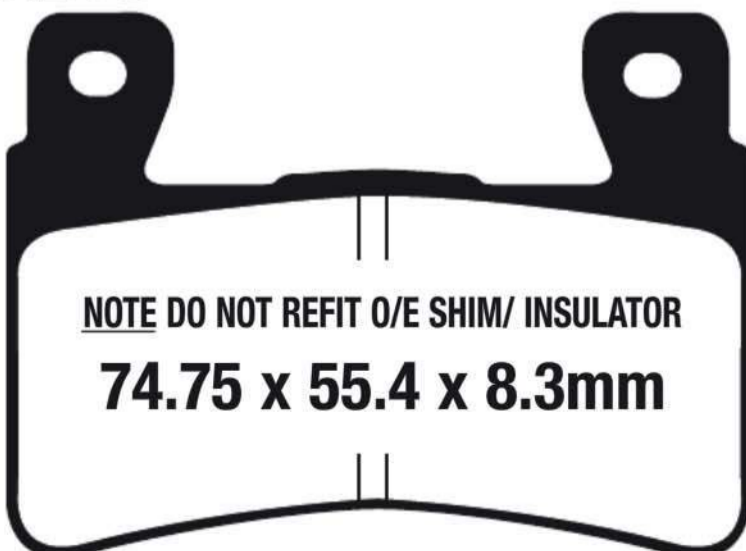

NOTE DO NOT REFIT O/E SHIM/ INSULATOR

74.75 x 55.4 x 8.3mm

HONDA

CBR 900 RR 'Fireblade'

98-99

F

CBR 929 RR (929cc model)

00-01

F

CBR 954 RR (954cc model)

02-03

F

RVT 1000 R (RC51)

00-06

F

Equivalents OE#

06455 MAS E01

STD FA265HH Street Performance Sintered Pad Blend

OPTIONS EPFA265HH Fast Street Use & Track Day Sintered Pad Blend

Dealer Stocking Recommendation

Single/Pair
2

Popularity #
-

Rec Stocking Level
2

BUYERS GUIDE
BRAKE PADS

NOTE:- Size identification is shown as follows
Dimension 1=Width or Diameter, Dimension 2=Height or Diameter, Dimension 3=Thickness (Material and backplate)

FA266



**54.05 x 50.9
x 7.9mm**

**BUYERS GUIDE
BRAKE PADS**

Dimension 1=Width or Diameter, Dimension 2=Height or Diameter, Dimension 3=Thickness (Material and backplate)

NOTE:- Size identification is shown as follows

APRILIA

ETV 1000 Caponord (Non ABS - Bolt fixing)	01-03	R
ETV 1000 Caponord Rally (Non ABS - Bush fixing)	03	R
ETV 1000 Caponord (ABS - Bush fixing)	04-07	R
RSV 1000 All models (All models)	98-03	R
RSV 1000 R Factory/R	04-12	R
SL 1000 "Falco" (All models)	00-05	R
RSV Tuono	02-09	R
RSV Tuono R/Factory R	02-10	R
Tuono V4 R APRC	11-13	R
Tuono V4 R APRC ABS	14-15	R
RSV4 R	09-12	R
RSV4 Factory	09-12	R
RSV4 Factort APRC SE	11-12	R
RSV4 R APRC	11-12	R
RSV4 Factory APRC ABS	13-15	R
RSV4 R APRC ABS	13-15	R

BENELLI

TNT 600i Tornado	16-17	R
------------------	-------	---

BOMBARDIER

Traxter (4x4)	99-00	F & R
Traxter XL (4x4)	01	F & R
Traxter XT (4x4)	00	F & R
Traxter Autoshift	01	F & R
Traxter Footshift	01	F & R

BREMBO AFTERMARKET CALIPER

20 6950 51 - 2 Piston P2/32 Rear Caliper		
20 6951 12//50/63 - P2/34 Rear Caliper		

CAGIVA

Raptor/V-Raptor 650/1000	01-02	R
--------------------------	-------	---

DERBI

GPR 50 Nude	04-05	F
GPR 80 Cup	05	F

DUCATI

620 Multistrada		
(Twin disc/single pin pad fixing)	06	R
620 Multistrada Dark		
(Single disc/twin pin pad fixing)	06	R
620 Sport	03	R
Monster 696	08-14	R
M 696 Monster - 20th Anniversary Model	13-14	R
749 Dark	04-06	R
749 R (Radial caliper)	04-06	R
749 S (Monoposto/Biposto)	03-06	R
749 (Monoposto/Biposto)	03-06	R
750 Supersport	99	R
750 Supersport IE	00-02	R
750 Sport	01-02	R
Hypermotard 796	10-13	R
796 Monster (Non ABS)	10-14	R
796 Monster (ABS)	10-15	R
M 796 Monster - 20th Anniversary Model	13-14	R
800 Supersport	03-05	R
Hypermotard(821cc)	13-15	R
HypermotardSP (821cc)	13-15	R
Hyperstrada(821cc)	13-15	R
Monster 821	15-17	R
Monster Dark 821	15	R
Monster Stripe 821	15-17	R
848	08-09	R

DUCATI Contd.

848 Evo (Monobloc Front Calipers)	10-13	R
848 Evo Corse Special Edition	12-13	R
848 Streetfighter	12-15	R
899 Panigale	14-15	R
900 Supersport	98-99	R
900 Supersport IE	00-01	R
900 Sport	02	R
900 MH Evoluzione	00-01	R
ST4 (916cc)	99-00	R
Supersport (936cc)	17	R
Supersport S (936cc)	17	R
939 Hypermotard	16-17	R
939 Hypermotard SP	16-17	R
939 Hyperstrada	16	R
ST2 (944cc)	97-03	R
959 Panigale ABS	16-17	R
ST3 S (ABS Model) (992cc)	06-07	R
ST4S (996cc)	01-05	R
996 Monster (ABS)	10-12	R
999 S (Std Caliper Mount)		
(Monoposto/Biposto)	03-04	R
999 S (Radial mount caliper)		
Monoposto/Biposto	05-06	R
999 (Std Mount Caliper)	03-06	R
999 R (Radial mount caliper)	03-06	R
Desmosedici (989cc) DD16RR	08	R
Multistrada 1000 DS/S 1000 DS (992cc)	03-05	R
Supersport 1000 DS (992cc)	03-06	R
Streetfighter (1099cc)	09-12	R
Streetfighter S (1099cc)	09-12	R
Hypermotard 1100/1100 S	07-09	R
Hypermotard 1100 Evo	10-12	R
Hypermotard 1100 Evo SP	10-13	R
Monster 1100/1100 S	09-10	R
Monster 1100 EV (ABS)	11-12	R
Multistrada 1100 (1078cc)	07-09	R
Multistrada 1100 S (1078cc)	07-09	R
1098	07-08	R
1098 S	07-08	R
1098 S Tricolore (1099cc)	07	R
1098 R	08-09	R
Monster 1100	09-10	R
Monster 1100 S	09-10	R
1100 Monster Evo	11-14	R
1100 Monster (ABS)	09-10	R
1100 Monster S (ABS)	09-10	R
1100 Monster Diesel	13-14	R
M 1100 Evo Monster		
- 20th Anniversary Model	13-14	R
1198	09-12	R
1198 S	09-11	R
1198 SP	11-12	R
1198 R Corse Special Edition	11	R
1199 Panigale	12-15	R
1199 Panigale S	12-15	R
1199 Panigale S Tricolore	12-14	R
1199 Panigale R	13-15	R
1199 Panigale Superleggera	14-15	R
1200 Monster	14-17	R

DUCATI Contd.

1200 S Monster	14-17	R
1200 S Monster Stripe	15	R
1200 R Monster	16-17	R
Multistrada 1200	10-15	R
Multistrada 1200 S (Sport)	10	R
Multistrada 1200 S Pikes Peak	11-14	R
Multistrada 1200 S Grandtourismo	13-14	R
Multistarda 1200 S Touring	10-14	R
1299 Panigale	15-17	R
1299 Panigale S	15-17	R
1299 Panigale R	15-17	R

GOGORO

SmartScooter	15-17	F
--------------	-------	---

HONDA

MSX 125 GROM (Brembo Aftermarket Single Pin Caliper)	14-17	F&R
RC 213 V-S	15-17	R

INDIAN

Empulse TT	16	R
------------	----	---

KAWASAKI

Ninja H2/Carbon (ZX 1000 NNF/NGF/XHF)	15-17	R
Ninja H2R (ZX 1000 PFF/PGF/YHF)	15-17	R

KTM

1190 RC8	08-12	R
1190 RC8 R	09-14	R
1290 Superduke R	14-15	R

MOTO GUZZI

750 Nevada Club (From LK112434)	98-01	R
750 Nevada Base/Club	02-03	R
Nevada Classic 750 ie	04-09	R
V7 Cafe Classic	11-12	R
V 750 ie Brevia	03-08	R
V7 Classic	08-12	R
V7 Racer	10-11	R
MGS-01 1000cc	04-05	R

MOTUS

MST-01	12-13	R
MSTR-01	12-13	R
MST	14-17	R
MSTR	14-17	R

MV

Brutale 675	12-14	R
F3 675 Serie Oro	12	R
F3 675	12-14	R
Brutale 800	12-14	R
Rivale 800	13-14	R
Turismo Veloce 800	14	R
Turismo Veloce Lusso 800	14	R

SFA266

PIAGGIO

X9 500	05-09	R
BV 500	06-10	F&R

STD	FA266	Premium Organic Street Pad Blend
	FA266R	Utility Grade Sintered Pad Blend
	FA266HH	Street Performance Sintered Pad Blend
OPTIONS	FA266SV	High Durability Off Road Sintered Blend
	FA266V	Semi Sintered Long Lasting Street Pad Blend
	SFA266	Premium Organic Scooter Pad Blend
	SFA266HH	Scooter Performance Sintered Pad Blend

Equivalents OE#

613 4 021 1A	07BB2010
705 600 041	07BB2050
8000 95280	8133542
8000 B5975	

Dealer Stocking Recommendation

Single/Pair	Popularity #	Rec Stocking Level
1	-	1

FA267



**51.85 x 59.75 x
8.9mm**

YAMAHA

YZF 750 R7 OW02 Road version
YZF 1000 R1

99-00 R
98-01 R

Equivalents OE#

4XV W0046 00

Dealer Stocking Recommendation

Single/Pair	Popularity #	Rec Stocking Level
1	Y23	1

STD FA267 Premium Organic Street Pad Blend
OPTION FA267HH Street Performance Sintered Pad Blend

SFA268



**45.8 x 52.8 x
6.5mm**

YAMAHA

EW 50 Stunt (5LH2/5YN1)

01-03 F

Equivalents OE#

5BR F5811 00
5BR FS811 10

STD SFA268 Premium Organic Scooter Pad Blend
OPTION SFA268HH Scooter Performance Sintered Pad Blend

FA270



**73.85 x 52.8 x
6.82mm**

POLARIS

All disc rear brake models - check application pages for main fitments.

Equivalents OE#

2201093	1910339
2201189	1930860
2202411	

Dealer Stocking Recommendation

Single/Pair	Popularity #	Rec Stocking Level
1	P4	2

STD FA270X Carbon Dual Purpose Pad Blend
OPTIONS FA270SV High Durability Off Road Sintered Blend
OPTIONS FA270R Utility Grade Sintered Pad Blend

FA271



**67.6 x 43.95 x
7.7mm**

Equivalents OE#

0402 096	0402 882
0502 019	0402 886
0402 494	0436 293

ARCTIC CAT

- 250 (2 x 4)
 - 250 (2 x 4 / 4 x 4)
 - 300 (2 x 4 / 4 x 4)
 - 375 (Auto)
 - 400 (Auto 2 x 4 / 4 x 4)
 - 400 (2 x 4 / 4 x 4)
 - 400 (2 x 4)
 - 400 2 x 4 Utility
 - 400 4 x 4 Auto Act Utility
 - 400 4 x 4 Auto Utility
 - 400 4 x 4 ACT
 - 400 4 x 4 Utility
 - 400 2 x 4 Auto Utility
 - Bearcat 454 (4 x 4)
 - Bearcat 454 (2 x 4)
 - 454 Bearcat (2 x 4)
 - 454 Bearcat (4 x 4)
 - 500 (4 x 4)
 - 500 (Auto)
 - 500 (4 x 4) Manual
 - 500 4 x 4 Auto TRV Utility
 - 500 4 x 4 Auto TBX Utility
 - 500 4 x 4 Auto Utility
 - 500 4 x 4 Utility / Manual Gearbox
- WILWOOD AFTERMARKET CALIPER**
PS1 Caliper (Part # 150-4091K)

- 99-00 F & R
- 01-04 F & R
- 98-04 F & R
- 01 F & R
- 03-04 F & R
- 98/00-04 F & R
- 98 F & R
- 98-04 F & R
- 04 F & R
- 04 F & R
- 04 F & R
- 00-04 F & R
- 04 F & R
- 96-98 F & R
- 97-98 F & R
- 97-98 F & R
- 96-98 F & R
- 98-02 F & R
- 00-04 F & R
- 03-04 F & R
- 04 F & R
- 04 F & R
- 98-04 F & R
- 98-04 F & R

STD	FA271X	Carbon Dual Purpose Pad Blend
OPTIONS	FA271R	Utility Grade Sintered Pad Blend

Dealer Stocking Recommendation

Single/Pair	Popularity #	Rec Stocking Level
1	A1	2

FA273



**60.7 x 50.3 x
12.3mm**

POLARIS

- Magnum 425 96 Middle Axle Brake
- Big Boss 400 L 96 Middle Axle Brake
- Ranger 99 R

Equivalents OE#

2200807
2201304

STD	FA273R	Utility Grade Sintered Pad Blend
------------	---------------	----------------------------------

Dealer Stocking Recommendation

Single/Pair	Popularity #	Rec Stocking Level
1	P3	2

FA275



99.77 x 30.2 x 9mm

YAMAHA

TW 200 N/NC/P/PC/R/RC/S/SCT/TC/VC/W/WC/X/Y/Z/A/B/D/E/F	01-15	F
XT 225 N/NC/P/PC/R/RC/S/SC/T/TC/VC/W/WC	01-07	F
XT 250 X/Y/Z/A/B/D/E/F/G/H	08-17	F
YZF 600 RRL/RRM/RRN/RRP 'R6'	99-02	R
YZF 1000 R1	02-03	R

SFA275

YAMAHA

AT 115-C Nuovo (5MX6/2D51)	05-06	F
AT 115 (21P1)	07	F
RXS 115 (3HB8)	99	F
YP 250 Majesty (5GM2/9-5SJ2/5/9)	00-03	R
T10SE Crypton (5AM4)	99-02	F
T105SE Crypton (1D81/1D82)	03-09	F

Equivalents OE#

3C5 25805 00
3C5 W0045 00
5EB W0046 00
5LB W0045 00
4JG W0045 00
4US W0045 10
5PW W0046 50
5GM W0046 00

STD	FA275	Premium Organic Street Pad Blend
OPTION	FA275X	Carbon Dual Purpose Pad Blend
OPTION	FA275HH	Street Performance Sintered Pad Blend

Dealer Stocking Recommendation

Single/Pair	Popularity #	Rec Stocking Level
1	Y24	1

FA276

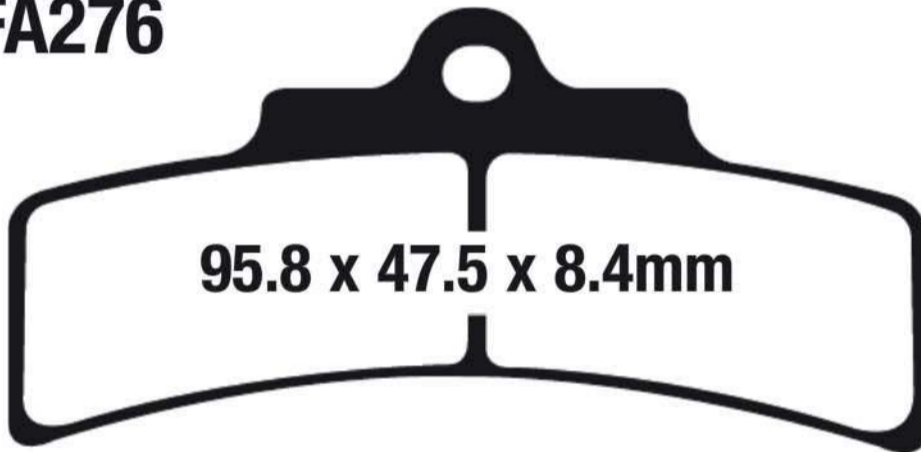

95.8 x 47.5 x 8.4mm

PVM AFTERMARKET CALIPER
6 Piston (new small design)

Equivalents OE#

N/A

STD	GPFA276HH	Sintered Race Use Only (Closed Circuit)
------------	------------------	---

Dealer Stocking Recommendation

Single/Pair	Popularity #	Rec Stocking Level
2	N/A	0

FA281



115.6 x 41 x 9.3mm

115.6 x 41 x 9.3mm

KAWASAKI

EN 650 Vulcan S (Non ABS) EN 650 AFF/AGF/CHF	15-17	F
EN 650 Vulcan S (ABS) EN 650 BFF/BGF/DHF	15-17	F

SFA281

HONDA

NSS 250/250 A/AS Reflex	01-07	F
FSC 600 Silverwing	02-10	F
FSC 600/D Silverwing Non ABS Model (256mm f/disc)	02-06	F

Equivalents OE#

06455 KFG 016
06455 KFG 641
06455 MCT 016

Dealer Stocking Recommendation

Single/Pair	Popularity #	Rec Stocking Level
1	-	1

STD	FA281HH	Street Performance Sintered Pad Blend
OPTION	SFA281HH	Scooter Performance Sintered Pad Blend

FA282



HYOSUNG

TE 50	05-08	R
TE 90	05-08	R
TE 100	05-08	R

Equivalents OE#

59500 21000

Dealer Stocking Recommendation

Single/Pair	Popularity #	Rec Stocking Level
1	HK4	1

STD FA282R Utility Grade Sintered Pad Blend

SFA283/4



SUZUKI

AN 400 K3/K4/K5/K6/SK6 Burgman 03-06 F

Equivalents OE#

59301 14870

59301 14880

Dealer Stocking Recommendation

Single/Pair	Popularity #	Rec Stocking Level
2	-	2

STD SFA283/4 Premium Organic Scooter Pad Blend

OPTIONS SFA283/4HH Scooter Performance Sintered Pad

FA291

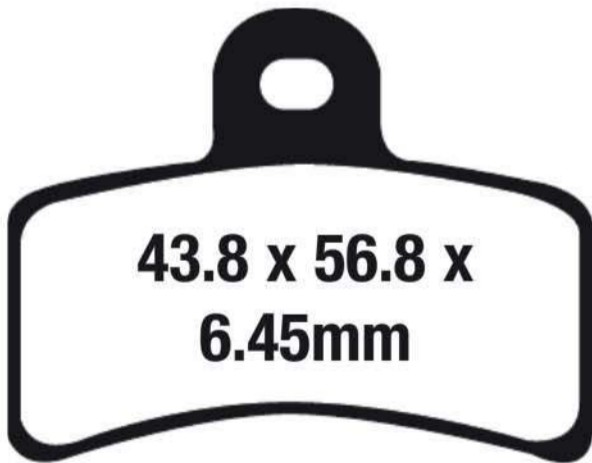

GAS-GAS

EC 50 (Boy)	01-04	F&R
EC 50 (Rookie)	01-04	R
EC 50	05	R
SM 50 (Rookie)	01-04	R
SM 50	05	R
TXT 50 (Boy)	01	F&R
TXT 50/80 (Rookie)	02-03	F&R
Pampera 125/250/280	04	R
TXT 125/200/249/280/321	00-03	F&R
TXT 200/270/321	99	F&R
Pampera 250	02-03	R

Equivalents OE#

BT 280022065

Dealer Stocking Recommendation

Single/Pair	Popularity #	Rec Stocking Level
-	-	-

STD FA291X Carbon Dual Purpose Pad Blend

FA294

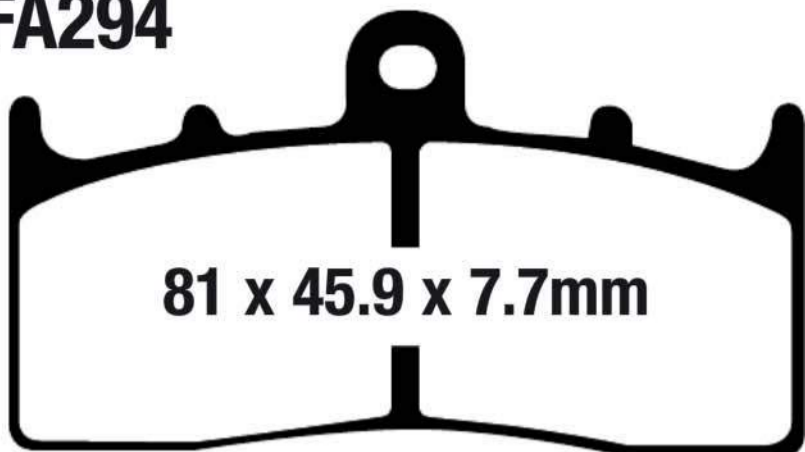

81 x 45.9 x 7.7mm

BMW

R 850 R	03-06	F
R 1100 S	12/00-06	F
R 1150 R	01-06	F
R 1150 R Rockster	03-06	F
R 1150 RS	01-05	F
R 1200 CL	02-04	F
K 1200 LT (Evo Integral ABS)	11/00-09	F
K 1200 R	05-09	F
R 1200 C Montauk	04-05	F
R 1200 R (K27)	06-11/07	F
R 1200 R (Disc has fixed bobbins)	08-14	F
K 1300 R	09-15	F

Equivalents OE#

43082 1217	34 11 7 655 898
34 11 7 658 386	34 11 769 0169

STD FA294HH Street Performance Sintered Pad Blend
OPTION EPFA294HH Fast Street Use & Track Day Sintered Pad Blend

Dealer Stocking Recommendation

Single/Pair	Popularity #	Rec Stocking Level
2	-	2

EPFA295HH

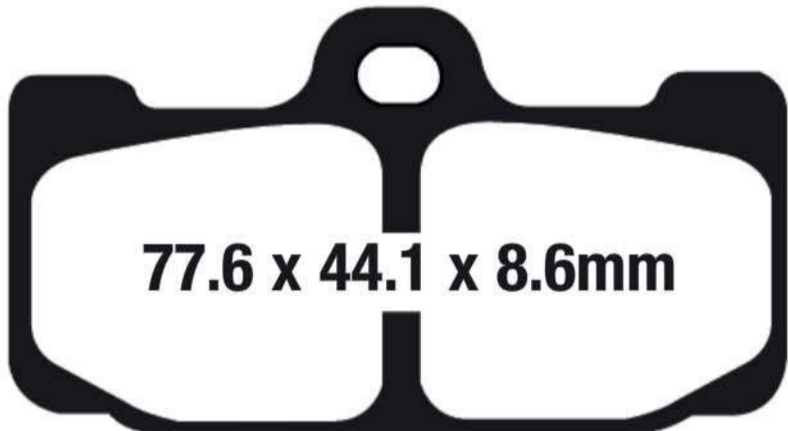

77.6 x 44.1 x 8.6mm

BREMBO

X9737 80/81 Radial Mount Endurance Caliper 108mm Spacing

Equivalents OE#

107684612

Dealer Stocking Recommendation

Single/Pair	Popularity #	Rec Stocking Level
1	N/A	0

STD EPFA295HH Fast Street Use & Track Day Sintered Pad Blend
OPTION GPFA295HH RACE USE ONLY

FA296

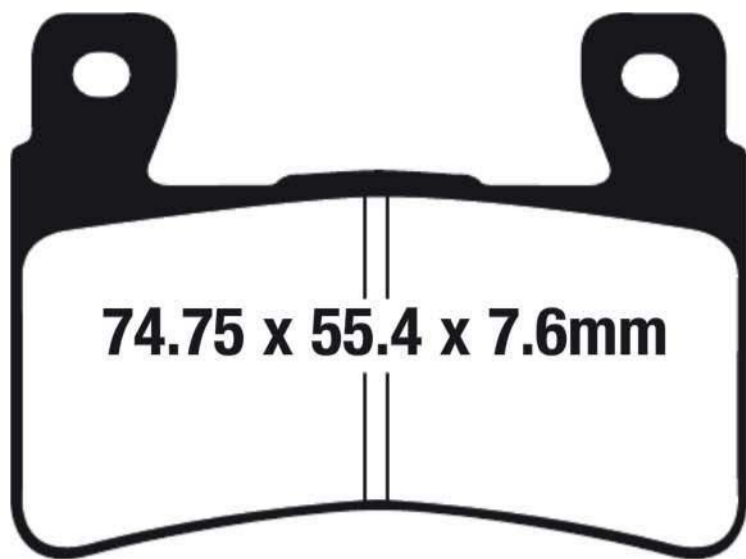

74.75 x 55.4 x 7.6mm

BUYERS GUIDE
BRAKE PADS

Dimension 1=Width or Diameter, Dimension 2=Height or Diameter, Dimension 3=Thickness (Material and backplate)

NOTE:- Size identification is shown as follows

HARLEY DAVIDSON

XR 1200	08-10	F
XR 1200 X	10-12	F
FLS Softail Slim	15-17	F
FLSS Softail Slim S	16-17	F
FLSTC Heritage Softail Classic	15-17	F
FLSTF Fat Boy	15-17	F
FLSTFB Fat Boy Lo	15-17	F
FLSTFBS Fat Boy S	16-17	F
FLSTN Softail Deluxe	15-17	F
FXSB Breakout	15-17	F
FXST Softail Standard	15	F
FLFB Fat Boy	18	F
FLFBS Fat boy 114	18	F
FLFBS Fat Boy Anniv	18	F
FLHC Heritage Classic	18	F
FLHCS Heritage Classic 114	18	F
FLHCS Heritage Classic 114 Anniv.	18	F
FLSL Softail Slim	18	F
FXBR Breakout	18	F
FXBRS Breakout 114	18	F
FXBRS Breakout 114 Anniv	18	F
FLDE Deluxe	18	F
FXBB Street Bob	18	F
FXFB Fat Bob	18	F
FXBS Fat Bob	18	F
FXLR Low Rider	18	F

HONDA

CBR 600 F4/F4i Sport	99-06	F
CBR 600 RR	03-04	F
CB1100 (Non ABS)	13-14	F
CB 1100 EX (ABS)	14-17	F
GL 1800 C Valkyrie	14-15	F

HYOSUNG

ST7 Custom	10-11	F
------------	-------	---

KAWASAKI

ZX6R (ZX 636 EDF/EEF/EFF/EGF/EHF) 636cc/Non ABS	13-17	F
ZX6R (ZX 636 EEFA) 636cc/30th Anniversary Edition /Non ABS	15	F
ZX6R (ZX 636 EGFA/EHFA) 636cc/Non ABS/KRT Edition	16-17	F
ZX6R (ZX 636 FDF/FEF/FFF/FGF/FHF) 636cc/ABS	13-17	F
ZX6R (ZX 636 FFFA) 636cc/30th Anniversary Edition /Non ABS	15	F
ZX6R (ZX 636 FGFA/FHFA) 636cc/ ABS/KRT Edition	16-17	F

Dealer Stocking Recommendation

Single/Pair	Popularity #	Rec Stocking Level
2	N/A	4

STD	FA296HH	Street Performance Sintered Pad Blend
OPTIONS	EPFA296HH	Fast Street Use & Track Day Sintered Pad Blend
OPTIONS	GPFAX296HH	Race Only Sintered Pad Blend

Equivalent OE#

06455 MBW 006	41300102
59330 HPP 700	06455 MJM D41
42739-08	

FA298



**50.96 x 53.4 x
9.5mm**

APRILIA		
RS 125	06-12	R
SFA298		
APRILIA		
SR50 (Factory)	04-15	R
Scarabeo 150	99-03	R
Sport City Cube 250	08-09	R
Atlantic 500	03-05	R
Atlantic 200	04-06	R
Scarabeo 125/250 GT	04-05	R
Scarabeo 200	08-14	R
Scarabeo 250	06-08	R
Sport City 250	07-14	R
Scarabeo 500 ie	03-14	R
BETA		
Eikon 150	04	R
MALAGUTI		
F18 Warrior	03-04	R

STD	FA298	Premium Organic Street Pad Blend
OPTIONS	FA298HH	Street Performance Sintered Pad Blend
	SFA298	Premium Organic Scooter Pad Blend
	SFA298HH	Scooter Performance Sintered Pad Blend

Dealer Stocking Recommendation

Equivalents OE#	8113869	8113577	8213462
Single/Pair	1		
Popularity #	-		
Rec Stocking Level	1		

SFA301

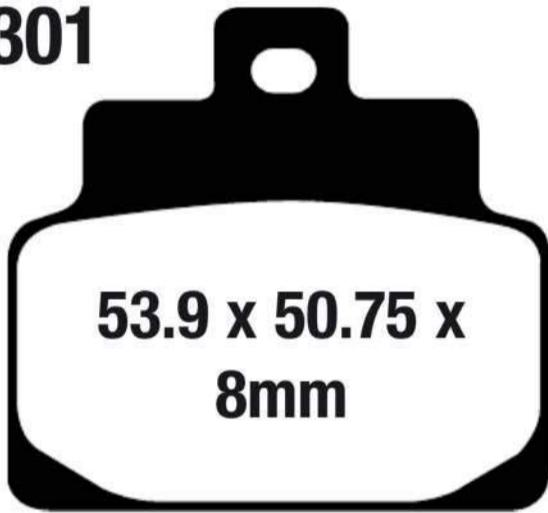

**53.9 x 50.75 x
8mm**

APRILIA	
Mojito Custom 150	05-09

Equivalents OE#	8213460
------------------------	---------

Dealer Stocking Recommendation

Single/Pair	-		
Popularity #	-		
Rec Stocking Level	-		

STD	SFA301	Premium Organic Scooter Pad Blend
OPTION	SFA301HH	Scooter Performance Sintered Pad Blend

**BUYERS GUIDE
BRAKE PADS**

**NOTE:- Size identification is shown as follows
Dimension 1=Width or Diameter, Dimension 2=Height or Diameter, Dimension 3=Thickness (Material and backplate)**

FA302



KAWASAKI

KX 65 A1/A2/A3/A4/A5/A6F/A7F/A8F/A9F/AAF/ABF/ACF/ADF//AEF/AFF/AGF/AHF 00-17 F

SUZUKI

RM 65 K3/K4/K5 03-05 F

Equivalents OE#

43082 0042
43082 1242
K4308-21242

STD	FA302X	Carbon Dual Purpose Pad Blend
OPTIONS	FA302R	Utility Grade Sintered Pad Blend
OPTIONS	MXS302	Sintered Sport Off Road Pad Blend

Dealer Stocking Recommendation

Single/Pair	Popularity #	Rec Stocking Level
1	N/A	2

FA303



Equivalents OE#

45105 NNZ 830
25-25352

Dealer Stocking Recommendation

Single/Pair	Popularity #	Rec Stocking Level
1	-	-

STD FA303X Carbon Dual Purpose Pad Blend

BETA

Evo 80	09-12	F
Evo 80 JR	09-12	F
Rev 3 (125/200/250/270)	00-04	F&R
Rev 3 125/200	05	F&R
Rev 3 125/200	06-08	F
Evo 125 (2T)	10-15	F
Evo 200 (2T)	10-15	F
Rev 3 250/270	05-08	F
Evo 250 (2T)	09-15	F
Evo 250 (4T)	09-15	F
Evo 300 (2T)	09-15	F
Evo 300 (4T)	09-15	F

GAS-GAS

EC 50 Boy (LC)	05	F
TX 200 Randonne (4T)	14-15	
TXT 70 Cadet/Rookie	10-11	F
TXT 80 Rookie/Cadet	04-08	F
TXT 80 Cadet Pro	15	F
TXT 125/200/250/280/300 (TXT Pro)	04-15	F
TXT 250/280/300 Raga	07-11	F

MONTESA

315 R	01-04	F
4RT Cota (250cc)	05-08	F
4RT Cota Standard Edition (260cc)	09-17	F

SCORPA

SR 125 (2T)	11	F
SY 250	03-10	F
SY 250 Long Ride	05-09	F
SY 250 F	06-09	F
SY 250 FR	11	F
SR 280 (2T)	11	F

SHERCO

2.5/2.9 (2T)	03-10	F
3.2 (4T)	05-10	F

FA304



75.05 x 54.9 x 8.97mm

BMW

R 1200 CL
K 1200 LT

02-04 R
97-09 R

Equivalents OE#

34-21 2 333 337
34 21 7 680 374
34 21 7 657 492
34 21 7 671 246

STD	FA304	Premium Organic Street Pad Blend
OPTION	FA304HH	Street Performance Sintered Pad Blend
OPTION	FA304V	Semi Sintered Long Lasting Street Pad Blend

Dealer Stocking Recommendation

Single/Pair	Popularity #	Rec Stocking Level
1	N/A	1

FA305



A. 84.95 x 43.5 x 8.6mm



B. 69/95 x 36 x 10.96mm

ARCTIC CAT

50 4x4 Auto Youth	08	R
DVX 50 (Y6)	06	R
50 Utility	06-08	R
50 DVX (4T)	06-08	R
50 DVX (4T) Sport	06/08	R
DVX 90 (Y12 4 Stroke)	06-09	R
90 2x4 (4T) Youth Rear Disc Model	06	R
90 Utility (2x4)	06-11	R
90 DVX	06-14	R
90 DVX SE	09	R
90 SE	09	R
90 (Reverse Gear Model)	10-14	R
150 Utility	09-14	R

KAWASAKI

KFX 50 (KSF 50 B7F/B8F/B9S/BDF/BEF/BFF/BGF/BHF)	07-09/13-17	R
KFX 90 (KSF 90 A7F/A8F/A9F/AAF/ABF/ACF/ADF/AEF /AFF/AGF/AHF)	07-17	R

KYMCO ATV

Mongoose 70 (4T)	07-16	R
Mongoose 90	02-16	R
Mongoose 90 R (Reverse gear)	10-14	R
MXer 150	03-05	R
MXU 150	05-16	R

SFA305

KYMCO STREET

Like 50 (2T)	09-14	F
Like 50 LX (2T)	12-14	F
People 50 (2T)	02-12	F
People S50 (4T)	05-09	F
Super 8 (50cc) (2T)	07-14	F
People S 125	05-09	F
People 150	07-12	F
Super 8 (150cc)	07-14	F
Like 200i	10-15	F
People S 200	05-10	F
Super 9 (2T/AC)	02-09	R

KYMCO ATV

MXer 150	03-05	R
MXU 150	05-14	R
Mongoose 50 (4T) (Rear disc model)	08-09	R
Mongoose 70 (4T)	07-16	R
Mongoose 90	02-16	R
Mongoose 90 R (Reverse Gear)	02-14	R

SYM

HS 125/200	04-08	F
HD 125 (LH 125 W)	08-12	F
HD 200	08-12	F

Equivalents OE#

45105 KFA6 3050	3303 446
45105 LDC8 305	3303 567
43082 Y001	3305 139

STD	SFA305	Premium Organic Scooter Pad Blend
OPTIONS	FA305X	Carbon Dual Purpose Pad Blend
	FA305R	Utility Grade Sintered Pad Blend
	SFA305HH	Scooter Performance Sintered Pad Blend

Dealer Stocking Recommendation

Single/Pair	Popularity #	Rec Stocking Level
1	N/A	1

SFA306

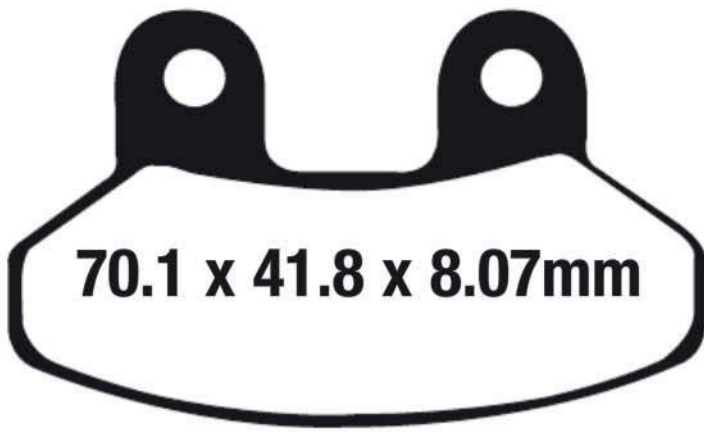

70.1 x 41.8 x 8.07mm

SYM

RS 50
RV 200 EVO

04-10 F
12-14 F

Equivalents OE#

45105 H3A 000A

STD SFA306 Premium Organic Scooter Pad Blend

Dealer Stocking Recommendation

Single/Pair	Popularity #	Rec Stocking Level
1	N/A	1

FA307



A. 82.08 x 40.85 x 9.46mm



B. 62.03 x 40.8 x 9.46mm

BOMBARDIER/BRP

Rally 200	05-06	R
Outlander 330 HO	04-05	F Left & R
Outlander 400	03-05	F Left & R
Outlander 400 Max HO	03-06	F Left & R
Traxter Autoshift	01-05	F Left & R
Traxter Footshift	01	F Left
Quest 500 (2x4)	02	F Left
Quest 500 (4x4)	02-04	F Left
Quest 650 (2x4)	02	F Left
Quest 650 (4x4)	02-04	F Left
Quest 650 XT (4x4)	02	F Left
Quest Max 650	03-05	F Left
DS 650	00-05	F Left & R
DS 650 Baja/X	01-06	F Left & R
Traxter Max	03-04	F Left
Traxter Max 650	04-05	F Left
Outlander 650 HO EFI 4x4/HO EFI XT 4x4	06	F Left & R
Outlander Max 650 HO EFI 4x4/HO EFI XT 4x4	06	F Left & R
Traxter XL (7920/7921)	04	F Left
Quest Max/Std/XT	04-05	F Left
Outlander 800 (All models)	06	F Left & R

CAN-AM

Rally 200 (4A7A/B/C/D/E/F)	07	R
Outlander 400 (4x4 STD) (2D7A/B/C/D/E/F/G/H 4x4 STD)	07-14	F Left & R
Outlander 400 (XT 4x4) (2E7A/B/C/D/E/F)	07-14	F Left & R
Outlander Max 400 (STD 4x4) (2F7B/C/D/E/F/G/H/J)	07-14	F Left & R
Outlander Max 400 (XT 4x4) (2G7A/B/C/D/E)	07-08	F Left & R
Outlander 500 (STD 4x4) (2T7A/B/C/D)	07-12	F Left & R
Outlander 500 (XT 4x4) (2U7A/B/C/D)	07-12	F Left & R
Outlander Max 500 (Std 4x4) (2W7A/B/C)	07-12	F Left & R
Outlander Max 500 (XT 4x4) (2X7A/B/C)	07-12	F Left & R
Renegade 500 (4x4/EFI)	08-11	F Left & R
DS 650 X (3B7A/B)	07	F Left & R
Outlander 650 (4x4 STD) (2N7A/B/C/D/E/F/G/H)	07-11	F Left & R
Outlander 650 (XT 4x4) (2P7A/B/C/D/E/F)	07-11	F Left & R
Outlander Max 650 (STD 4x4) (2R7A/B/C/D/E/F/G/H/J/K)	07-11	F Left & R
Outlander Max 650 (XT 4x4) (2S7A/B/C/D/E/F)	07-10	F Left & R
Outlander Max XT-P 650	12	F Left & R
Outlander 800 (STD 4x4) (2H7A/B/C/D/E/F/G/H)	07-08	F Left & R
Outlander 800 (XT 4x4) (2J7A/B/C/D/E/F)	07-08	F Left & R
Outlander 800 R EFI	09	F Left & R
Outlander 800 R XT	09-10	F Left & R

CAN-AM Contd.

Outlander 800 R (XMR)	11	F Left & R
Outlander 800 R (XXC)	11	F Left & R
Outlander Max XT-P 800 R	12	F Left & R
Outlander Max 800 Ltd 4x4 (2M7A/B/C)	07-08	F Left & R
Outlander Max 800 (Std 4x4) (2J7A/B/C/D/E/F/G/H/J)	07-11	F Left & R
Outlander Max 800 (XT 4x4) (2L7A/B/C/D/E/F)	07-11	F Left & R
Outlander Max 800 R EFI	09-11	F Left & R
Outlander Max 800 R XT	09-10	F Left & R
Renegade 800 X (4x4/EFI)	08	F Left & R
Renegade 800 (4x4/EFI)	07-08	F Left & R
Renegade 800 R EFI	09-11	F Left & R
Renegade 800 R X	09-11	F Left & R
Renegade 800 R (XXC)	11	F Left & R
Commander Max 1000 DPS/XT	14	R Left
Commander Max 1000 LTD	15	R Left
Maverick 1000 - STD	13	R Left
Maverick 1000 - XRS	13	R Left
Maverick 1000 - XRS -DPS	14-15	R Left
Maverick 1000 - XMR	14-15	R Left
Maverick 1000 - XXC	14-15	R Left
Maverick Max 1000 - STD	14-15	R Left
Maverick Max 1000 - XRS-DPS	14-15	R Left

JOHN DEERE ATV

Trail Buck 500/650 EX/EXT	04-08	F Left
Buck 500/650 EX/EXT	04-08	F Left

YAMAHA

YFM 400 FAM/FAN/FAP	00-02	R
YFM 400 AM/AN	00-01	R
YFM 400 FAHM/MC/N/NC/P Kodiak 4x4 Kodiak Hunter	00-02	R
YFM 400 FAT/FAHT/FAV	05-06	R
YFM 450 FAR/FAS/FAT/FAHT/FAV Kodiak	03-06	R
YFM 450 FGW/FGX/FGY/FGZ Grizzly 4x4	07-10	R
YFM 450 FXV/FXW/FXX/FXY/FXZ Wolverine Auto 4x4	06-10	R
YFM 450 450 FXSEW Wolverine Sport Special Edition	07	R

Equivalents OE#

5GH W0046 00	59100 31860
705 600 014	1D9 W0046 00
5GH W0046 10	705600398
072 6000015	705600349
C705 600014	

Dealer Stocking Recommendation

Single/Pair	Popularity #	Rec Stocking Level
1	N/A	4

STD FA307X Carbon Dual Purpose Pad Blend

OPTIONS FA307R Utility Grade Sintered Pad Blend

OPTIONS FA307SV High Durability Off Road Sintered Blend

FA313

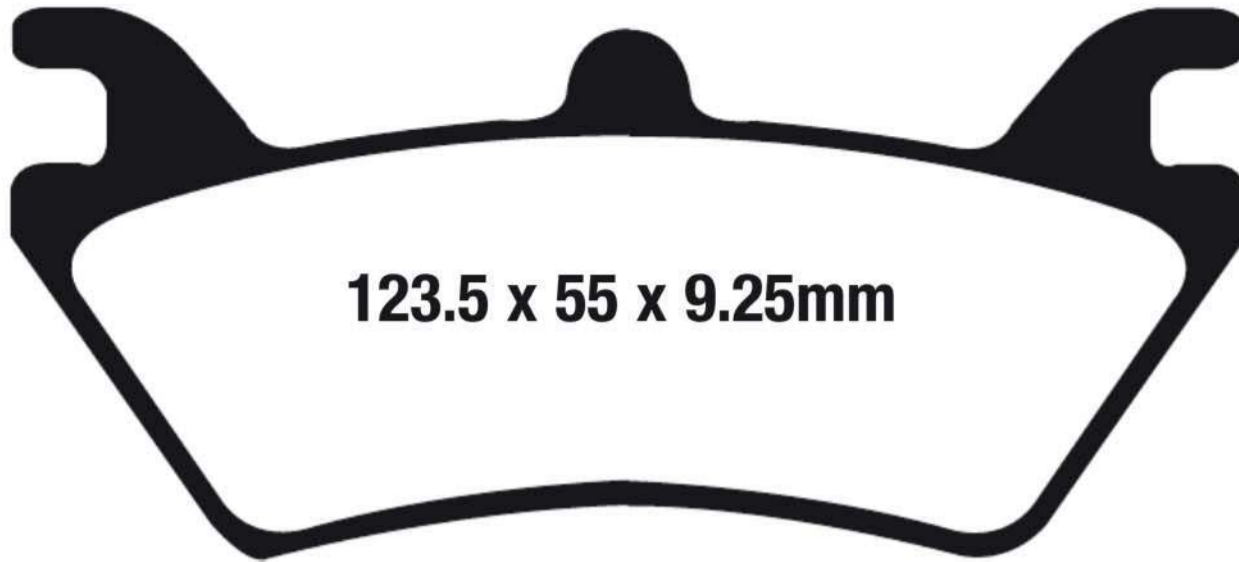

123.5 x 55 x 9.25mm

POLARIS

Sportsman 6x6 (500) 00-08 R
 PPS/PTV 6X6/Series 10 R
 PPS LUH 6X6 02 R

Equivalents OE#

1910450
2201685
2201749

STD	FA313R	Utility Grade Sintered Pad Blend
OPTIONS	FA313SV	High Durability Off Road Sintered Blend

Dealer Stocking Recommendation

Single/Pair	Popularity #	Rec Stocking Level
1	N/A	1

FA314

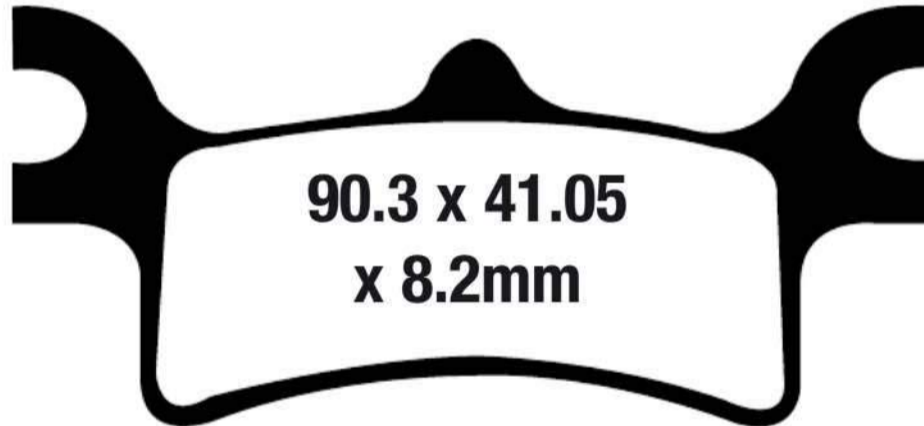

**90.3 x 41.05
x 8.2mm**

POLARIS

Trail Blazer 250 05-06 R
 Magnum 325/500 02-03 R
 Magnum 330 (2x4/4x4) 03-06 R
 Trail Boss 330 05-09 R
 330 Trail Boss 10-13 R
 330 Trail Blazer 08-12 R
 Sportsman 400 03-05 R
 Sportsman 450 07 R
 ATV Pro 500 4x4 PPS 02 R
 500 E Predator 06 R
 Scrambler 500 (4x4) 05-10 R
 500 Scrambler 4x4 10-12 R
 Scrambler 500 2x4 07-08 R
 Sportsman 500 HO/EFI 03-08 R
 500 Sportsman Touring EFI Quad 08-10 R
 500 Sportsman HO 08 R
 500 Sportsman Forest 12 R
 Sportsman 600 (4x4) 03-05 R
 Sportsman 700/EFI 02-06 R
 Sportsman 700 EFI 07 R
 Sportsman MV 700 05-06 R
 Sportsman 800 EFI/Touring 03-09 R
 800 Sportsman Big Boss/6x6/EFI 09-13 R
 800 Sportsman HO/EFI 08 R
 PPS/PTV 4X4/Series 10 R

Equivalents OE#

2201871	1910683
2202414	2203451

STD	FA314R	Utility Grade Sintered Pad Blend
OPTIONS	FA314SV	High Durability Off Road Sintered Blend

Dealer Stocking Recommendation

Single/Pair	Popularity #	Rec Stocking Level
1	N/A	1

BUYERS GUIDE
BRAKE PADS
NOTE:- Size identification is shown as follows
Dimension 1=Width or Diameter, Dimension 2=Height or Diameter, Dimension 3=Thickness (Material and backplate)

FA317

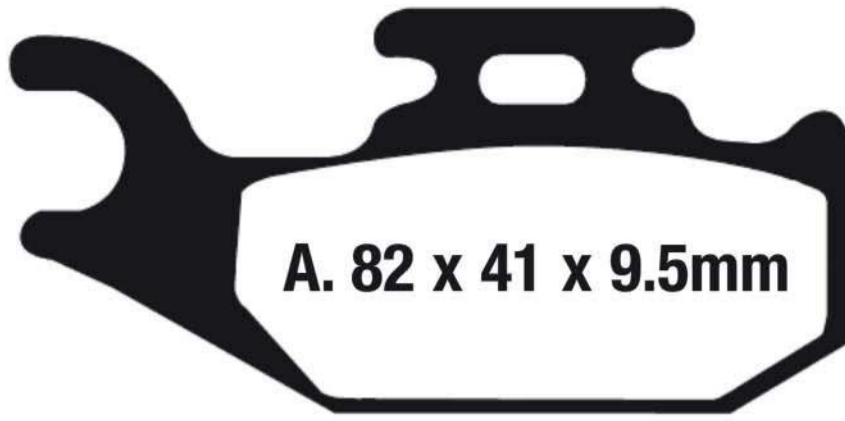

NOTE:- Size identification is shown as follows

BOMBARDIER/BRP

Outlander 330 HO	04-05	F Right
Outlander 400	03-05	F Right
Outlander 400 Max HO	03-06	F Right
Traxter (4x4)	01	F Right
Traxter XL (4x4)	01-04	F Right & R
Traxter XT (4x4)	01	F Right & R
Traxter Autoshift	01-05	F Right & R
Traxter Footshift	01	F Right & R
Quest 500 (2x4)	02	F Right
Quest 500 (4x4)	02-04	F Right & R
Quest 650 (2x4)	02	F Right & R
Quest 650 (4x4)	02-04	F Right & R
Quest 650 XT (4x4)	02	F Right & R
DS 650	00-05	F Right
DS 650 Baja/X	01-06	F Right
Outlander 650 HO EFI 4x4/HO EFI XT 4x4	06	F Right
Outlander Max 650 HO EFI 4x4/HO EFI XT 4x4	06	F Right
Quest Max 650	03-	F Right & R
Traxter Max	03-05	F Right
Traxter Max 650	04-05	F Right & R
Traxter XL (7920/7921)	04	F Right & R
Quest Max/STD/XT	04-05	F Right & R
Outlander 800 (All models)	06	F Right

CAN AM

DS 650 X (3B7A/B)	07	F Right
Outlander 400 (4x4 STD) (2D7A/B/C/D/E/F/G/H)	07-14	F Right
Outlander 400 (XT 4x4) (2E7A/B/C/D/E/F)	07-14	F Right
Outlander Max 400 (STD 4x4) (2F7B/C/D/E/F/G/H/J)	07-14	F Right
Outlander Max 400 (XT 4x4) (2G7A/B/C/D/E)	07-08	F Right
Outlander 500 (STD 4x4) (2T7A/B/C/D)	07-12	F Right
Outlander 500 (XT 4x4) (2U7A/B/C/D)	07-12	F Right
Outlander Max 500 (STD 4x4) (2WA/B/C)	07-12	F Right
Outlander Max 500 (XT 4x4) (2X7A/B/C)	07-12	F Right
Renegade 500 (4x4/EFI)	08-11	F Right
Outlander 650 (4x4 STD) (2N7A/B/C/D/E/F/G/H)	07-11	F Right
Outlander 650 (XT 4x4) (2P7A/B/C/D/E/F)	07-11	F Right
Outlander Max 650 (STD 4x4) (2R7A/B/C/D/E/F/G/H/J/K)	07-11	F Right
Outlander Max 650 (XT 4x4) (2S7A/B/C/D/E/F)	07-11	F Right
Outlander Max XT-P 650	12	F Right
Outlander 800 R EFI	09	F Right

CAN AM Contd.

Outlander 800 R XT	09-11	F Right
Outlander 800 R (XMR)	11	F Right
Outlander 800 R (XXC)	11	F Right
Outlander 800 (STD 4x4) (2H7A/B/C/D/E/F/G/H)	07-08	F Right
Outlander 800 (XT 4x4) (2J7A/B/C/D/E/F)	07-08	F Right
Outlander Max 800 Ltd 4x4 (2M7A/B/C)	07-08	F Right
Outlander Max 800 (STD 4x4) (2K7A/B/C/D/E/F/G/H/J)	07-08	F Right
Outlander Max 800 (XT 4x4) (2L7A/B/C/D/E/F)	07-08	F Right
Outlander Max 800 R EFI	09-11	F Right
Outlander Max 800 R XT	09-11	F Right
Outlander Max XT-P 800 R	12	F Right
Renegade 800 X (4x4/EFI)	08	F Right
Renegade 800 (4x4/EFI)	07-08	F Right
Renegare 800 R EFI	09-11	F Right
Renegade 800 R X	09-11	F Right
Renegade 800 R (XXC)	11	F Right
Commander Max 1000 DPS/XT	14	R Right
Commander Max 1000LTD	15	R Right
Maverick 1000 - STD	13	R Right
Maverick 1000 - XRS	13	R Right
Maverick 1000 - XRS -DPS	14-15	R Right
Maverick 1000 - XMR	14-15	R Right
Maverick 1000 - XXC	14-15	R Right
Maverick Max 1000 - STD	14-15	R Right
Maverick Max 1000 - XRS-DPS	14-15	R Right

CF MOTO

500 C-Force HO EPS	14-16	R
--------------------	-------	---

JOHN DEERE

Trail Buck 500/650 EX/EXT	04-08	F Right & R
Buck 500/650 EX/EXT	04-08	F Right & R

SUZUKI

LT-A 500 FK2 Vinson 4WD	02	R
-------------------------	----	---

STD FA317X Carbon Dual Purpose Pad Blend

OPTION FA317R Utility Grade Sintered Pad Blend

OPTION FA317SV High Durability Off Road Sintered Blend

Equivalent OE#

705 600 004	C705600004
705 600 150	C705600150
705 600 350	69100 03841
69100 03840	705601147

Dealer Stocking Recommendation

Single/Pair	Popularity #	Rec Stocking Level
1	N/A	1

SFA319 99.95 x 36.25 x 11.95mm

FA319/2 99.95 x 36.25 x 9.5mm

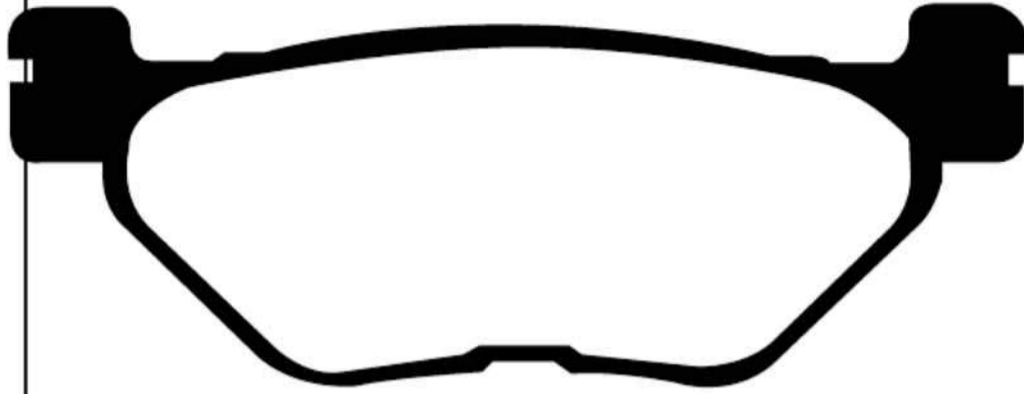

Dealer Stocking Recommendation

Single/Pair	Popularity #	Rec Stocking Level
1	N/A	1

Equivalents OE#
SFA319

5GJ W0045 00

Equivalents OE#
FA319/2

5JW W0046 00	2S3 W0046 00
5PS W0046 00	3D8 25806 00
1D7 W0046 00	

STD	SFA319	Premium Organic Scooter Pad Blend
STD	FA319/2	Premium Organic Street Pad Blend
OPTIONS	SFA319/2HH	Scooter Performance Sintered Pad Blend
OPTIONS	FA319/2V	Semi Sintered Long Lasting Street Pad Blend

SFA319

YAMAHA

XP 500 T-Max (5GJ5)	01	R
FA319/2		
YAMAHA		
SCR 950 (SCR 950 H)	17	R
XVS 950 (V-Star 950)	09-14	R
XVS 950 (V-Star 950 Tourer)	09-14	R
XVS 950 Bolt C Spec (Remote Reservoir Rear Shocks)	15-18	R
XVS 950 Bolt R Spec (Remote Reservoir Rear Shocks)	14-18	R
XT 1200 Z Super Tenere	12-18	R
XT 1200 Z Super Tenere ES	14-18	R
FJR 1300 R/RC/S/AS/T/AT	03-05	R
FJR 1300 AV/AW/AX/AZ/AA/AB	06-12	R
FJR 1300 AEV/AEW/AEX/AEY Electric Shift	06-09	R
FJR 1300 A	13-18	R
FJR 1300 ES	14-18	R
XVS 1300 V-Star 1300 Tourer	07-14	R
XVS 1300 V-Star	07-14	R
XVS 1300 V-Star Deluxe	13-14	R
XVS 1300 Stryker	11-14	R
VMX 1700 V-Max (6 piston radial caliper)	09-16	R
XV 1700 Road Star Midnight Warrior 5 spoke cast wheel XV17 PCMV/ PCMVC/PCMW/PCMX/PCMY	06-09	R
XV 1700 Road Star Warrior 5 spoke wheel XV17 PCV/PCW/PCX	06-08	R
XV 1700 Road Star Midnight Warrior (Front floating discs/3 spoke cast wheels) XV17 PCTC/PCTB/PCTCB	05	R
XV 1700 Road Star Warrior (Floating discs /3 spoke cast wheels) (XV17 PCS/PCT)	04-05	R
XV 1900 Roadliner	06-07	R
XV 1900 Roadliner Midnight	06-09	R
XV 1900 Roadliner S	06-10/12-14	R
XV 1900 Stratoliner	06-09	R
XV 1900 Stratoliner	06-08	R
XV 1900 Stratoliner S	06-14	R
XV 1900 Stratoliner Deluxe	11-14	R
XV 1900 Raider	08-14	R
XV 1900 Raider S	08-14	R
XV 1900 Raider SCL	12-14	R

FA320



69.75 x 42.6 x 7.45mm

MV

F4 750 (All models) (Nissin Calipers)	99-03	R
Brutale 750 (All models) (Nissin Calipers)	03-06	R
Brutale 910 S (Nissin Calipers)	05-07	R
Brutale 910 R (Brembo Calipers)	05-07	R
Brutale 989 R	08-09	R
Brutale 990 R	10	R
F4 (998cc)	10-14	R
F4R (998cc)	12-14	R
F4 RR(998cc)	12-14	R
F4 1000 (All models) (Nissin Calipers)	04-06	R
F4R 1000 (Brembo Calipers)	06-07	R
F4RR 312R 1000 (Brembo Calipers)	07	R
F4RR 312 1078cc	08-09	R
F4 100 CC (1078cc)	07	R
Brutale 1078 RR	08-09	R
F4 RR 1078	08-09	R
Brutale 1090	13-14	R
Brutale 1090 R	12-14	R
Brutale 1090 RR	10-14	R

Equivalents OE#

8000 82748

STD FA320HH Street Performance Sintered Pad Blend

Dealer Stocking Recommendation

Single/Pair	Popularity #	Rec Stocking Level
1	N/A	1

BUYERS GUIDE
BRAKE PADS

NOTE:- Size identification is shown as follows
Dimension 1=Width or Diameter, Dimension 2=Height or Diameter, Dimension 3=Thickness (Material and backplate)

SFA321



55.5 x 49 x 7.5mm

PIAGGIO

Fly 150 (4T/3V)	13-14	R
VESPA		
946 (155cc/ABS/4T/3V/ie)	13-15	R
GT 200 L Granturismo	05-09	R
GTS 250	05-09	R
GTV 250	07-09	R
LXV 250	07-09	R
GTS 300 ie	08-15	R
GTS 300 Super	10-15	R
GTV 300 ie	10-15	R
GT 60 (250cc Ltd Edition)	06-08	R

Equivalents OE#

497002
497348

STD SFA321 Premium Organic Scooter Pad Blend

OPTION SFA321HH Scooter Performance Sintered Pad Blend

Dealer Stocking Recommendation

Single/Pair	Popularity #	Rec Stocking Level
1	N/A	1

FA322/4



35 x 40.53
x 7.4mm
3mm
backplate

NOTE: Backplate thickness ONLY 3mm

NOTE - Backplate thickness must be 4.5mm

NOTE: FOR RACE USE GPFA604/4HH CAN BE USED

NOTE: Pads are sold as 4pcs per set - i.e. one caliper set

IMPORTANT NOTE: Do not use this pad for BMW S1000RR fitment or later TRIUMPH SPEED TRIPLE fitments- see FA604/4HH. Backplate thickness = 4.5mm

APRILIA

RSV Mille R/1000/Mille (All models) 01-03 F
RSV Tuono R/Factory R (Radial mount Caliper) 02-10 F
RSV 1000 R Factory/R 04-12 F

BENELLI

TNT 600i Tornado 16-17 F

BREMBO AFTERMARKET CALIPER

20 7860 11/21 4 Piston P4/34
20 8343 11/21 or 35/45 4 Piston P4/34

DUCATI

748 R 01-02 F
749 Dark (Monoposto/Biposto) 04-06 F
749 R (Radial caliper) 04-06 F
749 S (Monoposto/Biposto) 03-06 F
749 (Monoposto/Biposto) 03-06 F
996 R 01 F
S4RS Monster (998cc) (Radial 4 pad caliper) 06 F
S4R/S4RS Testastretta Monster (998cc) (Radial 4 pad caliper) 07-08 F
998 Matrix (998cc) 04 F
998 R (998cc) 02 F
998 S Bayliss/Bostrom 02 F
998 S (998cc) (4 pad caliper) 02-06 F
999 S (Std caliper mount) (Monoposto/Biposto) 03-04 F
999 (Std mount caliper) 03-06 F
999 R (Radial mount caliper) 03-06 F

HUSQVARNA

SMR 450 RR 06-08 F
SM 450 R 07-10 F
SM 510 R 06-11 F
SM 610 S 06 F
SM 610 IE 07-09 F
SM 630 09-10 F
SMS 630 10-11 F
STR 650 CRC 07 F

KTM

690 Duke (4 Separate Pad Type Caliper) 08-11 F
690 Duke R (4 Separate Pad Type Caliper) 10-11 F
690 SMC 08-11 F
950 Supermoto 05-08 F
950 Supermoto R 07-08 F
990 Superduke 05-11 F
990 Superduke T 07-11 F
990 SM-T 10-14 F

MOTO GUZZI

MGS-01 1000 cc 04-05 F

MOTUS

MST-01 12-13 F
MSTR-01 12-13 F

MV

Brutale 910 R (Brembo Calipers) 05-07 F
F4R 1000 (Brembo Calipers) 06-07 F
F4RR 312R 1000 (Brembo Calipers) 07 F

SHERCO

4.5iF Supermoto 08-12 F
SM4.5i 12-14 F

TM

SMX 450 F Competition (4T) 05-08 F
SMX 530 F Competition 05-08 F

TRIUMPH

Speed Triple (1050cc - 4 Pad Brembo F/Caliper/220mm R/Disc/Non ABS Model) 07-09 F
Speed Triple (1050cc - 4 Pad Brembo F/Caliper/220mm R/Disc/ABS Model) 07-09 F

Equivalents OE#

613 403 01A	A486 47	M478Z04
8223972	07BB0510	R320063112000
T2020715	07BB05RC	

STD FA322/4HH Street Performance Sintered Pad Blend

OPTIONS EPFA322/4HH Fast Street Use & Track Day Sintered Pad Blend

Dealer Stocking Recommendation

Single/Pair	Popularity #	Rec Stocking Level
1	N/A	1

FA323



81 x 42 x 9mm

YAMAHA

YFZ 450 V/W/X/Y/B/D	06-09/12-13	R
YFZ 450 RY/RZ/RA/RB/RD/RE/RSE/RF	09-15	R
YFZ 450 BBV/BBW Bill Balance Edition	06-07	R
YFZ 450 SPV/SEW/SPX Special Edition	06-08	R
YFZ 450 BB/DB	12-13	R
YFM 700 RD/RE Raptor	13-14	R

SFA323

HONDA

NHX 110 Elite	10-11	F
SH 150 i	10-11	F

U.M.

Powermax 150 XX	05-06	F
Matrix II-150	07-08	F

Equivalents OE#

5TG W0046 10
SG1 23 19

STD FA323X	Carbon Dual Purpose Pad Blend
OPTION FA323R	Utility Grade Sintered Pad Blend
OPTION SFA323	Premium Organic Scooter Pad Blend
OPTION SFA323HH	Scooter Performance Sintered Pad Blend

Dealer Stocking Recommendation

Single/Pair	Popularity #	Rec Stocking Level
1	N/A	1

SFA324



1 pad left, 1 pad right
117.5 x 41.3 x 8.6mm

Equivalents OE#

119 481 00
811 33603

APRILIA

Atlantic 200	04-06	F
Scarabeo 200	08-14	F
Scarabeo 250	06-08	F

KYMCO STREET

People GT 200 i	11-12	F
People GT 300i	11-15	F

Dealer Stocking Recommendation

Single/Pair	Popularity #	Rec Stocking Level
1	N/A	1

STD SFA324 Premium Organic Scooter Pad Blend

OPTION SFA324HH Scooter Performance Sintered Pad Blend

FA325



1 left / 1 right
43 x 25 x 5mm

COBRA

King 50	04-06	F&R
DC 65	06	R

HUSQVARNA

CR 50 Senior Pro	05	R
CR 50	11	F&R
SM 50	11	F&R

KTM

50 SX Pro Senior LC	02-03	F
50 SX Pro Senior LC/Mini Senior Adventure	02-07	F
50 Supermoto	06	F&R
SX 50 Junior LC	07-09	F
SX 50 Mini (F&R 10" wheels)	09-16	F&R
SX 50 Pro Senior (F12"/R10)	09-16	F&R

65 SX	04-09	R
XC 65	08-09	R

LEM

RX 2/3	03-08	F
--------	-------	---

Equivalents OE#

451 13 030 000	2025000712/1	BCKG0009
----------------	--------------	----------

STD FA325X	Carbon Dual Purpose Pad Blend
OPTION FA325R	Utility Grade Sintered Pad Blend

Dealer Stocking Recommendation

Single/Pair	Popularity #	Rec Stocking Level
1	N/A	1

FA335

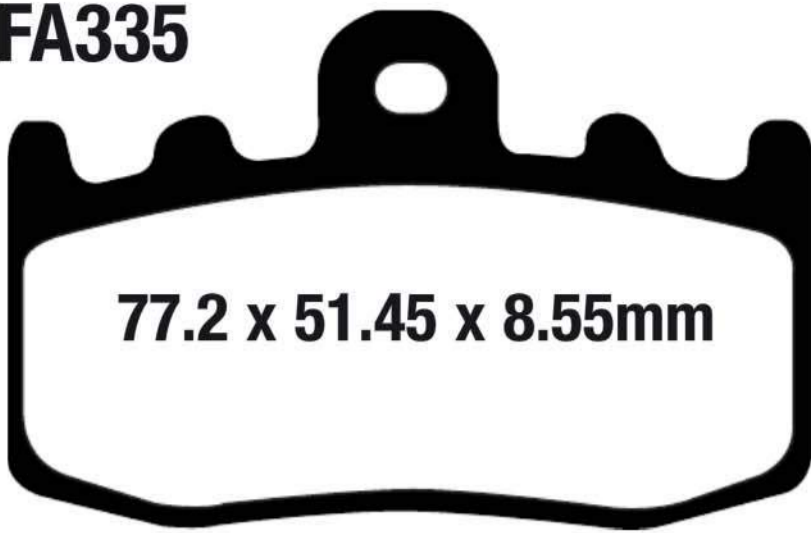

77.2 x 51.45 x 8.55mm

Equivalents OE#

34 11 7 660 448
34 11 7 671 780

BMW

R 850 RT	06	F
R 1100 S (Without integral ABS)	12/00-06	F
R 1150 GS (Evo-R21/0415/0495)	11/01-03	F
R 1150 GS Adventure	07/01-06	F
R 1150 RT (Integral ABS)	00-06	F
K 1200 RS	01-05	F
K 1200 GT	03-06	F
K 1200 GT (K44)	06	F Left
K 1200 S	05-08	F
R 1200 GS	02-07	F
R 1200 GS Adventure	05-07	F
R 1200 GS Adventure/M	06-12	F
R 1200 GS/M	06-12	F
R 1200 GS Water Cooled Model	13	F
R 1200 RT	05-13	F
R 1200 S	06-08	F
R 1200 ST (K28)	03-08	F
HP2 Megamoto	Nov 07-09	F
K 1200 S	03-08	F
K 1300 S	09-15	F
K 1300 GT Touring	09-11	F

STD FA335HH Street Performance Sintered Pad Blend

OPTIONS EPFA335HH Fast Street Use & Track Day Sintered Pad Blend

Dealer Stocking Recommendation

Single/Pair
2

Popularity #
N/A

Rec Stocking Level
1

FA337



**35.2 x 51.5
x 6mm**

KTM

60 SX	00	R
65 SX	00-03	R

Equivalents OE#

460 13 090 000

STD FA337X Carbon Dual Purpose Pad Blend

OPTION FA337R Utility Grade Sintered Pad Blend

Dealer Stocking Recommendation

Single/Pair
1

Popularity #
N/A

Rec Stocking Level
1

FA342

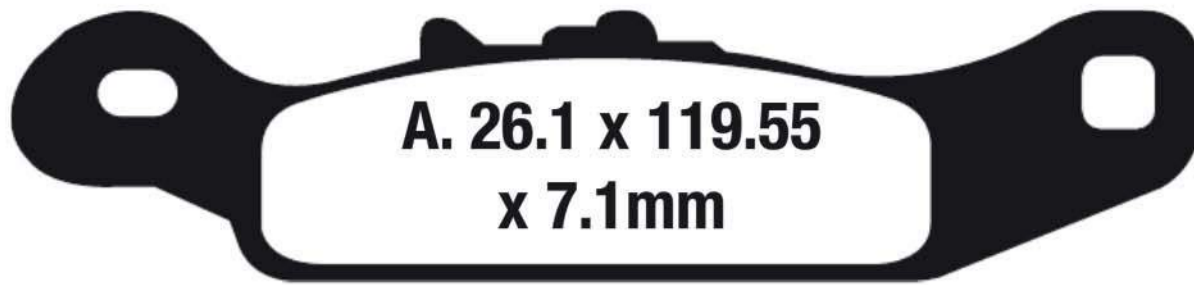

**A. 26.1 x 119.55
x 7.1mm**

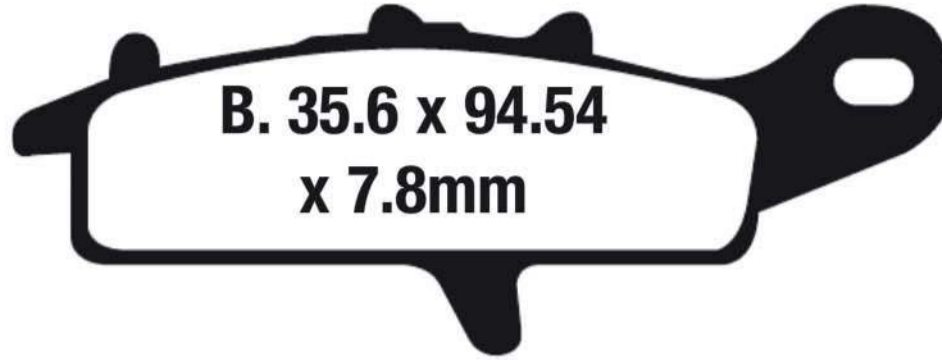

**B. 35.6 x 94.54
x 7.8mm**

KAWASAKI

KFX 450 R (KSF 450 B8F/B9F/BAF/BBF/BCS) 08-12 F Left
 KVF 650 A1/A2/B2 02-03 F Left
 KVF 650 D1/D6F/D7F/D8F/DAF Brute Force 4x4 05-10 F Left
 KVF 650 E1/E6F/E7F/E8F Brute Force 4x4 Hardwoods Green HD 05-08 F Left
 KVF 650 E1/E6F/E7F/E8F/E9F Brute Force 650 4x4 Hardwoods Green HD 05-09 F Left
 KSV 700 A1/A2/A6F/A7F/A8F/A9F (KFX 700 V-Force) 04-09 F Left
 KSV 700 A1/B1 (KFX 700 V-Force) 04 F Left
 KVF 700 A1/A2/A6F (Prairie 700 4x4)/B1/B2/B6F (Prairie 700 4x4 Hardwoods Green HD) 04-06 F Left
 KVF 700 D1/D6F Team Green Special Edition 05-06 F Left
 KSV 700 B1/B2/B6F/B7F/B8F (KFX 700 V Force) 04-08 F Left

SUZUKI

LT-V 700 FK4/FK5 Twin Peaks 700 4x4 04-05 F Left

Equivalents OE#

43082 1255	K4308 21255
43082 0077	

STD FA342R Utility Grade Sintered Pad Blend

OPTION FA342SV High Durability Off Road Sintered Blend

Dealer Stocking Recommendation

Single/Pair	Popularity #	Rec Stocking Level
1	N/A	1

FA343



A. 107 x 41 x 10mm



**B. 91.6 x 40.6 x
10mm**

HONDA

CBR125 R4/R5/RS5/RW5/RW6/RW7/RW8 04-10 R
 /RW9/RWA (6 Bolt Front Disc / Canada)

YAMAHA

YZF-R15 (150cc) (54C2/3/6-2PB1) 10-13 R

Equivalents OE#

06435 KPC 641	4S3 W0045 00
06435 KPC 901	20P W0046 00

STD FA343 Premium Organic Street Pad Blend

OPTION FA343HH Street Performance Sintered Pad Blend

Dealer Stocking Recommendation

Single/Pair	Popularity #	Rec Stocking Level
1	N/A	1

FA344



BENNCHE

500 Gray Wolf 15-16 R
700 Gray Wolf 15-16 R

CF MOTO

400 C-Force 14-16 R
500 C-Force 14-16 R
800 C-Force EPS 14-16 R

UNISON

Mobility 500 04 R

YAMAHA

YFM 660 FAP/FHAP/FSAP/FAR/FS/FHS/FHT/FT/FV/FGHW/FGX
/FGHX Grizzly/660 Hunter Edition 02-08 R
YFM 660 FAHDV/W Ducks Unlimited Edition/Side x Side 06-07 R

Equivalents OE#

5KM W0046 00

STD	FA344X	Carbon Dual Purpose Pad Blend
OPTION	FA344R	Utility Grade Sintered Pad Blend
OPTION	FA344SV	High Durability Off Road Sintered Blend

Dealer Stocking Recommendation

Single/Pair	Popularity #	Rec Stocking Level
1	N/A	1

FA345

6 piston caliper



BUELL

XB9R 02-07 F
XB9S 03-04 F
XB9SX Lightning City X 05-09 F
XB9SX Lightning 08-10 F
XB12R 04-08 F
XB12S 04-08 F
XB12X Ulysses 06-10 F
XB12 SCG Lightning 06-08 F
XB12SS Lightning Long 06-08 F
XB12 STT Lightning 08 F
XB 12 XT Ulysses 08-10 F

Equivalents OE#

H0300 2AB

STD	FA345HH	Street Performance Sintered Pad Blend
OPTION	EPFA345HH	Fast Street Use & Track Day Sintered Pad Blend
OPTION	EPFA345HHLC	Fast Street Use & Track Day Sintered Pad Blend

Dealer Stocking Recommendation

Single/Pair	Popularity #	Rec Stocking Level
1	N/A	1

FA346

Note - do not refit
O/E shim & insulator

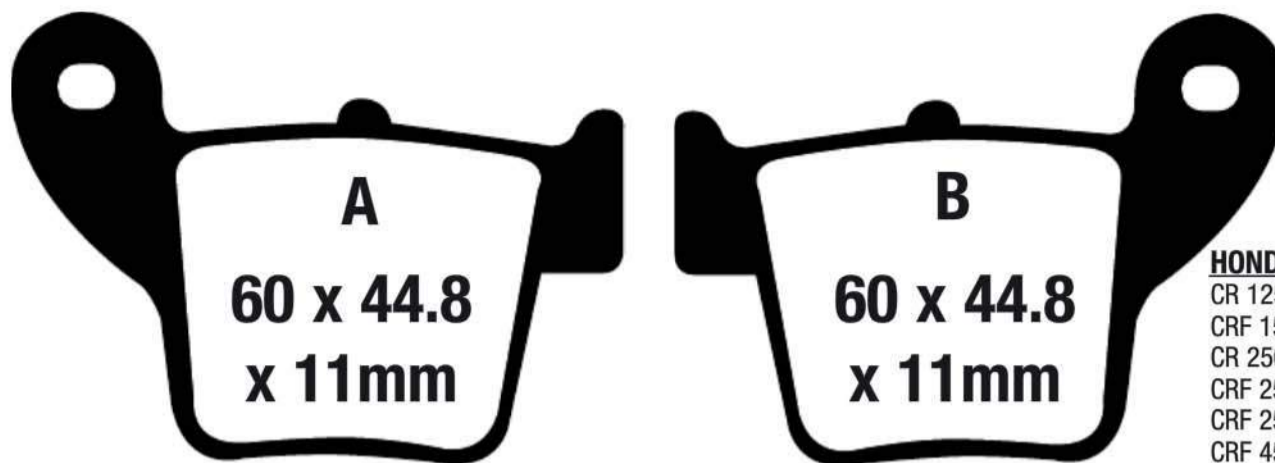

HONDA		
CR 125 R	02-07	R
CRF 150 R/RB	07-16	R
CR 250 R	02-07	R
CRF 250 R	04-17	R
CRF 250 X	04-17	R
CRF 450 R	02-17	R
CRF 450 RX (18" Rear wheel)	17	R
CRF 450 X	05-17	R

STD	FA346X	Carbon Dual Purpose Pad Blend
OPTION	MXS346	Sintered Sport Off Road Pad Blend
OPTION	FA346R	Utility Grade Sintered Pad Blend
OPTION	EPFA346HH	Fast Street Use & Track Day Sintered Pad Blend

Equivalents OE#	06435 KZ4 J41	06435 KRN 711
	06435 KRN 712	

Dealer Stocking
Recommendation

Single/Pair	Popularity #	Rec Stocking Level
1	N/A	4

FA347

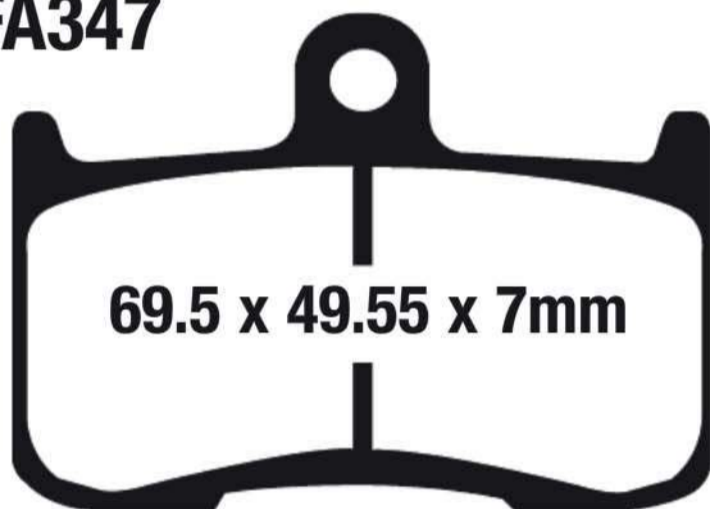

MORIWAKI/HONDA

MD 250 H 08-13 F

SUZUKI

GSX 1300 BKAK8/K9 B-King ABS 08-09 F

GSX 1300 BKK8/K9 B-King 08-09 F

TRIUMPH

Speed Triple R (Radial caliper 1050cc) 05-11 F

Street Triple R 675 (Nissin Radial caliper) 09-17 F

Street Triple 675 RXSE (ABS) 15 F

Daytona 675 06-08 F

Tiger (1050cc) 07-15 F

Tiger 1050 SE/ABS 11-13 F

Tiger 1050 Sport (Radial Caliper/ABS) 13-17 F

VICTORY

Broadwalk (Spoke Wheels) 13-14 F

Vegas 08-17 F

Vegas 8-Ball 08-17 F

Vegas Low 08-09 F

Vegas Jackpot 08-12 F

Gunner 15-17 F

Hammer 08-11 F

Hammer S 08-17 F

Hammer 8 Ball 10-16 F

Highball (Cast & Spoke Wheels) 14-17 F

Kingpin 08-12 F

Kingpin Tour 08-09 F

Kingpin 8-Ball 08-11 F

Kingpin-Low 09 F

Cory Ness Jackpot 08-11 F

Cory Ness Victory Cross Country 11-12 F

Cross Country 10-17 F

Cross Country Touring 13-17 F

Cross Country 8-Ball 15-16 F

Cross Roads 10-13 F

Cross Roads Classic (Spoke Wheel) 13-14 F

Cross Country Touring 13-17 F

Jackpot 10-16 F

Judge 13-17 F

Magnum 15-17 F

Magnum X-1 15-17 F

Zach Ness Vegas 11-12 F

Hard Ball (Spoke Wheel) 12-13 F

YAMAHA

TZ 250 (Radial Calipers) 02-10 F

HONDA

RS 125 (Radial caliper) 04-07 F

INDIAN

Chief Classic (Spoke Wheel/Nissin Calipers) 14-17 F

Chief Dark Horse 16-17 F

Chief Vintage (Spoke Wheel/Nissin Calipers) 14-17 F

Chieftan (Cast Wheel/Nissin Calipers) 14-17 F

Roadmaster (Cast Wheel/Nissin Calipers) 15-17 F

Springfield 16-17 F

KAWASAKI

Z 800 BGF (ABS) 16 F

ZX9R (ZX 900 F1/F2) 02-03 F

Z 900 (ZR 900 AHF/NON ABS) 17 F

Z 900 (ZR 900 BHF/ABS) 17 F

Z 1000 (ZR 1000 A1/A2/A3) 03-05 F

Z 1000 (ZR 1000 A6F) 06 F

Equivalents OE#

2203670	59100 23830
2204196	59100 23840
43082 0002	T2020329
43082 0168	T2020475
43082 1290	

Dealer Stocking Recommendation

Single/Pair	Popularity #	Rec Stocking Level
2	N/A	2

STD	FA347HH	Street Performance Sintered Pad Blend
OPTION	EPFA347HH	Fast Street Use & Track Day Sintered Pad Blend
OPTION	GPFA347HH	Race Only Sintered Pad Blend

FA348



**63.35 x 60.32 x
8.9mm**

YAMAHA

FZS 1000 N/NC/P/PC/R/RC/S/RS/T 'FZ1'

01-05 R

Equivalents OE#

5LV W0046 50

STD	FA348	Premium Organic Street Pad Blend
OPTION	FA348HH	Street Performance Sintered Pad Blend

Dealer Stocking Recommendation

Single/Pair	Popularity #	Rec Stocking Level
1	N/A	1

FA349

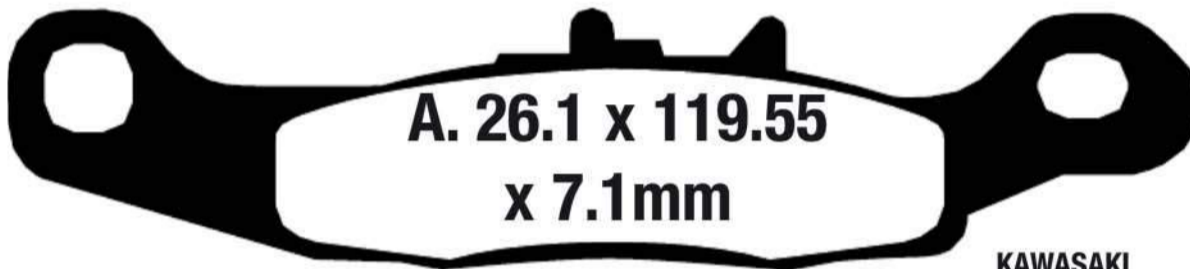

**A. 26.1 x 119.55
x 7.1mm**

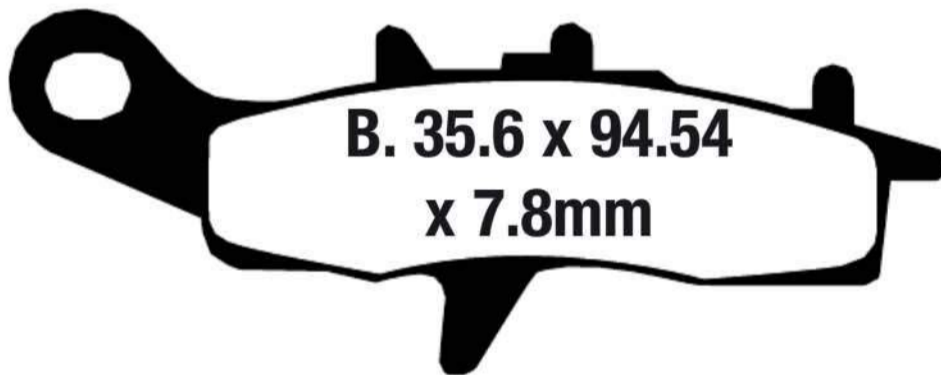

**B. 35.6 x 94.54
x 7.8mm**

KAWASAKI

KFX 450 R (KSF 450 B8F/B9F/BAF/BBF/BCS)

08-12 F Right

KVF 650 A1/A2/B2

02-03 F Right

KVF 650 D1/D6F/D7F/D8F/DAF Brute Force 4x4

05-10 F Right

KVF 650 E1/E6F/E7F/E8F Brute Force 4x4 Hardwoods Green HD

05-08 F Right

KVF 650 E1/E6F/E7F/E8F/E9F

Brute Force 650 4x4 Hardwoods Green HD

05-09 F Right

KSV 700 A1/A2/A6F/A7F/A8F/A9F (KFX 700 V-Force)

04-09 F Right

KSV 700 A1/B1 (KFX 700 V-Force)

04 F Right

KVF 700 A1/B2/A2/A6F (Prairie 700 4x4)/B1/B6F

(Prairie 700 4x4 Hardwoods Green HD)

04-06 F Right

KVF 700 D1/D6F Team Green Special Edition

05-06 F Right

KSV 700 B1/B2/B6F/B7F/B8F (KXF 700 V Force)

04-08 F Right

SUZUKI

LT-V 700 FK4/FK5 Twin Peaks 700 4x4

04-05 F Right

Equivalents OE#

43082 1273

43082 0078

K4308 21273

STD	FA349R	Utility Grade Sintered Pad Blend
OPTION	FA349SV	High Durability Off Road Sintered Blend

Dealer Stocking Recommendation

Single/Pair	Popularity #	Rec Stocking Level
1	N/A	1

FA350



50.1 x 47.4
x 6.8mm

SCORPA

T-Ride 125 (4T) 11 R
T-Ride 250 F 09-11 R

SFA350

DERBI
Boulevard 150 03-05 F

ITALJET

Jet Set 50 03 F
Jet Set 125/150 03 F

PEUGEOT

Elyseo 125/150 03-05 R
Elystar 50 P 03-05 R
Elystar 125/150 P 03-05 R
Jet Force 125 EFI/Compressor 03-05 R

Equivalents OE#

745658
755981
4722090

STD	SFA350	Premium Organic Scooter Pad Blend
OPTION	FA350X	Carbon Dual Purpose Pad Blend
OPTION	SFA350HH	Scooter Performance Sintered Pad Blend

Dealer Stocking Recommendation

Single/Pair	Popularity #	Rec Stocking Level
1	N/A	1

FA351



36 x 39 x
6mm

BETA DIRT BIKES

Mini Trail 50 09-10 F

GAS-GAS

EC 50 Boy (Air Cooled) 05 R
EC Boy (LC) 05 R
MC 65 05-06 F
TX 200 Randonne (4T) 14-15 R
TXT 70 Cadet/Rookie 10-11 R
TXT 80 Rookie/Cadet 04-08 R
TXT 80 Cadet Pro 15 R
TXT 125/200/250/280/300 (TXT Pro) 04-15 R
TXT 125/200/250/280/300 (TXT Racing) 14-15 R
TXT 250/280/300 (Raga) 07-11 R

HUSQVARNA

CR 50 Junior 05 F
CR 50 Senior Pro 05 F
TE 100 05 F

MONTESA

315 R 01-04 R
4RT Cota (250cc) 05-08 R
4RT Cota Standard Edition (260cc) 09-17 R
4RT Cota Repsol Edition (260cc) 14-17 R
4RT Cota 300RR 16 R

SCORPA

TY-S 125 F 04-09 R
SR 125 (2T) 11 R
SY 125 F 05-09 R
SY 175 F 05-08 R
SY 250 03-10 R
SY 250 F 06-10 F
SY 250 Long Ride 05-09 F
SY 250 FR 11 R
SR 280 (2T) 11 R

SHERCO

ST 1.25 (2T) 12-14 R
2.5/2.9 (2T) 03-09 R
ST 2.5 (2T) 12-14 R
ST 2.9 (2T) 12-14 R
3.2 (4T) 05-12 R

Equivalents OE#

43105 - NN3 - 820
43105 NN3 830

Dealer Stocking Recommendation

STD	FA351X	Carbon Dual Purpose Pad Blend
------------	---------------	-------------------------------

Single/Pair	Popularity #	Rec Stocking Level
1	N/A	1

NOTE:- Size identification is shown as follows
Dimension 1=Width or Diameter, Dimension 2=Height or Diameter, Dimension 3=Thickness (Material and backplate)

SFA353

APRILIA

Sportcity 50 (4T) 08-14 F
 SR 50 Motard (4T) 12-15

PIAGGIO

Fly 50 (2T) 05-06 F
 Fly 50 (4T/2V) 07-10 F
 Fly 50 (4T/4V) 11-15 F
 Typhoon 50 (4T/4V/12" wheels) 10-11 F
 Typhoon 50 (4T/4V/14" wheels) 12-15 F
 Typhoon 125 (4T) (12" wheels) 10-15 F
 Fly 150 (4T/2V) 06-12 F
 Fly 150 (4T/3V) 13-15 F
 BV 250 (Heng Tong Caliper) 06-11 F&R
 BV 300 Tourer 10-12 F&R
 BV 350 (4V/4T/330cc) 12-15 F
 MP3 400ie (Three wheeler) 07-15 R
 MP3 500 (Three wheeler - 12" Front / 14" Rear) 07-14 R
 MP3 500 Sport ABS
 (Three wheeler - 12" Front / 14" Rear) 15-16 R

VESPA

Primavera 50 (4T/4V) 13-15 F
 Sprint 50 (4T/4V) 14-15 F
 Primavera 150 (4T/3V/ie) 13-15 F
 Sprint 150 (4T/3V/ie) 14-15 F
 946 (155cc/ABS/4T/3V/ie) 13-15 F
 GT 200 L Granturismo (Heng Tong Caliper) 05-09 F
 GTS 250 05-09 F
 GTV 250 07-09 F
 LXV 250 07-09 F
 GTS 300 ie 08-15 F
 GTS 300 Super 10-14 F
 GTV 300 ie 10-15 F
 GT 60 (250cc Ltd Edition) 06-08 F

Equivalents OE#

497072	647078	56012R
497116	650983	

STD	SFA353	Premium Organic Scooter Pad Blend
OPTIONS	SFA353HH	Scooter Performance Sintered Pad Blend

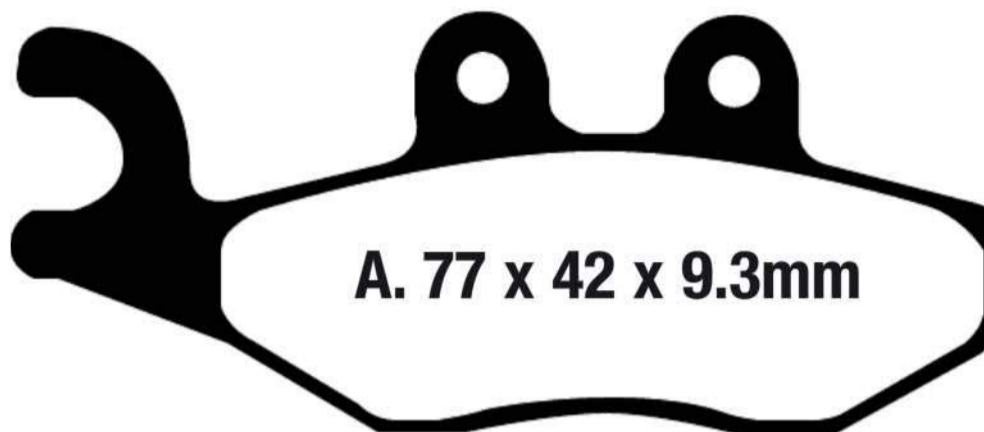
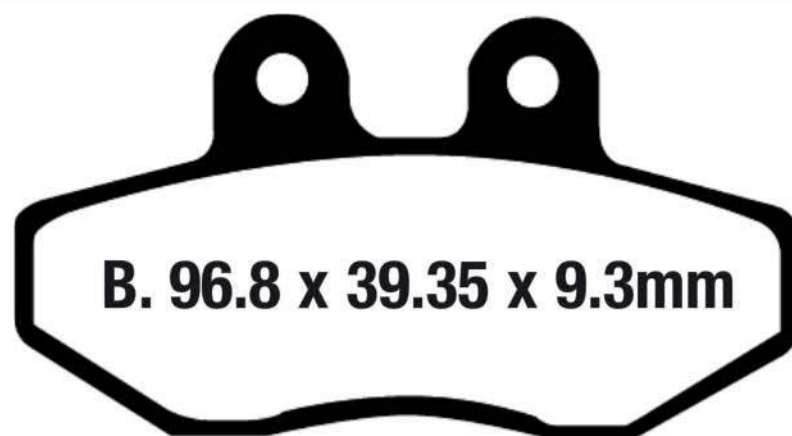

Dealer Stocking Recommendation

Single/Pair	Popularity #	Rec Stocking Level
1	-	1

BUYERS GUIDE
BRAKE PADS

Dimension 1=Width or Diameter, Dimension 2=Height or Diameter, Dimension 3=Thickness (Material and backplate)

NOTE:- Size identification is shown as follows

FA354

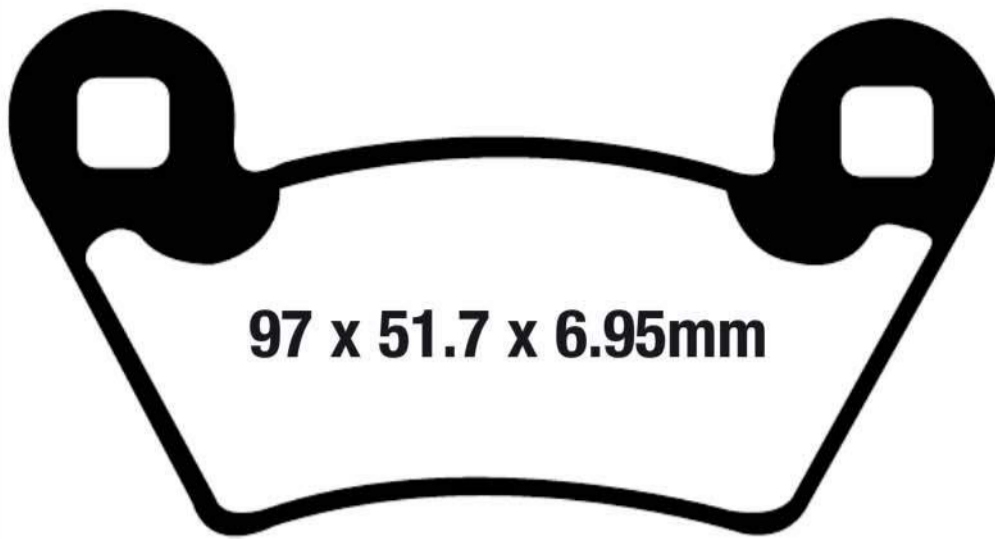

97 x 51.7 x 6.95mm

POLARIS

Brutus	13-14	R
PPS/UTV 2x4 Series 10		F&R
PPS/UTV 4x6 Series 10		F&R
PPS/Series 11 UTV 1500 2x4		F&R
Ranger EV (Electric)	10	R
Ranger Series 10		F&R
Ranger Series 10 500 6x6		F&R
Ranger Series 11		F&R
PPS/Series 11 2x4/4x4		F&R
PPS/Series 11 6x6		F&R
Ranger 6x6	04-05	F&R
Ranger TM	04-05	F&R
Ranger XP	05	F&R
Ranger 2x4/4x4	04-05	F&R
325 Ranger ETX	15-16	F&R
325 Sportsman Ace	14	R
325 Sportsman Ace Efi	15	R
325 Sportsman Ace Euro	14-15	R
325 Sportsman Ace HD	15	R
400 Ranger (All models)	10-13	F&R
400 Ranger 4x4	12	F&R
Ranger 500 (2x4/4x4)	06-07	F&R
Ranger 500 (4x4 EFI)	06-07	F&R
Ranger 500 4x4 EFI	08-13	R
500 Ranger 4x4 EFI	11-13	F&R
500 Ranger (Carb) 2x4	08-09	R
500 Ranger (EFI) 4x4 H.O.	09-10	R
Ranger Crew 500	11-13	R
500 Sportsman Touring HO	11-13	R
570 Sportsman Ace	15	R
570 Sportsman Ace Euro	15	R
570 Ranger Efi	14	F&R
570 Ranger Crew Efi	14	F&R
Ranger 6x6 EFI 700	06-09	F&R
Ranger XP 700 4x4	06/08	F&R
Ranger 700 4x4 EFI/LE	07	F&R
Ranger TM	06	F&R
Ranger 700 6x4 EFI	08	R
700 Ranger 4x4 EFI	09	R
800 Ranger RZR 4 EPS	12	R
800 Ranger XP	10-12	R
800 Ranger	10-13	R
800 Ranger Efi	13-14	R
800 Ranger Mid Size	13	F&R
Ranger EV (Electric)	10-13	R
800 Ranger RZR-4	10-13	R
Ranger 900 D (Diesel)	11-12	R
Ranger RZR XP 900	13-15	R
1000 Ranger Diesel	15	R
1000 Ranger Diesel Crew	15	R

Equivalents OE#

1910514	2202413
2202097	

Dealer Stocking Recommendation

Single/Pair	Popularity #	Rec Stocking Level
2	N/A	2

STD FA354R Utility Grade Sintered Pad Blend

OPTION FA354SV High Durability Off Road Sintered Blend

FA355/4



44.9 x 50.75 x 7mm

ARCTIC CAT

250 DVX Sport	06-08	R
300 DVX	09-12	R

KYMCO ATV

KXR 250 Mongoose	04-10	R
MXU 250	04-10	R
Mongoose 300	06-16	R

SYM

RV 250 (LM 250 W)	07-12	F
-------------------	-------	---

Equivalents OE#

45105 HMA 000A
45106 KKC4 9000
3304-697

STD FA355/4X Carbon Dual Purpose Pad Blend

OPTION FA355/4R Utility Grade Sintered Pad Blend

Dealer Stocking Recommendation

Single/Pair	Popularity #	Rec Stocking Level
2	N/A	2

BUYERS GUIDE
BRAKE PADS

NOTE:- Size identification is shown as follows
Dimension 1=Width or Diameter, Dimension 2=Height or Diameter, Dimension 3=Thickness (Material and backplate)

SFA356



55.5 x 46 x
7.1mm

KYMCO STREET
Grand Vista 240 (SH 50 DF)

05-11 R

Equivalents OE# 43105 KKC4 9000

STD SFA356 Premium Organic Scooter Pad Blend
OPTION SFA356HH Scooter Performance Sintered Pad Blend

Dealer Stocking Recommendation

Single/Pair	Popularity #	Rec Stocking Level
2	N/A	2

FA357



A. 1 pad left
62.1 x 31.4 x
6.55mm



A. 1 pad right
62.1 x 31.4 x
6.55mm

HUSQVARNA

CR 65	12	F
KTM		
65 SX	02-08	F
SX 65	09-16	F&R
XC 65	08-10	F
85 SX	03-10	F&R
SX 85 (19"/16" wheels)	03-10	F&R
SX 85 (17"/14" wheels)	11	F
XC 85	08-10	F&R
SX 105	07-11	F&R
XC 105	08-10	F&R

Equivalents OE# 461 13 030 000
470 13 090 000

STD FA357X Carbon Dual Purpose Pad Blend
OPTION FA357R Utility Grade Sintered Pad Blend

Dealer Stocking Recommendation

Single/Pair	Popularity #	Rec Stocking Level
1	N/A	1

SFA358

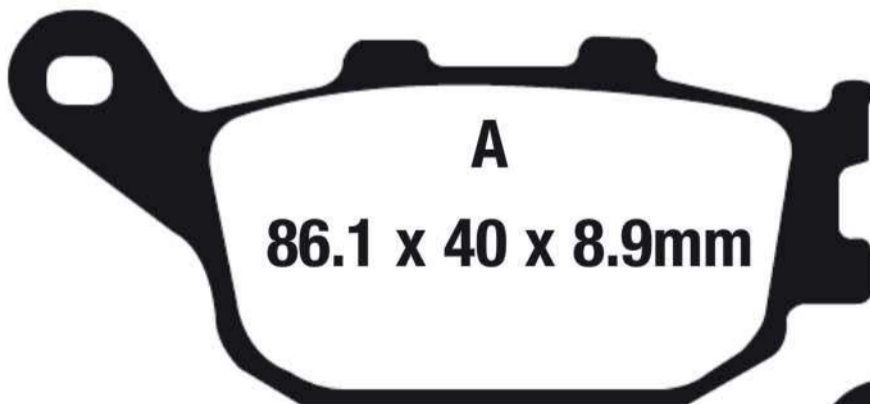

A
86.1 x 40 x 8.9mm

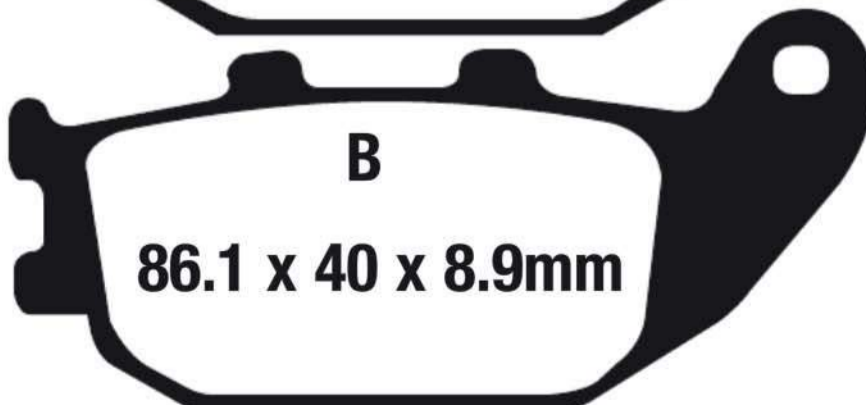

B
86.1 x 40 x 8.9mm

HONDA

NSS 250/250 A/A5 Reflex 01-07 R

Equivalents OE# 06435 KPB 016

Dealer Stocking Recommendation

STD SFA358 Premium Organic Scooter Pad Blend
OPTIONS SFA358HH Scooter Performance Sintered Pad Blend

Single/Pair	Popularity #	Rec Stocking Level
1	N/A	1

FA363

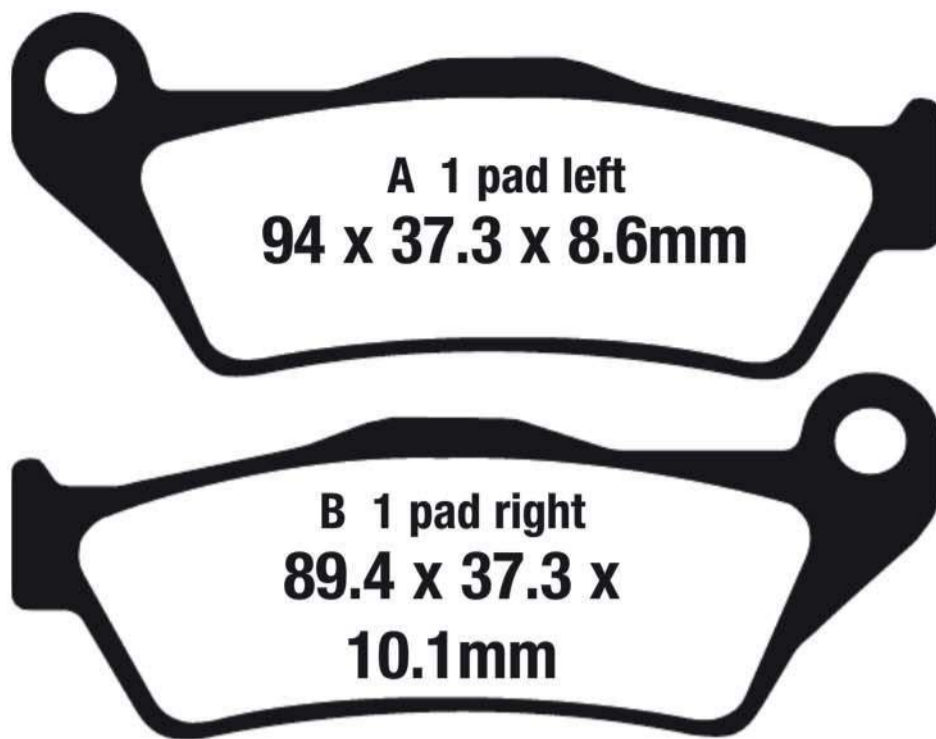

A 1 pad left
94 x 37.3 x 8.6mm

B 1 pad right
89.4 x 37.3 x 10.1mm

Equivalents OE#

34 21 2 314 947
34 21 2 335 465
34 21 2 330 633
34 21 7 660 281
34 21 8 556 442

STD	FA363	Premium Organic Street Pad Blend
OPTIONS	FA363HH	Street Performance Sintered Pad Blend
OPTIONS	FA363V	Semi Sintered Long Lasting Street Pad

Dealer Stocking Recommendation

BMW

R 850 GS	96-00	R
R 850 C	97-00	R
R 850 R	94-06	R
R 850 RT	96-01/06	R
S 1000 XR	14-17	R
R 1100 GS	93-99	R
R 1100 R	93-06/96	R
R 1100 S	96-11/00	R
R 1100 S	12/00-06	R
R 1100 RT	94-01	R
R 1150 GS (Evo-R21/0415/0495)	11/01-03	R
R 1150 GS (R21/0415/0495)	98-10/01	R
R 1150 GS Adventure	07/01-06	R
R 1150 R	01-06	R
R 1150 R Rockster	03-05	R
R 1150 RS	01-05	R
R 1150 RT	00-06	R
R 1200	00-02	R
R 1200 C	96-03	R
R 1200 C	96-03	R
R 1200 C Montauk	04-05	R
R 1200 GS (K25/0307/Cast/Spoke wheel)	02-07	R
R 1200 GS Adventure (K25/0382/Spoke wheel)	05-07	R
R 1200 GS Adventure/M (K25/0380/spoke wheel)	06-12	R
R 1200 GS/M (K25/0303/Cast/Spoke Wheel)	06-12	R
R 1200 R (K27)	06-11/07	R
R 1200 R (Disc has fixed bobbins)	08-14	R
R 1200 RT	05-13	R
R 1200 S	06-08	R
R 1200 ST (K28)	03-08	R
R Nine T (1200cc)	14-16	R
HP-2 Enduro	05-09	R
HP2 Megamoto	Nov 07-09	R
HP2 Sport	08-11	R
K 1300 GT (Touring)	09-11	R

Single/Pair	Popularity #	Rec Stocking Level
1	N/A	2

FA366

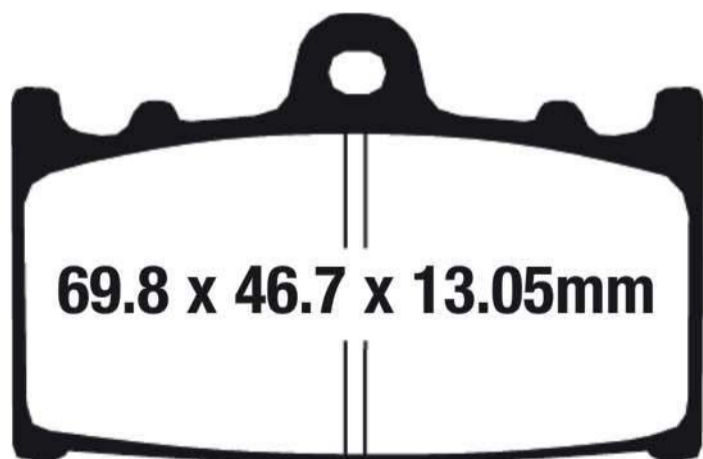

69.8 x 46.7 x 13.05mm

STD	FA366	Carbon Dual Purpose Pad Blend
OPTIONS	FA366HH	Street Performance Sintered Pad Blend
OPTIONS	FA366V	Semi Sintered Long Lasting Street Pad Blend
OPTIONS	FA366VLD	Chrome Backed Semi Sintered Long Lasting Street Pad Blend

Dealer Stocking Recommendation

Single/Pair	Popularity #	Rec Stocking Level
1	N/A	1

SUZUKI

VL 1500 K2/K3/K4 Intruder LC	02-04	R
VL 1500 K5/TK5/K6/TK6/K7/TK7/K8/TK8/K9/TK9/L0 (C90/C90T)	05-10	R

Equivalents OE#

69100 10820
69100 10850

FA367 10.75mm thickness

FA367/2 8.5mm thickness



NOTE:- Size identification is shown as follows

FA367

AJP

PR3 240 Enduro	14-17	R
PR4 240 Enduro	14-17	R
PR4 240 Extreme	17	R
PR5 250 Enduro	14-17	R
PR5 250 Extreme	17	R
PR7 650 Adventure	17	R

APRILIA

RVX 450/550	06-12	R
MXV 4.5	09-12	R
SVX 4.5/5.5 (450/550) (Radial mount caliper)	06-12	R

BETA

RR 250 (2T)	13-15	R
RR 250 4T	05-08	R
RR 300 (2T)	13-15	R
RR 350 (4T)	11-15	R
RS 350 Dual Sport	11-12	R
RR 390 (4T)	15	R
RR 400 4T	05-14	R
RS 400 Dual Sport (4T)	08-11	R
SM 400 Supermoto (4T)	10-11	R
RR 430 (4T)	15	R
RS 430 (4T)	15	R
RR 450 4T	05-14	R
RS 450 Dual Sport (4T)	08-14	R
SM 450 Supermoto (4T)	10-11	R
RR 480 (4T)	15	R
RR 498 (4T)	12-14	R
RS 500 (4T)	15	R
RS 520 Dual Sport (4T)	08-14	R
SM 520 Supermoto (4T)	10-11	R
RR 525 4T	05-09	R

GAS-GAS

EC 125 (All models/2T)	10-12	R
EC 200/250/300 (All models/2T)	10-12	R

KAWASAKI

KX 250 N1/N2 (KX 250 F)	04-05	R
KX 250 F (T6F/T7F/T8F)	06-08	R
KX 250 F (W9F/XAFB/YBF/YCF/ZDF/ZEF/ZFF/ZGF/AHF) (4T)	09-17	R
KX 450 F (D6F/D7F/D8F)	06-08	R
KX 450 F (E9F/EAF/EBF/FCF/FDF/FEF/FFF/HGF/HHF)	09-17	R
KLX 450 R (A8F/A9F/AAF/ABF/ACF)	08-12	R

SHERCO

2.5i Enduro	05-12	R
4.5i Enduro	05-12	R
4.5 Supermoto	04-07	R
4.5i Supermoto	08-12	R
SM4.5i	12-14	R
5.1i Enduro	05-12	R

SUZUKI

RM-Z 250 K4/K5/K6/K7/K8/K9/L0/L1/L2/L3/L4/L5/L6/L7	04-17	R
RM-Z 450 K5/K6/K7/ZK7/K8/K9/L0/L1/L2/L3/L4/L5/L6/L7	05-17	R

TM

MX 85 KR (2T)	05-08	R
EN 125 (2T)	05-08	R
SMR 125 (2T)	05-08	R
MX 144 (2T)	07-08	R
EN 250 (2T)	05-08	R
EN 250 F-ES (4T)	05-08	R
MX 250/300 (2T)	05-08	R
MX 250 F (4T)	05-07	R
EN 300 (2T)	05-08	R
EN 450 F-ES (4T)	05-08	R
MX 450 F	05-08	R
SMR 450 F ES (4T)	05-08	R
SMX 450 F Competition (4T)	05-08	R
EN 530 F-ES (4T)	05-08	R
MX 530 F (4T)	05-08	R
SMX 530 F Competition	05-08	R
SMR 530 F ES (4T)	05-08	R

YAMAHA

YZ 125 R/S/T/V/W/X/Y/Z/A/B/D/E/F/G/H/J (2T)	03-18	R
YZ 250 R/S/T/V/W/X/Y/Z/A/B/D/E/F/G/H/J (2T)	03-18	R
YZ 250 XG (2T)	16	R
YZ 250 FR/FS/FT/FV/FW/FX/FY/FZ/FA/FB/FD/FE/FF/FG/FH/FJ (4T)	03-18	R
WR 250 FR/FS/FT/FV/FW/FX/FY/FZ/FA/FB/FD/FE/FF/FG/FH/FJ (4T)	03-18	R
WR 250 XX/XY/XZ (Supermotard)	08-11	R
WR 250 RX/RZ/RY/RA/RB/RD/RE/RF	08-15	R
YZ 450 FR/FS/FT/FV/FW/FX/FY/FZ/FA/FB/FD/FE/FF/FG/FH/FJ	03-18	R
WR 450 FR/FS/FT/FV/FW/FX/FY/FZ/FA/FB/FD/FE/FF/FG/FH	03-18	R

ZERO ELECTRIC BIKES

DS ZF8.5/ZF11.4 (Nissin calipers)	13	R
FX ZF2.8/ZF5.7 (Nissin calipers)	13	R
MX ZF2.8/ZF5.7 (Nissin calipers)	13	R
S ZF8.5/ZF11.4 (Nissin calipers)	13	R
XU ZF2.8/ZF5.7 (Nissin calipers)	13	R

FA367/2

BETA

RR 350 3T Enduro	11	R
RR 400 T Enduro	12	R
RR 450 4T Enduro	12	R
RR 525 4T Enduro	05-09	R

Dealer Stocking Recommendation

Single/Pair	Popularity #	Rec Stocking Level
1	N/A	4

STD	FA367X	Carbon Dual Purpose Pad Blend
STD	FA367/2X	Carbon Dual Purpose Pad Blend
OPTION	FA367R	Utility Grade Sintered Pad Blend
OPTION	FA367/2R	Utility Grade Sintered Pad Blend
OPTION	MXS367	Sintered Sport Off Road Pad Blend
OPTION	EPFA367HH	Fast Street Use & Track Day Sintered Pad Blend

Equivalents OE#

K4308 20006	43082 0048	1C3 W0046 50
69096 05	25 25362	1C3 W0046 B0
69100 35810	BE 675 002509	5UN W0046 00
69100 28820	43082 0107	5UN W0046 50
43082 0006	1C3 W0046 00	5UN W0046 51
225362000	1C3 W0046 10	5UN W0046 60

FA368

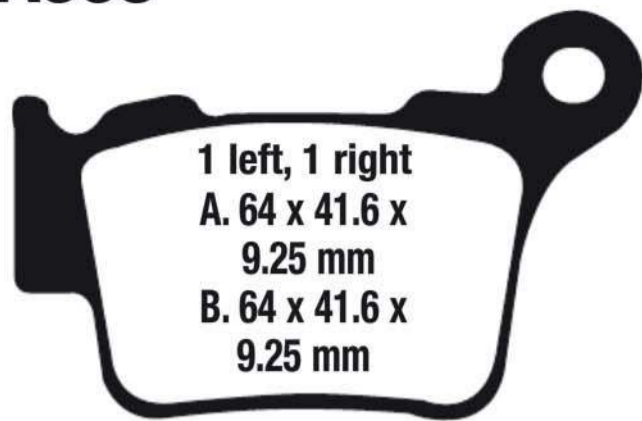

Refit old shim
& insulator

ALTA MOTORS (Electric)

Redshift - MX 16-18 R
Redshift - SM 16-18 R

BMW

G 450 X 08-11 R

HUSABERG

TE250 (2T) 11-14 R
TE300 (2T) 11-14 R
FE 390 10-12 R
FE 450 Enduro 09-14 R
FX 450 10-11 R
FE 501 (4T) 13-14 R
FE 570 Enduro 09-12 R
FS 570 Supermoto 10-11 R

HUSQVARNA

CR 125 05-13 R
TC125 (2T) 14 R
TE 125 11 R
TE125 (2T) 14 R
WR 125 06-13 R
CR 250 05 R
FC 250 (4T) 14 R
FE 250 (4T) 14 R
TC 250 05-12 R
TC 250 R (4T) (Kayaba Forks) 13 R
TC 250 (2T) 14-15 R
TE 250 06-12 R
TE 250 (2T) 11 R
TE 250 (2T) 14 R
TXC 250 Cross Country 08-12 R
TXC 250 R (4T) (Kayaba Forks) 13 R
TE 300 (2T) 14 R
TE 310 (4T) 09-13 R
TE 310 R (4T) (Kayaba Forks) 13 R
TE 310 (4T) (Kayaba Forks) 11-12 R
TXC 310 Cross Country 12 R
TXC 310 R (4T) (Kayaba Forks) 13 R
FC 350 (4T) 14 R
FE 350 (4T) 14 R
XC-W 400 10 R
TE 410 06 R
TC 449 11-13 R
TE 449 (4T) 11-12 R
FC 450 (4T) 14 R
FE 450 (4T) 14 R
FS450 Supermoto 15 R
SMR 450 RR (Radial caliper) 06-08 R
SM 450 R (Radial caliper) 07-10 R
TC 450 05-11 R
TE 450 06-11 R
TXC 450 Cross Country 08-11 R
FE 501 (4T) 14-15 R
SM 510 R (Radial caliper) 06-11 R
TC 510 05-09 R
TE 510 06-11 R
TXC 510 Cross Country 08-10 R
TE 511 (4T) 11-13 R
TXC 511 Cross Country 11-12 R

KTM

SX 125 04-16 R
SX 150 08-17 R
XC 150 10-15 R

XC/EXC 200 04-08 R
XC-W 200 07-16 R
XC 200 06-08 R
XC/EXC 250 04-07 R
XC/XC 250 F 06-07 R
SX-F 250 (4T) 06-16 R
SX-F 250 Factory Edition 15 R
SX 250 (2T) 03-16 R
XC-F 250 06-16 R
XCF-W 250 06-16 R
XCF-W 250 Six Days 11-12 R
XC 250 (2T) 06-16 R
XC-W 250 06-16 R
EXC 300 (Upside down forks) 04-08 R
EXC 300 04-07 R
MXC 300 (Upside down forks) 04-06 R
XC 300 (2T) 06-16 R
XC-W 300 06-16 R
XC-W 300 Six Days 14-16 R
EXC-F 350 (Diaphragm Spring) 12-16 R
SX-F 350 11-16 R
XC-F 350 11-16 R
XCF-W 350 (Diaphragm Clutch Spring) 12-16 R
XCF-W 350 Six Days 14-16 R
XC/EXC 400 04-07 R
XC-W 400 08-11 R
EXC 450 04-07 R
EXC 450 (4T) 09-10 R
EXC 450 10-11 R
SMR 450 04-12 R
SX-F 450 03-16 R
XCR-W 450 08 R
EXC-R 450 08 R
XC-F 450 08-09 R
XC-F 450 13-16 R
450 XC-W (4T) Six Days/Champion Edition 10 R
XCR-W 450 09 R
XC-W 450 Six Days 10-11 R
XC-W 450 Champions Edition 10 R
XC-W 450 12-16 R
EXC 500 (Diaphragm Spring) 12-16 R
EXC 500 Six Days 16 R
XC-W 500 12-16 R
XC-F 505 08 R
EXC 525 04-07 R
SMR 525 04-05 R
SX 525 03-05 R
EXC 530 (4T) 09-11 R
EXC 530 10-11 R
XCR-W 530 08 R
EXC-R 530 08 R
XC-W 530 (4T) Six Days 10 R
SMR 560 06 R
SXC 625 05-06 R
SX-F 505 07 R
XC 525 Desert Racing 07 R
450 SMR 07 R
560 SMR 07 R

STD	FA368X	Carbon Dual Purpose Pad Blend
OPTION	FA368R	Utility Grade Sintered Pad Blend
OPTION	MXS368	Sintered Sport Off Road Pad Blend
OPTION	EPFA368HH	Fast Street Use & Track Day Sintered Pad Blend

Equivalents OE#

548 13 090 000	8000A2790	07849312
548 13 090 100	548 13 090 000	07849327
34 21 7 717 324	548 13 090 100	
07849312/27	8000A2790	

Dealer Stocking Recommendation

Single/Pair	Popularity #	Rec Stocking Level
1	N/A	1

BUYERS GUIDE
BRAKE PADS

NOTE:- Size identification is shown as follows
Dimension 1=Width or Diameter, Dimension 2=Height or Diameter, Dimension 3=Thickness (Material and backplate)

FA369/4

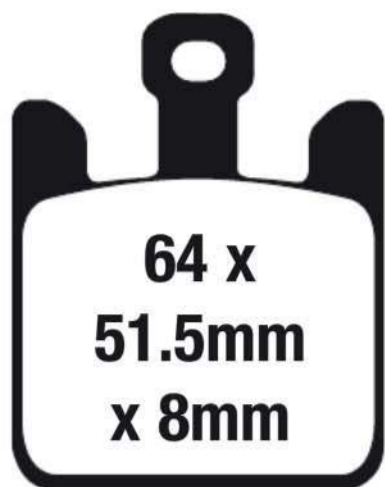

**64 x
51.5mm
x 8mm**

NOTE: Pads are sold as 4pcs per set - i.e. one caliper set

KAWASAKI

ZX6RR (ZX 600 K1/M1/N1/N6F)	03-06	F
ZX6R (ZX 636 B1/B2/C1/C6F)	03-06	F
ZX-10 R (ZX 1000 C1/C2/D6F/D7F)	04-06	F
ZX-12R (ZX 1200 B3/B4)	04-05	F
VN 1600 B2/B6F/B7F/B7FA/B8F/B8FA Mean Streak	05-08	F

SUZUKI

GSXR 1000 K3	03	F
VZ 1600 K5 M95 Boulevard/Marauder	05	F

Equivalents OE#

43082 0018	43082 1293	59100 18851
43082 0019	43082 0037	

Dealer Stocking Recommendation

Single/Pair	Popularity #	Rec Stocking Level
2	-	2

STD	FA369/4HH	Street Performance Sintered Pad Blend
OPTION	EPFA369/4HH	Fast Street Use & Track Day Sintered Pad Blend

FA372



**A. 55.5 x 37 x
10.9 mm**

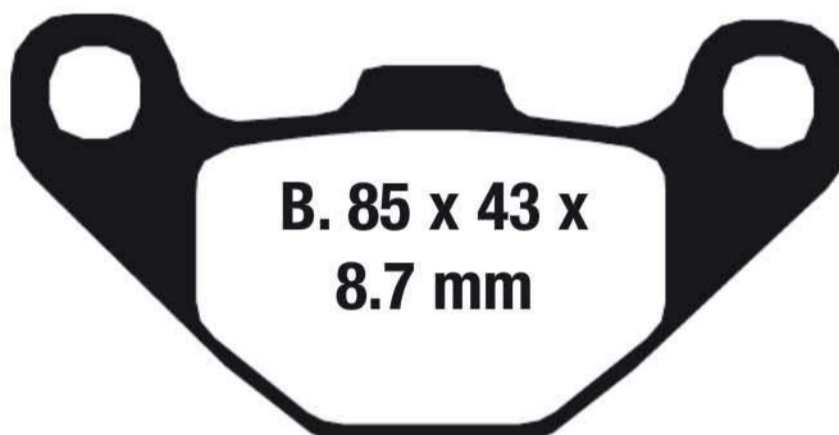

**B. 85 x 43 x
8.7 mm**

SUZUKI

LT-A 500 FK3/FK4/FK5/FCK5/FK6/FCK6/FK7/FCK7	03-07	R
LT-F 500 FK3/FK4/FK5/FK6	03-06	R

Equivalents OE#

69100 03850
69100 03860

Dealer Stocking Recommendation

Single/Pair	Popularity #	Rec Stocking Level
1	N/A	1

STD	FA372X	Carbon Dual Purpose Pad Blend
OPTION	FA372R	Utility Grade Sintered Pad Blend
OPTION	FA372SV	High Durability Off Road Sintered Blend

NOTE:- Size identification is shown as follows

FA373



HONDA

TRX 420 FPA Power Steering Fourtrax Rancher AT/IRS	09-14	R
TRX 420 FA Fourtrax Rancher AT/IRS	09-14	R
TRX 420 FA5 Fourtrax Rancher Auto/DCT/IRS	14-15	R
TRX 420 FA6 Fourtrax Rancher Auto/DCT/IRS/EPS	14-15	R
TRX 450 R/ER	04-11	R
TRX 500 FA5 Foreman Rubicon 4 x 4 Auto/DCT	15	R
TRX 500 FA6 Foreman Rubicon 4 x 4/Auto/DCT/EPS	15	R
TRX 500 FM5 Foreman Rubicon 4x 4	15	R
TRX 500 FM6 Foreman Rubicon 4x 4/EPS	15	R
TRX 650 FA Rincon	03-05	R
TRX 650 FGA Fourtrax Rincon Gpscape	04-05	R
TRX 680 FGA6/FGA7/FGA8 Fourtrax Rincon (675cc) Gpscape	06-09	R
TRX 680 FA Fourtrax Rincon	06-15	R

STD	FA373X	Carbon Dual Purpose Pad Blend
OPTION	FA373R	Utility Grade Sintered Pad Blend
OPTION	FA373SV	High Durability Off Road Sintered Blend

Equivalents OE#

06435 HN8 006

06435 HN8 016

Dealer Stocking Recommendation

Single/Pair

1

Popularity

N/A

Rec Stocking Level

1

FA375

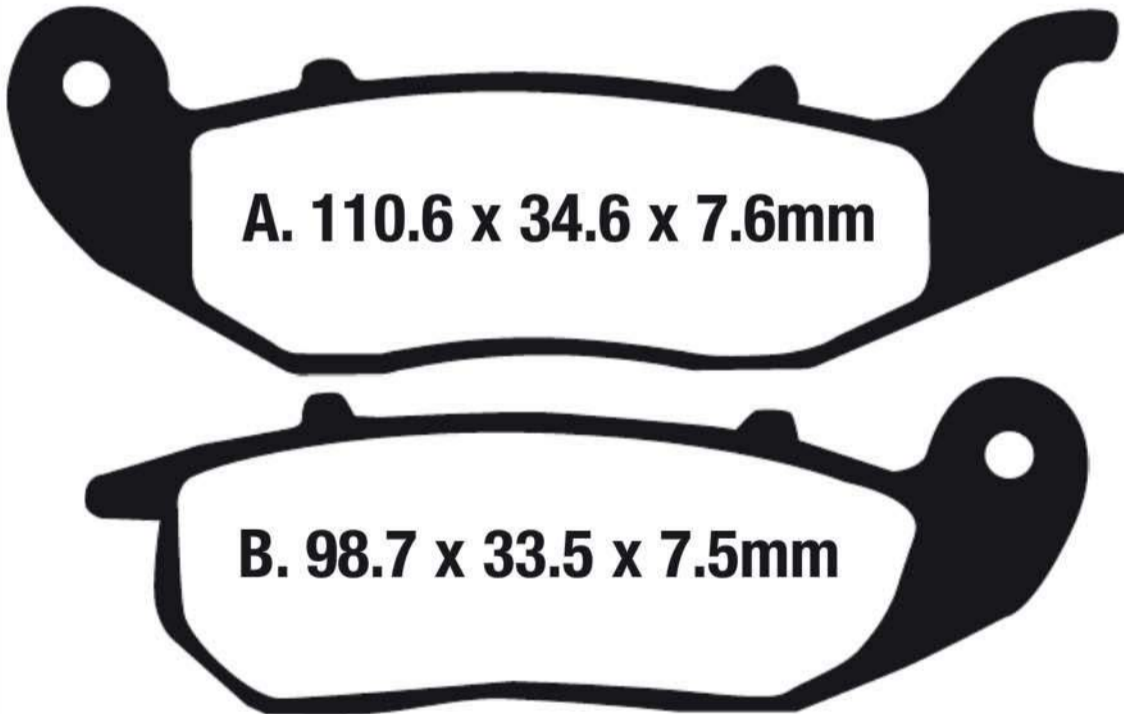

HONDA

CBR 125 R4/R5/RS5/RW5/RWW6/RW7/RW8/RW9/RWA (6 Bolt Front Disc / Canada)	04-10	F
CBR 125 RWB/RC/RD (5 Bolt Front Disc / Canada)	11-13	F
MSX 125 D/E/F/G/H/ Grom (Non ABS)	14-18	F
MSX 125 AH Grom (ABS)	18	

Equivalents OE#

06455 KPH 951

06455 KPP 901

0000 640 7210

STD	FA375	Carbon Dual Purpose Pad Blend
OPTION	FA375HH	Street Performance Sintered Pad Blend

Dealer Stocking Recommendation

Single/Pair

1

Popularity

N/A

Rec Stocking Level

1

FA377

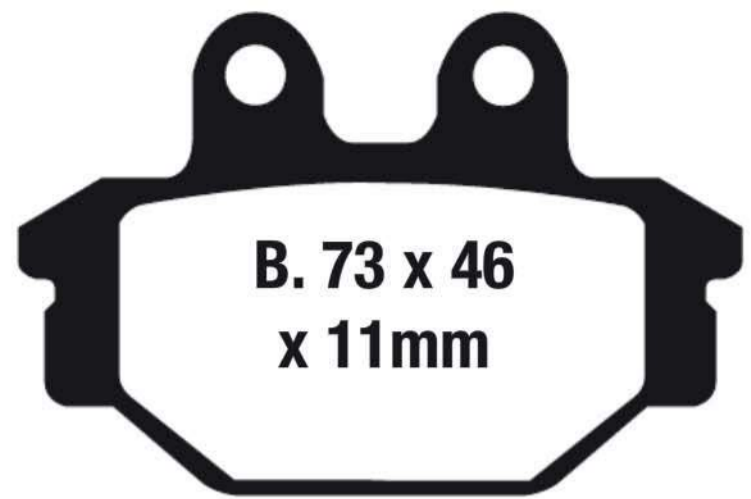

NOTE:- Size identification is shown as follows

ARCTIC CAT

250 Utility	06-09	F & R
250 DVX	06-08	F
250 DVX Sport	06-08	F
300 ATV 2x4 Utility	10-13	F & R
300 DVX	09-12	F

BOMBARDIER

DS 250	06	F & R
--------	----	-------

CAN AM

DS 250 (3J7A/B)	07-14	F & R
-----------------	-------	-------

INDIAN

Scout (Toso Calipers/Cast Wheels)	15-16	R
Scout Sixty (Toso Calipers/Cast Wheels)	16	R

KAWASAKI

KVF 300 CCF/CDF/CEF/CFF/CGF/CHF Brute Force	12-17	F & R
---	-------	-------

KYMCO ATV

KXR 250 Mongoose	04-09	F
MXU 250	04-10	F
MXU 270	16	F & R
Mongoose 300	06-16	F
MXU 300	05-14	F & R
MXU 500 4 x 4 (Carb models)	07-09	F & R

KYMCO SIDE X SIDE

UXV 450i (All EFI models)	15-16	F & R
UXV 500 4 x 4 (All Carb models)	08-14	F & R
UXV 500 I (All EFI models)	13-16	F & R
UXV 700i 4 x 4 (All models)	14-16	F & R

SYM

Quadlander 300	07-10	F & R
Quadlander 600	08-10	R

TGB

Outback 425 X 4x4	07-09	F & R
Outback 425 S.E. 4x4 Auto	07-09	F & R
Outback 425 Real Tree Camo Edition 4x4 Auto	07-09	F & R

Equivalents OE#

45105 LBA7 3050	515049
S4511ACA1000	43082 Y003
S4311ARCA000	43082 Y004
3303-908	43082 0140
3305-258	2205854
515050	

Dealer Stocking Recommendation

Single/Pair	Popularity #	Rec Stocking Level
2	N/A	2

STD FA377	Premium Organic Street Pad Blend
STD FA377X	Carbon Dual Purpose Pad Blend
OPTION FA377R	Utility Grade Sintered Pad Blend
OPTION FA377V	Semi Sintered Long Lasting Street Pad Blend

FA379



**71.45 x 49.9 x 7.76mm
(without shim fitted)**

KAWASAKI

ZX10R (ZX 1000 E8F/E9F/FAF)	08-10	F
ZX10R (ZX 1000 JBF/JCF/JDF/JEF/JFF - Non ABS Model)	11-15	F
ZX10R (ZX 1000 JFFA - 30th Anniversary Edition - Non ABS Version)	15	F
ZX10R ABS (ZX 1000 KBF/KCF/KDF/KEF/KFF)	11-15	F
ZX10R ABS (ZX 1000 KFFA - 30th Anniversary Edition - ABS Version)	15	F
Z 1000 (ZR 1000 DAF/DBF/DCF/DDF/DDFA) Non ABS	10-13	F
Z 1000 ABS (ZR 1000 GEG/GEFA/GFF/GGF) ABS	14-16	F
ZX 1000 HCF/HDF Ninja 1000 ABS	12-13	F
1000 Ninja (ZX 1000 GBF/GCF/GDF)	11-13	F
1000 Ninja ABS (ZX 1000 MEF/MFF)	14-15	F

SUZUKI

GSXR 600 K4/K5/XK5/K6/K7/K8/K9	04-10	F
GSXR 750 K4/K5/XK5/K6/K7/K8/K9	04-10	F
DL 1000 AL4/AL5/AL6/AL7/AL8 V-Strom ABS	14-18	F
DL 1000 AAL4/AAL5/AAL6 V-Strom Adventure ABS	14-16	F
DL 1000 XT XAL8 V-Strom (ABS)	18	F
GSXR 1000 K4/ZK4/K5/K6/K7/K8/K9	04-11	F
GSX 1300 RK8/RK9/RL/RL2	08-12	F
VZR1800 K6/K7/K8/K9/L1/L2/L3/L4 (Boulevard M109R)	06-14	F
VZR1800 NK8/NK9 (Boulevard Limited M109R2)	08-09	F
VZR1800 ZK8/ZK9/ZL1/ZL2/ZL3/ZL4 (Boulevard RZ Limited -M109RZ)	08-14	F
VZR1800 BL4/BL5/BL6/BL7 (Boulevard B.O.S.S. M109R)	14-17	F

Equivalents OE#

59100 29820	43082 0091	59300 47890
59100 29850	43082 0113	107 A486 51
59100 29840	43082 0144	
59100 29860	43082 0147	

STD	FA379HH	Street Performance Sintered Pad Blend
OPTION	EPFA379HH	Fast Street Use & Track Day Sintered Pad Blend
OPTION	GPFAX379HH	Race Only Sintered Pad Blend

Dealer Stocking Recommendation

Single/Pair	Popularity #	Rec Stocking Level
2	N/A	2

FA380

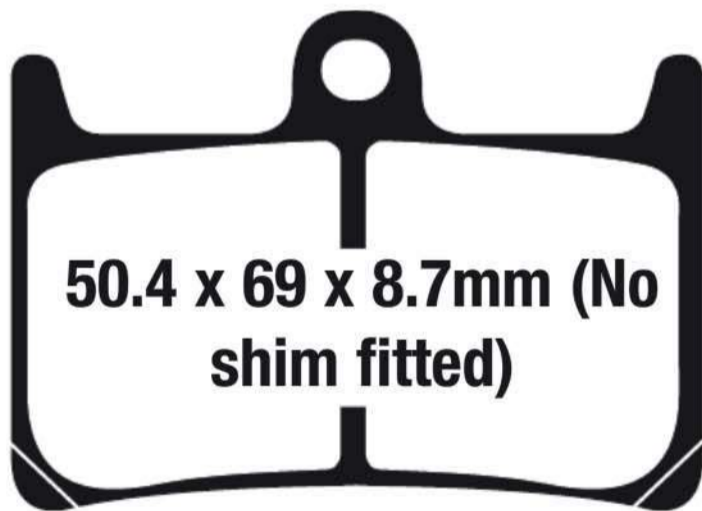

50.4 x 69 x 8.7mm (No shim fitted)

YAMAHA

YZF-R6 T/V/W (310mm rotor)	05-07	F
YZF-R6 X/Y/Z/A/B/D/E/F/G	08-16	F
XSR 900 ABS (MTM 850)	16-17	F
YZF R1	04-05	F
YZF R1 LE	06	F
YZF R1	15-17	F
YZF R1M	15-17	F
YZF R1S	16-17	F
YZF-R6 X/Y/Z/A/B/D/E/F/G	08-16	F
YZF-R6 H (320mm Rotor)	17	F
(FZ1) FZS 1000 V/W/X/Y/Z/A/B/D/E	06-14	F
FZ8	11-13	F
FZ-10	17	F
XT 1200 Z Super Tenere	12-18	F
XT 1200 Z Super Tenere ES	14-18	F

Equivalents OE#

5VY W0045 00
5VN W0045 00
2C0 25805 00

Dealer Stocking Recommendation

Single/Pair	Popularity #	Rec Stocking Level
2	N/A	2

STD	FA380HH	Street Performance Sintered Pad Blend
OPTION	EPFA380HH	Fast Street Use & Track Day Sintered Pad Blend
OPTION	GPFAX380HH	Race Only Sintered Pad Blend

FA381

Note: When using HH version refit the original heat insulator and shim. DO NOT use the shim and insulator when using the standard EBC black pads/V pads.



HARLEY DAVIDSON

XL 883 Sportster Standard	04-08	F
XL 883 C Sportster Custom	04-10	F
XL 883 L "883 Low"	04-10	F
XL 883 R Sportster R	05-13	F
XL 883 R Roadster	10-13	F
XL 883 N Iron	09-12	F
XL 883 L Superlow	11-12	F
XL 1200 C Sportster Custom	04-12	F
XL 1200 L Sportster Low	07-11	F
XL 1200 N Nightster (Spoke wheel)	08-12	F
XL 1200 R Sportster Roadster	04-08	F
XL 1200 X Sportster Forty Eight	10-12	F
XL 1200 V Sportster Seventy Two	12-13	F

LYNDALL BRAKES

PAD REF 7233

Equivalents OE# 42831-04

Dealer Stocking Recommendation

Single/Pair	Popularity #	Rec Stocking Level
2	N/A	2

STD	FA381	Premium Organic Street Pad Blend
OPTION	FA381HH	Street Performance Sintered Pad Blend
OPTION	FA381V	Semi Sintered Long Lasting Street Pad Blend
OPTION	EPFA381HH	Fast Street Use & Track Day Sintered Pad Blend

SFA384

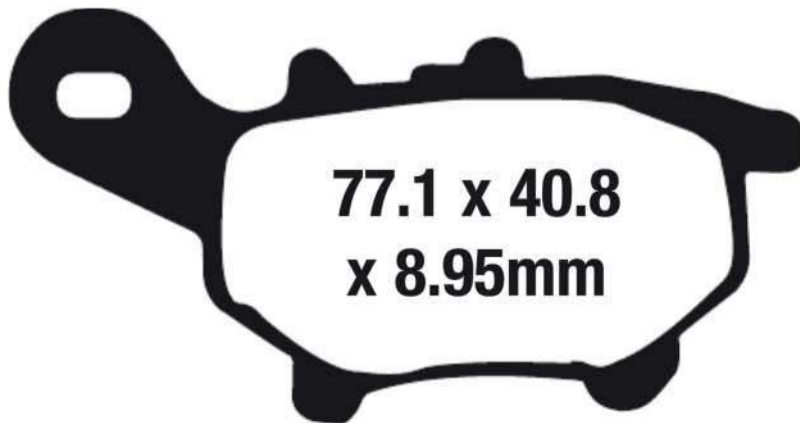
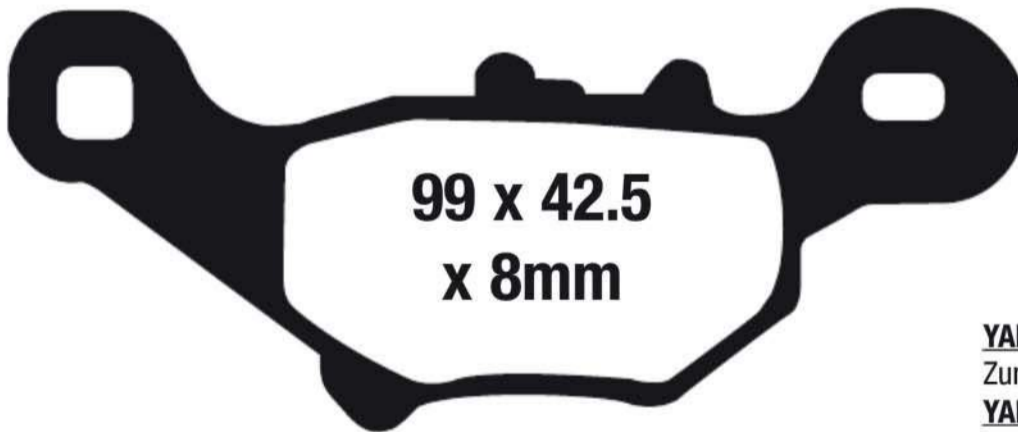

YAMAHA (TWIN HEADLIGHTS)

Zuma 50 F (YW 50 FB/FD/FE/FF/FG) 12-16 F

YAMAHA (SINGLE HEADLIGHTS)

Zuma 50 FX (YW 50 FXE/FXF/FXG) 14-16 F

Equivalents OE#

5SU W0045 00
5SU W0045 02

Dealer Stocking Recommendation

Single/Pair	Popularity #	Rec Stocking Level
2	-	2

STD	SFA384	Premium Organic Scooter Pad Blend
------------	---------------	-----------------------------------

FA387



Note: When using HH version refit the original heat insulator and shim. DO NOT use the shim and insulator when using the standard EBC black pads/V pads.

HARLEY DAVIDSON

XL 883 Sportster Standard	04-08	R
XL 883 C Sportster Custom	04-10	R
XL 883 L "883 Low"	04-10	R
XL 883 R Sportster R	05-09	R
XL 883 R Roadster	10-13	R
XL 883 N Iron	09-12	R
XL 883 L Superlow	11-12	R
XL 1200 C Sportster Custom	04-12	R
XL 1200 L Sportster Low	07-11	R
XL 1200 N Nightster (Spoke wheel)	08-12	R
XL 1200 R Sportster Roadster	04-08	R
XL 1200 X Sportster Forty Eight	10-12	R
XL 1200 V Sportster Seventy Two	12-13	R
XR 1200	08-10	R
XR 1200 X	10-12	R

LYNDALL BRAKES

PAD REF 7234

STD	FA387	Premium Organic Street Pad Blend
OPTION	FA387HH	Street Performance Sintered Pad Blend
OPTION	EPFA387HH	Fast Street Use & Track Day Sintered Pad Blend
OPTION	FA387V	Semi Sintered Long Lasting Street Pad Blend

Dealer Stocking Recommendation

Equivalents OE#

42836-04
42029-07

<u>Single/Pair</u>	<u>Popularity #</u>	<u>Rec Stocking Level</u>
1	N/A	1

FA388

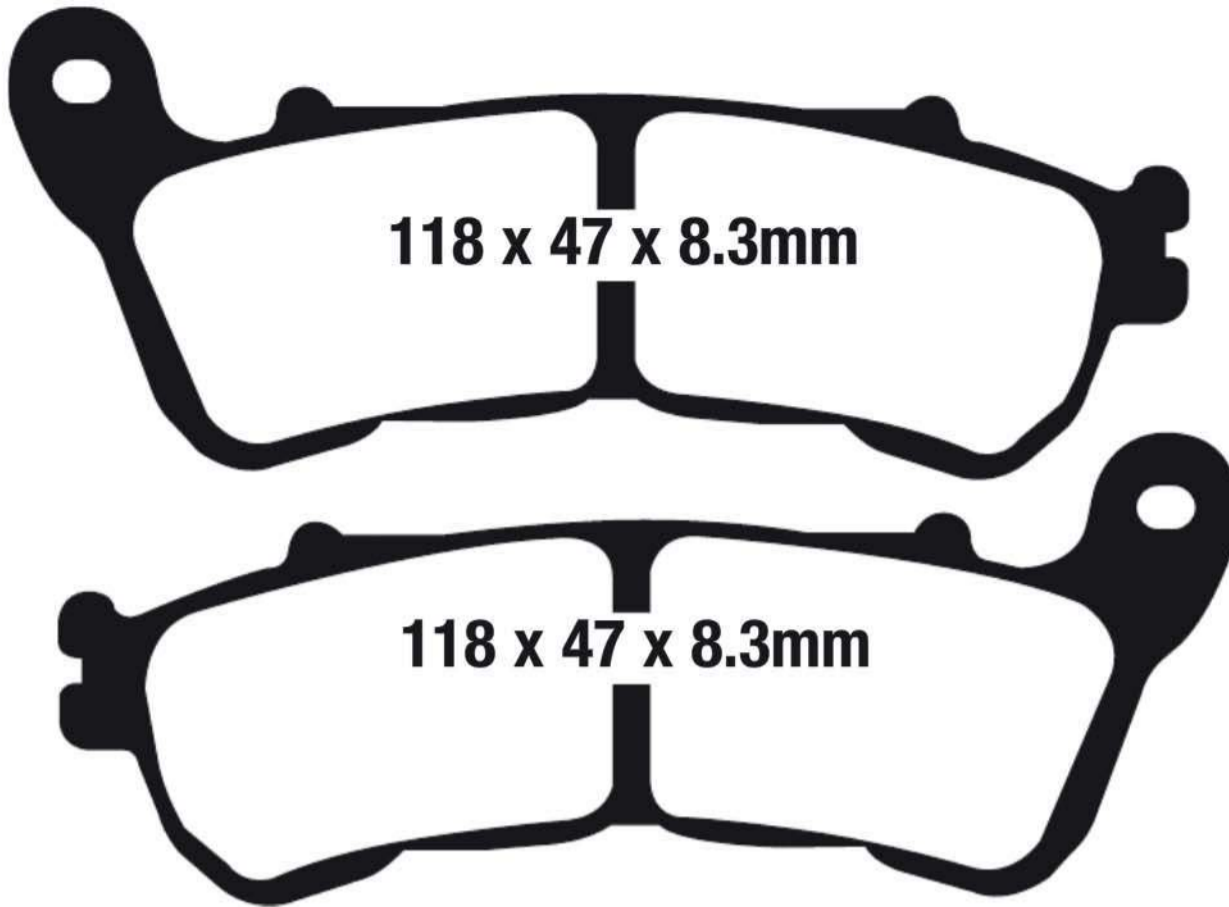

BUYERS GUIDE
BRAKE PADS

Dimension 1=Width or Diameter, Dimension 2=Height or Diameter, Dimension 3=Thickness (Material and backplate)

NOTE:- Size identification is shown as follows

HONDA

- CBR 250 RA (ABS Model) 11-14 F
- NSS 300 Forza (Non ABS) 14-16 F
- NSS 300 A Forza (ABS) 14-16 F
- NC 700 XD (Auto G/Box) 12-14 F
- NT 700 V/VA (ABS) 10-13 F
- VT 750 C2E Shadow Aero (ABS/Rear Disc Model) 13-14 F
- VT 750 C2S Shadow Spirit (ABS/Rear Disc Model) 13-14 F
- VFR 800 Interceptor 06-09 F
- CBF 1000 A8 (Canada) 08 F&R
- XL 1000 VA8 Varadero (Canada) 08 F
- CB 1100 A (ABS) 13-14 F
- VFR 1200 XA (Manual G/Box) 16-17 F
- VFR 1200 XD DCT (Automatic Transmission Model) 16-17 F
- CTX 1300 14 F
- CTX 1300 DLX (ABS) 14 F
- ST 1300/ST 1300 A ABS 08-13 F
- VT 1300 CXA Fury (ABS Model) 10-15 F
- VT 1300 CSA Sabre ABS 10-14 F
- VT 1300 CRA Stateline ABS 10-15 F
- VT 1300 CTA Interstate ABS 10-15 F
- F6B Goldwing (GL1800B) 13-15 F
- F6B Goldwing Deluxe (GL1800BD) 13-15 F

SUZUKI

- C 109 RT Boulevard (1783cc) VLR 1800 RTK8/RTK9/RL0 08-10 F
- C 109 R Boulevard (VLR 1800 K8/K9 1783cc) 08-10 F
- VLR 1800 TK8/TK9/TKL0 C109 RT Touring 08-10 F
- VLR 1800 K8/K9/L0 C109 R 08-10 F

SFA388

HONDA

- PS 250 Big Ruckus 05-06 F
- NSA 700 A9 "DN-01" 09-11 F
- CBR 600 RR 05-15 F
- NSS300 (Non ABS) 14-16 F
- NSS300A (ABS) 14-16 F

SUZUKI

- UH 200 AL4/AL5/AL6 Burgman ABS 14-16 F

STD	FA388	Premium Organic Street Pad Blend
OPTION	FA388HH	Street Performance Sintered Pad Blend
OPTION	SFA388	Premium Organic Scooter Pad Blend
OPTION	SFA388HH	Scooter Performance Sintered Pad Blend
OPTION	EPFA388HH	Fast Street Use & Track Day Sintered Pad Blend

Equivalents OE#

06455 KSV J03	59100 22830
06455 KSV J41	59101 03810
06455 KSV J01	59300 22830
06455 MCS R01	
06455 MGS D81	

Dealer Stocking Recommendation

Single/Pair	Popularity #	Rec Stocking Level
1	N/A	1

FA390

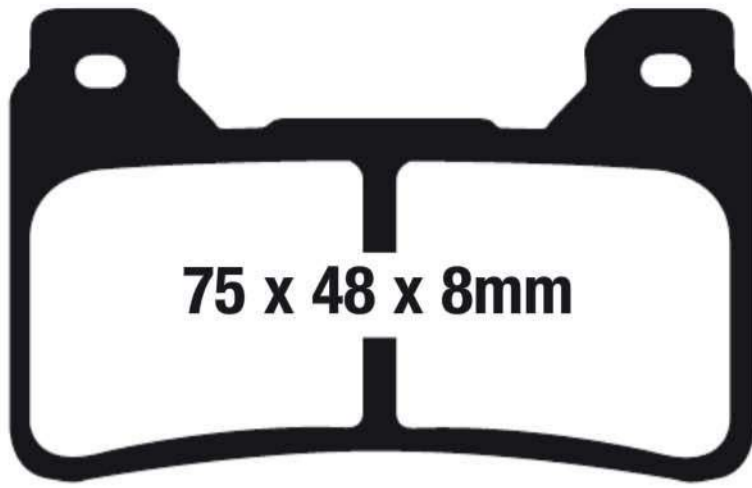

75 x 48 x 8mm

HONDA

CBR 600 RR (Non ABS)	05-17	F
CBR 600 RRA (ABS Model)	09-17	F
VFR 800 F Interceptor (Non ABS Model)	14-15	F
VFR 800 FD Interceptor DLX (ABS Model)	14-15	F
CB 1000 R	10-16	F
CBR 1000 RR	04-15	F
CBR 1000 RRA (ABS)	09-16	F

Equivalents OE#

06455 MEL 003	06455 MJH D01
06455 MEL D22	107 A486 48
06455 MFJ D01	

STD	FA390HH	Street Performance Sintered Pad Blend
OPTION	EPFA390HH	Fast Street Use & Track Day Sintered Pad Blend
OPTION	GPFA390HH	Race Only Sintered Pad Blend

Dealer Stocking Recommendation

Single/Pair	Popularity #	Rec Stocking Level
2	N/A	2

FA395



95 x 48 x 7mm

ARCTIC CAT

250 2 X 4 Utility	05-09	F & R
250 4 X 4 Utility	05/08	F & R
300 4 X 4 Utility	05	F & R
300 ATV	10-12	F & R
350 ATV	12	F & R
366 4 X 4 Auto Utility	08-09	F & R
366 SE	10	F & R
400 4 X 4 Utility	05-07	F & R
400 4 X 4 VP Utility	05-06	F & R
400 4 X 4 Auto Utility	05-08	F & R
400 4 X 4 Auto LE Utility	05-07	F & R
400 4 X 4 Auto VP Utility	05-06	F & R
400 4 X 4 Auto TBX Utility	05-06	F & R
400 ATV (Core/2-UP)	13-14	F & R
400 TRV (Core/2-UP)	13-14	F & R
400 TRV H1	10	F & R
400 4X Auto TRV Multirider	06	F & R
400 4X Auto TRV Plus Multirider	07	F & R
425i	12	F & R
425i SE	12	F & R
450 ATV (Core/2-UP)	13-14	F & R
450 H1 EFI	10	F & R
450i	11-12	F & R
450i GT	12	F & R
450 TRV	11-12	F & R
450i TRV	11	F & R
450i XC	13-14	F & R
XC450i	11-12	F & R
500 4 x 4 Auto Utility	05-08	F & R
500 4 x 4 Auto LE Utility	05-06	F & R
500 4 x 4 Manual G/Box Utility	05-09	F & R
500 4 x 4 Auto TBX Utility	05-06	F & R
500 ATV (Mid Size)	13-14	F & R
500 ATV XT (Mid Size)	13-14	F & R
TRV 500 (Core/2-UP)	13-14	F & R
550 HI EFI	09-10	F & R
500 4 x 4 Auto TRV Multirider	05-06/08	F & R
550 ATV (Mid Size)	13-14	F & R
550 ATV LTD (Mid Size)	12-13	F & R
550 ATV XT (Mid Size)	13	F & R
550 HI EFI LE	09-10	F & R
550 TRV	11	F & R
550 TRV Cruiser	11	F & R

ARCTIC CAT Contd.

550 TRV EFI	09-10	F & R
550 TRV Efi LE	09-10	F & R
TRV 550 LTD (2-UP)	13-14	F & R
TRV 550 XT (2-UP)	13-14	F & R
550i	11-12	F & R
550i LTD	11-12	F & R
550i GT	11-12	F & R
550i GT TRV	11	F & R
550i TRV Cruiser	11	F & R
550 GT TRV	11-12	F & R
550 GT S TRV	10	F & R
550 Hi EFI Prowler	09	F & R
HDX 500 Prowler	14	F & R
HDX 500 LTD Prowler	14	F & R
HDX 500 XT Prowler	14	F & R
550 S	10	F & R
550 S LTD	10	F & R
XT 550	10-11	F & R
XT 550 Prowler	11-14	F & R
650 H1 Prowler	07	F & R
650 H1	10	F & R
650 Mudpro	10-11	F & R
650 H1 Mudpro	10-11	F & R
650 H1 TRV	09	F & R
650 H1 TBX 4x4 Auto Utility	07	F & R
650 H1 TRV 4X4 Auto Plus Multirider	07	F & R
650 H1 TRV 4X4 Auto Plus LE Multirider	07	F & R
650 H1 TRV 4X4 Auto	08	F & R
650 Prowler 4 X 4 / M4	08	F & R
650 TBX	09	F & R
650 V2 4 X 4 Auto Utility	04-06	F & R
650 V2 4 X 4 Auto LE Utility	04-05	F & R
650 V2 4 X 4 Auto LE TS Utility	06	F & R
XT 650 H1 Prowler	06-09	F & R
700 ATV/Core	13-14	F & R
700 ATV Diesel	12-14	F & R
700 ATV LTD	12-14	F & R
700 ATV Mud Pro LTD	12-14	F & R
700 Diesel Utility	07-08	F & R
700i GT	11-12	F & R
700 TBX	13	F & R
700 TRV H2 EFI Cruiser	09-10	F & R
700 TRV	11-12	F & R

BUYERS GUIDE
BRAKE PADS

NOTE:- Size identification is shown as follows
Dimension 1=Width or Diameter, Dimension 2=Height or Diameter, Dimension 3=Thickness (Material and backplate)

FA395 Contd.

ARCTIC CAT Contd.

700 TRV Cruiser	11-12	F & R
700 TRV GT	11-12	F & R
700 TRV LTD (2-UP)	13-14	F & R
700 TRV XT	13-14	F & R
700 ATV XT	13-14	F & R
700 Efi 4 X 4 Utility	07-08	F & R
700 Efi 4 X 4 LE Utility	06	F & R
700 Efi 4 X 4 SE Utility	06	F & R
700 Efi Cruiser	11	F & R
700 Efi 4 x 4 Auto M4	08	F & R
700 Efi 4 x 4 Auto TRV LE	08	F & R
700 H1 Efi	09-10	F & R
700 H1 Efi LE	09-10	F & R
700 HI Efi 4x4 Auto SE	08-09	F & R
700 H1 TBX Efi	10	F & R
700 Super Duty Diesel	10-11	F & R
700 Mudpro	10-11	F & R
700 H1 Efi Mudpro	09-11	F & R
700i	11-12	F & R
700i LTD	11-12	F & R
700i Mudpro	11-12	F & R
700i Mudpro LTD	11	F & R
700 S	10	F & R
700 S LTD	10	F & R
700 TBX LTD	11	F & R
HDX 700 Prowler	11-13	F & R
HDX 700 LTD Prowler	14	F & R
XTX 700 Hi LE Prowler	08	F & R
XTX 700 Hi Efi Prowler	09	F & R
XTX 700 Prowler	11-14	F & R
Prowler 700 HDX Trail	14-17	F & R
1000 GT	11-12	F & R
1000 Mudpro	10-11	F & R
1000 ATV 4x4 Auto Mudpro	10	F & R

ARCTIC CAT Contd.

1000 H2 Mudpro Efi	11-12	F & R
1000 ATV H2 Efi	11	F & R
1000i Mudpro LTD	12-14	F & R
1000 TRV Cruiser	11	F & R
1000 TRV H2 Efi Cruiser	09-10	F & R
Thundercat 1000 H2	08-10	F & R
Thundercat 1000 H2 LE	10	F & R
1000 TRV H2 Efi	10	F & R
TRV 1000 LTD (2-UP)	13-14	F & R
1000 XT	13-14	F & R
XTZ 1000 Prowler	09-14	F & R
Wildcat 1000i GT	12	F & R
Wildcat 1000 GT	13-14	F & R
Wildcat 1000 LTD	13-14	F & R
Wildcat X1000	14	R
Wildcat 4 X1000	14	R
Wildcat 4 1000	14	R
Wildcat 4 LTD 1000	14	R
Wildcat 1000	15-18	R
wildcat 1000 4	15-18	R
Wildcat X EPS 1000	15-18	R

KYMCO ATV

Maxxer 375 4 x 4 IRS	10-12	F & R
MXU 375 4 x 4 IRS	08-12	F & R
Maxxer 450 4 x 4 IRS	11-16	F & R
MXU 450 4 x 4 IRS	11-14	F & R
MXU 450 4 x 4 IRS LE	11-14	F & R

POLARIS

Hawkeye 300 2x4/4x4	06	F & R
---------------------	----	-------

BUYERS GUIDE
BRAKE PADS

Dimension 1=Width or Diameter, Dimension 2=Height or Diameter, Dimension 3=Thickness (Material and backplate)

NOTE:- Size identification is shown as follows

STD	FA395X	Carbon Dual Purpose Pad Blend
OPTION	FA395R	Utility Grade Sintered Pad Blend
OPTION	FA395SV	High Durability Off Road Sintered Blend

Equivalents OE#

0502 604	1436-420
0502 875	1502-694
2203045	45105 PWB 1305
1436-165	1436-811

Dealer Stocking Recommendation

Single/Pair	Popularity #	Rec Stocking Level
2	N/A	2

FA398



CAN AM

DS 450 (2x4/EFI)	08-15	R
DS 450 X (2x4/EFI)	08-11	R
DS 450 Xxc/Xmx	10-15	R

JOHN DEERE

Gator HPX All models	04-08	F & R
HPX 4x2 Gator (Petrol)	10-11	F & R & Parking brake
HPX 4x4/4x4 Trail Gator (Petrol)	10-11	F & R
HPX 4x4 (Diesel) (SN040000)	10	F & R

Equivalents OE#

VGA 12182
VGA 12183
Z150-9261
705600485

STD	FA398R	Utility Grade Sintered Pad Blend
OPTION	FA398SV	High Durability Off Road Sintered Blend

Dealer Stocking Recommendation

Single/Pair	Popularity #	Rec Stocking Level
2	2	2

FA399



**69.65 x 51.55 x
7.25mm**

DERBI

GPR 125/Nude (Radial Caliper)

05-06

F

Equivalents OE#

00H01201221

STD FA399 Premium Organic Street Pad Blend

Dealer Stocking Recommendation

Single/Pair	Popularity #	Rec Stocking Level
1	-	-

BUYERS GUIDE
BRAKE PADS

FA400

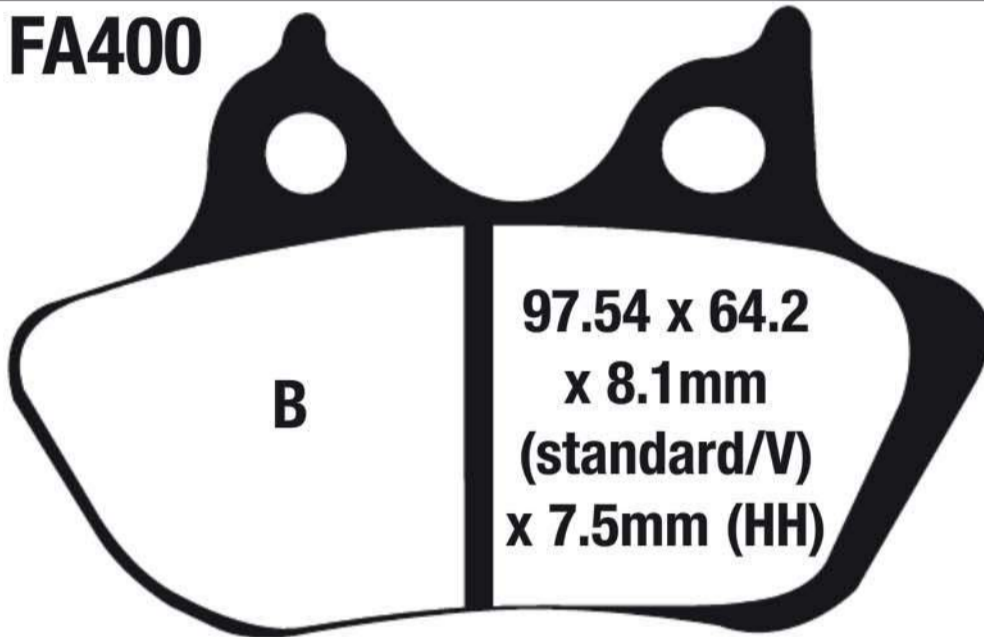

B

**97.54 x 64.2
x 8.1mm
(standard/V)
x 7.5mm (HH)**

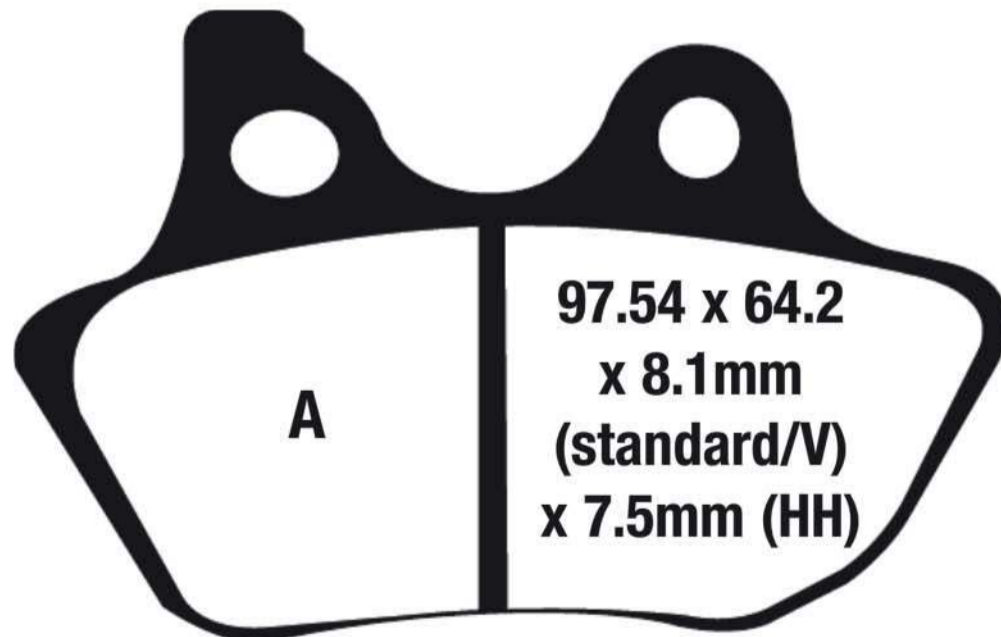

A

**97.54 x 64.2
x 8.1mm
(standard/V)
x 7.5mm (HH)**

**Check pad shape to confirm correct pad has been selected
NOTE - Use FA400V or HH for best performance on rear caliper**

STD	FA400	Premium Organic Street Pad Blend
OPTION	FA400HH	Street Performance Sintered Pad Blend
OPTION	FA400V	Semi Sintered Long Lasting Street Pad Blend
OPTION	FA400VLD	Chrome Backed Semi Sintered Long Lasting Street Pad
OPTION	EPFA400HH	Fast Street Use & Track Day Sintered Pad Blend

Dealer Stocking Recommendation

Single/Pair	Popularity #	Rec Stocking Level
1	N/A	4

HARLEY DAVIDSON

XLH883 Sportster	00-03	F&R
XLH883r Sportster Flat Track	00-03	F&R
XL883 Sportster Hugger	00-03	F&R
XL53c Sportster Custom (883cc)	00-03	F&R
XL883 R 100th Anniversary Edition	03	F&R
XL1200c Sportster Custom	00-03	F&R
XL1200s Sportster Sport	00-03	F&R
FXD Super Glide	00-03	F&R
FXDX Super Glide Sport	00-03	F&R
FXDL Low Rider	00-03	F&R
FXDWG Wide Glide	00-03	F&R
FXDS-CON Dyna Convertible	00-02	F&R
FXDXT Superglide T-Sport	01-03	F&R
FXDi Super Glide 1450	04-05	F&R
FXDi 35 35th Anniversary Super Glide (Spoke wheels)	06	F&R
FXDXi Super Glide Sport	04-05	F&R
FXDLi Low Rider 1450	04-05	F&R
FXDLi Dyna Low Rider (Spoke wheels)	06	F&R
FXDWGi Wide Glide 1450	04-05	F&R
FXDWGi Dyna Wide Glide (Spoke wheels)	06-07	F&R
FXDC/FXDCi Super Glide Custom	05	F&R
FXDCi Dyna Superglide Custom (Spoke wheels)	06-07	F&R
FXDBi Street Bob (Spoke wheels)	06-07	F&R
FXDi Super Glide (Cast wheel)	06-07	F&R
FXDLi Low Rider (Cast wheel)	06-07	F&R
FXDLi Low Rider (Spoke wheel)	06-07	F&R
FXDCi Superglide Custom (Cast wheel)	06	F&R
FXST/FXSTi Softail Standard	00-05	F&R
FXSTB/FXSTBi Night Train	00-05	F&R
FXSTDi/FXSTDi Softail Deuce/i	00-07	F&R
FLSTF/FLSTFi Fat Boy	00-06	F&R
FLSTFi Fat Boy 15th Anniversary Edition	05	F&R
FLSTF/FLSTFi Fat Boy	07	F&R
FLSTCi/FLSTCi Heritage Classic/i	00-07	F&R
FLSTN/FLSTNi Softail Deluxe	05-07	F&R
FLST/FLSTi Heritage Softail	06	F&R
FXST/FXSTi Softail Standard	06-07	F&R
FXSTB/FXSTBi Night Train Softail	06-07	F&R
FXSTC Softail Custom	07	F&R
FLSTC Heritage Softail Classic	07	F&R
FLHRI/FLHR Road King	00-07	F&R
FLHRCi Road King Classic	00-07	F&R
FLHT/FLHTi Electra Glide Standard	00-07	F&R
FLTR/FLTR-i Road Glide	00-07	F&R
FLHTCU-i Electra Glide Ultra Classic	00-07	F&R
FLHRS/FLHRSi Road King Custom	04-07	F&R
FLHTC/FLHTCi Electra Glide Classic	04-07	F&R
FLHX/FLHXi Street Glide	06-07	F&R
V-Rod (Hayes Caliper)	02-05	F&R
XLH883 Sportster	00-03	F&R
XLH883r Sportster Flat Track	00-03	F&R
XL883 Sportster Hugger	00-03	F&R
XL53c Sportster Custom (883cc)	00-03	F&R
XL883 R 100th Anniversary Edition	03	F&R
XL1200c Sportster Custom	00-03	F&R
XL1200s Sportster Sport	00-03	F&R

Equivalents OE#

44082 00C	44442-00
44082 00D	44442-00A
44082 00B	

NOTE:- Size identification is shown as follows
Dimension 1=Width or Diameter, Dimension 2=Height or Diameter, Dimension 3=Thickness (Material and backplate)

NOTE:- Size identification is shown as follows
Dimension 1=Width or Diameter, Dimension 2=Height or Diameter, Dimension 3=Thickness (Material and backplate)

FA401

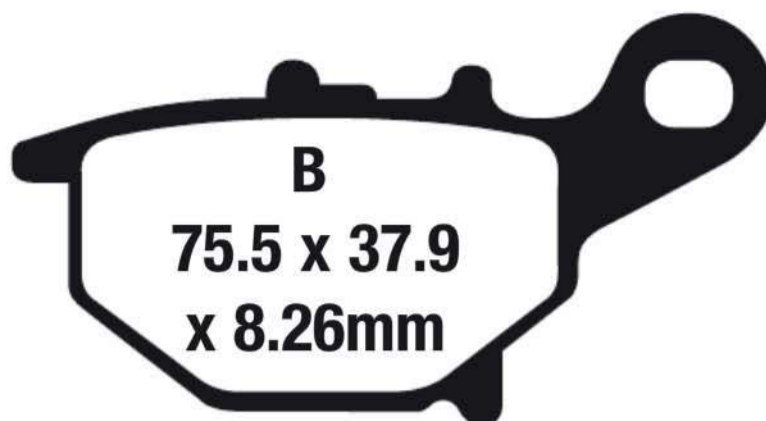
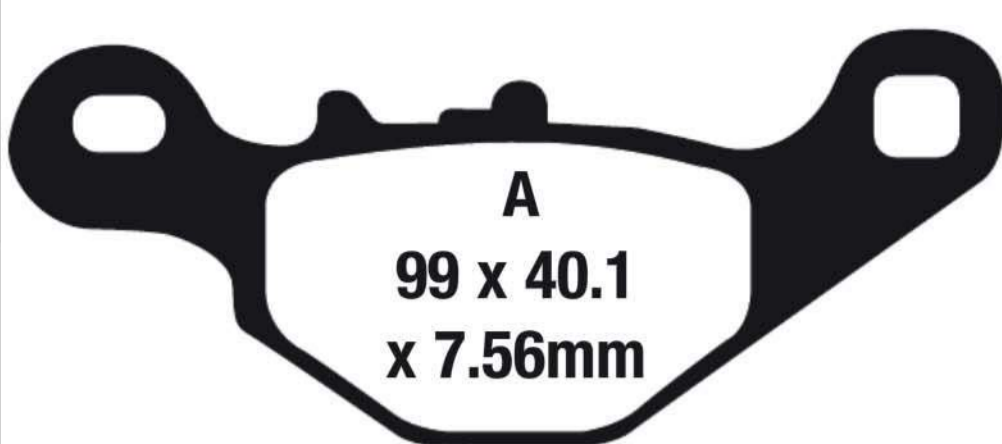

SUZUKI

RM 85 LK5/K5/LK6/K6/K7/LK7/K8/LK8/K9/LK9/L0/
LL0/L2/LL2/LL5/LL6/LL7

05-12/15-17 R

Equivalents OE# 69100 03880

STD FA401X Carbon Dual Purpose Pad Blend
OPTION FA401R Utility Grade Sintered Pad Blend

Dealer Stocking Recommendation

Single/Pair	Popularity #	Rec Stocking Level
-------------	--------------	--------------------

FA403



BETA

Evo 80 09-10 R
Rev 3 125/200 06-08 R
Rev 3 250/270 05-08 R

Equivalents OE# 25-25363

STD FA403X Carbon Dual Purpose Pad Blend

Dealer Stocking Recommendation

Single/Pair	Popularity #	Rec Stocking Level
-------------	--------------	--------------------

FA405



APRILIA

SVX 4.5/5.5 (450/550) (Radial mount caliper) 06-12 F

BERINGER AFTERMARKET CALIPER

4 Piston (Radial)

FTE AFTERMARKET CALIPER

4 Piston Radial Supermoto

HUSABERG

FS Supermotard Models 05-08

KTM

SMR 450/525 05 F
SMR 560 06 F

Equivalents OE# 586 13 030 100

Dealer Stocking Recommendation

STD MXS405 Sintered Sport Off Road Pad Blend
OPTION EPFA405HH Fast Street Use & Track Day Sintered Pad Blend

Single/Pair	Popularity #	Rec Stocking Level
-	-	-

FA406



Note Pads are handed left & right
102.2 x 47.8 x 7.9mm

HUSABERG

FS Models

04

BERINGER AFTERMARKET CALIPER

6 Piston (New Design)

FTE AFTERMARKET CALIPER

Piston Radial Supermoto

Equivalents OE#

800 13 030 000

STD	MXS406	Sintered Sport Off Road Pad Blend
OPTION	EPFA406HH	Fast Street Use & Track Day Sintered Pad Blend

Dealer Stocking Recommendation

Single/Pair	Popularity #	Rec Stocking Level
1	-	-

FA407

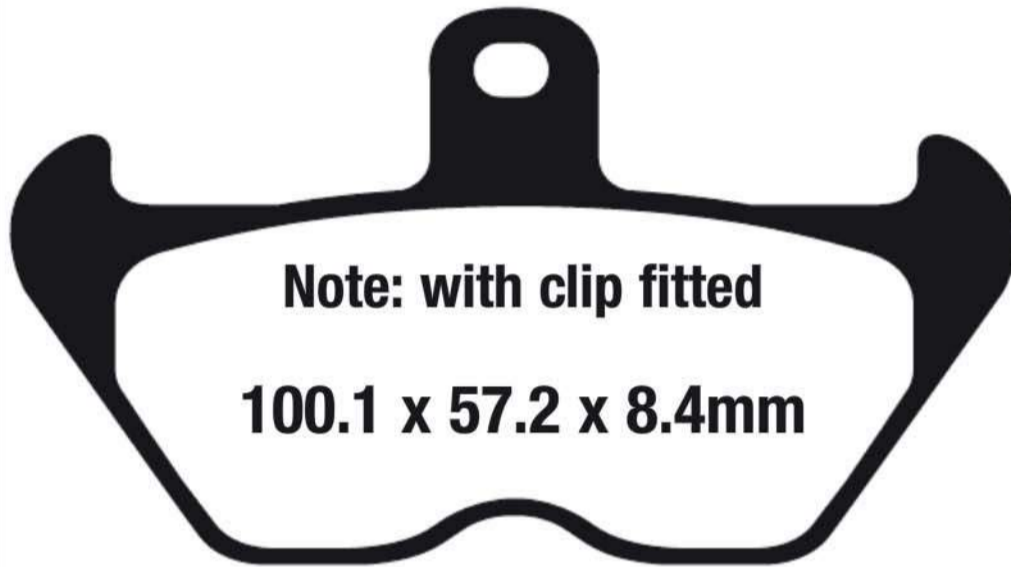

Note: with clip fitted
100.1 x 57.2 x 8.4mm

BMW

R 80 Mystic	94-95	F
R 80 R	91-94	F
R 100 Mystic	93-96	F
R 100 R	91-95	F
R 850 GS (STD & ABS models)	96-00	F
R 850 C (Cast wheel/ABS)	97-00	F
R 850 C (Spoke wheel/ABS)	97-00	F
R 850 R (Cast wheel/ABS)	94-02	F
R 850 R (Spoke wheel)	94-05/96	F
R 850 R (Spoke wheel)	06/96-02	F
R 850 RT (Cast wheel/ABS)	96-01	F
R 850 RT (Spoke wheel)	96-01	F
R 1100 GS (STD & ABS)	93-99	F
R 1150 GS (R21/0415/0495)	98-10/01	F
R 1100 R	93-01	F
R 1100 RS	92-01	F
R 1100 S	96-11/00	F
R 1100 RT	94-01	F
R 1200 (Independence)	00-02	F
R 1200 C	96-02	F
K 100 RS (16 valve)	89-92	F
K1 (16 valve)	88-93	F
K 1200 RS	96-00	F
K 1200 LT	97-10/00	F
K 1100 LT	89-99	F
K 1100 RS	92-96	F

Equivalents OE#

34 11 2 314 996
34 11 2 310 983

STD	FA407	Premium Organic Street Pad Blend
OPTIONS	FA407HH	Street Performance Sintered Pad Blend
OPTIONS	EPFA407HH	Fast Street Use & Track Day Sintered Pad Blend

Dealer Stocking Recommendation

Single/Pair	Popularity #	Rec Stocking Level
2	-	2

SFA408



99.84 x 38.52 x 11.8mm

YAMAHA

CP 250 V/W/X Morphus	06-08	R
YP 400 RS/T/V/W/X/Y/Z/B Majesty	05-10-12-13	R
XP 500 Y/Z/A (T-Max)	09-11	R
XP 500 T-Max (5VUA/15B1)	05-08	R

Equivalents OE#

5RU W0046 00
5VU W0046 01
1B7 W0046 00

STD	SFA408	Premium Organic Scooter Pad Blend
OPTIONS	SFA408HH	Scooter Performance Sintered Pad Blend

Dealer Stocking Recommendation

Single/Pair	Popularity #	Rec Stocking Level
1	-	-

FA409

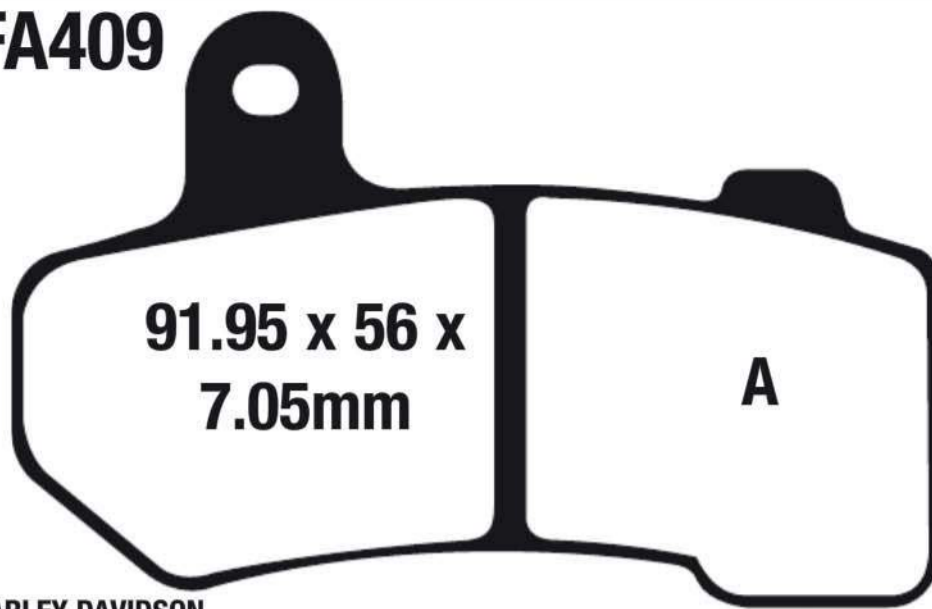

91.95 x 56 x
7.05mm

A

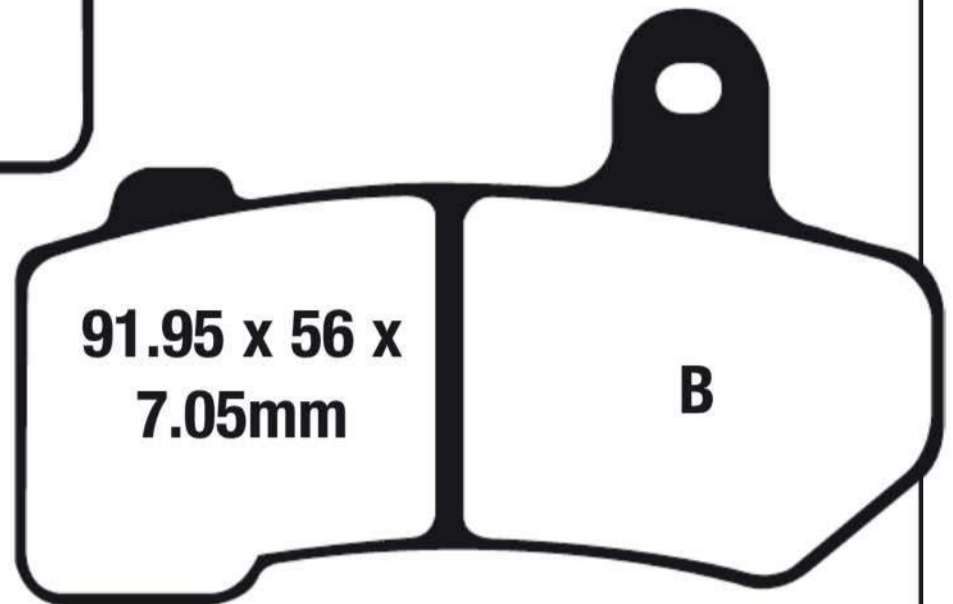

91.95 x 56 x
7.05mm

B

HARLEY DAVIDSON

VRSCR Street Rod	06-07	F & R
VRSCA V-Rod	06	F & R
VRSCD Night Rod	06-08	F & R
VRSCDX Night Rod Special	07-17	F & R
VRSCAW V-Rod	08-11	F & R
VRSCF V-Rod Muscle	09-17	F & R
VRSC Night Rod Special	12	F & R
VRSC 10th Anniversary V-Rod	12	F & R
FLHR Road King (Spoke Wheel Type)	08-16	F & R
FLHR Road King (Cast Wheel Type)	15-18	F & R
FLHRC Road King Classic	08-18	F & R
FLHRXS Road King Special	18	F & R
FLHX Street Glide	08-18	F & R
FLHX Street Glide Anniv.	18	F & R
FLHXS Street Glide Special	15-18	F & R
FLHXS Street Glide Special Anniv.	18	F & R
FLTR Road Glide	08-09	F & R
FLTRX Road Glide Custom	10-12	F & R
FLTRX Road Glide	15-18	F & R
FLTRXS Road Glide Special	15-17	F & R
FLTRXS Road Glide Special	18	F & R
FLHT Electra Glide Standard	08-10	F & R
FLHTC Electra Glide Classic	08-12	F & R
FLHTCU Ultra Glide Classic Electra Glide	08-18	F & R
FLHTCUL Electra Glide Ultra Classic Low	15-16	F & R
FLHTK Electra Glide Ultra Ltd	10-13	F & R
FLHTK Ultra Ltd	15-18	F & R
FLHTK Electra Glide Ultra LTD Anniv.	18	F & R
FLHTK Electra Glide Ultra LTD Shrine Edition	18	F & R
FLHTKL Ultra Ltd Low	15-18	F & R
FLHTCUTG Tri Glide Ultra Classic (Trike)	09-13	F
FLTRU Road Glide Ultra	11-12/16-17	F & R

LYNDALL BRAKES

PAD REF 7254

Equivalents OE#

42850-06A	41854-08
42897-08	41852-08
42897-06A	42850 06B

Dealer Stocking Recommendation

Single/Pair	Popularity #	Rec Stocking Level
2	-	2

STD	FA409	Premium Organic Street Pad Blend
OPTION	FA409HH	Street Performance Sintered Pad Blend
OPTION	FA409V	Semi Sintered Long Lasting Street Pad Blend
OPTION	FA409VLD	Chrome Backed Semi Sintered Long Lasting Street Pad
OPTION	EPFA409HH	Fast Street Use & Track Day Sintered Pad Blend

FA410

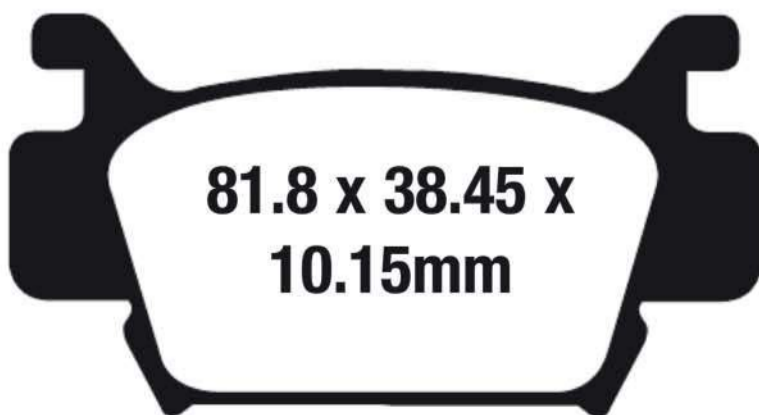

81.8 x 38.45 x
10.15mm

HONDA

TRX 500 FA/FAA Fourtrax Foreman Rubicon	05-14	F
TRX 500 FE5/FE6/FE7/FE8 Fourtrax Foreman 4x4/ES	05-08	F
TRX 500 FE8/FE9 Fourtrax Foreman 4x4 EPS	08-09	F
TRX 500 FE/FEA Fourtrax Foreman Rubicon Gpscape	05-11	F
TRX 500 FM/FMA Fourtrax Foreman 4x4	05-10	F
TRX 500 FPE Fourtrax Foreman 4x4 ES/EP	08-11	F
TRX 500 FPM Fourtrax Foreman 4x4/EP	08-11	F
TRX 500 TM5/TM6 Fourtrax Foreman 2x4	05-06	F
TRX 680 FA Fourtrax Rincon	06-15	F
TRX 680 FGA6/7/8/9	06-09	F
TRX 700 XX	08-11	R

Equivalents OE#

06451 HPO A01
06452 HPO A01
06435 HP6 A01

STD	FA410X	Carbon Dual Purpose Pad Blend
OPTIONS	FA410R	Utility Grade Sintered Pad Blend
OPTIONS	FA410SV	High Durability Off Road Sintered Blend

Dealer Stocking Recommendation

Single/Pair	Popularity #	Rec Stocking Level
1	-	1

SFA411



81 x 42 x 8.2mm

SUZUKI

AN 400 K3/K4/K5/K6/SK6 Burgman

03-06 R

Equivalents OE#

69100 14860
69100 14890

STD	SFA411	Premium Organic Scooter Pad Blend
OPTIONS	SFA411HH	Scooter Performance Sintered Pad Blend

Dealer Stocking Recommendation

Single/Pair	Popularity #	Rec Stocking Level
1	N/A	1

SFA412

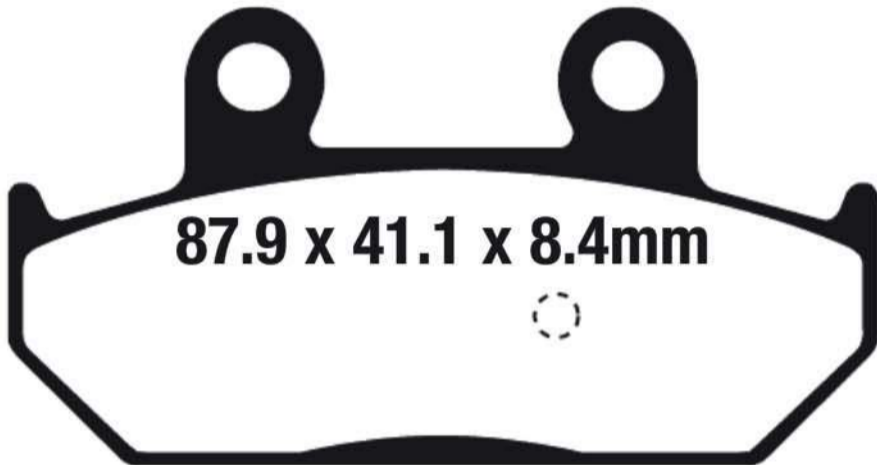

87.9 x 41.1 x 8.4mm

SUZUKI

AN 400 K7/K8/K9/AK9/AL1/AL2/AL3/AL4/AL5/AL6 Burgman 07-16 R
 AN 650 K3/K4/K5/K6/K7/K8/K9/L1 Burgman (Non ABS) 03-11 R
 AN 650 AK6/AK7/AK8/AK9/AL1/AL2/L3/L4/L5/L6 Burgman (ABS) 06-16 R
 AN 650 ZL3/ZL4/ZL5/ZL6/ZL7 Burgman Executive (ABS) 13-17 R

Equivalents OE#

69100 10840
69100 10860

STD	SFA412	Premium Organic Scooter Pad Blend
OPTIONS	SFA412HH	Scooter Performance Sintered Pad Blend

Dealer Stocking Recommendation

Single/Pair	Popularity #	Rec Stocking Level
1	-	1

FA413



A. 82 x 40.85 x 8.2mm



B. 62 x 40.8 x 8.6mm

Equivalents OE#

59100 31860

Dealer Stocking Recommendation

Single/Pair	Popularity #	Rec Stocking Level
1	-	1

STD	FA413X	Carbon Dual Purpose Pad Blend
OPTION	FA413SV	High Durability Off Road Sintered Blend
OPTION	FA413R	Utility Grade Sintered Pad Blend
STD	SFA413	Premium Organic Scooter Pad Blend
OPTION	SFA413HH	Scooter Performance Sintered Pad Blend

**BUYERS GUIDE
BRAKE PADS**

**NOTE:- Size identification is shown as follows
Dimension 1=Width or Diameter, Dimension 2=Height or Diameter, Dimension 3=Thickness (Material and backplate)**

FA413 Contd.

SUZUKI

LT-A 400 FK8/FK9/FL0 King Quad 400 AS	08-10	F Left
LT-A 400 FCK8/9 King Quad 400 AS Camo	08-09	F Left
LT-A 400 FQK9 King Quad 400 AS Anniversary Edition	09	F Left
LT-F 400 FK8/FK9/FL0 King Quad 400 FS	08-10	F Left
LT-F 400 FCK8/FCK9 King Quad 400 FS Camo	08-09	F Left
LT-F 400 FQK9 King Quad 400 FS Anniversary Edition	09	F Left
LT-A 400 FK8 King Quad Auto 4WD	08-09	F Left
LT-F 400 K8 Manual 2WD	08	F Left
LT-A 400 FL1/FL2/FL3/FL4/FL5/FL6 King Quad 400 ASi	11-16	F Left
LT-A 400 FCL1/FCL2/FCL3/FCL4/FCL5/FCL6 King Quad 400 FSi Camo	11-16	F Left
LT-F 400 FL1/FL2/FL3/FL4/FL5/FL6 King Quad 400 FSi	11-16	F Left
LT-F 400 FCL1/FCL2/FCL3/FCL4/FCL5/FCL6 King Quad 400 FSi Camo	11-16	F Left
LT-A 450 XK7/XK8/XK9/XL0 King Quad 4x4	07-10	F Left
LT-A 450 XCK7/8/9 King Quad 450 AXi Camo	07-09	F Left
LT-A 450 XZK8/XZK9 King Quad 450 AXi Special Edition	08-09	F Left
LT-A 500 XPK9/XPL1/XPL2/XPL3/XPL4/XPL5/XPL6 King Quad 500 AXi Power Steering	09-16	F Left
LT-A 500 XPZK9/XPZL1 King Quad 500 AXi Power Steering Limited	09/11	F Left
LT-A 500 XL1/XL2/XL3/XL4/XL5/XL6 King Quad 500 AXi	11-16	F Left

LT-A 500 XCL1/XCL2/XCL3/XCL4/XCL5/XCL6 King Quad 500 AXi Camo

11-16	F Left	
LT-A 700 XK5/XCK6/XK6/XK7/XCK7 King Quad	05-09	F Left
LT-A 750 XK8/XK9/XL1/XL2/XL3/XL4/XL5/XL6 King Quad 750 AXi	08-15	F Left
LT-A 750 XCK8/XCK9/XCL1/XCL2/XCL3/XCL4/XCL5/XCL6 King Quad 750 AXi Camo	08-16	F Left
LT-A 750 XZK8/XZK9/XZL4 King Quad 750 AXi Limited	08-09/14	F Left
LT-A 750 XRK9 King Quad 750 AXi Rockstar Edition	09	F Left
LT-A 750 XPL1/XPL2/XPL3/XPL4/XPL5/XPL6 King Quad 750 AXi Power Steering	11-16	F Left
LT-A 750 XPZX9/XPZL5/XPZL6 King Quad 750 AXi Power Steering Limited	09/15-16	F Left
LT-A 750 XPCK9/XPCL1/XPCL2/XPCL3/XPCL4/XPCL5/XPCL6 King Quad 750 AXi Power Steering Camo	09-16	F Left

SFA413

SUZUKI

UH200 AL4/AL5/AL6 Burgman ABS	14-16	R
-------------------------------	-------	---

BUYERS GUIDE
BRAKE PADS

Dimension 1=Width or Diameter, Dimension 2=Height or Diameter, Dimension 3=Thickness (Material and backplate)

NOTE:- Size identification is shown as follows

FA414

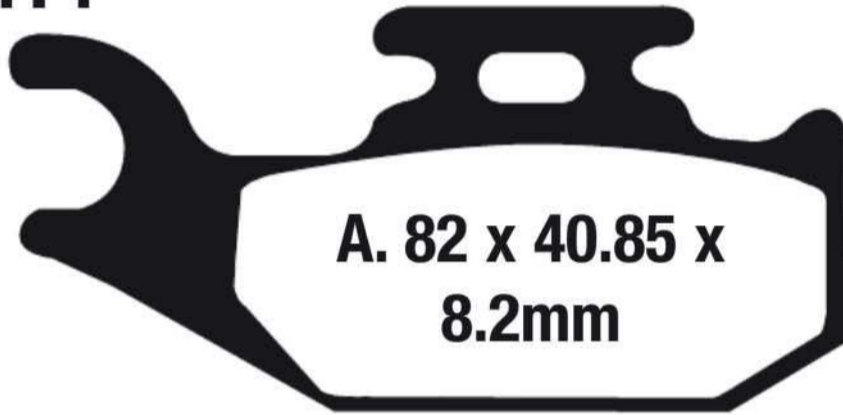

SUZUKI

LT-A 400 FK8/FK9/FL0 King Quad 400 AS	08-10	F Right
LT-A 400 FCK8/9 King Quad 400 AS Camo	08-09	F Right
LT-A 400 FQK9 King Quad 400 AS Anniversary Edition	08-09	F Right
LT-F 400 FK8/FK9/FL0 King Quad 400 FS	08-10	F Right
LT-F 400 FCK8/FCK9 King Quad 400 FS Camo	08-09	F Right
LT-F 400 FQK9 King Quad 400 FS Anniversary Edition	09	F Right
LT-A 400 FK8 King Quad Auto 4WD	08-09	F Right
LT-A 400 FL1/FL2/FL3/FL4/FL5/FL6 King Quad 400 ASi	11-16	F Right
LT-A 400 FCL1/FCL2/FCL3/FCL4/FCL5/FCL6 King Quad 400 ASi Camo	11-16	F Right
LT-F 400 K8 Manual 2WD	08	F Right
LT-F 400 FL1/FL2/FL3/FL4/FL5/FL6 King Quad 400 FSi	11-16	F Right
LT-F 400 FCL1/FCL2/FCL3/FCL4/FCL5/FCL6 King Quad 400 FSi Camo	11-16	F Right
LT-A 450 XK7/XK8/XK9/XL0 King Quad 4x4	07-10	F Right
LT-A 450 XCK7/8/9 King Quad 450 AXi Camo	07-09	F Right
LT-A 450 XZK8/XZK9 King Quad 450 AXi Special Edition	08-09	F Right
LT-A 500 XPK9/XPL1/XPL2/XPL3/XPL4/XPL5/XPL6 King Quad 500 AXi Power Steering	09-16	F Right
LT-A 500 XPZK9/XPZL3 King Quad 500 AXi Power Steering Limited	09/13	F Right
LT-A 500 XL1/XL2/XL3/XL4/XPL5/XPL6 King Quad 500 AXi	11-16	F Right
LT-A 500 XCL1/XCL2/XCL3/XCL4/XCL5/XCL6 King Quad 500 AXi Camo	11-16	F Right
LT-A 700 XK5/XCK6/XK6/XK7/XCK7/XCK8/XCK9 "Kingquad"	05-09	F Right
LT-A 750 XK8/XK9/XL1/XL2/XL3/XL4/XL5/XL6 King Quad 750 AXi	08-16	F Right
LT-A 750 XCK8/XCK9/XCL1/XCL2/XCL3/XCL4/XCL5/XCL6 King Quad 750 AXi Camo	08-16	F Right
LT-A 750 XZK8/XZK9/XZL4 King Quad 750 AXi Limited	08-09/14	F Right
LT-A 750 XRK9 King Quad 750 AXi Rockstar Edition	09	F Right
LT-A 750 XPK9/XPL1/XPL2/XPL3/XPL4/XPL5/XPL6 King Quad 750 AXi Power Steering	09-16	F Right
LT-A 750 XPZX9/XPZL5/XPZL6 King Quad 750 AXi Power Steering Limited	09/15-16	F Right
LT-A 750 XPCK9/XPCL1/XPCL2/XPCL3/XPCL4/XPCL5/XPCL6 King Quad 750 AXi Power Steering Camo	09-16	F Right

Equivalents OE#

59100 31850

STD	FA414X	Carbon Dual Purpose Pad Blend
OPTION	FA414SV	High Durability Off Road Sintered Blend
OPTION	FA414R	Utility Grade Sintered Pad Blend

Dealer Stocking Recommendation

Single/Pair	Popularity #	Rec Stocking Level
1	-	1

SFA415



HONDA

NSS 300 Forza (Non ABS)
NSS 300 A (ABS)

14-16 R
14-16 R

Equivalents OE#

06435 K04 701

STD SFA415 Premium Organic Scooter Pad Blend

FA417/4

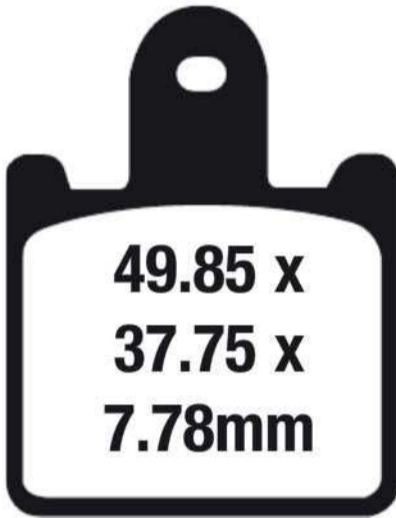

KAWASAKI

ZX6R (ZX 600 P7F/P8F/R9F/RAF/RBF/RCF) 07-12 F
Z 1000 (ZR 1000 B7F/B8F) 07-08 F
Z 1000 (ABS) ZR 1000 C7F 07 F
Concours 14 (ZG 1400 B8F/B9F/DAF) 08-10 F
Concours 14 ABS (ZG 1400 A8F/A9F/CAF/CBF/CCF/CDF/CEFEFF/EGF) 08-16 F
ZX14R Ninja (ZX 1400 A6F/A7F/C8F/C9F/CAF/CBF/ECF/ECFA/EDF/EDFA/EEF) 06-14 F
ZX14R Ninja ABS (ZX 1400 FDF/FEFA/FFFA/FFFB/HGF/HHF) ABS Model 13-17 F

Equivalents OE#

43082 0053
43082 0071
43082 0072
43082 0104
43082 0122

STD FA417/4HH Street Performance Sintered Pad Blend
OPTION EPFA417/4HH Fast Street Use & Track Day Sintered Pad Blend
OPTION GPFAX417/4HH Race Only Sintered Pad Blend

Dealer Stocking Recommendation

Single/Pair	Popularity #	Rec Stocking Level
2	-	2

SFA418

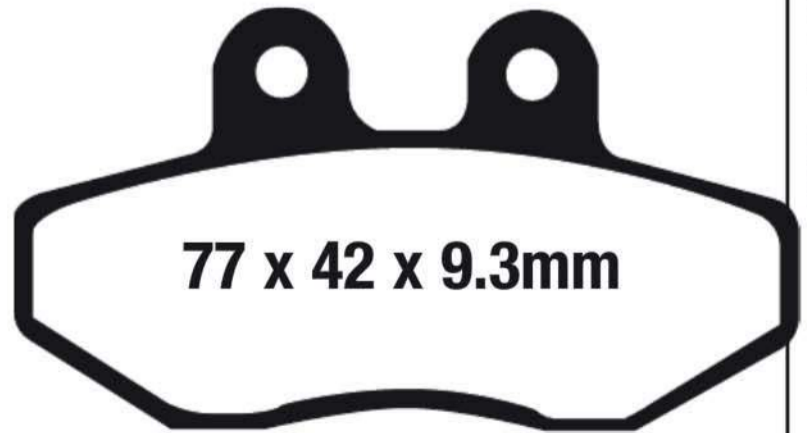

PIAGGIO

BV350 (4T/4V/330cc)
MP3 250 LE (14" Rear Wheel)

12-15 R
10-15 R

Equivalents OE#

497395
647079
665842
668021

STD SFA418 Premium Organic Scooter Pad Blend
OPTION SFA418HH Scooter Performance Sintered Pad Blend

Dealer Stocking Recommendation

Single/Pair	Popularity #	Rec Stocking Level
1	-	1

BUYERS GUIDE
BRAKE PADS

NOTE:- Size identification is shown as follows
Dimension 1=Width or Diameter, Dimension 2=Height or Diameter, Dimension 3=Thickness (Material and backplate)

FA419

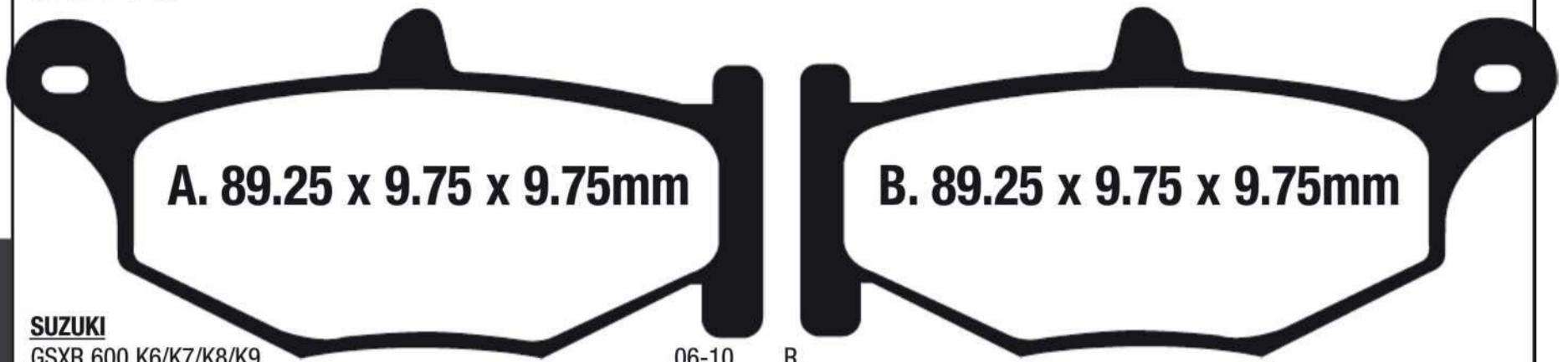

A. 89.25 x 9.75 x 9.75mm

B. 89.25 x 9.75 x 9.75mm

SUZUKI

GSXR 600 K6/K7/K8/K9	06-10	R
GSXR 750 K6/K7/K8/K9	06-10	R
DL1000 AL4/AL5/AL6/AL7/AL8 V-Strom ABS	14-18	R
DL1000 AAL4/AAL5/AAL6 V-Strom Adventure ABS	14-16	R
DL 1000XT XAL8 V-Strom (ABS)	18	R
GSXR 1000 K7/K8	07-08	R
GSX 1300 RK8/RK9/RL1/RL2	08-12	R
GSX 1300 RAL3/RAL4/RAL5/RAL6/RAL7	13-17	R
GSX 1300 RZL4 (Hayabusa 50th Anniversary Edition)	14	R
GSX 1300 BKAK8/K9 B-King ABS	08-09	R
GSX 1300 BKK8/K9 B-King	08-09	R

Equivalents OE#

69100 15820	69101 44820
69101 44810	69100 15850

STD	FA419	Premium Organic Street Pad Blend
OPTION	FA419HH	Street Performance Sintered Pad Blend
OPTION	FA419V	Semi Sintered Long Lasting Street Pad Blend

Dealer Stocking Recommendation

Single/Pair	Popularity #	Rec Stocking Level
1	-	1

FA420

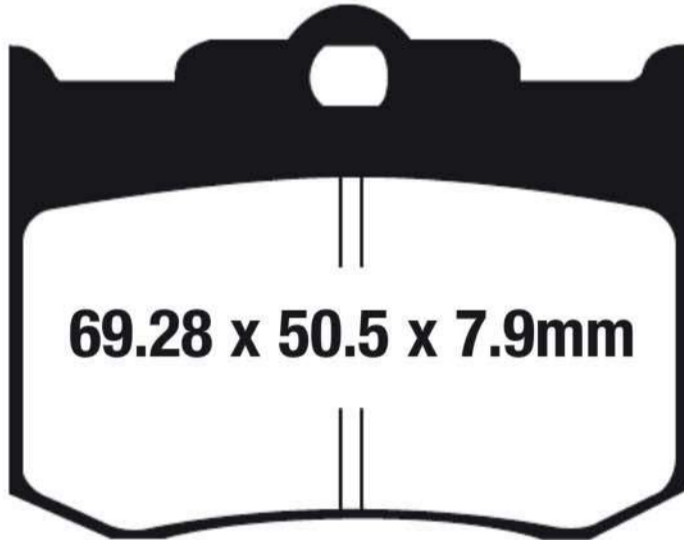

69.28 x 50.5 x 7.9mm

PERFORMANCE MACHINE AFTERMARKET CALIPER 137 X 4 (2006)

Equivalents OE#

137X4

STD	FA420HH	Street Performance Sintered Pad Blend
------------	----------------	---------------------------------------

Dealer Stocking Recommendation

Single/Pair	Popularity #	Rec Stocking Level
1	-	1

FA423/4

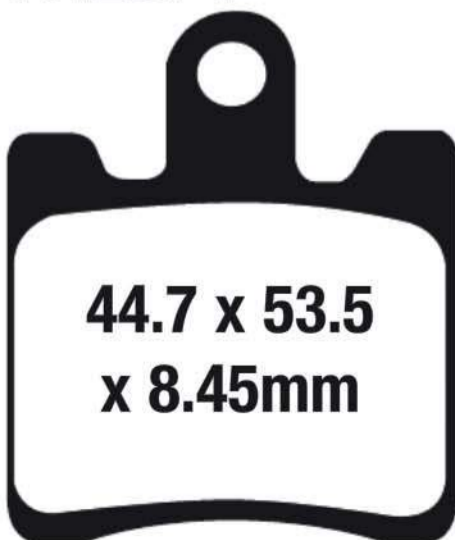

**44.7 x 53.5
x 8.45mm**

TRIUMPH

Trophy SE (1215cc) 13-15 F

YAMAHA

FJR 1300 AV/AW/AX/AZ/AA/AB 06-12 F

FJR 1300 AEW/AEW/AEX/AEY Electric Shift 06-09 F

FJR 1300 A 13-18 F

FJR 1300 ES 14-18 F

Equivalents OE#

3P6 W0045 00
T2022395

STD	FA423/4HH	Street Performance Sintered Pad Blend
------------	------------------	---------------------------------------

Dealer Stocking Recommendation

Single/Pair	Popularity #	Rec Stocking Level
2	-	2

FA424

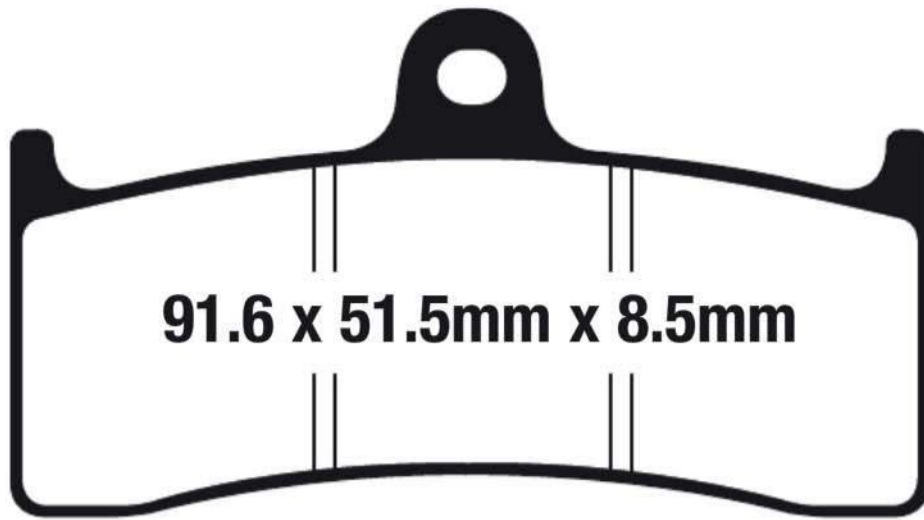

91.6 x 51.5mm x 8.5mm

Equivalents OE#

8000 94024	43082 1181	03 487S-B
8000 98710	42386 98Y	

STD	FA424	Premium Organic Street Pad Blend
OPTION	FA424HH	Street Performance Sintered Pad Blend
OPTION	EPFA424HH	Fast Street Use & Track Day Sintered Pad Blend

Dealer Stocking Recommendation

Single/Pair	Popularity #	Rec Stocking Level
2	-	2

BUELL

M2 Cyclone	98-05	F
S1 Lightning	98-00	F
S1 White Lightning	98-00	F
S3/S3T Thunderbolt	98-00	F
X1 Lightning	98-05	F

HHI - HAWG HALTERS AFTERMARKET CALIPER

6 Piston - All types

JAYBRAKE AFTERMARKET CALIPER

J-Four (300-44) (4 Piston)

KAWASAKI

ZX-7RR (6 piston pad) Nissin Caliper (ZX 750 N1/N2)	96-99	F
---	-------	---

LYNDALL BRAKES

PAD REF 7202

MV

F4 750 (All models) (Nissin Calipers)	99-03	F
F4 (All models)	99-05	F
Brutale 750 (All models) (Nissin Calipers)	03-05	F
Brutale 910 S (Nissin Calipers)	05-07	F
F4 1000 (All models) (Nissin Calipers)	04-06	F

YAMAHA

YZF 750 R7 OW02 Race version	99-01	F
------------------------------	-------	---

SFA425



**55.5 x 54.5
x 8mm**

Dealer Stocking Recommendation

PIAGGIO

MP3 (250cc)

07-12 R

Equivalents OE#

647400
497429
647080

Single/Pair	Popularity #	Rec Stocking Level
2	-	2

STD	SFA425	Premium Organic Scooter Pad Blend
OPTION	SFA425HH	Scooter Performance Sintered Pad Blend

SFA427

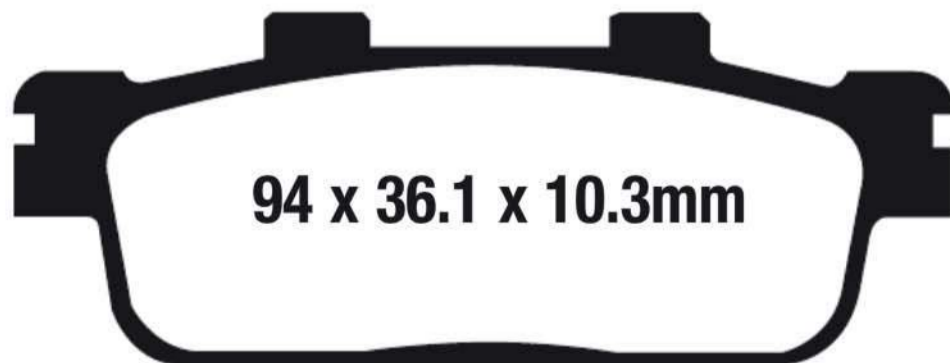

94 x 36.1 x 10.3mm

SYM

RV 200	12-14	R
RV 250 (LM 250 W)	07-12	R

Equivalents OE#

43108 HWW 000A
43105 HMA 00DA
43105 LDH 1E00

STD	SFA427	Premium Organic Scooter Pad Blend
OPTION	SFA427HH	Scooter Performance Sintered Pad Blend

Dealer Stocking Recommendation

Single/Pair	Popularity #	Rec Stocking Level
2	-	2

**BUYERS GUIDE
BRAKE PADS**

**NOTE:- Size identification is shown as follows
Dimension 1=Width or Diameter, Dimension 2=Height or Diameter, Dimension 3=Thickness (Material and backplate)**

FA428

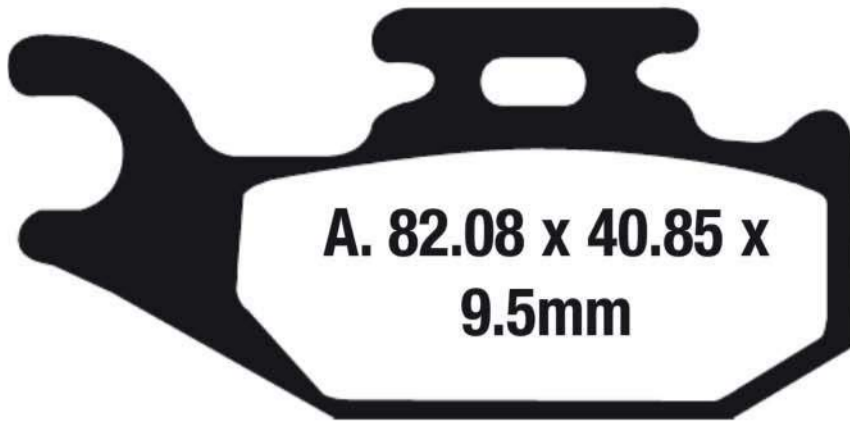

HISUN

250 Sector	15-16	Parking brake
250 Strike	15-16	Parking brake
400 Forge	15-16	Parking brake
HS 400	15-16	Parking brake
450 Sector	15-16	Parking brake
500 Forge	15-16	Parking brake
HS 500	15-16	Parking brake
550 Sector	15-16	Parking brake
700 Forge	15-16	Parking brake
HS 700	15-16	Parking brake
750 Sector	15-16	Parking brake
HS 750 Crew	15-16	Parking brake
800 Tactic	15-16	Parking brake
HS 800 Crew	15-16	Parking brake
1000 Sector	15-16	Parking brake
1000 Strike	15-16	Parking brake
1000 Strike Crew	15-16	Parking brake
1000 Tactic	15-16	Parking brake

MASSIMO

250 Gunner	15-16	R (Left)
250 Gunner S	15-16	R (Left)
500 Alligator	15-16	R (Left)
550 EPS Alligator	15-16	R (Left)
700 Alligator	15-16	Parking brake
MSU 700	15-16	Parking brake
MSU 800	15-16	Parking brake

YAMAHA

YXR 450 Rhino (All models)	06-09	R
YXR 660 Rhino	04-07	R
YFM 700 RSPV 50th Anniversary Edition	06	R
YFM 700 RSEW/RSPX/RSPY/RSEA/RSEB/RSED /RSE/RSF	07-15	R
YFM 700 RV/RW/RX/RV/RA/RB Raptor	06-12	R

BENNCHE

250 Cowboy	15-16	R
250 Spire	15-16	R
400 Bighorn Parking Brake	11-16	
400 Cowboy Parking Brake	15-16	
500 Bighorn Parking Brake	15-16	
700 Bighorn Parking Brake	15-16	
700 X Bighorn Parking Brake	15-16	
500 Cowboy Parking Brake	14-16	
700 Cowboy Parking Brake	14-16	
1000 Cowboy Parking Brake	15-16	
1000 Spire Parking Brake	14-16	
1000 X Spire Parking Brake	14-16	

Equivalents OE#

1S3 W0046 00

5UG W0046 00

STD	FA428X	Carbon Dual Purpose Pad Blend
OPTION	FA428R	Utility Grade Sintered Pad Blend
OPTION	FA428SV	High Durability Off Road Sintered Blend

Dealer Stocking Recommendation

Single/Pair	Popularity #	Rec Stocking Level
2	-	2

FA432



APRILIA

RS 125	06-12	F
Dorsoduro 750 (ABS)	08-15	F
Shiver 750 SL	07-15	F
Mana 850	08-12	F
Mana 850 GT ABS	09-15	F

SFA432

KYMCO STREET

My Road 700i	11-15	F
--------------	-------	---

Equivalents OE#

8133943

95105 LKF5 305

STD	FA432	Premium Organic Street Pad Blend
OPTION	FA432HH	Street Performance Sintered Pad Blend
OPTION	SFA432	Premium Organic Scooter Pad Blend
OPTION	SFA432HH	Scooter Performance Sintered Pad Blend

Dealer Stocking Recommendation

Single/Pair	Popularity #	Rec Stocking Level
2	-	2

FA433/4

4 pieces per set



46 x 35 x
7.4mm

Equivalents OE#

0722189
072223
0723 024
594 13 030 000

HUSABERG

FS 570 Supermoto

10-11 F

KTM

450 SMR

07-12 F

560 SMR

07 F

MAGURA AFTERMARKET CALIPER

4 Piston Radial Supermoto Caliper

Dealer Stocking Recommendation

Single/Pair	Popularity #	Rec Stocking Level
2	-	2

STD	FA433/4	Premium Organic Street Pad Blend
OPTION	FA433/4HH	Street Performance Sintered Pad Blend
OPTION	EPFA433/4HH	Fast Street Use & Track Day Sintered Pad Blend

BUYERS GUIDE
BRAKE PADS

FA434

NOTE: WILL NOT INTERCHANGE WITH FA299 OR FA400. CHECK OLD PAD SHAPE AGAINST DRAWING BELOW TO ENSURE CORRECT PAD SELECTED

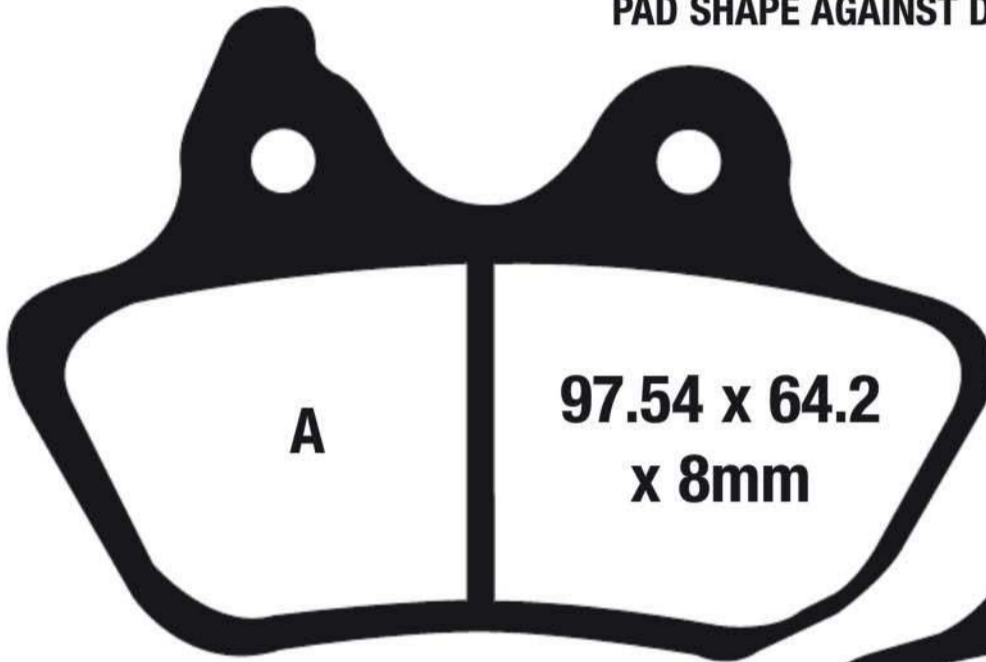

A

97.54 x 64.2
x 8mm

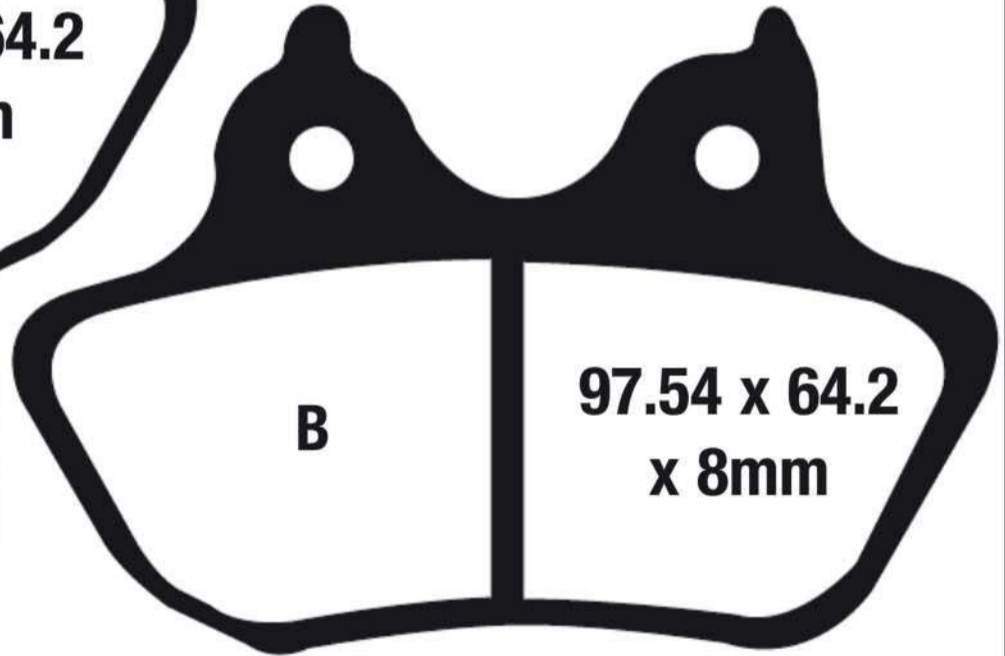

B

97.54 x 64.2
x 8mm

HARLEY DAVIDSON

FXST/FXSTI Softail Standard
FXSTB/FXSTBi Night Train Softail
FLSTC Heritage Softail Classic
FLSTF/FLSTFi Fat Boy
FXSTC Softail Custom

06-07 R
06-07 R
07 R
07 R
07 R

LYNDALL BRAKES

PAD REF 7196

STD	FA434	Premium Organic Street Pad Blend
OPTION	FA434HH	Street Performance Sintered Pad Blend
OPTION	FA434V	Semi Sintered Long Lasting Street Pad
OPTION	FA434VLD	Chrome Backed Semi Sintered Long Lasting Street Pad
OPTION	EPFA434HH	Fast Street Use & Track Day Sintered Pad Blend

Equivalents OE#

46721-06
46721-0617

Dealer Stocking Recommendation

Single/Pair	Popularity #	Rec Stocking Level
2	-	2

NOTE:- Size identification is shown as follows
Dimension 1=Width or Diameter, Dimension 2=Height or Diameter, Dimension 3=Thickness (Material and backplate)

FA435/4



**49 x 43.5 x
9.5mm**

AP/LOCKHEED AFTERMARKET CALIPER

4 Piston Radial Mount / 4 Separate Pads
(CP6688 - 8EOM/9EOM)

BREMBO AFTERMARKET CALIPER

X99/C04 60/61 4 Piston P 34/34 Radial Mount Caliper @ 108mm
Spacing (4 pad set)

XA07680 2 Piston P2 34 Radial Mount

PVM AFTERMARKET CALIPER

2 Piston Rear Caliper
4 Piston Radial Mount Caliper

MV

F4 100 CC (1078cc)

07-08

F

Equivalents OE#

07-7874 24
8000B1421
CP6688-029
107 A486 04
M049Z04

STD	FA435/4HH	Street Performance Sintered Pad Blend
OPTION	EPFA435/4HH	Fast Street Use & Track Day Sintered Pad Blend

**Dealer Stocking
Recommendation**

Single/Pair	Popularity #	Rec Stocking Level
2	-	2

FA436

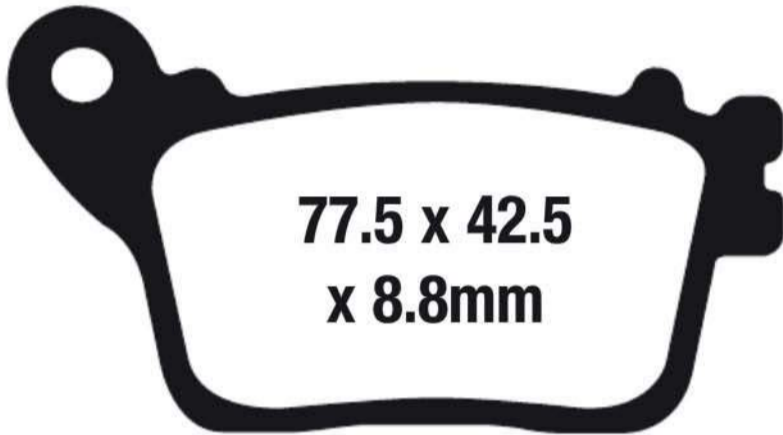

**77.5 x 42.5
x 8.8mm**

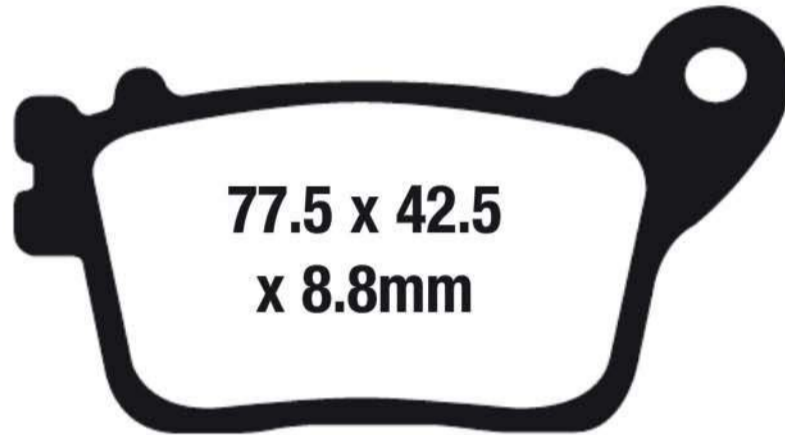

**77.5 x 42.5
x 8.8mm**

HONDA

CBR 600 RR (Non ABS)	07-17	R
CBR 600 RRA (ABS Model)	09-17	R
CBR 1000 RR	06-15	R
CBR 1000 RRA (ABS Model)	09-17	R
CBR 1000 RR SP	14-17	R

KAWASAKI

ZX-6R (ZX 636 EDF/EEF/EFF/EGF/EHF) 636cc/Non ABS	13-17	R
ZX-6R (ZX 636 EFFA) 636cc/Non ABS 30th Anniversary Edition	15	R
ZX-6R (ZX 636 EGFA/EHFA) 636cc/Non ABS/KRT Edition	16-17	R
ZX-6R (ZX 636 FDF/FEF/FFF/FGF/FHF) 636cc/ ABS	13-17	R
ZX-6R (ZX 636 FFFA) 636cc/ ABS 30th Anniversary Edition	15	R
ZX-6R (ZX 636 FGFA/FHFA) 636cc/ABS/KRT Edition	16-17	R
ZX10R (ZX 1000 JBF/JCF/JDF/JEF/JFF - Non ABS Model)	11-15	R
ZX10R (ZX 1000 JFFA 30th Anniversary Edition - Non ABS Version)	15	R
ZX10R ABS (ZX 1000 KBF/KCF/KDF/KEF/KFF)	11-15	R
ZX10R ABS (ZX 1000 KFFA 30th Anniversary Edition - ABS Version)	15	R
ZX10R ABS (ZX 1000 SGF/SHF/SJF)	16-18	R
ZX10R ABS KRT Replica (ZX 1000 SGFA/SHFA/SJFA)	16-18	R
Ninja ZX-10 RR (ZX1000 ZHF)	17	

SUZUKI

GSXR 600 L1/L2/L3/L4/L5/L6/L7	11-17	R
GSXR 750 L1/L2/L3/L4/L5/L6/L7	11-17	R
GSXR 1000 K9/L1/L2/L3/L4/L5/L6	09-16	R
GSXR 1000 AL5/AL6/AL7 ABS	15-17	R
GSX-R 1000R RAL (Brembo Radial)	17	R

YAMAHA

YZF R1	15-17	R
YZF R1M	15-17	R
YZF R1S	16-17	R
YZF-R6 H (320mm Front Rotor)	17	R

**Note: refit any original shims
fitted to original pads.**

Equivalents OE#

06435 MEL D21
06435 MFG 201
69100 47820
69100 47830
43082 0115
43082 0133

STD	FA436	Premium Organic Street Pad Blend
OPTION	FA436HH	Street Performance Sintered Pad Blend
OPTION	FA436V	Semi Sintered Long Lasting Street Pad

**Dealer Stocking
Recommendation**

Single/Pair	Popularity #	Rec Stocking Level
2	-	2

FA438

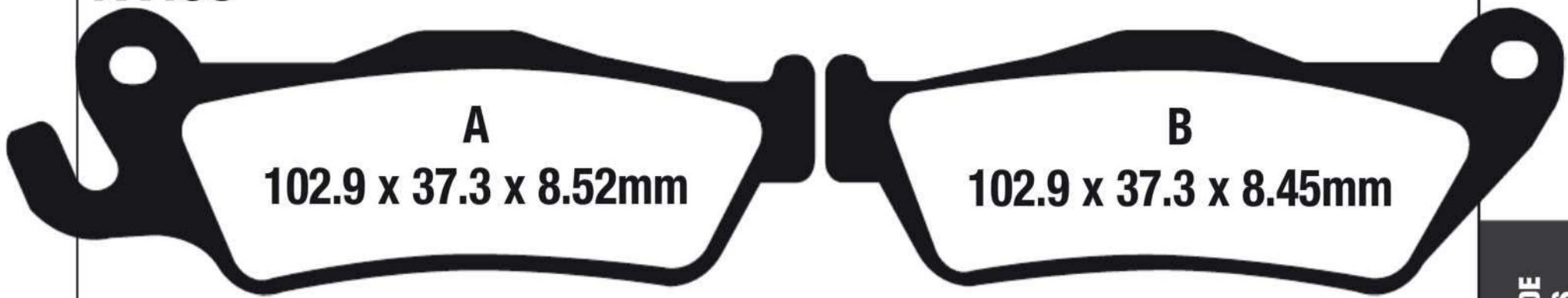

A
102.9 x 37.3 x 8.52mm

B
102.9 x 37.3 x 8.45mm

BMW
K 1200 GT (K44)

06-08 R

**IF NEW WEAR LEAD REQUIRED
ORDER PART NO. MWL002
(NOT SUPPLIED WITH PADS)**

Equivalents OE# 34 21 7 690 262

STD FA438HH Street Performance Sintered Pad Blend

Dealer Stocking Recommendation

Single/Pair	Popularity #	Rec Stocking Level
2	-	2

FA441

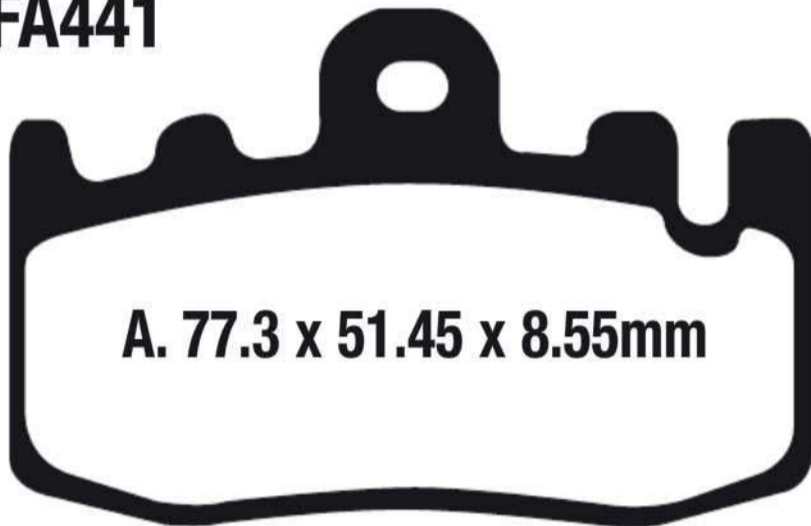

A. 77.3 x 51.45 x 8.55mm

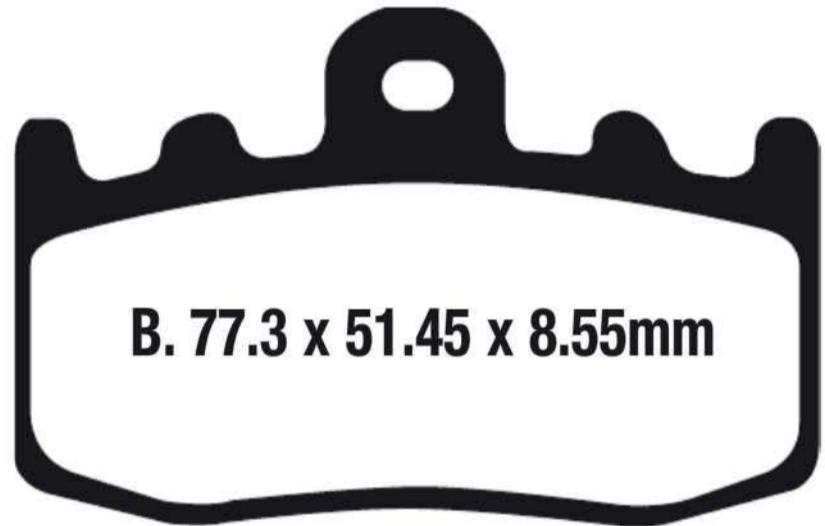

B. 77.3 x 51.45 x 8.55mm

BMW
K 1200 GT (K44)

06-08 F Right

**IF NEW WEAR LEAD REQUIRED
ORDER PART NO. MWL001
(NOT SUPPLIED WITH PADS)**

Equivalents OE#

34 11 7 690 259	34 11 7 704 614
34 11 7 712 948	34 11 8 535 400

STD FA441HH Street Performance Sintered Pad Blend

Dealer Stocking Recommendation

Single/Pair	Popularity #	Rec Stocking Level
2	-	2

FA442/4

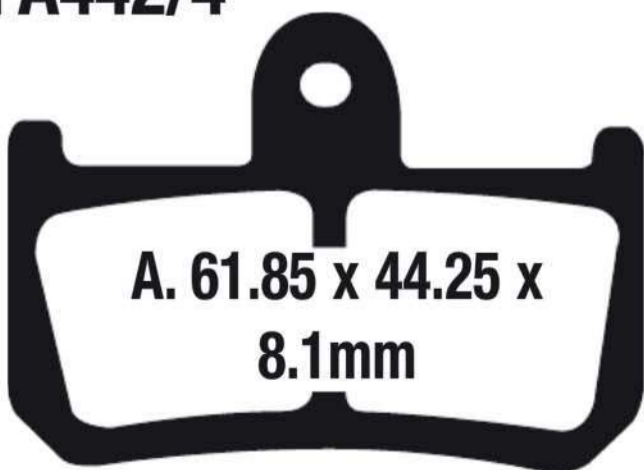

A. 61.85 x 44.25 x 8.1mm

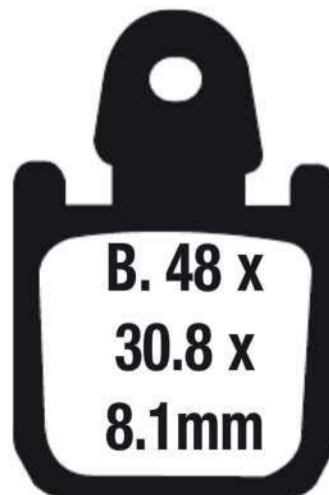

B. 48 x 30.8 x 8.1mm

YAMAHA

YZF-R1 (6 piston caliper) 07-14 F

VMX 1700 V-Max (6 piston radial caliper) 09-16 F

Equivalents OE#

4C8 W0045 00
17 A225 40

- STD FA442/4** Premium Organic Street Pad Blend (9mm thickness)
- OPTION FA442/4HH** Street Performance Sintered Pad Blend
- OPTION EPFA442/4HH** Fast Street Use & Track Day Sintered Pad Blend
- OPTION GPFA442/4HH** Race Only Sintered Pad Blend

Dealer Stocking Recommendation

Single/Pair	Popularity #	Rec Stocking Level
2	-	2

**BUYERS GUIDE
BRAKE PADS**

**NOTE:- Size identification is shown as follows
Dimension 1=Width or Diameter, Dimension 2=Height or Diameter, Dimension 3=Thickness (Material and backplate)**

FA443

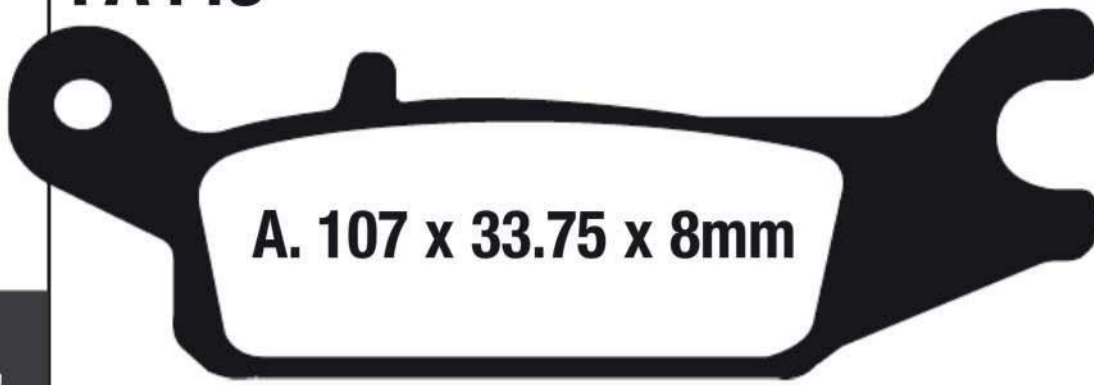

A. 107 x 33.75 x 8mm

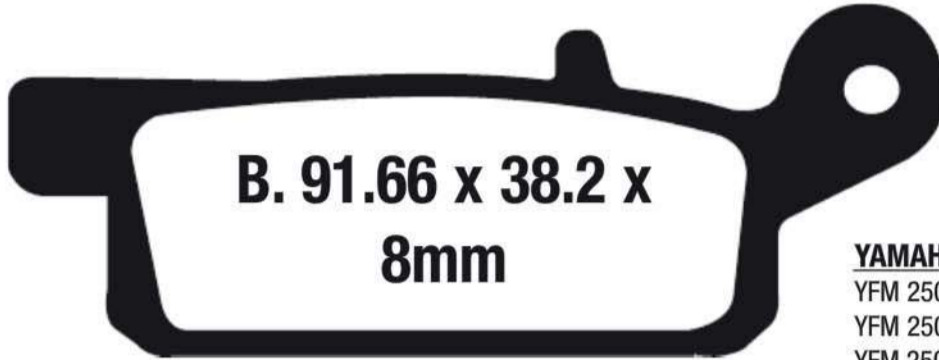

B. 91.66 x 38.2 x 8mm

YAMAHA

YFM 250 RX/RV/RZ/RA/RB/RD Raptor	08-13	F Left
YFM 250 RSPX/RSEY Special Edition	08-09	F Left
YFM 250 RSPXC Special Edition Custom	08	F Left
YFM 250 R (RSPA)	11	F Left
YFM 250 RSPA Special Edition	11	F Left
YFM 550 FGY/Z/A/B/D/E 4WD Grizzly Auto Fi	09-14	F Left
YFM 550 FGPY/Z/A/B/D/E EPS Grizzly Auto Fi	09-14	F Left & R
YFM 700 FGPW/FGPX/FGPY/FGPZ/FGPA/FGPB/FGPD Grizzly Fi Auto 4x4	07-13	F Left
YFM 700 FGPDUW/FGPDUX/FGPDUY Ducks Unlimited Edition	07-09	F
YFM 700 FGX/FGY/FGZ/FGA/FGB/FGD Grizzly	08-13	F Left
YFM 700 FGPSEY/Z/A/B/D Grizzly Fi Auto 4x4 EPS Special Edition	09-13	F Left
YFM 700 DHFH Grizzly 4WD Hunter	15	F Left
YFM 700 DFG/DFL Grizzly 4WD	15	F Left
YFM 700 PFG Grizzly EPS/4WD	15	F Left
YFM 700 PHFH Grizzly EPS Hunter	15	F Left

Equivalents OE#

3B4 W0045 00
4D3 W0045 00

STD	FA443X	Carbon Dual Purpose Pad Blend
OPTION	FA443SV	High Durability Off Road Sintered Blend
OPTION	FA443R	Utility Grade Sintered Pad Blend

Dealer Stocking Recommendation

Single/Pair	Popularity #	Rec Stocking Level
2	-	2

FA444

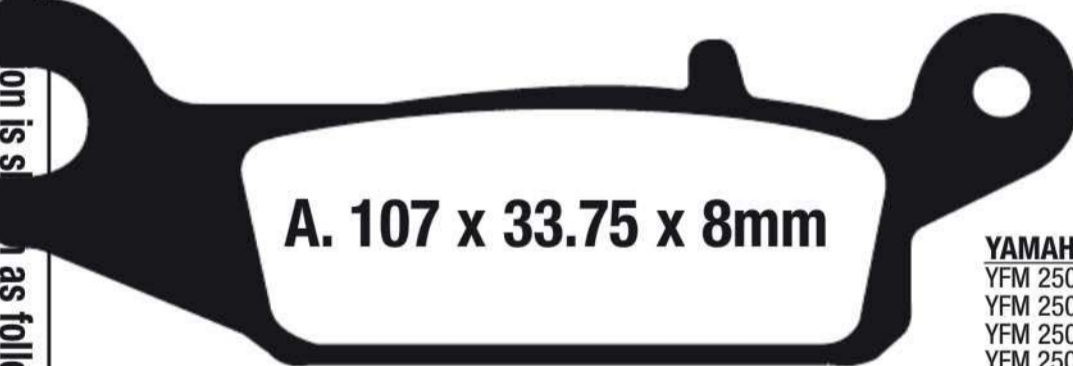

A. 107 x 33.75 x 8mm

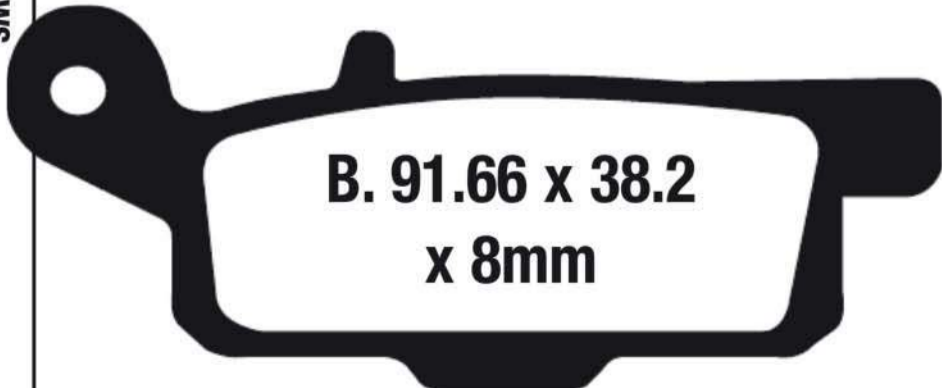

B. 91.66 x 38.2 x 8mm

YAMAHA

YFM 250 RX/RV/RZ/RA/RB/RD Raptor	08-13	F Right
YFM 250 RSPX/RSEY Special Edition	08-09	F Right
YFM 250 RSPXC Special Edition Custom	08	F Right
YFM 250 R (RSPA)	11	F Right
YFM 250 RSPA Special Edition	11	F Right
YFM 550 FGY/Z/A/B/D/E 4WD Grizzly Auto Fi	09-14	F Right
YFM 550 FGPY/Z/A/B/D/E EPS Grizzly Auto Fi	09-14	F Right
YFM 700 FGPW/FGPX/FGPY/FGPZ/FGPA/FGPB/FGPD/E Grizzly Fi Auto 4x4	07-14	F Right
YFM 700 FGX/FGY/FGZ/FGA/FGB/FGD/E Grizzly	08-14	F Right
YFM 700 FGPDUW/FGPDUX/FGPDUY Ducks Unlimited Edition	07-09	F Right
YFM 700 FGPSEY/Z/A/B/D/E Grizzly Fi Auto 4x4 EPS Special Edition	09-14	F Right
YFM 700 DHFH Grizzly 4WD Hunter	15	F Right
YFM 700 DFG/DFL Grizzly 4WD	15	F Right
YFM 700 PFG Grizzly EPS/4WD	15	F Right
YFM 700 PHFH Grizzly EPS Hunter	15	F Right

Equivalents OE#

3B4 W0045 10
4D3 W0045 10

STD	FA444X	Carbon Dual Purpose Pad Blend
OPTION	FA444SV	High Durability Off Road Sintered Blend
OPTION	FA444R	Utility Grade Sintered Pad Blend

Dealer Stocking Recommendation

Single/Pair	Popularity #	Rec Stocking Level
2	-	2

FA445

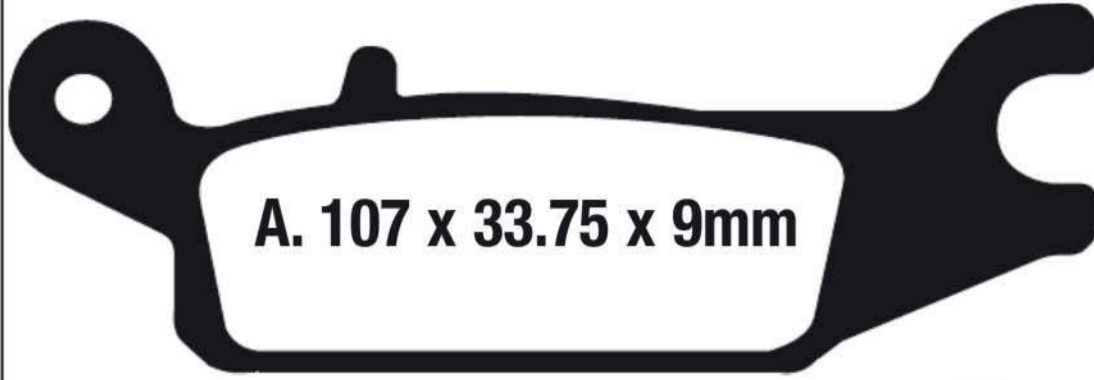

A. 107 x 33.75 x 9mm

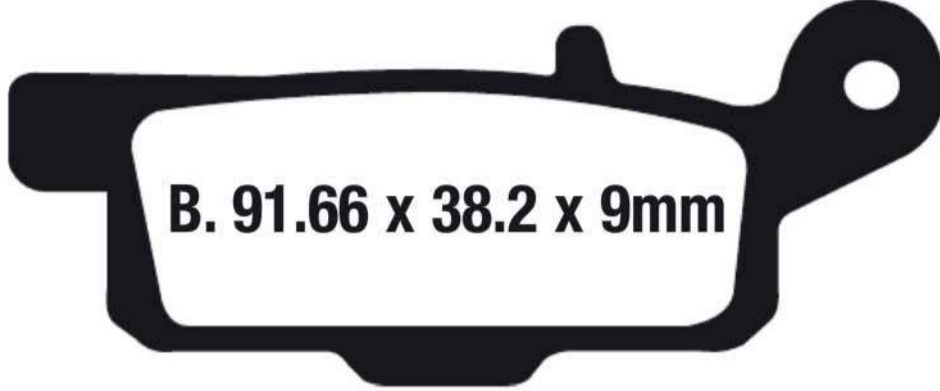

B. 91.66 x 38.2 x 9mm

YAMAHA

YFM 550 FGPY/Z/A/B/D/E EPS Grizzly Auto Fi	09-14	R Left
YFM 550 FGY/Z/A/B/D/E Grizzly Auto Fi	09-14	R Left
YFM 700 FGPW/FGPX/FGPY/FGPZ/FGPA/FGPB /FGPD/E Grizzly FI Auto 4x4	07-14	R Left
YFM 700 FGPDUW/FGPDUX/FGPDUY Ducks Unlimited Edition	07-09	R Left
YFM 700 FGX/FGY/FGZ/FGA/FGB/FGD/D Grizzly	08-14	R Left
YFM 700 FGPSEY/Z/A/B/D/E Grizzly FI Auto4x4 EPS Special Edition	09-14	R Left
YFM 700 DHFH Grizzly 4WD Hunter	15	R Left
YFM 700 DFG/DFL Grizzly 4WD	15	R Left
YFM 700 PFG Grizzly EPS/4WD	15	R Left
YFM 700 PHFH Grizzly EPS Hunter	15	R Left

Equivalents OE#

3B4 W0046 00

STD	FA445X	Carbon Dual Purpose Pad Blend
OPTION	FA445SV	High Durability Off Road Sintered Blend
OPTION	FA445R	Utility Grade Sintered Pad Blend

Dealer Stocking Recommendation

Single/Pair	Popularity #	Rec Stocking Level
2	-	2

FA446

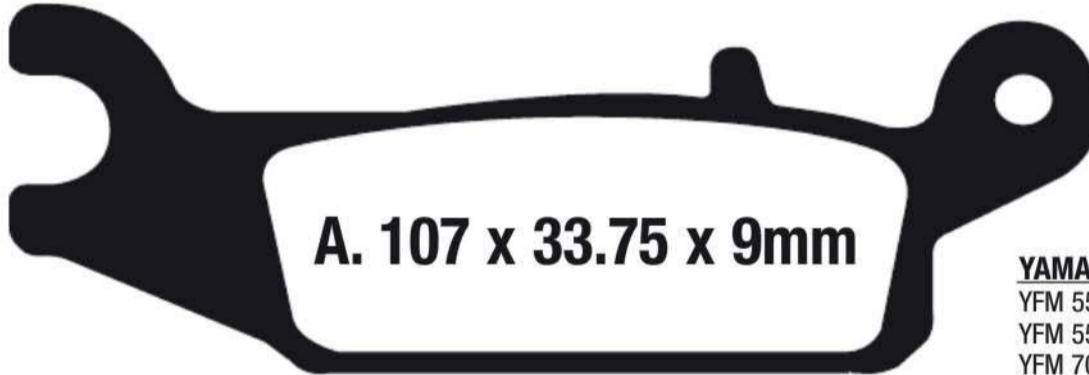

A. 107 x 33.75 x 9mm



B. 91.66 x 38.2 x 9mm

YAMAHA

YFM 550 FGPY/Z/A/B/D/E EPS Grizzly Auto Fi	09-14	R Right
YFM 550 FGY/Z/A/B/D/E Grizzly Auto Fi	09-14	R Right
YFM 700 FGPW/FGPX/FGPY/FGPZ/FGPA/FGPB /FGPD/E Grizzly FI Auto 4x4	07-14	R Right
YFM 700 FGPDUW/FGPDUX/FGPDUY Ducks Unlimited Edition	07-09	R Right
YFM 700 FGX/FGY/FGZ/FGA/FGB/FGD/E Grizzly	08-14	R Right
YFM 700 FGPSEY/Z/A/B/D/E Grizzly FI Auto 4x4 EPS Special Edition	09-14	R Right
YFM 700 DHFH Grizzly 4WD Hunter	15	R Right
YFM 700 DFG/DFL Grizzly 4WD	15	R Right
YFM 700 PFG Grizzly EPS/4WD	15	R Right
YFM 700 PHFH Grizzly EPS Hunter	15	R Right

Equivalents OE#

3B4 W0046 10

STD	FA446X	Carbon Dual Purpose Pad Blend
OPTION	FA446SV	High Durability Off Road Sintered Blend
OPTION	FA446R	Utility Grade Sintered Pad Blend

Dealer Stocking Recommendation

Single/Pair	Popularity #	Rec Stocking Level
2	-	2

FA447

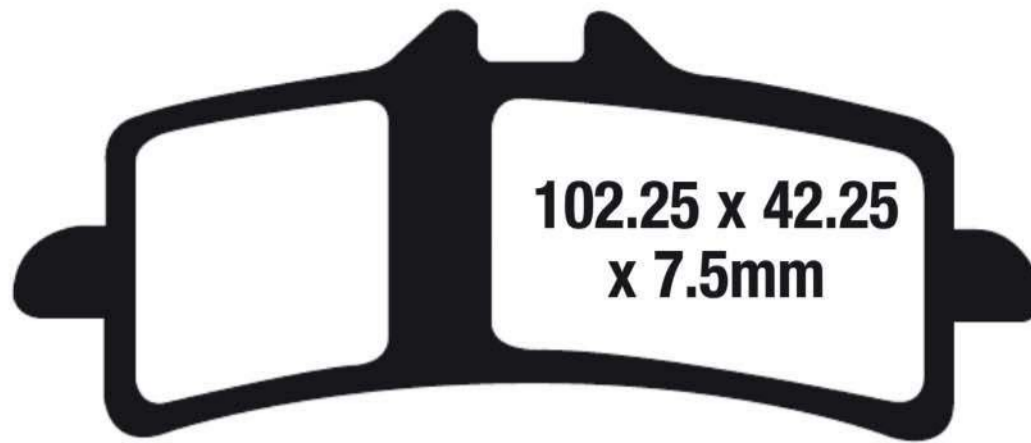

102.25 x 42.25
x 7.5mm

NOTE:- Size identification is shown as follows

APRILIA

RSV4 R/RSV4 Factory	09-12	F
RSV4 Factory APRC SE	11-12	F
RSV4 R APRC	11-12	F
RSV4 Factory APRC ABS	13-15	F
RSV4 R APRC ABS	13-15	F

BMW

HP2 Sport	08-11	F
HP4 (1000cc)	13-14	F

BREMBO AFTERMARKET CALIPER

220B01010 GP4-RX 4 Piston Radial Mount 108mm spacing

DUCATI

848 Evo (Monobloc front calipers)	10-13	F
848 Evo Corse Special Edition	12-13	F
Hypermotard 1100 S	07-09	F
Hypermotard 1100 Evo	10-12	F
Hypermotard 1100 Evo SP	10-13	F
Desmosedici RR (989cc) (D16RR)	08	F
1098	07-08	F
1098 S Tricolore	07	F
1098 S	07-08	F
1098 R	08-09	F
Streetfighter (1099cc)	09-12	F
Streetfighter S (1099cc)	09-12	F
1198	09-12	F
1198 S	09-10	F
1198 SP	11-12	F
1198 R Corse Special Edition	11	F
1199 Panigale	12-14	F
1199 Panigale S	12-15	F
1199 Panigale S Tricolore	12-14	F
1199 Panigale R	13-15	F
1199 Panigale Superleggera	14-15	F
1200 S Monster	14-15	F
Diavel ABS	11-15	F
Multistrada 1200 S DVT	15-17	F
Multistrada 1200 S D/Air	16-17	F
Multistrada 1200 S	16-17	F
Multistrada 1200 Pikes Peak	16-17	F
Monster 1200 S Stripe	15	F
Diavel Carbon ABS	11-15	F
Diavel Carbon ABS	16-17	f
Diavel AMG	12	F
Diavel Cromo	12-14	F
Diavel Dark (ABS)	13	F
Diavel Strada	13-15	F
1262 Xdiavel S	16-17	F
1299 Panigale	15-17	F
1299 Panigale R	15-17	F
1299 Panigale S	15-17	F

HONDA

CBR 1000 RR SP	14-17	F
RC 213 V-S	15-17	F

HUSQVARNA

FS450 Supermoto	15	F
900 Nuda R	12-13	F

KAWASAKI

ZX10R ABS (ZX 1000 SGF/SHF/SJF)	16-18	F
ZX10R ABS KRT Replica (ZX 1000 SGFA/SHFA/SJFA)	16-18	F
Ninja ZX-10 RR (ZX1000 ZHF)	17	
Ninja H2/Carbon (ZX1000NNF/NGF/XHF)	15-17	F
Ninja H2R(ZX1000PFF/PGF/YHF)	15-17	F
ZX14 R Ninja (ABS/SE Model) ZX1400 JGF/JHF	16-17	F

KTM

990 SM-R	09-11	F
1190 RC8	08-12	F
1190 RC8 R	09-14	F
1290 Superduke R	14-15	F

MOTUS

MSTR	14-17	F
------	-------	---

MV (AGUSTA)

Brutale 1078 RR	08-09	F
Brutale 1090 RR	10-14	F
F3 675 Serie Oro	12	F
F3 800	13-14	F
F4 RR 312 1078	08-09	F
F4 R (998cc)	12-14	F
F4 RR (998cc)	12-14	F
F4 (998cc)	10-14	F

SUZUKI

GSXR 600 L1/L2/L3/L4/L5/L6/L7	11-17	F
GSXR 750 L1/L2/L3/L4/L5/L6/L7	11-17	F
GSXR 1000 L2/L3/ZL3/L4/L5/L6 (Brembo caliper)	12-16	F
GSXR 1000 AL5/AL6/AL7 ABS (Brembo caliper)	15-17	F
GSX-R 1000R RAL (Brembo Radial)	17	F
GSX-S1000 L5 ABS (Brembo caliper)	15	F
GSX-S 1000 L6/L7/L8 (Naked - Non ABS)	16-18	F
GSX-S 1000 AL6/AL7/AL8 (Naked-ABS)	16-18	F
GSX-S 1000F L6/L7/L8 (Faired-Non ABS)	16-18	F
GSX-S 1000F AL6/AL7/AL8 (Faired-ABS)	16-18	F
GSX 1300 RAL3/RAL4/RAL5/RAL6/RAL7 (Brembo caliper)	13-17	F
GSX 1300 RZL4 (Hayabusa 50th Anniversary Edition)	14	F

TRIUMPH

Daytona 675 R (Brembo calipers)	11-17	F
Speed Triple R (1050cc)	13-17	F
Speed Triple S (1050cc - 2Pad Brembo F/Caliper/255mm R/Disc/ABS Model)	16-17	F
Thruxton R (1200cc)	16-17	F

Equivalents OE#

107988210	34 11 853 4234	61340901A
06455 MGP D81	43082 0157	61340961A
07 9882 10	59100 14830	690 13 030 000
07BB3050	59100 14850	8000B1663
07BB30RC	59100 14860	M497Z04
107 A486 49	59100 14870	T2021451
34 11 771 0743	613407914	

STD	FA447HH	Street Performance Sintered Pad Blend
OPTION	EPFA447HH	Fast Street Use & Track Day Sintered Pad Blend
OPTION	GPFA447HH	Race Only Sintered Pad Blend

Dealer Stocking
Recommendation

Single/Pair	Popularity #	Rec Stocking Level
2	-	2

FA450

YAMAHA

YZ 125 X/Y/Z/A/B/D/E/F/G/H/J (2T)	08-18	F
YZ 250 X/Y/Z/A/B/D/E/F/G/H/J (2T)	08-18	F
YZ 250 XG (2T)	16	F
YZ 250 FW/FX/FY/FZ/FA/FB/FD/FE/FF/FG/FGY/FH/FJ (4T)	07-18	F
YZ 450 FX/FY/FZ/FA/FB/FD/FE/FF/FG/FGY/FH/FH (4T)	08-18	F
WR 450 FG/FH/FJ (4T)	16-18	F

Equivalents OE#

5XC W0045 00
B29 25805-00

STD	FA450X	Carbon Dual Purpose Pad Blend
OPTION	FA450R	Utility Grade Sintered Pad Blend
OPTION	EPFA450HH	Fast Street Use & Track Day Sintered Pad Blend
OPTION	MXS450	Sintered Sport Off Road Pad Blend

Dealer Stocking Recommendation

Single/Pair	Popularity #	Rec Stocking Level
2	-	2

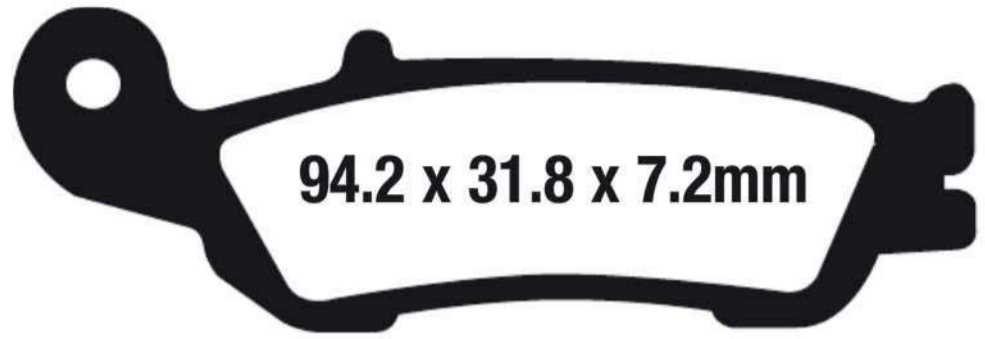

FA452

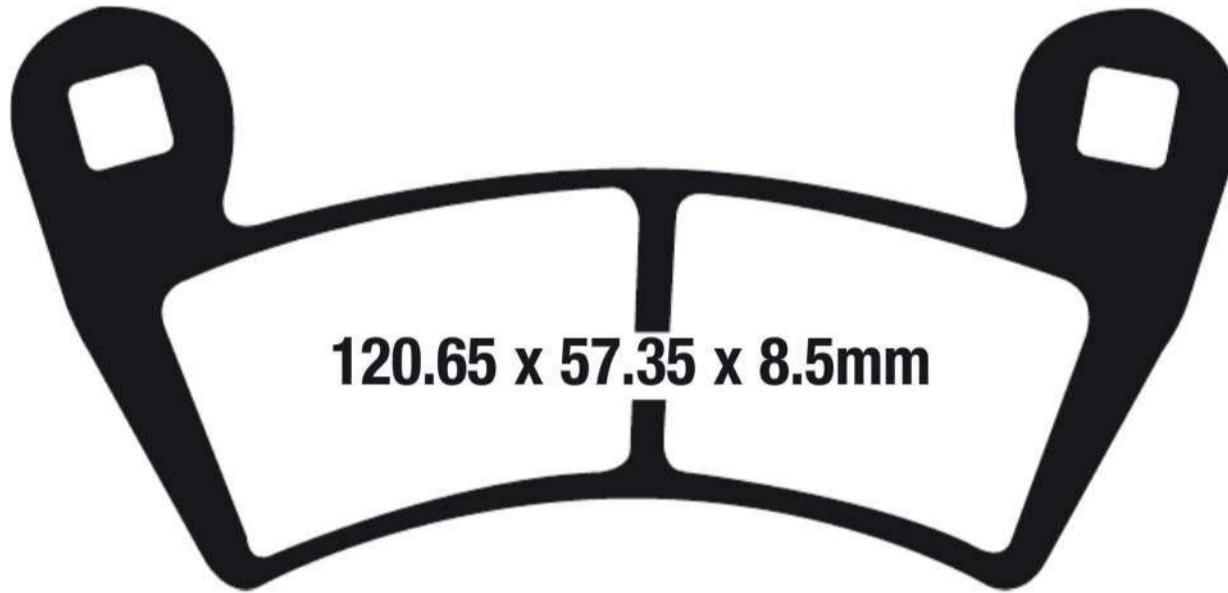

POLARIS ATV

325 Sportsman Ace	14	F
325 Sportsman Ace EFI	15	F
325 Sportsman Ace Euro	14-15	F
325 Sportsman Ace HD	15	F
570 Sportsman Ace	15	F
570 Sportsman Ace Euro	15	F

POLARIS RANGER (SIDE X SIDE)

Ranger 500 (4x4 EFI)	08-10	F
500 Ranger (Carb) 2x4	08-09	F
500 Ranger (EFI) 4x4 H.O.	09-10	F
Ranger 500 Crew	11-12	F
570 Ranger Cre EFI	14-15	F
700 Ranger 4x4 EFI	09	F
700 Ranger Crew (EFI) 4x4	09	F & R
700 Ranger 6x4 EFI	08	F
700 Ranger XP 4x4	08	F
Ranger EV (Electric)	10	F
800 Ranger	10-12	F
800 Ranger EFI	13-14	F
800 Ranger XP	10-12	F & R
800 Ranger 6x6	10-15	F
800 Ranger Crew	10-14	F

POLARIS RZR (SIDE X SIDE)

Ranger 500 (4x4 EFI)	08-10	F
RZR-4 800 EPS	12	F

Equivalents OE#

2203747

Dealer Stocking Recommendation

Single/Pair	Popularity #	Rec Stocking Level
2	-	2

STD	FA452X	Carbon Dual Purpose Pad Blend
OPTION	FA452R	Utility Grade Sintered Pad Blend
OPTION	FA452SV	High Durability Off Road Sintered Blend

Dimension 1=Width or Diameter, Dimension 2=Height or Diameter, Dimension 3=Thickness (Material and backplate)

NOTE:- Size identification is shown as follows

FA453



96.96 x 37.25 x
7.15mm

CF MOTO

400 C-Force	14-16	F
500 C-Force	14-16	F
500 C-Force HO EPS	14-16	F
800 C-Force EPS	14-16	F

UNISON

Mobility 500	04-	F
--------------	-----	---

Dealer Stocking Recommendation

Single/Pair	Popularity #	Rec Stocking Level
-	-	-

Equivalents OE#

9010-0808B0

STD FA453X Carbon Dual Purpose Pad Blend
OPTION FA453R Utility Grade Sintered Pad Blend

FA454/4

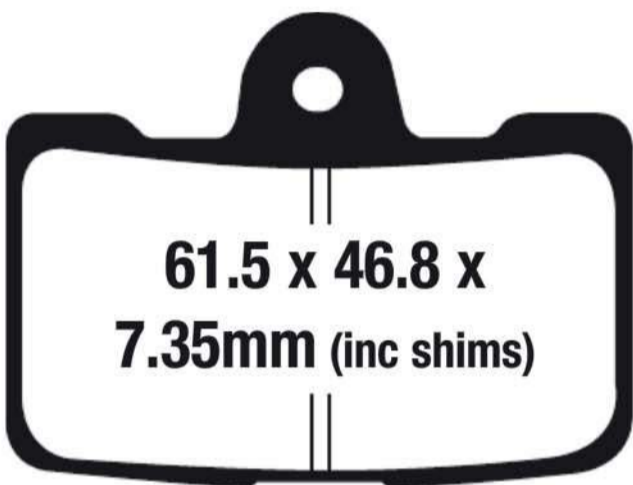

61.5 x 46.8 x
7.35mm (inc shims)

8 piston caliper

BUELL

1125 R	08-10	F
1125 CR	09-10	F
XB 12 SCG Lightning	09-10	F
XB 12 R Firebolt	09-10	F
XB 12 SS Lightning	09-10	F

EBR

1190RS (Sport)	14-15	F
1190RX (Sport)	14-15	F
1190SX (Naked)	14-15	F

Equivalents OE#

H0300-1AMA	H0300-09AZ
H0300-13BB	H030-06AH

Dealer Stocking Recommendation

Single/Pair	Popularity #	Rec Stocking Level
2	-	2

STD FA454/4HH Street Performance Sintered Pad Blend
OPTION EPFA454/4HH Fast Street Use & Track Day Sintered Pad Blend

FA455



98.8 x 55 x 8.8mm

JAYBRAKE AFTERMARKET CALIPER

6 PF-L (6 Piston/For 13" Disc Full Height Friction)

Equivalents OE#

300-64B

Dealer Stocking Recommendation

Single/Pair	Popularity #	Rec Stocking Level
2	-	2

STD FA455HH Street Performance Sintered Pad Blend

FA456

POLARIS

450 S Outlaw	08	F
Outlaw 450 MXR	09-10	F
525 S Outlaw	08-10	F
525 Outlaw IRS	08-10	F
RZR 570	12-14	F
800 Ranger RZR	08-12	F
RZR 800 S EFI	09-14	F
RZR 900 (50" All Options)	15	R
RZR-S 900 (60" All Options)	15	R
1000 General EPS (2 Seat)	16	F
1000 General EPS (2 Seat)	17	F
1000 General EPS (4 Seat)	17	F

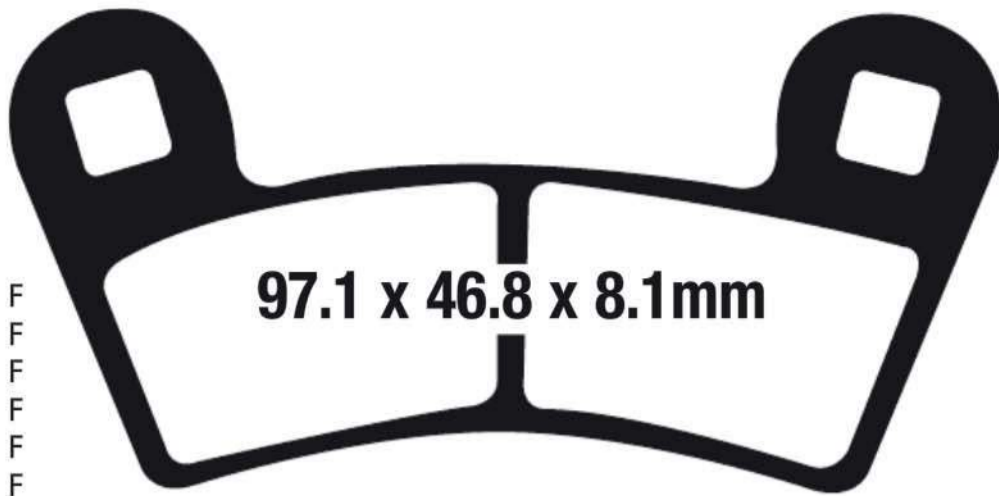

97.1 x 46.8 x 8.1mm

Equivalents OE#

2203318
2203930
1911197

- STD FA456X** Carbon Dual Purpose Pad Blend
- OPTION FA456R** Utility Grade Sintered Pad Blend
- OPTION FA456SV** High Durability Off Road Sintered Blend

Dealer Stocking Recommendation

Single/Pair	Popularity #	Rec Stocking Level
2	-	2

FA457

HARLEY DAVIDSON

FXD Super Glide	08-10	F
FXDC Super Glide Custom	08-14	F
FXDB Street Bob	08-17	F
FXDBC Street Bob LTD	16	F
FDXL Low Rider (Cast Wheel)	08-17	F
FDXL Low Rider (Spoke Wheel)	14-17	F
FDXLS Low Rider S	17	F
FXDF Fat Bob	08-17	F
FXSTB Night Train	08-09	F
FXSTC Softail Custom	08-10	F
FLSTF Fat Boy	08-14	F
FLSTN Softail Deluxe	08-14	F
FLSTC Heritage Softail Classic	08-14	F
FXCW Rocker	08-09	F
FXCWC Rocker C	08-13	F
FXDWG Dyna Wide Glide (Spoke wheels)	08-17	F
FXS Blackline	11-13	F
FXSB Breakout	13-14	F
FXST Softail Standard	08-14	F
FLSTFB Fat Boy Special	10-13	F
FLD Switchback	12-16	F
FLSTFB Fat Boy LO Softail	10-14	F
FLS Softail Slim	12-14	F

LYNDALL BRAKES

PAD REF 7256

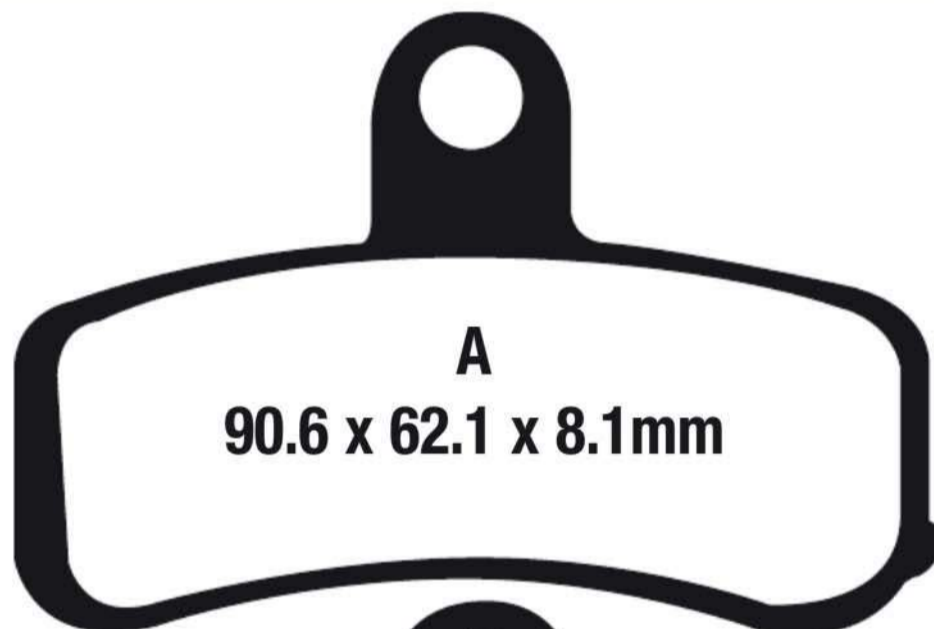

A
90.6 x 62.1 x 8.1mm

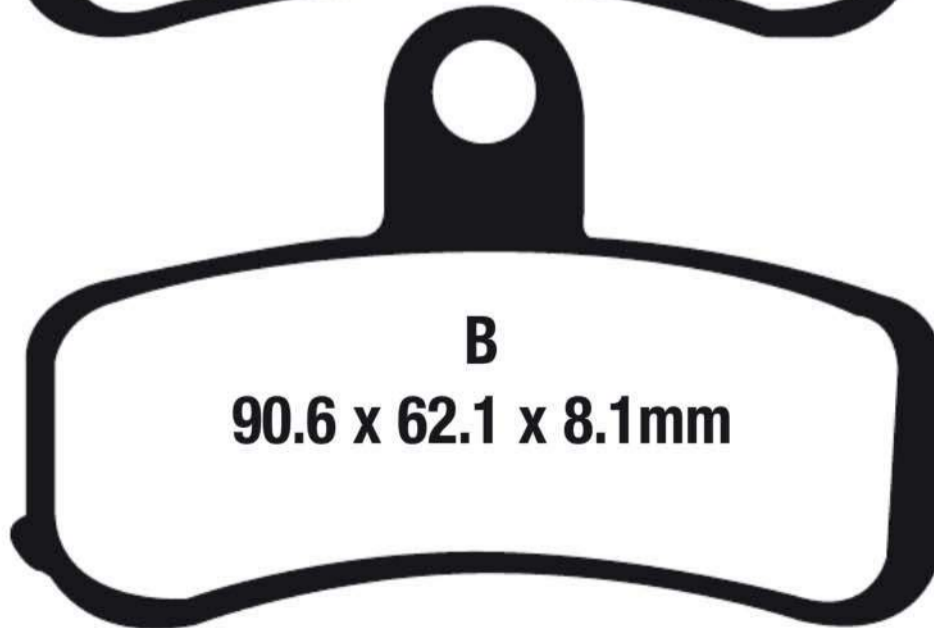

B
90.6 x 62.1 x 8.1mm

Dealer Stocking Recommendation

Single/Pair	Popularity #	Rec Stocking Level
2	-	2

- STD FA457HH** Street Performance Sintered Pad Blend
- OPTIONS EPFA457HH** Fast Street Use & Track Day Sintered Pad Blend
- OPTIONS FA457V** Semi Sintered Long Lasting Street Pad Blend
- OPTIONS FA457VLD** Chrome Backed Semi Sintered Long Lasting Street Pad Blend

NOTE: Do not refit any original insulator shims from old original pads

Equivalents OE#

44082-08
46363-11

FA458

Refit O/E shim to "A" side pad only

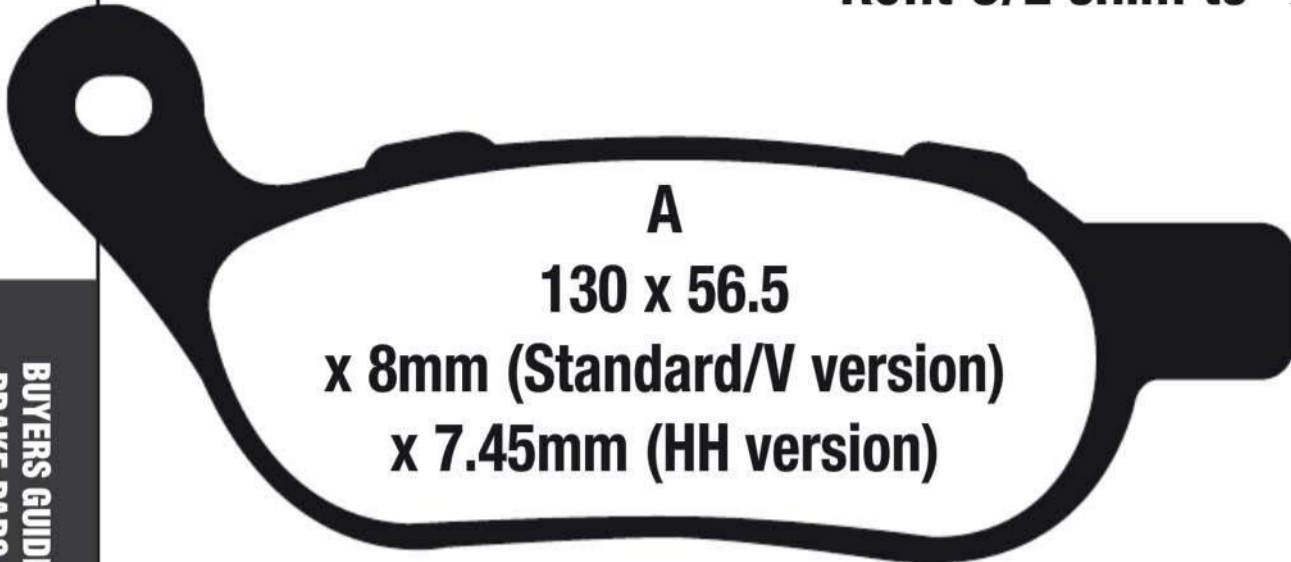

A

130 x 56.5
x 8mm (Standard/V version)
x 7.45mm (HH version)

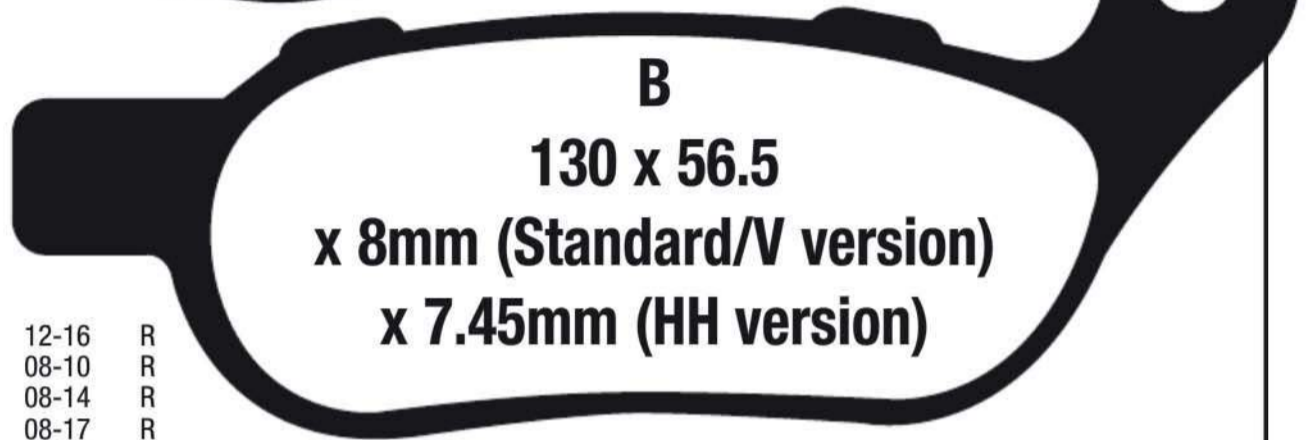

B

130 x 56.5
x 8mm (Standard/V version)
x 7.45mm (HH version)

**Refit original shim/insulator
on non piston side on HH
pads only**

Equivalents OE#

42298-08

STD	FA458HH	Street Performance Sintered Pad Blend
OPTIONS	EPFA458HH	Fast Street Use & Track Day Sintered Pad Blend
OPTIONS	FA458V	Semi Sintered Long Lasting Street Pad Blend
OPTIONS	FA458VLD	Chrome Backed Semi Sintered Long Lasting Street Pad Blend

Single/Pair	Popularity #	Rec Stocking Level
2	-	2

**Dealer Stocking
Recommendation**

HARLEY DAVIDSON

FLD Switchback	12-16	R
FXD Super Glide	08-10	R
FXDC Super Glide Custom	08-14	R
FXDB Street Bob	08-17	R
FXDBC Street Bob LTD	08-16	R
FDXL Low Rider (Cast Wheel)	08-17	R
FDXL Low Rider (Spoke Wheel)	08-17	R
FDXLS Low Rider S	17	R
FXDF Fat Bob	08-17	R
FXSTB Night Train	08-09	R
FXSTC Softail Custom	08-10	R
FXS Blackline	11-13	R
FLSTF Fat Boy	08-17	R
FLSTFB Fat Boy Lo	10-16	R
FLSTFBS Fat Boy S	16-17	R
FLSTN Softail Deluxe	08-17	R
FLSTC Heritage Softail Classic	08-17	R
FXCW Rocker	08-09	R
FXCWC Rocker C	08-11	R
FXDWG Dyna Wide Glide (Spoke wheels)	08-17	R
FXSB Breakout	13-17	R
FXST Softail Standard	08-15	R
FLSTSB Softail Cross Bones	08-11	R
FLS Softail Slim	12-17	R
FLSS Softail Slim S	16-17	R

LYNDALL BRAKES
PAD REF 7257

NOTE:- Size identification is shown as follows

**BUYERS GUIDE
BRAKE PADS**

Dimension 1=Width or Diameter, Dimension 2=Height or Diameter, Dimension 3=Thickness (Material and backplate)

FA460



49.2 x 46.4 x
6.9mm

BUELL

1125 R	08-10	R
1125 CR	09-10	R
EBR		
1190RS (Sport)	14-15	R
1190RX (Sport)	14-15	R
1190SX (Naked)	14-15	R

Equivalents OE#

H0301-1AM

Single/Pair	Popularity #	Rec Stocking Level
2	-	2

**Dealer Stocking
Recommendation**

STD FA460HH Street Performance Sintered Pad Blend

FA462



KTM

SX 450	09-12	F
XC 450	08-12	F
SX 505	09-12	F
XC 525	08-12	F

Equivalents OE#

830 13 030 100

STD FA462R Utility Grade Sintered Pad Blend

Dealer Stocking Recommendation

Single/Pair	Popularity #	Rec Stocking Level
2	-	2

FA463



KTM

SX 450	09-12	R
XC 450	08-12	R
SX 505	09-12	R
XC 525	08-12	R

Equivalents OE#

830 13 090 100

STD FA463R Utility Grade Sintered Pad Blend

Dealer Stocking Recommendation

Single/Pair	Popularity #	Rec Stocking Level
2	-	2

FA464



Equivalents OE#

4S5 W0045 00
4C9 W0045 00
5D9 W0045 01
3C1 W0045 10

YAMAHA

YBR 125 R (1PX1/X2)	11-12	F
YBR 125 ESG (43B1/3/5/6/8)	08-13	F
FZ 150 (3C12/3C11)	07-08	F
YZF-R15 (150cc) (54C2/3/6-2PB1)	10-13	F
YBR 250 (41S2/3)	10-12	F

SFA464

YAMAHA

T 110 C (40B4/7)	11-13	F
T 110 (40B3)	10	F
AF 115 S Fino (2BN1/2)	12	F
XA 125 Cygnus (2BK1)	12	F



STD FA464 Premium Organic Street Pad Blend

STD SFA464 Premium Organic Scooter Pad Blend

FA465



110.6 x 34.6 x
7.42mm

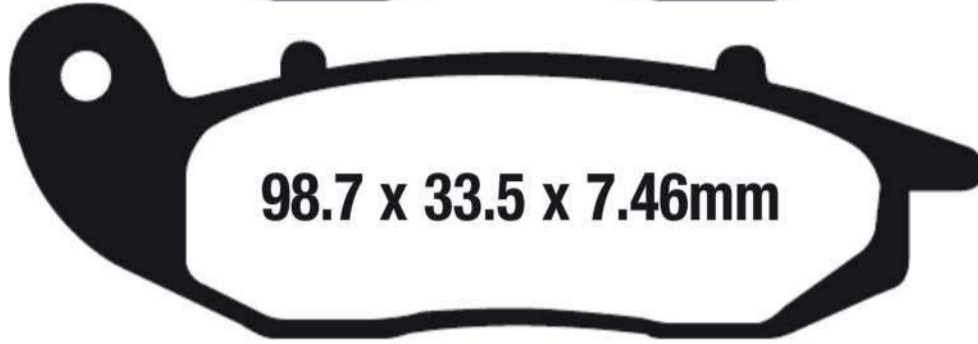

98.7 x 33.5 x 7.46mm

AJP

PR3 240 Enduro	14-17	F
PR4 240 Enduro	14-17	F
PR4 240 Extreme	14-17	F
PR5 250 Enduro	14-17	F
PR5 250 Extreme	17	F
PR7 650 Adventure	17	F

HONDA

CRF 250 L (Non ABS)	13-17	F
CRF 250 LA (ABS)	17	F
CRF 250 RL Rally (Non ABS)	17	F
CRF 250 RLA Rally (ABS)	17	F

YAMAHA

XTZ 250 Lander	16-18	F
SCORPA		
T-Ride 125 (4T)	11	F
T-Ride 250 F	09-11	F

Equivalents OE#

864342
SD11 40102 00 00
06451 KZZ 901
2CC F5805 00

STD FA465X	Carbon Dual Purpose Pad Blend
STD FA465R	Utility Grade Sintered Pad Blend

Dealer Stocking
Recommendation

Single/Pair	Popularity #	Rec Stocking Level
2	-	2

NOTE:- Size identification is shown as follows

Dimension 1=Width or Diameter, Dimension 2=Height or Diameter, Dimension 3=Thickness (Material and backplate)

FA468R



67.2 x 52 x 7.6mm

CAN AM

DS 450 (2x4/EFI)	08-15	F
DS 450 X (2x4/EFI)	08-11	F
DS 450 Xxc/Xxm	10-15	F

Equivalents OE#

705600402
Z 150 9260

STD FA468R	Utility Grade Sintered Pad Blend
-------------------	----------------------------------

Dealer Stocking
Recommendation

Single/Pair	Popularity #	Rec Stocking Level
2	-	2



FA473

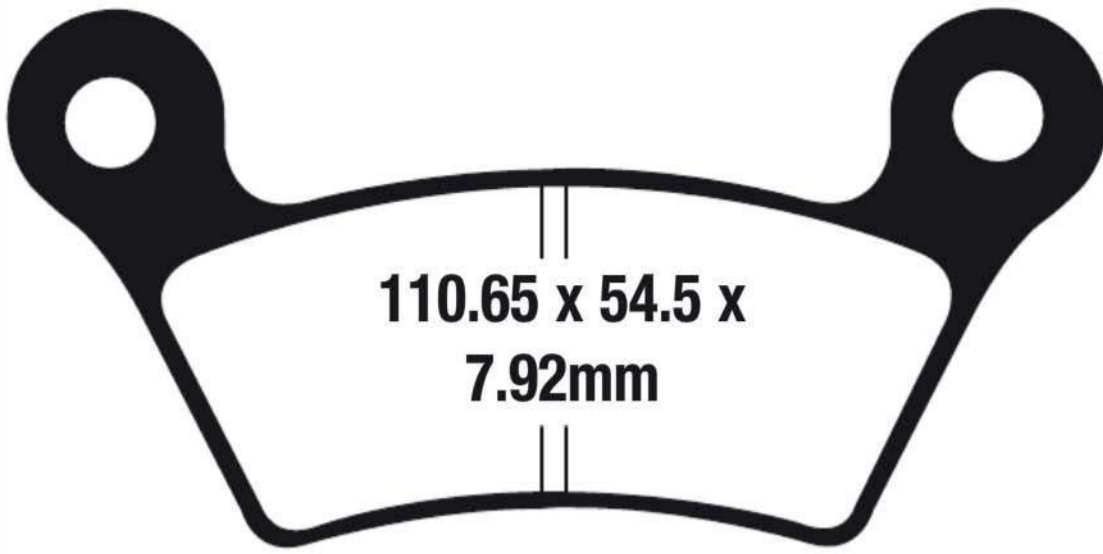

**110.65 x 54.5 x
7.92mm**

CAN AM

Spyder RS SES 990cc	08-09	R
Spyder RS SMS 990cc	08-09	R
Spyder RS Phantom Black	09	R
Spyder RS	10-12	R
Spyder RS-S	10-12	R
Spyder RT-S	10-12	R
Spyder RT	10-12	R
Spyder RT Ltd	11-12	R

Equivalents OE#

219800031
219800015

STD FA473	Premium Organic Street Pad Blend
OPTION FA473V	Semi Sintered Long Lasting Street Pad Blend

Dealer Stocking Recommendation

Single/Pair	Popularity #	Rec Stocking Level
2	-	2

FA474

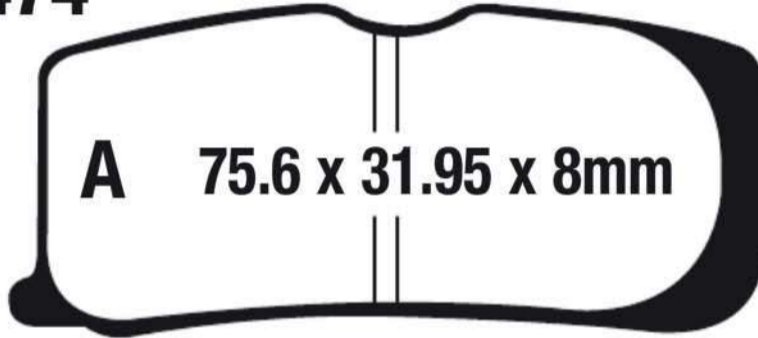

A 75.6 x 31.95 x 8mm

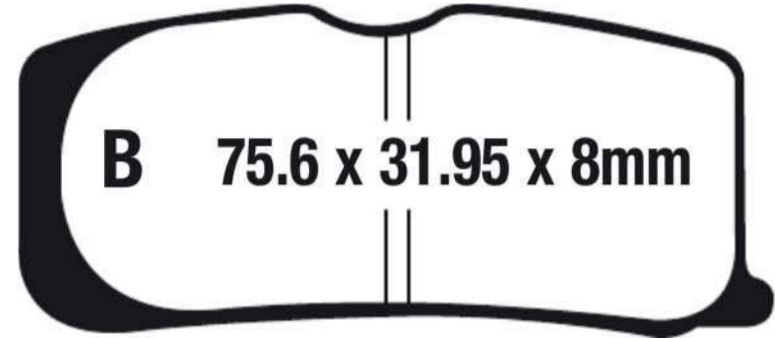

B 75.6 x 31.95 x 8mm

CAN AM

Spyder RS SES 990cc	08-09	F
Spyder RS SMS 990cc	08-09	F
Spyder RS Phantom Black	09	F
Spyder RS	10-12	F
Spyder RS-S	10-12	F
Spyder RT-S	10-12	F
Spyder RT	10-12	F
Spyder RT Ltd	11-12	F

(Includes 4 new retaining clips)

Equivalents OE#

219800038
219800164

STD FA474	Premium Organic Street Pad Blend
OPTION FA474V	Semi Sintered Long Lasting Street Pad Blend

Dealer Stocking Recommendation

Single/Pair	Popularity #	Rec Stocking Level
2	-	2

FA475



**96.88 x 42.45 x
6.87mm**

POLARIS

400 Hawkeye HO 4x4	13-14	R
400 Sportsman HO 4x4	11-14	R
500 XP Sportsman	09	F&R
500 Sportsman HO	09-13	R
550 Sportsman	11-13	F&R
550 XP Sportsman EPS	09-11	F&R
550 Sportsman Forest	12	F&R
550 Sportsman Touring EPS	10-14	F&R
550 Sportsman X2	10-14	F&R
550 Sportsman EPS	10-14	F&R
570 Forest Tractor EFI/EPS	15	R
570 Sportsman EFI EPS	14-15	R
570 Sportsman Touring EFI	14-15	R
800 Sportsman HO/EFI	09	R
800 Sportsman EFI	10-12	R
800 Sportsman Forest	12	R
800 Sportsman	12-14	F&R
800 Sportsman XP 850 HP EPS	13	F&R
850 Scrambler	15	F&R
850 Forest	15	F&R
850 Scrambler XP HO	13-15	F&R
850 XP Sportsman	09-13	F&R
850 XP ES Sportsman	09-10	F&R
850 Sportsman Touring EPS	10-14	F&R
850 Sportsman Touring H.O. EPS	13-15	F&R
1000 Scrambler	15	F&R
1000 XP Scrambler	15	F&R
1000 Forest	15	F&R
1000 Sportsman MD/XP	15	F&R

Equivalents OE#

2203628
2204088
2205606

STD	FA475X	Carbon Dual Purpose Pad Blend
OPTION	FA475R	Utility Grade Sintered Pad Blend
OPTION	FA475SV	High Durability Off Road Sintered Blend

Dealer Stocking Recommendation

Single/Pair	Popularity #	Rec Stocking Level
2	-	2

FA476X

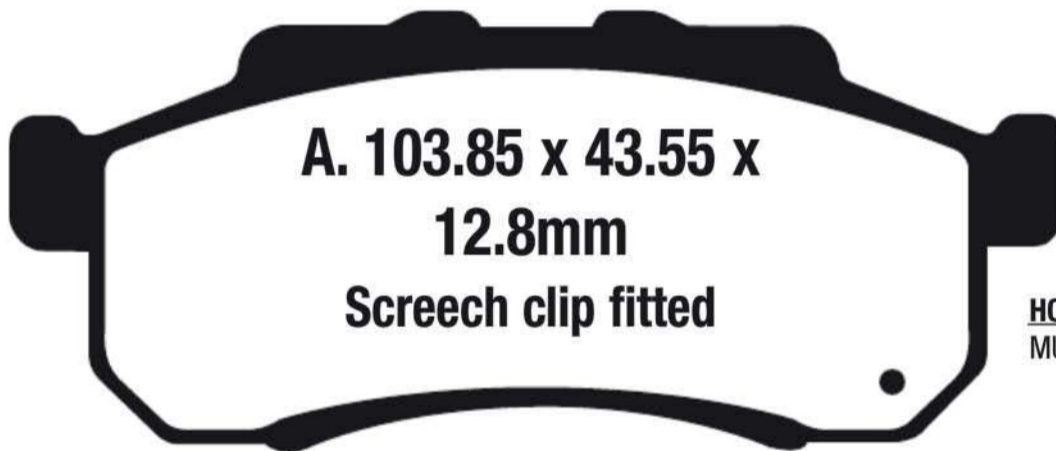

**A. 103.85 x 43.55 x
12.8mm
Screech clip fitted**

HONDA

MUV 700 Big Red	09-13	F Left
-----------------	-------	--------



**B. 103.85 x 43.55 x
12.8mm**

Equivalents OE#

06451 HL1 A01

STD	FA476X	Carbon Dual Purpose Pad Blend
------------	---------------	-------------------------------

Dealer Stocking Recommendation

Single/Pair	Popularity #	Rec Stocking Level
2	-	2

FA477X

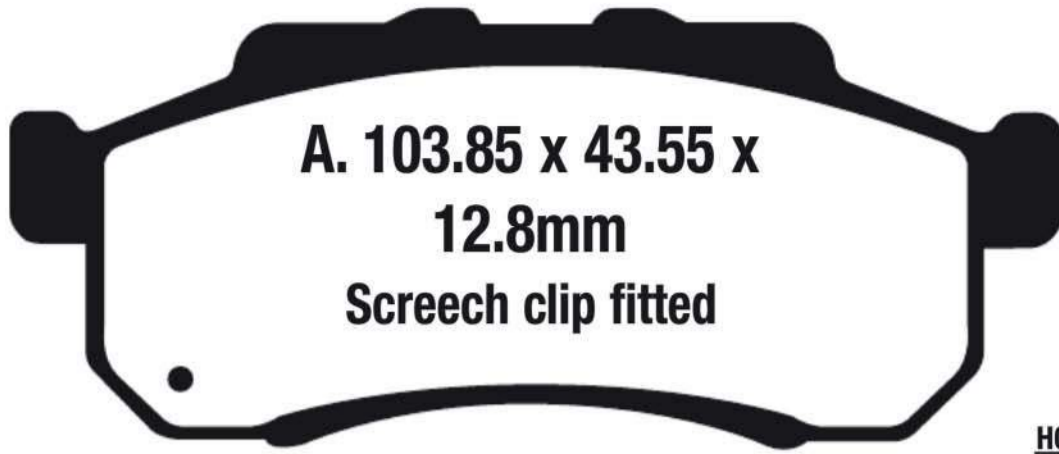

HONDA
MUV 700 Big Red

09-13 F Right



Equivalents OE#

06452 HL1 A01

Dealer Stocking Recommendation

<u>Single/Pair</u>	<u>Popularity #</u>	<u>Rec Stocking Level</u>
2	-	2

STD FA477X Carbon Dual Purpose Pad Blend

FA478X

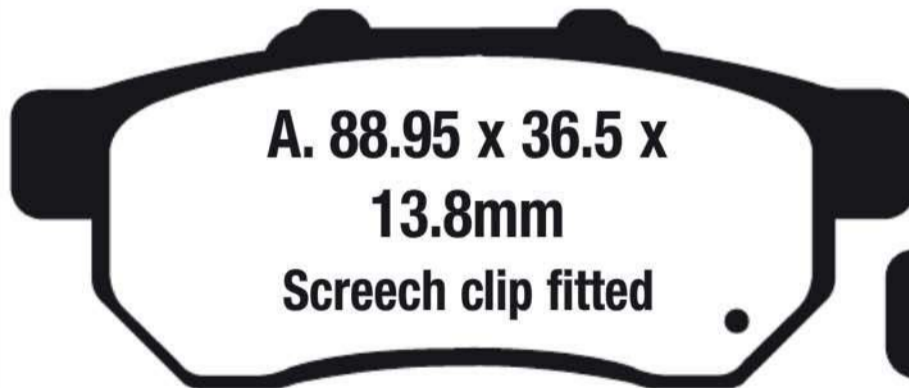

HONDA
MUV 700 Big Red

09-13 R Left

Equivalents OE#

06454 HL1 A01

Dealer Stocking Recommendation

<u>Single/Pair</u>	<u>Popularity #</u>	<u>Rec Stocking Level</u>
2	-	2

STD FA478X Carbon Dual Purpose Pad Blend

FA479

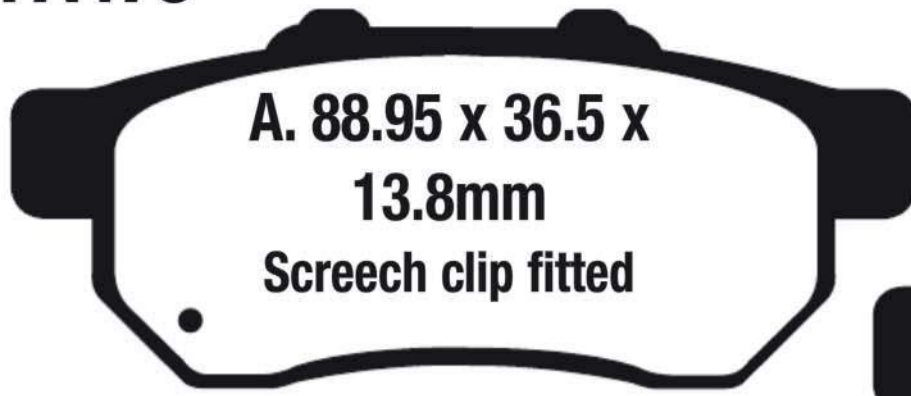

**A. 88.95 x 36.5 x
13.8mm
Screech clip fitted**



**B. 88.95 x 36.5 x
13.8mm**

HONDA
MUV 700 Big Red

09-13 R Right

Equivalents OE#

06455 HL1 A01

Dealer Stocking
Recommendation

<u>Single/Pair</u>
2

<u>Popularity #</u>
-

<u>Rec Stocking Level</u>
2

STD FA479X Carbon Dual Purpose Pad Blend

FA488HH

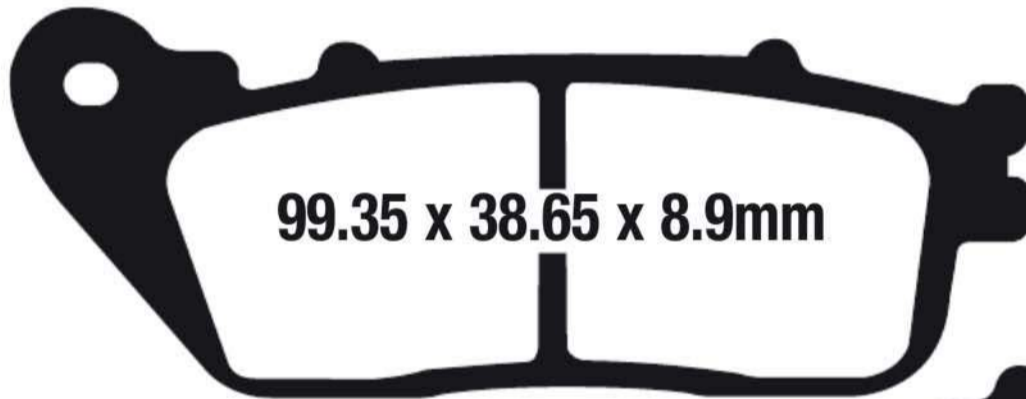

99.35 x 38.65 x 8.9mm

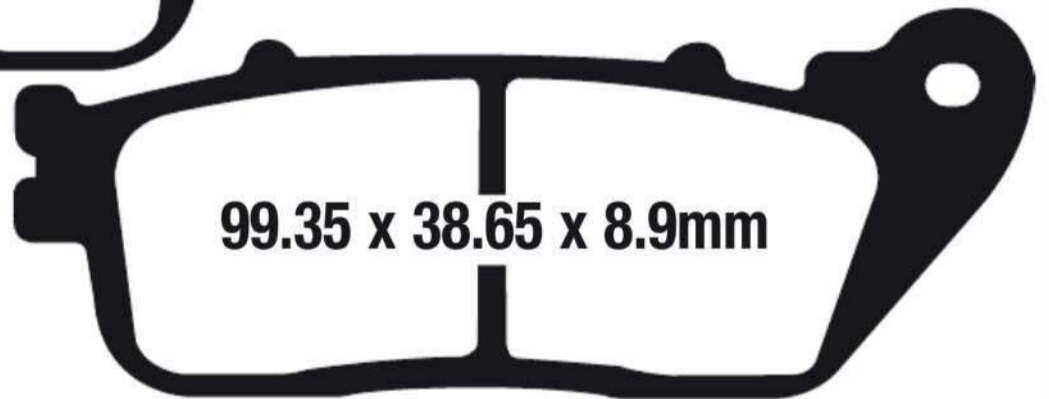

99.35 x 38.65 x 8.9mm

HONDA

VFR 800 F Interceptor Non ABS	14-15	R
VFR 800 FD Interceptor DLX ABS	14-15	R
CB 1000 R	10-16	R
VFR 1200 F	10-14	R

Equivalents OE#

06435 MFN D01	06435 MGY 641
06435 MFN D02	06435 MJM D01
06435 MFN D11	06435 MJM D02
06435 MFN D12	

Dealer Stocking
Recommendation

<u>Single/Pair</u>
2

<u>Popularity #</u>
-

<u>Rec Stocking Level</u>
2

STD FA488HH Street Performance Sintered Pad Blend

FA489R



**88.6 x 46.65
x 7.8mm**

POLARIS
Ranger RZR 170

09-14 R

Equivalents OE#

43120 214 00 AEON
0454444

STD FA489R Utility Grade Sintered Pad Blend

Dealer Stocking Recommendation

Single/Pair	Popularity #	Rec Stocking Level
2	-	2

FA490R



**87.1 x 42.65
x 7.8mm**

POLARIS
Pheonix 200 (Rear Drum Model) 10 F
Pheonix Quadricycle 200 (Rear Disc Model) 10 F
Ranger RZR 170 09-14 F

Equivalents OE#

43121 205 001 AEON
0454440
0454664

STD FA490R Utility Grade Sintered Pad Blend

Dealer Stocking Recommendation

Single/Pair	Popularity #	Rec Stocking Level
2	-	2

FA491HH



**78.1 x 46.2
x 7.6mm**

TRIUMPH (HINCKLEY PRODUCED MODELS)

675 Daytona Black Monobloc Radial caliper/Nissin Rear Caliper 09-12 F
675 Daytona Black Monobloc Radial caliper/Brembo Rear Caliper 13-17 F
Daytona 675 SE 12 F

Equivalents OE#

107 A486 55
T2021221

STD FA491HH Street Performance Sintered Pad Blend
OPTIONS EPFA491HH Fast Street Use & Track Day Sintered Pad Blend
OPTIONS GPFAX491HH Race Only Sintered Pad Blend

Dealer Stocking Recommendation

Single/Pair	Popularity #	Rec Stocking Level
2	-	2

**BUYERS GUIDE
BRAKE PADS**

**NOTE:- Size identification is shown as follows
Dimension 1=Width or Diameter, Dimension 2=Height or Diameter, Dimension 3=Thickness (Material and backplate)**

SFA492



**A. 109.6 x 51.1 x
9.7mm**



**B. 113.75 x 41.5 x
8.9mm**

YAMAHA

YYW125 Y/Z/A/B/D/E/F Zuma (Rear Drum Model) 09-15 F

Equivalents OE#

5S9 W0045 00

Dealer Stocking Recommendation

Single/Pair	Popularity #	Rec Stocking Level
2	-	2

STD SFA492 Premium Organic Scooter Pad Blend

FA495X



**35.7 x 42.2
x 5.6mm**

BETA

Evo 125 (2T)	10-15	R
Evo 200 (2T)	10-15	R
Evo 250 (2T)	09-15	R
Evo 250 (4T)	09-15	R
Evo 300 (2T)	09-15	R
Evo 300 (4T)	09-15	R

Equivalents OE#

007360718000

Dealer Stocking Recommendation

Single/Pair	Popularity #	Rec Stocking Level
2	-	1

STD FA495X Carbon Dual Purpose Pad Blend

FA496

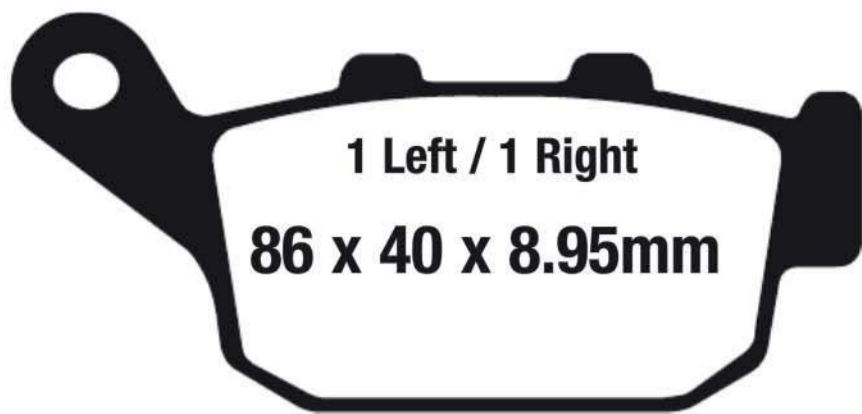

Equivalents OE#

69101 44850
06435 KYJ 901

STD	FA496	Premium Organic Street Pad Blend
OPTIONS	FA496HH	Street Performance Sintered Pad Blend
OPTIONS	FA496V	Semi Sintered Long Lasting Street Pad Blend

Dealer Stocking Recommendation

Single/Pair	Popularity #	Rec Stocking Level
2	-	1

HONDA		
CRB 250 R (Non ABS)	11-14	R
CBR 250 RA (ABS Model)	11-14	R
CB 300 F	15	R
CBR 300 R (Non ABS Model)	15	R
CBR 300 R (ABS Model)	15	R
CB 650 F (Non ABS)	18	R
CB 650 F (ABS)	18	R
CBR 650 F (Non ABS Model)	14-18	R
CBR 650 F (ABS Model)	14-18	R
KAWASAKI		
NEW Vulcan 650 S ABS	15	R
NEW Versys 650	15	R
SUZUKI		
GSX 250 R	17-18	R
GW 250 L4/L5 (Naked)	14-15	R
GW 250 FL5 (Fairing)	15	R
SFV 650 K9/L3/L4/L5	09-10/13-15	R
SV 650 AL7 (ABS)	17	R

FA497



YAMAHA

Rhino Parking Brake (All Models)	08-13	Parking Brake
YXC 700 DFG/DXG Viking VI	15-16	Parking Brake
YXC 700 PFG/PXG Viking VI EPS	15-16	Parking Brake
YXC 700 PSFS/PXGS Viking VI EPS SE	15-16	Parking Brake
YXM 700 DEG/DFG/VDXG Viking	14-16	Parking Brake
YXM 700 PEG/PFG/VPXG Viking EPS	14-16	Parking Brake
YXM 700 PSE/PSF/VPSG Viking EPS SE	14-16	Parking Brake

Equivalents OE#

5B4 W0046 00

Dealer Stocking Recommendation

Single/Pair	Popularity #	Rec Stocking Level
2	-	1

STD	FA497X	Carbon Dual Purpose Pad Blend
------------	---------------	-------------------------------

SFA498



KYMCO STREET

Downtown 200i	11-12
Downtown 300i	10-15

Equivalents OE#

43105 LEA7 305

Dealer Stocking Recommendation

Single/Pair	Popularity #	Rec Stocking Level
2	-	1

STD	SFA498	Premium Organic Scooter Pad Blend
OPTIONS	SFA498HH	Scooter Performance Sintered Pad Blend

FA499/4HH



69.2 x 51.55 x 8.9mm

A Side x 2 pieces
2 Pieces A side

Fitted to lower end of caliper

Refit original shims



33 x 51.55 x 8.9mm

B1 Side
x 1 piece

Fitted to top
inside of caliper

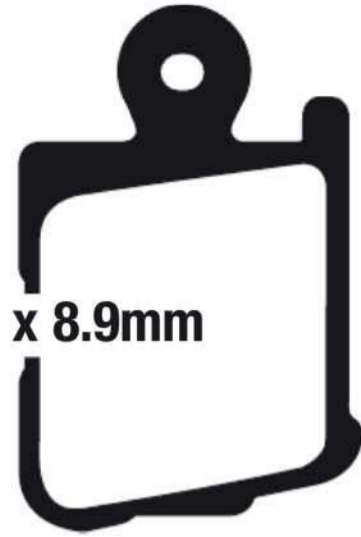

B2 Side
x 1 piece

Fitted to top
outside of
caliper

HONDA

VFR 1200 F 10-14 F
VFR 1200 FD (Automatic Transmission Model) 10-14 F

Equivalents OE#

06455 MGE 006

Dealer Stocking Recommendation

Single/Pair
2

Popularity #
-

Rec Stocking Level
2

STD FA499/4HH Street Performance Sintered Pad Blend

FA600



102.3 x 42.7
x 7.85mm

Equivalents OE#

45105 LFE9 305

KYMCO ATV

MXU 500 4x4 IRS (Carb Model) 10-11 F
MXU 500i IRS (All EFI Models) 10-11 F
MXU 700i (All Models) 14 F

Dealer Stocking Recommendation

Single/Pair
2

Popularity #
-

Rec Stocking Level
2

STD FA600X Carbon Dual Purpose Pad Blend

FA600/2



**102.3 x 42.7
x 7.1mm**

KYMCO ATV

MXU 500 4x4 IRS (Carb Model)	10-11	R
MXU500i IRS (All EFI Models)	10-11	R
MXU700i (All Models)	14	R

Equivalents OE#

43105 LFE9 305

STD FA600/2X Carbon Dual Purpose Pad Blend

Dealer Stocking Recommendation

Single/Pair	Popularity #	Rec Stocking Level
2	-	2

FA602



**40.95 x 42.35
x 7.3mm**

HUSQVARNA

CR 65	12	R
TC85 (17/14" wheels)	14-15	R
TC85 (19/16" wheels)	14	R

KTM

SX 85 (17/14" wheels)	11-17	R
SX 85 (19/16" wheels)	11-17	R
250R Freeride	15-16	R
350 Freeride	12/14	R
Freeride E	12	R

Equivalents OE#

470 13 090 300

STD FA602X Carbon Dual Purpose Pad Blend

OPTIONS FA602R Utility Grade Sintered Pad Blend

Dealer Stocking Recommendation

Single/Pair	Popularity #	Rec Stocking Level
2	-	2

SFA603

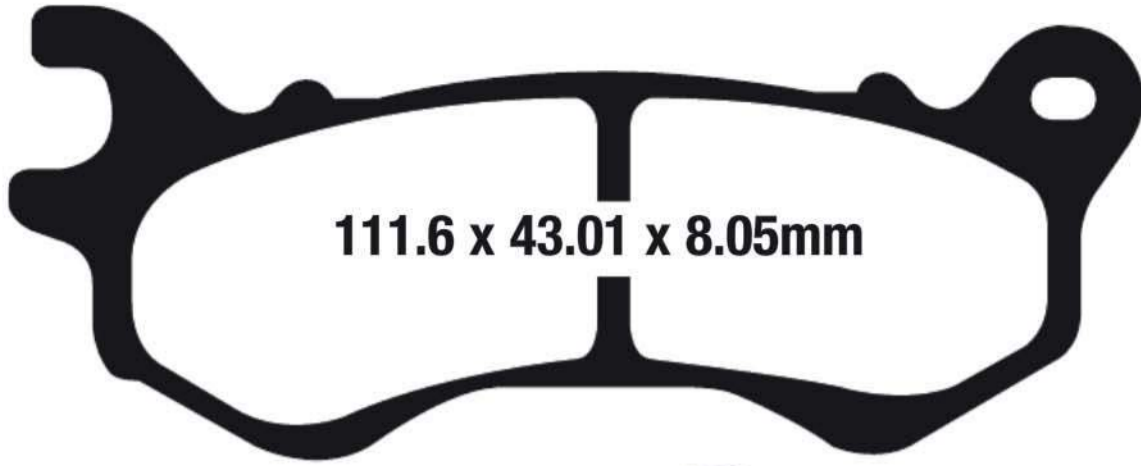

111.6 x 43.01 x 8.05mm

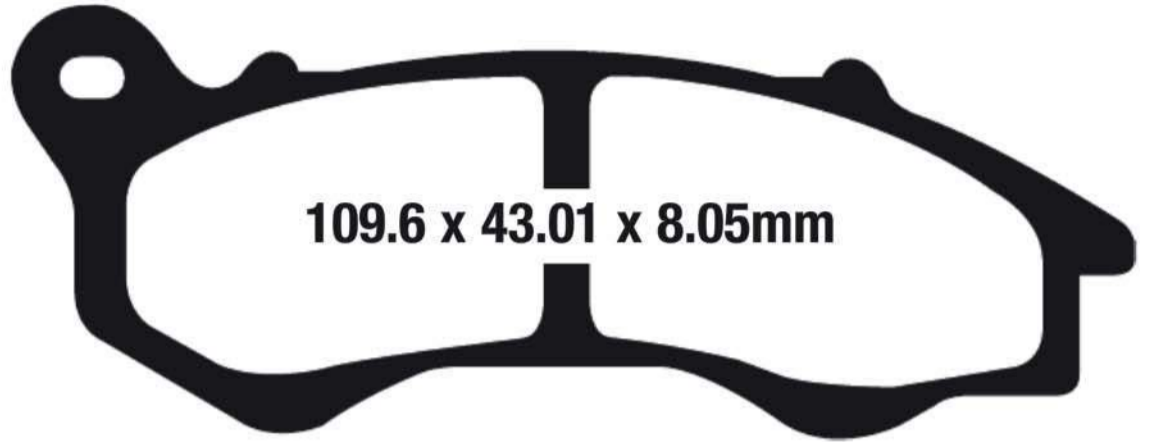

109.6 x 43.01 x 8.05mm

Equivalents OE#

06455 KWN 641
06455 KWM 931

HONDA

PCX 125	11	F
PCX 150 (WW150)	13-16	F

STD SFA603 Premium Organic Scooter Pad Blend
OPTIONS SFA603HH Scooter Performance Sintered Pad Blend

Dealer Stocking Recommendation

Single/Pair	Popularity #	Rec Stocking Level
2	-	2

FA604/4HH

Please refer to original BMW workshop manual for correct fitting information.

Note - backplate thickness must be 4.5mm



35 x 40.53
x 8mm

BMW

S 1000 R Naked	14	F
S 1000 RR	10-17	F
S 1000 RR (Models fitted with Forged race wheels 7 spoke type)	15-17	F

TRIUMPH

Speed Triple (1050cc - 4 Pad Brembo F/Caliper/220mm R/Disc/Non ABS Model)	10-12	F
Speed Triple (1050cc - 4 Pad Brembo F/Caliper/220mm R/Disc/ABS Model)	10-12	F

Equivalents OE#

34 11 7 714 800

STD FA604/4HH Street Performance Sintered Pad Blend
OPTIONS EPFA604/4HH Fast Street Use & Track Day Sintered Pad Blend
OPTIONS GPFAX604/4HH Race Only Sintered Pad Blend

Dealer Stocking Recommendation

Single/Pair	Popularity #	Rec Stocking Level
2	-	2

FA605/4

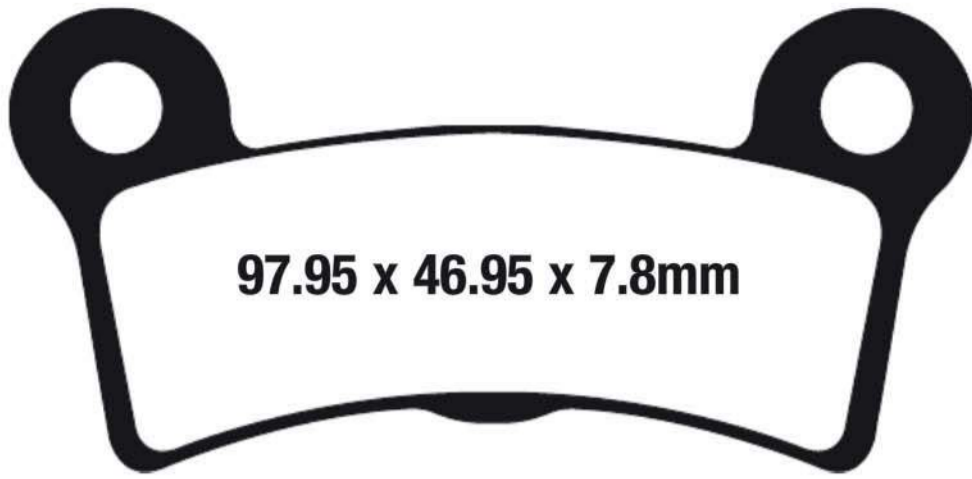

97.95 x 46.95 x 7.8mm

HARLEY DAVIDSON®
Harley Trikes
LYNDALL BRAKES
PAD REF 7255

09-13 R

Equivalents OE#

83911-09
83911-09B

STD FA605/4V Semi Sintered Long Lasting Street Pad Blend
OPTIONS FA605/4HH Street Performance Sintered Pad Blend

Dealer Stocking Recommendation

Single/Pair	Popularity #	Rec Stocking Level
2	-	2

FA606



69.4 x 45 x 8.6mm

BMW

G 310 R 17-18 F
G 310 GS 17-18 F

KTM

390 Duke 15-16 F
RC390 15-16 F

Equivalents OE#

901-13-030-000

STD FA606 Premium Organic Scooter Pad Blend
OPTIONS FA606HH Street Performance Sintered Pad Blend
OPTIONS EPFA606HH Fast Street Use & Track Day Sintered Pad Blend

Dealer Stocking Recommendation

Single/Pair	Popularity #	Rec Stocking Level
2	-	2

FA607



94 x 36.15 x 10.45mm

KYMCO STREET

XCiting 250 (All models) 05-11 R
People S 250 07-11 R
People GT 200i 11-12 R
People GT 300i 11-15 R
My Road 700 i 11-15 R

Equivalents OE#

43105 LDH1 E00
43105 LGE5 305

STD SFA607 Premium Organic Scooter Pad Blend
OPTIONS SFA607HH Scooter Performance Sintered Pad Blend

Dealer Stocking Recommendation

Single/Pair	Popularity #	Rec Stocking Level
2	-	2

SFA608

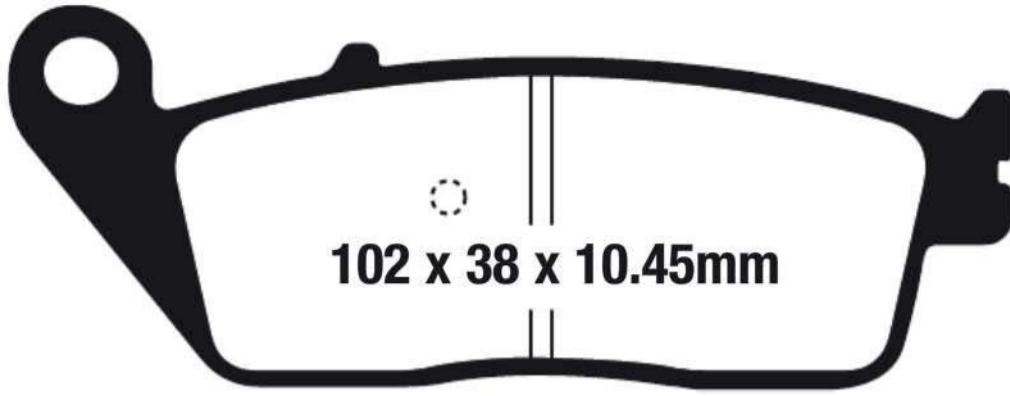

102 x 38 x 10.45mm

(With Handbrake Pin)

KYMCO STREET

XCiting 500 (All models)

04-14 R

Equivalents OE#

43105 LBA2 305
43105 LFH1 305

STD	SFA608	Premium Organic Scooter Pad Blend
OPTIONS	SFA608HH	Scooter Performance Sintered Pad Blend

Dealer Stocking Recommendation

Single/Pair	Popularity #	Rec Stocking Level
2	-	2

FA609



97.8 x 42.4 x 7.5mm
DO NOT REFIT O/E SHIM

JOHN DEERE

XUV 620i Gator (Petrol)	10	F & R
XUV 625i Gator (Petrol)	11	R
XUV 825i (Petrol)	11	R
XUV 850 D Gator (Diesel)	10	F & R
XUV 855 Gator D (Diesel)	11	R
HPX 4x4 (Diesel)	10-11	F & R

Equivalents OE#

AM 141182

STD	FA609R	Utility Grade Sintered Pad Blend
------------	---------------	----------------------------------

Dealer Stocking Recommendation

Single/Pair	Popularity #	Rec Stocking Level
2	-	2

FA610

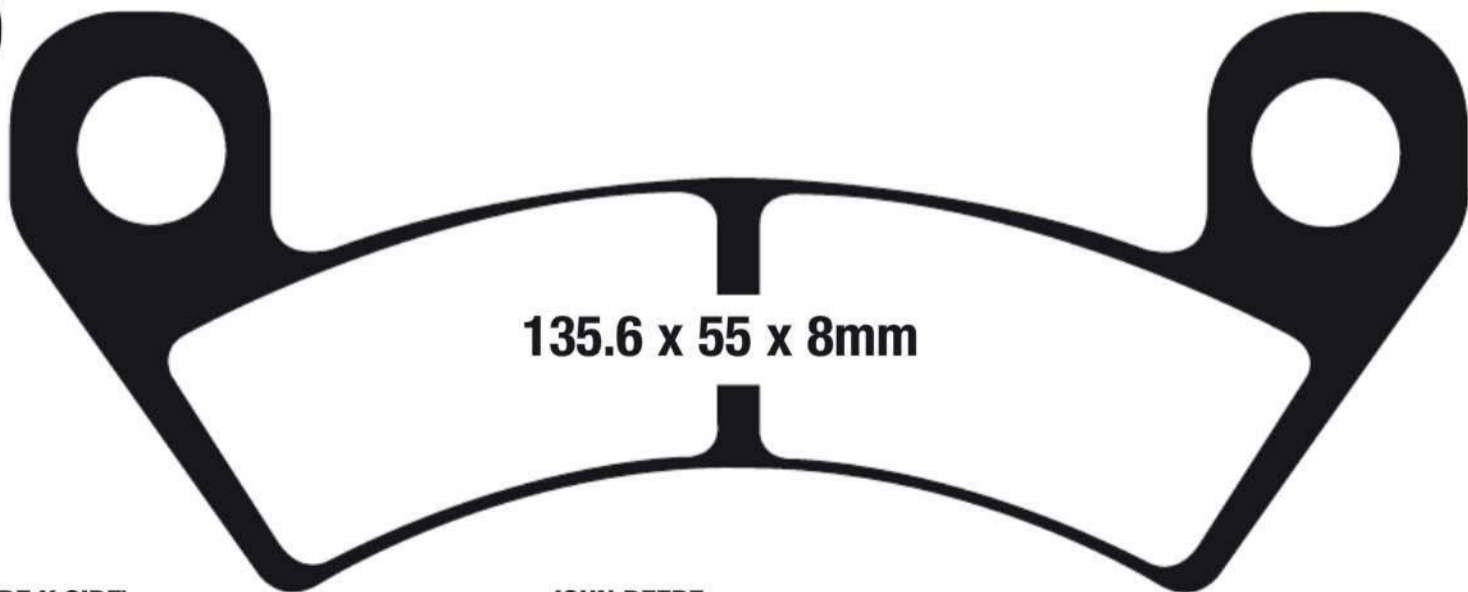

135.6 x 55 x 8mm

ARCTIC CAT (SIDE X SIDE)

Wildcat 1000	15-18	F
wildcat 1000 4	15-18	F
Wildcat X EPS 1000	15-18	F

JOHN DEERE

XUV 625i Gator (Petrol)	11	F
XUV 825i (Petrol)	11	F
XUV 855 Gator D (Diesel)	11	F
HPX 4x4 (Diesel)	10-11	F & R

Equivalents OE#

AM 140607

STD	FA610X	Carbon Dual Purpose Pad Blend
OPTIONS	FA610R	Utility Grade Sintered Pad Blend
OPTIONS	FA610SV	High Durability Off Road Sintered Pad Blend

Dealer Stocking Recommendation

Single/Pair	Popularity #	Rec Stocking Level
2	-	2

BUYERS GUIDE
BRAKE PADS

NOTE:- Size identification is shown as follows
Dimension 1=Width or Diameter, Dimension 2=Height or Diameter, Dimension 3=Thickness (Material and backplate)

FA611



82.15 x 28.8 x 9.5mm

BREMBO AFTERMARKET CALIPER

XA3.J7.50/51 - 4 Piston P 34/38 Radial Mount @108mm Spacing
 XA3.J7.60/61 - 4 Piston P 34/38 Radial Mount @108mm Spacing
 XA8.Y3.310/11 - 4 Piston P 34/38 Radial Mount @130mm Spacing

Equivalents OE#

07-8354-24

STD GPFA611HH Race Only Sintered Pad Blend

Dealer Stocking Recommendation

Single/Pair	Popularity #	Rec Stocking Level
2	-	2

FA612

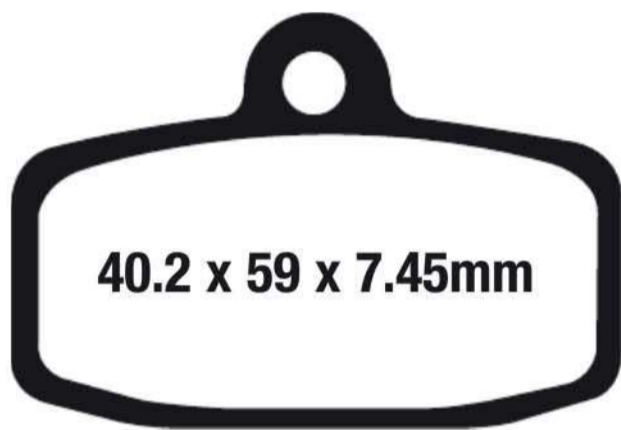

40.2 x 59 x 7.45mm

HUSQVARNA

TC85 (17/14" wheels) 14-15 F
 TC85 (19/16" wheels) 14 F

KTM

SX 85 (17/14" wheels) 12-17 F
 SX 85 (19/16" wheels) 12-17 F
 250R Freeride 15-16 F

SHERCO

ST1.25 (2T) 12-14 F
 ST2.5 (2T) 12-14 F
 ST2.9 (2T) 12-14 F

Equivalents OE#

470 13 030 000

STD FA612X Carbon Dual Purpose Pad Blend

OPTIONS FA612R Utility Grade Sintered Pad Blend

Dealer Stocking Recommendation

Single/Pair	Popularity #	Rec Stocking Level
2	-	2

FA613

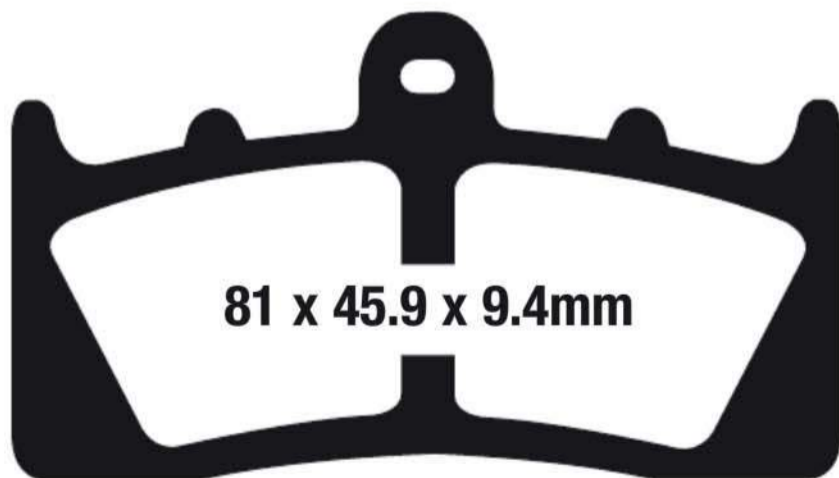

81 x 45.9 x 9.4mm

BMW

K 1600 GT 11-15 F
 K 1600 GTL 11-15 F
 K 1600 GTL Exclusive 15 F

Equivalents OE#

34 11 7 728 945

STD FA613HH Street Performance Sintered Pad Blend

Dealer Stocking Recommendation

Single/Pair	Popularity #	Rec Stocking Level
2	-	2

FA617



A. 109.15 x 39.2 x 7.65mm

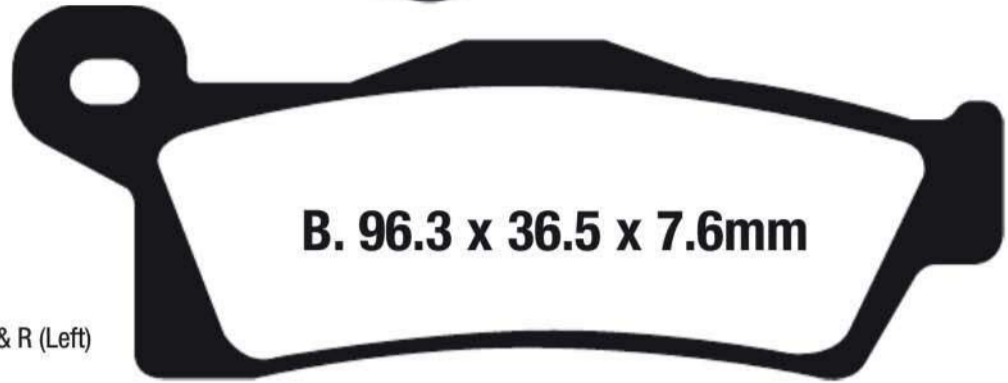

B. 96.3 x 36.5 x 7.6mm

CAN-AM

Outlander L 450 EFI	15	F (Left)
Outlander L Max 450 EFI	15	F (Left)
Outlander 500 4x4 (STD/DPS/XT)	13-15	F (Left)
Outlander L 500 EFI	15	F (Left)
Outlander L Max 500 EFI	15	F (Left)
Outlander Max 500 4x4 (STD/DPS/XT)	13-14	F (Left)
Renegade 500 (STD/EFI)	12-15	F (Left) & R (Left)
Outlander Max 650 4x4 (STD/DPS/XT)	13-14	F (Left)
Outlander 650 4x4 (DPS/XT/STD)	13-15	F (Left)
Outlander 650 4x4 (X-mr)	15	F (Right)
Outlander 800 R STD	12-15	F (Left)
Outlander 800 R XT	12-14	F (Left)
Outlander 800 R XT-P	13-14	F (Left)
Outlander 800 R 4x4 DPS	13	F (Left)
Outlander Max 800 R 4x4 (STD/XT/XT-P)	13-14	F (Right)
Renegade 800 R STD/EFI	12-15	F (Left) & R (Left)
Renegade 800 R XXC	12-14	F (Left) & R (Left)
Outlander 800R 4x4 (X-mr)	15	F (Right)
Outlander 1000 STD	12-14	F (Left) & R (Left)
Outlander 1000 XT/XT-P	12-14	F (Left) & R (Left)
Outlander 1000 4x4 (DPS)	13	F (Left)
Outlander 1000 (4x4 X mr)	13-14	F (Left)
Outlander Max 1000 (4x4 LTD)	13	F (Left)
Outlander Max 1000 (4x4 XMR)	13	F (Left)
Outlander Max 1000 (4x4 DPS/XT/XT-P/LTD/STD)	13-14	F (Left)
Outlander 6 x 6 XT	15	F (Left) & R (Left)
Renegade 1000 STD/EFI	12-15	F (Left) & R (Left)
Renegade 1000 XXC	12-14	F (Left) & R (Left)

Equivalents OE#

705601014

Dealer Stocking Recommendation

Single/Pair	Popularity #	Rec Stocking Level
2	-	2

STD	FA617X	Carbon Dual Purpose Pad Blend
OPTIONS	FA617R	Utility Grade Sintered Pad Blend
OPTIONS	FA617SV	High Durability Off Road Sintered Pad Blend

NOTE:- Size identification is shown as follows

Dimension 1=Width or Diameter, Dimension 2=Height or Diameter, Dimension 3=Thickness (Material and backplate)

BUYERS GUIDE
BRAKE PADS

FA618

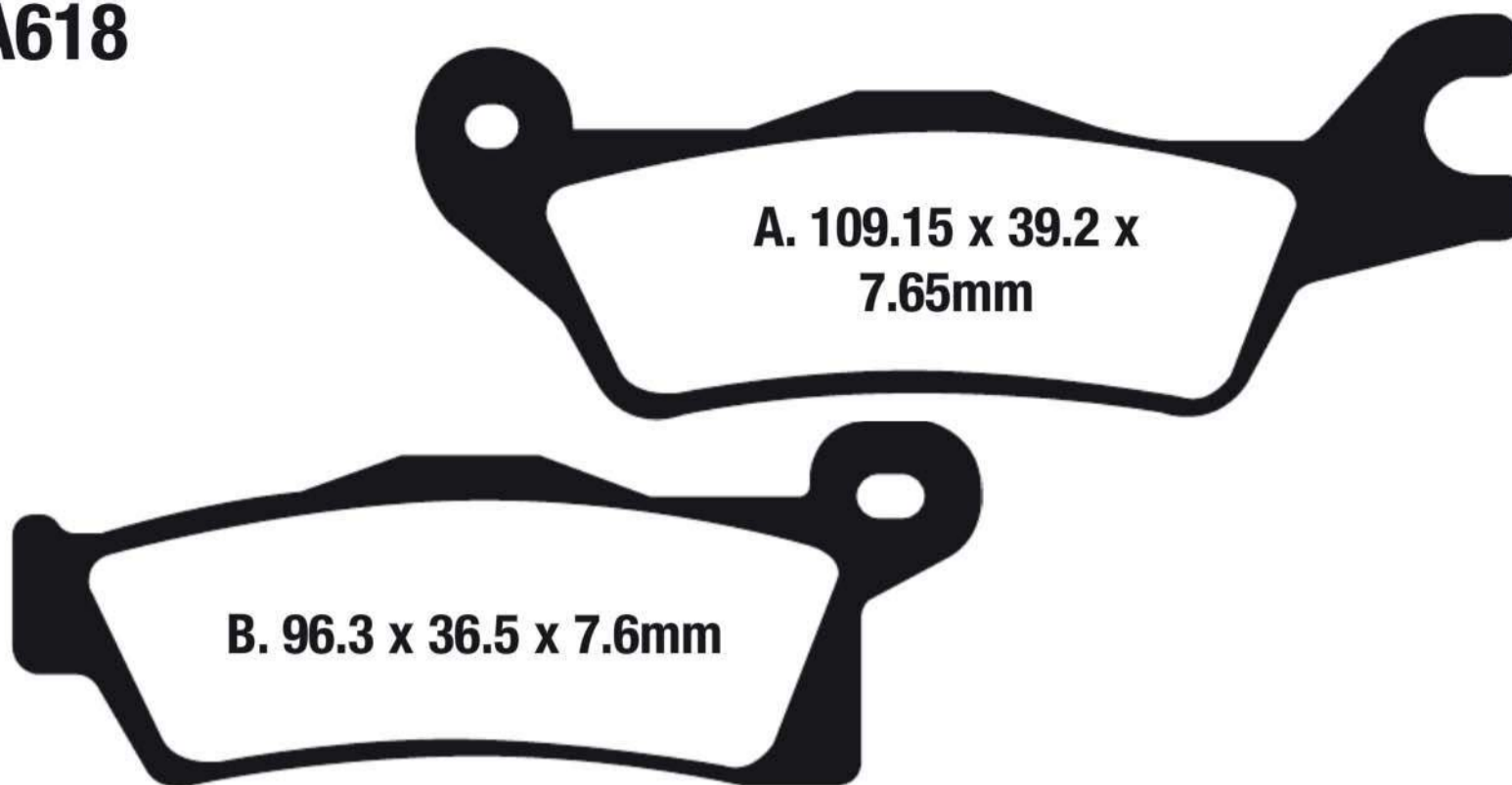

CAN-AM

Outlander L 450 EFI	15	F (Left)
Outlander L Max 450 EFI	15	F (Left)
Outlander 500 4x4 (STD/DPS/XT)	13-15	F (Left)
Outlander L 500 EFI	15	F (Left)
Outlander L Max 500 EFI	15	F (Left)
Outlander Max 500 4x4 (STD/DPS/XT)	13-14	F (Left)
Renegade 500 (STD/EFI)	12-15	F (Left) & R (Left)
Outlander Max 650 4x4 (STD/DPS/XT)	13-14	F (Left)
Outlander 650 4x4 (DPS/XT/STD)	13-15	F (Left)
Outlander 650 4x4 (X-mr)	15	F (Right)
Outlander 800 R STD	12-15	F (Left)
Outlander 800 R XT	12-14	F (Left)
Outlander 800 R XT-P	13-14	F (Left)
Outlander 800 R 4x4 DPS	13	F (Left)
Outlander Max 800 R 4x4 (STD/XT/XT-P)	13-14	F (Right)
Renegade 800 R STD/EFI	12-15	F (Left) & R (Left)
Renegade 800 R XXC	12-14	F (Left) & R (Left)
Outlander 800R 4x4 (X-mr)	15	F (Right)
Outlander 1000 STD	12-14	F (Left) & R (Left)
Outlander 1000 XT/XT-P	12-14	F (Left) & R (Left)
Outlander 1000 4x4 (DPS)	13	F (Left)
Outlander 1000 (4x4 X mr)	13-14	F (Left)
Outlander Max 1000 (4x4 LTD)	13	F (Left)
Outlander Max 1000 (4x4 XMR)	13	F (Left)
Outlander Max 1000 (4x4 DPS/XT/XT-P/LTD/STD)	13-14	F (Left)
Outlander 6 x 6 XT	15	F (Left) & R (Left)
Renegade 1000 STD/EFI	12-15	F (Left) & R (Left)
Renegade 1000 XXC	12-14	F (Left) & R (Left)

STD FA618X Carbon Dual Purpose Pad Blend
OPTIONS FA618R Utility Grade Sintered Pad Blend
OPTIONS FA618SV High Durability Off Road Sintered Pad Blend

Dealer Stocking Recommendation

Single/Pair	Popularity #	Rec Stocking Level
2	-	2

Equivalents OE#
705601015

CFA619

BULTACO

Brinco (Electric Trials Bike - C/R/RE/S Models) 15-17 R



33.52 x 29.93 x 4mm

Equivalents OE#

-

Dealer Stocking Recommendation	Single/Pair	Popularity #	Rec Stocking Level
	2	-	2

STD CFA619 Premium Organic Pad Blend

FA622



77.3 x 42.2 x 7.2mm

KOTI/MECHRON
2200 UTV (Side x Side)

09-14 F&R

Equivalents OE#

Dealer Stocking Recommendation

Single/Pair	Popularity #	Rec Stocking Level
2	-	2

STD	FA622X	Carbon Dual Purpose Pad Blend
OPTION	FA622SV	High Durability Off Road Sintered Blend
OPTION	FA622R	Utility Grade Sintered Pad Blend

FA623



84.4 x 59.7 x 10.2mm

HHI HAWG HALTERS AFTERMARKET CALIPERS
4 Piston Sprocket Brake

Equivalents OE#

STD	FA623	Premium Organic Street Pad Blend
OPTION	FA623HH	Street Performance Sintered Pad Blend

Dealer Stocking Recommendation

Single/Pair	Popularity #	Rec Stocking Level
2	-	2

FA629

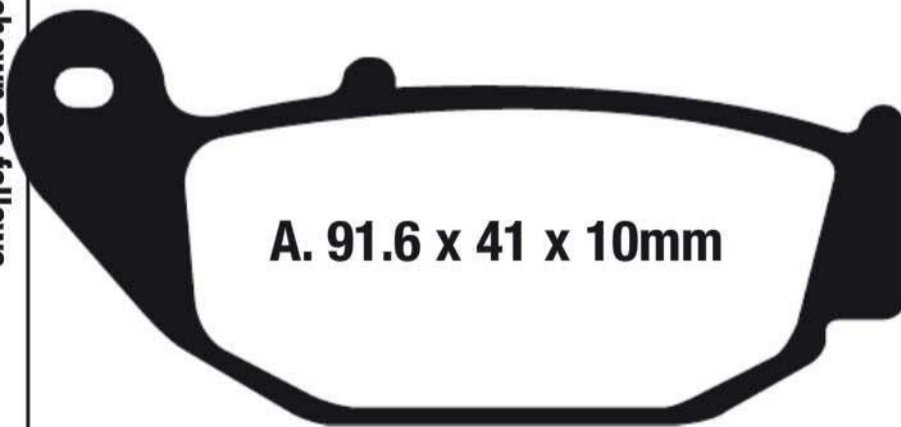

A. 91.6 x 41 x 10mm

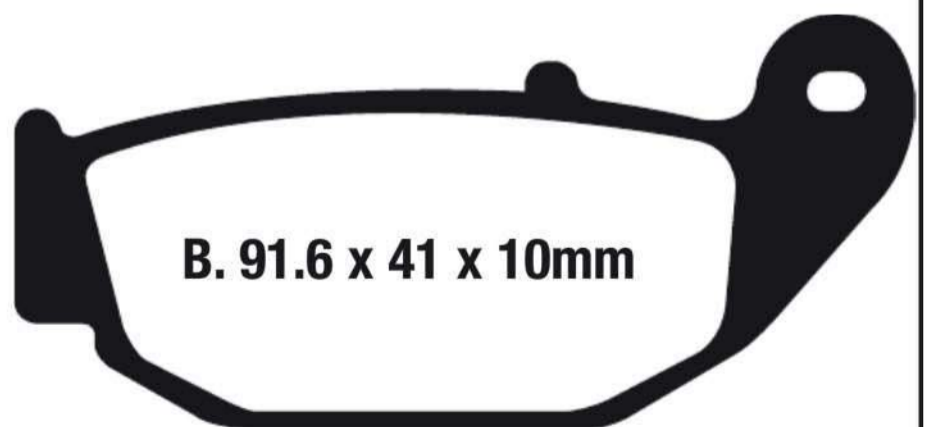

B. 91.6 x 41 x 10mm

Equivalents OE#

STD	FA629	Premium Organic Street Pad Blend
OPTION	FA629X	Carbon Dual Purpose Pad Blend
OPTION	FA629HH	Street Performance Sintered Pad Blend
OPTION	FA629R	Utility Grade Sintered Pad Blend

Dealer Stocking Recommendation

HONDA	Year	Side
CBR 125 RWB/RC/RD (5 Bolt Front Disc / Canada)	11-13	R
MSX 125 D/E/F/G/H Grom (Non ABS)	14-18	R
MSX 125 AH Grom (ABS)	18	R
CRF 250 L (Non ABS)	13-17	R
CRF 250 LA (ABS)	17	R
CRF 250 RL Rally (Non ABS)	17	R
CRF 250 RLA Rally (ABS)	17	R

Single/Pair	Popularity #	Rec Stocking Level
2	-	2

FA630

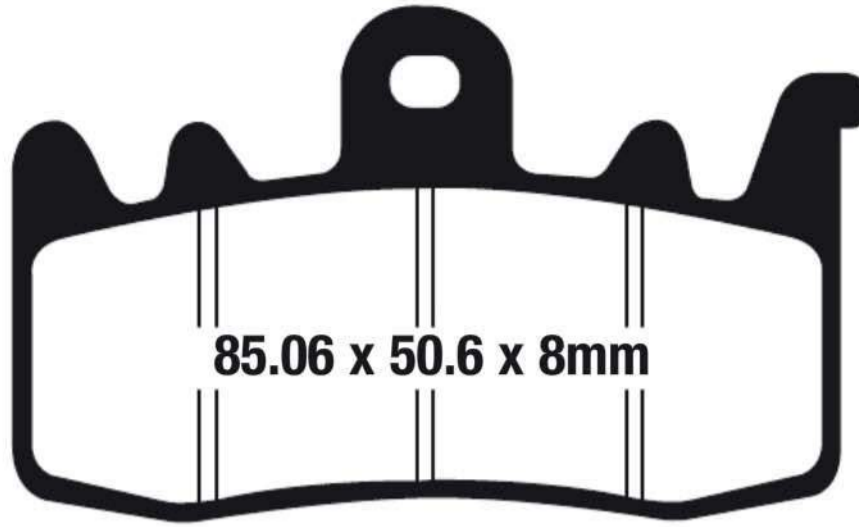

APRILIA

Tuono V4 R APRC ABS
Caponord 1200

BMW

F 800 R
S 1000 XR
R 1200 GS (Liquid Cooled/Radial Mount Caliper)
R 1200 GS Adventure (Liquid Cooled/Radial Mount Caliper)
R Nine T (K21/1170cc)
R 1200 R
R 1200 RS
R 1200 RT

BREMBO

M4-32 Monobloc Radial

CAN-AM

Spyder F3
Spyder F3 LTD
Spyder F3-S (SE6/SM6)
Spyder F3-S (Special Series)
Spyder F3-S Daytona 500
Spyder F3-T
Spyder RT (3 Cyl Eng/ 6 Speed)
Spyder RT-S (3 Cyl Eng/ 6 Speed)
Spyder RT-S (Special Series)
Spyder RT Ltd (3 Cyl Eng/ 6 Speed)
Spyder ST Brembo Calipers
Spyder ST-S Brembo Calipers
Spyder ST LTD Brembo Calipers
Spyder RS Brembo Calipers
Spyder RS-S Brembo Calipers

DUCATI

797 Monster
Scrambler Classic (Spoke Wheels/803cc)
Scrambler Icon (Cast Wheels/803cc)
Scrambler Urban Enduro (Spoke Wheels/803cc)
Scrambler Full Throttle (Cast Wheels/803cc)
Scrambler Flat Track Pro (Cast Wheels/803cc)

14-15 F
14-15 F
15 F
14-17 F
13-15 F
14-15 F
14-16 F
15 F
15 F
14 F

Scrambler Café Racer (Cast wheels/803cc)

Hypermotard(821cc)
HypermotardSP (821cc)
Hyperstrada(821cc)
Monster 821
Monster Dark 821
Monster Stripe 821
899 Panigale
Supersport (936cc)
Supersport S (936cc)
939 Hypermotard
939 Hypermotard SP
939 Hyperstrada
950 Multistrada (936cc)
959 Panigale (ABS)
1200 Monster
Multistrada 1200
Multistrada 1200 Enduro
1200 Multistrada DVT
1262 Xdiavel

MV

Rivale 800
Turismo Veloce 800
Turismo Veloce Lusso 800

TRIUMPH

Tiger Explorer XC 1200 (Vin # 740277 onwards/1215cc/Spoke Wheels)
Tiger Explorer XCa 1200 (1215cc/Spoke Wheels)
Tiger Explorer XCx 1200 (1215cc/Spoke Wheels/STD & Low)
Tiger Explorer XR 1200 (1215cc/Cast Wheels)
Tiger Explorer XRx 1200 (1215cc/Cast Wheels/STD & Low)
Tiger Explorer XRT 1200 (1215cc/Cast Wheels)

17 F
13-15 F
13-15 F
13-15 F
15-17 F
15 F
15-17 F
14-15 F
17 F
17 F
16-17 F
16-17 F
16 F
17 F
16-17 F
14-17 F
16-17 F
16-17 F
15 F
16-17 F
13-14 F
14 F
14 F
16-17 F
16-17 F
16-17 F
16-17 F
16-17 F
16-17 F

STD FA630HH Street Performance Sintered Pad Blend

OPTION FA630V Semi Sintered Long Lasting Street Pad Blend

OPTION EPFA630HH Fast Street Use & Track Day Sintered Pad Blend

OPTION GPFAX630HH Race Only Sintered Pad Blend

Equivalents OE#

219 800237

2B000214

613 41021A

34 11 8 548 028

T2022458

Dealer Stocking Recommendation

Single/Pair	Popularity #	Rec Stocking Level
2	-	2

FA631

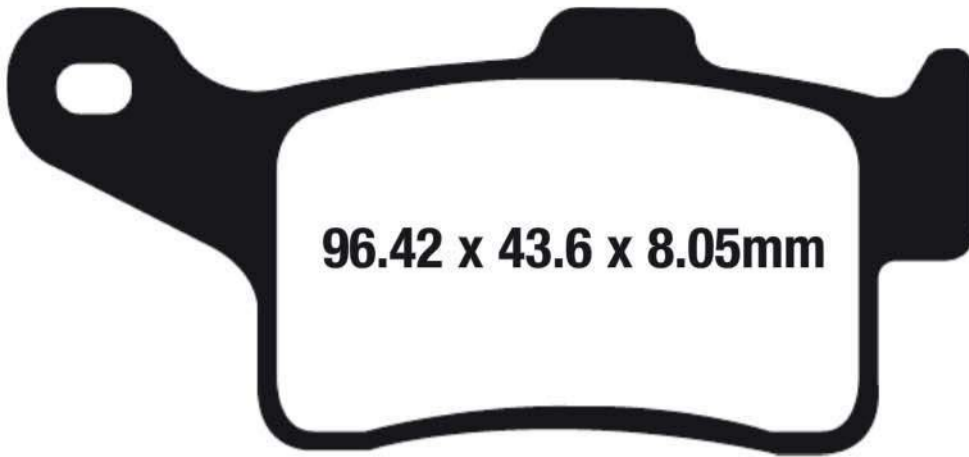

96.42 x 43.6 x 8.05mm



96.42 x 43.6 x 8.05mm

CAN-AM

Spyder RT (Brembo Calipers)	13	F
Spyder RT LTD (Brembo Calipers)	13	F
Spyder RT-S (Brembo Calipers)	13	F
Spyder F3	15-17	F
Spyder F3 LTD	16-17	F
Spyder F3-S (SE6/SM6)	15-17	F
Spyder F3-S (Special Series)	16	F
Spyder F3-S Daytona 500	17	F
Spyder F3-T	16-17	F
Spyder RT (3 Cyl Eng/ 6 Speed)	13-17	F
Spyder RT-S (3 Cyl Eng/ 6 Speed)	13-15	F
Spyder RT-S (Special Series)	16-17	F
Spyder RT Ltd (3 Cyl Eng/ 6 Speed)	13-17	F
Spyder ST Brembo Calipers	13-16	F
Spyder ST-S Brembo Calipers	13-16	F
Spyder ST LTD Brembo Calipers	13-15	F
Spyder RS Brembo Calipers	13-16	F
Spyder RS-S Brembo Calipers	13-16	F

Equivalents OE#

219800239

STD FA631V Semi Sintered Long Lasting Street Pad Blend

OPTIONS FA631HH Street Performance Sintered Pad Blend

Dealer Stocking Recommendation

Single/Pair

2

Popularity #

-

Rec Stocking Level

2

SFA632



90 x 39.6 x 10.3mm

2 clips included



Equivalents OE#

17C W0045 00

4C6 W0045 00

YAMAHA
YW125 X (1DN1/2)

10-13 F

Dealer Stocking Recommendation

Single/Pair

2

Popularity #

-

Rec Stocking Level

2

STD SFA632 Premium Organic Scooter Pad Blend

FA636

Refit O/E shim/insulator



**101.95 x 39.9
x 9.4mm**



**101.95 x 39.9
x 9.4mm**

HONDA

VFR 1200 FD	10-14	R
VFR 1200 XA (Manual G/Box)	16-17	R
VFR 1200 XD DCT (Automatic Transmission Model)	16-17	R

Equivalents OE#

06435 MGE D01	06435 MGE D02
---------------	---------------

STD FA636V	Semi Sintered Long Lasting Street Pad Blend
OPTIONS FA636HH	Street Performance Sintered Pad Blend

Dealer Stocking Recommendation

Single/Pair	Popularity #	Rec Stocking Level
2	-	2

FA638

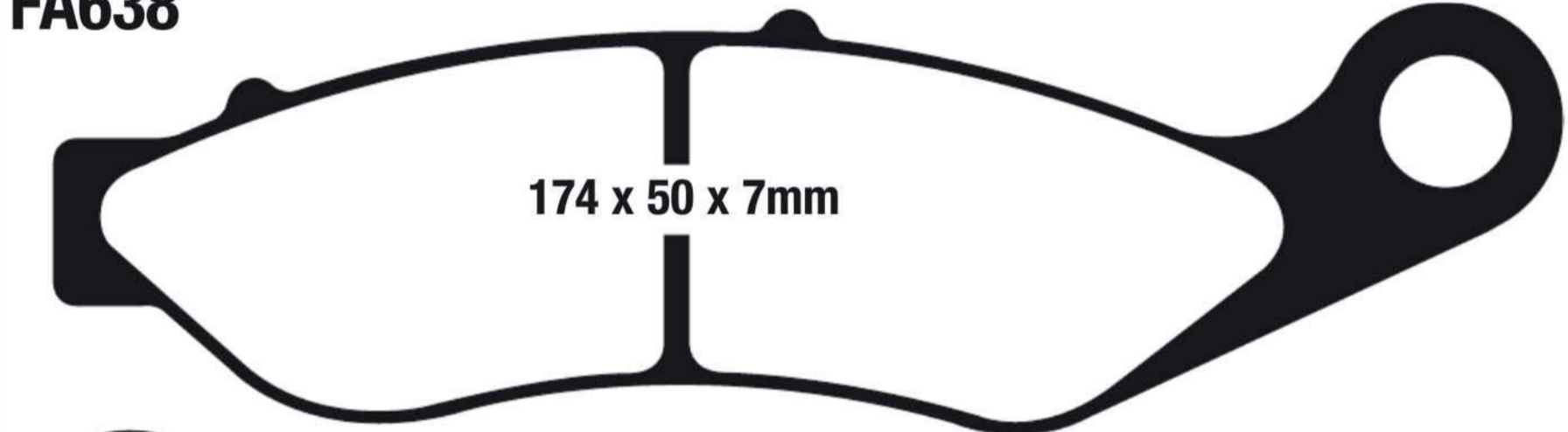

174 x 50 x 7mm

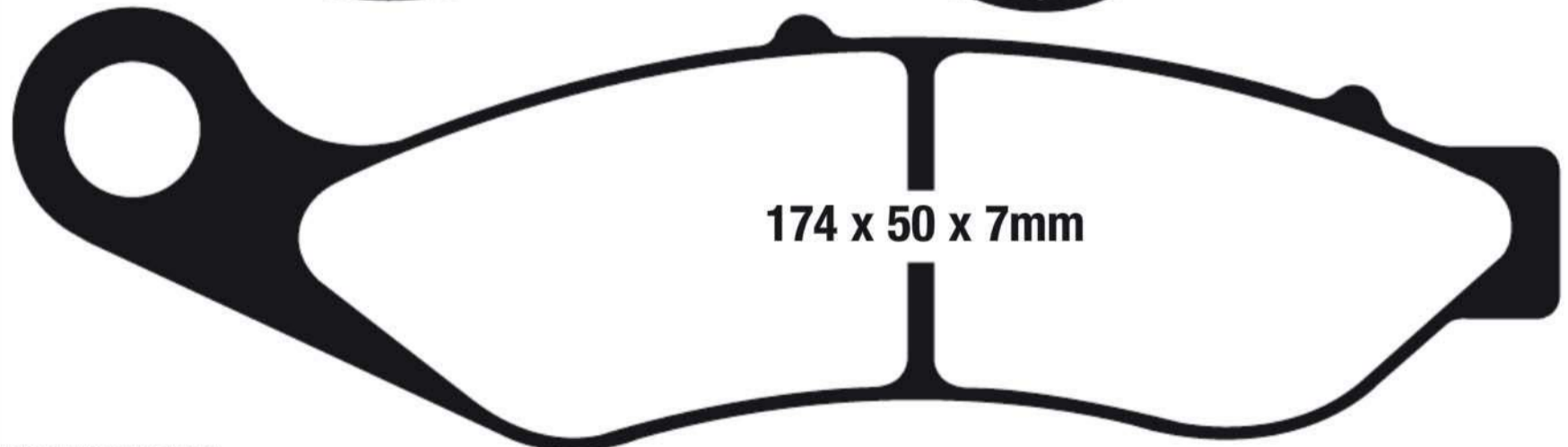

174 x 50 x 7mm

HARLEY DAVIDSON

FLRT Freewheeler Trike	15-18	F
FLHTCUTG Trike	14-18	F
FLHTCUTG Tri Glide Ultra Trike Anniversary	18	F

Equivalents OE#

41300027

STD FA638	Premium Organic Street Pad Blend
OPTIONS FA638V	Semi Sintered Long Lasting Street Pad Blend
OPTIONS FA638HH	Street Performance Sintered Pad Blend

Dealer Stocking Recommendation

Single/Pair	Popularity #	Rec Stocking Level
2	-	2

**BUYERS GUIDE
BRAKE PADS**

**NOTE:- Size identification is shown as follows
Dimension 1=Width or Diameter, Dimension 2=Height or Diameter, Dimension 3=Thickness (Material and backplate)**

FA640

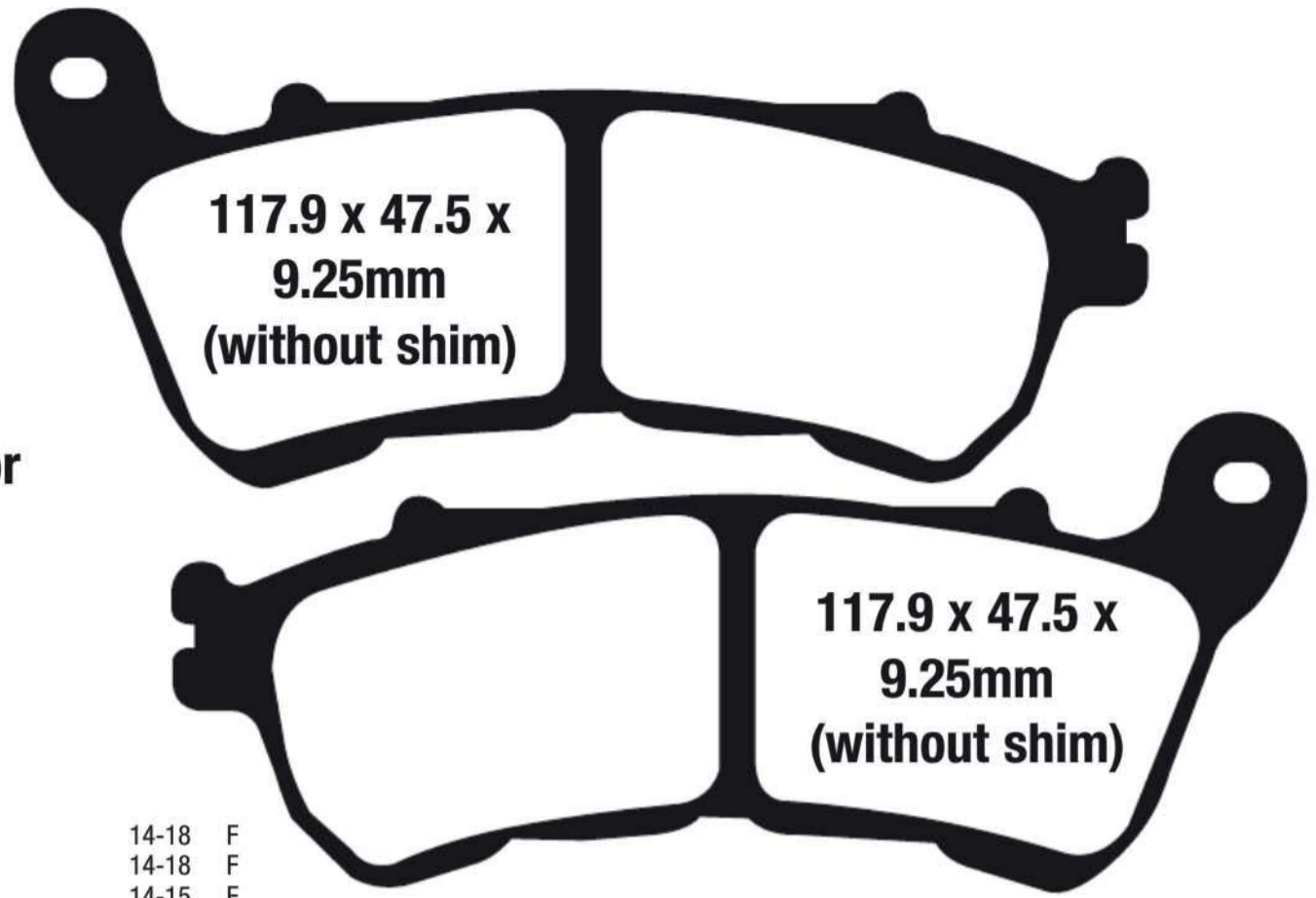

**Refit OE
shim/insulator**

**117.9 x 47.5 x
9.25mm
(without shim)**

**117.9 x 47.5 x
9.25mm
(without shim)**

HARLEY DAVIDSON

XL 883 L Super Low (Cast Wheel)	14-18	F
XL 883 N Iron (Cast Wheel)	14-18	F
XL 883 R Roadster (Cast Wheel)	14-15	F
XL 1200 C Custom (Spoke Wheel)	14-18	F
XL 1200 CX Roadster	16-18	F
XL 1200 T Superlow	14-18	F
XL 1200 V Seventy Two	14-16	F
XL 1200 X Forty Eight	14-18	F
XL 1200 Forty Eight Anniversary	18	F

Equivalents OE#

41300004

**Dealer Stocking
Recommendation**

Single/Pair	Popularity #	Rec Stocking Level
2	-	2

FA641/4



88 x 43 x 7.65mm

HARLEY DAVIDSON

FLRT Freewheeler Trike	15-18	R
FLHTCUTG Trike	14-18	R
FLHTCUTG Tri Glide Ultra Trike Anniversary	18	R

Equivalents OE#

41300033

STD	FA641/4	Premium Organic Street Pad Blend
OPTIONS	FA641/4V	Semi Sintered Long Lasting Street Pad Blend
OPTIONS	FA641/4HH	Street Performance Sintered Pad Blend

**Dealer Stocking
Recommendation**

Single/Pair	Popularity #	Rec Stocking Level
2	-	2

FA642

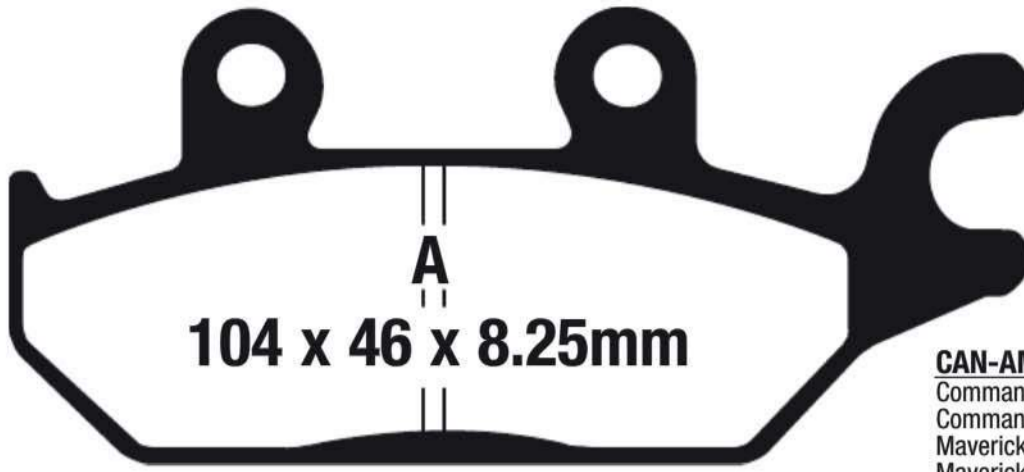

104 x 46 x 8.25mm

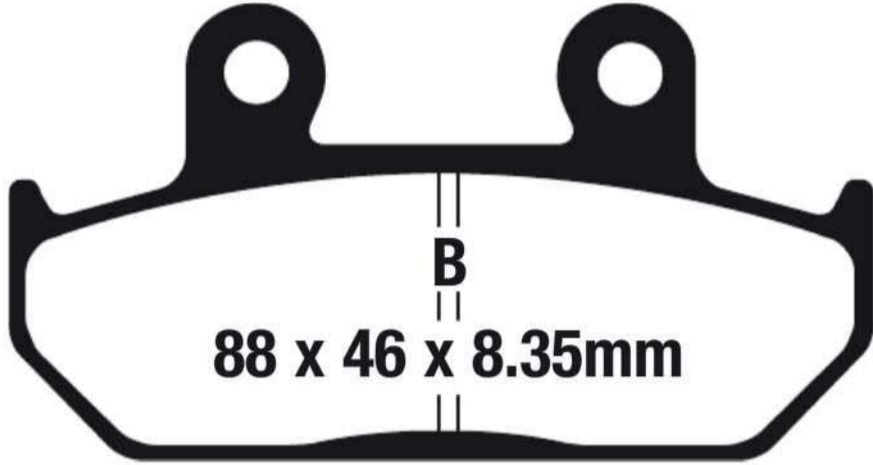

88 x 46 x 8.35mm

CAN-AM

Commander Max 1000 DPS/XT	14	F Left
Commander Max 1000 LTD	14	F Left
Maverick 1000 - XRS -DPS	14	F Left
Maverick 1000 - XMR	14-15	F Left
Maverick 1000 - XXC	14-15	F Left
Maverick 1000 - XDS -DPS	15	F Left
Maverick Max 1000 - STD	14-15	F Left
Maverick Max 1000 - XRS-DPS	14-15	F Left
Maverick Max STD/XRS/DPS	15	F Left
Maverick Max 1000 - XDS -DPS	15	F Left

YAMAHA

YXC 700 DFG/DXG Viking VI	15-16	F Left
YXC 700 PFG/PXG Viking VI EPS	15-16	F Left
YXC 700 PSFS/PXGS Viking VI EPS SE	15-16	F Left
YXC 70 PRGC Viking VI EPS Edition	16	F Left
YXE 70 WDBGG Wolverine	16	F Left
YXE 70 WDXGG Wolverine R Spec	16	F Left
YXE 70 WPXGG Wolverine R Spec EPS	16	F Left
YXM 700 DEG/DFG/VDXG Viking	14-16	F Left
YXM 700 PEG/PFG/VPXG Viking EPS	14-16	F Left
YXM 700 PSE/PSF/VPSG Viking EPS SE	14-16	F Left

Equivalents OE#

1XD 25805 00

705601149

STD FA642X	Carbon Dual Purpose Pad Blend
OPTIONS FA642R	Utility Grade Sintered Pad Blend
OPTIONS FA642SV	High Durability Off Road Sintered Pad Blend

Dealer Stocking Recommendation

Single/Pair	Popularity #	Rec Stocking Level
2	-	2

FA643



94 x 37.3 x 8.95mm

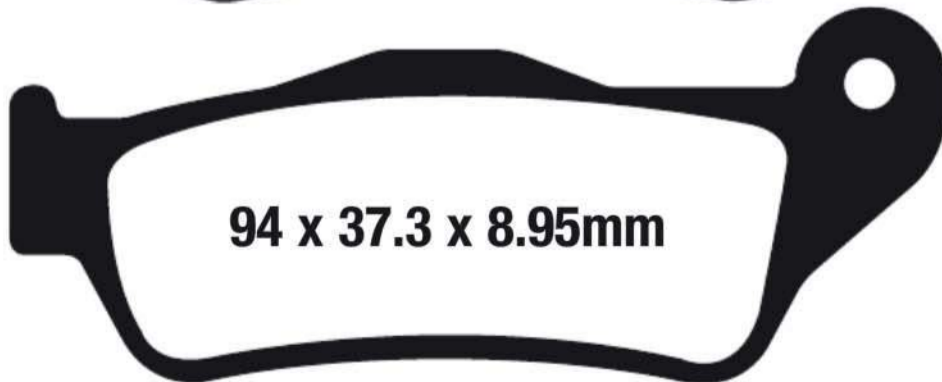

94 x 37.3 x 8.95mm

Equivalents OE#

41300072

HARLEY DAVIDSON

XG 500 Street	14-15	F & R
XG 750 Street	14-15	F & R

Dealer Stocking Recommendation

Single/Pair	Popularity #	Rec Stocking Level
2	-	2

STD FA643	Premium Organic Street Pad Blend
OPTIONS FA643V	Semi Sintered Long Lasting Street Pad Blend
OPTIONS FA643HH	Street Performance Sintered Pad Blend

FA644



56 x 31.8 x 5mm

GAS-GAS

TXT 125/200/250/280/300 (TXT Racing)

14-15 F

MONTESA

4RT Cota Repsol Edition (260cc)

14-17 F

4RT Cota 300RR

16 F

Equivalents OE#

BT65003013
45105 NN4 K20

STD FA644X Carbon Dual Purpose Pad Blend

Dealer Stocking Recommendation

Single/Pair	Popularity #	Rec Stocking Level
2	-	2

FA645

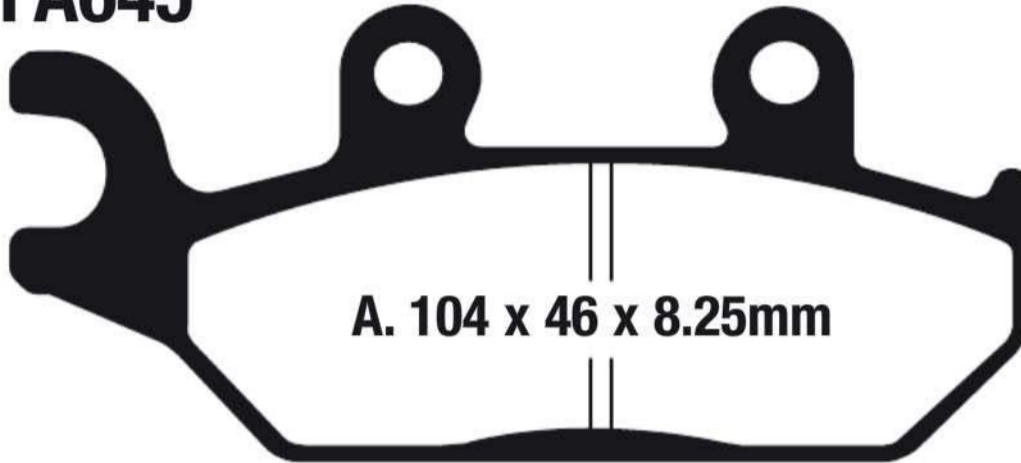

A. 104 x 46 x 8.25mm

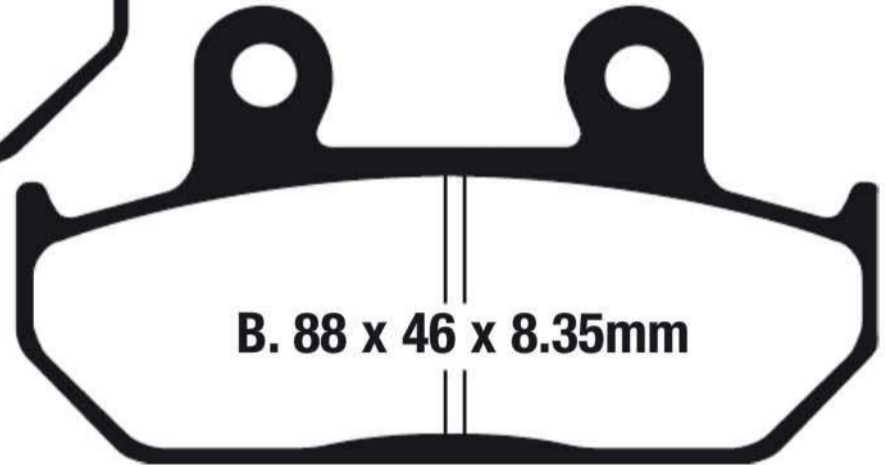

B. 88 x 46 x 8.35mm

CAN-AM

Commander Max 1000 DPS/XT	14	F Right
Commander Max 1000 LTD	15	F Right
Maverick 1000 - XRS -DPS	14-15	F Right
Maverick 1000 - XMR	14-15	F Right
Maverick 1000 - XXC	14-15	F Right
Maverick 1000 - XDS -DPS	15	F Right
Maverick Max 1000 - STD	14-15	F Right
Maverick Max 1000 - XRS-DPS	14-15	F Right
Maverick Max STD/XRS/DPS	15	F Right
Maverick Max 1000 - XDS -DPS	15	F Right

YAMAHA

YXC 700 DFG/DXG Viking VI	15-16	F Right
YXC 700 PFG/PXG Viking VI EPS	15-16	F Right
YXC 700 PSFS/PXGS Viking VI EPS SE	15-16	F Right
YXC 70 PRGC Viking VI EPS Edition	16	F Right
YXE 70 WDBGG Wolverine	16	F Right
YXE 70 WDXGG Wolverine R Spec	16	F Right
YXE 70 WPXGG Wolverine R Spec EPS	16	F Right
YXM 700 DEG/DFG/VDXG Viking	14-16	F Right
YXM 700 PEG/PFG/VPXG Viking EPS	14-16	F Right
YXM 700 PSE/PSF/VPSG Viking EPS SE	14-16	F Right

Equivalents OE#

75601150
1XD 25805 10

STD FA645X Carbon Dual Purpose Pad Blend

OPTION FA645SV High Durability Off Road Sintered Blend

OPTION FA645R Utility Grade Sintered Pad Blend

Dealer Stocking Recommendation

Single/Pair	Popularity #	Rec Stocking Level
2	-	2

GPFA646HH



94.14 x 33.94 x 11.55mm

BREMBO AFTERMARKET CALIPER

XB2P710/XB2P711 Endurance Caliper

Equivalents OE#

07 8366 40

Competitor X Ref

SBS	Vesrah	Ferodo
-	-	-

STD GPFA646HH Race Only Sintered Pad Blend

Dealer Stocking Recommendation

Single/Pair	Popularity #	Rec Stocking Level
2	-	2

FA649



98.8 x 55 x 8.8mm

JAYBRAKE AFTERMARKET CALIPER

6 PF-L (6 Piston/For 11.5" Disc - Lower Friction Material)

Equivalents OE#

300-64A

STD FA649HH Street Performance Sintered Pad Blend

Dealer Stocking Recommendation

Single/Pair	Popularity #	Rec Stocking Level
2	-	2

FA651

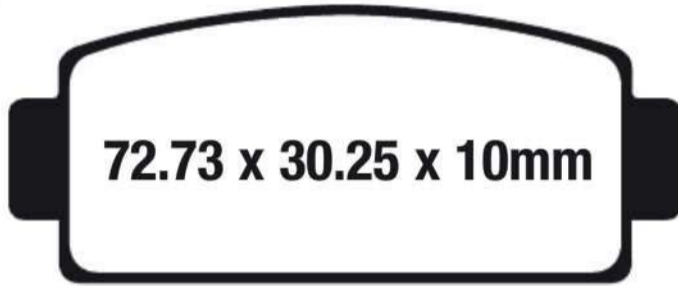

72.73 x 30.25 x 10mm

CF MOTO

500 Z-Force
800 Z-Force
800 EX Z-Force

14-16
15-16
14-16

R (left) & R (Right)
R (left) & R (Right)
R (left) & R (Right)

Equivalents OE#

9060 081010

STD FA651X Street Performance Sintered Pad Blend
OPTION FA651R Utility Grade Sintered Pad Blend

Dealer Stocking Recommendation

Single/Pair	Popularity #	Rec Stocking Level
	-	

FA656

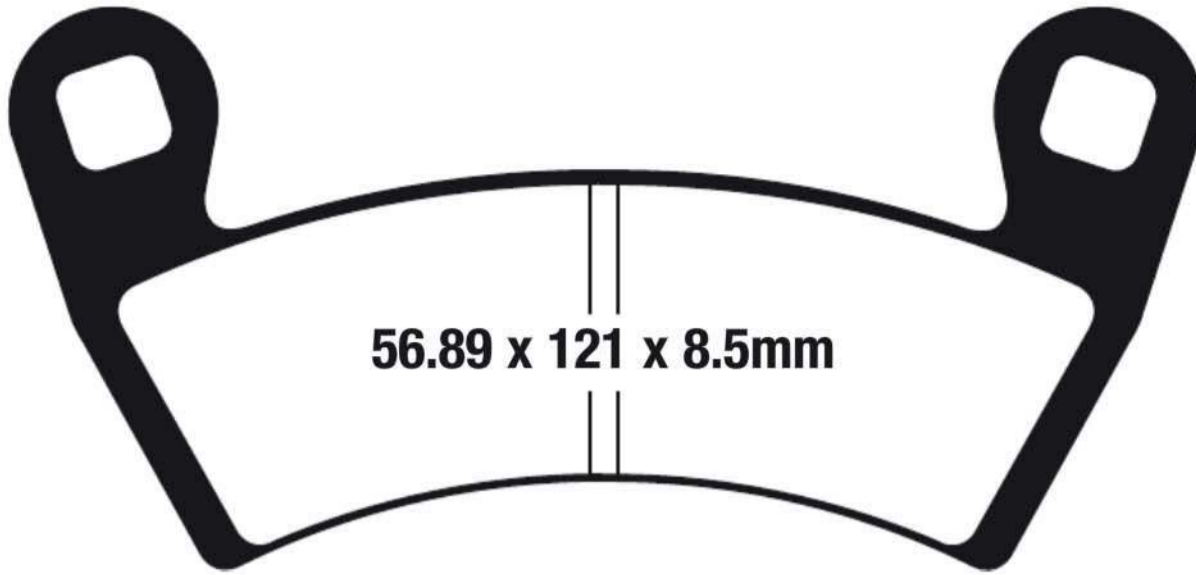

56.89 x 121 x 8.5mm

POLARIS GENERAL (SIDE X SIDE)

1000 General EPS (2 Seat)
1000 General EPS (4 Seat)

16-17 F
17 F

POLARIS RANGER (COMMERCIAL)

Brutus

13-14 F

POLARIS RANGER (SIDE X SIDE)

900 Ranger Crew
900 D Crew Ranger Diesel
900 D Ranger Diesel
900 (Ranger XP 900)
1000 Ranger Diesel
1000 Ranger Diesel Crew

10-15 F & R
13-14 F & R
11-14 F
13-15 F
15 F
15 F

POLARIS RZR (SIDE X SIDE)

RZR XP 900 (Inc EPS Models)
RZR 4 XP 900
RZR XP 1000
RZR XP Turbo
RZR XP 4 Turbo

11-14 F
12-15 F & R
14-15 F & R
16 R
16 R

Equivalents OE#

1911228
1912508
2205949

STD	FA656X	Carbon Dual Purpose Pad Blend
OPTION	FA656SV	High Durability Off Road Sintered Blend
OPTION	FA656R	Utility Grade Sintered Pad Blend

Dealer Stocking Recommendation

Single/Pair	Popularity #	Rec Stocking Level
2	-	2

FA657

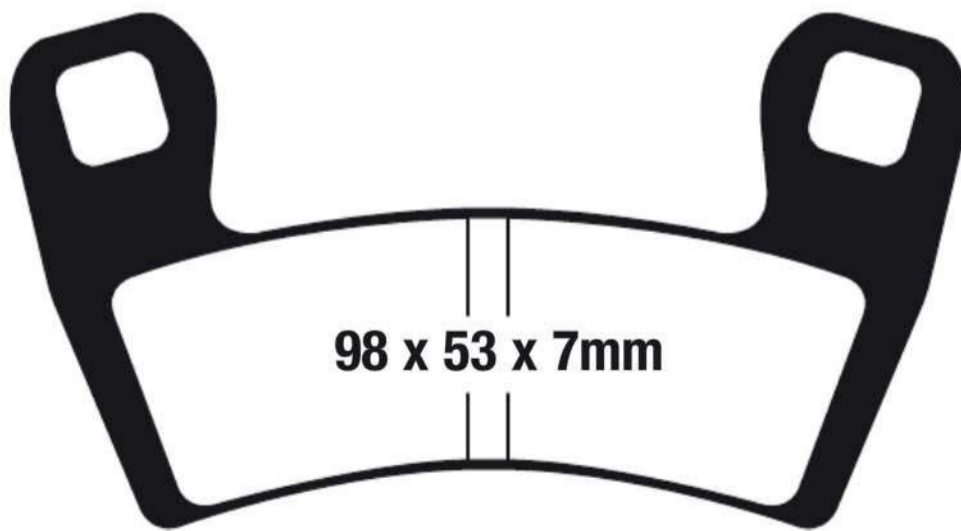

98 x 53 x 7mm

POLARIS

RZR 900 (50" Inch All Options)
RZR-S 900 (60" Inch All Options)

15 R
15 R

Equivalents OE#

1911085
2206025

STD	FA657X	Carbon Dual Purpose Pad Blend
OPTION	FA657R	Utility Grade Sintered Pad Blend
OPTION	FA657SV	High Durability Off Road Sintered Blend

Dealer Stocking Recommendation

Single/Pair	Popularity #	Rec Stocking Level
2	-	2

BUYERS GUIDE
BRAKE PADS

Dimension 1=Width or Diameter, Dimension 2=Height or Diameter, Dimension 3=Thickness (Material and backplate)

NOTE:- Size identification is shown as follows

FA659



134.47 x 44.38 x 7.55mm
4x12mm Holes



134.47 x 44.38 x 7.55mm
2x12mm Holes 2x10mm Holes

POLARIS

Ranger Handbrake Pads - Various Models 05-16 05-16 Parking Brake

Equivalents OE#

2203147

STD FA659X Carbon Dual Purpose Pad Blend

Dealer Stocking Recommendation

Single/Pair	Popularity #	Rec Stocking Level
-	-	-

SFA661/4



53.25
x 44.8
x 7.45mm
(4 PADS)

DAELIM
S1-125

06-09 F

Equivalents OE#

45105 SZ1 0100

STD SFA661/4 Premium Organic Scooter Pad Blend

Dealer Stocking Recommendation

Single/Pair	Popularity #	Rec Stocking Level
1	-	1

Dimension 1=Width or Diameter, Dimension 2=Height or Diameter, Dimension 3=Thickness (Material and backplate)

NOTE:- Size identification is shown as follows

FA662



109.6 x 50.6 x 10.8mm



95.6 x 36.9 x 10.75mm

YAMAHA

YZF R3 (321cc)

15-17 R

Equivalents OE#

1WD 25806 00

STD	FA662	Premium Organic Street Pad Blend
OPTIONS	FA662HH	Street Performance Sintered Pad Blend
OPTIONS	GPFAX662HH	Race Only Sintered Pad Blend

Dealer Stocking Recommendation

Single/Pair	Popularity #	Rec Stocking Level
1	-	1

FA663



113.45 x 54.5 x 8.3mm



98.9 x 45.25 x 8.35mm

YAMAHA

YZF R3 (321cc)

15-17 F

Equivalents OE#

1WD 25805 00

STD	FA663	Premium Organic Street Pad Blend
OPTIONS	FA663HH	Street Performance Sintered Pad Blend
OPTIONS	GPFAX663HH	Race Only Sintered Pad Blend

Dealer Stocking Recommendation

Single/Pair	Popularity #	Rec Stocking Level
1	-	1

FA664

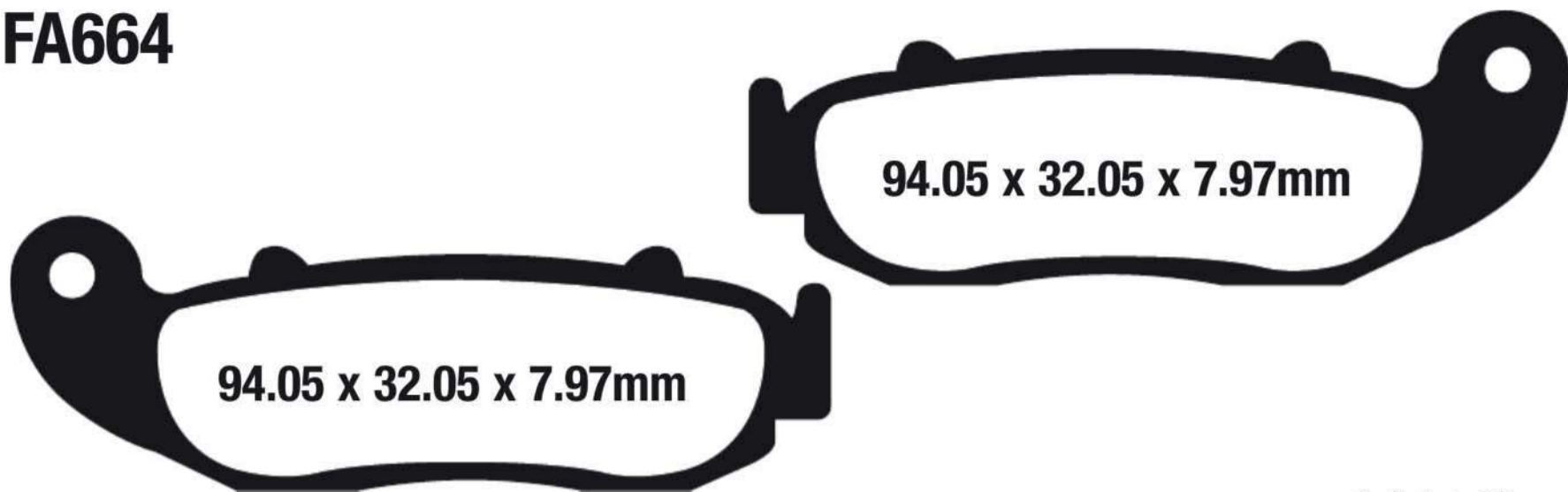

CSC

RX3 Cyclone 250

15-16 F

Equivalents OE#

Z48-105
Z48-106
CSC-1700

STD FA664 Premium Organic Street Pad Blend

Dealer Stocking Recommendation

Single/Pair	Popularity #	Rec Stocking Level
1	-	1

FA669/4

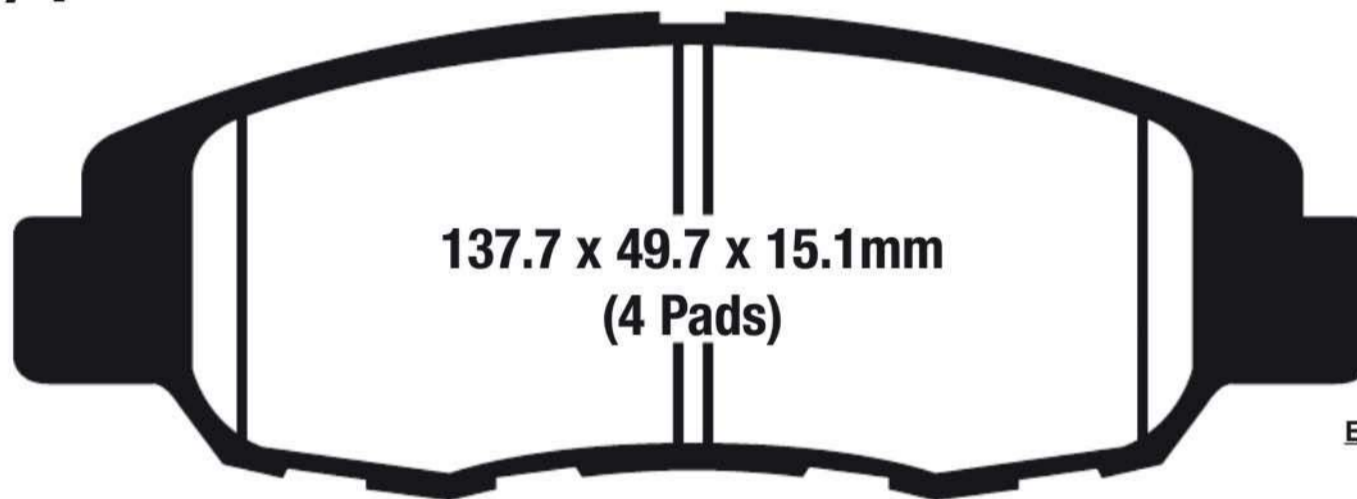

POLARIS

Slingshot (Note Built Up to 01 SEPT 2016 / Front pads sold as an axle set of 4 pads) 15-16 F

Slingshot SL (Note Built Up to 01 SEPT 2016 / Front pads sold as an axle set of 4 pads) 15-16 F

Equivalents OE#

1911741
2205829
2205613

STD FA669/4 Automotive Sport Pad Blend

Dealer Stocking Recommendation

Single/Pair	Popularity #	Rec Stocking Level
2	-	2

FA670

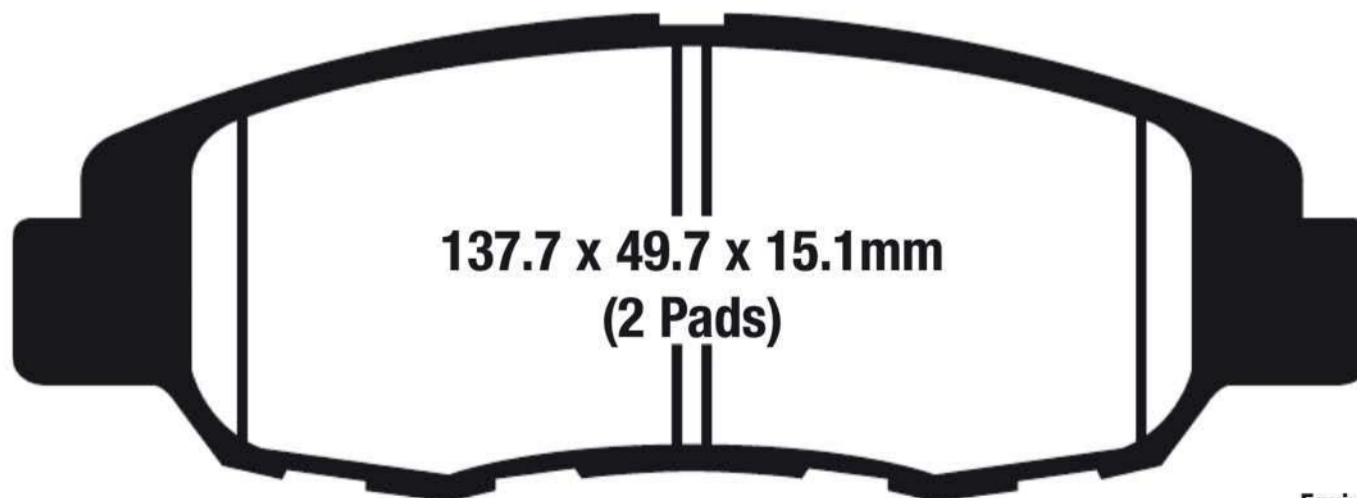

POLARIS

Slingshot (Note Built Up to 01 SEPT 2016 / Front pads sold as an axle set of 4 pads) 15-16 R

Slingshot SL (Note Built Up to 01 SEPT 2016 / Front pads sold as an axle set of 4 pads) 15-16 R

Equivalents OE#

1911741
2205829
2205613

STD FA670 Automotive Sport Pad Blend

Dealer Stocking Recommendation

Single/Pair	Popularity #	Rec Stocking Level
2	-	2

Dimension 1=Width or Diameter, Dimension 2=Height or Diameter, Dimension 3=Thickness (Material and backplate)

NOTE:- Size identification is shown as follows

FA671

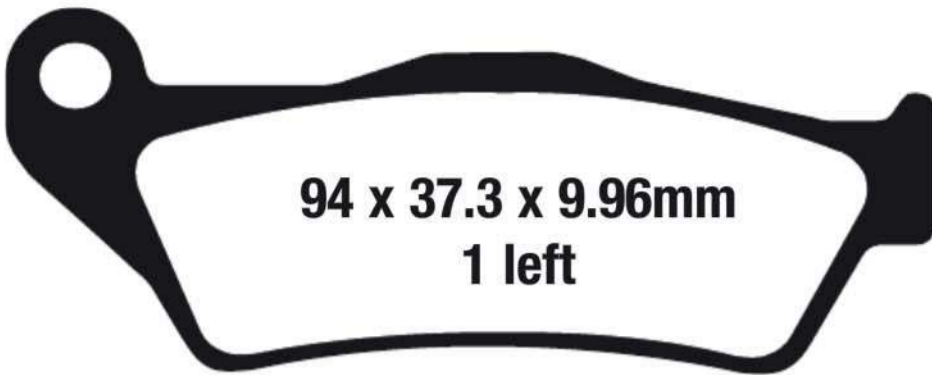

**94 x 37.3 x 9.96mm
1 left**

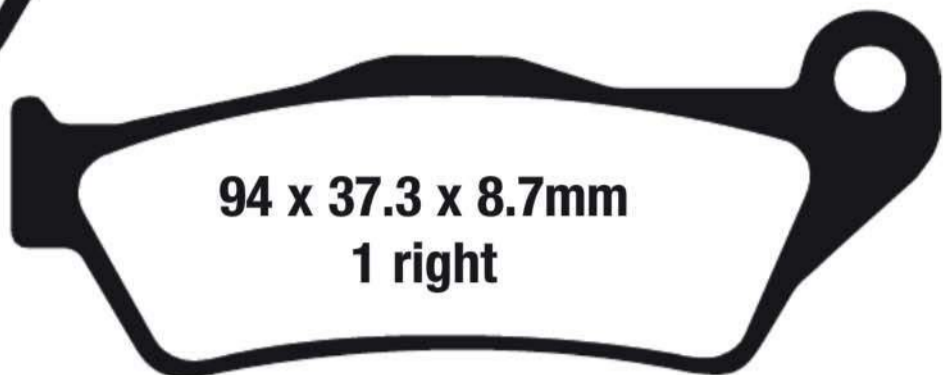

**94 x 37.3 x 8.7mm
1 right**

BMW		
K 1200 S	03-08	R
K 1200 R	05-10	R
K 1300 S	09-15	R
K 1300 R	09-15	R

Equivalents OE#
34 21 767 1881
34 21 854 1388

STD	FA671	Premium Organic Street Pad Blend
OPTIONS	FA671HH	Street Performance Sintered Pad Blend
OPTIONS	FA671V	Semi Sintered Long Lasting Street Pad

Dealer Stocking Recommendation

Single/Pair	Popularity #	Rec Stocking Level
2	-	2

FA672

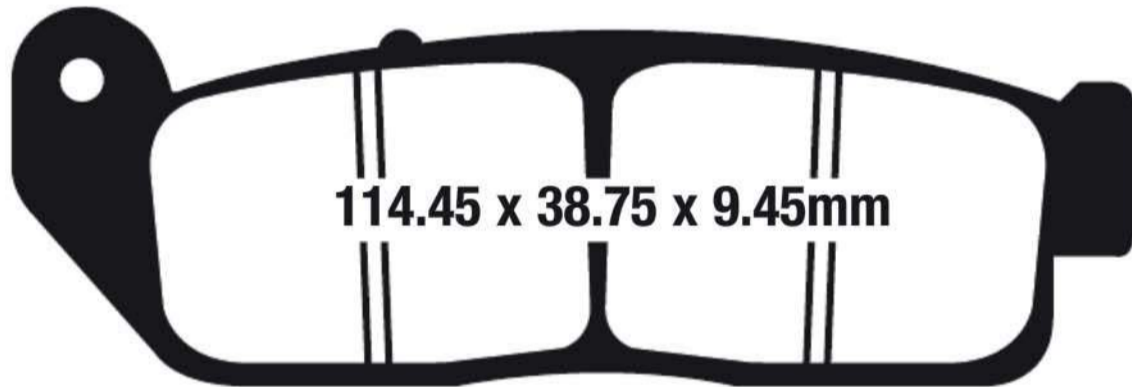

114.45 x 38.75 x 9.45mm

INDIAN (Toso Caliper / Cast Wheels)		
Scout (Toso Calipers/Cast Wheels)	15-16	F
Scout Sixty (Toso Calipers/Cast Wheels)	16	F

Equivalents OE#
2205849

STD	FA672	Premium Organic Street Pad Blend
OPTIONS	FA672HH	Street Performance Sintered Pad Blend
OPTIONS	FA672V	Semi Sintered Long Lasting Street Pad

Dealer Stocking Recommendation

Single/Pair	Popularity #	Rec Stocking Level
1	-	1

FA674



96.7 x 42 x 7.3mm



77 x 42 x 8.1mm

YAMAHA

YXC 700 DFG/DXG Viking VI	15-16	R Left
YXC 700 PFG/PXG Viking VI EPS	15-16	R Left
YXC 700 PSFS/PXGS Viking VI EPS SE	15-16	R Left
YXC 700 PRGC Viking VI EPS Ranger Edition	16	R Left
YXE 70 WDBGG Wolverine	16	R Left
YXE 70 WDGG Wolverine R Spec	16	R Left
YXE 70 WXGG Wolverine R Spec EPS	16	R Left
YXM 700 DEG/DFG/VDXG Viking	14-16	R Left
YXM 700 PEG/PFG/VPXG Viking EPS	14-16	R Left
YXM 700 PSE/PSF/VPSG Viking EPS SE	14-16	R Left

Equivalents OE#

1XD 25806 00

STD	FA674X	Carbon Dual Purpose Pad Blend
OPTIONS	FA674R	Utility Grade Sintered Pad Blend
OPTIONS	FA674SV	High Durability Off Road Sintered Blend

Dealer Stocking Recommendation

Single/Pair	Popularity #	Rec Stocking Level
1	-	1

FA675

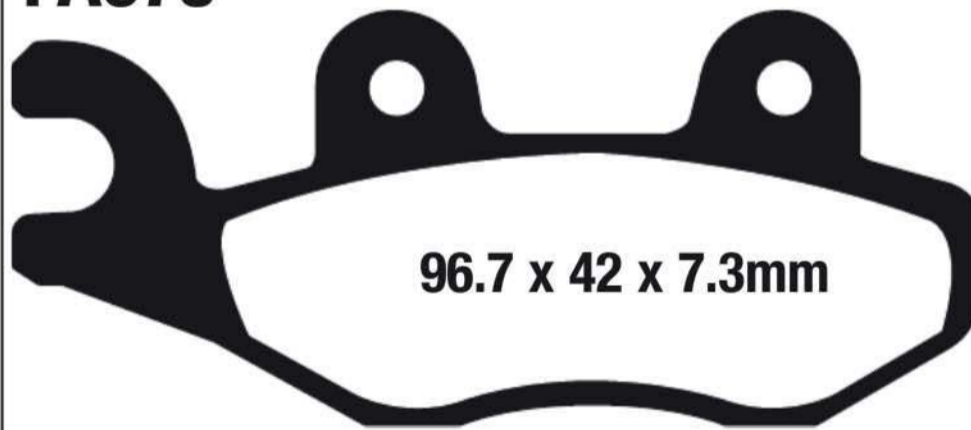

96.7 x 42 x 7.3mm



77 x 42 x 8.1mm

YAMAHA

YXC 700 DFG/DXG Viking VI	15-16	R Right
YXC 700 PFG/PXG Viking VI EPS	15-16	R Right
YXC 700 PSFS/PXGS Viking VI EPS SE	15-16	R Right
YXC 700 PRGC Viking VI EPS Ranger Edition	16	R Right
YXE 70 WDBGG Wolverine	16	R Right
YXE 70 WDGG Wolverine R Spec	16	R Right
YXE 70 WXGG Wolverine R Spec EPS	16	R Right
YXM 700 DEG/DFG/VDXG Viking	14-16	R Right
YXM 700 PEG/PFG/VPXG Viking EPS	14-16	R Right
YXM 700 PSE/PSF/VPSG Viking EPS SE	14-16	R Right

Equivalents OE#

1XD 25806 10

STD	FA675X	Carbon Dual Purpose Pad Blend
OPTIONS	FA675R	Utility Grade Sintered Pad Blend
OPTIONS	FA675SV	High Durability Off Road Sintered Blend

Dealer Stocking Recommendation

Single/Pair	Popularity #	Rec Stocking Level
1	-	1

FA676

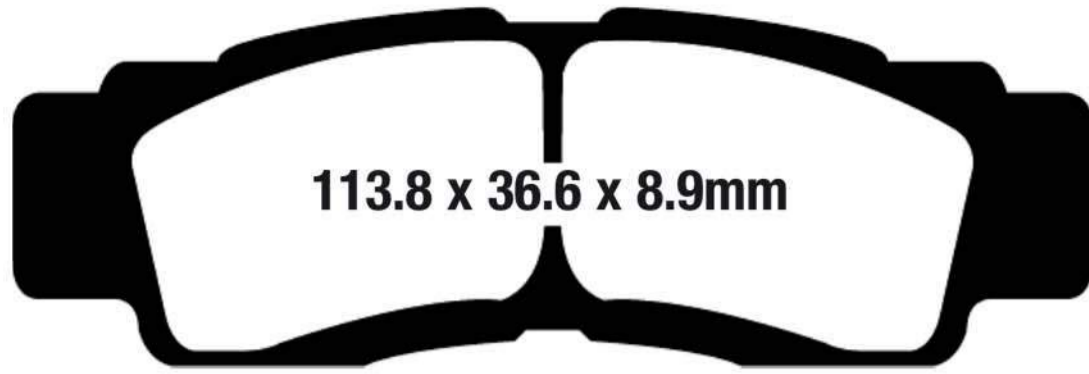

113.8 x 36.6 x 8.9mm

YAMAHA

YZX 1000 R 16 F
YZX 1000 EPS Special Edition 16 F

Equivalents OE#

2HC 25805 00

STD	FA676X	Carbon Dual Purpose Pad Blend
OPTIONS	FA676R	Utility Grade Sintered Pad Blend
OPTIONS	FA676SV	High Durability Off Road Sintered Blend

Dealer Stocking Recommendation

Single/Pair	Popularity #	Rec Stocking Level
2	-	2

FA677

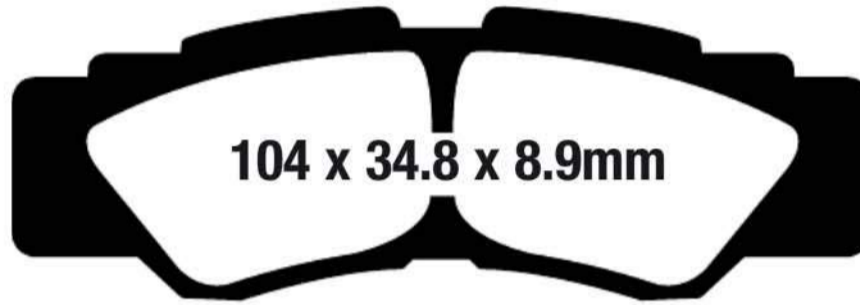

104 x 34.8 x 8.9mm

YAMAHA

YZX 1000 R 16 R
YZX 1000 EPS Special Edition 16 R

Equivalents OE#

2HC 25806 00

STD	FA677X	Carbon Dual Purpose Pad Blend
OPTIONS	FA677R	Utility Grade Sintered Pad Blend
OPTIONS	FA677SV	High Durability Off Road Sintered Blend

Dealer Stocking Recommendation

Single/Pair	Popularity #	Rec Stocking Level
2	-	2

FA679HH



82.83 x 39.76 x 7.88mm

HONDA

CRF 1000 LAG/LAH Africa Twin 16-17 F
CRF 1000 LDAG/LDAH Africa Twin 16-17 F

Equivalents OE#

06455 MJP G51

STD	FA679HH	Street Performance Sintered Pad Blend
------------	----------------	---------------------------------------

Dealer Stocking Recommendation

Single/Pair	Popularity #	Rec Stocking Level
2	-	-

BUYERS GUIDE
BRAKE PADS

NOTE:- Size identification is shown as follows
Dimension 1=Width or Diameter, Dimension 2=Height or Diameter, Dimension 3=Thickness (Material and backplate)

FA680

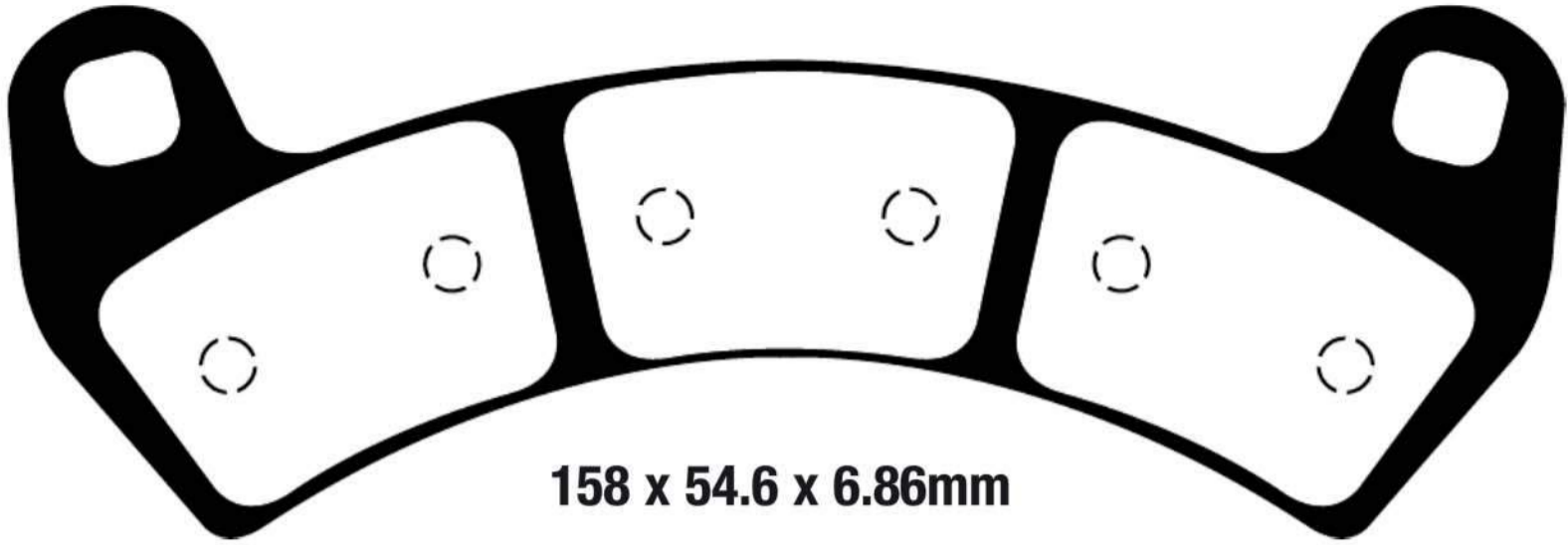

158 x 54.6 x 6.86mm

POLARIS

RZR XP Turbo 16 F
RZR XP 4 Turbo 16 F

Equivalents OE#

2206231

STD FA680R Carbon Dual Purpose Pad Blend

Dealer Stocking Recommendation

<u>Single/Pair</u>	<u>Popularity #</u>	<u>Rec Stocking Level</u>
2	-	-

SFA681



55.5 x 49.55
x 7.25mm

PIAGGIO

MP3 500 Sport ABS (Three wheeler - 13" Front / 14" Rear) 15-16 R

Equivalents OE#

1C000818

STD SFA681 Premium Organic Scooter Pad Blend
OPTIONS SFA681HH Scooter Performance Sintered Pad Blend

Dealer Stocking Recommendation

<u>Single/Pair</u>	<u>Popularity #</u>	<u>Rec Stocking Level</u>
2	-	-

FA682



CAN-AM (Side x Side)

Defender 799cc	16	F Left
Defender DPS 799cc	16	F Left
Defender XT 799cc	16	F Left
Defender XT Cab 799cc	16	F Left
Defender 976cc	16	F Left
Defender DPS 976cc	16	F Left
Defender XT 976cc	16	F Left
Defender XT Cab 976cc	16	F Left
Maverick X3	17	F Left/R Left
Maverick X3 Max	17	F Left/R Left
Maverick X3 Turbo	18	F Left/R Left
Maverick X3 Max Turbo	18	F Left/R Left
Maverick X3 Turbo R	18	F Left/R Left
Maverick X3 Max Turbo R	18	F Left/R Left

Equivalents OE#

715900379
715900386

STD	FA682X	Carbon Dual Purpose Pad Blend
OPTIONS	FA682R	Utility Grade Sintered Pad Blend

Dealer Stocking Recommendation

<u>Single/Pair</u>	<u>Popularity #</u>	<u>Rec Stocking Level</u>
2	-	-

BUYERS GUIDE
BRAKE PADS

NOTE:- Size identification is shown as follows
Dimension 1=Width or Diameter, Dimension 2=Height or Diameter, Dimension 3=Thickness (Material and backplate)

FA683



CAN-AM (Side x Side)

Defender 799cc	16	F Right
Defender DPS 799cc	16	F Right
Defender XT 799cc	16	F Right
Defender XT Cab 799cc	16	F Right
Defender 976cc	16	F Right
Defender DPS 976cc	16	F Right
Defender XT 976cc	16	F Right
Defender XT Cab 976cc	16	F Right
Maverick X3	17	F Right/R Right
Maverick X3 Max	17	F Right/R Right
Maverick X3 Turbo	18	F Right/R Right
Maverick X3 Max Turbo	18	F Right/R Right
Maverick X3 Turbo R	18	F Right/R Right
Maverick X3 Max Turbo R	18	F Right/R Right

Equivalents OE#

715900380
715900387

STD	FA683X	Carbon Dual Purpose Pad Blend
OPTIONS	FA683R	Utility Grade Sintered Pad Blend

Dealer Stocking Recommendation

Single/Pair	Popularity #	Rec Stocking Level
2	-	-

FA684

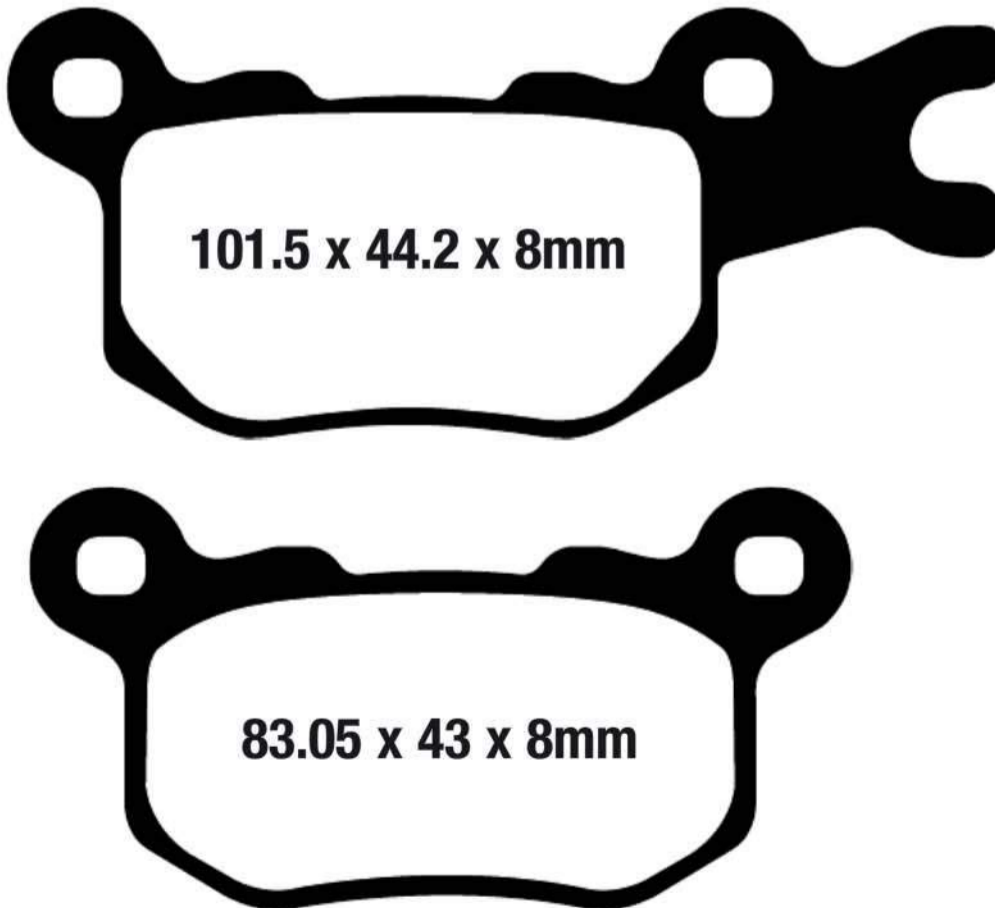

CAN-AM (Side x side)

Defender 799cc	16	R Left
Defender DPS 799cc	16	R Left
Defender XT 799cc	16	R Left
Defender XT Cab 799cc	16	R Left
Defender 976cc	16	R Left
Defender DPS 976cc	16	R Left
Defender XT 976cc	16	R Left
Defender XT Cab 976cc	16	R Left

Equivalents OE#

715900381

STD	FA684X	Carbon Dual Purpose Pad Blend
OPTIONS	FA684R	Utility Grade Sintered Pad Blend

Dealer Stocking Recommendation

Single/Pair	Popularity #	Rec Stocking Level
2	-	-

**BUYERS GUIDE
BRAKE PADS**

**NOTE:- Size identification is shown as follows
Dimension 1=Width or Diameter, Dimension 2=Height or Diameter, Dimension 3=Thickness (Material and backplate)**

Dimension 1=Width or Diameter, Dimension 2=Height or Diameter, Dimension 3=Thickness (Material and backplate)

NOTE:- Size identification is shown as follows

FA685

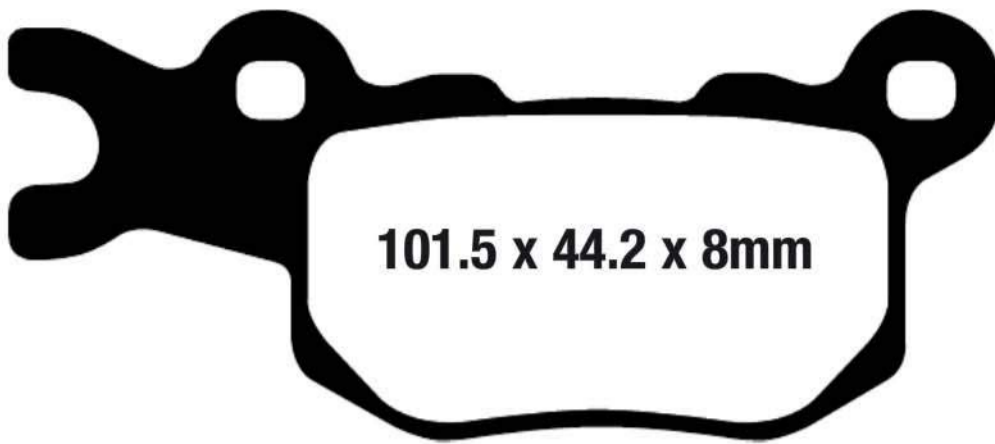

101.5 x 44.2 x 8mm



83.05 x 43 x 8mm

CAN-AM (Side x Side)

Defender 799cc	16	R Right
Defender DPS 799cc	16	R Right
Defender XT 799cc	16	R Right
Defender XT Cab 799cc	16	R Right
Defender 976cc	16	R Right
Defender DPS 976cc	16	R Right
Defender XT 976cc	16	R Right
Defender XT Cab 976cc	16	R Right

Equivalents OE#

715900382

STD	FA685X	Carbon Dual Purpose Pad Blend
OPTIONS	FA685R	Utility Grade Sintered Pad Blend

Dealer Stocking Recommendation

Single/Pair	Popularity #	Rec Stocking Level
2	-	-

FA686

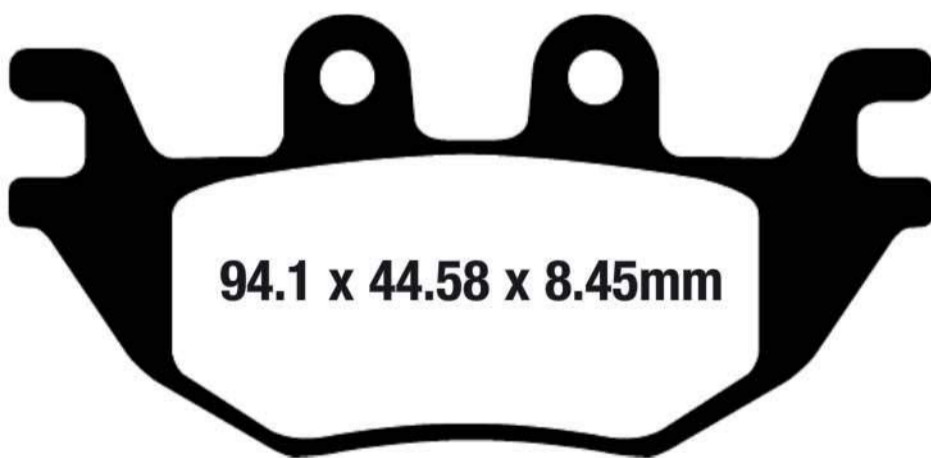

94.1 x 44.58 x 8.45mm



73.2 x 46.11 x 10.06mm

KAWASAKI

KAF 820 AFF/AGF/AHF Mule PRO - FXT	15-17	R Left & Right
KAF 820 BFF/BGF/BHF Mule PRO - FXT /EPS	15-17	R Left & Right
KAF 820 CFF/CGF/CHF Mule PRO - FXT /EPS LE	15-17	R Left & Right
KAF 820 DFF/DGF/DHF Mule PRO - FXT /EPS Camo	15-17	R Left & Right
KAF 820 EGF/EHF Mule PRO - FX	16-17	R Left & Right
KAF 820 FGF/FHF Mule PRO - FX/EPS	16-17	R Left & Right
KAF 820 GGF/GHF Mule PRO - FX/EPS LE	16-17	R Left & Right
KAF 820 HGF/HHF Mule PRO - FX/EPS Camo	16-17	R Left & Right

KAWASAKI Contd.

KAF 820 JGF/JHF Mule PRO - FXT Ranch Edition	16-17	R Left & Right
KAF 1000 AGF/AHF - Mule Pro DXT/ Diesel	16-17	R Left & Right
KAF 1000 BGF/BHF - Mule Pro DXT/Diesel EPS	16-17	R Left & Right
KAF 1000 CGF/CHF - Mule Pro DXT EPS LE/Diesel	16-17	R Left & Right
KAF 1000 DGF/DHF - Mule Pro DX /Diesel	16-17	R Left & Right
KAF 1000 EGF/EHF - Mule Pro DX EPS/Diesel	16-17	R Left & Right
KAF 1000 FGF/FHF - Mule Pro DX EPS LE/Diesel	16-17	R Left & Right

Equivalents OE#

43082-0140

STD	FA686X	Carbon Dual Purpose Pad Blend
OPTIONS	FA686R	Utility Grade Sintered Pad Blend

Dealer Stocking Recommendation

Single/Pair	Popularity #	Rec Stocking Level
2	-	-

CFA689



43.25 x 28.8 x 3.4mm

BULTACO

Brinco (Electric Trials Bike - C/R/RE/S Models)

15-17 F

2HC 25805 00

STD CFA689 Premium Organic Pad Blend

Dealer Stocking Recommendation

Single/Pair

Popularity #

Rec Stocking Level

FA690

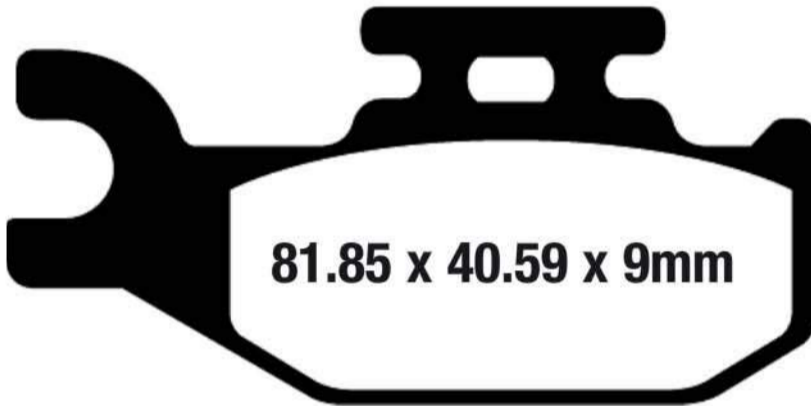

81.85 x 40.59 x 9mm



61.85 x 40.59 x 9mm

CF MOTO - Side x Side

tba

Equivalents OE#

9CR6 0812A0

STD FA690X Carbon Dual Purpose Pad Blend
FA690R Utility Grade Sintered Pad Blend

Dealer Stocking Recommendation

Single/Pair

Popularity #

Rec Stocking Level

FA691



**84.9 x 44.05
x 7mm**

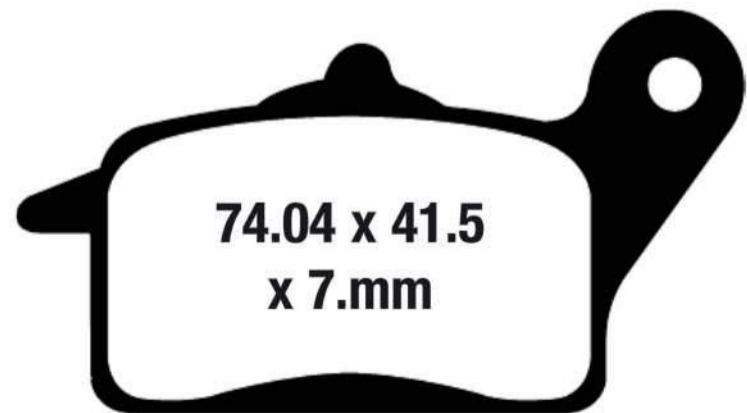

**74.04 x 41.5
x 7mm**

KAWASAKI

Z125 Pro (BR125 JHF)

17 F

Equivalents OE#

43082 0134

STD FA691 Premium Organic Street Pad Blend
OPTIONS FA691HH Street Performance Sintered Pad Blend

Dealer Stocking Recommendation

Single/Pair

Popularity #

Rec Stocking Level

FA696



**54.93 x 53.67
x 9mm**

INDIAN

Chief Blackhawk (Brembo calipers)	11	R
Chief Blackhawk Dark (Brembo calipers)	11	R
Chief Classic (Brembo calipers)	11-13	R
Chief Standard (Brembo calipers)	09-11	R
Chief Deluxe (Brembo calipers)	09	R
Chief Roadmaster (Brembo calipers)	09-11	R
Chief Vintage (Brembo calipers)	09-13	R
Bomber (Brembo calipers)	10-11	R
Dark Horse (Brembo calipers)	10-13	R

Equivalents OE#

N50250062

STD	FA696	Premium Organic Street Pad Blend
OPTIONS	FA696HH	Street Performance Sintered Pad Blend

Dealer Stocking Recommendation

<u>Single/Pair</u>	<u>Popularity #</u>	<u>Rec Stocking Level</u>
--------------------	---------------------	---------------------------

FA700

Refit old shim

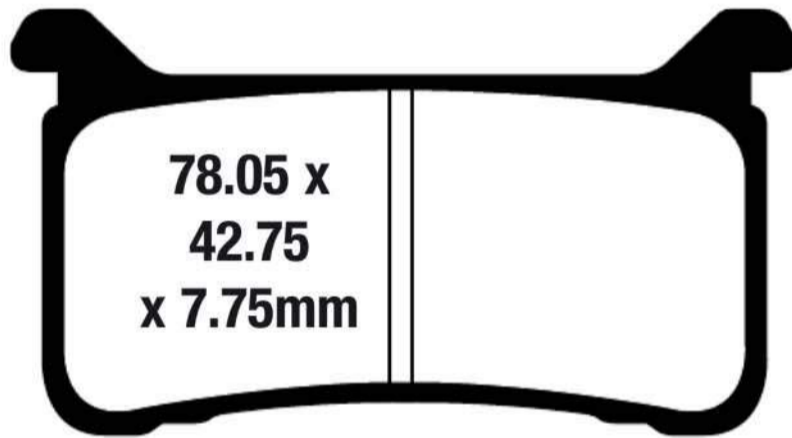

**78.05 x
42.75
x 7.75mm**

HONDA

CBR 1000 RRA (ABS Model - Nissin Caliper)	17	F
---	----	---

Equivalents OE#

06455 MKF D41

STD	FA700HH	Street Performance Sintered Pad Blend
------------	----------------	---------------------------------------

Dealer Stocking Recommendation

<u>Single/Pair</u>	<u>Popularity #</u>	<u>Rec Stocking Level</u>
--------------------	---------------------	---------------------------

Dimension 1=Width or Diameter, Dimension 2=Height or Diameter, Dimension 3=Thickness (Material and backplate)

NOTE:- Size identification is shown as follows

FA701

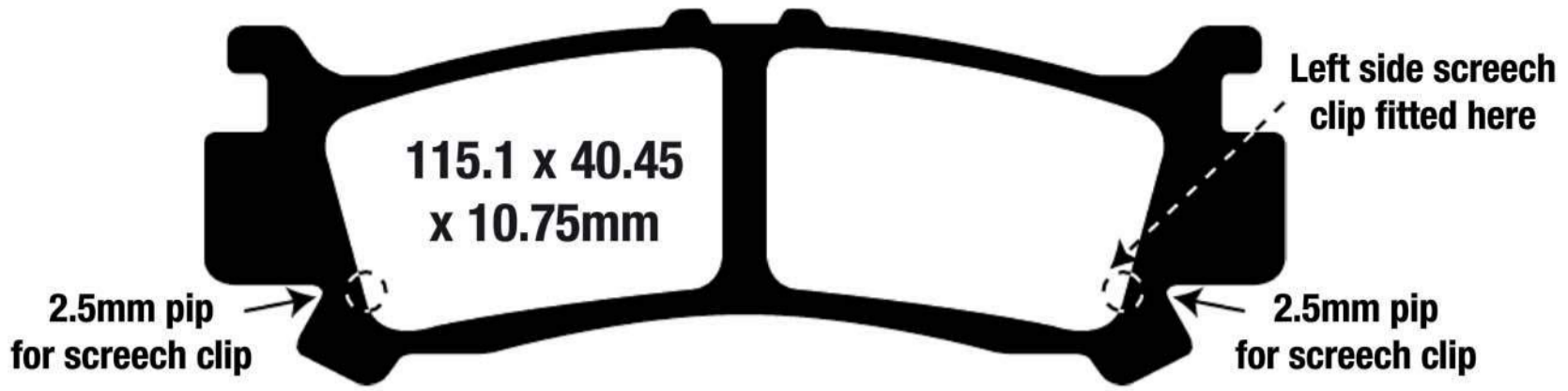

HONDA

Pioneer 1000 SXS (2 Seater)	16-18	F Left
Pioneer 1000 SXS (4 Seater)	16-18	F Left

Equivalents OE#

06451 HL4 A01

STD	FA701X	Carbon Dual Purpose Pad Blend
OPTIONS	FA701R	Utility Grade Sintered Pad Blend
	FA701SV	High Durability Off Road Sintered Blend

Dealer Stocking Recommendation

Single/Pair	Popularity #	Rec Stocking Level

FA702

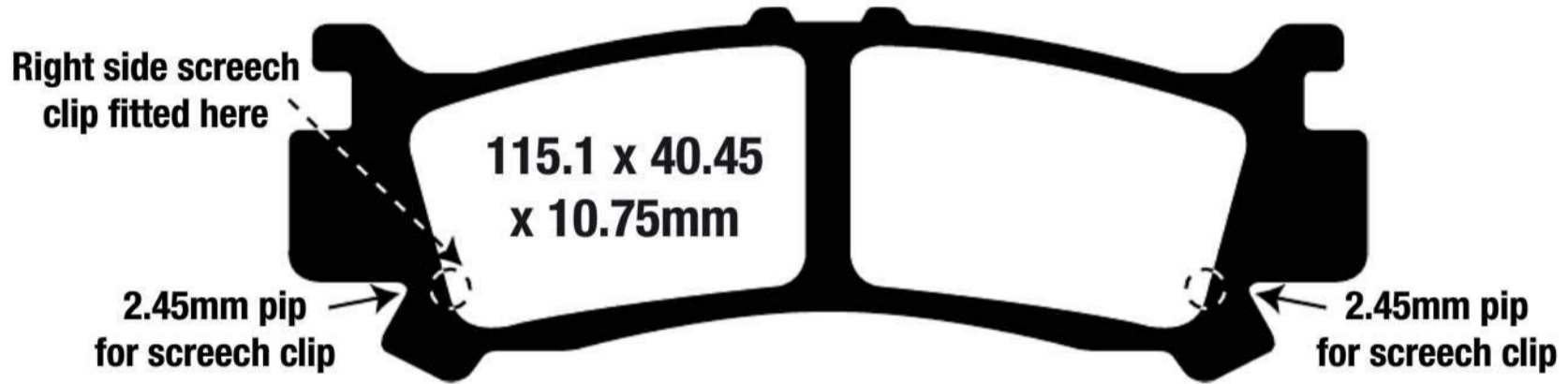

HONDA

Pioneer 1000 SXS (2 Seater)	16-18	F Right
Pioneer 1000 SXS (4 Seater)	16-18	F Right

Equivalents OE#

06452 HL4 A01

STD	FA702X	Carbon Dual Purpose Pad Blend
OPTIONS	FA702R	Utility Grade Sintered Pad Blend
	FA702SV	High Durability Off Road Sintered Blend

Dealer Stocking Recommendation

Single/Pair	Popularity #	Rec Stocking Level

**BUYERS GUIDE
BRAKE PADS**

**NOTE:- Size identification is shown as follows
Dimension 1=Width or Diameter, Dimension 2=Height or Diameter, Dimension 3=Thickness (Material and backplate)**

FA703

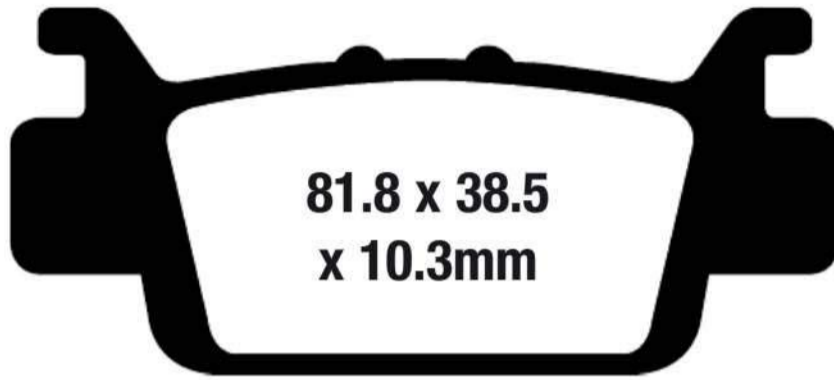

HONDA
 Pioneer 1000 SXS (2 Seater) 16-18 R Left
 Pioneer 1000 SXS (4 Seater) 16-18 R Left

Equivalents OE#

06431 HL4 A01

STD	FA703X	Carbon Dual Purpose Pad Blend
OPTIONS	FA703R	Utility Grade Sintered Pad Blend
	FA703SV	High Durability Off Road Sintered Blend

Dealer Stocking Recommendation

Single/Pair

Popularity #

Rec Stocking Level

FA704

Right side screech clip fitted here

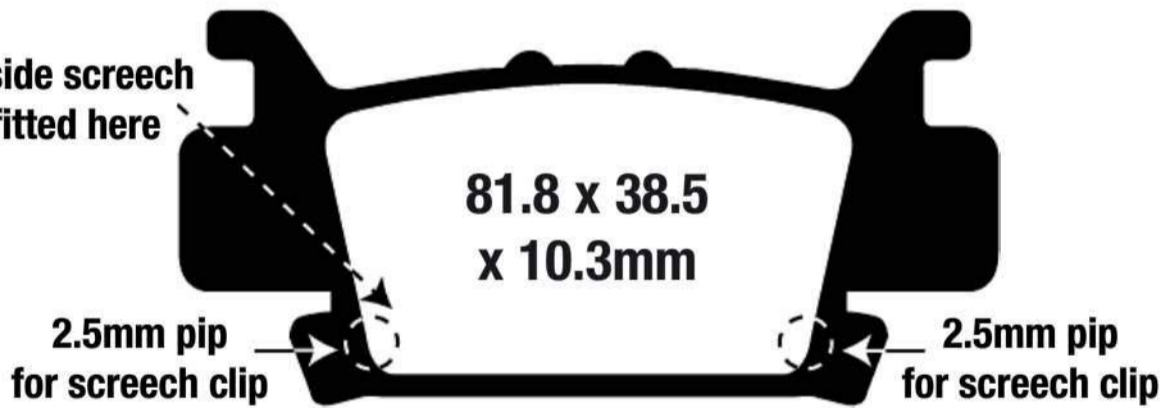

HONDA
 Pioneer 1000 SXS (2 Seater) 16-18 R Right
 Pioneer 1000 SXS (4 Seater) 16-18 R Right

Equivalents OE#

06432 HL4 A01

STD	FA704X	Carbon Dual Purpose Pad Blend
OPTIONS	FA704R	Utility Grade Sintered Pad Blend
	FA704SV	High Durability Off Road Sintered Blend

Dealer Stocking Recommendation

Single/Pair

Popularity #

Rec Stocking Level

FA710

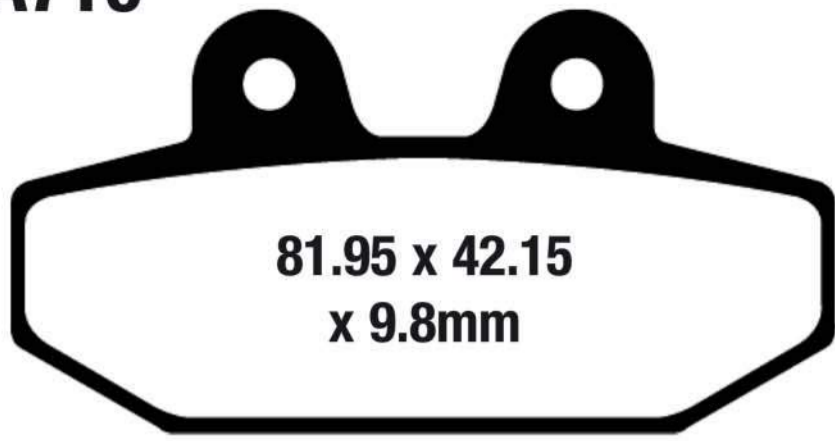

HARLEY-DAVIDSON

FLFB Fat Boy	18	R
FLFBS Fat boy 114	18	R
FLFBS Fat Boy Anniv	18	R
FLHC Heritage Classic	18	R
FLHCS Heritage Classic 114	18	R
FLHCS Heritage Classic 114 Anniv.	18	R
FLSL Softail Slim	18	R
FXBR Breakout	18	R
FXBRS Breakout 114	18	R
FXBRS Breakout 114 Anniv	18	R
FLDE Deluxe	18	R
FXBB Street Bob	18	R
FXFB Fat Bob	18	R
FXBS Fat Bob	18	R
FXLR Low Rider	18	R

Equivalents OE#

41300197

STD	FA710V	Semi Sintered Long Lasting Street Pad
OPTIONS	FA710HH	Street Performance Sintered Pad Blend

Dealer Stocking Recommendation

Single/Pair	Popularity #	Rec Stocking Level
-------------	--------------	--------------------

FA712

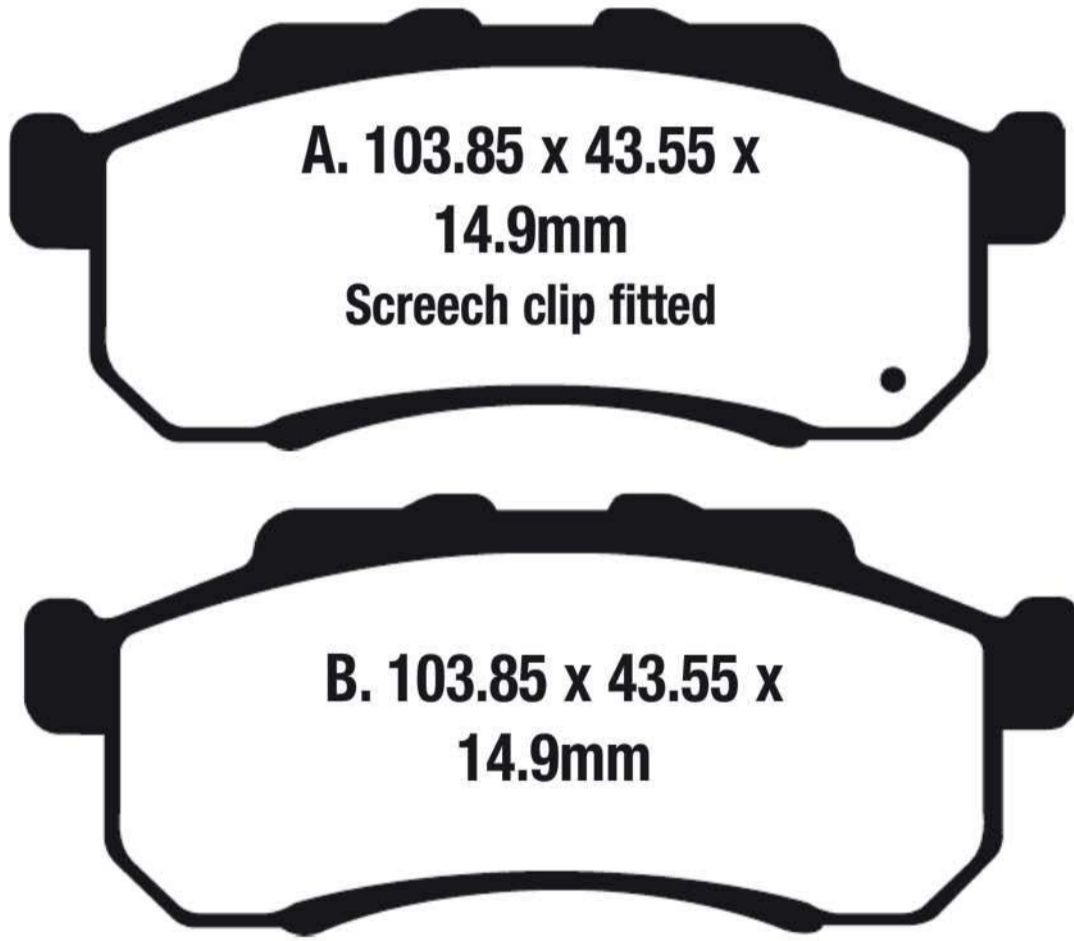

HONDA

SXS 500 M2 Pioneer (2 Seat)	15-17	F Left
SXS 700 M2 Pioneer (2 Seat)	16-18	F Left
SXS 700 M4 Pioneer (4 Seat)	16-18	F Left

Equivalents OE#

06452 HL1 A00

STD	FA712X	Carbon Dual Purpose Pad Blend
OPTIONS	FA712R	Utility Grade Sintered Pad Blend
	FA712SV	High Durability Off Road Sintered Blend

Dealer Stocking Recommendation

Single/Pair	Popularity #	Rec Stocking Level
2		2

FA713

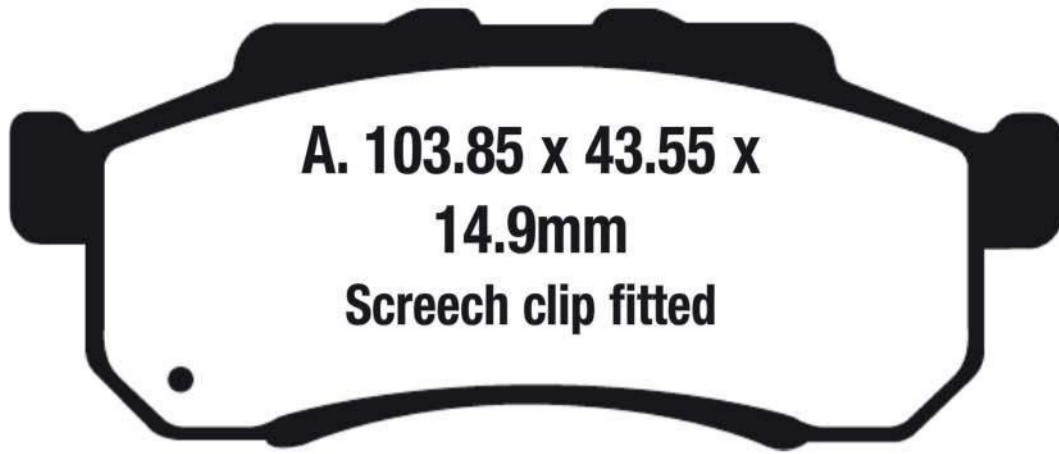

HONDA

SXS 500 M2 Pioneer (2 Seat)	15-17	F Right
SXS 700 M2 Pioneer (2 Seat)	16-18	F Right
SXS 700 M4 Pioneer (4 Seat)	16-18	F Right

Equivalents OE#

06451 HL3 A00

STD	FA713X	Carbon Dual Purpose Pad Blend
OPTIONS	FA713R	Utility Grade Sintered Pad Blend
	FA713SV	High Durability Off Road Sintered Blend

Dealer Stocking Recommendation

Single/Pair	Popularity #	Rec Stocking Level
2		2

FA714



HONDA

SXS 500 M2 Pioneer (2 Seat)	15-17	R
SXS 700 M2 Pioneer (2 Seat)	16-18	R
SXS 700 M4 Pioneer (4 Seat)	16-18	R

Equivalents OE#

06435 HN8 016

STD	FA714X	Carbon Dual Purpose Pad Blend
OPTIONS	FA714R	Utility Grade Sintered Pad Blend
	FA714SV	High Durability Off Road Sintered Blend

Dealer Stocking Recommendation

Single/Pair	Popularity #	Rec Stocking Level
2		2

BRAKE SHOE BUYERS GUIDE

Part No.	Make/Model	Year	Fr/Rear	Part No.	Make/Model	Year	Fr/Rear
301	HONDA			303/303G Contd.	HONDA Contd.		
	CRF 50 F	04-17	F & R		CB 125 S	84-85	R
	MR 50 K0/K1 Elsinore	74-75	F & R		CL 125 S (Single)	67-74	F & R
	NA 50 Express II	79-81	F		CL 125 S1 (Single) Up to frame no. 1120001	67-74	F & R
	NB 50/NB 50 M Aero 50	83-87	F		NH 125 Aero	84	F & R
	NC 50 Express	77-80	F & R		SL 125 K1/K2	71-73	F
	NC 50 Express	81-83	F		TRX 125 Fourtrax	85-88	F
	NN 50 MD 'Gyro'	84	F & R		XL 125	77-78	F & R
	NQ 50 D/NQ 50 Spree/Spree Special	84-87	F & R		CH 150/150 D Elite/Elite Deluxe	85-87	F & R
	NX 50 M Express SR	81-82	F		ATC* 185	80	F
	P 50		F		ATC* 185 S	81-83	F
	PA 50	78-81	F		ATC* 200	81-83	F
	PA 50	82-83	F & R		ATC* 200 E Big Red	82-83	F
	SA 50 Elite LX/SR	88-93	F		ATC* 200 ES Big Red	84	F
	SB 50/SB 50 P Elite/Elite ES	88-90	F & R		ATC* 200 M	84-85	F
	SE 50/SE 50 P Elite/Elite 50 S	87-88	F		ATC* 200 S	84-86	F
	TG 50/TG 50 M Gyro S	85-86	F & R		* - ATC is a Registered Trademark of Honda Motor Corporation		
	XR 50 R	00-03	F & R		KYMC0 ATV		
	Z 50 R	80-99	F & R		MXer 150	03-05	F
	Z 50 RD	86	F & R		MXU 150	05-14	F
	SUZUKI				KYMC0 STREET		
	DR-Z 70 K8/K9	08-09/15-18	F & R		Agility 50 (4T)	05-15	R
	YAMAHA				Filly 50	02-05	R
TT-R 50 EV/EW/EX/EY/EB/ED/EE	06-09/14	F & R	Sento 50	09-12	R		
302	HONDA			Sting 50 (2T)	07-11	R	
	NA 50 Express II	79-81	R	Vitality 50 (4T)	05-08	R	
	NC 50 Express	81-83	R	Yup 50	02-06	R	
	NB 50/NB 50 M Aero 50	83-87	R	Agility 125	06-15	R	
	NU 50/NU 50 M Urban Express	82-83	R	Cobra Racer 50 (SF10AG)	00-04	R	
	NX 50 M Express SR	81-82	R	Cobra Cross/Racer 50 (SF10AF)	05-06	R	
	SA 50 Elite LX/SR	88-93	R	ZX 50 Super Fever	02-05	R	
	SE 50/SE 50 P Elite/Elite 50 S	88-87	R	Like 50 (2T)	09-14	R	
	NH 80 MD 'Aero'	83-84	R	Like 50 LX (2T)	12-14	R	
	KYMC0 STREET			PEUGEOT			
	Compagno 50i 4T (SE 50 BG)	14	R	Speedfight 2 X/Team (A/C)	02-05	R	
	Compagno 110i (4T - SE22BD)	13-14	R	Vivacity X-Race 50/Pulsa 50	02-05	R	
	SYM			Metal-X	02-05	R	
	Fiddle 50	99-12	R	Trekker 50	02-05	R	
	303/303G	ARCTIC CAT			Looxor 50	02-05	R
		150 Utility 2x4	09-14	F	Elyseo 50	02-05	R
		E-TON QUADS			Scoot Elec	04-05	F & R
CXL 150 Yukon II/Challenger		02-09	F	Ludix 50 Trend/One/Snake/Bullet	04-05	R	
YXL 150 Yukon		00-02	F	Ludix 50 Elegance/Ambition	04-05	R	
RXL 150 Viper R		05-09	F	Ludix 125	04-05	R	
RXL 150 Viper		05-06	F	SYM			
HONDA				Jet Euro 50	99-12	R	
NS 50 F		90	F	Jet 50 Evo	14	R	
QA 50 K1-K3			F & R	Fiddle 50 Front drum model	99-12	F	
ZB 50		88	F & R	Fiddle 50 Front disc model	08-11	R	
C 70 Passport		80-83	F & R	MiO 50	05-12	R	
CT 70 Trail		77-82	F & R	Simply 50	07-12	R	
CT 70 Trail		91-94	F & R	Symba 110	09-12	R	
SL 70 K1		70-73	F & R	304/304G	HONDA		
XL 70 (Up to F # 103001)		74	F & R		MB 5	82	R
XL 75		78	F & R		NCH 50 Metropolitan	13-16	R
XR 75 K1/K2/76		71-76	F & R		NS 50 F	90	R
NH 80 MD 'Aero'		83-84	F		XL 70 (From F. # 1030002)	74	F & R
NH 80 'Aero'		85	F		XL 70 K1/76	75-76	F & R
CH 80 Elite		85-07	F		XL 75	77/79	F & R
EZ 90 'CUB'		91-96	F & R		XR 75	77-78	F & R
TRX 90 Fourtrax		93-06	F		CR 80 R	80-81	F & R
TRX 90 EX		07-08	F		CR 80 R	82	F
TRX 90 X		09-15	F		XL 80 S	80-85	F & R
SL 100 K1/K2/K3		70-74	F & R		XR 80	79-84	F & R
XL 100 (Up to F # 1020001)		74	F & R		XL 100 (From F. # 1020002)	74	F & R
XL 100		77-78	F & R		XL 100 K1	75	F & R
CT 110		80-86	F & R		XL 100	76	F & R
ATC* 125 M		84-87	F		XL 100 S	79-85	F & R
CH 125 'Elite'		84	F & R	XR 100	81-84	F & R	

BRAKE SHOE BUYERS GUIDE

Part No.	Make/Model	Year	Fr/Rear	Part No.	Make/Model	Year	Fr/Rear	
313 Contd.	HONDA Contd.			320 Contd.	HONDA Contd.			
	CM 400 A/T	79-81	R		CB 750 C (from frame CM 204182)	82	R	
	CM 400 C Custom	81	R		CB 750 K1-76	70-76	R	
	CM 400 E	80-81	R		CB 750 K	77-78	R	
	CB 450 T 'Hawk'	82	R		CB 750 K	79-82	R	
	CB 450 SC 'Nighthawk'	82-86	R		CB 750 L Limited Edition	79	R	
	CM 450 E	82-83	R		CB 750 SC Nighthawk	82-83	R	
	CM 450 C Custom (to CM 001211)	82	R		321	HONDA		
	CM 450 C Custom (from CM 001212)	82	R			CX 500	78-79	R
	CM 450 A Hondamatic	82	R			CX 500 C Custom	79-82	R
	CM 450 A Hondamatic	83	R			CX 500 D Deluxe	79-81	R
	CMX 450 C Rebel	86-87	R			GL 500 Silverwing	81-82	R
	VT 500 C 'Shadow'	83-86	R			GL 500 I Silverwing Interstate	81-82	R
	VT 500 FT 'Ascot'	83-84	R			VF 500 C 'V30 Magna'	84-85	R
CB 550 SC 'Nighthawk'	83	R	VLX 600 Shadow (VT 600 C/CD)	88-93		R		
314/314G	HONDA			VT 600 C/CD/CD2 Shadow VLX/Deluxe		94-07	R	
	CB 350 K2/K3/K4		F	CB 650 SC 'Nighthawk'		83-85	R	
	SL 350 K	69-70	F	CX 650 C 'Custom'		83	R	
	CB 360		F	GL 650 Silverwing/GL 650 Silverwing Interstate		83	R	
	CJ 360 T/76/77	76-77	F	VF 700 C 'Magna'		84	R	
	CB 400 T/MK 1 Hawk	78-79	F	VF 700 'S' Sabre	84-85	R		
	CM 400 E	80-81	F	VF 750 S 'Sabre'	82-83	R		
CM 450 E	82-83	F	VT 700 C 'Shadow'	84-85	R			
315/315G	HONDA			VF 750 C 'V45 Magna'	82-83	R		
	ATC* 250 ES Big Red	85-87	R	VT 750 C 'Shadow'	83	R		
	ATC* 250 SX	85-87	R	CB 750 Nighthawk	91-03	R		
	TRX 250 'fourtrax'	85-87	R	KYMCO STREET				
	TRX 300 (2WD & 4WD FW 'Fourtrax')	88-00	R	Venox 250	03-07	R		
	CB 350 F/F1/G		R	322	HONDA			
	CB 350 K2/K3/K4		R		PA 50	78-81	R	
	SL 350 K	69-70	R		KTM			
	CB 360 G/T/76	74-76	R		50 SX/SXR Pro Junior/Senior/Adventure	96-07	F & R	
	CB 360		R		50 SX Mini Adventure	04-05	F & R	
	CJ 360 T/76/77	76-77	R		50 SX Pro Senior LC	02-03	R	
	CB 400 F	75-77	R		50 SX Pro Senior LC/Mini Senior Adventure	02-07	R	
	* - ATC is a Registered Trademark of Honda Motor Corporation			SX 50 Junior LC	07-09	R		
316	HONDA			323/323G	HONDA			
	CB 450 K3-K7	70-74	R		XL 250 S	78-80	R	
	CB 500 K1/K2		R		XL 250 R Pro Link	82-87	R	
	CB 500 T/76	75-76	R		XR 250	79-80	R	
	CB 550 F	75-77	R		XR 250 R Pro Link	81-82	R	
	CB 550 K1/76	74-78	R		NX 250	88-90	R	
318/318G	HONDA			XL 350 R	84-85	R		
	CMX 250 C 'Rebel'	96/97/99-14	R	324/324G	HONDA			
	CMX 250 C2	99-00	R		CR 125 R	79-81	F	
	CMX 250 X Rebel	15	R		CR 250 R	78-80	F	
	XL 250 S	81	R	XR 500	79-80	F		
	XL 500 S	79-81	R	325/325G	HONDA			
	XL 500 R Pro Link	82	R		CR 250 R	78-80	R	
	XR 500	79-80	R		327/327G	HONDA		
	XR 500 R Pro Link	81-82	R	CR 250 R		81-	F	
	XL 600 R	83-87	R	XR 250 R Pro Link		81-82	F	
XL 600 V Transalp	89-90	R	CR 450 R	81		F		
NX 650	88-89	R	CR 480 R	82		F		
319/319G	HONDA			XR 500 R Pro Link	81-82	F		
	CR 250 R	81	R	328/328G	HONDA			
CR 450 R	81	R	CR 250 R		82-83	F		
320	HONDA			CR 480 R	83	F		
	CB 650	79-81	R	330/330G	BOMBARDIER			
	CB 650	82	R		DS 50 (2 stroke)	02-06	R	
	CB 650 C Custom	80-81	R		Quest 50	03-04	R	
	CB 650 SC 'Nighthawk'	82	R		DS 90 (2/4 stroke)	02-06	R	
	CB 750 A Hondamatic	76-78	R		Quest 90 (2/4 stroke)	03-04	R	
CB 750 C Custom	80-82	R						

BRAKE SHOE BUYERS GUIDE

Part No.	Make/Model	Year	Fr/Rear	Part No.	Make/Model	Year	Fr/Rear		
330/330G Contd.	E-TON QUADS			338/338G Contd.	E-TON QUADS Contd.				
	IXL 40 Rascal	98-01	R		RXL-50M Viper (4T)			F	
	RXL-40 E Viper Junior	01-06	R		TXL 50 Wizz 50	98-99		F	
	Viper 40 E	99-08	R		Viper 70 RXL 70/70M	05-09		F	
	AXL 90 Thunder	99-00	R		AXL 90 Thunder	99-00		F	
	DXL-90 Sierra	99-03	R		NXL 90 Thunder	01-02		F	
	NXL 90 Thunder	01-02	R		RXL 90 Viper 90	03-06		F	
	YXL 150 Yukon	00-02	R		RXL 90 R Viper 90 R Reverse	03-09		F	
	Yukon EXL 150	05-06	R		BXL 100 Draco	05-06		F	
	Viper EXL 150 ST Quad	05-06	R		KAWASAKI				
	EXL 150 Yukon ST	05-06	R		KFX 50 (KSF 50 B7F/B8F/B9F/BDF /BEF/BFF/BGF/BHF)	07-09 /13-17		F	
	HONDA				KFX 90 (KSF 90 A7F/A8F/A9F/AAF/ABF /ACF/ADF/AEF/AFF/AGF/AHF)	07-17		F	
	TRX 70 Fourtrax	86-87	R						
	CB 125 S	84-85	F		339/339G	HONDA			
	CR 125 R	82	F & R		TRX 200 'Fourtrax'	TRX 200 'Fourtrax'	84		F
	CR 125 R	79-81	R		TRX 250 'fourtrax'	TRX 250 'fourtrax'	85-87		F
	XL 125 S	85	F		FL 350 R Odyssey	FL 350 R Odyssey	85-87		F
	CH 250 Elite	85-90	F		FL 400 R Pilot	FL 400 R Pilot	89-90		F
	CR 250 R	82	R						
	XL 250 R Pro Link	82-87	F		340/340G	HONDA			
CR 480 R	82	R	TRX 250 EX Sportrax 250 EX	TRX 250 EX Sportrax 250 EX	01-08		R		
* - ATC is a Registered Trademark of Honda Motor Corporation			TRX 250 X	TRX 250 X	09-14		R		
			TRX 250 TE Recon ES	TRX 250 TE Recon ES	97-14		R		
			TRX 250 TM Recon	TRX 250 TM Recon	97-14		R		
			GB 500	GB 500	89-90		R		
331/331G	HONDA			341	HONDA				
CR 125 R	83	F & R		CH 250 'Elite'	85-86		R		
CR 125 R	84-85	R							
CR 250 R	83-85	R		342/342G	HONDA				
XR 350 R	83	F		TRX 350/TRX 350 D Fourtrax Foreman	86-89		F		
CR 480 R	83	R							
CR 500 R	84-85	R		343/343G	HONDA				
				TRX 350/TRX 350/D Fourtrax Foreman	86-89		R		
332/332G	HONDA			TRX 500 FA Fourtrax Foreman Rubicon	01-14		R		
XL 500 R Pro Link	82	F		TRX 500 FGA Fourtrax Foreman Rubicon Gpscape	04-08		R		
				TRX 500 FE/FA Fourtrax Foreman 4x4/ES	05-08		R		
333/333G	HONDA			TRX 500 FM/FMA Fourtrax Foreman 4x4	05-11		R		
CHF 50/50 P/S Metropolitan /Metropolitan II/Jazz	02-11	F & R		TRX 500 FE Fourtrax Foreman	12-13		R		
NCH 50 Metropolitan	13-16	F		TRX 500 FM Fourtrax Foreman	12-13		R		
NPS 50/50 S Ruckus	03-16	F & R		TRX 500 FPE Fourtrax Foreman	12-13		R		
NU 50/NU 50 M Urban Express	82-83	F		TRX 500 FPM Fourtrax Foreman	12-13		R		
SA 50 Elite SR/SA 50 P Elite S	94-01	F & R		TRX 500 FPA Fourtrax Rubicon with EPS/Power Steering	09-14		R		
CR 60 R	83-84	F & R		TRX 500 TM5/TM6 Fourtrax Foreman 2x4	05-06		R		
CRF 70 F	04-14	F & R		TRX 500 FPE Fourtrax Foreman 4x4 ES/EP	08-11		R		
XR 70 R	97-03	F & R		CB 700 SC/S 'Nighthawk'	84-86		R		
CH 80 Elite	85-07	R		VF 700 C 'Magna'	85-87		R		
CRF 80 F	04-14	F & R		VT 700 C 'Shadow'	86-87		R		
CR 80 R	82	R		VF 750 C Magna/Magna Deluxe CD/C2	94-03		R		
CR 80 R	83-84	F & R		VF 750 C V45 Magna	88		R		
CR 80 R	85	F		VT 750 DC/DCA/DCB Shadow Spirit	01-08		R		
NH 80 Aero	85	R		VT 750 C/CD/CD2	98-02		R		
XR 80 R	85-03	F & R		VT 750 CDA/CDB/CDC/CDD	02-03		R		
CRF 100 F	04-16	F & R		VT 750 C2/C2F Shadow Spirit	07-10		R		
XR 100 R	85-03	F & R		VT 750 RS Shadow	10-14		R		
CRF 110 R	13-16	F & R		VT 750 Shadow Aero	08-14		R		
CRF 125 F (17/14" Small Wheels)	14-16	R		VT 750 C2B Shadow Phantom	10-14		R		
CRF 125 FB (19/16" Big Wheels)	14-16	R		VT 750 T Shadow Tourer	09		R		
TLR 200 Reflex	86-87	R		VT 750 C/CA Shadow Aero	04-07		R		
NSS 300 Forza (Non ABS) - Parking brake shoe	14-16			VT 750 DC Shadow Spirit	01-02		R		
NSS 300 Forza (ABS) - Parking brake shoe	14-16			VT 750 DCA/DCB Shadow Spirit	03-07		R		
SYM				VT 750 C Shadow Spirit	08-14		R		
DD 50	02-12	R		PC 800 Pacific Coast	89-90/94-99		R		
				VT 800 C Shadow	88		R		
338/338G	HONDA			VT 1100 C Shadow/Shadow Spirit	85-07		R		
CR 80 R	85-91	R							
E-TON QUADS									
AXL 50 Lightning 50	99-00	F							
BXL 50 Draco	05-06	F							
NXL 50 Lightning 50	01-02	F							

BRAKE SHOE BUYERS GUIDE

Part No.	Make/Model	Year	Fr/Rear	Part No.	Make/Model	Year	Fr/Rear	
344/344G	HONDA			347S/347SG	HONDA			
	CR 125 R	86	R		TRX 450 ES	98-01	F	
	CR 250 R	86	R		TRX 450 S	98-01	F	
345/345G	HONDA			350	HONDA			
	TRX 200 SX 'fourtrax'	86-88	F		NX 125	88-90	F	
	TRX 200 'fourtrax'	90-91	F		CH 250 Elite	87-90	R	
	TRX 200 D Type II 'fourtrax'	91-97	F	CN 250 Helix	86-01/05-07	R		
	TRX 250 TE Recon ES	97-14	F	ITALJET				
	TRX 250 TM Recon	97-14	F	Velocifero 50	98-03	F		
346/346G	ARCTIC CAT			351/351G	HONDA			
	50-Y6 Youth (2T)	04-05	F		PS 250 Big Ruckus	05-06	R	
	50 DVX (4T)	06-08	F		TRX 350 TE/FE	00-06	R	
	50 DVX (4T) Sport	06/08	F		TRX 350 TM/FM	00-06	R	
	50 Utility	06-08	F		TRX 400 FW Fourtrax Foreman	95-01/03	R	
	50 2x4 (2T) Youth	02-04	F		TRX 400 FM Fourtrax Foreman	02	R	
	50 4x4 Auto Youth	08	F		TRX 400 FGA/FA	04-07	R	
	90-Y12 Youth (2T)	02-04	F		TRX 420 FA1 Rancher 4x4 Auto DCT	14-15	R	
	90-Y12 Youth (4T)	04-05	F		TRX 420 FA2 Rancher 4x4 Auto/DCT/EP	14-15	R	
	90 DVX	06-14	F		TRX 420 FA5 Rancher 4x4 Auto/DCT/EP	14-15	R	
	90 DVX SE	09	F		TRX 420 FE1 Rancher 4x4/ES	14-15	R	
	90 SE	09	F		TRX 420 FM1 Rancher 4x4	14-15	R	
	90 Utility (2x4)	06-11	F		TRX 420 FM2 Rancher 4x4/EP	14-15	R	
	90 2x4 (2T) Youth	02-04	F		TRX 420 Fourtrax Rancher	07-13	R	
	90 2x4 (4T) Youth Rear Drum Model	04-05	F		TRX 420 TE Fourtrax Rancher ES	07-13	R	
	90 2x4 (4T) Youth Rear Disc Model	06	F		TRX 420 FM Fourtrax Rancher 4x4	07-13	R	
	90 (Reverse Gear Model)	10-14	F		TRX 420 FPE Fourtrax Rancher 4x4 ES/EP	09-13	R	
	BOMBARDIER				TRX 420 FE Fourtrax Rancher 4x4/ES	07-13	R	
	DS 50 (2 strokes)	02-06	F		TRX 420 FEI Rancher 4x4 ES	14-15	R	
	Quest 50	03-04	F		TRX 420 FPM Fourtrax Rancher 4x4 PS	09-13	R	
	DS 90 (2/4 stroke)	02-06	F		TRX 420 TM1 Rancher	14-15	R	
	Quest 90 (2/4 stroke)	03-04	F		TRX 420 TE1 Rancher ES	14-15	R	
	CAN AM				TRX 500 FE Fourtrax Foreman 4x4 EP	07-10	R	
	DS 70 (2x4/4T)	08-15	F		TRX 500 FE1 Foreman ES	14-15	R	
	DS 90 (4T/2x4)	07-15	F		TRX 500 FM2 Foreman ES	14-15	R	
	HONDA				TRX 500 FE2 Foreman ES/EP	14-15	R	
	TRX 70 Fourtrax	86-87	F		TRX 500 FM1 Foreman	14-15	R	
	KYMCO ATV			TRX 500 FPM Fourtrax Foreman 4x4/EP	09-10	R		
	MXer 50 Mongoose (2T)	02-07	F	TRX 500 FPE Fourtrax Foreman 4x4 ES/EP	08-10	R		
	Mongoose 70 (4T)	07-14	F	TRX 450 ES	98-01	R		
	Mongoose 90 R (Reverse Gear)	10-14	F	TRX 450 S	98-01	R		
	Mongoose 90	02-10	F	TRX 450 FE	02-04	R		
	POLARIS			TRX 450 FM	02-04	R		
	50 Scrambler	01-02	F	352	HONDA			
	50 Outlaw	08-16	F		NHX 110 Elite	10-11	R	
	Predator 50 (2 stroke)	04-06	F		CG 125 CA12/KS12/CA2/3/4/KS2/3/4			
	90 X Scrambler	01-03	F		/5/6/KSE2/3/4 (JC30)	01-06	F & R	
	90 Sportsman	01-16	F		CCT 125 ES12/ES2/3/4 (JC30)	01-04	R	
	Predator 90	03-06	F		NXR 125 (JC30)	03-08	F	
	Outlaw 90	07-16	F		PCX 125	11	R	
	YAMAHA				NXR 150 (KD03)	06-08	F	
	YFZ 50 Y	17-18	F		PCX 150 (WW 150)	13-17	R	
	YFM09 RYXG/H Raptor 90	16-17	F		SH 150 i	10-11	R	
	347/347G	HONDA			501	YAMAHA		
		TRX 300 FW Fourtrax (4WD)	88-00	F		CA 50 K/L/N/S Riva	83-86	F
		TRX 350 TE/FE	00-06	F		CE 50 ES/ET	86-87	F
TRX 350 TM/FM		00-06	F	CG 50 EU/W/A/B		88-91	F	
TRX 400 FW Fourtrax Foreman		95-00/03	F	MJ 50 J 'Towney'		82	F & R	
TRX 400 FM Fourtrax Foreman		02	F	PW 50 H/J/K/N/S/T/A/B/D/E/F/G/H//J/K		81-09		
TRX 400 FGA/FA		04-07	F	/L/M/N/P/R/S/T/V/W/X/Y/B/D/E/F		/12-15	F & R	
TRX 450 FE		02-04	F	QT 50 G/2G/H/J/K/L/N/S/T Yamahopper		80-87	F & R	
TRX 450 FM		02-04	F	SH 50 T/EMT/U/MU/W/MW/A/MA/B/D		87-94		
TRX 500 FA Foreman Rubicon		01-04	F	/MD/E/F/K/L Razz		/98-99	F	
TRX 500 FGA		04-	F	YFM 90 RY Raptor	09	F		
TRX 650 FA Rincon		03-05	F	502/502G	SUZUKI			
TRX 650 FGA		04-05	F		RM 80 Z/D/E/F	82-85	R	
					RM 80 G/H/J/K	86-89	R	

BRAKE SHOE BUYERS GUIDE

Part No.	Make/Model	Year	Fr/Rear	Part No.	Make/Model	Year	Fr/Rear
502/502G Contd.	YAMAHA			503/503G Contd.	YAMAHA Contd.		
	YZ 50 G	80	F & R		TW 200 T/TC/U/UC/W/WC/A/AC/B/BC/D		
	YZ 60 H/J/K	81-83	F & R		/DC/E/EC/F/FC/G/GC/H/HC/J/JC/EK/ECK		
	BW 80 S/T/U/A	86-88/90	F		/L/LC/M/MC/N/NC/P/PC/R/RC/S/SC/T	87-15	R
	PW 80 K/N/B/D/E/F/G/H/J/K/L/M	83-85			/TC/N/NC/W/WC/X/Y/Z/A/B/D/E/F	82-83	R
	/N/P/R/S/T/V	/91-08	F		XT 200 J/K/KC	85	F
	YZ 80 G/H/J/K/L/N	80-85	F & R		YFM 200 N 'Moto 4'	86-89	F
	YZ 80 S/T/U/W/A/B/D	86-92	R		YFM 200 DXS/DXT/DXU/D/DXW 'Moto 4'		
	TT-R 90 M/N/P/R/ES/S/ET/EV/EW	00-07	F		YFS 200 U/W/A/B/D/E/F/G/H/J		
TT-R 110 EX/EY/EA/EB/ED/EE/EF/EG	08-16	F	/K/L/M/N/P 'Blaster'	88-02	F		
503/503G	ADLY			YTM 200 K/L/N 'Tri-Moto'	83-85	F	
	Noble 50/Thunderbike	07-09	R	YTM 200 EK/EL 'Tri-Moto'	83-84	F	
	Panther 50	07-08	R	YTM 200 ERN 'Tri-Moto'	85	F	
	Jet 50	07-09	R	TT 225 S/T	86-87	R	
	Fox 50	07-09	R	XT 225 D/DC/E/EC/F/FC/G/GC/F/FH/J/JC			
	CPI			/K/KC/L/M/MC/N/NC/P/PC/R/RC/S/SC			
	Oliver City 50	05-09	R	/T/TC/V/VC/W/WC	93-07	R	
	MZ/MUZ			YTM 225 DXK/DXL/DXN 'Tri-Moto'	83-85	F	
	Moskito/SX 50/RX 50	97-05	R	YTM 225 DRN/DRS 'Tri-Moto'	85-86	F	
	POLARIS			YFM 225 S/T/U 'Moto 4'	86-88	F	
	Trail Boss (2x4)	85-87	F	YFB 250 D/E/F Timberwolf	92-94	F	
	Scrambler (3 wheeler)	85-86	F	YFM 350 ERT/ERU 'Moto 4'	87-88	F	
	Cyclone 250 X	87	F				
	UM (UNITED MOTORS)			504/504G	UM (UNITED MOTORS)		
	X-Peed 50/Special Edition	00-05	R		Zyclone 50	04-05	R
	YAMAHA				YAMAHA		
	CW 50 K Riva	98	F & R		LB 50 PG/PH/PJ Chappy	80-82	F & R
	CW 50 L/TL Zuma/Zuma II	99	R		RX 50 MK/K/L	83-84	R
	CV 50 L 'Riva'	84	F & R		DT 80 H/J	81-82	F & R
	CY 50 D/E/F/K Jog	92-94/98	R		DT 100 G/H/J	80-82	F & R
	EW 50 Stunt (5LH2/5YN1)	01-03	R		MX 100 G/H/J	80-82	F & R
	YFM 50 S/T/RV/RW/RX Raptor	04-08	F		YZ 100 F/G/H	80-81	F
	YSR 50 T/U/W/A/B/D	87-92	R		IT 125 G/H	80-81	F
	CV 80 K/L/N/S/T 'Riva'	83-87	F & R		RXZ 135 (2UX/3UK1)	87-89	R
	DT 80 K	83	F & R		MX 175 G/H	80-81	F
	LB 80 II-A Chappy 3VS2/4RP1	95-98	F & R		TY 350 N/S	85-86	R
	PW 80 D/E/F/G/H/J/K/L/M/N/P/R/S/T/V	92-08	R		BW 350 T/U	87-88	R
	V 80 (3NX3/4)	94	F & R				
	V 80 D (4GC2/3/4)	93-96	F & R	506/506G	YAMAHA		
	V 80 (4GC5/6/3NX6)	98	F & R		YFM 80 N/S/T/U	85-88	R
	YFM 80 D/E/F/G/H/J/K/L/M/N	92-01	F		YFAI W/A/B Breeze	89-91	R
	YFM 80 WP/WR/WS/RT/RV/RW/RX Raptor	02-08	F		YFM 100 T/U/W/A/B Champ	87-91	R
	YFM 80 GT/GV/GW/GX Grizzly	05-08	F		YZ 100 F/G/H/J/K	80-83	R
	JYM 90 T Axis 4RT6	01	R		DT 125 G/H	80-81	F & R
	TT-R 90 M/N/P/R/ES/S/ET/EV/EW	00-07	R		IT 125 G/H	80-81	R
	YA 90 Axis (4CY7-4EN7)	96	R		XC 125 N/NC/SC/T/TC/U/W/ZS/ZSC		
	DT 100 K	83	F & R		/ZT/ZTC/ZU/ZW/ZA/B/D Riva	85-92	R
	MX 100 K	83	F & R		XT 125 J/K/KC	82-83	F
	RT 100 A/D/E/F/G/H/J/K/L/M	91-00	F & R		YBA 125 Enticer (5US1/3P41)	05	F & R
	RX 100 (5RD3/4)	04	F & R		YZ 125 F/G/H/J	80-82	R
	RX 100 (36L/36L0/5RD1/2)	01-03	F & R		YZ 125 T	87	R
	RX 100 C (5RC1/2/3)	04	F & R		DT 175 G/H	80-81	F & R
	RXZ 100 S (3HS1/2)	88-95	F & R	IT 175 G/H/J/K	80-83	R	
	YFM 100 W/A/B Champ	89-91	F	MX 175 G/H	80-81	R	
	YFAI D/E/F/G/H/J/K/L/M/N/P/R/S "Breeze"	92-04	F	RT 180 A/B/D	90-92	R	
	YZ 100 J/K	82-83	F	SR 185 H/J	81-82	F	
	T 105 SE Crypton (1D81/1D82)	03-09	R	TW 200 T/TC/U/UC/W/WC/A/AC/B/BC	87-89	F	
TT-R 110 EX/EY/EA/EB/ED/EE/EF/EG	08-16	F	XT 200 J/K/KC	82-83	F		
TTR 125 M/N/P/R/ER/S/ES/ET/EV/EW/EX/EY	00-09	F & R	SR 250 G/H/J/TH Exciter I/II	80-82	R		
TTR 125 LWM/LN/LP/LER/LR/LES/LS/LET			SR 250 K (3Y9)	93	R		
/LT/LEV/LV/LW/LEW/LX/LEX/LEY/LEA	00-09		TT 250 G/H/J	80-82	R		
/LEB/LED/LEE/LEF	/11-15	R	XT 250 G/H/J/K/KC/L/LC	80-84	F & R		
XT 125 J/K/KC	82-83	R	XV 250 U/UC/W/WC/A/AC	88-90	R		
YBR 125 (5PY1/2)	01	F & R	YZ 250 G	80	R		
YFM 125 S/GT/GHT/GV/GW/GX/GY/GZ			YZ 250 J/K/L/N/S/T	82-87	R		
/GA/GB/GD Grizzly	04-13	F	TT 350 S/T	86-87	R		
YT 175 J/K 'Tri-Moto'	82-83	F	XT 350 N/NC/S/SC	85-86	R		
SR 185 H/J	81-82	R	XT 350 T/TC/U/UC/W/WC/A	87-90	R		
BW 200 N/S/ES/ET/EU	85-87	F & R	YZ 490 K	83	R		
			TT 600 K/L	83-84	R		
			TT 600 N/S	85-86	R		

BRAKE SHOE BUYERS GUIDE

Part No.	Make/Model	Year	Fr/Rear	Part No.	Make/Model	Year	Fr/Rear	
507/507G	YAMAHA			515 Contd.	YAMAHA Contd.			
	YZ 125 F/G/H/J/K	80-83	F		XV 700 L/LC/N/NC/CS/CT/CTCCSC/SS	84-87	R	
	IT 175 G/H/J/K	80-83	F		/SSC/ST/STC	73-74	R	
	IT 250 F/G/H/J	77-82	F		TX 750/TX 750 A	82	R	
	TT 250 G/H/J	80-82	F		XJ 750 J/K/MK 'Maxim'	81-83	R	
	YZ 250 G/H	80-81	F		XJ 750 RH/RJ/RK 'Seca'			
	IT 425 G	80	F		XV 750 U/UC/W/WC/A/AC/B/BC/D/DC	88-97	R	
TT 500 G/H	80-81	F	/E/EC/F/FC/G/GC/H/HC/J/JC Virago		81-82	R		
508/508G	YAMAHA				516/516G	YAMAHA		
	YZ 125 L	84	F			YP 250 Majesty (5CV1)	97	R
	IT 250 K	83	F			YFM 350 UH/UJ/UK/UL/ULC	96-99	R
	YZ 250 J/K/L	82-84	F			YFM 350 FWH/FWJ/FWBK	96-98	R
	IT 465 H/J	81-82	F			XS 400 2G/H	80-81	R
	YZ 465 G/H	80-81	F			XS 400 SG/SH	80-81	R
	IT 490 K/L	83/84	F			XS 400 SJ	82	R
YZ 490 J/K/L	82-84	F	XS 400 J/K 'Maxim'	82-83		R		
TT 600 K/L	83-84	F	XS 400 RJ/RK	82-83		R		
510/510G	YAMAHA			YFM 400 FWE/FWF/FWG/FWH/FWJ				
	DT 250 A	74	F & R	/FWK Kodiak		93-98	R	
	DT 250 B/C/D/E/F	75-79	R	YFM 400 FWHM/FWHN/FHP/FP 'Big Bear'		00-02	R	
	IT 250 H/J	81-82	R	YFM 400 FWNM/MC/FWNN/FWHN/FHP				
	IT 250 K	83	R	/FP/FR/FS Big Bear 4WD		00-04	R	
	YZ 250 H	81	R	YFM 400 NR/NS (2x4) Big Bear		03-04	R	
	SR 400 F	15	R	YFM 400 FAR Kodiak Auto	03-04	R		
	IT 465 H/J	81-82	R	YFM 400 S Big Bear 4WD	04	R		
	YZ 465 H	81	R	YFM 400 NM/NMC/NN/NHN/P/HP	00-02	R		
	IT 490 K/L	83-84	R	XJ 550 RH/RJ/RK 'Seca'	81-83	R		
	YZ 490 J	82	R	YFM 600 FWAK/FWAL/LC/FWAM				
	YZ 490 L	84	R	/MC Grizzly	98-00	R		
	YZ 490 N/S/T/U/W	85-89	R	YFM 600 HM/HMC 'Grizzly Hunting'	00	R		
	SR 500 E/F/G/H	78-81	R	YFM 600 FWAN/FWAHN	01	R		
	XT 500 G/H	80-81	R					
XT 550 J/K	82-83	F & R						
XT 600 L/LC/N/LN/S/SC	84-86	R						
XT 600 T/TC/U/UC/W/WC	87-89	R						
511/511G	USE 528/528G			517/517G	YAMAHA			
512	YAMAHA				YZ 125 K/L/N/S	83-86	R	
	XV 500 K 'Virago'	83	R		IT 200 L/N	84-85	F & R	
	XS 500 B	75	R		IT 200 S	86	R	
	XJ 550 H/J/K 'Maxim'	81-83	R		TY 350 N/S	85-86	F	
	XZ 550 RJ	82	R	BW 350 T/U	87-88	F		
	XZ 550 RK	83	R					
	YX 600 S/SC/T/TC/UC/V/W/WC/A			518/518G	YAMAHA			
/ACC 'Radian'	86-90	R	CW 50 W/TA Riva Zuma		89-90	F & R		
XJ 650 G/H/J/K 'Maxim'	80-83	R	DT 50 U/W/A (DTL/C)		88-90	F & R		
XJ 650 LH 'Midnight'	81	R	YT 60 L/N 'Tri-Zinger'		84-85	R		
XV 750 H/J/K/MK Virago	81-83	R	YF 60 S 'Moto 4'		86	R		
			PW 80 K/N/B		83-85/91	R		
			YFM 80 T/U		87-88	F		
			YA 90 Axis (4CY1/5 - 4EN5/6)		91-95	R		
			YFM 100 T/U Champ		87-88	F		
			T 105 SE 'Crypton' (5AM4)		99-02	R		
			RXS 115 (3HB6/7)	94-97	R			
			RXS 115 (3HB8)	99	R			
513	YAMAHA			519	YAMAHA			
XS 400 2G/H	80-81	F	LC 50 G/H Champ		80-81	F & R		
XS 400 SJ	82	F	CA 50 K/L/N/S 'Riva'		83-86	R		
			CE 50 ES/ET		86-87	R		
			CG 50 EU/W/A/B		88-91	R		
			SH 50 T/EMT/U/MU/W/MW/A/MA/D		87-94			
			/MD/E/F/K/L Razz		/98-99	R		
			SH 50 Ed-Mint (3PR1/4CK1/3/4)		89-94	F & R		
			CY 50 D/E/F/K/L Jog		92-94/98-99	F		
			YJ 50 RAP/YJ 50 RRP Vino/Vino Classic		-02	F		
			BW 80 S/T/U/A	86/88-90	R			
514	YAMAHA							
TX 650 A/XS 650 B/C	74-76	R						
XS 2/TX 650	72-73	R						
XS 650 D/E/F/2F/G/H/SH	77-81	R						
XS 650 SJ/SK Heritage Special	82-83	R						
515	YAMAHA							
XV 535 Virago All Models	87-99	R						
XJ 650 RJ 'Seca'	82	R						
XJ 650 LK 'Seca'	83	R						
XJ 650 LJ 'Seca Turbo'	82	R						
XVS 650 V Star Classic	98-10	R						
XVS 650 V Star Custom	97-11/13-14	R						
XVS 650 V-Star Silverado	03-10	R						
XJ 700 N/NC/XN/XNC/XS/XSC/S/SC	85-86	R						

BRAKE SHOE BUYERS GUIDE

Part No.	Make/Model	Year	Fr/Rear	Part No.	Make/Model	Year	Fr/Rear
535	YAMAHA			602/602G Contd.	SUZUKI Contd.		
	YBA 125 Enticer (16C1/3P42/3)	07-12	R		SP 125 Z/D	82-83	F & R
	FZ 16 (160cc) (IES1/2/3)	10-13	R		SP 125 G/H/J	86-88	R
	FZ 16 S (160cc) (IES40)	12-13	R		T125/11/R Stinger	69-71	F & R
	FZ 16 ST-Fazer (1KS2/3)	11-13	R		TC 125 J/K Prospector	72-73	R
	XV 250 V-Star	12-14	R		TC 125 L/M/A/B Prospector	74-77	F & R
	YBR 250 (41S2/3)	10-12	R		TM 125 K/L/M Challenger	73-75	R
YS 250 Fazer (5D41/2/3/56C1)	06-10	R	TS 125 T/X		80-81	F & R	
536/536G	YAMAHA				PE 175 C/N	78-79	F & R
	YFM 90 RY/RZ/RA/RB/RD Raptor	09-13	F		PE 175 T/X	80-81	F
537	YAMAHA				RS 175 T/X/Z	80-82	F
	XC 180 K/KC/L/LC/N/NC/ZL/ZLC/ZN	83-85	R		DS 185 T	80	F & R
	/ZNC/DN/DWC/ Riva	87-91	R		GT 185 K Adventurer (Drum Front)	73	R
	XC 200 T/ZCT/U/W/ZU/ZW/ZA/ZB Riva	87	R		GT 185 L/M/A/B Adventurer	74-76	R
601	SUZUKI				TS 185 T/X	80-81	F & R
	FZ 50 N/T/X/Z/D	79-83	F & R		DR 200 G/H/J/SET/SEV/SEW/SEX/SEY	86-90	
602/602G	HYOSUNG				/SEK1/SEK2/SEK3/SEK4/SEK5/SEK6	/96-09	R
	RX 125	06-08	R		/SEK7/SEK8/SEK9/SEL3/SEL5/SEL6	/13-16	R
	KAWASAKI				SP 200 G/H/J	86-88	R
	KLF 110 A1/A2/B1/B2 'Mojave'	87-88	R		DR 250 Z/D	82-83	F & R
	KLT 110 A1/A2/A3	84-86	R		DR 250 F	85	R
	BN 125 A4-A8/A6F/A7F/A9F	01-09	R		GN 250 Z/D/F/J	82-88	R
	KD 125 A2/A3/A4/A5	75-79	R		GZ 250 X/Y/K1-K9/L0 Marauder	99-10	R
	KE 125 A3-A10	76-83	R		RM 250 A/B/C/C2	76-78	F
	KX 125 A/A3/A4/A5/A6/A7	74-81	R		RS 250 T/X	80-81	F
	KX 125 B1	82	R		SP 250 Z/D	82-83	R
	KLT 160 A1	85	R		SP 250 F	85	R
	KDX 175 A1/A2/A3	80-82	R		TU 250 XK9/XL1/XL2/XL3/XL4/XL5/XL6	09-16	R
	KLT 185 A1/A2	86-87	R		DR 370 C/N	78-79	F
	KDX 250 B3/B4	83-84	R		RM 370 A/B	76-77	F
	KLX 250 A1/A2	79-80	R		DR 400 T	80	F
	KX 250 B1	82	R		RM 400 C	78	F
	KX 250 C1/C2/D1	83-85	R		TM 400 R/J/K/L/M Cyclone	71-75	F
	KZ 250 D1 (LTD)/D2(CSR)	80-81	R		RM 465 X/Z	81-82	R
	KZ 250 L1 (CSR)	82	R	DR 500 X/Z/D	81-83	F	
	KZ 250 W1 (LTD)	83	R	SP 600 F	85-87	R	
	KX 500 A1/A2/B1	83-85	R	U.M.			
	KL 600 A1/B1/B2 (KLR)	84-86	R	V2C-250T	06	R	
	SUZUKI			603/603G	KAWASAKI		
	TC 90 Blazer	70	F & R		AR 50 A1	82	R
	TC 90 R/J Blazer	71-72	R		AR 80 A1	82	R
	TS 90 Honcho	70	F & R		KD 80 M1-M8	80-87	F & R
	TS 90 R/J Honcho	71-72	R		KD 80 N1/N2/N3	88-90	R
	A100 A/B Go-Fer	76-77	F		KE 100 A5/A6/A7/A8/A9/A10	76-81	F & R
	B100 P Magnum (118cc)	65-66	F & R		KE 100 B1-B3/B6-B20	82-01	F & R
	DS 100 C/N/T/X	78-81	F & R		KM 100 A1/A2/A3/A3A/A4/A6/A7	76-81	F & R
	RM 100 A/B/C	76-78	R		KLT 110 A1/A2/A3	84-86	F
	TC 100 K/L/M Blazer	73-75	R		KLF 110 A1/A2/B1/B2 'Mojave'	87-88	F
	TC 100 A/B Blazer	76-77	F & R		KLX 110 (A1/A2/A3/A4/A6F/A7F/A8F		
	TS 100 A/B/C/N/T/X	76-81	F & R		/A9F/CAF/CBF/CCF/CDF/CEF/CFF/CGF)	02-16	R
	TS 100 A/B Honcho	76-77	F & R		KLX 110L (DAF/DBF/DCF/DDF/DEF		
	TS 100 K/L/M Honcho	73-75	R		/DF/DGF)	10-16	R
	B 105 P Bear Cat (118cc)	67-68	F & R		KLT 160 A1	85	F
	B 120 (118cc)	71-77	F & R		KLT 185 A1/A2	86-87	F
	KT 120 Trail	68-70	F & R		KLT 200 A1/A2/A3/A4/A4A	81-83	F
	TC 120 Trailcat	68-71	F & R		KLT 200 B1	83	F
	DR 125 Z/D	82-83	F & R		KLT 200 C1/C2	83-84	F
	DR 125 E	84	F & R		KLT 250 A1/A2	82-83	F
	DR 125 G/H/J/SER/SES/SET	86-96	R		KLT 250 C1/C2/C3 'Prairie'	83-85	F
	DS 125 N/T/X	79-81	F & R		KLT 250 P1 'Police'	84	F
	GN 125 Z/D	82-83	F & R		SUZUKI		
	GN 125 EM/EN/EP/ER/ES/ET	91-96	R		AC 50/R	70-71	F & R
	RM 125 A/B/C	76-78	F & R		AS 50 Sport/Colt	68-69	F & R
	RM 125 N/T	79-80	F		TC 90 R/J Blazer	71-72	F
	RV 125 K Tracker	73	R		TS 90 R/J Honcho	71-72	F
	RV 125 L/M/A/B Tracker	74-77	F & R		A100 A/B Go-Fer	76-77	R
					RM 100 A/B/C	76-78	F
					TC 100 K/L/M Blazer	73-75	F
					TS 100 K/L/M Honcho	73-75	F
			DR-Z 110 K3/K4/K5		03-05	R	

BRAKE SHOE BUYERS GUIDE

Part No.	Make/Model	Year	Fr/Rear	Part No.	Make/Model	Year	Fr/Rear	
603/603G Contd.	SUZUKI Contd.			605/605G Contd.	SUZUKI Contd.			
	RV 125 K Tracker	73	F		RM 400 C	78	R	
	TC 125 J/K Prospector	72-73	F		RM 400 N	79	F	
	TM 125 K/L/M Challenger	73-75	F		TM 400 R/J/K/L/M Cyclone	71-75	R	
	RV 200 L6/L7 Van-Van	16-17	R	TS 400 J/K/L/M/A/B	72-77	F & R		
				DR 500 X/Z/D	81-83	R		
				SP 500 X/Z/D	81-83	F & R		
604/604G	KAWASAKI			606/606G	ATK			
	KSF 50 A1/A2/A3 (KFX 50)	03-05	R		GV 250 V-Twin Cruiser	11	R	
	KLX 125 A1/A2/A3/A6F	03-06	F & R		HYOSUNG			
	KLX 125 L (B1/B2/B3/B6F)	03-06	R		GV 250 V	16-12	R	
	SUZUKI				SUZUKI			
	GSXR 50 (RB 50 H)	87	R		GS 250 TT/TX	80-81	R	
	LT-A 50 K2/K3/K4/K5	02-05	R		GS 300 LZ/LD	82-83	R	
	LT-Z 50 K6/K7/K8/K9/ZK9	06-11	R		GS 300 LF	85	R	
	LT-Z 50 L7/L8	17-18	R		GN 400 T/XT/XX/TX/TZ	80-82	R	
	OR 50 T	80	F & R		LT-A 400 FK2/FK3/FK4/FK5/FK6/FCK5			
	RM 50 C/N/T	78-80	F & R		/FCK6/FK7/FK8/FL0	02-10	R	
	RM 50 X	81	F & R		LT-A 400 FL1/FL2/FL3/FL4/FL5			
	RM 60 N/T	79-80	F & R		King Quad 400 Asi	11-15	R	
	RM 60 X/Z/D	81-83	F & R		LT-A 400 FCL1/FCL2/FCL3/FCL4/FCL5			
	DS 80 T/X/Z/D/F/G/H/J/K/L/M/N/P/R/S				King Quad 400 Asi Camo	11-15	R	
	/T/V/W/X/Y	80-00	F & R		LT-A 400 K2/K3/K4/K6	02-04/06	R	
	JR 80 K1/K2/K3/K4	01-04	F & R		LT-A 400 FK8 King Quad Auto 4WD	08	R	
	RM 80 T/X	80-81	F & R		LT-A 400 K8 King Quad Auto 2WD	08	R	
	LT-Z 90 K7/K8/K9/ZK9/L4/L5/L6	07-11			LT-A 400 FCK8/9 King Quad	09	R	
	QuadSport	/14-18	F		LT-A 400 FQK9 King Quad	08-09	R	
	DR 100 D/E/F/G/H/J/K/L	83-90	F & R		LT-F 400 FK2/FK3/FK4/FK5/FK6/FCK5			
	RM 100 N/T/X	79-81	F		/FCK6/FCK7/K8	02-08	R	
	SP 100 D	83	R		LT-F 4WD V/W Quadrunner 4WD (250cc)	97-98	R	
	DR-Z 125 K3/K4/K5/K6/K7/K8/K9/L2				LT-F 400 K2 Eiger Manual 2WD	02	R	
	/L3/L4/L5/L6	03-16	F & R		LT-F 400 K3/4/5/6/7	03-08	R	
	DR-Z 125 LK3/LK4/LK5/LK6/LK7/LK8				LT-F 400 FL1/FL2/FL3/FL4/FL5			
	/LK9/LL2/LL3/LL4/LL5/LL6	03-16	R		King Quad 400 FSi	11-15	R	
					LT-F 400 FCL1/FCL2/FCL3/FCL4/FCL5			
					King Quad 400 FSi Camo	11-15	R	
					LT-F 400 FK8/FK9/FL0	08-10	R	
					GS 425 EN (Cast Wheel)	79	R	
			GS 425 LN	79	R			
			GS 450 ET/ST/EX/SX/EZ/ED	80-83	R			
			GS 450 GAZ/GAD/GAF	82-85	R			
			GS 450 LT/LX/LZ/LD/LF/LG/LH/LJ	80-88	R			
			GS 450 TX/TZ	81-82	R			
			GS 450 TXD	83	R			
			GS 550 LD/LF/LG	83-86	R			
			LS 650 FG/PG/PH/FH/PJ//PS/PT/PV/PW	86-88	R			
			/PX/PY/PK1/PK2/PK3/PK4 Savage	/95-04	R			
			LS 650 K5/K6/K7/K8/K9/L1/L2/L3 /L4					
			/L5 S40 Boulevard	05-15	R			
			GR 650 D/XD Tempter	83	R			
605/605G	KAWASAKI			608	SUZUKI			
	KDX 250 A1/B1/B2	80-82	R		T 250 II/R/J Hustler	69-72	F	
	KL 250 A1/A1A/A2	78-80	R		TC 250 X6 Scrambler	67-69	F	
	KX 250 A6/A7	80-81	R		GS 300 LZ/LD	82-83	F	
	KZ 250 D1 (LTD) D2 (CSR)	80-81	F		T 305 Raider	68-69	F	
	KZ 250 L1 (CSR)	82	F		TC 305 Laredo	68	F	
	KZ 250 W1 (LTD)	83	F		T 350 1/2/R/J Rebel	69-72	F	
	KDX 400 A1/A2	79-80	R		GT 380 J Sebring	72	F	
	KDX 420 B1	81	R		T10 (Twin leading shoe f/brake cable			
	KX 420 A1/A2	80-81	R		rear brake) E/No T10 16816 -	66-67	F	
	KDX 450 A1	82	R		T20 X6	65-69	F	
	SUZUKI							
	ALT 125 E/F/G	84-86	R		609	SUZUKI		
	LT 125 E	84	R			GT 250 K/L/M/A/B Hustler	73-77	R
	S32 (150cc) (Single cam f/brake)	65	F & R			T 250 II/R/J Hustler	69-72	R
	S32-11 (150cc)	66-67	F			TC 250 X6 Scrambler	67-69	R
	LT 160 EK/EL/EM/EN	89-92	R			T 305 Raider	68-69	R
	LT-F 160 M/N/P/R/S/T/V/W/X/Y/K1/K3	91-01/03	R			TC 305 Laredo	68	R
	LT 160 K3/K4	03-04	R			T 350 1/2/R/J Rebel	69-72	R
	ALT 185 F	85	R					
	LT 185 E/F/G/H	84-86	R					
	T 200 X5 Invader	67-69	R					
	TC 200 X5 Stingray	67-69	R					
	LT 230 GEF/GEG	85-86	R					
	LT-F 230 G/H	86-87	R					
	DS 250 T	80	F & R					
	PE 250 B/C/N/T/X	77-81	F & R					
	RS 250 T/X	80-81	R					
	TS 250 R/J/K/L/M/A/B/C/N/T/X	71-81	F & R					
	RM 250 A/B/C/C2	76-78	R					
	RM 250 N	79	F					
DR 370 C/N	78-79	F & R						
RM 370 A/B	76-77	R						
SP 370 C/N	78-79	F & R						
DR 400 T	80	R						
SP 400 T	80	F & R						
PE 400 T/X	80-81	F & R						

BRAKE SHOE BUYERS GUIDE

Part No.	Make/Model	Year	Fr/Rear	Part No.	Make/Model	Year	Fr/Rear	
609 Contd.	SUZUKI Contd.			618/618G Contd.	SUZUKI Contd.			
	GT 380 J/K/L/M/A/B Sebring	72-77	R		PE 175 Z/D/E	82-84	F	
	GS 400 XB/XC (Drum Brake)	77-78	R		RM 125 X/Z/D	81-83	F	
	GS 400 B/C (Disc Brake)	77-78	R		RM 250 T	80	F	
	GS 425 N (Spoke wheel)	79	R		RM 250 E/F/G	84-86	R	
	GS 450 TXZ	82	R		RM 400 T	80-	F	
	T 500 I Cobra	68	R		RM 500 D/E	83-84	R	
	T 500 2/3 Titan	69-70	R					
	T 500 R/J/K/L/M Titan	71-75	R		619/619G	SUZUKI	80-84	R
	GT 550 K Indy (Front drum brake)	72	R		PE 175 T/X/Z/D/E			
GT 550 K/L/M Indy	73-75	R						
T10 (Twin leading shoe f/brake cable rear brake) E/No T10 16816 - T20 X6	66-67 65-69	R R		620/620G	SUZUKI	82-83 79-80 79-	F R R	
611	SUZUKI			621/621G	SUZUKI			
	GS 550 LZ	82	R		RM 250 X/Z	81-82	F	
	GS 550 B	77	R		RM 465 X/Z	81-82	F	
	GT 550 A/B Indy (Tokico Caliper)	76-77	R		LT 125 D	83	R	
GT 550 B Indy (Asco Caliper)	77	R	LT 125 F/G/H	85-87	R			
				ALT 125 D	83	R		
612	SUZUKI			622/622G	SUZUKI			
	GS 300 LF	85	F		RM 125 E	84	F	
	GS 400 XB/XC (Drum Brake)	77-78	F		RM 250 D/E	83-84	F	
	GS 450 TXD	83	F		RM 500 D/E	83-84	F	
	T 500 I Cobra	68	F					
T 500 2/3 Titan	69-70	F						
T 500 R/J/K/L/M Titan	71-75	F						
613/613G	KAWASAKI			624/624G	DERBI			
	KDX 50 A1/A2/A3/A6F	03-06	F & R		Atlantis 50 (All models)	99-01	R	
	SUZUKI				GP1 50	02-06	R	
	JR 50 C/N/T/X/Z/RD/F/G/H/J/K/L /M/N/P/R/V/W/X/Y/K1-K6	78-06	F & R		HUSQVARNA			
	LT 50 E/F/G/H	84-87	R		WRS 50 Scooter	98-00	R	
ALT 50 D/E	83-84	R	ITALJET					
				Formula 50 (Air Cooled)	99-03	R		
614/614G	E-TON QUADS			Torpedo 50	98-04	R		
	DXL-90 Sierra	99-03	F	Velocifero 50	98-03	R		
	KAWASAKI			SUZUKI				
	KSF 50 A1/A2/A3 (KFX 50)	03-05	F	LT 160 EK/EL/EM/EN	89-92	F		
	KSF 80 A1/A2/A3/A6F (KFX 80)	03-06	F	LT 160 K3/K4	03-04	F		
	SUZUKI			LT-F 160 M/N/P/R/S/T/V/W/X/Y/K1/K3	91-01/03	F		
	FA 50 T/X/MX/Z/D/E/F/G/H/J/K/L/M	80-91	F & R					
	FS 50 T/X	80-81	F & R	625/625G	SUZUKI			
	SUZUKI ATV			LT 230 GEF/GEG	85-86	F		
	LT-A 50 K2-K5 QuadSport	02-05	F	LT-F 230 G/H	86-87	F		
LT-Z 50 K6/K7/K8/K9/ZK9	06-11	F	LT 250 EFF/EFK	85-86	F			
LT-Z 50 L7/L8	17-18	F	LT 300 EH/EJ/EK	87-89	F			
LT 80 H/J/K/L/M/N/P/R/S/T/V/W/X/Y /K1/K2/K3/K4/K5/K6	87-06	F						
615/615G	SUZUKI			626	SUZUKI			
	RM 80 Z/D/E/F	82-85	F		LT-F 4 WDXM/N/P/R/S/T/V/W	91-98	R	
616/616G	SUZUKI				LT-F 400 FK2/K2/FK3/K3 Eiger	02-03	R	
	RM 125 X/Z/D/E/F/G/H	81-87	R		LT-A 400 FK2/FK3 Eiger 4WD	02-03	R	
RM 250 X/Z/D	81-83	R	LS 650 K5 Boulevard S40 (650cc)		05	R		
617/617G	SUZUKI				GV 700 GLF/GLF2	85	R	
	SP 100 D	83	F		VS 700 All models	86-87	R	
	RM 100 N/T/X	79-81	R		VS 750 GLPJ/GLPK/GLPL/GLPM Intruder	88-91	R	
	RM 125 N/T	79-80	R		VL 800 K1-K4 'Intruder Volusia'	01-05	R	
RS 175 T/X/Z	80-82	R	VL 800 K5/K6/CK5/TK5/CK6/TK6/K7 /TK7/ZK7/K8/TK8/ZK8/K9/TK9/ZK9 /L1/TL1-TL5 Boulevard C50T		05-15	R		
618/618G	KAWASAKI			VL 800 ZL2 C 50 T Boulevard Classic	12	R		
	KSF 80 A1/A2/A3/A6F (KFX 80)	03-06	R	VL 800 ZK3/ZK4 Volusia Ltd	03-04	R		
	SUZUKI			VL 800 CL3 (Boulevard C50 Special Edition/Cast Wheels)	13	R		
	LT 80 H/J/K/L/M/N/P/R/S/T/V/W/X/Y /K1/K2/K3/K4/K5/K6	87-06	R	VL 800 BT L4 (Boulevard C50 B.O.S.S. Cast Wheels)	14	R		
	LT-Z 90 K7/K8/K9/ZK9/L4/L5/L6	07-11/14-18	R	VS 800 GLN/GLP/GLR/GLS/GLT/GLV/GLW /GLX/GLY/GLK1/GLK2/GLK3 /GLK4 Intruder	92-04	R		
			VS 800 K5/CK5/K6/CK6/K7/ZK8/ZK9/L1 /L2/L3/L4/L5 C50 Boulevard	05-15	R			

BRAKE SHOE BUYERS GUIDE

Part No.	Make/Model	Year	Fr/Rear	Part No.	Make/Model	Year	Fr/Rear
626 Contd.	SUZUKI Contd. VZ 800 V/W/X/Y/K1-K4 'Marauder' VZ 800 K5/K6/BK6/K7/ZK7/K8/ZK8/K9 /ZK9/L0/L1/L2/L3/L4/L5 M50 Boulevard	97-04 05-15	R R	705/705G	KAWASAKI KLF 185 A2/A3/A4 'Bayou' KLT 200 A1/A2/A3/A4/A4A KLT 200 B1 KLT 200 C1/C2 KLF 220 A1-A15 Bayou KDX 250 A1/B1/B2 KDX 250 B3/B4 KL 250 A1/A1A/A2 KLF 250 A1/A2/A3/A6F/A7F/A8F /A9F/AAF/ABF Bayou KLT 250 A1/A2 KLT 250 C1/C2/C3 'Prairie' KLT 250 P1 'Police' KX 250 A6/A7 KXT 250 A1 'Tecate' KDX 400 A1/A2 KDX 420 B1 KX 420 A1/A2 KDX 450 A1	86-88 81-83 83 83-84 88-02 80-82 83-84 78-80 03-11 82-83 83-85 84 80-81 84 79-80 81 80-81 82	F R R R F F F F R R R R F F F F
628/628G	KAWASAKI KAF 300 A1/B1/B2 (Mule 500) KAF 300 C1/C2/C3/C4/C6/C7 (Mule 550) KAF 300 D1/D2 (Mule 520) SUZUKI LT-4WD H/J/K/L/M/N/P/R/S/T/V LT-F 4WD V/W LT-F 250 J/K/L/M/N/P/R/S/T/V/W LT-F 250 FX/FY/FK1/FK2 "Quadrunner"	87-97 97-98 88-98 99-02	F F F F	706/706G	KAWASAKI KLF 185 A1/A1A 'Bayou' KLF 185 A2/A3/A4 'Bayou' KLF 220 A1-A15 Bayou EL 250 B2/B3 Eliminator EL 250 E1/E2/E3/E4 250 HS EL 250 F2 'EL252' KLF 250 A1-A3/A6F-A9F/AAF/ABF Bayou KLF 300 A1/A2 Bayou KLF 300 B1-B17 'Bayou' KZ 305 A1/A2 (CSR) KZ 305 B1 (CSR) KZ 305 B2/B3 (LTD) EX 305 B1 (GPz) KZ 440 A1/A2/A3/A4 KZ 440 B1/B2 KZ 440 D1/D2/D3/D4 (LTD) KZ 440 D5 (LTD) KZ 440 G1 EX 500 A1-A7 W 650 (EJ 650 A1/A2/A3/A4)	85 86-88 88-02 88-89 91-95 97-99 03-11 86-87 88-04 81-82 82 87-88 83 80-83 80-81 80-82 83 82 87-93 00-02	R R R R R R R R R R R R R R R R R
629/629G	SUZUKI LT-4WD H/J/K/L/M/N/P/R/S/T/V LT-F 4 WDT/V LT-F 4 WD/V/W LT-F 250 J/K/L/M/N/P/R/S/T/V/W LT-F 250 FX/FY/FK1/FK2 "Quadrunner"	87-97 96-97 97-98 88-98 99-02	R R R R R	708	KAWASAKI KH 250 A5 S1-A/B/C (250cc) S2 (350cc) S2-A (350cc) S3/S3-A (400cc) KH 400 A3/A4/A5	76 73-75 72-73 72-73 74-75 76-78	R R R R R R
633/633G	SUZUKI LT-F 4WDXM/N/P/R/S/T/V/W LT-F 300 FX/FY/FK1 "King Quad"	91-98 99-01	F F	709	KAWASAKI EN 450 A1-A6 (454 Ltd) EN 500 A1-A6/B2/C1 Vulcan EN 500 C1-C10/C6F/C7F/C8F/C9F Vulcan KZ 550 A1/A2/A3/A4 KZ 550 C1/C2/C3/C4 (LTD) KZ 550 F1 (Spectre) F2 (LTD) KZ 550 M1 (LTD) ZL 600 A1/A2 ZL 600 B2/B3 Eliminator KZ 650 B1/B2/B2A/B3 KZ 650 E1 (LTD) KZ 650 F1 KZ 650 H1/H2/H3 (CSR) VN 700 A1 'Vulcan' KZ 750 G1 (LTD) KZ 750 K1/K2 (LTD) KZ 750 M1 (CSR) VN 750 A2-A21/A6F 'Vulcan' VN 800 A1-A11/B1-B9 Vulcan/Vulcan Classic	85-90 90-96 96-09 80-83 80-83 83-84 83 86-87 96-97 77-79 80 80 81-83 85 80 83-84 82 86-06 95-05	R R R R R R R R R R R R R R R R R
634/634G	SUZUKI LT 250 EFF/EFG LT 300 EH/EJ/EK LT-F 300 FX/FY/FK1 "King Quad" LT-F 300 FK2 LT-F 300 FX/FY LT-F 4WD XM/N/P/R/S/T/V/W LT-A 500 FY/FK1 LT-F 500 FW/FX/FY/FK1/FK2 RE 5 M/A (Rotary) GS 750 TZ/TD (16 valve) GT 750 J (Drum Brake) Le-Mans GT 750 K/L/M/A/B	85-86 87-89 99-01 02 99-00 91-98 00-01 98-02 75-76 82-83 72 73-77	R R R R R R R R R R R R	701/701G	KAWASAKI KDX 80 A1/A2 KDX 80 B2/B3 KX 80 C1/C2	80-81 82-83 81-82	F & R F & R F & R
636/636G	SUZUKI LT-Z 250 K4/K5/K6/K7/K8/K9 QuadSport LT-F 250 K2-K9/L2/L3/L4 Ozark	04-09 02-14	R R	702/702G	KAWASAKI KX 125 B2/C1/D1 KDX 200 A1/A2/A3 KDX 200 C1/C2/C3	83-85 83-85 86-88	R R R
701/701G	KAWASAKI KDX 80 A1/A2 KDX 80 B2/B3 KX 80 C1/C2	80-81 82-83 81-82	F & R F & R F & R	703/703G	KAWASAKI KE 175 D2/D3/D4/D5 KDX 200 A1/A2/A3 KL 250 A3/A4/A5 KL 250 C1/C2 KL 250 D2/D3 (KLR 250) KL 250 D4-D22 (KLR 250)	80-83 83-85 80-82 83-84 85-86 87-05	R F R R R R
702/702G	KAWASAKI KX 125 B2/C1/D1 KDX 200 A1/A2/A3 KDX 200 C1/C2/C3	83-85 83-85 86-88	R R R	704/704G	KAWASAKI KD 125 A2/A3/A4/A5 KE 125 A3-A10 KX 125 A/A3/A4/A5/A6/A7 KDX 175 A1/A2/A3 KE 175 D2/D3/D4/D5 KL 250 A3/A4/A5 KL 250 C1/C2 KLX 250 A1/A2	75-79 76-83 74-81 80-82 80-83 80-82 83-84 79-80	R F F F F F F F

BUYERS GUIDE
BRAKE SHOES

BRAKE SHOE BUYERS GUIDE

Part No.	Make/Model	Year	Fr/Rear	Part No.	Make/Model	Year	Fr/Rear
710/710G	KAWASAKI			719	KAWASAKI		
	KLF 300 C1-C17	89-05	R		KAF 400 ABF/ACF/ADF/AEF/AFF (Mule 610 4x4)	11-15	R
	KVF 300 A1-A4/B1-B4 Prairie	99-02	R		KAF 400 DAF/DBD/DCF/DDF/DEF/DFE (Mule 610 4x4 XC)	10-15	R
	KLF 400 B1-B7	93-99	R		KAF 400 EBF/ECF/EDF/EEF/EFF (Mule 610 4x4 Realtree Camo XC)	11-15	R
	KVF 400 A1/A2/B1/C1-C4/D1-D4 'Prairie'	97-02	R		KAF 400 FEF (Mule 610 4x4 XC SE)	14	R
	KH 500 A8	76	R		KAF 450 B1 (Mule 1000)		F
	HI-D/HI-E/HI-F 500	73-75	R	KAF 540 C1 (Mule 2010)		F	
711	HONDA			KAF 540 D1 (Mule 2020)		F	
	KH 250 A5	76	F	KAF 540 E1 (Mule 2030)		F	
	S1-A/B/C (250cc)	73-75	F	KAF 620 A1-A6 (Mule 2510)		F	
	S2 (350cc)	72-73	F	KAF 620 B1-B6 (Mule 2520)		F	
	KAWASAKI			KAF 620 C1-C6 (Mule 2500)		F	
	KZ 440 B1/B2	80-81	F	KAF 620 E1-E5 Mule 3010		F	
713	KAWASAKI			KAF 620 F1/F2/F3 Mule 3020		F	
	H2/H2-A "Mach IV"	72-73	R	KAF 620 G1-G5 Mule 3000		F	
	H2-B/H2-C "Mach IV"	74-75	R	KAF 620 H1-H3 Mule 3010 4x4	03-05	F	
	Z1/A/B 900	73-75	R	KAF 620 K1/K6F/K7F Mule 3010 Trans 4x4	05-07	F	
	KZ 900 A4/A5	76-77	R	KAF 620 J1 Mule 3010 Trans 4x4	05	F	
714/714G	KAWASAKI			KAF 620 M9F/MAF/MBF/MCF/MDF/MEF /MFF/MGF/MHF (Mule 4010 4x4)	09-17	F	
	KDX 80 C1/C2/C3/C4/C5	84-88	F	KAF 620 N9F (Mule 4010 4x4 Hardwoods Green)	09	F	
	KX 80 E1	83	F	KAF 620 P9F/PAF /PBF/PCF/PDF/PEF /PFF/PGF/PHF (Mule 4000)	09-17	F	
715/715G NOW with SPRING to avoid fouling	KAWASAKI			KAF 620 R9F/RAF/RBF/RCF/RDF/REF/RFF /RFFA/RGF/RHF (Mule 4010 Trans 4x4)	09-17	F	
	KX 60 A1/A2	83-84	F & R	KAF 620 S9F/SAF/SBF/SCF/SDF/SEF/SFF /SFG/SHF (Mule 4010 Trans 4x4 Hardwoods Green HD)	09-17	F	
	KX 60 B1-B19	85-03	F & R	KAF 620 TGF/TGF (Mule 4010 4x4 SE)	16-17	F	
	KDX 80 C1/C2/C3/C4/C5	84-88	R	KAF 620 VGF/VHF (Mule 4010 Trans 4x4 SE)	16-17	F	
	KX 80 E1-E3	83-85	R	KAF 950 A1/A2/A3 (Mule 2510 Diesel)		F	
	KX 80 G1/G2	86-87	R	KAF 950 B1-B3/B6F/B7F (Mule 3010 Diesel)	03-07	F	
	KX 80 J2	87	R	KAF 950 C8F/D8F Mule 3010 Diesel 4x4	07-08	F	
	KLX 110 (KLX 110 A1-A4/A6F/A7F/A8F /A9F/CAF/CBF/CCF/CDF/CEF/CFF/CGF)	02-16	F	KAF 950 E8F Mule 3010 Trans 4x4 Diesel	08	F	
	KLX 110 L (KX 110 DAF/DBF/DCF/DDF /DEF/DFE/DGF)	10-16	R	KAF 950 F9F/FAF/FBF/FCF/FDF (Mule 4010 Diesel 4x4)	09-13	F	
	SUZUKI			KAF 950 G9F/GAF/GBF/GCF/GDF (Mule 4010 Trans 4x4 Diesel)	09-13	F	
	RM 60 K3	03	F & R	KAF 950 HAF (Mule 4010 Trans 4x4 Diesel Realtree)	10	F	
DR-Z 110 K3/K4/K5	03-05	F	SUZUKI				
			QUV 620 FK5 Side x Side	05	F		
717/717G	KAWASAKI			720	KAWASAKI		
	KLF 300 A1/A2 'Bayou'	86-87	F		KAF 450 B1 (Mule 1000)		R
718	KAWASAKI				KAF 540 C1 (Mule 2010)		R
	KAF 300 A1/B1/B2 (Mule 500)	92-95	R		KAF 540 D1 (Mule 2020)		R
	KAF 300 C1/C2/C3/C4/C6/C7 (Mule 550)		R		KAF 540 E1 (Mule 2030)		R
	KAF 300 D1/D2 (Mule 520)		R		KAF 620 A1-A6 (Mule 2510)		R
	KAF 400 ABF/ACF/ADF/AEF/AFF (Mule 610 4x4)	11-15	F		KAF 620 B1-B6 (Mule 2520)		R
	KAF 400 B1 Mule 600	05	F & R		KAF 620 C1-C6 (Mule 2500)		R
	KAF 400 A1/C1 Mule 610 4x4	05	F & R		KAF 620 E1-E5 Mule 3010		R
	KAF 400 A6F/A7F/A8F/A9F/AAF (Mule 610 4x4)	06-10	F & R		KAF 620 F1/F2/F3 Mule 3020		R
	KAF 400 B6F/B7F/B8F/B9F/BAF/BBF /BCF/BDF/BEF/BFF (Mule 600)	06-15	F & R		KAF 620 G1-G5 Mule 3000		R
	KAF 400 C6F/C7F/C8F/C9F (Mule 610 4x4 Hardwoods Green HD)	06-09	F & R	KAF 620 H1-H3 Mule 3010 4x4	03-05	R	
	KAF 400 DAF/DBD/DCF/DDF/DEF/DFE (Mule 610 4x4 XC)	10-15	F	KAF 620 K1/K6F/K7F Mule 3010 Trans 4x4	05-07	R	
	KAF 400 DBF/DCF/DDF/EBF/ECF/EDF/EEF /EFF (Mule 610 4x4 Realtree/Camo)	11-15	F	KAF 620 J1 Mule 3010 Trans 4x4	05	R	
	KAF 400 FEF/FFF (Mule 610 4x4 XC SE)	14-15	F	KAF 620 M9F/MAF/MBF/MCF/MDF/MEF /MFF/MGF/MHF (Mule 4010 4x4)	09-17	R	
	KAF 400 JHF (Mule SX)	17	F&R	KAF 620 N9F (Mule 4010 4x4 Hardwoods Green)	09	R	
	KAF 400 HHF (Mule SX 4X4)	17	F&R	KAF 620 P9F/PAF /PBF/PCF/PDF/PEF /PFF/PGF/PHF (Mule 4000)	09-17	R	
	KAF 400 NHF (Mule SX 4X4 SE)	17	F&R	KAF 620 R9F/RAF/RBF/RCF/RDF/REF/RFF /RFFA/RGF/RHF (Mule 4010 Trans 4x4)	09-17	R	
KAF 400 KHf (Mule SX 4X4 XC)	17	F&R	KAF 620 S9F/SAF/SBF/SCF/SDF/SEF/SFF /SFG/SHF (Mule 4010 Trans 4x4 Hardwoods Green HD)	09-17	R		
KAF 400 LHF (Mule SX 4X4 XC Camo)	17	F&R					
KAF 400 MHF (Mule SX 4X4 XC SE)	17	F&R					

BUYERS GUIDE
BRAKE SHOES

BRAKE SHOE BUYERS GUIDE

Part No.	Make/Model	Year	Fr/Rear	Part No.	Make/Model	Year	Fr/Rear
720 Contd.	KAWASAKI Contd.			802G Contd.	HUSQVARNA		
	KAF 620 TGF/TGF (Mule 4010 4x4 SE)	16-17	R		430 Automatic	87-88	R
	KAF 620 VGF/VHF (Mule 4010 Trans 4x4 SE)	16-17	R		CR 430	80-81	F
	KAF 950 A1 (Mule 2510 Diesel)		R		CR 430	87-88	R
	KAF 950 B1-B3 (Mule 3010 Diesel)	03-05	R		WR 430	80-81	F & R
	KAF 950 C7F/D8F Mule 3010 Diesel 4x4	07-08	R		WR 430	87-88	R
	KAF 950 E8F Mule 3010 Trans 4x4 Diesel	08	R		WR-E 430	80-81	F & R
	KAF 950 F9F/FAF/FBF/FCF/FDF (Mule 4010 Diesel 4x4)	09-13	R		WR-E 430	82-84	R
	KAF 950 G9F/GAF/GBF/GCF/GDF (Mule 4010 Trans 4x4 Diesel)	09-13	R		WRU 430	82-84	R
	KAF 950 HAF (Mule 4010 Trans 4x4 Diesel Realtree)	10	F		XC 430	80-81	F & R
				XC 430	87-88	R	
				AE 500	82-84	F	
				CR 500	85-88	R	
				XC 500	82-84	R	
				XC 500	87-88	R	
	SUZUKI						
	QUV 620 FK5 Side x Side	05	R				
801G	HUSQVARNA			803G	HUSQVARNA		
	CR 125	78	F		CR 125	82-84	F
	CR 125	79-81	F & R		WR 125	82-84	F
	CR 125	82-84	R		XC 125	82-84	F
	WR 125	79	F & R		CR 240	82-84	F
	XC 125	85-86	R		WR 240	82-84	F
	CR 240	80-84	R		CR 250	82-84	F
	WR 240	78	F & R		WR 250	82-84	F
	CR 250	71-74	R		XC 250	82-84	F
	CR 250	75-79	F & R		WR-E 430	82-84	F
	CR 250	80-84	R		WRU 430	82-84	F
	WR 250	71-74	R		AE 500	82-84	F
	WR 250	75-78	F & R		CR 500	82-84	F
	XC 250	85-86	R		XC 500	82-84	F
	360 Automatic	75-77	R				
	CR 360	75-78	F & R	811G	KTM		
	WR 360	75-78	F & R		MX 125	83	
	ACC 390	80-81	F & R	812G	KTM		
	ACCE 390	80-81	F & R		MX 125	83	R
	CR 390	75-81	F & R	814G	ATK		
	CR 390 Automatic	78	F & R		560	84-85	R
	WR 390	78	F & R		KTM		
	CR 400	71-74	F & R		80 MX	86-92	R
	WR 400	75-78	F & R		GSXC/GS 125	85	R
	CR 430	80-81	R		MX 125	84	F & R
	CR 450	71-74	F & R		MX/MXC 125	85	R
	WR 450	71-72	F & R		GSXC/GS 250	85	R
	CR 500	82-84	R		MX/MXC/GS 250	84	F & R
	XC 500	85-86	R		MX/MXC 250	85	R
	TC 510	87-	R		GSXC/GS 300	85	R
TE 510	87-89	R		MX/MXC 300	85	R	
TX 510	87-88	R		MX/MXC/XC-GS 500	85	R	
WMX 510	89	R					
WXE 510	89	R					
802G	HUSQVARNA			815	USE 873		
	CR 125	85-86	R	816	APRILIA		
	WR 125	80-81	F & R		Sport City 50 (4T)	08-12	R
	WR 125	82-84	R		SR 50 Motard (4T)	12-15	R
	XC 125	82-84	R		Mojito Custom 150	05-09	R
	CR 240	80-81	F		Scarabeo 100 4T	04-12	R
	CR 240	85-88	R		Sport City 125 (4T)	08-12	R
	WR 240	80-81	F & R		DERBI		
	WR 240	82-84	R		Boulevard 150	03-05	R
	WR 240	87-88	R		Atlantis Bullet/City	02-05	R
	CR 250	80-81	F		ITALJET		
	CR 250	85-88	R		Torpedo 125 4T	99-04	R
	WR 250	80-81	F & R		Torpedo 150	03	R
	WR 250	82-84	R		Jet Set 125/150	03	R
	WR 250	87-88	R		PIAGGIO		
XC 250	80-81	F & R	Fly 50		05-11	R	
XC 250	82-84	R	Fly 50 (4T/2V)	07-10	R		
XC 250	87-88	R	Fly 50 (4T/4V)	11-15	R		
WR 400	87-88	R	LT 50	97-05	R		



BRAKE SHOE BUYERS GUIDE

Part No.	Make/Model	Year	Fr/Rear	Part No.	Make/Model	Year	Fr/Rear
816 Contd.	PIAGGIO Contd.			859 Contd.	BMW		
	Typhoon 50 (4T/4V/14" wheels)	12-15	R		R 100 RS	9/89-92	R
	Typhoon 50 (4T/4V/12" wheels)	10-11	R		R 100 RT	09/89-95	R
	Typhoon 125 (4T) (12" wheels)	10-15	R		R 80 Mystic	94-95	R
	LT 150	98-04	R		R 80 R	91-94	R
	Fly 150	06-11	R		R 100 Mystic	93-96	R
	VESPA				R 100 R	91-95	R
	Primavera 50 (4T/4V)	13-15	R		R 850 GS	96	R
	Sprint 50 (4T/4V)	14-15	R				
	Primavera 150 (4T/3V/ie)	13-15	R				
Sprint 150 ABS (4T/3V/ie)	14-15	R					
817	APRILIA			860	BMW		
	Mojito Retro 50	04-05	R		R 45/45 N	78-09/80	R
	Mojito Custom 50	04-06	R		R 50/5 / 60/5 / 60/6 / 75/5	69-76	R
Scarabeo 100 4T	04-05	R	R 60/7		76-80	R	
			R 60 TIC		78-82	R	
			R 75/6, 75/5		73-79	R	
			R 80		77-09/80	R	
			R 80 TIC		78-08/80	R	
			R 90 S		73-76	R	
			R 90/6		73-76	R	
818	KYMCO STREET			R 100	76-77	R	
	People 50 (2T)	02-10	R	R 100/7 T	77-09/80	R	
	People S 50/125	05-09	R	R 100 S	76-08/80	R	
	People 150	07-12	R	R 100 RS	76-09/80	R	
	Super 8 (150cc)	07-12	R	R 100 RT	78-09/80	R	
	People S200	05-10	R				
	MALAGUTI						
Ciak 150	02-03	R					
820	KYMCO STREET			861	BMW		
	Super 8 (50cc) (2T)	07-12	R		R 45/45 N	10/80-85	R
	SYM				R 45 T	80-85	R
	Symba 110	09-12	F		R 65	07/88-08/89	R
	HS 125/200	04-10	R		R 65 GS	87-92	R
	Fiddle II 125 (AW 125 W)	08-12	R		R 65 RT	85-88	R
	Sym Wolf 150 Classic	11-14	R		R 65 T	80-85	R
	TGB/PEIRSPEED				R 80	10/80-84	R
Laser R9/i (151cc)	08-11	R	R 80/R 80 RT		84-95	R	
			R 80 RT		82-84	R	
821G	MAICO/M-STAR			R 80 GS	80-87	R	
	All Models	84-85	F	R 80 ST	82-84	R	
822G	MAICO/M-STAR			R 80 TIC	09/80-85	R	
	All Models	84-85	R	R 100/7T	09/80-84	R	
	Front disc models	85	R	R 100 RS	86/08/89	R	
824	USE 307/307G			R 100 RT	87-08/89	R	
				K 75/75-2 (Non ABS)	84-96	R	
				K 75/75-2 (ABS model)	84-07/90	R	
				K 75 C	85-12/88	R	
841G	BETA			862	BMW		
	125 TR 32/33	86-87	R		R 65 LS	81-85	R
	240 TR 33	86-88	R	863	BMW		
	CAGIVA				K 75/75-S (Non ABS)	84-08/88	R
WMX 125/250	-85	R	864	BMW			
MAICO/M-STAR				R 50/5 / 60/5 / 60/6 / 75/5	69-76	F	
	All models		F & R				
	Disc Models	86	R				
853	TRIUMPH			873	KTM		
	T 120 (650cc/Twin Leading Shoe)	66-70	F		60 SX	98-99	R
	T 150 (Trident 3 cycl)	69-72	F	65 SX	98-99	R	
854	TRIUMPH			893	APRILIA		
	T 120 (650cc/Twin Leading Shoe)	66-70	R		Scarabeo 50	99-05	R
	T 150 (Trident 3 cycl)	69-72	R		Rally 50 (Air cooled)	04-05	R
858	TRIUMPH				MALAGUTI		
	Cub 500		F & R		Yesterday	98-04	R
					Ciak 50	02-04	R
					F10 Jet Line	02-04	R
					F15 Firefox	02-03	R
859	BMW				PIAGGIO		
	R 80/R 80 RT	09/8-95	R		Typhoon 50	07-09	R
	R 80 GS	87-95	R				
	R 80 PD/CH	90-95	R				
	R 100 GS	86-94	R				
	R 100 PD	89-96	R				

BRAKE SHOE BUYERS GUIDE

Part No.	Make/Model	Year	Fr/Rear	Part No.	Make/Model	Year	Fr/Rear
897	TGB/PEIRSPEED						
	101 S/Key West (50)	05-08	R				
	Delivery 50 (Up to E.No. 609099)	05-06	R				
	Delivery 50 (From F.No. 609100)	06-08	R				
	Sunset 50	06-08	R				
899	PIAGGIO						
	Typhoon 50/SE	06	R				
	Typhoon 50 (2T) 10" wheels	07-09	R				
	VESPA						
	ET2 50cc	97-05	R				
	LX 50	05-15	R				
	S 50 4T/4V	08-15	R				
	ET4 150cc	99-05	R				
	LX 150 ie	05-15	R				
	LXV 150 ie	10-15	R				
S 150	08-15	R					
903	VESPA PX 150 (All models)	05-06	R				
921	DUCATI 250/350/450 'Desmo'	74-77	R				
928	DUCATI 250/350/450 'Desmo'	-76	F				
929	DUCATI 250/350/450 'Desmo'	-76	R				
938	HYOSUNG						
	TE 50	05-08	F				
	TE 90	05-08	F				
	TE 100	05-08	F				
944G	CAGIVA WMX 125	-85	F				
950	CZ/JAWA						
	Scrambler Cross 125-380	65-76	F & R				
	Jawa 250/400 Cross	65-76	F & R				
	250/380 (Models 513/514)	77-79	R				
977G	CAGIVA WMX 125/250	86-88	R				
978	MUZ 500 Country	93-98	R				
982G	CAGIVA WMX 500	84-86	R				
984	HUSQVARNA						
	Husky Boy Racing S	00	F & R				
	Husky Boy Drum front & rear	00-02	F & R				
	Husky Boy Racing J	00	F & R				
	Husky Boy J/S	01-02	R				
	Husky Boy R	01	R				

BUYERS GUIDE
BRAKE SHOES

GOLF CART BRAKE SHOE BUYERS GUIDE

Part No.	Make/Model	Year	Type	Fr/Rear	Part No.	Make/Model	Year	Type	Fr/Rear
GOLFS1	CLUB CAR				GOLFS1	YAMAHA Contd.			
	DS	95-	Gas/Elec	R (L&R)	Contd.	G11AK	94	Gas	F & R (L&R)
	Precedent Signature 4Pass	04-	Gas/Elec	R (L&R)		G1AM	86	Gas	R (L&R)
	Precedent	04-	Gas/Elec	R (L&R)		G1AM4	84	Gas	R (L&R)
	Precedent L2	04-	Gas/Elec	R (L&R)		G1AM5	85	Gas	R (L&R)
	Precedent Professional IQ	04-	Gas/Elec	R (L&R)		G1AMD	89	Gas	R (L&R)
	Precedent Signature	04-	Gas/Elec	R (L&R)		G2-A	86	Gas	F & R (L&R)
	Precedent Villager 4	04-	Gas/Elec	R (L&R)		G2-AB	88	Gas	F & R (L&R)
	Precedent Villager 4 IQ	04-	Gas/Elec	R (L&R)		G2-AC	88	Gas	F & R (L&R)
	Precedent Professional	04-	Gas/Elec	R (L&R)		G2-AD	89	Gas	F & R (L&R)
	XRT1200	05-	Gas	R (L&R)		G2-AF	90	Gas	F & R (L&R)
	XRT1200SE	05-	Gas	R (L&R)		G2-AG	91	Gas	F & R (L&R)
	EZGO					G2-AM5	85	Gas	F & R (L&R)
	Express L4	12-15	Gas/Elec	R (L&R)		G2-E	86	Elec	F & R (L&R)
	Express L6	12-16	Gas/Elec	R (L&R)		G2-E5	85	Elec	F & R (L&R)
	Express S4	12-16	Gas/Elec	R (L&R)		G2-EB	87-88	Elec	F & R (L&R)
	Express S6	12-16	Gas/Elec	R (L&R)		G2-EC	88	Elec	F & R (L&R)
	Marathon 3 Wheel	89-92	Elec	R (L&R)		G2-ED	89	Elec	F & R (L&R)
	Marathon 4 Wheel	89-92	Elec	R (L&R)		G2-EF	90	Elec	F & R (L&R)
	Marathon GX444 2-cycle	91-93	Gas	R (L&R)		G2-EG	91	Elec	F & R (L&R)
	Marathon GX444 4-cycle	91-93	Gas	R (L&R)		G2AB	87	Gas	F & R (L&R)
	Marathon Spirit GX444J 2-Cycle	91	Gas	R (L&R)		G3A	86	Gas	R (L&R)
	Marathon Spirit GX444J 4-Cycle	91-93	Gas	R (L&R)		G3E	87	Elec	F & R (L&R)
	Medalist	93-95	Gas	R (L&R)		G5AF	90	Gas	F & R (L&R)
	Medalist	93-96	Elec	R (L&R)		G5AG	91	Gas	F & R (L&R)
	Medalist	96-99	Gas	R (L&R)		G5AH	92	Gas	F & R (L&R)
	Medalist (DCS)	95-96	Elec	R (L&R)		G5AJ	93	Gas	F & R (L&R)
	MPT 1000	10-12	Elec	R (L&R)		G5AK	94	Gas	F & R (L&R)
	MPT 800	10-12	Elec	R (L&R)		G5AM	95	Gas	F & R (L&R)
	RXV Standard	09-16	Gas	R (L&R)		G5EF	90	Elec	F & R (L&R)
	RXV with Lights	09-16	Gas	R (L&R)		G5EG	91	Elec	F & R (L&R)
	RXV with Lights and Rear Seat	09-16	Gas	R (L&R)		G5EH	92	Elec	F & R (L&R)
	ST 400	10-12	Elec	R (L&R)		G8AF	90	Gas	F & R (L&R)
	ST Sport II	11-12	Elec	R (L&R)		G8AG	91	Gas	F & R (L&R)
	Terrain 250	12-16	Elec	R (L&R)		G8AH	92	Gas	F & R (L&R)
	TXT Standard	96	Gas/Elec	R (L&R)		G8AJ	93	Gas	F & R (L&R)
	TXT Standard	08-13	Elec	R (L&R)		G8AK	94	Gas	F & R (L&R)
	TXT Standard	10-13	Gas	R (L&R)		G8EF	90	Elec	F & R (L&R)
	TXT Standard (DCS)	1996	Elec	R (L&R)		G8EG	91	Elec	F & R (L&R)
	TXT Standard Redesigned	14-16	Gas	R (L&R)		G8EH	92	Elec	F & R (L&R)
	TXT Standard Redesigned	14-17	Elec	R (L&R)		G8EJ	92	Elec	F & R (L&R)
	TXT with Lights	96	Gas/Elec	R (L&R)		G8EK	94	Elec	F & R (L&R)
	TXT with Lights	08-13	Elec	R (L&R)		G8EKP	94	Elec	F & R (L&R)
	TXT with Lights	10-13	Gas	R (L&R)		G9EG	91	Elec	F & R (L&R)
	TXT with Lights (DCS)	96	Elec	R (L&R)		G9EH1	92	Elec	F & R (L&R)
	TXT with Lights and Rear Seat	13-16	Gas	R (L&R)		YDRAX5	15	Gas	F & R (L&R)
	TXT with Lights Redesigned	14	Elec	R (L&R)		YDRAX5 F	15	Gas	F & R (L&R)
	YAMAHA					YDRAX5 PTV	15	Gas	F & R (L&R)
	DR2A17	17	Gas	R (L&R)		YDRAX5 PTV4	15	Gas	F & R (L&R)
	DR2A17 EFI	17	Gas	R (L&R)		YDRAX5 PTV6	15	Gas	F & R (L&R)
	DR2A17 PTV	17	Gas	R (L&R)		YDRAX5 SPOR	15	Gas	F & R (L&R)
	DR2A18	18	Gas	R (L&R)		YDRAX5 SUP	15	Gas	F & R (L&R)
	DR2A18 EFI	18	Gas	R (L&R)		YDRAX6	16	Gas	R (L&R)
	DR2A18 PTV	18	Gas	R (L&R)		YDRAX6 F	16	Gas	R (L&R)
	DR2E17 AC	17	Elec	R (L&R)		YDRAX6 PTV	16	Gas	R (L&R)
	DR2E17 PTV	17	Elec	R (L&R)		YDRAX6 SPO	16	Gas	R (L&R)
	DR2E18	18	Gas	R (L&R)		YDRAX6 SUP	16	Gas	R (L&R)
	DR2E18 AC	18	Gas	R (L&R)		YDRE X5	15	Elec	F & R (L&R)
	DR2E18 PTV	18	Gas	R (L&R)		YDRE X5 ACP	15	Elec	F & R (L&R)
	DRIVE-YDRA	11	Gas	F & R (L&R)		YDRE X5 ACS	15	Elec	F & R (L&R)
	DRIVE-YDRE	11	Elec	F & R (L&R)		YDRE X5 PTV	15	Elec	F & R (L&R)
	G1-A3	82	Gas	R (L&R)		YDRE X5 PTV4	15	Elec	F & R (L&R)
	G1-AM	86	Gas	R (L&R)		YDRE X5 PTV6	15	Elec	F & R (L&R)
	G1-AM3	83	Gas	R (L&R)		YDRE X5 SPO	15	Elec	F & R (L&R)
	G1-AM5	85	Gas	R (L&R)		YDRE X6	16	Elec	R (L&R)
	G1-E3	82	Elec	R (L&R)		YDRE X6 AC	16	Elec	R (L&R)
	G1-EM	86	Elec	R (L&R)		YDRE X6 PTV	16	Elec	R (L&R)
	G1-EM3	83	Elec	R (L&R)		YDRE X6 PTV4	16	Elec	R (L&R)
	G1-EM4	84	Elec	R (L&R)		YDRE X6 PTV6	16	Elec	R (L&R)
	G1-EM5	85	Elec	R (L&R)		YDRE X6 SPO	16	Elec	R (L&R)
	G11AJ	93	Gas	F & R (L&R)		YDRE X6 SUP	16	Elec	R (L&R)

GOLF CART BRAKE SHOE BUYERS GUIDE

Part No.	Make/Model	Year	Type	Fr/Rear	Part No.	Make/Model	Year	Type	Fr/Rear
GOLFS1 Contd.	YAMAHA Contd.				GOLFS2 Contd.	YAMAHA Contd.			
	YTF1 A18	18	Gas	F & R (L&R)		G11AR	97	Gas	R (L&R)
	YTF1 AX5 SP	15	Gas	F & R (L&R)		G11AS	98	Gas	F & R (L&R)
	YTF1 AX6 F	16	Gas	R (L&R)		G11AT	99	Gas	F & R (L&R)
	YTF1 AX6 SP	16	Gas	R (L&R)		G11AU	00	Gas	F & R (L&R)
	YTF1 EX5 AC	15	Elec	R (L&R)		G11AW	01	Gas	F & R (L&R)
	YTF1 EX6 AC	16	Elec	R (L&R)		G14AM	95	Gas	F & R (L&R)
	YTF2	09	Gas	F & R (L&R)		G14AP	96	Gas	F & R (L&R)
	YTF2 A18	18	Gas	F & R (L&R)		G14EM	95	Elec	F & R (L&R)
	YTF2 AT X5	15	Gas	F & R (L&R)		G14EP	96	Elec	F & R (L&R)
	YTF2 AT X5-2	15	Gas	F & R (L&R)		G16AP	96	Gas	F & R (L&R)
	YTF2 AT X5-3	15	Gas	F & R (L&R)		G16AR	97	Gas	F & R (L&R)
	YTF2 AT X5-4	15	Gas	F & R (L&R)		G16AS	98	Gas	F & R (L&R)
	YTF2 AX 4	14	Gas	F & R (L&R)		G16AT	99	Gas	F & R (L&R)
	YTF2 AX 4F	14	Gas	F & R (L&R)		G16AU	00	Gas	F & R (L&R)
	YTF2 AX 5F	15	Gas	F & R (L&R)		G16AW	01	Gas	F & R (L&R)
	YTF2 AX 6-BE	16	Gas	F & R (L&R)		G16AX	02	Gas	F & R (L&R)
	YTF2 AX 6F	16	Gas	F & R (L&R)		G16EP	96	Elec	F & R (L&R)
	YTF2 E18	18	Gas	F & R (L&R)		G16ER	97	Elec	F & R (L&R)
	YTF2 EX5	15	Elec	R (L&R)		G16ES	98	Elec	F & R (L&R)
	YTF2 P	10	Gas	F & R (L&R)		G16ET	99	Elec	F & R (L&R)
	YTF2 X	11	Gas	F & R (L&R)		G16EU	00	Elec	F & R (L&R)
	YTF2 X SVB2	11-13	Gas	F & R (L&R)		G16EW	01	Elec	F & R (L&R)
	YTF2 X2	12	Gas	F & R (L&R)		G16EX	02	Elec	F & R (L&R)
	YTF2 X3	13	Gas	F & R (L&R)		G19EP	96	Elec	F & R (L&R)
	YTF2 XP	11	Gas	F & R (L&R)		G19ER	97	Elec	F & R (L&R)
YTF2 XP SVB	11-13	Gas	F & R (L&R)	G19ES	98	Elec	F & R (L&R)		
GOLFS2	CLUB CAR				G19ET	99	Elec	F & R (L&R)	
	Café Express	95-04	Gas	R (L&R)	G19EU	00	Elec	F & R (L&R)	
	Carryall 1	95-04	Gas	R (L&R)	G19EW	01	Elec	F & R (L&R)	
	Carryall 2	95-04	Gas	R (L&R)	G19EX	02	Elec	F & R (L&R)	
	Carryall 2 Plus	95-04	Gas	R (L&R)	G20AU	00	Gas	F & R (L&R)	
	Carryall 232	95-04	Gas	R (L&R)	G20AW	01	Gas	F & R (L&R)	
	Carryall 252	95-04	Gas	R (L&R)	G20AX	02	Gas	F & R (L&R)	
	Carryall 272	95-04	Gas	R (L&R)	G21AW	01	Gas	F & R (L&R)	
	Carryall 294	95-04	Gas	R (L&R)	G21AX	02	Gas	F & R (L&R)	
	Carryall 295	95-04	Gas	R (L&R)	G21AY	03	Gas	F & R (L&R)	
	Carryall 472	95-04	Gas	R (L&R)	G21AZ	04	Gas	F & R (L&R)	
	Carryall 6	95-04	Gas	R (L&R)	G22AA	05	Gas	F & R (L&R)	
	Champion	95-04	Gas	R (L&R)	G22AB	05	Gas	F & R (L&R)	
	DS	95-04	Gas	R (L&R)	G22AC	06	Gas	F & R (L&R)	
	Fairway Villager	95-04	Gas	R (L&R)	G22AD	06	Gas	F & R (L&R)	
	Pioneer 1200	95-04	Gas	R (L&R)	G22AD-LE	06	Gas	F & R (L&R)	
	Pioneer 1200SE	95-04	Elec	R (L&R)	G22AE	07	Gas	F & R (L&R)	
	Pioneer 900	95-04	Gas	R (L&R)	G22AY	03	Gas	F & R (L&R)	
	Precedent	95-04	Gas/Elec	R (L&R)	G22AZ	04	Gas	F & R (L&R)	
	Transporter 4	95-04	Gas	R (L&R)	G22EA	05	Elec	F & R (L&R)	
	Transporter 6	95-04	Gas	R (L&R)	G22EB	05	Elec	F & R (L&R)	
	Turf 1	95-04	Gas	R (L&R)	G22EC	06	Elec	F & R (L&R)	
	Turf 2	95-04	Gas	R (L&R)	G22ED	06	Elec	F & R (L&R)	
	Turf 252	95-04	Gas	R (L&R)	G22ED-LE	06	Elec	F & R (L&R)	
	Turf 6	95-04	Gas	R (L&R)	G22EE	07	Elec	F & R (L&R)	
	Villager 2+2	95-04	Gas	R (L&R)	G22EY	03	Elec	F & R (L&R)	
	Villager 6	95-04	Gas	R (L&R)	G22EZ	04	Elec	F & R (L&R)	
	Villager 8	95-04	Gas	R (L&R)	G23AC	06	Gas	F & R (L&R)	
	X2	95-04	Gas	R (L&R)	G23AE	07	Gas	F & R (L&R)	
	XRT1200	95-04	Gas	R (L&R)	G23AF	08	Gas	F & R (L&R)	
	XRT1200SE	95-04	Elec	R (L&R)	G23AG	09	Gas	F & R (L&R)	
	XRT1500	95-04	Gas	R (L&R)	G23AZ	04	Gas	F & R (L&R)	
	XRT1500SE	95-04	Elec	R (L&R)	G23EC	06	Elec	F & R (L&R)	
	XRT800	95-04	Gas	R (L&R)	G23EE	07	Elec	F & R (L&R)	
	XRT800E	95-04	Elec	R (L&R)	G23EF	08	Elec	F & R (L&R)	
	XRT810	95-04	Gas	R (L&R)	G23EZ	04	Elec	F & R (L&R)	
	XRT810E	95-04	Elec	R (L&R)	G27AC	06	Gas	F & R (L&R)	
	XRT850	95-04	Gas	R (L&R)	G27AE	07	Gas	F & R (L&R)	
	XRT900	95-04	Gas	R (L&R)	G27AF	08	Gas	F & R (L&R)	
	XRT950 2x4	95-04	Gas	R (L&R)	G27AZ	04-05	Gas	F & R (L&R)	
	XRT950EX 4x4	95-04	Gas	R (L&R)	G27EC	06	Gas	F & R (L&R)	
	YAMAHA	G11-AP	96	Gas	R (L&R)	G27EE	07	Elec	F & R (L&R)
						G27EF	08	Elec	F & R (L&R)
						G27EZ	04-05	Elec	F & R (L&R)

GOLF CART BRAKE SHOE BUYERS GUIDE

Part No.	Make/Model	Year	Type	Fr/Rear	Part No.	Make/Model	Year	Type	Fr/Rear
GOLFS2 Contd.	YAMAHA Contd.								
	G28AA	05	Gas	R (L&R)					
	G28AC	06	Gas	R (L&R)					
	G28AE	07	Gas	R (L&R)					
	G28AF	08	Gas	R (L&R)					
	G28AG	09	Gas	R (L&R)					
	G28AZ	04	Gas	R (L&R)					
	G9AG	91	Gas	F & R (L&R)					
	G9AH	92	Gas	F & R (L&R)					
	G9AJ	93	Gas	F & R (L&R)					
	G9AJ LATE	93	Gas	F & R (L&R)					
	G9AK	94	Gas	F & R (L&R)					
	G9EG	91	Elec	F & R (L&R)					
	G9EH2	92	Elec	F & R (L&R)					
	G9EJ	93	Elec	F & R (L&R)					
	G9EK	94	Elec	F & R (L&R)					
	G9EKP	94	Elec	F & R (L&R)					
GOLFS5	CLUB CAR								
	Café Express	81-94	Gas	R (L&R)					
	Carryall 1	81-94	Gas	R (L&R)					
	Carryall 2	81-94	Gas	R (L&R)					
	Carryall 2 Plus	81-94	Gas	R (L&R)					
	Carryall 232	81-94	Gas	R (L&R)					
	Carryall 252	81-94	Gas	R (L&R)					
	Carryall 272	81-94	Gas	R (L&R)					
	Carryall 294	81-94	Gas	R (L&R)					
	Carryall 295	81-94	Gas	R (L&R)					
	Carryall 472	81-94	Gas	R (L&R)					
	Carryall 6	81-94	Gas	R (L&R)					
	Champion	81-94	Gas	R (L&R)					
	DS	81-94	Gas	R (L&R)					
	Fairway Villager	81-94	Gas	R (L&R)					
	Pioneer 1200	81-94	Gas	R (L&R)					
	Pioneer 1200SE	81-94	Elec	R (L&R)					
	Pioneer 900	81-94	Gas	R (L&R)					
	Precedent	81-94	Gas/Elec	R (L&R)					
	Transporter 4	81-94	Gas	R (L&R)					
	Transporter 6	81-94	Gas	R (L&R)					
	Turf 1	81-94	Gas	R (L&R)					
	Turf 2	81-94	Gas	R (L&R)					
	Turf 252	81-94	Gas	R (L&R)					
	Turf 6	81-94	Gas	R (L&R)					
	Villager 2+2	81-94	Gas	R (L&R)					
	Villager 6	81-94	Gas	R (L&R)					
	Villager 8	81-94	Gas	R (L&R)					
	X2	81-94	Gas	R (L&R)					
	XRT1200	81-94	Gas	R (L&R)					
	XRT1200SE	81-94	Elec	R (L&R)					
	XRT1500	81-94	Gas	R (L&R)					
	XRT1550SE	81-94	Elec	R (L&R)					
	XRT800	81-94	Gas	R (L&R)					
XRT800E	81-94	Elec	R (L&R)						
XRT810	81-94	Gas	R (L&R)						
XRT810E	81-94	Elec	R (L&R)						
XRT850	81-94	Gas	R (L&R)						
XRT900	81-94	Gas	R (L&R)						
XRT950 2x4	81-94	Gas	R (L&R)						
XRT950EX 4x4	81-94	Gas	R (L&R)						

BRAKE SHOE ILLUSTRATIONS

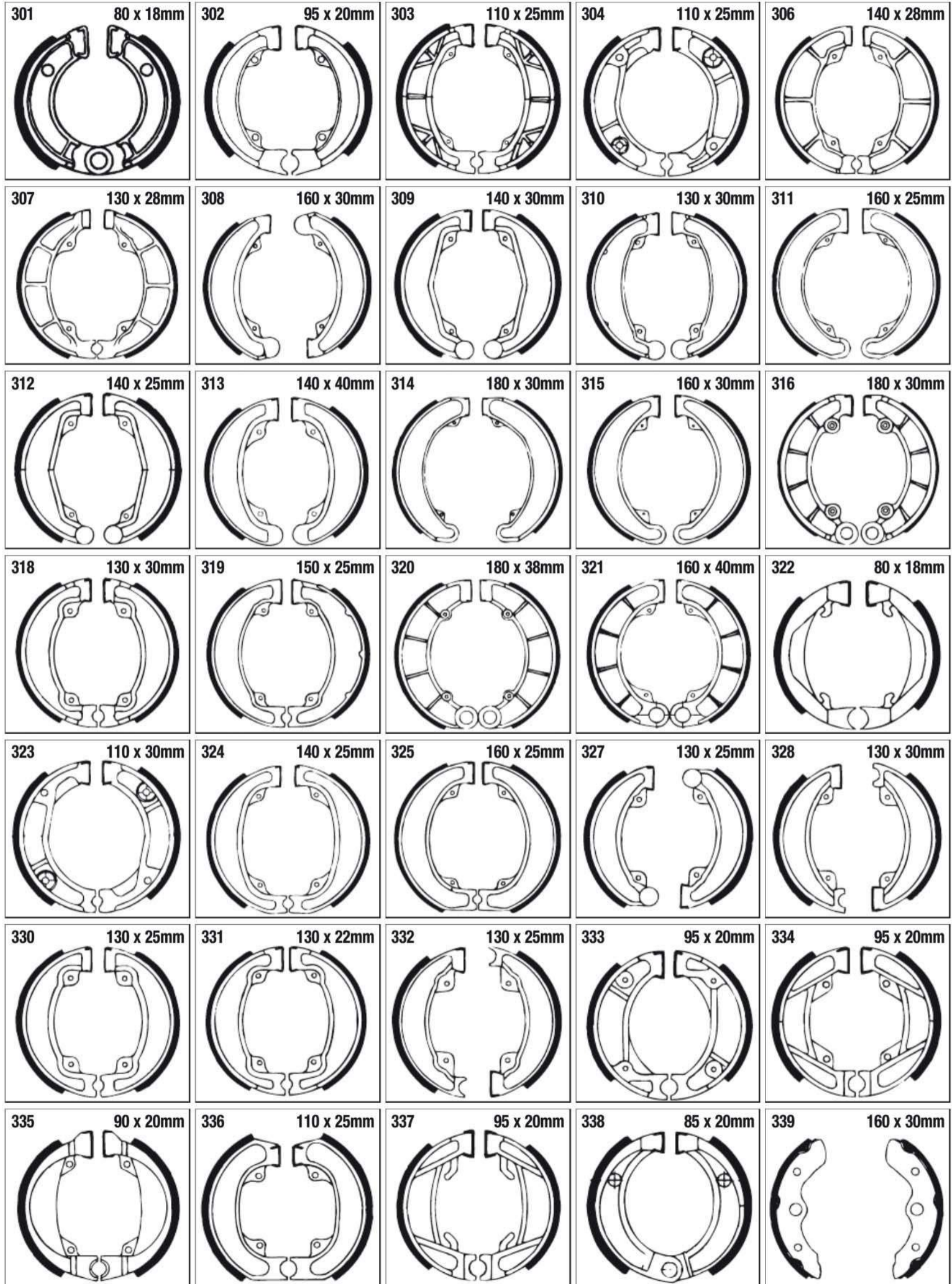



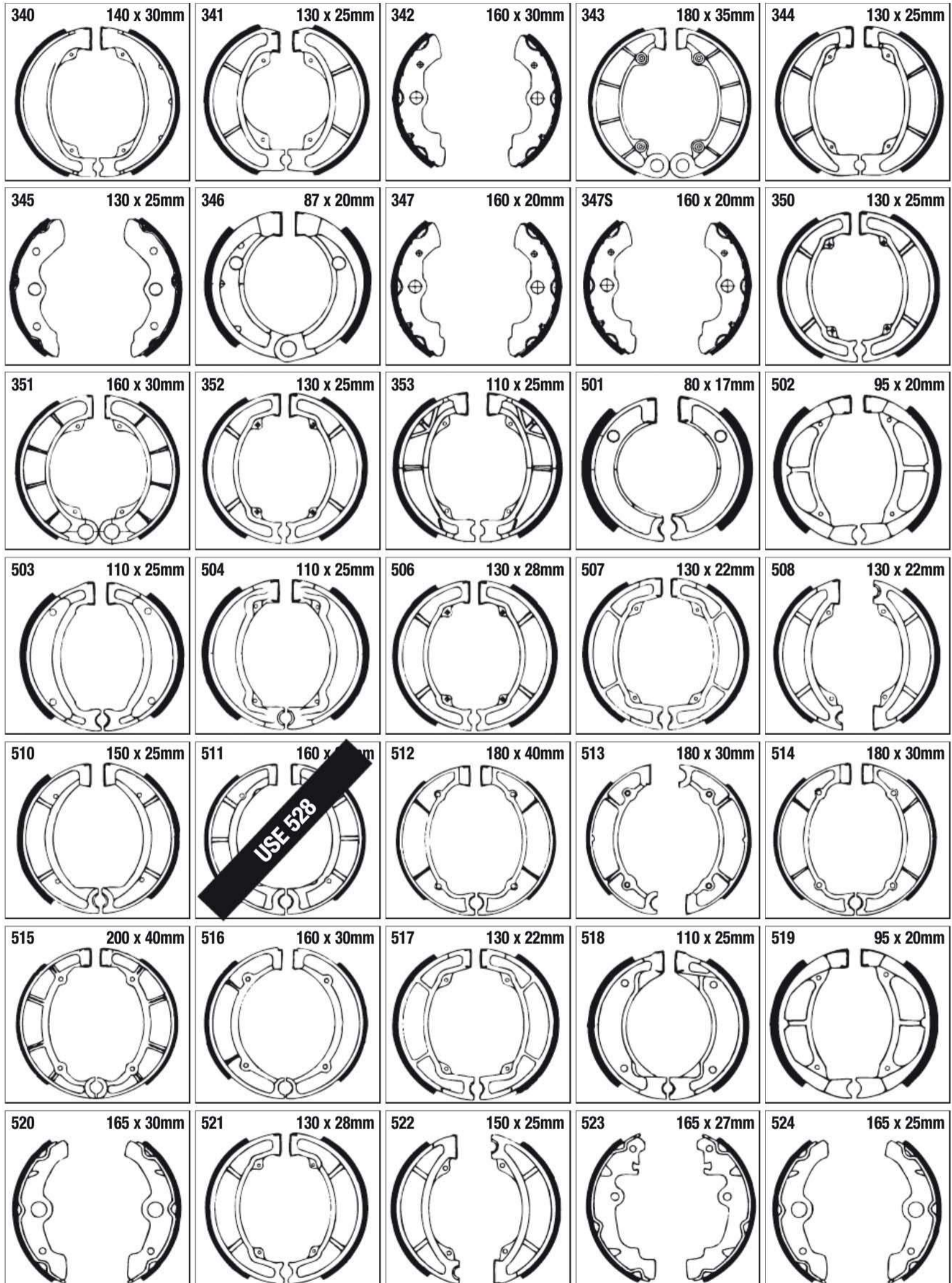





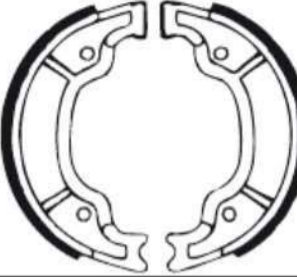
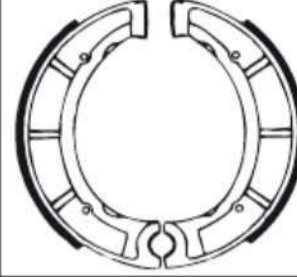
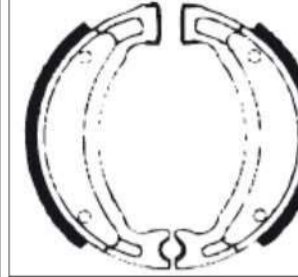
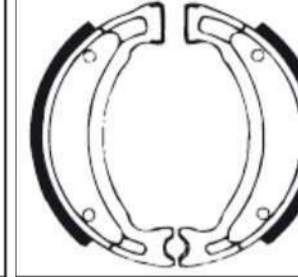
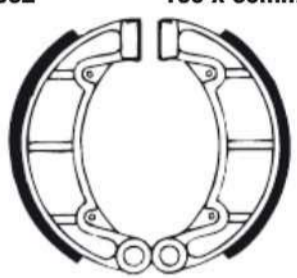

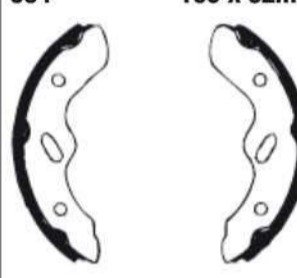
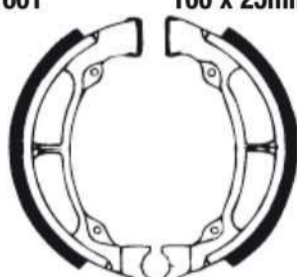
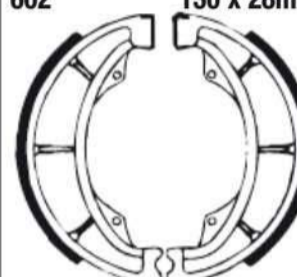
BRAKE SHOE ILLUSTRATIONS

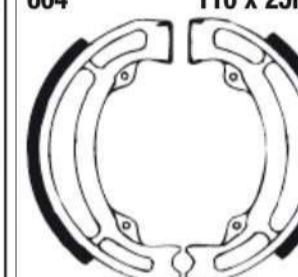
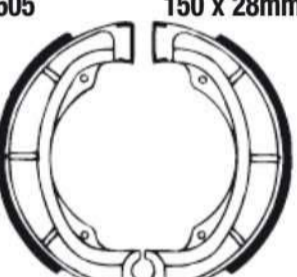
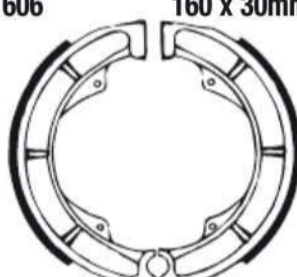
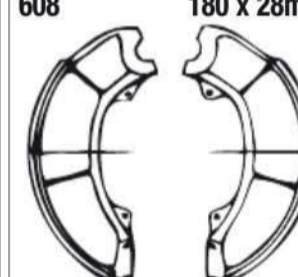
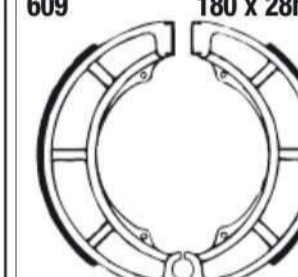

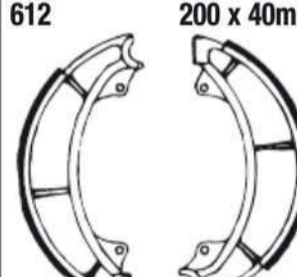
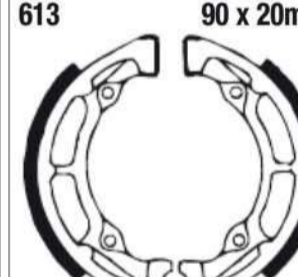
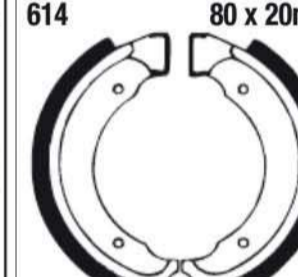
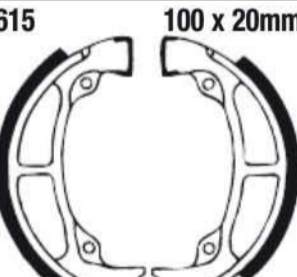
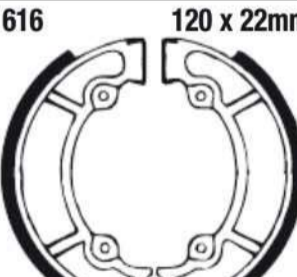
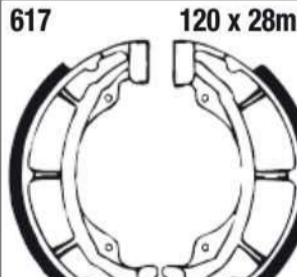
BRAKE SHOE ILLUSTRATIONS

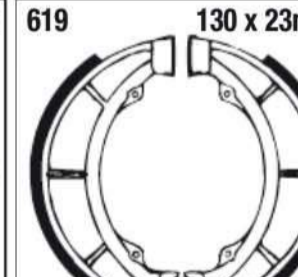
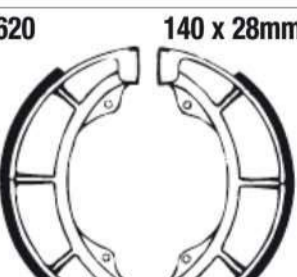
BUYERS GUIDE
BRAKE SHOES

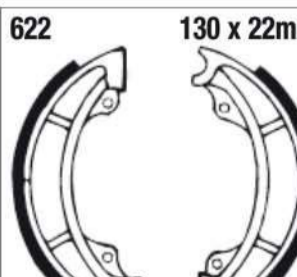
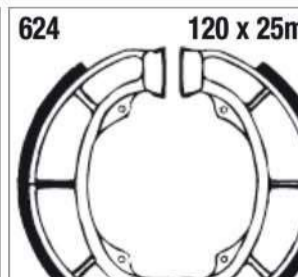
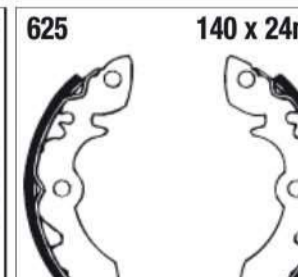

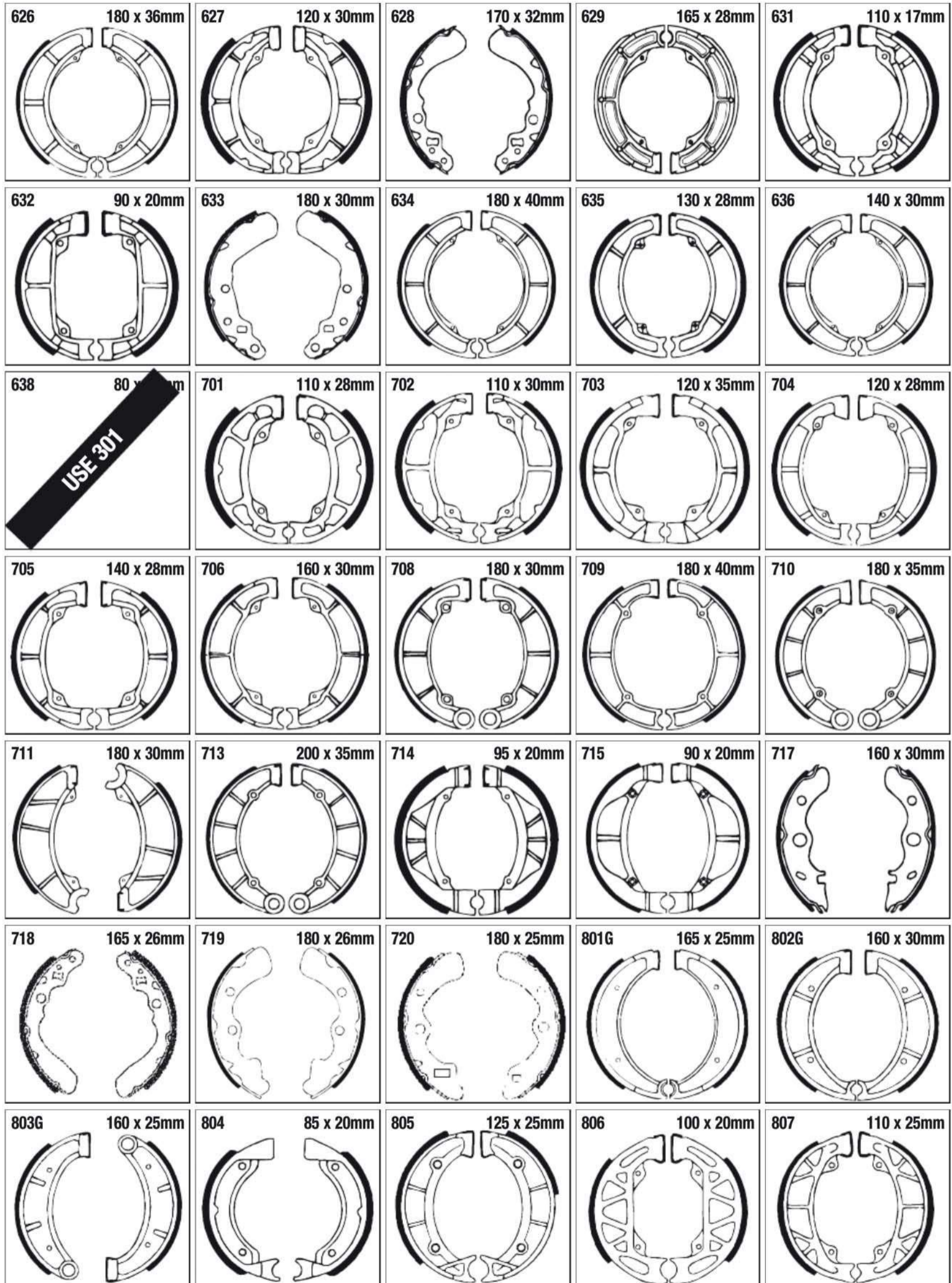

526 200 x 35mm 	527 130 x 28mm 	528 159 x 25mm 	530 110 x 25mm 	531 130 x 28mm 
532 160 x 30mm 	533 150 x 28mm 	534 160 x 32mm 	535 130 x 28mm PIC NOT AVAILABLE	536 100 x 20mm PIC NOT AVAILABLE
537 PIC NOT AVAILABLE	601 100 x 25mm 	602 130 x 28mm 	603 110 x 30mm 	604 110 x 25mm 
605 150 x 28mm 	606 160 x 30mm 	607 160 x 32mm DISCONTINUED	608 180 x 28mm 	609 180 x 28mm 
610 180 x 32mm USE 634	611 180 x 32mm 	612 200 x 40mm 	613 90 x 20mm 	614 80 x 20mm 
615 100 x 20mm 	616 120 x 22mm 	617 120 x 28mm 	618 130 x 22mm 	619 130 x 23mm 
620 140 x 28mm 	621 150 x 22mm 	622 130 x 22mm 	624 120 x 25mm 	625 140 x 24mm 

BRAKE SHOE ILLUSTRATIONS



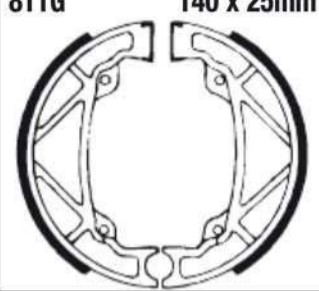
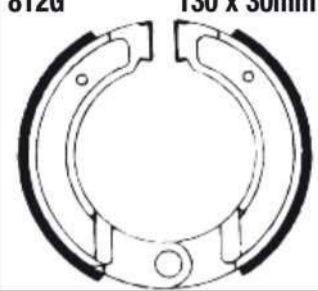

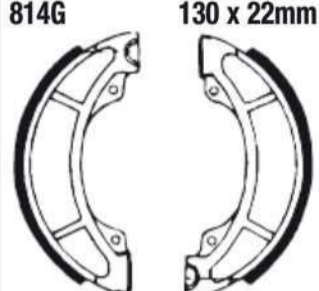
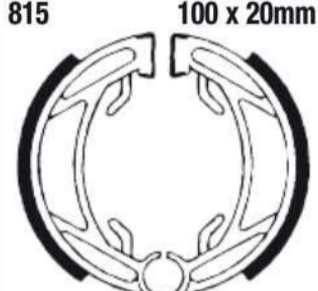
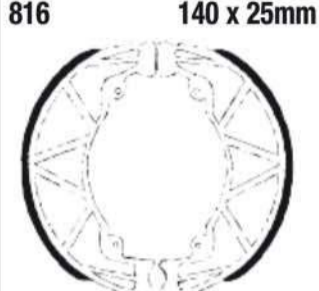
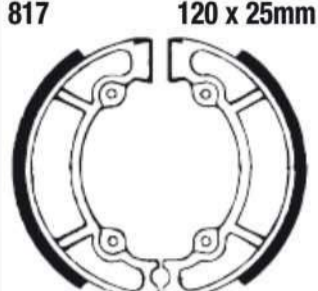
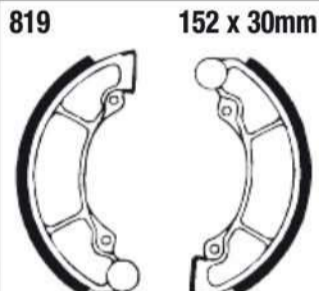
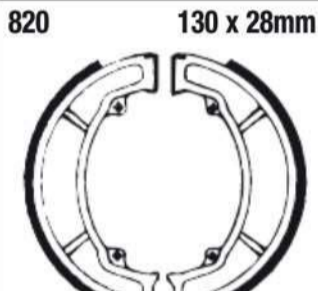
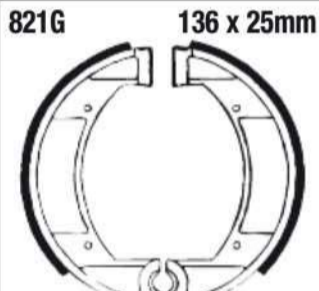
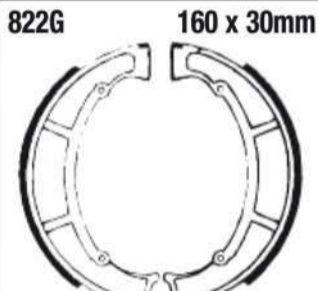

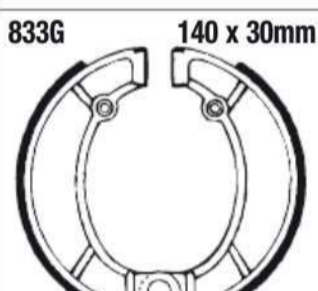
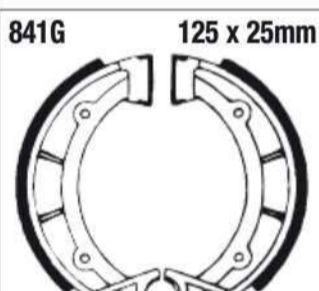
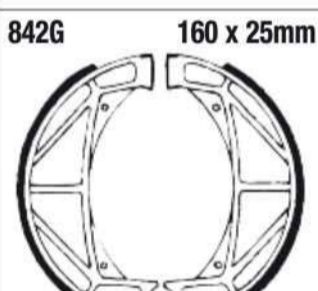
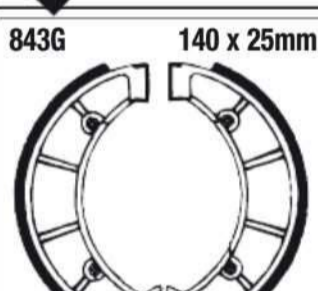
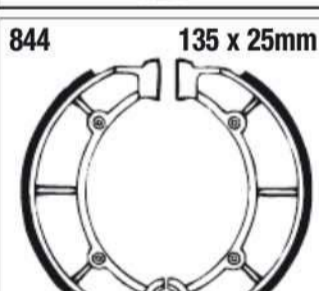
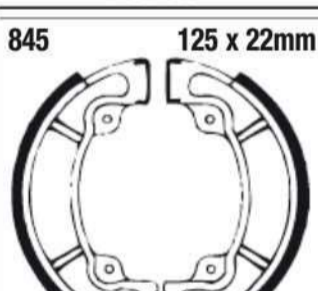
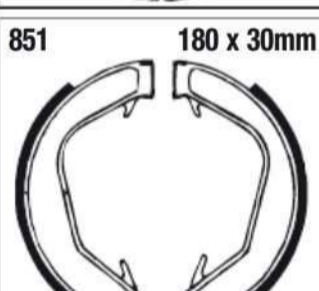
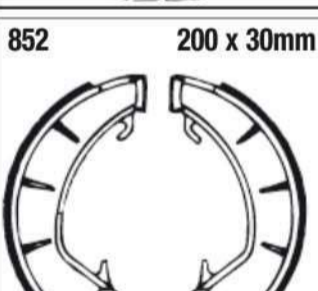
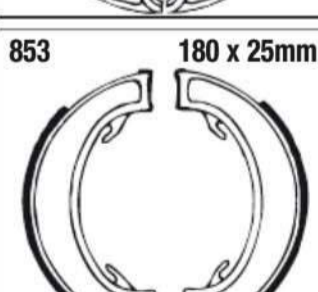
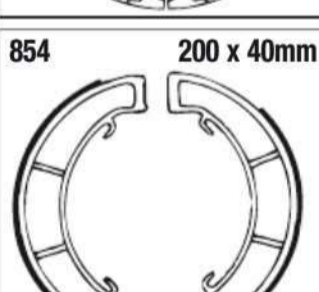
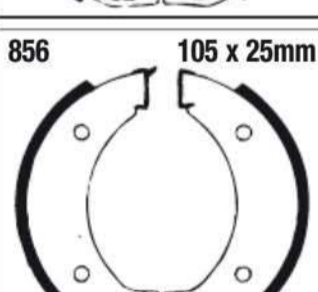
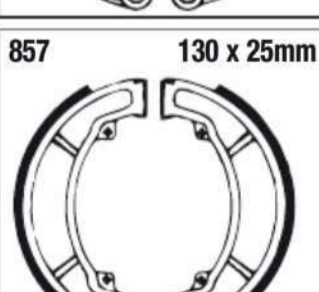
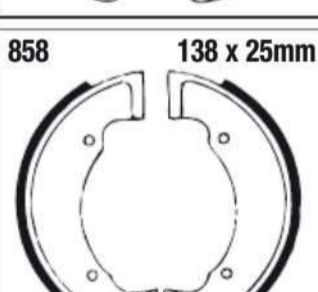
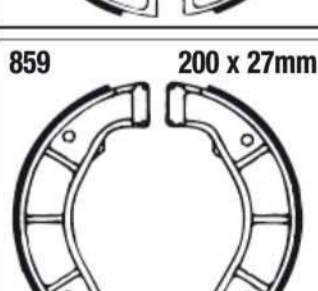
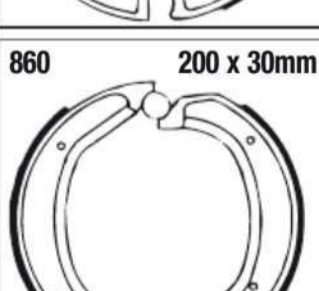
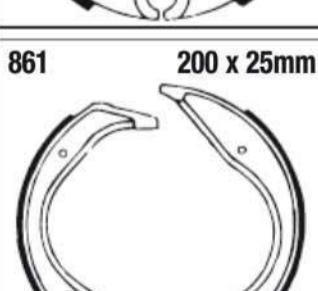
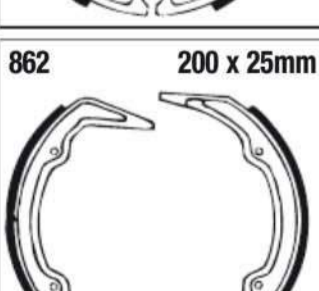
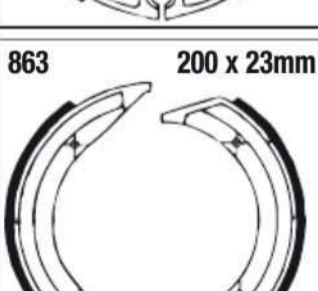

BRAKE SHOE ILLUSTRATIONS

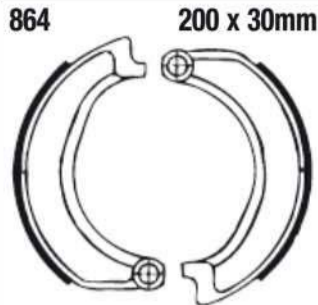
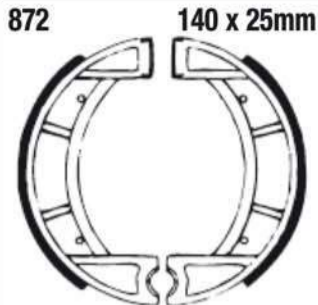
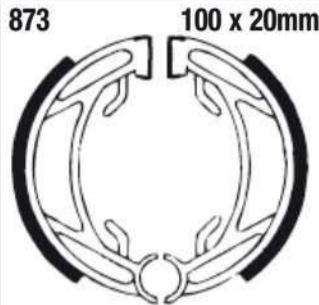
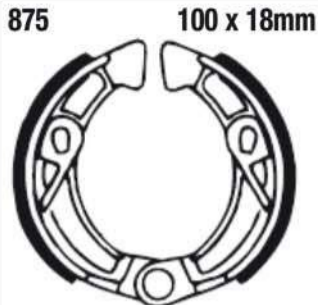
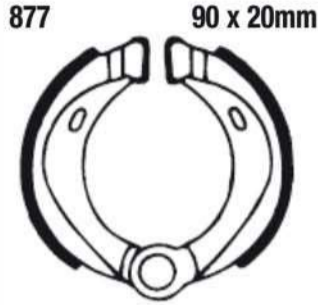
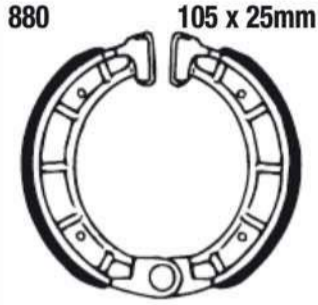
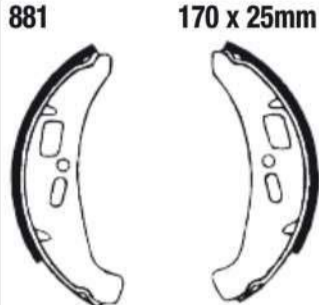
BUYERS GUIDE
BRAKE SHOES

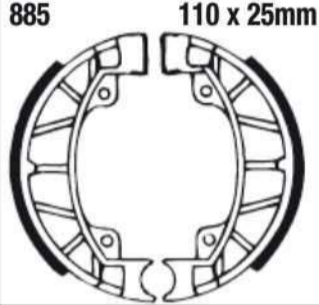
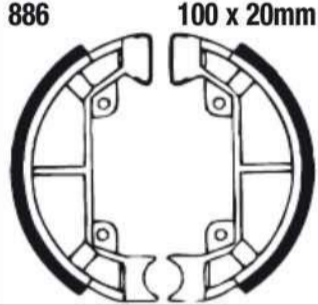
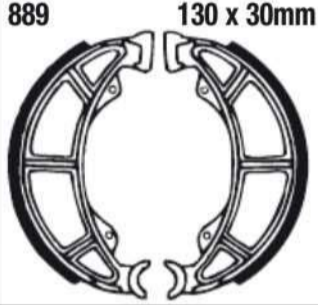
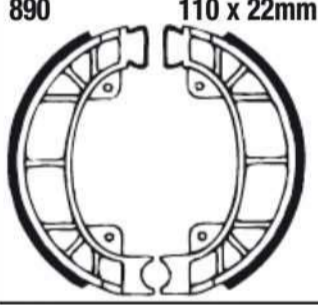
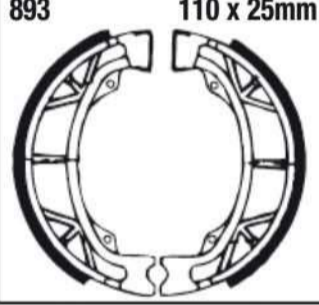
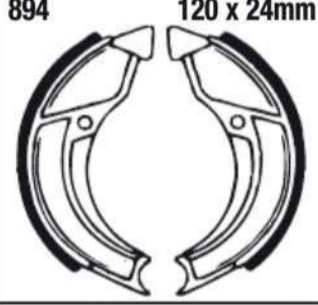

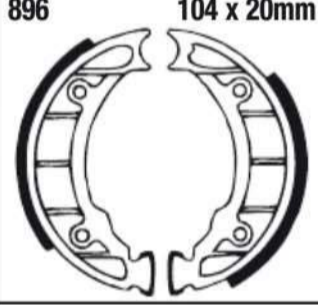
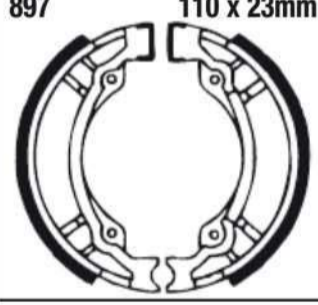
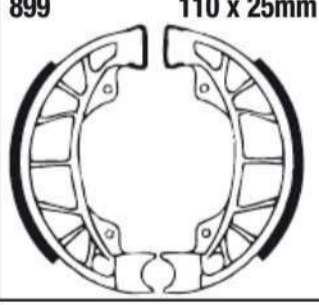
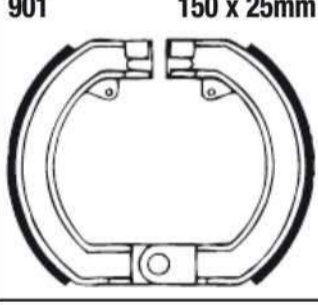
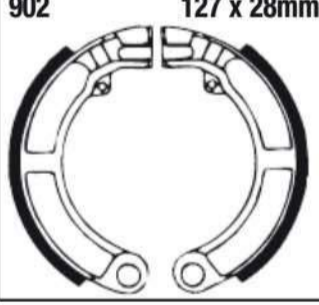
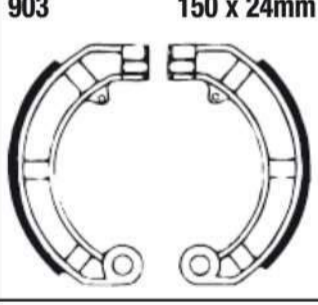
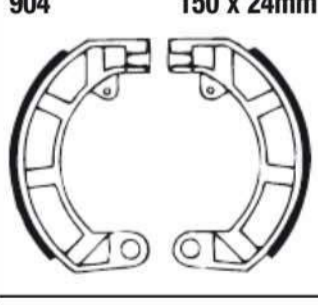
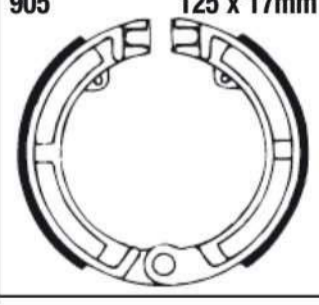
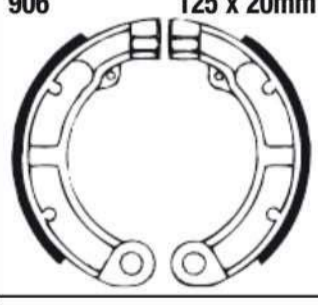
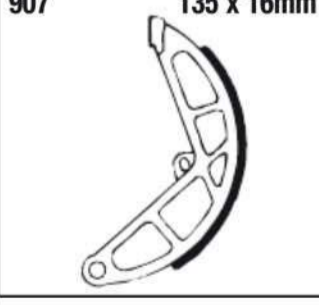
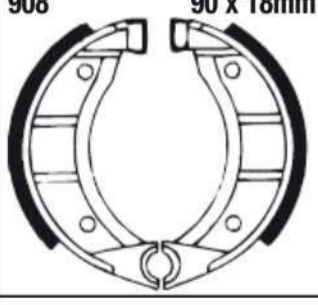
808 100 x 22mm PIC NOT AVAILABLE	809 150 x 24mm PIC NOT AVAILABLE	810 140 x 25mm USE 816	811G 140 x 25mm 	812G 130 x 30mm 
813G 181 x 25mm 	814G 130 x 22mm 	815 100 x 20mm 	816 140 x 25mm 	817 120 x 25mm 
818 130 x 25mm PIC NOT AVAILABLE	819 152 x 30mm 	820 130 x 28mm 	821G 136 x 25mm 	822G 160 x 30mm 
824 130 x 25mm USE 307/307G	831G 125 x 25mm 	833G 140 x 30mm 	841G 125 x 25mm 	842G 160 x 25mm 
843G 140 x 25mm 	844 135 x 25mm 	845 125 x 22mm 	851 180 x 30mm 	852 200 x 30mm 
853 180 x 25mm 	854 200 x 40mm 	856 105 x 25mm 	857 130 x 25mm 	858 138 x 25mm 
859 200 x 27mm 	860 200 x 30mm 	861 200 x 25mm 	862 200 x 25mm 	863 200 x 23mm 

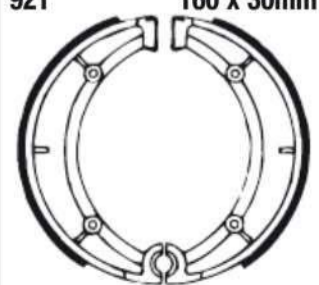
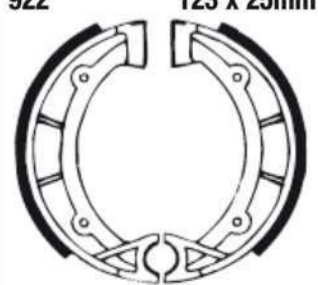
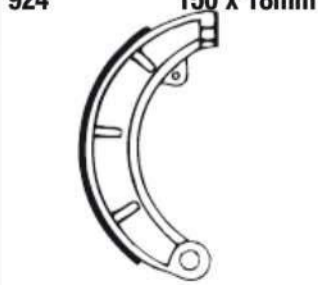
BRAKE SHOE ILLUSTRATIONS

864 200 x 30mm 	869 PIC NOT AVAILABLE	872 140 x 25mm 	873 100 x 20mm 	875 100 x 18mm 
877 90 x 20mm 	878 80 x 20mm DISCONTINUED	880 105 x 25mm 	881 170 x 25mm 	882 170 x 25mm 
883 140 x 20mm 	885 110 x 25mm 	886 100 x 20mm 	887 110 x 20mm USE 503	889 130 x 30mm 
890 110 x 22mm 	893 110 x 25mm 	894 120 x 24mm 	895 140 x 35mm 	896 104 x 20mm 
897 110 x 23mm 	899 110 x 25mm 	901 150 x 25mm 	902 127 x 28mm 	903 150 x 24mm 
904 150 x 24mm 	905 125 x 17mm 	906 125 x 20mm 	907 135 x 16mm 	908 90 x 18mm 
909 105 x 20mm 	921 160 x 30mm 	922 123 x 25mm 	923 PIC NOT AVAILABLE	924 150 x 18mm 

BRAKE SHOE ILLUSTRATIONS

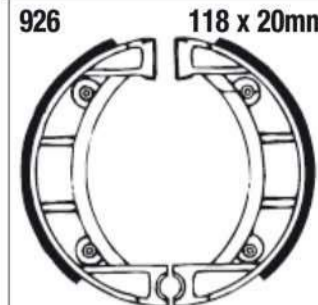
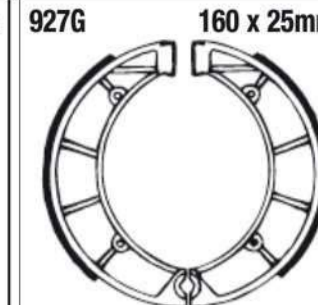
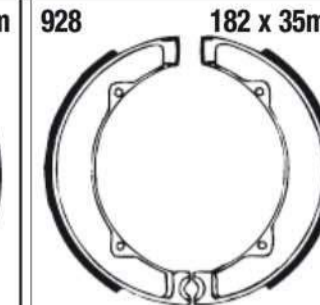
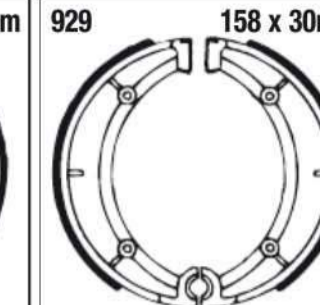
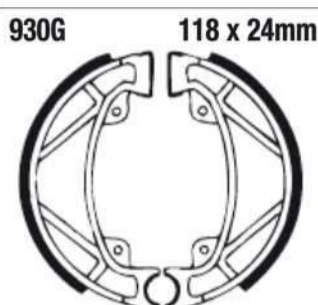
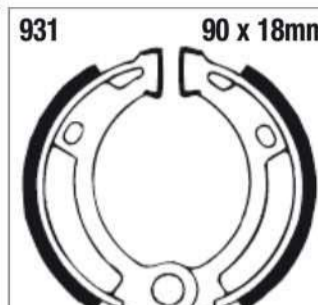
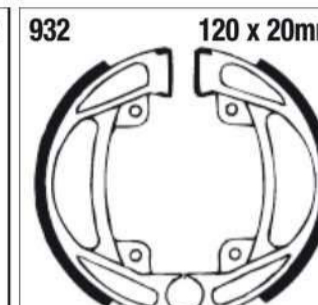
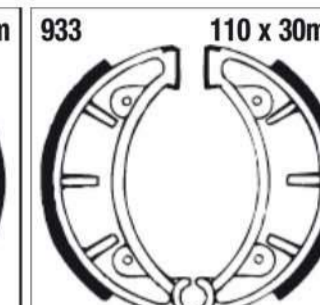
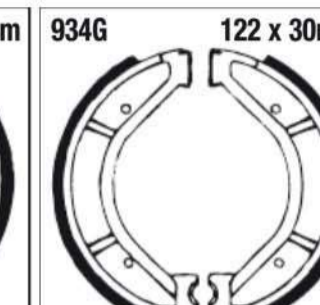
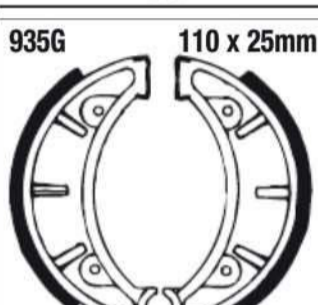
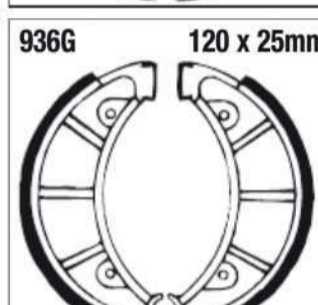
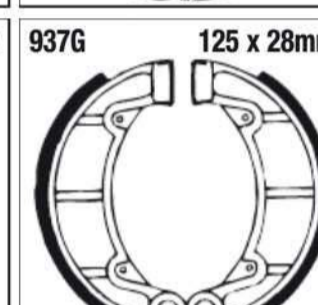
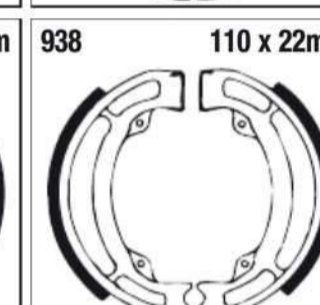
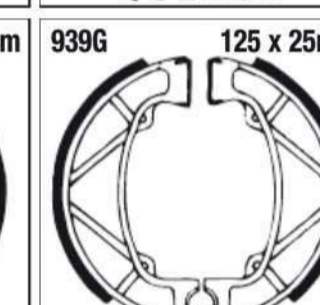
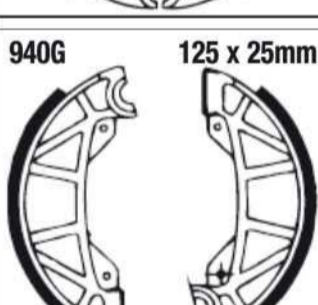
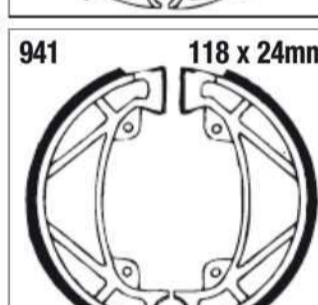
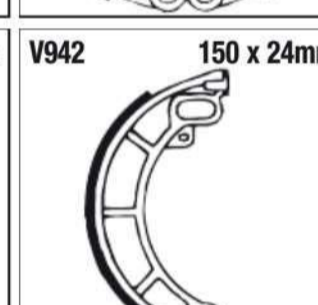
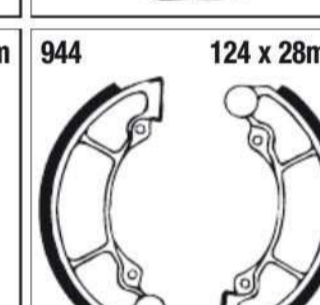
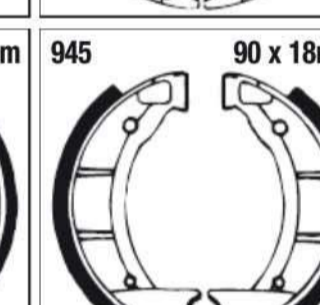
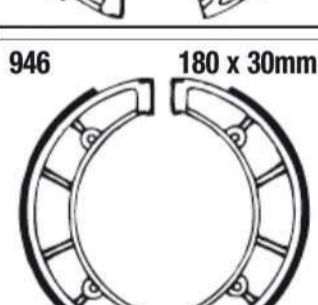
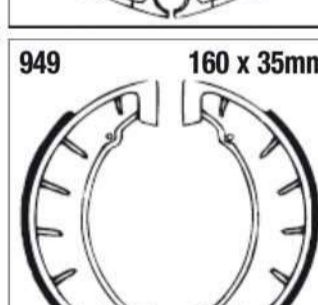
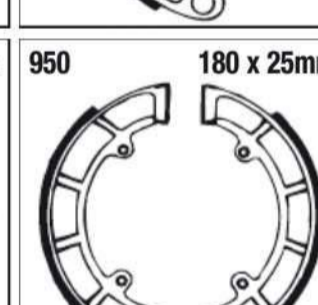
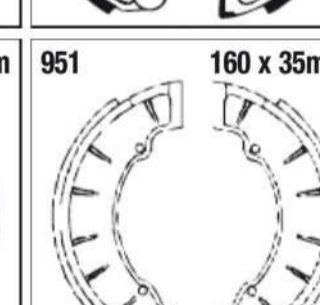
BUYERS GUIDE
BRAKE SHOES

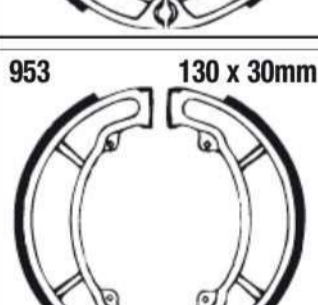
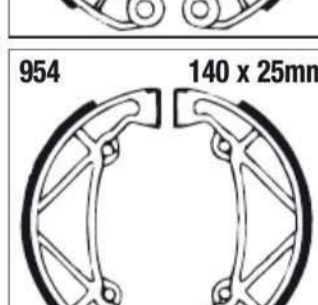
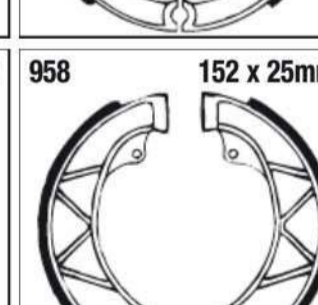
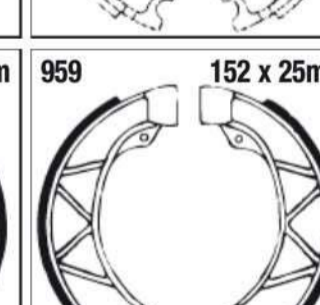
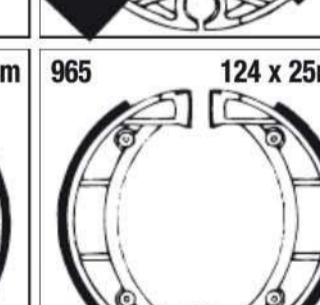
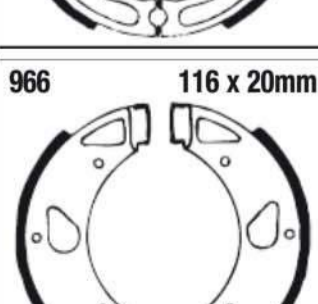
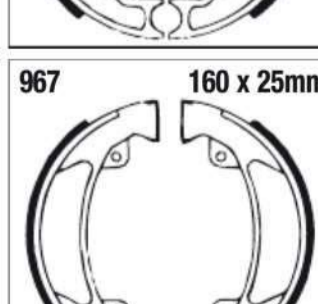
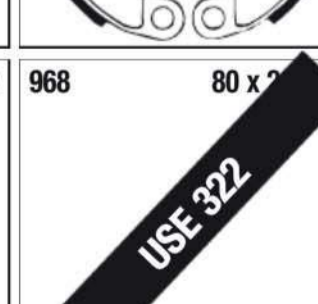
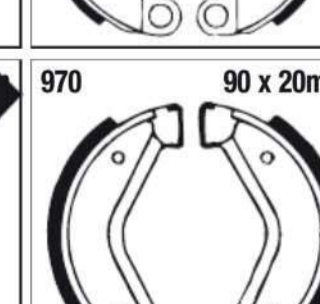
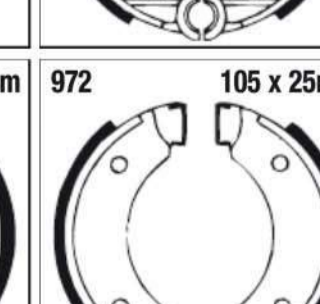
925 160 x 30mm 	926 118 x 20mm 	927G 160 x 25mm 	928 182 x 35mm 	929 158 x 30mm 
930G 118 x 24mm 	931 90 x 18mm 	932 120 x 20mm 	933 110 x 30mm 	934G 122 x 30mm 
935G 110 x 25mm 	936G 120 x 25mm 	937G 125 x 28mm 	938 110 x 22mm 	939G 125 x 25mm 
940G 125 x 25mm 	941 118 x 24mm 	V942 150 x 24mm 	944 124 x 28mm 	945 90 x 18mm 
946 180 x 30mm 	949 160 x 35mm 	950 180 x 25mm 	951 160 x 35mm 	952 125 x 25mm  DISCONTINUED
953 130 x 30mm 	954 140 x 25mm 	958 152 x 25mm 	959 152 x 25mm 	965 124 x 25mm 
966 116 x 20mm 	967 160 x 25mm 	968 80 x 25mm  USE 322	970 90 x 20mm 	972 105 x 25mm 

BRAKE SHOE ILLUSTRATIONS

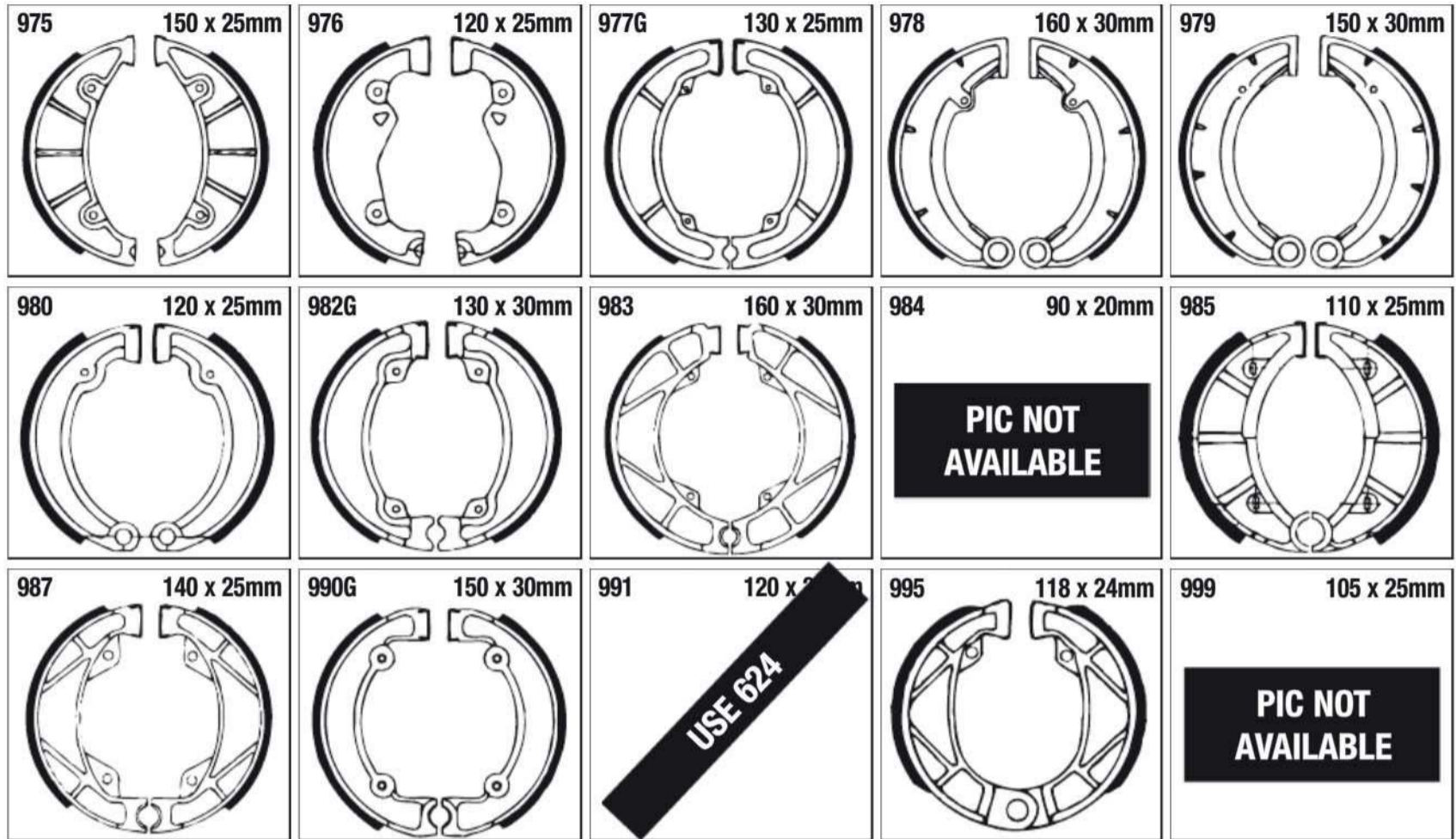

BUYERS GUIDE
BRAKE SHOES

GOLF CART BRAKE SHOE ILLUSTRATIONS



BRAKE SHOE DIAMETER CHART
(in mm)

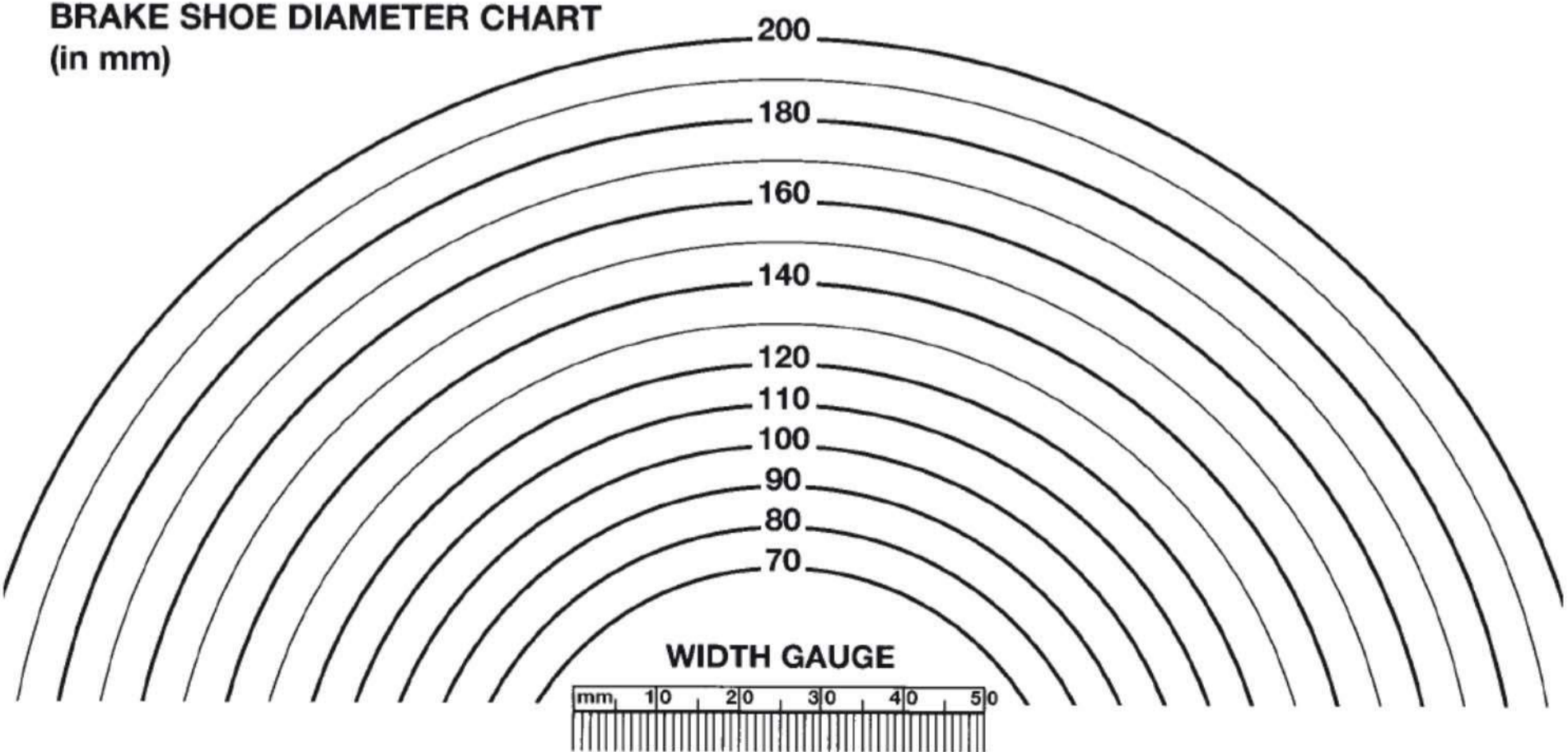

BRAKE ROTOR BUYERS GUIDE - STREET

Rotor No.	Front/Rear	Type	Models	Dia (mm)	Rotor No.	Front/Rear	Type	Models	Dia (mm)
FSD001	Front	S/F	Replacement solid rotor for all 11½" 5 bobbin rotors		FSD010 FSD010BLK Contd.	Front	S/F	HARLEY DAVIDSON Contd. FXST Softail Standard 08-14 FXSTB/FXSTBi Night Train Softail 06-07 FXSTB Night Train (Spoke wheel) 08-09 FXSTC Softail Custom 07 FXSTC Softail Custom (Spoke wheel) 08-10 FLSTSC/FLSTSCi Springer Softail Classic 06-07 FLSTC Heritage Softail Classic 07-14 FLSTN Softail Deluxe (Spoke wheel) 08-14 FLS Softail Slim 12-14 FXCW Rocker (Cast wheel) 08-09 FXCWC Rocker C (Cast wheel) 08-11 FXS Blackline 11-13 FXSB Breakout 13-14 FLHRI/FLHR Road King 00-07 FLHRCi Road King Classic 00-07 FLHT/FLHTi Electra Glide Standard 00-07 FLTR/FLTR-i Road Glide 00-07 FLHTCU-i Electra Glide Ultra Classic 00-07 FLHRS/FLHRSi Road King Custom 04-07 FLHTC/FLHTCi Electra Glide Classic 04-07 FLHX/FLHXi Street Glide 06-07 XL 50 50th Anniversary Sportster 07 XLH 883 Sportster 00-03 XLH 883r Sportster Flat Track 00-03 XL 883 Sportster Hugger 00-03 XL 53c Sportster Custom (883cc) 00-03 XL 883 Sportster Standard 04-08 XL 883 C Sportster Custom 04-10 XL 883 L 883 Low 04-10 XL 883 L Superlow 11-13 XL 883 N Iron 09-10 XL 883 N Iron (Cast Wheel) 11-13 XL 883 R 100th Anniversary Edition 03 XL 883 R Sportster R 05-13 XL 883 R Roadster 10 XL 883 R Roadster (Cast Wheel) 11-13 XL 1200c Sportster Custom 00-03 XL 1200s Sportster Sport 00-03 XL 1200 L Sportster Low (Spoke Wheel) 07-11 XL 1200 L Sportster Low (Cast Wheel) 07-11 XL 1200 N Nightster (Spoke wheel) 08-12 XL 1200 V Seventy Two 12-13 XL 1200 X Forty Eight 10-13	292 11½"
RSD001	Rear	S/F	Replacement solid rotor for all 11½" 5 bobbin rotors						
FSD002	Front	S/F	Replacement solid rotor for all 11½" 5 bobbin rotors						
RSD002	Rear	S/F	Replacement solid rotor for all 11½" 5 bobbin rotors						
FSD003 FSD003BLK	Front	S/F	Replacement solid rotor for all 11½" 5 bobbin rotors						
FSD004 FSD004BLK	Front	S/F	HARLEY DAVIDSON XL 1200 R Sportster Roadster 04-08 XL 1200 C Sportster Custom 04-10 XL 1200 C Sportster Custom (Cast & Spoke Wheels) 11-13	292 11½"					
FSD005C FSD005CBLK	Front	S/F	Replacement solid rotor for all 11½" 5 bobbin rotors						
FSD006C FSD006CBLK	Front	S/F	Replacement solid rotor for all 11½" 5 bobbin rotors						
FSD007	Front	S/F	Replacement solid rotor for all 11½" 5 bobbin rotors						
RSD007	Rear	S/F	Replacement solid rotor for all 11½" 5 bobbin rotors						
FSD008	Front	S/F	HARLEY DAVIDSON FXBR Breakout 18 FXBRS Breakout 114 18 FXBRS Breakout 114 Anniv 18 FXFB Fat Bob 18 FXBS Fat Bob 18 XL883 N Iron (Cast Wheel) 14-18 XL1200 CX Roadster 16-18	292 11½"					
RSD008	Rear	S/F	Replacement solid rotor for all 11½" 5 bobbin rotors						
FSD009 FSD009BLK	Front	S/F	HARLEY DAVIDSON FX, FXE, FXS 84-86 FXDL, FXDWG, FXR, FXRS, FXRT, FXRD, FXLR84-99 FXST, FXSTB, FXSTC, FXSTS, FLST, FLSTC, FLSTF, FLSTS, FLSTN 84-99 FXSTS/FXSTSi Softail Springer 00-05	292 11½"					
FSD010 FSD010BLK	Front	S/F	HARLEY DAVIDSON FXD Super Glide 00-03 FXDX Super Glide Sport 00-03 FXDL Low Rider 00-03 FXDWG Wide Glide 00-03 FXDS-CON Dyna Convertible 00-02 FXDXT Superglide T-Sport 01-03 FXDi Super Glide 1450 04-05 FXDXi Super Glide Sport 04-05 FXDLi Low Rider 1450 04-05 FXDWGi Wide Glide 1450 04-05 FXDC/FXDCi Super Glide Custom 05 FXST/FXSTi Softail Standard 00-05 FXSTB/FXSTBi Night Train 00-05 FXSTDI/FXSTD Softail Deuce/i 00-07 FLSTF/FLSTFi Fat Boy 00-07 FLSTFi Fat Boy 15th Anniversary Edition 05 FLSTF Fat Boy 08-14 FLSTFB Fat Boy LO 10-14 FLSTCi/FLSTC Heritage Classic/i 00-07 FLSTS Heritage Springer 00-03 FLSTN/FLSTNi Softail Deluxe 05-07 FLSTSC/FLSTSCi Springer Classic 05-07 FLST/FLSTi Heritage Softail 06 FLSTSB Softail Cross Bones 08-11 FXST/FXSTi Softail Standard 06-07	292 11½"	FSD011C FSD011CBLK	Front	S/F	Replacement solid rotor for all 11½" 5 bobbin rotors	
					FSD012C FSD012CBLK	Front	S/F	Replacement solid rotor for all 11½" 5 bobbin rotors	
					RSD013C RSD013CBLK	Rear	S/F	Replacement solid rotor for all 11½" 10 bobbin rotors	
					RSD014C RSD014CBLK	Rear	S/F	Replacement solid rotor for all 11½" 10 bobbin rotors	
					RSD015 RSD015BLK	Rear	S/F	Replacement solid rotor for all 11½" 10 bobbin rotors	
					RSD016 RSD016BLK	Rear	S/F	HARLEY DAVIDSON FLHC Heritage Classic 18 FLHCS Heritage Classic 114 18 FLHCS Heritage Classic 114 Anniversary 18 FLSL Softail Slim 18 FLDE Deluxe 18 FXBB Street Bob 18 FXLR Low Rider 18	292 11½"
					RSD017C RSD017CBLK	Rear	S/F	Replacement solid rotor for all 11½" 10 bobbin rotors	

ROTOR BUYERS GUIDE
 CODES FOR TYPES
 S = FLAT SOLID
 D = FLOATING ROTOR CONVERSION FOR DISHED SOLID ROTOR
 F = FLOATING ROTOR
 S/F = FLOATING CONVERSION FOR FLAT SOLID ROTOR

BRAKE ROTOR BUYERS GUIDE - STREET

Rotor No.	Front/Rear	Type	Models	Dia (mm)	Rotor No.	Front/Rear	Type	Models	Dia (mm)
RSD018C RSD018CBLK	Rear	S/F	Replacement solid rotor for all 11½" 10 bobbin rotors		RSD020 RSD020BLK Contd.	Rear	S/F	HARLEY DAVIDSON Contd. FLSTFi Fat Boy 15th Anniversary Edition 05 FLSTF/FLSTFi Fat Boy 07 FLSTF Fat Boy 08-17 FLSTFB Fat Boy LO 10-17 FLSTCi/FLSTC Heritage Classic/i 00-07 FLSTS Heritage Springer 00-03 FLSTN/FLSTNi Softail Deluxe 05-07 FLSTSC/FLSTSCi Springer Classic 05-07 FLST/FLSTi Heritage Softail 06 FLSTSB Softail Cross Bones 08-11 FXST/FXSTi Softail Standard 06-07 FXST Softail Standard 08-15 FXSTB/FXSTBi Night Train Softail 06-07 FXSTB Night Train (Spoke wheel) 08-09 FXSTC Softail Custom 07 FXSTC Softail Custom (Spoke wheel) 08-10 FLSTSC/FLSTSCi Springer Softail Classic 06-07 FLSTC Heritage Softail Classic 07-17 FLSTN Softail Deluxe (Spoke wheel) 08-14 FLSTN Softail Deluxe 15-17 FLS Softail Slim 12-17 FXCW Rocker (Cast wheel) 08-09 FXCWC Rocker C (Cast wheel) 08-11 FXS Blackline 11-13 FXSB Breakout 13-14 FXDLS Dyna Low Rider S 17 FLHri/FLHR Road King 00-07 FLHRCi Road King Classic 00-07 FLHT/FLHTi Electra Glide Standard 00-07 FLTR/FLTR-i Road Glide 00-07 FLHTCU-i Electra Glide Ultra Classic 00-07 FLHRS/FLHRSi Road King Custom 04-07 FLHTC/FLHTCi Electra Glide Classic 04-07 FLHX/FLHXi Street Glide 06-07	292 11½"
RSD019 RSD019BLK	Rear	S/F	HARLEY DAVIDSON FXD, FXDL, FXDWG, FXR, FXRS, FXRT, FXRD, FXLR Late 87-99 FXST, FXSTB, FXSTC, FXSTS, FLST, FLSTC, FLSTF, FLSTS, FLSTN Late 87-99 Sportster Late 87-99	292 11½"	FSD021 FSD021BLK	Front	S/F	Replacement solid rotor for all 11½" 10 bobbin rotors	
RSD020 RSD020BLK	Rear	S/F	HARLEY DAVIDSON XL 50 50th Anniversary Sportster 07 XLH 883 Sportster 00-03 XLH 883r Sportster Flat Track 00-03 XL 883 Sportster Hugger 00-03 XL 53c Sportster Custom (883cc) 00-03 XL 883 Sportster Standard 04-08 XL 883 C Sportster Custom 04-10 XL 883 L 883 Low 04-10 XL 883 N Iron 09-10 XL 883 R 100th Anniversary Edition 03 XL 883 R Sportster R 05-13 XL 883 R Roadster 10 XL 1200c Sportster Custom 00-03 XL 1200s Sportster Sport 00-03 XL 1200 R Sportster Roadster 04-08 XL 1200 C Sportster Custom 04-10 XL 1200 C Sportster Custom (Cast & Spoke Wheels) 11-13 XL 1200 L Sportster Low (Spoke Wheel) 07-11 XL 1200 N Nightster (Spoke wheel) 08-12 XL 1200 V Seventy Two 12-13 XL 1200 X Forty Eight 10-13 FLD Switchback 12-16 FXD Super Glide 00-03 FXD Super Glide (Cast wheel) 08-10 FXDF Fat Bob (Cast wheel) 08-17 FXDX Super Glide Sport 00-03 FXDL Low Rider 00-03 FXDWG Wide Glide 00-03 FXDWG Wide Glide (Spoke wheel) 08 FXDS-CON Dyna Convertible 00-02 FXDXT Superglide T-Sport 01-03 FXDi Super Glide 1450 04-05 FXDi 35 35th Anniversary Super Glide (Spoke wheels) 06 FXDXi Super Glide Sport 04-05 FXDLi Low Rider 1450 04-05 FXDLi Dyna Low Rider (Spoke wheels) 06 FXDWGi Wide Glide 1450 04-05 FXDWGi Dyna Wide Glide (Spoke wheels) 06-07 FXDWG Dyna Wide Glide (Spoke Wheels) 08-17 FXDC/FXDCi Super Glide Custom 05 FXDCi Dyna Superglide Custom (Spoke wheels) 06-07 FXDC Super Glide Custom (Spoke wheel) 08-14 FXDBi Street Bob (Spoke wheels) 06-07 FXDB Street Bob (Spoke wheel) 08-17 FXDBC Street Bob LTD 16 FXDi Super Glide (Cast wheel) 06-07 FXDLi Low Rider (Cast wheel) 06-07 FXDLi Low Rider (Spoke wheel) 06-07 FXDL Low Rider (Cast wheel) 08-13 FXDL Low Rider (Spoke wheel) 08-09 FXDL Low Rider (Cast wheel) 14-17 FXDL Low Rider (Spoke wheel) 14-17 FXDCi Superglide Custom (Cast wheel) 06 FXST/FXSTi Softail Standard 00-05 FXSTB/FXSTBi Night Train 00-05 FXSTDi/FXSTDi Softail Deuce/i 00-07 FXSTS/FXSTSi Softail Springer 00-05 FLSTF/FLSTFi Fat Boy 00-06	292 11½"	FSD022 FSD022BLK	Front	S/F	Replacement solid rotor for all 11½" 10 bobbin rotors	
					FSD023 FSD023BLK	Front	S/F	Replacement solid rotor for all 11½" 10 bobbin rotors	
					FSD024C FSD024CBLK	Front	S/F	Replacement solid rotor for all 11½" 10 bobbin rotors	
					FSD025C FSD025CBLK	Front	S/F	Replacement solid rotor for all 11½" 10 bobbin rotors	
					FSD026C FSD026CBLK	Front	S/F	Replacement solid rotor for all 11½" 10 bobbin rotors	
					FSD027C FSD027CBLK	Front	S/F	Replacement solid rotor for all 11½" 10 bobbin rotors	
					FSD028 FSD028BLK	Front	S/F	Replacement solid rotor for all 11½" 10 bobbin rotors	
					MD509SR	Rear	S	HARLEY DAVIDSON FLT, FLHT, FLHTCi 86-99 FLHR, FLHRCi 94-99	292 11½"
					MD511 Countersunk screw fixing	Rear	S	BUELL All twin models M2 Cyclone®, S1 Lightning®, S2 Thunderbolt®, S3 Thunderbolt® 94-97 M2 Cyclone®, S1 Lightning®, S1 Whitelighting®, S3 Thunderbolt®, S3T Thunderbolt®, X1 Lightning 98-00	240 9½"

ROTOR BUYERS GUIDE

F = FLOATING ROTOR
S/F = FLOATING CONVERSION FOR
FLAT SOLID ROTOR

CODES FOR TYPES
S = FLAT SOLID
D = FLOATING ROTOR CONVERSION FOR DISHED SOLID ROTOR

BRAKE ROTOR BUYERS GUIDE - STREET

Rotor No.	Front/Rear	Type	Models	Dia (mm)	Rotor No.	Front/Rear	Type	Models	Dia (mm)
MD514LS MD514RS	Front	S/F	HARLEY DAVIDSON V-Rod (Hayes Caliper) 02-05	292 11½"	MD521	Rear	F	HARLEY DAVIDSON FLHR Road King (Spoke Wheel Type) 08-16 FLHR Road King (Cast Wheel Type) 15-18 FLHRC Road King Classic 08-18 FLHRXS Road King Special 18 FLTR Road Glide 08-09 FLTRX Road Glide 15-18 FLTRX Road Glide Custom 10-12 FLTRXS Road Glide Special 15-17 FLTRXS Road Glide Special 18 FLTRU Road Glide Ultra 11-18 FLHTC Electra Glide Classic 08-12 FLHTCU Ultra Classic Electra Glide 08-18 FLHTCUL Ultra Classic Electra Glide Low 15-16 FLHT Electra Glide Standard 08-10 FLHTK Electra Glide Ultra LTD 10-18 FLHTK Electra Glide Ultra LTD Anniv. 18 FLHTK Electra Glide Ultra LTD Shrine Edition 18 FLHTKL Electra Glide Ultra LTD Low 15-18 FLHX Street Glide 08-18 FLHX Street Glide Anniv. 18 FLHXS Street Glide Special 15-18 FLHXS Street Glide Special Anniv. 18	300 13"
MD515	Rear	S	HARLEY DAVIDSON V-Rod (Hayes Caliper) 02-05	292 11 ½"					
MD516 MD516X Floating Conversion	Front Front	S F	HARLEY DAVIDSON V-Rod (Brembo Caliper) 06 VRSCAW V-Rod 07 VRSCR Street Rod 06-07 VRSCD Night Rod (Cast Wheel) 06-08 VRSCDX Night Rod Special (Cast Wheel) 07-17 VRSC 10th Anniversary V Rod 12 VRSCF V-Rod Muscle 09-17 FLD Switchback 12-16 FXD Super Glide (Cast wheel) 08-10 FXDi Super Glide (Cast wheel) 06-07 FXDLi Low Rider (Cast wheel) 06-07 FXDL Low Rider (Cast wheel) 08-13 FXDL Low Rider (Cast wheel) 14-17 FXDCi Superglide Custom (Cast wheel) 06 FXDLS Dyna Low Rider S 17	300	MD522	Rear	S	BUELL Firebolt XB9R 02-07 XB9S Lightning 03-04 XB9SX Lightning City X 05-09 XB9SX Lightning 08-10 XB12 S Lightning 04-08 XB12 X Ulysses 06-10 XB12 XT Ulysses 08-10 XB12 SCG Lightning 06-08 XB12 Ss Lightning Long 06-08 XB12 Ss Lightning 09-10 XB12 STT Lightning 08 XB12 SCG Lightning 09-10 XB12 R Firebolt 04-08 XB12 R Firebolt 09-10	240 9½"
MD517	Rear	S	HARLEY DAVIDSON V-Rod (Brembo Caliper) 06 VRSCAW V-Rod 07 VRSCAW V-Rod (Spoke wheel) 08-09 VRSCR Street Rod 06-07 VRSCD Night Rod (Cast Wheel) 06-08 VRSCDX Night Rod Special (Cast Wheel) 07-17 VRSC 10th Anniversary V Rod 12 VRSCX V-Rod 07	300 12"					
MD518	Front	F	HARLEY DAVIDSON FXDF Fat Bob (Cast wheel) 08-17 FXDWG Wide Glide (Spoke wheel) 08 FXDi 35 35th Anniversary Super Glide (Spoke wheels) 06 FXDLi Dyna Low Rider (Spoke wheels) 06 FXDWGi Dyna Wide Glide (Spoke wheels) 06-07 FXDWG Dyna Wide Glide (Spoke Wheels) 08-17 FXDCi Dyna Superglide Custom (Spoke wheels) 06-07 FXDC Super Glide Custom (Spoke wheel) 08-14 FXDBi Street Bob (Spoke wheels) 06-07 FXDB Street Bob (Spoke wheel) 08-17 FXDBC Street Bob LTD 16 FXDLi Low Rider (Spoke wheel) 06-07 FXDL Low Rider (Spoke wheel) 08-09 FXDL Low Rider (Spoke wheel) 14-17	300 12"	MD523X	Front	F	HARLEY DAVIDSON XR 1200 08-10 XR 1200 X 10-12	292 11½"
MD519	Front	F	HARLEY DAVIDSON VRSCAW V-Rod (Spoke wheel) 08-09 VRSCX V-Rod 07	300 12"					
MD520	Front	F	HARLEY DAVIDSON FLHR Road King (Spoke Wheel Type) 08-16 FLHRC Road King Classic 08-17 FLTR Road Glide 08-09 FLTRX Road Glide Custom 10-12 FLTRU Road Glide Ultra 11-12 FLHTC Electra Glide Classic 08-12 FLHTCU Ultra Classic Electra Glide 08-13 FLHT Electra Glide Standard 08-10 FLHTK Electra Glide Ultra LTD 10-13 FLHX Street Glide 08-13 FLHTCUTG Tri Glide Ultra Classic Trike 09-13 FLHXXX Street Glide Trike 10-11	300 12"	MD524	Rear	S	HARLEY DAVIDSON XL 883 L Super Low (Cast Wheels) 11-18 XL 883 N Iron (Cast Wheels) 11-18 XL 883 R Roadster (Cast Wheels) 11-15 XL 1200 C Custom (Spoke Wheels) 14-18 XL 1200 CX Roadster 16-18 XL 1200 L Sportster Low (Cast Wheels) 07-11 XL 1200 V Seventy Two (Spoke Wheels) 14-16 XL 1200 X Forty Eight (Spoke Wheels) 14-17 XL 1200 T Superlow 14-18 XR 1200 08-10 XR 1200 X 10-12 XL1200 X Forty Eight 18 XL1200 Forty Eight Anniversary 18	260 10¼"
MD521	Front	F	VRSCA/VRSCB V-Rod Muscle - VRSCF 09-17	300 12"					
MD522	Front	S	HARLEY DAVIDSON XL 883 L Super Low (Cast Wheels) 14-18 XL 883 N Iron (Cast Wheels) 14-17 XL 883 R Sportster (Cast Wheels) 14-15 XL 1200 C Custom (Spoke Wheels) 14-18 XL 1200 V Seventy Two (Spoke Wheels) 14-16 XL 1200 X Forty Eight (Spoke Wheels) 14-17 XL 1200 T Superlow 14-18 FXST Softail Standard 15	300					

ROTOR BUYERS GUIDE
 CODES FOR TYPES
 S = FLAT SOLID
 D = FLOATING ROTOR CONVERSION FOR DISHED SOLID ROTOR
 F = FLOATING ROTOR
 S/F = FLOATING CONVERSION FOR FLAT SOLID ROTOR

BRAKE ROTOR BUYERS GUIDE - STREET

Rotor No.	Front/Rear	Type	Models	Dia (mm)	Rotor No.	Front/Rear	Type	Models	Dia (mm)
MD526 Contd.	Front	S	HARLEY DAVIDSON	300	MD536	Front	S	HARLEY DAVIDSON	300
			FLS Softail Slim 15-17					XG 500 Street (494cc) 16-18	
			FLSTC Heritage Softail Classic 15-17					XG 750 Street (749cc) 16-18	
			FLSTN Softail Deluxe 15-17					XG 750 A Street Rod (749cc) 17-18	
			FLHC Heritage Classic 18		MD537	Rear	S	HARLEY DAVIDSON	300
			FLHCS Heritage Classic 114 18					XG 500 Street (494cc) 16-18	
			FLHCS Heritage Classic 114 Anniv. 18					XG 750 Street (749cc) 16-18	
			FLSL Softail Slim 18					XG 750 A Street Rod (749cc) 17-18	
			FLDE Deluxe 18		MD601LS MD601RS	Front	F	HONDA	310
			FXBB Street Bob 18					CBR 600 F2 91-94	
MD528	Rear		HARLEY DAVIDSON	290	Floating Conversion			Floating conversion for Triumph models using MD649 solid disc. Will require bracket kit on Honda models only - order BRK15S.	
			FXSB Breakout 13-14	11½"					
MD529	Front	S	HARLEY DAVIDSON	300	MD602LS MD602RS	Front	D	BMW	260
			FLHTCU Ultra Classic Electra Glide 14-16					R 60/7 76-80	
			FLHTCUL Ultra Classic Electra Glide Low 15-16					R 60 TIC 78-82	
			FLHTK Ultra Ltd 15-18					R 65 LS 81-85	
			FLHTK Ultra Ltd Anniv. 18					R 75/6 73-79	
			FLHTK Ultra Ltd Shrine Edition 18					R 80 77-84	
			FLHTKL Ultra Ltd Low 15-18					R 80 RT 82-84	
			FLHX Street Glide 14-18					BMW	
			FLHX Street Glide Anniv. 18					R 80 TIC 78-85	
			FLHR Road Ring (Cast Wheel Type) 15-18					R 90 S 73-76	
			FLHXS Street Glide Special 15-18					R 90/6 73-76	
			FLHXS Street Glide Special Anniv. 18					R 100 76-77	
			FLTRU Road Glide Ultra 16-18					R 100/7T 77-84	
			FLTRX Road Glide 15-18					R 100 S 76-80	
FLTRXS Road Glide Special 15-16	R 100 RS 76-84								
								R 100 RT 78-84	
								R 100 S 09/80-80	
								R 100 RS 10/80-84	
								R 100 RT 10/80-84	
MD530	Front	F	HARLEY DAVIDSON	300	MD603LS MD603RS	Front	D	BMW	285
			FLHTCUTG Trike 14-18	12"				K 75/75-2 84-96	
			FLRT Freewheeler Trike 15-18		K 75 RT 89-96				
			FLHTCUTG Tri Glide Ultra Trike Anniv. 18		K 75 S 85-95				
			FLSTF Fatboy 15-17		K 100/2 87-90				
			FLSTFB Fatboy Lo 15-16		K 100 LT 86-91				
			XL1200 X Forty Eight 18		K 100 RS 83-89				
			XL1200 Forty Eight Anniv. 18		K 100 RT 83-89				
MD531	Front	S	HARLEY DAVIDSON	290	MD604LS MD604RS	Front	D	BMW	285
			XG 500 Street (494cc) 14-15	11½"				K 75/75-2 84-96	
			XG 750 Street (749cc) 14-15		K 75 C 85-12/88				
MD532	Rear	S	HARLEY DAVIDSON	260	(Non ABS)			K 75 RT 89-96	
			XG 500 Street (494cc) 14-15	11¼"				K 75 S 85-95	
			XG 750 Street (749cc) 14-15					K 100 82-09/88	
								K 100/2 87-90	
								K 100 LT 86-91	
MD533	Front/ Rear	S	POLARIS	299				K 100 RS 83-89	
			Slingshot 15-17					K 100 RT 83-89	
			Slingshot SL 15-17						
			Slingshot SLR 17						
MD534	Front/ Rear	S	INDIAN	298	MD605LS MD605RS	Front	D	BMW	285
			Scout (Toso Calipers/Cast Wheels) 15-16					R 65 07/88-08/89	
			Scout 17					R 65 RT 85-88	
			Scout Sixty (Toso Calipers/Cast Wheels) 16					R 80/R 80 RT 84-95	
			Scout Sixty 17					R 100 RS 86-92	
VICTORY							R 100 RT 87-95		
			Octane 1200cc 17					R 80 Mystic 94-95	
								R 80 R 91-94	
								R 100 GS 86-94	
								R 100 PD 89-96	
MD535	Front/ Rear	F	INDIAN	292				R 100 Mystic 93-96	
			Chief Blackhawk (Brembo calipers) 11	11½"				R 100 R 91-95	
			Chief Blackhawk Dark (Brembo calipers) 11					R 850 GS 96	
			Chief Classic (Brembo calipers) 11-13						
			Chief Standard (Brembo calipers) 09-11						
			Chief Deluxe (Brembo calipers) 09						
			Chief Roadmaster (Brembo calipers) 09-11						
			Chief Vintage (Brembo calipers) 09-13						
			Bomber (Brembo calipers) 10-11						
			Dark Horse (Brembo calipers) 10-13						

ROTOR BUYERS GUIDE

F = FLOATING ROTOR
S/F = FLOATING CONVERSION FOR FLAT SOLID ROTOR

D = FLOATING ROTOR CONVERSION FOR DISHED SOLID ROTOR

BRAKE ROTOR BUYERS GUIDE - STREET

Rotor No.	Front/Rear	Type	Models	Dia (mm)	Rotor No.	Front/Rear	Type	Models	Dia (mm)		
MD606LS MD606RS	Front	D	BMW	260	MD614X MD614XC VR614BLK VR614BLU VR614RED VR614GLD Contd.	Front	F	DUCATI	320		
			R 45/45 N					78-85		600 Monster	00-01
MD607LS MD607RS	Front	F	BMW	305				620 IE Monster	02-04		
			R 45 T					80-85	620 ie Monster (Series 1-Twin Pin Pad Fixing Caliper)	05	
			R 65 GS					87-92	620 Sport	03	
			R 65 T					80-85	696 Monster	08-14	
			R 65 LS					81-85	M 696 Monster 20th Anniversary Model	13-14	
			R 80 GS					80-95	748 Biposto	99-02	
			R 80 PD/CH					90-95	748 SP/Monoposto	99-2002	
			R 80 ST					82-84	748 Testa Bassa (Mono/Biposto)	01	
			R 100/7T					09/80-84	750 Supersport IE	00-02	
									750 Sport	01-02	
MD609LS MD609RS	Front	D	LAVERDA	280				750 Monster	00-01		
			900 SS Darmah					78	Monster ie 750	02	
			900 Hailwood Replica					79	Monster 800	03-04	
			1000 R1 Hailwood Replica					84	800 Sport	03	
			Jota 1000					76	800 Supersport	03-05	
			Mirage 1200					76	900 Supersport IE	00-01	
MD609LS	Rear	D	LAVERDA	280				900 Sport	02		
			900 Hailwood Replica					79	900 IE Monster	00-01	
			1000 R1 Hailwood Replica					84	900 MH Evoluzione	00-01	
			1000 SFC	85-86				ST4 (916cc)	01-02		
								ST2 (944cc)	00-03		
								GT 1000 (992cc)	07-10		
MD609ALS MD609ARS	Front	D	LAVERDA	280				GT 1000 Touring - Sport Classic	09		
			RGS 1000					83	Monster 1000 Dark	03	
MD611 Non ABS Models	Rear	F	BMW	285				Monster 1000 ie (992cc)	04-05		
			K 75/75-2					08/90-96	Monster 1000 S ie (992cc)	03-05	
			K 75 RT					89-96	Monster S2R 1000 (992cc)	06-08	
			K 75 S					85-95	Paul Smart 1000 LE (992cc)	06	
			K 100					82-09/88	Sport 1000 S	07-09	
			K 100/2					87-90	Sport Classic 1000 (992cc) (Monoposto -Japan/Biposto-Europe)	06-08	
			K 100 LT					86-91	Supersport 1000 DS (992cc)	03-06	
			K 100 RS					83-89	KTM		
			K 100 RT					83-09/88	690 Duke	08-11	
			K 100 RS (Non ABS)					89-92	MOTO GUZZI		
			K1 (16 valve - Non ABS)					88-93	750 Nevada Base/Club	02-03	
MD613 MD613C VR613	Rear	S	APRILIA	220				Nevada Classic 750 ie	04-09		
			RSV4 R					09-12	V 750 ie Brevia	03-08	
			RSV4 Factory					09-12	V 7 Classic	08-12	
			RSV4 Factory APRC SBK					11-14	V 7 Cafe Classic	11-12	
			RSV4 R APRC					11-14	V 7 Racer	10-14	
			RSV4 Factory APRC ABS					13-15	V 7 Special	12-14	
			RSV4 Factory APRC ABS					13-15	V 7 Stone	02-14	
			RSV Mille All models					98-03	V10 Centauro	97-99	
			RSV 1000 Tuono/Tuono R/Factory R					02-10	California EVII	97-01	
			SL 1000 Falco					00-05	Sport 1100	94-99	
			RSV 1000 R Factory/R					04-12	California Jackel 1100/Special 1100	99-01	
			Tuono V4 R STD					11-12	V11 Sport/Scuro/Naked	99-00	
			Tuono V4R APRC					11-12	V11 Le-Mans Series	01-06	
			Tuono V4R APRC/ABS					13-15	California Stone Series	02-06	
			California EV Series	02-06							
			California Vintage 750	06-10							
MD615	Rear	F	BMW	285				K 1200 LT	97-09		
			K 1200 CL					02-04			
MD614X MD614XC VR614BLK VR614BLU VR614RED VR614GLD	Front	F	CAGIVA	320				BMW	320		
			Mito 125					92-02		R 850 R	03-06
			DUCATI							R 1100 S	12/00-06
			Monster 400 (Single disc)					00-02		R 1150 R	01-06
			Monster 400 (Twin disc)					03-04		R 1150 Rockster	03-06
			400 Monster (Japan)					00-04		R 1150 RS	01-05
			Monster Dark ie 400 (Japan)					05-06		R 1150 GS	03-06
			Monster Dark ie 400 (Single disc)					05		K 1200 R-Urban (K43)	05-08
			600 Monster City/City Dark					99		K 1200 LT	11/00-07
										R 1200 R	07-08
		K 1300 R	09								

ROTOR BUYERS GUIDE

CODES FOR TYPES
S = FLAT SOLID
D = FLOATING ROTOR CONVERSION FOR DISHED SOLID ROTOR

F = FLOATING ROTOR
S/F = FLOATING CONVERSION FOR FLAT SOLID ROTOR

BRAKE ROTOR BUYERS GUIDE - STREET

Rotor No.	Front/Rear	Type	Models	Dia (mm)	Rotor No.	Front/Rear	Type	Models	Dia (mm)
MD617	Rear	S	CAGIVA Raptor 650/V-Raptor 650 00-02 Raptor 1000/V-Raptor 1000 00-02	220	MD624 VR624BLK VR624BLU VR624RED VR624GLD Contd.	Front	F	MOTO-GUZZI 1100 Brevia 05-12 Norge 1200 GT/2V (ABS Model) 06-12 Norge 1200 GT 8V 10-12 Stelvio 1200 NTX 8V (ABS) 09-15	320
MD618 MD618C VR618	Rear	S	DUCATI 749/749 S/749 R 03-06 999/999 S/999 R 03-06 Desmosedici 1000 08	240	MD626X MD626XC VR626BLK VR626BLU VR626RED VR626GLD	Front	F	DUCATI Monster 400 ie (Japan) 07-08 620 Multistrada (Twin Disc/Single Pin Pad Fixing) 06 695 Monster 06-09 Monster S2R (803cc) 05-07 Monster S2R Dark (803cc) 05-06 620 ie Monster (Series 2 - Single Pin Pad Fixing Caliper) 05-06	300
MD619RS	Front	F	MZ/MUZ Skorpion Tour/Traveller 95-02	315	MD627 MD627C VR627	Rear	S	DUCATI Hypermotard 796 10-12 796 Monster (Non ABS) 10-13 Monster S2R (803cc) 05-07 Monster S2R Dark (803cc) 05-06 Hypermotard (821cc) 13-14 Hypermotard SP (821cc) 13-14 Hyperstrada (821cc) 13-14 848 (Radial 2 pad caliper) 08-09 848 Evo (Monobloc Front Calipers) 10-12 848 Streetfighter 12-14 Monster S4R (996cc) (2 pad caliper) 05-06 Monster S4R (996cc) 03-06 S4RS Monster (998cc) (Radial 4 pad caliper) 06 S4R Testastretta Monster (998cc) (Radial 4 pad caliper) 07-08 S4RS Testastretta Monster (998cc) (Radial 4 pad caliper) 07-08 S4RS (Tricolore/Monster Testastretta) (998cc)# (Radial 4 pad caliper) 08 Monster S2R 1000 (992cc) 06-08 Multistrada 1000 DS (992cc) 03-05 Multistrada S 1000 DS (992cc) 05-06 1100 Monster Evo 11-12 Hypermotard 1100 07-09 Hypermotard 1100 S 07-09 Hypermotard 1100 Evo 10-12 Hypermotard 1100 Evo SP 10-12 Monster 1100 (Non-ABS) 09-10 Monster 1100 S (Non-ABS) 09-10 Multistrada 1100 (1078cc) 07-09 Multistrada 1100 S (1078cc) 07-09 1199 Panigale R 13-14	245
MD620 Loose bobbin type	Front	S	BMW R 850 RT 06 R 1100 S 12/00-05 R 1150 RT 00-06 K 1200 GT (K41) 03-06 K 1200 R 05-08 K 1200 RS 01-05 K 1200 S 03-08 R 1200 S 06-08	320					
MD621X MD621XC VR621BLK VR621BLU VR621RED VR621GLD	Front	S	APRILIA RS 125 06-12 Shiver 750 07-14 Mana 850 08-12 RSV Mille/Mille R (All models) 01-03 RSV Tuono/Tuono R/Factory R 02-10 BMW G 650 Xmoto 07-09 MOTO GUZZI MGS-01 04-05 1100 Griso (1064cc) Standard mount calipers 05-12 Griso 1200 8V 09-12 1200 Griso SE (8V) (Radial caliper) 1151cc 09-12	320					
MD622X MD622XC VR622BLK VR622BLU VR622RED VR622GLD	Front	F	DUCATI 749 Dark (Monoposto/Biposto) 04-06 749 R (Radial caliper) 04-06 749 S (Monoposto/Biposto) 03-06 749 (Monoposto/Biposto) 03-06 999 S (Std Caliper Mount) (Monoposto/Biposto) 03-04 999 (Std mount caliper) 03-06 999 R (Radial mount caliper) 03-06 999 R Fila (Radial mount caliper) 03-06 999 R Xerox 06 999 S (Radial mount caliper) Monoposto/Biposto 05-06	320					
MD623RS	Front	S	MUZ 500 Country 93-98	280					
MD624 VR624BLK VR624BLU VR624RED VR624GLD	Front	F	DUCATI Monster S4 Foggy (916cc) 02 Monster S4 (916cc) 01-02 ST3 S (ABS Model) (992cc) 06-07 Monster S4R (996cc) (2 pad caliper) 05-06 996 SPS (996cc) 99 996 (996cc) (Monoposto/Biposto) 99-01 996 S 01 Monster S4R (996) 03-06 ST4S (Non ABS/996cc) 01-05 ST4S (ABS Model/996cc) 03-05 Monster S4 Foggy(916cc) 02 Monster S4 (916cc) 01-02 ST3 S (ABS Model) (992cc) 06-07 Monster S4R (996cc) (2 pad caliper) 05-06 996 SPS (996cc) 99 996 (996cc) (Monoposto/Biposto) 99-01 996 S 01	320	MD629X/XC VR629BLK VR629BLU VR629RED VR629GLD	Front	F	TRIUMPH Thruxton SE (865cc) 12 Thruxton 900 04-15 Thruxton 900 Ace Cafe SE 14-15	320
					MD630LS MD630RS	Front	S	DUCATI 750 Paso 88-90 750 Sport 88-90	280
					MD631	Rear	S	DUCATI 906 Paso 88-89 750 Paso/Sport 87-90	270

ROTOR BUYERS GUIDE

F = FLOATING ROTOR
S/F = FLOATING CONVERSION FOR FLAT SOLID ROTOR

CODES FOR TYPES
S = FLAT SOLID
D = FLOATING ROTOR CONVERSION FOR DISHED SOLID ROTOR

BRAKE ROTOR BUYERS GUIDE - STREET

Rotor No.	Front/Rear	Type	Models	Dia (mm)	Rotor No.	Front/Rear	Type	Models	Dia (mm)		
MD632 MD632C VR632	Rear	S	DUCATI	220	MD641 VR641	Rear	S	MOTO GUZZI	255		
			748 R (2 pad caliper)					00		Daytona 750 (3cyl)	92
			748 R (4 pad caliper)					01-02		Daytona 1000 (4cyl)	92
			748 Biposto					95-02		Daytona 900 (3cyl)	93-96
			748 SP					95-98		Daytona Super III (3cyl)	94-97
			748 (Biposto)					00-02		Daytona 1200 (4cyl)	93-98
			748 (Monoposto)					00-02		Speed Triple (Carb Models)	94-97
			748 SPS					98-99		Sprint (All carb models)	93-98
			748 Testa Bassa (Mono/Biposto)					01		Tiger 885cc	92-96
			900 MH Evoluzione					00-01		Trident 900	92-98
			916 (Biposto)					94-96		Trophy 900 (3cyl)	92
			916 Sienna					94-98		Trophy 1200 (4cyl)	93-01
			916 SPS (996cc)					97-98			
			996 SPS (996cc)					99			
			996 (996cc) (Monoposto/Biposto)					99-01			
			996 R					01			
			996 S					01			
998 Matrix (998cc)	04										
998 R (998cc)	02										
998 S Bayliss/Bostrom	02										
998 S (998cc) (4 pad caliper)	02-04										
998 (998cc) (2 pad caliper) (Monoposto/Biposto)	02-03										
MD633X MD633XC NOTE Disc type with Counterbored holes. Check Correct type before fitting.	Front	F	DUCATI	320	MD642LS Note: Floating conversion kit available MD629X/XC VR629BLK VR629BLU VR629RED VR629GLD	Front	S	TRIUMPH	320		
			998 Matrix (998cc)					04		Adventurer	96-01
			998 S Bayliss/Bostrom					02		Legend TT	98-01
			998 S (998cc) (4 pad caliper)					02-04		Thunderbird	95-03
			998 (998cc) (2 pad caliper) (Monoposto/Biposto)					02-03			
			ST4 (916cc)					99			
			KTM								
			990 Superduke					05-11			
			990 Superduke R					07-11			
			1190 RC8					08-12			
1190 RC8 R	09-14										
MD634LS MD634RS	Front	F	DUCATI	280	MD643 VR643	Rear	S	TRIUMPH	285		
			250/350/450 Desmo					74-77		Legend TT	98-01
			750 Sport					74		Adventurer	96-01
			750 SS					75-76		Bonneville America	02-06
			860 GT/GTS					75-76		America (Cast Wheel) 865cc	06-09
			900 GTS					75-76		America (865cc/cast wheel)	10-17
			900 SS Darmah					76-77		America LT (865cc)	14-17
MD634LS	Rear	F	DUCATI	280	MD644 (6 Bolt)	Front	S	HONDA	276		
			860 GT/GTS					75-76		CBR 125 R4/R5/RS5/RW5/RW6/RW7 /RW8/RW9/RWA (Canada)	04-10
			900 GTS					75-76		TRIUMPH	
900 SS Darmah	76-78	Tiger	92-98								
MD636X MD636XC	Front		DUCATI	320	MD645	Rear	S	TRIUMPH	255		
			748 R					00-02		Tiger	92-98
996 R	01										
MD640 MD640X VR640BLK VR640BLU VR640RED VR640GLD (Will not fit early models with dished-solid rotor)	Front	F	MOTO GUZZI	310	MD646LS MD646RS VR646BLK VR646BLU VR646RED VR646GLD	Front	F	TRIUMPH	296		
			Daytona 750 (3cyl)					92		Trident 750	92
			Daytona 1000 (4cyl)					92		Trophy 900/1200	92
			Daytona 900 (3cyl)					93-96		Sprint (All carb models)	93
			Daytona Super III (3cyl)					94-97		Trident 900	92-98
			Daytona 1200 (4cyl)					93-98		Trophy 900 (3cyl)	92-93
			Speed Triple (Carb Models)					94-96		Trophy 1200 (4cyl)	92-93
			Sprint (All carb models)					94-98			
			Trophy 900 (3cyl)					94-01			
			Trophy 1200 (4cyl)					94-01			
MD647X VR647BLK VR647BLU VR647RED VR647GLD 6 Bolt	Front	F	TRIUMPH	320				TRIUMPH	320		
			T595 Daytona					97		Daytona 955i	98-00
			Daytona 955i					98-00		Speed Triple (EFI) T509	97-01
			Speed Triple (EFI) T509					97-01		Sprint RS	99-04
			Sprint RS					99-04		Sprint ST	99-04
Sprint ST	99-04										

ROTOR BUYERS GUIDE

CODES FOR TYPES
 S = FLAT SOLID
 D = FLOATING ROTOR CONVERSION FOR DISHED SOLID ROTOR
 F = FLOATING ROTOR
 S/F = FLOATING CONVERSION FOR FLAT SOLID ROTOR

BRAKE ROTOR BUYERS GUIDE - STREET

Rotor No.	Front/Rear	Type	Models	Dia (mm)	Rotor No.	Front/Rear	Type	Models	Dia (mm)							
MD648 MD648C VR648	Rear	S	TRIUMPH	220	MD652 MD652C (Rotor ring only)	Front	S	BMW	305							
			T595 Daytona					97		K 1200 RS	96-00					
			Daytona 600					03-04		K 1200 LT	97-10/00					
			Daytona 650					05		R 850 GS	96-00					
			Daytona 675					06-08		R 850 C	97-00					
			Daytona 675 SE					12		R 850 R	94-02					
			675 Daytona Black Monobloc Radial Caliper					09-12		R 850 RT	96-01					
			Daytona 955i					98-06		R 1100 GS	93-99					
			Speed Triple (EFI)					97-01		R 1100 R	93-06/96					
			Speed Triple 955cc					02-04		R 1100 RT	94-01					
			Speed Triple (Radial caliper 1050cc)					05-11		R 1150 GS (Evo-R21/0415/0495)	11/01-03					
			Speed Four 600					02-05		R 1150 GS (R21/0415/0495)	98-10/01					
			TT 600					00-03		R 1150 GS Adventure	07/01-06					
			Street Triple 675					07-12		R 1200	00-02					
			Speed Triple R 675					09-12		R 1200 C	96-03					
675 R (Brembo calipers)	11	R 1200 CL	02-04													
Tiger 1050 (Radial caliper)	07-09	R 1200 C Montauk	04-05													
MD649 MD649CX Note: Floating conversion kit available MD601LS MD601RS	Front	S	TRIUMPH	310	MD653 MD653C	Rear	S	BMW	276							
			Speedmaster (765cc/Carbs)					03-04		R 850 GS	96-00					
			Bonneville America					02-06		R 850 R	94-06					
			Bonneville 800					01-05		R 850 RT	96-01/06					
			Bonneville T-100					02-09		R 1100 GS	93-99					
			Thunderbird Sport					98-03		R 1100 R	93-01					
			Scrambler (865cc)					06-11		R 1100 S	96-06					
			Speedmaster (865cc/Carbs)					05-08		R 1100 RT	94-01					
			Tiger 885cc					97-99		R 1150 GS (Evo-R21/0415/0495)	11/01-03					
			Tiger 885i					98-99		R 1150 GS (R21/0415/0495)	98-10/01					
			Tiger 955cc					99-04		R 1150 GS Adventure	07/01-06					
			America (Cast Wheel) 865cc					06-09		R 1150 R	01-06					
Bonneville/Bonneville Black (865cc)	06-08	R 1150 Rockster	03-06													
		R 1150 RS	01-05													
		R 1150 RT	00-06													
MD650	Front	S	BMW	300	MD656 VMD656 4 bolt fixing	Front/Rear	F	TRIUMPH	250							
			F 650 (E169/0161)					09/93-96		T 140 V Bonneville	73-78					
			F 650 (E169/0162) Funduro /High Screen/19" front wheel					97-00		T 140 Silver Jubilee Bonneville	77					
		F 650 ST (E169/163/168) Strada (18" front wheel/low screen)	97-00	T 140 E Bonneville	78-83											
MD651	Rear	S	BMW	240	MD657LS MD657RS MD657LS	Front	D	DUCATI	260							
			F 650 (E169/0161)					09/93-96		500/600 Pantah	79-81					
			F 650 (E169/0162) Funduro /High Screen/19" front wheel					97-00		DUCATI	260					
			F 650 ST (E169/163/168) Strada (18" front wheel/low screen)					97-00		Ducati 500 Pantah		79				
			F 650 GS (R13/0172/0182)					99-03		MD660LS MD660RS	Front	F	APRILIA	298		
			F 650 GS Dakar (R13/0173/0183) 21" front wheel					99-03							Aprilia RS 250	99-03
			F 650 GS (R13/0175/0185) Single Cylinder 19" front wheel					04-07		MD661 ABS Models	Rear	F	BMW	285		
			F 650 GS Dakar (R13/0176/0186) 21" front wheel					04-07							K 75 'S'	85-95
			F 650 CS Scarver (K14/0174/0184) (Belt drive/17" cast wheel)					00-03							K 75 TY (ABS)	89-96
			F 650 CS Scarver K14/0177/087 Belt Drive 17" cast wheel					04-07							K 100/2	87-90
			F 650 GS "Sertao" (Spoke wheel /single cylinder/Chain drive)												K 100 LT	86-91
			G 650 GS Sertao (Spoke Wheel/Single Cylinder/Chain Drive)					10-14							K 100 RS	83-92
			G 650 GS (R131) (Single cylinder /chain drive/Cast Wheel)					09-15							K 100 RT	83-89
			TR 650 Terra (Spoke Wheel)					13							K1	88-93
			TR 650 Strada (Cast Wheel)					13							K 1200 RS	96-05
			ROYAL ENFIELD												K 1200 GT	03-06
			Continental GT					13-17							K 1100 RS	92-96
			Bullet 500 EFI (Brembo caliper F & R)					16-17							KL 1100 LT	89-99
			Classic 500 (Brembo caliper F & R)					16-17		R 1100 RS	92-01					
			Classic 500 Chrome (Brembo caliper Front & Rear)					16-17		MD662X MD662XC VR662BLK VR662BLU VR662RED VR662GLD	Front	F	TRIUMPH	310		
										Speedfour 600					02-05	
										TT 600					00-03	
					Daytona 650	05										

ROTOR BUYERS GUIDE

F = FLOATING ROTOR
S/F = FLOATING CONVERSION FOR FLAT SOLID ROTOR

D = FLOATING ROTOR CONVERSION FOR DISHED SOLID ROTOR
S = FLAT SOLID

BRAKE ROTOR BUYERS GUIDE - STREET

Rotor No.	Front/Rear	Type	Models	Dia (mm)	Rotor No.	Front/Rear	Type	Models	Dia (mm)
MD663 VR663	Rear	S	TRIUMPH	255	MD671 Contd.	Rear	S	BMW	265
			Bonneville 800 01-05 Bonneville T-100 02-12 Scrambler (865cc/Carbs) 06-09 Scrambler (865cc/EFI) 10-16 Sprint RS 99-04 Tiger 800 (Non ABS) 11-14 Tiger 800 XC (Non ABS) 11-14 Thrupton SE (865cc) 12 Thrupton 900 04-15 Thrupton 900 Ace Cafe SE 14-15 Bonneville/Bonneville Black (865cc) 06-08 Bonneville (865cc/cast wheel) 09-15 Bonneville SE (865cc/cast wheel) 09-12 Bonneville T100 (865cc) 10-15 Bonneville T100 (865cc) Steve McQueen 12 Bonneville T100 Black (865cc/Spoke Wheels) 14-15 Bonneville T100 Spirit SE (Spoke wheels) 15 Bonneville T100 Newchurch SE (Cast wheels) 15 Bonneville T214 (Black/Spoke Wheels) 15 Speed Triple (1050cc) Brembo radial calipers 08-11 Speed Triple R (1050cc) 5 Spoke Cast Wheel Brembo Monobloc Radial Calipers 12 Speed Triple (1050cc) Non ABS/Brembo calipers From VIN 461332 11-12 Sprint 1050 ST VIN 208167- (5 Spoke Wheel/Non ABS) 05-10 Sprint 1050 ST Non ABS/Zero offset disc 11-12 Tiger 1050 Twin Side S/Arm 07-16					F 800 GS (Twin cylinder model /798cc/Spoke wheel) 08-17 F 800 GS Adventure (Twin cylinder model/798cc/Spoke wheel) 12-17 F 800 GT 13-15 S 1000 XR 14-17 K 1200 S 05-08 K 1200 R 05-09 K 1200 R-Urban (K43) 05-08 K 1200 R-Sport (K43) 07-08 HP2 Enduro 05-09 HP2 Megamoto Nov 07-09 HP2 Sport 08-11 RnineT (K21/1170cc) 14-16 R 1200 RT 05-15 R 1200 ST 03-08 R 1200 GS 02-12 R 1200 S 06-10 R 1200 R (K27) 06-11/07 R 1200 R (Disc has fixed bobbins) 08-13 K 1300 R 09-15 K 1300 S 09-15 S 1000 XR 14-17 HUSQVARNA 900 Nuda/Nuda R 12-13	
MD664	Rear	S	APRILIA RS 50 Replica 99-05 RS 125 06-10	220	MD675	Front	F	MV (AGUSTA) F4 750 (All models) (Nissin Calipers) 99-03 Brutale 750 (All models) (Nissin calipers) 03-05 Brutale 910 S (Nissin calipers) 05-07 Brutale 989 R 08-09 Brutale 990 R 10 F4 1000 (All models) (Nissin Calipers) 04-06	310
MD666X MD666XC	Front	F	APRILIA RSV 1000 'Mille'/SP 98-01 SL 1000 "Falco" 00-05	320	MD676	Front	F	TRIUMPH Tiger 955 (Cast wheel) (From VIN 198875) 04-06	310
MD667	Front	F	MOTO GUZZI Daytona 1000 92-95	300	MD677	Rear	S	TRIUMPH Tiger 955 (Cast wheel) (From VIN 198875) 04-06	285
MD668LS MD668RS	Front	F	LAVARDA 1000 SFC 85-86	299	MD678	Front	F	VICTORY Cory Ness Victory Cross Country 11-12 Cross Roads 10-13 Arlen Ness Victory Vision 10-12 Cory Ness Jackpot 08-10 Victory Vegas 03-07 Victory King Pin 04-07 King Pin 04-12 King Pin Tour 04-09 King Pin - 8 Ball 08-11 King Pin Low 09 Vegas 03-12 Vegas - 8 Ball 05-12 Ness Signature Series 05-07 Vegas Jackpot 06-09 Hammer 05-11 Hammer 8 Ball 10-16 Hammer S 07-16 Jackpot 10-16 Zach Ness Vegas 11-12 Vegas Low 08-09 Vision 8 Ball 10-11 Vision Street 08-09 Vision Tour 08-14 Hard Ball (Spoke Wheel) 12-13 Judge 12-16	300
MD669X MD669XC VR669BLK VR669BLU VR669RED VR669GLD	Front 5 Bolt	F	TRIUMPH Daytona 955i 01-06 Speedtriple 955cc 02-04 Sprint 1050 ST VIN 208167- (5 Spoke Wheel) 05-10 Rocket III 2300cc 04-08 Rocket III Classic 07-08 Rocket III Roadstar 11	320					
MD671	Rear	S	BMW F 650 GS (K72/0218/0228) (798cc twin cylinder/cast wheel) 07-13 F 650 GS (30 Years GS) (Twin cylinder 798cc/cast wheel) 11 F 700 GS (Twin cylinder model/798cc /Spoke wheel) 11-17 F 800 GS (Twin cylinder model/798cc /Spoke wheel) 08-17 F 800 GS Adventure (Twin cylinder model/798cc/Spoke wheel) 12-17 F 800 R 09-15 F 800 S/ST 06-12	265					

ROTOR BUYERS GUIDE
 CODES FOR TYPES
 S = FLAT SOLID
 D = FLOATING ROTOR CONVERSION FOR DISHED SOLID ROTOR
 F = FLOATING ROTOR
 S/F = FLOATING CONVERSION FOR FLAT SOLID ROTOR

BRAKE ROTOR BUYERS GUIDE - STREET

Rotor No.	Front/Rear	Type	Models	Dia (mm)	Rotor No.	Front/Rear	Type	Models	Dia (mm)	
MD696 Contd.	Rear	S	MV (AGUSTA) F4 1000cc (1078cc) 07 Brutale 1078 RR 08-09 F4 RR 312 1078cc 08-09 Brutale 1090 R 12 Brutale 1090 RR 10 Brutale 1090 13-14	210	MD800X MD800XC VR800BLK VR800BLU VR800RED VR800GLD	Front	F	TRIUMPH Daytona 675 06-12 Daytona 675 SE 12 Street Triple 675 07-12 Street Triple 675 (Brembo Rear Caliper) 13-17 Street Triple R 675 (Radial caliper) 09-12 Street Triple R 675 (Nissin Front Radial/Brembo Brembo Rear Caliper) From Vin # 560477 13-17 Street Triple 675 RXSE (ABS) 15	308	
MD699	Rear	S	TRIUMPH Rocket III 04-09 Rocket III Classic (2300cc) 07-09 Rocket III Roadster 11-17 Rocket III Touring (2300cc) 09-17	316	MD801	Front	S	CAN-AM Spyder RS SE5 08-09 Spyder RS SM5 08-09 Spyder RS Phantom Black 09 Spyder RT 10-12 Spyder RT LTD 10-12 Spyder RT-S 10-12 Spyder RS 10-12 Spyder RS-S 10-12	260	
MD711LD MD711RD	Front	F	YAMAHA TZ 250 89-96	282	MD802	Rear	S	CAN-AM Spyder RS SE5 08-09 Spyder RS SM5 08-09 Spyder RS Phantom Black 09 Spyder RT 10-12 Spyder RT LTD 10-12 Spyder RT-S 10-12 Spyder RS 10-12 Spyder RS-S 10-12	260	
MD713	Rear	S	MORIWAKI/HONDA MD 250 H 08-11 MD 250 S	185	MD803	Front	S	BMW F 800 S/ST 06-08 R 1100 S (Non ABS) 12/00-06 R 1200 RT 05-10 R 1200 ST 03-08 R 1200 S 06-11/07 HP2 Megamoto Loose bobbins Nov 07	320	
MD714X MD714XC	Front	S/F	KAWASAKI EX 500 A1-A7 87-93 EX 500 D1/D2/D3/D4/D5/D6 94-99	280	MD804	Front	S	BMW K 1200 R-Sport (K43) 07-08 K 1200 R 11/05-11/07 R 1200 R (K27) 06-11/07	320	
MD719RS Countersunk screw fixing	Front	F	BUELL M2 Cyclone®, S1 Lightning®, S2 Thunderbolt®, S3 Thunderbolt® 94-97	340	MD809 MD809C	Front	S	BMW G 650 Xchallenge 07-09 G 650 Xcountry 07-09	300	
MD719RS Countersunk screw fixing Contd.	Front	F	BUELL Contd. S1 Whitelightning®, S3 Thunderbolt®, S3T Thunderbolt®, X1 Lightning 98-00	340	MD810 MD810C	Rear	S	BMW G 650 Xchallenge 07-09 G 650 Xcountry 07-09	240	
MD727	Front /Rear	F	VICTORY V92/SC 98-03	300	MD812	Rear	S	KTM 1190 RC8 08-12 1190 RC8 R 09-14	220	
MD730	Front	F	YAMAHA TZ 250 97-01 TZ 250 (Radial Calipers) 02-10	298	MD814	Rear	S	DAELIM Roadwin 125 04-09	220	
MD732	Rear	S	YAMAHA TZ 250 89-90/92-01 TZ 250 (Radial Calipers) 02-10	185	MD817X MD817XC VR817BLK VR817BLU VR817RED VR817GLD	Front	F	TRIUMPH Sprint GT (1050cc/ABS) 10-12 Sprint GT SE(1050cc/ABS) 13-16 Speed Triple (1050cc) From VIN 333179 08-10 Speed Triple (1050cc) Non ABS/Brembo calipers From VIN 461332 11-12 Speed Triple (1050cc) ABS from VIN 461332 (Brembo Calipers) 11-15 Speed Triple R (1050cc) 5 Spoke Cast Wheel Brembo Monobloc Radial Calipers 12 Sprint 1050 ST Zero offset disc 11-12 Trophy SE (1215cc) 13-17	320	
MD734RS	Front	F	BUELL (All models counterbored fixing) 00-05	340						
MD735RS	Front	S	BUELL Firebolt XB9R 02-07 XB9S Lightning 03-04 XB9SX Lightning City X 05-09 XB9SX Lightning 08-10 XB12 S Lightning 04-08 XB12 X Ulysses 06-10 XB12 XT Ulysses 08-10 XB12 SCG Lightning 06-08 XB12 Ss Lightning Long 06-08 XB12 Ss Lightning 09-10 XB12 STT Lightning 08 XB12 SCG Lightning 09-10 XB12 R Firebolt 04-08 XB12 R Firebolt 09-10 1125R 08-10 1125CR 09-10 EBR 1190 RX (Sport) 14-15 1190 SX (Naked) 14-15 1190 RS (Sport) 14-15	375						

ROTOR BUYERS GUIDE

CODES FOR TYPES
S = FLAT SOLID
D = FLOATING ROTOR CONVERSION FOR DISHED SOLID ROTOR

F = FLOATING ROTOR
S/F = FLOATING CONVERSION FOR
FLAT SOLID ROTOR

BRAKE ROTOR BUYERS GUIDE - STREET

Rotor No.	Front/Rear	Type	Models	Dia (mm)	Rotor No.	Front/Rear	Type	Models	Dia (mm)
MD820 MD820C VR820	Rear	S	TRIUMPH	255	MD832	Rear	S	BMW	220
			Tiger 800 (with ABS) 11-14					S 1000 RR 10-17	
			Tiger 800 XC (With ABS) 11-17					S 1000 RR (Models fitted with Forged race wheels 7 spoke type) 15-17	
			Tiger 800 XC SE (Spoke wheel) 14					S 1000 R Naked 14-15	
			Tiger 800 XCX (ABS/Spoke Wheels) 15					HP4 (1000cc) 13-14	
			Tiger 800 XCa (ABS/Spoke Wheels) 15-17						
			Tiger 800 XCx (With ABS/Spoke Wheels/STD & Low) 15-17						
			Tiger 800 XR (ABS/Cast Wheel) 15-17						
			Tiger 800 XR Touring (ABS/Cast Wheel) 15						
			Tiger 800 XRt (With ABS/Cast Wheels) 16-17						
			Tiger 800 XRx (With ABS/Cast Wheels/STD & Low) 15-17						
			Tiger 1050 (Single Sided S/Arm) 13-15						
			Speed Triple (1050cc) ABS from VIN 461332 (Brembo Calipers) 11-15						
Sprint GT (1050cc/ABS) 10-12									
Sprint GT SE (1050cc/ABS) 13-16									
Sprint 1050 ST VIN 208167- (5 Spoke Wheel/ABS Model) 05-10									
Sprint 1050 ST ABS/Zero Offset Disc 11-12									
MD821 MD821X MD821XC Floating Conversion	Front	S	TRIUMPH	310	MD834 MD834X	Front	S	BMW	300
			Bonneville (865cc/cast wheel) 09-15					F 650 GS (R13/0172/0182) 99-03	
			Bonneville SE (865cc/cast wheel) 09-12					F 650 GS Dakar (R13/0173/0183) 21" front wheel 99-03	
			Bonneville T100 Newchurch SE (Cast Wheels) 15					F 650 GS (R13/0175/0185) Single Cylinder 19" front wheel 04-07	
			Speedmaster (865cc/EFI) 11-12					F 650 GS Dakar (R13/0176/0186) 21" front wheel 04-07	
			Speedmaster (865cc EFI) 5 Spoke Wheel Eng # 4609050 onwards/5 bolt fr disc 11-17					F 650 CS Scarver (K14/0174/0184) (Belt drive/17" cast wheel) 00-03	
			America LT (865cc) 14-15					F 650 CS Scarver K14/0177/087 Belt Drive 17" cast wheel 04-07	
								F 650 GS (30 Years GS) (Twin cylinder 798cc/cast wheel) 11	
								F 650 GS (K72/0218/0228) (798cc twin cylinder/cast wheel) 06-17	
								F 650 GS "Sertao" (Spoke wheel /single cylinder/Chain drive) 10-14	
MD822 MD822X MD822XC Floating Conversion	Front	S	TRIUMPH	310	MD838 6 bolt fixing	Front Rear	F F	TRIUMPH	250
			Bonneville T100 (865cc) 10-15					T140 D Bonneville (Lester Alloy Wheels 6 bolt disc) 79-81	
			Bonneville T100 (865cc) Steve McQueen 12					T140 D Bonneville (Lester Alloy Wheels) 79-81	
			Bonneville T100 Black (865cc/Spoke Wheels) 14-15						
			Bonneville T100 Spirit SE (Spoke Wheels) 15						
			Bonneville T214 (Black/Spoke Wheels) 15						
			America (865cc/cast wheel) 10-15						
			America (865cc) (Cast wheel) America LT (865cc) (Cast wheel/Wind Shield) 14-17						
			Speedmaster (865cc EFI) Cast Wheel Eng # 392060 to 46049/6 bolt fr disc 09-10						
			Scrambler (865cc/EFI) 10-15						
Scrambler (900cc/EFI) 17									
MD825	Front	F	TRIUMPH	310	MD840 MD840C	Rear	S	MOTO GUZZI	282
			Thunderbird (1600cc/Cast Wheel) 09-17					1100 Griso (1064cc) Standard mount calipers 05-12	
			Thunderbird (1600cc/Windscreen) 12					1100 Brevia 05-12	
			Thunderbird Commander (1700cc/Cast wheel) 14-17					Norge 1200/GT/GV 06-12	
			Thunderbird LT (Windscreen) (1700cc/Cast wheel) 14-17					Norge 1200 GT 8V 10-12	
			Thunderbird Storm (1700cc/Cast wheel) 09-17					Griso 1200 8V 09-12	
			Thunderbird NightStorm (1700cc/Cast wheel) 09-17					1200 Griso SE (8V) (Radial caliper) 1151cc 09-12	
	Stelvio 1200 8V (NTX/ABS) 09-14								
MD831	Rear	S	TRIUMPH	310	MD841X MD841XC VR841BLK VR841BLU VR841RED VR841GLD	Front	F	DUCATI	320
			Thunderbird Storm (1700cc) 11-15					796 Monster (Non ABS) 10-14	
			Thunderbird (1600cc/Cast Wheel) 09-15					796 Monster (ABS) 10-14	
			Thunderbird SE (1600cc/Windscreen) 12					M796 Monster 20th Anniversary Model 13-14	
			Thunderbird Commander (1700cc) 14-15					797 Monster 17	
			Thunderbird LT (Windscreen) (1700cc) 14-15					Monster 821 15-17	
								Monster Dark 821 15	
								Monster Stripe 821 15-17	
								848 Streetfighter 12-14	
								Supersport (936cc) 17	
	Supersport S (936cc) 17								
	939 Hypermotard 16-17								
	939 Hypermotard SP 16-17								
	950 Multistrada (936cc) 17								
	Multistrada 1200 10-17								
	Multistrada 1200 Enduro 16-17								
	Multistrada 1200 S (Sport) 10-								
	Multistrada 1200 S 16-17								

ROTOR BUYERS GUIDE
 F = FLOATING ROTOR
 S/F = FLOATING CONVERSION FOR FLAT SOLID ROTOR
 D = FLOATING ROTOR CONVERSION FOR DISHED SOLID ROTOR
CODES FOR TYPES
 S = FLAT SOLID
 D = FLOATING ROTOR CONVERSION FOR DISHED SOLID ROTOR

BRAKE ROTOR BUYERS GUIDE - STREET

Rotor No.	Front/Rear	Type	Models	Dia (mm)	Rotor No.	Front/Rear	Type	Models	Dia (mm)		
MD841X MD841XC VR841BLK VR841BLU VR841RED VR841GLD Contd.	Front	F	DUCATI	320	MD844X MD844XC	Front	F	KTM	300		
			Multistrada 1200 S Pikes Peak					11-14		990 Adventure (ABS Model)	07-12
			Multistrada 1200 Pikes Peak					16-17		(For left side)	
			1200 S Multistrada Grandtourismo					13-14			
			1200 S Touring					10-14			
			1200 Monster					14-17			
			1200 S Monster					14-17			
			1200 R Monster					16-17			
			Diavel ABS					11-17			
			Diavel Carbon (ABS)					16-17			
Diavel AMG	12										
Diavel Cromo	12-14										
Diavel Dark (ABS)	13-14										
Diavel Dark	13-14										
Diavel Strada	13-14										
1262 Xdiavel	16-17										
1262 Xdiavel S	16-17										
MD842X MD842XC VR842BLK VR842BLU VR842RED VR842GLD	Front	F	TRIUMPH	305	MD848X MD848XC	Front	F	KTM	300		
			Tiger 800 (Inc ABS)					11-14		990 Adventure (ABS Model) (For right side)	07-12
			Tiger 800 XC (Inc ABS)					11-17		990 Adventure Baja Edition	
			Tiger 800 XC SE (Spoke wheel)					14			
			Tiger 800 XCX (ABS/Spoke Wheels)					15			
			Tiger 800 XCa (With ABS/Spoke Wheels)					15			
			Tiger 800 XCx (With ABS/Spoke Wheels/STD & Low)					15-17			
			Tiger 800 XR (ABS/Cast Wheel)					15-17			
			Tiger 800 XR Touring (ABS/Cast Wheel)					15			
			Tiger 800 XRt (With ABS/Cast Wheels)					16-17			
Tiger 800 XRx (With ABS/Cast Wheels /STD & Low)	15-17										
Tiger 1200 Explorer (1215cc)	12-15										
Tiger Explorer XC 1200 (Up to Vin # 740276 /1215cc/Cast & Spoke Wheels)	13-15										
Tiger Explorer XC 1200 (Vin # 740277 onwards/1215cc/Spoke Wheels)	16-17										
Tiger Explorer XCa 1200 (1215cc /Spoke Wheels)	16-17										
Tiger Explorer XCx 1200 (1215cc /Spoke Wheels/STD & Low)	16-17										
Tiger Explorer XR 1200 (1215cc/Cast Wheels)	16-17										
Tiger Explorer XRx 1200 (1215cc/Cast Wheels/STD & Low)	16-17										
Tiger Explorer XRt 1200 (1215cc /Cast Wheels)	16-17										
MD843X MD843XC VR843BLK VR843BLU VR843RED VR843GLD	Front	F	DUCATI	320	MD851 MD851C	Rear	S	TRIUMPH	220		
			848 (Radial 2 pad caliper)					08-09		Daytona 675	13-17
			848 Evo (Monobloc Front Calipers)					10-12		Daytona 675 R	13-17
			899 Panigale					14-15		Street Triple 675	13-17
			959 Panigale (ABS)					16-17		Street Triple R 675	13-17
			Monster 1100 (Non ABS)					09-10		Street Triple 675 RXSE (ABS)	15
			Monster 1100 (ABS)					09-10			
			Monster 1100 S (Non ABS)					09-10			
			Monster 1100 S (ABS)					09-10			
			Monster 1100 EV (ABS)					11-12			
1100 Monster Diesel	13-14										
M 1100 Evo Monster 20th Anniversary Model	13-14										
S4RS Monster (998cc) (Radial 4 pad caliper)	06										
S4R Testastretta Monster (998cc) (Radial 4 pad caliper)	07-08										
S4RS Testastretta Monster (998cc) (Radial 4 pad caliper)	07-										
S4RS (Tricolore/Monster Testastretta) (998cc)# (Radial 4 pad caliper)	08										
MD843X MD843XC VR843BLK VR843BLU VR843RED VR843GLD	Front	F	DUCATI	320	MD852X MD852XC	Front	F	TRIUMPH	310		
			848 (Radial 2 pad caliper)					08-09		Daytona 675 / 675 R	13-17
			848 Evo (Monobloc Front Calipers)					10-12		Street Triple 675	13-17
			899 Panigale					14-15		Street Triple R 675	13-17
			959 Panigale (ABS)					16-17		Thruxton (1200cc)	
			Monster 1100 (Non ABS)					09-10		Floating disc conversion	16-17
			Monster 1100 (ABS)					09-10		Thruxton R (1200cc)	16-17
			Monster 1100 S (Non ABS)					09-10			
			Monster 1100 S (ABS)					09-10			
			Monster 1100 EV (ABS)					11-12			
1100 Monster Diesel	13-14										
M 1100 Evo Monster 20th Anniversary Model	13-14										
S4RS Monster (998cc) (Radial 4 pad caliper)	06										
S4R Testastretta Monster (998cc) (Radial 4 pad caliper)	07-08										
S4RS Testastretta Monster (998cc) (Radial 4 pad caliper)	07-										
S4RS (Tricolore/Monster Testastretta) (998cc)# (Radial 4 pad caliper)	08										
MD843X MD843XC VR843BLK VR843BLU VR843RED VR843GLD	Front	F	DUCATI	320	MD853	Front	S	CAN AM	270		
			848 (Radial 2 pad caliper)					08-09		Spyder RS (Brembo Caliper)	13-16
			848 Evo (Monobloc Front Calipers)					10-12		Spyder RS -S (Brembo Caliper)	13-16
			899 Panigale					14-15		Spyder RT (3 Cyl Eng/ 6 Speed)	13-17
			959 Panigale (ABS)					16-17		Spyder RT LTD (3 Cyl Eng/ 6 Speed)	13-17
			Monster 1100 (Non ABS)					09-10		Spyder RT-S (3 Cyl Eng/ 6 Speed)	13-15
			Monster 1100 (ABS)					09-10		Spyder RT-S (Special Series)	16-17
			Monster 1100 S (Non ABS)					09-10		Spyder ST (Brembo Calipers)	13-16
			Monster 1100 S (ABS)					09-10		Spyder ST LTD (Brembo Calipers)	13-15
			Monster 1100 EV (ABS)					11-12		Spyder ST-S (Brembo Calipers)	13-16
1100 Monster Diesel	13-14	Spyder F3 (SE6/SM6)	15-17								
M 1100 Evo Monster 20th Anniversary Model	13-14	Spyder F3 LTD	16-17								
S4RS Monster (998cc) (Radial 4 pad caliper)	06	Spyder F3-S (SE6/SM6)	15-17								
S4R Testastretta Monster (998cc) (Radial 4 pad caliper)	07-08	Spyder F3-S (Special Series)	16								
S4RS Testastretta Monster (998cc) (Radial 4 pad caliper)	07-	Spyder F3-S Daytona 500	17								
S4RS (Tricolore/Monster Testastretta) (998cc)# (Radial 4 pad caliper)	08	Spyder F3-T	16-17								
MD843X MD843XC VR843BLK VR843BLU VR843RED VR843GLD	Front	F	DUCATI	320	MD854	Rear	S	CAN AM	270		
			848 (Radial 2 pad caliper)					08-09		Spyder RS (Brembo Caliper)	13-16
			848 Evo (Monobloc Front Calipers)					10-12		Spyder RS -S (Brembo Caliper)	13-16
			899 Panigale					14-15		Spyder RT (3 Cyl Eng/ 6 Speed)	13-17
			959 Panigale (ABS)					16-17		Spyder RT LTD (3 Cyl Eng/ 6 Speed)	13-17
			Monster 1100 (Non ABS)					09-10		Spyder RT-S (3 Cyl Eng/ 6 Speed)	13-15
			Monster 1100 (ABS)					09-10		Spyder RT-S (Special Series)	16-17
			Monster 1100 S (Non ABS)					09-10		Spyder ST (Brembo Calipers)	13-16
			Monster 1100 S (ABS)					09-10		Spyder ST LTD (Brembo Calipers)	13-15
			Monster 1100 EV (ABS)					11-12		Spyder ST-S (Brembo Calipers)	13-16
1100 Monster Diesel	13-14										
M 1100 Evo Monster 20th Anniversary Model	13-14										
S4RS Monster (998cc) (Radial 4 pad caliper)	06										
S4R Testastretta Monster (998cc) (Radial 4 pad caliper)	07-08										
S4RS Testastretta Monster (998cc) (Radial 4 pad caliper)	07-										
S4RS (Tricolore/Monster Testastretta) (998cc)# (Radial 4 pad caliper)	08										

ROTOR BUYERS GUIDE
 CODES FOR TYPES
 S = FLAT SOLID
 D = FLOATING ROTOR CONVERSION FOR DISHED SOLID ROTOR
 F = FLOATING ROTOR
 S/F = FLOATING CONVERSION FOR FLAT SOLID ROTOR

BRAKE ROTOR BUYERS GUIDE - STREET

Rotor No.	Front/Rear	Type	Models	Dia (mm)	Rotor No.	Front/Rear	Type	Models	Dia (mm)		
MD854 Contd.	Rear	S	CAN AM	270	MD872 MD872C VR872	Rear	S	APRILIA	256		
			Spyder F3 (SE6/SM6)					15-17		Mana 850 GT ABS	09-16
			Spyder F3 LTD					16-17			
			Spyder F3-S (SE6/SM6)					15-17			
			Spyder F3-S (Special Series)					16			
			Spyder F3-S Daytona 500					17			
			Spyder F3-T	16-17							
MD856X MD856XC	Front	F	KTM	320	MD873 MD873X	Front	S F	TRIUMPH	310		
			690 Duke (2 pad caliper)					12-15		Bonneville T100 (900cc)	17
MD857 MD857C	Rear	S	KTM	240	MD874	Rear	S	TRIUMPH	255		
			690 Duke (2 pad caliper)					12-15		Bonneville Bobber (1200cc)	17
MD858 MD858C VR858	Rear	S	APRILIA	256	MD878 MD878C VR878	Rear	S	DUCATI	245		
			Mana 850					08-12		796 Monster (ABS)	10-15
MD862X	Front	F	BMW	320	MD879	Rear	S	DUCATI	265		
			S 1000 RR (Models fitted with Forged race wheels 7 spoke type)	15-17				Multistrada 1200		16-17	
MD863	Rear	S	TRIUMPH	282	MD880 MD880C VR880	Rear	S	DUCATI	265		
			Tiger Explorer 1200					12-15		1200 Monster	14-17
			Tiger Explorer XC 1200 (Up to Vin # 740276 /1215cc/Cast & Spoke Wheels)					13-15		1200 S Monster	14-17
			Tiger Explorer XC 1200 (Vin # 740277 onwards/1215cc/Spoke Wheels)					16-17		1200 R Monster	16-17
			Tiger Explorer XCa 1200 (1215cc/Spoke Wheels)					16-17		1299 Panigale	15-17
			Tiger Explorer XCx 1200 (1215cc/Spoke Wheels/STD & Low)					16-17		1299 Panigale S	15-17
			Tiger Explorer XR 1200 (1215cc/Cast Wheels)					16-17		1299 Panigale R	15-17
			Tiger Explorer XRx 1200 (1215cc/Cast Wheels/STD & Low)					16-17		Supersport (936cc)	17
			Tiger Explorer XRt 1200 (1215cc/Cast Wheels)					16-17		Supersport S (936cc)	17
										1199 Panigale	12-15
										1199 Panigale S	12-15
MD864 MD864XC	Front	S/F	KTM	300							
			Duke 390	15-16							
			RC 390	15-16							
MD865X MD865XC	Front	F	DUCATI	305	MD901D	Front /Rear	S	BETA	190		
			796 Hypermotard					10-12		Eikon 50 Team	02-03
			1100 Hypermotard					07-09		MALAGUTI	
			1100 Hypermotard GVO					10-12		F15 Firefox	02-03
			1100 Hypermotard GVOSP					10-13		F12 Phantom (A/C)	98-03
1100 Hypermotard 1100S	07-09	Phantom F12	98-03								
							F15 Firefox (L/C)	04			
MD868X MD868XC	Front	F	DUCATI	330	MD903D MD903C	Front	S	PEUGEOT	245		
			Scrambler Classic (Spoke wheels /803cc)					15-17		Vivacity X-Race 50/Pulsa 50	02-05
			Scrambler Icon (Cast wheels/803cc)					15-17		Metal-X	02-05
			Scrambler Urban Enduro (Spoke wheels/803cc)					15-17		Trekker 50	02-05
			Scrambler Full Throttle (Cast wheels /803cc)					15-17		Elyseo 50	03-05
			Scrambler Flat Track Pro (Cast wheels /803cc)					16-17		Jet Force 50	03-05
			Scrambler Café Racer (Cast wheels /803cc)					17		Ludix 50 (14" wheels) Elegance/Ambition	04-05
										Ludix 125	04-05
MD871	Rear	S	MOTO GUZZI	260				YAMAHA	245		
			750 Nevada Club (From LK112434)					98-01		YP 250 Majesty (5CV1)	97
			750 Nevada Base/Club					02-03		YP 250 Majesty (5GM2/9-5SJ2/5/9)	00-03
			Nevada Classic 750ie					04-09			
			V 750 ie Brevia					03-08			
			V7 Classic					08-12			
			V7 Cafe Classic					11-12			
			V7 Racer					10-11			
V 750 ie Brevia	03-08										

ROTOR BUYERS GUIDE

F = FLOATING ROTOR
 S/F = FLOATING CONVERSION FOR FLAT SOLID ROTOR

S = FLAT SOLID
 D = FLOATING ROTOR CONVERSION FOR DISHED SOLID ROTOR

BRAKE ROTOR BUYERS GUIDE - STREET

Rotor No.	Front/Rear	Type	Models	Dia (mm)	Rotor No.	Front/Rear	Type	Models	Dia (mm)
MD904D	Front	S	PEUGEOT	155	MD941D	Front	S	ITALJET	175
			Ludix 50 (10" wheels) Trend/One /Snake/Bullet 04 Fox 50 07-08 CW 50 L/TL Zuma/Zuma II 99 JYM 90 T Axis 4RT6 01 YA 90 Axis (4CY1/5/7 - 4EN5/6/7) 91-96 YA 100 W Grand Axis (5TC2/4/5) 01-03 YW 100 BW's (4VPS/PC/PV/PX/5XR1/R2/R3/R4) 97-08					Dragster 50 98-03 Formula 50 (Air Cooled) 99-03 Formula 50 (Liquid Cooled) 96-03 Formula 125 LC 96-03	
MD908D	Front	S	HONDA CN 250 Helix 86-87 CN 250 Helix 92-01/05-07	186	MD942D	Rear	S	APRILIA	220
MD910D	Front	S	PIAGGIO Fly 50 05-12 Fly 50 (4T/2V) 07-14 Typhoon 50 (4T/4V/12" Wheels) 10-11 Fly 150 (Fly 150) 05-12 VESPA ET2 50cc 97-05 LX 50 05-15 Primavera 50 (4T/4V) 13-15 S 50 4T/4V 08-15 Sprint 50 (4T/4V) 14-15 ET4 150cc 99-05 Primavera 150 (4T/3V/ie) 13-15 PX 150 (All models) 05-06 LX 150 ie 05-15 LXV 150 ie 10-15 S 150 ie 08-15	200				Scarabeo 150 99-06 Scarabeo 125/200 GT 04 Scarabeo 250 06-08 Sport City 250 07-14 Sport City Cube 250 08-09	
MD915D	Front	S	MALAGUTI Yesterday 50 98-03 F10 Fast Time 02-03	155	MD943D	Front Rear	S	APRILIA Rally 50 (Air Cooled) 04-05 Mojito Retro 50 04-05 Scarabeo 50 Ditech (Rear disc model) 02-08 SR 50 (Factory) 99-15 Mojito Custom 50 04-06 Mojito Custom 150 05-08 DERBI Atlantis 50 02-06 GP1 50 02-06	190
MD922D	Front	S	HONDA NSS 250/250 A/A5 Reflex 01-07 PS 250 Big Ruckus 05-06	240	MD945D	Front	S	APRILIA Scarabeo 50 Ditech (Rear disc model) 02-08 Scarabeo Street 50 99-05 Scarabeo 100 4T 04-14	220
MD923D	Front	S	YAMAHA CW 50 M/N Zuma II 00-01 Delivery 50 (From F. No 609100) 06-08 EW 50 Stunt (5LH2/5YN1) 01-03 X-peed 50/Special Edition 00-05 Zyclone 50 04-05 Thunderbike 150 07-08	190	MD946D	Front	S	MALAGUTI Phantom F12 98-03 F12 Phantom (A/C) 98-03 F15 Firefox (L/C) 04	200
MD924D	Front	S	DERBI Boulevard 150 03-05 Sport City 50 (4T) 08-14 SR 50 Motard (4T) 12-15	220	MD947D	Front	S	PEUGEOT Elyseo 100 03-05 Elystar 50 P 03-05	226
MD925D	Front	S	PEUGEOT Speedfight 2 X-Team (A/C) 02-05 Elyseo 50 03-05 Elyseo 100 03-05 Speedfight X-Race 50 LNDP/100 NP 03-05	180	MD948D	Rear	S	ITALJET Dragster 50 LC 96-03	190
MD925D	Rear	S	PEUGEOT Speedfight X-Race 50 LNDP/100 NP 03-05	180	MD950D	Front	S	ITALJET Formula 50/125 (Liquid Cooled) 96-03	175
MD931D	Front	S	HONDA NHX 110 Elite 10-11	190	MD951D	Front	S	ITALJET Torpedo 50 98-03 Torpedo 125 4T 99-03 Torpedo 150 03	220
MD933D	Front	S	SYM Mio 50 05-12 DD 50 02-12	160	MD952D	Front	S	APRILIA Scarabeo 150 99-06 Scarabeo 125/250 GT 04-05 Sport City 125 (4T) 08-14 Scarabeo 200 08-14 Sport City 250 07-14 Sport City Cube 250 08-09 Scarabeo 250 06-08 Atlantic 500 03-05 Scarabeo 500/ie 03-14	260
					MD953D MD953C	Rear	S	YAMAHA YP 250 Majesty (5GM2/9-5SJ2/5/9)00-03	230
					MD954D	Front	S	PEUGEOT Looxor 50 02-05	226
					MD955D	Front	S	MALAGUTI Ciak 50 02-03 Ciak 150 02-03	230

ROTOR BUYERS GUIDE

CODES FOR TYPES
 S = FLAT SOLID
 D = FLOATING ROTOR CONVERSION FOR DISHED SOLID ROTOR
 F = FLOATING ROTOR
 S/F = FLOATING CONVERSION FOR FLAT SOLID ROTOR

BRAKE ROTOR BUYERS GUIDE - STREET

Rotor No.	Front/Rear	Type	Models	Dia (mm)	Rotor No.	Front/Rear	Type	Models	Dia (mm)					
MD9108D	Rear	S	YAMAHA CP 250 V/W/X Morphus 06-08	245	MD9162D VR9162	Front	S	GOGORO SmartScooter 15-17	205					
MD9109D	Rear	S	SUZUKI AN 400 K7/K8/K9/AK9/AL1/AL2/AL3 /AL4/AL5/AL6 Burgman 07-16	210	MD9163D VR9163	Rear	S	GOGORO SmartScooter 15-17	162					
MD9112D	Front	S	PIAGGIO MP3 (250cc) 07-15 MP3 400ie (Three wheeler) 07-15 MP3 500 (Three wheeler - 12" Front/14" Rear Wheel) 07-14	240	MD1001	Rear Front	S S	HONDA CBR 1000 F Hurricane 87-88 GB 500 89-90 CBR 600 F Hurricane 87-90 CBR 600 F2 91-94 CB 650 SC Nighthawk 83-85 CB 700 SC/S Nighthawk 84-86 VF 700 F Interceptor 84-85 VFR 700 F/F2 Interceptor 86-87 VF 700 S Sabre 84-85 VF 750 V45 Interceptor 83-84 VFR 750 F Interceptor 86 VF 750 S Sabre 82-83 PC 800 Pacific Coast 89-90/94-98 VF 1000 F Interceptor 84 VF 1100 S V65 Sabre 84-85 CB 1100 F Supersport 83	276					
MD9115D	Front	S	TGB/PEIRSPEED R 50 X 06-11 Delivery 151 04-11 Laser R9/i (151cc) 08-11	220										
MD9115D	Rear	S	TGB/PEIRSPEED R 50 X 06-11	220										
MD9116D	Front	S	SYM Jet Euro X 50 99-11 Jet 50 Evo 14	190										
MD9117D VR9117	Front /Rear	S	SUZUKI UH 200 AL4/AL5/AL6 Burgman ABS14-16	240						MD1002	Rear	S	HONDA CBR 600 F Hurricane 87-90	220
MD9126D	Front	S	PIAGGIO Typhoon 50/SE 06 Typhoon 50 07-08 Typhoon 50" (2T) 10" wheels 07-09	190						MD1003X MD1003XC MD1003CC VR1003BLK VR1003BLU VR1003RED (Check bolt PCD with 1014LS/RS)	Front	F	HONDA CBR 600 F3/SJR/SE 95-98 VFR 750 F 94-97 VFR 800 Fi-W 98-99 CBR 900 RR Fireblade (Hub bolt PCD 74mm) 95-97 VTR 1000 F Superhawk 98-05 MORIWAKI/HONDA MD 250 H 08-13	296
MD9128C	Front	F	KYMCO Downtown 200i 11-12 Downtown 300i 10-15	260						MD1004 MD1004C VR1004	Rear	S	HONDA CBR 250 R (Non ABS Models) 11-14 NSS 250/250 A/A5 Reflex 01-07 599 (CB 600 F) 04/06 CBR 600 F2 91-94 CBR 600 F3/SJR/SE 95-98 CBR 600 F4 Carb Model 99-03 CBR 600 Sport F4i (Injection Model) 01-06 CBR 600 RR 03-16 CBR 900 RR Fireblade 93-00 CBR 929 RR (929cc model) 00-01 CBR 954 RR 02-03 CBR 1000 RR 04-14 CBR 1000 RR SP (Brembo front calipers) 14-17 CBR 1000 RA/RAA 09-16 VTR 1000 F Super Hawk 98-05 RVT 1000 R (RC5I) 00-06	220
MD9129D	Rear	S	KYMCO STREET Downtown 200i 11-12 Downtown 300i 10-15	240						MD1006C MD1006C VR1006	Front Rear	S S	HONDA VF 500 F Interceptor 84-86 HONDA VF 500 F Interceptor 84-86 FSC 600/D Silverwing 02-06 VFR 700 F/F2 Interceptor 86-87 VFR 750 F Interceptor 86 CBR 1000 F 93-99 XL 1000 VA8 Varadero (Canada) 08 CBR 1100 XX Blackbird 97-03	256 256
VR9133	Front	S	YAMAHA YW 125 G Zuma (Rear Disc Model) 16 XC 155 F/G S-Max 15-16	245										
MD9134D	Front	S	HONDA PCX 125 11 PCX 150 (WW 150) 13-17	220										
MD9143D MD9143C	Rear	S	YAMAHA XP 500 F/G (T-Max 530cc) 15-16	282										
MD9144D VR9144BLK	Front	F	SUZUKI AN 650 L3/L4/L5/L6 Burgman (ABS/5 Bolt rear disc) 13-16 AN 650 ZL3/ZL4/ZL5/ZL6/ZL7 Burgman Executive (ABS/5 Bolt rear disc) 13-17	260										
VR9145	Front	S	YAMAHA XC 155 F/G S-Max 15-16	267										
MD9150D VR9150	Rear	S	YAMAHA YW 125 G Zuma (Rear Disc Model) 16	200										
MD9158D	Front	S	PIAGGIO MP3 500 (Three wheeler - 12" Front/14" Rear Wheel) 15-16	258										
VR9159	Front	S	YAMAHA Zuma 50 F (Twin Headlights) F 4T (YW 50 FB/FD/FE/FF/FG) 12-16 Zuma 50 FX (Single Headlight) 4T (YW 50 FXE/FXF/FXG) 14-16	180	MD1007 MD1007C	Rear	S	HONDA VFR 750 F 90-98	256					

ROTOR BUYERS GUIDE

CODES FOR TYPES
 S = FLAT SOLID
 D = FLOATING ROTOR CONVERSION FOR DISHED SOLID ROTOR
 F = FLOATING ROTOR
 S/F = FLOATING CONVERSION FOR FLAT SOLID ROTOR

BRAKE ROTOR BUYERS GUIDE - STREET

Rotor No.	Front/Rear	Type	Models	Dia (mm)	Rotor No.	Front/Rear	Type	Models	Dia (mm)
MD1008	Front	S	HONDA	296	MD1036LS MD1036RS 5 BOLT FIXING VMD1036 Contd.	Front	D	HONDA	276
			NT 700 V/VA (ABS) 10-13					CB 750 C Custom 81-82	
			VFR 750 F 90-93					CB 750 F Supersport 79-82	
			CBR 1000 F (Hurricane) 87-88					CB 750 SC Nighthawk 82-83	
			CBR 1000 F 90-91/93-99					CB 900 C Custom 80-82	
			ST 1100 A 96-02					CB 900 F Supersport 81-82	
MD1010LS MD1010RS	Front	F	HONDA VFR 750 R (RC 30) 90	310				CBX 79-80	
MD1011	Rear	S	HONDA VFR 750 R (RC 30) 90	220	MD1038RS	Front	F	HONDA CB-1 (CB 400F) 89-90	310
MD1012LS MD1012RS	Front	F	HONDA RVF 750 R (RC45) 94-95	310					
MD1013	Rear	S	HONDA RVF 750 R (RC45) 94-95	220	MD1040LS MD1040RS	Front	S	HONDA CB 450 SC Nighthawk 83-86 CM 450 A Hondamatic 83 GL 650 Silverwing/GL 650 Silverwing Interstate 83 VF 700 C Magna 84 VF 700 C Magna 85-86 VT 700 C Shadow 84-85 VF 750 C V45 Magna 82-83 VT 750 C Shadow 83 CB 1000 C Custom 83 VF 1100 C V65 Magna 83-86 VT 1100 C Shadow 85-86	276
MD1014X MD1014XC MD1014CC VR1014BLK VR1014BLU VR1014RED (Check bolt PCD with 1003LS/RS)	Front	F	HONDA CBR 600 F4 (Carb Model) 99-00 CBR 900 RR Fireblade (Hub bolt PCD 78mm) 93-94 VFR 800 Fi/Interceptor 98-09 XL 1000 VA8 Varadero (Canada) 08 GL 1500 Valkyrie All models 97-03 GL1800/1800 A (ABS) Goldwing All models 01-17	296	MD1041LS	Front	S	HONDA CMX 450 C Rebel 86-87	276
MD1016	Rear	S	HONDA NT 700 V/VA (ABS) 10-13 CB 1000 94-95 CBR 1000 F 90-91 VT 1100 C2 American Classic Edition /C2-2/C3 95-02 VT 1100 C2 Shadow American Classic Tourer 98-02 VT 1100 C2 Shadow Sabre 00-07	276	MD1047LS	Front	S	HONDA VT 500 FT Ascot 83-84 VT 500 C Shadow 83-86 VF 500 C V30 Magna 84-85 CB 550 SC 'Nighthawk' 83 VLX 600 Shadow (VT 600 C/CD) 88-93 VT 600 C/CD/C2D Shadow VLX/Deluxe 94-07 CX 650 C Custom 83 VT 700 C Shadow 86-87 VT 800 C Shadow 88	296
MD1020 MD1020C VR1020	Rear	S	HONDA CB-1 (CB 400 F) 89-90 CB 900 F (919) 02-07	240	MD1048	Rear	F	HONDA FT 500 Ascot 82-83	276
MD1021LS MD1021RS (Original Disc is solid)	Front	S/F	HONDA NT 650 Hawk GT 88-91 CB 750 Nighthawk 91-03 VF 750 C Magna/Magna Delux CD/C2 94-03 ST 1100 91-02 ST 1100 A 95	316	MD1052LS MD1052RS VMD1052	Front	D	HONDA CB750 C Custom 80 CB 750 L "Ltd Edition" 79 CB 750 K 79-82	296
MD1022	Rear	S	HONDA NT 650 Hawk GT 88-91	240	MD1056	Front	F	HONDA CB 1000 94-95	310
MD1030	Front	S	HONDA CMX 250 C Rebel 96/97/99-14 CMX 250 C/CD Rebel 85-87 CMX 250 C2 99-00 CMX 250 X Rebel 15	240	MD1059LS	Front	S	HONDA VF 700 C Magna 87 VF 750 C V45 Magna 88	316
MD1036LS MD1036RS 5 BOLT FIXING VMD1036	Front	D	HONDA CB 250 N/T CM 250 T CB 400 T Hawk 80-81 CM 400 A/T 79-81 CM 400 C Custom 81 CB 450 T Hawk 82 CB 450 SC Nighthawk 82 CM 450 C Custom 82 CM 450 A Hondamatic 82 CB 650 79-81 CB 650 C Custom 80-81 CB 650 SC Nighthawk 82	276	MD1062LS VMD1062	Front	D	HONDA CB 750 F 'Supersport' 75-76 CB 750 76/K7 76-78	296
					MD1064	Rear	D	HONDA CB 750 F 'Supersport' 75-78 GL 1000 Goldwing All models 75-79	296
					MD1068	Rear	S	HONDA VF 700 F Interceptor 84 VF 750 V 45 Interceptor 83-84 CB 1100 F Supersport 83	296

ROTOR BUYERS GUIDE

 F = FLOATING ROTOR
 S/F = FLOATING CONVERSION FOR FLAT SOLID ROTOR
 D = FLOATING ROTOR CONVERSION FOR DISHED SOLID ROTOR

BRAKE ROTOR BUYERS GUIDE - STREET

Rotor No.	Front/Rear	Type	Models	Dia (mm)	Rotor No.	Front/Rear	Type	Models	Dia (mm)
MD1071 VMD1071	Rear	D	HONDA CB 750 F Supersport 79-80 CB 900 C Custom 80-81 CBX 79-80 GL 1100/1100 I Goldwing 80 GL 1100/1100 I Goldwing/Interstate 81	296	MD1135	Rear	S	HONDA ST 1100 A 96-02	296
MD1074LS/RS 6 Bolt Fixing	Front	F	HONDA GL 1000 K/76/L Goldwing 75-77	276	MD1136X MD1136XC VR1136BLK VR1136BLU VR1136RED	Front	F	HONDA CBR 1100 XX Blackbird 99-03	310
MD1077	Rear	S	HONDA ST 1100 91-02 ST 1100 A 95 GL 1500 'Valkyrie'/CT Tourer 97-99 GL 1500/1500SE/A/I Goldwing 90-00	316	MD1137X/XC VR1137BLK VR1137BLU VR1137RED	Front	F	HONDA CBR 929 RR (929cc model) 00-01 CBR 954 RR (954cc) 02-03	330
MD1078	Rear	S	HONDA CB 1000 C Custom 83 VF 1100 C V65 Magna 83-86	296	MD1138X MD1138XC/CC	Front	F	HONDA RVT 1000 R (RC5I) 00-06	320
MD1079	Rear	S	HONDA VF 700 F Interceptor 85 VF 1000 Interceptor 84 VF 1100 S V65 Sabre 84-85	276	MD1139 MD1139C	Front	F	HONDA 599 (CB 600 F) 04/06	296
MD1080RS	Front	F	HONDA VT 1100 C Shadow/Shadow Spirit 87-94	336	MD1141X MD1141XC MD1141CC VR1141BLK VR1141BLU VR1141RED	Front	F	HONDA CBR 600 Sport F4i (Injection Model) 01-06 919 (CB 900 F) 02-07 VTX 1800 R 02-08 VTX 1800 S 02-07 VTX 1800 C/C1/C2/C3 02-08 VTX 1800 F1/F2/F3 05-11 VTX 1800 N1/N2/N3 04-11 VTX 1800 T1/T2 07-11	296
MD1082	Rear	D	HONDA CB 750 F Supersport 81-82 CB 900 C Custom 82 CB 900 F Supersport 81-82 CBX 81-82 GL 1100/1100 I Goldwing/Interstate 82-83 GL 1100 A Goldwing Aspencade 82-83 GL 1200 All models 84-87	296	MD1146	Front	S	HONDA VF 1000 R 85-86	276
MD1083LS MD1083RS	Front	D	HONDA GL 1200/1200I/1200 A Goldwing (5mm rotor) 84-85	276	MD1148	Rear	S	HONDA GL 1500 CF/CD Valkyrie All models 00-02 VTX 1800 C/C1/C2/C3 02-08 VTX 1800 R 02-08 VTX 1800 S 02-07 VTX 1800 F1/F2/F3 05-11 VTX 1800 N1/N2/N3 04-11 VTX 1800 T1/T2 07-11	316
MD1101	Front	S	HONDA Venox 250 00-07	316	MD1149	Rear	S	HONDA FSC 600 Silverwing All models 02-14	240
MD1120X/XC VR1120BLK VR1120BLU VR1120RED	Front	F	HONDA CBR 1100 XX Blackbird 97-98	310	MD1151	Rear	S	HONDA CBR 125 RW4/RW5/RW6/RW7/RW8 /RW9/RWA/RWB/RWC/RWD 04-16	220
MD1125	Front	D	HONDA GL 1200 L/1200 I/1200 A/GL 12SE-i Goldwing (10mm rotor) 85-87	276	MD1152X/XC MD1152CC VR1152BLK VR1152BLU VR1152RED	Front	F	HONDA CBR 600 RR 03-16 CBR 600 RRA 09-16 CB 1000 R 10-16	310
MD1126	Front	S	HONDA GL 1500 Goldwing All models 88-89 GL 1500 SE/A/I/Goldwing 90-00	296	MD1153X/XC VR1153BLK VR1153BLU VR1153RED	Front	F	HONDA CBR 1000 RR 04-05	310
MD1127	Rear	S	HONDA GL 1500 Goldwing All models 88-89	296	MD1154X MD1154XC	Front	F	HONDA ST 1300/1300 A 02-13	310
MD1131LS	Front	F	HONDA FT 500 Ascot 82-83	296	MD1157X MD1157XC	Front	F	HONDA VFR 800 A/Interceptor ABS 02-11 GL 1800/1800 ABS (All models) 01-13	296
MD1133	Front	F	HONDA GL 1100 A Goldwing Aspencade 82-83	296	MD1158RS	Front	F	HONDA VTX 1300 S 03-07	336
MD1134X/XC MD1134CC VR1134BLK VR1134BLU VR1134RED	Front	F	HONDA CBR 900 RR Fireblade 98-99	310					

BUYERS GUIDE

ROTOR

CODES FOR TYPES
 S = FLAT SOLID
 D = FLOATING ROTOR CONVERSION FOR DISHED SOLID ROTOR
 F = FLOATING ROTOR
 S/F = FLOATING CONVERSION FOR FLAT SOLID ROTOR

BRAKE ROTOR BUYERS GUIDE - STREET

Rotor No.	Front/Rear	Type	Models	Dia (mm)	Rotor No.	Front/Rear	Type	Models	Dia (mm)
MD1159	Front	S	HONDA VT 750 C2/C2F Shadow Spirit 07-12 VT 750 RS Shadow 10-13 VT 750 Shadow Phantom 10-12 VT 750 Shadow Aero 08-12	296	MD1176X	Front	S	HONDA VFR 1200 FD (Automatic Transmission) 10-14 VFR 1200 F (Manual Gearbox Model) 10-14	320
	Rear	S	HONDA VT 750 C/CD/CD2 Shadow /Shadow Deluxe 98-02 VT 750 CDA/CDB/CDC/CDD Shadow American Classic Edition 750 Deluxe 02-05 VT 1300 CXA Fury (Non ABS Model) 10-13 VT 1300 CXAA Fury (ABS Model) 10-11 VT 1300 Sabre/Sabre ABS 10-13 VT 1300 Stateline/Stateline ABS 10-13 VT 1300 Interstate 10-13 VTX 1300 S 03-07 VTX 1300 C 04-11 VTX 1300 R 05-11 VTX 1300 T 08-11	296	MD1177 MD1177C	Rear	S	HONDA CB 1000 R 10-16	276
MD1160	Front	F	HONDA CBF 1000 A8 (Canada) 08	296	MD1179	Front	S	HONDA VT 1100 C2/C3/D2/T 95-07	316
MD1161X/XC MD1161CC VR1161BLK VR1161BLU VR1161RED	Front	F	HONDA CBR 1000 RR 06-08	320	MD1180X	Front	F	HONDA CBR 250 R (Non ABS) 11-14 CBR 250 RA (ABS Model) 11-14 CB 300 F 15 CBR 300 R (Non ABS) 15 CBR 300 RA (ABS Model) 15	296
MD1163	Rear	S	HONDA ST 1300/1300 A 02-13	316	MD1181	Rear	S	HONDA CBR 250 RA (ABS Model) 11-14 CBR 300 RA (ABS Model) 15	220
MD1164 MD1164C	Rear	S	HONDA VFR 800 Interceptor 00-10 VFR 800 A Interceptor (ABS) 02-10	256	MD1182RS	Front	S	HONDA VTX 1300 C 04-11 VTX 1300 R 05-11 VTX 1300 T 08-11	336
MD1165 MD1165C	Rear	S	HONDA VFR 800 Fi Interceptor 98-09	256	MD1183X MD1183C VR1183 OS1183C	Front	S	HONDA MSX 125 D/E/F/G/H Grom (Non ABS) 14-18	220
MD1166RS	Front	S	HONDA CBR 125 RWB/RC/RD (5 Bolt Front Disc / Canada) 11-13	276	MD1184 MD1184C VR1184	Rear	S	HONDA MSX 125 D/E/F/G/H Grom (Non ABS) 14-18 MSX 125 AH Grom (ABS) 18	190
MD1167RS	Front	S	HONDA VT 1100 C 95-07	330	MD1186C	Front	S	HONDA CB 650 F (Non ABS) 18 CB 650 F (ABS) 18 CBR 650 F (Non ABS) 14-18 CBR 650 F (ABS) 14-18	320
MD1169C MD1169CF	Front	S	HONDA NSF 100 R 06	220	MD1187C	Front	S	HONDA CB 650 F (ABS) 18 CBR 650 F (ABS) 14-18	320
MD1170C	Rear	S	HONDA NSF 100 R 06	160	MD1188X	Front	F	HONDA VFR 800 F Interceptor (Non ABS Model) 14-15 VFR 800 FD Interceptor DLX (ABS Model) 14-15	310
MD1171X/XC VR1171BLK VR1171BLU VR1171RED	Front	F	HONDA CBR 1000 RR 08-14 CBR 1000 RR SP (Brembo front calipers) 14-17 CBR 1000 RA 09-16	320	MD1190	Rear	S	HONDA VFR 800 F Interceptor (Non ABS) 14-15 VFR 800 FD Interceptor DLX (ABS) 14-15	256
MD1172LS	Front	S	HONDA FSC 600 Silverwing (All models) 03-14	276	MD1191 MD1191C VR1191	Front	S	HONDA MSX 125 AH Grom (ABS) 18	220
MD1173X/C VR1173	Rear	S	HONDA CBR 600 RA (ABS) 09-16	220	MD2001X MD2001XC MD2001CC VR2001BLK VR2001BLU VR2001RED	Front	F	APRILIA RST 1000 Futura 01-05 DUCATI 900 Supersport 89-90 907 IE 90-91 YAMAHA FZR 400 RRSP/RR 91-92 FZR 600 W/WC 89 FZR 600 AC/RA/RAC/RBC/RD/RE/REC/RF /RFC/RG/RGC/RH/RHC/RJ/RJC/RK /RKC/RL/RLC 90-00 YZF 600 RG/RGC/RH/RHC 95-96 TDM 850 D/DC/E/EC 92-93 FJ 1200 W/WC/A/B/AD/ADC/AE /AEC/D/DC 89-92	298
MD1175	Rear	S	HONDA VFR 1200 FD (Automatic Transmission Model) 10-14 VFR 1200 F (Manual Gearbox Model) 10-14	276					

ROTOR BUYERS GUIDE

F = FLOATING ROTOR
S/F = FLOATING CONVERSION FOR FLAT SOLID ROTOR

D = FLOATING ROTOR CONVERSION FOR DISHED SOLID ROTOR
S = FLAT SOLID

BRAKE ROTOR BUYERS GUIDE - STREET

Rotor No.	Front/Rear	Type	Models	Dia (mm)	Rotor No.	Front/Rear	Type	Models	Dia (mm)
MD2002 MD2002C VR2002	Rear	S	DUCATI	245	MD2002 MD2002C VR2002 Contd.	Rear	S	DUCATI Contd.	245
			Scrambler Sixty 2 (Cast wheels/399cc) 16-17					900 Sport 02	
			Supersport 400 (Single disc) 93-97					900 Monster 93-99	
			Supersport 400 (Twin disc) 93-97					900 Monster Cromo/Special 98	
			400 Monster 95-97					900 Monster City/City Dark 99	
			Monster 400 (Single disc) 00-02					900 IE Monster 00-01	
			Monster 400 (Twin disc) 03-04					907 IE 90-93	
			400 Monster (Japan) 00-04					Monster S4 Foggy(916cc) 02	
			Monster Dark ie 400 (Japan) 05-06					Monster S4 (916cc) 01-02	
			Monster Dark ie 400 (Single disc) 05					ST4 (916cc) 99-02	
			Monster 400 ie (Japan) 07-08					ST2 (944cc) 97-03	
			Monster 600 (Twin disc) 93-97					ST3 S (ABS Model) (992cc) 06-07	
			600 Monster (Single disc) 93-99					ST4S (Non ABS/996cc) 01-05	
			600 Monster Dark 98-99					ST4S (ABS Model/996cc) 03-05	
			600 Monster City/City Dark 99					GT 1000 (992cc) 07-10	
			600 Monster 00-01					GT 1000 Touring - Sport Classic 09	
			600 Supersport (Single disc) 91-97					959 Panigale (ABS) 16-17	
			620 IE Monster 02-04					Monster 1000 Dark 03	
			620 ie Monster (Series 1 - Twin Pin Pad Fixing Caliper) 05					Monster 1000 ie (992cc) 04-05	
			620 ie Monster (Series 2 - Single Pin Pad Fixing Caliper) 05-06					Monster 1000 S ie (992cc) 03-05	
			620 Sport 03					Paul Smart 1000 LE (992cc) 06	
			Monster 620 Dark 03-04					Sport 1000 S 07-09	
			Monster 620 05-06					Sport Classic 1000 (992cc) (Monoposto - Japan/Biposto - Europe) 06-08	
			620 Multistrada (Twin Disc/Single Pin Pad Fixing) 06					Supersport 1000 DS (992cc) 03-06	
			620 Multistrada Dark (Single Disc/Twin Pin Pad Fixing) 06					LAVERDA	
			695 Monster 06-09					All models 94-00	
			696 Monster 08-14					YAMAHA	
			M 696 Monster 20th Anniversary Model 13-14					XJ 400 S Seca II 93	
			748 SP/Monoposto 99-2002					FZ 600 S/SC/T/TC/U/UC 86-88	
			750 Supersport (Single disc) 91-98					FZR 600 W/WC 89	
			Supersport 750 (Twin disc) 91-98					FZR 600 AC/RA/RAC/RBC/RD/RE /REC/RF/RFC/RG/RGC/RH /RHC/RJ/RJC/RK/RKC/RL/RLC 90-00	
			750 Supersport 99					YZF 600 RG/RGC/RH/RHC 95-96	
			750 Supersport IE 00-02					YZF 600 R RJ/RK/RL/RM/RN/RP /RR/RS/RT/RV/RW 97-07	
			750 Sport 01-02					SRX 600 S/SC 86	
			750 Monster (Single disc) 96-97					XJ 600 Seca IISD/SDC/SE/SEC/SF /SFC/SG/SGC/SH/SHC/SJ/SJC /SK/SKC 92-98	
			750 Monster (Twin disc) 96-98					YZF 750 R/SP 93-96	
			750 Monster City/City Dark 99					YZF 750 R7 OW02 Road version 99	
			750 Monster/Monster Dark 99					TDM 850 D/DC/E/EC 92-93	
			750 Monster 00-01					YZF 1000 R RJ 97	
			Monster ie 750 02					YZF 1000 R1 98-00	
			797 Monster 17						
			Monster 800 03-04						
			800 Sport 03						
			800 Supersport 03-05						
			Scrambler Classic (Spoke Wheels/803cc) 15-17						
			Scrambler Icon (Cast Wheels/803cc) 15-17						
			Scrambler Urban Enduro (Spoke Wheels/803cc) 15-17						
			Scrambler Full Throttle (Cast Wheels/803cc) 15-17						
			Scrambler Flat Track Pro (Cast wheels /803cc) 16-17						
			Scrambler Café Racer (Cast wheels /803cc) 17						
			Monster 821 15-17						
			Monster Dark 821 15						
			Monster Stripe 821 15-17						
			851 Superbike Biposto 89-92						
			888 SP4/SP5 92-93						
888 Superbike Strada 94-95									
899 Panigale 14									
900 Supersport 89-90									
900 Supersport/Superlight 91-97									
900 Supersport 98-99									
900 Supersport CR USA 98									
900 Supersport FE 98									
900 Supersport IE 00-01									
					MD2003X MD2003XC MD2003CC VR2003BLK VR2003BLU VR2003RED	Front	F	APRILIA	320
								RSV4 R 09-12	
								RSV4 Factory 09-12	
								RSV4 Factory APRC ABS 13-15	
								Ducati	
								Supersport 400 (Single disc) 93-97	
								Supersport 400 (Twin disc) 93-97	
								400 Monster 95-97	
								Monster 600 (Twin disc) 93-97	
								600 Monster Dark 98-99	
								600 Monster (Single disc) 93-99	
								600 Supersport (Single disc) 91-97	
								Monster 620 Dark 03-04	
								620 Multistrada Dark (Single Disc/Twin Pin Pad Fixing) 06	
								748 Biposto 95-98	
					748 SP 98				
					750 Supersport (Single disc) 91-98				
					Supersport 750 (Twin disc) 91-98				
					750 Supersport 99				
					750 Monster (Single disc) 96-97				
					750 Monster (Twin disc) 96-98				
					750 Monster City/City Dark 99				
					750 Monster/Monster Dark 99				

ROTOR BUYERS GUIDE

CODES FOR TYPES
S = FLAT SOLID
D = FLOATING ROTOR CONVERSION FOR DISHED SOLID ROTOR

F = FLOATING ROTOR
S/F = FLOATING CONVERSION FOR FLAT SOLID ROTOR

BRAKE ROTOR BUYERS GUIDE - STREET

Rotor No.	Front/Rear	Type	Models	Dia (mm)	Rotor No.	Front/Rear	Type	Models	Dia (mm)										
MD2003X MD2003XC MD2003CC VR2003BLK VR2003BLU VR2003RED Contd.	Front	F	APRILIA	320	MD2020LS MD2020RS	Front	F	YAMAHA	282										
			851 Superbike Biposto					89-92		FZR 400 U/SUC/W/SWC	88-89								
			888 Superbike Strada					94-95		MD2021 MD2021C VR2021	Rear	S	YAMAHA	210					
			900 Supersport/Superlight					91-97					TZ 250		91				
			900 Supersport					98-99					FZR 400 U/SUC/W/SWC		88-89				
			900 Supersport CR USA					98					FZR 400 A		90				
			900 Supersport FE					98					FZR 400 RRSP/RR		91-92				
			900 Monster					93-99					MD2022LS MD2022RS		Front	S	YAMAHA	282	
			900 Monster Cromo/Special					98									FZR 400 A		90
			900 Monster City/City Dark					99									MD2023LS MD2023RS VMD2023		Front
907 IE	92-93	XV 500 K Virago	83																
916 (Biposto)	94-96	SR 500 E/F/G/H	78-81																
ST2 (944cc)	97-99	XV 535 Virago T/TC/U/A/AC/E/EC/F/FC/SF/SFC	87-94																
LAVERDA		XJ 550 H/J/K Maxim	81-83																
All models	94-00	XJ 550 RH/RJ/RK Seca	81-83																
YAMAHA		XJ 650 G/H/J/K Maxim	80-83																
FZR 750 Genesis RU/RT	87-88	XS 650 SE/SF/SG	78-80																
YZF 750 R/SP	93-96	XS 650 G/H/SH	80-81																
FZR 1000 Genesis T/TC/U/UC/W/WC	87-89	XS 650 SJ/SK Heritage Special	82-83																
FZR 1000 EX UP A/AC/B/BC/D/DC	90-96			XJ 750 RH/RJ/RK Seca	81-83														
/E/EC/F/FC/G/GC				XV 750 H/J/K/MK Virago	81-83														
MD2008	Rear	S	YAMAHA FZR 750 (OW01)	210	MD2024 VMD2024	Front	D	YAMAHA	298										
MD2009LS MD2009RS	Front	F	YAMAHA FZR 750 (OW01)	320				XS 500 C/D/E		76-78									
MD2011 MD2011C VR2011	Front	S	YAMAHA	267	MD2024 VMD2024	Rear	D	YAMAHA	298										
			SRX 250 T/TC					87		XS 500 D/E/F/2F	77-79								
			RX 350 L/N/NC11					84-85		XJ 650 LH Midnight	81								
			XS 400 RJ/RK					82-83		XV 920 MK 'Virago'	83								
			XZ 550 RK					-83		XV 920 K	83								
			FJ 600 L/LC/N/NC					84-85		XJ 1100 J	82								
			FZ 600 S/SC/T/TC/U/UC					86-88		XS 1100 E/F/G/H	78-81								
			YX 600 S/SC/T/TC/UC/U/W/WC							XS 1100 SF/SG/SH	79-81								
			/A/AC Radian					86-90		XS 1100 LG/LH Midnight Special	80-81								
			SRX 600 S/SC					86		MD2025 MD2025 VMD2025	Front	D	YAMAHA	266					
XJ 650 LK Seca/LJ Seca Turbo	82-83	XS 750 D/2D/E/F/SE/SF	77-79																
FZ 700 T/TC Genesis	87	XS 850 G/H	80-81																
FZX 700 S/SC/T/TC Fazer	86-87	XS 850 LG/LH/SG/SH	80-81																
XJ 700 N/NC/XN/XNC/XS/XSC/S/SC	85-86	MD2025 VMD2025	Rear	D	YAMAHA	266													
XV 700 L/LC/N/NC/CS/CT/CTC/CSC					RD 400 F Daytona		79												
/SS/SSC/ST/STC	84-87				XS 500 C/D/E		76-78												
XV 750 U/UC/W/WC/A/AC/B/BC/D					XS 650 SE/SF		78-79												
/DC/E/EC Virago	88-94				XS 750 SE/SF		78-79												
XV 1100 All models	86-97				XS 750 D/E2/2D/E/F		77-79												
					XS 850 G/H		80-81												
					XS 850 LG/LH/SG/SH		80-81												
					MD2031LS		Front	S	YAMAHA	320									
									XJ 400 'S' Seca II		93								
		XJ 600 Seca IISD/SDC/SE/SEC/SF/SFC																	
		/SG/SGC/SH/SHC/SJ/SJC/SK/SKC	92-98																
		MD2046	Front	F		YAMAHA			298										
						FJ 1200 AD/ADC/AEE/AEC					92-93								
		MD2049	Rear	S/F		YAMAHA			320										
						XVZ 13 D Series Venture Royale					86-93								
						XVZ 13 T/T/C/U/UC Venture					87-88								
MD2019LS MD2019RS	Front	D	YAMAHA	266															
			XV 250 U/UC/W/WC/A/AC	88-90															
			XS 400 SG/SH	80-81															
			XS 400 J/K Maxim	82-83															
			XJ 650 RJ Seca	82															
			XJ 750 J/K/MK Maxim	82															
			XV 920 RH/RJ	81-82															
			XV 920 J Virago	82															

ROTOR BUYERS GUIDE

F = FLOATING ROTOR
S/F = FLOATING CONVERSION FOR FLAT SOLID ROTOR

D = FLOATING ROTOR CONVERSION FOR DISHED SOLID ROTOR

BRAKE ROTOR BUYERS GUIDE - STREET

Rotor No.	Front/Rear	Type	Models	Dia (mm)	Rotor No.	Front/Rear	Type	Models	Dia (mm)
MD2067	Front	S	YAMAHA XV 250 Virago All models 95-07 XV 250 V-Star 08-14 XV 750 F/FC/G/GC/H/HC/J/JC Virago 94-97	282	MD2074X MD2074XC MD2074CC VR2074BLK VR2074BLU VR2074RED Contd.	Front	F	YAMAHA Contd. XV 1700 Road Star Midnight Silverado Floating front discs/9 spoke cast wheel XV17 ATMS/ATMSC/ATMT /ATMTC/ATMW/ATMVC 04-07 XV 1700 Road Star Warrior (Floating discs/3 spoke cast wheel) XV17 PCS/PCT 04-05 XV 1900 Roadliner 06-07 XV 1900 Roadliner Midnight 06-09 XV 1900 Roadliner S 06-10/12-14 XV 1900 Stratoliner 06-09 XV 1900 Stratoliner Midnight 06-08 XV 1900 Stratoliner S 06-14 XV 1900 Stratoliner Deluxe 11-14	298
MD2068	Front	S	YAMAHA V-Max All models 85-92 FJ 1100 L/LC/N/NC 84-85 FJ 1200 S/SC/T/TC 86-87 VMX 12 R/RC V-Max 03	280	MD2075	Rear	S	YAMAHA GTS 1000 AE/AEC/AF/AFC 93-96	280
MD2068	Rear	S	YAMAHA XV 1100 L/LC/N/NC 84-85 FJ 1100 L/LC/N/NC 84-85 FJ 1200 S/SC/T/TC/W/WC/A/B /AC/BC/D/DC 86-93 V-Max 'All models' 85-07	280	MD2076	Front	S	YAMAHA XZ 500 RJ 82 XV 535 Virago G/GC/SG/SGC/H /HC/SH/SHC/J/JC/SJ/SJC 95-99 XVS 650 V Star Custom 97-11/13-14 XVS 650 V Star Classic 98-10 XVS 650 V-Star Silverado 03-10 XVS 1100 V Star Custom 99-07 XVS 1100 V-Star Silverado 03- XVS 1100 W-M V-Star Custom Midnight 07-09 XVZ 1300 Royal Star 96-97/00 XVZ 1300 Royal Star Tour Clasic 96-00 XVZ 1300 Royal Star Standard 98 XVZ 1300 Royal Star Boulevard 99-01 XVZ 1300 Royal Star Midnight Venture 02-07 XVZ 1300 Royal Star Midnight Tour Deluxe 06-07 XVZ 1300 Royal Star Venture 99-07 XVZ 1300 Royal Star Venture S 08-12 XVZ 1300 Royal Star Tour Deluxe 97-01/05-07 XVZ 1300 LTK Venture 96-98 XVZ 1300 Venture MM Limited Edition 01 XV 1600 Road Star 99-05 XV 1600 Road Star Silverado 99-09 XV 1600 Road Star Midnight 03 XV 1600 Midnight Star 02-03 XV 1700 Road Star (Spoke wheels) 06 XV 1700 Road Star Silverado 9 Spoke Cast XV17 ATV 07 XV 1700 Road Star Silverado Spoke Wheel (XV17 ATX/ATY/ATZ) 08-10 XV 1700 Road Star 9 Spoke Cast XV17 AWX 08 XV 1700 Road Star (Solid front discs /spoke wheels) (XV17 AT/ATC/AV /AVC/ATW) 05-07	298
MD2069	Front	S	YAMAHA RZ 500 84-86 FZ 750 N/S/SC/U/UC 85-88 XJ 900 RK Seca 83	267	MD2070	Rear	S	YAMAHA RZ 500 84-86	245
MD2069	Rear	S	YAMAHA FZ 750 N/S/SC/U/UC 85-88 FZX 700 S/SC/T/TC Fazer 86-87 XJ 900 RK Seca 83	267	MD2074X MD2074XC MD2074CC VR2074BLK VR2074BLU VR2074RED	Front	F	YAMAHA YZF 600 R RJ/RK/RL/RM/RN/RR/RR /RS/RT/RV/RW 97-07 YZF 600 RRL/RRM/RRN/RRP 'R6' 99-02 XVS 950 Bolt C Spec (Remote Reservoir Rear Shocks) 15-18 XVS 950 Bolt R Spec (Remote Reservoir Rear Shocks) 14-18 FZS 1000 N/NC/P/PC/R/RC/S/RS/T 'FZ1' 01-05 YZF R1 98-03 YZF 1000 R (RJ) 97 FZS 1000 R/RC FZ1 03 XVS 1100 ATS V-Star Silverado 04-09 XVS 1100 AS V-Star Classic 04-09 FJR 1300 R/RC 03 XVS 1300 V-Star 1300 Tourer 07-14 XVS 1300 V-Star 07-14 XVS 1300 V-Star Deluxe 13-14 XV 1700 Road Star S 9 Spoke Cast XV17 ASX/ASY/ASZ/ASA/ASB 08-14 XV 1700 Road Star Silverado 9 Spoke Cast XV17 ATSA/ATSB 11-14 XV 1700 Road Star Midnight (Floating front discs/9 spoke cast wheel) XV17 AMT/AMTC /AMV/AMVC 05-06 XV 1700 Road Star Midnight Warrior (Front Floating Discs/3 spoke cast wheels) XV17 PCTC/PCT /PCTB/PCTCB 05 XV 1700 Road Star (Front floating discs/9 spoke cast wheels) XV17 AWT/AWTC/AWV/AWVC 05-06 XV 1700 Road Star 9 Spoke Cast Wheels XV17 AS/ASC/AWY /AW/AWVC 04-07/09 XV 1700 Road Star Midnight Floating front discs/9 spoke cast wheel XV17 AMS/AMSC/AMW/AMWC 04/07	298
MD2070	Rear	S	YAMAHA RZ 500 84-86	245	MD2078	Rear	S	YAMAHA XVZ 1300 Royal Star 96-97/00 XVZ 1300 Royal Star Tour Clasic 96-00 XVZ 1300 Royal Star Standard 98 XVZ 1300 Royal Star Boulevard 99-01 XVZ 1300 Royal Star Midnight Venture 02-07 XVZ 1300 Royal Star Midnight Tour Deluxe 06-07 XVZ 1300 Royal Star Venture 99-07 XVZ 1300 Royal Star Venture S 08-12 XVZ 1300 Royal Star Tour Deluxe 97-01/05-07 XVZ 1300 LTK Venture 96-98 XVZ 1300 Venture MM Limited Edition 01	320

BUYERS GUIDE

ROTOR

CODES FOR TYPES
 S = FLAT SOLID
 D = FLOATING ROTOR CONVERSION FOR DISHED SOLID ROTOR
 F = FLOATING ROTOR
 S/F = FLOATING CONVERSION FOR FLAT SOLID ROTOR

BRAKE ROTOR BUYERS GUIDE - STREET

Rotor No.	Front/Rear	Type	Models	Dia (mm)	Rotor No.	Front/Rear	Type	Models	Dia (mm)											
MD2081	Front	S	YAMAHA XVZ 12 TK/L/KC2 Venture 83-84 XVZ 12 TDK/DL/DKC2/DN Venture Royale 83-84	298	MD2089X MD2089XC MD2089CC VR2089BLK VR2089BLU VR2089RED	Front	F	YAMAHA XVS 950 (V-Star 950) 09-14 XVS 950 (V-Star 950 Tourer) 09-14 FJR 1300 S/RS/T/AS/T/AT 04-05 FJR 1300 AV/AW/AX/AY/AZ/AA/AB 06-12 FJR 1300 A 13-18 FJR 1300 AEV/AEW/AEX/AEY Electric Shift 06-09 FJR 1300 ES 14-18	320											
	Rear	S	YAMAHA XVZ 12 TK/L/KC2 Venture 83-84 XVZ 12 TDK/DL/DKC2/DN Venture Royale 83-84																	
MD2082X MD2082XC MD2082CC VR2082BLK VR2082BLU VR2082RED	Front	F	YAMAHA YZF 600 RRR/RRS R6 03-04 FZ6 04-06 FZ6 (4 piston caliper) 07-09 FZ6R 09-17 FZ6R (Y/Z/A) 09-11 YZF R6S (YZFR 6 SV/SW/SX/SY) (298mm rotor) 06-09 XV 1700 Road Star Midnight Warrior 5 Spoke Cast Wheel XV17 PCMV /PCMVC/PCMW/PCMX/PCMY 06-09 XV 1700 Road Star Warrior 5 Spoke Cast Wheel XV17 PCV/PCW/PCX 06-08 XV 1900 Raider 08-14 XV 1900 Raider S 08-14 XV 1900 Raider SCL 12-14	298	MD2091 MD2091C VR2091	Rear	S	YAMAHA YZF 600 RRR/RRS R6 03-04 YZF-R1 (5VY) 04-06 YZF-R1 (6 piston caliper) 07-14 YZF-R6 T/V/W (310mm rotor) 05-07 YZF R6S (YZFR 6 SV/SW) (298mm rotor) 06-08 YZF-R6 X/Y/Z/A/B/D/E/G/H 08-16 YZF-R6 H (320mm Front Rotor) 17	220											
			MD2092 MD2092C VR2092					Rear		S	YAMAHA XVS 1100 V-Star Custom/Classic 99-09 XVS 1100 V-Star Silverado 03-09 XVS 1100 W-M V-Star Custom Midnight 07-09 FJR 1300 R/RC/S/AS/T/AT 03-05 XV 1700 Road Star Midnight Warrior 5 Spoke Cast Wheel XV17 PCMV /PCMVC/PCMW/PCMX/PCMY 06-09 XV 1700 Road Star Warrior 5 Spoke Cast Wheel XV17 PCV/PCW/PCX 06-08 XV 1700 Road Star Midnight Warrior (Front Floating Discs/3 spoke cast wheels) XV17 PCTC/PCT/PCTB/PCTCB 05 XV 1700 Road Star Warrior (Floating discs/3 spoke cast wheel) XV17 PCS/PCT 04-05	282								
											MD2093 MD2093C VR2093		Rear	S	YAMAHA FZ6 04-06 FZS 1000 V/W/X/Y/Z/A/B/D/E (FZ1) 06-14 FZ6 (4 piston caliper) W/X/Y 07-09	245				
															MD2094X/XC MD2094CC VR2094BLK VR2094BLU VR2094RED		Front	F	YAMAHA YZF R1 04-06	320
											MD2095X/XC MD2095CC VR2095BLK VR2095BLU VR2095RED		Front	F		YAMAHA YZF-R6 TC/SV/SVC 05-06 YZF-R6 T/V/W (310mm rotor) 05-07 FZ8 11-13 XT 1200 Z Super Tenere 12-18 XT 1200 Z Super Tenere ES 14-18			310	
																MD2096				
											MD2097RS		Front	S	YAMAHA YBR 125 ESD (4P26/4P2A/4P2G) Cast Wheel 07-13 YBR 125 ED (4P28/4P2C/4P2J) Cast Wheel 07-13		245			
															MD2098 MD2098C	Front		F	YAMAHA XP500 F/G (T-Max 530cc) 15-16	267
											MD2083		Front	F			YAMAHA YZF 750 R7 OW02 Road version 99-00		320	
															MD2084 MD2084C VR2084	Rear	S	YAMAHA YZF 600 RRL/RRM/RRN/RRP 'R6' 99-02 YZF R1 02-03		220
MD2086 MD2086C VR2086	Rear	S	YAMAHA YZF 750 R7 99 YZF R1 98-01	245																
			MD2088		Rear	S	YAMAHA XV 1600 Road Star 99-05 XV 1600 Road Star Silverado 99-09 XV 1600 Road Star Midnight 03 XV 1600 Midnight Star 02-03 XV 1700 Road Star Silverado 9 Spoke Cast XV17 ATV 07 XV 1700 Road Star S 9 Spoke Cast XV17 ASX/ASY/ASZ/ASA/ASB 08-14 XV 1700 Road Star Silverado 9 Spoke Cast XV17 ATSA/ATSB 11-14 XV 1700 Road Star Silverado Spoke Wheel XV17 ATX/ATY/ATZ 08-10 XV 1700 Road Star 9 Spoke Cast XV17 AWX 08 XV 1700 Road Star (Solid front discs /spoke wheels) (XV17 AT/ATC/AV /AVC/ATW) 05-07 XV 1700 Road Star Midnight (Floating front discs/9 spoke cast wheel) XV17 AMT/AMTC/AMV/AMVC 05-06 XV 1700 Road Star (Front floating discs /9 spoke cast wheels) XV17 AWT/AWTC/AWV/AWVC 05-06 XV 1700 Road Star 9 Spoke Cast Wheels XV17 AS/ASC/AWY/AW/AWVC 04-07/09 XV 1700 Road Star Midnight Floating front discs/9 spoke cast wheel XV17 AMS/AMSC/AMW/AMWC 04/07 XV 1700 Road Star Midnight Silverado Floating front discs/9 spoke cast wheel XV17 ATMS/ATMSC/ATMT/ATMTC /ATMW/ATMVC 04-07	320												

ROTOR BUYERS GUIDE

 F = FLOATING ROTOR
 S/F = FLOATING CONVERSION FOR FLAT SOLID ROTOR
 D = FLOATING ROTOR CONVERSION FOR DISHED SOLID ROTOR

BRAKE ROTOR BUYERS GUIDE - STREET

Rotor No.	Front/Rear	Type	Models	Dia (mm)	Rotor No.	Front/Rear	Type	Models	Dia (mm)
MD2099	Rear	S	YAMAHA	320	MD2117 VR2117	Rear	S	YAMAHA	245
			XV 1700 Road Star Warrior 02-05					FZ6R 09-17	
			XV 1900 Roadliner 06-07					FZ6R (Y/Z/A) 09-11	
			XV 1900 Roadliner Midnight 06-09						
			XV 1900 Roadliner S 06-10/12-14						
			XV 1900 Stratoliner 06-09						
			XV 1900 Stratoliner Midnight 06-08						
XV 1900 Stratoliner S 06-14									
XV 1900 Stratoliner Deluxe 11-14									
MD2100 MD2100C VR2100	Rear	R	YAMAHA	282	MD2118	Rear	S	YAMAHA	220
			FJR 1300 AV/AW/AX/AY/AZ/AA/AB 06-12					YZF-R1 LE 06	
			FJR 1300 A 13-18						
			FJR 1300 AEW/AEW/AEX/AEY Electric Shift 06-09						
FJR 1300 ES 14-18									
MD2101X/XC VR2101BLK VR2101BLU VR2101RED	Front	F	YAMAHA	320	MD2119X MD2119XC VR2119BLK VR2119BLU VR2119RED	Front	F	YAMAHA	298
			FZS 1000 V/W/X/Y/Z/A/B/D/E (FZ1) 06-14					YZF R3 (321cc) 15-17	
			XVS 1300 Stryker 11-14					FZ-09 (847cc/3 cyl) 14-17	
								XSR 900 ABS (MTM 850) 16-17	
MD2102X/XC MD2102CC VR2102BLK VR2102BLU VR2102RED	Front	F	YAMAHA	310	MD2120 MD2120C VR2120	Rear	S	YAMAHA	245
			YZF-1 (6 piston caliper) 07-14					FZ-07 (689cc/2 cyl) 15-17	
								FZ-07 A (689cc/2 Cyl/ABS) 17	
								XSR 700 (MTM 690-U) 18	
	FZ-09 (847cc/3 cyl) 14-17								
	XSR 900 ABS (MTM 850) 16-17								
MD2103 MD2103C VR2103	Rear	S	YAMAHA	298	MD2123 MD2123C VR2123	Rear	S	YAMAHA	220
			XVS 950 (V-Star 950) 10-14					YZF R3 (321cc) 15-16	
			XVS 950 (V-Star 950 Tourer) 10-14						
			XVS 1300 V-Star 1300 Tourer 07-14						
			XVS 1300 V-Star 07-14						
XVS 1300 V-Star Deluxe 13-14									
MD2104RS	Front	S	YAMAHA	245	MD2124X MD2124XC VR2124BLK VR2124RED VR2124BLU	Front	F	YAMAHA	320
			YBR 125 R (1PX1/X2) 11-12					YZF-R1 15-17	
YBR 125 ESG (43B1/3/5/6/8) 08-13									
MD2105X/XC VR2105BLK VR2105BLU VR2105RED	Front	F	YAMAHA	310	MD2125 MD2125C VR2125	Rear	S	YAMAHA	220
			YZF-R6 X/Y/Z/A/B/D/E/F/G 08-16					YZF-R1 15-17	
								YZF-R1M 15-17	
								XSR 700 (MTM 690-U) 18	
MD2106RS	Front	S	YAMAHA	280	MD2127X MD2127XC VR2127BLK VR2127BLU VR2127RED	Front	S	YAMAHA	282
			YS 250 Fazer (5D41/2/3/56C1) 06-10					FZ-07 (689cc/2 cyl) 15-17	
MD2107 MD2107C	Front	F	YAMAHA	267	MD2129X MD2129XC	Front	F	YAMAHA	298
			XP 500 Y/Z/A (T-Max) 09-11					VMX12 (V-Max 1200 All models) 93-07	
MD2108C	Rear	F	YAMAHA	298	MD2130C	Rear	S	YAMAHA	298
			VMX 1700 V-Max (6 piston radial caliper) 09-14					SCR 950 (SCR 950 H) 17	
MD2109XC	Front	F	YAMAHA	320	MD3001	Front	S	SUZUKI	290
			VMX 1700 V-Max (6 piston radial caliper) 09-14					GSX 600 FJ 88	
MD2114 MD2114C	Rear	S	YAMAHA	310	MD3002 MD3002C VR3002	Rear	S	SUZUKI	250
			XVS 1300 Stryker 11-14					GSF 400 M/N/P Bandit 91-93	
			XV 1900 Raider 08-14					GS 500 EK/EL/EM/EN/EP/ER/ES /ET/EV/EW/EX/EY/K1/K2/K3 89-03	
			XV 1900 Raider S 08-14					GS 500 FK4/FK5/FK6/FK7/FK8/FK9 04-10	
			XV 1900 Raider SCL 12-14					GSX 600 FJ/FK/FL/FM/FN/FP /FR/FT Katana 88-97	
MD2115C	Rear	S	YAMAHA	280				SUZUKI	
			XT 1200 Z Super Tenere 12-18					GSX 750 FK/FL/FM/FN/FP/FR /FS/FT Katana 89-97	
XT 1200 Z Super Tenere ES 14-18									
MD2116 MD2116C VR2116	Rear	S	YAMAHA	267					
			FZ8 11-13						

ROTOR BUYERS GUIDE

CODES FOR TYPES
S = FLAT SOLID
D = FLOATING ROTOR CONVERSION FOR DISHED SOLID ROTOR

F = FLOATING ROTOR
S/F = FLOATING CONVERSION FOR FLAT SOLID ROTOR

BRAKE ROTOR BUYERS GUIDE - STREET

Rotor No.	Front/Rear	Type	Models	Dia (mm)	Rotor No.	Front/Rear	Type	Models	Dia (mm)					
MD3003X MD3003XC MD3003CC VR3003BLK VR3003BLU VR3003RED	Front	F	SUZUKI GSF 600 Bandit ST/SV/V 96-97 GSX 600 FK/FL/FM/FN/FP/FR/FS/FT /FV/FW/FX/FY/FK1/FK2 Katana 89-02 GSF 600 SY/SK1/SK2/SK3 89-02 RF 600 RR/RS/RT/RV 00-03 SV 650 X/Y/K1/SK1/K2/SK2 94-97 GSX 750 FK/FL/FM/FN/FP/FR/FS/FT /FV/FW/FX/FY/K1/FK/FK2 Katana 99-02	290	MD3014LS MD3014RS VMD3014 Contd.	Front	D	SUZUKI Contd. GS 450 TXZ 82 GS 550 ET 80 GS 550 MZ 82 GS 550 LD/LF/LG 83-86 GR 650 D/XD 'Tempter' 83 GS 650 EX/EZ 81-82 GS 650 GX/GZ/GD 81-83 GS 650 MD 83 GS 750 EC/EN/LN (8 valve) 78-79 GS 750 ET/EX/EZ (16 valve) 80-82 GS 750 LT/LX (16 valve) 80-81 GS 750 SD 83 GS 850 GN/GT/GX/GLT/GLX/GLZ /GZ/GLD/GD 79-83 GS 1000 ET/ST/SZ 80-82 GS 1000 EC/EN/SN/LN 78-79 GS 1000 GT/GX 80-81 GS 1000 GLT/GLX 80-81 GS 1100 ET/EX/EZ/ED/ESD 80-83 GS 1100 LT 80 GS 1100 GZ/GD 82-83 GS 1100 GLZ/GLD 82-83 GS 1100 GKZ/GK2/GKD 82-83 GS 1100 SD 83	276					
MD3004	Front	F	SUZUKI GSX-R 1100 G/H/J 86-88	310	MD3014RS VMD3014	Rear	D	SUZUKI XN 85 D (673cc) 83 GS 550 C/N/E/EN 77-79 GS 550 ET/TX 80-81 GS 550 MZ 82 GS 550 LT/LX 80-81 GS 750 ET/EX/EZ (16 valve) 80-82 GS 750 LT/LX (16 valve) 80-81 GS 750 SD 83 GS 750 C/N/EC/EN/LN (8 valve) 78-79 GS 850 GN/GT/GX/GLT 79-81 GS 1000 C/N 78-79 GS 1000 EC/EN/SN/LN 78-79 GS 1000 ET/ST/SZ 80-82 GS 1000 GT/GX 80-81 GS 1000 GLT/GLX 80-81 GS 1100 ET/EX/EZ/ED/ESD 80-83 GS 1100 LT 80 GS 1100 SD 83	276					
MD3005	Front	F	SUZUKI GSX-R 750 RG/G/H 86-87	300										
MD3006X MD3006XC MD3006CC VR3006BLK VR3006BLU VR3006RED	Front	F	SUZUKI GSF 400 M/N/P Bandit 91-93 GS 500 EK/EL/EM/EN/EP/ER/ES/ET /EV/EW/EX/EY/K1/K2/K3 89-03 GS 500 FK4/FK5/FK6/FK7/FK8/FK9 04-10 RF 900 RR/RS/RS2/RT/RV/RW 94-98 GSF 1200 SV/SW/SX/SY/SK1-5/K1-K3 96-05	310										
MD3007X MD3007XC VR3007BLK VR3007BLU VR3007RED	Front	F	SUZUKI GSX-R 600 WN/WP 92-93 GSX-R 750 J/K/L/M/N/WP 89-93 GSX-R 750 WR/WS 94-95 GSX-R 1100 K/L/M/N 89-92 GSX-R 1100 WP/WR/WS/WT/WV/WW 93-98	310	MD3017LS	Front	S	LS 650 FG/PG/PH/FH/PJ/PS/PT/PV/PW /PX/PY/PK1/PK2/PK3/PK4 Savage 86-88/95-04 LS 650 K5/K6/K7/K8/K9/L1/L2 /L3/L4/L5 Boulevard S40 05-15	260					
MD3008 MD3008C VR3008	Rear	S	SUZUKI GSF 600 Bandit ST/S/SV/V 96-97 GSF 600 SY/SK1/SK2/SK3 00-03 GSX-R 600 WN/WP 92-93 GSX 600 FW/FX/FY/FK1-FK6 Katana 98-06 RF 600 RR/RS/RT/RV 94-97 SV 650 X/Y/K1/SK1/K2/SK2 99-02 GSX 750 W/X/Y Inazuma 98-00 GSX 750 FW/FX/FY/FK1/FK2/FK3 Katana 98-03 GSK 750 FK4/FK5/FK6 04-06 GSX-R 750 J/K/L/M/N/WP/WR/WS 89-95 RF 900 RR/RS/RS2/RT/RV/RW 94-98 GSX-R 1100 K/L/M/N 89-92 GSX-R 1100 WP/WR/WS/WT/WV/WW 93-98 GSF 1200 SV-SK5/K1-K3 96-05 GSX 1300 RX/RY/RK1/RK2/RZK3/RK4 /RZK4/RK5/RZK6/RK6/RK7 99-07	240										
MD3009	Rear	S	SUZUKI GSX-R 750 RG/G/H 86-87 GSX-R 1100 G/H/J 86-88	220										
MD3010LS	Front	S	SUZUKI GSXR 50 (RB 50 H) 87	162	MD3019LS MD3019RS VMD3019	Front	F	SUZUKI GS 550 B 77 GT 550 K/L/M Indy 73-75 GT 550 A/B Indy (Tokico Caliper) 76-77 GT 550 B Indy (Asco Caliper) 77 GS 750 B (8 valve) 77 GT 750 K/L/M/A/B 73-77 RE 5 M/A (Rotary) 75-76	296					
MD3014LS MD3014RS VMD3014	Front	D	SUZUKI GS 250 TT/TX 80-81 GN 250 J 88 GT 250 K/L/M/A/B Hustler 73-77 GT 380 K/L/M/A/B Sebring 73-77 GN 400 T/XT/XX/TX/TZ 80-82 GS 400 B/C (Disc Brake) 77-78 GS 425 N (Spoke Wheel) 79 GS 425 EN (Cast Wheel) 79 GS 425 LN 79 GS 450 ET/ST/EX/SX/EZ/ED 80-83 GS 450 GAZ/GAD/GAF 82-85 GS 450 LT/LX/LZ/LD/LF/LG/LH/LJ 80-88 GS 450 TX/TZ 81-82	276										
MD3019RS VMD3019	Rear	F	SUZUKI GS 750 (8 valve) 77	296	MD3019RS VMD3019	Front	D	SUZUKI GS 550 C/N/EC/EN 77-79 GS 550 LT 80 GS 750 C/N (8 Valve) 78-79 GS 1000 C/N 78-79	296					
										MD3020LS	Front	D	SUZUKI GS 550 C/N/EC/EN 77-79 GS 550 LT 80 GS 750 C/N (8 Valve) 78-79 GS 1000 C/N 78-79	296

ROTOR BUYERS GUIDE

F = FLOATING ROTOR
S/F = FLOATING CONVERSION FOR FLAT SOLID ROTOR

D = FLOATING ROTOR CONVERSION FOR DISHED SOLID ROTOR

BRAKE ROTOR BUYERS GUIDE - STREET

Rotor No.	Front/Rear	Type	Models	Dia (mm)	Rotor No.	Front/Rear	Type	Models	Dia (mm)
MD3022LS	Front	D	SUZUKI	295	MD3041	Rear	D	SUZUKI	275
			GS 550 LX 81					GV 1200 GLF/GLF2/GLG 'Madura' 85-86	
			GS 550 LZ 82						
			GS 550 TX 81						
			GS 650 GLX/GLZ/GLD 81-83						
GS 750 TZ/TD (16 valve) 82-83									
MD3024LS MD3024RS	Front	D	SUZUKI	260	MD3043	Rear	S	SUZUKI	296
			GS 550 ED/ESD/ES3/ES/EF/ESF/ESG 83-86					GV 1400 GDG/GTG/GCG/GDH/GTH/GCH/GDJ 86-88	
MD3025	Rear	S	SUZUKI	250	MD3044	Rear	S	SUZUKI	275
MD3027	Rear	S	SUZUKI	276	MD3045	Front	F	SUZUKI	300
			GS 650 EX/EZ 81-82					VS 1400 GLPH/GLFH/GLPJ/GLPL/GLPM/GLPN/GLPP	
			GS 650 GX/GZ/GD 81-83					/GLPR/GLPS/GLPT/GLPV/GLPW/GLPX/GLPY/GLPK1	
			GS 650 GLX/GLZ/GLD 81-83					/GLPK2/GLPK3/GLPK4 Intruder 87-04	
			GS 650 MD 83					VS 1400 GLPK5/GLPK6/GLPK7/GLPK8	
			GS 850 GLX/GLZ/GZ/GLD/GD 80-83					/K9/LO Boulevard S83 (1400cc) 05-10	
			GS 1100 GZ/GLZ/GD/GLD 82-83						
GS 1100 GKZ/GK2/GKD 82-83									
MD3028LS MD3028RS	Front	D	SUZUKI	260	MD3058X MD3058XC MD3058CC VR3058BLK VR3058RED	Front	F	SUZUKI	320
			XN 85 D (673cc) 83					GSXR 600 V/W/X/Y/K1/K2/K3/ZK3 97-03	
			GS 700 EF/ESF 85					GSXR 750 T/V/W/X/Y/K1/K2/K3 96-03	
GS 750 ED/ESD 83		GSXR 1000 K1/K2 01-02	TL 1000 SV/SW/SX/SY/RW/RX/RY						
MD3029	Rear	D	SUZUKI	260	MD3060 MD3060C VR3060	Rear	S	SUZUKI	220
			GS 700 EF/ESF 85					GSXR 600 V/W/X/Y/K1/K2/K3/ZK3 97-03	
GS 750 ED/ESD 83		GSXR 600 K4/K5/XK5/K6/K7/K8/K9 04-10	GSXR 600 L1/L2/L3/L4/L5/L6/L7 11-17						
MD3030LS MD3030RS	Front	S	SUZUKI	276	MD3061	Rear	S	SUZUKI	250
			GV 700 GLF/GLF2 85					VX 800 L/M/N/P 90-93	
GV 1200 GLF/GLF2/GLG 'Madura' 85-86				MD3073LS	Front	S/F	SUZUKI	296	
MD3031LS	Front	S	SUZUKI	296	MD3075LS MD3075RS	Front	F	SUZUKI	310
			VS 700 GLFG/GLPG 86-87					GSF 1200 SAV 'ABS model Bandit' 97	
MD3032LS MD3032RS	Front	S/F	SUZUKI	296	MD3076	Rear	S	SUZUKI	276
			VS 700 GLFH/GLPH 86-87					GSF 1200 SAV 'ABS model Bandit' 97	
			VS 750 GLPJ/GLPK/GLPL/GLPM Intruder 88-91						
			VS 800 Intruder GLN/GLP/GLR/GLS						
			/GLT/GLV/GLW/GLX/GLY/GLK1						
			/GLK2/GLK3/GLK4 92-04						
			VS 800 K5/K6/K7/K8/K9/ZK9/LO						
			S50 Boulevard 05-10						
			VS 1400 GLPH/GLFH/GLPJ/GLPL/GLPM						
			/GLPN/GLPP/GLPR/GLPS/GLPT/GLPV						
/GLPW/GLPX/GLPY/GLPK1/GLPK2									
/GLPK3/GLPK4 Intruder 87-04									
VS 1400 GLPK5/GLPK6/GLPK7/GLPK									
8/K9/LO Boulevard S83 (1400cc) 05-10									
MD3033LS	Front	S	SUZUKI	310	MD3078RS	Front	S	SUZUKI	300
VX 800 L/M/N/P 90-93				VL 1500 W/X/Y/K1			SUZUKI		
MD3036	Rear	S	SUZUKI	275	MD3079	Rear	F	SUZUKI	276
			GSX 1100 FK/FL/FM/FN/FP Katana 88-93					VL 1500 W/X Intruder Legendary Classic 98-01	
MD3037LS MD3037RS	Front	S	SUZUKI	310	MD3086	Rear	F	SUZUKI	276
			GSX 1100 GM/GN/GP 91-93					VL 1500 Y/K1/K2/K3/K4 00-04	
MD3038	Rear	S	SUZUKI	295	MD3086	Rear	F	SUZUKI	276
			GSX 1100 GM/GN/GP 91-93					VL 1500 BK5/K5/TK5/BK6/K6/TK6	
MD3039	Rear	F	SUZUKI	276	MD3086	Rear	F	SUZUKI	276
			GSX 1150 ES3/ESE/EF/ESF/EF2/EG/ESG 83-86					/K7/TK7/K8/TK8/K9/TK9/LO	
MD3039LS MD3039RS	Front	F	SUZUKI	276	MD3086	Rear	F	SUZUKI	276
			GSX 1150 ES3/ESE/EF/ESF/EF2/EG/ESG 83-86					Boulevard C90/C90T 05-10	
MD3039LS MD3039RS	Front	F	SUZUKI	276	MD3086	Rear	F	SUZUKI	276
			GSX 1150 ES3/ESE/EF/ESF/EF2/EG/ESG 83-86					VL 1500 L3 (C90 Boulevard) 13	
MD3039LS MD3039RS	Front	F	SUZUKI	276	MD3086	Rear	F	SUZUKI	276
			GSX 1150 ES3/ESE/EF/ESF/EF2/EG/ESG 83-86					VL 1500 TL3/TL4/TL5	
MD3039LS MD3039RS	Front	F	SUZUKI	276	MD3086	Rear	F	SUZUKI	276
			GSX 1150 ES3/ESE/EF/ESF/EF2/EG/ESG 83-86					(C90T Boulevard with windshield) 13-15	
MD3039LS MD3039RS	Front	F	SUZUKI	276	MD3086	Rear	F	SUZUKI	276
			GSX 1150 ES3/ESE/EF/ESF/EF2/EG/ESG 83-86					V 1500 BL3/BL4/BL5	
MD3039LS MD3039RS	Front	F	SUZUKI	276	MD3086	Rear	F	SUZUKI	276
			GSX 1150 ES3/ESE/EF/ESF/EF2/EG/ESG 83-86					(Boulevard C90 B.O.S.S.) 13-15	
MD3039LS MD3039RS	Front	F	SUZUKI	276	MD3086	Rear	F	SUZUKI	276
			GSX 1150 ES3/ESE/EF/ESF/EF2/EG/ESG 83-86					V 1500 BTL3/4 (Boulevard C90 B.O.S.S. with windshield) 13-14	

ROTOR BUYERS GUIDE

CODES FOR TYPES
 S = FLAT SOLID
 D = FLOATING ROTOR CONVERSION FOR DISHED SOLID ROTOR
 F = FLOATING ROTOR
 S/F = FLOATING CONVERSION FOR FLAT SOLID ROTOR

BRAKE ROTOR BUYERS GUIDE - STREET

Rotor No.	Front/Rear	Type	Models	Dia (mm)	Rotor No.	Front/Rear	Type	Models	Dia (mm)
MD3087LS MD3087RS	Front	S	SUZUKI VL 1500 K2/K3/K4/K5/BK5/K5/TK5/BK6/K6 /TK6/TK7/K7/K8/TK8/K9/TK9/L0 02-10	290	MD3095RS	Front	S	SUZUKI VL 800 K1-K8/CK5/K6/CK6/TK5/TK6/K7 /TK7/CK7/ZK9/TK8/CK8/ZK8/K9/TK9 /L1/L2/L3/L4/L5/TL1/TL2/TL3 /TL4/TL5 05-15 VL 800 ZK3/ZK4 Volusia Ltd 03-04 VL 800 BTL4 (Boulevard C50 B.O.S.S. Cast Wheels) 14 VL 800 CL3 (Boulevard C50 Special Edition/Cast Wheels) 13	300
MD3088X/XC MD3088CC VR3088BLK VR3088BLU VR3088RED	Front	F	SUZUKI DL 650 K4/K5/K6 V-Strom 04-06 DL 1000 K2/K3/K4/K5/K6/K7/K8 /K9/L2 02-12 DI 1000 AAL2 V-Strom Adventure 12 SV 1000 K3/SK3/K4/SK4/K5/SK5 /SK6/SK7 03-07	310	MD3096RS	Front	S	SUZUKI VZ 800 K5/K6/BK6/K7/ZK7/K8/ZK8 /K9/ZK9/L0 M50 Boulevard 05-10 VZ 800 L0/L1/L2/L3/L4/L5 (M50 Boulevard) 10-15	300
MD3089X/XC MD3089CC VR3089BLK VR3089BLU VR3089RED	Front	F	SUZUKI GSXR 1000 K3 03	300	MD3097	Rear	F	SUZUKI VZ 1500 K9/L3/L4/L5 M90 Boulevard 09/13-15 VLR 1800 TK8/TK9/TLO C109 RT Touring 08-10 VLR 1800 K8/K9/L0 C109 R 08-10 VZR 1800 BL4/BL5/BL6/BL7 (Boulevard M109R B.O.S.S.) 14-17 VZR 1800 K6/K7/K8/K9/L1/L2/L3/L4 (M109R Boulevard) 06-14 VZR 1800 NK8/NK9 M109 R2 Limited 08-09 VZR 1800 ZK8/ZK9/ZL1/ZL2/ZL3 /ZL4 M109 RZ Limited 08-14	275
MD3090X MD3090XC MD3090CC VR3090BLK VR3090BLU VR3090RED	Front	F	SUZUKI SV 650 K3-K9/SK3-SK9 03-10 GSX 600 FK3/FK4/FK5/FK6 03-06 GSX 750 FK3/FK4/FK5/FK6 03-06 VZ 1500 K9/L3/L4/L5 M90 Boulevard 09/13-15 C 109 RT Boulevard (1783cc) VLR 1800 RTK8/RTK9 08-09 C 109 R VLR 1800 RK8/RK9 08-09 VLR 1800 TK8/TK9/TLO C109 RT Touring 08-10	290	MD3098 MD3098XC MD3098CC VR3098BLK VR3098BLU VR3098RED	Front	F	SUZUKI GSX 1300 RK8/RK9/RL1/RL2 08-12 GSX 1300 BKAK8/BKAK9 B-King ABS 08-10 GSX 1300 BKK8/BKK9 B-King 08-10 GSX 1300 RZL4 Hayabusa 50th Anniversary Edition 14 GSX 1300 RAL3/RAL4/RAL5/RAL6/RAL7 ABS Hayabusa (Brembo Caliper) 13-17	310
MD3091X MD3091XC MD3091CC VR3091BLK VR3091BLU VR3091RED	Front	F	SUZUKI GSXR 600 K6/K7 06-07 GSXR 750 K6/K7 06-07 GSXR 1000 K5/K6/K7/K8/K9 05-08 VZR 1800 BL4/BL5/BL6/BL7 (Boulevard M109R B.O.S.S.) 14-17 VZR 1800 K6/K7/K8/K9/L1/L2/L3/L4 (M109R Boulevard) 06-14 VZR 1800 NK8/NK9 M109 R2 Limited 08-09 VZR 1800 ZK8/ZK9/ZL1/ZL2/ZL3 /ZL4 M109 RZ Limited 08-14	310	MD3099 MD3099C VR3099	Rear	S	SUZUKI GSX 1300 RK8/RK9/RL1/RL2 08-12 GSX 1300 BKAK8/BKAK9 B-King ABS 08-10 GSX 1300 BKK8/BKK9 B-King 08-10 GSX 1300 RZL4 Hayabusa 50th Anniversary Edition 14 GSX 1300 RAL3/RAL4/RAL5/RAL6/RAL7 ABS Hayabusa (Brembo Caliper) 13-17	260
MD3092X MD3092XC MD3092CC VR3092BLK VR3092BLU VR3092RED	Front	F	SUZUKI DL 650 AK7/K7/AK8/K8/AK9/K9/AL1 /AL2/AL3/AL4/AL5/AL6/AL7 V-Strom 07-17 DL 650 AAL2/AAL3/AAL4 V-Strom ABS Adventure 12-15 DL 650 XT V-Strom ABS (DL 650 XAL5/XAL6/XAL7) 15-17 GSX 650 FK8/FK9/FLO 08-10 GSR 750 L5/L6 (Non ABS) 15-16 GSR 750 AL5/AL6 (ABS) 15-16 GSX-S 750 L5/L6/L7/L8 15-18 GSX-S 750 ZL5/ZL6/ZL7/ZL8 15-18 GSF 1250 K7/AK7/SAK7/SAK8/SAK907-10 GSF 1250 SK7/SK8/SK9 Bandit 07-10 GSX 1250 FAL1/FAL2 11-14	310	MD3100X/XC VR3100BLK VR3100BLU VR3100RED	Front	F	SUZUKI GSXR 600 K8/K9/L1-L7 08-17 GSXR 750 K8/K9/L1-L7 08-17	310
MD3093 MD3093C VR3093	Rear	S	SUZUKI GW 250 L3 13 GW 250 FL5 (Fairing) 15 GSX 650 FK8/FK9 08-10 SV 650 SAK7/SAK8/SAK9/AK9 ABS 07-10 SFV 650 K9/L3/L4 Gladius 09-10/13-14 GSR 750 L5/L6 (Non ABS) 15-16 GSR 750 AL5/AL6 (ABS) 15-16 GSX-S 750 L5/L6/L7/L8 15-18 GSX-S 750 ZL5/ZL6/ZL7/ZL8 15-18 GSF 1250 AK7/SAK7/SAK8/SAK9 ABS 07-10 GSF 1250 SK7/SK8/SK9 Bandit 07-10 GSX 1250 FAL1/FAL2 11-12	240	MD3102X/XC VR3102BLK VR3102BLU VR3102RED	Front	F	SUZUKI GSXR 1000 K9/L1/L2/L3/ZL3/L4-L6 09-16 GSX-R 1000 AL5/AL6 ABS (Brembo Radial Caliper/310mm Disc) 15-16	310
					MD3103X MD3103XC	Front	F	SUZUKI SFV 650 K9/L3/L4 09-10/13-14 SV 650 SAK7/SAK8/SAK9/AK9/AL0 /SFA8/SFA9/SFLO ABS 07-10	290
					MD3104X/XC VR3104BLK VR3104BLU VR3104RED	Front	F	SUZUKI GSXR 600 K4/K5/XK5 04-05 GSXR 750 K4/K5/XK5 04-05 GSXR 1000 K4/ZK4 04	300

ROTOR BUYERS GUIDE

F = FLOATING ROTOR
S/F = FLOATING CONVERSION FOR
FLAT SOLID ROTOR

D = FLOATING ROTOR CONVERSION FOR DISHED SOLID ROTOR

CODES FOR TYPES

BRAKE ROTOR BUYERS GUIDE - STREET

Rotor No.	Front/Rear	Type	Models	Dia (mm)	Rotor No.	Front/Rear	Type	Models	Dia (mm)
MD3105LS	Front	S	SUZUKI GW 250 L4/L5 14-15 GW 250 FL5 (Fairing) 15	290	MD4010LS MD4010RS 5mm thickness	Front	S	KAWASAKI KZ 440 D5 (LTD) 83 KZ 440 G1 82 KZ 550 D1 (GPZ) 81 KZ 700 A1 84 VN 700 A1 Vulcan 85 KZ 750 E1-E3 80-82 KZ 750 F1 (LTD) 83 KZ 750 H1-H4 (LTD) 80-83 KZ 750 L3 83 KZ 750 N1/N2 Spectre 82-83 KZ 750 R1 (GPZ) 82 VN 750 A2-A21/A6F Vulcan 86-06	260
MD3106 MD3106C VR3106			GSX-R 1000 AL5/AL6/AL7 ABS 15-17 GSX-R 1000 R RAL7 ABS 17	220					
MD3107X MD3107XC VR3107BLK VR3107BLU VR3107RED			GSX-R 1000 AL7 ABS 17 GSX-R 1000 R RAL7 ABS 17	320					
MD3108 MD3108C VR3108	Rear		GSX-S 1000 L6/L7/L8 (Naked - Non ABS) 16-18 GSX-S 1000 AL6/AL7/AL8 (Naked - ABS) 16-18 GSX-S 1000F L6/L7/L8 (Faired - Non ABS) 16-18 GSX-S 1000F AL6/AL7/AL8 (Faired - ABS) 16-18	250	MD4012X MD4012XC MD4012CC VR4012BLK VR4012GRN	Front	F	KAWASAKI ZX 750 H1/H2 (ZX7) 89-90 ZX 9R (ZX 900 E1/E2) 00-01 ZR 1100 A1-A4 Zephyr 92-95 ZR 1100 B1 Zephyr 96 ZX 1100 C1-C4 (ZX11) Ninja 90-93 (ZR 1100 C3/C4) ZRX 1100 99-00 ZRX 1200 R (ZR 1200 A1/A2/A3/A4/A5) 01-05	310
MD3109X MD3109XC VR3109BLK VR3109BLU VR3109RED	Front		GSX-S 1000 L6/L7/L8 (Naked - Non ABS) 16-18 GSX-S 1000 AL6/AL7/AL8 (Naked - ABS) 16-18 GSX-S 1000F L6/L7/L8 (Faired - Non ABS) 16-18 GSX-S 1000F AL6/AL7/AL8 (Faired - ABS) 16-18	250					
MD4001	Rear	S	KAWASAKI ZX 550 A1-A3 (GPZ) 84-86	260	MD4013 MD4013C VR4013	Rear	S	KAWASAKI ZX 750 H1/H2/J1/J2/L1-L3 (ZX-7) 89-95 ZX 750 K1/K2/M1/M2/P1/P2/P3/P4/P5/P6/P7/P8 (ZX7R) 91-03 ZX7RR (ZX 750 N1/N2) 96-99 ZX 900 B1-B4 (ZX9R) 94-97	230
MD4002LS MD4002RS	Front	S	KAWASAKI EL 250 B2/B3 Eliminator 88-89 EX 250 E1-E2 Ninja 86-87 ZX 550 A1-A3 (GPZ) 84-86	260	MD4014 MD4014C VR4014	Rear	S	KAWASAKI ZX 1100 D1-D9 Ninja (ZX11) 93-01	250
MD4006LS MD4006RS (5mm thickness)	Front	S	KAWASAKI EN 450 A1-A6 (454 LTD) 85-90 EN 500 A1-A6/B2 Vulcan 90-95 KZ 550 F1 (Spectre) F2 (Ltd) 83-84 KZ 550 M1 (LTD) 83 KZ 550 A2/A3/A4/C1-C4 (Ltd) 80-83 KZ 1000 J1-J2 81-82 KZ 1000 K1/K2 (LTD) 81-82 KZ 1100 A1-A3 81-83 KZ 1100 B1 (GPZ) 81 KZ 1100 D1/D2 (Spectre) 82-83 KZ 1100 L1 (LTD) 83	270	MD4015 MD4015C VR4015	Rear	S	KAWASAKI ZX 600 A1-A3/B1 Ninja 85-87 ZX 1000 B1-B3 Ninja ZX10 88-90 ZX 1100 C1-C4 (ZX11) Ninja 90-93	250
MD4007 VR4007	Rear	S	KAWASAKI ZX 600 D1-D4 (ZX6) 90-93 ZX 750 F1-F4 Ninja 87-90 ZR 750 C1-C3 91-93	230	MD4016 *Floating Disc kit available for these bikes See MD714LS/RS	Front	S	KAWASAKI EX 500 A1-A7* 87-93 EX 500 D1-D12/D6F/D7F/D8F/D9F* 94-09 ZL 600 A1/A2 86-87 ZX 750 E1/E2 Turbo 84-85 ZL 900 A1/A2 Eliminator 85-86 ZX 900 A1-A3 Ninja 84-86 ZL 1000 A1 87 ZX 1000 A1/A2 (Ninja) 86-87 ZX 1100 A1/A2 (GPZ) 83-84	280
MD4008X MD4008XC MD4008CC VR4008BLK VR4008GRN	Front	F	KAWASAKI ZR 550 B1-B4 Zephyr 90-93 ZL 600 B2/B3 Eliminator 96-97 ZX 600 F1/F2/F3 (ZX6R) 95-97 EJ 650 A2/A3/A4 (W650) 00-02 ZR 750 C1-C3 91-93 ZG 1000 A9-A20/A6F Con Cours 94-06 GPZ 1100 (ZX 1100 E1/E2/E3) 95-97	300	MD4017	Rear	S	KAWASAKI ZX 750 E1/E2 Turbo 84-85 ZL 900 A1/A2 Eliminator 85-86 ZX 900 A1/A2/A3 84-86 ZL 1000 A1 87 ZX 1100 A1/A2 (GPZ) 83-84	270
MD4009 MD4009C VR4009	Rear	S	KAWASAKI ZR 550 B1-B4 Zephyr 90-93 ZX 600 E1-E13 (Ninja ZX6) 93-05	240	MD4019	Rear	S	KAWASAKI ZX 750 A1/A2/A2L/A3 (GPZ) 83-85 ZX 1000 A1/A2 (Ninja) 86-87	260
					MD4021	Front	S	KAWASAKI ZX 1000 B1-B3 Ninja ZX10 88-90	300

ROTOR BUYERS GUIDE

CODES FOR TYPES
S = FLAT SOLID
D = FLOATING ROTOR CONVERSION FOR DISHED SOLID ROTOR

F = FLOATING ROTOR
S/F = FLOATING CONVERSION FOR FLAT SOLID ROTOR

BRAKE ROTOR BUYERS GUIDE - STREET

Rotor No.	Front/Rear	Type	Models	Dia (mm)	Rotor No.	Front/Rear	Type	Models	Dia (mm)
MD4022X MD4022XC MD4022CC VR4022BLK VR4022GRN	Front	F	KAWASAKI Ninja ZX-750 J1/J2/L1-L3 (ZX-7) 91-95 Ninja ZX 7R (ZX750 K1/K2/M1/M2) 91-95 Ninja ZX 7R (ZX 750 P1-P8) 96-03 Ninja ZX-7RR (ZX750 N1/N2) 96-99 ZX-9R B1-B4 Ninja 94-97 ZX-9R F1/F2 Ninja 02-03 ZX 1100 D1-D9 Ninja 93-01 ZRX 1200 R (ZR 1200 A1-A4) 01-04 ZX 12 R A1/A2/B1/B2 00-03 ZX 1200 C1/C2/C3/C4 (ZZR 1200) 02-05 VN 1500 P1/P2 Vulcan Mean Streak 02-03 VZ 1600 K4/K5 04-05 VN 1600 B1/B2/B6F/B7F/B7FA/B8F/B8FA 04-08	320	MD4053LS	Front	D	KAWASAKI KZ 550 A1 80	296
MD4023 MD4023C VR4023	Rear	S	KAWASAKI ZX 6R (ZX 600 F1-F3) 95-97 ZX 12R (ZX 1200 A1/A2/B1/B2/B3/B4) 00-05	230	MD4054 (7mm thickness)	Rear	S	KAWASAKI KZ 1000 J1-J3 81-83 KZ 1000 K1/K2 (LTD) 81-82 KZ 1000 M1/M2 (CSR) 81-82 KZ 1000 P1-P22/P24 (Police) 82-03/05 KZ 1000 R1/R2 (Replica) 82-83 KZ 1100 A1-A3 81-83 KZ 1100 B1/B2 (GPZ) 81-82 KZ 1100 D1/D2 (Spectre) 82-83 KZ 1100 L1 (LTD) 83 VN 1500 A1-A13 Vulcan 87-99 VN 1500 B1-B4 Vulcan 88 SE 87-90	270
MD4024	Rear	S	KAWASAKI KZ 550 H1/H2 (GPZ) 82-83	260	MD4059LS MD4059RS VMD4059	Front	D	KAWASAKI KZ 650 C1-C3 Custom 77-79 KZ 650 D1/D1A/D2 'SR' series 78-79	278
MD4026LS MD4026RS	Front	S	KAWASAKI ZX 600 C1-C9 Ninja 600 R 88-96	260	MD4062	Rear	D	KAWASAKI KZ 650 C3 Custom From F/No 023101-79	276
MD4027 MD4027C VR4027	Rear	S	KAWASAKI ZX 600 C1-C9 Ninja 600 R 88-96 ZR 1100 A1-A4/B1 Zephyr 92-96	240	MD4063 VMD4063	Rear	D	KAWASAKI KZ 650 D2 'SR' series 79 KZ 1000 B3/B4 (LTD) 79-80 KZ 1000 G1 Classic 80	278
MD4028	Front	S	KAWASAKI ZX 600 A1-A3/B1 Ninja 85-87 ZX 750 A1-A3 (GPZ) 83-85 ZG 1000 A1-A8 Con Cours 86-93	270	MD4064LS MD4064RS VMD4064	Front	D	KAWASAKI KZ 650 E1 (LTD) 80 KZ 650 F1 80 KZ 1000 A3/A3A/A4 79-80 KZ 1000 B3/B4 (LTD) 79-80 KZ 1000 C2/C3/C4 79-81 KZ 1000 G1 Classic 80	295
MD4032	Rear	S	KAWASAKI EX 250 E1-E2 Ninja 86-87	240	MD4065LS	Front	D	KAWASAKI KZ 650 H1-H3 (CSR) 81-83	280
MD4038	Front	S	KAWASAKI KZ 1000 R1/R2 (Replica) 82-83 KZ 1000 J3 83 KZ 1100 B2 (GPz) 82	280	MD4066LS	Front	D	KAWASAKI KZ 750 M1 (CSR) 82	280
MD4040LS	Front	S	KAWASAKI AR 50 A1 82 AR 80 A1 82	210	MD4067LS MD4067RS	Front	S	KAWASAKI ZN 700 A1/A2 (LTD) 84-85	270
MD4041RS	Front	S	KAWASAKI EX 250 F2-F19/D6F/D7F Ninja 250 88-07	260	MD4068	Rear	S	KAWASAKI ZN 700 A1/A2 (Ltd) 84-85	260
MD4042	Rear	S	KAWASAKI EX 250 F2-F19/D6F/D7F Ninja 250 88-07	230	MD4069LS VMD4069	Front	D	KAWASAKI HI-D/HI-E/HI-F 500 73-75 H2/H2-A "Mach IV" 72-73 H2-B/H2-C "Mach IV" 74-75 Z1/A/B 900 73-75	296
MD4043LS	Front	D	KAWASAKI KZ 305 A1/A2/B1 (CSR) 81-82 KZ 305 B2/B3 (LTD) 87-88	260	MD4070LS	Front	D	KAWASAKI KZ 750 K1/K2 (LTD) 83-84	270
MD4047LS	Front	D	KAWASAKI KZ 440 A1-A4 80-83 KZ 440 K1/D1-D4 (LTD) 80-82	278	MD4071LS MD4071RS	Front	S	KAWASAKI ZX 750 F1-F4 Ninja 87-90	270
MD4051 MD4051C	Rear	S	KAWASAKI EX 500 D1-D12/D6F/D7F/D8F/D9F 94-09	230	MD4073	Rear	D	KAWASAKI KZ 900 B1 'LTD' 76	TBA
MD4052LS VMD4052	Front	F	KAWASAKI KH 500 A8 76 KZ 650 B1-B3 77-79 KZ 750 B1-B4 76-79 KZ 900 A4/A5 76-77 KZ 1000 A1/A2/A2A 77-78	295	MD4076LS MD4076RS VMD4076	Front	D	KAWASAKI KZ 900 B1 'LTD' 76 KZ 1000 B1/B2 'LTD' 77-78 KZ 1000 D1/D3 (Z1-R series) 78-80 KZ 1000 C1/C1A Police Series 78	296

ROTOR BUYERS GUIDE

F = FLOATING ROTOR
S/F = FLOATING CONVERSION FOR FLAT SOLID ROTOR

D = FLOATING ROTOR CONVERSION FOR DISHED SOLID ROTOR

CODES FOR TYPES
S = FLAT SOLID
D = FLOATING ROTOR CONVERSION FOR DISHED SOLID ROTOR

BRAKE ROTOR BUYERS GUIDE - STREET

Rotor No.	Front/Rear	Type	Models	Dia (mm)	Rotor No.	Front/Rear	Type	Models	Dia (mm)
MD4077 VMD4077	Rear	D	KAWASAKI KZ 1000 A1/A2/A2A 77-78 KZ 1000 A3/A3A/A4 79-80 KZ 1000 C1/C1A Police Series 78 KZ 1000 C2/C3/C4 79-81 KZ 1000 D1/D3 (Z1-R series) 78-80	290	MD4125LS Contd.	Front	S	KAWASAKI Contd. VN 1500 N1/N2/N3 Classic Fi 00-02 VN 1500 N4/N6F/N7F/N8F/N8FA Vulcan 1500 Classic 05-08	300
MD4078LS MD4078RS VMD4078	Front	D	KAWASAKI KZ 1000 E1/E2 ST & Shaft 79-80	286	MD4128	Rear	S	KAWASAKI VN 1500 C3/C4 96-97 VN 1500 D1/D2/E1-E3 Vulcan Classic 96-00	270
MD4080LS MD4080RS	Front	D	KAWASAKI KZ 1000 M1/M2 (CSR) 81-82	270	MD4130 MD4130C VR4130	Rear	S	KAWASAKI GPZ 1100 (ZX1100 E1/E2/E3) 95-97 GPZ 1100 (ZX1100 F1) 96-97	250
MD4082	Rear	S	KAWASAKI ZG 1000 A1-A8 Con Cours 86-93 ZG 1000 A9-A20/A6F Con Cours 94-06	280	MD4132C VR4132BLK VR4132GRN	Front	F	KAWASAKI GPZ 1100 F1 ABS Model 96-97	300
MD4084	Front	S	KAWASAKI ZN 1100 B1/B2 (LTD) 84-85	280	MD4133 MD4133C VR4133	Rear	S	KAWASAKI (ZR 1100 C3/C4) ZRX 1100 99-00 ZRX 1200 R (ZR 1200 A1/A2/A3/A4/A5) 01-05 ZX 1200 C1/C2/C3/C4 (ZZR 1200) 02-05	250
MD4085	Rear	S	KAWASAKI VN 900 B6F-B9F/BAF/BBF/BCF/BDFA/BEF/BEFA/BFF 06-15 VN 900 BBFA/CCFA Vulcan Custom Special Edition 11-12 VN 900 C7F/C8F/C9F/CAF/CBF/CCF /CFF (Cast wheels) 07-15 VN 900 D6F/D7F/D8F/D9F/DAF /DBF/DCF/DDF/DEF/DFE 06-15 ZN 1100 B1/B2 (LTD) 84-85	270	MD4136X MD4136XC MD4136CC VR4136BLK VR4136GRN	Front	F	KAWASAKI ZX 6R (ZX 600 G1/G2/J1/J2/J3) 98-02 ZX 6R (ZX636A1) 02 ZZR 600 (ZX 600 J4/J6F/J7F/J8F) 05-08 ZX 9R (ZX 900 C1/C2) 98-99	300
MD4087	Front	S	KAWASAKI ZG 1200 A1/A2/B1-B17 (Voyager XII) 86-03	280	MD4137RS	Front	S	KAWASAKI BN 125 A4-A8/A6F/A7F/A9F 01-09	260
MD4088	Rear	S	KAWASAKI ZG 1200 A1/A2/B1-B17 (Voyager XII) 86-03	290	MD4138 MD4138C VR4138	Rear	S	KAWASAKI ZX 6R (ZX 600 G1/G2/J1/J2/J3) 98-02 ZX 6R (ZX636A1) 02 ZX 6R (ZX 636 C1/C6F/D6F 636cc) 05-06 ZX 6RR (ZX 600 K1/M1/N1) 599cc 03-05 ZX 6R (ZX 636 B1/B2) 636cc 03-04 ZX6R (ZX 600 P7F/P8F/R9F/RAF /RBF/RCF) 07-12 ZZR 600 (ZX 600 J4/J6F/J7F/J8F) 05-08 ER 650 C9F/CAF ER-6N 09-10 EX 650 Ninja (EX 650 ECF/EDS/EEF/EFF) (Non ABS) 12-15 EX 650 R (EX 650 CBF) 11 KLE 650 A7F/A8F/A9F/CAF/CBF/CCF /CDF/CEF Versys 07-14 Ninja 650 R (EX 650 A6F/A7F /A8F/C9F/CAF) 06-10 Z 750 S (ZR 750 K1/K6F) 05-06 ZX 9R (ZX 900 C1/C2/E1/E2/F1/F2) 98-03 Z 1000 (ZR 1000 A1/A2/A3) 03-05 Z 1000 (ZR 1000 A6F) 06 ZX 10R (ZX 1000 C1/C2/DF6/D7F) 04-07 ZX 10R (ZX 1000 E8F/E9F/FAF) 08-10	220
MD4089LS MD4089RS VMD4089	Front	D	KAWASAKI KZ 1300 A1-A4 79-82 KZ 1300 B2 (Touring) 80	299	MD4141X MD4141XC MD4141CC	Front	F	KAWASAKI ZX 600 D1-D4 (ZX6) 90-93 ZR 750 F2 (ZR-7) 00-01 ZR 750 H1/H2/H3/H4/H5 (ZR7S) 01-05 ZR 750 S (ZR 750 K1/K6F) 05-06	300
MD4090	Rear	S	KAWASAKI KZ 1000 E1/E2 ST & Shaft 79-80 KZ 1300 A1-A4 79-82 KZ 1300 B2 (Touring) 80	290	MD4142 MD4142C	Rear	S	KAWASAKI ZR 750 F2 (ZR-7) 00-01 ZR 750 H1/H2/H3/H4/H5 (ZR7S) 01-05	240
MD4091	Front	S	KAWASAKI KZ 1000 P1-P22/P24 (Police) 82-03/05 ZN 1300 A1-A6 (Voyager) 83-88	300	MD4146	Rear	S	KAWASAKI VN 1500 P1/P2 02-03 VN 1600 A1/A2/A3/A6F/A7F/B6F/B7F /A7FA/A8F/A8FA Classic 03-08 VN 1600 B1/B2/B6F/B7F/B7FA/B8F /B8FA Mean Streak 04-08	300
MD4092	Rear	S	KAWASAKI ZN 1300 A1-A6 (Voyager) 83-88	330					
MD4094LS	Front	F	KAWASAKI VN 1500 B1-B4 Vulcan 88 SE 87-90	300					
MD4099	Front	S	KAWASAKI EX 305 B1 (GPZ) 83 KZ 550 H1/H2 (GPZ) 82-83	260					
MD4124LS	Front	F	KAWASAKI EN 500 C1-C10/C6F-C9F Vulcan 500 Ltd 96-09 VN 800 A1-A11 Vulcan Classic 96-05 VN 1500 C3/C4 96-97 VN 1500 A1-A13 Vulcan 87-99	300					
MD4125LS	Front	S	KAWASAKI VN 800 B1-B10 Vulcan Classic 96-05 VN 800 C1/C 2/E1/E2/E3/E4/E5/E6F 99-06 VN 1500 D1/D2/E1-E7 Vulcan Classic 96-04 VN 1500 J1/J2/R1/R2/R3/R4/R5 99-05	300					

ROTOR BUYERS GUIDE
 CODES FOR TYPES
 S = FLAT SOLID
 D = FLOATING ROTOR CONVERSION FOR DISHED SOLID ROTOR
 F = FLOATING ROTOR
 S/F = FLOATING CONVERSION FOR FLAT SOLID ROTOR

BRAKE ROTOR BUYERS GUIDE - STREET

Rotor No.	Front/Rear	Type	Models	Dia (mm)	Rotor No.	Front/Rear	Type	Models	Dia (mm)
MD4146 Contd.	Rear	S	KAWASAKI Contd. VN 1600 D1/D6F/D7F/D7FA/D8F/D8FA Nomad 05-08	300	MD4156XC RIGHT SIDE NO ABS RING	Front	F	KAWASAKI EX 650 Ninja 650 (EX 650 FDS/FEF /FFF/FGF) ABS Model 13-16 KLE 650 DEF Versys (ABS) 14	300
			SUZUKI VZ 1600 K4 Marauder 04 VZ 1600 K5 M95 Boulevard/Marauder 05						
MD4147	Rear	S	KAWASAKI VN 1500 G1/G2/G3/L2/L3/L4/L5 99-05 VN 2000 D1/D6F Vulcan Ltd 05-06 VN 2000 A1/A2/A6F/A7F/G8F/G9F Vulcan 04-09 VN 2000 E6F/E7F/H8F/H9F Vulcan Classic 06-09	320	MD4156AXC LEFT SIDE WITH ABS RING FITTED	Front	F	KAWASAKI EX 650 Ninja 650 (EX 650 FDS/FEF /FFF/FGF) ABS Model 13-16 KLE 650 DEF Versys (ABS) 14	300
MD4148	Rear	S	KAWASAKI VN 2000 F6F/F7F/J8F/J9F Vulcan Classic LT 06-09 VN 800 C1/C2/E1/E2/E3/E4/E5/E6F 99-06 VN 1500 J1/J1L/J2/J2L/R1/R2/R3/R4 /R5/N1/N2/E4/E5/E6/E7 00-05 VN 1500 N4/N6F/N7F/N7FA/N8F/N8FA Vulcan 1500 Classic 05-08	270	MD4157C VR4157	Rear	S	KAWASAKI 1000 Ninja (ZX 1000 GBF/GCF) 11-12 1000 Ninja (ABS) (ZX 1000 MEF/MFF) 14-15 Z 1000 (ZR 1000 B7F/B8F/B9F/BAF) 07-08 Z 1000 (ZR 1000 DAF/DBF/DCF/DDF) 10-13 Z 1000 HCF/HDF Ninja 1000 ABS 12-13 Z 1000 ABS (ZR 1000 GEF/GFF) 13-14 ZX 14 Ninja (ZX 1400 A6F/A7F/C8F /C9C/CAF/CBF) 06-11 ZXR 1400 (ZX 1400 A6F/A7F/C8F /C9F/CAF) 06-10 ZX 14R ABS (ZX 1400 FDF/FEFA/FFFA/HGF) /HHF) ABS Model 13-17 ZX 14R 30th Anniversary Edition/ABS (ZX 1400 FFFB) 15 ZX14 R Ninja (ABS/SE Model) ZX 1400 JGF/JHF 16-17	250
MD4150	Front	S	KAWASAKI VN 1500 G1/G1A/G2A/G3/L2/L3/L4/L5 99-05	280	MD4158	Front	S	KAWASAKI VN 900 B6F/B7F/B8F/B9F/BAF/BBF/BCF /BDFA/BEF/BEFA/BFF Classic 06-15 VN 900 BBFA/CCFA Vulcan Custom Special Edition 11-12 VN 900 C7F/C8F/C9F/CAF/CBF/CCF /CDFA/CEFA/CFE (Cast wheels) 07-15 VN 900 D6F/D7F/D8F/D9F/DAF/DBF/DDF /DEF/DCF/DEF Classic LT 06-15 VN 1600 D1/D6F/D7F/D7FA/D8F/D8FA Nomad 05-08 VN 1700 A9FA/AAF/ABF/ACF Vulcan 1700 Voyager 09-12 VN1700 B9FA/BAF/BBF/BCF/BDF/BEF/BFF /BGF/BHF Vulcan 1700 Voyager ABS 09-17 VN 1700 C9F/CAF/CBF/CCF Vulcan 1700 Nomad 09-12 VN 1700 C9FA Vulcan 1700 Nomad 2T 09 VN 1700 DEF/DEFA (Vulcan Nomad ABS) 14 VN 1700 E9F/EAF/EBF/ECF Vulcan 1700 Classic 09-12 VN 1700 G9F/GAF Vulcan 1700 Classic LT 09-12 VN 1700 KEF/KEFA Vaquero ABS Voyager 14 VN 1600 A1/A2/A3/A6F/A7F/A7FA /A8F/A8FA 03-08 VN 2000 D1/D6F Vulcan Ltd 05-06 VN 2000 A1/A2/A6F/A7F/G8F/G9F Vulcan 04-09 VN 2000 E6F/E7F/H8F/H9F Vulcan Classic 06-09 VN 2000 F6F/F7F/J8F/J9F/JAF Vulcan Classic LT 06-10	300
MD4151X MD4151XC	Front	F	KAWASAKI ZX 6RR (ZX 600 K1/M1) 599cc 03-04 ZX 6R (ZX 636 B1/B2) 636cc 03-04	280					
MD4152XC MD4152CC VR4152BLK VR4152GRN	Front	F	KAWASAKI ZX6RR (ZX 600 N1/N6F 599cc) 05-06 ZX6R (ZX 636 C1/C6F/D6F 636cc) 05-06 ZX6R (ZX 600 P7F/P8F/R9F/RAF /RBF/RCF) 07-12 ZX 1000 C1/C2/D6F/D7F (ZX10R) 04-07 Z 1000 (ZR 1000 B7F/B8F) 07-08	300	MD4159XC VR4159BLK VR4159GRN	Front	F	KAWASAKI ER 650 C9F ER-6N 09 EX 650 A6F/A7F/A8F/C9F/CAF (Ninja 650 R) 06-10 EX 650 Ninja (EX 650 ECF/EDS/EEF/EFF) (Non ABS) 12-15 EX 650 R (EX 650 CBF) 11 KLE 650 A7F/A8F/A9F/CAF/CBF /CCF/CDF/CEF Versys 07-14	300
MD4153X/XC MD4153CC VR4153BLK VR4153GRN	Front	F	KAWASAKI ZX 600 E4-E13 (ZZR 600) 96-05	300					
MD4154X/XC MD4154CC VR4154BLK VR4154GRN	Front	F	KAWASAKI Z 1000 (ZR 1000 A1-A3/A6F) 03-06 ZX 12 R (EX 1200 B3-B4) 04-05	300					
MD4155XC MD4155CC VR4155BLK VR4155GRN	Front	F	KAWASAKI ZX6R (ZX 636 EDF/EEF/EFF/EGF/EHF) 636cc/Non ABS 13-17 ZX6R (ZX 636 EFFA) 636cc/ 30th Anniversary Edition Non ABS 15 ZX6R (ZX 636 EGFA/EHFA) 636cc/ Non ABS/KRT Edition 16-17 ZX6R (ZX 636 FDF/FDF/FFF/FGF/FHF) 636cc/ABS 13-17 ZX6R (ZX 636 FFFA) 636cc/ 30th Anniversary Edition ABS 15 ZX6R (ZX 636 FGFA/FHFA) 636cc/ ABS/ KRT Edition 16-17 Concours 14 (ZG 1400 B8F/B9F/DAF) 08-11 Concours 14 ABS (ZG 1400 A8F/A9F/CAF /CBF/CCF/CDF/CEF) 08-14 ZX 14 Ninja (ZX 1400 A6F/A7F/C8F /C9C/CAF/CBF) 06-11 ZX 14R ABS (ZX 1400 FDF/FEFA/FFFA /FFFB/HGF/HHF) ABS Model 13-17 ZX 14R 30th Anniversary Edition /ABS (ZX 1400 FFFB) 15	310					

ROTOR BUYERS GUIDE

 F = FLOATING ROTOR
 S = FLAT SOLID
 D = FLOATING ROTOR CONVERSION FOR DISHED SOLID ROTOR
 S/F = FLOATING CONVERSION FOR FLAT SOLID ROTOR

BRAKE ROTOR BUYERS GUIDE - STREET

Rotor No.	Front/Rear	Type	Models	Dia (mm)	Rotor No.	Front/Rear	Type	Models	Dia (mm)
MD4160C VR4160	Rear	S	KAWASAKI Concours 14 (ZG 1400 B8F/B9F/DAF) 08-11 Concours 14 ABS (ZG 1400 A8F/A9F/CAF /CBF/CCF/CDF/CEF) 08-14	270	MD4166C	Front	S	KAWASAKI EX 300 Ninja (EX 300 ADF/ADFA/AEF) 13-14 EX 300 Ninja (EX 300 BADF/BDF/BEF) 13-14	290
MD4161XC VR4161BLK VR4161GRN	Front	F	KAWASAKI ZX 10 R E8F/E9F/FAF 08-10 ZX 10 R (ZX 1000 JBF/JCF/JDF/JEF/JFF) Non ABS 11-15 ZX 10 R (ZX 1000 KBF/KCF/KDF/KEF/KFF) ABS 12-15 ZX 10 R (ZX 1000 VFFA) 30th Anniversary Edition (Non ABS Version) 15 ZX 10 R (ZX 1000 KFFA) 30th Anniversary Edition (ABS Version) 15	310	Floating Conversion MD4166XC VR4166BLK VR4166GRN 5 bolt fixing	Front	F	KAWASAKI EX 300 Ninja (EX 300 ADF/ADFA/AEF) 13-14 EX 300 Ninja (EX 300 BADF/BDF/BEF) 13-14 Ninja 300 SE - Non ABS (ZX 300 AEF/AEFA/AFFA/AESA) 14-15 Ninja 300 SE - ABS (ZX 300 BEFA /BESA/BFFA) 14-15	290
MD4162C Floating Conversion MD4162XC VR4162BLK VR4162GRN	Front	S	KAWASAKI EX 250 J8F/J9F/JAF/JBF/JCF (Ninja 250 R) 08-12	290	MD4167X MD4167XC	Front	F	KAWASAKI ZX9R C1/C2 98-99	296
	Front	F	KAWASAKI EX 250 J8F/J9F/JAF/JBF/JCF (Ninja 250 R) 08-12	290	MD4169 7mm thickness	Rear	S	KAWASAKI KZ 550 D1 (GPZ) 81 KZ 700 A1 84 KZ 750 E1-E3 80-82 KZ 750 F1 (LTD) 83 KZ 750 H1-H4 (LTD) 80-83 KZ 750 L3 83 KZ 750 N1/N2 Spectre 82-83 KZ 750 R1 (GPZ) 82	260
MD4163C VR4163	Rear	S	KAWASAKI EX 250 J8F/J9F/JAF/JBF/JCF (Ninja 250 R) 08-12 EX 300 ADF/ADFA/AEF/AES/AESA/AFF Ninja 300 (Non ABS) 13-15 Ninja 300 SE - Non ABS (ZX 300 AEF/AEFA/AFFA/AESA) 14-15	220	MD4170X	Front	F	KAWASAKI ZX 10 R Ninja (ZX 1000 SGF/SHF/SJF) 16-18 ZX 10 R Ninja KRT Replica (ZX 1000 SGFA/SHFA/SJFA) 16-18	330
MD4164AC	Rear	S	KAWASAKI EX 650 Ninja (EX 650 FDS/FEF/FFF) (ABS Model) 13-15 KLE 650 DEF Versys (ABS) 13	220	MD4171C OS4171C	Front	S	KAWASAKI Z125 Pro (BR125 JHF) 17	200
MD4165 MD4165C VR4165	Rear	S	KAWASAKI ZX6R (ZX 636 EDF/EEF/EFF/EGF/EHF) 636cc/Non ABS 13-17 ZX6R (ZX 636 EFFA) 636cc/ 30th Anniversary Edition Non ABS 15 ZX6R (ZX 636 EGFA/EHFA) 636cc/ Non ABS/ KRT Edition 16-17 ZX6R (ZX 636 FDF/FDF/FFF/FGF/FHF) 636cc/ABS 13-17 ZX6R (ZX 636 FFFA) 636cc/ 30th Anniversary Edition ABS 15 ZX6R (ZX 636 FGFA/FHFA) 636cc/ ABS/KRT Edition 16-17 ZX 10 R (ZX 1000 JBF/JCF/JDF/JEF/JFF) (Non ABS) 11-15 ZX 10 R (ZX 1000 KBF/KCF/KDF /KEF/KFF) ABS 12-15 ZX 10 R (ZX 1000 VFFA) 30th Anniversary Edition (Non ABS Version) 15 ZX 10 R (ZX 1000 KFFA) 30th Anniversary Edition (ABS Version) 15 ZX 10 R Ninja (ZX 1000 SGF/SHF/SJF) 16-18 ZX 10 R Ninja KRT Replica (ZX 1000 SGFA/SHFA/SJFA) 16-18 Ninja ZX-10 RR (ZX1000 ZHF) 17	220	MD4172C	Rear	S	KAWASAKI Z125 Pro (BR125 JHF) 17	184

ROTOR BUYERS GUIDE

CODES FOR TYPES
 S = FLAT SOLID
 D = FLOATING ROTOR CONVERSION FOR DISHED SOLID ROTOR
 F = FLOATING ROTOR
 S/F = FLOATING CONVERSION FOR FLAT SOLID ROTOR

BRAKE ROTOR BUYERS GUIDE - DIRTBIKE/ATV/UTV

Rotor No.	Front/Rear	Type	Models	Dia (mm)	Rotor No.	Front/Rear	Type	Models	Dia (mm)			
MD6001D Options: OS6001C OS6001CE OSX6001 280mm oversize SM6001C SMX6001 320mm oversize MD6001CX	Front	S	HONDA	240	MD6012D	Front	S	YAMAHA	245			
			CR 125 R					92-94		YZ 125 A/B	90-91	
			CRF 230 F					03-16		YZ 250 A/B	90-91	
			CRF 230 L					08-11		WR 250 ZB	91	
			CRF 230 M					09-11				
			CR 250 R					92-94				
			NX 250					88-90				
			XR 250 R Pro Link					91-95				
			XR 250 R					96-04				
			XR 250 L					91-96				
XR 400 R	96-04											
CR 500 R	92-94											
XR 600 R	91-00											
XR 650 R	00-07											
MD6002D MD6002CX	Rear	S	HONDA	220	MD6013D MD6013C MD6013CX	Rear	S	HONDA	220			
			CR 125 R					89-97		CRF 230 L	08-11	
			CR 250 R	89-96			CRF 230 M	09-11				
			CR 500 R	89-00			XR 250 R Pro Link	90-95				
MD6003D	Front	S	HONDA	240	MD6014D MD6014C MD6014CX	Rear	S	KAWASAKI	220			
			CR 125 R					90-91		KLX 400 R (KLX 400 B1/B2)	03-04	
			CR 250 R					90-91		KLX 400 SR (KLX 400 A1/A2)	03-04	
CR 500 R	90-91	SUZUKI										
			RM 125 J	88								
			RM 125 K/L/M/N/P/R/S/T/V/W	89-98								
			RM 250 H/J	87-88								
			RM 250 K/L/M/N/P/R/S/T/V/W	89-98								
			RMX 250 K/M/N/P/R/S/T/V/W	89-98								
			DR-Z 400 SY/SK1/SK2/SK3/SK4/SK5									
MD6004D	Front	S	HONDA	215				/SK6/SK7/SK8/SK9/SL1/SL2/SL3				
			CR 80 R		86-95	/SL4/SL5/SL6	00-16					
MD6005D MD6005C MD6005CX	Rear	S	HONDA	190	MD6015D Options: OS6015C OSX6015 280mm oversize SM6015C SMX6015 320mm oversize MD6015CX	Front	S	KAWASAKI	250			
			CR 80 R					92-95		KX 125 G1/H1/H2/J1/J2/K1-K5/L1-L4	89-02	
			CR 80 R/RB Expert					96-02		KDX 200 E5/E6	93-94	
CR 85R/85R Expert	03-07	KDX 250 D2/D3/D4	92-94									
		KLX 250 R D2/D3/D4	94-96									
		KX 250 G1/H1/H2/J1/J2/K1-K5/L1-L4	89-02									
		KLX 300 R A2-A10/A6F/A7F	97-07									
		KX 500 E1-E16	89-04									
		KLX 650 R A1/A2/A3	93-94									
		KLX 650 R D1	96									
MD6006D	Front	S	HONDA	174	MD6016D	Front	S	YAMAHA	230			
			TRX 250 R 'Fourtrax'					88-92		YZ 125 W	89	
			TRX 250 EX Sportrax 250 EX					01-07		YZ 250 W	89	
			TRX 250 X					09-14		YZ 250 WRW	89	
			TRX 300 EX Fourtrax					93-08		WR 500 ZD/ZE	92-93	
			TRX 300 X					09-11				
			TRX 400 EX Fourtrax					99-08				
TRX 400 X	09-14											
TRX 450 R/ER Sportrax	04-14											
TRX 700 XX	08-11											
MD6007D	Rear	S	HONDA	186	MD6017D MD6017C Options: OS6017C OS6017CE OSX6017 280mm oversize MD6017CX SM6017C SMX6017 320mm oversize	Front	S	KAWASAKI	250			
			ATC 250 R					85-86		KLX 400 R (KLX 400 B1/B2)	03-04	
TRX 250 R 'Fourtrax'	86-89	KLX 400 SR (KLX 400 A1/A2)	03-04									
		SUZUKI										
		RM 125 K/L/M/N/P/R/S/T/V/W/X/Y/K1-K8	89-08									
		DR-Z 250 K1/K2/K3/K4/K5/K6	01-06									
		RM 250 K/L/M/N/P/R/S/T/V/W/X/Y/K1-K8	89-08									
		RMX 250 K/M/N/P/R/S/T/V/W/X/Y	89-00									
		DR 350 SEW/SEX	98-99									
		DR-Z 400 SY/SK1/SK2/SK3/SK4/SK5										
MD6008D	Front	S	HONDA	240				/SK6/SK7/SK8/SK9/SL1/SL2/SL3				
			CR 125 R		89	/SL4/SL5/SL6	00-16					
			CR 250 R		89	DR-Z 400 EY/Y/EK1/K1/EK2/K2/K3						
			CR 500 R	89			/EK3/K4/EK4/EK5/EK6/EK7	00-07				
MD6009D	Rear	S	HONDA	220	MD6018D MD6018C OS6018C	Front	S	SUZUKI	200			
			CR 125 R					87-88		RM 80 G/H/J/K/L/M/N/P/R/S/T/V/W/X/Y/K1	86-01	
			CR 250 R					87-88		RM 85 K2/K3/LK3/K4/LK4	02-04	
CR 500 R	87-88											
MD6010D SM6010C MD6010CX	Front	S	HONDA	256								
			NX 650					88-89				
			XR 650 L					93-14				
MD6011D	Rear	S	YAMAHA	220								
			YZ 125 U/W/A/B/D/E/F/G/H/J					88-97				
			WR 125 K					98				
			YZ 250 U/A/B/D/E/F/G/H/J		88-97							
			YZ 250 WRW/WRA		89-90							
			WR 250 ZB/ZD/ZE/ZF/ZG/ZH/ZJ		91-97							
WR 400 FK	98											
WR 500 ZD/ZE	92-93											

ROTOR BUYERS GUIDE

 F = FLOATING ROTOR
 S/F = FLOATING CONVERSION FOR FLAT SOLID ROTOR
 D = FLOATING ROTOR CONVERSION FOR DISHED SOLID ROTOR

BRAKE ROTOR BUYERS GUIDE - DIRTBIKE/ATV/UTV

Rotor No.	Front/Rear	Type	Models	Dia (mm)	Rotor No.	Front/Rear	Type	Models	Dia (mm)
MD6020D	Front	S	SUZUKI LT 230 EH/EJ/EK/EL/EM/EN/EP 86-93 LT 230 SF/SG/SH/ 85-90 LT 250 RF/RG/RH/RJ/RK/RL/RM/RN 85-92	160	MD6032D	Front	S	ATK 700 (2T) Intimidator 04 620 (2T) Intimidator 04 500 (2T) 04 270 (2T) 04 250 (2T) 04	260
MD6021D	Rear	S	SUZUKI LT 250 RH/RJ/RK/RL/RM/RN 87-92 LT 230 EH Early axle 64710 22A00 86 LT 230 SF/SG 85-86 LT 230 SH up to F no 2108531 87 LT 250 RF/RG 85-86	220	Options: OS6032C OS6032CE OSX6032 280mm oversize SMX6032 320mm oversize MD6032CX			HUSABERG All MX/Enduro Models 00-08 HUSQVARNA TC 125 (2T) 14-15 TE 125 (2T) 14-15 FC 250 (4T) 14-15 FE 250 (4T) 14-15 TC 250 (2T) 14-15 TE 250 (2T) 14-15 TE 300 (3T) 14-15 FC 350 (4T) 14-15 FE 350 (4T) 14-15 FC 450 4T 14-15 FE 450 (4T) 14-15 FE 501 14-15	
MD6022D	Front	S	SUZUKI LT 500 RH/RJ/RK/RL 87-90	170				KTM EXC 125 95-07 EXC/EGS 125 94 EXE 125 00 MX 125 92-93 SX 125 94-16 SX 150 08-17 XC 150 10-15 XC/EXC/EGS 200 98-08 XC-W 200 07-15 XC 200 06-08 D-XC/E-XC/T-XC/E-GS 250 92-93 EXC 250 95-07 EXC/EGS 250 94 MX 250 92-93 SX F 250 (4T) 05-16 EXC-F 250 06-07 SX 250 (2T) 94-16 XC-F 250 06-15 XC-F-W 250 06-13 XC 250 (2T) 06-15 XCF-W 250 Six Days 11 XC-W 250 06-15 EXC 300 04-05 XC 300 (2T) 06-15 XC-W 300 06-15 EXC 350 LC4 94-95 EXC 350 96-97 EXC-F 350 12-15 SX-F 350 11-15 XCF-W 350 12-13 SX 360 96-97 EXC 380 98-03 SX 380 98-03 EXC/EGS 400 00-02 EXC 400 Racing 00 EXC-R 450 08 XC/EXC 400 04-07 SC 400 96-99 SX 400 00-02 XC-W 400 08-11 XCR-W 450 13 EXC 440/SX 440 94-95 EXC 450 03-06 EXC 450 (4T) 09-10 EXC 450 10-11 SX-F 450 03-16 XC-F 450 08-09/13-15 450 XC-W (4T) Sixdays/Champion Edition 10	
MD6023D	Rear	S	SUZUKI LT 500 RH/RJ/RK/RL 87-90	240					
MD6024D MD6024C MD6024CX	Rear	S	KAWASAKI KX 125 G1/H1/H2/J1/J2/K1-K5/L1-L4 89-02 KDX 200 E1/E2/E3/E4/ E5/E6 89-94 KX 250 G1/H1/H2/J1/J2/K1-K5/L1-L4 89-02 KX 500 E1-E16 89-04	220					
MD6025D MD6025C	Rear	S	KAWASAKI KX 80 L1-L3/N1-N3/R1-R7/W1-W3 88-00 RM 80 L/M/N/P/R/S/T/V/W/X/Y/K1 90-01 RM 85 K2/K3/LK3/K4/LK4 02-04 KX 100 B5/B6/B7/C1/C2/C3 95-00	185					
MD6026D	Front	S	KAWASAKI KX 80 R2/R3/R4/R5/R6/R7/W1/W2/W3 92-00 KX 100 B5/B6/B7/C1/C2/C3 95-00	220					
MD6027D	Front	S	KAWASAKI KX 80 L1/L2/L3/N1/N2/N3/R1 88-91 KX 80 E2/E3/G1/G2/J2 84-87	200					
MD6028D Options: OS6028C OSX6028 280mm oversize SM6028C SMX6028 320mm oversize MD6028CX	Front	S	YAMAHA YZ 125 D/E/F/G/H/J/K/L/M 98-00 WR 125 K 98 YZ 250 D/E/F/G/H/J/ K/L/M 92-00 YZ 250 WRA 90 WR 250 ZD/ZE/ZF/ZG/ZH/ZJ 92-97 WR 400 FK/FL/FM 98-00 YZ 400 FK/ FL 98-99 YZ 426 FM 00	245					
MD6029D	Front	S	YAMAHA YZ 80 S/T/U/W/A/B/D 86-92	190					
MD6030D MD6030C MD6030CX OSS6030C (SUZUKI) OSXS6030C (SUZUKI) OSY6030C (YAMAHA) OSXY6030C (YAMAHA)	Front	S	SUZUKI RM 85 LK5/K5/LK6/K6/K7/LK7 /K8/LK8/K9/LK9/L0/LL0/L2/LL2 /LL5/LL6/LL7 05-12/15-17 YAMAHA YZ 80 E/F/G/H/J/K/L/M/N 93-01 YZ 85 P/R/S/T/N/W/X/Y/Z/A/B/D/E/F/G 02-16	220					
MD6031D MD6031C MD6031CX	Rear	F	YAMAHA YZ 80 E/F/G/H/J/K/L/M/N 93-01 YZ 85 P/R/S/T/N/W/X/Y/Z/A/B/D/E 02-14	190					

ROTOR BUYERS GUIDE

CODES FOR TYPES
S = FLAT SOLID
D = FLOATING ROTOR CONVERSION FOR DISHED SOLID ROTOR
F = FLOATING ROTOR
S/F = FLOATING CONVERSION FOR FLAT SOLID ROTOR

BRAKE ROTOR BUYERS GUIDE - DIRTBIKE/ATV/UTV

Rotor No.	Front/Rear	Type	Models	Dia (mm)	Rotor No.	Front/Rear	Type	Models	Dia (mm)		
MD6032D Options: OS6032C OS6032CE OSX6032 280mm oversize SMX6032 320mm oversize MD6032CX Contd.	Front	S	KTM Contd.	260	MD6035D MD6035C MD6035CE MD6035CX Contd.	Rear	S	KTM Contd.	220		
			XC-W 450 Six Days					10-11		EXE 125	00
			XC-W 450					12-13		SM 125 Supermoto	00
			XC-W 450 Champions Edition					10		SX 125	94-16
			XCR-W 450					08		SX 150	08-16
			EXC 500					12-15		XC 150	10-15
			XC-W 500					12-13		XC/EXC 200	04-08
			FE 501 (4T)					13-14		XC-W 200	07-15
			SX-F 505					07-08		XC 200	06-08
			XC-F 505					08		XC/EXC 250	95-07
			EXC 520/SX 520					01-03		EXC/EGS 250	94
			EXC 525					03-07		EXC/EGS 250	98-03
			MXC 525					03-04		SX F 250 (4T)	05-16
			SX 525					03-06		EXC-F 250	06-07
			XC 525 Desert Racing					07		SX 250 (2T)	94-16
			EXC-R 530					08		XC 250 (2T)	06-15
			EXC 530 (4T)					09-11		XC-W 250	06-15
			EXC 530					10-11		XC-F 250	06-15
			XCR-W 530					08		XC-F-W 250	06-08/12
			XC-W 530 (4T) Sixdays					10-11		XCF-W 250	10-13
			MXC 550					96		XCF-W 250 Six Days	11
			EGS-E 620 Adventure/Rallye					99		EXC 300 (USD)	04-05
			SC 620 Supercompetition					96-00		XC 300 (2T)	06-15
			SX 620/EXC/EGS					94		XC-W 300	06-15
			SMC 625					05		EXC 350 LC4	94-95
			SX EXC/EGS 820					95		EXC 350	96-97
			SX 620					96-99		EXC-F 350	12-15
			LC4 625 SC Supercompetition					02		SX-F 350	11-16
			SXC 625					03-04		XC-F 350	11-15
										XCF-W 350	12-13
										SX 360	96-97
										EXC 380	98-03
										SX 380	98-03
		EGS 400/EGS-E/LSE (LC4 Enduro)	96-99								
		EXC/EGS 400	00-02								
		EXC 400 Racing	00								
		XC/EXC 400	04-07								
		LC4-E 400 Enduro	00-01								
		SC 400	96-99								
		SX 400	00-02								
		XC-W 400	08-11								
		SX 440	94-95								
		EXC 450	03-06								
		EXC 450 (4T)	09-11								
		EXC-R 450	08								
		SMR 450	05-12								
		SX-F 450	03-16								
		XCR-W 450	13								
		XC-F 450	08-09/13-15								
		450 XC-W (4T) Sixdays/Champion Edition	10								
		XC-W 450 Six Days	10-11								
		XC-W 450 Champions Edition	10								
		EXC 500	12-15								
		LC-4 MX 500/EXC 500	90-91								
		XC-W 500	12-13								
		XC-F 505	08								
		SX-F 505	07-08								
		EXC 520/SX 520	01-03								
		EXC 525	03-07								
		MXC 525	03-04								
		SMR 525	05-06								
		SX 525	03-06								
		XC 525 Desert Racing	07								
		XCR-W 530	08								
		EXC-R 530	08								
		EXC 530 (4T)	09-11								
		EXC 530	10-11								
		XC-W 530 (4T) Sixdays	10-11								
		MXC 550	96								
		560 SMR	07								
		LC4 MX 600	90-91								

ROTOR BUYERS GUIDE

ROTOR TYPES
 F = FLOATING ROTOR
 S = FLAT SOLID
 D = FLOATING ROTOR CONVERSION FOR DISHED SOLID ROTOR
 S/F = FLOATING CONVERSION FOR FLAT SOLID ROTOR

BRAKE ROTOR BUYERS GUIDE - DIRTBIKE/ATV/UTV

Rotor No.	Front/Rear	Type	Models	Dia (mm)	Rotor No.	Front/Rear	Type	Models	Dia (mm)								
MD6035D MD6035C MD6035CE MD6035CX Contd.	Rear	S	KTM Contd.	220	MD6047D	Front	S	YAMAHA	203								
			LC4 EXC 600					90-93		YZ 250 N/S (Tri Moto)	85-86						
			EGS 620 Enduro/EGS-E/LSE					96-99		MD6050D	Rear	S	YAMAHA	YFS 200 U/W/A/B/D/E/F/G/H/J/K/L /M/N/P Blaster	88-02		
			EGS-E 620 Adventure Style					99									
			LC4 620 SC Supermoto					00									
			SC 620 Supercompetition					96-00									
			SX EXC/EGS 620					95									
			SX 620					96-99									
			LC4 625 SC Supermoto/Supercompetition					02									
			SXC 625					03-04									
Duke II 640 Orpheus/Titan/Lime	01																
Duke II 640 Black/Orange	02-06																
640 Duke (Jet Black/Yellow /Adrenalin Orange)	03-06	MD6051D MD6051C	Front	S	YAMAHA	YFM 350 XT YFM 350 XU Warrior YFZ 350 Banshee T/U/W	87 88 87-89										
LC4-E 640 Enduro/Supermoto	00-04																
SC 660 Supermoto	03-04																
690 Enduro	08																
MD6036D	Front							S	KAWASAKI	250	MD6054D	Front	S	YAMAHA	161		
									KX 125 E1/E2/F1					86-88		YFM 125 RA/RB/RD Raptor	11-13
									KDX 200 C1/C2/C3					86-88		YFS 200 R/S/T/V Blaster	03-06
									KDX 200 E1/E2/E3/E4					89-92		YFM 250 XN/XHN/XP/XHP/XR/XHR /XS Beartracker	01-04
									KX 250 E1/F1					87-88		YFM 250 BT/B Bruin	05-06
KX 500 C1/D1	87-88							YFM 250 BW/BX/BY Big Bear	07-09								
MD6037D Options: OS6037C OS6437C OSX6437 280mm oversize SM6037 SM6437C SMX6437 320mm oversize MD6037CX	Front	S	HONDA	240	MD6055D	Rear	S	YAMAHA	245								
			CR 125 R					95-07		YFM 350 XA/XB/XD/XE/XF/XG/XH/XJ /XK/XL/XM/XN/XP/XR/XS Warrior	90-04						
			CR 250 R					95-08		YFM 350 RS/RT/RV/RW/RX/RY/RZ/RA /RB/RD Raptor	04-13						
			CRF 250 R					04-14		YFZ 350 A/B/D/E/F/G/H/J/K/L/M/N /P/R/S/T/V Banshee	90-06						
			CRF 250 X					04-17		YFZ 450 RY/RZ/RA/RB/RD	09-13						
			CRF 450 R					02-14		YFZ 450 LES Limited Edition	04						
			CRF 450 X					05-17		YFZ 450 R Special Edition (3 spring clutch) YFZ 450 RSE	14						
			CR 500 R					95-01		YFZ 450 S/T	04-05						
			MD6038D MD6038CX					Rear		S	SUZUKI	220	MD6057D	Front	S	KAWASAKI	240
											DR 250 L/M/N/P/R/S					90-95	
DR 250 SL/SM/SN/SEP/SER/SES	90-95	MD6058D MD6058C OS6058C MD6058CX		Front	S	HONDA	CR 80 R/RB Expert CR 85R/85R Expert		96-02 03-07								
DR 350 L/M/N/P/R/S/T	90-96																
DR 350 SL/SM/SN/SP/SEP/SES	90-95																
DR 350 SL/SM/SN/SP/SEP/SES	90-95																
MD6039D	Front	S	YAMAHA	230	MD6040D MD6040CX	Front	S	SUZUKI	250								
			YZ 125 U					88		DR 250 L/M/N/P/R/S	90-95						
			IT 200 S					86		DR 250 SL/SM/SN/SEP/SER/SES	90-95						
			YZ 250 U/W					88-89		DR 350 L/M/N/P/R/S/T	90-96						
			TT 350 S/T					86-87		DR 350 SL/SM/SN/SP/SEP/SES /SET/SEV	90-97						
YZ 490 U/W	88-89	MD6042D MD6042CX SM6042C	Front	S	KAWASAKI	KL 650 A1-A19/A6F/A7F (KLR)	87-07										
TT 600 N/S	85-86																
MD6044D	Front							S	HONDA	276	MD6045D MD6045CX	Rear	S	HONDA	220		
									XL 600 V Transalp							89-90	
									MD6046D							Front	S

ROTOR BUYERS GUIDE

CODES FOR TYPES
S = FLAT SOLID
D = FLOATING ROTOR CONVERSION FOR DISHED SOLID ROTOR
F = FLOATING ROTOR
S/F = FLOATING CONVERSION FOR FLAT SOLID ROTOR

BRAKE ROTOR BUYERS GUIDE - DIRTBIKE/ATV/UTV

Rotor No.	Front/Rear	Type	Models	Dia (mm)	Rotor No.	Front/Rear	Type	Models	Dia (mm)
MD6121D	Rear	S	YAMAHA WR 200 D 92 TT-R 250 L/M/N/P/R/S/T/V 99-06	220	MD6130D MD6130CF MD6130DF	Front	S	KTM EGS 400/EGS-E/LSE (LC4 Enduro) 96-99 LC4-E 400 Enduro 00-01 EGS 620 Enduro/EGS-E/LSE 96-99 LC4-E 640 Enduro 00-04 LC-4 640 Adventure 99-02 690 Enduro 08	300
MD6123D	Front	S	YAMAHA YFM 350 FXG/FXH/FXJ/FXK/FXL/FXM/FXN /FXP/FXR/FXS/FXT Wolverine 95-05 YFM 350 FWB/LC Big Bear 99 YFM 350 UL/ULC 99 YFM 350 UL/ULC 99 YFM 400 FAM/FAN/FAP Kodiak 00-02 YFM 400 FWNM/MC/FWNN/FWHN/FHP /FP/FR/FS/FT/FV "Big Bear" 00-06 YFM 400 AM/AN 00-01 YFM 400 NN/NHN/P/HP 00-02 YFM 400 FWNHM/FHM Big Bear Buckmaster 4WD 01 YFM 400 FAHM/MC/N/NC/P Kodiak 4x4 Kodiak/Hunter 00-02 YFM 400 NR/NS (2x4) Big Bear 03-04 YFM 400 S Big Bear 2WD 04 YFM 400 FS/FT/FAV Big Bear 4WD 04-06 YFM 400 FWBL Kodiak 99	180	MD6131D	Front	S	KAWASAKI KLF 300 C1-C17 Bayou 89-05 KVF 300 A1/A2/A3/A4 (4 x 4) 'Prairie' 99-02 KVF 300 B1/B2/B3/B4 (2 x 4) 'Prairie' 99-02 KLF 400 B1-B7 Bayou (4 x 4) 93-99 KVF 400 A1/A2/B1 Prairie 97-98 KVF 400 C1/C2/C3/C4 (4 x 4) Prairie 99-02 KVF 400 D1/D2/D3/D4 (2 x 4) Prairie 99-02 LTA 700 XK5 Kingquad 05	200
MD6124D MD6124C MD6124CX	Rear	S	HONDA CR 125 R 98-01 CR 250 R 97-01	240	MD6132D	Rear	S	KAWASAKI KSF 250 A1-A18 Mojave 87-04 KEF 300 A1/A2/A3/A4/A5/A6 Lakota 95-00 KEF 300 B1/B2/B3 Lakota Sport 01-03	220
MD6125D Option: SM6125C SMX6125 320mm oversize OS6125C OSX6125 280mm oversize	Front	S	HUSQVARNA CR 125 92-99 SM 125 98-99 WR 125 93-99 WRE 125 93-99 CR 250 92-99 WR 250 92-99 TE 350 92-97 CR 360 92-94 WR 360 92-99 TE 410 95-99 TC 610 92-94 TC 610/E 95-99 TE 610 92-94 TE 610/E 95-99	260	MD6133D	Front	S	KAWASAKI KSF 250 A1-A18 Mojave 87-04 KXF 250 A1/A2 Tecate 87-88 KEF 300 A1/A2/A3/A4/A5/A6 Lakota 95-00 KEF 300 B1/B2/B3 Lakota Sport 01-03 KLF 300 B1-B17 Bayou 88-04	170
MD6126D	Rear	S	HUSQVARNA CR 125 91-99 SM 125 98-99 WR 125 91-99 WRE 125 93-99 WR 240 90-91 CR 250 91-99 WR 250 90-99 WR 260 90-91 TE 350 90-97 CR 360 92-94 WR 360 92-99 TE 410 95-99 TE 410 E 00 TC 510 90 TE 510 90 SM 610 (6 bolt front disc) 98-99 TC 610 91-94 TC 610/E 95-99 TE 610 91-94 TE 610/E 95-00	220	MD6134D	Rear	S	KAWASAKI KXT 250 B2 87	220
MD6128D	Rear	S	APRILIA Pegaso 650 ie (All models) 99-04	220	MD6135D MD6135C MD6135CX	Rear	S	YAMAHA YZ 125 K/L/M/N 98-01 WR 250 FN 01 YZ 250 K/L/M/N 98-01 WR 400 FL/FM 99-00 WR 426 FN 01 YZ 400 FL 99 YZ 426 FM/FN 00-01	240
MD6129D	Front	S	APRILIA Pegaso 650 ie (All models) 99-04	300	MD6136D	Rear	S	KAWASAKI KXF 250 A1/A2 Tecate 87-88	230
					MD6137D	Front	S	KAWASAKI KFX 450 R (KSF 450 B8F/B9F/BAF/BBF /BCS/BDF/BEF) 08-14 KSV 700 A1/A2/A6F/A7F/A8F (KFX 700 V-Force) 04-08 KSV 700 B1/B2/B6F/B7F/B8F (KFX 700 V Force) 04-08	163
					MD6138D	Front /Rear	S	KAWASAKI KXT 250 B1/B2 86-87	206
					MD6140D	Front	S	YAMAHA YFM 600 FWAK/FWK/FWAL/LL/FWAM /AK Grizzly 98-00 YFM 600 HM/HMC Grizzly Hunting 00	220
					MD6144D	Rear	S	HONDA FL 400 R Pilot 89-90	256
					MD6145D	Front	S	SUZUKI LT-F 500 FW/FX/FY/FK1/FK2 Quadrunner 98-02 LT-A 500 FY/FK1 00-01	206

ROTOR BUYERS GUIDE

CODES FOR TYPES
S = FLAT SOLID
D = FLOATING ROTOR CONVERSION FOR DISHED SOLID ROTOR

F = FLOATING ROTOR
S/F = FLOATING CONVERSION FOR FLAT SOLID ROTOR

BRAKE ROTOR BUYERS GUIDE - DIRTBIKE/ATV/UTV

Rotor No.	Front/Rear	Type	Models	Dia (mm)	Rotor No.	Front/Rear	Type	Models	Dia (mm)	
MD6169D	Rear	S	POLARIS Xplorer 400 L 4x4	203	MD6173D UTVX6173 Contd.	Front	S	ARCTIC CAT Contd.	202	
MD6170D	Rear	S	POLARIS Sportsman 6x6 PPS LUB 6x6	228				550i		11-12
MD6171D	Front	S	BOMBARDIER/BRP DS 650 DS 650 Baja/X CAN-AM DS 650 X	166				550i LTD		11-12
								550i GT		11-12
								550i GT TRV		11
MD6172D	Rear	S	BOMBARDIER/BRP DS 650 DS 650 Baja/X CAN-AM DS 650 X	196				550i TRV Cruiser		11
								550 GT TRV		11-12
MD6173D UTVX6173	Front	S	ARCTIC CAT 250 2 x 4 Utility 250 2 x 4 Utility 250 4 x 4 Utility 250 4 x 4 Utility 300 (4 x 4) 300 4 x 4 Utility 350 ATV 366 4 x 4 Auto Utility 366 SE 400 4 x 4 ACT 400 4 x 4 Auto ACT 400 2 x 4 Utility 400 2 x 4 Auto Utility 400 4 x 4 Utility 400 4 x 4 Utility 400 4 x 4 VP Utility 400 4 x 4 Auto Utility 400 4 x 4 Auto Utility 400 4 x 4 Auto LE Utility 400 4 x 4 Auto VP Utility 400 4 x 4 Auto TBX Utility 400 4 x 4 Auto TBX Utility 400 TRV 400 TRV H1 400 4 x 4 Auto TRV Multirider 400 4 x 4 Auto TRV Plus Multirider 425i 425i SE 450 H1 EFI 450i 450i GT 450 TRV 450i TRV XC 450i 454 Bearcat 2 x 4 454 Bearcat 4 x 4 500 4 x 4 Auto Utility 500 4 x 4 Auto Utility 500 4 x 4 Auto LE Utility 500 4 x 4 Manual G/Box Utility 500 4 x 4 Manual G/Box Utility 500 4 x 4 Auto TBX Utility 500 4 x 4 Auto TBX Utility 500 4 x 4 Auto TRV Utility 500 4 x 4 Auto TRV Multirider 550 HI EFI 550 HI EFI LE 550 TRV 550 TRV Cruiser 550 TRV EFI 550 TRV Efi LE	202				550 GT S TRV		10
								550 S		10
								550 S LTD		10
								650 H1 4 x 4 Auto Utility		04
								650 H1 4 x 4 Auto Utility		05/08
								650 H1 4 x 4 Auto LE Utility		07
								650 H1 4 x 4 SE Auto Utility		06
								650 H1		10
								650 Mudpro		10-11
								650 H1 Mudpro		10
								650 H1 TRV		09
								650 H1 TBX 4 x 4 Auto Utility		07
								650 H1 TRV 4 x 4 Auto Plus Multirider		07
					650 H1 TRV 4 x 4 Auto Plus LE Multirider	07				
					650 H1 TRV 4 x 4 Auto	08				
					650 TBX	09				
					650 V2 4 x 4 Auto Utility	04-06				
					650 V2 4 x 4 Auto LE Utility	04-05				
					650 V2 4 x 4 Auto LE TS Utility	06				
					700 Diesel Utility	07-08				
					700i GT	11-12				
					700 TRV H2 EFI Cruiser	09-10				
					700 TRV	11-12				
					700 TRV Cruiser	11-12				
					700 TRV GT	11-12				
					700 EFI 4 x 4 Utility	07-08				
					700 EFI 4 x 4 LE Utility	06				
					700 EFI 4 x 4 SE Utility	06				
					700 EFI Cruiser	11				
					700 EFI 4 x 4 Auto M4	08				
					700 EFI 4 x 4 Auto TRV LE	08				
					700 H1 EFI	09-10				
					700 H1 EFI LE	09-10				
					700 H1 EFI 4 x 4 Auto SE	08-09				
					700 H1 TBX EFI	10				
					700 Super Duty Diesel	10-11				
					700 Mudpro	10-11				
					700 H1 EFI Mudpro	09-10				
					700i	11-12				
					700i LTD	11-12				
					700i Mudpro	11-13				
					700i Mudpro LTD	11				
					700 S	10				
					700 S LTD	10				
					700 TBX LTD	11				
1000 H2 Mudpro EFI	10									
1000 TRV Cruiser	11									
1000 TRV H2 EFI Cruiser	09-10									
Thundercat 1000 H2	08-10									
Thundercat 1000 H2 LE	10									
1000 TRV H2 Efi	10									
KYMCO ATV										
Maxxer 375 4 x 4 IRS	10-12									
MXU 375 4 x 4 IRS	08-12									
Maxxer 450 4 x 4 IRS	11-16									
MXU 450 4 x 4 IRS	11-14									
MXU 450 4 x 4 IRS LE	11-14									
MXU 500 4 x 4 (Carb models)	07-09									
MXU 500 4 x 4 IRS (Carb Models)	10-11									
MXU 500i IRS (All EFI Models)	10-11									
MXU 700i (All Models)	14-16									

ROTOR BUYERS GUIDE
CODES FOR TYPES
 S = FLAT SOLID
 D = FLOATING ROTOR CONVERSION FOR DISHED SOLID ROTOR
 F = FLOATING ROTOR
 S/F = FLOATING CONVERSION FOR FLAT SOLID ROTOR

BRAKE ROTOR BUYERS GUIDE - DIRTBIKE/ATV/UTV

Rotor No.	Front/Rear	Type	Models	Dia (mm)	Rotor No.	Front/Rear	Type	Models	Dia (mm)
MD6173D UTVX6173	Rear	S	ARCTIC CAT	202	MD6186D MD6186C OS6186C MD6186CX	Front	S	KAWASAKI	220
			HDX 700 Prowler 11-14 HDX 700 LTD Prowler 14 XTZ 1000 Prowler 10-14 Wildcat 1000 GT 11-12 KYMCO ATV Maxxer 375 4 x 4 IRS 10-12 MXU 375 4 x 4 IRS 08-12 Maxxer 450 4 x 4 IRS 11-16 MXU 450 4 x 4 IRS 11-14 MXU 450 4 x 4 IRS LE 11-14					KX 85 A1/A2/A3/A4/A5/A6F/A7F/A8F/A9F /AAF/ABF/ACF/ADF/CEF/CFF /CGF/CHF 01-17 KX 100 D1/D2/D3/D4/D5/D6F/D7F /D8F/D9F/DBF/DCF/DDF/FEF/FFF /FGF/FHF 01-09/11-17 SUZUKI RM 100 K3 03	
MD6174D	Rear	S	YAMAHA	220	MD6187D MD6187C MD6187CX	Rear	S	KAWASAKI	185
			YFM 400 FAM/FAN/FAP Kodiak 00-02 YFM 400 AM/AN 00-01 YFM 400 FAHM/MC/N/NC/P Kodiak 4x4 Kodiak/Hunter 00-02 YFM 450 FAR/FAS Kodiak 03-04 YFM 450 FXV/FXW/FXX/FXY/FXZ Wolverine Auto 4x4 07-10 YFM 450 FXSEW Wolverine Sport Special Edition 07-08					KX 85 A1/A2/A3/A4/A5/A6F/A7F/A8F /A9F/AAF/ABF/ACF/ADF/CEF/CFF /CGF/CHF 01-17 KX 100 D1/D2/D3/D4/D5/D6F/D7F /D8F/D9F/DBF/DCF/DDF/FEF/FFF /FGF/FHF 01-09/11-17 SUZUKI RM 100 K3 03	
MD6181D/C MD6181CX	Rear	S	HONDA XR 650 R 00-11	240	MD6188D UTVX6188	Front	S	KAWASAKI	200
MD6184D MD6184C Option: SM6184HC SMX6184 320mm oversize OS6184HC OS6184KC OSX6184 280mm oversize OS6184K9C OSX6184K9C	Front	S	HUSQVARNA	260				KVF 360 A1/A2/A3/A6F/A7F/A8F/A9F /AAF/ABF/ACF Prairie 360 4x4 03-12 KVF 360 B1/B2/B3/B6F/B7F/B8F/BF Prairie 360 03-09 KVF 360 C1/C2/C3/C6F/C7F/C8F/C9F /CAF/CBF Prairie 360 4x4 Hardwoods Green HD 03-11 KVF 650 A1/A2/B2 Prairie 02-03 KVF 650 D1/D6F/D7F/D8F/D9F/DAF /DBF Brute Force 4x4 05-11 KVF 650 E1/E6F/E7F/E8F/E9F Brute Force 650 4x4 Hardwoods Green HD 05-09 KVF 650 F6F/F7F/F8F/F9F/FAF/FAF Brute Force 650 4x4i 06-11 KV 650 FCS (Brute Force 650 4x4i) 12 KVF 650 G6F/G7F/G8F/G9F/GAF Brute Force 650 4x4i Hardwoods Green HD 06-10 KVF 650 H7F/H8F Brute Force 4x4i 07-08 KSV 700 A1/B1 (KFX 700 V-Force) 04 KVF 700 D1/D6F Team Green Special Edition 05-06 KVF 700 A1/A2/A6F/A7F/A8F/A9F (Prairie 700 4x4)/B1/B2/B6F (Prairie 700 4x4 Hardwoods Green HD) 04-09 KVF 750 A1/A6F/A7F Brute Force 750 4x4i 05-07 KVF 750 B6F/B7F/B7FA Brute Force 750 4x4i 06-07 KVF 750 B1/E8F/E9F Brute Force 750 4x4i Hardwoods Green HD 05/08-09 KVF 750 E8FA/E9FA/EAF Brute Force 750 4x4i NRA Outdoors 08-09 KVF 750 F8F/FAF/FAF Brute Force 750 4x4i 08/10-11 KVF 750 GCF/GDF/GEF/GFF/GGF/GHF (Brute Force 750 4x4i/EP) 12-17 KVF 750 HCF/HDF/HEF/HFF/HGF/HHF Brute Force 750 4x4i/EP) 12-17 KVF 750 JCF/JDF/JEF/JFF/JGF/JHF Brute Force 750 4x4i/EP) 12-17 KVF 750 LCF/LDF/LEF/LFF/LGF/LHF (Brute Force 750 4x4i) 12-17 SUZUKI LT-V 700 FK4/FK5 Twin Peaks 700 4x404-05	
			MD6181D/C MD6181CX		Rear	S	HONDA XR 650 R 00-11	240	MD6189D

ROTOR BUYERS GUIDE

F = FLOATING ROTOR
S/F = FLOATING CONVERSION FOR
FLAT SOLID ROTOR

CODES FOR TYPES
S = FLAT SOLID
D = FLOATING ROTOR CONVERSION FOR DISHED SOLID ROTOR

BRAKE ROTOR BUYERS GUIDE - DIRTBIKE/ATV/UTV

Rotor No.	Front/Rear	Type	Models	Dia (mm)	Rotor No.	Front/Rear	Type	Models	Dia (mm)
MD6189D Contd.	Front	S	YAMAHA Contd. YFM 660 FAHDV/W Ducks Unlimited Edition/Side x Side 06-07	220	MD6196D	Rear	S	SUZUKI LT-A 500 FK2/FK3/FK4/FK5/FK6/FK7 Vinson 4WD 02-07 LT-F 500 FK3/FK4/FK5 Vinson Quadrunner 03-05	216
MD6190D MD6190C MD6190CE MD6190CX	Rear	S	YAMAHA YZ 125 P/R/S/T/V/W/X/Y/Z/A/B /D/E/F/G/H/J (2T) 02-18 YZ 250 P/R/S/T/V/W/X/Y/Z/A/B /D/E/F/G/H/J (2T) 02-18 YZ 250 FP/FR/FS/FT/FV/FW/FX/FY /FZ/FA/FB/FD/FE/FF/FG/FH/FJ 02-18 WR 250 FR/FS/FT/FV/FW/FX/FY/FZ/FA /FB/FD/FE/FF/FG/FH/FJ (4T) 03-18 YZ 426 FP 02 WR 426 FP 02 YZ 450 FR/FS/FT/FV/FW/FX/FY/FZ/FA /FB/FD/FE/FF/FG/FH/FJ 03-18 WR 450 FR/FS/FT/FV/FW/FX/FY /FZ/FA/FB/FD/FE/FF/FG/FH/FJ 03-18	245	MD6197D	Rear	S	YAMAHA YFM 660 FAP/FHAP/FSAP/FAR/FS/FHS/FHT /FT/FV/FGHW/FGX/FGHX Grizzly 02-08 YFM 660 FAHDV/W Ducks Unlimited Edition/Side x Side 06-07	150
MD6191D MD6191C MD6191CE MD6191CX	Rear	S	HONDA CR 125 R 02-07 CR 250 R 02-07 CRF 250 R 04-16 CRF 250 X 05-16 CRF 450 R 02-16 CRF 450 RX (18" Rear Wheel) 17 CRF 450 X 05-17	240	MD6199D MD6199C	Front	F	KTM Duke 400 LC4 94-98 Duke 620 LC4 94-98 LC4 620 SC Supermoto 00 LC4 625 SC Supermoto 02 SMC 625 05 LC4 640 Adventure -R 99-02 LC4 640 Adventure 03 640 Duke (Jet Black/Yellow /Adrenalin Orange) 03-06 Duke II 640 Orpheus/Titan/Lime 01- Duke II 640 Black/Orange 02 LC4-E 640 Supermoto 00-04	320
MD6192D MD6192C	Front	S	KTM 60 SX 98-99 65 SX 98-03	198	MD6200D	Rear	S	POLARIS Magnum 330 (2x4/4x4/HDS) 03-06 ATP 330 (4x4) 04-05 ATV Pro 500 4x4 PPS 02 Magnum 500 4x4 HDS 02-04 PPS/PTV 4x4/Series 10 PPS/PTV 6x6/Series 10	206
MD6195D	Front	S	SUZUKI LT-A 400 FK8/FK9/FL0 King Quad 400 AS 08-10 LT-A 400 FCK8/9 King Quad 400 AS Camo 08-09 LT-A 400 FQK9 King Quad 400 AS Anniversary Edition -09 LT-A 400 FL1/FL2/FL3/FL4/FL5 King Quad 400 ASi 11-15 LT-A 400 FCL1/FCL2/FCL3/FCL4/FCL5 King Quad 400 ASi Camo 11-15 LT-F 400 FK8/FK9/FL0 King Quad 400 FS 08-10 LT-F 400 FCK8/FCK9 King Quad 400 FS Camo 08-09 LT-F 400 FQK9 King Quad 400 FS Anniversary Edition 09 LT-F 4WD V/W Quadrunner 4WD (250cc) 97-98 LT-A 400 FK2/FK3/FK4/FK5/FK6 /FCK5/FCK6/FCK7/FK7 Eiger 02-07 LT-A 400 FK8 Kingquad Auto 4WD 08-09 LT-A 400 K8 Kingquad Auto 2WD 08 LT-A 400 K2/K3/K4/K6 Eiger 02-04/06 LT-F 400 FK2/FK3/FK4/FK5/FK6/FCK5 /FCK6/FCK7/FK7 (Eiger 4WD) 02-07 LT-F 400 FL1/FL2/FL3/FL4/FL5 King Quad 400 FSi 11-15 LT-F 400 FCL1/FCL2/FCL3/FCL4/FCL5 King Quad 400 FSi Camo 11-15 LT-F 400 K2 Eiger Manual 2WD 02 LT-F 400 K3/4/5/6/7 03-08 LT-F 400 K8 Manual 08 LT-A 500 FK2/FK3/FK4/FK5/FK6/FK7 Vinson 4WD 02-07 LT-F 500 FK3/FK4/FK5 Vinson Quadrunner 03-05	190	MD6201D	Rear	S	POLARIS 400 Sportsman 03-04 Sportsman 500 HO/EFI 04-06 Sportsman 600 (4x4) 03-05 Sportsman 700 (4x4)/EFI 02-06 Sportsman MV 700 05-06 Sportsman 800 EFI 05-06 PPS/Series 10 UTV 2x4 PPS/Series 10 UTV 4X6 PPS/Series 11 UTV 1500 2x4 Ranger Series 10 Ranger Series 10 500 6x6 Ranger Series 11 PPS/Series 11 2x4/4x4 PPS/Series 11 6x6 Ranger 6x6 04-05 Ranger TM 04-05 Ranger XP 05 Ranger 2x4/4x4 04-05 Sportsman 800 EFI 07	218
					MD6202D UTVX6202	Front	S	POLARIS 325 Hawkeye 2x4 15 325 Ranger ETX 15 325 Sportsman Ace 14 Magnum 330 (4x4/HDS) 03-06 ATP 330 (4x4) 04-05 330 Trail Boss 10-12 330 Trail Blazer 10-12 400 Hawkeye H.O. (2x4) 13-14 400 Ranger 4x4 12 400 Ranger (All models) 10-13 400 Sportsman HO 4x4 11-12 400 Sportsman 04 ATP 500 H.O (4x4) 04-05 ATV Pro 500 4x4 PPS 02 Magnum 500 4x4 HDS 02-04	228

ROTOR BUYERS GUIDE

CODES FOR TYPES
 S = FLAT SOLID
 D = FLOATING ROTOR CONVERSION FOR DISHED SOLID ROTOR
 F = FLOATING ROTOR
 S/F = FLOATING CONVERSION FOR FLAT SOLID ROTOR

BRAKE ROTOR BUYERS GUIDE - DIRTBIKE/ATV/UTV

Rotor No.	Front/Rear	Type	Models	Dia (mm)	Rotor No.	Front/Rear	Type	Models	Dia (mm)
MD6202D UTVX6202 Contd.	Front	S	POLARIS Contd.	228	MD6208D MD6208C MD6208CE MD6208CX	Rear	S	KAWASAKI	240
			Sportsman 450	07				KX 125 M1/M2/M3	03-05
			500 Ranger 4x4 EFI	11-12				KX 250 M1/M2/R1/R6F	03-06
			500 Scrambler 4x4	10-12				KX 250 F N1/N2	04-05
			Sportsman 500 HO/EFI	03-06				KX 250 F (T6F/T7F/T8F)	06-08
			Sportsman 500 X2/EFI	06-08				KX 250 F (W9F/XAFB/YBF/YCF/ZDF /ZEF/ZFF/ZGF) (4T)	09-16
			500 Sportsman Touring HO	11-12				KX 250 R6F/R7F	06-07
			570 Forest Tractor EFI/EPS	15				KX 250 ZFF (4T) 270mm front rotor	15
			570 Sportsman Ace	15				KLX 450 R (A8F/A9F/AAF/ABF/ACF)	08-12
			570 Sportsman Ace Euro	15				KX 450 F (D6F/D7F/D8F)	06-08
			Sportsman 600 4x4	03-05				KX 450 F (E9F/EAF/EBF/FCF/FDF /FEF/FFF/HGH/HHF) (4T)	09-17
			Sportsman 700 4x4/EFI	03-06				SUZUKI	
			Sportsman MV 700	05-06				RM-Z 250 K4/K5/K6/K7	04-07
			Sportsman 800 EFI	05-07					
			PPS/PTV 4x4/Series 10						
			PPS/Series 10 UTV 2x4/4x6						
			PPS/Series 11 UTV 1500 2x4						
			Ranger Series 10						
			Ranger Series 10 500 6x6						
			Ranger Series 11						
			PPS/Series 11 2x4/4x4						
			PPS/Series 11 6x6						
			Sportsman 500 EFI/HO	07-08					
			500 Ranger (Carb) 2x4	08-09					
			Ranger 6x6	04-05					
			Ranger TM	04-05					
			Ranger XP	05					
			Ranger 2x4/4x4	04-05					
			Ranger 400 HO	10-11					
			Ranger 500 (2x4/4x4)	06-07					
			Ranger 500 (4x4 EFI)	06-08					
			Ranger 500 2x4	08					
			Ranger Crew 500	11-12					
			570 Ranger EFI	14					
			700 Ranger Crew (EFI) 4x4	09					
			Ranger 6x6 EFI 700	06-09					
			Ranger XP 700 4x4	06					
			Ranger TM	06					
			Ranger 700 6x4 EFI	08					
			Ranger 700 4x4 EFI/LE	07					
Ranger XP 700 4x4	08								
Ranger EV (Electric)	10-15								
Sportsman 700 EFI	07								
700 Sportsman X2	08								
Sportsman 800 EFI	07								
Sportsman X2 500 EFI	07-09								
500 Sportsman Forest	12								
500 Sportsman Touring H.O.	08-12								
500 Sportsman EFI Quad H.O.	08-10								
500 Sportsman HO	08-12								
570 Ranger Crew EFI	14-15								
570 Sportsman EFI (inc EPS)	14-15								
570 Sportsman Touring EFI	14-15								
800 Ranger Mid Size	13								
Sportsman X2 800 EFI	07-09								
Sportsman 800 EFI Intl/HO	07-09								
800 Sportsman Forest	12								
800 Sportsman Forest Trader	12								
800 Sportsman Big Boss 6x6/EFI	09-12								
800 Sportsman Touring/EFI	08-10								
800 Sportsman HO/EFI	08-09								
800 Sportsman EFI	10-12								
MD6206D	Front	S	SUZUKI LT-F 300 FK2	168					
MD6207D	Front	S	SUZUKI LT-F 250 K2/K3/K4/K5/K6/K7/K8/K9 /L2/L3/L4 Ozark	160					
					MD6210D	Front	S	ARCTIC CAT 400 DVX (2x4) Sport	170
								KAWASAKI KSF 400 A1/A2/A3/A6F (KFX 400)	03-06
								SUZUKI LT-Z 250 K4/K5/K6/K7/K8/K9	04-11
								LT-Z 400 K3/K4/K5/K6/K7/K8/K9 /L0/ZK9/L2/ZL2	03-12
					MD6211D	Rear	S	ARCTIC CAT 400 DVX (2x4) Sport	220
								400 DVX TS Sport	06-07
								KAWASAKI KSF 400 A1/A2/A3/A6F (KFX 400)	03-06
								SUZUKI LT-Z 400 K3/K4/K5/K6/K7/K8 /K9/L0/ZK9/L2/ZL2	03-12
					MD6212D	Front	S	KAWASAKI KLX 125 L (B1/B2/B3/B6F)	220
								SUZUKI DR-Z 125 LK3/LK4/LK5/LK6/LK7/LK8 /LK9/LL0/LL2LL4/LL5/LL6	03-16
					MD6213D	Front	S	KAWASAKI Options: OS6213C OSX6213 280mm oversize	250
								KX 125 M1/M2/M3	03-05
								KX 250 M1/M2/R1/R6F	03-06
								KX 250 N1/N2 (KX 250 F)	04-05
								KX 250 F (T6F)	06
								KX 250 R6F/R7F	06-07
								KX 450 F (D6F)	06
								SUZUKI RM-Z 250 K4/K5/K6/K7	04-07
					MD6214D	Front	S	APRILIA MX 50	230
								RX 50/RX 50 Racing	04
					MD6215D	Front	S	YAMAHA YFM 350 FAS/FAT 350 Bruin 4x4 Auto	200
								YFM 350 AS/AT/AV 350 Bruin 2x4 Auto	04-06
								YFM 350 GW/GX/GY/GZ/GA	
								Grizzly 2x4 (2WD)	07-11
								YFM 350 XV/XW/XX/XY Wolverine (2WD)	06-09
								YFM 350 FGIW/FGIX/FGIY/FGIZ/FGIA	
								/FGB/FGD Grizzly Auto IRS 4x4	07-13
								YFM 350 DE Grizzly Auto 4x4	14
								YFM 400 FGW/FGX/FGY/FGZ/FGA	
								Grizzly 4x4	07-11
								YFM 400 FAR/FAS Kodiak Auto	03-04
								YFM 400 AR/AS Kodiak 2WD	03-04
								YFM 400 FAS/FAT/FAHT/FAV	
								Kodiak 4WD	04-05
								YFM 400 FBHW/FBHZ/Y/Z	
								Big Bear 400 Hunter-IRS	07-10

ROTOR BUYERS GUIDE

F = FLOATING ROTOR
S/F = FLOATING CONVERSION FOR
FLAT SOLID ROTOR

CODES FOR TYPES
S = FLAT SOLID
D = FLOATING ROTOR CONVERSION FOR DISHED SOLID ROTOR

BRAKE ROTOR BUYERS GUIDE - DIRTBIKE/ATV/UTV

Rotor No.	Front/Rear	Type	Models	Dia (mm)	Rotor No.	Front/Rear	Type	Models	Dia (mm)
MD6215D Contd.	Front	S	YAMAHA Contd.	200	MD6222D UTVX6222	Front	S	BOMBARDIER	205
			YFM 400 FBEW Big Bear 400 IRS Exploring Edition 07 YFM 400 FBW/FBX/FBY/FBA/FBB Big Bear 4WD IRS 08-12 YFM 450 DE Grizzly 450 Auto 4x4 14 YFM 450 FAR/FAS/FAT/FAHT/FAV Kodiak 03-05 YFM 450 FGPA/B/D (Grizzly 450 Auto/4x4/EPS) 11-13 YFM 450 FGW Grizzly Auto 4x4 IRS 07 YFM 450 FGX/FGY/FGZ/FGA/FGB/FGD Grizzly 450 Auto 4x4 08-13 YFM 450 FXV/FXW/FXX/FXY/FXZ Wolverine Auto 4x4 06-10 YFM 450 FXSEW Wolverine Sport Special Edition 07 YFM 450 PE Grizzly 450 Auto 4x4 EPS 14					Outlander 330 H.O. 04-05 Outlander 400 03-05 Outlander 400 Max H.O. 03-06 Outlander 650 HO EFI 4x4/HO EFI XT 4x4 06 Outlander Max 650 HO EFI 4x4/HO EFI XT 4x4 06 Outlander 800 (All models) 06	
MD6216D	Rear	S	KTM 60 SX 00 65 SX 00-03	160	MD6223D UTVX6223	Rear	S	BOMBARDIER	180
MD6217D	Rear	F	HONDA TRX 420 FPA Power Steering Fourtrax Rancher AT/IRS 09-14 TRX 420 FA Fourtrax Rancher AT/IRS 09-14 TRX 420 FA5 Rancher 4x4 Auto DCT/IRS14-15 TRX 420 FA6 Rancher 4x4 Auto/DCT/IRS/EPS 14-15 SX5 500 M2 Pioneer 15-17 TRX 500 FA5 Foreman Rubicon 4x4 Auto/DCT 15 TRX 500 FA6 Foreman Rubicon 4x4 Auto/DCT/EPS 15 TRX 500 FM5 Foreman Rubicon 4x4 15 TRX 500 FM6 Foreman Rubicon 4x4/EPS 15 TRX 650 FA 03-05 TRX 650 FGA 04-05 TRX 680 FGA6/FGA7/FGA8 Fourtrax Rincon Gpscape (675cc) 06-08 TRX 680 FA Fourtrax Rincon 06-14 SXS 700 M2 Pioneer (2 Seat) 16-18 SXS 700 M4 Pioneer (4 Seat) 16-18	205				Outlander 400 (4x4 STD) 2D7A/B/C/D /E/F/G/H) 07-14 Outlander 400 (XT 4X4) 07-14 Outlander Max 400 (4x4/XT 4x4) 07-14 Outlander 500 (STD 4x4) 07-12 Outlander 500 (XT 4x4) 07-12 Outlander Max 500 (Std 4x4/XT 4x4) 07-12 Renegade 500 (4x4/EFI) 08-12 Outlander 650 (4x4 STD) 07-12 Outlander 650 (XT 4x4) 07-12 Outlander Max 650 (Std 4x4/XT 4x4) 07-12 Outlander Max XTP 650 12 Outlander 800 (STD 4x4) 07-08 Outlander 800 (XT 4x4) 07-08 Outlander 800 R EFI 09 Outlander 800 R XT 09-12 Outlander Max 800 R XT 09-10 Outlander Max 800 R EFI 09-12 Outlander Max 800 (Ltd 4x4/Std 4x4/XT 4x4) 07-08 Outlander Max XT-P 800 R 12	
MD6218D	Rear	S	POLARIS Outlaw 450 S 08 Predator 500 03-07 500 E Predator 06	196	MD6224D	Front	S	BOMBARDIER	203
MD6219D	Front	S	POLARIS Phoenix 200/200 Phoenix Quadricycle 05 200 Phoenix (AA/AB Model/Rear drum model) 05 200 Phoenix (EA/EB) Quadricycle Model (Rear disc model) 05 Outlaw 450 S 08 Outlaw 450 MXR 09-10 Outlaw 500 06-07 Predator 500 03-07 500 E Predator 06 525 S Outlaw 08-10 525 Outlaw IRS 08-10	178				Quest 500 (4x4) 02-04 Quest 500 (2x4) 02 Quest 650 (2x4) 02 Quest 650 (4x4) 02-04 Quest 650 XT (4x4) 02 Quest Max 650 03-04	
MD6220D	Front	S	BOMBARDIER Rally 200 03-06 CAN-AM Rally 200 06	155	MD6224D	Rear	S	BOMBARDIER	203
MD6221D	Rear	S	BOMBARDIER Rally 200 03-05	155				Traxter Autoshift 01-04	

ROTOR BUYERS GUIDE
 CODES FOR TYPES
 S = FLAT SOLID
 D = FLOATING ROTOR CONVERSION FOR DISHED SOLID ROTOR
 F = FLOATING ROTOR
 S/F = FLOATING CONVERSION FOR FLAT SOLID ROTOR

BRAKE ROTOR BUYERS GUIDE - DIRTBIKE/ATV/UTV

Rotor No.	Front/Rear	Type	Models	Dia (mm)	Rotor No.	Front/Rear	Type	Models	Dia (mm)				
MD6225D	Rear	S	BOMBARDIER	218	MD6236D Contd.	Rear	S	YAMAHA Contd.	200				
			Quest 500 (4x4) 02-04					YFZ 450 S/T 04-05					
			Quest 500 (2x4) 02					YFZ 450 SET Special Edition 05					
MD6227D	Rear		KTM	220	MD6237D	Rear	S	YAMAHA	220				
			EXC 125 88-89					YFS 200 R/S/T/V Blaster 03-06					
			MX/MXC/GS 125 86					YFZ 350 A/B/D/E/F/G/H/J/K/L/M/N /P/R/S/T/V Banshee 90-06					
			MX 125 88-89		MD6239D	Front	S	KAWASAKI	240				
			EXC/EGS 250 88-89					KL 250 G4-G8 00-04					
			GS 250 86					MD6241D UTVX6241		Front	S	YAMAHA	200
			MX 250 88-89									YXR 450 Rhino (All models) 06-09	
			MX/MXC 250 86									YXR 660 Rhino 04-07	
			MX/MXC/GS 300 86					MD6242D UTVX6242 OS6242C 190mm oversize kit		Rear	S	YAMAHA	165
			EXC 350 89									YXR 450 Rhino (All models) 06-09	
MX/MXC/GS 350 86/88	YXR 660 Rhino 04-07												
MX 350 89	MD6243D MD6243C MD6243CX	Front	S	KTM	198								
MD6229D				Front		S	65 SX 04-09						
							Traxter (4x4) 99-00	SX 65 09-16					
	Traxter XL (4x4) 01	XC 65 08-10											
Traxter XT (4x4) 00-01	MD6244D	Rear	S	YAMAHA	203								
Traxter Autoshift 01				XT 250 X/Y/Z/A/B/D/E/F/G/H 08-17									
Traxter Footshift 01				XTZ 250 Lander (F 21"/R 18" Wheels) 07-14									
Traxter (4x4) 01	MD6245D	Front	S	BOMBARDIER	203								
Traxter XL (4x4) 01-04				Traxter Max 03-05									
Traxter XL (4x4) 01-04				Traxter Max 650 04-05									
MD6230D	Rear	S	BOMBARDIER	220	MD6246C MD6246CX	Rear	S	SUZUKI	200				
			Traxter (4x4) 99-00					RM 85 LK5/K5/LK6/K6/K7/LK7/K8/LK8/K9/LK9 /L0/LLO/L2/LL2/LL5/LL6/LL7 05-12/15-17					
			Traxter (4x4) 01					MD6247D MD6247C		Front	F	SUZUKI	310
Traxter XL (4x4) 01-04	DR-Z 400 SMK5/SMK6/SMK7/SMK8/SMK9 /SML3/SML4/SML5/SML6 05-09/13-16												
Traxter XT (4x4) 00-01	MD6249C MD6249CX	Rear	S	KTM	160								
Traxter Autoshift 01				65 SX 04-09									
Traxter Footshift 01				SX 65 09-16									
MD6232D MD6232CX	Rear	S	SUZUKI	260	MD6251D	Front	S	HONDA	180				
			DL 650 K4/K5/K6/AK7/K7/AK8/K8/AK9/K9 /AL1/AL2/AL3/AL4/AL5/AL6 /AL7 V-Strom 04-17					TRX 500 FA/FG 05-14					
			DL 650 AAL2/AAL3/AAL4 V-Strom ABS Adventure 12-15					TRX 500 FE/FA Fourtrax Foreman 4x4/ES 05-12					
			DL 650 XT V-Strom AVS (DL 650 XAL5/XAL6/XAL7) 15-17					TRX 500 FMA Fourtrax Foreman 4x4 05-12					
			DL 1000 K2/K3/K4/K5/K6/K7/K8 /K9/L2 02-12					TRX 500 TM5/TM6 Fourtrax Foreman 2x4 05-06					
DL 1000 AAL2/AAL4/AAL5/AAL6 V-Strom Adventure 12/14-16	TRX 500 FPA Fourtrax Rubicon with EPS/Power Steering 09-14												
DL 1000 ALf/AL5/AL6 (V-Strom ABS) 14-16	TRX 500 FPE Fourtrax Foreman 4x4 ES/EPs 08-12												
MD6233D	Rear	S	HONDA	190				TRX 500 FPM8 Fourtrax Foreman 4x4/EPs 08-11					
			TRX 450 R/ER 04-14					TRX 680 FA Fourtrax Rincon 06-14					
MD6236D	Rear	S	YAMAHA	200									
			YFM 125 RA/RB/RD Raptor 11-13										
			YFM 250 R (RSPA) 11										
			YFM 250 RX/RV/RZ/RA/RB/RD Raptor 08-13										
			YFM 250 RSPA Special Edition 11										
			YFM 250 RSPX/RSEY Special Edition 08-09										
			YFM 250 RSXPC Special Edition Custom 08										
			YFM 350 RS/RT/RV/RW/RX/RV/RZ/RA /RB/RD Raptor 04-13										
			YFZ 450 LES Limited Edition 04										

ROTOR BUYERS GUIDE

F = FLOATING ROTOR
 S/F = FLOATING CONVERSION FOR FLAT SOLID ROTOR

D = FLOATING ROTOR CONVERSION FOR DISHED SOLID ROTOR
CODES FOR TYPES
 S = FLAT SOLID

BRAKE ROTOR BUYERS GUIDE - DIRTBIKE/ATV/UTV

Rotor No.	Front/Rear	Type	Models	Dia (mm)	Rotor No.	Front/Rear	Type	Models	Dia (mm)
MD6252D	Rear	S	YAMAHA YFM 400 FAT/FAHT/FAV 05-06 YFM 400 FGW/FGX Grizzly 4x4 07-08 YFM 450 FGW/FGX/FGY/FGZ Grizzly Auto 4x4 IRS 07-10 YFM 450 FAT/FAHT/FAV 05-06	220	MD6262D	Front	S	POLARIS Trail Blazer 250 05-06 Trail Boss 330 05-10 330 Trail Blazer 08-10 Scrambler 500 2x4 07-08	182
MD6253D MD6253C	Rear	S	GAS-GAS Enduro EC 200/250/300 99-00 EC 125/200/250/300 01-09 EC 200/250/300 (All models/2T) 10-12 MC 125 05 MX 125/250 01-04 Pampera 125/450 05 SM 125/250 (4T) 01-05 MX 200/250/300 99-00 SM 400 FSE (2T) 01-02 SM 450 03-05	220	MD6263D MD6263C	Rear	S	YAMAHA YFZ 450 V/W/X/Y/B/D 06-09/11-13 YFZ 450 RY/RZ/RA/RB/RD/RE 09-14 YFZ 450 R Special Edition (3 spring clutch) YFZ 450 RSE 14 YZF 450 BBV/BBW Bill Balance Edition 06-07 YZF 450 SPV/SEW/SPX Special Edition 06-08 YFM 700 RV/RW/RX/RY/RA/RB/RD /RE Raptor 06-14 YFM 700 RSEW/RSPX/RSEA/RSEY/RSEZ /RSEA/RSEB/RSED/RSE Special Edition 07-14 YFM 700 R (RSEY/RSEZ/RSEA/RSEB /RSED/RSE/RSF) Raptor Special Edition 09-15 YFM 700 50th Anniversary Edition - YFM 700 RSPV 06 YFM 700 RD/RE/RF Raptor 13-15	200
MD6254D/C OS6254C OSX6254 SM6254C SMX6254 MD6254CX	Front	S	SUZUKI RMZ 250 K7/K8/K9/L0/L1/L2/L3 /L4/L5/L6/L7 07-17 RMZ 450 K5/K6/K7/ZK7/K8/K9 /L0/L1-L7 05-17	250	MD6264D MD6264C OS6264C OSX6264 SM6264C SMX6264 MD6264CX	Front	F	KAWASAKI KX 250 R6F/T6F/R7F/T7F/T8F 06-08 KX 250 F (W9F/XAFB/YBF/YCF /ZDF/ZEF) (4T) 09-14 KX 450 D6F/D7F/D8F 06-08 KX 450 F (E9F/EAF/EBF/FCF/FDF/FEF) (4T) 09-14 KLX 450 R (A8F/A9F/AAF/ABF/ACF) 08-12	250
MD6255D MD6255C MD6255CE MD6255CX	Rear	S	SUZUKI RMZ 250 K7/K8/K9/L0/L1/L2/L3 /L4/L5/L6/L7 07-17 RMZ 450 K5/K6/K7/ZK7/K8/K9/L0/L1-L7 05-17	240	MD6265D	Front	F	CAGIVA Elefant 650 86-87 86-87	260
MD6256D UTVX6256	Rear	S	POLARIS Scrambler 500 (2X4/4X4) 05-10 500 Scrambler 4x4 10-12 Trail Blazer 250 05-06 Trail Boss 330 05-10 330 Trail Blazer 08-12 330 Trail Boss 10-12	203	MD6266D	Front	S	ARCTIC CAT 250 DVX Sport 06-08 KTM LC-4 640 Adventure R 04 LC-4 640 Adventure 05-07 950 Adventure/S 04-06	300
MD6257C	Rear	S	KTM 85 SX 03-10 SX 85 (19"/16" wheels) 03-10 XC 85 08-09 SX 105 07-11 XC 105 08-10	200	MD6267D	Front /Rear	S	ARCTIC CAT 50 4x4 Auto Youth 09 50 DVX (4T) 06-08 50 DVX (4T) Sport 06/08 50 Utility 06-08 90 (Reverse Gear) 10-14 90 DVX 06-14 90 DVX SE 09 90 SE 09 90 Utility (2 x 4) 06-10 90 2x4 (4T) Youth 06 150 Utility 2x4 09-14 250 Utility 06-09 250 DVX 06-08 250 DVX Sport 06-08 300 ATV 2x4 Utility 10-14 300 DVX 09-14 KAWASAKI KFX 50 (KSF 50 B7F/B8F/B9F/BDF /BEF/BFF/BGF/BHF) 07-09/13-17 KFX 90 (KSF 90 A7F/A8F/A9F/AAF/ABF /ACF/ADF/AEF/AFF/AGF/AHF) 07-17 KVF 300 CCF/CDF/CEF/CFF /CGF/CHF Brute Force 12-17 KYMCO ATV Mongoose 50 (4T) (Rear disc model) 08-09 Mongoose 70 (4T) 07-16 Mongoose 90 02-16	180
MD6258C OS6258C OSX6258	Front	S	KTM SX 85 (17"/14" wheels) 03-11 SX 85 (19"/16" wheels) 03-12 XC 85 08-09 SX 105 07-11 XC 105 08-10	220					
MD6259D	Rear	S	CAGIVA Elefant 650 86-87	240					
MD6261D	Front	S	SUZUKI LT-A 450 XK7/XK8/XK9 07-09 LT-A 450 XCK7/8/9 King Quad 450 AXi Camo 07-09 LT-A 450 XZK8/XZK9 King Quad 450 AXi Special Edition 08-09 LT-A 700 XK5/XCK6/XK6/XK7/XCK7 05-07 LT-A 750 XK8/XK9/XL1/XL2/XL3/XL4 King Quad 750 AXi 08-14 LT-A 750 XCK8/XCK9 King Quad 750 AXi Camo 08-14 LT-A 750 XZK8/XZK9/XCL1/XCL2/XCL3/XCL4 King Quad 750 AXi Limited 08-09/13 LT-A 750 XRK9 King Quad 750 AXi Rockstar Edition 09	200					

ROTOR BUYERS GUIDE

CODES FOR TYPES
 S = FLAT SOLID
 D = FLOATING ROTOR CONVERSION FOR DISHED SOLID ROTOR
 F = FLOATING ROTOR
 S/F = FLOATING CONVERSION FOR FLAT SOLID ROTOR

BRAKE ROTOR BUYERS GUIDE - DIRTBIKE/ATV/UTV

Rotor No.	Front/Rear	Type	Models	Dia (mm)	Rotor No.	Front/Rear	Type	Models	Dia (mm)
MD6267D Contd.	Front /Rear	S	Mongoose 90 R (Reverse Gear) 02-14	180	MD6274D	Front	S	POLARIS	173
			MXer 150 03-05					200 Phoenix (AC/AD Model and following rear drum model) 05-09	
MD6268D	Rear	S	MXU 150 05-14	220	MD6275D UTVX6275	Rear	S	200 Phoenix (Rear drum model) 10-14	218
			KXR 250 Mongoose 04-09					200 Phoenix (EC/ED Onwards - Quadricycle Rear Disc Model) 05-09	
MD6269D MD6269C	Rear	S	MXU 250 04-10	240	MD6275D UTVX6275	Rear	S	200 Phoenix Quadricycle (Rear disc model) 05-10	218
			Mongoose 300 06-16					200 Sawtooth (Rear drum model) 06-07	
MD6270D MD6270C	Front	F	MXU 300 05-14	310	MD6275D UTVX6275	Rear	S	200 Sawtooth Quadricycle (Rear disc model) 06/08	218
								325 Hawkeye 2x4 15	
MD6271D UTVX6271	Front	S	ARCTIC CAT	252	MD6275D UTVX6275	Rear	S	325 Sportsman Ace 14	218
			1000 Mudpro 10-13					325 Sportsman Ace EFI 15	
MD6271D UTVX6271	Rear	S	550 H1 EFI Prowler 09	252	MD6275D UTVX6275	Rear	S	325 Sportsman Ace Euro 14-15	218
			HDX 500 Prowler 14					325 Sportsman Ace HD 15	
MD6272D	Front	S	HDX 500 LTD Prowler 14	198	MD6275D UTVX6275	Rear	S	325 Ranger ETX 15	218
			HDX 500 XT Prowler 14					Sportsman 500 EFI/HO 07-08	
MD6273D	Rear	S	XT 550 10-11	202	MD6275D UTVX6275	Rear	S	500 Sportsman EFI Quad H.O. 08-10	218
			XT 550 Prowler 11-14					Sportsman 450 07	
MD6273D	Rear	S	XT 550 Prowler 11-14	202	MD6275D UTVX6275	Rear	S	500 Sportsman X2/EFI 06-08	218
			XT 650 H1 Prowler 06-09					500 Sportsman Touring H.O. 08-10	
MD6273D	Rear	S	650 H1 Prowler 07	202	MD6275D UTVX6275	Rear	S	400 Hawkeye H.O. (2x4) 13-14	218
			650 Prowler 4 x 4/M4 08					400 Ranger 10	
MD6273D	Rear	S	HDX 700 Prowler 11-14	202	MD6275D UTVX6275	Rear	S	400 Ranger 4x4 12	218
			HDX 700 LTD Prowler 14					400 Ranger (All models) 10-13	
MD6273D	Rear	S	XTX 700 H1 LE Prowler 08	202	MD6275D UTVX6275	Rear	S	Ranger 400 HO 10-11	218
			XTX 700 H1 EFI Prowler 09					400 Sportsman HO 4x4 11-12	
MD6273D	Rear	S	XTX 700 Prowler 11-14	202	MD6275D UTVX6275	Rear	S	Ranger EV (Electric) 10	218
			XTZ 1000 Prowler 10-14					500 Ranger (Carb) 2x4 08-09	
MD6273D	Rear	S	Wildcat 1000 GT 11-12	202	MD6275D UTVX6275	Rear	S	500 Ranger (EFI) 2x4 09-10	218
								500 Ranger 4x4 EFI 11-12	
MD6273D	Rear	S		202	MD6275D UTVX6275	Rear	S	Ranger 500 (2x4/4x4) 06-07	218
								Ranger 500 (4x4 EFI) 06-07	
MD6273D	Rear	S		202	MD6275D UTVX6275	Rear	S	Ranger 500 4x4 EFI 08	218
								500 Sportsman Touring HO 11-12	
MD6273D	Rear	S		202	MD6275D UTVX6275	Rear	S	Ranger Crew 500 11-12	218
								Sportsman X2 500 EFI 07-09	
MD6273D	Rear	S		202	MD6275D UTVX6275	Rear	S	570 Forest Tractor EFI/EPS 15	218
								570 Ranger EFI 14	
MD6273D	Rear	S		202	MD6275D UTVX6275	Rear	S	570 Ranger Crew EFI 14-15	218
								RZR 570 14	
MD6273D	Rear	S		202	MD6275D UTVX6275	Rear	S	570 Sportsman EFI (inc EPS) 14-15	218
								570 Sportsman Touring EFI 14-15	
MD6273D	Rear	S		202	MD6275D UTVX6275	Rear	S	570 Sportsman Ace 15	218
								570 Sportsman Ace Euro 15	
MD6273D	Rear	S		202	MD6275D UTVX6275	Rear	S	700 Ranger 4x4 EFI 09	218
								700 Ranger Crew (EFI) 4x4 09	
MD6273D	Rear	S		202	MD6275D UTVX6275	Rear	S	Ranger 6x6 EFI 700 06	218
								Ranger XP 700 4x4 06	
MD6273D	Rear	S		202	MD6275D UTVX6275	Rear	S	Ranger TM 06	218
								Ranger 700 6x4 EFI 08	
MD6273D	Rear	S		202	MD6275D UTVX6275	Rear	S	Ranger 700 4x4 EFI/LE 07	218
								Ranger XP 700 4x4 08	
MD6273D	Rear	S		202	MD6275D UTVX6275	Rear	S	Sportsman 700 EFI 07	218
								700 Sportsman X2 08	
MD6273D	Rear	S		202	MD6275D UTVX6275	Rear	S	Ranger Crew 800 10-12	218
								800 Ranger 6x6 10-12	
MD6273D	Rear	S		202	MD6275D UTVX6275	Rear	S	800 Ranger XP 10-12	218
								800 Ranger HD 10-12	
MD6273D	Rear	S		202	MD6275D UTVX6275	Rear	S	800 Ranger RZR-4 11	218
								800 Ranger RZR 4 EPS 12	
MD6273D	Rear	S		202	MD6275D UTVX6275	Rear	S	RZR 800 EFI (inc EPS Models) 08-14	218
								RZR 4 800 EFI 10-14	
MD6273D	Rear	S		202	MD6275D UTVX6275	Rear	S	RZR 4 800 EPS 12	218
								RZR S 800 EFI 09-14	
MD6273D	Rear	S		202	MD6275D UTVX6275	Rear	S	800 Ranger Mid Size 13	218
								800 Ranger 6x6 800 10-15	
MD6273D	Rear	S		202	MD6275D UTVX6275	Rear	S	800 Ranger EFI 13-14	218

ROTOR BUYERS GUIDE

F = FLOATING ROTOR
S/F = FLOATING CONVERSION FOR FLAT SOLID ROTOR

CODES FOR TYPES
S = FLAT SOLID
D = FLOATING ROTOR CONVERSION FOR DISHED SOLID ROTOR

BRAKE ROTOR BUYERS GUIDE - DIRTBIKE/ATV/UTV

Rotor No.	Front/Rear	Type	Models	Dia (mm)	Rotor No.	Front/Rear	Type	Models	Dia (mm)
MD6275D UTVX6275 Contd.	Rear	S	POLARIS Contd.	218	MD6287D Contd.	Rear	S	HUSQVARNA Contd.	220
			Ranger EV (Electric) 10-15					SM 610/S (4 bolt front disc) 02-06	
MD6277D	Front	S	SUZUKI	160	MD6288D MD6288C	Rear	S	HUSQVARNA	240
			LT-R 450 K6/K7/K8/K9/L1 06-11					CR 125 06-08	
MD6278D	Rear	S	SUZUKI	190	MD6289D MD6289C	Front	S	GAS-GAS	260
			LT-R 450 ZK8/ZK9 08-09					EC 125/200/250/300 (2T) 00-12	
MD6281D	Front	S	SUZUKI	220	MD6290D	Rear	S	POLARIS	228
			RV 200 L6/L7 Van-Van 16-17					450 Outlaw MXR 09-10	
MD6282D	Rear	S	BOMBARDIER	190	MD6291D	Front	S	YAMAHA	220
			DS 250 06					YFM 550 FGY/Z/A/B/D/E 4WD Grizzly Auto Fi 09-14	
MD6283D	Front	S	CAN-AM	175	MD6292D	Rear	S	YAMAHA	205
			DS 250 07-15					YFM 550 FGPY/Z/A/B/D/E EPS Grizzly Auto Fi 09-14	
MD6285D	Rear	S	YAMAHA	200	MD6293D	Front	F	HUSQVARNA	240
			YM 90 RY/RZ/RA/RB/RD Raptor 09-13					SM 400 R 02	
MD6287D	Rear	S	BOMBARDIER	200				SM 450 R 03-06	
			Rally 200 05-06					SMR 450 RR (Radial caliper) 06-08	
MD6287D	Rear	S	CAN-AM	220				SM 450 R (Radial caliper) 07-10	
			Rally 200 07					SM 510 R 05	
MD6287D	Rear	S	HUSQVARNA	220				SM 510 R (Radial caliper) 06-10	
			CR 125 00-01						
			SM 125 00						
			SMS 125 (2T) 02-11						
			SMS-4-125 (4T) 10-11						
			WR 125 00-01						
			WRE 125 00-11						
			CR 250 00-01						
			WR 250 00-01						
			WR 360 00-01						
			TE 410 00						
			SM 570 R (4 bolt front disc) 01-						
			TE 570 01-04						
			SM 610 R 00						

ROTOR BUYERS GUIDE

CODES FOR TYPES
S = FLAT SOLID
D = FLOATING ROTOR CONVERSION FOR DISHED SOLID ROTOR

F = FLOATING ROTOR
S/F = FLOATING CONVERSION FOR FLAT SOLID ROTOR

BRAKE ROTOR BUYERS GUIDE - DIRTBIKE/ATV/UTV

Rotor No.	Front/Rear	Type	Models	Dia (mm)	Rotor No.	Front/Rear	Type	Models	Dia (mm)								
MD6293D Contd.	Front	F	HUSQVARNA Contd.	240	MD6304C	Rear	S	KAWASAKI	200								
			SM 570 R (4 bolt front disc) 01-02-04					KSF 450 B8F/B9F/BAF/BBF/BCF/BDF/BEF (KFX 450 R) 07-14									
			SM 570 R 02-04														
			SM 610/S (4 bolt front disc) 02-06														
MD6294D	Front	F	HUSQVARNA	320	MD6305D MD6305C MD6305CX	Rear	S	SUZUKI	240								
			LT 610 (6 bolt front disc) 00					RM 125 K6/K7/K8 06-08									
			SM 610 (6 bolt front disc) 98-99					RM 250 K6/K7/K8 06-08									
			MD6295D					Rear		S	HUSQVARNA	220	MD6307D	Front	S	APRILIA	300
											CR 125 02-05					ETV 1000 Caponord (Non ABS - Bolt fixing) 01-03	
											WR 125 02-05						
											CR 250 02-05						
											TC 250 02-03						
											TE 250 02-05						
			WR 250 02-05														
WR 360 02																	
SM 400 R 02																	
TE 400 02																	
SM 450 R 03-06																	
TC 450 03																	
TE 450 03-05																	
SM 510 R 05																	
TC 510 04																	
TE 510 04-05																	
SM 570 R 02-04																	
TC 570 02-03																	
LT 610 (6 bolt front disc) 00																	
SM 610 IE 07-09																	
SM 630 09-10																	
SMR 630 06																	
SMS 630 10-11																	
TE 630 10																	
STR 650 CRC 07																	
MD6298D	Rear	F	KTM	240	MD6308D	Rear	S	APRILIA	270								
			690 SMC 08-10					ETV 1000 Caponord (Non ABS - Bolt fixing) 01-03									
			950 R Super Enduro 07-08					ETV 1000 Caponord Rally (Non ABS - Bush fixing) 03									
			990 Adventure R 09-12					ETV 1000 Caponord (ABS - Bush fixing) 04-07									
990 Adventure S 06-08																	
990 Adventure (ABS Model) 07-12																	
990 Adventure Baja Edition 13-14																	
MD6299D MD6299C	Front	F	KTM	300	MD6309C SM6309 SMX6309 MD6309CX	Front	S	KAWASAKI	280								
			690 Enduro R 10-13					KL 650 E8F/E9F/EAF/EBF/ECF/EDF /EEF/EFF (KLR 650) 08-15									
			950 R Super Enduro 07-08														
			990 Adventure R (Non ABS) 09-12														
990 Adventure S (Non ABS) 06-08																	
MD6301D	Rear	S	HYOSUNG	160	MD6310C MD6310CX	Rear	S	KAWASAKI	240								
			TE 50 05-08					KL 650 E8F/E9F/EAF/EBF/ECF/EDF /EEF/EFF (KLR 650) 08-15									
			TE 90 05-08														
TE 100 05-08																	
MD6302D	Front	S	HONDA	185	MD6311D	Rear	S	POLARIS	220								
			TRX 420 FA Fourtrax Rancher AT/IRS 09-14					200 Phoenix (EA/EB) Quadricycle Model (Rear disc model) 05									
			TRX 420 FM Fourtrax Rancher 4x4 07-13					200 Phoenix (EC/ED Onwards - Quadricycle Rear Disc Model) 05-09									
			TRX 420 FPE Fourtrax Rancher 4x4 ES/EPS 09-13					200 Sawtooth Quadricycle (Rear disc model) 06/08									
			TRX 420 FPM Fourtrax Rancher 44 PS 09-13					200 Phoenix Quadricycle (Rear disc model) 05-09									
			TRX 420 TM Fourtrax Rancher 07-13														
			TRX 420 TE Fourtrax Rancher ES 07-13														
			TRX 420 FPA Power Steering Fourtrax Rancher AT/IRS 09-14														
			MD6312D UTVX6312					Front		S	POLARIS	235	MD6312D UTVX6312	Front	S	POLARIS	235
											RZR 570 12-13					RZR 570 12-13	
RZR 800 EFI (inc EPS Models) 08-14	RZR 800 EFI (inc EPS Models) 08-14																
RZR S 800 EFI 09-14	RZR S 800 EFI 09-14																
MD6313C	Front	S	KTM	310	MD6313C	Front	S	KTM	310								
			450 SMR 07-12					450 SMR 07-12									
			560 SMR 07					560 SMR 07									
MD6314D MD6314C OS6314C OSX6314 MD6314CX SMX6314	Front	S	HONDA	220	MD6314D MD6314C OS6314C OSX6314 MD6314CX SMX6314	Front	S	HONDA	220								
			CRF 150 R/RB 07-16					CRF 150 R/RB 07-16									
			MD6316D MD6316C MD6316CX					Rear		S	HONDA	190	MD6316D MD6316C MD6316CX	Rear	S	HONDA	190
											CRF 150 R/RB 07-16					CRF 150 R/RB 07-16	
MD6317D MD6317C OS6317C OSX6317 SM6317C SMX6317	Front	S		HONDA	240	MD6317D MD6317C OS6317C OSX6317 SM6317C SMX6317	Front		S		HONDA					240	
			CRF 150 F 03-16	CRF 150 F 03-16													
			MD6319C	Rear				S		YAMAHA	230	MD6319C	Rear	S	YAMAHA		230
										WR 250 RX/RV/RZ/RA/RB/RD/RE/RF 08-15					WR 250 RX/RV/RZ/RA/RB/RD/RE/RF 08-15		
WR 250 XX/XY/XZ/XA (Supermotard) 08-11	WR 250 XX/XY/XZ/XA (Supermotard) 08-11																

ROTOR BUYERS GUIDE

F = FLOATING ROTOR
S/F = FLOATING CONVERSION FOR FLAT SOLID ROTOR

D = FLOATING ROTOR CONVERSION FOR DISHED SOLID ROTOR

BRAKE ROTOR BUYERS GUIDE - DIRTBIKE/ATV/UTV

Rotor No.	Front/Rear	Type	Models	Dia (mm)	Rotor No.	Front/Rear	Type	Models	Dia (mm)
MD6320C	Front	F	YAMAHA WR 250 RX/RV/RZ/RA/RB/RD/RE/RF 08-15	250	MD6334D	Rear	S	BOMBARDIER DS 90 X (2x4/4T) 08-15	180
MD6321C	Rear	F	CAN AM DS 450 (2x4/EFI) 08-15 DS 450 X (2x4/EFI) 08-09 DS 450 Xxc/Xxm 10-15	198	MD6335D	Front	S	BOMBARDIER DS 90 X (2x4/4T) 08-15	165
MD6322C	Front	S	CAN AM DS 450 (2x4/EFI) 08-15 DS 450 X (2x4/EFI) 08-09 DS 450 Xxc/Xxm 10-15	190	MD6336C	Front	F	KTM SX 450 09-12 XC 450 08-12 SX 505 09-12 XC 525 08-12	180
MD6323C	Front	F	HUSQVARNA WR 250 XX/XY/XZ/XA (Supermotard)08-11	298	MD6337D	Rear	S	KTM SX 450 09-12 XC 450 08-12 SX 505 09-12 XC 525 08-12	200
MD6325D UTVX6325	Front	S	KAWASAKI KRF 750 A8F/B8F (Teryx 750 4x4) 08 KRF 750 C8F/D8F (Teryx 750 4x4 LE) 08 KRF 750 F8F (Teryx 750 4x4 NRA Outdoors) 08 KRF 750 G9F/NAF/NBF/NCS/NDF (Teryx 750 Fi 4x4) 09-13 KRF 750 J9FA/K9F/PAF/PBF/RAF/RBF /RCS/PCF/RDF/PDF (Teryx 750 Fi 4x4 LE) 09-13 KRF 750 L9F (Teryx 750 Fi 4x4 Le Sport) 09 KRF 750 M9F (Teryx 750 Fi 4x4 NRA Outdoors) 09 KRF 750 SAF/SAFA/SBF/SBFA/SCS/SCSA /SDF (Teryx 750 Fi 4x4 Sport) 10-13 KRF 750 TAF/VBF/VCS (Teryx 750 Fi 4x4 SGE) 10-12	220	MD6338D UTVX6338	Front	S	POLARIS 500 Ranger (EFI) 4x4 H.O. 09-10 RZR 570 14 700 Ranger 4x4 EFI 09 RZR 4 800 EFI 10-14 RZR 4 800 EPS 12 Ranger Crew 800 10-12 800 Ranger 6x6 10-15 800 Ranger XP 10-12 800 Ranger HD 10-12 800 Ranger 6x6 800 10-13 800 Ranger EFI 13-14 Ranger 4x4 900 D (Diesel) 11-12 900 Ranger RZR XP 12 900 Ranger XP 900 13 900 Ranger Crew Diesel 11-14 900 Ranger Crew 10-15 RZR XP 900 (inc EPS Models) 11-14 RZR-4 XP 900 12-15 RZR 900 50 inch all options 15 RZR S 900 60 inch all options 15 900 (Ranger XP 900) 15 1000 Ranger Diesel 15 1000 Ranger Diesel Crew 15 1000 General EPS (2 Seat) 16 1000 General EPS (4 Seat) 17 Brutus 13-14	227
MD6326C	Rear	S	KAWASAKI KLX 250 S (KLX 250 T9F/TAF/TBF /TCF/TDF) 09-13	240	MD6338D UTVX6338	Rear	S	POLARIS 1000 General EPS (2 Seat) 16 RZR 900 50 inch all options 15 RZR S 900 60 inch all options 15	227
MD6327C	Rear	S	KAWASAKI KLX 140 A8F/A9F/AAF/ABF/ACF/ADF /AEF/AFF/AGF (KLX 140) 08-16 KLX 140 B8F/B9F/BAF/BBF/BCF/BDF /BEF/BFF/BGF (KLX 140 L) 08-16	186	MD6339D	Front /Rear	S	POLARIS 550 XP Sportsman EPS 09-10 550 Sportsman 11-12 550 Sportsman X2 10-12 550 Sportsman Touring EPS 10-12 550 Sportsman EPS 10-12 550 Sportsman Forest 12 800 Sportsman XP 850 HO EPS 13-15 850 Forest 15 850 Scrambler XP HO 13-15 850 Scrambler 15 850 XP Sportsman 09-10 850 Sportsman XP EPS 09-10 850 Sportsman Touring EPS 10-12 850 Sportsman Touring H.O. EPS 13-15 850 Sportsman Forest 12 1000 Forest 15 1000 Scrambler 15 1000 XP Scrambler 14 1000 Sportsman MD/XP 15	246
MD6328C OSX6328 SMX6328	Front	S	KAWASAKI KLX 140 A8F/A9F/AAF/ABF/ACF/ADF /AEF/AFF/AGF (KLX 140) 08-15 KLX 140 B8F/B9F/BAF/BBF/BCF/BDF /BEF/BFF/BGF (KLX 140 L) 08-16	220					
MD6329C OS6329C OSX6329 SM6329C SMX6329	Front	F	KAWASAKI KLX 250 S (KLX 250 T9F/TAF/TBF /TCF/TDF) 09-13	250					
MD6330D/C OS6330C SM6330C MD6330CX	Front	F	KAWASAKI KLX 250 S (KLX 250 H6F/H7F) 06-07 KLX 250 S (KLX 250 T9F/TAF/TBF /TCF/TDF/TEF) 09-14	250					
MD6331D	Rear	S	HONDA TRX 700 XX 08-11	200					
MD6332D UTVX6332	Rear	S	YAMAHA YXR 700 Rhino F1 (All models) 08-09/11-13	185					
MD6333D	Rear	S	YAMAHA YXR 700 Rhino F1 (All models) 08-09/11-13	165					

ROTOR BUYERS GUIDE

CODES FOR TYPES
S = FLAT SOLID
D = FLOATING ROTOR CONVERSION FOR DISHED SOLID ROTOR

F = FLOATING ROTOR
S/F = FLOATING CONVERSION FOR
FLAT SOLID ROTOR

BRAKE ROTOR BUYERS GUIDE - DIRTBIKE/ATV/UTV

Rotor No.	Front/Rear	Type	Models	Dia (mm)	Rotor No.	Front/Rear	Type	Models	Dia (mm)
MD6341D	Front /Rear	S	HONDA SXS 500 M2 Pioneer 15-17 MUV 700 Big Red 09-13 SXS 700 M2 Pioneer (2 Seat) 16-18 SXS 700 M4 Pioneer (4 Seat) 16-18	200	MD6362C	Rear	S	KAWASAKI KLX 150 S 09	190
					MD6363C	Front	S	KAWASAKI KLX 150 S 09	240
MD6342D MD6342C	Rear	S	BMW G 450 X 08-11	220	MD6365D	Front	S	HONDA TRX 500 FPM Fourtrax Foreman 12-13 TRX 500 FM Fourtrax Foreman 12-13 TRX 500 FPE Fourtrax Foreman 12-13 TRX 500 FE Fourtrax Foreman 12-13	196
MD6343C OS6343C SM6343C	Front	S	BMW G 450 X 08-11	260	MD6366D UTVX6366	Front /Rear	S	CAN AM Commander 800 R (STD) 11-15 Commander 800 (XT/DPS) 11-15 Commander 1000 (DPS) 13-15 Commander 1000 (LTD) 12-15 Commander 1000 (STD) 11-15 Commander 1000 X 11-13 Commander 1000 XT 11-15 Commander 1000 XT-P 14-15	215
MD6344D UTVX6344	Rear	S	POLARIS RZR 170 09-15	220					
MD6351C	Front	F	KAWASAKI KLX 250 SF Supermotard (KLX 250 W9F/WAF) 09-10	300	MD6367C	Front	F	BETA RR 350 4T Enduro 11 RR 525 4T Enduro 05-09	260
MD6352C	Rear	S	KAWASAKI KLX 250 SF Supermotard (KLX 250 W9F/WAF) 09-10	240	MD6368C	Rear	S	BETA RR 350 4T Enduro 11 RR 525 4T Enduro 05-09	240
MD6353D UTVX6353	Front	S	POLARIS RZR 170 09-15	125	MD6369D	Rear	S	YAMAHA YFM 300 FB Grizzly 12 YFM 300 GB/GD Grizzly 12-13	220
MD6355D	Front	S	SUZUKI LT-A 500 XPZK9/XPZL3 King Quad 500 AXi Power Steering Limited 09/13 LT-A 500 XPK9 King Quad 500 AXi Power Steering Camo 09 LT-A 500 XPK9/XPL1/XPL2/XPL3 /XPL4/XPL5 King Quad 500 AXi Power Steering 09-15 LT-A 500 XL1/XL2/XL3/XL4/XL5 King Quad 500 AXi 11-15 LT-A 500 XCLI/XCL2/XCL3/XCL4/XCL5 King Quad 500 AXi Camo 11-15 LT-A 750 CRK9 King Quad 740 AXi Rockstar Edition 09 LT-A 750 XPX9/XPL1/XPL2/XPL3 /XPL4/XPL5 King Quad 750 AXi Power Steering 09-15 LT-A 750 XPZX9/XPZL5 King Quad 750 AXi Power Steering Limited 09/15 LT-A 750 XPK9/XPCL1/XPL2/XPL3 /XPL4/XPL5 King Quad 750 AXi Power Steering Camo 09-15	190	MD6370D UTVX6370	Front /Rear	S	CAN AM Outlander L 450 EFI 15 Outlander L Max 450 EFI 15 Outlander L 500 EFI 15 Outlander 500 4x4 (DPS) 13-14 Outlander 6x6 XT 14-15 Renegade 500 (STD/EFI) 12-15 Outlander 650 (4x4 DPS/XT/STD) 13-14 Outlander 500 (STD) 13-14 Outlander 500 XT 13-14 Outlander Max 500 XT 13-14 Outlander Max 500 4x4 (DPS) 13-14 Outlander Max 500 (STD) 13-14 Outlander L Max 500 EFI 13-14 Outlander Max 650 4x4 (STD/DPS/XT) 13-14 Outlander 650 XMR 14-15 Outlander 800 R STD 12-14 Outlander 800 R XT 12-14 Outlander 800 R XT-P 13-14 Outlander 800 R (DPS) 13 Outlander 800 R XMR 15 Outlander Max 800 R 4x4 (DPS/XT/XT-P) 10-14 Renegade 800 R STD 12-15 Renegade 800 R Xxc 12-14 Commander Max 1000 DPS/XT 14 Commander Max 1000 LTD 14 Maverick 1000 STD 13-15 Maverick 1000 STD/XRS/XRS-DPS 14-15 Maverick 1000 XDS-DPS 15 Maverick 1000 XMR 14-15 Maverick 1000 XRS 13-15 Maverick 1000 XRS - DPS 13-15 Maverick 1000 XXC 14-15 Maverick Max 1000 STD 14-15 Maverick Max 1000 XRS-DPS 14-15 Maverick Max 1000 XDS-DPS 15 Outlander 1000 STD 12-14	215
MD6360C	Rear	S	KTM 85 SX (17"/14" wheels) 11-17 85 SX (19"/16" wheels) 11-17 Freeride 250 R 15-16 350 Freewind (4T) 12 350 Freewind Electric 12	210					

ROTOR BUYERS GUIDE

F = FLOATING ROTOR
S/F = FLOATING CONVERSION FOR FLAT SOLID ROTOR

D = FLOATING ROTOR CONVERSION FOR DISHED SOLID ROTOR

BRAKE ROTOR BUYERS GUIDE - DIRTBIKE/ATV/UTV

Rotor No.	Front/Rear	Type	Models	Dia (mm)	Rotor No.	Front/Rear	Type	Models	Dia (mm)	
MD6370D UTVX6370 Contd.	Front /Rear	S	CAN AM Contd.	215	MD6380D UTVX6380	Front /Rear	S	POLARIS	14-15	245
			Outlander 1000 XT/XTP 12-14 Outlander 1000 4x4 (DPS) 13 Outlander Max 1000 (4x4/DPS/XT /XT-P/LTD/STD) 13-14 Renegade 1000 STD/EFI 12-15 Renegade 1000 Xxc 12-14					RZR XP 1000		
MD6371D MD6371C		S	KTM	220	MD6381D	Rear	S	YAMAHA	14-15	200
			Duke 400 LC4 94-98 EGS 400/EGS-E/LSE (LC4 Enduro) 96-99 LC4-E 400 Enduro 00-01 SC 400 (Supercompetition LC4) 96-99 LC4 MX 600 Brembo Calipers 90-91 LC4 EXC 600 Brembo Calipers 90-91 LC4 MX 600 Grimeca Calipers 90-91 LC4 EXC 600 Grimeca Calipers 90-91 LC4 EXC 600 92-93 Duke 620 LC4 94-98 EGS 620 Enduro/EGS-E/LSE 96-99 EGS-E 620 Adventure/Rallye 99 LC4 620 SC Supermoto 00 SC 620 Supercompetition 96-00 SX 620/EXC/EGS 94 SX EXC/EGS 620 95 SX 620 96-99 LC4 625 SC Supermoto 02 LC4 625 SC Supercompetition 02 Duke II 640 Orpheus/Titan/Lime 01- Duke II 640 Black/Orange 02 LC4-E 640 Enduro 00-04 LC4-E 640 Supermoto 00-04 LC-4 640 Adventure R 99-02 LC-4 Adventure 03 LC 640 Adventure R 04 LC 640 Adventure 05-07 640 Duke (Jet Black/Yellow /Adrenalin Orange) 03-06 SMC 660 Supermoto 03-04 SMC 640 LC4 05-06 SMC 660 05-06					YXM 700 Viking Fi 4x4 EPS (Parking brake) 14-15 YXM 700 Viking Fi (Parking brake) 14-15 YXC 700 DFG Viking V1 (Parking brake) 15-16 YXC 700 PFG Viking V1 EPS (Parking brake) 15 YXC 700 PSF Viking EPS (Parking brake) 15 YXM 700 PSE/PSF Viking EPS (Parking brake) 14-15		
MD6372C MD6372CX OSX6372 SMX6372	Front	S	HONDA	256	MD6382D UTVX6382	Front /Rear	S	YAMAHA	14-15	205
			CRF 250 L (Non ABS) 13-17 CRF 250 LA (ABS) 17					YXM 700 Viking Fi 4x4 EPS 14-15 YXM 700 Viking Fi 14-15 YXC 700 DFG/dxg Viking V1 15-16 YXC 700 PFG Viking V1 EPS 15 YXC 700 PSF Viking EPS 15 YXM 700 PSE/PSF Viking EPS 14-15		
MD6373C MD6373CX	Rear	S	HONDA	220	MD6387D	Front	S	HONDA	14-15	190
			CRF 250 L (Non ABS) 13-17 CRF 250 LA (ABS) 17 CRF 250 RL Rally (Non ABS) 17 CRF 250 RLA Rally (ABS) 17					TRX 420 TM1 Rancher 14-15 TRX 420 TE1 Rancher ES 14-15 TRX 420 FA1 Rancher 4x4 Auto DCT 14-15 TRX 420 FA2 Rancher 4x4 Auto/DCT/EPS 14-15 TRX 420 FA6 Rancher 4x4 Auto/DCT/IRS/EPS 14-15 TRX 420 FE1 Rancher 4x4/ES 14-15 TRX 420 FM1 Rancher 4x4 14-15 TRX 420 FM2 Rancher 4x4/EP 14-15 TRX 500 FA5 Foreman Rubicon 4x4 Auto/DCT 15 TRX 500 FA6 Foreman Rubicon 4x4 Auto/DCT/EP 15 TRX 500 FE1 Foreman ES 14-15 TRX 500 FM1 Foreman 14-15 TRX 500 FM2 Foreman EPS 14-15 TRX 500 FM5 Foreman Rubicon 4x4 15 TRX 500 FM6 Foreman Rubicon 4x4/EP 15 TRX 500 FZ2 Foreman ES/EP 14-15		
MD6374D UTVX6374	Rear	S	POLARIS	218	MD6388C MD6388CX OSX6388 SMX6388	Front	F	KAWASAKI	15-17	270
			See application listings for more details					KX 250 ZFF/ZGF/AHF (4T) 270mm front rotor ZGF 15-17 KX 450 FFF/HGH/HHF (4T) 270mm front rotor 15-17		
MD6375D	Front/ Rear	S	ARCTIC CAT	200	MD6389C MD6389CX OSX6389 SMX6389	Front	F	HONDA	15-17	260
			See application listings for more details					CRF 250 R 15-17 CRF 450 R 15-16 CRF 450 RX (18" Rear Wheel) 17		
MD6376D UTVX6376	Rear	S	KYMCO ATV	200	MD6390D MD6390C	Front	S	HONDA	14-15	220
			MXU 500 (4x4/IRS) 10-11 MXU 500 (Side x Side) 09-14 MXU 500i/IRS (All EFI Models) 12-14 UXV 500i (All EFI Models) 13-14 MXU 700i (All models) 13-14					CRF 125 F (17/14" Small Wheels) 14-15 CRF 125 FB (19/16" Big Wheels) 14-15		
MD6379C	Front	S	KTM	240	MD6392C MD6392CX OSX6392 SMX6392	Front	F	YAMAHA	16-18	270
			SX 85 (Wheel 17/14" 240mm F/disc) 16-17 SX 85 (19"/16" Wheels/240mm F/Disc) 13-17					YZ 125 H/J 17-18 YZ 250 FG/FH/FJ 16-18 YZ 250 FGY 60th Anniversary Model 16 WR 450 FG/FH (270mm F/Disc) 16-18 YZ 450 FG/FH/FJ 16-18 YZ 450 FGY 60th Anniversary Model 16		
					MD6395D UTVX6395	Front/ Rear	S	YAMAHA	16	245
								YXZ 1000 R EPS Special Edition		

ROTOR BUYERS GUIDE

CODES FOR TYPES
S = FLAT SOLID
D = FLOATING ROTOR CONVERSION FOR DISHED SOLID ROTOR

F = FLOATING ROTOR
S/F = FLOATING CONVERSION FOR FLAT SOLID ROTOR

BRAKE ROTOR BUYERS GUIDE - STREET

Rotor No.	Front/Rear	Type	Models	Dia (mm)	Rotor No.	Front/Rear	Type	Models	Dia (mm)		
MD6396D	Front/ Rear	S	CAN AM	16	220	MD6408D UTVX6408	Front /Rear	S	POLARIS		227
			Defender 799cc	16					1000 General EPS (2 Seat)	17	
			Defender DPS 799cc	16					1000 General EPS (4 Seat)	17	
			Defender XT 799cc	16							
			Defender XT Cab 799cc	16							
			Defender 976cc	16							
			Defender DPS 976cc	16							
			Defender XT 976cc	16							
			Defender XT Cab 976cc	16							
MD6397D	Front/ Rear	S	POLARIS		248	MD6409C	Front	F	HONDA		296
			RZR XP Turbo	16					CRF 250 RL Rally (Non ABS)	17	
			RZR XP 4 Turbo	16					CRF 250 RLA Rally (ABS)	17	
MD6398D UTVX6398	Front/ Rear	S	KAWASAKI		212	MD6410D UTVX6410	Front /Rear	S	HONDA		210
			KAF820 AFF/AGF/AHF Mule PRO - FXT	15-17					Pioneer 1000 SXS (2 Seater)	16-17	
			KAF820 BFF/BGF/BHF Mule PRO						Pioneer 1000 SXS (4 Seater)	16-17	
			- FXT /EPS	15-17							
			KAF820 CFF/CGF/CHF Mule PRO								
			- FXT /EPS LE	15-17							
			KAF820 DFF/DGF/DHF Mule PRO								
			- FXT /EPS Camo	15-17							
			KAF820 EGF/EHF Mule PRO - FX	16-17							
			KAF820 FGF/FHF Mule PRO - FX/EPS	16-17							
			KAF820 GGF/GHF Mule PRO								
			- FX/EPS LE	16-17							
			KAF820 HGF/HHF Mule PRO								
			- FX/EPS Camo	16-17							
			KAF820 JGF/JHF Mule PRO								
			- FXT Ranch Edition	16-17							
			KAF1000 AGF/AHF								
			- Mule Pro DXT/ Diesel	16-17							
			KAF1000 BGF/BHF								
			- Mule Pro DXT/Diesel EPS	16-17							
KAF1000 CGF/CHF											
- Mule Pro DXT EPS LE/Diesel	16-17										
KAF1000 DGF/DHF											
- Mule Pro DX /Diesel	16-17										
KAF1000 EGF/EHF											
- Mule Pro DX EPS/Diesel	16-17										
KAF1000 FGF/FHF											
- Mule Pro DX EPS LE/Diesel	16-17										
MD6399D UTVX6399	Front	S	KAWASAKI		200	MD6411D UTVX6411	Front	S	CAN AM		260
			KRT750 ACF/ADF (Teryx 4 750 4X4)	12-13					Maverick X3	17	
			KRT750 ACFA/ADFA						Maverick X3 Max	17	
			(Teryx 4 750 4X4 EPS)	12-13					Maverick X3 Turbo	18	
			KRT750 CCF/CDF						Maverick X3 Max Turbo	18	
			(Teryx 4 750 4X4 EPS LE)	12-13					Maverick X3 Turbo R	18	
			KRT750 DCF/DDF						Maverick X3 Max Turbo R	18	
			(Teryx 4 750 4X4 EPS Realtree)	12-13							
			KRF800 CEF/CFF/GGF/GHF								
			(Teryx LE)	14-17							
			KRF800 DEF/DFF/HGF/HFF								
			(Teryx Camo)	14-17							
			KRT800 BEF/BFF/FGF/FHF (Teryx 4)	14-17							
			KRT800 CEF/CFF/GGF/GHF (Teryx 4 LE)	14-17							
KRT800 DEF/DFF/HGF/HFF											
(Teryx 4 Camo)	14-17										
MD6406D	Front	S	APRILIA		300	MD6412D UTVX6412	Front	S	CAN AM		247.5
			ETV 1000 Caponord Rally						Maverick X3	17	
			(Non ABS - Bush fixing)	03					Maverick X3 Max	17	
			ETV 1000 Caponord						Maverick X3 Turbo	18	
			(ABS - Bush fixing)	04-07					Maverick X3 Max Turbo	18	
									Maverick X3 Turbo R	18	
									Maverick X3 Max Turbo R	18	
MD6407C OSX6407	Front	S	KTM		220						
			85 SX (17"/14" Wheels								
			/220mm F/Disc)	12-15							
			85 SX (19"/16" Wheels/220mm F/Disc)	12							

ROTOR BUYERS GUIDE

F = FLOATING ROTOR
S/F = FLOATING CONVERSION FOR FLAT SOLID ROTOR

D = FLOATING ROTOR CONVERSION FOR DISHED SOLID ROTOR
S = FLAT SOLID

EBC BRAKES CLUTCH KITS



HONDA



		CK cork OEM style Kit #	CKF carbon fiber style upgrade Kit #	CSK Spring Kit #	DRC Series Kit #	DRCF Series Kit #	SRC Series Kit #	SRK Series Kit #	CT Tool #
MB 5	82	CK1150		CSK3					CT012SP
CRF 50 F	04-16	CK1148		N/A					
Dream 50 R (CB 50 R) (AR02)	04	CK1150		CSK48					CT012SP
MR 50 K0/K1 Elsinore	74-75	N/A		N/A					
NSR 50 R (RS 50)	04	CK1150		CSK3					CT012SP
XR 50 R	00-03	CK1148		N/A					
CR 60 R	83-84	CK1151	CKF1151	CSK3					CT012SP
ATC 70	78-85	CK1148		CSK18					
C 70	80-81	CK1148		CSK18					
C 70	82-83	CK1148		CSK18					
CRF 70 F	04-14	CK1148		CSK18					
CT 70 Trail	77-82	CK1148		CSK18					
CT 70 Trail	91-94	CK1148		CSK18					
SL 70 /K1	70-73	CK1105		N/A					
TRX 70 Fourtrax	86-87	CK1148		CSK18					
XR 70 R	97-03	CK1148		CSK18					
XL 75	77-79	CK1150		CSK48					CT012SP
CR 80 R	80-82	CK1151	CKF1151	CSK3					CT012SP
CR 80 R	83	CK1151	CKF1151	CSK23					CT012SP
CR 80 R	84	CK1119		CSK23					CT012SP
CR 80 R	85-86	CK1119		CSK173	DRC1				CT012SP
CR 80 R/RB Expert	87-02	CK1119		CSK173	DRC1				CT012SP
CRF 80 F	04-16	CK1150		CSK48					CT012SP
XL 80 S	80-85	CK1150		CSK22					CT012SP
XR 80/XR 80 R	79-94	CK1150		CSK22					CT012SP
XR 80 R	95-03	CK1150		CSK48					CT012SP
CR 85 R/RB	03-07	CK1119		CSK173	DRC1				CT012SP
TRX 90 Fourtrax/Sportrax	93-06	CK1151	CKF1151	N/A					CT012SP
TRX 90 EX	07-08	CK1151	CKF1151	N/A					CT012SP
TRX 90 X	09-15	CK1151	CKF1151	N/A					CT012SP
CRF 100 F	04-15	CK1151	CKF1151	CSK23	DRC49	DRCF49			CT012SP
NSF 100 R	06	CK1151	CKF1151	CSK23					CT012SP
SL 100 K	70-74	CK1119		CSK4					CT012SP
XL 100	74	CK1119		CSK4					CT012SP
XL 100 K	75	CK1119		CSK4					CT012SP
XL 100	76-78	CK1119		CSK167					CT012SP
XL 100 S	79-80	CK1151	CKF1151	CSK8					CT012SP
XL 100 S	81-85	CK1151	CKF1151	CSK8					CT012SP
XR 100 R	81-86	CK1151	CKF1151	CSK22					CT012SP
XR 100 R	87-03	CK1151	CKF1151	CSK23	DRC49	DRCF49			CT012SP
ATC 110	79-85	CK1156		CSK18					
CRF 110 R	13-16	TBA		N/A					
CT 110 Trail	80-86	CK1156		CSK18					
ATC 125 M	84-85	CK1156		CSK21					
ATC 125 M	86-87	CK1151	CKF1151	CSK48					CT012SP
CB 125 S	80-82	CK1119		CSK167					CT012SP
CB 125 S	84-85	CK1119		CSK167					CT012SP
CB 125 TT	90	CK1252		CSK167					CT012SP
CBR 125 R/RW (With Judder Spring / Canada)	04-06	CK1252		CSK193					CT012SP
CBR 125 RW/R (No Judder Spring / Canada)	07-13	CK1119	CKF1119	CSK193			SRC119	SRK119	CT012SP
CG 125 (CA/KS/KSE) Drum Front Brake	01-06	CK1119		CSK167					CT012SP
CG 125 (ES) Disc Front Brake	01-04	CK1119		CSK167					CT012SP
CL 125 A (Scrambler Twin)	65	N/A		N/A					
CL 125 S (Single)	67-74	CK1119		CSK4					CT012SP
CR 125 M Elsinore	74-78	CK1144		CSK36					CT002
CR 125 R Elsinore	79-80	CK1199		CSK31					
CR 125 R Elsinore	81	CK1191	CFK1191	CSK31					CT002

CLUTCH APPLICATIONS

EBC BRAKES CLUTCH KITS



HONDA



		CK cork OEM style Kit #	CKF carbon fiber style upgrade Kit #	CSK Spring Kit #	DRC Series Kit #	DRCF Series Kit #	SRC Series Kit #	SRK Series Kit #	CT Tool #
CR 125 R	82	CK1186		CSK31					CT002
CR 125 R	83-84	CK1190	CKF1190	CSK24	DRC67				CT013
CR 125 R	85	CK1200		CSK24	DRC68				CT001
CR 125 R	86-99	CK1222		CSK24	DRC2				CT001
CR 125 R	00-03	CK1293	CKF1293	CSK77	DRC262	DRCF262			CT001
CR 125 R	00-07	CK1293	CKF1293	CSK77	DRC101	DRCF101			CT001
CRF 125 F	14-16	TBA		TBA					
CRF 125 FB	14-16	TBA		TBA					
CT 125	77	CK1119		CSK167					CT012SP
MSX 125 GROM	13-18	CK1315		CSK197			SRC122	SRK122	CT084SP
MSX 125 GROM (ABS)	18	CK1315		CSK197			SRC122	SRK122	CT084SP
MT 125/K1 Elsinore	74-76	CK1144		N/A					CT002
NX 125	88-90	CK1252		CSK167	DRC50				CT012SP
NXR 125 (JC30)	03-08	CK1119		CSK167					CT012SP
SL 125 K	71-73	CK1119		CSK4					CT012SP
SS 125 A (Supersport 125)	65	N/A		N/A					
TL 125 K	71-75	CK1151		CSK167					CT012SP
TL 125 S	76	CK1119		CSK167					CT012SP
TRX 125 Fourtrax	85-86	CK1156		CSK21					
TRX 125 Fourtrax	87-88	CK1151	CKF1151	CSK48					CT012SP
XL 125 K	74-75	CK1119		CSK4					CT012SP
XL 125	76-78	CK1119		CSK4					CT012SP
XL 125 S	79-84	CK1119		CSK31					CT012SP
XL 125 S	85	CK1119		CSK167					CT012SP
CRF 150 F	03-05	CK1304		CSK77	DRC180				CT012SP
CRF 150 F	06-16	CK1119		CSK6	DRC181				CT012SP
CRF 150 R	07-16	CK1191	CKF1191	CSK134	DRC182	DRCF182			CT002
NXR 150 (KD02)	03-08	CK1252		TBA					CT012SP
NXR 150 (KD03) Front Disc Model	03-08	CK1119		TBA					CT012SP
NXR 150 (KD03) Front Drum Model	03-08	CK1119		TBA					CT012SP
CD 175	67-68	CK1123		CSK8					
CD 175 K	69-71	CK1134		CSK8					
CL 175 (6 Friction Plate Clutch)	68-69	CK1123		CSK8					
CL 175 K (5 Friction Plate Clutch)	70-71	CK1134		CSK8					
MR 175 Elsinore	75-77	CK1144		CSK36					CT002
SL 175 K	72-73	CK1134		CSK8					
XL 175 K/76/77/78	72-78	CK1134		CSK8					
ATC 185/185 S	80-83	CK1151	CKF1151	CSK22					CT012SP
ATC 185/185 S Centrifugal (one way) clutch	80-83	CK5544							
XL 185 S	79-80	CK1119		CSK167					CT012SP
XL 185 S	81-83	CK1119		CSK9					CT012SP
XR 185	79	CK1119		CSK167					CT012SP
ATC 200	81-83	CK1151	CKF1151	CSK22					CT012SP
ATC 200 Centrifugal (one way) clutch	81-83	CK5544							
ATC 200 E Big Red	82-83	CK1151	CKF1151	CSK22					CT012SP
ATC 200 E Big Red Centrifugal (one way) clutch	82-83	CK5544							
ATC 200 ES Big Red	84	CK1151	CKF1151	CSK22					CT012SP
ATC 200 ES Big Red Centrifugal (one way) clutch	84	CK5544							
ATC 200 M	84-85	CK1151	CKF1151	CSK22					CT012SP
ATC 200 M Centrifugal (one way) clutch	84-85	CK5544							
ATC 200 S	84-86	CK1151	CKF1151	CSK22					CT012SP
ATC 200 S Centrifugal (one way) clutch	84-86	CK5544							
ATC 200 X	83-85	CK1119		CSK24					CT012SP
ATC 200 X	86-87	CK1119		CSK30					CT012SP
CM 200 T	80-82	CK1119		CSK9					CT012SP
TLR 200	86-87	CK1119		CSK167					CT012SP
TR 200 Fatcat	86-87	CK1119		CSK172					CT012SP

CLUTCH APPLICATIONS

EBC BRAKES CLUTCH KITS



HONDA



		CK cork OEM style Kit #	CKF carbon fiber style upgrade Kit #	CSK Spring Kit #	DRC Series Kit #	DRCF Series Kit #	SRC Series Kit #	SRK Series Kit #	CT Tool #
TRX 200 Fourtrax	84	CK1151	CKF1151	CSK22					CT012SP
TRX 200 Fourtrax Centrifugal (one way) clutch	84	CK5544							
TRX 200 SX Fourtrax	86-88	CK1119		CSK172	DRC4				CT012SP
TRX 200 Fourtrax	90-91	CK1119		CSK172	DRC4				CT012SP
TRX 200 D Type II Fourtrax	91-97	CK1119		CSK172	DRC4				CT012SP
XL 200 R	83-84	CK1119		CSK105					CT012SP
XR 200	80-84	CK1119		CSK105	DRC91				CT012SP
XR 200 R	81-83	CK1119		CSK105	DRC91				CT012SP
XR 200 R	84-85	CK1180		CSK4	DRC60				CT013SP
XR 200 R	86-02	CK1119		CSK105	DRC91				CT012SP
CRF 230 F	03-16	CK1304		CSK24	DRC136				CT012SP
CRF 230 L	08-11	CK1252		CSK9	DRC249				CT012SP
CRF 230 M	09-11	CK1252		CSK9	DRC249				CT012SP
ATC 250 R	81-84	CK1163		CSK31					
ATC 250 R	85	CK1193	CKF1193	CSK28	DRC93				CT013SP
ATC 250 R	86	CK1193	CKF1193	CSK32	DRC5				CT013SP
ATC 250 ES Big Red	85-87	CK1194		CSK4					CT013SP
ATC 250 SX	85-87	CK1194		CSK4					CT013SP
CB 250 Nighthawk	91-08	CK1191	CKF1191	CSK24					CT012SP
CBR 250 R (Non ABS)	11-14	CK1313		CSK188					
CBR 250 RA (ABS Model)	11-14	CK1313		CSK188					
CM 250 C Rebel	82-83	CK1191	CKF1191	CSK105					CT012SP
CMX 250 C/CD Rebel	85-87	CK1191	CKF1191	CSK105					CT012SP
CMX 250 C/C2 Rebel	96/97/99-14	CK1191	CKF1191	CSK105					CT012SP
CMX 250 X	15	CK1191	CKF1191	CSK105					CT012SP
CR 250 M 76 Elsinore	73-77	CK1131		N/A					CT009
CR 250 R Elsinore	78-80	CK1163		CSK31					
CR 250 R Elsinore	81	CK1131		CSK41					CT009
CR 250 R	82	CK1170	CKF1170	CSK41					CT009
CR 250 R	83-89	CK1170	CKF1170	CSK28	DRC3				CT009
CR 250 R	90-93	CK1247	CKF1247	CSK28	DRC75				CT009
CR 250 R	94-07	CK1247	CKF1247	CSK178	DRC79	DRCF79			CT009
CRF 250 L (Non ABS)	13-17	CK1314	CKF1314	CSK188	DRC277	DRCF277			CT081SP
CRF 250 LA (ABS)	17	CK1314	CKF1314	CSK188	DRC277	DRCF277			CT081SP
CRF 250 Rally (Non ABS)	17	CK1314	CKF1314	CSK188	DRC277	DRCF277			CT081SP
CRF 250 Rally (ABS)	17	CK1314	CKF1314	CSK188	DRC277	DRCF277			CT081SP
CRF 250 R	04-07	CK1293	CKF1293	CSK176	DRC129	DRCF129			CT001
CRF 250 R	08-09	CK1305	CKF1305	CSK176	DRC208	DRCF208			CT001
CRF 250 R	10	CK1293	CKF1293	CSK164	DRC256	DRCF256			CT001
CRF 250 R	11-17	CK1305	CKF1305	CSK215	DRC261	DRCF261			CT001
CRF 250 X	04-17	CK1305	CKF1305	CSK176	DRC208	DRCF208			CT001
MR 250 Elsinore	76	CK1131		N/A					CT009
MT 250 K1/76	74-76	CK1131		N/A					CT009
NX 250	88-90	CK1190	CKF1190	CSK30	DRC51				CT013SP
TL 250	75-76	CK1131		CSK4					
TRX 250 Fourtrax	85-87	CK1194		CSK4					CT013SP
TRX 250 R Fourtrax	86-87	CK1193	CKF1193	CSK32	DRC5				CT013
TRX 250 R Fourtrax	88-89	CK1193	CKF1193	CSK45	DRC81				CT013
TRX 250 X Fourtrax	87-88/91-92	CK1190	CKF1190	CSK4	DRC44	DRCF44			CT013SP
TRX 250 EX (Sportrax 250 EX)	01-08	CK1119		CSK172	DRC4				CT012SP
TRX 250 TE Recon ES	97-14	CK1119		CSK172	DRC4				CT012SP
TRX 250 TM Recon	97-14	CK1119		CSK172	DRC4				CT012SP
TRX 250 X	09-14	CK1119		TBA					CT012SP
VTR 250 Interceptor	88-90	CK1235		CSK9					CT012SP
XL 250 K/76	72-76	CK1119		CSK4					
XL 250 S	78-80	CK1152		CSK9					CT013SP
XL 250 S	81	CK1153		CSK9					CT013SP

APPLICATIONS
CLUTCH

EBC BRAKES CLUTCH KITS



HONDA



		CK cork OEM style Kit #	CKF carbon fiber style upgrade Kit #	CSK Spring Kit #	DRC Series Kit #	DRCF Series Kit #	SRC Series Kit #	SRK Series Kit #	CT Tool #
XL 250 R	82-83	CK1153		CSK9					CT013SP
XL 250 R	84-87	CK1180		CSK4	DRC60				CT013SP
XR 250	79-80	CK1152		CSK9					CT013SP
XR 250 R	81-82	CK1153		CSK9					CT013SP
XR 250 R	84-85	CK1180		CSK4	DRC60				CT013SP
XR 250 R	86-95	CK1190	CKF1190	CSK4	DRC44	DRCF44			CT013SP
XR 250 R	96-04	CK1190	CKF1190	CSK77	DRC84				CT013SP
XR 250 L	91-96	CK1190	CKF1190	CSK4	DRC44	DRCF44			CT013SP
CB 300 F	15	TBA		TBA					
CBR 300 R (Non ABS Model)	15	TBA		TBA					
CBR 300 R (ABS Model)	15	TBA		TBA					
TRX 300 All models (2wd & 4wd) Fourtrax	88-00	CK1196		CSK23	DRC6				CT013SP
TRX 300 EX Fourtrax/Sportrax	93-08	CK1190	CKF1190	CSK4	DRC44	DRCF44			CT013SP
TRX 300 X	09-11	CK1190	CKF1190	CSK4	DRC44	DRCF44			CT013SP
ATC 350 X	85-86	CK1190	CKF1190	CSK173					CT013SP
CB 350 F/F1		CK1140		CSK82					CT013SP
CB 350 G/K		CK1132		CSK82					CT009
SL 350 KO/K1/K2	69-73	CK1134		CSK3					
TRX 350 All models	86-89	CK1196		CSK23	DRC6				CT013SP
TRX 350 TE/FE (Electric Shift)	00-05	CK1160		CSK48	DRC127				CT013SP
TRX 350 TM/FM (Manual Shift)	00-05	CK1196		CSK48	DRC126				CT013SP
XL 350 R	84-85	CK1217		CSK4					CT013SP
XR 350 R	83-85	CK1190	CKF1190	CSK4	DRC44	DRCF44			CT013SP
CB 360/360 G/T	75-76	CK1132		CSK82					CT009
CJ 360 T	76-77	CK1132		CSK82					CT009
CB 400 F	75-77	CK1140		CSK82					CT013SP
CB 400 T Hawk All models	78-81	CK1140		CSK15					CT013SP
CB-1 (CB 400 F)	89-90	CK1228		CSK6					CT009SP
CM 400 T	79-81	CK1140		CSK47					CT013SP
CM 400 C Custom	81	CK1140		CSK47					CT013SP
CM 400 E	80-81	CK1140		CSK47					CT013SP
FL 400 R Pilot	89-90	CK1234		TBA					
TRX 400 FW Fourtrax Foreman	95-01/03	CK1196		CSK23	DRC6				CT013SP
TRX 400 EX Fourtrax/Sportrax	99-08	CK1193	CKF1193	CSK73	DRC100	DRCF100			
TRX 400 FM Fourtrax Foreman	02	CK1196		CSK23	DRC6				CT013SP
TRX 400 X	09-14	CK1193	CKF1193	CSK73	DRC100	DRCF100			CT013
XR 400 R	96	CK1193	CKF1193	CSK28	DRC93				CT013
XR 400 R	97-04	CK1193	CKF1193	CSK33	DRC106				CT013
TRX 420 TM Fourtrax Rancher	07-13	CK1196		CSK154	DRC239				CT013SP
TRX 420 TM1 Rancher	14-15	CK1196		CSK154	DRC239				CT013SP
TRX 420 TE Fourtrax Rancher ES	07-13	CK1196		CSK155	DRC238				CT013SP
TRX 420 TE1 Rancher ES	13-15	CK1196		CSK155	DRC238				CT013SP
TRX 420 FP/FPA Fourtrax Rancher 4x4 ES/EPS	09-13	CK1196		CSK155	DRC238				CT013SP
TRX 420 FE/FEA Fourtrax Rancher 4x4/ES	07-13	CK1196		CSK155	DRC238				CT013SP
TRX 420 FE1 Rancher 4x4/ES	14-15	CK1196		CSK155	DRC238				CT013SP
TRX 420 FM/FMA Fourtrax Rancher 4x4	07-13	CK1154		CSK154	DRC239				CT013SP
TRX 420 FM1 Rancher 4x4	14-15	CK1196		CSK154	DRC239				CT013SP
TRX 420 FM2 Rancher 4x4 With Power Steering	14-15	CK1196		CSK154	DRC239				CT013SP
TRX 420 FPM/FPMA Fourtrax 4WD	09-13	CK1154		CSK154	DRC239				CT013SP
CB 450 K		CK1130		N/A					CT031
CB 450 T Hawk	82	CK1140		CSK47					CT013SP
CB 450 SC Nighthawk	82-86	CK1140		TBA					CT013SP
CB 450 DX-K	89-92	CK1140		CSK47					CT013SP
CM 450 E	82/83	CK1140		CSK15					CT013SP
CM 450 C Custom	82	CK1140		CSK15					CT013SP
CMX 450 C Rebel	86-87	CK1140		TBA					CT013SP
CR 450 R	81	CK1131		CSK41					CT009

CLUTCH APPLICATIONS

EBC BRAKES CLUTCH KITS



HONDA



		CK cork OEM style Kit #	CKF carbon fiber style upgrade Kit #	CSK Spring Kit #	DRC Series Kit #	DRCF Series Kit #	SRC Series Kit #	SRK Series Kit #	CT Tool #
CRF 450 R (6 Spring type)	02-03	CK1247	CKF1247	CSK178	DRC112				CT009
CRF 450 R (6 Spring type)	04-05	CK1247	CKF1247	CSK120	DRC148	DRCF148			CT009
CRF 450 R (6 Spring type)	06-08	CK1247	CKF1247	CSK178	DRC112				CT009
CRF 450 R (4 Spring type)	09-10	CK1247	CKF1247	CSK157	DRC244	DRCF244			CT009
CRF 450 R (4 Spring type)	11-12	CK3433	CKF3433	CSK174	DRC259	DRCF259			CT009
CRF 450 R (6 Spring type)	13	CK3433	CKF3433	CSK201	DRC276	DRCF276			CT009
CRF 450 R (6 Spring type)	14-16	CK3433	CKF3433	CSK227	DRC301	DRCF301			CT009
CRF 450 R (6 Spring type)	17-18	CK1317	CKF1317	CSK227	DRC299	DRCF299			CT092
CRF 450 RX (18" Rear wheel)	17-18	CK1317	CKF1317	CSK227	DRC299	DRCF299			CT092
CRF 450 X	05-17	CK1247	CKF1247	CSK120	DRC148	DRCF148			CT009
TRX 450 ES	98-01	CK1196		CSK23	DRC6				CT013SP
TRX 450 R/ER	04-14	CK1302	CKF1302	CSK178	DRC131	DRCF131			CT009
TRX 450 S	98-01	CK1196		CSK23	DRC6				CT013SP
TRX 450 FE	02-04	CK1196		CSK23	DRC6				CT013SP
TRX 450 FM	02-04	CK1196		CSK23	DRC6				CT013SP
CR 480 R	82	CK1170	CKF1170	CSK24					CT009
CR 480 R	83	CK1170	CKF1170	CSK28	DRC3				CT009
CB 500 K	71-73	CK1135		CSK82					CT009
CB 500 F (Non ABS)	13-14	TBA		CSK33					
CB 500 FA (ABS)	13-14	TBA		CSK33					
CB 500 X (Non ABS)	13-14	TBA		CSK33					
CB 500 XA (ABS)	13-14	TBA		CSK33					
CBR 500 R (Non ABS)	13-14	TBA		CSK33					
CBR 500 RA (ABS)	13-14	TBA		CSK33					
CR 500 R	84-89	CK1170	CKF1170	CSK28	DRC3				CT009
CR 500 R	90-94	CK1247	CKF1247	CSK28	DRC75				CT009
CR 500 R	95-01	CK1247	CKF1247	CSK28	DRC75				CT009
CX 500 C/D Custom/Deluxe	79-82	CK1146		CSK41					
CX 500 TC Turbo	82	CK1159		CSK167					
SXS 500 M2 Pioneer	15	CK1140		TBA					
FT 500 Ascot	82-83	CK1140		CSK15					CT013SP
GB 500	89-90	CK1219		CSK16					CT009
GL 500/500 I Silverwing/Silverwing Interstate	81-82	CK1146		CSK41					
TRX 500 FE/FEA Fourtrax Foreman 4x4/ES	05-11	CK1154		CSK117	DRC236				CT013SP
TRX 500 FE Fourtrax Foreman 4x4	12-13	CK1154		CSK29	DRC270				CT013SP
TRX 500 FM/FMA Fourtrax Foreman 4x4	05-11	CK1154		CSK153	DRC237				CT013SP
TRX 500 FM Fourtrax Foreman 4x4	12-13	CK1154		CSK79	DRC271				CT013SP
TRX 500 FPE Fourtrax Foreman 4x4 ES/EPS	08-11	CK1154		CSK117	DRC236				CT013SP
TRX 500 FPE Fourtrax Foreman 4x4	12-13	CK1154		CSK29	DRC270				CT013SP
TRX 500 FPM Fourtrax Foreman 4x4 EPS	08-11	CK1154		CSK153	DRC237				CT013SP
TRX 500 FPM Fourtrax Foreman 4x4	12-13	CK1154		CSK79	DRC271				CT013SP
TRX 500 TM Fourtrax Foreman 2x4	05-06	CK1154		CSK153	DRC237				CT013SP
VT 500 C Shadow	83-86	CK1160		N/A					CT013SP
VT 500 FT Ascot	83-84	CK1160		N/A					CT013SP
VF 500 C V 30 Magna	84-85	CK1177		CSK9					CT002
VF 500 F Interceptor	84-86	CK1177		CSK9					CT002
XL 500 S	79-81	CK1140		CSK15					CT013SP
XL 500 R	82	CK1140		CSK15					CT013SP
XR 500	79-80	CK1154		CSK15					CT013SP
XR 500 R	81-82	CK1154		CSK15					CT013SP
XR 500 R	83-84	CK1170	CKF1170	CSK15					CT009
CB 550 F/K	75-78	CK1146		CSK9					
CB 550 K/K1	74-75	CK1147		CSK9					
CB 550 SC Nighthawk	83	CK1171		CSK167					CT009
599 (CB 600 F)	04/06	CK1206		CSK45			SRC19	SRK19	CT014SP
CBR 600 F Hurricane	87	CK1228		CSK12			SRC16	SRK16	CT009SP
CBR 600 F1	88-89	CK1228		CSK12			SRC16	SRK16	CT009SP

CLUTCH
APPLICATIONS

EBC BRAKES CLUTCH KITS



HONDA



		CK cork OEM style Kit #	CKF carbon fiber style upgrade Kit #	CSK Spring Kit #	DRC Series Kit #	DRCF Series Kit #	SRC Series Kit #	SRK Series Kit #	CT Tool #
CBR 600 F1	90	CK1228		CSK47			SRC42	SRK42	CT009SP
CBR 600 F2	91-94	CK1206		CSK45			SRC19	SRK19	CT014SP
CBR 600 F3/SJR/SE	95-98	CK1206		CSK45			SRC19	SRK19	CT014SP
CBR 600 F4 (Carb Model)	99-00	CK1193	CKF1193	CSK29			SRC66	SRK66	CT014
CBR 600 F4i Sport Injection Model)	01-06	CK1218	CKF1218	CSK178			SRC143	SRK143	CT014
CBR 600 RR	03-17	CK1218	CKF1218	CSK101			SRC75	SRK75	CT014
CBR 600 RRA ABS Model	09-17	CK1218	CKF1218	CSK101			SRC75	SRK75	CT014
VT 600 C Shadow VLX	88	CK1181		CSK33					CT013SP
VT 600 C Shadow VLX	89-90	CK1230		CSK28					CT013SP
VT 600 C/CD Shadow VLX/Shadow Deluxe CD2	91-07	CK1181		CSK33					CT013SP
XL 600 V	89-90	CK1181		CSK33	DRC53				CT013SP
XL 600 R	83-84	CK1170	CKF1170	CSK15	DRC92				CT009
XL 600 R to 520822	85	CK1170	CKF1170	CSK15	DRC92				CT009
XL 600 R from 5208023	85	CK1170	CKF1170	CSK15	DRC92				CT009
XL 600 R	86-87	CK1170	CKF1170	CSK15	DRC92				CT009
XR 600 R	85-00	CK1170	CKF1170	CSK16	DRC54	DRCF54			CT009
CB 650	79-82	CK1147		CSK167					
CB 650 C Custom	80-81	CK1147		CSK167					
CB 650 SC Nighthawk	82	CK1147		CSK167					
CB 650 SC Nighthawk	83-85	CK1171		CSK167					CT009
CBR 650 F (Non ABS Model)	14	CK1181		TBA					CT013SP
CBR 650 F (ABS Model)	14	CK1181		TBA					CT013SP
CX 650 C Custom	83	CK1147		CSK12					
CX 650 T Turbo	83	CK1159		CSK167					
GL 650/650 I Silverwing/Silverwing Interstate	83	CK1147		CSK12					
NT 650 Hawk GT	88-90	CK1230		CSK28			SRC64	SRK64	CT013SP
NX 650	88-89	CK1170	CKF1170	CSK16	DRC54	DRCF54			CT009
XR 650 L	93-15	CK1170	CKF1170	CSK16	DRC54	DRCF54			CT009
XR 650 R	00-07	CK1295		CSK45	DRC179				
CB 700 SC/S Nighthawk	84-86	CK1166		CSK167					CT031
CTX 700 (Top Fairing/Manual Clutch Model)	14	CK1230		CSK33			SRC62	SRK62	CT013SP
CTX 700 N (Naked/ Manual Clutch Model)	14	CK1230		CSK33			SRC62	SRK62	CT013SP
NC 700 X (Manual Clutch Model)	12-14	CK1230		CSK33			SRC62	SRK62	CT013SP
NT 700 VVA	10-13	CK1230		CSK33			SRC62	SRK62	CT013SP
TRX 700 XX	08-11	CK1302	CKF1302	CSK178	DRC240	DRCF240			CT009
VF 700 C Magna	84-87	CK1166		CSK167					CT031
VF 700 F Interceptor	84-85	CK1167		CSK900			SRC2	SRK2	CT031
VFR 700 F Interceptor	86-87	CK1206		CSK28			SRC3	SRK3	CT014
VF 700 S Sabre	84-85	CK1166		CSK167					CT031
VT 700 C Shadow	84-87	CK1166		N/A					CT031
CB 750 C Custom	80-82	CK1149		CSK41					CT078SP
CB 750 F Supersport	76	CK1145		CSK82					CT076SP
CB 750 F Supersport	79-82	CK1149		CSK41					CT078SP
CB 750 K	71-75	CK1133		CSK82					CT076SP
CB 750 K	77-78	CK1145		CSK82					CT076SP
CB 750 K	79-82	CK1149		CSK41					CT078SP
CB 750 L Limited Edition	79	CK1149		CSK9					CT078SP
CB 750 SC Nighthawk	82-83	CK1149		CSK41					CT078SP
CB 750 Nighthawk	91-03	CK1265		CSK12					CT009SP
VF 750 C V45 Magna	82-88	CK1166		CSK167					CT031
VF 750 F V45 Interceptor	83-84	CK1167		CSK900			SRC2	SRK2	CT031
VF 750 C Magna/CD Magna Deluxe	94-03	CK1206		CSK28			SRC3	SRK3	CT014
RVF 750 R (RC 45)	94	CK1257		N/A					CT031
VFR 750 F Interceptor 750	86	CK1206		CSK28			SRC3	SRK3	CT014
VFR 750 F	90-97	CK1206		CSK28			SRC3	SRK3	CT014
VFR 750 R (RC 30)	90	CK1229		CSK901			SRC5	SRK5	CT014
VF 750 S V45 Sabre	82	CK1166		CSK167					CT031

CLUTCH APPLICATIONS

EBC BRAKES CLUTCH KITS



HONDA



		CK cork OEM style Kit #	CKF carbon fiber style upgrade Kit #	CSK Spring Kit #	DRC Series Kit #	DRCF Series Kit #	SRC Series Kit #	SRK Series Kit #	CT Tool #
VF 750 S V45 Sabre	83	CK1166		N/A					CT031
VT 750 C Shadow	83	CK1166		N/A					CT031
VT 750 C/CD Shadow/Shadow Deluxe	98-02	CK1230		CSK28					CT013SP
VT 750 Shadow Aero	04-07	CK1230		CSK28					CT013SP
VT 750 Shadow Aero	08-14	CK1230		CSK28					CT013SP
VT 750 CSE Shadow Aero	13-14	CK1230		CSK28					CT013SP
VT 750 C2 Shadow Spirit	08-14	CK1230		CSK28					CT013SP
VT 750 DC Shadow Spirit	01-02	CK1230		CSK28					CT013SP
VT 750 C2S Shadow Spirit	13-14	CK1230		CSK28					CT013SP
VT 750 DC Shadow Spirit	03-07	CK1230		CSK28					CT013SP
VT 750 CD Shadow American Classic Edition	02-03	CK1230		CSK28					CT013SP
VT 750 C2B Shadow Phantom	10-15	CK1230		CSK28					CT013SP
VT 750 RS Shadow	10-14	CK1230		CSK28					CT013SP
VT 800 Shadow	88	CK1166		CSK24					CT031
VFR 800 Fi	98-99	CK1206		CSK135					CT014
VFR 800 Fi	00-01	CK1253		CSK101					CT014
VFR 800 Interceptor/ABS	02-11	CK1218	CKF1218	CSK101			SRC75	SRK75	CT014
VFR 800 F Interceptor	14-15	CK1218	CKF1218	CSK101			SRC75	SRK75	CT014
VFR 800 FD Interceptor DLX	14-15	CK1218	CKF1218	CSK101			SRC75	SRK75	CT014
PC 800 Pacific Coast	89-90/94-98	CK1167		CSK30					CT009
CB 900 C Custom	80-82	CK1149		CSK167					CT078SP
CB 900 F Supersport	81-82	CK1149		CSK167					CT078SP
CBR 900 RR	93-95	CK1206		CSK28			SRC94	SRK94	CT014
CBR 900 RR	96-97	CK1284		CSK45			SRC55	SRK55	CT014
CBR 900 RR	98-99	CK1218	CKF1218	CSK45			SRC57	SRK57	CT014
919 (CB 900 F)	02-07	CK1218	CKF1218	CSK45			SRC57	SRK57	CT014
CBR 929 RR (929cc model)	00-01	CK1206		CSK45			SRC19	SRK100	CT014
CBR 954 RR	02-03	CK1206		CSK45			SRC19	SRK100	CT014
CBX	79	CK1183		CSK167					CT066SP
CBX	80-82	CK1183		CSK10					CT066SP
RVT 1000 R (RC51)	00-01	CK1291		CSK43					CT021
RVT 1000 (RC51)	02-06	CK1300		CSK43					CT021
VTR 1000 F Superhawk	98-05	CK1290		CSK206			SRC60	SRK60	CT009
CB 1000 C Custom	83	CK1149		CSK207					CT078SP
CB 1000	94-95	CK1248		CSK29			SRC4	SRK4	CT009
CB 1000 R	11-14	CK1303		CSK90					CT009SP
CBF 1000 A8 (Canada)	08	CK1303		CSK90					
CBR 1000 F Hurricane	87-88	CK1248		CSK29			SRC4	SRK4	CT009
CBR 1000 F	90-96	CK1248		CSK29			SRC4	SRK4	CT009
CBR 1000 RR (Coil Spring Type Clutch)	04-07	CK1303		CSK112			SRC80	SRK80	CT009SP
CBR 1000 RR (Diaphragm Type Clutch)	08-15	CK1312		CSK905			SRC95	SRK95	CT043SP
CBR 1000 RAA ABS Model (Diaphragm Type Clutch)	09-15	CK1312		CSK905			SRC95	SRK95	CT043SP
CBR 1000 RR SP	14-15	CK1312		CSK905			SRC95	SRK95	CT043SP
CRF 1000 LAG Africa Twin (Manual clutch)	16	TBA		TBA					
GL 1000 K Goldwing (Up to Eng No 1020727)	75	CK1143		CSK167					CT076SP
GL 1000 K Goldwing (From Eng No 1020728)	75	CK1221		CSK167					CT053SP
GL 1000 Goldwing All models	76-79	CK1143		CSK167					CT076SP
VF 1000 F Interceptor	84	CK1176		N/A					CT031
VF 1000 R	85-86	CK1176		N/A					CT031
XL 1000 VA8 Varadero (Canada)	08	CK1257		CSK138					CT009
CB 1100 F Supersport	83	CK1149		CSK207					CT078SP
CB 1100 (Non ABS)	13-14	CK1257		CSK43					CT009
CB 1100 (ABS)	13-14	CK1257		CSK43					CT009
CBR 1100 XX Blackbird	97-98	CK1286		CSK70					CT021
CBR 1100 XX Blackbird	99-03	CK1291		CSK43					CT021
GL 1100/1100 I Goldwing/Goldwing Interstate	80-83	CK1159		CSK167					CT053SP
GL 1100 A Goldwing Aspencade	82-83	CK1159		CSK167					CT053SP

CLUTCH
APPLICATIONS

EBC BRAKES CLUTCH KITS



HONDA



		CK cork OEM style Kit #	CKF carbon fiber style upgrade Kit #	CSK Spring Kit #	DRC Series Kit #	DRCF Series Kit #	SRC Series Kit #	SRK Series Kit #	CT Tool #
ST 1100/1100A	91-01	CK1264		CSK33			SRC70	SRK70	CT056SP
VF 1100 C V65 Magna	83-86	CK4409		N/A					
VF 1100 S V65 Sabre	84-85	CK4409		N/A					
VT 1100 C Shadow 1100	85-86	CK1209		N/A					CT009
VT 1100 C Shadow 1100	87-94	CK1239		N/A					CT009
VT 1100 C Shadow 1100	95-96	CK1239		N/A					CT009
VT 1100 C Shadow 1100 Spirit	97-06	CK1176		CSK68					CT009
VT 1100 CS Shadow American Classic Edition	95-97	CK1176		CSK68					CT009
VT 1100 C2-2 Shadow American Classic Edition	97	CK1176		CSK68					CT009
VT 1100 D2 Shadow American Classic Edition	99	CK1176		CSK68					CT009
VT 1100 C2 Shadow Sabre	00-06	CK1176		CSK68					CT009
VT 1100 C3 Shadow Aero	98-02	CK1176		CSK68					CT009
VT 1100 T Shadow American Classic Edition Tourer	98-01	CK1176		CSK68					CT009
GL 1200/1200 I-A/1200 L Goldwing All models	84-85	CK1210		N/A					CT053SP
GL 1200 I-A/GL 12SE-I	86	CK1224		N/A					
GL 1200 1/A Goldwing All models	87	CK1224		N/A					
VFR 1200 F (Manual Gearbox Model)	10-14	CK1312		CSK907			SRC103	SRK103	CT043SP
CTX 1300	14	TBA		TBA					
CTX 1300 DLX (ABS)	14	TBA		TBA					
ST 1300/1300 A	02-13	CK1297		CSK175					CT021
VT 1300 CX Fury (Non ABS Model)	10-15	CK1298		CSK90					TBA
VT 1300 CXA Fury (ABS Model)	10-15	CK1298		CSK90					TBA
VT 1300 CS Sabre (Non ABS)	10-14	CK1298		CSK90					TBA
VT 1300 CSA Sabre (ABS)	11-14	CK1298		CSK90					TBA
VT 1300 CT Interstate (Non ABS)	10-15	CK1298		CSK90					TBA
VT 1300 CTA Interstate (ABS)	11-15	CK1298		CSK90					TBA
VT 1300 CR Stateline (Non ABS)	10-15	CK1298		CSK90					TBA
VT 1300 CRA Stateline (ABS)	11-15	CK1298		CSK90					TBA
VTX 1300 C	04-11	CK1298		CSK90					TBA
VTX 1300 S	03-07	CK1298		CSK90					TBA
VTX 1300 R	05-11	CK1298		CSK90					TBA
VTX 1300 T	08-11	CK1298		CSK90					TBA
GL 1500 Goldwing	88-96	CK1285		N/A					CT068SP
GL 1500 A/SE/I Goldwing	99-00	CK1285		N/A					CT068SP
GL 1500 C/CT Valkyrie/Valkyrie Tourer	97-03	CK1285		N/A					CT068SP
GL 1800 A (ABS)/1800 Goldwing (All models)	01-16	CK1297		N/A					CT073
F6B Goldwing (GL 1800 B)	13-16	CK1297		N/A					CT073
F6B Goldwing Deluxe (GL 1800 BD)	13-16	CK1297		N/A					CT073
GL 1800 C Valkyrie	13-14	CK1297		N/A					CT073
NRX 1800 Rune DA/DB/EA	04-05	CK1297		N/A					CT073
VTX 1800 C	02-08	CK1298		CSK90					TBA
VTX 1800 R (Cast Models)	02-08	CK1298		CSK90					TBA
VTX 1800 S (Spoke Model)	02-07	CK1298		CSK90					TBA
VTX 1800 T	07-11	CK1298		CSK90					TBA
VTX 1800 F	05-11	CK1298		CSK90					TBA
VTX 1800 N	04-11	CK1298		CSK90					TBA
KAWASAKI									
AR 50 A	82	CK4442		CSK18					
KDX 50 A	03-06	CK3366		N/A					
KX 60 A	83-84	CK4438	CKF4438	CSK18					CT070SP
KX 60 B	85-03	CK4438	CKF4438	CSK18	DRC7				CT070SP
KX 65 A	00-16	CK4438	CKF4438	CSK40	DRC98	DRCF98			CT070SP
AR 80 A	82	CK4440		CSK18					
KD 80 M	80-81	CK4440		CSK19					
KD 80 M	82-87	CK4440		CSK19					
KD 80 N	88-90	CK4440		CSK19					

CLUTCH APPLICATIONS

EBC BRAKES CLUTCH KITS



KAWASAKI



		CK cork OEM style Kit #	CKF carbon fiber style upgrade Kit #	CSK Spring Kit #	DRC Series Kit #	DRCF Series Kit #	SRC Series Kit #	SRK Series Kit #	CT Tool #
KX 80 A	80	CK4440		CSK18					
KDX 80 A	81	CK4440		CSK40					
KDX 80 B	82-83	CK4438	CKF4438	CSK40					CT070SP
KDX 80 C	84-88	CK4438	CKF4438	CSK40					CT070SP
KX 80 C	81/82	CK4438	CKF4438	CSK40					CT070SP
KX 80 E	83/84	CK4438	CKF4438	CSK40					CT070SP
KX 80 E/G/J	85-87	CK4468		CSK34	DRC8				CT070SP
KX 80 L	88	CK4477		CSK35	DRC9				
KX 80 L/N	89-90	CK4478		CSK35	DRC10				
KX 80 R	91-97	CK4478		CSK35	DRC10				
KX 80 W	98-00	CK4453	CKF4453	CSK41	DRC45	DRCF45			CT002
KX 85 A/C	01-17	CK4453	CKF4453	CSK41	DRC45	DRCF45			CT002
KE 100 A	76-81	CK4440		CSK19					
KE 100 B	85-01	CK4440		CSK19					
KM 100 A	76-81	CK4440		CSK19					
KX 100 B	95-97	CK4478		CSK35	DRC10				
KX 100 C/D/F	98-09/11-16	CK4453	CKF4453	CSK41	DRC45	DRCF45			CT002
KLF 110 A/B Mojave	87-88	CK4463		N/A					
KLT 110 A	84-86	CK4463		N/A					
KLX 110 (KLX 110 A/C)	02-17	CK4438	CKF4438	CSK40					CT070SP
KLX 110 L (KLX 110 D)	10-17	CK4438	CKF4438	CSK40					CT070SP
BN 125 A Eliminator	01-09	CK4511		CSK41					
KD 125 A	75-79	CK4411		CSK143					CT058
KE 125 A	80-83	CK4411		CSK143					CT058
KLX 125 A	03-06	CK3318	CKF3318	CSK34					CT011
KLX 125 L (B)	03-06	CK3318	CKF3318	CSK34					CT011
KX 125 A	78-81	CK4436		CSK143					CT058
KX 125 B	82	CK4436		CSK143					CT058
KX 125 B	83	CK4457		CSK152					CT058
KX 125 C	84	CK4457		CSK143					CT058
KX 125 D/E	85-87	CK4469		CSK143	DRC11				CT042
KX 125 F/G	88-89	CK4482		CSK6	DRC13				CT042
KX 125 H	90-91	CK4485		CSK116	DRC36				CT042
KX 125 J	92	CK4485		CSK116	DRC83				CT042
KX 125 J	93	CK4498		CSK116	DRC69				CT042
KX 125 K	94-96	CK4425		CSK7	DRC73				CT004
KX 125 K/L	97-02	CK4425		CSK65	DRC73				CT004
KX 125 M	03-05	CK4425		CSK97	DRC122				CT004
KLX 140 A (KLX 140)	08-17	CK4522		CSK142	DRC211				
KLX 140 B (KLX 140 L)	08-17	CK4522		CSK142	DRC211				
KLX 140 CHF (KLX 140 G)	17	CK4522		CSK142	DRC211				
KLX 150 S	09-11	CK4522		CSK142	DRC211				
KLT 160 A	85	CK1119		CSK3					CT012SP
KDX 175 A	80-82	CK4436		CSK143					CT058
KE 175 D	80-83	CK4411		CSK39					CT058
KLF 185 A Bayou	85-88	CK1119		CSK3					CT012SP
KLT 185 A	86-87	CK1119		CSK3					CT012SP
KDX 200 A	83-84	CK4457		CSK152					CT058
KDX 200 A	85	CK4457		CSK143					CT058
KDX 200 C	86-88	CK4469		CSK143	DRC74				CT042
KDX 200 E	89-94	CK4482		CSK10	DRC61				CT042
KDX 200 H	95-06	CK4505		CSK30	DRC62				
KLT 200 A	81-83	CK4425		CSK148					CT004
KLT 200 B	83	CK4425		CSK148					CT004
KLT 200 C	83-84	CK4425		CSK148					CT004
KDX 220 R A	97-06	CK4505		CSK30	DRC62				
KLF 220 A Bayou	88-02	CK1180		CSK116	DRC224				CT013SP

CLUTCH APPLICATIONS

EBC BRAKES CLUTCH KITS



KAWASAKI



		CK cork OEM style Kit #	CKF carbon fiber style upgrade Kit #	CSK Spring Kit #	DRC Series Kit #	DRCF Series Kit #	SRC Series Kit #	SRK Series Kit #	CT Tool #
EL 250 B Eliminator	88-89	CK4473		CSK4					CT016
EL 250 E 250 HS	91-95	CK4473		CSK4					CT016
EX 250 E Ninja	86-87	CK4473		CSK4					CT016
EX 250 F/D Ninja	88-07	CK4484		CSK4					CT016
EX 250 J Ninja 250 R	08-12	CK4521		CSK142					CT009
KDX 250 A/B	80-81	CK4439		CSK10					CT006
KDX 250 B	82-84	CK4433		CSK10					CT006
KDX 250 D	91-94	CK4475		CSK30	DRC41				CT006
KE 250 B	77-79	CK4439		CSK116					CT006
KH 250 A	76	CK4436		CSK1					CT058
KL 250 A	78-79	CK4425		CSK148					CT004
KL 250 A	80-82	CK4425		CSK148					CT004
KL 250 C	83-84	CK4425		CSK148					CT004
KL 250 G Super Sherpa	00-04	CK4469		CSK74					
KLF 250 A Bayou	03-11	CK1180		CSK116	DRC224				CT013SP
KLR 250 (KL 250) D	85-05	CK4446		CSK148	DRC63				CT004
KLT 250 A	82-83	CK4425		CSK148					CT004
KLT 250 C	83-85	CK4425		CSK148					CT004
KLT 250 P Police	84	CK4425		CSK148					CT004
KLX 250 A	79-80	CK4425		CSK148					CT004
KLX 250 D	93-95	CK4469		CSK1					CT042
KLX 250 S (KLX 250 H)	06-07	CK4469		CSK144	DRC212				CT042
KLX 250 S (KLX 250 T)	09-14	CK4469		CSK144	DRC212				CT042
KLX 250 SF (KLX 250 W) Supermotard	09-10	CK4469		CSK144	DRC212				CT042
KSF 250 A Mojave	87-04	CK4425		CSK148	DRC225				CT004
KX 250 A	80-81	CK4439		CSK10					CT006
KX 250 B/C	82-83	CK4433		CSK10					CT006
KX 250 C	84	CK4465		CSK10					CT006
KX 250 D	85-86	CK4459		CSK10					CT006
KX 250 E/F	87-88	CK4475		CSK10					CT006
KX 250 G	89	CK4475		CSK7	DRC15				CT006
KX 250 H	90	CK4475		CSK6	DRC17				CT006
KX 250 H	91	CK4475		CSK30	DRC41				CT006
KX 250 J/K/L/M/R	92-07	CK4435	CKF4435	CSK7	DRC46	DRCF46			CT016
KX 250 N (KX 250 F)	04-05	CK4514	CKF4514	CSK97	DRC123	DRCF123			CT004
KX 250 F (T)	06-08	CK4514	CKF4514	CSK97	DRC123	DRCF123			CT004
KX 250 F (W/X/Y/Z/A) (4T)	09-17	CK4514	CKF4514	CSK97	DRC123	DRCF123			CT004
KXF 250 A Tecate 4	87-88	CK4475		CSK10					CT006
KXT 250 A Tecate	84	CK4433		CSK148					CT006
KXT 250 A Tecate	85	CK4465		CSK148					CT006
KXT 250 B Tecate	86-87	CK4459		CSK10	DRC38				CT006
KZ 250 D (LTD)	80	CK4425		CSK148					CT004
KZ 250 D (CSR)	81	CK4425		CSK148					CT004
KZ 250 L (CSR)	82	CK4425		CSK148					CT004
KZ 250 W (LTD)	83	CK4425		CSK148					CT004
S1-A/B/C (250cc)	73-75	CK4436		CSK1					CT058
EX 300 A (Non ABS) Ninja 300	13-16	CK4524		CSK203			SRC118	SRK118	CT009
EX 300 A (Non ABS) Ninja SE 300	14-16	CK4524		CSK203			SRC118	SRK118	CT009
EX 300 B (With ABS) Ninja 300	13-16	CK4524		CSK203			SRC118	SRK118	CT009
EX 300 B (With ABS) Ninja SE 300	14-16	CK4524		CSK203			SRC118	SRK118	CT009
KEF 300 A Lakota	95-00	CK4419		CSK151	DRC233				CT006
KEF 300 B Lakota Sport	01-03	CK4419		CSK151	DRC233				CT006
KLF 300 A/B/C Bayou	86-05	CK4419		CSK151	DRC233				CT006
KLX 300 R A	97	CK4469		CSK1					CT042
KLX 300 R A	98-07	CK4469		CSK144	DRC212				CT042
EX 305 B (GPz)	83	CK4433		CSK6					CT006
KZ 305 A (CSR)	81-82	CK4433		CSK6					CT006

CLUTCH APPLICATIONS

EBC BRAKES CLUTCH KITS



KAWASAKI



		CK cork OEM style Kit #	CKF carbon fiber style upgrade Kit #	CSK Spring Kit #	DRC Series Kit #	DRCF Series Kit #	SRC Series Kit #	SRK Series Kit #	CT Tool #
KZ 305 B (CSR)	82	CK4433		CSK6					CT006
KZ 305 B (LTD)	87-88	CK4433		CSK6					CT006
S2/S2-A (350cc)	72-73	CK4436		CSK192					CT058
KDX 400 A	79-80	CK4439		CSK10					CT006
KH 400 A	76-78	CK4457		CSK192					CT058
KLF 400 B Bayou (4 x 4)	93-98	CK4439		CSK151	DRC234				CT006
KLX 400 R (KLX 400 B)	03-04	CK3433	CKF3433	CSK79	DRC105	DRCF105			CT006
KLX 400 SR (KLX 400 A)	03-04	CK3433	CKF3433	CSK79	DRC105	DRCF105			CT006
KSF 400 A (KFX 400)	03-04	CK3433	CKF3433	CSK79	DRC105	DRCF105			CT006
KSF 400 A (KFX 400)	05-06	CK3447	CKF3447	CSK79	DRC137	DRCF137			CT006
S3/S3-A (400cc)	74-75	CK4457		CSK192					CT058
KDX 420 B	81	CK4439		CSK10					CT006
KX 420 A	80-81	CK4439		CSK10					CT006
KZ 440 A	80-83	CK4421		CSK4					
KZ 440 B	80-81	CK4421		CSK4					
KZ 440 D	80-83	CK4421		CSK4					
KZ 440 G	82	CK4421		CSK4					
EN 450 A (454 LTD)	85-90	CK4424		CSK10			SRC11	SRK11	CT016
KDX 450 A	82	CK4439		CSK10					CT006
KFX 450 R (KSF 450 B8)	08-14	CK4519		CSK177	DRC185				CT006
KLX 450 R A	08-12	CK1247	CKF1247	CSK180	DRC158	DRCF158			CT006
KX 450 F D/E	06-11	CK1247	CKF1247	CSK180	DRC158	DRCF158			CT006
KX 450 F (F/H) (4T)	12-17	CK1247	CKF1247	CSK29	DRC269	DRCF269			CT006
EN 500 A/C	90-09	CK4424		CSK10			SRC11	SRK11	CT016
EX 500 A/D	87-09	CK4424		CSK10			SRC11	SRK11	CT016
HI 500 Mach III	69-70	CK4425		CSK194					CT004
HI-A 500 S Mach III	71	CK4425		CSK194					CT004
HI-B 500 Mach III	72	CK4425		CSK194					CT004
HI-C 500 Mach III	72	CK4425		CSK194					CT004
HI-D 500	73	CK4425		CSK194					CT004
HI-E 500	74	CK4425		CSK194					CT004
HI-F 500	75	CK4425		CSK194					CT004
KH 500 A8		CK4425		CSK194					CT004
KX 500 A	83/84	CK4433		CSK10					CT006
KX 500 B	85-86	CK4459		CSK10					CT006
KX 500 C/D	87-88	CK4475		CSK10	DRC16				CT006
KX 500 E	89-04	CK4475		CSK10	DRC16				CT006
KZ 550 A	80-83	CK4424		CSK10			SRC11	SRK11	CT016
KZ 550 C (LTD)	80-83	CK4424		CSK10			SRC11	SRK11	CT016
KZ 550 D (GPz)	81	CK4424		CSK10			SRC11	SRK11	CT016
KZ 550 F Spectre	83	CK4424		CSK10			SRC11	SRK11	CT016
KZ 550 F (LTD)	84	CK4424		CSK10			SRC11	SRK11	CT016
KZ 550 H (GPz)	82-83	CK4424		CSK10			SRC11	SRK11	CT016
KZ 550 M (LTD)	83	CK4424		CSK10			SRC11	SRK11	CT016
ZX 550 A (GPz)	84-86	CK4424		CSK10			SRC11	SRK11	CT016
ZR 550 B Zephyr	90-93	CK4424		CSK10			SRC11	SRK11	CT016
KLR 600 (KL 600 A/B)	84-86	CK4424		CSK23	DRC64				CT016
ZL 600 A	86-87	CK4424		CSK10			SRC11		CT016
ZL 600 Eliminator B	96-97	CK4424		CSK10					CT016
ZX 600 A/B Ninja	85-87	CK4424		CSK23					CT016
ZX 600 C Ninja R	88-89	CK4424		CSK10			SRC11	SRK11	CT016
ZX 600 C Ninja R	90-97	CK4424		CSK10			SRC11	SRK44	CT016
ZX 600 D (ZX6)	90-93	CK4424		CSK10			SRC22	SRK22	CT016
ZX 600 E (ZX6)	93-05	CK4424		CSK43			SRC43	SRK43	CT016
ZX6R (ZX 600 F/G)	95-99	CK4503		CSK56			SRC38	SRK108	CT004
ZX6R (ZX 600 J)	00-02	CK4503		CSK56			SRC38	SRK38	CT004
ZX6R (ZX 636 A)	02	CK4503		CSK56			SRC38	SRK38	CT004

APPLICATIONS
CLUTCH

EBC BRAKES CLUTCH KITS



KAWASAKI



		CK cork OEM style Kit #	CKF carbon fiber style upgrade Kit #	CSK Spring Kit #	DRC Series Kit #	DRCF Series Kit #	SRC Series Kit #	SRK Series Kit #	CT Tool #
ZX6R (ZX 636 B) 636cc	03-04	CK4503		CSK56			SRC38	SRK38	CT004
ZX6R (ZX 636 C) 636cc	05-06	CK4514	CKF4514	CSK117			SRC84	SRK84	CT004
ZX6R (ZX 600 P/R)	07-12	CK4514	CKF4514	CSK165			SRC101	SRK101	CT004
ZX6R (ZX 636 E) 636cc/Non ABS	13-17	CK4514		CSK202					CT004
ZX6R (ZX 636 E) 636cc/Non ABS/30th Anniversary Edition	15	CK4514		CSK202					CT004
ZX6R (ZX 636 E) 636cc/Non ABS/KRT Edition	16-17	CK4514		CSK202					CT004
ZX6R (ZX 636 F) 636cc/ABS	13-17	CK4514		CSK202					CT004
ZX6R (ZX 636 F) 636cc/ABS/30th Anniversary Edition ABS	15	CK4514		CSK202					CT004
ZX6R (ZX 636 F) 636cc/ABS/KRT Edition	16-17	CK4514		CSK202					CT004
ZX6RR (ZX 600 K) 599cc	03	CK4503		CSK99			SRC76	SRK76	CT004
ZX6RR (ZX 600 M)	04	CK4514	CKF4514	CSK99			SRC83	SRK83	CT004
ZX6RR (ZX 600 N) 599cc	05-06	CK4514	CKF4514	CSK117				SRK107	CT004
ZZR 600 (ZX 600 J)	05	CK4503		CSK56			SRC38	SRK38	CT004
ZZR 600 J	06-08	CK4503		CSK56			SRC38	SRK38	CT004
EN 650 Vulcan S (Non ABS) EN 650 A	15	CK4424		CSK10			SRC22	SRK22	CT016
EN 650 Vulcan S (ABS) EN 650 B	15	CK4424		CSK10			SRC22	SRK22	CT016
ER6-n (ER 650 C)	09-10	CK4424		CSK10			SRC22	SRK22	CT016
EX 650 A Ninja 650 R	06-08	CK4424		CSK10			SRC22	SRK102	CT016
EX 650 C Ninja 650 R	09-11	CK4424		CSK10			SRC22	SRK22	CT016
EX 650 E Ninja 650 (Non ABS)	12-16	CK4424		CSK10			SRC22	SRK22	CT016
EX 650 F Ninja 650 (ABS Model)	13-16	CK4424		CSK10			SRC22	SRK22	CT016
KL 650 B Tengai	90-91	CK4424		CSK7	DRC65				CT016
KL 650 E Up To KL650AEA72319 = 8 Friction Plates (KLR 650)	08-11	CK4435	CKF4435	CSK10	DRC168				CT016
KL 650 E From KL650AEA72320 = 7 Friction Plates (KLR 650)	11-15	CK4424		CSK10					CT016
KLE 650 A/C/D Versys	07-14	CK4424		CSK10			SRC22		CT016
KLE 650 F Versys/Versys LT	15-16	CK4424		CSK10					CT016
KLR 650 (KL 650 A)	87-95	CK4424		CSK7	DRC65				CT016
KLR 650 (KL 650 A)	96-07	CK4435	CKF4435	CSK10	DRC168				CT016
KLX 650 A/D (KLX 650 R)	93-96	CK4424		CSK10	DRC64				CT016
KLX 650 C	93-96	CK4424		CSK7	DRC65				CT016
KZ 650 B	77-79	CK4413		CSK10					CT019
KZ 650 C Custom	77-79	CK4413		CSK10					CT019
KZ 650 D SR	78-79	CK4413		CSK10					CT019
KZ 650 E (LTD)	80	CK4413		CSK10					CT019
KZ 650 F	80	CK4413		CSK10					CT019
KZ 650 H (CSR)	81-83	CK4413		CSK10					CT019
W 650 (EJ 650 A)	00-02	CK4435	CKF4435	CSK10			SRC46	SRK46	CT016
KZ 700 A	84	CK4413		CSK10					CT019
VN 700 A Vulcan	85	CK4435	CKF4435	CSK10			SRC46	SRK46	CT016
ZN 700 A (LTD)	84-85	CK4413		CSK10					CT019
H1/H2-A Mach IV (750-2T)	72-73	CK4415		CSK23					CT004
H2-B/H2-C Mach IV (750-2T)	74-75	CK4523		CSK23					CT004
KZ 750 E	80-82	CK4413		CSK10					CT016
KZ 750 F (LTD)	83	CK4413		CSK10					CT019
KZ 750 G (LTD)	80	CK4435		CSK10			SRC46	SRK46	CT016
KZ 750 H (LTD)	80-83	CK4413		CSK10					CT019
KZ 750 K (LTD)	83-84	CK4435	CKF4435	CSK10					CT016
KZ 750 L	83	CK4413		CSK10					CT019
KZ 750 M (CSR)	82	CK4435	CKF4435	CSK10			SRC46	SRK46	CT016
KZ 750 N Spectre	82-83	CK4413		CSK10					CT019
KZ 750 R (GPz)	82	CK4413		CSK10					CT019
VN 750 A Vulcan	86-06	CK4435	CKF4435	CSK10			SRC46	SRK46	CT016
ZX 750 A (GPz)	83-85	CK4413		CSK10					CT019
ZX 750 E (GPz Turbo)	84-85	CK4443		CSK10					CT019
ZX 750 F Ninja	87-90	CK4435	CKF4435	CSK7			SRC53	SRK53	CT016
ZX 750 H Ninja ZX-7	89-90	CK4424		CSK23					CT016
ZX 750 K	91-92	CK4435	CKF4435	CSK88			SRC24	SRK24	CT016

CLUTCH
APPLICATIONS

EBC BRAKES CLUTCH KITS



KAWASAKI



		CK cork OEM style Kit #	CKF carbon fiber style upgrade Kit #	CSK Spring Kit #	DRC Series Kit #	DRCF Series Kit #	SRC Series Kit #	SRK Series Kit #	CT Tool #
ZX 750 J	91-92	CK4435	CKF4435	CSK88			SRC24	SRK24	CT016
ZX 750 L (ZX-7)	93-95	CK4435	CKF4435	CSK88			SRC24	SRK24	CT016
ZX 750 M (ZX-7R)	93-94	CK4435	CKF4435	CSK88			SRC24	SRK24	CT016
ZX 750 P (ZX 7 R)	96-03	CK4435	CKF4435	CSK88			SRC24	SRK24	CT016
ZX 750 N (ZX 7 RR)	96-99	CK4435	CKF4435	CSK38			SRC41	SRK41	CT016
ZR 750 C Zephyr	91-93	CK4493		CSK10					CT019
ZR 750 F (ZR-7)	00-01	CK4493		CSK117					CT019
Z 750 S (ZR 750 K)	05-06	CK4503		CSK56			SRC38	SRK38	CT004
ZR7-S (ZR 750 H)	01-05	CK4493		CSK117					CT019
VN 800 A/B	95-05	CK4435	CKF4435	CSK10			SRC46	SRK46	CT016
VN 800 Drifter C/E	99-06	CK4435	CKF4435	CSK7			SRC53	SRK53	CT016
VN 900 Vulcan Classic LT (Spoke Wheels & Screen) (D)	06-16	CK4435	CKF4435	CSK7			SRC53	SRK53	CT016
VN 900 Vulcan Classic (Spoke Wheels) (B)	06-16	CK4435	CKF4435	CSK7			SRC53	SRK53	CT016
VN 900 Vulcan Custom (Cast Wheels) (C)	07-16	CK4435	CKF4435	CSK7			SRC53	SRK53	CT016
Z1/A/B 900	73-75	CK4409		CSK10					CT019
KZ 900 A	76-77	CK4409		CSK10					CT019
KZ 900 B LTD	76	CK4409		CSK10					CT019
ZL 900 A Eliminator	85-86	CK4434		CSK23			SRC20	SRK20	CT016
ZX 900 A Ninja	84-86	CK4435	CKF4435	CSK7			SRC53	SRK53	CT016
ZX9R B Ninja	94-97	CK4435	CKF4435	CSK38			SRC41	SRK41	CT016
ZX9R (ZX 900 C)	98-99	CK4510		CSK67			SRC59	SRK59	CT004
ZX9R (ZX 900 E/F)	00-03	CK4510		CSK128			SRC89	SRK89	CT004
KLZ 1000 B Versys	15-16	CK4503		TBA					CT004
KZ 1000 A	77-80	CK4409		CSK10					CT019
KZ 1000 B (LTD)	79-80	CK4409		CSK10					CT019
KZ 1000 C Police	78-81	CK4409		CSK10					CT019
KZ 1000 D (Z1-R)	78-80	CK4409		CSK10					CT019
KZ 1000 E Shaft	79-80	CK4434		CSK23			SRC20	SRK20	CT016
KZ 1000 G Classic	80	CK4409		CSK10					CT019
KZ 1000 J	81-83	CK4434		CSK10			SRC54	SRK54	CT016
KZ 1000 K (LTD)	81-82	CK4434		CSK10			SRC54	SRK54	CT016
KZ 1000 M (CSR)	81-82	CK4434		CSK10			SRC54	SRK54	CT016
KZ 1000 P Police	82-03/05	CK4434		CSK10			SRC54	SRK54	CT016
KZ 1000 R Replica	82-83	CK4434		CSK10			SRC54	SRK54	CT016
Z 1000 (ZR 1000 A)	03-05	CK4510		CSK128			SRC89	SRK89	CT004
Z 1000 (ZR 1000 A)	06	CK4510		CSK128			SRC89	SRK89	CT004
Z 1000 (ZR 1000 B)	07-08	CK4510		CSK110					CT004
Z 1000 (ZR 1000 C)	07	CK4510		CSK110					CT004
Z 1000 (ZR 1000 D) Non ABS	10-13	CK4510		CSK169					CT004
Z 1000 ABS (ZR 1000 D) ABS	14-15	CK4510		CSK169					CT004
Z 1000 ABS (ZR 1000 G) ABS/3 Spring Clutch	16	CK4503		TBA					CT004
ZG 1000 A Concours	86-05	CK4434		CSK23			SRC20	SRK20	CT016
ZG 1000 A Concours	06	CK4434		CSK23			SRC20	SRK20	CT016
ZL 1000 A	87	CK4434		CSK23			SRC20	SRK20	CT016
ZX 1000 A Ninja	86-87	CK4434		CSK23			SRC20	SRK20	CT016
ZX 1000 B Ninja ZX10	88-90	CK4434		CSK23			SRC20		CT016
1000 Ninja ABS (ZX 1000 H)	12-13	CK4510		CSK169					CT004
1000 Ninja (ZX 1000 G)	11-13	CK4510		CSK169					CT004
1000 Ninja ABS (ZX 1000 M)	14-15	CK4510		CSK169					CT004
1000 Ninja H2 (ZX 1000 N)	15-16	TBA		TBA					
1000 Ninja H2R (ZX 1000 P)	15-16	TBA		TBA					
ZX10 R (ZX 1000 C)	04-05	CK4510		CSK111			SRC79	SRK79	CT004
ZX10 R (ZX 1000 D/E/F)	06-10	CK4510		CSK111			SRC79		CT004
ZX10 R (ZX 1000 J - Non ABS)	11-15	CK4510		CSK111			SRC79		CT004
ZX10 R (ZX 1000 J 30th Anniversary Edition - Non ABS)	15	CK4510		CSK111			SRC79		CT004
ZX10 R (ZX 1000 K - ABS)	11-15	CK4510		CSK111			SRC79		CT004
ZX10 R (ZX 1000 F 30th Anniversary Edition - ABS)	15	CK4510		CSK111			SRC79		CT004

CLUTCH
APPLICATIONS

EBC BRAKES CLUTCH KITS



KAWASAKI



		CK cork OEM style Kit #	CKF carbon fiber style upgrade Kit #	CSK Spring Kit #	DRC Series Kit #	DRCF Series Kit #	SRC Series Kit #	SRK Series Kit #	CT Tool #
ZX10 R (ZX 1000 SGF)	16	CK4510		CSK111			SRC79		CT004
ZX10 R KRT Replica (ZX 1000 SGFA)	16	CK4510		CSK111			SRC79		CT004
KZ 1100 A	81-83	CK4434		CSK23			SRC20	SRK20	CT016
KZ 1100 B (GPz)	81-82	CK4434		CSK23			SRC20	SRK20	CT016
KZ 1100 D Spectre	82-83	CK4434		CSK23			SRC20	SRK20	CT016
KZ 1100 L (LTD)	83	CK4434		CSK23			SRC20	SRK20	CT016
ZN 1100 B (LTD)	84-85	CK4434		CSK23			SRC20	SRK20	CT016
ZX 1100 A (GPz)	83-84	CK4434		CSK23			SRC20	SRK20	CT016
ZR 1100 A Zephyr	92-95	CK4434		CSK23			SRC20	SRK20	CT016
(ZR 1100 C) ZRX 1100	99-00	CK4434		CSK23			SRC20	SRK20	CT016
ZX 1100 C/D (ZX11)	90-01	CK4488		CSK29			SRC25	SRK25	CT021
ZX 1100 E/F GPZ 1100	95-97	CK4488		CSK29			SRC25	SRK25	CT021
ZG 1200 A/B	86-90	CK4434		CSK23			SRC20		CT016
ZG 1200 B Voyager X11	91-03	CK4434		CSK23			SRC20		CT016
ZX12 R (ZX 1200 A)	00	CK4513		CSK109					CT009
ZX12 R (ZX 1200 A/B)	01-05	CK4515		CSK67					CT009
ZRX 1200 R (ZR 1200 A)	01-05	CK4434		CSK38					CT016
ZZR 1200 (ZX 1200 C)	02-05	CK4488		CSK29			SRC25	SRK25	CT021
KZ 1300 A	79-81	CK4452		CSK10					
KZ 1300 A	82	CK4458		CSK10					
KZ 1300 B Touring	80	CK4452		CSK10					
ZN 1300 A Voyager	83-88	CK4455		CSK10					CT032
Concours 14 (ZG 1400 A/C/E) ABS	08-16	CK4520		CSK23					CT021
Concours 14 (ZG 1400 B/D)	08-10	CK4520		CSK23					CT021
ZX14 (ZX 1400 A/C)	06-11	CK4518		CSK124					CT021
ZX14 R (ZX 1400 E) (Non ABS)	12-14	CK4518		CSK23					CT021
ZX14 R (ABS Model) ZX 1400 F/H (ABS)	13-16	CK4518		CSK23					CT021
ZX14 R (ABS/SE Model) ZX 1400 J	16	CK4518		CSK23					CT021
VN 1500 A Vulcan 88	87-99	CK4455		N/A					CT032
VN 1500 B/C Vulcan 88 SE/Classic	87-99	CK4455		N/A					CT032
VN 1500 D/E Vulcan 88 SE/Classic	96-04	CK4455		N/A					CT032
VN 1500 G Nomad	99-01	CK4455		N/A					CT032
VN 1500 Drifter J/R	99-05	CK4455		N/A					CT032
VN 1500 L Vulcan 1500 Nomad F1	01-05	CK4455		N/A					CT032
VN 1500 N Vulcan 1500 Classic Fi	00-02	CK4455		N/A					CT032
VN 1500 Vulcan Mean Streak P	02-03	CK4455		N/A					CT032
VN 1500 N Vulcan 1500 Classic	05-08	CK4455		N/A					CT032
VN 1600 A Classic	03-08	CK4455		N/A					CT032
VN 1600 B Mean Streak	04	CK4455		N/A					CT032
VN 1600 B Mean Streak	05-08	CK4455		N/A					CT032
VN 1600 D Nomad	05-08	CK4455		N/A					CT032
VN 1700 G Vulcan 1700 Classic LT	09-10	CK4516		CSK170					CT032
VN 1700 A Vulcan 1700 Voyager	09-13	CK4516		CSK170					CT032
VN 1700 B Vulcan 1700 Voyager ABS	09-16	CK4516		CSK170					CT032
VN 1700 C Vulcan 1700 Nomad	09-13	CK4516		CSK170					CT032
VN 1700 D Vulcan 1700 Nomad	14	CK4516		CSK170					CT032
VN 1700 C Vulcan 1700 Nomad 2T	09	CK4516		CSK170					CT032
VN 1700 E Vulcan 1700 Classic	09-11	CK4516		CSK170					CT032
VN 1700 G Vulcan 1700 Classic LT	09-10	CK4516		CSK170					CT032
VN 1700 J Vulcan Vaquero	11-13	CK4516		CSK170					CT032
VN 1700 K Vulcan Vaquero ABS	14-16	CK4516		CSK170					CT032
VN 1700 K Vulcan Vaquero ABS SE	14	CK4516		CSK170					CT032
VN 2000 A/G Vulcan	04-09	CK4516		CSK110					CT032
VN 2000 D/G Vulcan Ltd	05-06	CK4516		CSK110					CT032
VN 2000 E/H Vulcan Classic	06-09	CK4516		CSK110					CT032
VN 2000 F/J Vulcan Classic LT	06-10	CK4516		CSK110					CT032

CLUTCH APPLICATIONS

EBC BRAKES CLUTCH KITS



SUZUKI



		CK cork OEM style Kit #	CKF carbon fiber style upgrade Kit #	CSK Spring Kit #	DRC Series Kit #	DRCF Series Kit #	SRC Series Kit #	SRK Series Kit #	CT Tool #
AC 50 R	70-71	CK3311		CSK25					CT051
AS 50 Sport/Colt	68-69	CK3311		CSK25					CT051
JR 50 C/N/T/X/Z/F/G/H/J/K/L/N/P/R/S/T/N/W/X/Y/K	78-06	CK3366		N/A					
RB 50 H (GSXR 50)	87	CK3380		CSK13					CT051
RM 50 C/N/T	78-80	CK3328		CSK1					CT011
RM 60 N/T/X/Z/D	79-83	CK3318	CKF3318	CSK1					CT011
RM 60 K	03	CK4438	CKF4438	CSK18	DRC7				CT070SP
RM 65 K	03-05	CK4438	CKF4438	CSK40	DRC98	DRCF98			CT070SP
DR-Z 70 K/L	08-09/15	CK3458		N/A					
DS 80 T/X/Z	80-82	CK3340		CSK1					CT011
DS 80 D/F/G/H/J/K/L/M/N/P/R/S/T/N/W/X/Y	83-00	CK3340		CSK1					CT011
JR 80 K	01-04	CK3340		CSK1					CT011
RM 80 T/X	80-81	CK3318	CKF3318	CSK1					CT011
RM 80 Z/D	82-83	CK3340		CSK36					CT011
RM 80 E/F	84-85	CK3318	CKF3318	CSK34					CT011
RM 80 G	86	CK3367		CSK34					
RM 80 H/J	87-88	CK3367		CSK55	DRC19				
RM 80 K/L	89-90	CK3318		CSK36	DRC20				CT011
RM 80 M/N/P/R/S/T/N/W/X/Y/K	91-01	CK3318	CKF3318	CSK14	DRC25	DRCF25			CT011
RM 85 K/L/L/LL	02-12/15-16	CK3318	CKF3318	CSK14	DRC25	DRCF25			CT011
TC 90/R/J Blazer	70-72	CK3312		CSK25					CT051
TS 90/R/J Honcho	70-72	CK3312		CSK25					CT051
A 100 A/B Gofer	76-77	CK3312		CSK25					CT051
B 100 P Magnum (118cc)	65-66	N/A		N/A					
DR 100 D/E	83-84	CK3318	CKF3318	CSK34					CT011
DR 100 F/G/H/J/K/L	85-90	CK3318	CKF3318	CSK34					CT011
DS 100 C/N/T/X	78-81	CK3318	CKF3318	CSK25					CT011
RM 100 A	76	CK3319	CKF3319	CSK25					CT011
RM 100 A/B	77-78	CK3329		CSK25					CT011
RM 100 N/T/X	79-81	CK3319		CSK25					CT011
RM 100 K	03-04	CK4438	CKF4438	CSK40	DRC98	DRCF98			CT070SP
SP 100 D	83	CK3318	CKF3318	CSK1					CT011
TC 100 K/L/M/A/B Blazer	73-77	CK3326		CSK25					CT051
TS 100 K/L/M/A/B Honcho	73-77	CK3326		CSK25					CT051
TS 100 T/X	80-81	CK3337		CSK25					CT011
DR-Z 110 K	03-05	CK4438	CKF4438	CSK40	DRC98	DRCF98			CT070SP
B 120 (118cc - 106mm outer diameter friction plate)	71-77	CK3306		CSK1					CT052
KT 120 Trail	68-70	N/A		N/A					CT052
TC 120 Trailcat	68-71	CK3306		CSK1					CT052
ALT 125 D/E/F/G	83-86	CK3328		N/A					CT011
DR 125 Z/D/E	82-84	CK3318		CSK34					CT011
DR 125 G/H/J	86-88	CK3318		CSK34					CT011
DR 125 SER/SES/SET	94-96	CK3318		CSK34					CT011
DR-Z 125 K/L	03-16	CK3318		CSK34					CT011
DR-Z 125 LK/LL	03-16	CK3318		CSK34					CT011
DS 125 N/T/X	79-81	CK3318		CSK25					CT011
GN 125 Z/D	82-83	CK3318	CKF3318	CSK34					CT011
GN 125 E	91-97	CK3318	CKF3318	CSK34					CT011
LT 125 D/E/F/G/H	83-87	CK3328		N/A					CT011
RM 125 A/B/C	76-78	CK3329		CSK25					CT011
RM 125 X/Z	81-82	CK3329		CSK36					CT011
RM 125 D	83	CK3329		CSK34					CT011
RM 125 E	84	CK3356		CSK34					CT011
RM 125 F	85	CK3329		CSK34					CT011
RM 125 G/H	86-87	CK3319		CSK1	DRC21				CT011
RM 125 J/K/L/M	88-91	CK3356		CSK53	DRC22				CT011
RM 125 N	92	CK3401		CSK32	DRC114				CT003

CLUTCH
APPLICATIONS

EBC BRAKES CLUTCH KITS



SUZUKI



		CK cork OEM style Kit #	CKF carbon fiber style upgrade Kit #	CSK Spring Kit #	DRC Series Kit #	DRCF Series Kit #	SRC Series Kit #	SRK Series Kit #	CT Tool #
RM 125 P/R/S/T/V/W	93-98	CK3401		CSK27	DRC76S				CT003
RM 125 X/Y/K	99-01	CK3401		CSK91	DRC115				CT003
RM 125 K	02-08	CK4514	CKF4514	CSK91	DRC130	DRCF130			CT003
RV 125 K/L/M/A/B Tracker	73-77	CK3318	CKF3318	CSK25					CT011
SP 125 Z/D	82-83	CK3318	CKF3318	CSK34					CT011
SP 125 G/H/J	86-88	CK3318	CKF3318	CSK34					CT011
T 125/11/R Stinger	69-71	CK3306		CSK25					CT052
TC 125 J/K/L/M/A/B Prospector	72-77	CK3318	CKF3318	CSK25					CT011
TM 125 K/L/M Challenger	73-75	CK3319	CKF3319	CSK25					CT011
TS 125 T/X	80-81	CK3337		CSK25					CT011
S32 (150cc)	65	N/A		N/A					
S32-11 (150cc)	66-67	N/A		N/A					
LT 160 EK /EL/EM/EN	89-92	CK3364		CSK48	DRC218				CT011
LT 160 K	03-04	CK3364		CSK48	DRC218				CT011
LT-F 160 M/N/P/R/S/T/V/W/X/Y/K1/K3	91-03	CK3364		CSK48	DRC218				CT011
PE 175 T/X/Z/D/E	80-84	CK3329		CSK25					CT011
RS 175 T/X/Z	80-82	CK3329		CSK25					CT011
ALT 185 F	85	CK3328		N/A					CT011
DS 185 T	80	CK3319		CSK25					CT011
GT 185 K/L/M/A/B Adventurer	73-77	CK3319		CSK25					CT011
LT 185 E/F/G/H	84-87	CK3328		N/A					CT011
TS 185 T/X	80-81	CK3319		CSK25					CT011
DR 200 G/H/J	86-88	CK3319	CKF3319	CSK34	DRC94				CT011
DR 200 SE	96-09/13/15-16	CK3319	CKF3319	CSK34	DRC274				CT011
SP 200 G/H/J	86-88	CK3319	CKF3319	CSK34	DRC94				CT011
T 200 X5 - Invader	68-69	CK3319		CSK25					
TC 200 X5 Stingray	67-69	CK3319	CKF3319	CSK25					
LT 230 GEF/GEG	85-86	CK3364		CSK48	DRC218				CT011
LT 230 S up to E/No. 104360	85-88	CK3364		CSK34					CT011
LT 230 S from E/No. 104361	85-88	CK3319		CSK34	DRC94				CT011
LT-F 230 G/H	86-87	CK3364		CSK48	DRC218				CT011
LT 230 E	87-93	CK3364		CSK48	DRC218				CT011
DR 250 Z/D/F	82-85	CK3358		CSK26					CT029
DR 250 L/M/N/P	90-93	CK3399	CKF3399	CSK34	DRC58	DRCF58			CT022
DR 250 S/SE	90-95	CK3399	CKF3399	CSK34	DRC58	DRCF58			CT022
DR-Z 250 K	01-07	CK1181	CFK1181	CSK46	DRC280	DRCF280			CT013
DS 250 T	80	CK3315		CSK158					CT022
GS 250 TT/TX	80-81	CK3329		CSK36					CT011
GN 250 Z/D/F/J	82-88	CK3358		CSK158					CT029
GT 250 K/L Hustler	73-74	CK3313		CSK6					CT022
GT 250 M/A/B Hustler	75-77	CK3315		CSK6					CT022
GW 250 L (Naked)	14-15	CK3358		CSK204					CT029
GW 250 FL (Fairing)	14-15	CK3358		CSK204					CT029
GZ 250 X/Y/K/L Marauder	99-10	CK3358		CSK68					CT029
LT 250 EFF/EFG	85-86	CK3390		CSK48	DRC89				CT011
LT 250 SK/SL	89-90	CK3329		CSK34	DRC96				CT011
LT 250 R	85	CK3319		CSK34					CT011
LT 250 R	86	CK3319		CSK146					CT011
LT 250 R	87-92	CK3372		CSK34	DRC23				CT022
LT 4WD Quadrunner 4WD H/J/K/L/M/N/P/R/S/T/V	87-97	CK3390		CSK48	DRC89				CT011
LT-F 4WD V/W Quadrunner 4WD (250cc)	97-98	CK3390		CSK48	DRC89				CT011
LT-F 250 J/K/L/M/N/P/R/S/V/W/X/Y/K1	88-01	CK3390		CSK48	DRC89				CT011
LT-F 250 FX/FY/FK1/FK2 Quadrunner	99-02	CK3390		CSK48	DRC89				CT011
LT-F 250 K Ozark Up to frame JSAAJ51A22100696	02	CK3364		CSK48	DRC220				CT011
LT-F 250 K Ozark From frame JSAAJ51A22100697-	02	CK3364		CSK147	DRC297				CT011
LT-F 250 K Ozark	03	CK3390		CSK147	DRC221				CT011
LT-F 250 K Ozark	04	CK3448		CSK48	DRC222				CT011

CLUTCH APPLICATIONS

EBC BRAKES CLUTCH KITS



SUZUKI



		CK cork OEM style Kit #	CKF carbon fiber style upgrade Kit #	CSK Spring Kit #	DRC Series Kit #	DRCF Series Kit #	SRC Series Kit #	SRK Series Kit #	CT Tool #
LT-F 250 K/L Ozark	05-14	CK3390		CSK147	DRC221				CT011
LT-Z 250 K QuadSport	04-11	CK3448		CSK48	DRC222				CT011
PE 250 T/X	80-81	CK3331		CSK158					CT022
RM 250 T/X/Z/D/E/F	80-85	CK3331		CSK158					CT022
RM 250 G	86	CK3372		CSK34					CT022
RM 250 H	87	CK3372		CSK55	DRC52				CT022
RM 250 J/K/L	88-90	CK3374		CSK27	DRC24				CT022
RM 250 M	91	CK3400		CSK45	DRC40				CT022
RM 250 N/P	92-93	CK3400		CSK32	DRC48				CT022
RM 250 R/S	94-95	CK3374		CSK32	DRC72				CT022
RM 250 T	96	CK4435	CKF4435	CSK32	DRC80				CT016
RM 250 VW/X/Y/K	97-02	CK4435	CKF4435	CSK91	DRC95				CT016
RM 250 K	03-05	CK3454		CSK91	DRC161				CT016
RM 250 K	06-08	CK3453		CSK119	DRC160				CT016
RMX 250 K/L	89-90	CK3374		CSK27					CT022
RMX 250 M	91	CK3374		CSK45					CT022
RMX 250 N/P	92-93	CK3400		CSK32					CT022
RMX 250 R/S/T/V/W/X/Y	94-00	CK3374		CSK32	DRC72				CT022
RM-Z 250 K	04-06	CK4514	CKF4514	CSK97	DRC123	DRCF123			CT004
RM-Z 250 K	07-09	CK4514	CKF4514	CSK141	DRC189	DRCF189			CT004
RM-Z 250 L	10-16	CK4514	CKF4514	CSK164	DRC255	DRCF255			CT004
RS 250 T/X	80-81	CK3331		CSK158					CT022
SP 250 Z/D/F	82-85	CK3358		CSK26					CT029
T 10 (250cc)	66-67	N/A		N/A					
T 20 X6 (250cc)	65-69	CK3310		CSK76					CT038SP
T 250 11/R/J Hustler	69-72	CK3313		CSK6					CT046
TC 250 X6 Scrambler	67-69	CK3310		CSK76					CT038SP
TS 250 N/T/X	80-81	CK3315		CSK158					CT022
TU 250 XK/XL	09-16	CK3358		CSK158					CT029
GS 300 LZ/LD/LF	82-85	CK3356		CSK34					CT011
LT 300 EH/EJ/EK Quadrunner	87-88	CK3390		CSK48	DRC89				CT011
LT-F 300 F/FK King Quad	99-02	CK3356		CSK48	DRC103				CT011
LT-F 4WD XM/N/P/R/S/T/V/W 300 King Quad	91-97	CK3356		CSK48	DRC103				CT011
T 305 Raider	68-69	CK3313		CSK6					CT046
TC 305 Laredo	68	CK3313		CSK6					CT046
DR 350 L/M/N/P/R/S/T/V/W	90-98	CK3399	CKF3399	CSK34	DRC58	DRCF58			CT022
DR 350 S/SE	90-99	CK3399	CKF3399	CSK34	DRC58	DRCF58			CT022
T 350 Rebel	69-72	CK3313		CSK6					CT046
DR 370 C/N (4T)	78-79	CK3334		CSK158					CT022
RM 370 A/B (2T)	76-77	CK3315		CSK158					CT022
GT 380 J/K/L/M/A/B Sebring	72-77	CK3315		CSK6					CT022
DR 400 T	80	CK3332		CSK158					CT022
DR-Z 400 S	00-16	CK3433	CKF3433	CSK79	DRC105	DRCF105			CT006
DR-Z 400 EY/Y/EK/K	00-07	CK3433	CKF3433	CSK79	DRC105	DRCF105			CT006
DR-Z 400 SMK/SML	05-09/13-16	CK3433	CKF3433	CSK79	DRC105	DRCF105			CT006
GSF 400 M/N/P	91-93	CK3397		CSK34					CT011
GN 400 T/XT/TX/TZ	80-82	CK3332		CSK158					CT022
GS 400 B/C	77-78	CK3343		CSK6					CT018SP
GS 400 XB/XC	77-78	CK3343		CSK6					CT018SP
LT-F 400 FK King Quad 400 FS	08-09	CK4439		CSK98	DRC120				CT006
LT-F 400 FCK King Quad 400 FS Camo	08-09	CK4439		CSK98	DRC120				CT006
LT-F 400 FK (Eiger 4WD)	02-07	CK4439		CSK98	DRC120				CT006
LT-F 400 K Eiger Manual 2WD	02	CK4439		CSK98	DRC223				CT006
LT-F 400 K	03-08	CK4439		CSK98	DRC120				CT006
LT-F 400 FQK King Quad 400 FS Anniversary Edition	09	CK4439		CSK98	DRC120				CT006
LT-F 400 FL King Quad 400 FSi	11-16	CK4439		CSK98	DRC120				CT006
LT-F 400 FCL King Quad Camo 400 FSi	11-16	CK4439		CSK98	DRC120				CT006

CLUTCH
APPLICATIONS

EBC BRAKES CLUTCH KITS



SUZUKI



		CK cork OEM style Kit #	CKF carbon fiber style upgrade Kit #	CSK Spring Kit #	DRC Series Kit #	DRCF Series Kit #	SRC Series Kit #	SRK Series Kit #	CT Tool #
LT-Z 400 K QuadSport	03-04	CK3433	CKF3443	CSK79	DRC105	DRCF105			CT006
LT-Z 400 K/ZK/L2	05-14	CK3447	CKF3447	CSK79	DRC137	DRCF137			CT006
PE 400 T/X	80-81	CK3332		CSK158					CT022
RM 400 C	78	CK3315		CSK158					CT022
RM 400 N/T	79-80	CK3332		CSK158					CT022
SP 400 T	80	CK3332		CSK158					CT022
TM 400 R/J/K/L/M Cyclone	71-75	CK3316		CSK158					CT022
GS 425 N (Spoke Wheel)	79	CK3343		CSK6					CT018SP
GS 425 EN (Cast Wheel)	79	CK3343		CSK6					CT018SP
GS 425 LN	79	CK3343		CSK6					CT018SP
GS 450 E	80-83	CK3333		CSK158					CT022
GS 450 L	80-88	CK3333		CSK158					CT022
GS 450 T	81-83	CK3333		CSK158					CT022
LT-R 450 K	06-11	CK3450	CKF3450	CSK125	DRC164	DRCF164			CT045
LT-R 450 ZK Quadracer SE	08-10	CK3450	CKF3450	CSK125	DRC164	DRCF164			CT045
RMX 450 ZL	10-11	CK3450	CKF3450	CSK186	DRC155	DRCF155			CT045
RM-Z 450 K	05-07	CK3450	CKF3450	CSK164	DRC254	DRCF254			CT045
RM-Z 450 K/L	08-16	CK3450	CKF3450	CSK186	DRC155	DRCF155			CT045
RM 465 X/Z	81-82	CK3348		CSK158					CT029
DR 500 X/Z/D	81-83	CK3359		CSK115					CT029SP
GS 500 E/K	89-03	CK3333		CSK61					CT022
GS 500 FK	04-10	CK3333		CSK61					CT022
LT 500 RH/RJ/RK/RL	87-90	CK3374		CSK34	DRC26				CT022
LT-F 500 F/FK Quadrunner	98-02	CK4439		CSK88	DRC217				CT006
LT-F 500 FK Vinson 4WD	03-07	CK3452		CSK7	DRC216				CT006
RM 500 D/E	83-84	CK3348		CSK158					CT029
SP 500 X/Z/D	81-83	CK3359		CSK115					CT029SP
T 500 1 Cobra (18 Ear Clutch Plate)	68	CK3314		CSK6					CT046
T 500 39873 Titan (18 Ear Clutch Plate)	69-70	CK3314		CSK6					CT046
T 500 R/J/K/L/M Titan (12 Ear Clutch Plate)	71-75	CK3316		CSK6					CT022
RE 5 M/A (Rotary)	75-76	CK3373		CSK6					CT035SP
GS 550 B/C/EC/N/EN/ET	77-80	CK3344		CSK159					CT018SP
GS 550 MZ	82	CK3344		CSK159					CT018SP
GS 550 LT/LX/LZ	80-82	CK3344		CSK159					CT018SP
GS 550 LD/LF/LG/TX	81-85	CK3344		CSK159					CT018SP
GS 550 E/ES	83	CK3344		CSK159					CT018SP
GS 550 ES/E	84-85	CK3344		CSK159					CT018SP
GT 550 J/K/L/M/A/B Indy	72-77	CK3321		CSK158					CT035SP
GSF 600 S Bandit	96-98	CK3348		CSK198					CT047SP
GSF 600 S/SK	00-02	CK3348		CSK198					CT047SP
GSX 600 F Katana	88-91	CK3348		CSK26			SRC13	SRK13	CT047SP
GSX 600 F Katana	92-97	CK3387		CSK198			SRC17	SRK17	CT036SP
GSX 600 F/FK - Katana	98-06	CK3357		CSK198					CT047SP
GSX-R 600 WN/WP	92-93	CK3387		CSK198			SRC17	SRK104	CT036SP
GSX-R 600 V/W	97-98	CK1206		CSK902			SRC58	SRK106	CT055SP
GSX-R 600 X/Y	99-00	CK1206		CSK902			SRC58	SRK58	CT055SP
GSX-R 600 K/ZK	01-03	CK3466		CSK156			SRC112	SRK112	CT014
GSX-R 600 K	04-05	CK1206		CSK156			SRC78	SRK78	CT014
GSX-R 600 K	06-07	CK3455		CSK205			SRC86	SRK86	CT015
GSX-R 600 K	08-10	CK3456		CSK205			SRC88	SRK109	CT015
GSX-R 600 L	11-16	CK3456		CSK183			SRC110	SRK110	CT015
RF 600 R	94-96	CK3408		CSK198			SRC45	SRK45	CT036SP
SP 600 F	85	CK3359		CSK115					CT029SP
DL 650 K V-Strom	04-09	CK1219		CSK133					CT033SP
DL 650 AK/AL V-Strom (ABS Model)	07-16	CK1219		CSK133					CT033SP
DL 650 XT V-Strom ABS (DL 650 XAL5/XAL6)	15-16	CK1219		CSK133					CT033SP
DL 650 AAL V-Strom (ABS Adventure)	12-16	CK1219		CSK133					CT033SP

CLUTCH APPLICATIONS

EBC BRAKES CLUTCH KITS



SUZUKI



		CK cork OEM style Kit #	CKF carbon fiber style upgrade Kit #	CSK Spring Kit #	DRC Series Kit #	DRCF Series Kit #	SRC Series Kit #	SRK Series Kit #	CT Tool #
DR 650 S	90-93	CK3402		CSK115	DRC59				CT029SP
DR 650 S	94-95	CK3402		CSK115	DRC142				CT029SP
DR 650 SE/SEK/SEL	96-16	CK3386		CSK26	DRC87				CT024
GR 650 D/XD	83	CK3357		CSK26					CT029
GS 650 E/G	81-83	CK3330		CSK159					CT018SP
GS 650 GL	81-83	CK3330		CSK159					CT018SP
GS 650 MD	83	CK3330		CSK159					CT018SP
G SX 650 FK	08-10	CK1218	CKF1218	CSK122					CT014
LS 650 F/P/PK	86-88/95-04	CK3359		CSK26					CT029SP
LS 650 K/L Boulevard S40 (650cc)	05-15	CK3359		CSK26					CT029SP
SFV 650 K/L	09-10/13-15	CK1219		CSK133			SRC82	SRK82	CT033SP
SV 650 X/Y/K/SK	99-02	CK3377		CSK69			SRC81	SRK81	CT022
SV 650 K/SK	03-10	CK1219		CSK133			SRC82	SRK82	CT033SP
SV 650 AK/SAK ABS	07-10	CK1219		CSK133			SRC82	SRK82	CT033SP
SV 650 AL (ABS)	16-17	CK1219		CSK133			SRC82	SRK82	CT033SP
XN 85 D	83	CK3347		CSK158					CT018SP
GS 700 E	85	CK3330		CSK115					CT018SP
GV 700 GL	85	CK3374		CSK115					CT022
VS 700 GL	86-87	CK3377		CSK115					CT029
GS 750 B/C/E/N/E	77-79	CK3324		CSK158					CT018SP
GS 750 E	80-82	CK3330		CSK158					CT018SP
GS 750 T	82-83	CK3330		CSK158					CT018SP
GS 750 L	80-81	CK3330		CSK158					CT018SP
GS 750 E/ES	83	CK3330		CSK115					CT018SP
GS 750 SD	83	CK3330		TBA					CT018SP
G SX 750 F	89-96	CK3391		CSK12					
G SX 750 F Katana	98-06	CK3357		CSK198					CT047SP
G SX-R 750 RG (Dry Clutch - Sintered Friction)	86	CK3376		CSK198			N/A	SRK138	CT072SP
G SX-R 750 G/H	86-87	CK3348		CSK115			SRC13	SRK13	CT047SP
G SX-R 750 J/K	88-89	CK3387		CSK12			SRC14	SRK14	CT036SP
G SX-R 750 L/M/N	90-92	CK3387		CSK198			SRC17	SRK17	CT036SP
G SX-R 750 WP/WR/WS	93-95	CK3387		CSK198			SRC17	SRK104	CT036SP
G SX-R 750 T/V/W/X	96-99	CK3417		CSK902			SRC40	SRK40	CT055SP
G SX-R 750 Y	00	CK1229		CSK156			SRC71	SRK71	CT014
G SX-R 750 K	01-03	CK3465		CSK156			SRC111	SRK111	CT014
G SX-R 750 K	04-05	CK3417		CSK75			SRC121	SRK121	CT014
G SX-R 750 K	06-07	CK3456		CSK205			SRC88	SRK88	CT015
G SX-R 750 K/L	08-10	CK3456		CSK205			SRC88	SRK109	CT015
G SX-R 750 L	11-16	CK3456		CSK183			SRC110	SRK110	CT015
G SX-S 750 L	15-16	CK3417		CSK109					CT014
G SX-S 750 ZL	15	CK3417		CSK109					CT014
GT 750 J/K/L/M/A/B	73-77	CK3324		CSK15					CT018SP
VS 750 GLP	88-91	CK3377		CSK115					CT029
VL 800 K Intruder Volusia	01-04	CK3377		CSK66					CT029
VL 800 ZK Volusia LTD (Seat Trimmed With Chrome Studs)	03-04	CK3377		CSK66					CT029
VL 800 CK/K/ZK/L (C 50 Boulevard)	05-15	CK3377		CSK66					CT029
VL 800 TK/TL (C 50 T Boulevard Tourer)	05-15	CK3377		CSK66					CT029
VL 800 BTL4 (Boulevard C50 B.O.S.S./Cast Wheels)	14	CK3377		CSK66					CT029
VL 800 CL3 (Boulevard C50/Cast Wheels)	13	CK3377		CSK66					CT029
VX 800 L/M/N/P (8 spring CSK kit)	90-93	CK3377		CSK162					CT029
VS 800 Intruder GL/GLK	92-04	CK3377		CSK115					CT029
VS 800 K/L S50 Boulevard	05-10	CK3377		CSK115					CT029
VZ 800 V/W/X/Y/K Marauder (8 spring CSK kit)	97-04	CK3377		CSK162					CT029
VZ 800 K/BK/ZK (M50 Boulevard)	05-10	CK3377		CSK66					CT029
VZ 800 L (M50 Boulevard)	10-15	CK3377		CSK66					CT029
GS 850 G	79-80	CK3330		CSK158					CT018SP
GS 850 G	81-83	CK3330		CSK158					CT018SP

CLUTCH
APPLICATIONS

EBC BRAKES CLUTCH KITS



SUZUKI



		CK cork OEM style Kit #	CKF carbon fiber style upgrade Kit #	CSK Spring Kit #	DRC Series Kit #	DRCF Series Kit #	SRC Series Kit #	SRK Series Kit #	CT Tool #
GS 850 G	80-81	CK3330		CSK158					CT018SP
GS 850 G	82-83	CK3330		CSK158					CT018SP
RF 900 R	94	CK3418		CSK902			SRC39	SRK39	CT055SP
RF 900 R	95-97	CK3417		CSK29					CT014
DL 1000 K/L V-Strom	02-12	CK3443		CSK43					CT021
DL 1000 AL V-Strom ABS	12/14-16	CK3443		CSK43					CT021
DL 1000 AL/AAL V-Strom Adventure	12/14-16	CK3443		CSK43					CT021
GS 1000 C/N/EC/EN/SN/ET/ST	78-80	CK3345		CSK158			SRC115	SRK115	CT035SP
GS 1000 SZ	82	CK3335		CSK6					CT024SP
GS 1000 GT/GX	80-81	CK3335		CSK158			SRC50	SRK50	CT024SP
GS 1000 GLT/GLX/SZ	80-82	CK3335		CSK158			SRC50	SRK50	CT024SP
GSX-R 1000 K/ZK	01-04	CK4510		CSK128			SRC89	SRK89	CT004
GSX-R 1000 K	05-08	CK3451		CSK145			SRC85	SRK85	CT015
GSX-R 1000 K/L	09-11	CK3462		CSK160			SRC97	SRK97	CT009
GSX-R 1000 L	12-16	CK3462		CSK196			SRC120	TBA	CT009
GSX-R 1000 AL ABS	15-16	CK3462		CSK196			SRC120	TBA	CT009
GSX-R 1000 AL ABS/3 Spring clutch	17	CK3468		CSK242			SRC142	SRK142	CT009
GSX-S 1000 L (Non ABS)	16-17	CK4510		CSK223					CT004
GSX-S 1000 L (Non ABS)	18	CK3451		CSK145			SRC085	SRK085	CT015
GSX-S 1000 AL (ABS)	16-17	CK4510		CSK223					CT004
GSX-S 1000 AL (ABS)	18	CK3451		CSK145			SRC085	SRK085	CT015
GSX-S 1000F L (Non ABS)	16-17	CK4510		CSK223					CT004
GSX-S 1000F L (Non ABS)	18	CK3451		CSK145			SRC085	SRK085	CT015
GSX-S 1000F AL (ABS)	16-17	CK4510		CSK223					CT004
GSX-S 1000F AL (ABS)	18	CK3451		CSK145			SRC085	SRK085	CT015
SV 1000 K/SK	03-07	CK3443		CSK114					CT021
TL 1000 S	97-98	CK3417		CSK78					CT014
TL 1000 S	99-00	CK3428		CSK71			SRC68	SRK68	CT009
TL 1000 R	98-00	CK3428		CSK71			SRC68	SRK68	CT009
TL 1000 RK	01-03	CK3435		CSK71					CT009
TL1 000 SK	01-02	CK3435		CSK71					CT009
GS 1100 E	80-82	CK3335		CSK158			SRC50	SRK50	CT024SP
GS 1100 E	83	CK3346		CSK6					CT024SP
GS 1100 G	82-83	CK3335		CSK158			SRC50	SRK50	CT024SP
GS 1100 GL	82-83	CK3335		CSK158			SRC50	SRK50	CT024SP
GS 1100 GK	82-84	CK3335		CSK158			SRC50	SRK50	CT024SP
GS 1100 LT	80	CK3335		CSK158			SRC50	SRK50	CT024SP
GS 1100 SD	83	CK3346		CSK6					CT024SP
GSX 1100 F	88-93	CK3381		CSK12					CT048SP
GSX 1100 G	91-93	CK3392		CSK902			SRC10	SRK10	CT055SP
GSX-R 1100 G/H/J	86-88	CK3381		CSK115			SRC15	SRK15	CT048SP
GSX-R 1100 K/L/M/N	89-92	CK3392		CSK902			SRC10	SRK10	CT055SP
GSX-R 1100 W	93-98	CK3418		CSK902			SRC39	SRK39	CT055SP
GS 1150 ES	83-86	CK3335		CSK6					CT024SP
GSF 1200 S/SK	97-05	CK3417		CSK902			SRC40	SRK40	CT055SP
GV 1200 GL	85-86	CK3375		CSK115					CT029
GSF 1250 SAK (ABS)	07-10	CK3459		CSK124					CT021
GSF 1250 SK Bandit	07-10	CK3459		CSK124					CT021
GSX 1250 FAL	11-12	CK3459		CSK124					CT021
GSX 1250 SAL Bandit	16	CK3459		CSK124					CT021
GSX 1300 RX Hayabusa	99	CK3430		CSK72			SRC67	SRK67	CT021
GSX 1300 RY/RK1 Hayabusa	00-01	CK3430		CSK171					CT021
GSX 1300 RK/RZK	02-07	CK3443		CSK171					CT021
GSX 1300 RK/RL	08-12	CK3443		CSK139					CT021
GSX 1300 RAL ABS Hayabusa	13-16	CK3443		CSK139					CT021
GSX 1300 RZL (Hayabusa 50th Anniversary Edition)	14	CK3443		CSK139					CT021
GSX 1300 BKAK/K B-King ABS	08-10	CK3443		CSK139					CT021

CLUTCH APPLICATIONS

EBC BRAKES CLUTCH KITS



SUZUKI



		CK cork OEM style Kit #	CKF carbon fiber style upgrade Kit #	CSK Spring Kit #	DRC Series Kit #	DRCF Series Kit #	SRC Series Kit #	SRK Series Kit #	CT Tool #
GSX 1300 BKK/K B-King	08-10	CK3443		CSK139					CT021
GV 1400 G	86-88	CK3388		CSK115					CT029
VS 1400 GLP/GLF	87-04	CK3382		N/A					CT029
VS 1400 GLPK/K/L Boulevard S83 (1400cc)	05-10	CK3382		N/A					CT029
VL 1500 W/X/Y/K Intruder Legendary Classic	98-04	CK3335		CSK31					CT024SP
VL 1500 BK/K/TK/L/TL Boulevard C90/C90T	05-10/13	CK3335		CSK31					CT024SP
VL 1500 BL (Boulevard C90 B.O.S.S.)	13-15	CK3459		TBA					CT021
VL 1500 BTL (Boulevard C90T B.O.S.S./With Windshield)	13-14	CK3459		TBA					CT021
VL 1500 L (Boulevard C90)	13	CK3459		TBA					CT021
VL 1500 TL (Boulevard C90T/With Windshield)	13-14	CK3459		TBA					CT021
VZ 1500 K/L M90 Boulevard	09/13-15	CK3459		TBA					CT021
VZ 1600 K Marauder	04	CK4455		N/A					CT032
VZ 1600 K M95 Boulevard/Marauder	05	CK4455		N/A					CT032
VLR 1800 RTK (C109RT Boulevard Touring)	08-10	CK3463		CSK75					
VLR 1800 K (C109R Boulevard)	08-10	CK3463		CSK75					
VZR 1800 K/L Boulevard M109R	06-14	CK3457		CSK122					
VZR 1800 NK Boulevard Limited M109R2	08-09	CK3457		CSK122					
VZR 1800 ZK/ZL Boulevard RZ Limited (M109RZ)	08-14	CK3457		CSK122					
VZR 1800 BL (Boulevard B.O.S.S. M109R)	14-15	CK3457		CSK122					
YAMAHA									
DT 50 U/W/A (DTL/C)	88-89	CK2206		CSK42					CT044
RX 50 MK Midnight Special	83	CK2205		CSK42					CT044
RX 50 K/L 50 Special	83/84	CK2205		CSK42					CT044
TT-R 50 E	06-09/12-14	TBA		N/A					
YFM 50 S/T/R Raptor	04-08	CK2303		N/A					
YSR 50 T/U/W	87-89	CK2205		CSK42					CT044
YSR 50 A/B/D	90-92	CK2205		CSK42					CT044
YZ 50 G	80	CK2206		CSK42					CT044
YZ 60 H/J/K	81-83	CK2265		CSK42					CT010
BW 80 S/T/U/A	86-90	CK2303		N/A					
DT 80 H/J/K	81-83	CK2206		CSK42					CT044
MX 80 G/H/J	80-82	CK2206		CSK42					CT044
PW 80 K/N/B/D/E/F/G/H/J/K/L/M/N/P/R/S/T/V	83-06	CK2303		N/A					
V 80 (3NX3/4)	94	CK2303		N/A					
V 80 (4GC5/6/3NX6)	98	CK2303		N/A					
V 80 D (4GC2/3/4) - 3 = Single Seat / 4 = Dual Street	94-96	CK2303		N/A					
YFM 80 N/S/T/U (Moto 4)	85-88	CK2303		N/A					
YFM 80 D/E/F/G/H/J/K/L/M/N Badger	91-01	CK2303		N/A					
YFM 80 WP/WR/WS/RT/RV/RW/RX Raptor	02-08	CK2303		N/A					
YFM 80 GT/GV/GW/GX Grizzly	05-08	CK2303		N/A					
YZ 80 G	80	CK2238		CSK42					CT044
YZ 80 H/J/K/L/N	81-85	CK2287		CSK42					CT010
YZ 80 S/T/U/W/A/B/D	86-92	CK2304		CSK42	DRC27				CT010
YZ 80 E/F	93-94	CK2304		CSK39	DRC66				CT010
YZ 80 G/H/J/K/L/M/N	95-01	CK2335	CKF2335	CSK42	DRC78				CT010
YZ 85 P/R/S/T/N/W/X/Y/Z/A/B/D/E/F/G	02-16	CK2335	CKF2335	CSK42	DRC111	DRCF111			CT010
TT-R 90 M/N/P/R/ES/S/ET/EV/EW	00-07	CK2354		N/A					
DT 100 G/H/J/K	80-83	CK2254	CKF2254	CSK42					CT044
MX 100 G/H/J/K	80-83	CK2254	CKF2254	CSK42					CT044
RT 100 A/D/E/F/G/H/J/K/L/M	92-00	CK2254	CKF2254	CSK42					CT044
RX 100 (36L/36LO/5RD1/2)	01-03	CK2254		CSK42					CT044
RX 100 (5RD3/4)	04	CK2254		CSK42					CT044
RX 100 C (5RC1/2/3)	04	CK2254		CSK42					CT044
RXZ 100 S (3HS1/2)	88-95	CK2208		CSK42					CT039
YFM 100 T/U/W/A/B Champ	87-91	N/A		N/A					
YZ 100 G/H/J/K	80-83	CK2234		CSK39					CT039

CLUTCH
APPLICATIONS

EBC BRAKES CLUTCH KITS



YAMAHA



		CK cork OEM style Kit #	CKF carbon fiber style upgrade Kit #	CSK Spring Kit #	DRC Series Kit #	DRCF Series Kit #	SRC Series Kit #	SRK Series Kit #	CT Tool #
T 105 E Crypton (5AM4)	99-02	CK2354		N/A					
T 105 SE Crypton (1D81/1D82)	03-09	CK2354		N/A					
TTR 110 E	08-16	CK2375		CSK150					
RXS 115 (3HB6/7)	94-97	CK2254		CSK42					CT044
RXS 115 (3HB8)	99	CK2254		CSK42					CT044
DT 125 G/H	80-81	CK2236		CSK42					CT039
IT 125 G/H	80-81	CK2234		CSK42					CT039
TT-R 125 M/N/P/R/S/E	00-09	CK2254	CKF2254	CSK42	DRC230	DRCF230			CT044
TT-R 125 LWM/L/LE	00-09/11-15	CK2254	CKF2254	CSK42	DRC230	DRCF230			CT044
XT 125 J/K/KC	82-83	CK2256		CSK52					CT039
YBA 125 Vision (5AP1)	01	CK2254		CSK42					CT044
YBA 125 Enticer (3P41)	05	TBA		TBA					
YBA 125 Enticer (5U51)	05	TBA		TBA					
YBA 125 Enticer (16C1/3P42/3)	07-12	TBA		TBA					
YBR 125 (5PY1/2)	01	CK2283		CSK42					CT044
YBR 125 (2D0D/2CS1)	11-13	CK1151		N/A					CT012
YBR 125 C (36S1/2/3/4)	08-13	CK1151		N/A					CT012
YBR 125 E (4P24/4P27/4P2B/4P2H)	06-13	CK1151		N/A					CT012
YBR 125 EB (5RR2/3/4/5/6)	02-05	CK2254		CSK42					CT044
YBR 125 EB (5RR8/9)	06-08	CK2254		CSK42					CT044
YBR 125 ED (5RR1)	01	CK2254		CSK42					CT044
YBR 125 ED (4P28) Cast Wheel	07-09	CK1151		N/A					CT012
YBR 125 ED (4P2C/4P2J) Cast Wheel	10-13	CK1151		N/A					CT012
YBR 125 ESD (4P26) Cast Wheel	07-09	CK1151		N/A					CT012
YBR 125 ESD (4P2A/4P2G) Cast Wheel	10-13	CK1151		N/A					CT012
YBR 125 ESG (43B1/3/5/6/8)	08-13	CK1151		N/A					CT012
YBR 125 K (5TU1/2/4/6/8)	02-06	CK2254		CSK42					CT044
YBR 125 R (1PX1/X2)	11-12	CK1151		N/A					CT012
YFM 125 R Raptor	11-13	CK1151	CKF1151	CSK42					CT012
YT 125 G/H	80-81	CK2252		N/A					
YT 125 J/K/L/N	82-85	CK2251		N/A					
YZ 125 G	80	CK2234		CSK42					CT039
YZ 125 H	81	CK2235		CSK39					CT039
YZ 125 J	82	CK2276		CSK39					
YZ 125 K/L/N	83-85	CK2278		CSK39					CT054SP
YZ 125 S/T	86-87	CK2278		CSK2	DRC28				CT054SP
YZ 125 U	88	CK2312		CSK2	DRC29				CT054SP
YZ 125 W/A	89-90	CK2311		CSK2	DRC30				CT054SP
YZ 125 B/D	91-92	CK2319		CSK81	DRC39				CT005
YZ 125 E/F/G	93-95	CK2325	CKF2325	CSK81	DRC70	DRCF70			CT005
YZ 125 H	96	CK2325	CKF2325	CSK14	DRC85				CT005
YZ 125 J/K/L/M/N	97-01	CK2325	CKF2325	CSK81	DRC70	DRCF70			CT005
YZ 125 P/R/S	02-04	CK2325	CKF2325	CSK14	DRC85				CT005
YZ 125 T/N/W/X/Y/Z/A/B/D/E/F/G (2T)	05-16	CK2325	CKF2325	CSK81	DRC70	DRCF70			CT005
RX-Z 135 (2UX/3UK1)	87-89	CK2349		CSK42					
RX-Z 135 (3UK3/3RSA/3RSB/3UK1)	93-97	CK2349		CSK42					
RX-Z 135 (3XL3/5PV1/5PV2)	00-05	CK2304		CSK42					CT010
FZ 150 (3C12/3C11)	07-08	TBA		TBA					
SR 150 (3UR8)	95	CK2304		CSK42					CT010
YZF-R 15 (150cc) (54C2/3/6)	10-13	TBA		TBA					
FZ 16 (160cc) (1ES1/2/3)	10-13	TBA		TBA					
FZ 16 (160cc) (1ES4)	12-13	TBA		TBA					
FZ 16 ST (160cc) (1ES4)	11-13	TBA		TBA					
DT 175 G/H	80-81	CK2245		CSK42					CT039
IT 175 G/H/J/K	80-83	CK2235		CSK39					CT039
MX 175 G/H	80-81	CK2245		CSK42					CT039
YT 175 J/K	82-83	CK2251		N/A					

CLUTCH APPLICATIONS

EBC BRAKES CLUTCH KITS



YAMAHA



		CK cork OEM style Kit #	CKF carbon fiber style upgrade Kit #	CSK Spring Kit #	DRC Series Kit #	DRCF Series Kit #	SRC Series Kit #	SRK Series Kit #	CT Tool #
RT 180 A/B/D/E/G/H/J	90-97	CK2245		CSK42					CT039
XC 180 K/KC/L/LC/N/NC/DN/DWC/ZL/ZLC/ZN/ZNC	83-85	CK2298		N/A					
SR 185 H/J	81/82	CK2234		CSK42					CT039
BW 200 N/S/ES/ET/EU	85-88	CK2292		CSK149	DRC55				CT039
IT 200 L/N/S	84-86	CK2235		CSK1					CT039
TW 200 T/TC/U/UC/W/WCA/AC/D/DC/E/EC/F/FC/H/HC/J/JC/EK/EKC/L/LC/M									
/MC/N/NC/P/PC/R/RC/S/SC/T/TCN/NC/W/WC/X/Y/Z/A/B/D/E/F Trailway	87-15	CK2234		CSK149	DRC231				CT039
WR 200 D	92	CK2313	CKF2313	CSK42	DRC42	DRCF42			CT010
XT 200 J/K/KC	82-83	CK2236		N/A					CT039
YFM 200 N	85	CK2287		CSK149	DRC232				CT010SP
YFM 200 D (Moto 4)	86-89	CK2287		CSK149	DRC232				CT010SP
YFS 200 U/W/A/B/D/E/F/G/H/J/K/L/M/N/P/R/S/T/V Blaster	88-06	CK2313	CKF2313	CSK42	DRC42	DRCF42			CT010
YTM 200 K/L/N	83-85	CK2287		CSK149	DRC232				CT010SP
YTM 200 E	83-85	CK2287		CSK149	DRC232				CT010SP
TT 225 S/T	86-87	CK2324		CSK149	DRC229				CT039
TT-R 225 L/M/N/P/R/S	99-04	CK2324		CSK149	DRC229				CT039
XT 225 D/DC/E/EC/F/FC/G/GC/H/HC	92-96	CK2234		CSK149	DRC231				CT039
XT 225 J/JC/K/KC/L/M/MC/N/NC/P/PC/R/RC/S/SC/T/TC/V/VC/W/WC	92-07	CK2324		CSK149	DRC229				CT039
YFM 225 S/T/U/W (Moto 4)	86-89	CK2287		CSK52	DRC104				CT010SP
YTM 225 DX	83-85	CK2287		CSK52	DRC104				CT010SP
YTM 225 DR	85-86	CK2287		CSK149	DRC232				CT010SP
TT-R 230 T/V/W/X/Y/A/B/D/E/F	05-09/11-15	CK2324		CSK149	DRC229				CT039
DT 250 A/B/C	74-76	CK2240		CSK2					CT008
DT 250 D/E/F	77-79	CK2223		CSK2					CT008
IT 250 F/G	80	CK2250		CSK2					CT008
IT 250 H/J	81-82	CK2279	CKF2279	CSK2					CT008
IT 250 K	83	CK2280		CSK2	DRC32				CT060
SR 250 G/H/TH	80-81	CK2267		CSK2					CT008
SR 250 J	82	CK2267		CSK2					CT008
SR 250 K (3Y9)	93	CK2261		CSK2					CT008
SR 250 (4GR1/2/3/4/9)	93-08	CK2261		CSK2					CT008
SRX 250 T/TC	87	CK2261		CSK49					CT008
TT 250 G/H/J	80-82	CK2267		CSK1					CT008
TT-R 250 L/M/N/P/R/S/T/V	99-06	CK2319		CSK14	DRC226				CT005
WR 250 Z	91-93	CK2309		CSK81					CT020
WR 250 Z	94-97	CK2274	CKF2274	CSK81	DRC71				CT020
WR 250 F	01	CK2355	CKF2355	CSK81	DRC109	DRCF109			
WR 250 F	02-13	CK2355	CKF2355	CSK2	DRC119	DRCF119			
WR 250 R	08-15	CK2319		CSK81	DRC39				CT005
WR 250 X Supermotard	08-11	CK2319		CSK81	DRC39				CT005
XT 250 G/H/J/K/KC/L/LC	80-84	CK2267		CSK2					CT008
XT 250 X/Y/Z/A/B/D/E/F/G/H	08-17	CK2370	CKF2370	CSK81	DRC295				CT005
XTZ 250 Lander	07-14	CK1217		CSK132					CT014
XTZ 250 Lander	16-18	CK1217		CSK132					CT014
XTZ 250 X	08-10	CK1217		CSK132					CT014
XV 250 Route 66/Virago	88-90/95-07	CK2316		CSK2					CT008
XV 250 V-Star	08-13	CK2316		CSK2					CT008
YBR 250 (41S2/3)	10-12	CK1217		CSK132					CT014
YFB 250 D/E Timberwolf	92-93	CK2287		CSK52	DRC104				CT010SP
YFB 250 F/G/H/UH/J/UJ/UK Timberwolf	94-98	CK2287		CSK52	DRC104				CT010SP
YFB 250 FWF Timberwolf	94-00	CK2287		CSK52	DRC104				CT010SP
YFM 250 W/A/B	89-91	CK2287		CSK52	DRC104				CT010SP
YFM 250 Bear Tracker L/M/X	99-03	CK2287		CSK52	DRC104				CT010SP
YFM 250 B Bruin	05-06	CK2287		CSK52	DRC104				CT010SP
YFM 250 B Big Bear	07-09	CK2287		CSK52	DRC104				CT010SP
YFM 250 R Raptor	08-13	CK2370	CKF2370	CSK58	DRC200	DRCF200			CT005
YFM 250 RS Special Edition	08-09	CK2370	CKF2370	CSK58	DRC200	DRCF200			CT005

CLUTCH
APPLICATIONS

EBC BRAKES CLUTCH KITS



YAMAHA



		CK cork OEM style Kit #	CKF carbon fiber style upgrade Kit #	CSK Spring Kit #	DRC Series Kit #	DRCF Series Kit #	SRC Series Kit #	SRK Series Kit #	CT Tool #
YFM 250 RSPXC Special Edition Custom	08	CK2370	CKF2370	CSK58	DRC200	DRCF200			CT005
YFM 250 RSPA Special Edition	11	CK2370	CKF2370	TBA					CT005
YFUJW/YFUJTW Pro Hauler (230cc)	89	CK2287		CSK52	DRC104				CT010SP
YP 250 Fazer (5D41/2/3/56C1)	06-10	CK1217		CSK132					CT014
YZ 250 N/S	85-86	CK2280		CSK2	DRC32				CT060
YZ 250 H	81	CK2279	CKF2279	CSK2					CT008
YZ 250 J/K/L	82-84	CK2280		CSK2					CT060
YZ 250 N/S/T	85-87	CK2280		CSK103	DRC35				CT060
YZ 250 U/W/A/B/D	88-92	CK2309		CSK2	DRC31				CT020
YZ 250 WR	89-90	CK2309		CSK2					CT020
YZ 250 E/F/G/H/J/K/L	93-99	CK2274	CKF2274	CSK81	DRC71				CT020
YZ 250 M/N	00-01	CK2274	CKF2274	CSK49	DRC97				CT020
YZ 250 P/R/S/T/V/W/X/Y/Z/A/B/D/E/F/G (2T)	02-16	CK2274	CKF2274	CSK92	DRC113	DRCF113			CT020
YZ 250 XG (2T)	16	CK2274	CKF2274	CSK92	DRC113	DRCF113			CT020
YZ 250 F (4T)	01-07	CK2355	CKF2355	CSK191	DRC109	DRCF109			CT005
YZ 250 F (4T)	08-13	CK2355	CKF2355	CSK137	DRC227	DRCF227			CT005
YZ 250 F (4T)	14-16	CK2355	CKF2355	CSK214	DRC288	DRCF288			CT005
YZ-F R3 (321cc)	15-16	CK1193		CSK219			SRC128	SRK128	CT080
BW 350 T/U	87-88	CK2240		CSK103					CT008
R5/5A/5B - 350cc	70-72	CK2240		CSK39					CT008
RD 350 73-75	72-75	CK2240		CSK39					CT008
RZ 350 L/N/NCII	84-85	CK2240		CSK2					CT008
TT 350 S/T	86-87	CK2240		CSK14	DRC56				CT008
TY 350 N/S	85-86	CK2295		CSK34					CT060
XT 350 N/NC/S/SC/C/AC/B/BCT/TC/U/UC/N/WC/D/DC/E/EC/F/FC/G/GC/H/HC /J/JC/K/KC/L/M/MC	85-00	CK2240		CSK14	DRC56				CT008
YFM 350 ER	87-94	CK2290	CKF2290	CSK58	DRC33	DRCF33			CT090SP
YFM 350 ER	95	CK2290	CKF2290	CSK49	DRC82				CT008
YFM 350 FW (Big Bear)	87-93	CK2290	CKF2290	CSK58	DRC33	DRCF33			CT008
YFM 350 FW (Big Bear)	94-97	CK2290	CKF2290	CSK49	DRC82				CT090SP
YFM 350 FWB (Big Bear)	99	CK2240		CSK81	DRC228				CT008
YFM 350 FX Wolverine	95-05	CK2240		CSK81	DRC228				CT008
YFM 350 U	96-99	CK2290	CKF2290	CSK49	DRC82				CT090SP
YFM 350 X (Warrior)	87-04	CK2290	CKF2290	CSK58	DRC33	DRCF33			CT090SP
YFM 350 R Raptor	04-13	CK2290	CKF2290	CSK58	DRC33	DRCF33			CT090SP
YFZ 350 T/U/W/A/B/D/E/F/G/H/J/K/L/M/N/P/R/S/T/V (Banshee)	87-06	CK2279	CKF2279	CSK2	DRC43	DRCF43			CT008
YFP 350 U (Terrapro)	88	CK2279	CKF2279	CSK58					CT008
FZR 400 U/W/SUC/SWC/A/SAC	88-90	CK2317		CSK185			SRC6	SRK6	CT010
RD 400 C/D/E	76-78	CK2240		CSK2					CT008
RD 400 F Daytona	79	CK2240		CSK2					CT008
SR 400 F	14	CK2296		CSK2					CT008
XS 400 G/SG/H/SH/SJ	80-82	CK2279	CKF2279	CSK2					CT008
XS 400 J/K/RJ/RK	82-83	CK2262		CSK2					CT017
YFM 400 FW Kodiak	93-99	CK2290	CKF2290	CSK49	DRC82				CT090SP
YFM 400 FWN Big Bear 4WD/Real Tree Xtra	00-01	CK2240		CSK81	DRC228				CT008
YFM 400 NM/NMC/NN/NHN/P/HP Big Bear 2WD	00-03	CK2240		CSK81	DRC228				CT008
YFM 400 FWR (4x4) Big Bear	03	CK2290	CKF2290	CSK49	DRC82				CT008
YFM 400 S Big Bear 2WD	04	CK2240		CSK81	DRC228				CT008
YFM 400 F Big Bear 4WD	04-05	CK2240		CSK81	DRC228				CT008
YFM 400 FB Big Bear 4WD IRS	08-12	CK2240		CSK81	DRC228				CT008
YFM 400 FBHW Big Bear 400 Hunter-IRS	07	CK2240		CSK81	DRC228				CT008
YFM 400 FBEW Big Bear 400 IRS Exploring Edition	07	CK2240		CSK81	DRC228				CT008
WR 400 F	98-00	CK2310		CSK49	DRC99				CT008
YZ 400 F	98-99	CK2310		CSK181	DRC265				CT008
IT 425 G	80	CK2279	CKF2279	CSK2					CT008
WR 426 F	01-02	CK2356		CSK62	DRC110				CT020
YZ 426 F	00	CK2352		CSK181	DRC102				CT020

CLUTCH APPLICATIONS

EBC BRAKES CLUTCH KITS



YAMAHA



		CK cork OEM style Kit #	CKF carbon fiber style upgrade Kit #	CSK Spring Kit #	DRC Series Kit #	DRCF Series Kit #	SRC Series Kit #	SRK Series Kit #	CT Tool #
YZ 426 F	01-02	CK2356		CSK92	DRC116				CT020
WR 450 F	03	CK2356		CSK62	DRC110				CT020
WR 450 F	04	CK2352		CSK62	DRC263				CT020
WR 450 F	05-15	CK2274	CKF2274	CSK92	DRC194				CT020
WR 450 F	16-17	CK2274	CKF2274	CSK37	DRC298	DRCF298			CT020
YFZ 450 S/T/V	04-06	CK2364	CKF2364	CSK187	DRC159	DRCF159			CT020
YFZ 450 W/X/Y	07-09	CK2364	CKF2364	CSK58	DRC201	DRCF201			CT020
YFZ 450 B/D	12-13	CK2364	CKF2364	CSK92					CT020
YFZ 450 LES Limited Edition	04	CK2364	CKF2364	CSK187	DRC159	DRCF159			CT020
YFZ 450 BB Bill Balance Edition	06	CK2364	CKF2364	CSK187	DRC159	DRCF159			CT020
YFZ 450 BB Bill Balance Edition	07	CK2274		CSK58					CT020
YFZ 450 SET/SPV Special Edition	05-06	CK2364	CKF2364	CSK187	DRC159	DRCF159			CT020
YFZ 450 SEW/SPX Special Edition	07-08	CK2364	CKF2364	CSK58	DRC201	DRCF201			CT020
YFZ 450 R R	09-13	CK2274	CKF2274	CSK58					CT020
YFZ 450 R (3 Spring Clutch - YFZ 450 RE)	14	TBA		TBA					
YFZ 450 R Special Edition (3 Spring Clutch - YFZ 450 RSE)	14	TBA		TBA					
YZ 450 F	03-04	CK2352		CSK92	DRC121				CT020
YZ 450 F	05-06	CK2352		CSK58	DRC162				CT020
YZ 450 F (4T)	07-13	CK2274	CKF2274	CSK37	DRC195	DRCF195			CT020
YZ 450 F (4T)	14-16	CK2274	CKF2274	CSK213	DRC287	DRCF287			CT020
IT 465 H/J	81-82	CK2279	CKF2279	CSK2					CT008
YZ 465 G/H	80-81	CK2279	CKF2279	CSK2					CT008
IT 490 K/L	83-84	CK2280		CSK2	DRC32				CT060
YZ 490 J/K/L/N/S/T/U/W	82-89	CK2280		CSK2	DRC32				CT060
SR 500 E/F/G/H	78-81	CK2296		CSK14					CT008
TT 500 G/H	80-81	CK2255		CSK14					CT008
WR 500 Z	92-93	CK2280		CSK2	DRC32				CT060
XP 500 T-Max (5GJ5)	01	CK2378		CSK189					
XP 500 T-Max (5VUA/15B1)	05-08	CK2378		CSK189					
XP 500 T-Max (4B51)	09-11	CK2378		CSK189					
XT 500 G/H	80-81	CK2296		CSK14					CT008
XV 500 K Virago	83	CK2299		CSK91					CT020
XV 535 T/TC/U/A/AC/E/EC/F/FC/SF/SFC/G/GC/SG/SGC/H/HC/SH/SHC									
/J/JC/SJ/SJC Virago	87-99	CK2299		CSK91					CT020
XJ 550 H/J/K Maxim	81-83	CK2306		CSK14					CT008SP
XJ 550 R Seca	81-83	CK2306		CSK14					CT008SP
XT 550 J	82	CK2306		CSK14					CT008
XT 550 K	83	CK2297	CKF2297	CSK14					CT008
XZ 550 R/RK Vision	82-83	CK2296		CSK14					CT008
FJ 600 L/N	84-85	CK2255		CSK14					CT008SP
FZ 600 S/SC/T/TC/UC/U	86-88	CK2255		CSK14					CT008SP
FZR 600 W/R/A/H	89-99	CK2315		CSK185			SRC7	SRK7	CT010
FZ6	04-09	CK2255		CSK17			SRC51	SRK51	CT008SP
FZ6R (FZS 6 Y/Z/A/B/D/E)	09-14	CK2306		CSK17					CT008SP
YZF 600 R	95-07	CK2332		CSK102			SRC33	SRK33	CT054SP
YZF 600 R/RR/PC R6	99-02	CK2255		CSK17			SRC51	SRK51	CT008SP
YZF-R6 RR/T	03-05	CK2255		CSK92			SRC74	SRK74	CT008SP
YZF-R6 V/W/X/Y/Z/A/B/D/E/F/G	06-16	CK2318		CSK126			SRC87	SRK87	CT008SP
YZF-R6 S	06-09	CK2255		CSK92			SRC74	SRK74	CT008SP
SRX 600 S	86	CK2297	CKF2297	CSK14			SRC72	SRK72	CT008
TT 600 K/L/N/S	83-86	CK2297	CKF2297	CSK2	DRC57				CT008
XJ 600 SD/SE/SF/SG/SH/SJ/SK Seca 11	92-98	CK2255		CSK14					CT008SP
XT 600 L/LC/N/NC/S/SC/T/TC/U/UC/W/WC	84-89	CK2297	CKF2297	CSK2	DRC57				CT008
XT 600 E	90-95	CK2297	CKF2297	CSK14	DRC88	DRCF88			CT008
YX 600 S/SC/T/TC/U/UC/W/WC/A/AC	86-90	CK2255		CSK14					CT008SP
XJ 650 G/H/J/K Maxim	80-83	CK2255		CSK81					CT008SP
XJ 650 LH Midnight	81	CK2255		CSK81					CT008SP

APPLICATIONS
CLUTCH

EBC BRAKES CLUTCH KITS



YAMAHA



		CK cork OEM style Kit #	CKF carbon fiber style upgrade Kit #	CSK Spring Kit #	DRC Series Kit #	DRCF Series Kit #	SRC Series Kit #	SRK Series Kit #	CT Tool #
XJ 650 LJ/LK Seca Turbo	82-83	CK2255		CSK14					CT008SP
XJ 650 RJ Seca	82	CK2255		CSK81					CT008SP
TX 650 A/XS 650 B/C	74-76	CK2226		CSK2					CT074
XS 650 D/E/F/2F	77-79	CK2226		CSK2					CT074
XS 650 SG/G/H/SH/SJ/SK	80-83	CK2242		CSK14					CT074
XVS 650 V-Star Custom	97-11/13-14	CK2309		CSK91					CT020
XVS 650 V-Star Classic	98-10	CK2309		CSK91					CT020
XVS 650 V-Star Silverado	03-10	CK2309		CSK91					CT020
YFM 660 R Raptor	01-05	CK2297	CKF2297	CSK14	DRC88	DRCF88			CT008
FZ 700 T/TC	87	CK2306		CSK17					CT008SP
FZX 700 S/SC/T/TC	86-87	CK2255		CSK17			SRC51	SRK51	CT008SP
FZ-07 (689cc/2Cyl)	15-16	CK2309		CSK37					CT020
XJ 700 N/NC/S/SC Maxim	85-86	CK2255		CSK37					CT008SP
XJ 700 XN/XS Maxim	85-86	CK2255		N/A					CT008SP
XV 700 L/N Virago	84-85	CK2274	CKF2274	CSK81					CT020
XV 700 CS/CSC/SS/ST/STC/CT/CTC/SSC Virago	86-87	CK2274	CKF2274	CSK81					CT020
YFM 700 R Raptor	06-14	CK2364	CKF2364	CSK37	DRC128	DRCF128			CT020
YFM 700 RSPV Raptor 50th Anniversary Edition	06	CK2364	CKF2364	CSK37	DRC128	DRCF128			CT020
YFM 700 RS Raptor Special Edition	07-14	CK2364	CKF2364	CSK37	DRC128	DRCF128			CT020
FZ 750 N	85	CK2255		CSK17			SRC51	SRK51	CT008SP
FZ 750 S/SC	86	CK2255		CSK17			SRC51	SRK51	CT008SP
FZ 750 U/UC	88	CK2306		CSK17					CT008SP
FZR 750 R	87-88	CK2308		CSK17			SRC8	SRK8	CT008SP
FZR 750 OW01	89-91	CK2318		CSK17			SRC9	SRK9	CT008SP
XJ 750 J/K/MK Maxim	82-83	CK2255		CSK14					CT008SP
XJ 750 R Seca	81-83	CK2255		CSK14					CT008SP
XS 750 D/2D/E/F/SE/SF	77-79	CK2279	CKF2279	CSK14					CT008SP
XV 750 H/J/K/MK Virago	81-83	CK2274	CKF2274	CSK81					CT020
XV 750 U/UC/W/WCM Virago	88-89	CK2274	CKF2274	CSK81					CT020
XV 750 A/AC/B/BC Virago	90	CK2274	CKF2274	CSK81					CT020
XV 750 D/DC/E/EC/F/FC/G/GC/HI/HCI/J/JC Virago	92-97	CK2274	CKF2274	CSK81					CT020
YZF 750 SP/RF/RFC/RG/RGC/RH/RHC	94-96	CK2318		CSK17			SRC9	SRK9	CT008SP
YZF 750 R7 OW02	99-01	CK2353		N/A					CT020
FZ8	11-13	CK2364	CKF2364	CSK119					CT020
XS 850 G/H/LG/LH/SG/SH	80-81	CK2273		CSK14					CT008SP
TDM 850 D/DC/E/EC	92-93	CK2255		CSK17			SRC51	SRK51	CT008SP
FJ-09	15-16	CK2352		CSK119					CT020
FZ-09 (6 Spring clutch)	14-16	CK2352		CSK119					CT020
FZ-09 (3 Spring clutch)	17	TBA		TBA					
XJ 900 RK Seca	83	CK2255		CSK49					CT008SP
XSR 900 ABS (MTM850)	16	TBA		TBA					
XV 920 R	81-82	CK2274	CKF2274	CSK14					CT020
XV 920 J/K/MK Virago	82-83	CK2274	CKF2274	CSK14					CT020
XVS 950 (V-Star 950)	09-14	CK2379		CSK911					CT017
XVS 950 (V-Star 950 Tourer)	09-14	CK2379		CSK911					CT017
XVS 950 Bolt (Standard Rear Shocks)	14-16	CK2379		CSK911					CT017
XVS 950 Bolt C-Spec (Remote Rear Shocks)	15-16	CK2379		CSK911					CT017
XVS 950 Bolt R-Spec (Remote Rear Shocks)	14-16	CK2379		CSK911					CT017
FZR 1000 T/U Genesis	87-88	CK2308		CSK17			SRC8	SRK8	CT008SP
FZR 1000 W/WC/A/AC/B/BC/D/DC	89-92	CK2321		CSK37			SRC31	SRK31	CT008SP
FZR 1000 E/EC/F/FC/G/GC	93-95	CK2327		CSK37			SRC29	SRK29	CT008SP
FZ1-FZS 1000 N/P/R/S/T	01-05	CK2358		CSK37					CT008SP
FZ1-FZS 1000 V/W/X/Y/Z/A/B/D/E	06-14	CK2356		CSK119			SRC77	SRK77	CT020
FZ-10	17	CK4510		CSK218			SRC129	SRK129	CT079SP
GTS 1000 A	93-94	CK2327		CSK17					CT008SP
XV 1000 L/N Virago	84-85	CK2274	CKF2274	CSK14					CT020
YZF 1000 R (RJ)	97	CK2327		CSK37			SRC29	SRK29	CT008SP

CLUTCH APPLICATIONS

EBC BRAKES CLUTCH KITS



YAMAHA



		CK cork OEM style Kit #	CKF carbon fiber style upgrade Kit #	CSK Spring Kit #	DRC Series Kit #	DRCF Series Kit #	SRC Series Kit #	SRK Series Kit #	CT Tool #
YZF 1000 R1	98	CK2226		CSK903			SRC56	SRK56	CT017
YZF 1000 R1	99-03	CK2350		CSK903			SRC65	SRK65	CT017
YZF R1 (5V)	04-06	CK2356		CSK119			SRC77	SRK77	CT020
YZF R1 LE	06	CK2356		CSK211			SRC93	SRK93	CT020
YZF R1 (6 piston caliper)	07-08	CK2356		CSK211			SRC93	SRK93	CT020
YZF R1 (6 piston caliper)	09-14	CK2352		CSK211			SRC96	SRK96	CT020
YZF R1	15-16	CK4510		CSK218			SRC129	SRK129	CT079SP
YZF R1 M	15-16	CK4510		CSK218			SRC129	SRK129	CT079SP
YZF R1 S	16	CK4510		CSK218			SRC129	SRK129	CT079SP
FJ 1100 L/LC/N/NC	84-85	CK2285		CSK903					CT017
XJ 1100 J Maxim	82	CK2230		CSK14					CT017
XS 1100	82	CK2230		CSK14					CT077SP
XS 1100 H Venturer	82	CK2230		CSK14					CT077SP
XS 1100 SF/SG/SH	82	CK2230		CSK14					CT077SP
XS 1100 LG/LH Midnight Special	82	CK2230		CSK14					CT077SP
XV 1100 S/T/U/W/A/B/D/E/F/G/H/SH/J/SJ Virago	86-97	CK2274	CKF2274	N/A					CT020
XVS 1100 V-Star Custom L/LC/M/MC/N/NC/P/PC/R/RC/S/T	99-08	CK2274	CKF2274	N/A					CT020
XVS 1100 V-Star Classic	01-09	CK2274	CKF2274	N/A					CT020
XVS 1100 ATS V-Star Silverado	03-09	CK2274	CKF2274	N/A					CT020
XVS 1100 W-M V-Star Custom Midnight	07	CK2274	CKF2274	N/A					CT020
FJ 1200 S/T/U/W/A/B/AD/D/AE	86-94	CK2285		CSK903					CT017
V-Max VMX 12 N/NC	85	CK2300		CSK906					CT050SP
V-Max VMX 12 S/SC	86	CK2300		CSK906					CT050SP
VMX 12 (V-Max 1200 All Models)	88-07	CK2300		CSK906					CT050SP
XT 1200 Z Super Tenere	12-13	CK2362		CSK903			SRC131	SRK131	CT017
XVZ 12 TK Venture	83	CK2300		CSK46					CT050SP
XVZ 12 TDK Venture Royale	83	CK2300		CSK46					CT050SP
XVZ 12 L/KC2 Venture	84	CK2300		CSK46					CT050SP
XVZ 12 DL/DKC2 Venture Royale	84	CK2300		CSK46					CT050SP
XVZ 12 DN Venture Royale	85	CK2300		CSK46					CT050SP
FJR 1300 R/RC/S/AS/T/AT	03-05	CK2362		CSK903			SRC131	SRK131	CT017
FJR 1300 A	06-15	CK2362		CSK903			SRC131	SRK131	CT017
FJR 1300 AE (Electric Gear shift Model)	06-09	CK2362		N/A			N/A	N/A	CT017
FJR 1300 ES	14-15	TBA		TBA					
XVS 1300 V-Star	07-14	CK2362		CSK903			SRC131	SRK131	CT017
XVS 1300 V-Star De Luxe	13-14	CK2362		CSK903			SRC131	SRK131	CT017
XVS 1300 V-Star Tourer	07-14	CK2362		CSK903			SRC131	SRK131	CT017
XVS 1300 Stryker	11-14	CK2362		CSK903			SRC131	SRK131	CT017
XVZ 13 DS/DSC Venture	86	CK2300		CSK906					CT050SP
XVZ 13 T/TC Venture	87-88	CK2300		CSK906					CT050SP
XVZ 13 D Venture Royale	86-89	CK2300		CSK906					CT050SP
XVZ 13 D Venture Royale	92-93	CK2300		CSK906					CT050SP
XVZ 1300 Royal Star	96-97/00	CK2300		CSK906					CT050SP
XVZ 1300 Royal Star Boulevard	99-01	CK2300		CSK906					CT050SP
XVZ 1300 Royal Star Midnight Venture	02-07	CK2300		CSK906					CT050SP
XVZ 1300 Royal Star Standard	98	CK2300		CSK906					CT050SP
XVZ 1300 Royal Star Tour Classic	96-00	CK2300		CSK906					CT050SP
XVZ 1300 Royal Star Tour Deluxe	97-01/05-07	CK2300		CSK906					CT050SP
XVZ 1300 Royal Star Venture	99-07	CK2300		CSK906					CT050SP
XVZ 1300 Royal Star Venture S	08-13	CK2300		CSK906					CT050SP
XVZ 1300 CTM Royal Star Midnight Tour Deluxe	06-07	CK2300		CSK906					CT050SP
XVZ 1300 LTK Venture	96-98	CK2300		CSK906					CT050SP
XVZ 1300 Venture MM Limited Edition	01	CK2300		CSK906					CT050SP
XV 1600 Road Star	99-05	CK2351		CSK906					CT050SP
XV 1600 Road Star Silverado	99-09	CK2351		CSK906					CT050SP
XV 1600 Road Star Midnight	03	CK2351		CSK906					CT050SP
XV 1600 Midnight Star	02-03	CK2351		CSK906					CT050SP

CLUTCH
APPLICATIONS

EBC BRAKES CLUTCH KITS



YAMAHA



		CK cork OEM style Kit #	CKF carbon fiber style upgrade Kit #	CSK Spring Kit #	DRC Series Kit #	DRCF Series Kit #	SRC Series Kit #	SRK Series Kit #	CT Tool #
VMX 1700 V-Max (6 piston radial caliper)	09-16	CK2380		CSK903					CT017
XV 1700 Road Star (9 Spoke Cast wheels - XV17 AS/AW)	04-07/09	CK2351		CSK906					CT050SP
XV 1700 Road Star (9 Spoke Cast wheels - XV17 AWX)	08	CK2363		CSK906					CT050SP
XV 1700 Road Star (Spoke wheel / Solid Front Discs - XV17 ATW)	05-07	CK2351		CSK906					CT050SP
XV 1700 Road Star S (9 Spoke Cast wheels - XV17 AS)	08-13	CK2363		CSK906					CT050SP
XV 1700 Road Star Midnight (9 Spoke Cast Wheels - XV17 AM)	04-07	CK2351		CSK906					CT050SP
XV 1700 Road Star Midnight Warrior (3 Spoke Cast Wheels - XV17 PCT)	05	CK2351		CSK906					CT050SP
XV 1700 Road Star Midnight Warrior (5 Spoke Cast Wheels - XV17 PCM)	06-09	CK2363		CSK906					CT050SP
XV 1700 Road Star Midnight Silverado (9 Spoke Cast wheels - XV17 ATM)	04-07	CK2351		CSK906					CT050SP
XV 1700 Road Star (Spoke wheel / Solid Front Discs - XV17 ATW)	05-07	CK2351		CSK906					CT050SP
XV 1700 Road Star Silverado (Spoke Wheel - XV17 AT)	07	CK2363		CSK906					CT050SP
XV 1700 Road Star Silverado (Spoke Wheel - XV17 AT)	08-10	CK2363		CSK906					CT050SP
XV 1700 Road Star Silverado S (9 Spoke Cast Wheel - XV17 ATS)	11-13	CK2363		CSK906					CT050SP
XV 1700 Road Star Warrior (3 Spoke Cast Wheels - XV17 PC)	04-05	CK2363		CSK906					CT050SP
XV 1700 Road Star Warrior (5 Spoke Cast Wheels - XV17 PC)	06-08	CK2363		CSK906					CT050SP
XV 1900 Roadliner	06-07	CK2367		CSK903					CT017
XV 1900 M Roadliner Midnight	06-09	CK2367		CSK903					CT017
XV 1900 Roadliner S (Diaphragm Spring Clutch)	06-10/12	CK2367		CSK903					CT017
XV 1900 Roadliner S (3 Spring Clutch)	13-14	TBA		TBA					
XV 1900 Raider (Diaphragm Spring Clutch)	08-12	CK2367		TBA					CT017
XV 1900 Raider S (Diaphragm Spring Clutch)	08-12	CK2367		TBA					CT017
XV 1900 Raider SCL (Diaphragm Spring Clutch)	12	CK2367		TBA					CT017
XV 1900 Raider (3 Spring Clutch)	13-14	TBA		TBA					
XV 1900 Raider S (3 Spring Clutch)	13-14	TBA		TBA					
XV 1900 Raider SCL (3 Spring Clutch)	13-14	TBA		TBA					
XV 1900 Stratoliner	06-09	CK2367		CSK903					CT017
XV 1900 Stratoliner Midnight	06-08	CK2367		CSK903					CT017
XV 1900 Stratoliner S (Diaphragm Spring Clutch)	06-13	CK2367		CSK903					CT017
XV 1900 Stratoliner Deluxe (Diaphragm Spring Clutch)	11-12	CK2367		CSK903					CT017
XV 1900 Stratoliner S (3 Spring Clutch)	13-14	TBA		TBA					
XV 1900 Stratoliner Deluxe (3 Spring Clutch)	13-14	TBA		TBA					
ARCTIC CAT (NOTE MANUAL GEARBOX MODELS ONLY)									
250 (2 x 4 / 4 x 4)	01-04	CK3390		CSK48	DRC89				CT011
250 (2 x 4 / 4 x 4)	05	CK3390		CSK48	DRC89				CT011
300 (2 x 4 / 4 x 4)	98-04	CK3356		CSK48	DRC103				CT011
300 (4 x 4)	05	CK3356		CSK48	DRC103				CT011
400 (2 x 4 / 4 x 4)	98-	CK4439		CSK88	DRC215				CT006
400 (2 x 4)	98	CK4439		CSK88	DRC214				CT006
400 (2 x 4 / 4 x 4)	00-02	CK4419		CSK88	DRC215				CT006
400 (2 x 4 / 4 x 4)	03-04	CK4439		CSK98	DRC120				CT006
400 (4 x 4 Manual)	05-08	CK4439		CSK98	DRC120				CT006
400 DVX	04-06	CK3433	CKF3433	CSK79	DRC105	DRCF105			CT006
400 DVX	07-08	CK3447	CKF3447	CSK79	DRC137	DRCF137			CT006
Bearcat 454 (4 x 4)	96-98	CK4439		CSK88	DRC216				CT006
Bearcat 454 (2 x 4)	97-98	CK4439		CSK88	DRC216				CT006
500 (4 x 4)	98-02	CK4439		CSK88	DRC214				CT006
500 (4 x 4 Manual)	03-04	CK3452		CSK7	DRC216				CT006
500 (Manual 4x4)	05-09	CK3452		CSK7	DRC216				CT006
AJP									
PR5 TR	13-17	CK1318		CSK226	DRC300				CT091
PR5 SM	13-17	CK1318		CSK226	DRC300				CT091
PR5 EN	13-17	CK1318		CSK226	DRC300				CT091
PR5 EX	13-17	CK1318		CSK226	DRC300				CT091

CLUTCH APPLICATIONS

EBC BRAKES CLUTCH KITS



APRILIA



		CK cork OEM style Kit #	CKF carbon fiber style upgrade Kit #	CSK Spring Kit #	DRC Series Kit #	DRCF Series Kit #	SRC Series Kit #	SRK Series Kit #	CT Tool #
RSV 1000 R Factory/R	04-08	CK6680		CSK200					
RSV4 R	10-12	CK6681		CSK184			SRC113	SRK113	CT041
RSV4 Factory	09-12	CK6681		CSK184			SRC113	SRK113	CT041
RSV4 Factory APRC	11-12	CK6681		CSK184			SRC113	TBA	CT041
RSV4 APRC	11-12	CK6681		CSK184			SRC113	TBA	CT041

BENELLI

TNT 600 i Tornado	16-17	CK1230		CSK241			SRC141	SRK141	CT014SP
-------------------	-------	--------	--	--------	--	--	--------	--------	---------

BMW

F 650 (E169/0161)	09/93-96	CK5605		CSK104					
F 650 (E169/0162/Funduro/High Screen/19" Front Wheel)	97-00	CK5605		CSK104					
F 650 CS Scarver (K14/0174/0184/Belt Drive/17" Front Wheel)	00-03	CK5636		CSK104					
F 650 CS Scarver (K14/0177/0187/Belt Drive/17" Front Wheel)	04-07	CK5636		CSK104					
F 650 GS Dakar (R13/0173/0183/21" Front Wheel)	99-03	CK5636		CSK104					
F 650 GS Dakar (R13/0176/0186/21" Front Wheel)	04-07	CK5635		CSK104					
F650 GS (Late type plates 2 x 13mm/7 x 14mm ears)	07-17	CK5660		CSK240			SRC130	SRK130	CT085
F 650 ST (E169/163/168/Strada/18" Front Wheel)	97-00	CK5605		CSK104					
G 650 GS (R13)	08-16	CK5635		CSK133			SRC145	SRK145	CT083
G 650 GS Sertao (R13)	10-14	CK5635		CSK133			SRC145	SRK145	CT083
G 650 X (K15)	08-10	CK5635		CSK133			SRC145	SRK145	CT083
F700 GS (Late type plates 2 x 13mm/7 x 14mm ears)	11-17	CK5660		CSK240			SRC130	SRK130	CT085
F800 GS (Late type plates 2 x 13mm/7 x 14mm ears)	12-17	CK5660		CSK240			SRC130	SRK130	CT085
F800 GS Adventure (Late type plates 2 x 13mm/7 x 14mm ears)	12-17	CK5660		CSK240			SRC130	SRK130	CT085
F800 GT (Early type plates 14mm ears)	04-06	CK5667		CSK240			SRC144	SRK144	CT085
F800 GT (Late type plates 2 x 13mm/7 x 14mm ears)	07-17	CK5660		CSK240			SRC130	SRK130	CT085
F800 S (Early type plates 14mm ears)	04-06	CK5667		CSK240			SRC144	SRK144	CT085
F800 S (Late type plates 2 x 13mm/7 x 14mm ears)	07-17	CK5660		CSK240			SRC130	SRK130	CT085
F800 ST (Early type plates 14mm ears)	04-06	CK5667		CSK240			SRC144	SRK144	CT085
F800 ST (Late type plates 2 x 13mm/7 x 14mm ears)	07-17	CK5660		CSK240			SRC130	SRK130	CT085
F800 R (Late type plates 2 x 13mm/7 x 14mm ears)	05-17	CK5660		CSK240			SRC130	SRK130	CT085

HARLEY-DAVIDSON®

VRSC

VRSCA 1HAZ V-Rod	02-06	CK7006		CSK232			SRC7007	SRK7007	CT707SP
VRSCAW 1HFH V-Rod	09-10	CK7005		CSK233			SRC7006	SRK7006	CT706SP
VRSCAW 1HFH V-Rod Wide Tire	08	CK7005		CSK233			SRC7006	SRK7006	CT706SP
VRSCAW 1HFZ V-Rod	07	CK7006		CSK232			SRC7007	SRK7007	CT707SP
VRSCAWA 1HKH W/ABS	08	CK7005		CSK233			SRC7006	SRK7006	CT706SP
VRSCB 1HBZ V-Rod	04-05	CK7006		CSK232			SRC7007	SRK7007	CT707SP
VRSCD 1HDH Night Rod	08	CK7005		CSK233			SRC7006	SRK7006	CT706SP
VRSCDA 1HLH Night Rod W/ABS	08	CK7005		CSK233			SRC7006	SRK7006	CT706SP
VRSCDX 1HHH Night Rod Special	08-17	CK7005		CSK233			SRC7006	SRK7006	CT706SP
VRSCDX ANV 1HHH_ANV Night Rod Special Anv	12	CK7005		CSK233			SRC7006	SRK7006	CT706SP
VRSCDXA 1HMH Night Rod Special W/ABS	08	CK7005		CSK233			SRC7006	SRK7006	CT706SP
VRSCF 1HPP V-Rod Muscle	09-17	CK7005		CSK233			SRC7006	SRK7006	CT706SP
VRSCR 1HCZ Street Rod	06-07	CK7006		CSK232			SRC7007	SRK7007	CT707SP
VRSCSE 1PMG CVO V-Rod	05	CK7006		CSK232			SRC7007	SRK7007	CT707SP
VRSCSE2 1PPG CVO V-Rod	06	CK7006		CSK232			SRC7007	SRK7007	CT707SP
VRSCX 1HJG Screamin' Eagle V-Rod	07	CK7006		CSK232			SRC7007	SRK7007	CT707SP
VRXSE 7RC7 CVO VR Destroyer	06	CK7006		CSK232			SRC7007	SRK7007	CT707SP

TRIKE

FLHTCUTG 1MAD Tri Glide Ultra	17-18	CK7007		CSK236			SRC7008	SRK7008	CT708SP
FLHTCUTG 1MAL Tri Glide Ultra Classic	14-16	CK7002		CSK235			SRC7003	SRK7003	CT702SP
FLHTCUTG 1MAM Tri Glide Ultra Classic	09-13	CK7008		CSK914			SRC7009	SRK7009	CT703SP
FLHTCUTG 1MDD Tri Glide Ultra Anniversary	18	CK7007		CSK236			SRC7008	SRK7008	CT708SP
FLHTCUTG ANV 1MAM_ANV Tri Glide Ultra Classic Anv	13	CK7008		CSK914			SRC7009	SRK7009	CT703SP

APPLICATIONS
CLUTCH

EBC BRAKES CLUTCH KITS



HARLEY-DAVIDSON®



		CK cork OEM style Kit #	CKF carbon fiber style upgrade Kit #	CSK Spring Kit #	DRC Series Kit #	DRCF Series Kit #	SRC Series Kit #	SRK Series Kit #	CT Tool #
FLHXXX 1MBM Street Glide Trike	10	CK7008		CSK914			SRC7009	SRK7009	CT703SP
FLHXXX 1MBM Street Glide Trike	11	CK7008		CSK914			SRC7009	SRK7009	CT703SP
FLRT 1MCC Freewheeler	17-18	CK7007		CSK236			SRC7008	SRK7008	CT708SP
FLRT 1MCM Freewheeler	15-16	CK7002		CSK235			SRC7003	SRK7003	CT702SP
POLICE									
FLHP 1FHC Road King Police	17	CK7007		CSK236			SRC7008	SRK7008	CT708SP
FLHP 1FHM Road King Police	11-16	CK7008		CSK914			SRC7009	SRK7009	CT703SP
FLHPE 1FTM Road King Police	11	CK7008		CSK914			SRC7009	SRK7009	CT703SP
FLHTP 1FMC Electra Glide Standard Police	17	CK7007		CSK236			SRC7008	SRK7008	CT708SP
FLHTP 1FMM Electra Glide Standard Police	11-16	CK7008		CSK914			SRC7009	SRK7009	CT703SP
TOURING									
FLH ADKE Touring Electra Glide	Early 84	CK7011		TBA			SRC7017	SRK7017	CT704SP
FLH ADKE Touring Electra Glide	Later 84	CK7010		TBA			SRC7016	SRK7016	CT705SP
FLH ALKE Touring Electra Glide Shrine Shovelhead	83	CK7012		TBA			SRC7018	SRK7018	CT704SP
FLH ALKE Touring Electra Glide Shrine Shovelhead	Early 84	CK7011		TBA			SRC7017	SRK7017	CT704SP
FLH ALKE Touring Electra Glide Shrine Shovelhead	Later 84	CK7010		TBA			SRC7016	SRK7016	CT705SP
FLH Electra Glide	81-83	CK7012		TBA			SRC7018	SRK7018	CT704SP
FLHC ADKB Touring Electra Glide Classic	81	CK7012		TBA			SRC7018	SRK7018	CT704SP
FLHC ADKC Touring Electra Glide Classic	82	CK7012		TBA			SRC7018	SRK7018	CT704SP
FLHC AGKB Touring Electra Glide Classic	81	CK7012		TBA			SRC7018	SRK7018	CT704SP
FLHC Electra Glide Classic	81	CK7012		TBA			SRC7018	SRK7018	CT704SP
FLHR 1FDV Road King	01	CK7008		CSK917			SRC7011	SRK7011	CT703SP
FLHR 103 1FBM Road King	11	CK7008		CSK916			SRC7012	SRK7012	CT703SP
FLHR 1FB4 Road King	07-11	CK7008		CSK915			SRC7013	SRK7013	CT703SP
FLHR 1FBC Road King	17	CK7002		CSK236			SRC7010	SRK7010	CT702SP
FLHR 1FBM Road King	12-13	CK7008		CSK916			SRC7012	SRK7012	CT703SP
FLHR 1FBM Road King	15-16	CK7008		CSK917			SRC7011	SRK7011	CT703SP
FLHR 1FDL Road King	94-97	CK7009		TBA			SRC7014	SRK7014	CT701SP
FLHR 1FDL Road King	98	CK7008		CSK917			SRC7011	SRK7011	CT703SP
FLHR 1FDV Road King	99-03	CK7008		CSK917			SRC7011	SRK7011	CT703SP
FLHR 1FDV Road King	04-05	CK7008		CSK916			SRC7012	SRK7012	CT703SP
FLHR 1FDV Road King	06	CK7008		CSK915			SRC7013	SRK7013	CT703SP
FLHR 96 FB4 Road King	11	CK7008		CSK915			SRC7013	SRK7013	CT703SP
FLHR ANV 1FBM_ANV Road King ANV	13	CK7008		CSK916			SRC7012	SRK7012	CT703SP
FLHR FD93 Road King	93	CK7009		TBA			SRC7014	SRK7014	CT701SP
FLHRC 103 1FRM Road King Classic	11	CK7008		CSK916			SRC7012	SRK7012	CT703SP
FLHRC 1FR4 Road King Classic	07-11	CK7008		CSK915			SRC7013	SRK7013	CT703SP
FLHRC 1FRC Road King Classic	17	CK7002		CSK236			SRC7010	SRK7010	CT702SP
FLHRC 1FRM Road King Classic	12-13	CK7008		CSK916			SRC7012	SRK7012	CT703SP
FLHRC 1FRM Road King Classic	14-16	CK7008		CSK917			SRC7011	SRK7011	CT703SP
FLHRCI 1FRR Road King Classic	98	CK7008		CSK917			SRC7011	SRK7011	CT703SP
FLHRCI 1FRW Road King Classic	99-03	CK7008		CSK917			SRC7011	SRK7011	CT703SP
FLHRCI 1FRW Road King Classic	04-05	CK7008		CSK916			SRC7012	SRK7012	CT703SP
FLHRCI 1FRW Road King Classic	06	CK7008		CSK915			SRC7013	SRK7013	CT703SP
FLHRI 1FBR Road King	96-97	CK7009		TBA			SRC7014	SRK7014	CT701SP
FLHRI 1FBW Road King	00-03	CK7008		CSK917			SRC7011	SRK7011	CT703SP
FLHRI 1FBW Road King	04-05	CK7008		CSK916			SRC7012	SRK7012	CT703SP
FLHRI 1FBW Road King	06	CK7008		CSK915			SRC7013	SRK7013	CT703SP
FLHRS 1FXV Road King Custom	04-05	CK7008		CSK916			SRC7012	SRK7012	CT703SP
FLHRS 1FXV Road King Custom	06	CK7008		CSK915			SRC7013	SRK7013	CT703SP
FLHRS 1FY4 Road King Custom	07	CK7008		CSK915			SRC7013	SRK7013	CT703SP
FLHRSI 1FYW Road King Custom	04-05	CK7008		CSK916			SRC7012	SRK7012	CT703SP
FLHRSI 1FYW Road King Custom	06	CK7008		CSK915			SRC7013	SRK7013	CT703SP
FLHRXS 1KVC Road King Special	18	CK7002		CSK236			SRC7010	SRK7010	CT702SP
FLHS 1FAL Electra Glide Sport	91-94	CK7009		TBA			SRC7014	SRK7014	CT701SP
FLHS AKKB Touring Electra Glide Sport	81	CK7012		TBA			SRC7018	SRK7018	CT704SP
FLHS AKKC Touring Electra Glide Sport	82	CK7012		TBA			SRC7018	SRK7018	CT704SP

CLUTCH APPLICATIONS

EBC BRAKES CLUTCH KITS



HARLEY-DAVIDSON®



		CK cork OEM style Kit #	CKF carbon fiber style upgrade Kit #	CSK Spring Kit #	DRC Series Kit #	DRCF Series Kit #	SRC Series Kit #	SRK Series Kit #	CT Tool #
FLHS AKKD Touring Electra Glide Sport	83	CK7012		TBA			SRC7018	SRK7018	CT704SP
FLHS AKKE Touring Electra Glide Sport	Early 84	CK7011		TBA			SRC7017	SRK7017	CT704SP
FLHS AKKE Touring Electra Glide Sport	Later 84	CK7010		TBA			SRC7016	SRK7016	CT705SP
FLHS FALH Touring Electra Glide Sport	87	CK7010		TBA			SRC7016	SRK7016	CT705SP
FLHS FALJ Touring Electra Glide Sport	88	CK7010		TBA			SRC7016	SRK7016	CT705SP
FLHS FALK Touring Electra Glide Sport	89	CK7010		TBA			SRC7016	SRK7016	CT705SP
FLHS FALL Touring Electra Glide Sport	90	CK7009		TBA			SRC7015	SRK7015	CT701SP
FLHS Heritage, Electra Glide	81	CK7012		TBA			SRC7018	SRK7018	CT704SP
FLHT 1DDL Electra Glide Standard	95-97	CK7009		TBA			SRC7014	SRK7014	CT701SP
FLHT 1DDL Electra Glide Standard	98	CK7008		CSK917			SRC7011	SRK7011	CT703SP
FLHT 1DDV Electra Glide Standard	99-03	CK7008		CSK917			SRC7011	SRK7011	CT703SP
FLHT 1DDV Electra Glide Standard	04-05	CK7008		CSK916			SRC7012	SRK7012	CT703SP
FLHT 1DDV Electra Glide Standard	06	CK7008		CSK915			SRC7013	SRK7013	CT703SP
FLHT 1FV4 Electra Glide Standard	07-10	CK7008		CSK915			SRC7013	SRK7013	CT703SP
FLHT DCKD Touring Electra Glide Standard	83	CK7012		TBA			SRC7018	SRK7018	CT704SP
FLHT DDLJ Touring Electra Glide Standard	88	CK7010		TBA			SRC7016	SRK7016	CT705SP
FLHT Electra Glide	Early 84	CK7011		TBA			SRC7017	SRK7017	CT704SP
FLHT Electra Glide	83	CK7012		TBA			SRC7018	SRK7018	CT704SP
FLHT Electra Glide	Later 84	CK7010		TBA			SRC7016	SRK7016	CT705SP
FLHT Electra Glide Classic	83	CK7012		TBA			SRC7018	SRK7018	CT704SP
FLHT Electra Glide Classic	Early 84	CK7011		TBA			SRC7017	SRK7017	CT704SP
FLHT Electra Glide Classic	Later 84	CK7010		TBA			SRC7016	SRK7016	CT705SP
FLHTC 103 1FFM Electra Glide Classic	11	CK7008		CSK916			SRC7012	SRK7012	CT703SP
FLHTC 1DJL Electra Glide Classic	91-97	CK7009		TBA			SRC7014	SRK7014	CT701SP
FLHTC 1DJL Electra Glide Classic	98	CK7008		CSK917			SRC7011	SRK7011	CT703SP
FLHTC 1DJV Electra Glide Classic	99-03	CK7008		CSK917			SRC7011	SRK7011	CT703SP
FLHTC 1DJV Electra Glide Classic	04-05	CK7008		CSK916			SRC7012	SRK7012	CT703SP
FLHTC 1FF4 Electra Glide Classic	07-11	CK7008		CSK915			SRC7013	SRK7013	CT703SP
FLHTC 1FFM Electra Glide Classic	12-13	CK7008		CSK916			SRC7012	SRK7012	CT703SP
FLHTC ADKD Touring Electra Glide Classic	83	CK7012		TBA			SRC7018	SRK7018	CT704SP
FLHTC DDKD Touring Electra Glide Classic	83	CK7012		TBA			SRC7018	SRK7018	CT704SP
FLHTC DDLG Touring Electra Glide Classic	86	CK7010		TBA			SRC7016	SRK7016	CT705SP
FLHTC DDLH Touring Electra Glide Classic	87	CK7010		TBA			SRC7016	SRK7016	CT705SP
FLHTC DJJD Touring Electra Glide Classic	88	CK7010		TBA			SRC7016	SRK7016	CT705SP
FLHTC DJLE Touring Electra Glide Classic	Early 84	CK7012		TBA			SRC7018	SRK7018	CT704SP
FLHTC DJLE Touring Electra Glide Classic	Later 84	CK7010		TBA			SRC7016	SRK7016	CT705SP
FLHTC DJLF Touring Electra Glide Classic	85	CK7010		TBA			SRC7016	SRK7016	CT705SP
FLHTC DJLG Touring Electra Glide Classic	86	CK7010		TBA			SRC7016	SRK7016	CT705SP
FLHTC DJLH Touring Electra Glide Classic	87	CK7010		TBA			SRC7016	SRK7016	CT705SP
FLHTC DJLK Touring Electra Glide Classic	89	CK7010		TBA			SRC7016	SRK7016	CT705SP
FLHTC DJLL Touring Electra Glide Classic	90	CK7009		TBA			SRC7015	SRK7015	CT701SP
FLHTCI 1FCW Ultra Classic	05	CK7008		CSK916			SRC7012	SRK7012	CT703SP
FLHTCI 1FFR Electra Glide Classic	96-97	CK7009		TBA			SRC7014	SRK7014	CT701SP
FLHTCI 1FFR Electra Glide Classic	98	CK7008		CSK917			SRC7011	SRK7011	CT703SP
FLHTCI 1FFW Electra Glide Classic	99-03	CK7008		CSK917			SRC7011	SRK7011	CT703SP
FLHTCI 1FFW Electra Glide Classic	04-05	CK7008		CSK916			SRC7012	SRK7012	CT703SP
FLHTCI 1FFW Electra Glide Classic	06	CK7008		CSK915			SRC7013	SRK7013	CT703SP
FLHTCI 1FFW Electra Glide Classic	01	CK7008		CSK917			SRC7011	SRK7011	CT703SP
FLHTCU 103 1FCM Ultra Classic	11	CK7008		CSK916			SRC7012	SRK7012	CT703SP
FLHTCU 1DPL Ultra Classic	91-97	CK7009		TBA			SRC7014	SRK7014	CT701SP
FLHTCU 1FC4 Ultra Classic	07-11	CK7008		CSK915			SRC7013	SRK7013	CT703SP
FLHTCU 1FCC Electra Glide Ultra Classic	17-18	CK7002		CSK236			SRC7010	SRK7010	CT702SP
FLHTCU 1FCM Ultra Classic	12-13	CK7008		CSK916			SRC7012	SRK7012	CT703SP
FLHTCU 1FCM Ultra Classic	14-16	CK7008		CSK917			SRC7011	SRK7011	CT703SP
FLHTCU DPLK Touring Electra Glide Classic Ultra	89	CK7010		TBA			SRC7016	SRK7016	CT705SP
FLHTCU DPLL Touring Electra Glide Classic Ultra	90	CK7009		TBA			SRC7015	SRK7015	CT701SP
FLHTCU TC 1KSL Ultra Classic Twin-Cooled	14-16	CK7008		CSK917			SRC7011	SRK7011	CT703SP

CLUTCH
APPLICATIONS

EBC BRAKES CLUTCH KITS



HARLEY-DAVIDSON®



		CK cork OEM style Kit #	CKF carbon fiber style upgrade Kit #	CSK Spring Kit #	DRC Series Kit #	DRCF Series Kit #	SRC Series Kit #	SRK Series Kit #	CT Tool #
FLHTCUI 1FCR Ultra Classic	95-97	CK7009		TBA			SRC7014	SRK7014	CT701SP
FLHTCUI 1FCR Ultra Classic	98	CK7008		CSK917			SRC7011	SRK7011	CT703SP
FLHTCUI 1FCW Ultra Classic	99-03	CK7008		CSK917			SRC7011	SRK7011	CT703SP
FLHTCUI 1FCW Ultra Classic	06	CK7008		CSK915			SRC7013	SRK7013	CT703SP
FLHTCUI 1FCW Ultra Classic	02	CK7008		CSK917			SRC7011	SRK7011	CT703SP
FLHTCUI 1FCW Ultra Classic	04	CK7008		CSK916			SRC7012	SRK7012	CT703SP
FLHTCUL 1KDM Ultra Classic Low	15-16	CK7002		CSK235			SRC7003	SRK7003	CT702SP
FLHTCUL TC 1KFL Ultra Classic Low Twin-Cooled	15-16	CK7002		CSK235			SRC7003	SRK7003	CT702SP
FLHTI 1FVW Electra Glide Standard	03	CK7008		CSK917			SRC7011	SRK7011	CT703SP
FLHTI 1FVW Electra Glide Standard	04-05	CK7008		CSK916			SRC7012	SRK7012	CT703SP
FLHTI 1FVW Electra Glide Standard	06	CK7008		CSK915			SRC7013	SRK7013	CT703SP
FLHTK 103 1TEL CVO Limited	14	CK7002		CSK235			SRC7003	SRK7003	CT702SP
FLHTK 1KED Ultra Limited	17-18	CK7002		CSK236			SRC7010	SRK7010	CT702SP
FLHTK 1KEL Ultra Limited	14-16	CK7008		CSK917			SRC7011	SRK7011	CT703SP
FLHTK 1KEM Electra Glide Ultra Limited	10-13	CK7008		CSK916			SRC7012	SRK7012	CT703SP
FLHTK 1KND Ultra Limited Shrine Edition	18	CK7002		CSK236			SRC7010	SRK7010	CT702SP
FLHTK 1KWD Ultra Limited Anniversary	18	CK7002		CSK236			SRC7010	SRK7010	CT702SP
FLHTK ANV 1KEM_ANV Electra Glide Ultra Limited ANV	13	CK7008		CSK916			SRC7012	SRK7012	CT703SP
FLHTKL 1KKD Ultra Limited Low	17-18	CK7002		CSK236			SRC7010	SRK7010	CT702SP
FLHTKL 1KKL Ultra Limited Low	15-16	CK7002		CSK235			SRC7003	SRK7003	CT702SP
FLHX 103 1KBM Street Glide	11	CK7008		CSK916			SRC7012	SRK7012	CT703SP
FLHX 1KAV Street Glide	06	CK7008		CSK915			SRC7013	SRK7013	CT703SP
FLHX 1KB4 Street Glide	07-11	CK7008		CSK915			SRC7013	SRK7013	CT703SP
FLHX 1KBC Street Glide	17-18	CK7002		CSK236			SRC7010	SRK7010	CT702SP
FLHX 1KBM Street Glide	12-13	CK7008		CSK916			SRC7012	SRK7012	CT703SP
FLHX 1KBM Street Glide	14-16	CK7008		CSK917			SRC7011	SRK7011	CT703SP
FLHX 1KXC Street Glide Anniversary	18	CK7002		CSK236			SRC7010	SRK7010	CT702SP
FLHXI 1KBW Street Glide	06	CK7008		CSK915			SRC7013	SRK7013	CT703SP
FLHXS 1KRC Street Glide Special	17-18	CK7002		CSK236			SRC7010	SRK7010	CT702SP
FLHXS 1KRM Street Glide Special	14-16	CK7008		CSK917			SRC7011	SRK7011	CT703SP
FLHXS 1KYC Street Glide Special Anniversary	18	CK7002		CSK236			SRC7010	SRK7010	CT702SP
FLT Classic Tour Glide Classic	Later 84	CK7010		TBA			SRC7016	SRK7016	CT705SP
FLT AEKD Touring Tour Glide	81	CK7012		TBA			SRC7018	SRK7018	CT704SP
FLT Classic Tour Glide Classic	82-83	CK7012		TBA			SRC7018	SRK7018	CT704SP
FLT Classic Tour Glide Classic	Early 84	CK7011		TBA			SRC7017	SRK7017	CT704SP
FLT DAKC Touring Tour Glide	82	CK7012		TBA			SRC7018	SRK7018	CT704SP
FLT DAKD Touring Tour Glide	83	CK7012		TBA			SRC7018	SRK7018	CT704SP
FLT Tour Glide	81/83	CK7012		TBA			SRC7018	SRK7018	CT704SP
FLT Tour Glide	Early 84	CK7011		TBA			SRC7017	SRK7017	CT704SP
FLT Tour Glide	Later 84	CK7010		TBA			SRC7016	SRK7016	CT705SP
FLTC DBLJ Touring Tour Glide Classic	88	CK7010		TBA			SRC7016	SRK7016	CT705SP
FLTC DBLK Touring Tour Glide Classic	89	CK7010		TBA			SRC7016	SRK7016	CT705SP
FLTC 1DBL Tour Glide Classic	91-92	CK7009		TBA			SRC7014	SRK7014	CT701SP
FLTC 5G05 Touring Tour Glide Classic	80	CK7012		TBA			SRC7018	SRK7018	CT704SP
FLTC AFKB Touring Tour Glide Classic	81	CK7012		TBA			SRC7018	SRK7018	CT704SP
FLTC DBKC Touring Tour Glide Classic	82	CK7012		TBA			SRC7018	SRK7018	CT704SP
FLTC DBLE Touring Tour Glide Classic	Early 84	CK7012		TBA			SRC7018	SRK7018	CT704SP
FLTC DBLE Touring Tour Glide Classic	Later 84	CK7010		TBA			SRC7016	SRK7016	CT705SP
FLTC DBLF Touring Tour Glide Classic	85	CK7010		TBA			SRC7016	SRK7016	CT705SP
FLTC DBLG Touring Tour Glide Classic	86	CK7010		TBA			SRC7016	SRK7016	CT705SP
FLTC DBLH Touring Tour Glide Classic	87	CK7010		TBA			SRC7016	SRK7016	CT705SP
FLTC DBLK Touring Tour Glide Classic	89	CK7010		TBA			SRC7016	SRK7016	CT705SP
FLTC DBLL Touring Tour Glide Classic	90	CK7009		TBA			SRC7015	SRK7015	CT701SP
FLTC Tour Glide Classic	81	CK7012		TBA			SRC7018	SRK7018	CT704SP
FLTCU 1DML Tour Glide Ultra Classic	91-95	CK7009		TBA			SRC7014	SRK7014	CT701SP
FLTCU DMLK Touring Tour Glide Classic Ultra	89	CK7010		TBA			SRC7016	SRK7016	CT705SP
FLTCU DMLL Touring Tour Glide Classic Ultra	90	CK7009		TBA			SRC7015	SRK7015	CT701SP

CLUTCH APPLICATIONS

EBC BRAKES CLUTCH KITS



HARLEY-DAVIDSON®



		CK cork OEM style Kit #	CKF carbon fiber style upgrade Kit #	CSK Spring Kit #	DRC Series Kit #	DRCF Series Kit #	SRC Series Kit #	SRK Series Kit #	CT Tool #
FLTCUI 1FER Tour Glide Ultra Classic	96	CK7009		TBA			SRC7014	SRK7014	CT701SP
FLTR 1FPL Road Glide	98	CK7008		CSK917			SRC7011	SRK7011	CT703SP
FLTR 1FPV Road Glide	99-03	CK7008		CSK917			SRC7011	SRK7011	CT703SP
FLTR 1FS4 Road Glide	07-09	CK7008		CSK915			SRC7013	SRK7013	CT703SP
FLTRI 1FSR Road Glide	98	CK7008		CSK917			SRC7011	SRK7011	CT703SP
FLTRI 1FSW Road Glide	99-03	CK7008		CSK917			SRC7011	SRK7011	CT703SP
FLTRI 1FSW Road Glide	04-05	CK7008		CSK916			SRC7012	SRK7012	CT703SP
FLTRI 1FSW Road Glide	06	CK7008		CSK915			SRC7013	SRK7013	CT703SP
FLTRU 1KGD Road Glide Ultra	17-18	CK7002		CSK236			SRC7010	SRK7010	CT702SP
FLTRU 1KGL Road Glide Ultra	16	CK7008		CSK917			SRC7011	SRK7011	CT703SP
FLTRU 1KGM Road Glide Ultra	11-13	CK7008		CSK916			SRC7012	SRK7012	CT703SP
FLTRX 103 1KHM Road Glide Custom	11	CK7008		CSK916			SRC7012	SRK7012	CT703SP
FLTRX 1KH4 Road Glide Custom	10-11	CK7008		CSK915			SRC7013	SRK7013	CT703SP
FLTRX 1KHC Road Glide	17-18	CK7002		CSK236			SRC7010	SRK7010	CT702SP
FLTRX 1KHM Road Glide	15-16	CK7008		CSK917			SRC7011	SRK7011	CT703SP
FLTRX 1KHM Road Glide Custom	12-13	CK7008		CSK916			SRC7012	SRK7012	CT703SP
FLTRXS 1KTM Road Glide Special	15	CK7008		CSK917			SRC7011	SRK7011	CT703SP
FLTRXS 1KTC Road Glide Special	17-18	CK7002		CSK236			SRC7010	SRK7010	CT702SP
FLTRXS 1KTM Road Glide Special	16	CK7008		CSK917			SRC7011	SRK7011	CT703SP
DYNA									
FLD 103 1GZM Dyna Switchback	12-16	CK7008		CSK916			SRC7012	SRK7012	CT703SP
FLD 1GZ4 Dyna Switchback	12	CK7008		CSK915			SRC7013	SRK7013	CT703SP
FLD 1GZ4 Dyna Switchback	13	CK7008		CSK916			SRC7012	SRK7012	CT703SP
FLD 1GZ4 Dyna Switchback	14-16	CK7008		CSK915			SRC7013	SRK7013	CT703SP
FXD 1GHL Dyna Super Glide	95-97	CK7009		TBA			SRC7019	SRK7019	CT701SP
FXD 1GHL Dyna Super Glide	98-03	CK7008		CSK917			SRC7011	SRK7011	CT703SP
FXD 1GHV Dyna Super Glide	04-05	CK7008		CSK916			SRC7012	SRK7012	CT703SP
FXD 1GM4 Dyna Super Glide	07-10	CK7008		CSK915			SRC7013	SRK7013	CT703SP
FXD35 1GW1 Dyna 35th Anniversary Super Glide	06	CK7008		CSK915			SRC7013	SRK7013	CT703SP
FXDB 1GBL Dyna Sturgis	91	CK7009		TBA			SRC7019	SRK7019	CT701SP
FXDB 1GX4 Dyna Street Bob	10	CK7008		CSK915			SRC7013	SRK7013	CT703SP
FXDB 103 1GXM Dyna Street Bob	14-16	CK7008		CSK916			SRC7012	SRK7012	CT703SP
FXDB 103 1GXM Dyna Street Bob 103	17	CK7008		CSK916			SRC7012	SRK7012	CT703SP
FXDB 1GAL Dyna Daytona	92	CK7009		TBA			SRC7019	SRK7019	CT701SP
FXDB 1GX4 Dyna Street Bob	07-17	CK7008		CSK915			SRC7013	SRK7013	CT703SP
FXDB 1GX4 Dyna Street Bob	15	CK7008		CSK915			SRC7013	SRK7013	CT703SP
FXDBA 103 1VBM Dyna Street Bob (H-D1)	13	CK7008		CSK916			SRC7012	SRK7012	CT703SP
FXDBA 1VB4 Dyna Street Bob (H-D1)	13	CK7008		CSK915			SRC7013	SRK7013	CT703SP
FXDBB 103 1VCM Dyna Street Bob (H-D1)	14-15	CK7008		CSK916			SRC7012	SRK7012	CT703SP
FXDBB 1VC4 Dyna Street Bob (H-D1)	15	CK7008		CSK915			SRC7013	SRK7013	CT703SP
FXDBC 103 1VDM Dyna Street Bob Limited	16	CK7008		CSK916			SRC7012	SRK7012	CT703SP
FXDBC 1VD4 Dyna Street Bob Limited	16	CK7008		CSK915			SRC7013	SRK7013	CT703SP
FXDBI 1GX1 Dyna Street Bob	06	CK7008		CSK915			SRC7013	SRK7013	CT703SP
FXDBP 103 1VAM Dyna Street Bob	16	CK7008		CSK916			SRC7012	SRK7012	CT703SP
FXDBP 103 1VAM Dyna Street Bob (H-D1)	13-15	CK7008		CSK916			SRC7012	SRK7012	CT703SP
FXDC 103 1GVM Dyna Super Glide Custom	14	CK7008		CSK916			SRC7012	SRK7012	CT703SP
FXDC 1GCL Super Glide Custom	92	CK7009		TBA			SRC7019	SRK7019	CT701SP
FXDC 1GTV Dyna Super Glide Custom	05	CK7008		CSK916			SRC7012	SRK7012	CT703SP
FXDC 1GV4 Dyna Super Glide Custom	07-14	CK7008		CSK915			SRC7013	SRK7013	CT703SP
FXDC ANV 1GV4_ANV Dyna Super Glide Custom ANV	13	CK7008		CSK915			SRC7013	SRK7013	CT703SP
FXDCI 1GV1 Dyna Super Glide Custom	06	CK7008		CSK915			SRC7013	SRK7013	CT703SP
FXDCI 1GVW Dyna Super Glide Custom	05	CK7008		CSK916			SRC7012	SRK7012	CT703SP
FXDF 1GY4 Dyna Fat Bob	15	CK7008		CSK915			SRC7013	SRK7013	CT703SP
FXDF 103 1GYM Dyna Fat Bob	12-16	CK7008		CSK916			SRC7012	SRK7012	CT703SP
FXDF 103 1GYM Dyna Fat Bob 103	17	CK7008		CSK916			SRC7012	SRK7012	CT703SP
FXDF 1GY4 Dyna Fat Bob	08-16	CK7008		CSK915			SRC7013	SRK7013	CT703SP
FXDI 1GM1 Dyna Super Glide	06	CK7008		CSK915			SRC7013	SRK7013	CT703SP

CLUTCH APPLICATIONS

EBC BRAKES CLUTCH KITS



HARLEY-DAVIDSON®



		CK cork OEM style Kit #	CKF carbon fiber style upgrade Kit #	CSK Spring Kit #	DRC Series Kit #	DRCF Series Kit #	SRC Series Kit #	SRK Series Kit #	CT Tool #
FXDI 1GMW Dyna Super Glide	04-05	CK7008		CSK916			SRC7012	SRK7012	CT703SP
FXDL 103 1GNM Dyna Low Rider	14-16	CK7008		CSK916			SRC7012	SRK7012	CT703SP
FXDL 103 1GNM Low Rider 103	17	CK7008		CSK916			SRC7012	SRK7012	CT703SP
FXDL 1GDL Dyna Low Rider	93-97	CK7009		TBA			SRC7019	SRK7019	CT701SP
FXDL 1GDL Dyna Low Rider	98-03	CK7008		CSK917			SRC7011	SRK7011	CT703SP
FXDL 1GDV Dyna Low Rider	04-05	CK7008		CSK916			SRC7012	SRK7012	CT703SP
FXDL 1GN4 Dyna Low Rider	07-17	CK7008		CSK915			SRC7013	SRK7013	CT703SP
FXDLI 1GN1 Dyna Low Rider	06	CK7008		CSK915			SRC7013	SRK7013	CT703SP
FXDLI 1GNW Dyna Low Rider	04-05	CK7008		CSK916			SRC7012	SRK7012	CT703SP
FXDLS 1GS8 Dyna Low Rider S	16-17	CK7008		CSK914			SRC7009	SRK7009	CT703SP
FXDS-CONV GGLP Dyna Glide Convertible	93	CK7009		TBA			SRC7019	SRK7019	CT701SP
FXDS-CONV GGVX Dyna Glide Convertible	99	CK7008		CSK917			SRC7011	SRK7011	CT703SP
FXDS-CONV GGVY Dyna Glide Convertible	00	CK7008		CSK917			SRC7011	SRK7011	CT703SP
FXDWG 1GEL Dyna Wide Glide	98	CK7008		CSK917			SRC7011	SRK7011	CT703SP
FXDWG 103 1GPM Dyna Wide Glide	12-15	CK7008		CSK916			SRC7012	SRK7012	CT703SP
FXDWG 103 1GPM Dyna Wide Glide 103	17	CK7008		CSK916			SRC7012	SRK7012	CT703SP
FXDWG 1GEL Dyna Wide Glide	93-97	CK7009		TBA			SRC7019	SRK7019	CT701SP
FXDWG 1GEV Dyna Wide Glide	99-03	CK7008		CSK917			SRC7011	SRK7011	CT703SP
FXDWG 1GEV Dyna Wide Glide	04-05	CK7008		CSK916			SRC7012	SRK7012	CT703SP
FXDWG 1GP4 Dyna Wide Glide	07-16	CK7008		CSK915			SRC7013	SRK7013	CT703SP
FXDWG ANV 1GP4 Dyna Wide Glide 105th Anniversary	08	CK7008		CSK915			SRC7013	SRK7013	CT703SP
FXDWGI 1GP1 Dyna Wide Glide	06	CK7008		CSK915			SRC7013	SRK7013	CT703SP
FXDWGI 1GPW Dyna Wide Glide	04-05	CK7008		CSK916			SRC7012	SRK7012	CT703SP
FXDX 1GJV Dyna Super Glide Sport	99-03	CK7008		CSK917			SRC7011	SRK7011	CT703SP
FXDX 1GJV Dyna Super Glide Sport	04-05	CK7008		CSK916			SRC7012	SRK7012	CT703SP
FXDXI 1GRW Dyna Super Glide Sport	04-05	CK7008		CSK916			SRC7012	SRK7012	CT703SP
FXDXT 1GLV Dyna Super Glide T-Sport	01-03	CK7008		CSK917			SRC7011	SRK7011	CT703SP
SPORTSTER									
XL1200 1CAP Sportster 1200	91-03	CK7009		TBA			SRC7023	SRK7023	CT701SP
XL1200 1LN3 Forty Eight Anniversary	18	CK7009		CSK919			SRC7020	SRK7020	CT701SP
XL1200 CAPL Sportster 1200	90	CK7014		TBA			SRC7024	SRK7024	CT709SP
XL1200C 1CGP Sportster 1200 Custom	96-03	CK7009		TBA			SRC7023	SRK7023	CT701SP
XL1200C 1CGP Sportster 1200 Custom	04-06	CK7009		CSK919			SRC7020	SRK7020	CT701SP
XL1200C 1CT3 1200 Custom	17-18	CK7009		CSK919			SRC7020	SRK7020	CT701SP
XL1200C 1CT3 Sportster 1200 Custom	07-16	CK7009		CSK919			SRC7020	SRK7020	CT701SP
XL1200C ANV 1CT3_ANV Sportster 1200 Custom ANV	13	CK7009		CSK919			SRC7020	SRK7020	CT701SP
XL1200CA 1LJ3 Sportster 1200 Custom Limited A	13-16	CK7009		CSK919			SRC7020	SRK7020	CT701SP
XL1200CB 1LK3 1200 Custom Limited B	17	CK7009		CSK919			SRC7020	SRK7020	CT701SP
XL1200CB 1LK3 Sportster 1200 Custom Limited A	16	CK7009		CSK919			SRC7020	SRK7020	CT701SP
XL1200CB 1LK3 Sportster 1200 Custom Limited B	13-15	CK7009		CSK919			SRC7020	SRK7020	CT701SP
XL1200CP 1LH3 Sportster 1200 Custom (H-D1)	11-16	CK7009		CSK919			SRC7020	SRK7020	CT701SP
XL1200CX 1LM3 1200 Roadster	18	CK7009		CSK919			SRC7020	SRK7020	CT701SP
XL1200CX 1LM3 Roadster	16	CK7009		CSK919			SRC7020	SRK7020	CT701SP
XL1200CX 1LM3 Roadster	17	CK7009		CSK919			SRC7020	SRK7020	CT701SP
XL1200L 1CWP Sportster 1200 Low	06	CK7009		CSK919			SRC7020	SRK7020	CT701SP
XL1200L 1CX3 Sportster 1200 Low	07-11	CK7009		CSK919			SRC7020	SRK7020	CT701SP
XL1200N 1CZ3 Nightster	07-12	CK7009		CSK919			SRC7020	SRK7020	CT701SP
XL1200R 1CLP Sportster 1200 Roadster	04-06	CK7009		CSK919			SRC7020	SRK7020	CT701SP
XL1200R 1CV3 Sportster 1200 Roadster	07-08	CK7009		CSK919			SRC7020	SRK7020	CT701SP
XL1200R 1CV3 Sportster 1200R	09	CK7009		CSK919			SRC7020	SRK7020	CT701SP
XL1200S 1CHP Sportster 1200 Sport	96-03	CK7009		TBA			SRC7023	SRK7023	CT701SP
XL1200T 1LL3 SuperLow 1200T	14-18	CK7009		CSK919			SRC7020	SRK7020	CT701SP
XL1200T 1LL3 SuperLow 1200T	17	CK7009		CSK919			SRC7020	SRK7020	CT701SP
XL1200V 1LF3 Seventy-Two	12-16	CK7009		CSK919			SRC7020	SRK7020	CT701SP
XL1200X 1LC3 Forty-Eight	10-18	CK7009		CSK919			SRC7020	SRK7020	CT701SP
XL1200X 1LC3 Forty-Eight	18	CK7009		CSK919			SRC7020	SRK7020	CT701SP
XL50 1CY3 50th ANV Sportster	07	CK7009		CSK919			SRC7020	SRK7020	CT701SP

CLUTCH APPLICATIONS

EBC BRAKES CLUTCH KITS



HARLEY-DAVIDSON®



		CK cork OEM style Kit #	CKF carbon fiber style upgrade Kit #	CSK Spring Kit #	DRC Series Kit #	DRCF Series Kit #	SRC Series Kit #	SRK Series Kit #	CT Tool #
XL883 4CAM Sportster 883	91-03	CK7009		TBA			SRC7023	SRK7023	CT701SP
XL883 4CAM Sportster 883	04-06	CK7009		CSK918			SRC7021	SRK7021	CT701SP
XL883 4CN2 Sportster 883	07-09	CK7009		CSK918			SRC7021	SRK7021	CT701SP
XL883 CAMG Sportster 883	86	CK7014		TBA			SRC7024	SRK7024	CT709SP
XL883 CAMG Sportster 883 Deluxe	86	CK7014		TBA			SRC7024	SRK7024	CT709SP
XL883 CAMH Sportster 883	87	CK7014		TBA			SRC7024	SRK7024	CT709SP
XL883 CAML Sportster 883	90	CK7014		TBA			SRC7024	SRK7024	CT709SP
XL883C 4CJM Sportster 883 Custom	98-03	CK7009		TBA			SRC7023	SRK7023	CT701SP
XL883C 4CJM Sportster 883 Custom	04-06	CK7009		CSK918			SRC7021	SRK7021	CT701SP
XL883C 4CP2 Sportster 883 Custom	07-10	CK7009		CSK918			SRC7021	SRK7021	CT701SP
XL883DLX 4CFM Sportster 883 Deluxe	91-95	CK7009		TBA			SRC7023	SRK7023	CT701SP
XL883DLX CFML Sportster 883 Deluxe	90	CK7014		TBA			SRC7024	SRK7024	CT709SP
XL883HUG 4CEM Sportster 883 Hugger	91-03	CK7009		TBA			SRC7023	SRK7023	CT701SP
XL883HUG CEMH Sportster 883 Hugger	87	CK7014		TBA			SRC7024	SRK7024	CT709SP
XL883HUG CEML Sportster 883 Hugger	90	CK7014		TBA			SRC7024	SRK7024	CT709SP
XL883L 4CMM Sportster XL883 Low	05-06	CK7009		CSK918			SRC7021	SRK7021	CT701SP
XL883L 4CR2 Sportster 883 Low	10-11	CK7009		CSK918			SRC7021	SRK7021	CT701SP
XL883L 4CR2 Sportster XL883 Low	07-09	CK7009		CSK918			SRC7021	SRK7021	CT701SP
XL883L 4CR2 SuperLow	12-17	CK7009		CSK918			SRC7021	SRK7021	CT701SP
XL883L 4CR2 SuperLow	18	CK7009		CSK918			SRC7021	SRK7021	CT701SP
XL883L 4CR2 SuperLow 883	16	CK7009		CSK918			SRC7021	SRK7021	CT701SP
XL883N 4LE2 Iron 883	09-18	CK7009		CSK918			SRC7021	SRK7021	CT701SP
XL883N 4LE2 Iron 883	18	CK7009		CSK918			SRC7021	SRK7021	CT701SP
XL883R 4CKM Sportster 883R	02-03	CK7009		TBA			SRC7023	SRK7023	CT701SP
XL883R 4CKM Sportster 883R	05-06	CK7009		CSK918			SRC7021	SRK7021	CT701SP
XL883R 4CS2 883 Roadster	11-15	CK7009		CSK918			SRC7021	SRK7021	CT701SP
XL883R 4CS2 Sportster 883R	07-10	CK7009		CSK918			SRC7021	SRK7021	CT701SP
XLCH-1000 4AH0 Sportster 1000	70	CK7016		TBA					
XLCH-1000 4AH1 Sportster 1000	71	CK7015		TBA			SRC7025	SRK7025	CT709SP
XLCH-1000 4AH2 Sportster 1000	72	CK7015		TBA			SRC7025	SRK7025	CT709SP
XLCH-1000 4AH3 Sportster 1000	73	CK7015		TBA			SRC7025	SRK7025	CT709SP
XLCH-1000 4AH4 Sportster 1000	74	CK7015		TBA			SRC7025	SRK7025	CT709SP
XLCH-1000 4AH5 Sportster 1000	75	CK7015		TBA			SRC7025	SRK7025	CT709SP
XLCH-1000 4AH6 Sportster 1000	76	CK7015		TBA			SRC7025	SRK7025	CT709SP
XLCH-1000 4AH7 Sportster 1000	77	CK7015		TBA			SRC7025	SRK7025	CT709SP
XLCH-1000 4AH8 Sportster 1000	78	CK7015		TBA			SRC7025	SRK7025	CT709SP
XLCH-1000 4AH9 Sportster 1000	79	CK7015		TBA			SRC7025	SRK7025	CT709SP
XLCH-1000 4AJ0 Sportster 1000	80	CK7015		TBA			SRC7025	SRK7025	CT709SP
XLH CAHB Sportster 1000	81	CK7015		TBA			SRC7025	SRK7025	CT709SP
XLH CAHC Sportster 1000	82	CK7015		TBA			SRC7025	SRK7025	CT709SP
XLH CAHD Sportster 1000	83	CK7015		TBA			SRC7025	SRK7025	CT709SP
XLH CAHE Sportster 1000	84	CK7014		TBA			SRC7024	SRK7024	CT709SP
XLH CAHE Sportster 1000	Early 84	CK7015		TBA			SRC7025	SRK7025	CT709SP
XLH CAHF Sportster 1000 1985	Later 84	CK7014		TBA			SRC7024	SRK7024	CT709SP
XLH-1000 3AH0 Sportster Standard	70	CK7016		TBA					
XLH-1000 3AH1 Sportster Standard	71	CK7015		TBA			SRC7025	SRK7025	CT709SP
XLH-1000 3AH2 Sportster Standard	72	CK7015		TBA			SRC7025	SRK7025	CT709SP
XLH-1000 3AH3 Sportster Standard	73	CK7015		TBA			SRC7025	SRK7025	CT709SP
XLH-1000 3AH5 Sportster Standard	75	CK7015		TBA			SRC7025	SRK7025	CT709SP
XLH-1000 3AH6 Sportster Standard	76	CK7015		TBA			SRC7025	SRK7025	CT709SP
XLH-1000 3AH7 Sportster Standard	77	CK7015		TBA			SRC7025	SRK7025	CT709SP
XLH-1000 3AH8 Sportster Standard	78	CK7015		TBA			SRC7025	SRK7025	CT709SP
XLH-1000 3AH9 Sportster 1000	79	CK7015		TBA			SRC7025	SRK7025	CT709SP
XLH-1000 3AJ0 Sportster 1000	80	CK7015		TBA			SRC7025	SRK7025	CT709SP
XLH-1100 CANG Sportster 1100	86	CK7014		TBA			SRC7024	SRK7024	CT709SP
XLH-1100 CANH Sportster 1100	87	CK7014		TBA			SRC7024	SRK7024	CT709SP
XLH-1200 CAPJ Sportster 1200	88	CK7014		TBA			SRC7024	SRK7024	CT709SP

CLUTCH
APPLICATIONS

EBC BRAKES CLUTCH KITS



HARLEY-DAVIDSON®



		CK cork OEM style Kit #	CKF carbon fiber style upgrade Kit #	CSK Spring Kit #	DRC Series Kit #	DRCF Series Kit #	SRC Series Kit #	SRK Series Kit #	CT Tool #
XLH-1200 CAPK Sportster 1200	89	CK7014		TBA			SRC7024	SRK7024	CT709SP
XLH883 CAMJ Sportster 883	88	CK7014		TBA			SRC7024	SRK7024	CT709SP
XLH883 CAMK Sportster 883	89	CK7014		TBA			SRC7024	SRK7024	CT709SP
XLH883DLX CFMJ Sportster 883 Deluxe	88	CK7014		TBA			SRC7024	SRK7024	CT709SP
XLH883DLX CFMK Sportster 883 Deluxe	89	CK7014		TBA			SRC7024	SRK7024	CT709SP
XLH883HUG CEMJ Sportster 883 Hugger	88	CK7014		TBA			SRC7024	SRK7024	CT709SP
XLH883HUG CEMK Sportster 883 Hugger	89	CK7014		TBA			SRC7024	SRK7024	CT709SP
XLS CBHB Sportster Roadster 1000	81	CK7015		TBA			SRC7025	SRK7025	CT709SP
XLS CBHC Sportster Roadster 1000	82	CK7015		TBA			SRC7025	SRK7025	CT709SP
XLS CBHD Sportster Roadster 1000	83	CK7015		TBA			SRC7025	SRK7025	CT709SP
XLS CBHE Sportster Roadster 1000	84	CK7014		TBA			SRC7024	SRK7024	CT709SP
XLS CBHE Sportster Roadster 1000	Early 84	CK7015		TBA			SRC7025	SRK7025	CT709SP
XLS CBHF Sportster Roadster 1000	Later	CK7014		TBA			SRC7024	SRK7024	CT709SP
XLX CCHD Sportster Roadster 1000	83	CK7015		TBA			SRC7025	SRK7025	CT709SP
XLX CCHE Sportster Roadster 1000	84	CK7014		TBA			SRC7024	SRK7024	CT709SP
XLX CCHE Sportster Roadster 1000	Early 84	CK7015		TBA			SRC7025	SRK7025	CT709SP
XLX CCHF Sportster Roadster 1000	Later	CK7014		TBA			SRC7024	SRK7024	CT709SP
XR-1000 CDHD Sportster	83	CK7015		TBA			SRC7025	SRK7025	CT709SP
XR-1000 CDHE Sportster	84	CK7014		TBA			SRC7024	SRK7024	CT709SP
XR-1000 CDHE Sportster	Early 84	CK7015		TBA			SRC7025	SRK7025	CT709SP
XR1200 1LA6 Sportster 1200	08	CK7013		CSK913			SRC7022	SRK7022	CT701SP
XR1200 1LA6 XR1200	09-10	CK7013		CSK913			SRC7022	SRK7022	CT701SP
XR1200X 1LD6 XR1200X	10-13	CK7013		CSK913			SRC7022	SRK7022	CT701SP
SOFTAIL									
FLDE 1YCJ Deluxe	18	TBA		CSK236			TBA	TBA	
FLFB 1YFJ Fat Boy	18	TBA		CSK236			TBA	TBA	
FLFBS 1YGK Fat Boy 114	18	CK7007		CSK236			SRC7008	SRK7008	CT708SP
FLFBS 1YRK Fat Boy 114 Anniversary	18	CK7007		CSK236			SRC7008	SRK7008	CT708SP
FLFBS 1YSK Fat Boy 114 Anniversary	18	CK7007		CSK236			SRC7008	SRK7008	CT708SP
FLHC 1YAJ Heritage Classic	18	TBA		CSK236			TBA	TBA	
FLHCS 1YBK Heritage Classic 114	18	CK7007		CSK236			SRC7008	SRK7008	CT708SP
FLHCS 1YPK Heritage Classic 114 Anniversary	18	CK7007		CSK236			SRC7008	SRK7008	CT708SP
FLS 103 1JRV Softail Slim	12-15	CK7008		CSK916			SRC7012	SRK7012	CT703SP
FLS 1JR5 Softail Slim	12-15	CK7008		CSK915			SRC7013	SRK7013	CT703SP
FLS 1JRV Slim	17	CK7008		CSK916			SRC7012	SRK7012	CT703SP
FLS 1JRV Softail Slim	16	CK7008		CSK916			SRC7012	SRK7012	CT703SP
FLSL 1YDJ Slim	18	TBA		CSK236			TBA	TBA	
FLSS 1JS9 Slim S	17	CK7002		CSK235			SRC7003	SRK7003	CT702SP
FLSS 1JS9 Softail Slim S	16	CK7002		CSK235			SRC7003	SRK7003	CT702SP
FLST BJLL Softail Heritage	90	CK7009		TBA			SRC7019	SRK7019	CT701SP
FLST 1JE5 Heritage Softail	09-10	CK7008		CSK915			SRC7013	SRK7013	CT703SP
FLST 1JEY Heritage Softail	06	CK7008		CSK915			SRC7013	SRK7013	CT703SP
FLST BJLG Softail Heritage	86	CK7010		TBA			SRC7016	SRK7016	CT705SP
FLST BJLH Softail Heritage	87	CK7010		TBA			SRC7016	SRK7016	CT705SP
FLST BJLJ Softail Heritage	88	CK7010		TBA			SRC7016	SRK7016	CT705SP
FLST BJLK Softail Heritage	89	CK7010		TBA			SRC7016	SRK7016	CT705SP
FLSTC 103 1BWV Heritage Softail Classic	12	CK7008		CSK915			SRC7013	SRK7013	CT703SP
FLSTC 103 1BWV Heritage Softail Classic	13-15	CK7008		CSK916			SRC7012	SRK7012	CT703SP
FLSTC 103 ANV 1BWV_ANV Heritage Softail Classic ANV	13	CK7008		CSK916			SRC7012	SRK7012	CT703SP
FLSTC 1BJL Heritage Softail Classic	91-97	CK7009		TBA			SRC7019	SRK7019	CT701SP
FLSTC 1BJL Heritage Softail Classic	98-03	CK7008		CSK917			SRC7011	SRK7011	CT703SP
FLSTC 1BJY Heritage Softail Classic	04-05	CK7008		CSK916			SRC7012	SRK7012	CT703SP
FLSTC 1BJY Heritage Softail Classic	06	CK7008		CSK915			SRC7013	SRK7013	CT703SP
FLSTC 1BW5 Heritage Softail Classic	07-09	CK7008		CSK915			SRC7013	SRK7013	CT703SP
FLSTC 1BW5 Heritage Softail Classic	11-15	CK7008		CSK915			SRC7013	SRK7013	CT703SP
FLSTC 1BWV Heritage Softail Classic	16-17	CK7008		CSK916			SRC7012	SRK7012	CT703SP
FLSTC ANV 1BW5_ANV Heritage Softail Classic ANV	13	CK7008		CSK915			SRC7013	SRK7013	CT703SP

CLUTCH APPLICATIONS

EBC BRAKES CLUTCH KITS



HARLEY-DAVIDSON®



		CK cork OEM style Kit #	CKF carbon fiber style upgrade Kit #	CSK Spring Kit #	DRC Series Kit #	DRCF Series Kit #	SRC Series Kit #	SRK Series Kit #	CT Tool #
FLSTC BJ01 Softail Heritage Classic	87	CK7010		TBA			SRC7016	SRK7016	CT705SP
FLSTC BJ02 Softail Heritage Classic	88	CK7010		TBA			SRC7016	SRK7016	CT705SP
FLSTC BJ03 Softail Heritage Classic	89	CK7010		TBA			SRC7016	SRK7016	CT705SP
FLSTC BJ04 Softail Heritage Classic	90	CK7009		TBA			SRC7019	SRK7019	CT701SP
FLSTCI 1BWB Heritage Softail Classic	01-03	CK7008		CSK917			SRC7011	SRK7011	CT703SP
FLSTCI 1BWB Heritage Softail Classic	04-05	CK7008		CSK916			SRC7012	SRK7012	CT703SP
FLSTCI 1BWB Heritage Softail Classic	06	CK7008		CSK915			SRC7013	SRK7013	CT703SP
FLSTCI Shrine 1JHB Heritage Softail Classic Shrine	05	CK7008		CSK916			SRC7012	SRK7012	CT703SP
FLSTF 103 1BXV Fat Boy	12-15	CK7008		CSK916			SRC7012	SRK7012	CT703SP
FLSTF 1BML Fat Boy	91-97	CK7009		TBA			SRC7019	SRK7019	CT701SP
FLSTF 1BML Fat Boy	98-03	CK7008		CSK917			SRC7011	SRK7011	CT703SP
FLSTF 1BMY Fat Boy	04-05	CK7008		CSK916			SRC7012	SRK7012	CT703SP
FLSTF 1BMY Fat Boy	06	CK7008		CSK915			SRC7013	SRK7013	CT703SP
FLSTF 1BX5 Fat Boy	07-15	CK7008		CSK915			SRC7013	SRK7013	CT703SP
FLSTF 1BXV Fat Boy	16-17	CK7008		CSK916			SRC7012	SRK7012	CT703SP
FLSTF BMLL Softail Fat Boy	90	CK7009		TBA			SRC7019	SRK7019	CT701SP
FLSTFB 103 1JNV Fat Boy LO	12-15	CK7008		CSK916			SRC7012	SRK7012	CT703SP
FLSTFB 103 ANV 1JNV_ANV Fat Boy LO ANV	13	CK7008		CSK916			SRC7012	SRK7012	CT703SP
FLSTFB 1JN5 Fat Boy LO	10-11	CK7008		CSK915			SRC7013	SRK7013	CT703SP
FLSTFB 1JN5 Fat Boy LO	12	CK7008		CSK916			SRC7012	SRK7012	CT703SP
FLSTFB 1JN5 Fat Boy LO	13-15	CK7008		CSK915			SRC7013	SRK7013	CT703SP
FLSTFB 1JNV Fat Boy LO	16-17	CK7008		CSK916			SRC7012	SRK7012	CT703SP
FLSTFB ANV 1JN5_ANV Fat Boy LO ANV	13	CK7008		CSK915			SRC7013	SRK7013	CT703SP
FLSTFBS 1JT9 Fat Boy S	16-17	CK7002		CSK235			SRC7003	SRK7003	CT702SP
FLSTFI 1BXB Fat Boy	01-03	CK7008		CSK917			SRC7011	SRK7011	CT703SP
FLSTFI 1BXB Fat Boy	04-05	CK7008		CSK916			SRC7012	SRK7012	CT703SP
FLSTFI 1BXB Fat Boy	06	CK7008		CSK915			SRC7013	SRK7013	CT703SP
FLSTFI Shrine 1JGB Fat Boy Shrine	05	CK7008		CSK916			SRC7012	SRK7012	CT703SP
FLSTI 1JFB Heritage Softail	06	CK7008		CSK915			SRC7013	SRK7013	CT703SP
FLSTN 103 1JDV Softail Deluxe	12-15	CK7008		CSK916			SRC7012	SRK7012	CT703SP
FLSTN 1BNL Heritage Softail Nostalgia	93-96	CK7009		TBA			SRC7019	SRK7019	CT701SP
FLSTN 1BNY Softail Deluxe	05	CK7008		CSK916			SRC7012	SRK7012	CT703SP
FLSTN 1BNY Softail Deluxe	06	CK7008		CSK915			SRC7013	SRK7013	CT703SP
FLSTN 1JD5 Softail Deluxe	07-15	CK7008		CSK915			SRC7013	SRK7013	CT703SP
FLSTN 1JDV Deluxe	17	CK7008		CSK916			SRC7012	SRK7012	CT703SP
FLSTN 1JDV Softail Deluxe	16	CK7008		CSK916			SRC7012	SRK7012	CT703SP
FLSTNI 1JDB Softail Deluxe	05	CK7008		CSK916			SRC7012	SRK7012	CT703SP
FLSTNI 1JDB Softail Deluxe	06	CK7008		CSK915			SRC7013	SRK7013	CT703SP
FLSTS 1BRL Heritage Springer	97	CK7009		TBA			SRC7019	SRK7019	CT701SP
FLSTS 1BRL Heritage Springer	98-99	CK7008		CSK917			SRC7011	SRK7011	CT703SP
FLSTS 1BRY Heritage Springer	00-03	CK7008		CSK917			SRC7011	SRK7011	CT703SP
FLSTSB 1JM5 Cross Bones	08-11	CK7008		CSK915			SRC7013	SRK7013	CT703SP
FLSTSC 1BRY Springer Classic	06	CK7008		CSK915			SRC7013	SRK7013	CT703SP
FLSTSC 1BRY Springer Classic	05	CK7008		CSK916			SRC7012	SRK7012	CT703SP
FLSTSC 1BY5 Springer Classic	07	CK7008		CSK915			SRC7013	SRK7013	CT703SP
FLSTSCI 1BYB Springer Classic	05	CK7008		CSK916			SRC7012	SRK7012	CT703SP
FLSTSCI 1BYB Springer Classic	06	CK7008		CSK915			SRC7013	SRK7013	CT703SP
FLSTSI 1BYB Heritage Springer	01-03	CK7008		CSK917			SRC7011	SRK7011	CT703SP
FXB BDKB Super Glide B80	81	CK7012		TBA			SRC7018	SRK7018	CT704SP
FXB BDKC Super Glide B80	82	CK7012		TBA			SRC7018	SRK7018	CT704SP
FXBB 1YJJ Street Bob	18	TBA		CSK236			TBA	TBA	
FXBR 1YEJ Breakout	18	TBA		CSK236			TBA	TBA	
FXBRS 1YHK Breakout 114	18	CK7007		CSK236			SRC7008	SRK7008	CT708SP
FXBRS 1YTK Breakout 114 Anniversary	18	CK7007		CSK236			SRC7008	SRK7008	CT708SP
FXCW 1JJ5 Rocker	08-09	CK7008		CSK915			SRC7013	SRK7013	CT703SP
FXCWC 1JK5 Rocker C	08-11	CK7008		CSK915			SRC7013	SRK7013	CT703SP
FXDG BGKD Dyna Glide Custom	83	CK7012		TBA			SRC7018	SRK7018	CT704SP

CLUTCH
APPLICATIONS

EBC BRAKES CLUTCH KITS



HARLEY-DAVIDSON®



		CK cork OEM style Kit #	CKF carbon fiber style upgrade Kit #	CSK Spring Kit #	DRC Series Kit #	DRCF Series Kit #	SRC Series Kit #	SRK Series Kit #	CT Tool #
FXE BAKB FX Super Glide	81	CK7012		TBA			SRC7018	SRK7018	CT704SP
FXE BAKC FX Super Glide	82	CK7012		TBA			SRC7018	SRK7018	CT704SP
FXE BAKD FX Super Glide	83	CK7012		TBA			SRC7018	SRK7018	CT704SP
FXE BAKE FX Super Glide	Early 84	CK7012		TBA			SRC7018	SRK7018	CT704SP
FXE BAKE FX Super Glide	84	CK7010		TBA			SRC7016	SRK7016	CT705SP
FXEF BBKB FX Super Glide Fat Bob	81	CK7012		TBA			SRC7018	SRK7018	CT704SP
FXEF BBLF FX Super Glide Fat Bob	85	CK7010		TBA			SRC7016	SRK7016	CT705SP
FXFB 1YKJ Fat Bob	18	TBA		CSK236			TBA	TBA	
FXFBS 1YLK Fat Bob 114	18	CK7007		CSK236			SRC7008	SRK7008	CT708SP
FXLR 1YNJ Low Rider	18	TBA		CSK236			TBA	TBA	
FXS 103 1JPV Blackline	12-13	CK7008		CSK916			SRC7012	SRK7012	CT703SP
FXS 1JP5 Blackline	11	CK7008		CSK915			SRC7013	SRK7013	CT703SP
FXS 1JP5 Blackline	12	CK7008		CSK916			SRC7012	SRK7012	CT703SP
FXS 1JP5 Blackline	13	CK7008		CSK915			SRC7013	SRK7013	CT703SP
FXS BCKB FX Super Glide	81	CK7012		TBA			SRC7018	SRK7018	CT704SP
FXS BCKC FX Super Glide	82	CK7012		TBA			SRC7018	SRK7018	CT704SP
FXSB 103 1BFV Softail Breakout	13-15	CK7008		CSK916			SRC7012	SRK7012	CT703SP
FXSB 1BF5 Softail Breakout	13-15	CK7008		CSK915			SRC7013	SRK7013	CT703SP
FXSB 1BFV Breakout	17	CK7008		CSK916			SRC7012	SRK7012	CT703SP
FXSB 1BFV Softail Breakout	16	CK7008		CSK916			SRC7012	SRK7012	CT703SP
FXSB BFKD FX Low Rider	83	CK7012		TBA			SRC7018	SRK7018	CT704SP
FXSB BFKE FX Low Rider	Early 84	CK7012		TBA			SRC7018	SRK7018	CT704SP
FXSB BFKE FX Low Rider	84	CK7010		TBA			SRC7016	SRK7016	CT705SP
FXSB BFLF FX Low Rider	85	CK7010		TBA			SRC7016	SRK7016	CT705SP
FXST 1BHL Softail Standard	99	CK7008		CSK917			SRC7011	SRK7011	CT703SP
FXST 1BHY Softail Standard	00-03	CK7008		CSK917			SRC7011	SRK7011	CT703SP
FXST 1BHY Softail Standard	04-05	CK7008		CSK916			SRC7012	SRK7012	CT703SP
FXST 1BHY Softail Standard	06	CK7008		CSK915			SRC7013	SRK7013	CT703SP
FXST 1BV5 Softail Standard	07-11	CK7008		CSK915			SRC7013	SRK7013	CT703SP
FXST 1BVV Softail Standard	12-15	CK7008		CSK916			SRC7012	SRK7012	CT703SP
FXST BHLE Softail Standard	84	CK7010		TBA			SRC7016	SRK7016	CT705SP
FXST BHLE Softail Standard	Early 84	CK7012		TBA			SRC7018	SRK7018	CT704SP
FXST BHLF Softail Standard	85	CK7010		TBA			SRC7016	SRK7016	CT705SP
FXST BHLG Softail Standard	86	CK7010		TBA			SRC7016	SRK7016	CT705SP
FXST BHLH Softail Standard	87	CK7010		TBA			SRC7016	SRK7016	CT705SP
FXST BHLJ Softail Standard	88	CK7010		TBA			SRC7016	SRK7016	CT705SP
FXST BHLK Softail Standard	89	CK7010		TBA			SRC7016	SRK7016	CT705SP
FXST BHLL Softail Standard	90	CK7009		TBA			SRC7019	SRK7019	CT701SP
FXSTB 1BTL Night Train	99	CK7008		CSK917			SRC7011	SRK7011	CT703SP
FXSTB 1BTY Night Train	00-03	CK7008		CSK917			SRC7011	SRK7011	CT703SP
FXSTB 1BTY Night Train	04-05	CK7008		CSK916			SRC7012	SRK7012	CT703SP
FXSTB 1BTY Night Train	06	CK7008		CSK915			SRC7013	SRK7013	CT703SP
FXSTB 1JA5 Night Train	07-09	CK7008		CSK915			SRC7013	SRK7013	CT703SP
FXSTBI 1JAB Night Train	01-03	CK7008		CSK917			SRC7011	SRK7011	CT703SP
FXSTBI 1JAB Night Train	04-05	CK7008		CSK916			SRC7012	SRK7012	CT703SP
FXSTBI 1JAB Night Train	06	CK7008		CSK915			SRC7013	SRK7013	CT703SP
FXSTC 1BKL Softail Custom	91-97	CK7009		TBA			SRC7019	SRK7019	CT701SP
FXSTC 1BKL Softail Custom	98-99	CK7008		CSK917			SRC7011	SRK7011	CT703SP
FXSTC 1JL5 Softail Custom	07-10	CK7008		CSK915			SRC7013	SRK7013	CT703SP
FXSTC BKLK Softail Custom	86	CK7010		TBA			SRC7016	SRK7016	CT705SP
FXSTC BKLH Softail Custom	87	CK7010		TBA			SRC7016	SRK7016	CT705SP
FXSTC BKLL Softail Custom	88	CK7010		TBA			SRC7016	SRK7016	CT705SP
FXSTC BKLL Softail Custom	89	CK7010		TBA			SRC7016	SRK7016	CT705SP
FXSTC BKLL Softail Custom	90	CK7009		TBA			SRC7019	SRK7019	CT701SP
FXSTD 1BSY Softail Deuce	00-03	CK7008		CSK917			SRC7011	SRK7011	CT703SP
FXSTD 1BSY Softail Deuce	04-05	CK7008		CSK916			SRC7012	SRK7012	CT703SP
FXSTD 1BSY Softail Deuce	06	CK7008		CSK915			SRC7013	SRK7013	CT703SP

CLUTCH
APPLICATIONS

EBC BRAKES CLUTCH KITS



HARLEY-DAVIDSON®



		CK cork OEM style Kit #	CKF carbon fiber style upgrade Kit #	CSK Spring Kit #	DRC Series Kit #	DRCF Series Kit #	SRC Series Kit #	SRK Series Kit #	CT Tool #
FXSTD 1JB5 Softail Deuce	07	CK7008		CSK915			SRC7013	SRK7013	CT703SP
FXSTDI 1JBB Softail Deuce	01-03	CK7008		CSK917			SRC7011	SRK7011	CT703SP
FXSTDI 1JBB Softail Deuce	04-05	CK7008		CSK916			SRC7012	SRK7012	CT703SP
FXSTDI 1JBB Softail Deuce	06	CK7008		CSK915			SRC7013	SRK7013	CT703SP
FXSTI 1BVB Softail Standard	01-03	CK7008		CSK917			SRC7011	SRK7011	CT703SP
FXSTI 1BVB Softail Standard	04-05	CK7008		CSK916			SRC7012	SRK7012	CT703SP
FXSTI 1BVB Softail Standard	06	CK7008		CSK915			SRC7013	SRK7013	CT703SP
FXSTS 1BLL Springer Softail	91-97	CK7009		TBA			SRC7019	SRK7019	CT701SP
FXSTS 1BLL Springer Softail	98-99	CK7008		CSK917			SRC7011	SRK7011	CT703SP
FXSTS 1BLY Springer Softail	01-03	CK7008		CSK917			SRC7011	SRK7011	CT703SP
FXSTS 1BLY Springer Softail	04	CK7008		CSK916			SRC7012	SRK7012	CT703SP
FXSTS 1BLY Springer Softail	06	CK7008		CSK915			SRC7013	SRK7013	CT703SP
FXSTS 1BLY Springer Softail	00	CK7008		CSK917			SRC7011	SRK7011	CT703SP
FXSTS 1BLY Springer Softail	05	CK7008		CSK916			SRC7012	SRK7012	CT703SP
FXSTS BLLJ Softail Springer	88	CK7010		TBA			SRC7016	SRK7016	CT705SP
FXSTS BLLK Softail Springer	89	CK7010		TBA			SRC7016	SRK7016	CT705SP
FXSTS BLLL Softail Springer	90	CK7009		TBA			SRC7019	SRK7019	CT701SP
FXSTSB 1BPL Springer Softail	95-97	CK7009		TBA			SRC7019	SRK7019	CT701SP
FXSTSI 1BZB Springer Softail	01-03	CK7008		CSK917			SRC7011	SRK7011	CT703SP
FXSTSI 1BZB Springer Softail	04-05	CK7008		CSK916			SRC7012	SRK7012	CT703SP
FXSTSI 1BZB Springer Softail	06	CK7008		CSK915			SRC7013	SRK7013	CT703SP
FXWG BEKB FX Wide Glide	81	CK7012		TBA			SRC7018	SRK7018	CT704SP
FXWG BEKC FX Wide Glide	82	CK7012		TBA			SRC7018	SRK7018	CT704SP
FXWG BEKD FX Wide Glide	83	CK7012		TBA			SRC7018	SRK7018	CT704SP
FXWG BEKE FX Wide Glide	Early 84	CK7012		TBA			SRC7018	SRK7018	CT704SP
FXWG BEKE FX Wide Glide	84	CK7010		TBA			SRC7016	SRK7016	CT705SP
FXWG BELF FX Wide Glide	85	CK7010		TBA			SRC7016	SRK7016	CT705SP
FXWG BELG FX Wide Glide	86	CK7010		TBA			SRC7016	SRK7016	CT705SP
KTM									
SX 60	98-00	CK5594	CKF5594	CSK64	DRC107	DRCF107			CT027
SX 65	98-08	CK5594	CKF5594	CSK64	DRC107	DRCF107			CT027
SX 65	09-16	CK5594	CKF5594	CSK21	DRC241	DRCF241			CT057SP
XC 65	08	CK5594	CKF5594	CSK64	DRC107	DRCF107			CT027
XC 65	09-10	CK5594	CKF5594	CSK21	DRC241	DRCF241			CT057SP
SX 85 (17"/14")	03-17	CK5610		CSK42	DRC139				CT028
SX 85 (19"/16")	03-17	CK5610		CSK42	DRC139				CT028
XC 85	08-09	CK5610		CSK42	DRC139				CT028
SX 105	04-10	CK5610		CSK42	DRC139				CT028
XC 105	08-10	CK5610		CSK42	DRC139				CT028
125 EGS	98-99	CK5611		CSK24	DRC145				CT001
125 EXC	98-05	CK5611		CSK24	DRC145				CT001
125 EXE	00-01	CK5611		CSK24	DRC145				CT001
125 LC 2 Sting	96-98	N/A		N/A	N/A				
125 Supermoto	00-01	CK5611		CSK24	DRC145				CT001
SX 125	98-07	CK5611		CSK24	DRC145				CT001
SX 125	08	CK5611		CSK132	DRC174				CT001
SX 125	09-16	CK5611		CSK24	DRC145				CT001
125 SXS	01-02	CK5611		CSK24	DRC145				CT001
SX 150	08-17	CK5611		CSK91	DRC144				CT001
XC 150	10-14	CK5611		CSK91	DRC144				CT001
200 EGS	98-99	CK5611		CSK91	DRC144				CT001
200 EXC	97-05	CK5611		CSK91	DRC144				CT001
200 MXC	98-03	CK5611		CSK91	DRC144				CT001
SX 200	03	CK5611		CSK91	DRC144				CT001
XC-W 200	07-16	CK5611		CSK91	DRC144				CT001
XC 200	06-09	CK5611		CSK91	DRC144				CT001

CLUTCH
APPLICATIONS

EBC BRAKES CLUTCH KITS



KTM



		CK cork OEM style Kit #	CKF carbon fiber style upgrade Kit #	CSK Spring Kit #	DRC Series Kit #	DRCF Series Kit #	SRC Series Kit #	SRK Series Kit #	CT Tool #
250 EGS	94-99	CK5595	CKF5595	CSK80	DRC108	DRCF108			CT007
250 EXC	94-05	CK5595	CKF5595	CSK80	DRC108	DRCF108			CT007
250 EXC Racing	02-03	CK5612		CSK210	DRC171				CT023
250 EXC Racing	04	CK5602		CSK210	DRC117				CT059
250 EXC Racing	05	CK5612		CSK210	DRC154				CT023
250 EXG-G Racing	03	CK5612		CSK210	DRC171				CT023
250 EXC-G Racing	04	CK5602		CSK210	DRC117				CT059
250 MXC	98-99	CK5595	CKF5595	CSK80	DRC108	DRCF108			CT007
SX 250 (2T)	94-12	CK5595	CKF5595	CSK80	DRC108	DRCF108			CT007
SX 250 (2T) (Diaphragm Spring)	13-16	CK5651		CSK910	DRC275				CT023
SX-F 250	05-12	CK1293	CKF1293	CSK179	DRC163	DRCF163			CT001
SX-F 250	13-15	CK5651		CSK91	DRC260				CT023
SX-F 250	16	CK5612		CSK221	DRC292				CT023
SX-F 250 Factory Edition	15	CK5612		CSK221	DRC292				CT023
250 R Freeride	15-16	CK5612		TBA					
XC 250 (2T)	06-12	CK5595	CKF5595	CSK80	DRC108	DRCF108			CT007
XC 250 (2T) (Diaphragm Spring)	13-16	CK5651		CSK910	DRC275				CT023
XC-F 250	06-12	CK1293	CKF1293	CSK179	DRC163	DRCF163			CT001
XC-F 250	13-15	CK5651		CSK91	DRC260				CT023
XC-F 250	16	CK5612		CSK221	DRC292				CT023
XC-F-W 250	06-13	CK1293	CKF1293	CSK179	DRC163	DRCF163			CT001
XC-F-W 250 (Diaphragm spring)	14-16	CK5651		CSK910	DRC273				CT023
XC-W 250	06-12	CK5595	CKF5595	CSK80	DRC108	DRCF108			CT007
XC-W 250 (Diaphragm Spring)	13-16	CK5651		CSK910	DRC275				CT023
XC-W 250	06-12	CK5595	CKF5595	CSK80	DRC108	DRCF108			CT007
Rekluse Aftermarket Clutch for SX/XC 250/300 (2T Models/24 Tooth Steel Plate)	03-11	CK5595	CKF5595	N/A	N/A		N/A		CT049
250 SXS	01-03	CK5595	CKF5595	CSK80	DRC108	DRCF108			CT007
300 EGS	94-99	CK5595	CKF5595	CSK80	DRC108	DRCF108			CT007
300 EXC	94-05	CK5595	CKF5595	CSK80	DRC108	DRCF108			CT007
300 MXC	94-03	CK5595	CKF5595	CSK80	DRC108	DRCF108			CT007
300 MXC	04-05	CK5595	CKF5595	CSK80	DRC108	DRCF108			CT007
SX 300	94	CK5595	CKF5595	CSK80	DRC108	DRCF108			CT007
300 Six Days	96	CK5595	CKF5595	CSK80	DRC108	DRCF108			CT007
XC 300	06-12	CK5595	CKF5595	CSK80	DRC108	DRCF108			CT007
XC 300	13-15	CK5651		CSK910	DRC275				CT023
XC-W 300 (Diaphragm Spring)	13-15	CK5651		CSK910	DRC275				CT023
XC-W 300 Six Days (2T)	14-16	CK5651		CSK910	DRC275				CT023
350 EXC	94	CK5631		CSK80	DRC169				CT030
350 Super Comp	94-95	CK5631		CSK80	DRC169				CT030
EXC-F 350 (Diaphragm spring)	12-15	CK5651		CSK910	DRC273				CT023
SX-F 350	11-15	CK5651		CSK91	DRC260				CT023
SX-F 350	16	CK5612		CSK221	DRC292				CT023
XC-F 350	11-15	CK5651		CSK91	DRC260				CT023
XC-F 350	16	CK5612		CSK221	DRC292				CT023
XC-F-W 350 (Diaphragm spring)	12-15	CK5651		CSK910	DRC273				CT023
XC-F-W 350 Six Days (2T)	14-16	CK5651		CSK910	DRC273				CT023
360 EGS	96-97	CK5595	CKF5595	CSK80	DRC108	DRCF108			CT007
360 EXC	96-97	CK5595	CKF5595	CSK80	DRC108	DRCF108			CT007
360 MXC	96-97	CK5595	CKF5595	CSK80	DRC108	DRCF108			CT007
360 SX	96-97	CK5595	CKF5595	CSK80	DRC108	DRCF108			CT007
360 Six Days	96	CK5595	CKF5595	CSK80	DRC108	DRCF108			CT007
380 EGS	98-99	CK5631		CSK129	DRC170				CT030
380 EXC	98-02	CK5595	CKF5595	CSK80	DRC108	DRCF108			CT007
380 MXC	98-01	CK5595	CKF5595	CSK80	DRC108	DRCF108			CT007
SX 380	98-02	CK5595	CKF5595	CSK80	DRC108	DRCF108			CT007
390 Duke	15	TBA		TBA					

**CLUTCH
APPLICATIONS**

EBC BRAKES CLUTCH KITS



KTM



		CK cork OEM style Kit #	CKF carbon fiber style upgrade Kit #	CSK Spring Kit #	DRC Series Kit #	DRCF Series Kit #	SRC Series Kit #	SRK Series Kit #	CT Tool #
RC 390	15	TBA		TBA					
400 Duke	94-95	CK5631		CSK80	DRC169				CT030
400 EGS	94	CK5631		CSK80	DRC169				CT030
400 EGS	96-97	CK5631		CSK129	DRC170				CT030
400 EGS-E	97	CK5631		CSK129	DRC170				CT030
EXC 400 (LC4 Engine)	93-95	CK5632		CSK11	DRC178				CT075
400 EXC	94	CK5631		CSK80	DRC169				CT030
400 EXC	96	CK5631		CSK129	DRC170				CT030
400 EXC	00-01	CK5602		CSK210	DRC117				CT059
400 EXC	07	CK5612		CSK210	DRC171				CT023
400 EXC Racing	02	CK5612		CSK210	DRC171				CT023
400 EXC Racing	05	CK5612		CSK210	DRC154				CT023
400 EXC-G Racing	02	CK5612		CSK210	DRC171				CT023
400 EXC-G Racing	05	CK5612		CSK210	DRC154				CT023
400 EXC-G Racing	06	CK5612		CSK210	DRC171				CT023
400 LC-4	98	CK5631		CSK129	DRC170				CT030
LC4-R 400	99	CK5631		CSK129	DRC170				CT030
400 LC4-E	00-01	CK5631		CSK129	DRC170				CT030
400 LSE	97	CK5631		CSK129	DRC170				CT030
400 LSE	04	CK5631		CSK129	DRC170				CT030
400 MXC	01	CK5602		CSK210	DRC117				CT059
400 MXC	02	CK5612		CSK210	DRC171				CT023
400 Super Comp	95	CK5631		CSK80	DRC169				CT030
RXC-E 400	95	CK5595	CKF5595	CSK11	DRC108	DRCF108			CT007
400 Super Comp/EXC	96-99	CK5631		CSK129	DRC170				CT030
400 RXC-E	95	CK5632		CSK11	DRC178				CT075
400 RXC-E	96-97	CK5631		CSK129	DRC170				CT030
SC 400 (LC4 Engine)	93-95	CK5632		CSK11	DRC178				CT075
SXC 400	97	CK5631		CSK129	DRC170				CT030
400 SXC	98	CK5631		CSK129	DRC170				CT030
400 SX	99	CK5631		CSK129	DRC170				CT030
SX 400	00-01	CK5602		CSK210	DRC117				CT059
400 SX Racing	02	CK5612		CSK210	DRC171				CT023
400 SXC	00	CK5631		CSK129	DRC170				CT030
400 TXC	98	CK5631		CSK129	DRC170				CT030
XC-W 400	10-11	CK5648		CSK140	DRC252				CT041
EXC 440	94-95	N/A		N/A	N/A				
SX 440	94	N/A		N/A	N/A				
MXC 440	94	N/A		N/A	N/A				
450 EXC	06-07	CK5612		CSK210	DRC171				CT023
EXC 450	10-11	CK5648		CSK140	DRC252				CT041
450 EXC Racing	03	CK5612		CSK210	DRC171				CT023
450 EXC-G Racing	03	CK5612		CSK210	DRC171				CT023
450 EXC Racing	04	CK5602		CSK210	DRC117				CT059
450 EXC Racing	05	CK5612		CSK210	DRC154				CT023
450 EXC-G Racing	04	CK5602		CSK210	DRC117				CT059
450 LXC-G Racing	05	CK5612		CSK210	DRC154				CT023
450 EXC	04-05	CK5612		CSK210	DRC154				CT023
EXC-R 450	08	CK5648		CSK140	DRC252				CT041
MXC 450	06	CK5612		CSK210	DRC171				CT023
450 MXC-G Racing	03	CK5612		CSK210	DRC171				CT023
450 MXC-G Racing	04	CK5602		CSK210	DRC117				CT059
450 MXC-G Racing	05	CK5612		CSK210	DRC154				CT023
450 SMR	04-05	CK5612		CSK210	DRC154				CT023
SMR 450	06	CK5612		CSK210	DRC171				CT023
SMR 450	07-12	TBA		TBA					
450 SMS	04	CK5612		CSK210	DRC172				CT023

CLUTCH
APPLICATIONS

EBC BRAKES CLUTCH KITS



KTM



		CK cork OEM style Kit #	CKF carbon fiber style upgrade Kit #	CSK Spring Kit #	DRC Series Kit #	DRCF Series Kit #	SRC Series Kit #	SRK Series Kit #	CT Tool #
SX 450	06	CK5612		CSK210	DRC171				CT023
SX 450	09-12	CK5638		CSK136	DRC184				CT009
450 SX Racing	03	CK5612		CSK210	DRC171				CT023
450 SX Racing	04	CK5602		CSK210	DRC117				CT059
450 SX Racing	05	CK5612		CSK210	DRC154				CT023
SX-F 450 (Coil Spring)	07-11	CK5638		CSK136	DRC184				CT009
SX-F 450 (Diaphragm spring)	12	CK5651		CSK910	DRC273				CT023
SX-F 450 (Diaphragm spring)	13	CK5651		CSK910	DRC275				CT023
SX-F 450 (Diaphragm spring)	14-15	CK5651		CSK909	DRC281				CT023
XC 450	08-12	CK5612		CSK210	DRC171				CT023
XC-F 450	08-09	CK5638		CSK136	DRC184				CT009
XC-F 450 (Diaphragm spring)	13	CK5651		CSK910	DRC275				CT023
XC-F 450 (Diaphragm spring)	14	CK5651		CSK909	DRC281				CT023
XCR-W 450	08	CK5648		CSK140	DRC252				CT041
XC-W 450	08-09	CK5638		CSK136	DRC184				CT009
XC-W 450 Champions Edition	10	CK5648		CSK140	DRC252				CT041
XC-W 450 (Diaphragm spring)	12-13	CK5651		CSK910	DRC273				CT023
XC-W 450 (Diaphragm spring)	14-16	CK5651		CSK909	DRC281				CT023
XC-W 450 Six Days	10-11	CK5648		CSK140	DRC252				CT041
EXC 500 (Diaphragm spring)	12	CK5651		CSK910	DRC273				CT023
EXC 500 (Diaphragm spring)	13-15	CK5651		CSK910	DRC275				CT023
EXC 500 Six Days	16	CK5651		CSK910	DRC275				CT023
XC-W 500 (Diaphragm spring)	12	CK5651		CSK910	DRC273				CT023
XC-W 500 (Diaphragm spring)	13-15	CK5651		CSK910	DRC275				CT023
SX 505	09-12	CK5638		CSK136	DRC184				CT009
SX-F 505	07-08	CK5638		CSK136	DRC184				CT009
XC-F 505	08-09	CK5638		CSK136	DRC184				CT009
520 EXC	00-01	CK5602		CSK210	DRC117				CT059
SX 520	00-01	CK5602		CSK210	DRC117				CT059
520 SX Racing	02	CK5612		CSK210	DRC171				CT023
525 EXC-G Racing	03	CK5612		CSK210	DRC171				CT023
525 EXC	03	CK5612		CSK210	DRC171				CT023
525 EXC Racing	04	CK5602		CSK210	DRC117				CT059
525 EXC Racing	05	CK5612		CSK210	DRC154				CT023
525 EXC-G Racing	04	CK5602		CSK210	DRC117				CT059
525 EXC-G Racing	05	CK5612		CSK210	DRC154				CT023
EXC 525 Racing	07	CK5612		CSK210	DRC171				CT023
MXC 525	06	CK5612		CSK210	DRC171				CT023
525 MXC Desert Racing	03	CK5612		CSK210	DRC171				CT023
525 MXC Desert Racing	04	CK5602		CSK210	DRC117				CT059
525 MXC Desert Racing	05	CK5612		CSK210	DRC154				CT023
525 MXC-G Racing	04	CK5602		CSK210	DRC117				CT059
525 SMR	04-05	CK5612		CSK210	DRC154				CT023
SX 525	06	CK5612		CSK210	DRC171				CT023
525 SX Racing	03	CK5612		CSK210	DRC171				CT023
525 SX Racing	04	CK5602		CSK210	DRC117				CT059
525 SX Racing	05	CK5602		CSK210	DRC154				CT023
XC 525	08-12	CK5612		CSK210	DRC171				CT023
EXC 530 (9 Friction plates)	10-11	CK5648		CSK140	DRC252				CT041
EXC 530 Champion Edition (9 Friction plates)	10	CK5648		CSK140	DRC252				CT041
EXC-R 530 (9 Friction plate kit)	08	CK5648		CSK140	DRC252				CT041
WCR-W 530 (9 Friction plate kit)	08	CK5648		CSK140	DRC252				CT041
XC-W 530 Six Days (9 Friction plates)	10-11	CK5648		CSK140	DRC252				CT041
540 SXC	98-99	CK5639		CSK129	DRC196				CT030
540 SXS Racing	02	CK5612		CSK210	DRC171				CT023
MXC 550	94-96	N/A		N/A	N/A				
SMR 560	06	CK5612		CSK210	DRC171				CT023

CLUTCH
APPLICATIONS

EBC BRAKES CLUTCH KITS



KTM



		CK cork OEM style Kit #	CKF carbon fiber style upgrade Kit #	CSK Spring Kit #	DRC Series Kit #	DRCF Series Kit #	SRC Series Kit #	SRK Series Kit #	CT Tool #
620 Duke	94	CK5631		CSK80	DRC169				CT030
620 Duke	97	CK5631		CSK129	DRC170				CT030
620 EGS	94-95	CK5631		CSK80	DRC169				CT030
620 EGS-E	97	CK5631		CSK129	DRC170				CT030
620 EGS/Adventure	96-97	CK5631		CSK129	DRC170				CT030
620 Enduro Ltd	97	CK5631		CSK129	DRC170				CT030
620 EXC	94-95	CK5631		CSK80	DRC169				CT030
620 LC4	98	CK5631		CSK129	DRC170				CT030
620 LC4 Competition	99	CK5639		CSK129	DRC196				CT030
620 LC4 Super Moto	99	CK5639		CSK129	DRC196				CT030
620 LSE	97	CK5631		CSK129	DRC170				CT030
620 Six Days	96	CK5631		CSK129	DRC170				CT030
620 Super Comp	94-95	CK5631		CSK80	DRC169				CT030
620 Super Comp	96-99	CK5639		CSK129	DRC196				CT030
SX 620	97-99	CK5639		CSK129	DRC196				CT030
SX 620	99	CK5639		CSK129	DRC196				CT030
RXC-E 620	95	CK5595	CKF5595	CSK11	DRC108	DRCF108			CT007
620 RXC-E	95	CK5632		CSK11	DRC178				CT075
620 RXC-E	96-97	CK5631		CSK129	DRC170				CT030
620 SC	00-01	CK5639		CSK129	DRC196				CT030
SXC 620	97	CK5631		CSK129	DRC170				CT030
620 Supermoto	98	CK5639		CSK129	DRC196				CT030
620 TXC	98	CK5639		CSK129	DRC196				CT030
625 SMC	04/06	CK5639		CSK129	DRC196				CT030
625 SC	02	CK5639		CSK129	DRC196				CT030
625 SXC	03-04	CK5639		CSK129	DRC196				CT030
640 Adventure-R	98-02	CK5639		CSK129	DRC196				CT030
640 Duke-E	98	CK5639		CSK129	DRC196				CT030
640 Duke-II	99-04	CK5639		CSK129	DRC196				CT030
640 LC Rallye Dakar	97	CK5631		CSK129	DRC170				CT030
640 LC4	99-00	CK5639		CSK129	DRC196				CT030
640 LC4-E	00-02	CK5639		CSK129	DRC196				CT030
640 LC4 Adventure	03-06	CK5639		CSK129	DRC196				CT030
640 LC4 Supermoto	03-04	CK5639		CSK129	DRC196				CT030
640 LC4 Six Days	99	CK5639		CSK129	DRC196				CT030
660 LC4	97	CK5631		CSK129	DRC170				CT030
660 LC4 Rallye	99-00	CK5639		CSK129	DRC196				CT030
660 Rallye	01-03	CK5633		CSK129	DRC176				CT030
660 Rallye Factory	04	CK5633		CSK129	DRC176				CT030
660 SM Factory Replica	02-03	CK5639		CSK131	DRC175				CT030
660 SMC	03-04	CK5639		CSK131	DRC175				CT030
660 SMS	04	CK5639		CSK131	DRC175				CT030
690 Duke	08-14	CK5642		CSK131	DRC205				CT069
690 Enduro	08	CK5642		CSK131	DRC205				CT069
690 Enduro R	10-16	CK5642		CSK131	DRC205				CT069
690 Rally Factory Rep	07-08	CK5641		CSK131	DRC199				CT030
690 SMC	08-11	CK5642		CSK131	DRC205				CT069
690 SMR (Cast Wheel)	07-09	CK5642		CSK131	DRC205				CT069
690 Supermoto	07-08	CK5642		CSK131	DRC205				CT069
950 Adventure S	03-04	CK5634		CSK130	DRC177				CT015
950 Adventure	06	CK5634		CSK130	DRC177				CT015
950 Superenduro R	07-08	CK5634		CSK130	DRC177				CT015
950 Supermoto	05-07	CK5634		CSK130	DRC177				CT015
990 Adventure	07-11	CK5634		CSK130	DRC177				CT015
990 Adventure Baja Edition	13-14	CK5634		CSK130	DRC177				CT015
990 Adventure S	07-09	CK5634		CSK130	DRC177				CT015
990 SM-T	10-14	CK5634		CSK130	DRC177				CT015

CLUTCH
APPLICATIONS

EBC BRAKES CLUTCH KITS



KTM



CK
cork
OEM style
Kit #

CKF
carbon
fiber style
upgrade
Kit #

CSK
Spring
Kit #

DRC
Series
Kit #

DRCF
Series
Kit #

SRC
Series
Kit #

SRK
Series
Kit #

CT
Tool
#

990 SM-R	09-11	CK5634		CSK130	DRC177				CT015
990 Superduke	05-11	CK5634		CSK130	DRC177				CT015
990 Superduke R	07-11	CK5634		CSK130	DRC177				CT015
1190 Adventure	14-16	TBA		TBA					
1190 Adventure R	14-16	TBA		TBA					
1190 RC8 (6 Spring Type Clutch)	08-12	CK5644		CSK161			SRC98	SRK98	CT021
1190 RC8 R (6 Spring Type Clutch)	09-12	CK5644		CSK161			SRC98	SRK98	CT021
1190 RC8 R (3 Spring Type Clutch)	13-14	TBA		TBA					
1290 Super Adventure	15-16	TBA		TBA					
1290 Superduke R	14	TBA		TBA					

LIFAN

LF 200 GY-S	05-08	CK1119		CSK77	DRC209				CT012SP
-------------	-------	--------	--	-------	--------	--	--	--	---------

MORIWAKI/HONDA

MD 250 H	08-11	CK1305	CKF1305	CSK176					CT001
MD 250 S	08-11	CK1305	CKF1305	CSK176					CT001

TRIUMPH

Daytona 600	03-04	CK1206		CSK83					
Daytona 650	05	CK1181		CSK15					CT014
Speedfour 600	02-05	CK1206		CSK83					
TT 600	00-03	CK1206		CSK83					
Daytona 675	06-12	CK1206		CSK135					CT014
Street Triple 675	07-12	CK1206		CSK135					CT014
Street Triple R675 (Radial caliper)	09-12	TBA		TBA					
Daytona 750 (3cyl)	92	CK5588		CSK68					CT021
Bonneville 800	01-06	CK5597		CSK15					CT009SP
Speedmaster 800	03-08	CK5608		CSK15					
Bonneville America	02-07	CK5608		CSK15					
Bonneville T-100	02-04	CK5597		CSK15					CT009SP
Bonneville T-100	05-09	CK5608		CSK15					
America (865cc)	08-12	CK5608		CSK15					
Bonneville (865cc)/America	05-08	CK5608		CSK15					
Bonneville (865cc) (Cast wheel)	09-12	CK5608		CSK15					
Bonneville SE (865cc) (Cast wheel)	09-12	CK5608		CSK15					
Scrambler (865cc)	06-09	CK5608		CSK15					
Adventurer	96-01	CK5588		CSK68					CT021
Daytona 900 (3cyl)	93-96	CK5588		CSK68					CT021
Daytona Super III (3cyl)	94-97	CK5588		CSK68					CT021
Legend TT	98-01	CK5588		CSK68					CT021
Thunderbird	95-03	CK5588		CSK68					CT021
Thunderbird Sport	98-04	CK5588		CSK68					CT021
Street Twin (900cc)	16	TBA		TBA					
Thrupton 900	04-09	CK5608		CSK15					
Tiger 900cc (Up to VIN 71698)	93-96	CK5588		CSK68					CT021
Tiger 900cc (From VIN 71699)	97-98	CK5589		CSK29					CT009
Trident 900	92-98	CK5588		CSK68					CT021
Trophy 900 (3cyl)	92-01	CK5588		CSK68					CT021
T595 Daytona	97	CK5589		CSK29					CT009
Daytona 955i	98-00	CK5589		CSK29					CT009
Daytona 955i (From VIN 132513)	01-06	CK5599		CSK29					CT009
Speedtriple 955cc (From VIN 141872)	02-04	CK5599		CSK29					CT009
Tiger 955cc	99-06	CK5589		CSK29					CT009
Sprint (All carb models up to VIN 9082)	93	CK5588		CSK68					CT021
Sprint (All carb models from VIN 9083)	94-98	CK5588		CSK68					CT021
Sprint RS (Up to VIN 139276)	99-01	CK5589		CSK29					CT009

CLUTCH APPLICATIONS

CK CLUTCH KIT BUYERS GUIDE

Part No.	Make/Model	Year	Part No.	Make/Model	Year
CK1107	HONDA XL 70 XL 70 K1/76	74 75-76	CK1135	HONDA CB 500 / K1 / K3	71-73
CK1119 CKF1119 CT012SP ■	HONDA CR 80 R CR 85 R/85 R Expert SL 100 K1/K2/K3 XL 100 XL 100 K1 CB 125 S/S1/S2 CG 125 (CA12/KS12/CA2/3/4/KS2/3/4/5/6 /KSE2/3/4) Drum Front Brake CGT 125 (ES12/ES2/3/4) Disc Front Brake CL 125 S CT 125 NXR 125 (JC30) SL 125 K1/K2 TL 125 S XL 125 S XL 125 K1 XL 125 CRF 150 F NXR 150 (KD03) XL 185 S XR 185 ATC 200 X CM 200 T TRX 200 SX Fourtrax TLR 200 TR 200 'Fatcat' XL 200 R XR 200 TRX 200 D Type II Fourtrax XR 200 R XR 200 R TRX 250 EX TRX 250 X TRX 250 TE Recon ES TRX 250 TM Recon KAWASAKI KLT 160 A1 KLF 185 A1/A1A/A2/A3/A4 Bayou KLT 185 A1/A2 LIFAN LF 200 GY-S	84-02 ■ 03-07 ■ 70-74 ■ 74/76-78 ■ 75 ■ 80-82 ■ 01-06 ■ 01-04 ■ 84-85 ■ 77 ■ 03-08 ■ 71-73 ■ 76 ■ 79-85 ■ 74-75 ■ 76-78 ■ 06-16 ■ 03-08 ■ 79-83 ■ 79 ■ 83-87 ■ 80-82 ■ 86-91 ■ 86-87 ■ 86-87 ■ 83-84 ■ 80-84 ■ 91-97 ■ 81-83 ■ 86-02 ■ 01-08 ■ 09-14 ■ 97-14 ■ 97-14 ■ 85 ■ 85-88 ■ 86-87 ■ 05-08 ■	CK1140 CT013SP ■	HONDA CB 350 F/F1 CB 400 F CB 400 T 'Hawk' All models CM 400 T/C/E CB 450 DX-K CB 450 T 'Hawk' CB 450 SC 'Nighthawk' CM 450 C Custom CM 450 E CMX 450 C 'Rebel' FT 500 'Ascot' XL 500 S XL 500 R	75-77 ■ 78-81 ■ 79-81 ■ 89-92 ■ 82 ■ 82-86 ■ 82 ■ 82-83 ■ 86-87 ■ 82-83 ■ 79-81 ■ 82 ■
CK1130 CT031 ▲	HONDA CB 450 K2-K7	▲	CK1143	HONDA GL 1000 K Goldwing (Up to Eng No 1020727) GL 1000 Goldwing All models	75 76-79
CK1131 CT009 ▲	HONDA CR 250 R CR 250 M1/M/M76 Elsinore MR 250 Elsinore MT 250 K1/76 TL 250 XL 250 K1/K2/76 XL 350 K1 XL 350 CR 450 R	81 ▲ 73-77 ▲ 76 ▲ 74-76 ▲ 75-76 ▲ 72-76 ▲ 74-75 ▲ 76-78 ▲ 81 ▲	CK1144 CT002 ▲	HONDA CT 125 M/M1 Elsinore MT 125 K1 Elsinore MR 175 Elsinore	73-78 ▲ 74-76 ▲ 75-77 ▲
CK1132 CT009 ▲	HONDA CB 350 G/K2/K3/K4 CB 360/360 G/T CB 360 T	▲ 75-76 ▲ 76-77 ▲	CK1145	HONDA CB 750 F 'Supersport' CB 750 K	76 77-78
CK1133	HONDA CB 750 K1/K2/K3/K4/K5	71-75	CK1146	HONDA CX 500 C/D Custom/Deluxe GL 500/500 I Silverwing/Silverwing Interstate CB 550 F/K	79-82 81-82 75-78
CK1134	HONDA SL 175 K1 XL 175 K1/K2 XL 175 SL 350 K/K1/K2	73-73 73-75 72-78 69-73	CK1147	HONDA CB 550 K/K1 CB 650 CB 650 C Custom CB 650 SC 'Nighthawk' CX 650 C Custom GL 650/650 I Silverwing/Silverwing Interstate	74-75 79-82 80-81 82 83 83
			CK1148	HONDA CRF 50 F XR 50 R C 70 CRF 70 F CT 70 Trail SL 70 K1 XR 70 R ATC 70 TRX 70	04-16 00-03 80-83 04-14 77-82/91-94 70-73 97-03 78-85 86-87
			CK1149 CT021 ▲	HONDA CB 750 C Custom CB 750 F 'Supersport' CB 750 K CB 750 Limited Edition CB 750 SC 'Nighthawk' CB 900 C Custom CB 900 F Supersport CB 1000 C Custom CB 1100 F Supersport	80-82 ▲ 79-82 ▲ 79-82 ▲ 79 ▲ 82-83 ▲ 80-82 ▲ 81-82 ▲ 83 ▲ 83 ▲
			CK1150 CT012SP ■	HONDA Dream 50 R (CB50) NSR 50 MB5 XL 75 XR 75/K1/K2/76 XR 75 CRF 80 F XL 80 S 80/ XR 80 R	04 ■ 04 ■ 82 ■ 77-79 ■ 71-76 77-78 ■ 04-16 ■ 80-85 ■ 79-03 ■

CK CLUTCH KIT BUYERS GUIDE

Part No.	Make/Model	Year	Part No.	Make/Model	Year															
CK1151 CKF1151 CT012SP ■	HONDA CRF 100 F ATC 125 M ATC 185/185 S ATC 200/E/ES/M/S TRX 125 Fourtrax TRX 200 Fourtrax CR 60 R CR 80 R TRX 90 TRX 90 EX TRX 90 X XL 100 S XR 100 R TL 125 K1/K2	04-14 ■ 86-87 ■ 80-83 ■ 81-86 ■ 87-88 ■ 84 ■ 83-84 ■ 80-83 ■ 93-06 ■ 07-08 ■ 09-14 ■ 79-85 ■ 81-03 ■ 71-75 ■	CK1166 CT031 ▲	HONDA Contd. VF 700 C 'Magna' VF 700 S 'Sabre' VT 700 C 'Shadow' VF 750 C V45 'Magna' VF 750 S V45 'Sabre' VT 750 C 'Shadow' VT 800 Shadow	84-87 ▲ 84-85 ▲ 84-87 ▲ 82-88 ▲ 82-83 ▲ 83 ▲ 88 ▲															
	YAMAHA YBR 125 (2D0D/2CS1) YBR 125 C (36S1/2/3/4) YBR 125 E (4P24/4P27/4P2B/4P2H) YBR 125 ED (4P28) Cast Wheel YBR 125 ED (4P2C/4P2J) Cast Wheel YBR 125 ESD (4P26) Cast Wheel YBR 125 ESD (4P2A/4P2G) Cast Wheel YBR 125 ESG (43B1/3/5/6/8) YBR 125 R (1PX1/X2) YFM 125 RA/RB/RD Raptor	11-13 ■ 08-13 ■ 06-13 ■ 07-09 ■ 10-13 ■ 07-09 ■ 10-13 ■ 08-13 ■ 11-12 ■ 11-13 ■		HONDA VF 700 F 'Interceptor' VF 750 F V45 'Interceptor' PC 800 Pacific Coast	84-85 ▲ 83-84 ▲ 89-90/94-98 ■															
		CK1152 CT013SP ■			HONDA XL 250 S XR 250	78-80 ■ 79-80 ■	HONDA VF 700 F 'Interceptor' VF 750 F V45 'Interceptor' PC 800 Pacific Coast	84-85 ▲ 83-84 ▲ 89-90/94-98 ■												
					CK1153 CT013SP ■	HONDA XL 250 S XL 250 R XR 250 R		81 ■ 82-83 ■ 81-82 ■	HONDA CR 250 R CR 480 R CR 500 R XR 500 R XL 600 R XR 600 R NX 650 XR 650 L	82-89 ▲ 82-83 ▲ 84-89 ▲ 83-84 ▲ 83-87 ▲ 85-00 ▲ 88-89 ▲ 93-16 ▲										
						CK1154 CT013SP ■		HONDA TRX 420 TM Fourtrax Rancher TRX 420 FM7/FM8/FM9 Fourtrax Rancher 4x4 TRX 420 FPM/FPMA Fourtrax 4WD TRX 500 FE Fourtrax Foreman 4x4/ES TRX 500 FM Fourtrax Foreman 4x4 TRX 500 FM Fourtrax Foreman TRX 500 TM Fourtrax Foreman 2x4 TRX FE Fourtrax Foreman TRX 500 FPE Fourtrax Foreman 4x4 ES/EPS TRX FPE Fourtrax Foreman TRX 500 FPM Fourtrax Foreman 4x4/EPS TRX 500 FPM Fourtrax Foreman XR 500 XR 500 R		07-13 ■ 07-13 ■ 09-13 ■ 05-11 ■ 05-11 ■ 12-13 ■ 05-06 ■ 12-13 ■ 08-11 ■ 12-13 ■ 08-11 ■ 12-13 ■ 08-11 ■ 12-13 ■ 79-80 ■ 81-82 ■	HONDA CB 550 SC 'Nighthawk' CB 650 SC 'Nighthawk'	83 ▲ 83-85 ▲								
								CK1155		HONDA ATC 110 ATC 125 M TRX 125 Fourtrax CT 110 Trail		79-85 84-85 85-86 80-86	HONDA VF 1000 F 'Interceptor' VF 1000 R VT 1100 C Shadow 1100 Spirit VT 1100 C2 Shadow 1100 American Classic Edition VT 1100 C2-2 Shadow 1100 American Classic Edition VT 1100 D2 Shadow 1100 American Classic Edition VT 1100 CD2 Shadow Sabre VT 1100 C3 Shadow Aero VT 1100 T Shadow 1100 American Classic Edition Tourer	84 ■ 85-86 ■ 97-06 ▲ 95-97 ▲ 97 ▲ 99 ▲ 00-06 ▲ 98-02 ▲ 98-01 ▲						
										CK1156		HONDA CX 500 TC Turbo CX 650 T Turbo GL 1100/1100 1 Goldwing/Goldwing Interstate GL 1100 A Goldwing Aspencade		82 ▲ 83 ▲ 80-83 ▲ 82-83 ▲	HONDA VF 500 C 'V30 Magna' VF 500 F 'Interceptor'	84-85 ▲ 84-86 ▲				
												CK1159 CT053SP ▲		HONDA TRX 350 TE/FE VT 500 C 'Shadow' VT 500 FT 'Ascot'		00-05 ■ 83-86 ■ 83-84 ■	HONDA XR 200 R XL 250 R XR 250 R KAWASAKI KLF 220 A1-A15 Bayou KLF 250 A1/A2/A3/A6F/A7F/A8F/A9F/AAF/ABF Bayou	84-85 ■ 84-87 ■ 84-85 ■ 88-02 ■ 03-11 ■		
														CK1160 CT013SP ■		HONDA ATC 110 ATC 125 M TRX 125 Fourtrax CT 110 Trail		79-85 84-85 85-86 80-86	HONDA VF 500 C 'V30 Magna' VF 500 F 'Interceptor'	84-85 ▲ 84-86 ▲
																CK1163		HONDA ATC 250 R CR 250 R		81-84 78-80
CK1166 CT031 ▲			HONDA CB 700 SC/S 'Nighthawk'															84-86 ▲		HONDA CBX
	CK1171 CT009 ▲		HONDA CR 125 R	82														HONDA CR 125 R NX 250 TRX 250 X Fourtrax XR 250 L XR 250 R TRX 300 EX Fourtrax/Sportrax TRX 300 X		
		CK1176 CT031 ■ CT009 ▲	HONDA CR 125 R NX 250 TRX 250 X Fourtrax XR 250 L XR 250 R TRX 300 EX Fourtrax/Sportrax TRX 300 X	83-84 ▲ 88-90 ■ 87-88/91-92 ■ 91-96 ■ 86-04 ■ 93-08 ■ 09-11 ■			HONDA CBX													
			CK1177 CT002 ▲	HONDA CR 125 R NX 250 TRX 250 X Fourtrax XR 250 L XR 250 R TRX 300 EX Fourtrax/Sportrax TRX 300 X	83-84 ▲ 88-90 ■ 87-88/91-92 ■ 91-96 ■ 86-04 ■ 93-08 ■ 09-11 ■				HONDA CBX											
				CK1180 CT013SP ■	HONDA CR 125 R NX 250 TRX 250 X Fourtrax XR 250 L XR 250 R TRX 300 EX Fourtrax/Sportrax TRX 300 X	83-84 ▲ 88-90 ■ 87-88/91-92 ■ 91-96 ■ 86-04 ■ 93-08 ■ 09-11 ■					HONDA CBX									
					CK1181 CT013 ▲ CT013SP ■ CT014 ★	HONDA CR 125 R NX 250 TRX 250 X Fourtrax XR 250 L XR 250 R TRX 300 EX Fourtrax/Sportrax TRX 300 X		83-84 ▲ 88-90 ■ 87-88/91-92 ■ 91-96 ■ 86-04 ■ 93-08 ■ 09-11 ■					HONDA CBX							
						CK1183 CT066SP ▲		HONDA CR 125 R NX 250 TRX 250 X Fourtrax XR 250 L XR 250 R TRX 300 EX Fourtrax/Sportrax TRX 300 X		83-84 ▲ 88-90 ■ 87-88/91-92 ■ 91-96 ■ 86-04 ■ 93-08 ■ 09-11 ■					HONDA CBX					
								CK1186 CT002		HONDA CR 125 R NX 250 TRX 250 X Fourtrax XR 250 L XR 250 R TRX 300 EX Fourtrax/Sportrax TRX 300 X		83-84 ▲ 88-90 ■ 87-88/91-92 ■ 91-96 ■ 86-04 ■ 93-08 ■ 09-11 ■					HONDA CBX			
										CK1190 CKF1190 CT013 ▲ CT013SP ■		HONDA CR 125 R NX 250 TRX 250 X Fourtrax XR 250 L XR 250 R TRX 300 EX Fourtrax/Sportrax TRX 300 X		83-84 ▲ 88-90 ■ 87-88/91-92 ■ 91-96 ■ 86-04 ■ 93-08 ■ 09-11 ■					HONDA CBX	
												CK1190 CKF1190 CT013 ▲ CT013SP ■		HONDA CR 125 R NX 250 TRX 250 X Fourtrax XR 250 L XR 250 R TRX 300 EX Fourtrax/Sportrax TRX 300 X		83-84 ▲ 88-90 ■ 87-88/91-92 ■ 91-96 ■ 86-04 ■ 93-08 ■ 09-11 ■				

CK CLUTCH KIT BUYERS GUIDE

Part No.	Make/Model	Year	Part No.	Make/Model	Year
CK1190 CKF1190 CT013 ▲ CT013SP ■	HONDA Contd. XR 350 R ATC 350 X	83-85 ■ 85-86 ■	CK1209 CT008 ▲	HONDA VT 1100 C Shadow 1100	85-86 ▲
CK1191 CKF1191 CT002 ▲ CT012SP ■	HONDA CR 125 R Elsinore CRF 150 R/RB CB 250 Nighthawk CM 250 C Rebel CMX 250 C/C2 Rebel CMX 250 C/CD Rebel	81 ▲ 07-16 ▲ 91-08 ■ 82-83 ■ 96/97/99-14 ■ 85-87 ■	CK1210 CT053SP ▲	HONDA GL 1200/1200 1-A/1200 L Goldwing	84-85 ▲
CK1193 CKF1193 CT013 ▲ CT013SP ■ CT014 ★ CT080 ●	HONDA ATC 250 R TRX 250 R Fourtrax TRX 400 EX TRX 400 X XR 400 R TRX 450 S/ES CBR 600 F4 (Carb Model) YZ-F R3 (321cc)	85-86 ■ 86-89 ▲ 99-08 ▲ 09-14 ▲ 96-04 ▲ 99-00 ■ 99-00 ★ 15-16 ●	CK1217 CT013SP ▲ CT014 ■	HONDA XL 350 R YAMAHA XTZ 250 Lander XTZ 250 Lander XTZ 250 X YBR 250 (41S2/3) YP 250 Fazer (5D41/2/3/56C1)	84-85 ▲ 07-14 ■ 16-18 ■ 08-10 ■ 10-12 ■ 06-10 ■
CK1194 CT013SP ■	HONDA ATC 250 ES Big Red ATC 250 SX TRX 250 'Fourtrax'	85-87 ■ 85-87 ■ 85-87 ■	CK1218 CKF1218 CT014 ▲	HONDA CBR 600 RR/RA CBR 600 F4i Sport (Injection Model) VFR 800/A Interceptor ABS CBR 900 RR 919 (CB 900 F) SUZUKI GSX 650 FK8/FK9	03-14 ▲ 01-06 ▲ 02-11 ▲ 98-99 ▲ 02-07 ▲ 08-10 ▲
CK1196 CT013SP ■	HONDA TRX 300 (All Models 2WD/4WD) TRX 350 (All Models 2WD/4WD) TRX 350 TM/FM TRX 400 FW 'Fourtrax Foreman' TRX 400 FM TRX 420 TE Fourtrax Rancher ES TRX 420 FPA Fourtrax Rancher 4x4 ES/EPS TRX 420 FE/FEA Fourtrax Rancher 4x4/ES TRX 420 FE1 Rancher 4x4 ES TRX 420 FM1 Rancher 4x4 TRX 420 FM1 Rancher 4x4 EPS TRX 420 TE1 Rancher ES TRX 420 TM1 Rancher TRX 450 ES/S TRX 450 FE Fourtrax Foreman ES/ FM Fourtrax Foreman S	88-00 ■ 86-89 ■ 00-05 ■ 95-01/03 ■ 02 ■ 07-13 ■ 09-13 ■ 07-13 ■ 14-15 ■ 14-15 ■ 14-15 ■ 14-15 ■ 14-15 ■ 98-03 ■ 02-04 ■	CK1219 CT009 ▲ CT022 ■ CT033SP ●	HONDA GB 500 SUZUKI DL 650 K4/K5/K6/K7/AK7/K8/K9/AK8/AK9/ALO /AL1/AL2/AL3/AL4/AL5/AL6 V-Strom DL 650 AAL2/AAL3/AAL4/AAL5 DL 650XT V Strom ABS (DL650 XAL5/XAL6) SFV 650 K9/L3/L4/L5 SV 650 AK7/AK8 ABS SV 650 K3/SK3/K4/SK4/K5/SK5/K6/SK6/K7 /SK7/S8/K8/SK9 SV 650 SAK7/SAK8/SAK9 ABS	89-90 ▲ 04-16 ● 12-15 ● 15-16 09-10/13-15 ● 07-08 ■ 03-10 ● 07-10 ●
CK1199	HONDA CR 125 R Elsinore	79-80	CK1221 CT053SP ▲	HONDA GL 1000 K Goldwing (From Eng No.1020728)	75 ▲
CK1200 CT001 ▲	HONDA CR 125 R	85 ▲	CK1222 CT001 ▲	HONDA CR 125 R	86-99 ▲
CK1206 CKF1206 CT014 ▲ CT014SP ● CT055SP ■	HONDA CBR 600 F2 CBR 600 F3/SJR/SE 599 (CB 600 F) VFR 700 F/F2 'Interceptor' VFR 750 F 'Interceptor' 750 VFR 750 F VF 750 C Magna/CD Magna Deluxe VFR 800 Fi CBR 900 RR CBR 929 RR CBR 954 RR	91-94 ● 95-98 ● 04/06 ● 86 ▲ 86 ▲ 90-97 ▲ 94-03 ▲ 98-99 ▲ 93-95 ▲ 00-01 ▲ 02-03 ▲	CK1224	HONDA GL 1200 1-A/GL 12 SE/I GL 1200 1/A Goldwing	86 87
CK1206 CT014 ▲ CT014SP ● CT055SP ■	SUZUKI GSX R 600 V/W/X/Y GSX R 600 K4/K5/XK5 TRIUMPH Daytona 600 Speedfour 600 TT 600 Daytona 675 Street Triple 675	97-00 ■ 04-05 ■ 03-04 02-05 00-03 06-09 ▲ 07-12 ▲	CK1228 CT009SP ■	HONDA CB-1 400 (CB 400F) CBR 600 F Hurricane CB 600 F1	89-90 ■ 87 ■ 88-90 ■
CK1206 CT014 ▲ CT014SP ● CT055SP ■	SUZUKI GSX R 600 V/W/X/Y GSX R 600 K4/K5/XK5 TRIUMPH Daytona 600 Speedfour 600 TT 600 Daytona 675 Street Triple 675	97-00 ■ 04-05 ■ 03-04 02-05 00-03 06-09 ▲ 07-12 ▲	CK1229 CT014 ▲	HONDA VFR 750 R (RC30) GSXR 750 Y	90 ▲ 00 ▲
CK1206 CT014 ▲ CT014SP ● CT055SP ■	SUZUKI GSX R 600 V/W/X/Y GSX R 600 K4/K5/XK5 TRIUMPH Daytona 600 Speedfour 600 TT 600 Daytona 675 Street Triple 675	97-00 ■ 04-05 ■ 03-04 02-05 00-03 06-09 ▲ 07-12 ▲	CK1230 CT013SP ■ CT014SP ▲	HONDA PCX 150 VT 600 C Shadow VLX NT 650 Hawk GT CTX 700 N (Naked/Manual G/box) CTX 700 (Top Fairing/Manual G/box) NC 700 X (2 Piston Caliper) NT 700 V/VA VT 750 C/CD/CD2/DC/DCA/DCB VT 750 CDA/CDB/CDC/CDD Shadow American Classic Edition 750 Deluxe VT 750 C Shadow Spirit VT 750 DC Shadow Spirit VT 750 DCA/DCB Shadow Spirit VT 750 Shadow Aero VT 750 Shadow Aero VT 750 C2 Shadow Spirit VT 750 CSE Shadow Aero (ABS/Rear disc) VT 750 C2S Shadow Spirit (ABS/Rear disc) VT 750 RS Shadow	13-14 ■ 89-90 ■ 88-90 ■ 14 ■ 14 ■ 12-14 ■ 10-13 ■ 98-08 ■ 02-03 ■ 07-14 ■ 01-02 ■ 03-07 ■ 08-15 ■ 04-14 ■ 07-14 ■ 13-14 ■ 13-14 ■ 10-14 ■

CK CLUTCH KIT BUYERS GUIDE

Part No.	Make/Model	Year	Part No.	Make/Model	Year
CK1230 CT013SP ■ CT014SP ▲ Contd.	HONDA Contd. VT 750 T Shadow Tourer VT 750 C2B Shadow Phantom BENELLI TNT 600 i Tornado	09 ■ 10-15 ■ 16-17 ▲	CK1293 CKF1293 CT001 ▲ Contd.	HONDA Contd. SX-F 250 (4T) XC-F 250 XC-F-W 250 XC-F-W 250 Six Days	05-12 ▲ 06-12 ▲ 06-13 ▲ 11 ▲
CK1234	HONDA FL 400 R Pilot	89-90	CK1294 CT021 ▲	HONDA VT 1300 CRA Interstate (ABS)	11-14 ▲
CK1235 CT012SP ■	HONDA VTR 250 Interceptor	88-90 ■	CK1295 CT009 ▲	HONDA XR 650 R	00-07 ▲
CK1239 CT009 ▲	HONDA VT 1100 C Shadow 1100	87-96 ▲	CK1297 CT021 ▲ CT073 ■	HONDA ST 1300/1300 A GL 1800/ABS (All models) Goldwing F6B Deluxe (GL 1800 B2) Goldwing G6B (GL 1800 B) NRX 1800 DA/DB/EA/EB	02-13 ▲ 01-13 ■ 13 ■ 13 ■ 04-05 ■
CK1247 CKF1247 CT009 ▲ CT006 ■	HONDA CR 250 R CFR 450 R CRF 450 X CR 500 R KAWASAKI KLX 450 R A8F/A9F/AAF/ABF/ACF KX 450 F (D6F/D7F/D8F/D9F/EAF/EBF/FCF /FDF/FEF/FFF/HGF/HHF)	90-07 ▲ 02-12 ▲ 05-17 ▲ 90-01 ▲ 08-12 ■ 06-17 ■	CK1298	HONDA VT 1300 CXA Fury (ABS Model) VT 1300 CX Fury (Non ABS Model) VT 1300 CSA Sabre VT 1300 CSA Sabre (ABS) VT 1300 CR Stateline VT 1300 CRA Stateline (ABS) VT 1300 CT Interstate VT 1300 CTA Interstate (ABS) VTX 1300 C VTX 1300 R VTX 1300 S/T VTX 1800 C/C1/C2/C3 VTX 1800 R VTX 1800 S VTX 1800 C1/C2/C3 VTX 1800 F1/F2/F3 VTX 1800 N1/N2/N3 VTX 1800 T1/T2	10-15 10-15 10-14 11-14 10-15 10-15 10-15 11-14 10-15 10-15 11-14 04-11 05-10 03-10 02-08 02-08 02-07 05-08 05-11 04-11 07-11
CK1248 CKF1248 CT009 ▲	HONDA CB 1000 CBF 1000 F CBR 1000 F Hurricane	94-95 ▲ 90-96 ▲ 87-88 ▲	CK1300 CT021 ▲	HONDA RVT 1000 (RC51)	02-06 ▲
CK1252 CT012SP ■	HONDA NX 125 CB 125 TT NXR 150 (KD02) CRF 230 L CRF 230 M	88-90 ■ 90 ■ 03-08 ■ 08-11 ■ 09-11 ■	CK1302 CKF1302 CT009 ▲	HONDA TRX 450 R/ER TRX 700 XX	04-14 ▲ 08-11 ▲
CK1253 CT014 ▲	HONDA VFR 800 Fi	00-01 ▲	CK1303 CT009 ▲	HONDA CB 1000 R CBF 1000 A8 (Canada) CBR 1000 RR	11-14 ▲ 08 ▲ 04-07 ▲
CK1257 CT031 ▲ CT009 ■	HONDA RVF 750 R (RC45) XL 1000 VA8 Varadero (Canada) CB 1100 (Non ABS) CB 1100 A (ABS)	94 ▲ 08 ■ 13-14 ■ 13-14 ■	CK1304 CT012SP ■	HONDA CRF 150 F CRF 230 F	03-05 ■ 03-16 ■
CK1264 CT056SP ■	HONDA ST 1100/1100 A	91-01 ■	CK1305 CKF1305 CT001 ▲	HONDA CRF 250 X CRF 250 R CRF 250 R	04-17 ▲ 08-09 ▲ 11-17 ▲
CK1265 CT009SP ■	HONDA CB 750 Nighthawk	91-03 ■	CK1312 CKF1312 CT043SP ▲	HONDA CBR 1000 RR CBR 1000 RAA ABS Model VFR 1200 FA	08-15 ▲ 09-15 ▲ 10-14 ▲
CK1284 CT068SP ▲	HONDA CBR 900 RR	96-97 ▲	CK1313	HONDA CBR 250 R/RA (ABS/Non ABS Model)	11-14
CK1285 CT021 ▲	HONDA GL 1500 Goldwing GL 1500 A/SE/I Goldwing GL 1500 C/CT/CF/CD Valkyrie/Valkyrie Tourer	88-96 ▲ 99-00 ▲ 97-03 ▲	CK1314 CKF1314 CT081SP ■	HONDA CRF 250 L (Non ABS) CRF 250 LA (ABS) CRF 250 Rally (Non ABS) CRF 250 Rally (ABS)	13-17 ■ 17 ■ 17 ■ 17 ■
CK1286 CT021 ▲	HONDA CBR 1100 XX Blackbird	97-98 ▲			
CK1290 CT009 ▲	HONDA VTR 1000 F Superhawk	98-05 ▲			
CK1291 CT021 ▲	HONDA RVT 1000 (RC51) CBR 1100 XX Blackbird	00-01 ▲ 99-03 ▲			
CK1293 CKF1293 CT001 ▲	GAS-GAS EC 125 (All models/2T) HONDA CR 125 R CRF 250 R CRF 250 R	10-11 ▲ 00-07 ▲ 04-07 ▲ 10 ▲			

CK CLUTCH KIT BUYERS GUIDE

Part No.	Make/Model	Year	Part No.	Make/Model	Year
CK1315 CT084SP ■	HONDA MSX 125 GROM MSX 125 AH Grom (ABS)	13-14 ■ 18 ■	CK2240 CT008 ▲	YAMAHA Contd. XT 350 N/NC/S/SC/C/AC/B/BC/T/TC/U/UC /W/WC/D/DC/E/EC/F/FC/G/GC/H/HC/J /JC/K/KC/L/M/MC YFM 350 FXG/FXH/FXJ/FXK/FXL/FXM/FXN /FXP/FXR/FXS/FXT RD 400 C/D/E RD 400 F Daytona YFM 400 NM/NMC/NN/NHN/P/HP/NR YFM 400 S Big Bear 2WD YFM 400 FS/FT Big Bear 4WD YFM 400 FBHW Big Bear 400 Hunter IRS YFM 400 FBEW Big Bear 400 IRS Exploring Edition YFM 400 FBW/FBX/FBY/FBA/FBB Big Bear 4WD IRS	85-00 ▲ 95-05 ▲ 76-78 ▲ 79 ▲ 00-03 ▲ 04 ▲ 04-05 ▲ 07- ▲ 07 ▲ 07-12 ▲
CK1317 CKF1317 CT092 ■	HONDA CRF 450 R (6 Spring type) CRF 450 RX (18" Rear wheel)	17-18 ■ 17-18 ■	CK2242	YAMAHA XS 650 SG/G/H/SH/SJ/SK	80-83
CK1318 CT091 ■	AJP 250 - PR5 Trail 250 - PR5 Supermoto 250 - PR5 Enduro 250 - PR5 EX Extreme	13-17 ■ 13-17 ■ 13-17 ■ 13-17 ■	CK2245 CT039 ▲	YAMAHA DT 175 G/H MX 175 G/H RT 180 A/B/D/E/G/H/J	80-81 ▲ 80-81 ▲ 90-97 ▲
CK2205 CT044 ▲	YAMAHA RX 50 MK 'Midnight Special' RX 50 K/L 50 Special YSR 50 T/U/W/A/B/D	83 ▲ 83-84 ▲ 87-92 s	CK2250 CT008 ▲	YAMAHA IT 250 F/G	80 ▲
CK2206 CT044 ▲	YAMAHA YZ 50 G DT 50 U/W/A (DTL/C) DT 80 H/J/K MX 80 G/H/J	80 ▲ 88-89 ▲ 81-83 ▲ 80-82 ▲	CK2251	YAMAHA YT 125 J/K/L/N YT 175 J/K	82-85 82-83
CK2208	YAMAHA RXZ 100 S (3HS1/2)	88-95	CK2252	YAMAHA YT 125 G/H	80-81
CK2223 CT008 ▲	YAMAHA DT 250 D/E/F	77-79 ▲	CK2254 CKF2254 CT044 ▲	YAMAHA DT 100 G/H/J/K MX 100 G/H/J/K RT 100 A/D/E/F/G/H/J/K/L/M RX 100 (36L/36L0/5RD1/2) RX 100 (5RD3/4) RX 100 C (5RC1/2/3) RXS 115 (3HB6/7) RXS 115 (3HB8) TT-R 125 M/N/P/R/ER/S/ES/ET/EV/EW/EX/EY TT-R 125 LWM/LN/LP/LER/LR/LES/LS/LET /LT/LV/LEV/LW/LEW/LX/LEX/LEY/LEA/LEB/LED /LEE/LEF YBA 125 Vision (5AP1) YBR 125 EB (5RR2/3/4/5/6/8/9) YBR 125 ED (5RR1) YBR 125 K (5TU1/2/4/6/8)	80-83 ▲ 80-83 ▲ 92-00 ▲ 01-03 ▲ 04 ▲ 04 ▲ 94-97 ▲ 99 ▲ 00-09 ▲
CK2226	YAMAHA TX 650 A/XS 650 B/C	74-76 ■	CK2255 CKF2255 CT008 ▲ CT008SP ■	YAMAHA TT 500 G/H FJ 600 L/LC/N/NC FZ 600 S/SC/T/TC/UC/U XJ 600 SD/SDC/SE/SEC/SF/SFC/SG/SGC/SH /SHC/SJ/SJC/SK/SKC "Seca II" YZF-R6 RRR/RRS/T/TC YZF R6S (SV/SW/SX/SY) FZ6 (All models) YX 600 S/SC/T/TC/U/UC/W/WC/A/AC YZR 600 RL/RRL/RM/RMC/RN/RNC/P/PC "R6" XJ 650 G/H/J/K 'Maxim' XJ 650 LH 'Midnight' XJ 650 LJ/LK 'Seca Turbo' XJ 650 RJ 'Seca' FZX 700 S/SC/T/TC XJ 700 N/NC/S/SC 'Maxim' XJ 700 XN/XNC/XS/XSC 'Maxim' FZ 750 N FZ 750 S/SC XJ 750 J/K/MK 'Maxim' XJ 750 RH/RJ/RK Seca TDM 850 D/DC/E/EC XJ 900 RK 'Seca'	80-83 ▲ 80-81 ▲ 80 ▲ 81/82 ▲
CK2227 CT074 ■ CT017 ▲	YAMAHA YZF 1000 R1 XS 650 D/E/F/2F	98 ▲ 77-79 ■	CK2255 CKF2255 CT008 ▲ CT008SP ■	YAMAHA TT 500 G/H FJ 600 L/LC/N/NC FZ 600 S/SC/T/TC/UC/U XJ 600 SD/SDC/SE/SEC/SF/SFC/SG/SGC/SH /SHC/SJ/SJC/SK/SKC "Seca II" YZF-R6 RRR/RRS/T/TC YZF R6S (SV/SW/SX/SY) FZ6 (All models) YX 600 S/SC/T/TC/U/UC/W/WC/A/AC YZR 600 RL/RRL/RM/RMC/RN/RNC/P/PC "R6" XJ 650 G/H/J/K 'Maxim' XJ 650 LH 'Midnight' XJ 650 LJ/LK 'Seca Turbo' XJ 650 RJ 'Seca' FZX 700 S/SC/T/TC XJ 700 N/NC/S/SC 'Maxim' XJ 700 XN/XNC/XS/XSC 'Maxim' FZ 750 N FZ 750 S/SC XJ 750 J/K/MK 'Maxim' XJ 750 RH/RJ/RK Seca TDM 850 D/DC/E/EC XJ 900 RK 'Seca'	80-83 ▲ 80-83 ▲ 92-00 ▲ 01-03 ▲ 04 ▲ 04 ▲ 94-97 ▲ 99 ▲ 00-09 ▲
CK2230 CT017 ▲	YAMAHA XJ 1100 J 'Maxim' XS 1100 XS 1100 H 'Venturer' XS 1100 SF/SG/SH XS 1100 LG/LH 'Midnight Special'	82 ▲ 80 ▲ 81 ▲ 79-81 ▲ 80-81 ▲	CK2255 CKF2255 CT008 ▲ CT008SP ■	YAMAHA TT 500 G/H FJ 600 L/LC/N/NC FZ 600 S/SC/T/TC/UC/U XJ 600 SD/SDC/SE/SEC/SF/SFC/SG/SGC/SH /SHC/SJ/SJC/SK/SKC "Seca II" YZF-R6 RRR/RRS/T/TC YZF R6S (SV/SW/SX/SY) FZ6 (All models) YX 600 S/SC/T/TC/U/UC/W/WC/A/AC YZR 600 RL/RRL/RM/RMC/RN/RNC/P/PC "R6" XJ 650 G/H/J/K 'Maxim' XJ 650 LH 'Midnight' XJ 650 LJ/LK 'Seca Turbo' XJ 650 RJ 'Seca' FZX 700 S/SC/T/TC XJ 700 N/NC/S/SC 'Maxim' XJ 700 XN/XNC/XS/XSC 'Maxim' FZ 750 N FZ 750 S/SC XJ 750 J/K/MK 'Maxim' XJ 750 RH/RJ/RK Seca TDM 850 D/DC/E/EC XJ 900 RK 'Seca'	80-83 ▲ 80-81 ▲ 80 ▲ 81/82 ▲
CK2234 CT039 ▲	YAMAHA YZ 100 G/H/J/K IT 125 G/H YZ 125 G SR 185 H/J TW 200 T/TC/U/UC/W/WC/A/AC/D/DC/E/EC/F /FC/H/HC/J/JC/EK/EKC/L/LC/M/MC/N/NC/P /PC/R/RCS/SC/T/TC/N/NC/W/WC/X/Y/Z/A /B/D/E/F Trailway XT 225 D/DC/E/EC/F/FC/G/GC/H/HC	80-83 ▲ 80-81 ▲ 80 ▲ 81/82 ▲ 87-15 ▲ 92-96 ▲	CK2255 CKF2255 CT008 ▲ CT008SP ■	YAMAHA TT 500 G/H FJ 600 L/LC/N/NC FZ 600 S/SC/T/TC/UC/U XJ 600 SD/SDC/SE/SEC/SF/SFC/SG/SGC/SH /SHC/SJ/SJC/SK/SKC "Seca II" YZF-R6 RRR/RRS/T/TC YZF R6S (SV/SW/SX/SY) FZ6 (All models) YX 600 S/SC/T/TC/U/UC/W/WC/A/AC YZR 600 RL/RRL/RM/RMC/RN/RNC/P/PC "R6" XJ 650 G/H/J/K 'Maxim' XJ 650 LH 'Midnight' XJ 650 LJ/LK 'Seca Turbo' XJ 650 RJ 'Seca' FZX 700 S/SC/T/TC XJ 700 N/NC/S/SC 'Maxim' XJ 700 XN/XNC/XS/XSC 'Maxim' FZ 750 N FZ 750 S/SC XJ 750 J/K/MK 'Maxim' XJ 750 RH/RJ/RK Seca TDM 850 D/DC/E/EC XJ 900 RK 'Seca'	80-83 ▲ 80-81 ▲ 80 ▲ 81/82 ▲ 87-15 ▲ 92-96 ▲
CK2235 CT039 ▲	YAMAHA YZ 125 H IT 175 G/H/J/K IT 200 L/N/S	81 ▲ 80-83 ▲ 84-86 ▲	CK2255 CKF2255 CT008 ▲ CT008SP ■	YAMAHA TT 500 G/H FJ 600 L/LC/N/NC FZ 600 S/SC/T/TC/UC/U XJ 600 SD/SDC/SE/SEC/SF/SFC/SG/SGC/SH /SHC/SJ/SJC/SK/SKC "Seca II" YZF-R6 RRR/RRS/T/TC YZF R6S (SV/SW/SX/SY) FZ6 (All models) YX 600 S/SC/T/TC/U/UC/W/WC/A/AC YZR 600 RL/RRL/RM/RMC/RN/RNC/P/PC "R6" XJ 650 G/H/J/K 'Maxim' XJ 650 LH 'Midnight' XJ 650 LJ/LK 'Seca Turbo' XJ 650 RJ 'Seca' FZX 700 S/SC/T/TC XJ 700 N/NC/S/SC 'Maxim' XJ 700 XN/XNC/XS/XSC 'Maxim' FZ 750 N FZ 750 S/SC XJ 750 J/K/MK 'Maxim' XJ 750 RH/RJ/RK Seca TDM 850 D/DC/E/EC XJ 900 RK 'Seca'	80-81 ▲ 84-85 ■ 86-88 ■
CK2236 CT039 ▲	YAMAHA DT 125 G/H XT 200 J/K/KC	80-81 ▲ 82-83 ▲	CK2255 CKF2255 CT008 ▲ CT008SP ■	YAMAHA TT 500 G/H FJ 600 L/LC/N/NC FZ 600 S/SC/T/TC/UC/U XJ 600 SD/SDC/SE/SEC/SF/SFC/SG/SGC/SH /SHC/SJ/SJC/SK/SKC "Seca II" YZF-R6 RRR/RRS/T/TC YZF R6S (SV/SW/SX/SY) FZ6 (All models) YX 600 S/SC/T/TC/U/UC/W/WC/A/AC YZR 600 RL/RRL/RM/RMC/RN/RNC/P/PC "R6" XJ 650 G/H/J/K 'Maxim' XJ 650 LH 'Midnight' XJ 650 LJ/LK 'Seca Turbo' XJ 650 RJ 'Seca' FZX 700 S/SC/T/TC XJ 700 N/NC/S/SC 'Maxim' XJ 700 XN/XNC/XS/XSC 'Maxim' FZ 750 N FZ 750 S/SC XJ 750 J/K/MK 'Maxim' XJ 750 RH/RJ/RK Seca TDM 850 D/DC/E/EC XJ 900 RK 'Seca'	92-98 ■ 03-05 ■ 06-09 ■ 04-09 ■ 86-90 ■ 99-02 ■ 80-83 ■ 81 ■ 82-83 ■ 82 ■ 86-87 ■ 85-86 ■ 85-86 ■ 85 ■ 86 ■ 82-83 ■ 81-83 ■ 92-93 ▲ 83 ■
CK2238 CT044 ▲	YAMAHA YZ 80 G	80 ▲	CK2255 CKF2255 CT008 ▲ CT008SP ■	YAMAHA TT 500 G/H FJ 600 L/LC/N/NC FZ 600 S/SC/T/TC/UC/U XJ 600 SD/SDC/SE/SEC/SF/SFC/SG/SGC/SH /SHC/SJ/SJC/SK/SKC "Seca II" YZF-R6 RRR/RRS/T/TC YZF R6S (SV/SW/SX/SY) FZ6 (All models) YX 600 S/SC/T/TC/U/UC/W/WC/A/AC YZR 600 RL/RRL/RM/RMC/RN/RNC/P/PC "R6" XJ 650 G/H/J/K 'Maxim' XJ 650 LH 'Midnight' XJ 650 LJ/LK 'Seca Turbo' XJ 650 RJ 'Seca' FZX 700 S/SC/T/TC XJ 700 N/NC/S/SC 'Maxim' XJ 700 XN/XNC/XS/XSC 'Maxim' FZ 750 N FZ 750 S/SC XJ 750 J/K/MK 'Maxim' XJ 750 RH/RJ/RK Seca TDM 850 D/DC/E/EC XJ 900 RK 'Seca'	80-81 ▲ 84-85 ■ 86-88 ■
CK2240 CT008 ▲	YAMAHA DT 250 A/B/C BW 350 T/U R5/5A/5B - 350cc RD 350 73-75 RZ 350 L/N/NCII TT 350 S/T YFM 350 FWBL/LC Big Bear	74-76 ▲ 87-88 ▲ 70-72 ▲ 72-75 ▲ 84-85 ▲ 86-87 ▲ 99 ▲	CK2255 CKF2255 CT008 ▲ CT008SP ■	YAMAHA TT 500 G/H FJ 600 L/LC/N/NC FZ 600 S/SC/T/TC/UC/U XJ 600 SD/SDC/SE/SEC/SF/SFC/SG/SGC/SH /SHC/SJ/SJC/SK/SKC "Seca II" YZF-R6 RRR/RRS/T/TC YZF R6S (SV/SW/SX/SY) FZ6 (All models) YX 600 S/SC/T/TC/U/UC/W/WC/A/AC YZR 600 RL/RRL/RM/RMC/RN/RNC/P/PC "R6" XJ 650 G/H/J/K 'Maxim' XJ 650 LH 'Midnight' XJ 650 LJ/LK 'Seca Turbo' XJ 650 RJ 'Seca' FZX 700 S/SC/T/TC XJ 700 N/NC/S/SC 'Maxim' XJ 700 XN/XNC/XS/XSC 'Maxim' FZ 750 N FZ 750 S/SC XJ 750 J/K/MK 'Maxim' XJ 750 RH/RJ/RK Seca TDM 850 D/DC/E/EC XJ 900 RK 'Seca'	80-81 ▲ 84-85 ■ 86-88 ■

CK CLUTCH KIT BUYERS GUIDE

Part No.	Make/Model	Year	Part No.	Make/Model	Year
CK2256 CT039 ▲	YAMAHA XT 125 J/K/KC	82-83 ▲	CK2285 CT017 ▲	YAMAHA FJ 1100 L/LC/N/NC FJ 1200 S/SC/T/TC/U/UC/W/WC/A/AB/AD /ADC/D/DC/AE/AEC	84-85 ▲ 86-94 ▲
CK2261 CT008 ▲	YAMAHA SRX 250 T/TC SR 250 K (3Y9) SR 250 (4GR1/2/3/4/9)	87 ▲ 93 ▲ 93-08 ▲	CK2287 CT010 ▲ CT010SP ■	YAMAHA YZ 80 H/J/K/L/N YFM 200 N YFM 200 DXS/DXT/DXU/DXW YFB 250 D/E/F/G/H/UH/J/UJ/UK/FWF/FWG/FWH /FWJ/FWK/FWL/FWM YFM 250 W/A/B YFM 250 XL/XLC/M/MC/XN/XHN/XP /XHP/XR/XHR/XS Beartracker YTM 200 K/L/N/EK/EL/ERN YTM 225 DXK/DXL/DXN YTM 225 DRN/DRS YFM 225 S/T/U/W YFUIW/YFUITW Pro Hauler (230cc) YFM 250 BT/BV/BW/BX/BY	81-85 ▲ 85 ■ 86-89 ■ 92-00 ■ 89-91 ■ 00-04 ■ 83-85 ■ 83-85 ■ 85-86 ■ 86-89 ■ 89 ■ 05-09 ■
CK2262 CT017 ▲	YAMAHA XS 400 J/K/RJ/RK	82-83 ▲	CK2290 CKF2290 CT090SP ▲ CT008 ■	YAMAHA YFM 350 ERT/ERU/ERW/ERA/ERD/ERE/ERF/ERG YFM 350 FWT/FWU/FWW/FWA/FWB/FWD/FWE /FWF/FWG/FWH/FWJ Big Bear YFM 350 XT/XU/XW/XA/XB/XD/XE/XF/XG/XH/XJ /XK/XL/XM/XN/XP/XR/XS Warrior YFM 350 UH/UJ/UK/UL/ULC YFM 350 RS/RT/RV/RW/RX/RZ/RA/RB/RD Raptor YFM 400 FWE/FWF/FWG/FWH/FWJ/FWK/FWL Kodiak YFM 400 FWR	87-95 ▲ 87-97 ▲ 87-04 ▲ 96-99 ▲ 04-13 ▲ 93-99 ▲ 03 ■
CK2265 CT010 ▲	YAMAHA YZ 60 H/J/K	81-83 ▲	CK2292 CT039 ▲	YAMAHA BW 200 N/S/ES/ET/EU	85-88 ▲
CK2267 CT008 ▲	YAMAHA IT 250 G/H/J XT 250 G/H/J/K/KC/L/LC SR 250 G/H/TH/J	80-82 ▲ 80-84 ▲ 80-82 ▲	CK2295 CT060 ▲	YAMAHA TY 350 N/S	85-86 ▲
CK2273 CT008SP ■	YAMAHA XS 850 G/H/LG/LH/SG/SH	80-81 ■	CK2296 CT008 ▲	YAMAHA SR 500 E/F/G/H XT 500 G/H XZ 550 RJ/RK Vision	78-81 ▲ 80-81 ▲ 82-83 ▲
CK2274 CKF2274 CT020 ▲	YAMAHA WR 250 ZF/ZG/ZH/ZJ YZ 250 E/F/G/H/J/K/L/M/N/P/R/S/T/V/W/X/Y /Z/A/B/D/E/F/G (2T) YZ 450 FE/FF/FG/FGY (4T) WR 450 FT/FV/FW/FX/FY/FZ/FA/FB/FD/FE/FF/FG/FH YFZ 450 RY/RZ/RA/RB/RD YZ 450 FW/FX/FY/FZ/FA/FB/FD/FE/FF/FG/GY (4T) YFZ 450 BBW Bill Balance Edition XV 700 L/LC/N/NC 'Virago' XV 700 CS/CSC/SS/ST/STC/CT/CTC/SSC Virago XV 750 H/J/K/MK 'Virago' XV 750 U/UC/W/WCM/A/AC/B/BC Virago XV 750 D/DC/E/EC/F/FC/G/GC/HI/HC/J/JC Virago XV 920 RH/RJ XV 920 J/K/MK 'Virago' XV 1000 L/LC/N/NC 'Virago' XV 1100 S/SC/T/TC/U/UC/W/WC/A/AC/B/BC/D /DC/E/EC/F/FC/G/GC/H/HC/SH/SHC/J/JC /SJ/SJC Virago XVS 1100 V Star/V Star Custom XVS 1100 ATS V-Star Silverado XVS 1100 AS V-Star Classic XVS 1100 W-M V-Star Custom Midnight	94-97 ▲ 93-16 ▲ 14-16 05-17 ▲ 09-13 ▲ 07-16 ▲ 07 ▲ 84-85 ▲ 86-87 ▲ 81-83 ▲ 88-90 ▲ 92-97 ▲ 81-82 ▲ 82-83 ▲ 84-85 ▲ 86-97 ▲ 99-09 ▲ 03-09 ▲ 04-09 ▲ 07-09 ▲	CK2297 CKF2297 CT008 ▲	YAMAHA XT 550 K TT 600 K/L/N/S XT 600 L/LC/N/NC/S/SC/T/TC/U/UC/W/WC XT 600 EA/EAC/EB/EBC/ED/EDC/EE/EEC/EF /EFC/EG/EGC SRX 600 S/SC YFM 660 RN/RP/RPB/RR/RS/RT Raptor	83 ▲ 83-86 ▲ 84-89 ▲ 90-95 ▲ 86 ▲ 01-05 ▲
CK2276	YAMAHA YZ 125 J	82	CK2298	YAMAHA XC 180 All Models	83-85
CK2278 CT054SP ▲	YAMAHA YZ 125 K/L/N/S/T	83-87 ▲	CK2299 CT020 ▲	YAMAHA XV 500 K 'Virago' XV 535 T/TC/U/A/AC/E/EC/F/FC/SF/SFC/G/GC /SG/SGC/H/HC/SH/SHC/J/JC/SJ/SJC Virago	83 ▲ 87-99 ▲
CK2279 CT008 ▲	YAMAHA YFP 350 U Terrapro YFZ 350 T/U/W/A/B/D/E/F/G/H/J/K/L/M/N /P/R/S/T/V Banshee XS 400 G/SG/H/SH/SJ IT 250 H/J YZ 250 H IT 425 G IT 465 H/J YZ 465 G/H XS 750 D/2D/E/F/SE/SF	88 ▲ 87-06 ▲ 80-82 ▲ 81-82 ▲ 81 ▲ 80 ▲ 81-82 ▲ 80-81 ▲ 77-79 ■	CK2300 CT050SP ▲	YAMAHA XVZ 12 'All models' V-Max VMX 12 All models XVZ 1300 Royal Star Tour Deluxe XVZ 1300 LTK Venture XVZ 1300 Venture MM Limited Edition XVZ 1300 Royal Star XVZ 1300 Royal Star Standard XVZ 1300 Royal Star Boulevard XVZ 1300 Royal Star Midnight Venture XVZ 1300 Royal Star Midnight Tour Deluxe XVZ 1300 Royal Star Tour Classic XVZ 1300 Royal Star Venture XVZ 1300 Royal Star Venture S	83-85 ▲ 85-07 ▲ 97-01/05-07 ▲ 96-98 ▲ 01 ▲ 96-97/00 ▲ 98 ▲ 99-01 ▲ 02-07 ▲ 06-07 ▲ 96-00 ▲ 99-07 ▲ 08-13 ▲
CK2280 CT060 ▲	YAMAHA YZ 250 J/K/L/N/S/T IT 490 K/L YZ 490 J/K/L/N/S/T/U/W YTZ 250 N/S IT 250 K WR 500 ZD/ZE	82-87 ▲ 83-84 ▲ 82-89 ▲ 85-86 ▲ 83 ▲ 92-93 ▲			
CK2283	YAMAHA YBR 125 (5PY1/2)	01			

CK CLUTCH KIT BUYERS GUIDE

Part No.	Make/Model	Year	Part No.	Make/Model	Year
CK2303	YAMAHA YFM 50 S/T/RV/RW/RX Raptor V 80 (3NX3/4) V 80 D (4GC2/3/4) - 3= Single Seat / 4= Dual Street YFM 80 N/S/T/U/D/E/F/G/H/J/K/L/M/N BW 80 S/T/U/A PW 80 K/N/B/D/E/F/G/H/J/K/L/M/N/P/R/S/T/V YFM 80 WP/WR/WS/RT/RV/RW/RX Raptor YFM 80 GT/GV/GW/GX	04-08 94 94-96 85-02 86-90 83-06 02-08 05-08	CK2324 CT039 ▲	YAMAHA XT 225 D/DC/E/EC/F/FC/G/GC/H/HC/J/JC/K/KC/L /M/MC/N/NC/P/PC/R/RC/S/SC/T/TC/V/VC/W/WC TT 225 S/T TT-R 225 L/M/N/P/R/S/T TT-R 230 T/V/W/X/Y/A/B/D/E/F	92-07 ▲ 86-87 ▲ 99-05 ▲ 05-09/11-15 ▲
CK2304 CT010 ▲	YAMAHA YZ 80 S/T/U/W/A/B/D/E/F RX-Z 135 (3XL3/5PV1/5PV2) SR 150 (3UR8)	86-94 ▲ 00-05 ▲ 95 ▲	CK2325 CKF2325 CT005 ▲	YAMAHA YZ 125 E/F/G/H/J/K/L/M/N/P/R/S/T/V/W/X/Y /Z/A/B/D/E/F/G (2T)	93-16 ▲
CK2306 CKF2306 CT008SP ■	YAMAHA XJ 550 H/J/K 'Maxim' XJ 550 RH/RJ/RK 'Seca' XT 550 J FZ6R FZ 700 T/TC FZ 750 U/UC	81-83 ■ 81-83 ■ 82 ■ 09-14 ■ 87 ■ 88 ■	CK2327 CT008SP ■	YAMAHA GTS 1000 AE/AEC/AF/AFC FZR 1000 E/EC/F/FC/G/GC YZF 1000 Thunderace	93-94 ■ 93-95 ■ 97-00 ■
CK2308 CT008 ■	YAMAHA FZR 750 RT/RU FZR 1000 T/TC/U/UC/Genesis	87-88 ■ 87-88 ■	CK2332 CKF2332 CT054SP ▲	YAMAHA YZF 600 RG/RGC/RH/RHC YZF 600 R RJ/RK/RL/RM/RN/RP/RR/RS/RT/RV/RW	95-96 ▲ 97-07 ▲
CK2309 CT020 ▲	YAMAHA FZ 09 YZ 250 U/W/A/B/D YZ 250 WRW/WRA WR 250 ZB/ZD/ZE XVS 650 V Star Custom XVS 650 A V-Star Classic XVS 650 V Star Silverado	15-16 88-92 ▲ 89-90 ▲ 91-93 ▲ 97-11/13-14 ▲ 98-10 ▲ 03-10 ▲	CK2335 CT010 ▲	YAMAHA YZ 80 G/H/J/K/L/M/N YZ 85 P/R/S/T/V/W/X/Y/Z/A/B/D/E/F/G	95-01 ▲ 02-16 ▲
CK2310 CT008 ▲	YAMAHA WR 400 FK/FL/FM YZ 400 FK/FL	98-00 ▲ 98-99 ▲	CK2349	YAMAHA RX-Z 135 (2UX/3UK1) RX-Z 135 (3UK3/3RSA/3RSB/3UK1)	87-89 93-97
CK2311 CT054SP ▲	YAMAHA YZ 125 W/A	89-90 ▲	CK2350 CT017 ▲	YAMAHA YZF R1 (1000)	99-03 ▲
CK2312 CT054SP ▲	YAMAHA YZ 125 U	88 ▲	CK2351 CT050SP ▲	YAMAHA XV 1600 Road Star XV 1600 Road Star Silverado XV 1600 Midnight Star XV 1700 Road Star Silverado XV 1700 Road Star XV 1700 Road Star Midnight XV 1700 Road Star Midnight Silverado	99-05 ▲ 99-09 ▲ 02-03 ▲ 07 ▲ 05-09 ▲ 04-07 ▲ 04-07 ▲
CK2313 CKF2313 CT010 ▲	YAMAHA YFS 200 U/W/A/B/D/E/F/G/H/J/K/L/M/N/P/R /S/T/V Blaster WR 200 D	88-06 ▲ 92 ▲	CK2352 CKF2352 CT020 ▲	YAMAHA YZ 426 FM WR 450 FS YZ 450 FR/FS/FT/FV YZF-R1 FZ-09 (847cc/3 cyl/6 Spring clutch)	00 ▲ 04 ▲ 03-06 ▲ 09-14 ▲ 14-16 ▲
CK2315 CT010 ▲	YAMAHA FZR 600 W/WC/RA/AC/RAC/RB/RBC/RD/RDC/RE /REC/RF/RFC/RG/RGC/H/RHC/RJ/RJC/RK /RKC/RL/RLC	89-99 ▲	CK2354	YAMAHA TT-R 90 M/N/P/R/ES/S/ET/EV/EW T 105 E Crypton (5AM4) T 105 SE Crypton (1D81/1D82)	04-07 99-02 03-09
CK2316 CT008 ▲	YAMAHA XV 250 Route 66/Virago XV 250 X V-Star	88-90/95-07 ▲ 08-12 ▲	CK2355 CKF2355 CT005 ▲	YAMAHA WR 250 FN/FP/FR/FS/FT/FV/FW/FX/FY/FZ/FA/FB/FD YZ 250 FN/FP/FR/FS/FT/FV/FW/FX/FY/FZ/FA/FB /FD/FE/FF/FG/FGY YZ 250 FE/FF/FG/FGY (4T)	01-13 ▲ 01-16 ▲ 14-16
CK2317 CT010 ▲	YAMAHA FZR 400 U/W/SUC/SWC/A/SAC	88-90 ▲	CK2356 CKF2356 CT020 ▲	YAMAHA WR 426 FN/FP/YZ 426 FN/FP WR 450 FR YZF R1 (5VY) YZF R1 YZR R1 IE FZ1 V/W/X/Z/A/B/D/E	01-02 ▲ 03- ▲ 04-06 ▲ 07-08 ▲ 06 ▲ 06-14 ▲
CK2318 CKF2318 CT008SP ■	YAMAHA FZR 750 OWOI YZF 750 SP/RF/RFC/RG/RGC/RH/RHC YZF-R6 V/W/X/Y/Z/A/B/D/E/F/G	89-91 ■ 94-96 ■ 06-16 ■	CK2358 CT008SP ■	YAMAHA FZS 1000 N/NC/P/PC/R/RC/S/RS/T FZ1	01-05 ■
CK2319 CT005 ▲	YAMAHA YZ 125 B/D TT-R 250 L/M/N/P/R/S/T/V WR 250 RX/RZ/RA/RB/RD/RE/RF WR 250 XX/XY/XZ/ZA Supermotard	91-92 ▲ 99-06 ▲ 08-15 ▲ 08-11 ▲	CK2362 CT017 ▲	YAMAHA XT 1200 Z Super Tenere FJR 1300 R/RC/S/AS/T/AT/AV/AW/AX/AY/AZ/AA/AB FJR 1300 AEW/AEW/AEX/AEY FJR 1300 A FJR 1300 ES XVS 1300 V-Star 1300 Tourer	12-13 ▲ 03-12 ▲ 06-09 ▲ 06-15 ▲ 14-15 ▲ 07-14 ▲
CK2321 CT008SP ■	YAMAHA FZR 1000 W/WC/A/AC/B/BC/D/DC	89-92 ■			

CK CLUTCH KIT BUYERS GUIDE

Part No.	Make/Model	Year	Part No.	Make/Model	Year
CK2362 CT017 ▲	YAMAHA Contd. XVS 1300 V-Star XVS 1300 Stryker XVS 1300 V-Star De Luxe	07-14 ▲ 11-14 ▲ 13-14 ▲	CK3312 CT051 ▲	SUZUKI TC 90 R/J Blazer TS 90 R/J Honcho A 100 A/B Go-Fer	70-72 ▲ 70-72 ▲ 76-77 ▲
CK2363 CT050SP ▲	YAMAHA XV 1700 Road Star S (9 Spoke Cast Wheel) XV 1700 Road Star Silverado S XV 1700 Road Star Silverado XV 1700 Road Star XV 1700 Road Star Midnight Warrior XV 1700 Road Star Warrior	08-14 ▲ 11-14 ▲ 08-10 ▲ 08 ▲ 05-09 ▲ 04-08 ▲	CK3313 CT046 ▲	SUZUKI GT 250 K/L Hustler T 250 II/R/J Hustler T 305 Raider TC 305 Laredo T 350 1/2/R/J Rebel	73-74 ▲ 69-72 ▲ 68-69 ▲ 68 ▲ 69-72 ▲
CK2364 CKF2364 CT020 ▲ CT045 ■	YAMAHA YFZ 450 LES Limited Edition YFZ 450 S/T/V/W/X/Y/B/D YFZ 450 BBW Bill Balance Edition YFZ 450 SET Special Edition YFZ 450 SPV/SEW/SPX Special Edition YFZ 450 SPV Special Edition YFZ 450 BB/DB YFM 700 RV/RW/RX/RV/RA/RB/RD/RE Raptor YFM 700 RSEW/RSPX/RSPY/RSEA/RSEB/RSED /RSE Special Edition YFM 700 RSEY/RSEZ/RSEA/RSEB/RSED/RSE/RSF Raptor Special Edition YFM 700 RV/RW/RX/RV/RA/RB/RD/RE Raptor YFM 700 50th Anniversary Edition - YFM 700 RSPV FZ8	04 ▲ 04-09/12-13 ▲ 07 ▲ 05 ■ 06-08 ▲ 06 ▲ 12-13 ▲ 06-14 ▲ 07-14 ▲ 09-15 ▲ 06-14 ▲ 06-13 ▲ 11-13 ▲	CK3314 CT046 ▲	SUZUKI T 500 1 Cobra (18 Ear Clutch Plate) T 500 2/3 Titan (18 Ear Clutch Plate)	68 ▲ 69-70 ▲
CK2367 CT017 ▲	YAMAHA XV 1900 Roadliner XV 1900 Roadliner Midnight XV 1900 Roadliner S XV 1900 Raider XV 1900 Raider S XV 1900 Raider SCL XV 1900 Stratoliner S	06-07 ▲ 06-09 ▲ 06-12 ▲ 08-12 ▲ 08-12 ▲ 12 ▲ 06-12 ▲	CK3315 CT022 ▲	SUZUKI DS 250 T GT 250 M/A/B Hustler TS 250 N/T/X RM 370 A/B (2T) GT 380 J/K/L/M/A/B Sebring RM 400 C	80 ▲ 75-77 ▲ 80-81 ▲ 76-77 ▲ 72-77 ▲ 78 ▲
CK2370 CKF2370 CT005 ▲	YAMAHA XT 250 X/Y/Z/A/B/D/E/F/G/H YFM 250 RX/RV/RZ/RA/RB/RD Raptor YFM 250 RSPA Special Edition YFM 250 RSPX/RSEY Special Edition YFM 250 RSPXC Special Edition Custom	08-17 ▲ 08-13 ▲ 11 ▲ 08-09 ▲ 08 ▲	CK3316 CT022 ▲	SUZUKI TM 400 R/J/K/L/M Cyclone T 500 R/J/K/L/M Titan (12 Ear Clutch Plate)	71-75 ▲ 71-75 ▲
CK2375	YAMAHA TTR 110 EX/EY/EA/EB/ED/EE/EF/EG	08-16	CK3318 CKF3318 CT011 ▲	KAWASAKI KLX 125 A1/A2/A3/A6F KLX 125 L (B1/B2/B3/B6F) SUZUKI RM 60 N/T/X/Z/D RM 80 T/X RM 80 E/F RM 80 K/L/M/N/P/R/S/T/V/W/X/Y/K1 RM 85 K2/K3/LK3/K4/LK4/K5/LK5/K6/LK6/K7 /LK7/K8/LK8/K9/LK9/L0/LL0/L2/LL2/LL5/LL6 DR 100 D/E/F/G/H/J/K/L DS 100 C/N/T/X SP 100 D GN 125 Z/D GN 125 EM/EN/EP/ER/ES/ET/EV DR 125 Z/D/E/G/H/J DR 125 SER/SES/SET DR-Z 125 K3/K4/L5/K6/K7/K8/K9/L2/L3/L4/L5/L6 DR-Z 125 LK3/LK4/LK5/LK6/LK7/LK8/LK9/LL2 /LL3/LL4/LL5/LL6 DS 125 N/T/X RV 125 K/L/M/A/B Tracker SP 125 Z/D SP 125 G/H/J TC 125 J/K/L/M/A/B Prospector	79-83 ▲ 80-81 ▲ 84-85 ▲ 89-01 ▲ 02-12/16 ▲ 83-90 ▲ 78-81 ▲ 83 ▲ 82-83 ▲ 91-97 ▲ 82-88 ▲ 94-96 ▲ 03-16 ▲ 03-16 ▲ 79-81 ▲ 73-77 ▲ 82-83 ▲ 86-88 ▲ 72-77 ▲
CK2378	YAMAHA XP 500 T-Max (5GJ5) XP 500 T-Max (5VUA/15B1/4B51)	01 05-11	CK3319 CT011 ▲	SUZUKI RM 100 A RM 100 N/T/X RM 125 G/H TM 125 K/L/M Challenger DS 185 T GT 185 K/L/M/A/B Adventurer TS 185 T/X DR 200 G/H/J DR 200 SET/SEV/SEW/SEX/SEY/SEK1-SEK9/SEL3 SP 200 G/H/J T 200 X5-Invader TC 200 X5 Stingray DR 200 G/H/J DR 200 SET/SEV/SEW/SEX/SEY/SEK1-SEK9 /SEL3/SEL5 SP 200 G/H/J LT 230 SF/SG/SH/SJ (from E/No.104361) LT 250 RF/RG	76 ▲ 79-81 ▲ 86-87 ▲ 73-75 ▲ 80 ▲ 73-76 ▲ 80-81 ▲ 86-88 ▲ 96-09/13 ▲ 86-88 ▲ 67-69 ▲ 67-69 ▲ 86-88 ▲ 96-09/13/15 ▲ 86-88 ▲ 85-88 ▲ 85-86 ▲
CK2379 CT017 ▲	YAMAHA XVS 950 (V-Star 950) XVS 950 (V-Star 950 Tourer) XVS 950 Bolt (Standard rear shocks) XVS 950 R (Remote reservoir rear shocks)	09-14 ▲ 09-14 ▲ 14-16 ▲ 14-16 ▲			
CK2380 CT017 ▲	YAMAHA VMX 1700 V-Max (6 piston radial caliper)	09-14 ▲			
CK3306 CT052 ▲	SUZUKI B120 (118cc) (106mm outer dia. friction plate) TC 120 Trailcat T 125/11/R Stinger	71-77 ▲ 68-71 ▲ 69-71 ▲			
CK3310 CT038SP ▲	SUZUKI T 20 X6 TC 250 X6 Scrambler	65-69 ▲ 67-69 ▲			
CK3311 CT051 ▲	SUZUKI AC 50/R AS 50 Sport/Colt	70-71 ▲ 68-69 ▲			

CK CLUTCH KIT BUYERS GUIDE

Part No.	Make/Model	Year	Part No.	Make/Model	Year
CK3321 CT035SP ▲	SUZUKI GT 550 J/K/L/M Indy GT 550 A/B Indy	72-75 ▲ 76-77 ▲	CK3340 CT011 ▲	SUZUKI DS 80 T/X/Z/D/F/G/H/J/K/L/M/N/P/R/S/T/V/W/X/Y JR 80 K1/K2/K3/K4 RM 80 Z/D	80-00 ▲ 01-04 ▲ 82-83 ▲
CK3324 CT018SP ▲	SUZUKI GS 750 B/C/EC/N/EN/LN GT 750 J/K/L/M/A/B	77-79 ▲ 72-77 ▲	CK3343 CT018SP ▲	SUZUKI GS 400 XB/XC GS 400 B/C GS 425 N (Spoke Wheel) GS 425 EN (Cast Wheel) GS 425 LN	77-78 ▲ 77-78 ▲ 79 ▲ 79 ▲ 79 ▲
CK3326 CT051 ▲	SUZUKI TC 100 K/L/M/A/B Blazer TS 100 K/L/M/A/B Honcho	74-77 ▲ 74-77 ▲	CK3344 CT018SP ▲	SUZUKI GS 550 B/C/EC/N/EN/ET GS 550 MZ GS 550 LT/LX/LZ GS 550 LD/LF/LG/TX GS 550 ED/ESD/ES3/ESE/EF/ESF/ESG	77-80 ▲ 82 ▲ 80-82 ▲ 81-85 ▲ 83-85 ▲
CK3328 CT011 ▲	SUZUKI LT 125 D/E/F/G/H LT 185 E/F/G/H ALT 125 D/E/F/G ALT 185 F RM 50 C/N/T	83-87 ▲ 84-87 ▲ 83-86 ▲ 85 ▲ 78-80 ▲	CK3345 CT035SP ▲	SUZUKI GS 1000 C/N/EC/EN/SN/ET/ST	78-80 ▲
CK3329 CT011 ▲	SUZUKI RM 100 B/C RM 125 A/B/C RM 125 X/Z/D RM 125 F PE 175 T/X/Z/D/E RS 175 T/X/Z GS 250 TT/TX LT 250 SK/SL	77-78 ▲ 76-78 ▲ 81-83 ▲ 85 ▲ 80-84 ▲ 80-82 ▲ 80-81 ▲ 89-90 ▲	CK3346 CT024SP ▲	SUZUKI GS 1100 SD GS 1100 ED/ESD	83 ▲ 83 ▲
CK3329 CT011 ▲	SUZUKI RM 100 B/C RM 125 A/B/C RM 125 X/Z/D RM 125 F PE 175 T/X/Z/D/E RS 175 T/X/Z GS 250 TT/TX LT 250 SK/SL	77-78 ▲ 76-78 ▲ 81-83 ▲ 85 ▲ 80-84 ▲ 80-82 ▲ 80-81 ▲ 89-90 ▲	CK3347 CT018SP ▲	SUZUKI XN 85 D	83 ▲
CK3330 CT018SP ▲	SUZUKI GS 650 EX/EZ/GX/GZ/GD GS 650 GLX/GLZ/GLD/MD GS 700 EF/ESF GS 750 ET/EX/EZ/TZ/TD GS 750 LT/LX GS 750 ED/ESD/SD GS 850 GN/GT/GX/GZ/GD/GLT/GLX/GLZ/GLD	81-83 ▲ 81-83 ▲ 85 ▲ 80-83 ▲ 80-81 ▲ 83 ▲ 79-83 ▲	CK3348 CT029 ▲ CT047SP ■	SUZUKI RM 465 X/Z RM 500 D/E GSX 600 FJ/FK/FL/FM 'Katana' GSF 600 ST/SV/SW Bandit GSF 600 SY/SK1/SK2/SK3 GSX R 750 G/H	81-82 ■ 83-84 ■ 88-91 ▲ 96-98 ▲ 00-03 ▲ 86-87 ▲
CK3331 CT022 ▲	SUZUKI PE 250 T/X RS 250 T/X RM 250 T/X/Z/D/E/F	80-81 ▲ 80-81 ▲ 80-85 ▲	CK3356 CT011 ▲	SUZUKI GS 300 LZ/LD/LF RM 125 E RM 125 J/K/L/M LT-F 4WD XM/N/P/R/S/T/V/W 250 (2 x 4) LT-F 300 FX/FY/FK1/FK2 "King Quad" 300 (2 x 4 / 4 x 4) 30 (4 x 4)	82-85 ▲ 84 ▲ 88-91 ▲ 91-97 ▲ 99-00 ▲ 99-02 ▲ 98-04 ▲ 05 ▲
CK3332 CT022 ▲	SUZUKI GN 400 T/XT/TX/TZ DR 400 T SP 400 T PE 400 T/X RM 400 N/T	80-82 ▲ 80 ▲ 80 ▲ 80-81 ▲ 79-80 ▲	CK3357 CKF3357 CT029 ■ CT047SP ▲	SUZUKI GSX 600 FW/FX/FY/FK1-FK6/FK8 Katana GR 650 D/XD GSX 750 FW/FX/FY/FK1-FK6 Katana	98-06/08 ▲ 83 ■ 98-06 ▲
CK3333 CT022 ▲	SUZUKI GS 450 ET/ST/EX/SX/EZ/ED GS 450 LT/LX/LZ/LD/LF/LG/LH/LJ GS 450 TX/TZ/TXZ/TXD GS 500 EK/EL/EM/EN/EP/ER/ES/ET/EV/EW /EX/EY/K1/K2/K3 GS 500 FK4/FK5/FK6/FK7/FK8/FK9	80-83 ▲ 80-88 ▲ 81-83 ▲ 89-03 ▲ 04-09 ▲	CK3358 CT029 ■	SUZUKI GN 250 Z/D/F/J DR 250 Z/D/F GW 250 L4/L5 GZ 250 X/Y/K1-K9/L0 Marauder SP 250 Z/D/F TU 250 XL1/XL2/XL3/XL4/XL5/XL6	82-88 ■ 82-85 ■ 14-15 ■ 99-10 ■ 82-85 ■ 09-16 ■
CK3334 CT022 ▲	SUZUKI DR 370 C/N (4T)	78-79 ▲	CK3359 CT029SP ■	SUZUKI DR 500 X/Z/D SP 500 X/Z/D SP 600 F LS 650 FG/PG/FH/PH/PJ/PS/PT/PV/PW/PX/PY /PK1/PK2/PK3/PK4 LS 650 K5-K9/L1/L2/L3/L4/L5 Boulevard S40 (650cc)	81-83 ■ 81-83 ■ 85 ■ 86-88/95-04 ■ 05-15 ■
CK3335 CT024SP ▲	SUZUKI GS 1000 SZ GS 1000 GT/GX/GLT/GLX/SZ GS 1100 ET/EX/EZ GS 1100 GZ/GD/GLZ/GLD GS 1100 LT GS 1150 ES3/ESE/EF/ESF/EF2/EG/ESG VL 1500 W/X/Y/K1-K4 Intruder Legendary Classic VL 1500 BK5/K5/TK5/BK6/K6/TK6/K7//TK7 /TK8/K8/K9/TK9 Boulevard C90/C90T	82 ▲ 80-82 ▲ 80-82 ▲ 82-83 ▲ 80 ▲ 83-86 ▲ 98-04 ▲ 05-10 ▲	CK3364 CT011 ▲	SUZUKI LT 160 EK/EL/EM/EN LT-F 160 M/N/P/R/S/T/V/W/X/Y/K1/K3 LT 160 K3/K4 Quadrunner LT-F 230 G/H LT 230 GEF/GEG LT 230 EH/EJ/EK/EL/EM/EN/EP LT 230 SF/SG/SH/SJ up to E. no 104360	89-92 ▲ 91-01/03 ▲ 03-04 ▲ 86-87 ▲ 85-86 ▲ 87-93 ▲ 85-88 ▲
CK3337 CT011 ▲	SUZUKI TS 100 T/X TS 125 T/X	80-81 ▲ 80-81 ▲			

CK CLUTCH KIT BUYERS GUIDE

Part No.	Make/Model	Year	Part No.	Make/Model	Year
CK3364	SUZUKI Contd. LT-F 250 K2	02 ▲	CK3386 CT024 ▲	SUZUKI DR 650 SET/SEV/SEW/SEX/SEY/SEK1/SEK2 /SEK3/SEK4/SEK5/SEK6/SEK7/SEK8/SEK9 /SEL1/SEL2/SEL3/SEL4/SEL5/SEL6	96-16 ▲
CK3366	KAWASAKI KDX 50 A1/A2/A3/A6F SUZUKI JR 50 C/N/T/X/Z/F/G/H/J/K/L/N/P/R/S/T/V/W /X/Y/K1/K2/K3/K4/K5/K6	03-06 78-06	CK3387 CT036SP ▲	SUZUKI GSXR 600 WN/WP GSX 600 FN/FP/FR/FS/FT/FV Katana GSX R 750 J/K/L/M/N GSX-R 750 WP/WR/WS	92-93 ▲ 92-97 ▲ 88-92 ▲ 92-95 ▲
CK3367	SUZUKI RM 80 G/H/J	86-88	CK3388 CT029 ▲	SUZUKI GV 1400 GDG/GTG/GCG/GDH/GTH/GCH/GDJ	86-88 ▲
CK3372 CT022 ▲	SUZUKI LT 250 RH/RJ/RK/RL/RM/RN RM 250 G/H	87-92 ▲ 86-87 ▲	CK3390 CT011 ▲	SUZUKI LT 250 EFF/EFG LT-4WD (250cc) Quadrunner 4WD LT-F 4WD V/W Quadrunner 4WD (250cc) LT-F 250 J/K/L/M/N/P/R/S/V/W/X/Y/K1 LT-F 250 FX/FY/FK1/FK2 "Quadrunner" LT-F 250 K3/K5/K6/K7/K8/K9/L2/L3/L4 Ozark 250 (2 x 4 / 4 x 4) LT 300 EH/EJ/EK	85-86 ▲ 87-97 ▲ 97-98 ▲ 88-01 ▲ 99-02 ▲ 03/05-14 ▲ 01-05 ▲ 87-88 ▲
CK3373 CT035SP ▲	SUZUKI RE 5 M/A (Rotary)	75-76 ▲	CK3391	SUZUKI GSX 750 FK/FL/FM/FN/FP/FR/FS/FT	89-96
CK3374 CKF3374 CT022 ▲	SUZUKI RM 250 J/K/L/R/S RMX 250 K/L/M RMX 250 R/S/T/V/W/X/Y LT 500 RH/RJ/RK/RL GV 700 GLFG/GLF2	88-90/94-95 ▲ 89-91 ▲ 94-00 ▲ 87-90 ▲ 85 ▲	CK3392 CT055SP ▲	SUZUKI GSX R 1100 K/L/M/N GSX 1100 GM/GN/GP	89-92 ▲ 91-93 ▲
CK3375	SUZUKI GV 1200 GLF/GLF2/GLG	85-86	CK3397 CT011 ▲	SUZUKI GSF 400 M/N/P	91-93 ▲
CK3376 CT072SP ▲	SUZUKI GSX-R 750 RG (Dry Clutch - Sintered Friction)	86 ▲	CK3399 CKF3399 CT022 ▲	SUZUKI DR 250 L/M/N/P DR 250 SL/SM/SN/SEP/SER/SES DR 350 L/M/N/P/R/S/T DR 350 SL/SM/SN/SP/SER/SES/SET/SEV/SEW/SEX	90-93 ▲ 90-95 ▲ 90-96 ▲ 90-99 ▲
CK3377 CT022 ▲ CT029 ■	YAMAHA SV 650 X/Y/K1/SK1/K2/SK2 VS 700 GLF/GLP/GLEF/GLEP/GLEG/GLEH VS 750 GLPJ/GLPK/GLPL/GLPM VL 800 ZK3/ZK4 Volusia LTD (Seat Trimmed With Chrome Studs) VL 800 K5/CK5/K6/CK6/K7/ZK7/K8/ZK8/K9 /ZK9/L1/L2/L3/L4/L5 (C50 Boulevard) VL 800 TK5/TK6/TK7/TK8/TK9/TL1/TL2/TL3 /TL4/TL5 (C50T Boulevard Tourer) VL 800 K1/K2/K3/K4 Intruder Volusia VL 800 K5/K6/CK5/TK5/CK6/TK6/K7/TK7/ZK7 /K8/TK8/ZK8/K9/TK9/ZK9/L1/L2 Boulevard C50/C50 T VL 800 ZL2 C 50 T Boulevard Classic VL 800 BTL4 (Boulevard C50 B.O.S.S. Cast Wheels) VL 800 CL3 (Boulevard C50 Special Edition /Cast Wheels) VX 800 L/M/N/P VS 800 Intruder GLN/GLP/GLR/GLS/GLT/GLV/GLW /GLX/GLY/GLK1/GLK2/GLK3/GLK4 VZ 800 V/W/X/Y/K1-K4 Marauder VZ 800 K5/K6/BK6/K7/ZK7/K8/ZK8/K9/ZK9 M50 Boulevard VS 800 K5/K6/K7/K8/K9/L0 S50 Boulevard	99-02 ▲ 86-87 ■ 88-91 ■ 03-04 ■ 05-15 ■ 05-15 ■ 01-04 ■ 05-12 ■ 12 ■ 14 ■ 13 ■ 90-93 ■ 92-04 ■ 97-04 ■ 05-10 ■ 05-10 ■	CK3400 CT022 ▲	SUZUKI RM 250 M/N/P RMX 250 N/P	91-93 ▲ 92-93 ▲
CK3380 CT051 ▲	SUZUKI RB 50 H (GSXR50)	87 ▲	CK3401 CT003 ●	SUZUKI RM 125 N/P/R/S/T/V/W/X/Y/K1	92-01 ●
CK3381 CT048SP ▲	SUZUKI GSX 1100 FJ/FK/FL/FM/FN/FP GSXR 1100 G/H/J	88-93 ▲ 86-88 ▲	CK3402 CT029SP ■	SUZUKI DR 650 SL/SM/SN/SP/SER/SES	90-95 ■
CK3382 CT029 ■	SUZUKI VS 1400 GLPH/GLFH/GLPJ/GLPL/GLPM/GLPN /GLPP/GLPR/GLPS/GLPT/GLPV/GLPW/GLPX /GLPY/GLPK1/GLPK2/GLPK3/GLPK4 VS 1400 GLPK5/K6/K7/K8/K9/L0 Boulevard S83 (1400cc)	87-04 ■ 05-10 ■	CK3408 CKF3408 CT036SP ▲	SUZUKI RF 600 RR/RS/RT	94-96 ▲
			CK3417 CT014 ▲ CT055SP ■	SUZUKI GSX-R 750 T/V/W/X GSXR 750 K4/K5 RF 900 RS/RS2/RT/RV TL 1000 SV/SW GSF 1200 SV/SAV/SW/SX/SY/SK1/SK2K1/K2 /SK3/K3/SK4/SK5	96-99 ■ 04-05 ▲ 95-97 ▲ 97-98 ▲ 97-05 ■
			CK3418 CT055SP ▲	SUZUKI RF 900 RR GSXR 1100 WR/WP/WS/WT/WV/WW	94 ▲ 93-98 ▲
			CK3428 CT009 ▲	SUZUKI TL 1000 RW/RX/RV TL 1000 SX/SY	98-00 ▲ 99-00 ▲
			CK3430 CT021 ▲	SUZUKI GSX 1300 RX Hayabusa GSX 1300 RY/RK1 Hayabusa	99 ▲ 00-01 ▲

CK CLUTCH KIT BUYERS GUIDE

Part No.	Make/Model	Year	Part No.	Make/Model	Year
CK3433 CKF3433 CT006 ▲ CT009 ■	ARCTIC CAT 400 DVX HONDA CRF 450 R (4 Spring type) CRF 450 R (6 Spring type) CRF 450 R (6 Spring type) KAWASAKI KLX 400 R (KLX 400 B1) KLX 400 SR (KLX 400 A1) SUZUKI KSF 400 A1/A2 (KFX 400) DR-Z 400 SY/SK1/SK2/SK3/SK4/SK5/SK6/SK7 /SK8/SK9/SL1/SL2/SL3/SL4/SL5/SL6 DR-Z 400 /EY/Y/EK1/K1/EK2/K2/K3/EK3/K4 /EK4/EK5/EK6/EK7 DR-Z 400 SMK5/SMK6/SMK7/SMK8/SMK9 /SML3/SML4/SML5/SML6 LT-Z 400 K3/K4	04-06 ▲ 11-12 ■ 13 ■ 14-16 ■ 03-04 ▲ 03-04 ▲ 03-04 ▲ 00-16 ▲ 00-08 ▲ 05-08/13-16 ▲ 03-04 ▲	CK3457	SUZUKI VZR 1800 BL4/BL5 (Boulevard M109R B.O.S.S.) VZR 1800 K6/K7/K8/K9/L1/L2/3/L4 (M109R Boulevard) VZR 1800 NK8/NK9 M109R2 Limited VZR 1800 ZK8/ZK9/ZL1/ZL2/ZL3/ZL4 M109RZ Limited	14-15 06-14 08-11 08-14
CK3435 CT009 ▲	SUZUKI TL 1000 RK1/RK2/RK3 TL 1000 SK1	01-03 ▲ 01 ▲	CK3458	SUZUKI DR-Z 70 K8/K9/L5/L6	08-09/15-16
CK3443 CT021 ▲	SUZUKI DL 1000 AL4/AL5/AL6 DL 1000 AL2/AAL4/AAL5/AAL6 V-Strom Adventure DL 1000 K2-K9/L2 V-Strom SV 1000 K3/SK3/K4/SK4/K5/SK5/SK6/SK7 GSX 1300 ral3/ral4/ral5/ral6 GSX 1300 RK2/RZK3/RK4/RZK4/RK5/RZK6/RK6 /RK7/RK8/RK9/RL1/RL2 GSX 1300 RZL4 Hayabusa 50th Anniversary Edition GSX 1300 BKAK8/K9 B-King ABS GSX 1300 BKK8/K9 B-King	14-16 ▲ 12/14-16 ▲ 02-12 ▲ 03-07 ▲ 13-16 02-12 ▲ 14 ▲ 08-09 ▲ 08-09 ▲	CK3459 CT021 ▲	SUZUKI GSF 1250 SKA7/SKA8/SKA9 GSF 1250 SK7/SK8/SK9 Bandit GSX 1250 FAL1/FAL2 V 1500 BL3/BL4/BL5 (Boulevard C90 B.O.S.S.) V 1500 BTL3/4 (Boulevard C90T B.O.S.S. with windshield) VZ 1500 L3 C90 Boulevard VZ 1500 TL3/TL4/TL5 C90T Boulevard with windshield VZ 1500 K9/L3/L4/L5 M90 Boulevard	07-10 ▲ 07-10 ▲ 11-12 ▲ 13-15 ▲ 13-14 ▲ 13 ▲ 13-15 ▲ 09/13-15 ▲
CK3447 CKF3447 CT006 ▲	ARCTIC CAT 400 DVX KAWASAKI KSF 400 A3/A6F (KFX 400) SUZUKI LT-Z 400 K5/K6/K7/K8/K9/ZK9/L2/L3/L4	07-08 ▲ 05-06 ▲ 05-14 ▲	CK3462 CKF3462 CT009 ▲	SUZUKI GSXR 1000 K9/L1/L2/L3/ZL3/L4/L5/L6	09-16 ▲
CK3448 CT011 ▲	SUZUKI LT-Z 250 K4/K5/K6/K7/K8/K9/L0 Quad Sport LT-F 250 K4 Ozark	04-10 ▲ 04 ▲	CK3463	SUZUKI VLR 1800 TK8/TK9 C109 RT Touring VLR 1800 K8/K9 C109 R	08-10 08-10
CK3450 CKF3450 CT045 ▲	SUZUKI RM-Z 450 K5/K6/K7/K8/K9/L0/ZL0/L1/L2/L3/L4/L5/L6 LT-R 450 K6/K7/K8/K9 LTR 450 ZK8/ZK9 Quadracer Limited	05-16 ▲ 06-11 ▲ 08-10 ▲	CK3465 CT014 ▲	SUZUKI GSXR 750 K1/K2/K3	01-03 ▲
CK3451 CKF3451 CT015 ▲	SUZUKI GSXR 1000 K5/K6/K7/K8 GSX-S 1000 L8 (Naked - Non ABS) GSX-S 1000 AL8 (Naked - ABS) GSX-S 1000 F L8 (Faired -Non ABS) GSX-S 1000 F AL8 (Faired -ABS)	05-08 ▲ 18 ▲ 18 ▲ 18 ▲ 18 ▲	CK3466 CT014 ▲	SUZUKI GSXR6 600 K1/K2/K3/ZK3	01-03 ▲
CK3452 CT006 ▲	SUZUKI LT-F 500 FK3/FK4/FK5/FK6/FK7 500 (Manual 4x4)	03-07 ▲ 03-09 ▲	CK3468 CT009 ▲	SUZUKI GSX-R 1000 AL7	17 ▲
CK3453 CT016 ▲	SUZUKI RM 250 K6/K7/K8	06-08 ▲	CK4409 CT019 ▲	KAWASAKI Z1/A/B 900 KZ 900 A4/A5 Z 900 B1 Ltd KZ 1000 A1-A4 KZ 1000 B1-B4 (Ltd) KZ 1000 C1/C1A/C2/C3/C4 Police KZ 1000 D1/D3 (Z1-R) KZ 1000 G1 Classic	73-75 ▲ 76-77 ▲ 76 ▲ 77-80 ▲ 77-80 ▲ 78-81 ▲ 78-80 ▲ 80 ▲
CK3454 CKF3454 CT016 ▲	SUZUKI RM 250 K3/K4/K5	03-05 ▲	CK4411 CT058 ▲	KAWASAKI KD 125 A2/A3/A4/A5 KE 125 A7/A8/A9/A10 KE 175 D2/D3/D4/D5	75-79 ▲ 80-83 ▲ 80-83 ▲
CK3455 CKF3455 CT015 ▲	SUZUKI GSXR 600 K6/K7	06-07 ▲	CK4413 CT019 ▲	KAWASAKI KZ 650 B1/B2/B2A/B3 KZ 650 C1/C2/C3 Custom KZ 650 D1/D1A/D2 SR KZ 650 E1 (Ltd)/F1/H1/H2/H3 (CSR) KZ 700 A1 ZN 700 A1/A2 (Ltd) KZ 750 E1/E2/E3 KZ 750 F1 (Ltd) KZ 750 H1/H2/H3/H4 (Ltd) KZ 750 L3 KZ 750 N1/N2 'Spectre' KZ 750 R1 (GPZ) ZX 750 A1/A2/A3 (GPZ)	77-79 ▲ 77-79 ▲ 78-79 ▲ 80-83 ▲ 84 ▲ 84-85 ▲ 80-82 ▲ 83 ▲ 83 ▲ 80-83 ▲ 83 ▲ 82-83 ▲ 82 ▲ 83-85 ▲
CK3456 CKF3456 CT015 ▲	SUZUKI GSXR 600 K8/K9/L1/L2/L3/L4/L5/L6 GSXR 750 K6/K7/K8/K9/L1/L2/L3/L4/L5/L6	08-16 ▲ 06-16 ▲	CK4415 CT004 ▲	KAWASAKI H2/H2-A "Mach IV"	72-73 ▲

CK CLUTCH KIT BUYERS GUIDE

Part No.	Make/Model	Year	Part No.	Make/Model	Year
CK4419 CT006 ▲	ARCTIC CAT 400 (2 x 4 / 4 x 4) KAWASAKI KLF 300 A1/A2/B1-B17/C1-C17 'Bayou' KEF 300 A1/A2/A3/A4/A5/A6 'Lakota' KEF 300 B1/B2/B3 "Lakota Sport"	00-02 ▲ 86-05 ▲ 95-00 ▲ 01-03 ▲	CK4434 CT016 ▲	KAWASAKI Contd. KZ 1000 J1/J2/J3 ZG 1000 A6F Concours ZX 1000 A1/A2 Ninja ZX 1000 B1/B2/B3 Ninja ZX10 KZ 1100 A1/A2/A3 KZ 1100 B1/B2 (GPZ) KZ 1100 D1/D2 'Spectre' KZ 1100 L1 (Ltd) ZN 1100 B1/B2 (Ltd) ZX 1100 A1/A2 Ninja ZR 1100 A1/A2/A3/A4 Zephyr (ZR 1100 C3/C4) ZRX 1100 ZG 1200 A1/B1-B17 Voyager X11 ZRX 1200 R (ZR 1200 A1/A2/A3/A4/A5)	81-83 ▲ 06 ▲ 86-87 ▲ 88-90 ▲ 81-83 ▲ 81-82 ▲ 82-83 ▲ 83 ▲ 84-85 ▲ 86-87 ▲ 92-95 ▲ 99-00 ▲ 86-03 ▲ 01-05 ▲
CK4421	KAWASAKI KZ 440 A1/A2/A3/A4 KZ 440 B1/B2/D1/D2/D3/D4/D5 KZ 440 G1	80-83 80-83 82	CK4435 CKF4435 CT016 ▲	KAWASAKI KX 250 J1/J2/K1-K5/L1-L4/M1/M2/R1/R6F/R7F KL 650 E8F/E9F/EAF/EBF (KLR 650) KLR 650 (KL 650 A10-A19/A6F/A7F) W 650 (EJ 650 A2/A3/A4) VN 700 A1 'Vulcan' VN 750 A2-A21/A6F 'Vulcan' ZX 750 F1/F2/F3/F4 Ninja ZX 750 L1/L2/L3 (ZX7) ZX 750 J1/J2 ZX 750 P1-P8 (ZX7R) ZX 750 N1/N2 (ZX7RR) ZX 750 K1/K2 ZX 750 M1/M2 (ZX7R) KZ 750 G1 (Ltd) KZ 750 M1 (CSR) VN 800 A1-A11/B1-B10 VN 800 C1/C2/E1-E5/E6F Drifter VN 900 B6F/B7F/B8F/B9F/BAF/BBF/BCF /BDFA/BEF/BEFA/BFF VN 900 D6F/D7F/D8F/D9F/DAF/DBF/DCF/DDF /DEF/DFE VN 900 Custom C7F/C8F/C9F/CAF/CBF/CCF /CDF/CEFA/CFE ZX 900 A1/A2/A3 'Ninja' ZX-9R B1/B2/B3/B4 Ninja SUZUKI RM 250 T/V/W/X/Y/K1/K2	92-07 ▲ 08-11 ▲ 96-07 ▲ 00-02 ▲ 85 ▲ 86-06 ▲ 87-90 ▲ 93-95 ▲ 91-92 ▲ 96-03 ▲ 96-99 ▲ 91-92 ▲ 93-94 ▲ 80 ▲ 82 ▲ 95-05 ▲ 99-06 ▲ 06-15 ▲ 06-15 ▲ 07-15 ▲ 84-86 ▲ 94-97 ▲ 96-02 ▲
CK4424 CKF4424 CT016 ▲	KAWASAKI KLR 600 (KL 600 A1/B1/B2) EN 450 A1-A6 (454 Ltd) EN 500 A1-A7/C1-C10/C6F/C7F/C8F/C9F EX 500 A1-A7/D1-D12/D6F/D7F/D8F/D9F KZ 550 D1 (GPZ) KZ 550 F1 'Spectre' KZ 550 F2 (Ltd) KZ 550 H1/H2 (GPZ) KZ 550 M1 (Ltd) KZ 550 A1/A2/A3/A4 KZ 550 C1/C2/C3/C4 (Ltd) ZX 550 A1/A2/A3 (GPZ) ZR 550 B1-B4 "Zephyr" ZL 600 A1/A2 ZL 600 Eliminator B2/B3 ZX 600 C1-C10 Ninja R ZX 600 D1-D4/E1-E13 (ZX6) ZX 600 A1/A2/A3/B1 'Ninja' ER-6N (ER 650 C9F/CAF) EX 650 A6F/A7F/A8F/C9F/CAF/CBF EX 650 Ninja (Non ABS) (EX 650 ECF/EDS/EEF/EFF) EX 650 Ninja (ABS) (EX 650 FDS/FEF) KLE 650 A7F/A8F/AAF/CAF/CBF/CCF/CDF/CEF Verysys KLR 650 (KL 650 A1-A9) KLX 650 C1/C2/C3/C4 KL 650 B2/B3 "Tengai" KL 650 EBF/ECF/EDF/EEF (from KL 650 AEA 72320-) KLX 650 A1/A2/A3/D1 (KLX650R) ZX 750 H1/H2 Ninja ZX-7	84-86 ▲ 85-90 ▲ 90-09 87-09 ▲ 81 ▲ 83 ▲ 84 ▲ 82-83 ▲ 83 ▲ 80-83 ▲ 80-83 ▲ 84-86 ▲ 90-93 ▲ 86-87 ▲ 96-97 ▲ 88-97 ▲ 90-05 ▲ 85-87 ▲ 09-10 ▲ 06-11 ▲ 12-15 ▲ 13-15 ▲ 07-11 ▲ 87-95 ▲ 93-96 ▲ 90-91 ▲ 11-15 ▲ 93-96 ▲ 89-90 ▲	CK4425 CT004 ▲	KAWASAKI KX 125 K1/K2/K3/K4/K5/L1-L4/M1-M3 KLT 200 A1/A2/A3/A4/A4A KLT 200 B1/C1/C2 KL 250 A1/A1A/A2/A3/A4/A5 KL 250 C1/C2 KLT 250 A1/A2/C1/C2/C3/P1 KZ 250 D1 (Ltd) KZ 250 D2/L1 (CSR) KZ 250 W1 (Ltd) KLX 250 A1/A2 KSF 250 A1-A18 Mojave HI 500 Mach III KH 500 A8	94-05 ▲ 81-83 ▲ 83-84 ▲ 78-82 ▲ 83-84 ▲ 82-85 ▲ 80 ▲ 81-82 ▲ 83 ▲ 79-80 ▲ 87-04 ▲ 69-75 ▲ ▲
CK4433 CT006 ▲	KAWASAKI KXT 250 A1 'Tecate' KZ 305 A1/A2/B1 (CSR) EX 305 B1 (GPZ) KZ 305 B2/B3 (Ltd) KDX 250 B2/B3/B4 KX 250 B1/C1 KX 500 A1/A2	84 ▲ 81-82 ▲ 83 ▲ 87-88 ▲ 82-84 ▲ 82-83 ▲ 83-84 ▲	CK4436 CT058 ▲	KAWASAKI KX 125 A4/A5/A6/A7/B1 KDX 175 A1/A2/A3 S1-A/B/C (250cc) KH 250 A5 S2/S2A (350cc)	78-82 ▲ 80-82 ▲ 73-75 ▲ 76 ▲ 72-73 ▲
CK4434 CT016 ▲	KAWASAKI ZL 900 A1/A2 'Eliminator' ZG 1000 A1-A20 'Concours' ZL 1000 A1 KZ 1000 E1/E2 'Shaft' KZ 1000 K1/K2 (Ltd) KZ 1000 M1/M2 (CSR) KZ 1000 P1-P22/P24 Police KZ 1000 R1/R2 'Replica'	85-86 ▲ 86-05 ▲ 87 ▲ 79-80 ▲ 81-82 ▲ 81-82 ▲ 82-03/05 ▲ 82-83 ▲	CK4438 CKF4438	KAWASAKI KX 60 A1/A2/B1-B19 KX 65 A1/A2/A3/A4/A5/A6/A6F/A7F/A8F/A9F /AAF/ABF/ACF/ADF/AEF/AFF/AGF/AHF KX 80 C1/C2 KX 80 E1/E2 KDX 80 B2/B3 KDX 80 C1/C2/C3/C4/C5 KLX 110 (KLX 110 A1/A2/A3/A4/A6F/A7F/A8F /A9F/CAF/CBF/CCF/CDF/CEF/CFE/CGF/CHF) KLX 110L (DAF/DBF/DCF/DDF/DEF/DFE/DGF/DHF) SUZUKI RM 60 K3 RM 65 K3/K4/K5 RM 100 K3/K4 DR-Z 110 K3/K4/K5	83-03 00-17 81-82 83-84 82-83 84-88 02-17 10-17 03 03-05 03-04 03-05
CK4439 CKF4439	ARCTIC CAT 400 (2 x 4 / 4 x 4) 400 (2 x 4) 400 (2 x 4 / 4 x 4) 400 (4 x 4 Manual) Bearcat 454 (4 x 4) Bearcat 454 (2 x 4)	98- 98 03-04 05-08 96-98 97-98	CK4439 CKF4439	ARCTIC CAT 400 (2 x 4 / 4 x 4) 400 (2 x 4) 400 (2 x 4 / 4 x 4) 400 (4 x 4 Manual) Bearcat 454 (4 x 4) Bearcat 454 (2 x 4)	98- 98 03-04 05-08 96-98 97-98

CK CLUTCH KIT BUYERS GUIDE

Part No.	Make/Model	Year	Part No.	Make/Model	Year	
CK4439 CKF4439	ARCTIC CAT Contd.	98-02	CK4459	KAWASAKI	86-87	
	500 (4 x 4)			KXT 250 B1/B2 'Tecate'	85-86	
	KAWASAKI			KX 250 D1/D2	85-86	
	KDX 250 A1/B1	80-81		KX 500 B1/B2		
	KE 250 B1/B2/B3	77-79		CK4463	KAWASAKI	84-86
	KX 250 A6/A7	80-81			KLT 110 A1/A2/A3	87-88
	KDX 400 A1/A2	79-80			KLF 110 A1/A2/B1/B2 'Mojave'	
	KLF 400 B1-B7 Bayou (4 x 4)	93-98		CK4465 CT002 ▲	KAWASAKI	85 ▲
	KDX 420 B1	81			KXT 250 A2 Tecate	84 ▲
	KX 420 A1/A2	80-81		CK4468	KAWASAKI	85-87
KDX 450 A1	82	KX 80 E3/G1/G2/J2				
SUZUKI		CK4469 CT042 ▲	KAWASAKI	85-87 ▲		
LT-F 400 K2 Eiger Manual 2WD	03		KDX 200 C1/C2/C3	86-88 ▲		
LT-F 400 K3/4/5/6/7	03-08		KL 250 G4/G5/G6/G7/G8 "Super Sherpa"	00-04 ▲		
LT-F 400 FK2/FK3/FK4/FK5/FK6/FK7 (Eiger 4WD)	02-07		KLX 250 D2/D3/D4	93-95 ▲		
LT-F 400 FK8/FK9/FLO King Quad 400 FS	08-10		KLX 250 S (KLX 250 H6F/H7F)	06-07 ▲		
LT-F 400 FCK8/FCK9 King Quad 400 FS Camo	08-09		KLX 250 S (KLX 250 T9F/TAF/TBF/TCF/TDF/TEF)	09-14 ▲		
LT-F 500 FW/FX/FY/FK1-FK2	98-02		KLX 250 SF (KLX 250 W9F/TAF) Supermotard	09-10 ▲		
			KLX 300 R A2-A10/A6F/A7F	97-07 ▲		
CK4440	KAWASAKI	82	CK4473 CT016 ▲	KAWASAKI	88-89 ▲	
	AR 80 A1	80-87		EL 250 B2/B3 Eliminator	91-95 ▲	
	KD 80 M1-M8	88-90		EL 250 E1/E2/E3/E4 (250 HS)	86-87 ▲	
	KD 80 N1/N2/N3	80-81		EX 250 E1/E2 Ninja	88-07 ▲	
	KDX 80 A1/A2	76-81		EX 250 F2-F19/D6F/D7F Ninja		
KE 100 A5/A6/A7/A8/A9/A10	76-81	CK4475 CT006 ▲	KAWASAKI	87-91 ▲		
KE 100 B1-B20	82-01		KX 250 E1/F1/G1/H1/H2	87-04 ▲		
KM 100 A1/A2/A3/A3A/A4/A6/A7	76-81		KX 500 C1/D1/E1-E16	87-88 ▲		
CK4442	KAWASAKI	82	KXF 250 A1/A2 Tecate 4	91-94 ▲		
	AR 50 A1		KDX 250 D1/D2/D3/D4			
CK4443 CT019 ▲	KAWASAKI	84-85 ▲	CK4477	KAWASAKI	88	
ZX 750 E1/E2 (GPZ Turbo)		KX 80 L1				
CK4446 CT004 ▲	KAWASAKI	85-05 ▲	CK4478	KAWASAKI	89-97	
	KLR 250 (KL 250 D2-D22)			KX 80 L2/N2/L3/N3/R1/R2/R3/R4/R5/R6/R7	95-97	
CK4452	KAWASAKI	80	CK4482 CT042 ▲	KAWASAKI	88-89 ▲	
	KZ 1300 B2 'Touring'	79-81		KX 125	89-94 ▲	
	KZ 1300 A1/A2/A3		KDX 200 E1-E6			
CK4453 CKF4453 CT002 ▲	KAWASAKI	98-00 ▲	CK4485 CT042 ▲	KAWASAKI	90-92 ▲	
	KX 80 W1/W2/W3	01-17 ▲		KX 125 H1/H2/J1		
	KX 85 A1-A5/A6F/A7F/A8F/A9F/AAF/ABF/ACF /ADF/CEF/CFF/CGF/CHF			CK4488 CT021 ▲	KAWASAKI	90-01 ▲
KX 100 C1/C2/C3/D1/D2/D3/D4/D5/D6F/D7F /D8F/D9F/DBF/DCF/DDF/FEF/FFF/FGF	98-09/11-17 ▲	ZX 1100 C1-C4/D1-D9 (ZX11)	95-97 ▲			
CK4455 CT032 ▲	KAWASAKI	83-88 ▲	CK4493 CT019 ▲	KAWASAKI	91-93 ▲	
	ZN 1300 A1-A6 'Voyager'	87-99 ▲		ZR 750 C1/C2/C3/C4 Zephyr	00 ▲	
	VN 1500 A1-A13 Vulcan 88	87-04 ▲		ZR 750 F2 (ZR-7)	01-05 ▲	
	VN 1500 B1-B4/C3/C4/D1/D2/E1-E7 All Vulcan 88 SE	99-01 ▲		ZR 750 H1/H2/H3/H4/H5 (ZR-7S)		
	VN 1500 G1/G1A/G2A/G3 Nomad	00-02 ▲		CK4498 CT042 ▲	KAWASAKI	93 ▲
	VN 1500 Classic Fi (VN 1500 N1/N2/N3)	99-05 ▲			KAWASAKI	95-02 ▲
	VN 1500 J1/J2/R1-R5 Drifter	02-03 ▲			ZX6-R (ZX 600 F1-F3/G1/G2/J1/J2/J3)	03 ▲
	VN 1500 P1/P2 'Vulcan Mean Streak'	01-05 ▲		ZX6RR (ZX 600 K1)	03-04 ▲	
	VN 1500 L2/L3/L4/L5 Nomad Fi	05-08 ▲		ZX6R (ZX 636 B1/B2)	06-08 ▲	
	VN 1500 N4/N6F/N7F/N7FA/N8F/N8FA	03-08 ▲		ZZR 600 J6F/J7F/J8F	05-06 ▲	
	VN 1600 A1/A2/A3/A6F/A7F/A7FA/A8F/A8FA Classic	04 ▲		Z 750 S (ZR 750 K1/K6F)		
	VN 1600 B1 Mean Streak	05-08 ▲		CK4503 CT004 ▲	KAWASAKI	95-06
	VN 1600 B2/B6F/B7F/B7FA/B8F/B8FA Mean Streak	05-08 ▲			KDX 200 H1-H11/H6F	97-06
	VN 1600 D1/D6F/D7F/D7FA/D8F/D8FA Nomad	05-08 ▲		KDX 220 R A4-A12/A6F		
	SUZUKI					
VZ 1600 K4 Marauder	04 ▲					
VZ 1600 K5 M95 Boulevard/Marauder	05 ▲					
CK4457 CT058 ▲	KAWASAKI	83-85 ▲	CK4505	KAWASAKI	95-06	
	KDX 200 A1/A2/A3	83-84 ▲		KDX 200 H1-H11/H6F	97-06	
	KX 125 B2/C1	76-78 ▲				
	KH 400 A3/A4/A5	74-75 ▲				
	S3/S3-A (400cc)					
CK4458	KAWASAKI	82				
	KZ 1300 A4					

CK CLUTCH KIT BUYERS GUIDE

Part No.	Make/Model	Year	Part No.	Make/Model	Year	
CK4510 CKF4510 CT004 ▲ CT079SP ●	KAWASAKI ZX9R (ZX 900 C1/C2/E1/E2/F1/F2) Z 1000 (ZR 1000 A1/A2/A3) Z 1000 (ZR 1000 A6F/C7F) Z 1000 (ZR 1000 DAF/DBF/DCF/DDF) ZR 1000 B7F/B8F (Z1000) ZX 1000 C1/C2/D6F/D7F/E8F/E9F/FAF/JBF/KBF /JCF/KCF/JDF/JEF/JFF (ZX10R) ZX 1000 GBF/GCF/GDF 1000 Ninja ABS (ZX1000 HCF/HDF) 1000 Ninja ABS (ZX1000 MEF/MFF) ZX-10R (ZX 1000 KBF/KCF/KDF/KEF/KFF)	98-03 ▲ 03-05 ▲ 06-07 ▲ 10-13 ▲ 07-08 ▲ 04-15 ▲ 11-13 ▲ 12-13 ▲ 14-15 ▲ 11-15 ▲	CK4519 CT006 ▲	KAWASAKI KFX 450 R (KSF 450 B8F/B9F/BAF/BBF/BCS)	08-12 ▲	
			CK4520 CT021 ▲	KAWASAKI Concours 14 (ZG 1400 B8F/B9F/DAF) Concours 14 ABS (ZG 1400 A8F/A9F/CAF/CBF /CCF/CDF/CEF)	08-10 ▲ 08-14 ▲	
			CK4521 CT009 ▲	KAWASAKI EX 250 J8F/J9F/JAF/JBF/JCF Ninja 250 R	08-12 ▲	
			CK4522	KAWASAKI KLX 140 A8F/A9F/AAF/ABF/ACF/ADF /AEF/AFF/AGF/AHF (KLX 140) KLX 140 B8F/B9F/BAF/BBF/BCF/BDF/BEF /BFF/BGF/BHF (KLX 140 L) KLX 140 CHF (KLX 140 G) KLX 150 S	08-17 08-17 17 09	
			CK4523 CT004 ▲	KAWASAKI H2-B Mach IV (2T) H2-C Mach IV (2T)	74- ▲ 75 ▲	
			CK4524 CT009 ▲	KAWASAKI EX 300 ADF/ADFA/AEF/AEFA/AES/AESA Ninja EX 300 BDF/ADF/BEF/BEFA Ninja	13-14 ▲ 13-14 ▲	
	CK4511	KAWASAKI BN 125 A4-A8/A6F/A7F/A9F	01-09	CK5544	HONDA ATC 185/185 S Centrifugal (one way) clutch ATC 200 Centrifugal (one way) clutch ATC 200 E Big Red Centrifugal (one way) clutch ATC 200 ES Big Red Centrifugal (one way) clutch ATC 200 M Centrifugal (one way) clutch ATC 200 S Centrifugal (one way) clutch TRX 200 Fourtrax Centrifugal (one way) clutch	80-83 81-83 82-83 84 84-85 84-86 84
	CK4513 CT009 ▲	KAWASAKI ZX12R (ZX 1200 A1)	00 ▲	CK5588 CKF5588 CT021 ▲	TRIUMPH Adventurer Daytona 750 (3cyl) Daytona 1000 (4cyl) Daytona 900 (3cyl) Daytona Super III (3cyl) Daytona 1200 (4cyl) Legend TT Speed Triple (Carb model) Sprint (All carb models) Thunderbird Thunderbird Sport Tiger 900cc Trident 900 Trophy 900 (3cyl) Trophy 1200 (4cyl)	96-01 ▲ 92 ▲ 92 ▲ 93-96 ▲ 94-97 ▲ 93-98 ▲ 98-01 ▲ 94-97 ▲ 93-98 ▲ 95-03 ▲ 98-04 ▲ 93-96 ▲ 92-98 ▲ 92-01 ▲ 92-01 ▲
	CK4514 CKF4514 CT003 ● CT004 ▲	KAWASAKI KX 250 N1/N2/T6F/T7F/T8F/W9F/XAFB/YBF /YCF/ZDF/ZEF/ZFF/ZGF/AHF ZX6RR (ZX 600 M1/N1/N6F) ZX6R (ZX 600 P7F/P8F/R9F/RAF/RBF/RCF) ZX 636 C1/C6F ZX6R (ZX 636 EDF/EEF/EFF/EGF/EHF) 636cc/Non ABS ZX6R (ZX 636 EFFA) 636cc/ 30th Anniversary Edition Non ABS ZX6R (ZX 636 EGFA/EHFA) 636cc/Non ABS/ KRT Edition ZX6R (ZX 636 FDF/FDF/FFF/FGF/FHF) 636cc/ABS ZX6R (ZX 636 FFFA) 636cc/ 30th Anniversary Edition ABS ZX6R (ZX 636 FGFA/FHFA) 636cc/ABS/KRT Edition	04-17 ▲ 04-06 ▲ 07-12 ▲ 05-06 ▲ 13-17 ▲ 15 ▲ 16-17 ▲ 13-17 ▲ 15 ▲ 16-17 ▲	CK5589 CKF5589 CT009 ▲	TRIUMPH T595 Daytona Daytona 955i Speed Triple (EFI) Sprint RS Sprint ST Tiger 900cc Tiger 955cc	97 ▲ 98-00 ▲ 97-01 ▲ 99-01 ▲ 99-01 ▲ 97-98 ▲ 99-06 ▲
	CK4515 CT009 ▲	KAWASAKI ZX12R (ZX 1200 A2/B1/B2/B3/B4)	01-05 ▲	CK5594 CKF5594 CT027 ▲ CT057SP ■	KTM SX 60 SX 65 SX 65 XC 65 XC 65	98-00 ▲ 98-08 ▲ 09-15 ■ 08 ▲ 09-13 ■
CK4516 CT032 ▲	KAWASAKI VN 1700 G9F/GAF Vulcan 1700 Classic LT VN 1700 A9FA/AAF/ABF/ACF/ADF Vulcan 1700 Voyager VN 1700 B9FA/BAF/BBF/BCF/BDF/BEF Vulcan 1700 Voyager ABS VN 1700 C9F/CAF/CBF/CCF/CDF Vulcan 1700 Nomad VN 1700 C9FA Vulcan 1700 Nomad 2T VN 1700 E9F/EAF/EBF/ECF Vulcan 1700 Classic VN 1700 JBF/JBFA/JCF Vaquero VN 1700 DEF/DEFA (Vulcan Nomad ABS) VN 1700 KEF (Vaquero ABS Vulcan) VN 2000 A1/A2/A6F/A7F/G8F/G9F Vulcan VN 2000 D1/D6F/G8F Vulcan Ltd VN 2000 E6F/E7F/H8F/H9F Vulcan Classic VN 2000 F6F/F7F/J8F/J9F/JAF Vulcan Classic LT	09-10 ▲ 09-13 ▲ 09-14 ▲ 09-13 ▲ 09 ▲ 09-12 ▲ 11-13 ▲ 14 ▲ 14-15 ▲ 04-09 ▲ 05-06 ▲ 06-09 ▲ 06-10 ▲	CK5595 CKF5595 CT007 ▲ CT049 ■	KTM 250 EGS 250 EXC SX 250 (2T) 250 MXC 250 SXS XC 250 (2T)	94-99 ▲ 94-05 ▲ 94-12 ▲ 98-99 ▲ 01-03 ▲ 06-12 ▲	
CK4518 CT021 ▲	KAWASAKI ZX14 Ninja (ZX 1400 A6F/A7F/C8F/C9F/CAF/CBF) ZX-14 R (ZX1400 ECF/EDF/EEF) ZX-14 R (ABS Model) ZX1400 FDF/FEFA/FFFA	06-11 ▲ 12-14 ▲ 13-15 ▲				

CK CLUTCH KIT BUYERS GUIDE

Part No.	Make/Model	Year	Part No.	Make/Model	Year			
CK5595 CKF5595 CT007 ▲ CT049 ■	KTM Contd. XC-W 250 (2T) 300 E-GS 300 EXC 300 MXC SX 300 300 Six Days XC 300 XC-W 300 360 EXC 360 EGS 360 MXC 360 SX 360 Six Days SX 380 380 MXC 380 EXC RXC-E 400 RXC-E 620 Reklus Aftermarket Clutch for SX/XC (2T Models/24 tooth steel plate)	06-12 ▲ 94-99 ▲ 94-05 ▲ 94-05 ▲ 94 ▲ 96 ▲ 06-12 ▲ 06-11 ▲ 96-97 ▲ 96-97 ▲ 96-97 ▲ 96-97 ▲ 96 ▲ 98-02 ▲ 98-01 ▲ 98-02 ▲ 95 ▲ 95 ▲ 03-11 ■	CK5611 CKF5611 CT001 ▲	KTM SX 125 125 EXC 125 EXE 125 EGS 125 Supermoto 125 SXS SX 150 XC 150 SX 200 200 EGS 200 EXC 200 MXC XC-W 200 XC 200	98-16 ▲ 98-05 ▲ 00-01 ▲ 98-99 ▲ 00-01 ▲ 01-02 ▲ 08-17 ▲ 10-15 ▲ 03 ▲ 98-99 ▲ 97-05 ▲ 98-03 ▲ 07-15 ▲ 06-09 ▲			
	CK5597 CT009SP ■	TRIUMPH Bonneville 800 Bonneville T-100		01-06 ■ 02-04 ■	CK5612 CKF5612 CT023 ▲	KTM 250 EXC Racing 250 EXC-G Racing 400 SX Racing 400 EXC 400 EXC Racing 400 EXC-G Racing 400 MXC 450 EXC-G Racing 450 EXC Racing 450 EXC 450 LXC-G Racing 450 MXC-G Racing 450 SX Racing MXC 450 SMR 450 450 SMS SX 450 XC 450 (Quad) 520 SX Racing 525 EXC 525 EXC Racing EXC 525 Racing (4T) 525 EXC G Racing 525 MXC Desert Racing MXC 525 SX 525 525 SX Racing 525 SMR XC 525 (Quad) 540 SXS Racing SMR 560	02-03/05 ▲ 03 ▲ 02 ▲ 07 ▲ 02/05 ▲ 02/05-06 ▲ 02 ▲ 03 ▲ 03/05 ▲ 04-07 ▲ 05 ▲ 03/05 ▲ 03/05 ▲ 06 ▲ 04-06 ▲ 04 ▲ 06 ▲ 08-12 ▲ 02 ▲ 03 ▲ 05 ▲ 07 ▲ 03/05 ▲ 03/05 ▲ 06 ▲ 06 ▲ 03 ▲ 04-05 ▲ 08-12 ▲ 02 ▲ 06 ▲	
		CK5599 CT009 ▲		TRIUMPH Daytona 955i Speedtriple 955cc Sprint RS Sprint ST Speedtriple (1050cc) Tiger (1050cc)		01-06 ▲ 02-04 ▲ 02-04 ▲ 02-09 ▲ 05-09 ▲ 07-09 ▲	CK5619	KTM 660 SM Factory Replica 660 SMC 660 SMS
	CK5602			KTM 250 EXC-G Racing 250 EXC Racing 400 EXC 400 MXC SX 400 450 EXC-G Racing 450 EXC racing 450 MXC-G Racing 450 SX Racing 520 EXC SX 520 525 EXC Racing 525 EXC-G Racing 525 MXC-G Racing 525 MXC Desert Racing 525 SX Racing		04 04 00-01 01 00-01 04 04 04 04 04 00-01 00-01 04 04 04 04 04 04-05		CK5624 CT021 ▲
	CK5605	BMW F 650 (E169/0161) F 650 (E169/0162) F 650 ST (E169/163/168) Strada		09/93-96 97-00 97-00		CK5631 CKF5631 CT031 ▲	KTM 350 EXC 350 Super Comp 380 EGS 400 Duke 400 EGS 400 EGS-E 400 EXC 400 Super Comp 400 Super Comp/EXC 400 LSE 400 LC-4 400 LS-E 400 RXC-E 400 SX-C 400 SX SXC 400 400 SXC 400 LC4-E	
	CK5608	TRIUMPH America (865cc) Bonneville (865cc) (Cast wheel) Bonneville SE (865cc) (Cast wheel) Bonneville America Speedmaster 800 Scrambler (865cc) Thruxton SE (865cc) Thruxton 900 Bonneville T100 Bonneville T100 (865cc) Steve McQueen		08-12 09-12 42713 02-08 03-09 06-09 12 04-09 05-09 12			CK5610 CT027 ▲ CT028 ■	KTM 85 SX (17/14" & 19/16" Wheel Models) SX 85 (17"/14") SX 85 (19"/16") 85 XC 105 SX XC 105

CK CLUTCH KIT BUYERS GUIDE

Part No.	Make/Model	Year	Part No.	Make/Model	Year
CK5631 CKF5631 CT031 ▲	KTM Contd.		CK5639 CT031 ▲ Contd.	KTM	
	LC4 R 400	99 ▲		640 LC4 Adventure	05-06 ▲
	400 TXC	98 ▲		640 LC4 Supermoto	03-04 ▲
	620 Duke	94 ▲		640 LC4 Six Days	99 ▲
	620 Duke	97 ▲		660 LC4 Rallye	99-00 ▲
	620 Super Comp	94-95 ▲		660 SMC	03-04 ▲
	620 EXC	94-95 ▲		660 SMS	04 ▲
	620 EGS	94-95 ▲		660 SM Factory Replica	02-03 ▲
	620 EGS/Adventure	96-97 ▲			
	620 EGS-E	97 ▲			
	620 LSE	97 ▲			
	620 Enduro Ltd	97 ▲			
	620 LC-4	98 ▲			
	620 RXC-E	96-97 ▲			
	SXC 620	97 ▲			
620 Six Days	96 ▲				
640 LC Rallye Dakar	97 ▲				
660 LC4	97 ▲				
CK5632 CT075 ▲	KTM		CK5641 CT031 ▲	KTM	
400 RXC-E	95 ▲		690 Rally Factory Rep	07-08 ▲	
EXC 400 (LC4 Engine)	93-95 ▲				
SC 400	95 ▲				
620 RXC-E	95 ▲				
CK5633 CT031 ▲	KTM		CK5642	KTM	
660 Rallye	01-03 ▲		690 Duke	08-11	
660 Rallye Factory	04 ▲		690 Enduro	08	
			690 Enduro R	10-15	
			690 Supermoto	07-08	
			690 SMR	07-09	
			690 SMC	08-11	
			990 Superduke	05-11	
CK5634 CT015 ▲	KTM		CK5643	KTM	
950 Adventure	03-04/06 ▲		EC 200/250/300 (All models/2T)	10-11	
950 R Superenduro	07-08 ▲				
950 Supermoto	13-14 ▲				
990 Superduke	06-09 ▲				
990 Adventure	07-11 ▲				
990 Adventure S	07-09 ▲				
990 Adventure Baja Edition	13-14 ▲				
990 Superduke R	07-11 ▲				
990 SM-R	09-11 ▲				
990 SM-T	09-11 ▲				
CK5635 CT083 ▲	BMW		CK5644 CT021 ▲	KTM	
F 650 GS Dakar (R13/0176/0186)	04-07		1190 RC8-R (6 spring type clutch)	09-12 ▲	
F 650 CS Scarver (K14/0177/0187)	04-07		1190 RC8 (6 spring type clutch)	08-12 ▲	
G 650 GS (R13)	08-16 ▲				
G 650 GS Sertao (R13)	10-14 ▲				
G 650 X Country (K15)	08-10 ▲				
CK5636	BMW		CK5648 CKF5648 CT041 ▲	KTM	
F 650 GS Dakar (R13/0173/0183)	99-03		XC-W 400	10-11 ▲	
F 650 CS Scarver (K14/0174/0184)	00-03		XC-R-W 450	08 ▲	
			XC-W 450 Champions Edition	10 ▲	
			EXC-R 450	08 ▲	
			EXC 450	10-11 ▲	
			XC-W 450 Six Days	10-11 ▲	
			XC-R-W 530	08 ▲	
			EXC 530	10-11 ▲	
			EXC 530 Champion Edition	10 ▲	
			EXC-R 530	08 ▲	
			XC-W 530 Six Days	10-11 ▲	
CK5638 CT009 ▲	KTM		CK5651 CKF5651 CT023 ▲	KTM	
XC-W 450	08-09 ▲		SX-F 250 (4T)	13-15 ▲	
SX-F 450	07-11 ▲		SX 250 (2T)	13-16 ▲	
SX 450 (Quad)	09-12 ▲		XC 250 (2T)	13-15 ▲	
XC-F 450	08-09 ▲		XC-W 250 (2T) (Diaphragm Spring)	13-15 ▲	
SX-F 505	07-08 ▲		XC-F 250	13-15 ▲	
SX 505 (Quad)	09-12 ▲		XC-W 300 (Diaphragm Spring)	13-15 ▲	
XC-F 505	08-09 ▲		XC 300 (Diaphragm Spring)	13-15 ▲	
			XC 300	13 ▲	
			EXC-F 350	12-15 ▲	
			SX-F 350	11-15 ▲	
			XC-F 350	11-15 ▲	
			XCF-W 350	12-15 ▲	
			SX-F 450	12-15 ▲	
			SX-F 450 Diaphragm Spring	13-16 ▲	
			XC-F 450 Diaphragm Spring	13-15 ▲	
			XC-W 450	12 ▲	
			XC-W 450 Diaphragm Spring	12-15 ▲	
			EXC 500	12 ▲	
			EXC 500 Diaphragm Spring	13-15 ▲	
			XC-W 500	12 ▲	
			XC-W 500 Diaphragm Spring	13-15 ▲	
CK5639 CT031 ▲	KTM		CK5660 CT083 ▲	BMW	
540 SXC	98-99		F650 GS (Late type plates 2 x 13mm /7 x 14mm ears)	07-17 ▲	
620 LC4 Competition/Supermoto	99 ▲		F700 GS (Late type plates 2 x 13mm /7 x 14mm ears)	11-17 ▲	
620 Super Comp	96-99 ▲		F800 GS (Late type plates 2 x 13mm /7 x 14mm ears)	12-17 ▲	
SX 620	97-99 ▲		F800 GS Adventure (Late type plates 2 x 13mm /7 x 14mm ears)	12-17 ▲	
620 SC	00-01 ▲		F800 GT (Late type plates 2 x 13mm /7 x 14mm ears)	07-17 ▲	
620 Supermoto/TXC	98 ▲				
625 SMC	04/06 ▲				
625 SC	02 ▲				
625 SXC	03-04 ▲				
640 Adventure-R	98-02 ▲				
640 Duke-E	98 ▲				
640 Duke II	99-04 ▲				
640 LC4	99-00 ▲				
640 LC4-E	00-02 ▲				

CK CLUTCH KIT BUYERS GUIDE

Part No.	Make/Model	Year	Part No.	Make/Model	Year
CK5660 CT083 ▲ Contd.	BMW F800 S (Late type plates 2 x 13mm /7 x 14mm ears)	07-17 ▲	CK7007 CT708SP ▲	HARLEY DAVIDSON® TRIKE FLHTCUTG 1MAD Tri Glide Ultra	17-18
	F800 ST (Late type plates 2 x 13mm /7 x 14mm ears)	07-17 ▲		FLHTCUTG 1MDD Tri Glide Ultra Anniversary	18
	F800 R (Late type plates 2 x 13mm /7 x 14mm ears)	05-17 ▲		FLRT 1MCC Freewheeler	17-18
		POLICE FLHP 1FHC Road King Police		17	
				FLHTP 1FMC Electra Glide Standard Police	17
				SOFTAIL FLFBS 1YGK Fat Boy 114	18
				FLFBS 1YRK/1YSK Fat Boy 114 Anniversary	18
				FLHCS 1YBK Heritage Classic 114	18
				FLHCS 1YPK Heritage Classic 114 Anniversary	18
				FXBRS 1YHK Breakout 114	18
			FXBRS 1YTK Breakout 114 Anniversary	18	
			FXFBS 1YLK Fat Bob 114	18	
CK5667 CT085 ▲	BMW F800 GT (Early type plates 14mm ears)	04-06 ▲	CK7008 CT703SP ▲	HARLEY DAVIDSON® TRIKE FLHTCUTG 1MAM Tri Glide Ultra Classic	09-13
	F800 S (Early type plates 14mm ears)	04-06 ▲		FLHTCUTG ANV 1MAM_ANV Tri Glide Ultra Classic Anv	13
	F800 ST (Early type plates 14mm ears)	04-06 ▲		FLHXXX 1MBM Street Glide Trike	10-11
				POLICE FLHP 1FHM Road King Police	11-16
				FLHPE 1FTM Road King Police	11
				FLHTP 1FMM Electra Glide Standard Police	11-16
				TOURING FLHR 1FDV Road King	01
				FLHR 103 1FBM Road King	11
				FLHR 1FDL/1FDV Road King	98-06
				FLHR 1FB4/1FBM Road King	07-16
			FLHR 96 FB4 Road King	11	
			FLHR ANV 1FBM_ANV Road King ANV	13	
			FLHRC 103 1FRM Road King Classic	11	
			FLHRC 1FR4/1FRM Road King Classic	07-16	
			FLHRCI 1FRR/1FRW Road King Classic	98-06	
			FLHRI 1FBW Road King	00-06	
			FLHRS 1FXV/1FY4 Road King Custom	04-07	
			FLHRSI 1FYW Road King Custom	04-06	
			FLHT 1DDL/1DDV Electra Glide Standard	98-06	
			FLHT 1FV4 Electra Glide Standard	07-10	
			FLHTC 103 1FFM Electra Glide Classic	11	
			FLHTC 1DJL/1DJV Electra Glide Classic	98-05	
			FLHTC 1FF4 Electra Glide Classic	07-11	
			FLHTC 1FFM Electra Glide Classic	12-13	
			FLHTCI 1FCW Ultra Classic	05	
			FLHTCI 1FFR Electra Glide Classic	98	
			FLHTCI 1FFW Electra Glide Classic	99-06	
			FLHTCU 103 1FCM Ultra Classic	11	
			FLHTCU 1FC4 Ultra Classic	07-11	
			FLHTCU 1FCM Ultra Classic	12-16	
			FLHTCU TC 1KSL Ultra Classic Twin-Cooled	14-16	
			FLHTCUI 1FCR/1FCW Ultra Classic	98-04	
			FLHTI 1FVW Electra Glide Standard	03-06	
			FLHTK 1KEL Ultra Limited	14-16	
			FLHTK 1KEM Electra Glide Ultra Limited	10-13	
			FLHTK ANV 1KEM_ANV Electra Glide Ultra Limited ANV	13	
			FLHX 103 1KBM Street Glide	11	
			FLHX 1KAV/1KB4/1KBM Street Glide	06-16	
			FLHXI 1KBW Street Glide	06	
			FLHXS 1KRM Street Glide Special	14-16	
			FLTR 1FPL/1FPV Road Glide	98-03	
			FLTR 1FS4 Road Glide	07-09	
			FLTRI 1FSR/FSW Road Glide	98-06	
			FLTRU 1KGL Road Glide Ultra	16	
			FLTRU 1KGM Road Glide Ultra	11-13	
			FLTRX 103 1KHM Road Glide Custom	11	
			FLTRX 1KH4/1KHM Road Glide Custom	10-13	
			FLTRX 1KHM Road Glide	15-16	
			FLTRXS 1KTM Road Glide Special	15-16	
			DYNA FLD 103 1GZM Dyna Switchback	12-16	
			FLD 1GZ4 Dyna Switchback	12-16	
			FXD 1GHL/1GHV Dyna Super Glide	98-05	
			FXD 1GM4 Dyna Super Glide	07-10	
			FXD35 1GW1 Dyna 35th Anniversary Super Glide	06	
CK6680	APRILIA RSV 1000 R Factory/R	04-08			
CK6681 CT014 ▲	APRILIA RSV4R RSV4 Factory RSV4 Factory APRC	10-12 ▲ 09-12 ▲ 11-12 ▲			
CK7002 CT702SP ▲	HARLEY DAVIDSON® TRIKE FLHTCUTG 1MAL Tri Glide Ultra Classic FLRT 1MCM Freewheeler TOURING FLHR 1FBC Road King FLHRC 1FRC Road King Classic FLHRXS 1KVC Road King Special FLHTCU 1FCC Electra Glide Ultra Classic FLHTCUL 1KDM Ultra Classic Low FLHTCUL TC 1KFL Ultra Classic Low Twin-Cooled FLHTK 103 1TEL CVO Limited FLHTK 1KED Ultra Limited FLHTK 1KND Ultra Limited Shrine Edition FLHTK 1KWD Ultra Limited Anniversary FLHTKL 1KKD/1KKL Ultra Limited Low FLHX 1KBC Street Glide FLHX 1KXC Street Glide Anniversary FLHXS 1KRC Street Glide Special FLHXS 1KYC Street Glide Special Anniversary FLTRU 1KGD Road Glide Ultra FLTRX 1KHC Road Glide FLTRXS 1KTC Road Glide Special SOFTAIL FLSS 1JS9 Slim S FLSS 1JS9 Softail Slim S FLSTFBS 1JT9 Fat Boy S	14-16 15-16 17 17 18 17-18 15-16 15-16 14 17-18 18 18 15-18 17-18 18 18 15-18 17-18 18 17-18 18 17-18 18 17-18 18 17-18 17-18 17-18 17 16 16-17			
CK7005 CT706SP ▲	HARLEY DAVIDSON® VRSC VRSCAW 1HFH V-Rod VRSCAW 1HFH V-Rod Wide Tire VRSCAWA 1HKH W/ABS VRSCD 1HDH Night Rod VRSCDA 1HLH Night Rod W/ABS VRSCDX 1HHH Night Rod Special VRSCDX ANV 1HHH_ANV Night Rod Special Anv VRSCDXA 1HMH Night Rod Special W/ABS VRSCF 1HPH V-Rod Muscle	09-10 08 08 08 08 08-17 12 08 09-17			
CK7006 CT707SP ▲	HARLEY DAVIDSON® VRSC VRSCA 1HAZ V-Rod VRSCAW 1HFZ V-Rod VRSCB 1HBZ V-Rod VRSCR 1HCZ Street Rod VRSCSE 1PMG CVO V-Rod VRSCSE2 1PPG CVO V-Rod VRSCX 1HJG Screamin' Eagle V-Rod VRXSE 7RC7 CVO VR Destroyer	02-06 07 04-05 06-07 05 06 07 06			

CK CLUTCH KIT BUYERS GUIDE

Part No.	Make/Model	Year	Part No.	Make/Model	Year	
CK7008 Contd. CT703SP ▲	HARLEY DAVIDSON® DYNA		CK7008 Contd. CT703SP ▲	HARLEY DAVIDSON® SOFTAIL		
	FXDB 1GX4 Dyna Street Bob	10		FXCW 1JJ5 Rocker	08-09	
	FXDB 103 1GXM Dyna Street Bob	14-16		FXCWC 1JK5 Rocker C	08-11	
	FXDB 103 1GXM Dyna Street Bob 103	17		FXS 103 1JPV Blackline	12-13	
	FXDB 1GX4 Dyna Street Bob	07-17		FXS 1JP5 Blackline	11-13	
	FXDBA 103 1VBM Dyna Street Bob (H-D1)	13		FXSB 103 1BFV Softail Breakout	13-15	
	FXDBA 1VB4 Dyna Street Bob (H-D1)	13		FXSB 1BF5 Softail Breakout	13-16	
	FXDBB 103 1VCM Dyna Street Bob (H-D1)	14-15		FXSB 1BFV Breakout	17	
	FXDBB 1VC4 Dyna Street Bob (H-D1)	15		FXST 1BHL/1BHY/1BV5/1BW Softail Standard	99-15	
	FXDBC 103 1VDM Dyna Street Bob Limited	16		FXSTB 1BTL/1BTY Night Train	99-06	
	FXDBC 1VD4 Dyna Street Bob Limited	16		FXSTB 1JA5 Night Train	07-09	
	FXDBI 1GX1 Dyna Street Bob	06		FXSTBI 1JAB Night Train	01-06	
	FXDBP 103 1VAM Dyna Street Bob	16		FXSTC 1BKL Softail Custom	98-99	
	FXDBP 103 1VAM Dyna Street Bob (H-D1)	13-15		FXSTC 1JL5 Softail Custom	07-10	
	FXDC 103 1GVM Dyna Super Glide Custom	14		FXSTD 1BSY/1JB5 Softail Deuce	00-07	
	FXDC 1GTV Dyna Super Glide Custom	05		FXSTDI 1JBB Softail Deuce	01-06	
	FXDC 1GV4 Dyna Super Glide Custom	07-14		FXSTI 1BVB Softail Standard	01-06	
	FXDC ANV 1GV4_ANV Dyna Super Glide Custom ANV	13		FXSTS 1BLL/1BLY Springer Softail	98-06	
	FXDCI 1GVW/1GV1 Dyna Super Glide Custom	05-06		FXSTSI 1BZB Springer Softail	01-06	
	FXDF 1GY4 Dyna Fat Bob	15				
	FXDF 103 1GYM Dyna Fat Bob	12-16		CK7009 CT701SP ▲	HARLEY DAVIDSON® TOURING	
	FXDF 103 1GYM Dyna Fat Bob 103	17		FLHR 1FDL Road King	94-97	
	FXDF 1GY4 Dyna Fat Bob	08-16		FLHR FD93 Road King	93	
	FXDI 1GMW/1GM1 Dyna Super Glide	04-06		FLHRI 1FBR Road King	96-97	
	FXDL 103 1GNM Dyna Low Rider	14-16		FLHS 1FAL Electra Glide Sport	91-94	
	FXDL 103 1GNM Low Rider 103	17		FLHS FALL Touring Electra Glide Sport	90	
	FXDL 1GDL/1GDV Dyna Low Rider	98-05		FLHT 1DDL Electra Glide Standard	95-97	
	FXDL 1GN4 Dyna Low Rider	07-17		FLHTC 1DJL Electra Glide Classic	91-97	
	FXDLI 1GNW/1GN1 Dyna Low Rider	04-06		FLHTC DJLL Touring Electra Glide Classic	90	
	FXDLS 1GS8 Dyna Low Rider S	16-17		FLHTCI 1FFR Electra Glide Classic	96-97	
	FXDS-CONV GGVX/GGVY Dyna Glide Convertible	99-00		FLHTCU 1DPL Ultra Classic	91-97	
	FXDWG 1GEL Dyna Wide Glide	98		FLHTCU DPLL Touring Electra Glide Classic Ultra	90	
	FXDWG 103 1GPM Dyna Wide Glide	12-15		FLHTCUI 1FCR Ultra Classic	95-97	
	FXDWG 103 1GPM Dyna Wide Glide 103	17		FLTC 1DBL Tour Glide Classic	91-92	
	FXDWG 1GEV Dyna Wide Glide	99-05		FLTC DBLL Touring Tour Glide Classic	90	
	FXDWG 1GP4 Dyna Wide Glide	07-16		FLTCU 1DML Tour Glide Ultra Classic	91-95	
	FXDWG ANV 1GP4 Dyna Wide Glide 105th Anniversary	08		FLTCU DMLL Touring Tour Glide Classic Ultra	90	
	FXDWGI 1GPW/ 1GP1 Dyna Wide Glide	04-06		FLTCUI 1FER Tour Glide Ultra Classic	96	
	FXDX 1GJV Dyna Super Glide Sport	99-05		DYNA		
	FXDXI 1GRW Dyna Super Glide Sport	04-05		FXD 1GHL Dyna Super Glide	95-97	
	FXDXT 1GLV Dyna Super Glide T-Sport	01-03		FXDB 1GBL Dyna Sturgis	91	
	SOFTAIL			FXDB 1GAL Dyna Daytona	92	
	FLS 103 1JRV Softail Slim	12-15		FXDC 1GCL Super Glide Custom	92	
	FLS 1JR5 Softail Slim	12-15		FXDL 1GDL Dyna Low Rider	93-97	
	FLS 1JRV Slim	17		FXDS-CONV GGLP Dyna Glide Convertible	93	
	FLS 1JRV Softail Slim	16		FXDWG 1GEL Dyna Wide Glide	93-97	
	FLST 1JE5 Heritage Softail	09-10		SPORTSTER		
	FLST 1JEY Heritage Softail	06		XL1200 1CAP Sportster 1200	91-03	
	FLSTC 103 1BWV Heritage Softail Classic	12-15		XL1200 1LN3 Forty Eight Anniversary	18	
	FLSTC 103 ANV 1BWV_ANV Heritage Softail Classic ANV	13		XL1200C 1CGP Sportster 1200 Custom	96-06	
	FLSTC 1BJL/1BJY Heritage Softail Classic	98-06		XL1200C 1CT3 1200 Custom	17-18	
	FLSTC 1BW5/1BWV Heritage Softail Classic	07-17		XL1200C 1CT3 Sportster 1200 Custom	07-16	
	FLSTC ANV 1BW5_ANV Heritage Softail Classic ANV	13		XL1200C ANV 1CT3_ANV Sportster 1200 Custom ANV	13	
	FLSTCI 1BWB Heritage Softail Classic	01-06		XL1200CA 1LJ3 Sportster 1200 Custom Limited A	13-16	
	FLSTCI Shrine 1JHB Heritage Softail Classic Shrine	05		XL1200CB 1LK3 1200 Custom Limited B	17	
	FLSTF 103 1BXV Fat Boy	12-15		XL1200CB 1LK3 Sportster 1200 Custom Limited A	16	
	FLSTF 1BML/1BMY/1BX5 Fat Boy	98-15		XL1200CB 1LK3 Sportster 1200 Custom Limited B	13-15	
FLSTF 1BXV Fat Boy	16-17	XL1200CP 1LH3 Sportster 1200 Custom (H-D1)	11-16			
FLSTFB 103 1JNV Fat Boy LO	12-15	XL1200CX 1LM3 1200 Roadster	18			
FLSTFB 103 ANV 1JNV_ANV Fat Boy LO ANV	13	XL1200CX 1LM3 Roadster	16-17			
FLSTFB 1JN5/1JNV Fat Boy LO	10-17	XL1200L 1CWP/1CX3 Sportster 1200 Low	06-11			
FLSTFB ANV 1JN5_ANV Fat Boy LO ANV	13	XL1200N 1CZ3 Nightster	07-12			
FLSTFI 1BXB Fat Boy	01-06	XL1200R 1CLP Sportster 1200 Roadster	04-06			
FLSTFI Shrine 1JGB Fat Boy Shrine	05	XL1200R 1CV3 Sportster 1200 Roadster	07-08			
FLSTI 1JFB Heritage Softail	06	XL1200R 1CV3 Sportster 1200 R	09			
FLSTN 103 1JDV Softail Deluxe	12-15	XL1200S 1CHP Sportster 1200 Sport	96-03			
FLSTN 1BNY/1JD5 Softail Deluxe	05-15	XL1200T 1LL3 SuperLow 1200T	14-18			
FLSTN 1JDV Deluxe	17	XL1200V 1LF3 Seventy-Two	12-16			
FLSTN 1JDV Softail Deluxe	16	XL1200X 1LC3 Forty-Eight	10-18			
FLSTNI 1JDB Softail Deluxe	05-06	XL50 1CY3 50th ANV Sportster	07			
FLSTS 1BRL/1BRY Heritage Springer	98-03	XL883 4CAM/4CN2 Sportster 883	91-09			
FLSTSB 1JM5 Cross Bones	08-11	XL883C 4CJM Sportster 883 Custom	98-06			
FLSTSC 1BRY/1BY5 Springer Classic	05-07	XL883C 4CP2 Sportster 883 Custom	07-10			
FLSTSCI 1BYB Springer Classic	05-06	XL883DLX 4CFM Sportster 883 Deluxe	91-95			
FLSTSI 1BYB Heritage Springer	01-03					

CK CLUTCH KIT BUYERS GUIDE

Part No.	Make/Model	Year	Part No.	Make/Model	Year
CK7009 Contd. CT701SP ▲	HARLEY DAVIDSON® SPORTSTER XL883HUG 4CEM Sportster 883 Hugger XL883L 4CMM Sportster XL883 Low XL883L 4CR2 Sportster 883 Low XL883L 4CR2 Sportster XL883 Low XL883L 4CR2 SuperLow XL883L 4CR2 SuperLow 883 XL883N 4LE2 Iron 883 XL883R 4CKM Sportster 883R XL883R 4CS2 883 Roadster XL883R 4CS2 Sportster 883R	91-03 05-06 10-11 07-09 12-18 16 09-18 02--06 11-15 07-10	CK7012 Contd. CT704SP ▲	HARLEY DAVIDSON® TOURING FLHS AKKB/AKCC/AKCD Touring Electra Glide Sport FLHS Heritage, Electra Glide FLHT DCKD Touring Electra Glide Standard FLHT Electra Glide FLHT Electra Glide Classic FLHTC ADKD/DDKD Touring Electra Glide Classic FLHTC DJLE Touring Electra Glide Classic FLT AEKD Touring Tour Glide FLT Classic Tour Glide Classic FLT DAKC/DAKD Touring Tour Glide FLT Tour Glide FLTC 5G05 Touring Tour Glide Classic FLTC AFKB Touring Tour Glide Classic FLTC DBKC Touring Tour Glide Classic FLTC DBLE Touring Tour Glide Classic FLTC Tour Glide Classic	81-83 81 83 83 83 83 Early 84 81 82-83 82-83 81/83 80 81 82 Early 84 81
	SOFTAIL FLST BJLL Softtail Heritage FLSTC 1BJL Heritage Softtail Classic FLSTC BJ04 Softtail Heritage Classic FLSTF 1BML Fat Boy FLSTF BMLL Softtail Fat Boy FLSTN 1BNL Heritage Softtail Nostalgia FLSTS 1BRL Heritage Springer FXST BHLL Softtail Standard FXSTC 1BKL Softtail Custom FXSTC BKLL Softtail Custom FXSTS 1BLL Springer Softtail FXSTS BLLL Softtail Springer FXSTSB 1BPL Springer Softtail	90 91-97 90 91-97 90 93-96 97 90 91-97 90 91-97 90 91-97 90 95-97		SOFTAIL FXB BDKB Super Glide B80 FXB BDKC Super Glide B80 FXDG BGKD Dyna Glide Glide Custom FXE BAKB/BAKC/BAKD/BAKE FX Super Glide FXEF BBKB FX Super Glide Fat Bob FXS BCKB FX Super Glide FXS BCKC FX Super Glide FXSB BFKD/BFKE FX Low Rider FXST BHLE Softtail Standard FXWG BEKB/BEKC/BEKD/BEKE FX Wide Glide	81 82 83 81-Early 84 81 81 82 83-Early 84 Early 84 81-Early 84
CK7010 CT705SP ▲	HARLEY DAVIDSON® TOURING FLH ADKE Touring Electra Glide FLH ALKE Touring Electra Glide Shrine Shovelhead FLHS AKKE Touring Electra Glide Sport FLHS FALH/FALJ/FALK Touring Electra Glide Sport FLHT DDLJ Touring Electra Glide Standard FLHT Electra Glide FLHT Electra Glide Classic FLHTC DJLE/DJLF/DJLG/DJLH Touring Electra Glide Classic FLHTC DJLK Touring Electra Glide Classic FLHTC DDLG/DDLH/DJJD Touring Electra Glide Classic FLHTCU DPLK Touring Electra Glide Classic Ultra FLT Classic Tour Glide Classic FLT Tour Glide FLTC DBLJ/DBLK Touring Tour Glide Classic FLTC DBLE/DBLF/DBLG/DBLH Touring Tour Glide Classic FLTC DBLK Touring Tour Glide Classic FLTCU DMLK Touring Tour Glide Classic Ultra	Later 84 Later 84 Later 84 87-89 88 Later 84 Later 84 Later 84-87 89 86-88 89 Later 84 Later 84 88-89 Later 84-87 89 89	CK7013 CT701SP ▲	HARLEY DAVIDSON® SPORTSTER XR1200 1LA6 Sportster 1200 XR1200 1LA6 XR1200 XR1200X 1LD6 XR1200X	08 09-10 10-13
			CK7014 CT709SP ▲	HARLEY DAVIDSON® SPORTSTER XL1200 CAPL Sportster 1200 XL883 CAMG/CAMH Sportster 883 XL883 CAMG Sportster 883 Deluxe XL883 CAML Sportster 883 XL883DLX CFML Sportster 883 Deluxe XL883HUG CEMH Sportster 883 Hugger XL883HUG CEML Sportster 883 Hugger XLH CAHE Sportster 1000 XLH CAHF Sportster 1000 1985 XLH-1100 CANG/CANH Sportster 1100 XLH-1200 CAPJ/CAPK Sportster 1200 XLH883 CAMJ/CAMK Sportster 883 XLH883DLX CFMJ/CFMK Sportster 883 Deluxe XLH883HUG CEMJ/CEMK Sportster 883 Hugger XLS CBHE Sportster Roadster 1000 XLS CBHF Sportster Roadster 1000 XLX CCHE Sportster Roadster 1000 XLX CCHF Sportster Roadster 1000 XR-1000 CDHE Sportster	90 86-87 86 90 90 87 90 84 Later 84 86-87 88-89 88-89 88-89 88-89 84 Later 84 84 Later 84 84
			CK7015 CT709SP ▲	HARLEY DAVIDSON® SPORTSTER XLCH-1000 4AH1-4AH9 Sportster 1000 XLCH-1000 4AJ0 Sportster 1000 XLH CAHB/CAHC/CAHD/CAHE Sportster 1000 XLH-1000 3AH1-3AH9 Sportster Standard XLH-1000 3AJ0 Sportster 1000 XLS CBHB/CBHC/CBHD/CBHE Sportster Roadster 1000 XLX CCHD/CCHE Sportster Roadster 1000 XR-1000 CDHD/CDHE Sportster	71-79 80 81-Early 84 71-79 80 81-Early 84 83-Early 84 83-Early 84
CK7011 CT704SP ▲	HARLEY DAVIDSON® TOURING FLH ADKE Touring Electra Glide FLH ALKE Touring Electra Glide Shrine Shovelhead FLHS AKKE Touring Electra Glide Sport FLHT Electra Glide FLHT Electra Glide Classic FLT Classic Tour Glide Classic FLT Tour Glide	Early 84 Early 84 Early 84 Early 84 Early 84 Early 84 Early 84	CK7016	HARLEY DAVIDSON® SPORTSTER XLCH-1000 4AH0 Sportster 1000 XLH-1000 3AH0 Sportster Standard	70 70
CK7012 CT704SP ▲	HARLEY DAVIDSON® TOURING FLH ALKE Touring Electra Glide Shrine Shovelhead FLH Electra Glide FLHC ADKB/ADKCAGKB Touring Electra Glide Classic FLHC Electra Glide Classic	83 81-83 81-82 81			

DRC CLUTCH KIT BUYERS GUIDE

Part No.	Make/Model	Year	Part No.	Make/Model	Year
DRC1 CT012SP ■	HONDA CR 80 R/RB Expert CR 85 R/RB	85-02 ■ 03-07 ■	DRC22 CT011 ▲	SUZUKI RM 125 J/K/L/M	88-91 ▲
DRC2 CT001 ▲	HONDA CR 125 R	86-99 ▲	DRC23	KAWASAKI LT 250 RH/RJ/RK/RL/RM/RN	87-92
DRC3 CT009 ▲	HONDA CR 250 R CR 480 R CR 500 R	83-89 ▲ 83 ▲ 84-89 ▲	DRC24 CT022 ▲	SUZUKI RM 250 J/K/L	88-90 ▲
DRC4 CT012SP ▲	HONDA TRX 200 SX Fourtrax TRX 200 Fourtrax TRX 200 D Type II Fourtrax TRX 250 EX (Sportrax 250 EX) TRX 250 TE Recon ES TRX 250 TM Recon	86-88 ▲ 90-91 ▲ 91-97 ▲ 01-08 ▲ 97-14 ▲ 97-14 ▲	DRC25 DRCF25 CT011 ▲	SUZUKI RM 80 M/N/P/R/S/T/V/W/X/Y/K1 RM 85 K2/K3/LK3/K4/LK4/K5/LK5/LK6/K6/LK7 /K7/K8/LK8/K9/LK9/L0/LL0/L2/LL2/LL5/LL6	91-01 ▲ 02-12/15-16 ▲
DRC5 CT013 ▲	HONDA ATC 250 R TRX 250 R Fourtrax	86 ▲ 86-87 ▲	DRC26 CT022 ▲	KAWASAKI LT 500 RH/RJ/RK/RL	87-90 ▲
DRC6 CT013SP ▲	HONDA TRX 300 All models (2wd & 4wd) Fourtrax TRX 350 All models TRX 400 FW Fourtrax Foreman TRX 400 FM Fourtrax Foreman TRX 450 ES TRX 450 S TRX 450 FE TRX 450 FM	88-00 ▲ 86-89 ▲ 95-01/03 ▲ 02 ▲ 98-01 ▲ 98-01 ▲ 02-04 ▲ 02-04 ▲	DRC27 CT010 ▲	YAMAHA YZ 80 S/T/U/W/A/B/D	86-92 ▲
DRC7	KAWASAKI KX 60 B1-B19 SUZUKI RM 60 K3	85-03 03	DRC28 CT054SP ▲	YAMAHA YZ 125 S/T	86-87 ▲
DRC8	KAWASAKI KX 80 E3/G1/G2/J2	85-87	DRC29 CT054SP ▲	YAMAHA YZ 125 U	88 ▲
DRC9	KAWASAKI KX 80 L1	88	DRC30 CT054SP ▲	YAMAHA YZ 125 W/A	89-90 ▲
DRC10	KAWASAKI KX 80 L2/L3/N2/N3 KX 80 R1-R7 KX 100 B5/B6/B7	89-90 91-97 95-97	DRC31	YAMAHA YZ 250 U/W/A/B/D	88-92
DRC11 CT042 ▲	KAWASAKI KX 125 D1/E1/E2	85-87 ▲	DRC32 CT060 ▲	YAMAHA YTZ 250 N/S IT 250 K IT 490 K/L YZ 490 J/K/L/N/S/T/U/W WR 500 ZD/ZE	85-86 ▲ 83 ▲ 83-84 ▲ 82-89 ▲ 92-93 ▲
DRC13 CT042 ▲	KAWASAKI KX 125 F1/G1	88-89 ▲	DRC33 DRCF33 CT090SP ▲	YAMAHA YFM 350 ERT/ERU/ERW/ERA/ERD/ERE/ERF YFM 350 FWT/FWU/FWW/FWA/FWB/FWD /FWE (Big Bear) YFM 350 XT/XU/XW/XA/XB/XD/XE/XF/XG/XH/XJ /XK/XL/XM/XN/XP/XR/XS (Warrior) YFM 350 RS/RT/RV/RW/RX/RZ/RA/RB/RD Raptor	87-94 ▲ 87-93 ▲ 87-04 ▲ 04-13 ▲
DRC15 CT006 ▲	KAWASAKI KX 250 G1	89 ▲	DRC35 CT060 ▲	YAMAHA YZ 250 N/S/T	85-87 ▲
DRC16 CT006 ▲	KAWASAKI KX 500 C1/D1 KX 500 E1-E16	87-88 ▲ 89-04 ▲	DRC36 CT042 ▲	YAMAHA KX 125 H1/H2	90-91 ▲
DRC17 CT006 ▲	KAWASAKI KX 250 H1	90 ▲	DRC38 CT006 ▲	YAMAHA KXT 250 B1/B2 Tecate	86-87 ▲
DRC19	SUZUKI RM 80 H/J	87-88	DRC39 CT005 ▲	YAMAHA YZ 125 B/D WR 250 RX/RZ/RY/RA/RB/RD/RE/RF WR 250 XX/XY/XZ/XA Supermotard	91-92 ▲ 08-15 ▲ 08-11 ▲
DRC20 CT011 ▲	SUZUKI RM 80 K/L	89-90 ▲	DRC40 CT022 ▲	SUZUKI RM 250 M	91 ▲
DRC21 CT011 ▲	SUZUKI RM 125 G/H	86-87 ▲	DRC41 CT006 ▲	KAWASAKI KDX 250 D1/D2/D3/D4 KX 250 H2	91-94 ▲ 91 ▲
			DRC42 DRCF42 CT010 ▲	YAMAHA YFS 200 U/W/A/B/D/E/F/G/H/J/K/L/M/N/P/R/S /T/V Blaster WR 200 D	88-06 ▲ 92 ▲

CLUTCH BUYERS GUIDE

DRC CLUTCH KIT BUYERS GUIDE

Part No.	Make/Model	Year	Part No.	Make/Model	Year
DRC43 DRCF43 CT008 ▲	YAMAHA YFZ 350 T/U/W/A/B/D/E/F/G/H/J/K/L/M/N /P/R/S/T/V (Banshee)	87-06 ▲	DRC61 CT042 ▲	KAWASAKI KDX 200 E1-E6	89-94 ▲
DRC44 DRCF44 CT013SP ▲	HONDA ATC 250 SX TRX 250 X Fourtrax XR 250 R XR 250 L TRX 300 EX Fourtrax/Sportrax TRX 300 X XR 350 R	85-87 ▲ 87-88/91-92 ▲ 86-95 ▲ 91-96 ▲ 93-08 ▲ 09-11 ▲ 83-85 ▲	DRC62	KAWASAKI KDX 200 H1-H11/H6F KDX 220 R A4-A12/A6F	95-06 97-06
DRC45 DRCF45 CT002 ■	KAWASAKI KX 80 W1/W2/W3 KX 85 A1/A2/A3/A4/A5/A6F/A7F/A8F/A9F /AAF/ABF/ACF/ADF/CEF/CFF/CGF/CHF KX 100 C1/C2/C3/D1-D5/D6F/D7F/D8F/D9F /DBF/DCF/DDF/FEF/FFF/FGF/FHF	98-00 ■ 01-17 ■ 98-09/11-17 ■	DRC63 CT004 ▲	KAWASAKI KLR 250 (KL 250) D2 to D22	85-05 ▲
DRC46 DRCF46 CT016 ▲	KAWASAKI KX 250 J1/J2/K1-K5/L1-L4/M1/M2/R1/R6F/R7F	92-07 ▲	DRC64 CT016 ▲	KAWASAKI KLR 600 (KL 600 A1/B1/B2) KLX 650 A1/A2/A3/D1(KLX650R)	84-86 ▲ 93-96 ▲
DRC48 CT022 ▲	SUZUKI RM 250 M/N/P	91-93 ▲	DRC65 CT016 ▲	KAWASAKI KLR 650 (KL 650 A1-A9) KL 650 B2/B3 TENGAI KLX 650 C1/C2/C3/C4	87-95 ▲ 90-91 ▲ 93-96 ▲
DRC49 DRCF49 CT012SP ■	HONDA CRF 100 F XR 100 R	04-16 ■ 87-03 ■	DRC66 CT010 ▲	YAMAHA YZ 80 E/F	93-94 ▲
DRC50 CT012SP ■	HONDA NX 125	88-90 ■	DRC67 CT013 ▲	HONDA CR 125 R	83-84 ▲
DRC51 CT013SP ■	HONDA NX 250	88-90 ■	DRC68 CT001 ▲	HONDA CR 125 R	85 ▲
DRC52 CT022 ▲	SUZUKI RM 250 H	87 ▲	DRC69 CT042 ▲	KAWASAKI KX 125 J2	93 ▲
DRC53 CT013SP ■	HONDA XL 600 V	89-90 ■	DRC70 DRCF70 CT005 ▲	YAMAHA YZ 125 E/F/G YZ 125 J/K/L/M/N YZ 125 T/V/W/X/Y/Z/A/B/D/E/F/G	93-95 ▲ 97-01 ▲ 05-16 ▲
DRC54 DRCF54 CT009 ▲	HONDA XR 600 R NX 650 XR 650 L	85-00 ▲ 88-89 ▲ 93-16 ▲	DRC71 CT020 ▲	YAMAHA YZ 250 E/F/G/H/J/K/L WR 250 ZF/ZG/ZH/ZJ	93-99 ▲ 94-97 ▲
DRC55 CT039 ▲	YAMAHA BW 200 N/S/ES/ET/EU	85-88 ▲	DRC72 CT022 ▲	SUZUKI RM 250 R/S RMX 250 R/S/T/V/W/X/Y	94-95 ▲ 94-00 ▲
DRC56 CT008 ▲	YAMAHA XT 350 N/NC/S/SC/C/AC/B/BCT/TC/U/UC/W /WC/D/DC/E/EC/F/FC/G/GC/H/HC/J/JC/K/KC /L/M/MC TT 350 S/T	85-00 ▲ 86-87 ▲	DRC73 CT004 ▲	KAWASAKI KX 125 K4/K5/L1-L4	97-02 ▲
DRC57 CT008 ▲	YAMAHA TT 600 K/L/N/S XT 600 L/LC/N/NC/S/SC/T/TC/U/UC/W/WC	83-86 ▲ 84-89 ▲	DRC74 CT042 ▲	KAWASAKI KDX 200 C1/C2/C3	86-88 ▲
DRC58 DRCF58 CT022 ▲	SUZUKI DR 250 L/M/N/P DR 250 SL/SM/SN/SEP/SER/SES DR 350 L/M/N/P/R/S/T DR 350 SL/SM/SN/SP/SER/SES/SET/SEV/SEW/SEX	90-93 ▲ 90-95 ▲ 90-96 ▲ 90-99 ▲	DRC75 CT009 ▲	HONDA CR 250 R CR 500 R CR 500 R	90-93 ▲ 90-94 ▲ 95-01 ▲
DRC59 CT009SP ■	SUZUKI DR 650 SL/SM/SN/SP	90-95 ■	DRC76S CT003 ▲	SUZUKI RM 125 P/R/S/T/V/W	93-98 ▲
DRC60 CT013SP ■	HONDA XR 200 R XL 250 R XR 250 R	84-85 ■ 84-87 ■ 84-85 ■	DRC78 CT010 ▲	YAMAHA YZ 80 G/H/J/K/L/M/N	95-01 ▲
			DRC79 DRCF79 CT009 ▲	HONDA CR 250 R	94-07 ▲
			DRC80 CT016 ▲	SUZUKI RM 250 T	96 ▲
			DRC81 CT013 ▲	HONDA TRX 250 R Fourtrax	88-89 ▲

CLUTCH BUYERS GUIDE

DRC CLUTCH KIT BUYERS GUIDE

Part No.	Make/Model	Year	Part No.	Make/Model	Year
DRC82 CT008 ▲ CT090SP ■	YAMAHA YFM 350 ERG YFM 350 FWF/FWG/FWH/FWJ/FWBK#(Big Bear) YFM 350 UH/UJ/UK/UL/ULC YFM 400 FWE/FWF/FWG/FWH/FWJ/FWK/FWL Kodiak YFM 400 FWR (4x4) Big Bear	95 ■ 94-98 ■ 96-99 ■ 93-99 ▲ 03 ▲	DRC100 DRCF100 CT013 ▲	HONDA TRX 400 EX Fourtrax/Sportrax TRX 400 X	99-08 ▲ 09-14 ▲
DRC83 CT042 ▲	KAWASAKI KX 125 J1	92 ▲	DRC101 DRCF101 CT001 ▲	HONDA CR 125 R	00-07 ▲
DRC84 CT013SP ■	HONDA XR 250 R	96-04 ■	DRC102 CT020 ▲	YAMAHA YZ 426 FM	00 ▲
DRC85 CT005 ▲	YAMAHA YZ 125 H YZ 125 P/R/S	96 ▲ 02-04 ▲	DRC103 CT011 ▲	SUZUKI LT-F 300 FX/FY/FK1/FK2 King Quad LT-F 4WDXM/N/P/R/S/T/V/W 300 King Quad 250 (2 x 4) 300 (2 x 4 / 4 x 4) 300 (4 x 4)	99-02 ▲ 91-97 ▲ 99-00 ▲ 98-04 ▲ 05 ▲
DRC87 CT024 ▲	SUZUKI DR 650 SET/SEV/SEW/SEX/SEY/SEK1/SEK2/ SEK3/SEK4/SEK5/SEK6/SEK7/SEK8/SEK9 /SEL1/SEL2/SEL3/SEL4/SEL5/SEL6	96-16 ▲	DRC104 CT010SP ■	YAMAHA YTM 225 DXK/DXL/ DXN YFM 225 S/T/U/W (Moto 4) YFB 250 D/E Timberwolf YFB 250 F/G/H/UH/J/UJ/UK Timberwolf YFB 250 FWF/FWG/FWH/FWJ/FWK/FWL/FWM Timberwolf YFM 250 W/A/B YFM 250 Bear Tracker L/LC/M/MC/XN/XHN/XP /XHP/XR/XHR/XS YFM 250 BT/BV Bruin YFM 250 BW/BX/BY Big Bear YFUIW/YFUITW Pro Hauler (230cc)	83-85 ■ 86-89 ■ 92-93 ■ 94-98 ■ 94-00 ■ 89-91 ■ 99-03 ■ 05-06 ■ 07-09 ■ 89 ■
DRC88 DRCF88 CT008 ▲	YAMAHA YFM 660 RN/RP/RPB/RR/RS/RT Raptor XT 600 EA/EAC/EB/EBC/ED/EDC/EE/EEC/EF /EFC/EG/EGC	01-05 ▲ 90-95 ▲	DRC105 DRCF105 CT006 ▲	ARCTIC CAT 400 DVX KAWASAKI KLX 400 R (KLX 400 B1/B2) KLX 400 SR (KLX 400 A1/A2) KSF 400 A1/A2 (KFX 400) SUZUKI DR-Z 400 SY/SK1/SK2/SK3/SK4/SK5/SK6/SK7 /SK8/SK9/SL1/SL2/SL3/SL4/SL5/SL6 DR-Z 400 EY/Y/EK1/K1/EK2/K2/K3/EK3/K4 /EK4/EK5/EK6/EK7 DR-Z 400 SMK5/SMK6/SMK7/SMK8/SML3 /SMK9/SML4/SML5/SML6 LT-Z 400 K3/K4 Quadport	04-06 ▲ 03-04 ▲ 03-04 ▲ 03-04 ▲ 00-16 ▲ 00-07 ▲ 05-09/13-16 ▲ 03-04 ▲
DRC89 CT011 ▲	SUZUKI LT 250 EFF/EG LT-4WD Quadrunner 4WD H/J/K/L/M/N/P/R/S/T/V LT-F 4WD V/W Quadrunner 4WD (250cc) LT-F 250 J/K/L/M/N/P/R/S/V/W/X/Y/K1 LT-F 250 FX/FY/FK1/FK2 Quadrunner LT 300 EH/EJ/EK Quadrunner 250 (2 x 4 / 4 x 4)	85-86 ▲ 87-97 ▲ 97-98 ▲ 88-01 ▲ 99-02 ▲ 87-88 ▲ 01-05 ▲	DRC106 CT013 ▲	HONDA XR 400 R	97-04 ▲
DRC91 CT012SP ■	HONDA XR 200 XR 200 R XR 200 R	80-84 ■ 81-83 ■ 86-02 ■	DRC107 DRCF107 CT027 ▲	KTM SX 60 SX 65 XC 65	98-00 ▲ 98-08 ▲ 08 ▲
DRC92 CT009 ▲	HONDA XL 600 R XL 600 R to 520822 XL 600 R from 5208023 XL 600 R	83-84 ▲ 85 ▲ 85 ▲ 86-87 ▲	DRC108 DRCF108 CT007 ▲	KTM SX 250 (2T) 250 EGS 250 EXC 250 MXC XC-W 250 (2T) XC 250 (2T) 250 SXS 300 E-GS 300 EXC 300 MXC 300 MXC 300 MXC SX 300 300 Six Days XC 300 XC-W 300 360 EGS 360 EXC 360 MXC 360 SX	94-12 ▲ 94-99 ▲ 94-05 ▲ 98-99 ▲ 06-12 ▲ 06-12 ▲ 01-03 ▲ 94-99 ▲ 94-05 ▲ 94-03 ▲ 04-05 ▲ 94 ▲ 96 ▲ 06-12 ▲ 06-11 ▲ 96-97 ▲ 96-97 ▲ 96-97 ▲ 96-97 ▲
DRC93 CT013 ▲ CT013SP ■	HONDA ATC 250 R XR 400 R	85 ■ 96 ▲			
DRC94 CT011 ▲	SUZUKI DR 200 G/H/J SP 200 G/H/J LT 230 SF/SG/SH/SJ from E/No. 104361	86-88 ▲ 86-88 ▲ 85-88 ▲			
DRC95 CT016 ▲	SUZUKI RM 250 V/W/X/Y/K1/K2	97-02 ▲			
DRC96 CT011 ▲	KAWASAKI LT 250 SK/SL	89-90 ▲			
DRC97 CT020 ▲	YAMAHA YZ 250 M/N	00-01 ▲			
DRC98 DRCF98	KAWASAKI KX 65 A1/A2/A3/A4/A5/A6/A6F/A7F/A8F /A9F/AAF/ABF/ACF/ADF/AEF/AFF/AGF/AHF SUZUKI RM 65 K3/K4/K5 RM 100 K3/K4 DR-Z 110 K3/K4/K5	00-17 03-05 03-04 03-05			
DRC99 CT008 ▲	YAMAHA WR 400 FK/FL/FM	98-00 ▲			

CLUTCH BUYERS GUIDE

DRC CLUTCH KIT BUYERS GUIDE

Part No.	Make/Model	Year	Part No.	Make/Model	Year
DRC108 DRCF108 CT007 ▲	KTM Contd. 360 Six Days 380 EXC 380 MXC SX 380 RXC-E 400 RXC-E 620	96 ▲ 98-02 ▲ 98-01 ▲ 98-02 ▲ 95 ▲ 95 ▲	DRC123 DRCF123 CT004 ▲	KAWASAKI KX 250 N1/N2 (KX 250 F) KX 250 F (T6F/T7F/T8F/W9F/XAFB/YFB/YCF/ ZDF/ZEF/ZFF/ZGF/AHF) SUZUKI RM-Z 250 K4/K5/K6	04-05 ▲ 06-17 ▲ 04-06 ▲
DRC109 DRCF109 CT005 ▲	YAMAHA YZ 250 FN/FP/FR/FS/FT/FV/FW WR 250 FN	01-07 ▲ 01 ▲	DRC126 CT013SP ▲	HONDA TRX 350 TM/FM	00-05 ▲
DRC110 CT020 ▲	YAMAHA WR 426 FN/FP WR 450 FR	01-02 ▲ 03 ▲	DRC127 CT013SP ▲	HONDA TRX 350 TE/FE	00-05 ▲
DRC111 DRCF111 CT010 ▲	YAMAHA YZ 85 P/R/S/T/V/W/X/Y/Z/A/B/D/E/F/G	02-16 ▲	DRC128 DRCF128 CT020 ▲	YAMAHA YFZ 450 BB/DB YFM 700 RV/RW/RX/RV/RA/RB/RD/RE Raptor YFM 700 RSEW/RSPX/RSPY/RSEZ/RSEA/ RSEB/RSED/RSE/RSF Special Edition YFM 700 50th Anniversary Edition - YFM 700 RSPV YFM 700 RV/RW/RX/RV/RA/RB Raptor	12-13 ▲ 06-14 ▲ 07-15 ▲ 06-13 ▲ 06-12 ▲
DRC112 CT009 ▲	HONDA CRF 450 R	02-03 ▲	DRC129 DRCF129 CT001 ▲	HONDA CRF 250 R	04-07 ▲
DRC113 DRCF113 CT020 ▲	YAMAHA YZ 250 P/R/S/T/V/W/X/Y/Z/A/B/D/E/F/G (2T)	02-16 ▲	DRC130 DRCF130 CT003 ▲	SUZUKI RM 125 K2/K3/K4/K5/K6/K7/K8	02-08 ▲
DRC114 CT003 ▲	SUZUKI RM 125 N	92 ▲	DRC131 DRCF131 CT009 ▲	HONDA TRX 450 R/ER	04-14 ▲
DRC115 CT003 ▲	SUZUKI RM 125 X/Y/K1	99-01 ▲	DRC136 CT002 ▲	HONDA CRF 230 F	03-16 ▲
DRC116 CT020 ▲	YAMAHA YZ 426 FN/FP	01-02 ▲	DRC137 DRCF137 CT006 ▲	ARCTIC CAT 400 DVX KAWASAKI KSF 400 A3/A6F (KFX 400) SUZUKI LT-Z 400 K5/K6/K7/K8/K9/L2/ZL2/L3/L4	07-08 ▲ 05-06 ▲ 05-14 ▲
DRC117	KTM 250 EXC Racing 250 EXC-G Racing 400 EXC 400 MXC SX 400 450 EXC Racing 450 EXC-G Racing 450 MXC-G Racing 450 SX Racing 520 EXC SX 520 525 EXC Racing 525 EXC-G Racing 525 MXC Desert Racing 525 MXC-G Racing 525 SX Racing	04 04 00-01 01 00-01 04 04 04 04 04 00-01 00-01 04 04 04 04 04 04 04 04	DRC139 CT028 ▲	KTM SX 85 (17"/14" & 19"/16" Wheel Models) SX 85 (17"/14") SX 85 (19"/16") XC 85 SX 105 XC 105	03-17 ▲ 03-17 ▲ 03-17 ▲ 08-09 ▲ 04-11 ▲ 08-09 ▲
DRC119 DRCF119 CT005 ▲	YAMAHA WR 250 FP/FR/FS/FT/FV/FW/FX/FY/FZ/FA/FB/FD	02-13 ▲	DRC142 CT029SP ■	SUZUKI DR 650 SER/SES	94-95 ■
DRC120 CT006 ▲	SUZUKI LT-F 400 FK2/FK3/FK4/FK5/FK6/FK7#(Eiger 4WD) LT-F 400 K3/4/5/6/7 LT-F 400 FK8/FK9 King Quad 400 FS LT-F 400 FCK8/FCK9 King Quad 400 FS Camo 400 (2 x 4 / 4 x 4) 400 (4 x 4 Manual)	02-07 ▲ 03-08 ▲ 08-10 ▲ 08-09 ▲ 03-04 ▲ 05-08 ▲	DRC144 CT001 ▲	KTM SX 150 XC 150 200 EGS 200 EXC 200 MXC SX 200 XC-W 200 XC 200 XC 250	08-17 ▲ 10-15 ▲ 98-99 ▲ 97-05 ▲ 98-03 ▲ 03 ▲ 07-15 ▲ 06-09 ▲ 10 ▲
DRC121 CT020 ▲	YAMAHA YZ 450 FR/FS	03-04 ▲	DRC145 CT001 ▲	KTM 125 EXC 125 EXE 125 Supermoto SX 125 125 SXS	98-99 s 98-05 ▲ 00-01 ▲ 00-01 ▲ 98-07/09-16 ▲ 01-02 ▲
DRC122 CT004 ▲	KAWASAKI KX 125 M1/M2/M3	03-05 ▲	DRC148 DRCF148 CT009 ▲	HONDA CRF 450 R CRF 450 X	04-08 ▲ 05-17 ▲

DRC CLUTCH KIT BUYERS GUIDE

Part No.	Make/Model	Year	Part No.	Make/Model	Year
DRC154 CT023 ▲	KTM 250 EXC Racing 400 EXC Racing 400 EXC-G Racing 450 EXC Racing 450 EXC 450 LXC-G Racing 450 MXC-G Racing 450 SMR 450 SX Racing 525 EXC Racing 525 EXC-G Racing 525 MXC Desert Racing 525 SMR 525 SX Racing	05 ▲	DRC170 CT030 ▲	KTM Contd. 400 Super Comp/EXC 400 RXC-E SXC 400 400 SX-C 400 SX 400 SXC 400 TXC 620 Duke 620 EGS-E 620 EGS/Adventure 620 Enduro Ltd 620 LC-4 620 LSE 620 Six Days 620 RXC-E SXC 620 640 LC Rallye Dakar 660 LC4	96-99 ▲
		05 ▲			96-97 ▲
		05 ▲			97 ▲
		05 ▲			98 ▲
		04-05 ▲			99 ▲
		05 ▲			00 ▲
		05 ▲			98 ▲
		04-05 ▲			97 ▲
		05 ▲			97 ▲
		05 ▲			96-97 ▲
		05 ▲			97 ▲
		05 ▲			98 ▲
		04-05 ▲			97 ▲
		05 ▲			96 ▲
		05 ▲			96-97 ▲
DRC155 DRCF155 CT045 ▲	SUZUKI RMX 450 ZL0 RM-Z 450 K8/K9/L0/L1/L2/L3/L4/L5/L6	10-11	DRC171 CT023 ▲	KTM XC 450 (Quad) XC 525 (Quad) 250 EXC Racing 250 EXG-G Racing 400 EXC 400 EXC Racing 400 EXC-G Racing 400 EXC-G Racing 400 MXC 400 SX Racing 450 EXC 450 EXC Racing 450 EXC-G Racing MXC 450 450 MXC-G Racing SMR 450 SX 450 450 SX Racing 520 SX Racing 525 EXC-G Racing 525 EXC EXC 525 Racing (4T) MXC 525 525 MXC Desert Racing SX 525 525 SX Racing 540 SXS Racing SMR 560	97 ▲
		08-16			97 ▲
DRC158 DRCF158 CT006 ▲	KAWASAKI KLX 450 R (A8F/A9F/AAF/ABF/ACF) KX 450 F (D6F/D7F/D8F/D9F/EAF/EBF)	08-12 ▲	DRC172 CT023 ▲	KTM 450 SMS	08-12 ▲
		06-11 ▲			04 ▲
DRC159 DRCF159 CT020 ▲ CT045 ■	YAMAHA YFZ 450 LES Limited Edition YFZ 450 S/T/V YFZ 450 SET Special Edition YFZ 450 SPV Special Edition	04 ▲	DRC174 CT001 ▲	KTM SX 125	08-12 ▲
		04-06 ▲			02-03 ▲
		05 ■			03 ▲
		06 ▲			07 ▲
DRC160 CT016 ▲	SUZUKI RM 250 K6/K7/K8	06-08 ▲	DRC175 CT030 ▲	KTM 660 SM Factory Replica 660 SMC 660 SMS	03 ▲
					07 ▲
DRC161 CT016 ▲	SUZUKI RM 250 K3/K4/K5	03-05 ▲	DRC176 CT030 ▲	KTM 660 Rallye 660 Rallye Factory	03 ▲
					03 ▲
DRC162 CT020 ▲	YAMAHA YZ 450 FT/FV	05-06 ▲	DRC177 CT015 ▲	KTM 950 Adventure S 950 Adventure 950 Superduke 950 R Super Enduro 990 Adventure 990 Adventure S 990 Superduke R 990 SM-R 990 SM-T	06 ▲
					03 ▲
DRC163 DRCF163 CT001 ▲	KTM SX-F 250 (4T) XC-F 250 XC-F-W 250 XC-F-W 250 Six Days	05-12 ▲			02-03 ▲
		06-12 ▲			03-04 ▲
		06-13 ▲			04 ▲
		11 ▲			
DRC164 DRCF164 CT045 ▲	SUZUKI LT-R 450 K6/K7/K8/K9 LT-R 450 ZK8/ZK9 Quadracer SE	06-11 ▲			01-03 ▲
		08-10 ▲			04 ▲
DRC168 CT016 ▲	KAWASAKI KLR 650 (KL 650 A10-A19/A6F/A7F) KL 650 E8F/E9F/EAF/EBF (KLR 650)	96-07 ▲			
		08-11 ▲			
DRC169 CT030 ▲	KTM 350 EXC 350 Super Comp 400 Duke 400 EGS 400 EXC 400 Super Comp 620 Duke 620 EGS 620 EXC 620 Super Comp	94 ▲			
		94-95 ▲			
		94-95 ▲			
		94 ▲			
		94 ▲			
		95 ▲			
		94 ▲			
		94-95 ▲			
		94-95 ▲			
		94-95 ▲			
		94-95 ▲			
DRC170 CT030 ▲	KTM 380 EGS 400 EGS 400 EGS-E 400 EXC 400 LC-4 LC4 R 400 400 LC4-E 400 LSE 400 LS-E	98-99 ▲			
		96-97 ▲			
		97 ▲			
		96 ▲			
		98 ▲			
		99 ▲			
		00-01 ▲			
		97 ▲			
		97 ▲			
		04 ▲			

CLUTCH BUYERS GUIDE

DRC CLUTCH KIT BUYERS GUIDE

Part No.	Make/Model	Year	Part No.	Make/Model	Year
DRC178 CT075 ▲	KTM 400 RXC-E EXC 400 SC 400 620 RXC-E	95 ▲ 93-95 ▲ 95 ▲ 95 ▲	DRC201 DRCF201 CT020 ▲	YAMAHA YZF 450 BBW Bill Balance Edition YZF 450 SEW/SPX Special Edition YZF 450 W/X/Y/A/B/D	07 ▲ 07-08 ▲ 07-09/12-13 ▲
DRC179 CT009 ▲	HONDA XR 650 R	00-07 ▲	DRC205 CT069 ▲	KTM 690 Duke 690 Enduro 690 Enduro R 690 Supermoto 690 SMR (Cast Wheel) 690 SMC	08-14 ▲ 08 ▲ 10-15 ▲ 07-08 ▲ 07-09 ▲ 08-11 ▲
DRC180 CT012SP ■	HONDA CRF 150 F	03-05 ■	DRC208 DRCF208 CT001 ▲	HONDA CRF 250 R CRF 250 X	08-09 ▲ 04-17 ▲
DRC181 CT012SP ■	HONDA CRF 150 F	06-16 ■	DRC209 CT012SP ▲	LIFAN LF 200 GY-S	05-08 ▲
DRC182 DRCF182 CT002 ▲	HONDA CRF 150 R/RB	07-16 ▲	DRC211	KAWASAKI KLX 140 A8F/A9F/AAF/ABF/ACF/ADF/AEF/AFF /AGF/AHF (KLX 140) KLX 140 B8F/B9F/BAF/BBF/BCF/BDF/BEF /BFF/BGFBHF (KLX 140 L) KLX 140 CHF (KLX 140 G) KLX 150 S	08-17 08-17 17 09
DRC184 CT009 ▲	KTM SX 450 (Quad) SX 505 (Quad) SX-F 450 XC-F 450 SX-F 505 XC-F 505	09-12 ▲ 09-12 ▲ 07-11 ▲ 08-09 ▲ 07-08 ▲ 08-09 ▲	DRC212 CT042 ▲	KAWASAKI KLX 250 S (KLX 250H6F/H7F) KLX 250 S (KLX 250 T9F/TAF/TBF/TCF/TDF/TEF) KLX 250 SF (KLX 250 W9F/TAF) Supermotard KLX 300 R A3-A10/A6F/A7F	06-07 ▲ 09-14 ▲ 09-10 ▲ 98-07 ▲
DRC185 CT006 ▲	KAWASAKI KFX 450 R (KSF 450 B8F/B9F/BAF /BBF/BCF/BDF/BEF)	08-14 ▲	DRC213	USE DRC297	
DRC189 DRCF189 CT004 ▲	SUZUKI RM-Z 250 K7/K8/K9	07-09 ▲	DRC214 CT006 ▲	ARCTIC CAT 400 (2 x 4) 500 (4 x 4)	98 ▲ 98-02 ▲
DRC194 CT020 ▲	YAMAHA WR 450 FT/FV/FW/FX/FY/FZ/FA/FB/FD/FE/FF	05-15 ▲	DRC215 CT006 ▲	ARCTIC CAT 400 (2 x 4 / 4 x 4) 400 (2 x 4 / 4 x 4)	98- ▲ 00-02 ▲
DRC195 DRCF195 CT020 ▲	YAMAHA YZ 450 FW/FX/FY/FZ/FA/FB/FD	07-13 ▲	DRC216 CT006 ▲	ARCTIC CAT Bearcat 454 (4 x 4) Bearcat 454 (2 x 4) 500 (4 x 4 Manual) 500 (Manual 4x4) SUZUKI LT-F 500 FK3/FK4/FK5/FK6/FK7 #Vinson 4WD	96-98 ▲ 97-98 ▲ 03-04 ▲ 05-09 ▲ 03-07 ▲
DRC196 CT030 ▲	KTM 540 SXC 620 LC4 Competition 620 LC4 Super Moto 620 Super Comp SX 620 SX 620 620 SC 620 Supermoto 620 TXC 625 SMC 625 SC 625 SXC 640 Adventure-R 640 Duke-E 640 Duke-II 640 LC4 640 LC4-E 640 LC4 Adventure 640 LC4 Supermoto 640 LC4 Six Days 660 LC4 Rallye	98-99 ▲ 99 ▲ 99 ▲ 96-99 ▲ 97-99 ▲ 99 ▲ 00-01 ▲ 98 ▲ 98 ▲ 04/06 ▲ 02 ▲ 03-04 ▲ 98-02 ▲ 98 ▲ 99-04 ▲ 99-00 ▲ 00-02 ▲ 03-06 ▲ 03-04 ▲ 99 ▲ 99-00 ▲	DRC217 CT006 ▲	SUZUKI LT-F 500 FW/FX/FY/FK1/FK2 Quadrunner	98-02 ▲
DRC199 CT030 ▲	KTM 690 Rally Factory Rep	07-08 ▲	DRC218 CT011 ▲	SUZUKI LT 160 EK/EL/EM/EN LT 160 K3/K4 LT-F 160 M/N/P/R/S/T/V/W/X/Y/K1/K3 LT 230 GEF/GEG LT-F 230 G/H LT 230 EH/EJ/EK/EL/EM/EN/EP	89-92 ▲ 03-04 ▲ 91-03 ▲ 85-86 ▲ 86-87 ▲ 87-93 ▲
DRC200 DRCF200 CT005 ▲	YAMAHA YFM 250 RX/RV/RZ/RA/RB/RD Raptor YFM 250 RSPX/RSEY Special Edition YFM 250 RSPXC Special Edition Custom	08-13 ▲ 09-11 ▲ 08 ▲	DRC220 CT011 ▲	SUZUKI LT-F 250 K2 Ozark Up to frame JSAAJ51A22100696	02 ▲
			DRC221 CT011 ▲	SUZUKI LT-F 250 K3 Ozark LT-F 250 K5/K6/K7/K8/K9/L2/L3/L4 Ozark	03 ▲ 05-14 ▲
			DRC222 CT011 ▲	SUZUKI LT-F 250 K4 LT-Z 250 K4-K9 QuadSport	04 ▲ 04-11 ▲

CLUTCH BUYERS GUIDE

DRC CLUTCH KIT BUYERS GUIDE

Part No.	Make/Model	Year	Part No.	Make/Model	Year
DRC223 CT006 ▲	SUZUKI LT-F 400 K2 Eiger Manual 2WD	02 ▲	DRC237 CT013SP ▲	HONDA TRX 500 FE5/FE6/FE7/FE8 Fourtrax Foreman 4x4/ES TRX 500 FM Fourtrax Foreman 4x4 TRX 500 FPM Fourtrax Foreman 4x4/EPS TRX 500 TM Fourtrax Foreman 2x4	05-08 ▲ 05-11 ▲ 08-11 ▲ 05-06 ▲
DRC224 CT013SP ■	KAWASAKI KLF 220 A1-A15 Bayou KLF 250 A1/A2/A3/A6F/A7F/A8F/A9F /AAF/ABF Bayou	88-02 ■ 03-11 ■	DRC238 CT013SP ▲	HONDA TRX 420 TE Fourtrax Rancher ES TRX 420 FP/FPA Fourtrax Rancher 4x4 ES/EPS TRX 420 FE/FEA Fourtrax Rancher 4x4/ES TRX 420 FE1 Rancher 4x4 ES TRX 420 TE1 Rancher ES TRX 420 FM1 Rancher 4x4 TRX 420 FM1 Rancher 4x4 EPS TRX 420 TM Fourtrax Rancher	07-13 ▲ 09-13 ▲ 07-13 ▲ 14-15 ■ 14-15 ■ 14-15 ■ 14-15 ■ 07-13 ▲
DRC225 CT004 ▲	KAWASAKI KSF 250 A1-A18 Mojave	87-04 ▲	DRC239 CT013SP ▲	HONDA TRX 420 FM Fourtrax Rancher 4x4 TRX 420 FPM/FPMA Fourtrax 4WD TRX 420 TM1 Rancher	07-11 ▲ 09-11 ▲ 14-15 ■
DRC226 CT005 ▲	YAMAHA TT-R 250 L/M/N/P/R/S/T/V	99-06 ▲	DRC240 DRCF240 CT009 ▲	HONDA TRX 700 XX	08-11 ▲
DRC227 DRCF227 CT005 ▲	YAMAHA YZ 250 FX/FY/FZ/FA/FB/FD (4T)	08-13 ▲	DRC241 DRCF241 CT057SP ▲	KTM SX 65 XC 65	09-16 ▲ 09-10 ▲
DRC228 CT008 ▲	YAMAHA YFM 350 FWBL/LC Big Bear YFM 350 FXG/FXH/FXJ/FXK/FXL/FXM/FXN /FXP/FXR/FXS/FXT Wolverine YFM 400 FWNMC/FWNN/FWNHM Big Bear 4WD/Real Tree Xtra YFM 400 NM/NMC/NN/NHN/P/HP Big Bear 2WD YFM 400 S Big Bear 2WD YFM 400 FS/FT Big Bear 4WD YFM 400 FBW/FBX/FBY/FBA/FBB Big Bear 4WD IRS YFM 400 FBHW Big Bear 400 #Hunter-IRS YFM 400 FBEW Big Bear 400 IRS #Exploring Edition	99 ▲ 95-05 ▲ 00-01 ▲ 00-03 ▲ 04 ▲ 04-05 ▲ 07-12 ▲ 07- ▲ 07 ▲	DRC244 DRCF244 CT009 ▲	HONDA CRF 450 R/RA (4 spring)	09-10 ▲
DRC229 CT039 ▲	YAMAHA TT 225 S/T TT-R 225 L/M/N/P/R/S XT 225 J/JC/K/KC/L/M/MC/N/NC/P/PC/R /RC/S/SC/T/TC/N/NC/W/WC TT-R 230 T/V/W/X/Y/A/B/D/E/F	86-87 ▲ 99-04 ▲ 92-07 ▲ 05-09/11-15 ▲	DRC249 CT012SP ■	HONDA CRF 230 L CRF 230 M	08-11 ■ 09-11 ■
DRC230 DRCF230 CT044 ▲	YAMAHA TT-R 125 M/N/P/R/ER/S/ES/ET/EV/EW/EX/EY TT-R 125 LWM/LN/LP/LER/LR/LES/LS/LET /LT/LEV/LV/LEW/LW/LEX/LX/LEY/LEA/LEB /LED/LEE/LEF	00-09 ▲ 00-09/11-15 ▲	DRC252 CT041 ▲	KTM XC-W 400 XC-W 450 Six Days EXC 450 EXC-R 450 XCR-W 450 XCR-W 530 XC-W 450 Champions Edition EXC 530 EXC 530 Champion Edition EXC-R 530 XC-W Six Days	10-11 ▲ 10-11 ▲ 10-11 ▲ 08 ▲ 08 ▲ 08 ▲ 10 ▲ 10-11 ▲ 10 ▲ 08 ▲ 10-11 ▲
DRC231 CT039 ▲	YAMAHA TW 200 T/TC/U/UC/W/WCA/AC/D/DC/E/EC /F/FC/H/HC/J/JC/EK/EKC/L/LC/M/MC/N/NC /P/PC/R/RC/S/SC/T/TC/N/NC/W/WC/X/Y/Z /A/B/D/E/F Trailway XT 225 D/DC/E/EC/F/FC/G/GC/H/HC	87-15 ▲ 92-96 ▲	DRC254 DRCF254 CT045 ▲	SUZUKI RM-Z 450 K5/K6/K7	05-07 ▲
DRC232 CT010SP ■	YAMAHA YTM 200 K/L/N YTM 200 EK/EL/ERN YTM 225 DRN/DRS YFM 200 N YFM 200 DXS/DXT/DXU/DXW (Moto 4)	83-85 ■ 83-85 ■ 85-86 ■ 85 ■ 86-89 ■	DRC255 DRCF255 CT004 ▲	SUZUKI RM-Z 250 L0/L1/L2/L3/L4/L5/L6	10-16 ▲
DRC233 CT006 ▲	KAWASAKI KEF 300 A1-A6 Lakota KEF 300 B1/B2/B3 Lakota Sport KLF 300 A1/A2/B1-B17/C1-C17 Bayou	95-00 ▲ 01-03 ▲ 86-05 ▲	DRC256 DRCF256 CT001 ▲	HONDA CRF 250 R	10 ▲
DRC234 CT006 ▲	KAWASAKI KLF 400 B1-B7 Bayou (4 x 4)	93-98 ▲	DRC259 DRCF259 CT009 ▲	HONDA CRF 450 R (4 Spring type)	11-12 ▲
DRC236 CT013SP ▲	HONDA TRX 500 FPE Fourtrax Foreman 4x4 ES/EPS TRX 500 FE/FEA Fourtrax Foreman 4x4 EPS	08-11 ▲ 08-11 ▲	DRC260 CT023 ▲	KTM SX-F 250 (4T) XC-F 250 SX-F 350 XC-F 350	13-15 ▲ 13-15 ▲ 11-15 ▲ 11-15 ▲

CLUTCH BUYERS GUIDE

DRC CLUTCH KIT BUYERS GUIDE

Part No.	Make/Model	Year	Part No.	Make/Model	Year
DRC261 DRCF261 CT001 ▲	HONDA CRF 250 R	11-17 ▲	DRC298 DRCF298 CT020 ▲	YAMAHA WR 450 FG/FH	16-17 ▲
DRC263 CT020 ▲	YAMAHA WR 450 FS	04 ▲	DRC299 DRCF299 CT092 ▲	HONDA CRF 450 R CRF 450 RX (18" Rear wheel)	17-18 ▲ 17-18 ▲
DRC265 CT008 ▲	YAMAHA YZ 400 FK/FL	98-99 ▲	DRC300 CT091 ■	AJP 250 - PR5 Trail 250 - PR5 Supermoto 250 - PR5 Enduro 250 - PR5 EX Extreme	13-17 ■ 13-17 ■ 13-17 ■ 13-17 ■
DRC269 CT013SP ▲	KAWASAKI KX 450 F-FCF/FDF/FEF/FFF/HGF/HHF (4T)	12-17 ▲	DRC301 DRCF301 CT009 ▲	HONDA CRF 450 R	14-16 ▲
DRC270 CT013SP ▲	HONDA TRX 500 FE Fourtrax Foreman TRX 500 FPE Fourtrax Foreman	12-13 ▲ 12-13 ▲			
DRC271 CT013SP ▲	HONDA TRX 500 FM Fourtrax Foreman TRX 500 FPM Fourtrax Foreman	12-13 ▲ 12-13 ▲			
DRC273 CT023 ▲	KTM SX-F 450 XC-W 450 EXC 500 XC-W 500 EXC-F 350 XC-F-W 350 350 Freeride	12 ▲ 12 ▲ 12-14 ▲ 12 ▲ 12-15 ▲ 11-15 ▲ 12 ▲			
DRC274 CT011 ▲	SUZUKI DR 200 SET/SEV/SEW/SEX/SEY /SEK1-SEK9/SEL3/SEL5/SEL6	96-09 /13/15-16 ▲			
DRC275 CT023 ▲	KTM SX 250 (2T) Diaphragm Spring XC-W 250 (2T) (Diaphragm Spring) XC 250 XC-W 300 (Diaphragm Spring) XC 300 (Diaphragm Spring) XC 300 SX-F 450 Diaphragm Spring XC-F 450 Diaphragm Spring EXC 500 Diaphragm Spring XC-W 500 Diaphragm Spring	13-16 ▲ 13-14 ▲ 13-15 ▲ 13-15 ▲ 13-15 ▲ 13-14 ▲ 13 ▲ 13 ▲ 13-15 ▲ 13-15 ▲			
DRC276 DRCF276 CT009 ▲	HONDA CRF 450 R (6 spring type)	13 ▲			
DRC277 DRCF277 CT081SP ▲	HONDA CRF 250 L (Non ABS) CRF 250 LA (ABS) CRF 250 Rally (Non ABS) CRF 250 Rally (ABS)	13-17 ▲ 17 ▲ 17 ▲ 17 ▲			
DRC280 CT013 ▲	SUZUKI DR-Z 250 K1-K7	01-07 ▲			
DRC281 CT023 ▲	KTM SX-F 450 (4T) XC-F 450	14-16 ▲ 14-15 ▲			
DRC287 DRCF287 CT005 ▲	YAMAHA YZ 450 FE/FF//FG/FGY (4T)	14-16 ▲			
DRC288 DRCF288 CT020 ▲	YAMAHA YZ 250 FE/FF/FG/FGY (4T)	14-16 ▲			
DRC295 CT005 ▲	YAMAHA XT 250 X/Y/Z/A/B/D/E/F/G/H	08-17 ▲			
DRC297 CT011 ▲	HONDA LT-F 250 K Ozark From frame JSAAJ51A221006	02 ▲			

SRC CLUTCH KIT BUYERS GUIDE

Part No.	Make/Model	Year	Part No.	Make/Model	Year
SRC2 CT031 ▲	HONDA VF 700 F Interceptor VF 750 F V45 Interceptor	84-85 ▲ 83-84 ▲	SRC19 CT014 ▲ CT014SP ●	HONDA 599 (CB 600 F) CBR 600 F2 CBR 600 F3/SJR/SE CBR 929 RR (929cc model) CBR 954 RR	04/06 ● 91-94 ● 95-98 ● 00-01 ▲ 02-03 ▲
SRC3 CT014 ▲	HONDA VFR 700 F/F2 Interceptor VF 750 C Magna/CD Magna Deluxe VFR 750 F Interceptor 750 VFR 750 F	86-87 ▲ 94-03 ▲ 86 ▲ 90-97 ▲	SRC20 CT016 ▲	KAWASAKI ZL 900 A1/A2 Eliminator KZ 1000 E1/E2 Shaft ZG 1000 A1-A20 Concours ZG 1000 A6F Concours ZL 1000 A1 ZX 1000 A1/A2 Ninja ZX 1000 B1/B2/B3 Ninja ZX10 KZ 1100 B1/B2 (GPz) KZ 1100 A1/A2/A3 KZ 1100 D1/D2 Spectre KZ 1100 L1 (LTD) ZX 1100 A1/A2 (GPz) ZR 1100 A1/A2/A3/A4 Zephyr (ZR 1100 C3/C4) ZRX 1100 ZN 1100 B1/B2 (LTD) ZG 1200 A1/B1-B4 Voyager X11 ZG 1200 B5-B17 Voyager X11	85-86 ▲ 79-80 ▲ 86-05 ▲ 06 ▲ 87 ▲ 86-87 ▲ 88-90 ▲ 81-82 ▲ 81-83 ▲ 82-83 ▲ 83 ▲ 83-84 ▲ 92-95 ▲ 99-00 ▲ 84-85 ▲ 86-90 ▲ 91-03 ▲
SRC4 CT009 ▲	HONDA CB 1000 CBF 1000 F CBR 1000 F Hurricane	94-95 ▲ 90-96 ▲ 87-88 ▲	SRC22 CT016 ▲	KAWASAKI ER-6N (ER 650 C9F/CAF) ZX 600 D1/D2/D3/D4 (ZX6) EX 650 A6F/A7F/A8F/A9F/C9F/CAF/CBF EX 650 Ninja (Non ABS) (EX 650 ECF/EDS /EEF/EFF) EX 650 Ninja (ABS) (EX 650 FDS/FEF/FFF) KLE 650 A7F/A8F/A9F/CAF/CBF/CCF/CDF /DEF Versys	09-10 ▲ 90-93 ▲ 06-11 ▲ 12-15 ▲ 13-15 ▲ 07-14 ▲
SRC5 CT014 ▲	HONDA VFR 750 R (RC 30)	90 ▲	SRC24 CT016 ▲	KAWASAKI KZ 750 K1/K2 (LTD) ZX 750 K1/K2 ZX 750 J1/J2 ZX 750 L1/L2/L3 (ZX-7) ZX 750 M1/M2 (ZX-7R) ZX 750 P1-P8 (ZX 7 R)	83-84 ▲ 91-92 ▲ 91-92 ▲ 93-95 ▲ 93-94 ▲ 96-03 ▲
SRC6 CT010 ▲	YAMAHA FZR 400 U/W/SUC/SWC/A/SAC	88-90 ▲	SRC25 CT021 ▲	KAWASAKI ZX 1100 C1-C4/D1-D9 (ZX11) ZX 1100 E1/E2/E3/F1 GPZ 1100 ZZR 1200 (ZX 1200 C1-C4)	90-01 ▲ 95-97 ▲ 02-05 ▲
SRC7 CT010 ▲	YAMAHA FZR 600 W/WC/RA/AC/RAC/RB/RBC/RD /RDC/RE/REC/RF/RFC/RG/RGC/H/RHC/RJ /RJC/RK/RKC/RL/RLC	89-99 ▲	SRC29 CT008SP ■	YAMAHA FZR 1000 E/EC/F/FC/G/GC YZF 1000 R (RJ)	93-95 ■ 97 ■
SRC8 CT008SP ■	YAMAHA FZR 750 RT/RU FZR 1000 T/TC/U/UC Genesis	87-88 ■ 87-88 ■	SRC31 CT008SP ■	YAMAHA FZR 1000 W/WC/A/AC/B/BC/D/DC	89-92 ■
SRC9 CT008SP ■	YAMAHA FZR 750 OW01 YZF 750 SP/RF/RFC/RG/RGC/RH/RHC	89-91 ■ 94-96 ■	SRC33 CT054SP ▲	YAMAHA YZF 600 RJ/RK/RL/RM/RN/RP/RR/RS/RT/RV/RW	95-07 ▲
SRC10 CT055SP ▲	SUZUKI GSX 1100 GM/GN/GP GSXR 1100 K/L/M/N	91-93 ▲ 89-92 ▲	SRC38 CT004 ▲	KAWASAKI ZX 6R (ZX 600 F1/F2/F3/G1/G2) ZX 6R (ZX 600 J1/J2/J3) ZZR 600 (ZX 600 J4) ZZR 600 J6F/J7F/J8F ZX 6R (ZX 636 A1) ZX6R (ZX 636 B1/B2) 636cc Z 750 S (ZR 750 K1/K6F)	95-99 ▲ 00-02 ▲ 05 ▲ 06-08 ▲ 02 ▲ 03-04 ▲ 05-06 ▲
SRC11 CT016 ▲	KAWASAKI EN 450 A1-A6 (454 LTD) EN 500 A1-A7/C1-C10/C6F/C7F/C8F/C9F EX 500 A1-A7/D1-D12/D6F/D7F/D8F/D9F KZ 550 A1/A2/A3/A4 KZ 550 C1/C2/C3/C4 (LTD) KZ 550 D1 (GPz) KZ 550 F1 Spectre KZ 550 F2 (LTD) KZ 550 H1/H2 (GPz) KZ 550 M1 (LTD) ZX 550 A1/A2/A3 (GPz) ZR 550 B1/B2/B3/B4 Zephyr ZX 600 A1/A2/A3/B1 Ninja ZX 600 C1-C10 Ninja R ZL 600 A1/A2 ZL 600 B1/B2	85-90 ▲ 90-09 ▲ 87-09 ▲ 80-83 ▲ 80-83 ▲ 81 ▲ 83 ▲ 84 ▲ 82-83 ▲ 83 ▲ 84-86 ▲ 90-93 ▲ 85-87 ▲ 88-97 ▲ 86-87 ▲ 96-97 ▲	SRC39 CT055SP ▲	SUZUKI RF 900 RR GSXR 1100 WR/WP/WS/WT/WV/WW	94 ▲ 93-98 ▲
SRC13 CT029 ▲	SUZUKI GSX 600 FJ/FK/FL/FM Katana GSX-R 750 G/H	88-91 ▲ 86-87 ▲	SRC40 CT055SP ▲	SUZUKI GSX-R 750 T/V/W/X GSF 1200 SV/SAV/SW/SX/SY/SK1-SK5	96-99 ▲ 97-05 ▲
SRC14 CT036SP ▲	SUZUKI GSX-R 750 J/K	88-89 ▲			
SRC15 CT048SP ▲	SUZUKI GSXR 1100 G/H/J	86-88 ▲			
SRC16 CT009SP ■	HONDA CBR 600 F Hurricane CBR 600 F1	87 ■ 88-89 ■			
SRC17 CT036SP ▲	SUZUKI GSX 600 FN/FP/FR/FS/FT/FV Katana GSX R 600 WN/WP GSX-R 750 L/M/N GSX-R 750 WP/WR/WS	92-97 ▲ 92-93 ▲ 90-92 ▲ 92-95 ▲			

CLUTCH BUYERS GUIDE

SRC CLUTCH KIT BUYERS GUIDE

Part No.	Make/Model	Year	Part No.	Make/Model	Year
SRC41 CT016 ▲	KAWASAKI ZX 750 N1/N2 (ZX 7 RR) ZX-9R B1/B2/B3/B4 Ninja	96-99 ▲ 94-97 ▲	SRC62 CT013SP ■	HONDA CTX 700 N (Naked/Manual G/box) CTX 700 (Top Fairing/Manual G/box) NC 700 X (2 Piston Caliper) NT 700 V/A	14 ■ 14 ■ 12-14 ■ 10-13 ■
SRC42 CT009SP ■	HONDA CBR 600 F1	90 ■	SRC64 CT013SP ■	HONDA NT 650 Hawk GT	88-90 ■
SRC43 CT016 ▲	KAWASAKI ZX 600 E1-E13 (ZX6)	93-05 ▲	SRC65 CT017 ▲	YAMAHA YZF 1000 R1	99-03 ▲
SRC45 CT036SP ▲	SUZUKI RF 600 RR/RS/RT	94-96 ▲	SRC66 CT014 ★	HONDA CBR 600 F4 (Carb Model)	99-00 ★
SRC46 CT016 ▲	KAWASAKI W 650 (EJ650A1/A2/A3/A4) VN 800 A1-A11/B1-B10 VN 700 A1 Vulcan KZ 750 G1 (LTD) KZ 750 M1 (CSR) VN 750 A2-A21/A6F Vulcan	00-02 ▲ 95-05 ▲ 85 ▲ 80 ▲ 82 ▲ 86-06 ▲	SRC67 CT021 ▲	SUZUKI GSX 1300 RX Hayabusa	99 ▲
SRC50 CT024SP ▲	SUZUKI GS 1000 SZ GS 1000 GT/GX GS 1000 GLT/GLX/SZ GS 1100 ET/EX/EZ GS 1100 GZ/GD GS 1100 GLZ/GLD GS 1100 GKZ/GK2/GKD/GKE GS 1100 LT GS 1150 ES3/ESE/EFESF/EF2/EG/ESG	82 ▲ 80-81 ▲ 80-82 ▲ 80-82 ▲ 82-83 ▲ 82-83 ▲ 82-84 ▲ 80 ▲ 83-86 ▲	SRC68 CT009 ▲	SUZUKI TL 1000 RW/RX/RV TL 1000 SX/SY	98-00 ▲ 99-00 ▲
SRC51 CT008SP ■	YAMAHA FZ6 (All models) YZF 600 RL/RRL/RM/RMC/RN/RNC/P/PC R6 FZX 700 S/SC/T/TC FZ 750 N FZ 750 S/SC TDM 850 D/DC/E/EC	04-09 ■ 99-02 ■ 86-87 ■ 85 ■ 86 ■ 92-93 ■	SRC70 CT056SP ■	HONDA ST 1100/1100 A	91-01 ■
SRC53 CT016 ▲	KAWASAKI ZX 750 F1/F2/F3/F4 Ninja VN 800 Drifter C1/C2/E1-E5/E6F VN 900 Vulcan Classic LT (D6F/D7F/D8F/D9F /DAF/DBF/DCF/DDF/DEF/DFE) VN 900 B6F/B7F/B8F/B9F/BAF/BBF/BCF/BDF /BEF/BEFA/BFF Vulcan Classic VN 900 C7F/C8F/C9F/CAF/CBF/CCF/CDF /CEFA/CFE ZX 900 A1/A2/A3 Ninja	87-90 ▲ 99-06 ▲ 06-15 ▲ 06-15 ▲ 07-15 ▲ 84-86 ▲	SRC71 CT014 ▲	SUZUKI GSXR 750 Y	00- ▲
SRC54 CT016 ▲	KAWASAKI KZ 1000 J1/J2/J3 KZ 1000 K1/K2 (LTD) KZ 1000 M1/M2 (CSR) KZ 1000 P1-P22/P24 Police KZ 1000 R1/R2 Replica	81-83 ▲ 81-82 ▲ 81-82 ▲ 82-03/05 ▲ 82-83 ▲	SRC72 CT008 ▲	YAMAHA SRX 600 S/SC	86 ▲
SRC55 CT014 ▲	HONDA CBR 900 RR	96-97 ▲	SRC74 CT008SP ■	YAMAHA YZF-R6 RRR/RRS/T/TC YZF-R6S (SV/SW/SX/SY)	03-05 ■ 06-09 ■
SRC56 CT017 ▲	YAMAHA YZF 1000 R1	98 ▲	SRC75 CT014 ▲	HONDA CBR 600 RR CBR 600 RA	03-14 ▲ 09-14 ▲
SRC57 CT014 ▲	HONDA CBR 900 RR 919 (CB 900 F)	98-99 ▲ 02-07 ▲	SRC76 CT004 ▲	KAWASAKI ZX6RR (ZX 600 K1) 599cc	03 ▲
SRC58 CT055SP ▲	SUZUKI GSX R 600 V/W/X/Y	97-00 ▲	SRC77 CT020 ▲	YAMAHA (FZ1) FZS 1000 V/W/X/Y/Z/A/B/D/E YZF R1 (5VY)	06-14 ▲ 04-06 ▲
SRC59 CT004 ▲	KAWASAKI ZX 9R (ZX 900 C1/C2)	98-99 ▲	SRC78 CT014 ▲	SUZUKI GSXR 600 K4/K5	04-05 ▲
SRC60 CT009 ▲	HONDA VTR 1000 F Superhawk	98-05 ▲	SRC79 CT004 ▲	KAWASAKI ZX-10R (ZX 1000 C1/C2/D6F/D7F) ZX10R (ZX 1000 E8F/E9F/FAF/JBF/KBF/JCF /KCF/KDF/JDF/JEF/KEF/JJF/KFF)	04-07 ▲ 08-15 ▲
			SRC80 CT009SP ■	HONDA CBR 1000 RR	04-07 ■
			SRC81 CT022 ▲	SUZUKI SV 650 X/Y/K1/SK1/SK2/K2	99-02 ▲
			SRC82 CT033SP ▲	SUZUKI SFV 650 K9/L3/L4/L5 SV 650 K3/SK3/K4/SK4/K5/SK5/K6/SK6/K7 /SK7/SK8/K8/SK9/SLO SV 650 AK7/AK8 SV 650 SAK7/SAK8/SK9/SALO ABS	09-10/13-15 ▲ 03-10 ▲ 07-08 ▲ 07-10 ▲
			SRC83 CT004 ▲	KAWASAKI ZX6RR (ZX 600 M1)	04 ▲
			SRC84 CT004 ▲	KAWASAKI ZX6R (ZX 636 C1/C6F 636cc)	05-06 ▲

SRC CLUTCH KIT BUYERS GUIDE

Part No.	Make/Model	Year	Part No.	Make/Model	Year		
SRC85 CT015 ▲	SUZUKI GSXR 1000 K5/K6/K7/K8 GSX-S 1000 L8 (Naked - Non ABS) GSX-S 1000 AL8 (Naked - ABS) GSX-S 1000 F L8 (Faired - Non ABS) GSX-S 1000 F AL8 (Faired - ABS)	05-08 ▲	SRC119 CT012SP ▲	HONDA CBR 125 RW7/RW8/RW9/RWA/RWB/RC/RD (No judder spring)	07-13 ▲		
		18 ▲					
		18 ▲	SRC120 CT009 ▲	SUZUKI GSX-R 1000 L2/L3/ZL3/L4/L5/L6	12-16 ▲		
		18 ▲					
SRC86 CT015 ▲	SUZUKI GSXR 600 K6/K7	06-07 ▲	SRC121 CT014 ▲	SUZUKI GSX-R 750 K4/K5	04-05 ▲		
SRC87 CT008SP ■	YAMAHA YZF-R6 V/W/X/Z/A/B/D/E/F/G	06-16 ■	SRC122 CT083SP ▲	HONDA MSX 125 D/E/F/G/H Grom (Non ABS) MSX 125 AH Grom (ABS)	14-18 ▲		
SRC88 CT015 ▲	SUZUKI GSXR 600 K8/K9/L0 GSXR 750 K6/K7	08-10 ▲ 06-07 ▲			18 ▲		
SRC89 CT004 ▲	SUZUKI GSXR 1000 K1/K2/K3/K4/ZK4 KAWASAKI ZX9R (ZX 900 E1/E2/F1/F2) Z 1000 (ZR 1000 A1/A2/A3) Z 1000 (ZR 1000 A6F)	01-04 ▲	SRC128 CT080 ▲	YAMAHA YZ-F R3 (321cc)	15-16 ▲		
		01-03 ▲					
		03-05 ▲					
		06 ▲					
SRC93 CT020 ▲	YAMAHA YZF R1 LE YZF-R1 (6 piston caliper)	06 ▲	SRC129 CT079SP ●	YAMAHA FZ-10 YZF-R1 YZF-R1M YZF-R1S	17 ●		
		07-08 ▲			15-16 ●		
SRC94 CT014 ▲	HONDA CBR 900 RR	93-95 ▲			SRC130 CT085 ▲	BMW F650 GS (Late type plates 2 x 13mm /7 x 14mm ears) F700 GS (Late type plates 2 x 13mm /7 x 14mm ears) F800 GS (Late type plates 2 x 13mm /7 x 14mm ears) F800 GS Adventure (Late type plates 2 x 13mm /7 x 14mm ears) F800 GT (Late type plates 2 x 13mm /7 x 14mm ears) F800 S (Late type plates 2 x 13mm /7 x 14mm ears) F800 ST (Late type plates 2 x 13mm /7 x 14mm ears) F800 R (Late type plates 2 x 13mm /7 x 14mm ears)	07-17 ▲
		08-12 ▲ 09-12 ▲					11-17 ▲
SRC95 CT043SP ▲	HONDA CBR 1000 RR/RRA CBR 1000 RA/RAA	08-12 ▲ 09-12 ▲			12-17 ▲	12-17 ▲	
SRC96 CT020 ▲	YAMAHA YZF-R1 (6 piston caliper)	09-14 ▲			07-17 ▲	07-17 ▲	
SRC97 CT009 ▲	SUZUKI GSXR 1000 K9/L1	09-11 ▲			07-17 ▲	07-17 ▲	
SRC98 CT021 ▲	KTM 1190 RC8 (6 spring type clutch) 1190 RC8 R (6 spring type clutch)	09-12 ▲ 08-12 ▲			05-17 ▲		
SRC101 CT004 ▲	KAWASAKI ZX 6R (ZX 600 P7F/P8F/P9F/R9F/RAF/RBF/RCF)	07-12 ▲			SRC131 CT017 ▲	YAMAHA XT 1200 Z Super Tenere FJR 1300 R/RC/S/AS/T/AT FJR 1300 A XVS 1300 V-Star XVS 1300 V-Star De Luxe XVS 1300 V-Star Tourer XVS 1300 Stryker	12-13 ▲ 03-05 ▲ 06-15 ▲ 07-14 ▲ 13-14 ▲ 07-14 ▲ 11-14 ▲
SRC103 CT009 ▲	HONDA VFR 1200	10-14 ▲			SRC141 CT014SP ▲	BENELLI TNT 600 i Tornado	16-17 ▲
SRC110 CT015 ▲	SUZUKI GSXR 600 L1/L2/L3/L4/L5/L6 GSXR 750 L1/L2/L3/L4/L5/L6	11-16 ▲			SRC142 CT009 ▲	SUZUKI GSX-R 1000 AL7 ABS (3 Spring clutch)	17 ▲
		11-16 ▲			SRC143 CT014 ▲	SUZUKI CBR 600 F4i Sport Injection Model)	01-06 ▲
SRC111 CT014 ▲	SUZUKI GSXR 750 K1/K2/K3	01-03 ▲			SRC144 CT085 ▲	BMW F800 GT (Early type plates 14mm ears) F800 S (Early type plates 14mm ears) F800 ST (Early type plates 14mm ears)	04-06 ▲ 04-06 ▲ 04-06 ▲
SRC112 CT014 ▲	SUZUKI GSXR6 600 K1/K2/K3/ZK3	01-03 ▲			SRC145 CT083 ▲	BMW G 650 GS (R13) G 650 GS Sertao (R13) G 650 X Country (K15)	08-16 ▲
SRC113 CT014 ▲	APRILIA RSV4R RSV4 Factory RSV4 Factory APRC RSV4 R APRC	10-12 ▲	10-14 ▲				
		09-14 ▲	08-10 ▲				
SRC115 CT035SP ▲	SUZUKI GS 1000 C/N/EC/EN/SN/ET/ST	78-80 ▲					
SRC118 CT009 ▲	KAWASAKI EX 300 ADF/BDFA/ADFA/AEFA/AESA/AES /AESA/BDF/BEF/BEFA (Ninja)	13-14 ▲					

SRC CLUTCH KIT BUYERS GUIDE

Part No.	Make/Model	Year	Part No.	Make/Model	Year
SRC7003 CT702SP ▲	HARLEY DAVIDSON® TRIKE FLHTCUTG 1MAL Tri Glide Ultra Classic FLRT 1MCM Freewheeler TOURING FLHTCUL 1KDM Ultra Classic Low FLHTCUL TC 1KFL Ultra Classic Low Twin-Cooled FLHTK 103 1TEL CVO Limited FLHTKL 1KKL Ultra Limited Low SOFTAIL FLSS 1JS9 Slim S FLSS 1JS9 Softail Slim S FLSTFBS 1JT9 Fat Boy S	14-16 ▲	SRC7010 Contd. CT702SP ▲	HARLEY DAVIDSON® TOURING FLHX 1KBC Street Glide FLHX 1KXC Street Glide Anniversary FLHXS 1KRC Street Glide Special FLHXS 1KYC Street Glide Special Anniversary FLTRU 1KGD Road Glide Ultra FLTRX 1KHC Road Glide FLTRXS 1KTC Road Glide Special	17-18 ▲
		15-16 ▲			18 ▲
SRC7006 CT706SP ▲	HARLEY DAVIDSON® VRSC VRSCAW 1HFH V-Rod VRSCAW 1HFH V-Rod Wide Tire VRSCAWA 1HKH W/ABS VRSCD 1HDH Night Rod VRSCDA 1HLH Night Rod W/ABS VRSCDX 1HHH Night Rod Special VRSCDX ANV 1HHH_ANV Night Rod Special Anv VRSCDXA 1HMH Night Rod Special W/ABS VRSCF 1HPH V-Rod Muscle	09-10 ▲	SRC7011 CT703SP ▲	HARLEY DAVIDSON® TOURING FLHR 1FBM Road King FLHR 1FDL/1FDV Road King FLHRC 1FRM Road King Classic FLHRCI 1FRW Road King Classic FLHRI 1FBW Road King FLHT 1DDL Electra Glide Standard FLHTC 1DJL/1DJV Electra Glide Classic FLHTCI 1FFR/1FFW Electra Glide Classic FLHTCU 1FCM Ultra Classic FLHTCU TC 1KSL Ultra Classic Twin-Cooled FLHTCUI 1FCR/1FCW Ultra Classic FLHTI 1FWW Electra Glide Standard FLHTK 1KEL Ultra Limited FLHX 1KBM Street Glide FLHXS 1KRM Street Glide Special FLTR 1FPL/1FPV Road Glide FLTRI 1FSR/1FSW Road Glide FLTRU 1KGL Road Glide Ultra FLTRX 1KHM Road Glide FLTRXS 1KTM Road Glide Special DYNA FXD 1GHL Dyna Super Glide FXDL 1GDL Dyna Low Rider FXDS-CONV GGVX/GGVY Dyna Glide Convertible FXDWG 1GEL/1GEV Dyna Wide Glide FXDX 1GJV Dyna Super Glide Sport FXDXT 1GLV Dyna Super Glide T-Sport SOFTAIL FLSTC 1BJL Heritage Softail Classic FLSTCI 1BWB Heritage Softail Classic FLSTF 1BML Fat Boy FLSTFI 1BXX Fat Boy FLSTS 1BRL/1BRY Heritage Springer FLSTSI 1BYB Heritage Springer FXST 1BHL/1BHY Softail Standard FXSTB 1BTL/1BTY Night Train FXSTBI 1JAB Night Train FXSTC 1BKL Softail Custom FXSTD 1BSY Softail Deuce FXSTDI 1JBB Softail Deuce FXSTI 1BVB Softail Standard FXSTS 1BLL/1BLY Springer Softail FXSTSI 1BZB Springer Softail	15-16 ▲
		08 ▲			98-03 ▲
SRC7007 CT707SP ▲	HARLEY DAVIDSON® VRSC VRSCA 1HAZ V-Rod VRSCAW 1HFZ V-Rod VRSCB 1HBZ V-Rod VRSCR 1HCZ Street Rod VRSCSE 1PMG CVO V-Rod VRSCSE2 1PPG CVO V-Rod VRSCX 1HJG Screamin' Eagle V-Rod VRXSE 7RC7 CVO VR Destroyer	02-06 ▲	SRC7012 CT703SP ▲	HARLEY DAVIDSON® TOURING FLHR 103 1FBM Road King FLHR 1FBM Road King FLHR 1FDV Road King FLHR ANV 1FBM_ANV Road King ANV FLHRC 103 1FRM Road King Classic FLHRC 1FRM Road King Classic FLHRCI 1FRW Road King Classic FLHRI 1FBW Road King FLHRS 1FXV Road King Custom FLHRSI 1FYW Road King Custom FLHT 1DDV Electra Glide Standard FLHTC 103 1FFM Electra Glide Classic FLHTC 1DJV Electra Glide Classic FLHTC 1FFM Electra Glide Classic FLHTCI 1FCW Ultra Classic FLHTCI 1FFW Electra Glide Classic FLHTCU 103 1FCM Ultra Classic FLHTCU 1FCM Ultra Classic	14-16 ▲
		07 ▲			98-03 ▲
SRC7008 CT708SP ▲	HARLEY DAVIDSON® TRIKE FLHTCUTG 1MAD Tri Glide Ultra FLHTCUTG 1MDD Tri Glide Ultra Anniversary FLRT 1MCC Freewheeler POLICE FLHP 1FHC Road King Police FLHTP 1FMC Electra Glide Standard Police SOFTAIL FLFBS 1YBK Fat Boy 114 FLFBS 1YRK/1YSK Fat Boy 114 Anniversary FLHCS 1YBK Heritage Classic 114 FLHCS 1YPK Heritage Classic 114 Anniversary FXBRS 1YHK Breakout 114 FXBRS 1YTK Breakout 114 Anniversary FXFBS 1YLK Fat Bob 114	04-05 ▲	SRC7010 CT702SP ▲	HARLEY DAVIDSON® TOURING FLHR 1FBC Road King FLHRC 1FRC Road King Classic FLHRXS 1KVC Road King Special FLHTCU 1FCC Electra Glide Ultra Classic FLHTK 1KED Ultra Limited FLHTK 1KND Ultra Limited Shrine Edition FLHTK 1KWD Ultra Limited Anniversary FLHTKL 1KKD Ultra Limited Low	15-16 ▲
		06-07 ▲			17-18 ▲
SRC7009 CT703SP ▲	HARLEY DAVIDSON® TRIKE FLHTCUTG 1MAM Tri Glide Ultra Classic FLHTCUTG ANV 1MAM_ANV Tri Glide Ultra Classic Anv FLHXXX 1MBM Street Glide Trike POLICE FLHP 1FHM Road King Police FLHPE 1FTM Road King Police FLHTP 1FMM Electra Glide Standard Police DYNA FXDLS 1GS8 Dyna Low Rider S	05 ▲	SRC7010 CT702SP ▲	HARLEY DAVIDSON® TOURING FLHR 1FBC Road King FLHRC 1FRC Road King Classic FLHRXS 1KVC Road King Special FLHTCU 1FCC Electra Glide Ultra Classic FLHTK 1KED Ultra Limited FLHTK 1KND Ultra Limited Shrine Edition FLHTK 1KWD Ultra Limited Anniversary FLHTKL 1KKD Ultra Limited Low	16-17 ▲
		06 ▲			17-18 ▲
SRC7010 CT702SP ▲	HARLEY DAVIDSON® TRIKE FLHTCUTG 1MAM Tri Glide Ultra Classic FLHTCUTG ANV 1MAM_ANV Tri Glide Ultra Classic Anv FLHXXX 1MBM Street Glide Trike POLICE FLHP 1FHM Road King Police FLHPE 1FTM Road King Police FLHTP 1FMM Electra Glide Standard Police DYNA FXDLS 1GS8 Dyna Low Rider S	07 ▲	SRC7010 CT702SP ▲	HARLEY DAVIDSON® TOURING FLHR 1FBC Road King FLHRC 1FRC Road King Classic FLHRXS 1KVC Road King Special FLHTCU 1FCC Electra Glide Ultra Classic FLHTK 1KED Ultra Limited FLHTK 1KND Ultra Limited Shrine Edition FLHTK 1KWD Ultra Limited Anniversary FLHTKL 1KKD Ultra Limited Low	17-18 ▲
		08 ▲			17-18 ▲

SRC CLUTCH KIT BUYERS GUIDE

Part No.	Make/Model	Year	Part No.	Make/Model	Year
SRC7014 CT701SP ▲	HARLEY DAVIDSON® TOURING FLHR 1FDL Road King FLHR FD93 Road King FLHRI 1FBR Road King FLHS 1FAL Electra Glide Sport FLHT 1DDL Electra Glide Standard FLHTC 1DJL Electra Glide Classic FLHTCI 1FFR Electra Glide Classic FLHTCU 1DPL Ultra Classic FLHTCUI 1FCR Ultra Classic FLTC 1DBL Tour Glide Classic FLTCU 1DML Tour Glide Ultra Classic FLTCUI 1FER Tour Glide Ultra Classic	94-97 ▲ 93 ▲ 96-97 ▲ 91-94 ▲ 95-97 ▲ 91-97 ▲ 96-97 ▲ 91-97 ▲ 95-97 ▲ 91-92 ▲ 91-95 ▲ 96 ▲	SRC7018 Contd. CT704SP ▲	HARLEY DAVIDSON® TOURING FLHT Electra Glide FLHT Electra Glide Classic FLHTC ADKD/DDKD/DJLE Touring Electra Glide Classic FLT AEKD Touring Tour Glide FLT Classic Tour Glide Classic FLT DAKC Touring Tour Glide FLT Tour Glide FLTC 5G05/AFKB/DBKC Touring Tour Glide Classic FLTC DBLE Touring Tour Glide Classic FLTC Tour Glide Classic SOFTAIL FXB BDKB/BDKC Super Glide B80 FXDG BGKD Dyna Glide Glide Custom FXE BAKB/BAKC/BAKD/BAKE FX Super Glide FXEF BBKB FX Super Glide Fat Bob FXS BCKB/BCKC FX Super Glide FXSB BFKD/BFKE FX Low Rider FXST BHLE Softail Standard FXWG BEKB/BEKC/BEKD/BEKE FX Wide Glide	83 ▲ 83 ▲ 83-Early 84 ▲ 81 ▲ 82-83 ▲ 82-83 ▲ 81/83 ▲ 80-82 ▲ Early 84 ▲ 81 ▲ 81-82 ▲ 83 ▲ 81-Early 84 ▲ 81 ▲ 81-82 ▲ 83-Early 84 ▲ Early 84 ▲ 81-Early 84 ▲
SRC7015 CT701SP ▲	HARLEY DAVIDSON® TOURING FLHS FALL Touring Electra Glide Sport FLHTC DJLL Touring Electra Glide Classic FLHTCU DPLL Touring Electra Glide Classic Ultra FLTC DBLL Touring Tour Glide Classic FLTCU DMLL Touring Tour Glide Classic Ultra	90 ▲ 90 ▲ 90 ▲ 90 ▲ 90 ▲	SRC7019 CT701SP ▲	HARLEY DAVIDSON® DYNA FXD 1GHL Dyna Super Glide FXDB 1GBL Dyna Sturgis FXDB 1GAL Dyna Daytona FXDC 1GCL Super Glide Custom FXDL 1GDL Dyna Low Rider FXDS-CONV GGLP Dyna Glide Convertible FXDWG 1GEL Dyna Wide Glide SOFTAIL FLST BJLL Softail Heritage FLSTC 1BJL Heritage Softail Classic FLSTC BJ04 Softail Heritage Classic FLSTF 1BML Fat Boy FLSTF BMLL Softail Fat Boy FLSTN 1BNL Heritage Softail Nostalgia FLSTS 1BRL Heritage Springer FXST BHLL Softail Standard FXSTC 1BKL Softail Custom FXSTC BKLL Softail Custom FXSTS 1BLL Springer Softail FXSTS BLLL Softail Springer FXSTSB 1BPL Springer Softail	95-97 ▲ 91 ▲ 92 ▲ 92 ▲ 93-97 ▲ 93 ▲ 93-97 ▲ 90 ▲ 91-97 ▲ 90 ▲ 91-97 ▲ 90 ▲ 91-97 ▲ 93-96 ▲ 97 ▲ 90 ▲ 91-97 ▲ 90 ▲ 91-97 ▲ 90 ▲ 91-97 ▲ 90 ▲ 91-97 ▲ 90 ▲ 95-97 ▲
SRC7016 CT705SP ▲	HARLEY DAVIDSON® TOURING FLH ADKE Touring Electra Glide FLH ALKE Touring Electra Glide Shrine Shovelhead FLHS AKKE Touring Electra Glide Sport FLHS FALH/FALJ/FALK Touring Electra Glide Sport FLHT DDLJ Touring Electra Glide Standard FLHT Electra Glide FLHT Electra Glide Classic FLHTC DDLG/DDLH/DJJJ Touring Electra Glide Classic FLHTC DJLE/DJLF/DJLG/DJLH Touring Electra Glide Classic FLHTC DJLK Touring Electra Glide Classic FLHTCU DPLK Touring Electra Glide Classic Ultra FLT Classic Tour Glide Classic FLT Tour Glide FLTC DBLJ/DBLK Touring Tour Glide Classic FLTC DBLE Touring Tour Glide Classic FLTC DBLF/DBLG/DBLH/DBLK Touring Tour Glide Classic FLTCU DMLK Touring Tour Glide Classic Ultra SOFTAIL FLST BJLG/BJLH/BJLJ/BJLK Softail Heritage FLSTC BJ01/BJ02/BJ03 Softail Heritage Classic FXE BAKE FX Super Glide FXEF BBLF FX Super Glide Fat Bob FXSB BFKE/BFLF FX Low Rider FXST BHLE/BHLF/BHLG/BHLH/BHLJ/BHLK Softail Standard FXSTC BKLK/BKLH/BKLJ/BKLL Softail Custom FXSTS BLLJ/BLLK Softail Springer FXWG BEKE/BELF/BELG FX Wide Glide	Later 84 ▲ Later 84 ▲ Later 84 ▲ 87-89 ▲ 88 ▲ Later 84 ▲ Later 84 ▲ 86-88 ▲ Later 84-87 ▲ 89 ▲ 89 ▲ Later 84 ▲ Later 84 ▲ 88-89 ▲ Later 84 ▲ 85-87/89 ▲ 89 ▲ 86-89 ▲ 87-89 ▲ 84 ▲ 85 ▲ 84-85 ▲ 84-89 ▲ 86-89 ▲ 88-89 ▲ 84-86 ▲	SRC7020 CT701SP ▲	HARLEY DAVIDSON® SPORTSTER XL1200 1LN3 Forty Eight Anniversary XL1200C 1CGP Sportster 1200 Custom XL1200C 1CT3 1200 Custom XL1200C 1CT3 Sportster 1200 Custom XL1200C ANV 1CT3 ANV Sportster 1200 Custom ANV XL1200CA 1LJ3 Sportster 1200 Custom Limited A XL1200CB 1LK3 1200 Custom Limited B XL1200CB 1LK3 Sportster 1200 Custom Limited A XL1200CB 1LK3 Sportster 1200 Custom Limited B XL1200CP 1LH3 Sportster 1200 Custom (H-D1) XL1200CX 1LM3 1200 Roadster XL1200CX 1LM3 Roadster XL1200L 1CWP/1CX3 Sportster 1200 Low XL1200N 1CZ3 Nightster XL1200R 1CLP/1CV3 Sportster 1200 Roadster XL1200R 1CV3 Sportster 1200R XL1200T 1LL3 SuperLow 1200T XL1200V 1LF3 Seventy-Two XL1200X 1LC3 Forty-Eight XL50 1CY3 50th ANV Sportster	18 ▲ 04-06 ▲ 17-18 ▲ 07-16 ▲ 13 ▲ 13-16 ▲ 17 ▲ 16 ▲ 13-15 ▲ 11-16 ▲ 18 ▲ 16-17 ▲ 06-11 ▲ 07-12 ▲ 04-08 ▲ 09 ▲ 14-18 ▲ 12-16 ▲ 10-18 ▲ 07 ▲
SRC7017 CT704SP ▲	HARLEY DAVIDSON® TOURING FLH ADKE Touring Electra Glide FLH ALKE Touring Electra Glide Shrine Shovelhead FLHS AKKE Touring Electra Glide Sport FLHT Electra Glide FLHT Electra Glide Classic FLT Classic Tour Glide Classic FLT Tour Glide	Early 84 ▲ Early 84 ▲ Early 84 ▲ Early 84 ▲ Early 84 ▲ Early 84 ▲ Early 84 ▲			
SRC7018 CT704SP ▲	HARLEY DAVIDSON® TOURING FLH ALKE Touring Electra Glide Shrine Shovelhead FLH Electra Glide FLHC ADKB/ADKC Touring Electra Glide Classic FLHC AGKB Touring Electra Glide Classic FLHC Electra Glide Classic FLHS AKKB/AKKC/AKKD Touring Electra Glide Sport FLHS Heritage, Electra Glide FLHT DCKD Touring Electra Glide Standard	83 ▲ 81-83 ▲ 81-82 ▲ 81 ▲ 81 ▲ 81-83 ▲ 81 ▲ 83 ▲			

CLUTCH BUYERS GUIDE

SRC CLUTCH KIT BUYERS GUIDE

Part No.	Make/Model	Year	Part No.	Make/Model	Year
SRC7021 CT701SP ▲	HARLEY DAVIDSON® SPORTSTER XL883 4CAM/4CN2 Sportster 883 XL883C 4CJM/4CP2 Sportster 883 Custom XL883L 4CMM Sportster XL883 Low XL883L 4CR2 Sportster 883 Low XL883L 4CR2 Sportster XL883 Low XL883L 4CR2 SuperLow XL883L 4CR2 SuperLow 883 XL883N 4LE2 Iron 883 XL883R 4CKM Sportster 883R XL883R 4CS2 883 Roadster XL883R 4CS2 Sportster 883R	04-09 ▲ 04-10 ▲ 05-06 ▲ 10-11 ▲ 07-09 ▲ 12-18 ▲ 16 ▲ 09-18 ▲ 05-06 ▲ 11-15 ▲ 07-10 ▲			
SRC7022 CT701SP ▲	HARLEY DAVIDSON® SPORTSTER XR1200 1LA6 Sportster 1200 XR1200 1LA6 XR1200 XR1200X 1LD6 XR1200X	08 ▲ 09-10 ▲ 10-13 ▲			
SRC7023 CT701SP ▲	HARLEY DAVIDSON® SPORTSTER XL1200 1CAP Sportster 1200 XL1200C 1CGP Sportster 1200 Custom XL1200S 1CHP Sportster 1200 Sport XL883 4CAM Sportster 883 XL883C 4CJM Sportster 883 Custom XL883DLX 4CFM Sportster 883 Deluxe XL883HUG 4CEM Sportster 883 Hugger XL883R 4CKM Sportster 883R	91-03 ▲ 96-03 ▲ 96-03 ▲ 91-03 ▲ 98-03 ▲ 91-95 ▲ 91-03 ▲ 02-03 ▲			
SRC7024 CT709SP ▲	HARLEY DAVIDSON® SPORTSTER XL1200 CAPL Sportster 1200 XL883 CAMG/CAMH Sportster 883 XL883 CAMG Sportster 883 Deluxe XL883 CAML Sportster 883 XL883DLX CFML Sportster 883 Deluxe XL883HUG CEMH Sportster 883 Hugger XL883HUG CEML Sportster 883 Hugger XLH CAHE Sportster 1000 XLH CAHF Sportster 1000 1985 XLH-1100 CANG/CANH Sportster 1100 XLH-1200 CAPJ/CAPK Sportster 1200 XLH883 CAMJ/CAMK Sportster 883 XLH883DLX CFMJ/CFMK Sportster 883 Deluxe XLH883HUG CEMJ/CEMK Sportster 883 Hugger XLS CBHE Sportster Roadster 1000 XLS CBHF Sportster Roadster 1000 XLX CCHE Sportster Roadster 1000 XLX CCHF Sportster Roadster 1000 XR-1000 CDHE Sportster	90 ▲ 86-87 ▲ 86 ▲ 90 ▲ 90 ▲ 87 ▲ 90 ▲ 84 ▲ Later 84 ▲ 86-87 ▲ 88-89 ▲ 88-89 ▲ 88-89 ▲ 88-89 ▲ 84 ▲ Later 84 ▲ 84 ▲ Later 84 ▲ 84 ▲			
SRC7025 CT709SP ▲	HARLEY DAVIDSON® SPORTSTER XLCH-1000 4AH1/4AH2/4AH3/4AH4/4AH5/4AH6/ 4AH7/4AH8/4AH9/4AJ0 Sportster 1000 XLH CAHB/CAHC/CAHD/CAHE Sportster 1000 XLH-1000 3AH1/3AH2/3AH3/3AH5/3AH6/3AH7 /3AH8/3AH9/3AJ0 Sportster Standard XLS CBHB/CBHC/CBHD/CBHE Sportster Roadster 1000 XLX CCHD/CCHE Sportster Roadster 1000 XR-1000 CDHD/CDHE Sportster	71-80 ▲ 81-Early 84 ▲ 71-78 ▲ 81-Early 84 ▲ 83-Early 84 ▲ 83-Early 84 ▲			

CLUTCH BUYERS GUIDE

SRK CLUTCH KIT BUYERS GUIDE

Part No.	Make/Model	Year	Part No.	Make/Model	Year
SRK2 CT031 ▲	HONDA VF 700 F Interceptor VF 750 F V45 Interceptor	84-85 ▲ 83-84 ▲	SRK20 CT016 ▲	KAWASAKI ZL 900 A1/A2 Eliminator KZ 1000 E1/E2 Shaft ZG 1000 A1-A20/A6F Concours ZL 1000 A1 ZX 1000 A1/A2 Ninja KZ 1100 A1/A2/A3 KZ 1100 D1/D2 Spectre ZX 1100 A1/A2 (GPz) ZR 1100 A1/A2/A3/A4 Zephyr (ZR 1100 C3/C4) ZRX 1100 ZG 1200 B5-B17 Voyager X11	85-86 ▲ 79-80 ▲ 86-06 ▲ 87 ▲ 86-87 ▲ 81-83 ▲ 82-83 ▲ 83-84 ▲ 92-95 ▲ 99-00 ▲ 91-03 ▲
SRK3 CT014 ▲	HONDA VFR 700 F/F2 Interceptor VF 750 C Magna/CD Magna Deluxe VFR 750 F Interceptor 750 VFR 750 F	86-87 ▲ 94-03 ▲ 86 ▲ 90-96 ▲	SRK22 CT016 ▲	KAWASAKI ER-6N (ER 650 C9F/CAF) ZX 600 D1/D2/D3/D4 (ZX6) EX 650 A6F/A7F/A8F/A9F/CAF/CBF EX 650 Ninja (Non ABS) (EX 650 ECF/EDS/EEF/EFF) EX 650 Ninja (ABS) (EX 650 FDS/FEF/FFF) KLE 650 A7F/A8F/A9F/CAF/CBF/CCF/CDF/DEF Versys	09-10 ▲ 90-93 ▲ 06-11 ▲ 12-15 ▲ 13-15 ▲ 07-14 ▲
SRK4 CT009 ▲	HONDA CB 1000 CBF 1000 F CBR 1000 F Hurricane	94-95 ▲ 90-96 ▲ 87-88 ▲	SRK24 CT016 ▲	KAWASAKI ZX 750 K1/K2 ZX 750 J1/J2 ZX 750 L1/L2/L3 (ZX-7) ZX 750 M1/M2 (ZX-7R) ZX 750 P1-P8 (ZX 7 R)	91-92 ▲ 91-92 ▲ 93-95 ▲ 93-94 ▲ 96-03 ▲
SRK5 CT014 ▲	HONDA VFR 750 R (RC 30)	90 ▲	SRK25 CT021 ▲	KAWASAKI ZX 1100 C1-C4/D1-D9 (ZX11) ZX 1100 E1/E2/E3/F1 GPZ 1100 ZZR 1200 (ZX 1200 C1-C4)	90-01 ▲ 95-97 ▲ 02-05 ▲
SRK6 CT010 ▲	YAMAHA FZR 400 U/W/SUC/SWC/A/SAC	88-90 ▲	SRK29 CT008SP ■	YAMAHA FZR 1000 E/EC/F/FC/G/GC YZF 1000 R (Rj)	93-95 ■ 97 ■
SRK7 CT010 ▲	YAMAHA FZR 600 W/WC/RA/AC/RAC/RB/RBC/RD/RDC /RE/REC/RF/RFC/RG/RGC/H/RHC/RJ/RJC/RK /RKC/RL/RLC	89-99 ▲	SRK31 CT008SP ■	YAMAHA FZR 1000 W/WC/A/AC/B/BC/D/DC	89-92 ■
SRK8 CT008SP ■	YAMAHA FZR 750 RT/RU FZR 1000 T/TC/U/UC Genesis	87-88 ■ 87-88 ■	SRK33 CT054SP ▲	YAMAHA YZF 600 RJ/RK/RL/RM/RN/RP/RR/RS/RT/RV/RW	95-07 ▲
SRK9 CT008SP ■	YAMAHA FZR 750 OW01 YZF 750 SP/RF/RFC/RG/RGC/RH/RHC	89-91 ■ 94-96 ■	SRK38 CT004 ▲	KAWASAKI ZX 6R (ZX 600 J1/J2/J3) ZZR 600 (ZX 600 J4) ZZR 600 J6F/J7F/J8F ZX6R (ZX 636 A1) ZX6R (ZX 636 B1/B2) 636cc Z 750 S (ZR 750 K1/K6F)	00-02 ▲ 05 ▲ 06-08 ▲ 02 ▲ 03-04 ▲ 05-06 ▲
SRK10 CT055SP ▲	SUZUKI GSX 1100 GM/GN/GP GSXR 1100 K/L/M/N	91-93 ▲ 89-92 ▲	SRK39 CT055SP ▲	SUZUKI RF 900 RR GSXR 1100 WR/WP/WS/WT/WV/WW	94 ▲ 93-98 ▲
SRK11 CT016 ▲	KAWASAKI EN 450 A1-A6 (454 LTD) EN 500 A1-A7/C1-C10/C6F/C7F/C8F/C9F EX 500 A1-A7/D1-D12/D6F/D7F/D8F/D9F KZ 550 A1/A2/A3/A4 KZ 550 C1/C2/C3/C4 (LTD) KZ 550 D1 (GPz) KZ 550 F1 Spectre KZ 550 F2 (LTD) KZ 550 H1/H2 (GPz) KZ 550 M1 (LTD) ZX 550 A1/A2/A3 (GPz) ZX 600 A1/A2/A3/B1 Ninja ZX 600 C1/C2 Ninja R	85-90 ▲ 90-09 ▲ 87-09 ▲ 80-83 ▲ 80-83 ▲ 81 ▲ 83 ▲ 84 ▲ 82-83 ▲ 83 ▲ 84-86 ▲ 85-87 ▲ 88-89 ▲	SRK40 CT055SP ▲	SUZUKI GSX-R 750 T/V/W/X GSF 1200 SV/SAV/SW/SX/SY/SK1-SK5	96-99 ▲ 97-05 ▲
SRK13 CT029 ▲	SUZUKI GSX 600 FJ/FK/FL/FM Katana GSX-R 750 G/H	88-91 ▲ 86-87 ▲	SRK41 CT016 ▲	KAWASAKI ZX 750 N1/N2 (ZX 7 RR) ZX-9R B1/B2/B3/B4 Ninja	96-99 ▲ 94-97 ▲
SRK14 CT036SP ▲	SUZUKI GSX-R 750 J/K	88-89 ▲	SRK42 CT009SP ■	HONDA CBR 600 F1	90 ■
SRK15 CT048SP ▲	SUZUKI GSXR 1100 G/H/J	86-88 ▲	SRK43 CT016 ▲	KAWASAKI ZX 600 E1-E13 (ZX6)	93-05 ▲
SRK16 CT009SP ▲	HONDA CBR 600 F Hurricane CBR 600 F1	87 ▲ 88-89 ▲	SRK44 CT016 ▲	KAWASAKI ZX 600 C3-C10 Ninja R	90-97 ▲
SRK17 CT036SP ▲	SUZUKI GSX 600 FN/FP/FR/FS/FT/FV Katana GSX R 600 WN/WP GSX-R 750 L/M/N	92-97 ▲ 92-93 ▲ 90-92 ▲	SRK45 CT036SP ▲	SUZUKI RF 600 RR/RS/RT	94-96 ▲
SRK19 CT014SP ●	HONDA 599 (CB 600 F) CBR 600 F2/F3/SJR/SE	04/06 ● 91-98 ●			

SRK CLUTCH KIT BUYERS GUIDE

Part No.	Make/Model	Year	Part No.	Make/Model	Year
SRK46 CT016 ▲	KAWASAKI W 650 (EJ650A1/A2/A3/A4) VN 700 A1 Vulcan KZ 750 G1 (LTD) KZ 750 M1 (CSR) VN 750 A2-A21/A6F Vulcan VN 800 A1-A11/B1-B10	00-02 ▲ 85 ▲ 80 ▲ 82 ▲ 86-06 ▲ 95-05 ▲	SRK65 CT017 ▲	YAMAHA YZF 1000 R1	99-03 ▲
SRK50 CT024SP ▲	SUZUKI GS 1000 SZ GS 1000 GT/GX GS 1000 GLT/GLX/SZ GS 1100 ET/EX/EZ GS 1100 GZ/GD/GLZ/GLD GS 1100 GKZ/GK2/GKD/GKE GS 1100 LT GS 1150 ES3/ESE/EFESF/EF2/EG/ESG	82 ▲ 80-81 ▲ 80-82 ▲ 80-82 ▲ 82-83 ▲ 82-84 ▲ 80 ▲ 83-86 ▲	SRK66 CT014 ★	HONDA CBR 600 F4	99-00 ★
SRK51 CT008SP ■	YAMAHA FZ6 (All models) YZF 600 RL/RR/L/RM/RMC/RN/RNC/P/PC R6 FZX 700 S/SC/T/TC FZ 750 N FZ 750 S/SC TDM 850 D/DC/E/EC	04-09 ■ 99-02 ■ 86-87 ■ 85 ■ 86 ■ 92-93 ■	SRK67 CT021 ▲	SUZUKI GSX 1300 RX Hayabusa	99 ▲
SRK52 CT016 ▲	KAWASAKI KZ 1100 B1/B2 (GPz) KZ 1100 L1 (LTD) ZN 1100 B1/B2 (LTD)	81-82 ▲ 83 ▲ 84-85 ▲	SRK68 CT009 ▲	SUZUKI TL 1000 RW/RX/RV TL 1000 SX/SY	98-00 ▲ 99-00 ▲
SRK53 CT016 ▲	KAWASAKI ZX 750 F1/F2/F3/F4 Ninja VN 800 Drifter C1/C2/E1-E5/E6F VN 900 Vulcan Classic LT (D6F/D7F/D8F/D9F /DAF/DBF/DCF/DDF/DEF/DFE) VN 900 B6F/B7F/B8F/B9F/BAF/BBF/BCF/BDFA /BEF/BEFA/BFF Vulcan Classic VN 900 C7F/C8F/C9F/CAF/CBF/CCF/CDF/CEFA/CFE ZX 900 A1/A2/A3 Ninja	87-90 ▲ 99-06 ▲ 06-15 ▲ 06-15 ▲ 07-15 ▲ 84-86 ▲	SRK70 CT056SP ■	HONDA ST 1100/1100 A	91-01 ■
SRK54 CT016 ▲	KAWASAKI KZ 1000 J1/J2/J3 KZ 1000 K1/K2 (LTD) KZ 1000 M1/M2 (CSR) KZ 1000 P1-P22/P24 Police KZ 1000 R1/R2 Replica	81-83 ▲ 81-82 ▲ 81-82 ▲ 82-03/05 ▲ 82-83 ▲	SRK71 CT014 ▲	SUZUKI GSXR 750 Y	00- ▲
SRK55 CT014 ▲	HONDA CBR 900 RR	96-97 ▲	SRK72 CT008 ▲	YAMAHA SRX 600 S/SC	86 ▲
SRK56 CT017 ▲	YAMAHA YZF 1000 R1	98 ▲	SRK74 CT008SP ■	YAMAHA YZF-R6 RRR/RRS/T/TC YZF-R6S (SV/SW/SX/SY)	03-05 ■ 06-09 ■
SRK57 CT014 ▲	HONDA CBR 900 RR 919 (CB 900 F)	98-99 ▲ 02-07 ▲	SRK75 CT014 ▲	HONDA CBR 600 RR CBR 600 RA/R	03-14 ▲ 09-14 ▲
SRK58 CT055SP ▲	SUZUKI GSX R 600 X/Y	99-00 ▲	SRK76 CT004 ▲	KAWASAKI ZX6RR (ZX 600 K1) 599cc	03 ▲
SRK59 CT004 ▲	KAWASAKI ZX 9R (ZX 900 C1/C2)	98-99 ▲	SRK77 CT020 ▲	YAMAHA (FZ1) FZS 1000 V/W/X/Y/Z/A/B/D/E YZF R1 (5VY)	06-14 ▲ 04-06 ▲
SRK60 CT009 ▲	HONDA VTR 1000 F Superhawk	98-05 ▲	SRK78 CT014 ▲	SUZUKI GSXR 600 K4/K5	04-05 ▲
SRK62 CT013SP ▲	HONDA CTX 700 N (Naked/Manual G/box) CTX 700 (Top Fairing/Manual G/box) NC 700 X (2 Piston Caliper) NT 700 V/VA	14 ▲ 14 ■ 12-14 ▲ 10-13 ▲	SRK79 CT004 ▲	KAWASAKI ZX-10R (ZX 1000 C1/C2)	04-05 ▲
SRK64 CT013SP ▲	HONDA NT 650 Hawk GT	88-90 ▲	SRK80 CT009SP ■	HONDA CBR 1000 RR	04-07 ■
			SRK81 CT022 ▲	SUZUKI SV 650 X/Y/K1/SK1/SK2/K2	99-02 ▲
			SRK82 CT033SP ▲	SUZUKI SFK 650 K9/L3/L4/L5 SV 650 K3/SK3/K4/SK4/K5/SK5/K6/SK6 /K7/SK7/SK8/K8/SK9/SLO SV 650 AK7/AK8 SV 650 SAK7/SAK8/SAK9/SALO ABS	09-10/13-15 ▲ 03-10 ▲ 07-08 ▲ 07-10 ▲
			SRK83 CT004 ▲	KAWASAKI ZX6RR (ZX 600 M1)	04 ▲
			SRK84 CT004 ▲	KAWASAKI ZX6R (ZX 636 C1/C6F 636cc)	05-06 ▲
			SRK85 CT015 ▲	SUZUKI GSXR 1000 K5/K6/K7/K8 GSX-S 1000F L (Non ABS) GSX-S 1000F AL (ABS)	05-08 ▲ 18 ▲ 18 ▲
			SRK86 CT015 ▲	SUZUKI GSXR 600 K6/K7	06-07 ▲
			SRK87 CT008SP ■	YAMAHA YZF-R6 V/W/X/Z/A/B/D/E/F/G	06-16 ■
			SRK88 CT015 ▲	SUZUKI GSXR 600 K8/K9 GSXR 750 K6/K7/K8/K9/L0	08-10 ▲ 06-10 ▲

SRK CLUTCH KIT BUYERS GUIDE

Part No.	Make/Model	Year	Part No.	Make/Model	Year	
SRK89 CT004 ▲	KAWASAKI ZX-9R (ZX 900 E1/E2/F1/F2) Z 1000 (ZR 1000 A1/A2/A3) Z 1000 (ZR 1000 A6F) SUZUKI GSXR 1000 K1/K2/K3/K4/ZK4	00-03 ▲	SRK119 CT012SP ▲	HONDA CBR 125 RW7/RW8/RW9/RWA/RWB/RC/RD (No judder spring)	07-13 ▲	
		03-05 ▲	SRK121 CT014 ▲		SUZUKI GSX-R 750 K4/K5	04-05 ▲
SRK93 CT020 ▲	YAMAHA YZF R1 LE YZF-R1 (6 piston caliper)	06 ▲	SRK122 CT084SP ▲	HONDA MSX 125 D/E/F/G/H Grom (Non ABS) MSX 125 AH Grom (ABS)	14-18 ▲	
		07-08 ▲				18 ▲
SRK94 CT014 ▲	HONDA CBR 900 RR	93-95 ▲	SRK128 CT080 ▲	YAMAHA YZ-F R3 (321cc)	15-16 ▲	
SRK95 CT043SP ▲	HONDA CBR 1000 RR CBR 1000 RRA	08-12 ▲ 09-12 ▲	SRK129 CT079SP ●	YAMAHA FZ-10 YZF-R1 YZF-R1M YZF-R1S	17 ●	
SRK96 CT020 ▲	YAMAHA YZF-R1 (6 piston caliper)	09-14 ▲				15-16 ●
SRK97 CT009 ▲	SUZUKI GSXR 1000 K9/L1	09-11 ▲	SRK130 CT085 ▲	BMW F650 GS (Late type plates 2 x 13mm /7 x 14mm ears) F700 GS (Late type plates 2 x 13mm /7 x 14mm ears) F800 GS (Late type plates 2 x 13mm /7 x 14mm ears) F800 GS Adventure (Late type plates 2 x 13mm /7 x 14mm ears) F800 GT (Late type plates 2 x 13mm /7 x 14mm ears) F800 S (Late type plates 2 x 13mm /7 x 14mm ears) F800 ST (Late type plates 2 x 13mm /7 x 14mm ears) F800 R (Late type plates 2 x 13mm /7 x 14mm ears)	07-17 ▲	
SRK98 CT021 ▲	KTM 1190 RC8 R (6 spring type clutch) 1190 RC8 (6 spring type clutch)	09-12 ▲ 08-12 ▲				11-17 ▲
SRK100 CT014 ▲	HONDA CBR 929 RR (929cc model) CBR 954 RR	00-01 ▲ 02-03 ▲				12-17 ▲
SRK101 CT004 ▲	KAWASAKI ZX 6R (ZX 600 P7F/P8F/P9F/R9F/RAF/RBF/RCF)	07-12 ▲				07-17 ▲
SRK102 CT016 ▲	KAWASAKI EX 650 A6F/A7F/A8F Ninja 650 R)	06-08 ▲				07-17 ▲
SRK103 CT009 ▲	HONDA VFR 1200 F	10-14 ▲				07-17 ▲
SRK104 CT036SP ▲	SUZUKI GSX R 600 WN/WP GSX-R 750 WP/WR/WS	92-93 ▲ 93-95 ▲	SRK131 CT017 ▲	YAMAHA XT 1200 Z Super Tenere FJR 1300 R/RC/S/AS/T/AT FJR 1300 A FJR 1300 AEV/AEW/AEX/AEY (Electric Gear shift Model) XVS 1300 V-Star XVS 1300 V-Star De Luxe XVS 1300 V-Star Tourer XVS 1300 Stryker	12-13 ▲	
SRK106 CT055SP ▲	SUZUKI GSXR 600 V/W	97-98 ▲				03-05 ▲
SRK107 CT004 ▲	KAWASAKI ZX6RR (ZX 600 N1/N6F 599cc)	05-06 ▲				06-15 ▲
SRK108 CT004 ▲	KAWASAKI ZX 6R (ZX 600 F1/F2/F3/G1/G2)	95-99 ▲				06-09 ▲
SRK110 CT015 ▲	SUZUKI GSXR 600 L1/L2/L3/L4/L5/L6 GSXR 750 L1/L2/L3/L4/L5/L6	11-16 ▲ 11-16 ▲				07-14 ▲
SRK111 CT014 ▲	SUZUKI GSXR 750 K1/K2/K3	01-03 ▲				13-14 ▲
SRK112 CT014 ▲	SUZUKI GSXR6 600 K1/K2/K3/ZK3	01-03 ▲	SRK138 CT072SP ▲	SUZUKI GSX-R 750 RG (Dry Clutch - Sintered Friction)	86 ▲	
SRK113 CT014 ▲	APRILIA RSV4R APRC RSV4 Factory	10-12 ▲ 09-12 ▲	SRK141 CT014SP ▲	BENELLI TNT 600 i Tornado	16-17 ▲	
SRK115 CT035SP ▲	SUZUKI GS 1000 C/N/EC/EN/SN/ET/ST	78-80 ▲	SRK142 CT009 ▲	SUZUKI GSX-R 1000 AL7 ABS (3 Spring clutch)	17 ▲	
SRK118 CT009 ▲	KAWASAKI EX 300 ADF/BDF/ADF/AEF/AEFA/AES/AESA /BDF/BEF/BEFA (Ninja)	13-14 ▲	SRK143 CT014 ▲	SUZUKI CBR 600 F4i Sport Injection Model)	01-06 ▲	
			SRK144 CT085 ▲	BMW F800 GT (Early type plates 14mm ears) F800 S (Early type plates 14mm ears) F800 ST (Early type plates 14mm ears)	04-06 ▲ 04-06 ▲ 04-06 ▲	
			SRK145 CT083 ▲	BMW G 650 GS (R13) G 650 GS Sertao (R13) G 650 X Country (K15)	08-16 ▲ 10-14 ▲ 08-10 ▲	

SRK CLUTCH KIT BUYERS GUIDE

Part No.	Make/Model	Year	Part No.	Make/Model	Year
SRK7003 CT702SP ▲	HARLEY DAVIDSON® TRIKE FLHTCUTG 1MAL Tri Glide Ultra Classic FLRT 1MCM Freewheeler TOURING FLHTCUL 1KDM Ultra Classic Low FLHTCUL TC 1KFL Ultra Classic Low Twin-Cooled FLHTK 103 1TEL CVO Limited FLHTKL 1KKL Ultra Limited Low SOFTAIL FLSS 1JS9 Slim S FLSS 1JS9 Softail Slim S FLSTFBS 1JT9 Fat Boy S	14-16 ▲	SRK7010 Contd. CT702SP ▲	HARLEY DAVIDSON® TOURING FLHX 1KBC Street Glide FLHX 1KXC Street Glide Anniversary FLHXS 1KRC Street Glide Special FLHXS 1KYC Street Glide Special Anniversary FLTRU 1KGD Road Glide Ultra FLTRX 1KHC Road Glide FLTRXS 1KTC Road Glide Special	17-18 ▲
		15-16 ▲			18 ▲
SRK7006 CT706SP ▲	HARLEY DAVIDSON® VRSC VRSCAW 1HFH V-Rod VRSCAW 1HFH V-Rod Wide Tire VRSCAWA 1HKH W/ABS VRSCD 1HDH Night Rod VRSCDA 1HLH Night Rod W/ABS VRSCDX 1HHH Night Rod Special VRSCDX ANV 1HHH_ANV Night Rod Special Anv VRSCDXA 1HMH Night Rod Special W/ABS VRSCF 1HPH V-Rod Muscle	09-10 ▲	SRK7011 CT703SP ▲	HARLEY DAVIDSON® TOURING FLHR 1FBM Road King FLHR 1FDL/1FDV Road King FLHRC 1FRM Road King Classic FLHRCI 1FRW Road King Classic FLHRI 1FBW Road King FLHT 1DDL Electra Glide Standard FLHTC 1DJL/1DJV Electra Glide Classic FLHTCI 1FFR/1FFW Electra Glide Classic FLHTCU 1FCM Ultra Classic FLHTCU TC 1KSL Ultra Classic Twin-Cooled FLHTCUI 1FCR/1FCW Ultra Classic FLHTI 1FWW Electra Glide Standard FLHTK 1KEL Ultra Limited FLHX 1KBM Street Glide FLHXS 1KRM Street Glide Special FLTR 1FPL/1FPV Road Glide FLTRI 1FSR/1FSW Road Glide FLTRU 1KGL Road Glide Ultra FLTRX 1KHM Road Glide FLTRXS 1KTM Road Glide Special DYNA FXD 1GHL Dyna Super Glide FXDL 1GDL Dyna Low Rider FXDS-CONV GGVX/GGVY Dyna Glide Convertible FXDWG 1GEL/1GEV Dyna Wide Glide FXDX 1GJV Dyna Super Glide Sport FXDXT 1GLV Dyna Super Glide T-Sport SOFTAIL FLSTC 1BJL Heritage Softail Classic FLSTCI 1BWB Heritage Softail Classic FLSTF 1BML Fat Boy FLSTFI 1BXX Fat Boy FLSTS 1BRL/1BRY Heritage Springer FLSTSI 1BYB Heritage Springer FXST 1BHL/1BHY Softail Standard FXSTB 1BTL/1BTY Night Train FXSTBI 1JAB Night Train FXSTC 1BKL Softail Custom FXSTD 1BSY Softail Deuce FXSTDI 1JBB Softail Deuce FXSTI 1BVB Softail Standard FXSTS 1BLL/1BLY Springer Softail FXSTSI 1BZB Springer Softail	15-16 ▲
		08 ▲			98-03 ▲
SRK7007 CT707SP ▲	HARLEY DAVIDSON® VRSC VRSCA 1HAZ V-Rod VRSCAW 1HFZ V-Rod VRSCB 1HBZ V-Rod VRSCR 1HCZ Street Rod VRSCSE 1PMG CVO V-Rod VRSCSE2 1PPG CVO V-Rod VRSCX 1HJG Screamin' Eagle V-Rod VRXSE 7RC7 CVO VR Destroyer	02-06 ▲	SRK7012 CT703SP ▲	HARLEY DAVIDSON® TOURING FLHR 103 1FBM Road King FLHR 1FBM Road King FLHR 1FDV Road King FLHR ANV 1FBM_ANV Road King ANV FLHRC 103 1FRM Road King Classic FLHRC 1FRM Road King Classic FLHRCI 1FRW Road King Classic FLHRI 1FBW Road King FLHRS 1FXV Road King Custom FLHRSI 1FYW Road King Custom FLHT 1DDV Electra Glide Standard FLHTC 103 1FFM Electra Glide Classic FLHTC 1DJV Electra Glide Classic FLHTC 1FFM Electra Glide Classic FLHTCI 1FCW Ultra Classic FLHTCI 1FFW Electra Glide Classic FLHTCU 103 1FCM Ultra Classic FLHTCU 1FCM Ultra Classic	00-03 ▲
		07 ▲			11 ▲
SRK7008 CT708SP ▲	HARLEY DAVIDSON® TRIKE FLHTCUTG 1MAD Tri Glide Ultra FLHTCUTG 1MDD Tri Glide Ultra Anniversary FLRT 1MCC Freewheeler POLICE FLHP 1FHC Road King Police FLHTP 1FMC Electra Glide Standard Police SOFTAIL FLFBS 1YBK Fat Boy 114 FLFBS 1YRK/1YSK Fat Boy 114 Anniversary FLHCS 1YBK Heritage Classic 114 FLHCS 1YPK Heritage Classic 114 Anniversary FXBRS 1YHK Breakout 114 FXBRS 1YTK Breakout 114 Anniversary FXFBS 1YLK Fat Bob 114	04-05 ▲	SRK7010 CT702SP ▲	HARLEY DAVIDSON® TOURING FLHR 1FBC Road King FLHRC 1FRC Road King Classic FLHRXS 1KVC Road King Special FLHTCU 1FCC Electra Glide Ultra Classic FLHTK 1KED Ultra Limited FLHTK 1KND Ultra Limited Shrine Edition FLHTK 1KWD Ultra Limited Anniversary FLHTKL 1KKD Ultra Limited Low	17-18 ▲
		06-07 ▲			17-18 ▲
SRK7009 CT703SP ▲	HARLEY DAVIDSON® TRIKE FLHTCUTG 1MAM Tri Glide Ultra Classic FLHTCUTG ANV 1MAM_ANV Tri Glide Ultra Classic Anv FLHXXX 1MBM Street Glide Trike POLICE FLHP 1FHM Road King Police FLHPE 1FTM Road King Police FLHTP 1FMM Electra Glide Standard Police DYNA FXDLS 1GS8 Dyna Low Rider S	06 ▲	SRK7010 CT702SP ▲	HARLEY DAVIDSON® TOURING FLHR 1FBC Road King FLHRC 1FRC Road King Classic FLHRXS 1KVC Road King Special FLHTCU 1FCC Electra Glide Ultra Classic FLHTK 1KED Ultra Limited FLHTK 1KND Ultra Limited Shrine Edition FLHTK 1KWD Ultra Limited Anniversary FLHTKL 1KKD Ultra Limited Low	17-18 ▲
		07 ▲			17-18 ▲
SRK7010 CT702SP ▲	HARLEY DAVIDSON® TRIKE FLHTCUTG 1MAM Tri Glide Ultra Classic FLHTCUTG ANV 1MAM_ANV Tri Glide Ultra Classic Anv FLHXXX 1MBM Street Glide Trike POLICE FLHP 1FHM Road King Police FLHPE 1FTM Road King Police FLHTP 1FMM Electra Glide Standard Police DYNA FXDLS 1GS8 Dyna Low Rider S	16-17 ▲	SRK7010 CT702SP ▲	HARLEY DAVIDSON® TOURING FLHR 1FBC Road King FLHRC 1FRC Road King Classic FLHRXS 1KVC Road King Special FLHTCU 1FCC Electra Glide Ultra Classic FLHTK 1KED Ultra Limited FLHTK 1KND Ultra Limited Shrine Edition FLHTK 1KWD Ultra Limited Anniversary FLHTKL 1KKD Ultra Limited Low	17-18 ▲
		16-17 ▲			17-18 ▲

CLUTCH
BUYERS GUIDE

SRK CLUTCH KIT BUYERS GUIDE

Part No.	Make/Model	Year	Part No.	Make/Model	Year
SRK7012 Contd. CT703SP ▲	HARLEY DAVIDSON®		SRK7013 CT703SP ▲	HARLEY DAVIDSON®	
	TOURING			TOURING	
	FLHTCUI 1FCW Ultra Classic	04 ▲		FLHR 1FB4 Road King	07-11 ▲
	FLHTI 1FVW Electra Glide Standard	04-05 ▲		FLHR 1FDV Road King	06 ▲
	FLHTK 1KEM Electra Glide Ultra Limited	10-13 ▲		FLHR 96 FB4 Road King	11 ▲
	FLHTK ANV 1KEM_ANV Electra Glide Ultra Limited ANV	13 ▲		FLHRC 1FR4 Road King Classic	07-11 ▲
	FLHX 103 1KBM Street Glide	11 ▲		FLHRCI 1FRW Road King Classic	06 ▲
	FLHX 1KBM Street Glide	12-13 ▲		FLHRI 1FBW Road King	06 ▲
	FLTRI 1FSW Road Glide	04-05 ▲		FLHRS 1FXV/1FY4 Road King Custom	06-07 ▲
	FLTRU 1KGM Road Glide Ultra	11-13 ▲		FLHRSI 1FYW Road King Custom	06 ▲
	FLTRX 103 1KHM Road Glide Custom	11 ▲		FLHT 1DDV/1FV4 Electra Glide Standard	06-10 ▲
	FLTRX 1KHM Road Glide Custom	12-13 ▲		FLHTC 1FF4 Electra Glide Classic	07-11 ▲
	DYNA			FLHTCI 1FFW Electra Glide Classic	06 ▲
	FLD 103 1GZM Dyna Switchback	12-16 ▲		FLHTCU 1FC4 Ultra Classic	07-11 ▲
	FLD 1GZ4 Dyna Switchback	13 ▲		FLHTCUI 1FCW Ultra Classic	06 ▲
	FXD 1GHV Dyna Super Glide	04-05 ▲		FLHTI 1FVW Electra Glide Standard	06 ▲
	FXDB 103 1GXM Dyna Street Bob	14-16 ▲		FLHX 1KAV/1KB4 Street Glide	06-11 ▲
	FXDB 103 1GXM Dyna Street Bob 103	17 ▲		FLHXI 1KBW Street Glide	06 ▲
	FXDBB 103 1VBM/1VCM Dyna Street Bob (H-D1)	13-15 ▲		FLTR 1FS4 Road Glide	07-09 ▲
	FXDBC 103 1VDM Dyna Street Bob Limited	16 ▲		FLTRI 1FSW Road Glide	06 ▲
	FXDBP 103 1VAM Dyna Street Bob	16 ▲		FLTRX 1KH4 Road Glide Custom	10-11 ▲
	FXDBP 103 1VAM Dyna Street Bob (H-D1)	13-15 ▲		DYNA	
	FXDC 103 1GVM Dyna Super Glide Custom	14 ▲		FLD 1GZ4 Dyna Switchback	12/14-16 ▲
	FXDC 1GTV Dyna Super Glide Custom	05 ▲		FXD 1GM4 Dyna Super Glide	07-10 ▲
	FXDCI 1GVW Dyna Super Glide Custom	05 ▲		FXD35 1GW1 Dyna 35th Anniversary Super Glide	06 ▲
	FXDF 103 1GYM Dyna Fat Bob	12-16 ▲		FXDB 1GX4 Dyna Street Bob	07-17 ▲
	FXDF 103 1GYM Dyna Fat Bob 103	17 ▲		FXDBA 1VB4 Dyna Street Bob (H-D1)	13 ▲
	FXDI 1GMW Dyna Super Glide	04-05 ▲		FXDBB 1VC4 Dyna Street Bob (H-D1)	15 ▲
	FXDL 103 1GNM Dyna Low Rider	14-16 ▲		FXDBC 1VD4 Dyna Street Bob Limited	16 ▲
	FXDL 103 1GNM Low Rider 103	17 ▲		FXDBI 1GX1 Dyna Street Bob	06 ▲
	FXDL 1GDV Dyna Low Rider	04-05 ▲		FXDC 1GV4 Dyna Super Glide Custom	07-14 ▲
	FXDLI 1GNW Dyna Low Rider	04-05 ▲		FXDC ANV 1GV4_ANV Dyna Super Glide Custom ANV	13 ▲
	FXDWG 103 1GPM Dyna Wide Glide	12-15 ▲		FXDCI 1GV1 Dyna Super Glide Custom	06 ▲
	FXDWG 103 1GPM Dyna Wide Glide 103	17 ▲		FXDF 1GY4 Dyna Fat Bob	08-16 ▲
	FXDWG 1GEV Dyna Wide Glide	04-05 ▲		FXDI 1GM1 Dyna Super Glide	06 ▲
	FXDWGI 1GPW Dyna Wide Glide	04-05 ▲		FXDL 1GN4 Dyna Low Rider	07-17 ▲
	FXDX 1GJV Dyna Super Glide Sport	04-05 ▲		FXDLI 1GN1 Dyna Low Rider	06 ▲
	FXDXI 1GRW Dyna Super Glide Sport	04-05 ▲		FXDWG 1GP4 Dyna Wide Glide	07-16 ▲
	SOFTAIL			FXDWG ANV 1GP4 Dyna Wide Glide 105th Anniversary	08 ▲
	FLS 103 1JRV Softail Slim	12-15 ▲		FXDWGI 1GP1 Dyna Wide Glide	06 ▲
	FLS 1JRV Softail Slim	16-17 ▲		SOFTAIL	
	FLSTC 103 1BWV Heritage Softail Classic	13-15 ▲		FLS 1JR5 Softail Slim	12-15 ▲
	FLSTC 103 ANV 1BWV_ANV Heritage Softail Classic ANV	13 ▲		FLST 1JE5 Heritage Softail	09-10 ▲
	FLSTC 1BJY Heritage Softail Classic	04-05 ▲		FLST 1JEY Heritage Softail	06 ▲
	FLSTC 1BWV Heritage Softail Classic	16-17 ▲		FLSTC 103 1BWV Heritage Softail Classic	12 ▲
	FLSTCI 1BWB Heritage Softail Classic	04-05 ▲		FLSTC 1BJY/1BW5 Heritage Softail Classic	06-09/11-15 ▲
	FLSTCI Shrine 1JHB Heritage Softail Classic Shrine	05 ▲		FLSTC ANV 1BW5_ANV Heritage Softail Classic ANV	13 ▲
	FLSTF 103 1BXV Fat Boy	12-15 ▲		FLSTCI 1BWB Heritage Softail Classic	06 ▲
	FLSTF 1BMY/1BXV Fat Boy	04-17 ▲		FLSTF 1BMY/1BX5 Fat Boy	06-15 ▲
	FLSTFB 103 1JNV Fat Boy LO	12-15 ▲		FLSTFB 1JN5 Fat Boy LO	10-11/13-15 ▲
	FLSTFB 103 ANV 1JNV_ANV Fat Boy LO ANV	13 ▲		FLSTFB ANV 1JN5_ANV Fat Boy LO ANV	13 ▲
	FLSTFB 1JN5 Fat Boy LO	12 ▲		FLSTFI 1BVB Fat Boy	06 ▲
	FLSTFB 1JNV Fat Boy LO	16-17 ▲		FLSTI 1JFB Heritage Softail	06 ▲
	FLSTFI 1BVB Fat Boy	04-05 ▲		FLSTN 1BNY Softail Deluxe	06 ▲
	FLSTFI Shrine 1JGB Fat Boy Shrine	05 ▲		FLSTN 1JD5 Softail Deluxe	07-15 ▲
	FLSTN 103 1JDV Softail Deluxe	12-15 ▲		FLSTNI 1JDB Softail Deluxe	06 ▲
	FLSTN 1BNY Softail Deluxe	05 ▲		FLSTSB 1JM5 Cross Bones	08-11 ▲
FLSTN 1JDV Deluxe	17 ▲	FLSTSC 1BRY/1BY5 Springer Classic	06-07 ▲		
FLSTN 1JDV Softail Deluxe	16 ▲	FLSTSCI 1BYB Springer Classic	06 ▲		
FLSTNI 1JDB Softail Deluxe	05 ▲	FXCW 1JJ5 Rocker	08-09 ▲		
FLSTSC 1BRY Springer Classic	05 ▲	FXCWC 1JK5 Rocker C	08-11 ▲		
FLSTSCI 1BYB Springer Classic	05 ▲	FXS 1JP5 Blackline	11/13 ▲		
FXS 103 1JPV Blackline	12-13 ▲	FXSB 1BF5 Softail Breakout	13-15 ▲		
FXS 1JP5 Blackline	12 ▲	FXST 1BHY/1BV5 Softail Standard	06-11 ▲		
FXSB 103 1BFV Softail Breakout	13-15 ▲	FXSTB 1BTY/1JA5 Night Train	06-09 ▲		
FXSB 1BFV Breakout	17 ▲	FXSTBI 1JAB Night Train	06 ▲		
FXSB 1BFV Softail Breakout	16 ▲	FXSTC 1JL5 Softail Custom	07-10 ▲		
FXST 1BHY Softail Standard	04-05 ▲	FXSTD 1BSY/1JB5 Softail Deuce	06-07 ▲		
FXST 1BV Softail Standard	12-15 ▲	FXSTDI 1JBB Softail Deuce	06 ▲		
FXSTB 1BTY Night Train	04-05 ▲	FXSTI 1BVB Softail Standard	06 ▲		
FXSTBI 1JAB Night Train	04-05 ▲	FXSTS 1BLY Springer Softail	06 ▲		
FXSTD 1BSY Softail Deuce	04-05 ▲	FXSTSI 1BZB Springer Softail	06 ▲		
FXSTDI 1JBB Softail Deuce	04-05 ▲				
FXSTI 1BVB Softail Standard	04-05 ▲				
FXSTS 1BLY Springer Softail	04-05 ▲				
FXSTSI 1BZB Springer Softail	04-05 ▲				

SRK CLUTCH KIT BUYERS GUIDE

Part No.	Make/Model	Year	Part No.	Make/Model	Year
SRK7014 CT701SP ▲	HARLEY DAVIDSON® TOURING FLHR 1FDL Road King FLHR FD93 Road King FLHRI 1FBR Road King FLHS 1FAL Electra Glide Sport FLHT 1DDL Electra Glide Standard FLHTC 1DJL Electra Glide Classic FLHTCI 1FFR Electra Glide Classic FLHTCU 1DPL Ultra Classic FLHTCUI 1FCR Ultra Classic FLTC 1DBL Tour Glide Classic FLTCU 1DML Tour Glide Ultra Classic FLTCUI 1FER Tour Glide Ultra Classic	94-97 ▲ 93 ▲ 96-97 ▲ 91-94 ▲ 95-97 ▲ 91-97 ▲ 96-97 ▲ 91-97 ▲ 95-97 ▲ 91-92 ▲ 91-95 ▲ 96 ▲	SRK7018 Contd. CT704SP ▲	HARLEY DAVIDSON® TOURING FLHT Electra Glide FLHT Electra Glide Classic FLHTC ADKD/DDKD/DJLE Touring Electra Glide Classic FLT AEKD Touring Tour Glide FLT Classic Tour Glide Classic FLT DAKC Touring Tour Glide FLT Tour Glide FLTC 5G05/AFKB/DBKC Touring Tour Glide Classic FLTC DBLE Touring Tour Glide Classic FLTC Tour Glide Classic SOFTAIL FXB BDKB/BDKC Super Glide B80 FXDG BGKD Dyna Glide Glide Custom FXE BAKB/BAKC/BAKD/BAKE FX Super Glide FXEF BBKB FX Super Glide Fat Bob FXS BCKB/BCKC FX Super Glide FXSB BFKD/BFKE FX Low Rider FXST BHLE Softail Standard FXWG BEKB/BEKC/BEKD/BEKE FX Wide Glide	83 ▲ 83 ▲ 83-Early 84 ▲ 81 ▲ 82-83 ▲ 82-83 ▲ 81/83 ▲ 80-82 ▲ Early 84 ▲ 81 ▲ 81-82 ▲ 83 ▲ 81-Early 84 ▲ 81 ▲ 81-82 ▲ 83-Early 84 ▲ Early 84 ▲ 81-Early 84 ▲
SRK7015 CT701SP ▲	HARLEY DAVIDSON® TOURING FLHS FALL Touring Electra Glide Sport FLHTC DJLL Touring Electra Glide Classic FLHTCU DPLL Touring Electra Glide Classic Ultra FLTC DBLL Touring Tour Glide Classic FLTCU DMLL Touring Tour Glide Classic Ultra	90 ▲ 90 ▲ 90 ▲ 90 ▲ 90 ▲	SRK7019 CT701SP ▲	HARLEY DAVIDSON® DYNA FXD 1GHL Dyna Super Glide FXDB 1GBL Dyna Sturgis FXDB 1GAL Dyna Daytona FXDC 1GCL Super Glide Custom FXDL 1GDL Dyna Low Rider FXDS-CONV GGLP Dyna Glide Convertible FXDWG 1GEL Dyna Wide Glide SOFTAIL FLST BJLL Softail Heritage FLSTC 1BJL Heritage Softail Classic FLSTC BJ04 Softail Heritage Classic FLSTF 1BML Fat Boy FLSTF BMLL Softail Fat Boy FLSTN 1BNL Heritage Softail Nostalgia FLSTS 1BRL Heritage Springer FXST BHLL Softail Standard FXSTC 1BKL Softail Custom FXSTC BKLL Softail Custom FXSTS 1BLL Springer Softail FXSTS BLLL Softail Springer FXSTSB 1BPL Springer Softail	95-97 ▲ 91 ▲ 92 ▲ 92 ▲ 93-97 ▲ 93 ▲ 93-97 ▲ 90 ▲ 91-97 ▲ 90 ▲ 91-97 ▲ 90 ▲ 91-97 ▲ 93-96 ▲ 97 ▲ 90 ▲ 91-97 ▲ 90 ▲ 91-97 ▲ 90 ▲ 91-97 ▲ 90 ▲ 91-97 ▲ 90 ▲ 95-97 ▲
SRK7016 CT705SP ▲	HARLEY DAVIDSON® TOURING FLH ADKE Touring Electra Glide FLH ALKE Touring Electra Glide Shrine Shovelhead FLHS AKKE Touring Electra Glide Sport FLHS FALH/FALJ/FALK Touring Electra Glide Sport FLHT DDLJ Touring Electra Glide Standard FLHT Electra Glide FLHT Electra Glide Classic FLHTC DDLG/DDLH/DJJD Touring Electra Glide Classic FLHTC DJLE/DJLF/DJLG/DJLH Touring Electra Glide Classic FLHTC DJLK Touring Electra Glide Classic FLHTCU DPLK Touring Electra Glide Classic Ultra FLT Classic Tour Glide Classic FLT Tour Glide FLTC DBLJ/DBLK Touring Tour Glide Classic FLTC DBLE Touring Tour Glide Classic FLTC DBLF/DBLG/DBLH/DBLK Touring Tour Glide Classic FLTCU DMLK Touring Tour Glide Classic Ultra SOFTAIL FLST BJLG/BJLH/BJLJ/BJLK Softail Heritage FLSTC BJ01/BJ02/BJ03 Softail Heritage Classic FXE BAKE FX Super Glide FXEF BBLF FX Super Glide Fat Bob FXSB BFKE/BFLF FX Low Rider FXST BHLE/BHLF/BHLG/BHLH/BHLJ/BHLK Softail Standard FXSTC BKLK/BKLH/BKLJ/BKLL Softail Custom FXSTS BLLJ/BLLK Softail Springer FXWG BEKE/BELF/BELG FX Wide Glide	Later 84 ▲ Later 84 ▲ Later 84 ▲ 87-89 ▲ 88 ▲ Later 84 ▲ Later 84 ▲ 86-88 ▲ Later 84-87 ▲ 89 ▲ 89 ▲ Later 84 ▲ Later 84 ▲ 88-89 ▲ Later 84 ▲ 85-87/89 ▲ 89 ▲ 86-89 ▲ 87-89 ▲ 84 ▲ 85 ▲ 84-85 ▲ 84-89 ▲ 86-89 ▲ 88-89 ▲ 84-86 ▲	SRK7020 CT701SP ▲	HARLEY DAVIDSON® SPORTSTER XL1200 1LN3 Forty Eight Anniversary XL1200C 1CGP Sportster 1200 Custom XL1200C 1CT3 1200 Custom XL1200C 1CT3 Sportster 1200 Custom XL1200C ANV 1CT3_ANV Sportster 1200 Custom ANV XL1200CA 1LJ3 Sportster 1200 Custom Limited A XL1200CB 1LK3 1200 Custom Limited B XL1200CB 1LK3 Sportster 1200 Custom Limited A XL1200CB 1LK3 Sportster 1200 Custom Limited B XL1200CP 1LH3 Sportster 1200 Custom (H-D1) XL1200CX 1LM3 1200 Roadster XL1200CX 1LM3 Roadster XL1200L 1CWP/1CX3 Sportster 1200 Low XL1200N 1CZ3 Nightster XL1200R 1CLP/1CV3 Sportster 1200 Roadster XL1200R 1CV3 Sportster 1200R XL1200T 1LL3 SuperLow 1200T XL1200V 1LF3 Seventy-Two XL1200X 1LC3 Forty-Eight XL50 1CY3 50th ANV Sportster	18 ▲ 04-06 ▲ 17-18 ▲ 07-16 ▲ 13 ▲ 13-16 ▲ 17 ▲ 16 ▲ 13-15 ▲ 11-16 ▲ 18 ▲ 16-17 ▲ 06-11 ▲ 07-12 ▲ 04-08 ▲ 09 ▲ 14-18 ▲ 12-16 ▲ 10-18 ▲ 07 ▲
SRK7017 CT704SP ▲	HARLEY DAVIDSON® TOURING FLH ADKE Touring Electra Glide FLH ALKE Touring Electra Glide Shrine Shovelhead FLHS AKKE Touring Electra Glide Sport FLHT Electra Glide FLHT Electra Glide Classic FLT Classic Tour Glide Classic FLT Tour Glide	Early 84 ▲ Early 84 ▲ Early 84 ▲ Early 84 ▲ Early 84 ▲ Early 84 ▲ Early 84 ▲			
SRK7018 CT704SP ▲	HARLEY DAVIDSON® TOURING FLH ALKE Touring Electra Glide Shrine Shovelhead FLH Electra Glide FLHC ADKB/ADKC Touring Electra Glide Classic FLHC AGKB Touring Electra Glide Classic FLHC Electra Glide Classic FLHS AKKB/AKKC/AKCD Touring Electra Glide Sport FLHS Heritage, Electra Glide FLHT DCKD Touring Electra Glide Standard	83 ▲ 81-83 ▲ 81-82 ▲ 81 ▲ 81 ▲ 81-83 ▲ 81 ▲ 83 ▲			

CLUTCH BUYERS GUIDE

SRK CLUTCH KIT BUYERS GUIDE

Part No.	Make/Model	Year	Part No.	Make/Model	Year
SRK7021 CT701SP ▲	HARLEY DAVIDSON® SPORTSTER XL883 4CAM/4CN2 Sportster 883 XL883C 4CJM/4CP2 Sportster 883 Custom XL883L 4CMM Sportster XL883 Low XL883L 4CR2 Sportster 883 Low XL883L 4CR2 Sportster XL883 Low XL883L 4CR2 SuperLow XL883L 4CR2 SuperLow 883 XL883N 4LE2 Iron 883 XL883R 4CKM Sportster 883R XL883R 4CS2 883 Roadster XL883R 4CS2 Sportster 883R	04-09 ▲ 04-10 ▲ 05-06 ▲ 10-11 ▲ 07-09 ▲ 12-18 ▲ 16 ▲ 09-18 ▲ 05-06 ▲ 11-15 ▲ 07-10 ▲			
SRK7022 CT701SP ▲	HARLEY DAVIDSON® SPORTSTER XR1200 1LA6 Sportster 1200 XR1200 1LA6 XR1200 XR1200X 1LD6 XR1200X	08 ▲ 09-10 ▲ 10-13 ▲			
SRK7023 CT701SP ▲	HARLEY DAVIDSON® SPORTSTER XL1200 1CAP Sportster 1200 XL1200C 1CGP Sportster 1200 Custom XL1200S 1CHP Sportster 1200 Sport XL883 4CAM Sportster 883 XL883C 4CJM Sportster 883 Custom XL883DLX 4CFM Sportster 883 Deluxe XL883HUG 4CEM Sportster 883 Hugger XL883R 4CKM Sportster 883R	91-03 ▲ 96-03 ▲ 96-03 ▲ 91-03 ▲ 98-03 ▲ 91-95 ▲ 91-03 ▲ 02-03 ▲			
SRK7024 CT709SP ▲	HARLEY DAVIDSON® SPORTSTER XL1200 CAPL Sportster 1200 XL883 CAMG/CAMH Sportster 883 XL883 CAMG Sportster 883 Deluxe XL883 CAML Sportster 883 XL883DLX CFML Sportster 883 Deluxe XL883HUG CEMH Sportster 883 Hugger XL883HUG CEML Sportster 883 Hugger XLH CAHE Sportster 1000 XLH CAHF Sportster 1000 1985 XLH-1100 CANG/CANH Sportster 1100 XLH-1200 CAPJ/CAPK Sportster 1200 XLH883 CAMJ/CAMK Sportster 883 XLH883DLX CFMJ/CFMK Sportster 883 Deluxe XLH883HUG CEMJ/CEMK Sportster 883 Hugger XLS CBHE Sportster Roadster 1000 XLS CBHF Sportster Roadster 1000 XLX CCHE Sportster Roadster 1000 XLX CCHF Sportster Roadster 1000 XR-1000 CDHE Sportster	90 ▲ 86-87 ▲ 86 ▲ 90 ▲ 90 ▲ 87 ▲ 90 ▲ 84 ▲ Later 84 ▲ 86-87 ▲ 88-89 ▲ 88-89 ▲ 88-89 ▲ 88-89 ▲ 88-89 ▲ 84 ▲ Later 84 ▲ 84 ▲ Later 84 ▲ 84 ▲			
SRK7025 CT709SP ▲	HARLEY DAVIDSON® SPORTSTER XLCH-1000 4AH1/4AH2/4AH3/4AH4/4AH5/4AH6/ 4AH7/4AH8/4AH9/4AJ0 Sportster 1000 XLH CAHB/CAHC/CAHD/CAHE Sportster 1000 XLH-1000 3AH1/3AH2/3AH3/3AH5/3AH6/3AH7 /3AH8/3AH9/3AJ0 Sportster Standard XLS CBHB/CBHC/CBHD/CBHE Sportster Roadster 1000 XLX CCHD/CCHE Sportster Roadster 1000 XR-1000 CDHD/CDHE Sportster	71-80 ▲ 81-Early 84 ▲ 71-78 ▲ 81-Early 84 ▲ 83-Early 84 ▲ 83-Early 84 ▲			

How To Make Precision Pilot Jets

Everyone knows how sensitive an engine is to pilot jets in the acceleration stages from 1000 to 3500 rpm and getting fuel mixture right in this area is critical. For this reason jets have to be perfectly accurate in their marked size and incremental size steps. EBC Brakes' sister company A-BAX Precision Engineering Ltd in the UK has purchased the most accurate machine on the planet for this work shown below. A-BAX Precision Engineering Ltd pilot jets are precise, clearly marked and reliably gauged using pin gauges, accurate to one tenth of a thousandth of an inch, you can rely on their accuracy.

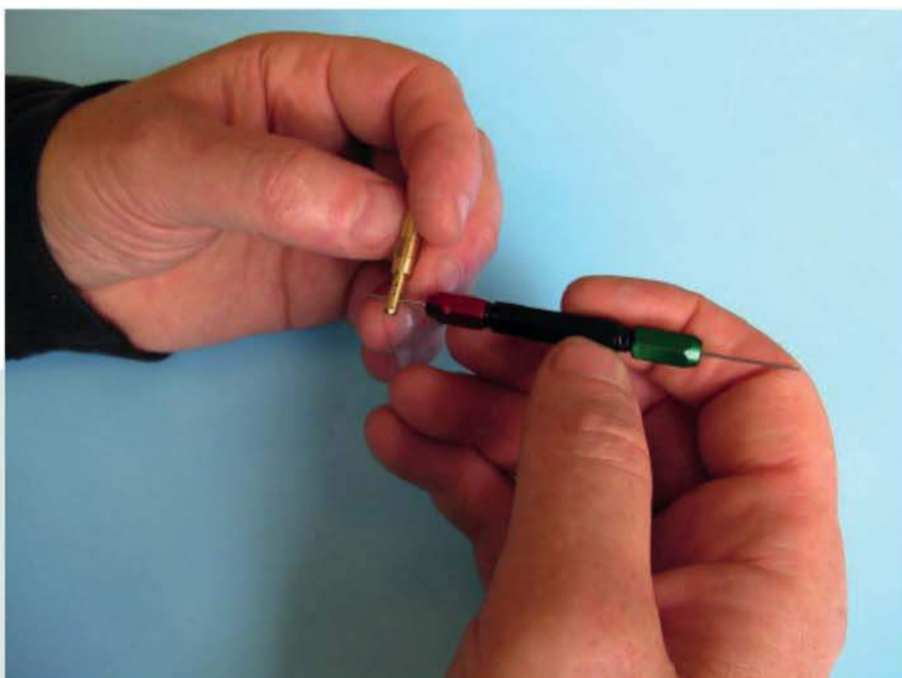
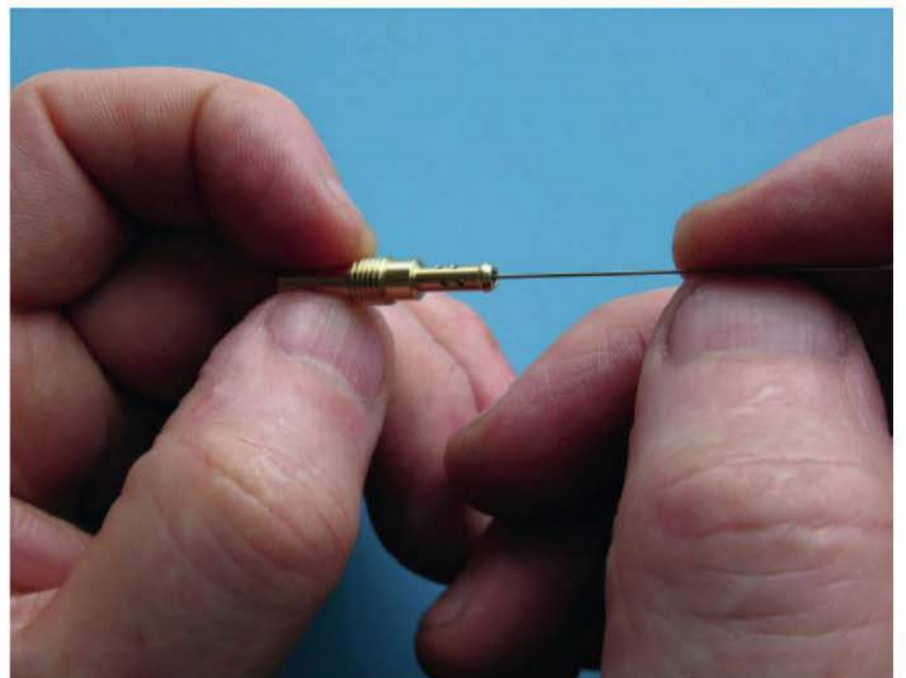
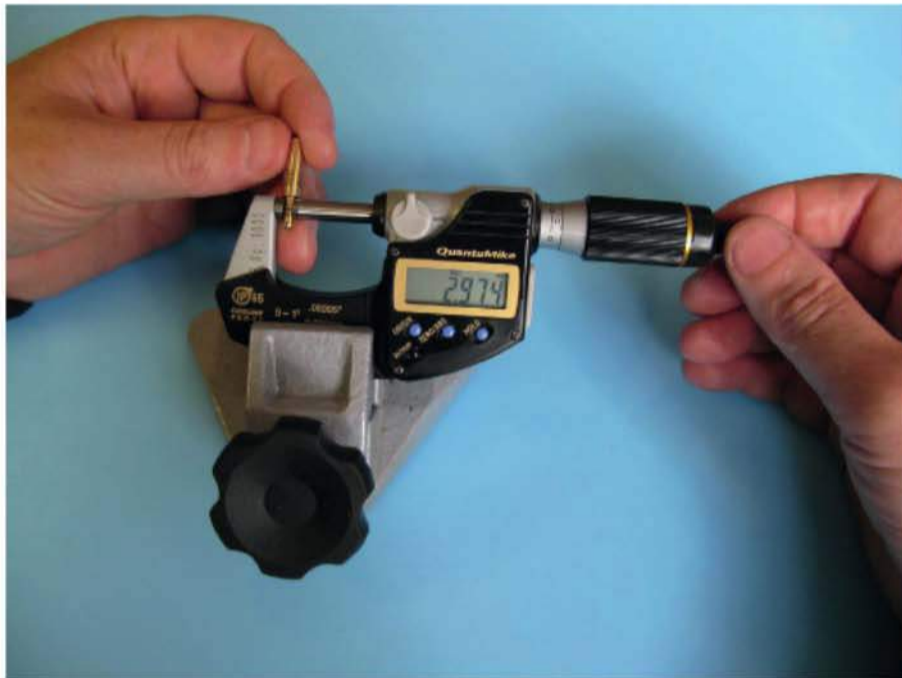
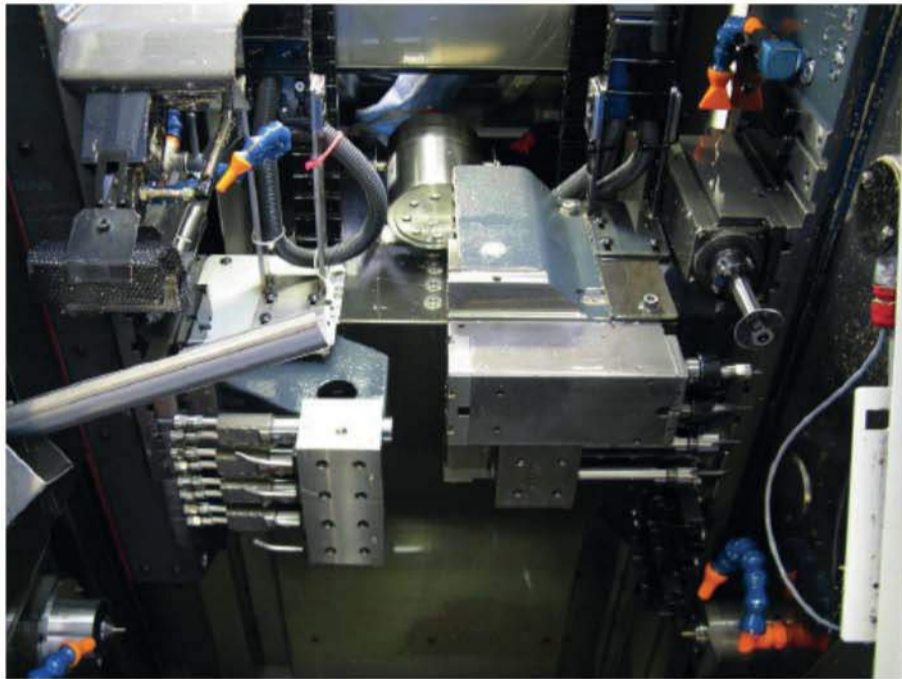

A-BAX Precision Engineering Ltd Pilot Jets for Mikuni Carbs (Sold in packs of 4)

Jet Style - VM22/210

8 bleed hole type
VM18 / VM22 / VM26-34 Flange Type
VM26-44 Spigot Type
TM24-38 (No accelerator pump)
Early TMX/TMX Carb Types

Size	Part #
10	EBC22/210-10
12.5	EBC22/210-12.5
15	EBC22/210-15
17.5	EBC22/210-17.5
20	EBC22/210-20
22.5	EBC22/210-22.5
25	EBC22/210-25
27.5	EBC22/210-27.5
30	EBC22/210-30
32.5	EBC22/210-32.5
35	EBC22/210-35
37.5	EBC22/210-37.5
40	EBC22/210-40
42.5	EBC22/210-42.5
45	EBC22/210-45
47.5	EBC22/210-47.5
50	EBC22/210-50
52.5	EBC22/210-52.5
55	EBC22/210-55
57.5	EBC22/210-57.5
60	EBC22/210-60
65	EBC22/210-65
70	EBC22/210-70
75	EBC22/210-75
80	EBC22/210-80
85	EBC22/210-85
90	EBC22/210-90
95	EBC22/210-95
100	EBC22/210-100
105	EBC22/210-105
110	EBC22/210-110
120	EBC22/210-120
130	EBC22/210-130
140	EBC22/210-140



Jet Style - N224.103

2.5mm bleed end
Early TMS/TMX
OEM MX36/38 BSR CV type
Honda / Kawasaki / Suzuki / Yamaha

Size	Part #
10	EBC224-10
12.5	EBC224-12.5
15	EBC224-15
17.5	EBC224-17.5
20	EBC224-20
22.5	EBC224-22.5
25	EBC224-25
27.5	EBC224-27.5
30	EBC224-30
32.5	EBC224-32.5
35	EBC224-35
37.5	EBC224-37.5
40	EBC224-40
42.5	EBC224-42.5
45	EBC224-45
47.5	EBC224-47.5
50	EBC224-50
52.5	EBC224-52.5
55	EBC224-55
57.5	EBC224-57.5
60	EBC224-60
62.5	EBC224-62.5
65	EBC224-65
67.5	EBC224-67.5
70	EBC224-70



Jet Style - N151.067

No bleed holes
Later OEM BS range CV carbs
Kawasaki / Suzuki / Yamaha

Size	Part #
30	EBC151-30
32.5	EBC151-32.5
35	EBC151-35
37.5	EBC151-37.5
40	EBC151-40
42.5	EBC151-42.5
45	EBC151-45
47.5	EBC151-47.5
50	EBC151-50
52.5	EBC151-52.5
55	EBC151-55
57.5	EBC151-57.5
60	EBC151-60

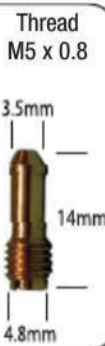

Jet Style - VM28/486

2mm bleed hole type
HS40 / HSR42 / 45 / 48 / RS34-40
TM33 / 36 / 40 with accelerator pump
Kawasaki / Suzuki / Yamaha

Size	Part #
10	EBC28/486-10
12.5	EBC28/486-12.5
15	EBC28/486-15
17.5	EBC28/486-17.5
20	EBC28/486-20
22.5	EBC28/486-22.5
25	EBC28/486-25
27.5	EBC28/486-27.5
30	EBC28/486-30
32.5	EBC28/486-32.5
35	EBC28/486-35
37.5	EBC28/486-37.5
40	EBC28/486-40
42.5	EBC28/486-42.5
45	EBC28/486-45
47.5	EBC28/486-47.5
50	EBC28/486-50
52.5	EBC28/486-52.5
55	EBC28/486-55
57.5	EBC28/486-57.5
60	EBC28/486-60
62.5	EBC28/486-62.5
65	EBC28/486-65
67.5	EBC28/486-67.5
70	EBC28/486-70



Jet Style - BS30/96

6 bleed hole type
Various OEM BS range CV carbs
Kawasaki / Suzuki / Yamaha

Size	Part #
30	EBC30/96-30
32.5	EBC30/96-32.5
35	EBC30/96-35
37.5	EBC30/96-37.5
40	EBC30/96-40
42.5	EBC30/96-42.5
45	EBC30/96-45
47.5	EBC30/96-47.5
50	EBC30/96-50
52.5	EBC30/96-52.5
55	EBC30/96-55
57.5	EBC30/96-57.5
60	EBC30/96-60



Jet Style - M28/1001

Yamaha P/No. 260-14142-Size
Blaster/Banshee/LC

Size	Part #
15	EBC1001-15
17.5	EBC1001-17.5
20	EBC1001-20
22.5	EBC1001-22.5
25	EBC1001-25
27.5	EBC1001-27.5
30	EBC1001-30
32.5	EBC1001-32.5
35	EBC1001-35
37.5	EBC1001-37.5
40	EBC1001-40
42.5	EBC1001-42.5
45	EBC1001-45
47.5	EBC1001-47.5
50	EBC1001-50
52.5	EBC1001-52.5
55	EBC1001-55
57.5	EBC1001-57.5
60	EBC1001-60
62.5	EBC1001-62.5
65	EBC1001-65
67.5	EBC1001-67.5
70	EBC1001-70



A-BAX Precision Engineering Ltd Pilot Jets for Keihin Carbs (Sold in packs of 4)

Jet Style - N424-21

Pilot / Slow Running Jet
PB16 / 18 / 20
Yamaha R6 99-07
Various Kawasaki / Suzuki Quads

Size	Part #
35	EBC424-21-35
38	EBC424-21-38
40	EBC424-21-40
42	EBC424-21-42
45	EBC424-21-45
48	EBC424-21-48
50	EBC424-21-50
52	EBC424-21-52
55	EBC424-21-55
58	EBC424-21-58
60	EBC424-21-60
62	EBC424-21-62
65	EBC424-21-65
68	EBC424-21-68
70	EBC424-21-70
72	EBC424-21-72
75	EBC424-21-75
78	EBC424-21-78
80	EBC424-21-80



Jet Style - N424-25

Pilot / Slow Running Jet
FCR 28 / 32 / 33 / 35 / 37 / 39 / 41mm
Harley D Keihin BH (Non CV Type)
Various Kawasaki / Yamaha Models with CVK
/ FCR / BD style carbs

Size	Part #
35	EBC424-25-35
38	EBC424-25-38
40	EBC424-25-40
42	EBC424-25-42
45	EBC424-25-45
48	EBC424-25-48
50	EBC424-25-50
52	EBC424-25-52
55	EBC424-25-55
58	EBC424-25-58
60	EBC424-25-60
62	EBC424-25-62
65	EBC424-25-65



Dealer Pilot Jet Selection Kits

(Kits include one pilot jet per size)



Kit No.	Carb Model	Jet Style	Qty Jets in Kit	Sizes
KPJK-01	Keihin	N424-21	19	35-80
KPJK-02	Keihin	N424-25B	13	35-65
MPJK-01	Mikuni	VM22/210	34	10-140
MPJK-02	Mikuni	N224.103	25	10-70
MPJK-03	Mikuni	N151.067	13	30-60
MPJK-04	Mikuni	BS30/96	13	30-60
MPJK-05	Mikuni	M28/486	25	10-70

Precision machined in the UK A-BAX Precision Engineering Ltd Dealer selection kits include all the popular sizes for the better selling pilot jets and refills can be purchased from your distributor in packets of four.



MAIN JETS







A-BAX Precision Engineering Ltd MAINJETS

Made in the UK, these high precision BRASS carburettor jets are available in dealer selection kits or in top-up packs of 5 jets or 4 jets. All jets are flow calibrated and extremely accurate in terms of fuel flow rate as stamped.

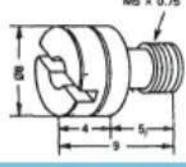
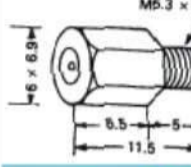
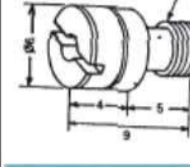
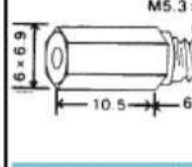
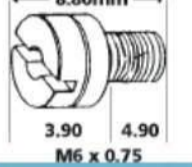

DEALER SELECTION KITS.

KIT TYPE	PART#	CONTENTS	
Mikuni Slot	SJK 36	4pcs each jet sizes 72.5 thru 160	144 Jets
Mikuni Hex	HJK 27A	2pcs each jet sizes 70 thru 230	54 Jets
Mikuni Hex	HJK 27B	2pcs each jet sizes 240 thru 500	54 Jets
Keihin Slot	KJK 30	4pcs each jet sizes 80 thru 190	132 Jets
Keihin Hex	CRK 32A	2pcs each jet sizes 80 thru 158	64 Jets
Keihin Hex	CRK 32B	2pcs each jet sizes 160 thru 235	64 Jets

 A-BAX Slot Jets for Mikuni	 A-BAX Hex Jets for Mikuni	 A-BAX Slot Jets for Keihin	 A-BAX Hex Jets for Keihin	 A-BAX Slot Jets for Dell 'Orto
 (N 100/604) SJ Prefix	 (4/042) HJ Prefix	 (N102 221) KJ Prefix	 (357) CR Prefix	 (6413) DO Prefix

SIZES AVAILABLE	SIZES AVAILABLE	SIZES AVAILABLE	SIZES AVAILABLE	SIZES AVAILABLE	SIZES AVAILABLE
SJ72.5	HJ70	HJ370	KJ72.5	CR80	CR180
SJ75	HJ80	HJ380	KJ75	CR82	CR182
SJ77.5	HJ90	HJ390	KJ77.5	CR85	CR185
SJ80	HJ100	HJ400	KJ80	CR88	CR188
SJ82.5	HJ105	HJ410	KJ82.5	CR90	CR190
SJ85	HJ110	HJ420	KJ85	CR92	CR192
SJ87.5	HJ115	HJ430	KJ87.5	CR95	CR195
SJ90	HJ120	HJ440	KJ90	CR98	CR198
SJ92.5	HJ125	HJ450	KJ92.5	CR100	CR200
SJ95	HJ130	HJ460	KJ95	CR102	CR202
SJ97.5	HJ135	HJ470	KJ97.5	CR105	CR205
SJ100	HJ140	HJ480	KJ100	CR108	CR208
SJ102.5	HJ145	HJ490	KJ102.5	CR110	CR210
SJ105	HJ150	HJ500	KJ105	CR112	CR212
SJ107.5	HJ155	HJ510	KJ107.5	CR115	CR215
SJ110	HJ160	HJ520	KJ110	CR118	CR218
SJ112.5	HJ165	HJ530	KJ112.5	CR120	CR220
SJ115	HJ170	HJ540	KJ115	CR122	CR222
SJ117.5	HJ175	HJ550	KJ117.5	CR125	CR225
SJ120	HJ180	HJ560	KJ120	CR128	CR228
SJ122.5	HJ185	HJ570	KJ122.5	CR130	CR230
SJ125	HJ190	HJ580	KJ125	CR132	CR232
SJ127.5	HJ195	HJ590	KJ127.5	CR135	CR235
SJ130	HJ200	HJ600	KJ130	CR138	CR238
SJ132.5	HJ210	HJ610	KJ132.5	CR140	
SJ135	HJ220	HJ620	KJ135	CR142	
SJ137.5	HJ230	HJ630	KJ137.5	CR145	
SJ140	HJ240	HJ640	KJ140	CR148	
SJ142.5	HJ250	HJ650	KJ142.5	CR150	
SJ145	HJ260	HJ660	KJ145	CR152	
SJ147.5	HJ270	HJ670	KJ147.5	CR155	
SJ150	HJ280	HJ680	KJ150	CR158	
SJ152.5	HJ290	HJ690	KJ152.5	CR160	
SJ155	HJ300		KJ160	CR162	
SJ157.5	HJ310		KJ170	CR165	
SJ160	HJ320		KJ190	CR168	
SJ170	HJ330			CR170	
	HJ340			CR172	
	HJ350			CR175	
	HJ360			CR178	
					DO70
					DO75
					DO80
					DO85
					DO90
					DO95
					DO100
					DO105
					DO110
					DO115
					DO120
					DO125
					DO130
					DO135
					DO140
					DO145
					DO150
					DO155
					DO160
					DO165
					DO170
					DO175
					DO180
					DO185
					DO190
					DO195
					DO200

NOTE: The names Mikuni & Keihin are for description purposes only. These are NOT original Mikuni or Keihin jets, simply a high quality replacement.

MAIN JETS



**DEALER SELECTION KIT
PART NO - HDJK-12**

A-BAX Precision Engineering Ltd brass main jets for Keihin CVH carburettors, used on most big twins. Sold in packets of 2 pieces and in dealer assortment kits of 12 sizes (2 pieces each size).





**A-BAX
Slot Jets
for Harley
Davidson**



**(424-27)
HDJK Prefix**

**SIZES
AVAILABLE**

EBC424-27-165
EBC424-27-170
EBC424-27-175
EBC424-27-180
EBC424-27-185
EBC424-27-190
EBC424-27-195
EBC424-27-200
EBC424-27-205
EBC424-27-210
EBC424-27-220

ACCESSORIES

BRAKE FLUID

Now tested to meet Florida EPA requirements. Bottle label shows all specifications of the fluid.

DOT 4 - A refined specification polyglycol fluid as fitted to most faster street bikes now produced.

DOT 5 - Silicone fluid as used in Harley Davidson Motorcycles and many special High Performance Brake systems.

BF307 - Highly refined Dot 4 Brake fluid, ideal for Racing or High performance Road bikes. Can be used in all systems specifying Dot 3 or Dot 4 but **NOT** with (Dot 5) silicone fluids.



**EBC Brake Fluid is available
in DOT 4 or DOT 5 (Silicone)
Grades or BF 307 Race
Grade.**

TO ORDER USE THESE NUMBERS

SIX PACK

DOT 4 (Six Pack)DOT-4
DOT 5 (Six Pack) (Silicone).....DOT-5
BF 307 (Six Pack).....BF-307

SINGLE BOTTLES

DOT 4 (Single)DOT-4/1
DOT 5 (Single) (Silicone)DOT-5/1
BF 307 (Single)BF-307/1

Caution: Please check carefully the type of brake fluid used in your system. Adding incorrect fluids could cause major brake failure. DO NOT ever mix glycol fluids (Dot 3, Dot 4 or BF-307) with Dot 5 silicone.

BRAKE CALIPER LUBE



These sachets of dedicated, high viscosity greases are perfect for all of your customers' brake service needs. Always use sparingly on caliper slider pins and rails, but to NOT get near the pad surface and do NOT use as anti-squeal as it will not help at all. Each sachet contains 5 grammes of grease.

TO ORDER USE THESE NUMBERS

Ten Sachets.....LUBE010
Fifty Sachets.....LUBE050